



Design Review Guidelines For Avion

Revised September 2019

AVION DESIGN GUIDELINES

I. INTRODUCTION

As shown in **Figure 1**, the Avion project (“Project”) is located just south of Heritage Bluffs II and the East Clusters at Black Mountain Ranch. The Project is designed to adopt several of the Design Review Guidelines from both developments to maintain unified standards for the area. Distinct architectural guidelines and an appropriate landscape development plan have been prepared for Avion in order to create a unique sense of place for the community.

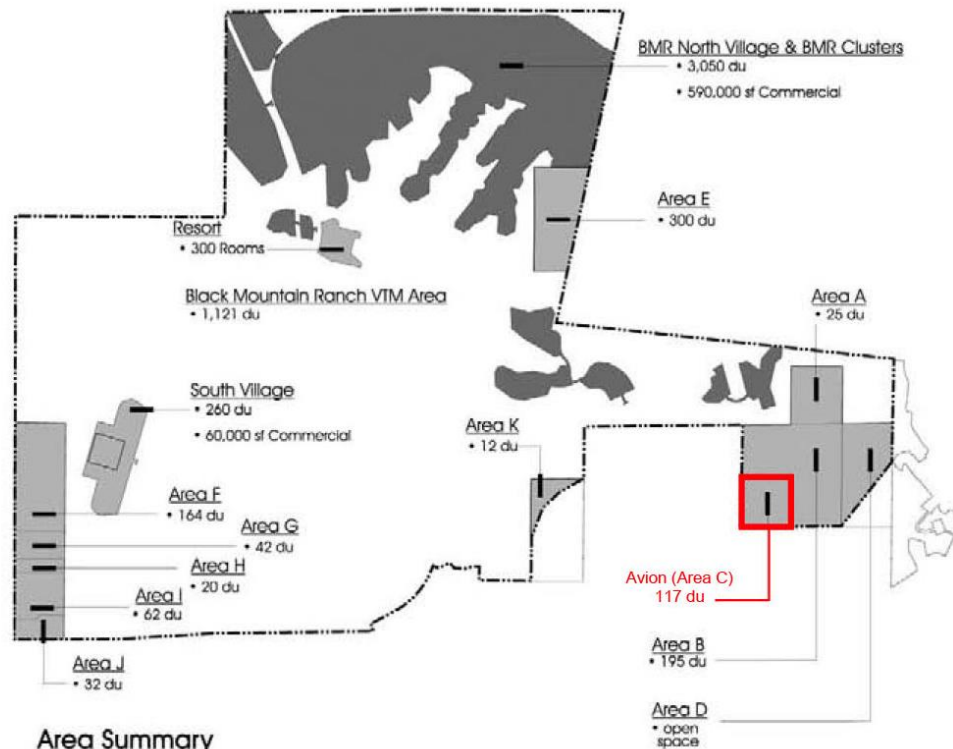

Area Summary

Does not include area in Rancho Peñasquitos

Perimeter Ownerships		
A: 44.8 ac	E: 67.2 ac	I: 30.6 ac
B: 125.0 ac	F: 82.1 ac	J: 21.2 ac
C: 41.5 ac	G: 20.7 ac	K: 16.0 ac
D: 55.0 ac	H: 10.4 ac	
Sub-Total: 514.5 ac		

Black Mountain Ranch	
North Village & BMR North Clusters:	815.0 ac
South Village:	58.5 ac
Resort:	19.5 ac
Black Mountain Ranch VTM Area:	3,690.0 ac
Sub-Total:	4,583.0 ac
Total Area:	5,097.5 ac

Figure 1 – Vicinity Map

Source: Figure 2.2. Development Summary by Area from Black Mountain Ranch Subarea Plan

I. INTRODUCTION

A. PROJECT DESCRIPTION

The Project encompasses approximately 41.48 acres of vacant land located in the northern part of the City of San Diego, approximately 1.2 miles west of Interstate 15. Carmel Valley Road/Bernardo Center Drive is located approximately 0.6 mile to the north, and Black Mountain Road is located approximately 1.4 miles to the west. Heritage Bluffs II abuts the northern edge of the property. Future access would be provided at the northeast corner of the project site via Winecreek Road. Land uses surrounding the site include a portion of the Black Mountain Open Space Park to the west, east, and south, and residential development and open space to the north.

The project site is identified as Area “C” of the Southeast Perimeter Properties of the Black Mountain Ranch (BMR) Subarea Plan (APN 312-010-16). The BMR Subarea Plan designates approximately 22.4 acres of the site as Low Residential (2-5 dwelling units per acre) and the remainder (approximately 19 acres) as part of the City’s Multiple Habitat Planning Area (MHPA). MHPA lands have been included within the City’s Multiple Species Conservation Program Subarea Plan (MSCP) for habitat conservation. The RS-1-14 zone is recommended as a compatible zone for the Low Residential land use designation; however, if development to be clustered, or if the housing type(s) proposed are other than those allowed by the underlying zone, then a planned development process may be employed.

As shown in **Figure 2**, The BMR Subarea Plan allows a total of 117 dwelling units to be developed onsite including a requirement for 19 affordable units. The Project proposes to develop 84 market rate detached single dwelling units on one residential lot with a condominium map applied. Per the California Building Code (CBC), the dwelling units are built with R-3 occupancy and per the San Diego Municipal Code (SDMC) the dwelling units are defined as multiple dwelling units on a single lot. The transfer of 19 affordable units and 14 market rate units to Parcel 1 of Parcel Map 21331 in the Black Mountain Ranch North Village Town Center is also proposed. The project density onsite would be consistent with the density prescribed for the area.

AVION DESIGN GUIDELINES

I. INTRODUCTION

The transfer receiving site encompasses approximately 1.68 acres and is currently designated Mixed-Use Core (25-45 dwelling units per acre) and zoned CC-3-5 (Community Commercial). The site is generally bordered by Paseo Del Sur to the west, Templeton Street to the north, and Zaslavsky Place to the east. Surrounding uses include the Target commercial center (171,500 square feet) to the west, the Sprouts grocery store (38,500 square feet) to the north, the Design39Campus (K-8) to the east, and an age restricted affordable housing development to the south. The Project's affordable units are intended to supplement the affordable housing to the south and facilitate ongoing resident programs and management.

The Project requests the following entitlements:

- Rezone of the residential portion of the site from the AR-1-1 (Agricultural – Residential) zone to the RS-1-14 (Residential – Single Unit) zone;
- Vesting Tentative Map (VTM) to subdivide lots and create condominium units;
- Site Development Permit (SDP) due to the presence of environmentally sensitive lands (steep hillsides, sensitive biological resources, and wetlands);
- Planned Development Permit (PDP) to allow for single dwelling units on a single lot in the underlying zone and to exceed the retaining wall heights outside of required setbacks; and a
- MHPA Boundary Line Adjustment (MHPA BLA) to dedicate remaining AR-1-1 (Agricultural – Residential) lots to MHPA in lieu of a Covenant of Easement over remaining ESL.

A Supplemental EIR that will tier off of the previously approved Environmental Impact Report No. 96-7902/SCH No. 97111070 prepared for the Black Mountain Ranch Subarea Plan will be analyzed for the project.

I. INTRODUCTION

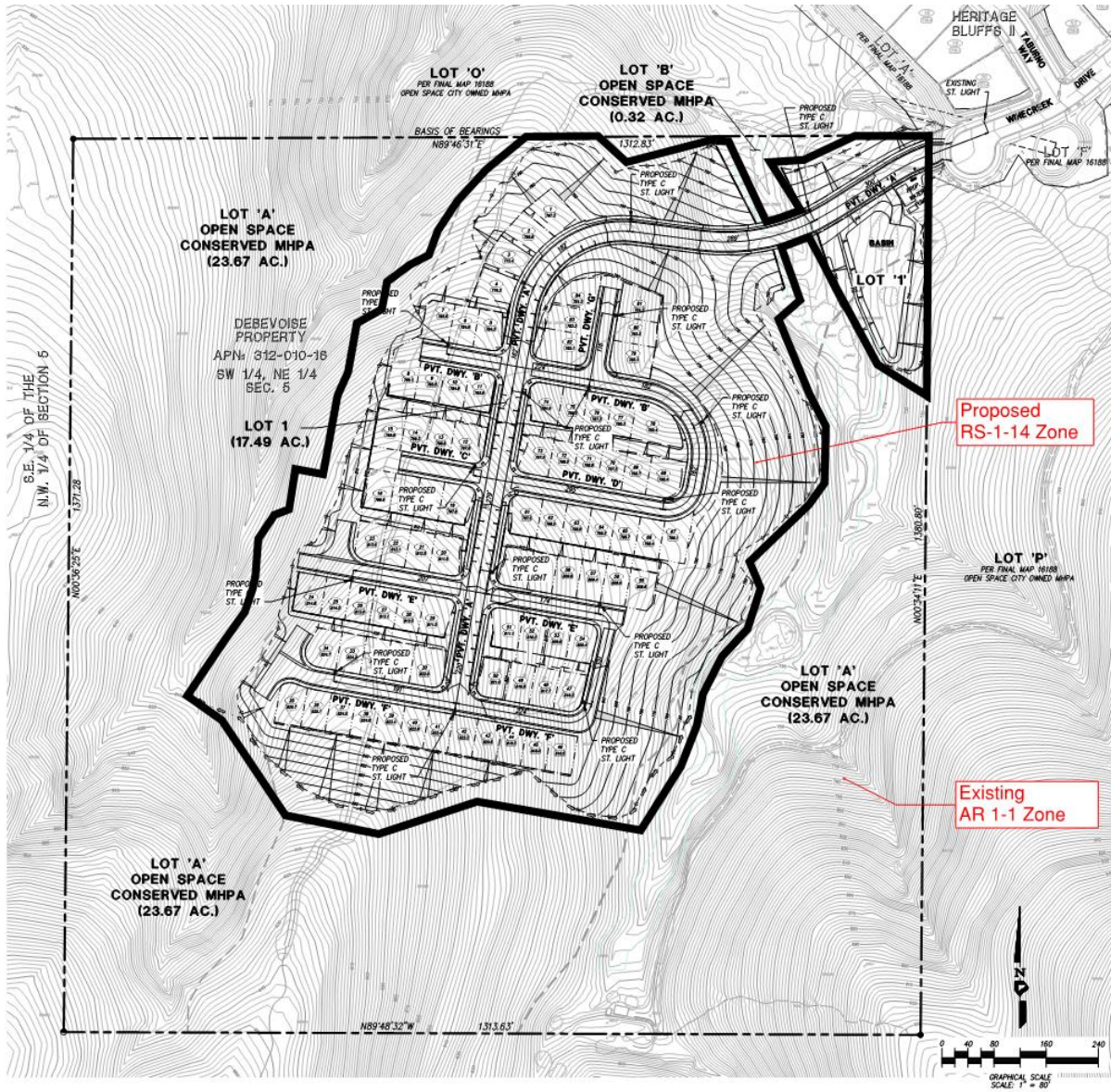

Figure 2 – Site Plan with Zoning Designation

AVION DESIGN GUIDELINES

II. RESIDENTIAL DESIGN

A. GENERAL DEVELOPMENT REGULATIONS

The City of San Diego Municipal Code sets forth the general development regulations subject to the site. The residential development regulations are based on the RS-1-14 zone and the open space development regulations are based on the AR-1-1 zone. In any instance where development regulations of the Avion Design Review Guidelines conflict with regulations of the City of San Diego zoning regulations, the Avion Design Review Guidelines shall prevail. In addition to the Residential Base Zone and Agricultural Base Zone Requirements, the project shall comply with Chapter 14, Article 2, Division 5 (Parking Regulations), Chapter 14, Article 2, Division 10 (Off-Street Loading Requirements), Chapter 14, Article 2, Division 8 (Refuse and Recyclable Materials Storage Regulations), and Land Development Code Tables 142-05L and 142-05M.

The residential portion of the site shall be rezoned to RS-1-14. The remaining open space lot will be conserved as MHPA and will maintain the AR-1-1 zone. The proposed development is in full compliance with the Land Development Code. Deviations are requested for the retaining wall heights outside of required setbacks. Pursuant to Section 142.0340, retaining walls are limited to 12 feet outside of required yard setback. The requested retaining wall deviation is to support the roadway and avoid impacts to the existing drainage course. **Figure 3**, on the following page, illustrates the typical setbacks for each condo lot. The maximum building height within the RS-1-14 zone is 35 feet and 30 feet to the building eave. Any future development, addition, or modification to an existing residence must be favorably reviewed and approved by the Homeowner's Association (HOA) and the City of San Diego. Please refer to Section V, Implementation, for further details.

Figure 4, on the following page, identifies how the project complies with the open space requirements per unit required for Planned Development Permits.

II. RESIDENTIAL DESIGN

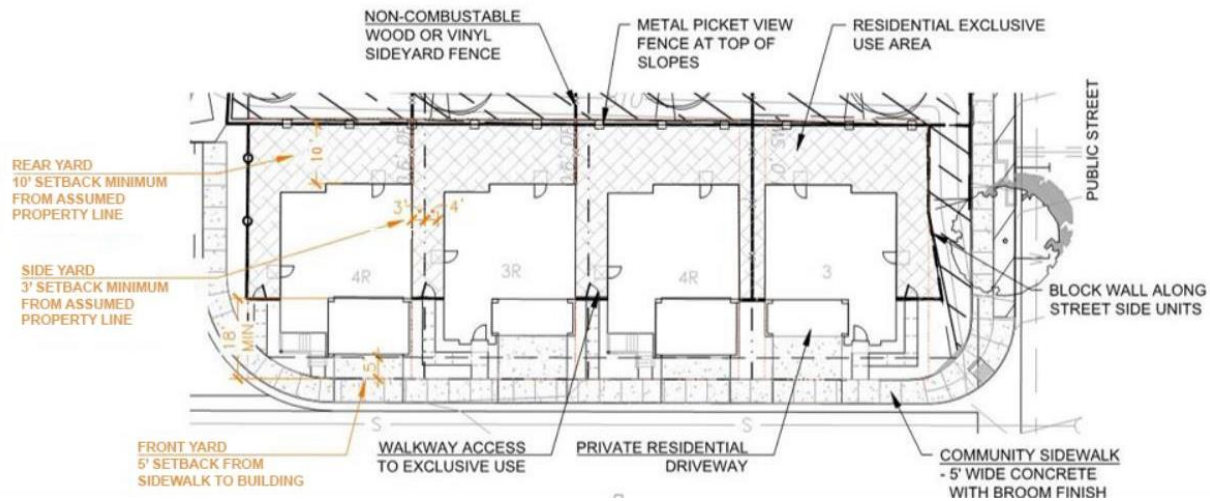

Figure 3: Typical Streetscape and Minimum Setbacks

The maximum buildable area for each lot is limited to the proposed lot size and building setbacks for the project. Per Section 143.0410(j)(8) of the Municipal Code, elements such as varied setbacks should be used to enhance the visual appearance of the development. The existing and proposed setbacks are as follows:

Table 1: Existing and Proposed Setbacks		
Setbacks	Existing RS-1-14 Zone	Proposed Project
Front	15' minimum	5' minimum. Driveway must be adequate to accommodate approximately 18' from the back of the sidewalk to the roll-up garage door.
Side	4' minimum	3' minimum if the adjacent lot has a 4' side setback. 4' minimum if the adjacent lot has a 3' side setback.
Street side	10' minimum	10' minimum
Rear	10' minimum	10 minimum

As shown in Figure 3, the rear yard setback varies based on building siting and the limits of the lot line. The rear setback, including slopes, typically

AVION DESIGN GUIDELINES

II. RESIDENTIAL DESIGN

ranges from 10' to 38'. The minimum side setback is 3' from the property line. This minimum only occurs when the adjacent lot has a 4' side setback. The front setback measures 5' from the property line, provided there is 18' minimum from the back of the sidewalk to the roll-up garage door.

The maximum FAR for the RS-1-14 zone is 0.60 and the lot size is 772,901 s.f. The total square footage for the entire development is 463,741 s.f., which is calculated by multiplying the maximum FAR by the lot size. The buildable area is allowed to be distributed to approximately 84 lots. The maximum buildable area for each lot is 5,521 s.f., which is calculated by dividing the total square footage for the entire development by 84 lots. Therefore, the maximum size of each house for each lot shall not exceed 5,521 s.f. Any changes or modifications to a resident wants to make to the existing structure must be approved by the HOA based on this comparison and potentially concurrently with the City of San Diego.

II. RESIDENTIAL DESIGN

LEGEND

- Internal Slopes 40,595 s.f.
- Perimeter Slopes 241,124 s.f.
- Private Open Space (RS-1-14 condo areas)
- Zone 1 Permanently Irrigated Slope
- Zone 2 Brush Management
- MHPA Open Space Preserve
- Park Overlook (5,906 +/- s.f.)
- Storm Water Basin

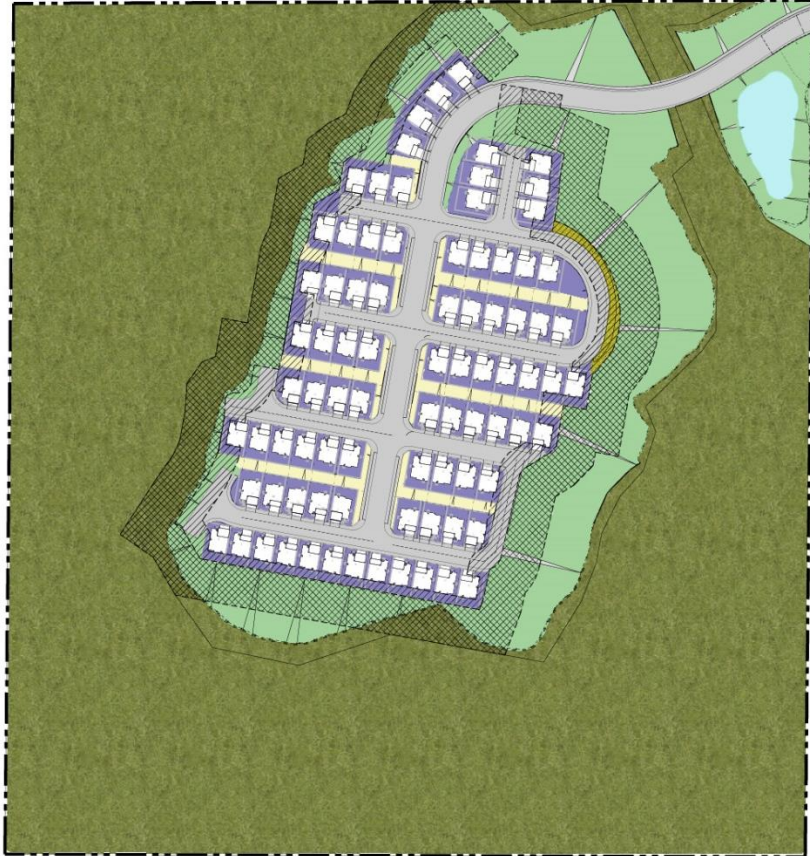

OPEN SPACE EXHIBIT

AVION

(1) Assumes per RS-1-14 Code 21.5% % lot coverage with the remainder in open space

ZONE	MIN. USABLE OPEN SPACE REQ. PER UNIT	TOTAL MIN. OPEN SPACE REQ. PER UNIT	USEABLE OPEN SPACE PROVIDED PER UNIT	TOTAL OPEN SPACE PROVIDED PER UNIT (EXCL. MHPA)	TOTAL OPEN SPACE PROVIDED PER UNIT (INCL. MHPA)
RS-1-14	750 S.F.	1,500 S.F.	1,783 S.F.	6,176 S.F.	18,923 S.F.

Figure 4 – Open Space Exhibit

AVION DESIGN GUIDELINES

II. RESIDENTIAL DESIGN

MHPA ADJACENCY

In March of 1997, the City of San Diego adopted the Multiple Species Conservation Program (MSCP) Subarea Plan. The MSCP identifies lands proposed for open space and habitat preservation and designates these areas as Multiple Habitat Planning Areas (MHPA). The MHPA boundary surrounds the area of the site proposed for development. To ensure implementation of the MHPA, the Project will comply with the general planning principles and design guidelines outlined in Sections 1.4.2 and 1.4.3 of the MSCP Subarea Plan. These policies and guidelines will specifically address the following issues areas during the planning or maintenance phase of the project:

- Prevent drainage from flowing directly into the MHPA;
- Reduce the impact of toxics;
- Direct lighting away from the MHPA;
- Reduce noise impacts that may interfere with wildlife utilization of the MHPA;
- Implement barriers to direct public access to appropriate locations and reduce domestic animal predation;
- Prevent the introduction of invasive species into the MHPA;
- Reduce fire hazards through brush management; and
- Ensure that manufactured slopes are located within the development footprint.

It is anticipated that the MHPA area will be dedicated to the City of San Diego as open space or encumbered with appropriate conservation easements as part of individual project development.

II. RESIDENTIAL DESIGN

This page intentionally left blank

AVION DESIGN GUIDELINES

III. STREETScape DESIGN

Consistent with the adopted Black Mountain Ranch Subarea Plan, access to the project site would be provided by extending access from the proposed development to the north, as provided for in the East Clusters and Avion maps. Access to the project would be from the easement extending from the western terminus of the Winecreek Drive cul-de-sac. All roads within the project would be private driveways.

The main access drive will extend from Winecreek Drive onto the property, across a culvert bridge and climb to the top of the residential plateau. The access drive will provide for a sidewalk on the north side until reaching the plateau and transition into sidewalks on both sides of the road. Street trees will be provided on an average of 30' on center between the curb and sidewalk along the length of the drive. Residential driveways will have contiguous sidewalks with residential street trees and connecting to the main drive linking the residential neighborhoods. Typical driveway sections are included on the project plans for the Vesting Tentative Map for Avion.

The streetscape design for Avion includes both drought tolerant and naturalized landscape treatment. Consistent quality and design of landscape elements and streetscape areas softens the aesthetics of buildings and ties together neighborhoods in a cohesive way. The intent is to relate the landscape to the adjacent character or the open space rather than to reinforce the road network. Street trees will provide shade and be selected to fit the scale of the plantable area, long lived, drought tolerant, and low maintenance. The street tree species will be as recommended by the City's Tree Selection Guide for the appropriate parkway width.

The landscaping for the streetscape is illustrated in **Figure 5** below and on the Landscape Development Plan for Avion. As shown, there is a discernible landscape character along street fronts. Landscaping and sidewalks are located within the front setback and create a visually interesting transitional space between the public realm of the street and the private realm of the residents' building and exclusive use areas. It also provides privacy and visual screening and enhances the open space along the street. Landscaping design should utilize the natural topography, existing vegetation, drainage, and microclimate appropriate to the site. Retaining walls should be designed to blend into the surroundings by

III. STREETScape DESIGN

visually softening walls with landscaping or selecting colors and textures complementing the adjacent landscape.

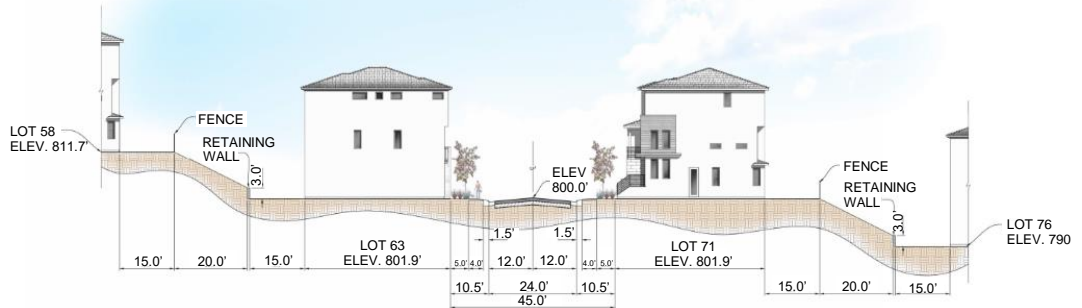

Figure 5: Typical Streetscape/Backyard

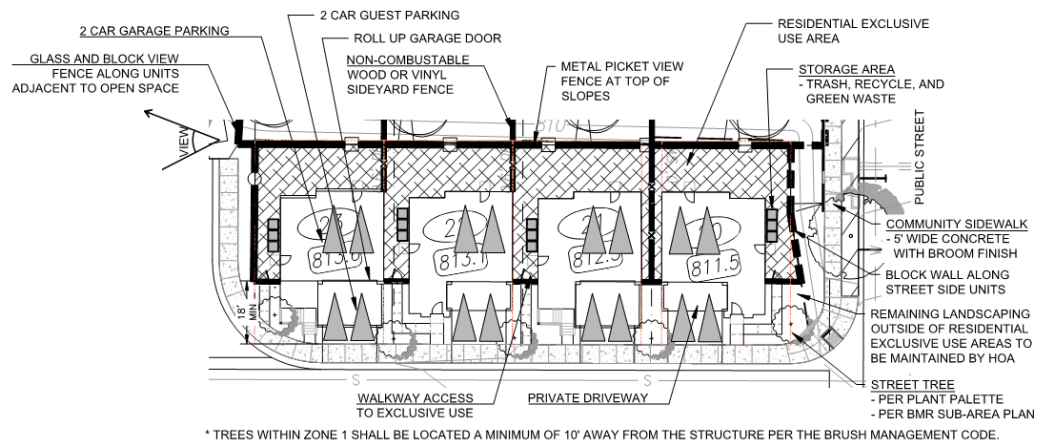

Figure 6: Typical Streetscape/Exclusive Use Area

Driveway widths shall comply with City of San Diego Municipal Code Tables 142-05L and 142-05M. Parking will comply with Chapter 14, Article 2, Division 5 (Parking Regulations) of the City of San Diego Municipal Code. As shown in **Figure 6**, private driveways leading to an attached two-car garage are provided for each residence. Each residential driveway has a minimum length of 18' between the roll-up garage door and public right-of-way and can accommodate two guest parking spaces. Additional guest parking is provided along the primary access road leading to the

AVION DESIGN GUIDELINES

III. STREETScape DESIGN

residential driveways. The two-car attached garage is recessed and located towards the front of the house on the first floor of the residence. Garage siting varies according to the building type.

Architectural features shall be sensitively located not to dominate the appearance of the building. The allowable architectural projections and encroachments in the residential zone are described in Section 131.0461.

Development shall conform to Chapter 14, Article 2, Division 8 of the Municipal Code that encourages recycling of solid waste to reduce the amount of waste material entering landfills and to meet the recycling goals established by the City Council and mandated by the state of California. As shown in **Figure 6**, trash, recyclable, and green waste materials storage areas are located in the exclusive use area of each residence. Storage areas are enclosed and screened from public view through the use of fencing and landscaping.

III. STREETScape DESIGN

This page intentionally left blank

AVION DESIGN GUIDELINES

IV. ARCHITECTURAL DESIGN GUIDELINES

A. DESIGN INTENT

These guidelines are intended to inspire thoughtful interpretation and response to design opportunities, while promoting and reinforcing the physical image of the Avion community. These guidelines are intended to encourage high-quality development that is harmonious with the surrounding environment, promotes visual quality, and enhances overall quality of life.

More specifically, the objectives of these guidelines are to:

- Provide guidance to developers, builders, engineers, architects, landscape architects, and other professionals during the implementation and construction phase(s) of the project.
- Provide a framework for the preparation of Covenants, Conditions and Restrictions.
- Provide guidance in formulating precise development plans and all residential components of the project.
- Provide the City of San Diego with the necessary assurances that Avion will be developed in accordance with the quality and character proposed in this document.

These guidelines are intended to be flexible and illustrative in nature. The guidelines are intended to accommodate changes in lifestyles, buyers' tastes, economic conditions, community desires, and the marketplace. Some sections are purposefully generic to allow creative implementation of the guidelines based on the specific circumstance being addressed. In these circumstances, it is anticipated that when more in-depth marketing studies have been completed for individual neighborhoods, designs of the generic sections will respond to the market conditions existing at the time of construction. The intent of these guidelines is to provide architectural direction for residential elements (single-unit) while utilizing existing City of San Diego residential zoning classifications to meet the objectives of the project.

The following narratives and graphics or exhibits address the design of specific and typical community elements within Avion.

IV. ARCHITECTURAL DESIGN GUIDELINES

B. PROJECT DESIGN THEME

The architectural design themes for Avion have been created by integrating the historically rural setting of the Heritage Bluffs II site with the rich and varied architectural forms and styles associated with contemporary California design. A varied palette of architectural styles will be provided to establish project identity, while remaining consistent with the overall development concept. The Architectural Design Guidelines are intended to form a distinctive community offering a high quality environment and clear identity.

C. ARCHITECTURAL STYLES

The architectural theme for Avion embodies a palette of modern styles that are inherent to the contextual character of the site and California. Four architectural styles – Contemporary California, Modern Spanish, Farmhouse, and Ballpark have been selected and are discussed below.

1. Contemporary California

Extrapolated from various interpretations of International styled elevations scattered throughout California, the Contemporary California is a fresh take on modernism's favorite aesthetic. Striking and iconic in nature, the style artfully merges streamlined forms, bold roof lines, stunning glass, and subtle textures. Balanced, asymmetrical masses, shed and parapet roofs, strong eyebrow roof accents, and carefully composed window patterns are essential for executing this style properly.

AVION DESIGN GUIDELINES

IV. ARCHITECTURAL DESIGN GUIDELINES

Cantilevered projections framing window compositions, or accentuating roof lines, balconies, or second-story elements are strongly encouraged as they add drama to Contemporary California's inherent simplicity. The material palette is comprised predominantly of siding, stucco elements, and accents of soft stone textures. Stucco body colors should be light and tonal, allowing for bold, contrasting fascia and dark eyebrow roofs, with playful siding body colors. Overall, the California Contemporary style is spirited and modern without being sterile.

1.1 Style Elements

Massing and Roof Forms

- Simple, asymmetrical massed, well-composed facades
- Shed and parapet roof forms with eyebrow roof accents
- Cantilevered, projecting, or recessed elements encouraged at balconies and second-story and third-story elements or to accentuate roof lines and fenestration compositions

Windows & Doors

- Structured and organized placement of windows and doors
- Large glass expanses and grouped window compositions are encouraged

Materials

- Flat, concrete tile are acceptable roof materials
- A variety of siding types, stucco, clean and subtle stone textures are the primary materials

Additional Elements

- Clean, well-articulated details
- Single-story elements, eyebrow roofs, and cantilevered portions encouraged at highly-visible or exposed elevations

Typical elevations and architectural characters illustrating the Contemporary California Style are shown on **Figures 7 and 8**.

IV. ARCHITECTURAL DESIGN GUIDELINES



Figure 7 – Typical Contemporary California Elevations

AVION DESIGN GUIDELINES

IV. ARCHITECTURAL DESIGN GUIDELINES



Figure 8 – Typical Contemporary California Character

IV. ARCHITECTURAL DESIGN GUIDELINES

2. Modern Spanish

Directly inspired by California's most beloved and quintessential architecture, the Modern Spanish Style is an artful blend of Spanish vernaculars, with a refined and structured edge. The roof forms reflect the composed, stately nature of the style, combining low-pitched, hipped roofs with its massing. Simplistic in nature, clean stucco facades express the style's purity of forms, while minimal trim and smooth limestone elements contribute to its clean execution. Overall, this native, revitalized Californian style is characterized by its unadulterated elegance, refined in its masses and simplistic forms.

2.1 Style Elements

Massing and Roof Forms

- Strong and structured massing
- Low-pitched hipped roofs with minimal overhangs

Windows & Doors

- Structured and grouped window compositions

Materials

- Concrete, barrel 'S' tile as only acceptable roof material
- Stucco as the primary material
- Heavy knock down or "Spanish Lace" stucco is not permissible
- Allowable stucco finish options include: light lace, sand, or smooth

Additional Elements

- Clean, minimalistic, well-articulated details
- Boxy, single-story elements, and cantilevered portions at highly-visible or exposed elevations

Typical elevations and architectural characters illustrating the Modern Spanish Style are shown on **Figures 9 and 10**.

AVION DESIGN GUIDELINES

IV. ARCHITECTURAL DESIGN GUIDELINES



Figure 9 – Typical Modern Spanish Elevations

IV. ARCHITECTURAL DESIGN GUIDELINES

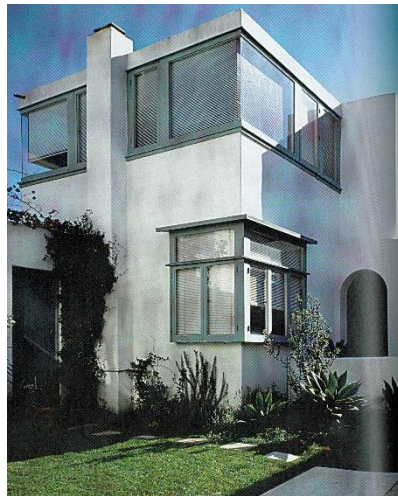

Figure 10 – Typical Modern Spanish Character

AVION DESIGN GUIDELINES

IV. ARCHITECTURAL DESIGN GUIDELINES

3. Farmhouse

Rooted in the tradition of the farmhouse vernacular that is widespread throughout California's farmlands and vineyard estates, Avion's Farmhouse is a fresh take on this classic style. Simplistic and understated in its forms, the vernacular features clean details. The material palette is expressed through smooth stucco, vertical board and batten siding, standing seam metal roof accents, and light, playful colors contrasted by bold accents. Firmly celebrating California's agrarian roots, the Farmhouse style captures the charming simplicity of the charming aesthetic with a touch of refined sophistication.

3.1 Style Elements

Massing & Scale

- Simple back-to-front primary roof with intersecting gables
Simple, yet elegant massing is preferred

Roof Forms

- Steep roof pitches are preferred
- Gable, hip, shed, and bonnet roof forms are allowed
- Careful compositions that avoid overly complex and confusing roof combinations are desired
- A clear hierarchy of forms is required

Windows & Doors

- Logic in the placement of windows is required
- Clear organization of fenestrations is essential to executing the simple, yet elegant massing of this style
- Large glass expanses, and structured fenestration compositions
- Windows with or without mullions may be incorporated

Materials

- Stucco, and vertical board and batten siding are the primary exterior materials
- Metal, composition shingles, and concrete tile are acceptable roof materials. Metal must be clean in its appearance

IV. ARCHITECTURAL DESIGN GUIDELINES

Enhanced Elements

- Clean and simple detailing, wood posts, and beams are preferred and contributed to a feeling of refined simplicity

Typical elevations and architectural characters illustrating the Farmhouse Style are shown on **Figures 11 and 12**.

AVION DESIGN GUIDELINES

IV. ARCHITECTURAL DESIGN GUIDELINES



Figure 11 – Typical Farmhouse Elevations

IV. ARCHITECTURAL DESIGN GUIDELINES



Figure 12 – Typical Farmhouse Character

AVION DESIGN GUIDELINES

IV. ARCHITECTURAL DESIGN GUIDELINES

4. Ballpark

Capturing the sophistication urban streetscapes with an urban material palette and structured grace, the Ballpark style boasts of cosmopolitan elegance. Striking in the simplicity of its forms, the style Composed primarily of brick, the façade is accented by smooth stucco, metal details and awning roofs. Large glass and structured window compositions further the impression of an urban loft. At roofs, both composition shingle and concrete tile are allowed. Overall, the Ballpark style is iconic in nature. Dramatic, yet refined the Ballpark vernacular will offer a style that reads metropolitan modern.

4.1 Style Elements

Massing & Scale

- Simple, stacking, and structured form

Roof Forms

- Primary roof form is simple, back-to-front
- Parapet and flat roofs are required for this style

Windows & Doors

- Large glass expanses, and structured fenestration compositions are encouraged for this style

Materials

- Brick and stucco are the primary materials
- Composition shingle, concrete roof tile are primary roof materials allowed for this style
- Metal awning roofs, and clean metal detail are encouraged for this style
- Dark Bronze or black window casements are encouraged

IV. ARCHITECTURAL DESIGN GUIDELINES

Enhanced Elements

- Single-story brick elements, metal awning roofs, and large, structured glass expanses and compositions are encouraged at enhanced elevation conditions

Metal detailing shall be clean in its appearance

Typical elevations and architectural characters illustrating the Ballpark Style are shown on **Figures 13 and 14**.

AVION DESIGN GUIDELINES

IV. ARCHITECTURAL DESIGN GUIDELINES



Figure 13 – Typical Ballpark Elevations

IV. ARCHITECTURAL DESIGN GUIDELINES

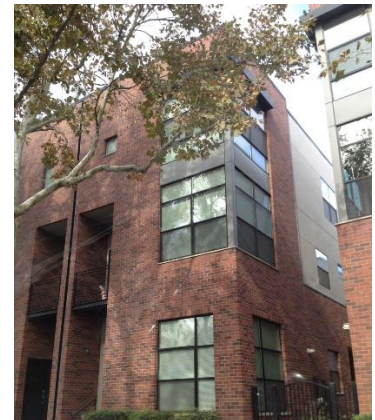

Figure 14 – Typical Ballpark Character

AVION DESIGN GUIDELINES

V. LANDSCAPE DESIGN

Landscaping and open space are an integral part of any project. The project uses landscaping and open space as a unifying element to obtain a cohesive appearance that is compatible with the surrounding community and preserves, protects, and restores native site vegetation and habitat.

A. LANDSCAPE DEVELOPMENT PLAN

The landscape development plan is identified and illustrated on the project plans for Avion. The primary goal of the landscape design is to unify and complement the existing native vegetation in the area. Interior treatments shall be ornamental in nature, fire-resistant, and complement the building architecture.

Landscaping within the project shall conform to standard horticultural practice, the City of San Diego Land Development Manual, landscape standards, and other applicable city and regional standards for landscape installation and maintenance.

B. PROHIBITED PLANT PALETTE

Table 1, Section 2, of Appendix B of the Black Mountain Ranch Subarea Plan includes a list of plant species that are prohibited to be planted within Black Mountain Ranch. These plants possess characteristics that are potentially destructive to native vegetation and open space by reason of profuse and noxious pollen, excessive height, weed-like characteristics of excessive growth, high water demands, and other desirable traits. These species will periodically be eradicated when found in substantial quantity in any of the project. The following plant species are prohibited:

- *Ailanthus altissima*
- *Arundo donax*
- *Atriplex semibaccata*
- *Brassica* spp
- *Broussonetia papyrifera*
- *Cortaderia selloana*
- *Cynara cardunculus*

V. LANDSCAPE DESIGN

- *Cynara scolymus*
- *Foeniculum vulgare*
- *Melilotus* spp.
- *Nicotiana glauca*
- *Pennisetum setaceum*
- *Picris echioides*
- *Rhynchelytrum repens*
- *Ricinus communis*
- *Salsola salina*
- *Spartium junceum*
- *Tamari* spp
- *Xanthium strumarium*

C. APPROVED PLANT PALETTE

Table 1 Section 1, of Appendix B of the Black Mountain Ranch Subarea Plan includes a list of the plant species that are approved to be planted within Black Mountain Ranch and the application's Landscape Development Plan. Any species not contained in the list of approved plants shall not be used without the written approval from the Avion Home Owner's Association and the City of San Diego.

D. SLOPE REVEGETATION

All graded slopes will be promptly revegetated in compliance with City requirements and in conformance with the overall Landscape Development Plan. Refer to Table 2 of Appendix B of the Black Mountain Ranch Subarea Plan for the revegetation plant palette.

E. IRRIGATION STANDARDS

All irrigation systems shall conform to the Citywide Landscape Regulations SDMC 142.0403(c) and all other applicable City and regional standards for irrigation installation and maintenance. The irrigation design will be based on the Maximum Applied Water Allowance (MAWA) and Estimated Total Water Use (ETWU). Irrigation systems shall be designed so that separate areas of maintenance responsibility are metered and controlled independently.

AVION DESIGN GUIDELINES

V. LANDSCAPE DESIGN

All permanent irrigation systems will be below ground, automatically controlled, and in full compliance with building code requirements. The irrigation system will utilize reclaimed water to the maximum extent available and permissible. Water conserving systems such as drip irrigation, moisture sensors, low gallonage heads, and matched precipitation rate heads will be used. Temporary irrigation systems in naturalized or native areas may utilize above ground systems. All backflow control devices will be located or screened from public view. Habitat areas in the riparian zone will be watered with a combination of overhead spray and drip emitters. The riparian zone system will be installed permanently but used only during initial plant establishment.

F. MAINTENANCE

All required common landscape areas shall be maintained by the Home Owner's Association. The landscape areas shall be maintained free of debris and litter and all plant material shall be maintained in a healthy growing condition. Diseased or dead plant material shall be satisfactorily treated or replaced per the conditions of the permit. For crime prevention purposes, canopies of mature trees should be maintained at least 8 feet above the ground. Bushes should be trimmed to less than 3 feet except where privacy or environmental noise mitigation is a primary concern, or where higher plants would not block any views, lighting, or provide hiding places.

Residential property owners will be required to maintain landscaping within their exclusive use area in conformance with the criteria in CC&Rs which will be established and administered and enforced by the Home Owner's Association.

City open space lots will be dedicated to the and maintained by the City of San Diego in accordance with its standards.

G. OPEN SPACE SYSTEM

The components of the open space system include native and naturalized riparian areas. In order to minimize impacts to sensitive lands and

V. LANDSCAPE DESIGN

promote the objectives of the City of San Diego Multiple Species Conservation Program, no public access to the open space preserve is permitted. As shown in **Figure 15**, an approximately 5,906 square foot park/overlook area is planned to provide a recreational amenity for project residents. This area will feature a decomposed granite walkway, dog park, community overlook with benches set in decomposed granite, a memorial plaque for the DebeVoise family, and shade trees. Tree-lined parkways are designed to provide pedestrian circulation opportunities within the site, connect to the park/overlook, and provide pedestrian access to the adjacent Heritage Bluffs II development. Exclusive use areas located within the rear yard setback of each residence also provide additional open space. The remaining landscaping outside of the residential exclusive use areas are to be maintained by the HOA.

AVION DESIGN GUIDELINES

V. LANDSCAPE DESIGN

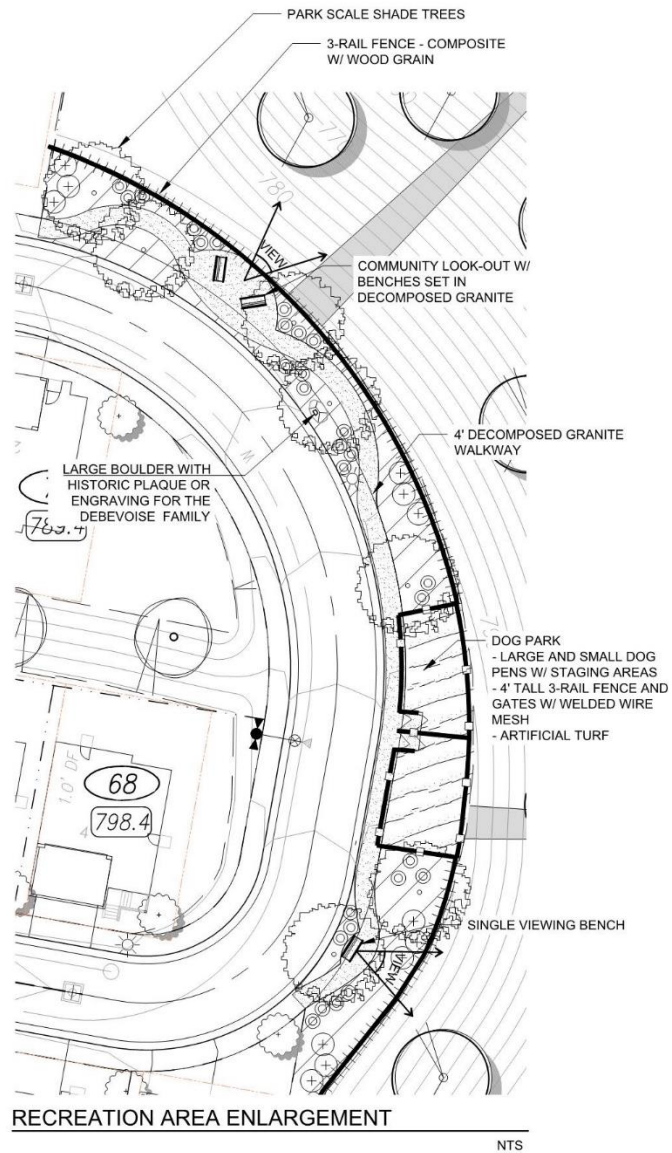

Figure 15: Park/Overlook Area

V. LANDSCAPE DESIGN

H. WALLS AND FENCES

- 1) Walls and fence design may be used for privacy and security as well as to delineate MHPA open space areas, private areas, service areas, and auto-courts. Walls and fences shall be compatible with the color, texture, material, and architectural style of the surrounding neighborhood. They should be located in a way that is not visually prominent from the road or neighbors. Landscaping is strongly encouraged to reduce the fence's prominence. **Figures 116– 20** identify typical walls and fence styles, which complement the architecture within Avion. The primary role of walls and fences is to maintain adequate visibility on private property and in public rights-of-way, maintain the openness of front and street side yards, protect the light and air to abutting properties, and provide adequate screening by regulating the height, location, and design of fences and walls. Wall and fence design shall conform to the general development regulations outlined in Chapter 14, Article 2, Division 3. Any wall or fence that exceeds a height of six feet or greater will require a building permit. The following guidelines ensure that the walls and fences maintain high quality design and variation throughout Avion. Long straight lines, over 100 feet in length, of fences or walls must be avoided through the use of staggered, offset, or curved wall sections.
- 2) Long uninterrupted wall faces, over 100 feet in length, must be avoided through the use of periodic columns, offsets, panels, or semi-open areas, and changes in materials.
- 3) Chain link fences may only be used in areas not visible from common open space and public streets. When used, chain link fences must be vinyl coated and/or vine covered. Vine covered fences are only permitted outside of required brush management zones.
- 4) Grapestake fences are not allowed.
- 5) Unfinished concrete block is not allowed.
- 6) Acceptable wall or fence materials include wrought iron or tubular steel pickets, pilaster, metal frame, glass, concrete, split rail or wood pole, rail, masonry, wood, or vinyl.
- 7) Fences in areas of grade change must be periodically stair-stepped.

AVION DESIGN GUIDELINES

V. LANDSCAPE DESIGN

- 8) Fences and walls bordering or fronting open space or other common areas shall be designed to be compatible with fences and walls on adjacent private properties.
- 9) Solid or open fences and walls may run alongside yard property lines from the street/front yard setback to the rear yard setback on any lot.
- 10) Solid or open fences and walls may run alongside yard and rear yard property lines adjacent to other developed or private properties, i.e. interior lots.
- 11) Retaining walls shall be designed either as visual extension of the main structure on the property with regard to materials, color, and details, or as natural landscape elements blending with the setting.
- 12) Fences or barrier plantings are required between the developed portion of individual residential lots and public MHPA open space lots.
- 13) For the dog park enclosures, a 4' tall ranch rail fence should be used. Vinyl coated black welded wire mesh will be permanently attached to the ranch rails and posts to secure the enclosure.

V. LANDSCAPE DESIGN

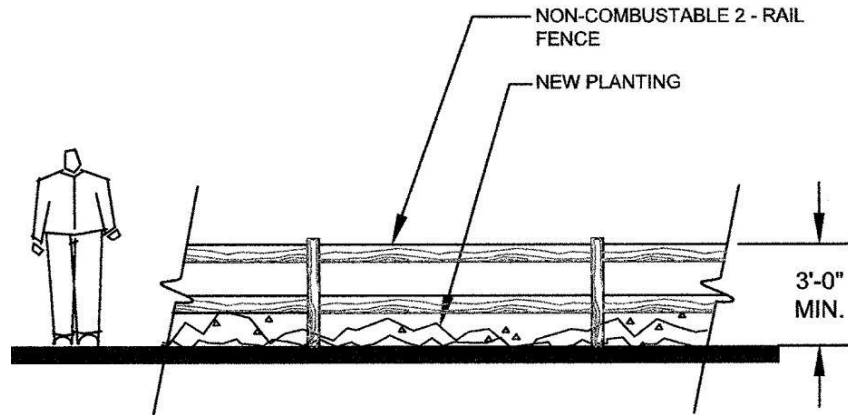
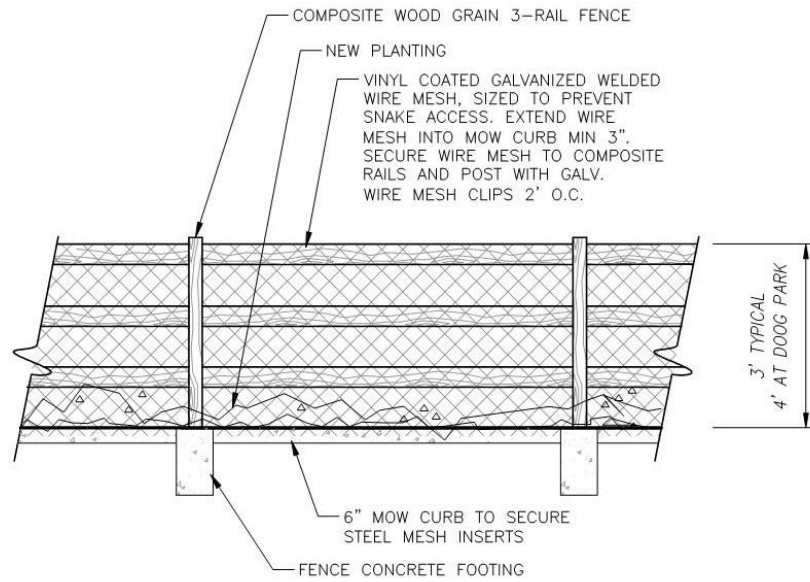

Figure 16: Rail Fence



3-RAIL FENCE - COMPOSITE WOOD GRAIN

Figure 17: Rail Fence at Dog Park

AVION DESIGN GUIDELINES

V. LANDSCAPE DESIGN

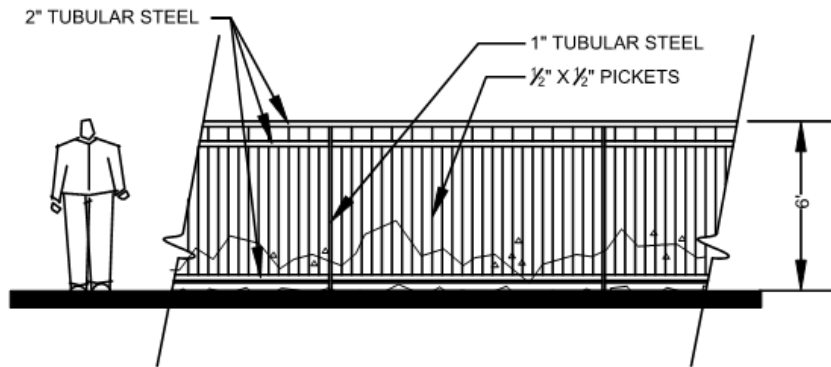

Figure 18: Tubular Steel View Fence

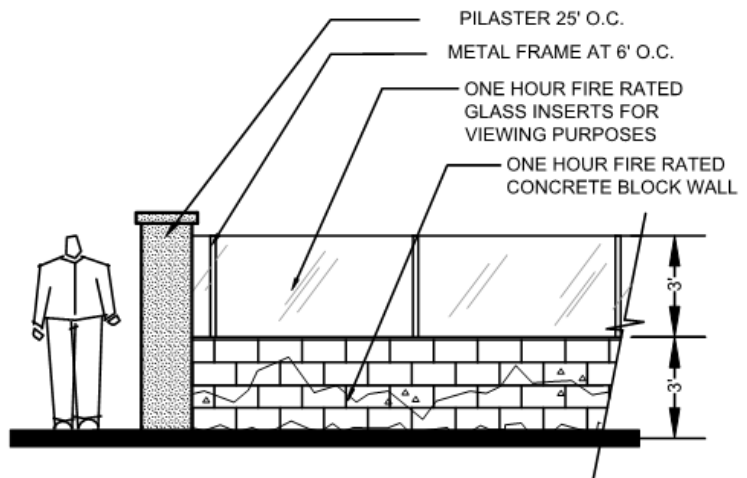

Figure 19: Masonry and Glass View Fence and Radiant Heat Wall

V. LANDSCAPE DESIGN

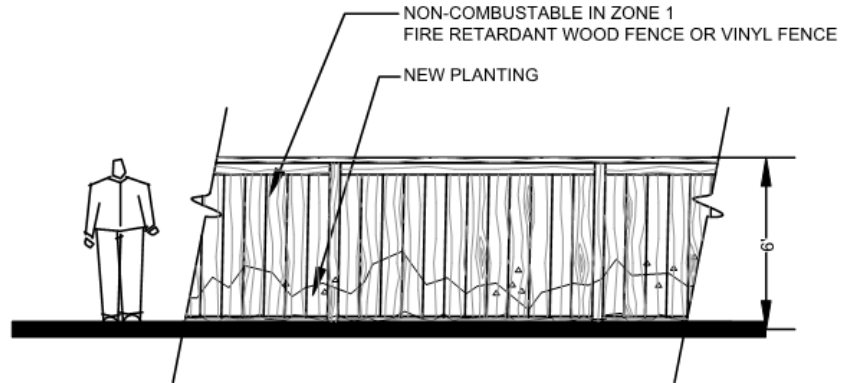

Figure 209: Solid Fence

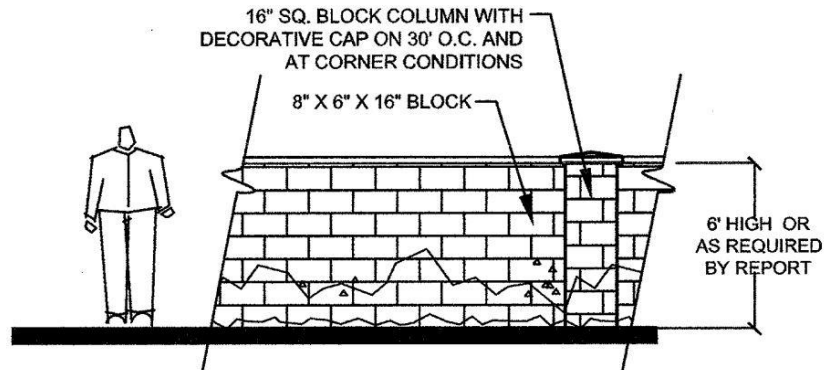

Figure 21: Masonry Wall

AVION DESIGN GUIDELINES

V. LANDSCAPE DESIGN

I. SIGNAGE



The project will feature identification signage at street intersections while ensuring a safe roadway environment that adheres to existing laws and regulations. As shown in **Figure 22**, the determination of size, color, and locations of signs will conform to Municipal Code Chapter 14, Article 2, Division 2 and the adjacent Heritage Bluffs development. No project monument is proposed.

Figure 22: Typical Street and Safety Signage

J. LIGHTING

The need for adequate lighting to assure the safety and security of the residents of Avion is recognized. Within the limits of safety; however, the intensity of exterior lighting shall be kept to a minimum to promote a rural character and limit impacts to the wildlife, which will occupy the extensive open space system in the entire Black Mountain Ranch community. In general, exterior lights shall be directed downward and the light source shall be shielded. Development of properties immediately adjacent to natural open space areas shall be specifically designed so that light or glare shall not be cast on the open space lots.

J. BRUSH MANAGEMENT

The Brush Management Program described in this section implements the City of San Diego's Brush Management Regulations found in Section 142.0412 of the Land Development Code, which establishes a means of providing fire safety in the landscape for public or privately owned premises that are within 100 feet of a structure and contain native or naturalized vegetation. The Brush Management Plan is identified on the project plans for Avion. Two distinct brush management areas referred to as "zone one" and "zone two" provide an effective break between all structures by providing an effective fire break between all structures and contiguous areas of native or naturalized vegetation. Brush management zone one is the area adjacent to the structure and shall be the least

V. LANDSCAPE DESIGN

flammable. It shall consist of pavement and permanently irrigated ornamental planting and trees no closer than 10' from the habitable structure. Brush management zone one shall not be allowed on slopes with a gradient greater than 4:1. Alternative compliance to the Zone 1 setback may be granted by the Fire and Landscape Departments with the appropriate non-combustible elements. Brush management Zone Two is the area between Zone One and any area of native or naturalized vegetation and shall consist of thinned, native, or non-irrigated vegetation. Maintenance of brush management lots shall include the removal of invasive species.

Management and maintenance of brush management lots will be the responsibility of the Avion Home Owners Association and shall be conducted in strict conformance with the plan as set forth on the project plans for Avion. Compliance with these guidelines shall not be construed as a guarantee against any damage, destruction, or loss of property that may be caused by brush fire.

AVION DESIGN GUIDELINES

VI. IMPLEMENTATION

The Avion Design Review Guidelines will be implemented by the Avion Homeowner's Association (HOA) and the City of San Diego. The processes described in this section are not intended to supersede or supplant the responsibility of municipal authorities duly authorized to issue construction permits within Avion.

Avion Homeowner's Association: The Avion HOA will oversee the maintenance and operation of community-wide facilities within the project boundary, including but not limited to, brush management areas, open space area, signs and monuments, etc. Any future development, addition, or modification to an existing residence must obtain HOA approval prior to project submittal with the Development Services Department.

The HOA shall be responsible for the aesthetic review and approval of all room additions, patio covers, decks, patios, and other structures requiring a building permit within the Avion development. All future room additions by homeowners shall comply with the standards set forth in Section IV of this document. This shall be clearly stated in the Master Covenants, Conditions, and Restrictions (CC&Rs) for this project, which describe the requirements and limits of what can be done with the property.

The HOA will be responsible for administering the Avion CC&Rs with the intent to protect, preserve, and enhance property values in the community. These shall be recorded prior to the sale of any home-site to an individual. The City of San Diego will not be responsible for the administration or enforcement of CC&Rs.

City of San Diego: Prior to submitting an application for any building permit to the City of San Diego, the developer shall submit an application for Substantial Conformance Review (SCR) to the Development Services Department. The goal of SCR is to determine if the proposed project is consistent and in conformance with a previously approved permit. This includes review of the revised project against the approved exhibits, permit conditions, environmental documentation, applicable land use policies, and the public record for the prior permit. Application requirements for a SCR can be obtained from the City of San Diego Development Services Department. The Development Services Department will review the architecture, site design and landscape for

AVION DESIGN GUIDELINES

VI. IMPLEMENTATION

consistency with the Vesting Tentative Map, Planned Development Permit, Site Development Permit, and these Design Guidelines for Avion. A SCR decision is either at staff-level (Process 1) or is a decision by staff that may require input from the Community Planning Group and is appealable to a Hearing Officer (Process 2). If the plans are found to not be in conformance, an amendment will be required to the Vesting Tentative Map, Planned Development Permit, and Site Development Permit to be consistent with the City of San Diego's process guidelines.

Following SCR and approval, an applicant may apply for a building permit through the City of San Diego Development Services Department.

The developers of Avion are obligated to install certain public improvements as part of project development. The requirements for these improvements are established in the conditions of approval for the Vesting Tentative Map, Planned Development Permit, and Site Development Permit. The phasing requirements of these conditions may affect the timing of building permit issuance. Individual home builders are encouraged to determine what effect, if any, infrastructure phasing may have on the timing of building permit issuance for their property prior to applying for a building permit.