

Summary Form for Electronic Document Submittal

Form F

Lead agencies may include 15 hardcopies of this document when submitting electronic copies of Environmental Impact Reports, Negative Declarations, Mitigated Negative Declarations, or Notices of Preparation to the State Clearinghouse (SCH). The SCH also accepts other summaries, such as EIR Executive Summaries prepared pursuant to CEQA Guidelines Section 15123. Please include one copy of the Notice of Completion Form (NOC) with your submission and attach the summary to each electronic copy of the document.

SCH #: 2001082058

Project Title: Eagle Rock Aggregates Oakland Terminal Project

Lead Agency: Port of Oakland

Contact Name: Khamly Chuop

Email: kchuop@portoakland.com Phone Number: (510) 627-1758

Project Location: Oakland, Alameda County

City

County

Project Description (Proposed actions, location, and/or consequences).

Eagle Rock Aggregates (ERA) proposes to construct and operate the ERA Oakland Terminal Project (Project), a marine terminal at the Port of Oakland that would import, store, and distribute bulk construction aggregates (i.e., sand and gravel). The Project is located at the Port of Oakland's Outer Harbor Terminal and would utilize Berth 22 vessel and barge operations and approximately 18 acres of Berth 20, 21, and 22 backlands (land directly adjacent to a vessel berth) for stockpiling and distribution of construction aggregates. The Project site lies within the boundary of the Oakland Army Base (OAB) Area Redevelopment Plan.

Identify the project's significant or potentially significant effects and briefly describe any proposed mitigation measures that would reduce or avoid that effect.

The following Proposed Project impacts would be below thresholds of significance with mitigation measures:

- Create new source of light or glare which would adversely affect daytime or nighttime views (Mitigation Measure 4.11-1).
- Expose sensitive receptors to substantial pollutant concentrations (Mitigation Measures ERA AQ-1 and ERA AQ-2).
- Result in a substantial increase in diesel emissions (Mitigation Measures ERA AQ-1 and ERA AQ-2).
- Be located on a site that is included on a list of hazardous materials sites (Mitigation Measures 4.7-4, 4.7-5, and 4.7-10).
- Generate noise in violation of City of Oakland Noise Ordinance and City nuisance standards (Mitigation Measure 4.5-1).
- Cause existing or future baseline LOS to degrade to worse than LOS D (Mitigation Measure ERA TRANS-1).
- Be served by a landfill with insufficient permitted capacity to accommodate solid waste disposal needs / violate applicable federal, state, or local statutes and regulations related to solid waste (Mitigation Measures 4.9-7 and 4.9-8).
- Contribute to a cumulative impact on landfill permitted capacity (Mitigation Measures 4.9-7 and 4.9-8).

The following Proposed Project impacts would exceed air quality thresholds of significance even with mitigation:

- Result in construction emissions or total operational emissions exceeding BAAQMD recommended NOx thresholds.
- Conflict with or obstruct implementation of applicable air quality plan (due to NOx and PM2.5 at MEIW).
- Violate any air quality standard or contribute to an existing or projected violation (due to NOx and PM2.5 at MEIW).
- Result in a cumulatively considerable net increase of NOx and PM2.5.
- Result in a cumulative exposure of sensitive people to substantial pollutant concentrations.

If applicable, describe any of the project's areas of controversy known to the Lead Agency, including issues raised by agencies and the public.

Areas of controversy raised by agencies and/or the public include:

- West Oakland communities will be exposed to additional air quality and health effects with implementation of the Project.
- The Project will create few jobs for West Oakland residents.
- Dust and air pollution impacts associated with the construction and operation of the Project.
- Potential health risk to sensitive populations as a result of Project construction and operation
- Diesel emissions from ocean-going vessels and tugs (to transport barges) will contribute West Oakland pollution.
- The Project will increase truck traffic.
- The Project will displace parking without alternatives.

Provide a list of the responsible or trustee agencies for the project.

San Francisco Bay Conservation and Development Commission
Bay Area Air Quality Management District
San Francisco Bay Regional Water Quality Control Board
City of Oakland

Port of Oakland

Eagle Rock Aggregates Oakland Terminal Project



Draft Supplemental Environmental Impact Report Appendices



November 2020

This page intentionally left blank

Appendix A

**2012 Oakland Army Base (OARB) Project Standard Conditions of
Approval and Mitigation Monitoring and Reporting Program**

**STANDARD CONDITIONS OF APPROVAL AND
MITIGATION MONITORING AND REPORTING PROGRAM**

This Standard Conditions of Approval and Mitigation Monitoring and Reporting Program (SCA/MMRP) is based on the Initial Study/Addendum (IS/A) prepared for the 2012 OARB Project. This revised version of the SCA/MMRP was approved by the City Council on July 16, 2013 and supersedes the previous version (dated October 15, 2012).¹

This SCA/MMRP is in compliance with Section 15097 of the CEQA Guidelines, which requires that the Lead Agency “adopt a program for monitoring or reporting on the revisions which it has required in the project and the measures it has imposed to mitigate or avoid significant environmental effects.” The SCA/MMRP lists mitigation measures recommended in the IS/A and identifies mitigation monitoring requirements, as well as the City’s Standard Conditions of Approval identified in the IS/A as measures that would minimize potential adverse effects that could result from implementation of the project, to ensure the conditions are implemented and monitored. In addition, “recommended measures,” not required by CEQA are also included in this SCA/MMRP.

All mitigation measures, Standard Conditions of Approval, and recommended measures identified in the 2012 OARB IS/A are included herein. To the extent that there is any inconsistency between the SCA and Mitigation Measures, the more restrictive conditions shall govern; to the extent any mitigation measures, recommended measures and/or Standard Conditions of Approval identified in the 2012 OARB IS/A were inadvertently omitted, they are automatically incorporated herein by reference.

Mitigation measures from the 2002 EIR that are applicable to the 2012 OARB Project retain the same numbering; each new mitigation measures is numbered according to the section of the IS/A from which it is derived. For example, Mitigation Measure 3.16-1 is the first new mitigation measure identified in the Section 3.16 Traffic and Transportation of the IS/A. The Standard Conditions are identified with the prefix SCA- followed by an abbreviation of the environmental topic to which it applies (e.g., SCA AES-1 is the first SCA relating to aesthetic impacts).

- The first column indicates the environmental impact as identified in the 2002 EIR and the 2012 IS/A;
- The second column identifies the Standard Condition of Approval (SCA), mitigation measure (MM) or recommended measure applicable to that impact in the 2002 EIR and the 2012 IS/A;
- The third column identifies the monitoring schedule or timing applicable to the 2012 Project; and
- The fourth column names the party responsible for monitoring the required action for the 2012 Project.²

¹ The following mitigation measures were added to the SCA/MMRP by the City Council on July 16, 2013: Mitigation 4.4-3b (West Gateway Rail and Maritime Emissions Reduction Program); Mitigation PO-1 (Stakeholder Review of Air Quality and Trucking Plans); and Mitigation 4.3-10 (Parking Demand Study). No other changes were made to the previous version (dated October 15, 2012).

² At various places throughout the IS/A, mitigation measures and standard conditions of approval indicate that the project sponsor, project applicant, developer, City and/or Port are responsible for implementation. Regardless of such, the City within its jurisdiction and the Port within its jurisdiction are responsible for implementing the mitigation measures and/or standard conditions of approval. Where both the City and Port jurisdictions are involved, both entities are responsible. The Port will impose the City of Oakland SCAs where the 2012 Project requires building and electrical permits, which apply to most projects at the Port. The Port Engineering Department shall review as appropriate any mitigations and SCAs for components of the Project that occur within the Port’s jurisdiction.

Environmental Impact	Standard Conditions of Approval/Mitigation Measures	Mitigation Implementation/ Monitoring:	
		Schedule	Responsibility
Aesthetics, Wind and Shadows			
1. Would the project create a new source of substantial light or glare which would adversely affect daytime or nighttime views in the area?	SCA-AES-1: Lighting Plan: The proposed lighting fixtures shall be adequately shielded to a point below the light bulb and reflector and that prevent unnecessary glare onto adjacent properties. Plans shall be submitted to the Planning and Zoning Division and the Electrical Services Division of the Public Works Agency for review and approval. All lighting shall be architecturally integrated into the site.	Prior to the issuance of an electrical or building permit.	City/Port
	Mitigation 4.11-1: New lighting shall be designed to minimize off-site light spillage; “stadium” style lighting shall be prohibited. Modern security lighting is available that directs light toward a specific site, and substantially reduces spillage of light onto adjacent properties. The City and the Port shall require the use of such directional lighting as a condition of approval for redevelopment projects throughout the project area. In no case shall the City and the Port allow the use of stadium-style lighting, which directs light outward across a broad area.	Prior to the issuance of an electrical or building permit.	City/Port
2. Would the project introduce structures or landscape that would now or in the future cast substantial shadow on existing solar collectors (in conflict with California Public Resources Code §§ 25980-25986), photovoltaic cells, or impair the function of a building using passive solar heat collection?	Mitigation 4.11-3: New active or passive solar systems within or adjacent to the project area shall be set back from the property line a minimum of 25 feet. Through design review, the City shall ensure that proposed solar systems are not located in a manner that would unduly restrict design of future development. Such conflicts are to be resolved in design review. If the proposed solar system cannot be designed to accommodate adjacent actions, it shall be disallowed.	Prior to the issuance of an electrical or building permit.	City/Port
	Mitigation 4.11-4: New construction within the Gateway development area adjacent to a parcel containing permitted or existing active or passive solar systems shall demonstrate through design review that the proposed structures shall not substantially impair operation of existing solar systems. Through design review, the City shall ensure that the effectiveness an operation of existing or permitted active or passive solar systems shall not be substantially impaired. The design of the subsequent proposed structures shall be modified so as not to have such an adverse effect.	Prior to the issuance of an electrical or building permit.	City
	Mitigation 4.11-5: The City and Port shall coordinate with respect to the design of new, permanent buildings constructed along the Port/Gateway boundary to minimize conflicts over solar access. The City and Port shall coordinate with one another regarding design of subsequent redevelopment activities within their respective jurisdictions that may affect operation of solar installations in the other’s jurisdiction.	Prior to the issuance of an electrical or building permit.	City/Port
	Mitigation 4.11-6: New construction adjacent to a public park or open space shall demonstrate through design review that development shall not substantially impair enjoyment of the public utilizing the space. Through design review, the City shall ensure that new building or landscaping shall not shade existing or proposed parks or open spaces in a manner that would make these public spaces	Prior to the issuance of a building permit	City/Port

Environmental Impact	Standard Conditions of Approval/Mitigation Measures	Mitigation Implementation/ Monitoring:	
		Schedule	Responsibility
	substantially less useful or enjoyable to the public. The City may require specific building placement, tiered roofs, or other means of reducing shadow effects on public opens spaces. It is not the intent of this measure to completely eliminate shade in these areas, but to reduce shade to the maximum extent feasible.		
Air Quality			
1. Would the project conflict with or obstruct implementation of the applicable air quality plan?	<p><u>SCA AIR-2: Construction-Related Air Pollution Controls (Dust and Equipment Emissions):</u> During construction, the project applicant shall require the construction contractor to implement all of the following applicable measures recommended by the Bay Area Air Quality Management District (BAAQMD):</p> <ul style="list-style-type: none"> a) Water all exposed surfaces of active construction areas at least twice daily (using reclaimed water if possible). Watering should be sufficient to prevent airborne dust from leaving the site. Increased watering frequency may be necessary whenever wind speeds exceed 15 miles per hour. Reclaimed water should be used whenever possible. b) Cover all trucks hauling soil, sand, and other loose materials or require all trucks to maintain at least two feet of freeboard (i.e., the minimum required space between the top of the load and the top of the trailer). c) All visible mud or dirt track-out onto adjacent public roads shall be removed using wet power vacuum street sweepers at least once per day. The use of dry power sweeping is prohibited. d) Pave all roadways, driveways, sidewalks, etc. as soon as feasible. In addition, building pads should be laid as soon as possible after grading unless seeding or soil binders are used. e) Enclose, cover, water twice daily or apply (non-toxic) soil stabilizers to exposed stockpiles (dirt, sand, etc.). f) Limit vehicle speeds on unpaved roads to 15 miles per hour. g) Idling times on all diesel-fueled commercial vehicles over 10,000 lbs. shall be minimized either by shutting equipment off when not is use or reducing the maximum idling time to five minutes (as required by Title 13, Section 2485, of the California Code of Regulations. Clear signage to this effect shall be provided for construction workers at all access points. h) Idling times on all diesel-fueled off-road vehicles over 25 horsepower shall be shall be minimized either by shutting equipment off when not is use or reducing the maximum idling time to five minutes and fleet operators must develop a written idling policy (as required by Title 13, Section 2449 of the California Code of Regulations.) i) All construction equipment shall be maintained and properly tuned in accordance with the manufacturer's specifications. All equipment shall be checked by a certified mechanic and determined to be running in proper condition prior to operation. j) Post a publicly visible sign that includes the contractor's name and telephone number to contact regarding dust complaints. When contacted, the contractor shall respond and take corrective action within 48 hours. The telephone numbers of contacts at the City and the BAAQMD shall also be visible. This information may be posted on other required on-site signage. 	Ongoing throughout demolition, grading, and/or construction	City/Port

Environmental Impact	Standard Conditions of Approval/Mitigation Measures	Mitigation Implementation/ Monitoring:	
		Schedule	Responsibility
	<p>k) All exposed surfaces shall be watered at a frequency adequate to maintain minimum soil moisture of 12 percent. Moisture content can be verified by lab samples or moisture probe.</p> <p>l) All excavation, grading, and demolition activities shall be suspended when average wind speeds exceed 20 mph.</p> <p>m) Install sandbags or other erosion control measures to prevent silt runoff to public roadways.</p> <p>n) Hydroseed or apply (non-toxic) soil stabilizers to inactive construction areas (previously graded areas inactive for one month or more).</p> <p>o) Designate a person or persons to monitor the dust control program and to order increased watering, as necessary, to prevent transport of dust offsite. Their duties shall include holidays and weekend periods when work may not be in progress.</p> <p>p) Install appropriate wind breaks (e.g., trees, fences) on the windward side(s) of actively disturbed areas of the construction site to minimize wind blown dust. Wind breaks must have a maximum 50 percent air porosity.</p> <p>q) Vegetative ground cover (e.g., fast-germinating native grass seed) shall be planted in disturbed areas as soon as possible and watered appropriately until vegetation is established.</p> <p>r) The simultaneous occurrence of excavation, grading, and ground-disturbing construction activities on the same area at any one time shall be limited. Activities shall be phased to reduce the amount of disturbed surfaces at any one time.</p> <p>s) All trucks and equipment, including tires, shall be washed off prior to leaving the site.</p> <p>t) Site accesses to a distance of 100 feet from the paved road shall be treated with a 6 to 12 inch compacted layer of wood chips, mulch, or gravel.</p> <p>u) All equipment to be used on the construction site and subject to the requirements of Title 13, Section 2449 of the California Code of Regulations (“California Air Resources Board Off-Road Diesel Regulations”) must meet Emissions and Performance Requirements one year in advance of any fleet deadlines. The project applicant shall provide written documentation that the fleet requirements have been met.</p> <p>v) Use low VOC (i.e., ROG) coatings beyond the local requirements (i.e., BAAQMD Regulation 8, Rule 3: Architectural Coatings).</p>		
	<p>Mitigation 4.4-3a: The Port shall develop and implement a criteria pollutant reduction program aimed at reducing or off-setting Port-related emissions in West Oakland from its maritime and rail operations to less than significant levels, consistent with applicable federal, state and local air quality standards. The program shall be sufficiently funded to strive to reduce emissions from redevelopment related contributors to local West Oakland air quality, and shall continually reexamine potential reductions toward achieving less than significant impacts as new technologies emerge. The adopted program shall define measurable reductions within specific time periods.</p> <p>This program shall be periodically reviewed and updated every one to three years, corresponding to regular updates of the CAP. The review and update shall include, and not be limited to, an assessment of any potential new strategies, a reassessment of funding requirements, technical</p>	Prior to starting operations	Port

Environmental Impact	Standard Conditions of Approval/Mitigation Measures	Mitigation Implementation/ Monitoring:	
		Schedule	Responsibility
	<p>feasibility, and cost benefit assumptions. Periodic updates shall be submitted to the City/Port Liaison Committee or its equivalent.</p> <p>The pollutant reduction program shall give priority to emission reduction strategies that address PM₁₀ emissions, but shall also provide for reductions in NO_x and ROG emissions. The emission reduction program shall include a list of potential emission reduction strategies. Strategies that shall be included in the program and implemented over the buildout period include:</p> <ul style="list-style-type: none"> • The Port shall expand its existing cargo handling equipment re-powering and retrofitting program (part of the Berths 55-58 Project air quality mitigation program) to include marine and rail terminal yard equipment added or relocated as part of redevelopment build-out. • The Port shall extend its grant program (part of the Berths 55-58 Project air quality mitigation program) to provide financial incentives to tugboat operators at New Berth 21 and other Port facilities to implement emission reduction control measures or to replace tugboat engines to low NOx technology. • The Port shall require rail terminal operators to use switch engines at the New Intermodal Facility that comply with federal air emission regulations for diesel operated locomotives as set forth in federal air regulations. In addition, the rail terminal operator and the Port are to exchange information with the goal of investigating options to accelerate compliance with Tier 0, 1 and 2 requirements of the federal regulations. • The Port shall not preclude in its design of the New Intermodal Facility the installation of an alternative fueling station and shall to the extent feasible accommodate such a fueling station. • The Port shall encourage ships to implement source control technologies when in the port area (such as reduced hoteling). <p>Other strategies to be included in the Port criteria pollutant reduction program when technically and economically feasible, include:</p> <ul style="list-style-type: none"> • Inclusion of an alternative fueling facility at the New Intermodal Facility. 		
	<p>Mitigation 4.4-3b (West Gateway Rail and Maritime Emissions Reduction Program): The ground lessee of the West Gateway and the Railroad Right of Way (“WG Ground Lessee”) shall develop, for City review and approval, a criteria pollutant reduction program aimed at reducing or off-setting emissions from its rail-related and maritime-related operations, to the extent feasible, to less than significant levels, consistent with applicable federal, state and local air quality standards. The WG Ground Lessee shall implement the approved program and shall periodically review and update the program every one to three years, concurrently with the update of the Bay Area Clean Air Plan.</p> <p>The review and update shall include, and not be limited to, assessment of: potential new reduction strategies based on then-available technologies; funding requirements; technical feasibility; economic feasibility and cost benefit analysis. The updates shall be submitted to the City for its</p>	Prior to starting operations	City

Environmental Impact	Standard Conditions of Approval/Mitigation Measures	Mitigation Implementation/ Monitoring:	
		Schedule	Responsibility
	<p>review and approval. The WG Ground Lessee shall implement the City-approved, updated program.</p> <p>The program shall give priority to emission reduction strategies that address PM₁₀ emissions, but shall also provide for reductions in NO_x and ROG emissions. The emission reduction program shall include a list of potential emission reduction strategies and shall define measurable reduction goals within specific time periods. Strategies that shall be included in the program may include without limitation:</p> <ul style="list-style-type: none"> • Requiring rail terminal operators to use switch engines that comply with federal air emission regulations for diesel operated locomotives as set forth in federal air regulations. In addition, the rail terminal operator and the WG Ground Lessee to exchange information with the goal of investigating options to accelerate compliance with Tier 0, 1 and 2 requirements of the federal regulations. • Encourage ships to implement source control technologies when in the West Gateway area (such as reduced hoteling). • Working with tugboat operators to implement emission reduction control measures or to replace tugboat engines to low NO_x technology. 		
	<p>Mitigation 4.4-4: The City and the Port shall jointly create, maintain and fund on a fair share basis, a truck diesel emission reduction program. The program shall be sufficiently funded to strive to reduce redevelopment related contributions to local West Oakland diesel emissions to less than significant levels, consistent with applicable federal, state and local air quality standards, and shall continually reexamine potential reductions toward achieving less than significant impacts as new technologies emerge. The adopted program shall define measurable reduction within specific time periods.</p> <p>This program shall be periodically reviewed and updated every one to three years, corresponding to regular updates of the CAP. The review and update shall include, and not be limited to, an assessment of any potential new strategies, a reassessment of funding requirements, technical feasibility, and cost benefit assumptions. Periodic updates shall be submitted to the City/Port Liaison Committee or its equivalent.</p> <p>The diesel emissions reduction program shall include a list of potential emission reduction strategies that shall include on-site Port improvements and/or practices; loan, grant or incentive-based programs; and on-going studies.</p> <p>Strategies that shall be included in the diesel emissions reduction program and implemented over the build-out period include the following:</p> <ol style="list-style-type: none"> 1. On-site Port improvements. <ul style="list-style-type: none"> • Configure truck parking in the Port to minimize traffic interference and reduce idling times. 	Prior to operations	City/Port

Environmental Impact	Standard Conditions of Approval/Mitigation Measures	Mitigation Implementation/ Monitoring:	
		Schedule	Responsibility
	<ul style="list-style-type: none"> Allow easy access to a truck parking facility at the Port 24-hours a day. Synchronize traffic lights in the Port area to reduce congestion (requires coordination with the City). <p>2. City/Port loan or grant/incentive programs for local businesses or entities.</p> <ul style="list-style-type: none"> Provide incentives for re-powering, retrofitting, electrifying, or switching to alternative fuels to local businesses, franchises or truck fleets operating in West Oakland. Such businesses may include, for example, locally owned and operated trucking operations, refuse and recycling collection vehicles, school buses, Port and/or City fleet vehicles, and US Mail trucks. <p>Other strategies to be included in the diesel emissions reduction program to be examined and incorporate when technically and economically feasible, include the following:</p> <p>1. On-site Port improvements.</p> <ul style="list-style-type: none"> Allow trucks using alternative fuels to the head of queues or have separate gate entrances. <p>2. On-going studies.</p> <ul style="list-style-type: none"> Explore methods to minimize truck idling times at the Port. Explore and encourage the use of alternative fuels for Port marine, rail and truck operations. Propose and fund a random roadside heavy duty diesel vehicle (HDDV) emissions testing program and an HDDV repair subsidy program. <p>3. City/Port loan or grant/incentive programs for local businesses or entities.</p> <ul style="list-style-type: none"> Provide subsidies, training programs and/or voucher programs for local West Oakland businesses to conduct timing retard, compressions changes and other adjustments to diesel engines to reduce emissions. Install oxidative catalyst and particulate traps on diesel engines with low NOx, alternatively fueled or electrified engines. 		
	<p>Mitigation Measure 4.4-5: Major developers¹ shall fund on a fair share basis BAAQMD – recommended feasible Transportation Control Measures (TCMs) for reducing vehicle emissions from commercial, institutional, and industrial operations, as well as all CAP TCMs the BAAQMD has identified as appropriate for local implementation.</p> <p>Each major developer of a subsequent redevelopment activity shall fund its fair share toward some or all of the following TCMs:</p>	Prior to operations	City/Port

¹ Defined as City, Port, and private developers whose subsequent redevelopment activity would generate more than 20,000 square feet of employment-generating land uses, or that would generate 100 or greater local jobs.

Environmental Impact	Standard Conditions of Approval/Mitigation Measures	Mitigation Implementation/ Monitoring:																																	
		Schedule	Responsibility																																
	<p>BAAQMD-Recommended Transportation Control Measure, Modified for this Action</p> <hr/> <table border="1"> <thead> <tr> <th>Control Measure</th> <th>Measure</th> </tr> </thead> <tbody> <tr> <td>1</td> <td>Construct transit facilities such as bus turnouts/bus bulbs, benches, shelters, etc. Improve transit bus service to the area.</td> </tr> <tr> <td>2</td> <td>Design and locate buildings to facilitate transit access, e.g., locate building entrances near transit stops, eliminate building setbacks, etc.</td> </tr> <tr> <td>3</td> <td>Provide and make public transit convenient for 16th and Wood sub-district residents and tenants. <i>(Note: Not applicable to the 2012 OARB Project)</i></td> </tr> <tr> <td>4</td> <td>Encourage OARB sub-district tenants to use car pools, vanpools, and public transit by providing incentives.</td> </tr> <tr> <td>5</td> <td>Provide a shuttle to and from the West Oakland BART station</td> </tr> <tr> <td>6</td> <td>Provide on-site shops and services for employees, such as cafeteria, bank, dry cleaners, convenience market, etc.</td> </tr> <tr> <td>7</td> <td>Provide on-site child care, or contribute to off-site child care within walking distance.</td> </tr> <tr> <td>8</td> <td>Establish mid-day shuttle service from worksite to food service establishments/commercial areas.</td> </tr> <tr> <td>9</td> <td>Provide preferential parking for carpool and vanpool vehicles</td> </tr> <tr> <td>10</td> <td>Implement parking fees for single occupancy vehicle commuters.</td> </tr> <tr> <td>11</td> <td>Provide secure, weather-protected bicycle parking for employees.</td> </tr> <tr> <td>12</td> <td>Provide safe, direct access for bicyclists to adjacent bicycle routes.</td> </tr> <tr> <td>13</td> <td>Provide showers and lockers for employees bicycling or walking to work.</td> </tr> <tr> <td>14</td> <td>Provide direct, safe, attractive pedestrian access from project to transit stops and adjacent development.</td> </tr> <tr> <td>15</td> <td>Provide neighborhood-serving shops and services within or adjacent to the 16th and Wood sub-district. <i>(Note: Not applicable to the 2012 OARB Project)</i></td> </tr> </tbody> </table> <p>Source: BAAQMD 1996, as amended through 1999. Based on Table 15: "Mitigation Measures for Reducing Motor Vehicle Emissions from Commercial, Institutional, and Industrial Projects."</p>	Control Measure	Measure	1	Construct transit facilities such as bus turnouts/bus bulbs, benches, shelters, etc. Improve transit bus service to the area.	2	Design and locate buildings to facilitate transit access, e.g., locate building entrances near transit stops, eliminate building setbacks, etc.	3	Provide and make public transit convenient for 16th and Wood sub-district residents and tenants. <i>(Note: Not applicable to the 2012 OARB Project)</i>	4	Encourage OARB sub-district tenants to use car pools, vanpools, and public transit by providing incentives.	5	Provide a shuttle to and from the West Oakland BART station	6	Provide on-site shops and services for employees, such as cafeteria, bank, dry cleaners, convenience market, etc.	7	Provide on-site child care, or contribute to off-site child care within walking distance.	8	Establish mid-day shuttle service from worksite to food service establishments/commercial areas.	9	Provide preferential parking for carpool and vanpool vehicles	10	Implement parking fees for single occupancy vehicle commuters.	11	Provide secure, weather-protected bicycle parking for employees.	12	Provide safe, direct access for bicyclists to adjacent bicycle routes.	13	Provide showers and lockers for employees bicycling or walking to work.	14	Provide direct, safe, attractive pedestrian access from project to transit stops and adjacent development.	15	Provide neighborhood-serving shops and services within or adjacent to the 16th and Wood sub-district. <i>(Note: Not applicable to the 2012 OARB Project)</i>		
Control Measure	Measure																																		
1	Construct transit facilities such as bus turnouts/bus bulbs, benches, shelters, etc. Improve transit bus service to the area.																																		
2	Design and locate buildings to facilitate transit access, e.g., locate building entrances near transit stops, eliminate building setbacks, etc.																																		
3	Provide and make public transit convenient for 16th and Wood sub-district residents and tenants. <i>(Note: Not applicable to the 2012 OARB Project)</i>																																		
4	Encourage OARB sub-district tenants to use car pools, vanpools, and public transit by providing incentives.																																		
5	Provide a shuttle to and from the West Oakland BART station																																		
6	Provide on-site shops and services for employees, such as cafeteria, bank, dry cleaners, convenience market, etc.																																		
7	Provide on-site child care, or contribute to off-site child care within walking distance.																																		
8	Establish mid-day shuttle service from worksite to food service establishments/commercial areas.																																		
9	Provide preferential parking for carpool and vanpool vehicles																																		
10	Implement parking fees for single occupancy vehicle commuters.																																		
11	Provide secure, weather-protected bicycle parking for employees.																																		
12	Provide safe, direct access for bicyclists to adjacent bicycle routes.																																		
13	Provide showers and lockers for employees bicycling or walking to work.																																		
14	Provide direct, safe, attractive pedestrian access from project to transit stops and adjacent development.																																		
15	Provide neighborhood-serving shops and services within or adjacent to the 16th and Wood sub-district. <i>(Note: Not applicable to the 2012 OARB Project)</i>																																		

Environmental Impact	Standard Conditions of Approval/Mitigation Measures	Mitigation Implementation/ Monitoring:															
		Schedule	Responsibility														
	<p>Each major developer of a subsequent redevelopment activity shall also fund its fair share of the following CAP TCMs, which the BAAQMD has identified as appropriate for local implementation, with redevelopment-specific modifications:</p> <table border="1"> <thead> <tr> <th>CAP TCMs</th> <th>Description</th> </tr> </thead> <tbody> <tr> <td>1. Support Voluntary Employer-Based Trip Reduction Programs</td> <td> <p>The City and Port will explore ways to promote transit use and support employer-based trip reduction programs through development incentives such as density bonuses, reduced parking requirements, incentives for permanent bicycle facilities, etc.</p> <p>The City will encourage development of transit transfer stations near employment concentrations in the Gateway development area and 16th/Wood sub-district.</p> </td> </tr> <tr> <td>9. Improve Bicycle Access and Facilities</td> <td> <p>Redevelopment includes extensive multi-use trails serving as both “spine” thoroughfares and “spurs” connecting main trails to the Oakland waterfront.</p> <p>The City and Port will encourage employers and developers to provide permanent bicycle facilities.</p> </td> </tr> <tr> <td>12. Improve Arterial Traffic Management</td> <td> <p>Maritime Street and other roadways in the project area will include facilities to encourage bicycling and walking.</p> <p>Roadways and intersections will be designed to operate at City-standard LOS, to facilitate traffic flow and avoid unnecessary queuing.</p> </td> </tr> <tr> <td>15. Local Air Clean Plans, Policies and Programs</td> <td> <p>Redevelopment as presented in Chapter 2.0 Project Description and Chapters 3.3 Air Quality and 3.16 Transportation and Traffic (in the 2012 OARB Project Initial Study/Addendum), incorporate land uses such as a rail terminal in conjunction with logistics uses, and measures intended to reduce the number and length of truck trips and single-occupant automobile trips.</p> </td> </tr> <tr> <td>17. Conduct Demonstration Projects</td> <td> <p>The City will encourage through development incentives demonstration projects for fleet electrification or alternative fueling. In addition, the Port will not preclude alternative fueling in its design of rail facilities.</p> </td> </tr> <tr> <td>19. Pedestrian Travel</td> <td> <p>OARB and Maritime sub-districts will include multi-use trails to encourage safe pedestrian travel.</p> </td> </tr> </tbody> </table>	CAP TCMs	Description	1. Support Voluntary Employer-Based Trip Reduction Programs	<p>The City and Port will explore ways to promote transit use and support employer-based trip reduction programs through development incentives such as density bonuses, reduced parking requirements, incentives for permanent bicycle facilities, etc.</p> <p>The City will encourage development of transit transfer stations near employment concentrations in the Gateway development area and 16th/Wood sub-district.</p>	9. Improve Bicycle Access and Facilities	<p>Redevelopment includes extensive multi-use trails serving as both “spine” thoroughfares and “spurs” connecting main trails to the Oakland waterfront.</p> <p>The City and Port will encourage employers and developers to provide permanent bicycle facilities.</p>	12. Improve Arterial Traffic Management	<p>Maritime Street and other roadways in the project area will include facilities to encourage bicycling and walking.</p> <p>Roadways and intersections will be designed to operate at City-standard LOS, to facilitate traffic flow and avoid unnecessary queuing.</p>	15. Local Air Clean Plans, Policies and Programs	<p>Redevelopment as presented in Chapter 2.0 Project Description and Chapters 3.3 Air Quality and 3.16 Transportation and Traffic (in the 2012 OARB Project Initial Study/Addendum), incorporate land uses such as a rail terminal in conjunction with logistics uses, and measures intended to reduce the number and length of truck trips and single-occupant automobile trips.</p>	17. Conduct Demonstration Projects	<p>The City will encourage through development incentives demonstration projects for fleet electrification or alternative fueling. In addition, the Port will not preclude alternative fueling in its design of rail facilities.</p>	19. Pedestrian Travel	<p>OARB and Maritime sub-districts will include multi-use trails to encourage safe pedestrian travel.</p>		
CAP TCMs	Description																
1. Support Voluntary Employer-Based Trip Reduction Programs	<p>The City and Port will explore ways to promote transit use and support employer-based trip reduction programs through development incentives such as density bonuses, reduced parking requirements, incentives for permanent bicycle facilities, etc.</p> <p>The City will encourage development of transit transfer stations near employment concentrations in the Gateway development area and 16th/Wood sub-district.</p>																
9. Improve Bicycle Access and Facilities	<p>Redevelopment includes extensive multi-use trails serving as both “spine” thoroughfares and “spurs” connecting main trails to the Oakland waterfront.</p> <p>The City and Port will encourage employers and developers to provide permanent bicycle facilities.</p>																
12. Improve Arterial Traffic Management	<p>Maritime Street and other roadways in the project area will include facilities to encourage bicycling and walking.</p> <p>Roadways and intersections will be designed to operate at City-standard LOS, to facilitate traffic flow and avoid unnecessary queuing.</p>																
15. Local Air Clean Plans, Policies and Programs	<p>Redevelopment as presented in Chapter 2.0 Project Description and Chapters 3.3 Air Quality and 3.16 Transportation and Traffic (in the 2012 OARB Project Initial Study/Addendum), incorporate land uses such as a rail terminal in conjunction with logistics uses, and measures intended to reduce the number and length of truck trips and single-occupant automobile trips.</p>																
17. Conduct Demonstration Projects	<p>The City will encourage through development incentives demonstration projects for fleet electrification or alternative fueling. In addition, the Port will not preclude alternative fueling in its design of rail facilities.</p>																
19. Pedestrian Travel	<p>OARB and Maritime sub-districts will include multi-use trails to encourage safe pedestrian travel.</p>																

Environmental Impact	Standard Conditions of Approval/Mitigation Measures	Mitigation Implementation/ Monitoring:	
		Schedule	Responsibility
	<p>20. Promote Traffic Calming Measures</p> <p>Redevelopment will include traffic calming measures to the extent appropriate, consistent with the General Plan and sound traffic management of the project area.</p> <hr/> <p>Source: BAAQMD CEQA Guidelines, revised 1999 Table 5.</p> <hr/> <p>These TCMs shall be coordinated with transportation demand management (TDM) measures implemented under SCA TRANS-1.</p>		
	<u>SCA TRANS-1: Parking and Transportation Demand Management</u> , see Traffic and Transportation section below.		
2. Would the project violate any air quality standard or contribute substantially to an existing or projected air quality violation?	See above for SCA AIR-2 and 2002 EIR Mitigation Measures 4.4-3a, 4.4-3b, 4.4-4, 4.4-5		
	<u>SCA AIR-1: Construction Management Plan:</u> The project applicant shall submit to the Planning and Zoning Division and the Building Services Division for review and approval a construction management plan that identifies the conditions of approval and mitigation measures to construction impacts of the project and explains how the project applicant will comply with these construction-related conditions of approval and mitigation measures.	Prior to issuance of a demolition, grading, or building permit	City/Port
	<p>Mitigation 4.4-6: Title 24 of the International Building Code (IBC) requires that new construction include energy-conserving fixtures and designs. Additionally, the City and Port shall implement sustainable development policies and strategies related to new development design and construction. Implementation of IBC requirements would reduce the need for space and water heating that would emit pollutants.</p> <p>City and Port policies and strategies shall be conditioned for all new development within the redevelopment project area. Specific examples may include, and are not limited to the following:</p> <ul style="list-style-type: none"> • Wood fire heating shall be prohibited in new live/work development. • Where siting allows and where feasible, buildings shall be oriented to take advantage of passive and active climate control designs. • To the maximum extent feasible, central water heating systems shall be installed. 	Prior to issuance of a demolition, grading, or building permit	City/Port
3. Would the project result in a cumulatively considerable net increase of any criteria air pollutant for which the project region is non-attainment under an applicable federal or state ambient air quality	See above for SCA AIR-2 and 2002 EIR Mitigation Measures 4.4-3a, 4.4-3b, 4.4-4, 4.4-5 and 4.4-6		
	Mitigation Measure 5.4-1: The City and the Port shall encourage, lobby, and potentially participate in emission reduction demonstration projects that promote technological advances in improving air quality.	Pre-operations; Operations	City/Port

Environmental Impact	Standard Conditions of Approval/Mitigation Measures	Mitigation Implementation/ Monitoring:	
		Schedule	Responsibility
standard (including releasing emissions which exceed quantitative thresholds for ozone precursors)?	<p>Such encouragement, lobbying, and participation may include the following:</p> <ul style="list-style-type: none"> • Retrofitting locomotive engines to meet current federal standards. • Using reduced sulfur fuels in ships while the ships are in the San Francisco Bay. • Treating NO_x with selective catalytic reductions. • Implementing random roadside emissions tests and develop a system of fines for trucks not in compliance with emission regulations. • Establishing emissions-based berthing fees. • Buying relatively old, highly polluting cars to take them off the road. <p>Although these programs may assist in advancing emission reduction technologies or implementing emission reduction methods, the incremental contribution of the redevelopment program would remain cumulatively considerable, and the cumulative impact on air quality remains significant and unavoidable</p>		
4. Would the project result in a cumulatively considerable net increase of any criteria air pollutant for which the project region is non-attainment under an applicable federal or state ambient air quality standard (including releasing emissions which exceed quantitative thresholds for ozone precursors)?	See above SCA AIR-1, SCA AIR-2 and 2002 EIR Mitigation Measures 4.4-3a, 4.4-3b, 4.4-4, 4.4-5 and 4.4-6		
	<p><u>SCA AIR-3: Exposure to Air Pollution (Toxic Air Contaminants: Particulate Matter):</u></p> <p>A. Indoor Air Quality: In accordance with the recommendations of the California Air Resources Board (ARB) and the Bay Area Air Quality Management District, appropriate measures shall be incorporated into the project design in order to reduce the potential health risk due to exposure to diesel particulate matter to achieve an acceptable interior air quality level for sensitive receptors. The appropriate measures shall include one of the following methods:</p> <ol style="list-style-type: none"> 1) The project applicant shall retain a qualified air quality consultant to prepare a health risk assessment (HRA) in accordance with the ARB and the Office of Environmental Health and Hazard Assessment requirements to determine the exposure of project residents/occupants/users to air pollutants prior to issuance of a demolition, grading, or building permit. The HRA shall be submitted to the Planning and Zoning Division for review and approval. The applicant shall implement the approved HRA recommendations, if any. If the HRA concludes that the air quality risks from nearby sources are at or below acceptable levels, then additional measures are not required. 2) The applicant shall implement all of the following features that have been found to reduce the air quality risk to sensitive receptors and shall be included in the project construction plans. These features shall be submitted to the Planning and Zoning Division and the Building Services Division for review and approval prior to the issuance of a demolition, grading, or building permit and shall be maintained on an ongoing basis during operation of the project. <ol style="list-style-type: none"> a) Redesign the site layout to locate sensitive receptors as far as possible from any freeways, major roadways, or other sources of air pollution (e.g., loading docks, 	Prior to issuance of a demolition, grading, or building permit	City/Port

Environmental Impact	Standard Conditions of Approval/Mitigation Measures	Mitigation Implementation/ Monitoring:	
		Schedule	Responsibility
	<p>parking lots).</p> <p>b) Do not locate sensitive receptors near distribution center's entry and exit points.</p> <p>c) Incorporate tiered plantings of trees (redwood, deodar cedar, live oak, and/or oleander) to the maximum extent feasible between the sources of pollution and the sensitive receptors.</p> <p>d) Install, operate and maintain in good working order a central heating and ventilation (HV) system or other air take system in the building, or in each individual residential unit, that meets or exceeds an efficiency standard of MERV 13. The HV system shall include the following features: Installation of a high efficiency filter and/or carbon filter to filter particulates and other chemical matter from entering the building. Either HEPA filters or ASHRAE 85% supply filters shall be used.</p> <p>e) Retain a qualified HV consultant or HERS rater during the design phase of the project to locate the HV system based on exposure modeling from the pollutant sources.</p> <p>f) Install indoor air quality monitoring units in buildings.</p> <p>g) Project applicant shall maintain, repair and/or replace HV system on an ongoing and as needed basis or shall prepare an operation and maintenance manual for the HV system and the filter. The manual shall include the operating instructions and the maintenance and replacement schedule. This manual shall be included in the CC&Rs for residential projects and distributed to the building maintenance staff. In addition, the applicant shall prepare a separate homeowners manual. The manual shall contain the operating instructions and the maintenance and replacement schedule for the HV system and the filters.</p> <p>B. Outdoor Air Quality: To the maximum extent practicable, individual and common exterior open space, including playgrounds, patios, and decks, shall either be shielded from the source of air pollution by buildings or otherwise buffered to further reduce air pollution for project occupants.</p>		

Environmental Impact	Standard Conditions of Approval/Mitigation Measures	Mitigation Implementation/ Monitoring:	
		Schedule	Responsibility
Biological Resources			
1. Would the project have a substantial adverse effect, either directly or through habitat modifications, on any species identified as a candidate, sensitive, or special-status species in local or regional plans, policies, or regulations, or by the California Department of Fish and Game or U.S. Fish and Wildlife Service?	<p>SCA BIO-1: Tree Removal During Breeding Season: To the extent feasible, removal of any tree and/or other vegetation suitable for nesting of raptors shall not occur during the breeding season of March 15 through August 15. If tree removal must occur during the breeding season, all sites shall be surveyed by a qualified biologist to verify the presence or absence of nesting raptors or other birds. Pre-removal surveys shall be conducted within 15 days prior to start of work from March 15 through May 31, and within 30 days prior to the start of work from June 1 through August 15. The pre-removal surveys shall be submitted to the Planning and Zoning Division and the Tree Services Division of the Public Works Agency. If the survey indicates the potential presences of nesting raptors or other birds, the biologist shall determine an appropriately sized buffer around the nest in which no work will be allowed until the young have successfully fledged. The size of the nest buffer will be determined by the biologist in consultation with the CDFG, and will be based to a large extent on the nesting species and its sensitivity to disturbance. In general, buffer sizes of 200 feet for raptors and 50 feet for other birds should suffice to prevent disturbance to birds nesting in the urban environment, but these buffers may be increased or decreased, as appropriate, depending on the bird species and the level of disturbance anticipated near the nest.</p>	Prior to issuance of a tree removal permit	City/Port
	<p>SCA BIO-5 Regulatory Permits and Authorizations: Prior to construction in or near the water, the project applicant shall obtain all necessary regulatory permits and authorizations, including without limitation, from the U.S. Army Corps of Engineers (Corps), Regional Water Quality Control Board (RWQCB), San Francisco Bay Conservation and Development Commission (BCDC) and the City of Oakland, and shall comply with all conditions issued by applicable agencies. Required permit approvals and certifications may include, but not be limited to the following:</p> <ul style="list-style-type: none"> a) U.S. Army Corps of Engineers (Corps): Section 404. Permit approval from the Corps shall be obtained for the placement of dredge or fill material in Waters of the U.S., if any, within the interior of the project site, pursuant to Section 404 of the federal Clean Water Act. b) Regional Water Quality Control Board (RWQCB): Section 401 Water Quality Certification. Certification that the project will not violate state water quality standards is required before the Corps can issue a 404 permit, above. c) San Francisco Bay Conservation and Development Commission (BCDC) approvals. 	Prior to issuance of a demolition, grading, or building permit within vicinity of the shoreline	City/Port
	<p>Mitigation Measure 4.12-5: A qualified observer shall be present on site during all in-water construction activities near potential herring spawning areas between December 1 and March 1.</p> <p>This measure shall be enforced via contract specifications. The observer shall have the authority to redirect, but not to stop work.</p>	During construction	City/Port

Environmental Impact	Standard Conditions of Approval/Mitigation Measures	Mitigation Implementation/ Monitoring:	
		Schedule	Responsibility
	<p>Mitigation Measure 4.12-6: If spawning is observed, in-water construction activities shall be redirected for 200 meters around the spawning area for two weeks.</p> <p>Work may resume in the spawning area after two weeks, providing additional spawning does not occur. This measure shall be enforced via contract specifications.</p>	During construction	City/Port
	<p>Mitigation Measure 4.12-10: The Port shall continue to enforce its tariff requirements regarding ballast water and if the State law sunsets, shall implement the remainder of its ballast water ordinance, as it may be amended from time to time.</p> <p>Item No. 02215 of the Port's tariff (its operating rules and regulations) defines the Port's Ballast Water Management Program. Among other things, the Port's program compiles information regarding the ballasting behavior of carriers calling at the Port of Oakland. This information is expected to be valuable in crafting durable solutions to the problems ballast water-borne invasive species pose to the ecology of the Bay, and to invasive species issues elsewhere. This mitigation measure would continue the Port's program through the build-out year of this project, or 2020, or until required by regulatory permit conditions, whichever is later. Should portions of the Port's program be redundant to federal, state, or regional programs, or be pre-empted by such programs, the Port will continue to operate those non-pre-empted portions of its program that provide information not obtained through other programs.</p>	During construction	Port
	<p>Modified Mitigation Measure 4.12-11: The Port, and developer and sub-tenants at Berths 7 and 8 (Wharves 6½ and 7), shall continue to develop and implement a carrier ballast water education program.</p> <p>Either by itself or by participating in programs by others, <i>e.g.</i>, Sea Grant, the Port and developer and sub-tenants at Berths 7 and 8 (Wharves 6½ and 7), shall create a program to educate ocean carriers regarding the potential harm of ballasting activities. The program shall at a minimum, include the following elements:</p> <ul style="list-style-type: none"> • Educate carriers to all applicable regulations and guidelines. • Inform carriers of the benefits of ships constructed with internal ballast water transfer systems. These systems allow ballast water to be shifted internally from tank to tank, minimizing or eliminating the need for discharge of ballast water when ships are at berth • Encourage carriers to purchase internally-ballasting vessels when they place orders for new ships. • Educate carriers regarding potential benefits of reducing ballast water discharges, even if ballast water has already been exchanged in the open ocean. 	Operations	City/Port
	<p>Modified Mitigation Measure 4.12-12: The Port, and developer and sub-tenants at Berths 7 and 8 (Wharves 6½ and 7), shall support international and United States efforts to adopt uniform international or national standards to avoid introduction of exotic species through shipping activities.</p> <p>The Port, and developer and sub-tenants at Berths 7 and 8 (Wharves 6½ and 7) shall provide in-kind</p>	Operations	City/Port

Environmental Impact	Standard Conditions of Approval/Mitigation Measures	Mitigation Implementation/ Monitoring:	
		Schedule	Responsibility
	(personnel) support to assist international and U.S. entities to develop and adopt a uniform set of standards to reduce the risk of invasive species. In order to achieve optimal environmental success and to maintain a competitive market between ports, it is important that such standards be effective and uniformly applied.		
	<p>Mitigation Measure 3.4-1a: The developer shall submit a Landscape Plan for City review and approval. The plan shall not include tall ornamental trees that could provide perches for raptors in the northern project site, in the vicinity of Gateway Park.</p> <p>Mitigation Measure 3.4-1b: The developer shall submit a Lighting Plan for City review and approval. The plan shall note that raptor deterrents shall be placed on light standards in the northern project site, in the vicinity of Gateway Park, or lighting fixtures or posts in the area shall have limited horizontal elements which could be used as perches.</p>	Prior to issuance of a building permit, associated with the Planned Unit Development (PUD) process	City/Port
2. Would the project have a substantial adverse effect on any riparian habitat or other sensitive natural community identified in local or regional plans, policies, regulations or by the California Department of Fish and Game or US Fish and Wildlife Service?	See above for Modified 2002 EIR Mitigation Measures 4.12-11 and 4.12-12		
3. Would the project have a substantial adverse effect on federally protected wetlands (as defined by Section 404 of the Clean Water Act) or state protected wetlands, through direct removal, filling, hydrological interruption, or other means?	See above for SCA BIO-5		
4. Would the project substantially interfere with the movement of any native resident or migratory fish or wildlife species or with established native resident or migratory wildlife corridors, or impede the use of native wildlife nursery sites?	See above for Mitigation Measures 4.12-5, 4.12-6, 4.12-11 and 4.12-12		
5. Would the project fundamentally conflict with the City of Oakland Tree Protection Ordinance (Oakland Municipal Code (OMC) Chapter	SCA BIO-2: Tree Removal Permit: Prior to removal of any protected trees, per the Protected Tree Ordinance, located on the project site or in the public right-of-way adjacent to the project, the project applicant must secure a tree removal permit from the Tree Division of the Public Works Agency, and abide by the conditions of that permit.	Prior to issuance of a demolition, grading, or building permit.	City/Port

Environmental Impact	Standard Conditions of Approval/Mitigation Measures	Mitigation Implementation/ Monitoring:	
		Schedule	Responsibility
12.36) by removal of protected trees under certain circumstances?	<p>SCA BIO-3: Tree Replacement Plantings: Replacement plantings shall be required for erosion control, groundwater replenishment, visual screening and wildlife habitat, and in order to prevent excessive loss of shade, in accordance with the following criteria:</p> <ul style="list-style-type: none"> a) No tree replacement shall be required for the removal of nonnative species, for the removal of trees which is required for the benefit of remaining trees, or where insufficient planting area exists for a mature tree of the species being considered. b) Replacement tree species shall consist of Sequoia sempervirens (Coast Redwood), Quercus agrifolia (Coast Live Oak), Arbutus menziesii (Madrone), Aesculus californica (California Buckeye) or Umbellularia californica (California Bay Laurel) or other tree species acceptable to the Tree Services Division. c) Replacement trees shall be at least of twenty-four (24) inch box size, unless a smaller size is recommended by the arborist, except that three fifteen (15) gallon size trees may be substituted for each twenty-four (24) inch box size tree where appropriate. d) Minimum planting areas must be available on site as follows: <ul style="list-style-type: none"> i. For Sequoia sempervirens, three hundred fifteen square feet per tree; ii. For all other species listed in #2 above, seven hundred (700) square feet per tree. e) In the event that replacement trees are required but cannot be planted due to site constraints, an in lieu fee as determined by the master fee schedule of the city may be substituted for required replacement plantings, with all such revenues applied toward tree planting in city parks, streets and medians. f) Plantings shall be installed prior to the issuance of a final inspection of the building permit, subject to seasonal constraints, and shall be maintained by the project applicant until established. The Tree Reviewer of the Tree Division of the Public Works Agency may require a landscape plan showing the replacement planting and the method of irrigation. Any replacement planting which fails to become established within one year of planting shall be replanted at the project applicant's expense. 	Prior to issuance of a final inspection of the building permit.	City/Port
	<p>SCA BIO-4: Tree Protection During Construction: Adequate protection shall be provided during the construction period for any trees which are to remain standing, including the following, plus any recommendations of an arborist:</p> <ul style="list-style-type: none"> a) Before the start of any clearing, excavation, construction or other work on the site, every protected tree deemed to be potentially endangered by said site work shall be securely fenced off at a distance from the base of the tree to be determined by the City Tree Reviewer. Such fences shall remain in place for duration of all such work. All trees to be removed shall be clearly marked. A scheme shall be established for the removal and disposal of logs, brush, earth and other debris which will avoid injury to any protected tree. b) Where proposed development or other site work is to encroach upon the protected perimeter of any protected tree, special measures shall be incorporated to allow the roots to breathe and obtain water and nutrients. Any excavation, cutting, filing, or compaction of the existing 	Prior to issuance of a demolition, grading, or building permit.	City/Port

Environmental Impact	Standard Conditions of Approval/Mitigation Measures	Mitigation Implementation/ Monitoring:	
		Schedule	Responsibility
	<p>ground surface within the protected perimeter shall be minimized. No change in existing ground level shall occur within a distance to be determined by the City Tree Reviewer from the base of any protected tree at any time. No burning or use of equipment with an open flame shall occur near or within the protected perimeter of any protected tree.</p> <p>c) No storage or dumping of oil, gas, chemicals, or other substances that may be harmful to trees shall occur within the distance to be determined by the Tree Reviewer from the base of any protected trees, or any other location on the site from which such substances might enter the protected perimeter. No heavy construction equipment or construction materials shall be operated or stored within a distance from the base of any protected trees to be determined by the tree reviewer. Wires, ropes, or other devices shall not be attached to any protected tree, except as needed for support of the tree. No sign, other than a tag showing the botanical classification, shall be attached to any protected tree.</p> <p>d) Periodically during construction, the leaves of protected trees shall be thoroughly sprayed with water to prevent buildup of dust and other pollution that would inhibit leaf transpiration.</p> <p>e) If any damage to a protected tree should occur during or as a result of work on the site, the project applicant shall immediately notify the Public Works Agency of such damage. If, in the professional opinion of the Tree Reviewer, such tree cannot be preserved in a healthy state, the Tree Reviewer shall require replacement of any tree removed with another tree or trees on the same site deemed adequate by the Tree Reviewer to compensate for the loss of the tree that is removed.</p> <p>f) All debris created as a result of any tree removal work shall be removed by the project applicant from the property within two weeks of debris creation, and such debris shall be properly disposed of by the project applicant in accordance with all applicable laws, ordinances, and regulations.</p>		

Cultural Resources

<p>1. Would the project cause a substantial adverse change in the significance of a historical resource as defined in <i>CEQA Guidelines</i> Section 15064.5? Specifically, a substantial adverse change includes physical demolition, destruction, relocation, or alteration of the resource or its immediate surroundings such that the significance of the historical resource would be “materially impaired?”</p>	<p><u>SCA CULT-4: Compliance with Policy 3.7 of the Historic Preservation Element (Property Relocation Rather than Demolition)</u></p> <p>The project applicant shall make a good faith effort to relocate the buildings considered contributors to the Historic District to a site acceptable to the Planning and Zoning Division and the Oakland Cultural Heritage Survey. Good faith efforts include, at a minimum, the following:</p> <p>a) Advertising the availability of the building by: (1) posting of large visible signs (such as banners, at a minimum of 3’ x 6’ size or larger) at the site; (2) placement of advertisements in Bay Area news media acceptable to the City ;and (3) contacting neighborhood associations and for-profit and not-for-profit housing and preservation organizations;</p> <p>b) Maintaining a log of all the good faith efforts and submitting that along with photos of the subject building showing the large signs (banners) to the Planning and Zoning Division;</p> <p>c) Maintaining the signs and advertising in place for a minimum of 90 days; and</p>	<p>Prior to issuance of a demolition permit</p>	<p>City/Port</p>
---	---	---	------------------

Environmental Impact	Standard Conditions of Approval/Mitigation Measures	Mitigation Implementation/ Monitoring:	
		Schedule	Responsibility
	d) Making the building available at no or nominal cost (the amount to be reviewed by the Oakland Cultural Heritage Survey) until removal is necessary for construction of a replacement project, but in no case for less than a period of 90 days after such advertisement.		
	<p>Mitigation Measure 4.6-2: The City, Port and OARB sub-district developers shall fund on a fair-share basis development of a commemoration site, including preparation of a Master Plan for such a site, at a public place located within the Gateway development area. The City shall ensure that the scale and scope of the commemoration site reflects the actual loss of historic resources.</p> <p>Land shall be set aside for development of a commemoration site at a publicly accessible place located within the Gateway development area (potentially the Gateway Park at the Bay Bridge touchdown peninsula). The commemoration site should include relocated physical elements of the OARB Historic District, along with appropriate monument(s) to memorialize the contributions of civilians and the military in the Bay Area to all wars.</p> <ul style="list-style-type: none"> • An appropriate location shall be set aside for development of a commemoration site. The commemoration site shall be at a publicly accessible place. It may be located within or adjacent to any historic district contributor buildings that are preserved on a permanent basis (see Mitigation Measure 4.6-16). If that is not feasible, another potential location is within or near to the Gateway Park. • A design plan for the commemoration site shall be prepared, and shall include the design of monuments and the selection of appropriate relocated physical elements from the OARB, potentially including relocated structures or portions of structures to be included in the site. The City and the Port shall identify structures and/or portions of structures to be preserved or moved to the commemoration site prior to demolition. • The master planning process should involve the City and the Port, the public and interested historical and veterans groups, historic experts, and other public agencies. • Implementation of the commemoration site master plan may be phased along with the timing of new development. • The master plan shall include an endowment to be funded by the City and the Port, or their designee, for on-going maintenance and replacement and may also include curator costs associated with commemoration site and with trail signage, exhibits, and design elements as described below. • The City and the Port shall develop an ongoing outreach program informing the public of the importance of the OARB to the community and the region, and of the existence of the commemorative site. 	Prior to approval of PUD.	City/Port
	<p>Mitigation Measure 4.6-3: The City shall ensure the commemoration site is linked to the Gateway Park and the Bay Trail via a public access trail.</p> <p>Within the Gateway development area, this trail may be located along the shoreline. Beyond the Gateway, the trail would follow the new alignment of Maritime Street, connecting to 7th Street,</p>	Prior to approval of PUD.	City/Port

Environmental Impact	Standard Conditions of Approval/Mitigation Measures	Mitigation Implementation/ Monitoring:	
		Schedule	Responsibility
	<p>which connects to the Port’s Middle Harbor Shoreline Park and other existing and planned trail segments.</p> <ul style="list-style-type: none"> • The design and development of this on-site trail shall include a series of interpretive panels, exhibits and design elements that communicate the scope and historical significance of Base activities and their impact on the community throughout the life of the Base. • A brochure shall be developed and made available describing the history of the Army Base that could be used as a self-guided tour, related to the interpretive panels and exhibits described above. 		
	<p>Mitigation Measure 4.6-5: The City, Port, and OARB sub-district developers shall fund on a fair share basis collaboration with “military.com” or a similar military history web site.</p> <ul style="list-style-type: none"> • The parties shall fund development of an interactive web page to be provided to military.com or other web-based organization where former military personnel can be connected to the OARB documentation. • A list of list of draftees/enlistees processed through the OARB during WWII and the Korean and Vietnam Wars may be an element of such a site. 	Prior to issuance of a building permit	City/Port
	<p>Mitigation Measure 4.6-7: If determined of significant historical educational value by the Oakland Landmarks Preservation Advisory Board and the Oakland Heritage Alliance, the City, Port, and OARB sub-district developers shall fund on a fair share basis distribution of copies of “A Job Well Done” documentary video published by the Army.</p> <p>The Army has produced a television broadcast-quality video documentary that describes the mission and historical significance of the OARB. This documentary is not widely distributed, and has not been viewed by the Oakland Landmarks Preservation Advisory Board or the Oakland Heritage Alliance. This documentary is currently available to the public, but is not widely distributed. This mitigation measure will ensure that the documentary is widely distributed and made available to a larger audience interested in the history of the Base. It will also offset the modification and/or destruction of many of the historic buildings on the base, preserve their images, and provide a description of their function and role to the interested public. Copies of the video shall be distributed to: the Oakland History Room, Oakland Public Library, Bancroft Library, University of California; the Port of Oakland Archives; local public schools and libraries; and local public broadcasting stations. Funding shall also be used to copy this video onto more permanent archive-stable medium such as a CD.</p>	Prior to issuance of a building permit	City/Port
	<p>Mitigation Measure 4.6-9: The City, Port, and OARB sub-district developers shall fund on a fair share basis a program to salvage as whole timber posts, beams, trusses and siding of warehouses to be deconstructed. These materials shall be used on site if deconstruction is the only option. Reuse of a warehouse building or part of a warehouse building at its current location, or relocated to another Gateway location is preferable.</p>	Prior to issuance of a building permit	City/Port

Environmental Impact	Standard Conditions of Approval/Mitigation Measures	Mitigation Implementation/ Monitoring:	
		Schedule	Responsibility
	<p>To the extent feasible, these materials shall be used in whole, on site, in the construction of new buildings within the Gateway development area. Special consideration shall be given to the use of these materials at the commemoration site through the site's Master Planning effort.</p> <p>If on-site reuse is found infeasible, opportunities shall be sought for reuse of these materials in other East Bay Area construction, or be sold into the recycled construction materials market. Landfill disposal of salvageable construction material from contributing historic structures shall be prohibited by contract specification. Salvage and reuse requirements shall be enforced via contract specification.</p> <p>Salvage operations shall employ members of local job-training bridge programs (Youth Employment Program, Joint Apprenticeship Training Committee, Homeless Collaborative) or other similar organizations, if feasible, to provide construction-training opportunities to Oakland residents.</p> <p>Salvage and reuse of the timber from these structures will help to reduce the impacts on the environment and save this ecologically and historically valuable material for reuse in the local community.</p>		
	<p>Mitigation Measure 4.6-10: The City, Port, and OARB sub-district developers shall fund on a fair share basis production of a brochure describing history and architectural history of the OARB.</p> <ul style="list-style-type: none"> The brochure shall be distributed to local libraries and schools, and be made available to the public at select pick-up and drop-off locations along the Bay Trail to be used for self-guided tours. This brochure shall build upon the previously completed historical documentation produced by the Port of Oakland, the Navy, and the Army for previous projects and on the original research completed for preparation of the Historical Resource Documentation Program and book. This brochure shall will document the history of the redevelopment area and provide references to where more detailed information about the Base may be found. 	Prior to issuance of a building permit	City/Port
	<p>Modified Mitigation Measure 4.6-14: No demolition or deconstruction of contributing structures to the OARB Historic District shall occur until a master plan and/or Lease Disposition and Development Agreement has been approved by the City, and demolition or deconstruction of a building is required to realize the master infrastructure development plan necessary for approved redevelopment activities, in conformity with applicable General Plan Historic Preservation Element and City of Oakland Planning requirements.³</p>	Approval of master plan and/or Lease Disposition and Development Agreement	City/Port

³ The 2002 EIR mitigation measure 4.6-14 states that the Port shall not demolish or deconstruct structures until it has approved a final development plan for the relevant new facility or

Environmental Impact	Standard Conditions of Approval/Mitigation Measures	Mitigation Implementation/ Monitoring:	
		Schedule	Responsibility
2. Would the project cause a substantial adverse change in the significance of an archaeological resource pursuant to <i>CEQA Guidelines</i> Section 15064.5?	<p><u>SCA CULT-1: Archaeological Resources:</u></p> <p>a) Pursuant to CEQA Guidelines section 15064.5 (f), “provisions for historical or unique archaeological resources accidentally discovered during construction” should be instituted. Therefore, in the event that any prehistoric or historic subsurface cultural resources are discovered during ground disturbing activities, all work within 50 feet of the resources shall be halted and the project applicant and/or lead agency shall consult with a qualified archaeologist or paleontologist to assess the significance of the find. If any find is determined to be significant, representatives of the project proponent and/or lead agency and the qualified archaeologist would meet to determine the appropriate avoidance measures or other appropriate measure, with the ultimate determination to be made by the City of Oakland. All significant cultural materials recovered shall be subject to scientific analysis, professional museum curation, and a report prepared by the qualified archaeologist according to current professional standards.</p> <p>b) In considering any suggested measure proposed by the consulting archaeologist in order to mitigate impacts to historical resources or unique archaeological resources, the project applicant shall determine whether avoidance is necessary and feasible in light of factors such as the nature of the find, project design, costs, and other considerations. If avoidance is unnecessary or infeasible, other appropriate measures (e.g., data recovery) shall be instituted. Work may proceed on other parts of the project site while measure for historical resources or unique archaeological resources is carried out.</p> <p>c) Should an archaeological artifact or feature be discovered on-site during project construction, all activities within a 50-foot radius of the find would be halted until the findings can be fully investigated by a qualified archaeologist to evaluate the find and assess the significance of the find according to the CEQA definition of a historical or unique archaeological resource. If the deposit is determined to be significant, the project applicant and the qualified archaeologist shall meet to determine the appropriate avoidance measures or other appropriate measure, subject to approval by the City of Oakland, which shall assure implementation of appropriate measure measures recommended by the archaeologist. Should archaeologically-significant materials be recovered, the qualified archaeologist shall recommend appropriate analysis and treatment, and shall prepare a report on the findings for submittal to the Northwest Information Center.</p> <p>d) Require storage (curation) of recovered materials, such as artifacts and soil samples, and records generated by an archaeological study in a facility that allows access to the materials.</p>	Ongoing throughout demolition, grading, and/or construction.	City/Port

facilities. This requirement shall continue to apply to the Port in the absence of a Lease Disposition and Development Agreement.

Environmental Impact	Standard Conditions of Approval/Mitigation Measures	Mitigation Implementation/ Monitoring:	
		Schedule	Responsibility
3. Would the project directly or indirectly destroy a unique paleontological resource or site or unique geologic feature?	SCA CULT-3: Paleontological Resources: In the event of an unanticipated discovery of a paleontological resource during construction, excavations within 50 feet of the find shall be temporarily halted or diverted until the discovery is examined by a qualified paleontologist (per Society of Vertebrate Paleontology standards [SVP 1995,1996]). The qualified paleontologist shall document the discovery as needed, evaluate the potential resource, and assess the significance of the find under the criteria set forth in Section 15064.5 of the CEQA Guidelines. The paleontologist shall notify the appropriate agencies to determine procedures that would be followed before construction is allowed to resume at the location of the find. If the City determines that avoidance is not feasible, the paleontologist shall prepare an excavation plan for mitigating the effect of the project on the qualities that make the resource important, and such plan shall be implemented. The plan shall be submitted to the City for review and approval.	Ongoing throughout demolition, grading, and/or construction.	City/Port
4. Would the project disturb any human remains, including those interred outside of formal cemeteries?	SCA CULT-2: Human Remains: In the event that human skeletal remains are uncovered at the project site during construction or ground-breaking activities, all work shall immediately halt and the Alameda County Coroner shall be contacted to evaluate the remains, and following the procedures and protocols pursuant to Section 15064.5 (e)(1) of the CEQA Guidelines. If the County Coroner determines that the remains are Native American, the City shall contact the California Native American Heritage Commission (NAHC), pursuant to subdivision (c) of Section 7050.5 of the Health and Safety Code, and all excavation and site preparation activities shall cease within a 50-foot radius of the find until appropriate arrangements are made. If the agencies determine that avoidance is not feasible, then an alternative plan shall be prepared with specific steps and timeframe required to resume construction activities. Monitoring, data recovery, determination of significance and avoidance measures (if applicable) shall be completed expeditiously.	Ongoing throughout demolition, grading, and/or construction	City/Port
Geology and Soils			
1. Would the project expose people or structures to substantial risk of loss, injury, or death involving: i) Rupture of a known earthquake fault, as delineated on the most recent Alquist-Priolo Earthquake Fault Zoning Map or Seismic Hazards Map issued by the State Geologist for the area or based on other substantial evidence of a known fault? Refer to California Geological Survey 42 and 117 and Public Resources Code section 2690 et. seq.; ii) Strong seismic ground shaking; iii) Seismic-related ground	SCA GEO-2: Soils Report: A preliminary soils report for each construction site within the project area shall be required as part of this project and submitted for review and approval by the Building Services Division. The soils reports shall be based, at least in part, on information obtained from on-site testing. Specifically the minimum contents of the report should include: A. Logs of borings and/or profiles of test pits and trenches: a) The minimum number of borings acceptable, when not used in combination with test pits or trenches, shall be two (2), when in the opinion of the Soils Engineer such borings shall be sufficient to establish a soils profile suitable for the design of all the footings, foundations, and retaining structures. b) The depth of each boring shall be sufficient to provide adequate design criteria for all proposed structures. c) All boring logs shall be included in the soils report.	Prior to issuance of demolition, grading or building permit	City/Port

Environmental Impact	Standard Conditions of Approval/Mitigation Measures	Mitigation Implementation/ Monitoring:	
		Schedule	Responsibility
failure, including liquefaction, lateral spreading, subsidence, collapse; iv) Landslides?	<p>B. Test pits and trenches</p> <p>a) Test pits and trenches shall be of sufficient length and depth to establish a suitable soils profile for the design of all proposed structures.</p> <p>b) Soils profiles of all test pits and trenches shall be included in the soils report.</p> <p>C. A plat shall be included which shows the relationship of all the borings, test pits, and trenches to the exterior boundary of the site. The plat shall also show the location of all proposed site improvements. All proposed improvements shall be labeled.</p> <p>D. Copies of all data generated by the field and/or laboratory testing to determine allowable soil bearing pressures, sheer strength, active and passive pressures, maximum allowable slopes where applicable and any other information which may be required for the proper design of foundations, retaining walls, and other structures to be erected subsequent to or concurrent with work done under the grading permit.</p> <p>E. Soils Report. A written report shall be submitted which shall include, but is not limited to, the following:</p> <p>a) Site description;</p> <p>b) Local and site geology;</p> <p>c) Review of previous field and laboratory investigations for the site;</p> <p>d) Review of information on or in the vicinity of the site on file at the Information Counter, City of Oakland, Office of Planning and Building;</p> <p>e) Site stability shall be addressed with particular attention to existing conditions and proposed corrective attention to existing conditions and proposed corrective actions at locations where land stability problems exist;</p> <p>f) Conclusions and recommendations for foundations and retaining structures, resistance to lateral loading, slopes, and specifications, for fills, and pavement design as required;</p> <p>g) Conclusions and recommendations for temporary and permanent erosion control and drainage. If not provided in a separate report they shall be appended to the required soils report;</p> <p>h) All other items which a Soils Engineer deems necessary;</p> <p>i) The signature and registration number of the Civil Engineer preparing the report.</p> <p>F. The Director of Planning and Building may reject a report that she/he believes is not sufficient. The Director of Planning and Building may refuse to accept a soils report if the certification date of the responsible soils engineer on said document is more than three years old. In this instance, the Director may be require that the old soils report be recertified, that an addendum to the soils report be submitted, or that a new soils report be provided.</p>		

Environmental Impact	Standard Conditions of Approval/Mitigation Measures	Mitigation Implementation/ Monitoring:	
		Schedule	Responsibility
	<p><u>SCA-GEO-3: Geotechnical Report:</u></p> <p>a) A site-specific, design level, landslide or liquefaction geotechnical investigation for each construction site within the project area shall be required as part of this project and submitted for review and approval by the Building Services Division. Specifically:</p> <ul style="list-style-type: none"> i. Each investigation shall include an analysis of expected ground motions at the site from identified faults. The analyses shall be accordance with applicable City ordinances and polices, and consistent with the most recent version of the California Building Code, which requires structural design that can accommodate ground accelerations expected from identified faults. ii. The investigations shall determine final design parameters for the walls, foundations, foundation slabs, surrounding related improvements, and infrastructure (utilities, roadways, parking lots, and sidewalks). iii. The investigations shall be reviewed and approved by a registered geotechnical engineer. All recommendations by the project engineer, geotechnical engineer, shall be included in the final design, as approved by the City of Oakland. iv. The geotechnical report shall include a map prepared by a land surveyor or civil engineer that shows all field work and location of the “No Build” zone. The map shall include a statement that the locations and limitations of the geologic features are accurate representations of said features as they exist on the ground, were placed on this map by the surveyor, the civil engineer or under their supervision, and are accurate to the best of their knowledge. v. Recommendations that are applicable to foundation design, earthwork, and site preparation that were prepared prior to or during the projects design phase, shall be incorporated in the project. vi. Final seismic considerations for the site shall be submitted to and approved by the City of Oakland Building Services Division prior to commencement of the project. vii. A peer review is required for the Geotechnical Report. Personnel reviewing the geologic report shall approve the report, reject it, or withhold approval pending the submission by the applicant or subdivider of further geologic and engineering studies to more adequately define active fault traces. <p>b) Tentative Tract or Parcel Map approvals shall require, but not be limited to, approval of the Geotechnical Report.</p>	Prior to issuance of demolition, grading or building permit	City/Port
	<p>Mitigation 4.13-1: Redevelopment elements shall be designed in accordance with criteria established by the IBC, soil investigation and construction requirements established in the Oakland General Plan, the Bay Conservation and Development Commission Safety of Fill Policy, and wharf design criteria established by the Port or City of Oakland (depending on the location of the wharf).</p>	Prior to issuance of demolition, grading or building permit	City/Port

Environmental Impact	Standard Conditions of Approval/Mitigation Measures	Mitigation Implementation/ Monitoring:	
		Schedule	Responsibility
	<p>The IBC requires structures in the San Francisco Bay Area to be designed to withstand a ground acceleration of 0.4 g or the most current standard. A licensed engineer should monitor construction activities to ensure that the design and construction criteria are followed.</p> <p>The Health and Safety element of the Oakland General Plan requires a soils and geologic report be submitted to the Department of Public Works (DPW) prior to the issuance of any building permit. The Oakland General Plan also requires all structures of three or more stories to be supported on pile foundations that penetrate Bay Mud deposits, and to be anchored in firm, non-compressible materials unless geotechnical findings indicate a more appropriate design. The General Plan also provides for the identification and evaluation of existing structural hazards and abatement of those hazards to acceptable levels of risk.</p> <p>To comply with the BCDC safety of fill policy, the plans and specifications for the placement of Bay fill will be submitted to the BCDC Engineering Criteria Review Board for review and approval.</p> <p>The Port of Oakland has developed wharf design criteria to be used in the design, construction, reconstruction, and repairs of existing and future wharf structures, except in the event that current engineering practice requires adjustments or modification of the wharf design criteria. All construction associated with New Berth 21 must adhere to the wharf design criteria established by the Port of Oakland. A licensed engineer should monitor construction activities to ensure that the design and construction criteria are followed.</p> <p>The City shall adopt wharf design criteria and apply them to any wharf in the City's jurisdiction.</p>		
	<p>Mitigation 4.13-2: Redevelopment elements shall be designed and constructed in accordance with requirements of a site-specific geotechnical evaluation.</p> <p>Site-specific geotechnical, soils, and foundation investigation reports shall be prepared by a licensed geotechnical or soil engineer experienced in construction methods on fill materials in an active seismic area. The reports shall provide site-specific construction methods and recommendations regarding grading activities, fill placement, compaction, foundation construction, drainage control (both surface and subsurface), and seismic safety. Designers and contractors shall comply with recommendations in the reports. A licensed geotechnical or soil engineer shall monitor earthwork and construction activities to ensure that recommended site-specific construction methods are followed.</p> <p>The Oakland General Plan requires all structures of three or more stories to be supported on pile foundations that penetrate Bay Mud deposits and to be anchored in firm, non-compressible materials unless geotechnical findings indicate a more appropriate design. The General Plan also provides for the identification and evaluation of existing structural hazards and abatement of those hazards to acceptable levels of risk.</p>	Prior to issuance of demolition, grading or building permit	City/Port
2. Would the project result in substantial soil erosion or loss of topsoil, creating substantial risks to life, property, or	See Hydrology and Water Quality section below for SCA HYD-1 through SCA HYD-4		
	<u>SCA GEO-1: Erosion and Sedimentation Control Plan:</u>	Prior to issuance of	City/Port

Environmental Impact	Standard Conditions of Approval/Mitigation Measures	Mitigation Implementation/ Monitoring:	
		Schedule	Responsibility
creeks/waterways?	<p><i>Prior to issuance of a demolition, grading, or building permit.</i></p> <p>A. The project applicant shall obtain a grading permit if required by the Oakland Grading Regulations pursuant to Section 15.04.660 of the Oakland Municipal Code. The grading permit application shall include an erosion and sedimentation control plan for review and approval by the Building Services Division. The erosion and sedimentation control plan shall include all necessary measures to be taken to prevent excessive stormwater runoff or carrying by stormwater runoff of solid materials on to lands of adjacent property owners, public streets, or to creeks as a result of conditions created by grading operations. The plan shall include, but not be limited to, such measures as short-term erosion control planting, waterproof slope covering, check dams, interceptor ditches, benches, storm drains, dissipation structures, diversion dikes, retarding berms and barriers, devices to trap, store and filter out sediment, and stormwater retention basins. Off-site work by the project applicant may be necessary. The project applicant shall obtain permission or easements necessary for off-site work. There shall be a clear notation that the plan is subject to changes as changing conditions occur. Calculations of anticipated stormwater runoff and sediment volumes shall be included, if required by the Director of Development or designee. The plan shall specify that, after construction is complete, the project applicant shall ensure that the storm drain system shall be inspected and that the project applicant shall clear the system of any debris or sediment.</p> <p><i>Ongoing throughout and construction activities</i></p> <p>B. The project applicant shall implement the approved erosion and sedimentation plan. No grading shall occur during the wet weather season (October 15 through April 15) unless specifically authorized in writing by the Building Services Division.</p>	a demolition, grading, or building permit; and ongoing throughout and construction activities (refer to SCA language to the left)	
3. Would the project be located on expansive soil, as defined in section 1802.3.2 of the California Building Code (2007, as it may be revised), creating substantial risks to life or property?	See above for SCA GEO-2 and SCA GEO-3		
4. Would the project be located above a well, pit, swamp, mound, tank vault, or unmarked sewer line, creating substantial risks to life or property?	See above for SCA GEO-2 and SCA GEO-3 and Mitigation Measure 4.13-2		
	<p>Mitigation 4.13-4: The project applicant shall thoroughly review available building and environmental records.</p> <p>The City and Port shall keep a record of, and the designer shall review, available plans, and facility, building, and environmental records in order to identify underground utilities and facilities, so that these may be either avoided or incorporated into design as relevant.</p>	Prior to issuance of demolition, grading or building permit; and on-going	City/Port
	<p>Mitigation 4.13-5: The developer shall perform due diligence, including without limitation, retaining the services of subsurface utility locators and other technical experts prior to any ground-</p>	Prior to issuance of demolition, grading	City/Port

Environmental Impact	Standard Conditions of Approval/Mitigation Measures	Mitigation Implementation/ Monitoring:	
		Schedule	Responsibility
	<p>disturbing activities.</p> <p>The contractor shall utilize Underground Service Alert or other subsurface utility locators to identify and avoid underground utilities and facilities during construction of redevelopment elements. The contractor shall keep a record of its contacts regarding underground features, and shall make these records available to the City or Port upon request. This condition shall be enforced through contract specification.</p>	or building permit; and on-going	
5. Would the project be located above landfills for which there is no approved closure or post-closure plan, or unknown fill soils, creating substantial risks to life or property?	See above for SCA-GEO-2 and Mitigation Measures 4.13-2, 4.13-4, and 4.13-5		
Greenhouse Gas Emissions			
1. Would the project generate greenhouse gas emissions, either directly or indirectly, that may have a significant impact on the environment?	<p>SCA GCC-1: Greenhouse Gas (GHG) Reduction Plan: The project applicant shall retain a qualified air quality consultant to develop a Greenhouse Gas (GHG) Reduction Plan for City review and approval. The applicant shall implement the approved GHG Reduction Plan.</p> <p>The goal of the GHG Reduction Plan shall be to increase energy efficiency and reduce GHG emissions by at least 20 percent, with a goal of 36 percent below the project’s “adjusted” baseline GHG emissions (as explained below) to help achieve the City’s goal of reducing GHG emissions. The GHG Reduction Plan shall include, at a minimum, (a) a detailed GHG emissions inventory for the project under a “business-as-usual” scenario with no consideration of project design features, or other energy efficiencies, (b) an “adjusted” baseline GHG emissions inventory for the project, taking into consideration energy efficiencies included as part of the project (including the City’s Standard Conditions of Approval, proposed mitigation measures, project design features, and other City requirements), (c) a comprehensive set of quantified <u>additional</u> GHG reduction measures available to further reduce GHG emissions beyond the adjusted GHG emissions, and (d) requirements for ongoing monitoring and reporting to demonstrate that the additional GHG reduction measures are being implemented. If the project is to be constructed in phases, the GHG Reduction Plan shall provide GHG emission scenarios by phase.</p> <p>Specifically, the applicant/sponsor shall adhere to the following:</p> <p>a) GHG Reduction Measures Program. Prepare and submit to the City Planning Director or his/her designee for review and approval a GHG Reduction Plan that specifies and quantifies GHG reduction measures that the project will implement by phase.</p> <p>Potential GHG reduction measures to be considered include, but are not be limited to, measures recommended in BAAQMD’s latest CEQA Air Quality Guidelines, the California Air Resources Board Scoping Plan (December 2008, as may be revised), the California Air</p>	Prior to approval of PUD.	City/Port

Environmental Impact	Standard Conditions of Approval/Mitigation Measures	Mitigation Implementation/ Monitoring:	
		Schedule	Responsibility
	<p>Pollution Control Officers Association (CAPCOA) Quantifying Greenhouse Gas Mitigation Measures Document (August 2010, as may be revised), the California Attorney General’s website, and Reference Guides on Leadership in Energy and Environmental Design (LEED) published by the U.S. Green Building Council.</p> <p>The proposed GHG reduction measures must be reviewed and approved by the City Planning Director or his/her designee. The types of allowable GHG reduction measures include the following (listed in order of City preference): (1) physical design features; (2) operational features; and (3) the payment of fees to fund GHG-reducing programs (i.e., the purchase of “offset carbon credits,” pursuant to item “b” below).</p> <p>The allowable locations of the GHG reduction measures include the following (listed in order of City preference): (1) the project site; (2) off-site within the City of Oakland; (3) off-site within the San Francisco Bay Area Air Basin; (4) off-site within the State of California; then (5) elsewhere in the United States.</p> <p>b) Offset Carbon Credits Guidelines. For GHG reduction measures involving the purchase of offset carbon credits, evidence of the payment/purchase shall be submitted to the City Planning Director or his/her designee for review and approval prior to completion of the project (or prior to completion of the project phase, if the project includes more one phase).</p> <p>As with preferred locations for the implementation of all GHG reductions measures, the preference for offset carbon credit purchases include those that can be achieved as follows (listed in order of City preference): (1) within the City of Oakland; (2) within the San Francisco Bay Area Air Basin; (3) within the State of California; then (4) elsewhere in the United States. The cost of offset carbon credit purchases shall be based on current market value at the time purchased and shall be based on the Project’s operational emissions estimated in the GHG Reduction Plan or subsequent approved emissions inventory, which may result in emissions that are higher or lower than those estimated in the GHG Reduction Plan.</p> <p>c) Plan Implementation and Documentation. For physical GHG reduction measures to be incorporated into the design of the project, the measures shall be included on the drawings submitted for construction-related permits. For operational GHG reduction measures to be incorporated into the project, the measures shall be implemented on an indefinite and ongoing basis beginning at the time of project completion (or at the completion of the project phase for phased projects).</p> <p>For physical GHG reduction measures to be incorporated into off-site projects, the measures shall be included on drawings and submitted to the City Planning Director or his/her designee for review and approval and then installed prior to completion of the subject project (or prior to completion of the project phase for phased projects). For operational GHG reduction measures to be incorporated into off-site projects, the measures shall be implemented on an indefinite and ongoing basis beginning at the time of completion of the subject project (or at the completion</p>		

Environmental Impact	Standard Conditions of Approval/Mitigation Measures	Mitigation Implementation/ Monitoring:	
		Schedule	Responsibility
	<p>of the project phase for phased projects).</p> <p>d) Compliance, Monitoring and Reporting. Upon City review and approval of the GHG Reduction Plan program by phase, the applicant/sponsor shall satisfy the following requirements for ongoing monitoring and reporting to demonstrate that the additional GHG reduction measures are being implemented. The GHG Reduction Plan requires regular periodic evaluation over the life of the Project (generally estimated to be at least 40 years) to determine how the Plan is achieving required GHG emissions reductions over time, as well as the efficacy of the specific additional GHG reduction measures identified in the Plan.</p> <p>Implementation of the GHG reduction measures and related requirements shall be ensured through the project applicant/sponsor's compliance with Conditions of Approval adopted for the project. Generally, starting two years after the City issues the first Certificate of Occupancy for the project, the project applicant/sponsor shall prepare each year of the useful life of the project an Annual GHG Emissions Reduction Report (Annual Report), subject to the City Planning Director or his/her designee for review and approval. The Annual Report shall be submitted to an independent reviewer of the City Planning Director's or his/her designee's choosing, to be paid for by the project applicant/sponsor (see <i>Funding</i>, below), within two months of the anniversary of the Certificate of Occupancy.</p> <p>The Annual Report shall summarize the project's implementation of GHG reduction measures over the preceding year, intended upcoming changes, compliance with the conditions of the Plan, and include a brief summary of the previous year's Annual Report results (starting the second year). The Annual Report shall include a comparison of annual project emissions to the baseline emissions reported in the GHG Plan.</p> <p>The GHG Reduction Plan shall be considered fully attained when project emissions are 36 percent below the project's "adjusted" baseline GHG emissions, as confirmed by the City Planning Director or his/her designee through an established monitoring program unless the applicant demonstrates it is infeasible to achieve the 36 percent goal. Monitoring and reporting activities will continue at the City's discretion, as discussed below.</p> <p>e) Funding. Within two months after the Certificate of Occupancy, the project applicant/sponsor shall fund an escrow-type account or endowment fund to be used exclusively for preparation of Annual Reports and review and evaluation by the City Planning Director or his/her designee, or its selected peer reviewers. The escrow-type account shall be initially funded by the project applicant/sponsor in an amount determined by the City Planning Director or his/her designee and shall be replenished by the project applicant/sponsor so that the amount does not fall below an amount determined by the City Planning Director or his/her designee. The mechanism of this account shall be mutually agreed upon by the project applicant/sponsor and the City Planning Director or his/her designee, including the ability of the City to access the funds if the project applicant/sponsor is not complying with the GHG Reduction Plan requirements, and/or to reimburse the City for its monitoring and enforcement costs.</p>		

Environmental Impact	Standard Conditions of Approval/Mitigation Measures	Mitigation Implementation/ Monitoring:	
		Schedule	Responsibility
	<p>f) Corrective Procedure. If the third Annual Report, or any report thereafter, indicates that, in spite of the implementation of the GHG Reduction Plan, the project is not achieving the GHG reduction goal, the project applicant/sponsor shall prepare a report for City review and approval, which proposes additional or revised GHG measures to better achieve the GHG emissions reduction goals, including without limitation, a discussion on the feasibility and effectiveness of the menu of other additional measures (Corrective GHG Action Plan). The project applicant/sponsor shall then implement the approved Corrective GHG Action Plan.</p> <p>If, one year after the Corrective GHG Action Plan is implemented, the required GHG emissions reduction target is still not being achieved, or if the project applicant/owner fails to submit a report at the times described above, or if the reports do not meet City requirements outlined above, the City Planning Director or his/her designee may, in addition to its other remedies, (a) assess the project applicant/sponsor a financial penalty based upon actual percentage reduction in GHG emissions as compared to the percent reduction in GHG emissions established in the GHG Reduction Plan; or (b) refer the matter to the City Planning Commission for scheduling of a compliance hearing to determine whether the project's approvals should be revoked, altered or additional conditions of approval imposed.</p> <p>The penalty as described in (a) above shall be determined by the City Planning Director or his/her designee and be commensurate with the percentage GHG emissions reduction not achieved (compared to the applicable numeric significance thresholds) or required percentage reduction from the "adjusted" baseline.</p> <p>In determining whether a financial penalty or other remedy is appropriate, the City shall not impose a penalty if the project applicant/sponsor has made a good faith effort to comply with the GHG Reduction Plan.</p> <p>The City would only have the ability to impose a monetary penalty after a reasonable cure period and in accordance with the enforcement process outlined in Planning Code Chapter 17.152. If a financial penalty is imposed, such penalty sums shall be used by the City solely toward the implementation of the GHG Reduction Plan.</p> <p>g) Timeline Discretion and Summary. The City Planning Director or his/her designee shall have the discretion to reasonably modify the timing of reporting, with reasonable notice and opportunity to comment by the applicant, to coincide with other related monitoring and reporting required for the project.</p> <ul style="list-style-type: none"> • <i>Fund Escrow-type Account for City Review:</i> Certificate of Occupancy plus 2 months • <i>Submit Baseline Inventory of "Actual Adjusted Emissions":</i> Certificate of Occupancy plus 1 year • <i>Submit Annual Report #1:</i> Certificate of Occupancy plus 2 years 		

Environmental Impact	Standard Conditions of Approval/Mitigation Measures	Mitigation Implementation/ Monitoring:	
		Schedule	Responsibility
	<ul style="list-style-type: none"> • <i>Submit Corrective GHG Action Plan</i> (if needed): Certificate of Occupancy plus 4 years (based on findings of Annual Report #3) • <i>Post Attainment Annual Reports</i>: Minimum every 3 years and at the City Planning Director's or his/her designee's reasonable discretion 		
Hazards and Hazardous Materials			
1. Would the project create a significant hazard to the public or the environment through reasonably foreseeable upset and accident conditions involving the release of hazardous materials into the environment?	<p><u>SCA HAZ-1: Best Management Practices for Soil and Groundwater Hazards</u></p> <p>The project applicant shall implement all of the following Best Management Practices (BMPs) regarding potential soil and groundwater hazards.</p> <p>a) Soil generated by construction activities shall be stockpiled onsite in a secure and safe manner or if designated for off-site disposal at a permitted facility, the soil shall be loaded, transported and disposed of in a safe and secure manner. All contaminated soils determined to be hazardous or non-hazardous waste must be adequately profiled (sampled) prior to acceptable reuse or disposal at an appropriate off-site facility. Specific sampling and handling and transport procedures for reuse or disposal shall be in accordance with applicable local, state and federal agencies laws, in particular, the Regional Water Quality Control Board (RWQCB) and/or the Alameda County Department of Environmental Health (ACDEH) and policies of the City of Oakland. The excavation, on-site management, and off-site disposal of soil from Project areas within the OARB shall follow the DTSC-approved RAP/RMP.</p> <p>b) Groundwater pumped from the subsurface shall be contained onsite in a secure and safe manner, prior to treatment and disposal, to ensure environmental and health issues are resolved pursuant to applicable laws and policies of the City of Oakland, the RWQCB and/or the ACDEH. The on-site management and off-site disposal of groundwater extracted from Project areas within the OARB shall follow the DTSC-approved RAP/RMP for Project areas within the OARB. Engineering controls shall be utilized, which include impermeable barriers to prohibit groundwater and vapor intrusion into the building (pursuant to the Standard Condition of Approval regarding Radon or Vapor Intrusion from Soil and Groundwater Sources.</p> <p>c) Prior to issuance of any demolition, grading, or building permit, the applicant shall submit for review and approval by the City of Oakland, written verification that the appropriate federal, state or county oversight authorities, including but not limited to the RWQCB and/or the ACDEH, have granted all required clearances and confirmed that the all applicable standards, regulations and conditions for all previous contamination at the site. The applicant also shall provide evidence from the City's Fire Department, Office of Emergency Services, indicating compliance with the Standard Condition of Approval requiring a Site Review by the Fire Services Division pursuant to City Ordinance No. 12323, and compliance with the Standard Condition of Approval requiring a Phase I and/or Phase II Reports.</p>	Ongoing throughout demolition, grading, and construction activities.	City/Port
	<p><u>SCA HAZ-2: Hazards Best Management Practices:</u> The project applicant and construction contractor shall ensure Best Management Practices (BMPs) are implemented as part of construction</p>	Prior to commencement of	City/Port

Environmental Impact	Standard Conditions of Approval/Mitigation Measures	Mitigation Implementation/ Monitoring:	
		Schedule	Responsibility
	<p>to minimize the potential negative effects to groundwater and soils. These shall include the following:</p> <ul style="list-style-type: none"> a) Follow manufacture’s recommendations on use, storage, and disposal of chemical products used in construction; b) Avoid overtopping construction equipment fuel gas tanks; c) During routine maintenance of construction equipment, properly contain and remove grease and oils; d) Properly dispose of discarded containers of fuels and other chemicals. e) Ensure that construction would not have a significant impact on the environment or pose a substantial health risk to construction workers and the occupants of the proposed development. Soil sampling and chemical analyses of samples shall be performed to determine the extent of potential contamination beneath all USTs, elevator shafts, clarifiers, and subsurface hydraulic lifts when on-site demolition, or construction activities would potentially affect a particular development or building. f) If soil, groundwater or other environmental medium with suspected contamination is encountered unexpectedly during construction activities (e.g., identified by odor or visual staining, or if any underground storage tanks, abandoned drums or other hazardous materials or wastes are encountered), the applicant shall cease work in the vicinity of the suspect material, the area shall be secured as necessary, and the applicant shall take all appropriate measures to protect human health and the environment. Appropriate measures shall include notification of regulatory agency(ies) and implementation of the actions described in the City’s Standard Conditions of Approval (and DTSC-approved RAP/RMP for Project area within the OARB), as necessary, to identify the nature and extent of contamination. Work shall not resume in the area(s) affected until the measures have been implemented under the oversight of the City or regulatory agency, as appropriate. 	demolition, grading, or construction.	
	<p>SCA HAZ-3: Hazardous Materials Business Plan: The project applicant shall submit a Hazardous Materials Business Plan for review and approval by Fire Prevention Bureau, Hazardous Materials Unit. Once approved this plan shall be kept on file with the City and will be updated as applicable. The purpose of the Hazardous Materials Business Plan is to ensure that employees are adequately trained to handle the materials and provides information to the Fire Services Division should emergency response be required. The Hazardous Materials Business Plan shall include the following:</p> <ul style="list-style-type: none"> a) The types of hazardous materials or chemicals stored and/or used on site, such as petroleum fuel products, lubricants, solvents, and cleaning fluids. b) The location of such hazardous materials. c) An emergency response plan including employee training information. d) A plan that describes the manner in which these materials are handled, transported and disposed. 	Prior to issuance of a business license.	City/Port

Environmental Impact	Standard Conditions of Approval/Mitigation Measures	Mitigation Implementation/ Monitoring:	
		Schedule	Responsibility
2. Would the project create a significant hazard to the public through the storage or use of acutely hazardous materials near sensitive receptors?	See above for SCA HAZ-1 and SCA HAZ-2		
3. Would the project be located on a site which is included on a list of hazardous materials sites compiled pursuant to Government Code Section 65962.5 (i.e., the "Cortese List") and, as a result, would create a significant hazard to the public or the environment.	SCA HAZ-4: Asbestos Removal in Structures: If asbestos-containing materials (ACM) are found to be present in building materials to be removed, demolished and disposed of, the project applicant shall submit specifications signed by a certified asbestos consultant for the removal, encapsulation, or enclosure of the identified ACM in accordance with all applicable laws and regulations, including but not necessarily limited to: California Code of Regulations, Title 8; Business and Professions Code; Division 3; California Health & Safety Code 25915-25919.7; and Bay Area Air Quality Management District, Regulation 11, Rule 2, as may be amended.	Prior to issuance of a demolition permit.	City/Port
	SCA HAZ-5: Lead-Based Paint/Coatings, Asbestos, or PCB Occurrence Assessment: The project applicant shall submit a comprehensive assessment report to the Fire Prevention Bureau, Hazardous Materials Unit, signed by a qualified environmental professional, documenting the presence or lack thereof of asbestos-containing materials (ACM), lead-based paint, and any other building materials or stored materials classified as hazardous waste by State or federal law.	Prior to issuance of any demolition, grading or building permit	City/Port
	SCA HAZ-6: Lead-based Paint Remediation: If lead-based paint is present, the project applicant shall submit specifications to the Fire Prevention Bureau, Hazardous Materials Unit signed by a certified Lead Supervisor, Project Monitor, or Project Designer for the stabilization and/or removal of the identified lead paint in accordance with all applicable laws and regulations, including but not necessarily limited to: Cal/OSHA's Construction Lead Standard, 8 CCR1532.1 and DHS regulation 17 CCR Sections 35001 through 36100, as may be amended.	Prior to issuance of any demolition, grading or building permit.	City/Port
	SCA HAZ-7: Other Materials Classified as Hazardous Waste: If other materials classified as hazardous waste by State or federal law are present, the project applicant shall submit written confirmation to Fire Prevention Bureau, Hazardous Materials Unit that all State and federal laws and regulations shall be followed when profiling, handling, treating, transporting and/or disposing of such materials.	Prior to issuance of any demolition, grading or building permit.	City/Port
	SCA HAZ-8: Health and Safety Plan per Assessment: If the required lead-based paint/coatings, asbestos, or PCB assessment finds presence of such materials, the project applicant shall create and implement a health and safety plan to protect workers from risks associated with hazardous materials during demolition, renovation of affected structures, and transport and disposal.	Prior to issuance of any demolition, grading or building permit.	City/Port
	Mitigation 4.7-3: Implement RAP/RMP as approved by DTSC, and if future use proposals include uses not identified in the Reuse Plan and incorporated into the RAP/RMP or if future amendments to the remediation requirements are proposed, obtain DTSC and, as required, City approval.	Prior to issuance of any demolition, grading or building permit; and on-going	City/Port

Environmental Impact	Standard Conditions of Approval/Mitigation Measures	Mitigation Implementation/ Monitoring:	
		Schedule	Responsibility
	<p>Mitigation 4.7-4: For the project areas not covered by the DTSC-approved RAP/RMP, investigate potentially contaminated sites; if contamination is found, assess potential risks to human health and the environment, prepare and implement a clean up plan for DTSC or RWQCB approval, prepare and implement a Risk Management Plan and prepare and implement a Site Health and Safety Plan prior to commencing work.</p> <p>Since implementation of the RAP/RMP approved by DTSC is proposed as part of the project for the OARB, and the RAP/RMP requires remediation to be fully protective of human health and the environment for the proposed future uses of the OARB, no further mitigation is required for the OARB unless either (1) future use proposals include those that were not identified in the Reuse Plan and incorporated into the RAP/RMP or (2) future amendments are proposed to the remediation requirements included in the approved RAP/RMP. In either of these two circumstances, required remediation includes obtaining the DTSC and, as required, City approval, for proposed changes in full conformance with applicable legal requirements including but not limited to the HSAA and CEQA.</p> <p>Specific contaminants and concentrations may vary across the redevelopment project area. Nevertheless, the types of impacts expected, and therefore, the general response actions and approaches to mitigation would be consistent throughout the redevelopment project area. With respect to the OARB and as described in greater detail above, the process across the redevelopment project area would mirror the RAP/RMP process that is already underway at the OARB. With respect to the OARB sub-district, pursuant to HSAA Chapter 6.8, the OBRA has proposed a RAP/RMP. The OBRA's remedial goal is to remediate soil and groundwater contamination consistent with the City of Oakland ULR Program 10⁻⁵ remedy with appropriate land use restrictions. This RAP/RMP must be approved by DTSC, which has the legal discretion to impose remedies falling within the 10⁻⁴ and 10⁻⁶ risk range.</p> <p>For the other sub-districts and areas not included in the DTSC-approved RAP/RMP, prior to beginning redevelopment-related activities, potentially affected areas shall be investigated, potentially including additional studies or site characterization activities, as required by the regulatory agencies (DTSC or RWQCB). Once contaminated areas are identified, potential human health risks from contaminants of concern based upon realistic future land use shall be assessed, health risk-based and environmental risk-based cleanup goals shall be established, and a determination regarding the need for additional site assessment work shall be made.</p> <p>The potential risks associated with affected areas shall be assessed in accordance with regulatory agency guidance and approvals and may result in remediation requirements. Such cleanup plans shall address each area where soil or groundwater is contaminated above ULR goals could be encountered during redevelopment. The clean up plan, the names of which vary based on the type and source of contamination and the legal framework for the particular oversight agency, shall specify measures to be taken to protect workers and the public from exposure to potential contamination and certify that the proposed remediation measures, including removal, disposal, stabilization and/or institutional controls are protective of human health and the environment and</p>	Prior to issuance of any demolition, grading or building permit; and on-going	City/Port

Environmental Impact	Standard Conditions of Approval/Mitigation Measures	Mitigation Implementation/ Monitoring:	
		Schedule	Responsibility
	implemented in accordance with federal, state and local requirements. Additionally, a Risk Management Plan may be required by the oversight agency to address site redevelopment activities and operations and provide an enforcement structure to be in place during and post-construction. Finally, a Site Health and Safety Plan shall be prepared in accordance with the OSHA and Cal/OSHA regulations. Off-hauling of contamination shall comply with applicable laws, and construction hours shall be limited as provided for in SCA NOI-1 through SCA NOI-6 in order to prevent night-time glare. Additionally, potential odor impact measures, and dust or other nuisance conditions from remediation-related truck traffic is provided for in Mitigation Measure 4.3-13, and safety concerns are addressed in Mitigation Measure 4.9-3.		
	<p>Mitigation 4.7-5: For the project areas not covered by the DTSC-approved RAP/RMP, remediate soil and groundwater contamination consistent with the City of Oakland ULR Program and other applicable laws and regulations.</p> <p>The City of Oakland ULR Program has determined that reducing the target risk level to 1×10^{-5} for commercial or industrial land uses in combination with appropriate institutional controls would reduce the risk to future residents, employees, and visitors to less than significant. Within the OARB area covered by the DTSC-approved RAP/RMP, implementation will result in avoidance of any potentially significant impact to future commercial/industrial/maritime/utility workers, and site visitors. Moreover, the measures required for the areas not covered by the DTSC-approved RAP/RMP, (Measure 4.7-4) would evaluate and control potential human health risks from contaminants of concern in the redevelopment project area and will sufficiently address this potential impact. In addition, Mitigation Measures 4.14-1 and 4.14-2, which prohibit the installation of groundwater wells for any purpose other than construction de-watering and remediation and require that even for construction de-watering and remediation use of those wells be minimized, will reduce the potential for contaminants to migrate to other underlying ground aquifers, thus lessening the impact to future residents, employees and visitors to less than significant.</p>	Prior to issuance of any demolition, grading or building permit; and on-going	City/Port
	<p>Mitigation 4.7-6: Buildings and structures constructed prior to 1978 slated for demolition or renovation that have not previously been evaluated for the presence of LBP shall be sampled to determine whether LBP is present in painted surfaces, and the safety precautions and work practices as specified in government regulations shall be followed during demolition.</p>	Prior to issuance of any demolition, grading or building permit; and on-going	City/Port
	<p>Mitigation 4.7-7: Buildings, structures and utilities that have not been surveyed for ACM, shall be surveyed to determine whether ACM is present prior to demolition or renovation, and the safety precautions and work practices as specified in government regulations shall be followed during demolition.</p>	Prior to issuance of any demolition, grading or building permit; and on-going	City/Port
	<p>Mitigation 4.7-8: Buildings and structures proposed for demolition or renovation shall be surveyed for PCB-impacted building materials, and the safety precautions and work practices as specified in government regulations shall be followed during demolition.</p>	Prior to issuance of any demolition, grading or building permit; and on-going	City/Port

Environmental Impact	Standard Conditions of Approval/Mitigation Measures	Mitigation Implementation/ Monitoring:	
		Schedule	Responsibility
	Mitigation 4.7-9: For above-ground and underground storage tanks (ASTs/USTs) on the OARB, implement the RAP/RMP.	Prior to issuance of any demolition, grading or building permit; and on-going	City/Port
	Mitigation 4.7-11: For LBP-impacted ground on the OARB, implementation of RAP/RMP to be approved by DTSC as part of the project will result in avoidance of this potentially significant impact. For the remainder of the development project area, sampling shall be performed on soil or paved areas around buildings that are known or suspected to have LBP, and the safety precautions and work practices specified in government regulations shall be followed.	Prior to issuance of any demolition, grading or building permit; and on-going	City/Port
	Mitigation 4.7-12: The condition of identified ACM shall be assessed annually, and prior to reuse of a building known to contain ACM.	Prior to issuance of any demolition, grading or building permit; and on-going	City/Port
	<p>Mitigation 4.7-13: No future tenancies shall be authorized at the OARB for use categories that are inconsistent with the Reuse Plan without an updated environmental analysis and DTSC approval as provided for in the RAP/RMP.</p> <p>For the OARB, baseline environmental analyses have been completed to support current interim uses of existing structures, including numerous commercial, trucking, warehouse and other tenants, the Oakland Military Institute and transitional housing uses for formerly-incarcerated women and their families and for various homeless service providers including an overnight shelter. Other environmental hazards may also be encountered by future interim occupants of existing OARB structures, and completion of a baseline environmental evaluation to identify and abate such hazards prior to occupancy by tenants will mitigate such hazards.</p> <p>Interim occupancy by future tenants who may propose land uses which are inconsistent with the Reuse Plan, and thus may not have been considered in the DTSC-approved RAP/RMP, shall occur only after DTSC approval as provided for in the RAP/RMP in order to assure that such future non-conforming tenants are protected from other environmental hazards. As stated above, for the remainder of the redevelopment project area, any building that has not been surveyed for ACM but potentially contains ACM shall be surveyed to determine whether ACM is present prior to demolition, renovation or reuse.</p>	Pre-operations	City/Port
	Mitigation 4.7-16: Oil-filled electrical equipment in the redevelopment project area that has not been surveyed shall be investigated prior to the equipment being taken out of service to determine whether PCBs are present.	Prior to issuance of any demolition, grading or building permit; and on-	City/Port

Environmental Impact	Standard Conditions of Approval/Mitigation Measures	Mitigation Implementation/ Monitoring:	
		Schedule	Responsibility
	Equipment found to contain PCBs should be part of an ongoing monitoring program. Surface and subsurface contamination from any PCB equipment shall be investigated and remediated in compliance with applicable laws and regulations.	going during operations	
	<p>Mitigation 4.7-17: PCB-containing or PCB-contaminated equipment taken out of service shall be handled and disposed in compliance with applicable laws and regulations.</p> <p>Equipment filled with dielectric fluid (oil) including transformers, ballast, etc. containing more than 5 ppm PCBs is considered a hazardous waste in California</p>	Prior to issuance of any demolition, grading or building permit; and ongoing during operations	City/Port
4. Would the project fundamentally impair implementation of or physically interfere with an adopted emergency response plan or emergency evacuation plan?	See below in Traffic and Transportation for Mitigation Measures 4.3-8, and Mitigation Measure 3.16-15a and 3.16-15b		
Hydrology and Water Quality			
1. Would the project violate any water quality standards or waste discharge requirements during in-water construction or encountering shallow groundwater during construction?	See above in Hazards and Hazardous Materials section for SCA HAZ-1		
	<p>SCA HYD-1: Stormwater Pollution Prevention Plan (SWPPP): The project applicant must obtain coverage under the General Construction Activity Storm Water Permit (General Construction Permit) issued by the State Water Resources Control Board (SWRCB). The project applicant must file a notice of intent (NOI) with the SWRCB. The project applicant will be required to prepare a stormwater pollution prevention plan (SWPPP) and submit the plan for review and approval by the Building Services Division. At a minimum, the SWPPP shall include a description of construction materials, practices, and equipment storage and maintenance; a list of pollutants likely to contact stormwater; site-specific erosion and sedimentation control practices; a list of provisions to eliminate or reduce discharge of materials to stormwater; Best Management Practices (BMPs), and an inspection and monitoring program. Prior to the issuance of any construction-related permits, the project applicant shall submit to the Building Services Division a copy of the SWPPP and evidence of submittal of the NOI to the SWRCB. Implementation of the SWPPP shall start with the commencement of construction and continue through the completion of the project. After construction is completed, the project applicant shall submit a notice of termination to the SWRCB.</p>	Prior to and ongoing throughout demolition, grading, and/or construction activities.	City/Port
	<p>Mitigation 4.15-1: Prior to in-water construction, the contractor shall prepare a water quality protection plan acceptable to the RWQCB, including site-specific best management practices for protection of Bay waters, and shall implement this plan during construction.</p> <p>BMPs to effectively control turbidity and/or contaminant suspension and migration would be site-</p>	Prior to issuance of any demolition, grading or building permit; and ongoing during	City/Port

Environmental Impact	Standard Conditions of Approval/Mitigation Measures	Mitigation Implementation/ Monitoring:	
		Schedule	Responsibility
	<p>specific. They may include, and are not limited to, the following:</p> <ul style="list-style-type: none"> • Use environmental or clamshell dredges or hydraulic cutterhead dredges designed to reduce release of solids. • Reduce or eliminate overflow of decant water from barges used to transport material. • Use silt curtains or other specialized equipment to reduce dispersion of material during dredging and filling operations. 	operations	
	<p>Mitigation 4.15-2: Contractors and developers shall comply with all permit conditions from the Corps, RWQCB and BCDC.</p> <p>This measure shall be enforced on Contractors by contract specifications.</p>	Prior to issuance of any demolition, grading or building permit; and on-going during operations	City/Port
2. Would the project result in substantial erosion or siltation on- or off-site that would affect the quality of receiving waters?	See above for SCA HYD-1, SCA GEO-1 (Geology and Soils section) and SCA HAZ-1 (Hazards and Hazardous Materials)		
3. Would the project result in substantial flooding on- or off-site?	<p>Mitigation 3.9-1: Coordinate and consult with EBMUD and if necessary design and build storm drain improvements resulting from increased elevation in the North Gateway area.</p>	Prior to issuance of building permit (or other construction-related permit).	City/Port
4. Would the project create or contribute substantial runoff which would exceed the capacity of existing or planned stormwater drainage systems?	<p>SCA HYD-2: Post-Construction Stormwater Management Plan: The applicant shall comply with the requirements of Provision C.3 of the National Pollutant Discharge Elimination System (NPDES) permit issued to the Alameda Countywide Clean Water Program. The applicant shall submit with the application for a building permit (or other construction-related permit) a completed Construction-Permit-Phase Stormwater Supplemental Form to the Building Services Division. The project drawings submitted for the building permit (or other construction-related permit) shall contain a stormwater management plan, for review and approval by the City, to manage stormwater run-off and to limit the discharge of pollutants in stormwater after construction of the project to the maximum extent practicable.</p> <p>a) The post-construction stormwater management plan shall include and identify the following:</p> <ol style="list-style-type: none"> i. All proposed impervious surface on the site; ii. Anticipated directional flows of on-site stormwater runoff; and iii. Site design measures to reduce the amount of impervious surface area and directly connected impervious surfaces; and iv. Source control measures to limit the potential for stormwater pollution; v. Stormwater treatment measures to remove pollutants from stormwater runoff; and vi. Hydromodification management measures so that post-project stormwater runoff does not 	<p>Prior to issuance of building permit (or other construction-related permit).</p> <p>Prior to final permit inspection, the applicant shall also implement the approved stormwater management plan.</p>	City/Port

Environmental Impact	Standard Conditions of Approval/Mitigation Measures	Mitigation Implementation/ Monitoring:	
		Schedule	Responsibility
	<p>exceed the flow and duration of pre-project runoff, if required under the NPDES permit.</p> <p>b) The following additional information shall be submitted with the post-construction stormwater management plan:</p> <ol style="list-style-type: none"> i. Detailed hydraulic sizing calculations for each stormwater treatment measure proposed; and ii. Pollutant removal information demonstrating that any proposed manufactured/mechanical (i.e., non-landscape-based) stormwater treatment measure, when not used in combination with a landscape-based treatment measure, is capable of removing the range of pollutants typically removed by landscape-based treatment measures and/or the range of pollutants expected to be generated by the project. <p>All proposed stormwater treatment measures shall incorporate appropriate planting materials for stormwater treatment (for landscape-based treatment measures) and shall be designed with considerations for vector/mosquito control. Proposed planting materials for all proposed landscape-based stormwater treatment measures shall be included on the landscape and irrigation plan for the project. The applicant is not required to include on-site stormwater treatment measures in the post-construction stormwater management plan if he or she secures approval from Planning and Zoning of a proposal that demonstrates compliance with the requirements of the City's Alternative Compliance Program.</p>		
	<p>SCA HYD-3: Maintenance Agreement for Stormwater Treatment Measures: For projects incorporating stormwater treatment measures, the applicant shall enter into the "Standard City of Oakland Stormwater Treatment Measures Maintenance Agreement," in accordance with Provision C.3.e of the NPDES permit, which provides, in part, for the following:</p> <ol style="list-style-type: none"> i. The applicant accepting responsibility for the adequate installation/construction, operation, maintenance, inspection, and reporting of any on-site stormwater treatment measures being incorporated into the project until the responsibility is legally transferred to another entity; and ii. Legal access to the on-site stormwater treatment measures for representatives of the City, the local vector control district, and staff of the Regional Water Quality Control Board, San Francisco Region, for the purpose of verifying the implementation, operation, and maintenance of the on-site stormwater treatment measures and to take corrective action if necessary. The agreement shall be recorded at the County Recorder's Office at the applicant's expense. 	Prior to final zoning inspection.	City/Port
	<p>SCA HYD-4: Stormwater and Sewer: Confirmation of the capacity of the City's surrounding stormwater and sanitary sewer system and state of repair shall be completed by a qualified civil engineer with funding from the project applicant. The project applicant shall be responsible for the necessary stormwater and sanitary sewer infrastructure improvements to accommodate the proposed project. In addition, the applicant shall be required to pay additional fees to improve sanitary sewer infrastructure if required by the Sewer and Stormwater Division. Improvements to the existing sanitary sewer collection system shall specifically include, but are not limited to, mechanisms to control or minimize increases in infiltration/inflow to offset sanitary sewer increases associated with the proposed project. To the maximum extent practicable, the applicant will be required to</p>	Prior to completing the final design for the project's sewer service.	City/Port

Environmental Impact	Standard Conditions of Approval/Mitigation Measures	Mitigation Implementation/ Monitoring:	
		Schedule	Responsibility
	implement Best Management Practices to reduce the peak stormwater runoff from the project site. Additionally, the project applicant shall be responsible for payment of the required installation or hook-up fees to the affected service providers.		
5. Would the project create or contribute substantial runoff which would be an additional source of polluted runoff?	<p>See above for SCA HYD-1 through SCA HYD-3 and SCA GEO-1 (Geology and Soils section)</p> <p>Mitigation 4.15-5: Post-construction controls of stormwater shall be incorporated into the design of new redevelopment elements to reduce pollutant loads.</p> <p>NPDES permitting requires that BMPs to control post-construction stormwater be implemented to the maximum extent practicable. Analysis of anticipated runoff volumes and potential effects to receiving water quality from stormwater shall be made for specific redevelopment elements, and site-specific BMPs shall be incorporated into design. BMPs shall be incorporated such that runoff volume from 85 percent of average annual rainfall at a development site is pre-treated prior to its discharge from that site, or a pre-treated volume in compliance with RWQCB policy in effect at the time of design.</p> <p>Non-structural BMPs may include and are not limited to good housekeeping and other source control measures, such as the following:</p> <ul style="list-style-type: none"> • Stencil catch basins and inlets to inform the public they are connected to the Bay; • Sweep streets on a regular schedule; • Use and dispose of paints, solvents, pesticides, and other chemicals properly; • Keep debris bins covered; and • Clean storm drain catch basins and properly dispose of sediment. <p>Structural BMPs may include and are not limited to the following:</p> <ul style="list-style-type: none"> • Minimize impervious areas directly connected to storm sewers; • Include drainage system elements in design as appropriate such as: <ul style="list-style-type: none"> ○ infiltration basins ○ detention/retention basins ○ vegetated swales (biofilters) ○ curb/drop inlet protection. 	Prior to issuance of building permit (or other construction-related permit).	City/Port
6. Would the project otherwise substantially degrade water quality? Would the project cause saltwater to intrude into shallow groundwater, cause contaminants to migrate to uncontaminated groundwater, or lead to degradation of surface water quality?	<p>Mitigation 4.14-1: Installation of groundwater extraction wells into the shallow water-bearing zone or Merritt Sand aquifer for any purpose other than construction de-watering and remediation, including monitoring, shall be prohibited.</p> <p>Implementation of this measure would prevent saltwater from being drawn into the aquifer and potentially causing fresh water to become brackish or saline. Limiting extraction of shallow groundwater and groundwater from the Merritt Sand unit will prevent potential impacts to existing study area groundwater resources.</p>	Prior to issuance of building permit (or other construction-related permit); and during operations.	City/Port

Environmental Impact	Standard Conditions of Approval/Mitigation Measures	Mitigation Implementation/ Monitoring:	
		Schedule	Responsibility
	<p>Mitigation 4.14-2: Extraction of groundwater for construction de-watering or remediation, including monitoring, shall be minimized where practicable; if extraction will penetrate into the deeper aquifers, than a study shall be conducted to determine whether contaminants of concern could migrate into the aquifer; if so, extraction shall be prohibited in that location.</p> <p>Implementation of this measure would prevent unnecessary extraction of groundwater and prohibit its extraction where contaminants of concern could migrate into deeper aquifers; therefore it will help avoid or reduce the potential migration of contaminants. The City and Port shall ensure that groundwater extraction, other than for remediation or construction dewatering, is minimized where practicable in the redevelopment project area.</p>	Prior to issuance of building permit (or other construction-related permit); and during operations.	City/Port
	<p>Mitigation 4.15-6: Site-specific design and best management practices shall be implemented to prevent runoff of recycled water to receiving waters.</p> <p>Design of subsequent redevelopment activities shall ensure recycled water does not leave the site and enter receiving waters. Best management practices shall be implemented to prevent runoff of recycled water. These BMPs may be either structural or non-structural in nature and may include but are not limited to the following:</p> <ul style="list-style-type: none"> • Preventing recycled water from escaping designated use areas through the use of: <ul style="list-style-type: none"> ○ berms ○ detention/retention basins ○ vegetated swales (biofilters) • Not allowing recycled water to be applied to irrigation areas when soils are saturated. • Plumbing portions of irrigation systems adjacent to receiving waters with potable water. 	Prior to issuance of building permit (or other construction-related permit).	City/Port
7. Would the project place housing, structures within a 100-year flood hazard area, as mapped on a federal Flood Hazard Boundary or Flood Insurance Rate Map or other flood hazard delineation map that would impede or redirect flood flows; or would the project expose people or structures to a substantial risk of loss, injury or death involving flooding?	<p>Recommended Measure (not required by CEQA):</p> <p>The Project Sponsor should prepare a Sea Level Rise Adaptation Plan for City of Oakland for review and approval.</p>	Prior to approval of PUD.	City/Port
8. Would the project substantially alter the existing drainage pattern of the site or area, including through the alteration of the course, or increasing	See above for Mitigation Measure 4.15-5, SCA HYD-1 through SCA HYD-3 and SCA GEO-1 (Geology and Soils section)		

Environmental Impact	Standard Conditions of Approval/Mitigation Measures	Mitigation Implementation/ Monitoring:	
		Schedule	Responsibility
the rate or amount of flow, of a creek, river or stream in a manner that would result in substantial erosion, siltation, or flooding, both on- or off-site?			
Noise			
1. Would the project generate noise in violation of the City of Oakland Noise Ordinance (Oakland Planning Code section 17.120.050) regarding construction noise, except if an acoustical analysis is performed that identifies recommend measures to reduce potential impacts?	<p><u>SCA NOI-1: Days/Hours of Construction Operation:</u> The project applicant shall require construction contractors to limit standard construction activities as follows:</p> <p>a) Construction activities are limited to between 7:00 a.m. and 7:00 p.m. Monday through Saturday, except that barging and unloading of soil shall be allowed 24 hours per day, 7 days per week for about 15 months.</p> <p>b) Any construction activity proposed to occur outside of the standard hours of 7:00 a.m. to 7:00 p.m. Monday through Saturday for special activities (such as concrete pouring which may require more continuous amounts of time) shall be evaluated on a case by case basis, with criteria including the proximity of residential uses and a consideration of resident's preferences for whether the activity is acceptable if the overall duration of construction is shortened and such construction activities shall only be allowed with the prior written authorization of the Building Services Division. The project applicant shall also submit an air quality report prepared by a qualified professional evaluating the air quality impacts of the special activities, if the duration of each activity exceeds 6 months.</p> <p>c) No construction activity shall take place on Sundays or Federal holidays, except as noted above.</p> <p>d) Construction activities include but are not limited to: truck idling, moving equipment (including trucks, elevators, etc) or materials, deliveries, and construction meetings held on-site in a non-enclosed area.</p> <p>e) Applicant shall use temporary power poles instead of generators where feasible.</p>	Ongoing throughout demolition, grading, and/or construction.	City/Port
	<p><u>SCA NOI-2: Noise Control:</u> To reduce noise impacts due to construction, the project applicant shall require construction contractors to implement a site-specific noise reduction program, subject to the Planning and Zoning Division and the Building Services Division review and approval, which includes the following measures:</p> <p>a) Equipment and trucks used for project construction shall utilize the best available noise control techniques (e.g., improved mufflers, equipment redesign, use of intake silencers, ducts, engine enclosures and acoustically-attenuating shields or shrouds, wherever feasible).</p> <p>b) Except as provided herein, Impact tools (e.g., jack hammers, pavement breakers, and rock drills) used for project construction shall be hydraulically or electrically powered to avoid noise associated with compressed air exhaust from pneumatically powered tools. However, where use of pneumatic tools is unavoidable, an exhaust muffler on the compressed air exhaust shall be used; this muffler can lower noise levels from the exhaust by up to about 10 dBA. External</p>	Ongoing throughout demolition, grading, and/or construction.	City/Port

Environmental Impact	Standard Conditions of Approval/Mitigation Measures	Mitigation Implementation/ Monitoring:	
		Schedule	Responsibility
	<p>jackets on the tools themselves shall be used, if such jackets are commercially available and this could achieve a reduction of 5 dBA. Quieter procedures shall be used, such as drills rather than impact equipment, whenever such procedures are available and consistent with construction procedures.</p> <p>c) Stationary noise sources shall be located as far from adjacent receptors as possible, and they shall be muffled and enclosed within temporary sheds, incorporate insulation barriers, or use other measures as determined by the City to provide equivalent noise reduction.</p> <p>d) The noisiest phases of construction shall be limited to less than 10 days at a time. Exceptions may be allowed if the City determines an extension is necessary and all available noise reduction controls are implemented.</p>		
	<p>SCA NOI-3: Noise Complaint Procedures: Prior to the issuance of each building permit, along with the submission of construction documents, the project applicant shall submit to the Building Services Division a list of measures to respond to and track complaints pertaining to construction noise. These measures shall include:</p> <p>a) A procedure and phone numbers for notifying the Building Services Division staff and Oakland Police Department; (during regular construction hours and off-hours);</p> <p>b) A sign posted on-site pertaining with permitted construction days and hours and complaint procedures and who to notify in the event of a problem. The sign shall also include a listing of both the City and construction contractor's telephone numbers (during regular construction hours and off-hours);</p> <p>c) The designation of an on-site construction complaint and enforcement manager for the project;</p> <p>d) Notification of neighbors and occupants within 300 feet of the project construction area at least 30 days in advance of extreme noise generating activities about the estimated duration of the activity; and</p> <p>e) A preconstruction meeting shall be held with the job inspectors and the general contractor/on-site project manager to confirm that noise measures and practices (including construction hours, neighborhood notification, posted signs, etc.) are completed.</p>	Ongoing throughout demolition, grading, and/or construction.	City/Port
	<p>SCA NOI-6: Pile Driving and Other Extreme Noise Generators: To further reduce potential pier drilling, pile driving and/or other extreme noise generating construction impacts greater than 90dBA, a set of site-specific noise attenuation measures shall be completed under the supervision of a qualified acoustical consultant. Prior to commencing construction, a plan for such measures shall be submitted for review and approval by the Planning and Zoning Division and the Building Services Division to ensure that maximum feasible noise attenuation will be achieved. This plan shall be based on the final design of the project. A third-party peer review, paid for by the project applicant, may be required to assist the City in evaluating the feasibility and effectiveness of the noise reduction plan submitted by the project applicant. The criterion for approving the plan shall be a determination that maximum feasible noise attenuation will be achieved. A special inspection</p>	Ongoing throughout demolition, grading, and/or construction.	City/Port

Environmental Impact	Standard Conditions of Approval/Mitigation Measures	Mitigation Implementation/ Monitoring:	
		Schedule	Responsibility
	<p>deposit is required to ensure compliance with the noise reduction plan. The amount of the deposit shall be determined by the Building Official, and the deposit shall be submitted by the project applicant concurrent with submittal of the noise reduction plan. The noise reduction plan shall include, but not be limited to, an evaluation of implementing the following measures. These attenuation measures shall include as many of the following control strategies as applicable to the site and construction activity:</p> <ul style="list-style-type: none"> a) Erect temporary plywood noise barriers around the construction site, particularly along on sites adjacent to residential buildings; b) Implement “quiet” pile driving technology (such as pre-drilling of piles, the use of more than one pile driver to shorten the total pile driving duration), where feasible, in consideration of geotechnical and structural requirements and conditions; c) Utilize noise control blankets on the building structure as the building is erected to reduce noise emission from the site; d) Evaluate the feasibility of noise control at the receivers by temporarily improving the noise reduction capability of adjacent buildings by the use of sound blankets for example and implement such measure if such measures are feasible and would noticeably reduce noise impacts; and e) Monitor the effectiveness of noise attenuation measures by taking noise measurements. 		
2. Would the project generate noise in violation of the City of Oakland nuisance standards (Oakland Municipal Code section 8.18.020) regarding persistent construction-related noise?	See above for SCA NOI-1, SCA NOI-2, SCA NOI-3, and SCA NOI-6		
3. Would the project generate noise in violation of the City of Oakland Noise Ordinance (Oakland Planning Code section 17.120.050) regarding operational noise?	<p>SCA NOI-4: Interior Noise: If necessary to comply with the interior noise requirements of the City of Oakland’s General Plan Noise Element and achieve an acceptable interior noise level, noise reduction in the form of sound-rated assemblies (i.e., windows, exterior doors, and walls), and/or other appropriate features/measures, shall be incorporated into project building design, based upon recommendations of a qualified acoustical engineer and submitted to the Building Services Division for review and approval prior to issuance of building permit. Final recommendations for sound-rated assemblies, and/or other appropriate features/measures, will depend on the specific building designs and layout of buildings on the site and shall be determined during the design phases. Written confirmation by the acoustical consultant, HVAC or HERS specialist, shall be submitted for City review and approval, prior to Certificate of Occupancy (or equivalent) that:</p> <ul style="list-style-type: none"> a) Quality control was exercised during construction to ensure all air-gaps and penetrations of the building shell are controlled and sealed; and 	Prior to issuance of a building permit and Certificate of Occupancy.	City/Port

Environmental Impact	Standard Conditions of Approval/Mitigation Measures	Mitigation Implementation/ Monitoring:	
		Schedule	Responsibility
	<ul style="list-style-type: none"> b) Demonstrates compliance with interior noise standards based upon performance testing of a sample unit. c) Inclusion of a Statement of Disclosure Notice in the CC&R's on the lease or title to all new tenants or owners of the units acknowledging the noise generating activity and the single event noise occurrences. Potential features/measures to reduce interior noise could include, but are not limited to, the following: <ul style="list-style-type: none"> i) Installation of an alternative form of ventilation in all units identified in the acoustical analysis as not being able to meet the interior noise requirements due to adjacency to a noise generating activity, filtration of ambient make-up air in each unit and analysis of ventilation noise if ventilation is included in the recommendations by the acoustical analysis. ii) Prohibition of Z-duct construction. 		
	<p>SCA NOI-5: Operational Noise-General: Noise levels from the activity, property, or any mechanical equipment on site shall comply with the performance standards of Section 17.120 of the Oakland Planning Code and Section 8.18 of the Oakland Municipal Code. If noise levels exceed these standards, the activity causing the noise shall be abated until appropriate noise reduction measures have been installed and compliance verified by the Planning and Zoning Division and Building Services.</p>	Ongoing	City/Port
<p>4. Would the project generate noise resulting in a 5 dBA permanent increase in ambient noise levels in the project vicinity above levels existing without the project; or, if under a cumulative scenario where the cumulative increase results in a 5 dBA permanent increase in ambient noise levels in the project vicinity without the project (i.e., the cumulative condition including the project compared to the existing conditions) and a 3 dBA permanent increase is attributable to the project (i.e., the cumulative condition including the project compared to the cumulative baseline condition without the project)?</p>	<p>See above for SCA NOI-4 and NOI-5</p>		
<p>5. Would the project be exposed to a</p>	<p>See above for SCA NOI-4 and NOI-5</p>		

Environmental Impact	Standard Conditions of Approval/Mitigation Measures	Mitigation Implementation/ Monitoring:	
		Schedule	Responsibility
community noise in conflict with the land use compatibility guidelines of the Oakland General Plan after incorporation of all applicable Standard Conditions of Approval?			
6. Would the project expose persons to or generate noise levels in excess of applicable standards established by a regulatory agency (e.g., occupational noise standards of OSHA)?	See above for SCA NOI-5		
7. Would the project, during either project construction or project operation, expose persons to or generate groundborne vibration that exceeds the criteria established by the Federal Transit Administration (FTA)?	See above for SCA NOI-1, SCA NOI-2, SCA NOI-3, and SCA NOI-6		
Public Outreach			
	<p>Mitigation PO-1 (Stakeholder Review of Air Quality and Trucking Plans): The City of Oakland (“City”) and Prologis CCIG Oakland Global, LLC (“Developer”) shall engage the public in the development of the following plans required by the SCA/MMRP related to potential air quality and trucking impacts on the surrounding area during construction and operation of the project (the “Subject Plans”):</p> <ul style="list-style-type: none"> • SCA AIR-1 (Construction Management Plan) • SCA AIR-2 (Construction-Related Air Pollution Controls) • Mitigation 4.3-7 (Truck Management Plan) • Mitigation 4.4-3b (Maritime and Rail-Related Emissions Reduction Plan) • Mitigation 4.4-4 (Truck Diesel Emission Reduction Plan) • Mitigation 4.4-5 (Transportation Control Measures) • Mitigation 4.4-6 (Energy-Conserving Fixtures and Designs) • Mitigation 5.4-1 (Demonstration Projects) • SCA TRANS-1 (Parking and Transportation Demand Management) • SCA TRANS-2 (Construction Traffic and Parking) • Mitigation 4.3-13 (Traffic Control Plan – Hazardous Materials) <p>a. <u>Stakeholder List</u>. The City shall maintain a list of the names and electronic mail addresses of the stakeholders that have expressed an interest in receiving information on the Subject Plans (the “Stakeholder List”). The Stakeholder List shall include the recipients of the July 3, 2013, letter related to the Construction Management Plan for the Public Improvements (which included SCA</p>	Ongoing; as stated	City

Environmental Impact	Standard Conditions of Approval/Mitigation Measures	Mitigation Implementation/ Monitoring:	
		Schedule	Responsibility
	<p>AIR-1, SCA AIR-2, SCA TRANS-2, MM 4.3-13 and SCA 4.4-6) and such additional stakeholders that submit a written request to the City to be added to the Stakeholder List.</p> <p>b. <u>Quarterly Meetings</u>. Beginning in September of 2013 and continuing until such time as the City Administrator has approved all of the Subject Plans, the City and the Developer shall jointly host quarterly meetings to discuss the status of the Subject Plans. The City and the Developer shall make a good faith effort to schedule the meetings at a day/time to maximize Stakeholder attendance. The meetings shall be noticed via electronic mail to all parties included in the Stakeholder List providing at least ten (10) calendar days' prior notice of the time and place of the meeting.</p> <p>c. <u>Notice of Plan Review</u>. The party responsible for the preparation and implementation of the applicable Subject Plan shall provide at least forty five (45) calendar days' prior notice of the date that a draft of the applicable Subject Plan shall be available for review pursuant to Item (d) below. Such notice shall be delivered via electronic mail to the parties included in the Stakeholder List. The notice shall include an express reference to the specific SCA/MMRP requiring the applicable Subject Plan. The requirement set forth in this item (c) shall not apply to the Construction Management Plan for the Public Improvements (which included SCA AIR-1, SCA AIR-2, SCA TRANS-2, MM 4.3-13 and SCA 4.4-6) because said plans were released on July 3, 2013. However, the subsequent development of plans pursuant to SCA AIR-1, SCA AIR-2, SCA TRANS-2, MM 4.3-13 and SCA 4.4-6 with respect to vertical improvements will be subject to this item (c).</p> <p>d. <u>Public Review and Comment Period</u>. Prior to approving any draft Subject Plan, the City shall provide the parties included in the Stakeholder List with seventeen (17) calendar days within which to review and provide written comments to any draft Subject Plan, and such written comments must be received by the City no later than 5:00 p.m. on the seventeenth day; provided, however, if the seventeen (17) day period expires on any day other a business day, the expiration date shall be extended to 5:00 p.m. on the next business day. The seventeen (17) day period shall be initiated by the City's electronic mail to the parties included in the Stakeholder List. During the 17-day public review and comment period the City shall make the draft Subject Plan available for public review such as posting the document on the City's website.</p> <p>e. <u>Informational Council Presentation</u>. City staff shall provide the City Council with an informational presentation of each approved Subject Plan within ninety (90) calendar days after the City Administrator's approval of such Subject Plan. Such presentation shall include a summary of the public outreach implemented pursuant to this mitigation measure and the requirements and goals of the applicable approved Subject Plan.</p>		
Public Services			
1. Would the project result in increased demand for fire protection services and first responder medical emergency services?	<p>SCA PSU-1: Underground Utilities: The project applicant shall submit plans for review and approval by the Building Services Division and the Public Works Agency, and other relevant agencies as appropriate that show all fire alarm conduits and similar facilities placed underground. The new facilities shall be placed underground along the project applicant's street frontage and from the project applicant's structures to the point of service. The plans shall show all fire water service and fire alarm facilities installed in accordance with standard specifications of the serving utilities.</p>	Prior to issuance of a building permit.	City/Port

Environmental Impact	Standard Conditions of Approval/Mitigation Measures	Mitigation Implementation/ Monitoring:	
		Schedule	Responsibility
	<p>SCA PSU-2: Fire Safety Phasing Plan: The project applicant shall submit a separate fire safety phasing plan to the Planning and Zoning Division and Fire Services Division for their review and approval. The fire safety plan shall include all of the fire safety features incorporated into the project and the schedule for implementation of the features. Fire Services Division may require changes to the plan or may reject the plan if it does not adequately address fire hazards associated with the project as a whole or the individual phase.</p>	Prior to issuance of a demolition, grading, and/or construction and concurrent with any p-job submittal permit.	City/Port
	<p>Mitigation 4.9-1. The City and Port shall cooperatively investigate the need for, and if required shall fund on a fair-share basis, development and operation of increased firefighting and medical emergency response services via fireboat to serve the OARB sub-district.</p> <p>The City and Port of Oakland will each contribute a fair share toward cooperatively investigating the need for increased firefighting and emergency response services to serve the redevelopment area west of I-880. This investigation shall include consultation with the OES and OFD. Should this investigation conclude, based on detailed redevelopment design, that increased fireboat services are required, the Port and the City shall each fund its fair share to equip and staff fireboat-based services in the OARB sub-district. In addition, as subsequent redevelopment activities occur, the City and Port shall be allowed to develop fee formulae (to recoup initial investment from future development or tenants), as well as a long-term cost-sharing formula (to equitably distribute the cost of continuing operations).</p> <p>The fire facility will be constructed after basic underground infrastructure is constructed, and before any people-attracting subsequent redevelopment activities begin operations.</p>	Pre-operations; at time Port and Gateway development area employees exceed 2,044 (1995 baseline)	City/Port
	<p>Mitigation 4.9-2: The Port and City shall work with OES to ensure changes in local area circulation are reflected in the revised Response Concept.</p> <p>The Port and City would provide information to the OES to facilitate that agency's accurate revision of its Response Concept and Annex H. In particular, the City and Port would provide OES information regarding new and proposed project area development, intensification and changes in land uses, realignment of area roadways, and construction of new local circulation facilities.</p>	Pre-construction	City/Port
	<p>Mitigation 4.9-3: The Port and City shall require developers within their respective jurisdictions to notify OES of their plans in advance of construction or remediation activities.</p> <p>Each developer proposing construction in the redevelopment project area would be required to notify OES prior to initiation of construction, so that OES may plan emergency access and egress taking into consideration possible conflicts or interference during the construction phase. The developer would also be required to notify OES once construction is complete.</p>	Pre-construction	City/Port

Environmental Impact	Standard Conditions of Approval/Mitigation Measures	Mitigation Implementation/ Monitoring:	
		Schedule	Responsibility
Traffic and Transportation			
<p><u>Project Impacts</u></p> <p>1. At a study, signalized intersection which is located outside the Downtown area, would the Project cause the level of service (LOS) to degrade to worse than LOS D (i.e., LOS E)?</p>	<p>Mitigation Measure 3.16-1: 7th Street & I-880 Northbound Off-Ramp (#12)⁴. The project sponsor shall fund, prepare, and install the approved plans and improvements:</p> <ul style="list-style-type: none"> Optimize signal timing (i.e., adjust the allocation of green time for each intersection approach) for the PM peak hour. Coordinate the signal timing changes at this intersection with the adjacent intersections that are in the same signal coordination group. <p>To implement this measure, the project sponsor shall submit the following to City of Oakland's Transportation Engineering Division and Caltrans for review and approval:</p> <ul style="list-style-type: none"> Plans, Specifications, and Estimates (PS&E) to modify the intersection. All elements shall be designed to City standards in effect at the time of construction and all new or upgraded signals should include these enhancements. All other facilities supporting vehicle travel and alternative modes through the intersection should be brought up to both City standards and ADA standards (according to Federal and State Access Board guidelines) at the time of construction. <p>Current City Standards call for the elements listed below:</p> <ul style="list-style-type: none"> 2070L Type Controller GPS communication (clock) Accessible pedestrian crosswalks according to Federal and State Access Board guidelines City Standard ADA wheelchair ramps Full actuation (video detection, pedestrian push buttons, bicycle detection) Accessible Pedestrian Signals, audible and tactile according to Federal Access Board guidelines Countdown Pedestrian Signals Signal interconnect and communication to City Traffic Management Center for corridors identified in the City's ITS Master Plan for a maximum of 600 feet Signal timing plans for the signals in the coordination group. 	At issuance of first Certificate of Occupancy (CO)	City/Port
	<p>Mitigation Measure 3.16-2: San Pablo Ave & Ashby Avenue (#42). To implement this measure, the Project Sponsor shall coordinate with City of Berkeley and Caltrans, and shall fund, prepare, and install the improvements consistent with City of Berkeley and/or Caltrans standards.</p> <ul style="list-style-type: none"> Optimize signal timing (i.e., adjust the allocation of green time for each intersection approach) 	At issuance of first Certificate of Occupancy (CO)	City/Port

⁴ The numbers appearing after the location of the intersection listed refer to Figure 3.16-1 in the IS/Addendum that illustrates the study intersections.

Environmental Impact	Standard Conditions of Approval/Mitigation Measures	Mitigation Implementation/ Monitoring:	
		Schedule	Responsibility
	<p>for the PM peak hour.</p> <ul style="list-style-type: none"> Coordinate the signal timing changes at this intersection with the adjacent intersections that are in the same signal coordination group. 		
<p>2. At two intersections, the project would cause (a) the total intersection average vehicle delay to increase by two (2) or more seconds, or (b) an increase in average delay for any of the critical movements of four (4) seconds or more; or (c) the volume-to-capacity (“V/C”) ratio exceeds 0.03 or more (<u>but only if the delay values are greater than 120 seconds of average intersection delay as delay values over 120 seconds tend to increase exponentially and are then generally considered unreliable</u>).</p>	<p>Mitigation Measure 3.16-3: 7th Street & Harrison Street (#18). To implement this measure, the project sponsor shall submit plans specifications and estimates (PS&E) as detailed in Mitigation Measure 3.16-1 that are consistent with the City’s standards to City of Oakland’s Transportation Engineering Division for review and approval.</p> <ul style="list-style-type: none"> Optimize signal timing (i.e., adjust the allocation of green time for each intersection approach) for the PM peak hour. Coordinate the signal timing changes at this intersection with the adjacent intersections that are in the same signal coordination group. <p>The project sponsor shall fund, prepare, and install the approved plans and improvements.</p>	At issuance of first Certificate of Occupancy (CO)	City/Port
	<p>Mitigation Measure 3.16-4: 12th Street & Castro Street (#29). To implement this measure, the project sponsor shall submit plans specifications and estimates (PS&E) as detailed in Mitigation Measure 3.16-1 that are consistent with the City’s standards to City of Oakland’s Transportation Engineering Division for review and approval.</p> <ul style="list-style-type: none"> Optimize signal timing (i.e., adjust the allocation of green time for each intersection approach) for the PM peak hour. Coordinate the signal timing changes at this intersection with the adjacent intersections that are in the same signal coordination group. <p>The project sponsor shall fund, prepare, and install the approved plans and improvements.</p>	At issuance of first Certificate of Occupancy (CO)	City/Port
<p>3. Redevelopment would cause some roadway segments on the Congestion Management Program (CMP) to a) degrade to LOS F; or b) increase the V/C ratio by more than three percent for a roadway segment that would operate at LOS F without the project.</p>	<p>SCA TRANS-1: Parking and Transportation Demand Management: The project sponsor shall pay for and submit for review and approval by the City a Transportation Demand Management (TDM) plan containing strategies to:</p> <ol style="list-style-type: none"> Reduce the amount of traffic generated by new development and the expansion of existing development, pursuant to the City’s police power and necessary in order to protect the public health, safety and welfare. Ensure that expected increases in traffic resulting from growth in employment and housing opportunities in the City of Oakland will be adequately mitigated. Reduce drive-alone commute trips during peak traffic periods by using a combination of services, incentives, and facilities. Promote more efficient use of existing transportation facilities and ensure that new developments are designed in ways to maximize the potential for alternative transportation usage. 	<p><u>For construction:</u> Prior to issuance of first permit related to construction (e.g., demolition, grading, etc.)</p> <p><u>For operation:</u> Prior to issuance of a final building permit and on-going related to submission of Parking and TDM Plan annual compliance report</p>	City/Port

Environmental Impact	Standard Conditions of Approval/Mitigation Measures	Mitigation Implementation/ Monitoring:	
		Schedule	Responsibility
	<p>5. Establish an ongoing monitoring and enforcement program to ensure that the desired alternative mode use percentages are achieved.</p> <p>The project sponsor shall implement the approved TDM plan. The TDM plan shall include strategies to increase pedestrian, bicycle, transit, and carpool/vanpool use. All four modes of travel shall be considered, and parking management and parking reduction strategies should be included.</p> <p>Actions to consider include the following:</p> <ul style="list-style-type: none"> a) Inclusion of additional long term and short term bicycle parking that meets the design standards set forth in chapter five of the Bicycle Master Plan, and Bicycle Parking Ordinance, and shower and locker facilities in commercial developments that exceed the requirement. b) Construction of and/or access to bikeways per the Bicycle Master Plan; construction of priority bikeways, onsite signage and bike lane striping. c) Installation of safety elements per the Pedestrian Master Plan (such as cross walk striping, curb ramps, count down signals, bulb outs, etc.) to encourage convenient and safe crossing at arterials. d) Installation of amenities such as lighting, street trees, trash receptacles per the Pedestrian Master Plan and any applicable streetscape plan. e) Construction and development of transit stops/shelters, pedestrian access, way finding signage, and lighting around transit stops per transit agency plans or negotiated improvements. f) Direct onsite sales of transit passes purchased and sold at a bulk group rate (through programs such as AC Transit Easy Pass or a similar program through another transit agency). g) Employees or residents can be provided with a subsidy, determined by the project sponsor and subject to review by the City, if the employees or residents use transit or commute by other alternative modes. h) Provision of ongoing contribution to AC Transit service to the area between the development and nearest mass transit station. If that is not available, an ongoing contribution to an existing area shuttle service between the development and nearest mass transit station. The last option is establishment of a new shuttle service between the development and nearest mass transit station may be developed. The contribution required for the service (any option) will be based on the cost of the last option. i) Guaranteed ride home program for employees, either through 511.org or through separate program. j) Pre-tax commuter benefits (commuter checks) for employees. k) Free designated parking spaces for on-site car-sharing program (such as City Car Share, Zip Car, etc.) and/or car-share membership for employees or tenants. l) On-site carpooling and/or vanpool program that includes preferential (discounted or free) parking for carpools and vanpools. m) Distribution of information concerning alternative transportation options. 		

Environmental Impact	Standard Conditions of Approval/Mitigation Measures	Mitigation Implementation/ Monitoring:	
		Schedule	Responsibility
	<p>n) Parking spaces sold/leased separately for residential units. Charge employees for parking, or provide a cash incentive or transit pass alternative to a free parking space in commercial properties.</p> <p>o) Parking management strategies; including attendant/valet parking and shared parking spaces.</p> <p>p) Requiring tenants to provide opportunities and the ability to work off-site.</p> <p>q) Allow employees or residents to adjust their work schedule in order to complete the basic work requirement of five eight-hour workdays by adjusting their schedule to reduce vehicle trips to the worksite.</p> <p>r) Provide or require tenants to provide employees with staggered work hours involving a shift in the set work hours of all employees at the workplace or flexible work hours involving individually determined work hours.</p> <p>The project sponsor shall submit an annual compliance report for review and approval by the City. This report will be reviewed either by City staff (or a peer review consultant, chosen by the City and paid for by the project sponsor). If timely reports are not submitted, the reports indicate a failure to achieve the stated policy goals, or the required alternative mode split is still not achieved, staff will work with the project sponsor to find ways to meet their commitments and achieve trip reduction goals. If the issues cannot be resolved, the matter may be referred to the Planning Commission for resolution. Project sponsors shall be required, as a condition of approval, to reimburse the City for costs incurred in maintaining and enforcing the trip reduction program for the approved project.</p>		
4. The project would directly or indirectly cause or expose roadway users to a permanent and substantial transportation hazard due to a new or existing physical design feature or incompatible uses?	<p>Mitigation 4.3-5: Redevelopment elements shall be designed in accordance with standard design practice and shall be subject to review and approval of the City or Port design engineer.</p> <p>Through design review, the City and/or Port, as applicable, shall ensure the design of roadways, bicycle and pedestrian facilities, parking lots, and other transportation features comply with design standards and disallow design proposals that likely to result in traffic hazards. Any mitigation or redevelopment features that may directly affect Caltrans facilities shall be submitted for review by that agency.</p>	Prior to approval of PUD.	City/Port
	<p>Mitigation 4.3-7: The City and the Port shall continue and shall work together to create a truck management plan designed to reduce the effects of transport trucks on local streets. The City and Port shall fund on a fair share basis, implementation of this plan.</p> <p>The truck management plan may include, and is not limited to, the following elements:</p> <ul style="list-style-type: none"> • Analyze truck traffic in West Oakland; • Traffic calming strategies on streets not designated as truck routes designed to discourage truck through travel; • Truck driver education programs; • Expanded signage, including truck prohibitions on streets not designated as truck routes; • Traffic signal timing improvements; • Explore the feasibility of truck access to Frontage Road; 	Prior to issuance of a final building permit	City/Port

Environmental Impact	Standard Conditions of Approval/Mitigation Measures	Mitigation Implementation/ Monitoring:	
		Schedule	Responsibility
	<ul style="list-style-type: none"> Roadway and terminal gate design elements to prevent truck queues from impeding the flow of traffic on public streets; and Continue Port funding of two police officers to enforce truck traffic prohibitions on local streets. 		
	<p>Mitigation 4.3-8: Provide an emergency service program and emergency evacuation plan using waterborne vessels.</p> <p>The City shall provide emergency access to the OARB sub-district by vessel. The area is currently served by fire boat out of the Jack London Square Fire Station. The City may elect to equip that fire boat with first response medical emergency personnel as well as limited hazardous materials response personnel and equipment (see also Mitigation Measure 4.9-1). Major developers shall fund these improvements on a fair share basis.</p>	Pre-operations; at time Port and Gateway development area employees exceed 2,044 (1995 baseline)	City/Port
	<p><u>With regard to Maritime Street between 7th Street and West Grand Avenue:</u></p> <p>Mitigation Measure 3.16-5: The City shall provide a shoulder with a minimum width of 8 feet on the west side of Maritime Street to accommodate queuing trucks and minimize intrusion onto the southbound travel lane.</p> <p>Mitigation Measure 3.16-6: The City shall provide a 9-foot wide area along the entire west side of Maritime Street in this area to accommodate a sidewalk and utilities; exact dimensions of these elements will be determined by the City’s Transportation and Infrastructure Divisions during the PUD process.</p> <p>Mitigation Measure 3.16-7: The City shall provide an 18-foot wide area along the entire east side of Maritime Street in this area to accommodate a Class 1 bicycle path and utilities; exact dimensions of these elements will be determined by the City’s Transportation and Infrastructure Divisions during the PUD process.</p>	Prior to approval of the PUD	City/Port
	<p><u>With regard to North Maritime (formerly Wake Avenue):</u></p> <p>Mitigation Measure 3.16-8: The City shall provide 2 travel lanes in each direction in this area with shoulders on each side for bicycle lanes. The exact dimensions of these elements will be determined by the City’s Transportation and Infrastructure Divisions during the PUD process.</p>	Prior to approval of the PUD	City/Port
	<p><u>With regard to Burma Road between Maritime Street and West Oakland (Burma East):</u></p> <p>Mitigation Measure 3.16-9: The City shall provide a 9-foot wide area along the entire north side of Burma Street in this area to accommodate utilities and a sidewalk; bicycles will be accommodated on the shoulder; exact dimensions of these elements will be determined by the City’s Transportation and Infrastructure Divisions during the PUD process.</p>	Prior to approval of the PUD	City/Port

Environmental Impact	Standard Conditions of Approval/Mitigation Measures	Mitigation Implementation/ Monitoring:	
		Schedule	Responsibility
	Mitigation Measure 3.16-10: The City shall provide a 7-foot wide area along the entire south side of Burma Street in this area to accommodate utilities; bicycles will be accommodated on the shoulder; exact dimensions of these elements will be determined by the City's Transportation and Infrastructure Divisions during the PUD process.	Prior to approval of the PUD	City/Port
	<u>With regard to Burma Road between Maritime Street and Railroad Tracks (Burma West):</u> Mitigation Measure 3.16-11: The City shall provide a 9-foot wide area along the entire south side of Burma Street in this area to accommodate utilities and a sidewalk; bicycles will be accommodated on the shoulder; exact dimensions of these elements will be determined by the City's Transportation and Infrastructure Divisions during the PUD process. Mitigation Measure 3.16-12: The City shall provide a 20-foot wide area along the entire north side of Burma Street in this area to accommodate utilities and a Class 1 bicycle path; exact dimensions of these elements will be determined by the City's Transportation and Infrastructure Divisions during the PUD process.	Prior to approval of the PUD	City/Port
	<u>With regard to Burma Road between Railroad Tracks and Gateway Park (Burma Far West):</u> Mitigation Measure 3.16-13: The City shall provide an 8-foot wide area along the entire south side of Burma Street in this area to accommodate utilities and a sidewalk; bicycles will be accommodated on the shoulder with a Class 2 bicycle lane; exact dimensions of these elements will be determined by the City's Transportation and Infrastructure Divisions during the PUD process.	Prior to approval of the PUD	City/Port
	Mitigation Measure 3.16-14: The City shall provide a shoulder along the entire north side of Burma Street in this area to accommodate bicycles with a Class 2 bicycle lane; exact dimensions of these elements will be determined by the City's Transportation and Infrastructure Divisions during the PUD process.	Prior to approval of the PUD	City/Port
	<u>With regard to Emergency Access:</u> Mitigation Measure 3.16-15a: The Project Sponsor shall develop, in consultation and coordination with adjacent property owners, including EBMUD, an emergency response plan for the 2012 Army Base Project, which addresses emergency ingress/egress. Mitigation Measure 3.16-15b: The Project Sponsor shall include in the design of West Burma Road turn-outs and turn-arounds at the appropriate locations and dimensions as required by the Fire Department, in order to allow for appropriate ingress and egress of emergency vehicles.	For MM 3.15-15a: at the time of issuance of the first Certificate of Occupancy (CO); For MM 3.15-15b: prior to approval of the PUD	City/Port
	Mitigation 4.3-10 (Parking Demand Study): The number of parking spaces provided in the project area shall comply with City Code or Port requirements, and/or with recommendations of a developer funded parking demand analysis.	Prior to issuance of demolition, grading, or building permit;	City/Port

Environmental Impact	Standard Conditions of Approval/Mitigation Measures	Mitigation Implementation/ Monitoring:	
		Schedule	Responsibility
	Through project review, the City and/or Port shall ensure an adequate supply of parking spaces will be provided. Major redevelopment project area developers shall fund on a fair share basis a project area-wide, or potentially a sub-area specific parking demand study that shall take into consideration the TDM programs and policies developed through the Standard Conditions of Approval and Mitigation and Monitoring Program.	or ongoing as specified in SCA ULT-2.	
5. Project would directly or indirectly result in a permanent substantial decrease in pedestrian safety.	See above for Mitigation Measures 4.3-5		
6. Project would directly or indirectly result in a permanent substantial decrease in bicyclist safety.	See above for Mitigation Measures 4.3-5 and new Mitigation Measures 3.16-5 through 3.16-15a and 3.16-15b		
7. Project would generate substantial multi-modal traffic traveling across at-grade railroad crossings that cause or expose roadway users to a permanent and substantial transportation hazard?	See above for Mitigation Measures 4.3-5 and 4.3-7		
	<p>SCA TRANS-3: Railroad Crossings: Any proposed new or relocated railroad crossing improvements must be coordinated with California Public Utility Commission (CPUC) and affected railroads and all necessary permits/approvals obtained, including a GO 88-B Request (Authorization to Alter Highway Rail Crossings), if applicable. Appropriate safety-related design features and measures should be incorporated, including without limitation:</p> <ul style="list-style-type: none"> a) Installation of grade separations at crossings, i.e., physically separating roads and railroad tracks by constructing overpasses or underpasses. b) Improvements to warning devices at existing highway rail crossings that are impacted by project traffic. c) Installation of additional warning signage. d) Improvements to traffic signaling at intersections adjacent to crossings, e.g., signal preemption. e) Installation of median separation to prevent vehicles from driving around railroad crossing gates. f) Where soundwalls, landscaping, buildings, etc. would be installed near crossings, maintaining the visibility of warning devices and approaching trains. g) Prohibition of parking within 100 feet of the crossings to improve the visibility of warning devices and approaching trains. h) Construction of pull-out lanes for buses and vehicles transporting hazardous materials. i) Installation of vandal-resistant fencing or walls to limit the access of pedestrians onto the 	Action required prior to railroad crossing construction	City/Port

Environmental Impact	Standard Conditions of Approval/Mitigation Measures	Mitigation Implementation/ Monitoring:	
		Schedule	Responsibility
	<p>railroad right-of-way.</p> <p>j) Elimination of driveways near crossings.</p> <p>k) Increased enforcement of traffic laws at crossings.</p> <p>l) Rail safety awareness programs to educate the public about the hazards of highway-rail grade crossings.</p>		
	<p>Mitigation Measure 3.16-16:</p> <p>a. Redesign the Engineers Road to intersect the EBMUD driveway at least 100 feet north of the at-grade rail crossing or configure an internal circulation plan that prohibits turns from Engineers Road onto Wake Avenue.</p> <p>b. Provide a high visibility crosswalk with pedestrian crossing signs at the pedestrian crossing just west of the rail crossing on West Burma Road.</p> <p>c. Paint “KEEP CLEAR” on West Burma Road for westbound vehicles at the Truck Services driveway.</p> <p>d. Unless approved otherwise by the California Public Utility Commission (CPUC), construct all rail crossings at a minimum street-crossing angle of 45 degrees consistent with Institute of Transportation Engineers recommendations, 90 degrees is preferred for cross-traffic safety.</p>	At the time of issuance of the first Certificate of Occupancy (CO)	City/Port
	<p>Recommended Measures (not required by CEQA):</p> <ul style="list-style-type: none"> The Project Sponsor shall negotiate with EBMUD in good faith to reach an agreement which reasonably limits train movements from unreasonably parking, stopping and/or blocking access to EBMUD’s main gate to the MWWTP. Specifically, the Master Developer shall coordinate the timing of its use of the tracks to a schedule that reduces, to the maximum extent feasible, any potentially adverse impacts to EBMUD’s main gate to the MWWTP. The Project Sponsor shall make reasonable good faith efforts to explore the feasibility of, and if determined feasible, obtain/secure alternate emergency vehicle access to the MWWTP that would not be impacted by the 2012 Army Base rail traffic. The City shall coordinate its efforts with EBMUD. 	At the time of issuance of the first Certificate of Occupancy (CO)	City/Port
8. Project could fundamentally conflict with adopted City policies, plans, or programs regarding public transit, bicycle, or pedestrian facilities adopted for the purpose of avoiding or mitigating an environmental effect.	<p>See above for Mitigation Measures 3.16-5 through 3.16-15a and 3.16-15b</p> <p>Mitigation 4.3-9: Redevelopment plans shall conform to City of Oakland or Port development standards with facilities that support transportation alternatives to the single-occupant automobile. Facilities that support transportation alternatives to the single-occupant automobile may include, and are not limited to, bus turnouts, bicycle racks, on-site showers, on-site lockers, and pedestrian and bicycle ways.</p>	Prior to issuance of first permit related to construction (e.g., demolition, grading, etc.)	City/Port

Environmental Impact	Standard Conditions of Approval/Mitigation Measures	Mitigation Implementation/ Monitoring:	
		Schedule	Responsibility
9. Would the project result in a substantial, though temporary, adverse effect on the circulation system during construction of the project.	<p>SCA TRANS-2: Construction Traffic and Parking: The project sponsor and construction contractor shall meet with appropriate City of Oakland agencies to determine traffic management strategies to reduce, to the maximum extent feasible, traffic congestion and the effects of parking demand by construction workers during construction of this project (see also SCA TRANS-1, especially “h”) and other nearby projects that could be simultaneously under construction. The project sponsor shall develop a construction management plan. The plan shall be submitted to EBMUD, the Port, and Caltrans for their review and comment ten (10) business days before submittal to the City. The project sponsor shall consider in good faith such comments and revise the plan as appropriate. The revised plan shall be submitted for review and approval by the City’s Planning and Zoning Division, the Building Services Division, and the Transportation Services Division. The plan shall include at least the following items and requirements:</p> <ul style="list-style-type: none"> a) A set of comprehensive traffic control measures, including scheduling of major truck trips and deliveries to avoid peak traffic hours, detour signs if required, lane closure procedures, signs, cones for drivers, and designated construction access routes. b) Notification procedures for adjacent project sponsors and public safety personnel regarding when major deliveries, detours, and lane closures will occur. c) Location of construction staging areas for materials, equipment, and vehicles at an approved location. d) A process for responding to, and tracking, complaints pertaining to construction activity, including identification of an onsite complaint manager. The manager shall determine the cause of the complaints and shall take prompt action to correct the problem. Planning and Zoning shall be informed who the Manager is prior to the issuance of the first permit issued by Building Services. e) Provision for accommodation of pedestrian flow. f) Provision for parking management and spaces for all construction workers to ensure that construction workers do not park in on-street spaces (see also SCA TRANS-1, especially “h”). g) Any damage to the street caused by heavy equipment, or as a result of this construction, shall be repaired, at the applicant's expense, within one week of the occurrence of the damage (or excessive wear), unless further damage/excessive wear may continue; in such case, repair shall occur prior to issuance of a final inspection of the building permit. All damage that is a threat to public health or safety shall be repaired immediately. The street shall be restored to its condition prior to the new construction as established by the City Building Inspector and/or photo documentation, at the applicant's expense, before the issuance of a Certificate of Occupancy. h) Any heavy equipment brought to the construction site shall be transported by truck, where feasible. i) No materials or equipment shall be stored on the traveled roadway at any time. j) Prior to construction, a portable toilet facility and a debris box shall be installed on the site, and properly maintained through project completion. 	Prior to the issuance of a demolition, grading or building permit	City/Port

Environmental Impact	Standard Conditions of Approval/Mitigation Measures	Mitigation Implementation/ Monitoring:	
		Schedule	Responsibility
	<p>k) All equipment shall be equipped with mufflers.</p> <p>l) Prior to the end of each work day during construction, the contractor or contractors shall pick up and properly dispose of all litter resulting from or related to the project, whether located on the property, within the public rights-of-way, or properties of adjacent or nearby neighbors.</p> <p>Specifically, to further implement SCA TRANS-2, a traffic construction management analysis was performed which recommended certain improvements to the Adeline/5th and Adeline/3rd Street and Adeline Street intersection, which is discussed under construction impacts of the Traffic and Transportation section of the 2012 OARB Initial Study/Addendum.</p>		
	<p>Mitigation 4.3-13: Prior to commencing hazardous materials or hazardous waste remediation, demolition, or construction activities, a Traffic Control Plan (TCP) shall be implemented to control peak hours trips to the extent feasible, assure the safety on the street system and assure that transportation activities are protective of human health, safety, and the environment.</p> <p>Construction and remediation TCPs shall be designed and implemented to reduce to the maximum feasible extent traffic and safety impacts to regional and local roadways.</p> <p>The TCP shall address items including but not limited to: truck routes, street closures, parking for workers and staff, access to the project area and land closures or parking restrictions that may require coordination with and/or approval by the City, the Port and/or Caltrans. The TCP shall be submitted to the City Traffic Engineering and Planning divisions or the Port, as appropriate, for review and approval prior to the issuance of any building, demolition or grading permits. The City and the Port shall coordinate their respective approvals to maximize the effectiveness of the TCP measures. DTSC would have ongoing authority under its Remedial Action Plan/Remedial Monitoring Plan oversight and the Hazardous Substances Account Act to regulate remediation transportation activities, which must be protective of human health, safety and the environment.</p> <p>Remediation and demolition/construction traffic shall be restricted to designated truck routes within the City, and the TCP shall include a signage program for all truck routes serving the site during remediation or demolition/construction. A signage program details the location and type of truck route signs that would be installed during remediation and demolition/construction to direct trucks to and from the project area. Truck access points for entry and exit should be included in the TCP. In addition, as determined by City of Port staff, the developer shall be responsible for repairing any damage to the pavement that is caused by remediation or demolition/construction vehicles for restoring pavement to pre-construction conditions.</p> <p>Remediation and demolition/construction-related trips will be restricted to daytime hours, unless expressly permitted by the City or the Port, and to the extent feasible, trips will be minimized during the a.m. and p.m. peak hours.</p> <p>The TCP shall identify locations for construction/remediation staging. Remediation staging areas are anticipated to be located near construction areas, since remediation will be largely coordinated with redevelopment. In addition, the TCP shall identify and provide off-street parking for remediation and demolition/construction staff to the extent possible throughout all phases of redevelopment. If</p>	<p>Prior to issuance of first permit related to construction (e.g., demolition, grading, etc.)</p>	<p>City/Port</p>

Environmental Impact	Standard Conditions of Approval/Mitigation Measures	Mitigation Implementation/ Monitoring:	
		Schedule	Responsibility
	<p>there is insufficient parking available within walking distance of the site for workers, the developer shall provide a shuttle bus or other appropriate system to transfer workers between the satellite parking areas and remediation or demolition/construction site.</p> <p>The TCP shall also include measures to control dust, requirements to cover all loads to control odors, and provisions for emergency response procedures, health and safety driver education, and accident notification.</p>		
<p><u>Cumulative Impacts Year 2020 for 2012 OARB Project (Compared to Year 2025 for 2002 EIR Project)</u></p> <p>1. Increased congestion at signalized intersections outside the Downtown area exceeding the cumulatively significant threshold. (Year 2020)</p>	<p>Mitigation Measure 3.16-17: West Grand Avenue & I-880 Frontage Road (#2).</p> <ul style="list-style-type: none"> Optimize signal timing (i.e., adjust the allocation of green time for each intersection approach) for the AM peak hour. Coordinate the signal timing changes at this intersection with the adjacent intersections that are in the same signal coordination group. <p>To implement this measure, the project sponsor shall submit plans specifications and estimates (PS&E) as detailed in Mitigation Measure 3.16-1 that are consistent with the City's standards to City of Oakland's Transportation Engineering Division for review and approval.</p> <p>The project sponsor shall fund, prepare, and install the approved plans and improvements.</p>	At the time of issuance of the first Certificate of Occupancy (CO)	City/Port
	7th Street & I-880 Northbound Off-Ramp (#12). See above for Mitigation 3.16-1		
<p>2. One intersection located outside the downtown area, where the level of service is LOS E, the project would cause the total intersection average vehicle delay to increase by four (4) or more seconds, or degrade to worse than LOS E. (Year 2020)</p>	<p>Mitigation Measure 3.16-18: San Pablo Ave & Ashby Ave (#42).</p> <ul style="list-style-type: none"> Optimize signal timing (i.e., adjust the allocation of green time for each intersection approach) for the PM peak hour. Coordinate the signal timing changes at this intersection with the adjacent intersections that are in the same signal coordination group. <p>To implement this measure, the project sponsor shall coordinate with the City of Berkeley and Caltrans, and shall fund, prepare, and install the approved plans and improvements.</p>	At the time of issuance of the first Certificate of Occupancy (CO)	City/Port
<p>3. One intersection with LOS F, where the project would cause (a) the total intersection average vehicle delay to increase by two (2) or more seconds, or (b) an increase in average delay for any of the critical movements of four (4) seconds or more; or (c) the volume-to-capacity ("V/C") ratio exceeds three (3) percent. (Year 2020)</p>	12th Street and Castro Street (#29) - See above for Mitigation Measure 3.16-4.		
<p>4. Four roadway segments of the</p>	See above for Mitigation Measure 4.3-4 and SCA TRANS-1.		

Environmental Impact	Standard Conditions of Approval/Mitigation Measures	Mitigation Implementation/ Monitoring:		
		Schedule	Responsibility	
Congestion Management Program (CMP) would a) degrade to LOS F; or b) increase the V/C ratio by more than three percent for a roadway segment that would operate at LOS F without the project (Year 2020).				
<p><u>Cumulative Impacts for Year 2035 for 2012 OARB Project (Compared to Year 2025 for 2002 EIR Project)</u></p> <p>1. Three intersections located outside the Downtown area, which the project would cause the level of service (LOS) to degrade to worse than LOS D. (Year 2035)</p>	<p>Mitigation Measure 3.16-19: West Grand Avenue & Maritime Street (#1).</p> <ul style="list-style-type: none"> Optimize signal timing (i.e., adjust the allocation of green time for each intersection approach) for the PM peak hour. Coordinate the signal timing changes at this intersection with the adjacent intersections that are in the same signal coordination group. <p>To implement this measure, the project sponsor shall submit plans specifications and estimates (PS&E) as detailed in Mitigation Measure 3.16-1 that are consistent with the City's standards to City of Oakland's Transportation Engineering Division for review and approval.</p> <p>The project sponsor shall fund, prepare, and install the approved plans and improvements.</p>	Mitigation at this intersection may be required by Year 2028. Investigation of the need for this mitigation shall be studied in 2028 and every three years thereafter until 2035 or until the mitigation measure is implemented, whichever occurs first.	City/Port	
	<p>Mitigation Measure: 7th Street & I-880 Northbound Off-Ramp (#12). See above for Mitigation Measure 3.16-1.</p>			
	<p>Mitigation Measure 3.16-20: 7th Street & Union Street (#15).</p> <ul style="list-style-type: none"> Optimize signal timing (i.e., adjust the allocation of green time for each intersection approach) for the AM peak hour. Coordinate the signal timing changes at this intersection with the adjacent intersections that are in the same signal coordination group. <p>To implement this measure, the project sponsor shall submit plans specifications and estimates (PS&E) as detailed in Mitigation Measure 3.16-1 that are consistent with the City's standards to City of Oakland's Transportation Engineering Division for review and approval.</p> <p>The project sponsor shall fund, prepare, and install the approved plans and improvements.</p>	Mitigation at this intersection may be required by Year 2032. Investigation of the need for this mitigation shall be studied in 2032 and every three years thereafter until 2035 or until the mitigation measure is implemented, whichever occurs first.	City/Port	
1. At one intersection located within the Downtown area, the project would cause the LOS to degrade to worse than LOS E. (Year 2035)	<p>Mitigation Measure 3.16-21: West Grand Avenue & Northgate Avenue (#8).</p> <ul style="list-style-type: none"> Optimize signal timing (i.e., adjust the allocation of green time for each intersection approach) for the AM peak hour. 	Mitigation at this intersection may be required by Year 2030. Investigation of the need for this	City/Port	

Environmental Impact	Standard Conditions of Approval/Mitigation Measures	Mitigation Implementation/ Monitoring:	
		Schedule	Responsibility
	<ul style="list-style-type: none"> Coordinate the signal timing changes at this intersection with the adjacent intersections that are in the same signal coordination group. <p>To implement this measure, the project sponsor shall submit plans specifications and estimates (PS&E) as detailed in Mitigation Measure 3.16-1 that are consistent with the City's standards to City of Oakland's Transportation Engineering Division for review and approval.</p> <p>The project sponsor shall fund, prepare, and install the approved plans and improvements.</p>	mitigation shall be studied in 2030 and every three years thereafter until 2035 or until the mitigation measure is implemented, whichever occurs first.	
3. At two intersections located outside the Downtown area where the level of service is LOS E, would the project cause the total intersection average vehicle delay to increase by four (4) or more seconds, or degrade to worse than LOS E (Year 2035)	<p>Mitigation Measure 3.16-22: 5th Street & Union Street / I-880 North Ramps (#21).</p> <ul style="list-style-type: none"> Optimize signal timing (i.e., increase the traffic signal cycle length to 100 seconds and adjust the allocation of green time for each intersection approach) for the PM peak hour. Coordinate the signal timing changes at this intersection with the adjacent intersections that are in the same signal coordination group. <p>To implement this measure, the project sponsor shall submit plans specifications and estimates (PS&E) as detailed in Mitigation Measure 3.16-1 that are consistent with the City's standards to City of Oakland's Transportation Engineering Division for review and approval.</p> <p>The project sponsor shall fund, prepare, and install the approved plans and improvements.</p>	Mitigation at this intersection may be required by Year 2022. Investigation of the need for this mitigation shall be studied in 2022 and every three years thereafter until 2035 or until the mitigation measure is implemented, whichever occurs first.	City/Port
	<p>Mitigation Measure 3.16-23: MacArthur Boulevard & Market Street (#33).</p> <ul style="list-style-type: none"> Optimize signal timing (i.e., adjust the allocation of green time for each intersection approach) for the AM peak hour. Coordinate the signal timing changes at this intersection with the adjacent intersections that are in the same signal coordination group. <p>To implement this measure, the project sponsor shall submit plans specifications and estimates (PS&E) as detailed in Mitigation Measure 3.16-1 that are consistent with the City's standards to City of Oakland's Transportation Engineering Division for review and approval.</p> <p>The project sponsor shall fund, prepare, and install the approved plans and improvements.</p>	Mitigation at this intersection may be required by Year 2032. Investigation of the need for this mitigation shall be studied in 2032 and every three years thereafter until 2035 or until the mitigation measure is implemented, whichever occurs first.	City/Port
4. Eleven intersections where the level of service is LOS F, the project would cause (a) the total intersection average vehicle delay to increase by two (2) or	<p>Mitigation Measure 3.16- 24: West Grand Avenue & I-880 Frontage Road (#2).</p> <ul style="list-style-type: none"> Optimize signal timing (i.e., increase the traffic signal cycle length and adjust the allocation of green time for each intersection approach) for the AM and PM peak hours. 	Mitigation at this intersection may be required by Year 2021. Investigation	City/Port

Environmental Impact	Standard Conditions of Approval/Mitigation Measures	Mitigation Implementation/ Monitoring:	
		Schedule	Responsibility
<p>more seconds, or (b) an increase in average delay for any of the critical movements of four (4) seconds or more; or (c) the volume-to-capacity (“V/C”) ratio increases 0.03 or more (but only if the delay values are greater than 120 seconds of average intersection delay as delay values over 120 seconds tend to increase exponentially and are then generally considered unreliable). (Year 2035)</p>	<ul style="list-style-type: none"> Coordinate the signal timing changes at this intersection with the adjacent intersections that are in the same signal coordination group <p>To implement this measure, the project sponsor shall submit plans specifications and estimates (PS&E) as detailed in Mitigation Measure 3.16-1 that are consistent with the City’s standards to City of Oakland’s Transportation Engineering Division for review and approval.</p> <p>The project sponsor shall fund, prepare, and install the approved plans and improvements.</p>	of the need for this mitigation shall be studied in 2021 and every three years thereafter until 2035 or until the mitigation measure is implemented, whichever occurs first.	
	<p>Mitigation Measure 3.16- 25: West Grand Avenue & Adeline Street (#4).</p> <ul style="list-style-type: none"> Optimize signal timing (i.e., increase the traffic signal cycle length to 90 seconds and adjust the allocation of green time for each intersection approach) for the PM peak hour. Coordinate the signal timing changes at this intersection with the adjacent intersections that are in the same signal coordination group. <p>To implement this measure, the project sponsor shall submit plans specifications and estimates (PS&E) as detailed in Mitigation Measure 3.16-1 that are consistent with the City’s standards to City of Oakland’s Transportation Engineering Division for review and approval.</p> <p>The project sponsor shall fund, prepare, and install the approved plans and improvements.</p>	Mitigation at this intersection may be required by Year 2032. Investigation of the need for this mitigation shall be studied in 2032 and every three years thereafter until 2035 or until the mitigation measure is implemented, whichever occurs first.	City/Port
	<p>Mitigation Measure 3.16- 26: West Grand Avenue & Market Street (#5)</p> <ul style="list-style-type: none"> Provide split phasing for northbound and southbound movements. Optimize signal timing (i.e., increase the traffic signal cycle length to 120 seconds and adjust the allocation of green time for each intersection approach) for both the AM and PM peak hours. Coordinate the signal timing changes at this intersection with the adjacent intersections that are in the same signal coordination group. <p>To implement this measure, the project sponsor shall submit plans specifications and estimates (PS&E) as detailed in Mitigation Measure 3.16-1 that are consistent with the City’s standards to City of Oakland’s Transportation Engineering Division for review and approval.</p> <p>The project sponsor shall fund, prepare, and install the approved plans and improvements.</p>	Mitigation at this intersection may be required by Year 2022. Investigation of the need for this mitigation shall be studied in 2022 and every three years thereafter until 2035 or until the mitigation measure is implemented, whichever occurs first.	City/Port
	<p>Mitigation Measure 3.16- 27: West Grand Avenue & San Pablo Avenue (#6)</p> <ul style="list-style-type: none"> Remove approximately seven (7) parking spaces on the south side of West Grand Avenue; add an eastbound through lane between San Pablo Avenue and Martin Luther King Jr. Way; and convert 	Mitigation at this intersection may be required by Year 2026. Investigation	City/Port

Environmental Impact	Standard Conditions of Approval/Mitigation Measures	Mitigation Implementation/ Monitoring:	
		Schedule	Responsibility
	<p>the eastbound right turn lane to a through-right combination lane.</p> <ul style="list-style-type: none"> • Optimize signal timing (i.e., adjust the allocation of green time for each intersection approach) for the PM peak hour. • Coordinate the signal timing changes at this intersection with the adjacent intersections that are in the same signal coordination group. <p>To implement this measure, the project sponsor shall submit plans specifications and estimates (PS&E) as detailed in Mitigation Measure 3.16-1 that are consistent with the City's standards to City of Oakland's Transportation Engineering Division for review and approval.</p> <p>The project sponsor shall fund, prepare, and install the approved plans and improvements.</p>	of the need for this mitigation shall be studied in 2026 and every three years thereafter until 2035 or until the mitigation measure is implemented, whichever occurs first.	
	<p>Mitigation Measure 3.16- 28: West Grand Avenue & Harrison Street (#9)</p> <ul style="list-style-type: none"> • Optimize signal timing (i.e., adjust the allocation of green time for each intersection approach) for the PM peak hour. • Coordinate the signal timing changes at this intersection with the adjacent intersections that are in the same signal coordination group. <p>To implement this measure, the project sponsor shall submit plans specifications and estimates (PS&E) as detailed in Mitigation Measure 3.16-1 that are consistent with the City's standards to City of Oakland's Transportation Engineering Division for review and approval.</p> <p>The project sponsor shall fund, prepare, and install the approved plans and improvements.</p>	Mitigation at this intersection may be required by Year 2025. Investigation of the need for this mitigation shall be studied in 2025 and every three years thereafter until 2035 or until the mitigation measure is implemented, whichever occurs first.	City/Port
	<p>Mitigation Measure 3.16- 29: 7th Street & Harrison Street (#18)</p> <ul style="list-style-type: none"> • Optimize signal timing (i.e., increase the traffic signal cycle length to 80 seconds and adjust the allocation of green time for each intersection approach) for the PM peak hour. • Coordinate the signal timing changes at this intersection with the adjacent intersections that are in the same signal coordination group. <p>To implement this measure, the project sponsor shall submit plans specifications and estimates (PS&E) as detailed in Mitigation Measure 3.16-1 that are consistent with the City's standards to City of Oakland's Transportation Engineering Division for review and approval.</p> <p>The project sponsor shall fund, prepare, and install the approved plans and improvements.</p>	Mitigation at this intersection may be required at the time of Project construction. Investigation of the need for this mitigation shall be studied at the time of construction and every three years thereafter until 2035 or until the mitigation measure is implemented, whichever occurs first.	City/Port

Environmental Impact	Standard Conditions of Approval/Mitigation Measures	Mitigation Implementation/ Monitoring:	
		Schedule	Responsibility
	<p>Mitigation Measure 3.16- 30: 6th Street & Jackson Street (#20)</p> <ul style="list-style-type: none"> • Optimize signal timing (i.e., increase the traffic signal cycle length to 80 seconds and adjust the allocation of green time for each intersection approach) for the AM peak hour. • Coordinate the signal timing changes at this intersection with the adjacent intersections that are in the same signal coordination group. <p>To implement this measure, the project sponsor shall submit plans specifications and estimates (PS&E) as detailed in Mitigation Measure 3.16-1 that are consistent with the City’s standards to City of Oakland’s Transportation Engineering Division for review and approval.</p> <p>The project sponsor shall fund, prepare, and install the approved plans and improvements.</p>	Mitigation at this intersection may be required by Year 2025. Investigation of the need for this mitigation shall be studied in 2025 and every three years thereafter until 2035 or until the mitigation measure is implemented, whichever occurs first.	City/Port
	<p>Mitigation Measure 3.16- 31: 12th Street & Brush Street (#28)</p> <ul style="list-style-type: none"> • Optimize signal timing (i.e., increase the traffic signal cycle length to 120 seconds and adjust the allocation of green time for each intersection approach) for the AM peak hour. • Coordinate the signal timing changes at this intersection with the adjacent intersections that are in the same signal coordination group. <p>To implement this measure, the project sponsor shall submit plans specifications and estimates (PS&E) as detailed in Mitigation Measure 3.16-1 that are consistent with the City’s standards to City of Oakland’s Transportation Engineering Division for review and approval.</p> <p>The project sponsor shall fund, prepare, and install the approved plans and improvements.</p>	Mitigation at this intersection may be required by Year 2023. Investigation of the need for this mitigation shall be studied in 2023 and every three years thereafter until 2035 or until the mitigation measure is implemented, whichever occurs first.	City/Port
	12th Street & Castro Street (#29). See Mitigation Measure 3.16-4 above.		
	<p>Mitigation Measure 3.16- 32: Powell Street & Hollis Street (#37)</p> <ul style="list-style-type: none"> • Provide protected plus permitted traffic signal phasing for the northbound and southbound Hollis Street movements. • Optimize signal timing (i.e., adjust the allocation of green time for each intersection approach) for both the AM and PM peak hours. • Coordinate the signal timing changes at this intersection with the adjacent intersections that are in the same signal coordination group. <p>To implement this measure, the project sponsor shall submit plans specifications and estimates (PS&E) as detailed in Mitigation Measure 3.16-1 that are consistent with the City’s standards to</p>	Mitigation at this intersection may be required by Year 2028. Investigation of the need for this mitigation shall be studied in 2028 and every three years thereafter until 2035 or until the mitigation measure is implemented,	City/Port

Environmental Impact	Standard Conditions of Approval/Mitigation Measures	Mitigation Implementation/ Monitoring:	
		Schedule	Responsibility
	<p>City of Emeryville's Transportation Engineering Division for review and approval.</p> <p>The project sponsor shall fund, prepare, and install the approved plans and improvements.</p>	whichever occurs first.	
	<p>Mitigation Measure 3.16- 33: Powell Street/Stanford Avenue & San Pablo Avenue (#38)</p> <ul style="list-style-type: none"> • Optimize signal timing (i.e., adjust the allocation of green time for each intersection approach) for the AM peak hour. • Coordinate the signal timing changes at this intersection with the adjacent intersections that are in the same signal coordination group. <p>To implement this measure, the project sponsor shall submit plans specifications and estimates (PS&E) as detailed in Mitigation Measure 3.16-1 that are consistent with the City's standards to City of Oakland's Transportation Engineering Division for review and approval.</p> <p>The project sponsor shall fund, prepare, and install the approved plans and improvements.</p>	Mitigation at this intersection may be required by Year 2021. Investigation of the need for this mitigation shall be studied in 2021 and every three years thereafter until 2035 or until the mitigation measure is implemented, whichever occurs first.	City/Port
4. Four roadway segments of the Congestion Management Program (CMP) would a) degrade to LOS F; or b) increase the V/C ratio by more than three percent for a roadway segment that would operate at LOS F without the project (Year 2035).	See above for Mitigation Measure 4.3-4		
<p>Planning Related Non-CEQA Issues</p> <p>Queuing</p> <p>Existing Plus Project: The project would result in exceedance of available storage capacity at only the following locations:</p> <ul style="list-style-type: none"> • Northbound left-turn at W. Grand Avenue & Maritime Street (#1) - PM peak hour • Westbound left-turn at 7th Street & Maritime Street (#10) – AM & PM peak hours • Eastbound left-turn at 7th Street & I-880 northbound off-ramp (#12) – PM 	<p>Recommended Measures (not required by CEQA)</p> <p>The following improvements are recommended to accommodate the anticipated queues:</p> <ul style="list-style-type: none"> ▪ W. Grand Avenue & Maritime Street (#1). Extend the northbound left-turn storage length to 475 feet; while providing a minimum of 100 feet storage length for the southbound left-turn movement at the Burma Road and Maritime Street intersection (#46). ▪ 7th Street & Maritime Street (#10). Extend the westbound left-turn storage length to 320 feet by removing a portion of the existing center median. ▪ 7th Street & I-880 northbound off-ramp (#12). Convert one of the existing eastbound through lane to an exclusive left-turn lane to provide two left-turn lanes, and one through lane. 	At issuance of first Certificate of Occupancy (CO)	City/Port

Environmental Impact	Standard Conditions of Approval/Mitigation Measures	Mitigation Implementation/ Monitoring:	
		Schedule	Responsibility
peak hour			
<p>Year 2020 cumulative conditions: Similar to Existing plus Project conditions, the Project would result in exceedance of available storage at the same three intersections:</p> <ul style="list-style-type: none"> • Northbound left-turn at W. Grand Avenue & Maritime Street (#1) - PM peak hour • Westbound left-turn at 7th Street & Maritime Street (#10) – AM & PM peak hours • Eastbound and southbound left-turn at 7th Street & I-880 northbound off-ramp (#12) – PM peak hour 	<p>Recommended Measures (not required by CEQA) The following improvements are recommended to accommodate the anticipated queues:</p> <ul style="list-style-type: none"> ▪ W. Grand Avenue & Maritime Street (#1). Widen Maritime Street to provide two northbound left-turn lanes at the intersection. ▪ 7th Street & Maritime Street (#10). Extend the westbound left-turn storage length to 320 feet by removing a portion of the existing center median. ▪ 7th Street & I-880 northbound off-ramp (#12). Convert one of the existing eastbound through lane to an exclusive left-turn lane to provide two left-turn lanes, and one through lane; and extend the southbound left-turn storage pocket to 250 feet by removing a portion of the existing center median. 	At issuance of first Certificate of Occupancy (CO) or 2020, whichever is later	City/Port
Utilities			
1. Exceed wastewater treatment requirements of the applicable Regional Water Quality Control Board?	See above for SCA HYD-4 (Hydrology and Water Quality section)		
2. Require or result in the construction of new water or wastewater treatment facilities or expansion of existing facilities, the construction of which could cause significant environmental effects?	<p>SCA UTL-3: Underground Utilities: The project applicant shall submit plans for review and approval by the Building Services Division and the Public Works Agency, and other relevant agencies as appropriate, that show all new electric and telephone facilities; fire alarm conduits; street light wiring; and other wiring, conduits, and similar facilities placed underground. The new facilities shall be placed underground along the project applicant's street frontage and from the project applicant's structures to the point of service. The plans shall show all electric, telephone, water service, fire water service, cable, and fire alarm facilities installed in accordance with standard specifications of the serving utilities.</p>	Prior to issuance of a building permit.	City/Port
	<p>SCA UTL-5: Improvements in the Public Right-of Way (Specific): Final building and public improvement plans submitted to the Building Services Division shall include the following components: Examples include:</p> <ul style="list-style-type: none"> a) Install additional standard City of Oakland streetlights. b) Remove and replace any existing driveway that will not be used for access to the property with new concrete sidewalk, curb and gutter. c) Reconstruct drainage facility to current City standard. d) Provide separation between sanitary sewer and water lines to comply with current City of Oakland and Alameda Health Department standards. 	Approved prior to the issuance of a grading or building permit.	City/Port

Environmental Impact	Standard Conditions of Approval/Mitigation Measures	Mitigation Implementation/ Monitoring:	
		Schedule	Responsibility
	<p>e) Construct wheelchair ramps that comply with Americans with Disability Act requirements and current City Standards.</p> <p>f) Remove and replace deficient concrete sidewalk, curb and gutter within property frontage.</p> <p>g) Provide adequate fire department access and water supply, including, but not limited to currently adopted fire codes and standards.</p>		
	<p>SCA UTL-6: Payment for Public Improvements: The project applicant shall pay for and install public improvements made necessary by the project including damage caused by construction activity.</p>	Prior to issuance of a final inspection of the building permit.	City/Port
3. Have sufficient water supplies available to serve the project from existing entitlements and resources, or are new or expanded entitlements needed?	<p>Mitigation 4.9-4: Individual actions with landscaping requirements of one or more acres shall plumb landscape areas for irrigation with recycled water.</p> <p>As subsequent redevelopment activities are designed, the City and Port would require that activities of a certain magnitude shall include a reclaimed landscaping irrigation system. The City and Port would make this a condition of approval for private actions that require such approval, and would include reclaimed landscape water systems in the design of their own public projects.</p>	Prior to issuance of a building permit or other construction-related permit.	City/Port
	<p>Mitigation 4.9-5: Individual buildings with gross floor area exceeding 10,000 square feet shall install dual plumbing for both potable and recycled water, unless determined to be infeasible by the approving agency (City or Port).</p> <p>Any major subsequent redevelopment activity that includes total usable floor area within or more building of 10,000 square feet or more would be required to provide a dual plumbing system—one for potable water, and one for reclaimed water. Reclaimed water may be used for certain industrial uses, and for landscape irrigation, toilet flushing, and other appropriate purposes.</p>	Prior to issuance of a building permit or other construction-related permit.	City/Port
	<p>Mitigation 4.9-6: Site design shall facilitate use of recycled water, and shall comply with requirements of CCR Title 22 regarding prohibitions of site run-off to surface waters.</p> <p>When subsequent redevelopment activities are required to include reclaimed water in their design, the City and Port would ensure that requirements of Title 22 intended to protect the environment are reflected in that design, including prohibitions against run-off to surface waters. The City, Port, and proponents of subsequent redevelopment activities should coordinate these efforts with the reclaimed water supplier, EBMUD.</p>	Prior to issuance of a building permit or other construction-related permit.	City/Port
	<p>SCA UTL-1a: Compliance with the Green Building Ordinance, OMC Chapter 18.02:</p> <p><i>(Note: Final details for text highlighted in gray below to be provided upon issuance of a permit)</i></p> <p>Prior to issuance of a demolition, grading, or building permit</p> <p>The applicant shall comply with the requirements of the California Green Building Standards (CALGreen) mandatory measures and the applicable requirements of the Green Building Ordinance,</p>	Prior to issuance of a demolition, grading, or building permit; or during construction or after construction as specified in SCA	City/Port

Environmental Impact	Standard Conditions of Approval/Mitigation Measures	Mitigation Implementation/ Monitoring:	
		Schedule	Responsibility
	<p>OMC Chapter 18.02.</p> <p>a) The following information shall be submitted to the Building Services Division for review and approval with the application for a building permit:</p> <ul style="list-style-type: none"> i. Documentation showing compliance with Title 24 of the 2008 California Building Energy Efficiency Standards. ii. Completed copy of the final green building checklist approved during the review of the Planning and Zoning permit. iii. Copy of the Unreasonable Hardship Exemption, if granted, during the review of the Planning and Zoning permit. iv. Permit plans that show, in general notes, detailed design drawings, and specifications as necessary, compliance with the items listed in subsection (b) below. v. Copy of the signed statement by the Green Building Certifier approved during the review of the Planning and Zoning permit that the project complied with the requirements of the Green Building Ordinance. vi. Signed statement by the Green Building Certifier that the project still complies with the requirements of the Green Building Ordinance, unless an Unreasonable Hardship Exemption was granted during the review of the Planning and Zoning permit. vii. Other documentation as deemed necessary by the City to demonstrate compliance with the Green Building Ordinance. <p>b) The set of plans in subsection (a) shall demonstrate compliance with the following:</p> <ul style="list-style-type: none"> i. CALGreen mandatory measures. ii. All pre-requisites per the LEED / GreenPoint Rated checklist approved during the review of the Planning and Zoning permit, or, if applicable, all the green building measures approved as part of the Unreasonable Hardship Exemption granted during the review of the Planning and Zoning permit. iii. Insert green building point level/certification requirement: (See Green Building Summary Table) per the appropriate checklist approved during the Planning entitlement process. iv. All green building points identified on the checklist approved during review of the Planning and Zoning permit, unless a Request for Revision Plan-check application is submitted and approved by the Planning and Zoning Division that shows the previously approved points that will be eliminated or substituted. v. The required green building point minimums in the appropriate credit categories. <p><i>During construction</i></p> <p>The applicant shall comply with the applicable requirements CALGreen and the Green Building Ordinance, Chapter 18.02.</p> <p>a) The following information shall be submitted to the Building Inspections Division of the</p>	UTL-1a or UTL-1b.	

Environmental Impact	Standard Conditions of Approval/Mitigation Measures	Mitigation Implementation/ Monitoring:	
		Schedule	Responsibility
	<p>Building Services Division for review and approval:</p> <ul style="list-style-type: none"> i. Completed copies of the green building checklists approved during the review of the Planning and Zoning permit and during the review of the building permit. ii. Signed statement(s) by the Green Building Certifier during all relevant phases of construction that the project complies with the requirements of the Green Building Ordinance. iii. Other documentation as deemed necessary by the City to demonstrate compliance with the Green Building Ordinance. <p><i>After construction, as specified below</i></p> <p>Within sixty (60) days of the final inspection of the building permit for the project, the Green Building Certifier shall submit the appropriate documentation to Build It Green/Green Building Certification Institute and attain the minimum certification/point level identified in subsection (a) above. Within one year of the final inspection of the building permit for the project, the applicant shall submit to the Planning and Zoning Division the Certificate from the organization listed above demonstrating certification and compliance with the minimum point/certification level noted above.</p> <p><u>SCA UTL-1b: Compliance with the Green Building Ordinance, OMC Chapter 18.02, for Building and Landscape Projects Using the StopWaste.Org Small Commercial or Bay Friendly Basic Landscape Checklist</u></p> <p><i>Prior to issuance of a building permit</i></p> <p>The applicant shall comply with the requirements of the California Green Building Standards (CALGreen) mandatory measures and the applicable requirements of the Green Building Ordinance, (OMC Chapter 18.02.) for projects using the StopWaste.Org Small Commercial or Bay Friendly Basic Landscape Checklist.</p> <ul style="list-style-type: none"> a) The following information shall be submitted to the Building Services Division for review and approval with application for a Building permit: <ul style="list-style-type: none"> i. Documentation showing compliance with the 2008 Title 24, California Building Energy Efficiency Standards. ii. Completed copy of the green building checklist approved during the review of a Planning and Zoning permit. iii. Permit plans that show in general notes, detailed design drawings and specifications as necessary compliance with the items listed in subsection (b) below. iv. Other documentation to prove compliance. b) The set of plans in subsection (a) shall demonstrate compliance with the following: <ul style="list-style-type: none"> i. CALGreen mandatory measures. ii. All applicable green building measures identified on the StopWaste.Org checklist approved during the review of a Planning and Zoning permit, or submittal of a Request for 		

Environmental Impact	Standard Conditions of Approval/Mitigation Measures	Mitigation Implementation/ Monitoring:	
		Schedule	Responsibility
	<p>Revision Plan-check application that shows the previously approved points that will be eliminated or substituted.</p> <p>During construction The applicant shall comply with the applicable requirements of CALGreen and Green Building Ordinance, Chapter 18.02 for projects using the StopWaste.Org Small Commercial or Bay Friendly Basic Landscape Checklist.</p> <p>a) The following information shall be submitted to the Building Inspections Division for review and approval:</p> <p>i. Completed copy of the green building checklists approved during review of the Planning and Zoning permit and during the review of the Building permit.</p> <p>ii. Other documentation as deemed necessary by the City to demonstrate compliance with the Green Building Ordinance.</p>		
4. Result in a determination by the wastewater treatment provider, which serves or may serve the project that it has adequate capacity to serve the project's projected demand in addition to the provider's existing commitments?	See above for SCA HYD-4 (Hydrology and Water Quality section)		
5. Be served by a landfill with sufficient permitted capacity to accommodate the project's solid waste disposal needs?	<p>SCA UTL-2: Waste Reduction and Recycling:The project applicant will submit a Construction & Demolition Waste Reduction and Recycling Plan (WRRP) and an Operational Diversion Plan (ODP) for review and approval by the Public Works Agency.</p> <p>Prior to issuance of demolition, grading, or building permit</p> <p>Chapter 15.34 of the Oakland Municipal Code outlines requirements for reducing waste and optimizing construction and demolition (C&D) recycling. Affected projects include all new construction, renovations/alterations/modifications with construction values of \$50,000 or more (except R-3), and all demolition (including soft demo). The WRRP must specify the methods by which the development will divert C&D debris waste generated by the proposed project from landfill disposal in accordance with current City requirements. Current standards, FAQs, and forms are available at http://www2.oaklandnet.com/Government/o/PWA/o/FE/s/GAR/OAK024368 or in the Green Building Resource Center. After approval of the plan, the project applicant shall implement the plan.</p> <p>Ongoing</p> <p>The ODP will identify how the project complies with the Recycling Space Allocation Ordinance, (Chapter 17.118 of the Oakland Municipal Code), including capacity calculations, and specify the methods by which the development will meet the current diversion of solid waste generated by</p>	Prior to issuance of demolition, grading, or building permit; or ongoing as specified in SCA UTL-2.	City/Port

Environmental Impact	Standard Conditions of Approval/Mitigation Measures	Mitigation Implementation/ Monitoring:	
		Schedule	Responsibility
	operation of the proposed project from landfill disposal in accordance with current City requirements. The proposed program shall be implemented and maintained for the duration of the proposed activity or facility. Changes to the plan may be re-submitted to the Environmental Services Division of the Public Works Agency for review and approval. Any incentive programs shall remain fully operational as long as residents and businesses exist at the project site.		
	<p>Mitigation 4.9-7: To the maximum extent feasible, the City and Port shall jointly participate in a deconstruction program to capture materials and recycle them into the construction market.</p> <p>Substantial quantities of construction debris would be generated by the removal of structures at the OARB, in both the Gateway and Port development areas. Some of the buildings span both development areas, and coordination between the Port and City is critical in reducing the amount of solid waste disposal that occurs in this sub-district. The City and Port would jointly plan, implement, and operate a program whereby buildings would be deconstructed, rather than demolished, and the resulting material would be recycled to the construction market as practicable. Material for recycling may include, and is not limited to, timbers and siding, ceramic fixtures, metal, and copper wiring. The City and Port may elect to partner with local job-training bridge programs to provide construction training opportunities to Oakland residents through their deconstruction program.</p>	Prior to issuance of a demolition permit	City/Port
	<p>Mitigation 4.9-8: Concrete and asphalt removed during demolition/construction shall be crushed on site or at a near site location, and reused in redevelopment or recycled to the construction market.</p> <p>Foundation and paving removal would generate substantial debris, and the City and Port would ensure these materials are crushed and recycled. As a first preference, these materials should be re-used on-site; as a second preference, they would be sold to the construction market. The City and Port would make every effort practicable to avoid disposal to landfill of this material.</p> <p>This mitigation measure may itself result in impacts to the environment relative to noise and air quality. These impacts are discussed in Sections 4.4: Air Quality, and 4.15: Noise.</p>	On-going, during construction	City/Port
6. Comply with federal, State, and local statutes and regulations related to solid waste?	See above for SCA UTL-2		
7. Would the project violate applicable federal, state and local statutes and regulations relating to energy standards?	See above for SCA UTL-1		

Environmental Impact	Standard Conditions of Approval/Mitigation Measures	Mitigation Implementation/ Monitoring:	
		Schedule	Responsibility
8. Would the project result in a determination by the energy provider which serves or may serve the project that it does not have adequate capacity to serve the project's projected demand in addition to the providers' existing commitments and require or result in construction of new energy facilities or expansion of existing facilities, construction of which could cause significant environmental effects?	See above for SCA UTL-1		

Appendix B

Safety Data Sheet for ERA Material



MATERIAL SAFETY DATA SHEET

Issue Date: April 12, 2018

1. IDENTIFICATION OF THE PRODUCT AND THE COMPANY

Product Name: Natural Sand and Gravel

Supplier: Orca Sand & Gravel Ltd.
PO Box 699
6505 Island Highway
Port McNeill, British Columbia
V0N 2R0, Canada
Telephone: (604) 628 3353, Facsimile: (604) 628 3354

Common Names: Construction Aggregate, Concrete Sand, Concrete Gravel

2. COMPOSITION INFORMATION ON INGREDIENTS

Identification Of Ingredients: Natural sand and gravel consisting of particles of volcanic and igneous rocks with a varying composition.

The product typically contains less than 5% of quartzite (a mineral consisting predominantly of crystalline silica).

3. HAZARDS IDENTIFICATION

Potential Hazards: Dust which may irritate the eyes, respiratory tract and skin. Avoid breathing excessive dust. If the product is being sawn, ground or pulverized, usually as a result of being present in a hardened concrete product, the fine dust liberated should not be inhaled.

4. FIRST AID MEASURES

Inhalation: Move to fresh air. If this is not possible, wear a suitable NIOSH-approved respirator when dust levels exceed, or are likely to exceed, allowable exposure limits. A qualified health and safety professional should evaluate this need.

Eye Contact: Immediately flush eyes with plenty of clean water especially under the eyelids. Consult a physician if irritation persists or develops later.

Skin Contact: Wash affected skin area with mild soap and clean water. Consult a physician if irritation persists or develops later.

Ingestion: This product is not considered toxic. If person is conscious do not induce vomiting, give large quantity of water and get medical attention.

5. FIRE FIGHTING MEASURES

Extinguishing Media: This product is non-flammable and its presence in a fire does not prevent the use of any standard extinguishing media.

No special precautions are required.

6. ACCIDENTAL RELEASE MEASURES

Personal Precautions: No special precautions required. If cleanup is required where dust may be generated follow Section 4 requirements under "Inhalation". Do not dry sweep or use compressed air to recover spilled material.

Environmental Precautions: Prevent spilled material from entering storm drains, sewers, streams or other watercourses.

7. HANDLING AND STORAGE

Handling: Avoid contact with skin and eyes. Avoid dust formation. Use personal protection and controls as identified in Section 8.

Storage: Do not store near food.

8. EXPOSURE CONTROLS AND PERSONAL PROTECTION

Eye Protection: Wear safety glasses with side shields or dust goggles if excessively dusty conditions are present. Do not wear contact lenses.

Skin Protection: Wear gloves and long sleeved clothing.

Respiratory Protection: Dust safety masks to be worn appropriate to the exposure level present. All respirators must be NIOSH-approved. A health and safety professional should assess the exposure level and allowable limits and recommend appropriate respirators. Particular care should be taken if respirable silica levels are likely to exceed the appropriate Time Weighted Average.

Engineering Controls: Activities that generate dust require the use of natural ventilation or local extraction and exhaust of atmosphere and/or wet suppression methods for control of exposure. Respirable dust and quartz levels should be monitored regularly to determine worker exposure levels and where measured exposure is in excess of allowable exposure limits then engineering controls should be implemented wherever possible.

Hygiene Measures: Wash hands at the end of the workday, wash work clothing regularly.

9. PHYSICAL AND CHEMICAL PROPERTIES

- Form:** Granular solid consisting of multicolored round or angular particles.
- Specific Gravity:** 2.70 to 2.90 (H₂O = 1.0)
- Other Properties:** None to be considered, the product is a stable solid mineral which is insoluble in water.

10. STABILITY AND REACTIVITY

- Stability:** Stable under normal temperatures and pressures.
- Conditions to Avoid:** Contact with powerful oxidizing agents such as hydrofluoric acid and fluorine.
- Hazardous Decomposition Products:** Thermal decomposition of quartz begins above 860°C (1580°F) when it slowly transforms into tridymite a form of the mineral considered more problematic to the respiratory system than quartz.

11. TOXICOLOGICAL INFORMATION

- Acute Effects:** No specific data on product.
- Prolonged or Repeated Exposure:** Prolonged exposure to respirable dusts in excess of allowable exposure can cause inflammation of the lungs leading to a medical condition known as pneumoconiosis. Prolonged exposure respirable dusts containing crystalline silica in excess of allowable exposure limits may cause a chronic form of silicosis an incurable lung disease.
- Carcinogenicity:** In October 1996, an IARC Working Group designated respirable crystalline silica as carcinogenic (Group 1). The American Conference of Governmental Industrial Hygienists (ACGIH) in 2000 listed respirable crystalline silica (quartz) as a suspected human carcinogen (A-2).

12. ECOLOGICAL INFORMATION

- Aquatic:** This product is not toxic to aquatic organisms.
- Environmental Fate:** No specific data, product is considered to be non-biodegradable.

13. DISPOSAL CONSIDERATIONS

- Unused Product/Spillage:** Dispose in accordance with federal, state and local regulation for solid, non-hazardous wastes.

14. TRANSPORT INFORMATION

DOT: This product is not regulated by DOT.

USDA / APHIS: This product is not regulated by USDA or APHIS.

15. REGULATORY INFORMATION

CERCLA/RCRA: Not reportable, not a hazardous waste.

Hazardous Waste Number: Not applicable.

California Proposition 65: This product contains a chemical (crystalline silica) known to the State of California to cause cancer.

**Cal/OSHA
8 CCR 1529, 5208:** This product does not contain 0.1% or greater of asbestiform minerals by weight and is free of any component that would trigger any of the applicable requirements of Cal/OSHA 8 CCR 1529 or 5208.

16. OTHER INFORMATION

Contact Persons: Scott Dryden, President & CEO
Telephone: (604) 915-5000 ext 106, Facsimile: (604) 915-5001

Mike McDonald, Manager, Technical Services
Telephone: (604) 628-3353 ext 104, Facsimile: (604) 628-3354

DISCLAIMER OF LIABILITY

Orca Sand & Gravel Ltd. presents this information in good faith believing it to be accurate but assumes no liability in connection with the use of this information by any party.

Orca Sand & Gravel Ltd. does not accept responsibility for compliance with federal, state or local laws and regulation in any jurisdiction in which the product is used. Parties using this product should always seek their own legal advice prior to use.

No warranty is made, either expressed or implied, of the fitness of the product for any purpose.

Appendix C

Air Quality and Greenhouse Gas Analysis



APPENDIX C AIR QUALITY AND GREENHOUSE GAS ANALYSIS

Project Applicant:

Eagle Rock Aggregates
1055 West Georgia St. Suite 2740
PO Box 11175
Vancouver, BC V6E 3P3

Lead Agency:

Port of Oakland
530 Water Street,
Oakland, CA 94607

Alta Project: EGLR-19-8635

October 29, 2020

Contents

1	Introduction	6
1.1	Introduction.....	6
2	Operations	7
2.1	Ocean-Going Vessels.....	7
2.2	Assist Tugs.....	15
2.3	Barge Tugs.....	16
2.4	Aggregate Transfer and Storage.....	17
2.5	Off-Road Equipment.....	19
2.6	Trucks.....	21
2.7	Employee Commute.....	23
2.8	Operations Summary.....	24
2.9	Greenhouse Gas Emissions.....	26
2.10	Toxic Air Contaminants	27
3	Construction	31
3.1	Construction Activity and Construction-Related Vehicle Travel.....	31
3.2	Construction Barge Deliveries	33
3.3	Construction Summary	34
3.4	Construction TACs	35

Tables

Table 1: Vessel Specifications

Table 2: Main Engine Emission Factors

Table 3: OGV Main Engine Travel Link Descriptions – HH Jackman

Table 4: OGV Main Engine Travel Link Descriptions – CSL Tecumseh

Table 5: OGV Main Engine Travel Link Descriptions – Sheila Ann

Table 6: Main Engine Load Adjustment Factors

Table 7: OGV Main Engine Emissions Per Voyage – HH Jackman

Table 8: OGV Main Engine Emissions Per Voyage – CSL Tecumseh

Table 9: OGV Main Engine Emissions Per Voyage – Sheila Ann

Table 10: Auxiliary Engine Emission Factors

Table 11: Auxiliary Engine Activity and Load Factors

Table 12: OGV Auxiliary Engine Emissions Per Voyage – HH Jackman

Table 13: OGV Auxiliary Engine Emissions Per Voyage – CSL Tecumseh

Table 14: OGV Auxiliary Engine Emissions Per Voyage – Sheila Ann

Table 15: OGV Boiler Emission Factors

Table 16: OGV Boiler Emissions Per Voyage – HH Jackman

Table 17: OGV Boiler Emissions Per Voyage – CSL Tecumseh

Table 18: OGV Boiler Emissions Per Voyage – Sheila Ann

Table 19: OGV Emissions – Per Voyage (tpy)

Table 20: OGV Annual Emissions Summary – 25% Tier 2

Table 21: Assist Tug Specifications

Table 22: Assist Tug Emissions

Table 23: Annual Barge Usage Summary

Table 24: Barge Tug Emissions

Table 25: Aggregate Transfer and Storage Emissions Summary

Table 26: Aggregate Transfer Emissions

Table 27: Stockpile Emissions

Table 28: Unmitigated Off-Road Equipment Emissions

Table 29: Mitigated Off-Road Equipment Emissions

Table 30: Off-road Equipment Fugitive Dust

Table 31: On-Site Truck Emissions Summary

Table 32: Off-Site Truck Emissions

Table 33: Employee Commute Emissions

Tables Continued

- Table 34: Unmitigated Operational Emissions Summary – TPY
- Table 35: Unmitigated Operational Emissions Summary – Average Pounds per Day
- Table 36: Mitigated Operational Emissions Summary – TPY
- Table 37: Mitigated Operational Emissions Summary – Average Pounds per Day
- Table 38: Unmitigated GHG Emissions Summary
- Table 39: Mitigated GHG Emissions Summary
- Table 40: Diesel Particulate Matter Emissions Summary
- Table 41: Respirable Silica Emissions Summary
- Table 42: Organic TACs – OGVs, Tugs, and Off-Road Equipment – Unmitigated
- Table 43: Organic TACs – OGV Boilers Only
- Table 44: Organic TACs – OGVs, Tugs, and Off-Road Equipment – Mitigated
- Table 45: Organic TAC Emissions – Trucks and Diesel Employee Vehicles
- Table 46: Organic TAC Emissions – Gasoline Employee Vehicles
- Table 47: CalEEMod Source Emissions – Unmitigated
- Table 48: Construction Barge Travel
- Table 49: Construction Barge Emission Factors
- Table 50: Construction Barge Emissions
- Table 51: Construction Emissions – Unmitigated Criteria Pollutant Summary
- Table 52: Construction Emissions – Unmitigated PM Summary
- Table 53: Construction Emissions – Greenhouse Gas (GHG) Summary
- Table 54: Construction Emissions – Mitigated Criteria Pollutant Summary
- Table 55: Construction Emissions – Mitigated PM Summary
- Table 56: Construction DPM Summary
- Table 57: Construction Organic TACs Summary

Attachments

- Attachment C-1 Emissions Calculation Tables
- Attachment C-2 CalEEMod Report

List of Acronyms

BAAQMD	Bay Area Air Quality Management District
BSFC	brake-specific fuel consumption
CalEEMod	California Emissions Estimator Model
CAPCOA	California Air Pollution Control Officers Association
CARB	California Air Resources Board
CH ₄	methane
CHC	Commercial Harbor Craft
CO	carbon monoxide
CO ₂	carbon dioxide
CO ₂ e	carbon dioxide equivalent
CSL	CSL Group, Inc
DPM	diesel particulate matter
EI	Emissions Inventory
ERA	Eagle Rock Aggregates
g/hp-hr	grams per horsepower-hour
g/kW-hr	grams per kilowatt-hour
GHG	greenhouse gases
GVWR	gross vehicle weight training
GWP	Global Warming Potential
HH Jackman	Honourable Henry Jackman
HHDT	Heavy-Heavy Duty Truck
HRA	health risk assessment
kn	knot or nautical miles per hour
kW	kilowatt
LDA	light-duty vehicles
N ₂ O	nitrous oxide
nm	nautical miles
NO _x	oxides of nitrogen
OGV	ocean-going vessel
PM ₁₀	particulate matter with aerodynamic diameter of 10 microns or less
PM _{2.5}	particulate matter with aerodynamic diameter of 2.5 microns or less
Port	Port of Oakland
ppm	parts per million
PZ	Precautionary Zone
ROG	reactive organic gases
SCAQMD	South Coast Air Quality Management District
SDS	Safety Data Sheet
SF	San Francisco
SO _x	oxides of sulfur
TAC	Toxic Air Contaminant
ULSD	ultra-low-sulfur diesel
USEPA	United States Environmental Protection Agency
WRRP	Waste Reduction and Recycling Plan

1 INTRODUCTION

1.1 Introduction

This appendix describes the methods and assumptions used to estimate air pollutant emissions generated from construction and operation of the proposed Eagle Rock Aggregates (ERA) Oakland Terminal Project (Oakland Terminal, Proposed Project). This appendix includes a description of the methodologies and sources used to develop emission factors and formulas used to estimate emissions, summarizes control measure assumptions utilized in the calculations, and summarizes emissions from the various source types. Emission calculation tables are provided as Attachment C-1 to this Appendix.

Emissions associated with construction and operation of the Proposed Project were estimated using emission factors and methodology from published documents and emission models obtained from various agencies including but not limited to the California Air Resources Board (CARB), the California Air Pollution Control Officers Association (CAPCOA), the Bay Area Air Quality Management District (BAAQMD), the South Coast Air Quality Management District (SCAQMD), and the United States Environmental Protection Agency (USEPA). The following sections describe the formulas and assumptions used to estimate emissions for each source type.

Emissions were estimated for reactive organic gases (ROG), oxides of nitrogen (NO_x), oxides of sulfur (SO_x), carbon monoxide (CO), particulate matter with aerodynamic diameter of 10 microns or less (PM₁₀), particulate matter with aerodynamic diameter of 2.5 microns or less (PM_{2.5}), carbon dioxide (CO₂), methane (CH₄), nitrous oxide (N₂O), and toxic air contaminants (TACs).

2 OPERATIONS

Operation of the Proposed Project will generate emissions from sources including ocean-going vessels (OGVs), tugs (assist and barge), trucks, off-road equipment, employee vehicles, on-site aggregate transfer operations, and on-site stockpiles. Emissions will be generated on- and off-site from fossil-fuel combustion in OGV, tug, truck, vehicle, and off-road engines as well as fugitive sources of dust. Emissions were estimated using published methodology and emission factors from agencies such as BAAQMD, CARB, CAPCOA, and USEPA. Project-specific information was used as input parameters where available. The following sections detail the methodology, emission factors, and assumptions used to estimate operational emissions from each source type.

2.1 Ocean-Going Vessels

The Proposed Project involves using OGVs to transport construction aggregates from British Columbia, Canada to the Port. Once operational, the ERA Oakland Terminal will receive up to 48 vessel calls per year. Emissions from OGVs were calculated from the outer edge of the precautionary zone (PZ), to the Port of Oakland (Port), and back to the outer edge of the PZ (the PZ is shown in Reference 10, Figure 2-1). Emissions include transit, maneuvering, and hoteling. Emissions from OGVs include the vessels’ main engines, auxiliary engines, and boilers.

The Project vessel fleet is expected to include a mix of vessels from the CSL Group, Inc. (CSL) with Tier 0, Tier 1, and Tier 2 slow-speed diesel engines. The primary vessels anticipated to be utilized for the Proposed Project are the Honourable Henry Jackman (HH Jackman), CSL Tecumseh, and Sheila Ann. These vessels are used as representative vessels that will be used, even though not all calls may use these specific vessels. The actual vessels are expected to be similar to these vessels in size and other characteristics. Specifications for each vessel are summarized in Table 1.

Table 1 – Vessel Specifications

Vessel	Design Speed (kn)	Main Engine		Auxiliary Engines	
		Power (kW)	Tier	Total Power (kW)	Tier
HH Jackman	15.75	12,085	Tier 0	2,700	Tier 0
CSL Tecumseh	14.5	10,430	Tier 2	3,438	Tier 2
Sheila Ann	15.0	10,784	Tier 0	3,225	Tier 0

Design Speed obtained from the IHS Fairplay Database
 Engine power and tier information obtained from CSL
 kn = nautical miles per hour or knots; kW = kilowatts

Methodology and assumptions for OGV emissions were primarily obtained from the CARB 2019 OGV At Berth Emissions Inventory (EI) Model (CARB, 2019a) and the Port of Oakland 2017 Seaport Air Emissions Inventory (Port 2017 Emissions Inventory; Port, 2018).

The general methodology for calculating emissions from OGVs follows the following formula:

$E = EF * Activity * LF * EP * C$, where:

- E = emissions per vessel engine (tpy)
- EF = emission factor in grams per kilowatt hour (g/kW-hr) or grams per horsepower hour (g/hp-hr)
- Activity = hours per vessel call (hr)
- LF = Load Factor (%)
- EP = Engine Power (kW or hp)
- C = Conversion Factor (grams to tons)

2.1.1 Main Engines

Main engine emission factors were obtained from the CARB 2019 OGV EI (CARB 2019a). California 0.1% sulfur content fuel is required within California waters; therefore, emission factors reflecting 0.1% sulfur fuel were used. Main engine emission factors are provided in Table 2:

Table 2: Main Engine Emission Factors (g/kW-hr)

Tier	ROG	CO	NOx	PM ₁₀	PM _{2.5}	SOx	CO ₂	CH ₄	N ₂ O
Tier 0	0.78	1.38	17.00	0.189	0.174	0.362	576	0.012	0.028
Tier 2	0.78	1.38	14.40	0.189	0.174	0.362	576	0.012	0.028

Tier 1 Emission Factors not included as the representative three vessels are Tier 0 or Tier 2.

Distance in nautical miles (nm) and vessel speed in nautical miles per hour (knots, kn) for each link of the OGV journey were obtained from the Port 2017 Emissions Inventory. Travel time for each link was derived by dividing distance by speed. Main engine load factors over any given link were determined from the classic Stokes Law cubic relationship for speed and load, which is expressed as:

$$\text{Load Factor} = (\text{Vessel Speed} / \text{Vessel Maximum Speed})^3,$$

Where the 100% load factor would correspond to the vessel operating at maximum speed. Design/cruise speed of the vessel is assumed to be 93.7% of maximum speed, which corresponds to a load factor of 82.3% (Port, 2018). Main engine load factor for maneuvering links is assumed to be 2% (Port, 2018). Distance, speed, travel time, and load factor for each link of the journey for each vessel are provided in Tables 3, 4, and 5.

Table 3: OGV Main Engine Travel Link Descriptions – HH Jackman

Link Start	Link End	Operation Mode	Distance (nm)	Speed (kn)	Hours	Load Factor
<u>Inbound</u>						
PZ Outer Edge	Pilot Station	Transit	6.8	15.75	0.43	82%
Pilot Station	Sea Buoy	Transit	1.5	9.0	0.17	15%
Sea Buoy	Golden Gate	Transit	8.7	13.5	0.64	52%
Golden Gate	Bay Bridge	Transit	6.5	13.5	0.48	52%
<u>Maneuvering</u>						
Bay Bridge	Outer Harbor	Maneuvering	N/A	N/A	1.33	2%
Outer Harbor	Bay Bridge	Maneuvering	N/A	N/A	0.75	2%
<u>Outbound</u>						
Bay Bridge	Golden Gate	Transit	6.6	13.5	0.49	52%
Golden Gate	Sea Buoy	Transit	8.9	13.5	0.66	52%
Sea Buoy	Pilot Station	Transit	1.5	9.0	0.17	15%
Pilot Station	PZ Outer Edge	Transit	6.8	15.75	0.43	82%

1. Distance and speed obtained from Table 2-4 of the Port 2017 Emissions Inventory.

2. Maneuvering time obtained from Table 2-4 of the Port 2017 Emissions Inventory.

Table 4: OGV Main Engine Travel Link Descriptions – CSL Tecumseh

Link Start	Link End	Operation Mode	Distance (nm)	Speed (kn)	Hours	Load Factor
<u>Inbound</u>						
PZ Outer Edge	Pilot Station	Transit	6.8	14.5	0.47	82%
Pilot Station	Sea Buoy	Transit	1.5	9.0	0.17	20%
Sea Buoy	Golden Gate	Transit	8.7	13.5	0.64	66%
Golden Gate	Bay Bridge	Transit	6.5	13.5	0.48	66%
<u>Maneuvering</u>						
Bay Bridge	Outer Harbor	Maneuvering	N/A	N/A	1.33	2%
Outer Harbor	Bay Bridge	Maneuvering	N/A	N/A	0.75	2%
<u>Outbound</u>						
Bay Bridge	Golden Gate	Transit	6.6	13.5	0.49	66%
Golden Gate	Sea Buoy	Transit	8.9	13.5	0.66	66%
Sea Buoy	Pilot Station	Transit	1.5	9.0	0.17	20%
Pilot Station	PZ Outer Edge	Transit	6.8	14.5	0.47	82%

Table 5: OGV Main Engine Travel Link Descriptions – Sheila Ann

Link Start	Link End	Operation Mode	Distance (nm)	Speed (kn)	Hours	Load Factor
<u>Inbound</u>						
PZ Outer Edge	Pilot Station	Transit	6.8	15.0	0.45	82%
Pilot Station	Sea Buoy	Transit	1.5	9.0	0.17	18%
Sea Buoy	Golden Gate	Transit	8.7	13.5	0.64	60%
Golden Gate	Bay Bridge	Transit	6.5	13.5	0.48	60%
<u>Maneuvering</u>						
Bay Bridge	Outer Harbor	Maneuvering	N/A	N/A	1.33	2%
Outer Harbor	Bay Bridge	Maneuvering	N/A	N/A	0.75	2%
<u>Outbound</u>						
Bay Bridge	Golden Gate	Transit	6.6	13.5	0.49	60%
Golden Gate	Sea Buoy	Transit	8.9	13.5	0.66	60%
Sea Buoy	Pilot Station	Transit	1.5	9.0	0.17	18%
Pilot Station	PZ Outer Edge	Transit	6.8	15.0	0.45	82%

Load adjustment factors for engines with slide valves were applied to the emission factors for each link of the journey for the CSL Tecumseh and Sheila Ann. Adjustment factors for traditional valves were applied to emission factors for the HH Jackman. Load adjustment factors are provided in Table 6.

Table 6: Main Engine Load Adjustment Factors

Load	ROG	CO	NOx	PM ₁₀	PM _{2.5}	SOx	CO ₂	CH ₄	N ₂ O
Slide Valves (CSL Tecumseh and Sheila Ann)									
2%	1.32	0.12	1.86	0.37	0.37	1.10	1.10	1.32	1.86
18%	0.86	1.04	1.34	0.49	0.49	1.05	1.05	0.86	1.34
20%	0.82	1.20	1.30	0.51	0.51	1.05	1.05	0.82	1.30
60%	0.81	1.16	0.98	0.88	0.88	0.99	0.99	0.81	0.98
66%	0.88	0.95	0.99	0.94	0.94	0.99	0.99	0.88	0.99
82%	1.10	0.57	0.99	1.12	1.12	0.99	0.99	1.10	0.99
Traditional Valves (HH Jackman)									
2%	2.45	1.38	1.91	0.84	0.84	1.11	1.11	2.53	1.91
15%	1.65	1.18	1.36	0.77	0.77	1.06	1.06	1.65	1.36
52%	0.95	0.97	0.94	0.81	0.81	1.00	1.00	0.95	0.94
82%	1.01	0.91	1.02	1.06	1.06	0.99	0.99	1.01	1.02

Main engine emissions were calculated separately for each link in the journey. Detailed emission calculations can be found in Attachment C-1. Main engine emissions per voyage for each vessel are summarized in Tables 7, 8, and 9.

Table 7: OGV Main Engine Emissions Per Voyage – HH Jackman (tons)

Vessel	ROG	CO	NOx	PM ₁₀	PM _{2.5}	SOx	CO ₂	CH ₄	N ₂ O
Transit	0.020	0.034	0.431	0.004	0.004	0.009	14.854	<0.001	0.001
Maneuvering	0.001	0.001	0.018	<0.001	<0.001	<0.001	0.354	<0.001	<0.001
Total	0.021	0.035	0.448	0.004	0.004	0.010	15.209	<0.001	0.001

Table 8: OGV Main Engine Emissions Per Voyage – CSL Tecumseh (tons)

Vessel	ROG	CO	NOx	PM ₁₀	PM _{2.5}	SOx	CO ₂	CH ₄	N ₂ O
Transit	0.020	0.031	0.388	0.005	0.005	0.010	15.415	<0.001	0.001
Maneuvering	<0.001	<0.001	0.013	<0.001	<0.001	<0.001	0.303	<0.001	<0.001
Total	0.021	0.031	0.401	0.005	0.005	0.010	15.718	<0.001	0.001

Table 9: OGV Main Engine Emissions Per Voyage – Sheila Ann (tons)

Vessel	ROG	CO	NOx	PM ₁₀	PM _{2.5}	SOx	CO ₂	CH ₄	N ₂ O
Transit	0.018	0.034	0.435	0.005	0.004	0.009	14.729	<0.001	0.001
Maneuvering	0.001	<0.001	0.016	<0.001	<0.001	<0.001	0.313	<0.001	<0.001
Total	0.019	0.034	0.451	0.005	0.004	0.009	15.042	<0.001	0.001

2.1.2 Auxiliary Engines

Auxiliary engine emission factors were obtained from the CARB 2019 Update to Inventory for OGVs At Berth: Methodology and Results (CARB, 2019b), further referred to in this Appendix as “CARB Appendix H”. Although the Project vessel fleet will include a mix of Tier 0, Tier 1, and Tier 2 auxiliary engines, emissions were conservatively estimated assuming Tier 0 engines.

California 0.1% sulfur content fuel is required within California waters; therefore, emission factors reflecting 0.1% sulfur fuel were used. Auxiliary engine emission factors are provided in Table 10.

Table 10: Auxiliary Engine Emission Factors (g/kW-hr)

ROG	CO	NOx	PM ₁₀	PM _{2.5}	SOx	CO ₂	CH ₄	N ₂ O
0.52	1.10	13.80	0.182	0.168	0.424	676	0.008	0.033

The HH Jackman and the CSL Tecumseh each have three auxiliary engines, and the Sheila Ann has four. Each auxiliary engine can be operated separately depending on the demand during each part of the journey. Auxiliary engine power data were obtained from CSL. Load factors for each vessel's auxiliary engines were obtained from CSL data logs for a typical voyage into the San Francisco Bay for each vessel where available. These data included load factors for the vessels' auxiliary engines for the following links:

- Pilot Station to Golden Gate Bridge
- Golden Gate Bridge to San Francisco (SF) Anchorage 9
- Discharging at the existing Richmond Terminal
- SF Anchorage 9 to Golden Gate Bridge
- Golden Gate Bridge to Pilot Station

Auxiliary engine load factors were obtained from the Port 2017 Emissions Inventory for the following journey links:

- PZ Outer Edge to Pilot Station
- Maneuvering Inbound and Outbound
- Pilot Station to PZ Outer Edge

Operational hours, engine power, and load factors for each auxiliary engine for each link of the journey are provided in Table 11.

Table 11: Auxiliary Engine Activity and Load Factors

Link	HH Jackman			CSL Tecumseh			Sheila Ann		
	Eng kW	LF (%)	Hours	Eng kW	LF	Hours	Eng kW	LF	Hours
PZ Outer Edge – Pilot Station	900	13	0.43	1,250	13	0.47	1,368	13	0.45
	900	13		1,250	13		1,368	13	
	900	13		938	13		658	13	
	--	--		--	--		658	13	
Pilot Station – Sea Buoy	900	47	0.17	1,250	28	0.17	1,368	0	0.17
	900	47		1,250	0		1,368	0	
	900	0		938	35		658	46	
	--	--		--	--		658	46	
Pilot Station – Golden Gate	900	47	0.64	1,250	28	0.64	1,368	0	0.64
	900	47		1,250	0		1,368	0	
	900	0		938	35		658	46	
	--	--		--	--		658	46	

Link	HH Jackman			CSL Tecumseh			Sheila Ann		
	Eng kW	LF (%)	Hours	Eng kW	LF	Hours	Eng kW	LF	Hours
Golden Gate – Bay Bridge	900	47	0.48	1,250	23	0.48	1,368	32	0.48
	900	47		1,250	23		1,368	32	
	900	47		938	0		658	35	
	--	--		--	--		658	0	
Maneuvering Inbound	900	50	1.33	1,250	50	1.33	1,368	50	1.33
	900	50		1,250	50		1,368	50	
	900	50		938	50		658	50	
	--	--		--	--		658	50	
Hotelling – Waiting	900	47	1.00	1,250	0	1.00	1,368	54	1.00
	900	0		1,250	0		1,368	0	
	900	0		938	52		658	0	
	--	--		--	--		658	0	
Hotelling – Discharging	900	62	24.00	1,250	46	24.00	1,368	62	24.00
	900	62		1,250	0		1,368	0	
	900	62		938	53		658	84	
	--	--		--	--		658	0	
Hotelling – Waiting	900	47	1.00	1,250	0	1.00	1,368	0	1.00
	900	0		1,250	0		1,368	0	
	900	0		938	52		658	80	
	--	--		--	--		658	0	
Maneuvering Outbound	900	50	0.75	1,250	50	0.75	1,368	50	0.75
	900	50		1,250	50		1,368	50	
	900	50		938	50		658	50	
	--	--		--	--		658	50	
Bay Bridge – Golden Gate	900	47	0.49	1,250	24	0.49	1,368	50	0.49
	900	47		1,250	0		1,368	0	
	900	47		938	28		658	64	
	--	--		--	--		658	0	
Golden Gate – Sea Buoy	900	47	0.66	1,250	28	0.66	1,368	50	0.66
	900	47		1,250	0		1,368	0	
	900	0		938	32		658	64	
	--	--		--	--		658	0	
Sea Buoy – Pilot Station	900	47	0.17	1,250	28	0.17	1,368	50	0.17
	900	47		1,250	0		1,368	0	
	900	0		938	32		658	64	
	--	--		--	--		658	0	
Pilot Station – PZ Outer Edge	900	13	0.43	1,250	13	0.47	1,368	13	0.45
	900	13		1,250	13		1,368	13	
	900	13		938	13		658	13	
	--	--		--	--		658	13	

Auxiliary engine emissions were calculated separately for each link in the journey. Detailed emission calculations can be found in Attachment C-1. Auxiliary engine emissions per voyage for each vessel are summarized in Tables 12, 13, and 14.

Table 12: OGV Auxiliary Engine Emissions Per Voyage – HH Jackman (tons)

Vessel	ROG	CO	NOx	PM ₁₀	PM _{2.5}	SOx	CO ₂	CH ₄	N ₂ O
Transit	0.002	0.004	0.044	0.001	0.001	0.001	2.175	<0.001	<0.001
Maneuvering	0.002	0.003	0.043	0.001	0.001	0.001	2.092	<0.001	<0.001
Hotelling	0.024	0.050	0.624	0.008	0.008	0.019	30.568	<0.001	0.001
Total	0.027	0.057	0.711	0.009	0.009	0.022	34.835	<0.001	0.002

Table 13: OGV Auxiliary Engine Emissions Per Voyage – CSL Tecumseh (tons)

Vessel	ROG	CO	NOx	PM ₁₀	PM _{2.5}	SOx	CO ₂	CH ₄	N ₂ O
Transit	0.001	0.002	0.031	<0.001	<0.001	0.001	1.534	<0.001	<0.001
Maneuvering	0.002	0.004	0.054	0.001	0.001	0.002	2.664	<0.001	<0.001
Hotelling	0.015	0.032	0.406	0.005	0.005	0.012	19.901	<0.001	0.001
Total	0.019	0.039	0.492	0.006	0.006	0.015	24.099	<0.001	0.001

Table 14: OGV Auxiliary Engine Emissions Per Voyage – Sheila Ann (tons)

Vessel	ROG	CO	NOx	PM ₁₀	PM _{2.5}	SOx	CO ₂	CH ₄	N ₂ O
Transit	0.002	0.004	0.045	0.001	0.001	0.001	2.201	<0.001	<0.001
Maneuvering	0.002	0.005	0.064	0.001	0.001	0.002	3.140	<0.001	<0.001
Hotelling	0.020	0.042	0.531	0.007	0.006	0.016	25.995	<0.001	0.001
Total	0.024	0.051	0.640	0.008	0.008	0.020	31.337	<0.001	0.002

2.1.3 Boilers

Boiler emission factors were obtained from CARB Appendix H. California 0.1% sulfur content fuel is required within the PZ; therefore, emission factors reflecting 0.1% sulfur fuel were used. Boiler emission factors are provided in Table 15:

Table 15: OGV Boiler Emission Factors (g/kW-hr)

ROG	CO	NOx	PM ₁₀	PM _{2.5}	SOx	CO ₂	CH ₄	N ₂ O
0.11	0.20	1.995	0.164	0.151	0.587	934	0.002	0.045

Activity values (hours) for boilers during each vessel call followed the methodology of the main and auxiliary engines.

Effective engine power obtained from CARB Appendix H was used to estimate boiler engine emissions during transit, maneuvering, and hoteling. Effective power is defined as, “the average power produced by the engines while in use. Effective power is the combination of maximum power and the average load factor on the engines. For example, an engine that could produce 2,000 kW at maximum power that is running at 50 percent average load would have an effective power of 1,000 kW” (CARB, 2019b) The effective power for boilers on self-discharging bulk cargo vessels is 132 kW.

Boiler emissions were calculated separately for each link in the journey. Detailed emission calculations can be found in Attachment C-1. Boiler emissions per voyage for each vessel are summarized in Tables 16, 17, and 18.

Table 16: OGV Boiler Emissions Per Voyage – HH Jackman (tons)

Vessel	ROG	CO	NOx	PM ₁₀	PM _{2.5}	SOx	CO ₂	CH ₄	N ₂ O
Transit	<0.001	<0.001	0.001	<0.001	<0.001	<0.001	0.472	<0.001	<0.001
Maneuvering	<0.001	<0.001	0.001	<0.001	<0.001	<0.001	0.283	<0.001	<0.001
Hotelling	<0.001	0.001	0.008	0.001	0.001	0.002	3.533	<0.001	<0.001
Total	0.001	0.001	0.009	0.001	0.001	0.003	4.288	<0.001	<0.001

Table 17: OGV Boiler Emissions Per Voyage – CSL Tecumseh (tons)

Vessel	ROG	CO	NOx	PM ₁₀	PM _{2.5}	SOx	CO ₂	CH ₄	N ₂ O
Transit	<0.001	<0.001	0.001	<0.001	<0.001	<0.001	0.482	<0.001	<0.001
Maneuvering	<0.001	<0.001	0.001	<0.001	<0.001	<0.001	0.283	<0.001	<0.001
Hotelling	<0.001	0.001	0.008	0.001	0.001	0.002	3.533	<0.001	<0.001
Total	0.001	0.001	0.009	0.001	0.001	0.003	4.298	<0.001	<0.001

Table 18: OGV Boiler Emissions Per Voyage – Sheila Ann (tons)

Vessel	ROG	CO	NOx	PM ₁₀	PM _{2.5}	SOx	CO ₂	CH ₄	N ₂ O
Transit	<0.001	<0.001	0.001	<0.001	<0.001	<0.001	0.478	<0.001	<0.001
Maneuvering	<0.001	<0.001	0.001	<0.001	<0.001	<0.001	0.283	<0.001	<0.001
Hotelling	<0.001	0.001	0.008	0.001	0.001	0.002	3.533	<0.001	<0.001
Total	0.001	0.001	0.009	0.001	0.001	0.003	4.294	<0.001	<0.001

2.1.4 OGV Emissions Summary

OGV emissions on a per voyage basis for each vessel are summarized in Table 19.

Table 19: OGV Emissions – Per Voyage (tpy)

	ROG	CO	NOx	PM ₁₀	PM _{2.5}	SOx	CO ₂	CH ₄	N ₂ O
HH Jackman									
Transit	0.022	0.038	0.476	0.005	0.005	0.011	17.507	<0.001	0.001
Maneuvering	0.003	0.005	0.061	0.001	0.001	0.002	2.729	<0.001	<0.001
Hotelling	0.024	0.050	0.632	0.009	0.008	0.021	34.101	<0.001	0.002
Total	0.048	0.093	1.168	0.015	0.013	0.034	54.332	0.001	0.003
CSL Tecumseh									
Transit	0.021	0.034	0.420	0.006	0.005	0.011	17.431	<0.001	0.001
Maneuvering	0.003	0.004	0.068	0.001	0.001	0.002	3.250	<0.001	<0.001
Hotelling	0.016	0.033	0.414	0.006	0.006	0.015	23.434	<0.001	0.001
Total	0.040	0.071	0.902	0.012	0.011	0.028	44.115	0.001	0.002

Sheila Ann									
Transit	0.020	0.038	0.481	0.005	0.005	0.011	17.407	<0.001	0.001
Maneuvering	0.003	0.005	0.080	0.001	0.001	0.002	3.736	<0.001	<0.001
Hotelling	0.020	0.043	0.538	0.008	0.007	0.019	29.529	<0.001	0.001
Total	0.043	0.086	1.100	0.014	0.013	0.032	50.672	0.001	0.002

The lease agreement between ERA and the Port will include a requirement that at least 25% of vessels that visit the Project Site have main engines that meet Tier 2 marine engine standards. Based on emissions presented in Table 18, the HH Jackman has the highest emissions on a per voyage basis. Therefore, maximum annual emissions from OGVs assuming 36 calls for the HH Jackman (Tier 0) and 12 calls for the CSL Tecumseh (Tier 2) are summarized in Table 20.

Table 20 – OGV Annual Emissions Summary – 25% Tier 2 (tpy)

	ROG	CO	NOx	PM ₁₀	PM _{2.5}	SOx	CO ₂	CH ₄	N ₂ O
Transit	1.04	1.76	22.18	0.25	0.23	0.53	893.21	0.02	0.04
Maneuvering	0.13	0.22	3.00	0.03	0.03	0.09	137.26	0.00	0.01
Hotelling	1.05	2.22	27.70	0.39	0.36	0.95	1,508.84	0.02	0.07
Total	2.22	4.19	52.89	0.67	0.62	1.56	2,485.32	0.03	0.12

2.2 Assist Tugs

The Proposed Project will utilize tugs in two capacities: assist tugs during OGV maneuvering and barge tugs to transport barges from the Oakland Terminal to two destination facilities. Up to two assist tugs will be utilized per OGV call, which results in up to 96 assist tugs per year. The Proposed Project will utilize the following assist tugs shown in Table 21:

Table 21: Assist Tug Specifications

Tug Name	Engine Tier	Main Eng HP	Aux Eng HP
Revolution	Tier 3	5,000	281
Sandra Hugh	Tier 3	5,000	281
Patricia Ann	Tier 3	5,000	281
Dr. Hank Kaplan	Tier 3	5,150	281
Average:		5,038	281

Main engine tier and horsepower (HP) obtained from AmNav Maritime Corporation (AmNav)
 Auxiliary engine HP obtained from IHS Fairplay Database.

Methodology and assumptions for tug emissions were primarily obtained from the CARB 2012 Commercial Harbor Craft (CHC) Emissions Inventory Model (CARB, 2012a) and the Port 2017 Emissions Inventory (Port, 2018). CARB provides additional information in two appendices: Appendix B, Emissions Estimation Methodology for CHC Operating in California (CARB, 2012b) and Appendix C: Updates on the Emissions Inventory for CHC Operating in California (CARB, 2010). These two appendices will be further referred to as “CARB Appendix B” and “CARB Appendix C,” respectively.

The general methodology for calculating emissions from tugs follows the following formula:

$E = EF * F * (1 + D * A/UL) * Activity * LF * EP * C$, where:

- E = emissions per vessel engine (tpy)
- EF = emission factor (g/kW-h or g/hp-hr)
- F = Fuel Correction Factor (unitless)
- D = Deterioration Factor (unitless)
- A = Age of engine (years)
- UL = Useful life of engine (years)
- Activity = hours per vessel call (hr)
- LF = Load Factor (%)
- EP = Engine Power (kW or hp)
- C = Conversion Factor (grams to tons)

Emission factors for assist tugs were obtained from the CARB Commercial Harbor Craft Emissions Inventory. Emission factors for SO_x and CO₂ were derived from fuel consumption rates. Assist tugs will utilize ultra-low-sulfur diesel (ULSD). SO₂ emission factors were calculated from the brake-specific fuel consumption (BSFC) assuming a sulfur content of 15 parts per million (ppm). CO₂ emission factors were calculated from the BSFC assuming a fuel carbon content of 86.8 percent by weight and a ratio of molecular weights of CO₂ and carbon at 3.667.

As shown in Table 21, each tug is equipped with Tier 3 main and auxiliary engines. Therefore, zero-hour emission factors for model year 2014 were utilized. All deterioration factors and fuel correction factors for NO_x and PM were obtained from the CARB Appendix B. The fuel correction factor for ROG was obtained from CARB Off-road Documentation (CARB, 2017). Engine age was assumed to be 8 years (model year 2014 operating in calendar year 2022). Useful life is 21 years for main engines and 22.5 for auxiliary engines (CARB, 2012a).

According to data gathered as part of the 2017 Port Emissions Inventory, during calendar year 2017, there were a total of 1,837 Outer Harbor one-way tug assists and a total of 2,692 hours of operation associated with these assists. Therefore, the average tug activity per round-trip assist was assumed to be 2.93 hours of operation (2,692 hours / 1,837 one-way assists * 2), which includes transit to the pickup point, inbound assist, transit to home base, transit to the ERA Oakland Terminal, outbound assist, and transit to home base.

Assist tug load factors of 31% for main engines and 43% for auxiliary engines were obtained from the Port of Oakland 2017 Emissions Inventory. Assist tug emissions are summarized in Table 22.

Table 22: Assist Tug Emissions (tpy)

	ROG	CO	NO _x	PM ₁₀	PM _{2.5}	SO _x	CO ₂	CH ₄	N ₂ O
Main Engine	0.346	1.979	2.167	0.049	0.049	0.003	284.301	0.030	0.010
Auxiliary Engines	0.030	0.148	0.142	0.003	0.003	<0.001	22.029	0.003	0.001
Assist Total	0.376	2.127	2.309	0.052	0.052	0.003	306.330	0.032	0.010

2.3 Barge Tugs

Barges are currently used to transport ERA material to destinations on the San Francisco Bay, and the Proposed Project will continue to utilize barges to transport material from the Oakland Terminal to its destination. Three sets of barges, each with a respective tug or set of tugs, will be utilized as part of the Proposed Project. Proposed barge usage is summarized in Table 23.

Table 23: Annual Barge Usage Summary

Destination	Barge(s)	Tug(s)	Proposed Trips
SF Pier 92	Peter Lind	The Orion + 1 ¹	36
Petaluma	Shamrock Barges	Sarah Reed	40
Bay Area-Variou	Westar Rock Barge #2	Fat Cat	33

The Peter Lind requires two tugs: the Orion and a similar tug.

A typical journey for the Fat Cat would be to SF Pier 92 or to Treasure Island. Emissions for the Fat Cat and Westar Rock Barge #2 were based on a journey to SF Pier 92 and modeled along with the Peter Lind operations.

Emission factors for barge tugs were obtained from the CARB CHC Emissions Inventory. Barge tugs will utilize ULSD. SO₂ emission factors were calculated from the BSFC assuming a sulfur content of 15 ppm. CO₂ emission factors were calculated from the BSFC assuming a fuel carbon content of 86.8 percent by weight and a ratio of molecular weights of CO₂ and carbon at 3.667.

Barge tug main engine and auxiliary engine power are based on the engine specifications listed in the IHS Fairplay Database for each tug in Table 23. See Attachment C-1 for additional details. Similarly, zero-hour emission factors were derived from the engine power and model year for each tug in Table 23.

Useful life values for barge tugs (26 years for main engines and 25 years for auxiliary engines) were obtained from the CARB CHC Emissions inventory. All deterioration factors and fuel correction factors for NO_x and PM were obtained from the CARB Appendix B. The fuel correction factor for ROG was obtained from CARB Off-road Documentation (CARB, 2017). When engine model year was not available, engine age was assumed to be 2022 minus the model year listed for each engine when available. If model year for an engine was not available, the age of the engine was assumed to be half of its useful life.

Hours of operation per trip were based on approximate round-trip distance of each trip divided by an average speed of 8 knots, which is based on the representative average speed for dredger tugs listed in the Port 2017 Emissions Inventory. Barges will be tied fast to the pier during loading so auxiliary engine use is not expected while at berth. Barge tug load factors of 68% for main engines and 43% for auxiliary engines were obtained from the CARB CHC Emissions Inventory. Barge tug emissions are summarized in Table 24.

Table 24: Barge Tug Emissions (tpy)

Destination	ROG	CO	NO _x	PM ₁₀	PM _{2.5}	SO _x	CO ₂	CH ₄	N ₂ O
SF Pier 92	0.218	1.199	1.658	0.062	0.062	0.002	166.002	0.017	0.006
Petaluma	0.310	1.719	2.362	0.089	0.089	0.002	238.825	0.025	0.008
Bay Area-Variou	0.067	0.195	0.657	0.035	0.035	<0.001	49.114	0.005	0.002
Total	0.594	3.112	4.677	0.186	0.186	0.004	453.941	0.048	0.015

2.4 Aggregate Transfer and Storage

PM emissions are generated during the transfer and storage of ERA material. ERA material is washed prior to being loaded onto the vessel in British Columbia, and the material will have a moisture content of 6-8% during offloading at the Oakland Terminal. Stockpiles will be watered, and the moisture content of stored material will be maintained between 1 and 8%. Emissions from aggregate transfer and storage are summarized in Table 25.

Table 25: Aggregate Transfer and Storage Emissions Summary (tpy)

Source	PM ₁₀	PM _{2.5}
Aggregate Transfer	0.610	0.091
Aggregate Storage (Stockpiles)	2.966	0.448

Aggregate transfer operations of the Proposed Project include the following transfer points:

- Ship to Shore
- Shore to Barge
- Truck Loading

The general methodology for calculating emissions from aggregate transfer follows the following formula:

$E = EF * TP * C$, where:

- E = emissions (tpy)
- EF = emission factor in pounds per ton (lb/ton)
- TP = Throughput (tpy)
- C = Conversion Factor (lb to ton)

Total annual throughput for the Proposed Project will not exceed 2,500,000 tons of material. Aggregate transfer emission factors were obtained from USEPA’s AP-42 Compilation of Air Emission Factors, Chapter 11.19.2, “Crushed Stone Processing and Pulverized Material Processing,” Table 11.19.2-2. Sand will have a moisture content of 6 to 8% and aggregate will have a moisture content of approximately 1% when offloaded from the vessel, and water sprays will be utilized at conveyor transfer points, so controlled emission factors were utilized for aggregate transfer. In 2006, USEPA issued a background document that revised the ratio of PM_{2.5} to PM₁₀ in various fugitive dust sources. The ratio of PM_{2.5} to PM₁₀ in aggregate transfer emissions is 0.15 (USEPA, 2006). Aggregate Transfer emissions are summarized in Table 26.

Table 26: Aggregate Transfer Emissions (tpy)

Source	PM ₁₀	PM _{2.5}
Ship to Shore	0.403	0.060
Shore to Barge	0.173	0.026
Truck Loading	0.035	0.005
Total	0.610	0.091

PM emissions may also be generated from the onsite material stockpiles. Emissions from stockpiles are generated from the drop operation (transfer of material from conveyors to stockpiles), wind erosion, and truck and equipment traffic near the piles. Fugitive dust from truck and equipment traffic are estimated in Sections 2.2.5 and 2.2.6, respectively. The general methodology for calculating emissions from the drop operation follows the following formula:

$E = EF * TP * C$, where:

- E = emissions (tpy)
- EF = emission factor in pounds per ton (lb/ton)
- TP = Throughput (tpy)
- C = Conversion Factor (lb to ton)

PM₁₀ and PM_{2.5} emission factors for stockpiles were derived from Chapter 13.2.4 of USEPA AP-42.

$EF = k * (0.0032) * (U/5)^{1.3} / (M/2)^{1.4}$, where

- K = constant, 0.35 for PM₁₀ and 0.05 for PM_{2.5}
- U = average wind speed, 11.14 mph for Oakland
- M = moisture content of material

Average wind speed was derived from the meteorological data obtained from the Oakland Sewage Treatment Plant for 2014. Moisture content assumed to be 6% for sand as it is the low end of the range of moisture content of sand when transferred from the vessel to the stockpiles. A moisture content of 2% was utilized for aggregate as continuous water sprays along the conveyor belt will increase the moisture content from 1% to 2% during transfer (Western Region Air Partnership [WRAP] 2006). For stockpile emissions, the throughput for sand and aggregate was split equally at 50% each (1,250,000 tons sand, 1,250,000 tons aggregate).

Emissions from wind erosion were estimated using the emission factor of 1.7 lb of PM₁₀ per acre per day, which is contained in USEPA’s AP-42 Fourth Edition, Chapter 8.19. Based on site plan drawings, each stockpile has a radius of approximately 180 feet. The radial stacker will occupy the interior radius of 69 feet. Therefore, the area of each stockpile is approximately 86,830 square feet, and the total area of the three stockpiles is 260,491 square feet or 5.98 acres. Emissions were calculated using the following methodology:

$E = EF * A * D * (1-CE) * C$, where

- E = Emissions (tpy)
- EF = Emission Factor (lb/acre/day)
- A = Area (acres)
- D = Days (365)
- CE = Control Efficiency = 70% for watering piles per the BAAQMD Permitting Handbook (BAAQMD, 2006)
- C = Conversion Factor (pounds to tons)

Stockpile emissions are summarized in Table 27.

Table 27: Stockpile Emissions (tpy)

Source	PM ₁₀	PM _{2.5}
Transfer	2.409	0.365
Wind Erosion	0.557	0.083
Total	2.966	0.448

2.5 Off-Road Equipment

The Proposed Project includes operation of four pieces of off-road, diesel-fueled equipment:

- 3 x John Deere 944k front end loaders
- Doosan D34P (or equivalent) skid steer loader
- Tennant Sentinel Sweeper or equivalent

Off-road equipment will be powered by engines that meet or exceed Tier 4 final emission standards in accordance with the CARB Cargo Handling Equipment Regulations; Tier 4 final emission standards were used to calculate unmitigated emissions in this analysis. The general methodology for calculating emissions from off-road equipment follows the following formula:

$E = (EF + D * A) * \text{Activity} * LF * EP * C$, where:

- E = emissions (tpy)
- EF = emission factor (g/hp-hr)
- D = Deterioration Factor (g/hp-hr²)
- A = Age of engine (hours of operation), maximum value: 12,000 hrs
- Activity = hours per year
- LF = Load Factor (%)
- EP = Engine Power (hp)
- C = Conversion Factor (grams to tons)

Criteria pollutant zero-hour emission factors were obtained from CARB and USEPA Tier 4 emission standards. GHG emission factors were obtained from USEPA Emission Factors for GHG Inventories (USEPA, 2018). The equipment is expected to be operated up to 16 hours per day, 6 days per week, 52 weeks per year. Emissions were estimated assuming a total of 5,000 hours per year per engine. Load factors were obtained from the CARB Off-road Emissions Model (CARB, 2019c), deterioration factors were obtained from CARB’s 2011 Cargo Handling Equipment Emissions Inventory (CARB, 2011), and respective engine power for each piece of equipment was obtained from CARB engine certifications. Emissions from each piece of equipment are summarized in Table 28.

Table 28: Unmitigated Off-Road Equipment Emissions (tpy)

Equipment	ROG	CO	NOx	PM ₁₀	PM _{2.5}	CO ₂	CH ₄	N ₂ O
Loader 1	0.46	4.60	0.55	0.03	0.03	857	0.05	0.02
Loader 2	0.46	4.60	0.55	0.03	0.03	857	0.05	0.02
Loader 3	0.46	4.60	0.55	0.03	0.03	857	0.05	0.02
Skid-Steer	0.06	1.07	0.07	0.01	0.01	133	0.01	0.00
Sweeper	0.08	1.32	0.09	0.01	0.01	165	0.01	0.00
Total	1.52	16.19	1.82	0.11	0.10	2,870	0.16	0.07

ERA proposes a mitigation measure (Mitigation Measure ERA AQ-1) to prepare an Operations Air Quality Plan, which will describe operational measures that the Proposed Project applicant will implement to reduce air emissions. These measures include utilization of hybrid-electric front-end loaders and an electric sweeper. Mitigated off-road equipment emissions (assuming use of hybrid-electric loaders and an electric sweeper instead of standard Tier 4 Final models) are summarized in Table 29. Emission factors for the hybrid-electric front-end loaders were obtained from their engine-specific CARB certification for Engine Family JJDXL13.5310 (CARB, 2020b).

Table 29: Mitigated Off-Road Equipment Emissions (tpy)

Equipment	ROG	CO	NOx	PM ₁₀	PM _{2.5}	CO ₂	CH ₄	N ₂ O
Loader 1	0.26	0.48	0.20	0.01	0.01	857	0.05	0.02
Loader 2	0.26	0.48	0.20	0.01	0.01	857	0.05	0.02
Loader 3	0.26	0.48	0.20	0.01	0.01	857	0.05	0.02
Skid-Steer	0.06	1.07	0.07	0.01	0.01	133	0.01	0.00
Sweeper	0.00	0.00	0.00	0.00	0.00	0.00	0.00	0.00
Total	0.86	2.50	0.68	0.04	0.04	2,705	0.15	0.07

Emission factors for the hybrid loaders based on the CARB engine certification for Engine Family JJDXL13.5310. Emissions associated with electricity consumption of the electric sweeper are shown in Table 38, which includes electricity consumption for other aspects of the Project.

Fugitive dust emissions from equipment movement were derived from CARB’s Miscellaneous Process Methodology 79, Entrained Road Travel, Paved Road Dust (CARB, 2018). The general methodology for calculating emissions from off-road equipment follows the following formula:

$$E = EF * VMT * (1-CE) * C$$

E = Emissions (tpy)

EF = Emission Factor (lb PM₁₀/VMT), PM_{2.5} = 0.15 PM₁₀ per USEPA, 2006

VMT = Vehicle miles traveled (miles/year)

CE = 70% for watering per BAAQMD Permitting Handbook (BAAQMD, 2006)

C = Conversion Factor (pounds to tons)

$$EF = [k(sL)^{0.91} * W^{1.02}] * (1 - P/4N), \text{ where:}$$

k = particle size multiplier

sL = silt loading in grams per square meter (g/m²)

Mean sL for concrete batch plants (12 g/m²) selected from AP-42 Table 13.2.1-3.

There are no crushing or screening operations, and the material is prewashed prior to arriving at the site, so the ERA Oakland Terminal more closely resembles a concrete batch plant instead of a sand and gravel processing plant.

W = average vehicle weight (operating weight of loaders = ~61 tons)

P = number of “wet days,” default = 61 for Alameda County

N = annual averaging period (365)

Off-road equipment is expected to travel approximately 7,000 miles per year. Each truck will require one to two loader trips. The distance from the stockpiles to the truck lanes is up to 0.025 miles each way. Assuming up to 70,000 trucks per year and up to 0.1 mile traveled per truck, total VMT would be up to 7,000 miles per year. Off-road equipment fugitive dust emissions are summarized in Table 30.

Table 30: Off-road Equipment Fugitive Dust (tpy)

	PM ₁₀	PM _{2.5}
Off-road Fugitive Emissions	1.407	0.211

Fugitive dust emissions will be the same before and after mitigation.

2.6 Trucks

Material at the Oakland Terminal will be transported to destination facilities via trucks. The Proposed Project will result in up to 70,000 truck trips per year. Trucks generate emissions in multiple ways, including running exhaust, idling exhaust, brake and tire wear, and fugitive dust. Emissions were calculated separately for on-site and off-site truck operations.

2.6.1 Onsite Trucks

Trucks will enter the Project Site through the gate on the eastern side of the site. Empty trucks will travel into the site, be weighed, and continue to where a front-end loader will load material into the truck. The truck will proceed through the site to the scales. After weighing, the truck will exit the site and depart towards its destination facility.

The general methodology for calculating emissions from aggregate transfer follows the following formula:

E = EF * Activity * C, where:

- E = emissions per vessel engine (tpy)
- EF = emission factor (g/mile or g/vehicle)
- Activity = Vehicle miles traveled (VMT) per year or vehicles per year
- C = Conversion Factor (grams to tons)

Exhaust emission factors for trucks in motion (running), brake and tire wear, and idling were derived from CARB’s EMFAC2017 Web Database (CARB, 2019d). The following assumptions were made in EMFAC2017 to derive weighted average emission factors for onsite truck exhaust:

- EMFAC2007 Vehicle Category Heavy-Heavy Duty Truck (HHDT)
- 2022 Scenario Year
- Bay Area AQMD
- Running exhaust speeds: 5 – 20 miles per hour
 - Idling and brake/tire wear emission factors utilize aggregated speed
- Model years 2010 - 2023

Fugitive dust emissions were derived from CARB’s Miscellaneous Process Methodology 79, Entrained Road Travel, Paved Road Dust (CARB, 2018). Each truck will travel up to approximately 0.6 miles on-site per trip. Average vehicle weight assumed to be 17.5 tons (average of 5 tons empty and 30 tons full). The average sL value for concrete batch plants (12 g/m²) from AP-42 Table 13.2.1-3 was selected for onsite trucks. There are no crushing or screening operations, and the material is prewashed prior to arriving at the site, so the ERA Oakland Terminal more closely resembles a concrete batch plant instead of a sand and gravel processing plant. On-site truck emissions are summarized in Table 31.

Table 31: On-Site Truck Emissions Summary (tpy)

	ROG	CO	NOx	PM ₁₀	PM _{2.5}	SOx	CO ₂	CH ₄	N ₂ O
Exhaust - Running	0.01	0.06	0.38	0.001	0.001	<0.01	119	<0.01	0.02
Exhaust - Idling	0.39	5.60	4.68	0.002	0.002	0.01	966	0.02	0.15
Brake and Tire Wear	--	--	--	0.004	0.002	--	--	--	--
Fugitive Dust	--	--	--	2.361	0.354	--	--	--	--

2.6.2 Offsite Trucks

Emissions calculation methodology for off-site truck operations is similar to on-site truck operations. Emission factors were derived from the same sources described in the previous two sections. The following assumptions were made in EMFAC2017 to derive weighted average emission factors for onsite truck exhaust:

- EMFAC2007 Vehicle Category Heavy-Heavy Duty Truck (HHDT)
- 2022 Scenario Year
- Bay Area AQMD
- Aggregated Speed
- Model years 2010 - 2023

Fugitive dust emissions were calculated using the formula described in Section 2.5. The default state-wide silt loading factor for collector and major roadways (0.032 g/m²) was selected as trucks will travel on a combination of all roadway categories, but the majority of vehicle miles traveled will be on collector, major, or freeway roadway types (CARB, 2018). Average vehicle weight was

taken as the weighted average vehicle weight based on the gross vehicle weight rating (GVWR) and total VMT traveled for each vehicle category from EMFAC2017. Parameters used to obtain data from EMFAC include: BAAQMD, Calendar Year 2022, all vehicle categories and fuel types, and aggregated speed and model year. The average weight was determined to be approximately 3.36 tons.

VMT per year for offsite trucks was calculated using trucking data for ERA’s existing Richmond Terminal operations. In 2018, a total of 30,932 trucks traveled from Richmond to over 20 destination facilities within the Bay Area. The total one-way distance traveled in 2018 was 507,313 miles. Changing the origin from Richmond to Oakland would have resulted in a total one-way distance of 412,388 miles. The destination facilities for off-site trucks are not expected to change as a result of imitating operations at the Oakland Terminal. Assuming a maximum of 70,000 trucks per year, the expected maximum round-trip VMT for off-site trucks was then determined to be 1,866,493 miles, which results in an average round-trip distance of approximately 27 miles per truck. Off-site truck emissions are summarized in Table 32.

Table 32: Off-Site Truck Emissions (tpy)

	ROG	CO	NOx	PM ₁₀	PM _{2.5}	SOx	CO ₂	CH ₄	N ₂ O
Exhaust	0.083	0.542	5.614	0.056	0.054	0.028	2,917	0.004	0.459
Brake and Tire Wear	--	--	--	0.198	0.072	--	--	--	--
Fugitive Dust	--	--	--	0.295	0.044	--	--	--	--

Loaded trucks will maintain a minimum of two feet of freeboard, and moisture content of materials will be controlled during loading to minimize fugitive dust emissions from the loaded truck bed. Fugitive dust emissions from offsite trucks includes re-entrained dust from on-road travel, which incorporates resuspension of material deposited along the roadway from all sources, including any material deposited from other loaded trucks.

2.7 Employee Commute

Employees commuting to the Project Site will generate exhaust, brake and tire wear, and fugitive dust emissions. Methodology for calculating employee commute emissions is similar to the methodology employed for on-site and off-site trucks. Exhaust and brake and tire wear emission factors were obtained from the CARB EMFAC2017 Web Database, and fugitive dust emission factors were derived from derived from CARB’s Paved Road Dust Methodology. Similar to off-site trucks, a silt loading value of 0.032 g/m² and an average vehicle weight of 3.36 tons were used. Assumptions used to derive emission factors from EMFAC2017 include vehicle category light duty (LDA), Bay Area AQMD, calendar year 2022, aggregated model year and speed, and diesel- and gasoline-fueled. ERA expects to have up to 15 full-time employees. Employee round trip commute distance was assumed to be 20 miles. The employee parking lot is located directly inside the site entrance. Therefore, on-site travel by employee vehicles will be negligible. Employee commute emissions are summarized in Table 33.

Table 33: Employee Commute Emissions (tpy)

	ROG	CO	NOx	PM ₁₀	PM _{2.5}	SOx	CO ₂	CH ₄	N ₂ O
Exhaust	0.001	0.065	0.004	<0.001	<0.001	<0.001	26.968	<0.001	<0.001
Brake and Tire Wear	--	--	--	0.005	0.002	--	--	--	--
Fugitive Dust	--	--	--	0.004	0.001	--	--	--	--

2.8 Operations Summary

Operational emissions from the Proposed Project in terms of tons per year and pounds per day are summarized in Tables 34 through 37.

Table 34: Unmitigated Operational Emissions Summary - TPY

Source	ROG	CO	NOx	PM ₁₀	PM _{2.5}	SOx	CO ₂	CH ₄	N ₂ O
OGVs – Transit and Maneuvering	1.17	1.97	25.19	0.28	0.26	0.61	976	0.02	0.05
OGVs - Hotelling	1.05	2.22	27.70	0.39	0.36	0.95	1,509	0.02	0.07
Tugs (Assist + Barge)	0.97	5.24	6.99	0.24	0.24	0.01	760	0.08	0.03
Agg. Transfer	--	--	--	0.61	0.09	--	--	--	--
Stockpiles	--	--	--	2.97	0.45	--	--	--	--
Off-Road Eq Exhaust	1.52	16.19	1.82	0.11	0.10	--	2,870	0.16	0.07
Off-Road Eq Dust	--	--	--	1.41	0.21	--	--	--	--
On-Site Truck Ex.	0.40	5.65	5.06	<0.01	<0.01	0.01	1,085	0.02	0.17
On-Site Truck Dust and BTW	--	--	--	2.37	0.36	--	--	--	--
Off-Site Truck Ex.	0.08	0.54	5.61	0.06	0.05	0.03	2,917	<0.01	0.46
Off-Site Truck Dust, BTW	--	--	--	0.49	0.12	--	--	--	--
Employee Commute	<0.01	0.06	<0.01	0.01	<0.01	<0.01	27	<0.01	<0.01
Electricity Use	--	--	--	--	--	--	296	0.05	0.01
Total	5.18	31.88	72.37	8.93	2.24	1.60	10,441	0.34	0.86

Table 35: Unmitigated Operational Emissions Summary – Average Pounds per Day (lb/day)

Source	ROG	CO	NOx	PM ₁₀	PM _{2.5}	SOx
OGVs – Transit and Maneuvering	7.47	12.65	161.45	1.82	1.68	3.93
OGVs - Hotelling	6.73	14.20	177.58	2.50	2.31	6.07
Tugs (Assist + Barge)	6.22	33.58	44.78	1.52	1.52	0.05
Agg. Transfer	--	--	--	3.91	0.59	--
Stockpiles	--	--	--	16.25	2.46	--
Off-Road Eq Exhaust	9.74	103.77	11.69	0.70	0.64	--
Off-Road Eq Fugitive Dust	--	--	--	9.02	1.35	--
On-Site Truck Ex.	2.53	36.24	32.42	0.01	0.01	0.07
On-Site Truck Dust and BTW	--	--	--	15.17	2.28	--
Off-Site Truck Ex.	0.53	3.48	35.99	0.36	0.34	0.18
Off-Site Truck Dust, BTW	--	--	--	3.16	0.75	--
Employee Commute	0.01	0.41	0.03	0.06	0.02	<0.01
Total	33.24	204.33	463.93	54.48	13.94	10.29

Table 36: Mitigated Operational Emissions Summary - TPY

Source	ROG	CO	NOx	PM ₁₀	PM _{2.5}	SOx	CO ₂	CH ₄	N ₂ O
OGVs – Transit and Maneuvering	1.17	1.97	25.19	0.28	0.26	0.61	976	0.02	0.05
OGVs - Hotelling	1.05	2.22	27.70	0.39	0.36	0.95	1,509	0.02	0.07
Tugs (Assist + Barge)	0.97	5.24	6.99	0.24	0.24	0.01	760	0.08	0.03
Agg. Transfer	--	--	--	0.61	0.09	--	--	--	--
Stockpiles	--	--	--	2.97	0.45	--	--	--	--
Off-Road Eq Exhaust	0.86	2.50	0.68	0.04	0.04	--	2,705	0.15	0.07
Off-Road Eq Dust	--	--	--	1.41	0.21	--	--	--	--
On-Site Truck Ex.	0.40	5.65	5.06	<0.01	<0.01	0.01	1,085	0.02	0.17
On-Site Truck Dust and BTW	--	--	--	2.37	0.36	--	--	--	--
Off-Site Truck Ex.	0.08	0.54	5.61	0.06	0.05	0.03	2,917	<0.01	0.46
Off-Site Truck Dust, BTW	--	--	--	0.49	0.12	--	--	--	--
Employee Commute	<0.01	0.06	<0.01	0.01	<0.01	<0.01	27	<0.01	<0.01
Electricity Use	--	--	--	--	--	--	298	0.05	0.01
Total	4.52	18.19	71.23	8.86	2.18	1.60	10,278	0.34	0.85

Table 37: Mitigated Operational Emissions Summary – Average Pounds per Day (lb/day)

Source	ROG	CO	NOx	PM ₁₀	PM _{2.5}	SOx
OGVs – Transit and Maneuvering	7.47	12.65	161.45	1.82	1.68	3.93
OGVs - Hotelling	6.73	14.20	177.58	2.50	2.31	6.07
Tugs (Assist + Barge)	6.22	33.58	44.78	1.52	1.52	0.05
Agg. Transfer	--	--	--	3.91	0.59	--
Stockpiles	--	--	--	16.25	2.46	--
Off-Road Eq Exhaust	5.50	16.01	4.36	0.25	0.23	--
Off-Road Eq Fugitive Dust	--	--	--	9.02	1.35	--
On-Site Truck Ex.	2.53	36.24	32.42	0.01	0.01	0.07
On-Site Truck Dust and BTW	--	--	--	15.17	2.28	--
Off-Site Truck Ex.	0.53	3.48	35.99	0.36	0.34	0.18
Off-Site Truck Dust, BTW	--	--	--	3.16	0.75	--
Employee Commute	0.01	0.41	0.03	0.06	0.02	<0.01
Total	29.00	116.58	456.60	54.03	13.53	10.29

2.9 Greenhouse Gas Emissions

GHG emissions are commonly expressed in metric tonnes of carbon dioxide equivalent (CO₂e). Emissions presented in Section 2 are in terms of tons per year of individual pollutants. CO₂e is calculated by summing the products of each pollutant multiplied by each pollutant’s respective Global Warming Potential (GWP). The GWPs for CO₂, CH₄, and N₂O are 1, 25, and 298, respectively (USEPA, 2018).

Carbon emissions associated with electricity generation are included as part of the Proposed Project. Emission factors for CO₂ (206 lb CO₂/MWh) were obtained from Pacific Gas and Electric’s (PG&E’s) 2019 Sustainability Report (PG&E, 2019). Emission factors for CH₄ and N₂O were obtained from USEPA’s Emission Factors for GHG Inventories (USEPA, 2018). Project GHG emissions in terms of CO₂e are summarized Tables 38 and 39:

Table 38: Unmitigated GHG Emissions Summary

Source	CO ₂ (tpy)	CH ₄ (tpy)	N ₂ O (tpy)	CO ₂ e (mtpy)
OGVs – Transit and Maneuvering	976	0.02	0.05	899
OGVs - Hotelling	1,509	0.02	0.07	1,389
Tugs (Assist + Barge)	760	0.08	0.03	699
Off-Road Equipment	2,870	0.16	0.07	2,627
On-Site Trucks	1,085	0.02	0.17	1,031
Off-Site Trucks	2,917	<0.01	0.46	2,771
Employee Commute	27	<0.01	<0.01	25
Electricity Usage	296	0.05	0.01	271
Total	10,441	0.34	0.86	9,711

mtpy = metric tonnes per year
 1 ton = 0.9072 metric tonne

Table 39: Mitigated GHG Emissions Summary

Source	CO ₂ (tpy)	CH ₄ (tpy)	N ₂ O (tpy)	CO ₂ e (mtpy)
OGVs – Transit and Maneuvering	976	0.02	0.05	899
OGVs - Hotelling	1,509	0.02	0.07	1,389
Tugs (Assist + Barge)	760	0.08	0.03	699
Off-Road Equipment	2,705	0.15	0.07	2,476
On-Site Trucks	1,085	0.02	0.17	1,031
Off-Site Trucks	2,917	<0.01	0.46	2,771
Employee Commute	27	<0.01	<0.01	25
Electricity Usage	298	0.05	0.01	273
Total	10,278	0.34	0.85	9,562

mtpy = metric tonnes per year
 1 ton = 0.9072 metric tonne

2.10 Toxic Air Contaminants

The Proposed Project is expected to generate emissions of TACs, including, but not limited to diesel particulate matter (DPM) and respirable silica. DPM will be generated from diesel-fueled combustion sources including OGVs, tugs, trucks, off-road equipment, and a portion of employee vehicles. Respirable silica will be generated from aggregate transfer, stockpiles, and fugitive dust from the site.

All PM₁₀ generated by combustion of diesel fuel was considered DPM, except for emissions from OGV boilers. Expected DPM emissions from the Proposed Project are summarized in Table 40:

Table 40: Diesel Particulate Matter Emissions Summary

Source	DPM (lb/yr)	
	Unmitigated	Mitigated
OGV – Transit		
- Main Engines	438.05	438.05
- Auxiliary Engines	52.08	52.08
OGV – Maneuvering	643.38	643.38
- Main Engines	7.07	7.07
- Auxiliary Engines	57.78	57.78
OGV – Hotelling	721.13	721.13
Tugs (Assist and Barge)	475.01	475.01
Off-Road Equipment	217.25	77.84
On-Site Trucks	4.44	4.44
Off-Site Trucks	112.48	112.48
Employee Commute	0.02	0.02
Total	2,085.32	1,945.90

OGV – Hotelling is from auxiliary engines only. Main engines will not run while hotelling.

The Safety Data Sheet (SDS) for ERA material shows that ERA construction aggregates consists of up to 5% respirable silica. Respirable silica emissions were calculated by conservatively assuming 5% of PM₁₀ emissions from sources involving ERA material were respirable silica. Respirable silica emissions are summarized in Table 41.

Table 41: Respirable Silica Emissions Summary (lb/yr)

Source	Respirable Silica
Aggregate Transfer	60.95
Stockpiles	296.59
Off-road Equipment Fugitive Dust	140.66
On-Site Truck Fugitive Dust	236.15
Total	734.35

In addition to DPM, combustion of diesel fuel generates toxic organics which is used to estimate acute health effects since DPM does not have an acute REL toxicity factor. Organic speciation factors were obtained from the 2012 HRA of the 2002 EIR As Addended. These factors are based on USEPA or CARB speciation profiles for on-road diesel trucks and off-road diesel equipment (USEPA, 2020; CARB, 2020c). Organic TAC emissions are summarized Tables 42 through 46.

Table 42: Organic TACs – OGVs, Tugs, and Off-Road Equipment - Unmitigated (lb/yr)

	Fraction of ROG	OGV Transit and Maneuvering	OGV Hotelling	Tugs Assist + Barge	Off-Road Equipment
ROG (total)	1.00000	2,331.47	2,100.32	1,940.93	3,037.99
1,3-Butadiene	0.00190	4.43	3.99	3.69	5.77
Acetaldehyde	0.07353	171.43	154.44	142.72	223.38
Benzene	0.02001	46.65	42.03	38.84	60.79
Ethylbenzene	0.00305	7.11	6.41	5.92	9.27
Formaldehyde	0.14714	343.05	309.04	285.59	447.01
Methanol	0.00030	0.70	0.63	0.58	0.91
MEK (2-butanone)	0.01477	34.44	31.02	28.67	44.87
m-Xylene	0.00611	14.25	12.83	11.86	18.56
Naphthalene	0.00085	1.98	1.79	1.65	2.58
n-Hexane	0.00157	3.66	3.30	3.05	4.77
o-Xylene	0.00335	7.81	7.04	6.50	10.18
Propene	0.02597	60.55	54.55	50.41	78.90
p-Xylene	0.00095	2.21	2.00	1.84	2.89
Styrene	0.00058	1.35	1.22	1.13	1.76
Toluene	0.01473	34.34	30.94	28.59	44.75

ROG Fraction from CARB Speciation Profile 818. List refined to match 2002 EIR as Added.

For chronic risk analysis, speciated TAC emissions are not included for DPM, as their associated risk are already included in risk from DPM. However, speciated TAC emissions are needed for acute analysis. Emissions from OGV boilers are not considered DPM, and therefore, their speciated emissions need to be included in cancer risk, as well as chronic and acute risk analyses.

To clarify, the following emissions are utilized in chronic and cancer risk:

- DPM
- Respirable Silica
- Organic TACs from OGV Boilers and gasoline-fueled employee vehicles

The following emissions are utilized for acute risk:

- All Organic TACs (OGV main engines, auxiliary engines, and boilers; tugs; off-road equipment, trucks, and employee vehicles)

Table 43: Organic TACs – OGV Boilers Only

	Fraction of ROG	OGV Transit and Maneuvering	OGV Hotelling
ROG (total)	1.00000	8.56	39.95
1,3-Butadiene	0.00190	0.02	0.08
Acetaldehyde	0.07353	0.63	2.94
Benzene	0.02001	0.17	0.80
Ethylbenzene	0.00305	0.03	0.12
Formaldehyde	0.14714	1.26	5.88
Methanol	0.00030	<0.01	0.01
MEK (2-butanone)	0.01477	0.13	0.59
m-Xylene	0.00611	0.05	0.24
Naphthalene	0.00085	0.01	0.03
n-Hexane	0.00157	0.01	0.06
o-Xylene	0.00335	0.03	0.13
Propene	0.02597	0.22	1.04
p-Xylene	0.00095	0.01	0.04
Styrene	0.00058	<0.01	0.02
Toluene	0.01473	0.13	0.59

Table 44: Organic TACs – Off-Road Equipment - Mitigated (lb/yr)

	Fraction of ROG	Off-Road Equipment
ROG (total)	1.00000	1,715.31
1,3-Butadiene	0.00190	3.26
Acetaldehyde	0.07353	126.13
Benzene	0.02001	34.32
Ethylbenzene	0.00305	5.23
Formaldehyde	0.14714	252.39
Methanol	0.00030	0.51
MEK (2-butanone)	0.01477	25.34
m-Xylene	0.00611	10.48
Naphthalene	0.00085	1.46
n-Hexane	0.00157	2.69
o-Xylene	0.00335	5.75
Propene	0.02597	44.55
p-Xylene	0.00095	1.63
Styrene	0.00058	0.99
Toluene	0.01473	25.27

ROG Fraction from CARB Speciation Profile 818. List refined to match 2002 EIR as Addended. Mitigated and Unmitigated emissions are equal for OGVs and Tugs

Table 45: Organic TAC Emissions – Trucks and Diesel Employee Vehicles (lb/yr)

	Fraction of ROG	Onsite	Offsite
ROG (total)	1.00000	790.30	166.48
Acetaldehyde	0.15942	125.99	26.54
Benzene	0.01045	8.26	1.74
Formaldehyde	0.08505	67.21	14.16
MEK (2-butanone)	0.02860	22.61	4.76
m-Xylene	0.00889	7.03	1.48
o-Xylene	0.00317	2.51	0.53
Toluene	0.01518	12.00	2.53

ROG Fraction from CARB Speciation Profile 4674. List refined to match 2002 EIR as Addended. Employee Vehicle emissions applied to offsite only. Onsite employee travel is negligible.

Table 46: Organic TAC Emissions – Gasoline Employee Vehicles (lb/yr)

	Fraction of ROG	Gasoline Employee Vehicles
ROG (total)	1.00000	1.934
1,3-Butadiene	0.00550	0.011
Acetaldehyde	0.00250	0.005
Benzene	0.02670	0.052
Ethylbenzene	0.01090	0.021
Formaldehyde	0.01720	0.033
Methanol	0.00410	0.008
MEK (2-butanone)	0.00020	<0.001
m-Xylene	0.03690	0.071
Naphthalene	0.00050	0.001
n-Hexane	0.01600	0.031
o-Xylene	0.01280	0.025
Styrene	0.00120	0.002
Toluene	0.05950	0.115

ROG Fractions from USEPA Speciation Profile 3163.

Details regarding each source of TACs and a project-level health risk assessment (HRA) are provided in Appendix D of this Draft SEIR.

3 CONSTRUCTION

Construction activities would include demolition, site preparation and grading, construction of Project components, and paving. The weight of the construction aggregates stored at the Project Site would result in compaction and settlement of portions of the site outside of where piles are installed as part of conveyor structure foundations; thus, site restoration activities at the end of the Proposed Project life are considered as a phase of Project construction. No in-water work would be required during construction of the Proposed Project and no off-site staging would be needed.

Construction of the Proposed Project is anticipated to take approximately 9 to 12 months. Construction is anticipated to begin in June 2021 and end by May 2022. Construction would generally occur between the hours of 7:00 a.m. and 7:00 p.m., Monday through Saturday. Barging and unloading of material for construction is a possibility and could occur at any time on any day of the week during the construction period. Up to six barge deliveries are assumed for the purposes of environmental analysis.

Demolition activities would include capping existing utilities (i.e., electric, lighting, water supply and fire hydrants, storm drain lines, and catch basins) where conflicts with Proposed Project facilities exist and the cutting and removal of sections of asphalt paving. As part of the building permit process, ERA would prepare a Construction and Demolition Waste Reduction and Recycling Plan (WRRP) for review and approval that would minimize waste diverted to the landfill.

Site preparation would include constructing ramps for accessing the Project Site from non-compacted areas, installing a perimeter security fence and security lights, and grading/installation of new utilities. This construction phase would also include grading of the stormwater retention pond.

Following site preparation and grading, the various Project components would be installed, including: vibratory pile driving of approximately 446 piles, installation of concrete foundations, placement of perimeter containers, and erecting structures (e.g., conveyors and scale house).

Existing electric infrastructure that crosses the Project Site will be relocated in a new underground electrical feed to continue to support existing electrical services in the area in addition to the Proposed Project facilities, conveyor systems, and associated lighting.

Any disturbed or damaged asphalt paving within the Project Site would be patch repaired as necessary to match the existing grade.

The number of required workers will range from 10 to 20 workers per day depending on the phase of construction. The equipment required and number of workers for each construction activity phase is presented in Table 2.5-1 of the Project Description of the Draft SEIR.

Project construction would generate waste materials consisting of asphalt and fill soil. Approximately 14 percent of construction waste (asphalt) would be diverted to a recycler for reuse and the remainder would be taken to the landfill. All other construction debris would be removed from the Project Site and recycled or otherwise disposed of off-site. Required construction materials would include structural fill and concrete. Approximate quantities and associated haul trips are listed in Table 2.5-2 of the Project Description.

3.1 Construction Activity and Construction-Related Vehicle Travel

Construction emissions, with the exception of the potential barge trips, were estimated using CAPCOA's California Emissions Estimator Model (CalEEMod). CalEEMod allows users to input

project parameters, such as land use square footage, construction equipment, material import and export quantities, and vehicle trips.

Construction schedule, construction equipment, material haul quantities, and vehicle trips following information provided in Tables 2.5-1 and Tables 2.5-2 of the Draft SEIR were used as inputs for CalEEMod. Additional assumptions used to estimate construction emissions include:

- Project Location: BAAQMD
- CEC Forecast Climate Zone: 5
- Each piece of construction equipment will operate up to 12 hours per day
- 6 Days per Week

Default horsepower and load factor were used for each piece of construction equipment. However, CalEEMod does not have a selectable option for water trucks or pile drivers. Water trucks were modeled as “Off-Highway Trucks” per the CalEEMod user’s guide (CAPCOA, 2013) and pile drivers were modeled as “Other Construction Equipment” per email correspondence with CARB personnel (CARB, 2020c). information on the specific type(s) of pile drivers to be used was not available so classification of “other” is appropriate. Default horsepower and load factors were used for these two equipment types.

CalEEMod generates emission estimates in terms of tons per calendar year for each phase of construction. Since construction is expected to occur from June 2021 through May 2022, overall construction emissions were broken up into two years, 2021 and 2022. Emissions occurring in 2021 were summed with emissions occurring in 2022 to represent a continuous 12-month construction period. Average daily emissions were calculated by dividing the total emissions by the number of expected working days, 312.

Two CalEEMod runs were performed. The first run shows unmitigated construction emissions. Site watering, which is considered a mitigation measure in CalEEMod but is actually a project requirement, is incorporated into the unmitigated emissions. Construction equipment is assumed to utilize engine tiers equal to the fleet average of the BAAQMD region.

The second run shows emissions after mitigation. ERA proposes Mitigation Measure ERA AQ-2: Project construction shall utilize construction equipment (excluding on-road trucks which must meet CARB on-road emission standards) meeting Tier 4 emission requirements with the possible exception of certain types of equipment (vibratory pile drivers and concrete saws), for which suitable Tier 4 equipment may not be available. Unmitigated and mitigated emissions are presented in the CalEEMod output files presented in Attachment C-2.

Unmitigated and mitigated CalEEMod results are summarized in Table 47.

Table 47: CalEEMod Source Emissions – Unmitigated (tpy)

CalEEMod Sources	ROG	CO	NOx	PM ₁₀	PM _{2.5}	SOx	CO ₂	CH ₄	N ₂ O
Unmitigated	0.62	5.35	5.96	0.35	0.28	0.01	1,156	0.29	0.00
Mitigated	0.32	5.72	2.86	0.19	0.13	0.01	1,156	0.29	0.00

3.2 Construction Barge Deliveries

Up to six barge deliveries are assumed for the purposes of this analysis. The origin of each barge delivery is unknown but assumed to be somewhere within the San Francisco Bay. For the purposes of this analysis, emissions were estimated assuming travel from the Golden Gate Bridge to the Port and vice versa. The average speed of each barge/tug is estimated to be 8 knots, which is based on the representative average speed for dredger tugs listed in the Port 2017 Emissions Inventory. The distance travel time of each link in the journey is provided in Table 48.

Table 48: Construction Barge Travel

Journey Link	Distance (nm)	Time (hours)
Golden Gate to Bay Bridge	6.5	0.81
Bay Bridge to Oakland	3.5	0.44
Oakland to Bay Bridge	3.5	0.44
Bay Bridge to Golden Gate	6.6	0.83
Total:		2.51

Emissions calculation methodology for construction barges follows the methodology of assist and barge tugs discussed in Section 2. Emission factors and load factors for construction barge tugs were obtained from the CARB Commercial Harbor Craft Emissions Inventory. Barge tugs will utilize ULSD. SO₂ emission factors were calculated from the BSFC assuming a sulfur content of 15 ppm. CO₂ emission factors were calculated from the BSFC assuming a fuel carbon content of 86.8 percent by weight and a ratio of molecular weights of CO₂ and carbon at 3.667.

Tug main and auxiliary engine power were derived from the average of the specifications for the Orion, the Sarah Reed, and the Fat Cat, which are the barge tugs discussed in Section 2.3: 2,258 HP for main engines and 157 HP for auxiliary engines. The average model year for the three tugs listed above is 2007, so 2007 main engine emissions factors were utilized for construction barge tugs. Auxiliary engine emissions factors were derived as the average emission factors over the useful life of auxiliary engines (MY 1996 – 2020). Emission factors are provided in Table 49.

Table 49: Construction Barge Emission Factors (g/hp-hr)

	ROG	CO	NOx	PM ₁₀	PM _{2.5}	SOx	CO ₂	CH ₄	N ₂ O
Main Engine	0.68	3.73	5.53	0.20	0.20	0.0055	587	0.06	0.02
Aux Engine	0.81	3.43	5.53	0.21	0.21	0.0055	587	0.07	0.02

All deterioration factors and fuel correction factors for NOx and PM were obtained from the CARB Appendix B. The fuel correction factor for ROG was obtained from CARB Off-road Documentation (CARB, 2017). Construction barge emissions are summarized in Table 50.

Table 50: Construction Barge Emissions (tpy)

	ROG	CO	NOx	PM ₁₀	PM _{2.5}	SOx	CO ₂	CH ₄	N ₂ O
Main Engine	0.020	0.109	0.150	0.006	0.006	<0.001	14.977	0.002	0.001
Aux Engine	0.001	0.004	0.006	<0.001	<0.001	<0.001	0.660	<0.001	0.000
Total	0.021	0.113	0.156	0.006	0.006	<0.001	15.637	0.002	0.001

3.3 Construction Summary

Unmitigated construction emissions are summarized in Table 51 through Table 55.

Table 51: Construction Emissions – Unmitigated Criteria Pollutant Summary

	ROG	CO	NOx	PM ₁₀	PM _{2.5}	SOx
CalEEMod Sources	0.62	5.35	5.96	0.35	0.28	0.01
Barges	0.02	0.11	0.16	0.01	0.01	<0.01
Total (tpy)	0.64	5.46	6.11	0.36	0.28	0.01
Working Days	312					
Total (lb/day)	4.11	35.02	39.19	2.30	1.82	0.08

Lb/day = pounds per day

Table 52: Construction Emissions – Unmitigated PM Summary

Pollutant	PM ₁₀	PM _{2.5}
Fugitive (tpy)	0.10	0.04
Exhaust (tpy)	0.26	0.25
Total (tpy)	0.36	0.28
Fugitive (lb/day)	0.62	0.24
Exhaust (lb/day)	1.68	1.58
Total (lb/day)	2.30	1.82

312 working days.

Table 53: Construction Emissions – Greenhouse Gas (GHG) Summary

Pollutant	CO ₂ (tpy)	CH ₄ (tpy)	N ₂ O (tpy)	CO ₂ e (mtpy)
CalEEMOD Sources	1,155.52	0.29	<0.01	1,054.82
Barges	15.64	<0.01	<0.01	14.37
Total	1,171.15	0.29	<0.01	1,069.18

mtpy = metric tonnes per year

Mitigated construction emissions are summarized in Table 51 and Table 52.

Table 54: Construction Emissions – Mitigated Criteria Pollutant Summary

	ROG	CO	NOx	PM ₁₀	PM _{2.5}	SOx
CalEEMod Sources	0.32	5.72	2.86	0.19	0.13	0.01
Barges	0.02	0.11	0.16	0.01	0.01	<0.01
Total (tpy)	0.34	5.84	3.02	0.20	0.13	0.01
Working Days	312					
Total (lb/day)	2.18	37.41	19.33	1.26	0.84	0.08

Lb/day = pounds per day

Table 55: Construction Emissions – Mitigated PM Summary

Pollutant	PM ₁₀	PM _{2.5}
Fugitive (tpy)	0.10	0.04
Exhaust (tpy)	0.10	0.09
Total (tpy)	0.20	0.13
Fugitive (lb/day)	0.62	0.24
Exhaust (lb/day)	0.64	0.60
Total (lb/day)	1.26	0.84

312 working days

Mitigated and unmitigated GHG emissions are equal.

3.4 Construction TACs

DPM is the primary TAC generated during construction of the Proposed Project. Additional organic TACs will be generated as part of diesel and gasoline combustion. Construction TACs are summarized in Table 56 and Table 57.

Table 56: Construction DPM Summary (lb/yr)

Source	Unmitigated	Mitigated
CalEEMod – Onsite	510.40	186.36
CalEEMod – Offsite	1.92	1.92
Barges	11.78	11.78
Total	524.10	200.06

Table 57: Construction Organic TACs Summary

Pollutant	Unmitigated (lb/yr)				Mitigated (lb/yr)			
	Onsite	Offsite	Barge	Total	Onsite	Offsite	Barge	Total
1,3-butadiene	2.29	--	0.08	2.37	1.15	--	0.08	1.23
Acetaldehyde	88.79	5.21	3.02	97.02	44.70	5.21	3.02	52.92
Benzene	24.16	0.34	0.82	25.33	12.16	0.34	0.82	13.33
Ethylbenzene	3.68	--	0.13	3.81	1.85	--	0.13	1.98
Formaldehyde	177.68	2.78	6.04	186.49	89.44	2.78	6.04	98.25
Methanol	0.36	--	0.01	0.37	0.18	--	0.01	0.19
MEK (2-butanone)	17.84	0.93	0.61	19.38	8.98	0.93	0.61	10.52
m-xylene	7.38	0.29	0.25	7.92	3.71	0.29	0.25	4.26
Naphthalene	1.03	--	0.03	1.06	0.52	--	0.03	0.55
n-hexane	1.90	--	0.06	1.93	0.95	--	0.06	1.02
o-xylene	4.05	0.10	0.14	4.29	2.04	0.10	0.14	2.28
Propene	31.36	--	1.07	32.43	15.79	--	1.07	16.85
p-xylene	1.15	--	0.04	1.19	0.58	--	0.04	0.62
Styrene	0.70	--	0.02	0.72	0.35	--	0.02	0.38
Toluene	17.79	0.50	0.60	18.89	8.95	0.50	0.60	10.05

ROG Fraction from CARB Speciation Profile 818. List refined to match 2002 EIR as Addended.

References:

1. Bay Area Air Quality Management District (BAAQMD, 2006), Permit Handbook. July 18.
2. California Air Resources Board (CARB), 1989. Technical Guidance Document for the Emission Inventory Criteria and Guidelines Regulation for AB2588. August.
3. California Air Resources Board (CARB) 2010. Appendix C: Updates on the Emissions Inventory for commercial harbor Craft Operating in California.
4. California Air Resources Board (CARB) 2011. Cargo Handling Equipment Emissions Inventory Model.
5. California Air Resources Board (CARB) 2012a. Commercial Harbor Craft Emissions Inventory Model.
6. California Air Resources Board (CARB) 2012b. Appendix B: Emissions Estimation Methodology for Commercial Harbor Craft Operating in California.
7. California Air Resources Board (CARB), 2017. 2017 Off-Road Diesel Emission Factor Update for NOx and PM.
8. California Air Resources Board (CARB) 2018. Miscellaneous Process Methodology 7.9, Entrained Road Travel, Paved Road Dust. March.
9. California Air Resources Board (CARB) 2019a. 2019 OGV At Berth Emissions Inventory Model.
10. California Air Resources Board (CARB) 2019b. Appendix H: Update to Inventory for Ocean-Going Vessels at Berth: Methodology and Results.
11. California Air Resources Board (CARB) 2019c. OFFROAD2017 Orion Database v1.0.1. <https://www.arb.ca.gov/orion/>.
12. California Air Resources Board (CARB) 2019d. EMFAC2017 Web Database v1.0.2. <https://www.arb.ca.gov/emfac/2017/>.
13. California Air Resources Board (CARB) ,2020a Off-Road Certification Database. <https://ww3.arb.ca.gov/msprog/offroad/cert/cert.php>.
14. California Air Resources Board (CARB), 2020b. Speciation Profiles Used in CARB Modeling. <https://ww2.arb.ca.gov/speciation-profiles-used-carb-modeling>.
15. California Air Resources Board (CARB), 2020c. Email with CARB personnel on 31 August, 2020.

16. Pacific Gas & Electric (PG&E), 2019. Climate Change, Benchmarking Greenhouse Gas Emissions for Delivered Electricity.
http://www.pgecorp.com/corp_responsibility/reports/2019/en02_climate_change.html
17. Port of Oakland (Port, 2018). Port of Oakland 2017 Seaport Air Emissions Inventory. August 28.
18. United States Environmental Protection Agency (USEPA), 2006. Background Document for Revisions to Fine Fraction Ratios Used for AP-42 Fugitive Dust Emission Factors.
19. United States Environmental Protection Agency (USEPA), 2018. Emission Factors for Greenhouse Gas Inventories. March 9.
20. United States Environmental Protection Agency (USEPA), 2020. Speciate 5.1. July.
21. United States Environmental Protection Agency (USEPA). AP-42 Compilation of Air Emission Factors. <https://www.epa.gov/air-emissions-factors-and-quantification/ap-42-compilation-air-emissions-factors>
22. Western Region Air Partnership (WRAP), 2006. WRAP Fugitive Dust Handbook. September 7.

Attachment C-1

Emission Calculation Tables

Ocean Going Vessel Emissions - Summary

Emissions Summary - Per Vessel (tons)

	ROG	CO	NOx	PM10	PM2.5	SO _x	CO ₂	CH ₄	N ₂ O	DPM
HH Jackman										
Transit (Inbound and Outbound)	0.022	0.038	0.476	0.005	0.005	0.011	17.501	0.000	0.001	HHJackman 0.005
Maneuvering (Inbound and Outbound)	0.003	0.005	0.061	0.001	0.001	0.002	2.729	0.000	0.000	0.001
Hotelling	0.024	0.050	0.632	0.009	0.008	0.021	34.101	0.000	0.002	0.008
Total	0.048	0.093	1.168	0.015	0.013	0.034	54.332	0.001	0.003	0.014
CSL Tecumseh										
Transit (Inbound and Outbound)	0.021	0.034	0.420	0.006	0.005	0.011	17.431	0.000	0.001	Tecumseh 0.005
Maneuvering (Inbound and Outbound)	0.003	0.004	0.068	0.001	0.001	0.002	3.250	0.000	0.000	0.001
Hotelling	0.016	0.033	0.414	0.006	0.006	0.015	23.434	0.000	0.001	0.005
Total	0.040	0.071	0.902	0.012	0.011	0.028	44.115	0.001	0.002	0.012
Sheila Ann										
Transit (Inbound and Outbound)	0.020	0.038	0.481	0.005	0.005	0.011	17.407	0.000	0.001	Sheila Ann 0.005
Maneuvering (Inbound and Outbound)	0.003	0.005	0.080	0.001	0.001	0.002	3.736	0.000	0.000	0.001
Hotelling	0.020	0.043	0.538	0.008	0.007	0.019	29.529	0.000	0.001	0.007
Total	0.043	0.086	1.100	0.014	0.013	0.032	50.672	0.001	0.002	0.013

Emissions Summary - Total (48 Vessels), (tpy) - 36 HH Jackman, 12 Tecumseh (75% Tier 0, 25% Tier 2)

	ROG	CO	NOx	PM10	PM2.5	SO _x	CO ₂	CH ₄	N ₂ O	DPM
Transit (Inbound and Outbound)	1.04	1.76	22.18	0.25	0.23	0.53	839.21	0.02	0.04	0.245
Maneuvering (Inbound and Outbound)	0.13	0.22	3.00	0.03	0.03	0.09	137.26	0.00	0.01	0.032
Hotelling	1.05	2.22	27.70	0.39	0.36	0.95	1,508.84	0.02	0.07	0.361
Total	2.22	4.19	52.89	0.67	0.62	1.56	2,485.32	0.03	0.12	0.638

Ocean Going Vessel Emissions - H.H. Jackman

Emissions Summary - Per Vessel (tons)

	ROG	CO	NOx	PM10	PM2.5	SO _x	CO ₂	CH ₄	N ₂ O	DPM
Transit (Inbound and Outbound)	0.022	0.038	0.476	0.005	0.005	0.011	17.501	0.000	0.001	0.005
Maneuvering (Inbound and Outbound)	0.003	0.005	0.061	0.001	0.001	0.002	2.729	0.000	0.000	0.001
Hotelling	0.024	0.050	0.632	0.009	0.008	0.021	34.101	0.000	0.002	0.008
Total	0.048	0.093	1.168	0.015	0.013	0.034	54.332	0.001	0.003	0.014

Emission Factors

Engine Type & Speed	Precontrol (Tier 0) Emissions Factor (g/kw-hr), 0.1% Sulfur									
	ROG	CO	NOx	PM10	PM2.5	SO _x	CO ₂	CH ₄	N ₂ O	
Main Engine Slow Speed	0.78	1.38	17.00	0.189	0.174	0.362	576	0.012	0.028	
Auxiliary Engine	0.52	1.10	13.80	0.182	0.168	0.424	676	0.008	0.033	
Auxiliary Boiler	0.11	0.20	1.995	0.164	0.151	0.587	934	0.002	0.045	

- Main Engine Criteria Pollutant Emission Factors obtained from CARB 2019 OGV Emission Inventory Model

- Auxiliary Engine and Boiler Emission Factors from CARB 2019 Update to Inventory for OGV at Berth (Appendix H)

Main Engine Emissions

Operation Mode	Link Start	Link End	Distance (nautical miles)	Speed (nmph)	Hours	Load Factor	Engine kW	ROG	CO	NOx	PM10	PM2.5	SO _x	CO ₂	CH ₄	N ₂ O
Transit into Port																
Transit	PZ Outer Edge	Pilot Station	6.8	15.8	0.43	82%	12,085	0.0037	0.0059	0.0820	0.0009	0.0009	0.0017	2.6985	0.0001	0.0001
Transit	Pilot Station	Sea Buoy	1.5	9.0	0.17	15%	12,085	0.0004	0.0006	0.0079	0.0000	0.0000	0.0001	0.2081	0.0000	0.0000
Transit	Sea Buoy	Golden Gate	8.7	13.5	0.64	52%	12,085	0.0033	0.0060	0.0711	0.0007	0.0006	0.0016	2.5621	0.0001	0.0001
Transit	Golden Gate	Bay Bridge	6.5	13.5	0.48	52%	12,085	0.0025	0.0044	0.0531	0.0005	0.0005	0.0012	1.9142	0.0000	0.0001
Maneuvering																
Maneuvering: Into Oakland Terminal	Bay Bridge	Dock	--	--	1.33	2%	12,085	0.0007	0.0007	0.0112	0.0001	0.0001	0.0001	0.2266	0.0000	0.0000
Maneuvering: Out of Oakland Terminal	Dock	Bay Bridge	--	--	0.75	2%	12,085	0.0004	0.0004	0.0063	0.0000	0.0000	0.0001	0.1278	0.0000	0.0000
Transit Out of Bay																
Transit	Bay Bridge	Golden Gate	6.6	13.5	0.49	52%	12,085	0.0025	0.0045	0.0539	0.0005	0.0005	0.0012	1.9437	0.0000	0.0001
Transit	Golden Gate	Sea Buoy	8.9	13.5	0.66	52%	12,085	0.0034	0.0061	0.0727	0.0007	0.0006	0.0016	2.6210	0.0001	0.0001
Transit	Sea Buoy	Pilot Station	1.5	9.0	0.17	15%	12,085	0.0004	0.0006	0.0079	0.0000	0.0000	0.0001	0.2081	0.0000	0.0000
Transit	Pilot Station	PZ Outer Edge	6.8	15.8	0.43	82%	12,085	0.0037	0.0059	0.0820	0.0009	0.0009	0.0017	2.6985	0.0001	0.0001
Transit per Vessel (tons):								0.020	0.034	0.431	0.004	0.004	0.009	14.854	0.000	0.001
Maneuvering per Vessel (tons):								0.001	0.001	0.018	0.000	0.000	0.000	0.354	0.000	0.000
Total per Vessel (tons):								0.021	0.035	0.448	0.004	0.004	0.010	15.209	0.000	0.001

- Engine kW obtained from the ship operator (CSL).

- Design speed of the HH Jackman is 15.75 knots. Design Speed assumed to be 93.7% of Maximum Speed.

- Load Factor = (Vessel Speed / Maximum Speed)³, except for maneuvering, which was obtained from the Port of Oakland 2017 Emissions Inventory

- Distance and speed of each journey link obtained from Port of Oakland 2017 Emissions Inventory

Auxiliary Engine Emissions

Operation Mode	Link Start	Link End	Distance (nautical miles)	Speed	Hours	Load Factor	Engine kW	ROG	CO	NOx	PM10	PM2.5	SO _x	CO ₂	CH ₄	N ₂ O
Transit into Port																
Transit	PZ Outer Edge	Pilot Station	6.8	15.8	0.43	13%	2,700	0.0001	0.0002	0.0023	0.0000	0.0000	0.0001	0.1129	0.0000	0.0000
Transit	Pilot Station	Sea Buoy	1.5	9.0	0.17	31%	2,700	0.0001	0.0002	0.0021	0.0000	0.0000	0.0001	0.1051	0.0000	0.0000
Transit	Sea Buoy	Golden Gate	8.7	13.5	0.64	31%	2,700	0.0003	0.0007	0.0083	0.0001	0.0001	0.0003	0.4063	0.0000	0.0000
Transit	Golden Gate	Bay Bridge	6.5	13.5	0.48	47%	2,700	0.0004	0.0007	0.0093	0.0001	0.0001	0.0003	0.4553	0.0000	0.0000
Maneuvering																
Maneuvering: Into Oakland Terminal	Bay Bridge	Dock	--	--	1.33	50%	2,700	0.0010	0.0022	0.0273	0.0004	0.0003	0.0008	1.3379	0.0000	0.0001
Maneuvering: Out of Oakland Terminal	Dock	Bay Bridge	--	--	0.75	50%	2,700	0.0006	0.0012	0.0154	0.0002	0.0002	0.0005	0.7545	0.0000	0.0000
Hotelling Oakland																
Hotelling: Waiting	Dock	Dock	--	--	1.00	16%	2,700	0.0002	0.0005	0.0064	0.0001	0.0001	0.0002	0.3152	0.0000	0.0000
Hotelling: Discharging	Dock	Dock	--	--	24.00	62%	2,700	0.0230	0.0487	0.6111	0.0081	0.0074	0.0188	29.9371	0.0004	0.0015
Hotelling: Waiting	Dock	Dock	--	--	1.00	16%	2,700	0.0002	0.0005	0.0064	0.0001	0.0001	0.0002	0.3152	0.0000	0.0000
Transit Out of Bay																
Transit	Bay Bridge	Golden Gate	6.6	13.5	0.49	47%	2,700	0.0004	0.0008	0.0094	0.0001	0.0001	0.0003	0.4623	0.0000	0.0000
Transit	Golden Gate	Sea Buoy	8.9	13.5	0.66	31%	2,700	0.0003	0.0007	0.0085	0.0001	0.0001	0.0003	0.4156	0.0000	0.0000
Transit	Sea Buoy	Pilot Station	1.5	9.0	0.17	31%	2,700	0.0001	0.0002	0.0021	0.0000	0.0000	0.0001	0.1051	0.0000	0.0000
Transit	Pilot Station	PZ Outer Edge	6.8	15.8	0.43	13%	2,700	0.0001	0.0002	0.0023	0.0000	0.0000	0.0001	0.1129	0.0000	0.0000
Transit per Vessel (tons):								0.002	0.004	0.044	0.001	0.001	0.001	2.175	0.000	0.000
Maneuvering per Vessel (tons):								0.002	0.003	0.043	0.001	0.001	0.001	2.092	0.000	0.000
Hotelling per Vessel (tons):								0.024	0.050	0.624	0.008	0.008	0.019	30.568	0.000	0.001
Total per Vessel (tons):								0.027	0.057	0.711	0.009	0.009	0.022	34.835	0.000	0.002

- PZ Outer Edge - Pilot Station link LF based on Port of Oakland 2017 Emissions Inventory
 - Maneuvering Load Factors obtained from Port of Oakland 2017 Emissions Inventory
 - Engine kW based on 3 auxiliary engines rated at 900, 900, and 900 kW respectively.

Auxiliary Engine Load Factor Data - Obtained from a log from a HH Jackman Voyage into the SF Bay

Link	Aux Engine kW	LF
Pilot Station to Golden Gate	900	47%
	900	47%
	900	0%
Golden Gate to Bay Bridge	900	47%
	900	47%
	900	47%
Hotelling - Waiting	900	47%
	900	0%
	900	0%
Hotelling - Discharging	900	62%
	900	62%
	900	62%
Hotelling - Waiting	900	47%
	900	0%
	900	0%
Bay Bridge to Golden Gate	900	47%
	900	47%
	900	47%
Golden Gate to Pilot Station	900	47%
	900	47%
	900	0%

Boiler Emissions

Operation Mode	Link Start	Link End	Distance (nautical miles)	Speed	Hours	Load Factor	Boiler kW	ROG	CO	NOx	PM10	PM2.5	SO _x	CO ₂	CH ₄	N ₂ O
Transit into Port																
Transit	PZ Outer Edge	Pilot Station	6.8	15.8	0.43	--	132	0.0000	0.0000	0.0001	0.0000	0.0000	0.0000	0.0587	0.0000	0.0000
Transit	Pilot Station	Sea Buoy	1.5	9.0	0.17	--	132	0.0000	0.0000	0.0000	0.0000	0.0000	0.0000	0.0226	0.0000	0.0000
Transit	Sea Buoy	Golden Gate	8.7	13.5	0.64	--	132	0.0000	0.0000	0.0002	0.0000	0.0000	0.0001	0.0876	0.0000	0.0000
Transit	Golden Gate	Bay Bridge	6.5	13.5	0.48	--	132	0.0000	0.0000	0.0001	0.0000	0.0000	0.0000	0.0654	0.0000	0.0000
Maneuvering																
Maneuvering: Into Oakland Terminal	Bay Bridge	Dock	--	--	1.33	--	132	0.0000	0.0000	0.0004	0.0000	0.0000	0.0001	0.1807	0.0000	0.0000
Maneuvering: Out of Oakland Terminal	Dock	Bay Bridge	--	--	0.75	--	132	0.0000	0.0000	0.0002	0.0000	0.0000	0.0001	0.1019	0.0000	0.0000
Hotelling Oakland																
Hotelling: Waiting	Dock	Dock	--	--	1.00	--	132	0.0000	0.0000	0.0003	0.0000	0.0000	0.0001	0.1359	0.0000	0.0000
Hotelling: Discharging	Dock	Dock	--	--	24.00	--	132	0.0004	0.0007	0.0070	0.0006	0.0005	0.0020	3.2616	0.0000	0.0002
Hotelling: Waiting	Dock	Dock	--	--	1.00	--	132	0.0000	0.0000	0.0003	0.0000	0.0000	0.0001	0.1359	0.0000	0.0000
Transit Out of Bay																
Transit	Bay Bridge	Golden Gate	6.6	13.5	0.49	--	132	0.0000	0.0000	0.0001	0.0000	0.0000	0.0000	0.0664	0.0000	0.0000
Transit	Golden Gate	Sea Buoy	8.9	13.5	0.66	--	132	0.0000	0.0000	0.0002	0.0000	0.0000	0.0001	0.0896	0.0000	0.0000
Transit	Sea Buoy	Pilot Station	1.5	9.0	0.17	--	132	0.0000	0.0000	0.0000	0.0000	0.0000	0.0000	0.0226	0.0000	0.0000
Transit	Pilot Station	PZ Outer Edge	6.8	15.8	0.43	--	132	0.0000	0.0000	0.0001	0.0000	0.0000	0.0000	0.0587	0.0000	0.0000
Transit per Vessel (tons):								0.000	0.000	0.001	0.000	0.000	0.000	0.472	0.000	0.000
Maneuvering per Vessel (tons):								0.000	0.000	0.001	0.000	0.000	0.000	0.283	0.000	0.000
Hotelling per Vessel (tons):								0.000	0.001	0.008	0.001	0.001	0.002	3.533	0.000	0.000
Total per Vessel (tons):								0.001	0.001	0.009	0.001	0.001	0.003	4.288	0.000	0.000

- Boiler kW is "Effective Power" obtained from ARB, 2019: Update to Inventory for OGV at Berth, Appendix H, Table 10

Ocean Going Vessel Emissions - Tecumseh

Emissions Summary - Per Vessel (tons)

	ROG	CO	NOx	PM10	PM2.5	SO _x	CO ₂	CH ₄	N ₂ O	DPM
Transit (Inbound and Outbound)	0.021	0.034	0.420	0.006	0.005	0.011	17.431	0.000	0.001	0.005
Maneuvering (Inbound and Outbound)	0.003	0.004	0.068	0.001	0.001	0.002	3.250	0.000	0.000	0.001
Hotelling	0.016	0.033	0.414	0.006	0.006	0.015	23.434	0.000	0.001	0.005
Total	0.040	0.071	0.902	0.012	0.011	0.028	44.115	0.001	0.002	0.012

Emission Factors

Engine Type & Speed	2013 (Tier 2) Emissions Factor (g/kw-hr), 0.1% Sulfur									
	ROG	CO	NOx	PM10	PM2.5	SO _x	CO ₂	CH ₄	N ₂ O	
Main Engine Slow Speed	0.78	1.38	14.40	0.189	0.174	0.362	576	0.012	0.028	
Auxiliary Engine	0.52	1.10	13.80	0.182	0.168	0.424	676	0.008	0.033	
Auxiliary Boiler	0.11	0.20	1.995	0.164	0.151	0.587	934	0.002	0.045	

- Main Engine Criteria Pollutant Emission Factors obtained from CARB 2019 OGV Emission Inventory Model

- Auxiliary Engine and Boiler Emission Factors from CARB 2019 Update to Inventory for OGV at Berth (Appendix H)

Main Engine Emissions

Operation Mode	Link Start	Link End	Distance (nautical miles)	Speed (nmph)	Hours	Load Factor	Engine kW	ROG	CO	NOx	PM10	PM2.5	SO _x	CO ₂	CH ₄	N ₂ O
Transit into Port																
Transit	PZ Outer Edge	Pilot Station	6.8	14.5	0.47	82%	10,430	0.0038	0.0035	0.0632	0.0009	0.0009	0.0016	2.5297	0.0001	0.0001
Transit	Pilot Station	Sea Buoy	1.5	9.0	0.17	20%	10,430	0.0002	0.0006	0.0071	0.0000	0.0000	0.0001	0.2280	0.0000	0.0000
Transit	Sea Buoy	Golden Gate	8.7	13.5	0.64	66%	10,430	0.0034	0.0064	0.0701	0.0009	0.0008	0.0018	2.8055	0.0001	0.0001
Transit	Golden Gate	Bay Bridge	6.5	13.5	0.48	66%	10,430	0.0025	0.0048	0.0524	0.0007	0.0006	0.0013	2.0961	0.0000	0.0001
Maneuvering																
Maneuvering: Into Oakland Terminal	Bay Bridge	Dock	--	--	1.33	2%	10,430	0.0003	0.0001	0.0082	0.0000	0.0000	0.0001	0.1938	0.0000	0.0000
Maneuvering: Out of Oakland Terminal	Dock	Bay Bridge	--	--	0.75	2%	10,430	0.0002	0.0000	0.0046	0.0000	0.0000	0.0001	0.1093	0.0000	0.0000
Transit Out of Bay																
Transit	Bay Bridge	Golden Gate	6.6	13.5	0.49	66%	10,430	0.0026	0.0049	0.0532	0.0007	0.0006	0.0013	2.1283	0.0000	0.0001
Transit	Golden Gate	Sea Buoy	8.9	13.5	0.66	66%	10,430	0.0035	0.0066	0.0717	0.0009	0.0008	0.0018	2.8700	0.0001	0.0001
Transit	Sea Buoy	Pilot Station	1.5	9.0	0.17	20%	10,430	0.0002	0.0006	0.0071	0.0000	0.0000	0.0001	0.2280	0.0000	0.0000
Transit	Pilot Station	PZ Outer Edge	6.8	14.5	0.47	82%	10,430	0.0038	0.0035	0.0632	0.0009	0.0009	0.0016	2.5297	0.0001	0.0001
Transit per Vessel (tons):								0.020	0.031	0.388	0.005	0.005	0.010	15.415	0.000	0.001
Maneuvering per Vessel (tons):								0.000	0.000	0.013	0.000	0.000	0.000	0.303	0.000	0.000
Total per Vessel (tons):								0.021	0.031	0.401	0.005	0.005	0.010	15.718	0.000	0.001

- Engine kW obtained from the ship operator (CSL).

- Design speed of the Tecumseh is 14.5 knots. Design Speed assumed to be 93.7% of Maximum Speed.

- Load Factor = (Vessel Speed / Maximum Speed)³, except for maneuvering, which was obtained from the Port of Oakland 2017 Emissions Inventory

- Distance and speed of each journey link obtained from Port of Oakland 2017 Emissions Inventory

Auxiliary Engine Emissions

Operation Mode	Link Start	Link End	Distance (nautical miles)	Speed	Hours	Load Factor	Engine kW	ROG	CO	NOx	PM10	PM2.5	SO _x	CO ₂	CH ₄	N ₂ O
Transit into Port																
Transit	PZ Outer Edge	Pilot Station	6.8	14.5	0.47	13%	3,438	0.0001	0.0003	0.0032	0.0000	0.0000	0.0001	0.1562	0.0000	0.0000
Transit	Pilot Station	Sea Buoy	1.5	9.0	0.17	20%	3,438	0.0001	0.0001	0.0017	0.0000	0.0000	0.0001	0.0842	0.0000	0.0000
Transit	Sea Buoy	Golden Gate	8.7	13.5	0.64	20%	3,438	0.0003	0.0005	0.0066	0.0001	0.0001	0.0002	0.3257	0.0000	0.0000
Transit	Golden Gate	Bay Bridge	6.5	13.5	0.48	17%	3,438	0.0002	0.0003	0.0042	0.0001	0.0001	0.0001	0.2063	0.0000	0.0000
Maneuvering																
Maneuvering: Into Oakland Terminal	Bay Bridge	Dock	--	--	1.33	50%	3,438	0.0013	0.0028	0.0348	0.0005	0.0004	0.0011	1.7036	0.0000	0.0001
Maneuvering: Out of Oakland Terminal	Dock	Bay Bridge	--	--	0.75	50%	3,438	0.0007	0.0016	0.0196	0.0003	0.0002	0.0006	0.9607	0.0000	0.0000
Hotelling Oakland																
Hotelling: Waiting	Dock	Dock	--	--	1.00	14%	3,438	0.0003	0.0006	0.0074	0.0001	0.0001	0.0002	0.3635	0.0000	0.0000
Hotelling: Discharging	Dock	Dock	--	--	24.00	31%	3,438	0.0147	0.0312	0.3914	0.0052	0.0048	0.0120	19.1737	0.0002	0.0009
Hotelling: Waiting	Dock	Dock	--	--	1.00	14%	3,438	0.0003	0.0006	0.0074	0.0001	0.0001	0.0002	0.3635	0.0000	0.0000
Transit Out of Bay																
Transit	Bay Bridge	Golden Gate	6.6	13.5	0.49	16%	3,438	0.0002	0.0003	0.0042	0.0001	0.0001	0.0001	0.2050	0.0000	0.0000
Transit	Golden Gate	Sea Buoy	8.9	13.5	0.66	19%	3,438	0.0002	0.0005	0.0065	0.0001	0.0001	0.0002	0.3194	0.0000	0.0000
Transit	Sea Buoy	Pilot Station	1.5	9.0	0.17	19%	3,438	0.0001	0.0001	0.0016	0.0000	0.0000	0.0001	0.0807	0.0000	0.0000
Transit	Pilot Station	PZ Outer Edge	6.8	14.5	0.47	13%	3,438	0.0001	0.0003	0.0032	0.0000	0.0000	0.0001	0.1562	0.0000	0.0000
Transit per Vessel (tons):								0.001	0.002	0.031	0.000	0.000	0.001	1.534	0.000	0.000
Maneuvering per Vessel (tons):								0.002	0.004	0.054	0.001	0.001	0.002	2.664	0.000	0.000
Hotelling per Vessel (tons):								0.015	0.032	0.406	0.005	0.005	0.012	19.901	0.000	0.001
Total per Vessel (tons):								0.019	0.039	0.492	0.006	0.006	0.015	24.099	0.000	0.001

- PZ Outer Edge - Pilot Station link LF based on Port of Oakland 2017 Emissions Inventory
 - Maneuvering Load Factors obtained from Port of Oakland 2017 Emissions Inventory
 - Engine kW based on 3 auxiliary engines rated at 1250, 1250, and 938 kW respectively.

Auxiliary Engine Load Factor Data - Obtained from a log from a Tecumseh Voyage into the SF Bay

Link	Aux Engine kW	LF
Pilot Station to Golden Gate	1,250	28%
	1,250	0%
	938	35%
Golden Gate to Bay Bridge	1,250	23%
	1,250	23%
	938	0%
Hotelling - Waiting	1,250	0%
	1,250	0%
	938	52%
Hotelling - Discharging	1,250	46%
	1,250	0%
	938	53%
Hotelling - Waiting	1,250	0%
	1,250	0%
	938	52%
Bay Bridge to Golden Gate	1,250	24%
	1,250	0%
	938	28%
Golden Gate to Pilot Station	1,250	28%
	1,250	0%
	938	32%

Boiler Emissions

Operation Mode	Link Start	Link End	Distance (nautical miles)	Speed	Hours	Load Factor	Boiler kW	ROG	CO	NOx	PM10	PM2.5	SO _x	CO ₂	CH ₄	N ₂ O
Transit into Port																
Transit	PZ Outer Edge	Pilot Station	6.8	14.5	0.47	--	132	0.0000	0.0000	0.0001	0.0000	0.0000	0.0000	0.0637	0.0000	0.0000
Transit	Pilot Station	Sea Buoy	1.5	9.0	0.17	--	132	0.0000	0.0000	0.0000	0.0000	0.0000	0.0000	0.0226	0.0000	0.0000
Transit	Sea Buoy	Golden Gate	8.7	13.5	0.64	--	132	0.0000	0.0000	0.0002	0.0000	0.0000	0.0001	0.0876	0.0000	0.0000
Transit	Golden Gate	Bay Bridge	6.5	13.5	0.48	--	132	0.0000	0.0000	0.0001	0.0000	0.0000	0.0000	0.0654	0.0000	0.0000
Maneuvering																
Maneuvering: Into Oakland Terminal	Bay Bridge	Dock	--	--	1.33	--	132	0.0000	0.0000	0.0004	0.0000	0.0000	0.0001	0.1807	0.0000	0.0000
Maneuvering: Out of Oakland Terminal	Dock	Bay Bridge	--	--	0.75	--	132	0.0000	0.0000	0.0002	0.0000	0.0000	0.0001	0.1019	0.0000	0.0000
Hotelling Oakland																
Hotelling: Waiting	Dock	Dock	--	--	1.00	--	132	0.0000	0.0000	0.0003	0.0000	0.0000	0.0001	0.1359	0.0000	0.0000
Hotelling: Discharging	Dock	Dock	--	--	24.00	--	132	0.0004	0.0007	0.0070	0.0006	0.0005	0.0020	3.2616	0.0000	0.0002
Hotelling: Waiting	Dock	Dock	--	--	1.00	--	132	0.0000	0.0000	0.0003	0.0000	0.0000	0.0001	0.1359	0.0000	0.0000
Transit Out of Bay																
Transit	Bay Bridge	Golden Gate	6.6	13.5	0.49	--	132	0.0000	0.0000	0.0001	0.0000	0.0000	0.0000	0.0664	0.0000	0.0000
Transit	Golden Gate	Sea Buoy	8.9	13.5	0.66	--	132	0.0000	0.0000	0.0002	0.0000	0.0000	0.0001	0.0896	0.0000	0.0000
Transit	Sea Buoy	Pilot Station	1.5	9.0	0.17	--	132	0.0000	0.0000	0.0000	0.0000	0.0000	0.0000	0.0226	0.0000	0.0000
Transit	Pilot Station	PZ Outer Edge	6.8	14.5	0.47	--	132	0.0000	0.0000	0.0001	0.0000	0.0000	0.0000	0.0637	0.0000	0.0000
Transit per Vessel (tons):								0.000	0.000	0.001	0.000	0.000	0.000	0.482	0.000	0.000
Maneuvering per Vessel (tons):								0.000	0.000	0.001	0.000	0.000	0.000	0.283	0.000	0.000
Hotelling per Vessel (tons):								0.000	0.001	0.008	0.001	0.001	0.002	3.533	0.000	0.000
Total per Vessel (tons):								0.001	0.001	0.009	0.001	0.001	0.003	4.298	0.000	0.000

- Boiler kW is "Effective Power" obtained from ARB, 2019: Update to Inventory for OGV at Berth, Appendix H, Table 10

Ocean Going Vessel Emissions - Sheila Ann

Emissions Summary - Per Vessel (tons)

	ROG	CO	NOx	PM10	PM2.5	SO _x	CO ₂	CH ₄	N ₂ O	DPM
Transit (Inbound and Outbound)	0.020	0.038	0.481	0.005	0.005	0.011	17.407	0.000	0.001	0.005
Maneuvering (Inbound and Outbound)	0.003	0.005	0.080	0.001	0.001	0.002	3.736	0.000	0.000	0.001
Hotelling	0.020	0.043	0.538	0.008	0.007	0.019	29.529	0.000	0.001	0.007
Total	0.043	0.086	1.100	0.014	0.013	0.032	50.672	0.001	0.002	0.013

Emission Factors

Engine Type & Speed	Precontrol (Tier 0) Emissions Factor (g/kw-hr), 0.1% Sulfur									
	ROG	CO	NOx	PM10	PM2.5	SO _x	CO ₂	CH ₄	N ₂ O	
Main Engine Slow Speed	0.78	1.38	17.00	0.189	0.174	0.362	576	0.012	0.028	
Auxiliary Engine	0.52	1.10	13.80	0.182	0.168	0.424	676	0.008	0.033	
Auxiliary Boiler	0.11	0.20	1.995	0.164	0.151	0.587	934	0.002	0.045	

- Main Engine Criteria Pollutant Emission Factors obtained from CARB 2019 OGV Emission Inventory Model

- Auxiliary Engine and Boiler Emission Factors from CARB 2019 Update to Inventory for OGV at Berth (Appendix H)

Main Engine Emissions

Operation Mode	Link Start	Link End	Distance (nautical miles)	Speed (nmph)	Hours	Load Factor	Engine kW	ROG	CO	NOx	PM10	PM2.5	SO _x	CO ₂	CH ₄	N ₂ O
Transit into Port																
Transit	PZ Outer Edge	Pilot Station	6.8	15.0	0.45	82%	10,784	0.0038	0.0035	0.0746	0.0009	0.0009	0.0016	2.5284	0.0001	0.0001
Transit	Pilot Station	Sea Buoy	1.5	9.0	0.17	18%	10,784	0.0002	0.0005	0.0080	0.0000	0.0000	0.0001	0.2130	0.0000	0.0000
Transit	Sea Buoy	Golden Gate	8.7	13.5	0.64	60%	10,784	0.0029	0.0074	0.0765	0.0008	0.0007	0.0016	2.6202	0.0000	0.0001
Transit	Golden Gate	Bay Bridge	6.5	13.5	0.48	60%	10,784	0.0022	0.0055	0.0572	0.0006	0.0005	0.0012	1.9576	0.0000	0.0001
Maneuvering																
Maneuvering: Into Oakland Terminal	Bay Bridge	Dock	--	--	1.33	2%	10,784	0.0003	0.0001	0.0100	0.0000	0.0000	0.0001	0.2004	0.0000	0.0000
Maneuvering: Out of Oakland Terminal	Dock	Bay Bridge	--	--	0.75	2%	10,784	0.0002	0.0000	0.0056	0.0000	0.0000	0.0001	0.1130	0.0000	0.0000
Transit Out of Bay																
Transit	Bay Bridge	Golden Gate	6.6	13.5	0.49	60%	10,784	0.0022	0.0056	0.0581	0.0006	0.0005	0.0012	1.9877	0.0000	0.0001
Transit	Golden Gate	Sea Buoy	8.9	13.5	0.66	60%	10,784	0.0030	0.0075	0.0783	0.0008	0.0007	0.0017	2.6804	0.0000	0.0001
Transit	Sea Buoy	Pilot Station	1.5	9.0	0.17	18%	10,784	0.0002	0.0005	0.0080	0.0000	0.0000	0.0001	0.2130	0.0000	0.0000
Transit	Pilot Station	PZ Outer Edge	6.8	15.0	0.45	82%	10,784	0.0038	0.0035	0.0746	0.0009	0.0009	0.0016	2.5284	0.0001	0.0001
Transit per Vessel (tons):								0.018	0.034	0.435	0.005	0.004	0.009	14.729	0.000	0.001
Maneuvering per Vessel (tons):								0.001	0.000	0.016	0.000	0.000	0.000	0.313	0.000	0.000
Total per Vessel (tons):								0.019	0.034	0.451	0.005	0.004	0.009	15.042	0.000	0.001

- Engine kW obtained from the ship operator (CSL).

- Design speed of the Sheila Ann is 15 knots. Design Speed assumed to be 93.7% of Maximum Speed.

- Load Factor = (Vessel Speed / Maximum Speed)³, except for maneuvering, which was obtained from the Port of Oakland 2017 Emissions Inventory

- Distance and speed of each journey link obtained from Port of Oakland 2017 Emissions Inventory

Auxiliary Engine Emissions

Operation Mode	Link Start	Link End	Distance (nautical miles)	Speed	Hours	Load Factor	Engine kW	ROG	CO	NOx	PM10	PM2.5	SO _x	CO ₂	CH ₄	N ₂ O
Transit into Port																
Transit	PZ Outer Edge	Pilot Station	6.8	15.0	0.45	13%	4,052	0.0001	0.0003	0.0036	0.0000	0.0000	0.0001	0.1779	0.0000	0.0000
Transit	Pilot Station	Sea Buoy	1.5	9.0	0.17	15%	4,052	0.0001	0.0001	0.0015	0.0000	0.0000	0.0000	0.0752	0.0000	0.0000
Transit	Sea Buoy	Golden Gate	8.7	13.5	0.64	15%	4,052	0.0002	0.0005	0.0059	0.0001	0.0001	0.0002	0.2907	0.0000	0.0000
Transit	Golden Gate	Bay Bridge	6.5	13.5	0.48	27%	4,052	0.0003	0.0006	0.0081	0.0001	0.0001	0.0002	0.3967	0.0000	0.0000
Maneuvering																
Maneuvering: Into Oakland Terminal	Bay Bridge	Dock	--	--	1.33	50%	4,052	0.0015	0.0033	0.0410	0.0005	0.0005	0.0013	2.0079	0.0000	0.0001
Maneuvering: Out of Oakland Terminal	Dock	Bay Bridge	--	--	0.75	50%	4,052	0.0009	0.0018	0.0231	0.0003	0.0003	0.0007	1.1323	0.0000	0.0001
Hotelling Oakland																
Hotelling: Waiting	Dock	Dock	--	--	1.00	18%	4,052	0.0004	0.0009	0.0112	0.0001	0.0001	0.0003	0.5505	0.0000	0.0000
Hotelling: Discharging	Dock	Dock	--	--	24.00	35%	4,052	0.0193	0.0408	0.5114	0.0067	0.0062	0.0157	25.0528	0.0003	0.0012
Hotelling: Waiting	Dock	Dock	--	--	1.00	13%	4,052	0.0003	0.0006	0.0080	0.0001	0.0001	0.0002	0.3922	0.0000	0.0000
Transit Out of Bay																
Transit	Bay Bridge	Golden Gate	6.6	13.5	0.49	27%	4,052	0.0003	0.0007	0.0082	0.0001	0.0001	0.0003	0.4026	0.0000	0.0000
Transit	Golden Gate	Sea Buoy	8.9	13.5	0.66	27%	4,052	0.0004	0.0009	0.0111	0.0001	0.0001	0.0003	0.5429	0.0000	0.0000
Transit	Sea Buoy	Pilot Station	1.5	9.0	0.17	27%	4,052	0.0001	0.0002	0.0028	0.0000	0.0000	0.0001	0.1372	0.0000	0.0000
Transit	Pilot Station	PZ Outer Edge	6.8	15.0	0.45	13%	4,052	0.0001	0.0003	0.0036	0.0000	0.0000	0.0001	0.1779	0.0000	0.0000
Transit per Vessel (tons):								0.002	0.004	0.045	0.001	0.001	0.001	2.201	0.000	0.000
Maneuvering per Vessel (tons):								0.002	0.005	0.064	0.001	0.001	0.002	3.140	0.000	0.000
Hotelling per Vessel (tons):								0.020	0.042	0.531	0.007	0.006	0.016	25.995	0.000	0.001
Total per Vessel (tons):								0.024	0.051	0.640	0.008	0.008	0.020	31.337	0.000	0.002

- PZ Outer Edge - Pilot Station link LF based on Port of Oakland 2017 Emissions Inventory
 - Maneuvering Load Factors obtained from Port of Oakland 2017 Emissions Inventory
 - Engine kW based on 3 auxiliary engines rated at 1,300, 1,300, and 625 kW respectively.

Auxiliary Engine Load Factor Data - Obtained from a log from a Sheila Ann Voyage into the SF Bay

Link	Aux Engine kW	LF
Pilot Station to Golden Gate	1,368	0%
	1,368	0%
	658	46%
	658	46%
Golden Gate to Bay Bridge	1,368	32%
	1,368	32%
	658	35%
	658	0%
Hotelling - Waiting	1,368	54%
	1,368	0%
	658	0%
	658	0%
Hotelling - Discharging	1,368	62%
	1,368	0%
	658	84%
	658	0%
Hotelling - Waiting	1,368	0%
	1,368	0%
	658	80%
	658	0%
Bay Bridge to Golden Gate	1,368	50%
	1,368	0%
	658	64%
	658	0%
Golden Gate to Pilot Station	1,368	50%
	1,368	0%
	658	64%
	658	0%

Boiler Emissions

Operation Mode	Link Start	Link End	Distance (nautical miles)	Speed	Hours	Load Factor	Boiler kW	ROG	CO	NOx	PM10	PM2.5	SO _x	CO ₂	CH ₄	N ₂ O
Transit into Port																
Transit	PZ Outer Edge	Pilot Station	6.8	15.0	0.45	--	132	0.0000	0.0000	0.0001	0.0000	0.0000	0.0000	0.0616	0.0000	0.0000
Transit	Pilot Station	Sea Buoy	1.5	9.0	0.17	--	132	0.0000	0.0000	0.0000	0.0000	0.0000	0.0000	0.0226	0.0000	0.0000
Transit	Sea Buoy	Golden Gate	8.7	13.5	0.64	--	132	0.0000	0.0000	0.0002	0.0000	0.0000	0.0001	0.0876	0.0000	0.0000
Transit	Golden Gate	Bay Bridge	6.5	13.5	0.48	--	132	0.0000	0.0000	0.0001	0.0000	0.0000	0.0000	0.0654	0.0000	0.0000
Maneuvering																
Maneuvering: Into Oakland Terminal	Bay Bridge	Dock	--	--	1.33	--	132	0.0000	0.0000	0.0004	0.0000	0.0000	0.0001	0.1807	0.0000	0.0000
Maneuvering: Out of Oakland Terminal	Dock	Bay Bridge	--	--	0.75	--	132	0.0000	0.0000	0.0002	0.0000	0.0000	0.0001	0.1019	0.0000	0.0000
Hotelling Oakland																
Hotelling: Waiting	Dock	Dock	--	--	1.00	--	132	0.0000	0.0000	0.0003	0.0000	0.0000	0.0001	0.1359	0.0000	0.0000
Hotelling: Discharging	Dock	Dock	--	--	24.00	--	132	0.0004	0.0007	0.0070	0.0006	0.0005	0.0020	3.2616	0.0000	0.0002
Hotelling: Waiting	Dock	Dock	--	--	1.00	--	132	0.0000	0.0000	0.0003	0.0000	0.0000	0.0001	0.1359	0.0000	0.0000
Transit Out of Bay																
Transit	Bay Bridge	Golden Gate	6.6	13.5	0.49	--	132	0.0000	0.0000	0.0001	0.0000	0.0000	0.0000	0.0664	0.0000	0.0000
Transit	Golden Gate	Sea Buoy	8.9	13.5	0.66	--	132	0.0000	0.0000	0.0002	0.0000	0.0000	0.0001	0.0896	0.0000	0.0000
Transit	Sea Buoy	Pilot Station	1.5	9.0	0.17	--	132	0.0000	0.0000	0.0000	0.0000	0.0000	0.0000	0.0226	0.0000	0.0000
Transit	Pilot Station	PZ Outer Edge	6.8	15.0	0.45	--	132	0.0000	0.0000	0.0001	0.0000	0.0000	0.0000	0.0616	0.0000	0.0000
Transit per Vessel (tons):								0.000	0.000	0.001	0.000	0.000	0.000	0.478	0.000	0.000
Maneuvering per Vessel (tons):								0.000	0.000	0.001	0.000	0.000	0.000	0.283	0.000	0.000
Hotelling per Vessel (tons):								0.000	0.001	0.008	0.001	0.001	0.002	3.533	0.000	0.000
Total per Vessel (tons):								0.001	0.001	0.009	0.001	0.001	0.003	4.294	0.000	0.000

- Boiler kW is "Effective Power" obtained from ARB, 2019: Update to Inventory for OGV at Berth, Appendix H, Table 10

Assist Tug Emissions - Proposed Project

Emissions Summary (tpy)

	ROG	CO	NOx	PM10	PM2.5	SO _x	CO2	CH4	N2O
Assist - Oakland	0.376	2.127	2.309	0.052	0.052	0.003	306.330	0.032	0.010
Total	0.376	2.127	2.309	0.052	0.052	0.003	306.330	0.032	0.010

OGV Tugs (Assist Tugs)

Assist Tug Information:

Tug Name	Engine Tier	Main HP	Aux HP
Revolution	Tier 3	5,000	281
Sandra Hugh	Tier 3	5,000	281
Patricia Ann	Tier 3	5,000	281
Dr. Hank Kaplan	Tier 3	5,150	281
Average:		5,038	281

- Main Engine Tier and HP obtained from a data sheet provided by AMNAV, Inc.

- Aux Engine HP obtained from Port 2017 Emissions Inventory

Operations Information:

ME Power	5,038	hp	ME LF	31%
AE Power	281	hp	AE LF	43%
OGV Calls / yr	48			
# of Tugboats/yr	96			
Tugboat hrs/call (roundtrip)	2.93		Useful Life (yrs)	
			ME	AE
			21	22.5

- LF from Port of Oakland 2017 Emissions Inventory

- F, D, and Useful Life values from CARB Commercial Harbor Craft Emissions Model (<https://ww2.arb.ca.gov/our-work/programs/mobile-source-emissions-inventory/road-documentation/msei-documentation-road>)

Fuel Corection and Deterioration Factors

F =	ROG	CO	NOx	PM10	PM2.5	SO _x
ME	0.9	1	0.948	0.8	0.8	1
AE	0.9	1	0.948	0.8	0.8	1

D =	ROG	CO	NOx	PM10	PM2.5	SO _x
ME	0.44	0.25	0.21	0.67	0.67	0
AE	0.28	0.16	0.14	0.44	0.44	0

Hours per Call:

Assist Tug Outer Harbor Assists: 1,837 Hours per Call: 1.47 (one way)
 Assist Tug Outer Harbor Hours: 2,692

- Assists and Hours obtained from Port 2017 Emissions Inventory

Emission Factors and Emissions:

	Emission Factor (g/hp-hr)									Annual Emissions (tpy)								
	ROG	CO	NOx	PM10	PM2.5	SO _x	CO2	CH4	N2O	ROG	CO	NOx	PM10	PM2.5	SO _x	CO2	CH4	N2O
Main (Tier 3, HP8 MY2014)	0.68	3.73	4.37	0.10	0.10	0.0055	587	0.06	0.02	0.346	1.979	2.167	0.049	0.049	0.003	284.301	0.030	0.010
Aux (Tier 3, HP3 MY2014)	0.81	3.73	3.80	0.09	0.09	0.0055	587	0.07	0.02	0.030	0.148	0.142	0.003	0.003	0.000	22.029	0.003	0.001

- Hours per call based on average hours per call for the Outer Harbor obtained from Port 2017 Emissions Inventory (2,692 hours, 1,837 one-way assists)

- EFs from CARB Commercial Harbor Craft Emissions Model (<https://ww2.arb.ca.gov/our-work/programs/mobile-source-emissions-inventory/road-documentation/msei-documentation-road>)

- EFs for SO_x and CO₂ derived from fuel consumption rate.

Barge Tug Emissions

Emissions Summary (tpy)

Proposed Project

Barge(s)	Destination	ROG	CO	NOx	PM10	PM2.5	SO _x	CO2	CH4	N2O
Peter Lind	SF Pier 92	0.218	1.199	1.658	0.062	0.062	0.002	166.002	0.017	0.006
CalMat Shamrock	Petaluma	0.310	1.719	2.362	0.089	0.089	0.002	238.825	0.025	0.008
Westar Rock Barge #2	Bay Area - Variou	0.067	0.195	0.657	0.035	0.035	0.000	49.114	0.005	0.002
Total		0.594	3.112	4.677	0.186	0.186	0.004	453.941	0.048	0.015

Peter Lind - Destination: San Francisco Pier 92

Vessel Engine Information:

ME Power	3,046	hp
AE Power	266	hp
Average Speed	8	knots
Average Speed	9.2	mph

ME LF	68%
AE LF	43%

Useful Life (yrs)	
ME	AE
26	25

Fuel Corection and Deterioration Factors

F =	ROG	CO	NOx	PM10	PM2.5	SO _x
	0.9	1	0.948	0.8	0.8	1

D =	ROG	CO	NOx	PM10	PM2.5	SO _x
ME	0.44	0.25	0.21	0.67	0.67	0
AE	0.28	0.16	0.14	0.44	0.44	0

Emission Factors

	Emission Factor (g/hp-hr)								
	ROG	CO	NOx	PM10	PM2.5	SO _x	CO2	CH4	N2O
Main (HP7 MY2007)	0.68	3.73	5.53	0.20	0.20	0.0055	587	0.06	0.02
Aux (HP3)	0.81	3.43	5.53	0.21	0.21	0.0055	587	0.07	0.02

- ME and AE Power based on The Orion

- LF from CARB Commercial Harbor Craft Emissions Model

- EFs, F, D, and Useful Life values from CARB Commercial Harbor Craft Emissions Model (<https://ww2.arb.ca.gov/our-work/programs/mobile-source-emissions-inventory/road-document>)

- EFs for SO_x and GHG not available in CARB Commercial Harbor Craft Emissions Model. EFs for OGV used.

Proposed Project:

# Trips/yr	36
Tugs/Trip	2
Miles/Trip	15
Hours/tug-trip	1.63
Tug Hours/yr	117.4

	Annual Emissions (tpy)								
	ROG	CO	NOx	PM10	PM2.5	SO _x	CO2	CH4	N2O
Main	0.206	1.144	1.575	0.059	0.059	0.001	157.329	0.016	0.005
Aux	0.012	0.055	0.083	0.003	0.003	0.000	8.672	0.001	0.000
Total	0.218	1.199	1.658	0.062	0.062	0.002	166.002	0.017	0.006

CalMat Shamrock Barges - Destination: Petaluma

Vessel Engine Information:

ME Power	1,700	hp
AE Power	132	hp
Average Speed	8	knots
Average Speed	9.2	mph

ME LF	68%
AE LF	43%

Useful Life (yrs)	
ME	AE
26	25

Fuel Corection and Deterioration Factors

F =	ROG	CO	NOx	PM10	PM2.5	SOx
	0.9	1	0.948	0.8	0.8	1

D =	ROG	CO	NOx	PM10	PM2.5	SOx
	0.44	0.25	0.21	0.67	0.67	0
AE	0.28	0.16	0.14	0.44	0.44	0

Emission Factors

	Emission Factor (g/hp-hr)								
	ROG	CO	NOx	PM10	PM2.5	SO _x	CO2	CH4	N2O
Main (HP7 MY2008)	0.68	3.73	5.53	0.20	0.20	0.0055	587	0.06	0.02
Aux (HP3 MY2008)	0.81	3.73	5.10	0.22	0.22	0.0055	587	0.07	0.02

- ME and AE Power based on The Sarah Reed
- LF from CARB Commercial Harbor Craft Emissions Model
- EFs, F, D, and Useful Life values from CARB Commercial Harbor Craft Emissions Model (<https://ww2.arb.ca.gov/our-work/programs/mobile-source-emissions-inventory/road-document>)
- EFs for SO_x and GHG not available in CARB Commercial Harbor Craft Emissions Model. EFs for OGV used.

Proposed Project:

# Trips/yr	40
Tugs/Trip	1
Miles/Trip	70
Hours/tug-trip	7.61
Tug Hours/yr	304.3

	Annual Emissions (tpy)								
	ROG	CO	NOx	PM10	PM2.5	SO _x	CO2	CH4	N2O
Main	0.294	1.641	2.263	0.084	0.084	0.002	227.648	0.024	0.008
Aux	0.016	0.077	0.099	0.004	0.004	0.000	11.178	0.001	0.000
Total	0.310	1.719	2.362	0.089	0.089	0.002	238.825	0.025	0.008

Westar Rock Barge #2 - Destination: Bay Area-Various

Vessel Engine Information:

ME Power	2,028	hp
AE Power	74	hp
Average Speed	8	knots
Average Speed	9.2	mph

ME LF	68%
AE LF	43%

Useful Life (yrs)	
ME	AE
26	25

Fuel Corection and Deterioration Factors

F =	ROG	CO	NOx	PM10	PM2.5	SOx
	0.9	1	0.948	0.8	0.8	1

D =	ROG	CO	NOx	PM10	PM2.5	SOx
	ME	0.44	0.25	0.21	0.67	0.67
AE	0.28	0.16	0.14	0.44	0.44	0

Emission Factors

	Emission Factor (g/hp-hr)								
	ROG	CO	NOx	PM10	PM2.5	SO _x	CO2	CH4	N2O
Main (HP7 MY2005)	0.68	1.97	7.31	0.36	0.36	0.0055	587	0.06	0.02
Aux (HP2)	1.20	3.74	6.44	0.37	0.37	0.0055	587	0.11	0.02

- ME and AE Power based on The Fat Cat
- LF from CARB Commercial Harbor Craft Emissions Model
- EFs, F, D, and Useful Life values from CARB Commercial Harbor Craft Emissions Model (<https://ww2.arb.ca.gov/our-work/programs/mobile-source-emissions-inventory/road-document>)
- EFs for SOx and GHG not available in CARB Commercial Harbor Craft Emissions Model. EFs for OGV used.

Proposed Project:

# Trips/yr	33
Tugs/Trip	1
Miles/Trip	15
Hours/tug-trip	1.63
Tug Hours/yr	53.8

	Annual Emissions (tpy)								
	ROG	CO	NOx	PM10	PM2.5	SO _x	CO2	CH4	N2O
Main	0.064	0.188	0.645	0.034	0.034	0.000	48.010	0.005	0.002
Aux	0.002	0.008	0.012	0.001	0.001	0.000	1.104	0.000	0.000
Total	0.067	0.195	0.657	0.035	0.035	0.000	49.114	0.005	0.002

Aggregate Transfer Emissions

	Emissions (tpy)		
	PM10	PM2.5	Resp. Silica
Ship to Shore	0.403	0.060	0.020
Shore to Barge	0.173	0.026	0.009
Truck Loading	0.035	0.005	1.73E-03
Total	0.610	0.091	0.030

Respirable Silica assumed to be 5% of PM10 per ERA Material SDS and OSHA Definition of Respirable Silica

2,500,000

Annual Aggregate Throughput (tons/year)

Note: 1,500,000 tpy to each barges and trucks

1,500,000

Maximum Aggregate to Barges (tons/year)

to allow for flexibility. Total throughput will not

1,500,000

Maximum Aggregate to Trucks (tons/year)

exceed 2,500,000 tpy.

Ship to Shore

Transfer Points	Controlled EF (lb/ton)*		Emissions (tpy)	
	PM10	PM2.5	PM10	PM2.5
Ship to Hopper	4.60E-05	6.90E-06	0.058	0.009
Hopper to BC-01	4.60E-05	6.90E-06	0.058	0.009
BC-01 to BC-02	4.60E-05	6.90E-06	0.058	0.009
BC-02 to BC-03	4.60E-05	6.90E-06	0.058	0.009
BC-03 to BC-04	4.60E-05	6.90E-06	0.058	0.009
BC-04 to BC-05	4.60E-05	6.90E-06	0.058	0.009
BC-05 to BC-06	4.60E-05	6.90E-06	0.058	0.009
BC-06 to Stockpile3	--	--	--	--
Total Ship to Shore:			0.403	0.060

- Accounted for in Stockpiles

Shore to Barge

	Controlled EF (lb/ton)*		Emissions (tpy)	
	PM10	PM2.5	PM10	PM2.5
Loader to Hopper/RBC-01	4.60E-05	6.90E-06	0.035	0.005
RBC-01 to RBC-02	4.60E-05	6.90E-06	0.035	0.005
RBC-02 to RBC-03	4.60E-05	6.90E-06	0.035	0.005
RBC-03 to RBC-04	4.60E-05	6.90E-06	0.035	0.005
RBC-04 to Barge	4.60E-05	6.90E-06	0.035	0.005
Total Shore to Barge:			0.173	0.026

Truck Loading

	Controlled EF (lb/ton)*		Emissions (tpy)	
	PM10	PM2.5	PM10	PM2.5
Truck Loading	4.60E-05	6.90E-06	0.035	0.005

*PM10 Emission Factors and Control Efficiency from AP-42 table 11.19.2-2 (crushed stone processing and pulverized mineral processing)

*PM2.5 = 0.15*PM10 per <https://www3.epa.gov/ttn/chief/ap42/ch13/bgdocs/b13s02.pdf>

Stockpile Emissions

Stockpile Summary (tpy)

	PM10	PM2.5	Resp. Silica
Transfer	2.409	0.365	0.120
Wind Erosion	0.557	0.083	0.028
Total	2.966	0.448	0.148

Transfer:

Stockpiled Material: 2,500,000 tpy

$$E = k(0.0032) \frac{\left(\frac{U}{5}\right)^{1.3}}{\left(\frac{M}{2}\right)^{1.4}}$$

$k_{PM10} = 0.35$
 $k_{PM2.5} = 0.05$
 $U \text{ [mph]} = 11.14$
 $M \text{ (\%)} = 6.00 \text{ Sand}$
 $M \text{ (\%)} = 2.00 \text{ Aggregate}$

- Equation and k values from AP-42, Chapter 13.2.4 Aggregate Handling and Storage Piles

Sand (1,250,000 tpy)

	Emission Factor (lb/ton)	Emissions (lb/yr)	Emissions (tpy)
PM10	6.82E-04	852	0.426
PM2.5	1.03E-04	129	0.065
Respirable Silica (5% of PM10)		43	0.021

Aggregate (1,250,000 tpy)

	Emission Factor (lb/ton)	Emissions (lb/yr)	Emissions (tpy)
PM10	3.17E-03	3,967	1.983
PM2.5	4.81E-04	601	0.300
Respirable Silica (5% of PM10)		198	0.099

Wind Erosion:

Radius of Pile 180 ft
Radius of Stacker Area 69 ft
Stockpile Area 260,491 ft² 86830
- $3 * \pi * (r1^2 - r2^2)$
Stockpile Area 5.98 acre

Emission Factor: 1.7 lb PM10 / acre-day

	Uncontrolled		Control Efficiency (%)	Controlled	
	lb/yr	tpy		lb/yr	tpy
PM10:	3,711	1.86	70	1,113	0.557
PM2.5:	557	0.28	70	167	0.083
Resp Silica:	186	0.09	70	56	0.028

- Control efficiency for watering piles from BAAQMD Permitting Handbook.

Off-Road Equipment Emissions - Proposed Project

Annual Unmitigated Emissions

Equipment Type	Engine Tier	Engine Make and Model	Engine HP	Emission Factors (g/bhp-hr)						Activity (hr/yr)	Load Factor	Annual Emissions (ton/yr)									
				NMHC	NOx	CO	PM	CO2*	CH4*			N2O*	NMHC	NOx	CO	PM	PM10	PM2.5	CO2	CH4	N2O
Rubber Tired Loader	4 - Hybrid	John Deere 944K	536	0.28	0.34	2.83	0.02	527.50	0.03	0.01	5000	0.55	0.46	0.55	4.60	0.03	0.03	0.03	857.08	0.05	0.02
Rubber Tired Loader	4 - Hybrid	John Deere 944K	536	0.28	0.34	2.83	0.02	527.50	0.03	0.01	5000	0.55	0.46	0.55	4.60	0.03	0.03	0.03	857.08	0.05	0.02
Rubber Tired Loader	4 - Hybrid	John Deere 944K	536	0.28	0.34	2.83	0.02	527.50	0.03	0.01	5000	0.55	0.46	0.55	4.60	0.03	0.03	0.03	857.08	0.05	0.02
Skid Steer Loader	4	Doosan D34P (2017 MY)	75	0.28	0.31	4.70	0.03	587.01	0.03	0.01	5000	0.55	0.06	0.07	1.07	0.01	0.01	0.01	133.46	0.01	0.00
Sweeper	4	Tennant Sentinel (2019 MY)	100	0.28	0.31	4.70	0.03	587.01	0.03	0.01	5000	0.51	0.08	0.09	1.32	0.01	0.01	0.01	165.00	0.01	0.00
Total:												1.52	1.82	16.19	0.11	0.11	0.10	2,869.71	0.16	0.07	

- Assumes approximately 16-hour days, 6 days a week, 52 weeks per year

Max Daily Unmitigated Emissions

Equipment Type	Engine Tier	Engine Make and Model	Engine HP	Emission Factors (g/bhp-hr)						Activity (hr/day)	Load Factor	Max Daily Emissions (lb/day)									
				NMHC	NOx	CO	PM	CO2*	CH4*			N2O*	NMHC	NOx	CO	PM	PM10	PM2.5	CO2	CH4	N2O
Rubber Tired Loader	4 - Hybrid	John Deere 944K	536	0.28	0.34	2.83	0.02	527.50	0.03	0.01	24	0.55	4.40	5.32	44.15	0.30	0.30	0.28	8,227.87	0.46	0.21
Rubber Tired Loader	4 - Hybrid	John Deere 944K	536	0.28	0.34	2.83	0.02	527.50	0.03	0.01	24	0.55	4.40	5.32	44.15	0.30	0.30	0.28	8,227.87	0.46	0.21
Rubber Tired Loader	4 - Hybrid	John Deere 944K	536	0.28	0.34	2.83	0.02	527.50	0.03	0.01	24	0.55	4.40	5.32	44.15	0.30	0.30	0.28	8,227.87	0.46	0.21
Skid Steer Loader	4	Doosan D34P (2017 MY)	75	0.28	0.31	4.70	0.03	587.01	0.03	0.01	24	0.55	0.62	0.69	10.27	0.06	0.06	0.06	1,281.18	0.07	0.03
Sweeper	4	Tennant Sentinel (2019 MY)	100	0.28	0.31	4.70	0.03	587.01	0.03	0.01	24	0.51	0.76	0.85	12.69	0.08	0.08	0.07	1,584.00	0.09	0.04

Load factor from CARB OFFROAD Database

Emission factors based on Tier 4 Final Standard

* Source: https://www.epa.gov/sites/production/files/2018-03/documents/emission-factors_mar_2018_0.pdf

Annual Mitigated Emissions

Equipment Type	Engine Tier	Engine Make and Model	Engine HP	Emission Factors (g/bhp-hr)						Activity (hr/yr)	Load Factor	Annual Emissions (ton/yr)									
				NMHC	NOx	CO	PM	CO2*	CH4*			N2O*	NMHC	NOx	CO	PM	PM10	PM2.5	CO2	CH4	N2O
Rubber Tired Loader	4 - Hybrid	John Deere 944K	536	0.16	0.12	0.29	0.007	527.50	0.03	0.01	5000	0.55	0.26	0.20	0.48	0.01	0.01	0.01	857.08	0.05	0.02
Rubber Tired Loader	4 - Hybrid	John Deere 944K	536	0.16	0.12	0.29	0.007	527.50	0.03	0.01	5000	0.55	0.26	0.20	0.48	0.01	0.01	0.01	857.08	0.05	0.02
Rubber Tired Loader	4 - Hybrid	John Deere 944K	536	0.16	0.12	0.29	0.007	527.50	0.03	0.01	5000	0.55	0.26	0.20	0.48	0.01	0.01	0.01	857.08	0.05	0.02
Skid Steer Loader	4	Doosan D34P (2017 MY)	75	0.28	0.31	4.70	0.03	587.01	0.03	0.01	5000	0.55	0.06	0.07	1.07	0.01	0.01	0.01	133.46	0.01	0.00
Sweeper	Electric	Tennant Sentinel (2019 MY)	100	--	--	--	--	--	--	--	5000	0.51	--	--	--	--	--	--	--	--	--
Total:												0.86	0.68	2.50	0.04	0.04	0.04	2,704.71	0.15	0.07	

- Mitigated loader EFs from CARB engine certification for Engine Family JDXL13.5310

Max Daily Mitigated Emissions

Equipment Type	Engine Tier	Engine Make and Model	Engine HP	Emission Factors (g/bhp-hr)						Activity (hr/day)	Load Factor	Max Daily Emissions (lb/day)									
				NMHC	NOx	CO	PM	CO2*	CH4*			N2O*	NMHC	NOx	CO	PM	PM10	PM2.5	CO2	CH4	N2O
Rubber Tired Loader	4 - Hybrid	John Deere 944K	536	0.16	0.12	0.29	0.007	527.50	0.03	0.01	24	0.55	2.54	1.95	4.57	0.10	0.10	0.10	8,227.87	0.46	0.21
Rubber Tired Loader	4 - Hybrid	John Deere 944K	536	0.16	0.12	0.29	0.007	527.50	0.03	0.01	24	0.55	2.54	1.95	4.57	0.10	0.10	0.10	8,227.87	0.46	0.21
Rubber Tired Loader	4 - Hybrid	John Deere 944K	536	0.16	0.12	0.29	0.007	527.50	0.03	0.01	24	0.55	2.54	1.95	4.57	0.10	0.10	0.10	8,227.87	0.46	0.21
Skid Steer Loader	4	Doosan D34P (2017 MY)	75	0.28	0.31	4.70	0.03	587.01	0.03	0.01	24	0.55	0.62	0.69	10.27	0.06	0.06	0.06	1,281.18	0.07	0.03
Sweeper	Electric	Tennant Sentinel (2019 MY)	100	--	--	--	--	--	--	--	24	0.51	--	--	--	--	--	--	--	--	--

Load factor from CARB OFFROAD Database

Loader EFs based on Engine Certification, Skid Steer EFs based on Tier 4 Final Standard

* Source: https://www.epa.gov/sites/production/files/2018-03/documents/emission-factors_mar_2018_0.pdf

Diesel-Fueled Offroad Equipment**		
PM10 Fraction of Total PM		PM2.5 Fraction of Total PM
1		0.92

**Source: [http://www.aqmd.gov/docs/default-source/ceqa/handbook/localized-significance-thresholds/particulate-matter-\(pm\)-2.5-significance-thresholds-and-calculation-methodology/final_pm2_5methodology.pdf](http://www.aqmd.gov/docs/default-source/ceqa/handbook/localized-significance-thresholds/particulate-matter-(pm)-2.5-significance-thresholds-and-calculation-methodology/final_pm2_5methodology.pdf)
Table A

Engine HP Bin	Deterioration Rates (g/hp-hr ²)			
	THC	CO	NOx	PM
100	1.17E-05	8.10E-05	1.30E-06	4.67E-07
600	1.17E-05	1.82E-05	3.56E-06	3.70E-07

Source: CHE 2011 Inventory Model Access Database. <https://ww2.arb.ca.gov/our-work/programs/mobile-source-emissions-inventory/road-documentation/msei-documentation-road>
EF = Zero Hour EF * DR * 12,000 hours

Fugitive Emissions

Paved Road Emission Factor

$$E = [k(sL)^{0.91} \times (W)^{1.02}] \times (1 - P/4N)$$

CARB Paved Road Dust Methodology

March 2018

$$0.00220 \text{ k PM10 (lb/VMT)}$$

12 sL AP-42 Table 13.2.1-3

61 W Operating weight of Front End Loaders

61 P # of wet days

365 N Averaging Period

https://ww3.arb.ca.gov/ei/areasrc/fullpdf/full7-9_2018.pdf

$$E_{PM10} = 1.340 \text{ lb/VMT}$$

$$E_{PM2.5} = 0.201 \text{ lb/VMT}$$

$$PM2.5 = 0.15 * PM10 \text{ per } \text{https://www3.epa.gov/ttn/chief/ap42/ch13/bgdocs/b13s02.pdf}$$

Pollutant	VMT	EF (lb/VMT)	Emissions (lb/yr)	Emissions (tpy)	Control Eff (%)	Emissions (lb/yr)	Emissions (tpy)
PM10	7,000	1.340	9,377	4.689	70	2,813	1.407
PM2.5	7,000	0.201	1,407	0.703	70	422	0.211
Resp. Silica	7,000	0.067	469	0.234	70	141	0.070

VMT based on 0.1 miles per truck. Distance from center of the stock piles to the truck lane is approximately 0.05 miles (one way)

Onsite Truck Emissions - Proposed Project

EMFAC2007 Vehicle Category Heavy Heavy Duty Truck, 2022 Scenario Year, Bay Area AQMD, 5-20 mph, Diesel-Fueled

70,000 number of trucks/year
0.60 Average onsite truck trip distance (mile)

Exhaust Emissions (onsite)		Emission Factors (g/mile)								
Model Year	VMT (EMFAC)	ROG	CO	NOx	CO2	PM10	PM2.5	SOx	CH4	N2O
2010	5,869	1.40	4.01	14.01	3,246.21	0.07	0.07	0.03	0.07	0.51
2011	6,488	0.45	2.18	11.19	3,155.19	0.03	0.03	0.03	0.02	0.50
2012	10,009	0.07	1.20	8.89	3,037.46	0.01	0.01	0.03	0.00	0.48
2013	8,498	0.07	1.20	8.96	3,023.35	0.01	0.01	0.03	0.00	0.48
2014	10,081	0.06	1.02	8.42	2,483.96	0.01	0.01	0.02	0.00	0.39
2015	13,571	0.06	0.94	7.94	2,431.16	0.01	0.01	0.02	0.00	0.38
2016	17,257	0.06	0.96	8.10	2,438.01	0.01	0.01	0.02	0.00	0.38
2017	7,635	0.06	0.93	7.68	2,385.46	0.01	0.01	0.02	0.00	0.37
2018	5,771	0.05	0.90	7.16	2,336.24	0.01	0.01	0.02	0.00	0.37
2019	5,767	0.05	0.85	6.59	2,330.66	0.01	0.01	0.02	0.00	0.37
2020	5,684	0.05	0.80	6.01	2,324.47	0.00	0.00	0.02	0.00	0.37
2021	5,764	0.05	0.75	5.44	2,013.38	0.00	0.00	0.02	0.00	0.32
2022	4,005	0.04	0.70	4.84	2,017.03	0.00	0.00	0.02	0.00	0.32
2023	850	0.04	0.67	4.34	2,017.99	0.00	0.00	0.02	0.00	0.32

- Emission Factors obtained from CARB EMFAC Database. Emission Factors and VMT are averages for speeds of 5 to 20 mph.

	ROG	CO	NOx	CO2	PM10	PM2.5	SOx	CH4	N2O
Weighted Average EF (g/mile)	0.156	1.202	8.196	2,568.523	0.012	0.012	0.024	0.007	0.404
	ROG	CO	NOx	CO2	PM10	PM2.5	SOx	CH4	N2O
Annual Emissions (tpy)	0.01	0.06	0.38	118.92	0.001	0.001	0.00	0.00	0.02
Annual Emissions (lb/yr)					1.1409	1.0915			
Annual Emissions/per source (lb/yr)					0.0259	0.0248			

Idling Emissions

Model Year	Population	Emission Factors (g/vehicle/day)								
		ROG	CO	NOx	CO2	PM10	PM2.5	SOx	CH4	N2O
2010	1,454	3.21	17.95	57.57	10,327.47	0.01	0.01	0.10	0.15	1.62
2011	1,576	3.47	44.39	46.56	10,079.07	0.01	0.01	0.10	0.16	1.58
2012	4,322	3.07	45.41	36.31	8,669.14	0.01	0.01	0.08	0.14	1.36
2013	2,542	3.88	57.37	45.88	10,953.71	0.02	0.02	0.10	0.18	1.72
2014	2,786	4.45	65.73	52.56	10,921.80	0.02	0.02	0.10	0.21	1.72
2015	3,667	4.97	73.44	58.73	12,203.87	0.02	0.02	0.12	0.23	1.92
2016	4,990	6.61	97.71	78.14	16,236.93	0.03	0.03	0.15	0.31	2.55
2017	2,556	5.49	81.14	64.89	13,095.09	0.02	0.02	0.12	0.26	2.06
2018	1,461	6.09	90.04	72.01	14,532.42	0.03	0.02	0.14	0.28	2.28
2019	1,389	6.22	91.87	73.47	14,827.00	0.03	0.03	0.14	0.29	2.33
2020	1,298	6.42	94.93	75.92	15,320.66	0.03	0.03	0.14	0.30	2.41
2021	1,275	6.60	97.50	77.97	13,812.09	0.03	0.03	0.13	0.31	2.17
2022	883	6.10	90.12	72.07	12,766.44	0.03	0.02	0.12	0.28	2.01
2023	407	8.04	118.75	94.97	16,823.50	0.03	0.03	0.16	0.37	2.64

- Emission Factors obtained from CARB EMFAC Database.

	ROG	CO	NOx	CO2	PM10	PM2.5	SOx	CH4	N2O
Weighted Average EF (g/vehicle)	5.03	72.54	60.64	12524.55	0.02	0.02	0.12	0.23	1.97
Annual Emissions (tpy)	0.39	5.60	4.68	966.42	0.002	0.002	0.01	0.02	0.15
Annual Emissions (lb/yr)					3.30402	3.16109			
Annual Emissions (lb/hr)					0.00038	0.00036			

Fugitive Emissions

Paved Road Emission Factor

$$E = [k(sL)^{0.91} \times (W)^{1.02}] \times (1 - P/4N)$$

CARB Paved Road Dust Methodology

March 2018

0.00220 k PM10 (lb/VMT)

12 sL AP-42 Table 13.2.1-3

17.5 W (Average of Loaded vs. Unloaded [5 vs. 30 tons])

61 P # of wet days (CARB Methodology Table 8 - Alameda County)

365 N Averaging Period

https://ww3.arb.ca.gov/ei/areasrc/fullpdf/full7-9_2018.pdf

$E_{PM10} = 0.375$ lb/VMT

$E_{PM2.5} = 0.056$ lb/VMT

PM2.5 = 0.15*PM10 per <https://www3.epa.gov/ttn/chief/ap42/ch13/bgdocs/b13s02.pdf>

Pollutant	VMT	EF (lb/VMT)	Emissions (lb/yr)	Emissions (tpy)	Control Eff (%)	Emissions (lb/yr)	Emissions (tpy)
PM10	42,000	0.375	15,743	7.872	70	4,723	2.361
PM2.5	42,000	0.056	2,361	1.181	70	708	0.354
Resp. Silica	42,000	0.019	787	0.394	70	236	0.118

Brake and Tire Wear (on site)

Total VMT	Weighted Average EF (g/mile)		Annual Emissions (tpy)	
	PM10 BTW	PM2.5 BTW	PM10	PM2.5
42,000	0.096	0.035	0.004	0.002

- Brake and Tire wear PM emissions are for aggregated speed for each model year

Offsite Truck Emissions - Proposed Project

EMFAC2007 Vehicle Category Heavy Heavy Duty Truck, 2022 Scenario Year, Bay Area AQMD, Aggregated Speed, Diesel-Fueled

70,000 number of trucks/year (Potential)
30,932 number of trucks/year (2018 - Richmond)

VMT traveled from Richmond in 2018: 507,313
VMT estimated from Oakland (2018 numbers) 412,388

Exhaust Emissions (off site)

Facility	Potential Total Annual VMT	Weighted Average EF (g/mile)										Total Annual Emissions (tpy)							
		ROG	CO	NOx	CO2	PM10	PM2.5	SOx	CH4	N2O	ROG	CO	NOx	CO2	PM10	PM2.5	SOx	CH4	N2O
Oakland	1,866,493	0.040	0.264	2.729	1417.924	0.027	0.026	0.013	0.002	0.223	0.083	0.542	5.614	2917.315	0.056	0.054	0.028	0.004	0.459

- Annual VMT = 2018 VMT * Ratio of Potential 70,000 Trucks / 2018 Trucks (30,932) * 2 (round trip)

Model Year	VMT (EMFAC)	Emission Factors (g/mile)									
		ROG	CO	NOx	CO2	PM10	PM2.5	SOx	CH4	N2O	
2010	138,890	0.419	1.123	8.602	2,012.20	0.064	0.061	0.019	0.019	0.316	
2011	165,517	0.161	0.588	5.527	1,821.20	0.059	0.056	0.017	0.007	0.286	
2012	310,263	0.028	0.307	4.352	1,725.52	0.036	0.035	0.016	0.001	0.271	
2013	269,051	0.027	0.300	4.127	1,708.24	0.035	0.033	0.016	0.001	0.269	
2014	327,644	0.023	0.253	2.790	1,415.62	0.028	0.027	0.013	0.001	0.223	
2015	478,961	0.022	0.228	2.345	1,382.82	0.026	0.025	0.013	0.001	0.217	
2016	768,131	0.021	0.207	2.181	1,356.97	0.027	0.026	0.013	0.001	0.213	
2017	384,034	0.019	0.190	1.970	1,303.76	0.024	0.023	0.012	0.001	0.205	
2018	246,089	0.019	0.194	1.925	1,298.85	0.021	0.021	0.012	0.001	0.204	
2019	243,820	0.018	0.184	1.777	1,299.89	0.019	0.018	0.012	0.001	0.204	
2020	237,412	0.017	0.174	1.626	1,301.26	0.016	0.016	0.012	0.001	0.205	
2021	240,151	0.016	0.164	1.466	1,122.79	0.014	0.013	0.011	0.001	0.176	
2022	160,798	0.015	0.155	1.310	1,126.91	0.011	0.010	0.011	0.001	0.177	
2023	37,165	0.014	0.140	1.122	1,117.89	0.008	0.008	0.011	0.001	0.176	

	ROG	CO	NOx	CO2	PM10	PM2.5	SOx	CH4	N2O
Weighted Average EF (g/mile)	0.040	0.264	2.729	1417.924	0.027	0.026	0.013	0.002	0.223

Brake and Tire Wear (off site)

Facility	Potential Total Annual VMT	Weighted Average EF (g/mile)		Annual Emissions (tpy)	
		PM10 BTW	PM2.5 BTW	PM10	PM2.5
Oakland	1,866,493	0.096	0.035	0.198	0.072

Fugitive Emissions

Paved Road Emission Factor

$E = [k(sL)^{0.91} \times (W)^{1.02}] \times (1 - P/4N)$ 0.00220 k PM10 (lb/VMT)

CARB Paved Road Dust Methodology

March 2018

0.032 sL https://ww3.arb.ca.gov/ei/areasrc/fullpdf/full7-9_2018.pdf

3.36 W Weighted Average from EMFAC

61 P # of wet days

365 N Averaging Period

$E_{PM10} = 0.00032 \text{ lb/VMT}$

$E_{PM2.5} = 0.00005 \text{ lb/VMT}$ $PM2.5 = 0.15 \times PM10$ per <https://www3.epa.gov/ttn/chief/ap42/ch13/bgdocs/b13s02.pdf>

Pollutant	VMT	EF (lb/VMT)	Emissions (lb/yr)	Emissions (tpy)
PM10	1,866,493	0.00032	591	0.295
PM2.5	1,866,493	0.00005	89	0.044

Employee Commute

Exhaust Emissions

Region	Calendar Year	Vehicle Category	Model Year	Speed	Fuel	VMT	%VMT	Emission Factors (g/mile)								
								ROG	CO	NOx	CO2	CH4	PM10	PM2_5	SOx	N2O
BAY AREA AQMD	2022	LDA	Aggregated	Aggregated	GAS	96,209,643	99%	0.01	0.63	0.04	261.98	0.002	0.001	0.001	0.003	0.005
BAY AREA AQMD	2022	LDA	Aggregated	Aggregated	DSL	1,098,266	1%	0.02	0.23	0.09	209.05	0.001	0.008	0.008	0.002	0.033

of Employees 15
 Annual VMT 6,240 miles/employee
 Total VMT 93,600 miles/year

- Employee Round Trip assumed to be 20 miles
 - Assumes 6 days per week, 52 weeks per year

		Emission(tpy)								
		ROG	CO	NOx	CO2	CH4	PM10	PM2_5	SOx	N2O
LDA	GAS	0.001	0.064	0.004	26.725	0.000	0.000	0.000	0.000	0.000
LDA	DSL	0.000	0.000	0.000	0.243	0.000	0.000	0.000	0.000	0.000
Total		0.001	0.065	0.004	26.968	0.000	0.000	0.00015	0.000	0.000

Brake and Tire Wear

Potential Total Annual VMT	Weighted Average F (g/mile)		Annual Emissions (tpy)	
	PM10 BTW	PM2.5 BTW	PM10	PM2.5
93,600	0.045	0.018	0.005	0.002

Fugitive Dust

Paved Road Emission Factor

$E = [k(sL)0.91 \times (W)1.02] \times (1 - P/4N)$ 0.00220 k PM10 (lb/VMT)
 0.032 sL https://ww3.arb.ca.gov/ei/areasrc/fullpdf/full7-9_2018.pdf
 CARB Paved Road Dust Methodology 1 W Passenger Vehicle Weight
 March 2018 61 P # of wet days
 365 N Averaging Period

$E_{PM10} = 9.60E-05$ lb/VMT

$E_{PM2.5} = 1.44E-05$ lb/VMT PM2.5 = 0.15*PM10 per <https://www3.epa.gov/ttn/chief/ap42/ch13/bgdocs/b13s02.pdf>

Pollutant	VMT	EF (lb/VMT)	Emissions (lb/yr)	Emissions (tpy)
PM10	93,600	9.60E-05	8.98	0.004
PM2.5	93,600	1.44E-05	1.35	0.001

Indirect GHG Emissions from Electricity Generation

Source	HP	kW	Hours per Operation	Operations per Year	MWh per year	EF (lb/MWh)			Emissions (lb/yr)			Emissions (mtpy)
						CO2	CH4	N2O	CO2	CH4	N2O	CO2e
BC-01	400	298	24	48	344	206	0.033	0.004	70,814	11.34	1.38	32.50
BC-02	450	336	24	48	387	206	0.033	0.004	79,666	12.76	1.55	36.57
BC-03	200	149	24	48	172	206	0.033	0.004	35,407	5.67	0.69	16.25
BC-04	450	336	24	48	387	206	0.033	0.004	79,666	12.76	1.55	36.57
BC-05	200	149	24	48	172	206	0.033	0.004	35,407	5.67	0.69	16.25
BC-06	450	336	24	48	387	206	0.033	0.004	79,666	12.76	1.55	36.57
RCV01	150	112	8.75	109	107	206	0.033	0.004	21,985	3.52	0.43	10.09
RCV02	125	93	8.75	109	89	206	0.033	0.004	18,321	2.93	0.36	8.41
RCV03	100	75	8.75	109	71	206	0.033	0.004	14,657	2.35	0.28	6.73
RCV04	100	75	8.75	109	71	206	0.033	0.004	14,657	2.35	0.28	6.73
Sweeper	--	55	1.00	365	20	206	0.033	0.004	4,135	0.66	0.08	1.90
Lighting	--	100	--	--	438	206	0.033	0.004	90,228	14.45	1.75	41.41
Facilities	--	50	--	--	250	206	0.033	0.004	51,500	8.25	1.00	23.64
												273.61

- 1 hp = 0.746 kW

- Sweeper battery assumed to need 55 kWh per charge, 365 charges per year.

- Lighting assumed to be used up to 12 hours per day, 365 days per year

- Facilities assumed to be used up to 5,000 hours per day

- Emission factor for CO2 obtained from http://www.pgecorp.com/corp_responsibility/reports/2019/en02_climate_change.html

- Emissions Factors for CH4 and N2O from https://www.epa.gov/sites/production/files/2018-03/documents/emission-factors_mar_2018_0.pdf

CEQA Summary- Proposed Project - Unmitigated

Source Name	Max Annual Emissions (tpy)					
	ROG	CO	NOx	PM10	PM2.5	SOx
OGV - Transit and Maneuvering	1.17	1.97	25.19	0.28	0.26	0.61
OGV - Hotelling	1.05	2.22	27.70	0.39	0.36	0.95
Tugs (Assist and Barge)	0.97	5.24	6.99	0.24	0.24	0.01
Agg. Transfer	--	--	--	0.61	0.09	--
Stockpile	--	--	--	2.97	0.45	--
Offroad Equipment Exhaust	1.52	16.19	1.82	0.11	0.10	--
Offroad Equipment Fugitive Dust	--	--	--	1.41	0.21	--
On-Site Truck Exhaust	0.40	5.65	5.06	0.00	0.00	0.01
On-Site Truck Fugitive Dust, BTW	--	--	--	2.37	0.36	--
Off-Site Truck Exhaust	0.08	0.54	5.61	0.06	0.05	0.03
Off-Site Truck Fugitive Dust, BTW	--	--	--	0.49	0.12	--
Employee Commute	0.00	0.06	0.00	0.01	0.00	0.00
Electricity Use	--	--	--	--	--	--
Total (tpy)	5.18	31.88	72.37	8.93	2.24	1.60

Emissions tpy			Emissions (mtpy)
CO2	CH4	N2O	CO2e
976	0.02	0.05	899
1,509	0.02	0.07	1,389
760	0.08	0.03	699
--	--	--	--
--	--	--	--
2,870	0.16	0.07	2,627
--	--	--	--
1,085	0.02	0.17	1,031
--	--	--	--
2,917	0.00	0.46	2,771
--	--	--	--
27	0.00	0.00	25
296	0.05	0.01	271
10,441	0.34	0.86	9,711

- CO2e (mtpy) = (CO2 + CH4*25 + N2O*298) * 0.9072 (ton/tonne)

Average Daily Emissions (lb/day)						
Source Name	ROG	CO	NOx	PM10	PM2.5	SOx
OGV - Transit and Maneuvering	7.47	12.65	161.45	1.82	1.68	3.93
OGV - Hotelling	6.73	14.20	177.58	2.50	2.31	6.07
Tugs (Assist and Barge)	6.22	33.58	44.78	1.52	1.52	0.05
Agg. Transfer	--	--	--	3.91	0.59	--
Stockpile	--	--	--	16.25	2.46	--
Offroad Equipment Exhaust	9.74	103.77	11.69	0.70	0.64	--
Offroad Equipment Fugitive Dust	--	--	--	9.02	1.35	--
On-Site Truck Exhaust	2.53	36.24	32.42	0.01	0.01	0.07
On-Site Truck Fugitive Dust, BTW	--	--	--	15.17	2.28	--
Off-Site Truck Exhaust	0.53	3.48	35.99	0.36	0.34	0.18
Off-Site Truck Fugitive Dust, BTW	--	--	--	3.16	0.75	--
Employee Commute	0.01	0.41	0.03	0.06	0.02	0.00
Total (lb/day)	33.24	204.33	463.93	54.48	13.94	10.29

Source Name	Diesel PM	
	tpy	lb/yr
OGV - Transit and Maneuvering	0.28	554.98
OGV - Hotelling	0.36	721.13
Tugs (Assist and Barge)	0.24	475.01
Aggregate Transfer	--	--
Stockpile	--	--
Offroad Equipment Exhaust	0.11	217.25
Offroad Equipment Fugitive Dust	--	--
On-site Truck Exhaust	0.00	4.44
On-site Truck BTW, Fugitive Dust	--	--
Off-site Truck Exhaust	0.06	112.48
Off-site Truck BTW, Fugitive Dust	--	--
Employee Commute	0.00	0.02
Total (tpy)	1.04	2,085.32

CEQA Summary- Proposed Project - Mitigated

Source Name	Max Annual Emissions (tpy)					
	ROG	CO	NOx	PM10	PM2.5	SOx
OGV - Transit and Maneuvering	1.17	1.97	25.19	0.28	0.26	0.61
OGV - Hotelling	1.05	2.22	27.70	0.39	0.36	0.95
Tugs (Assist and Barge)	0.97	5.24	6.99	0.24	0.24	0.01
Agg. Transfer	--	--	--	0.61	0.09	--
Stockpile	--	--	--	2.97	0.45	--
Offroad Equipment Exhaust	0.86	2.50	0.68	0.04	0.04	--
Offroad Equipment Fugitive Dust	--	--	--	1.41	0.21	--
On-Site Truck Exhaust	0.40	5.65	5.06	0.00	0.00	0.01
On-Site Truck Fugitive Dust, BTW	--	--	--	2.37	0.36	--
Off-Site Truck Exhaust	0.08	0.54	5.61	0.06	0.05	0.03
Off-Site Truck Fugitive Dust, BTW	--	--	--	0.49	0.12	--
Employee Commute	0.00	0.06	0.00	0.01	0.00	0.00
Electricity Use	--	--	--	--	--	--
Total (tpy)	4.52	18.19	71.23	8.86	2.18	1.60

Emissions tpy			Emissions (mtpy)
CO2	CH4	N2O	CO2e
976	0.02	0.05	899
1,509	0.02	0.07	1,389
760	0.08	0.03	699
--	--	--	--
--	--	--	--
2,705	0.15	0.07	2,476
--	--	--	--
1,085	0.02	0.17	1,031
--	--	--	--
2,917	0.00	0.46	2,771
--	--	--	--
27	0.00	0.00	25
298	0.05	0.01	273
10,278	0.34	0.85	9,562

- CO2e (mtpy) = (CO2 + CH4*25 + N2O*298) * 0.9072 (ton/tonne)

Average Daily Emissions (lb/day)						
Source Name	ROG	CO	NOx	PM10	PM2.5	SOx
OGV - Transit and Maneuvering	7.47	12.65	161.45	1.82	1.68	3.93
OGV - Hotelling	6.73	14.20	177.58	2.50	2.31	6.07
Tugs (Assist and Barge)	6.22	33.58	44.78	1.52	1.52	0.05
Agg. Transfer	--	--	--	3.91	0.59	--
Stockpile	--	--	--	16.25	2.46	--
Offroad Equipment	5.50	16.01	4.36	0.25	0.23	--
Offroad Equipment Fugitive Dust	--	--	--	9.02	1.35	--
On-Site Truck Exhaust	2.53	36.24	32.42	0.01	0.01	0.07
On-Site Truck Fugitive Dust, BTW	--	--	--	15.17	2.28	--
Off-Site Truck Exhaust	0.53	3.48	35.99	0.36	0.34	0.18
Off-Site Truck Fugitive Dust, BTW	--	--	--	3.16	0.75	--
Employee Commute	0.01	0.41	0.03	0.06	0.02	0.00
Total (lb/day)	29.00	116.58	456.60	54.03	13.53	10.29

Source Name	Diesel PM	
	tpy	lb/yr
OGV - Transit and Maneuvering	0.28	554.98
OGV - Hotelling	0.36	721.13
Tugs (Assist and Barge)	0.24	475.01
Aggregate Transfer	--	--
Stockpile	--	--
Offroad Equipment	0.04	77.84
Offroad Equipment Fugitive Dust	--	--
On-site Truck Exhaust	0.00	4.44
On-site Truck BTW, Fugitive Dust	--	--
Off-site Truck Exhaust	0.06	112.48
Off-site Truck BTW, Fugitive Dust	--	--
Employee Commute	0.00	0.02
Total (tpy)	0.97	1,945.90

Attachment C-2
CalEEMod Report

Construction Emissions Summary

Unmitigated Construction Emissions Summary

	ROG	CO	NOx	PM10	PM2.5	SOx	CO2	CH4	N2O	CO2e (MT)
CalEEMod Sources	0.62	5.35	5.96	0.35	0.28	0.01	1,155.52	0.29	0.00	1,054.82
Barges	0.02	0.11	0.16	0.01	0.01	0.00	15.64	0.00	0.00	14.37
Total (tpy)	0.64	5.46	6.11	0.36	0.28	0.01	1,171.15	0.29	0.00	1,069.18
Working Days	312									
Total (lb/day)	4.11	35.02	39.19	2.30	1.82	0.08				

Mitigated Construction Emissions Summary

	ROG	CO	NOx	PM10	PM2.5	SOx	CO2	CH4	N2O	CO2e (MT)
CalEEMod Sources	0.32	5.72	2.86	0.19	0.13	0.01	1,155.52	0.29	0.00	1,054.82
Barges	0.02	0.11	0.16	0.01	0.01	0.00	15.64	0.00	0.00	14.37
Total (tpy)	0.34	5.84	3.02	0.20	0.13	0.01	1,171.15	0.29	0.00	1,069.18
Working Days	312									
Total (lb/day)	2.18	37.41	19.33	1.26	0.84	0.08				

Particulate Matter Summary (CalEEMod + Barges)

Unmitigated

	PM10	PM2.5	
Fugitive	0.10	0.04	tpy
Exhaust	0.26	0.25	tpy
Total	0.36	0.28	tpy

Fugitive	0.62	0.24	lb/day
Exhaust	1.68	1.58	lb/day
Total	2.30	1.82	lb/day

Mitigated

	PM10	PM2.5	
Fugitive	0.10	0.04	tpy
Exhaust	0.10	0.09	tpy
Total	0.20	0.13	tpy

Fugitive	0.62	0.24	lb/day
Exhaust	0.64	0.60	lb/day
Total	1.26	0.84	lb/day

DPM Summary

	Unmitigated	Mitigated
CalEEMod Onsite	510.40	186.36
CalEEMod Offsite	1.92	1.92
Barges	11.78	11.78
Total	524.10	200.06

Construction Emissions Summary

Mitigation	Working Days	Emissions (tpy)						Emissions (lb/day)					
		ROG	CO	NOx	PM10	PM2.5	SOx	ROG	CO	NOx	PM10	PM2.5	SOx
No	313	0.62	5.35	5.96	0.35	0.28	0.01	3.96	34.19	38.06	2.25	1.78	0.08
Yes	313	0.32	5.72	2.86	0.19	0.13	0.01	2.05	36.57	18.27	1.21	0.80	0.08

Mitigation	Emissions (tpy)			(mtpy)
	CO2	CH4	N2O	CO2e
No	1,155.52	0.29	0.00	1,054.82
Yes	1,155.52	0.29	0.00	1,054.82

Particulate Matter Summary

Unmitigated

	PM10	PM2.5	
Fugitive	0.10	0.04	tpy
Exhaust	0.26	0.24	tpy
Total	0.35	0.28	tpy

Fugitive	0.61	0.24	lb/day
Exhaust	1.64	1.54	lb/day
Total	2.25	1.78	lb/day

Mitigated

	PM10	PM2.5	
Fugitive	0.10	0.04	tpy
Exhaust	0.09	0.09	tpy
Total	0.19	0.13	tpy

Fugitive	0.61	0.24	lb/day
Exhaust	0.60	0.56	lb/day
Total	1.21	0.80	lb/day

PM10 Summary - Unmitigated

Phase	Working Days	Emissions (tpy)		
		Fugitive	Exhaust	Total
Demo	Onsite	0.005	0.008	0.013
	Offsite	0.002	0.000	0.002
	Total	0.007	0.008	0.015
Site Prep	Onsite	0.052	0.030	0.082
	Offsite	0.006	0.000	0.007
	Total	0.058	0.030	0.089
Foundations	Onsite	0.000	0.126	0.126
	Offsite	0.014	0.000	0.014
	Total	0.014	0.127	0.141
Structure Erection	Onsite	0.000	0.080	0.080
	Offsite	0.015	0.000	0.015
	Total	0.015	0.080	0.095
Paving	Onsite	0.000	0.004	0.004
	Offsite	0.001	0.000	0.001
	Total	0.001	0.004	0.005
Finishing	Onsite	0.000	0.007	0.007
	Offsite	0.001	0.000	0.001
	Total	0.001	0.007	0.008
		0.096	0.256	0.353

Diesel PM	tpy	lb/yr	lb/hr
Unmitigated Onsite	0.255	510.40	0.058
Unmitigated Offsite	0.001	1.92	0.000
PM10	tpy	lb/yr	lb/hr
Onsite Fugitive Dust	0.057	113.02	0.013
Offsite DPM+Fugitive	0.041	81.00	0.009

		Fugitive	Exhaust	Total
Structure Erection 2021	Onsite	0.000	0.035	0.035
	Offsite	0.006	0.000	0.006
	Total	0.006	0.035	0.042
Structure Erection 2022	Onsite	0.000	0.045	0.045
	Offsite	0.009	0.000	0.009
	Total	0.009	0.045	0.053

PM10 Summary - Mitigated (Tier 4 Equipment)

Phase		Working Days	Emissions (tpy)		
			Fugitive	Exhaust	Total
Demo	Onsite	26	0.005	0.004	0.009
	Offsite		0.002	0.000	0.002
	Total		0.007	0.004	0.011
Site Prep	Onsite	27	0.052	0.009	0.060
	Offsite		0.006	0.000	0.007
	Total		0.058	0.009	0.067
Foundations	Onsite	78	0.000	0.075	0.075
	Offsite		0.014	0.000	0.014
	Total		0.014	0.075	0.089
Structure Erection	Onsite	130	0.000	0.005	0.005
	Offsite		0.015	0.000	0.015
	Total		0.015	0.006	0.020
Paving	Onsite	26	0.000	0.000	0.000
	Offsite		0.001	0.000	0.001
	Total		0.001	0.000	0.001
Finishing	Onsite	26	0.000	0.000	0.000
	Offsite		0.001	0.000	0.001
	Total		0.001	0.000	0.002
			0.096	0.094	0.190

Diesel PM	tpy	lb/yr	lb/hr	# sources	lb/yr/source	lb/hr/source
Mitigated Onsite	0.093	186.4	0.021	155	1.202	1.37E-04
Mitigated Offsite	0.001	1.92	0.000	256	0.00750	8.56E-07
PM10	tpy	lb/yr	lb/hr	# sources	lb/yr/source	lb/hr/source
Onsite Fugitive Dust	0.057	113.0	0.013	1	113.020	0.013
Offsite DPM+Fugitive	0.041	81.0	0.009	256	0.316	3.61E-05

		Fugitive	Exhaust	Total
Structure Erection 2021	Onsite	0.000	0.002	0.002
	Offsite	0.006	0.000	0.006
	Total	0.006	0.002	0.008
Structure Erection 2022	Onsite	0.000	0.003	0.003
	Offsite	0.009	0.000	0.009
	Total	0.009	0.003	0.012

PM2.5 Summary - Unmitigated

Phase		Working Days	Emissions (tpy)		
			Fugitive	Exhaust	Total
Demo	Onsite	26	0.001	0.007	0.008
	Offsite		0.001	0.000	0.001
	Total		0.001	0.007	0.009
Site Prep	Onsite	27	0.027	0.028	0.054
	Offsite		0.002	0.000	0.002
	Total		0.028	0.028	0.056
Foundations	Onsite	78	0.000	0.119	0.119
	Offsite		0.004	0.000	0.004
	Total		0.004	0.119	0.123
Structure Erection	Onsite	130	0.000	0.075	0.075
	Offsite		0.004	0.000	0.004
	Total		0.004	0.076	0.079
Paving	Onsite	26	0.000	0.004	0.004
	Offsite		0.000	0.000	0.000
	Total		0.000	0.004	0.004
Finishing	Onsite	26	0.000	0.007	0.007
	Offsite		0.000	0.000	0.000
	Total		0.000	0.007	0.007
			0.038	0.241	0.279

Exhaust PM2.5	tpy	lb/yr	lb/hr	# sources	lb/yr/source	lb/hr/source
Unmitigated Onsite	0.240	479.40	0.055	113	4.242478	0.000484
Unmitigated Offsite	0.001	1.84	0.000	272	0.006765	0.000001
PM2.5	tpy	lb/yr	lb/hr	# sources	lb/yr/source	lb/hr/source
Onsite Fugitive Dust	0.027	54.72	0.006	1	54.72	0.006246575
Offsite PM2.5+Fugitive	0.012	23.26	0.003	272	0.085515	9.76195E-06

		Fugitive	Exhaust	Total
Structure Erection 2021	Onsite	0.000	0.033	0.033
	Offsite	0.002	0.000	0.002
	Total	0.002	0.033	0.035
Structure Erection 2022	Onsite	0.000	0.042	0.042
	Offsite	0.002	0.000	0.002
	Total	0.002	0.042	0.045

PM2.5 Summary - Mitigated (Tier 4 Equipment)

Phase		Working Days	Emissions (tpy)		
			Fugitive	Exhaust	Total
Demo	Onsite	26	0.001	0.004	0.004
	Offsite		0.001	0.000	0.001
	Total		0.001	0.004	0.005
Site Prep	Onsite	27	0.027	0.008	0.035
	Offsite		0.002	0.000	0.002
	Total		0.028	0.008	0.037
Foundations	Onsite	78	0.000	0.069	0.069
	Offsite		0.004	0.000	0.004
	Total		0.004	0.069	0.073
Structure Erection	Onsite	130	0.000	0.005	0.005
	Offsite		0.004	0.000	0.004
	Total		0.004	0.006	0.010
Paving	Onsite	26	0.000	0.000	0.000
	Offsite		0.000	0.000	0.000
	Total		0.000	0.000	0.001
Finishing	Onsite	26	0.000	0.000	0.000
	Offsite		0.000	0.000	0.000
	Total		0.000	0.000	0.001
			0.038	0.087	0.125

Exhaust PM2.5	tpy	lb/yr	lb/hr
Mitigated Onsite	0.086	172.9	0.020
Mitigated Offsite	0.001	1.8	0.000

PM2.5	tpy	lb/yr	lb/hr
Onsite Fugitive Dust	0.027	54.72	0.006
Offsite Ex+Fugitive	0.012	23.26	0.003

		Fugitive	Exhaust	Total
Structure Erection 2021	Onsite	0.000	0.002	0.002
	Offsite	0.002	0.000	0.002
	Total	0.002	0.002	0.004
Structure Erection 2022	Onsite	0.000	0.003	0.003
	Offsite	0.002	0.000	0.002
	Total	0.002	0.003	0.006

Construction Barge Tug Emissions

Construction Barge Summary (tpy)

Proposed Project

Barge(s)	Destination	ROG	CO	NOx	PM10	PM2.5	SO _x	CO2	CH4	N2O
Construction Barge	ERA Oakland	0.02	0.11	0.16	0.01	0.01	0.00	15.64	0.00	0.00

Construction Materials Barge - Destination: ERA Oakland

Vessel Engine Information:

ME Power	2,258	hp
AE Power	157	hp
Average Speed	8	knots

ME LF	68%
AE LF	43%

Useful Life (yrs)

ME	AE
26	25

Fuel Corection and Deterioration Factors

F =	ROG	CO	NOx	PM10	PM2.5	SO _x
	0.9	1	0.948	0.8	0.8	1

D =	ROG	CO	NOx	PM10	PM2.5	SO _x
ME	0.44	0.25	0.21	0.67	0.67	0
AE	0.28	0.16	0.14	0.44	0.44	0

Hours of Operation

Journey Link	Distance (nm)	Hours
Golden Gate to Bay Bridge	6.5	0.81
Bay Bridge to Oakland	3.5	0.44
Oakland to Bay Bridge	3.5	0.44
Bay Bridge to Golden Gate	6.6	0.83
Total:		2.51

Emission Factors

	Emission Factor (g/hp-hr)								
	ROG	CO	NOx	PM10	PM2.5	SO _x	CO2	CH4	N2O
Main (HP7 MY2007)	0.68	3.73	5.53	0.20	0.20	0.0055	587	0.06	0.02
Aux (HP3)	0.81	3.43	5.53	0.21	0.21	0.0055	587	0.07	0.02

- ME and AE Power based on average of three barge tugs discussed in operation emissions

- LF from CARB Commercial Harbor Craft Emissions Model

- EFs, F, D, and Useful Life values from CARB Commercial Harbor Craft Emissions Model (<https://ww2.arb.ca.gov/our-work/programs/mobile-source-emissions-inventory/road-documentation/>)

- EFs for SO_x and GHG not available in CARB Commercial Harbor Craft Emissions Model. EFs derived from fuel consumption.

Proposed Project:

# Trips/yr	6
Tugs/Trip	1
Hours/tug-trip	2.51
Tug Hours/yr	15.08

	Annual Emissions (tpy)								
	ROG	CO	NOx	PM10	PM2.5	SO _x	CO2	CH4	N2O
Main	0.020	0.109	0.150	0.006	0.006	0.000	14.977	0.002	0.001
Aux	0.001	0.004	0.006	0.000	0.000	0.000	0.660	0.000	0.000
Total	0.021	0.113	0.156	0.006	0.006	0.000	15.637	0.002	0.001

Off-road Equipment - Expected equipment

Trips and VMT - Expected Trips, Vendor Trips = Workers / 2.56 per default for Building Erection

Demolition - 1.2 ton/yd³ per CalRecycle <https://www.calrecycle.ca.gov/swfacilities/cdi/tools/calculations>

Grading - Project Specific

Landscape Equipment - no operational

Construction Off-road Equipment Mitigation -

Vehicle Trips - no operation

Fleet Mix - no operational

Energy Use - no operational

Water And Wastewater - no operational

Solid Waste - no operational

Consumer Products - no operational

Table Name	Column Name	Default Value	New Value
tblAreaCoating	Area_Nonresidential_Exterior	392000	0
tblAreaCoating	Area_Nonresidential_Interior	1176000	0
tblConstructionPhase	NumDays	20.00	26.00
tblConstructionPhase	NumDays	30.00	27.00
tblConstructionPhase	NumDays	300.00	78.00
tblConstructionPhase	NumDays	300.00	130.00
tblConstructionPhase	NumDays	20.00	26.00
tblConstructionPhase	NumDays	300.00	26.00
tblConstructionPhase	NumDaysWeek	5.00	6.00
tblConstructionPhase	NumDaysWeek	5.00	6.00
tblConstructionPhase	NumDaysWeek	5.00	6.00
tblConstructionPhase	NumDaysWeek	5.00	6.00
tblConstructionPhase	NumDaysWeek	5.00	6.00
tblConstructionPhase	NumDaysWeek	5.00	6.00
tblEnergyUse	LightingElect	2.99	0.00
tblEnergyUse	NT24E	3.36	0.00
tblEnergyUse	NT24NG	6.90	0.00

tblEnergyUse	T24E	1.21	0.00
tblEnergyUse	T24NG	17.85	0.00
tblFleetMix	HHD	0.03	0.00
tblFleetMix	LDA	0.58	1.00
tblFleetMix	LDT1	0.04	0.00
tblFleetMix	LDT2	0.19	0.00
tblFleetMix	LHD1	0.02	0.00
tblFleetMix	LHD2	5.3580e-003	0.00
tblFleetMix	MCY	5.8740e-003	0.00
tblFleetMix	MDV	0.11	0.00
tblFleetMix	MH	7.6800e-004	0.00
tblFleetMix	MHD	0.02	0.00
tblFleetMix	OBUS	2.6140e-003	0.00
tblFleetMix	SBUS	8.8700e-004	0.00
tblFleetMix	UBUS	2.2740e-003	0.00
tblGrading	AcresOfGrading	0.00	18.00
tblGrading	MaterialExported	0.00	3,000.00
tblGrading	MaterialImported	0.00	6,000.00
tblOffRoadEquipment	HorsePower	63.00	97.00
tblOffRoadEquipment	LoadFactor	0.31	0.37
tblOffRoadEquipment	OffRoadEquipmentUnitAmount	3.00	1.00
tblOffRoadEquipment	OffRoadEquipmentUnitAmount	0.00	1.00
tblOffRoadEquipment	OffRoadEquipmentUnitAmount	0.00	1.00
tblOffRoadEquipment	OffRoadEquipmentUnitAmount	2.00	1.00
tblOffRoadEquipment	OffRoadEquipmentUnitAmount	2.00	1.00
tblOffRoadEquipment	OffRoadEquipmentUnitAmount	3.00	2.00
tblOffRoadEquipment	OffRoadEquipmentUnitAmount	1.00	2.00
tblOffRoadEquipment	OffRoadEquipmentUnitAmount	3.00	2.00
tblOffRoadEquipment	OffRoadEquipmentUnitAmount	2.00	1.00
tblOffRoadEquipment	OffRoadEquipmentUnitAmount	2.00	1.00

tblOffRoadEquipment	OffRoadEquipmentUnitAmount	3.00	2.00
tblOffRoadEquipment	PhaseName		1 Demolition
tblOffRoadEquipment	PhaseName		1 Demolition
tblOffRoadEquipment	UsageHours	7.00	12.00
tblOffRoadEquipment	UsageHours	8.00	12.00
tblOffRoadEquipment	UsageHours	8.00	12.00
tblOffRoadEquipment	UsageHours	8.00	12.00
tblOffRoadEquipment	UsageHours	8.00	12.00
tblOffRoadEquipment	UsageHours	8.00	12.00
tblOffRoadEquipment	UsageHours	8.00	12.00
tblOffRoadEquipment	UsageHours	8.00	12.00
tblOffRoadEquipment	UsageHours	8.00	12.00
tblOffRoadEquipment	UsageHours	8.00	12.00
tblOffRoadEquipment	UsageHours	8.00	12.00
tblOffRoadEquipment	UsageHours	7.00	12.00
tblOffRoadEquipment	UsageHours	8.00	12.00
tblOffRoadEquipment	UsageHours	8.00	12.00
tblOffRoadEquipment	UsageHours	8.00	12.00
tblOffRoadEquipment	UsageHours	8.00	12.00
tblSolidWaste	SolidWasteGenerationRate	972.16	0.00
tblTripsAndVMT	HaulingTripNumber	119.00	100.00
tblTripsAndVMT	HaulingTripNumber	1,125.00	600.00
tblTripsAndVMT	HaulingTripNumber	0.00	700.00
tblTripsAndVMT	HaulingTripNumber	0.00	100.00
tblTripsAndVMT	VendorTripNumber	0.00	3.00
tblTripsAndVMT	VendorTripNumber	0.00	3.00
tblTripsAndVMT	VendorTripNumber	128.00	7.00
tblTripsAndVMT	VendorTripNumber	128.00	7.00
tblTripsAndVMT	VendorTripNumber	0.00	2.00
tblTripsAndVMT	VendorTripNumber	128.00	2.00

tblTripsAndVMT	WorkerTripNumber	8.00	10.00
tblTripsAndVMT	WorkerTripNumber	18.00	10.00
tblTripsAndVMT	WorkerTripNumber	329.00	20.00
tblTripsAndVMT	WorkerTripNumber	329.00	20.00
tblTripsAndVMT	WorkerTripNumber	5.00	10.00
tblTripsAndVMT	WorkerTripNumber	329.00	10.00
tblVehicleTrips	CC_TL	7.30	0.00
tblVehicleTrips	CNW_TL	7.30	0.00
tblVehicleTrips	CW_TL	9.50	0.00
tblVehicleTrips	ST_TR	1.50	0.00
tblVehicleTrips	SU_TR	1.50	0.00
tblVehicleTrips	WD_TR	1.50	0.00
tblWater	ElectricityIntensityFactorForWastewater Treatment	1,911.00	0.00
tblWater	ElectricityIntensityFactorToDistribute	1,272.00	0.00
tblWater	ElectricityIntensityFactorToSupply	2,117.00	0.00
tblWater	ElectricityIntensityFactorToTreat	111.00	0.00
tblWater	IndoorWaterUseRate	181,300,000.00	0.00

2.0 Emissions Summary

2.1 Overall Construction

Unmitigated Construction

	ROG	NOx	CO	SO2	Fugitive PM10	Exhaust PM10	PM10 Total	Fugitive PM2.5	Exhaust PM2.5	PM2.5 Total	Bio- CO2	NBio- CO2	Total CO2	CH4	N2O	CO2e
Year	tons/yr										MT/yr					
2021	0.4845	4.5960	3.9084	9.2500e-003	0.1734	0.2002	0.3736	0.0779	0.1878	0.2656	0.0000	812.7426	812.7426	0.2056	0.0000	817.8833
2022	0.1356	1.3609	1.4422	2.7100e-003	0.0110	0.0560	0.0670	2.9800e-003	0.0528	0.0558	0.0000	235.5266	235.5266	0.0563	0.0000	236.9335

Maximum	0.4845	4.5960	3.9084	9.2500e-003	0.1734	0.2002	0.3736	0.0779	0.1878	0.2656	0.0000	812.7426	812.7426	0.2056	0.0000	817.8833
---------	--------	--------	--------	-------------	--------	--------	--------	--------	--------	--------	--------	----------	----------	--------	--------	----------

Mitigated Construction

	ROG	NOx	CO	SO2	Fugitive PM10	Exhaust PM10	PM10 Total	Fugitive PM2.5	Exhaust PM2.5	PM2.5 Total	Bio- CO2	NBio- CO2	Total CO2	CH4	N2O	CO2e
Year	tons/yr										MT/yr					
2021	0.4845	4.5960	3.9084	9.2500e-003	0.0850	0.2002	0.2852	0.0351	0.1878	0.2229	0.0000	812.7418	812.7418	0.2056	0.0000	817.8824
2022	0.1356	1.3609	1.4422	2.7100e-003	0.0110	0.0560	0.0670	2.9800e-003	0.0528	0.0558	0.0000	235.5263	235.5263	0.0563	0.0000	236.9333
Maximum	0.4845	4.5960	3.9084	9.2500e-003	0.0850	0.2002	0.2852	0.0351	0.1878	0.2229	0.0000	812.7418	812.7418	0.2056	0.0000	817.8824

	ROG	NOx	CO	SO2	Fugitive PM10	Exhaust PM10	PM10 Total	Fugitive PM2.5	Exhaust PM2.5	PM2.5 Total	Bio- CO2	NBio- CO2	Total CO2	CH4	N2O	CO2e
Percent Reduction	0.00	0.00	0.00	0.00	47.93	0.00	20.05	52.89	0.00	13.30	0.00	0.00	0.00	0.00	0.00	0.00

Quarter	Start Date	End Date	Maximum Unmitigated ROG + NOX (tons/quarter)	Maximum Mitigated ROG + NOX (tons/quarter)
3	3-7-2021	6-6-2021	0.0435	0.0435
4	6-7-2021	9-6-2021	2.2036	2.2036
5	9-7-2021	12-6-2021	2.4192	2.4192
6	12-7-2021	3-6-2022	1.2827	1.2827
7	3-7-2022	6-6-2022	0.6031	0.6031
		Highest	2.4192	2.4192

2.2 Overall Operational

Unmitigated Operational

	ROG	NOx	CO	SO2	Fugitive PM10	Exhaust PM10	PM10 Total	Fugitive PM2.5	Exhaust PM2.5	PM2.5 Total	Bio- CO2	NBio- CO2	Total CO2	CH4	N2O	CO2e
--	-----	-----	----	-----	---------------	--------------	------------	----------------	---------------	-------------	----------	-----------	-----------	-----	-----	------

3.0 Construction Detail

Construction Phase

Phase Number	Phase Name	Phase Type	Start Date	End Date	Num Days Week	Num Days	Phase Description
1	1 Demolition	Demolition	6/1/2021	6/30/2021	6	26	
2	2 Site Preparation and Grading	Grading	7/1/2021	7/31/2021	6	27	
3	3 Foundations and Piles	Building Construction	8/1/2021	10/30/2021	6	78	
4	4 Structure Erection	Building Construction	11/1/2021	3/31/2022	6	130	
5	5 Paving	Paving	4/1/2022	4/30/2022	6	26	
6	6 Finishing	Building Construction	5/1/2022	5/31/2022	6	26	

Acres of Grading (Site Preparation Phase): 0

Acres of Grading (Grading Phase): 0

Acres of Paving: 0

Residential Indoor: 0; Residential Outdoor: 0; Non-Residential Indoor: 0; Non-Residential Outdoor: 0; Striped Parking Area: 0

OffRoad Equipment

Phase Name	Offroad Equipment Type	Amount	Usage Hours	Horse Power	Load Factor
1 Demolition	Excavators	1	12.00	158	0.38
1 Demolition	Off-Highway Trucks	1	12.00	402	0.38
1 Demolition	Tractors/Loaders/Backhoes	1	12.00	97	0.37
2 Site Preparation and Grading	Excavators	1	12.00	158	0.38
2 Site Preparation and Grading	Forklifts	1	12.00	89	0.20
2 Site Preparation and Grading	Off-Highway Trucks	2	12.00	402	0.38
2 Site Preparation and Grading	Rubber Tired Dozers	1	12.00	247	0.40
2 Site Preparation and Grading	Tractors/Loaders/Backhoes	1	12.00	97	0.37
2 Site Preparation and Grading	Trenchers	1	12.00	78	0.50
3 Foundations and Piles	Concrete/Industrial Saws	2	12.00	81	0.73
3 Foundations and Piles	Generator Sets	1	12.00	84	0.74
3 Foundations and Piles	Off-Highway Trucks	4	12.00	402	0.38

3 Foundations and Piles	Other Construction Equipment	2	12.00	172	0.42
3 Foundations and Piles	Rollers	1	12.00	80	0.38
3 Foundations and Piles	Tractors/Loaders/Backhoes	2	12.00	97	0.37
3 Foundations and Piles	Welders	1	12.00	46	0.45
4 Structure Erection	Aerial Lifts	4	12.00	97	0.37
4 Structure Erection	Cranes	2	12.00	231	0.29
4 Structure Erection	Forklifts	2	12.00	89	0.20
4 Structure Erection	Generator Sets	1	12.00	84	0.74
4 Structure Erection	Welders	1	12.00	46	0.45
5 Paving	Pavers	1	12.00	130	0.42
5 Paving	Rollers	1	12.00	80	0.38
6 Finishing	Aerial Lifts	2	12.00	63	0.31
6 Finishing	Forklifts	2	12.00	89	0.20
6 Finishing	Generator Sets	1	12.00	84	0.74
6 Finishing	Welders	1	12.00	46	0.45

Trips and VMT

Phase Name	Offroad Equipment Count	Worker Trip Number	Vendor Trip Number	Hauling Trip Number	Worker Trip Length	Vendor Trip Length	Hauling Trip Length	Worker Vehicle Class	Vendor Vehicle Class	Hauling Vehicle Class
1 Demolition	3	10.00	3.00	100.00	10.80	7.30	20.00	LD_Mix	HDT_Mix	HHDT
2 Site Preparation and Grading	7	10.00	3.00	600.00	10.80	7.30	20.00	LD_Mix	HDT_Mix	HHDT
3 Foundations and Piles	13	20.00	7.00	700.00	10.80	7.30	20.00	LD_Mix	HDT_Mix	HHDT
4 Structure Erection	10	20.00	7.00	100.00	10.80	7.30	20.00	LD_Mix	HDT_Mix	HHDT
5 Paving	2	10.00	2.00	0.00	10.80	7.30	20.00	LD_Mix	HDT_Mix	HHDT
6 Finishing	6	10.00	2.00	0.00	10.80	7.30	20.00	LD_Mix	HDT_Mix	HHDT

3.1 Mitigation Measures Construction

Water Exposed Area

3.2 1 Demolition - 2021

Unmitigated Construction On-Site

	ROG	NOx	CO	SO2	Fugitive PM10	Exhaust PM10	PM10 Total	Fugitive PM2.5	Exhaust PM2.5	PM2.5 Total	Bio- CO2	NBio- CO2	Total CO2	CH4	N2O	CO2e
Category	tons/yr										MT/yr					
Fugitive Dust					0.0128	0.0000	0.0128	1.9400e-003	0.0000	1.9400e-003	0.0000	0.0000	0.0000	0.0000	0.0000	0.0000
Off-Road	0.0199	0.1816	0.1782	4.2000e-004		7.9800e-003	7.9800e-003		7.3400e-003	7.3400e-003	0.0000	36.7886	36.7886	0.0119	0.0000	37.0861
Total	0.0199	0.1816	0.1782	4.2000e-004	0.0128	7.9800e-003	0.0208	1.9400e-003	7.3400e-003	9.2800e-003	0.0000	36.7886	36.7886	0.0119	0.0000	37.0861

Unmitigated Construction Off-Site

	ROG	NOx	CO	SO2	Fugitive PM10	Exhaust PM10	PM10 Total	Fugitive PM2.5	Exhaust PM2.5	PM2.5 Total	Bio- CO2	NBio- CO2	Total CO2	CH4	N2O	CO2e
Category	tons/yr										MT/yr					
Hauling	3.9000e-004	0.0135	2.8800e-003	4.0000e-005	8.4000e-004	4.0000e-005	8.9000e-004	2.3000e-004	4.0000e-005	2.7000e-004	0.0000	3.7827	3.7827	1.9000e-004	0.0000	3.7875
Vendor	1.2000e-004	4.0700e-003	1.0200e-003	1.0000e-005	2.6000e-004	1.0000e-005	2.6000e-004	7.0000e-005	1.0000e-005	8.0000e-005	0.0000	1.0114	1.0114	5.0000e-005	0.0000	1.0127
Worker	4.0000e-004	2.8000e-004	2.9200e-003	1.0000e-005	1.0300e-003	1.0000e-005	1.0300e-003	2.7000e-004	1.0000e-005	2.8000e-004	0.0000	0.8684	0.8684	2.0000e-005	0.0000	0.8689
Total	9.1000e-004	0.0178	6.8200e-003	6.0000e-005	2.1300e-003	6.0000e-005	2.1800e-003	5.7000e-004	6.0000e-005	6.3000e-004	0.0000	5.6626	5.6626	2.6000e-004	0.0000	5.6691

Mitigated Construction On-Site

	ROG	NOx	CO	SO2	Fugitive PM10	Exhaust PM10	PM10 Total	Fugitive PM2.5	Exhaust PM2.5	PM2.5 Total	Bio- CO2	NBio- CO2	Total CO2	CH4	N2O	CO2e
--	-----	-----	----	-----	---------------	--------------	------------	----------------	---------------	-------------	----------	-----------	-----------	-----	-----	------

Category	tons/yr										MT/yr					
Fugitive Dust					5.0100e-003	0.0000	5.0100e-003	7.6000e-004	0.0000	7.6000e-004	0.0000	0.0000	0.0000	0.0000	0.0000	
Off-Road	0.0199	0.1816	0.1782	4.2000e-004		7.9800e-003	7.9800e-003		7.3400e-003	7.3400e-003	0.0000	36.7886	36.7886	0.0119	0.0000	37.0860
Total	0.0199	0.1816	0.1782	4.2000e-004	5.0100e-003	7.9800e-003	0.0130	7.6000e-004	7.3400e-003	8.1000e-003	0.0000	36.7886	36.7886	0.0119	0.0000	37.0860

Mitigated Construction Off-Site

	ROG	NOx	CO	SO2	Fugitive PM10	Exhaust PM10	PM10 Total	Fugitive PM2.5	Exhaust PM2.5	PM2.5 Total	Bio- CO2	NBio- CO2	Total CO2	CH4	N2O	CO2e
Category	tons/yr										MT/yr					
Hauling	3.9000e-004	0.0135	2.8800e-003	4.0000e-005	8.4000e-004	4.0000e-005	8.9000e-004	2.3000e-004	4.0000e-005	2.7000e-004	0.0000	3.7827	3.7827	1.9000e-004	0.0000	3.7875
Vendor	1.2000e-004	4.0700e-003	1.0200e-003	1.0000e-005	2.6000e-004	1.0000e-005	2.6000e-004	7.0000e-005	1.0000e-005	8.0000e-005	0.0000	1.0114	1.0114	5.0000e-005	0.0000	1.0127
Worker	4.0000e-004	2.8000e-004	2.9200e-003	1.0000e-005	1.0300e-003	1.0000e-005	1.0300e-003	2.7000e-004	1.0000e-005	2.8000e-004	0.0000	0.8684	0.8684	2.0000e-005	0.0000	0.8689
Total	9.1000e-004	0.0178	6.8200e-003	6.0000e-005	2.1300e-003	6.0000e-005	2.1800e-003	5.7000e-004	6.0000e-005	6.3000e-004	0.0000	5.6626	5.6626	2.6000e-004	0.0000	5.6691

3.3 2 Site Preparation and Grading - 2021

Unmitigated Construction On-Site

	ROG	NOx	CO	SO2	Fugitive PM10	Exhaust PM10	PM10 Total	Fugitive PM2.5	Exhaust PM2.5	PM2.5 Total	Bio- CO2	NBio- CO2	Total CO2	CH4	N2O	CO2e
Category	tons/yr										MT/yr					
Fugitive Dust					0.1320	0.0000	0.1320	0.0681	0.0000	0.0681	0.0000	0.0000	0.0000	0.0000	0.0000	0.0000
Off-Road	0.0645	0.6123	0.4162	9.7000e-004		0.0298	0.0298		0.0275	0.0275	0.0000	85.6146	85.6146	0.0277	0.0000	86.3069

Total	0.0645	0.6123	0.4162	9.7000e-004	0.1320	0.0298	0.1618	0.0681	0.0275	0.0956	0.0000	85.6146	85.6146	0.0277	0.0000	86.3069
--------------	---------------	---------------	---------------	--------------------	---------------	---------------	---------------	---------------	---------------	---------------	---------------	----------------	----------------	---------------	---------------	----------------

Unmitigated Construction Off-Site

	ROG	NOx	CO	SO2	Fugitive PM10	Exhaust PM10	PM10 Total	Fugitive PM2.5	Exhaust PM2.5	PM2.5 Total	Bio- CO2	NBio- CO2	Total CO2	CH4	N2O	CO2e
Category	tons/yr										MT/yr					
Hauling	2.3600e-003	0.0810	0.0173	2.3000e-004	5.0700e-003	2.5000e-004	5.3200e-003	1.3900e-003	2.4000e-004	1.6300e-003	0.0000	22.6963	22.6963	1.1600e-003	0.0000	22.7253
Vendor	1.3000e-004	4.2300e-003	1.0600e-003	1.0000e-005	2.7000e-004	1.0000e-005	2.7000e-004	8.0000e-005	1.0000e-005	9.0000e-005	0.0000	1.0503	1.0503	5.0000e-005	0.0000	1.0516
Worker	4.1000e-004	2.9000e-004	3.0300e-003	1.0000e-005	1.0700e-003	1.0000e-005	1.0700e-003	2.8000e-004	1.0000e-005	2.9000e-004	0.0000	0.9018	0.9018	2.0000e-005	0.0000	0.9023
Total	2.9000e-003	0.0855	0.0213	2.5000e-004	6.4100e-003	2.7000e-004	6.6600e-003	1.7500e-003	2.6000e-004	2.0100e-003	0.0000	24.6484	24.6484	1.2300e-003	0.0000	24.6792

Mitigated Construction On-Site

	ROG	NOx	CO	SO2	Fugitive PM10	Exhaust PM10	PM10 Total	Fugitive PM2.5	Exhaust PM2.5	PM2.5 Total	Bio- CO2	NBio- CO2	Total CO2	CH4	N2O	CO2e
Category	tons/yr										MT/yr					
Fugitive Dust					0.0515	0.0000	0.0515	0.0266	0.0000	0.0266	0.0000	0.0000	0.0000	0.0000	0.0000	0.0000
Off-Road	0.0645	0.6123	0.4162	9.7000e-004		0.0298	0.0298		0.0275	0.0275	0.0000	85.6145	85.6145	0.0277	0.0000	86.3068
Total	0.0645	0.6123	0.4162	9.7000e-004	0.0515	0.0298	0.0813	0.0266	0.0275	0.0540	0.0000	85.6145	85.6145	0.0277	0.0000	86.3068

Mitigated Construction Off-Site

	ROG	NOx	CO	SO2	Fugitive PM10	Exhaust PM10	PM10 Total	Fugitive PM2.5	Exhaust PM2.5	PM2.5 Total	Bio- CO2	NBio- CO2	Total CO2	CH4	N2O	CO2e
Category	tons/yr										MT/yr					
Hauling	2.3600e-003	0.0810	0.0173	2.3000e-004	5.0700e-003	2.5000e-004	5.3200e-003	1.3900e-003	2.4000e-004	1.6300e-003	0.0000	22.6963	22.6963	1.1600e-003	0.0000	22.7253
Vendor	1.3000e-004	4.2300e-003	1.0600e-003	1.0000e-005	2.7000e-004	1.0000e-005	2.7000e-004	8.0000e-005	1.0000e-005	9.0000e-005	0.0000	1.0503	1.0503	5.0000e-005	0.0000	1.0516
Worker	4.1000e-004	2.9000e-004	3.0300e-003	1.0000e-005	1.0700e-003	1.0000e-005	1.0700e-003	2.8000e-004	1.0000e-005	2.9000e-004	0.0000	0.9018	0.9018	2.0000e-005	0.0000	0.9023
Total	2.9000e-003	0.0855	0.0213	2.5000e-004	6.4100e-003	2.7000e-004	6.6600e-003	1.7500e-003	2.6000e-004	2.0100e-003	0.0000	24.6484	24.6484	1.2300e-003	0.0000	24.6792

3.4 3 Foundations and Piles - 2021

Unmitigated Construction On-Site

	ROG	NOx	CO	SO2	Fugitive PM10	Exhaust PM10	PM10 Total	Fugitive PM2.5	Exhaust PM2.5	PM2.5 Total	Bio- CO2	NBio- CO2	Total CO2	CH4	N2O	CO2e
Category	tons/yr										MT/yr					
Off-Road	0.3075	2.7075	2.4383	5.6000e-003		0.1263	0.1263		0.1190	0.1190	0.0000	487.3378	487.3378	0.1298	0.0000	490.5825
Total	0.3075	2.7075	2.4383	5.6000e-003		0.1263	0.1263		0.1190	0.1190	0.0000	487.3378	487.3378	0.1298	0.0000	490.5825

Unmitigated Construction Off-Site

	ROG	NOx	CO	SO2	Fugitive PM10	Exhaust PM10	PM10 Total	Fugitive PM2.5	Exhaust PM2.5	PM2.5 Total	Bio- CO2	NBio- CO2	Total CO2	CH4	N2O	CO2e
Category	tons/yr										MT/yr					

Hauling	2.7600e-003	0.0945	0.0201	2.7000e-004	5.9100e-003	2.9000e-004	6.2000e-003	1.6300e-003	2.8000e-004	1.9100e-003	0.0000	26.4790	26.4790	1.3500e-003	0.0000	26.5128
Vendor	8.7000e-004	0.0285	7.1200e-003	7.0000e-005	1.7900e-003	6.0000e-005	1.8500e-003	5.2000e-004	6.0000e-005	5.8000e-004	0.0000	7.0801	7.0801	3.5000e-004	0.0000	7.0888
Worker	2.3900e-003	1.6500e-003	0.0175	6.0000e-005	6.1600e-003	4.0000e-005	6.2000e-003	1.6400e-003	4.0000e-005	1.6800e-003	0.0000	5.2103	5.2103	1.2000e-004	0.0000	5.2132
Total	6.0200e-003	0.1246	0.0447	4.0000e-004	0.0139	3.9000e-004	0.0143	3.7900e-003	3.8000e-004	4.1700e-003	0.0000	38.7694	38.7694	1.8200e-003	0.0000	38.8148

Mitigated Construction On-Site

	ROG	NOx	CO	SO2	Fugitive PM10	Exhaust PM10	PM10 Total	Fugitive PM2.5	Exhaust PM2.5	PM2.5 Total	Bio- CO2	NBio- CO2	Total CO2	CH4	N2O	CO2e
Category	tons/yr										MT/yr					
Off-Road	0.3075	2.7075	2.4383	5.6000e-003		0.1263	0.1263		0.1190	0.1190	0.0000	487.3372	487.3372	0.1298	0.0000	490.5820
Total	0.3075	2.7075	2.4383	5.6000e-003		0.1263	0.1263		0.1190	0.1190	0.0000	487.3372	487.3372	0.1298	0.0000	490.5820

Mitigated Construction Off-Site

	ROG	NOx	CO	SO2	Fugitive PM10	Exhaust PM10	PM10 Total	Fugitive PM2.5	Exhaust PM2.5	PM2.5 Total	Bio- CO2	NBio- CO2	Total CO2	CH4	N2O	CO2e
Category	tons/yr										MT/yr					
Hauling	2.7600e-003	0.0945	0.0201	2.7000e-004	5.9100e-003	2.9000e-004	6.2000e-003	1.6300e-003	2.8000e-004	1.9100e-003	0.0000	26.4790	26.4790	1.3500e-003	0.0000	26.5128
Vendor	8.7000e-004	0.0285	7.1200e-003	7.0000e-005	1.7900e-003	6.0000e-005	1.8500e-003	5.2000e-004	6.0000e-005	5.8000e-004	0.0000	7.0801	7.0801	3.5000e-004	0.0000	7.0888
Worker	2.3900e-003	1.6500e-003	0.0175	6.0000e-005	6.1600e-003	4.0000e-005	6.2000e-003	1.6400e-003	4.0000e-005	1.6800e-003	0.0000	5.2103	5.2103	1.2000e-004	0.0000	5.2132

Total	6.0200e-003	0.1246	0.0447	4.0000e-004	0.0139	3.9000e-004	0.0143	3.7900e-003	3.8000e-004	4.1700e-003	0.0000	38.7694	38.7694	1.8200e-003	0.0000	38.8148
-------	-------------	--------	--------	-------------	--------	-------------	--------	-------------	-------------	-------------	--------	---------	---------	-------------	--------	---------

3.5 4 Structure Erection - 2021

Unmitigated Construction On-Site

	ROG	NOx	CO	SO2	Fugitive PM10	Exhaust PM10	PM10 Total	Fugitive PM2.5	Exhaust PM2.5	PM2.5 Total	Bio- CO2	NBio-CO2	Total CO2	CH4	N2O	CO2e
Category	tons/yr										MT/yr					
Off-Road	0.0803	0.8406	0.7850	1.4300e-003		0.0353	0.0353		0.0332	0.0332	0.0000	124.0278	124.0278	0.0326	0.0000	124.8415
Total	0.0803	0.8406	0.7850	1.4300e-003		0.0353	0.0353		0.0332	0.0332	0.0000	124.0278	124.0278	0.0326	0.0000	124.8415

Unmitigated Construction Off-Site

	ROG	NOx	CO	SO2	Fugitive PM10	Exhaust PM10	PM10 Total	Fugitive PM2.5	Exhaust PM2.5	PM2.5 Total	Bio- CO2	NBio-CO2	Total CO2	CH4	N2O	CO2e
Category	tons/yr										MT/yr					
Hauling	1.6000e-004	5.5000e-003	1.1700e-003	2.0000e-005	7.2000e-004	2.0000e-005	7.4000e-004	1.9000e-004	2.0000e-005	2.0000e-004	0.0000	1.5422	1.5422	8.0000e-005	0.0000	1.5442
Vendor	5.9000e-004	0.0194	4.8400e-003	5.0000e-005	1.2200e-003	4.0000e-005	1.2600e-003	3.5000e-004	4.0000e-005	3.9000e-004	0.0000	4.8108	4.8108	2.4000e-004	0.0000	4.8167
Worker	1.6300e-003	1.1200e-003	0.0119	4.0000e-005	4.1900e-003	3.0000e-005	4.2200e-003	1.1100e-003	3.0000e-005	1.1400e-003	0.0000	3.5404	3.5404	8.0000e-005	0.0000	3.5423
Total	2.3800e-003	0.0260	0.0179	1.1000e-004	6.1300e-003	9.0000e-005	6.2200e-003	1.6500e-003	9.0000e-005	1.7300e-003	0.0000	9.8934	9.8934	4.0000e-004	0.0000	9.9032

Mitigated Construction On-Site

	ROG	NOx	CO	SO2	Fugitive PM10	Exhaust PM10	PM10 Total	Fugitive PM2.5	Exhaust PM2.5	PM2.5 Total	Bio- CO2	NBio-CO2	Total CO2	CH4	N2O	CO2e
Category	tons/yr										MT/yr					
Off-Road	0.0803	0.8406	0.7849	1.4300e-003		0.0353	0.0353		0.0332	0.0332	0.0000	124.0277	124.0277	0.0326	0.0000	124.8414
Total	0.0803	0.8406	0.7849	1.4300e-003		0.0353	0.0353		0.0332	0.0332	0.0000	124.0277	124.0277	0.0326	0.0000	124.8414

Mitigated Construction Off-Site

	ROG	NOx	CO	SO2	Fugitive PM10	Exhaust PM10	PM10 Total	Fugitive PM2.5	Exhaust PM2.5	PM2.5 Total	Bio- CO2	NBio-CO2	Total CO2	CH4	N2O	CO2e
Category	tons/yr										MT/yr					
Hauling	1.6000e-004	5.5000e-003	1.1700e-003	2.0000e-005	7.2000e-004	2.0000e-005	7.4000e-004	1.9000e-004	2.0000e-005	2.0000e-004	0.0000	1.5422	1.5422	8.0000e-005	0.0000	1.5442
Vendor	5.9000e-004	0.0194	4.8400e-003	5.0000e-005	1.2200e-003	4.0000e-005	1.2600e-003	3.5000e-004	4.0000e-005	3.9000e-004	0.0000	4.8108	4.8108	2.4000e-004	0.0000	4.8167
Worker	1.6300e-003	1.1200e-003	0.0119	4.0000e-005	4.1900e-003	3.0000e-005	4.2200e-003	1.1100e-003	3.0000e-005	1.1400e-003	0.0000	3.5404	3.5404	8.0000e-005	0.0000	3.5423
Total	2.3800e-003	0.0260	0.0179	1.1000e-004	6.1300e-003	9.0000e-005	6.2200e-003	1.6500e-003	9.0000e-005	1.7300e-003	0.0000	9.8934	9.8934	4.0000e-004	0.0000	9.9032

3.5 4 Structure Erection - 2022

Unmitigated Construction On-Site

	ROG	NOx	CO	SO2	Fugitive PM10	Exhaust PM10	PM10 Total	Fugitive PM2.5	Exhaust PM2.5	PM2.5 Total	Bio- CO2	NBio-CO2	Total CO2	CH4	N2O	CO2e
Category	tons/yr										MT/yr					

Off-Road	0.1066	1.0966	1.1264	2.0800e-003		0.0447	0.0447		0.0421	0.0421	0.0000	180.2010	180.2010	0.0471	0.0000	181.3775
Total	0.1066	1.0966	1.1264	2.0800e-003		0.0447	0.0447		0.0421	0.0421	0.0000	180.2010	180.2010	0.0471	0.0000	181.3775

Unmitigated Construction Off-Site

	ROG	NOx	CO	SO2	Fugitive PM10	Exhaust PM10	PM10 Total	Fugitive PM2.5	Exhaust PM2.5	PM2.5 Total	Bio- CO2	NBio- CO2	Total CO2	CH4	N2O	CO2e
Category	tons/yr										MT/yr					
Hauling	2.2000e-004	7.3500e-003	1.6700e-003	2.0000e-005	7.6000e-004	2.0000e-005	7.8000e-004	2.0000e-004	2.0000e-005	2.2000e-004	0.0000	2.2100	2.2100	1.1000e-004	0.0000	2.2128
Vendor	8.0000e-004	0.0267	6.6100e-003	7.0000e-005	1.7700e-003	5.0000e-005	1.8200e-003	5.1000e-004	5.0000e-005	5.6000e-004	0.0000	6.9208	6.9208	3.3000e-004	0.0000	6.9290
Worker	2.2000e-003	1.4600e-003	0.0159	5.0000e-005	6.0800e-003	4.0000e-005	6.1200e-003	1.6200e-003	4.0000e-005	1.6500e-003	0.0000	4.9550	4.9550	1.0000e-004	0.0000	4.9575
Total	3.2200e-003	0.0355	0.0242	1.4000e-004	8.6100e-003	1.1000e-004	8.7200e-003	2.3300e-003	1.1000e-004	2.4300e-003	0.0000	14.0858	14.0858	5.4000e-004	0.0000	14.0994

Mitigated Construction On-Site

	ROG	NOx	CO	SO2	Fugitive PM10	Exhaust PM10	PM10 Total	Fugitive PM2.5	Exhaust PM2.5	PM2.5 Total	Bio- CO2	NBio- CO2	Total CO2	CH4	N2O	CO2e
Category	tons/yr										MT/yr					
Off-Road	0.1066	1.0966	1.1264	2.0800e-003		0.0447	0.0447		0.0421	0.0421	0.0000	180.2007	180.2007	0.0471	0.0000	181.3772
Total	0.1066	1.0966	1.1264	2.0800e-003		0.0447	0.0447		0.0421	0.0421	0.0000	180.2007	180.2007	0.0471	0.0000	181.3772

Mitigated Construction Off-Site

	ROG	NOx	CO	SO2	Fugitive PM10	Exhaust PM10	PM10 Total	Fugitive PM2.5	Exhaust PM2.5	PM2.5 Total	Bio- CO2	NBio- CO2	Total CO2	CH4	N2O	CO2e
Category	tons/yr										MT/yr					
Hauling	2.2000e-004	7.3500e-003	1.6700e-003	2.0000e-005	7.6000e-004	2.0000e-005	7.8000e-004	2.0000e-004	2.0000e-005	2.2000e-004	0.0000	2.2100	2.2100	1.1000e-004	0.0000	2.2128
Vendor	8.0000e-004	0.0267	6.6100e-003	7.0000e-005	1.7700e-003	5.0000e-005	1.8200e-003	5.1000e-004	5.0000e-005	5.6000e-004	0.0000	6.9208	6.9208	3.3000e-004	0.0000	6.9290
Worker	2.2000e-003	1.4600e-003	0.0159	5.0000e-005	6.0800e-003	4.0000e-005	6.1200e-003	1.6200e-003	4.0000e-005	1.6500e-003	0.0000	4.9550	4.9550	1.0000e-004	0.0000	4.9575
Total	3.2200e-003	0.0355	0.0242	1.4000e-004	8.6100e-003	1.1000e-004	8.7200e-003	2.3300e-003	1.1000e-004	2.4300e-003	0.0000	14.0858	14.0858	5.4000e-004	0.0000	14.0994

3.6 5 Paving - 2022

Unmitigated Construction On-Site

	ROG	NOx	CO	SO2	Fugitive PM10	Exhaust PM10	PM10 Total	Fugitive PM2.5	Exhaust PM2.5	PM2.5 Total	Bio- CO2	NBio- CO2	Total CO2	CH4	N2O	CO2e
Category	tons/yr										MT/yr					
Off-Road	7.2800e-003	0.0746	0.0925	1.4000e-004		3.8800e-003	3.8800e-003		3.5700e-003	3.5700e-003	0.0000	12.5487	12.5487	4.0600e-003	0.0000	12.6501
Paving	0.0000					0.0000	0.0000		0.0000	0.0000	0.0000	0.0000	0.0000	0.0000	0.0000	0.0000
Total	7.2800e-003	0.0746	0.0925	1.4000e-004		3.8800e-003	3.8800e-003		3.5700e-003	3.5700e-003	0.0000	12.5487	12.5487	4.0600e-003	0.0000	12.6501

Unmitigated Construction Off-Site

Vendor	8.0000e-005	2.5700e-003	6.4000e-004	1.0000e-005	1.7000e-004	1.0000e-005	1.8000e-004	5.0000e-005	0.0000	5.0000e-005	0.0000	0.6677	0.6677	3.0000e-005	0.0000	0.6685
Worker	3.7000e-004	2.5000e-004	2.6800e-003	1.0000e-005	1.0300e-003	1.0000e-005	1.0300e-003	2.7000e-004	1.0000e-005	2.8000e-004	0.0000	0.8366	0.8366	2.0000e-005	0.0000	0.8370
Total	4.5000e-004	2.8200e-003	3.3200e-003	2.0000e-005	1.2000e-003	2.0000e-005	1.2100e-003	3.2000e-004	1.0000e-005	3.3000e-004	0.0000	1.5042	1.5042	5.0000e-005	0.0000	1.5055

3.7 6 Finishing - 2022

Unmitigated Construction On-Site

	ROG	NOx	CO	SO2	Fugitive PM10	Exhaust PM10	PM10 Total	Fugitive PM2.5	Exhaust PM2.5	PM2.5 Total	Bio- CO2	NBio- CO2	Total CO2	CH4	N2O	CO2e
Category	tons/yr										MT/yr					
Off-Road	0.0177	0.1486	0.1924	3.0000e-004		7.2400e-003	7.2400e-003		6.9900e-003	6.9900e-003	0.0000	25.6827	25.6827	4.5200e-003	0.0000	25.7957
Total	0.0177	0.1486	0.1924	3.0000e-004		7.2400e-003	7.2400e-003		6.9900e-003	6.9900e-003	0.0000	25.6827	25.6827	4.5200e-003	0.0000	25.7957

Unmitigated Construction Off-Site

	ROG	NOx	CO	SO2	Fugitive PM10	Exhaust PM10	PM10 Total	Fugitive PM2.5	Exhaust PM2.5	PM2.5 Total	Bio- CO2	NBio- CO2	Total CO2	CH4	N2O	CO2e
Category	tons/yr										MT/yr					
Hauling	0.0000	0.0000	0.0000	0.0000	0.0000	0.0000	0.0000	0.0000	0.0000	0.0000	0.0000	0.0000	0.0000	0.0000	0.0000	0.0000
Vendor	8.0000e-005	2.5700e-003	6.4000e-004	1.0000e-005	1.7000e-004	1.0000e-005	1.8000e-004	5.0000e-005	0.0000	5.0000e-005	0.0000	0.6677	0.6677	3.0000e-005	0.0000	0.6685
Worker	3.7000e-004	2.5000e-004	2.6800e-003	1.0000e-005	1.0300e-003	1.0000e-005	1.0300e-003	2.7000e-004	1.0000e-005	2.8000e-004	0.0000	0.8366	0.8366	2.0000e-005	0.0000	0.8370
Total	4.5000e-004	2.8200e-003	3.3200e-003	2.0000e-005	1.2000e-003	2.0000e-005	1.2100e-003	3.2000e-004	1.0000e-005	3.3000e-004	0.0000	1.5042	1.5042	5.0000e-005	0.0000	1.5055

Mitigated Construction On-Site

	ROG	NOx	CO	SO2	Fugitive PM10	Exhaust PM10	PM10 Total	Fugitive PM2.5	Exhaust PM2.5	PM2.5 Total	Bio- CO2	NBio-CO2	Total CO2	CH4	N2O	CO2e
Category	tons/yr										MT/yr					
Off-Road	0.0177	0.1486	0.1924	3.0000e-004		7.2400e-003	7.2400e-003		6.9900e-003	6.9900e-003	0.0000	25.6827	25.6827	4.5200e-003	0.0000	25.7956
Total	0.0177	0.1486	0.1924	3.0000e-004		7.2400e-003	7.2400e-003		6.9900e-003	6.9900e-003	0.0000	25.6827	25.6827	4.5200e-003	0.0000	25.7956

Mitigated Construction Off-Site

	ROG	NOx	CO	SO2	Fugitive PM10	Exhaust PM10	PM10 Total	Fugitive PM2.5	Exhaust PM2.5	PM2.5 Total	Bio- CO2	NBio-CO2	Total CO2	CH4	N2O	CO2e
Category	tons/yr										MT/yr					
Hauling	0.0000	0.0000	0.0000	0.0000	0.0000	0.0000	0.0000	0.0000	0.0000	0.0000	0.0000	0.0000	0.0000	0.0000	0.0000	0.0000
Vendor	8.0000e-005	2.5700e-003	6.4000e-004	1.0000e-005	1.7000e-004	1.0000e-005	1.8000e-004	5.0000e-005	0.0000	5.0000e-005	0.0000	0.6677	0.6677	3.0000e-005	0.0000	0.6685
Worker	3.7000e-004	2.5000e-004	2.6800e-003	1.0000e-005	1.0300e-003	1.0000e-005	1.0300e-003	2.7000e-004	1.0000e-005	2.8000e-004	0.0000	0.8366	0.8366	2.0000e-005	0.0000	0.8370
Total	4.5000e-004	2.8200e-003	3.3200e-003	2.0000e-005	1.2000e-003	2.0000e-005	1.2100e-003	3.2000e-004	1.0000e-005	3.3000e-004	0.0000	1.5042	1.5042	5.0000e-005	0.0000	1.5055

4.0 Operational Detail - Mobile

4.1 Mitigation Measures Mobile

	ROG	NOx	CO	SO2	Fugitive PM10	Exhaust PM10	PM10 Total	Fugitive PM2.5	Exhaust PM2.5	PM2.5 Total	Bio- CO2	NBio- CO2	Total CO2	CH4	N2O	CO2e
Category	tons/yr										MT/yr					
Mitigated	0.0000	0.0000	0.0000	0.0000	0.0000	0.0000	0.0000	0.0000	0.0000	0.0000	0.0000	0.0000	0.0000	0.0000	0.0000	0.0000
Unmitigated	0.0000	0.0000	0.0000	0.0000	0.0000	0.0000	0.0000	0.0000	0.0000	0.0000	0.0000	0.0000	0.0000	0.0000	0.0000	0.0000

4.2 Trip Summary Information

Land Use	Average Daily Trip Rate			Unmitigated	Mitigated
	Weekday	Saturday	Sunday	Annual VMT	Annual VMT
General Heavy Industry	0.00	0.00	0.00		
Total	0.00	0.00	0.00		

4.3 Trip Type Information

Land Use	Miles			Trip %			Trip Purpose %		
	H-W or C-W	H-S or C-C	H-O or C-NW	H-W or C-	H-S or C-C	H-O or C-NW	Primary	Diverted	Pass-by
General Heavy Industry	0.00	0.00	0.00	59.00	28.00	13.00	92	5	3

4.4 Fleet Mix

Land Use	LDA	LDT1	LDT2	MDV	LHD1	LHD2	MHD	HHD	OBUS	UBUS	MCY	SBUS	MH
General Heavy Industry	1.000000	0.000000	0.000000	0.000000	0.000000	0.000000	0.000000	0.000000	0.000000	0.000000	0.000000	0.000000	0.000000

5.0 Energy Detail

Historical Energy Use: N

5.1 Mitigation Measures Energy

	ROG	NOx	CO	SO2	Fugitive PM10	Exhaust PM10	PM10 Total	Fugitive PM2.5	Exhaust PM2.5	PM2.5 Total	Bio- CO2	NBio- CO2	Total CO2	CH4	N2O	CO2e
Category	tons/yr										MT/yr					
Electricity Mitigated							0.0000	0.0000		0.0000	0.0000	0.0000	0.0000	0.0000	0.0000	0.0000
Electricity Unmitigated							0.0000	0.0000		0.0000	0.0000	0.0000	0.0000	0.0000	0.0000	0.0000
NaturalGas Mitigated	0.0000	0.0000	0.0000	0.0000			0.0000	0.0000		0.0000	0.0000	0.0000	0.0000	0.0000	0.0000	0.0000
NaturalGas Unmitigated	0.0000	0.0000	0.0000	0.0000			0.0000	0.0000		0.0000	0.0000	0.0000	0.0000	0.0000	0.0000	0.0000

5.2 Energy by Land Use - NaturalGas

Unmitigated

	NaturalGas Use	ROG	NOx	CO	SO2	Fugitive PM10	Exhaust PM10	PM10 Total	Fugitive PM2.5	Exhaust PM2.5	PM2.5 Total	Bio- CO2	NBio- CO2	Total CO2	CH4	N2O	CO2e
Land Use	kBTU/yr	tons/yr										MT/yr					
General Heavy Industry	0	0.0000	0.0000	0.0000	0.0000			0.0000		0.0000	0.0000	0.0000	0.0000	0.0000	0.0000	0.0000	0.0000
Total		0.0000	0.0000	0.0000	0.0000			0.0000		0.0000	0.0000	0.0000	0.0000	0.0000	0.0000	0.0000	0.0000

Mitigated

	NaturalGas Use	ROG	NOx	CO	SO2	Fugitive PM10	Exhaust PM10	PM10 Total	Fugitive PM2.5	Exhaust PM2.5	PM2.5 Total	Bio- CO2	NBio- CO2	Total CO2	CH4	N2O	CO2e
--	----------------	-----	-----	----	-----	---------------	--------------	------------	----------------	---------------	-------------	----------	-----------	-----------	-----	-----	------

Land Use	kBTU/yr	tons/yr										MT/yr					
General Heavy Industry	0	0.0000	0.0000	0.0000	0.0000	0.0000	0.0000	0.0000	0.0000	0.0000	0.0000	0.0000	0.0000	0.0000	0.0000	0.0000	0.0000
Total		0.0000	0.0000	0.0000	0.0000	0.0000	0.0000	0.0000	0.0000	0.0000	0.0000	0.0000	0.0000	0.0000	0.0000	0.0000	0.0000

5.3 Energy by Land Use - Electricity

Unmitigated

	Electricity Use	Total CO2	CH4	N2O	CO2e
Land Use	kWh/yr	MT/yr			
General Heavy Industry	0	0.0000	0.0000	0.0000	0.0000
Total		0.0000	0.0000	0.0000	0.0000

Mitigated

	Electricity Use	Total CO2	CH4	N2O	CO2e
Land Use	kWh/yr	MT/yr			
General Heavy Industry	0	0.0000	0.0000	0.0000	0.0000
Total		0.0000	0.0000	0.0000	0.0000

6.0 Area Detail

6.1 Mitigation Measures Area

	ROG	NOx	CO	SO2	Fugitive PM10	Exhaust PM10	PM10 Total	Fugitive PM2.5	Exhaust PM2.5	PM2.5 Total	Bio- CO2	NBio- CO2	Total CO2	CH4	N2O	CO2e
Category	tons/yr										MT/yr					
Mitigated	0.0000					0.0000	0.0000		0.0000	0.0000	0.0000	0.0000	0.0000	0.0000	0.0000	0.0000
Unmitigated	0.0000					0.0000	0.0000		0.0000	0.0000	0.0000	0.0000	0.0000	0.0000	0.0000	0.0000

6.2 Area by SubCategory

Unmitigated

	ROG	NOx	CO	SO2	Fugitive PM10	Exhaust PM10	PM10 Total	Fugitive PM2.5	Exhaust PM2.5	PM2.5 Total	Bio- CO2	NBio- CO2	Total CO2	CH4	N2O	CO2e
SubCategory	tons/yr										MT/yr					
Architectural Coating	0.0000					0.0000	0.0000		0.0000	0.0000	0.0000	0.0000	0.0000	0.0000	0.0000	0.0000
Total	0.0000					0.0000	0.0000		0.0000	0.0000	0.0000	0.0000	0.0000	0.0000	0.0000	0.0000

Mitigated

	ROG	NOx	CO	SO2	Fugitive PM10	Exhaust PM10	PM10 Total	Fugitive PM2.5	Exhaust PM2.5	PM2.5 Total	Bio- CO2	NBio- CO2	Total CO2	CH4	N2O	CO2e
SubCategory	tons/yr										MT/yr					
Architectural Coating	0.0000					0.0000	0.0000		0.0000	0.0000	0.0000	0.0000	0.0000	0.0000	0.0000	0.0000
Total	0.0000					0.0000	0.0000		0.0000	0.0000	0.0000	0.0000	0.0000	0.0000	0.0000	0.0000

7.0 Water Detail

7.1 Mitigation Measures Water

	Total CO2	CH4	N2O	CO2e
Category	MT/yr			
Mitigated	0.0000	0.0000	0.0000	0.0000
Unmitigated	0.0000	0.0000	0.0000	0.0000

7.2 Water by Land Use

Unmitigated

	Indoor/Outdoor Use	Total CO2	CH4	N2O	CO2e

Land Use	Mgal	MT/yr			
General Heavy Industry	0 / 0	0.0000	0.0000	0.0000	0.0000
Total		0.0000	0.0000	0.0000	0.0000

Mitigated

	Indoor/Outdoor Use	Total CO2	CH4	N2O	CO2e
Land Use	Mgal	MT/yr			
General Heavy Industry	0 / 0	0.0000	0.0000	0.0000	0.0000
Total		0.0000	0.0000	0.0000	0.0000

8.0 Waste Detail

8.1 Mitigation Measures Waste

Category/Year

	Total CO2	CH4	N2O	CO2e
	MT/yr			
Mitigated	0.0000	0.0000	0.0000	0.0000

Unmitigated	0.0000	0.0000	0.0000	0.0000
-------------	--------	--------	--------	--------

8.2 Waste by Land Use

Unmitigated

	Waste Disposed	Total CO2	CH4	N2O	CO2e
Land Use	tons	MT/yr			
General Heavy Industry	0	0.0000	0.0000	0.0000	0.0000
Total		0.0000	0.0000	0.0000	0.0000

Mitigated

	Waste Disposed	Total CO2	CH4	N2O	CO2e
Land Use	tons	MT/yr			
General Heavy Industry	0	0.0000	0.0000	0.0000	0.0000
Total		0.0000	0.0000	0.0000	0.0000

9.0 Operational Offroad

Equipment Type	Number	Hours/Day	Days/Year	Horse Power	Load Factor	Fuel Type
----------------	--------	-----------	-----------	-------------	-------------	-----------

10.0 Stationary Equipment

Fire Pumps and Emergency Generators

Equipment Type	Number	Hours/Day	Hours/Year	Horse Power	Load Factor	Fuel Type
----------------	--------	-----------	------------	-------------	-------------	-----------

Boilers

Equipment Type	Number	Heat Input/Day	Heat Input/Year	Boiler Rating	Fuel Type
----------------	--------	----------------	-----------------	---------------	-----------

User Defined Equipment

Equipment Type	Number
----------------	--------

11.0 Vegetation

Off-road Equipment - Expected equipment

Trips and VMT - Expected Trips, Vendor Trips = Workers / 2.56 per default for Building Erection

Demolition - 1.2 ton/yd³ per CalRecycle <https://www.calrecycle.ca.gov/swfacilities/cdi/tools/calculations>

Grading - Project Specific

Landscape Equipment - no operational

Construction Off-road Equipment Mitigation - Tier 4F Mitigation

Vehicle Trips - no operational

Fleet Mix - no operational

Consumer Products - no operational

Energy Use - no operational

Water And Wastewater - no operational

Solid Waste - no operational

Table Name	Column Name	Default Value	New Value
tblAreaCoating	Area_Nonresidential_Exterior	392000	0
tblAreaCoating	Area_Nonresidential_Interior	1176000	0
tblConstEquipMitigation	NumberOfEquipmentMitigated	0.00	6.00
tblConstEquipMitigation	NumberOfEquipmentMitigated	0.00	2.00
tblConstEquipMitigation	NumberOfEquipmentMitigated	0.00	2.00
tblConstEquipMitigation	NumberOfEquipmentMitigated	0.00	2.00
tblConstEquipMitigation	NumberOfEquipmentMitigated	0.00	5.00
tblConstEquipMitigation	NumberOfEquipmentMitigated	0.00	3.00
tblConstEquipMitigation	NumberOfEquipmentMitigated	0.00	1.00
tblConstEquipMitigation	NumberOfEquipmentMitigated	0.00	2.00
tblConstEquipMitigation	NumberOfEquipmentMitigated	0.00	1.00
tblConstEquipMitigation	NumberOfEquipmentMitigated	0.00	4.00
tblConstEquipMitigation	NumberOfEquipmentMitigated	0.00	1.00
tblConstEquipMitigation	NumberOfEquipmentMitigated	0.00	3.00
tblConstEquipMitigation	Tier	No Change	Tier 4 Final
tblConstEquipMitigation	Tier	No Change	Tier 4 Final
tblConstEquipMitigation	Tier	No Change	Tier 4 Final

tblConstEquipMitigation	Tier	No Change	Tier 4 Final
tblConstEquipMitigation	Tier	No Change	Tier 4 Final
tblConstEquipMitigation	Tier	No Change	Tier 4 Final
tblConstEquipMitigation	Tier	No Change	Tier 4 Final
tblConstEquipMitigation	Tier	No Change	Tier 4 Final
tblConstEquipMitigation	Tier	No Change	Tier 4 Final
tblConstEquipMitigation	Tier	No Change	Tier 4 Final
tblConstEquipMitigation	Tier	No Change	Tier 4 Final
tblConstEquipMitigation	Tier	No Change	Tier 4 Final
tblConstructionPhase	NumDays	20.00	26.00
tblConstructionPhase	NumDays	30.00	27.00
tblConstructionPhase	NumDays	300.00	78.00
tblConstructionPhase	NumDays	300.00	130.00
tblConstructionPhase	NumDays	20.00	26.00
tblConstructionPhase	NumDays	300.00	26.00
tblConstructionPhase	NumDaysWeek	5.00	6.00
tblConstructionPhase	NumDaysWeek	5.00	6.00
tblConstructionPhase	NumDaysWeek	5.00	6.00
tblConstructionPhase	NumDaysWeek	5.00	6.00
tblConstructionPhase	NumDaysWeek	5.00	6.00
tblConstructionPhase	NumDaysWeek	5.00	6.00
tblEnergyUse	LightingElect	2.99	0.00
tblEnergyUse	NT24E	3.36	0.00
tblEnergyUse	NT24NG	6.90	0.00
tblEnergyUse	T24E	1.21	0.00
tblEnergyUse	T24NG	17.85	0.00
tblFleetMix	HHD	0.03	0.00
tblFleetMix	LDA	0.58	1.00
tblFleetMix	LDT1	0.04	0.00
tblFleetMix	LDT2	0.19	0.00

tblOffRoadEquipment	UsageHours	8.00	12.00
tblOffRoadEquipment	UsageHours	8.00	12.00
tblOffRoadEquipment	UsageHours	8.00	12.00
tblOffRoadEquipment	UsageHours	8.00	12.00
tblOffRoadEquipment	UsageHours	7.00	12.00
tblOffRoadEquipment	UsageHours	8.00	12.00
tblOffRoadEquipment	UsageHours	8.00	12.00
tblOffRoadEquipment	UsageHours	8.00	12.00
tblOffRoadEquipment	UsageHours	8.00	12.00
tblSolidWaste	SolidWasteGenerationRate	972.16	0.00
tblTripsAndVMT	HaulingTripNumber	119.00	100.00
tblTripsAndVMT	HaulingTripNumber	1,125.00	600.00
tblTripsAndVMT	HaulingTripNumber	0.00	700.00
tblTripsAndVMT	HaulingTripNumber	0.00	100.00
tblTripsAndVMT	VendorTripNumber	0.00	3.00
tblTripsAndVMT	VendorTripNumber	0.00	3.00
tblTripsAndVMT	VendorTripNumber	128.00	7.00
tblTripsAndVMT	VendorTripNumber	128.00	7.00
tblTripsAndVMT	VendorTripNumber	0.00	2.00
tblTripsAndVMT	VendorTripNumber	128.00	2.00
tblTripsAndVMT	WorkerTripNumber	8.00	10.00
tblTripsAndVMT	WorkerTripNumber	18.00	10.00
tblTripsAndVMT	WorkerTripNumber	329.00	20.00
tblTripsAndVMT	WorkerTripNumber	329.00	20.00
tblTripsAndVMT	WorkerTripNumber	5.00	10.00
tblTripsAndVMT	WorkerTripNumber	329.00	10.00
tblVehicleTrips	CC_TL	7.30	0.00
tblVehicleTrips	CNW_TL	7.30	0.00
tblVehicleTrips	CW_TL	9.50	0.00
tblVehicleTrips	ST_TR	1.50	0.00

tblVehicleTrips	SU_TR	1.50	0.00
tblVehicleTrips	WD_TR	1.50	0.00
tblWater	ElectricityIntensityFactorForWastewater Treatment	1,911.00	0.00
tblWater	ElectricityIntensityFactorToDistribute	1,272.00	0.00
tblWater	ElectricityIntensityFactorToSupply	2,117.00	0.00
tblWater	ElectricityIntensityFactorToTreat	111.00	0.00
tblWater	IndoorWaterUseRate	181,300,000.00	0.00

2.0 Emissions Summary

2.1 Overall Construction

Unmitigated Construction

	ROG	NOx	CO	SO2	Fugitive PM10	Exhaust PM10	PM10 Total	Fugitive PM2.5	Exhaust PM2.5	PM2.5 Total	Bio- CO2	NBio- CO2	Total CO2	CH4	N2O	CO2e
Year	tons/yr										MT/yr					
2021	0.4845	4.5960	3.9084	9.2500e-003	0.1734	0.2002	0.3736	0.0779	0.1878	0.2656	0.0000	812.7426	812.7426	0.2056	0.0000	817.8833
2022	0.1356	1.3609	1.4422	2.7100e-003	0.0110	0.0560	0.0670	2.9800e-003	0.0528	0.0558	0.0000	235.5266	235.5266	0.0563	0.0000	236.9335
Maximum	0.4845	4.5960	3.9084	9.2500e-003	0.1734	0.2002	0.3736	0.0779	0.1878	0.2656	0.0000	812.7426	812.7426	0.2056	0.0000	817.8833

Mitigated Construction

	ROG	NOx	CO	SO2	Fugitive PM10	Exhaust PM10	PM10 Total	Fugitive PM2.5	Exhaust PM2.5	PM2.5 Total	Bio- CO2	NBio- CO2	Total CO2	CH4	N2O	CO2e
Year	tons/yr										MT/yr					
2021	0.2844	2.5887	4.0849	9.2500e-003	0.0850	0.0901	0.1751	0.0351	0.0834	0.1185	0.0000	812.7418	812.7418	0.2056	0.0000	817.8824

Mitigated Operational

	ROG	NOx	CO	SO2	Fugitive PM10	Exhaust PM10	PM10 Total	Fugitive PM2.5	Exhaust PM2.5	PM2.5 Total	Bio- CO2	NBio- CO2	Total CO2	CH4	N2O	CO2e
Category	tons/yr										MT/yr					
Area	0.0000					0.0000	0.0000		0.0000	0.0000	0.0000	0.0000	0.0000	0.0000	0.0000	0.0000
Energy	0.0000	0.0000	0.0000	0.0000		0.0000	0.0000		0.0000	0.0000	0.0000	0.0000	0.0000	0.0000	0.0000	0.0000
Mobile	0.0000	0.0000	0.0000	0.0000	0.0000	0.0000	0.0000	0.0000	0.0000	0.0000	0.0000	0.0000	0.0000	0.0000	0.0000	0.0000
Waste						0.0000	0.0000		0.0000	0.0000	0.0000	0.0000	0.0000	0.0000	0.0000	0.0000
Water						0.0000	0.0000		0.0000	0.0000	0.0000	0.0000	0.0000	0.0000	0.0000	0.0000
Total	0.0000	0.0000	0.0000	0.0000	0.0000	0.0000	0.0000	0.0000	0.0000	0.0000	0.0000	0.0000	0.0000	0.0000	0.0000	0.0000

	ROG	NOx	CO	SO2	Fugitive PM10	Exhaust PM10	PM10 Total	Fugitive PM2.5	Exhaust PM2.5	PM2.5 Total	Bio- CO2	NBio- CO2	Total CO2	CH4	N2O	CO2e
Percent Reduction	0.00	0.00	0.00	0.00	0.00	0.00	0.00	0.00	0.00	0.00	0.00	0.00	0.00	0.00	0.00	0.00

3.0 Construction Detail

Construction Phase

Phase Number	Phase Name	Phase Type	Start Date	End Date	Num Days Week	Num Days	Phase Description
1	1 Demolition	Demolition	6/1/2021	6/30/2021	6	26	
2	2 Site Preparation and Grading	Grading	7/1/2021	7/31/2021	6	27	
3	3 Foundations and Piles	Building Construction	8/1/2021	10/30/2021	6	78	
4	4 Structure Erection	Building Construction	11/1/2021	3/31/2022	6	130	
5	5 Paving	Paving	4/1/2022	4/30/2022	6	26	
6	6 Finishing	Building Construction	5/1/2022	5/31/2022	6	26	

Acres of Grading (Site Preparation Phase): 0

Acres of Grading (Grading Phase): 0

Acres of Paving: 0

Residential Indoor: 0; Residential Outdoor: 0; Non-Residential Indoor: 0; Non-Residential Outdoor: 0; Striped Parking Area: 0

OffRoad Equipment

Phase Name	Offroad Equipment Type	Amount	Usage Hours	Horse Power	Load Factor
1 Demolition	Excavators	1	12.00	158	0.38
1 Demolition	Off-Highway Trucks	1	12.00	402	0.38
1 Demolition	Tractors/Loaders/Backhoes	1	12.00	97	0.37
2 Site Preparation and Grading	Excavators	1	12.00	158	0.38
2 Site Preparation and Grading	Forklifts	1	12.00	89	0.20
2 Site Preparation and Grading	Off-Highway Trucks	2	12.00	402	0.38
2 Site Preparation and Grading	Rubber Tired Dozers	1	12.00	247	0.40
2 Site Preparation and Grading	Tractors/Loaders/Backhoes	1	12.00	97	0.37
2 Site Preparation and Grading	Trenchers	1	12.00	78	0.50
3 Foundations and Piles	Concrete/Industrial Saws	2	12.00	81	0.73
3 Foundations and Piles	Generator Sets	1	12.00	84	0.74
3 Foundations and Piles	Off-Highway Trucks	4	12.00	402	0.38
3 Foundations and Piles	Other Construction Equipment	2	12.00	172	0.42
3 Foundations and Piles	Rollers	1	12.00	80	0.38
3 Foundations and Piles	Tractors/Loaders/Backhoes	2	12.00	97	0.37
3 Foundations and Piles	Welders	1	12.00	46	0.45
4 Structure Erection	Aerial Lifts	4	12.00	97	0.37
4 Structure Erection	Cranes	2	12.00	231	0.29
4 Structure Erection	Forklifts	2	12.00	89	0.20
4 Structure Erection	Generator Sets	1	12.00	84	0.74
4 Structure Erection	Welders	1	12.00	46	0.45
5 Paving	Pavers	1	12.00	130	0.42
5 Paving	Rollers	1	12.00	80	0.38

6 Finishing	Aerial Lifts	2	12.00	63	0.31
6 Finishing	Forklifts	2	12.00	89	0.20
6 Finishing	Generator Sets	1	12.00	84	0.74
6 Finishing	Welders	1	12.00	46	0.45

Trips and VMT

Phase Name	Offroad Equipment Count	Worker Trip Number	Vendor Trip Number	Hauling Trip Number	Worker Trip Length	Vendor Trip Length	Hauling Trip Length	Worker Vehicle Class	Vendor Vehicle Class	Hauling Vehicle Class	
1 Demolition		3	10.00	3.00	100.00	10.80	7.30	20.00	LD_Mix	HDT_Mix	HHDT
2 Site Preparation and Grading		7	10.00	3.00	600.00	10.80	7.30	20.00	LD_Mix	HDT_Mix	HHDT
3 Foundations and Piles		13	20.00	7.00	700.00	10.80	7.30	20.00	LD_Mix	HDT_Mix	HHDT
4 Structure Erection		10	20.00	7.00	100.00	10.80	7.30	20.00	LD_Mix	HDT_Mix	HHDT
5 Paving		2	10.00	2.00	0.00	10.80	7.30	20.00	LD_Mix	HDT_Mix	HHDT
6 Finishing		6	10.00	2.00	0.00	10.80	7.30	20.00	LD_Mix	HDT_Mix	HHDT

3.1 Mitigation Measures Construction

Use Cleaner Engines for Construction Equipment

Water Exposed Area

3.2 1 Demolition - 2021

Unmitigated Construction On-Site

	ROG	NOx	CO	SO2	Fugitive PM10	Exhaust PM10	PM10 Total	Fugitive PM2.5	Exhaust PM2.5	PM2.5 Total	Bio- CO2	NBio- CO2	Total CO2	CH4	N2O	CO2e
Category	tons/yr										MT/yr					
Fugitive Dust					0.0128	0.0000	0.0128	1.9400e-003	0.0000	1.9400e-003	0.0000	0.0000	0.0000	0.0000	0.0000	0.0000
Off-Road	0.0199	0.1816	0.1782	4.2000e-004		7.9800e-003	7.9800e-003		7.3400e-003	7.3400e-003	0.0000	36.7886	36.7886	0.0119	0.0000	37.0861

Total	0.0199	0.1816	0.1782	4.2000e-004	0.0128	7.9800e-003	0.0208	1.9400e-003	7.3400e-003	9.2800e-003	0.0000	36.7886	36.7886	0.0119	0.0000	37.0861
--------------	---------------	---------------	---------------	--------------------	---------------	--------------------	---------------	--------------------	--------------------	--------------------	---------------	----------------	----------------	---------------	---------------	----------------

Unmitigated Construction Off-Site

	ROG	NOx	CO	SO2	Fugitive PM10	Exhaust PM10	PM10 Total	Fugitive PM2.5	Exhaust PM2.5	PM2.5 Total	Bio- CO2	NBio- CO2	Total CO2	CH4	N2O	CO2e
Category	tons/yr										MT/yr					
Hauling	3.9000e-004	0.0135	2.8800e-003	4.0000e-005	8.4000e-004	4.0000e-005	8.9000e-004	2.3000e-004	4.0000e-005	2.7000e-004	0.0000	3.7827	3.7827	1.9000e-004	0.0000	3.7875
Vendor	1.2000e-004	4.0700e-003	1.0200e-003	1.0000e-005	2.6000e-004	1.0000e-005	2.6000e-004	7.0000e-005	1.0000e-005	8.0000e-005	0.0000	1.0114	1.0114	5.0000e-005	0.0000	1.0127
Worker	4.0000e-004	2.8000e-004	2.9200e-003	1.0000e-005	1.0300e-003	1.0000e-005	1.0300e-003	2.7000e-004	1.0000e-005	2.8000e-004	0.0000	0.8684	0.8684	2.0000e-005	0.0000	0.8689
Total	9.1000e-004	0.0178	6.8200e-003	6.0000e-005	2.1300e-003	6.0000e-005	2.1800e-003	5.7000e-004	6.0000e-005	6.3000e-004	0.0000	5.6626	5.6626	2.6000e-004	0.0000	5.6691

Mitigated Construction On-Site

	ROG	NOx	CO	SO2	Fugitive PM10	Exhaust PM10	PM10 Total	Fugitive PM2.5	Exhaust PM2.5	PM2.5 Total	Bio- CO2	NBio- CO2	Total CO2	CH4	N2O	CO2e
Category	tons/yr										MT/yr					
Fugitive Dust					5.0100e-003	0.0000	5.0100e-003	7.6000e-004	0.0000	7.6000e-004	0.0000	0.0000	0.0000	0.0000	0.0000	0.0000
Off-Road	0.0138	0.1112	0.1924	4.2000e-004		4.0300e-003	4.0300e-003		3.7300e-003	3.7300e-003	0.0000	36.7886	36.7886	0.0119	0.0000	37.0860
Total	0.0138	0.1112	0.1924	4.2000e-004	5.0100e-003	4.0300e-003	9.0400e-003	7.6000e-004	3.7300e-003	4.4900e-003	0.0000	36.7886	36.7886	0.0119	0.0000	37.0860

Mitigated Construction Off-Site

	ROG	NOx	CO	SO2	Fugitive PM10	Exhaust PM10	PM10 Total	Fugitive PM2.5	Exhaust PM2.5	PM2.5 Total	Bio- CO2	NBio- CO2	Total CO2	CH4	N2O	CO2e
Category	tons/yr										MT/yr					
Hauling	3.9000e-004	0.0135	2.8800e-003	4.0000e-005	8.4000e-004	4.0000e-005	8.9000e-004	2.3000e-004	4.0000e-005	2.7000e-004	0.0000	3.7827	3.7827	1.9000e-004	0.0000	3.7875
Vendor	1.2000e-004	4.0700e-003	1.0200e-003	1.0000e-005	2.6000e-004	1.0000e-005	2.6000e-004	7.0000e-005	1.0000e-005	8.0000e-005	0.0000	1.0114	1.0114	5.0000e-005	0.0000	1.0127
Worker	4.0000e-004	2.8000e-004	2.9200e-003	1.0000e-005	1.0300e-003	1.0000e-005	1.0300e-003	2.7000e-004	1.0000e-005	2.8000e-004	0.0000	0.8684	0.8684	2.0000e-005	0.0000	0.8689
Total	9.1000e-004	0.0178	6.8200e-003	6.0000e-005	2.1300e-003	6.0000e-005	2.1800e-003	5.7000e-004	6.0000e-005	6.3000e-004	0.0000	5.6626	5.6626	2.6000e-004	0.0000	5.6691

3.3 2 Site Preparation and Grading - 2021

Unmitigated Construction On-Site

	ROG	NOx	CO	SO2	Fugitive PM10	Exhaust PM10	PM10 Total	Fugitive PM2.5	Exhaust PM2.5	PM2.5 Total	Bio- CO2	NBio- CO2	Total CO2	CH4	N2O	CO2e
Category	tons/yr										MT/yr					
Fugitive Dust					0.1320	0.0000	0.1320	0.0681	0.0000	0.0681	0.0000	0.0000	0.0000	0.0000	0.0000	0.0000
Off-Road	0.0645	0.6123	0.4162	9.7000e-004		0.0298	0.0298		0.0275	0.0275	0.0000	85.6146	85.6146	0.0277	0.0000	86.3069
Total	0.0645	0.6123	0.4162	9.7000e-004	0.1320	0.0298	0.1618	0.0681	0.0275	0.0956	0.0000	85.6146	85.6146	0.0277	0.0000	86.3069

Unmitigated Construction Off-Site

	ROG	NOx	CO	SO2	Fugitive PM10	Exhaust PM10	PM10 Total	Fugitive PM2.5	Exhaust PM2.5	PM2.5 Total	Bio- CO2	NBio- CO2	Total CO2	CH4	N2O	CO2e
Category	tons/yr										MT/yr					

Hauling	2.3600e-003	0.0810	0.0173	2.3000e-004	5.0700e-003	2.5000e-004	5.3200e-003	1.3900e-003	2.4000e-004	1.6300e-003	0.0000	22.6963	22.6963	1.1600e-003	0.0000	22.7253
Vendor	1.3000e-004	4.2300e-003	1.0600e-003	1.0000e-005	2.7000e-004	1.0000e-005	2.7000e-004	8.0000e-005	1.0000e-005	9.0000e-005	0.0000	1.0503	1.0503	5.0000e-005	0.0000	1.0516
Worker	4.1000e-004	2.9000e-004	3.0300e-003	1.0000e-005	1.0700e-003	1.0000e-005	1.0700e-003	2.8000e-004	1.0000e-005	2.9000e-004	0.0000	0.9018	0.9018	2.0000e-005	0.0000	0.9023
Total	2.9000e-003	0.0855	0.0213	2.5000e-004	6.4100e-003	2.7000e-004	6.6600e-003	1.7500e-003	2.6000e-004	2.0100e-003	0.0000	24.6484	24.6484	1.2300e-003	0.0000	24.6792

Mitigated Construction On-Site

	ROG	NOx	CO	SO2	Fugitive PM10	Exhaust PM10	PM10 Total	Fugitive PM2.5	Exhaust PM2.5	PM2.5 Total	Bio- CO2	NBio- CO2	Total CO2	CH4	N2O	CO2e
Category	tons/yr										MT/yr					
Fugitive Dust					0.0515	0.0000	0.0515	0.0266	0.0000	0.0266	0.0000	0.0000	0.0000	0.0000	0.0000	0.0000
Off-Road	0.0299	0.2365	0.4254	9.7000e-004		8.5400e-003	8.5400e-003		7.9100e-003	7.9100e-003	0.0000	85.6145	85.6145	0.0277	0.0000	86.3068
Total	0.0299	0.2365	0.4254	9.7000e-004	0.0515	8.5400e-003	0.0600	0.0266	7.9100e-003	0.0345	0.0000	85.6145	85.6145	0.0277	0.0000	86.3068

Mitigated Construction Off-Site

	ROG	NOx	CO	SO2	Fugitive PM10	Exhaust PM10	PM10 Total	Fugitive PM2.5	Exhaust PM2.5	PM2.5 Total	Bio- CO2	NBio- CO2	Total CO2	CH4	N2O	CO2e
Category	tons/yr										MT/yr					
Hauling	2.3600e-003	0.0810	0.0173	2.3000e-004	5.0700e-003	2.5000e-004	5.3200e-003	1.3900e-003	2.4000e-004	1.6300e-003	0.0000	22.6963	22.6963	1.1600e-003	0.0000	22.7253
Vendor	1.3000e-004	4.2300e-003	1.0600e-003	1.0000e-005	2.7000e-004	1.0000e-005	2.7000e-004	8.0000e-005	1.0000e-005	9.0000e-005	0.0000	1.0503	1.0503	5.0000e-005	0.0000	1.0516
Worker	4.1000e-004	2.9000e-004	3.0300e-003	1.0000e-005	1.0700e-003	1.0000e-005	1.0700e-003	2.8000e-004	1.0000e-005	2.9000e-004	0.0000	0.9018	0.9018	2.0000e-005	0.0000	0.9023

Total	2.9000e-003	0.0855	0.0213	2.5000e-004	6.4100e-003	2.7000e-004	6.6600e-003	1.7500e-003	2.6000e-004	2.0100e-003	0.0000	24.6484	24.6484	1.2300e-003	0.0000	24.6792
--------------	--------------------	---------------	---------------	--------------------	--------------------	--------------------	--------------------	--------------------	--------------------	--------------------	---------------	----------------	----------------	--------------------	---------------	----------------

3.4 3 Foundations and Piles - 2021

Unmitigated Construction On-Site

	ROG	NOx	CO	SO2	Fugitive PM10	Exhaust PM10	PM10 Total	Fugitive PM2.5	Exhaust PM2.5	PM2.5 Total	Bio- CO2	NBio-CO2	Total CO2	CH4	N2O	CO2e
Category	tons/yr										MT/yr					
Off-Road	0.3075	2.7075	2.4383	5.6000e-003		0.1263	0.1263		0.1190	0.1190	0.0000	487.3378	487.3378	0.1298	0.0000	490.5825
Total	0.3075	2.7075	2.4383	5.6000e-003		0.1263	0.1263		0.1190	0.1190	0.0000	487.3378	487.3378	0.1298	0.0000	490.5825

Unmitigated Construction Off-Site

	ROG	NOx	CO	SO2	Fugitive PM10	Exhaust PM10	PM10 Total	Fugitive PM2.5	Exhaust PM2.5	PM2.5 Total	Bio- CO2	NBio-CO2	Total CO2	CH4	N2O	CO2e
Category	tons/yr										MT/yr					
Hauling	2.7600e-003	0.0945	0.0201	2.7000e-004	5.9100e-003	2.9000e-004	6.2000e-003	1.6300e-003	2.8000e-004	1.9100e-003	0.0000	26.4790	26.4790	1.3500e-003	0.0000	26.5128
Vendor	8.7000e-004	0.0285	7.1200e-003	7.0000e-005	1.7900e-003	6.0000e-005	1.8500e-003	5.2000e-004	6.0000e-005	5.8000e-004	0.0000	7.0801	7.0801	3.5000e-004	0.0000	7.0888
Worker	2.3900e-003	1.6500e-003	0.0175	6.0000e-005	6.1600e-003	4.0000e-005	6.2000e-003	1.6400e-003	4.0000e-005	1.6800e-003	0.0000	5.2103	5.2103	1.2000e-004	0.0000	5.2132
Total	6.0200e-003	0.1246	0.0447	4.0000e-004	0.0139	3.9000e-004	0.0143	3.7900e-003	3.8000e-004	4.1700e-003	0.0000	38.7694	38.7694	1.8200e-003	0.0000	38.8148

Mitigated Construction On-Site

	ROG	NOx	CO	SO2	Fugitive PM10	Exhaust PM10	PM10 Total	Fugitive PM2.5	Exhaust PM2.5	PM2.5 Total	Bio- CO2	NBio-CO2	Total CO2	CH4	N2O	CO2e
Category	tons/yr										MT/yr					
Off-Road	0.2110	1.8787	2.4843	5.6000e-003		0.0745	0.0745		0.0687	0.0687	0.0000	487.3372	487.3372	0.1298	0.0000	490.5820
Total	0.2110	1.8787	2.4843	5.6000e-003		0.0745	0.0745		0.0687	0.0687	0.0000	487.3372	487.3372	0.1298	0.0000	490.5820

Mitigated Construction Off-Site

	ROG	NOx	CO	SO2	Fugitive PM10	Exhaust PM10	PM10 Total	Fugitive PM2.5	Exhaust PM2.5	PM2.5 Total	Bio- CO2	NBio-CO2	Total CO2	CH4	N2O	CO2e
Category	tons/yr										MT/yr					
Hauling	2.7600e-003	0.0945	0.0201	2.7000e-004	5.9100e-003	2.9000e-004	6.2000e-003	1.6300e-003	2.8000e-004	1.9100e-003	0.0000	26.4790	26.4790	1.3500e-003	0.0000	26.5128
Vendor	8.7000e-004	0.0285	7.1200e-003	7.0000e-005	1.7900e-003	6.0000e-005	1.8500e-003	5.2000e-004	6.0000e-005	5.8000e-004	0.0000	7.0801	7.0801	3.5000e-004	0.0000	7.0888
Worker	2.3900e-003	1.6500e-003	0.0175	6.0000e-005	6.1600e-003	4.0000e-005	6.2000e-003	1.6400e-003	4.0000e-005	1.6800e-003	0.0000	5.2103	5.2103	1.2000e-004	0.0000	5.2132
Total	6.0200e-003	0.1246	0.0447	4.0000e-004	0.0139	3.9000e-004	0.0143	3.7900e-003	3.8000e-004	4.1700e-003	0.0000	38.7694	38.7694	1.8200e-003	0.0000	38.8148

3.5 4 Structure Erection - 2021

Unmitigated Construction On-Site

	ROG	NOx	CO	SO2	Fugitive PM10	Exhaust PM10	PM10 Total	Fugitive PM2.5	Exhaust PM2.5	PM2.5 Total	Bio- CO2	NBio-CO2	Total CO2	CH4	N2O	CO2e
Category	tons/yr										MT/yr					

Off-Road	0.0803	0.8406	0.7850	1.4300e-003		0.0353	0.0353		0.0332	0.0332	0.0000	124.0278	124.0278	0.0326	0.0000	124.8415
Total	0.0803	0.8406	0.7850	1.4300e-003		0.0353	0.0353		0.0332	0.0332	0.0000	124.0278	124.0278	0.0326	0.0000	124.8415

Unmitigated Construction Off-Site

	ROG	NOx	CO	SO2	Fugitive PM10	Exhaust PM10	PM10 Total	Fugitive PM2.5	Exhaust PM2.5	PM2.5 Total	Bio- CO2	NBio- CO2	Total CO2	CH4	N2O	CO2e
Category	tons/yr										MT/yr					
Hauling	1.6000e-004	5.5000e-003	1.1700e-003	2.0000e-005	7.2000e-004	2.0000e-005	7.4000e-004	1.9000e-004	2.0000e-005	2.0000e-004	0.0000	1.5422	1.5422	8.0000e-005	0.0000	1.5442
Vendor	5.9000e-004	0.0194	4.8400e-003	5.0000e-005	1.2200e-003	4.0000e-005	1.2600e-003	3.5000e-004	4.0000e-005	3.9000e-004	0.0000	4.8108	4.8108	2.4000e-004	0.0000	4.8167
Worker	1.6300e-003	1.1200e-003	0.0119	4.0000e-005	4.1900e-003	3.0000e-005	4.2200e-003	1.1100e-003	3.0000e-005	1.1400e-003	0.0000	3.5404	3.5404	8.0000e-005	0.0000	3.5423
Total	2.3800e-003	0.0260	0.0179	1.1000e-004	6.1300e-003	9.0000e-005	6.2200e-003	1.6500e-003	9.0000e-005	1.7300e-003	0.0000	9.8934	9.8934	4.0000e-004	0.0000	9.9032

Mitigated Construction On-Site

	ROG	NOx	CO	SO2	Fugitive PM10	Exhaust PM10	PM10 Total	Fugitive PM2.5	Exhaust PM2.5	PM2.5 Total	Bio- CO2	NBio- CO2	Total CO2	CH4	N2O	CO2e
Category	tons/yr										MT/yr					
Off-Road	0.0175	0.1083	0.8921	1.4300e-003		2.2200e-003	2.2200e-003		2.2200e-003	2.2200e-003	0.0000	124.0277	124.0277	0.0326	0.0000	124.8414
Total	0.0175	0.1083	0.8921	1.4300e-003		2.2200e-003	2.2200e-003		2.2200e-003	2.2200e-003	0.0000	124.0277	124.0277	0.0326	0.0000	124.8414

Mitigated Construction Off-Site

	ROG	NOx	CO	SO2	Fugitive PM10	Exhaust PM10	PM10 Total	Fugitive PM2.5	Exhaust PM2.5	PM2.5 Total	Bio- CO2	NBio- CO2	Total CO2	CH4	N2O	CO2e
Category	tons/yr										MT/yr					
Hauling	1.6000e-004	5.5000e-003	1.1700e-003	2.0000e-005	7.2000e-004	2.0000e-005	7.4000e-004	1.9000e-004	2.0000e-005	2.0000e-004	0.0000	1.5422	1.5422	8.0000e-005	0.0000	1.5442
Vendor	5.9000e-004	0.0194	4.8400e-003	5.0000e-005	1.2200e-003	4.0000e-005	1.2600e-003	3.5000e-004	4.0000e-005	3.9000e-004	0.0000	4.8108	4.8108	2.4000e-004	0.0000	4.8167
Worker	1.6300e-003	1.1200e-003	0.0119	4.0000e-005	4.1900e-003	3.0000e-005	4.2200e-003	1.1100e-003	3.0000e-005	1.1400e-003	0.0000	3.5404	3.5404	8.0000e-005	0.0000	3.5423
Total	2.3800e-003	0.0260	0.0179	1.1000e-004	6.1300e-003	9.0000e-005	6.2200e-003	1.6500e-003	9.0000e-005	1.7300e-003	0.0000	9.8934	9.8934	4.0000e-004	0.0000	9.9032

3.5 4 Structure Erection - 2022

Unmitigated Construction On-Site

	ROG	NOx	CO	SO2	Fugitive PM10	Exhaust PM10	PM10 Total	Fugitive PM2.5	Exhaust PM2.5	PM2.5 Total	Bio- CO2	NBio- CO2	Total CO2	CH4	N2O	CO2e
Category	tons/yr										MT/yr					
Off-Road	0.1066	1.0966	1.1264	2.0800e-003		0.0447	0.0447		0.0421	0.0421	0.0000	180.2010	180.2010	0.0471	0.0000	181.3775
Total	0.1066	1.0966	1.1264	2.0800e-003		0.0447	0.0447		0.0421	0.0421	0.0000	180.2010	180.2010	0.0471	0.0000	181.3775

Unmitigated Construction Off-Site

	ROG	NOx	CO	SO2	Fugitive PM10	Exhaust PM10	PM10 Total	Fugitive PM2.5	Exhaust PM2.5	PM2.5 Total	Bio- CO2	NBio- CO2	Total CO2	CH4	N2O	CO2e
Category	tons/yr										MT/yr					
Hauling	2.2000e-004	7.3500e-003	1.6700e-003	2.0000e-005	7.6000e-004	2.0000e-005	7.8000e-004	2.0000e-004	2.0000e-005	2.2000e-004	0.0000	2.2100	2.2100	1.1000e-004	0.0000	2.2128
Vendor	8.0000e-004	0.0267	6.6100e-003	7.0000e-005	1.7700e-003	5.0000e-005	1.8200e-003	5.1000e-004	5.0000e-005	5.6000e-004	0.0000	6.9208	6.9208	3.3000e-004	0.0000	6.9290
Worker	2.2000e-003	1.4600e-003	0.0159	5.0000e-005	6.0800e-003	4.0000e-005	6.1200e-003	1.6200e-003	4.0000e-005	1.6500e-003	0.0000	4.9550	4.9550	1.0000e-004	0.0000	4.9575
Total	3.2200e-003	0.0355	0.0242	1.4000e-004	8.6100e-003	1.1000e-004	8.7200e-003	2.3300e-003	1.1000e-004	2.4300e-003	0.0000	14.0858	14.0858	5.4000e-004	0.0000	14.0994

Mitigated Construction On-Site

	ROG	NOx	CO	SO2	Fugitive PM10	Exhaust PM10	PM10 Total	Fugitive PM2.5	Exhaust PM2.5	PM2.5 Total	Bio- CO2	NBio- CO2	Total CO2	CH4	N2O	CO2e
Category	tons/yr										MT/yr					
Off-Road	0.0255	0.1574	1.2961	2.0800e-003		3.2300e-003	3.2300e-003		3.2300e-003	3.2300e-003	0.0000	180.2007	180.2007	0.0471	0.0000	181.3772
Total	0.0255	0.1574	1.2961	2.0800e-003		3.2300e-003	3.2300e-003		3.2300e-003	3.2300e-003	0.0000	180.2007	180.2007	0.0471	0.0000	181.3772

Mitigated Construction Off-Site

	ROG	NOx	CO	SO2	Fugitive PM10	Exhaust PM10	PM10 Total	Fugitive PM2.5	Exhaust PM2.5	PM2.5 Total	Bio- CO2	NBio- CO2	Total CO2	CH4	N2O	CO2e
Category	tons/yr										MT/yr					
Hauling	2.2000e-004	7.3500e-003	1.6700e-003	2.0000e-005	7.6000e-004	2.0000e-005	7.8000e-004	2.0000e-004	2.0000e-005	2.2000e-004	0.0000	2.2100	2.2100	1.1000e-004	0.0000	2.2128

Vendor	8.0000e-004	0.0267	6.6100e-003	7.0000e-005	1.7700e-003	5.0000e-005	1.8200e-003	5.1000e-004	5.0000e-005	5.6000e-004	0.0000	6.9208	6.9208	3.3000e-004	0.0000	6.9290
Worker	2.2000e-003	1.4600e-003	0.0159	5.0000e-005	6.0800e-003	4.0000e-005	6.1200e-003	1.6200e-003	4.0000e-005	1.6500e-003	0.0000	4.9550	4.9550	1.0000e-004	0.0000	4.9575
Total	3.2200e-003	0.0355	0.0242	1.4000e-004	8.6100e-003	1.1000e-004	8.7200e-003	2.3300e-003	1.1000e-004	2.4300e-003	0.0000	14.0858	14.0858	5.4000e-004	0.0000	14.0994

3.6 5 Paving - 2022

Unmitigated Construction On-Site

	ROG	NOx	CO	SO2	Fugitive PM10	Exhaust PM10	PM10 Total	Fugitive PM2.5	Exhaust PM2.5	PM2.5 Total	Bio- CO2	NBio- CO2	Total CO2	CH4	N2O	CO2e
Category	tons/yr										MT/yr					
Off-Road	7.2800e-003	0.0746	0.0925	1.4000e-004		3.8800e-003	3.8800e-003		3.5700e-003	3.5700e-003	0.0000	12.5487	12.5487	4.0600e-003	0.0000	12.6501
Paving	0.0000					0.0000	0.0000		0.0000	0.0000	0.0000	0.0000	0.0000	0.0000	0.0000	0.0000
Total	7.2800e-003	0.0746	0.0925	1.4000e-004		3.8800e-003	3.8800e-003		3.5700e-003	3.5700e-003	0.0000	12.5487	12.5487	4.0600e-003	0.0000	12.6501

Unmitigated Construction Off-Site

	ROG	NOx	CO	SO2	Fugitive PM10	Exhaust PM10	PM10 Total	Fugitive PM2.5	Exhaust PM2.5	PM2.5 Total	Bio- CO2	NBio- CO2	Total CO2	CH4	N2O	CO2e
Category	tons/yr										MT/yr					
Hauling	0.0000	0.0000	0.0000	0.0000	0.0000	0.0000	0.0000	0.0000	0.0000	0.0000	0.0000	0.0000	0.0000	0.0000	0.0000	0.0000
Vendor	8.0000e-005	2.5700e-003	6.4000e-004	1.0000e-005	1.7000e-004	1.0000e-005	1.8000e-004	5.0000e-005	0.0000	5.0000e-005	0.0000	0.6677	0.6677	3.0000e-005	0.0000	0.6685
Worker	3.7000e-004	2.5000e-004	2.6800e-003	1.0000e-005	1.0300e-003	1.0000e-005	1.0300e-003	2.7000e-004	1.0000e-005	2.8000e-004	0.0000	0.8366	0.8366	2.0000e-005	0.0000	0.8370
Total	4.5000e-004	2.8200e-003	3.3200e-003	2.0000e-005	1.2000e-003	2.0000e-005	1.2100e-003	3.2000e-004	1.0000e-005	3.3000e-004	0.0000	1.5042	1.5042	5.0000e-005	0.0000	1.5055

Mitigated Construction On-Site

	ROG	NOx	CO	SO2	Fugitive PM10	Exhaust PM10	PM10 Total	Fugitive PM2.5	Exhaust PM2.5	PM2.5 Total	Bio- CO2	NBio- CO2	Total CO2	CH4	N2O	CO2e
Category	tons/yr										MT/yr					
Off-Road	1.7500e-003	7.6000e-003	0.1082	1.4000e-004		2.3000e-004	2.3000e-004		2.3000e-004	2.3000e-004	0.0000	12.5487	12.5487	4.0600e-003	0.0000	12.6501
Paving	0.0000					0.0000	0.0000		0.0000	0.0000	0.0000	0.0000	0.0000	0.0000	0.0000	0.0000
Total	1.7500e-003	7.6000e-003	0.1082	1.4000e-004		2.3000e-004	2.3000e-004		2.3000e-004	2.3000e-004	0.0000	12.5487	12.5487	4.0600e-003	0.0000	12.6501

Mitigated Construction Off-Site

	ROG	NOx	CO	SO2	Fugitive PM10	Exhaust PM10	PM10 Total	Fugitive PM2.5	Exhaust PM2.5	PM2.5 Total	Bio- CO2	NBio- CO2	Total CO2	CH4	N2O	CO2e
Category	tons/yr										MT/yr					
Hauling	0.0000	0.0000	0.0000	0.0000	0.0000	0.0000	0.0000	0.0000	0.0000	0.0000	0.0000	0.0000	0.0000	0.0000	0.0000	0.0000
Vendor	8.0000e-005	2.5700e-003	6.4000e-004	1.0000e-005	1.7000e-004	1.0000e-005	1.8000e-004	5.0000e-005	0.0000	5.0000e-005	0.0000	0.6677	0.6677	3.0000e-005	0.0000	0.6685
Worker	3.7000e-004	2.5000e-004	2.6800e-003	1.0000e-005	1.0300e-003	1.0000e-005	1.0300e-003	2.7000e-004	1.0000e-005	2.8000e-004	0.0000	0.8366	0.8366	2.0000e-005	0.0000	0.8370
Total	4.5000e-004	2.8200e-003	3.3200e-003	2.0000e-005	1.2000e-003	2.0000e-005	1.2100e-003	3.2000e-004	1.0000e-005	3.3000e-004	0.0000	1.5042	1.5042	5.0000e-005	0.0000	1.5055

3.7 6 Finishing - 2022

Unmitigated Construction On-Site

	ROG	NOx	CO	SO2	Fugitive PM10	Exhaust PM10	PM10 Total	Fugitive PM2.5	Exhaust PM2.5	PM2.5 Total	Bio- CO2	NBio- CO2	Total CO2	CH4	N2O	CO2e
Category	tons/yr										MT/yr					
Off-Road	0.0177	0.1486	0.1924	3.0000e-004		7.2400e-003	7.2400e-003		6.9900e-003	6.9900e-003	0.0000	25.6827	25.6827	4.5200e-003	0.0000	25.7957
Total	0.0177	0.1486	0.1924	3.0000e-004		7.2400e-003	7.2400e-003		6.9900e-003	6.9900e-003	0.0000	25.6827	25.6827	4.5200e-003	0.0000	25.7957

Unmitigated Construction Off-Site

	ROG	NOx	CO	SO2	Fugitive PM10	Exhaust PM10	PM10 Total	Fugitive PM2.5	Exhaust PM2.5	PM2.5 Total	Bio- CO2	NBio- CO2	Total CO2	CH4	N2O	CO2e
Category	tons/yr										MT/yr					
Hauling	0.0000	0.0000	0.0000	0.0000	0.0000	0.0000	0.0000	0.0000	0.0000	0.0000	0.0000	0.0000	0.0000	0.0000	0.0000	0.0000
Vendor	8.0000e-005	2.5700e-003	6.4000e-004	1.0000e-005	1.7000e-004	1.0000e-005	1.8000e-004	5.0000e-005	0.0000	5.0000e-005	0.0000	0.6677	0.6677	3.0000e-005	0.0000	0.6685
Worker	3.7000e-004	2.5000e-004	2.6800e-003	1.0000e-005	1.0300e-003	1.0000e-005	1.0300e-003	2.7000e-004	1.0000e-005	2.8000e-004	0.0000	0.8366	0.8366	2.0000e-005	0.0000	0.8370
Total	4.5000e-004	2.8200e-003	3.3200e-003	2.0000e-005	1.2000e-003	2.0000e-005	1.2100e-003	3.2000e-004	1.0000e-005	3.3000e-004	0.0000	1.5042	1.5042	5.0000e-005	0.0000	1.5055

Mitigated Construction On-Site

	ROG	NOx	CO	SO2	Fugitive PM10	Exhaust PM10	PM10 Total	Fugitive PM2.5	Exhaust PM2.5	PM2.5 Total	Bio- CO2	NBio- CO2	Total CO2	CH4	N2O	CO2e
Category	tons/yr										MT/yr					
Off-Road	4.4800e-003	0.0651	0.2033	3.0000e-004		4.3000e-004	4.3000e-004		4.3000e-004	4.3000e-004	0.0000	25.6827	25.6827	4.5200e-003	0.0000	25.7956

Electricity Unmitigated						0.0000	0.0000		0.0000	0.0000	0.0000	0.0000	0.0000	0.0000	0.0000	0.0000
NaturalGas Mitigated	0.0000	0.0000	0.0000	0.0000		0.0000	0.0000		0.0000	0.0000	0.0000	0.0000	0.0000	0.0000	0.0000	0.0000
NaturalGas Unmitigated	0.0000	0.0000	0.0000	0.0000		0.0000	0.0000		0.0000	0.0000	0.0000	0.0000	0.0000	0.0000	0.0000	0.0000

5.2 Energy by Land Use - NaturalGas

Unmitigated

	NaturalGas Use	ROG	NOx	CO	SO2	Fugitive PM10	Exhaust PM10	PM10 Total	Fugitive PM2.5	Exhaust PM2.5	PM2.5 Total	Bio- CO2	NBio- CO2	Total CO2	CH4	N2O	CO2e
Land Use	kBTU/yr	tons/yr										MT/yr					
General Heavy Industry	0	0.0000	0.0000	0.0000	0.0000		0.0000	0.0000		0.0000	0.0000	0.0000	0.0000	0.0000	0.0000	0.0000	0.0000
Total		0.0000	0.0000	0.0000	0.0000		0.0000	0.0000		0.0000	0.0000	0.0000	0.0000	0.0000	0.0000	0.0000	0.0000

Mitigated

	NaturalGas Use	ROG	NOx	CO	SO2	Fugitive PM10	Exhaust PM10	PM10 Total	Fugitive PM2.5	Exhaust PM2.5	PM2.5 Total	Bio- CO2	NBio- CO2	Total CO2	CH4	N2O	CO2e
Land Use	kBTU/yr	tons/yr										MT/yr					
General Heavy Industry	0	0.0000	0.0000	0.0000	0.0000		0.0000	0.0000		0.0000	0.0000	0.0000	0.0000	0.0000	0.0000	0.0000	0.0000
Total		0.0000	0.0000	0.0000	0.0000		0.0000	0.0000		0.0000	0.0000	0.0000	0.0000	0.0000	0.0000	0.0000	0.0000

5.3 Energy by Land Use - Electricity

Unmitigated

	Electricity Use	Total CO2	CH4	N2O	CO2e
Land Use	kWh/yr	MT/yr			
General Heavy Industry	0	0.0000	0.0000	0.0000	0.0000
Total		0.0000	0.0000	0.0000	0.0000

Mitigated

	Electricity Use	Total CO2	CH4	N2O	CO2e
Land Use	kWh/yr	MT/yr			
General Heavy Industry	0	0.0000	0.0000	0.0000	0.0000
Total		0.0000	0.0000	0.0000	0.0000

6.0 Area Detail

6.1 Mitigation Measures Area

7.0 Water Detail

7.1 Mitigation Measures Water

	Total CO2	CH4	N2O	CO2e
Category	MT/yr			
Mitigated	0.0000	0.0000	0.0000	0.0000
Unmitigated	0.0000	0.0000	0.0000	0.0000

7.2 Water by Land Use

Unmitigated

	Indoor/Outdoor Use	Total CO2	CH4	N2O	CO2e
Land Use	Mgal	MT/yr			
General Heavy Industry	0 / 0	0.0000	0.0000	0.0000	0.0000
Total		0.0000	0.0000	0.0000	0.0000

Mitigated

	Indoor/Outdoor Use	Total CO2	CH4	N2O	CO2e
Land Use	Mgal	MT/yr			
General Heavy Industry	0 / 0	0.0000	0.0000	0.0000	0.0000
Total		0.0000	0.0000	0.0000	0.0000

8.0 Waste Detail

8.1 Mitigation Measures Waste

Category/Year

	Total CO2	CH4	N2O	CO2e
	MT/yr			
Mitigated	0.0000	0.0000	0.0000	0.0000
Unmitigated	0.0000	0.0000	0.0000	0.0000

8.2 Waste by Land Use

Unmitigated

	Waste Disposed	Total CO2	CH4	N2O	CO2e
Land Use	tons	MT/yr			
General Heavy Industry	0	0.0000	0.0000	0.0000	0.0000
Total		0.0000	0.0000	0.0000	0.0000

Mitigated

	Waste Disposed	Total CO2	CH4	N2O	CO2e
Land Use	tons	MT/yr			
General Heavy Industry	0	0.0000	0.0000	0.0000	0.0000
Total		0.0000	0.0000	0.0000	0.0000

9.0 Operational Offroad

Equipment Type	Number	Hours/Day	Days/Year	Horse Power	Load Factor	Fuel Type
----------------	--------	-----------	-----------	-------------	-------------	-----------

10.0 Stationary Equipment

Fire Pumps and Emergency Generators

Equipment Type	Number	Hours/Day	Hours/Year	Horse Power	Load Factor	Fuel Type
----------------	--------	-----------	------------	-------------	-------------	-----------

Boilers

Equipment Type	Number	Heat Input/Day	Heat Input/Year	Boiler Rating	Fuel Type
----------------	--------	----------------	-----------------	---------------	-----------

User Defined Equipment

Equipment Type	Number
----------------	--------

11.0 Vegetation

This page intentionally left blank

Appendix D

Health Risk Assessment for the Draft SEIR



HEALTH RISK ASSESSMENT FOR THE DRAFT SEIR

Appendix D

For the:

Eagle Rock Aggregates, Inc.
Oakland Terminal

October 29, 2020

Contents

1.0	Introduction	1
1.1	Purpose	1
1.2	Project Setting	1
1.2.1	Project Location.....	1
1.2.2	Construction Activities	1
1.2.3	Operation.....	2
2.0	Risk Assessment Methodology	3
2.1	Emissions Calculations.....	3
2.2	Air Dispersion Modelling.....	3
2.2.1	General.....	3
2.2.2	Meteorological Data	3
2.2.3	Terrain Data	4
2.2.4	Receptors	4
2.2.5	Risk Characterization	4
3.0	Operation	8
3.1	Sources	8
3.2	Emissions	9
3.3	Exposure Assessment.....	9
3.3.1	Exposure Pathways.....	9
3.3.2	HARP Exposure Analysis Methods and Assumptions	10
3.4	Results.....	11
3.4.1	Cancer Risks	11
3.4.2	Non-Cancer Chronic Health Index	12
3.4.3	Non-Cancer Acute Health Index.....	13
3.4.4	PM _{2.5} Concentration	14
4.0	Construction	16
4.1	Sources	16
4.2	Emissions	16
4.3	Exposure Assessment.....	17
4.3.1	Exposure Pathways.....	17
4.3.2	HARP Exposure Analysis Methods and Assumptions	17
4.4	Results.....	18
4.4.1	Cancer Risks	18

4.4.2	Non-Cancer Chronic Health Index	19
4.4.3	Non-Cancer Acute Health Index.....	20
4.4.4	PM _{2.5} Concentration	20
5.0	Cumulative Impacts.....	22
6.0	References	23

Tables

Table 1:	Receptor Locations
Table 2:	Cancer Potency Factors and RELs
Table 3:	AERMOD Source Parameters - Operation
Table 4:	Operation Emissions - Cancer & Chronic
Table 5:	Operation Emissions - PM _{2.5}
Table 6:	Mitigation Measures
Table 7:	Cancer Risk - Operation – Unmitigated
Table 8:	Cancer Risk – Operation – Mitigated
Table 9:	Chronic HI - Operation - Unmitigated
Table 10:	Chronic HI - Operation - Mitigated
Table 11:	Acute HI - Operation – Mitigated and Unmitigated
Table 12:	PM _{2.5} Concentration – Operation – Mitigated and Unmitigated
Table 13:	PM _{2.5} Concentration – Operation – Mitigated - Exhaust vs. Fugitive Dust
Table 14:	AERMOD Source Parameters - Construction
Table 15:	Construction Emissions - Cancer & Chronic
Table 16:	Construction Emissions - PM _{2.5}
Table 17:	Cancer Risk - Construction - Unmitigated
Table 18:	Cancer Risk – Construction - Mitigated
Table 19:	Chronic HI - Concentration - Unmitigated
Table 20:	Chronic HI - Concentration - Mitigated
Table 21:	Acute HI - Operation – Mitigated and Unmitigated
Table 22:	PM _{2.5} Concentration – Construction – Mitigated and Unmitigated
Table 23:	Cumulative Cancer Results
Table 24:	Residential Cumulative Cancer Risk Weighting Factor Calculations

Figures

Figure 1:	Facility Location and Boundary
Figure 2:	Windrose
Figure 3:	Receptor Locations Zoom Out
Figure 4:	Receptor Locations Zoom In

Figures Continued

- Figure 5: Operation Source Locations Zoom Out
- Figure 6: Operation Source Locations Zoom In
- Figure 7: Operation Cancer Risk Unmitigated
- Figure 8: Operation Cancer Risk Mitigated Zoom In
- Figure 9: Operation Cancer Risk Mitigated Zoom Out
- Figure 10: Operation Chronic HI
- Figure 11: Operation Acute HI
- Figure 12: Operation PM_{2.5} Unmitigated
- Figure 13: Operation PM_{2.5} Mitigated
- Figure 14: Operation PM_{2.5} Mitigated - Exhaust Only
- Figure 15: Operation PM_{2.5} Mitigated - Fugitive Dust Only
- Figure 16: Construction Source Locations Zoom Out
- Figure 17: Construction Source Locations Zoom In
- Figure 18: Construction Cancer Risk Mitigated
- Figure 19: Construction PM_{2.5} Mitigated

List of Acronyms

$\mu\text{g}/\text{m}^3$	microgram per cubic meter
$\mu\text{g}/\text{m}^3$	Microgram per cubic meter
ADMRT	Air Dispersion Modeling and Risk Tool
ASF	Age Sensitivity Factor
ATCM	Airborne Toxic Control Measure
BAAQMD	Bay Area Air Quality Management District
CA	California
CAPCOA	California Air Pollution Control Officers Association
CARB	California Air Resources Board
CAS	Chemical Abstract Service
CEQA	California Environmental Quality Act
CPF	Cancer Potency Factor
DBR	Daily Breathing Rate
DPM	diesel particulate matter
GLC	Ground Level Concentration
HARP	Hot Spots Analysis and Reporting Program
HI	Hazard Index
HQ	Hazard Quotient
hr	hour
HRA	Health Risk Assessment
Inc	Incorporated
kg	kilogram
KOAK	Oakland Airport Weather Station
lb	pound
lb/hr	pound per hour
lb/yr	pound per year
m	meters
MEIR	Maximum Exposed Individual Resident
MEIW	Maximum Exposed Individual Worker
mg	milligram
mg/kg-day	milligrams per kilogram per day
NED	National Elevation Dataset
NLDC	National Land Cover Database
OEHHA	Office of Environmental Health Hazard Assessments
OGV	ocean-going vessel
OHT	Outer Harbor Terminal
OSP	Oakland Sewage Treatment Plant
PAHs	polycyclic aromatic hydrocarbons
PM _{2.5}	particulate matter with an aerodynamic diameter of 2.5 microns or less
PMI	Point of Maximum Impact
Port	Port of Oakland
REL	Reference Exposure Level
RMP	Risk Management Policy
SEIR	Supplemental Environmental Impact Report
TACs	Toxic Air Contaminants

USEPA	United States Environmental Protection Agency
USGS	United States Geological Survey
UTM	Universal Transverse Mercator
WAF	Worker Adjustment Factor
WGS	World Geodetic System
WOCAP	West Oakland Community Action Plan

1.0 INTRODUCTION

1.1 Purpose

The purpose of this document is to evaluate local community risk and hazard impacts for the proposed Eagle Rock Aggregates Oakland Terminal (the Proposed Project). This document provides details on the analysis performed to assess the potential risks associated with Toxic Air Contaminants (TACs) and particulate matter with an aerodynamic diameter of 2.5 microns or less (PM_{2.5}) emitted during construction and operation of the Proposed Project. This document is Appendix D to the Draft Supplemental Environmental Impact Report (Draft SEIR) for the Proposed Project.

1.2 Project Setting

1.2.1 Project Location

ERA proposes to initiate operations of a bulk construction aggregates import, storage, and distribution marine terminal at the Port of Oakland (Port). The construction aggregates includes 1-inch rock, ½-inch rock, and concrete sand. The Project Site is located at the Outer Harbor Terminal (OHT) within the Outer Harbor of the Port and will utilize Berth 22 for vessel and barge operations and approximately 18 acres of Berth 20, 21, and 22 backlands (land directly adjacent to a vessel berth) for material stockpiling and distribution. The Proposed Project Site is centered at approximately 37.8178 Latitude, 122.3105 Longitude.

The Project Site will be located 0.33 miles south of Interstate 80 (I-80) and 0.38 miles northwest of Interstate 880 (I-880). The Bay Bridge touchdown, the eastern end of where the bridge and land meet, is directly north of the proposed site. The closest residential community is located approximately one half mile southeast of the proposed site. The location of the facility is illustrated in Figure 1.

1.2.2 Construction Activities

Construction activities would include demolition, site preparation and grading, construction of Project components, and paving. The weight of the construction aggregates stored at the Project site would result in compaction and settlement of portions of the site outside of where piles are installed as part of conveyor structure foundations; thus, site restoration activities at the end of the Proposed Project life are considered as a phase of Project construction. No in-water work would be required during construction of the Proposed Project and no off-site staging would be needed.

Construction of the Proposed Project is anticipated to take approximately 9 to 12 months. Construction is anticipated to begin in June 2021 and end by May 2022. Construction would generally occur between the hours of 7:00 a.m. and 7:00 p.m., Monday through Saturday. Barging and unloading of material for construction is a possibility and could occur at any time on any day of the week during the construction period. Up to six barge deliveries are assumed for the purposes of environmental analysis.

Demolition activities would include capping existing utilities (i.e., electric, lighting, water supply and fire hydrants, storm drain lines, and catch basins) where conflicts with Proposed Project facilities exist and the cutting and removal of sections of asphalt paving. As part of the building permit process, ERA would prepare a Construction and Demolition Waste Reduction and Recycling Plan (WRRP) for review and approval that would minimize waste diverted to the landfill.

Site preparation would include constructing ramps for accessing the Project Site from non-compacted areas, installing a perimeter security fence and security lights, and grading/installation of new utilities. This construction phase would also include grading of the stormwater retention pond.

Following site preparation and grading, the various Project components would be installed, including: vibratory pile driving of approximately 446 piles, installation of concrete foundations, placement of perimeter containers, and erecting structures (e.g., conveyors and scale house).

Existing electric infrastructure that crosses the Project site will be relocated in a new underground electrical feed to continue to support existing electrical services in the area in addition to the Proposed Project facilities, conveyor systems, and associated lighting.

Any disturbed or damaged asphalt paving within the Project site would be patch repaired as necessary to match the existing grade.

The number of required workers will range from 10 to 20 workers per day depending on the phase of construction. The equipment required and number of workers for each construction activity phase is presented in Table 2.5-1 of the Project Description of the Draft SEIR.

Project construction would generate waste materials consisting of asphalt and fill soil. Approximately 14 percent of construction waste (asphalt) would be diverted to a recycler for reuse and the remainder would be taken to the landfill. All other construction debris would be removed from the Project site and recycled or otherwise disposed of off-site. Required construction materials would include structural fill and concrete. Approximate quantities and associated haul trips are listed in Table 2.5-2 of the Project Description.

1.2.3 Operation

Operation of the Proposed Project will generate emissions from sources including ocean-going vessels (OGVs), tugs (assist and barge), trucks, off-road equipment, employee vehicles, aggregate transfer, and stockpiles. Emissions will be generated on- and off-site from fuel combustion and fugitive sources. Detailed information about project operations can be found in the Project Description of the SEIR, and emissions calculation methodology is outlined in Appendix C.

2.0 RISK ASSESSMENT METHODOLOGY

2.1 Emissions Calculations

Operation of the Proposed Project will generate emissions from sources including ocean-going vessels (OGVs), tugs (assist and barge), trucks, off-road equipment, employee vehicles, aggregate transfer, and stockpiles. Emissions will be generated on- and off-site from combustion as well as fugitive sources. Emissions were estimated using published methodology and emission factors from agencies such as the California Air Resources Board (CARB), the California Air Pollution Control Officers Association (CAPCOA), the Bay Area Air Quality Management District (BAAQMD), the South Coast Air Quality Management District (SCAQMD), and the United States Environmental Protection Agency (USEPA). Detailed emission calculation methodology and tables are provided in Appendix C of the Draft SEIR.

2.2 Air Dispersion Modelling

2.2.1 General

Air dispersion modelling was performed to estimate breathing-zone concentrations of TACs and PM_{2.5} at and beyond the property boundary of the Facility. Modelling was performed using USEPA's AERMOD executable version 19191 via BREEZE AERMOD software. The following options were used in running the AERMOD model:

- AERMOD was executed using the urban modeling option.
 - According to USEPA, the population density within a one-mile radius of the facility is approximately 2,113 persons per square mile. This equates to approximately 816 person per square kilometer. USEPA's Guideline on Air Quality Models (Appendix W), states that the urban option should be selected for population densities greater than 750 persons per square kilometer.
 - The approximate population of the City of Oakland, 430,000, was utilized as the population input value (United States Census Bureau, 2019).
- USEPA regulatory default options were implemented.
- The UTM Zone 10, World Geodetic System (WGS) 1984 map projection was implemented.
- The pollutant was set to "Other"
- Regulatory default concentration only, was used, and no depletion options were selected.

Air dispersion modelling results in terms of period average and maximum one-hour concentration were exported as plot (.plt) files, and separate plot files were created for each source. Separate dispersion model inputs were developed for construction and operations, respectively.

2.2.2 Meteorological Data

AERMOD-ready meteorological data were obtained from BAAQMD. The Oakland Sewage Treatment Plant (OSP) meteorological station is located approximately 0.75 miles to the northeast of the Project Site. Meteorological data from OSP are available for 2014. This meteorological data

set was selected as it is the same data set used in the analysis for the West Oakland Community Action Plan (WOCAP; BAAQMD, 2019). A wind rose is provided as Figure 2.

2.2.3 Terrain Data

Surface elevations used to model terrain were imported from National Elevation Dataset (NED) files developed by the United States Geological Survey (USGS). NED files are available in 1-arc second resolution which is a sufficient spatial resolution given the generally flat terrain within the modeling domain. A NED file purchased from BREEZE Modeling Software was used in the air dispersion modeling.

2.2.4 Receptors

A total of 1,003 receptors were established for this analysis. Four sets of dispersion model receptors were used in the air dispersion modelling process in order to adequately represent the spatial distribution of downwind concentrations in key areas of interest. The main receptor grid consists of receptors with 250-meter spacing, spanning from approximately 1.5 miles southwest of the southern boundary of the facility to 3 miles northeast of the northern boundary of the facility in order to best characterize risk over a general area within the vicinity of the Project Site. A fine grid of receptors with 50-meter spacing was generated in the residential area located east of the facility to best characterize risk to residents of West Oakland. Another fine grid of receptors with 50-meter spacing was generated outside of the facility up to 150 meter radius from the boundary of the facility to best characterize the risk to the worker receptors that are in close proximity of the facility. Lastly, a set of receptors with 1000-meter spacing was generated starting at approximately 3.5 miles east of the facility in order to best characterize results over a large geographical area. The flagpole height for all receptors was set at 1.8 meters (m), which matches methodology from the WOCAP and represents the breathing height of an average adult. The location of each receptor is provided in Table 1, and receptor locations are shown in Figures 3 and 4.

Receptors located in areas with residences or other sensitive receptors (e.g. schools) were designated as residential receptors. Other receptors were designated as non-residential or worker receptors. Receptor designation is provided in Table 1 and shown in Figures 3 and 4.

2.2.5 Risk Characterization

Air dispersion modeling results (plot files) were imported into CARB's Hotspots Analysis and Reporting Program (HARP) software. HARP2 Air Dispersion Modeling and Risk Tool (ADMRT) software version 19121 was utilized to perform the dose-response assessment and calculate the potential cancer risk and non-cancer health impacts for the various receptors surrounding the facility. The dose-response assessment and risk calculations were performed in accordance with OEHHA's Risk Assessment Guidelines (OEHHA, 2015), BAAQMD Risk Assessment Guidelines (BAAQMD, 2016), and CARB Risk Management Guidance (CARB, 2015). Cancer and non-cancer health impacts can be evaluated in HARP.

Cancer risk is expressed as a theoretical probability of an individual person developing cancer as a result of exposure to carcinogenic substances over a defined period of time. Noncancer risk is expressed with a hazard index number (HI) for each pollutant-targeted organ system: the cardiovascular system, central nervous system, immune system, kidneys, gastrointestinal tract

and liver, reproductive/developmental system, respiratory system, skin, eyes, skeletal system, endocrine system, hematological system, physiological response to odors, and general toxicity. The HI is determined by dividing the one-hour concentration (acute) or annual average concentration (chronic) of a TAC by the applicable reference exposure level (REL) for that pollutant (CARB, 2018). Calculations built into HARP2 ADMRT are based on the dose-response calculation methodologies and pollutant toxicity factors contained within the OEHHA Risk Assessment Guidelines.

According to OEHHA, dose-response assessment describes the quantitative relationship between the amount of exposure to a substance (the dose) and the incidence or occurrence of an adverse health impact (the response). Dose-response information for noncancer health effects is used to determine Relative Exposure Levels (RELs). RELs are the concentrations or doses at or below which adverse non-cancer health effects are not expected even in sensitive members of the general population under the exposure scenarios. Dose-response information for cancer risks are based on cancer potency factors (OEHHA, 2015). Chronic RELs, Acute RELs, and cancer potency factors for each pollutant are listed in the OEHHA Guidelines and built into HARP2. These values are periodically updated and are incorporated into new versions of HARP2. Cancer potency factors and RELs for each pollutant in this analysis are provided in Table 2 (OEHHA, 2019a; OEHHA, 2019b).

Table 2: Cancer Potency Factors and RELs

Pollutant	CAS	CPF	Chronic REL	Acute REL
Diesel Particulate Matter (DPM)	9901	1.1E+0	5.0E+00	--
Respirable crystalline silica	1175	--	3.0E+00	--
1,3- Butadiene	106990	6.0E-1	2.0E+00	6.6E+02
Acetaldehyde	75070	1.0E-2	1.4E+02	4.7E+02
Benzene	71432	1.0E-1	3.0E+00	2.7E+01
Ethyl benzene - Inhalation	100414	8.7E-3	2.0E+03	--
Ethyl benzene – Oral	100414	1.1E-2	--	--
Formaldehyde	50000	2.1E-2	9.0E+00	5.5E+01
Methanol	67561	--	4.0E+03	2.8E+04
Methyl ethyl ketone (MEK)	78933	--	--	1.3E+04
m-Xylene	108383	--	7.0E+02	2.2E+04
Naphthalene	91203	1.2E-1	9.0E+00	--
Hexane	110543	--	7.0E+03	--
o-Xylene	95476	--	7.0E+02	2.2E+04
Propylene	115071	--	3.0E+03	--
p-Xylene	106423	--	7.0E+02	2.2E+04
Styrene	100425	--	9.0E+02	2.1E+04
Toluene	108883	--	4.2E+02	5.0E+03

CPF = Cancer Potency Factor in (mg chemical/kg body weigh-day)⁻¹
REL in µg/m³

Risks are characterized using calculations and methodology contained in the OEHHA Guidelines and built into HARP2. Cancer risk and non-cancer hazard impacts are calculated based on dose,

dose-response values (RELs or cancer potency factors), and exposure duration and frequency. For this HRA, all risks were calculated using a Tier 1 approach for operation and Tier 2 approach for construction. Tier 1 uses point estimates supplied by OEHHA for calculating potential health risk, and Tier 2 uses user-defined site-specific point estimates for calculating risk. In this instance, Tier 1 assumes 30-year exposure for residential receptors and 25-year worker receptors, and Tier 2 assumes a 3-year exposure per BAAQMD guidance (BAAQMD, 2016).

Carcinogenic risks are calculated for each receptor by calculating the dose of each pollutant at that receptor then following the calculation methodology in Section 8 of the OEHHA Guidelines. Multi-pathway risks are accounted for within HARP2 and follow the methodology in the guidelines. In general, excess cancer risk is represented by the following equation:

$Risk_i = Dose * CPF_i * ASF$ Where:

- $Risk_i$ = Cancer risk, the incremental probability of an individual developing cancer as a result of exposure to a particular potential carcinogen (unitless)
- Dose = Dose of chemical (mg/kg-day)
- CPF = Cancer Potency Factor for Chemical I (mg chemical/kg body weigh-day)⁻¹
- ASF = Age Sensitivity Factor (unitless)
 - Studies have shown that infants and children are more sensitive than adults to exposure to many carcinogens. Therefore, OEHHA applied ASFs to take into account the increased sensitivity to carcinogens during early-in-life exposure (OEHHA, 2015).

Chronic hazards are calculated using the period average ground level concentration of each pollutant compared to the chronic REL for each pollutant. When calculated for a single chemical, the comparison yields a ratio termed a hazard quotient (HQ). To evaluate the potential from simultaneous exposure to multiple chemicals, the HQs for each pollutant is summed to give the total chronic Hazard Index (HI) for each receptor. This is represented by the following equations:

$$Chronic HQ_i = C_i / REL_i$$

$$Chronic HI = \sum_i HQ_i$$

Where:

- Chronic HQ_i = Chronic Hazard Quotient for chemical i (unitless)
- Chronic HI = Hazard Index (unitless)
- C_i = Annual average air concentration for Chemical i ($\mu\text{g}/\text{m}^3$)
- REL_i = Chronic Non-cancer Reference Exposure Level for Chemical i ($\mu\text{g}/\text{m}^3$)

Acute non-cancer hazards are identical for residential and non-residential (worker) receptors. Therefore, only one set of methodology was utilized for acute non-cancer hazard index calculation. Acute hazards are calculated similar to the chronic hazards except using the

maximum 1-hour concentration of each pollutant compared to the acute REL for each pollutant. The sum of the HQs for each pollutant is the total acute HI.

3.0 OPERATION

3.1 Sources

Once operational, the Proposed Project will generate emissions of TACs through a variety of sources including OGVs, tugs, off-road equipment, trucks, employee vehicles, and aggregate transfer and storage. Emission sources are modeled as point sources, volume sources, or area sources based on the nature of the source and the manner in which emissions are released. Point sources are utilized to model emissions that are released to the atmosphere from a pipe or stack. Point sources are typically stationary. Area sources are used to model emissions that are released from a flat surface, such as fugitive dust off of a construction site. Volume sources are utilized to model emissions that are released from a 3-dimensional space. Mobile sources, such as trucks or OGVs are typically modeled as a series of volume sources. Table 3 summarizes how each source of TAC emissions were modeled in AERMOD.

Sources were placed in their expected operating locations. OGVs were modeled as a series of volume sources during transit, an area source during maneuvering, and a point source during hoteling. During transit, OGVs follow set shipping lanes, and OGV transit emissions were modeled as a series of volume sources in the 2002 EIR as Addended and the San Francisco Citywide Health Risk Assessment (SF HRA, San Francisco Department of Public Health [SFDPH], 2020). An area source was selected for maneuvering to match at-berth modeling methodology utilized in the WOCAP (BAAQMD, 2019). Hotelling emissions were modeled as point sources, as the OGV will be stationary during hotelling and release emissions vertically out of the vessel's stack. Assist tugs were modeled as an area source that matched the shape and size of the OGV maneuvering source. Barge tugs were modeled as series of volume sources along their expected travel pathways. Spacing and release parameters for OGVs, assist tugs, and barge tugs follow methodology used in the WOCAP and SF HRA.

On-site sources were placed within the site boundary in the area where materials will be stockpiled. Fugitive dust emissions from stockpiles and onsite traffic were modeled as area sources, on-site truck and off-road equipment exhaust emissions were modeled as a series of volume sources, and aggregate transfer points were modeled as single volume sources. Truck idling emissions were modeled as a point source. Release parameters for onsite sources follow methodology used in the WOCAP and SCAQMD's Localized Significance Thresholds Methodology (SCAQMD, 2008).

Offsite truck and employee vehicle sources were placed on expected roadways. Trucks traveling to or from the north will utilize Grand Avenue to access Maritime Street, and trucks traveling to or from the south will utilize 7th Street. This pattern will divert trucks away from the stretch of 880 between 7th and Grand and the associated frontage road. The Port will place signage at appropriate locations along the truck routes to indicate the required routes for aggregate trucks, and ERA will impose a three-strike rule to ban truck drivers from the Oakland Terminal if they do not adhere to the route restrictions. Off-site truck release parameters follow methodology used in the WOCAP. The locations of operation sources are illustrated in Figures 4 and 5.

3.2 Emissions

Emissions for each source group for cancer and chronic HI are presented in Table 4. PM_{2.5} emissions for each source group are presented in Table 5. Additional organic TACs included in the acute analysis can be found in Tables 42 through 46 of Appendix C. Organic TACs associated with diesel exhaust were utilized for acute HI, only. DPM accounts for cancer and chronic risks for multiple substances emitted from diesel combustion, and inclusion of organic TACs in addition to DPM for cancer and chronic risks would be double counting.

Table 4 and Table 5 presented mitigated and unmitigated emissions. ERA proposes Mitigation Measure ERA AQ-1: Development of an Operations Air Quality Plan, which will include the use of hybrid-electric front-end loaders and use of an electric sweeper. Table 6 summarizes the differences between unmitigated and mitigated emissions.

Table 6: Mitigation Measures

Source Group	Unmitigated	Mitigated
OFFR	Standard Tier 4 (diesel) Models	Hybrid-electric loaders and an electric sweeper

The use of Tier 2 vessels for 25% of vessel calls each year and techniques to control fugitive dust (water sprayers at transfer points, moisture content of materials, etc.) are project features, and therefore, are accounted for under the unmitigated emissions scenario.

3.3 Exposure Assessment

3.3.1 Exposure Pathways

3.3.1.1 Residents

The following residential exposure pathways were included in this HRA:

- Inhalation
- Soil ingestion
- Dermal absorption
- Mother’s Milk
- Home Grown Produce

No site- or receptor-specific exposure pathways were identified within the residential neighborhoods.

Exposure and risk from non-inhalation pathways follow default assumptions built into HARP2 and described in the OEHHA’s Risk Assessment Guidelines. Soil concentrations are calculated within HARP2 and follow the guidance provided in Section 5.3 of the OEHHA Guidelines.

3.3.1.2 Off-Site Workers

The following worker exposure pathways were included in this HRA:

- Inhalation
- Soil ingestion
- Dermal absorption

3.3.2 HARP Exposure Analysis Methods and Assumptions

According to the OEHHA guidelines, different exposure scenarios should be used for residential and worker receptors. Exposure scenarios and assumptions for residential and worker receptors are summarized below.

3.3.2.1 Resident

A 30-year exposure scenario is used for residential receptors to estimate cancer and chronic non-cancer risk from operation emissions. The following additional parameters were selected in HARP:

- Receptor Type: Individual Resident
- Intake Rate Percentile:
 - Risk Management Policy (RMP) using the Derived Method for Cancer
 - This method utilizes the 95th percentile daily breathing rate (DBR) for the most sensitive age groups and the 80th percentile DBR for all other age groups (i.e. greater than age 2) (CARB, 2015a; BAAQMD, 2016).
 - This method includes ASFs, which are built into the HARP application.
 - OEHHA Derived Method for Non-Cancer
 - In non-cancer chronic assessments, the inhalation pathway is always considered a driving pathway, the next two risk driving pathways will use the 95th percentile intake rate, and the remaining pathways will use the mean intake rate (CARB, 2015b).
- Exposure Frequency: 350 days per year
- Starting Age: 3rd Trimester
- Fraction of Time at Home (FAH) 1.00
 - In the 2003 risk assessment methodology, people were assumed to be at their home for 24 hours a day. In 2015, OEHHA and ARB evaluated information from activity pattern databases to estimate FAH during the day (CARB, 2015).
 - There are multiple schools within West Oakland, so FAH should be set at 1.0 (BAAQMD, 2016).
- Deposition Rate: 0.05 meters per second

3.3.2.2 Off-Site Workers

A 25-year exposure scenario starting at the age of 16 is used for off-site worker receptors to estimate cancer risk from operation emissions. The following additional parameters were selected in HARP:

- Receptor Type: Worker
- Intake Rate Percentile: OEHHA Derived Method (when applicable)
 - In cancer risk assessments, the derived method uses the high-end point estimate (i.e., 95th percentile intake rate) for the two driving (dominant) exposure pathways and the mean (65th percentile) point estimate for the remaining pathways (CARB, 2015b).
- Exposure Frequency: 250 days per year
- Starting Age: 16 Years Old
- Deposition Rate: 0.05 meters per second

Although on-site equipment will typically operate 16 hours per day, the ERA Facility may be operational up to 24 hours per day and will not follow a typical 8 AM to 5 PM work schedule. Operation may occur during any time of the day. Therefore, the Worker Adjustment Factor (WAF) is 1.0.

As described in the Project Description in the Draft SEIR, OGVs that visit the Project Site would tie up to and discharge from Berth 22. When discharging from Berth 22, the OGV may be oriented either starboard side to (bow pointing northeast into the harbor) or port side to (bow pointing southwest out of the harbor). Therefore, there are two potential locations for the OGV exhaust stack during hotelling. See Figures 5 and 6 for source locations. The two locations were modeled separately, and the scenario where the vessel is oriented port side to was determined to be the worst-case scenario (resulting in the highest calculated risks). Results presented below represent this worst-case scenario.

3.4 Results

3.4.1 Cancer Risks

For unmitigated cancer risks, the Maximum Exposed Individual Resident (MEIR) is located at Receptor 714, which is located approximately one-half mile east, southeast of the Project Site, and the Maximum Exposed Individual Worker (MEIW) is located at Receptor 1063, which is located approximately 300 feet east of the Project Site. The maximum off-site impact occurs at Receptor 1061 (UTMX560600, UTMY 4185750). However, Receptor 1061 is located on a vacant lot, so the long-term exposure pathway is incomplete. Receptor 1063 is the location of maximum off-site impact with an existing receptor. Breathing zone concentrations of DPM, the risk driving pollutant, and the resulting cancer risk are summarized in Table 7.

Table 7: Cancer Risk - Operation - Unmitigated

Receptor	Receptor #	UTM X (m)	UTM Y (m)	Annual Avg. DPM Concentration (µg/m ³)	Cancer Risk
MEIR	714	561711.8	4185513.5	0.0154	11.7 in one million
MEIW	1063	560950.0	4185750.0	0.1221	7.7 in one million

Organic TACs from OGV boilers and gasoline employee vehicles are not listed but have minor contributions to cancer risk.

After mitigation, the MEIR and MEIW are in the same locations as pre-mitigation. Table 8 summarizes breathing zone concentrations of DPM and resulting cancer risk from mitigated operational emissions for the MEIR and MEIW.

Table 8: Cancer Risk – Operation - Mitigated

Receptor	Receptor #	UTM X (m)	UTM Y (m)	Annual Avg. DPM Concentration (µg/m ³)	Cancer Risk
MEIR	714	561711.8	4185513.5	0.0095	7.2 in one million
MEIW	1063	560950.0	4185750.0	0.0527	3.3 in one million

Organic TACs from OGV boilers and gasoline employee vehicles are not listed but have minor contributions to cancer risk.

Cancer risk results risk results are illustrated in Figures 7 through 9. As shown in Figures 7 through 9, there are receptors that have cancer risk higher than directly adjacent receptors. These higher risks are due to these specific receptors being located directly adjacent to major roadways and modeled off-site truck and vehicle traffic.

3.4.2 Non-Cancer Chronic Health Index

For unmitigated Chronic HI, the MEIR is located at Receptor 729 and the MEIW is located at Receptor 1063. Pre-mitigation breathing zone concentrations of DPM and respirable silica, the risk driving pollutants, and the resulting Chronic HQs and Chronic HI are summarized in Table 9.

Table 9: Chronic HI - Operation - Unmitigated

Pollutant	Chronic REL (µg/m ³)	Annual Avg. Concentration (µg/m ³)	Chronic HQ
MEIR – Receptor 729 – UTMX 561761.8, UTM Y 4185563.5			
DPM	5.0E+00	0.0150	0.003
Respirable Silica	3.0E+00	0.0341	0.011
Total Chronic HI:			0.014

Pollutant	Chronic REL (µg/m ³)	Annual Avg. Concentration (µg/m ³)	Chronic HQ
MEIW – Receptor 1063 – UTMX 560950.0, UTMY 4185750.0			
DPM	5.0E+00	0.1221	0.024
Respirable Silica	3.0E+00	0.3721	0.124
Total Chronic HI:			0.148

Organic TACs from OGV boiler and gasoline employee vehicles are not listed but have minor contributions to Chronic HI.

After mitigation, the MEIR and MEIW are in the same locations as pre-mitigation. Post-mitigation breathing zone concentrations of DPM and respirable silica, and the resulting Chronic HQs and Chronic HI are summarized in Table 10.

Table 10: Chronic HI - Operation - Mitigated

Pollutant	Chronic REL (µg/m ³)	Annual Avg. Concentration (µg/m ³)	Chronic HQ
MEIR – Receptor 729 – UTMX 561761.8, UTMY 4185563.5			
DPM	5.0E+00	0.0094	0.002
Respirable Silica	3.0E+00	0.0334	0.011
Total Chronic HI:			0.013
MEIW – Receptor 1063 – UTMX 560950.0, UTMY 4185750.0			
DPM	5.0E+00	0.0527	0.011
Respirable Silica	3.0E+00	0.3565	0.119
Total Chronic HI:			0.129

Organic TACs from OGV boilers and gasoline employee vehicles are not listed but have minor contributions to Chronic HI.

Chronic HI results are illustrated in Figure 10.

3.4.3 Non-Cancer Acute Health Index

Acute HI calculations are same for both residential and worker receptors. DPM does not have an Acute REL. Therefore, organic TACs associated with DPM are included in acute analysis (unlike cancer and chronic analysis). The maximum exposed receptor for Acute HI is located at Receptor 1273 (UTMX 560884.6, UTMY 4185768.5). Table 11 shows the one-hour breathing zone concentrations and the resulting Acute HQs and Acute HI.

Table 11: Acute HI - Operation – Mitigated and Unmitigated

Pollutant	Acute REL ($\mu\text{g}/\text{m}^3$)	1-Hour Concentration ($\mu\text{g}/\text{m}^3$)	Acute HQ
Unmitigated			
1,3- Butadiene	6.6E+02	0.072	<0.001
Acetaldehyde	4.7E+02	3.074	0.007
Benzene	2.7E+01	0.785	0.029
Formaldehyde	5.5E+01	5.764	0.105
Methanol	2.8E+04	0.011	<0.001
Methyl ethyl ketone (MEK)	1.3E+04	0.611	<0.001
m-Xylene	2.2E+04	0.248	<0.001
o-Xylene	2.2E+04	0.134	<0.001
p-Xylene	2.2E+04	0.036	<0.001
Styrene	2.1E+04	0.022	<0.001
Toluene	5.0E+03	0.588	<0.001
Unmitigated Acute HI:			0.111
Mitigated			
1,3- Butadiene	6.6E+02	0.042	<0.001
Acetaldehyde	4.7E+02	1.882	0.004
Benzene	2.7E+01	0.458	0.017
Formaldehyde	5.5E+01	3.385	0.062
Methanol	2.8E+04	0.007	<0.001
Methyl ethyl ketone (MEK)	1.3E+04	0.373	<0.001
m-Xylene	2.2E+04	0.150	<0.001
o-Xylene	2.2E+04	0.079	<0.001
p-Xylene	2.2E+04	0.021	<0.001
Styrene	2.1E+04	0.013	<0.001
Toluene	5.0E+03	0.349	<0.001
Mitigated Acute HI:			0.066

Acute HI is the sum of acetaldehyde and formaldehyde because they target the same organ (eye). Benzene is not included in the max Acute HI because it has a different target organ (blood).

The Acute HI results are illustrated in Figure 11.

3.4.4 PM_{2.5} Concentration

The maximum increase in PM_{2.5} concentration at a residential receptor and non-residential receptor were modeled to be at Receptor 729 and Receptor 1063, respectively, for both unmitigated and mitigated emissions. The maximum off-site impact occurs at Receptor 1097 (UTMX 560650, UTMX 4185900). However, Receptor 1097 is located on a vacant lot, so the long-term exposure pathway is incomplete. Receptor 1063 is the location of maximum off-site impact with an existing receptor. Breathing zone concentrations of PM_{2.5} summarized in Table 12.

Table 12: PM_{2.5} Concentration – Operation – Mitigated and Unmitigated

Mitigation	Receptor	Receptor #	UTM X (m)	UTM Y (m)	PM _{2.5} (µg/m ³)
Unmitigated	MEIR	729	561761.8	4185563.5	0.120
	MEIW	1063	560950.0	4185750.0	1.239
Mitigated	MEIR	729	561761.8	4185563.5	0.115
	MEIW	1063	560950.0	4185750.0	1.175

PM_{2.5} is generated by combustion of fossil fuels and fugitive dust sources. Table 13 shows the PM_{2.5} concentration contribution at the MEIR and MEIW from exhaust emissions only and the contribution from fugitive dust sources only. As shown in Table 13, the fugitive dust component accounts for approximately 95% of the total PM_{2.5} concentration increment at the MEIW.

Table 13: PM_{2.5} Concentration – Operation – Mitigated - Exhaust vs. Fugitive Dust

Mitigation	Receptor	Receptor #	UTM X (m)	UTM Y (m)	PM _{2.5} (µg/m ³)
Exhaust Only	MEIR	729	561761.8	4185563.5	0.009
	MEIW	1063	560950.0	4185750.0	0.049
Fugitive Dust Only	MEIR	729	561761.8	4185563.5	0.106
	MEIW	1063	560950.0	4185750.0	1.126

The MEIR for exhaust only is located at Receptor 714. However, results from Receptor 729 are presented to stay consistent with the overall MEIR for PM_{2.5}.

PM_{2.5} concentrations are shown in Figures 12 through 15.

4.0 CONSTRUCTION

4.1 Sources

Construction activities would include demolition, site preparation and grading, construction of Project components, and paving. The weight of the construction aggregates stored at the Project site would result in compaction and settlement of portions of the site outside of where piles are installed as part of conveyor structure foundations; thus, site restoration activities at the end of the Proposed Project life are considered as a phase of Project construction. No in-water work would be required during construction of the Proposed Project and no off-site staging would be needed.

For this analysis, construction sources were broken into four source groups: on-site construction equipment exhaust, on-site fugitive dust, off-site vehicles and trucks, and barges. Table 14 summarizes how each source of TAC emissions were modeled in AERMOD. Sources were placed in their expected locations. Onsite sources were confined within the final site boundary, and off-site sources were modeled on the same roadways as operation off-site vehicles. On-site fugitive dust sources were modeled as area sources, and on-site equipment exhaust emissions were modeled as a series of volume sources. Barges were modeled as a line of volume sources heading from the Oakland Terminal out to the Golden Gate Bridge. Construction source locations are provided in Figures 16 and 17.

4.2 Emissions

Construction emissions, with the exception of the potential barge trips, were estimated using CAPCOA's California Emissions Estimator Model (CalEEMod). CalEEMod allows users to input project parameters, such as land use square footage, construction equipment, material import and export quantities, and vehicle trips. Construction schedule, construction equipment, material haul quantities, and vehicle trips following information provided in Tables 2.5-1 and Tables 2.5-2 of the Draft SEIR were used as inputs for CalEEMod. Additional details regarding construction emission calculations can be found in Appendix C.

Emissions for each source group for cancer and chronic HI are presented in Table 15. PM_{2.5} emissions for each source group are presented in Table 16. Additional organic TACs included in the acute analysis can be found in Table 57 of Appendix C.

Table 15 and Table 16 present mitigated and unmitigated emissions. ERA proposes Mitigation Measure ERA AQ-2: Project construction shall utilize construction equipment (excluding on-road trucks which must meet CARB on-road emission standards) meeting Tier 4 emission requirements with the possible exception of certain types of equipment (vibratory pile drivers and concrete saws), for which suitable Tier 4 equipment may not be available. Site watering is required. Therefore, dust control from site watering is incorporated in unmitigated and mitigated emissions.

4.3 Exposure Assessment

4.3.1 Exposure Pathways

4.3.1.1 Residents

The following residential exposure pathways were included in this HRA:

- Inhalation
- Soil ingestion
- Dermal absorption
- Mother's Milk
- Home Grown Produce

Exposure and risk from non-inhalation pathways follow default assumptions built into HARP2 and described in the OEHHA's Risk Assessment Guidelines. Soil concentrations are calculated within HARP2 and follow the guidance provided in Section 5.3 of the OEHHA Guidelines.

4.3.1.2 Off-Site Workers

The following worker exposure pathways were included in this HRA:

- Inhalation
- Soil ingestion
- Dermal absorption

4.3.2 HARP Exposure Analysis Methods and Assumptions

According to the OEHHA guidelines, different exposure scenarios should be used for residential and off-site worker receptors. Exposure scenarios and assumptions for residential and worker receptors are summarized below.

4.3.2.1 Resident

Construction is expected to take up to one year to complete. According to BAAQMD Guidance, projects with durations of three or fewer years should be assessed assuming an exposure duration of three years (BAAQMD, 2016). Therefore, a three-year exposure scenario is used to estimate risk from construction emissions. The following additional parameters were selected in HARP:

- Receptor Type: Individual Resident
- Intake Rate Percentile:
 - RMP using the Derived Method for Cancer
 - This method utilizes the 95th percentile DBR for the most sensitive age groups and the 80th percentile DBR for all other age groups (i.e. greater than age 2) (CARB, 2015a; BAAQMD, 2016).
 - This method includes ASFs, which are built into the HARP application.
 - OEHHA Derived Method for Non-Cancer
 - In non-cancer chronic assessments, the inhalation pathway is always considered a driving pathway, the next two risk driving pathways will use

the 95th percentile DBR, and the remaining pathways will use the mean intake rate (CARB, 2015b).

- Exposure Frequency: 350 days per year
- Starting Age: 3rd Trimester
- (FAH 1.00
 - In the 2003 risk assessment methodology, people were assumed to be at their home for 24 hours a day. In 2015, OEHHA and CARB evaluated information from activity pattern databases to estimate FAH during the day (CARB, 2015).
 - There are multiple schools within West Oakland, so FAH should be set at 1.0 (BAAQMD, 2016).
- Deposition Rate: 0.05 meters per second

4.3.2.2 Off-Site Workers

A three-year exposure scenario is used to estimate risk from construction emissions. The following additional parameters were selected in HARP:

- Receptor Type: Worker
- Intake Rate Percentile: OEHHA Derived Method (when applicable)
 - In cancer risk assessments, the derived method uses the high-end point estimate (i.e., 95th percentile intake rate) for the two driving (dominant) exposure pathways and the mean (65th percentile) point estimate for the remaining pathways (CARB, 2015b).
- Exposure Frequency: 250 days per year
- Starting Age: 16 Years Old
- Deposition Rate: 0.05 meters per second

4.4 Results

4.4.1 Cancer Risks

For unmitigated cancer risks, the MEIR is located at Receptor 714 and the MEIW is located at Receptor 1063. The maximum off-site impact occurs at Receptor 1061 (UTMX 560600, UTM Y 4185750). However, Receptor 1061 is located on a vacant lot, so the long-term exposure pathway is incomplete. Receptor 1063 is the location of maximum off-site impact with an existing receptor. Breathing zone concentrations of DPM and the resulting cancer risk are summarized in Table 17.

Table 17: Cancer Risk - Construction - Unmitigated

Receptor	Receptor #	UTM X (m)	UTM Y (m)	Annual Avg. DPM Concentration (µg/m ³)	Cancer Risk
MEIR	714	561711.8	4185513.5	0.020	7.6 in one million
MEIW	1063	560950.0	4185750.0	0.237	1.8 in one million

After mitigation, the MEIR and MEIW remained in the same location. Table 18 summarizes breathing zone concentrations of DPM and resulting cancer risk from mitigated operational emissions for the MEIR and MEIW.

Table 18: Cancer Risk – Construction - Mitigated

Receptor	Receptor #	UTM X (m)	UTM Y (m)	Annual Avg. DPM Concentration (µg/m ³)	Cancer Risk
MEIR	714	561711.8	4185513.5	0.008	2.8 in one million
MEIW	1063	560950.0	4185750.0	0.087	0.7 in one million

Construction cancer risk results are illustrated in Figure 18.

4.4.2 Non-Cancer Chronic Health Index

For unmitigated Chronic HI, the MEIR is located at Receptor 752 and the MEIW is located at Receptor 910. Pre-mitigation breathing zone concentrations of DPM and the resulting Chronic HIs are summarized in Table 19.

Table 19: Chronic HI - Concentration - Unmitigated

Pollutant	Chronic REL (µg/m ³)	Annual Avg. Concentration (µg/m ³)	Chronic HI
MEIR – Receptor 714 – UTMX 561711.8, UTM Y 4185513.5			
DPM	5.0E+00	0.020	0.004
MEIW – Receptor 1063 – UTMX 560950.0, UTM Y 4185750.0			
DPM	5.0E+00	0.237	0.047

After mitigation, the MEIR and MEIW are in the same locations as pre-mitigation. Post-mitigation breathing zone concentrations of DPM and the resulting Chronic HIs are summarized in Table 20.

Table 20: Chronic HI - Concentration - Mitigated

Pollutant	Chronic REL (µg/m ³)	Annual Avg. Concentration (µg/m ³)	Chronic HQ
MEIR – Receptor 714 – UTMX 561711.8, UTM Y 4185513.5			
DPM	5.0E+00	0.008	0.002
MEIW – Receptor 1063 – UTMX 560950.0, UTM Y 4185750.0			
DPM	5.0E+00	0.087	0.017

4.4.3 Non-Cancer Acute Health Index

Acute HI are the same for both residential and worker receptors. DPM does not have an Acute REL. Therefore, organic TACs associated with DPM are included in acute analysis (unlike cancer and chronic analysis). The maximum exposed off-site receptor for Acute HI is located at Receptor 1273 (UTMX 560884.6, UTMY 4185768.5). Table 21 shows the one-hour breathing zone concentrations and the resulting Acute HQs and Acute HI.

Table 21: Acute HI - Operation – Mitigated and Unmitigated

Pollutant	Acute REL ($\mu\text{g}/\text{m}^3$)	1-Hour Concentration ($\mu\text{g}/\text{m}^3$)	Acute HQ
Unmitigated			
1,3- Butadiene	6.6E+02	0.024	<0.001
Acetaldehyde	4.7E+02	0.919	0.002
Benzene	2.7E+01	0.249	0.009
Formaldehyde	5.5E+01	1.832	0.033
Methanol	2.8E+04	0.004	<0.001
Methyl ethyl ketone (MEK)	1.3E+04	0.184	<0.001
m-Xylene	2.2E+04	0.076	<0.001
o-Xylene	2.2E+04	0.042	<0.001
p-Xylene	2.2E+04	0.012	<0.001
Styrene	2.1E+04	0.007	<0.001
Toluene	5.0E+03	0.184	<0.001
Unmitigated Acute HI:			0.035
Mitigated			
1,3- Butadiene	6.6E+02	0.012	<0.001
Acetaldehyde	4.7E+02	0.456	0.001
Benzene	2.7E+01	0.124	0.005
Formaldehyde	5.5E+01	0.913	0.017
Methanol	2.8E+04	0.002	<0.001
Methyl ethyl ketone (MEK)	1.3E+04	0.092	<0.001
m-Xylene	2.2E+04	0.038	<0.001
o-Xylene	2.2E+04	0.021	<0.001
p-Xylene	2.2E+04	0.006	<0.001
Styrene	2.1E+04	0.004	<0.001
Toluene	5.0E+03	0.091	<0.001
Mitigated Acute HI:			0.018

Acute HI is the sum of acetaldehyde and formaldehyde because they target the same organ (eye). Benzene is not included in the max Acute HI because it has a different target organ (blood).

4.4.4 PM_{2.5} Concentration

The maximum increase in PM_{2.5} concentration at a residential receptor and non-residential receptor were modeled to be at Receptor 714 and Receptor 1063, respectively, for both unmitigated and mitigated emissions. The maximum off-site impact occurs at Receptor 1061

(UTMX 560600, UTM Y 4185750) for unmitigated PM_{2.5} emissions and at Receptor 1097 (UTMX 560650, UTM Y 4185900) for mitigated PM_{2.5} emissions. However, Receptors 1061 and 1097 are located on a vacant lot, so the long-term exposure pathway is incomplete. Receptor 1063 is the location of maximum off-site impact with an existing receptor. Breathing zone concentrations of PM_{2.5} summarized in Table 22.

Table 22: PM_{2.5} Concentration – Construction – Mitigated and Unmitigated

Mitigation	Receptor	Receptor #	UTM X (m)	UTM Y (m)	PM _{2.5} (µg/m ³)
Unmitigated	MEIR	714	561711.8	4185513.5	0.022
	MEIW	1063	560950.0	4185750.0	0.258
Mitigated	MEIR	714	561711.8	4185513.5	0.010
	MEIW	1063	560950.0	4185750.0	0.116

Construction PM_{2.5} concentrations are illustrated in Figure 19.

5.0 CUMULATIVE IMPACTS

The BAAQMD 2017 California Environmental Quality Act (CEQA) Guidelines separate construction and operation-related impacts for project level significance thresholds. However, cumulative impacts take into account construction in addition to operation. The following table summarizes construction plus operation-related impacts after mitigation. The cumulative impacts assume 1 year of construction and 29 years of operation. Therefore, residential cancer risk from operation is assumed to start at age 0.75, and will be lower than the risk assuming an initial age of the third trimester. Cumulative cancer risk for the MEIW was estimated by simply summing construction and operation cancer risks. Table 23 summarizes the cumulative cancer risk, and weighting factor calculations are provided in Table 24.

Table 23: Cumulative Cancer Results

Risk Parameter	MEIR	MEIW
Construction Cancer Risk (1-Year)	1.3 in one million	0.2 in one million
Operation Cancer Risk (30-Year)	7.2 in one million	3.3 in one million
Operation Weighting Factor	0.82	--
Operation Cancer Risk (29-Year)	5.9 in one million	--
Cumulative Cancer Risk	7.2 in one million	3.5 in one million

Cumulative HIC was estimated by summing HIC from construction with HIC from operation. The cumulative HIC for the MEIR and MEIW are 0.015 and 0.146, respectively.

6.0 REFERENCES

1. Bay Area Air Quality Management District (BAAQMD), 2016. Air Toxics New Source Review Program Health Risk Assessment Guidelines. December.
2. Bay Area Air Quality Management District (BAAQMD), 2019. Owing Our Air, the West Oakland Community Action Plan. October.
3. California Air Resources Board (CARB), 2015a. Risk Management Guidelines for Stationary Sources of Air Toxics. July 23, 2015.
4. California Air Resources Board (CARB), 2015b. User Manual for the Hotspots Analysis and Reporting Program Air Dispersion Modeling and Risk Assessment Tool, Version 2. March 17.
5. California Air Resources Board (CARB), 2018. Hotspots Analysis and Reporting Program (HARP).” June 11. Available online at: <https://www.arb.ca.gov/toxics/harp/harp.htm>.
6. Office of Environmental Health Hazard Assessment (OEHHA), 2015. “Air Toxics Hot Spots Program. Risk Assessment Guidelines. Guidance Manual for Preparation of Risk Assessments.” February.
7. Office of Environmental Health Hazard Assessment (OEHHA), 2019a. Appendix A: Hot Spots Unit Risk and Cancer Potency Values. May.
8. Office of Environmental Health Hazard Assessment (OEHHA), 2019b. OEHHA Acute, 8-hour and Chronic Reference Exposure Level (REL) Summary. November 4.
9. San Francisco Department of Public Health (SFDEH), 2020. Draft San Francisco Citywide Health Risk Assessment: Technical Support Documentation. February.
10. South Coast Air Quality Management District (SCAQMD), 2008. Final Localized Significance Threshold Methodology. July.
11. South Coast Air Quality Management District (SCAQMD), 2015. “Supplemental Guidelines for Preparing Risk Assessments for the Air Toxics “Hot Spots” Information and Assessment Act.” June 5.
12. South Coast Air Quality Management District (SCAQMD), 2019. “SCAQMD Modeling Guidance for AERMOD.”
13. United States Census Bureau, 2019. Quick Facts: Oakland City, California. July 1.

Tables

Table 1
List and Location of Receptors

HARP Rec Index	HARP Rec ID	UTM X (m)	UTM Y (m)	Residential or Non-residential
1	D1	559000.0	4184000.0	Non-residential
2	D2	559250.0	4184000.0	Non-residential
3	D3	559500.0	4184000.0	Non-residential
4	D4	559750.0	4184000.0	Non-residential
5	D5	560000.0	4184000.0	Non-residential
6	D6	560250.0	4184000.0	Non-residential
7	D7	560500.0	4184000.0	Non-residential
8	D8	560750.0	4184000.0	Non-residential
9	D9	561000.0	4184000.0	Non-residential
10	D10	561250.0	4184000.0	Non-residential
11	D11	561500.0	4184000.0	Non-residential
12	D12	561750.0	4184000.0	Non-residential
13	D13	562000.0	4184000.0	Non-residential
14	D14	562250.0	4184000.0	Non-residential
15	D15	562500.0	4184000.0	Non-residential
16	D16	562750.0	4184000.0	Non-residential
17	D17	563000.0	4184000.0	Non-residential
18	D18	563250.0	4184000.0	Residential
19	D19	563500.0	4184000.0	Residential
20	D20	563750.0	4184000.0	Residential
21	D21	564000.0	4184000.0	Residential
22	D22	564250.0	4184000.0	Residential
23	D23	564500.0	4184000.0	Residential
24	D24	564750.0	4184000.0	Residential
25	D25	565000.0	4184000.0	Residential
26	D26	559000.0	4184250.0	Non-residential
27	D27	559250.0	4184250.0	Non-residential
28	D28	559500.0	4184250.0	Non-residential
29	D29	559750.0	4184250.0	Non-residential
30	D30	560000.0	4184250.0	Non-residential
31	D31	560250.0	4184250.0	Non-residential
32	D32	560500.0	4184250.0	Non-residential
33	D33	560750.0	4184250.0	Non-residential
34	D34	561000.0	4184250.0	Non-residential
35	D35	561250.0	4184250.0	Non-residential
36	D36	561500.0	4184250.0	Residential
37	D37	561750.0	4184250.0	Residential
38	D38	562000.0	4184250.0	Residential
39	D39	562250.0	4184250.0	Residential
40	D40	562500.0	4184250.0	Residential
41	D41	562750.0	4184250.0	Residential

HARP Rec Index	HARP Rec ID	UTM X (m)	UTM Y (m)	Residential or Non-residential
42	D42	563000.0	4184250.0	Residential
43	D43	563250.0	4184250.0	Residential
44	D44	563500.0	4184250.0	Residential
45	D45	563750.0	4184250.0	Residential
46	D46	564000.0	4184250.0	Residential
47	D47	564250.0	4184250.0	Residential
48	D48	564500.0	4184250.0	Residential
49	D49	564750.0	4184250.0	Residential
50	D50	565000.0	4184250.0	Residential
51	D51	559000.0	4184500.0	Non-residential
52	D52	559250.0	4184500.0	Non-residential
53	D53	559500.0	4184500.0	Non-residential
54	D54	559750.0	4184500.0	Non-residential
55	D55	560000.0	4184500.0	Non-residential
56	D56	560250.0	4184500.0	Non-residential
57	D57	560500.0	4184500.0	Non-residential
58	D58	560750.0	4184500.0	Non-residential
59	D59	561000.0	4184500.0	Non-residential
60	D60	561250.0	4184500.0	Non-residential
61	D61	561500.0	4184500.0	Non-residential
62	D62	561750.0	4184500.0	Residential
63	D63	562250.0	4184500.0	Residential
64	D64	562500.0	4184500.0	Residential
65	D65	562750.0	4184500.0	Residential
66	D66	563000.0	4184500.0	Residential
67	D67	563250.0	4184500.0	Residential
68	D68	563500.0	4184500.0	Residential
69	D69	563750.0	4184500.0	Residential
70	D70	564000.0	4184500.0	Residential
71	D71	564250.0	4184500.0	Residential
72	D72	564500.0	4184500.0	Residential
73	D73	564750.0	4184500.0	Residential
74	D74	565000.0	4184500.0	Residential
75	D75	559000.0	4184750.0	Non-residential
76	D76	559250.0	4184750.0	Non-residential
77	D77	559500.0	4184750.0	Non-residential
78	D78	559750.0	4184750.0	Non-residential
79	D79	560000.0	4184750.0	Non-residential
80	D80	560250.0	4184750.0	Non-residential
81	D81	560500.0	4184750.0	Non-residential
82	D82	560750.0	4184750.0	Non-residential
83	D83	561000.0	4184750.0	Non-residential
84	D84	561250.0	4184750.0	Residential
85	D85	562250.0	4184750.0	Residential
86	D86	562500.0	4184750.0	Residential

HARP Rec Index	HARP Rec ID	UTM X (m)	UTM Y (m)	Residential or Non-residential
87	D87	562750.0	4184750.0	Residential
88	D88	563000.0	4184750.0	Residential
89	D89	563250.0	4184750.0	Residential
90	D90	563500.0	4184750.0	Residential
91	D91	563750.0	4184750.0	Residential
92	D92	564000.0	4184750.0	Residential
93	D93	564250.0	4184750.0	Residential
94	D94	564500.0	4184750.0	Residential
95	D95	564750.0	4184750.0	Residential
96	D96	565000.0	4184750.0	Residential
97	D97	559000.0	4185000.0	Non-residential
98	D98	559250.0	4185000.0	Non-residential
99	D99	559500.0	4185000.0	Non-residential
100	D100	559750.0	4185000.0	Non-residential
101	D101	560000.0	4185000.0	Non-residential
102	D102	560250.0	4185000.0	Non-residential
103	D103	560500.0	4185000.0	Non-residential
104	D104	560750.0	4185000.0	Non-residential
105	D105	561000.0	4185000.0	Non-residential
106	D106	561250.0	4185000.0	Non-residential
107	D107	562500.0	4185000.0	Residential
108	D108	562750.0	4185000.0	Residential
109	D109	563000.0	4185000.0	Residential
110	D110	563250.0	4185000.0	Residential
111	D111	563500.0	4185000.0	Residential
112	D112	563750.0	4185000.0	Residential
113	D113	564000.0	4185000.0	Residential
114	D114	564250.0	4185000.0	Residential
115	D115	564500.0	4185000.0	Residential
116	D116	564750.0	4185000.0	Residential
117	D117	565000.0	4185000.0	Residential
118	D118	559000.0	4185250.0	Non-residential
119	D119	559250.0	4185250.0	Non-residential
120	D120	559500.0	4185250.0	Non-residential
121	D121	559750.0	4185250.0	Non-residential
122	D122	560000.0	4185250.0	Non-residential
123	D123	562500.0	4185250.0	Residential
124	D124	562750.0	4185250.0	Residential
125	D125	563000.0	4185250.0	Residential
126	D126	563250.0	4185250.0	Residential
127	D127	563500.0	4185250.0	Residential
128	D128	563750.0	4185250.0	Residential
129	D129	564000.0	4185250.0	Residential
130	D130	564250.0	4185250.0	Residential
131	D131	564500.0	4185250.0	Residential

HARP Rec Index	HARP Rec ID	UTM X (m)	UTM Y (m)	Residential or Non-residential
132	D132	564750.0	4185250.0	Residential
133	D133	565000.0	4185250.0	Residential
134	D134	559000.0	4185500.0	Non-residential
135	D135	559250.0	4185500.0	Non-residential
136	D136	559500.0	4185500.0	Non-residential
137	D137	559750.0	4185500.0	Non-residential
138	D138	560000.0	4185500.0	Non-residential
139	D139	561500.0	4185500.0	Non-residential
140	D140	562500.0	4185500.0	Residential
141	D141	562750.0	4185500.0	Residential
142	D142	563000.0	4185500.0	Residential
143	D143	563250.0	4185500.0	Residential
144	D144	563500.0	4185500.0	Residential
145	D145	563750.0	4185500.0	Residential
146	D146	564000.0	4185500.0	Residential
147	D147	564250.0	4185500.0	Residential
148	D148	564500.0	4185500.0	Residential
149	D149	564750.0	4185500.0	Residential
150	D150	565000.0	4185500.0	Residential
151	D151	559000.0	4185750.0	Non-residential
152	D152	559250.0	4185750.0	Non-residential
153	D153	559500.0	4185750.0	Non-residential
154	D154	559750.0	4185750.0	Non-residential
155	D155	560000.0	4185750.0	Non-residential
156	D156	561500.0	4185750.0	Non-residential
157	D157	561750.0	4185750.0	Non-residential
158	D158	562000.0	4185750.0	Residential
159	D159	562250.0	4185750.0	Non-residential
160	D160	562500.0	4185750.0	Non-residential
161	D161	562750.0	4185750.0	Residential
162	D162	563000.0	4185750.0	Residential
163	D163	563250.0	4185750.0	Residential
164	D164	563500.0	4185750.0	Residential
165	D165	563750.0	4185750.0	Residential
166	D166	564000.0	4185750.0	Residential
167	D167	564250.0	4185750.0	Residential
168	D168	564500.0	4185750.0	Residential
169	D169	564750.0	4185750.0	Residential
170	D170	565000.0	4185750.0	Residential
171	D171	559000.0	4186000.0	Non-residential
172	D172	559250.0	4186000.0	Non-residential
173	D173	559500.0	4186000.0	Non-residential
174	D174	559750.0	4186000.0	Non-residential
175	D175	560000.0	4186000.0	Non-residential
176	D176	561500.0	4186000.0	Non-residential

HARP Rec Index	HARP Rec ID	UTM X (m)	UTM Y (m)	Residential or Non-residential
177	D177	561750.0	4186000.0	Non-residential
178	D178	562000.0	4186000.0	Non-residential
179	D179	562250.0	4186000.0	Non-residential
180	D180	562500.0	4186000.0	Non-residential
181	D181	562750.0	4186000.0	Residential
182	D182	563000.0	4186000.0	Residential
183	D183	563250.0	4186000.0	Residential
184	D184	563500.0	4186000.0	Residential
185	D185	563750.0	4186000.0	Residential
186	D186	564000.0	4186000.0	Residential
187	D187	564250.0	4186000.0	Residential
188	D188	564500.0	4186000.0	Residential
189	D189	564750.0	4186000.0	Residential
190	D190	565000.0	4186000.0	Residential
191	D191	559000.0	4186250.0	Non-residential
192	D192	559250.0	4186250.0	Non-residential
193	D193	559500.0	4186250.0	Non-residential
194	D194	559750.0	4186250.0	Non-residential
195	D195	560000.0	4186250.0	Non-residential
196	D196	561500.0	4186250.0	Non-residential
197	D197	561750.0	4186250.0	Non-residential
198	D198	562000.0	4186250.0	Non-residential
199	D199	562250.0	4186250.0	Non-residential
200	D200	562500.0	4186250.0	Non-residential
201	D201	562750.0	4186250.0	Non-residential
202	D202	563000.0	4186250.0	Residential
203	D203	563250.0	4186250.0	Residential
204	D204	563500.0	4186250.0	Residential
205	D205	563750.0	4186250.0	Residential
206	D206	564000.0	4186250.0	Residential
207	D207	564250.0	4186250.0	Residential
208	D208	564500.0	4186250.0	Residential
209	D209	564750.0	4186250.0	Residential
210	D210	565000.0	4186250.0	Residential
211	D211	559000.0	4186500.0	Non-residential
212	D212	559250.0	4186500.0	Non-residential
213	D213	559500.0	4186500.0	Non-residential
214	D214	559750.0	4186500.0	Non-residential
215	D215	560000.0	4186500.0	Non-residential
216	D216	560250.0	4186500.0	Non-residential
217	D217	560500.0	4186500.0	Non-residential
218	D218	560750.0	4186500.0	Non-residential
219	D219	561000.0	4186500.0	Non-residential
220	D220	561250.0	4186500.0	Non-residential
221	D221	561500.0	4186500.0	Non-residential

HARP Rec Index	HARP Rec ID	UTM X (m)	UTM Y (m)	Residential or Non-residential
222	D222	561750.0	4186500.0	Non-residential
223	D223	562000.0	4186500.0	Non-residential
224	D224	562250.0	4186500.0	Non-residential
225	D225	562500.0	4186500.0	Non-residential
226	D226	562750.0	4186500.0	Residential
227	D227	563000.0	4186500.0	Residential
228	D228	563250.0	4186500.0	Residential
229	D229	563500.0	4186500.0	Residential
230	D230	563750.0	4186500.0	Residential
231	D231	564000.0	4186500.0	Residential
232	D232	564250.0	4186500.0	Residential
233	D233	564500.0	4186500.0	Residential
234	D234	564750.0	4186500.0	Residential
235	D235	565000.0	4186500.0	Residential
236	D236	559000.0	4186750.0	Non-residential
237	D237	559250.0	4186750.0	Non-residential
238	D238	559500.0	4186750.0	Non-residential
239	D239	559750.0	4186750.0	Non-residential
240	D240	560000.0	4186750.0	Non-residential
241	D241	560250.0	4186750.0	Non-residential
242	D242	560500.0	4186750.0	Non-residential
243	D243	560750.0	4186750.0	Non-residential
244	D244	561000.0	4186750.0	Non-residential
245	D245	561250.0	4186750.0	Non-residential
246	D246	561500.0	4186750.0	Non-residential
247	D247	561750.0	4186750.0	Non-residential
248	D248	562000.0	4186750.0	Non-residential
249	D249	562250.0	4186750.0	Non-residential
250	D250	562500.0	4186750.0	Non-residential
251	D251	562750.0	4186750.0	Residential
252	D252	563000.0	4186750.0	Residential
253	D253	563250.0	4186750.0	Residential
254	D254	563500.0	4186750.0	Residential
255	D255	563750.0	4186750.0	Residential
256	D256	564000.0	4186750.0	Residential
257	D257	564250.0	4186750.0	Residential
258	D258	564500.0	4186750.0	Residential
259	D259	564750.0	4186750.0	Residential
260	D260	565000.0	4186750.0	Residential
261	D261	559000.0	4187000.0	Non-residential
262	D262	559250.0	4187000.0	Non-residential
263	D263	559500.0	4187000.0	Non-residential
264	D264	559750.0	4187000.0	Non-residential
265	D265	560000.0	4187000.0	Non-residential
266	D266	560250.0	4187000.0	Non-residential

HARP Rec Index	HARP Rec ID	UTM X (m)	UTM Y (m)	Residential or Non-residential
267	D267	560500.0	4187000.0	Non-residential
268	D268	560750.0	4187000.0	Non-residential
269	D269	561000.0	4187000.0	Non-residential
270	D270	561250.0	4187000.0	Non-residential
271	D271	561500.0	4187000.0	Non-residential
272	D272	561750.0	4187000.0	Non-residential
273	D273	562000.0	4187000.0	Non-residential
274	D274	562250.0	4187000.0	Non-residential
275	D275	562500.0	4187000.0	Non-residential
276	D276	562750.0	4187000.0	Non-residential
277	D277	563000.0	4187000.0	Non-residential
278	D278	563250.0	4187000.0	Residential
279	D279	563500.0	4187000.0	Residential
280	D280	563750.0	4187000.0	Residential
281	D281	564000.0	4187000.0	Residential
282	D282	564250.0	4187000.0	Residential
283	D283	564500.0	4187000.0	Residential
284	D284	564750.0	4187000.0	Residential
285	D285	565000.0	4187000.0	Residential
286	D286	559000.0	4187250.0	Non-residential
287	D287	559250.0	4187250.0	Non-residential
288	D288	559500.0	4187250.0	Non-residential
289	D289	559750.0	4187250.0	Non-residential
290	D290	560000.0	4187250.0	Non-residential
291	D291	560250.0	4187250.0	Non-residential
292	D292	560500.0	4187250.0	Non-residential
293	D293	560750.0	4187250.0	Non-residential
294	D294	561000.0	4187250.0	Non-residential
295	D295	561250.0	4187250.0	Non-residential
296	D296	561500.0	4187250.0	Non-residential
297	D297	561750.0	4187250.0	Non-residential
298	D298	562000.0	4187250.0	Non-residential
299	D299	562250.0	4187250.0	Non-residential
300	D300	562500.0	4187250.0	Non-residential
301	D301	562750.0	4187250.0	Non-residential
302	D302	563000.0	4187250.0	Non-residential
303	D303	563250.0	4187250.0	Non-residential
304	D304	563500.0	4187250.0	Residential
305	D305	563750.0	4187250.0	Residential
306	D306	564000.0	4187250.0	Residential
307	D307	564250.0	4187250.0	Residential
308	D308	564500.0	4187250.0	Residential
309	D309	564750.0	4187250.0	Residential
310	D310	565000.0	4187250.0	Residential
311	D311	559000.0	4187500.0	Non-residential

HARP Rec Index	HARP Rec ID	UTM X (m)	UTM Y (m)	Residential or Non-residential
312	D312	559250.0	4187500.0	Non-residential
313	D313	559500.0	4187500.0	Non-residential
314	D314	559750.0	4187500.0	Non-residential
315	D315	560000.0	4187500.0	Non-residential
316	D316	560250.0	4187500.0	Non-residential
317	D317	560500.0	4187500.0	Non-residential
318	D318	560750.0	4187500.0	Non-residential
319	D319	561000.0	4187500.0	Non-residential
320	D320	561250.0	4187500.0	Non-residential
321	D321	561500.0	4187500.0	Non-residential
322	D322	561750.0	4187500.0	Non-residential
323	D323	562000.0	4187500.0	Non-residential
324	D324	562250.0	4187500.0	Non-residential
325	D325	562500.0	4187500.0	Non-residential
326	D326	562750.0	4187500.0	Non-residential
327	D327	563000.0	4187500.0	Non-residential
328	D328	563250.0	4187500.0	Non-residential
329	D329	563500.0	4187500.0	Residential
330	D330	563750.0	4187500.0	Residential
331	D331	564000.0	4187500.0	Residential
332	D332	564250.0	4187500.0	Residential
333	D333	564500.0	4187500.0	Residential
334	D334	564750.0	4187500.0	Residential
335	D335	565000.0	4187500.0	Residential
336	D336	559000.0	4187750.0	Non-residential
337	D337	559250.0	4187750.0	Non-residential
338	D338	559500.0	4187750.0	Non-residential
339	D339	559750.0	4187750.0	Non-residential
340	D340	560000.0	4187750.0	Non-residential
341	D341	560250.0	4187750.0	Non-residential
342	D342	560500.0	4187750.0	Non-residential
343	D343	560750.0	4187750.0	Non-residential
344	D344	561000.0	4187750.0	Non-residential
345	D345	561250.0	4187750.0	Non-residential
346	D346	561500.0	4187750.0	Non-residential
347	D347	561750.0	4187750.0	Non-residential
348	D348	562000.0	4187750.0	Non-residential
349	D349	562250.0	4187750.0	Non-residential
350	D350	562500.0	4187750.0	Non-residential
351	D351	562750.0	4187750.0	Non-residential
352	D352	563000.0	4187750.0	Non-residential
353	D353	563250.0	4187750.0	Residential
354	D354	563500.0	4187750.0	Residential
355	D355	563750.0	4187750.0	Residential
356	D356	564000.0	4187750.0	Residential

HARP Rec Index	HARP Rec ID	UTM X (m)	UTM Y (m)	Residential or Non-residential
357	D357	564250.0	4187750.0	Residential
358	D358	564500.0	4187750.0	Residential
359	D359	564750.0	4187750.0	Residential
360	D360	565000.0	4187750.0	Residential
361	D361	561961.8	4184463.5	Residential
362	D362	562011.8	4184463.5	Residential
363	D363	562061.8	4184463.5	Residential
364	D364	562111.8	4184463.5	Residential
365	D365	561811.8	4184513.5	Residential
366	D366	561861.8	4184513.5	Residential
367	D367	561911.8	4184513.5	Residential
368	D368	561961.8	4184513.5	Residential
369	D369	562011.8	4184513.5	Residential
370	D370	562061.8	4184513.5	Residential
371	D371	562111.8	4184513.5	Residential
372	D372	561661.8	4184563.5	Residential
373	D373	561711.8	4184563.5	Residential
374	D374	561761.8	4184563.5	Residential
375	D375	561811.8	4184563.5	Residential
376	D376	561861.8	4184563.5	Residential
377	D377	561911.8	4184563.5	Residential
378	D378	561961.8	4184563.5	Residential
379	D379	562011.8	4184563.5	Residential
380	D380	562061.8	4184563.5	Residential
381	D381	562111.8	4184563.5	Residential
382	D382	562161.8	4184563.5	Residential
383	D383	561511.8	4184613.5	Residential
384	D384	561561.8	4184613.5	Residential
385	D385	561611.8	4184613.5	Residential
386	D386	561661.8	4184613.5	Residential
387	D387	561711.8	4184613.5	Residential
388	D388	561761.8	4184613.5	Residential
389	D389	561811.8	4184613.5	Residential
390	D390	561861.8	4184613.5	Residential
391	D391	561911.8	4184613.5	Residential
392	D392	561961.8	4184613.5	Residential
393	D393	562011.8	4184613.5	Residential
394	D394	562061.8	4184613.5	Residential
395	D395	562111.8	4184613.5	Residential
396	D396	562161.8	4184613.5	Residential
397	D397	561361.8	4184663.5	Residential
398	D398	561411.8	4184663.5	Residential
399	D399	561461.8	4184663.5	Residential
400	D400	561511.8	4184663.5	Residential
401	D401	561561.8	4184663.5	Residential

HARP Rec Index	HARP Rec ID	UTM X (m)	UTM Y (m)	Residential or Non-residential
402	D402	561611.8	4184663.5	Residential
403	D403	561661.8	4184663.5	Residential
404	D404	561711.8	4184663.5	Residential
405	D405	561761.8	4184663.5	Residential
406	D406	561811.8	4184663.5	Residential
407	D407	561861.8	4184663.5	Residential
408	D408	561911.8	4184663.5	Residential
409	D409	561961.8	4184663.5	Residential
410	D410	562011.8	4184663.5	Residential
411	D411	562061.8	4184663.5	Residential
412	D412	562111.8	4184663.5	Residential
413	D413	562161.8	4184663.5	Residential
414	D414	561311.8	4184713.5	Residential
415	D415	561361.8	4184713.5	Residential
416	D416	561411.8	4184713.5	Residential
417	D417	561461.8	4184713.5	Residential
418	D418	561511.8	4184713.5	Residential
419	D419	561561.8	4184713.5	Residential
420	D420	561611.8	4184713.5	Residential
421	D421	561661.8	4184713.5	Residential
422	D422	561711.8	4184713.5	Residential
423	D423	561761.8	4184713.5	Residential
424	D424	561811.8	4184713.5	Residential
425	D425	561861.8	4184713.5	Residential
426	D426	561911.8	4184713.5	Residential
427	D427	561961.8	4184713.5	Residential
428	D428	562011.8	4184713.5	Residential
429	D429	562061.8	4184713.5	Residential
430	D430	562111.8	4184713.5	Residential
431	D431	562161.8	4184713.5	Residential
432	D432	561311.8	4184763.5	Residential
433	D433	561361.8	4184763.5	Residential
434	D434	561411.8	4184763.5	Residential
435	D435	561461.8	4184763.5	Residential
436	D436	561511.8	4184763.5	Residential
437	D437	561561.8	4184763.5	Residential
438	D438	561611.8	4184763.5	Residential
439	D439	561661.8	4184763.5	Residential
440	D440	561711.8	4184763.5	Residential
441	D441	561761.8	4184763.5	Residential
442	D442	561811.8	4184763.5	Residential
443	D443	561861.8	4184763.5	Residential
444	D444	561911.8	4184763.5	Residential
445	D445	561961.8	4184763.5	Residential
446	D446	562011.8	4184763.5	Residential

HARP Rec Index	HARP Rec ID	UTM X (m)	UTM Y (m)	Residential or Non-residential
447	D447	562061.8	4184763.5	Residential
448	D448	562111.8	4184763.5	Residential
449	D449	562161.8	4184763.5	Residential
450	D450	562211.8	4184763.5	Residential
451	D451	561311.8	4184813.5	Residential
452	D452	561361.8	4184813.5	Residential
453	D453	561411.8	4184813.5	Residential
454	D454	561461.8	4184813.5	Residential
455	D455	561511.8	4184813.5	Residential
456	D456	561561.8	4184813.5	Residential
457	D457	561611.8	4184813.5	Residential
458	D458	561661.8	4184813.5	Residential
459	D459	561711.8	4184813.5	Residential
460	D460	561761.8	4184813.5	Residential
461	D461	561811.8	4184813.5	Residential
462	D462	561861.8	4184813.5	Residential
463	D463	561911.8	4184813.5	Residential
464	D464	561961.8	4184813.5	Residential
465	D465	562011.8	4184813.5	Residential
466	D466	562061.8	4184813.5	Residential
467	D467	562111.8	4184813.5	Residential
468	D468	562161.8	4184813.5	Residential
469	D469	562211.8	4184813.5	Residential
470	D470	561311.8	4184863.5	Residential
471	D471	561361.8	4184863.5	Residential
472	D472	561411.8	4184863.5	Residential
473	D473	561461.8	4184863.5	Residential
474	D474	561511.8	4184863.5	Residential
475	D475	561561.8	4184863.5	Residential
476	D476	561611.8	4184863.5	Residential
477	D477	561661.8	4184863.5	Residential
478	D478	561711.8	4184863.5	Residential
479	D479	561761.8	4184863.5	Residential
480	D480	561811.8	4184863.5	Residential
481	D481	561861.8	4184863.5	Residential
482	D482	561911.8	4184863.5	Residential
483	D483	561961.8	4184863.5	Residential
484	D484	562011.8	4184863.5	Residential
485	D485	562061.8	4184863.5	Residential
486	D486	562111.8	4184863.5	Residential
487	D487	562161.8	4184863.5	Residential
488	D488	562211.8	4184863.5	Residential
489	D489	561311.8	4184913.5	Residential
490	D490	561361.8	4184913.5	Residential
491	D491	561411.8	4184913.5	Residential

HARP Rec Index	HARP Rec ID	UTM X (m)	UTM Y (m)	Residential or Non-residential
492	D492	561461.8	4184913.5	Residential
493	D493	561511.8	4184913.5	Residential
494	D494	561561.8	4184913.5	Residential
495	D495	561611.8	4184913.5	Residential
496	D496	561661.8	4184913.5	Residential
497	D497	561711.8	4184913.5	Residential
498	D498	561761.8	4184913.5	Residential
499	D499	561811.8	4184913.5	Residential
500	D500	561861.8	4184913.5	Residential
501	D501	561911.8	4184913.5	Residential
502	D502	561961.8	4184913.5	Residential
503	D503	562011.8	4184913.5	Residential
504	D504	562061.8	4184913.5	Residential
505	D505	562111.8	4184913.5	Residential
506	D506	562161.8	4184913.5	Residential
507	D507	562211.8	4184913.5	Residential
508	D508	562261.8	4184913.5	Residential
509	D509	561311.8	4184963.5	Residential
510	D510	561361.8	4184963.5	Residential
511	D511	561411.8	4184963.5	Residential
512	D512	561461.8	4184963.5	Residential
513	D513	561511.8	4184963.5	Residential
514	D514	561561.8	4184963.5	Residential
515	D515	561611.8	4184963.5	Residential
516	D516	561661.8	4184963.5	Residential
517	D517	561711.8	4184963.5	Residential
518	D518	561761.8	4184963.5	Residential
519	D519	561811.8	4184963.5	Residential
520	D520	561861.8	4184963.5	Residential
521	D521	561911.8	4184963.5	Residential
522	D522	561961.8	4184963.5	Residential
523	D523	562011.8	4184963.5	Residential
524	D524	562061.8	4184963.5	Residential
525	D525	562111.8	4184963.5	Residential
526	D526	562161.8	4184963.5	Residential
527	D527	562211.8	4184963.5	Residential
528	D528	562261.8	4184963.5	Residential
529	D529	561311.8	4185013.5	Residential
530	D530	561361.8	4185013.5	Residential
531	D531	561411.8	4185013.5	Residential
532	D532	561461.8	4185013.5	Residential
533	D533	561511.8	4185013.5	Residential
534	D534	561561.8	4185013.5	Residential
535	D535	561611.8	4185013.5	Residential
536	D536	561661.8	4185013.5	Residential

HARP Rec Index	HARP Rec ID	UTM X (m)	UTM Y (m)	Residential or Non-residential
537	D537	561711.8	4185013.5	Residential
538	D538	561761.8	4185013.5	Residential
539	D539	561811.8	4185013.5	Residential
540	D540	561861.8	4185013.5	Residential
541	D541	561911.8	4185013.5	Residential
542	D542	561961.8	4185013.5	Residential
543	D543	562011.8	4185013.5	Residential
544	D544	562061.8	4185013.5	Residential
545	D545	562111.8	4185013.5	Residential
546	D546	562161.8	4185013.5	Residential
547	D547	562211.8	4185013.5	Residential
548	D548	562261.8	4185013.5	Residential
549	D549	561311.8	4185063.5	Residential
550	D550	561361.8	4185063.5	Residential
551	D551	561411.8	4185063.5	Residential
552	D552	561461.8	4185063.5	Residential
553	D553	561511.8	4185063.5	Residential
554	D554	561561.8	4185063.5	Residential
555	D555	561611.8	4185063.5	Residential
556	D556	561661.8	4185063.5	Residential
557	D557	561711.8	4185063.5	Residential
558	D558	561761.8	4185063.5	Residential
559	D559	561811.8	4185063.5	Residential
560	D560	561861.8	4185063.5	Residential
561	D561	561911.8	4185063.5	Residential
562	D562	561961.8	4185063.5	Residential
563	D563	562011.8	4185063.5	Residential
564	D564	562061.8	4185063.5	Residential
565	D565	562111.8	4185063.5	Residential
566	D566	562161.8	4185063.5	Residential
567	D567	562211.8	4185063.5	Residential
568	D568	562261.8	4185063.5	Residential
569	D569	561361.8	4185113.5	Residential
570	D570	561411.8	4185113.5	Residential
571	D571	561461.8	4185113.5	Residential
572	D572	561511.8	4185113.5	Residential
573	D573	561561.8	4185113.5	Residential
574	D574	561611.8	4185113.5	Residential
575	D575	561661.8	4185113.5	Residential
576	D576	561711.8	4185113.5	Residential
577	D577	561761.8	4185113.5	Residential
578	D578	561811.8	4185113.5	Residential
579	D579	561861.8	4185113.5	Residential
580	D580	561911.8	4185113.5	Residential
581	D581	561961.8	4185113.5	Residential

HARP Rec Index	HARP Rec ID	UTM X (m)	UTM Y (m)	Residential or Non-residential
582	D582	562011.8	4185113.5	Residential
583	D583	562061.8	4185113.5	Residential
584	D584	562111.8	4185113.5	Residential
585	D585	562161.8	4185113.5	Residential
586	D586	562211.8	4185113.5	Residential
587	D587	562261.8	4185113.5	Residential
588	D588	562311.8	4185113.5	Residential
589	D589	561361.8	4185163.5	Residential
590	D590	561411.8	4185163.5	Residential
591	D591	561461.8	4185163.5	Residential
592	D592	561511.8	4185163.5	Residential
593	D593	561561.8	4185163.5	Residential
594	D594	561611.8	4185163.5	Residential
595	D595	561661.8	4185163.5	Residential
596	D596	561711.8	4185163.5	Residential
597	D597	561761.8	4185163.5	Residential
598	D598	561811.8	4185163.5	Residential
599	D599	561861.8	4185163.5	Residential
600	D600	561911.8	4185163.5	Residential
601	D601	561961.8	4185163.5	Residential
602	D602	562011.8	4185163.5	Residential
603	D603	562061.8	4185163.5	Residential
604	D604	562111.8	4185163.5	Residential
605	D605	562161.8	4185163.5	Residential
606	D606	562211.8	4185163.5	Residential
607	D607	562261.8	4185163.5	Residential
608	D608	562311.8	4185163.5	Residential
609	D609	561411.8	4185213.5	Residential
610	D610	561461.8	4185213.5	Residential
611	D611	561511.8	4185213.5	Residential
612	D612	561561.8	4185213.5	Residential
613	D613	561611.8	4185213.5	Residential
614	D614	561661.8	4185213.5	Residential
615	D615	561711.8	4185213.5	Residential
616	D616	561761.8	4185213.5	Residential
617	D617	561811.8	4185213.5	Residential
618	D618	561861.8	4185213.5	Residential
619	D619	561911.8	4185213.5	Residential
620	D620	561961.8	4185213.5	Residential
621	D621	562011.8	4185213.5	Residential
622	D622	562061.8	4185213.5	Residential
623	D623	562111.8	4185213.5	Residential
624	D624	562161.8	4185213.5	Residential
625	D625	562211.8	4185213.5	Residential
626	D626	562261.8	4185213.5	Residential

HARP Rec Index	HARP Rec ID	UTM X (m)	UTM Y (m)	Residential or Non-residential
627	D627	562311.8	4185213.5	Residential
628	D628	561461.8	4185263.5	Residential
629	D629	561511.8	4185263.5	Residential
630	D630	561561.8	4185263.5	Residential
631	D631	561611.8	4185263.5	Residential
632	D632	561661.8	4185263.5	Residential
633	D633	561711.8	4185263.5	Residential
634	D634	561761.8	4185263.5	Residential
635	D635	561811.8	4185263.5	Residential
636	D636	561861.8	4185263.5	Residential
637	D637	561911.8	4185263.5	Residential
638	D638	561961.8	4185263.5	Residential
639	D639	562011.8	4185263.5	Residential
640	D640	562061.8	4185263.5	Residential
641	D641	562111.8	4185263.5	Residential
642	D642	562161.8	4185263.5	Residential
643	D643	562211.8	4185263.5	Residential
644	D644	562261.8	4185263.5	Residential
645	D645	562311.8	4185263.5	Residential
646	D646	562361.8	4185263.5	Residential
647	D647	561511.8	4185313.5	Residential
648	D648	561561.8	4185313.5	Residential
649	D649	561611.8	4185313.5	Residential
650	D650	561661.8	4185313.5	Residential
651	D651	561711.8	4185313.5	Residential
652	D652	561761.8	4185313.5	Residential
653	D653	561811.8	4185313.5	Residential
654	D654	561861.8	4185313.5	Residential
655	D655	561911.8	4185313.5	Residential
656	D656	561961.8	4185313.5	Residential
657	D657	562011.8	4185313.5	Residential
658	D658	562061.8	4185313.5	Residential
659	D659	562111.8	4185313.5	Residential
660	D660	562161.8	4185313.5	Residential
661	D661	562211.8	4185313.5	Residential
662	D662	562261.8	4185313.5	Residential
663	D663	562311.8	4185313.5	Residential
664	D664	562361.8	4185313.5	Residential
665	D665	561561.8	4185363.5	Residential
666	D666	561611.8	4185363.5	Residential
667	D667	561661.8	4185363.5	Residential
668	D668	561711.8	4185363.5	Residential
669	D669	561761.8	4185363.5	Residential
670	D670	561811.8	4185363.5	Residential
671	D671	561861.8	4185363.5	Residential

HARP Rec Index	HARP Rec ID	UTM X (m)	UTM Y (m)	Residential or Non-residential
672	D672	561911.8	4185363.5	Residential
673	D673	561961.8	4185363.5	Residential
674	D674	562011.8	4185363.5	Residential
675	D675	562061.8	4185363.5	Residential
676	D676	562111.8	4185363.5	Residential
677	D677	562161.8	4185363.5	Residential
678	D678	562211.8	4185363.5	Residential
679	D679	562261.8	4185363.5	Residential
680	D680	562311.8	4185363.5	Residential
681	D681	562361.8	4185363.5	Residential
682	D682	561611.8	4185413.5	Residential
683	D683	561661.8	4185413.5	Residential
684	D684	561711.8	4185413.5	Residential
685	D685	561761.8	4185413.5	Residential
686	D686	561811.8	4185413.5	Residential
687	D687	561861.8	4185413.5	Residential
688	D688	561911.8	4185413.5	Residential
689	D689	561961.8	4185413.5	Residential
690	D690	562011.8	4185413.5	Residential
691	D691	562061.8	4185413.5	Residential
692	D692	562111.8	4185413.5	Residential
693	D693	562161.8	4185413.5	Residential
694	D694	562211.8	4185413.5	Residential
695	D695	562261.8	4185413.5	Residential
696	D696	562311.8	4185413.5	Residential
697	D697	562361.8	4185413.5	Residential
698	D698	561661.8	4185463.5	Residential
699	D699	561711.8	4185463.5	Residential
700	D700	561761.8	4185463.5	Residential
701	D701	561811.8	4185463.5	Residential
702	D702	561861.8	4185463.5	Residential
703	D703	561911.8	4185463.5	Residential
704	D704	561961.8	4185463.5	Residential
705	D705	562011.8	4185463.5	Residential
706	D706	562061.8	4185463.5	Residential
707	D707	562111.8	4185463.5	Residential
708	D708	562161.8	4185463.5	Residential
709	D709	562211.8	4185463.5	Residential
710	D710	562261.8	4185463.5	Residential
711	D711	562311.8	4185463.5	Residential
712	D712	562361.8	4185463.5	Residential
713	D713	562411.8	4185463.5	Residential
714	D714	561711.8	4185513.5	Residential
715	D715	561761.8	4185513.5	Residential
716	D716	561811.8	4185513.5	Residential

HARP Rec Index	HARP Rec ID	UTM X (m)	UTM Y (m)	Residential or Non-residential
717	D717	561861.8	4185513.5	Residential
718	D718	561911.8	4185513.5	Residential
719	D719	561961.8	4185513.5	Residential
720	D720	562011.8	4185513.5	Residential
721	D721	562061.8	4185513.5	Residential
722	D722	562111.8	4185513.5	Residential
723	D723	562161.8	4185513.5	Residential
724	D724	562211.8	4185513.5	Residential
725	D725	562261.8	4185513.5	Residential
726	D726	562311.8	4185513.5	Residential
727	D727	562361.8	4185513.5	Residential
728	D728	562411.8	4185513.5	Residential
729	D729	561761.8	4185563.5	Residential
730	D730	561811.8	4185563.5	Residential
731	D731	561861.8	4185563.5	Residential
732	D732	561911.8	4185563.5	Residential
733	D733	561961.8	4185563.5	Residential
734	D734	562011.8	4185563.5	Residential
735	D735	562061.8	4185563.5	Residential
736	D736	562111.8	4185563.5	Residential
737	D737	562161.8	4185563.5	Residential
738	D738	562211.8	4185563.5	Residential
739	D739	562261.8	4185563.5	Residential
740	D740	562311.8	4185563.5	Residential
741	D741	562361.8	4185563.5	Residential
742	D742	562411.8	4185563.5	Residential
743	D743	561811.8	4185613.5	Residential
744	D744	561861.8	4185613.5	Residential
745	D745	561911.8	4185613.5	Residential
746	D746	561961.8	4185613.5	Residential
747	D747	562011.8	4185613.5	Residential
748	D748	562061.8	4185613.5	Residential
749	D749	562111.8	4185613.5	Residential
750	D750	562161.8	4185613.5	Residential
751	D751	562211.8	4185613.5	Residential
752	D752	562261.8	4185613.5	Residential
753	D753	562311.8	4185613.5	Residential
754	D754	562361.8	4185613.5	Residential
755	D755	561861.8	4185663.5	Residential
756	D756	561911.8	4185663.5	Residential
757	D757	561961.8	4185663.5	Residential
758	D758	562011.8	4185663.5	Residential
759	D759	562061.8	4185663.5	Residential
760	D760	562111.8	4185663.5	Residential
761	D761	562161.8	4185663.5	Residential

HARP Rec Index	HARP Rec ID	UTM X (m)	UTM Y (m)	Residential or Non-residential
762	D762	562211.8	4185663.5	Residential
763	D763	562261.8	4185663.5	Residential
764	D764	561911.8	4185713.5	Residential
765	D765	561961.8	4185713.5	Residential
766	D766	562011.8	4185713.5	Residential
767	D767	562061.8	4185713.5	Residential
768	D768	562111.8	4185713.5	Residential
769	D769	562161.8	4185713.5	Residential
770	D770	562211.8	4185713.5	Residential
771	D771	568260.0	4181646.9	Residential
772	D772	569260.0	4181646.9	Residential
773	D773	570260.0	4181646.9	Residential
774	D774	567260.0	4182646.9	Residential
775	D775	568260.0	4182646.9	Residential
776	D776	569260.0	4182646.9	Residential
777	D777	570260.0	4182646.9	Residential
778	D778	566260.0	4183646.9	Residential
779	D779	567260.0	4183646.9	Residential
780	D780	568260.0	4183646.9	Residential
781	D781	569260.0	4183646.9	Residential
782	D782	570260.0	4183646.9	Residential
783	D783	566260.0	4184646.9	Residential
784	D784	567260.0	4184646.9	Residential
785	D785	568260.0	4184646.9	Residential
786	D786	569260.0	4184646.9	Residential
787	D787	570260.0	4184646.9	Residential
788	D788	566260.0	4185646.9	Residential
789	D789	567260.0	4185646.9	Residential
790	D790	568260.0	4185646.9	Residential
791	D791	569260.0	4185646.9	Residential
792	D792	570260.0	4185646.9	Residential
793	D793	566260.0	4186646.9	Residential
794	D794	567260.0	4186646.9	Residential
795	D795	568260.0	4186646.9	Residential
796	D796	569260.0	4186646.9	Residential
797	D797	570260.0	4186646.9	Residential
798	D798	566260.0	4187646.9	Residential
799	D799	567260.0	4187646.9	Residential
800	D800	568260.0	4187646.9	Residential
801	D801	569260.0	4187646.9	Residential
802	D802	570260.0	4187646.9	Residential
803	D803	565000.0	4183750.0	Residential
804	D804	565000.0	4183500.0	Residential
805	D805	565000.0	4183250.0	Residential
806	D806	565000.0	4183000.0	Residential

HARP Rec Index	HARP Rec ID	UTM X (m)	UTM Y (m)	Residential or Non-residential
807	D807	564750.0	4183750.0	Residential
808	D808	564750.0	4183500.0	Residential
809	D809	564750.0	4183250.0	Residential
810	D810	564500.0	4183750.0	Residential
811	D811	565000.0	4183750.0	Residential
812	D812	565000.0	4183500.0	Residential
813	D813	565000.0	4183250.0	Residential
814	D814	565000.0	4183000.0	Residential
815	D815	564750.0	4183750.0	Residential
816	D816	564750.0	4183500.0	Residential
817	D817	564750.0	4183250.0	Residential
818	D818	564500.0	4183750.0	Residential
819	D819	565000.0	4183750.0	Residential
820	D820	565000.0	4183500.0	Residential
821	D821	565000.0	4183250.0	Residential
822	D822	565000.0	4183000.0	Residential
823	D823	564750.0	4183750.0	Residential
824	D824	564750.0	4183500.0	Residential
825	D825	564750.0	4183250.0	Residential
826	D826	564500.0	4183750.0	Residential
827	D827	565260.0	4184646.9	Residential
828	D828	565260.0	4185646.9	Residential
829	D829	565260.0	4186646.9	Residential
830	D830	567260.0	4180646.9	Residential
831	D831	568260.0	4180646.9	Residential
832	D832	569260.0	4180646.9	Residential
833	D833	570260.0	4180646.9	Residential
834	D834	565260.0	4187646.9	Residential
835	D835	565260.0	4183646.9	Residential
836	D836	566260.0	4182646.9	Residential
837	D837	564500.0	4183500.0	Residential
838	D838	564250.0	4183750.0	Residential
839	D839	564000.0	4183750.0	Residential
840	D840	563750.0	4183750.0	Residential
841	D841	564250.0	4183500.0	Residential
842	D842	565260.0	4182746.9	Non-residential
843	D843	567260.0	4181546.9	Residential
844	D844	560250.0	4185250.0	Non-residential
845	D845	560300.0	4185250.0	Non-residential
846	D846	560350.0	4185250.0	Non-residential
847	D847	560400.0	4185250.0	Non-residential
848	D848	560450.0	4185250.0	Non-residential
849	D849	560500.0	4185250.0	Non-residential
850	D850	560550.0	4185250.0	Non-residential
851	D851	560600.0	4185250.0	Non-residential

HARP Rec Index	HARP Rec ID	UTM X (m)	UTM Y (m)	Residential or Non-residential
852	D852	560650.0	4185250.0	Non-residential
853	D853	560700.0	4185250.0	Non-residential
854	D854	560750.0	4185250.0	Non-residential
855	D855	560800.0	4185250.0	Non-residential
856	D856	560850.0	4185250.0	Non-residential
857	D857	560900.0	4185250.0	Non-residential
858	D858	560950.0	4185250.0	Non-residential
859	D859	561000.0	4185250.0	Non-residential
860	D860	561050.0	4185250.0	Non-residential
861	D861	561100.0	4185250.0	Non-residential
862	D862	561150.0	4185250.0	Non-residential
863	D863	561200.0	4185250.0	Non-residential
864	D864	561250.0	4185250.0	Non-residential
865	D865	560250.0	4185300.0	Non-residential
866	D866	560300.0	4185300.0	Non-residential
867	D867	560350.0	4185300.0	Non-residential
868	D868	560400.0	4185300.0	Non-residential
869	D869	560450.0	4185300.0	Non-residential
870	D870	560500.0	4185300.0	Non-residential
871	D871	560550.0	4185300.0	Non-residential
872	D872	560600.0	4185300.0	Non-residential
873	D873	560650.0	4185300.0	Non-residential
874	D874	560700.0	4185300.0	Non-residential
875	D875	560750.0	4185300.0	Non-residential
876	D876	560800.0	4185300.0	Non-residential
877	D877	560850.0	4185300.0	Non-residential
878	D878	560900.0	4185300.0	Non-residential
879	D879	560950.0	4185300.0	Non-residential
880	D880	561000.0	4185300.0	Non-residential
881	D881	561050.0	4185300.0	Non-residential
882	D882	561100.0	4185300.0	Non-residential
883	D883	561150.0	4185300.0	Non-residential
884	D884	561200.0	4185300.0	Non-residential
885	D885	561250.0	4185300.0	Non-residential
886	D886	560250.0	4185350.0	Non-residential
887	D887	560300.0	4185350.0	Non-residential
888	D888	560350.0	4185350.0	Non-residential
889	D889	560400.0	4185350.0	Non-residential
890	D890	560450.0	4185350.0	Non-residential
891	D891	560500.0	4185350.0	Non-residential
892	D892	560550.0	4185350.0	Non-residential
893	D893	560600.0	4185350.0	Non-residential
894	D894	560650.0	4185350.0	Non-residential
895	D895	560700.0	4185350.0	Non-residential
896	D896	560750.0	4185350.0	Non-residential

HARP Rec Index	HARP Rec ID	UTM X (m)	UTM Y (m)	Residential or Non-residential
897	D897	560800.0	4185350.0	Non-residential
898	D898	560850.0	4185350.0	Non-residential
899	D899	560900.0	4185350.0	Non-residential
900	D900	560950.0	4185350.0	Non-residential
901	D901	561000.0	4185350.0	Non-residential
902	D902	561050.0	4185350.0	Non-residential
903	D903	561100.0	4185350.0	Non-residential
904	D904	561150.0	4185350.0	Non-residential
905	D905	561200.0	4185350.0	Non-residential
906	D906	561250.0	4185350.0	Non-residential
907	D907	560250.0	4185400.0	Non-residential
908	D908	560300.0	4185400.0	Non-residential
909	D909	560350.0	4185400.0	Non-residential
910	D910	560400.0	4185400.0	Non-residential
911	D911	560450.0	4185400.0	Non-residential
912	D912	560500.0	4185400.0	Non-residential
913	D913	560550.0	4185400.0	Non-residential
914	D914	560600.0	4185400.0	Non-residential
915	D915	560650.0	4185400.0	Non-residential
916	D916	560700.0	4185400.0	Non-residential
917	D917	560750.0	4185400.0	Non-residential
918	D918	560800.0	4185400.0	Non-residential
919	D919	560850.0	4185400.0	Non-residential
920	D920	560900.0	4185400.0	Non-residential
921	D921	560950.0	4185400.0	Non-residential
922	D922	561000.0	4185400.0	Non-residential
923	D923	561050.0	4185400.0	Non-residential
924	D924	561100.0	4185400.0	Non-residential
925	D925	561150.0	4185400.0	Non-residential
926	D926	561200.0	4185400.0	Non-residential
927	D927	561250.0	4185400.0	Non-residential
928	D928	560250.0	4185450.0	Non-residential
929	D929	560300.0	4185450.0	Non-residential
930	D930	560350.0	4185450.0	Non-residential
931	D931	560400.0	4185450.0	Non-residential
932	D932	560450.0	4185450.0	Non-residential
933	D933	560500.0	4185450.0	Non-residential
934	D934	560550.0	4185450.0	Non-residential
935	D935	560600.0	4185450.0	Non-residential
936	D936	560650.0	4185450.0	Non-residential
937	D937	560700.0	4185450.0	Non-residential
938	D938	560750.0	4185450.0	Non-residential
939	D939	560800.0	4185450.0	Non-residential
940	D940	560850.0	4185450.0	Non-residential
941	D941	560900.0	4185450.0	Non-residential

HARP Rec Index	HARP Rec ID	UTM X (m)	UTM Y (m)	Residential or Non-residential
942	D942	560950.0	4185450.0	Non-residential
943	D943	561000.0	4185450.0	Non-residential
944	D944	561050.0	4185450.0	Non-residential
945	D945	561100.0	4185450.0	Non-residential
946	D946	561150.0	4185450.0	Non-residential
947	D947	561200.0	4185450.0	Non-residential
948	D948	561250.0	4185450.0	Non-residential
949	D949	560250.0	4185500.0	Non-residential
950	D950	560300.0	4185500.0	Non-residential
951	D951	560350.0	4185500.0	Non-residential
952	D952	560400.0	4185500.0	Non-residential
953	D953	560450.0	4185500.0	Non-residential
954	D954	560500.0	4185500.0	Non-residential
955	D955	560550.0	4185500.0	Non-residential
956	D956	560600.0	4185500.0	Non-residential
957	D957	560650.0	4185500.0	Non-residential
958	D958	560700.0	4185500.0	Non-residential
959	D959	560750.0	4185500.0	Non-residential
960	D960	560800.0	4185500.0	Non-residential
961	D961	560850.0	4185500.0	Non-residential
962	D962	560900.0	4185500.0	Non-residential
963	D963	560950.0	4185500.0	Non-residential
964	D964	561000.0	4185500.0	Non-residential
965	D965	561050.0	4185500.0	Non-residential
966	D966	561100.0	4185500.0	Non-residential
967	D967	561150.0	4185500.0	Non-residential
968	D968	561200.0	4185500.0	Non-residential
969	D969	561250.0	4185500.0	Non-residential
970	D970	560250.0	4185550.0	Non-residential
971	D971	560300.0	4185550.0	Non-residential
972	D972	560350.0	4185550.0	Non-residential
973	D973	560400.0	4185550.0	Non-residential
974	D974	560450.0	4185550.0	Non-residential
975	D975	560500.0	4185550.0	Non-residential
976	D976	560550.0	4185550.0	Non-residential
977	D977	560600.0	4185550.0	Non-residential
978	D978	560650.0	4185550.0	Non-residential
979	D979	560700.0	4185550.0	Non-residential
980	D980	560750.0	4185550.0	Non-residential
981	D981	560800.0	4185550.0	Non-residential
982	D982	560850.0	4185550.0	Non-residential
983	D983	560900.0	4185550.0	Non-residential
984	D984	560950.0	4185550.0	Non-residential
985	D985	561000.0	4185550.0	Non-residential
986	D986	561050.0	4185550.0	Non-residential

HARP Rec Index	HARP Rec ID	UTM X (m)	UTM Y (m)	Residential or Non-residential
987	D987	561100.0	4185550.0	Non-residential
988	D988	561150.0	4185550.0	Non-residential
989	D989	561200.0	4185550.0	Non-residential
990	D990	561250.0	4185550.0	Non-residential
991	D991	560250.0	4185600.0	Non-residential
992	D992	560300.0	4185600.0	Non-residential
993	D993	560350.0	4185600.0	Non-residential
994	D994	560400.0	4185600.0	Non-residential
995	D995	560450.0	4185600.0	Non-residential
996	D996	560500.0	4185600.0	Non-residential
997	D997	560550.0	4185600.0	Non-residential
998	D998	560600.0	4185600.0	Non-residential
999	D999	560650.0	4185600.0	Non-residential
1000	D1000	560700.0	4185600.0	Non-residential
1001	D1001	560750.0	4185600.0	Non-residential
1002	D1002	560800.0	4185600.0	Non-residential
1003	D1003	560850.0	4185600.0	Non-residential
1004	D1004	560900.0	4185600.0	Non-residential
1005	D1005	560950.0	4185600.0	Non-residential
1006	D1006	561000.0	4185600.0	Non-residential
1007	D1007	561050.0	4185600.0	Non-residential
1008	D1008	561100.0	4185600.0	Non-residential
1009	D1009	561150.0	4185600.0	Non-residential
1010	D1010	561200.0	4185600.0	Non-residential
1011	D1011	561250.0	4185600.0	Non-residential
1012	D1012	560250.0	4185650.0	Non-residential
1013	D1013	560300.0	4185650.0	Non-residential
1014	D1014	560350.0	4185650.0	Non-residential
1015	D1015	560400.0	4185650.0	Non-residential
1016	D1016	560450.0	4185650.0	Non-residential
1017	D1017	560500.0	4185650.0	Non-residential
1018	D1018	560550.0	4185650.0	Non-residential
1019	D1019	560600.0	4185650.0	Non-residential
1020	D1020	560650.0	4185650.0	Non-residential
1021	D1021	560700.0	4185650.0	Non-residential
1022	D1022	560750.0	4185650.0	Non-residential
1023	D1023	560800.0	4185650.0	Non-residential
1024	D1024	560850.0	4185650.0	Non-residential
1025	D1025	560900.0	4185650.0	Non-residential
1026	D1026	560950.0	4185650.0	Non-residential
1027	D1027	561000.0	4185650.0	Non-residential
1028	D1028	561050.0	4185650.0	Non-residential
1029	D1029	561100.0	4185650.0	Non-residential
1030	D1030	561150.0	4185650.0	Non-residential
1031	D1031	561200.0	4185650.0	Non-residential

HARP Rec Index	HARP Rec ID	UTM X (m)	UTM Y (m)	Residential or Non-residential
1032	D1032	561250.0	4185650.0	Non-residential
1033	D1033	560250.0	4185700.0	Non-residential
1034	D1034	560300.0	4185700.0	Non-residential
1035	D1035	560350.0	4185700.0	Non-residential
1036	D1036	560400.0	4185700.0	Non-residential
1037	D1037	560450.0	4185700.0	Non-residential
1038	D1038	560500.0	4185700.0	Non-residential
1039	D1039	560550.0	4185700.0	Non-residential
1040	D1040	560600.0	4185700.0	Non-residential
1041	D1041	560650.0	4185700.0	Non-residential
1042	D1042	560700.0	4185700.0	Non-residential
1043	D1043	560750.0	4185700.0	Non-residential
1044	D1044	560800.0	4185700.0	Non-residential
1045	D1045	560850.0	4185700.0	Non-residential
1046	D1046	560900.0	4185700.0	Non-residential
1047	D1047	560950.0	4185700.0	Non-residential
1048	D1048	561000.0	4185700.0	Non-residential
1049	D1049	561050.0	4185700.0	Non-residential
1050	D1050	561100.0	4185700.0	Non-residential
1051	D1051	561150.0	4185700.0	Non-residential
1052	D1052	561200.0	4185700.0	Non-residential
1053	D1053	561250.0	4185700.0	Non-residential
1054	D1054	560250.0	4185750.0	Non-residential
1055	D1055	560300.0	4185750.0	Non-residential
1056	D1056	560350.0	4185750.0	Non-residential
1057	D1057	560400.0	4185750.0	Non-residential
1058	D1058	560450.0	4185750.0	Non-residential
1059	D1059	560500.0	4185750.0	Non-residential
1060	D1060	560550.0	4185750.0	Non-residential
1061	D1061	560600.0	4185750.0	Non-residential
1062	D1062	560900.0	4185750.0	Non-residential
1063	D1063	560950.0	4185750.0	Non-residential
1064	D1064	561000.0	4185750.0	Non-residential
1065	D1065	561050.0	4185750.0	Non-residential
1066	D1066	561100.0	4185750.0	Non-residential
1067	D1067	561150.0	4185750.0	Non-residential
1068	D1068	561200.0	4185750.0	Non-residential
1069	D1069	561250.0	4185750.0	Non-residential
1070	D1070	560250.0	4185800.0	Non-residential
1071	D1071	560300.0	4185800.0	Non-residential
1072	D1072	560350.0	4185800.0	Non-residential
1073	D1073	560400.0	4185800.0	Non-residential
1074	D1074	560450.0	4185800.0	Non-residential
1075	D1075	560900.0	4185800.0	Non-residential
1076	D1076	560950.0	4185800.0	Non-residential

HARP Rec Index	HARP Rec ID	UTM X (m)	UTM Y (m)	Residential or Non-residential
1077	D1077	561000.0	4185800.0	Non-residential
1078	D1078	561050.0	4185800.0	Non-residential
1079	D1079	561100.0	4185800.0	Non-residential
1080	D1080	561150.0	4185800.0	Non-residential
1081	D1081	561200.0	4185800.0	Non-residential
1082	D1082	561250.0	4185800.0	Non-residential
1083	D1083	560250.0	4185850.0	Non-residential
1084	D1084	560300.0	4185850.0	Non-residential
1085	D1085	560350.0	4185850.0	Non-residential
1086	D1086	560900.0	4185850.0	Non-residential
1087	D1087	560950.0	4185850.0	Non-residential
1088	D1088	561000.0	4185850.0	Non-residential
1089	D1089	561050.0	4185850.0	Non-residential
1090	D1090	561100.0	4185850.0	Non-residential
1091	D1091	561150.0	4185850.0	Non-residential
1092	D1092	561200.0	4185850.0	Non-residential
1093	D1093	561250.0	4185850.0	Non-residential
1094	D1094	560250.0	4185900.0	Non-residential
1095	D1095	560300.0	4185900.0	Non-residential
1096	D1096	560350.0	4185900.0	Non-residential
1097	D1097	560650.0	4185900.0	Non-residential
1098	D1098	560700.0	4185900.0	Non-residential
1099	D1099	560750.0	4185900.0	Non-residential
1100	D1100	560800.0	4185900.0	Non-residential
1101	D1101	560850.0	4185900.0	Non-residential
1102	D1102	560900.0	4185900.0	Non-residential
1103	D1103	560950.0	4185900.0	Non-residential
1104	D1104	561000.0	4185900.0	Non-residential
1105	D1105	561050.0	4185900.0	Non-residential
1106	D1106	561100.0	4185900.0	Non-residential
1107	D1107	561150.0	4185900.0	Non-residential
1108	D1108	561200.0	4185900.0	Non-residential
1109	D1109	561250.0	4185900.0	Non-residential
1110	D1110	560250.0	4185950.0	Non-residential
1111	D1111	560300.0	4185950.0	Non-residential
1112	D1112	560350.0	4185950.0	Non-residential
1113	D1113	560400.0	4185950.0	Non-residential
1114	D1114	560500.0	4185950.0	Non-residential
1115	D1115	560550.0	4185950.0	Non-residential
1116	D1116	560600.0	4185950.0	Non-residential
1117	D1117	560650.0	4185950.0	Non-residential
1118	D1118	560700.0	4185950.0	Non-residential
1119	D1119	560750.0	4185950.0	Non-residential
1120	D1120	560800.0	4185950.0	Non-residential
1121	D1121	560850.0	4185950.0	Non-residential

HARP Rec Index	HARP Rec ID	UTM X (m)	UTM Y (m)	Residential or Non-residential
1122	D1122	560900.0	4185950.0	Non-residential
1123	D1123	560950.0	4185950.0	Non-residential
1124	D1124	561000.0	4185950.0	Non-residential
1125	D1125	561050.0	4185950.0	Non-residential
1126	D1126	561100.0	4185950.0	Non-residential
1127	D1127	561150.0	4185950.0	Non-residential
1128	D1128	561200.0	4185950.0	Non-residential
1129	D1129	561250.0	4185950.0	Non-residential
1130	D1130	560250.0	4186000.0	Non-residential
1131	D1131	560300.0	4186000.0	Non-residential
1132	D1132	560350.0	4186000.0	Non-residential
1133	D1133	560400.0	4186000.0	Non-residential
1134	D1134	560450.0	4186000.0	Non-residential
1135	D1135	560500.0	4186000.0	Non-residential
1136	D1136	560550.0	4186000.0	Non-residential
1137	D1137	560600.0	4186000.0	Non-residential
1138	D1138	560650.0	4186000.0	Non-residential
1139	D1139	560700.0	4186000.0	Non-residential
1140	D1140	560750.0	4186000.0	Non-residential
1141	D1141	560800.0	4186000.0	Non-residential
1142	D1142	560850.0	4186000.0	Non-residential
1143	D1143	560900.0	4186000.0	Non-residential
1144	D1144	560950.0	4186000.0	Non-residential
1145	D1145	561000.0	4186000.0	Non-residential
1146	D1146	561050.0	4186000.0	Non-residential
1147	D1147	561100.0	4186000.0	Non-residential
1148	D1148	561150.0	4186000.0	Non-residential
1149	D1149	561200.0	4186000.0	Non-residential
1150	D1150	561250.0	4186000.0	Non-residential
1151	D1151	560250.0	4186050.0	Non-residential
1152	D1152	560300.0	4186050.0	Non-residential
1153	D1153	560350.0	4186050.0	Non-residential
1154	D1154	560400.0	4186050.0	Non-residential
1155	D1155	560450.0	4186050.0	Non-residential
1156	D1156	560500.0	4186050.0	Non-residential
1157	D1157	560550.0	4186050.0	Non-residential
1158	D1158	560600.0	4186050.0	Non-residential
1159	D1159	560650.0	4186050.0	Non-residential
1160	D1160	560700.0	4186050.0	Non-residential
1161	D1161	560750.0	4186050.0	Non-residential
1162	D1162	560800.0	4186050.0	Non-residential
1163	D1163	560850.0	4186050.0	Non-residential
1164	D1164	560900.0	4186050.0	Non-residential
1165	D1165	560950.0	4186050.0	Non-residential
1166	D1166	561000.0	4186050.0	Non-residential

HARP Rec Index	HARP Rec ID	UTM X (m)	UTM Y (m)	Residential or Non-residential
1167	D1167	561050.0	4186050.0	Non-residential
1168	D1168	561100.0	4186050.0	Non-residential
1169	D1169	561150.0	4186050.0	Non-residential
1170	D1170	561200.0	4186050.0	Non-residential
1171	D1171	561250.0	4186050.0	Non-residential
1172	D1172	560250.0	4186100.0	Non-residential
1173	D1173	560300.0	4186100.0	Non-residential
1174	D1174	560350.0	4186100.0	Non-residential
1175	D1175	560400.0	4186100.0	Non-residential
1176	D1176	560450.0	4186100.0	Non-residential
1177	D1177	560500.0	4186100.0	Non-residential
1178	D1178	560550.0	4186100.0	Non-residential
1179	D1179	560600.0	4186100.0	Non-residential
1180	D1180	560650.0	4186100.0	Non-residential
1181	D1181	560700.0	4186100.0	Non-residential
1182	D1182	560750.0	4186100.0	Non-residential
1183	D1183	560800.0	4186100.0	Non-residential
1184	D1184	560850.0	4186100.0	Non-residential
1185	D1185	560900.0	4186100.0	Non-residential
1186	D1186	560950.0	4186100.0	Non-residential
1187	D1187	561000.0	4186100.0	Non-residential
1188	D1188	561050.0	4186100.0	Non-residential
1189	D1189	561100.0	4186100.0	Non-residential
1190	D1190	561150.0	4186100.0	Non-residential
1191	D1191	561200.0	4186100.0	Non-residential
1192	D1192	561250.0	4186100.0	Non-residential
1193	D1193	560250.0	4186150.0	Non-residential
1194	D1194	560300.0	4186150.0	Non-residential
1195	D1195	560350.0	4186150.0	Non-residential
1196	D1196	560400.0	4186150.0	Non-residential
1197	D1197	560450.0	4186150.0	Non-residential
1198	D1198	560500.0	4186150.0	Non-residential
1199	D1199	560550.0	4186150.0	Non-residential
1200	D1200	560600.0	4186150.0	Non-residential
1201	D1201	560650.0	4186150.0	Non-residential
1202	D1202	560700.0	4186150.0	Non-residential
1203	D1203	560750.0	4186150.0	Non-residential
1204	D1204	560800.0	4186150.0	Non-residential
1205	D1205	560850.0	4186150.0	Non-residential
1206	D1206	560900.0	4186150.0	Non-residential
1207	D1207	560950.0	4186150.0	Non-residential
1208	D1208	561000.0	4186150.0	Non-residential
1209	D1209	561050.0	4186150.0	Non-residential
1210	D1210	561100.0	4186150.0	Non-residential
1211	D1211	561150.0	4186150.0	Non-residential

HARP Rec Index	HARP Rec ID	UTM X (m)	UTM Y (m)	Residential or Non-residential
1212	D1212	561200.0	4186150.0	Non-residential
1213	D1213	561250.0	4186150.0	Non-residential
1214	D1214	560250.0	4186200.0	Non-residential
1215	D1215	560300.0	4186200.0	Non-residential
1216	D1216	560350.0	4186200.0	Non-residential
1217	D1217	560400.0	4186200.0	Non-residential
1218	D1218	560450.0	4186200.0	Non-residential
1219	D1219	560500.0	4186200.0	Non-residential
1220	D1220	560550.0	4186200.0	Non-residential
1221	D1221	560600.0	4186200.0	Non-residential
1222	D1222	560650.0	4186200.0	Non-residential
1223	D1223	560700.0	4186200.0	Non-residential
1224	D1224	560750.0	4186200.0	Non-residential
1225	D1225	560800.0	4186200.0	Non-residential
1226	D1226	560850.0	4186200.0	Non-residential
1227	D1227	560900.0	4186200.0	Non-residential
1228	D1228	560950.0	4186200.0	Non-residential
1229	D1229	561000.0	4186200.0	Non-residential
1230	D1230	561050.0	4186200.0	Non-residential
1231	D1231	561100.0	4186200.0	Non-residential
1232	D1232	561150.0	4186200.0	Non-residential
1233	D1233	561200.0	4186200.0	Non-residential
1234	D1234	561250.0	4186200.0	Non-residential
1235	D1235	560250.0	4186250.0	Non-residential
1236	D1236	560300.0	4186250.0	Non-residential
1237	D1237	560350.0	4186250.0	Non-residential
1238	D1238	560400.0	4186250.0	Non-residential
1239	D1239	560450.0	4186250.0	Non-residential
1240	D1240	560500.0	4186250.0	Non-residential
1241	D1241	560550.0	4186250.0	Non-residential
1242	D1242	560600.0	4186250.0	Non-residential
1243	D1243	560650.0	4186250.0	Non-residential
1244	D1244	560700.0	4186250.0	Non-residential
1245	D1245	560750.0	4186250.0	Non-residential
1246	D1246	560800.0	4186250.0	Non-residential
1247	D1247	560850.0	4186250.0	Non-residential
1248	D1248	560900.0	4186250.0	Non-residential
1249	D1249	560950.0	4186250.0	Non-residential
1250	D1250	561000.0	4186250.0	Non-residential
1251	D1251	561050.0	4186250.0	Non-residential
1252	D1252	561100.0	4186250.0	Non-residential
1253	D1253	561150.0	4186250.0	Non-residential
1254	D1254	561200.0	4186250.0	Non-residential
1255	D1255	561250.0	4186250.0	Non-residential
1256	D1256	561300.0	4185550.0	Non-residential

HARP Rec Index	HARP Rec ID	UTM X (m)	UTM Y (m)	Residential or Non-residential
1257	D1257	561350.0	4185550.0	Non-residential
1258	D1258	561300.0	4185600.0	Non-residential
1259	D1259	561350.0	4185600.0	Non-residential
1260	D1260	561300.0	4185650.0	Non-residential
1261	D1261	561350.0	4185650.0	Non-residential
1262	D1262	561300.0	4185700.0	Non-residential
1263	D1263	561350.0	4185700.0	Non-residential
1264	D1264	561300.0	4185750.0	Non-residential
1265	D1265	561350.0	4185750.0	Non-residential
1266	D1266	561300.0	4185800.0	Non-residential
1267	D1267	561350.0	4185800.0	Non-residential
1268	D1268	561300.0	4185850.0	Non-residential
1269	D1269	561350.0	4185850.0	Non-residential
1270	D1270	561300.0	4185900.0	Non-residential
1271	D1271	561350.0	4185900.0	Non-residential
1272	D1272	560895.0	4185868.0	Boundary
1273	D1273	560884.6	4185768.5	Boundary
1274	D1274	560880.0	4185724.0	Boundary
1275	D1275	560825.1	4185730.1	Boundary
1276	D1276	560725.7	4185741.1	Boundary
1277	D1277	560626.3	4185752.2	Boundary
1278	D1278	560527.0	4185763.2	Boundary
1279	D1279	560511.0	4185765.0	Boundary
1280	D1280	560442.1	4185812.9	Boundary
1281	D1281	560360.0	4185870.0	Boundary
1282	D1282	560350.0	4185877.0	Boundary
1283	D1283	560406.7	4185944.0	Boundary
1284	D1284	560438.0	4185981.0	Boundary
1285	D1285	560463.0	4185962.0	Boundary
1286	D1286	560453.0	4185944.5	Boundary
1287	D1287	560451.0	4185941.0	Boundary
1288	D1288	560489.0	4185913.0	Boundary
1289	D1289	560537.5	4185907.6	Boundary
1290	D1290	560636.9	4185896.6	Boundary
1291	D1291	560736.3	4185885.6	Boundary
1292	D1292	560835.7	4185874.6	Boundary

Table 3: AERMOD Source Parameters - Operation

Point Sources								
AERMOD Source Group	Source Description	# of Sources	Unit Rate (g/s)	Release Height (m)	Temp (k)	Exit Velocity (m/s)	Diameter (m)	Notes
HOTELN/HOTELS	OGV hotelling	1	1.000E+00	43	618	16	0.5	Following parameters for hotelling from the San Francisco Citywide HRA (SFHRA) - Table 8
TRCKIDL	Onsite Truck Idling	1	1.000E+00	3.4	644	17.8	0.3048	Following WOCAP Table 3-2

Area Sources						
AERMOD Source Group	Source Description	Area (m ²)	Unit Rate (g/s-m ²)	Release Height (m)	Sigma-z	Notes
OGVMAN	OGV Maneuvering Inbound and Outbound	2,032,877	4.919E-07	50	11.63	Following WOCAP parameters
ASTTUGS	Assist Tugs Inbound and Outbound	2,032,877	4.919E-07	6	4.744	Following WOCAP parameters
STCKPLA	Stock Pile 1 (West)	7,854	1.273E-04	12	2.8	40' piles, default H/4.3 Sigma z
STCKPLB	Stock Pile 2 (Center)	7,854	1.273E-04	12	2.8	40' piles, default H/4.3 Sigma z
STCKPLC	Stock Pile 3 (East)	7,854	1.273E-04	12	2.8	40' piles, default H/4.3 Sigma z
TRUCKDU	Onsite Truck and Off-road Equipment Fugitive Dust (including BTW)	49,884	2.005E-05	0	1	SCAQMD LST Methodology
TRCKLD	Truck Loading	126	7.955E-03	3.4	3.16	Release heigh and Sigma-Z based on truck height from WOCAP

Table 3: AERMOD Source Parameters - Operation

Volume Sources								
AERMOD Source Group	Source Description	# of Sources	Unit Rate (g/s)	Release Height (m)	Spacing (m)	Sigma-y (m)	Sigma-z (m)	Notes
OGVPZGG	OGV - Transit Precautionary Zone to Golden Gate and return	112	8.929E-03	50	100	46.51	11.63	SFHRA - Table 8
OGVGGBB	OGV - Transit Golden Gate to Bay Bridge and return	129	7.752E-03	50	100	46.51	11.63	SFHRA - Table 8
BRGPT	Barge tugs from Treasure Island (TI) to Petaluma	341	2.933E-03	15.2	50	23.26	3.53	SFHRA - Table 8
BRGTI	Barge tugs from Oakland Terminal to TI	80	1.250E-02	15.2	50	23.26	3.53	SFHRA - Table 8
BRGSF	Barge tugs from Oakland Terminal to SF Pier 92	194	5.155E-03	15.2	50	23.26	3.53	SFHRA - Table 8
OFFR	Onsite Offroad Equipment Exhaust	110	9.091E-03	5.5	20	9.3	2.56	Release height and Sigma-z from WOCAP, spacing and sigma-y from SCAQMD LST Methodology
OFTRK	Offsite Truck and Employee Vehicles exhaust, brake and tire wear (BTW), and fugitive dust	256	3.906E-03	3.4	100	3.3	3.16	Release parameters following WOCAP on-road mobile source parameters. Release heights for sources located on roadways above grade were increased to reflect the elevated roadway.
ONTRCK	Onsite Truck running exhaust	40	2.500E-02	3.4	100	3.3	3.16	Release parameters following WOCAP on-road mobile source parameters.
HOPPER	Transfer point (TP) - Ship to Hopper and BC-01	1	1.000E+00	11	--	1.4	2.56	Elevations and specifications determined from conveyor system schematics
AGGTR1	TP - BC-01 to BC-02	1	1.000E+00	9	--	0.35	2.09	
AGGTR2	TP - BC-02 to BC-03	1	1.000E+00	12	--	0.35	2.79	
AGGTR3	TP - BC-03 to BC-04	1	1.000E+00	9	--	0.35	2.09	
AGGTR4	TP - BC-04 to BC-05	1	1.000E+00	9	--	0.35	2.09	
AGGTR5	TP - BC-05 to BC-06	1	1.000E+00	12	--	0.35	2.79	
HOPPER2	TP - Loader to Return Hopper	1	1.000E+00	1	--	1.4	0.23	
AGGTR6	TP - RBC-01 to RBC-02	1	1.000E+00	8.5	--	0.35	1.98	
AGGTR7	TP - RBC-02 to RBC-03	1	1.000E+00	13	--	0.35	3.02	
AGGTR8	TP - RBC-03 to RBC-04	1	1.000E+00	13	--	0.35	3.02	
AGGTR9	TP - RBC-04 to Barge	1	1.000E+00	13	--	0.35	3.02	

Table 4: Operation Emissions - Cancer & Chronic

AERMOD Source Group	Source Description	Pollutant	Pollutant ID	Unmitigated		Mitigated	
				lb/yr	lb/hr	lb/yr	lb/hr
AGGTR1	TP - BC-01 to BC-02	Respirable Silica	1175	5.750	1.15E-03	5.750	1.15E-03
AGGTR2	TP - BC-02 to BC-03	Respirable Silica	1175	5.750	1.15E-03	5.750	1.15E-03
AGGTR3	TP - BC-03 to BC-04	Respirable Silica	1175	5.750	1.15E-03	5.750	1.15E-03
AGGTR4	TP - BC-04 to BC-05	Respirable Silica	1175	5.750	1.15E-03	5.750	1.15E-03
AGGTR5	TP - BC-05 to BC-06	Respirable Silica	1175	5.750	1.15E-03	5.750	1.15E-03
AGGTR6	TP - RBC-01 to RBC-02	Respirable Silica	1175	3.450	6.90E-04	3.450	6.90E-04
AGGTR7	TP - RBC-02 to RBC-03	Respirable Silica	1175	3.450	6.90E-04	3.450	6.90E-04
AGGTR8	TP - RBC-03 to RBC-04	Respirable Silica	1175	3.450	6.90E-04	3.450	6.90E-04
AGGTR9	TP - RBC-04 to Barge	Respirable Silica	1175	3.450	6.90E-04	3.450	6.90E-04
HOPPER	Transfer point (TP) - Ship to Hopper and BC-01	Respirable Silica	1175	11.500	2.30E-03	11.500	2.30E-03
HOPPER2	TP - Loader to Return Hopper	Respirable Silica	1175	3.450	6.90E-04	3.450	6.90E-04
ASTTUGS	Assist Tugs Inbound and Outbound	DPM	9901	103.521	2.07E-02	103.521	2.07E-02
BRGPT	Barge tugs from Treasure Island (TI) to Petaluma	DPM	9901	162.036	3.24E-02	162.036	3.24E-02
BRGSF	Barge tugs from Oakland Terminal to SF Pier 92	DPM	9901	194.401	3.89E-02	194.401	3.89E-02
BRGTI	Barge tugs from Oakland Terminal to TI	DPM	9901	15.191	3.04E-03	15.191	3.04E-03

AERMOD Source Group	Source Description	Pollutant	Pollutant ID	Unmitigated		Mitigated	
				lb/yr	lb/hr	lb/yr	lb/hr
HOTELN/HOTELS	OGV hotelling	DPM	9901	721.129	1.44E-01	721.129	7.21E+02
		1,3-Butadiene	106990	0.076	1.52E-05	0.076	7.59E-02
		Acetaldehyde	75070	2.937	5.87E-04	2.937	2.94E+00
		Benzene	71432	0.799	1.60E-04	0.799	7.99E-01
		Ethyl Benzene	100414	0.122	2.44E-05	0.122	1.22E-01
		Formaldehyde	50000	5.878	1.18E-03	5.878	5.88E+00
		Methanol	67561	0.012	2.40E-06	0.012	1.20E-02
		MEK	78933	0.590	1.18E-04	0.590	5.90E-01
		m-Xylene	108383	0.244	4.88E-05	0.244	2.44E-01
		Naphthalene	91203	0.034	6.79E-06	0.034	3.40E-02
		Hexane	110543	0.063	1.25E-05	0.063	6.27E-02
		o-Xylene	95476	0.134	2.68E-05	0.134	1.34E-01
		Propylene	115071	1.037	2.07E-04	1.037	1.04E+00
		p-Xylene	106423	0.038	7.59E-06	0.038	3.80E-02
		Styrene	100425	0.023	4.63E-06	0.023	2.32E-02
Toluene	108883	0.588	1.18E-04	0.588	5.88E-01		
OFFR	Onsite Offroad Equipment Exhaust	DPM	9901	217.255	4.35E-02	77.839	1.56E-02
OGVPZGG	OGV - Transit PZ - GG - Inbound and Outbound	DPM	9901	364.145	7.28E-02	364.145	3.64E+02
		1,3-Butadiene	106990	0.007	1.47E-06	0.007	7.35E-03
		Acetaldehyde	75070	0.285	5.69E-05	0.285	2.85E-01
		Benzene	71432	0.077	1.55E-05	0.077	7.75E-02
		Ethyl Benzene	100414	0.012	2.36E-06	0.012	1.18E-02
		Formaldehyde	50000	0.570	1.14E-04	0.570	5.70E-01
		Methanol	67561	0.001	2.32E-07	0.001	1.16E-03
		MEK	78933	0.057	1.14E-05	0.057	5.72E-02
		m-Xylene	108383	0.024	4.73E-06	0.024	2.36E-02
		Naphthalene	91203	0.003	6.58E-07	0.003	3.29E-03
		Hexane	110543	0.006	1.22E-06	0.006	6.08E-03
		o-Xylene	95476	0.013	2.59E-06	0.013	1.30E-02
		Propylene	115071	0.101	2.01E-05	0.101	1.01E-01
		p-Xylene	106423	0.004	7.35E-07	0.004	3.68E-03
		Styrene	100425	0.002	4.49E-07	0.002	2.24E-03
Toluene	108883	0.057	1.14E-05	0.057	5.70E-02		

AERMOD Source Group	Source Description	Pollutant	Pollutant ID	Unmitigated		Mitigated	
				lb/yr	lb/hr	lb/yr	lb/hr
OGVGGBB	OGV - Transit GG - BB - Inbound and Outbound	DPM	9901	125.986	2.52E-02	125.986	1.26E+02
		1,3-Butadiene	106990	0.003	5.67E-07	0.003	2.83E-03
		Acetaldehyde	75070	0.110	2.19E-05	0.110	1.10E-01
		Benzene	71432	0.030	5.97E-06	0.030	2.98E-02
		Ethyl Benzene	100414	0.005	9.09E-07	0.005	4.55E-03
		Formaldehyde	50000	0.219	4.39E-05	0.219	2.19E-01
		Methanol	67561	0.000	8.95E-08	0.000	4.47E-04
		MEK	78933	0.022	4.40E-06	0.022	2.20E-02
		m-Xylene	108383	0.009	1.82E-06	0.009	9.11E-03
		Naphthalene	91203	0.001	2.53E-07	0.001	1.27E-03
		Hexane	110543	0.002	4.68E-07	0.002	2.34E-03
		o-Xylene	95476	0.005	9.99E-07	0.005	4.99E-03
		Propylene	115071	0.039	7.74E-06	0.039	3.87E-02
		p-Xylene	106423	0.001	2.83E-07	0.001	1.42E-03
		Styrene	100425	0.001	1.73E-07	0.001	8.65E-04
Toluene	108883	0.022	4.39E-06	0.022	2.20E-02		
OGVMAN	OGV Maneuvering Inbound and Outbound	DPM	9901	64.847	1.30E-02	64.847	6.48E+01
		1,3-Butadiene	106990	0.006	1.21E-06	0.006	6.07E-03
		Acetaldehyde	75070	0.235	4.70E-05	0.235	2.35E-01
		Benzene	71432	0.064	1.28E-05	0.064	6.40E-02
		Ethyl Benzene	100414	0.010	1.95E-06	0.010	9.75E-03
		Formaldehyde	50000	0.470	9.41E-05	0.470	4.70E-01
		Methanol	67561	0.001	1.92E-07	0.001	9.59E-04
		MEK	78933	0.047	9.44E-06	0.047	4.72E-02
		m-Xylene	108383	0.020	3.91E-06	0.020	1.95E-02
		Naphthalene	91203	0.003	5.43E-07	0.003	2.72E-03
		Hexane	110543	0.005	1.00E-06	0.005	5.02E-03
		o-Xylene	95476	0.011	2.14E-06	0.011	1.07E-02
		Propylene	115071	0.083	1.66E-05	0.083	8.30E-02
		p-Xylene	106423	0.003	6.07E-07	0.003	3.04E-03
		Styrene	100425	0.002	3.71E-07	0.002	1.85E-03
Toluene	108883	0.047	9.42E-06	0.047	4.71E-02		

AERMOD Source Group	Source Description	Pollutant	Pollutant ID	Unmitigated		Mitigated	
				lb/yr	lb/hr	lb/yr	lb/hr
ONTRCK	Onsite Truck running exhaust	DPM	9901	1.141	2.28E-04	1.141	2.28E-04
STCKPLA	Stock Pile 1 (West)	Respirable Silica	1175	98.863	1.13E-02	150.773	1.72E-02
STCKPLB	Stock Pile 2 (Center)	Respirable Silica	1175	98.863	1.13E-02	98.863	1.13E-02
STCKPLC	Stock Pile 3 (East)	Respirable Silica	1175	98.863	1.13E-02	46.954	5.36E-03
TRCKIDL	Onsite Truck Idling	DPM	9901	3.304	6.61E-04	3.304	6.61E-04
TRCKLD	Truck Loading	Respirable Silica	1175	3.450	6.90E-04	3.450	6.90E-04
TRUCKDU	Onsite Truck and Off-road Equipment Fugitive Dust (including BTW)	Respirable Silica	1175	376.806	7.54E-02	376.806	7.54E-02
OFTRK	Offsite Truck and Employee Vehicles exhaust, brake and tire wear (BTW), and fugitive dust	DPM	9901	112.496	2.25E-02	112.496	2.25E-02
		1,3-Butadiene	106990	0.011	2.13E-06	0.011	2.13E-06
		Acetaldehyde	75070	0.005	9.67E-07	0.005	9.67E-07
		Benzene	71432	0.052	1.03E-05	0.052	1.03E-05
		Ethyl Benzene	100414	0.021	4.22E-06	0.021	4.22E-06
		Formaldehyde	50000	0.033	6.65E-06	0.033	6.65E-06
		Methanol	67561	0.008	1.59E-06	0.008	1.59E-06
		MEK	78933	0.000	7.73E-08	0.000	7.73E-08
		m-Xylene	108383	0.071	1.43E-05	0.071	1.43E-05
		Naphthalene	91203	0.001	1.93E-07	0.001	1.93E-07
		Hexane	110543	0.031	6.19E-06	0.031	6.19E-06
		o-Xylene	95476	0.025	4.95E-06	0.025	4.95E-06
		Styrene	100425	0.002	4.64E-07	0.002	4.64E-07
Toluene	108883	0.115	2.30E-05	0.115	2.30E-05		

Table 5: Operation Emissions - PM2.5

AERMOD Source Group	Source Description	Pollutant	Pollutant ID	Unmitigated		Mitigated	
				lb/yr	lb/hr	lb/yr	lb/hr
AGGTR1	TP - BC-01 to BC-02	PM2.5	88101	17.250	3.45E-03	17.250	3.45E-03
AGGTR2	TP - BC-02 to BC-03	PM2.5	88101	17.250	3.45E-03	17.250	3.45E-03
AGGTR3	TP - BC-03 to BC-04	PM2.5	88101	17.250	3.45E-03	17.250	3.45E-03
AGGTR4	TP - BC-04 to BC-05	PM2.5	88101	17.250	3.45E-03	17.250	3.45E-03
AGGTR5	TP - BC-05 to BC-06	PM2.5	88101	17.250	3.45E-03	17.250	3.45E-03
AGGTR6	TP - RBC-01 to RBC-02	PM2.5	88101	10.350	2.07E-03	10.350	2.07E-03
AGGTR7	TP - RBC-02 to RBC-03	PM2.5	88101	10.350	2.07E-03	10.350	2.07E-03
AGGTR8	TP - RBC-03 to RBC-04	PM2.5	88101	10.350	2.07E-03	10.350	2.07E-03
AGGTR9	TP - RBC-04 to Barge	PM2.5	88101	10.350	2.07E-03	10.350	2.07E-03
HOPPER	Transfer point (TP) - Ship to Hopper and BC-01	PM2.5	88101	34.500	6.90E-03	34.500	6.90E-03
HOPPER2	TP - Loader to Return Hopper	PM2.5	88101	10.350	2.07E-03	10.350	2.07E-03
ASTTUGS	Assist Tugs Inbound and Outbound	PM2.5	88101	103.521	2.07E-02	103.521	2.07E-02
BRGPT	Barge tugs from Treasure Island (TI) to Petaluma	PM2.5	88101	162.036	3.24E-02	162.036	3.24E-02
BRGSF	Barge tugs from Oakland Terminal to SF Pier 92	PM2.5	88101	194.401	3.89E-02	194.401	3.89E-02
BRGTI	Barge tugs from Oakland Terminal to TI	PM2.5	88101	15.191	3.04E-03	15.191	3.04E-03
HOTELN/HOTELS	OGV hotelling	PM2.5	88101	720.497	1.44E-01	720.497	1.44E-01
OFFR	Onsite Offroad Equipment Exhaust	PM2.5	88101	199.874	4.00E-02	71.612	1.43E-02
OGVPZGG	OGV - Transit PZ - GG - Inbound and Outbound	PM2.5	88101	340.424	6.81E-02	340.424	6.81E-02
OGVGGBB	OGV - Transit GG - BB - Inbound and Outbound	PM2.5	88101	118.017	2.36E-02	118.017	2.36E-02
OGVMAN	OGV Maneuvering Inbound and Outbound	PM2.5	88101	64.224	1.28E-02	64.224	1.28E-02
ONTRCK	Onsite Truck running exhaust	PM2.5	88101	1.092	2.18E-04	1.092	2.18E-04

AERMOD Source Group	Source Description	Pollutant	Pollutant ID	Unmitigated		Mitigated	
				lb/yr	lb/hr	lb/yr	lb/hr
STCKPLA	Stock Pile 1 (West)	PM2.5	88101	298.885	3.41E-02	298.885	3.41E-02
STCKPLB	Stock Pile 2 (Center)	PM2.5	88101	298.885	3.41E-02	298.885	3.41E-02
STCKPLC	Stock Pile 3 (East)	PM2.5	88101	298.885	3.41E-02	298.885	3.41E-02
TRCKIDL	Onsite Truck Idling	PM2.5	88101	3.161	6.32E-04	3.161	6.32E-04
TRCKLD	Truck Loading	PM2.5	88101	10.350	2.07E-03	10.350	2.07E-03
TRUCKDU	Onsite Truck and Off-road Equipment Fugitive Dust (including BTW)	PM2.5	88101	1133.654	2.27E-01	1133.654	2.27E-01
OFTRK	Offsite Truck and Employee Vehicles exhaust, brake and tire wear (BTW), and fugitive dust	PM2.5	88101	345.379	6.91E-02	345.379	6.91E-02

Table 14: AERMOD Source Parameters - Construction

Area Sources						
AERMOD Source Group	Source Description	Area (m ²)	Unit Rate (g/s-m ²)	Release Height (m)	Sigma-z	Notes
DUST	Onsite Fugitive Emissions (includes Brake and Tire Wear)	57,694	1.733E-05	0	1	SCAQMD LST Methodology

Volume Sources								
AERMOD Source Group	Source Description	# of Sources	Unit Rate (g/s)	Release Height (m)	Spacing (m)	Sigma-y (m)	Sigma-z (m)	Notes
BARGE	Potential construction barge deliveries	341	2.93E-03	15.2	50	23.26	3.53	Following parameters for barge tugs from the San Francisco Citywide HRA (SFHRA) - Table 8
ORE	Onsite Equipment and Vehicle Exhaust	110	9.09E-03	5.5	20	9.3	2.56	Release height and Sigma-z from WOCAP, spacing and sigma-y from SCAQMD LST Methodology
OFTRK	Offsite Truck and Vehicles exhaust, brake and tire wear (BTW), and fugitive dust	256	3.91E-03	3.4	100	3.3	3.16	Release parameters following WOCAP on-road mobile source parameters. Release heights for sources located on roadways above grade were increased to reflect the elevated roadway.

Table 15: Construction Emissions - Cancer & Chronic

AERMOD Source Group	Source Description	Pollutant	Pollutant ID	Unmitigated		Mitigated	
				lb/yr	lb/hr	lb/yr	lb/hr
ORE	On-site equipment and vehicle exhaust	DPM	9901	510.400	1.02E-01	186.360	3.73E-02
OFTRK	Offsite Truck and Vehicles exhaust, brake and tire wear (BTW), and fugitive dust	DPM	9901	1.920	3.84E-04	1.920	3.84E-04
BARGE	Potential construction barge deliveries	DPM	9901	11.782	2.36E-03	11.782	2.36E-03

Table 16: Construction Emissions - PM2.5

AERMOD Source Group	Source Description	Pollutant	Pollutant ID	Unmitigated		Mitigated	
				lb/yr	lb/hr	lb/yr	lb/hr
ORE	On-site equipment and vehicle exhaust	PM2.5	88101	479.400	9.59E-02	172.900	3.46E-02
OFTRK	Offsite Truck and Vehicles exhaust, brake and tire wear (BTW), and fugitive dust	PM2.5	88101	23.260	4.65E-03	23.260	4.65E-03
BARGE	Potential construction barge deliveries	PM2.5	88101	11.782	2.36E-03	11.782	2.36E-03
Dust	Onsite Fugitive Emissions (includes Brake and Tire Wear)	PM2.5	88101	54.720	1.09E-02	54.720	1.09E-02

Table 24: Residential Cumulative Cancer Risk Weighting Factor Calculations

Sensitive Population Type	Age	DBR	EF	TAF	CF	A	ED	ASF	AT
Resident Child	3rd trimester	361	350	1	1.00E-06	1	0.25	10	25550
	0<2	1090	350	1	1.00E-06	1	2	10	25550
	2<16	572	350	1	1.00E-06	1	14	3	25550
Resident Adult	16<70	261	350	1	1.00E-06	1	14	1	25550

Weighting Factor	1.24E-05	
	2.99E-04	
	3.29E-04	Total Cancer
	5.01E-05	6.90E-04

Sensitive Population Type	Age	DBR	EF	TAF	CF	A	ED	ASF	AT
Resident Child	3rd trimester	361	350	1	1.00E-06	1	0	10	25550
	0<2	1090	350	1	1.00E-06	1	1.25	10	25550
	2<16	572	350	1	1.00E-06	1	14	3	25550
Resident Adult	16<70	261	350	1	1.00E-06	1	14	1	25550

Weighting Factor	0.00E+00	
	1.87E-04	
	3.29E-04	Continuous Aging Factor
	5.01E-05	5.66E-04

	Cancer Risk Separate	Weighting Factor	Cancer Risk Continuous Aging
Construction (1-Year)	1.3	1	1.3
Operation	7.2	0.82	5.9
			7.2

The continuous aging resident from construction to operation for total of 30 years is less than new resident operation for 30 years.

1. Exposure Frequency assumed 350 days per year except for school children were assumed 180 days and daycare children were assumed 250 days per year.
2. Residential exposure assumed 30 years with a continuously aging child from 3rd trimester onward from construction through operation.
3. Averaging time is based on a 70 year lifetime cancer risk.

Figures



Figure #1
Facility Location and Boundary

 Facility Boundary



Project:
Eagle Rock Aggregates
Oakland Terminal

Prepared for Draft SEIR

Maritime Street
Oakland, CA 94607



3777 Long Beach Blvd.
Long Beach, CA 90807
www.altanviron.com

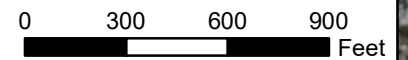

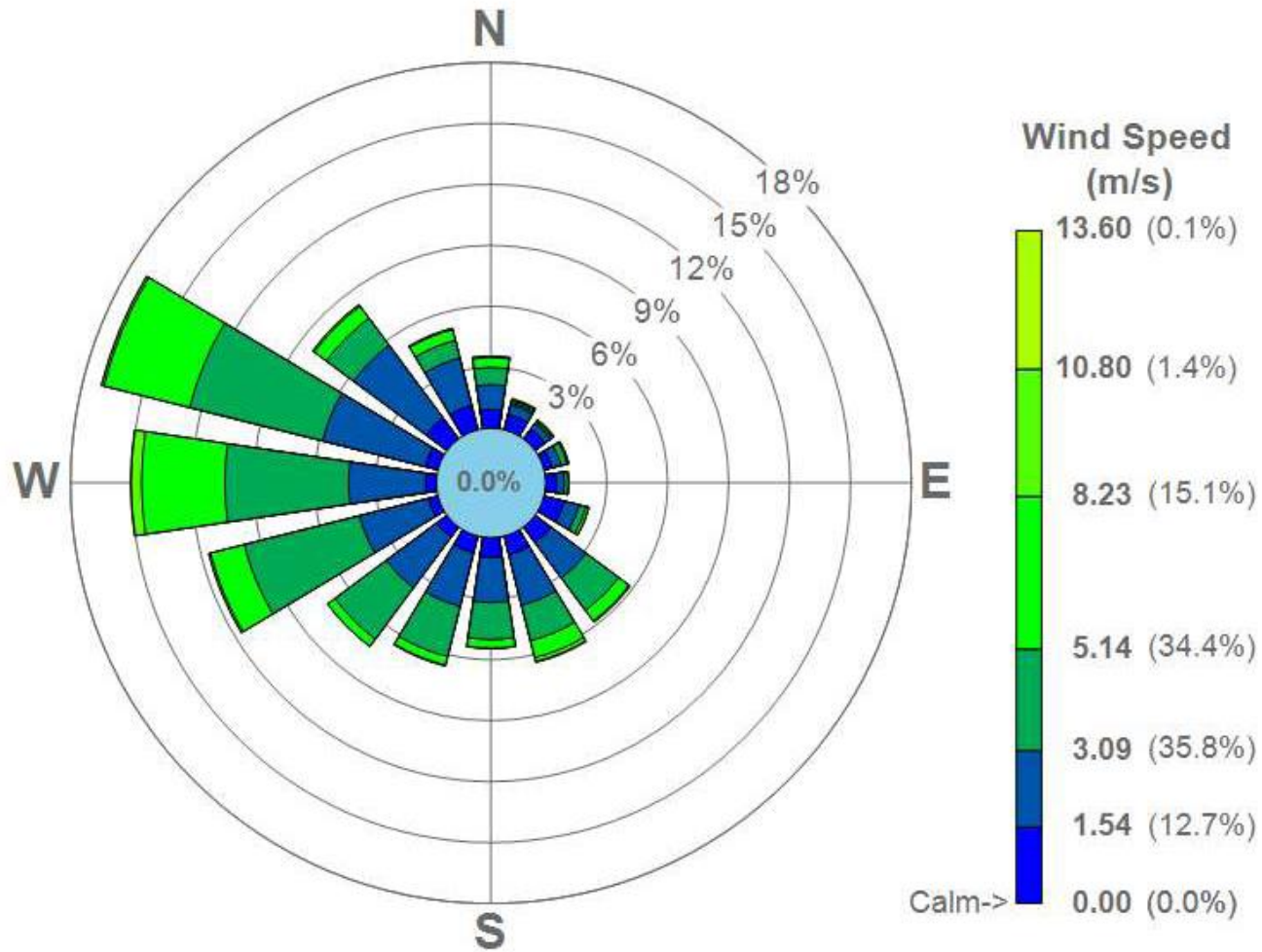



Figure #2

Project: Eagle Rock Aggregates Oakland Terminal Prepared for Draft SEIR	 ALTA ENVIRONMENTAL AN NV5 COMPANY
Maritime Street Oakland, CA 94607	3777 Long Beach Blvd. Long Beach, CA 90807 www.altaenviron.com

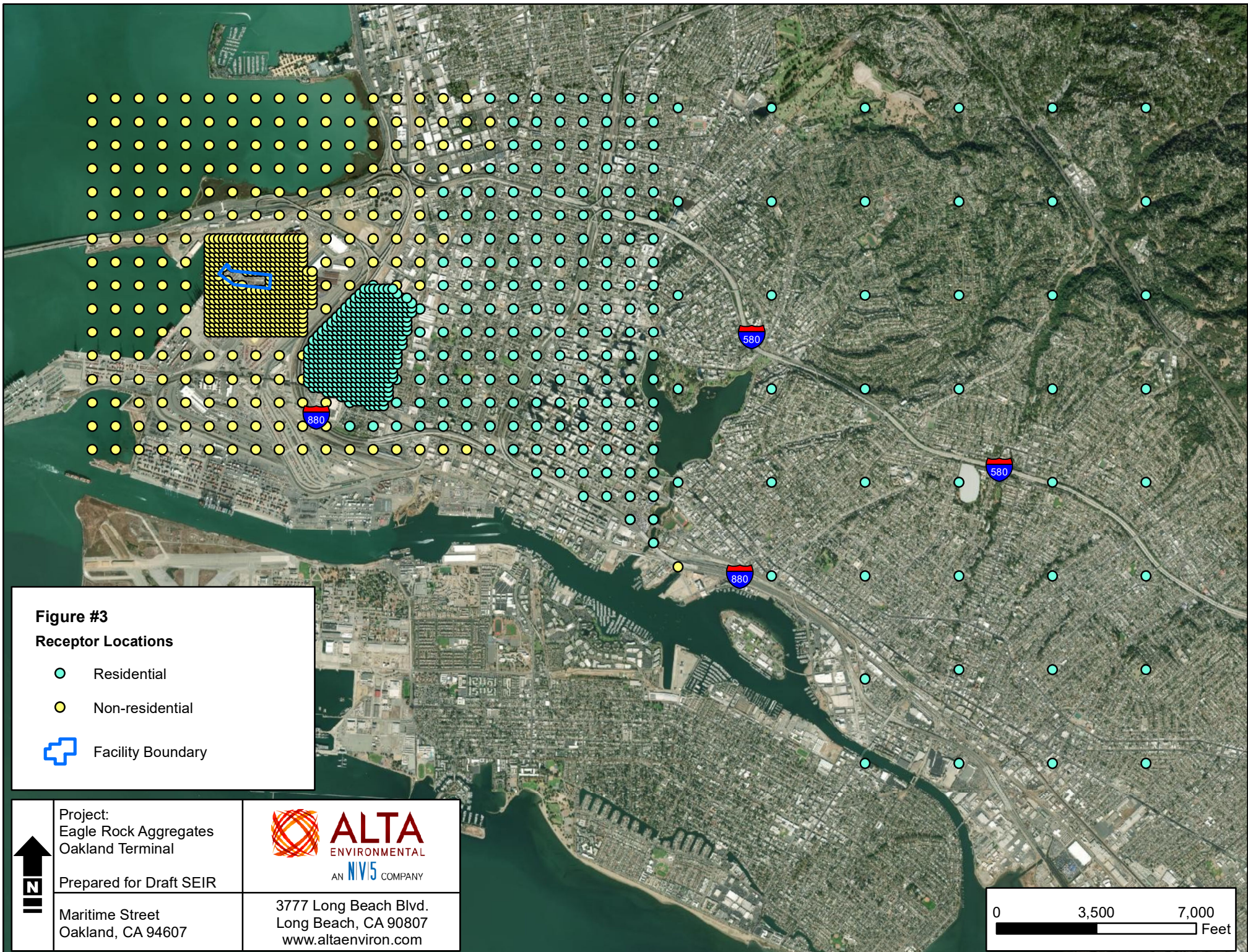

Figure #3
Receptor Locations

- Residential
- Non-residential
- ⊕ Facility Boundary



Project:
 Eagle Rock Aggregates
 Oakland Terminal

Prepared for Draft SEIR

Maritime Street
 Oakland, CA 94607



3777 Long Beach Blvd.
 Long Beach, CA 90807
 www.altaenviron.com

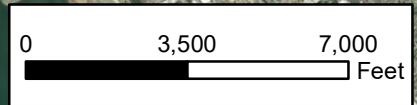

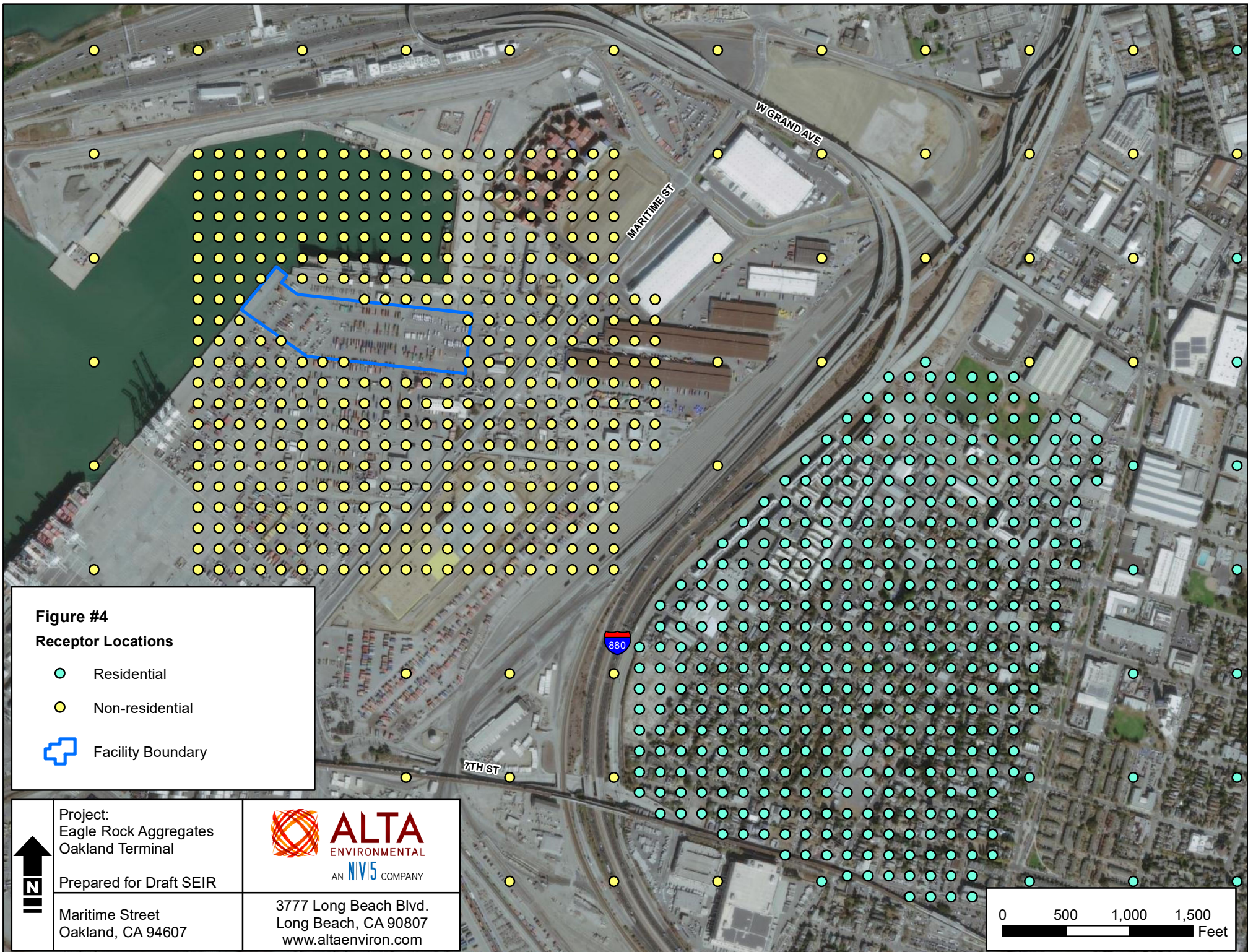



Figure #4
Receptor Locations

- Residential
- Non-residential
- Facility Boundary

 Project:
 Eagle Rock Aggregates
 Oakland Terminal
 Prepared for Draft SEIR
 Maritime Street
 Oakland, CA 94607

ALTA
 ENVIRONMENTAL
 AN **NVIS** COMPANY
 3777 Long Beach Blvd.
 Long Beach, CA 90807
www.altaenviron.com

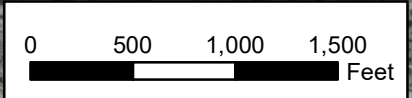
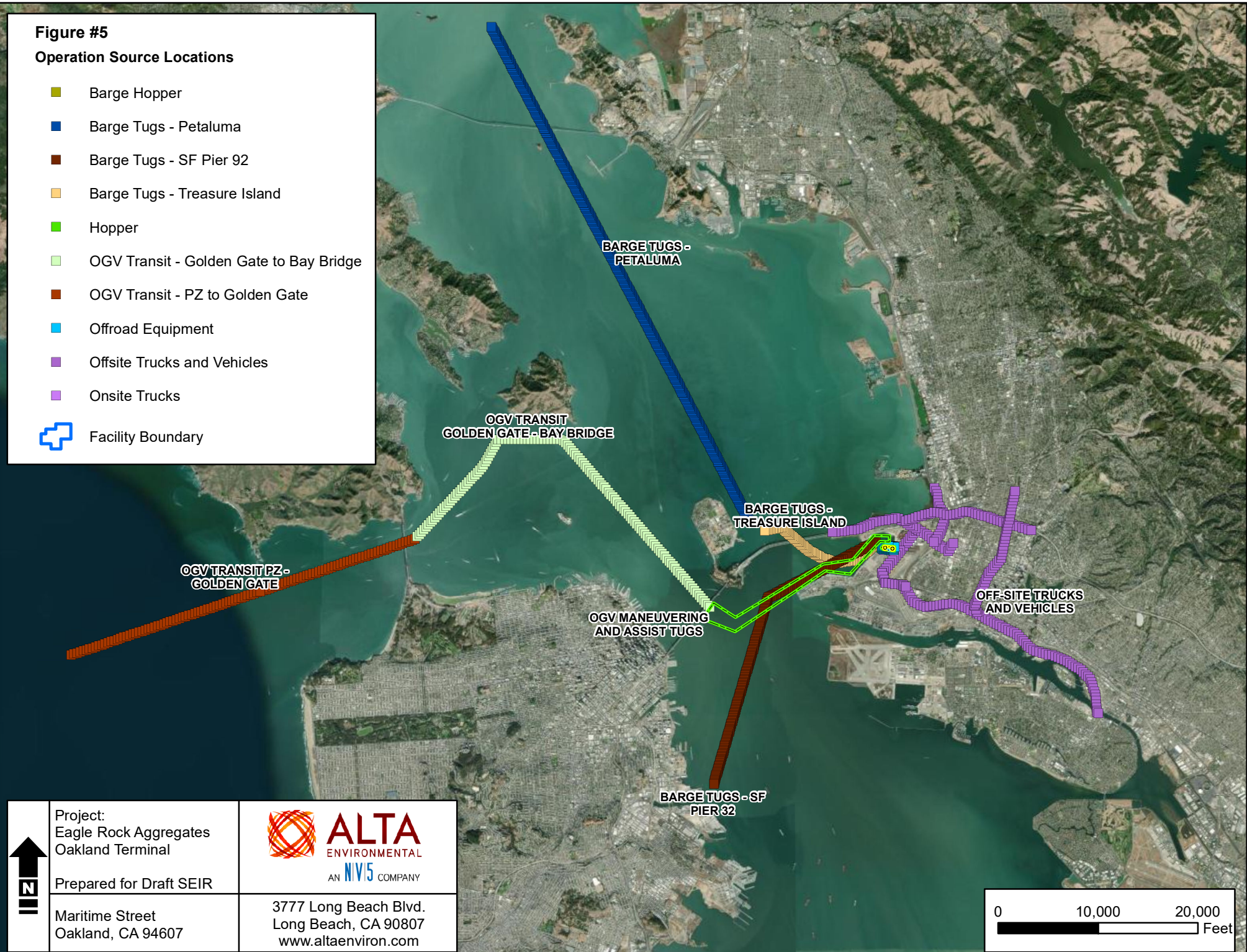

Figure #5

Operation Source Locations

- Barge Hopper
- Barge Tugs - Petaluma
- Barge Tugs - SF Pier 92
- Barge Tugs - Treasure Island
- Hopper
- OGV Transit - Golden Gate to Bay Bridge
- OGV Transit - PZ to Golden Gate
- Offroad Equipment
- Offsite Trucks and Vehicles
- Onsite Trucks
- ⊕ Facility Boundary



Project:
Eagle Rock Aggregates
Oakland Terminal

Prepared for Draft SEIR

Maritime Street
Oakland, CA 94607

 **ALTA**
ENVIRONMENTAL
AN NVIS COMPANY

3777 Long Beach Blvd.
Long Beach, CA 90807
www.altaenviron.com

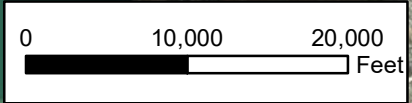





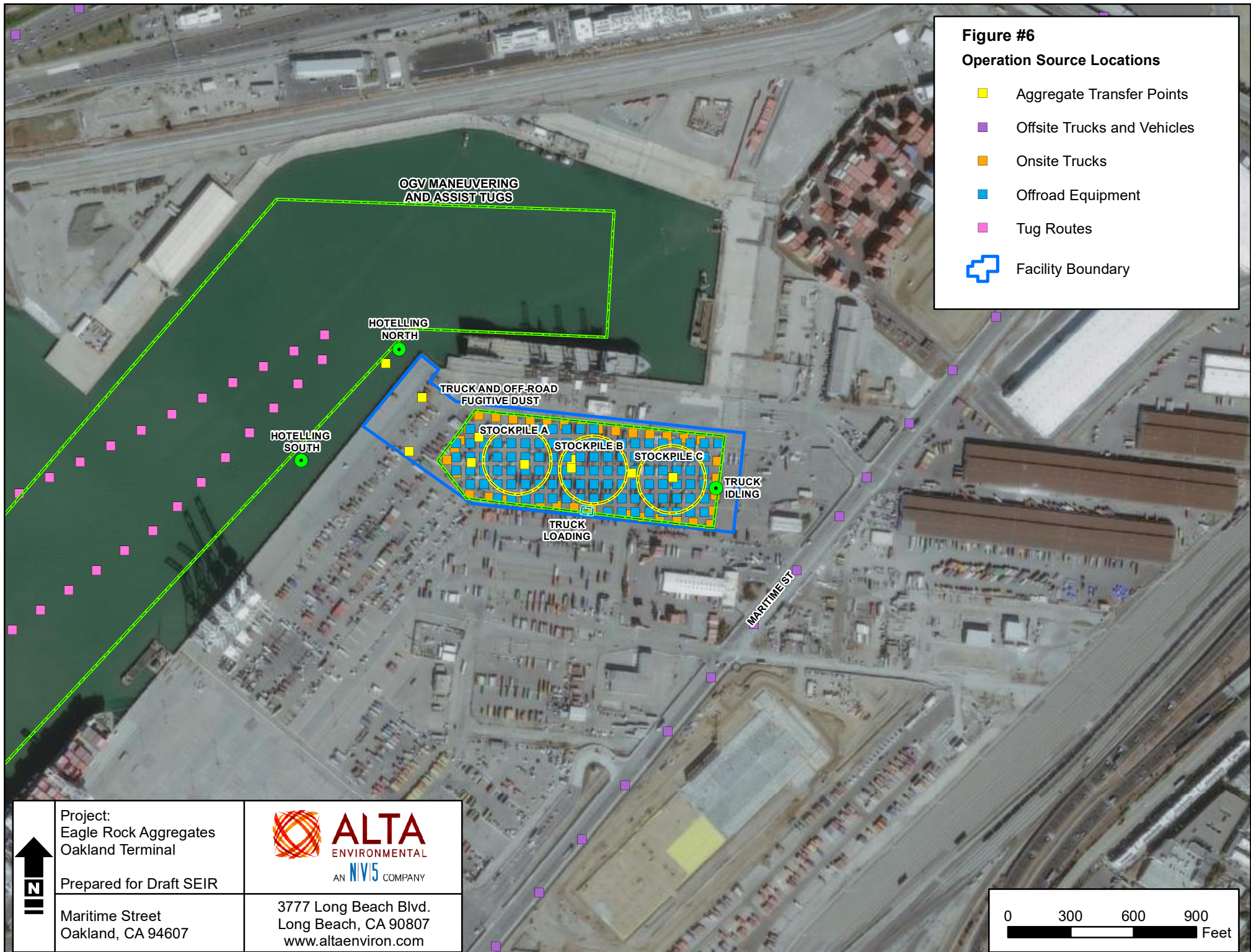

Figure #6

Operation Source Locations

-  Aggregate Transfer Points
-  Offsite Trucks and Vehicles
-  Onsite Trucks
-  Offroad Equipment
-  Tug Routes
-  Facility Boundary



Project:
Eagle Rock Aggregates
Oakland Terminal

Prepared for Draft SEIR

Maritime Street
Oakland, CA 94607

 **ALTA**
ENVIRONMENTAL
AN **NIVIS** COMPANY

3777 Long Beach Blvd.
Long Beach, CA 90807
www.altaenviron.com

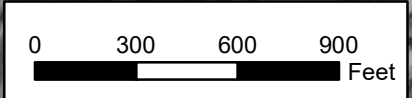

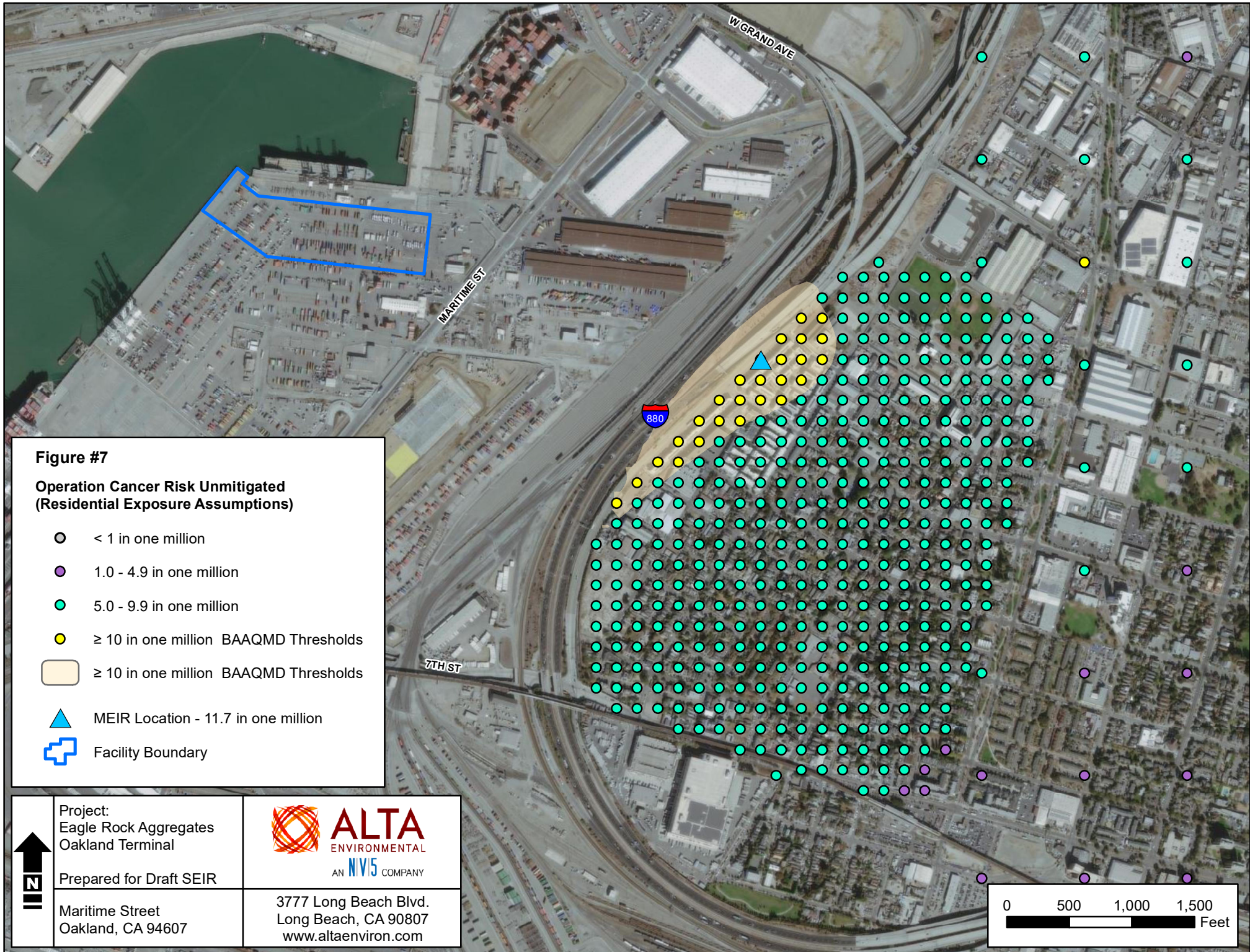

Figure #7

**Operation Cancer Risk Unmitigated
(Residential Exposure Assumptions)**

- < 1 in one million
- 1.0 - 4.9 in one million
- 5.0 - 9.9 in one million
- ≥ 10 in one million BAAQMD Thresholds
- ≥ 10 in one million BAAQMD Thresholds
- ▲ MEIR Location - 11.7 in one million
- ⊕ Facility Boundary

Project:
Eagle Rock Aggregates
Oakland Terminal

Prepared for Draft SEIR

Maritime Street
Oakland, CA 94607



3777 Long Beach Blvd.
Long Beach, CA 90807
www.altanviron.com

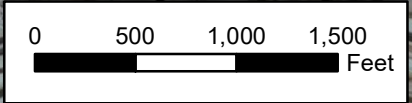

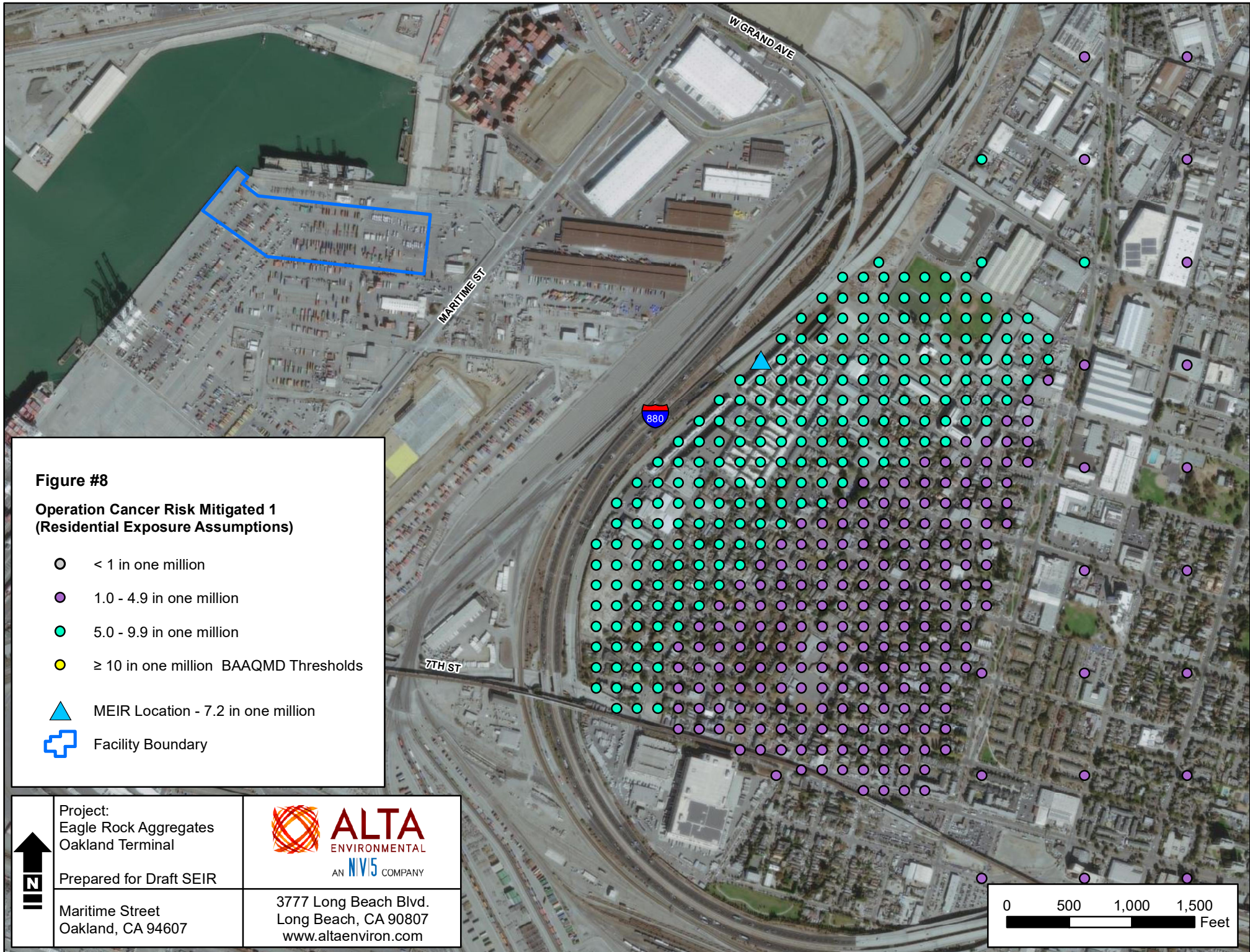



Figure #8

**Operation Cancer Risk Mitigated 1
(Residential Exposure Assumptions)**

- < 1 in one million
- 1.0 - 4.9 in one million
- 5.0 - 9.9 in one million
- ≥ 10 in one million BAAQMD Thresholds
- ▲ MEIR Location - 7.2 in one million
- Facility Boundary

 Project:
 Eagle Rock Aggregates
 Oakland Terminal
 Prepared for Draft SEIR
 Maritime Street
 Oakland, CA 94607

ALTA
 ENVIRONMENTAL
 AN NVIS COMPANY
 3777 Long Beach Blvd.
 Long Beach, CA 90807
www.altaenviron.com

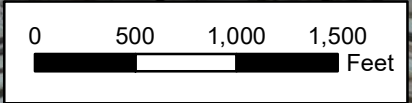

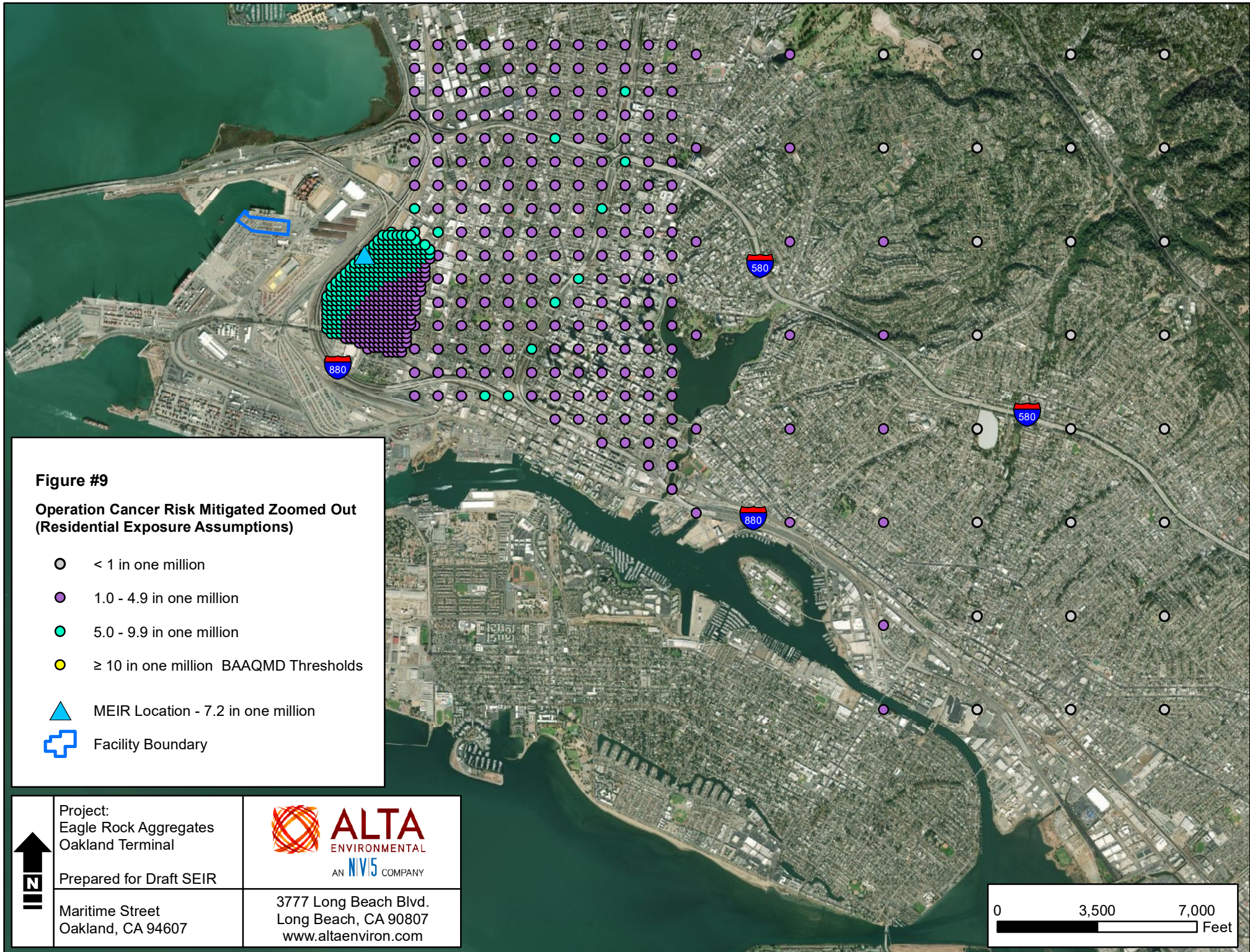

Figure #9

**Operation Cancer Risk Mitigated Zoomed Out
(Residential Exposure Assumptions)**

- < 1 in one million
- 1.0 - 4.9 in one million
- 5.0 - 9.9 in one million
- ≥ 10 in one million BAAQMD Thresholds
- ▲ MEIR Location - 7.2 in one million
- Facility Boundary



Project:
Eagle Rock Aggregates
Oakland Terminal

Prepared for Draft SEIR

Maritime Street
Oakland, CA 94607



3777 Long Beach Blvd.
Long Beach, CA 90807
www.altaenviron.com

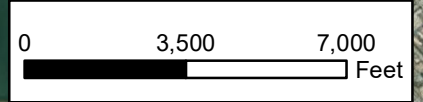





Figure #10
Operation Chronic HI (Mitigated)

- <0.50
- 0.50 - 0.99
- 1.00 - 2.99
- >3.00 BAAQMD Thresholds
- ▲ MEIR Location - 0.013
- ▲ MEIW Location - 0.129
- Facility Boundary

 Project:
 Eagle Rock Aggregates
 Oakland Terminal
 Prepared for Draft SEIR
 Maritime Street
 Oakland, CA 94607

ALTA
 ENVIRONMENTAL
 AN NVIS COMPANY
 3777 Long Beach Blvd.
 Long Beach, CA 90807
www.altanviron.com

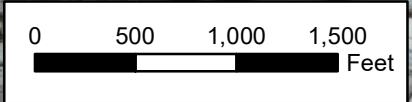





Figure #11

Operation Acute HI (Mitigated)

- <0.50
- 0.50 - 0.99
- 1.00 - 2.99
- >3.00 BAAQMD Thresholds
- ▲ MEI Location - 0.066
- Facility Boundary

 Project:
 Eagle Rock Aggregates
 Oakland Terminal
 Prepared for Draft SEIR
 Maritime Street
 Oakland, CA 94607

ALTA
 ENVIRONMENTAL
 AN NVIS COMPANY
 3777 Long Beach Blvd.
 Long Beach, CA 90807
www.altanviron.com

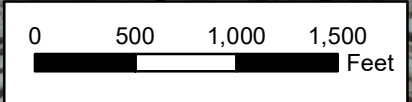

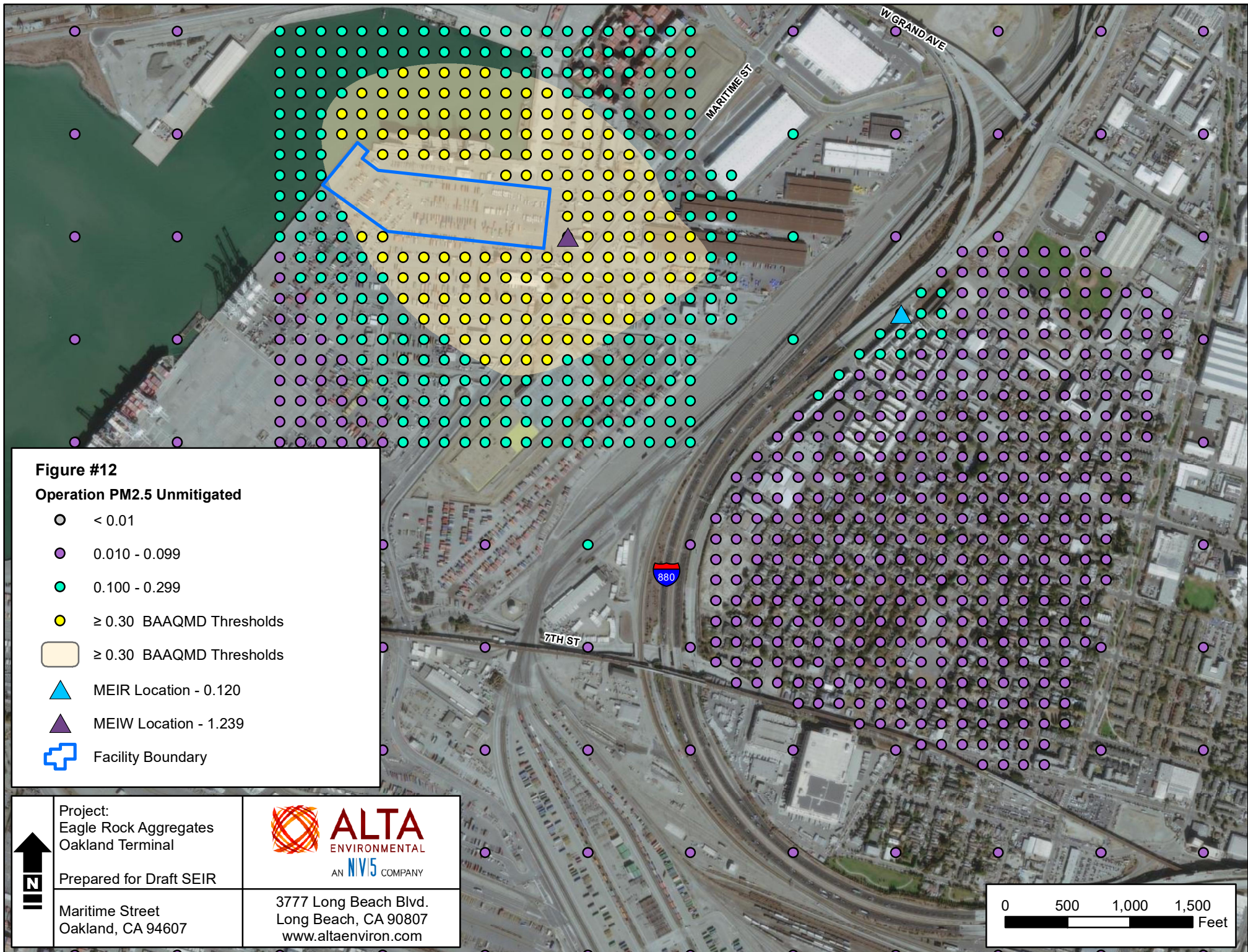

Figure #12
Operation PM2.5 Unmitigated

- < 0.01
- 0.010 - 0.099
- 0.100 - 0.299
- ≥ 0.30 BAAQMD Thresholds
- ≥ 0.30 BAAQMD Thresholds
- ▲ MEIR Location - 0.120
- ▲ MEIW Location - 1.239
- Facility Boundary

Project:
 Eagle Rock Aggregates
 Oakland Terminal

Prepared for Draft SEIR

Maritime Street
 Oakland, CA 94607

 **ALTA**
 ENVIRONMENTAL
 AN NVIS COMPANY

3777 Long Beach Blvd.
 Long Beach, CA 90807
www.altanviron.com

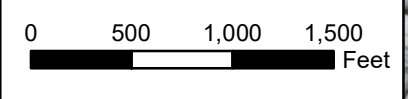

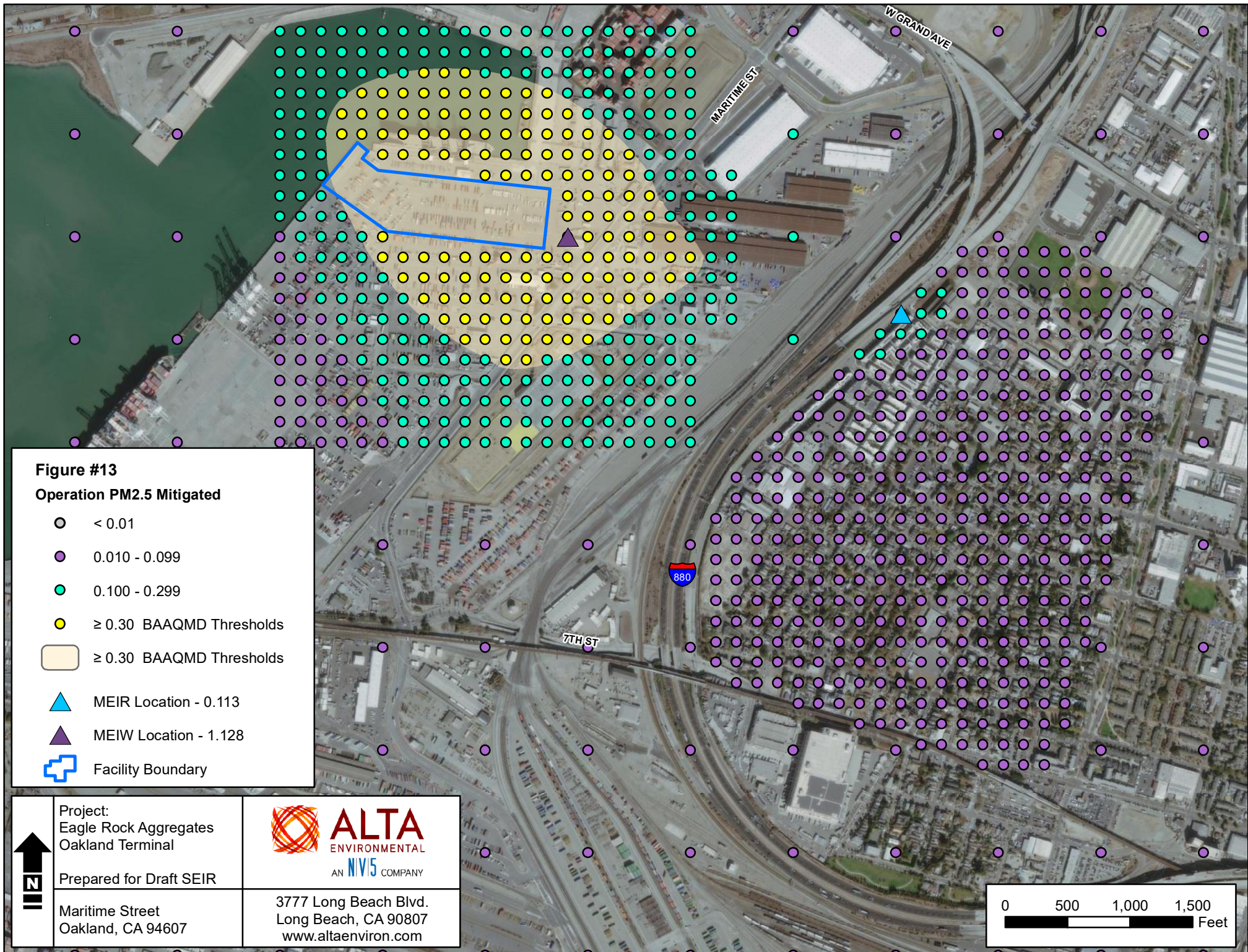

Figure #13

Operation PM2.5 Mitigated

- < 0.01
- 0.010 - 0.099
- 0.100 - 0.299
- ≥ 0.30 BAAQMD Thresholds
- ≥ 0.30 BAAQMD Thresholds
- ▲ MEIR Location - 0.113
- ▲ MEIW Location - 1.128
- Facility Boundary

 Project:
 Eagle Rock Aggregates
 Oakland Terminal
 Prepared for Draft SEIR
 Maritime Street
 Oakland, CA 94607

 **ALTA**
 ENVIRONMENTAL
 AN NVIS COMPANY
 3777 Long Beach Blvd.
 Long Beach, CA 90807
www.altanviron.com

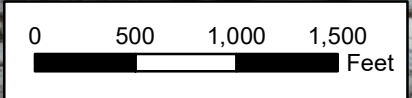

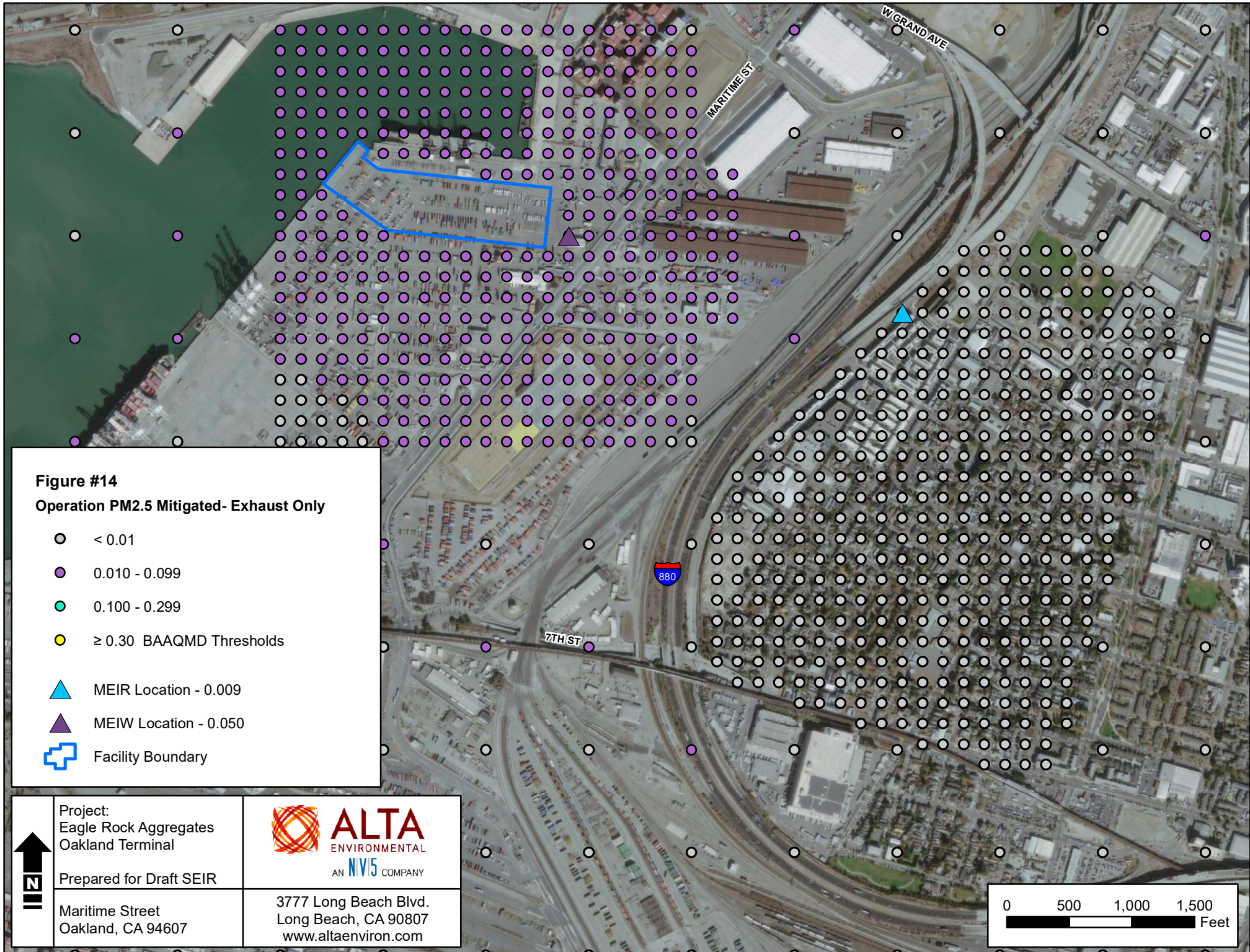



Figure #14

Operation PM2.5 Mitigated- Exhaust Only

- < 0.01
- 0.010 - 0.099
- 0.100 - 0.299
- ≥ 0.30 BAAQMD Thresholds
- ▲ MEIR Location - 0.009
- ▲ MEIW Location - 0.050
- Facility Boundary

 Project:
 Eagle Rock Aggregates
 Oakland Terminal
 Prepared for Draft SEIR
 Maritime Street
 Oakland, CA 94607



3777 Long Beach Blvd.
 Long Beach, CA 90807
www.altaenviron.com

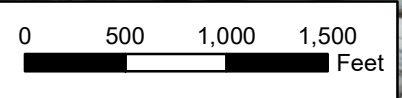

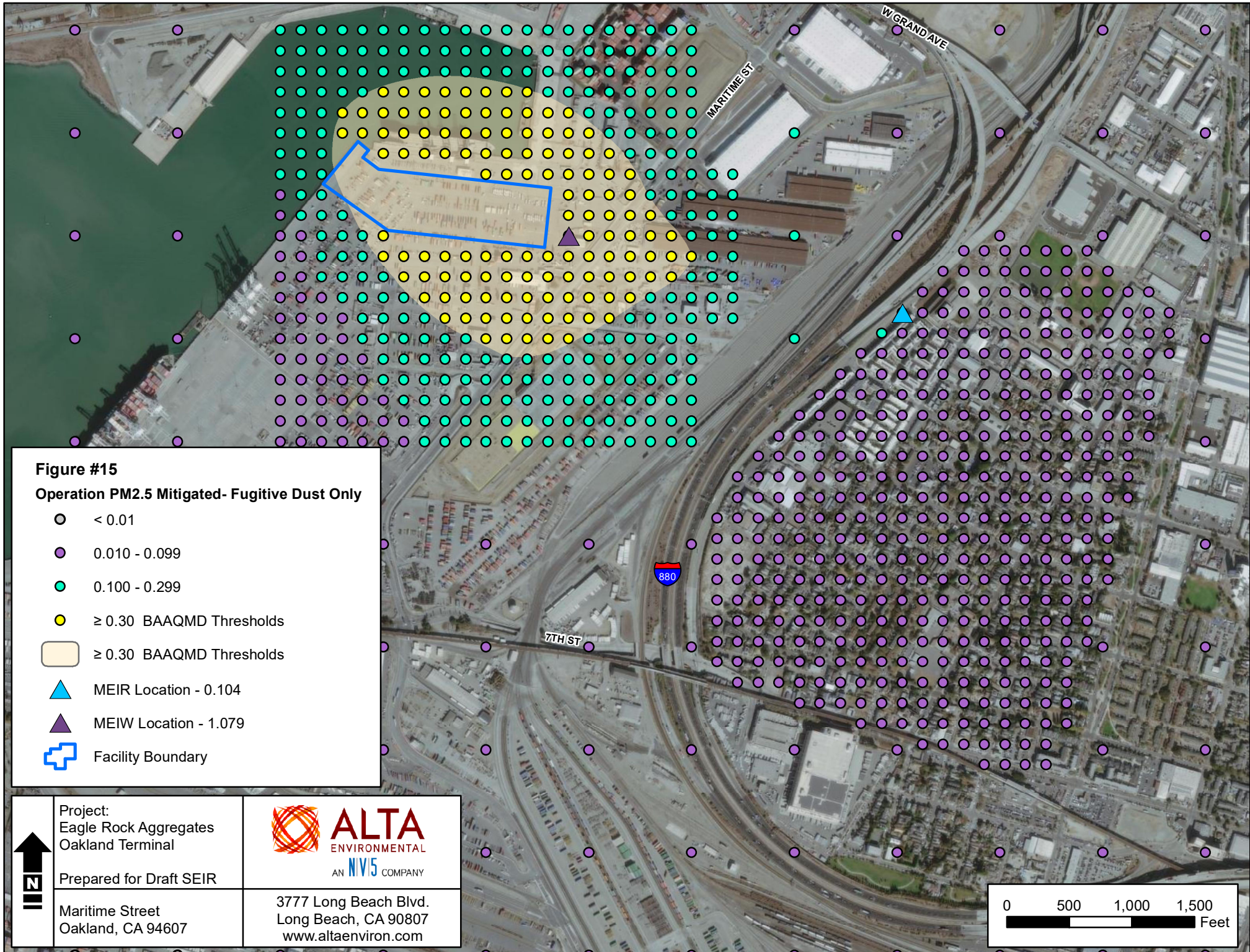

Figure #15
Operation PM2.5 Mitigated- Fugitive Dust Only

- < 0.01
- 0.010 - 0.099
- 0.100 - 0.299
- ≥ 0.30 BAAQMD Thresholds
- ≥ 0.30 BAAQMD Thresholds
- ▲ MEIR Location - 0.104
- ▲ MEIW Location - 1.079
- Facility Boundary

Project:
 Eagle Rock Aggregates
 Oakland Terminal

Prepared for Draft SEIR

Maritime Street
 Oakland, CA 94607



ALTA
 ENVIRONMENTAL
 AN NVIS COMPANY

3777 Long Beach Blvd.
 Long Beach, CA 90807
www.altaenviron.com

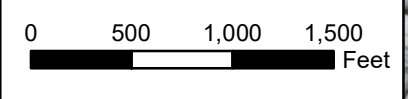



CONSTRUCTION BARGES

OFF-SITE TRUCKS AND VEHICLES

Figure #16
Construction Source Locations

- Barges
- Construction Equipment
- Off-site Trucks and Vehicles
- Facility Boundary



Project:
 Eagle Rock Aggregates
 Oakland Terminal

Prepared for Draft SEIR

Maritime Street
 Oakland, CA 94607



3777 Long Beach Blvd.
 Long Beach, CA 90807
 www.altaenviron.com

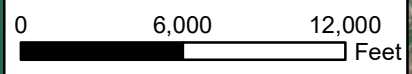



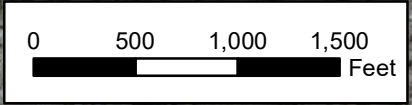

Figure #17
Construction Source Locations

- Barges
- Construction Equipment
- Off-site Trucks and Vehicles
- ⊕ Facility Boundary

 Project:
 Eagle Rock Aggregates
 Oakland Terminal
 Prepared for Draft SEIR
 Maritime Street
 Oakland, CA 94607

ALTA
 ENVIRONMENTAL
 AN NVIS COMPANY
 3777 Long Beach Blvd.
 Long Beach, CA 90807
www.altanviron.com



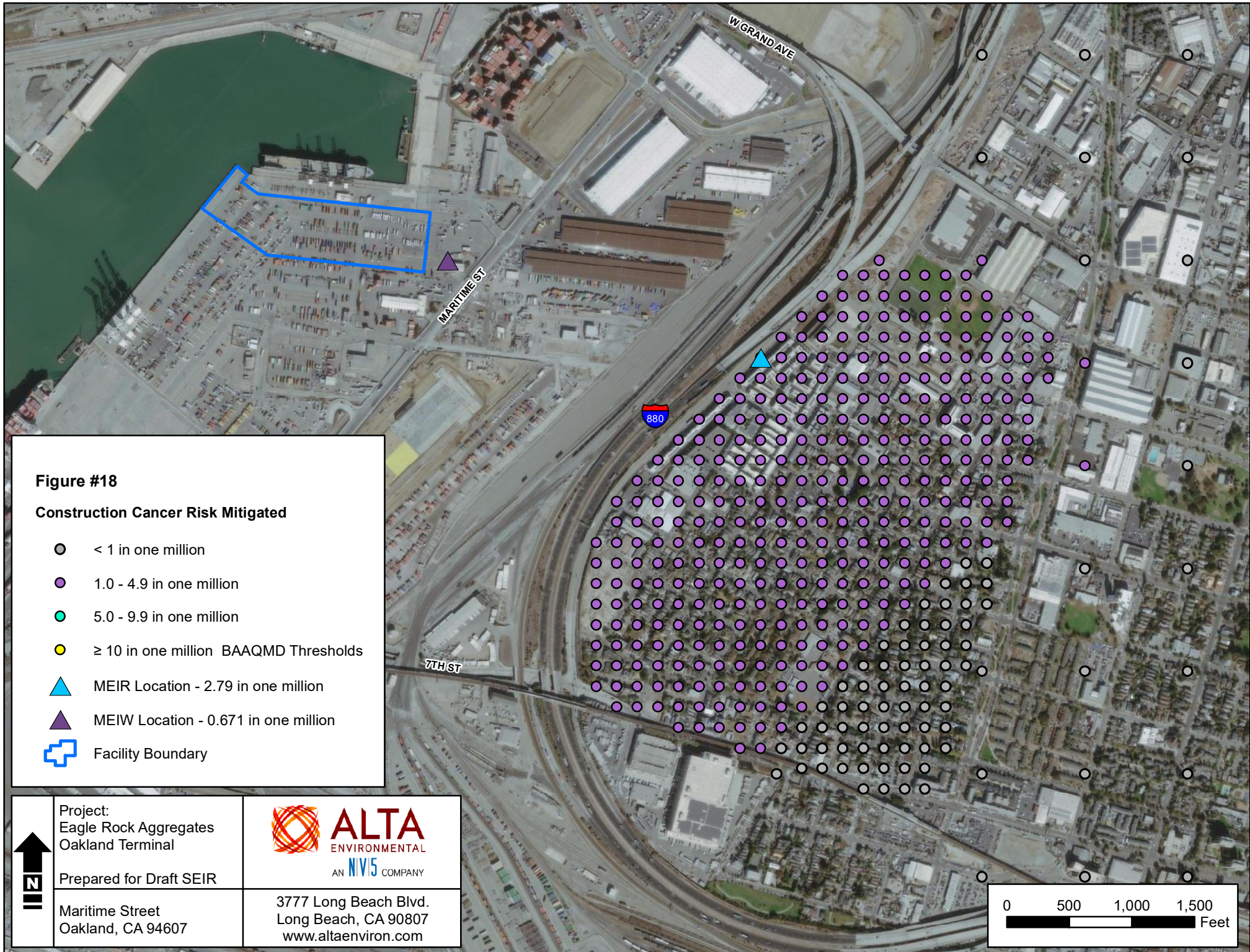



Figure #18

Construction Cancer Risk Mitigated

- < 1 in one million
- 1.0 - 4.9 in one million
- 5.0 - 9.9 in one million
- ≥ 10 in one million BAAQMD Thresholds
- ▲ MEIR Location - 2.79 in one million
- ▲ MEIW Location - 0.671 in one million
- Facility Boundary

 Project:
 Eagle Rock Aggregates
 Oakland Terminal
 Prepared for Draft SEIR
 Maritime Street
 Oakland, CA 94607

ALTA
 ENVIRONMENTAL
 AN NVIS COMPANY
 3777 Long Beach Blvd.
 Long Beach, CA 90807
www.altanviron.com

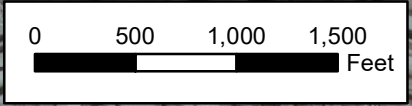

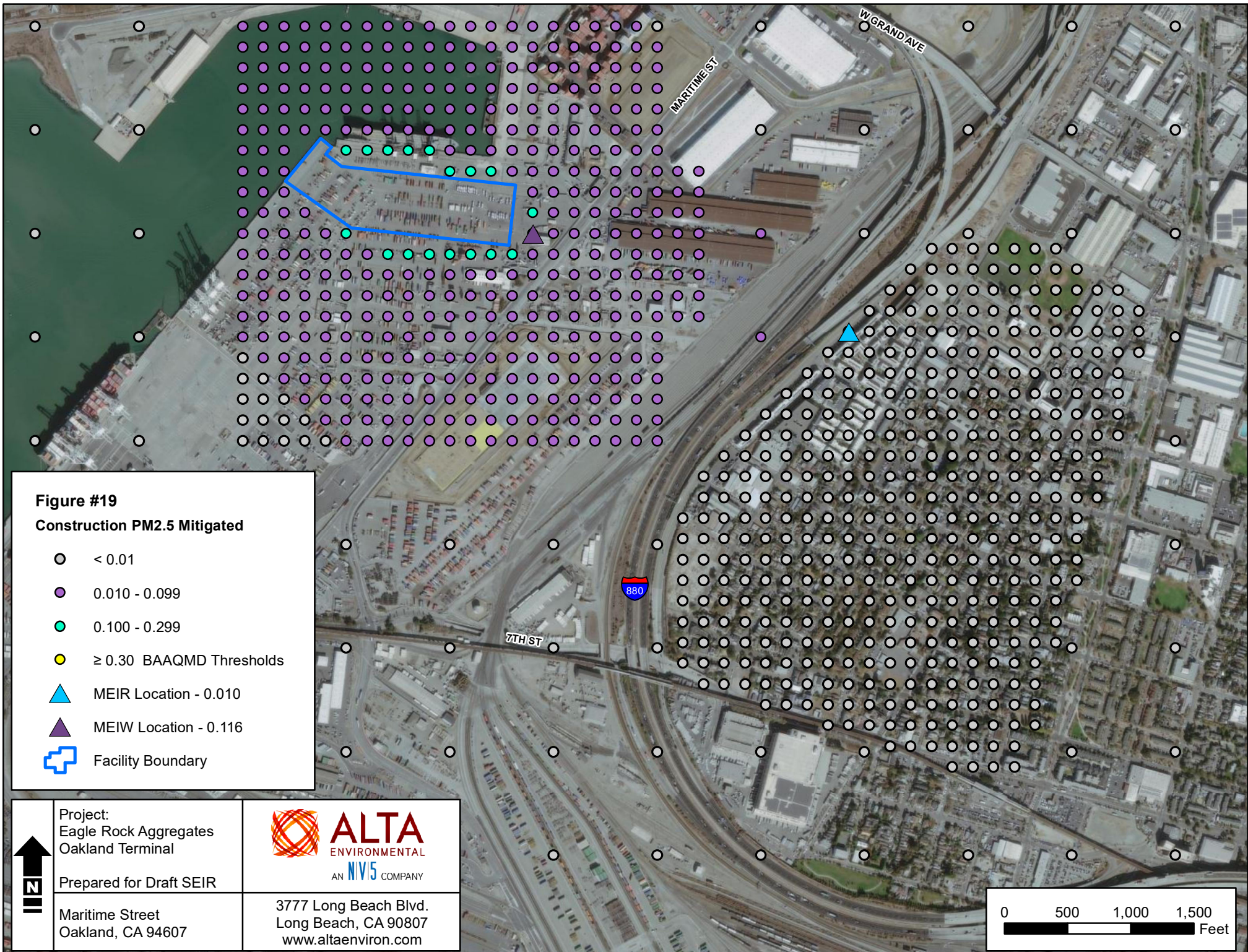



Figure #19

Construction PM2.5 Mitigated

- < 0.01
- 0.010 - 0.099
- 0.100 - 0.299
- ≥ 0.30 BAAQMD Thresholds
- ▲ MEIR Location - 0.010
- ▲ MEIW Location - 0.116
- Facility Boundary

 Project:
 Eagle Rock Aggregates
 Oakland Terminal
 Prepared for Draft SEIR
 Maritime Street
 Oakland, CA 94607

ALTA
 ENVIRONMENTAL
 AN NVIS COMPANY
 3777 Long Beach Blvd.
 Long Beach, CA 90807
www.altaenviron.com

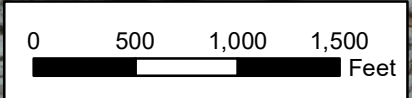

Appendix E
Geotechnical Conditions Report

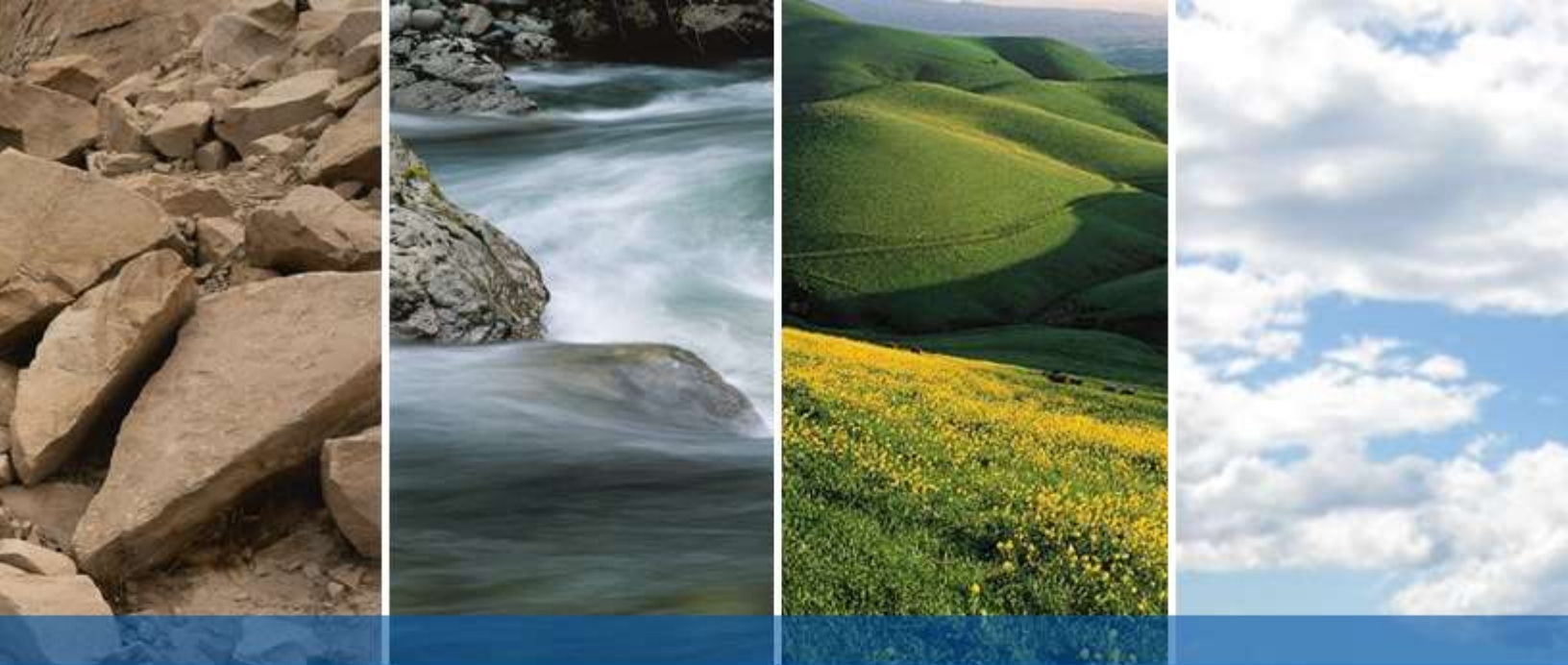

**AGGREGATE OPERATIONS AT PORT OF OAKLAND BERTHS 20 AND 21
OAKLAND, CALIFORNIA**

GEOTECHNICAL CONDITIONS REPORT

DRAFT

SUBMITTED TO:
Mr. Scott Dryden
Eagle Rock Aggregates, Inc.
700 Wright Avenue
Richmond, CA 94804

PREPARED BY:
ENGEO Incorporated

December 27, 2018

PROJECT NO.
15669.000.000

Project No.
15669.000.000

December 27, 2018

Mr. Scott Dryden
Eagle Rock Aggregates, Inc.
700 Wright Avenue
Richmond, CA 94804

Subject: Aggregate Operations at Port of Oakland Berths 20 and 21
Oakland, California

GEOTECHNICAL CONDITIONS REPORT

Dear Mr. Dryden:

With your authorization, we prepared this report on geotechnical conditions for the proposed activities associated with an aggregate operation to be located at Berths 20 and 21 in Oakland, California.

The accompanying report presents our preliminary geotechnical findings along with our preliminary conclusions regarding geotechnical constraints to aggregate operation and recommendations regarding mitigation opportunities for the proposed operations at Berths 20 and 21. Our findings indicate that the project site is suitable for aggregate operations provided the preliminary recommendations and guidelines provided in this report are implemented during project planning.

If you have any questions or comments regarding this report, please call and we will be glad to discuss them with you.

Sincerely,

ENGEO Incorporated

Joey Tognolini, EIT

Bahareh Heidarzadeh, PhD

Jeff Fippin, GE

TABLE OF CONTENTS

Letter of Transmittal

1.0	INTRODUCTION	1
1.1	PURPOSE AND SCOPE	1
1.2	PROJECT DESCRIPTION.....	1
2.0	GEOLOGY AND SEISMICITY	2
2.1	REGIONAL GEOLOGY	2
2.2	SITE GEOLOGY	2
2.2.1	Artificial Fill (af)	2
2.2.2	Young Bay Mud	3
2.2.3	Merritt (Sand) Formation.....	3
2.2.4	San Antonio Formation.....	3
2.3	FAULTING AND SEISMICITY	3
3.0	SITE HISTORY AND SUBSURFACE CONDITION	4
4.0	PRELIMINARY CONCLUSIONS AND RECOMMENDATIONS	5
4.1	IMMEDIATE AND CONSOLIDATION-INDUCED SETTLEMENT	5
4.2	BEARING CAPACITY EVALUATION	6
4.3	SEISMIC HAZARDS	7
4.3.1	Ground Rupture	7
4.3.2	Ground Shaking	7
4.3.3	Ground Lurching	7
4.3.4	Liquefaction and Lateral Spreading	7
4.3.5	Tsunamis.....	8
4.4	SLOPE STABILITY	8
5.0	DESIGN GEOTECHNICAL REPORT	9
6.0	LIMITATIONS AND UNIFORMITY OF CONDITIONS	9

SELECTED REFERENCES

FIGURES

APPENDIX A

1.0 INTRODUCTION

1.1 PURPOSE AND SCOPE

We prepared this report on geotechnical conditions for the subject project located at the current Berths 20 and 21 in Oakland, California. Our current scope of study included:

- Review of available geologic maps, aerial photographs, and seismic hazard maps for the site.
- Review of available information from the Port of Oakland, including previous geotechnical reports and as-built construction plans of the facility.
- Review of the existing boring logs in and around Berths 20 and 21, including those from geotechnical reports by others dated 2001, 2008, and 2011.
- Assessment of potential geotechnical hazards at the site.
- Preliminary evaluation of geotechnical constraints such as existing compressible and liquefiable soil and provide preliminary discussion of mitigation opportunities in the context of the planned activities.
- Preparation of this report summarizing our initial recommendations.

We prepared this report for the exclusive use of our client and their consultants for design of this project. In the event that any changes are made in the character and design of the development, we must be contacted to review the conclusions and recommendations contained in this report to evaluate whether modifications are recommended.

1.2 PROJECT DESCRIPTION

As shown on Figure 2, the site comprises approximately 22 acres of land, owned by the Port of Oakland south of the Bay Bridge Toll Plaza. The site is currently vacant but was previously used as a transfer facility for containerized freight. The site has a marginal wharf along the northern and western boundaries that is constructed with a concrete deck supported on concrete and timber piles. The site has three large container cranes for unloading ships and the majority of the land is used for storage of shipping containers and transfer of containers to trucks. We discuss site history in Section 3. Based on our conversations with you, we understand that the project will include aggregate importing operations considering the following assumptions:

- Stockpiling aggregates in open piles to a height of about 45 feet.
- Loader operation onsite (CAT 982 or equivalent) with gross vehicle weight (GVW) of about 100,000 pounds.
- Regular depleting and recharging of stockpiles (although some material may not turn over for several months).

2.0 GEOLOGY AND SEISMICITY

2.1 REGIONAL GEOLOGY

The San Francisco Bay Valley and the peripheral hill system, which encloses it, in association with two main fault structures (the San Andreas and Hayward rift zones), make up the main geological features of the San Francisco Bay Region. Diverse crustal movements within this system control the morphology and structural stability of the area.

Because of its close proximity to the Pacific Ocean, the Bay Area's hydrologic, and thus, sedimentologic conditions are dominated by relative sea-level fluctuations and changes in the rate of precipitation. The Bay Area has experienced four episodes of intense erosion followed by four periods of massive deposition in recent geologic history. This process has resulted in the removal of large amounts of bedrock that have been subsequently covered by Pleistocene sediments to considerable depths. We are currently in an interglacial period in which the earth is warming. During this warming period, relative sea level has risen and heavy sedimentation has occurred in the bay valley (the well-documented Bay Mud).

The Bay Area can thus be described as a region of depositional and erosional cyclicity with stratigraphic beds that increase in age with depth. The youngest deposits should be expected to be soft and unconsolidated, while the older horizons will be more indurated due to overburden pressure and severe in-situ weathering.

2.2 SITE GEOLOGY

The site is relatively level with a ground surface elevation that generally ranges from about Elevation 12 to 15 feet (Port of Oakland Datum). According to a published geologic map covering the site by Graymer (1997) (Figure 3), the surficial geology of the site is mapped as artificial fill. In general, the stratigraphy of the site from youngest to oldest consists of artificial fill, Young Bay Mud deposits, Merritt Sand, and San Antonio Formation. We discuss each of these units in subsequent sections of this report.

2.2.1 Artificial Fill (af)

As a consequence of the land reclamation and prior construction activities at this area of Oakland, a highly heterogeneous surficial layer of fill material exists at the surface. The fill material is composed of a mixture of sand, gravel, and clayey materials, much of which was dredged from the San Francisco Bay and placed on a pre-existing marshland. This layer can be characterized by abrupt and unpredictable changes in lithology, both laterally and vertically, in the soil profile.

The fill is highly variable and ranges from lean clay to a mixture of silt, sand and gravel, with scattered debris and organics. The density of the fill material also varies throughout the site from loose to medium dense.

Fill placement at the location of Berths 20 and 21 happened in the late 1800s to mid-1900s (Rogers and Figuers, 1991) primarily through using a variety of material types that were dredged from the Bay. The area between the historic shoreline and the existing quay wall structure was reclaimed by placing hydraulic fill on the historical marshland. Portions of this fill liquefied in the 1989 Loma Prieta earthquake as described by Fugro (2011).

2.2.2 Young Bay Mud

In the project area, soft sediment, locally known as Young Bay Mud (YBM) lies directly underneath the existing fill. The YBM deposits consist of greenish gray to blue gray soft silty clay that is highly compressible existing in a soft state. Based on the previous borings by others, the Young Bay Mud at the project site ranges from approximately 10 to 25 feet in thickness.

Based on fill history and previous laboratory testing, the Young Bay Mud is normally consolidated to slightly overconsolidated. Our prior experience near the project location indicates that the upper portion of the Young Bay Mud is likely moderately overconsolidated and stiffer because much of the site was a marsh prior to development, and because of past industrial uses at the site; however, the previous exploration data does not appear to indicate the presence of a stiffer crust at the top of the layer. New loads from stockpile placement could result in long-term, post-placement settlement. Further discussion of the effects of this soft/compressible soil and possible mitigation measures are provided in this report.

2.2.3 Merritt (Sand) Formation

Quaternary deposits known locally as Merritt Sand underlie the Bay Mud. This material is a beach or near-shore deposit of fine-grained clean to slightly clayey or silty sand.

2.2.4 San Antonio Formation

The San Antonio formation is composed of alluvium deposited in environments ranging from alluvial fans and flood plains to lakes and beaches. The unit is generally moderately dense to very dense sand and stiff to hard silt and clay. At this site, the upper part of the San Antonio Formation consists of medium-grained sand containing varying amounts of silt and clay.

2.3 FAULTING AND SEISMICITY

The site is not located within a currently designated Alquist-Priolo Earthquake Fault Zone and no known surface expression of a known active fault is believed to exist within the site. Fault rupture through the site, therefore, is not anticipated.

The California Geological Survey (CGS) defines an active fault as one that has experienced surface displacement within Holocene time (about the last 11,000 years) (SP42 CGS, 2007). Because of the presence of numerous active faults, the San Francisco Bay Region is considered seismically active. Numerous small earthquakes occur every year in the San Francisco Bay Region, and larger (greater than Moment Magnitude 7) earthquakes have been recorded and can be expected to occur in the future. Figure 4 shows the approximate locations of active and potentially active faults and significant historic earthquake epicenters mapped within the San Francisco Bay Region. Based on the 2008 update of the national seismic hazards maps, the table below shows the nearest known active faults capable of producing significant ground shaking at the site.

TABLE 2.3-1: Active Faults Capable of Producing Significant Ground Shaking at the Site

SOURCE	CLOSEST DISTANCE (mi)	MOMENT MAGNITUDE (M _w)	FAULT MECHANISM	SITE LIES
Hayward-Rodgers Creek	4.7	7.33	Strike Slip	W

SOURCE	CLOSEST DISTANCE (mi)	MOMENT MAGNITUDE (M _w)	FAULT MECHANISM	SITE LIES
Northern San Andreas	13.2	8.05	Strike Slip	SE
Mount Diablo Thrust	15.3	6.70	Thrust	W
Calaveras	16.4	7.03	Reverse	W
San Gregorio Connected	16.9	7.50	Strike Slip	E
Green Valley Connected	18.1	6.80	Strike Slip	SW
Monte Vista-Shannon	26.5	6.50	Thrust	N

The site is mapped in a seismic hazard zone for liquefaction in Figure 5 and is within the mapped Tsunami Inundation Area per the CGS (2009) as shown on Figure 6.

3.0 SITE HISTORY AND SUBSURFACE CONDITION

The site was developed in multiple phases. Based on review of a geological site characterization, the site was originally marshland until decades of hydraulic fill placement occurred between the late 1800s and early 1900s raised the site grade above sea level. The current shoreline and existing Berths were established between 1915 and the early 1940's. Based on the review of existing boring logs (Labarre 1941, Woodward-Clyde 1978, and Geomatrix 1988 reports), we divided the site into three general areas as shown in Table 3.0-1 and Figure 7. Earth Tech (2001) created a summary of these explorations. We summarize the varying subsurface strata of each zone in Table 3.0-1.

TABLE 3.0-1: Subsurface Profile

MATERIAL	BERTHS 20 AND 21 Thickness (feet)	Zone 1	Zone 2	Zone 3
Hydraulically Placed Fill	10 to 30	30	15	10
Bay Mud	10 to 25	10	25	20
Merritt Sand/San Antonio Formation	>50	>50	>50	>50

Based on plans from the Port of Oakland, the marginal wharf to the north and west of the site is supported on timber and concrete piles. According to as-built plans provided by the Port of Oakland, the slope along the northern edge of the property (adjacent to the Oakland Outer Harbor) slopes up from approximately Elevation -35 to above Elevation 0 feet (datum not explicitly shown but appears to be Mean Sea Level). There is a concrete bulkhead wall that retains the fill. The as-built plans show the wall footing is at about Elevation 0 feet, the exact dimensions of the wall are not shown in the plans provided, but the wall appears to be approximately 15 feet high from footing to top of wall. The composition of the slope material is not shown on the plans, so it is not known at this time if the slope was created by dredging or by placement of a rock dike. Reports indicate that Berths 20 and 21 were used as chassis and port packer operational facilities as early as the mid 1960's and continue to be used in this manner today.

Groundwater Condition

Based on review of the existing boring logs, proximity to the Bay and mapped historic shallowest groundwater in the area, we estimate the groundwater is at a depth of 7 to 15 feet below the ground surface but likely fluctuates several feet daily with the tide. Fluctuations in the level of groundwater may also occur due to variations in rainfall, irrigation practice, and other factors not evident at the time historic measurements were made.

4.0 PRELIMINARY CONCLUSIONS AND RECOMMENDATIONS

From a geotechnical engineering viewpoint, the site is generally suitable for proposed operations, provided the geotechnical recommendations included in this report, along with other sound engineering practices, are properly incorporated into the design plans and specifications.

The primary geotechnical concerns at the site are:

- Immediate and consolidation settlement of compressible soil.
- Bearing failure of subsurface soil.
- Liquefaction-induced settlement in the existing fill.
- Seismically induced lateral spreading.
- Strong ground shaking.

We summarize these hazards as they relate to the proposed aggregate operation in the sections below.

4.1 IMMEDIATE AND CONSOLIDATION-INDUCED SETTLEMENT

Most of this area is underlain by highly compressible YBM material that varies in thickness. As previously mentioned, the YBM deposits are considered highly susceptible to compression from loads imposed by stockpile placement and operation of heavy equipment. Because the YBM thickness varies, if not mitigated, settlement of the YBM will be differential in nature. Moreover, loose soil particles of hydraulically placed fill could undergo immediate settlement when loaded with aggregate stockpiles. Based on new loads estimated solely from stockpiling aggregates to a height of about 45 feet, we estimate the following amount of settlement if left unmitigated.

TABLE 4.1-1: Total Estimated Static Settlement from Stockpiling Aggregate

DURATION	TOTAL ESTIMATED STATIC SETTLEMENT (IN)		
	ZONE 1	ZONE 2	ZONE 3
Immediate Settlement	Negligible	Negligible	Negligible
18 months	9	27	28
30 months	10	33	29
Ultimate	17	51	51

We anticipate the differential consolidation-induced settlement values to be one-half of the estimated total settlement over a horizontal distance of 50 feet. We estimate that the ultimate settlement 50 feet away from the edge of a stockpile to be 4 inches and less than 1 inch of settlement at a distance of 100 feet away from the stockpile edge. This is an approximation and

if other infrastructure along the site boundaries is a concern, we recommend placing aggregate no closer than 100 feet from the site boundaries as shown in Figure 2.

Without mitigation, consolidation of the YBM deposits will continue for a long duration (20 years or greater). It seems that the long-term total and differential settlement are tolerable during the aggregate operation at the project site. If mitigation of consolidation-induced settlement is desired, we recommend “preconsolidation” or “surcharge” of the compressible YBM layer prior to stockpiling to reduce the future long-term settlement. This surcharge could be placed up to 45 feet high at the site over time but the staging should be similar to the staging discussed in Section 4.2. The aggregate material can be used for surcharging the compressible YBM.

In general, preconsolidation of compressible soil is achieved by the use of a surcharge fill program. A surcharge program would involve the placement of temporary fill, which will be removed once the desired degree of consolidation in these areas has occurred as determined by a site-specific settlement-monitoring program. If a surcharge program is desired, we should be contacted prior to fill placement to ensure compliance with the recommendations in this report.

The time required to achieve the desired degree of settlement (typically approximately 80 to 90 percent consolidation) could vary significantly across different areas of the site because the time for consolidation to occur is a function of the thickness of the compressible soil layer. In most areas of the site (Zones 1, 2, and 3), the placement of surcharge for one to two years would be adequate to mitigate the consolidation settlement hazard. If waiting one to two years is unacceptable, using wick drains could speed the consolidation of the YBM compressible layer and different staging from what is shown in Section 4.2 could be implemented.

Based on our evaluation of previous geotechnical explorations, the asphalt thickness at Berths 20 and 21 range from 7 inches to 20 inches. An in-depth asphalt study was conducted by Fugro Consultants in 2011. The asphalt may undergo distress and cracking due to consolidation-induced settlement. We conducted a preliminary desktop study of the area and did not find Department of Toxic Substances Control (DTSC) Deed restrictions. Based on the preliminary study, we do not anticipate further cracking of the existing pavement to cause environmental regulatory problems, the performance requirements of the existing pavement should be discussed with the Port of Oakland.

4.2 BEARING CAPACITY EVALUATION

We evaluated bearing capacities of the hydraulically placed fill, and YBM. We conclude that depending on the thickness of fill and YBM, YBM could undergo bearing capacity failure if the placement of 45 feet of stockpile were to occur in one stage. Therefore, we recommend staging the stockpile placement in order for YBM to gain shear strength through consolidation and time. The staging timeline can be accelerated by using wick drains, if desired. For areas with existing fill thickness of less than 20 feet (Zones 2 and 3), the stockpile should be placed in three stages as follows:

- Stage 1 – 18 feet of aggregate to be placed for 18 months.
- Stage 2 – Additional 14 feet of aggregate (total of 32 feet) to be placed for an additional 12 months.
- Stage 3 – Additional 13 feet of aggregate (total of 45 feet) to be placed permanently.

If further refinement of the staging is required, we will need to obtain site-specific subsurface information.

4.3 SEISMIC HAZARDS

Potential seismic hazards resulting from a nearby moderate to major earthquake can generally be classified as primary and secondary. The primary effect is ground rupture, also called surface faulting. The common secondary seismic hazards include ground shaking, ground lurching, liquefaction, lateral spreading, and tsunamis. The following sections present a discussion of these hazards as they apply to the site. Based on topographic and lithologic data, the risk of regional subsidence or uplift, landslides, flooding or seiches is considered low to negligible at the site.

4.3.1 Ground Rupture

Since there are no known active faults crossing the property and the site is not located within an Earthquake Fault Special Study Zone, ground rupture is unlikely at the subject property.

4.3.2 Ground Shaking

An earthquake of moderate to high magnitude generated within the San Francisco Bay Region could cause considerable ground shaking at the site, similar to that which has occurred in the past.

4.3.3 Ground Lurching

Ground lurching is a result of the rolling motion imparted to the ground surface during energy released by an earthquake. Such rolling motion can cause ground cracks to form in weaker soil. The potential for the formation of these cracks is considered greater at contacts between deep alluvium and bedrock. Such an occurrence is possible at the site as in other locations in the Bay Area, but based on the site location, the offset is expected to be minor.

4.3.4 Liquefaction and Lateral Spreading

Soil liquefaction results from loss of strength during cyclic loading, such as imposed by earthquakes. Soil most susceptible to liquefaction is clean, loose, saturated, uniformly graded fine-grained sand. Empirical evidence indicates that loose to medium-dense gravel, silty sand, low-plasticity silt, and some low-plasticity clay is also potentially liquefiable. The State of California Seismic Hazard Zones Map show areas susceptible to liquefaction within the property (Figure 5).

When seismic ground shaking occurs, the soil is subjected to cyclic shear stresses that can cause excess hydrostatic pressures to develop. If excess hydrostatic pressures exceed the effective confining stress from the overlying soil, the sand may undergo deformation. If the sand undergoes virtually unlimited deformation without developing significant resistance, it is said to have liquefied, and if the sand consolidates or vents to the surface during and following liquefaction, ground settlement and surface deformation may occur. In some cases, settlements of approximately 2 to 3 percent of the thickness of the liquefiable layer have been measured.

The hydraulically placed fill and some of the naturally deposited loose sand near the top of the Merritt Sand layer will likely liquefy during strong ground shaking in a major earthquake event associated with nearby active faults. As previously mentioned, liquefaction occurred at the site during the Loma Prieta earthquake in 1989 and the site is mapped in a Liquefaction Seismic Hazard Zone.

Without mitigation, based on the thickness of the hydraulically placed fill at Berths 20 and 21, settlement in this zone could range from ½ to over 1 foot at a building code Maximum Considered Earthquake level earthquake. Considerable settlement is likely even at significantly lower levels of seismic shaking. Differential settlement due to liquefaction is likely on the order of ½ the total amount over a lateral distance of 150 feet. Due to the shallow groundwater at the site, there is a high likelihood of surface disruption, such as sand boils or fissures in the ground surface occurring due to shallow-soil liquefaction.

Areas used for aggregate stockpiling are typically not mitigated for liquefaction-induced effects. Maintenance of the operation area during and after seismic events due to liquefaction-induced settlement should be expected. It is possible that temporary slope stability or localized bearing failures could occur within the aggregate stockpiles if liquefaction occurs. If desired to evaluate these effects further, we can perform additional analyses, though subsurface data within the fill will be necessary.

The documents and plans provided to us are insufficient to properly evaluate the subsurface conditions of the sloping free face beneath the marginal wharf. Lateral displacement of the fill and Young Bay Mud layers at the site would likely occur. The bulkhead wall and existing piles will provide some resistance to lateral movement but our experience indicates that they are not likely to arrest all displacement in a large seismic event. Therefore, the extent of movement due to lateral displacement is unknown. If the amount of displacement is important, we can provide a more extensive evaluation that would likely include subsurface exploration, laboratory testing and bathymetric survey of the waterside slope below the wharf.

4.3.5 Tsunamis

Maps showing areas of potential tsunami inundation (Figure 6) indicate that the site is within the area that would be impacted by tsunami waves having a 20-foot-high run up at the Golden Gate Bridge. Generally, uninhabitable structures and open fields are typically not mitigated for tsunami effects. However, if desired, the potential for tsunami impacts can be reduced by raising site grades or by constructing protective berms and sea walls. Additional recommendations for site planning can be found in “Designing for Tsunamis: Background Papers, March 2001 from the National Tsunami Hazard Mitigation Program (NTHMP)”.

4.4 SLOPE STABILITY

The marginal wharf currently sits above a slope with a concrete bulkhead constructed atop, according to plans from the Port of Oakland. The plans depict an approximate as-built slope beneath the wharf but do not include information on the type of soil or material that the slope consists of. With limited information, we assume the subsurface soil free faces in the slope at elevations below the bulkhead wall and that the bulkhead wall is supported on a spread footing.

The addition of stockpile aggregate on site may result in slope instability within the YBM layer if the aggregate is placed too closely to the slope. We conducted a preliminary analysis of the slope based upon available data. We recommend offsetting aggregate placement a minimum of 250 feet from the edge of the wharf along the northern and western sides of Berths 20 and 21.

If the setback distance is too restrictive on potential operations, we can conduct a more detailed assessment of the slope stability. To perform this analysis, we will need to perform site-specific explorations, laboratory testing and reconnaissance of the slope below the wharf.

5.0 DESIGN GEOTECHNICAL REPORT

This report presents preliminary geotechnical findings, conclusions and recommendations intended for preliminary planning purposes only. If desired, a design-level geotechnical exploration and assessment can be performed when operation plans are finalized. The design-level exploration should further evaluate the potential for consolidation of compressible soil, bearing capacity, liquefaction, shoreline slope stability and other geotechnical hazards.

6.0 LIMITATIONS AND UNIFORMITY OF CONDITIONS

This report presents geotechnical recommendations for design of the improvements discussed in Section 1.3 for the Aggregate Operation at Berths 20 and 21 project. If changes occur in the nature or design of the project, we should be allowed to review this report and provide additional recommendations, if any. It is the responsibility of the owner to transmit the information and recommendations of this report to the appropriate organizations or people involved in design of the project, including but not limited to developers, owners, buyers, architects, engineers, and designers. The conclusions and recommendations contained in this report are solely professional opinions and are valid for a period of no more than 2 years from the date of report issuance.

We strived to perform our professional services in accordance with generally accepted geotechnical engineering principles and practices currently employed in the area; no warranty is expressed or implied. There are risks of earth movement and property damages inherent in building on or with earth materials. We are unable to eliminate all risks or provide insurance; therefore, we are unable to guarantee or warrant the results of our services.

This report is based upon field and other conditions discovered at the time of report preparation. We developed this report with historic subsurface exploration data; no project specific exploration was performed for this report.

This document must not be subject to unauthorized reuse, that is, reusing without written authorization of ENGEO. Such authorization is essential because it requires ENGEO to evaluate the document's applicability given new circumstances, not the least of which is passage of time.

Actual field or other conditions will necessitate clarifications, adjustments, modifications or other changes to ENGEO's documents. Therefore, ENGEO must be engaged to prepare the necessary clarifications, adjustments, modifications or other changes before construction activities commence or further activity proceeds. If ENGEO's scope of services does not include onsite construction observation, or if other persons or entities are retained to provide such services, ENGEO cannot be held responsible for any or all claims arising from or resulting from the performance of such services by other persons or entities, and from any or all claims arising from or resulting from clarifications, adjustments, modifications, discrepancies or other changes necessary to reflect changed field or other conditions.

SELECTED REFERENCES

- Fugro Consultants (2011) *Geotechnical Data Report, Ports America Oakland Terminal*.
- Kleinfelder (2008) *Preliminary Geotechnical Investigation, 7th Street Grade Separation and Outer Harbor Intermodal Terminal Projects, Port of Oakland, Oakland, California*.
- Earth Tech (2001) *Oakland Army Base Utility Study Geotechnical Review*.
- Woodward-Clyde Consultants (1978) *DRAFT, Geotechnical Investigation, Berth 6-Phase II Buildings, Port of Oakland Outer Harbor, Oakland, CA*.
- Geomatrix Consultants (1988) *Geotechnical Study, Berth 22 Wharf Construction, Oakland, CA*.
- Port of Oakland (1993) Plans titled *Outer Harbor Terminal Asphalt concrete Overlay Berths 20 & 21 Yard*.
- Port of Oakland (1996) Plans titled *Outer Harbor Replacement of Bollards at Berths 20 & 21*.
- Port of Oakland (1970) Plans titled *Outer Harbor Terminal Berths 8 & 9 Ships Water Service*.
- Idriss, I. M., & Boulanger, R. W. (2008). Soil liquefaction during earthquakes. Earthquake Engineering Research Institute.
- Coduto, D. P., (2001). *Foundation Design, 2nd Edition*. Upper Saddle River, New Jersey: Prentice-Hall, Inc.
- Rogers, J. Davis & Figuers, Sands H. (1991) *Engineering Geologic Site Characterization of the Greater Oakland –Alameda Area*.
- Lee, Charles H. & Praszker, Michael (1969) *Bay Mud Developments and Related Structural Foundations*.

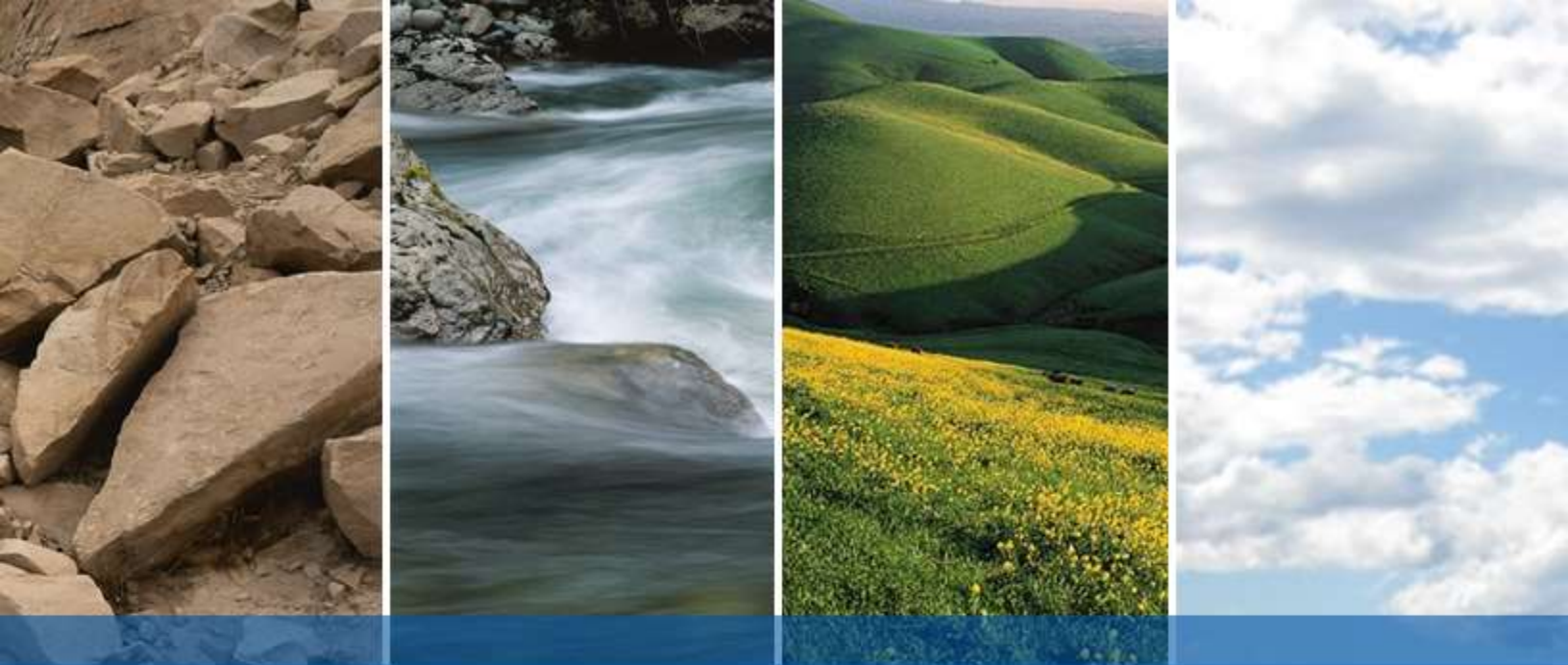

DRAFT

FIGURES

FIGURE 1: Vicinity Map

FIGURE 2: Site Plan

FIGURE 3: Regional Geologic Map (Graymer, 1997)

FIGURE 4: Regional Faulting and Seismicity Map

FIGURE 5: Seismic Hazard Zone Map (CGS, 2006)

FIGURE 6: Tsunami Inundation Map (CGS 2009)

FIGURE 7: Geotechnical Zone Plan

COPYRIGHT © 2018, BY ENGEО, INCORPORATED. THIS DOCUMENT MAY NOT BE REPRODUCED IN WHOLE OR IN PART BY ANY MEANS, WHATSOEVER. NOR MAY IT BE QUOTED WITHOUT THE EXPRESS WRITTEN CONSENT OF ENGEО, INCORPORATED.

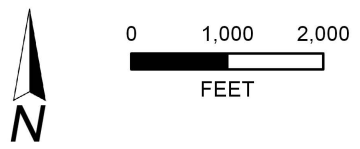

BASEMAP SOURCE: ESRI MAPPING SERVICE



VICINITY MAP
 PORT OF OAKLAND BERTH 20-21 AGGREGATE OPERATION
 OAKLAND, CALIFORNIA

PROJECT NO. : 15669.000.000
 SCALE: AS SHOWN
 DRAWN BY: QRL CHECKED BY: JAF

FIGURE NO.
1

COPYRIGHT © 2018 BY ENGEO INCORPORATED. THIS DOCUMENT MAY NOT BE REPRODUCED IN WHOLE OR IN PART BY ANY MEANS WHATSOEVER. NOR MAY IT BE QUOTED WITHOUT THE EXPRESS WRITTEN CONSENT OF ENGEO INCORPORATED.

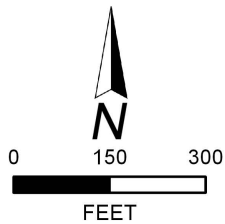

EXPLANATION

ALL LOCATIONS ARE APPROXIMATE

 PROJECT SITE

BASEMAP SOURCE: ESRI MAPPING SERVICE



SITE PLAN
PORT OF OAKLAND BERTH 20-21 AGGREGATE OPERATION
OAKLAND, CALIFORNIA

PROJECT NO. : 15669.000.000

SCALE: AS SHOWN

DRAWN BY:QRL

CHECKED BY:JAF

FIGURE NO.

2

COPYRIGHT © 2018 BY ENGEO INCORPORATED. THIS DOCUMENT MAY NOT BE REPRODUCED IN WHOLE OR IN PART BY ANY MEANS WHATSOEVER, NOR MAY IT BE QUOTED WITHOUT THE EXPRESS WRITTEN CONSENT OF ENGEO INCORPORATED.

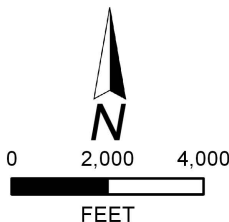

EXPLANATION

ALL LOCATIONS ARE APPROXIMATE

- af ARTIFICIAL FILL
- Qhaf ALLUVIAL FAN DEPOSITS (HOLOCENE)
- Qhb BASIN DEPOSITS (HOLOCENE)
- Qhl NATURAL LEVEE DEPOSITS (HOLOCENE)
- Qms MERRITT SAND DEPOSITS (HOLOCENE AND PLEISTOCENE)

BASEMAP SOURCE: GRAYMER, 1997



REGIONAL GEOLOGIC MAP
 PORT OF OAKLAND BERTH 20-21 AGGREGATE OPERATION
 OAKLAND, CALIFORNIA

PROJECT NO. : 15669.000.000
 SCALE: AS SHOWN
 DRAWN BY: QRL CHECKED BY: JAF

FIGURE NO.
3

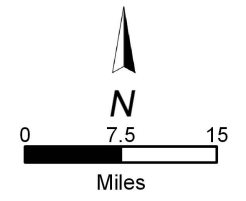
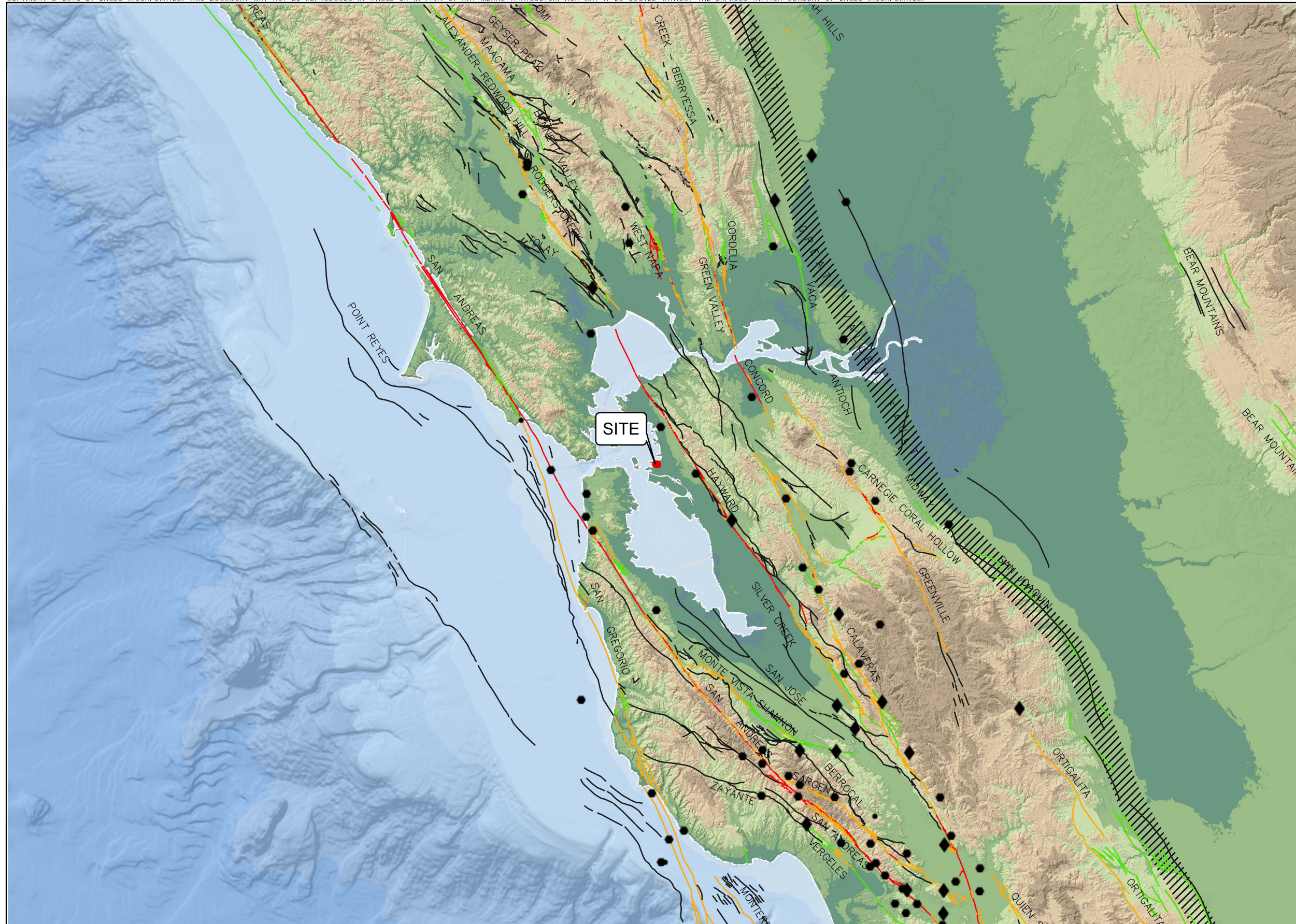

- EXPLANATION**
ALL LOCATIONS ARE APPROXIMATE EARTHQUAKE
- ◆ MAGNITUDE 7+
 - MAGNITUDE 6-7
 - MAGNITUDE 5-6
- USGS QUATERNARY FAULTS
- HISTORICAL
 - LATEST QUATERNARY
 - LATE QUATERNARY
 - UNDIFFERENTIATED QUATERNARY
 - ▨ HISTORIC BLIND THRUST FAULT ZONE

BASE MAP SOURCE
 ESRI, GARMIN, GEBCO, NOAA NGDC, AND OTHER CONTRIBUTORS
 COLOR HILLSHADE IMAGE BASED ON THE NATIONAL ELEVATION DATA SET (NED) AT 30 METER RESOLUTION
 U.S.G.S. QUATERNARY FAULT DATABASE, 2018
 U.S.G.S. HISTORIC EARTHQUAKE DATABASE (1800-PRESENT)



REGIONAL FAULTING AND SEISMICITY
 PORT OF OAKLAND BERTH 20-21 AGGREGATE OPERATION
 OAKLAND, CALIFORNIA

PROJECT NO. : 15669.000.000	FIGURE NO.
SCALE: AS SHOWN	4
DRAWN BY: QRL CHECKED BY: JAF	

COPYRIGHT © 2018 BY ENGEO INCORPORATED. THIS DOCUMENT MAY NOT BE REPRODUCED IN WHOLE OR IN PART BY ANY MEANS WHATSOEVER, NOR MAY IT BE QUOTED WITHOUT THE EXPRESS WRITTEN CONSENT OF ENGEO INCORPORATED.



EXPLANATION

ALL LOCATIONS ARE APPROXIMATE

- Liquefaction Zone
Areas where historical occurrence of liquefaction, or local geological, geotechnical and ground water conditions indicate a potential for permanent ground displacements such that mitigation as defined in Public Resources Code Section 2693(c) would be required

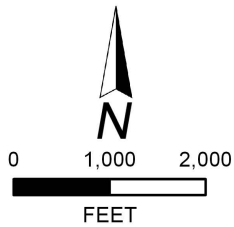

BASEMAP SOURCE: ESRI MAPPING SERVICE,
CALIFORNIA DEPARTMENT OF CONSERVATION, CALIFORNIA GEOLOGICAL SURVEY



SEISMIC HAZARDS ZONE MAP
PORT OF OAKLAND BERTH 20-21 AGGREGATE OPERATION
OAKLAND, CALIFORNIA

PROJECT NO. : 15669.000.000
SCALE: AS SHOWN
DRAWN BY: QRL CHECKED BY: JAF

FIGURE NO.
5

COPYRIGHT © 2018 BY ENGEО INCORPORATED. THIS DOCUMENT MAY NOT BE REPRODUCED IN WHOLE OR IN PART BY ANY MEANS WHATSOEVER, NOR MAY IT BE QUOTED WITHOUT THE EXPRESS WRITTEN CONSENT OF ENGEО INCORPORATED.

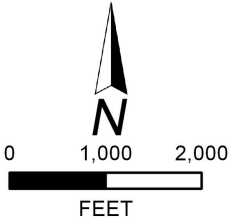
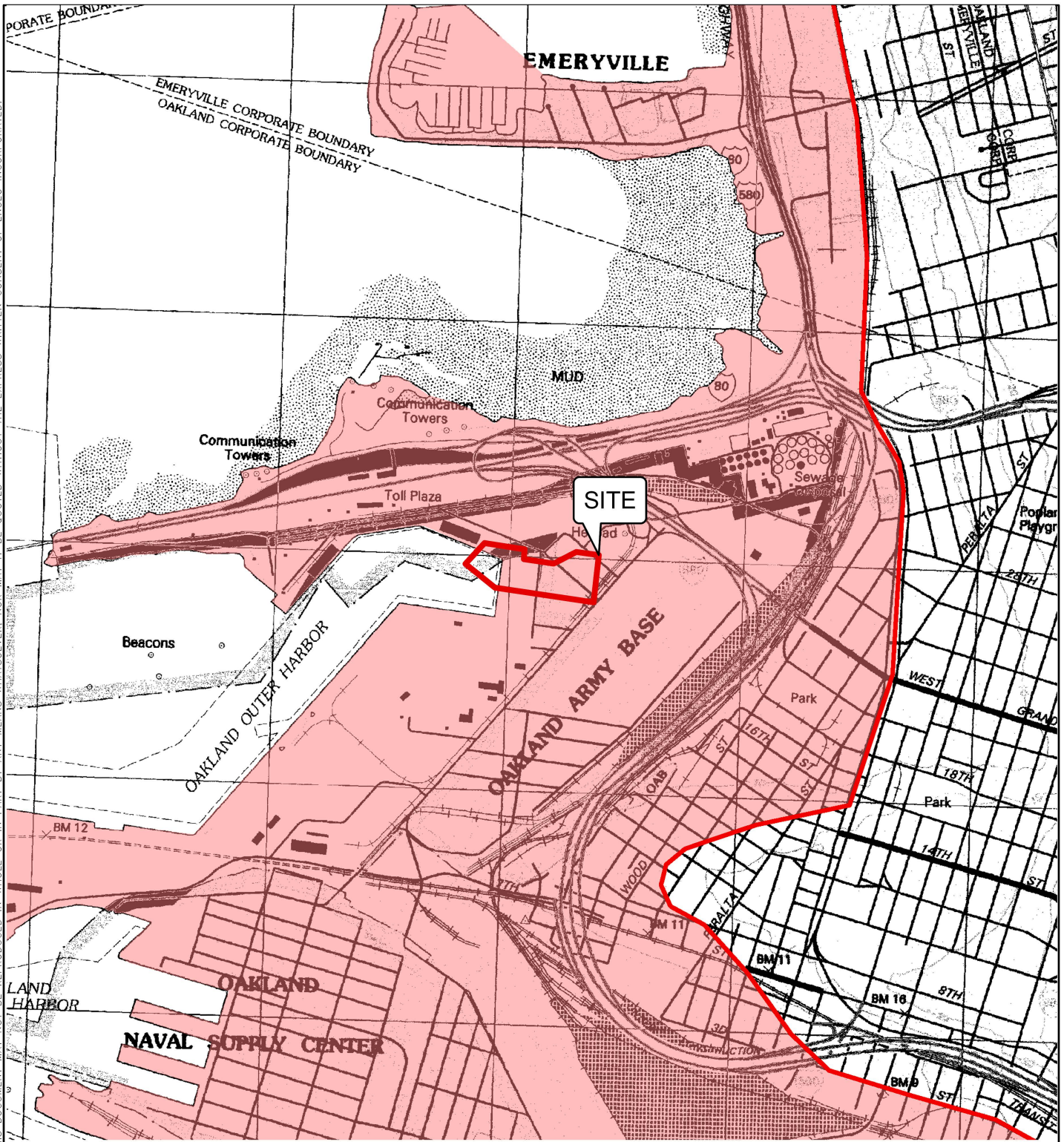

EXPLANATION

ALL LOCATIONS ARE APPROXIMATE

- TSUNAMI INUNDATION AREA
- TSUNAMI INUNDATION LINE

BASEMAP SOURCE: CALIFORNIA GEOLOGICAL SURVEY, 2009



TSUNAMI INUNDATION MAP
 PORT OF OAKLAND BERTH 20-21 AGGREGATE OPERATION
 OAKLAND OAKLAND, CALIFORNIA

PROJECT NO. : 15669.000.000
 SCALE: AS SHOWN
 DRAWN BY: QRL CHECKED BY: JAF

FIGURE NO.
6

COPYRIGHT © 2018 BY ENGEO INCORPORATED. THIS DOCUMENT MAY NOT BE REPRODUCED IN WHOLE OR IN PART BY ANY MEANS WHATSOEVER, NOR MAY IT BE QUOTED WITHOUT THE EXPRESS WRITTEN CONSENT OF ENGEO INCORPORATED.

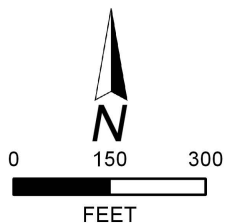

EXPLANATION

ALL LOCATIONS ARE APPROXIMATE

- ZONE 1
- ZONE 2
- ZONE 3

BASEMAP SOURCE: ESRI MAPPING SERVICE



GEOTECHNICAL ZONE PLAN
 PORT OF OAKLAND BERTH 20-21 AGGREGATE OPERATION
 OAKLAND, CALIFORNIA

PROJECT NO. : 15669.000.000	
SCALE: AS SHOWN	
DRAWN BY: QRL	CHECKED BY: JAF

FIGURE NO.

7

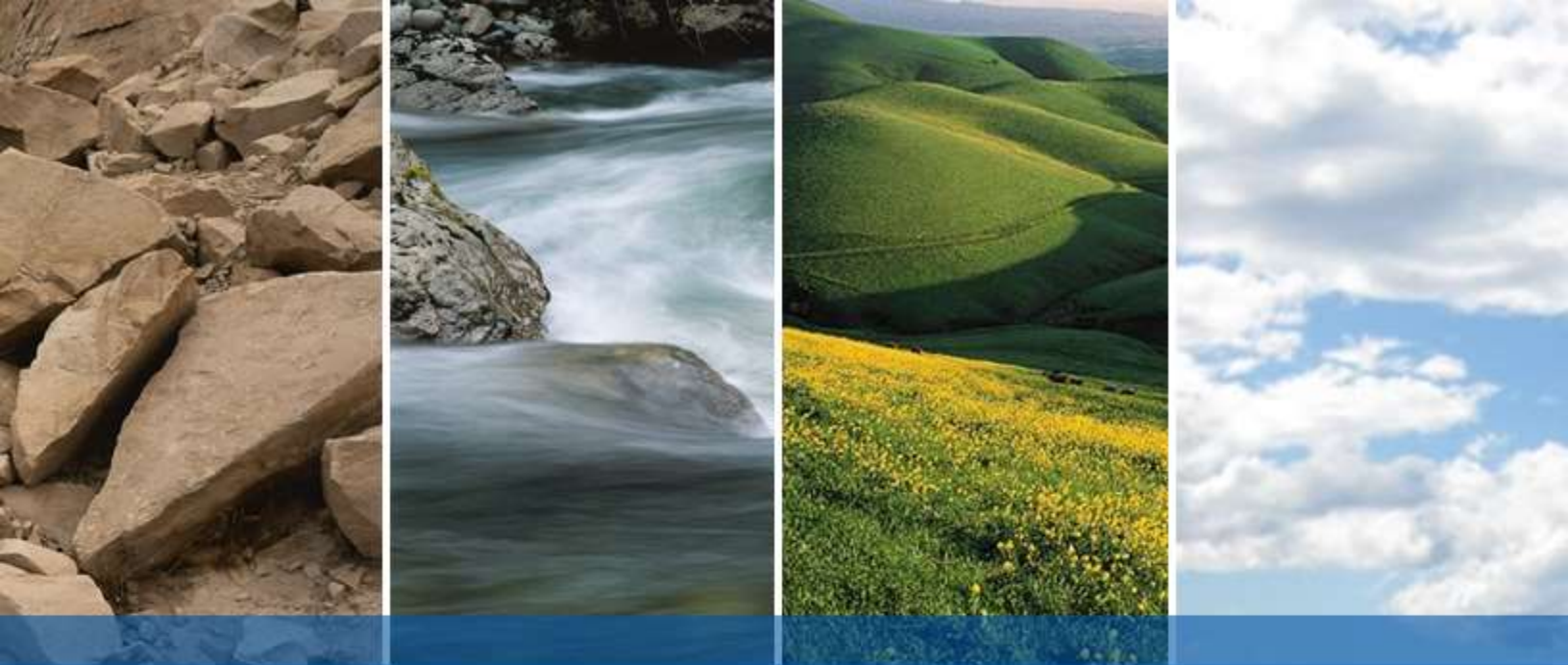

DRAFT

APPENDIX A

Port of Oakland Plans

U.S. ARMY

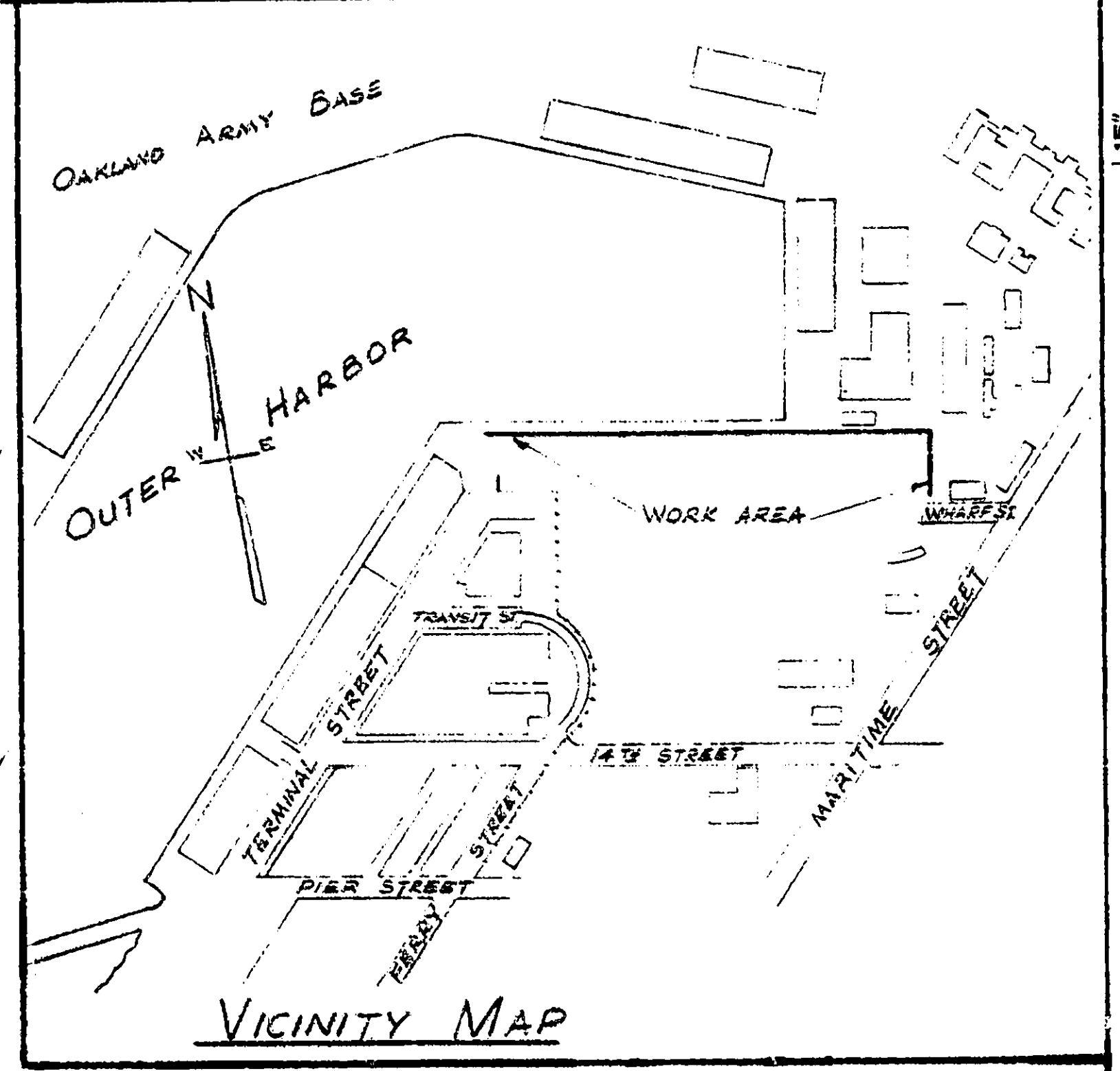
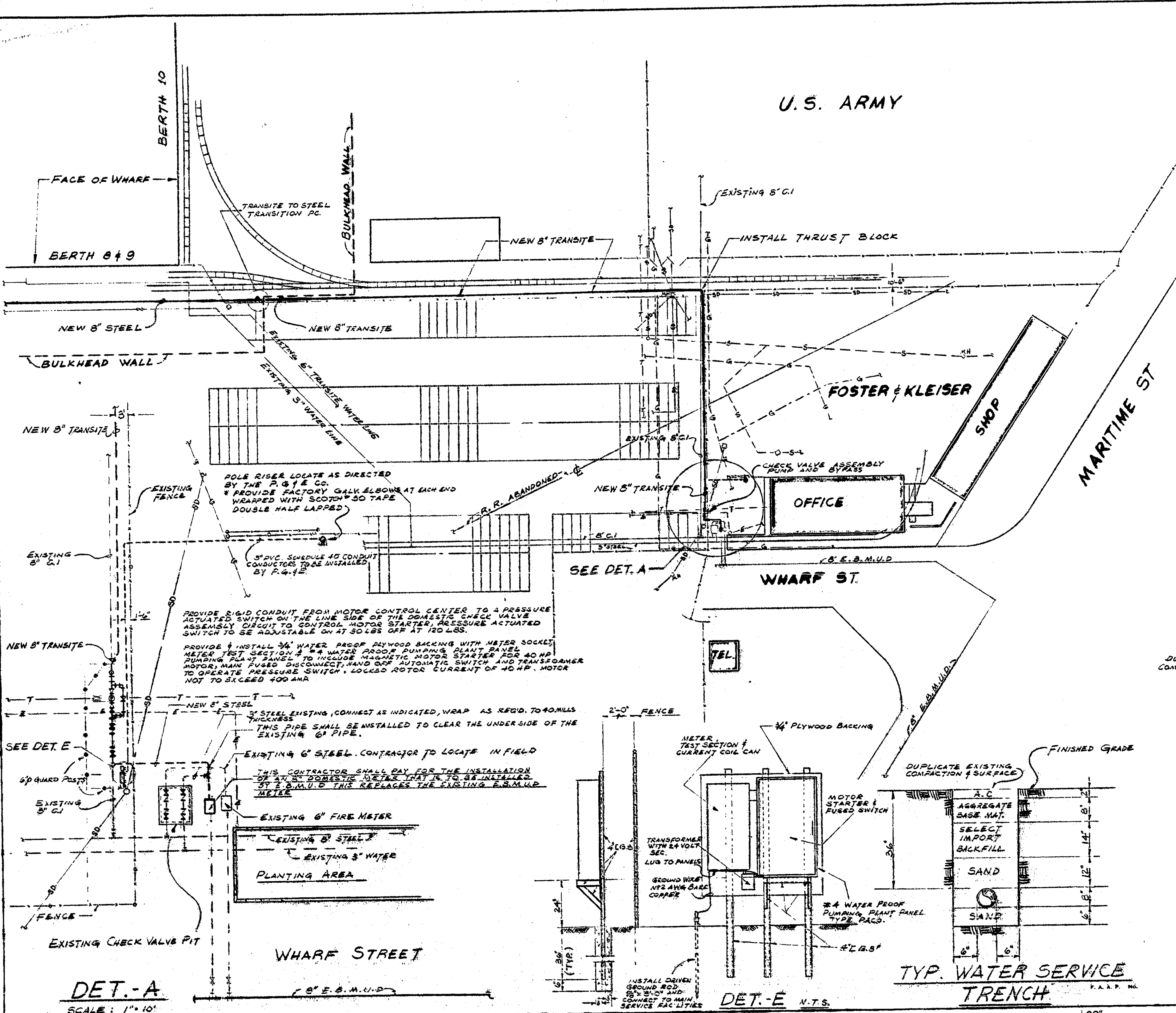

- SYMBOLS:
- ⊗ GATE VALVE
 - ⊘ CHECK VALVE
 - ⊘ P (with arrow) PRESSURE REDUCING VALVE
 - ⊘ C COOK
 - ⊘ P (with circle) PLUG VALVE
 - ⊘ P (with circle) PUMP
 - ⊘ R (with circle) REDUCER
 - ⊘ S (with circle) STRAINER

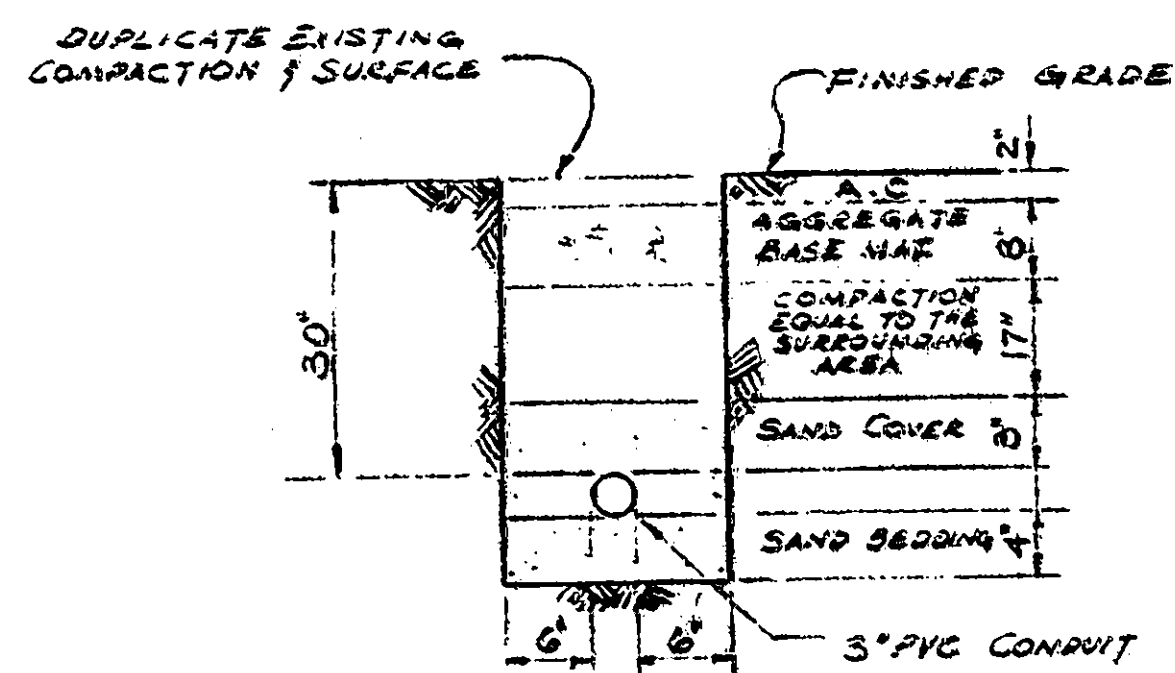

TYP. ELECTRIC POWER TRENCH DET.

PORT OF OAKLAND
OAKLAND, CALIFORNIA
OUTER HARBOR TERMINAL
BERTHS 8 & 9
SHIPS WATER SERVICE

DATE JUNE 9, 1970
SCALE AS NOTED
FILE AA-1242
SHEET 1 OF 3 SHEETS

NO. REVISIONS DATE

DRAWN C.P. & D.B.
CHECKED R.H.V.
RECOMMENDED
APPROVED [Signature] ASST. CHIEF ENGINEER

CHIEF ENGINEER [Signature]

DET.-A
SCALE: 1" = 10'

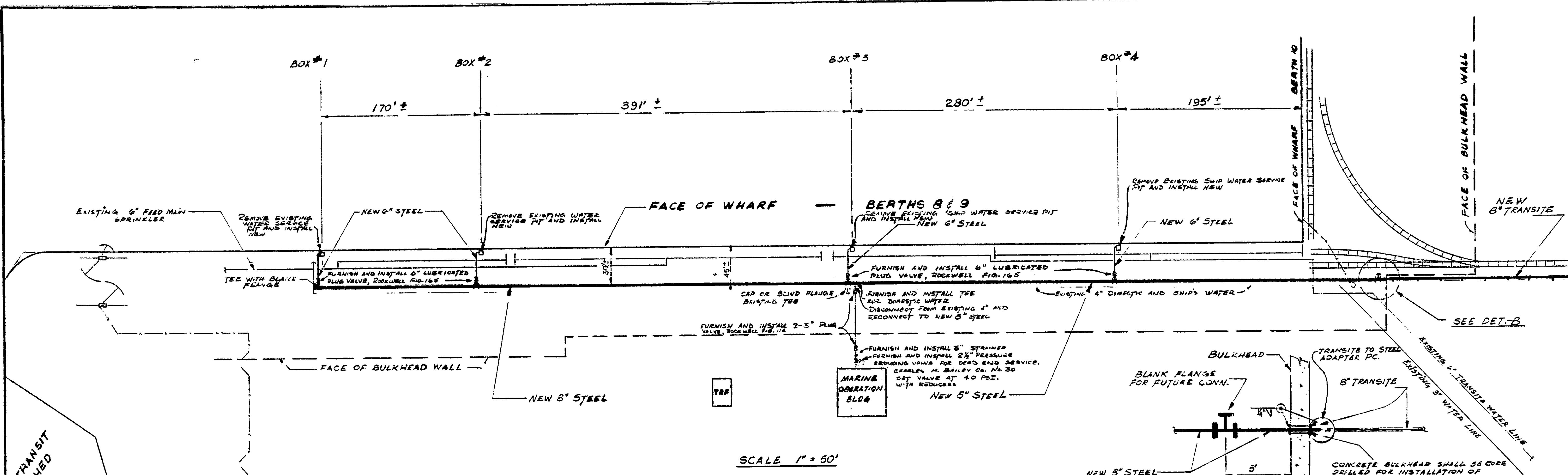

NOTE:
 1. PRESENT OUTLETS, METERS, CHECK VALVES & PIPING REMOVED DURING THE COURSE OF THE WORK SHALL BE RETURNED TO THE PORT OF OAKLAND.
 2. WHERE NEW SHIP WATER SERVICE PITS ARE INSTALLED THE EXISTING SHIP WATER PITS AT THESE LOCATIONS SHALL BE REMOVED TOGETHER WITH SERVICE PLATFORM, DOCK, PIT FRAME AND COVER AND LATERAL BACK TO EXISTING MAIN. THE LATERAL TAP ON THE MAIN SHALL THEN BE FLANGED OR CAPPED TO KEEP THE MAIN IN SERVICE.

SCALE 1" = 50'

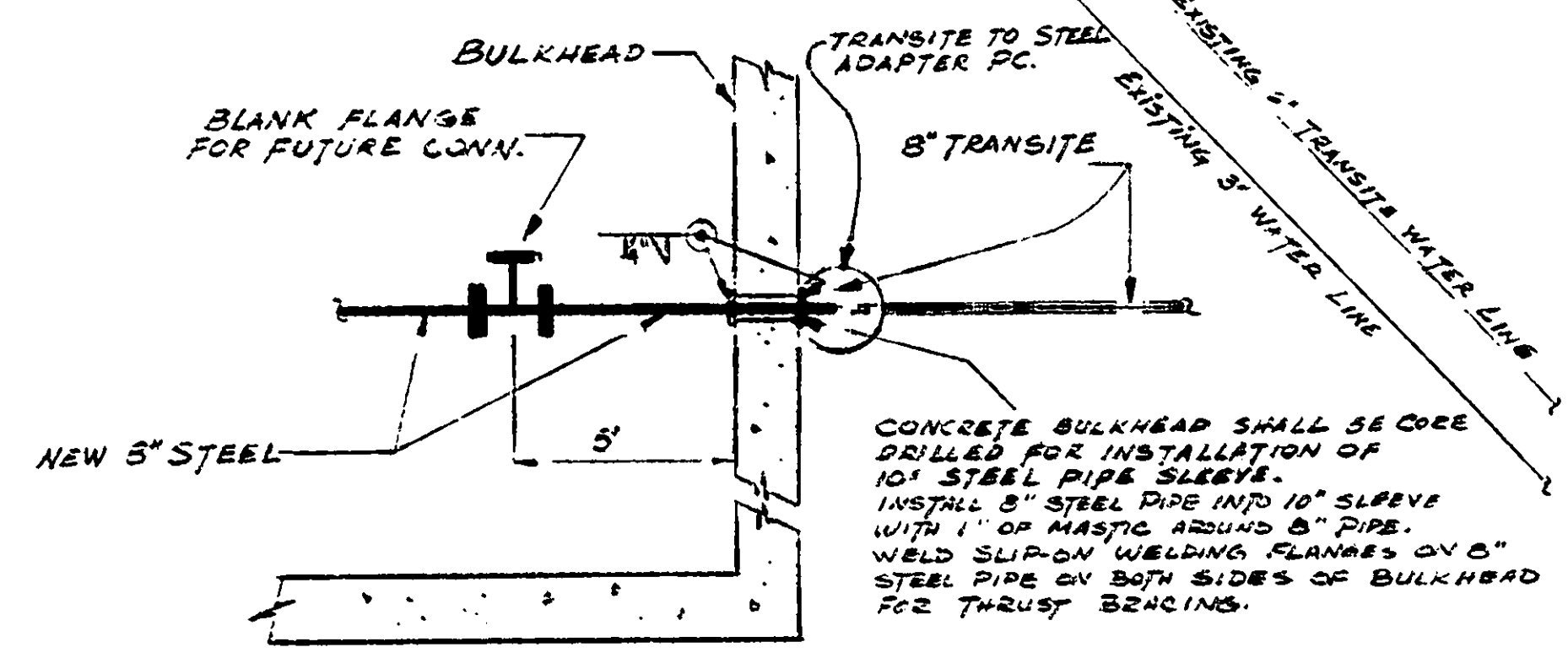

DET. B
 SCALE: NONE

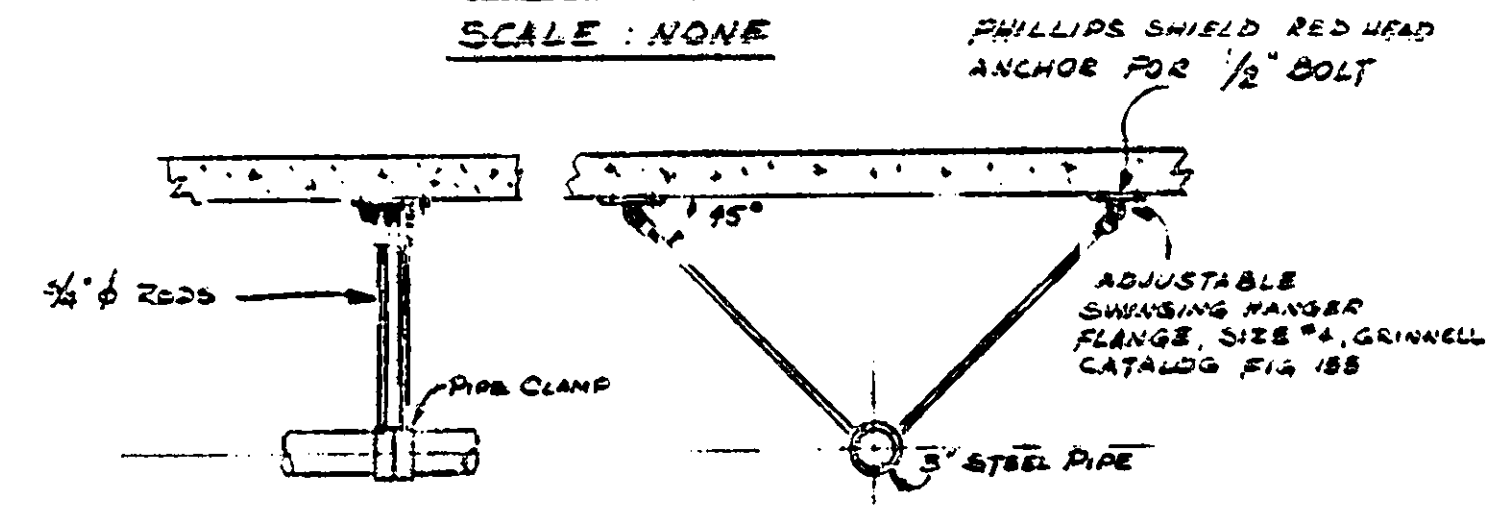

SWAY BRACING
 NOTE: INSTALL SWAY BRACING WITHIN 2' OF EACH TEE AND AT 100' INTERVALS

HANGER RODS		
PIPE SIZE	ROD SIZE	WASHER SIZE
6"	3/4"	2" x 3/32"
8"	7/8"	2" x 3/32"

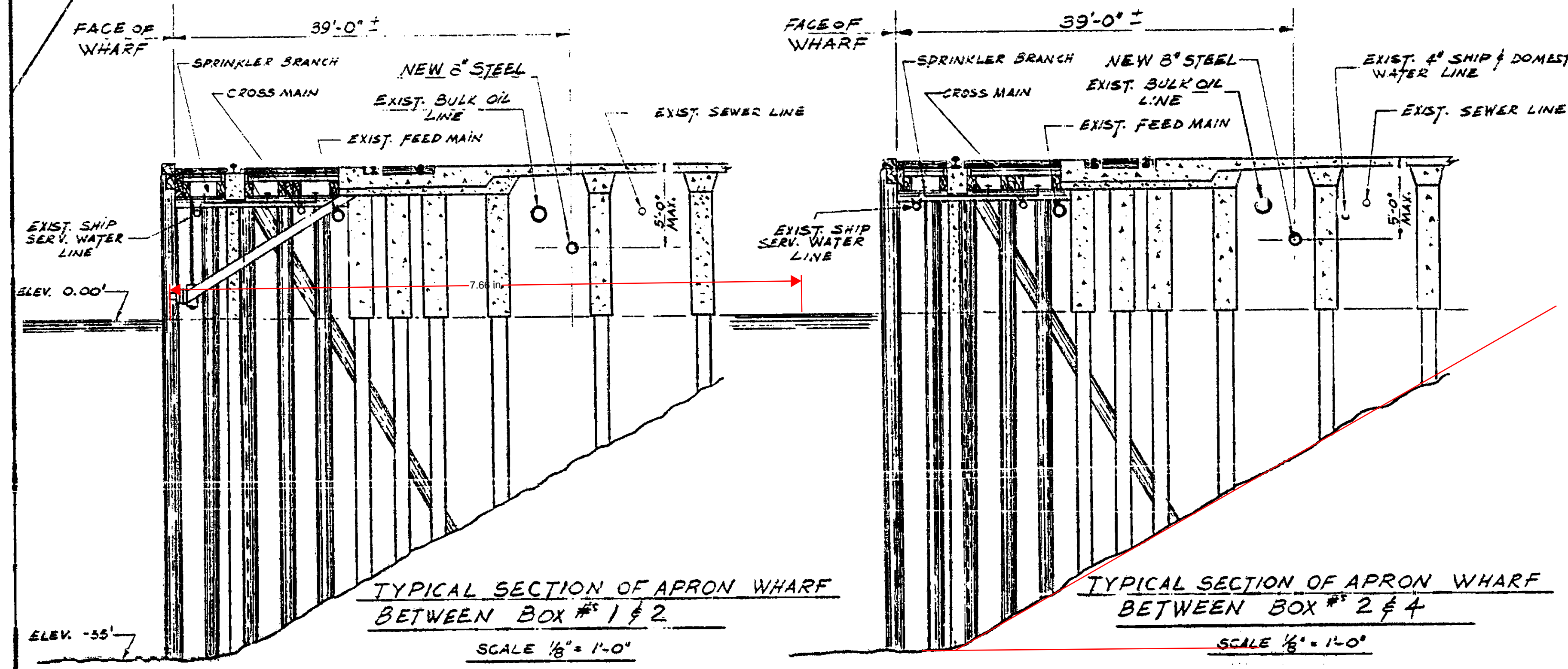

TYPICAL SECTION OF APRON WHARF BETWEEN BOX #1 & 2
 SCALE 1/8" = 1'-0"

TYPICAL SECTION OF APRON WHARF BETWEEN BOX #2 & 4
 SCALE 1/8" = 1'-0"

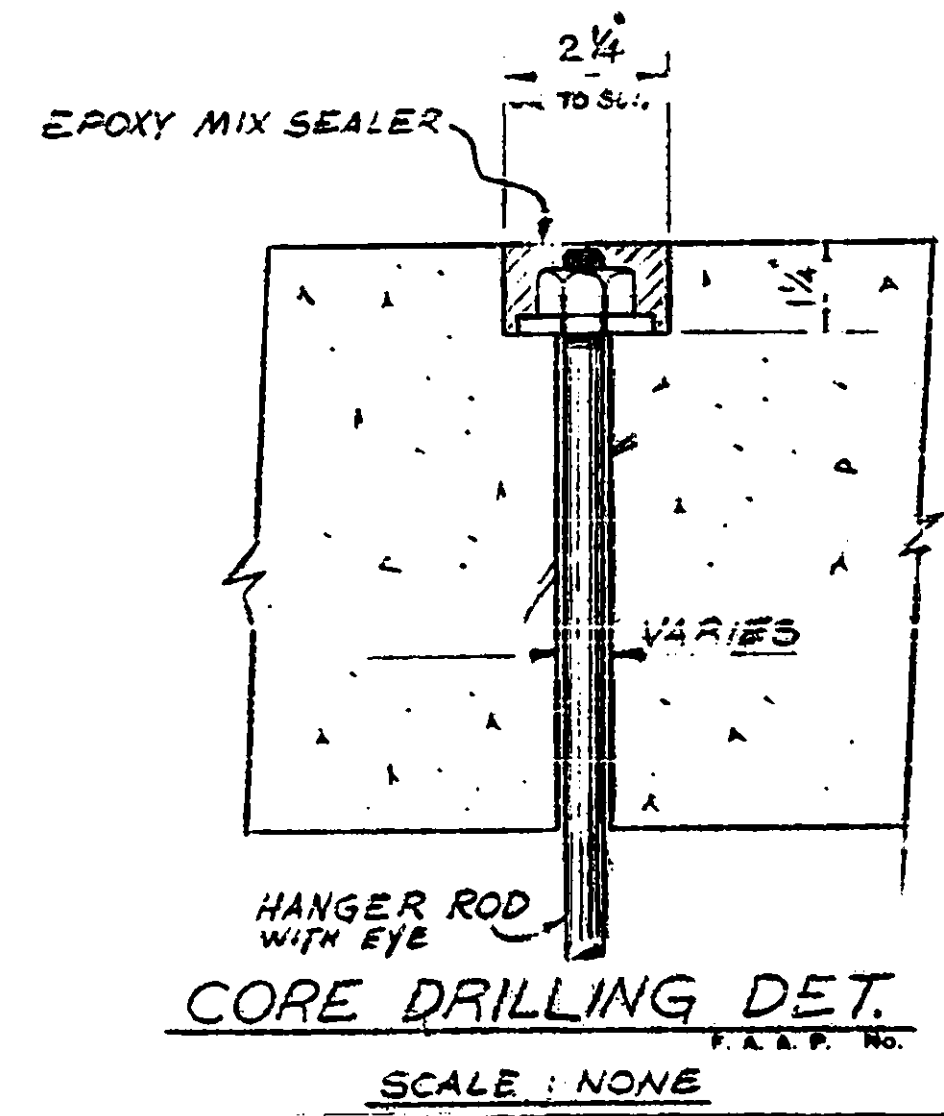

HANGER ROD WITH EYE
 CORE DRILLING DET.
 SCALE: NONE

NO. REVISIONS DATE			PORT OF OAKLAND OAKLAND, CALIFORNIA OUTER HARBOR TERMINAL BERTHS 8 & 9 SHIPS WATER SERVICE	
DRAWN: C.P. & D.B. CHECKED: R.H.W. RECOMMENDED: B. Skaggs APPROVED: William C. Dravot <small>LEAD CHIEF ENGINEER</small>				

OUTER HARBOR REPLACEMENT OF BOLLARDS AT BERTHS 20 & 21

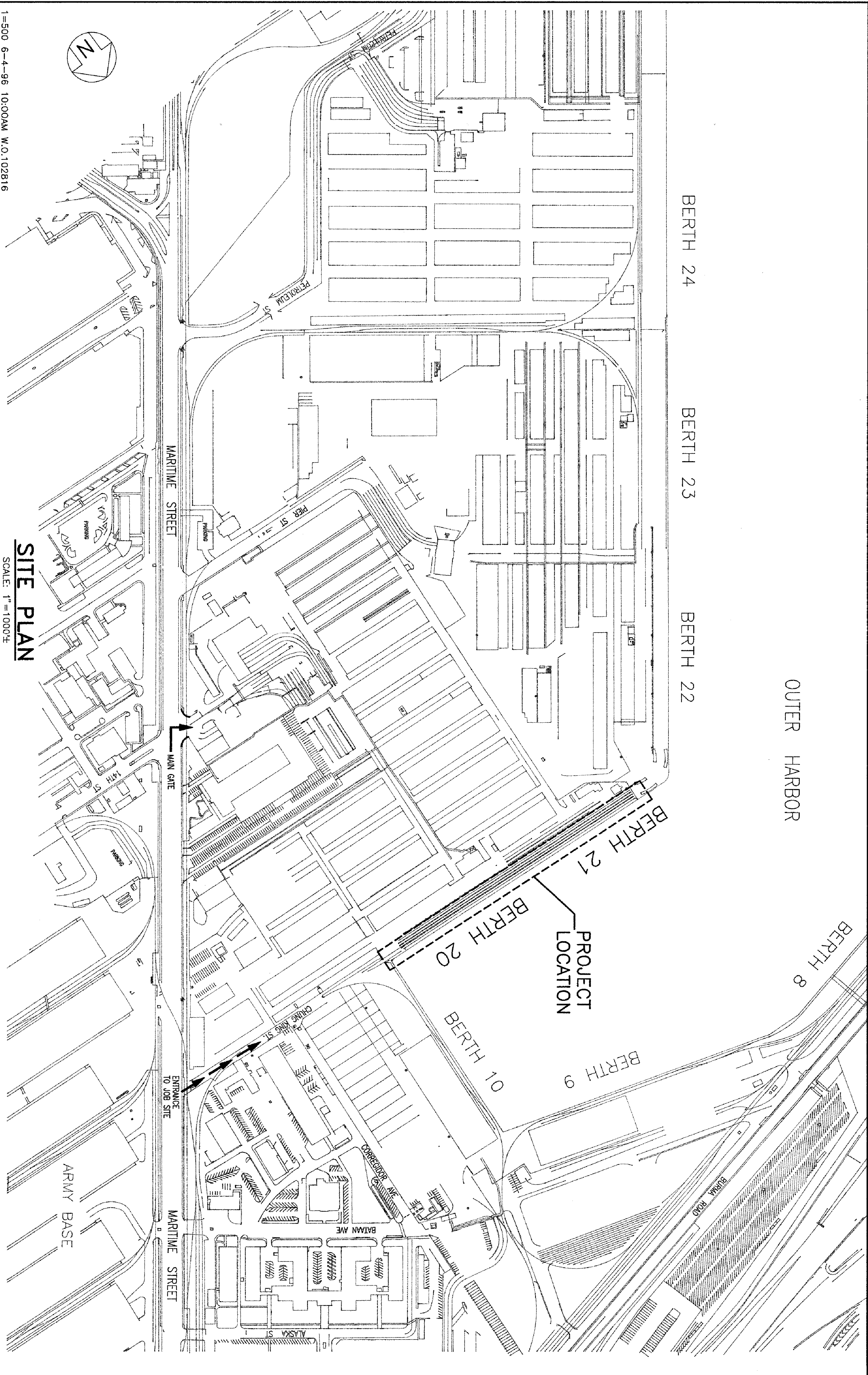

SITE PLAN
SCALE: 1"=1000'

1-500 6-4-96 10:00AM W.O.102816

REFERENCES:		REVISED		DESIGNED		CHIEF ENGINEER	
PLANS	AA-919	SCHEMES DEPARTMENT	WKS	WKS	REG. ENGINEER NO.	C 17439	
FIELD BOOKS	AA-1439	CONSTRUCTION DEPARTMENT	WKS	WKS	REG. ENGINEER NO.	C 18853	
*PORT OF OAKLAND DRAWING IS 320' BELOW MEAN SEA LEVEL		REVIEWED	WKS	WKS	REG. ENGINEER NO.	C 24933	RECOMMENDED
CAUTION: CHECK TRACKING FOR LATEST REVISIONS		REVIEWED	DATE	DATE	REG. ENGINEER NO.	C 24933	REG. ENGINEER NO.

PORT OF OAKLAND
530 WATER STREET OAKLAND, CALIFORNIA

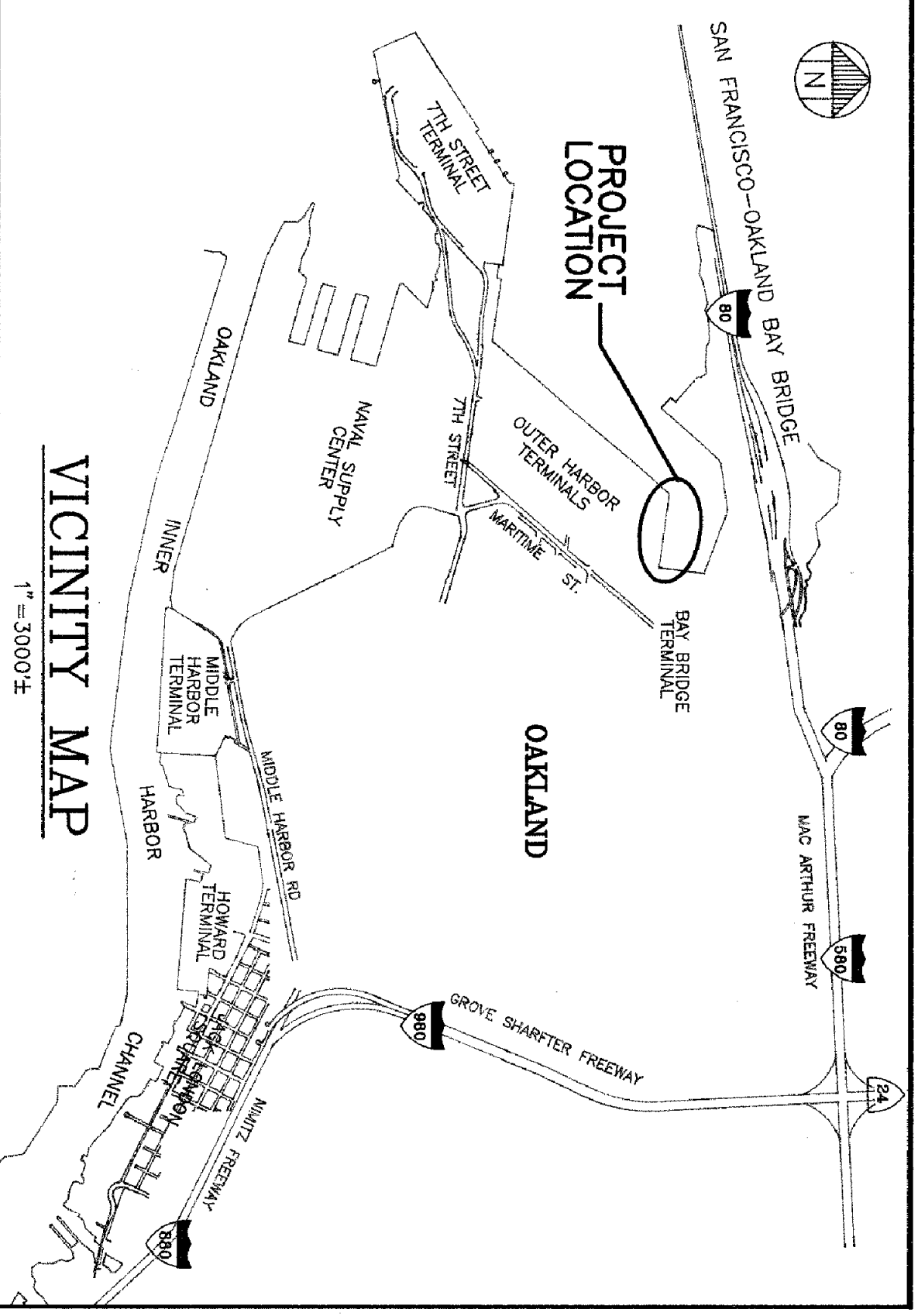

VICINITY MAP
1"=3000'

1. TITLE SHEET & SITE PLAN
2. DEMOLITION PLANS & DETAILS
3. PLANS, SECTIONS & DETAILS
4. DETAILS & SECTIONS
5. UTILITIES SITE PLAN
6. CATHODIC PROTECTION & PLUMBING DETAILS

LEGEND

- A SECTION IDENTIFICATION LETTER
SHEET NUMBER ON WHICH SECTION IS DRAWN
SHEET NUMBER FROM WHICH SECTION IS TAKEN
- 2 SECTION IDENTIFICATION LETTER
SECTION IS TAKEN AND DRAWN ON SAME SHEET
- 2 DETAIL IDENTIFICATION NUMBER
SHEET NUMBER ON WHICH DETAIL IS DRAWN
SHEET NUMBER FROM WHICH DETAIL IS TAKEN
- 2 DETAIL IDENTIFICATION NUMBER
DETAIL IS TAKEN AND DRAWN ON SAME SHEET

CAUTION: THIS PLAN MAY BE REDUCED

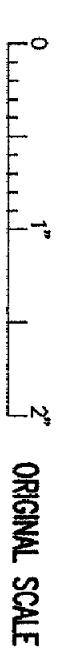

OUTER HARBOR REPLACEMENT OF BOLLARDS AT BERTHS 20 & 21	DATE: 06-24-96 SCALE AS SHOWN SHEET 1 OF 6 SHEETS AA-3344
---	---

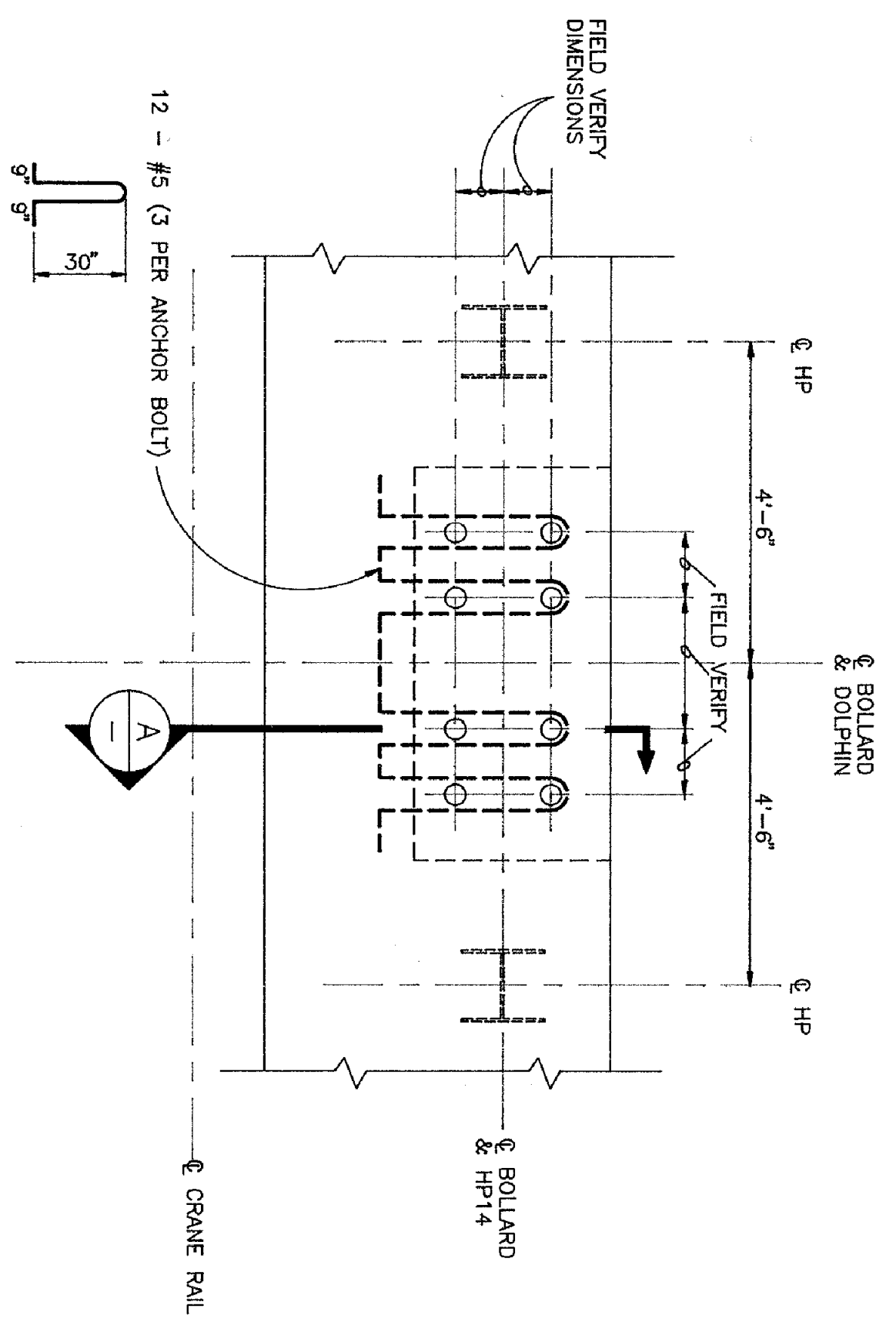

1
3/4
DETAIL PLAN
SCALE: 3/4"=1'-0"

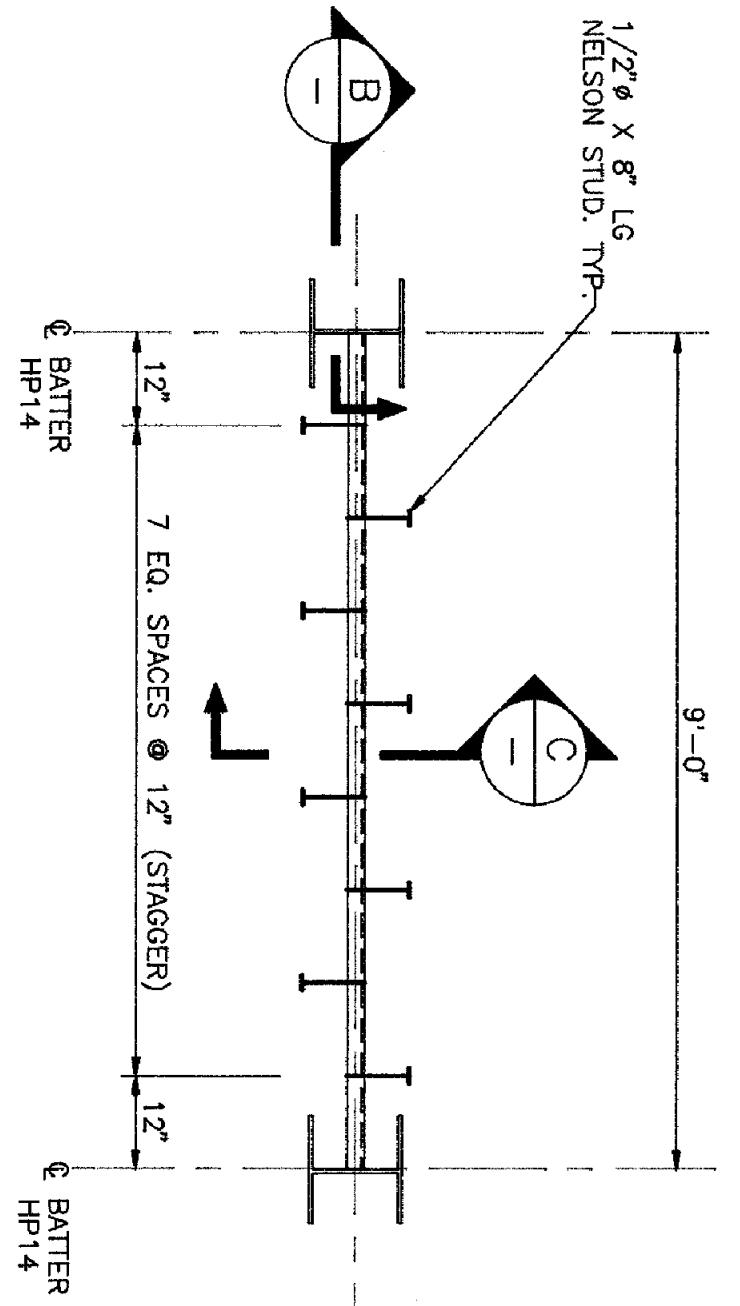

2
3/4
DETAIL PLAN
SCALE: 3/4"=1'-0"

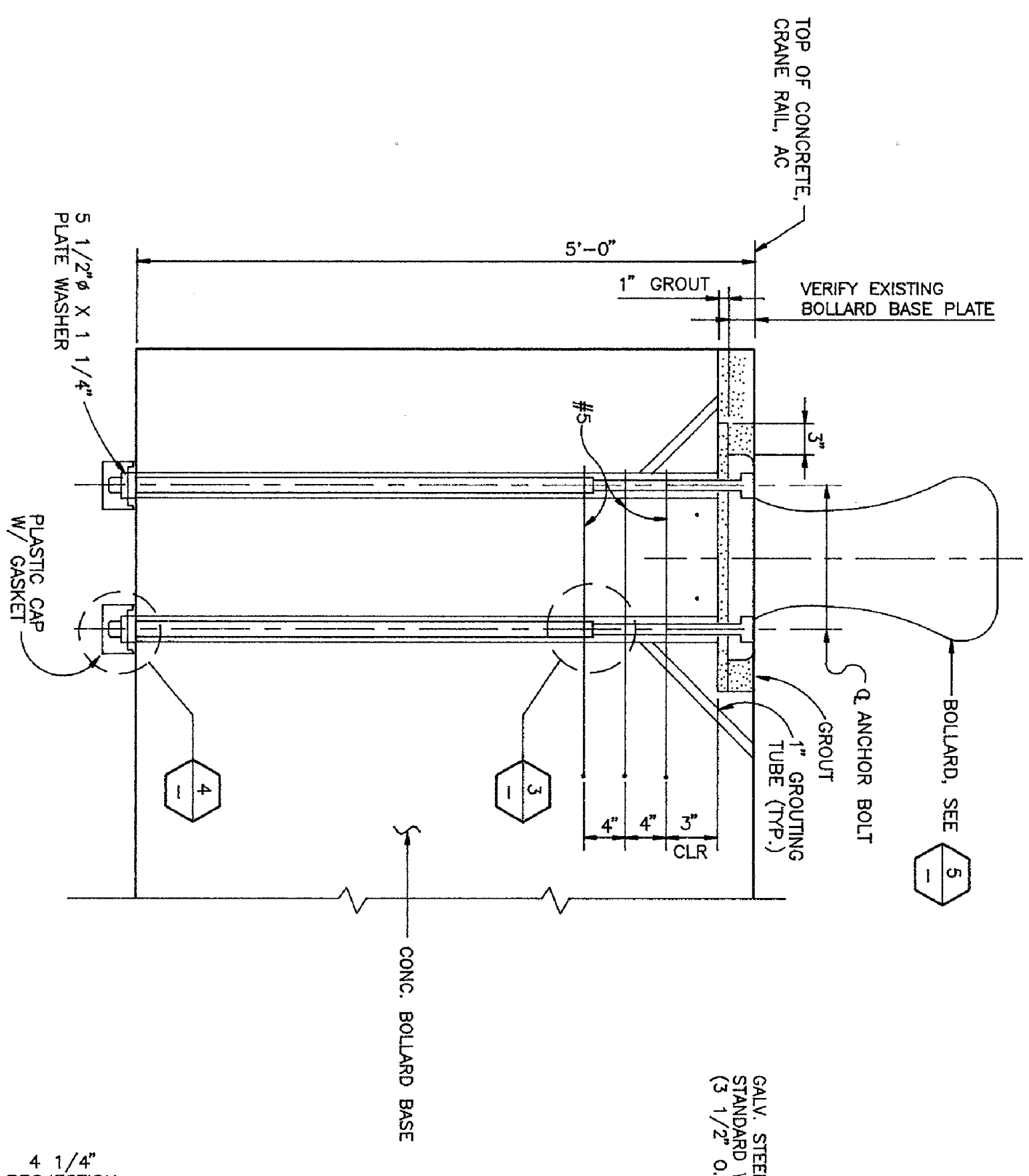
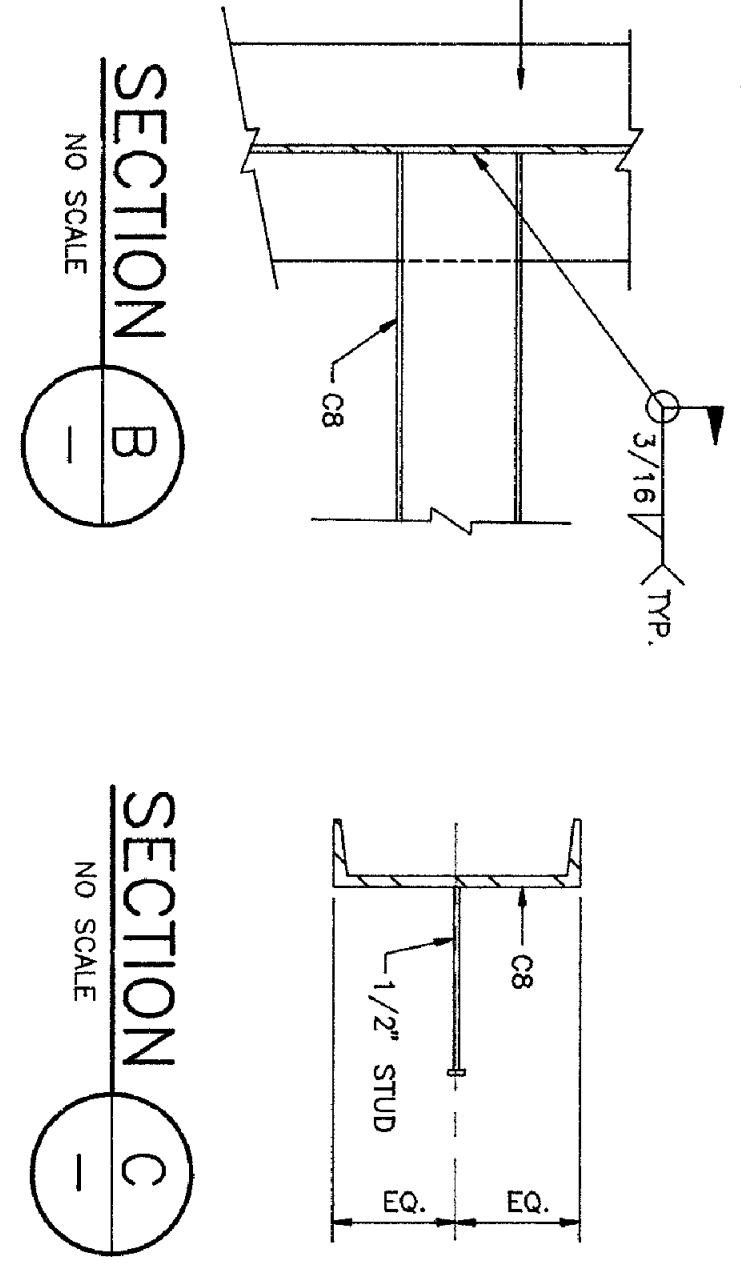

SECTION A
SCALE: 1"=1'-0"

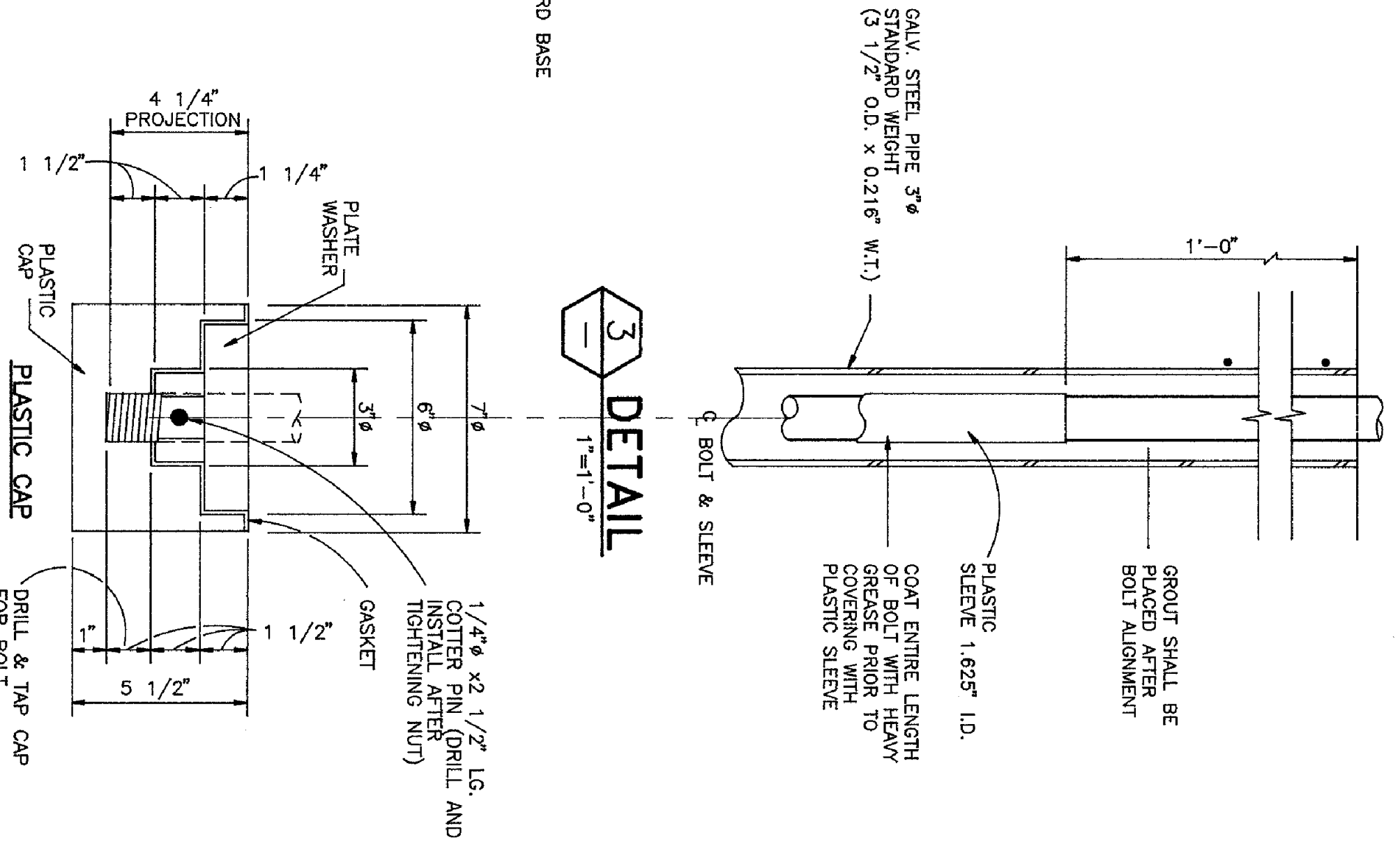

3
1
DETAIL
SCALE: 1"=1'-0"

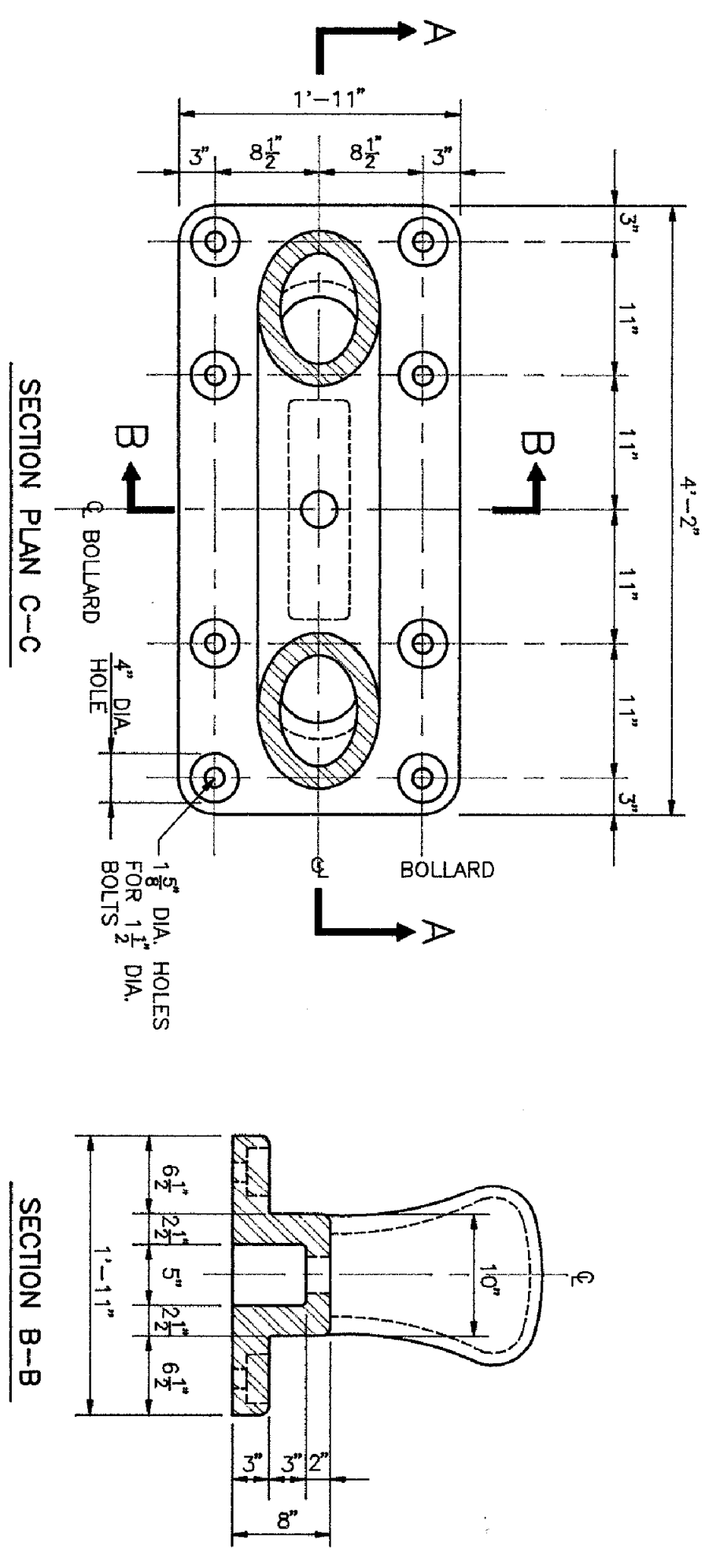

5
DOUBLE MOORING BOLLARD DETAILS
SCALE: 3/4"=1'-0"

CAUTION: THIS PLAN MAY BE REDUCED
ORIGINAL SCALE

REFERENCES:	AA 3180				
PLANS	AA 3180				
FIELD BOOKS					
"PORT OF OAKLAND DATA" IS 3.20' BELOW MEAN SEA LEVEL					
CAUTION: CHECK TRACING FOR LATEST REVISIONS					
NO.	DATE	APP'D	REVIEWED	REVIEWED	REVIEWED

DESIGNED	MIN	DRAWN	MIN
CHECKED		REVIEWED	
REG. ENGINEER NO.		REG. ENGINEER NO.	
REG. ENGINEER NO.		REG. ENGINEER NO.	

CHIEF ENGINEER	C 17439
APPROVED	C 18853
RECOMMENDED	C 24933
REG. ENGINEER NO.	
REG. ENGINEER NO.	

OUTER HARBOR	DATE: 06-24-96
REPLACEMENT OF BOLLARDS AT BERTHS 20 & 21	SCALE: AS NOTED
DETAILS & SECTIONS	SHEET: 4 OF 6
	AA-3344

PORT OF OAKLAND
530 WATER STREET OAKLAND, CALIFORNIA

3344-S (1=50) 6/12/96 9:00AM WO #102816

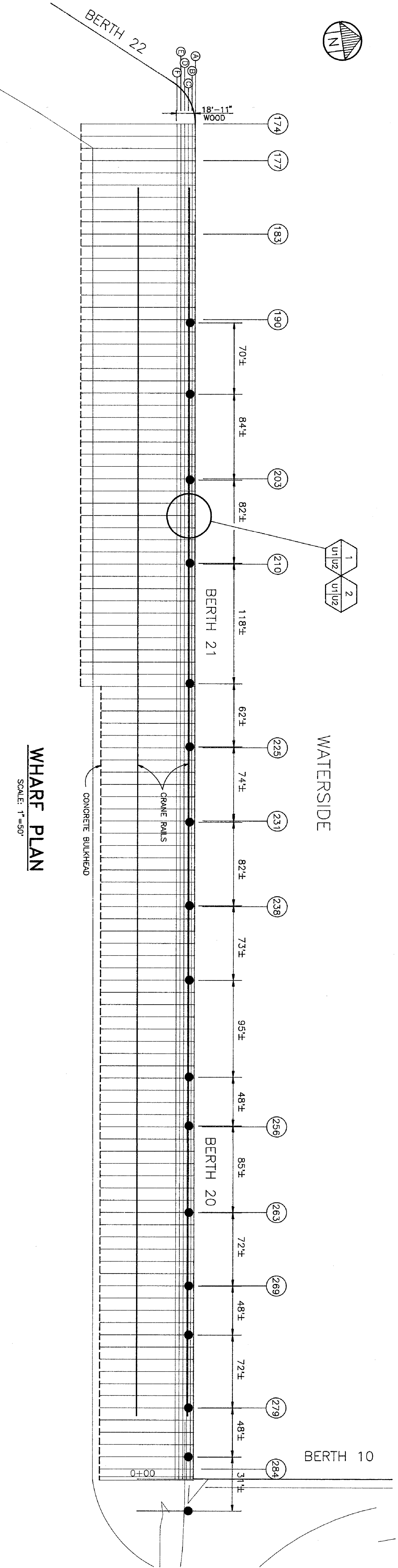
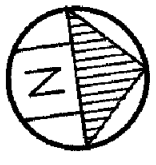

WHARF PLAN
SCALE: 1"=50'

LEGEND:

- APPROXIMATE BOLLARD LOCATIONS
- (E) EXISTING
- (N) NEW

ABBREVIATIONS

- CLR CLEAR
- CONC CONCRETE
- EXIST EXISTING
- GALV GALVANIZED
- HP14 STEEL PILE IDENTIFICATION
- REQD REQUIRED
- T.O.C. TOP OF CONCRETE
- VERT VERTICAL
- EA EACH

NOTES:

- 1 AFTER THE NEW PILES HAVE BEEN INSTALLED, INSTALL NEW ANODES ON THE STEEL PILES AS SHOWN. THE NEW ANODES SHALL BE TESTED IN ACCORDANCE WITH THE MANUFACTURER'S INSTRUCTIONS. TESTING & INSTALLATION SHALL BE PERFORMED UNDER THE GUIDANCE OF THE MANUFACTURER/SUPPLIER'S CORROSION ENGINEER. TEST RESULT SHALL BE SUBMITTED TO THE ENGINEER.
- 2 CONTRACTOR SHALL PROVIDE SAFETY EQUIPMENT TO HIS WORKERS AS REQD FOR THE REMOVAL & INSTALLATION OF WATERLINES INCLUDING SPRINKLER HEADS, PIPING, ETC & CATHODIC PROTECTION ANODES.
- 3 OTHER UTILITY LINES THAT ARE ENCOUNTERED & NOT SHOWN ON THE PLANS SHALL BE MARKED ON RECORD DRAWINGS & REPORTED TO THE ENGINEER AS SOON AS POSSIBLE. DO NOT REMOVE/RELOCATE THESE UTILITIES WITHOUT PRIOR APPROVAL OF THE ENGINEER.
- 4 ALL WORK SHALL BE IN COMPLIANCE WITH ALL APPLICABLE CODES.
- 5 WHEN WORKING BENEATH THE WHARF DECK, EXERCISE EXTREME CARE TO AVOID INJURY & TO MINIMIZE THE LOSS OF TOOLS & EQUIPMENT. ALL ITEMS WHICH FALL INTO THE WATER SHALL BE RETRIEVED & NOT ALLOWED TO REMAIN ON THE SPABED.

NO.	REVISIONS	DATE	APP'D

REVIEWED	REVIEWED	REVIEWED	REVIEWED

PORT OF OAKLAND
530 WATER STREET OAKLAND, CALIFORNIA

DESIGNED	CHECKED	REVIEWED

DATE	SCALE	SHEET	OF	SHEETS
6/24/96	AS SHOWN	5	6	

DATE	SCALE	SHEET	OF	SHEETS
6/24/96	AS SHOWN	5	6	

PLANNED

CAUTION: THIS PLAN MAY BE REDUCED

CAUTION: CHECK TRACING FOR LATEST REVISIONS

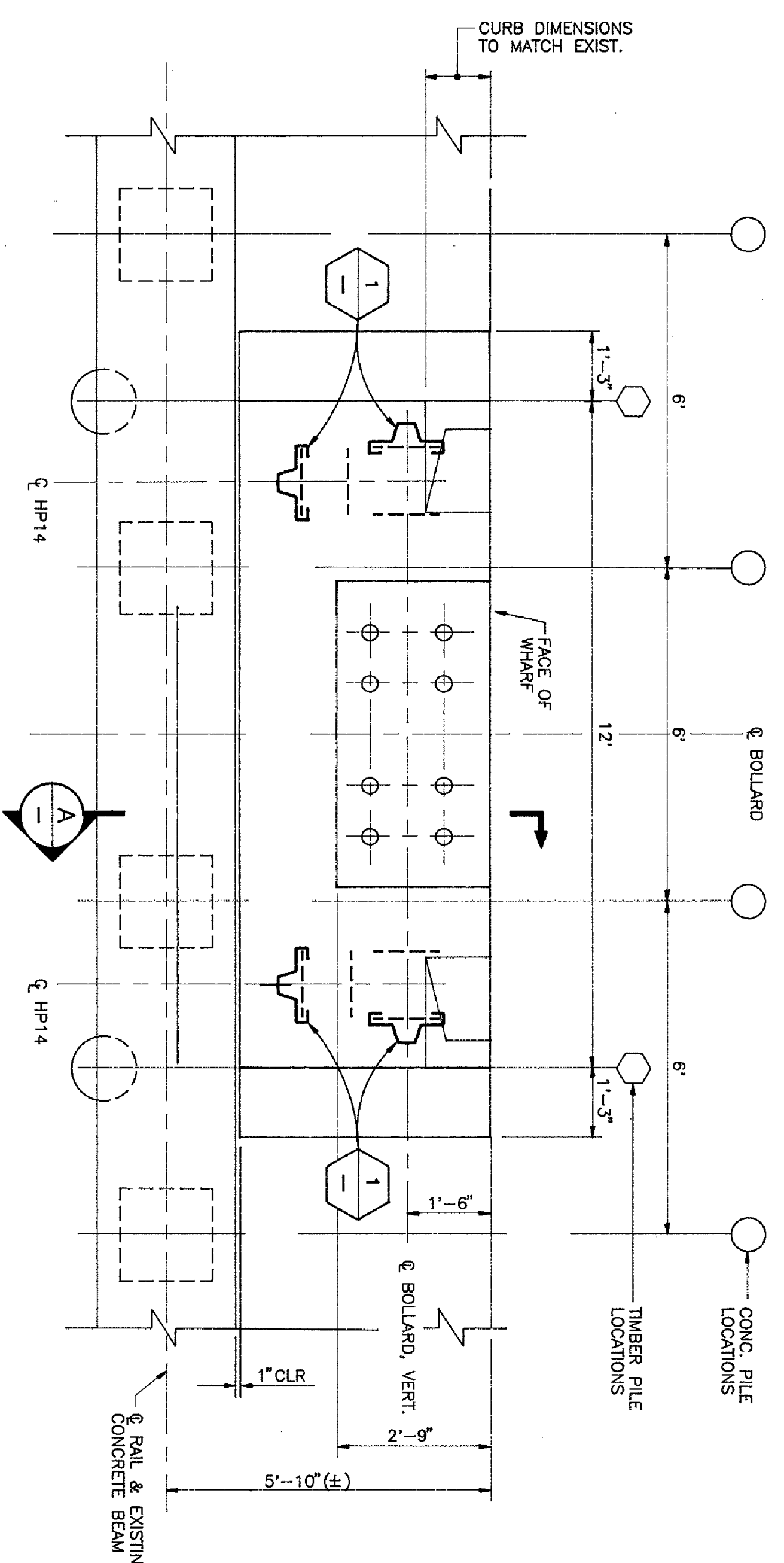

PARTIAL PLAN 1 CATHODIC PROTECTION
 1/2" = 1'-0"
 NOTE: NEW OR EXISTING WATERLINES, TIMBER DECK AND FRAMING NOT SHOWN FOR CLARITY.

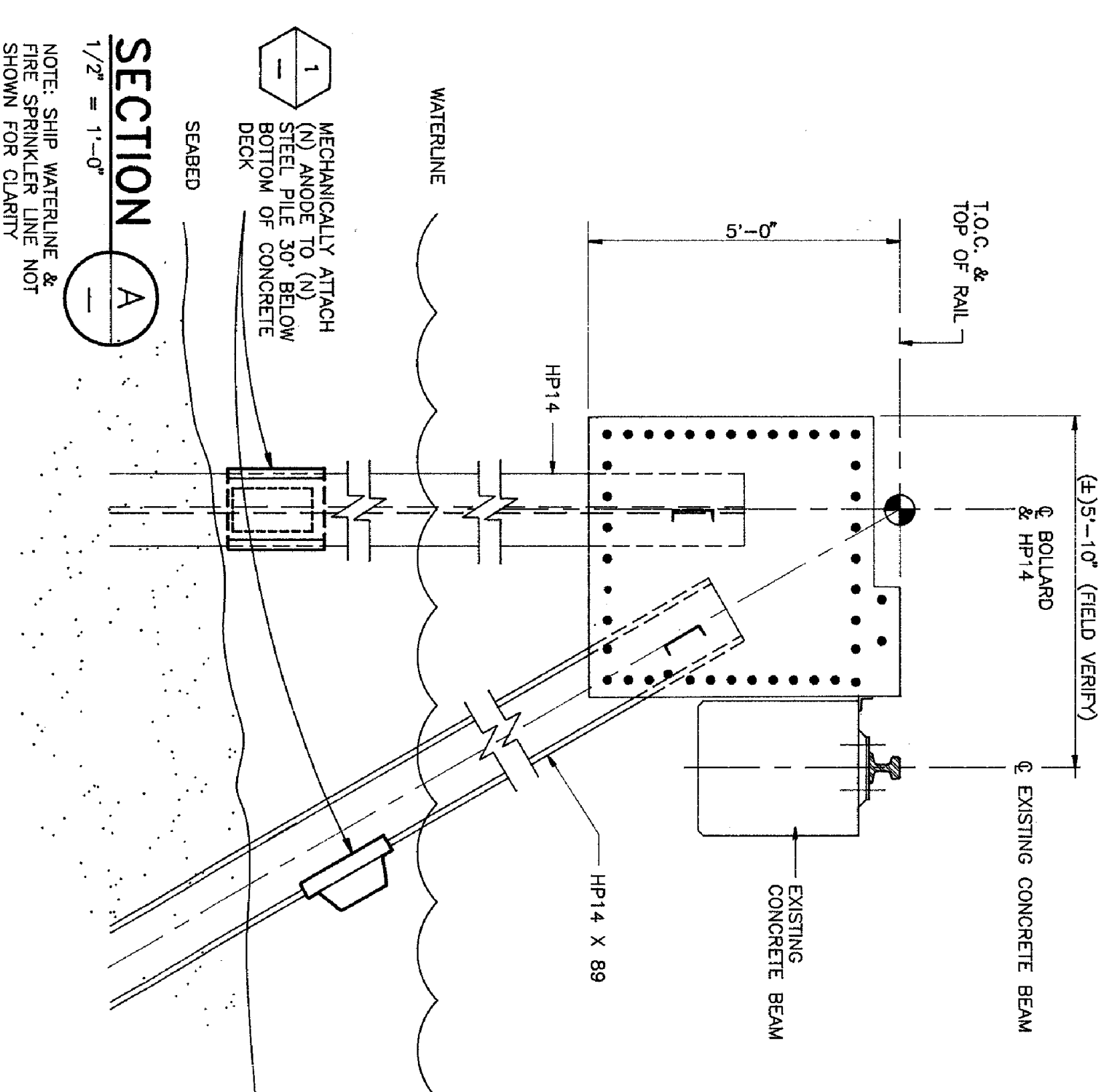

SECTION A
 1/2" = 1'-0"
 NOTE: SHIP WATERLINE & FIRE SPRINKLER LINE NOT SHOWN FOR CLARITY

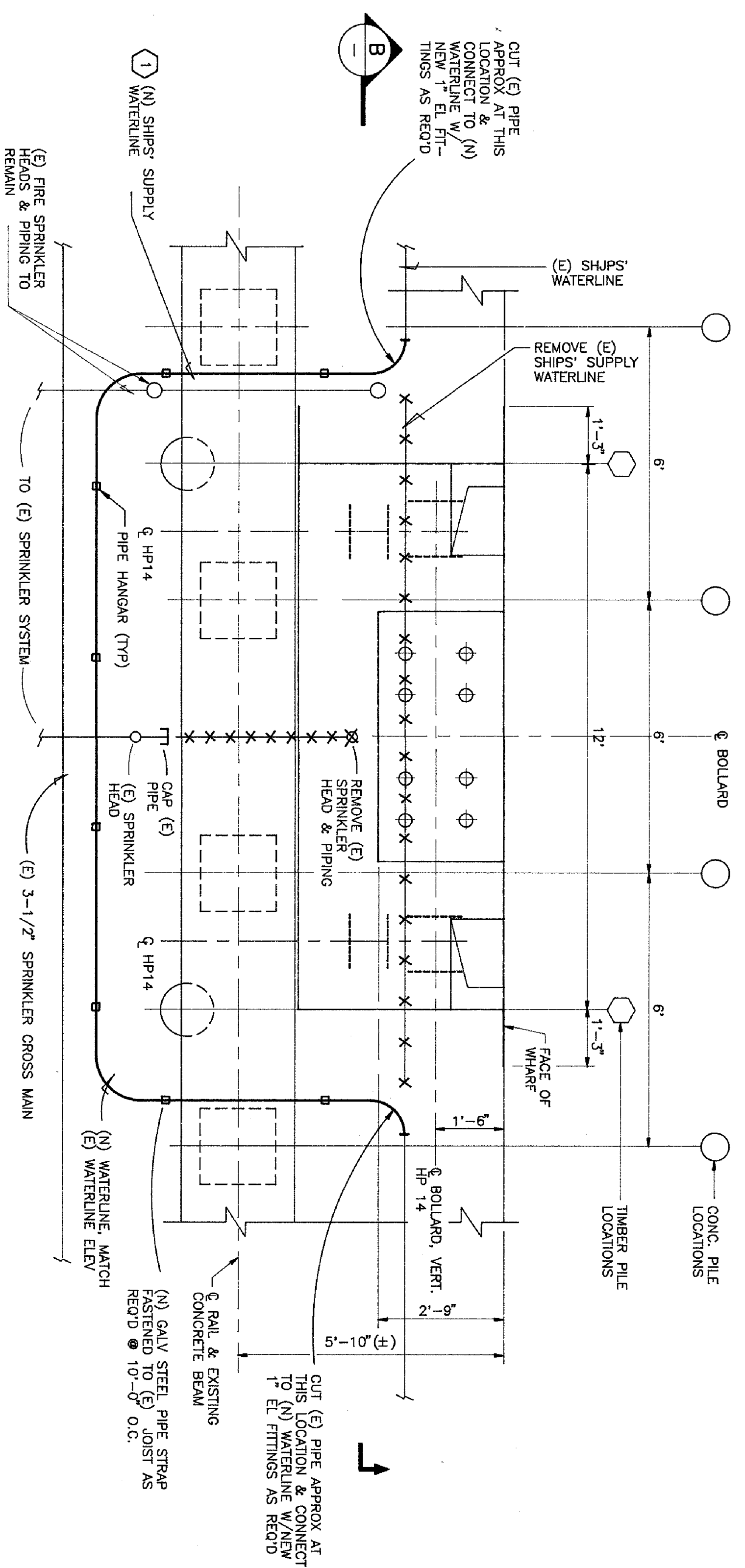

PARTIAL PLAN 2 DOMESTIC/FIRE WATER SERVICE
 1/2" = 1'-0"
 NOTE: NEW ANODES AND NEW OR EXISTING TIMBER DECK AND FRAMING NOT SHOWN FOR CLARITY.

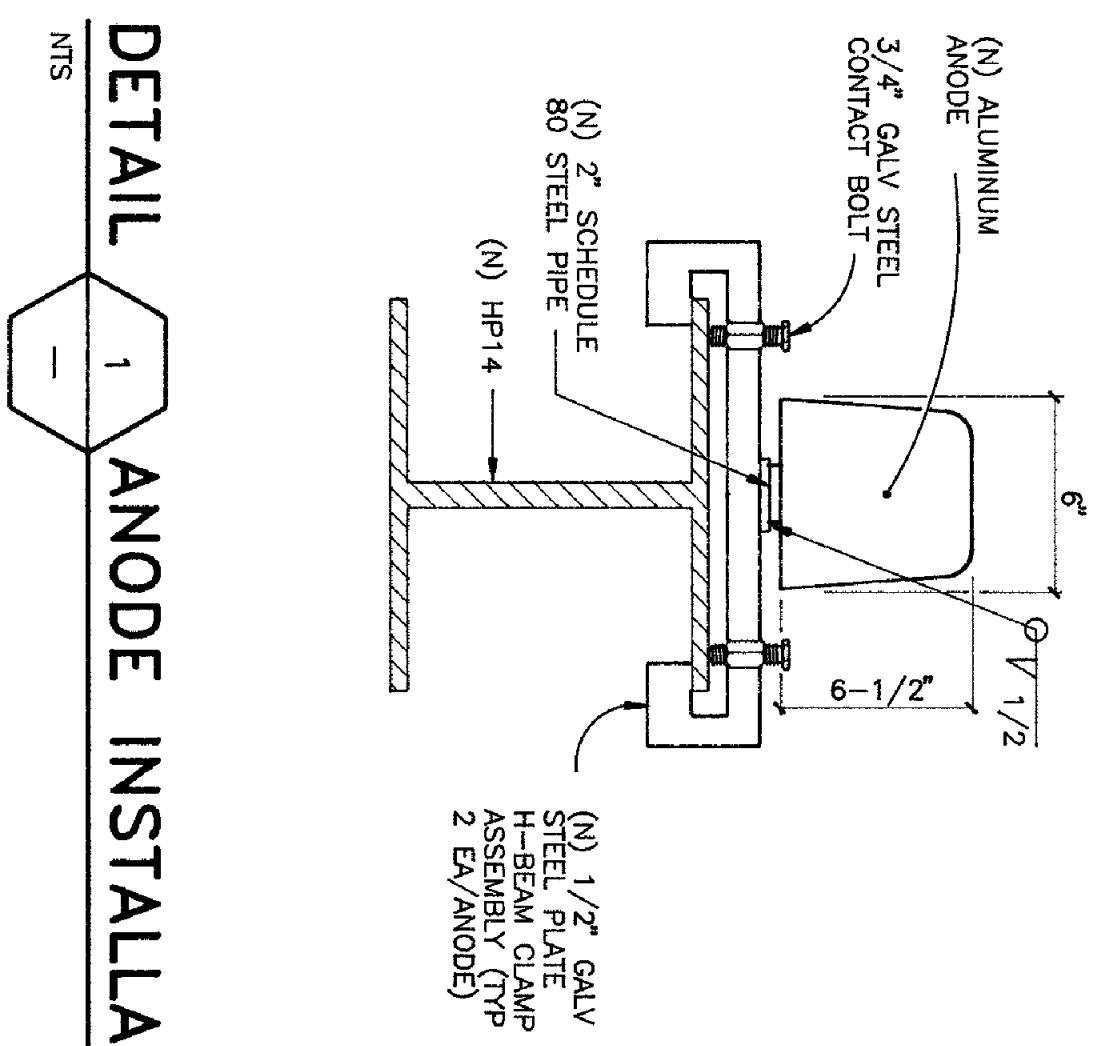

DETAIL 1 ANODE INSTALLATION

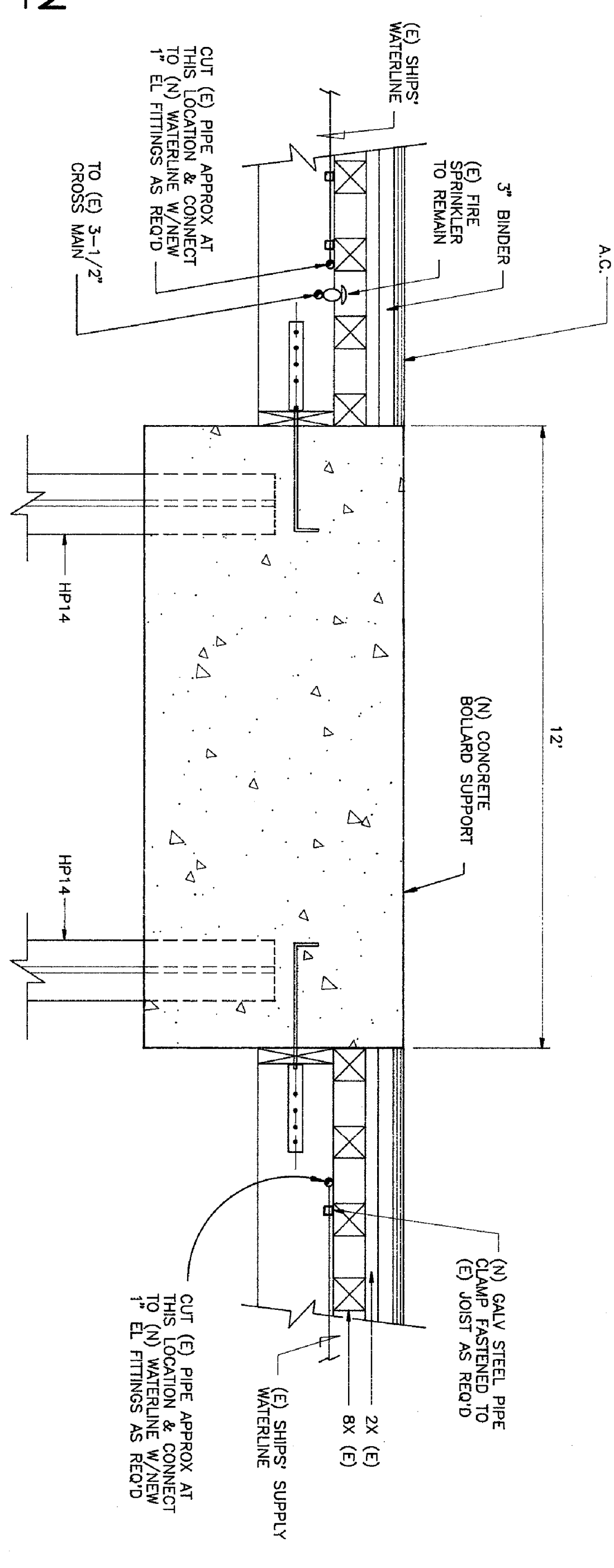

SECTION B
 1/2" = 1'-0"

3344-6 (1=2/1=4) 6/12/96 9:10AM WO #102816

REFERENCES		REVIEWED		REVIEWED	
PLANS	AA-3180	DESIGNED	L. Horan	CHECKED	J. Lee
FIELD BOOKS		REVIEWED	J. Lee	REVIEWED	J. Lee
"PORT OF OAKLAND DATUM" IS 3.20' BELOW MEAN SEA LEVEL		PROJECT PLANNING DEPARTMENT		PROJECT PLANNING DEPARTMENT	
CAUTION - CHECK TRACING FOR LATEST REVISIONS		DATE	APPROV	DATE	APPROV

PORT OF OAKLAND
 530 WATER STREET OAKLAND, CALIFORNIA

CHIEF ENGINEER		OUTER HARBOR TERMINAL	
APPROVED	J. Lee	REPLACEMENT OF BOLLARDS	AT BERTHS 20 & 21
RECOMMENDED	J. Lee	CATHODIC PROTECTION & PLUMBING DETAILS	
DATE	6/24/96	SCALE	AS SHOWN
SHEET	6 OF 6	FILE	AA-3344 U2

NOTES:
 SEE SHEET U1

CAUTION: THIS PLAN MAY BE REDUCED
 0 1" 2" ORIGINAL SCALE

OUTER HARBOR TERMINAL ASPHALT CONCRETE OVERLAY, BERTHS 20 & 21 YARD

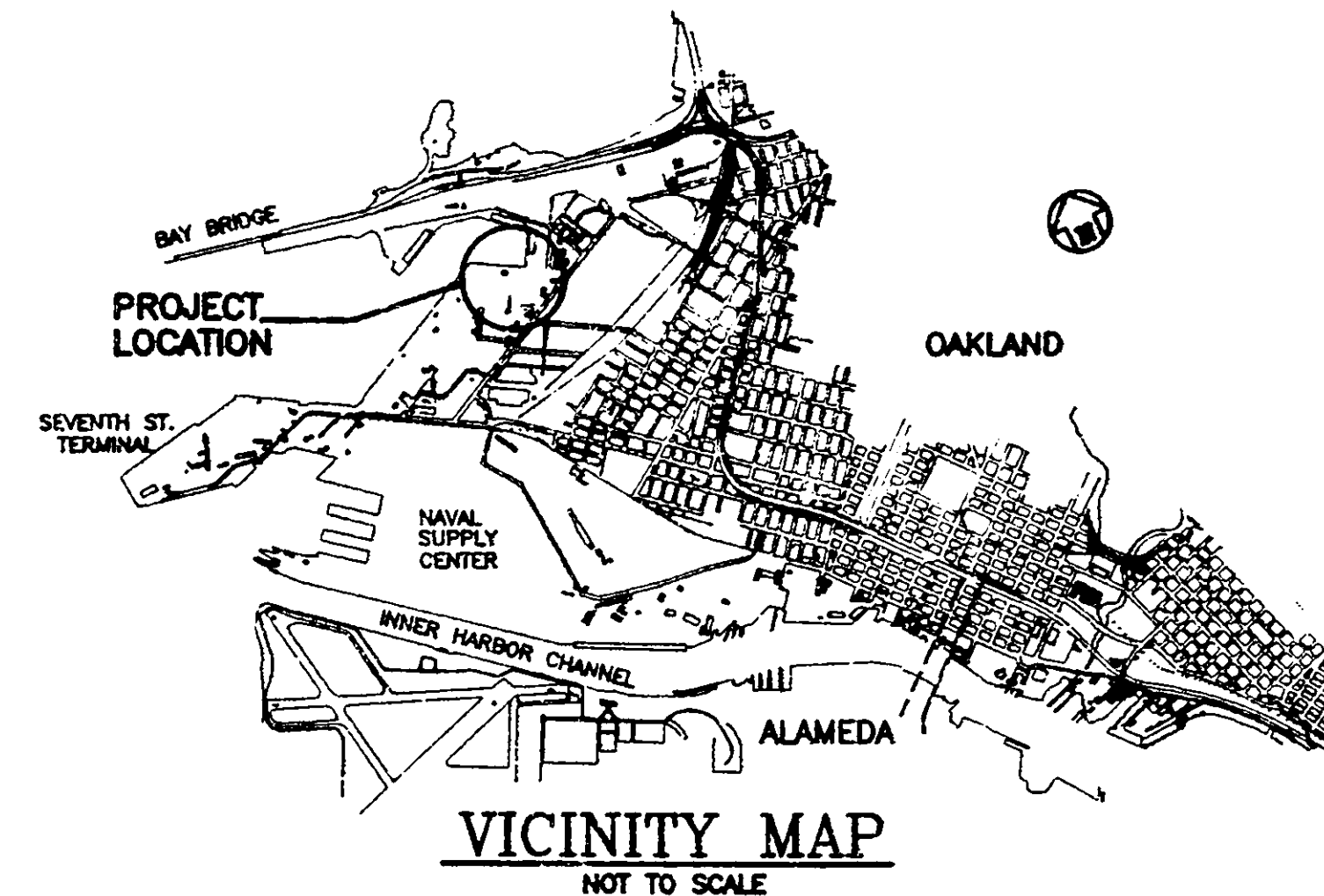

INDEX OF DRAWINGS

- | | | |
|----|-----|--|
| 1 | G1 | TITLE SHEET/SITE PLAN |
| 2 | G2 | LEGEND AND NOTES |
| 3 | G3 | SURVEY CONTROL PLAN |
| 4 | G4 | PHASING PLAN |
| 5 | Y1 | EXISTING CONDITIONS - SHEET 1 |
| 6 | Y2 | EXISTING CONDITIONS - SHEET 2 |
| 7 | Y3 | SITE PREPARATION AND DRAINAGE PLAN - SHEET 1 |
| 8 | Y4 | SITE PREPARATION AND DRAINAGE PLAN - SHEET 2 |
| 9 | Y5 | GRADING PLAN - SHEET 1 |
| 10 | Y6 | GRADING PLAN - SHEET 2 |
| 11 | Y7 | OVERALL PAVING PLAN |
| 12 | Y8 | GRADING CROSS SECTIONS - SHEET 1 |
| 13 | Y9 | GRADING CROSS SECTIONS - SHEET 2 |
| 14 | Y10 | GRADING CROSS SECTIONS - SHEET 3 |
| 15 | Y11 | GRADING CROSS SECTIONS - SHEET 4 |
| 16 | Y12 | UTILITY ADJUSTMENT SCHEDULE |
| 17 | Y13 | UTILITY ADJUSTMENT SCHEDULE |
| 18 | S1 | STRIPING PLAN - SHEET 1 |
| 19 | S2 | STRIPING PLAN - SHEET 2 |
| 20 | S3 | STRIPING DETAILS |
| 21 | D1 | SECTIONS & DETAILS |
| 22 | D2 | SECTIONS |
| 23 | D3 | SECTIONS & DETAILS |
| 24 | U1 | UTILITY PLANS - SHEET 1 |
| 25 | U2 | UTILITY PLANS - SHEET 2 |
| 26 | U3 | UTILITY PLAN, SECTION, DETAILS AND GENERAL NOTES |
| 27 | U4 | UTILITY DIAGRAMS AND NOTES |

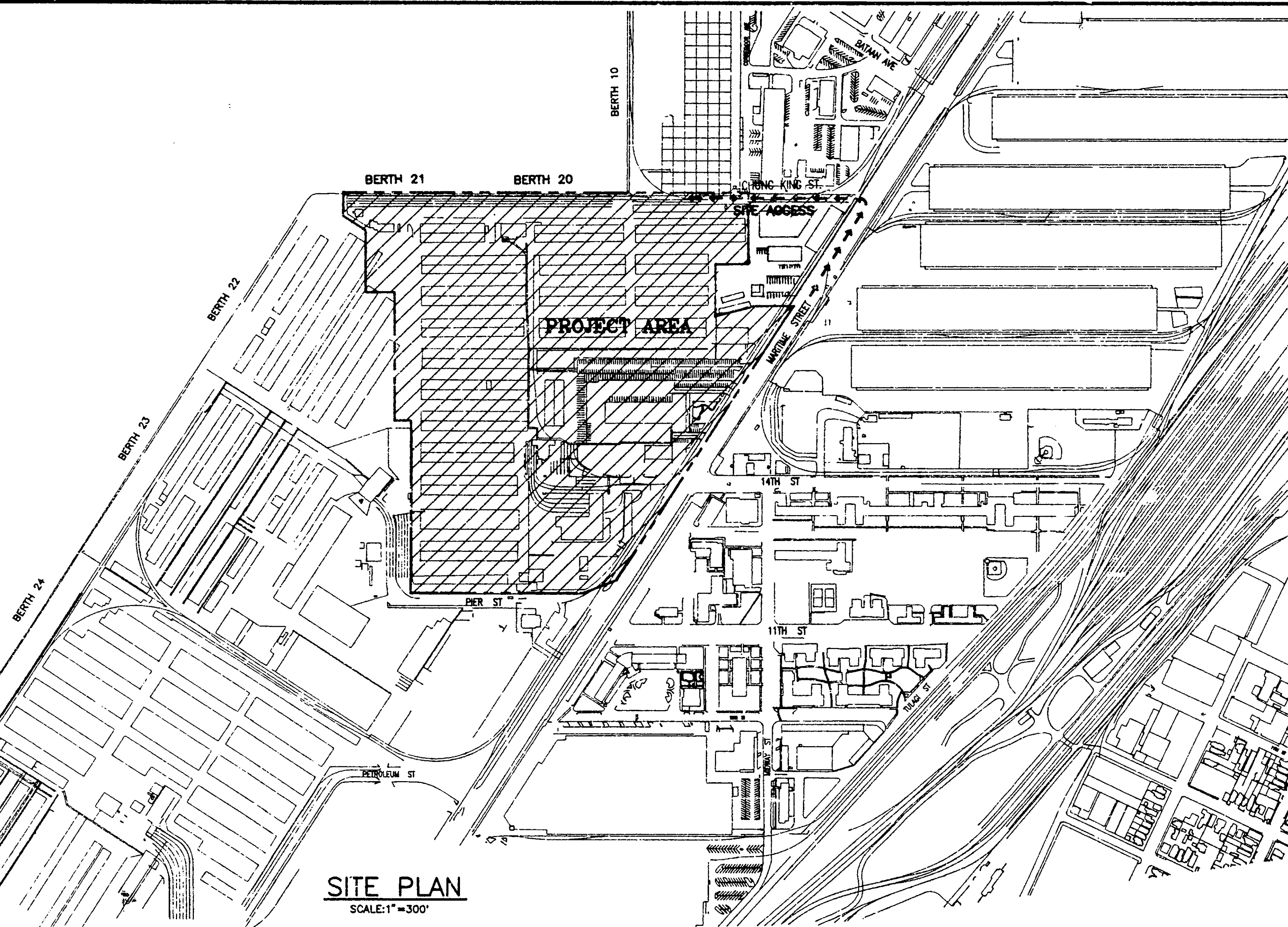
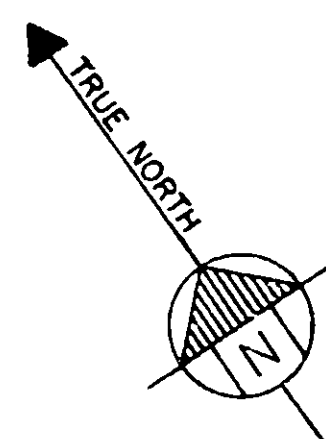

1-300 6-12-93 1:30 PM

FILMED BY
DATA IMAGE SYSTEMS CORP

REFERENCES		REVIEWED FACILITIES DEPARTMENT	DRAWN SS/MN/HL	PORT OF OAKLAND 530 WATER STREET OAKLAND, CALIFORNIA	CHIEF ENGINEER [Signature]	OUTER HARBOR TERMINAL	DATE 6/17/1993	
PLANS		REVIEWED CONSTRUCTION DEPARTMENT	DESIGNED M. Miley S 3414	[Logo]	REG. ENGINEER NO. C 17439	ASPHALT CONCRETE OVERLAY	SCALE AS SHOWN	
FIELD BOOKS		REVIEWED PROJECT PLANNING DEPARTMENT	CHECKED C. Chan C 43841		APPROVED [Signature]	REG. ENGINEER NO. C 18853	BERTHS 20 & 21 YARD	SHEET 1 OF 27 SHEETS
"PORT OF OAKLAND DATUM" IS 3.20' BELOW MEAN SEA LEVEL.			REVIEWED V. Smith		RECOMMENDED [Signature]	REG. ENGINEER NO. C 32172	TITLE SHEET	FILE AA-3147
NO.	REVISIONS	DATE	APP'D			G1		

CAUTION - CHECK TRACING FOR LATEST REVISIONS

CAUTION: THIS PLAN MAY BE REDUCED

0 1" 2" ORIGINAL SCALE

STANDARD SYMBOLS

	LIGHT POLE (E)
	FIRE HYDRANT (E)
	ELECTRICAL PULL BOX (E)
	STORM DRAIN/MANHOLE (N)
	CLEANOUT (N)
	UTILITY BOX (E)
	MANHOLE (E)
	FIRE ALARM PULL BOX (E)
	WATER METER (E)
	MONUMENT POINT /CONTROL POINT
	DRAIN INLET (E)
	STORM DRAIN/MANHOLE (E)
	CATCH BASIN (E)
	AISLE MARKER (E)
	EXISTING GRADE
	NEW GRADE
#101859	SURVEY POINT NUMBER
	BARRIER POST

STANDARD LINETYPE

	LIMIT OF WORK
	CENTER LINE
	EXISTING/HIDDEN
	EXISTING FENCE LINE
	FENCE LINE (N)
	REMOVE FENCE LINE
	TEMPORARY FENCE
	EXISTING CONTOUR LINE
	CONTOUR LINE (N)
	EXISTING TELEPHONE LINE
	EXISTING WATER LINE
	EXISTING GAS LINE
	EXISTING ELECTRICAL CONDUIT
	EXISTING SANITARY SEWER
	EXISTING STORM DRAIN
	STORM DRAIN (N)
	SLOTTED DRAIN (E)
	SLOTTED DRAIN (N)
	TRENCH DRAIN
	EXIST. RAIL
	EXIST. WALL

SYMBOLS & ABBREVIATIONS

AB	AGGREGATE BASE	FIN	FINISH	P.C.C.	PORTLAND CEMENT CONCRETE, POINT OF COMPOUND CURVE
AC	ASPHALT CONCRETE	FH	FIRE HYDRANT	P.G.& E.	PACIFIC GAS & ELECTRIC
ADD	ADDITIONAL, ADDITION	FL	FLOW LINE	P.I.	POINT OF INTERSECTION
ADJ	ADJACENT	FT OR (')	FOOT OR FEET	PRL	PARALLEL
ALTN	ALTERNATE	FTG	FOOTING	PVMT	PAVEMENT
&	AND	FDN	FOUNDATIONS	PERP	PERPENDICULAR
ASB	AGGREGATE SUBBASE	G	GAS	P.K. (NAIL)	SURVEY REFERENCE POINT
A.S.T.M.	AMERICAN SOCIETY FOR TESTING AND MATERIALS	GA	GAGE	R	PLATE
ASPH	ASPHALT	GALV	GALVANIZE	PC	POINT OF CURVATURE
AT	AT	GENL	GENERAL	PT	POINT OF TANGENCY
AVG	AVERAGE	GR	GRATE	POC.	POINT OF CURVE
AZ	AZIMUTH	G.B.	GRADE BREAK	PVC	POLYVINYL CHLORIDE
BC	BEGINNING OF CURVE	GUT.	GUTTER	PP	POWER POLE
BLDG	BUILDING	H	HORIZONTAL	P/C	PRECAST CONCRETE
BDRY	BOUNDARY	HGT	HEIGHT	P/S	PRESTRESSED CONCRETE
BM	BENCH MARK	HP	HIGH POINT	PROD	PRODUCED
BTM	BOTTOM	H.S.	HIGH STRENGTH	PF	PROFILE
BRG	BEARING	HORIZ	HORIZONTAL	QTY	QUANTITY
C.L.C	CALCULATED, CALCULATIONS	IN OR (")	INCHES	RDL	RADIAL
CBR	CALIFORNIA BEARING RATIO	I.D.	INSIDE DIAMETER	RAD OR R	RADIUS
CIP	CAST IRON PIPE	INVT/INV	INVERT	RCD	RECORD
CIPP	CAST-IN-PLACE PIPE	I.P.	IRON PIPE	REF	REFERENCE
CB	CATCH BASIN	JT	JOINT	SH.	SHEET
CEM	CEMENT	JCT	JUNCTION	SPECS.	SPECIFICATIONS
CTR	CENTER	JB	JUNCTION BOX	STA.	STATION
C/C	CENTER TO CENTER	K	KIP OR 1000 POUNDS	T.	THICKNESS
C	CENTER LINE	LT	LEFT	T.O.R.	TOP OF RAIL
CL	CLEARANCE	MIN.	MINIMUM	TYP.	TYPICAL
CMP	CORRUGATED METAL PIPE	MK	MARKED	W.	WEST, WIDE
CO	CLEAN OUT	M.L.	MATCH LINE		
CONC	CONCRETE	MATL	MATERIAL		
CONST	CONSTRUCTION	MEAS	MEASURE		
C.J	CONSTRUCTION JOINT	MECH	MECHANICAL		
CONT.	CONTINUED, CONTINUOUS	MDL	MIDWAY OR MIDDLE		
CORR.	CORRUGATED	MIN.	MINIMUM OR MINUTE		
X-SECT.	CROSS SECTION	MOD	MODIFY		
CULV.	CULVERT	MISC	MISCELLANEOUS		
		MON	MONUMENT		
DEG. OR (°)	DEGREE	N	NORTH, NORTHING		
DET.	DETAIL	N.T.S.	NOT TO SCALE		
DIA.	DIAMETER	(N)	NEW		
DIP.	DUCTILE IRON PIPE	NO. OR (#)	NUMBER		
DWG.	DRAWING	N.I.C	NOT IN CONTRACT		
EA.	EACH	O.C.	ON CENTERS		
(E)	EXISTING	O.D.	OUTSIDE DIAMETER		
E	EAST, EASTING	OPNG	OPENING		
E.B.M.U.D	EAST BAY MUNICIPAL UTILITY DISTRICT	ORIG.	ORIGINAL		
E.C	END CURVE				
ELEC	ELECTRICAL				
EL	ELEVATION (HT)				
ELEV.	ELEVATION (VIEW)				
EC	END OF CURVE				
ENGR.	ENGINEER				
EQ	EQUAL				
EXP	EXPANSION				
EXT.	EXTERIOR				

LEGEND

	SECTION IDENTIFICATION LETTER
	SHEET NUMBER ON WHICH SECTION IS DRAWN
	SHEET NUMBER FROM WHICH SECTION IS TAKEN
	SECTION IDENTIFICATION LETTER
	SECTION IS TAKEN AND DRAWN ON SAME SHEET
	DETAIL IDENTIFICATION NUMBER
	SHEET NUMBER ON WHICH DETAIL IS DRAWN
	SHEET NUMBER FROM WHICH DETAIL IS TAKEN
	DETAIL IDENTIFICATION NUMBER
	DETAIL IS TAKEN AND DRAWN ON SAME SHEET

FILMED BY DATA IMAGE SYSTEMS CORP

3147-G2.DWG(1=1)6-7-93

REFERENCES	
PLANS	
FIELD BOOKS	
"PORT OF OAKLAND DATUM" IS 3.20' BELOW MEAN SEA LEVEL	
NO.	REVISIONS
DATE	APP'D

REVIEWED:	FACILITIES DEPARTMENT
REVIEWED:	CONSTRUCTION DEPARTMENT
REVIEWED:	PROJECT PLANNING DEPARTMENT

DRAWN: SS/MN/HL	
DESIGNED: M. Marley	S 3414
CHECKED: C. Chan	C 43841
REVIEWED: V. Smith	

PORT OF OAKLAND
530 WATER STREET OAKLAND, CALIFORNIA

CHIEF ENGINEER	C 17439
	C 18853
APPROVED:	C 32172
RECOMMENDED:	

OUTER HARBOR TERMINAL	DATE: 6/17/1993
ASPHALT CONCRETE OVERLAY BERTHS 20 & 21 YARD	SCALE: AS SHOWN
LEGEND AND NOTES	SHEET: 2 OF 27 SHEETS
G2	FILE: AA-3147

CAUTION - CHECK TRACING FOR LATEST REVISIONS

CAUTION: THIS PLAN MAY BE REDUCED

1" ORIGINAL SCALE

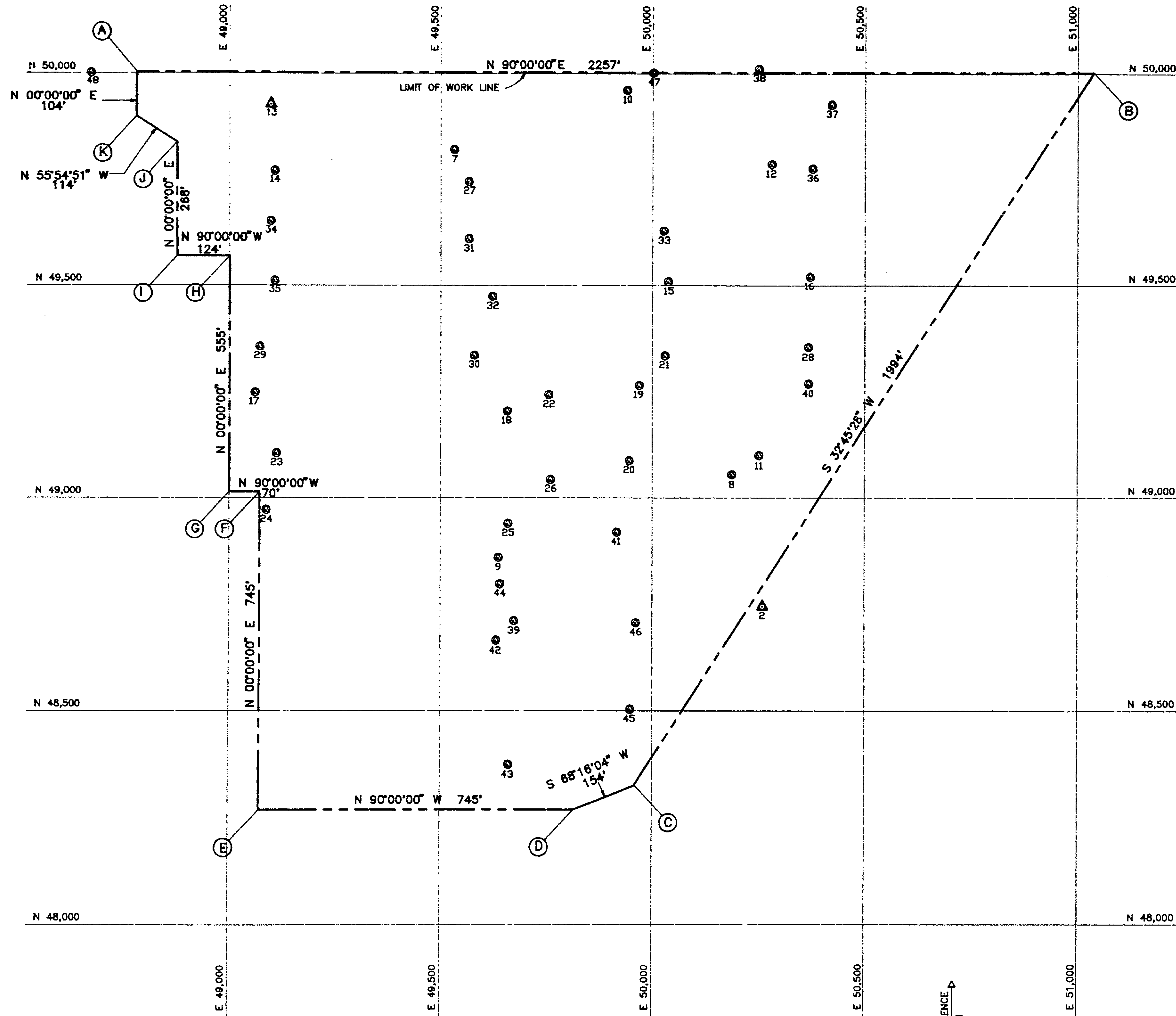

LIMIT OF WORK LINE		
POINT	NORTHING	EASTING
A	50002	48780
B	50002	51037
C	48325	49958
D	48268	49815
E	48268	49070
F	49013	49070
G	49013	49000
H	49568	49000
I	49568	49875
J	49836	49875
K	49898	48780

SURVEY CONTROL DATA					
PT. NO.	TYPE	NORTHING	EASTING	ELEV.	DESCRIPTION
2	CONTROL POINT	48744.93	50258.23		H021
5	CONTROL POINT	47738.98	49604.75		H006
7	WORK POINT	49819.00	49530.37		MA9
8	WORK POINT	49053.44	50184.90		SHD2
9	WORK POINT	48858.32	49636.37		CRNE
10	WORK POINT	49959.00	49938.04	14.83	SHD2
11	WORK POINT	49098.70	50248.67		AC1
12	WORK POINT	49784.29	50277.87	11.45	V
13	CONTROL POINT	49926.90	49096.51	14.85	CB
14	WORK POINT	49768.89	49105.15	13.25	WP2
15	WORK POINT	49508.08	50035.48		WP3
16	WORK POINT	49519.08	50368.59		WP4
17	WORK POINT	49248.90	49058.13		WP5
18	WORK POINT	49202.45	49656.99		WP6
19	WORK POINT	49261.10	49957.70		WP7
20	WORK POINT	49086.43	49944.00		WP8
21	WORK POINT	49333.00	50028.22	15.24	WP9
22	WORK POINT	49241.20	49754.50		WP10
23	WORK POINT	49104.31	49109.97	13.60	WP11
24	WORK POINT	48970.72	49085.50	13.00	WP12
25	WORK POINT	48938.59	49658.96	13.21	WP13
26	WORK POINT	49041.99	49758.82	15.01	WP14
27	WORK POINT	49743.84	49565.27	13.67	WP15
28	WORK POINT	49353.12	50364.45	15.43	WP16
29	WORK POINT	49354.94	49069.27	15.67	WP17
30	WORK POINT	49334.12	49578.25	15.08	WP18
31	WORK POINT	48608.81	49565.41	14.48	WP19
32	WORK POINT	49472.84	49621.67	14.74	WP20
33	WORK POINT	48626.37	50074.79	14.04	WP21
34	WORK POINT	49650.54	49096.07	13.76	WP22
35	WORK POINT	49510.50	49105.25	15.54	WP23
36	WORK POINT	49774.07	50374.08	11.12	WP24
37	WORK POINT	49925.57	50419.48	12.16	WP25
38	WORK POINT	50009.50	50247.08	14.11	WP26
39	WORK POINT	48709.96	49673.52		WP27
40	WORK POINT	49267.70	50385.06		WP28
41	WORK POINT	48918.10	49914.39		WP29
42	WORK POINT	48664.07	48631.08	12.54	WP30
43	WORK POINT	48372.52	49660.88	13.47	WP31
44	WORK POINT	48795.21	49639.50	11.92	WP32
45	WORK POINT	48502.49	49946.74	12.60	WP33
46	WORK POINT	48704.95	49959.87	12.18	WP34
47	WORK POINT	50000.00	50000.00		10.20 CORNER
48	WORK POINT	50000.00	48670.15		21 BC

PORT DESCRIP.	CALIF. COORD.	
	NORTHING	EASTING
H021	2124368.395	6039354.059
H006	2123462.007	6038565.728
V	2125701.547	6038369.508

NOTE:
 * CALIFORNIA COORDINATES ARE BASED ON N.A.D. 1983, PORT OF OAKLAND 1990 G.P.S. CONTROL SURVEY FEET. GRID FACTOR=0.9999298.

SURVEY CONTROL PLAN
 SCALE: 1"=150'

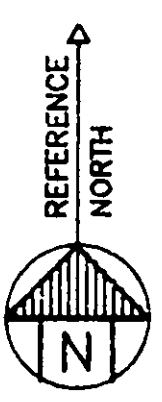

FILMED BY
 DATA IMAGE SYSTEMS CORP

3147-G3.DWG 1=150 6-14-93

REFERENCES	REVISIONS	DATE	APP'D	NO.
PLANS				
FIELD BOOKS				
"PORT OF OAKLAND DATUM" 18 3.20' BELOW MEAN SEA LEVEL				

REVIEWED	DESIGNED	CHECKED	REVIEWED
<i>[Signature]</i>	<i>M. Maly</i>	<i>E. Chan</i>	<i>[Signature]</i>
FACILITIES DEPARTMENT	S 3414	C 43841	
CONSTRUCTION DEPARTMENT			
PROJECT PLANNING DEPARTMENT			

STAFF	CHIEF ENGINEER
<i>[Signature]</i>	<i>[Signature]</i>
C 18853	C 17439
C 32172	C 32172

PORT OF OAKLAND
 530 WATER STREET OAKLAND, CALIFORNIA

CHIEF ENGINEER	DATE
<i>[Signature]</i>	6/17/1993

OUTER HARBOR TERMINAL	DATE
ASPHALT CONCRETE OVERLAY BERTHS 20 & 21 YARD	6/17/1993

SCALE	SHEET	OF	SHEETS
AS SHOWN	3	OF	27

CAUTION - CHECK TRACING FOR LATEST REVISIONS

CAUTION: THIS PLAN MAY BE REDUCED

ORIGINAL SCALE

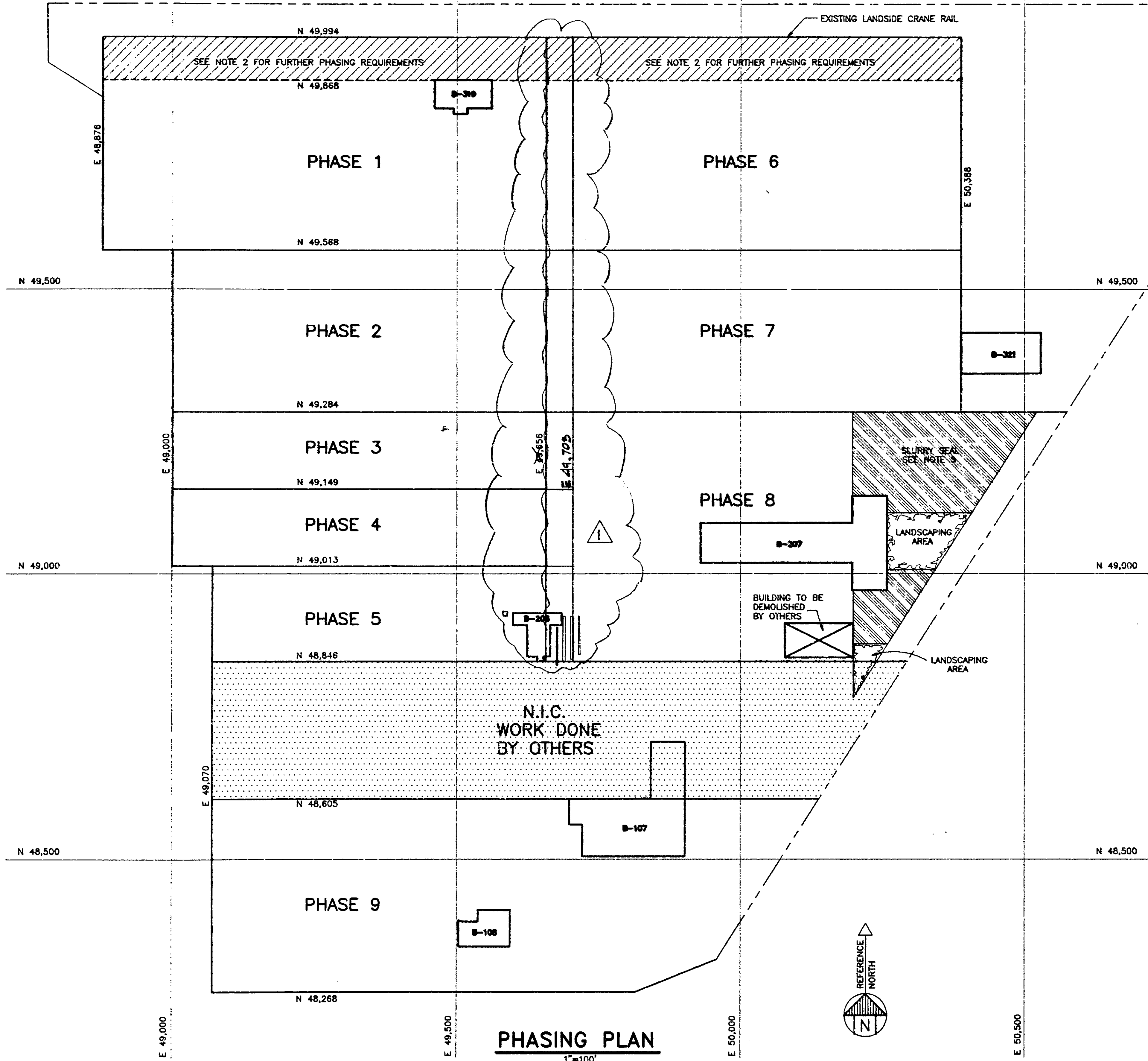

NOTES:

- 15 FOOT WIDE AC RAMPS SHALL BE PLACED AT THE INTERSECTION OF THE PHASE BEING CONSTRUCTED AND EACH ADJACENT AISLE WAY. THIS SHALL BE DONE DURING EACH PHASE TO PROVIDE A SMOOTH TRANSITION FOR TRAFFIC TRAVELING OVER THE PHASE BOUNDARY. REMOVE RAMPS PRIOR TO START OF NEXT PHASE OR AS DIRECTED BY THE ENGINEER.
- WORK BETWEEN THE LANDSIDE CRANE RAIL AND THE MARINE OPERATIONS BUILDING (B-319) AREA INCLUDED IN PHASES 1 AND 2 SHALL BE COMPLETED, IN BETWEEN SHIP SCHEDULES, FROM FRIDAY TO TUESDAY.
- ACCESS TO BUILDINGS B-321, B-207, B-208, B-107 AND B-108 SHALL BE MAINTAINED DURING THEIR RESPECTIVE PHASES. SEE SPECIFICATIONS FOR FURTHER DETAIL. LOADING DOCKS @ B-207 SHALL BE MAINTAINED ON ONE SIDE OF BUILDING @ ALL TIMES.
- PHASE BOUNDARIES ARE APPROXIMATE ONLY. EXACT BOUNDARIES TO BE DETERMINED IN THE FIELD BY THE ENGINEER.
- SLURRY SEAL CAN BE DONE WITHIN ANY PHASE, SUBJECT TO APPROVAL OF ENGINEER.
- WORK AT SUBSTATIONS CAN BE DONE DURING ANY PHASE, SUBJECT TO APPROVAL OF ENGINEER.
- DIGOUTS AROUND B-107 SHALL BE DONE ON THE WEEKENDS WHEN TENANT IS NOT USING FACILITY AND CAN BE SCHEDULED OUT OF PHASE, SUBJECT TO APPROVAL OF ENGINEER.

1=100 6-18-93 3:00 PM

NO.	REVISIONS	DATE	APP'D
1	SHIP PHASE BOUNDARIES	10/19/93	[Signature]

REVIEWED: [Signature]	DESIGNED: M. Maly 53414
REVIEWED: [Signature]	CHECKED: J. Chan 43841
REVIEWED: [Signature]	REVIEWED: [Signature]

PORT OF OAKLAND
530 WATER STREET OAKLAND, CALIFORNIA

CHIEF ENGINEER	C 17439
APPROVED: [Signature]	C 18853
RECOMMENDED: [Signature]	C 32172

OUTER HARBOR TERMINAL	DATE 6/17/1993
ASPHALT CONCRETE OVERLAY	SCALE AS SHOWN
BERTHS 20 & 21 YARD	SHEET 4 OF 27 SHEETS
PHASING PLAN	FILE AA-3147

FILMED BY
DATA IMAGE SYSTEMS CORP

CAUTION - CHECK TRACING FOR LATEST REVISIONS

CAUTION: THIS PLAN MAY BE REDUCED

0 1" 2" ORIGINAL SCALE

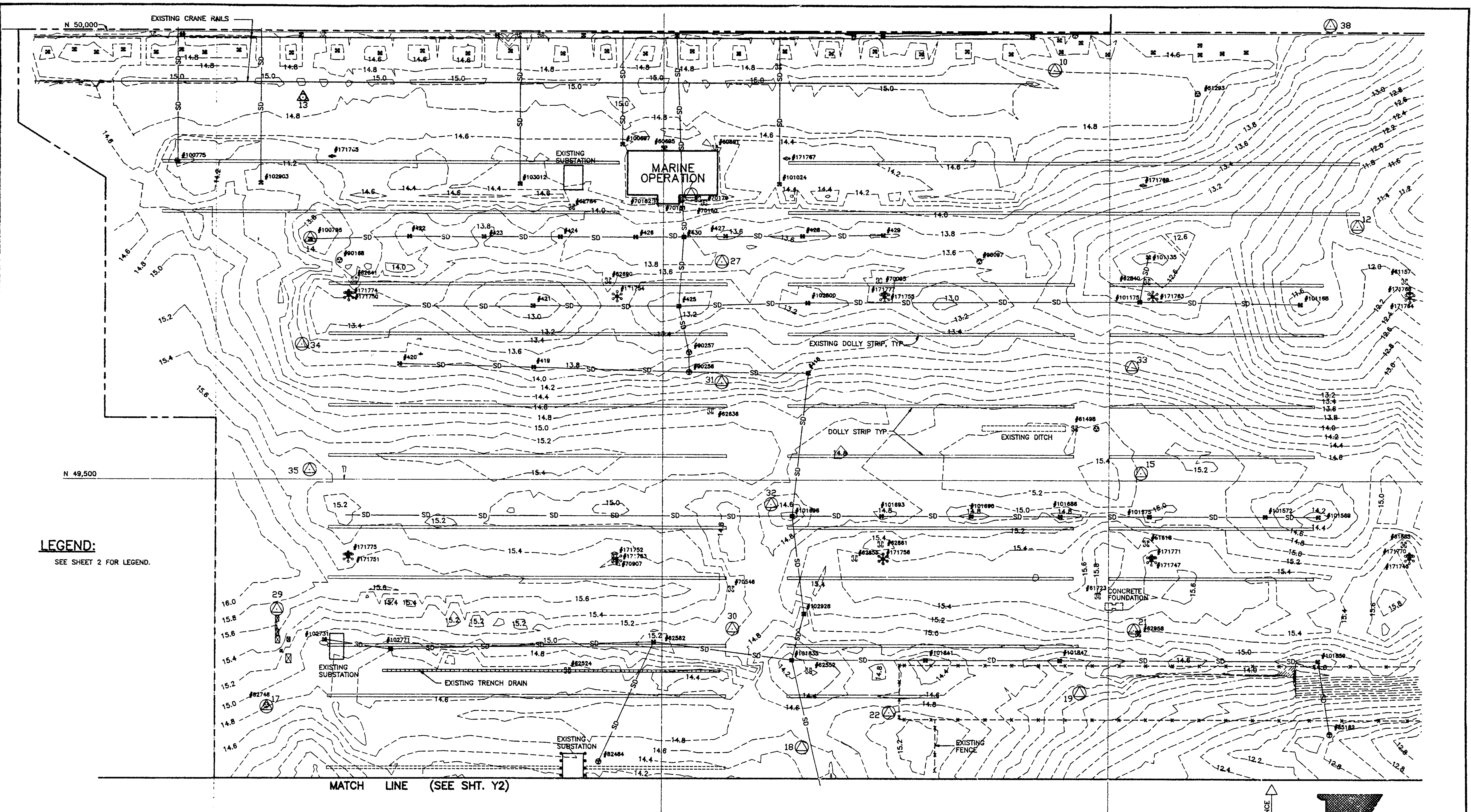

LEGEND:
SEE SHEET 2 FOR LEGEND.

MATCH LINE (SEE SHT. Y2)

EXISTING CONDITIONS - SHEET 1
SCALE: 1"=50'

FILMED BY
DATA IMAGE SYSTEMS CORP

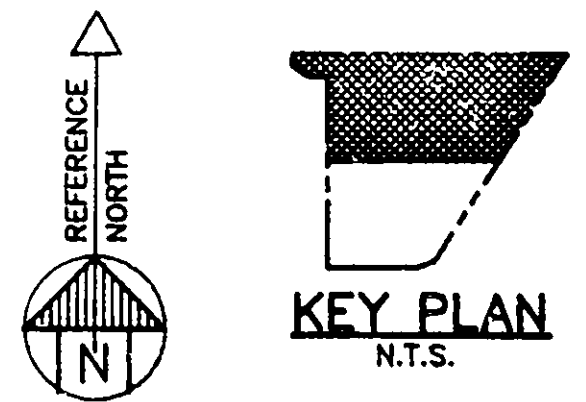

3147-Y1 1=50 6-17-93

NO.	REVISIONS	DATE	APP'D

REVIEWED: <i>[Signature]</i>	FACILITIES DEPARTMENT
DESIGNED: <i>[Signature]</i>	CONSTRUCTION DEPARTMENT
CHECKED: <i>[Signature]</i>	PROJECT PLANNING DEPARTMENT

DRAWN: <i>[Signature]</i>	S 3414
CHECKED: <i>[Signature]</i>	C 43841
REVIEWED: <i>[Signature]</i>	REG. ENGINEER NO.

PORT OF OAKLAND
530 WATER STREET OAKLAND, CALIFORNIA

CHIEF ENGINEER	C 17439
APPROVED: <i>[Signature]</i>	C 18853
RECOMMENDED: <i>[Signature]</i>	C 32172

OUTER HARBOR TERMINAL	DATE: 6/17/1993
ASPHALT CONCRETE OVERLAY	SCALE: 1"=50'
BERTH 20 & 21 YARD	SHEET 5 OF 27 SHEETS
EXISTING CONDITIONS - SHEET 1	FILE AA-3147

Y1	FILE AA-3147
----	--------------

CAUTION - CHECK TRACING FOR LATEST REVISIONS

CAUTION: THIS PLAN MAY BE REDUCED

ORIGINAL SCALE

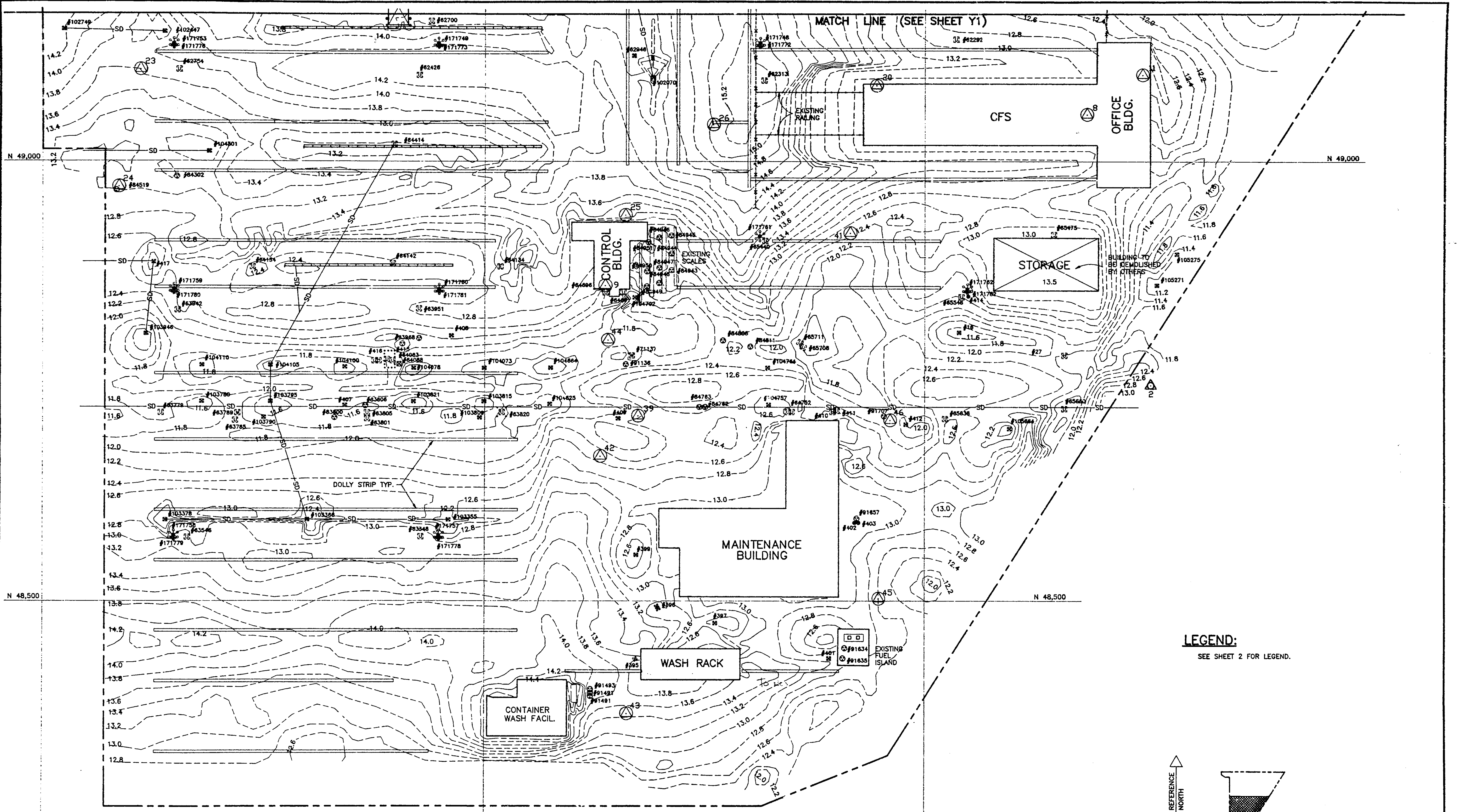

EXISTING CONDITIONS - SHEET 2

SCALE: 1"=50'

NO.	REVISIONS	DATE	APP'D

REVIEWED	<i>[Signature]</i>	FACILITIES DEPARTMENT
REVIEWED	<i>[Signature]</i>	CONSTRUCTION DEPARTMENT
REVIEWED	<i>[Signature]</i>	PROJECT PLANNING DEPARTMENT

DRAWN	<i>[Signature]</i>	S 3414
DESIGNED	<i>[Signature]</i>	C 43841
CHECKED	<i>[Signature]</i>	C 32172
REVIEWED	<i>[Signature]</i>	

PORT OF OAKLAND
 530 WATER STREET OAKLAND, CALIFORNIA

CHIEF ENGINEER	<i>[Signature]</i>	C 17439
APPROVED	<i>[Signature]</i>	C 18853
RECOMMENDED	<i>[Signature]</i>	C 32172

OUTER HARBOR TERMINAL	DATE 6/17/1993
ASPHALT CONCRETE OVERLAY	SCALE 1"=50'
BERTH 20 & 21 YARD	SHEET 6 OF 27 SHEETS
EXISTING CONDITIONS - SHEET 2	FILE AA-3147

FILMED BY
DATA IMAGE SYSTEMS CORP

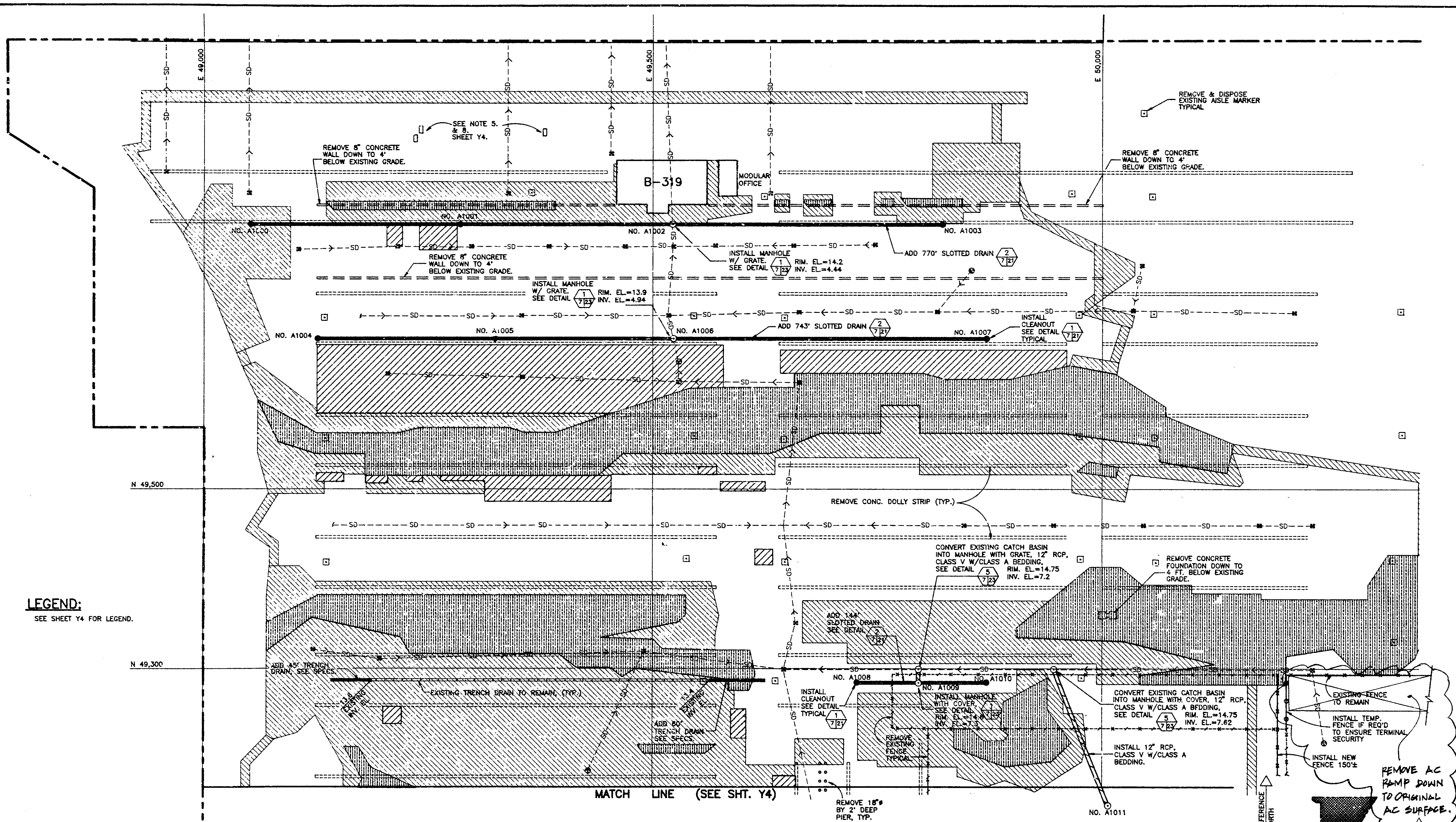

LEGEND:
SEE SHEET Y4 FOR LEGEND.

SITE PREPARATION & DRAINAGE PLAN - SHEET 1
SCALE: 1"=50'

FILMED BY
DATA IMAGE SYSTEMS CORP

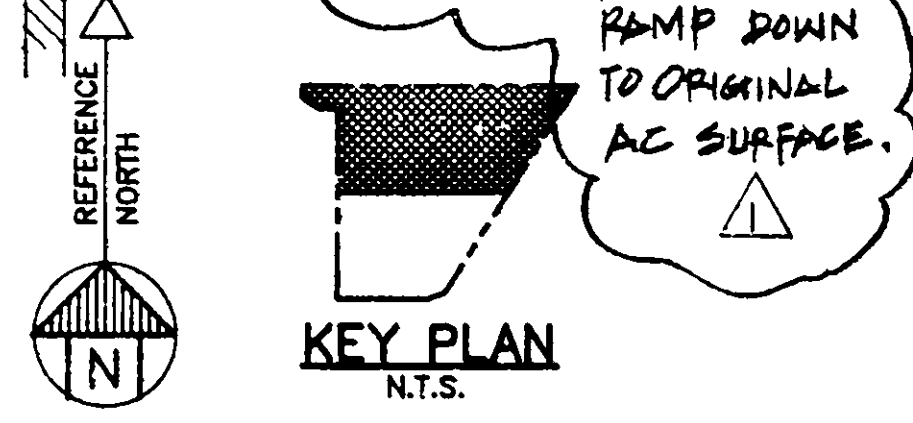

1=50 6-18-93 4:45 P.M.

REFERENCES PLANS FIELD BOOKS "PORT OF OAKLAND DATUM" IS 3.20' BELOW MEAN SEA LEVEL	REVIEWED: [Signature] FACILITIES DEPARTMENT	DRAWN: HL	PORT OF OAKLAND 530 WATER STREET OAKLAND, CALIFORNIA	CHIEF ENGINEER: [Signature]	OUTER HARBOR TERMINAL	DATE: 6/17/1993
	REVIEWED: [Signature] CONSTRUCTION DEPARTMENT	DESIGNED: M. Marley S 3414 <small>REG. ENGINEER NO.</small>		APPROVED: [Signature]	ASPHALT CONCRETE OVERLAY BERTH 20 & 21 YARD	SCALE: 1"=50'
	REVIEWED: [Signature] PROJECT PLANNING DEPARTMENT	CHECKED: E. Chan C 43841 <small>REG. ENGINEER NO.</small>		RECOMMENDED: [Signature]	SITE PREPARATION & DRAINAGE PLAN - SHEET 1 Y3	SHEET: 7 OF 27 SHEETS
	REMOVE AC RAMP <small>NO. REVISIONS</small>	REVIEWED: [Signature] DATE: 10/15/93 <small>AMP'D</small>		REVIEWED: [Signature]	C 17439 <small>REG. ENGINEER NO.</small>	FILE: AA-3147

CAUTION - CHECK TRACING FOR LATEST REVISIONS

CAUTION: THIS PLAN MAY BE REDUCED

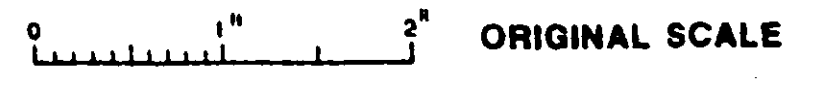

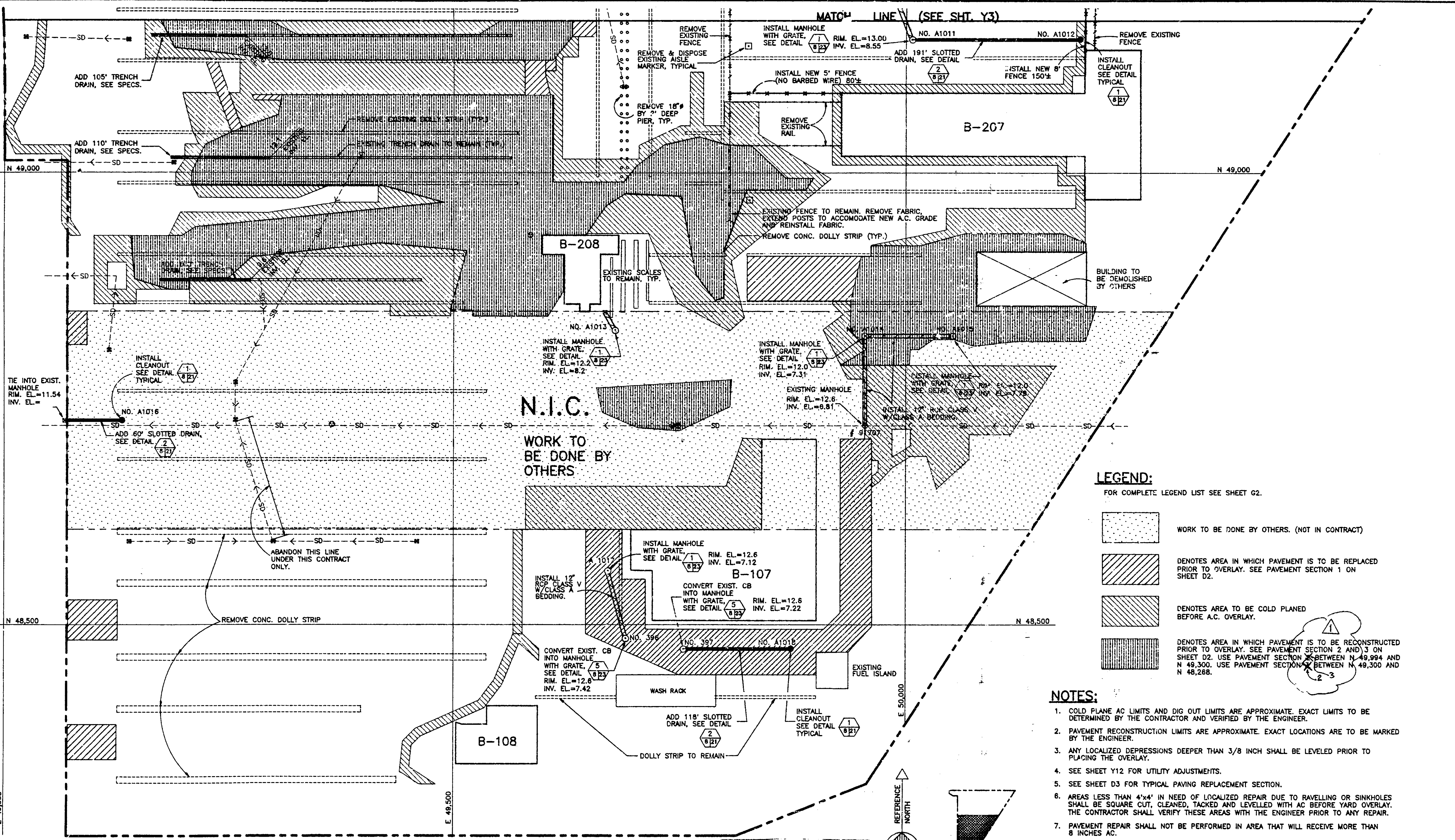

SITE PREPARATION & DRAINAGE PLAN - SHEET 2
 SCALE: 1"=50'

FILMED BY
 DATA IMAGE SYSTEMS CORP

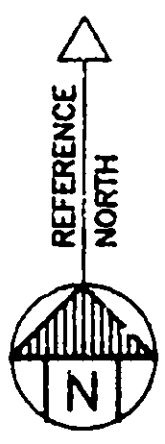

1=50 6-17-93 4:30 P.M.

NO.	REVISIONS	DATE	APP'D
1	CHANGE LEGEND NOTE	11/14/93	[Signature]

REVIEWED	[Signature]	DRAWN	HL
REVIEWED	[Signature]	DESIGNED	M. Maly S 3414
REVIEWED	[Signature]	CHECKED	G. Chan C 43841
REVIEWED	[Signature]	REVIEWED	[Signature]

PORT OF OAKLAND
 530 WATER STREET OAKLAND, CALIFORNIA

CHIEF ENGINEER	[Signature]	C 17439
APPROVED	[Signature]	C 18853
RECOMMENDED	[Signature]	C 32172

OUTER HARBOR TERMINAL	DATE	6/17/1993
ASPHALT CONCRETE OVERLAY	SCALE	1"=50'
BERTH 20 & 21 YARD	SHEET	8 OF 27 SHEETS
SITE PREPARATION & DRAINAGE PLAN - SHEET 2	FILE	AA-3147

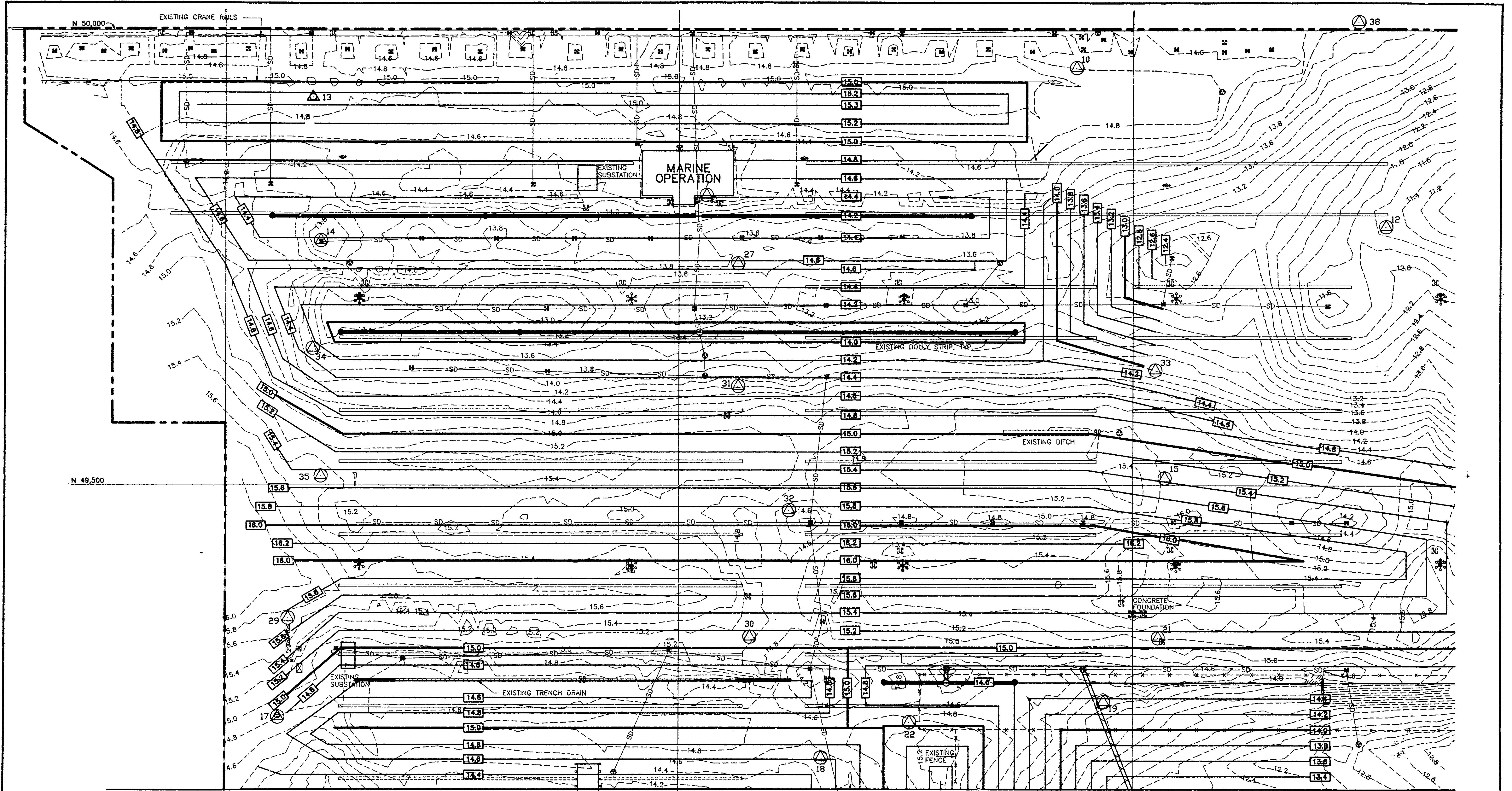

GRADING PLAN - SHEET 1
SCALE: 1"=50'

FILMED BY
DATA IMAGE SYSTEMS CORP

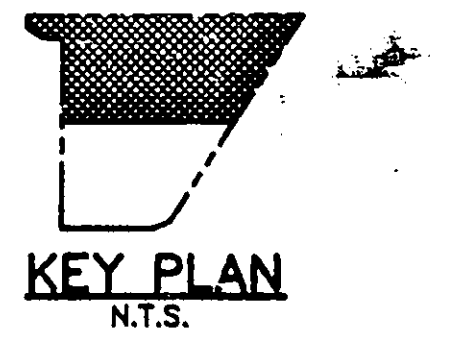
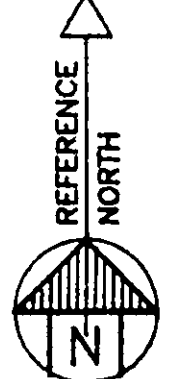

1"=50 6-18-93 12:00 P.M.

NO.	REVISIONS	DATE	APP'D

REVIEWED	STAFF
REVIEWED	DESIGNED
REVIEWED	CHECKED

PORT OF OAKLAND
530 WATER STREET OAKLAND, CALIFORNIA

CHIEF ENGINEER	C 17439
APPROVED	C 18853
RECOMMENDED	C 32172

OUTER HARBOR TERMINAL	DATE 6-17-93
ASPHALT CONCRETE OVERLAY	SCALE 1"=50'
BERTH 20 & 21 YARD	SHEET 9 OF 27 SHEETS
GRADING PLAN - SHEET 1	FILE AA-3147

CAUTION - CHECK TRACING FOR LATEST REVISIONS

CAUTION: THIS PLAN MAY BE REDUCED

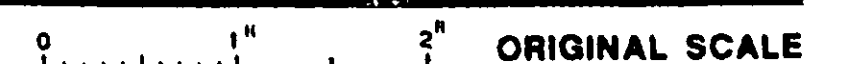

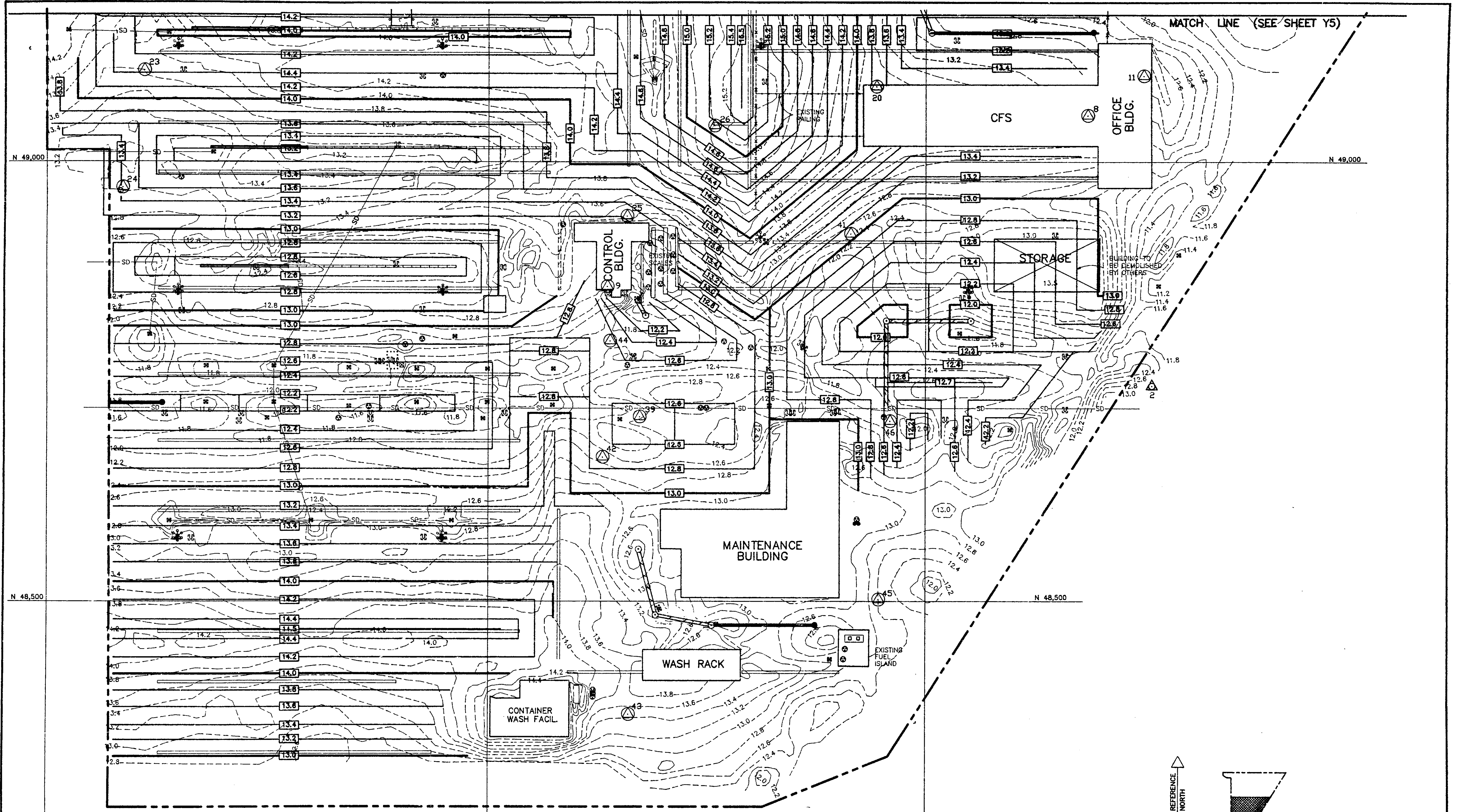

GRADING PLAN - SHEET 2
SCALE: 1"=50'

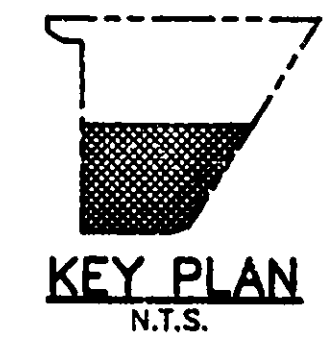
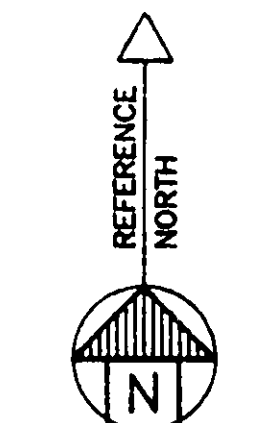

FILMED BY
DATA IMAGE SYSTEMS CORP

1"=50' 6-18-93 11:00 A.M.

NO.	REVISIONS	DATE	APP'D

REVIEWED	STAFF
REVIEWED	DESIGNED
REVIEWED	CHECKED
	REVIEWED

DESIGNED	S 3414
CHECKED	C 43841
REVIEWED	

PORT OF OAKLAND
530 WATER STREET OAKLAND, CALIFORNIA

CHIEF ENGINEER	C 17439
APPROVED	C 18853
RECOMMENDED	C 32172

OUTER HARBOR TERMINAL
ASPHALT CONCRETE OVERLAY
BERTH 20 & 21 YARD
GRADING PLAN - SHEET 2

DATE	6/17/1993
SCALE	1"=50'
SHEET	10 OF 27 SHEETS
FILE	AA-3147

CAUTION - CHECK TRACING FOR LATEST REVISIONS

CAUTION: THIS PLAN MAY BE REDUCED

1"=50' ORIGINAL SCALE

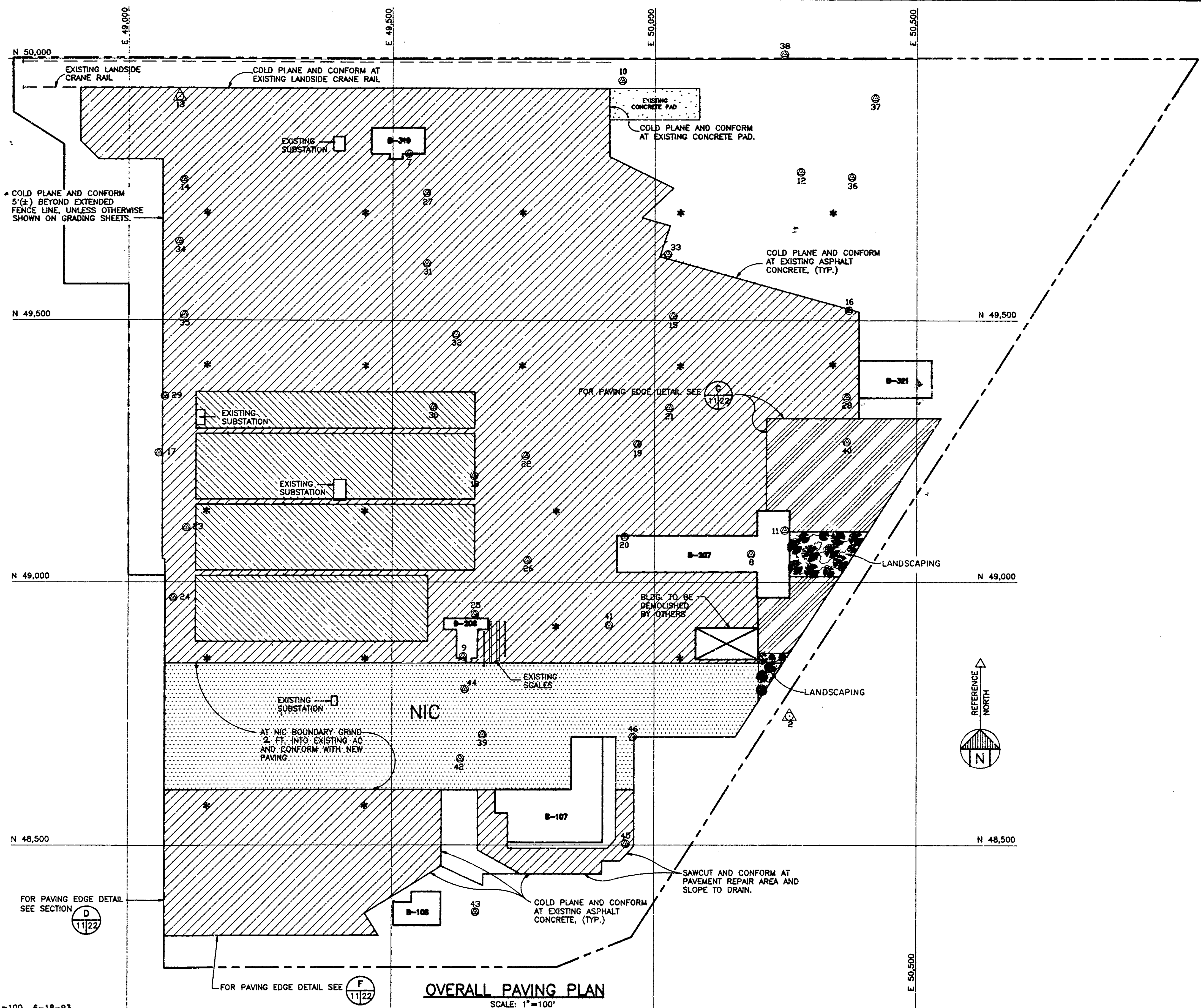

NOTES:

1. AC OVERLAY/PAVEMENT AND SLURRY SEAL LIMITS ARE APPROXIMATE. EXACT LIMITS TO BE DETERMINED BY THE CONTRACTOR AND VERIFIED BY THE ENGINEER.
2. SEE SHEET Y12 FOR UTILITY ADJUSTMENTS.
3. SEE SHEET D3 FOR PAVING SECTIONS AND DETAILS.
4. AREAS LESS THAN 4'x4' IN NEED OF LOCALIZED REPAIR DUE TO RAVELLING OR SINKHOLES SHALL BE SQUARE CUT, CLEANED, TACKED AND LEVELLED WITH AC BEFORE THE YARD OVERLAY. THE CONTRACTOR SHALL VERIFY THESE AREAS WITH THE ENGINEER PRIOR TO ANY REPAIR.

LEGEND:

- * EXISTING LIGHT STANDARD
- △ 13 ⊙ 8 SURVEY/CONTROL POINT AND NUMBER
- NEW AC OVERLAY/PAVEMENT AREA
- SLURRY SEAL
- NOT IN CONTRACT, DONE BY OTHERS
- AREAS WHERE PAVEMENT FABRIC IS TO BE INSTALLED BEFORE AC OVERLAY

OVERALL PAVING PLAN
SCALE: 1"=100'

FILMED BY
DATA IMAGE SYSTEMS CORP

REFERENCES PLANS FIELD BOOKS "PORT OF OAKLAND DATUM" IS 3.20' BELOW MEAN SEA LEVEL	NO.	REVISIONS	DATE	APP'D	REVIEWED: <i>[Signature]</i> FACILITIES DEPARTMENT REVIEWED: <i>[Signature]</i> CONSTRUCTION DEPARTMENT REVIEWED: <i>[Signature]</i> PROJECT PLANNING DEPARTMENT	DRAWN: <i>[Signature]</i> STAFF DESIGNED: <i>[Signature]</i> S 3414 CHECKED: <i>[Signature]</i> C 43841 REVIEWED: <i>[Signature]</i>	PORT OF OAKLAND 530 WATER STREET OAKLAND, CALIFORNIA	CHIEF ENGINEER <i>[Signature]</i> APPROVED: <i>[Signature]</i> RECOMMENDED: <i>[Signature]</i>	OUTER HARBOR TERMINAL ASPHALT CONCRETE OVERLAY BERTH 20 & 21 YARD OVERALL PAVING PLAN	DATE: 6/17/1993 SCALE: 1"=100' SHEET 11 OF 27 SHEETS FILE AA-3147
	C. 17439	C. 18853	C. 32172							

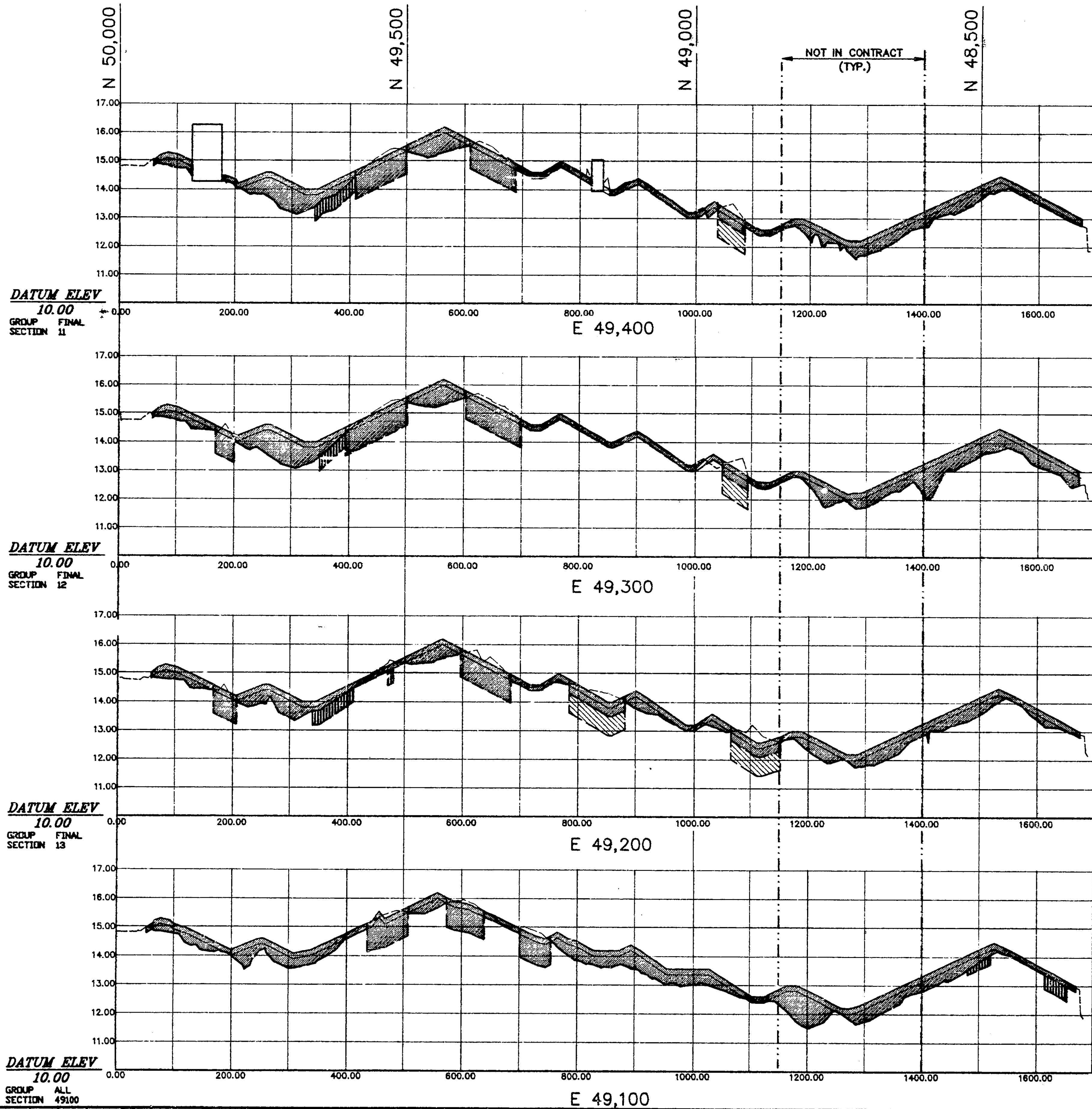

1"=100' 06-17-93 10:30am

NO.	REVISIONS	DATE	APP'D

REVIEWED	<i>[Signature]</i>	FACILITIES DEPARTMENT
REVIEWED	<i>[Signature]</i>	OPERATIONS DEPARTMENT
REVIEWED	<i>[Signature]</i>	PROJECT PLANNING DEPARTMENT

DRAWN	P. VALLI
DESIGNED	M. Murphy 53418
CHECKED	G. Chan 243841
REVIEWED	<i>[Signature]</i>

PORT OF OAKLAND
530 WATER STREET OAKLAND, CALIFORNIA

CHIEF ENGINEER	<i>[Signature]</i>	C 17439
APPROVED	<i>[Signature]</i>	C 18853
RECOMMENDED	<i>[Signature]</i>	C 32172



OUTER HARBOR TERMINAL	DATE 06-17-93
ASPHALT CONCRETE OVERLAY BERTH 20 & 21 YARD	SCALE AS SHOWN
GRADING CROSS SECTIONS	SHEET 12 OF 27 SHEETS
FILE AA-3147	Y8

CAUTION - CHECK TRACING FOR LATEST REVISIONS

CAUTION: THIS PLAN MAY BE REDUCED

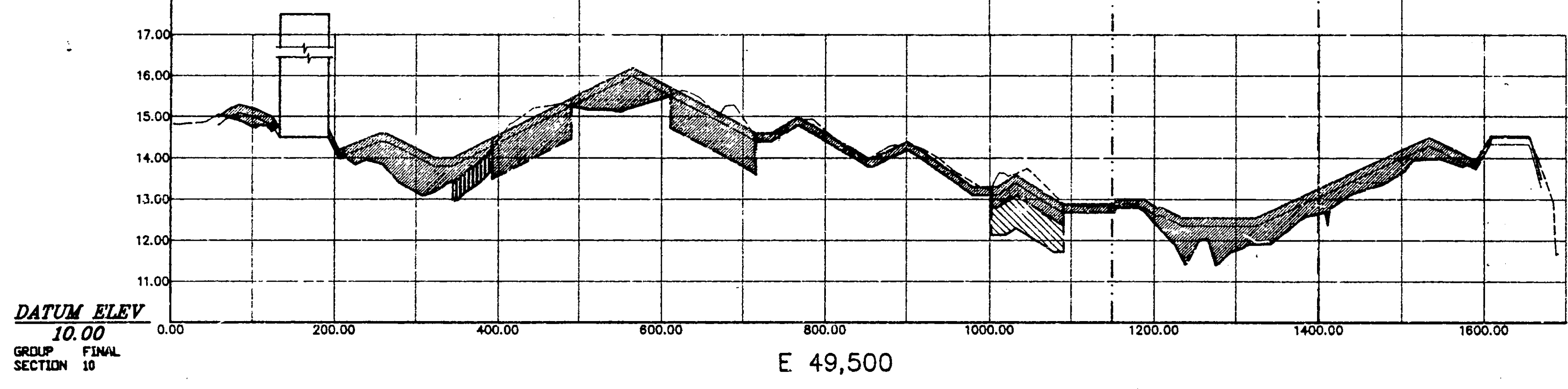
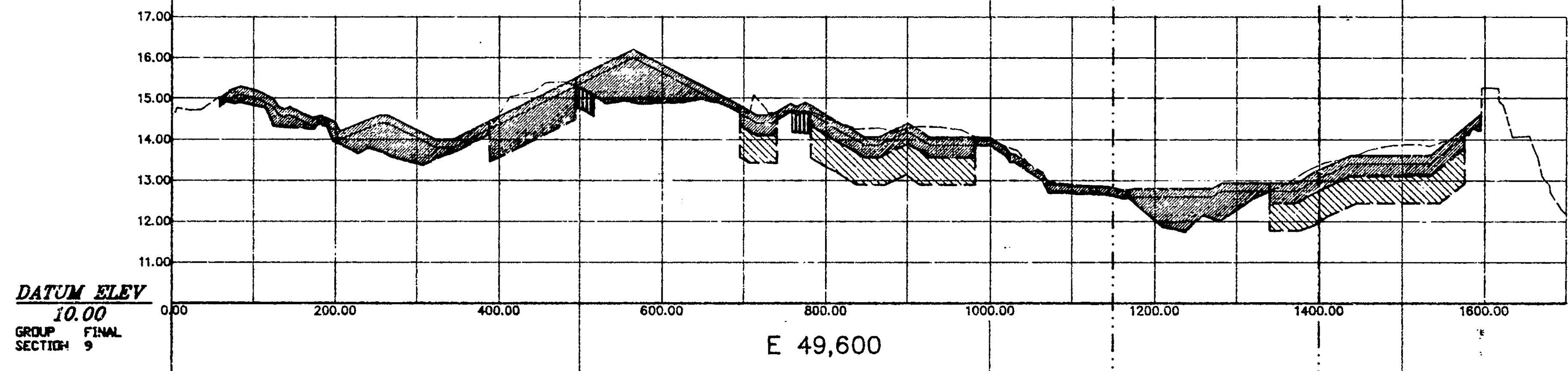
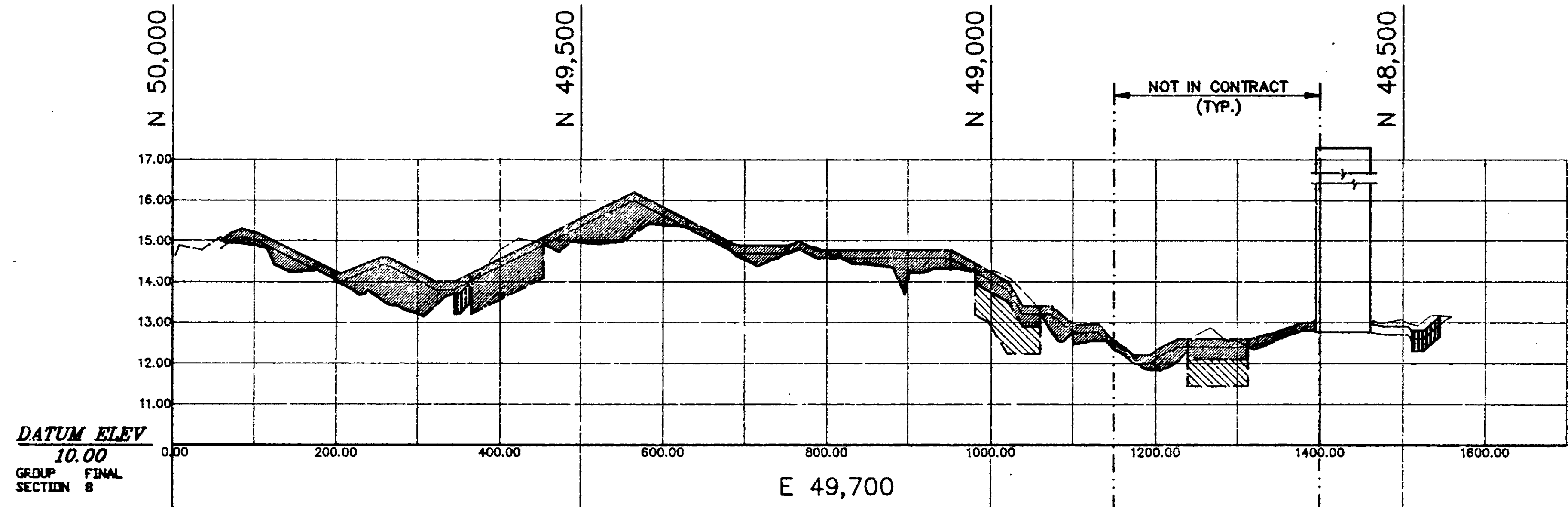
ORIGINAL SCALE



- LEGEND**
-  ASPHALT CONCRETE
 -  AGGREGATE BASE
 -  PAVEMENT REPAIR

NOTE: CROSS SECTIONS ARE APPROXIMATE. REFER TO SHEETS Y3 AND Y4 FOR LOCATIONS OF VARIOUS WORK.

SCALE: HORIZONTAL 1" = 100'
 VERTICAL 1" = 2'

FILMED BY
DATA IMAGE SYSTEMS CORP

1"=100' 06-17-93 10:30pm

REFERENCES

PLANS	
FIELD BOOKS	
"PORT OF OAKLAND DATUM" IF 3.20' BELOW MEAN SEA LEVEL	

NO.	REVISIONS	DATE	APP'D.

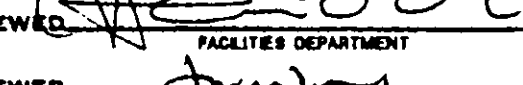
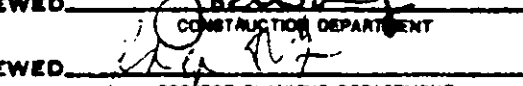
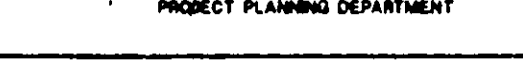
REVIEWED 	FACILITIES DEPARTMENT
REVIEWED 	CONTRACTOR DEPARTMENT
REVIEWED 	PROJECT PLANNING DEPARTMENT

DRAWN <u>P. VALL</u>	
DESIGNED <u>M. Miley</u> 53419	REG. ENGINEER NO.
CHECKED <u>G. Chan</u> 243841	REG. ENGINEER NO.
REVIEWED <u>J. Schul</u>	REG. ENGINEER NO.

PORT OF OAKLAND

330 WATER STREET OAKLAND, CALIFORNIA

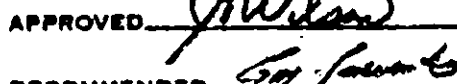
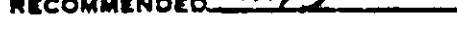
CHIEF ENGINEER	
	C 17439
APPROVED 	C 18553
RECOMMENDED 	C 32172

OUTER HARBOR TERMINAL	DATE 06-17-93
ASPHALT CONCRETE OVERLAY BERTH 20 & 21 YARD	SCALE AS SHOWN
GRADING CROSS SECTIONS	SHEET 13 OF 27 SHEETS

FILE AA-3147

CAUTION - CHECK TRACING FOR LATEST REVISIONS

CAUTION: THIS PLAN MAY BE REDUCED

0 1" 2" ORIGINAL SCALE

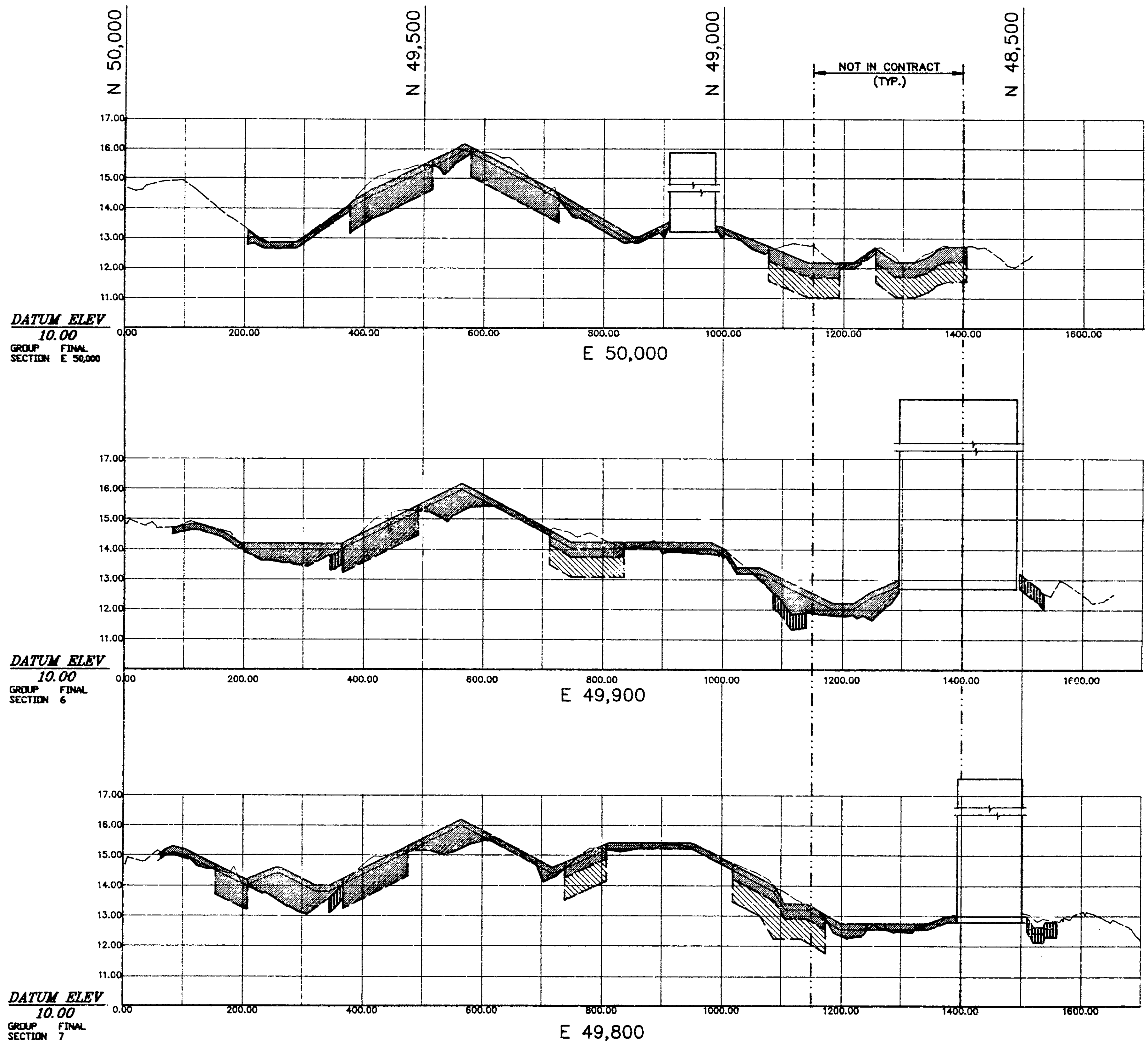

DATUM ELEV
10.00
GROUP FINAL
SECTION E 50,000

DATUM ELEV
10.00
GROUP FINAL
SECTION 6

DATUM ELEV
10.00
GROUP FINAL
SECTION 7

- LEGEND**
- ASPHALT CONCRETE
 - AGGREGATE BASE
 - PAVEMENT REPAIR

NOTE: CROSS SECTIONS ARE APPROXIMATE.
REFER TO SHEETS Y3 AND Y4 FOR
LOCATIONS OF VARIOUS WORK.



SCALE: HORIZONTAL 1" = 100'
VERTICAL 1" = 2'

FILMED BY
DATA IMAGE SYSTEMS CORP

1"=100' 06-17-93 10:30am

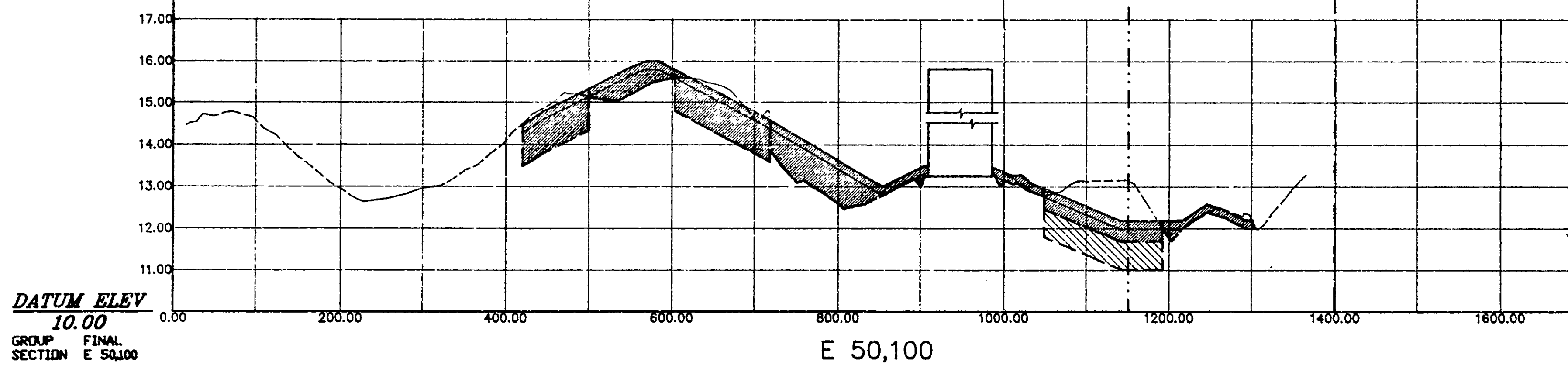
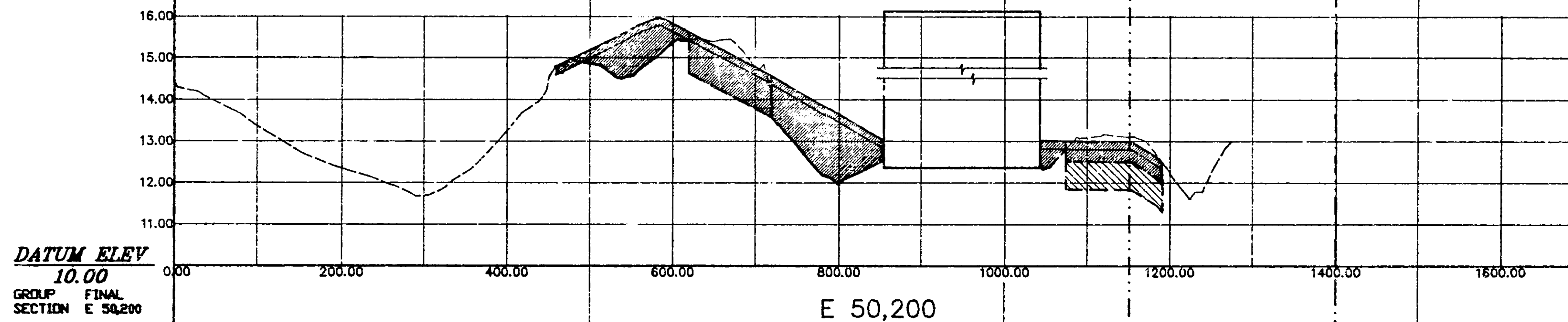
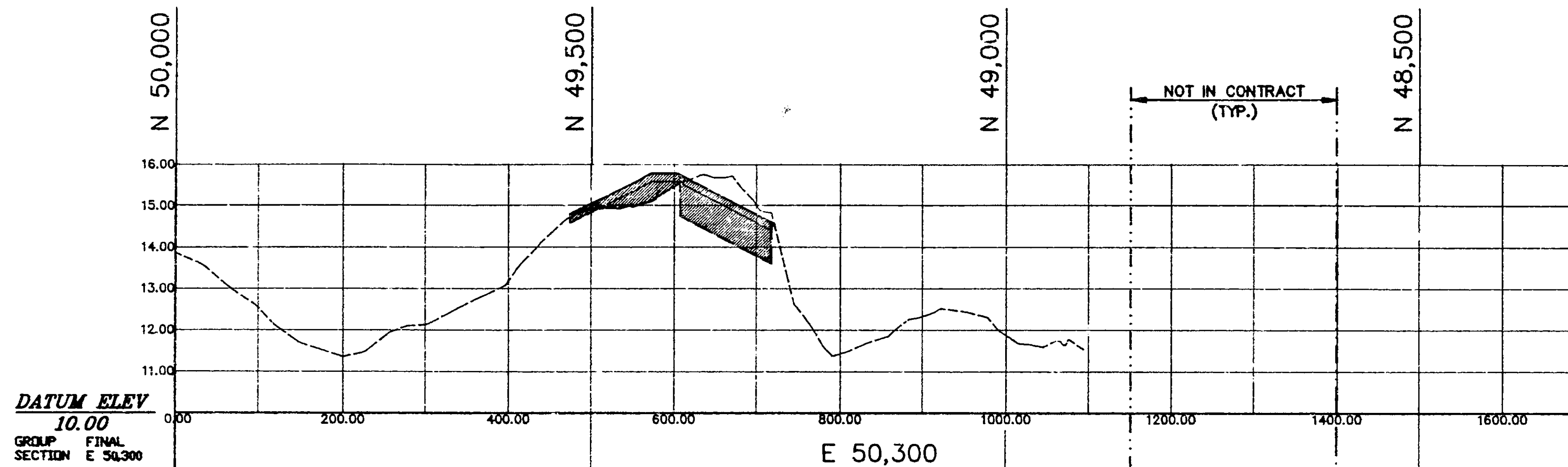
REFERENCE PLANS FIELD BOOKS "PORT OF OAKLAND DATUM" IS 3.20' BELOW MEAN SEA LEVEL	NO.	REVISIONS	DATE	APP'D	REVIEWED: FACILITIES DEPARTMENT REVIEWED: CONSTRUCTION DEPARTMENT REVIEWED: PROJECT PLANNING DEPARTMENT	DRAWN: <u>P. VALLI</u> DESIGNED: <u>M. Nuyly 5344</u> CHECKED: <u>C. Chan 493841</u> REVIEWED: <u>V. Achil</u>	PORT OF OAKLAND 530 WATER STREET OAKLAND, CALIFORNIA	CHIEF ENGINEER APPROVED: RECOMMENDED:	C-17439 C-18853 C-32172	OUTER HARBOR TERMINAL ASPHALT CONCRETE OVERLAY BERTH 20 & 21 YARD GRADING CROSS SECTIONS	DATE 06-17-93 SCALE AS SHOWN SHEET 14 OF 27 SHEETS FILE AA-3147
	CAUTION - CHECK TRACING FOR LATEST REVISIONS				CAUTION: THIS PLAN MAY BE REDUCED			ORIGINAL SCALE			



- LEGEND**
-  ASPHALT CONCRETE
 -  AGGREGATE BASE
 -  PAVEMENT REPAIR

NOTE: CROSS SECTIONS ARE APPROXIMATE. REFER TO SHEETS Y3 AND Y4 FOR LOCATIONS OF VARIOUS WORK.

SCALE: HORIZONTAL 1" = 100'
VERTICAL 1" = 2'

FILMED BY
DATA IMAGE SYSTEMS CORP

1"=100' 06-17-83 10:30am

NO.	REVISIONS	DATE	APPD.

REVIEWED: <i>[Signature]</i>	DESIGNED: <i>P. Vass</i>
REVIEWED: <i>[Signature]</i>	CHECKED: <i>M. Wally</i> 53414
REVIEWED: <i>[Signature]</i>	CHECKED: <i>C. Chan</i> 243841
	REVIEWED: <i>V. Schmitt</i>

DESIGNED: <i>P. Vass</i>	REG. ENGINEER NO.
CHECKED: <i>M. Wally</i> 53414	REG. ENGINEER NO.
CHECKED: <i>C. Chan</i> 243841	REG. ENGINEER NO.
REVIEWED: <i>V. Schmitt</i>	REG. ENGINEER NO.

PORT OF OAKLAND
530 WATER STREET OAKLAND, CALIFORNIA

CHIEF ENGINEER	<i>[Signature]</i>	C. 17438
APPROVED: <i>[Signature]</i>	C. 18853	REG. ENGINEER NO.
RECOMMENDED: <i>[Signature]</i>	C. 32172	REG. ENGINEER NO.

OUTER HARBOR TERMINAL
ASPHALT CONCRETE OVERLAY
BERTH 20 & 21 YARD
GRADING CROSS SECTIONS

DATE 06-17-83
SCALE AS SHOWN
SHEET 15 OF 27 SHEETS
FILE AA-3147

CAUTION - CHECK TRACING FOR LATEST REVISIONS

CAUTION: THIS PLAN MAY BE REDUCED

ORIGINAL SCALE

SURVEY POINT NO.	DESCRIPTION	EXIST. ELEV. (ft)	FINAL ELEV. (ft)	ADJUSTMENT (ft)	NORTHING (PROJECT)	EASTING (PROJECT)	REMARKS
16	DRAIN INLET	11.4	12.17	+0.77	48805.46	50039.96	NIC
27	UTILITY BOX	12.1	12.28	+0.18	48778.61	50119.23	NIC
395	GRADED SUMP W/SP	13.9	13.9	---	48419.95	49670.95	*
396	DRAIN INLET	12.8	12.8	---	48492.19	49695.74	*
397	DRAIN INLET	12.5	12.53	---	48474.51	49761.02	*
401	DRAIN INLET	12.3			48434.61	49390.78	ABANDON
402	MANHOLE	13.1	13.0	---	48588.32	49919.34	*
403	MANHOLE	13.1	13.0	---	48588.32	49923.78	*
407	DRAIN INLET	11.3	12.13	+0.83	48721.85	49342.08	NIC
408	DRAIN INLET	12.3	12.88	+0.58	48800.86	49462.27	NIC
409	DRAIN INLET	12.3	12.59	-0.01	48706.53	49651.47	NIC
410	UTILITY BOX	12.4	12.93	+0.53	48714.28	49894.59	NIC
411	UTILITY BOX	12.4	12.93	+0.53	48715.11	49899.47	NIC
412	DRAIN INLET	12.85	12.1	+0.25	48701.61	49991.99	NIC
414	MANHOLE	12.4	12.07	-0.33	48845.66	50049.38	NIC
415	UTILITY BOX	12.1	12.6	+0.5	48772.49	49374.90	NIC
416	UTILITY BOX	12.1	12.6	+0.5	48772.79	49379.18	NIC
417	DRAIN INLET	13.0	12.6	-0.4	49875.28	49123.44	
418	DRAIN INLET	13.9	14.4	+0.5	49619.12	49662.34	
419	DRAIN INLET	13.6	---	---	49624.89	49354.31	ABANDON
420	DRAIN INLET	13.8	---	---	49628.55	49205.59	ABANDON
421	DRAIN INLET	12.7	---	---	49694.20	49354.31	ABANDON
422	DRAIN INLET	13.5	---	---	49771.48	49216.27	ABANDON
423	DRAIN INLET	13.5	---	---	49771.48	49298.59	ABANDON
424	DRAIN INLET	13.6	---	---	49770.77	49384.49	ABANDON
425	DRAIN INLET	12.9	14.15	+1.25	49694.21	49516.59	
426	DRAIN INLET	13.8	---	---	49771.48	49468.66	ABANDON
427	DRAIN INLET	13.4	---	---	49772.25	49569.35	ABANDON
428	DRAIN INLET	13.3	14.4	---	49772.24	49655.87	ABANDON
429	DRAIN INLET	13.5	14.39	---	49772.95	49745.98	ABANDON
430	DRAIN INLET	13.8	14.4	+0.6	49771.29	49522.57	
60691	UTILITY BOX	14.6	---	---	49871.00	49556.85	*
60695	UTILITY BOX	14.8	---	---	49869.33	49500.25	*
61157	UTILITY BOX	12.0	---	---	49722.93	50332.59	NIC
61488	UTILITY BOX	15.2	14.98	-0.22	49558.18	49961.18	
61618	UTILITY BOX	15.7	16.0	+0.3	49429.93	50041.73	
61723	UTILITY BOX	15.8			49371.04	49987.58	
61882	UTILITY BOX				49371.09	50383.09	

* NO ADJUSTMENT

SURVEY POINT NO.	DESCRIPTION	EXIST. ELEV. (ft)	FINAL ELEV. (ft)	ADJUSTMENT (ft)	NORTHING (PROJECT)	EASTING (PROJECT)	REMARKS
61885	UTILITY BOX	15.6	15.52		49429.43	50331.37	*
62292	UTILITY BOX	12.9	13.28		49138.96	50034.94	
62313	UTILITY BOX	15.3	15.24		49091.89	49816.09	*
62426	UTILITY BOX	14.4	14.35		49097.93	49425.22	*
62524	UTILITY BOX	14.5	14.6	+0.1	49287.22	49394.20	
62552	UTILITY BOX	14.2	14.98		49287.34	49664.42	
62582	UTILITY BOX	15.4	14.98	-0.42	49319.22	49490.14	
62636	UTILITY BOX	15.0	14.8	-0.2	49576.54	49553.03	
62641	UTILITY BOX	13.9	14.45	+0.55	49722.24	49153.47	
62690	UTILITY BOX	13.7	14.45	+0.75	49722.27	49437.69	
62700	UTILITY BOX	14.1	14.13	---	49159.41	49439.24	*
62754	UTILITY BOX	13.6	14.38	+0.77	49104.03	49154.04	
62784	UTILITY BOX	14.2	14.29	---	49804.59	49397.15	*
62840	UTILITY BOX	12.7	12.7	---	49723.38	50039.98	NIC
62555	UTILITY BOX	15.4	15.95	+0.55	49412.69	49715.19	
62861	UTILITY BOX	15.5	16.1	+0.6	49428.46	49744.47	
62948	DRAIN INLET	14.3	---	---	49118.41	49667.55	ABANDON
62958	UTILITY BOX	15.0	15.07	---	49329.45	50033.12	*
63348	UTILITY BOX	13.2	13.5	+0.33	48572.73	49427.31	
63546	UTILITY BOX	13.1	13.47	+0.32	48572.05	49163.71	
63779	UTILITY BOX	11.8	12.22	+0.39	48713.35	49133.51	NIC
63785	UTILITY BOX	11.9	12.31	+0.41	48704.58	49216.91	NIC
63789	UTILITY BOX	12.0	12.22	+0.21	48713.16	49219.54	NIC
63801	UTILITY BOX	11.8	12.29	+0.49	48705.45	49364.71	NIC
63805	UTILITY BOX	11.5	12.22	+0.75	48713.29	49365.92	NIC
63820	UTILITY BOX	11.9	12.74	+0.85	48713.85	49518.85	NIC
63942	UTILITY BOX	12.6	13.0	+0.4	48829.91	49152.56	NIC
63951	UTILITY BOX	12.8	*	*	48831.66	49425.22	NIC
64083	UTILITY BOX	12.2	12.6	+0.42	48773.94	49388.51	NIC
64088	UTILITY BOX	12.1	12.6	+0.53	48772.57	49394.90	NIC
64134	ELECTRIC BOX	13.0	13.0	---	48879.60	49517.08	*
64142	UTILITY BOX	12.6	12.53	-0.07	48883.00	49395.22	*
64154	UTILITY BOX	12.3	12.52	+0.22	48879.37	49236.36	
64414	UTILITY BOX	13.1	13.26	+0.16	49014.98	49392.67	
64691	UTILITY BOX	11.8	11.8	---	48852.07	49655.81	*
64696	UTILITY BOX	12.3	12.3	---	48851.10	49636.89	*
64752	UTILITY BOX	12.5	12.93	+0.48	48714.23	49845.71	NIC
65440	UTILITY BOX	13.6	13.8	+0.2	48908.84	49817.36	

* NO ADJUSTMENT

SURVEY POINT NO.	DESCRIPTION	EXIST. ELEV. (ft)	FINAL ELEV. (ft)	ADJUSTMENT (ft)	NORTHING (PROJECT)	EASTING (PROJECT)	REMARKS
65475	UTILITY BOX	13.1	12.86	-0.44	48916.16	50147.25	
65546	UTILITY BOX	12.4	12.07	-0.33	48843.59	50043.59	NIC
65636	UTILITY BOX	12.5	12.47	-0.06	48706.42	50022.85	NIC
65660	UTILITY BOX	11.7	11.66	---	48717.83	50159.14	NIC
65708	UTILITY BOX	11.9	12.62	+0.72	48785.03	49860.71	NIC
65711	UTILITY BOX	11.8	12.65	+0.85	48791.11	49857.44	NIC
70095	ELECTRICAL BOX	13.6	14.45	+0.85	49722.63	49741.85	
70179	ELECTRICAL BOX	14.7	---	---	49813.93	49537.93	*
70180	ELECTRICAL BOX		---	---	49810.27	49538.67	*
70181	ELECTRICAL BOX	14.6	---	---	49813.61	49519.43	*
70182	ELECTRICAL BOX	14.5	---	---	49810.83	49490.60	*
70546	UTILITY BOX	15.2	15.6	+0.4	49378.41	49576.76	
70907	UTILITY BOX	15.6	15.92	+0.32	49410.09	49446.11	
71137	WATER BOX	11.9	12.56	+0.66	48778.39	49666.07	NIC
81121	MANHOLE	11.1	11.1	---	49774.28	50375.35	*
81293	MANHOLE	14.8	---	---	49932.89	50098.26	NIC
82484	MANHOLE	14.4	14.44	+0.04	49186.28	49428.91	*
82748	MANHOLE	14.8	14.8	---	49248.41	49057.89	*
83800	MANHOLE	11.7	12.27	+0.61	48707.76	49329.47	NIC
83806	MANHOLE	11.5	12.13	+0.59	48721.31	49363.99	NIC
83963	PG&E	12.4	12.86	+0.46	48797.85	49425.18	NIC
83968	PG&E MANHOLE	12.5	12.8	+0.27	48791.57	49406.06	NIC
84302	MANHOLE	13.2	13.44	+0.24	48981.97	49151.73	
84519	MANHOLE	13.0	13.4	+0.4	48966.31	45082.54	
84762	MANHOLE	12.7	12.60	-0.1	48719.82	49749.60	NIC
84763	MANHOLE	12.7	12.60	-0.14	48719.88	49743.12	NIC
84806	MANHOLE	12.3		+0.18	48795.57	49769.65	NIC
84811	MANHOLE	12.3		+0.46	48788.63	49800.34	NIC
84943	MANHOLE	12.6		---	48875.51	49711.32	*
84944	MANHOLE	12.6		---	48894.54	49711.46	*
84945	MANHOLE	12.6		---	48915.06	49711.20	*
84946	MANHOLE	12.5		---	48912.85	49697.20	*
84947	MANHOLE	12.5		---	48878.43	49697.33	*
84948	MANHOLE	12.5		---	48861.00	49697.09	*
84949	MANHOLE	12.4		---	48857.09	49683.13	*
84950	MANHOLE	12.3		---	48874.30	49683.31	*
84951	MANHOLE	12.3		---	48908.92	49683.17	*
85182	MANHOLE	15.4		---	49217.66	50248.34	*

* NO ADJUSTMENT

3147-Y12 1=1 6-17-93

FILMED BY DATA IMAGE SYSTEMS CORP

REFERENCES PLANS FIELD BOOKS "PORT OF OAKLAND DATUM" IS 3.20' BELOW MEAN SEA LEVEL	REVIEWED: <i>[Signature]</i> FACILITIES DEPARTMENT REVIEWED: <i>[Signature]</i> CONSTRUCTION DEPARTMENT REVIEWED: <i>[Signature]</i> PROJECT PLANNING DEPARTMENT	DRAWN: <i>[Signature]</i> STAFF DESIGNED: <i>[Signature]</i> S 3414 CHECKED: <i>[Signature]</i> C 43841 REVIEWED: <i>[Signature]</i>	PORT OF OAKLAND 530 WATER STREET OAKLAND, CALIFORNIA	CHIEF ENGINEER <i>[Signature]</i> C 17439 APPROVED: <i>[Signature]</i> C 18853 RECOMMENDED: <i>[Signature]</i> C 32172	OUTER HARBOR TERMINAL ASPHALT CONCRETE OVERLAY BERTHS 20 & 21 YARD UTILITY ADJUSTMENT SCHEDULE Y12	DATE: 6/17/1993 SCALE: N/A SHEET: 16 OF 27 SHEETS FILE: AA-3147
---	---	---	--	---	---	--

CAUTION - CHECK TRACING FOR LATEST REVISIONS

CAUTION: THIS PLAN MAY BE REDUCED

1" ORIGINAL SCALE

SURVEY POINT NO.	DESCRIPTION	EXIST. ELEV. (ft)	FINAL ELEV. (ft)	ADJUSTMENT (ft)	NORTHING (PROJECT)	EASTING (PROJECT)	REMARKS
85191	MANHOLE	14.5	14.5	---	49217.3	50472.00	
90097	MANHOLE	13.6	14.58	+0.98	49744.47	49853.68	ABANDON
90168	MANHOLE	14.1	14.60	+0.5	49744.33	49137.47	
90256	MANHOLE	14.0	14.38	+0.38	49260.06	49528.90	
90257	MANHOLE	13.7	14.35	+0.65	49642.19	49528.81	
91136	MANHOLE	12.1	12.42	+0.32	48768.38	49659.17	NIC
91491	MANHOLE	13.9	13.86	---	48392.12	49620.27	*
91492	MANHOLE	13.9	13.9	---	48395.98	49620.40	*
91493	MANHOLE	13.9	13.93	---	48399.74	49620.32	*
91634	MANHOLE	12.8	12.78	---	48446.12	49908.46	*
91635	MANHOLE	12.9	12.94	---	48434.57	49905.48	*
91657	MANHOLE	13.1	13.1	---	48593.24	49921.69	*
91707	MANHOLE	12.2	12.6	+0.44	48709.54	49952.64	NIC
100697	DRAIN INLET	14.4	14.98	+0.58	49875.19	49453.52	ABANDON
100775	DRAIN INLET	13.9	14.77	+0.87	49854.06	48957.15	ABANDON
100795	DRAIN INLET	13.3	---	---	49767.82	49105.14	ABANDON
101024	DRAIN INLET	14.2	14.53	+0.33	49830.65	49629.78	
101135	DRAIN INLET	12.3	12.3	---	49749.75	50043.13	NIC
101168	DRAIN INLET	11.4	11.4	---	49696.70	50214.14	NIC
101175	DRAIN INLET	12.9	12.9	---	49699.28	50033.38	NIC
101569	DRAIN INLET	14.1	15.46	+1.36	49459.37	50235.32	ABANDON
101572	DRAIN INLET	14.7	15.65	+0.95	49459.54	50175.42	ABANDON
101575	DRAIN INLET	14.7	15.84	+1.14	49459.43	50045.25	ABANDON
101686	DRAIN INLET	14.6	15.97	+1.37	49459.46	49945.42	ABANDON
101690	DRAIN INLET	14.6	15.97	+1.37	49459.46	49845.63	ABANDON
101693	DRAIN INLET	14.6	15.96	+1.36	49459.67	49745.58	ABANDON
101696	DRAIN INLET	14.3	15.97	+1.67	49459.61	49645.26	
101835	DRAIN INLET	14.1	14.75	+0.65	49299.07	49645.21	
101841	DRAIN INLET	14.1	14.77	+0.67	49299.09	49795.23	
101847	DRAIN INLET	14.2	14.77	+0.57	49298.95	49945.34	
101859	DRAIN INLET	14.3	14.76	+0.43	49298.69	50235.39	
102070	DRAIN INLET	13.2	---	---	49095.38	49689.82	ABANDON
102447	DRAIN INLET	13.5	14.0	+0.51	49147.05	49137.81	
102731	DRAIN INLET	14.8	15.05	+0.25	49321.24	49122.59	ABANDON
102749	DRAIN INLET	14.2	14.2	---	49149.77	49024.04	*
102771	DRAIN INLET	14.6	14.88	+0.28	49310.56	49196.71	
102800	DRAIN INLET	13.0	14.2	+1.2	49697.64	49661.94	
102903	DRAIN INLET	14.0	14.54	+0.54	49830.71	49049.79	ABANDON
102928	DRAIN INLET	14.6	15.30	+0.7	49350.65	49658.79	
103012	DRAIN INLET	14.3	14.54	+0.24	49830.56	49339.27	
103355	DRAIN INLET	11.9	13.35	---	48591.76	49458.85	ABANDON

* NO ADJUSTMENT

SURVEY POINT NO.	DESCRIPTION	EXIST. ELEV. (ft)	FINAL ELEV. (ft)	ADJUSTMENT (ft)	NORTHING (PROJECT)	EASTING (PROJECT)	REMARKS
103366	DRAIN INLET	12.0	13.35	---	48591.87	49298.92	ABANDON
103378	DRAIN INLET	11.9	13.35	---	48591.86	49138.84	ABANDON
103780	DRAIN INLET	11.4	12.1	+0.71	48726.04	49179.75	NIC
103790	DRAIN INLET	11.6	12.26	+0.67	48708.02	49249.24	NIC
103795	DRAIN INLET	11.3	12.11	+0.82	48726.11	49256.94	NIC
103809	DRAIN INLET	11.7	12.5	+0.78	48707.68	49493.96	NIC
103815	DRAIN INLET	11.4	12.53	+1.1	48726.15	49498.74	NIC
103821	DRAIN INLET	11.1	12.1	+0.37	48726.11	49413.94	NIC
103946	DRAIN INLET	11.3	12.91	+1.61	48803.11	49116.43	NIC
104073	DRAIN INLET	11.4	12.55	+1.12	48764.04	49499.11	NIC
104078	DRAIN INLET	11.5	12.52	+1.05	48764.11	49419.08	NIC
104100	DRAIN INLET	11.5	12.53	+1.08	48765.42	49341.10	NIC
104105	DRAIN INLET	11.5	12.55	+1.08	48767.52	49257.03	NIC
104110	DRAIN INLET	11.4	12.55	+1.11	48767.42	49179.95	NIC
104301	DRAIN INLET	12.8	13.2	+0.4	49010.79	49187.68	
104625	DRAIN INLET	11.6	12.9	+1.31	48723.14	49573.83	NIC
104664	DRAIN INLET	11.3	12.8	+1.5	48764.35	49574.88	NIC
104702	DRAIN INLET	11.3	12.15	+0.8	48844.67	49669.51	NIC
104757	DRAIN INLET	12.1	13.0	+0.94	48722.48	49821.69	NIC
104764	DRAIN INLET	12.1	13.0	+0.67	48764.52	49820.48	NIC
105111	DRAIN INLET	10.9	10.9	---	49212.64	50387.31	*
105201	DRAIN INLET	10.9	---	---	49275.49	50537.84	*
105271	DRAIN INLET	10.9	10.9	---	49958.62	50265.02	*
105275	DRAIN INLET	11.3	11.3	---	48893.93	50287.89	*
105664	DRAIN INLET	11.9	11.93	---	48894.99	50096.24	NIC
171746	LIGHT	15.8	15.46	---	49414.50	50337.41	*
171747	LIGHT	15.9	15.93	---	49411.39	50047.83	*
171748	LIGHT	15.3	15.29	---	49134.87	49811.87	*
171749	LIGHT	14.3	14.07	---	49134.79	49447.19	*
171750	LIGHT	13.6	14.3	---	49705.16	49147.71	*
171751	LIGHT	16.0	15.97	---	40414.15	49147.90	*
171752	LIGHT	15.7	15.98	---	49412.08	49498.32	*
171753	LIGHT	13.9	14.14	---	49135.12	49146.76	*
171754	LIGHT	13.7	14.26	---	49704.78	49447.74	*
171755	LIGHT	13.6	14.27	---	49705.17	49747.79	*
171756	LIGHT	15.7	15.95	---	49412.34	49747.43	*
171757	LIGHT	13.2	13.5	---	48574.33	49447.75	*
171758	LIGHT	13.2	13.47	---	48573.59	49148.51	*
171759	LIGHT	12.5	12.74	---	48854.13	49148.38	*
171760	LIGHT	12.8	12.76	---	48854.00	49448.09	*
171761	LIGHT	13.9	13.93	---	48914.40	49811.06	*

* NO ADJUSTMENT

SURVEY POINT NO.	DESCRIPTION	EXIST. ELEV. (ft)	FINAL ELEV. (ft)	ADJUSTMENT (ft)	NORTHING (PROJECT)	EASTING (PROJECT)	REMARKS
171762	LIGHT	12.6	12.14	---	48854.35	50048.32	*
171763	LIGHT	12.9	12.9	---	49705.21	50047.49	NIC
171764	LIGHT	12.4	---	---	49705.25	50337.79	NIC
171765	FIRE HYDRANT	14.5	14.83	+0.33	49860.62	49128.86	
171767	FIRE HYDRANT	14.3	14.83	+0.53	49859.56	49637.79	
171768	FIRE HYDRANT	12.2	---	---	49710.40	50337.49	NIC
171769	FIRE HYDRANT	13.6	13.6	---	49830.13	50037.09	NIC
171770	FIRE HYDRANT	15.9	15.46	-0.44	49417.69	50338.00	*
171771	FIRE HYDRANT	15.8	15.97	+0.17	49414.73	50048.28	
171772	FIRE HYDRANT	15.22	15.29	---	49131.22	49810.90	*
171773	FIRE HYDRANT	14.2	14.11	---	49131.03	49447.91	*
171774	FIRE HYDRANT	13.6	14.3	+0.7	49708.59	49147.51	
171775	FIRE HYDRANT	16.0	16.0	---	49417.12	49148.08	
171776	FIRE HYDRANT	14.0	14.12	+0.12	49130.66	49148.16	
171777	FIRE HYDRANT	13.5	14.3	+0.8	48708.25	49747.81	
171778	FIRE HYDRANT	13.57	13.5	---	48570.82	49448.48	*
171779	FIRE HYDRANT	13.6	13.6	---	48570.67	49148.29	*
171780	FIRE HYDRANT	12.9	12.8	---	48850.52	49148.53	*
171781	FIRE HYDRANT	12.9	12.8	---	48850.91	49448.37	*
171782	FIRE HYDRANT	12.6	12.12	---	48851.18	50048.05	*
171783	FIRE HYDRANT	15.8	16.0	+0.2	49417.76	49446.04	

* NO ADJUSTMENT

NEW UTILITY STRUCTURES

NEW UTILITY STRUCTURES NO.	DESCRIPTION	FINAL ELEV. (ft)	NORTHING (PROJECT)	EASTING (PROJECT)	
A1000	INSTALL CLEANOUT	14.2	49795.82	49051.46	
A1001	INSTALL CLEANOUT	14.2	49795.82	49286.43	
A1002	INSTALL MANHOLE W/GRATE	14.2	49796.00	49521.65	
A1003	INSTALL CLEANOUT	14.2	49795.92	49821.41	
A1004	INSTALL CLEANOUT	13.9	49668.04	49127.08	
A1005	INSTALL CLEANOUT	13.9	49667.89	49324.92	
A1006	INSTALL MANHOLE W/GRATE	13.9	49668.01	49522.80	
A1007	INSTALL CLEANOUT	13.9	49668.04	49870.32	
A1008	INSTALL CLEANOUT	14.0	49284.28	49726.95	
A1009	INSTALL MANHOLE W/GRATE	14.0	49284.18	49795.23	
A1010	INSTALL CLEANOUT	14.0	49284.28	49870.58	
A1011	INSTALL MANHOLE W/GRATE	13.0	49147.49	50005.20	
A1012	INSTALL CLEANOUT	13.0	49144.73	50200.26	
A1013	INSTALL MANHOLE W/GRATE	12.2	48824.96	49680.02	NIC
A1014	INSTALL MANHOLE W/GRATE	12.0	48819.15	49955.34	NIC
A1015	INSTALL MANHOLE W/GRATE	12.0	48819.07	50051.55	NIC
A1016	INSTALL CLEANOUT	12.1	48725.36	49130.79	NIC
A1017	INSTALL MANHOLE W/GRATE	12.6	48559.55	49672.26	
A1018	INSTALL CLEANOUT	12.6	49473.25	49872.19	

3147-Y13 1=1 6-18-93

FILMED BY DATA IMAGE SYSTEMS CORP

NO.	REVISIONS	DATE	APP'D

DESIGNED: <i>M. Malley</i>	NO. ENGINEER NO. S 3414
CHECKED: <i>E. Chan</i>	NO. ENGINEER NO. C 43841
REVIEWED: <i>V. A. ...</i>	NO. ENGINEER NO. ...



CHIEF ENGINEER: <i>F.H. ...</i>	NO. ENGINEER NO. C 17439
APPROVED: <i>[Signature]</i>	NO. ENGINEER NO. C 18853
RECOMMENDED: <i>[Signature]</i>	NO. ENGINEER NO. C 32172

OUTER HARBOR TERMINAL	DATE: 6/17/1997
ADSPHALT CONCRETE OVERLAY BERTHS 20 & 21 YARD	SCALE: N/A
UTILITY ADJUSTMENT SCHEDULE	SHEET 17 OF 27 SHEETS
Y13	FILE AA-3147

CAUTION: THIS PLAN MAY BE REDUCED

ORIGINAL SCALE

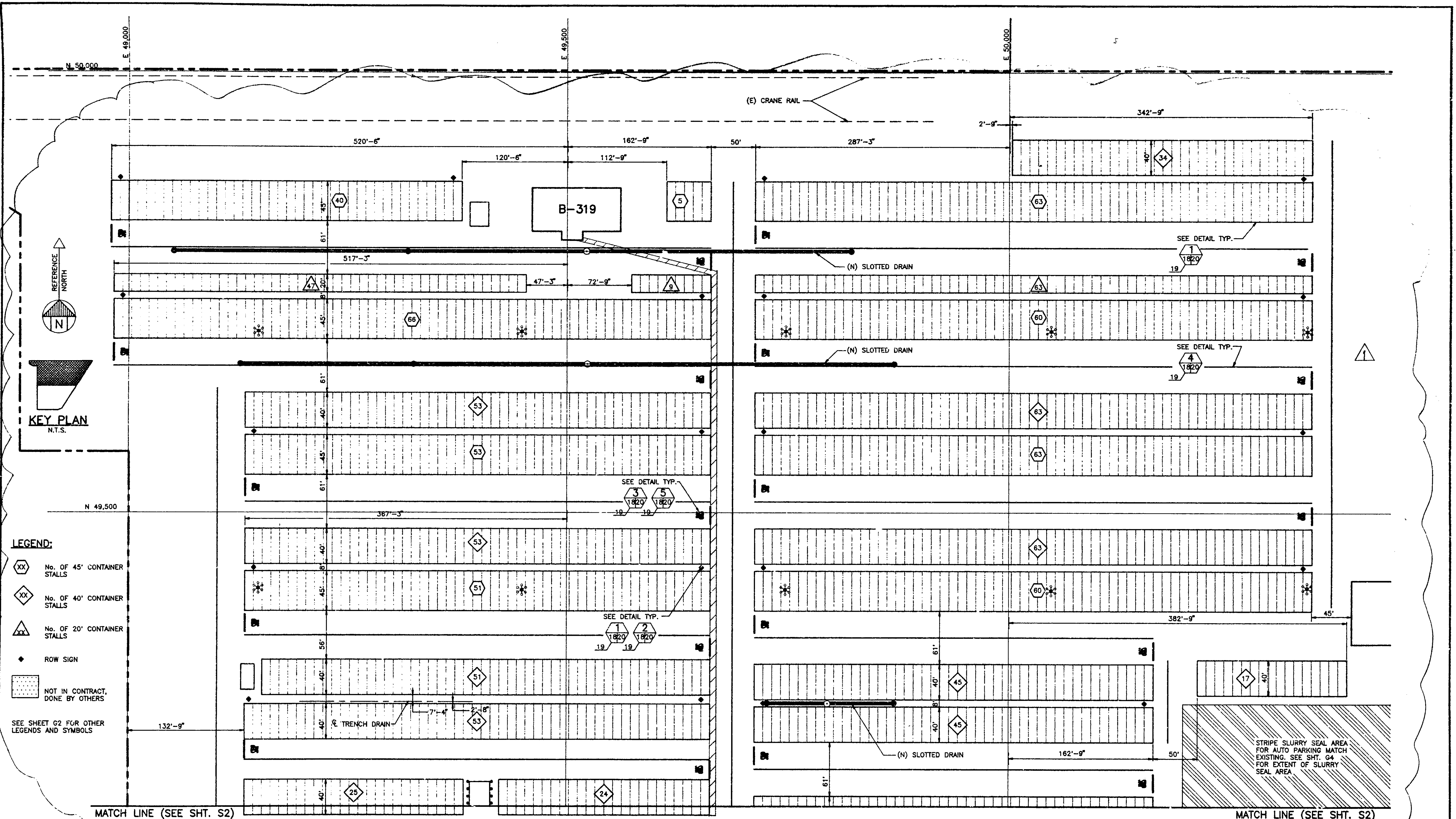

KEY PLAN
N.T.S.

- LEGEND:**
- XX No. OF 45' CONTAINER STALLS
 - ◇ No. OF 40' CONTAINER STALLS
 - △ No. OF 20' CONTAINER STALLS
 - ROW SIGN
 - ▨ NOT IN CONTRACT, DONE BY OTHERS
- SEE SHEET G2 FOR OTHER LEGENDS AND SYMBOLS

STRIPING PLAN

1"=50'

3147-S1.DWG(1=1PAPER,VIEW P1) 10-12-93

NO.	REVISIONS	DATE	APP'D
1	GENERAL CHANGE TO STRIPING	10/15/93	[Signature]

REVIEWED	[Signature]	SS/MN	
REVIEWED	[Signature]	DESIGNED	M. Manley
REVIEWED	[Signature]	CHECKED	E. [Signature]
REVIEWED	[Signature]	REVIEWED	V. [Signature]

PORT OF OAKLAND
530 WATER STREET OAKLAND, CALIFORNIA

CHIEF ENGINEER
[Signature]
APPROVED [Signature]
RECOMMENDED [Signature]

OUTER HARBOR TERMINAL
ASPHALT CONCRETE OVERLAY
BERTHS 20 & 21 YARD
STRIPING PLAN - SHEET 1

DATE 6/17/1993
SCALE AS SHOWN
SHEET 18 OF 27 SHEETS
FILE AA-3147

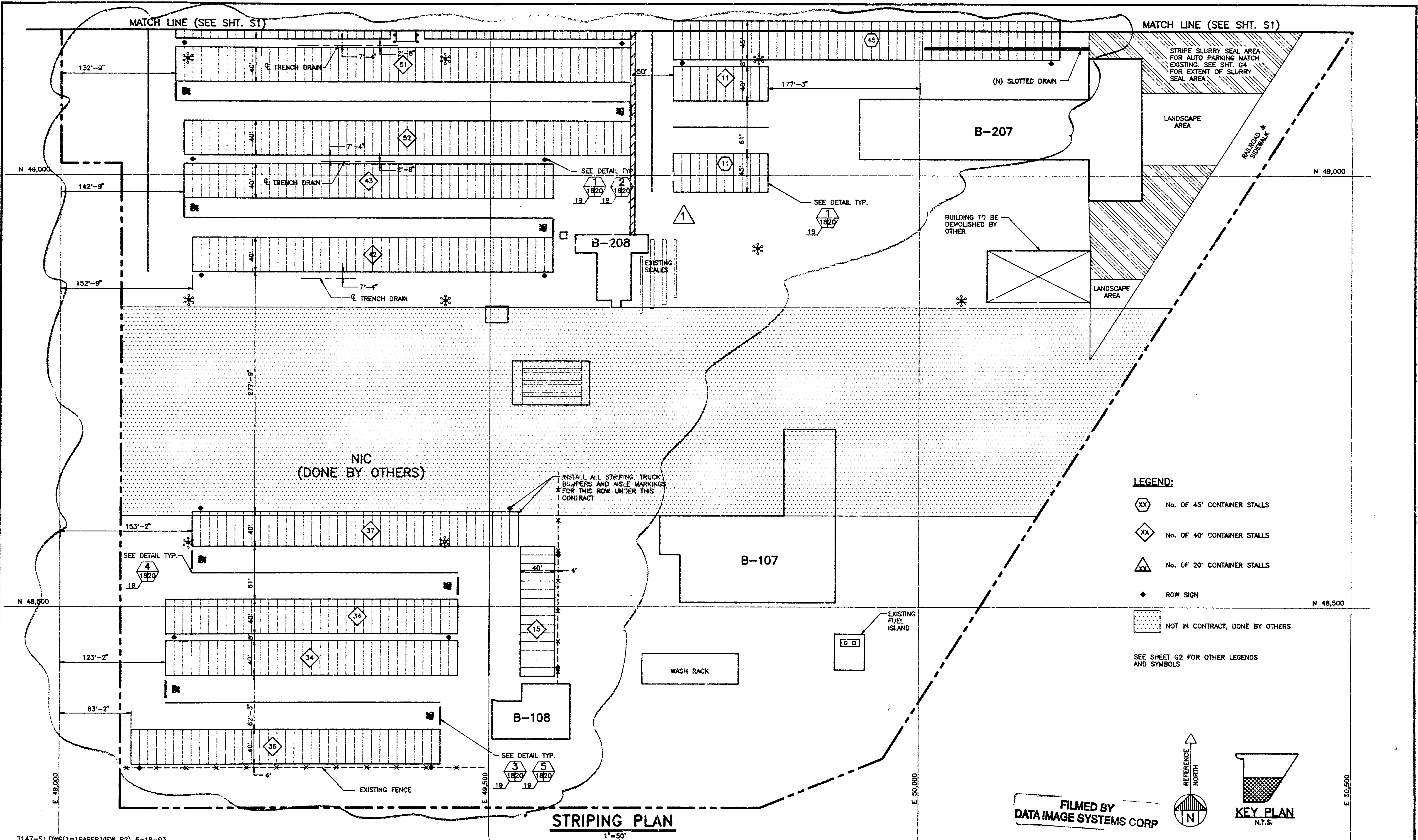

- LEGEND:**
- ⬡ No. OF 45' CONTAINER STALLS
 - ⬢ No. OF 40' CONTAINER STALLS
 - ⬠ No. OF 20' CONTAINER STALLS
 - ◆ ROW SIGN
 - ⬤ NOT IN CONTRACT, DONE BY OTHERS
- SEE SHEET G2 FOR OTHER LEGENDS AND SYMBOLS

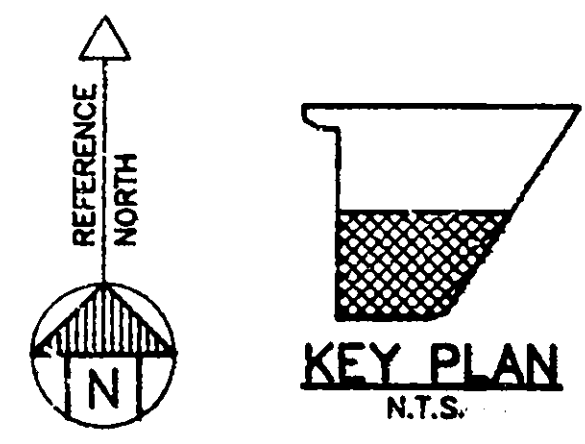

FILMED BY
DATA IMAGE SYSTEMS CORP

STRIPING PLAN
1"=50'

3147-S1.DWG(1=PAPER,VIEW P2) 6-18-93

NO.	REVISIONS	DATE	APP'D
1	GENERAL CHANGE TO STRIPING	10/15/93	710

REVIEWED	DESIGNED	CHECKED	REVIEWED
<i>[Signature]</i>	<i>[Signature]</i>	<i>[Signature]</i>	<i>[Signature]</i>

DESIGNED	SS/MN	S 3414
CHECKED	<i>[Signature]</i>	C 43841
REVIEWED	<i>[Signature]</i>	C 32172

PORT OF OAKLAND
530 WATER STREET OAKLAND, CALIFORNIA

CHIEF ENGINEER	<i>[Signature]</i>	C 17439
APPROVED	<i>[Signature]</i>	C 18853
RECOMMENDED	<i>[Signature]</i>	C 32172

OUTER HARBOR TERMINAL	DATE 6/17/1993
ASPHALT CONCRETE OVERLAY	SCALE AS SHOWN
BERTHS 20 & 21 YARD	SHEET 19 OF 27 SHEETS
STRIPING PLAN - SHEET 2	FILE AA-3147

DATE	6/17/1993
SCALE	AS SHOWN
SHEET	19 OF 27 SHEETS
FILE	AA-3147

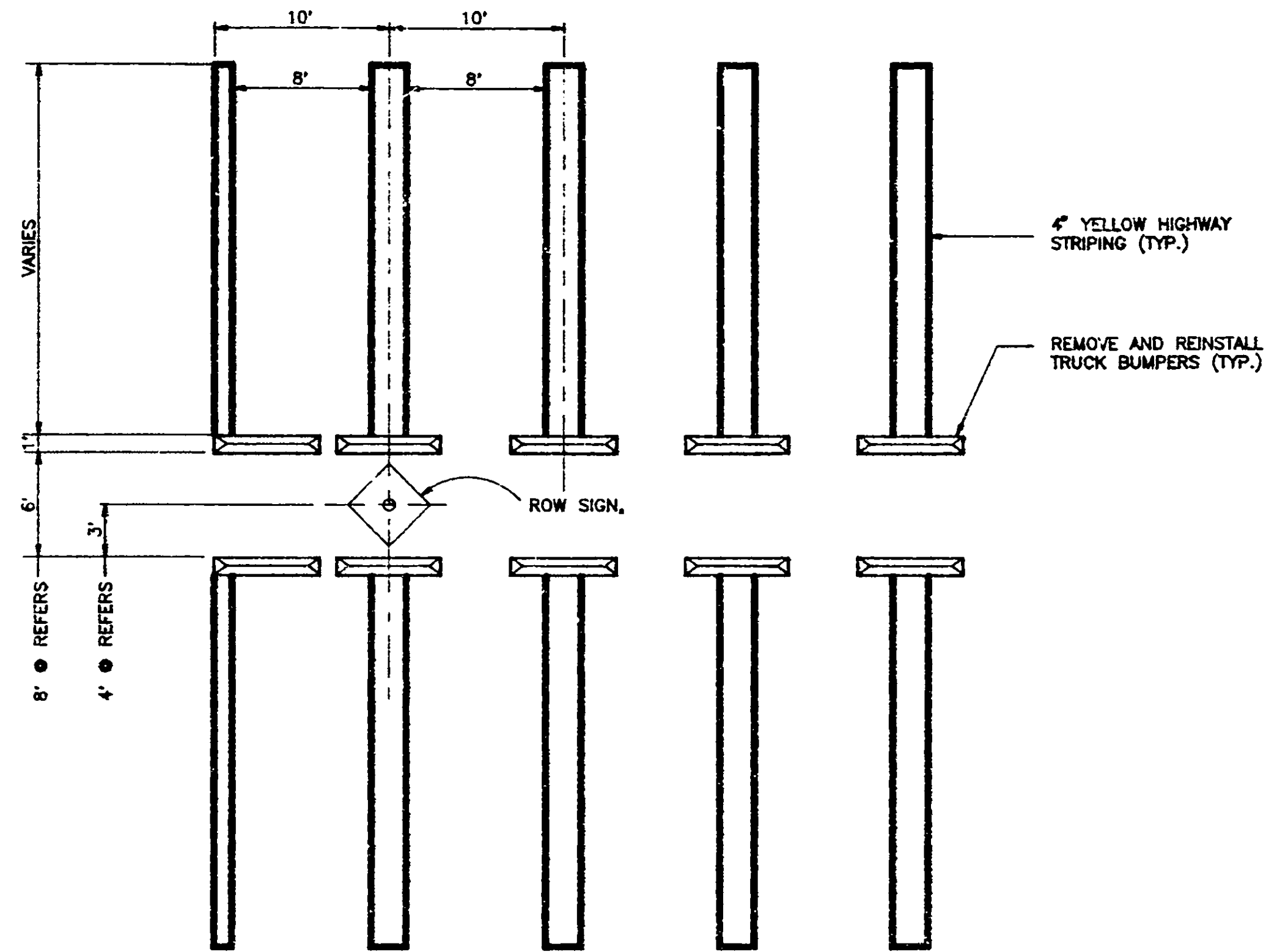

1 PARKING LAYOUT AND ROW SIGN TYPICAL DETAIL
18/20 NTS

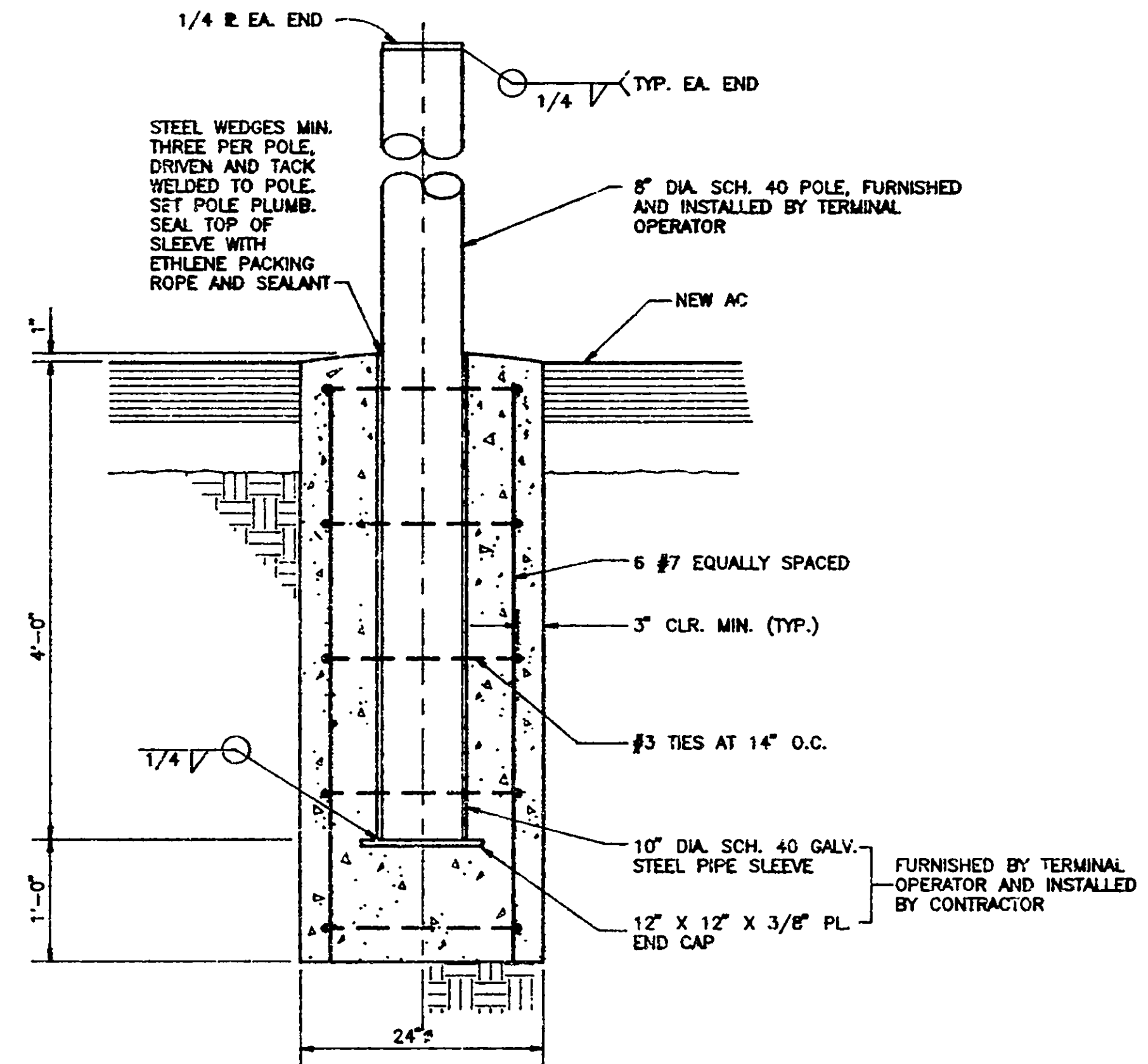

2 ROAD SIGN POST FOUNDATION DETAIL
18/20 NTS

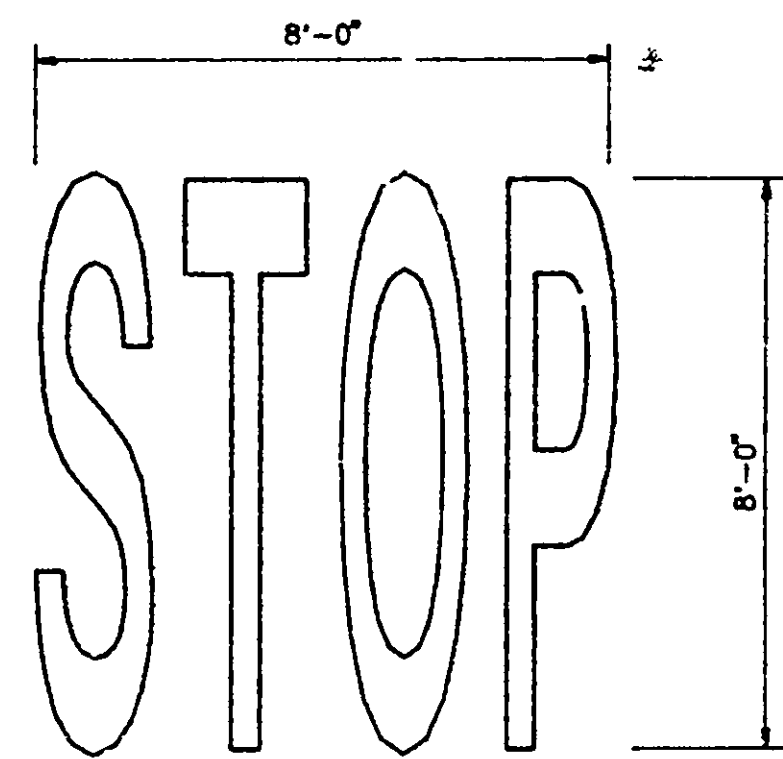

A=23 SQ.FT.
PAINT YELLOW

3 PAVEMENT MARKING DETAILS
18/20 SCALE: 1"=4'

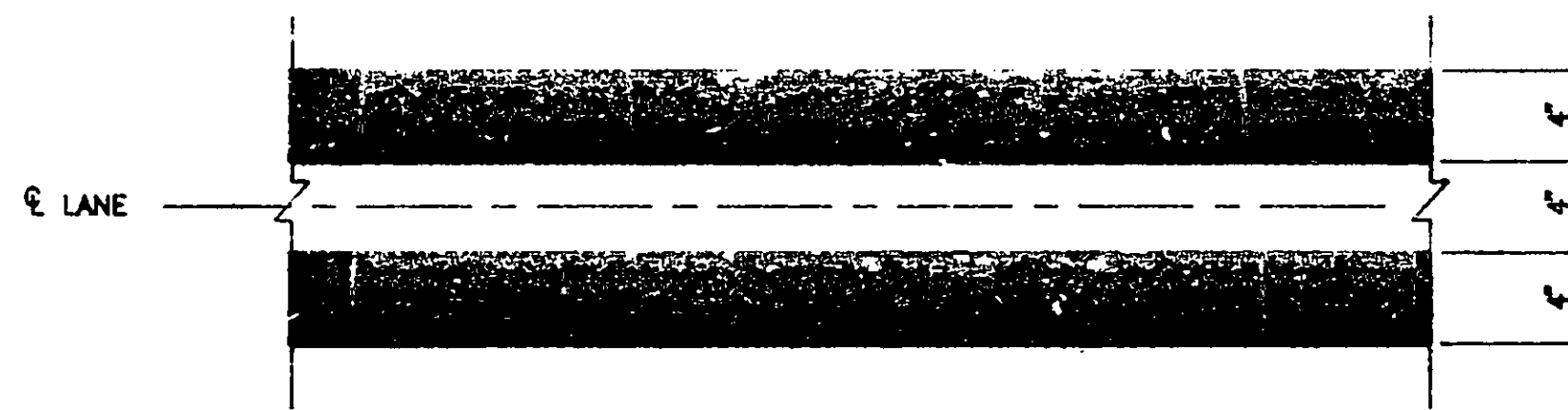

NOTE: ALL MARKINGS YELLOW

4 DOUBLE CENTERLINE PAVEMENT MARKING
18/20 SCALE: 1 1/2"=1'

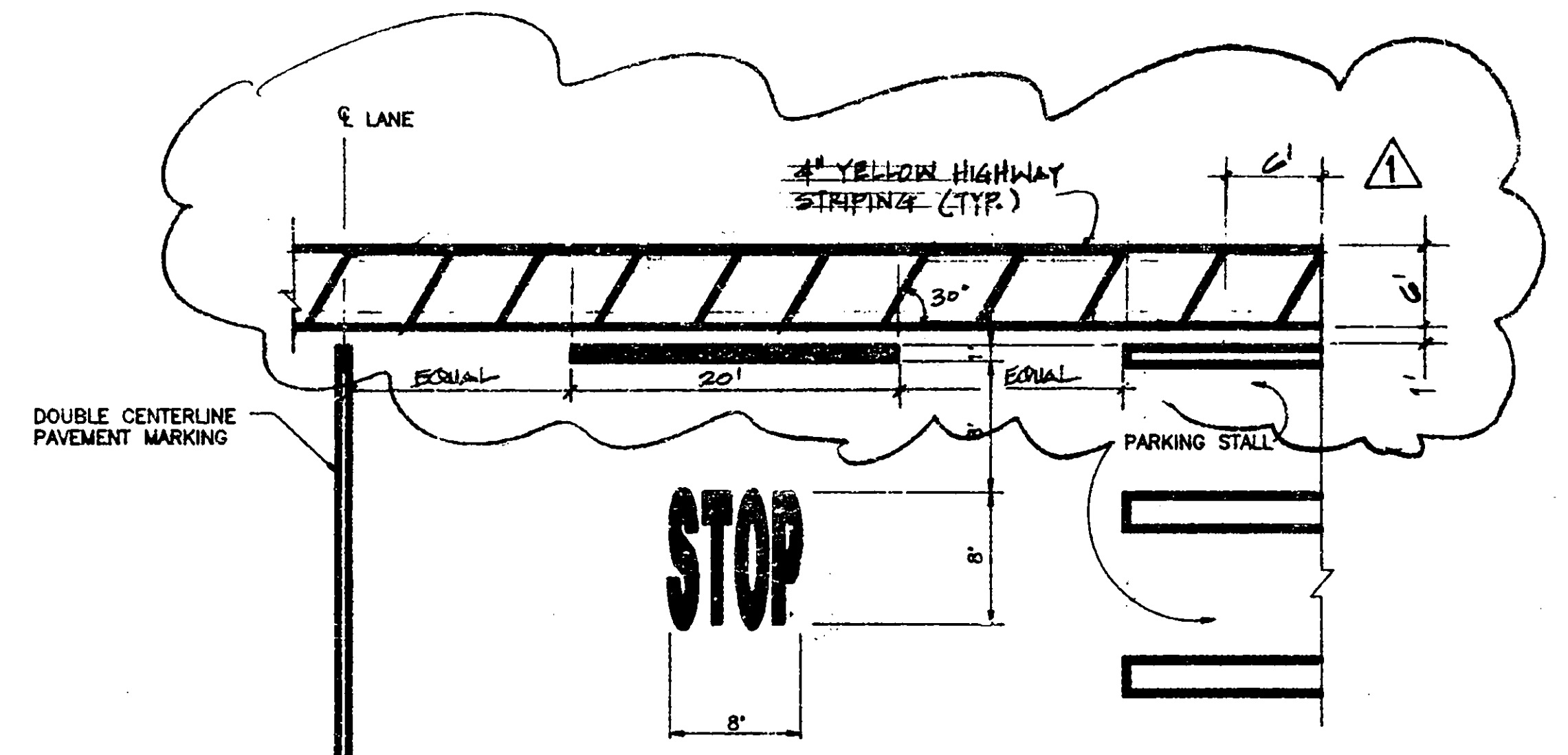

NOTE: ALL MARKINGS YELLOW

5 PAVEMENT MARKING DETAILS
18/20 SCALE: 1"=8'

FILMED BY
DATA IMAGE SYSTEMS CORP

3147-S3.DWG(1=2) 6-18-93

NO.	REVISIONS	DATE	APP'D
1	ADDED PEDESTRIAN STRIPING	10/15/93	[Signature]

REVIEWED	[Signature]	FACILITIES DEPARTMENT
REVIEWED	[Signature]	CONSTRUCTION DEPARTMENT
REVIEWED	[Signature]	PROJECT PLANNING DEPARTMENT

DRAWN	SS/MN/HL
DESIGNED	M. Moly S 3414
CHECKED	G. Khan C 43841
REVIEWED	V. Schulz [Signature]

PORT OF OAKLAND
530 WATER STREET OAKLAND, CALIFORNIA

CHIEF ENGINEER	[Signature]	C 17439
APPROVED	[Signature]	C 18853
RECOMMENDED	[Signature]	C 32172

OUTER HARBOR TERMINAL	DATE: 6/17/1993
ASPHALT CONCRETE OVERLAY	SCALE: AS SHOWN
BERTHS 20 & 21 YARD	SHEET 20 OF 27 SHEETS
STRIPING DETAILS	FILE AA-3147

S3

CAUTION - CHECK TRACING FOR LATEST REVISIONS

CAUTION: THIS PLAN MAY BE REDUCED

0 1 2 3 ORIGINAL SCALE

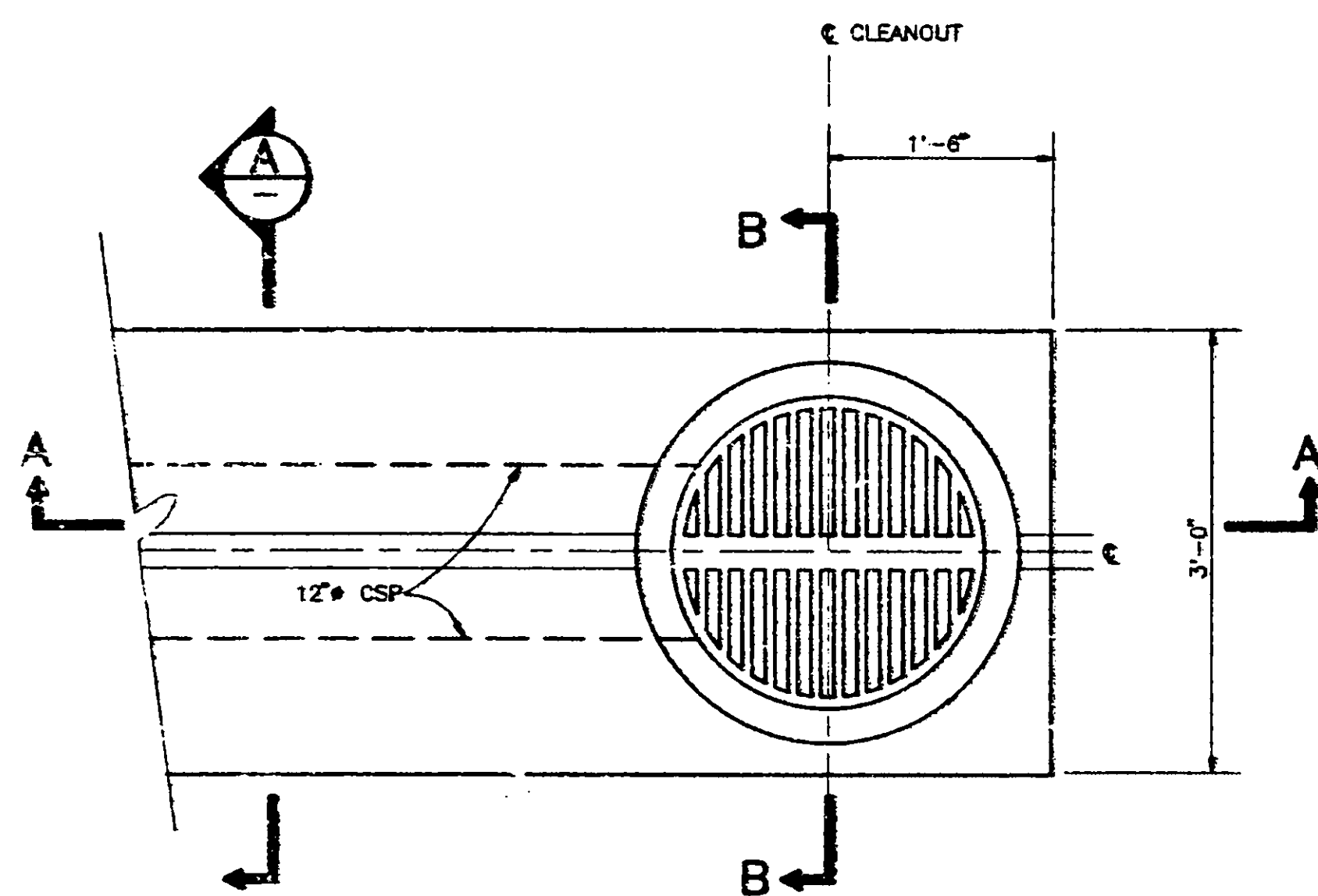

PLAN

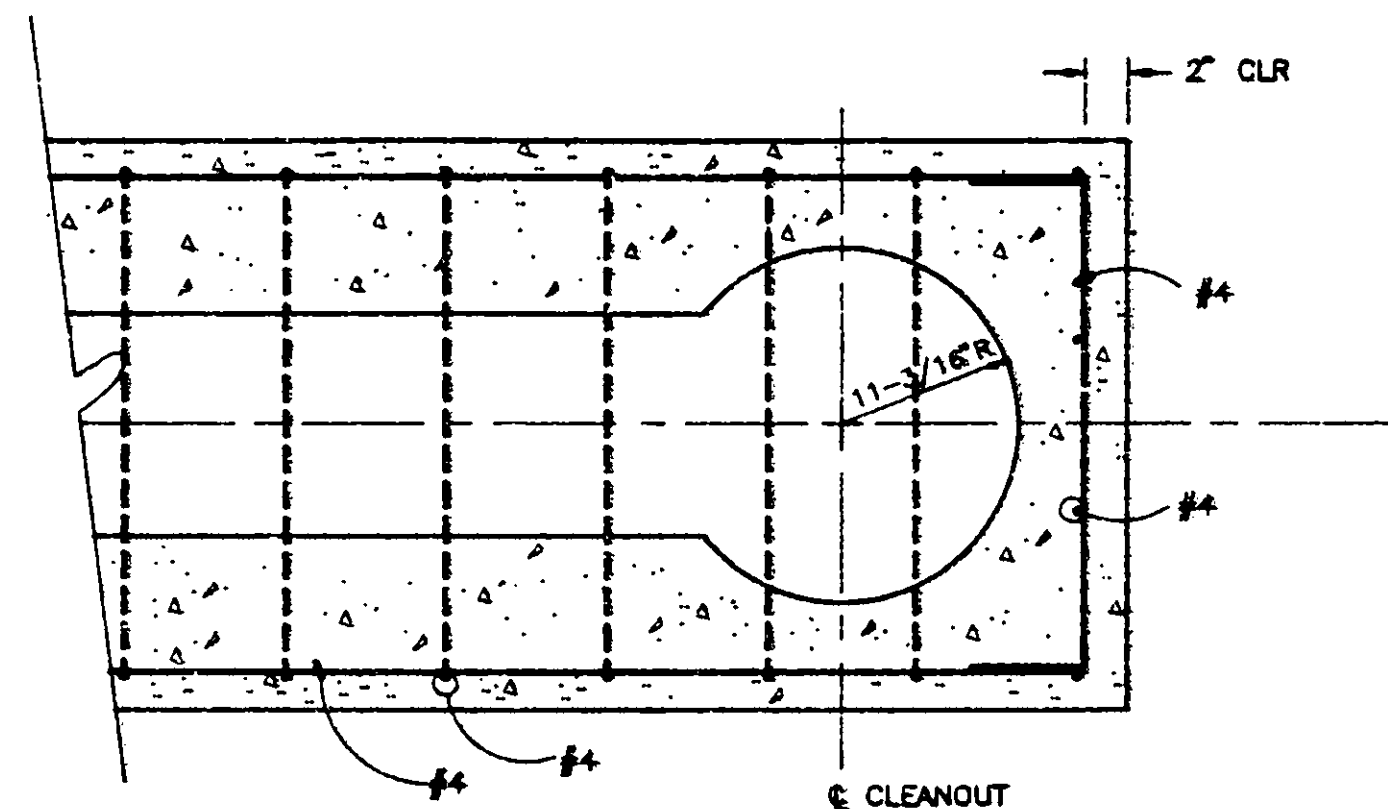

SECTION C-C

NOTE:
SIMILAR WHERE TRENCH DRAIN
EXTENDS BEYOND CLEANOUT ON
BOTH SIDES.

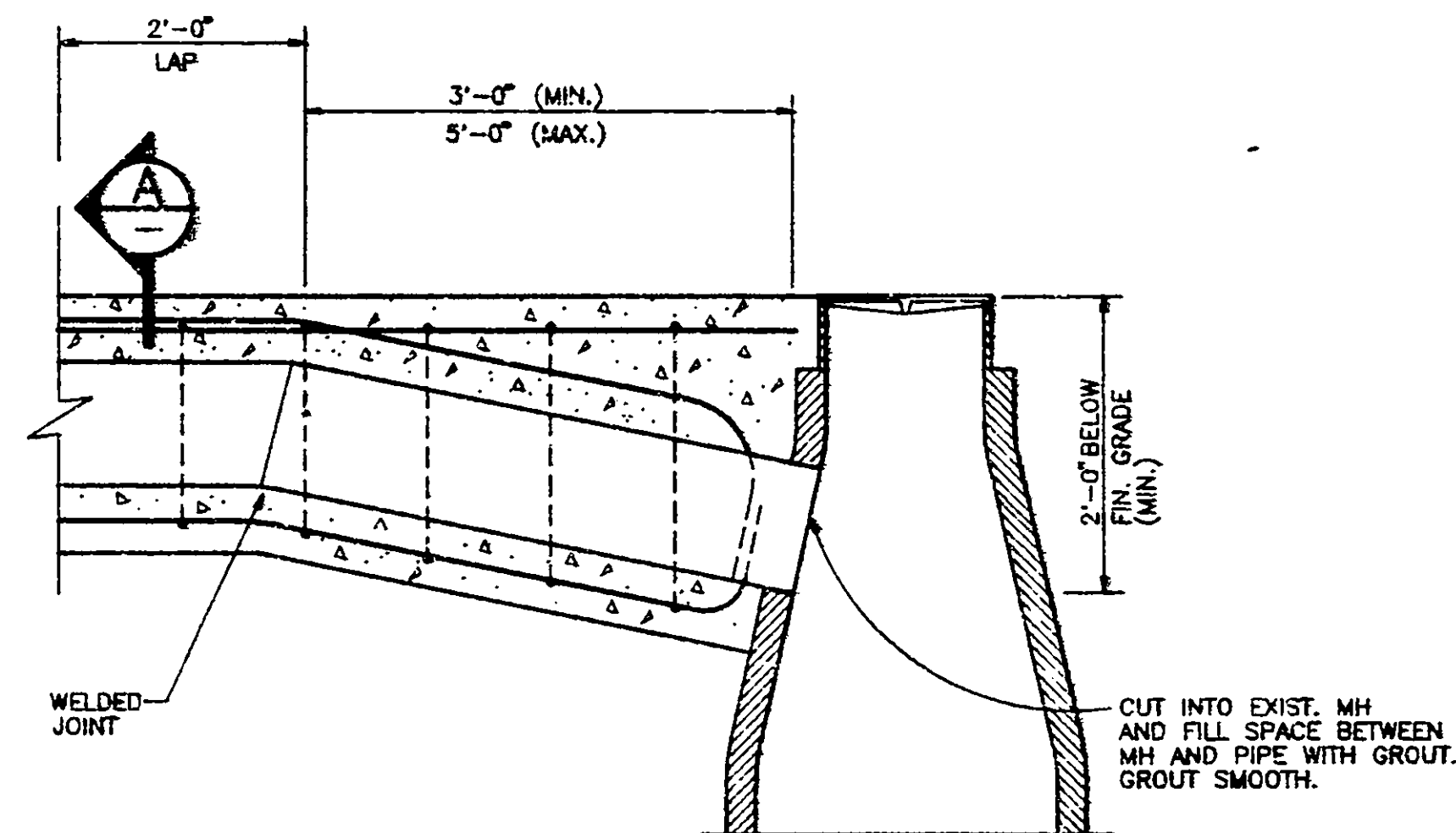

NOTE: ANGLE AND DIRECTION OF WELDED JOINT VARIES DUE TO DIFFERENCE IN
MANHOLE AND SLOTTED DRAIN ALIGNMENT. ANGLE AND DIRECTION TO BE
DETERMINED BY CONTRACTOR AND VERIFIED BY THE ENGINEER.

2 SLOTTED DRAIN CONNECTION DETAIL (TYP.)
7/21 NTS

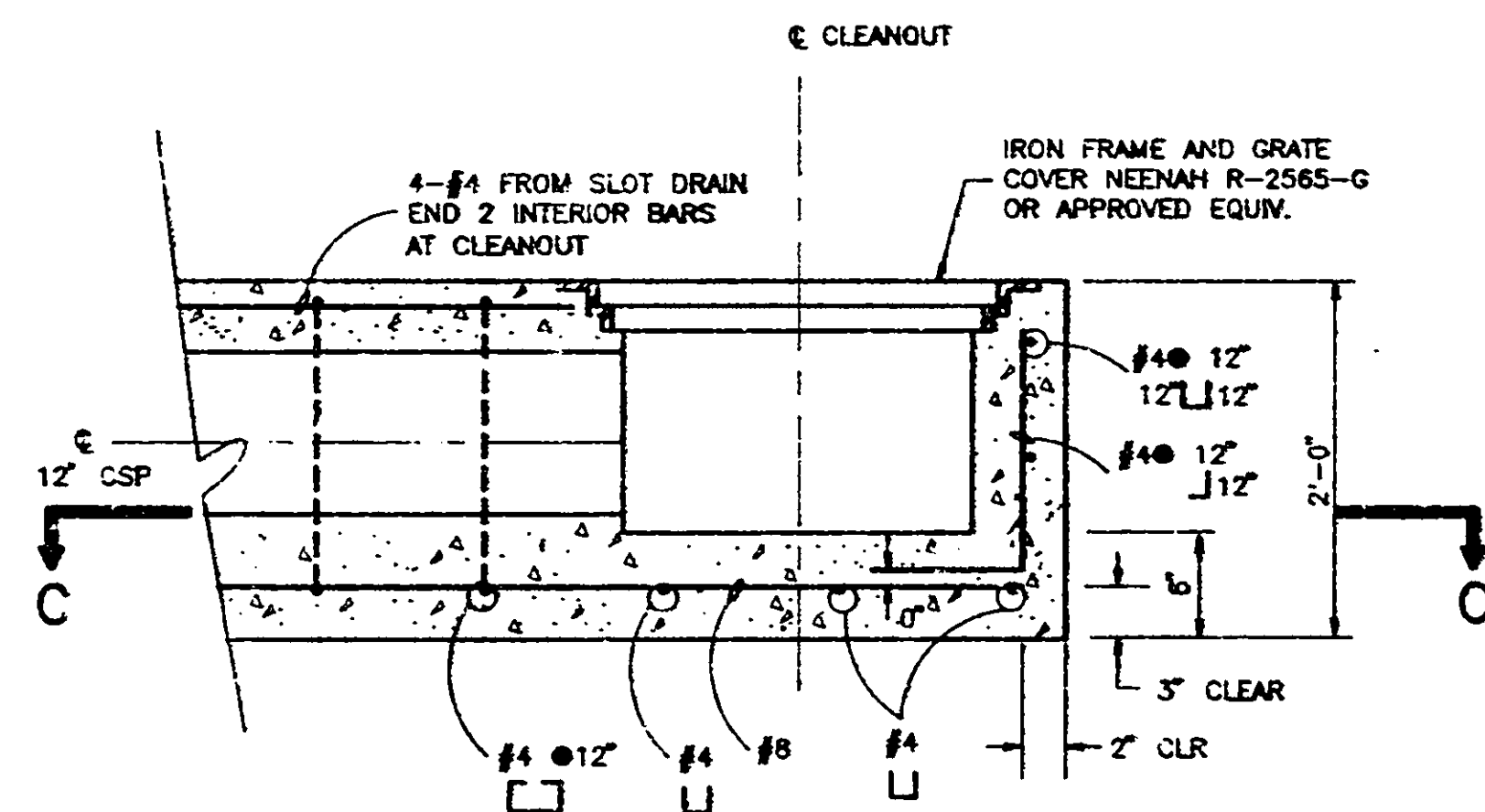

SECTION A-A

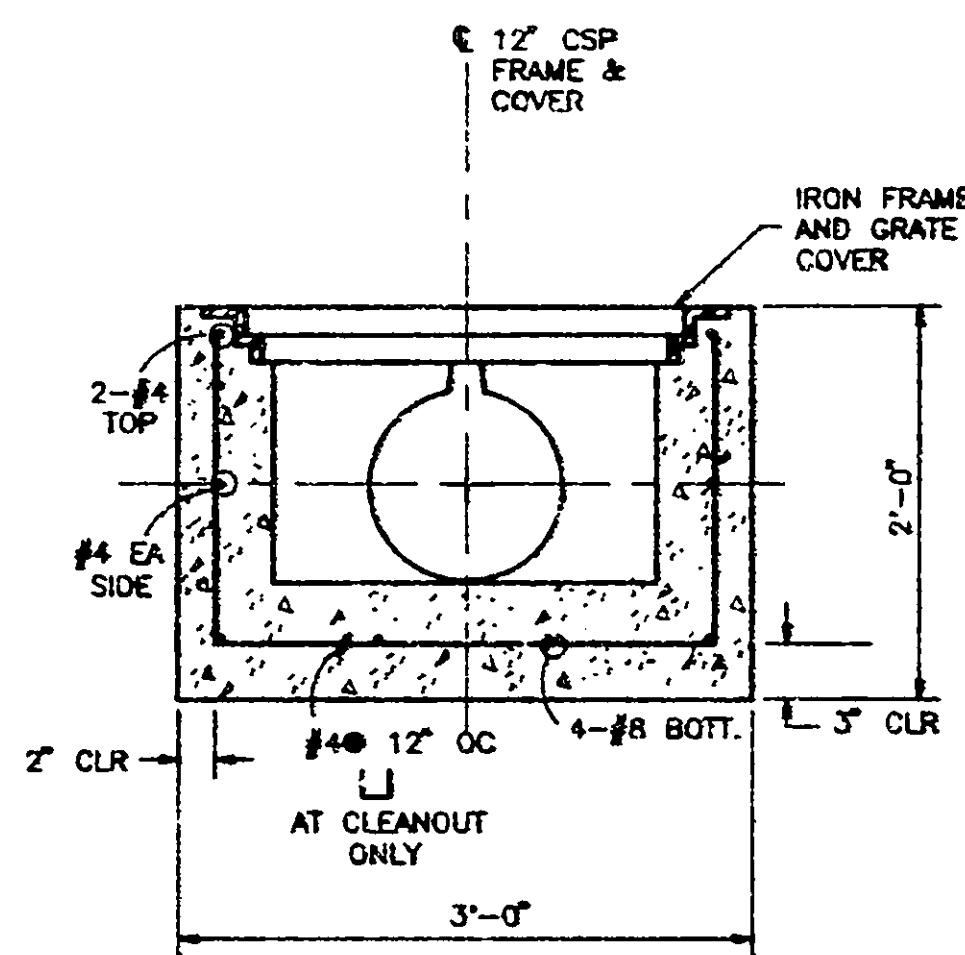

SECTION B-B

1 TYPICAL CLEANOUT DETAIL
7/21 1"=1'-0"

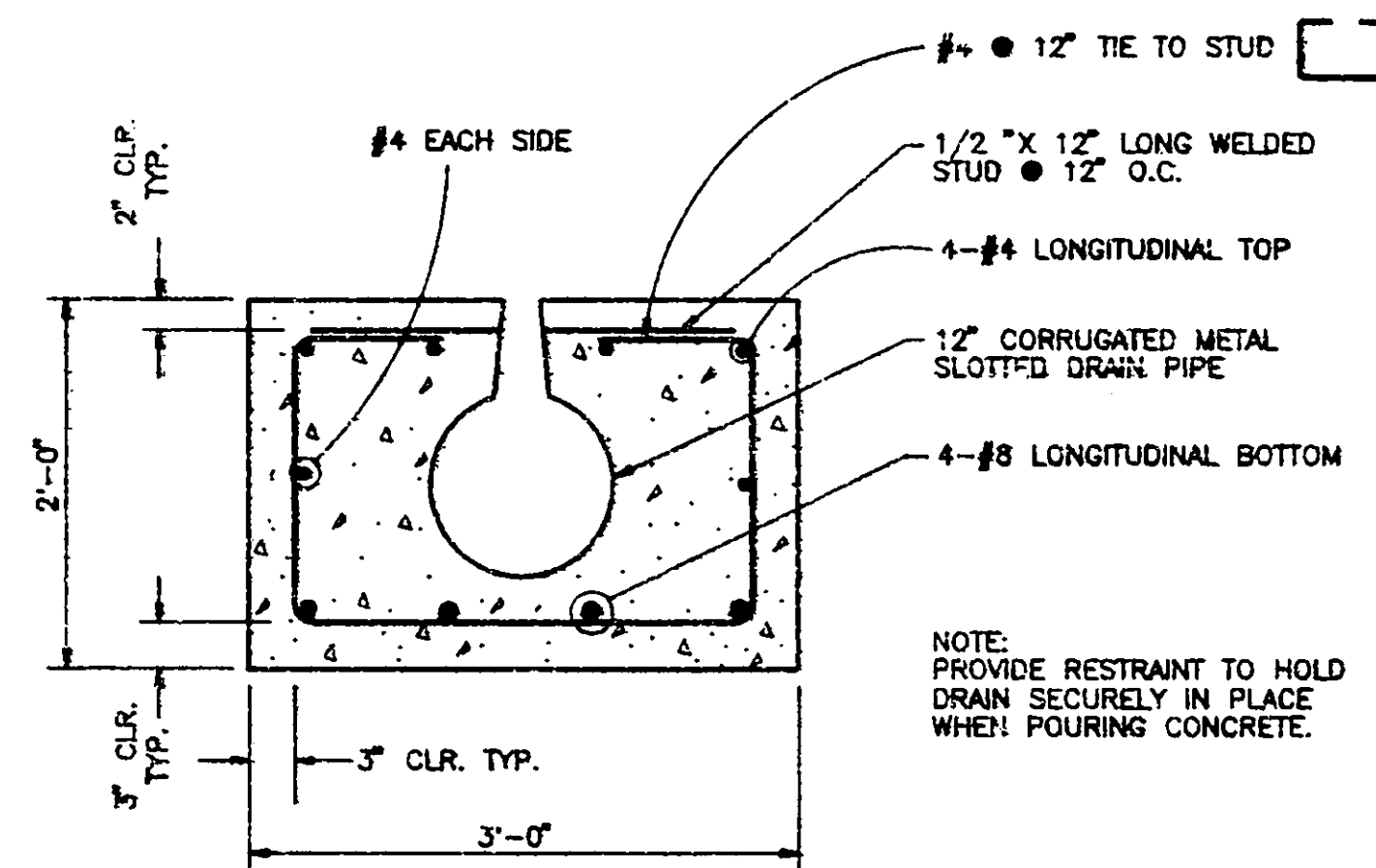

NOTE:
PROVIDE RESTRAINT TO HOLD
DRAIN SECURELY IN PLACE
WHEN POURING CONCRETE.

A SLOTTED DRAIN SECTION
NTS

1=1 6-17-93 8:15PM

FILMED BY
DATA IMAGE SYSTEMS CORP

NO.	REVISIONS	DATE	APP'D

REVIEWED	SS/MN/MH
REVIEWED	FACILITIES DEPARTMENT
REVIEWED	CONSTRUCTION DEPARTMENT
REVIEWED	PROJECT PLANNING DEPARTMENT

DRAWN	SS/MN/MH
DESIGNED	M. M. M. S. 3414
CHECKED	G. J. J. C. 4384
REVIEWED	V. J. J. S. 32172

PORT OF OAKLAND
530 WATER STREET OAKLAND, CALIFORNIA

CHIEF ENGINEER	C 17439
APPROVED	C 18853
RECOMMENDED	C 32172

OUTER HARBOR TERMINAL	DATE 6-17-93
ASPHALT CONCRETE OVERLAY BERTHS 20 & 21 YARD	SCALE AS SHOWN
SECTIONS AND DETAILS	SHEET 21 OF 27 SHEETS
D1	FILE AA-3147

CAUTION: THIS PLAN MAY BE REDUCED

0 1 2 ORIGINAL SCALE

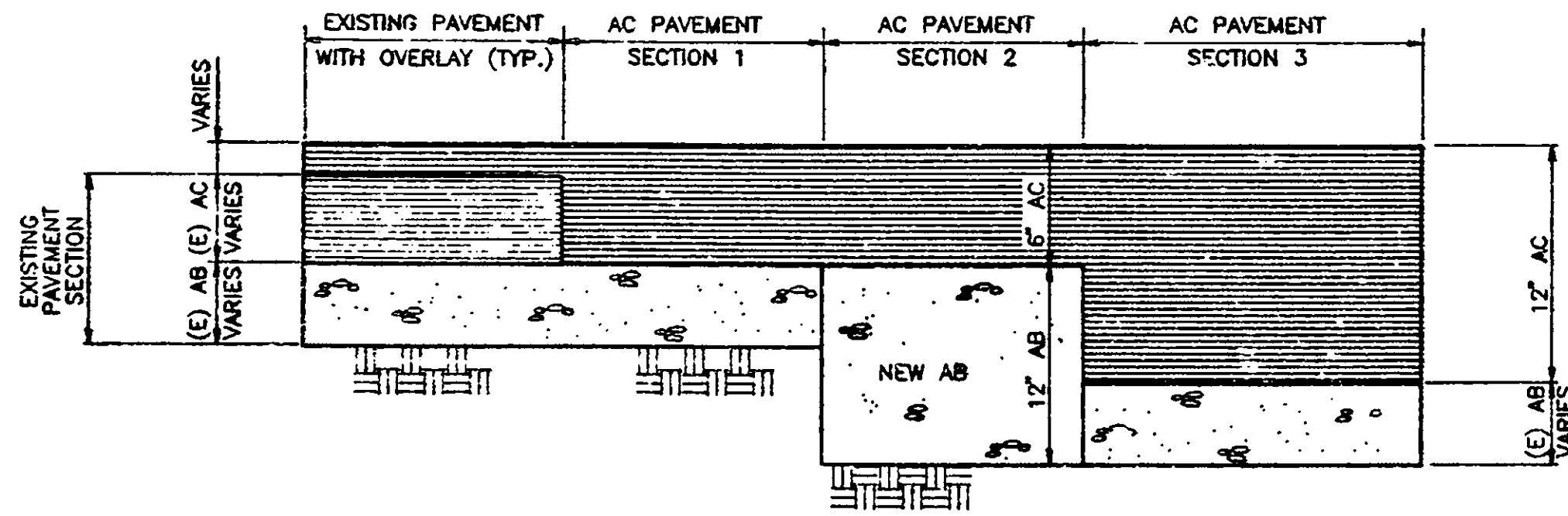

NOTE:
PAVEMENT REPLACEMENT SECTION 1 IS 8" AC.

A PAVEMENT REPLACEMENT SECTIONS 1 AND 2 (TYP.)
NTS

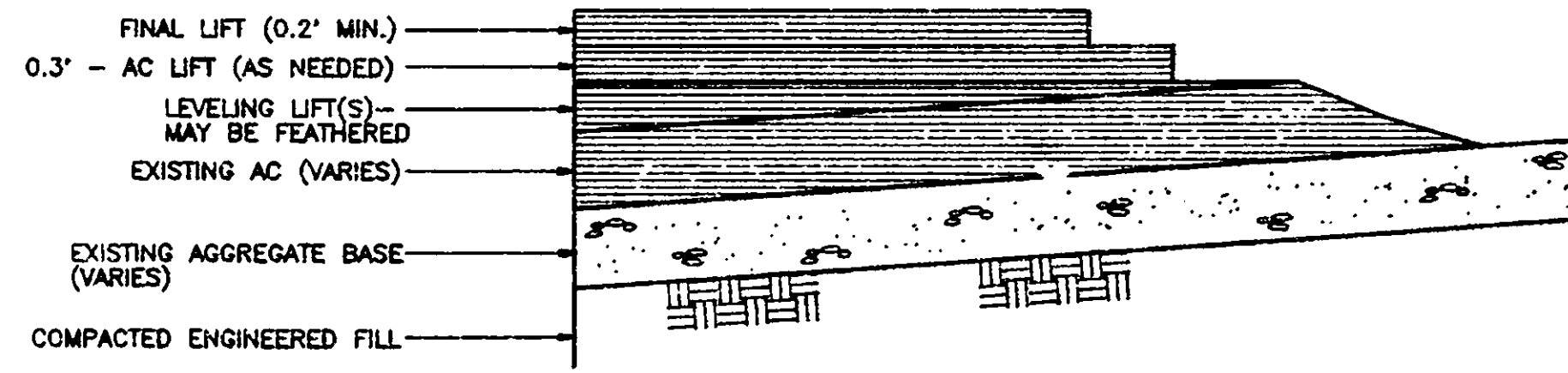

B EXISTING PAVING SECTION WITH OVERLAY (TYP.)
NTS

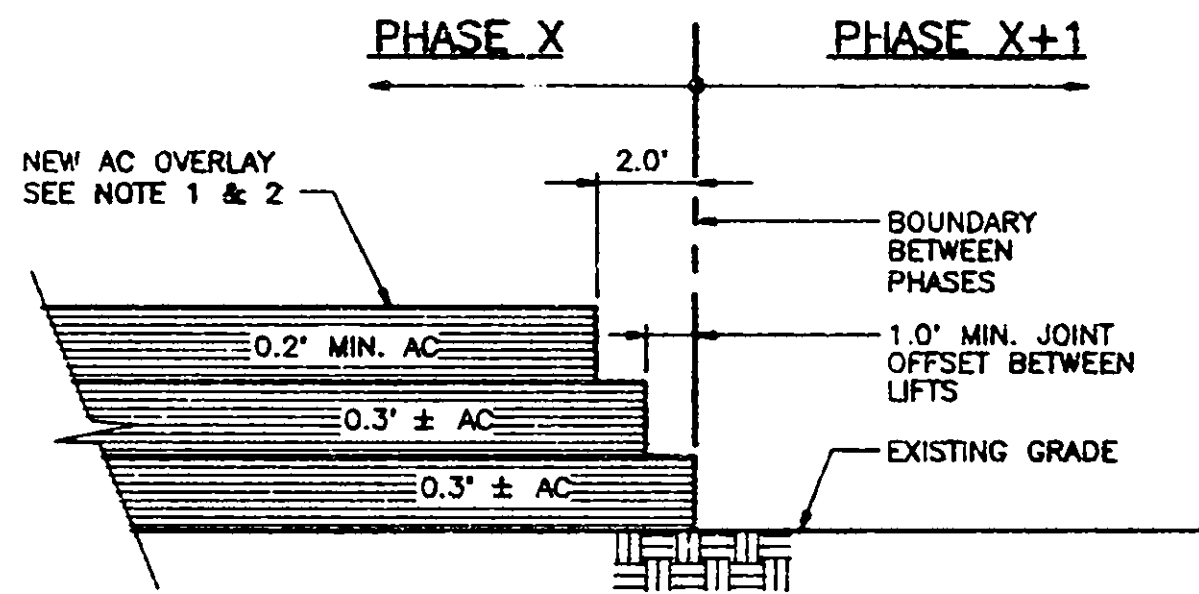

C OVERLAY BETWEEN PHASES (TYP.)
NTS

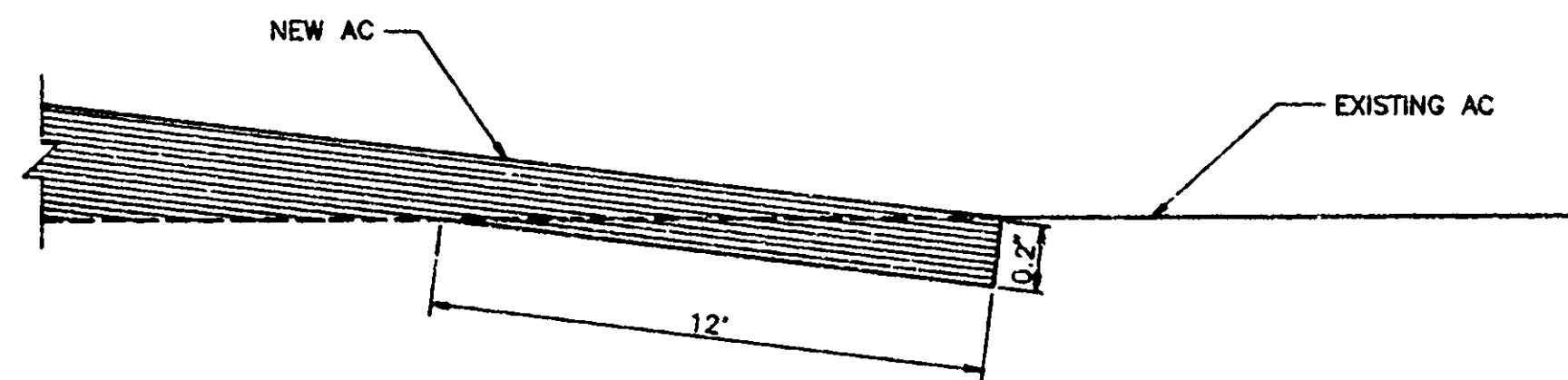

F SECTION
NTS

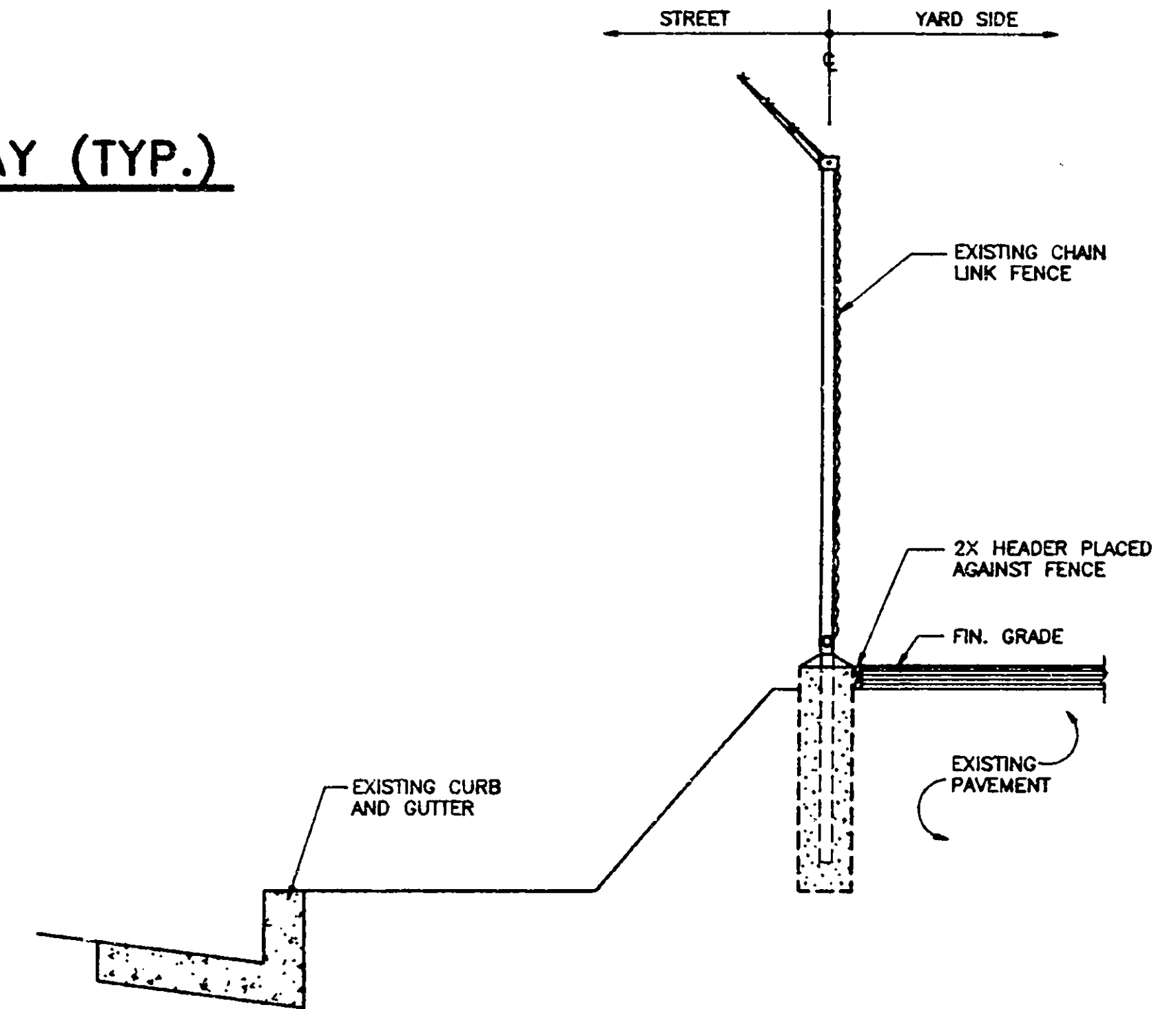

D SECTION
NTS

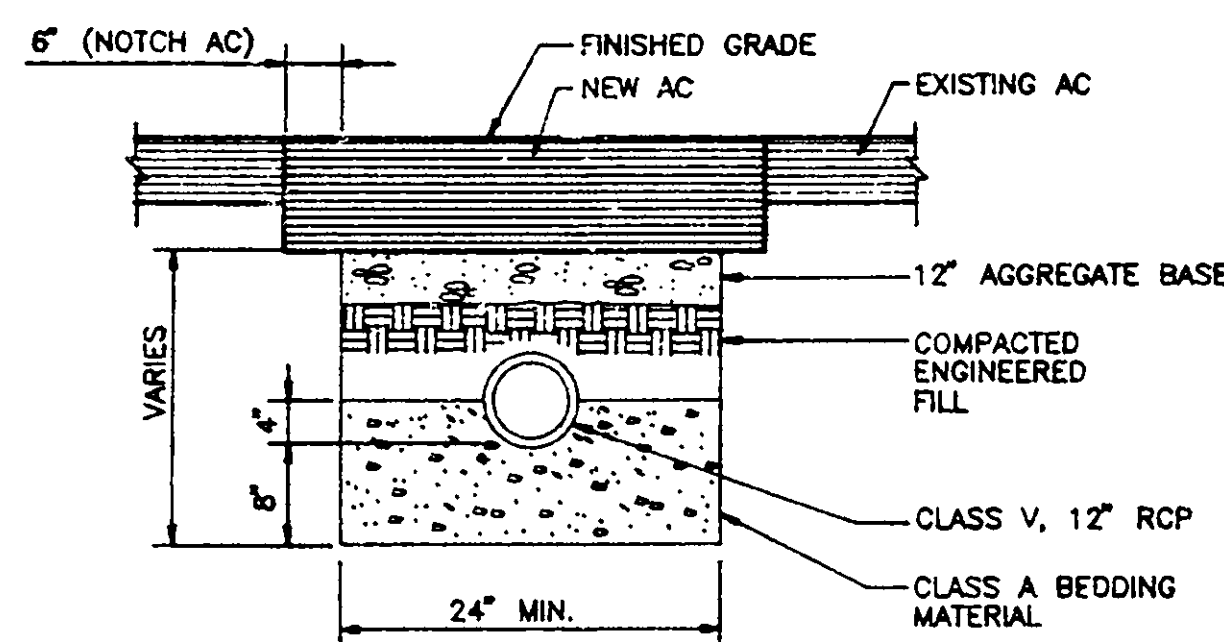

NOTE:
REPLACEMENT SECTION FOR PIPE
EXCAVATION IS PAVEMENT SECTION 2.
SEE DETAIL ON THIS SHEET.

E STORM DRAIN TRENCH SECTION (TYP.)
NTS

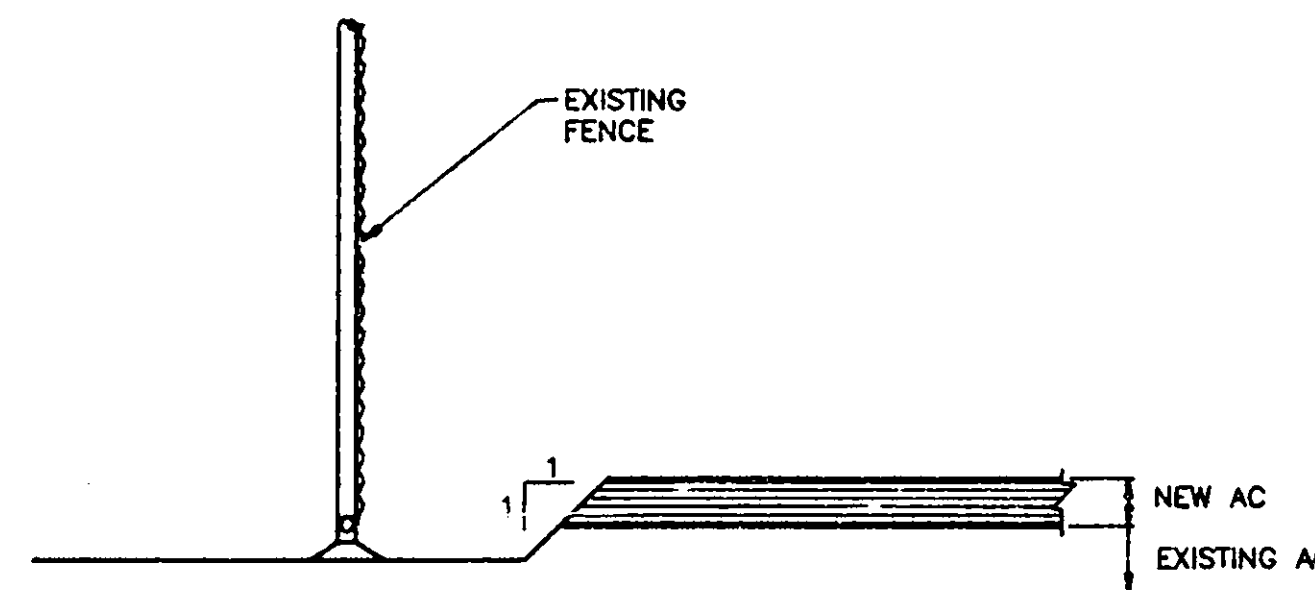

F SECTION
NTS

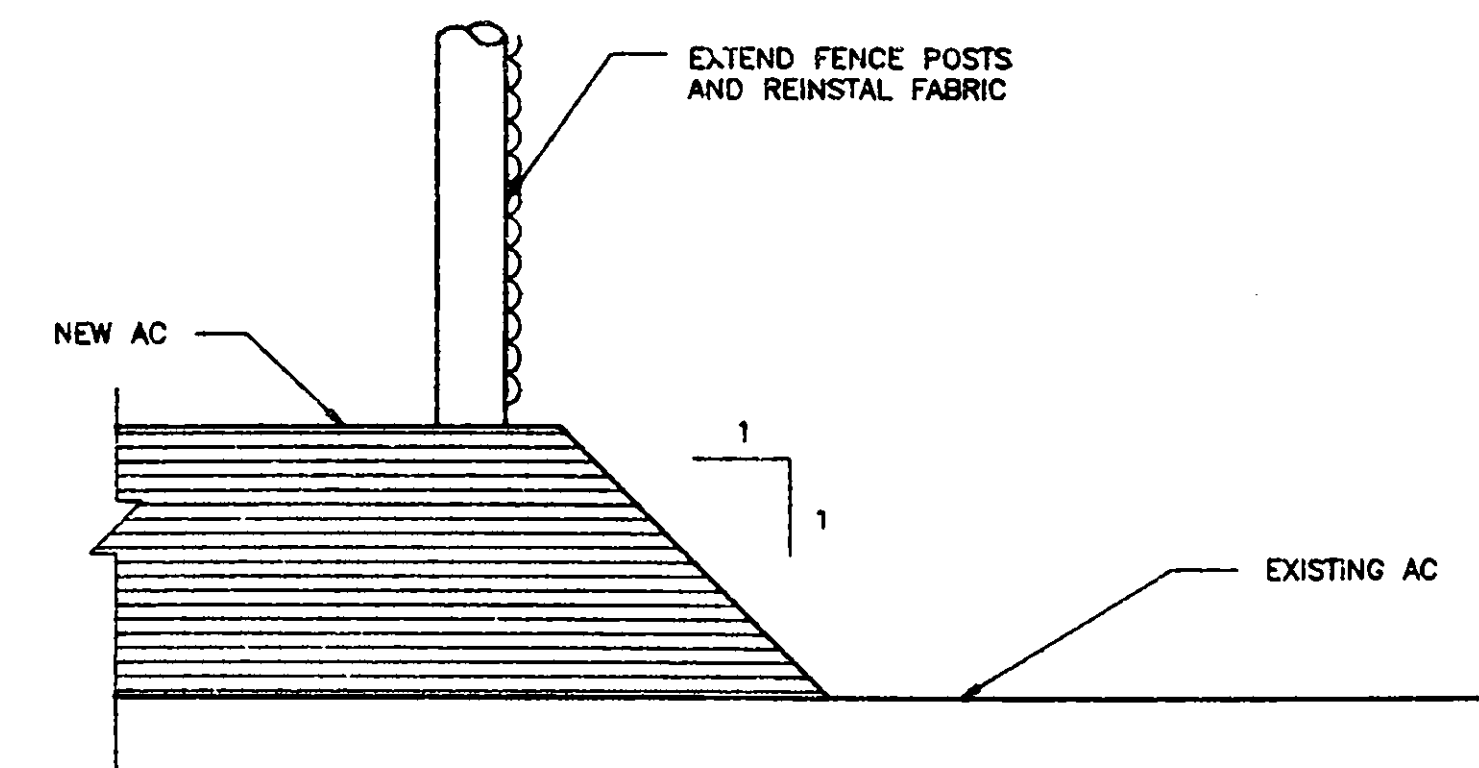

G SECTION
NTS

1=1 6-18-93 4:00 PM

FILMED BY
DATA IMAGE SYSTEMS CORP

NO.	REVISIONS	DATE	APP'D

REVIEWED	SS/MN/hl
REVIEWED	Facilities Department
REVIEWED	Construction Department
REVIEWED	Project Planning Department

DRAWN	SS/MN/hl
DESIGNED	M. M. M. S 3414
CHECKED	C 43841
REVIEWED	REG. ENGINEER NO.

PORT OF OAKLAND
530 WATER STREET OAKLAND, CALIFORNIA

CHIEF ENGINEER	C 17439
APPROVED	C 18353
RECOMMENDED	C 32172

OUTER HARBOR TERMINAL	DATE 6/17/1993
ASPHALT CONCRETE OVERLAY	SCALE AS SHOWN
BERTHS 20 & 21 YARD	SHEET 22 OF 27 SHEETS
SECTIONS	D2 FILE AA-3147

CAUTION - CHECK TRACING FOR LATEST REVISIONS

CAUTION: THIS PLAN MAY BE REDUCED

0 1" 2" ORIGINAL SCALE

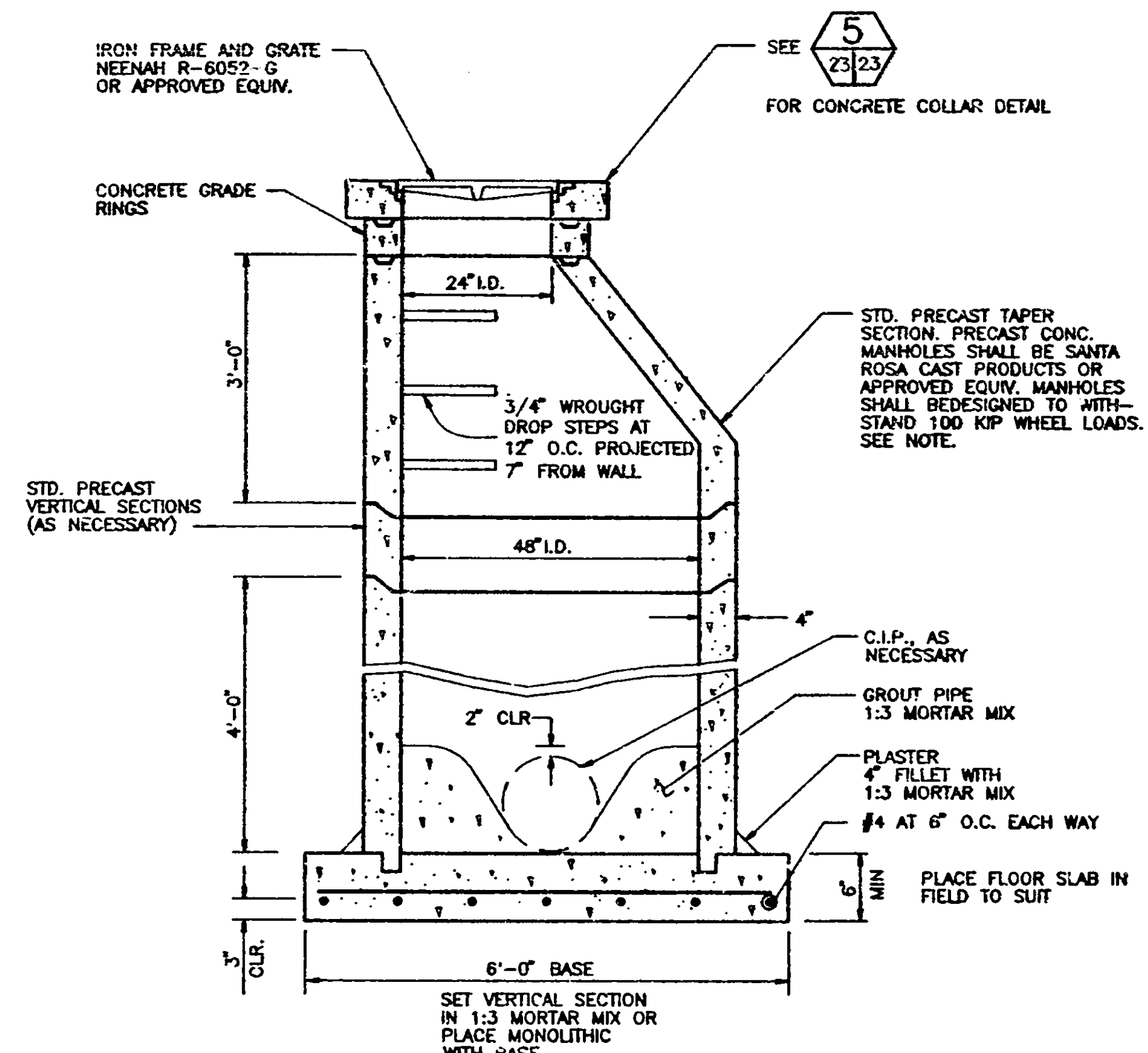

1 STORM DRAIN MANHOLE DETAIL (TYP.)
7/23 NTS

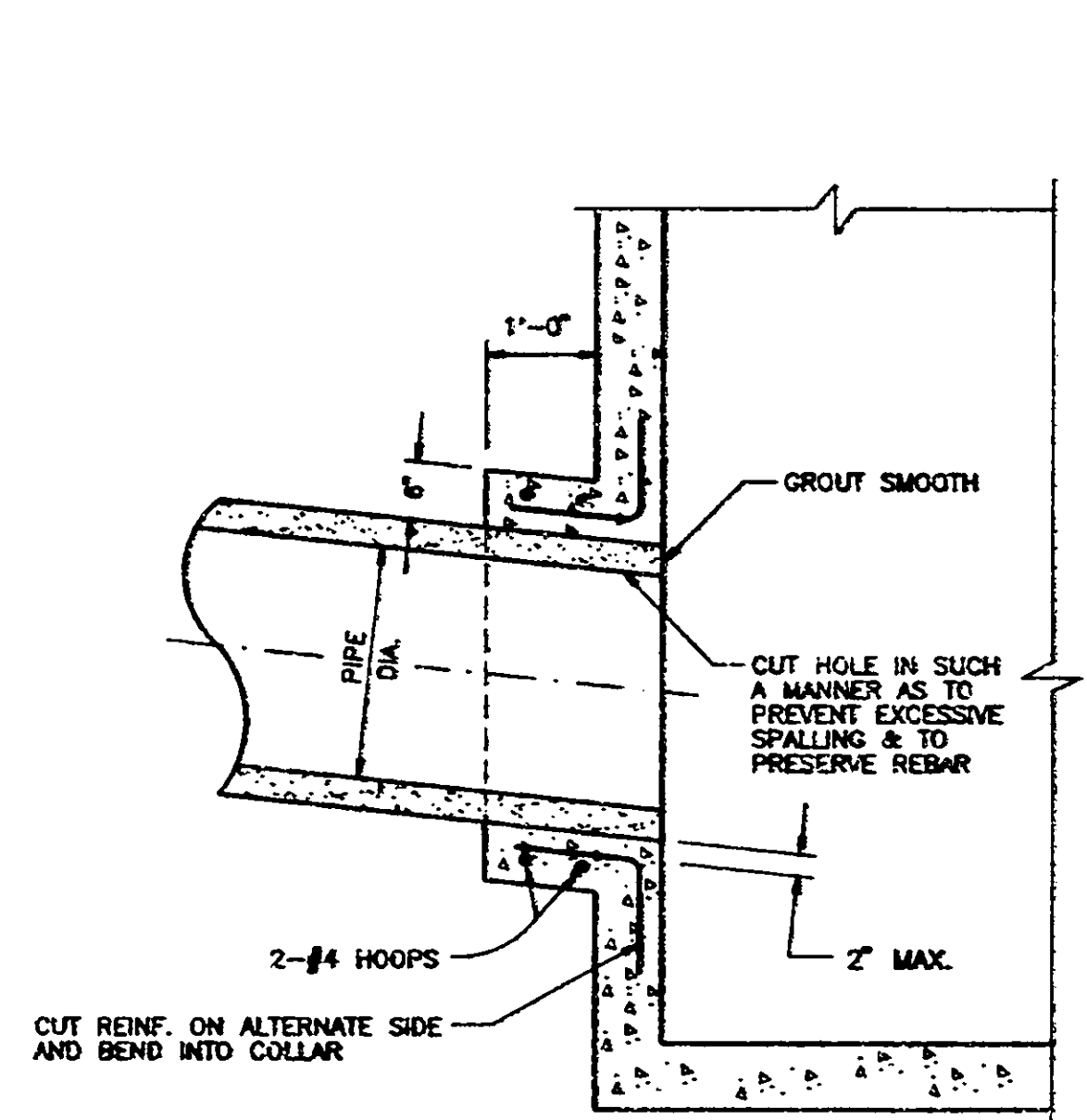

2 COLLAR DETAIL FOR PIPE CONNECTION TO EXISTING MH (TYP.)
7/23 NTS

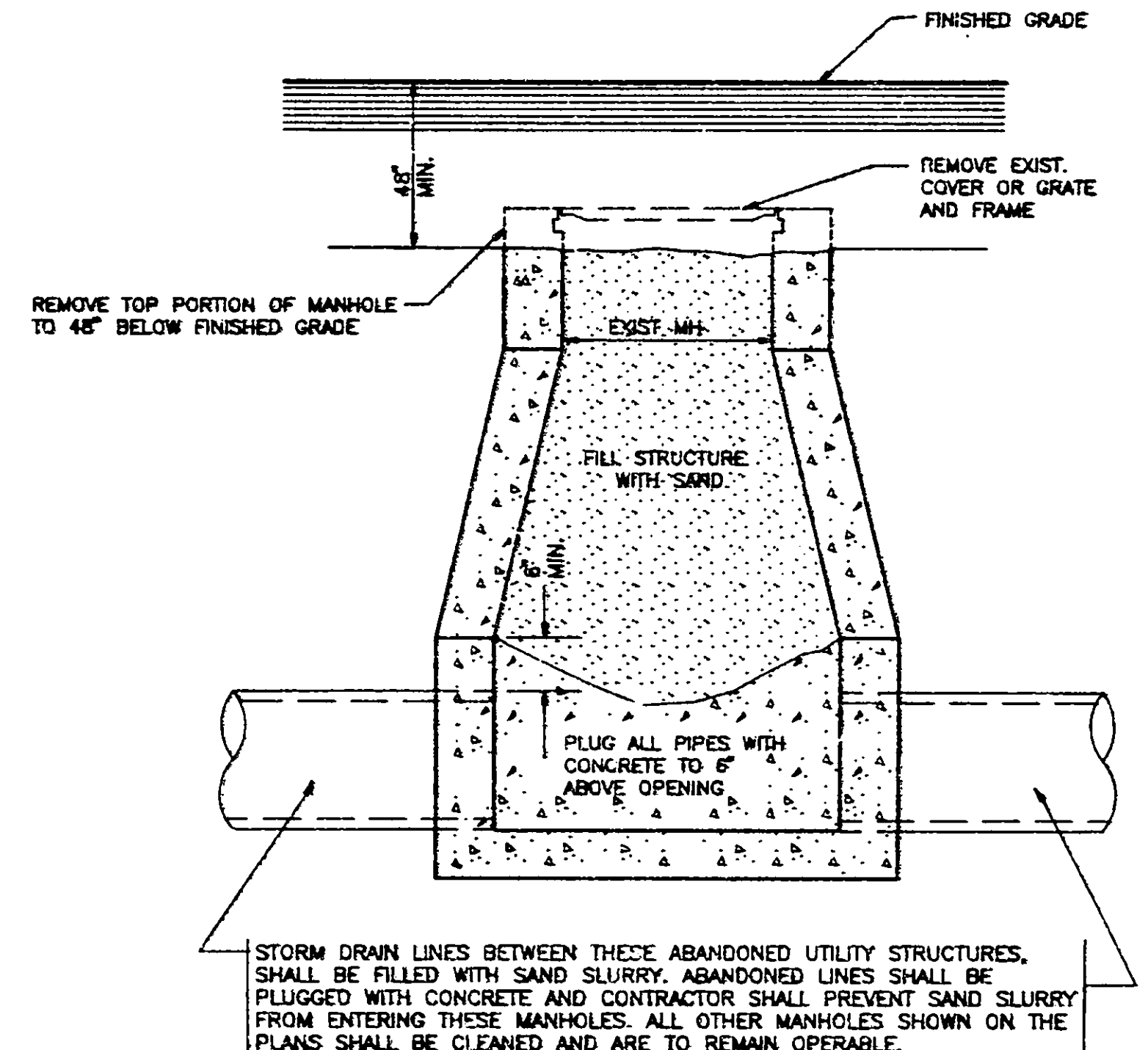

3 DETAIL FOR ABANDONING EXISTING MANHOLE (TYP.)
7/23 NTS

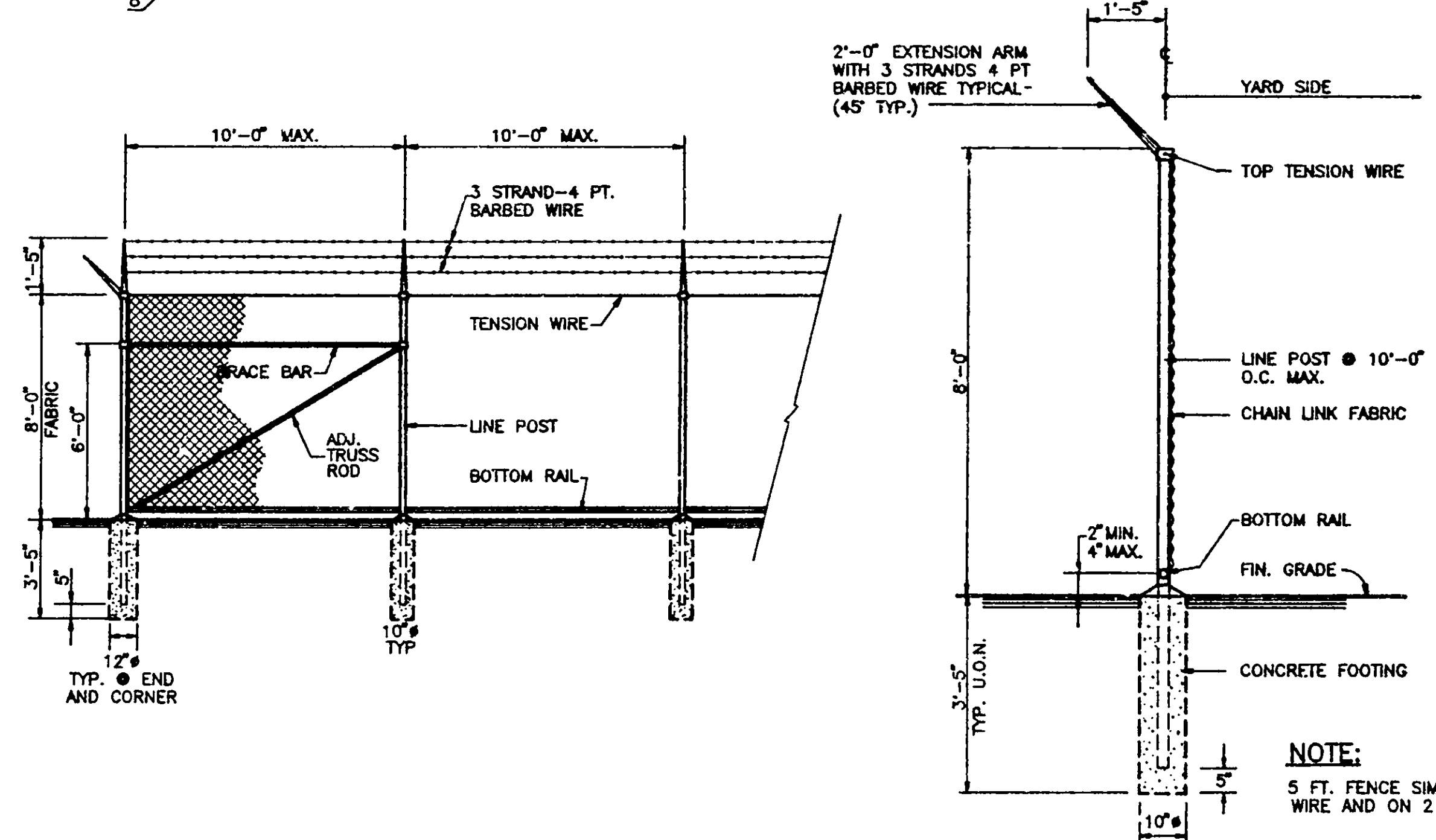

4 CHAIN LINK FENCE DETAIL
7/23 NTS

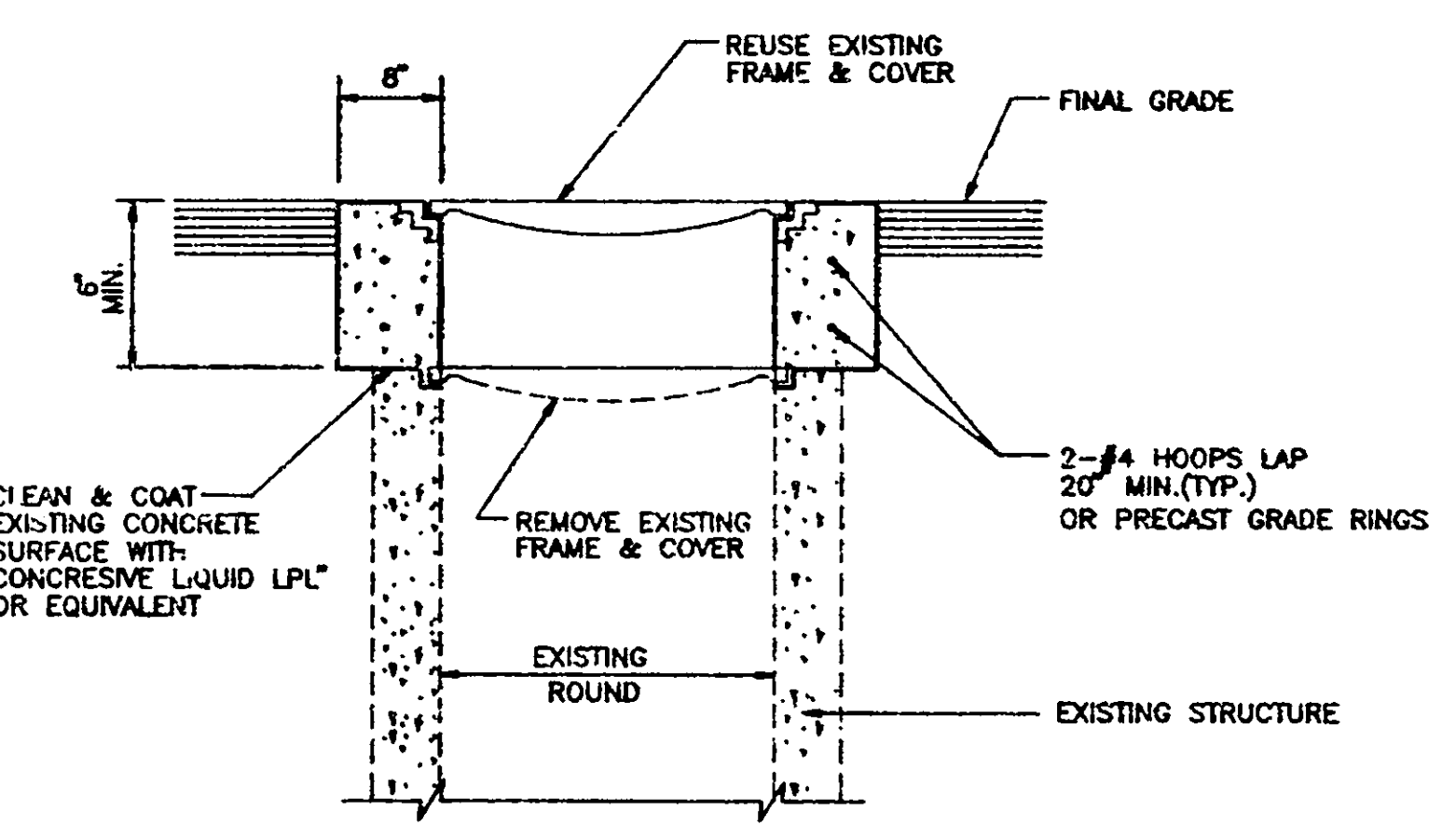

5 TYPICAL MANHOLE FRAME & COVER ADJUSTMENTS DETAIL (SQUARE CONCRETE COLLAR AROUND FRAME)
7/23 NTS

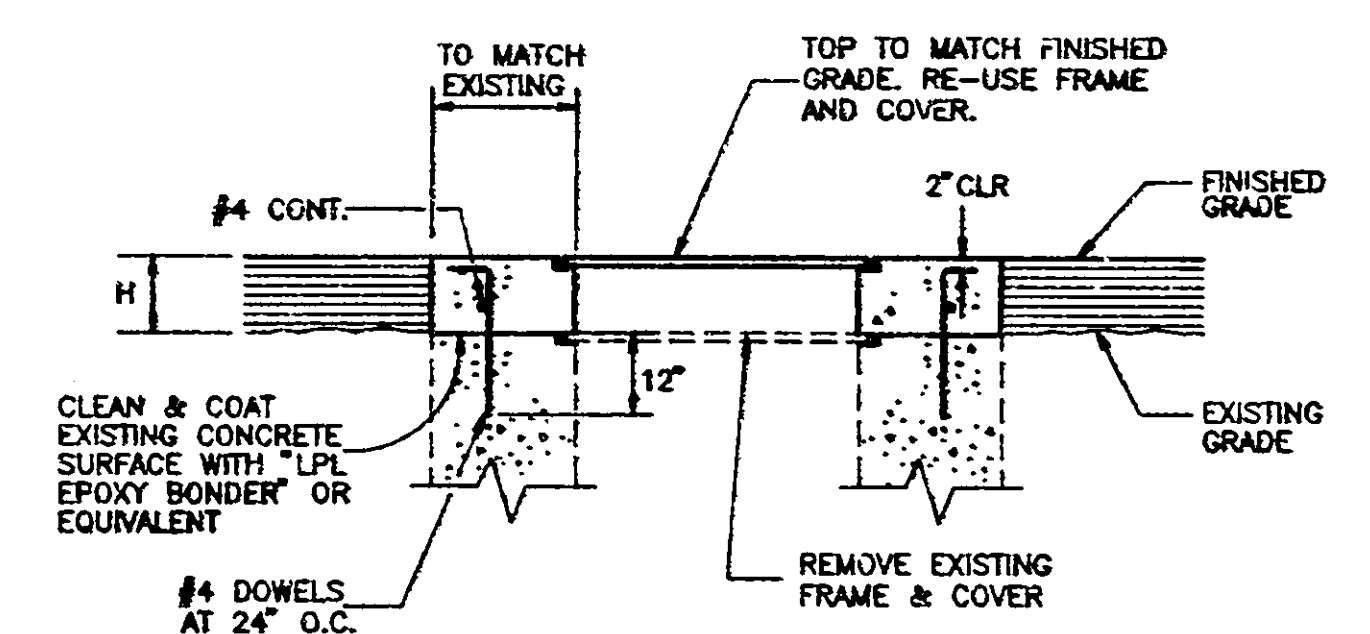

6 UTILITY BOX FRAME & COVER ADJUSTMENTS DETAIL (TYP.)
7/23 NTS

1=1 6-17-93 8:05 PM

NO.	REVISIONS	DATE	APP C

REVIEWED	STAFF
DESIGNED	M. Manley S 3414
CHECKED	G. Chong C 43841
REVIEWED	V. Bekard

PORT OF OAKLAND
530 WATER STREET OAKLAND, CALIFORNIA

CHIEF ENGINEER	C 17439
APPROVED	C 18853
RECOMMENDED	C 32172

OUTER HARBOR TERMINAL	DATE 6-17-93
ASPHALT CONCRETE OVERLAY	SCALE AS SHOWN
BERTHS 20 & 21 YARD	SHEET 23 OF 27 SHEETS
SECTIONS AND DETAILS	FILE AA-3147

NOTES:

1. REFER TO SHEETS Y1 & Y2 FOR EXISTING CONDITIONS.
2. REFER TO SHEETS 2 & U4 FOR LENGEND, SYMBOLS AND ABBREVIATIONS
3. FOR GENERAL NOTES ON UTILITIES SEE SHEET U3
4. EXISTING FIRE HYDRANT GATE VALVE BOXES AND ELECTRICAL BOXES LOCATED AT LIGHT POLES ARE NOT SHOWN FOR CLARITY. THIS EQUIPMENT INCLUDING THE FIRE HYDRANTS SHALL BE RAISED/EXTENDED AS REQUIRED PER THE EQUIPMENT EXTENSION SCHEDULE ON SHEET U4
5. GUARD POSTS AROUND EACH LIGHT POLE OMITTED FOR CLARITY.

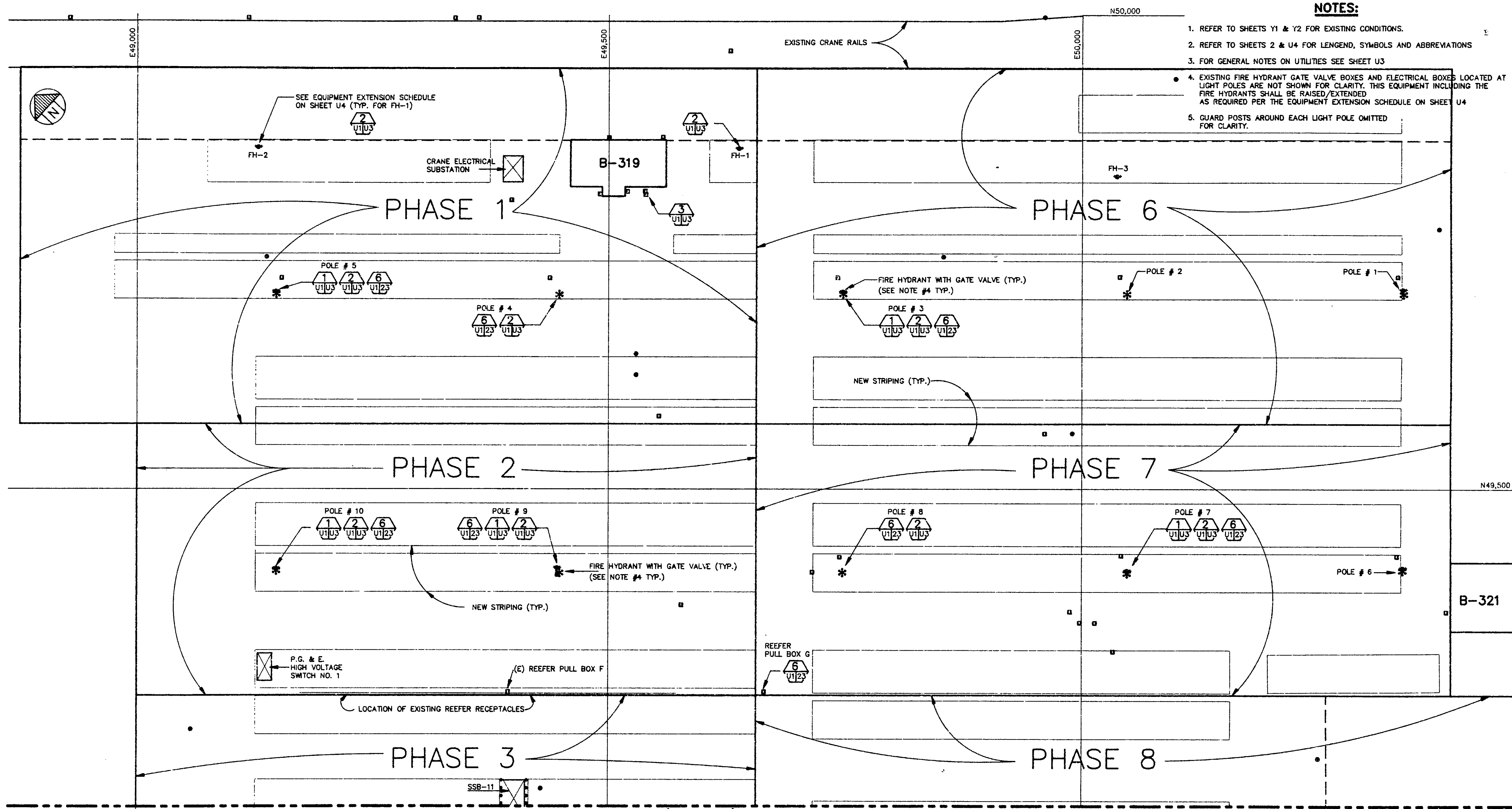

MATCH LINE (N.49:67.79) FOR CONTINUATION SEE SHEET U2

PARTIAL PLAN
1"=50'-0"

FILMED BY
DATA IMAGE SYSTEMS CORP

U-1 1=50 - 93

REFERENCE PLANS FIELD BOOKS "PORT OF OAKLAND DATUM" IS 3.20' BELOW MEAN SEA LEVEL	REVIEWED: <i>[Signature]</i>	DESIGNED: <i>[Signature]</i>	PORT OF OAKLAND 530 WATER STREET OAKLAND, CALIFORNIA	CHIEF ENGINEER: <i>[Signature]</i>	OUTER HARBOR TERMINAL ASPHALT CONCRETE OVERLAY BERTHS 20 & 21 YARD UTILITY PLAN SHEET 1	DATE: 6/17-93
	REVIEWED: <i>[Signature]</i>	CHECKED: <i>[Signature]</i>		APPROVED: <i>[Signature]</i>		SCALE: 1"=50'
	REVIEWED: <i>[Signature]</i>	REVIEWED: <i>[Signature]</i>		RECOMMENDED: <i>[Signature]</i>		SHEET 24(U1) OF 27 SHEETS
	NO.	REVISIONS		DATE		APP'D

CAUTION: THIS PLAN MAY BE REDUCED

0 1" 2" ORIGINAL SCALE

MATCH LINE (N.49167.79) FOR CONTINUATION SEE SHEET U1

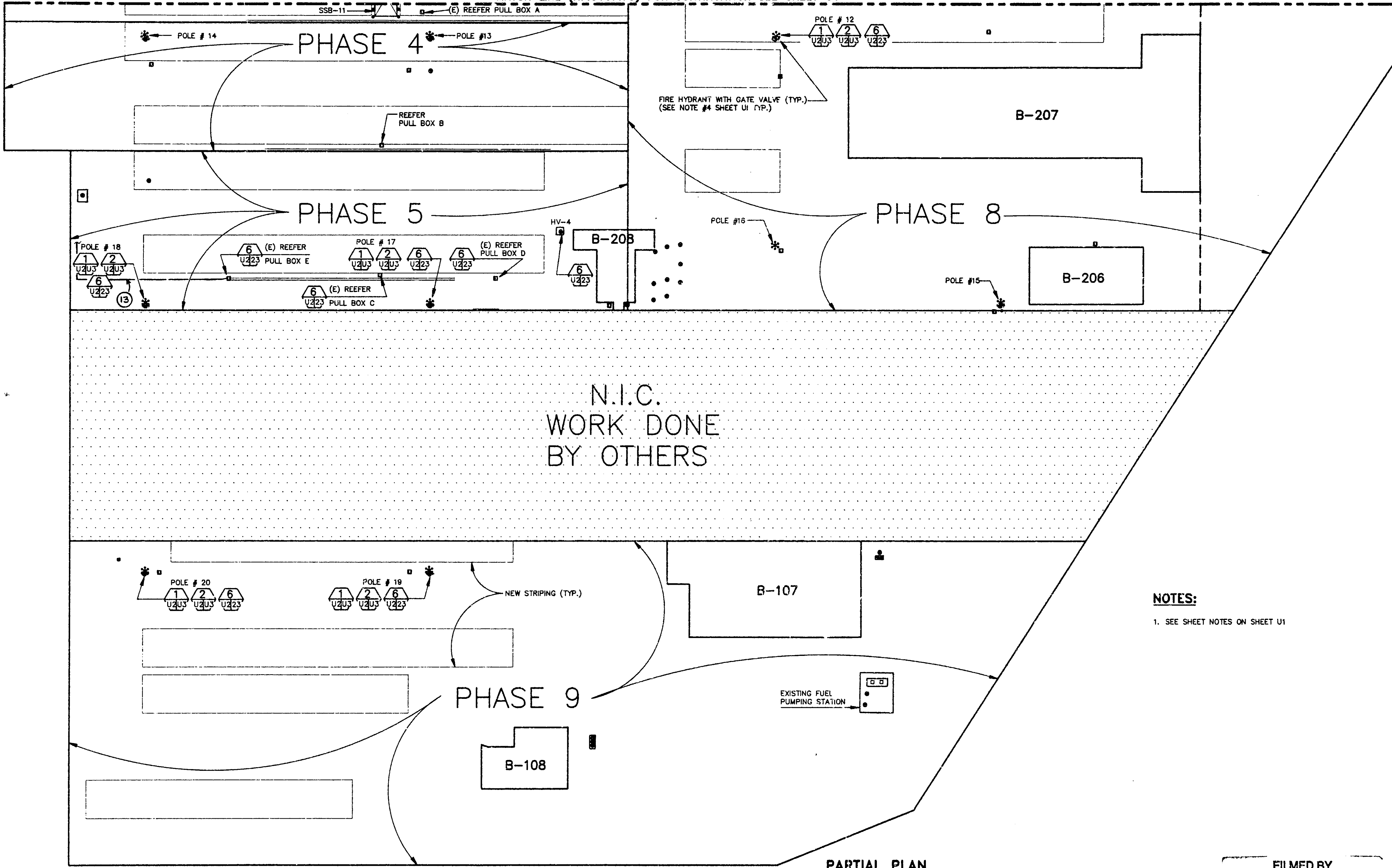
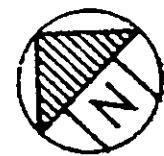

N.I.C.
WORK DONE
BY OTHERS

NOTES:
1. SEE SHEET NOTES ON SHEET U1

PARTIAL PLAN
1"=50'-0"

FILMED BY
DATA IMAGE SYSTEMS CORP

U-2 1=50 -93

REFERENCES PLANS FIELD BOOKS "PORT OF OAKLAND DATUM" IS 3.20' BELOW MEAN SEA LEVEL	NO.	REVISIONS	DATE	APP'D	REVIEWED: <i>[Signature]</i> FACILITIES DEPARTMENT REVIEWED: <i>[Signature]</i> CONSTRUCTION DEPARTMENT REVIEWED: <i>[Signature]</i> PROJECT PLANNING DEPARTMENT	DRAWN: TULLY DESIGNED: <i>[Signature]</i> CHECKED: <i>[Signature]</i> REVIEWED: <i>[Signature]</i>	PORT OF OAKLAND 530 WATER STREET OAKLAND, CALIFORNIA	CHIEF ENGINEER: <i>[Signature]</i> C17439 REG. ENGINEER NO. APPROVED: <i>[Signature]</i> ER351 REG. ENGINEER NO. RECOMMENDED: <i>[Signature]</i> ER950 REG. ENGINEER NO.	OUTER HARBOR TERMINAL ASPHALT CONCRETE OVERLAY BERTHS 20 & 21 YARD UTILITY PLAN SHEET 2	DATE: 6/17 - 93 SCALE: 1"=50' SHEET: 25(U2) OF 27 SHEETS FILE: AA-3147
	CAUTION - CHECK TRACING FOR LATEST REVISIONS									
	CAUTION: THIS PLAN MAY BE REDUCED									
	ORIGINAL SCALE									

GENERAL NOTES:

- 1 PRIOR TO COMMENCING WITH PHASES 3, 4 AND 5 OVERLAY WORK, CONTRACTOR SHALL FURNISH AT LEAST (2) PORTABLE GENERATOR SETS FOR EACH PHASE OF WORK, EQUIPPED WITH THE REQUIRED NUMBER OF RECEPTACLES FOR PROVIDING TEMPORARY POWER TO THE TENANT'S RELOCATED REEFER CONTAINERS. IT IS ESTIMATED THAT THERE WILL BE APPROXIMATELY 60 RELOCATED CONTAINERS UNDER PHASE 3, (2-200KW GEN) 60 RELOCATED CONTAINERS FOR PHASE 4 (2-200KW GEN) AND 80 RELOCATED CONTAINERS FOR PHASE 5 (2-300KW GEN). SEE NOTE (1)
- 2 PROTECT ALL EXISTING PORT, UTILITY COMPANIES AND TENANT EQUIPMENT THROUGHOUT THE CONSTRUCTION SITE. THIS EQUIPMENT SHALL REMAIN IN SERVICE AT ALL TIMES.
- 3 COORDINATE WITH THE ENGINEER TO HAVE PACIFIC BELL DISCONNECT AND REMOVE THE EXISTING TELEPHONE BOOTH PRIOR TO RAISING THE TELEPHONE BOOTH PAD. HAVE PACIFIC BELL REINSTALL AND RECONNECT THE TELEPHONE BOOTH ONCE THE PAD EXTENSION WORK IS COMPLETED.
- 4 TELEPHONE BOOTH PAD SHALL BE EXTENDED 3" ABOVE FINISHED GRADE. CONDUIT STUB-UP SHALL BE EXTENDED ACCORDINGLY TO MATCH EXISTING. RECONNECT TELEPHONE BOOTH LIGHT AS REQUIRED.
- 5 THE WORK OF RAISING THE EXISTING FIRE HYDRANT SHALL BE COORDINATED WITH THE ENGINEER. NO FIRE HYDRANT SHALL BE SHUT OFF WITHOUT THE APPROVAL OF THE CITY OF OAKLAND FIRE MARSHALL AND SEALAND. CLOSURE AND OPENING OF THE EXISTING FIRE WATER VALVE SHALL BE PERFORMED BY PORT MAINTENANCE PERSONNEL. EXISTING FIRE HYDRANT LINE SHALL BE RAISED/EXTENDED SUCH THAT THE EXISTING BREAKABLE COUPLING IS ABOVE THE NEW GRADE.
- 6 TEST AND CHLORINATE NEW WATER PIPE AS SPECIFIED. (SEE SPECIFICATIONS)
- 7 PERFORM WORK IN ACCORDANCE WITH THE NATIONAL ELECTRIC CODE, UNIFORM PLUMBING CODE AND OTHER APPLICABLE CODES.
- 8 AT DESIGNATED LIGHT POLE LOCATIONS EXTEND THE EXISTING WATER DRAIN PIPE AS SHOWN ON THE PLAN. MODIFY EACH LIGHT POLE FOUNDATION AS REQUIRED FOR EXTENDING EXISTING DRAIN PIPE.
- 9 ALL EXISTING REEFER RECEPTACLES SHALL BE COVERED AND PROTECTED DURING THE OVERLAY WORK.
- 10 EXISTING FIRE HYDRANT DRAIN LINE AND EXISTING PULL BOX AT EACH LIGHT POLE LOCATION VARY IN ORIENTATION, VERIFY IN FIELD FOR APPROXIMATE ORIENTATION.
- 11 REEFER GENERATOR SET(S) AND RELATED EQUIPMENT SHALL BE DELIVERED, INSTALLED, FUELED, MAINTAINED AND RELOCATED WHEN REQUIRED. CONTRACTOR TO REMOVE GENERATOR(S) AFTER COMPLETION OF OVERLAY WORK. IN PHASES 3, 4 AND 5 OF THE CONSTRUCTION.
- 12 RAISE FIRE HYDRANT BY REMOVING EXISTING BREAKAWAY COUPLING, INSTALLING EXTENSION AND THEN REINSTALLING BREAKAWAY COUPLING.
- 13 LOWER EXISTING SECONDARY AND TELEPHONE CONDUITS WITH CABLES AS DIRECTED BY THE ENGINEER.

REEFER GENERATOR SPECIFICATIONS:

REEFER GENERATOR SET SHALL BE THE PACKAGE TYPE CONSISTING OF A CUSTOM BUILT 20 FOOT CONTAINER HOUSING, A DIESEL GENERATOR, COOLING SYSTEM, FUEL TANK, CONTROLS, EXHAUST SILENCER AND ONE OR MORE INTEGRAL OR REMOTE MOUNT ELECTRICAL PANELS EQUIPPED WITH REQUIRED NO. AND SIZE OF CIRCUIT BREAKERS AND REEFER RECEPTACLES. MIPCO CAT. NO. 333FC RATED 32A AT 480V, 3P. REEFER GENERATOR SHALL BE RATED 200KW OR 300KW. (AS REQ'D) 480V, 3P, 60HZ. ALL EQUIPMENT SHALL HAVE NEMA 3R ENCLOSURE.

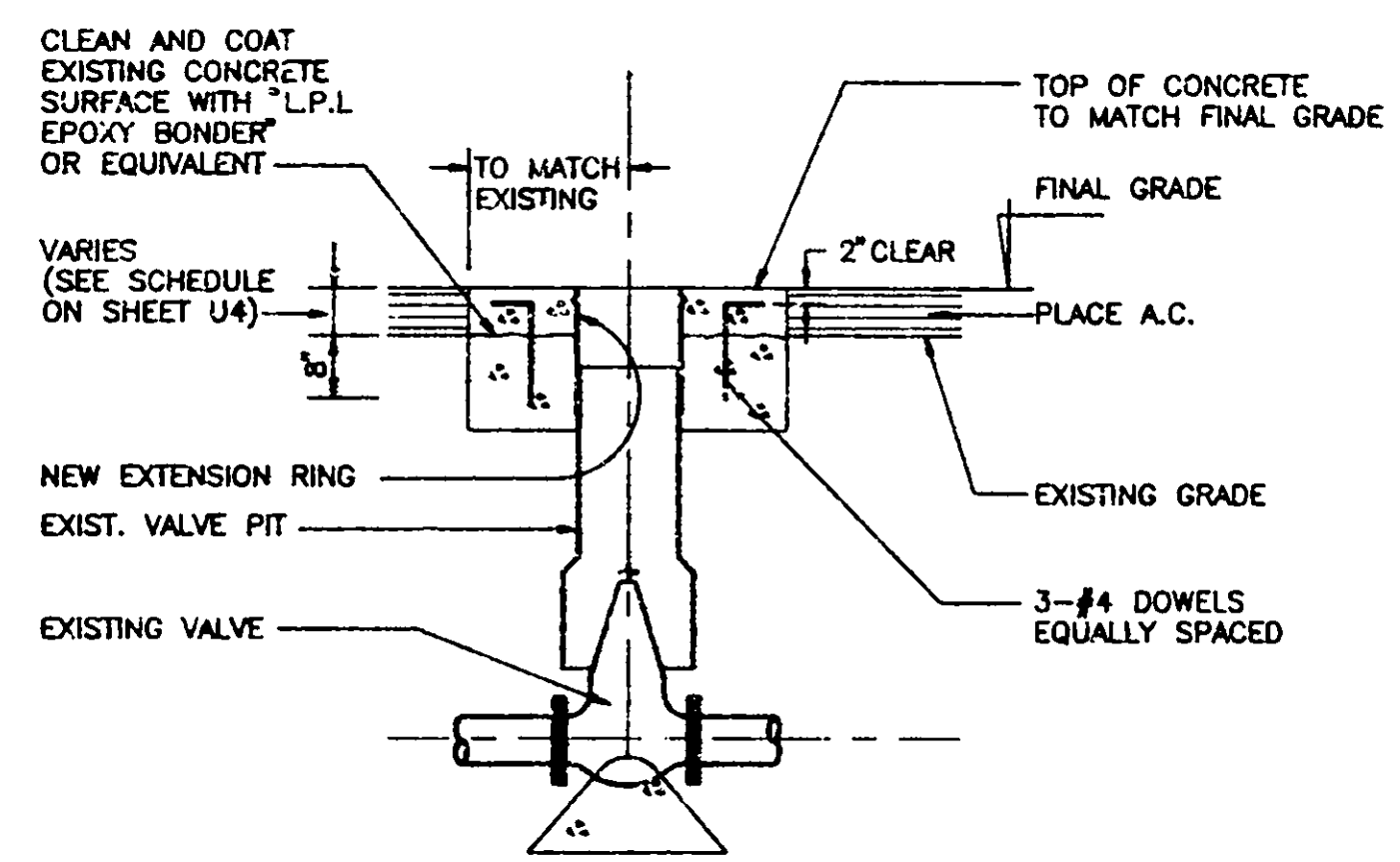
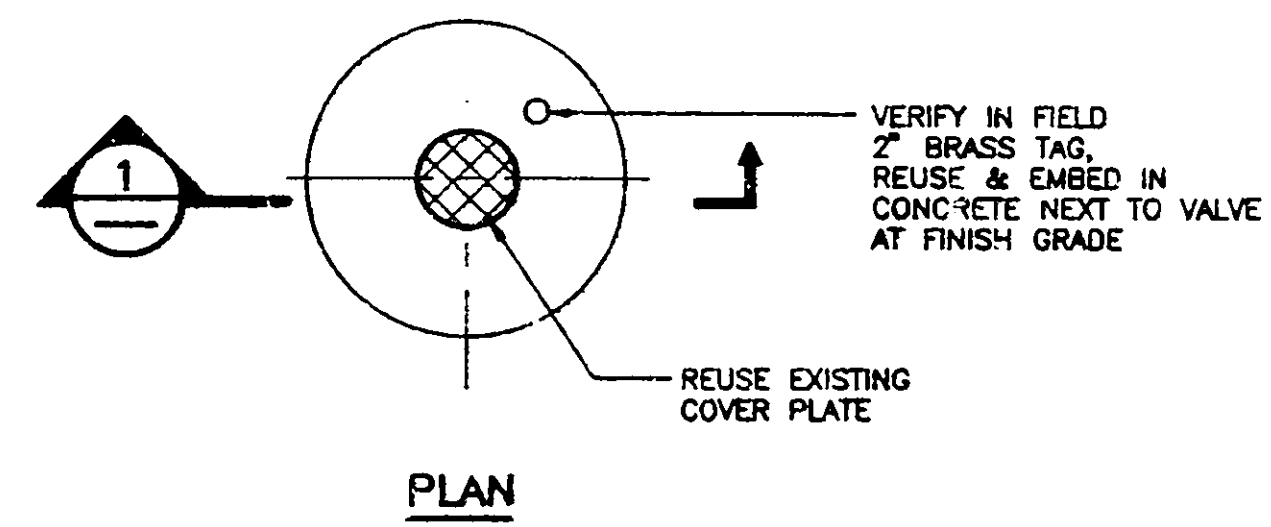

1 SECTION NTS

1 WATER VALVE ADJUSTMENT DETAIL (TYPICAL) NTS

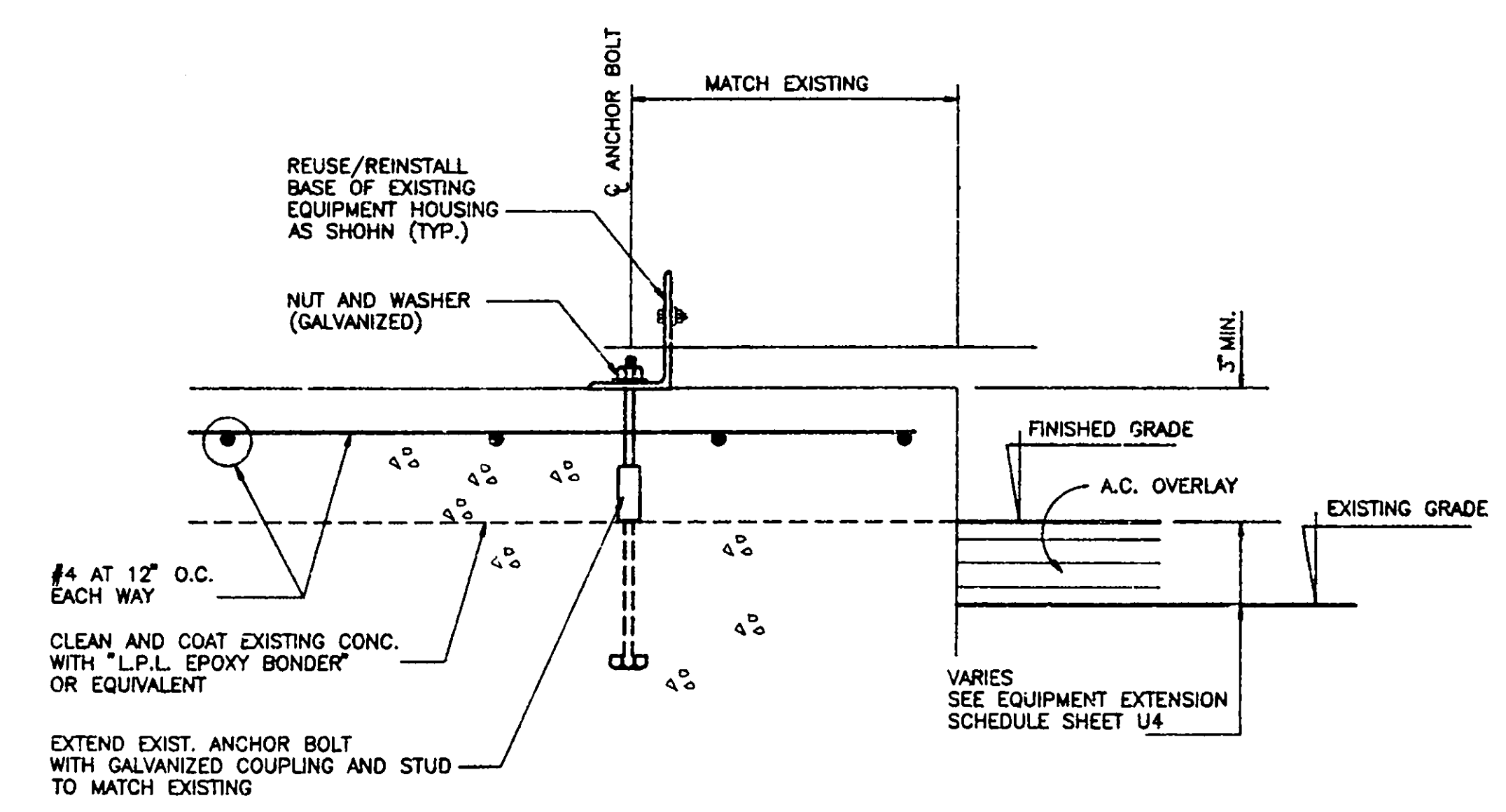
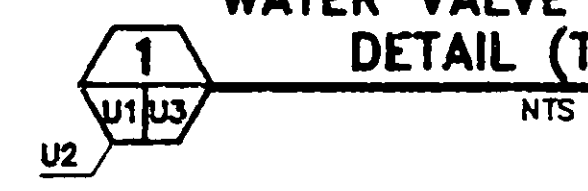

3 PACIFIC BELL EQUIPMENT PAD NTS

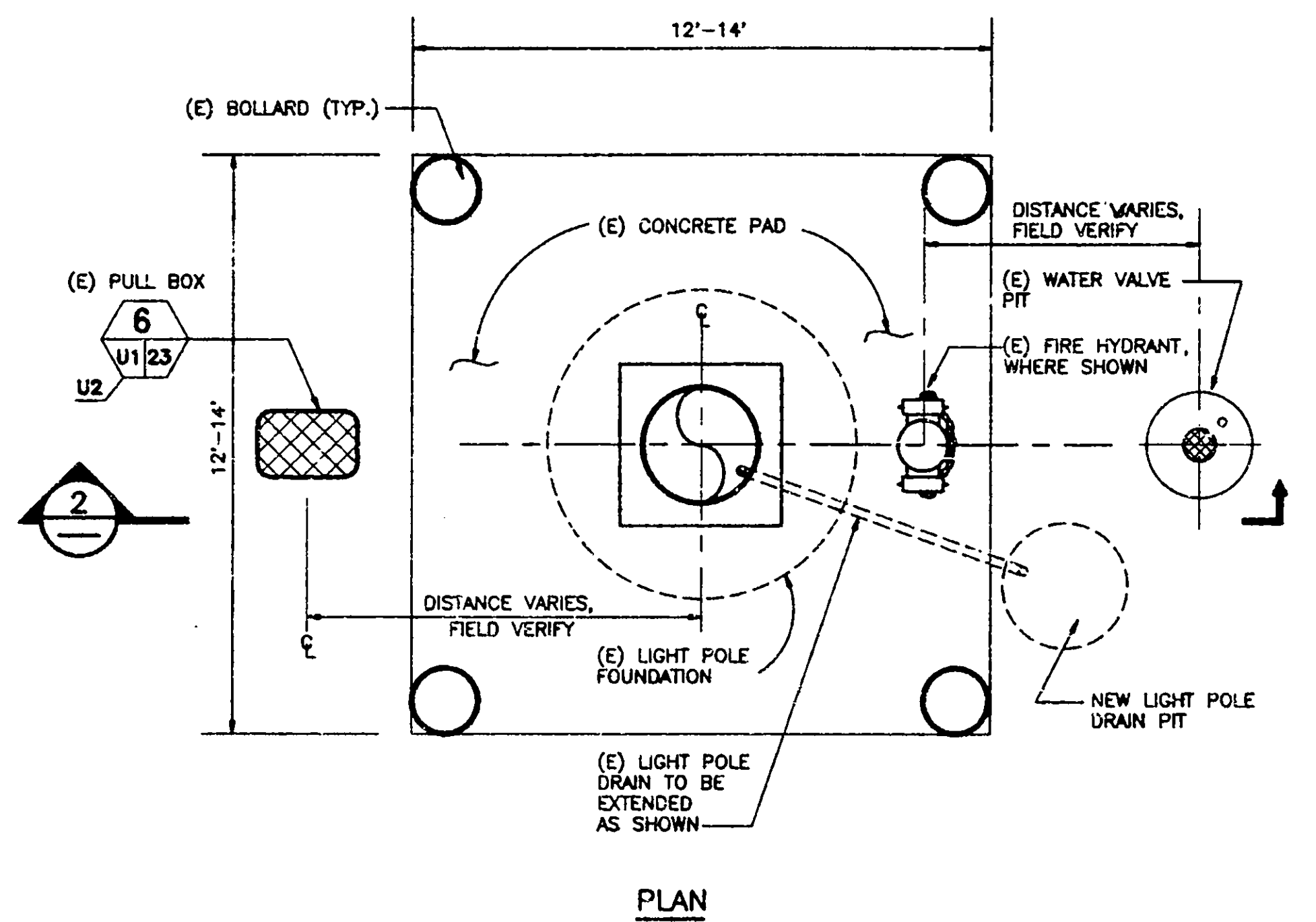
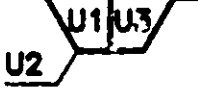

2 PLAN

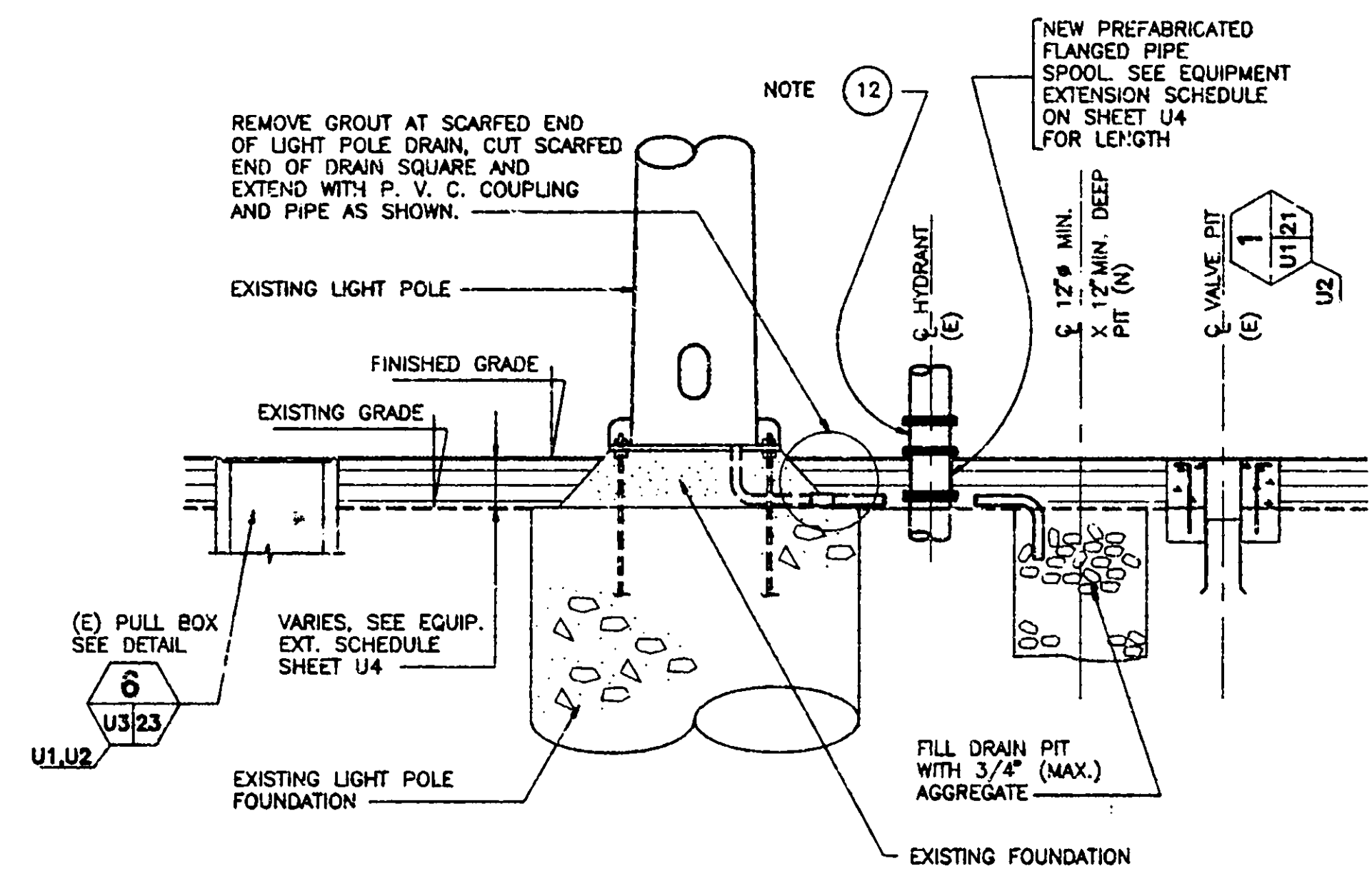

2 SECTION NTS

2 NEW DRAIN AT LIGHT POLE NTS



U-3 1=1

FILMED BY DATA IMAGE SYSTEMS CORP

<p>REFERENCES AA-</p> <p>PLANS</p> <p>FIELD BOOKS</p> <p>"PORT OF OAKLAND DATUM" IS 3.20' BELOW MEAN SEA LEVEL</p>	<table border="1" style="width: 100%; border-collapse: collapse;"> <tr> <th>NO.</th> <th>REVISIONS</th> <th>DATE</th> <th>APP'D</th> </tr> <tr> <td> </td> <td> </td> <td> </td> <td> </td> </tr> </table>	NO.	REVISIONS	DATE	APP'D					<p>REVIEWED: <i>[Signature]</i></p> <p>REVIEWED: <i>[Signature]</i></p> <p>REVIEWED: <i>[Signature]</i></p>	<p>DRAWN: TULLY</p> <p>DESIGNED: <i>[Signature]</i></p> <p>CHECKED: <i>[Signature]</i></p> <p>REVIEWED: <i>[Signature]</i></p>	<p>PORT OF OAKLAND</p> <p>530 WATER STREET OAKLAND, CALIFORNIA</p>	<p>CHIEF ENGINEER</p> <p><i>[Signature]</i></p> <p>APPROVED: <i>[Signature]</i></p> <p>RECOMMENDED: <i>[Signature]</i></p>	<p>OUTER HARBOR TERMINAL</p> <p>ASPHALT CONCRETE OVERLAY BERTHS 20 & 21 YARD</p> <p>UTILITY PLAN, SECTION, DETAILS AND GENERAL NOTES</p>	<p>DATE: 6/17 - 93</p> <p>SCALE: 1" = 1'-0"</p> <p>SHEET: 26(U3) OF 27 SHEETS</p> <p>FILE: AA-3147</p>
NO.	REVISIONS	DATE	APP'D												

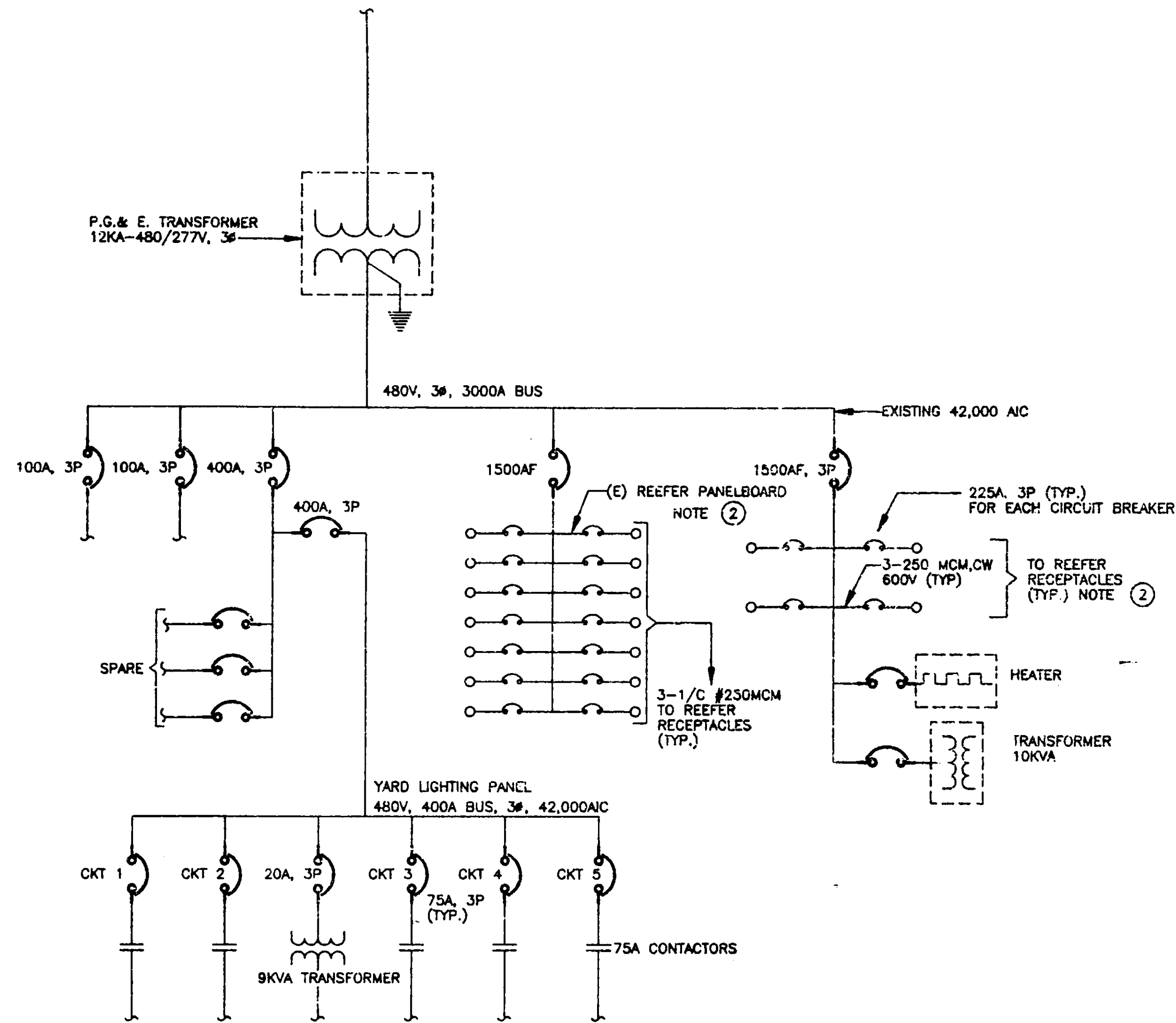

**SINGLE LINE DIAGRAM
EXISTING SUBSTATION SSB-11**
(FOR REFERENCE ONLY)

EQUIPMENT EXTENSION SCHEDULE		
SEE NOTE (3)		
EQUIPMENT LOCATION	ITEMS	EXTENSION REQUIRED
AT POLES # 3 AND # 5	VALVE PIT, FIRE HYDRANT AND PULL BOX	10 IN.
AT POLE # 4	VALVE PIT & PULL BOX	10 IN.
AT POLE # 8	VALVE PIT & PULL BOX	6 IN.
AT POLE # 7	VALVE PIT, FIRE HYDRANT & PULL BOX	5 IN.
AT POLES # 9 AND # 10	VALVE PIT, FIRE HYDRANT & PULL BOX	6 IN.
AT POLE # 12	VALVE PIT, FIRE HYDRANT & PULL BOX	4 IN.
AT POLE # 17	VALVE PIT, FIRE HYDRANT & PULL BOX	3 IN.
AT POLE # 18	VALVE PIT, FIRE HYDRANT & PULL BOX	5 IN.
AT POLE # 19	VALVE PIT, FIRE HYDRANT & PULL BOX	9 IN.
AT POLE # 20	VALVE PIT, FIRE HYDRANT & PULL BOX	6 IN.
FH-1 & FH-2		3 IN.
PACIFIC BELL BOOTH FDN.		3 IN.
REEFER PULL BOXES D & E		4 IN.
REEFER PULL BOX C		3 IN.
REEFER PULL BOX G		7.5 IN.
UTILITY VAULT HV-4		-4.0 IN.

SHEET NOTES:

- ① FOR GENERAL NOTES, SEE SHEET U3
- ② CONTRACTOR SHALL NOTIFY ENGINEER AT LEAST ONE DAY IN ADVANCE OF DOING OVERLAY WORK IN PHASES 3, 4, & 5 SO PORT MAINTENANCE PERSONNEL CAN SHUT OFF POWER TO REEFER RECEPTACLES PRIOR TO OVERLAY WORK. PROVIDE GENERATOR POWER TO RELOCATED REEFER CONTAINERS (SEE NOTE 1, SHEET U3)
- ③ EQUIPMENT EXTENSION SCHEDULE INCLUDES UTILITY BOXES AND ELECTRICAL PULL BOXES SHOWN ON THE ELECTRICAL PLANS ONLY (SHTS. U1 THRU U4). REFER TO SHEET 16 FOR OTHER BOXES REQUIRING ADJUSTMENTS.

LEGEND:

- FH-1 EXISTING FIRE HYDRANT NO. 1
- SSB 11 EXISTING ELECTRICAL SUBSTATION NO. 11
- HV-4 HIGH VOLTAGE BOX NO. 4
- (E) EXISTING
- (N) NEW

ABBREVIATIONS:

- FDN. FOUNDATION
- CGNC. CONCRETE
- GND. GROUND
- EQUIP. EQUIPMENT
- H.V. HIGH VOLTAGE
- M.C.B. MAIN CIRCUIT BREAKER
- EXIST. EXISTING
- SWGR. SWITCHGEAR

U-4 1=1 5/27/93

FILMED BY
DATA IMAGE SYSTEMS CORP

REFERENCES AA- PLANS FIELD BOOKS "PORT OF OAKLAND DATUM" IS 3.20' BELOW MEAN SEA LEVEL	REVIEWED: <i>[Signature]</i> FACILITIES DEPARTMENT	DRAWN: TULLY	PORT OF OAKLAND 530 WATER STREET OAKLAND, CALIFORNIA	CHIEF ENGINEER <i>[Signature]</i> C17439 REG. ENGINEER NO.	OUTER HARBOR TERMINAL ASPHALT CONCRETE OVERLAY BERTHS 20 & 21 YARD WIRING DIAGRAM AND GENERAL NOTES	DATE: 6/17 -93 SCALE: N.T.S. SHEET: 27(U4) OF 27 SHEETS FILE: AA-3147
	REVIEWED: <i>[Signature]</i> CONSTRUCTION DEPARTMENT	DESIGNED: <i>[Signature]</i> REG. ENGINEER NO.		APPROVED: <i>[Signature]</i> E8351 REG. ENGINEER NO.	U4	
NO. REVISIONS DATE APPD	REVIEWED: <i>[Signature]</i> PROJECT PLANNING DEPARTMENT	CHECKED: <i>[Signature]</i> REG. ENGINEER NO. E8950	REVIEWED: <i>[Signature]</i> REG. ENGINEER NO. E8950	RECOMMENDED: <i>[Signature]</i> REG. ENGINEER NO. E8950	U4	ORIGINAL SCALE

CAUTION: THIS PLAN MAY BE REDUCED

0 1" 2" ORIGINAL SCALE



DRAFT

Appendix F

Transportation Technical Appendix

HCM Worksheets

HCM 6th Signalized Intersection Summary
 1: Maritime Street & I-80 West & I-580 East Ramp - Grand Avenue

Eagle Rock Aggregate Terminal
 Existing AM



Movement	EBL	EBT	EBR	WBL	WBT	WBR	NBL	NBT	NBR	SBL	SBT	SBR
Lane Configurations												
Traffic Volume (veh/h)	13	134	140	215	438	16	214	16	71	18	1	7
Future Volume (veh/h)	13	134	140	215	438	16	214	16	71	18	1	7
Initial Q (Qb), veh	0	0	0	0	0	0	0	0	0	0	0	0
Ped-Bike Adj(A_pbT)	1.00		1.00	1.00		1.00	1.00		1.00	1.00		1.00
Parking Bus, Adj	1.00	1.00	1.00	1.00	1.00	1.00	1.00	1.00	1.00	1.00	1.00	1.00
Work Zone On Approach		No			No			No			No	
Adj Sat Flow, veh/h/ln	1693	1767	1737	1618	1856	1856	1752	1633	952	1248	1648	1648
Adj Flow Rate, veh/h	14	146	152	234	476	17	245	0	77	20	1	8
Peak Hour Factor	0.92	0.92	0.92	0.92	0.92	0.92	0.92	0.92	0.92	0.92	0.92	0.92
Percent Heavy Veh, %	14	9	11	19	3	3	10	18	64	44	17	17
Cap, veh/h	28	452	352	277	1031	37	350	0	306	28	467	417
Arrive On Green	0.02	0.13	0.13	0.18	0.30	0.30	0.10	0.00	0.38	0.02	0.30	0.30
Sat Flow, veh/h	1612	3357	1472	1541	3472	124	3337	0	806	1188	1566	1397
Grp Volume(v), veh/h	14	146	152	234	241	252	245	0	77	20	1	8
Grp Sat Flow(s),veh/h/ln	1612	1678	1472	1541	1763	1833	1668	0	806	1188	1566	1397
Q Serve(g_s), s	0.5	2.5	5.6	9.4	7.1	7.1	4.5	0.0	4.2	1.1	0.0	0.3
Cycle Q Clear(g_c), s	0.5	2.5	5.6	9.4	7.1	7.1	4.5	0.0	4.2	1.1	0.0	0.3
Prop In Lane	1.00		1.00	1.00		0.07	1.00		1.00	1.00		1.00
Lane Grp Cap(c), veh/h	28	452	352	277	523	544	350	0	306	28	467	417
V/C Ratio(X)	0.50	0.32	0.43	0.85	0.46	0.46	0.70	0.00	0.25	0.72	0.00	0.02
Avail Cap(c_a), veh/h	127	949	570	375	789	821	498	0	306	93	467	417
HCM Platoon Ratio	1.00	1.00	1.00	1.00	1.00	1.00	1.00	1.00	1.00	1.00	1.00	1.00
Upstream Filter(I)	1.00	1.00	1.00	1.00	1.00	1.00	1.00	0.00	1.00	1.00	1.00	1.00
Uniform Delay (d), s/veh	31.0	24.9	20.5	25.3	18.2	18.2	27.5	0.0	13.5	30.9	15.7	15.8
Incr Delay (d2), s/veh	13.4	0.4	0.8	12.4	0.6	0.6	2.6	0.0	2.0	29.1	0.0	0.1
Initial Q Delay(d3),s/veh	0.0	0.0	0.0	0.0	0.0	0.0	0.0	0.0	0.0	0.0	0.0	0.0
%ile BackOfQ(50%),veh/ln	0.3	1.0	1.9	4.2	2.8	2.9	1.8	0.0	0.9	0.5	0.0	0.1
Unsig. Movement Delay, s/veh												
LnGrp Delay(d),s/veh	44.5	25.3	21.4	37.7	18.9	18.9	30.1	0.0	15.5	60.0	15.7	15.8
LnGrp LOS	D	C	C	D	B	B	C	A	B	E	B	B
Approach Vol, veh/h		312			727			322				29
Approach Delay, s/veh		24.3			24.9			26.6				46.3
Approach LOS		C			C			C				D
Timer - Assigned Phs	1	2	3	4	5	6	7	8				
Phs Duration (G+Y+Rc), s	6.0	28.7	15.9	13.1	11.2	23.5	5.6	23.4				
Change Period (Y+Rc), s	4.5	4.5	4.5	4.5	4.5	4.5	4.5	4.5				
Max Green Setting (Gmax), s	5.0	23.5	15.5	18.0	9.5	19.0	5.0	28.5				
Max Q Clear Time (g_c+I1), s	3.1	6.2	11.4	7.6	6.5	2.3	2.5	9.1				
Green Ext Time (p_c), s	0.0	0.2	0.3	1.0	0.2	0.0	0.0	2.8				

Intersection Summary





















HCM 6th Ctrl Delay	25.6
HCM 6th LOS	C

Notes

User approved volume balancing among the lanes for turning movement.



















HCM 6th Signalized Intersection Summary
2: Burma Road & Maritime Street

Eagle Rock Aggregate Terminal
Existing AM

												
Movement	EBL	EBT	EBR	WBL	WBT	WBR	NBL	NBT	NBR	SBL	SBT	SBR
Lane Configurations												
Traffic Volume (veh/h)	10	2	33	1	2	7	27	247	2	35	217	79
Future Volume (veh/h)	10	2	33	1	2	7	27	247	2	35	217	79
Initial Q (Qb), veh	0	0	0	0	0	0	0	0	0	0	0	0
Ped-Bike Adj(A_pbT)	1.00		1.00	1.00		1.00	1.00		1.00	1.00		1.00
Parking Bus, Adj	1.00	1.00	1.00	1.00	1.00	1.00	1.00	1.00	1.00	1.00	1.00	1.00
Work Zone On Approach		No			No			No			No	
Adj Sat Flow, veh/h/ln	1366	1159	1159	907	1159	1159	1470	1500	1500	1693	1604	1604
Adj Flow Rate, veh/h	11	2	36	1	2	8	29	268	2	38	236	86
Peak Hour Factor	0.92	0.92	0.92	0.92	0.92	0.92	0.92	0.92	0.92	0.92	0.92	0.92
Percent Heavy Veh, %	36	50	50	67	50	50	29	27	27	14	20	20
Cap, veh/h	238	66	59	2	35	139	48	1317	10	69	1020	362
Arrive On Green	0.06	0.06	0.06	0.00	0.17	0.17	0.03	0.45	0.45	0.04	0.46	0.46
Sat Flow, veh/h	1026	1101	982	864	203	810	1400	2899	22	1612	2205	782
Grp Volume(v), veh/h	11	2	36	1	0	10	29	132	138	38	161	161
Grp Sat Flow(s),veh/h/ln	1026	1101	982	864	0	1013	1400	1425	1496	1612	1523	1463
Q Serve(g_s), s	0.4	0.1	1.5	0.0	0.0	0.3	0.8	2.3	2.3	0.9	2.6	2.7
Cycle Q Clear(g_c), s	0.4	0.1	1.5	0.0	0.0	0.3	0.8	2.3	2.3	0.9	2.6	2.7
Prop In Lane	1.00		1.00	1.00		0.80	1.00		0.01	1.00		0.53
Lane Grp Cap(c), veh/h	238	66	59	2	0	174	48	647	679	69	705	677
V/C Ratio(X)	0.05	0.03	0.61	0.47	0.00	0.06	0.60	0.20	0.20	0.55	0.23	0.24
Avail Cap(c_a), veh/h	630	486	434	106	0	684	189	647	679	218	705	677
HCM Platoon Ratio	1.00	1.00	1.00	1.00	1.00	1.00	1.00	1.00	1.00	1.00	1.00	1.00
Upstream Filter(I)	1.00	1.00	1.00	1.00	0.00	1.00	1.00	1.00	1.00	1.00	1.00	1.00
Uniform Delay (d), s/veh	18.2	18.0	18.7	20.3	0.0	14.1	19.4	6.7	6.7	19.1	6.6	6.6
Incr Delay (d2), s/veh	0.1	0.2	9.9	111.4	0.0	0.1	11.5	0.7	0.7	6.6	0.8	0.8
Initial Q Delay(d3),s/veh	0.0	0.0	0.0	0.0	0.0	0.0	0.0	0.0	0.0	0.0	0.0	0.0
%ile BackOfQ(50%),veh/ln	0.1	0.0	0.5	0.1	0.0	0.1	0.4	0.6	0.6	0.4	0.7	0.7
Unsig. Movement Delay, s/veh												
LnGrp Delay(d),s/veh	18.3	18.2	28.6	131.8	0.0	14.3	30.9	7.4	7.4	25.8	7.3	7.4
LnGrp LOS	B	B	C	F	A	B	C	A	A	C	A	A
Approach Vol, veh/h		49			11			299				360
Approach Delay, s/veh		25.9			24.9			9.7				9.3
Approach LOS		C			C			A				A
Timer - Assigned Phs	1	2	3	4	5	6		8				
Phs Duration (G+Y+Rc), s	6.2	23.0	4.6	6.9	5.9	23.3		11.5				
Change Period (Y+Rc), s	4.5	4.5	4.5	4.5	4.5	4.5		4.5				
Max Green Setting (Gmax), s	5.5	18.5	5.0	18.0	5.5	18.5		27.5				
Max Q Clear Time (g_c+I1), s	2.9	4.3	2.0	3.5	2.8	4.7		2.3				
Green Ext Time (p_c), s	0.0	1.3	0.0	0.1	0.0	1.6		0.0				
Intersection Summary												
HCM 6th Ctrl Delay				10.8								
HCM 6th LOS				B								

















HCM 6th Signalized Intersection Summary
3: Maritime Street & 17th Street

Eagle Rock Aggregate Terminal
Existing AM

												
Movement	EBL	EBT	EBR	WBL	WBT	WBR	NBL	NBT	NBR	SBL	SBT	SBR
Lane Configurations												
Traffic Volume (veh/h)	34	2	76	10	3	3	47	237	6	8	198	31
Future Volume (veh/h)	34	2	76	10	3	3	47	237	6	8	198	31
Initial Q (Qb), veh	0	0	0	0	0	0	0	0	0	0	0	0
Ped-Bike Adj(A_pbT)	1.00		1.00	1.00		1.00	1.00		1.00	1.00		1.00
Parking Bus, Adj	1.00	1.00	1.00	1.00	1.00	1.00	1.00	1.00	1.00	1.00	1.00	1.00
Work Zone On Approach		No			No			No			No	
Adj Sat Flow, veh/h/ln	418	418	418	418	418	418	1218	1604	1604	937	1485	1485
Adj Flow Rate, veh/h	37	2	83	11	3	3	51	258	7	9	215	34
Peak Hour Factor	0.92	0.92	0.92	0.92	0.92	0.92	0.92	0.92	0.92	0.92	0.92	0.92
Percent Heavy Veh, %	100	100	100	100	100	100	46	20	20	65	28	28
Cap, veh/h	121	11	61	167	18	11	61	1326	36	11	971	151
Arrive On Green	0.25	0.25	0.25	0.25	0.25	0.25	0.05	0.44	0.44	0.01	0.40	0.40
Sat Flow, veh/h	67	45	240	141	70	45	1160	3030	82	892	2446	381
Grp Volume(v), veh/h	122	0	0	17	0	0	51	129	136	9	123	126
Grp Sat Flow(s),veh/h/ln	353	0	0	257	0	0	1160	1523	1589	892	1411	1416
Q Serve(g_s), s	7.4	0.0	0.0	0.0	0.0	0.0	2.0	2.4	2.4	0.5	2.6	2.7
Cycle Q Clear(g_c), s	11.5	0.0	0.0	1.8	0.0	0.0	2.0	2.4	2.4	0.5	2.6	2.7
Prop In Lane	0.30		0.68	0.65		0.18	1.00		0.05	1.00		0.27
Lane Grp Cap(c), veh/h	193	0	0	196	0	0	61	667	695	11	560	563
V/C Ratio(X)	0.63	0.00	0.00	0.09	0.00	0.00	0.84	0.19	0.20	0.85	0.22	0.22
Avail Cap(c_a), veh/h	242	0	0	242	0	0	141	667	695	98	560	563
HCM Platoon Ratio	1.00	1.00	1.00	1.00	1.00	1.00	1.00	1.00	1.00	1.00	1.00	1.00
Upstream Filter(I)	1.00	0.00	0.00	1.00	0.00	0.00	1.00	1.00	1.00	1.00	1.00	1.00
Uniform Delay (d), s/veh	18.4	0.0	0.0	13.2	0.0	0.0	21.3	7.8	7.8	22.4	9.0	9.0
Incr Delay (d2), s/veh	3.5	0.0	0.0	0.2	0.0	0.0	24.8	0.6	0.6	89.7	0.9	0.9
Initial Q Delay(d3),s/veh	0.0	0.0	0.0	0.0	0.0	0.0	0.0	0.0	0.0	0.0	0.0	0.0
%ile BackOfQ(50%),veh/ln	1.4	0.0	0.0	0.1	0.0	0.0	0.9	0.7	0.7	0.4	0.8	0.8
Unsig. Movement Delay, s/veh												
LnGrp Delay(d),s/veh	21.9	0.0	0.0	13.4	0.0	0.0	46.1	8.5	8.5	112.1	9.9	10.0
LnGrp LOS	C	A	A	B	A	A	D	A	A	F	A	A
Approach Vol, veh/h		122			17			316				258
Approach Delay, s/veh		21.9			13.4			14.5				13.5
Approach LOS		C			B			B				B
Timer - Assigned Phs	1	2		4	5	6		8				
Phs Duration (G+Y+Rc), s	5.0	24.3		15.9	6.9	22.5		15.9				
Change Period (Y+Rc), s	4.5	4.5		4.5	4.5	4.5		4.5				
Max Green Setting (Gmax), s	5.0	18.5		18.0	5.5	18.0		18.0				
Max Q Clear Time (g_c+I1), s	2.5	4.4		13.5	4.0	4.7		3.8				
Green Ext Time (p_c), s	0.0	1.2		0.2	0.0	1.1		0.0				
Intersection Summary												
HCM 6th Ctrl Delay				15.4								
HCM 6th LOS				B								

HCM 6th Signalized Intersection Summary
4: Maritime Street & 14th Street

Eagle Rock Aggregate Terminal
Existing AM

												
Movement	EBL	EBT	EBR	WBL	WBT	WBR	NBL	NBT	NBR	SBL	SBT	SBR
Lane Configurations												
Traffic Volume (veh/h)	17	4	54	26	0	6	38	278	43	27	239	31
Future Volume (veh/h)	17	4	54	26	0	6	38	278	43	27	239	31
Initial Q (Qb), veh	0	0	0	0	0	0	0	0	0	0	0	0
Ped-Bike Adj(A_pbT)	1.00		1.00	1.00		1.00	1.00		1.00	1.00		1.00
Parking Bus, Adj	1.00	1.00	1.00	1.00	1.00	1.00	1.00	1.00	1.00	1.00	1.00	1.00
Work Zone On Approach		No			No			No			No	
Adj Sat Flow, veh/h/ln	418	418	418	1011	1011	1011	1189	1574	1574	1307	996	996
Adj Flow Rate, veh/h	18	4	59	28	0	7	41	302	47	29	260	34
Peak Hour Factor	0.92	0.92	0.92	0.92	0.92	0.92	0.92	0.92	0.92	0.92	0.92	0.92
Percent Heavy Veh, %	100	100	100	60	60	60	48	22	22	40	61	61
Cap, veh/h	119	7	39	249	10	23	52	1227	189	43	776	100
Arrive On Green	0.15	0.15	0.15	0.15	0.00	0.15	0.05	0.47	0.47	0.03	0.46	0.46
Sat Flow, veh/h	47	50	259	561	66	157	1132	2597	400	1245	1685	218
Grp Volume(v), veh/h	81	0	0	35	0	0	41	172	177	29	145	149
Grp Sat Flow(s),veh/h/ln	356	0	0	785	0	0	1132	1495	1502	1245	946	957
Q Serve(g_s), s	3.5	0.0	0.0	0.0	0.0	0.0	1.4	2.7	2.8	0.9	3.8	3.9
Cycle Q Clear(g_c), s	5.8	0.0	0.0	1.5	0.0	0.0	1.4	2.7	2.8	0.9	3.8	3.9
Prop In Lane	0.22		0.73	0.80		0.20	1.00		0.27	1.00		0.23
Lane Grp Cap(c), veh/h	165	0	0	282	0	0	52	706	709	43	436	441
V/C Ratio(X)	0.49	0.00	0.00	0.12	0.00	0.00	0.79	0.24	0.25	0.67	0.33	0.34
Avail Cap(c_a), veh/h	273	0	0	514	0	0	159	706	709	159	436	441
HCM Platoon Ratio	1.00	1.00	1.00	1.00	1.00	1.00	1.00	1.00	1.00	1.00	1.00	1.00
Upstream Filter(I)	1.00	0.00	0.00	1.00	0.00	0.00	1.00	1.00	1.00	1.00	1.00	1.00
Uniform Delay (d), s/veh	17.7	0.0	0.0	14.8	0.0	0.0	18.5	6.2	6.2	18.7	6.7	6.7
Incr Delay (d2), s/veh	2.2	0.0	0.0	0.2	0.0	0.0	22.5	0.8	0.8	16.7	2.0	2.1
Initial Q Delay(d3),s/veh	0.0	0.0	0.0	0.0	0.0	0.0	0.0	0.0	0.0	0.0	0.0	0.0
%ile BackOfQ(50%),veh/ln	0.7	0.0	0.0	0.2	0.0	0.0	0.6	0.7	0.7	0.4	0.8	0.8
Unsig. Movement Delay, s/veh												
LnGrp Delay(d),s/veh	19.9	0.0	0.0	15.0	0.0	0.0	40.9	7.0	7.0	35.4	8.8	8.8
LnGrp LOS	B	A	A	B	A	A	D	A	A	D	A	A
Approach Vol, veh/h		81			35			390			323	
Approach Delay, s/veh		19.9			15.0			10.6			11.2	
Approach LOS		B			B			B			B	
Timer - Assigned Phs	1	2		4	5	6		8				
Phs Duration (G+Y+Rc), s	5.9	23.0		10.3	6.3	22.6		10.3				
Change Period (Y+Rc), s	4.5	4.5		4.5	4.5	4.5		4.5				
Max Green Setting (Gmax), s	5.0	18.5		18.0	5.5	18.0		18.0				
Max Q Clear Time (g_c+I1), s	2.9	4.8		7.8	3.4	5.9		3.5				
Green Ext Time (p_c), s	0.0	1.7		0.3	0.0	1.4		0.1				
Intersection Summary												
HCM 6th Ctrl Delay				11.9								
HCM 6th LOS				B								

HCM 6th Signalized Intersection Summary
5: Maritime Street & Navy Roadway

Eagle Rock Aggregate Terminal
Existing AM



Movement	EBL	EBR	NBL	NBT	SBT	SBR
Lane Configurations						
Traffic Volume (veh/h)	8	1	23	417	154	144
Future Volume (veh/h)	8	1	23	417	154	144
Initial Q (Qb), veh	0	0	0	0	0	0
Ped-Bike Adj(A_pbT)	1.00	1.00	1.00			1.00
Parking Bus, Adj	1.00	1.00	1.00	1.00	1.00	1.00
Work Zone On Approach	No			No	No	
Adj Sat Flow, veh/h/ln	1767	1900	1515	1263	818	818
Adj Flow Rate, veh/h	10	0	25	453	167	157
Peak Hour Factor	0.92	0.92	0.92	0.92	0.92	0.92
Percent Heavy Veh, %	9	0	26	43	73	73
Cap, veh/h	44	21	644	1792	467	410
Arrive On Green	0.01	0.00	0.03	0.75	0.60	0.60
Sat Flow, veh/h	3365	1610	1443	2462	825	688
Grp Volume(v), veh/h	10	0	25	453	165	159
Grp Sat Flow(s),veh/h/ln	1682	1610	1443	1200	777	694
Q Serve(g_s), s	0.1	0.0	0.2	2.2	4.1	4.5
Cycle Q Clear(g_c), s	0.1	0.0	0.2	2.2	4.1	4.5
Prop In Lane	1.00	1.00	1.00			0.99
Lane Grp Cap(c), veh/h	44	21	644	1792	463	414
V/C Ratio(X)	0.23	0.00	0.04	0.25	0.36	0.38
Avail Cap(c_a), veh/h	1615	773	792	1792	463	414
HCM Platoon Ratio	1.00	1.00	1.00	1.00	1.00	1.00
Upstream Filter(I)	1.00	0.00	1.00	1.00	1.00	1.00
Uniform Delay (d), s/veh	18.3	0.0	2.5	1.5	3.9	4.0
Incr Delay (d2), s/veh	2.5	0.0	0.0	0.3	2.1	2.7
Initial Q Delay(d3),s/veh	0.0	0.0	0.0	0.0	0.0	0.0
%ile BackOfQ(50%),veh/ln	0.1	0.0	0.0	0.1	0.6	0.6
Unsig. Movement Delay, s/veh						
LnGrp Delay(d),s/veh	20.8	0.0	2.6	1.8	6.0	6.6
LnGrp LOS	C	A	A	A	A	A
Approach Vol, veh/h	10			478	324	
Approach Delay, s/veh	20.8			1.9	6.3	
Approach LOS	C			A	A	
Timer - Assigned Phs		2		4	5	6
Phs Duration (G+Y+Rc), s		32.5		5.0	5.6	26.9
Change Period (Y+Rc), s		4.5		4.5	4.5	4.5
Max Green Setting (Gmax), s		28.0		18.0	5.0	18.5
Max Q Clear Time (g_c+I1), s		4.2		2.1	2.2	6.5
Green Ext Time (p_c), s		3.3		0.0	0.0	1.6

Intersection Summary

























HCM 6th Ctrl Delay	3.9
HCM 6th LOS	A

Notes

User approved volume balancing among the lanes for turning movement.























HCM 6th Signalized Intersection Summary
6: 7th Street & Maritime Street

Eagle Rock Aggregate Terminal
Existing AM

												
Movement	EBL	EBT	EBR	WBL	WBT	WBR	NBL	NBT	NBR	SBL	SBT	SBR
Lane Configurations												
Traffic Volume (veh/h)	69	139	34	56	118	242	26	81	56	66	50	3
Future Volume (veh/h)	69	139	34	56	118	242	26	81	56	66	50	3
Initial Q (Qb), veh	0	0	0	0	0	0	0	0	0	0	0	0
Ped-Bike Adj(A_pbT)	1.00		1.00	1.00		1.00	1.00		1.00	1.00		1.00
Parking Bus, Adj	1.00	1.00	1.00	1.00	1.00	1.00	1.00	1.00	1.00	1.00	1.00	1.00
Work Zone On Approach		No			No			No			No	
Adj Sat Flow, veh/h/ln	477	507	581	1218	877	1633	507	581	581	729	788	788
Adj Flow Rate, veh/h	75	151	37	61	128	263	28	88	61	72	54	3
Peak Hour Factor	0.92	0.92	0.92	0.92	0.92	0.92	0.92	0.92	0.92	0.92	0.92	0.92
Percent Heavy Veh, %	96	94	89	46	69	18	94	89	89	79	75	75
Cap, veh/h	37	248	127	63	385	320	15	203	130	81	254	14
Arrive On Green	0.08	0.26	0.26	0.05	0.23	0.23	0.03	0.31	0.31	0.06	0.34	0.34
Sat Flow, veh/h	455	963	492	1160	1667	1384	483	646	413	1347	740	41
Grp Volume(v), veh/h	75	151	37	61	128	263	28	74	75	72	0	57
Grp Sat Flow(s),veh/h/ln	455	482	492	1160	834	1384	483	552	507	674	0	781
Q Serve(g_s), s	4.6	7.9	3.5	3.0	3.7	10.3	1.8	6.1	6.8	3.0	0.0	3.0
Cycle Q Clear(g_c), s	4.6	7.9	3.5	3.0	3.7	10.3	1.8	6.1	6.8	3.0	0.0	3.0
Prop In Lane	1.00		1.00	1.00		1.00	1.00		0.81	1.00		0.05
Lane Grp Cap(c), veh/h	37	248	127	63	385	320	15	173	159	81	0	268
V/C Ratio(X)	2.05	0.61	0.29	0.97	0.33	0.82	1.85	0.43	0.47	0.89	0.00	0.21
Avail Cap(c_a), veh/h	48	304	156	120	524	435	42	173	159	118	0	268
HCM Platoon Ratio	1.00	1.00	1.00	1.00	1.00	1.00	1.00	1.00	1.00	1.00	1.00	1.00
Upstream Filter(I)	1.00	1.00	1.00	1.00	1.00	1.00	1.00	1.00	1.00	1.00	0.00	1.00
Uniform Delay (d), s/veh	26.3	18.7	17.1	27.0	18.3	20.9	27.7	15.6	15.8	26.7	0.0	13.3
Incr Delay (d2), s/veh	553.4	2.4	1.3	46.7	0.5	8.9	479.2	7.5	9.6	39.4	0.0	1.8
Initial Q Delay(d3),s/veh	0.0	0.0	0.0	0.0	0.0	0.0	0.0	0.0	0.0	0.0	0.0	0.0
%ile BackOfQ(50%),veh/ln	6.1	0.9	0.4	1.6	0.7	3.8	2.2	1.0	1.1	0.9	0.0	0.6
Unsig. Movement Delay, s/veh												
LnGrp Delay(d),s/veh	579.7	21.2	18.4	73.8	18.9	29.8	507.0	23.1	25.5	66.1	0.0	15.2
LnGrp LOS	F	C	B	E	B	C	F	C	C	E	A	B
Approach Vol, veh/h		263			452			177			129	
Approach Delay, s/veh		180.1			32.7			100.6			43.6	
Approach LOS		F			C			F			D	
Timer - Assigned Phs	1	2	3	4	5	6	7	8				
Phs Duration (G+Y+Rc), s	7.9	22.5	7.6	19.2	6.3	24.1	9.1	17.7				
Change Period (Y+Rc), s	4.5	4.5	4.5	4.5	4.5	4.5	4.5	4.5				
Max Green Setting (Gmax), s	5.0	18.0	5.9	18.1	5.0	18.0	6.0	18.0				
Max Q Clear Time (g_c+I1), s	5.0	8.8	5.0	9.9	3.8	5.0	6.6	12.3				
Green Ext Time (p_c), s	0.0	0.5	0.0	0.6	0.0	0.2	0.0	0.9				
Intersection Summary												
HCM 6th Ctrl Delay				83.8								
HCM 6th LOS				F								

HCM 6th Signalized Intersection Summary
 7: Frontage Rd - I-80 On-Ramp & Grand Avenue

Eagle Rock Aggregate Terminal
 Existing AM

												
Movement	EBL	EBT	EBR	WBL	WBT	WBR	NBL	NBT	NBR	SBL	SBT	SBR
Lane Configurations												
Traffic Volume (veh/h)	52	173	41	119	490	307	52	138	213	165	119	76
Future Volume (veh/h)	52	173	41	119	490	307	52	138	213	165	119	76
Initial Q (Qb), veh	0	0	0	0	0	0	0	0	0	0	0	0
Ped-Bike Adj(A_pbT)	1.00		1.00	1.00		1.00	1.00		1.00	1.00		1.00
Parking Bus, Adj	1.00	1.00	1.00	1.00	1.00	1.00	1.00	1.00	1.00	1.00	1.00	1.00
Work Zone On Approach		No			No			No			No	
Adj Sat Flow, veh/h/ln	729	1722	1722	1426	1826	1752	1648	1441	1441	1767	1248	1248
Adj Flow Rate, veh/h	57	188	45	129	533	334	57	150	232	130	197	83
Peak Hour Factor	0.92	0.92	0.92	0.92	0.92	0.92	0.92	0.92	0.92	0.92	0.92	0.92
Percent Heavy Veh, %	79	12	12	32	5	10	17	31	31	9	44	44
Cap, veh/h	38	552	129	152	924	396	78	409	365	163	583	237
Arrive On Green	0.06	0.21	0.21	0.11	0.27	0.27	0.05	0.30	0.30	0.10	0.35	0.35
Sat Flow, veh/h	694	2632	615	1358	3469	1485	1570	1369	1221	1682	1688	685
Grp Volume(v), veh/h	57	115	118	129	533	334	57	150	232	130	144	136
Grp Sat Flow(s),veh/h/ln	694	1636	1611	1358	1735	1485	1570	1369	1221	1682	1248	1125
Q Serve(g_s), s	3.5	3.8	4.0	5.9	8.5	13.5	2.3	5.5	10.5	4.8	5.4	5.7
Cycle Q Clear(g_c), s	3.5	3.8	4.0	5.9	8.5	13.5	2.3	5.5	10.5	4.8	5.4	5.7
Prop In Lane	1.00		0.38	1.00		1.00	1.00		1.00	1.00		0.61
Lane Grp Cap(c), veh/h	38	343	338	152	924	396	78	409	365	163	431	389
V/C Ratio(X)	1.49	0.34	0.35	0.85	0.58	0.84	0.73	0.37	0.64	0.80	0.33	0.35
Avail Cap(c_a), veh/h	76	463	456	160	1009	432	123	409	365	198	431	389
HCM Platoon Ratio	1.00	1.00	1.00	1.00	1.00	1.00	1.00	1.00	1.00	1.00	1.00	1.00
Upstream Filter(I)	1.00	1.00	1.00	1.00	1.00	1.00	1.00	1.00	1.00	1.00	1.00	1.00
Uniform Delay (d), s/veh	30.0	21.4	21.4	27.7	20.2	22.1	29.8	17.6	19.3	28.1	15.4	15.5
Incr Delay (d2), s/veh	286.5	0.6	0.6	31.6	0.7	13.4	12.1	2.5	8.2	17.1	2.1	2.5
Initial Q Delay(d3),s/veh	0.0	0.0	0.0	0.0	0.0	0.0	0.0	0.0	0.0	0.0	0.0	0.0
%ile BackOfQ(50%),veh/ln	3.6	1.4	1.5	3.2	3.3	5.8	1.1	1.9	3.6	2.6	1.7	1.6
Unsig. Movement Delay, s/veh												
LnGrp Delay(d),s/veh	316.5	21.9	22.0	59.3	20.9	35.4	41.9	20.1	27.5	45.2	17.5	18.0
LnGrp LOS	F	C	C	E	C	D	D	C	C	D	B	B
Approach Vol, veh/h		290			996			439			410	
Approach Delay, s/veh		79.9			30.7			26.8			26.4	
Approach LOS		E			C			C			C	
Timer - Assigned Phs	1	2	3	4	5	6	7	8				
Phs Duration (G+Y+Rc), s	10.6	23.5	11.6	17.8	7.7	26.5	8.0	21.4				
Change Period (Y+Rc), s	4.5	4.5	4.5	4.5	4.5	4.5	4.5	4.5				
Max Green Setting (Gmax), s	7.5	19.0	7.5	18.0	5.0	21.5	7.0	18.5				
Max Q Clear Time (g_c+I1), s	6.8	12.5	7.9	6.0	4.3	7.7	5.5	15.5				
Green Ext Time (p_c), s	0.0	1.3	0.0	1.0	0.0	1.4	0.0	1.4				

Intersection Summary

HCM 6th Ctrl Delay	35.8
HCM 6th LOS	D

Notes

User approved volume balancing among the lanes for turning movement.

HCM 6th Signalized Intersection Summary
 8: I-880 SB On-Ramp & 7th Street

Eagle Rock Aggregate Terminal
 Existing AM



Movement	EBT	EBR	WBL	WBT	NBL	NBR
Lane Configurations	↑↑		↖↗	↑↑		
Traffic Volume (veh/h)	55	131	148	575	0	0
Future Volume (veh/h)	55	131	148	575	0	0
Initial Q (Qb), veh	0	0	0	0		
Ped-Bike Adj(A_pbT)		1.00	1.00			
Parking Bus, Adj	1.00	1.00	1.00	1.00		
Work Zone On Approach	No			No		
Adj Sat Flow, veh/h/ln	937	937	1455	833		
Adj Flow Rate, veh/h	60	142	161	625		
Peak Hour Factor	0.92	0.92	0.92	0.92		
Percent Heavy Veh, %	65	65	30	72		
Cap, veh/h	287	256	419	1170		
Arrive On Green	0.32	0.32	0.16	0.74		
Sat Flow, veh/h	937	794	2689	1624		
Grp Volume(v), veh/h	60	142	161	625		
Grp Sat Flow(s),veh/h/ln	890	794	1345	791		
Q Serve(g_s), s	0.8	2.5	0.9	2.9		
Cycle Q Clear(g_c), s	0.8	2.5	0.9	2.9		
Prop In Lane		1.00	1.00			
Lane Grp Cap(c), veh/h	287	256	419	1170		
V/C Ratio(X)	0.21	0.56	0.38	0.53		
Avail Cap(c_a), veh/h	1109	990	1481	3258		
HCM Platoon Ratio	1.00	1.00	1.00	1.00		
Upstream Filter(I)	1.00	1.00	1.00	1.00		
Uniform Delay (d), s/veh	4.2	4.8	6.5	1.0		
Incr Delay (d2), s/veh	0.4	1.9	0.6	0.4		
Initial Q Delay(d3),s/veh	0.0	0.0	0.0	0.0		
%ile BackOfQ(50%),veh/ln	0.1	0.2	0.1	0.1		
Unsig. Movement Delay, s/veh						
LnGrp Delay(d),s/veh	4.6	6.7	7.1	1.4		
LnGrp LOS	A	A	A	A		
Approach Vol, veh/h	202			786		
Approach Delay, s/veh	6.1			2.5		
Approach LOS	A			A		
Timer - Assigned Phs			3	4		8
Phs Duration (G+Y+Rc), s			7.2	10.1		17.2
Change Period (Y+Rc), s			4.5	4.5		4.5
Max Green Setting (Gmax), s			9.5	21.5		35.5
Max Q Clear Time (g_c+I1), s			2.9	4.5		4.9
Green Ext Time (p_c), s			0.3	1.1		5.2
Intersection Summary						
HCM 6th Ctrl Delay			3.3			
HCM 6th LOS			A			

HCM 6th Signalized Intersection Summary
 9: I-880 NB Off-Ramp - Frontage Road & 7th Street

Eagle Rock Aggregate Terminal
 Existing AM



Movement	EBL	EBT	EBR	WBL	WBT	WBR	NBL	NBT	NBR	SBL	SBT	SBR
Lane Configurations	↘	↑↑			↑↑		↘	↔		↘		↗
Traffic Volume (veh/h)	22	18	0	0	191	93	304	181	79	69	0	154
Future Volume (veh/h)	22	18	0	0	191	93	304	181	79	69	0	154
Initial Q (Qb), veh	0	0	0	0	0	0	0	0	0	0	0	0
Ped-Bike Adj(A_pbT)	1.00		1.00	1.00		1.00	1.00		1.00	1.00		1.00
Parking Bus, Adj	1.00	1.00	1.00	1.00	1.00	1.00	1.00	1.00	1.00	1.00	1.00	1.00
Work Zone On Approach		No			No			No			No	
Adj Sat Flow, veh/h/ln	744	1530	0	0	1767	1767	1307	1663	1663	1589	0	1900
Adj Flow Rate, veh/h	24	20	0	0	208	101	204	373	86	75	0	167
Peak Hour Factor	0.92	0.92	0.92	0.92	0.92	0.92	0.92	0.92	0.92	0.92	0.92	0.92
Percent Heavy Veh, %	78	25	0	0	9	9	40	16	16	21	0	0
Cap, veh/h	47	1066	0	0	533	249	257	951	217	137	0	0
Arrive On Green	0.07	0.37	0.00	0.00	0.24	0.24	0.21	0.36	0.36	0.09	0.00	0.00
Sat Flow, veh/h	709	2983	0	0	2308	1038	1245	2621	597	1513	75	
Grp Volume(v), veh/h	24	20	0	0	155	154	204	235	224	75	47.4	
Grp Sat Flow(s),veh/h/ln	709	1453	0	0	1678	1580	1245	1663	1555	1513	D	
Q Serve(g_s), s	2.5	0.3	0.0	0.0	5.8	6.1	11.7	7.9	8.0	3.6		
Cycle Q Clear(g_c), s	2.5	0.3	0.0	0.0	5.8	6.1	11.7	7.9	8.0	3.6		
Prop In Lane	1.00		0.00	0.00		0.66	1.00		0.38	1.00		
Lane Grp Cap(c), veh/h	47	1066	0	0	403	379	257	603	564	137		
V/C Ratio(X)	0.51	0.02	0.00	0.00	0.39	0.41	0.79	0.39	0.40	0.55		
Avail Cap(c_a), veh/h	47	1066	0	0	403	379	257	603	564	137		
HCM Platoon Ratio	1.00	1.00	1.00	1.00	1.00	1.00	1.00	1.00	1.00	1.00		
Upstream Filter(I)	1.00	1.00	0.00	0.00	1.00	1.00	1.00	1.00	1.00	1.00		
Uniform Delay (d), s/veh	33.8	15.1	0.0	0.0	23.9	24.0	28.2	17.7	17.8	32.6		
Incr Delay (d2), s/veh	34.1	0.0	0.0	0.0	2.8	3.2	21.7	1.9	2.1	14.8		
Initial Q Delay(d3),s/veh	0.0	0.0	0.0	0.0	0.0	0.0	0.0	0.0	0.0	0.0		
%ile BackOfQ(50%),veh/ln	0.9	0.1	0.0	0.0	2.5	2.5	4.9	3.2	3.0	1.8		
Unsig. Movement Delay, s/veh												
LnGrp Delay(d),s/veh	67.9	15.2	0.0	0.0	26.6	27.2	49.9	19.6	19.9	47.4		
LnGrp LOS	E	B	A	A	C	C	D	B	B	D		
Approach Vol, veh/h		44			309			663				
Approach Delay, s/veh		43.9			26.9			29.0				
Approach LOS		D			C			C				
Timer - Assigned Phs	1	2		4	5		7	8				
Phs Duration (G+Y+Rc), s	11.3	31.7		32.0	20.0		9.5	22.5				
Change Period (Y+Rc), s	4.5	4.5		4.5	4.5		4.5	4.5				
Max Green Setting (Gmax), s	6.8	27.2		27.5	15.5		5.0	18.0				
Max Q Clear Time (g_c+I1), s	5.6	10.0		2.3	13.7		4.5	8.1				
Green Ext Time (p_c), s	0.0	2.6		0.1	0.1		0.0	1.2				

Intersection Summary

HCM 6th Ctrl Delay	30.3
HCM 6th LOS	C

Notes

User approved volume balancing among the lanes for turning movement.

HCM 6th Signalized Intersection Summary

Eagle Rock Aggregate Terminal

1: Maritime Street & I-80 West & I-580 East Ramp - Grand Avenue

Existing PM



Movement	EBL	EBT	EBR	WBL	WBT	WBR	NBL	NBT	NBR	SBL	SBT	SBR
Lane Configurations												
Traffic Volume (veh/h)	9	1010	139	48	446	8	154	1	141	17	1	13
Future Volume (veh/h)	9	1010	139	48	446	8	154	1	141	17	1	13
Initial Q (Qb), veh	0	0	0	0	0	0	0	0	0	0	0	0
Ped-Bike Adj(A_pbT)	1.00		1.00	1.00		1.00	1.00		1.00	1.00		1.00
Parking Bus, Adj	1.00	1.00	1.00	1.00	1.00	1.00	1.00	1.00	1.00	1.00	1.00	1.00
Work Zone On Approach		No			No			No			No	
Adj Sat Flow, veh/h/ln	1559	1841	1544	1485	1826	1826	1856	1307	1633	1604	1159	1159
Adj Flow Rate, veh/h	10	1098	151	52	485	9	168	0	153	18	1	14
Peak Hour Factor	0.92	0.92	0.92	0.92	0.92	0.92	0.92	0.92	0.92	0.92	0.92	0.92
Percent Heavy Veh, %	23	4	24	28	5	5	3	40	18	20	50	50
Cap, veh/h	19	1240	558	64	1348	25	253	0	455	32	306	273
Arrive On Green	0.01	0.35	0.35	0.04	0.39	0.39	0.07	0.00	0.33	0.02	0.28	0.28
Sat Flow, veh/h	1485	3497	1309	1414	3484	65	3534	0	1384	1527	1101	982
Grp Volume(v), veh/h	10	1098	151	52	241	253	168	0	153	18	1	14
Grp Sat Flow(s),veh/h/ln	1485	1749	1309	1414	1735	1814	1767	0	1384	1527	1101	982
Q Serve(g_s), s	0.5	21.2	5.4	2.6	7.1	7.1	3.3	0.0	6.0	0.8	0.0	0.8
Cycle Q Clear(g_c), s	0.5	21.2	5.4	2.6	7.1	7.1	3.3	0.0	6.0	0.8	0.0	0.8
Prop In Lane	1.00		1.00	1.00		0.04	1.00		1.00	1.00		1.00
Lane Grp Cap(c), veh/h	19	1240	558	64	671	702	253	0	455	32	306	273
V/C Ratio(X)	0.53	0.89	0.27	0.82	0.36	0.36	0.66	0.00	0.34	0.56	0.00	0.05
Avail Cap(c_a), veh/h	103	1290	576	98	671	702	270	0	455	106	306	273
HCM Platoon Ratio	1.00	1.00	1.00	1.00	1.00	1.00	1.00	1.00	1.00	1.00	1.00	1.00
Upstream Filter(I)	1.00	1.00	1.00	1.00	1.00	1.00	1.00	0.00	1.00	1.00	1.00	1.00
Uniform Delay (d), s/veh	35.3	21.8	13.4	34.0	15.7	15.7	32.5	0.0	18.2	34.9	18.7	19.0
Incr Delay (d2), s/veh	21.7	7.5	0.3	25.4	0.3	0.3	5.5	0.0	2.0	14.5	0.0	0.4
Initial Q Delay(d3),s/veh	0.0	0.0	0.0	0.0	0.0	0.0	0.0	0.0	0.0	0.0	0.0	0.0
%ile BackOfQ(50%),veh/ln	0.3	9.3	1.5	1.3	2.7	2.8	1.6	0.0	2.1	0.4	0.0	0.2
Unsig. Movement Delay, s/veh												
LnGrp Delay(d),s/veh	57.0	29.3	13.6	59.4	16.0	16.0	38.0	0.0	20.2	49.3	18.8	19.3
LnGrp LOS	E	C	B	E	B	B	D	A	C	D	B	B
Approach Vol, veh/h		1259			546			321				33
Approach Delay, s/veh		27.7			20.1			29.5				35.7
Approach LOS		C			C			C				D
Timer - Assigned Phs	1	2	3	4	5	6	7	8				
Phs Duration (G+Y+Rc), s	6.0	28.1	7.7	30.0	9.7	24.5	5.4	32.3				
Change Period (Y+Rc), s	4.5	4.5	4.5	4.5	4.5	4.5	4.5	4.5				
Max Green Setting (Gmax), s	5.0	20.5	5.0	26.5	5.5	20.0	5.0	26.5				
Max Q Clear Time (g_c+I1), s	2.8	8.0	4.6	23.2	5.3	2.8	2.5	9.1				
Green Ext Time (p_c), s	0.0	0.4	0.0	2.3	0.0	0.0	0.0	2.7				

Intersection Summary























HCM 6th Ctrl Delay	26.1
HCM 6th LOS	C

Notes

User approved volume balancing among the lanes for turning movement.





















HCM 6th Signalized Intersection Summary
2: Burma Road & Maritime Street

Eagle Rock Aggregate Terminal
Existing PM

												
Movement	EBL	EBT	EBR	WBL	WBT	WBR	NBL	NBT	NBR	SBL	SBT	SBR
Lane Configurations		 						 			 	
Traffic Volume (veh/h)	76	0	24	0	0	6	26	268	5	2	161	24
Future Volume (veh/h)	76	0	24	0	0	6	26	268	5	2	161	24
Initial Q (Qb), veh	0	0	0	0	0	0	0	0	0	0	0	0
Ped-Bike Adj(A_pbT)	1.00		1.00	1.00		1.00	1.00		1.00	1.00		1.00
Parking Bus, Adj	1.00	1.00	1.00	1.00	1.00	1.00	1.00	1.00	1.00	1.00	1.00	1.00
Work Zone On Approach		No			No			No			No	
Adj Sat Flow, veh/h/ln	1841	1870	1870	1870	1870	1870	581	1722	1722	907	1500	1500
Adj Flow Rate, veh/h	83	0	26	0	0	7	28	291	5	2	175	26
Peak Hour Factor	0.92	0.92	0.92	0.92	0.92	0.92	0.92	0.92	0.92	0.92	0.92	0.92
Percent Heavy Veh, %	4	2	2	2	2	2	89	12	12	67	27	27
Cap, veh/h	322	168	150	5	0	150	19	1761	30	2	1257	184
Arrive On Green	0.09	0.00	0.09	0.00	0.00	0.09	0.03	0.54	0.54	0.00	0.50	0.50
Sat Flow, veh/h	1386	1777	1585	1781	0	1585	553	3292	56	864	2494	365
Grp Volume(v), veh/h	83	0	26	0	0	7	28	144	152	2	99	102
Grp Sat Flow(s),veh/h/ln	1386	1777	1585	1781	0	1585	553	1636	1712	864	1425	1434
Q Serve(g_s), s	2.1	0.0	0.6	0.0	0.0	0.1	1.2	1.7	1.7	0.1	1.4	1.4
Cycle Q Clear(g_c), s	2.3	0.0	0.6	0.0	0.0	0.1	1.2	1.7	1.7	0.1	1.4	1.4
Prop In Lane	1.00		1.00	1.00		1.00	1.00		0.03	1.00		0.25
Lane Grp Cap(c), veh/h	322	168	150	5	0	150	19	875	916	2	718	723
V/C Ratio(X)	0.26	0.00	0.17	0.00	0.00	0.05	1.50	0.17	0.17	0.84	0.14	0.14
Avail Cap(c_a), veh/h	870	871	777	243	0	1187	83	875	916	118	718	723
HCM Platoon Ratio	1.00	1.00	1.00	1.00	1.00	1.00	1.00	1.00	1.00	1.00	1.00	1.00
Upstream Filter(I)	1.00	0.00	1.00	0.00	0.00	1.00	1.00	1.00	1.00	1.00	1.00	1.00
Uniform Delay (d), s/veh	16.2	0.0	15.3	0.0	0.0	15.1	17.7	4.4	4.4	18.3	4.9	4.9
Incr Delay (d2), s/veh	0.4	0.0	0.5	0.0	0.0	0.1	274.1	0.4	0.4	216.0	0.4	0.4
Initial Q Delay(d3),s/veh	0.0	0.0	0.0	0.0	0.0	0.0	0.0	0.0	0.0	0.0	0.0	0.0
%ile BackOfQ(50%),veh/ln	0.6	0.0	0.2	0.0	0.0	0.1	1.6	0.4	0.4	0.2	0.3	0.3
Unsig. Movement Delay, s/veh												
LnGrp Delay(d),s/veh	16.6	0.0	15.8	0.0	0.0	15.2	291.8	4.8	4.7	234.3	5.3	5.3
LnGrp LOS	B	A	B	A	A	B	F	A	A	F	A	A
Approach Vol, veh/h		109			7			324			203	
Approach Delay, s/veh		16.4			15.2			29.6			7.5	
Approach LOS		B			B			C			A	
Timer - Assigned Phs	1	2	3	4	5	6		8				
Phs Duration (G+Y+Rc), s	4.6	24.1	0.0	8.0	5.7	23.0		8.0				
Change Period (Y+Rc), s	4.5	4.5	4.5	4.5	4.5	4.5		4.5				
Max Green Setting (Gmax), s	5.0	19.0	5.0	18.0	5.5	18.5		27.5				
Max Q Clear Time (g_c+I1), s	2.1	3.7	0.0	4.3	3.2	3.4		2.1				
Green Ext Time (p_c), s	0.0	1.4	0.0	0.2	0.0	0.9		0.0				
Intersection Summary												
HCM 6th Ctrl Delay			20.2									
HCM 6th LOS			C									

HCM 6th Signalized Intersection Summary
3: Maritime Street & 17th Street

Eagle Rock Aggregate Terminal
Existing PM

												
Movement	EBL	EBT	EBR	WBL	WBT	WBR	NBL	NBT	NBR	SBL	SBT	SBR
Lane Configurations												
Traffic Volume (veh/h)	54	0	89	12	1	30	130	254	22	2	113	18
Future Volume (veh/h)	54	0	89	12	1	30	130	254	22	2	113	18
Initial Q (Qb), veh	0	0	0	0	0	0	0	0	0	0	0	0
Ped-Bike Adj(A_pbT)	1.00		1.00	1.00		1.00	1.00		1.00	1.00		1.00
Parking Bus, Adj	1.00	1.00	1.00	1.00	1.00	1.00	1.00	1.00	1.00	1.00	1.00	1.00
Work Zone On Approach		No			No			No			No	
Adj Sat Flow, veh/h/ln	1870	1870	1870	418	418	418	537	1648	1648	907	1515	1515
Adj Flow Rate, veh/h	59	0	97	13	1	33	141	276	24	2	123	20
Peak Hour Factor	0.92	0.92	0.92	0.92	0.92	0.92	0.92	0.92	0.92	0.92	0.92	0.92
Percent Heavy Veh, %	2	2	2	100	100	100	92	17	17	67	26	26
Cap, veh/h	178	22	164	100	9	40	108	1659	143	2	897	143
Arrive On Green	0.16	0.00	0.16	0.16	0.16	0.16	0.21	0.57	0.57	0.00	0.36	0.36
Sat Flow, veh/h	495	137	1039	50	57	250	511	2917	252	864	2486	396
Grp Volume(v), veh/h	156	0	0	47	0	0	141	147	153	2	70	73
Grp Sat Flow(s),veh/h/ln	1671	0	0	357	0	0	511	1566	1603	864	1439	1443
Q Serve(g_s), s	0.0	0.0	0.0	2.0	0.0	0.0	10.5	2.2	2.3	0.1	1.6	1.7
Cycle Q Clear(g_c), s	4.2	0.0	0.0	6.3	0.0	0.0	10.5	2.2	2.3	0.1	1.6	1.7
Prop In Lane	0.38		0.62	0.28		0.70	1.00		0.16	1.00		0.27
Lane Grp Cap(c), veh/h	363	0	0	148	0	0	108	891	912	2	519	521
V/C Ratio(X)	0.43	0.00	0.00	0.32	0.00	0.00	1.31	0.17	0.17	0.85	0.14	0.14
Avail Cap(c_a), veh/h	668	0	0	216	0	0	108	891	912	87	519	521
HCM Platoon Ratio	1.00	1.00	1.00	1.00	1.00	1.00	1.00	1.00	1.00	1.00	1.00	1.00
Upstream Filter(I)	1.00	0.00	0.00	1.00	0.00	0.00	1.00	1.00	1.00	1.00	1.00	1.00
Uniform Delay (d), s/veh	19.5	0.0	0.0	20.3	0.0	0.0	19.7	5.1	5.1	24.9	10.7	10.7
Incr Delay (d2), s/veh	0.8	0.0	0.0	1.2	0.0	0.0	191.3	0.4	0.4	217.5	0.5	0.6
Initial Q Delay(d3),s/veh	0.0	0.0	0.0	0.0	0.0	0.0	0.0	0.0	0.0	0.0	0.0	0.0
%ile BackOfQ(50%),veh/ln	1.6	0.0	0.0	0.5	0.0	0.0	6.8	0.6	0.6	0.2	0.5	0.5
Unsig. Movement Delay, s/veh												
LnGrp Delay(d),s/veh	20.3	0.0	0.0	21.5	0.0	0.0	211.0	5.5	5.5	242.4	11.2	11.3
LnGrp LOS	C	A	A	C	A	A	F	A	A	F	B	B
Approach Vol, veh/h		156			47			441				145
Approach Delay, s/veh		20.3			21.5			71.2				14.5
Approach LOS		C			C			E				B
Timer - Assigned Phs	1	2		4	5	6		8				
Phs Duration (G+Y+Rc), s	4.6	32.9		12.4	15.0	22.5		12.4				
Change Period (Y+Rc), s	4.5	4.5		4.5	4.5	4.5		4.5				
Max Green Setting (Gmax), s	5.0	23.5		18.0	10.5	18.0		18.0				
Max Q Clear Time (g_c+I1), s	2.1	4.3		6.2	12.5	3.7		8.3				
Green Ext Time (p_c), s	0.0	1.6		0.6	0.0	0.6		0.1				
Intersection Summary												
HCM 6th Ctrl Delay				47.7								
HCM 6th LOS				D								

HCM 6th Signalized Intersection Summary
 4: Maritime Street & 14th Street

Eagle Rock Aggregate Terminal
 Existing PM



Movement	EBL	EBT	EBR	WBL	WBT	WBR	NBL	NBT	NBR	SBL	SBT	SBR
Lane Configurations		↕			↕		↗	↕		↗	↕	
Traffic Volume (veh/h)	38	8	61	73	9	65	99	287	53	17	178	12
Future Volume (veh/h)	38	8	61	73	9	65	99	287	53	17	178	12
Initial Q (Qb), veh	0	0	0	0	0	0	0	0	0	0	0	0
Ped-Bike Adj(A_pbT)	1.00		1.00	1.00		1.00	1.00		1.00	1.00		1.00
Parking Bus, Adj	1.00	1.00	1.00	1.00	1.00	1.00	1.00	1.00	1.00	1.00	1.00	1.00
Work Zone On Approach		No			No			No			No	
Adj Sat Flow, veh/h/ln	566	566	566	714	714	714	596	1115	1115	1100	1337	1337
Adj Flow Rate, veh/h	41	9	66	79	10	71	108	312	58	18	193	13
Peak Hour Factor	0.92	0.92	0.92	0.92	0.92	0.92	0.92	0.92	0.92	0.92	0.92	0.92
Percent Heavy Veh, %	90	90	90	80	80	80	88	53	53	54	38	38
Cap, veh/h	119	21	77	153	21	67	95	801	147	23	731	49
Arrive On Green	0.30	0.30	0.30	0.30	0.30	0.30	0.17	0.45	0.45	0.02	0.30	0.30
Sat Flow, veh/h	122	71	254	207	68	220	567	1786	328	1047	2416	162
Grp Volume(v), veh/h	116	0	0	160	0	0	108	183	187	18	101	105
Grp Sat Flow(s),veh/h/ln	447	0	0	495	0	0	567	1059	1055	1047	1270	1308
Q Serve(g_s), s	0.0	0.0	0.0	3.6	0.0	0.0	10.0	6.9	7.0	1.0	3.6	3.6
Cycle Q Clear(g_c), s	14.4	0.0	0.0	18.0	0.0	0.0	10.0	6.9	7.0	1.0	3.6	3.6
Prop In Lane	0.35		0.57	0.49		0.44	1.00		0.31	1.00		0.12
Lane Grp Cap(c), veh/h	217	0	0	240	0	0	95	475	474	23	384	396
V/C Ratio(X)	0.53	0.00	0.00	0.67	0.00	0.00	1.14	0.39	0.39	0.79	0.26	0.27
Avail Cap(c_a), veh/h	217	0	0	240	0	0	100	475	474	88	384	396
HCM Platoon Ratio	1.00	1.00	1.00	1.00	1.00	1.00	1.00	1.00	1.00	1.00	1.00	1.00
Upstream Filter(I)	1.00	0.00	0.00	1.00	0.00	0.00	1.00	1.00	1.00	1.00	1.00	1.00
Uniform Delay (d), s/veh	19.2	0.0	0.0	21.2	0.0	0.0	24.7	10.9	11.0	29.0	15.7	15.7
Incr Delay (d2), s/veh	2.5	0.0	0.0	6.8	0.0	0.0	133.3	2.4	2.4	44.7	1.7	1.6
Initial Q Delay(d3),s/veh	0.0	0.0	0.0	0.0	0.0	0.0	0.0	0.0	0.0	0.0	0.0	0.0
%ile BackOfQ(50%),veh/ln	1.5	0.0	0.0	2.5	0.0	0.0	4.8	1.7	1.7	0.5	1.1	1.2
Unsig. Movement Delay, s/veh												
LnGrp Delay(d),s/veh	21.8	0.0	0.0	28.0	0.0	0.0	158.1	13.3	13.4	73.7	17.4	17.4
LnGrp LOS	C	A	A	C	A	A	F	B	B	E	B	B
Approach Vol, veh/h		116			160			478				224
Approach Delay, s/veh		21.8			28.0			46.1				21.9
Approach LOS		C			C			D				C
Timer - Assigned Phs	1	2		4	5	6		8				
Phs Duration (G+Y+Rc), s	5.8	31.2		22.5	14.5	22.5		22.5				
Change Period (Y+Rc), s	4.5	4.5		4.5	4.5	4.5		4.5				
Max Green Setting (Gmax), s	5.0	23.5		18.0	10.5	18.0		18.0				
Max Q Clear Time (g_c+I1), s	3.0	9.0		16.4	12.0	5.6		20.0				
Green Ext Time (p_c), s	0.0	2.0		0.1	0.0	0.9		0.0				
Intersection Summary												
HCM 6th Ctrl Delay				34.7								
HCM 6th LOS				C								

HCM 6th Signalized Intersection Summary
5: Maritime Street & Navy Roadway

Eagle Rock Aggregate Terminal
Existing PM



Movement	EBL	EBR	NBL	NBT	SBT	SBR
Lane Configurations						
Traffic Volume (veh/h)	4	2	17	423	218	91
Future Volume (veh/h)	4	2	17	423	218	91
Initial Q (Qb), veh	0	0	0	0	0	0
Ped-Bike Adj(A_pbT)	1.00	1.00	1.00			1.00
Parking Bus, Adj	1.00	1.00	1.00	1.00	1.00	1.00
Work Zone On Approach	No			No	No	
Adj Sat Flow, veh/h/ln	1752	1900	833	892	1307	1307
Adj Flow Rate, veh/h	3	3	18	460	237	99
Peak Hour Factor	0.92	0.92	0.92	0.92	0.92	0.92
Percent Heavy Veh, %	10	0	72	68	40	40
Cap, veh/h	13	13	463	1273	1047	424
Arrive On Green	0.01	0.01	0.02	0.75	0.61	0.61
Sat Flow, veh/h	1668	1610	793	1740	1790	699
Grp Volume(v), veh/h	3	3	18	460	169	167
Grp Sat Flow(s),veh/h/ln	1668	1610	793	848	1242	1181
Q Serve(g_s), s	0.1	0.1	0.3	3.5	2.3	2.4
Cycle Q Clear(g_c), s	0.1	0.1	0.3	3.5	2.3	2.4
Prop In Lane	1.00	1.00	1.00			0.59
Lane Grp Cap(c), veh/h	13	13	463	1273	754	717
V/C Ratio(X)	0.22	0.23	0.04	0.36	0.22	0.23
Avail Cap(c_a), veh/h	805	777	552	1273	754	717
HCM Platoon Ratio	1.00	1.00	1.00	1.00	1.00	1.00
Upstream Filter(I)	1.00	1.00	1.00	1.00	1.00	1.00
Uniform Delay (d), s/veh	18.4	18.4	2.2	1.6	3.3	3.4
Incr Delay (d2), s/veh	8.1	8.7	0.0	0.8	0.7	0.8
Initial Q Delay(d3),s/veh	0.0	0.0	0.0	0.0	0.0	0.0
%ile BackOfQ(50%),veh/ln	0.1	0.0	0.0	0.1	0.4	0.4
Unsig. Movement Delay, s/veh						
LnGrp Delay(d),s/veh	26.5	27.1	2.2	2.4	4.0	4.1
LnGrp LOS	C	C	A	A	A	A
Approach Vol, veh/h	6			478	336	
Approach Delay, s/veh	26.8			2.4	4.1	
Approach LOS	C			A	A	
Timer - Assigned Phs		2		4	5	6
Phs Duration (G+Y+Rc), s		32.5		4.8	5.4	27.1
Change Period (Y+Rc), s		4.5		4.5	4.5	4.5
Max Green Setting (Gmax), s		28.0		18.0	5.0	18.5
Max Q Clear Time (g_c+I1), s		5.5		2.1	2.3	4.4
Green Ext Time (p_c), s		3.4		0.0	0.0	1.7

Intersection Summary

























HCM 6th Ctrl Delay	3.3
HCM 6th LOS	A

Notes

User approved volume balancing among the lanes for turning movement.

HCM 6th Signalized Intersection Summary
6: 7th Street & Maritime Street

Eagle Rock Aggregate Terminal
Existing PM

												
Movement	EBL	EBT	EBR	WBL	WBT	WBR	NBL	NBT	NBR	SBL	SBT	SBR
Lane Configurations												
Traffic Volume (veh/h)	174	148	12	36	58	78	1	209	67	156	73	0
Future Volume (veh/h)	174	148	12	36	58	78	1	209	67	156	73	0
Initial Q (Qb), veh	0	0	0	0	0	0	0	0	0	0	0	0
Ped-Bike Adj(A_pbT)	1.00		1.00	1.00		1.00	1.00		1.00	1.00		1.00
Parking Bus, Adj	1.00	1.00	1.00	1.00	1.00	1.00	1.00	1.00	1.00	1.00	1.00	1.00
Work Zone On Approach		No			No			No			No	
Adj Sat Flow, veh/h/ln	1203	1470	996	1026	1618	981	418	640	640	1470	1070	1070
Adj Flow Rate, veh/h	189	161	13	39	63	85	1	227	73	170	79	0
Peak Hour Factor	0.92	0.92	0.92	0.92	0.92	0.92	0.92	0.92	0.92	0.92	0.92	0.92
Percent Heavy Veh, %	47	29	61	59	19	62	100	85	85	29	56	56
Cap, veh/h	214	792	239	38	419	113	1	276	86	240	417	0
Arrive On Green	0.19	0.28	0.28	0.04	0.14	0.14	0.00	0.30	0.30	0.09	0.39	0.00
Sat Flow, veh/h	1146	2793	844	977	3075	831	398	912	286	2716	1070	0
Grp Volume(v), veh/h	189	161	13	39	63	85	1	149	151	170	79	0
Grp Sat Flow(s),veh/h/ln	1146	1397	844	977	1537	831	398	608	589	1358	1070	0
Q Serve(g_s), s	10.1	2.8	0.7	2.5	1.1	6.2	0.1	14.3	15.1	3.8	3.1	0.0
Cycle Q Clear(g_c), s	10.1	2.8	0.7	2.5	1.1	6.2	0.1	14.3	15.1	3.8	3.1	0.0
Prop In Lane	1.00		1.00	1.00		1.00	1.00		0.49	1.00		0.00
Lane Grp Cap(c), veh/h	214	792	239	38	419	113	1	184	178	240	417	0
V/C Ratio(X)	0.88	0.20	0.05	1.02	0.15	0.75	1.58	0.81	0.85	0.71	0.19	0.00
Avail Cap(c_a), veh/h	246	1013	306	135	881	238	32	184	178	281	417	0
HCM Platoon Ratio	1.00	1.00	1.00	1.00	1.00	1.00	1.00	1.00	1.00	1.00	1.00	1.00
Upstream Filter(I)	1.00	1.00	1.00	1.00	1.00	1.00	1.00	1.00	1.00	1.00	1.00	0.00
Uniform Delay (d), s/veh	24.9	17.1	16.4	30.2	23.9	26.1	31.4	20.3	20.5	27.9	12.6	0.0
Incr Delay (d2), s/veh	26.9	0.1	0.1	71.8	0.2	9.5	803.2	31.1	36.3	6.6	1.0	0.0
Initial Q Delay(d3),s/veh	0.0	0.0	0.0	0.0	0.0	0.0	0.0	0.0	0.0	0.0	0.0	0.0
%ile BackOfQ(50%),veh/ln	4.2	0.8	0.1	1.3	0.4	1.5	0.2	3.4	3.7	1.4	0.8	0.0
Unsig. Movement Delay, s/veh												
LnGrp Delay(d),s/veh	51.8	17.2	16.5	102.0	24.1	35.6	834.6	51.3	56.9	34.4	13.7	0.0
LnGrp LOS	D	B	B	F	C	D	F	D	E	C	B	A
Approach Vol, veh/h		363			187			301			249	
Approach Delay, s/veh		35.2			45.6			56.7			27.8	
Approach LOS		D			D			E			C	
Timer - Assigned Phs	1	2	3	4	5	6	7	8				
Phs Duration (G+Y+Rc), s	10.1	23.5	7.0	22.3	4.6	29.0	16.2	13.1				
Change Period (Y+Rc), s	4.5	4.5	4.5	4.5	4.5	4.5	4.5	4.5				
Max Green Setting (Gmax), s	6.5	19.0	8.7	22.8	5.0	20.5	13.5	18.0				
Max Q Clear Time (g_c+I1), s	5.8	17.1	4.5	4.8	2.1	5.1	12.1	8.2				
Green Ext Time (p_c), s	0.0	0.4	0.0	0.9	0.0	0.3	0.1	0.4				
Intersection Summary												
HCM 6th Ctrl Delay			41.2									
HCM 6th LOS			D									

HCM 6th Signalized Intersection Summary
 7: Frontage Rd - I-80 On-Ramp & Grand Avenue

Eagle Rock Aggregate Terminal
 Existing PM



Movement	EBL	EBT	EBR	WBL	WBT	WBR	NBL	NBT	NBR	SBL	SBT	SBR
Lane Configurations	↗	↗↘		↗	↗↘	↗	↗	↗↘		↗	↗↘	
Traffic Volume (veh/h)	296	768	78	65	454	155	46	84	265	387	117	19
Future Volume (veh/h)	296	768	78	65	454	155	46	84	265	387	117	19
Initial Q (Qb), veh	0	0	0	0	0	0	0	0	0	0	0	0
Ped-Bike Adj(A_pbT)	1.00		1.00	1.00		1.00	1.00		1.00	1.00		1.00
Parking Bus, Adj	1.00	1.00	1.00	1.00	1.00	1.00	1.00	1.00	1.00	1.00	1.00	1.00
Work Zone On Approach		No			No			No			No	
Adj Sat Flow, veh/h/ln	1707	1841	1841	1752	1826	1826	1648	1618	1618	1841	1648	1648
Adj Flow Rate, veh/h	322	835	85	71	493	168	50	91	288	421	127	21
Peak Hour Factor	0.92	0.92	0.92	0.92	0.92	0.92	0.92	0.92	0.92	0.92	0.92	0.92
Percent Heavy Veh, %	13	4	4	10	5	5	17	19	19	4	17	17
Cap, veh/h	358	1115	113	89	628	280	65	357	318	515	465	77
Arrive On Green	0.22	0.35	0.35	0.05	0.18	0.18	0.04	0.23	0.23	0.15	0.34	0.34
Sat Flow, veh/h	1626	3205	326	1668	3469	1547	1570	1537	1372	3506	1379	228
Grp Volume(v), veh/h	322	456	464	71	493	168	50	91	288	421	0	148
Grp Sat Flow(s),veh/h/ln	1626	1749	1782	1668	1735	1547	1570	1537	1372	1753	0	1607
Q Serve(g_s), s	15.8	18.8	18.8	3.4	11.1	8.2	2.6	4.0	16.7	9.5	0.0	5.5
Cycle Q Clear(g_c), s	15.8	18.8	18.8	3.4	11.1	8.2	2.6	4.0	16.7	9.5	0.0	5.5
Prop In Lane	1.00		0.18	1.00		1.00	1.00		1.00	1.00		0.14
Lane Grp Cap(c), veh/h	358	608	620	89	628	280	65	357	318	515	0	542
V/C Ratio(X)	0.90	0.75	0.75	0.80	0.79	0.60	0.77	0.26	0.90	0.82	0.00	0.27
Avail Cap(c_a), veh/h	407	675	688	141	763	340	144	357	318	621	0	542
HCM Platoon Ratio	1.00	1.00	1.00	1.00	1.00	1.00	1.00	1.00	1.00	1.00	1.00	1.00
Upstream Filter(I)	1.00	1.00	1.00	1.00	1.00	1.00	1.00	1.00	1.00	1.00	0.00	1.00
Uniform Delay (d), s/veh	31.0	23.5	23.5	38.3	32.0	30.8	38.9	25.7	30.6	33.9	0.0	19.8
Incr Delay (d2), s/veh	20.6	4.2	4.1	15.2	4.5	2.1	17.0	1.7	31.1	7.2	0.0	1.2
Initial Q Delay(d3),s/veh	0.0	0.0	0.0	0.0	0.0	0.0	0.0	0.0	0.0	0.0	0.0	0.0
%ile BackOfQ(50%),veh/ln	8.0	8.1	8.2	1.8	4.9	3.1	1.3	1.6	8.1	4.5	0.0	2.2
Unsig. Movement Delay, s/veh												
LnGrp Delay(d),s/veh	51.6	27.7	27.7	53.5	36.5	32.9	55.9	27.4	61.7	41.0	0.0	21.0
LnGrp LOS	D	C	C	D	D	C	E	C	E	D	A	C
Approach Vol, veh/h		1242			732			429				569
Approach Delay, s/veh		33.9			37.3			53.7				35.8
Approach LOS		C			D			D				D
Timer - Assigned Phs	1	2	3	4	5	6	7	8				
Phs Duration (G+Y+Rc), s	16.5	23.5	8.9	33.0	7.9	32.1	22.5	19.3				
Change Period (Y+Rc), s	4.5	4.5	4.5	4.5	4.5	4.5	4.5	4.5				
Max Green Setting (Gmax), s	14.5	19.0	6.9	31.6	7.5	26.0	20.5	18.0				
Max Q Clear Time (g_c+I1), s	11.5	18.7	5.4	20.8	4.6	7.5	17.8	13.1				
Green Ext Time (p_c), s	0.5	0.1	0.0	4.4	0.0	0.7	0.3	1.7				

Intersection Summary

HCM 6th Ctrl Delay	38.0
HCM 6th LOS	D

Notes

User approved volume balancing among the lanes for turning movement.

HCM 6th Signalized Intersection Summary
 8: I-880 SB On-Ramp & 7th Street

Eagle Rock Aggregate Terminal
 Existing PM



Movement	EBT	EBR	WBL	WBT	NBL	NBR
Lane Configurations	↑↑		↙↘	↑↑		
Traffic Volume (veh/h)	224	206	77	175	0	0
Future Volume (veh/h)	224	206	77	175	0	0
Initial Q (Qb), veh	0	0	0	0		
Ped-Bike Adj(A_pbT)		1.00	1.00			
Parking Bus, Adj	1.00	1.00	1.00	1.00		
Work Zone On Approach	No			No		
Adj Sat Flow, veh/h/ln	1648	1648	1633	1352		
Adj Flow Rate, veh/h	243	224	84	190		
Peak Hour Factor	0.92	0.92	0.92	0.92		
Percent Heavy Veh, %	17	17	18	37		
Cap, veh/h	603	533	290	1900		
Arrive On Green	0.38	0.38	0.10	0.74		
Sat Flow, veh/h	1655	1391	3018	2636		
Grp Volume(v), veh/h	242	225	84	190		
Grp Sat Flow(s),veh/h/ln	1566	1398	1509	1284		
Q Serve(g_s), s	1.9	2.0	0.4	0.4		
Cycle Q Clear(g_c), s	1.9	2.0	0.4	0.4		
Prop In Lane		0.99	1.00			
Lane Grp Cap(c), veh/h	600	536	290	1900		
V/C Ratio(X)	0.40	0.42	0.29	0.10		
Avail Cap(c_a), veh/h	2128	1900	1309	5273		
HCM Platoon Ratio	1.00	1.00	1.00	1.00		
Upstream Filter(I)	1.00	1.00	1.00	1.00		
Uniform Delay (d), s/veh	3.9	3.9	7.3	0.6		
Incr Delay (d2), s/veh	0.4	0.5	0.5	0.0		
Initial Q Delay(d3),s/veh	0.0	0.0	0.0	0.0		
%ile BackOfQ(50%),veh/ln	0.1	0.1	0.1	0.0		
Unsig. Movement Delay, s/veh						
LnGrp Delay(d),s/veh	4.3	4.4	7.8	0.7		
LnGrp LOS	A	A	A	A		
Approach Vol, veh/h	467			274		
Approach Delay, s/veh	4.4			2.8		
Approach LOS	A			A		
Timer - Assigned Phs			3	4		8
Phs Duration (G+Y+Rc), s			6.2	11.1		17.3
Change Period (Y+Rc), s			4.5	4.5		4.5
Max Green Setting (Gmax), s			7.5	23.5		35.5
Max Q Clear Time (g_c+I1), s			2.4	4.0		2.4
Green Ext Time (p_c), s			0.1	2.9		1.3
Intersection Summary						
HCM 6th Ctrl Delay			3.8			
HCM 6th LOS			A			

HCM 6th Signalized Intersection Summary
 9: I-880 NB Off-Ramp - Frontage Road & 7th Street

Eagle Rock Aggregate Terminal
 Existing PM



Movement	EBL	EBT	EBR	WBL	WBT	WBR	NBL	NBT	NBR	SBL	SBT	SBR
Lane Configurations	↘	↑↑			↑↑		↘	↑↑		↘		↑↑
Traffic Volume (veh/h)	57	150	0	0	86	107	85	229	110	118	0	77
Future Volume (veh/h)	57	150	0	0	86	107	85	229	110	118	0	77
Initial Q (Qb), veh	0	0	0	0	0	0	0	0	0	0	0	0
Ped-Bike Adj(A_pbT)	1.00		1.00	1.00		1.00	1.00		1.00	1.00		1.00
Parking Bus, Adj	1.00	1.00	1.00	1.00	1.00	1.00	1.00	1.00	1.00	1.00	1.00	1.00
Work Zone On Approach		No			No			No			No	
Adj Sat Flow, veh/h/ln	1426	1707	0	0	1604	1604	1070	1767	1767	1781	0	1604
Adj Flow Rate, veh/h	62	163	0	0	93	116	92	249	120	128	0	84
Peak Hour Factor	0.92	0.92	0.92	0.92	0.92	0.92	0.92	0.92	0.92	0.92	0.92	0.92
Percent Heavy Veh, %	32	13	0	0	20	20	56	9	9	8	0	20
Cap, veh/h	104	1372	0	0	422	376	93	635	296	154	0	0
Arrive On Green	0.08	0.42	0.00	0.00	0.28	0.28	0.09	0.28	0.28	0.09	0.00	0.00
Sat Flow, veh/h	1358	3329	0	0	1604	1359	1019	2279	1063	1697	128	
Grp Volume(v), veh/h	62	163	0	0	93	116	92	191	178	128	67.3	
Grp Sat Flow(s),veh/h/ln	1358	1622	0	0	1523	1359	1019	1767	1575	1697	E	
Q Serve(g_s), s	2.9	2.0	0.0	0.0	3.1	4.4	5.9	5.7	6.0	4.8		
Cycle Q Clear(g_c), s	2.9	2.0	0.0	0.0	3.1	4.4	5.9	5.7	6.0	4.8		
Prop In Lane	1.00		0.00	0.00		1.00	1.00		0.67	1.00		
Lane Grp Cap(c), veh/h	104	1372	0	0	422	376	93	492	439	154		
V/C Ratio(X)	0.59	0.12	0.00	0.00	0.22	0.31	0.99	0.39	0.41	0.83		
Avail Cap(c_a), veh/h	104	1372	0	0	422	376	93	492	439	154		
HCM Platoon Ratio	1.00	1.00	1.00	1.00	1.00	1.00	1.00	1.00	1.00	1.00		
Upstream Filter(I)	1.00	1.00	0.00	0.00	1.00	1.00	1.00	1.00	1.00	1.00		
Uniform Delay (d), s/veh	29.0	11.4	0.0	0.0	18.1	18.6	29.5	19.0	19.1	29.1		
Incr Delay (d2), s/veh	22.4	0.2	0.0	0.0	1.2	2.1	92.1	2.3	2.8	38.3		
Initial Q Delay(d3),s/veh	0.0	0.0	0.0	0.0	0.0	0.0	0.0	0.0	0.0	0.0		
%ile BackOfQ(50%),veh/ln	1.5	0.7	0.0	0.0	1.1	1.5	3.7	2.5	2.4	3.5		
Unsig. Movement Delay, s/veh												
LnGrp Delay(d),s/veh	51.4	11.6	0.0	0.0	19.3	20.7	121.6	21.3	21.8	67.3		
LnGrp LOS	D	B	A	A	B	C	F	C	C	E		
Approach Vol, veh/h		225			209			461				
Approach Delay, s/veh		22.6			20.1			41.5				
Approach LOS		C			C			D				
Timer - Assigned Phs	1	2		4	5		7	8				
Phs Duration (G+Y+Rc), s	10.4	22.6		32.0	10.4		9.5	22.5				
Change Period (Y+Rc), s	4.5	4.5		4.5	4.5		4.5	4.5				
Max Green Setting (Gmax), s	5.9	18.1		27.5	5.9		5.0	18.0				
Max Q Clear Time (g_c+I1), s	6.8	8.0		4.0	7.9		4.9	6.4				
Green Ext Time (p_c), s	0.0	1.6		1.0	0.0		0.0	0.9				

Intersection Summary

HCM 6th Ctrl Delay	36.2
HCM 6th LOS	D

Notes

User approved volume balancing among the lanes for turning movement.

HCM 6th Signalized Intersection Summary

Eagle Rock Aggregate Terminal

1: Maritime Street & I-80 West & I-580 East Ramp - Grand Avenue

Existing Plus Project AM



Movement	EBL	EBT	EBR	WBL	WBT	WBR	NBL	NBT	NBR	SBL	SBT	SBR
Lane Configurations												
Traffic Volume (veh/h)	13	134	142	223	438	16	216	16	79	18	1	7
Future Volume (veh/h)	13	134	142	223	438	16	216	16	79	18	1	7
Initial Q (Qb), veh	0	0	0	0	0	0	0	0	0	0	0	0
Ped-Bike Adj(A_pbT)	1.00		1.00	1.00		1.00	1.00		1.00	1.00		1.00
Parking Bus, Adj	1.00	1.00	1.00	1.00	1.00	1.00	1.00	1.00	1.00	1.00	1.00	1.00
Work Zone On Approach		No			No			No			No	
Adj Sat Flow, veh/h/ln	1693	1767	1722	1574	1856	1856	1737	1633	907	1248	1648	1648
Adj Flow Rate, veh/h	14	146	154	242	476	17	247	0	86	20	1	8
Peak Hour Factor	0.92	0.92	0.92	0.92	0.92	0.92	0.92	0.92	0.92	0.92	0.92	0.92
Percent Heavy Veh, %	14	9	12	22	3	3	11	18	67	44	17	17
Cap, veh/h	28	456	352	282	1065	38	349	0	288	28	459	409
Arrive On Green	0.02	0.14	0.14	0.19	0.31	0.31	0.11	0.00	0.38	0.02	0.29	0.29
Sat Flow, veh/h	1612	3357	1459	1499	3472	124	3309	0	769	1188	1566	1397
Grp Volume(v), veh/h	14	146	154	242	241	252	247	0	86	20	1	8
Grp Sat Flow(s),veh/h/ln	1612	1678	1459	1499	1763	1833	1654	0	769	1188	1566	1397
Q Serve(g_s), s	0.6	2.5	5.8	10.1	7.1	7.2	4.7	0.0	5.1	1.1	0.0	0.3
Cycle Q Clear(g_c), s	0.6	2.5	5.8	10.1	7.1	7.2	4.7	0.0	5.1	1.1	0.0	0.3
Prop In Lane	1.00		1.00	1.00		0.07	1.00		1.00	1.00		1.00
Lane Grp Cap(c), veh/h	28	456	352	282	541	562	349	0	288	28	459	409
V/C Ratio(X)	0.51	0.32	0.44	0.86	0.45	0.45	0.71	0.00	0.30	0.72	0.00	0.02
Avail Cap(c_a), veh/h	124	932	559	358	775	806	485	0	288	92	459	409
HCM Platoon Ratio	1.00	1.00	1.00	1.00	1.00	1.00	1.00	1.00	1.00	1.00	1.00	1.00
Upstream Filter(I)	1.00	1.00	1.00	1.00	1.00	1.00	1.00	0.00	1.00	1.00	1.00	1.00
Uniform Delay (d), s/veh	31.6	25.3	20.9	25.5	18.0	18.1	28.0	0.0	14.3	31.5	16.2	16.3
Incr Delay (d2), s/veh	13.5	0.4	0.9	15.2	0.6	0.6	2.8	0.0	2.6	29.4	0.0	0.1
Initial Q Delay(d3),s/veh	0.0	0.0	0.0	0.0	0.0	0.0	0.0	0.0	0.0	0.0	0.0	0.0
%ile BackOfQ(50%),veh/ln	0.3	1.0	1.9	4.6	2.8	2.9	1.9	0.0	1.0	0.5	0.0	0.1
Unsig. Movement Delay, s/veh												
LnGrp Delay(d),s/veh	45.1	25.7	21.7	40.7	18.6	18.6	30.9	0.0	16.9	60.9	16.2	16.4
LnGrp LOS	D	C	C	D	B	B	C	A	B	E	B	B
Approach Vol, veh/h		314			735			333				29
Approach Delay, s/veh		24.6			25.9			27.3				47.1
Approach LOS		C			C			C				D
Timer - Assigned Phs	1	2	3	4	5	6	7	8				
Phs Duration (G+Y+Rc), s	6.0	28.8	16.7	13.3	11.3	23.5	5.6	24.4				
Change Period (Y+Rc), s	4.5	4.5	4.5	4.5	4.5	4.5	4.5	4.5				
Max Green Setting (Gmax), s	5.0	23.5	15.5	18.0	9.5	19.0	5.0	28.5				
Max Q Clear Time (g_c+I1), s	3.1	7.1	12.1	7.8	6.7	2.3	2.6	9.2				
Green Ext Time (p_c), s	0.0	0.2	0.2	1.0	0.2	0.0	0.0	2.8				

Intersection Summary





















HCM 6th Ctrl Delay	26.4
HCM 6th LOS	C

Notes

User approved volume balancing among the lanes for turning movement.

HCM 6th Signalized Intersection Summary
2: Burma Road & Maritime Street

Eagle Rock Aggregate Terminal
Existing Plus Project AM

												
Movement	EBL	EBT	EBR	WBL	WBT	WBR	NBL	NBT	NBR	SBL	SBT	SBR
Lane Configurations												
Traffic Volume (veh/h)	10	2	33	1	2	7	27	257	2	35	227	79
Future Volume (veh/h)	10	2	33	1	2	7	27	257	2	35	227	79
Initial Q (Qb), veh	0	0	0	0	0	0	0	0	0	0	0	0
Ped-Bike Adj(A_pbT)	1.00		1.00	1.00		1.00	1.00		1.00	1.00		1.00
Parking Bus, Adj	1.00	1.00	1.00	1.00	1.00	1.00	1.00	1.00	1.00	1.00	1.00	1.00
Work Zone On Approach		No			No			No			No	
Adj Sat Flow, veh/h/ln	1366	1159	1159	907	1159	1159	1470	1455	1455	1693	1544	1544
Adj Flow Rate, veh/h	11	2	36	1	2	8	29	279	2	38	247	86
Peak Hour Factor	0.92	0.92	0.92	0.92	0.92	0.92	0.92	0.92	0.92	0.92	0.92	0.92
Percent Heavy Veh, %	36	50	50	67	50	50	29	30	30	14	24	24
Cap, veh/h	238	66	59	2	35	139	48	1278	9	69	995	338
Arrive On Green	0.06	0.06	0.06	0.00	0.17	0.17	0.03	0.45	0.45	0.04	0.46	0.46
Sat Flow, veh/h	1026	1101	982	864	203	810	1400	2814	20	1612	2150	730
Grp Volume(v), veh/h	11	2	36	1	0	10	29	137	144	38	167	166
Grp Sat Flow(s),veh/h/ln	1026	1101	982	864	0	1013	1400	1383	1452	1612	1467	1413
Q Serve(g_s), s	0.4	0.1	1.5	0.0	0.0	0.3	0.8	2.4	2.4	0.9	2.8	2.9
Cycle Q Clear(g_c), s	0.4	0.1	1.5	0.0	0.0	0.3	0.8	2.4	2.4	0.9	2.8	2.9
Prop In Lane	1.00		1.00	1.00		0.80	1.00		0.01	1.00		0.52
Lane Grp Cap(c), veh/h	238	66	59	2	0	174	48	628	659	69	679	654
V/C Ratio(X)	0.05	0.03	0.61	0.47	0.00	0.06	0.60	0.22	0.22	0.55	0.25	0.25
Avail Cap(c_a), veh/h	630	486	434	106	0	684	189	628	659	218	679	654
HCM Platoon Ratio	1.00	1.00	1.00	1.00	1.00	1.00	1.00	1.00	1.00	1.00	1.00	1.00
Upstream Filter(I)	1.00	1.00	1.00	1.00	0.00	1.00	1.00	1.00	1.00	1.00	1.00	1.00
Uniform Delay (d), s/veh	18.2	18.0	18.7	20.3	0.0	14.1	19.4	6.7	6.7	19.1	6.6	6.7
Incr Delay (d2), s/veh	0.1	0.2	9.9	111.4	0.0	0.1	11.5	0.8	0.8	6.6	0.9	0.9
Initial Q Delay(d3),s/veh	0.0	0.0	0.0	0.0	0.0	0.0	0.0	0.0	0.0	0.0	0.0	0.0
%ile BackOfQ(50%),veh/ln	0.1	0.0	0.5	0.1	0.0	0.1	0.4	0.6	0.7	0.4	0.8	0.8
Unsig. Movement Delay, s/veh												
LnGrp Delay(d),s/veh	18.3	18.2	28.6	131.8	0.0	14.3	30.9	7.5	7.5	25.8	7.5	7.6
LnGrp LOS	B	B	C	F	A	B	C	A	A	C	A	A
Approach Vol, veh/h		49			11			310				371
Approach Delay, s/veh		25.9			24.9			9.7				9.4
Approach LOS		C			C			A				A
Timer - Assigned Phs	1	2	3	4	5	6		8				
Phs Duration (G+Y+Rc), s	6.2	23.0	4.6	6.9	5.9	23.3		11.5				
Change Period (Y+Rc), s	4.5	4.5	4.5	4.5	4.5	4.5		4.5				
Max Green Setting (Gmax), s	5.5	18.5	5.0	18.0	5.5	18.5		27.5				
Max Q Clear Time (g_c+I1), s	2.9	4.4	2.0	3.5	2.8	4.9		2.3				
Green Ext Time (p_c), s	0.0	1.3	0.0	0.1	0.0	1.6		0.0				
Intersection Summary												
HCM 6th Ctrl Delay				10.9								
HCM 6th LOS				B								

HCM 6th Signalized Intersection Summary
 3: Maritime Street & 17th Street



















Eagle Rock Aggregate Terminal
 Existing Plus Project AM



Movement	EBL	EBT	EBR	WBL	WBT	WBR	NBL	NBT	NBR	SBL	SBT	SBR
Lane Configurations		↕			↕		↕	↕		↕	↕	
Traffic Volume (veh/h)	44	2	83	10	3	3	54	237	6	8	198	41
Future Volume (veh/h)	44	2	83	10	3	3	54	237	6	8	198	41
Initial Q (Qb), veh	0	0	0	0	0	0	0	0	0	0	0	0
Ped-Bike Adj(A_pbT)	1.00		1.00	1.00		1.00	1.00		1.00	1.00		1.00
Parking Bus, Adj	1.00	1.00	1.00	1.00	1.00	1.00	1.00	1.00	1.00	1.00	1.00	1.00
Work Zone On Approach		No			No			No			No	
Adj Sat Flow, veh/h/ln	418	418	418	418	418	418	1100	1604	1604	937	1485	1485
Adj Flow Rate, veh/h	48	2	90	11	3	3	59	258	7	9	215	45
Peak Hour Factor	0.92	0.92	0.92	0.92	0.92	0.92	0.92	0.92	0.92	0.92	0.92	0.92
Percent Heavy Veh, %	100	100	100	100	100	100	54	20	20	65	28	28
Cap, veh/h	124	11	75	158	19	13	58	1183	32	10	809	166
Arrive On Green	0.34	0.34	0.34	0.34	0.34	0.34	0.06	0.39	0.39	0.01	0.35	0.35
Sat Flow, veh/h	92	32	224	129	56	40	1047	3030	82	892	2331	479
Grp Volume(v), veh/h	140	0	0	17	0	0	59	129	136	9	128	132
Grp Sat Flow(s),veh/h/ln	348	0	0	225	0	0	1047	1523	1589	892	1411	1399
Q Serve(g_s), s	13.8	0.0	0.0	0.0	0.0	0.0	2.9	2.9	2.9	0.5	3.4	3.5
Cycle Q Clear(g_c), s	17.5	0.0	0.0	1.9	0.0	0.0	2.9	2.9	2.9	0.5	3.4	3.5
Prop In Lane	0.34		0.64	0.65		0.18	1.00		0.05	1.00		0.34
Lane Grp Cap(c), veh/h	211	0	0	190	0	0	58	595	620	10	490	485
V/C Ratio(X)	0.66	0.00	0.00	0.09	0.00	0.00	1.02	0.22	0.22	0.86	0.26	0.27
Avail Cap(c_a), veh/h	214	0	0	193	0	0	111	595	620	86	490	485
HCM Platoon Ratio	1.00	1.00	1.00	1.00	1.00	1.00	1.00	1.00	1.00	1.00	1.00	1.00
Upstream Filter(I)	1.00	0.00	0.00	1.00	0.00	0.00	1.00	1.00	1.00	1.00	1.00	1.00
Uniform Delay (d), s/veh	18.5	0.0	0.0	11.9	0.0	0.0	24.5	10.5	10.5	25.6	12.2	12.2
Incr Delay (d2), s/veh	7.4	0.0	0.0	0.2	0.0	0.0	66.2	0.8	0.8	92.5	1.3	1.4
Initial Q Delay(d3),s/veh	0.0	0.0	0.0	0.0	0.0	0.0	0.0	0.0	0.0	0.0	0.0	0.0
%ile BackOfQ(50%),veh/ln	2.0	0.0	0.0	0.1	0.0	0.0	1.7	1.0	1.0	0.4	1.1	1.1
Unsig. Movement Delay, s/veh												
LnGrp Delay(d),s/veh	25.9	0.0	0.0	12.1	0.0	0.0	90.7	11.4	11.3	118.1	13.5	13.6
LnGrp LOS	C	A	A	B	A	A	F	B	B	F	B	B
Approach Vol, veh/h		140			17			324				269
Approach Delay, s/veh		25.9			12.1			25.8				17.0
Approach LOS		C			B			C				B
Timer - Assigned Phs	1	2		4	5	6		8				
Phs Duration (G+Y+Rc), s	5.1	24.8		22.0	7.4	22.5		22.0				
Change Period (Y+Rc), s	4.5	4.5		4.5	4.5	4.5		4.5				
Max Green Setting (Gmax), s	5.0	18.5		18.0	5.5	18.0		18.0				
Max Q Clear Time (g_c+I1), s	2.5	4.9		19.5	4.9	5.5		3.9				
Green Ext Time (p_c), s	0.0	1.2		0.0	0.0	1.2		0.0				
Intersection Summary												
HCM 6th Ctrl Delay				22.4								
HCM 6th LOS				C								

HCM 6th Signalized Intersection Summary
4: Maritime Street & 14th Street

Eagle Rock Aggregate Terminal
Existing Plus Project AM

												
Movement	EBL	EBT	EBR	WBL	WBT	WBR	NBL	NBT	NBR	SBL	SBT	SBR
Lane Configurations												
Traffic Volume (veh/h)	17	4	54	26	0	6	38	285	43	27	246	31
Future Volume (veh/h)	17	4	54	26	0	6	38	285	43	27	246	31
Initial Q (Qb), veh	0	0	0	0	0	0	0	0	0	0	0	0
Ped-Bike Adj(A_pbT)	1.00		1.00	1.00		1.00	1.00		1.00	1.00		1.00
Parking Bus, Adj	1.00	1.00	1.00	1.00	1.00	1.00	1.00	1.00	1.00	1.00	1.00	1.00
Work Zone On Approach		No			No			No			No	
Adj Sat Flow, veh/h/ln	418	418	418	1011	1011	1011	1189	1544	1544	1307	981	981
Adj Flow Rate, veh/h	18	4	59	28	0	7	41	310	47	29	267	34
Peak Hour Factor	0.92	0.92	0.92	0.92	0.92	0.92	0.92	0.92	0.92	0.92	0.92	0.92
Percent Heavy Veh, %	100	100	100	60	60	60	48	24	24	40	62	62
Cap, veh/h	119	7	39	249	10	23	52	1208	181	43	768	97
Arrive On Green	0.15	0.15	0.15	0.15	0.00	0.15	0.05	0.47	0.47	0.03	0.46	0.46
Sat Flow, veh/h	47	50	259	561	66	157	1132	2558	384	1245	1666	210
Grp Volume(v), veh/h	81	0	0	35	0	0	41	176	181	29	148	153
Grp Sat Flow(s),veh/h/ln	356	0	0	785	0	0	1132	1467	1475	1245	932	943
Q Serve(g_s), s	3.5	0.0	0.0	0.0	0.0	0.0	1.4	2.8	2.9	0.9	4.0	4.1
Cycle Q Clear(g_c), s	5.8	0.0	0.0	1.5	0.0	0.0	1.4	2.8	2.9	0.9	4.0	4.1
Prop In Lane	0.22		0.73	0.80		0.20	1.00		0.26	1.00		0.22
Lane Grp Cap(c), veh/h	165	0	0	282	0	0	52	693	697	43	430	435
V/C Ratio(X)	0.49	0.00	0.00	0.12	0.00	0.00	0.79	0.25	0.26	0.67	0.35	0.35
Avail Cap(c_a), veh/h	273	0	0	514	0	0	159	693	697	159	430	435
HCM Platoon Ratio	1.00	1.00	1.00	1.00	1.00	1.00	1.00	1.00	1.00	1.00	1.00	1.00
Upstream Filter(I)	1.00	0.00	0.00	1.00	0.00	0.00	1.00	1.00	1.00	1.00	1.00	1.00
Uniform Delay (d), s/veh	17.7	0.0	0.0	14.8	0.0	0.0	18.5	6.2	6.2	18.7	6.8	6.8
Incr Delay (d2), s/veh	2.2	0.0	0.0	0.2	0.0	0.0	22.5	0.9	0.9	16.7	2.2	2.2
Initial Q Delay(d3),s/veh	0.0	0.0	0.0	0.0	0.0	0.0	0.0	0.0	0.0	0.0	0.0	0.0
%ile BackOfQ(50%),veh/ln	0.7	0.0	0.0	0.2	0.0	0.0	0.6	0.7	0.8	0.4	0.8	0.8
Unsig. Movement Delay, s/veh												
LnGrp Delay(d),s/veh	19.9	0.0	0.0	15.0	0.0	0.0	40.9	7.1	7.1	35.4	9.0	9.0
LnGrp LOS	B	A	A	B	A	A	D	A	A	D	A	A
Approach Vol, veh/h		81			35			398			330	
Approach Delay, s/veh		19.9			15.0			10.6			11.3	
Approach LOS		B			B			B			B	
Timer - Assigned Phs	1	2		4	5	6		8				
Phs Duration (G+Y+Rc), s	5.9	23.0		10.3	6.3	22.6		10.3				
Change Period (Y+Rc), s	4.5	4.5		4.5	4.5	4.5		4.5				
Max Green Setting (Gmax), s	5.0	18.5		18.0	5.5	18.0		18.0				
Max Q Clear Time (g_c+I1), s	2.9	4.9		7.8	3.4	6.1		3.5				
Green Ext Time (p_c), s	0.0	1.8		0.3	0.0	1.4		0.1				
Intersection Summary												
HCM 6th Ctrl Delay				11.9								
HCM 6th LOS				B								

HCM 6th Signalized Intersection Summary
5: Maritime Street & Navy Roadway

Eagle Rock Aggregate Terminal
Existing Plus Project AM



Movement	EBL	EBR	NBL	NBT	SBT	SBR
Lane Configurations						
Traffic Volume (veh/h)	8	1	23	424	161	144
Future Volume (veh/h)	8	1	23	424	161	144
Initial Q (Qb), veh	0	0	0	0	0	0
Ped-Bike Adj(A_pbT)	1.00	1.00	1.00			1.00
Parking Bus, Adj	1.00	1.00	1.00	1.00	1.00	1.00
Work Zone On Approach	No			No	No	
Adj Sat Flow, veh/h/ln	1767	1900	1515	1248	744	744
Adj Flow Rate, veh/h	10	0	25	461	175	157
Peak Hour Factor	0.92	0.92	0.92	0.92	0.92	0.92
Percent Heavy Veh, %	9	0	26	44	78	78
Cap, veh/h	44	21	624	1771	434	365
Arrive On Green	0.01	0.00	0.03	0.75	0.60	0.60
Sat Flow, veh/h	3365	1610	1443	2433	765	612
Grp Volume(v), veh/h	10	0	25	461	170	162
Grp Sat Flow(s),veh/h/ln	1682	1610	1443	1186	707	634
Q Serve(g_s), s	0.1	0.0	0.2	2.3	4.8	5.2
Cycle Q Clear(g_c), s	0.1	0.0	0.2	2.3	4.8	5.2
Prop In Lane	1.00	1.00	1.00			0.97
Lane Grp Cap(c), veh/h	44	21	624	1771	421	378
V/C Ratio(X)	0.23	0.00	0.04	0.26	0.40	0.43
Avail Cap(c_a), veh/h	1615	773	772	1771	421	378
HCM Platoon Ratio	1.00	1.00	1.00	1.00	1.00	1.00
Upstream Filter(I)	1.00	0.00	1.00	1.00	1.00	1.00
Uniform Delay (d), s/veh	18.3	0.0	2.7	1.5	4.0	4.1
Incr Delay (d2), s/veh	2.5	0.0	0.0	0.4	2.8	3.5
Initial Q Delay(d3),s/veh	0.0	0.0	0.0	0.0	0.0	0.0
%ile BackOfQ(50%),veh/ln	0.1	0.0	0.0	0.1	0.6	0.7
Unsig. Movement Delay, s/veh						
LnGrp Delay(d),s/veh	20.8	0.0	2.7	1.8	6.9	7.7
LnGrp LOS	C	A	A	A	A	A
Approach Vol, veh/h	10			486	332	
Approach Delay, s/veh	20.8			1.9	7.3	
Approach LOS	C			A	A	
Timer - Assigned Phs		2		4	5	6
Phs Duration (G+Y+Rc), s		32.5		5.0	5.6	26.9
Change Period (Y+Rc), s		4.5		4.5	4.5	4.5
Max Green Setting (Gmax), s		28.0		18.0	5.0	18.5
Max Q Clear Time (g_c+I1), s		4.3		2.1	2.2	7.2
Green Ext Time (p_c), s		3.3		0.0	0.0	1.6

Intersection Summary

























HCM 6th Ctrl Delay	4.3
HCM 6th LOS	A

Notes

User approved volume balancing among the lanes for turning movement.

HCM 6th Signalized Intersection Summary
6: 7th Street & Maritime Street

Eagle Rock Aggregate Terminal
Existing Plus Project AM

												
Movement	EBL	EBT	EBR	WBL	WBT	WBR	NBL	NBT	NBR	SBL	SBT	SBR
Lane Configurations												
Traffic Volume (veh/h)	69	139	34	56	125	242	26	81	56	73	50	3
Future Volume (veh/h)	69	139	34	56	125	242	26	81	56	73	50	3
Initial Q (Qb), veh	0	0	0	0	0	0	0	0	0	0	0	0
Ped-Bike Adj(A_pbT)	1.00		1.00	1.00		1.00	1.00		1.00	1.00		1.00
Parking Bus, Adj	1.00	1.00	1.00	1.00	1.00	1.00	1.00	1.00	1.00	1.00	1.00	1.00
Work Zone On Approach		No			No			No			No	
Adj Sat Flow, veh/h/ln	477	507	581	1218	848	1633	507	581	581	700	788	788
Adj Flow Rate, veh/h	75	151	37	61	136	263	28	88	61	79	54	3
Peak Hour Factor	0.92	0.92	0.92	0.92	0.92	0.92	0.92	0.92	0.92	0.92	0.92	0.92
Percent Heavy Veh, %	96	94	89	46	71	18	94	89	89	81	75	75
Cap, veh/h	37	248	127	63	371	319	15	200	128	89	257	14
Arrive On Green	0.08	0.26	0.26	0.05	0.23	0.23	0.03	0.31	0.31	0.07	0.35	0.35
Sat Flow, veh/h	455	963	492	1160	1611	1384	483	646	413	1293	740	41
Grp Volume(v), veh/h	75	151	37	61	136	263	28	74	75	79	0	57
Grp Sat Flow(s),veh/h/ln	455	482	492	1160	805	1384	483	552	507	646	0	781
Q Serve(g_s), s	4.7	8.0	3.5	3.0	4.1	10.5	1.8	6.2	7.0	3.5	0.0	3.0
Cycle Q Clear(g_c), s	4.7	8.0	3.5	3.0	4.1	10.5	1.8	6.2	7.0	3.5	0.0	3.0
Prop In Lane	1.00		1.00	1.00		1.00	1.00		0.81	1.00		0.05
Lane Grp Cap(c), veh/h	37	248	127	63	371	319	15	171	157	89	0	271
V/C Ratio(X)	2.03	0.61	0.29	0.96	0.37	0.82	1.85	0.43	0.48	0.89	0.00	0.21
Avail Cap(c_a), veh/h	47	300	153	118	499	429	42	171	157	111	0	271
HCM Platoon Ratio	1.00	1.00	1.00	1.00	1.00	1.00	1.00	1.00	1.00	1.00	1.00	1.00
Upstream Filter(I)	1.00	1.00	1.00	1.00	1.00	1.00	1.00	1.00	1.00	1.00	0.00	1.00
Uniform Delay (d), s/veh	26.7	19.0	17.3	27.4	18.8	21.2	28.1	16.0	16.2	26.8	0.0	13.4
Incr Delay (d2), s/veh	543.8	2.5	1.3	47.4	0.6	9.3	484.3	7.8	10.0	46.7	0.0	1.8
Initial Q Delay(d3),s/veh	0.0	0.0	0.0	0.0	0.0	0.0	0.0	0.0	0.0	0.0	0.0	0.0
%ile BackOfQ(50%),veh/ln	6.1	0.9	0.4	1.6	0.7	3.9	2.2	1.1	1.2	1.1	0.0	0.6
Unsig. Movement Delay, s/veh												
LnGrp Delay(d),s/veh	570.5	21.5	18.6	74.8	19.4	30.6	512.5	23.8	26.3	73.6	0.0	15.1
LnGrp LOS	F	C	B	E	B	C	F	C	C	E	A	B
Approach Vol, veh/h		263			460			177			136	
Approach Delay, s/veh		177.6			33.1			102.2			49.1	
Approach LOS		F			C			F			D	
Timer - Assigned Phs	1	2	3	4	5	6	7	8				
Phs Duration (G+Y+Rc), s	8.5	22.5	7.7	19.5	6.3	24.7	9.2	17.9				
Change Period (Y+Rc), s	4.5	4.5	4.5	4.5	4.5	4.5	4.5	4.5				
Max Green Setting (Gmax), s	5.0	18.0	5.9	18.1	5.0	18.0	6.0	18.0				
Max Q Clear Time (g_c+I1), s	5.5	9.0	5.0	10.0	3.8	5.0	6.7	12.5				
Green Ext Time (p_c), s	0.0	0.5	0.0	0.6	0.0	0.2	0.0	0.9				
Intersection Summary												
HCM 6th Ctrl Delay				83.7								
HCM 6th LOS				F								

HCM 6th Signalized Intersection Summary
7: Frontage Rd - I-80 On-Ramp & Grand Avenue

Eagle Rock Aggregate Terminal
Existing Plus Project AM



Movement	EBL	EBT	EBR	WBL	WBT	WBR	NBL	NBT	NBR	SBL	SBT	SBR
Lane Configurations												
Traffic Volume (veh/h)	58	173	43	119	492	307	52	138	213	165	119	82
Future Volume (veh/h)	58	173	43	119	492	307	52	138	213	165	119	82
Initial Q (Qb), veh	0	0	0	0	0	0	0	0	0	0	0	0
Ped-Bike Adj(A_pbT)	1.00		1.00	1.00		1.00	1.00		1.00	1.00		1.00
Parking Bus, Adj	1.00	1.00	1.00	1.00	1.00	1.00	1.00	1.00	1.00	1.00	1.00	1.00
Work Zone On Approach		No			No			No			No	
Adj Sat Flow, veh/h/ln	700	1722	1722	1426	1826	1752	1648	1441	1441	1767	1248	1248
Adj Flow Rate, veh/h	63	188	47	129	535	334	57	150	232	132	194	89
Peak Hour Factor	0.92	0.92	0.92	0.92	0.92	0.92	0.92	0.92	0.92	0.92	0.92	0.92
Percent Heavy Veh, %	81	12	12	32	5	10	17	31	31	9	44	44
Cap, veh/h	44	569	139	152	918	393	78	402	359	165	562	248
Arrive On Green	0.07	0.22	0.22	0.11	0.26	0.26	0.05	0.29	0.29	0.10	0.34	0.34
Sat Flow, veh/h	666	2607	636	1358	3469	1485	1570	1369	1221	1682	1642	723
Grp Volume(v), veh/h	63	116	119	129	535	334	57	150	232	132	145	138
Grp Sat Flow(s),veh/h/ln	666	1636	1608	1358	1735	1485	1570	1369	1221	1682	1248	1118
Q Serve(g_s), s	4.2	3.9	4.0	6.0	8.7	13.8	2.3	5.6	10.7	5.0	5.6	6.0
Cycle Q Clear(g_c), s	4.2	3.9	4.0	6.0	8.7	13.8	2.3	5.6	10.7	5.0	5.6	6.0
Prop In Lane	1.00		0.40	1.00		1.00	1.00		1.00	1.00		0.65
Lane Grp Cap(c), veh/h	44	357	351	152	918	393	78	402	359	165	427	382
V/C Ratio(X)	1.44	0.33	0.34	0.85	0.58	0.85	0.73	0.37	0.65	0.80	0.34	0.36
Avail Cap(c_a), veh/h	72	455	447	157	992	425	121	402	359	195	427	382
HCM Platoon Ratio	1.00	1.00	1.00	1.00	1.00	1.00	1.00	1.00	1.00	1.00	1.00	1.00
Upstream Filter(I)	1.00	1.00	1.00	1.00	1.00	1.00	1.00	1.00	1.00	1.00	1.00	1.00
Uniform Delay (d), s/veh	30.2	21.3	21.3	28.2	20.7	22.6	30.3	18.1	19.9	28.6	15.8	16.0
Incr Delay (d2), s/veh	277.3	0.5	0.6	32.3	0.8	14.3	12.4	2.6	8.7	18.1	2.2	2.6
Initial Q Delay(d3),s/veh	0.0	0.0	0.0	0.0	0.0	0.0	0.0	0.0	0.0	0.0	0.0	0.0
%ile BackOfQ(50%),veh/ln	4.0	1.4	1.5	3.2	3.4	6.0	1.1	1.9	3.7	2.7	1.7	1.7
Unsig. Movement Delay, s/veh												
LnGrp Delay(d),s/veh	307.5	21.8	21.9	60.5	21.4	36.9	42.7	20.8	28.6	46.6	18.0	18.6
LnGrp LOS	F	C	C	E	C	D	D	C	C	D	B	B
Approach Vol, veh/h		298			998			439			415	
Approach Delay, s/veh		82.3			31.7			27.8			27.3	
Approach LOS		F			C			C			C	
Timer - Assigned Phs	1	2	3	4	5	6	7	8				
Phs Duration (G+Y+Rc), s	10.8	23.5	11.7	18.6	7.7	26.6	8.7	21.6				
Change Period (Y+Rc), s	4.5	4.5	4.5	4.5	4.5	4.5	4.5	4.5				
Max Green Setting (Gmax), s	7.5	19.0	7.5	18.0	5.0	21.5	7.0	18.5				
Max Q Clear Time (g_c+I1), s	7.0	12.7	8.0	6.0	4.3	8.0	6.2	15.8				
Green Ext Time (p_c), s	0.0	1.3	0.0	1.0	0.0	1.4	0.0	1.3				

Intersection Summary

HCM 6th Ctrl Delay	37.0
HCM 6th LOS	D

Notes

User approved volume balancing among the lanes for turning movement.

HCM 6th Signalized Intersection Summary
 8: I-880 SB On-Ramp & 7th Street

Eagle Rock Aggregate Terminal
 Existing Plus Project AM



Movement	EBT	EBR	WBL	WBT	NBL	NBR
Lane Configurations	↑↑		↖↗	↑↑		
Traffic Volume (veh/h)	55	138	148	582	0	0
Future Volume (veh/h)	55	138	148	582	0	0
Initial Q (Qb), veh	0	0	0	0		
Ped-Bike Adj(A_pbT)		1.00	1.00			
Parking Bus, Adj	1.00	1.00	1.00	1.00		
Work Zone On Approach	No			No		
Adj Sat Flow, veh/h/ln	937	937	1455	833		
Adj Flow Rate, veh/h	60	150	161	633		
Peak Hour Factor	0.92	0.92	0.92	0.92		
Percent Heavy Veh, %	65	65	30	72		
Cap, veh/h	295	263	417	1176		
Arrive On Green	0.33	0.33	0.16	0.74		
Sat Flow, veh/h	937	794	2689	1624		
Grp Volume(v), veh/h	60	150	161	633		
Grp Sat Flow(s),veh/h/ln	890	794	1345	791		
Q Serve(g_s), s	0.8	2.7	0.9	3.0		
Cycle Q Clear(g_c), s	0.8	2.7	0.9	3.0		
Prop In Lane		1.00	1.00			
Lane Grp Cap(c), veh/h	295	263	417	1176		
V/C Ratio(X)	0.20	0.57	0.39	0.54		
Avail Cap(c_a), veh/h	1092	974	1458	3207		
HCM Platoon Ratio	1.00	1.00	1.00	1.00		
Upstream Filter(I)	1.00	1.00	1.00	1.00		
Uniform Delay (d), s/veh	4.2	4.8	6.7	1.0		
Incr Delay (d2), s/veh	0.3	1.9	0.6	0.4		
Initial Q Delay(d3),s/veh	0.0	0.0	0.0	0.0		
%ile BackOfQ(50%),veh/ln	0.1	0.2	0.1	0.1		
Unsig. Movement Delay, s/veh						
LnGrp Delay(d),s/veh	4.5	6.8	7.2	1.3		
LnGrp LOS	A	A	A	A		
Approach Vol, veh/h	210			794		
Approach Delay, s/veh	6.1			2.5		
Approach LOS	A			A		
Timer - Assigned Phs			3	4		8
Phs Duration (G+Y+Rc), s			7.2	10.3		17.5
Change Period (Y+Rc), s			4.5	4.5		4.5
Max Green Setting (Gmax), s			9.5	21.5		35.5
Max Q Clear Time (g_c+I1), s			2.9	4.7		5.0
Green Ext Time (p_c), s			0.3	1.2		5.3
Intersection Summary						
HCM 6th Ctrl Delay			3.3			
HCM 6th LOS			A			

HCM 6th Signalized Intersection Summary
 9: I-880 NB Off-Ramp - Frontage Road & 7th Street

Eagle Rock Aggregate Terminal
 Existing Plus Project AM



Movement	EBL	EBT	EBR	WBL	WBT	WBR	NBL	NBT	NBR	SBL	SBT	SBR
Lane Configurations	↘	↑↑			↑↑		↘	↔		↘		↗
Traffic Volume (veh/h)	22	18	0	0	191	93	311	181	79	69	0	154
Future Volume (veh/h)	22	18	0	0	191	93	311	181	79	69	0	154
Initial Q (Qb), veh	0	0	0	0	0	0	0	0	0	0	0	0
Ped-Bike Adj(A_pbT)	1.00		1.00	1.00		1.00	1.00		1.00	1.00		1.00
Parking Bus, Adj	1.00	1.00	1.00	1.00	1.00	1.00	1.00	1.00	1.00	1.00	1.00	1.00
Work Zone On Approach		No			No			No			No	
Adj Sat Flow, veh/h/ln	744	1530	0	0	1767	1767	1292	1663	1663	1589	0	1900
Adj Flow Rate, veh/h	24	20	0	0	208	101	207	380	86	75	0	167
Peak Hour Factor	0.92	0.92	0.92	0.92	0.92	0.92	0.92	0.92	0.92	0.92	0.92	0.92
Percent Heavy Veh, %	78	25	0	0	9	9	41	16	16	21	0	0
Cap, veh/h	47	1066	0	0	533	249	254	954	214	137	0	0
Arrive On Green	0.07	0.37	0.00	0.00	0.24	0.24	0.21	0.36	0.36	0.09	0.00	0.00
Sat Flow, veh/h	709	2983	0	0	2308	1038	1231	2631	589	1513	75	
Grp Volume(v), veh/h	24	20	0	0	155	154	207	239	227	75	47.4	
Grp Sat Flow(s),veh/h/ln	709	1453	0	0	1678	1580	1231	1663	1557	1513	D	
Q Serve(g_s), s	2.5	0.3	0.0	0.0	5.8	6.1	12.0	8.0	8.2	3.6		
Cycle Q Clear(g_c), s	2.5	0.3	0.0	0.0	5.8	6.1	12.0	8.0	8.2	3.6		
Prop In Lane	1.00		0.00	0.00		0.66	1.00		0.38	1.00		
Lane Grp Cap(c), veh/h	47	1066	0	0	403	379	254	603	565	137		
V/C Ratio(X)	0.51	0.02	0.00	0.00	0.39	0.41	0.81	0.40	0.40	0.55		
Avail Cap(c_a), veh/h	47	1066	0	0	403	379	254	603	565	137		
HCM Platoon Ratio	1.00	1.00	1.00	1.00	1.00	1.00	1.00	1.00	1.00	1.00		
Upstream Filter(I)	1.00	1.00	0.00	0.00	1.00	1.00	1.00	1.00	1.00	1.00		
Uniform Delay (d), s/veh	33.8	15.1	0.0	0.0	23.9	24.0	28.4	17.8	17.8	32.6		
Incr Delay (d2), s/veh	34.1	0.0	0.0	0.0	2.8	3.2	24.0	1.9	2.1	14.8		
Initial Q Delay(d3),s/veh	0.0	0.0	0.0	0.0	0.0	0.0	0.0	0.0	0.0	0.0		
%ile BackOfQ(50%),veh/ln	0.9	0.1	0.0	0.0	2.5	2.5	5.1	3.2	3.1	1.8		
Unsig. Movement Delay, s/veh												
LnGrp Delay(d),s/veh	67.9	15.2	0.0	0.0	26.6	27.2	52.4	19.7	20.0	47.4		
LnGrp LOS	E	B	A	A	C	C	D	B	B	D		
Approach Vol, veh/h		44			309			673				
Approach Delay, s/veh		43.9			26.9			29.9				
Approach LOS		D			C			C				
Timer - Assigned Phs	1	2		4	5		7	8				
Phs Duration (G+Y+Rc), s	11.3	31.7		32.0	20.0		9.5	22.5				
Change Period (Y+Rc), s	4.5	4.5		4.5	4.5		4.5	4.5				
Max Green Setting (Gmax), s	6.8	27.2		27.5	15.5		5.0	18.0				
Max Q Clear Time (g_c+I1), s	5.6	10.2		2.3	14.0		4.5	8.1				
Green Ext Time (p_c), s	0.0	2.6		0.1	0.1		0.0	1.2				

Intersection Summary

HCM 6th Ctrl Delay	30.8
HCM 6th LOS	C

Notes

User approved volume balancing among the lanes for turning movement.

HCM 6th Signalized Intersection Summary

Eagle Rock Aggregate Terminal

1: Maritime Street & I-80 West & I-580 East Ramp - Grand Avenue

Existing Plus Project PM

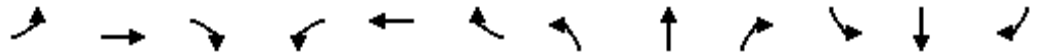

Movement	EBL	EBT	EBR	WBL	WBT	WBR	NBL	NBT	NBR	SBL	SBT	SBR
Lane Configurations	↘	↑↑	↗	↘	↑↑		↘	↑	↗	↘	↑↑	
Traffic Volume (veh/h)	9	1010	141	56	446	8	156	1	149	17	1	13
Future Volume (veh/h)	9	1010	141	56	446	8	156	1	149	17	1	13
Initial Q (Qb), veh	0	0	0	0	0	0	0	0	0	0	0	0
Ped-Bike Adj(A_pbT)	1.00		1.00	1.00		1.00	1.00		1.00	1.00		1.00
Parking Bus, Adj	1.00	1.00	1.00	1.00	1.00	1.00	1.00	1.00	1.00	1.00	1.00	1.00
Work Zone On Approach		No			No			No			No	
Adj Sat Flow, veh/h/ln	1559	1841	1530	1337	1826	1826	1841	1307	1574	1604	1159	1159
Adj Flow Rate, veh/h	10	1098	153	61	485	9	171	0	162	18	1	14
Peak Hour Factor	0.92	0.92	0.92	0.92	0.92	0.92	0.92	0.92	0.92	0.92	0.92	0.92
Percent Heavy Veh, %	23	4	25	38	5	5	4	40	22	20	50	50
Cap, veh/h	19	1231	551	68	1368	25	255	0	435	32	303	270
Arrive On Green	0.01	0.35	0.35	0.05	0.39	0.39	0.07	0.00	0.33	0.02	0.27	0.27
Sat Flow, veh/h	1485	3497	1296	1273	3484	65	3506	0	1334	1527	1101	982
Grp Volume(v), veh/h	10	1098	153	61	241	253	171	0	162	18	1	14
Grp Sat Flow(s),veh/h/ln	1485	1749	1296	1273	1735	1814	1753	0	1334	1527	1101	982
Q Serve(g_s), s	0.5	21.6	5.6	3.5	7.1	7.2	3.5	0.0	6.8	0.8	0.0	0.8
Cycle Q Clear(g_c), s	0.5	21.6	5.6	3.5	7.1	7.2	3.5	0.0	6.8	0.8	0.0	0.8
Prop In Lane	1.00		1.00	1.00		0.04	1.00		1.00	1.00		1.00
Lane Grp Cap(c), veh/h	19	1231	551	68	681	712	255	0	435	32	303	270
V/C Ratio(X)	0.54	0.89	0.28	0.90	0.35	0.35	0.67	0.00	0.37	0.56	0.00	0.05
Avail Cap(c_a), veh/h	102	1273	566	87	681	712	265	0	435	105	303	270
HCM Platoon Ratio	1.00	1.00	1.00	1.00	1.00	1.00	1.00	1.00	1.00	1.00	1.00	1.00
Upstream Filter(I)	1.00	1.00	1.00	1.00	1.00	1.00	1.00	0.00	1.00	1.00	1.00	1.00
Uniform Delay (d), s/veh	35.7	22.3	13.7	34.3	15.6	15.6	32.9	0.0	18.8	35.3	19.2	19.4
Incr Delay (d2), s/veh	21.8	8.1	0.3	56.0	0.3	0.3	6.1	0.0	2.4	14.5	0.0	0.4
Initial Q Delay(d3),s/veh	0.0	0.0	0.0	0.0	0.0	0.0	0.0	0.0	0.0	0.0	0.0	0.0
%ile BackOfQ(50%),veh/ln	0.3	9.6	1.6	2.1	2.7	2.8	1.6	0.0	2.3	0.4	0.0	0.2
Unsig. Movement Delay, s/veh												
LnGrp Delay(d),s/veh	57.5	30.4	13.9	90.2	15.9	15.9	39.0	0.0	21.2	49.8	19.2	19.8
LnGrp LOS	E	C	B	F	B	B	D	A	C	D	B	B
Approach Vol, veh/h		1261			555			333				33
Approach Delay, s/veh		28.6			24.1			30.4				36.2
Approach LOS		C			C			C				D
Timer - Assigned Phs	1	2	3	4	5	6	7	8				
Phs Duration (G+Y+Rc), s	6.0	28.3	8.4	30.1	9.8	24.5	5.4	33.1				
Change Period (Y+Rc), s	4.5	4.5	4.5	4.5	4.5	4.5	4.5	4.5				
Max Green Setting (Gmax), s	5.0	20.5	5.0	26.5	5.5	20.0	5.0	26.5				
Max Q Clear Time (g_c+I1), s	2.8	8.8	5.5	23.6	5.5	2.8	2.5	9.2				
Green Ext Time (p_c), s	0.0	0.4	0.0	2.0	0.0	0.0	0.0	2.7				

Intersection Summary

HCM 6th Ctrl Delay	27.8
HCM 6th LOS	C

Notes

User approved volume balancing among the lanes for turning movement.

HCM 6th Signalized Intersection Summary
2: Burma Road & Maritime Street

Eagle Rock Aggregate Terminal
Existing Plus Project PM



Movement	EBL	EBT	EBR	WBL	WBT	WBR	NBL	NBT	NBR	SBL	SBT	SBR
Lane Configurations	↖	↗		↖	↗		↖	↗		↖	↗	
Traffic Volume (veh/h)	76	0	24	0	0	6	26	278	5	2	171	24
Future Volume (veh/h)	76	0	24	0	0	6	26	278	5	2	171	24
Initial Q (Qb), veh	0	0	0	0	0	0	0	0	0	0	0	0
Ped-Bike Adj(A_pbT)	1.00		1.00	1.00		1.00	1.00		1.00	1.00		1.00
Parking Bus, Adj	1.00	1.00	1.00	1.00	1.00	1.00	1.00	1.00	1.00	1.00	1.00	1.00
Work Zone On Approach		No			No			No			No	
Adj Sat Flow, veh/h/ln	1841	1870	1870	1870	1870	1870	581	1678	1678	907	1441	1441
Adj Flow Rate, veh/h	83	0	26	0	0	7	28	302	5	2	186	26
Peak Hour Factor	0.92	0.92	0.92	0.92	0.92	0.92	0.92	0.92	0.92	0.92	0.92	0.92
Percent Heavy Veh, %	4	2	2	2	2	2	89	15	15	67	31	31
Cap, veh/h	322	168	150	5	0	150	19	1717	28	2	1218	168
Arrive On Green	0.09	0.00	0.09	0.00	0.00	0.09	0.03	0.54	0.54	0.00	0.50	0.50
Sat Flow, veh/h	1386	1777	1585	1781	0	1585	553	3209	53	864	2416	333
Grp Volume(v), veh/h	83	0	26	0	0	7	28	150	157	2	104	108
Grp Sat Flow(s),veh/h/ln	1386	1777	1585	1781	0	1585	553	1594	1668	864	1369	1381
Q Serve(g_s), s	2.1	0.0	0.6	0.0	0.0	0.1	1.2	1.8	1.8	0.1	1.5	1.5
Cycle Q Clear(g_c), s	2.3	0.0	0.6	0.0	0.0	0.1	1.2	1.8	1.8	0.1	1.5	1.5
Prop In Lane	1.00		1.00	1.00		1.00	1.00		0.03	1.00		0.24
Lane Grp Cap(c), veh/h	322	168	150	5	0	150	19	853	893	2	690	696
V/C Ratio(X)	0.26	0.00	0.17	0.00	0.00	0.05	1.50	0.18	0.18	0.84	0.15	0.15
Avail Cap(c_a), veh/h	870	871	777	243	0	1187	83	853	893	118	690	696
HCM Platoon Ratio	1.00	1.00	1.00	1.00	1.00	1.00	1.00	1.00	1.00	1.00	1.00	1.00
Upstream Filter(I)	1.00	0.00	1.00	0.00	0.00	1.00	1.00	1.00	1.00	1.00	1.00	1.00
Uniform Delay (d), s/veh	16.2	0.0	15.3	0.0	0.0	15.1	17.7	4.4	4.4	18.3	4.9	4.9
Incr Delay (d2), s/veh	0.4	0.0	0.5	0.0	0.0	0.1	274.1	0.4	0.4	216.0	0.5	0.5
Initial Q Delay(d3),s/veh	0.0	0.0	0.0	0.0	0.0	0.0	0.0	0.0	0.0	0.0	0.0	0.0
%ile BackOfQ(50%),veh/ln	0.6	0.0	0.2	0.0	0.0	0.1	1.6	0.4	0.4	0.2	0.3	0.3
Unsig. Movement Delay, s/veh												
LnGrp Delay(d),s/veh	16.6	0.0	15.8	0.0	0.0	15.2	291.8	4.8	4.8	234.3	5.4	5.4
LnGrp LOS	B	A	B	A	A	B	F	A	A	F	A	A
Approach Vol, veh/h		109			7			335			214	
Approach Delay, s/veh		16.4			15.2			28.8			7.5	
Approach LOS		B			B			C			A	
Timer - Assigned Phs	1	2	3	4	5	6		8				
Phs Duration (G+Y+Rc), s	4.6	24.1	0.0	8.0	5.7	23.0		8.0				
Change Period (Y+Rc), s	4.5	4.5	4.5	4.5	4.5	4.5		4.5				
Max Green Setting (Gmax), s	5.0	19.0	5.0	18.0	5.5	18.5		27.5				
Max Q Clear Time (g_c+I1), s	2.1	3.8	0.0	4.3	3.2	3.5		2.1				
Green Ext Time (p_c), s	0.0	1.5	0.0	0.2	0.0	1.0		0.0				
Intersection Summary												
HCM 6th Ctrl Delay				19.8								
HCM 6th LOS				B								

HCM 6th Signalized Intersection Summary
 3: Maritime Street & 17th Street



















Eagle Rock Aggregate Terminal
 Existing Plus Project PM



Movement	EBL	EBT	EBR	WBL	WBT	WBR	NBL	NBT	NBR	SBL	SBT	SBR
Lane Configurations		↕			↕		↕	↕		↕	↕	
Traffic Volume (veh/h)	64	0	96	12	1	30	137	254	22	2	113	28
Future Volume (veh/h)	64	0	96	12	1	30	137	254	22	2	113	28
Initial Q (Qb), veh	0	0	0	0	0	0	0	0	0	0	0	0
Ped-Bike Adj(A_pbT)	1.00		1.00	1.00		1.00	1.00		1.00	1.00		1.00
Parking Bus, Adj	1.00	1.00	1.00	1.00	1.00	1.00	1.00	1.00	1.00	1.00	1.00	1.00
Work Zone On Approach		No			No			No			No	
Adj Sat Flow, veh/h/ln	1870	1870	1870	418	418	418	522	1648	1648	907	1515	1515
Adj Flow Rate, veh/h	70	0	104	13	1	33	149	276	24	2	123	30
Peak Hour Factor	0.92	0.92	0.92	0.92	0.92	0.92	0.92	0.92	0.92	0.92	0.92	0.92
Percent Heavy Veh, %	2	2	2	100	100	100	93	17	17	67	26	26
Cap, veh/h	187	19	155	100	9	40	105	1660	143	2	834	198
Arrive On Green	0.16	0.00	0.16	0.16	0.16	0.16	0.21	0.57	0.57	0.00	0.36	0.36
Sat Flow, veh/h	545	119	987	51	57	254	497	2917	252	864	2308	547
Grp Volume(v), veh/h	174	0	0	47	0	0	149	147	153	2	75	78
Grp Sat Flow(s),veh/h/ln	1651	0	0	362	0	0	497	1566	1603	864	1439	1416
Q Serve(g_s), s	0.0	0.0	0.0	1.3	0.0	0.0	10.5	2.2	2.3	0.1	1.8	1.8
Cycle Q Clear(g_c), s	4.8	0.0	0.0	6.1	0.0	0.0	10.5	2.2	2.3	0.1	1.8	1.8
Prop In Lane	0.40		0.60	0.28		0.70	1.00		0.16	1.00		0.39
Lane Grp Cap(c), veh/h	361	0	0	149	0	0	105	891	912	2	520	512
V/C Ratio(X)	0.48	0.00	0.00	0.32	0.00	0.00	1.42	0.17	0.17	0.85	0.14	0.15
Avail Cap(c_a), veh/h	665	0	0	217	0	0	105	891	912	87	520	512
HCM Platoon Ratio	1.00	1.00	1.00	1.00	1.00	1.00	1.00	1.00	1.00	1.00	1.00	1.00
Upstream Filter(I)	1.00	0.00	0.00	1.00	0.00	0.00	1.00	1.00	1.00	1.00	1.00	1.00
Uniform Delay (d), s/veh	19.7	0.0	0.0	20.2	0.0	0.0	19.7	5.1	5.1	24.8	10.7	10.8
Incr Delay (d2), s/veh	1.0	0.0	0.0	1.2	0.0	0.0	236.9	0.4	0.4	217.5	0.6	0.6
Initial Q Delay(d3),s/veh	0.0	0.0	0.0	0.0	0.0	0.0	0.0	0.0	0.0	0.0	0.0	0.0
%ile BackOfQ(50%),veh/ln	1.8	0.0	0.0	0.5	0.0	0.0	8.0	0.6	0.6	0.2	0.6	0.6
Unsig. Movement Delay, s/veh												
LnGrp Delay(d),s/veh	20.7	0.0	0.0	21.4	0.0	0.0	256.5	5.5	5.5	242.4	11.3	11.4
LnGrp LOS	C	A	A	C	A	A	F	A	A	F	B	B
Approach Vol, veh/h		174			47			449				155
Approach Delay, s/veh		20.7			21.4			88.8				14.3
Approach LOS		C			C			F				B
Timer - Assigned Phs	1	2		4	5	6		8				
Phs Duration (G+Y+Rc), s	4.6	32.9		12.3	15.0	22.5		12.3				
Change Period (Y+Rc), s	4.5	4.5		4.5	4.5	4.5		4.5				
Max Green Setting (Gmax), s	5.0	23.5		18.0	10.5	18.0		18.0				
Max Q Clear Time (g_c+I1), s	2.1	4.3		6.8	12.5	3.8		8.1				
Green Ext Time (p_c), s	0.0	1.6		0.7	0.0	0.6		0.1				
Intersection Summary												
HCM 6th Ctrl Delay				56.6								
HCM 6th LOS				E								

HCM 6th Signalized Intersection Summary
4: Maritime Street & 14th Street

Eagle Rock Aggregate Terminal
Existing Plus Project PM

												
Movement	EBL	EBT	EBR	WBL	WBT	WBR	NBL	NBT	NBR	SBL	SBT	SBR
Lane Configurations												
Traffic Volume (veh/h)	38	8	61	73	9	65	99	294	53	17	185	12
Future Volume (veh/h)	38	8	61	73	9	65	99	294	53	17	185	12
Initial Q (Qb), veh	0	0	0	0	0	0	0	0	0	0	0	0
Ped-Bike Adj(A_pbT)	1.00		1.00	1.00		1.00	1.00		1.00	1.00		1.00
Parking Bus, Adj	1.00	1.00	1.00	1.00	1.00	1.00	1.00	1.00	1.00	1.00	1.00	1.00
Work Zone On Approach		No			No			No			No	
Adj Sat Flow, veh/h/ln	566	566	566	714	714	714	596	1100	1100	1100	1292	1292
Adj Flow Rate, veh/h	41	9	66	79	10	71	108	320	58	18	201	13
Peak Hour Factor	0.92	0.92	0.92	0.92	0.92	0.92	0.92	0.92	0.92	0.92	0.92	0.92
Percent Heavy Veh, %	90	90	90	80	80	80	88	54	54	54	41	41
Cap, veh/h	119	21	77	153	21	67	95	794	142	23	709	46
Arrive On Green	0.30	0.30	0.30	0.30	0.30	0.30	0.17	0.45	0.45	0.02	0.30	0.30
Sat Flow, veh/h	122	71	254	207	68	220	567	1770	317	1047	2343	150
Grp Volume(v), veh/h	116	0	0	160	0	0	108	187	191	18	105	109
Grp Sat Flow(s),veh/h/ln	447	0	0	495	0	0	567	1045	1043	1047	1228	1265
Q Serve(g_s), s	0.0	0.0	0.0	3.6	0.0	0.0	10.0	7.2	7.3	1.0	3.9	3.9
Cycle Q Clear(g_c), s	14.4	0.0	0.0	18.0	0.0	0.0	10.0	7.2	7.3	1.0	3.9	3.9
Prop In Lane	0.35		0.57	0.49		0.44	1.00		0.30	1.00		0.12
Lane Grp Cap(c), veh/h	217	0	0	240	0	0	95	469	468	23	372	383
V/C Ratio(X)	0.53	0.00	0.00	0.67	0.00	0.00	1.14	0.40	0.41	0.79	0.28	0.29
Avail Cap(c_a), veh/h	217	0	0	240	0	0	100	469	468	88	372	383
HCM Platoon Ratio	1.00	1.00	1.00	1.00	1.00	1.00	1.00	1.00	1.00	1.00	1.00	1.00
Upstream Filter(I)	1.00	0.00	0.00	1.00	0.00	0.00	1.00	1.00	1.00	1.00	1.00	1.00
Uniform Delay (d), s/veh	19.2	0.0	0.0	21.2	0.0	0.0	24.7	11.0	11.1	29.0	15.8	15.8
Incr Delay (d2), s/veh	2.5	0.0	0.0	6.8	0.0	0.0	133.3	2.5	2.6	44.7	1.9	1.9
Initial Q Delay(d3),s/veh	0.0	0.0	0.0	0.0	0.0	0.0	0.0	0.0	0.0	0.0	0.0	0.0
%ile BackOfQ(50%),veh/ln	1.5	0.0	0.0	2.5	0.0	0.0	4.8	1.7	1.8	0.5	1.2	1.2
Unsig. Movement Delay, s/veh												
LnGrp Delay(d),s/veh	21.8	0.0	0.0	28.0	0.0	0.0	158.1	13.5	13.7	73.7	17.7	17.7
LnGrp LOS	C	A	A	C	A	A	F	B	B	E	B	B
Approach Vol, veh/h		116			160			486			232	
Approach Delay, s/veh		21.8			28.0			45.7			22.0	
Approach LOS		C			C			D			C	
Timer - Assigned Phs	1	2		4	5	6		8				
Phs Duration (G+Y+Rc), s	5.8	31.2		22.5	14.5	22.5		22.5				
Change Period (Y+Rc), s	4.5	4.5		4.5	4.5	4.5		4.5				
Max Green Setting (Gmax), s	5.0	23.5		18.0	10.5	18.0		18.0				
Max Q Clear Time (g_c+I1), s	3.0	9.3		16.4	12.0	5.9		20.0				
Green Ext Time (p_c), s	0.0	2.0		0.1	0.0	0.9		0.0				
Intersection Summary												
HCM 6th Ctrl Delay				34.5								
HCM 6th LOS				C								

HCM 6th Signalized Intersection Summary
5: Maritime Street & Navy Roadway

Eagle Rock Aggregate Terminal
Existing Plus Project PM



Movement	EBL	EBR	NBL	NBT	SBT	SBR
Lane Configurations						
Traffic Volume (veh/h)	4	2	17	430	225	91
Future Volume (veh/h)	4	2	17	430	225	91
Initial Q (Qb), veh	0	0	0	0	0	0
Ped-Bike Adj(A_pbT)	1.00	1.00	1.00			1.00
Parking Bus, Adj	1.00	1.00	1.00	1.00	1.00	1.00
Work Zone On Approach	No			No	No	
Adj Sat Flow, veh/h/ln	1752	1900	833	877	1278	1278
Adj Flow Rate, veh/h	3	3	18	467	245	99
Peak Hour Factor	0.92	0.92	0.92	0.92	0.92	0.92
Percent Heavy Veh, %	10	0	72	69	42	42
Cap, veh/h	13	13	460	1251	1034	406
Arrive On Green	0.01	0.01	0.02	0.75	0.61	0.61
Sat Flow, veh/h	1668	1610	793	1711	1766	669
Grp Volume(v), veh/h	3	3	18	467	173	171
Grp Sat Flow(s),veh/h/ln	1668	1610	793	834	1214	1157
Q Serve(g_s), s	0.1	0.1	0.3	3.6	2.4	2.5
Cycle Q Clear(g_c), s	0.1	0.1	0.3	3.6	2.4	2.5
Prop In Lane	1.00	1.00	1.00			0.58
Lane Grp Cap(c), veh/h	13	13	460	1251	737	703
V/C Ratio(X)	0.22	0.23	0.04	0.37	0.23	0.24
Avail Cap(c_a), veh/h	805	777	548	1251	737	703
HCM Platoon Ratio	1.00	1.00	1.00	1.00	1.00	1.00
Upstream Filter(I)	1.00	1.00	1.00	1.00	1.00	1.00
Uniform Delay (d), s/veh	18.4	18.4	2.2	1.6	3.4	3.4
Incr Delay (d2), s/veh	8.1	8.7	0.0	0.9	0.7	0.8
Initial Q Delay(d3),s/veh	0.0	0.0	0.0	0.0	0.0	0.0
%ile BackOfQ(50%),veh/ln	0.1	0.0	0.0	0.1	0.4	0.4
Unsig. Movement Delay, s/veh						
LnGrp Delay(d),s/veh	26.5	27.1	2.2	2.5	4.1	4.2
LnGrp LOS	C	C	A	A	A	A
Approach Vol, veh/h	6			485	344	
Approach Delay, s/veh	26.8			2.5	4.2	
Approach LOS	C			A	A	
Timer - Assigned Phs		2		4	5	6
Phs Duration (G+Y+Rc), s		32.5		4.8	5.4	27.1
Change Period (Y+Rc), s		4.5		4.5	4.5	4.5
Max Green Setting (Gmax), s		28.0		18.0	5.0	18.5
Max Q Clear Time (g_c+I1), s		5.6		2.1	2.3	4.5
Green Ext Time (p_c), s		3.4		0.0	0.0	1.8

Intersection Summary























HCM 6th Ctrl Delay	3.3
HCM 6th LOS	A

Notes

User approved volume balancing among the lanes for turning movement.

HCM 6th Signalized Intersection Summary
6: 7th Street & Maritime Street

Eagle Rock Aggregate Terminal
Existing Plus Project PM

												
Movement	EBL	EBT	EBR	WBL	WBT	WBR	NBL	NBT	NBR	SBL	SBT	SBR
Lane Configurations												
Traffic Volume (veh/h)	174	148	12	36	58	85	1	209	67	163	73	0
Future Volume (veh/h)	174	148	12	36	58	85	1	209	67	163	73	0
Initial Q (Qb), veh	0	0	0	0	0	0	0	0	0	0	0	0
Ped-Bike Adj(A_pbT)	1.00		1.00	1.00		1.00	1.00		1.00	1.00		1.00
Parking Bus, Adj	1.00	1.00	1.00	1.00	1.00	1.00	1.00	1.00	1.00	1.00	1.00	1.00
Work Zone On Approach		No			No			No			No	
Adj Sat Flow, veh/h/ln	1203	1470	996	1026	1618	937	418	640	640	1426	1070	1070
Adj Flow Rate, veh/h	189	161	13	39	63	92	1	227	73	177	79	0
Peak Hour Factor	0.92	0.92	0.92	0.92	0.92	0.92	0.92	0.92	0.92	0.92	0.92	0.92
Percent Heavy Veh, %	47	29	61	59	19	65	100	85	85	32	56	56
Cap, veh/h	213	826	250	38	456	118	1	268	84	244	412	0
Arrive On Green	0.19	0.30	0.30	0.04	0.15	0.15	0.00	0.29	0.29	0.09	0.39	0.00
Sat Flow, veh/h	1146	2793	844	977	3075	794	398	912	286	2634	1070	0
Grp Volume(v), veh/h	189	161	13	39	63	92	1	149	151	177	79	0
Grp Sat Flow(s),veh/h/ln	1146	1397	844	977	1537	794	398	608	589	1317	1070	0
Q Serve(g_s), s	10.4	2.8	0.7	2.5	1.2	7.2	0.1	14.9	15.7	4.2	3.2	0.0
Cycle Q Clear(g_c), s	10.4	2.8	0.7	2.5	1.2	7.2	0.1	14.9	15.7	4.2	3.2	0.0
Prop In Lane	1.00		1.00	1.00		1.00	1.00		0.49	1.00		0.00
Lane Grp Cap(c), veh/h	213	826	250	38	456	118	1	179	173	244	412	0
V/C Ratio(X)	0.89	0.19	0.05	1.02	0.14	0.78	1.62	0.84	0.87	0.73	0.19	0.00
Avail Cap(c_a), veh/h	240	986	298	132	857	221	31	179	173	265	412	0
HCM Platoon Ratio	1.00	1.00	1.00	1.00	1.00	1.00	1.00	1.00	1.00	1.00	1.00	1.00
Upstream Filter(I)	1.00	1.00	1.00	1.00	1.00	1.00	1.00	1.00	1.00	1.00	1.00	0.00
Uniform Delay (d), s/veh	25.6	17.0	16.3	31.0	23.9	26.5	32.2	21.3	21.6	28.5	13.2	0.0
Incr Delay (d2), s/veh	28.2	0.1	0.1	74.5	0.1	10.6	832.9	34.8	40.7	8.7	1.0	0.0
Initial Q Delay(d3),s/veh	0.0	0.0	0.0	0.0	0.0	0.0	0.0	0.0	0.0	0.0	0.0	0.0
%ile BackOfQ(50%),veh/ln	4.3	0.8	0.1	1.4	0.4	1.6	0.2	3.7	3.9	1.6	0.8	0.0
Unsig. Movement Delay, s/veh												
LnGrp Delay(d),s/veh	53.9	17.1	16.4	105.5	24.0	37.1	865.2	56.1	62.3	37.3	14.2	0.0
LnGrp LOS	D	B	B	F	C	D	F	E	E	D	B	A
Approach Vol, veh/h		363			194			301			256	
Approach Delay, s/veh		36.2			46.6			61.9			30.1	
Approach LOS		D			D			E			C	
Timer - Assigned Phs	1	2	3	4	5	6	7	8				
Phs Duration (G+Y+Rc), s	10.5	23.5	7.0	23.6	4.6	29.4	16.5	14.1				
Change Period (Y+Rc), s	4.5	4.5	4.5	4.5	4.5	4.5	4.5	4.5				
Max Green Setting (Gmax), s	6.5	19.0	8.7	22.8	5.0	20.5	13.5	18.0				
Max Q Clear Time (g_c+I1), s	6.2	17.7	4.5	4.8	2.1	5.2	12.4	9.2				
Green Ext Time (p_c), s	0.0	0.3	0.0	0.9	0.0	0.3	0.1	0.4				
Intersection Summary												
HCM 6th Ctrl Delay			43.6									
HCM 6th LOS			D									

HCM 6th Signalized Intersection Summary
 7: Frontage Rd - I-80 On-Ramp & Grand Avenue

Eagle Rock Aggregate Terminal
 Existing Plus Project PM



Movement	EBL	EBT	EBR	WBL	WBT	WBR	NBL	NBT	NBR	SBL	SBT	SBR
Lane Configurations	↗	↗↘		↗	↗↘	↗	↗	↗↘		↗	↗↘	
Traffic Volume (veh/h)	302	768	80	65	456	155	46	84	265	387	117	25
Future Volume (veh/h)	302	768	80	65	456	155	46	84	265	387	117	25
Initial Q (Qb), veh	0	0	0	0	0	0	0	0	0	0	0	0
Ped-Bike Adj(A_pbT)	1.00		1.00	1.00		1.00	1.00		1.00	1.00		1.00
Parking Bus, Adj	1.00	1.00	1.00	1.00	1.00	1.00	1.00	1.00	1.00	1.00	1.00	1.00
Work Zone On Approach		No			No			No			No	
Adj Sat Flow, veh/h/ln	1678	1841	1841	1752	1826	1826	1648	1618	1618	1841	1648	1648
Adj Flow Rate, veh/h	328	835	87	71	496	168	50	91	288	421	127	27
Peak Hour Factor	0.92	0.92	0.92	0.92	0.92	0.92	0.92	0.92	0.92	0.92	0.92	0.92
Percent Heavy Veh, %	15	4	4	10	5	5	17	19	19	4	17	17
Cap, veh/h	362	1131	118	89	627	280	65	352	314	513	440	94
Arrive On Green	0.23	0.35	0.35	0.05	0.18	0.18	0.04	0.23	0.23	0.15	0.33	0.33
Sat Flow, veh/h	1598	3196	333	1668	3469	1547	1570	1537	1372	3506	1318	280
Grp Volume(v), veh/h	328	457	465	71	496	168	50	91	288	421	0	154
Grp Sat Flow(s),veh/h/ln	1598	1749	1781	1668	1735	1547	1570	1537	1372	1753	0	1598
Q Serve(g_s), s	16.6	18.9	18.9	3.5	11.3	8.3	2.6	4.0	17.0	9.7	0.0	5.9
Cycle Q Clear(g_c), s	16.6	18.9	18.9	3.5	11.3	8.3	2.6	4.0	17.0	9.7	0.0	5.9
Prop In Lane	1.00		0.19	1.00		1.00	1.00		1.00	1.00		0.18
Lane Grp Cap(c), veh/h	362	619	630	89	627	280	65	352	314	513	0	534
V/C Ratio(X)	0.91	0.74	0.74	0.80	0.79	0.60	0.77	0.26	0.92	0.82	0.00	0.29
Avail Cap(c_a), veh/h	395	667	679	139	753	336	142	352	314	613	0	534
HCM Platoon Ratio	1.00	1.00	1.00	1.00	1.00	1.00	1.00	1.00	1.00	1.00	1.00	1.00
Upstream Filter(I)	1.00	1.00	1.00	1.00	1.00	1.00	1.00	1.00	1.00	1.00	0.00	1.00
Uniform Delay (d), s/veh	31.2	23.4	23.4	38.8	32.5	31.2	39.3	26.2	31.2	34.3	0.0	20.3
Incr Delay (d2), s/veh	22.9	4.0	4.0	15.7	4.8	2.1	17.4	1.8	33.2	7.5	0.0	1.4
Initial Q Delay(d3),s/veh	0.0	0.0	0.0	0.0	0.0	0.0	0.0	0.0	0.0	0.0	0.0	0.0
%ile BackOfQ(50%),veh/ln	8.5	8.1	8.2	1.8	5.0	3.2	1.3	1.6	8.3	4.5	0.0	2.3
Unsig. Movement Delay, s/veh												
LnGrp Delay(d),s/veh	54.1	27.4	27.4	54.5	37.3	33.3	56.8	27.9	64.4	41.8	0.0	21.7
LnGrp LOS	D	C	C	D	D	C	E	C	E	D	A	C
Approach Vol, veh/h		1250			735			429				575
Approach Delay, s/veh		34.4			38.0			55.8				36.4
Approach LOS		C			D			E				D
Timer - Assigned Phs	1	2	3	4	5	6	7	8				
Phs Duration (G+Y+Rc), s	16.6	23.5	8.9	33.8	7.9	32.2	23.3	19.5				
Change Period (Y+Rc), s	4.5	4.5	4.5	4.5	4.5	4.5	4.5	4.5				
Max Green Setting (Gmax), s	14.5	19.0	6.9	31.6	7.5	26.0	20.5	18.0				
Max Q Clear Time (g_c+I1), s	11.7	19.0	5.5	20.9	4.6	7.9	18.6	13.3				
Green Ext Time (p_c), s	0.5	0.0	0.0	4.4	0.0	0.7	0.2	1.7				

Intersection Summary

HCM 6th Ctrl Delay	38.7
HCM 6th LOS	D

Notes

User approved volume balancing among the lanes for turning movement.

HCM 6th Signalized Intersection Summary
 8: I-880 SB On-Ramp & 7th Street

Eagle Rock Aggregate Terminal
 Existing Plus Project PM



Movement	EBT	EBR	WBL	WBT	NBL	NBR
Lane Configurations	↑↑		↙↘	↑↑		
Traffic Volume (veh/h)	224	213	77	182	0	0
Future Volume (veh/h)	224	213	77	182	0	0
Initial Q (Qb), veh	0	0	0	0		
Ped-Bike Adj(A_pbT)		1.00	1.00			
Parking Bus, Adj	1.00	1.00	1.00	1.00		
Work Zone On Approach	No			No		
Adj Sat Flow, veh/h/ln	1648	1648	1633	1322		
Adj Flow Rate, veh/h	243	232	84	198		
Peak Hour Factor	0.92	0.92	0.92	0.92		
Percent Heavy Veh, %	17	17	18	39		
Cap, veh/h	609	543	289	1865		
Arrive On Green	0.39	0.39	0.10	0.74		
Sat Flow, veh/h	1648	1397	3018	2578		
Grp Volume(v), veh/h	243	232	84	198		
Grp Sat Flow(s),veh/h/ln	1566	1397	1509	1256		
Q Serve(g_s), s	2.0	2.1	0.5	0.4		
Cycle Q Clear(g_c), s	2.0	2.1	0.5	0.4		
Prop In Lane		1.00	1.00			
Lane Grp Cap(c), veh/h	609	543	289	1865		
V/C Ratio(X)	0.40	0.43	0.29	0.11		
Avail Cap(c_a), veh/h	2107	1879	1296	5106		
HCM Platoon Ratio	1.00	1.00	1.00	1.00		
Upstream Filter(I)	1.00	1.00	1.00	1.00		
Uniform Delay (d), s/veh	3.9	3.9	7.3	0.6		
Incr Delay (d2), s/veh	0.4	0.5	0.5	0.0		
Initial Q Delay(d3),s/veh	0.0	0.0	0.0	0.0		
%ile BackOfQ(50%),veh/ln	0.1	0.1	0.1	0.0		
Unsig. Movement Delay, s/veh						
LnGrp Delay(d),s/veh	4.3	4.4	7.9	0.7		
LnGrp LOS	A	A	A	A		
Approach Vol, veh/h	475			282		
Approach Delay, s/veh	4.4			2.8		
Approach LOS	A			A		
Timer - Assigned Phs			3	4		8
Phs Duration (G+Y+Rc), s			6.2	11.3		17.5
Change Period (Y+Rc), s			4.5	4.5		4.5
Max Green Setting (Gmax), s			7.5	23.5		35.5
Max Q Clear Time (g_c+I1), s			2.5	4.1		2.4
Green Ext Time (p_c), s			0.1	2.9		1.4
Intersection Summary						
HCM 6th Ctrl Delay			3.8			
HCM 6th LOS			A			

HCM 6th Signalized Intersection Summary
 9: I-880 NB Off-Ramp - Frontage Road & 7th Street

Eagle Rock Aggregate Terminal
 Existing Plus Project PM



Movement	EBL	EBT	EBR	WBL	WBT	WBR	NBL	NBT	NBR	SBL	SBT	SBR
Lane Configurations	↘	↑↑			↑↑		↘	↑↑		↘		↑↑
Traffic Volume (veh/h)	57	150	0	0	86	107	92	229	110	118	0	77
Future Volume (veh/h)	57	150	0	0	86	107	92	229	110	118	0	77
Initial Q (Qb), veh	0	0	0	0	0	0	0	0	0	0	0	0
Ped-Bike Adj(A_pbT)	1.00		1.00	1.00		1.00	1.00		1.00	1.00		1.00
Parking Bus, Adj	1.00	1.00	1.00	1.00	1.00	1.00	1.00	1.00	1.00	1.00	1.00	1.00
Work Zone On Approach		No			No			No			No	
Adj Sat Flow, veh/h/ln	1426	1707	0	0	1604	1604	1011	1767	1767	1781	0	1604
Adj Flow Rate, veh/h	62	163	0	0	93	116	100	249	120	128	0	84
Peak Hour Factor	0.92	0.92	0.92	0.92	0.92	0.92	0.92	0.92	0.92	0.92	0.92	0.92
Percent Heavy Veh, %	32	13	0	0	20	20	60	9	9	8	0	20
Cap, veh/h	104	1372	0	0	422	376	87	635	296	154	0	0
Arrive On Green	0.08	0.42	0.00	0.00	0.28	0.28	0.09	0.28	0.28	0.09	0.00	0.00
Sat Flow, veh/h	1358	3329	0	0	1604	1359	963	2279	1063	1697	128	
Grp Volume(v), veh/h	62	163	0	0	93	116	100	191	178	128	67.3	
Grp Sat Flow(s),veh/h/ln	1358	1622	0	0	1523	1359	963	1767	1575	1697	E	
Q Serve(g_s), s	2.9	2.0	0.0	0.0	3.1	4.4	5.9	5.7	6.0	4.8		
Cycle Q Clear(g_c), s	2.9	2.0	0.0	0.0	3.1	4.4	5.9	5.7	6.0	4.8		
Prop In Lane	1.00		0.00	0.00		1.00	1.00		0.67	1.00		
Lane Grp Cap(c), veh/h	104	1372	0	0	422	376	87	492	439	154		
V/C Ratio(X)	0.59	0.12	0.00	0.00	0.22	0.31	1.14	0.39	0.41	0.83		
Avail Cap(c_a), veh/h	104	1372	0	0	422	376	87	492	439	154		
HCM Platoon Ratio	1.00	1.00	1.00	1.00	1.00	1.00	1.00	1.00	1.00	1.00		
Upstream Filter(I)	1.00	1.00	0.00	0.00	1.00	1.00	1.00	1.00	1.00	1.00		
Uniform Delay (d), s/veh	29.0	11.4	0.0	0.0	18.1	18.6	29.5	19.0	19.1	29.1		
Incr Delay (d2), s/veh	22.4	0.2	0.0	0.0	1.2	2.1	140.5	2.3	2.8	38.3		
Initial Q Delay(d3),s/veh	0.0	0.0	0.0	0.0	0.0	0.0	0.0	0.0	0.0	0.0		
%ile BackOfQ(50%),veh/ln	1.5	0.7	0.0	0.0	1.1	1.5	4.7	2.5	2.4	3.5		
Unsig. Movement Delay, s/veh												
LnGrp Delay(d),s/veh	51.4	11.6	0.0	0.0	19.3	20.7	170.0	21.3	21.8	67.3		
LnGrp LOS	D	B	A	A	B	C	F	C	C	E		
Approach Vol, veh/h		225			209			469				
Approach Delay, s/veh		22.6			20.1			53.2				
Approach LOS		C			C			D				
Timer - Assigned Phs	1	2		4	5		7	8				
Phs Duration (G+Y+Rc), s	10.4	22.6		32.0	10.4		9.5	22.5				
Change Period (Y+Rc), s	4.5	4.5		4.5	4.5		4.5	4.5				
Max Green Setting (Gmax), s	5.9	18.1		27.5	5.9		5.0	18.0				
Max Q Clear Time (g_c+I1), s	6.8	8.0		4.0	7.9		4.9	6.4				
Green Ext Time (p_c), s	0.0	1.6		1.0	0.0		0.0	0.9				

Intersection Summary

HCM 6th Ctrl Delay	41.6
HCM 6th LOS	D

Notes

User approved volume balancing among the lanes for turning movement.

Traffic Counts

City of Oakland
 N/S: Wake Avenue/Maritime Street
 E/W: I-80 Ramps/I-580 EB On R/Grand Ave
 Weather: Clear

File Name : 01_OKD_Maritime_Grand AM
 Site Code : 00319737
 Start Date : 10/23/2019
 Page No : 2

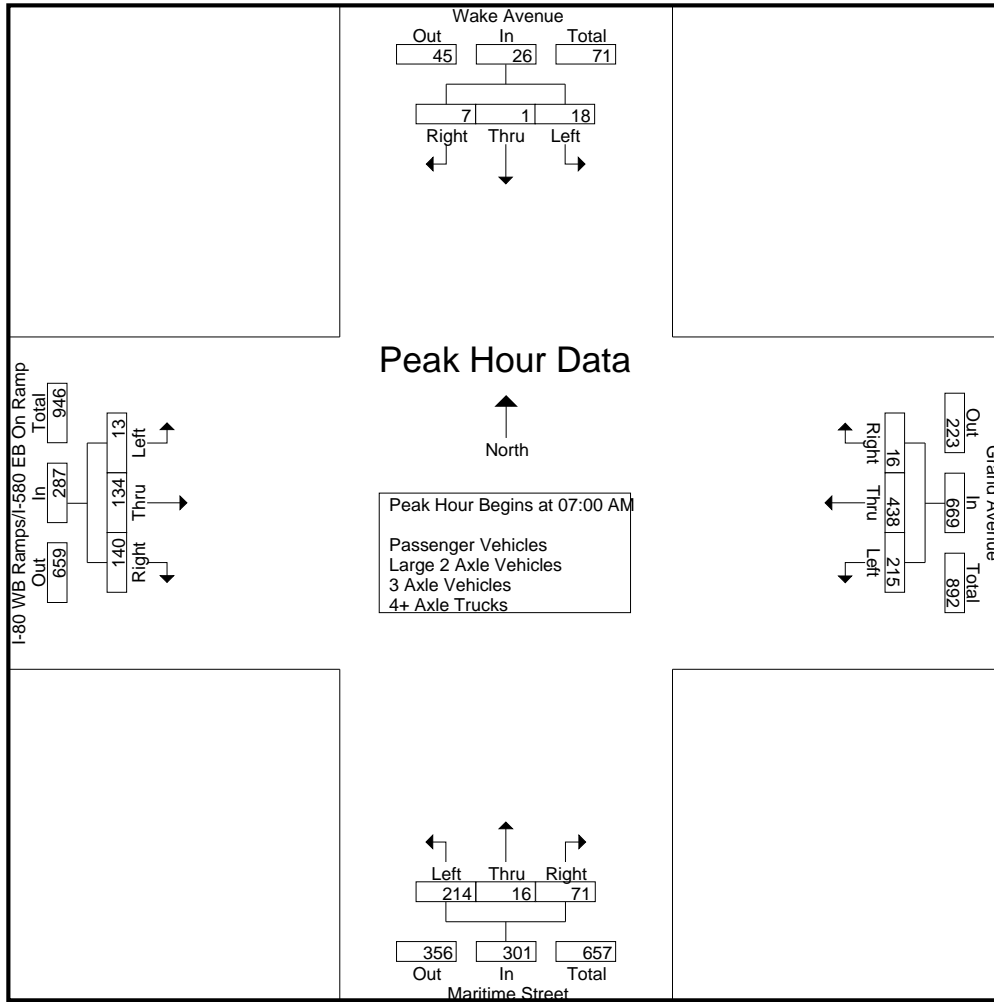

Peak Hour Analysis From 07:00 AM to 08:45 AM - Peak 1 of 1
 Peak Hour for Each Approach Begins at:

	08:00 AM				07:30 AM				07:00 AM				07:00 AM			
+0 mins.	3	0	3	6	56	113	2	171	63	3	20	86	3	43	38	84
+15 mins.	5	1	0	6	55	129	3	187	50	8	14	72	1	30	47	78
+30 mins.	3	1	4	8	55	107	5	167	49	4	15	68	5	30	30	65
+45 mins.	3	3	5	11	52	104	3	159	52	1	22	75	4	31	25	60
Total Volume	14	5	12	31	218	453	13	684	214	16	71	301	13	134	140	287
% App. Total	45.2	16.1	38.7		31.9	66.2	1.9		71.1	5.3	23.6		4.5	46.7	48.8	
PHF	.700	.417	.600	.705	.973	.878	.650	.914	.849	.500	.807	.875	.650	.779	.745	.854

City of Oakland
 N/S: Wake Avenue/Maritime Street
 E/W: I-80 Ramps/I-580 EB On R/Grand Ave
 Weather: Clear

File Name : 01_OKD_Maritime_Grand PM
 Site Code : 00319737
 Start Date : 10/23/2019
 Page No : 2

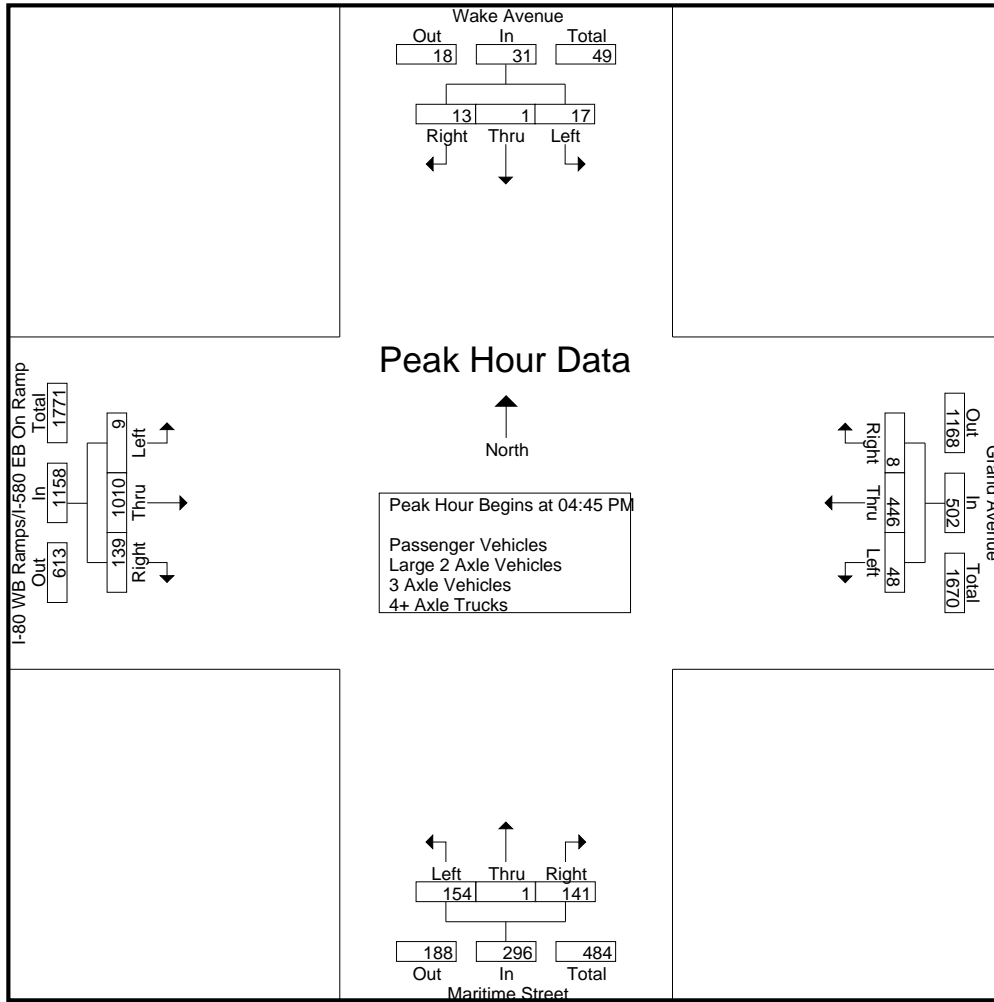

Peak Hour Analysis From 04:00 PM to 05:45 PM - Peak 1 of 1
 Peak Hour for Each Approach Begins at:

	04:00 PM				04:00 PM				04:00 PM				04:45 PM			
+0 mins.	8	2	20	30	9	120	0	129	66	2	52	120	3	233	20	256
+15 mins.	5	2	14	21	9	145	3	157	52	2	39	93	2	255	42	299
+30 mins.	12	1	5	18	11	107	5	123	44	0	51	95	3	272	44	319
+45 mins.	3	0	4	7	15	114	4	133	57	0	43	100	1	250	33	284
Total Volume	28	5	43	76	44	486	12	542	219	4	185	408	9	1010	139	1158
% App. Total	36.8	6.6	56.6		8.1	89.7	2.2		53.7	1	45.3		0.8	87.2	12	
PHF	.583	.625	.538	.633	.733	.838	.600	.863	.830	.500	.889	.850	.750	.928	.790	.908

City of Oakland
 N/S: Maritime Street
 E/W: Burma Road/Admiral Toney Way
 Weather: Clear

File Name : 03_OKD_Maritime_Burma AM
 Site Code : 00319737
 Start Date : 10/23/2019
 Page No : 2

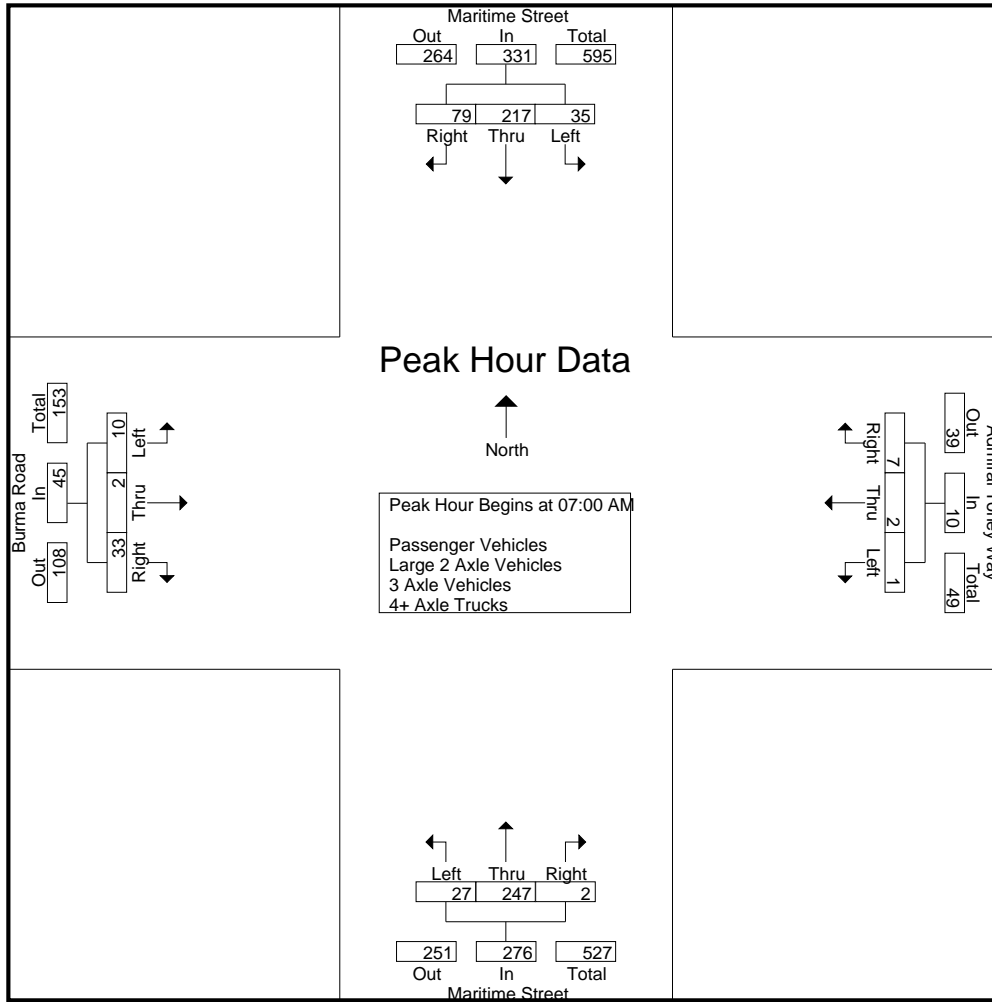

Peak Hour Analysis From 07:00 AM to 08:45 AM - Peak 1 of 1
 Peak Hour for Each Approach Begins at:

	07:00 AM				07:30 AM				07:00 AM				07:00 AM			
+0 mins.	5	55	18	78	1	0	2	3	6	94	2	102	4	0	8	12
+15 mins.	14	69	14	97	0	1	3	4	7	58	0	65	2	1	6	9
+30 mins.	6	54	18	78	1	0	0	1	9	33	0	42	2	1	12	15
+45 mins.	10	39	29	78	4	0	3	7	5	62	0	67	2	0	7	9
Total Volume	35	217	79	331	6	1	8	15	27	247	2	276	10	2	33	45
% App. Total	10.6	65.6	23.9		40	6.7	53.3		9.8	89.5	0.7		22.2	4.4	73.3	
PHF	.625	.786	.681	.853	.375	.250	.667	.536	.750	.657	.250	.676	.625	.500	.688	.750

City of Oakland
 N/S: Maritime Street
 E/W: Burma Road/Admiral Toney Way
 Weather: Clear

File Name : 03_OKD_Maritime_Burma PM
 Site Code : 00319737
 Start Date : 10/23/2019
 Page No : 2

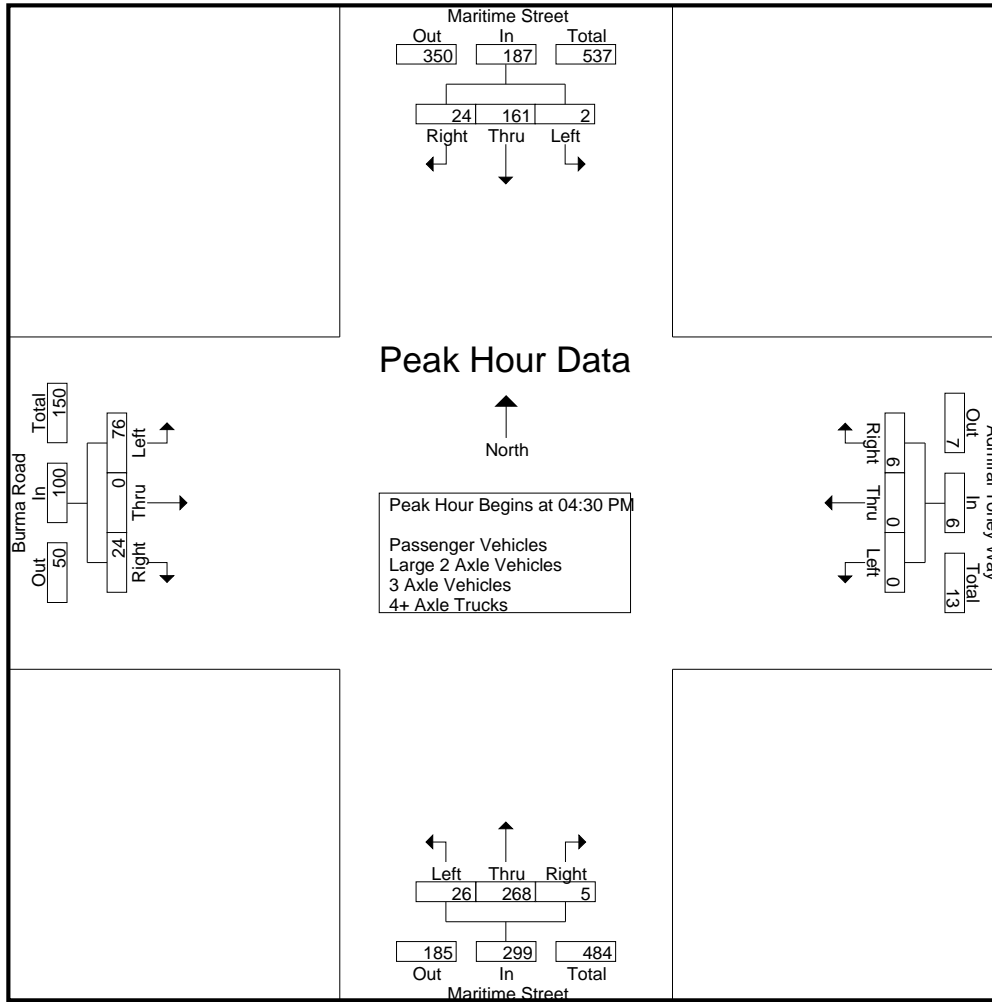

Peak Hour Analysis From 04:00 PM to 05:45 PM - Peak 1 of 1
 Peak Hour for Each Approach Begins at:

	04:45 PM				04:15 PM				04:00 PM				04:00 PM			
+0 mins.	1	25	6	32	0	0	1	1	9	102	0	111	22	0	8	30
+15 mins.	0	46	4	50	0	0	0	0	12	64	1	77	26	0	2	28
+30 mins.	1	54	8	63	0	0	1	1	10	73	1	84	21	0	8	29
+45 mins.	0	41	2	43	0	0	5	5	4	74	3	81	21	0	8	29
Total Volume	2	166	20	188	0	0	7	7	35	313	5	353	90	0	26	116
% App. Total	1.1	88.3	10.6		0	0	100		9.9	88.7	1.4		77.6	0	22.4	
PHF	.500	.769	.625	.746	.000	.000	.350	.350	.729	.767	.417	.795	.865	.000	.813	.967

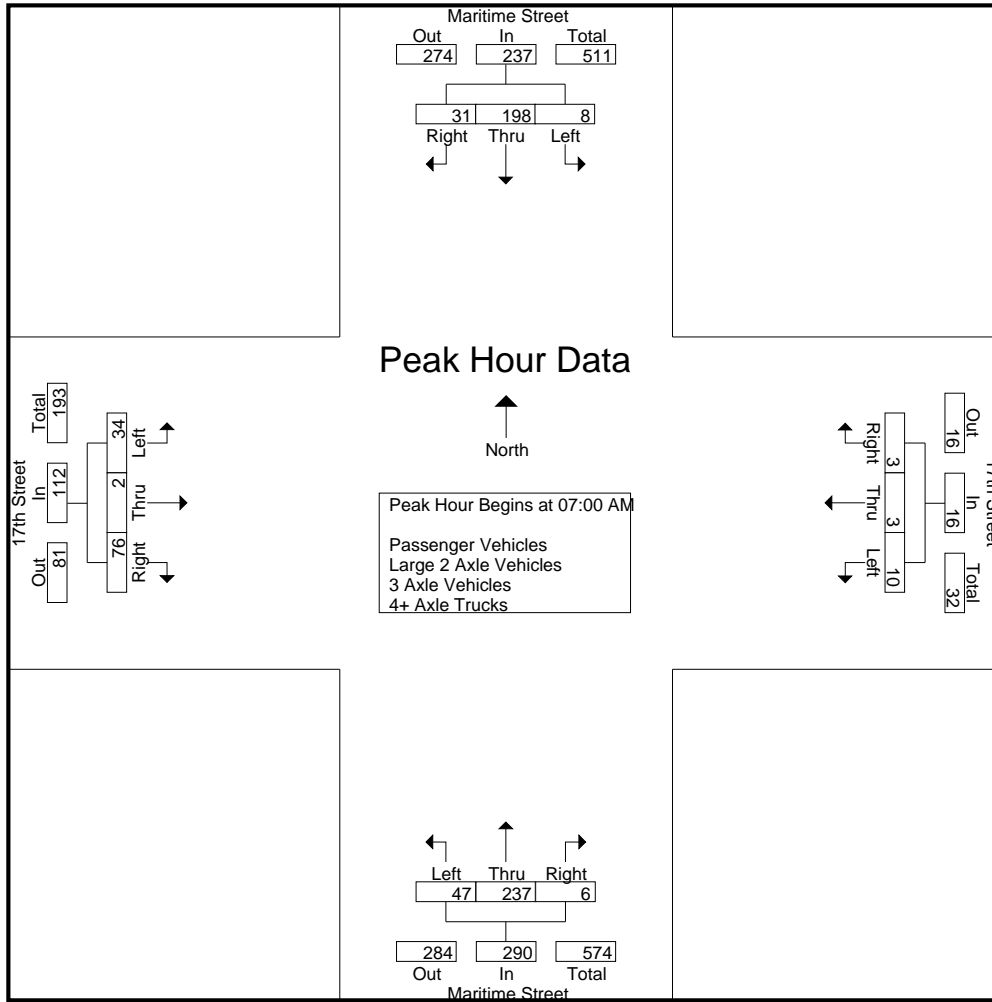

Peak Hour Analysis From 07:00 AM to 08:45 AM - Peak 1 of 1
 Peak Hour for Each Approach Begins at:

	07:00 AM				07:45 AM				07:00 AM				07:00 AM			
+0 mins.	4	49	9	62	2	2	1	5	13	90	1	104	9	1	28	38
+15 mins.	1	55	11	67	4	0	1	5	10	54	1	65	6	1	22	29
+30 mins.	0	60	3	63	1	1	1	3	12	31	4	47	8	0	17	25
+45 mins.	3	34	8	45	4	0	6	10	12	62	0	74	11	0	9	20
Total Volume	8	198	31	237	11	3	9	23	47	237	6	290	34	2	76	112
% App. Total	3.4	83.5	13.1		47.8	13	39.1		16.2	81.7	2.1		30.4	1.8	67.9	
PHF	.500	.825	.705	.884	.688	.375	.375	.575	.904	.658	.375	.697	.773	.500	.679	.737

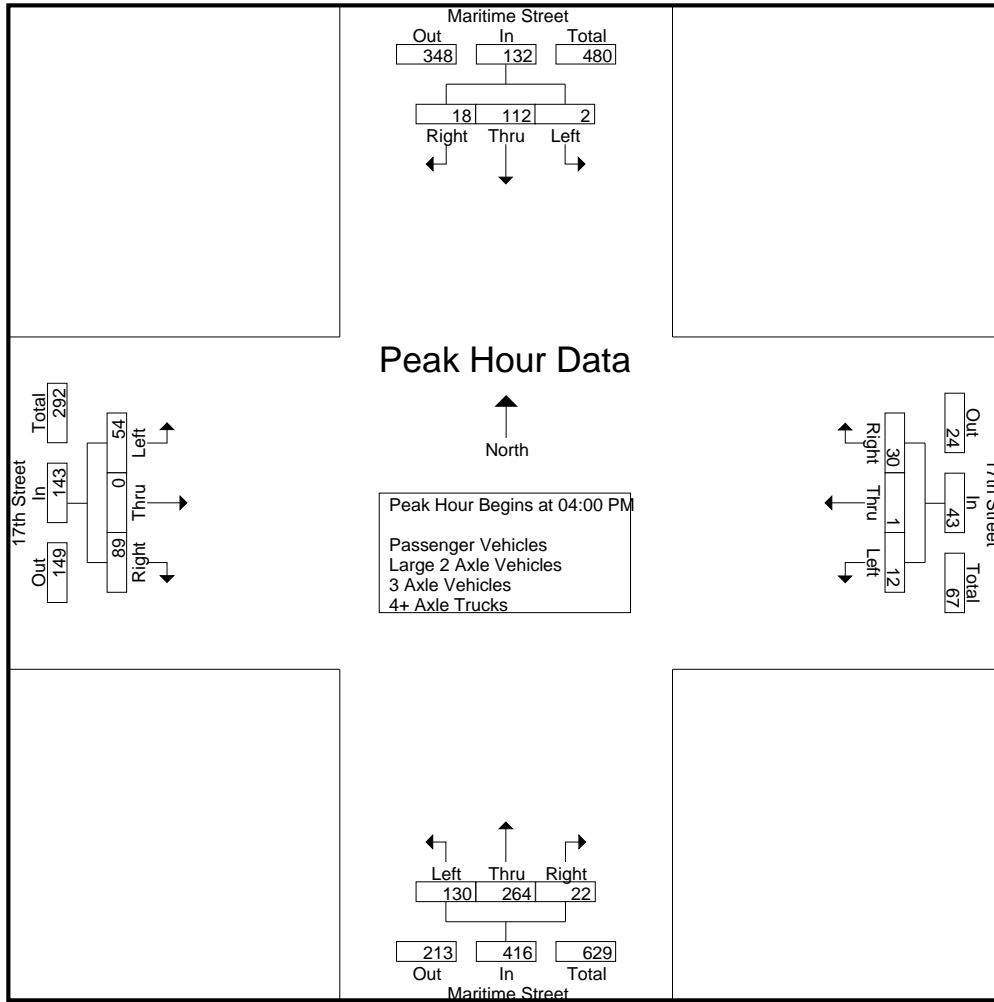

Peak Hour Analysis From 04:00 PM to 05:45 PM - Peak 1 of 1
 Peak Hour for Each Approach Begins at:

	04:30 PM				04:00 PM				04:00 PM				04:00 PM			
+0 mins.	1	41	6	48	5	1	11	17	27	75	8	110	21	0	24	45
+15 mins.	1	28	2	31	1	0	4	5	35	63	5	103	7	0	20	27
+30 mins.	0	50	5	55	3	0	10	13	35	58	4	97	15	0	18	33
+45 mins.	0	52	3	55	3	0	5	8	33	68	5	106	11	0	27	38
Total Volume	2	171	16	189	12	1	30	43	130	264	22	416	54	0	89	143
% App. Total	1.1	90.5	8.5		27.9	2.3	69.8		31.2	63.5	5.3		37.8	0	62.2	
PHF	.500	.822	.667	.859	.600	.250	.682	.632	.929	.880	.688	.945	.643	.000	.824	.794

City of Oakland
 N/S: Maritime Street
 E/W: 14th Street
 Weather: Clear

File Name : 05_OKD_Maritime_14th AM
 Site Code : 00319737
 Start Date : 10/23/2019
 Page No : 2

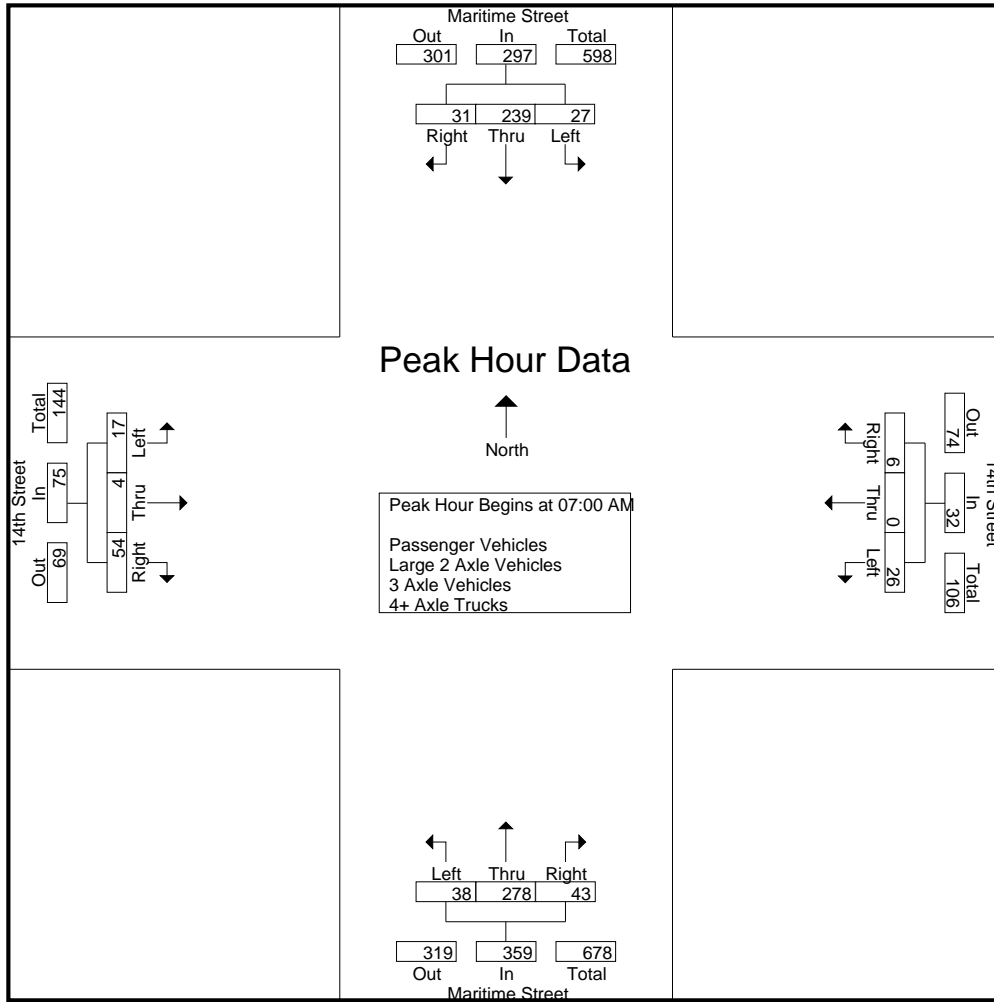

Peak Hour Analysis From 07:00 AM to 08:45 AM - Peak 1 of 1
 Peak Hour for Each Approach Begins at:

	07:00 AM				08:00 AM				07:00 AM				07:30 AM			
+0 mins.	5	66	6	77	9	0	3	12	10	111	4	125	2	2	13	17
+15 mins.	7	73	10	90	9	1	4	14	11	53	12	76	6	1	17	24
+30 mins.	9	66	9	84	6	0	3	9	9	46	13	68	0	0	15	15
+45 mins.	6	34	6	46	9	4	8	21	8	68	14	90	3	1	22	26
Total Volume	27	239	31	297	33	5	18	56	38	278	43	359	11	4	67	82
% App. Total	9.1	80.5	10.4		58.9	8.9	32.1		10.6	77.4	12		13.4	4.9	81.7	
PHF	.750	.818	.775	.825	.917	.313	.563	.667	.864	.626	.768	.718	.458	.500	.761	.788

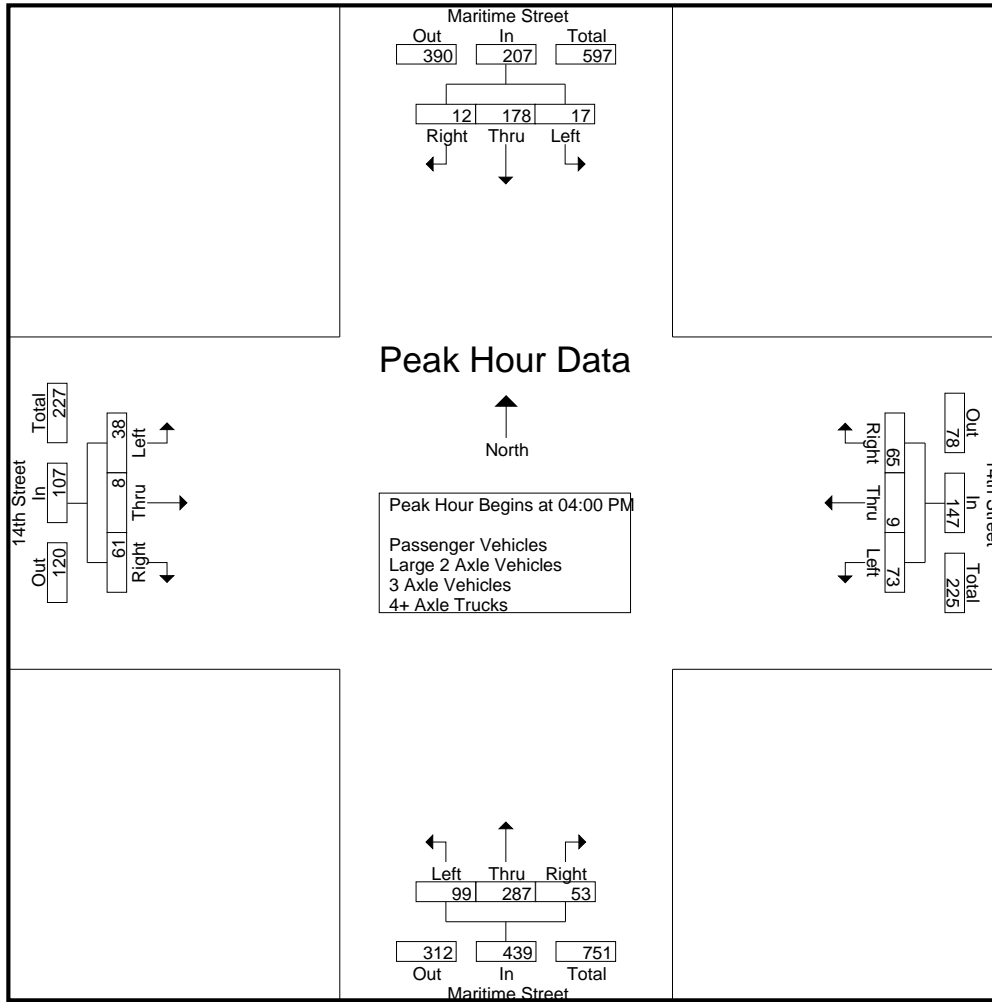

Peak Hour Analysis From 04:00 PM to 05:45 PM - Peak 1 of 1
 Peak Hour for Each Approach Begins at:

	04:30 PM				04:00 PM				04:00 PM				04:15 PM			
+0 mins.	4	51	5	60	23	1	24	48	35	60	17	112	5	1	17	23
+15 mins.	5	51	1	57	18	5	15	38	30	80	14	124	7	1	24	32
+30 mins.	4	70	2	76	18	1	19	38	23	77	12	112	15	3	12	30
+45 mins.	4	62	4	70	14	2	7	23	11	70	10	91	14	1	13	28
Total Volume	17	234	12	263	73	9	65	147	99	287	53	439	41	6	66	113
% App. Total	6.5	89	4.6		49.7	6.1	44.2		22.6	65.4	12.1		36.3	5.3	58.4	
PHF	.850	.836	.600	.865	.793	.450	.677	.766	.707	.897	.779	.885	.683	.500	.688	.883

City of Oakland
 N/S: Maritime Street
 E/W: Navy Roadway
 Weather: Clear

File Name : 06_OKD_Maritime_Navy Roadway AM
 Site Code : 00319737
 Start Date : 10/23/2019
 Page No : 2

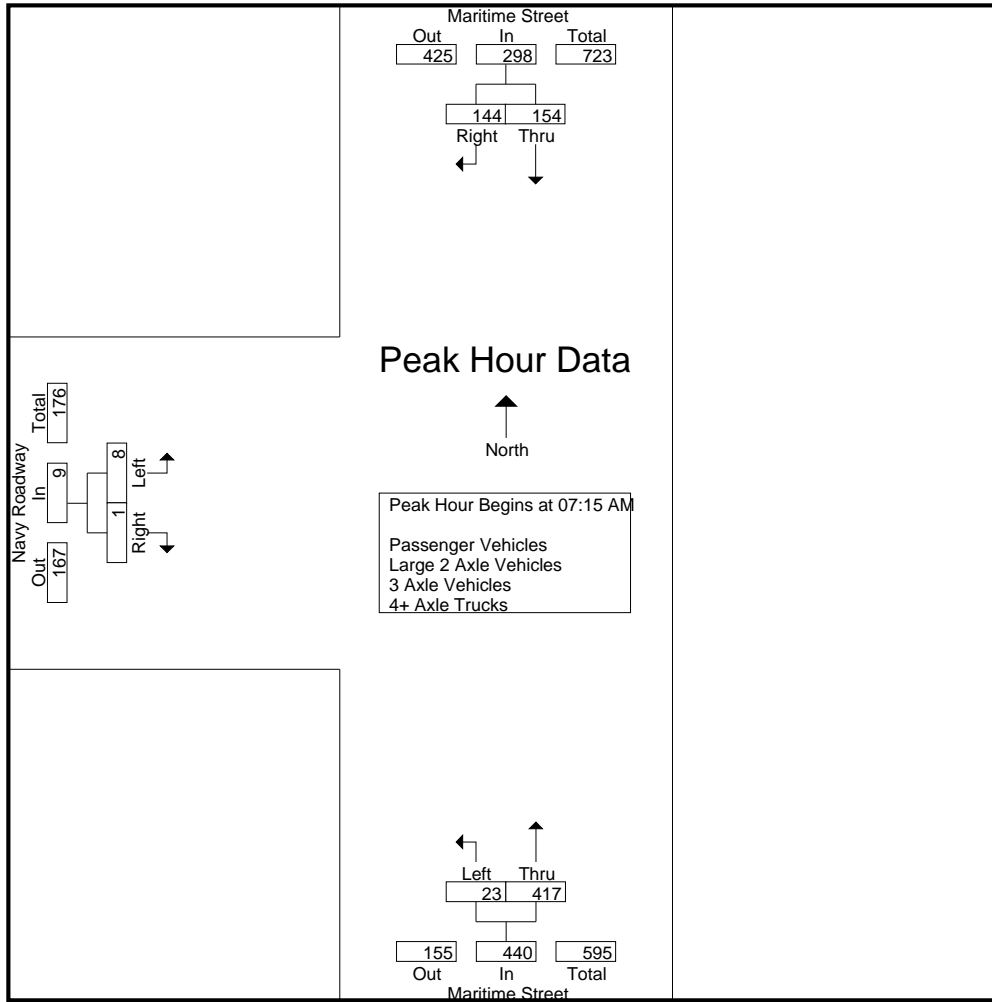

Peak Hour Analysis From 07:00 AM to 08:45 AM - Peak 1 of 1

Peak Hour for Each Approach Begins at:

	07:00 AM			07:15 AM			07:15 AM		
+0 mins.	32	40	72	4	89	93	2	1	3
+15 mins.	56	45	101	7	85	92	1	0	1
+30 mins.	42	42	84	8	109	117	3	0	3
+45 mins.	28	25	53	4	134	138	2	0	2
Total Volume	158	152	310	23	417	440	8	1	9
% App. Total	51	49		5.2	94.8		88.9	11.1	
PHF	.705	.844	.767	.719	.778	.797	.667	.250	.750

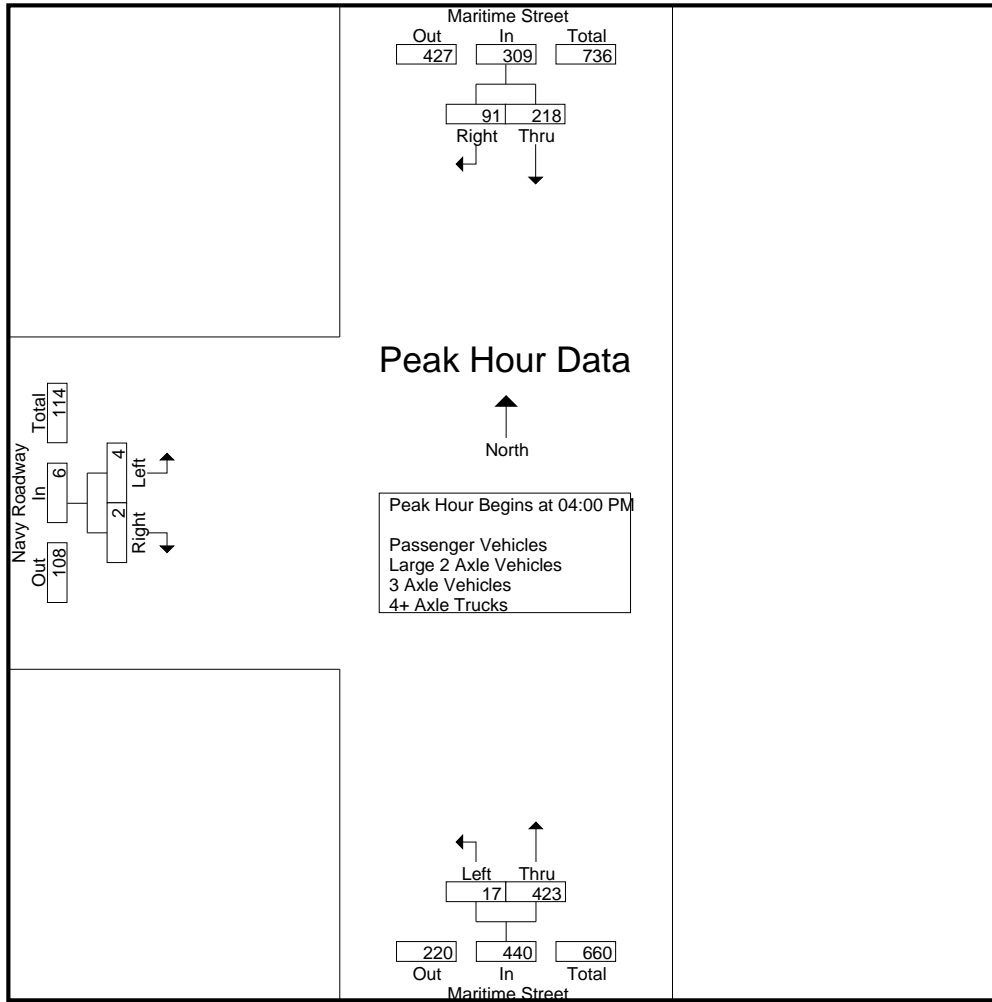

Peak Hour Analysis From 04:00 PM to 05:45 PM - Peak 1 of 1

Peak Hour for Each Approach Begins at:

	04:30 PM			04:00 PM			04:15 PM		
+0 mins.	51	32	83	4	119	123	0	0	0
+15 mins.	59	20	79	6	107	113	2	1	3
+30 mins.	78	26	104	5	111	116	0	0	0
+45 mins.	51	33	84	2	86	88	4	0	4
Total Volume	239	111	350	17	423	440	6	1	7
% App. Total	68.3	31.7		3.9	96.1		85.7	14.3	
PHF	.766	.841	.841	.708	.889	.894	.375	.250	.438

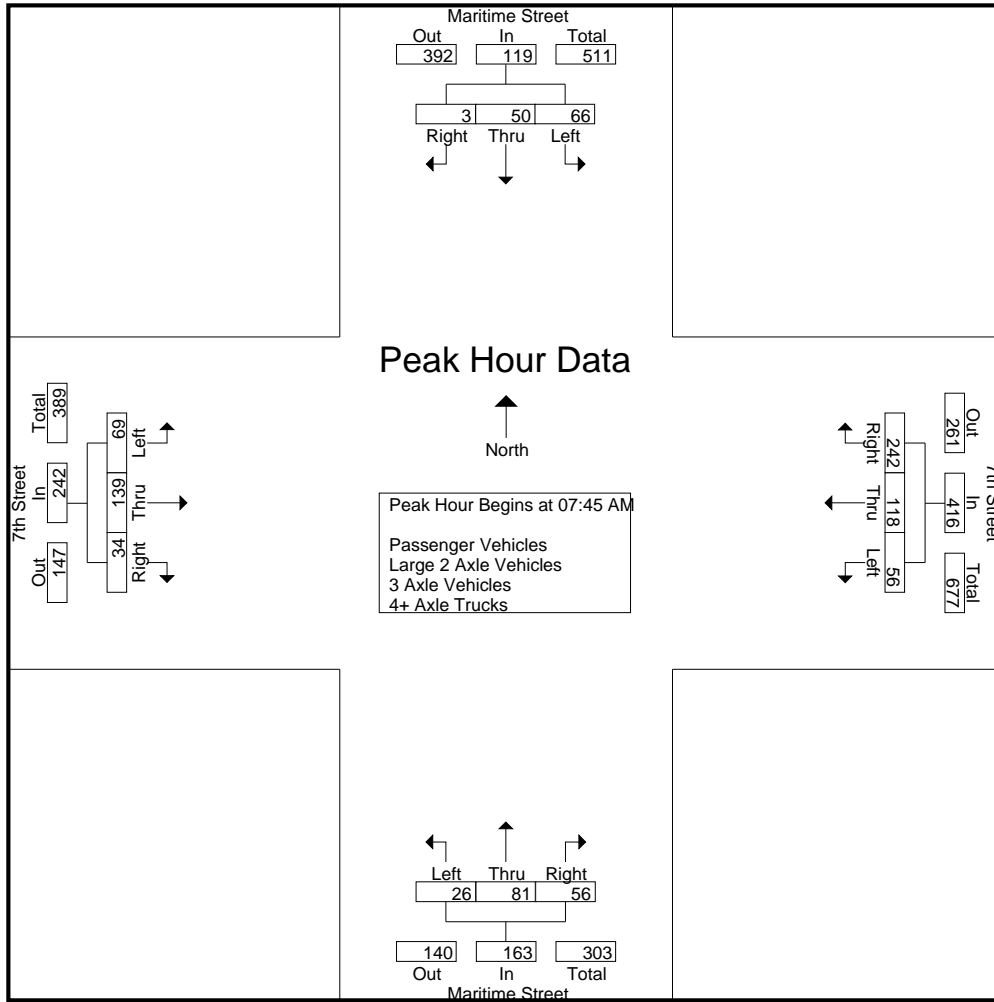

Peak Hour Analysis From 07:00 AM to 08:45 AM - Peak 1 of 1
 Peak Hour for Each Approach Begins at:

	07:00 AM				07:45 AM				08:00 AM							
+0 mins.	15	21	2	38	36	43	121	200	12	24	12	48	24	29	10	63
+15 mins.	25	30	1	56	22	24	82	128	2	20	11	33	18	39	5	62
+30 mins.	20	23	1	44	13	28	63	104	6	12	19	37	16	46	12	74
+45 mins.	14	10	0	24	19	36	70	125	6	25	14	45	21	50	6	77
Total Volume	74	84	4	162	90	131	336	557	26	81	56	163	79	164	33	276
% App. Total	45.7	51.9	2.5		16.2	23.5	60.3		16	49.7	34.4		28.6	59.4	12	
PHF	.740	.700	.500	.723	.625	.762	.694	.696	.542	.810	.737	.849	.823	.820	.688	.896

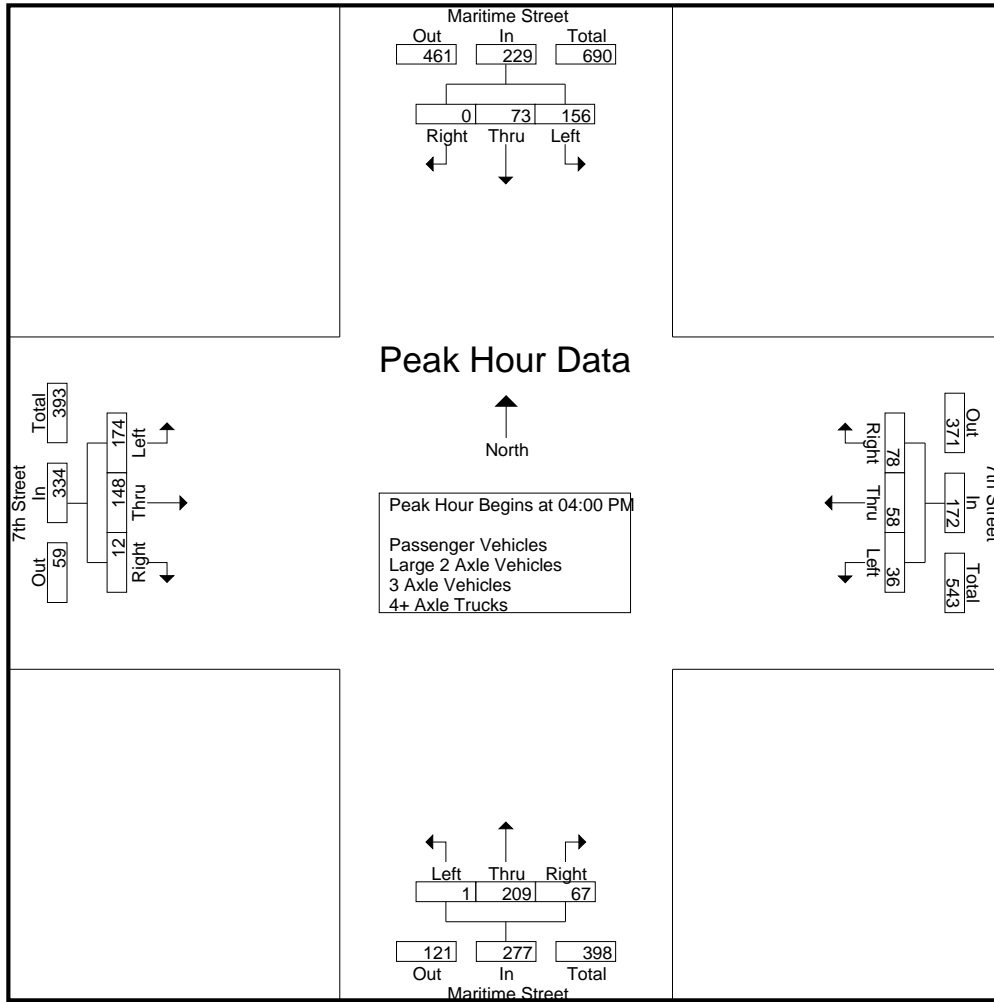

Peak Hour Analysis From 04:00 PM to 05:45 PM - Peak 1 of 1
 Peak Hour for Each Approach Begins at:

	04:15 PM				04:30 PM				04:00 PM				04:00 PM			
+0 mins.	41	19	0	60	8	14	19	41	1	49	14	64	63	40	6	109
+15 mins.	33	21	0	54	12	15	19	46	0	56	18	74	35	21	3	59
+30 mins.	36	22	0	58	13	20	15	48	0	58	20	78	41	46	2	89
+45 mins.	46	36	0	82	13	20	15	48	0	46	15	61	35	41	1	77
Total Volume	156	98	0	254	46	69	68	183	1	209	67	277	174	148	12	334
% App. Total	61.4	38.6	0		25.1	37.7	37.2		0.4	75.5	24.2		52.1	44.3	3.6	
PHF	.848	.681	.000	.774	.885	.863	.895	.953	.250	.901	.838	.888	.690	.804	.500	.766

City of Oakland
 N/S: I-80 Eastbound Ramps/Frontage Road
 E/W: Grand Avenue
 Weather: Clear

File Name : 09_OKD_Frontage_Grand AM
 Site Code : 00319737
 Start Date : 10/23/2019
 Page No : 2

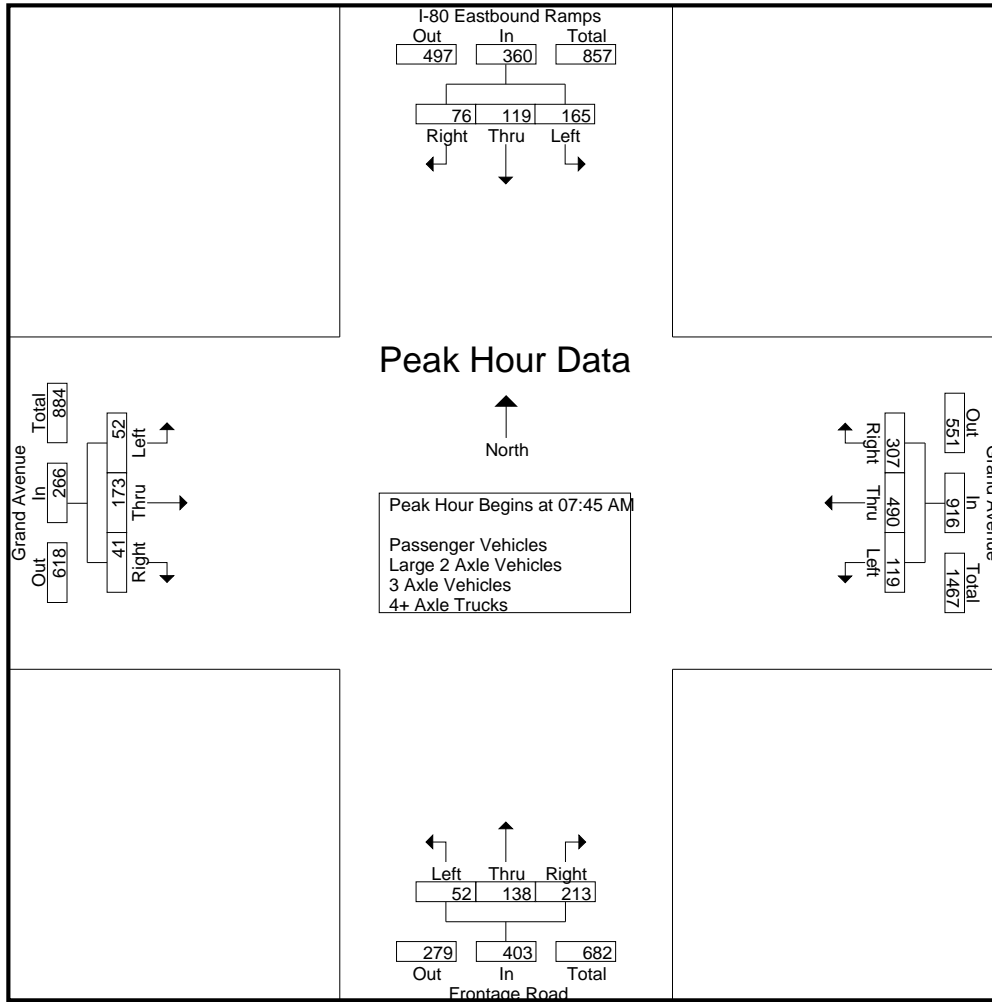

Peak Hour Analysis From 07:00 AM to 08:45 AM - Peak 1 of 1
 Peak Hour for Each Approach Begins at:

	07:45 AM				07:30 AM				07:45 AM				08:00 AM			
+0 mins.	47	30	20	97	23	133	79	235	13	35	60	108	12	46	9	67
+15 mins.	41	27	18	86	34	84	77	195	16	33	46	95	12	52	7	71
+30 mins.	41	29	22	92	36	141	74	251	12	31	51	94	13	47	15	75
+45 mins.	36	33	16	85	29	164	84	277	11	39	56	106	13	47	8	68
Total Volume	165	119	76	360	122	522	314	958	52	138	213	403	50	192	39	281
% App. Total	45.8	33.1	21.1		12.7	54.5	32.8		12.9	34.2	52.9		17.8	68.3	13.9	
PHF	.878	.902	.864	.928	.847	.796	.935	.865	.813	.885	.888	.933	.962	.923	.650	.937

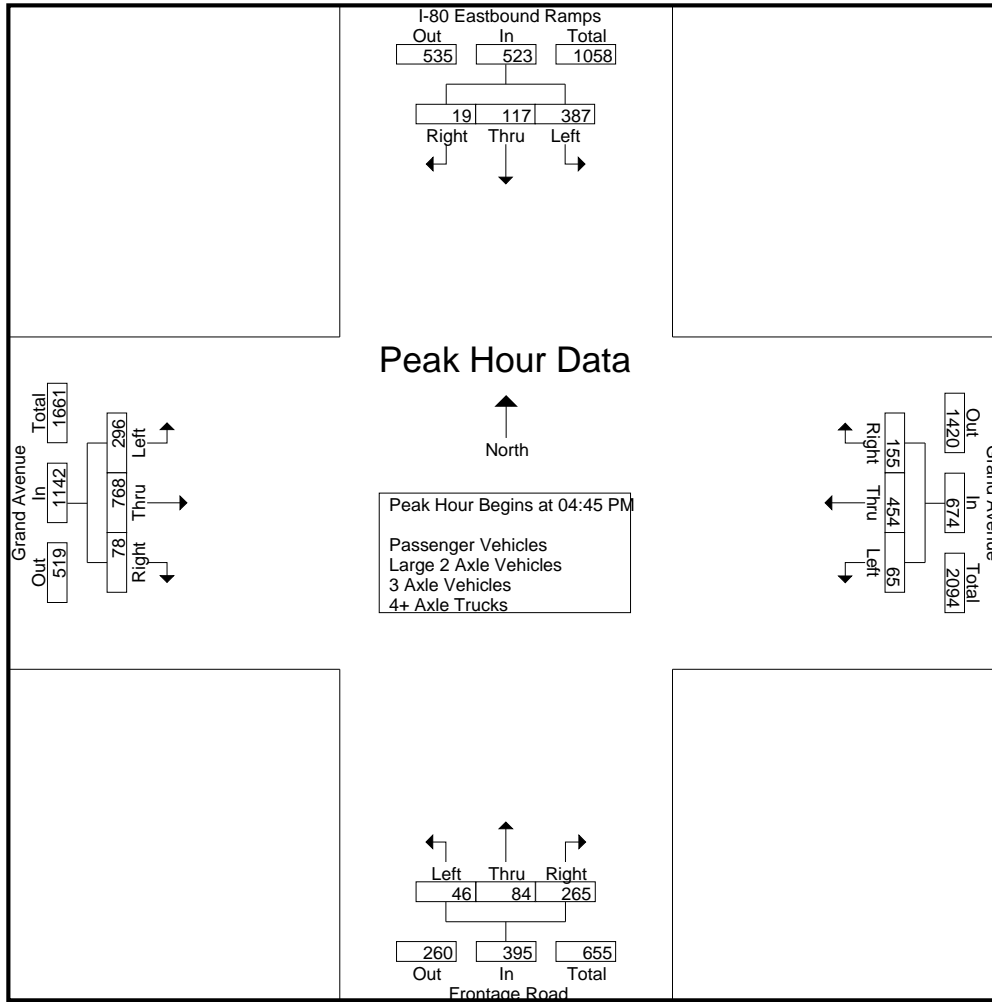

Peak Hour Analysis From 04:00 PM to 05:45 PM - Peak 1 of 1
 Peak Hour for Each Approach Begins at:

	04:45 PM				04:30 PM				04:00 PM				04:45 PM			
+0 mins.	101	28	8	137	14	97	39	150	14	27	74	115	80	141	18	239
+15 mins.	80	24	4	108	18	110	31	159	19	29	66	114	84	236	22	342
+30 mins.	99	29	6	134	22	137	40	199	13	35	62	110	74	200	22	296
+45 mins.	107	36	1	144	16	119	44	179	18	23	64	105	58	191	16	265
Total Volume	387	117	19	523	70	463	154	687	64	114	266	444	296	768	78	1142
% App. Total	74	22.4	3.6		10.2	67.4	22.4		14.4	25.7	59.9		25.9	67.3	6.8	
PHF	.904	.813	.594	.908	.795	.845	.875	.863	.842	.814	.899	.965	.881	.814	.886	.835

City of Oakland
 N/S: I-880 Southbound On Ramp
 E/W: 7th Street
 Weather: Clear

File Name : 10_OKD_880S_7th AM
 Site Code : 00319737
 Start Date : 10/23/2019
 Page No : 2

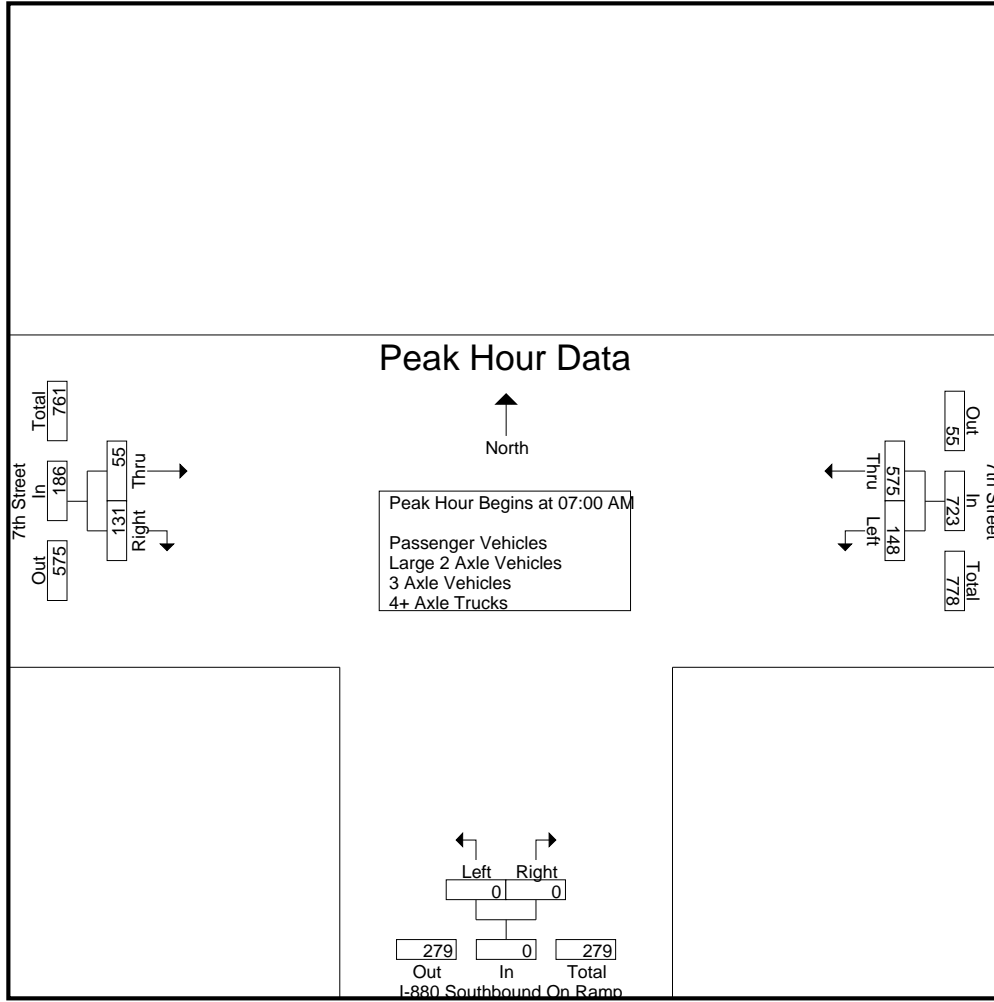

Peak Hour Analysis From 07:00 AM to 08:45 AM - Peak 1 of 1
 Peak Hour for Each Approach Begins at:

	07:00 AM			07:00 AM			08:00 AM		
+0 mins.	39	196	235	0	0	0	19	38	57
+15 mins.	45	123	168	0	0	0	21	50	71
+30 mins.	29	107	136	0	0	0	37	51	88
+45 mins.	35	149	184	0	0	0	19	55	74
Total Volume	148	575	723	0	0	0	96	194	290
% App. Total	20.5	79.5		0	0		33.1	66.9	
PHF	.822	.733	.769	.000	.000	.000	.649	.882	.824

City of Oakland
 N/S: I-880 Southbound On Ramp
 E/W: 7th Street
 Weather: Clear

File Name : 10_OKD_880S_7th PM
 Site Code : 00319737
 Start Date : 10/23/2019
 Page No : 2

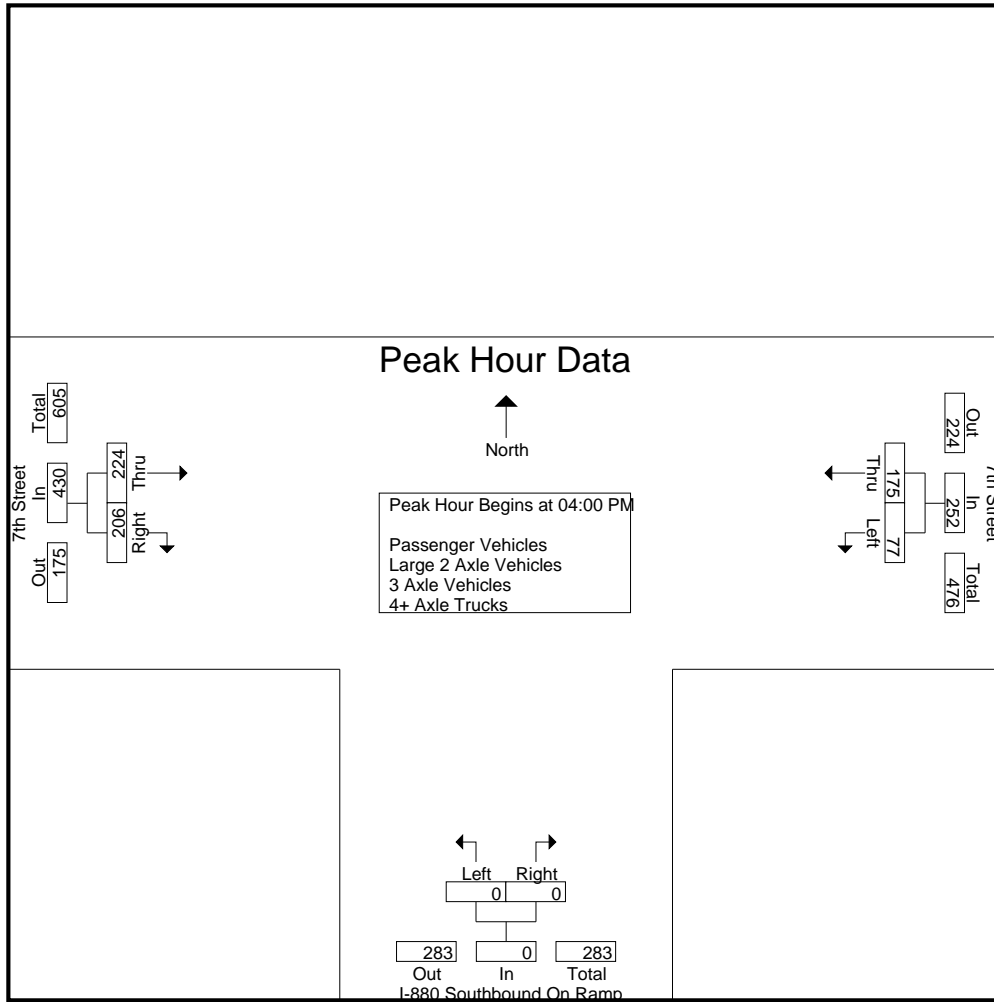

Peak Hour Analysis From 04:00 PM to 05:45 PM - Peak 1 of 1
 Peak Hour for Each Approach Begins at:

	04:00 PM			04:00 PM			04:00 PM		
+0 mins.	19	45	64	0	0	0	61	62	123
+15 mins.	18	45	63	0	0	0	49	41	90
+30 mins.	20	39	59	0	0	0	60	50	110
+45 mins.	20	46	66	0	0	0	54	53	107
Total Volume	77	175	252	0	0	0	224	206	430
% App. Total	30.6	69.4		0	0	0	52.1	47.9	
PHF	.963	.951	.955	.000	.000	.000	.918	.831	.874

City of Oakland
 N/S: Frontage Road/I-880 NB Off Ramp
 E/W: 7th Street
 Weather: Clear

File Name : 11_OKD_Frontage_7th AM
 Site Code : 00319737
 Start Date : 10/23/2019
 Page No : 2

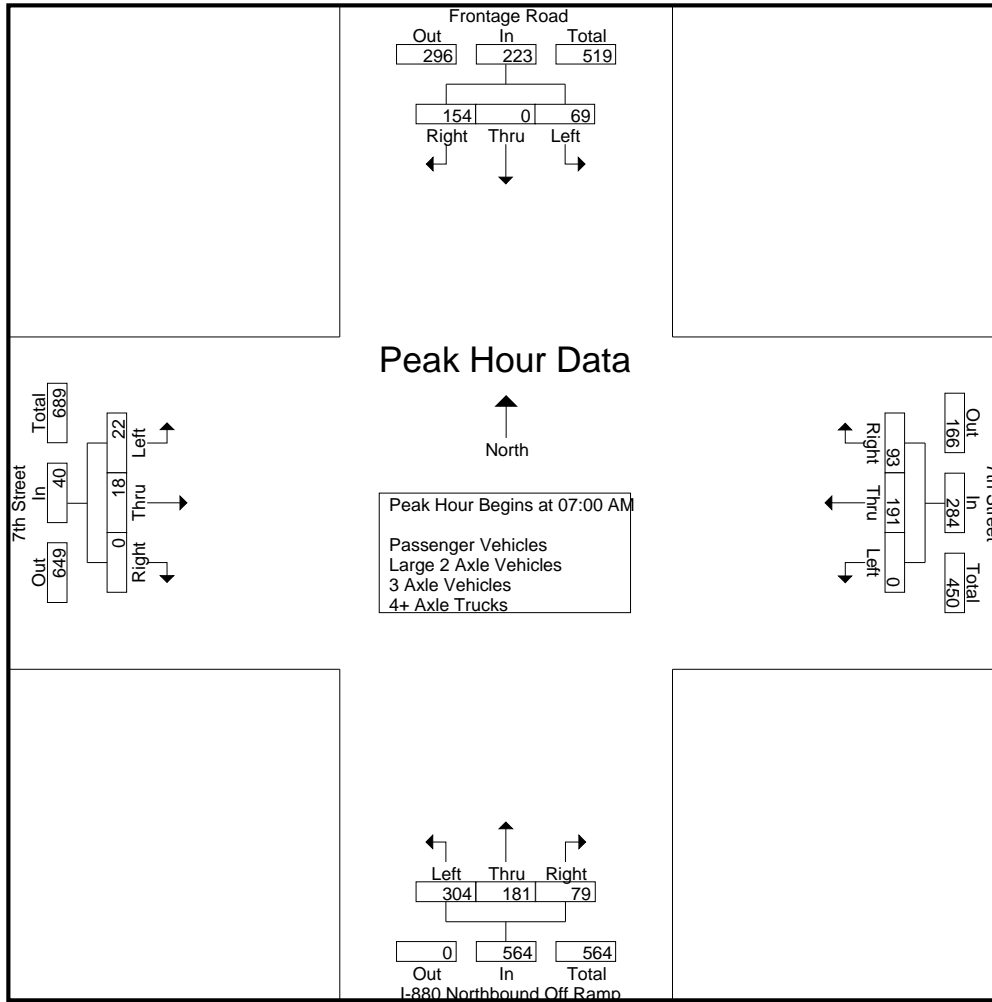

Peak Hour Analysis From 07:00 AM to 08:45 AM - Peak 1 of 1
 Peak Hour for Each Approach Begins at:

	07:00 AM				07:15 AM				07:00 AM				07:45 AM			
+0 mins.	15	0	49	64	0	46	15	61	106	41	18	165	12	4	0	16
+15 mins.	19	0	34	53	0	38	35	73	72	50	24	146	6	8	0	14
+30 mins.	21	0	31	52	0	50	27	77	59	47	18	124	7	7	0	14
+45 mins.	14	0	40	54	0	51	25	76	67	43	19	129	14	12	0	26
Total Volume	69	0	154	223	0	185	102	287	304	181	79	564	39	31	0	70
% App. Total	30.9	0	69.1		0	64.5	35.5		53.9	32.1	14		55.7	44.3	0	
PHF	.821	.000	.786	.871	.000	.907	.729	.932	.717	.905	.823	.855	.696	.646	.000	.673

City of Oakland
 N/S: Frontage Road/I-880 NB Off Ramp
 E/W: 7th Street
 Weather: Clear

File Name : 11_OKD_Frontage_7th PM
 Site Code : 00319737
 Start Date : 10/23/2019
 Page No : 2

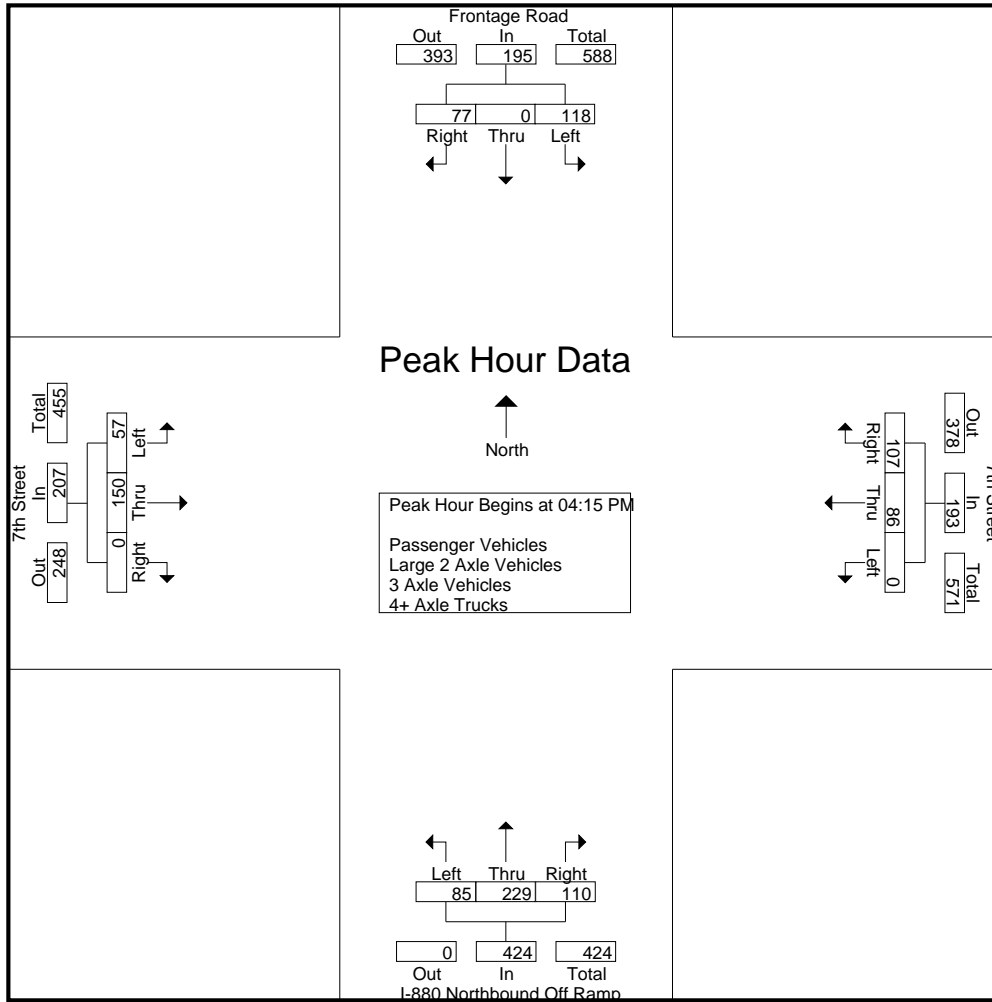

Peak Hour Analysis From 04:00 PM to 05:45 PM - Peak 1 of 1
 Peak Hour for Each Approach Begins at:

	05:00 PM				04:00 PM				04:30 PM				04:00 PM			
+0 mins.	35	0	20	55	0	26	23	49	23	56	30	109	15	38	0	53
+15 mins.	49	0	22	71	0	28	24	52	20	60	28	108	16	37	0	53
+30 mins.	38	0	23	61	0	21	27	48	26	57	25	108	16	38	0	54
+45 mins.	31	0	22	53	0	22	33	55	31	63	16	110	16	36	0	52
Total Volume	153	0	87	240	0	97	107	204	100	236	99	435	63	149	0	212
% App. Total	63.8	0	36.2		0	47.5	52.5		23	54.3	22.8		29.7	70.3	0	
PHF	.781	.000	.946	.845	.000	.866	.811	.927	.806	.937	.825	.989	.984	.980	.000	.981

Optimized Signal Timing at Maritime St./17th Street Intersection

HCM 6th Signalized Intersection Summary

3: Maritime Street & 17th Street

09/02/2020



Movement	EBL	EBT	EBR	WBL	WBT	WBR	NBL	NBT	NBR	SBL	SBT	SBR
Lane Configurations		↕			↕		↕	↕		↕	↕	
Traffic Volume (veh/h)	64	0	96	12	1	30	137	254	22	2	113	28
Future Volume (veh/h)	64	0	96	12	1	30	137	254	22	2	113	28
Initial Q (Qb), veh	0	0	0	0	0	0	0	0	0	0	0	0
Ped-Bike Adj(A_pbT)	1.00		1.00	1.00		1.00	1.00		1.00	1.00		1.00
Parking Bus, Adj	1.00	1.00	1.00	1.00	1.00	1.00	1.00	1.00	1.00	1.00	1.00	1.00
Work Zone On Approach		No			No			No			No	
Adj Sat Flow, veh/h/ln	1870	1870	1870	418	418	418	522	1648	1648	907	1515	1515
Adj Flow Rate, veh/h	70	0	104	13	1	33	149	276	24	2	123	30
Peak Hour Factor	0.92	0.92	0.92	0.92	0.92	0.92	0.92	0.92	0.92	0.92	0.92	0.92
Percent Heavy Veh, %	2	2	2	100	100	100	93	17	17	67	26	26
Cap, veh/h	173	18	148	91	8	40	139	1751	151	2	748	177
Arrive On Green	0.15	0.00	0.15	0.15	0.15	0.15	0.28	0.60	0.60	0.00	0.32	0.32
Sat Flow, veh/h	532	117	963	54	55	257	497	2917	252	864	2308	547
Grp Volume(v), veh/h	174	0	0	47	0	0	149	147	153	2	75	78
Grp Sat Flow(s),veh/h/ln	1611	0	0	366	0	0	497	1566	1603	864	1439	1416
Q Serve(g_s), s	0.0	0.0	0.0	1.2	0.0	0.0	15.5	2.3	2.3	0.1	2.1	2.2
Cycle Q Clear(g_c), s	5.6	0.0	0.0	6.7	0.0	0.0	15.5	2.3	2.3	0.1	2.1	2.2
Prop In Lane	0.40		0.60	0.28		0.70	1.00		0.16	1.00		0.39
Lane Grp Cap(c), veh/h	339	0	0	139	0	0	139	940	962	2	466	459
V/C Ratio(X)	0.51	0.00	0.00	0.34	0.00	0.00	1.07	0.16	0.16	0.85	0.16	0.17
Avail Cap(c_a), veh/h	593	0	0	196	0	0	139	940	962	78	466	459
HCM Platoon Ratio	1.00	1.00	1.00	1.00	1.00	1.00	1.00	1.00	1.00	1.00	1.00	1.00
Upstream Filter(I)	1.00	0.00	0.00	1.00	0.00	0.00	1.00	1.00	1.00	1.00	1.00	1.00
Uniform Delay (d), s/veh	22.2	0.0	0.0	22.7	0.0	0.0	20.0	4.9	4.9	27.7	13.4	13.4
Incr Delay (d2), s/veh	1.2	0.0	0.0	1.4	0.0	0.0	97.8	0.4	0.4	218.2	0.7	0.8
Initial Q Delay(d3),s/veh	0.0	0.0	0.0	0.0	0.0	0.0	0.0	0.0	0.0	0.0	0.0	0.0
%ile BackOfQ(50%),veh/ln	2.1	0.0	0.0	0.6	0.0	0.0	5.4	0.6	0.7	0.2	0.7	0.7
Unsig. Movement Delay, s/veh												
LnGrp Delay(d),s/veh	23.4	0.0	0.0	24.1	0.0	0.0	117.9	5.3	5.3	245.9	14.1	14.2
LnGrp LOS	C	A	A	C	A	A	F	A	A	F	B	B
Approach Vol, veh/h		174			47			449				155
Approach Delay, s/veh		23.4			24.1			42.6				17.2
Approach LOS		C			C			D				B
Timer - Assigned Phs	1	2		4	5	6		8				
Phs Duration (G+Y+Rc), s	4.7	37.8		13.1	20.0	22.5		13.1				
Change Period (Y+Rc), s	4.5	4.5		4.5	4.5	4.5		4.5				
Max Green Setting (Gmax), s	5.0	28.5		18.0	15.5	18.0		18.0				
Max Q Clear Time (g_c+I1), s	2.1	4.3		7.6	17.5	4.2		8.7				
Green Ext Time (p_c), s	0.0	1.8		0.7	0.0	0.6		0.1				

Intersection Summary

HCM 6th Ctrl Delay	32.7
HCM 6th LOS	C

This page intentionally left blank

Appendix G

Ocean Going Vessel Hold Water Quality Analysis



ENTHALPY
ANALYTICAL

Enthalpy Analytical
931 West Barkley Ave
Orange, CA 92868
(714) 771-6900

enthalpy.com

Lab Job Number: 435180
Report Level: II
Report Date: 10/30/2020

Analytical Report *prepared for:*

Michael Didula
U.S. Concrete
2740 - 1055 West Georgia St.
Vancouver, BC V6E 3R5

Authorized for release by:

Jess Silberman, Project Manager
510-204-2236
jessica.silberman@enthalpy.com

This data package has been reviewed for technical correctness and completeness. Release of this data has been authorized by the Laboratory Manager or the Manager's designee, as verified by the above signature which applies to this PDF file as well as any associated electronic data deliverable files. The results contained in this report meet all requirements of NELAP and pertain only to those samples which were submitted for analysis. This report may be reproduced only in its entirety.

CA ELAP# 1338, NELAP# 4038, SCAQMD LAP# 18LA0518, LACSD ID# 10105, CDC ELITE
Member

Sample Summary

Michael Didula
U.S. Concrete
2740 - 1055 West Georgia St.
Vancouver, BC V6E 3R5

Lab Job #: 435180
Date Received: 10/20/20

Sample ID	Lab ID	Collected	Matrix
HENRY JACKMAN	435180-001	10/16/20 00:00	Water

Case Narrative

U.S. Concrete
2740 - 1055 West Georgia St.
Vancouver, BC V6E 3R5
Michael Didula

Lab Job Number: 435180
Date Received: 10/20/20

This data package contains sample and QC results for one water sample, requested for the above referenced project on 10/20/20. The sample was received intact.

TPH-Purgeables and/or BTXE by GC (EPA 8015B):

No analytical problems were encountered.

TPH-Extractables by GC (EPA 8015B):

No analytical problems were encountered.

Volatile Organics by GC/MS (EPA 8260B):

No analytical problems were encountered.

Semivolatile Organics by GC/MS SIM (EPA 8270C-SIM):

No analytical problems were encountered.

Pesticides (EPA 8081A):

No analytical problems were encountered.

Metals (EPA 6010B and EPA 7470A):

High response was observed for arsenic in the CCV analyzed 10/25/20 18:14; affected data was qualified with "b". High response was observed for arsenic in the CCV analyzed 10/25/20 18:52; affected data was qualified with "b". High response was observed for arsenic in the CCV analyzed 10/25/20 19:30; affected data was qualified with "b". No other analytical problems were encountered.

Ion Chromatography (EPA 300.0):

Nitrogen, nitrate was analyzed outside of hold time; affected data was qualified with "H". No other analytical problems were encountered.

Total Phosphate as P (SM 4500-P-B2-E):

Low recoveries were observed for total phosphate as P and total phosphate as PO₄ in the MS/MSD of HENRY JACKMAN (lab # 435180-001); the LCS was within limits. No other analytical problems were encountered.

Salinity (SM2520B):

No analytical problems were encountered.

pH of Aqueous Samples (SM 4500-H+ B):

No analytical problems were encountered.

Total Coliform / E. coli by Quanti-Tray (SM 9223Bb):

No analytical problems were encountered.

Enterococcus by Enterolert (SM 9230D):

No analytical problems were encountered.

Cyanobacteria ():

No analytical problems were encountered.

SAMPLE RECEIPT CHECKLIST



Section 1: Login # 435780 Client: US Concrete
 Date Received: 10/20/20 Project: _____

Section 2: Shipping info (if applicable) _____
 Are custody seals present? No, or Yes. If yes, where? on cooler, on samples, on package
 Date: _____ How many _____ Signature, Initials, None
 Were custody seals intact upon arrival? Yes No N/A
 Samples received in a cooler? Yes, how many? _____ No (skip Section 3 below)
 If no cooler Sample Temp (°C): 22.1 using IR Gun # B, or C
 Samples received on ice directly from the field. Cooling process had begun
 If in cooler: Date Opened 10/20/20 By (print) MAE (sign) _____

Section 3: **Important: Notify PM if temperature exceeds 6°C or arrive frozen.**
 Packing in cooler: (if other, describe) _____
 Bubble Wrap, Foam blocks, Bags, None, Cloth material, Cardboard, Styrofoam, Paper towels
 Samples received on ice directly from the field. Cooling process had begun
 Type of ice used: Wet, Blue/Gel, None Temperature blank(s) included? Yes, No
 Temperature measured using Thermometer ID: _____, or IR Gun # B C
 Cooler Temp (°C): #1: _____, #2: _____, #3: _____, #4: _____, #5: _____, #6: _____, #7: _____

Section 4:	YES	NO	N/A
Were custody papers dry, filled out properly, and the project identifiable		<input checked="" type="checkbox"/>	
Were Method 5035 sampling containers present?		<input checked="" type="checkbox"/>	
If YES, what time were they transferred to freezer?			
Did all bottles arrive unbroken/unopened?	<input checked="" type="checkbox"/>		
Are there any missing / extra samples?		<input checked="" type="checkbox"/>	
Are samples in the appropriate containers for indicated tests?		<input checked="" type="checkbox"/>	
Are sample labels present, in good condition and complete?	<input checked="" type="checkbox"/>		
Does the container count match the CDC?			<input checked="" type="checkbox"/>
Do the sample labels agree with custody papers?	<input checked="" type="checkbox"/>		
Was sufficient amount of sample sent for tests requested?			
Did you change the hold time in LIMS for unpreserved VOAs?			<input checked="" type="checkbox"/>
Did you change the hold time in LIMS for preserved terracores?			<input checked="" type="checkbox"/>
Are bubbles > 6mm present in VOA samples?			<input checked="" type="checkbox"/>
Was the client contacted concerning this sample delivery?		<input checked="" type="checkbox"/>	
If YES, who was called? _____ By _____ Date: _____			

Section 5:
 Are the samples appropriately preserved? (if N/A, skip the rest of section 5)
 Did you check preservatives for all bottles for each sample?
 Did you document your preservative check?
 pH strip lot# _____, pH strip lot# _____, pH strip lot# _____
 Preservative added:
 H2SO4 lot# _____ added to samples _____ on/at _____
 HCL lot# _____ added to samples _____ on/at _____
 HNO3 lot# _____ added to samples _____ on/at _____
 NaOH lot# _____ added to samples _____ on/at _____

Section 6:
 Explanations/Comments: split sample into appropriate containers in lab.

Date Logged in 10/20/20 By (print) ZLA (sign) _____
 Date Labeled 10/20/20 By (print) MAE (sign) _____

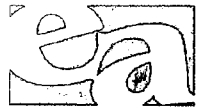

ENTHALPY ANALYTICAL

SAMPLE ACCEPTANCE CHECKLIST

Section 1
 Client: US Concrete Project: _____
 Date Received: 10/21/20 Sampler's Name Present: Yes No

Section 2
 Sample(s) received in a cooler? Yes, How many? 1 No (skip section 2) Sample Temp (°C) (No Cooler) : _____
 Sample Temp (°C), One from each cooler: #1: 2.0 #2: _____ #3: _____ #4: _____
(Acceptance range is < 6°C but not frozen (for Microbiology samples, acceptance range is < 10°C but not frozen). It is acceptable for samples collected the same day as sample receipt to have a higher temperature as long as there is evidence that cooling has begun.)
 Shipping Information: _____

Section 3
 Was the cooler packed with: Ice Ice Packs Bubble Wrap Styrofoam
 Paper None Other _____
 Cooler Temp (°C): #1: 0.2 #2: _____ #3: _____ #4: _____

Section 4	YES	NO	N/A
Was a COC received?	✓		
Are sample IDs present?	✓		
Are sampling dates & times present?	✓		
Is a relinquished signature present?	✓		
Are the tests required clearly indicated on the COC?		✓	
Are custody seals present?		✓	
If custody seals are present, were they intact?	✓		
Are all samples sealed in plastic bags? (Recommended for Microbiology samples)	✓		
Did all samples arrive intact? If no, indicate in Section 4 below.	✓		
Did all bottle labels agree with COC? (ID, dates and times)	✓		
Were the samples collected in the correct containers for the required tests?	✓		
Are the containers labeled with the correct preservatives?	✓		
Is there headspace in the VOA vials greater than 5-6 mm in diameter?			✓
Was a sufficient amount of sample submitted for the requested tests?	✓		

Section 5 Explanations/Comments
 Analysis not marked on COC.

Section 6
 For discrepancies, how was the Project Manager notified? Verbal PM Initials: _____ Date/Time: _____
 Email (email sent to/on): _____ / _____
 Project Manager's response: _____

Completed By: _____ Date: _____

SAMPLE RECEIPT CHECKLIST



Section 1: Login # 435780 Client: US Concrete
 Date Received: 10/20/20 Project: _____

Section 2: Shipping info (if applicable)
 Are custody seals present? No, or Yes. If yes, where? on cooler, on samples, on package
 Date: _____ How many _____ Signature, Initials, None
 Were custody seals intact upon arrival? Yes No N/A
 Samples received in a cooler? Yes, how many? _____ No (skip Section 3 below)
 If no cooler Sample Temp (°C): 22.1 using IR Gun # B, or C
 Samples received on ice directly from the field. Cooling process had begun
 If in cooler: Date Opened 10/20/20 By (print) MAG (sign) [Signature]

Section 3: **Important: Notify PM if temperature exceeds 6°C or arrive frozen.**
 Packing in cooler: (if other, describe) _____
 Bubble Wrap, Foam blocks, Bags, None, Cloth material, Cardboard, Styrofoam, Paper towels
 Samples received on ice directly from the field. Cooling process had begun
 Type of ice used: Wet, Blue/Gel, None Temperature blank(s) included? Yes, No
 Temperature measured using Thermometer ID: _____, or IR Gun # B C
 Cooler Temp (°C): #1: _____, #2: _____, #3: _____, #4: _____, #5: _____, #6: _____, #7: _____

Section 4:	YES	NO	N/A
Were custody papers dry, filled out properly, and the project identifiable		<input checked="" type="checkbox"/>	
Were Method 5035 sampling containers present?		<input checked="" type="checkbox"/>	
If YES, what time were they transferred to freezer?			
Did all bottles arrive unbroken/unopened?	<input checked="" type="checkbox"/>		
Are there any missing / extra samples?		<input checked="" type="checkbox"/>	
Are samples in the appropriate containers for indicated tests?		<input checked="" type="checkbox"/>	
Are sample labels present, in good condition and complete?	<input checked="" type="checkbox"/>		
Does the container count match the CDC?			<input checked="" type="checkbox"/>
Do the sample labels agree with custody papers?	<input checked="" type="checkbox"/>		
Was sufficient amount of sample sent for tests requested?			
Did you change the hold time in LIMS for unpreserved VOAs?			<input checked="" type="checkbox"/>
Did you change the hold time in LIMS for preserved terracores?			<input checked="" type="checkbox"/>
Are bubbles > 6mm present in VOA samples?			<input checked="" type="checkbox"/>
Was the client contacted concerning this sample delivery?		<input checked="" type="checkbox"/>	
If YES, who was called? _____ By _____ Date: _____			

Section 5:
 Are the samples appropriately preserved? (If N/A, skip the rest of section 5)
 Did you check preservatives for all bottles for each sample?
 Did you document your preservative check?
 pH strip lot# _____, pH strip lot# _____, pH strip lot# _____
 Preservative added:
 H2SO4 lot# _____ added to samples _____ on/at _____
 HCL lot# _____ added to samples _____ on/at _____
 HNO3 lot# _____ added to samples _____ on/at _____
 NaOH lot# _____ added to samples _____ on/at _____

Section 6:
 Explanations/Comments: split sample into appropriate containers in lab.

Date Logged in 10/20/20 By (print) ZLA (sign) _____
 Date Labeled 10/20/20 By (print) MAG (sign) [Signature]



SAMPLE ACCEPTANCE CHECKLIST

Section 1

Client: US Concrete Project: _____

Date Received: 10/21/20 Sampler's Name Present: Yes No

Section 2

Sample(s) received in a cooler? Yes, How many? 1 No (skip section 2) Sample Temp (°C) (No Cooler) : _____

Sample Temp (°C), One from each cooler: #1: 2.0 #2: _____ #3: _____ #4: _____

(Acceptance range is < 6°C but not frozen (for Microbiology samples, acceptance range is < 10°C but not frozen). It is acceptable for samples collected the same day as sample receipt to have a higher temperature as long as there is evidence that cooling has begun.)

Shipping Information: _____

Section 3

Was the cooler packed with: Ice Ice Packs Bubble Wrap Styrofoam
 Paper None Other _____

Cooler Temp (°C): #1: 0.2 #2: _____ #3: _____ #4: _____

Section 4	YES	NO	N/A
Was a COC received?	✓		
Are sample IDs present?	✓		
Are sampling dates & times present?	✓		
Is a relinquished signature present?	✓		
Are the tests required clearly indicated on the COC?		✓	
Are custody seals present?		✓	
If custody seals are present, were they intact?	✓		
Are all samples sealed in plastic bags? (Recommended for Microbiology samples)	✓		
Did all samples arrive intact? If no, indicate in Section 4 below.	✓		
Did all bottle labels agree with COC? (ID, dates and times)	✓		
Were the samples collected in the correct containers for the required tests?	✓		
Are the containers labeled with the correct preservatives?	✓		
Is there headspace in the VOA vials greater than 5-6 mm in diameter?			✓
Was a sufficient amount of sample submitted for the requested tests?	✓		

Section 5 Explanations/Comments

Analysis not marked on COC.

Section 6

For discrepancies, how was the Project Manager notified? Verbal PM Initials: _____ Date/Time _____
 Email (email sent to/on): _____ / _____

Project Manager's response: _____

Completed By: Liz E. H. Mendenhall Date: 10/21/2020



800-322-5555
www.gls-us.com

Ship From
ENTHALPY ANALYTICAL
JOHN GOYETTE
2323 5TH STREET
BERKELEY, CA 94710

Tracking #: 550861750

PDS



Ship To
ENTHALPY ANALYTICAL (ORG)
SAMPLE RECEIVING
931 W BARKLEY AVE.
ORANGE, CA 92868

ORANGE

S92868A

COD: \$0.00
Weight: 0 lb(s)
Reference:

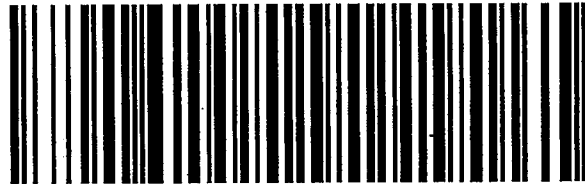

Delivery Instructions:

Signature Type: STANDARD

29161361

ORC CA927-CI0

Print Date: 10/20/2020 1:34 PM

20/02

Analysis Results for 435180

Michael Didula
 U.S. Concrete
 2740 - 1055 West Georgia St.
 Vancouver, BC V6E 3R5

Lab Job #: 435180
 Date Received: 10/20/20

Sample ID: HENRY JACKMAN	Lab ID: 435180-001	Collected: 10/16/20
	Matrix: Water	

435180-001 Analyte	Result	Qual	Units	RL	DF	Batch	Prepared	Analyzed	Chemist
Method: EPA 300.0 Prep Method: METHOD									
Chloride	27		mg/L	1.0	1	255178	10/27/20 16:03	10/27/20 16:03	RKV
Nitrogen, Nitrate	ND	H	mg/L	0.10	1	255178	10/27/20 16:03	10/27/20 16:03	RKV
Method: EPA 6010B Prep Method: EPA 3010A									
Antimony	ND		ug/L	40	1	254984	10/23/20	10/25/20	SBW
Arsenic	ND		ug/L	10	1	254984	10/23/20	10/25/20	SBW
Barium	18		ug/L	10	1	254984	10/23/20	10/25/20	SBW
Beryllium	ND		ug/L	1.0	1	254984	10/23/20	10/25/20	SBW
Cadmium	ND		ug/L	5.0	1	254984	10/23/20	10/25/20	SBW
Chromium	10		ug/L	10	1	254984	10/23/20	10/25/20	SBW
Cobalt	ND		ug/L	5.0	1	254984	10/23/20	10/25/20	SBW
Copper	ND		ug/L	10	1	254984	10/23/20	10/25/20	SBW
Lead	ND		ug/L	10	1	254984	10/23/20	10/25/20	SBW
Molybdenum	11		ug/L	10	1	254984	10/23/20	10/25/20	SBW
Nickel	ND		ug/L	10	1	254984	10/23/20	10/25/20	SBW
Selenium	ND		ug/L	30	1	254984	10/23/20	10/25/20	SBW
Silver	ND		ug/L	5.0	1	254984	10/23/20	10/25/20	SBW
Thallium	ND		ug/L	50	1	254984	10/23/20	10/25/20	SBW
Vanadium	17		ug/L	5.0	1	254984	10/23/20	10/25/20	SBW
Zinc	ND		ug/L	50	1	254984	10/23/20	10/25/20	SBW
Method: EPA 7470A Prep Method: METHOD									
Mercury	ND		ug/L	0.40	1	254856	10/21/20	10/21/20	JDB
Method: EPA 8015B Prep Method: EPA 5030B									
TPH Gasoline	ND		ug/L	50	1	254978	10/24/20	10/24/20	EMW
Surrogates				Limits					
Bromofluorobenzene (FID)	123%		%REC	60-140	1	254978	10/24/20	10/24/20	EMW
Method: EPA 8015B Prep Method: EPA 3510C									
Diesel C10-C28	190		ug/L	140	1.4	254965	10/22/20	10/24/20	MES
ORO C28-C44	ND		ug/L	410	1.4	254965	10/22/20	10/24/20	MES
Surrogates				Limits					
n-Triacontane	78%		%REC	35-130	1.4	254965	10/22/20	10/24/20	MES

Analysis Results for 435180

435180-001 Analyte	Result	Qual	Units	RL	DF	Batch	Prepared	Analyzed	Chemist
Method: EPA 8081A									
Prep Method: EPA 3510C									
alpha-BHC	ND		ug/L	0.05	1.1	254979	10/23/20	10/23/20	KTD
beta-BHC	ND		ug/L	0.05	1.1	254979	10/23/20	10/23/20	KTD
gamma-BHC	ND		ug/L	0.05	1.1	254979	10/23/20	10/23/20	KTD
delta-BHC	ND		ug/L	0.05	1.1	254979	10/23/20	10/23/20	KTD
Heptachlor	ND		ug/L	0.05	1.1	254979	10/23/20	10/23/20	KTD
Aldrin	ND		ug/L	0.05	1.1	254979	10/23/20	10/23/20	KTD
Heptachlor epoxide	ND		ug/L	0.05	1.1	254979	10/23/20	10/23/20	KTD
Endosulfan I	ND		ug/L	0.05	1.1	254979	10/23/20	10/23/20	KTD
Dieldrin	ND		ug/L	0.1	1.1	254979	10/23/20	10/23/20	KTD
4,4'-DDE	ND		ug/L	0.1	1.1	254979	10/23/20	10/23/20	KTD
Endrin	ND		ug/L	0.1	1.1	254979	10/23/20	10/23/20	KTD
Endosulfan II	ND		ug/L	0.1	1.1	254979	10/23/20	10/23/20	KTD
Endosulfan sulfate	ND		ug/L	0.1	1.1	254979	10/23/20	10/23/20	KTD
4,4'-DDD	ND		ug/L	0.1	1.1	254979	10/23/20	10/23/20	KTD
Endrin aldehyde	ND		ug/L	0.1	1.1	254979	10/23/20	10/23/20	KTD
Endrin ketone	ND		ug/L	0.1	1.1	254979	10/23/20	10/23/20	KTD
4,4'-DDT	ND		ug/L	0.1	1.1	254979	10/23/20	10/23/20	KTD
Methoxychlor	ND		ug/L	0.1	1.1	254979	10/23/20	10/23/20	KTD
Toxaphene	ND		ug/L	2.1	1.1	254979	10/23/20	10/23/20	KTD
Chlordane (Technical)	ND		ug/L	1.1	1.1	254979	10/23/20	10/23/20	KTD
Surrogates				Limits					
TCMX	50%		%REC	14-120	1.1	254979	10/23/20	10/23/20	KTD
Decachlorobiphenyl	67%		%REC	20-120	1.1	254979	10/23/20	10/23/20	KTD
Method: EPA 8260B									
Prep Method: EPA 5030B									
Benzene	ND		ug/L	1.0	1	255106	10/27/20	10/27/20	LYZ
Toluene	ND		ug/L	5.0	1	255106	10/27/20	10/27/20	LYZ
Ethylbenzene	ND		ug/L	5.0	1	255106	10/27/20	10/27/20	LYZ
o-Xylene	ND		ug/L	5.0	1	255106	10/27/20	10/27/20	LYZ
m,p-Xylenes	ND		ug/L	10	1	255106	10/27/20	10/27/20	LYZ
Xylene (total)	ND		ug/L	5.0	1	255106	10/27/20	10/27/20	LYZ
Surrogates				Limits					
Dibromofluoromethane	96%		%REC	70-140	1	255106	10/27/20	10/27/20	LYZ
1,2-Dichloroethane-d4	113%		%REC	70-140	1	255106	10/27/20	10/27/20	LYZ
Toluene-d8	96%		%REC	70-140	1	255106	10/27/20	10/27/20	LYZ
Bromofluorobenzene	98%		%REC	70-140	1	255106	10/27/20	10/27/20	LYZ
Method: EPA 8270C-SIM									
Prep Method: EPA 3510C									
1-Methylnaphthalene	ND		ug/L	0.50	1	254775	10/21/20	10/25/20	TJW
2-Methylnaphthalene	ND		ug/L	0.50	1	254775	10/21/20	10/25/20	TJW
Naphthalene	ND		ug/L	0.50	1	254775	10/21/20	10/25/20	TJW
Acenaphthylene	ND		ug/L	0.50	1	254775	10/21/20	10/25/20	TJW
Acenaphthene	ND		ug/L	0.50	1	254775	10/21/20	10/25/20	TJW
Fluorene	ND		ug/L	0.50	1	254775	10/21/20	10/25/20	TJW

Analysis Results for 435180

435180-001 Analyte	Result	Qual	Units	RL	DF	Batch	Prepared	Analyzed	Chemist
Phenanthrene	ND		ug/L	0.50	1	254775	10/21/20	10/25/20	TJW
Anthracene	ND		ug/L	0.50	1	254775	10/21/20	10/25/20	TJW
Fluoranthene	ND		ug/L	0.50	1	254775	10/21/20	10/25/20	TJW
Pyrene	ND		ug/L	0.50	1	254775	10/21/20	10/25/20	TJW
Benzo(a)anthracene	ND		ug/L	0.50	1	254775	10/21/20	10/25/20	TJW
Chrysene	ND		ug/L	0.50	1	254775	10/21/20	10/25/20	TJW
Benzo(b)fluoranthene	ND		ug/L	0.50	1	254775	10/21/20	10/25/20	TJW
Benzo(k)fluoranthene	ND		ug/L	0.50	1	254775	10/21/20	10/25/20	TJW
Benzo(a)pyrene	ND		ug/L	0.50	1	254775	10/21/20	10/25/20	TJW
Indeno(1,2,3-cd)pyrene	ND		ug/L	0.50	1	254775	10/21/20	10/25/20	TJW
Dibenz(a,h)anthracene	ND		ug/L	0.50	1	254775	10/21/20	10/25/20	TJW
Benzo(g,h,i)perylene	ND		ug/L	0.50	1	254775	10/21/20	10/25/20	TJW
Surrogates				Limits					
Nitrobenzene-d5	67%		%REC	41-119	1	254775	10/21/20	10/25/20	TJW
2-Fluorobiphenyl	85%		%REC	45-118	1	254775	10/21/20	10/25/20	TJW
Terphenyl-d14	116%		%REC	71-134	1	254775	10/21/20	10/25/20	TJW
Method: SM 4500-H+ B									
pH	7.95	H	SU		1	254823	10/21/20 15:00	10/21/20 15:00	SGC
Temperature	21.20	H	deg C	1.00	1	254823	10/21/20 15:00	10/21/20 15:00	SGC
Method: SM 4500-P-B2-E									
Total Phosphate as P	0.032		mg/L	0.020	1	255242	10/28/20	10/28/20	SGC
Total Phosphate as PO4	0.098		mg/L	0.060	1	255242	10/28/20	10/28/20	SGC
Method: SM 9223Bb									
Fecal Coliform	<1.0	H	MPN/100ml	1.0	1	254903	10/21/20 16:13	10/23/20 17:55	CCO
Method: SM 9230D									
Enterococcus	<1.0	H	MPN/100ml	1.0	1	254849	10/21/20 15:50	10/22/20 16:35	CCO
Method: SM2520B									
Salinity	0.20		S	0.10	1	254814	10/21/20	10/21/20	SGC

< Value is less than indicated concentration
 H Holding time was exceeded
 ND Not Detected

Batch QC

Type: Blank	Lab ID: QC891103	Batch: 254775
Matrix: Water	Method: EPA 8270C-SIM	Prep Method: EPA 3510C

QC891103 Analyte	Result	Qual	Units	RL	Prepared	Analyzed
1-Methylnaphthalene	ND		ug/L	0.50	10/20/20	10/23/20
2-Methylnaphthalene	ND		ug/L	0.50	10/20/20	10/23/20
Naphthalene	ND		ug/L	0.50	10/20/20	10/23/20
Acenaphthylene	ND		ug/L	0.50	10/20/20	10/23/20
Acenaphthene	ND		ug/L	0.50	10/20/20	10/23/20
Fluorene	ND		ug/L	0.50	10/20/20	10/23/20
Phenanthrene	ND		ug/L	0.50	10/20/20	10/23/20
Anthracene	ND		ug/L	0.50	10/20/20	10/23/20
Fluoranthene	ND		ug/L	0.50	10/20/20	10/23/20
Pyrene	ND		ug/L	0.50	10/20/20	10/23/20
Benzo(a)anthracene	ND		ug/L	0.50	10/20/20	10/23/20
Chrysene	ND		ug/L	0.50	10/20/20	10/23/20
Benzo(b)fluoranthene	ND		ug/L	0.50	10/20/20	10/23/20
Benzo(k)fluoranthene	ND		ug/L	0.50	10/20/20	10/23/20
Benzo(a)pyrene	ND		ug/L	0.50	10/20/20	10/23/20
Indeno(1,2,3-cd)pyrene	ND		ug/L	0.50	10/20/20	10/23/20
Dibenz(a,h)anthracene	ND		ug/L	0.50	10/20/20	10/23/20
Benzo(g,h,i)perylene	ND		ug/L	0.50	10/20/20	10/23/20
Surrogates				Limits		
Nitrobenzene-d5	71%		%REC	41-119	10/20/20	10/23/20
2-Fluorobiphenyl	77%		%REC	45-118	10/20/20	10/23/20
Terphenyl-d14	95%		%REC	71-134	10/20/20	10/23/20

Batch QC

Type: Lab Control Sample	Lab ID: QC891104	Batch: 254775
Matrix: Water	Method: EPA 8270C-SIM	Prep Method: EPA 3510C

QC891104 Analyte	Result	Spiked	Units	Recovery	Qual	Limits
1-Methylnaphthalene	0.7774	1.000	ug/L	78%		70-130
2-Methylnaphthalene	0.5270	1.000	ug/L	53%		40-130
Naphthalene	0.7799	1.000	ug/L	78%		41-130
Acenaphthylene	0.7650	1.000	ug/L	77%		43-130
Acenaphthene	0.6871	1.000	ug/L	69%		46-130
Fluorene	0.8074	1.000	ug/L	81%		49-130
Phenanthrene	0.7422	1.000	ug/L	74%		57-130
Anthracene	0.7090	1.000	ug/L	71%		50-130
Fluoranthene	0.8560	1.000	ug/L	86%		62-130
Pyrene	0.8151	1.000	ug/L	82%		62-130
Benzo(a)anthracene	0.8500	1.000	ug/L	85%		61-130
Chrysene	0.8182	1.000	ug/L	82%		61-130
Benzo(b)fluoranthene	0.8054	1.000	ug/L	81%		42-158
Benzo(k)fluoranthene	0.8739	1.000	ug/L	87%		58-134
Benzo(a)pyrene	0.7298	1.000	ug/L	73%		46-139
Indeno(1,2,3-cd)pyrene	0.8223	1.000	ug/L	82%		52-144
Dibenz(a,h)anthracene	0.8971	1.000	ug/L	90%		60-130
Benzo(g,h,i)perylene	0.7729	1.000	ug/L	77%		50-143
Surrogates						
Nitrobenzene-d5	0.7942	1.000	ug/L	79%		41-119
2-Fluorobiphenyl	0.8499	1.000	ug/L	85%		45-118
Terphenyl-d14	0.9953	1.000	ug/L	100%		71-134

Batch QC

Type: Lab Control Sample Duplicate	Lab ID: QC891105	Batch: 254775
Matrix: Water	Method: EPA 8270C-SIM	Prep Method: EPA 3510C

QC891105 Analyte	Result	Spiked	Units	Recovery	Qual	Limits	RPD	RPD Lim
1-Methylnaphthalene	0.8242	1.000	ug/L	82%		70-130	6	35
2-Methylnaphthalene	0.5581	1.000	ug/L	56%		40-130	6	35
Naphthalene	0.7962	1.000	ug/L	80%		41-130	2	35
Acenaphthylene	0.8003	1.000	ug/L	80%		43-130	5	35
Acenaphthene	0.7170	1.000	ug/L	72%		46-130	4	35
Fluorene	0.8409	1.000	ug/L	84%		49-130	4	35
Phenanthrene	0.7942	1.000	ug/L	79%		57-130	7	35
Anthracene	0.7605	1.000	ug/L	76%		50-130	7	35
Fluoranthene	0.9138	1.000	ug/L	91%		62-130	7	35
Pyrene	0.8691	1.000	ug/L	87%		62-130	6	35
Benzo(a)anthracene	0.8875	1.000	ug/L	89%		61-130	4	35
Chrysene	0.8484	1.000	ug/L	85%		61-130	4	35
Benzo(b)fluoranthene	0.8642	1.000	ug/L	86%		42-158	7	35
Benzo(k)fluoranthene	0.9348	1.000	ug/L	93%		58-134	7	35
Benzo(a)pyrene	0.7797	1.000	ug/L	78%		46-139	7	35
Indeno(1,2,3-cd)pyrene	0.8618	1.000	ug/L	86%		52-144	5	35
Dibenz(a,h)anthracene	0.8719	1.000	ug/L	87%		60-130	3	35
Benzo(g,h,i)perylene	0.8417	1.000	ug/L	84%		50-143	9	35
Surrogates								
Nitrobenzene-d5	0.7985	1.000	ug/L	80%		41-119		
2-Fluorobiphenyl	0.8774	1.000	ug/L	88%		45-118		
Terphenyl-d14	1.029	1.000	ug/L	103%		71-134		

Type: Sample Duplicate	Lab ID: QC891249	Batch: 254823
Matrix (Source ID): Water (435180-001)	Method: SM 4500-H+ B	

QC891249 Analyte	Result	Source Sample Result	Units	Qual	RPD	RPD Lim	DF
pH	7.990	7.950	SU		1	20	1
Temperature	21.20	21.20	deg C		0	20	1

Type: Blank	Lab ID: QC891313	Batch: 254856
Matrix: Water	Method: EPA 7470A	Prep Method: METHOD

QC891313 Analyte	Result	Qual	Units	RL	Prepared	Analyzed
Mercury	ND		mg/Kg	0.00040	10/21/20	10/21/20

Batch QC

Type: Lab Control Sample	Lab ID: QC891314	Batch: 254856
Matrix: Water	Method: EPA 7470A	Prep Method: METHOD

QC891314 Analyte	Result	Spiked	Units	Recovery	Qual	Limits
Mercury	0.004993	0.005000	mg/Kg	100%		80-120

Type: Matrix Spike	Lab ID: QC891315	Batch: 254856
Matrix (Source ID): Water (435187-001)	Method: EPA 7470A	Prep Method: METHOD

QC891315 Analyte	Result	Source Sample Result	Spiked	Units	Recovery	Qual	Limits	DF
Mercury	0.005127	ND	0.005000	mg/Kg	103%		75-125	1

Type: Matrix Spike Duplicate	Lab ID: QC891316	Batch: 254856
Matrix (Source ID): Water (435187-001)	Method: EPA 7470A	Prep Method: METHOD

QC891316 Analyte	Result	Source Sample Result	Spiked	Units	Recovery	Qual	Limits	RPD	Lim	DF
Mercury	0.005086	ND	0.005000	mg/Kg	102%		75-125	1	20	1

Type: Matrix Spike	Lab ID: QC891317	Batch: 254856
Matrix (Source ID): Water (435201-002)	Method: EPA 7470A	Prep Method: METHOD

QC891317 Analyte	Result	Source Sample Result	Spiked	Units	Recovery	Qual	Limits	DF
Mercury	0.004546	ND	0.005000	mg/Kg	91%		75-125	1

Type: Matrix Spike Duplicate	Lab ID: QC891318	Batch: 254856
Matrix (Source ID): Water (435201-002)	Method: EPA 7470A	Prep Method: METHOD

QC891318 Analyte	Result	Source Sample Result	Spiked	Units	Recovery	Qual	Limits	RPD	Lim	DF
Mercury	0.004928	ND	0.005000	mg/Kg	99%		75-125	8	20	1

Batch QC

Type: Blank	Lab ID: QC891627	Batch: 254965
Matrix: Water	Method: EPA 8015B	Prep Method: EPA 3510C

QC891627 Analyte	Result	Qual	Units	RL	Prepared	Analyzed
Diesel C10-C28	ND		ug/L	100	10/22/20	10/24/20
ORO C28-C44	ND		ug/L	300	10/22/20	10/24/20
Surrogates			Limits			
n-Triacontane	87%		%REC	35-130	10/22/20	10/24/20

Type: Lab Control Sample	Lab ID: QC891628	Batch: 254965
Matrix: Water	Method: EPA 8015B	Prep Method: EPA 3510C

QC891628 Analyte	Result	Spiked	Units	Recovery	Qual	Limits
Diesel C10-C28	866.3	1000	ug/L	87%		42-120
Surrogates						
n-Triacontane	16.73	20.00	ug/L	84%		35-130

Type: Lab Control Sample Duplicate	Lab ID: QC891629	Batch: 254965
Matrix: Water	Method: EPA 8015B	Prep Method: EPA 3510C

QC891629 Analyte	Result	Spiked	Units	Recovery	Qual	Limits	RPD	RPD Lim
Diesel C10-C28	868.2	1000	ug/L	87%		42-120	0	36
Surrogates								
n-Triacontane	16.66	20.00	ug/L	83%		35-130		

Type: Lab Control Sample	Lab ID: QC891806	Batch: 254978
Matrix: Water	Method: EPA 8015B	Prep Method: EPA 5030B

QC891806 Analyte	Result	Spiked	Units	Recovery	Qual	Limits
TPH Gasoline	463.5	500.0	ug/L	93%		70-130
Surrogates						
Bromofluorobenzene (FID)	253.0	200.0	ug/L	127%		60-140

Type: Matrix Spike	Lab ID: QC891807	Batch: 254978
Matrix (Source ID): Water (435061-001)	Method: EPA 8015B	Prep Method: EPA 5030B

QC891807 Analyte	Result	Source Sample Result	Spiked	Units	Recovery	Qual	Limits	DF
TPH Gasoline	483.4	ND	500.0	ug/L	94%		70-130	1
Surrogates								
Bromofluorobenzene (FID)	254.0		200.0	ug/L	127%		60-140	1

Batch QC

Type: Matrix Spike Duplicate	Lab ID: QC891808	Batch: 254978
Matrix (Source ID): Water (435061-001)	Method: EPA 8015B	Prep Method: EPA 5030B

QC891808 Analyte	Result	Source Sample Result	Spiked	Units	Recovery	Qual	Limits	RPD	RPD Lim	DF
TPH Gasoline	481.2	ND	500.0	ug/L	94%		70-130	0	30	1
Surrogates										
Bromofluorobenzene (FID)	256.0		200.0	ug/L	128%		60-140			1

Type: Blank	Lab ID: QC891809	Batch: 254978
Matrix: Water	Method: EPA 8015B	Prep Method: EPA 5030B

QC891809 Analyte	Result	Qual	Units	RL	Prepared	Analyzed
TPH Gasoline	ND		ug/L	50	10/24/20	10/24/20
Surrogates						
Bromofluorobenzene (FID)	121%		%REC	60-140	10/24/20	10/24/20

Type: Blank	Lab ID: QC891651	Batch: 254979
Matrix: Water	Method: EPA 8081A	Prep Method: EPA 3510C

QC891651 Analyte	Result	Qual	Units	RL	Prepared	Analyzed
alpha-BHC	ND		ug/L	0.05	10/23/20	10/23/20
beta-BHC	ND		ug/L	0.05	10/23/20	10/23/20
gamma-BHC	ND		ug/L	0.05	10/23/20	10/23/20
delta-BHC	ND		ug/L	0.05	10/23/20	10/23/20
Heptachlor	ND		ug/L	0.05	10/23/20	10/23/20
Aldrin	ND		ug/L	0.05	10/23/20	10/23/20
Heptachlor epoxide	ND		ug/L	0.05	10/23/20	10/23/20
Endosulfan I	ND		ug/L	0.05	10/23/20	10/23/20
Dieldrin	ND		ug/L	0.1	10/23/20	10/23/20
4,4'-DDE	ND		ug/L	0.1	10/23/20	10/23/20
Endrin	ND		ug/L	0.1	10/23/20	10/23/20
Endosulfan II	ND		ug/L	0.1	10/23/20	10/23/20
Endosulfan sulfate	ND		ug/L	0.1	10/23/20	10/23/20
4,4'-DDD	ND		ug/L	0.1	10/23/20	10/23/20
Endrin aldehyde	ND		ug/L	0.1	10/23/20	10/23/20
Endrin ketone	ND		ug/L	0.1	10/23/20	10/23/20
4,4'-DDT	ND		ug/L	0.1	10/23/20	10/23/20
Methoxychlor	ND		ug/L	0.1	10/23/20	10/23/20
Toxaphene	ND		ug/L	2.0	10/23/20	10/23/20
Chlordane (Technical)	ND		ug/L	1.0	10/23/20	10/23/20
Surrogates				Limits		
TCMX	50%		%REC	14-120	10/23/20	10/23/20
Decachlorobiphenyl	75%		%REC	20-120	10/23/20	10/23/20

Batch QC

Type: Lab Control Sample	Lab ID: QC891652	Batch: 254979
Matrix: Water	Method: EPA 8081A	Prep Method: EPA 3510C

QC891652 Analyte	Result	Spiked	Units	Recovery	Qual	Limits
alpha-BHC	0.4143	0.5000	ug/L	83%		53-120
beta-BHC	0.3744	0.5000	ug/L	75%		59-120
gamma-BHC	0.4224	0.5000	ug/L	84%		54-120
delta-BHC	0.3941	0.5000	ug/L	79%		58-120
Heptachlor	0.4258	0.5000	ug/L	85%		49-120
Aldrin	0.4137	0.5000	ug/L	83%		47-120
Heptachlor epoxide	0.3991	0.5000	ug/L	80%		53-120
Endosulfan I	0.4455	0.5000	ug/L	89%		56-120
Dieldrin	0.4445	0.5000	ug/L	89%		55-120
4,4'-DDE	0.4379	0.5000	ug/L	88%		55-120
Endrin	0.4318	0.5000	ug/L	86%		57-120
Endosulfan II	0.4480	0.5000	ug/L	90%		58-120
Endosulfan sulfate	0.4089	0.5000	ug/L	82%		56-120
4,4'-DDD	0.3931	0.5000	ug/L	79%		53-120
Endrin aldehyde	0.3424	0.5000	ug/L	68%		45-120
Endrin ketone	0.4293	0.5000	ug/L	86%		61-120
4,4'-DDT	0.4130	0.5000	ug/L	83%		58-120
Methoxychlor	0.4131	0.5000	ug/L	83%		54-120
Surrogates						
TCMX	0.3635	0.5000	ug/L	73%		14-120
Decachlorobiphenyl	0.5040	0.5000	ug/L	101%		20-120

Batch QC

Type: Lab Control Sample Duplicate	Lab ID: QC891653	Batch: 254979
Matrix: Water	Method: EPA 8081A	Prep Method: EPA 3510C

QC891653 Analyte	Result	Spiked	Units	Recovery	Qual	Limits	RPD	RPD Lim
alpha-BHC	0.3793	0.5000	ug/L	76%		53-120	9	20
beta-BHC	0.3496	0.5000	ug/L	70%		59-120	7	20
gamma-BHC	0.3881	0.5000	ug/L	78%		54-120	8	20
delta-BHC	0.3662	0.5000	ug/L	73%		58-120	7	20
Heptachlor	0.3934	0.5000	ug/L	79%		49-120	8	20
Aldrin	0.3775	0.5000	ug/L	75%		47-120	9	20
Heptachlor epoxide	0.3641	0.5000	ug/L	73%		53-120	9	20
Endosulfan I	0.4214	0.5000	ug/L	84%		56-120	6	20
Dieldrin	0.4238	0.5000	ug/L	85%		55-120	5	20
4,4'-DDE	0.4130	0.5000	ug/L	83%		55-120	6	20
Endrin	0.4040	0.5000	ug/L	81%		57-120	7	20
Endosulfan II	0.4267	0.5000	ug/L	85%		58-120	5	20
Endosulfan sulfate	0.3907	0.5000	ug/L	78%		56-120	5	20
4,4'-DDD	0.3740	0.5000	ug/L	75%		53-120	5	20
Endrin aldehyde	0.3222	0.5000	ug/L	64%		45-120	6	20
Endrin ketone	0.4033	0.5000	ug/L	81%		61-120	6	20
4,4'-DDT	0.3884	0.5000	ug/L	78%		58-120	6	20
Methoxychlor	0.3944	0.5000	ug/L	79%		54-120	5	20
Surrogates								
TCMX	0.3100	0.5000	ug/L	62%		14-120		
Decachlorobiphenyl	0.4763	0.5000	ug/L	95%		20-120		

Batch QC

Type: Blank	Lab ID: QC891670	Batch: 254984
Matrix: Water	Method: EPA 6010B	Prep Method: EPA 3010A

QC891670 Analyte	Result	Qual	Units	RL	Prepared	Analyzed
Antimony	ND		ug/L	40	10/23/20	10/25/20
Arsenic	ND		ug/L	10	10/23/20	10/25/20
Barium	ND		ug/L	10	10/23/20	10/25/20
Beryllium	ND		ug/L	1.0	10/23/20	10/25/20
Cadmium	ND		ug/L	5.0	10/23/20	10/25/20
Chromium	ND		ug/L	10	10/23/20	10/25/20
Cobalt	ND		ug/L	5.0	10/23/20	10/25/20
Copper	ND		ug/L	10	10/23/20	10/25/20
Lead	ND		ug/L	10	10/23/20	10/25/20
Molybdenum	ND		ug/L	10	10/23/20	10/25/20
Nickel	ND		ug/L	10	10/23/20	10/25/20
Selenium	ND		ug/L	30	10/23/20	10/25/20
Silver	ND		ug/L	5.0	10/23/20	10/25/20
Thallium	ND		ug/L	50	10/23/20	10/25/20
Vanadium	ND		ug/L	5.0	10/23/20	10/25/20
Zinc	ND		ug/L	50	10/23/20	10/25/20

Type: Lab Control Sample	Lab ID: QC891671	Batch: 254984
Matrix: Water	Method: EPA 6010B	Prep Method: EPA 3010A

QC891671 Analyte	Result	Spiked	Units	Recovery	Qual	Limits
Antimony	2,116	2000	ug/L	106%		80-120
Arsenic	2,215	2000	ug/L	111%	b	80-120
Barium	2,072	2000	ug/L	104%		80-120
Beryllium	2,047	2000	ug/L	102%		80-120
Cadmium	2,222	2000	ug/L	111%		80-120
Chromium	2,145	2000	ug/L	107%		80-120
Cobalt	2,212	2000	ug/L	111%		80-120
Copper	1,969	2000	ug/L	98%		80-120
Lead	2,132	2000	ug/L	107%		80-120
Molybdenum	2,227	2000	ug/L	111%		80-120
Nickel	2,170	2000	ug/L	108%		80-120
Selenium	2,002	2000	ug/L	100%		80-120
Silver	1,889	2000	ug/L	94%		80-120
Thallium	2,279	2000	ug/L	114%		80-120
Vanadium	2,074	2000	ug/L	104%		80-120
Zinc	2,357	2000	ug/L	118%		80-120

Batch QC

Type: Matrix Spike	Lab ID: QC891672	Batch: 254984
Matrix (Source ID): Water (435276-001)	Method: EPA 6010B	Prep Method: EPA 3010A

QC891672 Analyte	Result	Source Sample Result	Spiked	Units	Recovery	Qual	Limits	DF
Antimony	1,037	ND	1000	ug/L	104%		75-125	1
Arsenic	1,072	ND	1000	ug/L	107%	b	75-125	1
Barium	1,097	26.66	1000	ug/L	107%		75-125	1
Beryllium	1,042	ND	1000	ug/L	104%		75-125	1
Cadmium	1,067	ND	1000	ug/L	107%		75-125	1
Chromium	1,041	ND	1000	ug/L	104%		75-125	1
Cobalt	1,061	ND	1000	ug/L	106%		75-125	1
Copper	992.6	ND	1000	ug/L	99%		75-125	1
Lead	1,057	ND	1000	ug/L	106%		75-125	1
Molybdenum	1,098	ND	1000	ug/L	110%		75-125	1
Nickel	1,041	1.813	1000	ug/L	104%		75-125	1
Selenium	934.4	3.427	1000	ug/L	93%		75-125	1
Silver	933.1	ND	1000	ug/L	93%		75-125	1
Thallium	1,095	ND	1000	ug/L	110%		75-125	1
Vanadium	1,025	ND	1000	ug/L	103%		75-125	1
Zinc	1,093	1.851	1000	ug/L	109%		75-125	1

Type: Matrix Spike Duplicate	Lab ID: QC891673	Batch: 254984
Matrix (Source ID): Water (435276-001)	Method: EPA 6010B	Prep Method: EPA 3010A

QC891673 Analyte	Result	Source Sample Result	Spiked	Units	Recovery	Qual	Limits	RPD	Lim	DF
Antimony	1,023	ND	1000	ug/L	102%		75-125	1	20	1
Arsenic	1,073	ND	1000	ug/L	107%	b	75-125	0	20	1
Barium	1,092	26.66	1000	ug/L	107%		75-125	0	20	1
Beryllium	1,029	ND	1000	ug/L	103%		75-125	1	20	1
Cadmium	1,056	ND	1000	ug/L	106%		75-125	1	20	1
Chromium	1,029	ND	1000	ug/L	103%		75-125	1	20	1
Cobalt	1,052	ND	1000	ug/L	105%		75-125	1	20	1
Copper	971.6	ND	1000	ug/L	97%		75-125	2	20	1
Lead	1,050	ND	1000	ug/L	105%		75-125	1	20	1
Molybdenum	1,089	ND	1000	ug/L	109%		75-125	1	20	1
Nickel	1,033	1.813	1000	ug/L	103%		75-125	1	20	1
Selenium	935.9	3.427	1000	ug/L	93%		75-125	0	20	1
Silver	925.4	ND	1000	ug/L	93%		75-125	1	20	1
Thallium	1,093	ND	1000	ug/L	109%		75-125	0	20	1
Vanadium	1,015	ND	1000	ug/L	102%		75-125	1	20	1
Zinc	1,088	1.851	1000	ug/L	109%		75-125	0	20	1

Batch QC

Type: Blank	Lab ID: QC892060	Batch: 255106
Matrix: Water	Method: EPA 8260B	Prep Method: EPA 5030B

QC892060 Analyte	Result	Qual	Units	RL	Prepared	Analyzed
Benzene	ND		ug/L	1.0	10/27/20	10/27/20
Toluene	ND		ug/L	5.0	10/27/20	10/27/20
Ethylbenzene	ND		ug/L	5.0	10/27/20	10/27/20
o-Xylene	ND		ug/L	5.0	10/27/20	10/27/20
m,p-Xylenes	ND		ug/L	10	10/27/20	10/27/20
Xylene (total)	ND		ug/L	5.0	10/27/20	10/27/20
Surrogates			Limits			
Dibromofluoromethane	94%		%REC	70-140	10/27/20	10/27/20
1,2-Dichloroethane-d4	111%		%REC	70-140	10/27/20	10/27/20
Toluene-d8	93%		%REC	70-140	10/27/20	10/27/20
Bromofluorobenzene	102%		%REC	70-140	10/27/20	10/27/20

Type: Lab Control Sample	Lab ID: QC892061	Batch: 255106
Matrix: Water	Method: EPA 8260B	Prep Method: EPA 5030B

QC892061 Analyte	Result	Spiked	Units	Recovery	Qual	Limits
Benzene	50.03	50.00	ug/L	100%		70-130
Toluene	47.64	50.00	ug/L	95%		70-130
Ethylbenzene	48.01	50.00	ug/L	96%		70-130
o-Xylene	50.33	50.00	ug/L	101%		70-130
m,p-Xylenes	98.72	100.0	ug/L	99%		70-130
Surrogates						
Dibromofluoromethane	46.66	50.00	ug/L	93%		70-140
1,2-Dichloroethane-d4	55.04	50.00	ug/L	110%		70-140
Toluene-d8	48.99	50.00	ug/L	98%		70-140
Bromofluorobenzene	49.93	50.00	ug/L	100%		70-140

Batch QC

Type: Matrix Spike	Lab ID: QC892062	Batch: 255106
Matrix (Source ID): Water (435379-010)	Method: EPA 8260B	Prep Method: EPA 5030B

QC892062 Analyte	Result	Source Sample Result	Spiked	Units	Recovery	Qual	Limits	DF
Benzene	50.26	ND	50.00	ug/L	101%		70-130	1
Toluene	46.56	0.2011	50.00	ug/L	93%		70-130	1
Ethylbenzene	46.43	ND	50.00	ug/L	93%		70-130	1
o-Xylene	49.14	0.07733	50.00	ug/L	98%		70-130	1
m,p-Xylenes	95.94	0.2628	100.0	ug/L	96%		70-131	1
Surrogates								
Dibromofluoromethane	47.55		50.00	ug/L	95%		70-140	1
1,2-Dichloroethane-d4	55.16		50.00	ug/L	110%		70-140	1
Toluene-d8	46.79		50.00	ug/L	94%		70-140	1
Bromofluorobenzene	50.52		50.00	ug/L	101%		70-140	1

Type: Matrix Spike Duplicate	Lab ID: QC892063	Batch: 255106
Matrix (Source ID): Water (435379-010)	Method: EPA 8260B	Prep Method: EPA 5030B

QC892063 Analyte	Result	Source Sample Result	Spiked	Units	Recovery	Qual	Limits	RPD	RPD Lim	DF
Benzene	48.48	ND	50.00	ug/L	97%		70-130	4	30	1
Toluene	46.99	0.2011	50.00	ug/L	94%		70-130	1	30	1
Ethylbenzene	46.85	ND	50.00	ug/L	94%		70-130	1	30	1
o-Xylene	50.79	0.07733	50.00	ug/L	101%		70-130	3	30	1
m,p-Xylenes	98.37	0.2628	100.0	ug/L	98%		70-131	2	30	1
Surrogates										
Dibromofluoromethane	47.54		50.00	ug/L	95%		70-140			1
1,2-Dichloroethane-d4	55.55		50.00	ug/L	111%		70-140			1
Toluene-d8	47.82		50.00	ug/L	96%		70-140			1
Bromofluorobenzene	48.05		50.00	ug/L	96%		70-140			1

Type: Blank	Lab ID: QC892191	Batch: 255178
Matrix: Water	Method: EPA 300.0	Prep Method: METHOD

QC892191 Analyte	Result	Qual	Units	RL	Prepared	Analyzed
Chloride	ND		mg/L	1.0	10/27/20 10:32	10/27/20 10:32
Nitrogen, Nitrate	ND		mg/L	0.10	10/27/20 10:32	10/27/20 10:32

Batch QC

Type: Lab Control Sample	Lab ID: QC892192	Batch: 255178
Matrix: Water	Method: EPA 300.0	Prep Method: METHOD

QC892192 Analyte	Result	Spiked	Units	Recovery	Qual	Limits
Chloride	98.86	100.0	mg/L	99%		90-110
Nitrogen, Nitrate	9.238	9.036	mg/L	102%		90-110

Type: Matrix Spike	Lab ID: QC892193	Batch: 255178
Matrix (Source ID): Water (435417-001)	Method: EPA 300.0	Prep Method: METHOD

QC892193 Analyte	Result	Source Sample Result	Spiked	Units	Recovery	Qual	Limits	DF
Chloride	97.90	1.482	100.0	mg/L	96%		80-120	1
Nitrogen, Nitrate	8.588	ND	9.036	mg/L	95%		80-120	1

Type: Matrix Spike Duplicate	Lab ID: QC892194	Batch: 255178
Matrix (Source ID): Water (435417-001)	Method: EPA 300.0	Prep Method: METHOD

QC892194 Analyte	Result	Source Sample Result	Spiked	Units	Recovery	Qual	Limits	RPD	Lim	DF
Chloride	100.3	1.482	100.0	mg/L	99%		80-120	2	20	1
Nitrogen, Nitrate	8.977	ND	9.036	mg/L	99%		80-120	4	20	1

Type: Blank	Lab ID: QC892342	Batch: 255242
Matrix: Water	Method: SM 4500-P-B2-E	

QC892342 Analyte	Result	Qual	Units	RL	Prepared	Analyzed
Total Phosphate as P	ND		mg/L	0.020	10/28/20	10/28/20
Total Phosphate as PO4	ND		mg/L	0.060	10/28/20	10/28/20

Type: Lab Control Sample	Lab ID: QC892343	Batch: 255242
Matrix: Water	Method: SM 4500-P-B2-E	

QC892343 Analyte	Result	Spiked	Units	Recovery	Qual	Limits
Total Phosphate as P	0.4010	0.4000	mg/L	100%		80-120
Total Phosphate as PO4	1.230	1.230	mg/L	100%		80-120

Batch QC

Type: Matrix Spike	Lab ID: QC892344	Batch: 255242
Matrix (Source ID): Water (435180-001)	Method: SM 4500-P-B2-E	

QC892344 Analyte	Result	Source Sample Result	Spiked	Units	Recovery	Qual	Limits	DF
Total Phosphate as P	0.2560	0.03200	0.4000	mg/L	56%	*	75-125	1
Total Phosphate as PO4	0.7850	0.09800	1.230	mg/L	56%	*	75-125	1

Type: Matrix Spike Duplicate	Lab ID: QC892345	Batch: 255242
Matrix (Source ID): Water (435180-001)	Method: SM 4500-P-B2-E	

QC892345 Analyte	Result	Source Sample Result	Spiked	Units	Recovery	Qual	Limits	RPD	RPD Lim	DF
Total Phosphate as P	0.2550	0.03200	0.4000	mg/L	56%	*	75-125	0	20	1
Total Phosphate as PO4	0.7820	0.09800	1.230	mg/L	56%	*	75-125	0	20	1

* Value is outside QC limits

ND Not Detected

b See narrative

Laboratory Job Number 435180

Subcontracted Products

Eurofins Eaton Analytical

750 Royal Oaks Drive, Suite 100
Monrovia, California 91016-3629
Tel: (626) 386-1100
Fax: (866) 988-3757
1 800 566 LABS (1 800 566 5227)

Laboratory Report

for

Enthalpy Analytical
2323 5th Street
Berkley, CA 94710
Attention: Jessica Silberman

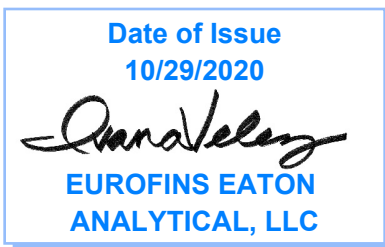

Utah ELCP CA00006

SZN3: Ivana Velez
Project Manager

Report: 900646
Project: MICRO
Group: Algae

* Accredited in accordance with TNI 2016 and ISO/IEC 17025:2017.

* Laboratory certifies that the test results meet all **TNI 2016 and ISO/IEC 17025:2017** requirements unless noted under the individual analysis.

* Following the cover page are State Certification List, ISO 17025 Accredited Method List, Acknowledgement of Samples Received, Comments, Hits Report, Data Report, QC Summary, QC Report and Regulatory Forms, as applicable.

* Test results relate only to the sample(s) tested.

* Test results apply to the sample(s) as received, unless otherwise noted in the comments report (ISO/IEC 17025:2017).

* This report shall not be reproduced except in full, without the written approval of the laboratory.

* This report includes ISO/IEC 17025 and non-ISO 17025 accredited methods.

STATE CERTIFICATION LIST

State	Certification Number	State	Certification Number
Alabama	41060	Montana	Cert 0035
Arizona	AZ0778	Nebraska	Certified
Arkansas	Certified	Nevada	CA000062018
California	2813	New Hampshire *	2959
Colorado	Certified	New Jersey *	CA 008
Connecticut	PH-0107	New Mexico	Certified
Delaware	CA 006	New York *	11320
Florida *	E871024	North Carolina	06701
Georgia	947	North Dakota	R-009
Guam	18-005R	Oregon *	CA200003-005
Hawaii	Certified	Pennsylvania *	68-565
Idaho	Certified	Puerto Rico	Certified
Illinois *	200033	Rhode Island	LAO00326
Indiana	C-CA-01	South Carolina	87016
Iowa - Asbestos	413	South Dakota	Certified
Kansas *	E-10268	Tennessee	TN02839
Kentucky	90107	Texas *	T104704230-18-15
Louisiana *	LA180000	Utah (Primary AB) *	CA00006
Maine	CA0006	Vermont	VT0114
Maryland	224	Virginia *	460260
Commonwealth of Northern Marianas Is.	MP0004	Washington	C838
Massachusetts	M-CA006	EPA Region 5	Certified
Michigan	9906	Los Angeles County Sanitation Districts	10264
Mississippi	Certified		

* NELAP/TNI Recognized Accreditation Bodies

ISO/IEC 17025 Accredited Method List

The tests listed below are accredited and meet the requirements of ISO/IEC 17025 as verified by the ANSI-ASQ National Accreditation Board/A2LA.
Refer to Certificate and scope of accreditation (5890) found at: <https://www.eurofinsus.com/Eaton>

SPECIFIC TESTS	METHOD OR TECHNIQUE USED	Environmental (Drinking Water)	Environmental (Waste Water)	Water as a Component of Food and Bev/Bev/ Bottled Water
1,2,3-TCP (5 PPT & 0.5 PPT)	CA SRL 524M-TCP	x		x
1,4-Dioxane	EPA 522	x		x
2,3,7,8-TCDD	Modified EPA 1613B	x		x
Acrylamide	In House Method (2440)	x		x
Algal Toxins/Microcystin	In House Method (3570)			
Alkalinity	SM 2320B	x	x	x
Ammonia	EPA 350.1		x	x
Ammonia	SM 4500-NH3 H		x	x
Anions and DBPs by IC	EPA 300.0	x	x	x
Anions and DBPs by IC	EPA 300.1	x		x
Asbestos	EPA 100.2	x	x	
BOD / CBOD	SM 5210B		x	x
Bromate	In House Method (2447)	x		x
Carbamates	EPA 531.2	x		x
Carbonate as CO3	SM 2330B	x	x	x
Carbonyls	EPA 556	x		x
COD	EPA 410.4 / SM 5220D		x	
Chloramines	SM 4500-CL G	x	x	x
Chlorinated Acids	EPA 515.4	x		x
Chlorinated Acids	EPA 555	x		x
Chlorine Dioxide	SM 4500-CLO2 D Palin Test	x		x
Chlorine -Total/Free/ Combined Residual	SM 4500-Cl G	x	x	x
Conductivity	EPA 120.1		x	
Conductivity	SM 2510B	x	x	x
Corrosivity (Langelier Index)	SM 2330B	x		x
Cyanide, Amenable	SM 4500-CN G	x	x	
Cyanide, Free	SM 4500CN F	x	x	x
Cyanide, Total	EPA 335.4	x	x	x
Cyanogen Chloride (screen)	In House Method (2470)	x		x
Diquat and Paraquat	EPA 549.2	x		x
DBP/HAA	SM 6251B	x		x
Dissolved Oxygen	SM 4500-O G		x	x
DOC	SM 5310C	x		x
E. Coli (MTF/EC+MUG)		x		x
E. Coli (CFR 141.21(f)(6)(i))		x		x
E. Coli (SM 9223)	SM 9223		x	
E. Coli (Enumeration)	SM 9221B.1/ SM 9221F	x		x
E. Coli (Enumeration)	SM 9223B	x		x
EDB/DCBP	EPA 504.1	x		
EDB/DBCP and DBP	EPA 551.1	x		x
EDTA and NTA	In House Method (2454)	x		x
Endothall	EPA 548.1	x		x
Endothall	In-house Method (2445)	x		x
Enterococci	SM 9230B	x	x	
Fecal Coliform	SM 9221 E (MTF/EC)	x		
Fecal Coliform	SM 9221C, E (MTF/EC)		x	
Fecal Coliform (Enumeration)	SM 9221E (MTF/EC)	x		x
Fecal Coliform with Chlorine Present	SM 9221E		x	
Fecal Streptococci	SM 9230B	x	x	
Fluoride	SM 4500-F C	x	x	x
Glyphosate	EPA 547	x		x
Glyphosate + AMPA	In House Method (3618)	x		x
Gross Alpha/Beta	EPA 900.0	x	x	x
Gross Alpha Coprecipitation	SM 7110 C	x	x	x
Hardness	SM 2340B	x	x	x
Heterotrophic Bacteria	In House Method (2439)	x		x
Heterotrophic Bacteria	SM 9215 B	x		x
Hexavalent Chromium	EPA 218.6	x	x	x

SPECIFIC TESTS	METHOD OR TECHNIQUE USED	Environmental (Drinking Water)	Environmental (Waste Water)	Water as a Component of Food and Bev/Bev/ Bottled Water
Hexavalent Chromium	EPA 218.7	x		x
Hexavalent Chromium	SM 3500-Cr B		x	
Hormones	EPA 539	x		x
Hydroxide as OH Calc.	SM 2330B	x		x
Kjeldahl Nitrogen	EPA 351.2		x	
Legionella	Legiolert	x		x
Mercury	EPA 200.8	x		x
Metals	EPA 200.7 / 200.8	x	x	x
Microcystin LR	ELISA (2360)	x		x
Microcystin, Total	EPA 546	x		x
NDMA	EEA/Agilent 521.1 In house method (2425)	x		x
Nitrate/Nitrite Nitrogen	EPA 353.2	x	x	x
OCL, Pesticides/PCB	EPA 505	x		x
Ortho Phosphate	EPA 365.1	x	x	x
Ortho Phosphorous	SM 4500P E	x		x
Oxyhalides Disinfection Byproducts	EPA 317.0	x		x
Perchlorate	EPA 331.0	x		x
Perchlorate (low and high)	EPA 314.0	x		x
Perfluorinated Alkyl Acids	EPA 537	x		x
Perfluorinated Pollutant	In house Method (2434)	x		x
pH	EPA 150.1	x		
pH	SM 4500-H+B	x	x	x
Phenylurea Pesticides/ Herbicides	In House Method, based on EPA 532 (2448)	x		x
Pseudomonas	IDEXX Pseudalert (2461)	x		x
Radium-226	GA Institute of Tech	x		x
Radium-228	GA Institute of Tech	x		x
Radon-222	SM 7500RN	x		x
Residue, Filterable	SM 2540C	x	x	x
Residue, Non-filterable	SM 2540D		x	
Residue, Total	SM 2540B		x	x
Residue, Volatile	EPA 160.4		x	
Semi-VOC	EPA 525.2	x		x
Silica	SM 4500-Si D	x	x	
Silica	SM 4500-SiO2 C	x	x	
Sulfide	SM 4500-S ⁻² D		x	
Sulfite	SM 4500-SO ³⁻ B	x	x	x
Surfactants	SM 5540C	x	x	x
Taste and Odor Analytes	SM 6040E	x		x
Total Coliform (P/A)	SM 9221 A, B	x		x
Total Coliform (Enumeration)	SM 9221 A, B, C	x		x
Total Coliform / E. coli	Colisure SM 9223	x		x
Total Coliform	SM 9221B		x	
Total Coliform with Chlorine Present	SM 9221B		x	
Total Coliform / E.coli (P/A and Enumeration)	SM 9223	x		x
TOC	SM 5310C	x	x	x
TOX	SM 5320B		x	
Total Phenols	EPA 420.1		x	
Total Phenols	EPA 420.4	x	x	x
Total Phosphorous	SM 4500 P E		x	
Triazine Pesticides & Degradates	In House (3617)	x		x
Turbidity	EPA 180.1	x	x	x
Turbidity	SM 2130B	x	x	
Uranium by ICP/MS	EPA 200.8	x		x
UV 254	SM 5910B	x		
VOC	EPA 524.2	x		x
VOC	In House Method (2411)	x		x
Yeast and Mold	SM 9610	x		x
Field Sampling	N/A			

Acknowledgement of Samples Received

Addr: **Enthalpy Analytical**
2323 5th Street
Berkeley, CA 94710

Client ID: CT-BERKELEY
Folder #: 900646
Project: MICRO
Sample Group: Algae

Attn: Jessica Silberman
Phone: (510) 204-2236

Project Manager: Ivana Velez
Phone: 626-386-1123

The following samples were received from you on **October 22, 2020 at 1004**. They have been scheduled for the tests listed below each sample. If this information is incorrect, please contact your service representative. Thank you for using Eurofins Eaton Analytical, LLC.

Sample #	Sample ID	Sample Date
202010280408	435180-001	10/16/2020 0000
Algae Identification		

Test Description

Subcontract Laboratory:

 Eurofins Eaton Analytical
 750 Royal Oaks Drive
 Suite 100
 Monrovia, CA 91016

ATTN:

PO #: Required, to be sent via email

Enthalpy Order: EO-435180

PM: Jess Silberman

Email: jessica.silberman@enthalpy.com

CC: incomingreports@enthalpy.com

Phone: 510-204-2236

900646

Results Due: Standard TAT

Report Level: II

Report To: RL

EDDs:

*BYES
10/22/20
1005*

Notes:



Sample ID	Collected	Lab ID	# Cont.	Matrix	Analysis Requested	Comment
HENRY JACKMAN	16-OCT-2020 00:00	435180-001	1	Water	Cyanobacteria	Algal identification

Notes:
Relinquished By:
Received By:

 Date: *10-21-20 1613*

 Date: *10-22-20 1004*

Date:

Date:

Date:

Date:



Eaton Analytical

INTERNAL CHAIN OF CUSTODY RECORD

EAA Folder Number: 916064

SAMPLE TEMP RECEIVED:

Note: If samples are out of temperature range, let the ASMs know. ASMs will determine whether to proceed with analysis or not.

SAMPLES REC'D DAY OF COLLECTION? Yes / No

IR Gun ID = 616 (Observation = 0.5 °C) (Corr. Factor = -0.3 °C) (Final = 0.2 °C)

TYPE OF ICE: Real Synthetic No Ice Partially Frozen Thawed N/A

METHOD OF SHIPMENT: Pick-Up / Walk-In / FedEx / UPS / DHL / Area Fast / Top Line / Other: GLS
550885110

Compliance Acceptance Criteria:

- 1) Chemistry: >0, ≤6°C, not frozen (NELAP) (if received after 24 hrs of sample collection)
- 2) Microbiology, Distribution: < 10°C, not frozen (can be ≥10°C if received on ice the same day as sample collection, within 8 hours)
- 3) Microbiology, Surface Water: < 10°C (if received after 2 hours of sample collection)

If out of temperature range for both Chemistry and Microbiology samples and temperature does not confirm, then measure the temperature of each quadrant and record each temperature of the quadrants

1 = (Observation = _____ °C) (Corr. Factor = _____ °C) (Final = _____ °C)	2 = (Observation = _____ °C) (Corr. Factor = _____ °C) (Final = _____ °C)
3 = (Observation = _____ °C) (Corr. Factor = _____ °C) (Final = _____ °C)	4 = (Observation = _____ °C) (Corr. Factor = _____ °C) (Final = _____ °C)

4 Dioxin (1613 or 2,3,7,8 TCDD): must be between 0-4 °C, not frozen (if received after 24 hrs of sample collection)

5) pH Check. Manufacturer: _____ Lot Number: _____ pH strip type: 0 - 14 or _____ Expiration Date: _____ Results: _____

6) Chlorine check. Manufacturer: Sansafe. Lot No.: _____ Expiration Date: _____ Results: _____

7) Headspace: No Samples with Headspace: Samples with Headspace (see below):

Headspace Documentation (use additional VOC and Radon Internal COFC for additional bottles)

Exempt from headspace concerns: Methods 515.4, HAA(6251,552), 505, SPME, @CH, 532LCMS, 556, 536, Anatoxin, LCMS methods using 40 ml vials, International clients:

Samp ID	Bottle #	None/<6	mm	Samp ID	Bottle #	None/<6	mm

Note Sample IDs which have dissimilar headspace (i.e. potential sampling errors): _____

RECEIVED BY: Chun Baochen PRINT NAME: Chun Baochen COMPANY/TITLE: Eurofins Eaton Analytical DATE: 10.22.20 TIME: 1004

Tel: (626) 386-1100
Fax: (866) 988-3757
1 800 566 LABS (1 800 566 5227)

Laboratory Comments

Report: 900646
Project: MICRO
Group: Algae

Enthalpy Analytical
Jessica Silberman
2323 5th Street
Berkeley, CA 94710

Flags Legend:

- H3 - Sample was received and/ or analysis requested past holding time.
- QP - Q10-Sample received in an inappropriate sample container.

Tel: (626) 386-1100
 Fax: (626) 988-3757
 1 800 566 LABS (1 800 566 5227)

Report: 900646
Project: MICRO
Group: Algae

Enthalpy Analytical
 Jessica Silberman
 2323 5th Street
 Berkley, CA 94710

Samples Received on:
 10/22/2020 1004

Analyzed	Analyte	Sample ID	Result	Federal MCL	Units	MRL
10/29/2020 12:06	202010280408 Algae Identification	<u>435180-001</u>	See Attached		Not Appl.	

Tel: (626) 386-1100
 Fax: (626) 988-3757
 1 800 566 LABS (1 800 566 5227)

Laboratory Data

Report: 900646
 Project: MICRO
 Group: Algae

Enthalpy Analytical

Jessica Silberman
 2323 5th Street
 Berkley, CA 94710

Samples Received on:
 10/22/2020 1004

Prepped	Analyzed	Prep Batch	Analytical Batch	Method	Analyte	Result	Units	MRL	Dilution
435180-001 (202010280408)						Sampled on 10/16/2020 0000			
SM 10900 - Algae Identification									
10/29/20 12:06			1284594	(SM 10900)	Algae Identification	See Attached (H3,QP)	Not Appl.		1

Rounding on totals after summation.
 (c) - indicates calculated results. Analysis is a calculated result. Reported results are not rounded until the final step before reporting. Therefore methods that use a test result with further calculation may have slight differences in final result than the component analyses.

Tel: (626) 386-1100
Fax: (866) 988-3757
1 800 566 LABS (1 800 566 5227)

Report: 900646
Project: MICRO
Group: Algae

Enthalpy Analytical

Algae Identification**Analytical Batch: 1284594**

202010280408

435180-001

Analysis Date: 10/29/2020

Analyzed by: R77L

This page intentionally left blank



ENTHALPY
ANALYTICAL

Enthalpy Analytical
931 West Barkley Ave
Orange, CA 92868
(714) 771-6900

enthalpy.com

Lab Job Number: 435578
Report Level: II
Report Date: 11/05/2020

Analytical Report *prepared for:*

Michael Didula
U.S. Concrete
2740 - 1055 West Georgia St.
Vancouver, BC V6E 3R5

Location: Port of Oakland

Authorized for release by:

Jess Silberman, Project Manager
510-204-2236
jessica.silberman@enthalpy.com

This data package has been reviewed for technical correctness and completeness. Release of this data has been authorized by the Laboratory Manager or the Manager's designee, as verified by the above signature which applies to this PDF file as well as any associated electronic data deliverable files. The results contained in this report meet all requirements of NELAP and pertain only to those samples which were submitted for analysis. This report may be reproduced only in its entirety.

CA ELAP# 1338, NELAP# 4038, SCAQMD LAP# 18LA0518, LACSD ID# 10105, CDC ELITE
Member

Sample Summary

Michael Didula
U.S. Concrete
2740 - 1055 West Georgia St.
Vancouver, BC V6E 3R5

Lab Job #: 435578
Location: Port of Oakland
Date Received: 10/28/20

Sample ID	Lab ID	Collected	Matrix
CARGO WASH WATER	435578-001	10/27/20 15:00	Water

SAMPLE RECEIPT CHECKLIST



Section 1: Login # 435578 Client: US Concrete
 Date Received: 10/28/20 Project: _____

Section 2: Shipping info (if applicable) _____
 Are custody seals present? No, or Yes. If yes, where? on cooler, on samples, on package
 Date: _____ How many _____ Signature, Initials, None
 Were custody seals intact upon arrival? Yes No N/A
 Samples received in a cooler? Yes, how many? _____ No (skip Section 3 below)
 If no cooler Sample Temp (°C): 22.5 using IR Gun # B, or C
 Samples received on ice directly from the field. Cooling process had begun
 If in cooler: Date Opened 10/28/20 By (print) MAG (sign) [Signature]

Section 3: Important : Notify PM if temperature exceeds 6°C or arrive frozen.

Packing in cooler: (if other, describe) _____
 Bubble Wrap, Foam blocks, Bags, None, Cloth material, Cardboard, Styrofoam, Paper towels
 Samples received on ice directly from the field. Cooling process had begun
 Type of ice used : Wet, Blue/Gel, None Temperature blank(s) included? Yes, No
 Temperature measured using Thermometer ID: _____, or IR Gun # B C
 Cooler Temp (°C): #1: _____, #2: _____, #3: _____, #4: _____, #5: _____, #6: _____, #7: _____

Section 4:	YES	NO	N/A
Were custody papers dry, filled out properly, and the project identifiable		—	
Were Method 5035 sampling containers present?		—	
If YES, what time were they transferred to freezer? _____			
Did all bottles arrive unbroken/unopened?	—		
Are there any missing / extra samples?		—	
Are samples in the appropriate containers for indicated tests?		—	
Are sample labels present, in good condition and complete?		—	
Does the container count match the COC?			—
Do the sample labels agree with custody papers?			
Was sufficient amount of sample sent for tests requested?			
Did you change the hold time in LIMS for unpreserved VOAs?			—
Did you change the hold time in LIMS for preserved terracores?			—
Are bubbles > 6mm present in VOA samples?			—
Was the client contacted concerning this sample delivery?		—	
If YES, who was called? _____ By _____ Date: _____			

Section 5:	YES	NO	N/A
Are the samples appropriately preserved? (if N/A, skip the rest of section 5)			
Did you check preservatives for all bottles for each sample?			
Did you document your preservative check? pH strip lot# _____, pH strip lot# _____, pH strip lot# _____			
Preservative added:			
<input type="checkbox"/> H2SO4 lot# _____ added to samples _____ on/at _____			
<input type="checkbox"/> HCL lot# _____ added to samples _____ on/at _____			
<input type="checkbox"/> HNO3 lot# _____ added to samples _____ on/at _____			
<input type="checkbox"/> NaOH lot# _____ added to samples _____ on/at _____			

Section 6:
 Explanations/Comments: Split sample into appropriate containers. No analyses on COC. No labels present. Logged based on previous job.

Date Logged in 10/28/20 By (print) MAG for ZLA (sign) [Signature]
 Date Labeled 10/28/20 By (print) MAG (sign) [Signature]

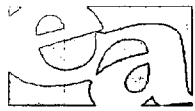

ENTHALPY ANALYTICAL

SAMPLE ACCEPTANCE CHECKLIST

Section 1
 Client: US Concrete Project: _____
 Date Received: 10/29/20 Sampler's Name Present: Yes No

Section 2
 Sample(s) received in a cooler? Yes, How many? 2 No (skip section 2) Sample Temp (°C) (No Cooler) : _____
 Sample Temp (°C), One from each cooler: #1: 3.8 #2: 2.7 #3: _____ #4: _____
 (Acceptance range is < 6°C but not frozen (for Microbiology samples, acceptance range is < 10°C but not frozen). It is acceptable for samples collected the same day as sample receipt to have a higher temperature as long as there is evidence that cooling has begun.)
 Shipping Information: _____

Section 3
 Was the cooler packed with: Ice Ice Packs Bubble Wrap Styrofoam
 Paper None Other _____
 Cooler Temp (°C): #1: 0.3 #2: 1.2 #3: _____ #4: _____

Section 4	YES	NO	N/A
Was a COC received?	✓		
Are sample IDs present?	✓		
Are sampling dates & times present?	✓		
Is a relinquished signature present?	✓		
Are the tests required clearly indicated on the COC?		✓	
Are custody seals present?		✓	
If custody seals are present, were they intact?			✓
Are all samples sealed in plastic bags? (Recommended for Microbiology samples)	✓		
Did all samples arrive intact? If no, indicate in Section 4 below.	✓		
Did all bottle labels agree with COC? (ID, dates and times)		✓	
Were the samples collected in the correct containers for the required tests?	✓		
Are the containers labeled with the correct preservatives?		✓	
Is there headspace in the VOA vials greater than 5-6 mm in diameter?			✓
Was a sufficient amount of sample submitted for the requested tests?	✓		

Section 5 Explanations/Comments
 No analyses on COC also no labels present. Logged according to previous job. Noted samples out of hold for microbiology test. Split sample see Berkley COC.

Section 6
 For discrepancies, how was the Project Manager notified? Verbal PM Initials: _____ Date/Time _____
 Email (email sent to/on): JS / 10/29/20
cc 10/29/20
 Project Manager's response: _____

Completed By: Luz E. H. Mendez Date: 10/29/20



800-322-5555
www.gls-us.com

Ship From
ENTHALPY ANALYTICAL
JOHN GOYETTE
2323 5TH STREET
BERKELEY, CA 94710

Tracking #: 550961196

PDS



Ship To
ENTHALPY ANALYTICAL (ORG)
SAMPLE RECEIVING
931 W BARKLEY AVE.
ORANGE, CA 92868

ORANGE

S92868A

COD: \$0.00
Weight: 0 lb(s)
Reference:

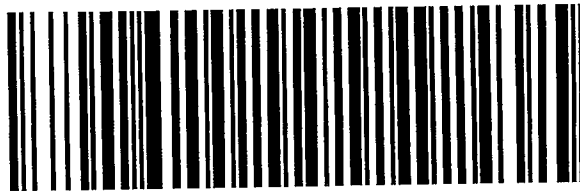

29656383

Delivery Instructions:

Signature Type: STANDARD

ORC CA927-CI0

Print Date: 10/28/2020 10:21 AM

3.8/0.8



800-322-5555
www.gls-us.com

Ship From

ENTHALPY ANALYTICAL
JOHN GOYETTE
2323 5TH STREET
BERKELEY, CA 94710

Tracking #: 550961187

CPS



Ship To

ENTHALPY ANALYTICAL (ORG)
SAMPLE RECEIVING
931 W BARKLEY AVE.
ORANGE, CA 92868

ORANGE 2.7/1.2

COD: \$0.00

Weight: 0 lb(s)

Reference:

Delivery Instructions:

Signature Type: STANDARD

S92868A

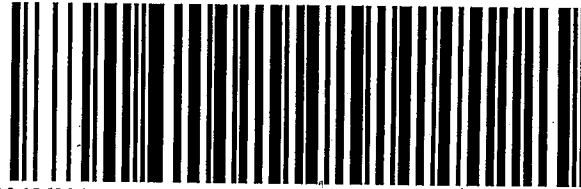

29656331

ORC CA927-CI1

Print Date: 10/28/2020 10:21 AM

Analysis Results for 435578

Michael Didula
 U.S. Concrete
 2740 - 1055 West Georgia St.
 Vancouver, BC V6E 3R5

Lab Job #: 435578
 Location: Port of Oakland
 Date Received: 10/28/20

Sample ID: CARGO WASH WATER	Lab ID: 435578-001	Collected: 10/27/20 15:00
Matrix: Water		

435578-001 Analyte	Result	Qual	Units	RL	DF	Batch	Prepared	Analyzed	Chemist
Method: EPA 300.0 Prep Method: METHOD									
Chloride	9.1		mg/L	5.0	1	255274	10/28/20 18:00	10/29/20 18:39	RKV
Nitrogen, Nitrate	0.15		mg/L	0.10	1	255274	10/28/20 18:00	10/29/20 18:39	RKV
Method: EPA 6010B Prep Method: EPA 3010A									
Antimony	ND		ug/L	40	1	255379	10/29/20	10/30/20	KLN
Arsenic	ND		ug/L	10	1	255379	10/29/20	10/30/20	KLN
Barium	ND		ug/L	10	1	255379	10/29/20	10/30/20	KLN
Beryllium	ND		ug/L	1.0	1	255379	10/29/20	10/30/20	KLN
Cadmium	ND		ug/L	5.0	1	255379	10/29/20	10/30/20	KLN
Chromium	ND		ug/L	10	1	255379	10/29/20	10/30/20	KLN
Cobalt	ND		ug/L	5.0	1	255379	10/29/20	10/30/20	KLN
Copper	ND		ug/L	10	1	255379	10/29/20	10/30/20	KLN
Lead	ND		ug/L	10	1	255379	10/29/20	10/30/20	KLN
Molybdenum	ND		ug/L	10	1	255379	10/29/20	10/30/20	KLN
Nickel	ND		ug/L	10	1	255379	10/29/20	10/30/20	KLN
Selenium	ND		ug/L	30	1	255379	10/29/20	10/30/20	KLN
Silver	ND		ug/L	5.0	1	255379	10/29/20	10/30/20	KLN
Thallium	ND		ug/L	50	1	255379	10/29/20	10/30/20	KLN
Vanadium	ND		ug/L	5.0	1	255379	10/29/20	10/30/20	KLN
Zinc	ND		ug/L	50	1	255379	10/29/20	10/30/20	KLN
Method: EPA 7470A Prep Method: METHOD									
Mercury	ND		ug/L	0.40	1	255428	10/30/20	10/30/20	JDB
Method: EPA 8015B Prep Method: EPA 5030B									
TPH Gasoline	ND		ug/L	50	1	255426	10/31/20	10/31/20	EMW
Surrogates									
Bromofluorobenzene (FID)	123%		%REC	60-140	1	255426	10/31/20	10/31/20	EMW
Method: EPA 8015B Prep Method: EPA 3510C									
Diesel C10-C28	120	B	ug/L	100	1	255418	10/30/20	10/31/20	JXS
ORO C28-C44	ND		ug/L	310	1	255418	10/30/20	10/31/20	JXS
Surrogates									
n-Triacontane	77%		%REC	35-130	1	255418	10/30/20	10/31/20	JXS

Analysis Results for 435578

435578-001 Analyte	Result	Qual	Units	RL	DF	Batch	Prepared	Analyzed	Chemist
Method: EPA 8081A									
Prep Method: EPA 3510C									
alpha-BHC	ND		ug/L	0.05	1	255378	10/30/20	10/30/20	KTD
beta-BHC	ND		ug/L	0.05	1	255378	10/30/20	10/30/20	KTD
gamma-BHC	ND		ug/L	0.05	1	255378	10/30/20	10/30/20	KTD
delta-BHC	ND		ug/L	0.05	1	255378	10/30/20	10/30/20	KTD
Heptachlor	ND		ug/L	0.05	1	255378	10/30/20	10/30/20	KTD
Aldrin	ND		ug/L	0.05	1	255378	10/30/20	10/30/20	KTD
Heptachlor epoxide	ND		ug/L	0.05	1	255378	10/30/20	10/30/20	KTD
Endosulfan I	ND		ug/L	0.05	1	255378	10/30/20	10/30/20	KTD
Dieldrin	ND		ug/L	0.1	1	255378	10/30/20	10/30/20	KTD
4,4'-DDE	ND		ug/L	0.1	1	255378	10/30/20	10/30/20	KTD
Endrin	ND		ug/L	0.1	1	255378	10/30/20	10/30/20	KTD
Endosulfan II	ND		ug/L	0.1	1	255378	10/30/20	10/30/20	KTD
Endosulfan sulfate	ND		ug/L	0.1	1	255378	10/30/20	10/30/20	KTD
4,4'-DDD	ND		ug/L	0.1	1	255378	10/30/20	10/30/20	KTD
Endrin aldehyde	ND		ug/L	0.1	1	255378	10/30/20	10/30/20	KTD
Endrin ketone	ND		ug/L	0.1	1	255378	10/30/20	10/30/20	KTD
4,4'-DDT	ND		ug/L	0.1	1	255378	10/30/20	10/30/20	KTD
Methoxychlor	ND		ug/L	0.1	1	255378	10/30/20	10/30/20	KTD
Toxaphene	ND		ug/L	2.1	1	255378	10/30/20	10/30/20	KTD
Chlordane (Technical)	ND		ug/L	1.0	1	255378	10/30/20	10/30/20	KTD
Surrogates				Limits					
TCMX	100%		%REC	14-120	1	255378	10/30/20	10/30/20	KTD
Decachlorobiphenyl	118%		%REC	20-120	1	255378	10/30/20	10/30/20	KTD
Method: EPA 8260B									
Prep Method: EPA 5030B									
MTBE	ND		ug/L	1.0	1	255465	11/02/20	11/02/20	LW
Benzene	ND		ug/L	1.0	1	255465	11/02/20	11/02/20	LW
Toluene	ND		ug/L	5.0	1	255465	11/02/20	11/02/20	LW
Ethylbenzene	ND		ug/L	5.0	1	255465	11/02/20	11/02/20	LW
o-Xylene	ND		ug/L	5.0	1	255465	11/02/20	11/02/20	LW
m,p-Xylenes	ND		ug/L	10	1	255465	11/02/20	11/02/20	LW
Xylene (total)	ND		ug/L	5.0	1	255465	11/02/20	11/02/20	LW
Surrogates				Limits					
Dibromofluoromethane	97%		%REC	70-140	1	255465	11/02/20	11/02/20	LW
1,2-Dichloroethane-d4	100%		%REC	70-140	1	255465	11/02/20	11/02/20	LW
Toluene-d8	101%		%REC	70-140	1	255465	11/02/20	11/02/20	LW
Bromofluorobenzene	110%		%REC	70-140	1	255465	11/02/20	11/02/20	LW
Method: EPA 8270C-SIM									
Prep Method: EPA 3510C									
1-Methylnaphthalene	ND		ug/L	0.51	1	255368	10/29/20	11/03/20	TJW
2-Methylnaphthalene	ND		ug/L	0.51	1	255368	10/29/20	11/03/20	TJW
Naphthalene	ND		ug/L	0.51	1	255368	10/29/20	11/03/20	TJW
Acenaphthylene	ND		ug/L	0.51	1	255368	10/29/20	11/03/20	TJW
Acenaphthene	ND		ug/L	0.51	1	255368	10/29/20	11/03/20	TJW

Analysis Results for 435578

435578-001 Analyte	Result	Qual	Units	RL	DF	Batch	Prepared	Analyzed	Chemist
Fluorene	ND		ug/L	0.51	1	255368	10/29/20	11/03/20	TJW
Phenanthrene	ND		ug/L	0.51	1	255368	10/29/20	11/03/20	TJW
Anthracene	ND		ug/L	0.51	1	255368	10/29/20	11/03/20	TJW
Fluoranthene	ND		ug/L	0.51	1	255368	10/29/20	11/03/20	TJW
Pyrene	ND		ug/L	0.51	1	255368	10/29/20	11/03/20	TJW
Benzo(a)anthracene	ND		ug/L	0.51	1	255368	10/29/20	11/03/20	TJW
Chrysene	ND		ug/L	0.51	1	255368	10/29/20	11/03/20	TJW
Benzo(b)fluoranthene	ND		ug/L	0.51	1	255368	10/29/20	11/03/20	TJW
Benzo(k)fluoranthene	ND		ug/L	0.51	1	255368	10/29/20	11/03/20	TJW
Benzo(a)pyrene	ND		ug/L	0.51	1	255368	10/29/20	11/03/20	TJW
Indeno(1,2,3-cd)pyrene	ND		ug/L	0.51	1	255368	10/29/20	11/03/20	TJW
Dibenz(a,h)anthracene	ND		ug/L	0.51	1	255368	10/29/20	11/03/20	TJW
Benzo(g,h,i)perylene	ND		ug/L	0.51	1	255368	10/29/20	11/03/20	TJW
Surrogates				Limits					
Nitrobenzene-d5	81%		%REC	41-119	1	255368	10/29/20	11/03/20	TJW
2-Fluorobiphenyl	76%		%REC	45-118	1	255368	10/29/20	11/03/20	TJW
Terphenyl-d14	107%		%REC	71-134	1	255368	10/29/20	11/03/20	TJW
Method: SM 4500-H+ B									
pH	7.21	H	SU		1	255354	10/29/20 16:40	10/29/20 16:40	SGC
Temperature	22.20	H	deg C	1.00	1	255354	10/29/20 16:40	10/29/20 16:40	SGC
Method: SM 4500-P-B2-E									
Total Phosphate as P	ND		mg/L	0.020	1	255421	10/30/20	10/30/20	SGC
Total Phosphate as PO4	ND		mg/L	0.060	1	255421	10/30/20	10/30/20	SGC
Method: SM 9223Bb									
Fecal Coliform	<1.0	H	MPN/100ml	1.0	1	255331	10/29/20 15:40	10/30/20 12:55	CCO
Method: SM 9230D									
Enterococcus	<1.0	H	MPN/100ml	1.0	1	255304	10/29/20 12:28	10/30/20 12:55	CCO
Method: SM2520B									
Salinity	0.20		S	0.10	1	255362	10/29/20	10/29/20	SGC

< Value is less than indicated concentration
 B Contamination found in associated Method Blank
 H Holding time was exceeded
 ND Not Detected

Batch QC

Type: Blank	Lab ID: QC892431	Batch: 255274
Matrix: Water	Method: EPA 300.0	Prep Method: METHOD

QC892431 Analyte	Result	Qual	Units	RL	Prepared	Analyzed
Chloride	ND		mg/L	5.0	10/28/20 18:00	10/29/20 09:32
Nitrogen, Nitrate	ND		mg/L	0.10	10/28/20 18:00	10/29/20 09:32

Type: Lab Control Sample	Lab ID: QC892432	Batch: 255274
Matrix: Water	Method: EPA 300.0	Prep Method: METHOD

QC892432 Analyte	Result	Spiked	Units	Recovery	Qual	Limits
Chloride	100.4	100.0	mg/L	100%		90-110
Nitrogen, Nitrate	9.459	9.036	mg/L	105%		90-110

Type: Matrix Spike	Lab ID: QC892433	Batch: 255274
Matrix (Source ID): Water (435557-009)	Method: EPA 300.0	Prep Method: METHOD

QC892433 Analyte	Result	Source Sample	Spiked	Units	Recovery	Qual	Limits	DF
		Result						
Chloride	129.2	29.12	100.0	mg/L	100%		80-120	1
Nitrogen, Nitrate	11.57	2.618	9.036	mg/L	99%		80-120	1

Type: Matrix Spike Duplicate	Lab ID: QC892434	Batch: 255274
Matrix (Source ID): Water (435557-009)	Method: EPA 300.0	Prep Method: METHOD

QC892434 Analyte	Result	Source Sample	Spiked	Units	Recovery	Qual	Limits	RPD		DF
		Result						RPD	Lim	
Chloride	130.4	29.12	100.0	mg/L	101%		80-120	1	20	1
Nitrogen, Nitrate	11.72	2.618	9.036	mg/L	101%		80-120	1	20	1

Type: Matrix Spike	Lab ID: QC892435	Batch: 255274
Matrix (Source ID): Water (435586-003)	Method: EPA 300.0	Prep Method: METHOD

QC892435 Analyte	Result	Source Sample	Spiked	Units	Recovery	Qual	Limits	DF
		Result						
Chloride	235.6	159.5	100.0	mg/L	76%	*	80-120	10
Nitrogen, Nitrate	24.02	15.52	9.036	mg/L	94%		80-120	10

Batch QC

Type: Matrix Spike Duplicate	Lab ID: QC892436	Batch: 255274
Matrix (Source ID): Water (435586-003)	Method: EPA 300.0	Prep Method: METHOD

QC892436 Analyte	Result	Source Sample	Spiked	Units	Recovery	Qual	Limits	RPD		DF
		Result						RPD	Lim	
Chloride	235.8	159.5	100.0	mg/L	76%	*	80-120	0	20	10
Nitrogen, Nitrate	24.34	15.52	9.036	mg/L	98%		80-120	1	20	10

Type: Sample Duplicate	Lab ID: QC892645	Batch: 255354
Matrix (Source ID): Water (435430-001)	Method: SM 4500-H+ B	

QC892645 Analyte	Result	Source Sample	Units	Qual	RPD	RPD		DF
		Result				Lim		
pH	1.960	1.990	SU		2	20		1
Temperature	12.90	13.30	deg C		3	20		1

Type: Blank	Lab ID: QC892668	Batch: 255368
Matrix: Water	Method: EPA 8270C-SIM	Prep Method: EPA 3510C

QC892668 Analyte	Result	Qual	Units	RL	Prepared	Analyzed
1-Methylnaphthalene	ND		ug/L	0.50	10/29/20	11/02/20
2-Methylnaphthalene	ND		ug/L	0.50	10/29/20	11/02/20
Naphthalene	ND		ug/L	0.50	10/29/20	11/02/20
Acenaphthylene	ND		ug/L	0.50	10/29/20	11/02/20
Acenaphthene	ND		ug/L	0.50	10/29/20	11/02/20
Fluorene	ND		ug/L	0.50	10/29/20	11/02/20
Phenanthrene	ND		ug/L	0.50	10/29/20	11/02/20
Anthracene	ND		ug/L	0.50	10/29/20	11/02/20
Fluoranthene	ND		ug/L	0.50	10/29/20	11/02/20
Pyrene	ND		ug/L	0.50	10/29/20	11/02/20
Benzo(a)anthracene	ND		ug/L	0.50	10/29/20	11/02/20
Chrysene	ND		ug/L	0.50	10/29/20	11/02/20
Benzo(b)fluoranthene	ND		ug/L	0.50	10/29/20	11/02/20
Benzo(k)fluoranthene	ND		ug/L	0.50	10/29/20	11/02/20
Benzo(a)pyrene	ND		ug/L	0.50	10/29/20	11/02/20
Indeno(1,2,3-cd)pyrene	ND		ug/L	0.50	10/29/20	11/02/20
Dibenz(a,h)anthracene	ND		ug/L	0.50	10/29/20	11/02/20
Benzo(g,h,i)perylene	ND		ug/L	0.50	10/29/20	11/02/20
Surrogates				Limits		
Nitrobenzene-d5	82%		%REC	41-119	10/29/20	11/02/20
2-Fluorobiphenyl	65%		%REC	45-118	10/29/20	11/02/20
Terphenyl-d14	101%		%REC	71-134	10/29/20	11/02/20

Batch QC

Type: Lab Control Sample	Lab ID: QC892669	Batch: 255368
Matrix: Water	Method: EPA 8270C-SIM	Prep Method: EPA 3510C

QC892669 Analyte	Result	Spiked	Units	Recovery	Qual	Limits
1-Methylnaphthalene	0.7982	1.000	ug/L	80%		70-130
2-Methylnaphthalene	0.8410	1.000	ug/L	84%		40-130
Naphthalene	0.8835	1.000	ug/L	88%		41-130
Acenaphthylene	0.7780	1.000	ug/L	78%		43-130
Acenaphthene	0.7042	1.000	ug/L	70%		46-130
Fluorene	0.8002	1.000	ug/L	80%		49-130
Phenanthrene	0.7716	1.000	ug/L	77%		57-130
Anthracene	0.7075	1.000	ug/L	71%		50-130
Fluoranthene	0.8485	1.000	ug/L	85%		62-130
Pyrene	0.8118	1.000	ug/L	81%		62-130
Benzo(a)anthracene	0.8577	1.000	ug/L	86%		61-130
Chrysene	0.7815	1.000	ug/L	78%		61-130
Benzo(b)fluoranthene	0.8220	1.000	ug/L	82%		42-158
Benzo(k)fluoranthene	0.8250	1.000	ug/L	82%		58-134
Benzo(a)pyrene	0.6922	1.000	ug/L	69%		46-139
Indeno(1,2,3-cd)pyrene	0.7808	1.000	ug/L	78%		52-144
Dibenz(a,h)anthracene	0.8518	1.000	ug/L	85%		60-130
Benzo(g,h,i)perylene	0.7537	1.000	ug/L	75%		50-143
Surrogates						
Nitrobenzene-d5	0.7556	1.000	ug/L	76%		41-119
2-Fluorobiphenyl	0.8708	1.000	ug/L	87%		45-118
Terphenyl-d14	0.9569	1.000	ug/L	96%		71-134

Batch QC

Type: Lab Control Sample Duplicate	Lab ID: QC892670	Batch: 255368
Matrix: Water	Method: EPA 8270C-SIM	Prep Method: EPA 3510C

QC892670 Analyte	Result	Spiked	Units	Recovery	Qual	Limits	RPD	RPD Lim
1-Methylnaphthalene	0.8479	1.000	ug/L	85%		70-130	6	35
2-Methylnaphthalene	0.8901	1.000	ug/L	89%		40-130	6	35
Naphthalene	0.9118	1.000	ug/L	91%		41-130	3	35
Acenaphthylene	0.8060	1.000	ug/L	81%		43-130	4	35
Acenaphthene	0.8275	1.000	ug/L	83%		46-130	16	35
Fluorene	0.9267	1.000	ug/L	93%		49-130	15	35
Phenanthrene	0.9317	1.000	ug/L	93%		57-130	19	35
Anthracene	0.8432	1.000	ug/L	84%		50-130	18	35
Fluoranthene	1.044	1.000	ug/L	104%		62-130	21	35
Pyrene	1.003	1.000	ug/L	100%		62-130	21	35
Benzo(a)anthracene	1.051	1.000	ug/L	105%		61-130	20	35
Chrysene	0.8732	1.000	ug/L	87%		61-130	11	35
Benzo(b)fluoranthene	1.036	1.000	ug/L	104%		42-158	23	35
Benzo(k)fluoranthene	0.9939	1.000	ug/L	99%		58-134	19	35
Benzo(a)pyrene	0.8410	1.000	ug/L	84%		46-139	19	35
Indeno(1,2,3-cd)pyrene	0.9606	1.000	ug/L	96%		52-144	21	35
Dibenz(a,h)anthracene	0.9655	1.000	ug/L	97%		60-130	13	35
Benzo(g,h,i)perylene	0.9399	1.000	ug/L	94%		50-143	22	35
Surrogates								
Nitrobenzene-d5	0.9626	1.000	ug/L	96%		41-119		
2-Fluorobiphenyl	0.8840	1.000	ug/L	88%		45-118		
Terphenyl-d14	1.144	1.000	ug/L	114%		71-134		

Batch QC

Type: Blank	Lab ID: QC892702	Batch: 255378
Matrix: Water	Method: EPA 8081A	Prep Method: EPA 3510C

QC892702 Analyte	Result	Qual	Units	RL	Prepared	Analyzed
alpha-BHC	ND		ug/L	0.05	10/30/20	10/30/20
beta-BHC	ND		ug/L	0.05	10/30/20	10/30/20
gamma-BHC	ND		ug/L	0.05	10/30/20	10/30/20
delta-BHC	ND		ug/L	0.05	10/30/20	10/30/20
Heptachlor	ND		ug/L	0.05	10/30/20	10/30/20
Aldrin	ND		ug/L	0.05	10/30/20	10/30/20
Heptachlor epoxide	ND		ug/L	0.05	10/30/20	10/30/20
Endosulfan I	ND		ug/L	0.05	10/30/20	10/30/20
Dieldrin	ND		ug/L	0.1	10/30/20	10/30/20
4,4'-DDE	ND		ug/L	0.1	10/30/20	10/30/20
Endrin	ND		ug/L	0.1	10/30/20	10/30/20
Endosulfan II	ND		ug/L	0.1	10/30/20	10/30/20
Endosulfan sulfate	ND		ug/L	0.1	10/30/20	10/30/20
4,4'-DDD	ND		ug/L	0.1	10/30/20	10/30/20
Endrin aldehyde	ND		ug/L	0.1	10/30/20	10/30/20
Endrin ketone	ND		ug/L	0.1	10/30/20	10/30/20
4,4'-DDT	ND		ug/L	0.1	10/30/20	10/30/20
Methoxychlor	ND		ug/L	0.1	10/30/20	10/30/20
Toxaphene	ND		ug/L	2.0	10/30/20	10/30/20
Chlordane (Technical)	ND		ug/L	1.0	10/30/20	10/30/20
Surrogates				Limits		
TCMX	63%		%REC	14-120	10/30/20	10/30/20
Decachlorobiphenyl	85%		%REC	20-120	10/30/20	10/30/20

Batch QC

Type: Lab Control Sample	Lab ID: QC892703	Batch: 255378
Matrix: Water	Method: EPA 8081A	Prep Method: EPA 3510C

QC892703 Analyte	Result	Spiked	Units	Recovery	Qual	Limits
alpha-BHC	0.5063	0.5000	ug/L	101%		53-120
beta-BHC	0.5047	0.5000	ug/L	101%		59-120
gamma-BHC	0.5136	0.5000	ug/L	103%		54-120
delta-BHC	0.5123	0.5000	ug/L	102%		58-120
Heptachlor	0.5014	0.5000	ug/L	100%		49-120
Aldrin	0.4732	0.5000	ug/L	95%		47-120
Heptachlor epoxide	0.4830	0.5000	ug/L	97%		53-120
Endosulfan I	0.5026	0.5000	ug/L	101%		56-120
Dieldrin	0.5256	0.5000	ug/L	105%		55-120
4,4'-DDE	0.5331	0.5000	ug/L	107%		55-120
Endrin	0.5420	0.5000	ug/L	108%		57-120
Endosulfan II	0.5499	0.5000	ug/L	110%		58-120
Endosulfan sulfate	0.5469	0.5000	ug/L	109%		56-120
4,4'-DDD	0.4903	0.5000	ug/L	98%		53-120
Endrin aldehyde	0.4379	0.5000	ug/L	88%		45-120
Endrin ketone	0.5373	0.5000	ug/L	107%		61-120
4,4'-DDT	0.5557	0.5000	ug/L	111%		58-120
Methoxychlor	0.5712	0.5000	ug/L	114%		54-120
Surrogates						
TCMX	0.4617	0.5000	ug/L	92%		14-120
Decachlorobiphenyl	0.6020	0.5000	ug/L	120%		20-120

Batch QC

Type: Lab Control Sample Duplicate	Lab ID: QC892704	Batch: 255378
Matrix: Water	Method: EPA 8081A	Prep Method: EPA 3510C

QC892704 Analyte	Result	Spiked	Units	Recovery	Qual	Limits	RPD	RPD Lim
alpha-BHC	0.5111	0.5000	ug/L	102%		53-120	1	20
beta-BHC	0.5086	0.5000	ug/L	102%		59-120	1	20
gamma-BHC	0.5163	0.5000	ug/L	103%		54-120	1	20
delta-BHC	0.5160	0.5000	ug/L	103%		58-120	1	20
Heptachlor	0.5017	0.5000	ug/L	100%		49-120	0	20
Aldrin	0.4786	0.5000	ug/L	96%		47-120	1	20
Heptachlor epoxide	0.4850	0.5000	ug/L	97%		53-120	0	20
Endosulfan I	0.5019	0.5000	ug/L	100%		56-120	0	20
Dieldrin	0.5272	0.5000	ug/L	105%		55-120	0	20
4,4'-DDE	0.5387	0.5000	ug/L	108%		55-120	1	20
Endrin	0.5478	0.5000	ug/L	110%		57-120	1	20
Endosulfan II	0.5570	0.5000	ug/L	111%		58-120	1	20
Endosulfan sulfate	0.5596	0.5000	ug/L	112%		56-120	2	20
4,4'-DDD	0.4961	0.5000	ug/L	99%		53-120	1	20
Endrin aldehyde	0.4430	0.5000	ug/L	89%		45-120	1	20
Endrin ketone	0.5517	0.5000	ug/L	110%		61-120	3	20
4,4'-DDT	0.5608	0.5000	ug/L	112%		58-120	1	20
Methoxychlor	0.5771	0.5000	ug/L	115%		54-120	1	20
Surrogates								
TCMX	0.4652	0.5000	ug/L	93%		14-120		
Decachlorobiphenyl	0.6096	0.5000	ug/L	122%	*	20-120		

Batch QC

Type: Blank	Lab ID: QC892705	Batch: 255379
Matrix: Water	Method: EPA 6010B	Prep Method: EPA 3010A

QC892705 Analyte	Result	Qual	Units	RL	Prepared	Analyzed
Antimony	ND		ug/L	40	10/29/20	10/30/20
Arsenic	ND		ug/L	10	10/29/20	10/30/20
Barium	ND		ug/L	10	10/29/20	10/30/20
Beryllium	ND		ug/L	1.0	10/29/20	10/30/20
Cadmium	ND		ug/L	5.0	10/29/20	10/30/20
Chromium	ND		ug/L	10	10/29/20	10/30/20
Cobalt	ND		ug/L	5.0	10/29/20	10/30/20
Copper	ND		ug/L	10	10/29/20	10/30/20
Lead	ND		ug/L	10	10/29/20	10/30/20
Molybdenum	ND		ug/L	10	10/29/20	10/30/20
Nickel	ND		ug/L	10	10/29/20	10/30/20
Selenium	ND		ug/L	30	10/29/20	10/30/20
Silver	ND		ug/L	5.0	10/29/20	10/30/20
Thallium	ND		ug/L	50	10/29/20	10/30/20
Vanadium	ND		ug/L	5.0	10/29/20	10/30/20
Zinc	ND		ug/L	50	10/29/20	10/30/20

Type: Lab Control Sample	Lab ID: QC892706	Batch: 255379
Matrix: Water	Method: EPA 6010B	Prep Method: EPA 3010A

QC892706 Analyte	Result	Spiked	Units	Recovery	Qual	Limits
Antimony	2,009	2000	ug/L	100%		80-120
Arsenic	2,056	2000	ug/L	103%		80-120
Barium	1,949	2000	ug/L	97%		80-120
Beryllium	1,934	2000	ug/L	97%		80-120
Cadmium	2,042	2000	ug/L	102%		80-120
Chromium	2,013	2000	ug/L	101%		80-120
Cobalt	2,071	2000	ug/L	104%		80-120
Copper	1,952	2000	ug/L	98%		80-120
Lead	2,067	2000	ug/L	103%		80-120
Molybdenum	2,085	2000	ug/L	104%		80-120
Nickel	2,066	2000	ug/L	103%		80-120
Selenium	1,856	2000	ug/L	93%		80-120
Silver	2,040	2000	ug/L	102%		80-120
Thallium	2,033	2000	ug/L	102%		80-120
Vanadium	2,038	2000	ug/L	102%		80-120
Zinc	2,092	2000	ug/L	105%		80-120

Batch QC

Type: Matrix Spike	Lab ID: QC892707	Batch: 255379
Matrix (Source ID): Water (435578-001)	Method: EPA 6010B	Prep Method: EPA 3010A

QC892707 Analyte	Result	Source Sample Result	Spiked	Units	Recovery	Qual	Limits	DF
Antimony	988.0	ND	1000	ug/L	99%		75-125	1
Arsenic	1,007	ND	1000	ug/L	101%		75-125	1
Barium	1,004	3.602	1000	ug/L	100%		75-125	1
Beryllium	1,004	ND	1000	ug/L	100%		75-125	1
Cadmium	984.7	ND	1000	ug/L	98%		75-125	1
Chromium	967.5	ND	1000	ug/L	97%		75-125	1
Cobalt	1,005	ND	1000	ug/L	100%		75-125	1
Copper	976.7	4.544	1000	ug/L	97%		75-125	1
Lead	1,039	ND	1000	ug/L	104%		75-125	1
Molybdenum	1,022	4.517	1000	ug/L	102%		75-125	1
Nickel	1,002	ND	1000	ug/L	100%		75-125	1
Selenium	911.0	ND	1000	ug/L	91%		75-125	1
Silver	1,018	ND	1000	ug/L	102%		75-125	1
Thallium	986.0	ND	1000	ug/L	99%		75-125	1
Vanadium	1,009	2.181	1000	ug/L	101%		75-125	1
Zinc	1,026	30.27	1000	ug/L	100%		75-125	1

Type: Matrix Spike Duplicate	Lab ID: QC892708	Batch: 255379
Matrix (Source ID): Water (435578-001)	Method: EPA 6010B	Prep Method: EPA 3010A

QC892708 Analyte	Result	Source Sample Result	Spiked	Units	Recovery	Qual	Limits	RPD	Lim	DF
Antimony	979.0	ND	1000	ug/L	98%		75-125	1	20	1
Arsenic	1,007	ND	1000	ug/L	101%		75-125	0	20	1
Barium	992.5	3.602	1000	ug/L	99%		75-125	1	20	1
Beryllium	990.7	ND	1000	ug/L	99%		75-125	1	20	1
Cadmium	978.0	ND	1000	ug/L	98%		75-125	1	20	1
Chromium	961.1	ND	1000	ug/L	96%		75-125	1	20	1
Cobalt	998.2	ND	1000	ug/L	100%		75-125	1	20	1
Copper	958.9	4.544	1000	ug/L	95%		75-125	2	20	1
Lead	1,038	ND	1000	ug/L	104%		75-125	0	20	1
Molybdenum	1,015	4.517	1000	ug/L	101%		75-125	1	20	1
Nickel	993.2	ND	1000	ug/L	99%		75-125	1	20	1
Selenium	909.5	ND	1000	ug/L	91%		75-125	0	20	1
Silver	1,001	ND	1000	ug/L	100%		75-125	2	20	1
Thallium	981.8	ND	1000	ug/L	98%		75-125	0	20	1
Vanadium	999.5	2.181	1000	ug/L	100%		75-125	1	20	1
Zinc	1,023	30.27	1000	ug/L	99%		75-125	0	20	1

Batch QC

Type: Blank	Lab ID: QC892835	Batch: 255418
Matrix: Water	Method: EPA 8015B	Prep Method: EPA 3510C

QC892835 Analyte	Result	Qual	Units	RL	Prepared	Analyzed
Diesel C10-C28	150		ug/L	100	10/30/20	10/31/20
ORO C28-C44	ND		ug/L	300	10/30/20	10/31/20
Surrogates				Limits		
n-Triacontane	70%		%REC	35-130	10/30/20	10/31/20

Type: Lab Control Sample	Lab ID: QC892836	Batch: 255418
Matrix: Water	Method: EPA 8015B	Prep Method: EPA 3510C

QC892836 Analyte	Result	Spiked	Units	Recovery	Qual	Limits
Diesel C10-C28	715.9	1000	ug/L	72%		42-120
Surrogates						
n-Triacontane	14.28	20.00	ug/L	71%		35-130

Type: Lab Control Sample Duplicate	Lab ID: QC892837	Batch: 255418
Matrix: Water	Method: EPA 8015B	Prep Method: EPA 3510C

QC892837 Analyte	Result	Spiked	Units	Recovery	Qual	Limits	RPD	RPD Lim
Diesel C10-C28	727.9	1000	ug/L	73%		42-120	2	36
Surrogates								
n-Triacontane	13.98	20.00	ug/L	70%		35-130		

Type: Blank	Lab ID: QC892841	Batch: 255421
Matrix: Water	Method: SM 4500-P-B2-E	

QC892841 Analyte	Result	Qual	Units	RL	Prepared	Analyzed
Total Phosphate as P	ND		mg/L	0.020	10/30/20	10/30/20
Total Phosphate as PO4	ND		mg/L	0.060	10/30/20	10/30/20

Type: Lab Control Sample	Lab ID: QC892842	Batch: 255421
Matrix: Water	Method: SM 4500-P-B2-E	

QC892842 Analyte	Result	Spiked	Units	Recovery	Qual	Limits
Total Phosphate as P	0.3870	0.4000	mg/L	97%		80-120
Total Phosphate as PO4	1.190	1.230	mg/L	97%		80-120

Batch QC

Type: Matrix Spike	Lab ID: QC892843	Batch: 255421
Matrix (Source ID): Water (435578-001)	Method: SM 4500-P-B2-E	

QC892843 Analyte	Result	Source Sample Result	Spiked	Units	Recovery	Qual	Limits	DF
Total Phosphate as P	0.3870	ND	0.4000	mg/L	97%		75-125	1
Total Phosphate as PO4	1.190	ND	1.230	mg/L	97%		75-125	1

Type: Matrix Spike Duplicate	Lab ID: QC892844	Batch: 255421
Matrix (Source ID): Water (435578-001)	Method: SM 4500-P-B2-E	

QC892844 Analyte	Result	Source Sample Result	Spiked	Units	Recovery	Qual	Limits	RPD	RPD Lim	DF
Total Phosphate as P	0.3890	ND	0.4000	mg/L	97%		75-125	1	20	1
Total Phosphate as PO4	1.190	ND	1.230	mg/L	97%		75-125	0	20	1

Type: Lab Control Sample	Lab ID: QC892850	Batch: 255426
Matrix: Water	Method: EPA 8015B	Prep Method: EPA 5030B

QC892850 Analyte	Result	Spiked	Units	Recovery	Qual	Limits
TPH Gasoline	495.7	500.0	ug/L	99%		70-130
Surrogates						
Bromofluorobenzene (FID)	259.0	200.0	ug/L	130%		60-140

Type: Matrix Spike	Lab ID: QC892851	Batch: 255426
Matrix (Source ID): Water (435555-001)	Method: EPA 8015B	Prep Method: EPA 5030B

QC892851 Analyte	Result	Source Sample Result	Spiked	Units	Recovery	Qual	Limits	DF
TPH Gasoline	501.1	ND	500.0	ug/L	99%		70-130	1
Surrogates								
Bromofluorobenzene (FID)	260.0		200.0	ug/L	130%		60-140	1

Type: Matrix Spike Duplicate	Lab ID: QC892852	Batch: 255426
Matrix (Source ID): Water (435555-001)	Method: EPA 8015B	Prep Method: EPA 5030B

QC892852 Analyte	Result	Source Sample Result	Spiked	Units	Recovery	Qual	Limits	RPD	RPD Lim	DF
TPH Gasoline	500.3	ND	500.0	ug/L	98%		70-130	0	30	1
Surrogates										
Bromofluorobenzene (FID)	259.0		200.0	ug/L	130%		60-140			1

Batch QC

Type: Blank	Lab ID: QC892853	Batch: 255426
Matrix: Water	Method: EPA 8015B	Prep Method: EPA 5030B

QC892853 Analyte	Result	Qual	Units	RL	Prepared	Analyzed
TPH Gasoline	ND		ug/L	50	10/31/20	10/31/20
Surrogates			Limits			
Bromofluorobenzene (FID)	122%		%REC	60-140	10/31/20	10/31/20

Type: Blank	Lab ID: QC892854	Batch: 255428
Matrix: Filtrate	Method: EPA 7470A	Prep Method: METHOD

QC892854 Analyte	Result	Qual	Units	RL	Prepared	Analyzed
Mercury	ND		ug/L	0.40	10/30/20	10/30/20

Type: Lab Control Sample	Lab ID: QC892855	Batch: 255428
Matrix: Filtrate	Method: EPA 7470A	Prep Method: METHOD

QC892855 Analyte	Result	Spiked	Units	Recovery	Qual	Limits
Mercury	4.951	5.000	ug/L	99%		80-120

Type: Matrix Spike	Lab ID: QC892856	Batch: 255428
Matrix (Source ID): Filtrate (435333-002)	Method: EPA 7470A	Prep Method: METHOD

QC892856 Analyte	Result	Source Sample Result	Spiked	Units	Recovery	Qual	Limits	DF
	Mercury	4.247	ND	5.000	ug/L	85%		75-125

Type: Matrix Spike Duplicate	Lab ID: QC892857	Batch: 255428
Matrix (Source ID): Filtrate (435333-002)	Method: EPA 7470A	Prep Method: METHOD

QC892857 Analyte	Result	Source Sample Result	Spiked	Units	Recovery	Qual	Limits	RPD	Lim	DF
	Mercury	4.109	ND	5.000	ug/L	82%		75-125	3	20

Type: Matrix Spike	Lab ID: QC892858	Batch: 255428
Matrix (Source ID): Filtrate (435292-006)	Method: EPA 7470A	Prep Method: METHOD

QC892858 Analyte	Result	Source Sample Result	Spiked	Units	Recovery	Qual	Limits	DF
	Mercury	4.167	ND	5.000	ug/L	83%		75-125

Batch QC

Type: Matrix Spike Duplicate	Lab ID: QC892859	Batch: 255428
Matrix (Source ID): Filtrate (435292-006)	Method: EPA 7470A	Prep Method: METHOD

QC892859 Analyte	Result	Source Sample Result	Spiked	Units	Recovery	Qual	Limits	RPD	RPD Lim	DF
Mercury	4.043	ND	5.000	ug/L	81%		75-125	3	20	1

Type: Blank	Lab ID: QC892972	Batch: 255465
Matrix: Water	Method: EPA 8260B	Prep Method: EPA 5030B

QC892972 Analyte	Result	Qual	Units	RL	Prepared	Analyzed
MTBE	ND		ug/L	1.0	11/02/20	11/02/20
Benzene	ND		ug/L	1.0	11/02/20	11/02/20
Toluene	ND		ug/L	5.0	11/02/20	11/02/20
Ethylbenzene	ND		ug/L	5.0	11/02/20	11/02/20
o-Xylene	ND		ug/L	5.0	11/02/20	11/02/20
m,p-Xylenes	ND		ug/L	10	11/02/20	11/02/20
Xylene (total)	ND		ug/L	5.0	11/02/20	11/02/20
Surrogates				Limits		
Dibromofluoromethane	98%		%REC	70-140	11/02/20	11/02/20
1,2-Dichloroethane-d4	102%		%REC	70-140	11/02/20	11/02/20
Toluene-d8	99%		%REC	70-140	11/02/20	11/02/20
Bromofluorobenzene	110%		%REC	70-140	11/02/20	11/02/20

Type: Lab Control Sample	Lab ID: QC892973	Batch: 255465
Matrix: Water	Method: EPA 8260B	Prep Method: EPA 5030B

QC892973 Analyte	Result	Spiked	Units	Recovery	Qual	Limits
MTBE	40.61	50.00	ug/L	81%		70-130
Benzene	44.95	50.00	ug/L	90%		70-130
Toluene	44.03	50.00	ug/L	88%		70-130
Ethylbenzene	45.59	50.00	ug/L	91%		70-130
o-Xylene	43.67	50.00	ug/L	87%		70-130
m,p-Xylenes	110.0	100.0	ug/L	110%		70-130
Surrogates						
Dibromofluoromethane	51.57	50.00	ug/L	103%		70-140
1,2-Dichloroethane-d4	52.44	50.00	ug/L	105%		70-140
Toluene-d8	48.94	50.00	ug/L	98%		70-140
Bromofluorobenzene	51.58	50.00	ug/L	103%		70-140

Batch QC

Type: Lab Control Sample Duplicate	Lab ID: QC892974	Batch: 255465
Matrix: Water	Method: EPA 8260B	Prep Method: EPA 5030B

QC892974 Analyte	Result	Spiked	Units	Recovery	Qual	Limits	RPD	RPD Lim
MTBE	43.47	50.00	ug/L	87%		70-130	7	30
Benzene	47.06	50.00	ug/L	94%		70-130	5	30
Toluene	46.05	50.00	ug/L	92%		70-130	4	30
Ethylbenzene	47.63	50.00	ug/L	95%		70-130	4	30
o-Xylene	45.67	50.00	ug/L	91%		70-130	4	30
m,p-Xylenes	115.4	100.0	ug/L	115%		70-130	5	30
Surrogates								
Dibromofluoromethane	51.81	50.00	ug/L	104%		70-140		
1,2-Dichloroethane-d4	52.51	50.00	ug/L	105%		70-140		
Toluene-d8	48.98	50.00	ug/L	98%		70-140		
Bromofluorobenzene	51.93	50.00	ug/L	104%		70-140		

* Value is outside QC limits

ND Not Detected

Laboratory Job Number 435578

Subcontracted Products

Eurofins Eaton Analytical

750 Royal Oaks Drive, Suite 100
Monrovia, California 91016-3629
Tel: (626) 386-1100
Fax: (866) 988-3757
1 800 566 LABS (1 800 566 5227)



Laboratory Report

for

Enthalpy Analytical
2323 5th Street
Berkley, CA 94710
Attention: Jessica Silberman

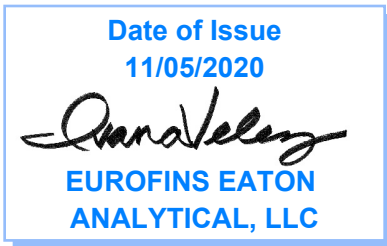

Utah ELCP CA00006

SZN3: Ivana Velez
Project Manager

Report: 901031
Project: MICRO
Group: Algae

* Accredited in accordance with TNI 2016 and ISO/IEC 17025:2017.

* Laboratory certifies that the test results meet all **TNI 2016 and ISO/IEC 17025:2017** requirements unless noted under the individual analysis.

* Following the cover page are State Certification List, ISO 17025 Accredited Method List, Acknowledgement of Samples Received, Comments, Hits Report, Data Report, QC Summary, QC Report and Regulatory Forms, as applicable.

* Test results relate only to the sample(s) tested.

* Test results apply to the sample(s) as received, unless otherwise noted in the comments report (ISO/IEC 17025:2017).

* This report shall not be reproduced except in full, without the written approval of the laboratory.

* This report includes ISO/IEC 17025 and non-ISO 17025 accredited methods.

STATE CERTIFICATION LIST

State	Certification Number	State	Certification Number
Alabama	41060	Montana	Cert 0035
Arizona	AZ0778	Nebraska	Certified
Arkansas	Certified	Nevada	CA000062018
California	2813	New Hampshire *	2959
Colorado	Certified	New Jersey *	CA 008
Connecticut	PH-0107	New Mexico	Certified
Delaware	CA 006	New York *	11320
Florida *	E871024	North Carolina	06701
Georgia	947	North Dakota	R-009
Guam	18-005R	Oregon *	CA200003-005
Hawaii	Certified	Pennsylvania *	68-565
Idaho	Certified	Puerto Rico	Certified
Illinois *	200033	Rhode Island	LAO00326
Indiana	C-CA-01	South Carolina	87016
Iowa - Asbestos	413	South Dakota	Certified
Kansas *	E-10268	Tennessee	TN02839
Kentucky	90107	Texas *	T104704230-18-15
Louisiana *	LA180000	Utah (Primary AB) *	CA00006
Maine	CA0006	Vermont	VT0114
Maryland	224	Virginia *	460260
Commonwealth of Northern Marianas Is.	MP0004	Washington	C838
Massachusetts	M-CA006	EPA Region 5	Certified
Michigan	9906	Los Angeles County Sanitation Districts	10264
Mississippi	Certified		

* NELAP/TNI Recognized Accreditation Bodies

ISO/IEC 17025 Accredited Method List

The tests listed below are accredited and meet the requirements of ISO/IEC 17025 as verified by the ANSI-ASQ National Accreditation Board/A2LA.
Refer to Certificate and scope of accreditation (5890) found at: <https://www.eurofinsus.com/Eaton>

SPECIFIC TESTS	METHOD OR TECHNIQUE USED	Environmental (Drinking Water)	Environmental (Waste Water)	Water as a Component of Food and Bev/Bev/ Bottled Water
1,2,3-TCP (5 PPT & 0.5 PPT)	CA SRL 524M-TCP	x		x
1,4-Dioxane	EPA 522	x		x
2,3,7,8-TCDD	Modified EPA 1613B	x		x
Acrylamide	In House Method (2440)	x		x
Algal Toxins/Microcystin	In House Method (3570)			
Alkalinity	SM 2320B	x	x	x
Ammonia	EPA 350.1		x	x
Ammonia	SM 4500-NH3 H		x	x
Anions and DBPs by IC	EPA 300.0	x	x	x
Anions and DBPs by IC	EPA 300.1	x		x
Asbestos	EPA 100.2	x	x	
BOD / CBOD	SM 5210B		x	x
Bromate	In House Method (2447)	x		x
Carbamates	EPA 531.2	x		x
Carbonate as CO3	SM 2330B	x	x	x
Carbonyls	EPA 556	x		x
COD	EPA 410.4 / SM 5220D		x	
Chloramines	SM 4500-CL G	x	x	x
Chlorinated Acids	EPA 515.4	x		x
Chlorinated Acids	EPA 555	x		x
Chlorine Dioxide	SM 4500-CLO2 D Palin Test	x		x
Chlorine -Total/Free/ Combined Residual	SM 4500-Cl G	x	x	x
Conductivity	EPA 120.1		x	
Conductivity	SM 2510B	x	x	x
Corrosivity (Langelier Index)	SM 2330B	x		x
Cyanide, Amenable	SM 4500-CN G	x	x	
Cyanide, Free	SM 4500CN F	x	x	x
Cyanide, Total	EPA 335.4	x	x	x
Cyanogen Chloride (screen)	In House Method (2470)	x		x
Diquat and Paraquat	EPA 549.2	x		x
DBP/HAA	SM 6251B	x		x
Dissolved Oxygen	SM 4500-O G		x	x
DOC	SM 5310C	x		x
E. Coli (MTF/EC+MUG)		x		x
E. Coli (CFR 141.21(f)(6)(i))		x		x
E. Coli (SM 9223)	SM 9223		x	
E. Coli (Enumeration)	SM 9221B.1/ SM 9221F	x		x
E. Coli (Enumeration)	SM 9223B	x		x
EDB/DCBP	EPA 504.1	x		
EDB/DBCP and DBP	EPA 551.1	x		x
EDTA and NTA	In House Method (2454)	x		x
Endothall	EPA 548.1	x		x
Endothall	In-house Method (2445)	x		x
Enterococci	SM 9230B	x	x	
Fecal Coliform	SM 9221 E (MTF/EC)	x		
Fecal Coliform	SM 9221C, E (MTF/EC)		x	
Fecal Coliform (Enumeration)	SM 9221E (MTF/EC)	x		x
Fecal Coliform with Chlorine Present	SM 9221E		x	
Fecal Streptococci	SM 9230B	x	x	
Fluoride	SM 4500-F C	x	x	x
Glyphosate	EPA 547	x		x
Glyphosate + AMPA	In House Method (3618)	x		x
Gross Alpha/Beta	EPA 900.0	x	x	x
Gross Alpha Coprecipitation	SM 7110 C	x	x	x
Hardness	SM 2340B	x	x	x
Heterotrophic Bacteria	In House Method (2439)	x		x
Heterotrophic Bacteria	SM 9215 B	x		x
Hexavalent Chromium	EPA 218.6	x	x	x

SPECIFIC TESTS	METHOD OR TECHNIQUE USED	Environmental (Drinking Water)	Environmental (Waste Water)	Water as a Component of Food and Bev/Bev/ Bottled Water
Hexavalent Chromium	EPA 218.7	x		x
Hexavalent Chromium	SM 3500-Cr B		x	
Hormones	EPA 539	x		x
Hydroxide as OH Calc.	SM 2330B	x		x
Kjeldahl Nitrogen	EPA 351.2		x	
Legionella	Legiolert	x		x
Mercury	EPA 200.8	x		x
Metals	EPA 200.7 / 200.8	x	x	x
Microcystin LR	ELISA (2360)	x		x
Microcystin, Total	EPA 546	x		x
NDMA	EEA/Agilent 521.1 In house method (2425)	x		x
Nitrate/Nitrite Nitrogen	EPA 353.2	x	x	x
OCL, Pesticides/PCB	EPA 505	x		x
Ortho Phosphate	EPA 365.1	x	x	x
Ortho Phosphorous	SM 4500P E	x		x
Oxyhalides Disinfection Byproducts	EPA 317.0	x		x
Perchlorate	EPA 331.0	x		x
Perchlorate (low and high)	EPA 314.0	x		x
Perfluorinated Alkyl Acids	EPA 537	x		x
Perfluorinated Pollutant	In house Method (2434)	x		x
pH	EPA 150.1	x		
pH	SM 4500-H+B	x	x	x
Phenylurea Pesticides/ Herbicides	In House Method, based on EPA 532 (2448)	x		x
Pseudomonas	IDEXX Pseudalert (2461)	x		x
Radium-226	GA Institute of Tech	x		x
Radium-228	GA Institute of Tech	x		x
Radon-222	SM 7500RN	x		x
Residue, Filterable	SM 2540C	x	x	x
Residue, Non-filterable	SM 2540D		x	
Residue, Total	SM 2540B		x	x
Residue, Volatile	EPA 160.4		x	
Semi-VOC	EPA 525.2	x		x
Silica	SM 4500-Si D	x	x	
Silica	SM 4500-SiO2 C	x	x	
Sulfide	SM 4500-S ⁻² D		x	
Sulfite	SM 4500-SO ³⁻ B	x	x	x
Surfactants	SM 5540C	x	x	x
Taste and Odor Analytes	SM 6040E	x		x
Total Coliform (P/A)	SM 9221 A, B	x		x
Total Coliform (Enumeration)	SM 9221 A, B, C	x		x
Total Coliform / E. coli	Colisure SM 9223	x		x
Total Coliform	SM 9221B		x	
Total Coliform with Chlorine Present	SM 9221B		x	
Total Coliform / E.coli (P/A and Enumeration)	SM 9223	x		x
TOC	SM 5310C	x	x	x
TOX	SM 5320B		x	
Total Phenols	EPA 420.1		x	
Total Phenols	EPA 420.4	x	x	x
Total Phosphorous	SM 4500 P E		x	
Triazine Pesticides & Degradates	In House (3617)	x		x
Turbidity	EPA 180.1	x	x	x
Turbidity	SM 2130B	x	x	
Uranium by ICP/MS	EPA 200.8	x		x
UV 254	SM 5910B	x		
VOC	EPA 524.2	x		x
VOC	In House Method (2411)	x		x
Yeast and Mold	SM 9610	x		x
Field Sampling	N/A			

Acknowledgement of Samples Received

Addr: **Enthalpy Analytical**
2323 5th Street
Berkeley, CA 94710

Client ID: CT-BERKELEY
Folder #: 901031
Project: MICRO
Sample Group: Algae

Attn: Jessica Silberman
Phone: (510) 204-2236

Project Manager: Ivana Velez
Phone: 626-386-1123

The following samples were received from you on **October 30, 2020 at 11:27**. They have been scheduled for the tests listed below each sample. If this information is incorrect, please contact your service representative. Thank you for using Eurofins Eaton Analytical, LLC.

Sample #	Sample ID	Sample Date
202010300084	Cargo Wash Water	10/28/2020 0000
	Variable ID: 435578-001	
	Algae Identification	RUSH

Test Description

Subcontract Laboratory:

Eurofins Eaton Analytical
 750 Royal Oaks Drive
 Suite 100
 Monrovia, CA 91016
 ATTN:

1-3° on IWE

Enthalpy Order: EO-435578

PM: Jess Silberman
 Email: jessica.silberman@enthalpy.com
 CC: incomingreports@enthalpy.com
 Phone: 510-204-2236

PO #: Required, to be sent via email

Results Due: 11/04/20

Report Level: II

Report To: RL

EDDs:

MSOF 10/30 1142

Notes:

Sample ID	Collected	Lab ID	# Cont.	Matrix	Analysis Requested	Comment
CARGO WASH WATER	28-OCT-2020 00:00	435578-001	1	Water	Cyanobacteria	

Notes:	Relinquished By:	Received By:
	<i>M. Silberman</i>	<i>J. Silberman</i>
	Date: <i>10/28/20 17:11</i>	Date: <i>10/30/20 1127</i>
	Date:	Date:
	Date:	Date:



Eaton Analytical

INTERNAL CHAIN OF CUSTODY RECORD

EEA Folder Number: 901031

SAMPLE TEMP RECEIVED:

Note: If samples are out of temperature range, let the ASMs know. ASMs will determine whether to proceed with analysis or not.

SAMPLES REC'D DAY OF COLLECTION? Yes / No

IR Gun ID = 631A (Observation = 1.4 °C) (Corr. Factor 0.1 °C) (Final = 1.3 °C)

TYPE OF ICE: Real Synthetic No Ice Condition of Ice: Frozen Partially Frozen Thawed N/A

METHOD OF SHIPMENT: Pick-Up / Walk-In / FedEx / UPS / DHL / Area Fast / Top Line / Other: 6-5

Compliance Acceptance Criteria:

- 1) Chemistry: >0, ≤6°C, not frozen (NELAP) (if received after 24 hrs of sample collection)
- 2) Microbiology, Distribution: < 10°C, not frozen (can be ≥10°C if received on ice the same day as sample collection, within 8 hours)
- 3) Microbiology, Surface Water: < 10°C (if received after 2 hours of sample collection)

If out of temperature range for both Chemistry and Microbiology samples and temperature does not confirm, then measure the temperature of each quadrant and record each temperature of the quadrants

1 = (Observation = _____ °C) (Corr. Factor _____ °C) (Final = _____ °C)	2 = (Observation = _____ °C) (Corr. Factor _____ °C) (Final = _____ °C)
3 = (Observation = _____ °C) (Corr. Factor _____ °C) (Final = _____ °C)	4 = (Observation = _____ °C) (Corr. Factor _____ °C) (Final = _____ °C)

4 Dioxin (1613 or 2,3,7,8 TCDD): must be between 0-4 °C, not frozen (if received after 24 hrs of sample collection)

5) pH Check. Manufacturer: _____ Lot Number: _____ pH strip type: 0 - 14 or _____ Expiration Date: _____ Results: _____

6) Chlorine check. Manufacturer: Sansafe. Lot No.: _____ Expiration Date: _____ Results: _____

7) VOA and Radon Headspace: No Samples with Headspace: Samples with Headspace (see below):

Headspace Documentation (use additional VOC and Radon Internal COFC for additional bottles)

Exempt from headspace concerns: Methods 515.4, HAA(6251,552), 505, SPME, @CH, 532LCMS, 556, 536, Anatoxin, LCMS methods using 40 ml vials, international clients:

Samp ID	Bottle #	None/<6 mm	>6mm	Samp ID	Bottle #	None/<6 mm	>6mm

Note Sample IDs which have dissimilar headspace (i.e. potential sampling errors): _____

RECEIVED BY: _____ PRINT NAME: _____ COMPANY/TITLE: Eurofins Eaton Analytical

SIGNATURE: _____ DATE: _____ TIME: _____

Tel: (626) 386-1100
Fax: (626) 988-3757
1 800 566 LABS (1 800 566 5227)

Report: 901031
Project: MICRO
Group: Algae

Enthalpy Analytical
Jessica Silberman
2323 5th Street
Berkeley, CA 94710

Samples Received on:
10/30/2020 11:27

Analyzed	Analyte	Sample ID	Result	Federal MCL	Units	MRL
11/04/2020 13:25	202010300084 Algae Identification	<u>Cargo Wash Water</u>	See Attached		Not Appl.	

Tel: (626) 386-1100
 Fax: (626) 988-3757
 1 800 566 LABS (1 800 566 5227)

Report: 901031
Project: MICRO
Group: Algae

Enthalpy Analytical
 Jessica Silberman
 2323 5th Street
 Berkley, CA 94710

Samples Received on:
 10/30/2020 11:27

Prepped	Analyzed	Prep Batch	Analytical Batch	Method	Analyte	Result	Units	MRL	Dilution
Cargo Wash Water (202010300084)						Sampled on 10/28/2020 0000			
Variable ID: 435578-001									
SM 10900 - Algae Identification									
11/04/20	13:25		1285831	(SM 10900)	Algae Identification	See Attached	Not Appl.		1

Rounding on totals after summation.
 (c) - indicates calculated results. Analysis is a calculated result. Reported results are not rounded until the final step before reporting. Therefore methods that use a test result with further calculation may have slight differences in final result than the component analyses.

Tel: (626) 386-1100
Fax: (866) 988-3757
1 800 566 LABS (1 800 566 5227)

Report: 901031
Project: MICRO
Group: Algae

Enthalpy Analytical

Algae Identification**Analytical Batch: 1285831**

202010300084

Cargo Wash Water

Analysis Date: 11/04/2020

Analyzed by: R77L

ALGAE ANALYSIS by FLOW CYTOMETRY

Flow cytometry analysis of algae is an advanced method for morphological identification and quick quantitative detection of individual particle in a sample.

Client CT-BERKELEY
Folder # 901031
Sample # 202010300084
Sample ID Cargo Wash Water

Prep Date/Time/Analyst: 10/30/20 1459 R77L
Analyzed Date/Time/Analyst: 11/04/20 1325 R77L

Picture #	Algae Genus

Sample Volume Analyzed ⁽¹⁾ 1 ml

(1) Sample results extrapolated to give results/ml of sample