

Page Ranch
Planned Community
PCD 79-93

Proposed Amendment (SPA 15-001)
Submitted: January 2019
Amended from the Previously Approved Version: March 2009

Prepared for:
City of Hemet
445 E. Florida Avenue
Hemet, CA 92543-4209

Submitted by:

Page/Strata/BP, LLC
Benchmark Pacific
550 Laguna Drive, Suite B
Carlsbad, CA 92008
Contact:
Rick Robotta
760-450-0444

Prepared by:

PANGAEA
LAND CONSULTANTS, INC.

Pangaea Land Consultants, Inc.
2834 La Mirada Drive, Suite H
Vista, CA 92081
Contact: Rich Brasher
760-936-3248



Page Ranch
Planned
Community
Development

1.0 PROJECT

1.1 PROJECT SUMMARY

This Amendment will modify the Page Ranch Planned Community Master Plan (PCD 79-93), adopted in 1980 by the City of Hemet and most recently amended in March 2009. This proposed amendment is to eliminate the alignment of New Warren Road, along with the elimination of Planning Area VI and the incorporation of Planning Area VI into Planning Area X. Mustang Way will be extended to the west and north to connect to the New Stetson Road and split the expanded Planning Area X. The boundary between Planning Areas X and XIII is also redefined. The land use for Planning Area XII is changed to Regional Commercial. The circulation and planning area changes are proposed in order to accommodate desired changes in land uses. There are no changes being proposed to the overall Plan boundary. As a result of the proposed changes, there is a conversion of 117.7 acres of Low Density residential to Low-Medium Residential; however, the total units reduce by 231 units from 6,952 to 6,721 units. The overall residential density of the Plan changes from 3.6 dwelling units per acre to 3.4 dwelling units per acre.

A summary of changes are shown in Tables 1 and 2 below.

Table 1
Specific Plan Amendment – 04

Planning Area	Adopted Land Use	Adopted Acreage	Adopted D/U's
III	Low Density	218.2	894
IV	Industrial	52.1	0
VI	Low Density	117.7	353
VII	Low Medium	38.5	193
X	Low-Med Density	99.4	391
XI	Low-Med Density	104.5	448
XII	Low Med Density	45.6	155
XIII	Low Density	24.4	73
Totals		694.1	2,507



Page Ranch
Planned
Community
Development

**Table 2
Specific Plan Amendment (15-001)**

Planning Area	Adopted Land Use	Adopted Acreage	Adopted D/U's
I	Medium Density	84.7	353
II	Low-Med Density	113.46	567
	Med-High Density	26.01	416
IIA	Low-Med Density	34	170
	Med-High Density	23.99	384
	Commercial	18.59	0
III	Low Density	211.9	894
IV	Industrial	52.1	0
V	Medium Density	116.4	1,164
	Med-High Density	40	640
	Open Space/Preserve	1.8	0
VII	Low Medium	38.6	193
VIII	Open Space/Preserve	16.0	0
	Open Space/Recreation	130.0	0
IX	Low Density	225.45	676
	Med-High Density	18.1	75
	Open Space/Preserve	92.0	0
X	Low-Med Density	221.83	586
XI	Low-Med Density	104.5	448
XII	Low-Med Density	45.6	155
XIII	Commercial (Regional)	19.67	0
Totals		1,634.74	6,721

1.2 LAND USE AND DENSITY CHANGES

Planning Area X has been enlarged by incorporating former Planning Area VI. The previous combination of Planning Areas and X contained 744 units on 217.1 acres for a composite density of 3.42 dwelling units per acre. The expanded Planning Area X contains 586 units on 221.83 acres for a density of 2.64 dwelling units per acre.

Planning Area XIII is amended to have Regional Commercial use. The ALUC adopted a new Hemet-Ryan Airport Land Use Compatibility Plan (ALUCP) in 2017. Most Commercial uses are allowable in Compatibility Zone C, provided that intensity is within the limits set forth for that Zone in the ALUCP.

The proposed amendment is intended to support the objectives of the Page Ranch Planned Community by:



Page Ranch Planned Community Development

- Contributing to the diversity of housing types and site locations that will be marketable in the developing economic profile for the City of Hemet;
- Providing residential product type to meet forecasted demand in the Specific Plan area;
- Contributing to the creation of a community identity for the City of Hemet through conformance with architectural and landscape standards;
- Providing a logical extension of utilities, drainage, facilities and circulation networks.
- Providing commercial use among residential uses to reduce the frequency and distance of automobile trips.

This Specific Plan Amendment is being processed concurrently with a General Plan Amendment to accommodate the deletion of New Warren Road from the General Plan Circulation Element and the extension of Mustang Way from existing Warren Road to the new alignment of Stetson Avenue.

1.3 ENVIRONMENTAL SUMMARY

Potential environmental impacts of development of the subject Planning Areas shall be evaluated as part of an environmental process, as determined by the City and the selected environmental consultant.

1.4 TRAFFIC IMPACT ANALYSIS

1.4.1 On-Site Improvements

This section to be updated based on the results of any required environmental analysis.

Planning Area X

The Traffic Impact Analysis completed for this Planning Area was done using two alternatives. One alternative for on-site improvements is that Mustang Way is extended through the project area and the other was done without the Mustang Way extension. In both instances the recommended roadway improvements were the same with the exception of Mustang Way extension which if extended would be constructed as a Secondary roadway from Warren Road to new Stetson Avenue in conjunction with development.

1.4.2 Off-Site Improvements

Off-site improvements to be implemented under the proposed Modified Project include construction of water and reclaimed water pipelines in the abutting roads, drainage conveyance features, and the construction of the westerly half of new Warren Road. The Warren Road improvements include modifications to the



Page Ranch Planned Community Development

Stetson Avenue intersection at the northeast corner of the Modified Project site including a realigned transition back to the existing Warren Road alignment (2.05 acres of permanent impacts) (Figure 2.2 provided in prior email). Proposed utility lines will be constructed to the extent they are required within the rights-of-way of the abutting roads. Off-site utility pipelines will be constructed by others during future off-site road construction. Off-site drainage improvements include connections to the existing Hemet Channel north of the site (0.05 acre of temporary impacts for the installation of seven drainage connections) and improvements to an existing drainage channel from the existing drainage basin in the southwest corner of the Modified Project site extending southerly to Simpson Road (4.17 acres of permanent impacts and 2.42 acres of temporary impacts). From Simpson Road, the channel would continue to convey runoff south toward Salt Creek without further modifications. Temporary impacts for the channel assume a width of 20 feet for construction purposes on both sides of the ultimate channel and maintenance drive. Modified Project permanent impacts for off-site improvements total 6.22 acres and temporary impacts total 2.47 acres.

Off-site improvements should be coordinated with the proposed Southwest Hemet Roadway Phasing and Financing Program. The proposed Southwest Hemet Roadway Phasing and Financing Program will include analysis of General Plan growth for the City of Hemet, and define improvement requirements appropriate for the overall level of proposed development.

1.5 AUTHORITY AND REQUIREMENTS

1.5.1 Authority for Specific Plan Amendment

The authority to prepare, adopt and implement specific plan amendments is granted to the City of Hemet by the California Government Code (Title 7, Division 1, Chapter 3, Article 8, Sections 65450 through 65457). As with General Plans, the Planning Commission must hold a public hearing before it can recommend adoption of a Specific Plan Amendment to the City Council. The City of Hemet City Council shall adopt a Specific Plan Amendment by ordinance.

1.5.2 Requirements for Specific Plan Amendment

The area covered by this Page Ranch Planned Community, Specific Plan Amendment, is located within the City of Hemet and is zoned PCD 79-93. The Specific Plan Amendment will establish the land uses and densities for the development of Planning Areas covered by this Amendment.

The Specific Plan Amendment is a regulatory plan which will serve as zoning for the subject property. Proposed development plans or agreements, tentative tract or parcel maps, along with all other development approvals, must be consistent with this Specific Plan Amendment. Projects which are found to be consistent with the Specific Plan Amendment will be deemed consistent with the City's General Plan.

Page Ranch History and Amendments

Ordinance	Project	Approval	Description	Environmental
806	ZC79-93	1.22.80	Page Ranch Planned Community Development	Specific land use plan for Southwest Area EIR (certified 1980)
1026		2.28.84	Site development standards TPM19795 & TPM19768	
1034		3.27.84	Site development standards TM16090-1	
1037		4.24.84	Site development standards TM16090-1	
1215	ZC86-30	1.27.87	Modification of Med/High classification	
1392	ZC90-005	7.24.90	Pre-Annexation	
1399		11.27.90	Sign programs	
1571	ZC97-3	9.23.97	R-1 setbacks	
1578	ZC97-5	1.20.98	Land use change from R-17 to R-1-6	
1644	SP00-01	4.10.01	Page Plaza	Mitigated Neg. Dec.
1689	SPA02-2	9.05.03	Sanderson Lakes (Willow Walk)	Mitigated Neg. Dec.
1750	SPA04-01	12.13.05	Land use change from Commercial to Med. Residential	Subsequent EIR
1790	SPA07-002	1.29.08	Brethren Square	Mitigated Neg. Dec.
1810	SPA06-004	3.24.09	Rancho Diamante	Subsequent EIR

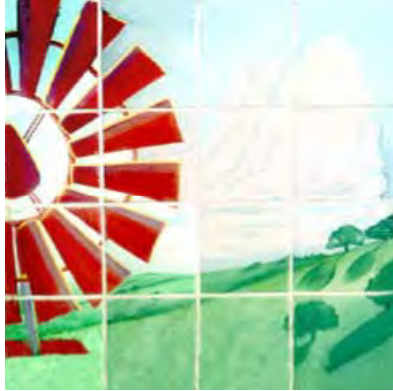

*Page Ranch
Planned Community
PCD 79-93
Master Plan and Development Standards
Amendment
Revised*

January 2019

Prepared for:

City of Hemet Planning Department

445 E. Florida Avenue, Hemet, California 92543

Tel (951) 765-2375

Fax (951) 765-2359

Contact Person: Carole Kendrick, Associate Planner

Amendment Prepared by:

Pangaea Land Consultants

2343 La Mirada Drive, Suite H, Vista, CA 92081

Tel (760) 936-3348

Fax (760) 727-1405

Contact Person: Rich Brasher, Partner/Owner



Page Ranch
Planned
Community
Development

Table of Contents

SECTION	PAGE
I. INTRODUCTION	1
A. Executive Summary	1
B. Location and Character	1
II. PURPOSE AND INTENT	4
III. GENERAL NOTES	5
A. Definitions	6
B. General Notes	6
IV. STATISTICAL SUMMARY	8
V. DISTRICT REGULATIONS	12
A. Residential Regulations	12
1. Low Density	12
2. Low-Medium Density	18
3. Medium Density	20
4. High-Medium Density	22
B. Commercial Regulations	24
C. Light Industrial Regulations	25
D. Public / Institutional Regulations	29
E. Open Space Preservation Regulations	30
F. Open Space Recreation	30
G. Community Facilities Regulations	33
H. Sign Regulations	34
VI. SITE PLAN REVIEW REGULATIONS	47
A. Purpose and Scope	47
B. Site Plans for Non-Residential Uses	47
C. Site Plans Requirements for Residential Uses	48
D. Procedures	48
VII. BICYCLE MASTER PLAN	48
A. General	49
B. Route Master Plan	49
C. Bicycle Trail Development Standards	49
VIII. GROWTH MANAGEMENT	54
APPENDICES	56
A. Page Ranch Amendment Design Guidelines	
B. City of Hemet Standard R.O.W. Sections	



Page Ranch
Planned
Community
Development

List of Figures

FIGURE NO.		PAGE
1	Vicinity Map	2
2	Land Use Plan	3
3	Circulation Plan	9
4	Planning Areas	10
5	Sign Area Measurement	37
6	Types of Signs	40
7	Bicycle Master Plan	50
8	Bicycle Route Standards	51
9	Bicycle Path Standards	52



Page Ranch
Planned
Community
Development

List of Tables

TABLE NO.		PAGE
1	Residential Summary	8
2	Land Use Summary	11
3	Maximum Sign Heights	39
4	Signs – Summary Matrix, Signs Permitted for Each Use	44



Page Ranch Planned Community Development

I. Introduction

A. EXECUTIVE SUMMARY

The proposed Amendment to the Page Ranch Planned Community Master Plan is to eliminate Planning Area VI (Low Density Residential), expand Planning Area X (Low-Medium Density Residential) to include the area from Planning Area VI, designate Planning Area XIII as Regional Commercial, eliminate New Warren Road, and extend Mustang Way from existing Warren Road to New Stetson Avenue.

The exhibits, tables and text have been amended as necessary to address the proposed changes to the Master Plan. The Master Plan is provided to the City of Hemet in two formats; as a strike-out/underline document so all textual changes are easily identified by the reader, as well as a separate version of the document with the changes incorporated.

Page Ranch is included in a special planning study commissioned by the City of Hemet entitled "The Specific Land Use Plan for the Southwest Area" and completed in January, 1979. The Page Ranch Planned Community Master Plan & Development Standards remain consistent with the adopted goals and objectives of this special study, along with related Planned Community Development (PCD) zone regulations of the Zoning Ordinance (No. 621) of the City of Hemet and of subsequent amendments.

The PCD regulations have been developed to provide a method whereby property may be classified for a variety of land uses governed by a supporting master plan and development standards. The specifications of this zoning district are intended to provide flexibility for both the land use and development standards and also achieve high quality development. The Master Plan and related Planned Community development standards, as contained herein, shall serve to govern all proposed non-commercial projects and uses within the designated Planned Community Area. A subsequent "Site Development Plan – Major" shall be required for the Planning Area XIII Regional Commercial, including detailed design review.

B. LOCATION AND CHARACTER

Page Ranch is located in the southwestern section of the City of Hemet, south of Stetson Avenue, west of the Seven Hills development, north of the Domenigoni Mountains and east of the San Diego Aqueduct. (See Figure 1, Vicinity Map.)



I. Introduction

Page Ranch

Planned Community Development

Vicinity Map

Figure 1

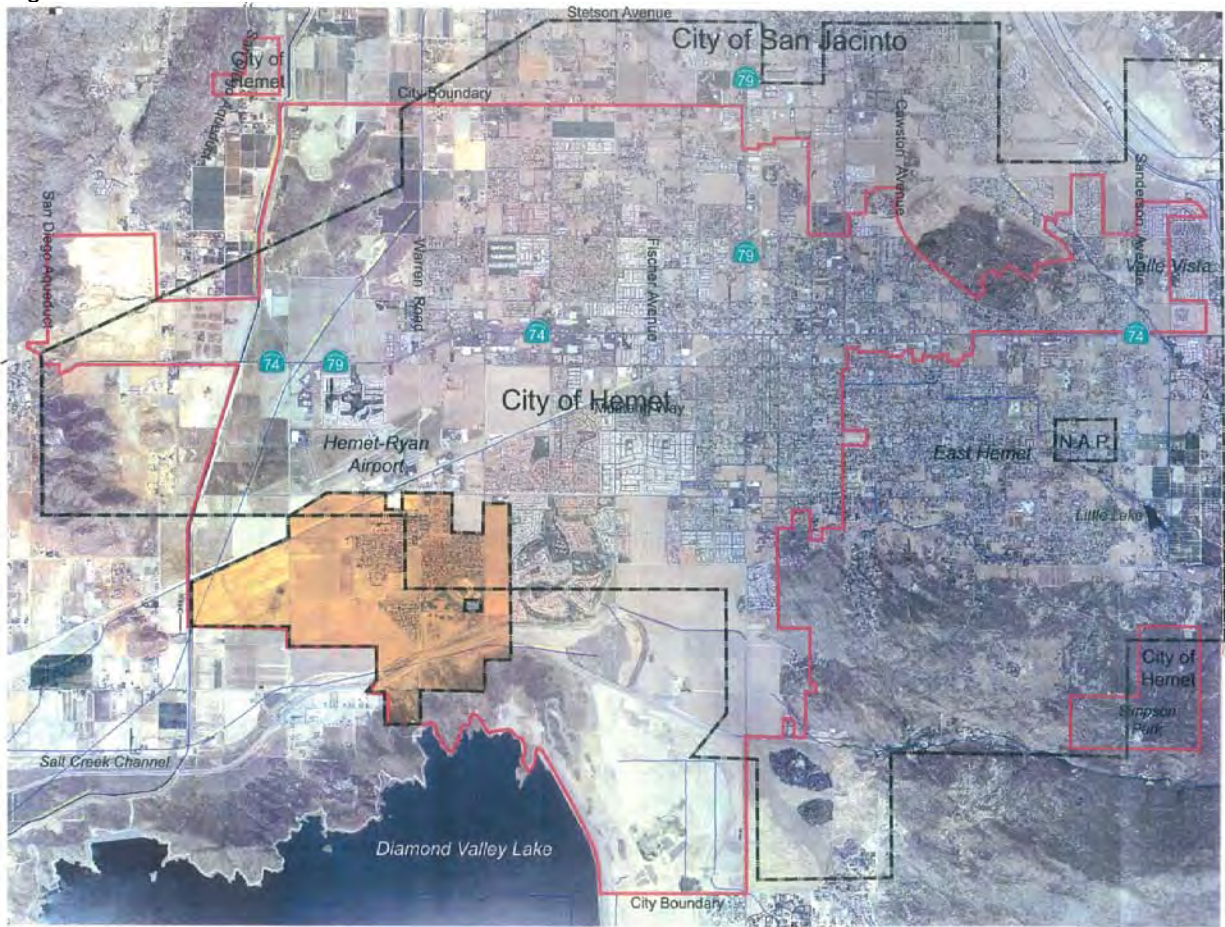

AEI+CASC
ENGINEERING

Page Ranch Planned Community Development
November, 2005

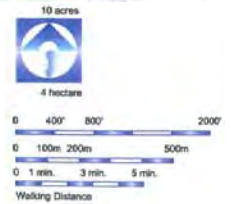



I. Introduction

Page Ranch

Planned Community Development

Proposed Land Use
Figure 2

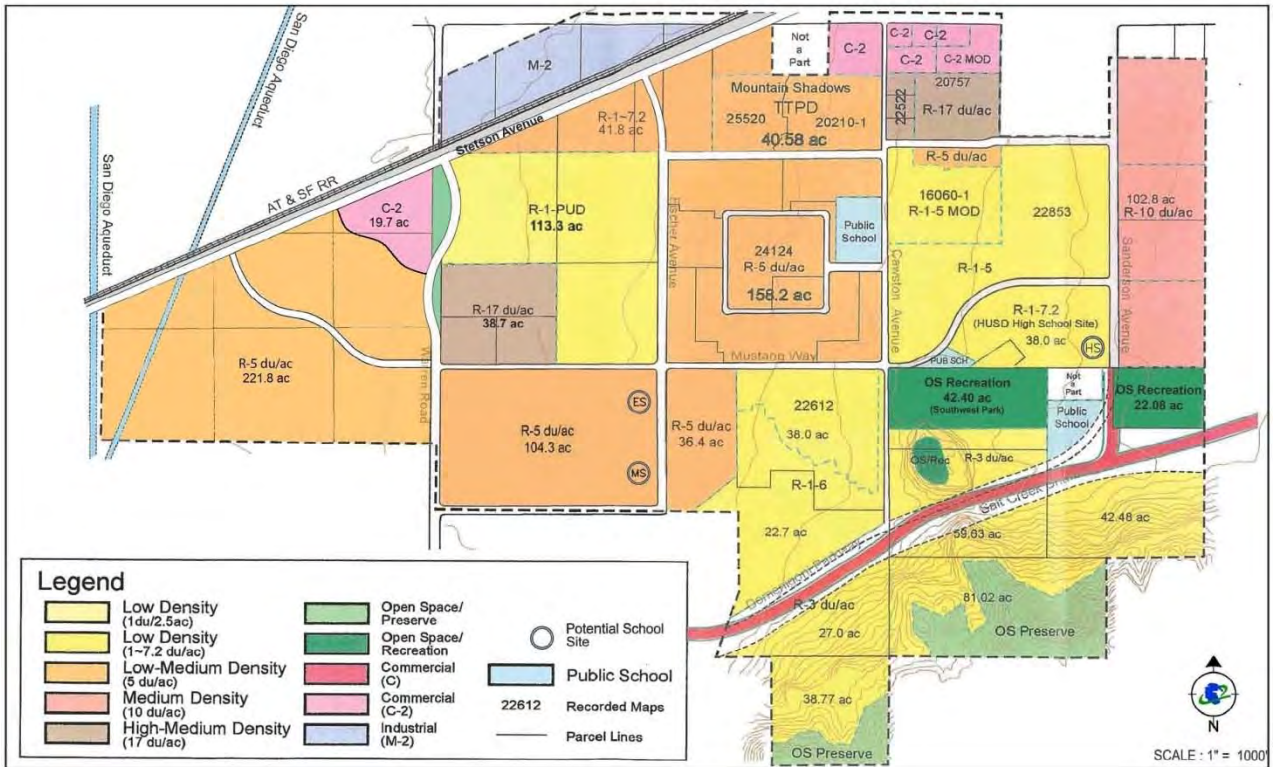



Page Ranch
Planned
Community
Development

II. Purpose and Intent

PURPOSE AND INTENT

The following document is a Master Plan and accompanying development standards for a planned community known as the Page Ranch, with a total area of 1,634.7 acres. The purpose of this Master Plan and supporting documents is to set forth permitted land uses, and establish appropriate development standards, design criteria, and guidelines for growth management as it relates to adequacy of public facilities and services.

The Master Plan and supporting documents are intended to allow a diversity of land uses and standards in compliance with the intent and provisions of the Southwest Area Specific Plan, the Hemet General Plan, the Zoning Ordinance, and Subdivision Ordinance of the City of Hemet.

This document originally provided the framework for development in the Page Ranch Master Plan. Future Specific Plans that separate themselves out of the original or Amended Page Ranch Planned Community may supersede this document (See Appendix F).



Page Ranch
Planned
Community
Development

III. General Notes

A. DEFINITIONS

Definition of terms shall be as defined in Section 90-4 of the City's Zoning Ordinance, Ordinance No. 621, unless otherwise defined herein.

1. *Single family residential* – refers to any residential use or development wherein each dwelling unit is situated on a residential lot of record and no lot contains more than one dwelling unit. Single family residential may include either attached or detached single-family dwellings, or a combination thereof, cluster developments, and may be applicable to subdivisions and planned developments.
2. *Cluster Development* – shall be defined as combining or arranging of attached or detached dwelling units and their accessory structures on contiguous or related building sites where the yards and open spaces are combined into more desirable arrangements and locations of open space.
3. A *planning area* – is a numbered area on the Planned Community Master Plan.
4. *Planning unit* – area refers to the total number of acres within a Planning Area boundary.
5. *Gross planning unit density* – is determined by dividing the total area of the Planning Unit by the number of dwelling units within the Planning Unit.
6. *Gross residential acres* – is the total number of acres within any planning unit that is to be devoted essentially to residential uses, including residential building sites, local streets, drive-ways, private recreation and recreation areas within designated residential areas only for use of the residents of the project, minor easements serving the project, and customary uses and structures accessory to residential development.
7. *The gross residential density of a project* – is computed by dividing the total number of dwelling units by the total number of gross residential acres in the project.

B. GENERAL NOTES

1. The maximum number of dwelling units is established in the Statistical Summary (Section IV) so that a development at a lower density may occur without requiring a zone change or change in this P.C.D. document. At no time, however, shall the maximum number of dwelling units established for any planning unit be exceeded.
2. Unless otherwise specified herein, the regulations specified by the



Page Ranch Planned Community Development

III. General Notes

Hemet Municipal Code shall regulate all development within the Page Ranch Planned Community. Definition of terms shall be as defined in the Hemet Municipal Code, except as modified herein.

3. The individual acreage figures shown in the Statistical Summary on the Planned Community Development Plan are accurate to within 10% of the acreage as shown and are based upon planimeter readings. Modifications that may result from precise planning such as at the Tentative Tract Map or Final Tract Map stage will not require a change to the Development Plan provided that the total number of residential dwelling units in the affected planning units does not exceed that specified by the statistical summary.
4. Residential Grading permits may be issued within the planned community and outside of the area proposed for immediate development. Soil may be stockpiled on or borrowed from locations within the planned community so long as these locations are indicated for development on the Master Plan and a Stockpile Permit has been obtained.
5. The continued use of the land for agricultural purposes and other similar uses including all necessary structures and appurtenances shall be permitted.
6. Water within the Page Ranch Planned Community shall be furnished by the Eastern Municipal Water District.
7. Sewage disposal facilities within the Page Ranch Planned Community shall be furnished by the Eastern Municipal Water District.
8. Drainage and flood protection facilities shall be provided in a manner meeting with the approval of the City Engineer and the Riverside County Flood Control District.
9. Detailed plans, including design, hydrology and hydraulic calculations shall be submitted to the City Engineer and Riverside County Flood Control District for approval, prior to the issuance of grading or building permits and prior to the recordation of a Final Map.
10. Local parks will be provided in conformance with the requirements of the Local Park Code.
11. The Community Development Director shall have the authority and responsibility to review uses not listed in these Planned Community District Regulations. A proposed unlisted use shall be permitted as a principal or conditionally permitted use within a base district if the



Page Ranch
Planned
Community
Development

III. General Notes

Community Development Director determines that said use falls within the purpose and intent of that base district, is of a comparable nature to the principal or conditionally permitted uses specified as permitted in the base district and will not be detrimental to property in the vicinity of said use.

12. A Development Plan as outlined in the Planned Community Development zoning text of the City must be filed with the Planning Commission prior to issuance of any building permits and prior to, or concurrent with, the filing of any Tentative Tract Map. Development Plans can cover all or a portion of the area included in the Page Ranch Master Plan.
13. Article XIX. – PCD Planned Community Development Zone of the Hemet Municipal Code addresses the guidelines for the creation and approval of a PCD, made up of a Community Master Plan and a Development Plan. Sec. 90-620 addresses the approval of the Development Plan and refers to Article II, Section 90-48 Site Development Plan Review, for the approval process for the Development Plan.



IV. Statistical Summary

Page Ranch
Planned Community Development

Residential Summary

Table 1

Planning Area	1	2	2A	3	5	7	9	10	11	12	TOTAL
Low Density											
Acres							225.45				225.45
DU/AC							3				3
Total DU							676				676
Population*							1,555				1,555
Low Medium											
Acres		113.46	34	211.90		38.6		221.83	104.5	45.6	769.89
DU/AC		5	5	4		5		2.64	4.4	3.5	3.9
Total DU		567	170	894		193		586	448	155	3,013
Population*		1,304	391	2,056		444		1,348	1,030	357	6,930
Medium Density											
Acres	84.7				116.4		18.1				219.2
DU/AC	4.2				10		4.2				7.3
Total DU's	353				1,164		75				1,592
Population*	812				2,677		173				3,662
Medium High											
Acres		26.01	23.99		40						90
DU/AC		16	16		16						16
Total DU		416	384		640						1,440
Population*		957	863		1,472						3,312
Total Acres	84.7	139.47	57.99	211.90	156.4	38.6	244	221.93	104.45	45.61	1,304.5
Total Population*	812	2,261	1,274	2,056	4,149	444	1,727	1,348	1,030	357	15,458
Total DU's	353	983	554	894	1,804	193	751	586	448	155	6,721

* Population Generation Factor is 2.3 persons per household

NOTE: This table has been updated from the approved 1980 Page Ranch PCD to incorporate the amended acreages, unit counts and updated Generation Factor.



IV. Statistical Summary

Page Ranch

Planned Community Development

Circulation Plan

Figure 3

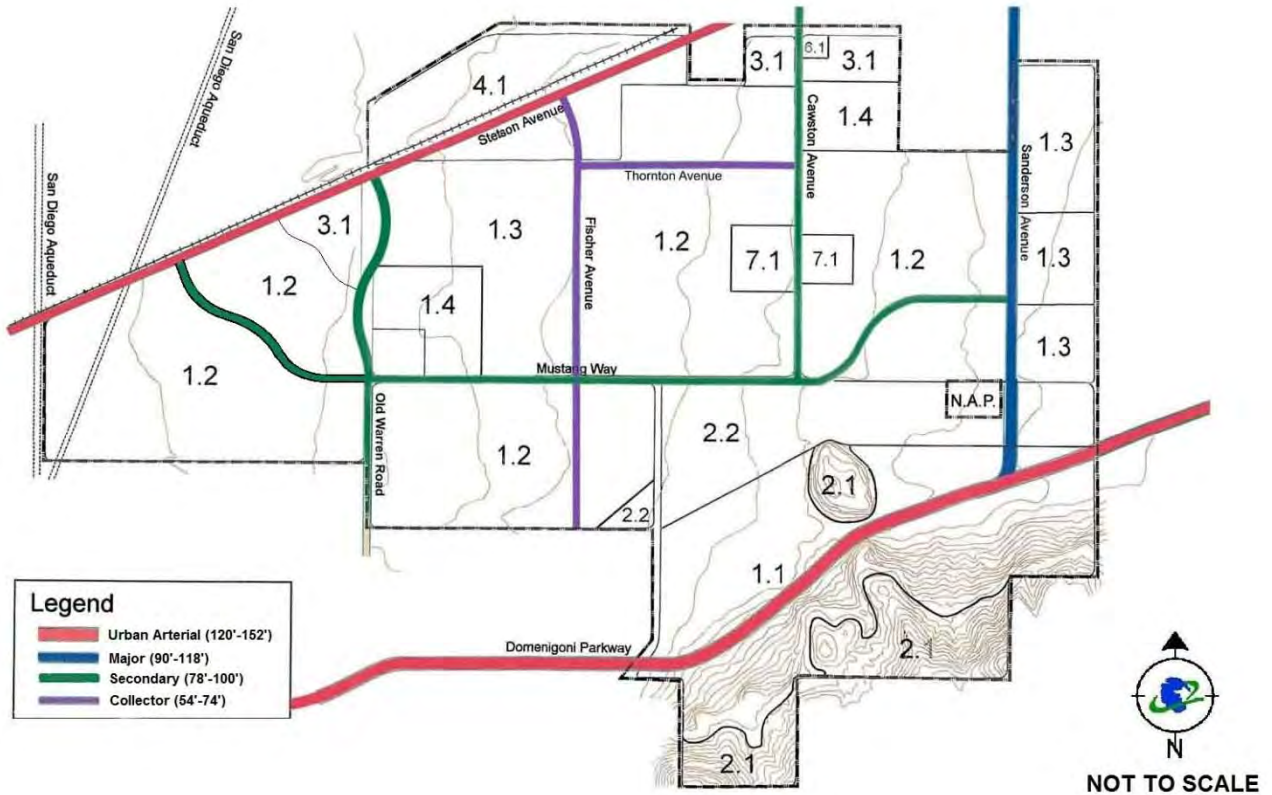



IV. Statistical Summary

Page Ranch

Planned Community Development

Planning Areas

Figure 4

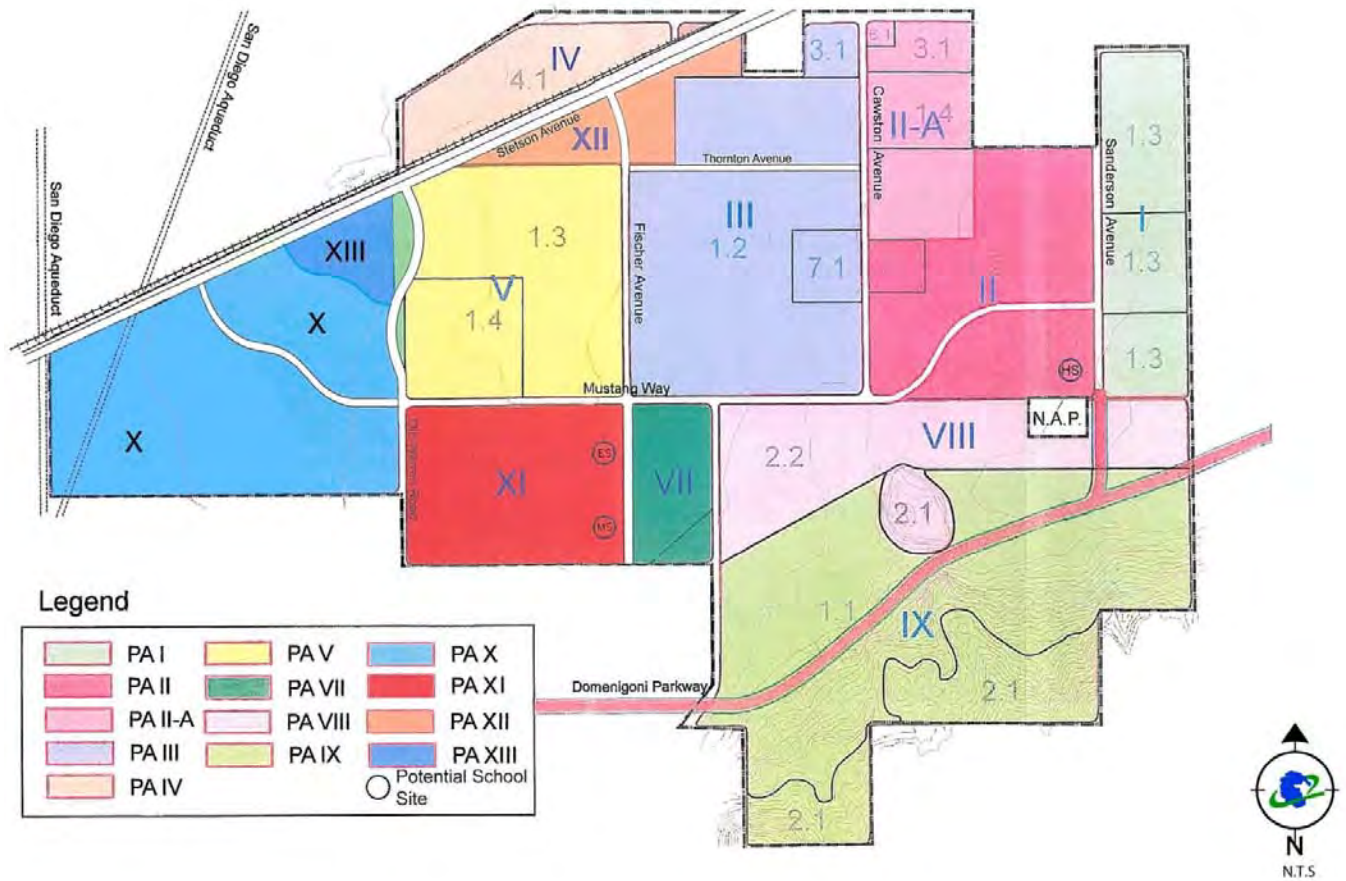



IV. Statistical Summary

Page Ranch
Planned Community Development

Land Use Summary

Table 2

Planning Area	1	2	2A	3	4	5	7	8	9	10	11	12	13	TOTAL
Low Density									225.45					225.45
Low Medium		113.48	34	211.94			38.6			221.83	104.5	45.6		769.93
Medium Density	84.7					116.4								201.1
High Medium		26.01	23.99			40			18.1					108.1
Open Space/Preserve						1.8		16	92					109.8
Open Space/Recreation								130						130
Schools														0
Commercial			18.59										19.67 ¹	38.26
Industrial					52.1									52.1
Total Acres	84.7	139.47	76.58	211.94	52.1	158.2	38.6	146	335.55	221.83	104.5	45.6	19.67	1634.74

NOTE: This table has been updated from the approved 1980 Page Ranch PCD to incorporate the amended acreages and unit counts.

1. Planning Area 13 Regional Commercial is limited to 100,000 square feet, consistent with the SEIR.



Page Ranch
Planned
Community
Development

V. District Regulations

A. RESIDENTIAL REGULATIONS

1. Low Density Regulations (1.1)

a. *Purpose and Intent*

The land designated for this type of residential use is meant to serve the particular housing need segment of the community where densities do not exceed 3.0 units per gross acre. This intensity of residential use includes areas where existing and proposed hillside development calls for protection of the hillside areas. A variety of other types of dwelling units or development compatible with adjacent areas (such as cluster or multi-family units) may also be accommodated in the manner prescribed for the Low Density category.

b. *Uses Permitted*

- Single-family residences
- Parks and playgrounds, public and private (non-commercial)
- Riding and hiking trails, equestrian facilities and accessory structures
- Golf courses, tennis clubs, athletic clubs and recreational facilities
- Signs subject to the requirements of Section V.H.

c. *Uses Permitted Subject to Site Plan Review (See Section VI)*

- Single-family residential
- Attached or detached multiple family residential
- Community facilities
- Model homes, temporary real estate offices and signs within subdivisions

d. *Temporary Uses Permitted*

- Temporary use of mobile home residence during construction for use as a security or construction trailer
- Continued use of an existing building during the construction of a new building on the same building site
- Real estate signs and future development signs



Page Ranch
Planned
Community
Development

V. District Regulations

e. *Accessory Uses Permitted*

Any of the following customary accessory uses and structures is permitted subject to applicable regulations of the Hemet Municipal Code, Article XI unless modified herein:

- Garages and carports
- Swimming pools
- Fences and walls
- Home occupations in compliance with the regulations provided in the Hemet Municipal Code.
- The keeping of pets of a type readily classified as being customarily incidental and accessory to a permitted principal residential use when no commercial activity is involved. The keeping of wild, exotic, or nondomestic animals is prohibited. As a PCD, the keeping of pets is more restrictive than that allowed by Hemet Municipal Code, Section 90-77.
- Barns, stables, paddocks and other structures necessary for the maintenance of horses shall be permitted on building sites with a minimum area of twenty-thousand (20,000) square feet.
- Horticulture of all types, unlighted and unenclosed by buildings or structures (non-commercial), and as regulated by the Hemet Municipal Code.
- Equines may be kept provided that the minimum building site area of a lot on which one or two may be kept shall be twenty-thousand (20,000) square feet and that for each additional equine over two kept thereon, an additional ten-thousand (10,000) square feet of area shall be required.

f. *Site Development Standards - Single Family Residences*

(1) Conventional subdivision:

Unless otherwise specified on the approved Tentative Tract Map, all single family residential development shall be deemed to be a conventional subdivision. The following regulations shall apply:

- (a) Minimum building site area - eight thousand (8,000) square feet (or as indicated on an approved site plan)
- (b) No minimum building site width required
- (c) Maximum building height - 35 feet or as indicated on an approved Site Plan



Page Ranch
Planned
Community
Development

V. District Regulations

- (d) Density - As stated in the Statistical Summary
 - (e) Maximum building site coverage - sixty (60) percent.
 - (f) Yard Requirements
 - i. All yard requirements shall be in accordance with those set forth in Article XI of the Hemet Municipal Code.
 - ii. Attached and detached garages or carports shall conform to the building setback requirements for main buildings except that when the setback is less than twenty (20) feet and the vehicular access faces the access street, the setback for garages or carports shall be a minimum of twenty (20) feet from the garage door to the sidewalk, or to the curb if there is no sidewalk.
 - (g) Access - each building site shall abut and have vehicular access to a public or private street.
 - (h) Off-Street Parking for motor vehicles shall be provided as required by Article XL, Hemet Municipal Code.
- (2) Planned concept subdivision:
- Where an approved Tentative Tract Map designates the proposed use as a planned concept subdivision, the following regulations shall apply:
- (a) Individual building sites: each dwelling unit, together with all accessory structures, shall be located on an individual building site, and there shall be not more than one single family dwelling per building site.
 - (b) Access: each building site shall abut and have vehicular access to a street.
 - (c) Building site area: the minimum building site area shall be five-thousand (5,000) square feet. However, where any building site has adequate and permanent access to a privately owned common open area that is usable and suitable for play-ground and recreational purposes, and where the residents of the building site have a guaranteed right of use of the common area for recreation purposes, the minimum building site area may be reduced by an amount equivalent to the proportionate share of the common area if it was divided equally among all such building site abutting the same common area. Any such common area shall not be deemed to be a residential building site.
 - (d) Building site width: no minimum required.



Page Ranch
Planned
Community
Development

V. District Regulations

- (e) Building height: thirty-five (35) feet maximum.
- (f) Building site coverage: sixty (60) percent maximum, except if building site area includes usable open space off-site (see V.A.1.f.(2)(c) above).
- (g) Main building setbacks:
 - i. From any property line abutting a street, ten (10) feet minimum from sidewalk, or from curb if there is no sidewalk.
 - ii. When a side property line does not abut a street:
 - Ten (10) feet minimum from one side only, or
 - Ten (10) feet aggregate total for both sides. Further, forty percent (40%) of the setback area may be encroached upon, but the setback of such encroaching structure shall be no less than five (5) feet.
 - iii. Rear setback not abutting a street - minimum of zero (0) feet.
 - iv. Setbacks -accessory structures shall conform to Article XI of the Hemet Municipal Code.
- (h) Garage and carport placement:
 - i. Attached and detached garages and carports shall conform to the building setback requirements for main buildings except that when the main building is set back less than twenty (20) feet and the vehicular access faces the access street, the setback for garages and carports shall be a minimum of twenty (20) feet from the sidewalk, or from the curb if there is no sidewalk, of the access street.
 - ii. The minimum twenty-foot setback for garages and carports, as required by subsection V.A.1.f.(2)(h)i., shall be measured from the nearest point of the garage door to the inside of the sidewalk, or the curb if there is no sidewalk.
- (i) Fences and walls, maximum height: the maximum height of fences and walls used as fences shall not exceed the following limitations:
 - i. Within intersection areas – same as Article X of the Hemet Municipal Code.



Page Ranch
Planned
Community
Development

V. District Regulations

- ii. Within other setback areas six (6) feet maximum height.
 - iii. Within areas where main buildings may be placed – restricted to six (6) feet in height.
 - (j) Off-street parking: two (2) usable automobile parking spaces in a garage or carport shall be provided and maintained on any building site containing a single family dwelling in compliance with Article XL of the Hemet Municipal Code.
- (3) Cluster development:
- When an approved Tentative Tract Map designates the proposed use as a single family cluster development, the following regulations shall apply:
- (a) Building site requirements: each development unit, as specified on the approved Tentative Tract Map, shall be deemed to be a building site - no minimum building site size.
 - (b) Individual lots: each dwelling unit shall be located on an individual lot of record and there shall be no more than one dwelling unit on any lot
 - (c) Access: each residential lot need not necessarily abut a street; however, the ownership of any residential lot shall include a recorded right of access from a street for pedestrians and emergency vehicles for a minimum width of not less than twenty (20) feet, or as approved by the Fire Department.
 - (d) Lot area: no minimum
 - (e) Lot width: no minimum
 - (f) Building height: thirty-five (35) feet maximum
 - (g) Building setbacks:
 - i. From any boundary line of the cluster development-ten (10) feet minimum
 - ii. From any interior property line - none except as may be otherwise specified by the California Building Code.
 - (h) Private street and driveway standards: private streets and driveways within cluster developments shall be in accordance with the following standards:



Page Ranch
Planned
Community
Development

V. District Regulations

- i. Driveways serving four (4) or less dwelling units, and having no parking within the travel way - minimum paved width twenty (20) feet
 - ii. Driveways used primarily for access to garages or carports for more than four (4) dwelling units and with no parking within the travel way - minimum paved width twenty-four (24) feet.
 - iii. Streets and driveways where on-street parking will be limited to one side only - minimum paved width twenty-eight (28) feet.
 - iv. Streets and driveways with on-street parking permitted on both sides - minimum paved width thirty-six (36) feet.
- (i) Garage and carport placement:
- i. Where streets and driveways serve to provide access to garages or carports and do not serve as the primary method of access to dwelling units, garages and carports shall be set back a minimum distance of five (5) feet from the street or driveway.
 - ii. In all other instances, garages and carports shall be set back a minimum distance of twenty (20) feet from the edge of the sidewalk or from the edge of the street or paving if there is no sidewalk.
- (j) Fences and walls, maximum height:
- i. Within intersection areas - as noted in the Hemet Municipal Code.
 - ii. All other areas: Six (6) feet
- (k) Off-street parking:
- i. At least two (2) usable automobile parking spaces, in a garage or carport, each not less than ten (10) feet by twenty (20) feet, shall be provided and maintained within the building site for each dwelling unit.
 - ii. At least one (1) off-street automobile parking space for each dwelling unit shall be provided for visitors and guests. Such parking space shall be convenient and accessible for visitors and guests and shall not be within the minimum travel way of any street or driveway as approved on the Tentative Tract Map.



Page Ranch
Planned
Community
Development

V. District Regulations

2. Low Medium Density Regulations (1.2)

a. *Purpose and Intent*

The Low Medium Density residential areas of the Page Ranch Planned Community are established to provide for the development of detached and attached single-family residential homes and condominiums, with residential densities that do not exceed 5.0 units per gross acre.

b. *Uses Permitted*

- All those uses specified in Section V.A.1.b.,c.,d. & e. of these Planned Community Regulations.

c. *Uses Permitted subject to Site Plan Review as provided herein (see Section VI)*

- Single family residential
- Multiple family residential

d. *Temporary Uses Permitted*

- All those uses specified in Section V.A.1.d. of these Planned Community Regulations

e. *Accessory Uses Permitted*

- All those uses specified in Section V.A.1.e. of these Planned Community Regulations.

f. *Site Development Standards - Single Family Residences*

(1) Conventional subdivision:

Unless otherwise specified on the approved Tentative Tract Map, all single family residential development shall be deemed to be a conventional subdivision. The following regulations shall apply:

- (a) Minimum building site area is five thousand (5,000) square feet.
- (b) Minimum building site width is fifty (50) feet, measured at the required front or rear setback line. The minimum width on a cul-de-sac, curving street or knuckle is thirty-five (35) feet, measured at the right-of-way line.
- (c) Flag lots are allowed with a minimum right-of-way frontage and flag width of twenty (20) feet. Minimum width of the building site portion of a flag lot is fifty (50) feet.
- (d) Minimum building site depth is one hundred (100) feet. If the minimum lot area is met, minimum building site depth may be reduced to ninety (90) feet.



Page Ranch
Planned
Community
Development

V. District Regulations

- (e) Maximum building height is thirty-five (35) feet.
- (f) Density is as stated in the Statistical Summary
- (g) Maximum building site coverage is sixty-five (65) percent for one-story and fifty (50) percent for two stories.
- (h) Yard Requirements
 - i. Minimum front yard setback is eighteen (18) feet for a home with an exclusively front-facing garage and twenty (20) feet average for all exclusively front-facing garage homes on one side of the street in a block. Minimum front setback may be reduced to fifteen (15) for homes with a single-story side-entry garage. No front-facing garage door shall be set back less than twenty (20) feet from the right-of-way or back of sidewalk, whichever is greater.
 - ii. Minimum rear yard setback is ten (10) feet
 - iii. Minimum interior side yard is five (5) feet.
 - iv. Minimum street side yard is ten (10) feet.
- (g) Access to each building site shall abut and have vehicular access to a public or private street. No front-loaded homes allowed to front on Collector Streets or higher classifications.
- (h) This document incorporates by reference required (mandatory) and suggested (optional) elements based in part on those found in the 2010 California Green Building Code (CALGreen Code). The CALGreen Code (codified in Part 11 of Title 24 of the California Code of Regulations and amended) has been adopted by the City of Hemet as the City's green building code. Development within remaining portions of Page Ranch will be reviewed for conformance with the provisions of the City's green building code during the Site Development Review process.

Several policies of the City's green building code require a measurement based on the aggregate of the entire plan. The master developer, developer, and/or builder shall be responsible for tracking compliance and submitting summary documentation along with applications for Site Development Review, building permits, or landscape plans to the City, as appropriate.



Page Ranch
Planned
Community
Development

V. District Regulations

(2) Planned concept subdivision:

Where an approved Tentative Tract Map designates the proposed use as a planned concept subdivision, all those standards specified in Section V.A.1.f.(2)

(3) Cluster development:

When an approved Tentative Tract Map designates the proposed use as a single family cluster development, the cluster development regulations specified in Section V.A.1.f.(3) of these Planned Community Regulations shall apply.

3. Medium Density Regulations (1.3)

The Medium Density area within Planning Area I (Sanderson Lakes), will utilize the Development Standards approved with the Sanderson Lakes at Page Ranch Amendment (See Appendix E).

a. *Purpose and Intent*

The medium density residential areas of the Planned Community are established to provide for the development of detached and attached single family residential homes, active adult, and mobile home parks. Residential densities shall not exceed 10.0 units per acre.

b. *Uses Permitted*

- All those uses specified in Section V.A.1. b. through e. of these Planned Community Regulations.

c. *Uses Permitted Subject to Site Plan Review as provided herein*

- Single-family residential, two (2) or more
- Active adult complexes
- Multiple family residential
- Mobile home parks

d. *Temporary Uses Permitted*

- All those uses specified in Section V.A.1.d. of these Planned Community Regulations

e. *Accessory Uses Permitted*

- All those uses specified in Section V.A.1.e. of these Planned Community Regulations

f. *Site Development standards*

(1) Conventional subdivision:



Page Ranch
Planned
Community
Development

V. District Regulations

Where an approved Tentative Tract Map designates the proposed use as a conventional subdivision, the following regulations shall apply: All those standards specified in Section V.A.1.f.(1) of these Planned Community Regulations except that the minimum lot size may be 6,000 square feet.

(2) Planned concept subdivision:

Where an approved Tentative Tract Map designates the proposed use as a planned concept subdivision, all those standards specified in Section V.A.1.f.(2) of these Planned Community Regulations shall apply.

(3) Cluster development:

When an approved Tentative Tract Map designates the proposed use as a single family cluster development, the cluster development regulations specified in Section V.A.1.f.(3) of these Planned Community Regulations shall apply.

(4) Mobile home parks:

(a) *Minimum lot size:* The minimum lot size shall be not less than 3,600 square feet.

(b) *Minimum lot frontage:* The minimum lot frontage shall be twenty-five feet (25) for single wide and forty-five feet (45) for double wide units.

(c) *Front yard setback:* ten (10) feet

(d) *Side yard setback:* five (5) feet

(e) *Rear yard setback:* ten (10) feet

(f) *Lot coverage:* sixty (60) percent of the area; ten (10) percent of the remaining area must be landscaped

(g) *Maximum building height:* thirty-five feet (35)

(h) *Community recreation:* A minimum of 270 square feet per mobile home space of recreation area, exclusive of any mobile home space, shall be provided within the mobile home park. The recreation areas shall contain a clubhouse and a recreational area for outdoor games and activities such as shuffleboard, horseshoes, putting green, and swimming pool. The community recreation and service area, as aforesaid, together with the activities planned thereon, shall be shown on the plans and specifications of such detail as shall be required from time to time by the Planning Commission. The location and size of all facilities indicated



Page Ranch
Planned
Community
Development

V. District Regulations

herein shall be subject to the approval of the Planning Commission and the Planning & Building Department. The clubhouse shall have a floor area of not less than 25 square feet for each residential lot, and shall contain adequate kitchen, restroom and storage facilities therein.

(g) *Other requirements:* All other requirements as outlined in Article XX of the Hemet Municipal Code and not modified above shall be applicable.

4. High-Medium Density Residential Regulations (1.4)

a. *Purpose and Intent*

The high-medium density residential areas of the Planned Community are established to provide for the development of detached and attached single family, active adult, and multiple family residential dwelling units. The land allocated for this type of residential use is designed to encourage and concentrate the development of housing of a more intense nature than single family detached units. Duplexes, triplexes, apartments, active adult and attached single family residences should predominate, with "small" lot, patio-type single family units permitted.

b. *Uses Permitted*

- Single family residences (Subject to Section V.A.3., Medium Density Residential)
- Parks and playgrounds, public and private (non-commercial)
- Golf courses, tennis clubs and other recreation facilities
- Riding and hiking trails

c. *Uses Permitted Subject to Site Plan Review*

- Single-family residential, two (2) or more
- Active adult complexes
- Mobile home parks and subdivisions subject to Section V.A.3.f.(4)
- Multiple-family residences
- Community apartment projects
- Recreation vehicle parks

d. *Temporary Uses Permitted*

All those uses specified in Section V.A.1.d. of these Planned Community Regulations



Page Ranch
Planned
Community
Development

V. District Regulations

e. *Accessory Uses Permitted*

All those uses specified in Section V.A.1.e. of these Planned Community Regulations

f. *Site Development Standards*

(1) Site Development Standards for Multiple Family and/or Active Adult Residences

- (a) Maximum building height – 50 feet or as approved in the site plan review procedure.
- (b) Setbacks from property lines abutting highways and streets (including accessory buildings). Where the building site abuts an arterial highway, the setback distance from the ultimate right-of-way shall be a minimum distance of twenty (20) feet.
- (c) Setbacks from property lines abutting areas zoned or developed with residential uses other than multi-family residences or detached condominiums shall be a minimum distance of five (5) feet plus ten (10) feet for each story of the multiple-family structure in excess of one story
- (d) Building Site Coverage - The maximum area covered by buildings shall be sixty (60) percent of the total gross site area. For the purpose of this ordinance, covered area shall mean all developed areas including streets, driveways, parking areas, garages and dwellings exclusive of open areas, patios or recreational facilities.
- (e) Building Areas - When multiple units are to be built on a lot under this section, the following rules shall apply:
 - i. Duplex, minimum floor area 1,000 square feet per unit.
 - ii. Triplex, minimum floor area 1,000 square feet per unit.
 - iii. Whether or not the units are under one roof or under separate roofs, each unit of a group of not to exceed two (2) on one (1) lot, shall have a floor area of not less than 1,000 square feet.
 - iv. Each unit of a group of three (3) or more on one (1) lot, shall have a floor area of not less than the following:
 - If the unit has two or more bedrooms, the area shall be not less than 850 square feet.
 - If the unit has only one bedroom, the area shall be not less than 700 feet.



Page Ranch
Planned
Community
Development

V. District Regulations

- If the unit has only a living room-bedroom combination (studio), the area shall be not less than 550 square feet.
- (f) Private street and driveway standards shall be the same as provided for cluster developments in Section V.A.1.f.3.(h) of these Planned Community Regulations.

B. REGIONAL COMMERCIAL REGULATIONS (3.1)

1. Regional Commercial Regulations (Planning Area XIII)

a. *Purpose and Intent*

This category designates land for commercial centers which provide appropriately located areas for retail stores, offices, and service establishments to primarily serve residents of the regional area.

b. *Uses Permitted and Site Development Standards*

(1) Regional Commercial Developments shall be permitted where shown on the Development Plan in conformance with provisions of Article XXVI of the City of Hemet Zoning Code. When located within Compatibility Zones C and D of the Hemet-Ryan Airport Influence Area, some of the uses permitted or conditionally permitted in the City of Hemet Zoning Code may not be permissible, and all uses are subject to limitations on intensity as specified by Table 2A of the Countywide Policies of the Riverside County Airport Land Use Compatibility Plan, as specifically modified by the Hemet-Ryan Airport Land Use Compatibility Plan.

(2) Community Facilities, as provided for in Section V.G. of these Planned Community Regulations, except schools (K-12, either public or private) and except child care centers subject to discretionary City review.

c. *Site Plan Review*

All development proposed for this Land Use Category shall be subject to the requirements of Section VI, Site Plan Review herein.

d. *Sign Regulations*

See Section V.H. of these Planned Community Regulations.

2. Community Commercial Regulations (Planning Areas II, II-A and III)

a. *Purpose and Intent*

This category designates land for commercial centers which provide a wide range of facilities for retail trade, convenience goods, services, and professional office uses. It includes areas of larger retail volume than that of Neighborhood Commercial; less than Regional Commercial.



Page Ranch
Planned
Community
Development

V. District Regulations

b. *Uses Permitted and Site Development Standards*

- (1) Community Commercial Developments shall be permitted where shown on the Development Plan in conformance with provisions of Article XXVI of the Hemet Municipal Code. When located within Compatibility Zones C and D of the Hemet-Ryan Airport Influence Area, some of the uses permitted or conditionally permitted in the City of Hemet Zoning Code may not be permissible, and all uses are subject to limitations on intensity as specified by Table 2A of the Countywide Policies of the Riverside County Airport Land Use Compatibility Plan, as specifically modified by the Hemet-Ryan Airport Land Use Compatibility Plan.
- (2) Community Facilities, as provided for in Section V.G. of these Planned Community Regulations, except schools (K-12, either public or private) and except child care centers subject to discretionary City review.

c. *Site Plan Review*

All development proposed for this Land Use Category shall be subject to the requirements of Section VI, Site Plan Review herein.

d. *Sign Regulations*

See Section V.H. of these Planned Community Regulations.

C. LIGHT INDUSTRIAL REGULATIONS (4.1)

1. Purpose and Intent

These areas should provide for the development of a variety of industrial uses of high quality physical development by requiring comprehensive planning and the coordination of building design and location, landscaping, parking, interior circulation, and other facilities.

The physical effects of permitted industrial activities should be limited so that the emission of air contaminants, noise, glare and other such effects that could be harmful to life or other nearby property does not occur.

2. Uses Permitted

Manufacturing, assembly, testing, repair of and research on components, devices, equipment and systems of electrical, electronic or electro-mechanical nature such as, but not limited to:

- Coils, tubes, semiconductors and similar components
- Metering instruments, equipment and systems
- Phonographs, turntables and audio units
- Radar, infrared and ultraviolet equipment and systems



Page Ranch
Planned
Community
Development

V. District Regulations

- Scientific and mechanical instruments
- Television and radio equipment and systems
- Manufacturing and assembly of retail or wholesale items to a finished product. Such items may be made from bone, cellophane, fiber, fur, glass, latex, ceramics, pottery, lead, leather, metal, paper, plastics, wood or yarn.
- Warehousing, storage and transfer, uses such as cold storage plants, trucking firms and beverage distributors.
- The wholesaling of products such as electrical supplies, plumbing supplies, hospital or sickroom supplies, plate glass and mirrors.
- Vehicle or equipment rental or leasing.
- Specialized service uses not requiring extensive customer access, including pest control services, linen or diaper supply, catering services, printing or reproduction shops, computer or data processing centers, plumbing services, and electrical services.
- Publishing or bookbinding.
- Broadcasting studios.
- Veterinary offices and clinics.
- Upholstering shops.
- Wholesale nurseries and plant storage.
- Repair uses and activities including vehicle repair and boat maintenance provided that all such activities take place within a building and there is no related outside storage.



Page Ranch
Planned
Community
Development

V. District Regulations

3. Accessory uses and Structures Permitted

- Accessory uses incidental to the operation of a permitted industrial use such as cafeterias, snack bars, delicatessens, industrial products showroom, conference rooms, business and professional offices, training classrooms, and caretaker residences.
- Government buildings and public utility uses accessory to warehousing and manufacturing, excluding public schools, police stations, fire stations, or hospitals.
- Outdoor sales, display and storage as accessory uses.

4. Conditional Uses and Structures Permitted

The following additional uses may be permitted subject to approval of a Conditional Use Permit:

- Yard storage for construction materials.
- Animal shelters.
- Collection and recycling of paper, glass and other materials, excluding junkyards or auto salvage.
- Kennels, commercial or non-commercial.
- Vehicle storage.

5. Operational Standards

a. The following effects shall not be permitted to emanate beyond the boundaries of the premises upon which a permitted use is located.

- (1) Objectionable noise, generation of heat or cold, or direct or reflected glare, odor, or vibration detectable by the human senses without the aid of instruments.
- (2) Air contaminants, including, but not limited to smoke, charred paper, dust, soot; carbon, noxious acids or oxides, fumes, gases, odors,-particulate matter, or any combination thereof that endangers human health of causes damage to vegetation or property.
- (3) Radioactivity, electric or electromagnetic disturbance which unduly interferes with the normal operation of equipment, instruments or appliances.
- (4) Any other emissions or radiation that endanger human health, result in damage to vegetation or property or which cause spoiling.

b. The standards prescribed by the County Air Pollution Control District



Page Ranch
Planned
Community
Development

V. District Regulations

and the County and State Departments of Public Health shall be taken into account in the administration of the fore-going Operational Standards.

- c. The Community Development Director shall be responsible for determining whether any premises fail to meet these Operational Standards. Any decision of the Community Development Director may be appealed to the Planning Commission and/or City Council.
6. Site Development Standards
 - a. Minimum Lot Size 15,000 sq. ft.
 - b. Minimum Street Frontage 100 ft.
 - c. Minimum Front Yard 20 ft.
 - d. Minimum Side Yard 5 ft.
 - e. Minimum Rear Yard 20 ft.
 - f. Maximum Lot Coverage 75%
 - g. Maximum Height 35 ft.
 - h. Enclosure, Screening, and Landscaping shall be provided as follows:
 - (1) All uses except plant nurseries, drive-in banks, off-street parking areas, drive-in restaurants, auto and farm machinery sales yards, and similar commercial uses, shall be conducted within a building or within an area enclosed on all sides by a solid wall or uniformly painted wood fence not less than six feet in height.
 - (2) Where a site adjoins a residential area, a solid masonry wall six feet in height shall be located adjoining the property line, except adjoining a required front yard, and an area at least ten feet in depth adjoining the property line shall be landscaped with plant materials, including a buffer of trees.
 - (3) When an industrial use fronts or sides on a public street there shall be maintained a setback of at least 10 feet in depth for landscaping and access purposes.
 - i. Storage Areas
 - (1) All outdoor storage shall be visually screened from access streets, freeways and adjacent property. Said screening shall form a complete opaque screen up to a point eight (8) feet in vertical height but need not be opaque above that point.
 - (2) Outdoor storage shall be meant to include all company owned and operated motor vehicles, with the exception of passenger vehicles.



Page Ranch
Planned
Community
Development

V. District Regulations

(3) No storage shall be permitted between a frontage street and the building line.

j. Refuse Collection Areas

(1) All outdoor refuse collection areas shall be visually screened from access streets, freeways and adjacent property by a complete opaque screen.

(2) No refuse collection areas shall be permitted between a frontage street and the building line.

D. PUBLIC/INSTITUTIONAL REGULATIONS (5.1, 6.1 & 7.1)

1. Purpose and Intent

- To accommodate the wide range of major public and quasi-public institutional and auxiliary uses established in response to the health safety, educational and cultural needs of the City.
- To encourage the assembly of specific public, quasi-public and related facilities into efficient, functionally-compatible, and attractively-designed administrative centers, educational institutions and similar complexes, in conformance with the General Plan.

2. Principal Uses and Structures Permitted

- Educational uses public or private, including colleges, universities, elementary or high schools; and business, vocational and professional schools including art, barber beauty, dance, drama, music and swimming. Also, child day care centers, preschools or nursery schools.
- Religious-related uses including churches, temples, synagogues, convents, monasteries, religious retreats and other places of religious worship are permitted with a Conditional Use Permit.
- Public and semi-public buildings, services and facilities, including museums, libraries, government buildings, parks, public utility offices and exchanges, bus, taxi or railroad stations, police stations and fire stations.

3. Development Standards

Projects proposed within areas set aside for public/institutional areas (areas 5.1, 6.1 and 7.1) shall be subject to Section VI, Site Plan Review Regulations of the Planned Community Regulations.



Page Ranch
Planned
Community
Development

V. District Regulations

E. OPEN SPACE/PRESERVATION REGULATIONS (2.1)

1. Purpose and Intent

- To greatly limit or prevent development in those areas of the planned community which present the greatest constraints in terms of existing natural resources and/or potential hazards and are most likely to result in an adverse public safety situation if development were to occur.
- To provide open space corridors to adequately buffer and to provide for a gradual transition between land use of higher intensity to those of lesser intensity both within the planned community area and surrounding areas.
- To preserve hillside areas where slopes exceed 25 feet or more in vertical height.

2. Principal Uses

Uses, public or private, which emphasize open space use of the land with only minimal development, such as:

- a. *Animal grazing*
- b. *Farming, crop or trees*
- c. *Open Space recreation uses, public or private, which focus on the use of outdoor areas instead of building development.*
- d. *Additional uses which the Planning Commission and City Council determine as consistent with the intent and purpose of the General Plan and Specific Plan.*

3. Development Standards

Projects proposed within areas designated for open space preservation shall be subject to a Conditional Use Permit.

F. OPEN SPACE AND RECREATION REGULATIONS (2.2)

1. Purpose and Intent

The purpose of the open space regulations is to protect and preserve open space for the preservation of natural resources, for the preservation and managed production of resources, for outdoor recreation and education, and for public health and safety. It is also the intent to provide open space areas which are so located, so configured, or possessed of physical features that they may provide valuable and functional open spaces, to provide local or buffer greenbelts and/or to serve as linkages between open space areas.



Page Ranch
Planned
Community
Development

V. District Regulations

2. Uses Permitted

Any of the following principal uses are permitted with the exception of those specific uses that are listed as prohibited uses:

- Field crops
- Grazing
- Orchards and vineyards
- Horticulture and nursery stock growing for off-site sale only
- Parks, playgrounds and outdoor recreation facilities
- Riding and hiking trails
- Apiaries, upon the following conditions:
 - No occupied hives shall be closer than 150 feet to any street or highway.
 - No occupied hives shall be closer than 400 feet to any existing dwelling not on the premises or the premises of another apiary, unless the written consent of the owner of such dwelling is secured.
 - No occupied hives shall be closer than 50 feet of any property line common to other property lines other than property lines of another apiary.
- The keeping of equines or bovines for purposes other than grazing upon the following conditions:
 - Such animal keeping shall not be for any commercial purpose
 - There shall be no shelter or supplementary feeding of, or any structures designed for such shelter or such feeding of said animals, within 75 feet of the right of way line of any street, or the boundary of any other district.
- Local and Buffer Greenbelts
- Water recharge, percolation and watershed areas
- Wildlife preserves and sanctuaries
- Public utility easements for overhead or underground transmission lines
- Archaeological sites
- Historical preserves
- Screening walls, fences and vegetation



Page Ranch
Planned
Community
Development

V. District Regulations

3. Uses Permitted Subject to a Conditional Use Permit

A Use Permit may be approved for any of the following uses only when the Planning Commission finds that the proposed use is consistent with the purpose and intent of the Open Space regulations and the Open Space and Conservation Elements of the General Plan:

- Commercial stables
- The reclamation for open space purposes of mines, quarries and pits resulting from the commercial extraction of rock, sand, gravel, earth, clay and similar materials.
- Livestock feeding ranches not feeding garbage, refuse or offal.
- Golf courses and riding clubs.
- Structures incidental and accessory to permitted uses such as gazebos, information centers, restrooms, concession stands, maintenance buildings, greenhouses, stable and clubhouses.
- Required parking facilities incidental and accessory to permitted uses.
- Commercial uses incidental and accessory to permitted uses including:
 - Sale of food and beverages.
 - Operation of riding academies and stables.
 - Parking facility concessions.
 - Schools, public and private, where the school site has a minimum net area of at least five acres.
 - Signs: business, real estate and identification, not exceeding six square feet in area.

4. Site Development Standards

- a. *Building Site Area:*
One acre minimum.
- b. *Building Site Width:*
No minimum requirement.
- c. *Building Height:*
No maximum except as approved by the Conditional Use Permit.
- d. *Setbacks:* All buildings, structures and off-street parking facilities shall be set back a minimum of 30 feet from any public or private street.



Page Ranch
Planned
Community
Development

V. District Regulations

e. *Off-Street Parking:*

Parking and parking development standards for motor vehicles shall be provided as required by Article XL of the Hemet Municipal Code.

f. *Screening:*

Walls and fences may be installed in accordance with the following limitations:

- (1) Natural wood, metal or fiber non-opaque fences may be installed, provided they are consistent with the purpose and intent of the Open Space Regulations.
- (2) Masonry or solid wood fences shall be shielded from view from any street or highway by landscaping, berm or other topographic feature.

G. COMMUNITY FACILITIES, ALL AREAS

1. Uses Permitted

The following uses shall be allowed in all land use areas, except where listed as prohibited uses pursuant to Table 2A of the Countywide Policies of the Riverside County Airport Land Use Compatibility Plan, as specifically modified by the Hemet-Ryan Airport Land Use Compatibility Plan. Within Compatibility Zones C and D, uses are subject to intensity limitations, as specified by the Hemet-Ryan Airport Land Use Compatibility Plan.

- Parks, playgrounds, recreation or open green areas, riding, hiking and bicycle trails and related facilities.
- School and establishments for the care of preschool children.
- Fire stations.
- Accessory buildings, structures and uses related and incidental to a permitted use.
- Signs identifying or giving directions to permitted uses and facilities or identifying sites of future uses and facilities. No sign shall exceed thirty-five (35) square feet in area.

2. Building Height Fifty (50) feet.

3. Building Setbacks

Twenty-five (25) feet from all residential property lines and ten (10) feet from any street side property line. No building structure shall be located closer to a residential structure on an adjacent site than a distance equal to twice the height of the nonresidential building. The height of the non-residential structure above the grade elevation of the residential site shall apply. Any structure which abuts upon a plaza, park, mall, greenbelt or other permanent open space may abut the common property line.



V. District Regulations

4. Off-Street Parking

The requirements of Article XL of the Hemet Municipal Code, as related to individually listed uses, shall apply.

H. SIGNS

1. Purpose and Intent

Signing is an important aspect of any community. When abused, signing creates a visual blight which detracts from the quality of the environment. When unduly restricted, the lack of signing creates a hardship for merchants who rely on effective signing to identify their establishments.

- Recognizing that the primary purpose of signing is property and business identification, the procedures and regulations of this Section are enacted to:
- Insure that signs erected within Page Ranch are compatible with their surroundings and are in keeping with the goals and objectives of the Community.
- Aid in the identification of properties, land uses and enterprises.
- Promote commerce, traffic safety and community identify while also promoting and enhancing the quality of the visual environment of the area.
- Establish procedures and regulations which control the location, size, type and number of signs permitted and which regulate and control all other matters pertaining to signs.

2. General Regulations

The regulations listed in this Paragraph are applicable to all signs erected within the Page Ranch Planned Community.

a. *Design Criteria*

Signs to be erected shall be subject to certain design criteria. These criteria have been developed in order to encourage signing which is in harmony with the semi-rural environment of the City. At the same time, the City recognizes that the primary purpose of signing is effective communication. Therefore, in applying the design criteria contained herein, the City shall give close attention to the need for adequate sign visibility, legibility and readability. These design criteria are not intended as rigid requirements.

For the purpose of administering these design criteria, the word "encourage" should mean to foster or be favorable toward a certain type of sign design. However, the fact that a certain design is encouraged by this Code shall not, in and of itself constitute grounds



Page Ranch
Planned
Community
Development

V. District Regulations

for denying a permit for sign whose design is not specifically referenced in these criteria.

The design criteria are as follows:

(1) Color:

The use of pastel "earth tone" sign colors shall be encouraged. Examples of such colors include, but are not necessarily limited to browns, pale yellows, tan, beige and similar shades. In applying these color criteria, the City shall recognize and give consideration to the need for adequate contrast between sign lettering and background.

(2) Materials:

The use of high quality wood signs, whether hand carved, sandblasted, painted, or routed shall be encouraged. Such signs may be lighted indirectly. The following materials may also be used if they are designed to conform to the other appearance standards listed herein: individual letters of metal or other materials, painted signs, stucco or similar backgrounds utilizing a variety of lettering materials, other materials designed and constructed to satisfy the design criteria specified herein.

(3) Lettering Style:

In order to promote effective sign communication, the use of the same lettering style and colors for all tenant names included in shopping center identification signs shall be encouraged.

(4) Use of Adopted Logos or Trademarks:

The use of an adopted logo or lettering style for a commercial or other development may be permitted. However, if the appearance of such a logo is in substantial conflict with the design criteria listed herein, the applicant shall be encouraged to modify the colors, materials, or other design features in order to lessen the conflict with said design criteria.

(5) Architectural Style:

Consistent with the criteria outlined herein and preceding, the City shall encourage design and location of signs in harmony with the architectural style of the buildings they serve. It is the purpose of this Section to encourage, to the extent possible, signs that are integrated into the architectural theme or style of a building.



V. District Regulations

(6) Scale:

The maximum heights and areas for different signs are specified elsewhere in this Section. Within these maximums, sign heights and areas shall be used that are in scale with the buildings and street environments where they are located. This scale criterion shall only be applied in unusual cases wherein the nature of a building site is such that the erection of a sign at full height and site maximums would not be in scale with neighboring buildings, existing signs, or the street adjacent to the site in question.

b. Area

The maximum area allowed for individual signs and the maximum aggregate area allowed for all signs on a building exposure, frontage and/or site are listed on Table 3. The measurement of area on different types of signs is illustrated in Figure 5.

(1) General:

Sign area is the entire surface area of a sign including nonstructural trim. The supports, uprights or structures on which any sign is supported shall not be included in determining sign area. Sign area for cutout letters or displays shall include the total area within the periphery of the cutout letters or display. If a sign consists of a symbol or statuary, the entire surface area of the symbol or statuary shall be computed as the sign area.

(2) Multi-Faced Signs:

- (a) If a sign is double-faced, its sign area shall be computed as the area of either face taken separately. For example, if the maximum allowable sign area is 60 square feet, a double-faced sign may have an area of 60 square feet per each face.
- (b) If a sign has three or more faces, its sign area shall be computed as the sum of the areas of each individual face. For example, if a sign has four faces and the maximum allowable sign area is 40 square feet, the maximum area for each of the four faces is 10 square feet.
- (c) If a sign is V-shaped, with an angle of greater than 60 degrees between the two faces, its sign area shall be computed by adding the areas of the two faces together. If the angle between the two faces is less than 60 degrees, its sign area shall be computed in the same manner as for a double-faced sign.



Page Ranch
Planned
Community
Development

V. District Regulations

(3) Multiple Signs:

Whenever more than one sign is placed on a freestanding structure or on a projecting structure, the combination of signs shall be considered as one sign for the purpose of computing sign area. Total sign area shall be computed by adding the areas of the individual signs.

(4) Aggregate Area:

Aggregate area of signs is measured per frontage, building exposure, parcel, or use. The term "building exposure" means the total wall area or elevation of an establishment on one side of a building. Interior arcades shall be considered building exposures for establishments which front such arcades. No establishment shall be considered to have more than four building exposures.

Under-canopy signs are permitted as part of the aggregate sign area allowed on the building exposure to which the canopy is attached.

c. *Height*

The height of a sign shall be measured from the finished grade at the base of a sign to the highest part of the sign structure, including any ornamentation.

(1) Maximum Heights:

The heights listed in Table 3, following, are the maximum allowable sign heights for each type of sign in all commercial and industrial areas.



V. District Reaulations

Page Ranch

Planned Community Development

Sign Area Measurement

Figure 5

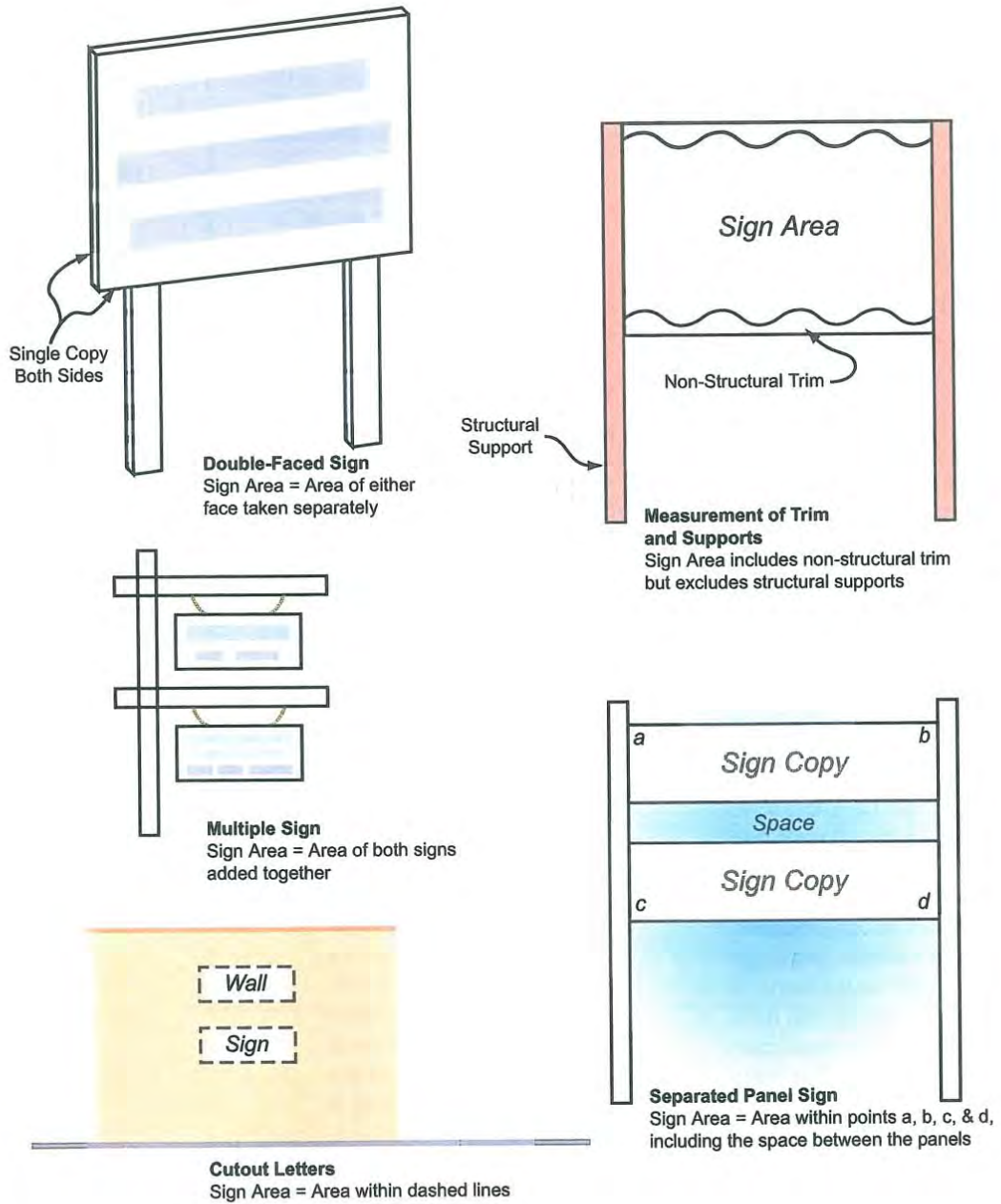



Page Ranch
Planned
Community
Development

Maximum Sign Heights

Table 3

Type of Sign	Height
Free-Standing Monument	6 feet
Free-Standing Pole	15 feet
Building-Mounted Projecting	15 feet
Building-Mounted Flush	25 feet*
*Includes signs painted on the side of a building	

d. *Location*

Free-Standing signs and sign structures may be located within required front, rear or side yards provided such signs do not obstruct the clear view of pedestrian or vehicular traffic or otherwise constitute safety hazard.

e. *Illumination*

In keeping with the semi-rural character of Hemet, the illumination of signs by subdued indirect lighting is encouraged. Illumination of signs shall conform to the following provisions:

- (1) Only flush, building-mounted signs may be internally illuminated. Internally-illuminated free-standing signs are prohibited.
- (2) Where allowed, internal illumination shall be by:
 - (a) Illumination of individual letters, or
 - (b) The use of translucent material with light letters on a dark or opaque background.

f. *Table of Regulations*

Unless otherwise specified in this Section, Table 3 establishes the maximum height, area and aggregate area for signs in commercial and industrial uses in the Page Ranch Planned Community.



V. District Regulations

Page Ranch

Planned Community Development

Types of Signs

Figure 6

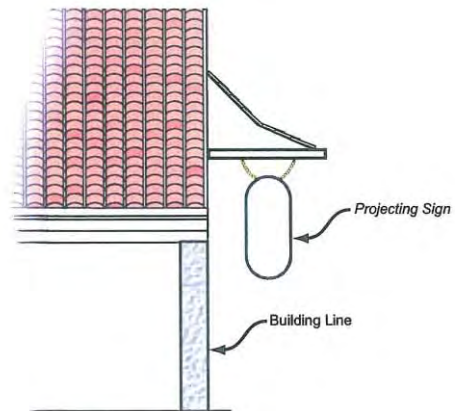
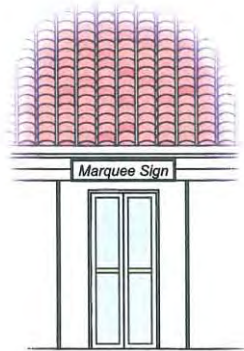
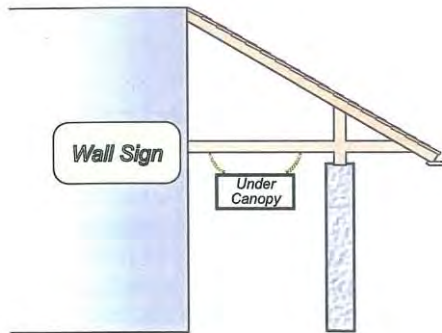

Building-Mounted Signs

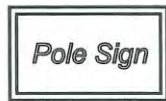

Free-Standing Signs



Page Ranch
Planned
Community
Development

V. District Regulations

(1) Signs Requiring Permits

Other signs: The following signs are permitted in The Page Ranch Planned Community subject to the issuance of a sign permit.

- (a) *Major Real Estate Signs*: A major real estate sign is a sign advertising the sale, rental or lease of the premises or property on which the sign is located and which is greater than 6 square feet in area. Such signs shall not exceed 6 feet in overall height or 32 square feet in area. Additionally, such signs shall not be located on a parcel of land which is less than one acre in area.
- (b) *Major Construction Signs*: A major construction sign is a sign identifying the project to be built on a site and may also identify major tenants, contractor or project participants (e.g., architect, lender). Construction signs shall be removed prior to the issuance of a Certificate of Use and Occupancy for the project or any part of the project. A Major Construction sign shall have an area greater than 6 feet but not greater than 32 square feet. It shall not exceed an overall height of 6 feet and shall not be located on a parcel of land which is less than one acre in area.
- (c) *Temporary Subdivision Signs*: Temporary on-site signs used to identify an approved residential development within the City are permitted subject to the following provisions: (a) Signs identifying each named development shall be located within boundaries of that development and shall have an aggregate area not exceeding 60 square feet. Overall height shall not exceed 15 feet. (b) Such signs shall be removed prior to the issuance of the last Certificate of Use and Occupancy for the units within the subdivision.
- (d) *Permanent Residential Development Entry Signs*: Each sign shall not exceed 32 square feet in area nor have an overall height greater than 6 feet.

(2) Signs Not Requiring A Permit:

Signs in this Subsection are permitted within the Planned Community subject to the limitations and requirements set forth in this Section and elsewhere in these Regulations. Sign permits are not required for these signs. However, building and electrical permits are required.

- (a) *Small Size Signs*: Signs less than 12 square feet in area. Such signs shall be included within the aggregate area allowed for each use of establishment.
- (b) *Grand Opening Signs*: A maximum of one temporary sign per street frontage indicating the grand opening of a business or



Page Ranch
Planned
Community
Development

V. District Regulations

industry is permitted subject to the following requirements:

- Maximum aggregate area: 60 square feet.
 - Such signs shall relate to the activity being conducted in the premises where they are placed.
 - Such signs shall be displayed for a maximum of 45 days, per the Hemet Municipal Code.
 - Illumination of such signs is prohibited.
- (c) *Convenience Signs*: The Community Development Director may authorize the placement of signs which are needed for public convenience, safety or to provide directional information. Such signs are designed to be viewed from within premises or adjacent to the premises by pedestrians or by motorists parking their automobiles. Examples of such signs include, but are not limited to, directional arrows, exit signs, fire extinguisher signs and no parking signs. Convenience sign area shall not be included within the calculation of aggregate area authorized for an establishment. These signs may be illuminated, either indirectly or internally.
- (d) *National and State Flags*: National and State flags shall be flown and displayed in a manner whereby they are not construed as an attraction-gaining device for the advertisement of a product or use, or in a manner to otherwise draw attention of the traveling public to an establishment or sales office. Such displays shall conform to the criteria established in House Document 209 of the 91st Session of Congress.
- (e) *Incidental Signs*: The following incidental signs, if non-illuminated, are permitted in all districts with no sign permit required:
- *Political Signs*: If they pertain to a specific election and are displayed no earlier than 30 calendar days prior to that election. Such signs shall not be located closer than 200 feet from any designated polling place and shall be removed within 3 days after election day. The candidate, person, or persons responsible for the placement of a political sign shall be responsible for its removal. Political signs shall not exceed 12 square feet in area and no more than 1 sign per land parcel is permitted for each candidate. These signs may be off-site signs.
 - *Religious, Charitable or Cultural Signs*: not exceeding 6 square feet in area and temporary in nature (displayed not



Page Ranch
Planned
Community
Development

V. District Regulations

more than 30 calendar days per year). These signs may be off-site signs.

- *Vacancy Signs:* Apartments, hotels and motels are permitted a maximum of 1 "vacancy & no vacancy" sign per street frontage not to exceed 6 square feet in area.
- *Real Estate Signs:* Each building or legal site is permitted one (1) real estate sign per street frontage advertising the sale, rental or lease of the premises or property on which said sign is placed subject to the following limitations: (a) for sites one acre or less, the sign area shall not exceed 6 square feet and shall not exceed 5 feet in overall height; (b) for sites greater than one acre, the sign area shall not exceed 32 square feet and shall not exceed 6 feet in overall height. However, real estate signs greater than 6 square feet shall require a sign permit.
- *Construction Signs:* A maximum of one (1) construction sign identifying the project to be built on the site and the project participants, subject to the following limitations: (a) for sites one acre or less, the sign area shall not exceed 6 square feet and shall not exceed 5 feet in overall height; (b) for sites greater than one acre, the sign area shall not exceed 32 square feet and shall not exceed 6 feet in overall height. However, construction signs greater than 6 square feet shall require a sign permit.
- *Temporary Window Signs:* Such signs shall not cover more than 25% of the area of the window within which they are placed.
- *Residential nameplates* not exceeding one square foot in area indicating the name of the occupant of the residence.
- *Professional occupation signs* or nameplates not exceeding 2 square feet in area denoting only the name and profession of an occupant on the premises where they are placed.
- *Memorial signs or tablets* or names of buildings and dates of erection - when cut into masonry surface or when constructed of bronze or other noncombustible materials. Such signs shall not exceed 6 square feet in area.
- *Temporary signs* associated with produce, vegetable, or fruit stands. Such signs shall not exceed an aggregate area of 80 square feet and shall be located within 100 feet of the produce stand which they identify.



V. District Regulations

Page Ranch

Planned Community Development

Sign – Summary Matrix, Signs Permitted for Each Use

Table 4

Type of Design	District	Maximum Height	Maximum Area/Size	Maximum Aggregate Area
*Free-Standing Pole	Commercial	15'	24 sq. ft.	Not more than 60 sq. ft. per frontage for all free-standing signs
*Free-Standing Monument	Commercial	6'	60 sq. ft.	Not more than 60 sq. ft. per frontage for all free-standing signs
Building Mounted	Commercial	25'	18 sq. ft.	24 sq. ft. per exposure
Free-Standing	Commercial	6'	60 sq. ft.	80 sq. ft.
Building Mounted	Commercial	25'	60 sq. ft.	Building-mounted signs shall be included as part of the permitted 80 sq. ft. aggregate area
*Free-Standing	Industrial	15'	60 sq. ft.	120 sq. ft. per Industrial Park
*Free-Standing Monument	Industrial	6'	30 sq. ft.	30 sq. ft.
Building Mounted	Industrial	25'	18 sq. ft.	24' sq. ft. per exposure
Temporary Subdivision	All Areas	15'	60 sq. ft.	80 sq. ft. per subdivision
Permanent Subdivision	All Areas	6'	32 sq. ft.	64 sq. ft. per subdivision
Political	All Areas	6'	12 sq. ft.	12 sq. ft. per parcel
Real Estate and Construction	All Areas	6'	6 sq. ft.	For Lot 1 acre or less
Real Estate and Construction	All Areas	6'	32 sq. ft.	For Lot greater than 1 acre, one sign per lot frontage

* Only one free-standing frontage is permitted for individual establishments or shopping centers. Establishments within shopping centers are not permitted individual free-standing signs.



Page Ranch
Planned
Community
Development

V. District Regulations

- Signs painted directly on vehicles indicating the name of the establishment using the vehicle.
- *Government or other legally required posters, notices and signs.* These signs may be off-site signs.
- *Traffic or safety signs, signs of public utility agencies, or construction contractors serving as directional or safety aids.* Examples include: street signs, freeway off ramp signs and roadwork signs.
- *Temporary placards, posters and subdivision directional signs* placed in public rights-of-way and not exceeding 6 square feet in area, providing that such signs do not exceed 3 feet in overall height. Such temporary signs shall not be displayed without first obtaining an encroachment permit from the Director of Public Works.

(3) Prohibited Signs:

The following signs, types of signs and attraction devices are prohibited within the Page Ranch Planned Community:

- (a) Signs mounted on or above roofs.
- (b) Signs which incorporate in any manner, flashing, moving, or intermittent lighting.
- (c) Signs incorporating mechanical movement of any kind, such as, but not limited to, rotating, revolving, moving, or animated signs.
- (d) Signs or sign structures other than those specifically permitted in previous section that project into a public vehicular right-of-way or private travel way. However, projecting signs are permitted above pedestrian ways or sidewalks, provided such signs are located at least 8 feet above finish grade and do not project more than 4 feet into the pedestrian way or sidewalk.
- (e) Off-site signs except those specifically permitted in previous paragraphs.
- (f) Billboards, off-site advertising signs, or other signs which give direction to or identify a use or product not sold or located at the location of the sign, except for temporary subdivision signs.
- (g) Flags, valances, pennants, banners, lights, or other similar attraction devices; except the display of temporary pennants or banners which are associated with a holiday or special event and which have received specific prior approval by the Community Development Director.
- (h) Signs, except for government notices, which are supported in



Page Ranch
Planned
Community
Development

whole or in part from any public utility installation or from any tree or telephone pole on public or private property.

- (i) Signs, which by color, wording, design, location or illumination resemble or conflict with any traffic control device, or with safe and efficient flow of traffic.
- (j) Signs that create a safety hazard by obstructing clear view of pedestrian or vehicular traffic.
- (k) Any sign that does not conform to the height or area restrictions contained in this Section.



VI. Site Plan Requirements

A. PURPOSE AND SCOPE

To ensure conformance with development standards set forth in these Planned Community Regulations, Policy Guidelines, and the General Plan of the City of Hemet.

B. SITE PLANS FOR NON-RESIDENTIAL USES

Shall contain, but are not limited to, the following information:

1. Site Plans drawn to scale, dimensioned and easily readable, containing, but not limited to, the following:
 - a. Title block (developer's name and date drawn)
 - b. Scale and north arrow
 - c. Property lines of all existing building sites within the site (dimensions)
 - d. Buildings; existing and proposed, location and size within the site
 - e. Streets; location, name and width
 - f. Easements; location, purpose and width
 - g. Access (driveways, etc.); existing and proposed
 - h. Parking areas
 - i. Signs, location, height, dimensions and copy, if available
 - j. Fencing (walls); type, location and height
 - k. Landscape area
 - l. Proposed topography and grading concept
 - m. Other outdoor uses; location and use
 - n. Existing topography and drainage improvements (if not shown on accompanying Tentative Tract Map).
2. Elevations of all structures and signs, including but not limited to, the following:
 - a. Exterior materials
 - b. Elevations shall include all sides of a structure or site
3. Landscape Plans including, but not limited to, the following information:
 - a. Plant material and species
 - b. Size and spacing of plant materials, when and where the Community Development Director deems necessary.
 - c. Irrigation concept



Page Ranch
Planned
Community
Development

VI. Site Plan Requirements

4. Open Space and Park Plans
 - a. Identification, location and proposed ownership of all permanent open space and parks.
 - b. Phasing of open space and park development.
 - c. Method of providing for assurance that maintenance will be guaranteed.

C. SITE PLAN REQUIREMENTS FOR RESIDENTIAL USES

Residential Site Plan requirements shall include the information required for non-residential Site Plans with the following exception:

Typical building elevations and typical building locations on building sites may be substituted for elevations and siting of all buildings.

D. PROCEDURES

1. The above listed data shall be submitted in the form and number prescribed by the Community Development Director. The Site Plan will be accepted for filing when the above prescribed materials have been submitted in the prescribed form and number. The Planning Commission shall review and act upon the plans in a timely manner after their acceptance by the Community Development Director.
2. The Planning Commission, may approve, conditionally approve or deny a Site Plan.
3. The appropriate City departments will insure that the development is substantially in accordance with the approved Site Plan. Any substantial deviation from the approved Site Plan, as determined by the Community Development Director shall require approval of an amendment to the Site Plan.
4. Action on a Site Plan may be appealed by any interested party within ten (10) days following the action date. Appeals of a decision of the Planning Commission shall be to the City Council. An appeal must be in writing and must set forth the reason(s) for the appeal and evidence why the City Council should hear the appeal.
5. A Site Plan may be amended by the same procedure listed above.
6. Minor adjustments of up to 10% may be approved by the Community Development Director.



VII. Bicycle Route Master Plan

A. GENERAL

This Section contains a description of the Bicycle Route Master Plan and the precise standards, pertaining to bicycle route location. In general terms, bicycle routes within Page Ranch will serve as a means of transportation equal to the automobile. All designs should be such as to encourage ease of safe and efficient bicycle usage.

B. ROUTE MASTER PLAN

1. Figure 7 shows the location of the major elements of the bicycle route master plan. Bicycle lanes are called for along all major roads including Warren Road, Fisher Street, Cawston Avenue, Sanderson Avenue, Stetson Avenue and Harrison Avenue.
2. Bicycle trails are also proposed along the A.T. and S.F. right-of-way, along the proposed Flood Control Channel and along the aqueduct as shown in Figure 7.
3. Alternative bicycle routes are also proposed. These alternative routes shall be constructed when and if the facilities they parallel are constructed.
4. Bicycle trails will also be provided within each Planning Area to provide access from the bicycle paths along the arterial roads to local shopping centers, work places, schools, parks, community shopping centers, recreational facilities and other activity centers as shall be required by the Community Development Director. These bicycle trails shall be planned and aligned when precise development plans are filed for each Planning Area.

C. BICYCLE TRAIL DEVELOPMENT STANDARDS

1. In order to ensure consistency in the design of bicycle trails, they shall be designed consistently with Figures 8 and 9.
2. Developers and/or property owners shall be required to plan and construct the section of the Bicycle Path Master Plan (Figure 7) lying within or bordering the parcel of land proposed for development.
3. Landscaping along bicycle paths and trails shall be in a manner approved by the Community Development Director.
4. Bicycle path and trail plans shall be submitted at the time of application for a site plan or tentative tract, and shall be of such detail as required by the Community Development Director to determine the consistency of the proposed bicycle paths and trails with these regulations.



VII. Bicycle Route Master Plan

Page Ranch
Planned Community Development

Bicycle Route Master Plan
Figure 7

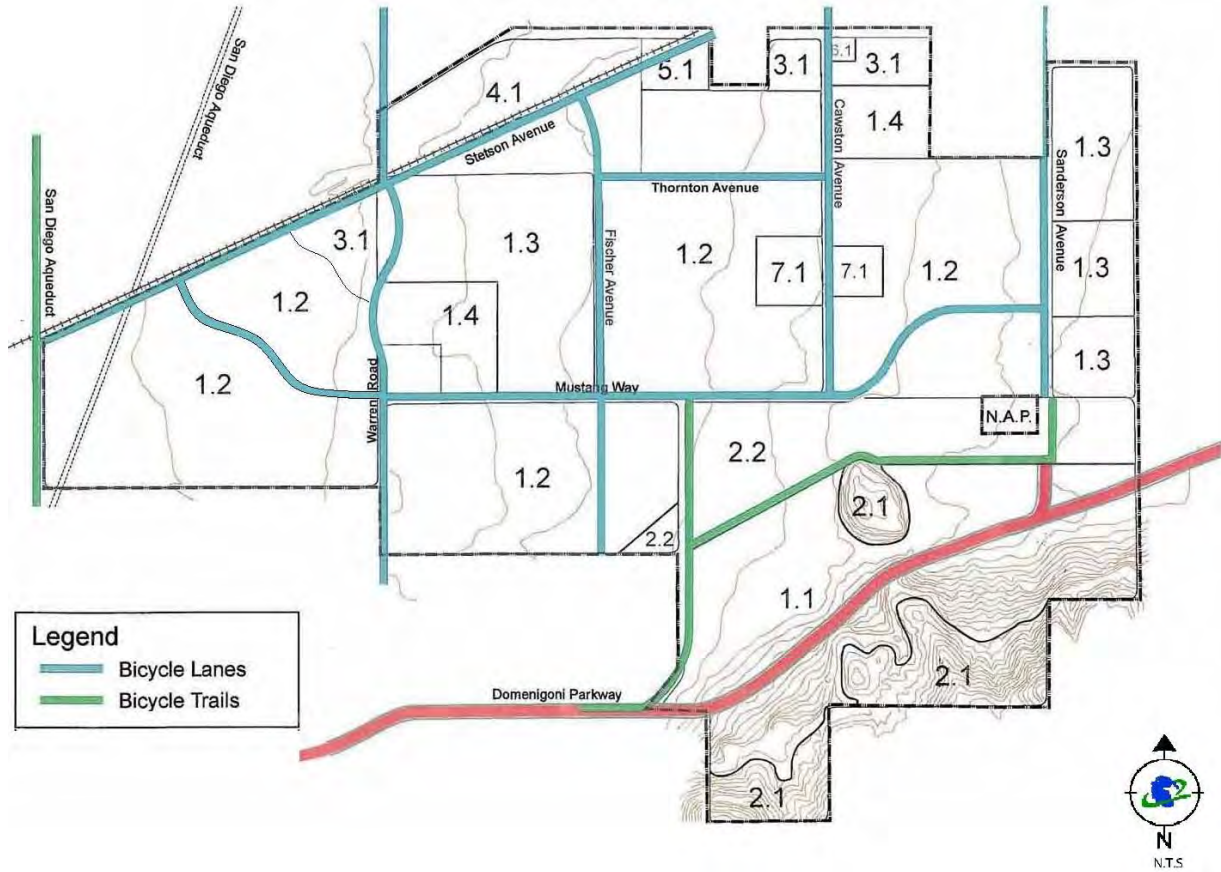



VII. Bicycle Route Master Plan

Page Ranch
Planned Community Development

Bicycle Route Standards
Figure 8

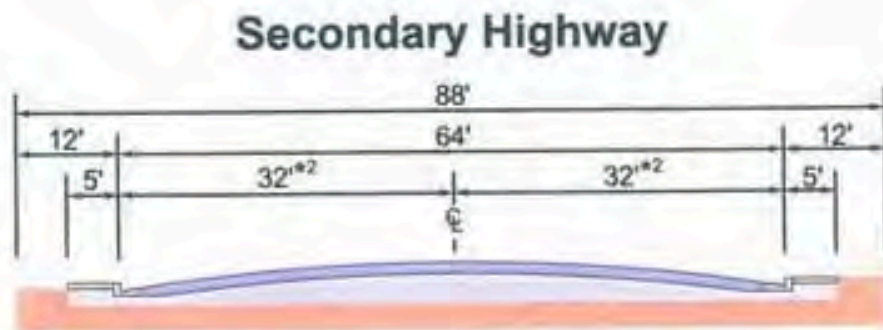
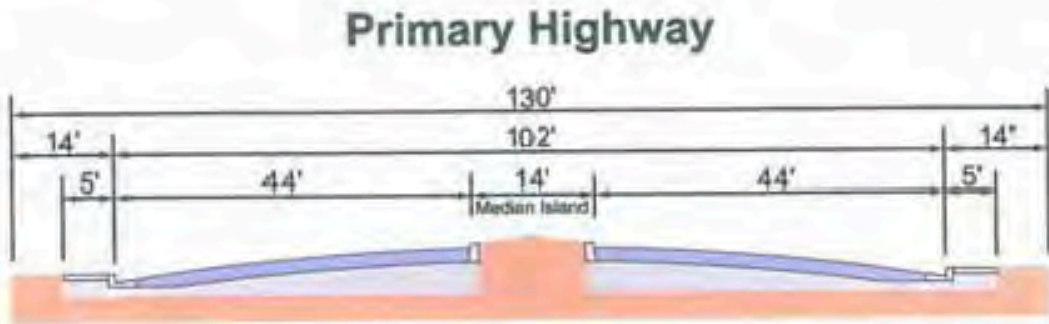

(*2: Including 8' parking & two 12' travel lanes both sides)





VII. Bicycle Route Master Plan

Page Ranch

Planned Community Development

Bicycle Path Standards

Figure 9

Alternative Street & Bikeway Standards (Local & Collector)

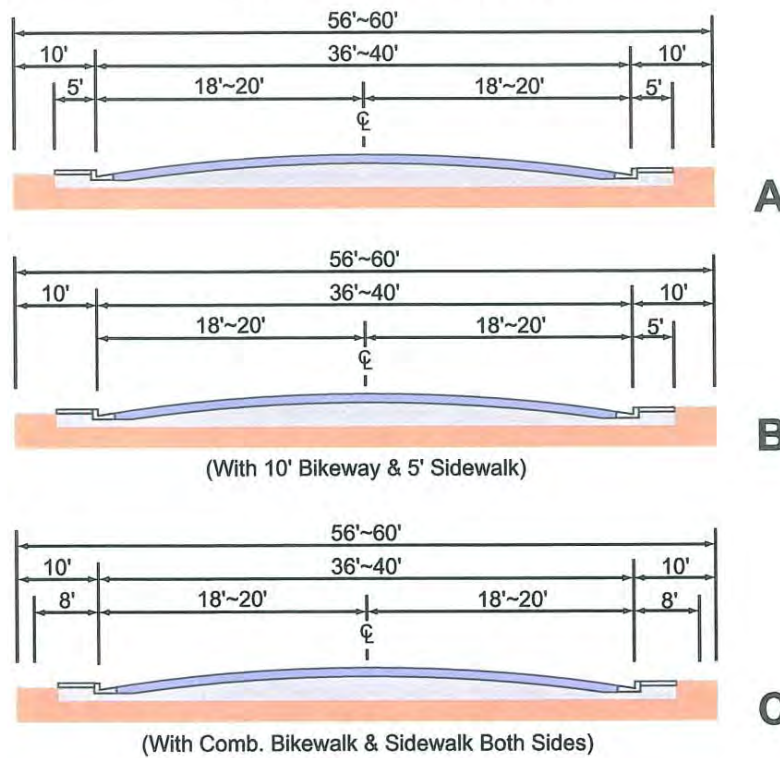

Off-Road Bike Trail

Including flood control, railroad & other utility rights-of-way

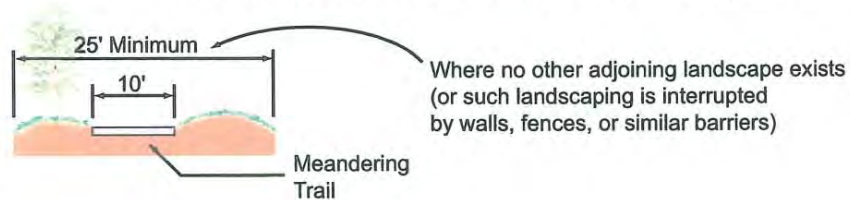



Page Ranch
Planned
Community
Development

VIII. Growth Management

GROWTH MANAGEMENT

Summary

One of the more significant policies adopted as a part of the Southwest Specific Land Use Plan was that dealing with growth. Page S-3 of the adopted plan states:

The amount of growth should be limited to that for which public services can be adequately, economically, and efficiently provided. Prior to any new construction of ten or more residential units, or construction of commercial or industrial facilities exceeding 10,000 square feet of gross floor area, the developer must provide a plan and program on how these facilities and services are to be provided. The plan and program are subject to review and approval by the City Council. The plan and program should include at least the following:

- a. *A statement of the increase in public services and facilities needed to support the project and the availability of affected services in relation to existing capacity and increased demand due to the Project.*
- b. *A plan of how they are to be constructed and phased in conjunction with proposed project.*
- c. *A program which indicates the portion of costs to be supported by the project for these facilities and services. Costs should be broken down into two categories; development of the facilities and the cost for maintenance and operation."*

Accordingly, a preliminary analysis has been made of the Page Ranch properties which attempts to evaluate future public facilities and service needs as development occurs. It is anticipated that more detailed programs for public services and facilities will be necessary as more detailed development plans are prepared. Therefore, the growth management plans provided on the following pages are preliminary in nature and subject to much more refinement as more detailed planning occurs, both by the landowner and affected public agencies.

Some general conclusions can be reached, however, on the adequacy of public services and facilities to serve urban development on the Page Ranch properties.

1. Based on preliminary in-house projections by the property owners, it is anticipated that future development of the remaining development areas will occur at the rate of approximately 200 dwelling units per year or an ultimate build-out between 15-20 years. It should be cautioned, however, that these are preliminary estimates subject to more refinement. We suggest that this number be utilized at this time for planning purposes of phasing necessary for public services and facilities.



Page Ranch
Planned
Community
Development

VIII. Growth Management

2. Commercial development will not occur immediately, but will commence once an adequate support population base is attained.
3. Development of the industrial park at the northwest corner will not occur until market demands dictate its development. Development of this site would accelerate the availability of the proposed corporation yard.
4. Because of the location and capacity of existing public facilities, utilities and services, as well as the location of existing urban development future phasing of development is expected to occur first in the northeast area of the property and eventually move in a southwesterly direction (with the exception of the industrial park in the northwest corner).
5. The majority of public facilities and services needed for development of the Page Ranch properties are adequate to accommodate anticipated growth over at least the next ten years.
6. It is anticipated that little development on the Page Ranch properties will be feasible until adequate flood control facilities are constructed. A proposal for funding these facilities as well as other necessary public facilities is addressed in a letter dated February 6, 1980 (Appendix B). Appendix B also outlines a schedule of activities and tentative time schedule necessary to implement this proposal.
7. Public Facilities that are anticipated as a part of the Page Ranch development include:
 - a. Construction of appropriate flood control facilities as a part of the Salt Creek Channel. This includes establishing an appropriate financing mechanism for the construction, maintenance and operation of the improved facilities (**completed**).
 - b. Dedication of land for a City Corporation Yard on the south side of Stetson Avenue (specific location to be subject to review and approval of the City Council). This site could also accommodate, if deemed necessary by the City, an additional fire station site.
 - c. Set aside an eventual dedication of a minimum of three park sites, two of which would be adjacent to proposed school sites (**one park proposed along westerly extension of Mustang**).
 - d. Improvement of the "fair share" of all road improvements as called for in the City's Master Plan of Arterial Highways. (Note: A traffic study has been prepared and is included as Appendix D. Certain modifications have been recommended and have been incorporated in the Master Circulation Plan.)
 - e. Development of a major recreational center in the Salt Creek Channel area that is proposed to include: 1) community center, 2) golf course, 3) soccer field facilities (Note: Specific facilities are subject to further discussion and input of the City Council and other



Page Ranch
Planned
Community
Development

VIII. Growth Management

community leaders.

- f. Development of all utility infrastructure requirements, such as water, sewer, electrical and internal road system.
 - g. Development of a supporting commercial and industrial base.
8. Funding for necessary public facilities as proposed via the redevelopment law mechanism. It is also recommended, however, that some type of maintenance district be established to offset future maintenance and operational costs once the facilities are constructed. Also suggested in the letter included in Appendix B is the possibility of expanding the proposal to include lands outside of the Page Ranch Planned Community.



Page Ranch
Planned
Community
Development

Appendices

A. Page Ranch Amendment Design
Guidelines

B. City of Hemet Standard ROW Sections

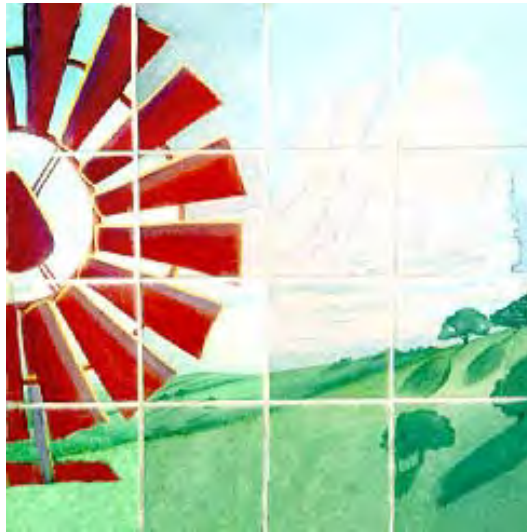

***Appendix A
Page Ranch
Planned Community
PCD 79-93
Master Plan and Development Standards
Amendment
Design Guidelines***

March 2019

Prepared for:

City of Hemet Planning Department

445 E. Florida Avenue, Hemet, California 92543

Tel (951) 765-2375

Fax (951) 765-2359

Contact Person: Deanna Elliano, Community Development Director

Amendment Prepared by:

Pangaea Land Consultants, Inc.

2834 La Mirada Drive, Suite H, Vista, California 92081

Tel (760) 726-4232

Fax (760) 727-1405

Contact Person: Rich Brasher



Page Ranch
Planned
Community
Development

Table of Contents

SECTION	Page
I. DESIGN GUIDELINES	3
A. Community Theme	5
B. Architecture Theme	5
C. Residential	8
D. Signage Program	37
E. Landscape Architecture	41

FIGURE NO.	Page
1-1 Proposed Design Guidelines Area	4
1-2 Walls/fences	9
1-3 Mediterranean	13
1-4 Craftsman/California Bungalow	20
1-5 California Ranch/Farmhouse	27
1-6 Cottage	34
1-7 Conceptual Landscape Master Plan—Amendment Area	45
1-8 Primary Entry	47
1-9 Secondary Entry	48
1-10 Neighborhood Entry Statement – Section	49
1-11 Neighborhood Entry	50
1-12 Secondary Highway Streetscape	51
1-13 Local and Collector Streetscapes	52
1-14 Paseo Section A-A	54
1-15 Paseo Section B-B	55
1-16 Paseo/Pocket Parks C-C	56
1-17 Paseo Typical	57
1-18 Pocket Park/Paseo Typical	58
1-19 Neighborhood Park	60

TABLE NO.	Page
1-1 Plant Palette	62



DESIGN GUIDELINES

Purpose and Intent

The following Design Guidelines have been developed as a method of achieving a high quality, cohesive design structure for the Page Ranch Planned Community Amendment (see figure 1-1.) Objectives of the design guidelines are:

- ◆ Provide the City with the necessary assurance that the Planned community area will develop in accordance with the quality and character proposed herein;
- ◆ To serve as design criteria for developers, builders, engineers, architects, landscape architects, and other professionals in preparing plans for various stages of construction and development;
- ◆ To lend guidance to staff, the Planning Commission and the City Council in the review and evaluation of future development projects in the Planned Community area;
- ◆ The Community Development Director, or his/her designee, shall have the authority for minor architectural changes focusing around items such as window treatments, color combinations, façade treatments, and architectural relief. Questions on the Interpretation of this provision or changes not clearly within the scope of this provision shall be submitted to the Planning Commission for consideration;
- ◆ Certain key design elements will contribute significantly to the visual order and consistency of the entire Planned Community area and a unique “sense of place”. The fundamental elements of these common features—site planning, architecture, landscape architecture, and other urban design details—are established by the Design Guidelines; and,
- ◆ Development of each planning area shall require review and approval by the Hemet Planning Commission as part of the Site Development Review (SDR) process.

Flexibility

The guidelines are intended to be flexible and illustrative in nature, with the capability of responding to unanticipated conditions, changes in buyer preferences, the market, and design trends. Creativity and innovation as well as consistent quality are encouraged in the implementation of these guidelines.

This section of the planned community includes site planning, architectural, landscaping, and community-wide guidelines and standards to promote



Page Ranch
Planned
Community
Development

Design Guidelines Area
Figure 1-1

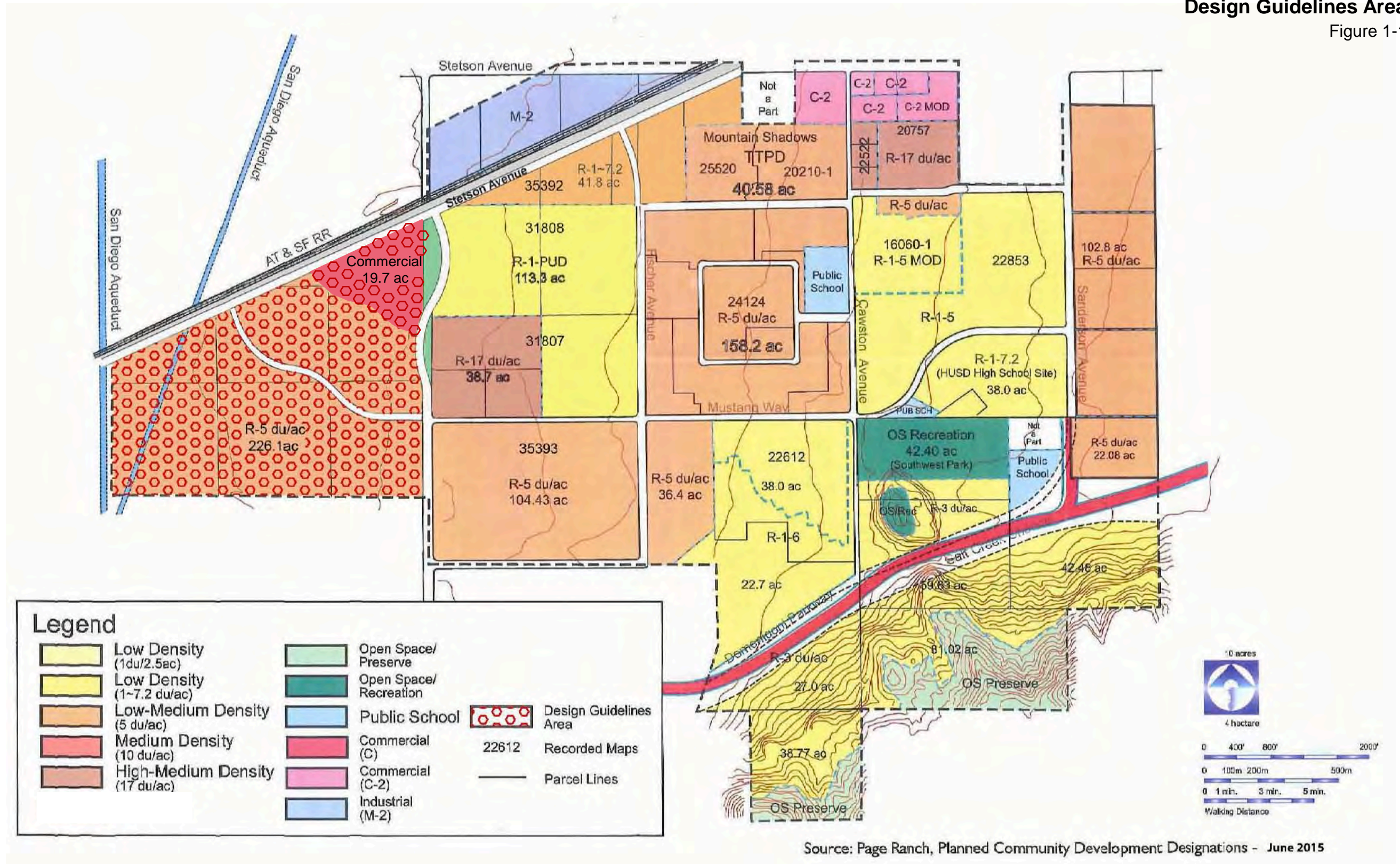



diversity and harmony in the architecture and landscaping within the project area. These guidelines are intended to set a direction for distinctive, high-quality commercial and residential and community facility development. Nevertheless, the guidelines are general enough in nature to allow the developer and/or builder some flexibility to respond to changing consumer tastes and market conditions.

A. Community Theme and Character

The Design Guidelines will ensure that the Planned community, is an environment that reflects the vision embodied in the following concepts:

- ◆ Develop a high quality, cohesive design concept to create a desirable community design image for the planned community.
- ◆ Establish development standards that ensure lasting value for the residential neighborhoods and activity centers.
- ◆ Materials and methods of construction should be specific to the region and/or climatic zone, exhibiting continuity of history, culture and compatibility of local character, as well as community identity.

B. Architectural Themes

The Page Ranch architectural theme will have a distinctive identity, expressing the integration of building structures and the natural environment. The theme will be based on Southern California vernacular, having its roots in the European, Mediterranean and Craftsman/California Bungalow styles and evolving over time, being shaped by the cultural and climatic influences of the region. The principle designs will consist of the following traditional architectural styles:

Mediterranean (*Neo-Mediterranean, Mediterranean Revival*)

Mediterranean vernacular architecture can be characterized by strong unifying elements such as tile roofs, simple and uncluttered detailing, and recessed openings conveying a sense of solidity and permanence. These forms and materials traditionally provide a response to the need to provide shelter from the sun with thick walls for insulation, light colors for reflection, and recessed windows for shade. The result is a structure both visually and functionally enduring which responds to the climate and culture of the Southern California environment.





Page Ranch
Planned
Community
Development

Craftsman/California Bungalow

Craftsman/California Bungalow vernacular architecture can be characterized by southern California's wood architectural designs inspired by the Arts and Crafts movement of the early 20th century. This theme is identified by detailed woodwork and design elements similar to Prairie houses with porches, exposed roof-wall junctions, and shallow roof pitches.

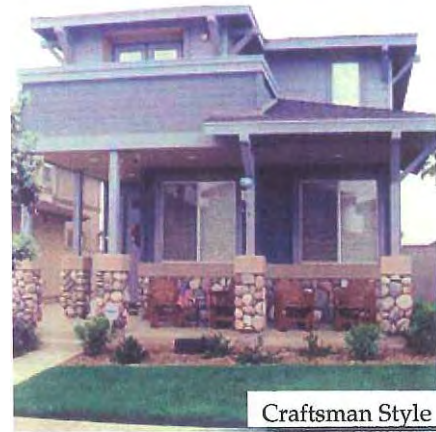

California Ranch/ Farmhouse

California Ranch/Farmhouse styles of architecture were concurrent with the Craftsman period. The California Ranch style is indigenous to California and is styled from early Spanish California architecture with influences based upon the horizontal Prairie Style.

The general character of the California Ranch style is derived from the Mediterranean, Bungalow, and the 1940's Ranch styles. California Ranch consists of one (1) and two (2) story volumes with hip and gable roofs. The roof pitches vary from 4:12 to 5:12 with moderate to broad roof overhangs or eaves. Indoor-outdoor relationships are accentuated by such elements as: large areas of glass, sheltered porches, greenhouse rooms and corner windows. Creation of strong shadow



patterns are achieved through use of exposed beam ends and deep fascias with columns and piers. Patios, private gardens and pot shelves are typical.

The Farmhouse style is typically characterized by wrapping front porches with a variety of wood columns and railings. An asymmetrical cottage look may be utilized. Details characteristic to Farmhouse are cupolas, dovecotes, vertical windows and shutters, wood pot shelves, siding and gable end vent details. Dormers and asymmetrical elevations can be thematic for elevation. Simple two-story massing forms are broken by gables both perpendicular and parallel to the front elevation and porches covered by either side hip roofs or shed.



Page Ranch
Planned
Community
Development

Cottage

The Cottage is styled after Tudor/English Country and/or French Eclectic styles that were a dominant architectural style popular in America from the 1920's through the 1930's. The Tudor/English architectural style generally has steeply pitched roofs, usually side-gabled, with one or more prominent cross gables, decorative half-timbering is present on most. Typical features may include tall narrow windows, massive chimneys, and doorways surrounded by brick work, or simple rounded archways.



The French Eclectic architectural influence on the cottage style is characterized by a steeply pitched hipped roof without dominant front-facing cross gable, eaves are commonly flared upward at the roof/wall junction with brick, stone, or stucco wall cladding, sometimes with decorative half-timbers. This architectural style has a great variety in form and detailing but is united by the characteristic roofline. Typical features may include symmetrical arched entrances surrounded by bricks or stone detailing, double-hung, casement or arched windows with some full-length casement windows with shutters.

The Cottage style blends the English country and French eclectic styles, incorporating the steep roofs, half timbers and entry treatments. The overall style elements create a great variety of one and two story façade possibilities.

This section characterizes and illustrates building materials and forms that are expressive of the intended architectural theme for Page Ranch. Architectural elements are defined as appropriate (required, encouraged, permitted), discretionary (limited) and inappropriate (prohibited).

It is the intent of these guidelines to create a consistent architectural theme for the planned community, while allowing for flexibility of design expression. The photographs and illustrations in this section are offered as a visual expression of the intended character and appropriate design responses.



C. Residential

Lotting concepts

Building setbacks and the spaces between buildings shall be varied to create interest between buildings and the streetscene.

Siting criteria

Attached residential product types such as duplexes, townhouses, apartments, and other multi-family dwellings shall orient internally in each development.

- ◆ Buildings shall be arranged to create a series of interesting open spaces or recreation areas and pedestrian gathering plazas within the interior of each development.
- ◆ Buildings shall be organized into informal clusters and groupings to create usable open space areas.
- ◆ Private recreation facilities shall be located internally to the project, in a location easily accessible to all dwelling units within the development.
- ◆ Whenever possible, residential units shall be arranged to take advantage of vistas.
- ◆ Parking areas should be placed internally to reduce the visual impact on adjacent uses and increase safety to residents and their vehicles.

Fencing/walls

Walls and fences are important urban design features of the community. They establish enclosure, delineate site areas, offer visual and physical privacy, provide for views into and out of a site, attenuate sound, and provide security. Walls and fences should be used to reinforce the theme, reflecting the characteristics of the major project entry monumentation in terms of configuration and materials. Where such elements face public streets and view corridors, they shall appear consistent in style, material, and height, therefore serving as a unifying element throughout the community (Refer to Figure 1– 2).



Outdoor Meeting Areas



Wall/Fence Elevations Figure 1-2



COMMUNITY WALL

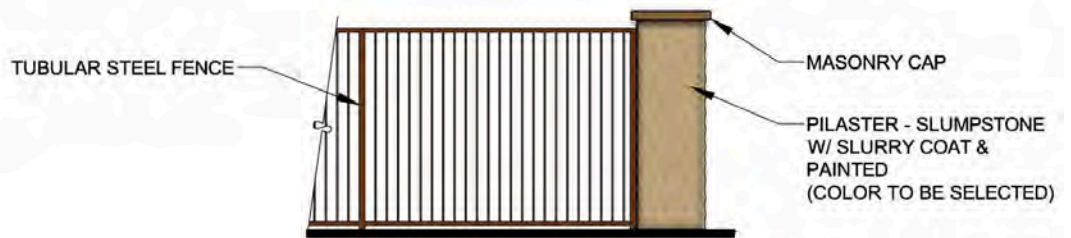

VIEW FENCE



VIEW WALL

NOTE:
PILASTER LOCATIONS TO
BE APPROVED BY CITY OF
HEMET 70'-100' O.C. TYP.



Appropriate:

- ◆ View fencing along view corridors (encouraged).
Varied setbacks and planting recesses (encouraged).
- ◆ Walls and fences will end with a pilaster reflecting the design of the entry monumentation (encouraged).
- ◆ Masonry cap on walls or wall pilasters (required).
- ◆ Decorative masonry for retaining walls visible from street (required).
- ◆ Changes in wall or fence stepping consistent with pad elevation changes (required).
- ◆ Accent trim, repeating cornice band or band of tile (encouraged).
- ◆ Adequate planting pockets between walls and walkways (encouraged).
- ◆ Semi-transparent walls and “view fences”, such as tubular steel grilles between plaster pilasters (permitted).
- ◆ Perimeter fencing shall be of a decorative block, textured concrete or stucco with pilasters and caps and/or other materials consistent with the project theme (required).
- ◆ Perimeter fencing landscaping shall be a minimum of vines planted next to the wall with varied spacing intervals of ten to fifteen feet (10' - 15') (required).
- ◆ Residential lot fencing visible to the public shall be the same or similar material as the perimeter walls to allow continuity of the theme throughout the project (required).
- ◆ Residential gates visible to the public such as: gates into backyards from paseos, or community areas, shall be of tubular steel or similar materials (required).
- ◆ Residential interior lot line fencing shall be constructed of masonry block walls, vinyl, or wood (required).

Inappropriate:

- ◆ Long stretches of unrelieved walls or fences (prohibited).
- ◆ Mixing of an assortment of the project's perimeter walls (prohibited).
- ◆ Wood fencing as perimeter fencing (prohibited).



Page Ranch
Planned
Community
Development

Mediterranean architectural features

Mediterranean theme

The Page Ranch community has four (4) dominant styles of architecture based on traditional architectural shapes and detailing. Mediterranean has a free-interpretation of Italian Renaissance, Spanish, Eclectic, Mission, and Monterey styles. These homes have Italian or Spanish inspiration and are identified by stucco walls, rounded arches, and red tile roofs (Refer to Figure 1-3).

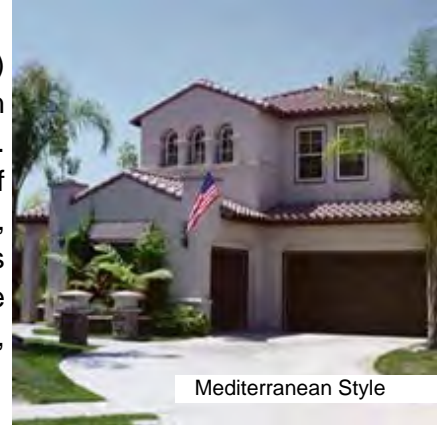

Form, massing, scale

The architectural image of Page Ranch will be perceived primarily from public spaces such as streets, open spaces and parks. Therefore, building massing, scale and roof forms as the primary design components require careful articulation in their architectural expression to the public spaces. Front elevations facing public streets warrant the highest architectural expression of the homes with varied materials and details. Side elevations at corners facing public streets shall receive a higher articulation of design over side elevations facing interior lot lines. Similarly, rear elevations facing either interior or perimeter streets are visible from the public realm and shall also receive elevated design consideration.



Buildings and attached dwelling units should be arranged, staggered, and offset to create dynamic building façades. Long, rows of “barracks-like” buildings and façades are prohibited.

The overall massing of each home should be organized as a whole unit. It should not appear as a mixture of unrelated forms.

Appropriate:

- ◆ Articulation (projections and recesses) with a minimum of four (4) varied wall planes on front elevations (required).
- ◆ Articulation of rear and side elevations facing interior or perimeter public streets with a minimum of two (2) varied planes (required).
- ◆ Articulation of interior facing rear and side elevations with a minimum



Page Ranch
Planned
Community
Development

- of two (2) varied planes (encouraged).
- ◆ Square, rectangular, or circular pop-outs, bay windows or building projections can provide interest, help to create variety and provide a quality appearance on all exterior elevations of a residence (encouraged).
 - ◆ Low plate lines and profiles at street fronts and boundary edges (required).
 - ◆ Garages shall be integrated into the architectural design of the structure; a garage should not exceed fifty percent (50%) of the first story building façade (required).
 - ◆ Architectural features such as side on garages with windows, setting garages back, porte cocheres, tandem parking and garages toward the rear of the property (encouraged).
 - ◆ Second-story elements should be setback between two to eight feet (2' - 8') to create a human-scale (encouraged).
 - ◆ One- and two-story elements and varied floor setbacks at the second story (encouraged).
 - ◆ Projections and recesses to provide shadow and depth (required).
 - ◆ Simple, bold forms (encouraged).
 - ◆ Combinations of one and two-story forms conveying the sense of human scale (encouraged).
 - ◆ Simple, clean, bold projections (encouraged).
 - ◆ Balconies, open or roofed with wood or iron railings and/or porches (encouraged).
 - ◆ One and two story covered porches (encouraged).
 - ◆ Wood or tubular steel balustrade (permitted).
 - ◆ Exterior stairway design and location to complement building form (encouraged).



Discretionary:

- ◆ Two story homes on corner lots except where additional setbacks from the street are provided to the second story (limited)

Inappropriate:

- ◆ Large expanses of flat wall planes vertically or horizontally on areas other than interior side elevations (prohibited).

Mediterranean Architecture

Figure 1-3



Stucco walls



Multi-lite inset windows



Exposed rafter tails

Wood shutters



Towers

Earthtone colors



Arches and columns

Tile roofs with little or no overhang



Recessed windows with tubular steel balustrade



Page Ranch
Planned
Community
Development

Building relief

Appropriate:

- ◆ Architectural detailing on all exterior attached residential building façades (required)
- ◆ Special architectural treatment on front façades of single-family residential dwellings (required)
- ◆ Architectural detailing on single-family side and rear façades (encouraged)
- ◆ Where similar floor plans of the same unit are located on adjacent lots, one (1) shall be a reverse plan and will have a different setback and façade treatment (required).



Deep Set/Recessed Windows and Doors

Windows, doors, and openings (fenestration)

Appropriate:

- ◆ Deep set or pop-out windows and doors along with other architectural projections and recesses used to achieve articulation through shadowing effects (encouraged).
- ◆ Second story windows oriented to the front and rear of the homes to minimize views into adjacent rear and side yards (encouraged).
- ◆ Divided window panes and arched openings (encouraged).
- ◆ Casement windows (encouraged).
- ◆ Window grills, wood or metal (encouraged).
- ◆ Recessed door, window and wall openings conveying the appearance of thick protective exterior walls (required).
- ◆ Panel doors (encouraged).
- ◆ Double sash doors opening onto patios or balconies (encouraged).
- ◆ Second floor side yard windows to be glass block or frosted glass panels to inhibit direct viewing into adjacent yards/homes, or clear glass windows must be a minimum of six feet (6') above floor level (encouraged).
- ◆ Fully recessed openings (encouraged).
- ◆ Staggered garage door setbacks to



Tower and Arches



- adjacent doors (required).
- ◆ Garage door recess from adjacent walls a minimum of twelve inches (12") (encouraged).
- ◆ Columns and archways (encouraged).
- ◆ Base incorporated at bottom of columns (encouraged).
- ◆ Square or cylindrical columns of plaster or pre-cast concrete (encouraged).
- ◆ Towers, round or square (encouraged).
- ◆ Free-standing plaster archways at entrance gates (encouraged).
- ◆ Chimneys with tile caps, brick or tile banding or change in plane (encouraged).
- ◆ Chimneys boldly projected from wall surfaces (encouraged).

Discretionary:

- ◆ Mill finish window or door frames (limited).
- ◆ Second story windows oriented to the side of the home (limited).

Inappropriate:

- ◆ Reflective window or door frames (prohibited).
- ◆ Reflective glass (prohibited).
- ◆ Metal awnings (prohibited).
- ◆ Corrugated metal garage doors (prohibited).
- ◆ Exposed pipe columns (prohibited).
- ◆ Applied rustic veneers on columns (prohibited).
- ◆ Thin posts, such as 4x4 wood or metal pipe column (prohibited).
- ◆ Exposed chimney flues (prohibited).
- ◆ Rustic material veneers on chimneys (prohibited).
- ◆ Extravagant metal fireplace caps (prohibited).

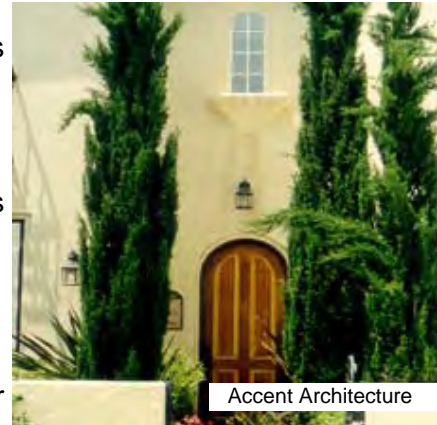

Materials, finishes and colors

Appropriate:

- ◆ Color palette with a minimum of three (3) colors per unit with five (5) or more palettes for use throughout each development to allow a variety of color (required)
- ◆ Natural materials which are compatible with and reflect the elements of the surrounding natural environment (encouraged)
- ◆ Smooth, sand, or other light finish texture on exterior plaster or stucco (required)
- ◆ Semi-transparent stain or accent painted wood trim (required)
- ◆ Crisp, clean and simple use of tile as design accents and trim



- (encouraged)
- ◆ Light colors with darker or lighter accents to highlight the character of the structure, particularly in respect to balcony rails, awnings, inlaid tile bands, and cornice bands (required)
 - ◆ Accents relating to architectural form and character of the building (required)
 - ◆ Ceramic tile accent trim (encouraged)
 - ◆ Painted wood trim (permitted)
 - ◆ CC&R's or other appropriate documents will provide paint pallet colors for "re-painting" houses (encouraged)

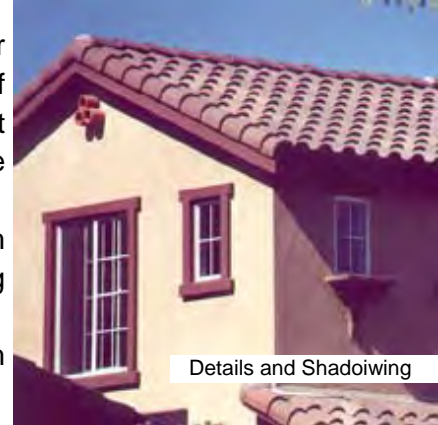

Roofs

Appropriate:

- ◆ Simple, low-pitched gable, hip or shed roof forms with slopes from 4:12 to 7:12 (required).
- ◆ Where two-story homes are sited on corner lots, both front and side facing street elevations must meet front elevation design (required).
- ◆ Overhangs of twelve inches (12") minimum to create strong shadow lines and contrast (required).
- ◆ Jogs in ridge line (encouraged).
- ◆ Varying plate heights and ridge heights (encouraged).
- ◆ Clay or concrete tile (required).
- ◆ Earth-toned clay mission tile (encouraged).
- ◆ Roof projections and overhangs (encouraged).
- ◆ Low-maintenance details, limiting the amount of exposed wood (encouraged).
- ◆ Roof materials shall be a minimum of a Class A-rating (required).
- ◆ Variation of color and texture of roof material throughout a development (required).

Discretionary:

- ◆ Small areas of flat roofs with parapet walls (limited).

Inappropriate:

- ◆ Flat roofs (prohibited).
- ◆ Metal or copper (prohibited).



Decorative Details

Appropriate

- ◆ Decorative iron, metal sconces (encouraged).
- ◆ Decorative iron, metal door knockers (encouraged).
- ◆ Decorative iron, metal accents (encouraged).



Spaces

The spacing of buildings shall be governed by the requirements for adequate light and air, proper access, fire regulations and the need for visual and auditory privacy.

Accessory structures

Appropriate:

- ◆ Patio trellises, pergolas and other exterior structures constructed as permitted by governing codes, with finishes complying with the approved material and color palette (encouraged).
- ◆ Trellises and patio covers of bold, clean forms (encouraged).

Screening

All exterior components of plumbing, processing, heating and cooling systems, and ventilating systems located near or at ground level shall be screened from views from adjacent or adjoining lots, buildings or streets by heavy landscape plantings, walls or fences, earth berms, or any combination thereof.

Appropriate:

- ◆ Solar panels are to be integrated into the roof design, flush with the roof slope. Frames must be colored to complement the roof and not be visible from the street (encouraged)

Inappropriate:

- ◆ Mill finish aluminum frames on solar panels (prohibited)



Page Ranch
Planned
Community
Development

Craftsman/California Bungalow architectural features

Craftsman/California Bungalow theme

The “Craftsman/California Bungalow” style of architecture originated in Southern California at the turn of the last century. The name comes from the inspiration of this style—the English Arts and Crafts movement which was interested in oriental wooden architecture and manual arts. This style introduced the ‘California’ bungalow which is the foundation for this theme in Page Ranch (Refer to Figure 1-4).



Form, massing, scale

The architectural image of Page Ranch will be perceived primarily from public spaces such as streets, open spaces and parks. Therefore, building massing, scale and roof forms, as the primary design components require careful articulation in their architectural expression to the public spaces. Front elevations facing public streets warrant the highest architectural expression of the homes with varied materials and details. Side elevations at corners facing public streets shall receive a higher articulation of design over side elevations facing interior lot lines. Similarly, rear elevations facing either interior or perimeter streets are visible from the public realm and shall also receive elevated design consideration.

Buildings and attached dwelling units should be arranged, staggered, and offset to create dynamic building façades. Long, rows of “barracks-like” buildings and façades are prohibited.

The overall massing of each home should be organized as a whole unit. It should not appear as a mixture of unrelated forms.

Appropriate:

- ◆ Articulation (projections and recesses) with a minimum of four (4) varied wall planes on front elevations (required).
- ◆ Square, rectangular, or circular pop-outs, bay windows or building projections can provide interest, help to create variety and provide a quality appearance on all exterior elevations of a residence (encouraged).
- ◆ Articulation of rear and side elevations facing interior or perimeter public streets with a minimum of two (2) varied planes (required).
- ◆ Articulation of interior facing rear and side elevations with a minimum of two (2) varied planes (encouraged).
- ◆ Low plate lines and profiles at street fronts (encouraged).



- ◆ Garages shall be integrated into the architectural design of the structure, a garage should not exceed fifty percent (50%) of the first story building façade (required).
- ◆ Architectural features such as side on garages with windows, setting garages back, porte cocheres, tandem parking and garages in the rear of the property (encouraged).
- ◆ Second-story elements should be setback between two to eight feet (2' - 8') to create a human-scale (encouraged).
- ◆ One- and two-story elements and varied floor setbacks at the second story (encouraged).
- ◆ Projections and recesses to provide shadow and depth (required).
- ◆ Simple, bold forms (encouraged).
- ◆ Combinations of one- and two-story forms conveying sense of human scale (encouraged).
- ◆ Simple, clean, bold projections (encouraged).
- ◆ Balconies and/or porches (encouraged).
- ◆ Porches full width or partial with square column supports (encouraged).
- ◆ Verandas (encouraged).
- ◆ Wood or tubular steel balustrade (permitted).



Discretionary:

- ◆ Two-story homes on corner lots except where additional setbacks from the street are provided to the second story (limited).

Inappropriate:

Large expanses of flat wall planes vertically or horizontally (prohibited).

Building relief

Appropriate:

- ◆ Architectural detailing on all exterior attached residential building façades (required).
- ◆ Special architectural treatment on front façades of single-family residential dwellings (required).
- ◆ Architectural detailing on single-family side and rear façades (encouraged).
- ◆ Where similar floor plans of the same unit are located on adjacent lots, one (1) shall be a reverse plan and will have a different setback and façade treatment (required).



Craftsman/California Bungalow Architecture

Figure 1-4



low pitched roof forms

Exposed Beams



Shutters



Porches / covered entries
by shed or side hip roof
forms

Deep overhangs

Predominate use of wood
siding



Brick or Stone accents





Page Ranch
Planned
Community
Development

Windows, doors, and openings (fenestration)

Appropriate:

- ◆ Deep set or pop-out windows and doors along with other architectural projections and recesses used to achieve articulation through shadowing effects. (encouraged)
- ◆ Second story windows oriented to the front and rear of the homes to minimize views into adjacent rear and side yards (encouraged).
- ◆ Divided window panes and arched openings (encouraged).
- ◆ Recessed door, window and wall openings conveying the appearance of thick protective exterior walls (required).
- ◆ Fully recessed openings (encouraged).
- ◆ Staggered garage door setbacks to adjacent doors (required).
- ◆ Garage door recess from adjacent walls a minimum of twelve inches (12") (encouraged).
- ◆ Columns and archways (encouraged).
- ◆ Bases incorporated at bottom of columns (encouraged).
- ◆ Capital and column bands (encouraged).
- ◆ Grouped casements, ribbon windows, heavily framed casement windows (encouraged).
- ◆ Line of three or more windows (encouraged).
- ◆ Multi-pane sash over sashes with one large glass pane or double hung sashes (encouraged).
- ◆ Second story side yard windows to be glass block or frosted glass panels to inhibit direct viewing into adjacent yards/homes or clear glass windows must be a minimum of six feet (6') above floor level (encouraged).
- ◆ Window boxes (encouraged).
- ◆ Paneled doors (encouraged).
- ◆ Small high windows on each side of chimneys (encouraged).
- ◆ Chimneys with brick banding (encouraged).
- ◆ Chimneys with exterior stone (encouraged).
- ◆ Chimneys boldly projected from wall surfaces (encouraged).

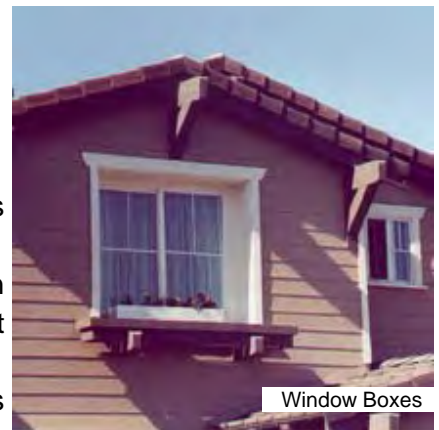



- ◆ Chimney design feature adding articulation to walls (permitted).
- ◆ Chimneys with decorative metal caps that match trim colors (permitted).

Discretionary:

- ◆ Mill finish window or door frames (limited).
- ◆ Second story windows oriented to the side of the home (limited).

Inappropriate:

- ◆ Reflective window or door frames (prohibited).
- ◆ Reflective glass (prohibited).
- ◆ Metal awnings (prohibited).
- ◆ Corrugated metal garage doors (prohibited).
- ◆ Exposed pipe columns (prohibited).
- ◆ Applied rustic veneers on columns (prohibited).
- ◆ Posts, such as 4x4 wood or metal pipe column (prohibited).
- ◆ Exposed chimney flues (prohibited).
- ◆ Rustic material veneers on chimneys (prohibited).
- ◆ Extravagant metal fireplace caps (prohibited).

Materials, finishes and colors

Appropriate:

- ◆ Color palette with a minimum of three (3) colors per unit with five (5) or more palettes for use throughout each development to allow for a variety of color. (required)
- ◆ Natural materials which are compatible with and reflect the elements of the surrounding natural environment (encouraged)
- ◆ Wood treatment (required)
- ◆ Semi-transparent stain or accent painted wood trim (required)
- ◆ Crisp, clean and simple use of brick, stone, masonry or pre-cast concrete as design accents and trim (encouraged).
- ◆ Pastel colors with darker or lighter accents to highlight the character of the structure, particularly in respect to balcony rails, awnings, inlaid tile bands, and cornice bands (required).
- ◆ Accents relating to architectural form and character of the building (required).
- ◆ Painted wood trim (permitted).
- ◆ CC&R's or other appropriate documents will provide paint pallet colors for "re-painting" houses (encouraged).





Roofs

Appropriate

- ◆ Simple, low-pitched gable, hip or shed roof forms with slopes from 4:12 to 7:12 (required).
- ◆ Where two-story homes are sited on corner lots, both front and side facing street elevations must meet front elevation design (required).
- ◆ Overhangs of twelve inches (12") minimum to create strong shadow lines and contrast (required).
- ◆ Cornice banding for detail (encouraged).
- ◆ Creating jogs in ridge line (encouraged).
- ◆ Varying plate heights and ridge heights (encouraged).
- ◆ Concrete tile (required).
- ◆ Metal or copper tile (permitted).
- ◆ Roof projections and overhangs (encouraged).
- ◆ Exposed roof beams and rafters (encouraged).
- ◆ Gabled or shed dormers with exposed beams (encouraged).
- ◆ Projecting eaves (encouraged).
- ◆ Shingles with split wood appearance (encouraged).
- ◆ Low-maintenance details, limiting the amount of exposed wood (encouraged).
- ◆ Roof materials shall be a minimum of a Class A-rating (required).
- ◆ Variation of color and texture of roof materials throughout a development (required).



Inappropriate:

- ◆ Flat roofs (prohibited).
- ◆ Parapet walls (prohibited).
- ◆ Real wood or shake shingles (prohibited).

Decorative Details

Appropriate

- ◆ Colored glass transoms (encouraged).
- ◆ Decorative beams or braces under gables (encouraged).
- ◆ Dwarf piers (encouraged).
- ◆ Extra stickwork in gables or porches (encouraged).





- ◆ Planter boxes (encouraged).
- ◆ Wood shutters (encouraged).

Spaces

The spacing of buildings shall be governed by the requirements for adequate light and air, proper access, fire regulations and the need for visual and auditory privacy.

Accessory structures

Appropriate:

- ◆ Patio trellises, pergolas and other exterior structures constructed as permitted by governing codes, with finishes complying with the approved material and color palette (encouraged).
- ◆ Trellises and patio covers of bold, clean forms (encouraged).
- ◆ Recessed or trellised porches (encouraged).



Screening

All exterior components of plumbing, processing, heating and cooling systems, and ventilating systems located near or at ground level shall be screened from views from adjacent or adjoining lots, buildings or streets by heavy landscape plantings, walls or fences, earth berms, or any combination thereof.

Appropriate:

- ◆ Solar panels are to be integrated into the roof design, flush with the roof slope. Frames must be colored to complement the roof and not be visible from the street (encouraged).

Inappropriate:

- ◆ Mill finish aluminum frames on solar panels (prohibited).



Page Ranch
Planned
Community
Development

California Ranch/Farmhouse architectural features

California Ranch/Farmhouse theme

The Craftsman period and California Ranch/Farmhouse period were happening concurrently. The California Ranch style is indigenous to California and is based loosely on Spanish California architecture with influences of the horizontal Prairie style (See Figure 1-5).



The general character of the California Ranch style comes from the Mediterranean, Bungalow and 1940's Ranch styles. It consists of one and two story volumes with hip and gable roofs. The Roof pitches vary from 4:12 to 5:12 with moderate to broad roof overhangs or eaves. Typical exterior wall cladding includes clapboard (horizontal boards), board and batten (vertical boards), shingles and stucco. Indoor-outdoor relationships are accentuated by elements such as: large areas of glass, green house rooms, sheltered porches and corner windows. Exposed beam ends and deep fascias are used with columns and piers to create strong shadow patterns. Patios, private gardens and pot shelves are typical.

The typical Farmhouse style is characterized by wrapping front porches with a variety of wood columns and railings. The asymmetrical cottage look may be used. Dormers and asymmetrical elevations can also be thematic for the elevation. Characteristic details may include cupolas, dovecotes, vertical windows and shutters, wood pot shelves siding, and gable end vent details. The simple two-story massing forms are broken up by gables both perpendicular and parallel to the front elevation and porches covered by side hip roofs or shed roofs.

Form, massing, scale

The architectural image of Page Ranch will be perceived primarily from public spaces such as streets, open spaces and parks. Therefore, building massing, scale and roof forms, as the primary design components require careful articulation in their architectural expression to the public spaces. Front elevations facing public streets warrant the highest architectural expression with varied materials and details. Side elevations at corners facing public streets shall receive a higher articulation of design over side elevations facing interior lot lines. Similarly, rear elevations facing either interior or





perimeter streets are visible from the public realm and shall also receive elevated design consideration.

Buildings and attached dwelling units should be arranged, staggered, and offset to create dynamic building façades. Long, rows of “barracks-like” buildings and façades are prohibited.

The overall massing of each home should be organized as a whole unit. It should not appear as a mixture of unrelated forms.

Appropriate:

- ◆ Building lines should emphasize horizontal elements and roof lines (encouraged).
- ◆ Articulation (projections and recesses) with a minimum of four (4) varied wall planes on front elevations (required).
- ◆ Articulation of rear and side elevations facing interior or perimeter public streets with a minimum of two (2) varied planes (required).
- ◆ Articulation of interior facing rear and side elevations with a minimum of two (2) varied planes (encouraged).
- ◆ Projections square, rectangular, or circular pop-outs, bay windows or building projections can provide interest, help to create variety and provide a quality appearance on all exterior elevations of a residence (encouraged).
- ◆ Low plate lines and profiles at street fronts and boundary edges (encouraged).
- ◆ Garages shall be integrated into the architectural design of the structure, a garage should not exceed fifty percent (50%) of the first story building façade (required).
- ◆ One- and two-story elements and varied floor setbacks at the second story (encouraged).
- ◆ Projections and recesses to provide shadow and depth (required).
- ◆ Second-story elements should be setback between two to eight feet (2' - 8') to create a human-scale (encouraged).
- ◆ Simple, bold forms (encouraged).
- ◆ Combinations of one and two-story forms conveying sense of human scale (encouraged).
- ◆ Simple, clean, bold projections (encouraged).
- ◆ Balconies which articulate wall surfaces (encouraged).
- ◆ Balconies and/or porches (encouraged).
- ◆ Porches full width or partial with square column supports (encouraged).
- ◆ Verandas (encouraged).
- ◆ Wood or tubular steel balustrade (permitted).



California Ranch/Farmhouse Architecture

Figure 1-5



Porch Entries

Trapezoid Window Shapes or simple rectangle shapes



Broad Porches / covered entries by shed or side hip roof forms



Shutters



Simple Gable roof forms

Predominate use of wood siding



Discretionary:

- ◆ Two-story homes on corner lots except where additional setbacks from the street are provided to the second story (limited).

Inappropriate:

- ◆ Large expanses of flat wall planes vertically or horizontally (prohibited).

Building relief

Appropriate:

- ◆ Building heights should vary throughout each tract (required).
- ◆ Architectural detailing on all exterior attached residential building façades (required).
- ◆ Special architectural treatment on front façades of single-family residential dwellings (required).
- ◆ Architectural detailing on single-family side and rear façades (encouraged).



- ◆ Front porches, bays, patios, private gardens, pot shelves and balconies are encouraged along the front façade (encouraged)
- ◆ Where similar floor plans of the same unit are located on adjacent lots, one (1) shall be a reverse plan and will have a different setback and façade treatment (required).
- ◆ Exposed beam ends and deep fascias with columns and piers (encouraged).

Windows, doors, and openings (fenestration)

Appropriate:

- ◆ Window frames, mullions, awnings and door frames, should be coordinated with the structure (encouraged).
- ◆ Architectural projections and recesses such as deep set or pop-out windows and doors, shutters and pot shelves may be used along with other architectural projections and recesses to achieve articulation through shadowing effects (encouraged).

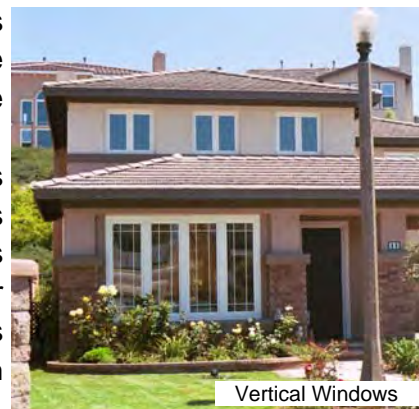

- ◆ Second story windows oriented to the front and rear of the homes to



- ◇ minimize views into adjacent rear and side yards (encouraged).
- ◇ Second story side yard windows to be glass block or frosted glass panels to inhibit direct viewing into adjacent yards/homes or clear glass windows must be a minimum of six feet (6') above floor level (encouraged).
- ◇ Staggered garage door setbacks to adjacent doors (required).
- ◇ Garage door recess from adjacent walls a minimum of twelve inches (12") (encouraged).
- ◇ Window details create an opportunity to provide contrasting trim colors (encouraged).
- ◇ Front entries should be articulated through the use of roof elements, porches, arches, columns or other architectural features (encouraged).
- ◇ Green house rooms, corner windows and or large areas of glass (encouraged).
- ◇ Vertical windows and shutters (encouraged).

Discretionary:

- ◇ Mill finish window or door frames (limited).
- ◇ Second story windows oriented to the side of the home (limited).

Inappropriate:

- ◇ Reflective window or door frames (prohibited).
- ◇ Reflective glass (prohibited).
- ◇ Metal awnings (prohibited).
- ◇ Corrugated metal garage doors (prohibited).
- ◇ Exposed pipe columns (prohibited).
- ◇ Applied rustic veneers on columns (prohibited).
- ◇ Exposed chimney flues (prohibited).
- ◇ Rustic material veneers on chimneys (prohibited).
- ◇ Extravagant metal fireplace caps (prohibited).



Materials, finishes and colors

Appropriate:

- ◇ Color palette with a minimum of three (3) colors per unit with five (5) or more pallet's for use throughout each development to allow for a variety of color (required).
- ◇ Natural materials which are compatible with and reflect the elements of the surrounding natural environment (encouraged).



- ◆ Accents relating to architectural form and character of the building (required).
- ◆ Painted wood trim (permitted).
- ◆ Clapboard, board and batten, shingles and stucco of exterior cladding materials (encouraged).
- ◆ Architectural screens, fences and accessory structures should be constructed of compatible material, color and texture of the main structure (required).
- ◆ CC&R's or other appropriate documents will provide paint pallet colors for "re-painting" house(encouraged).

Roofs

Appropriate

- ◆ Simple, low-pitched gable, hip or shed roof forms with slopes from 4:12 to 5:12 (required).
- ◆ Where two-story homes are sited on corner lots, both front and side facing street elevations must meet front elevation design (required).
- ◆ Overhangs of twelve inches (12") minimum to create strong shadow lines and contrast (required).
- ◆ Jogs in ridge line (encouraged).
- ◆ Varying plate heights and ridge heights (encouraged).
- ◆ Roofing material shall be clay, slate concrete or similar appearance tiles. Tile shall be variegated color and non-reflective (unglazed) (required).
- ◆ Roof vents and appurtenances shall be positioned away from the street and/or finished to match the roof color to minimize the visual impact (required).
- ◆ Roof projections and overhangs (encouraged).
- ◆ Exposed roof beams and rafters (encouraged).
- ◆ Roof pitches and forms should vary (encouraged).
- ◆ Projecting eaves (encouraged).
- ◆ Shingles with split wood appearance (encouraged).
- ◆ Low-maintenance details, limiting the amount of exposed wood (encouraged).
- ◆ Roof materials shall be a minimum of a Class A-rating (required).
- ◆ Variation of color and texture of roof materials throughout a development (required).

Inappropriate:

- ◆ Flat roofs (prohibited).
- ◆ Parapet walls (prohibited).
- ◆ Real wood or shake shingles (prohibited).



Page Ranch
Planned
Community
Development

Decorative Details

Appropriate

- ◆ Colored glass transoms (encouraged).
- ◆ Exposed beam ends (encouraged).
- ◆ Dwarf piers (encouraged).
- ◆ Planter boxes, pot shelves (encouraged).
- ◆ Cupolas, dovescotes (encouraged).



Spaces

The spacing of buildings shall be governed by the requirements for adequate light and air, proper access, fire regulations and the need for visual and auditory privacy.

Accessory structures

Appropriate:

- ◆ Patio trellises, pergolas and other exterior structures constructed as permitted by governing codes, with finishes complying with the approved material and color palette (encouraged).
- ◆ Trellises and patio covers of bold, clean forms (encouraged).

Screening

All exterior components of plumbing, processing, heating and cooling systems, and ventilating systems located near or at ground level shall be screened from views from adjacent or adjoining lots, buildings or streets by heavy landscape plantings, walls or fences, earth berms, or any combination thereof.

Appropriate:

- ◆ Solar panels are to be integrated into the roof design, flush with the roof slope. Frames must be colored to complement the roof and not be visible from the street (encouraged).

Inappropriate:

- ◆ Mill finish aluminum frames on solar panels (prohibited).



Page Ranch
Planned
Community
Development

Cottage architectural features

Cottage theme

The Cottage style combines both the Tudor/English Country architecture and the French Eclectic architectural styles. Generally this architectural style has a steeply pitched roof, side gabled, with one or more prominent cross gables, decorative half – timbers, tall narrow windows typically with multiple groups and multiple panes, massive chimneys crowned by decorative chimney



pots. The Tudor/English Country style has variations in cladding and details which are typical to the architecture. There are four varieties of cladding true to the style: Stucco wall cladding, Brick wall cladding, Stone wall cladding as well as Wooden wall cladding, of these Brick wall cladding is most common. Gables can be part of the design detail for this style, parapeted gables are distinctive, however overlapping gables with eaves is common as well. Chimneys are commonly paced in prominent locations on the front or side of the house. The chimneys are large and elaborate, with complex masonry or stone patterns. The Tudor/English Country style may feature doorways surrounded by brickwork “quoins” and/or simple round arched doorways with heavy board and batten doors. Casement windows made of wood or metal are typical, traditionally double-hung sash windows are used, with groups of three or more located below the main gable. A variety of wall materials can be utilized such as patterned brickwork, or stonework.

The “French Eclectic” style of architecture was commonly built in the 1920’s to 1930’s, this style gained popularity with Americans who served in France during World War I. This architectural style typically includes tall, a steeply pitched hipped roof without front-facing cross gables; eaves are commonly flared upward at roof/wall junctions. The French Eclectic architectural style has three subtypes that are easily recognized, Symmetrical, Asymmetrical and Towered. Symmetrical has a massive hipped roof with the ridge paralleling the front of the house, dominated by a symmetrical façade with centered entry. Asymmetrical is the most common style including a rambling French farmhouse as well as the more formal houses similar to the symmetrical style without the symmetry. Towered is a common style that has a prominent round tower with a high conically shaped roof. The tower is





typically where the entry door is located. Half-timbering is often utilized on towered forms of the French Eclectic style. Details found in the French Eclectic style include but are not limited to doors set in arched openings; arched doorway may be surrounded by stone/brick quoins or detailing. Windows can be double-hung or casement sashes, full length casement windows with shutters can also be used. (See Figure 1-6).

Form, massing, scale

The architectural image of Page Ranch will be perceived primarily from public spaces such as streets, open spaces and parks. Therefore, building massing, scale and roof forms, as the primary design components require careful articulation in their architectural expression to the public spaces. Front elevations facing public streets warrant the highest architectural expression with varied materials and details. Side elevations at corners facing public streets shall receive a higher articulation of design over side elevations facing interior lot lines. Similarly, rear elevations facing either interior or perimeter streets are visible from the public realm and shall also receive elevated design consideration.

Buildings and attached dwelling units should be arranged, staggered, and offset to create dynamic building façades. Long, rows of “barracks-like” buildings and façades are prohibited.

The overall massing of each home should be organized as a whole unit. It should not appear as a mixture of unrelated forms.



Cottage Architecture

Figure 1-6

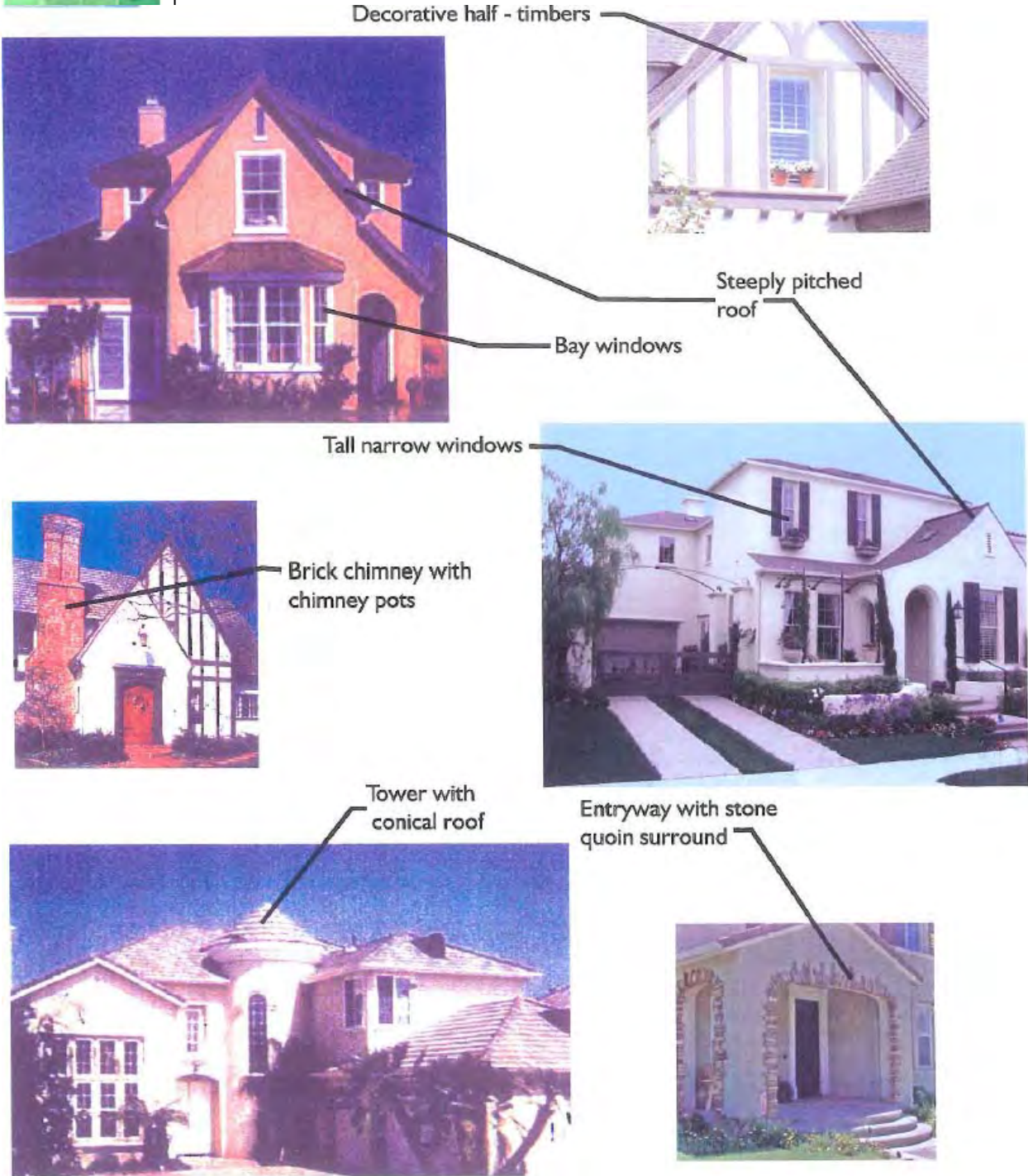



Appropriate:

- ◆ Articulation (projections and recesses) with a minimum of four (4) varied wall planes on front elevations (required).
- ◆ Articulation of rear and side elevations facing interior or perimeter public streets with a minimum of two (2) varied planes (required).
- ◆ Articulation of interior facing rear and side elevations with a minimum of two (2) varied planes (encouraged).
- ◆ Large elaborate chimneys (encouraged).
- ◆ Large elaborate chimneys with decorative masonry or stone patterns (encouraged).
- ◆ Projections square, rectangular, or circular pop-outs, bay windows or building projections can provide interest, help to create variety and provide a quality appearance on all exterior elevations of a residence (encouraged).
- ◆ Low plate lines and profiles at street fronts and boundary edges (encouraged).
- ◆ Garages shall be integrated into the architectural design of the structure; a garage should not exceed fifty percent (50%) of the first story building façade (required).
- ◆ Architectural features such as side on garages with windows, setting garages back, porte cocheres, tandem parking and garages in the rear of the property (encouraged).
- ◆ Second-story elements should be setback between two to eight feet (2' - 8') to create a human-scale (encouraged).
- ◆ One and two-story elements and varied floor setbacks at the second story (encouraged).
- ◆ Projections and recesses to provide shadow and depth (required)
- ◆ Simple, bold forms (encouraged)
- ◆ Combinations of one and two-story forms conveying sense of human scale (encouraged).
- ◆ Simple, clean, bold projections (encouraged).
- ◆ Wood, brick, stucco or stone wall cladding (encouraged).
- ◆ Steeply pitched front facing or side gabled roofs (required).
- ◆ Decorative half-timbering (encouraged)

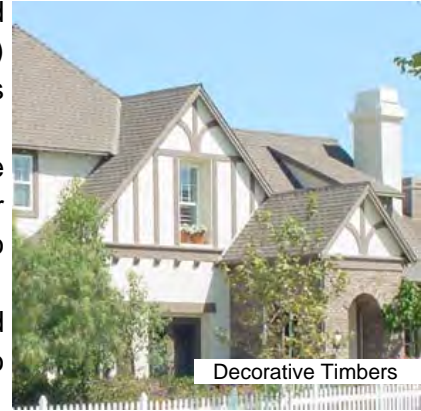



Discretionary:

- ◆ Two-story homes on corner lots except where additional setbacks from the street are provided to the second story (limited)

Building relief

Appropriate:

- ◆ Architectural detailing on all exterior attached residential building façades (required).
- ◆ Building heights should vary throughout each tract (required)
- ◆ Architectural detailing on single-family side and rear façades (encouraged).
- ◆ Special architectural treatment on front façades of single-family residential dwellings (required).
- ◆ Architectural detailing on single-family side and rear façades (encouraged).
- ◆ Where similar floor plans of the same unit are located on adjacent lots, one (1) shall be a reverse plan and will have a different setback and façade treatment (required).

Windows, doors, and openings (fenestration)

Appropriate:

- ◆ Casement windows of wood or non-reflective metal with multiple panes (encouraged).
- ◆ Bay windows (encouraged).
- ◆ Double-hung windows with multiple panes (encouraged).
- ◆ Dormers arched, circular, hipped or gabled (encouraged).
- ◆ Arched doorways (encouraged).
- ◆ Arched doorways with stone or brick quoins (encouraged)
- ◆ Second story windows oriented to the front and rear of the homes to minimize views into adjacent rear and side yards (encouraged).
- ◆ Second story side yard windows to be glass block or frosted glass panels to inhibit direct viewing into adjacent yards/homes or clear glass windows must be a minimum of six feet (6') above floor level (encouraged).
- ◆ Staggered garage door setbacks to adjacent doors (required).
- ◆ Garage door recess from adjacent walls a minimum of twelve inches (12") (encouraged).
- ◆ Archways (encouraged).





Discretionary:

- ◆ Use of wood lattice (limited).
- ◆ Mill finish window or door frames (limited).

Inappropriate:

- ◆ Reflective window or door frames (prohibited).
- ◆ Reflective glass (prohibited).
- ◆ Metal awnings (prohibited).
- ◆ Second story windows oriented to the side of the home (discouraged).
- ◆ Corrugated metal garage doors (prohibited).
- ◆ Exposed pipe columns (prohibited).
- ◆ Exposed chimney flues (prohibited).



Materials, finishes and colors

Appropriate:

- ◆ Color palette with a minimum of three (3) colors per unit with five (5) or more pallet's for use throughout each development to allow for a variety of color (required).
- ◆ Crisp, clean and simple use of brick, stone, masonry or pre-cast concrete as design accents and trim (encouraged).
- ◆ Architectural screens, fences and accessory structures should be constructed of compatible material, color and texture of the main structure (required).
- ◆ Painted wood trim (permitted).
- ◆ CC&R's provide paint pallet colors for "re-painting" houses (encouraged).

Roofs

Appropriate

- ◆ Tall steeply-pitched gable, hip (required).
- ◆ Where two-story homes are sited on corner lots, both front and side facing street elevations must meet front elevation design (required).
- ◆ Varying plate heights and ridge heights (encouraged).
- ◆ Concrete tile (required).
- ◆ Roof projections and overhangs (encouraged).
- ◆ Flared eaves (encouraged).
- ◆ Cross gables (encouraged).
- ◆ Roof materials shall be a minimum of a Class A-rating (required).



- ◆ Variation of color and texture of roof materials throughout a development (required).

Decorative Details

Appropriate

- ◆ Decorative half-timbers (encouraged).
- ◆ Parapeted gables (encouraged).
- ◆ Chimneys with decorative masonry or stone patterns (encouraged).
- ◆ Doorways with small tabs of cut stone projecting into brickwork for a quoin effect (encouraged).
- ◆ Simple round-arched doorways (encouraged).
- ◆ Double-hung sash windows (encouraged).
- ◆ Bay windows (encouraged).
- ◆ Towers with conical roof (encouraged).

Spaces

The spacing of buildings shall be governed by the requirements for adequate light and air, proper access, fire regulations and the need for visual and auditory privacy.

Accessory structures

Appropriate:

- ◆ Patio trellises, pergolas and other exterior structures constructed as permitted by governing codes, with finishes complying with the approved material and color palette (Permitted).
- ◆ Trellises and patio covers of bold, clean forms (Permitted).

Screening

All exterior components of plumbing, processing, heating and cooling systems, and ventilating systems located near or at ground level shall be screened from views from adjacent or adjoining lots, buildings or streets by heavy landscape plantings, walls or fences, earth berms, or any combination thereof.

Appropriate:

- ◆ Solar panels are to be integrated into the roof design, flush with the roof slope. Frames must be colored to complement the roof and not be visible from the street (encouraged).

Inappropriate:

- ◆ Mill finish aluminum frames on solar panels (prohibited).



Page Ranch
Planned
Community
Development

D. Signage Program

Theme

The signage program along with architecture and urban design create the identity for Page Ranch. The following guidelines are for signage used throughout the Page Ranch project area, from residential and commercial development to temporary “coming soon” signs. All signage within the Page Ranch project area shall be consistent with the architecture and theme. Signage requirements within the project will adhere to the signage program within the Page Ranch Planned Community. Should a sign type or situation not be addressed herein, the City Sign Ordinances XXXVI, XXVII, & XXXVIII shall apply.

Residential

Project Identification Signs

The following are project identification signs guidelines for the Page Ranch area’s residential and open space project identification signs, to be used throughout the project site and for the duration of the development of Page Ranch. Project identification signage includes but is not limited to signs on vacant parcels of land identifying the future site for school, park, residential, and/or community center. These signs assist in informing Page Ranch residents and visitors what type of land development will be taking place at specific locations, throughout the community.

- ◆ One (1) identification sign per frontage per planning area;
- ◆ Project identification signs maybe up to one hundred square feet (100 sf);
- ◆ Setbacks for signs minimum of ten feet (10’) with a maximum of twenty feet (20’);
- ◆ Height may not exceed fifteen feet (15’);
- ◆ Signs may be posted for up to two (2) years;
- ◆ Signs maybe double sided;
- ◆ Signs maybe installed upon Planned community approval; and,
- ◆ Sign permits must be obtained from the City of Hemet, per the City Zoning Ordinance.





Model Home Signs (Temporary)

The following are model home signs guidelines for the Page Ranch area's model home signs, to be used throughout the project site and for the duration of the development of Page Ranch. Temporary directory signs maybe placed at strategic locations to direct potential home buyers to the new housing tracts and the model homes/sales offices.

- ◆ Model home directory signs maybe be up to forty square feet (40 sf), placed at intersections with permission of the property owner.
- ◆ Tracts of twenty-one to forty acres (21 - 40 ac) signs maybe up to sixty-four square feet (64 sf);
- ◆ Tracts over forty acres (40 ac) signs maybe up to eighty square feet (80 sf);
- ◆ Setbacks for signs minimum of ten feet (10') from curb;
- ◆ Height may not exceed fifteen feet (15');
- ◆ Signs maybe double sided;
- ◆ Signs maybe installed upon approval final map, prior or during construction;
- ◆ Signs shall be removed when tract is sold out; and,
- ◆ Sign permits must be obtained from the City of Hemet, per the City Zoning Ordinance.

Subdivision Signs

The following are Subdivision signs guidelines for the Page Ranch area's subdivision signs, to be used throughout the project site and for the duration of the development of Page Ranch.

- ◆ Up to six (6) signs allowed along a one (1) mile frontage;
- ◆ Subdivisions of twenty acres (20 ac) or less signs maybe up to forty square feet (40 sf);
- ◆ Subdivisions of twenty-one to forty acres (21 –40 ac) signs maybe up to sixty-four square feet (64 sf);
- ◆ Subdivisions over forty acres (40 ac) signs maybe up to one hundred square feet (100 sf);
- ◆ Setbacks for signs minimum of ten feet (10') for forty square feet (40 sf) signs, fifteen feet (15') minimum for signs forty to sixty-four square feet (40—64 sf) and twenty feet (20') minimum for signs over sixty-four square feet (64 sf);
- ◆ Height may not exceed twenty feet (20');
- ◆ Signs maybe double sided;
- ◆ Signs maybe installed at subdivision map approval;
- ◆ In all subdivisions where an approved model home marketing complex is located, banners, balloons and pennants may be erected with or without advertisement to designate an open house or a sales



- office;
- ◆ Banners, balloons or pennants shall be removed when the last phase of the subdivision is sold or until the sales office is closed or removed, whichever comes first and,
- ◆ Sign permits must be obtained from the City of Hemet, per the City Zoning Ordinance.

Subdivision Flags

The following are Subdivision flag guidelines for the Page Ranch area's subdivision flags, to be used throughout the project site and for the duration of the development of Page Ranch. Subdivision flag placement is limited beyond the project entry monumentation based upon the subdivision size as follows:

- ◆ Up to five acres (0 - 5 ac), twelve (12) flag poles;
- ◆ Six to ten acres (6 - 10 ac), sixteen (16) flag poles;
- ◆ Eleven to twenty acres (11 - 20 ac), twenty (20) flag poles;
- ◆ Twenty-one plus acres (21+ ac), thirty (30) flag poles;
- ◆ Maximum flag pole/flag height twenty-five feet (25'); and,
- ◆ Deposit must be paid to the City of Hemet per flag pole, per the City Zoning Ordinance.

Rental Property Flags

The following are rental property flag guidelines for the Page Ranch area's rental property flags, to be used throughout the project site and for the duration of the development of Page Ranch.

- ◆ Flags on rental property (multi-family) limited to six (6) flag poles;
- ◆ One hundred feet (100') required between flag poles;
- ◆ Maximum flag pole/flag height twenty-five feet (25');
- ◆ Flags are limited to be displayed at a rental property to six (6) months, with one (1) six (6) month extension; and,
- ◆ Deposit must be paid to the City of Hemet per flag pole, per the City Zoning Ordinance.



Page Ranch
Planned
Community
Development

Weekend Tract Identification Signs (Temporary)

The following are weekend tract identification signs guidelines for the Page Ranch area's weekend tract identification signs, to be used throughout the project site and for the duration of the development of Page Ranch.

- ◆ Signs may not exceed ten feet (10') in height;
- ◆ Lighting of any type on these signs is not allowed;
- ◆ Signs must be removed by Monday, unless Monday is a federal holiday;
- ◆ Signs maybe double sided; and,
- ◆ Sign permits must be obtained from the City of Hemet, per the City Zoning Ordinance.



E. Landscape Architecture

A major component of Page Ranch is the provision of a carefully planned network of passive and active open space. A large area of the project site has been set aside for the development of parks and open spaces enhancing the livability of the project. This open space is deemed to be a critical element in the future success of Page Ranch as a “livable community”, and the following landscape guidelines are intended to fulfill the commitment made to this end.

General Guidelines

The purpose of the landscape guidelines is to establish landscape standards that will contribute to the thematic development of the Page Ranch community identity. Of vital importance to the development of a coordinated project, image and identity are the project-wide enhancements of streets, entry features, landscape paseos, community center, parks and open spaces. These various landscape design elements are intended to provide a varied and enjoyable experience for vehicular traffic, pedestrians and homeowners within the project.

The development of the project’s landscape identity focuses on the following areas:

- ◆ The incorporation of landscape materials that are naturalized to the project area and accentuate the surrounding character of the project site;
- ◆ The unification of landscape elements and materials in order to provide a coordinated project image;
- ◆ The provision of enhanced entry features, streetscapes and circulation corridors;
- ◆ To provide significant contiguous open space connections, accessible for walking and hiking to the general public.

Project Theme

Page Ranch has been designed to respect the character of the project surroundings by enhancing and restoring the landscape theme of the traditional agricultural and California Ranch Community. The focus of the following landscape details and discussion is to provide direction in establishing the guidelines that ensure that development is sensitively integrated with the surrounding environment, while creating an attractive residential community.

Community Elements

The Landscape Master Plan for the amendment area, Figure 1-7, contains



Page Ranch
Planned
Community
Development

landscape elements that form the basic structure of the project. Individually, the elements identify specific features of the project site. Collectively, the landscape features and elements provide the predominant community signature for Page Ranch.



LEGEND

- ① PRIMARY ENTRY
- ② SECONDARY ENTRY
- ③ PASEO
- * ④ POCKET PARK
- ⑤ COMMUNITY PARK
- ⑥ SINGLE FAMILY HOMES
- ⑦ NOT A PART





Project Entries

Landscaped entry features should be designed to introduce the theme and character of the Page Ranch community, as well as identify the project, its access points, and the different development areas.

◆ Primary Entries

Primary entries occur at the intersection of “Old” Warren Road and New Stetson Avenue. As shown in Figure 1-8, Primary Entry (Typical corner), this entry will consist of a raised lettering signage on a large monument wall generously setback from the street intersection. Large lawn areas, flowering accent trees, specimen size focal point trees, and background planting will compliment ornamental-iron ranch style fencing, low stone veneer walls, and slump block columns with concrete masonry caps.

◆ Secondary Entries

Secondary entrances occur at the intersection of Fisher Street and Mustang Way. As shown in Figure 1-9, Secondary Entry, this entry features a slump stone wall with raised lettering, slump stone columns with concrete masonry caps, and a stone veneer raised planter. The monument is enhanced by a lawn foreground and large accent specimen trees which connect to the adjacent streetscape.

◆ Neighborhood Entries

Neighborhood entries will occur throughout the project in each planning area (as shown in Figures 1-10 and 1-11). A monument sign, consisting of a slump stone wall and columns with stone veneer accents, will be integrated into the community wall at the corner. Shrubs and ground covers shall be planted to enhance the hardscape elements and flowering perennials and annual color maybe utilized by the HOA to provide an intense color display.

Streetscapes

Enhanced streetscapes with expanded setback landscaping are proposed within the Page Ranch Planned community, as illustrated in figures 1-12 to 1-13. To provide variety and to help define the project theme, New Stetson Avenue is designated as a scenic highway. Distinctive trees will be utilized in streetscape plantings. As shown in the streetscape illustrations, it is intended that landscaping will provide an informal appearance when viewed from a passing vehicle. Major elements, such as groupings of trees and shrubs, will be provided in landscape corridor areas adjacent to the roadways. The use of this varied planting pattern will provide an attractive streetscape that can also be enjoyed by pedestrians.



LEGEND

- ① PRIMARY ENTRY MONUMENT SIGN
- ② COMMUNITY WALL
- ③ STREETSCAPE/SETBACK LANDSCAPING
- ④ DROUGHT TOLERANT LANDSCAPING
- ⑤ PARKWAY PLANTING
- ⑥ LARGE FOCAL TREE
- ⑦ STREET TREE
- ⑧ RESIDENTIAL LOT (TYP.)





Secondary Entry
Figure 1-9

LEGEND

- ① SECONDARY ENTRY MONUMENT SIGN
- ② COMMUNITY WALL
- ③ STREETScape/SETBACK LANDSCAPING
- ④ DROUGHT TOLERANT LANDSCAPING
- ⑤ PARKWAY PLANTING
- ⑥ FOCAL TREES
- ⑦ STREET TREE
- ⑧ RESIDENTIAL LOT (TYP.)





Page Ranch
Planned
Community
Development

Neighborhood Entry Statement - Section
Figure 1-10

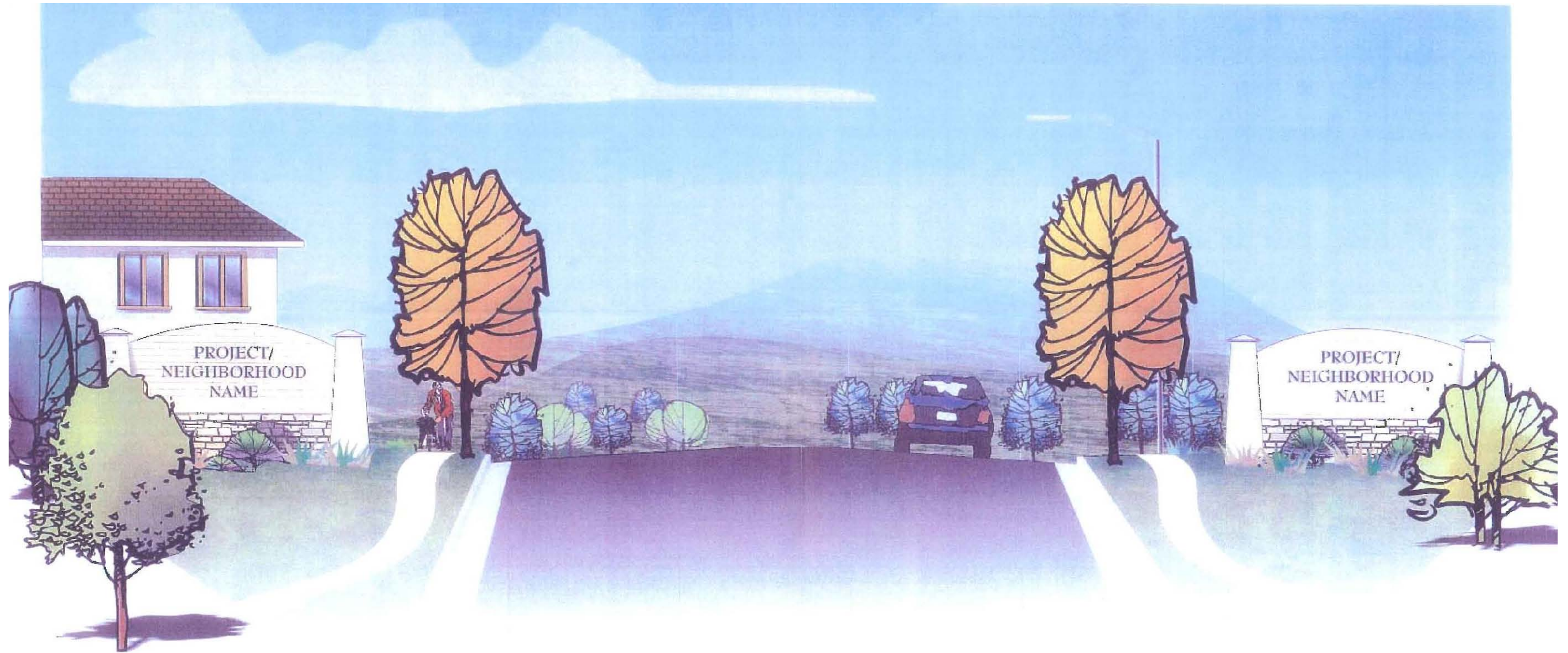



LEGEND

- ① NEIGHBORHOOD ENTRY MONUMENT SIGN
- ② COMMUNITY WALL
- ③ STREETScape / SETBACK LANDSCAPING
- ④ PARKWAY PLANTING
- ⑤ STREET TREE
- ⑥ RESIDENTIAL LOT (TYP.)

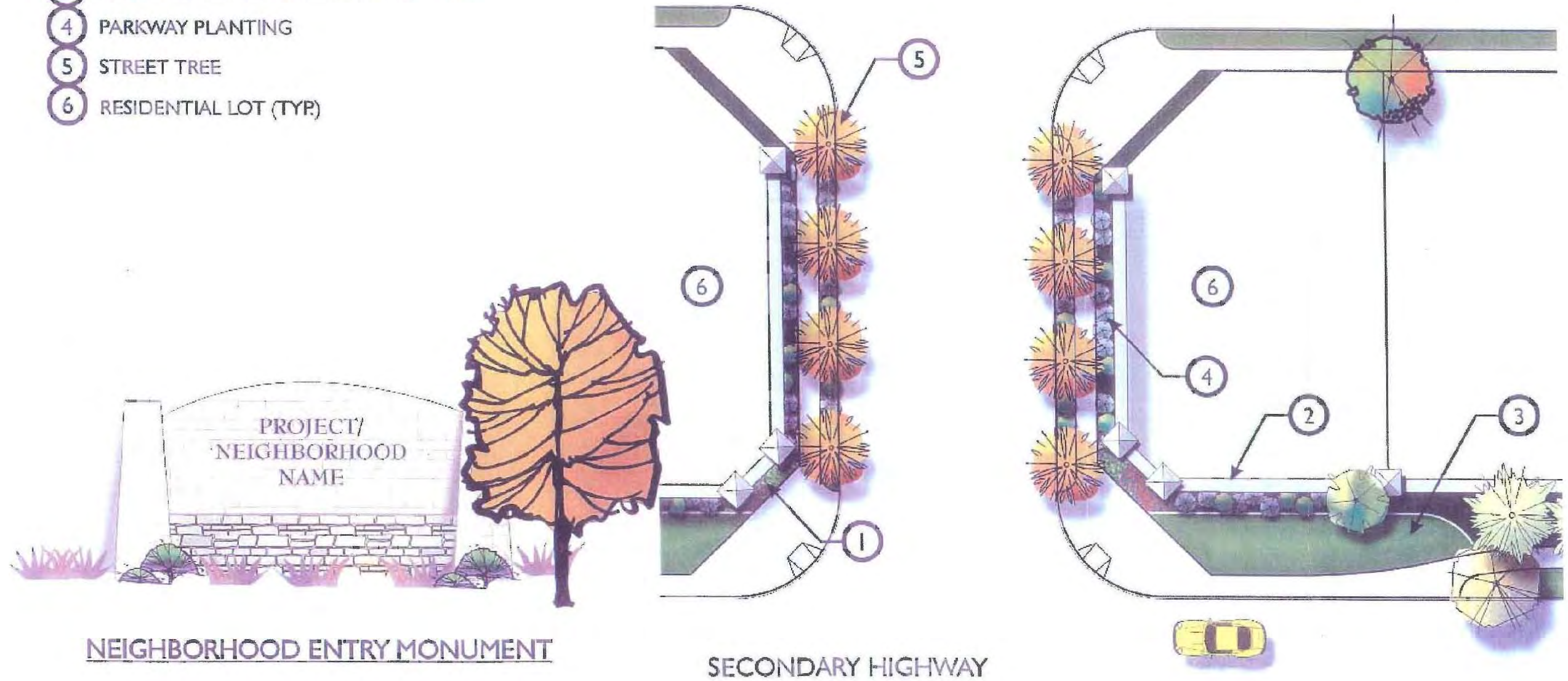



Secondary Highway Streetscape
Figure 1-12

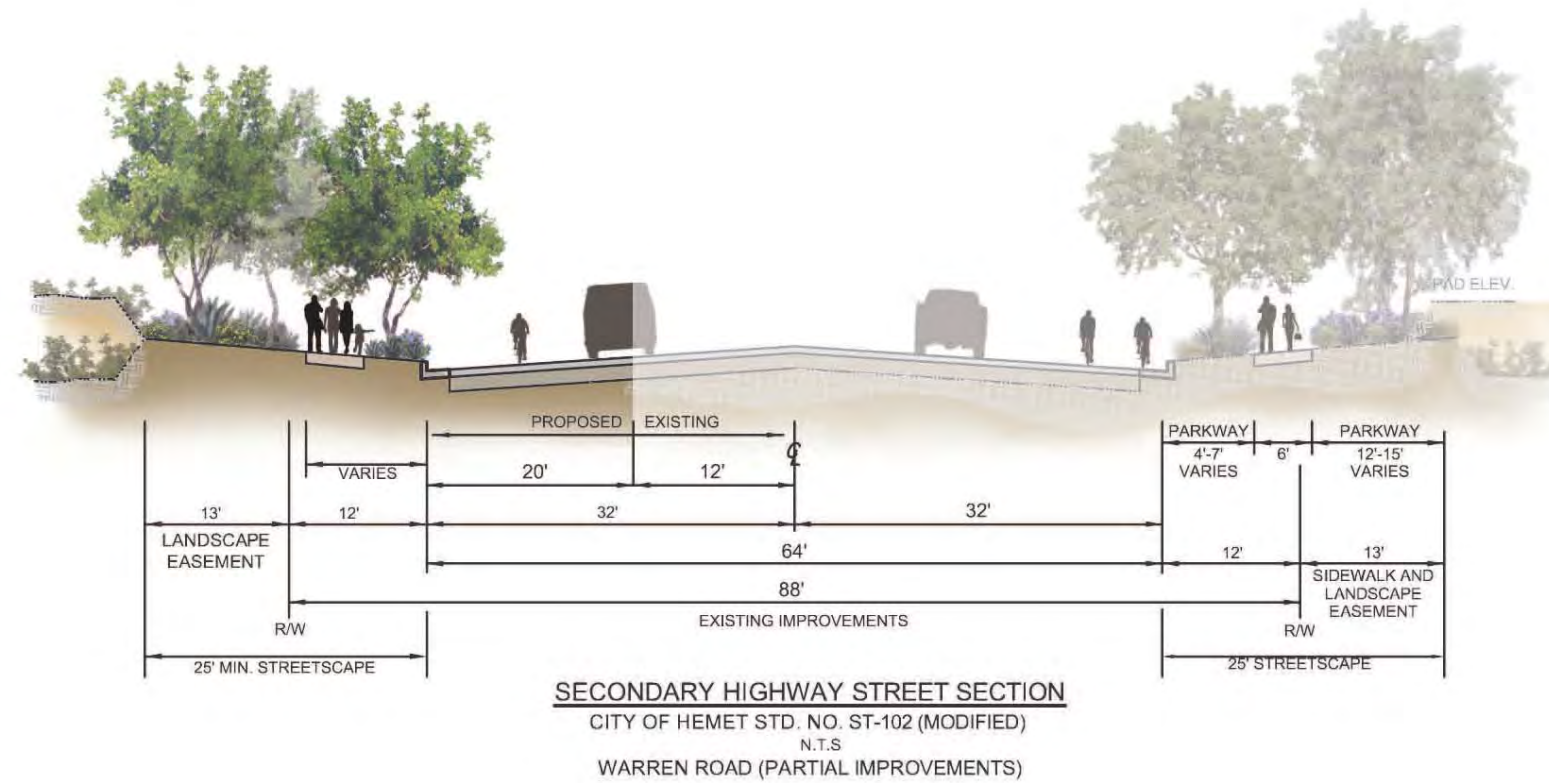
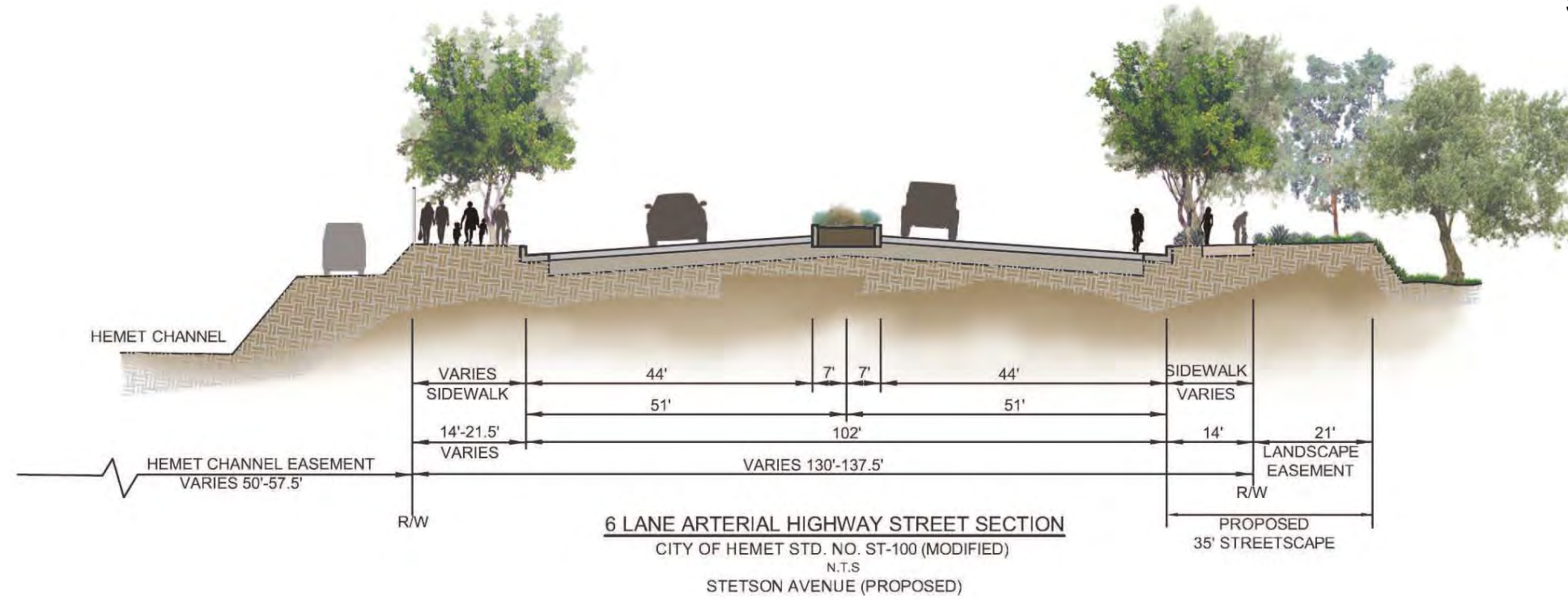



Page Ranch
 Planned
 Community
 Development





Paseos

A major design element for Page Ranch is the provision of paseos (greenbelts) located strategically throughout the project site, as illustrated on Figures 1-14 to 1-18. The intent of the paseos is three fold; to provide a landscape buffer separating the various planning areas into identifiable neighborhoods; to provide a large, passive landscape area in which to develop a system of trails and landscape enhancements; and to provide for project storm drainage.

It is envisioned that these paseos will become one of the dominant, unifying features of Page Ranch. Landscape features of the paseos include the following:

- ◆ The provision of a community trail system linking all the planning areas within Page Ranch.
- ◆ Provision of park/street furniture at strategic locations to include benches, picnic tables and drinking fountains.
- ◆ Open lawn for passive and active play opportunities
- ◆ Enhanced landscaping to provide for the screening of adjacent neighborhoods and an improved pedestrian experience.

Parks

Pocket Parks

Page Ranch will contain several smaller pocket parks located throughout the project. These pocket parks are intended to provide an area for active and passive recreational pursuits. These pocket parks are depicted on the various planning area exhibits, and have been located conveniently for the benefit of the adjoining residential neighborhood. Figures 1-16 and 1-18, Paseo/Pocket Parks, illustrate examples of the park development. The pocket park development will include a tot lot, informal turf and shaded picnic area, and large evergreen and deciduous tree masses and a pedestrian connection to adjacent neighborhoods and paseos.

Neighborhood Park

The proposed Neighborhood Park will provide a recreation and gathering space within the center of the Amendment Area to serve residents as the hub of community activity. The park shall be maintained by Valley-Wide Recreation and Park District and shall contain facilities as prescribed by Valley-Wide. These facilities may include a combination of active and passive use areas, such as a ball field, soccer field, open-air pavilions for picnics, lawn areas for passive activities, play equipment, restrooms, and basketball courts (see Figure 1-19).



Page Ranch
Planned
Community
Development

Paseo Section A-A
Figure 1-14

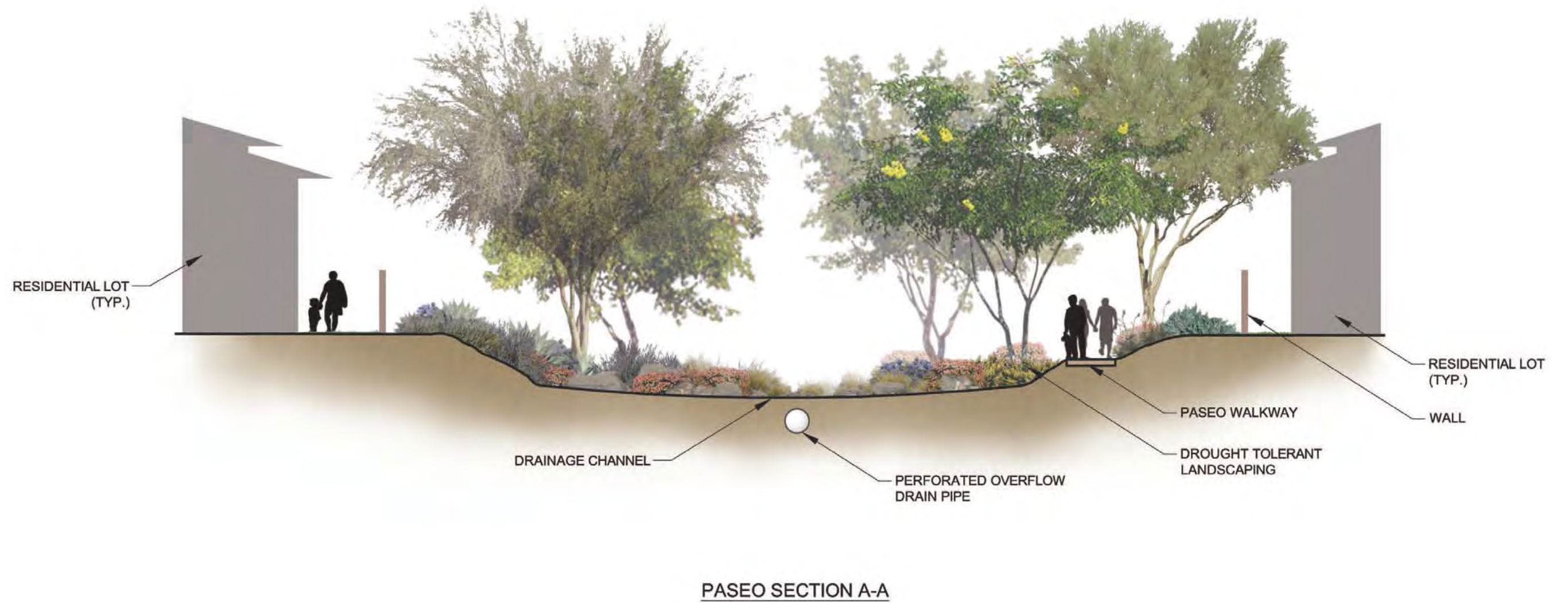



Page Ranch
Planned
Community
Development

Paseo Section B-B
Figure 1-15

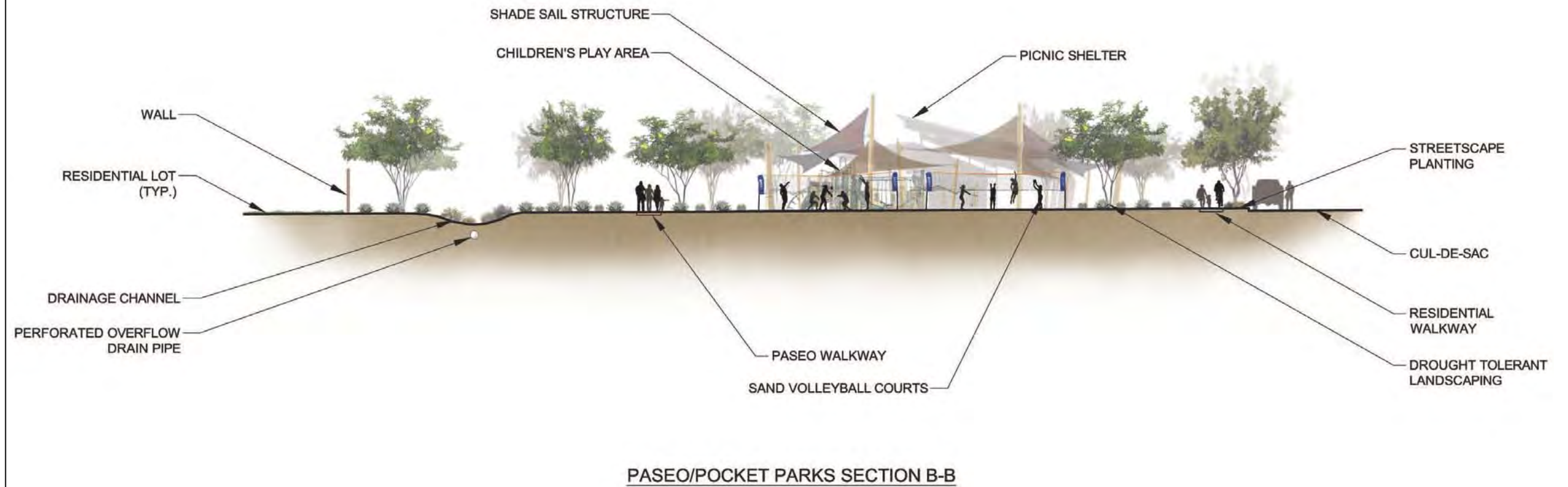

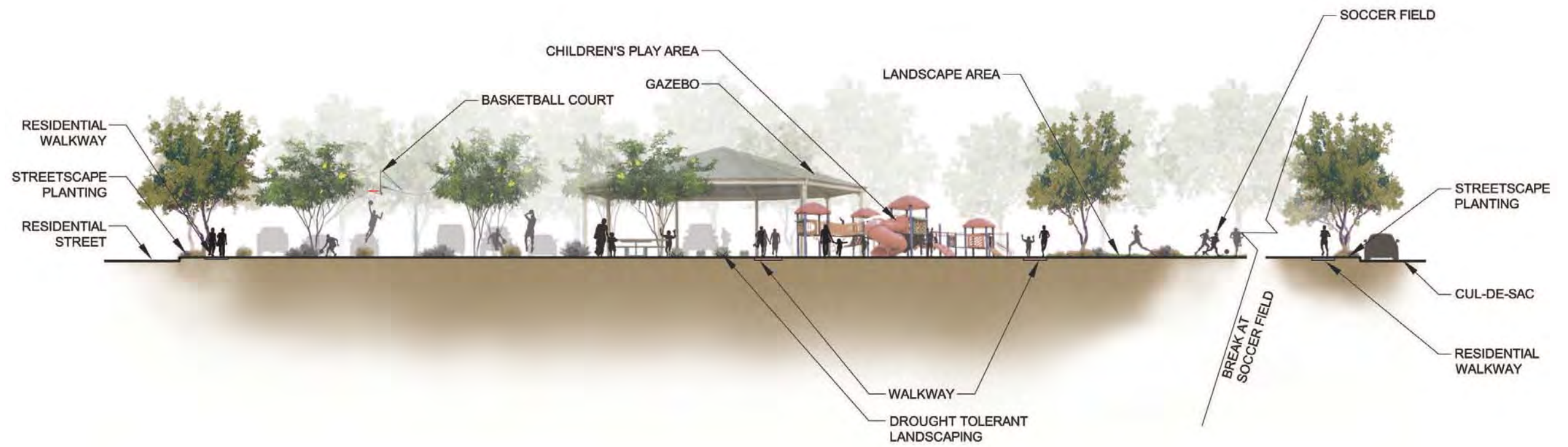

NEIGHBORHOOD PARK SECTION C-C



Page Ranch
Planned
Community
Development

Paseo Typical
Figure 1-17

LEGEND

- ① PASEO WALKWAY
- ② PASEO PLANTING
- ③ BENCH SEATING
- ④ ENHANCED PEDESTRIAN CROSSING
- ⑤ STORMWATER CHANNEL





Page Ranch
Planned
Community
Development

Pocket Park/Paseo Typical
Figure 1-18

NOTE: GRAPHICS DEPICT
ANTICIPATED AMENITIES. FINAL
DESIGN MAY VARY.

LEGEND

- ① CHILDREN'S PLAY AREA
- ② PICNIC SHELTER
- ③ DROUGHT TOLERANT LANDSCAPING
- ④ AQUEDUCT
- ⑤ NEIGHBORHOOD PATH CONNECTION
- ⑥ OPEN TURF/LANDSCAPE AREA
- ⑦ VOLLEYBALL COURTS
- ⑧ RESIDENTIAL LOT (TYP.)
- ⑨ DOG RUN AREA
- ⑩ SHADE SHELTER





Community Walls and Fences

Coordinated varieties of walls and fences have been designed to provide continuity throughout Page Ranch. The locations of the common theme walls and fences are primarily where public views and/or important interfaces of concern occur and the following common wall and fence guidelines will be required:

Community Walls

Theme walls are utilized along the perimeter street system where rear and/or sideyards are adjacent to the public street. Because of the concern for aesthetics and continuity, the theme walls will be required to be developed in conjunction with tract development. The walls will be constructed of decorative masonry with pilasters at corners.

View Fencing

A tubular steel fence with pilasters is utilized along the primary edge treatments adjacent to open space corridors. These areas are generally overlooking the open space corridors throughout the development, creating view opportunities and premium home sites. In some cases a combination wall/view fence may be selected to maintain privacy while allowing for view opportunities.

Interior Property Line Fencing

Guidelines will be contained within the CC&Rs for Page Ranch restricting the type of fencing which is permitted.

Lighting

The level of onsite lighting as well as lighting fixtures shall comply with any applicable requirements and policies of the City of Hemet. Exterior lighting such as streetlights and landscape lighting will be consistent throughout the development area. Energy conservation, safety and security should be emphasized when designing the lighting systems and should include the following considerations:

- ◆ It is recommended that all primary streets be adequately illuminated to provide for the safety and comfort of vehicular and pedestrian movement.
- ◆ Landscape lighting may be utilized for accentuating the landscape and hardscape areas.
- ◆ All lighting shall be designed and located in a manner that is compatible with scenic values and other public interests throughout the community.



Page Ranch
Planned
Community
Development

Neighborhood Park Figure 1-19

NOTE: GRAPHICS DEPICT
ANTICIPATED AMENITIES. FINAL
DESIGN MAY VARY.

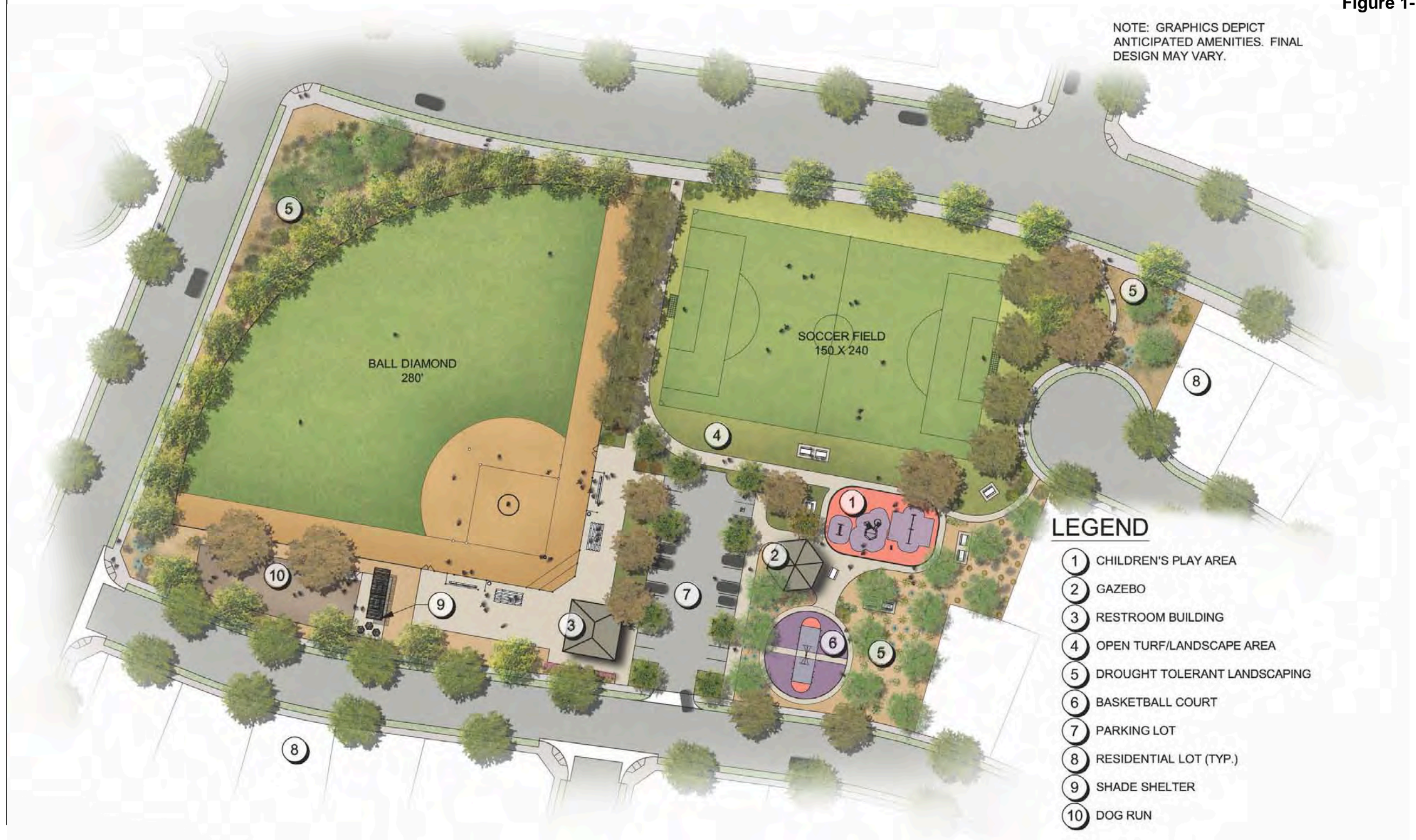

LEGEND

- ① CHILDREN'S PLAY AREA
- ② GAZEBO
- ③ RESTROOM BUILDING
- ④ OPEN TURF/LANDSCAPE AREA
- ⑤ DROUGHT TOLERANT LANDSCAPING
- ⑥ BASKETBALL COURT
- ⑦ PARKING LOT
- ⑧ RESIDENTIAL LOT (TYP.)
- ⑨ SHADE SHELTER
- ⑩ DOG RUN



Landscape Architecture Guidelines and Standards

Introduction

The following guidelines are intended to assist in providing the continuity and desired image that will enhance the Page Ranch community. The continuity will make the project a unique and special community, while respecting individual taste and creative design. The interface between the developed areas and the unique open space paseo network to be created within the project site is of special concern.

Plant Materials

It is the intent of the following plan materials palette to allow flexibility in landscape design within individual homes, while defining an acceptable palette in order to reinforce the thematic identity of Page Ranch. A limited selection of plant materials on the plant lists has been selected for their contribution to the project theme, adaptability to local climatic and soils conditions. Native or naturalized plants with water conserving or drought tolerant characteristics are encouraged.

Table 1-1 lists the various plants that are permitted within Page Ranch.

Planting Time

The project area experiences temperature extremes that can make it difficult for the installation of plant materials during the hot summer months (July-September) and the cold winter months (December-March). Container plants that have not been acclimated to the region may experience heat or frost damage resulting in partial or total loss of foliage even if these materials will be perfectly suited to the temperature extremes once they are established. If construction schedules permit, the ideal planting season is in the spring and/or fall months.

Landscape Installation Requirements

All areas required to be landscaped shall be planted with trees, shrubs, ground cover, vines or turf selected from the plant palette contained in the previous tables. Developers should assess the existing landscape palette on any adjoining development and whenever possible, reinforce and complement the established character and design theme. Detailed landscape plans shall be prepared by a licensed landscape architect for all areas to be landscaped.



Page Ranch
Planned
Community
Development

Plant Palette Table 1-1

BOTANICAL NAME	COMMON NAME
TREES	
<i>Arbutus unedo</i>	Strawberry Tree
<i>Callistemon citrinus</i>	Lemon Bottlebrush
<i>Cassia leptophylla</i>	Gold Medallion Tree
<i>Cassia surattensis</i>	Yellow Cassia
<i>Cercis occidentalis</i>	Western Redbud
<i>Chilopsis linearis</i>	Desert Willow
<i>Chitalpa tashkentensis</i>	Chitalpa
<i>Chorisia speciosa</i>	Floss silk Tree
<i>Cinnamomum Camphora</i>	Camphor Tree
<i>Cupressus sempervirens</i>	Italian Cypress
<i>Dracaena draco</i>	Dragon Tree
<i>Jacaranda mimosifolia</i>	Jacaranda
<i>Koelreuteria paniculata</i>	Golden Rain Tree
<i>Lagerstroemia indica</i>	Grape Myrtle
<i>Lagunaria patersonii</i>	Primrose Tree
<i>Lyonothamnus floribundus</i>	Catalina Ironwood
<i>Lophostemon confertus</i>	Brisbane Box
<i>Metaleuca linariifolia</i>	Flax Leaf Paper Bark
<i>Olea europaea 'Swan Hill'</i>	Fruitless Olive
<i>Parkinsonia spp.</i>	Palo Verde
<i>Pinus spp.</i>	Pine
<i>Pittosporum phylloaeoides</i>	Willow Pittosporum
<i>Podocarpus spp.</i>	Fern Pine
<i>Prosopis spp.</i>	Mesquite
<i>Prunus ilicifolia</i>	Catalina Cherry
<i>Quercus spp.</i>	Oak
<i>Rhus lancea</i>	African Sumac
<i>Sambucus mexicana</i>	Mexican Elderberry
<i>Schinus molle</i>	California Pepper Tree

BOTANICAL NAME	COMMON NAME
PALMS	
<i>Beaucarnea recurvata</i>	Bottle Palm
<i>Brahea edulis</i>	Guadalupe Palm
<i>Butia capitata</i>	Pindo Palm
<i>Chamaerops humilis</i>	Mediterranean Fan Palm
<i>Phoenix canariensis</i>	Canary Island Palm
<i>Phoenix dactylifera</i>	Date Palm
<i>Syagrus romanzoffianum</i>	Queen Palm
<i>Washingtonia filifera</i>	California Fan Palm

BOTANICAL NAME	COMMON NAME
SHRUBS	
<i>Aeonium spp.</i>	Aeonium
<i>Agave spp.</i>	Agave



Page Ranch
Planned
Community
Development

Plant Palette (Continued) Table 1-1

SHRUBS (continued)	COMMON NAME
<i>Aloe spp.</i>	Aloe
<i>Aloysia triphylla</i>	Lemon Verbena
<i>Alyogyne huegelii</i>	Blue Hibiscus
<i>Anigozanthos spp.</i>	Kangaroo Paw
<i>Archtoostaphylos spp.</i>	Manzanita
<i>Baccharis hybrid 'Starn'</i>	Thompson Baccharis
<i>Baccharis pilularis</i>	Coyote Brush
<i>Baccharis sarothroides</i>	Desert Broom
<i>Berberis thunbergii</i>	Japanese Barberry
<i>Bougainvillea spp.</i>	Bougainvillea
<i>Buddleia merrubiifolia</i>	Woolly Butterfly Bush
<i>Caesalpinia spp.</i>	Bird of Paradise
<i>Calliandra californica</i>	California Fairy Duster
<i>Ceanothus spp.</i>	California Wild Lilac
<i>Cistus spp.</i>	Rockrose
<i>Convolvulus mauritanicus</i>	Ground Morning Glory
<i>Cordyline spp.</i>	Cordyline
<i>Correa spp.</i>	Australian Fuchsia
<i>Cotoneaster parneryi</i>	Parney Cotoneaster
<i>Dalea bicolor</i>	Dalea
<i>Dasyliirion spp.</i>	Desert Spoon
<i>Deschampsia caespitosa</i>	Tufted Hair Grass
<i>Dianella caerulea</i>	Cassa Blue
<i>Dietes bicolor</i>	Fortnight Lily
<i>Dudleya lanceolata</i>	Live Forever
<i>Echeveria elegans</i>	Hens and Chicks
<i>Echinocactus grusonii</i>	Golden Barrel Cactus
<i>Elaeagnus pungens</i>	Silverberry
<i>Elymus magellanicus</i>	Magellan Wheatgrass
<i>Euoryops pectinatus</i>	Shrub Daisy
<i>Euphorbia spp.</i>	Euphorbia
<i>Ferocactus</i>	Barrel Cactus
<i>Galvezia speciosa</i>	Island Bush Snapdragon
<i>Grevillea 'Noelii'</i>	Noel's Grevillea
<i>Helictotrichon sempervirens</i>	Blue Oat Grass
<i>Hesperaloe parvifolia</i>	Red Yucca
<i>Heteromeles arbutifolia</i>	Toyon
<i>Ilex vomitoria</i>	Yaupon
<i>Kalanchoe thyrsiflora</i>	Paddle Plant
<i>Kniphofia spp.</i>	Red Hot Poker
<i>Lantana spp.</i>	Lantana
<i>Lavandula spp.</i>	Lavender
<i>Leonotis leonurus</i>	Lion's Tail
<i>Leptospermum laevigatum</i>	Australian Tea Tree
<i>Leucophyllum spp.</i>	Texas Sage



Page Ranch
Planned
Community
Development

Plant Palette (Continued) Table 1-1

SHRUBS (continued)	COMMON NAME
<i>Melaleuca nesophila</i>	Pink Melaleuca
<i>Muhlenbergia rigens</i>	Deer Grass
<i>Nolina spp.</i>	Grass Tree Nolina
<i>Pachyocereus marginatus</i>	Mexican Fence
<i>Prunus ilicifolia</i>	Hollyleaf Cherry
<i>Rhamnus californica</i>	Coffee Berry
<i>Rhaphiolepis indica</i>	India Hawthorn
<i>Rhus integrifolia</i>	Lemonade Berry
<i>Rhus laurina</i>	Laurel Sumac
<i>Ribes spp.</i>	Currant
<i>Rosa spp.</i>	Rose
<i>Rosmarinus spp.</i>	Rosemary
<i>Ruellia californica</i>	Sonoran Desert Ruellia
<i>Salvia spp.</i>	Sage
<i>Santolina spp.</i>	Cotton
<i>Senna spp.</i>	Cassia
<i>Solanum xanthii</i>	Purple Nightshade
<i>Tagetes lemmonii</i>	Mountain Marigold
<i>Trichostema lanatum</i>	Wooly Blue Curls
<i>Westringia fruticosa</i>	Coast Rosemary
<i>Yucca spp.</i>	Yucca
GROUNDCOVERS	COMMON NAME
<i>Acacia redolens</i> 'Desert Carpet'	Trailing Acacia
<i>Arctostaphylos</i> 'Emerald Carpet'	Emerald Carpet Manzanita
<i>Baccharis</i> 'Centennial'	Centennial Baccharis
<i>Baccharis pilularis</i> 'Pigeon Point'	Dwarf Coyote Brush
<i>Carex spp.</i>	Sedge
<i>Drosanthemum floribundum</i>	Rosea Ice Plant
<i>Dymondia margaritae</i>	Dymondia
<i>Gazania spp.</i>	Gazania
<i>Lonicera japonica</i> 'Halliana'	Hall's Japanese Honeysuckle
<i>Myoporum parvifolium</i>	Myoporum
<i>Osteospermum fruticosum</i>	Trailing African Daisy
<i>Rosmarinus officinalis</i> 'Prostratus'	Prostrate Rosemary
<i>Sedum spp.</i>	Stone Crop
<i>Senecio Mandraliscae</i>	Blue Chalk Sticks
<i>Verberna spp.</i>	Verberna
VINES	COMMON NAME
<i>Antigonon leptopus</i>	Queens Wreath
<i>Bougainvillea spp.</i>	Bougainvillea
<i>Distictis buccinatoria</i>	Blood Red Trumpet Vine
<i>Lonicera japonica</i>	Japanese Honeysuckle
<i>Macfadyena unguis-cati</i>	Cat's Claw Vine



Page Ranch
Planned
Community
Development

Plant Palette (Continued) Table 1-1

VINES (continued)	COMMON NAME
<i>Polygonum aubertii</i>	Silver Lace Vine
<i>Vitis californica</i>	California Wild Grape
<i>Vitis girdiana</i>	Desert Grape
BIO-RETENTION	COMMON NAME
<i>Carex spp.</i>	Sedge
<i>Chondropetalum tectorum</i>	Small Cape Rush
<i>Dietes iridioides</i>	Fortnight Lily
<i>Festuca rubra</i>	Rush
<i>Hemerocallis spp.</i>	Daylily
<i>Juncus spp.</i>	Red Fescue
<i>Muhlenbergia rigens</i>	Deer Grass



The following landscape installation requirements shall be followed:

- ◆ The plant materials for Page Ranch have been chosen for their ability to thrive within the project site's climate and location. The plants should grow to their full potential with a minimum amount of maintenance and replacement costs. Precipitation, temperature, and wind are the limiting climatic factors affecting plant choice.
- ◆ Average annual rainfall in the area varies from nine to thirteen inches (9 – 13"). Extreme temperatures range from eighteen degrees (18°) in the winter to one hundred-ten degrees (110°) in the summer. The average daily temperature range is forty to sixty-five degrees (40-65°) in the winter and fifty-eight to ninety degrees (58-90°) in the summer.
- ◆ A horticultural soils report shall be prepared to determine appropriate planting and maintenance requirements for planned community materials. This soils report shall be prepared by a qualified agricultural laboratory supervised by a member of the American Soils Testing Laboratory.
- ◆ All areas to be landscaped shall require the installation of a permanent automatic irrigation system to ensure proper plant growth. The irrigation system shall be designed to separate the various landscape areas into proper irrigation zones depending upon water needs. Detailed irrigation plans shall be prepared by a Licensed Landscape Architect. The following guidelines are provided:
 - ◆ The irrigation system shall be designed and operated to prevent or minimize run-off and discharge of irrigation water onto roadways, driveways, trails or adjacent properties.
 - ◆ The irrigation system shall be monitored so that the precipitation rate does not exceed the moisture demands of the plant materials within the landscaped area. Drip irrigation and low volume irrigation shall be installed, wherever appropriate.
 - ◆ Areas of separate maintenance responsibility shall be controlled by separate controllers.
 - ◆ To minimize negative visual impacts and nuisance damage, automatic valves shall be installed in protective valve boxes, and the pop-up variety of sprinkler head should be used where practical.

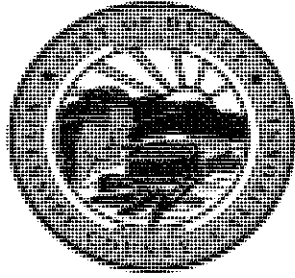

**CITY OF HEMET
PUBLIC WORKS DEPARTMENT**

STANDARD DRAWINGS

CITY OF HEMET PUBLIC WORKS DEPARTMENT

STANDARD DRAWINGS

TABLE OF CONTENTS

STANDARD No.	STANDARD STREET SECTIONS
ST-100	ARTERIAL HIGHWAY - 134'
ST-100A	ARTERIAL HIGHWAY - 110'
ST-101	MAJOR HIGHWAY - 100'
ST-101A	MAJOR HIGHWAY - 100' ALTERNATE
ST-102	SECONDARY HIGHWAY - 88'
ST-102A	SECONDARY HIGHWAY - 88'
ST-102B	SECONDARY HIGHWAY - 88'
ST-103	LOCAL STREET - 66'
ST-103A	LOCAL STREET - 66'
ST-104	GENERAL LOCAL STREET - 60'
ST-105	FRONTAGE ROAD - 52'
ST-106	RESTRICTED LOCAL STREET - 56'
ST-107	PART WIDTH RIGHT-OF-WAY - 66'
ST-108	TYPICAL STREET SECTION
ST-109	PRELIMINARY GENERAL NOTES
ST-109A	PRELIMINARY GENERAL NOTES
ST-110	TRENCH REPAIR
ST-110A	TRENCH REPAIR - LONGITUDINAL CUTS
ST-110B	TRENCH REPAIR - TRANSVERSE CUTS
ST-110C	TRENCH REPAIR AT INTERSECTIONS
ST-111	ESTATE STREET REQUIREMENTS

Text in **ITALICS** indicates 2011 revisions.

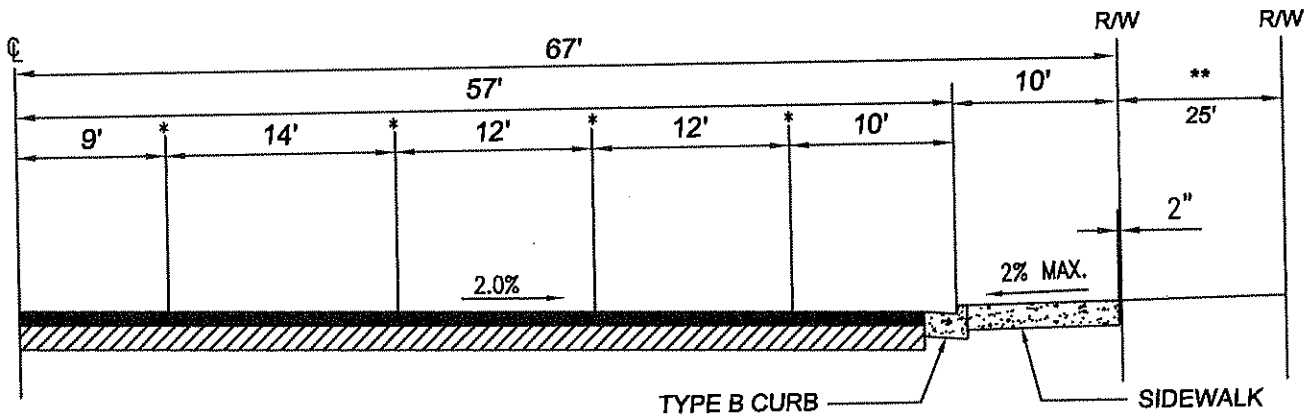

SECTIONS
SYMMETRICAL
ABOUT C

TYPICAL SECTION

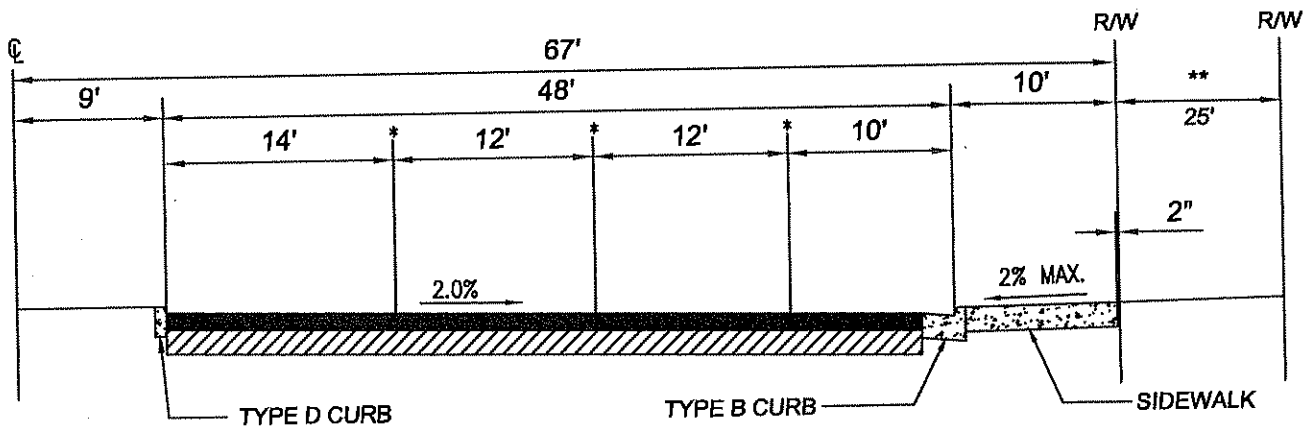

ALTERNATE SECTION

NOTES:

1. Construct 8" type "B" curb and gutter, Std. No. C-201.
2. Construct 4" thick P.C.C. sidewalk, Std. No. C-215.
3. The top 12" of native material shall be compacted to a minimum of 95% relative compaction per ASTM D-1557-70T.
4. Compaction per latest edition of the Standard Specifications for Public Works Construction.
5. Edge of paving to be 3/8" higher than lip of gutter.
6. Half street and ends of streets not terminating in cul-de-sac, must have 2"x 4" redwood headers placed at the edge of pavement, with 2"x 4"x 16" stakes on 6' C.C.
7. Center median to be either painted median or type "D" curb, Std. No. C-203, as determined by City Engineer.
8. Design speed shall be 55 m.p.h.
9. Thickness of improvement to be determined by the City Engineer.

* Longitudinal joint for finish course A. C.

** Additional right of way may be required when an arterial highway coincides with an adopted route for an additional public facility (i.e., pedestrian, bicycle, or equestrian trail), or for a scenic highway.



City of Hemet
PUBLIC WORKS DEPARTMENT
ENGINEERING DIVISION
510 E. FLORIDA AVENUE
HEMET, CA 92543
(951) 765-2360

**ALTERNATE STREET SECTION
ARTERIAL HIGHWAY**

134'

	MAR 2009
MICHAEL A. GOW, PW DIRECTOR/CITY ENG. R.C.E. 54164	DATE
REVISIONS	
N:\PW\4100\COH_STDS\REVISIONS\STREETS\ST-100.dwg	
N.Beltran 2009	

1
OF 2 SHEETS

STANDARD NO.
ST-100

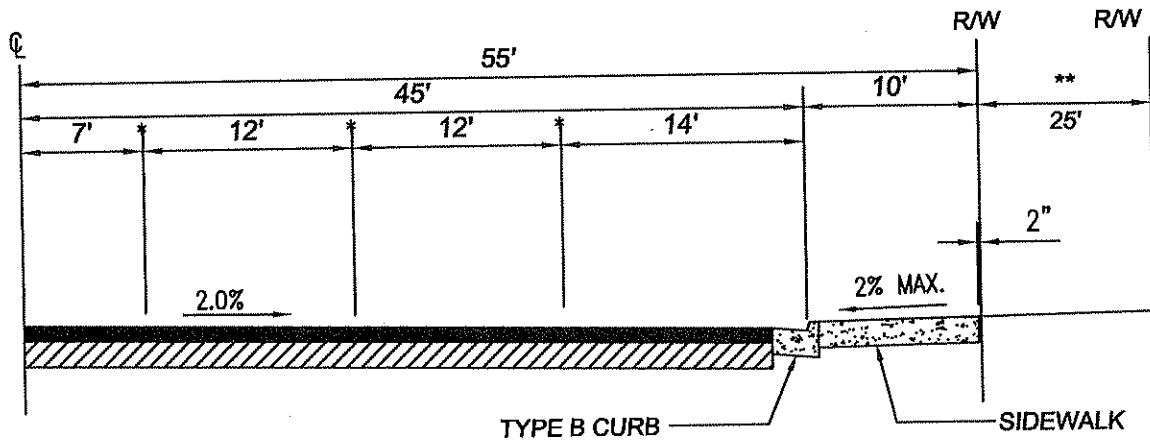

SECTIONS
SYMMETRICAL
ABOUT C

TYPICAL SECTION

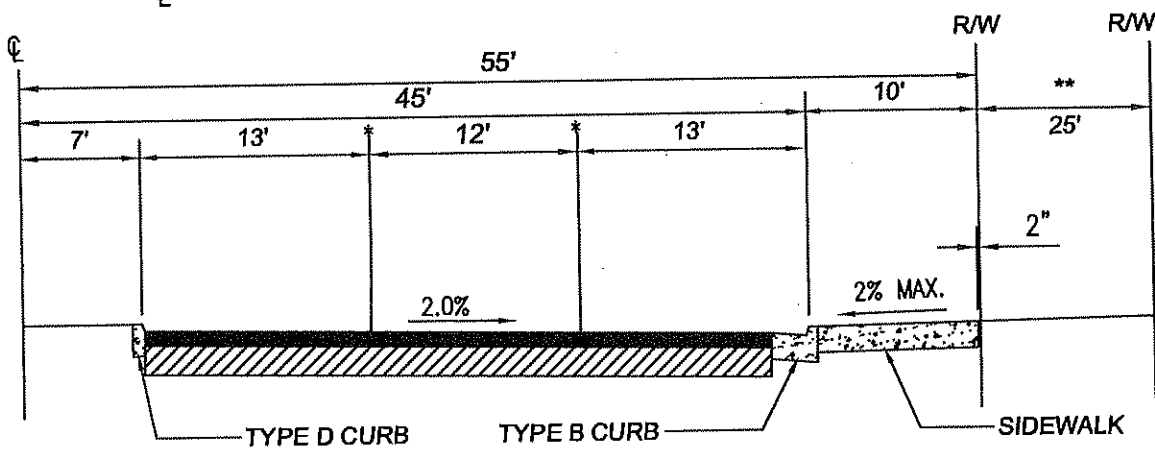

ALTERNATE SECTION

NOTES:

1. Construct 8" type "B" curb and gutter, Std. No. C-201.
2. Construct 4" thick P.C.C. sidewalk, Std. No. C-215.
3. The top 12" of native material shall be compacted to a minimum of 95% relative compaction per ASTM D-1557-70T.
4. Compaction per latest edition of the Standard Specifications for Public Works Construction.
5. Edge of paving to be 3/8" higher than lip of gutter.
6. Half street and ends of streets not terminating in cul-de-sac, must have 2"x 4" redwood headers placed at the edge of pavement, with 2"x 4"x 16" stakes on 6' C.C.
7. Center median to be either painted median or type "D" curb, Std. No. C-203, as determined by City Engineer.
8. Design speed shall be 55 m.p.h.
9. Thickness of improvement to be determined by the City Engineer.

* Longitudinal joint for finish course A. C.

** Additional right of way may be required when an arterial highway coincides with an adopted route for an additional public facility (i.e., pedestrian, bicycle, or equestrian trail), or for a scenic highway.

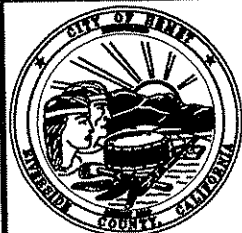

City of Hemet
PUBLIC WORKS DEPARTMENT
ENGINEERING DIVISION
510 E. FLORIDA AVENUE
HEMET, CA 92543
(951) 765-2360

**ALTERNATE STREET SECTION
ARTERIAL HIGHWAY**

110'

	MAR 2009
MICHAEL A. GOW, PW DIRECTOR/CITY ENG. R.C.E. 54164	DATE
REVISIONS	
N:\PWW4100\COH-STDS\REVISIONS\STREETS\ST-100A.dwg	
N.Beltran 2009	

2
OF 2 SHEETS
STANDARD NO.
ST-100A

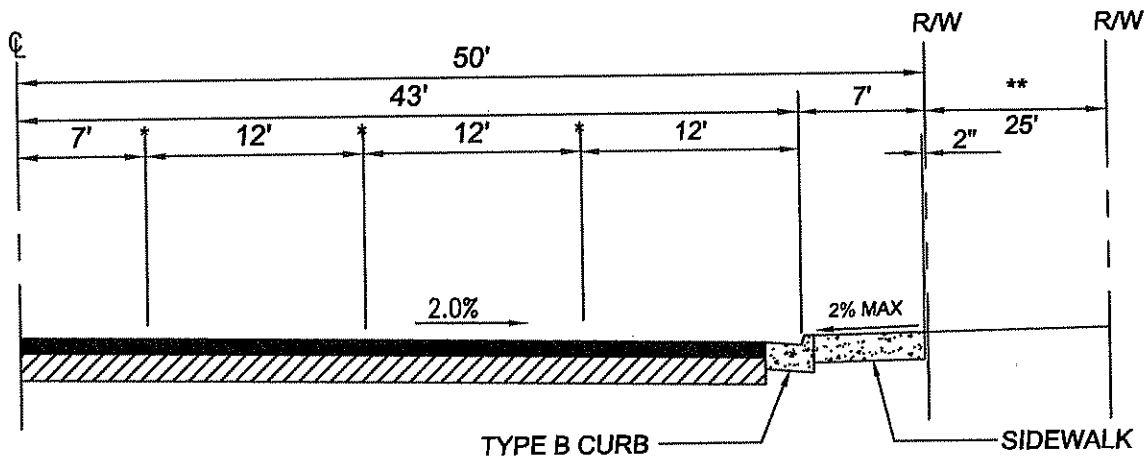

SECTIONS
SYMMETRICAL
ABOUT C

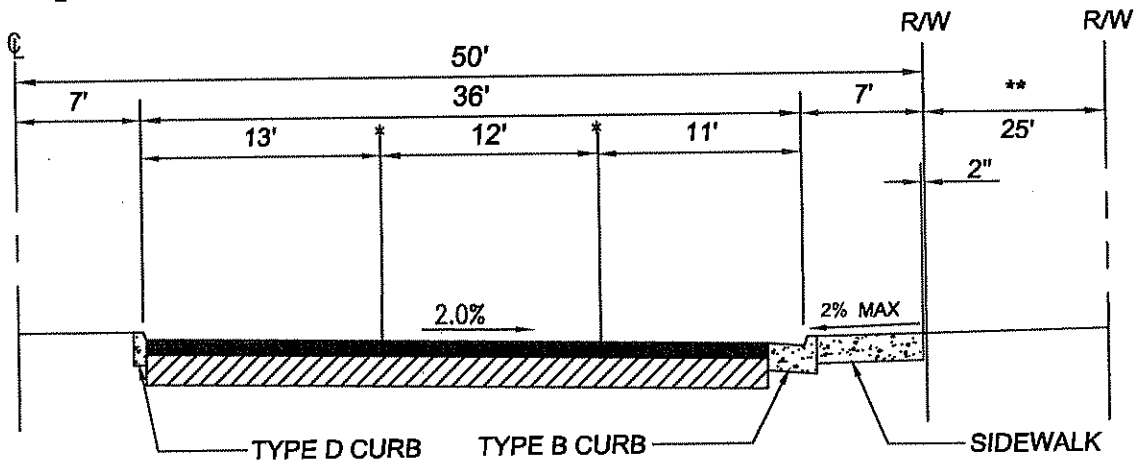

ALTERNATE SECTION

NOTES:

1. Construct 8" type "B" curb and gutter, Std. No. C-201.
2. Construct 4" thick P.C.C. sidewalk, Std. No. C-215.
3. The top 12" of native material shall be compacted to a minimum of 95% relative compaction per ASTM D-1557-70T.
4. Compaction per latest edition of the Standard Specifications for Public Works Construction.
5. Edge of paving to be 3/8" higher than lip of gutter.
6. Half street and ends of streets not terminating in cul-de-sac, must have 2"x 4" redwood headers placed at the edge of pavement, with 2"x 4"x 16" stakes on 6' C.C.
7. Center median to be either painted median or type "D" curb, Std. No. C-203, as determined by City Engineer.
8. Design speed shall be 55 m.p.h., or as determined by City Engineer.
9. Thickness of improvement to be determined by the City Engineer.

* Longitudinal joint for finish course A. C.

** Additional right of way may be required when an arterial highway coincides with an adopted route for an additional public facility (i.e., pedestrian, bicycle, or equestrian trail), or for a scenic highway.

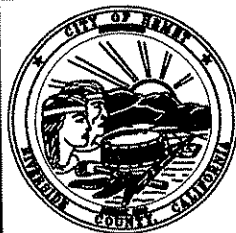

City of Hemet
PUBLIC WORKS DEPARTMENT
ENGINEERING DIVISION
510 E. FLORIDA AVENUE
HEMET, CA 92543
(951) 765-2360

**ALTERNATE STREET SECTION
MAJOR HIGHWAY**

100'

<i>M. A. Gow</i>	MAR 2009
MICHAEL A. GOW, PW DIRECTOR/CITY ENG. R.C.E. 54164	DATE
REVISIONS	
N:\PW4100\COH_STDS\REVISIONS\STREETS\ST-101A.dwg	
N.Beltran 2009	

2
OF 2 SHEETS

**STANDARD NO.
ST-101A**

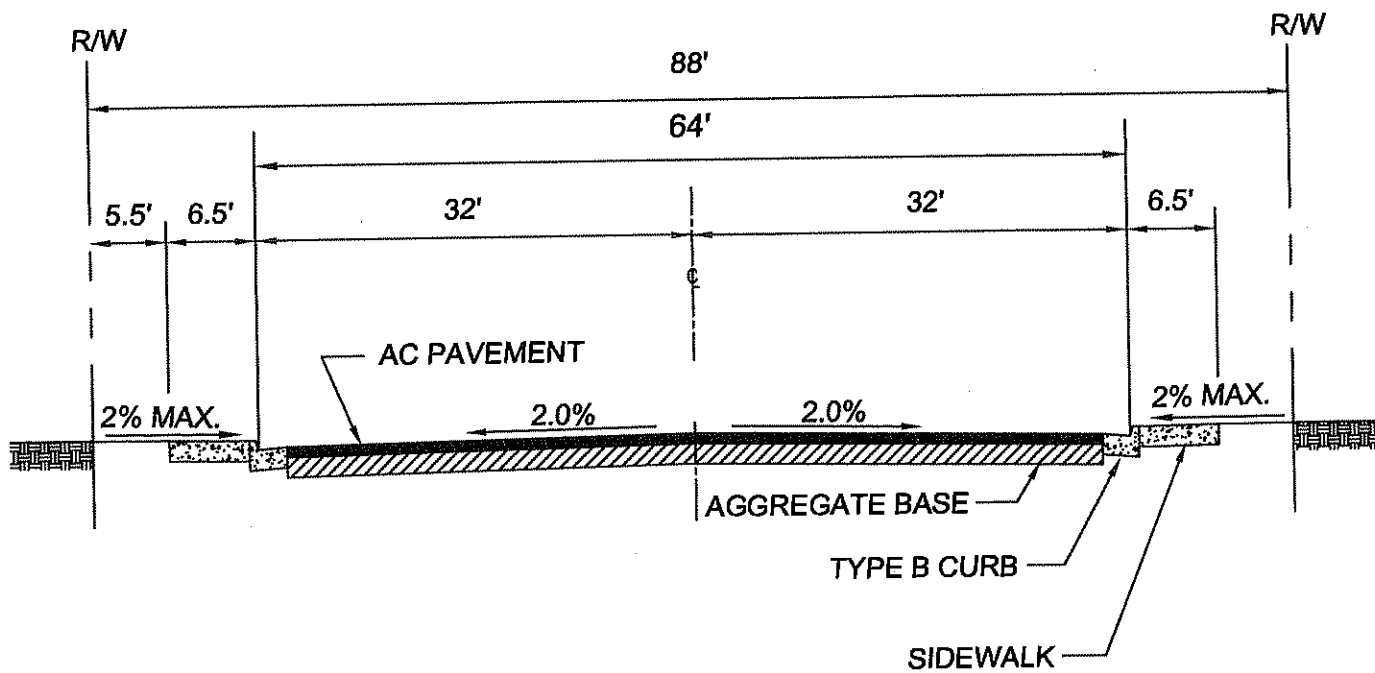

NOTES:

1. Construct 8" type "B" curb and gutter, Std. No. C-201.
2. Construct 4" thick P.C.C. sidewalk.
3. Construct Minimum 3" A.C. over 6" A.B. with SC-250 prime coat, final section to be determined by soils tests.
4. The top 12" pf native material shall be compacted to a minimum of 95% relative compaction per ASTM D-1557-70T.
5. Compaction per latest edition of the Standard Specifications for Public Works Construction.
6. Edge of paving to be 3/8" higher than lip of gutter.
7. Half street and ends of streets not terminating in cul-de-sac, must have 2"x 4" redwood headers placed at the edge of pavement, with 2"x 4"x 16" stakes on 6' C.C.



City of Hemet
PUBLIC WORKS DEPARTMENT
ENGINEERING DIVISION
 510 E. FLORIDA AVENUE
 HEMET, CA 92543
 (951) 765-2360

**TYPICAL STREET SECTION
 SECONDARY HIGHWAY**

88'

	MAR 2009
MICHAEL A. GOW, PW DIRECTOR/CITY ENG. R.C.E. 54164	DATE
REVISIONS	
N:\PWW4100\COH_STDS\REVISIONS\STREETS\ST-102.dwg	
N.Beltran 2009	

1
 OF 3 SHEETS
**STANDARD NO.
 ST-102**

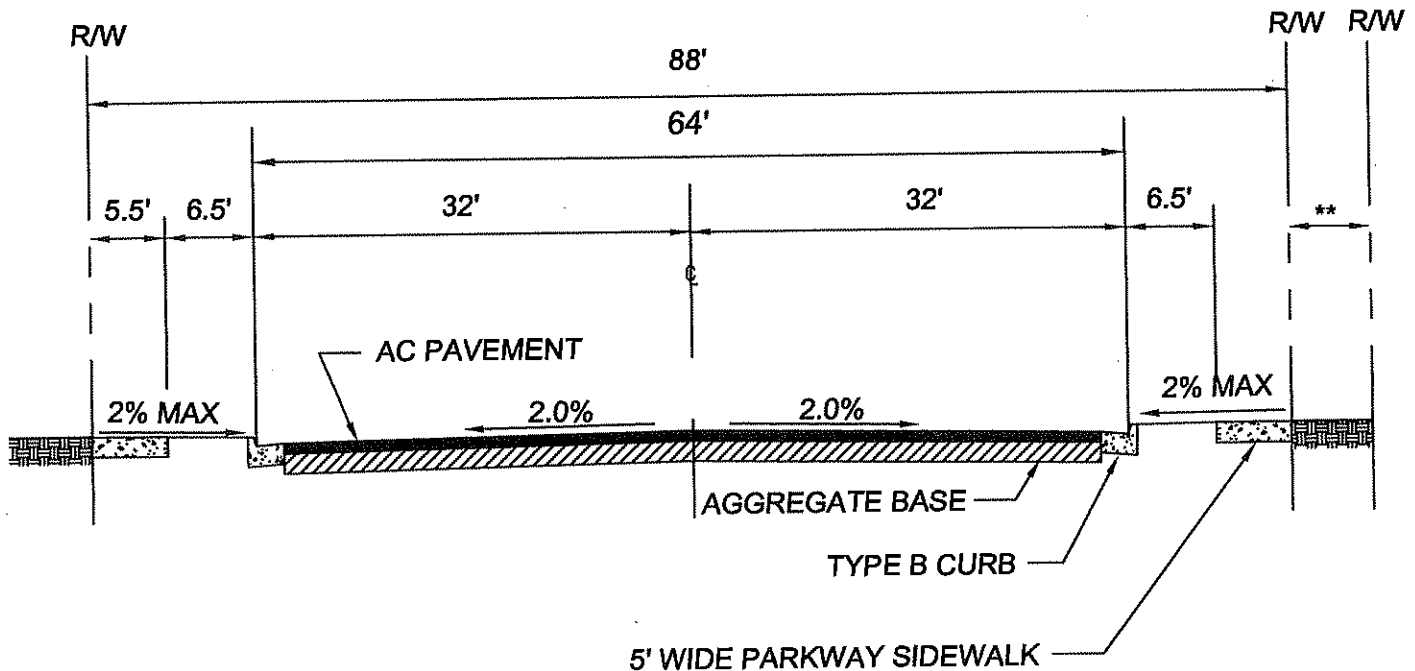

NOTES:

1. Construct 8" type "B" curb and gutter, Std. No. C-201.
2. Construct 4" thick P.C.C. sidewalk.
3. Construct Minimum 3" A.C. over 6" A.B. with SC-250 prime coat, final section to be determined by soils tests.
4. The top 12" pf native material shall be compacted to a minimum of 95% relative compaction per ASTM D-1557-70T.
5. Compaction per latest edition of the Standard Specifications for Public Works Construction.
6. Edge of paving to be 3/8" higher than lip of gutter.
7. Half street and ends of streets not terminating in cul-de-sac, must have 2"x 4" redwood headers placed at the edge of pavement, with 2"x 4"x 16" stakes on 6' C.C.

** Additional right of way may be required when an arterial highway coincides with an adopted route for an additional public facility (i.e., pedestrian, bicycle, or equestrian trail), or for a scenic highway.



City of Hemet
PUBLIC WORKS DEPARTMENT
ENGINEERING DIVISION
 510 E. FLORIDA AVENUE
 HEMET, CA 92543
 (951) 765-2360

**TYPICAL STREET SECTION
 SECONDARY HIGHWAY**

88'

<i>Michael A. Gow</i>	MAR 2009
MICHAEL A. GOW, PW DIRECTOR/CITY ENG. R.C.E. 54164	DATE
REVISIONS	
N:\A\PW\4100\COH_STDS\REVISIONS\STREETS\ST-102A.dwg	
N.Bellran 2009	

2

OF **3** SHEETS

**STANDARD NO.
 ST-102A**

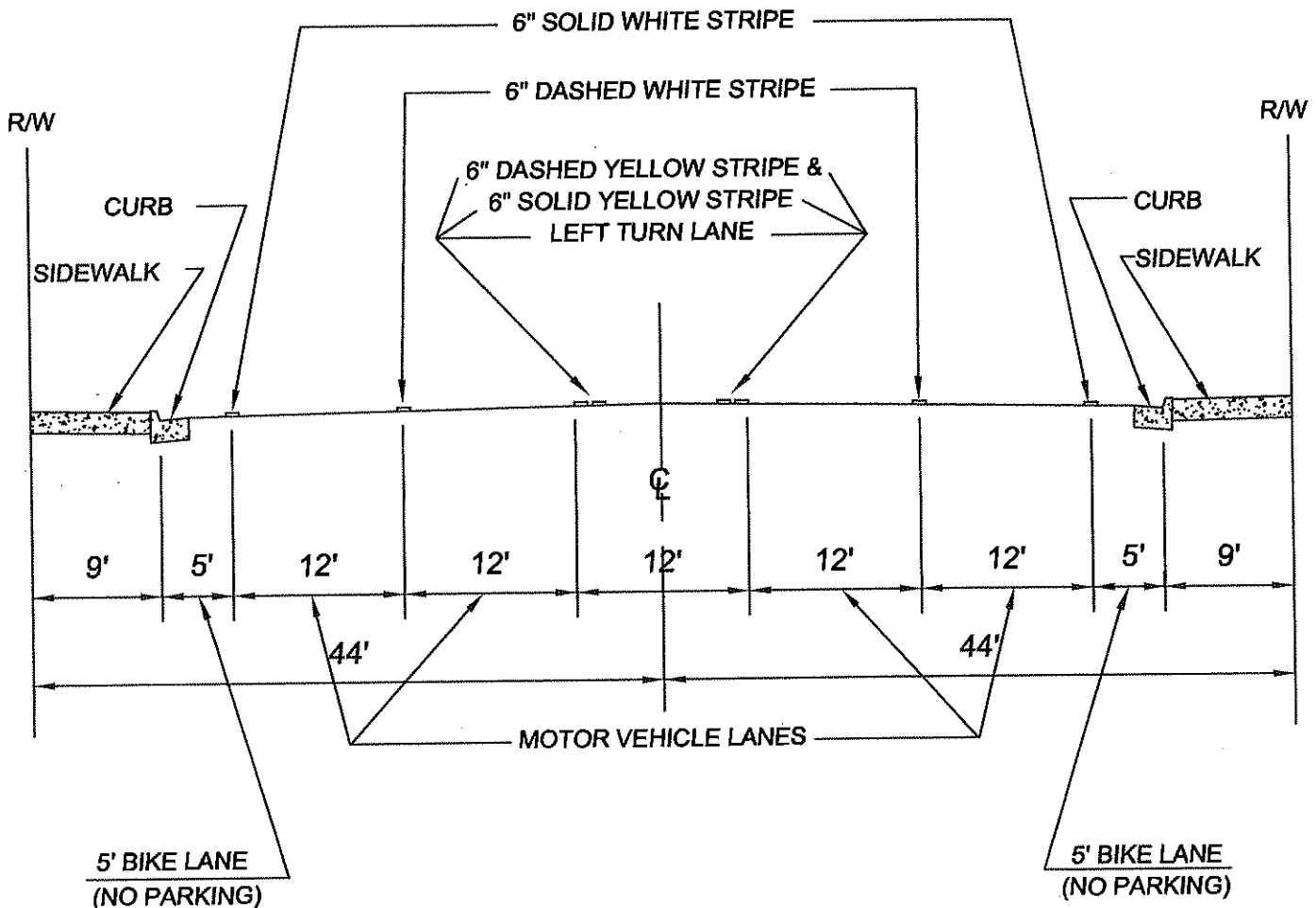

TYPE II BIKE LANE

NOTES:

1. Construct 8" type "B" curb and gutter, Std. No. C-201.
2. Construct 4" thick P.C.C. sidewalk.
3. Construct Minimum 3" A.C. over 6" A.B. with SC-250 prime coat, final section to be determined by soils tests.
4. The top 12" pf native material shall be compacted to a minimum of 95% relative compaction per ASTM D-1557-70T.
5. Compaction per latest edition of the Standard Specifications for Public Works Construction.
6. Edge of paving to be 3/8" higher than lip of gutter.
7. Half street and ends of streets not terminating in cul-de-sac, must have 2"x 4" redwood headers placed at the edge of pavement, with 2"x 4"x 16" stakes on 6' C.C.

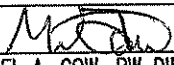

City of Hemet
PUBLIC WORKS DEPARTMENT
ENGINEERING DIVISION
 510 E. FLORIDA AVENUE
 HEMET, CA 92543
 (951) 765-2360

TYPICAL STREET SECTION SECONDARY HIGHWAY		88'
 MICHAEL A. GOW, PW DIRECTOR/CITY ENG. R.C.E. 54164		MAR 2009 DATE
REVISIONS		
N:\PW4100\COH_STDS\REVISIONS\STREETS\ST-102B.dwg		N.Beltran 2009
		3 OF 3 SHEETS
		STANDARD NO. ST-102B

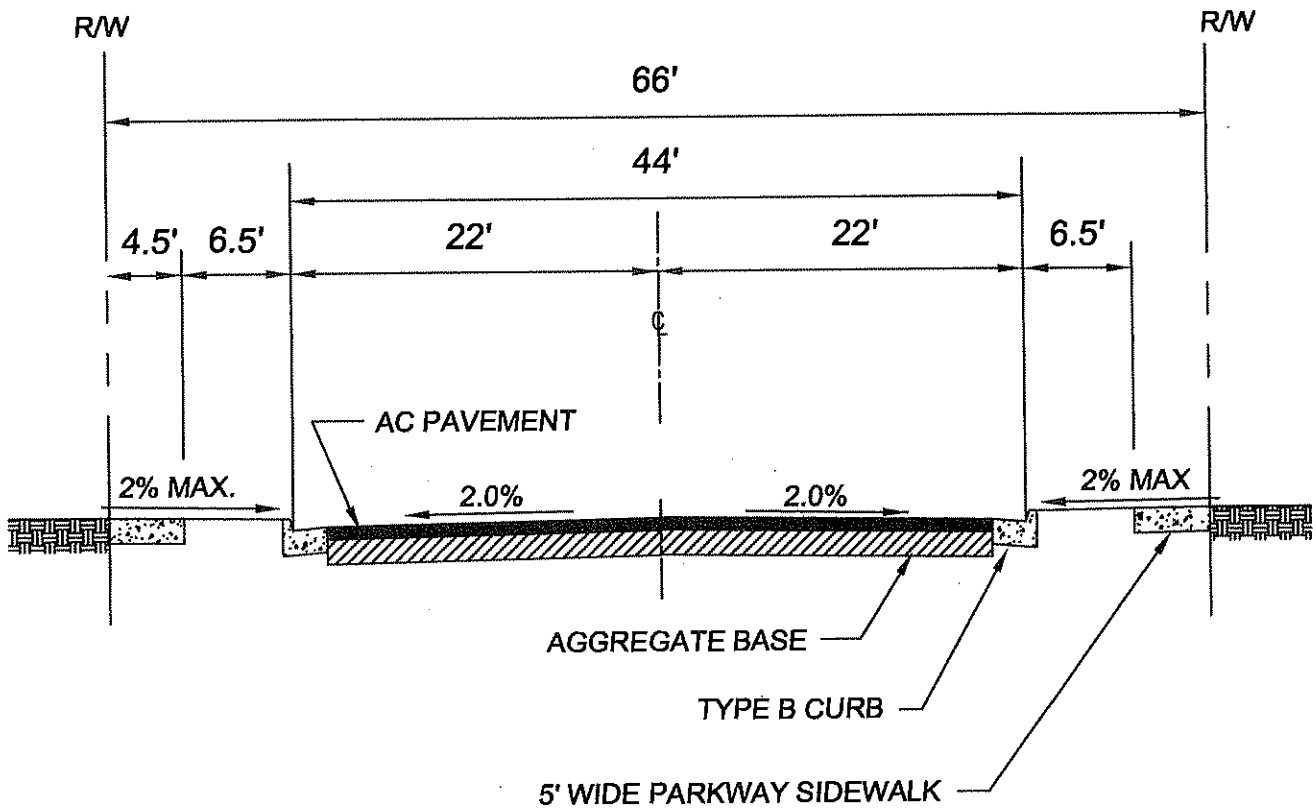

NOTES:

1. Construct 6" type "A" or 8" type "B" curb and gutter Std. No. C-200 or C-201, as determined by City Engineer.
2. Construct 4" thick P.C.C. sidewalk.
3. Construct Minimum 3" A.C. over 6" A.B. with SC-250 prime coat, final section to be determined by soils tests.
4. The top 12" pf native material shall be compacted to a minimum of 95% relative compaction per ASTM D-1557-70T.
5. Compaction per latest edition of the Standard Specifications for Public Works Construction.
6. Edge of paving to be 3/8" higher than lip of gutter.
7. Half street and ends of streets not terminating in cul-de-sac, must have 2"x 4" redwood headers placed at the edge of pavement, with 2"x 4"x 16" stakes on 6' C.C.

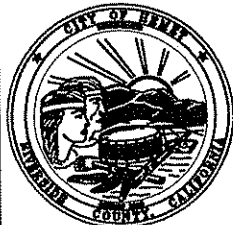

City of Hemet
PUBLIC WORKS DEPARTMENT
ENGINEERING DIVISION
 510 E. FLORIDA AVENUE
 HEMET, CA 92543
 (951) 785-2360

**TYPICAL STREET SECTION
 LOCAL STREET**

66'

<i>Michael A. Gow</i>	MAR 2009
MICHAEL A. GOW, PW DIRECTOR/CITY ENG. R.C.E. 54164	DATE
REVISIONS	
N:\A\PW4100\COH_STDS\REVISIONS\STREETS\ST-103.dwg	
N.Beltran 2009	

1
 OF 2 SHEETS

**STANDARD NO.
 ST-103**

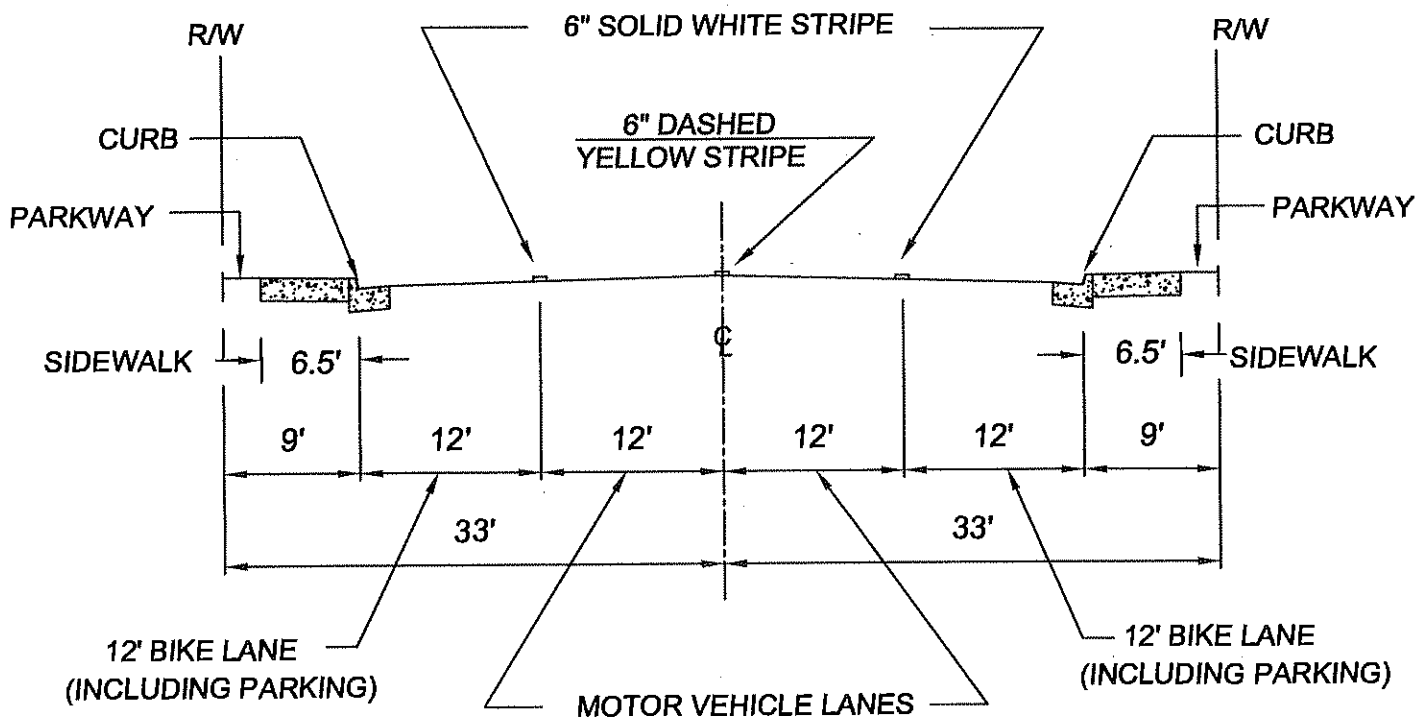

TYPE II BIKE LANE

NOTES:

1. Construct 6" type "A" or 8" type "B" curb and gutter, Std. No. C-200 or C-201, as determined by City Engineer.
2. Construct 4" thick P.C.C. sidewalk.
3. Construct Minimum 3" A.C. over 6" A.B. with SC-250 prime coat, final section to be determined by soils tests.
4. The top 12" of native material shall be compacted to a minimum of 95% relative compaction per ASTM D-1557-70T.
5. Compaction per latest edition of the Standard Specifications for Public Works Construction.
6. Edge of paving to be 3/8" higher than lip of gutter.
7. Half street and ends of streets not terminating in cul-de-sac, must have 2"x 4" redwood headers placed at the edge of pavement, with 2"x 4"x 16" stakes on 6' C.C.

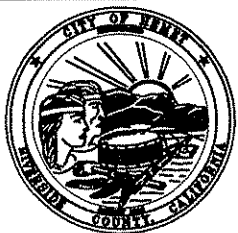

City of Hemet
PUBLIC WORKS DEPARTMENT
ENGINEERING DIVISION
 510 E. FLORIDA AVENUE
 HEMET, CA 92543
 (951) 765-2360

**TYPICAL STREET SECTION
 LOCAL STREET**

66'

	MAR 2009
MICHAEL A. GOW, PW DIRECTOR/CITY ENG. R.C.E. 54164	DATE
REVISIONS	
N:\PW\4100\COH_STDS\REVISIONS\STREETS\ST-103A.dwg	
N.Beltran 2009	

2

OF 2 SHEETS

**STANDARD NO.
 ST-103A**

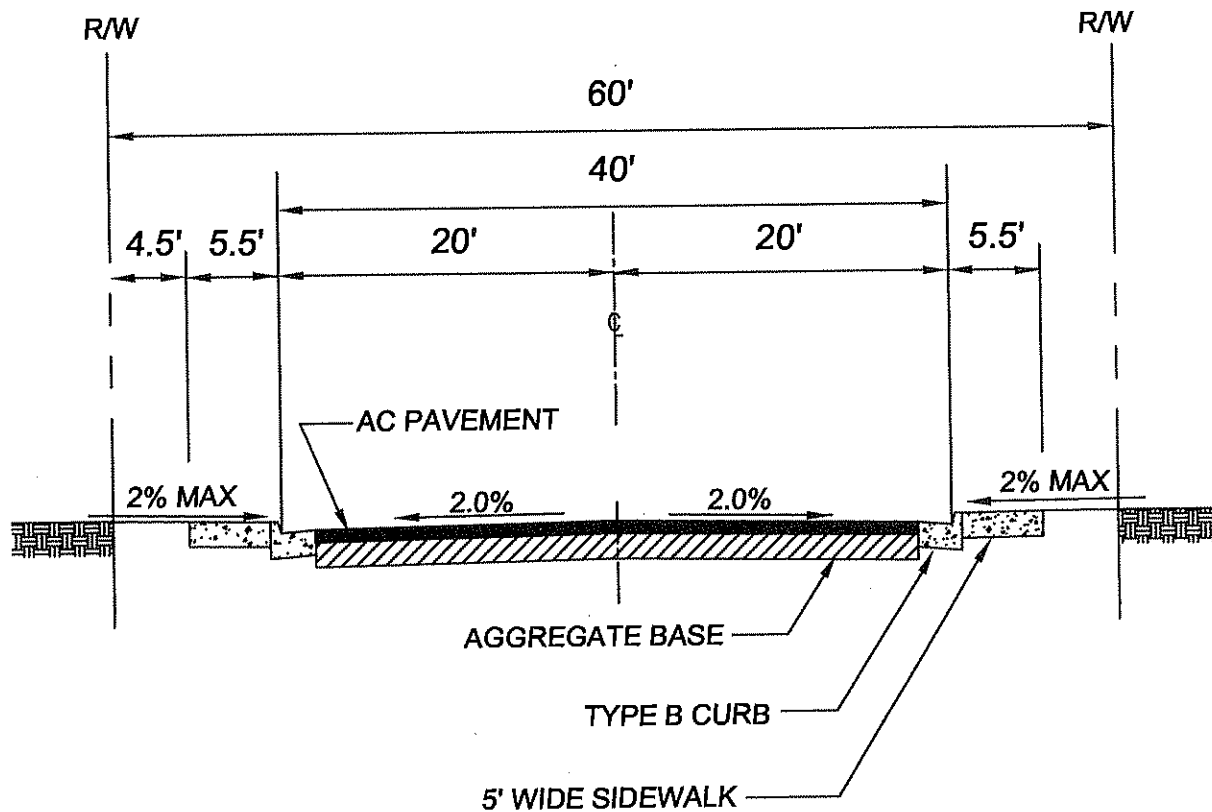

NOTES:

1. Construct 6" type "A" or 8" type "B" curb and gutter, Std. No. C-200 or C-201, as determined by City Engineer.
2. Construct 4" thick P.C.C. sidewalk.
3. Construct Minimum 3" A.C. over 6" A.B. with SC-250 prime coat, final section to be determined by soils tests.
4. The top 12" pf native material shall be compacted to a minimum of 95% relative compaction per ASTM D-1557-70T.
5. Compaction per latest edition of the Standard Specifications for Public Works Construction.
6. Edge of paving to be 3/8" higher than lip of gutter.
7. Half street and ends of streets not terminating in cul-de-sac, must have 2"x 4" redwood headers placed at the edge of pavement, with 2"x 4"x 16" stakes on 6' C.C.



City of Hemet
PUBLIC WORKS DEPARTMENT
ENGINEERING DIVISION
 510 E. FLORIDA AVENUE
 HEMET, CA 92543
 (951) 765-2360

**TYPICAL STREET SECTION
 GENERAL LOCAL STREET**

60'

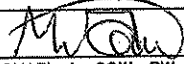
	MAR 2009
MICHAEL A. GOW, PW DIRECTOR/CITY ENG. R.C.E. 54164	DATE
REVISIONS	
N:\PW\4100\COH_STDS\REVISIONS\STREETS\ST-104.dwg	
N.Beltran 2009	

1
 OF **1** SHEETS

**STANDARD NO.
 ST-104**

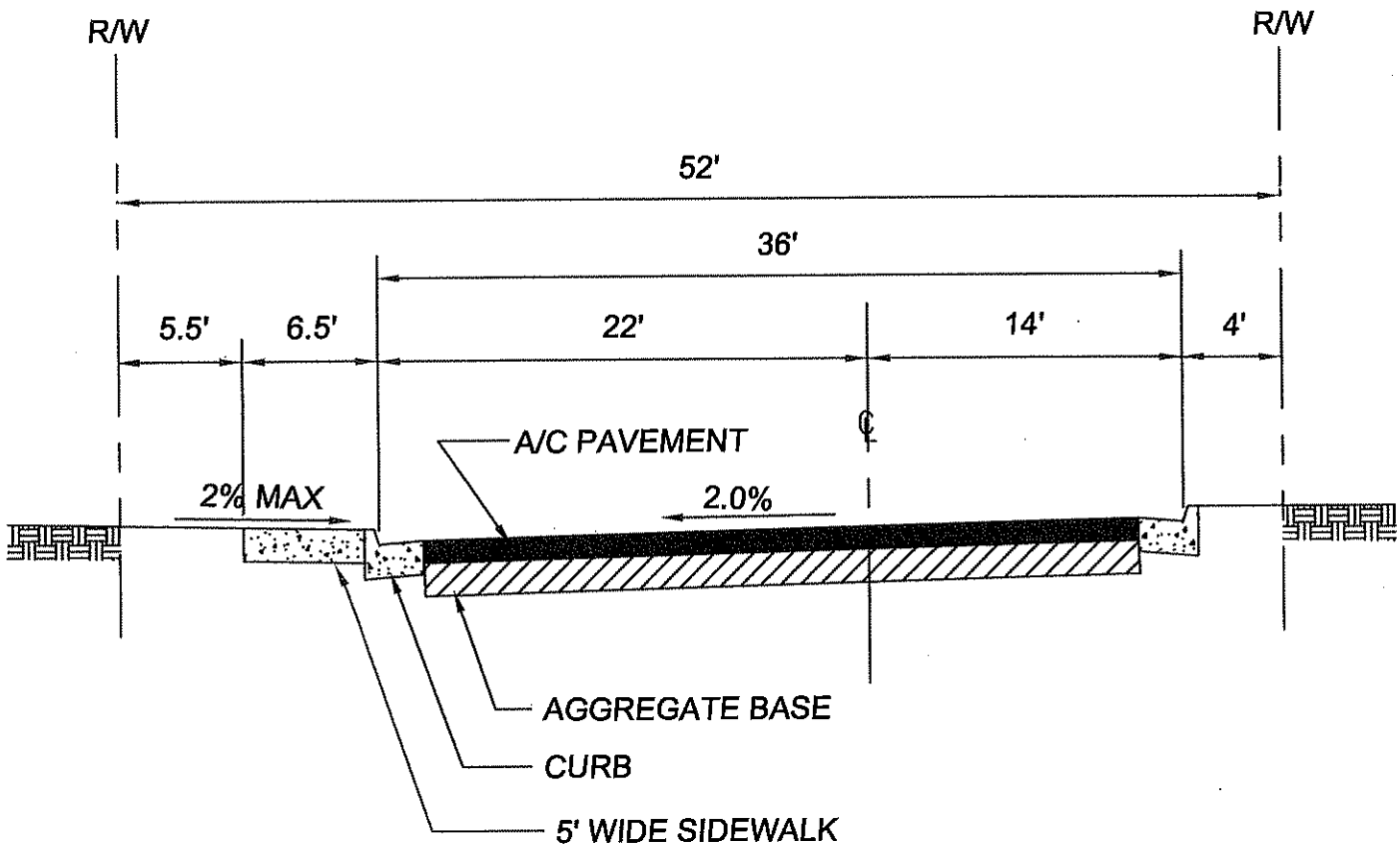

NOTES:

1. Construct 8" type "B" or 8" type "D" curb and gutter, Std. No. C-201 or C-203, as determined by City Engineer.
2. Construct 4" thick P.C.C. sidewalk.
3. Construct Minimum 3" A.C. over 6" A.B. with SC-250 prime coat, final section to be determined by soils tests.
4. The top 12" pf native material shall be compacted to a minimum of 95% relative compaction per ASTM D-1557-70T.
5. Compaction per latest edition of the Standard Specifications for Public Works Construction.
6. Edge of paving to be 3/8" higher than lip of gutter.
7. Half street and ends of streets not terminating in cul-de-sac, must have 2"x 4" redwood headers placed at the edge of pavement, with 2"x 4"x 16" stakes on 6' C.C.

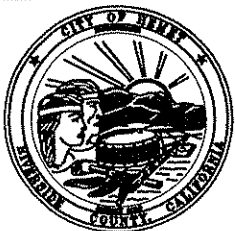

City of Hemet
PUBLIC WORKS DEPARTMENT
ENGINEERING DIVISION
 510 E. FLORIDA AVENUE
 HEMET, CA 92543
 (951) 765-2360

**TYPICAL STREET SECTION
 FRONTAGE ROAD**

52'

	MAR 2009
MICHAEL A. GOW, PW DIRECTOR/CITY ENG. R.C.E. 54164	DATE
REVISIONS	
N:\PW4100\COH_STDS\REVISIONS\STREETS\ST-105.dwg	
N.Beltran 2009	

1
 OF 1 SHEETS

**STANDARD NO.
 ST-105**

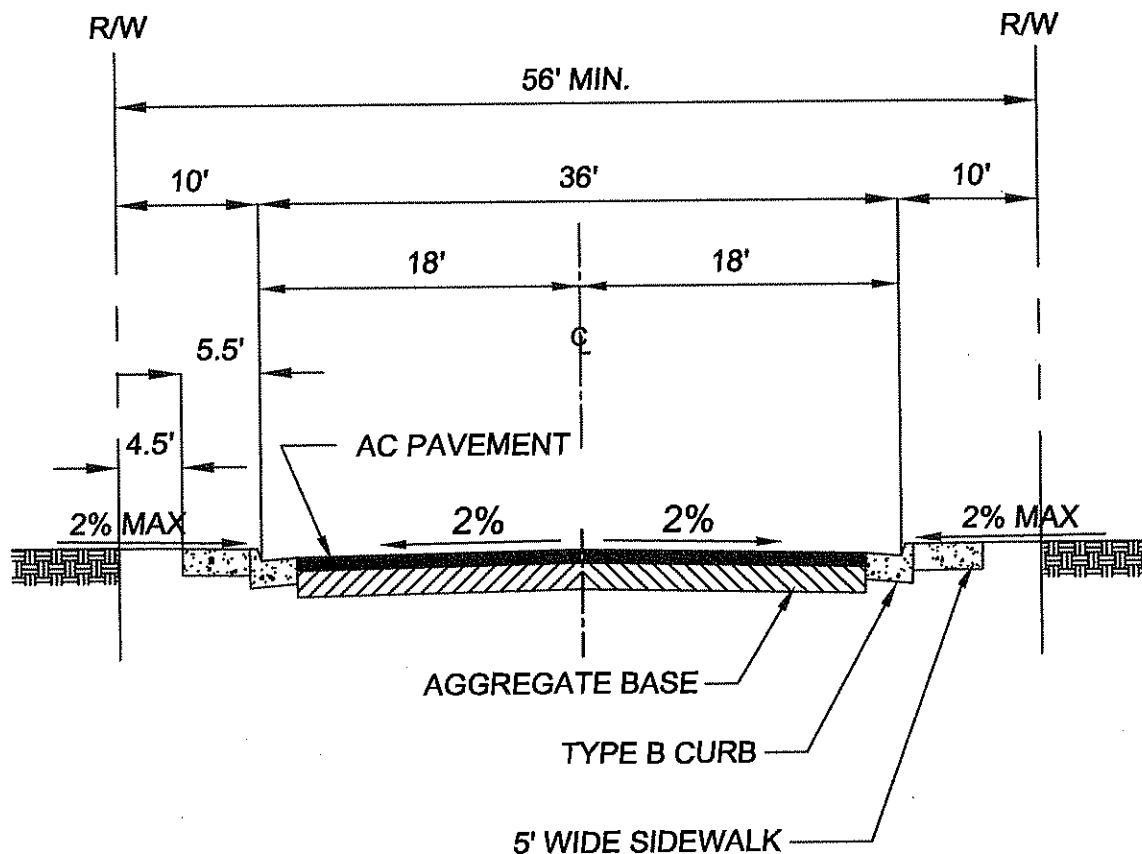

NOTES:

1. Construct 6" type "A" or 8" type "B" curb and gutter, Std. No. C-200 or C-201, as determined by City Engineer.
2. Construct 4" thick P.C.C. sidewalk.
3. Construct Minimum 3" A.C. over 6" A.B. with SC-250 prime coat, final section to be determined by soils tests.
4. The top 12" pf native material shall be compacted to a minimum of 95% relative compaction per ASTM D-1557-70T.
5. Compaction per latest edition of the Standard Specifications for Public Works Construction.
6. Edge of paving to be 3/8" higher than lip of gutter.
7. Half street and ends of streets not terminating in cul-de-sac, must have 2"x 4" redwood headers placed at the edge of pavement, with 2"x 4"x 16" stakes on 6' C.C.

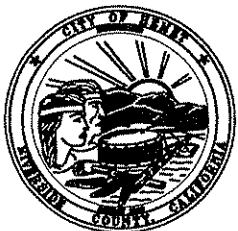

City of Hemet
PUBLIC WORKS DEPARTMENT
ENGINEERING DIVISION
 510 E. FLORIDA AVENUE
 HEMET, CA 92543
 (951) 765-2360

**TYPICAL STREET SECTION
 RESTRICTED LOCAL STREET**

56'

<i>M.A.G.</i>	MAR 2009
MICHAEL A. GOW, PW DIRECTOR/CITY ENG. R.C.E. 54164	DATE
REVISIONS	
N:\PW4100\COH_STDS\REVISIONS\STREETS\ST-106.dwg	
N.Beltran 2009	

1
 OF 1 SHEETS
**STANDARD NO.
 ST-106**

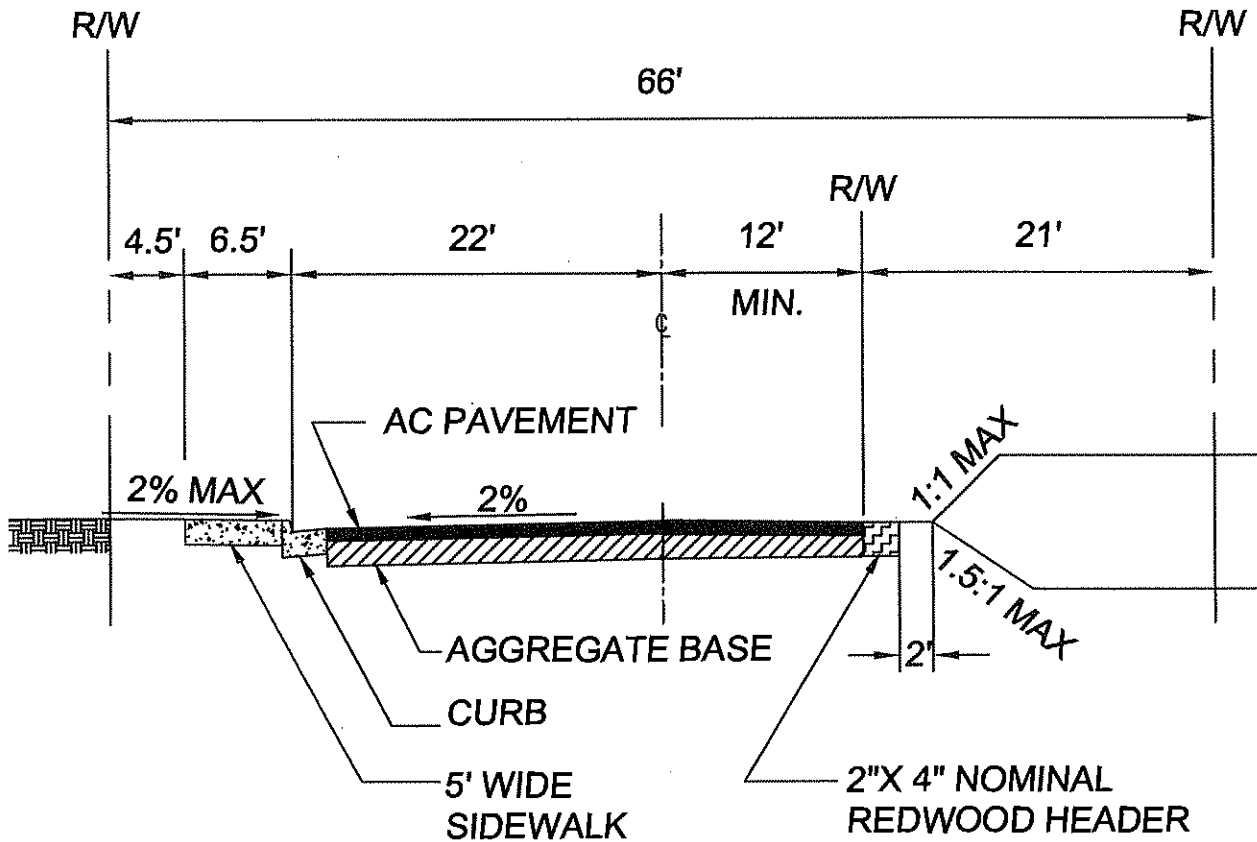

NOTES:

1. Construct 6" type "A" or 8" type "B" curb and gutter Std. No. C-200 or C-201, as determined by City Engineer.
2. Construct 4" thick P.C.C. sidewalk.
3. Construct Minimum 3" A.C. over 6" A.B. with SC-250 prime coat, final section to be determined by soils tests.
4. The top 12" pf native material shall be compacted to a minimum of 95% relative compaction per ASTM D-1557-70T.
5. Compaction per latest edition of the Standard Specifications for Public Works Construction.
6. Edge of paving to be 3/8" higher than lip of gutter.
7. Half street and ends of streets not terminating in cul-de-sac, must have 2"x 4" redwood headers placed at the edge of pavement, with 2"x 4"x 16" stakes on 6' C.C.

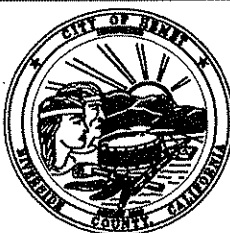

City of Hemet
PUBLIC WORKS DEPARTMENT
ENGINEERING DIVISION
 510 E. FLORIDA AVENUE
 HEMET, CA 92543
 (951) 765-2360

**TYPICAL 66' R/W
 PART WIDTH STREET SECTION**

66'

Michael A. Gow
 MICHAEL A. GOW, PW DIRECTOR/CITY ENG. R.C.E. 54164
 MAR 2009
 DATE

1
 OF 1 SHEETS

REVISIONS

**STANDARD NO.
 ST-107**

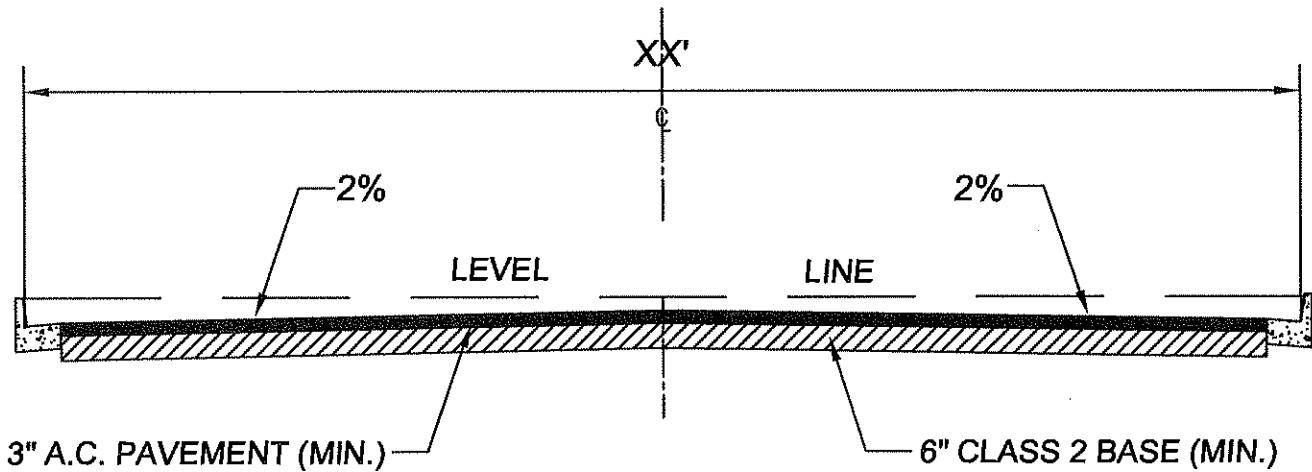

TYPICAL STREET SECTION

NOTES:

1. 3" A.C. pavement on 6" Aggregate Base is a minimum structural section--subject to soils reports.
2. Structural design sections should be incorporated in the preliminary soils reports.
3. Asphalt concrete surfacing shall comply with section 203-1 of the Standard Specifications for Public Works Construction, current edition.
4. Public Works requirements on curb sizes shall be for east and west streets 8" curb face and for north and south streets 6" curb face or as determined by City Engineer.

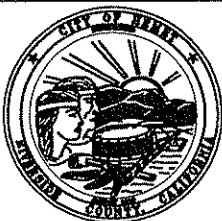

City of Hemet
PUBLIC WORKS DEPARTMENT
ENGINEERING DIVISION
 510 E. FLORIDA AVENUE
 HEMET, CA 92543
 (951) 765-2360

TYPICAL STREET SECTION

	MAR 2009
MICHAEL A. GOW, PW DIRECTOR/CITY ENG. R.C.E. 54164	DATE
REVISIONS	
N:\PW4100\COH_STDS\REVISIONS\STREETS\ST-108.dwg	
N.Beltran 2009	

1
 OF 1 SHEETS

STANDARD NO.
ST-108

Preliminary General Notes for Subdivisions and Large Developments Projects

1. All work shall be performed in accordance with the specifications for the improvements of developments within the City of Hemet in accordance with City of Hemet ordinances.
2. The Contractor or Developer shall secure all permits required by the City of Hemet.
3. It shall be the responsibility of the Contractor to notify the Public Works Department 72 hours in advance, prior to the concealing of each phase of work so that the Construction Inspector can inspect the work being done. Call the Inspection request line at (951) 765-3860.
4. Asphalt concrete paving shall comply with Section 203-1 of the Standard Specification for Public Works Construction, current edition.
5. Curbs, gutters, sidewalks and street signs shall be installed as per City of Hemet standards, except as noted.
6. Any relocation of existing facilities shall be the responsibility and at the expense of the developer.
7. Sewer pipe may be either vitrified clay or polyvinyl chloride and must meet specifications for sanitary sewers on file in the City of Hemet offices.
8. Sewer laterals shall be carried to property lines per Std. No. S-600, locations shall be marked on the curb as directed by the City of Hemet.
9. Sewer installation and construction shall comply with requirements of Standards or Specifications or sanitary sewers filed in the City offices, City of Hemet. Sewer mains shall be located 5' north or east of centerline or as shown on plans.
10. All sewer and storm drain line construction shall be inspected after installation with a mobile television inspection unit at the developer's expense. Video logs shall be VHS/DVD format submitted to the Public Works Dept. for review prior to approval of the facilities.
11. Manholes shall be standard 48" I.D. eccentric precast concrete manholes as per Standard No. S-602.
12. The top five feet of all trench backfill and all bedding shall be compacted to 90 percent minimum relative compaction except that the top 12 inches of subgrade material shall be compacted to 95 percent minimum relative compaction. Backfill below five feet shall be compacted to 85 percent minimum relative compaction. In no event shall the backfill material be compacted to a density of less than that of the undistributed soil surrounding the trench.
13. Street lights are a City requirement and shall be installed as per agreement between Southern California Edison Company, the City of Hemet, and the developer.
14. There shall be a minimum of 2.5' of full face curb between the prolongation of any property line and the beginning of any driveway approach. There shall be a minimum of 5.0' of full face curb between the beginning of any driveway approach and the beginning or end of the curb return.

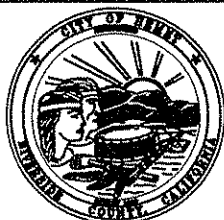

City of Hemet
PUBLIC WORKS DEPARTMENT
ENGINEERING DIVISION
 510 E. FLORIDA AVENUE
 HEMET, CA 92543
 (951) 765-2360

GENERAL NOTES

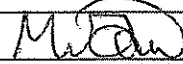
 MICHAEL A. GOW, PW DIRECTOR/CITY ENG. R.C.E. 54164	MAR 2009 DATE	<u>1</u> OF 2 SHEETS
REVISIONS		
STANDARD NO. ST-109		
N:\PW4100\COH_STDS\REVISIONS\STREETS\ST-109.dwg N.Beltran 2009		

15. Driveways are to be constructed to each lot per City Standards No. C-208, C-209, C-210 and C-217. Exact location and widths of driveways shall be provided by the subdivision owner.
16. All posts for street name signs and traffic control signs shall be installed prior to the installation of concrete sidewalk. Exact location for sign posts shall be designated by the Department of Public Works. All signs shall be furnished by the contractor/developer.
17. Install automatic irrigation system to all off-site vegetation.
18. All permits are to be issued by the City of Hemet prior to the preconstruction conference between the developer, his engineer, contractor, and a Public Works Inspector.
19. The final paving course for road mix and A.C. surface street shall be one tenth of a foot (.10') in thickness and a minimum of eight feet (8') in width or as wide as necessary to cover all break-outs and overlap existing pavement two feet (2') on either side of trench, whichever is the greater. This requirement also applies to paving tie-ins to new curb and gutter from an existing street. (In some instances, it will be necessary to overlay a minimum of one-half the street to obtain the proper tie-in to new curb and gutter. The amount of such overlay shall be determined in the field by the Public Works Inspector and the developer or owner will be responsible for payment thereof.) final paving course shall be laid with a self-propelled mechanical spreading and finishing machine equipped with tamper bars and automatic screed (Barber Green or approved equal).
20. All street and parking lot subgrade material and A.B. material shall be compacted to 95% density for the top 12". Class 2 base shall be obtained prior to the placement of any aggregate base material.
21. Provide ADA compliant ramps at all sidewalk intersections. Truncated dome tiles for vision impaired persons shall be provided at all handicap ramps.
22. It shall be the responsibility of the contractor or the developer to temporarily patch all utility trenches within existing paved streets. The temporary patch shall be removed and replaced with a permanent patch at time of A.C. resurfacing. Recessed steel plates may be used.
23. It shall be the responsibility of the contractor to notify the project engineer after the base course for the streets has been placed and before the paving has been installed so that the engineer may install the street center line monuments.
24. The contractor/Developer will hold harmless, indemnify and defend the City of Hemet, the owner, the architect, the engineer, and his consultants, and each of their officers and employees and agents, from any and all liability claims, losses or damage arising or alleged to arise from the performance of work described herein but not including the sole negligence of the City of Hemet, the owner, the architect, the engineer and his consultants, and each of their officers and employees and agents.
25. A 72-hour notice is required prior to Public Works inspections. Call the inspection request line at (951) 765-3860.
26. It shall be the responsibility of the Contractor and/or Developer to protect from damage any utility or other appurtenance that is to remain in place, be installed, relocated or otherwise re-arranged.

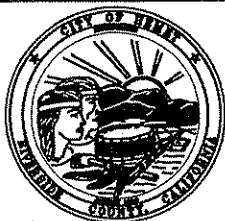

City of Hemet
PUBLIC WORKS DEPARTMENT
ENGINEERING DIVISION
 510 E. FLORIDA AVENUE
 HEMET, CA 92543
 (951) 765-2360

GENERAL NOTES

	MAR 2011
JORGE L. BIAGIONI, PRINCIPAL ENGINEER R.C.E. 33751	DATE
REVISIONS	
N:\PW\4100\COH_STDS\REVISIONS\STREETS\ST-109A.dwg	
N.Beltran 2011	

2
 OF 2 SHEETS
STANDARD NO.
ST-109A

NOTES FOR ALL STREETS:

- 1) GRIND AND PAVE AC MIN. 0.1'-FT EACH SIDE OF TRENCH. IF EDGE OF GRIND IS WITHIN 36" OF EDGE OF PAVEMENT THAN CONTRACTOR TO GRIND AND PAVE SAID AREA..
- 2) EXISTING AC EDGES TO BE SAWCUT PARALLEL TO THE WIDEST POINT.
- 3) REPLACE AC/BASE WITH EXISTING THICKNESS PLUS 1", E.G. 3" AC/6" BASE >> 4"AC/7" BASE
- 4) NEW AC TYPE TO MATCH EXISTING FOR AREAS GREATER THAN 50 SF, E.G ARHM
- 5) COMPACTION OF SOIL TO BE 90% FROM BOTTOM OF BASE TO TOP OF PIPE ZONE
- 6) TRENCHES LESS THAN 12" WIDE TO BE SLURRY-FILLED
- 7) COMPACTION TEST RESULTS FOR TRENCH TO BE PROVIDED BY PERMITTEE FOR AREAS GREATER THAN 50 SF.
- ⚠ 8) AC TO EXTEND FULL WIDTH OF TRAVEL LANES (12 FT Min.), UNLESS EXISTING PAVING IS SEVERELY DAMAGED.
- 9) AC JOINTS TO BE PERPENDICULAR OR PARALLEL W/ C.L. PARALLEL JOINTS TO BE AT LANE LINES.
- 10) TRENCHES CLOSER THAN 100 FEET REQUIRE COMPLETE REPAVEMENT BETWEEN THE TRENCHES WITH MIN. 1 1/2" GRIND AND AC OVERLAY.
- 11) GRIND AC MIN. 4 FEET IN FRONT/BACK OF TRENCH.
- ⚠ 12) CITY ENGINEER TO DETERMINE IF STREET IS IN A SEVERLY DAMAGED CONDITION.
- ⚠ 13) STEEL PLATES TO COVER TRENCHING ACTIVITIES SHALL BE RECESSED IN THE A.C.
- ⚠ 14) STEEL PLATES SHALL BE DESIGNED FOR H-20 LOADING AND BE SKID RESISTANT.
- ⚠ 15) STEEL PLATING SHALL NOT EXCEED 50 LINEAR FEET UNLESS OTHERWISE APPROVED BY THE CITY ENGINEER.
- ⚠ 16) IN PLACES WHERE TRENCHES IMPACT CROSS GUTTERS, FULL CONCRETE REPLACEMENT BETWEEN JOINTS SHALL BE REQUIRED. SPANDRELS AND CURB RETURN REQUIRE FULL RECONSTRUCTION IF AFFECTED BY TRENCHING OPERATIONS.

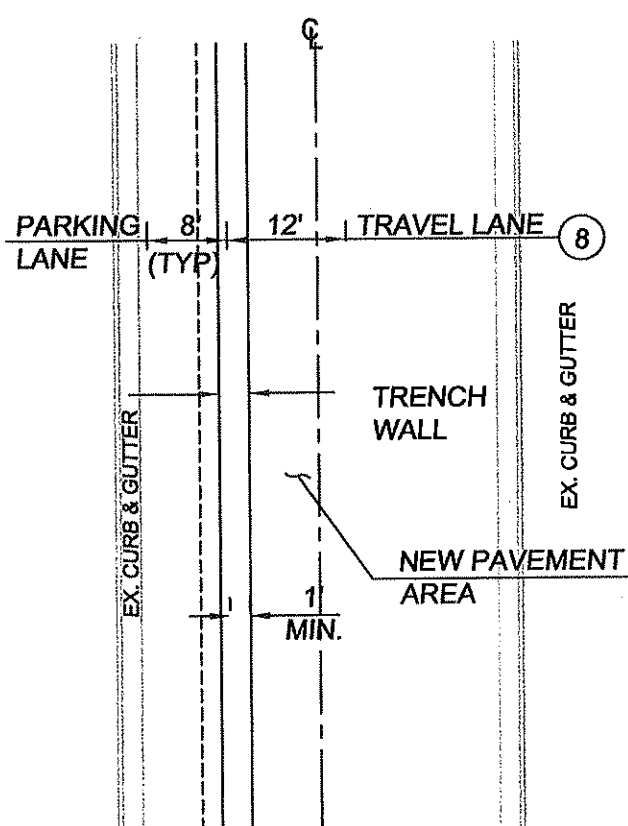

LONGITUDINAL CUTS

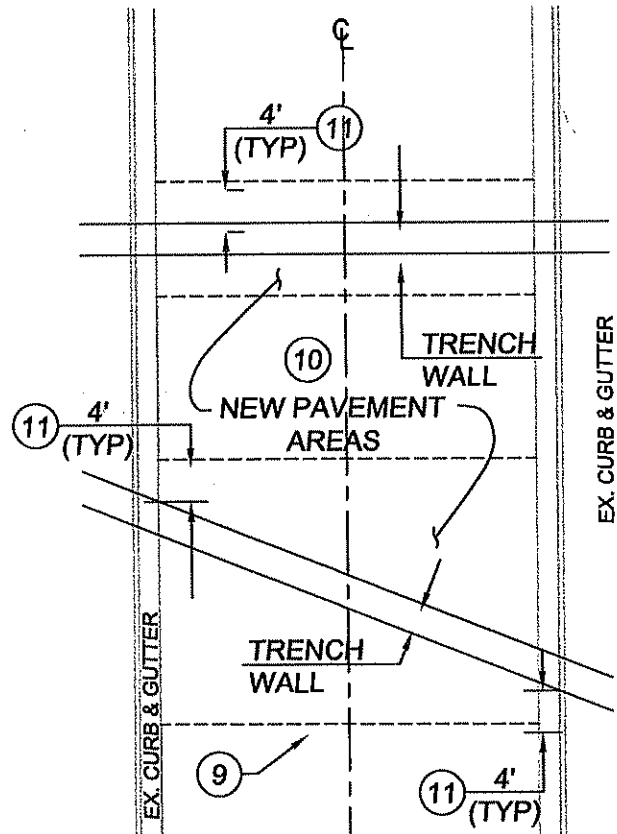

TRANSVERSE CUTS



City of Hemet
PUBLIC WORKS DEPARTMENT
ENGINEERING DIVISION
 510 E. FLORIDA AVENUE
 HEMET, CA 92543
 (951) 765-2360

TRENCH BACKFILL & REPAVING

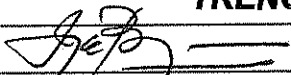
 JORGE L. BIACOMI, PRINCIPAL ENGINEER R.C.E. 33751		MAR 2011	1 OF 5 SHEETS
		DATE	
REVISIONS			
A MAR 2011	NOTES B, 12, 13, 14, 15, 16		
N:\PW\4100\COH_STDS\REVISIONS\STREETS\ST-110.dwg			N.Beltran 2011

STANDARD NO.
ST-110

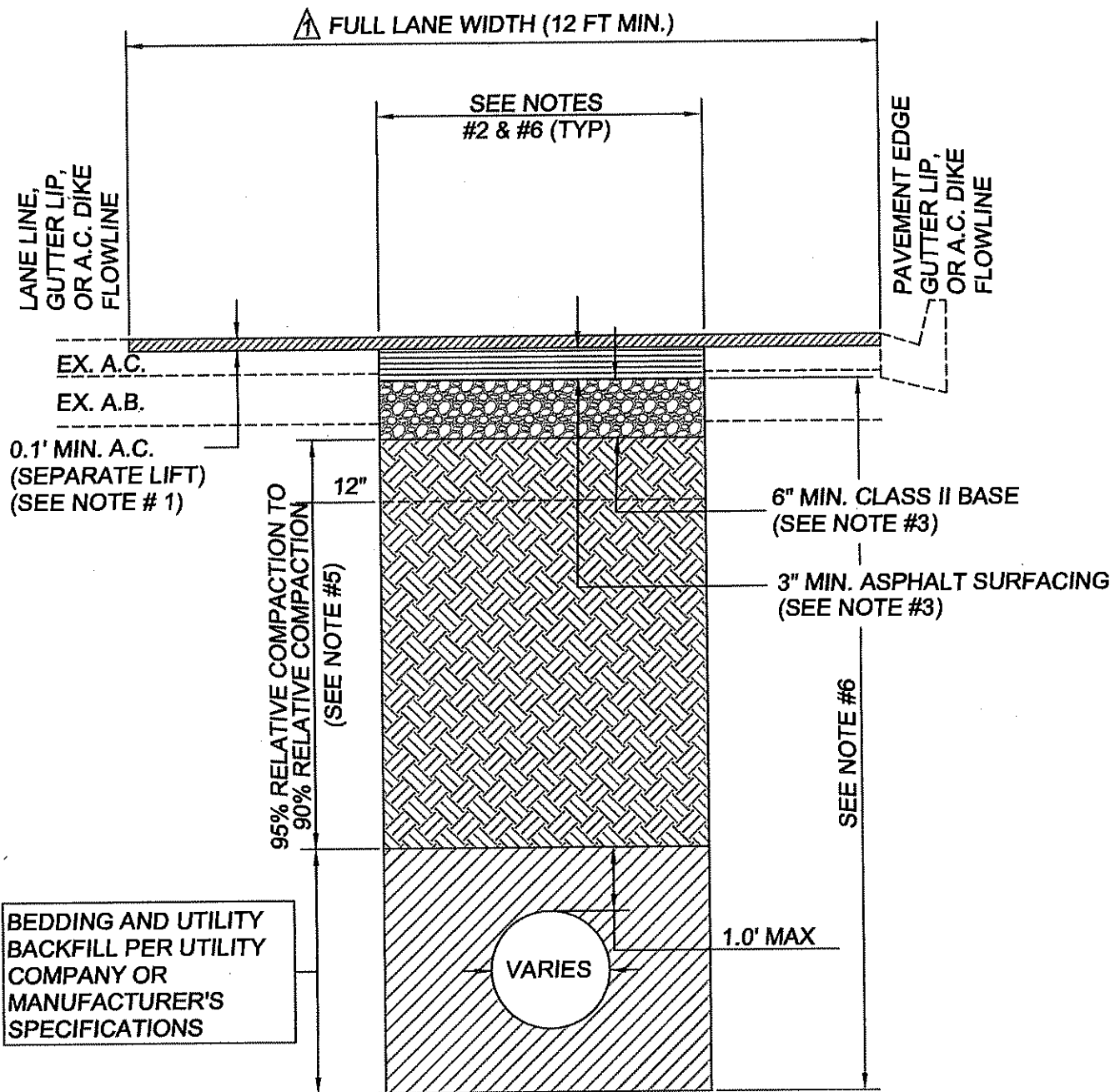

**** NOTE DESCRIPTION ON ST-110
LONGITUDINAL CUTS**

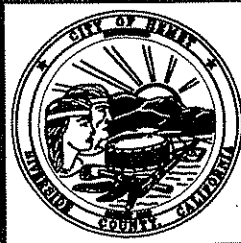

City of Hemet
PUBLIC WORKS DEPARTMENT
ENGINEERING DIVISION
 510 E. FLORIDA AVENUE
 HEMET, CA 92543
 (951) 765-2360

**TRENCH BACKFILL & REPAVING
CROSS SECTION**

 JORGE L. BIAGIONI, PRINCIPAL ENGINEER R.C.E. 33751		MAR 2011	<u>2</u> OF 4 SHEETS
		DATE	
REVISIONS			
A MAR 2011	LIMITS OF PAVING		
N:\PW\4100\COH_STDS\REVISIONS\STREETS\ST-110A.dwg			N.Beltran 2009

**STANDARD NO.
ST-110A**

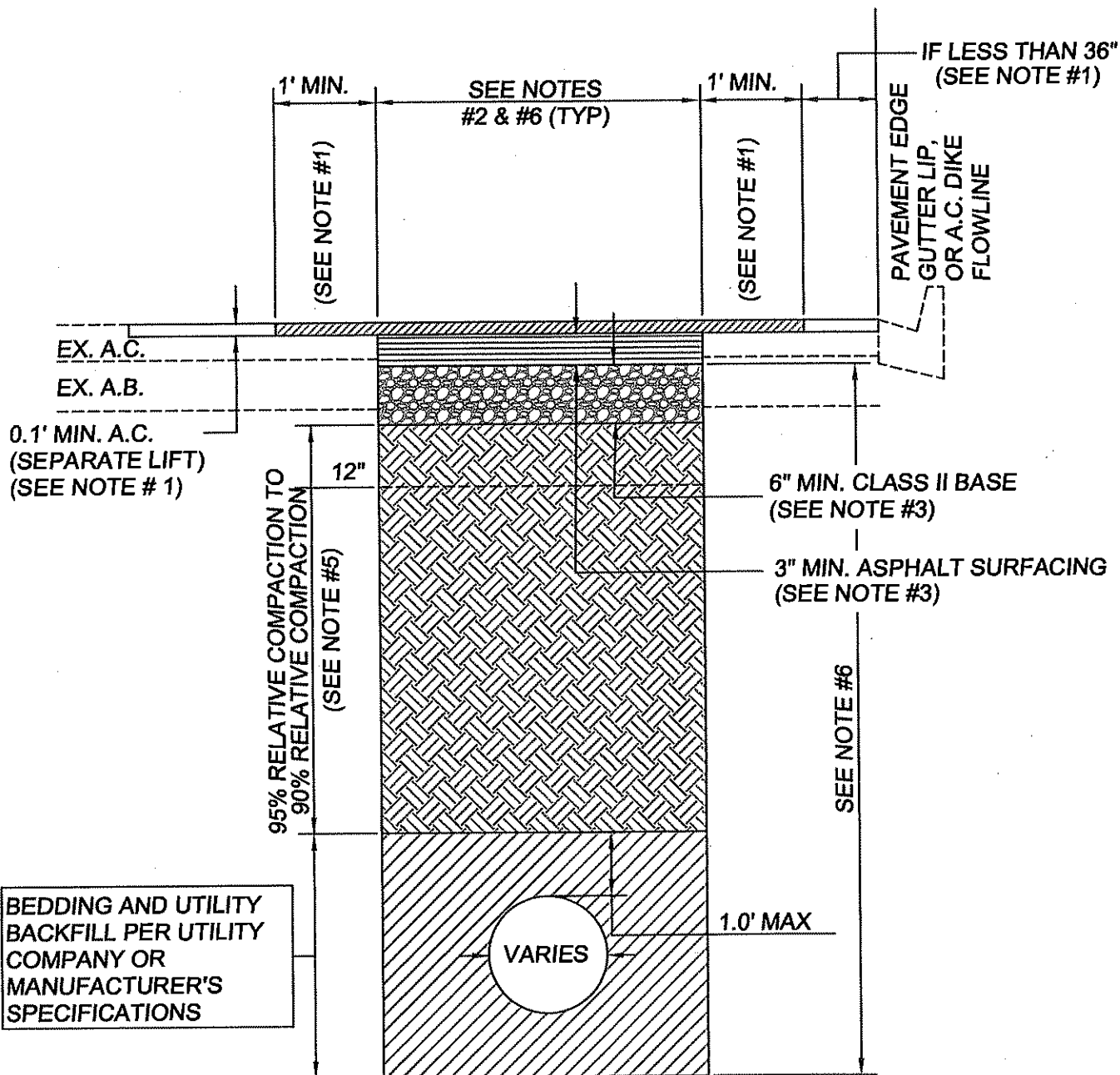

** NOTE DESCRIPTION ON ST-110

▲ TRANSVERSE CUTS

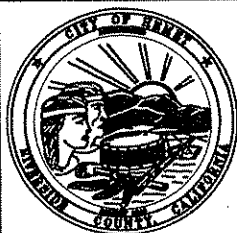

City of Hemet
PUBLIC WORKS DEPARTMENT
ENGINEERING DIVISION

510 E. FLORIDA AVENUE
HEMET, CA 92543
(951) 785-2360

**TRENCH BACKFILL & REPAVING
CROSS SECTION**

Jorge L. Biagioni

JORGE L. BIAGIONI, PRINCIPAL ENGINEER R.C.E. 33751

MAR 2011
DATE

REVISIONS

A MAR 2011 NEW STANDARD

N:\PW4100\COH_STDS\REVISIONS\STREETS\ST-110B.dwg

N.Beltran 2011

2

OF 4 SHEETS

STANDARD NO.
ST-110B

GRIND & OVERLAY

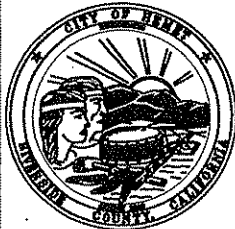
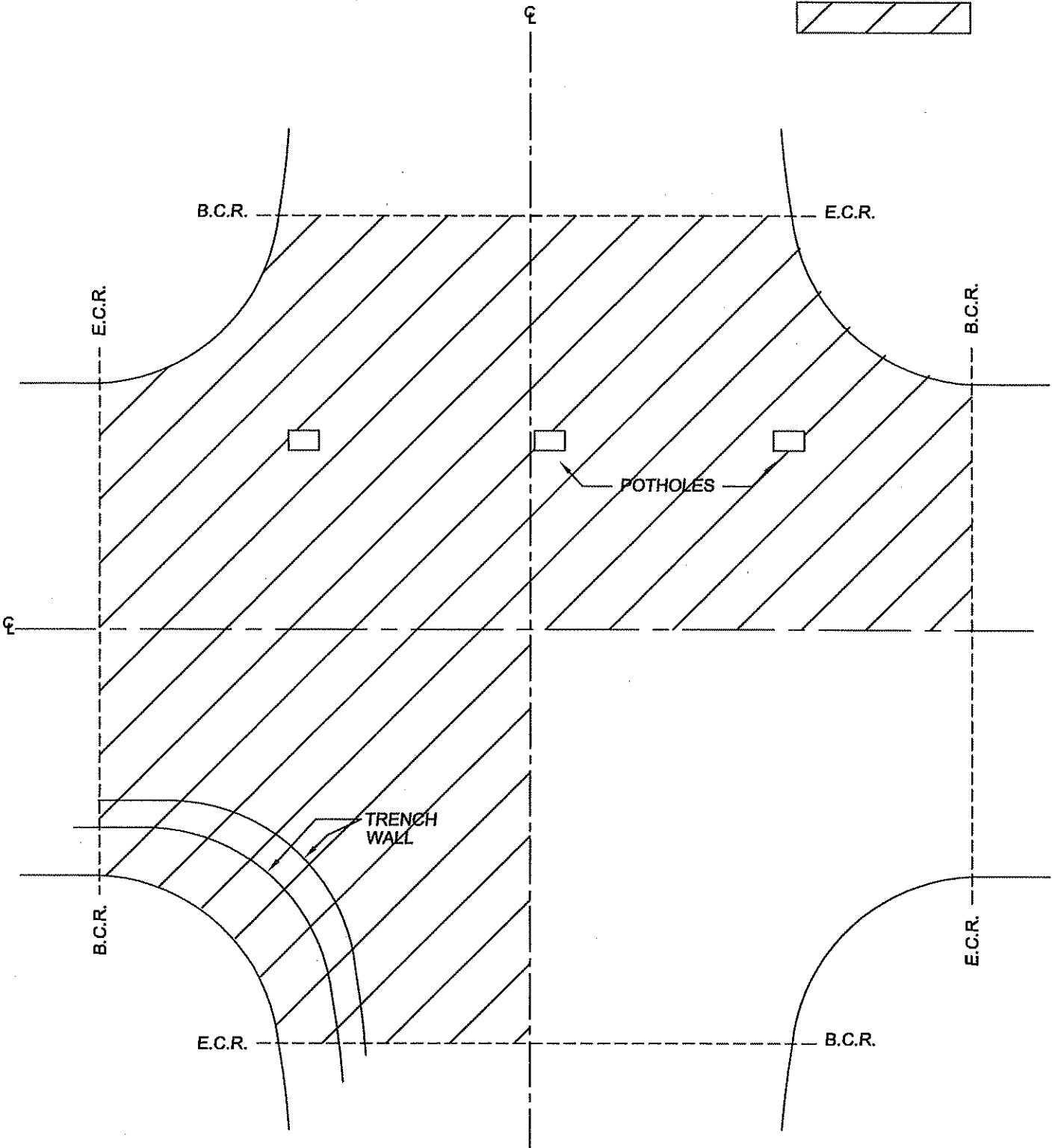

City of Hemet
PUBLIC WORKS DEPARTMENT
ENGINEERING DIVISION

510 E. FLORIDA AVENUE
 HEMET, CA 92543
 (951) 765-2360

TRENCH REPAIR AT INTERSECTIONS

		MAR 2009
MICHAEL A. GOW, PW DIRECTOR/CITY ENG. R.C.E. 54164		DATE
REVISIONS		
N:\PW\4100\COH_STDS\REVISIONS\STREETS\ST-110C.dwg		N.Bellran 2009

4
 OF 4 SHEETS
STANDARD NO.
ST-110C

CRITERIA FOR APPLYING ESTATE STREET STANDARDS

Use of revised standards are allowed when Estate Criteria are met with the design of new subdivisions, except when the Director of Public Works determines that the new subdivisions are infill projects with street frontages less than one block in length where the application of the Estate Street Standards would result in a "patchwork" pattern on the side of a street.

ESTATE CRITERIA:

1. Estate areas with lot sizes of at least 20,000 square feet.
2. Minimum lot widths of at least 120 feet.
3. Minimum front yard setbacks of at least 30 feet(except in Hillside zones).
4. Driveway designs that accomodate head-in and head-out access(such as on-site back up and turn around areas, or circular driveways).
5. When required, sidewalks shall be located adjacent to the edge of the right-of-way.
6. Improvements must otherwise conform to City of Hemet standards.

REQUIREMENTS MATRIX	56' ROW 36' curb-curb	60' ROW 40' curb-curb	66' ROW 44' curb-curb
Standard Number	ST-106	ST-104	ST-103
Sidewalks	No	No	Both Sides
Street Lights	1 at Corners	1 at Corners	1 at Corners
Private Carriage Yard Lights Required	2 Per Lot	2 Per Lot	
Scenic Highway Pedestrian Lights			Required
Deed Notice(Lights & Sidewalks)	Required	Required	
Maximum Street Length	660 Feet		
Cul-de-Sacs	Permitted		
Subdivision Internal Loop Streets		Permitted	
"Quarter-Mile" Streets			Permitted

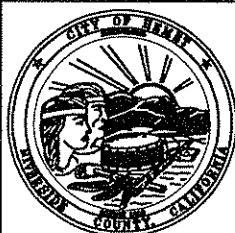

City of Hemet
PUBLIC WORKS DEPARTMENT
ENGINEERING DIVISION
 510 E. FLORIDA AVENUE
 HEMET, CA 92543
 (951) 765-2360

APPLICATION CRITERIA ESTATE STREET STANDARDS		1
<i>M. A. Gow</i> MICHAEL A. GOW, PW DIRECTOR/CITY ENG. R.C.E. 54164	MAR 2009 DATE	OF <u>1</u> SHEETS
REVISIONS		STANDARD NO. ST-111
N:\A\PW4100\COH_STDS\REVISIONS\STREETS\ST-111.dwg		
		N.Beltran 2009