

Appendix C

Revised Traffic Impact Study





Traffic Impact Study

for:

Continental Grand Campus Specific Plan

In the City of El Segundo

Prepared for:

ESA PCR

May, 2019

Kimley»»Horn

TRAFFIC IMPACT STUDY
FOR THE
CONTINENTAL GRAND CAMPUS SPECIFIC PLAN

IN THE
CITY OF EL SEGUNDO

Prepared for:

ESA PCR

Prepared by:

Kimley-Horn and Associates, Inc.
765 The City Drive, Suite 200
Orange, CA 92868

May, 2019

TABLE OF CONTENTS

	Page
INTRODUCTION	1
PROJECT DESCRIPTION	1
Existing Site	1
Proposed Project.....	4
ANALYSIS METHODOLOGY	4
Intersection Capacity Utilization (ICU) Methodology.....	6
Highway Capacity Manual (HCM) Methodology.....	7
Traffic Impact Criteria.....	8
EXISTING TRANSPORTATION SYSTEM	8
Roadway System	8
Existing Transit Service.....	10
EXISTING TRAFFIC CONDITIONS.....	12
Existing Traffic Volumes	12
Existing Intersection Operating Conditions.....	12
PROJECT TRAFFIC.....	12
Project Trip Generation.....	12
Project Trip Distribution and Assignment	16
EXISTING PLUS PROJECT CONDITIONS.....	16
FUTURE TRAFFIC CONDITIONS.....	24
Ambient Growth.....	24
Cumulative Projects Traffic	24
Opening Year 2022 Without Project Conditions	28
Opening Year 2022 With Phase 1 Conditions.....	28
Opening Year 2023 Without Project Conditions	33
Opening Year 2023 With Phase 1 and Phase 2 Conditions	36
MITIGATION MEASURES.....	39
FREEWAY MAINLINE ANALYSIS.....	40
Existing Conditions	40
Existing Plus Project.....	40
Opening Year 2022.....	46
Opening Year 2023	46
CONSTRUCTION TRAFFIC.....	46
SITE ACCESS.....	56
LOS ANGELES COUNTY CONGESTION MANAGEMENT PROGRAM	57
SUMMARY OF FINDINGS AND CONCLUSIONS.....	58

APPENDICES

APPENDIX A – Traffic Count Sheets

APPENDIX B – Intersection Analysis Worksheets – ICU

APPENDIX C – Intersection Analysis Worksheets – HCM

LIST OF FIGURES

	<i>Page</i>
Figure 1 – Vicinity Map	2
Figure 2 – Project Site Plan	5
Figure 3 – Existing Lane Configuration and Traffic Control	13
Figure 4 – Existing Peak Hour Traffic Volumes	14
Figure 5 – Project Trip Distribution.....	18
Figure 6 – Phase 1 Project-Related Traffic.....	19
Figure 7 – Phase 2 Project-Related Traffic.....	20
Figure 8 – Total Project-Related Traffic	21
Figure 9 – Existing Plus Project Peak Hour Traffic Volumes	22
Figure 10 – Location of Cumulative Projects	26
Figure 11 – Cumulative Project Peak Hour Traffic Volumes	27
Figure 12 – Opening Year 2022 Without Project Peak Hour Traffic Volumes	29
Figure 13 – Opening Year 2022 With Phase 1 Peak Hour Traffic Volumes	31
Figure 14 – Opening Year 2023 Without Project Peak Hour Traffic Volumes	34
Figure 15 – Opening Year 2023 With Phase 1 and Phase 2 Peak Hour Traffic Volumes	37

LIST OF TABLES

	<i>Page</i>
Table 1 – Summary of Intersection Operation – Existing Conditions	15
Table 2 – Summary of Project Trip Generation	17
Table 3 – Summary of Intersection Operation – Existing Plus Project Conditions	23
Table 4 – Cumulative Projects Trip Generation.....	25
Table 5 – Summary of Intersection Operation – Opening Year 2022 Without Project	30
Table 6 – Summary of Intersection Operation – Opening Year 2022 With Phase 1	32
Table 7 – Summary of Intersection Operation – Opening Year 2023 Without Project	35
Table 8 – Summary of Intersection Operation – Opening Year 2023 With Phase 1 and Phase 2	38
Table 9 – Summary of Intersection Operation with Proposed Mitigation Measures	41
Table 10 – Summary of I-405 Freeway Mainline Operation – Existing Conditions	42
Table 11 – Summary of I-105 Freeway Mainline Operation – Existing Conditions	43
Table 12 – Summary of I-405 Freeway Mainline Operation – Existing Plus Project Conditions	44
Table 13 – Summary of I-105 Freeway Mainline Operation – Existing Plus Project Conditions	45
Table 14 – Summary of I-405 Freeway Mainline Operation – Opening Year 2022 Without Project...47	47
Table 15 – Summary of I-105 Freeway Mainline Operation – Opening Year 2022 Without Project...48	48
Table 16 – Summary of I-405 Freeway Mainline Operation – Opening Year 2022 With Phase 1	49
Table 17 – Summary of I-105 Freeway Mainline Operation – Opening Year 2022 With Phase 1	50
Table 18 – Summary of I-405 Freeway Mainline Operation – Opening Year 2023 Without Project...51	51
Table 19 – Summary of I-105 Freeway Mainline Operation – Opening Year 2023 Without Project...52	52
Table 20 – Summary of I-405 Freeway Mainline Operation – Opening Year 2023 With Project	53
Table 21 – Summary of I-105 Freeway Mainline Operation – Opening Year 2023 With Project	54

TRAFFIC IMPACT STUDY
FOR THE
CONTINENTAL GRAND CAMPUS SPECIFIC PLAN PROJECT
IN THE CITY OF EL SEGUNDO

INTRODUCTION

The purpose of this traffic impact study is to evaluate the traffic-related impacts associated with the proposed Continental Grand Campus Specific Plan Project in the City of El Segundo. The scope of the analysis in this report is in accordance with direction provided by the City of El Segundo Planning Department staff.

PROJECT DESCRIPTION

Existing Site

The project applicant, Mattel Inc., proposes to expand its current headquarters in the City of El Segundo. The project site is a 12.5-acre office campus located in the northwest quadrant of the intersection of Grand Avenue and Continental Boulevard in the City of El Segundo, approximately 1.5 miles south of the Los Angeles International Airport (LAX) and 1.5 miles west of the San Diego Freeway (I-405). A regional vicinity map is provided on Figure 1.

The project site consists of three contiguous parcels at 333 Continental Boulevard, 455 Continental Boulevard, and 1955 East Grand Avenue.

The 333 Continental Boulevard parcel is located on the south side of the project site and is currently occupied by a 14-story, 328,612-square-foot office building which houses the Mattel corporate headquarters offices. Additionally, a two-story Pavilion Building occupies the southeastern portion of the parcel. The Pavilion Building is approximately 29,710 square feet, and is occupied by a cafeteria and child care center for Mattel employees. The 333 Continental Boulevard parcel also includes an eight-level above-grade parking structure with 1,132 parking spaces. Access to the parking structure is provided via a single un-gated entrance on the south side of the structure.

A Doubletree Hotel is located directly south of and adjacent to the 333 Continental Boulevard parcel, between the existing buildings and Grand Avenue. The Doubletree Hotel and the 333 Continental Boulevard parcel share driveway access on Continental Boulevard and on Grand Avenue.



NOT TO SCALE

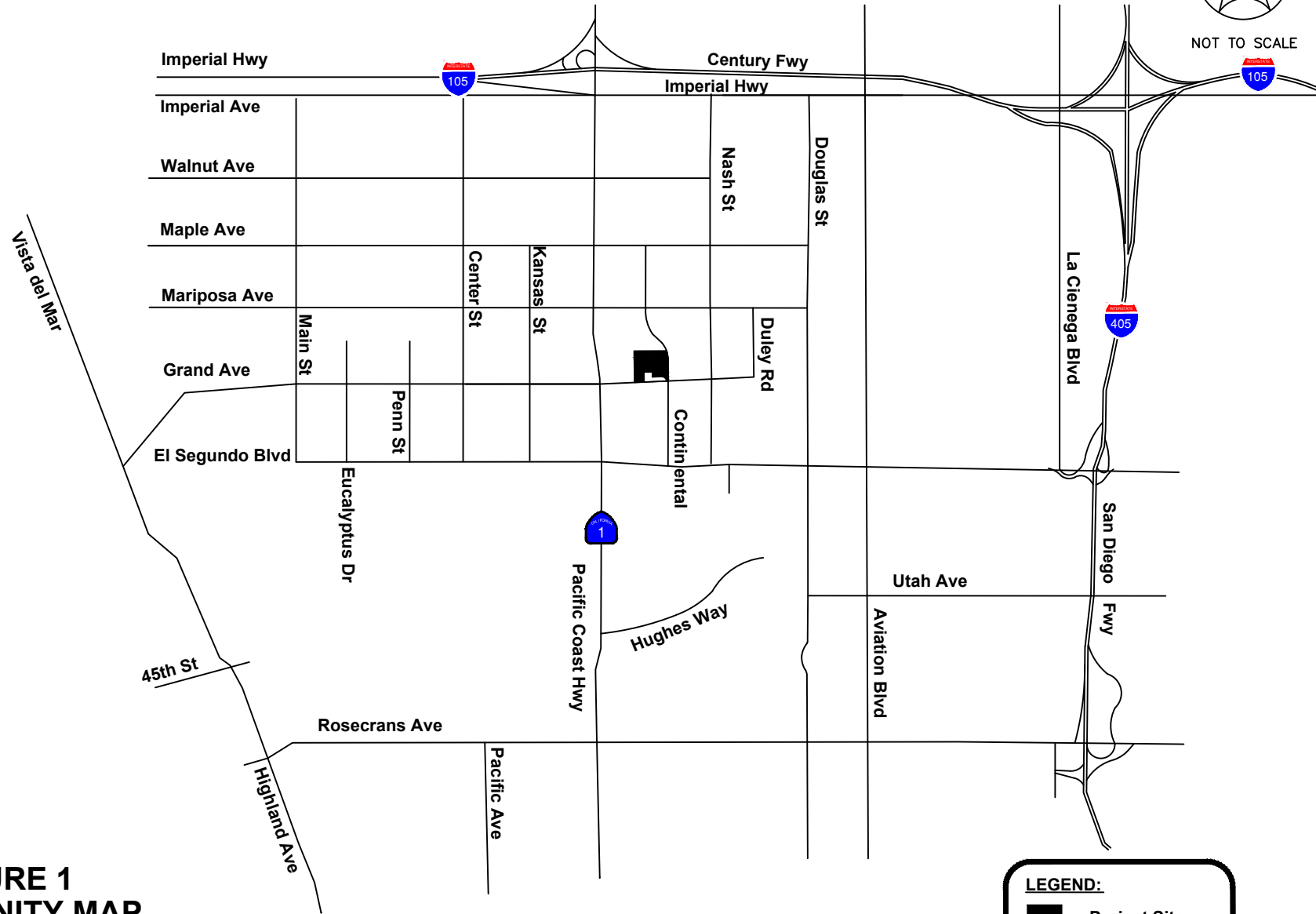

**FIGURE 1
VICINITY MAP**

LEGEND:
■ = Project Site



The 455 Continental Boulevard Parcel is the northernmost parcel, located directly north of and adjacent to the 333 Continental Boulevard parcel. It is improved with interim temporary uses that include outdoor recreational facilities for Mattel employees (basketball and sand volleyball courts), a landscaped area featuring the Mattel logo, and surface parking.

The 1955 East Grand Avenue parcel is directly west of the 333 Continental Boulevard parcel and the Doubletree Hotel. It is developed with a two-story, approximately 57,082-square-foot office building, fronting on Grand Avenue. The building serves as the location for a Toy Fair which occurs twice a year, for three weeks in June and in October. The rest of the year, the 1955 Grand Avenue building is occupied by a small staff and is used for training and internal meetings. Primary parking for the 1955 East Grand Avenue building is provided in a surface parking lot to the north of the building. The parking lot provides 365 parking spaces. A small visitor parking lot with eight spaces (4 standard, and 4 ADA spaces) is located at the front of the 1955 East Grand Avenue building.

Access to the 333 and 455 Continental Boulevard parcels consists of three driveways on Continental Boulevard, and one driveway on Grand Avenue:

- The main driveway on Continental Boulevard is the southernmost driveway, which is a full-movement, joint access driveway that also serves the adjacent Doubletree Hotel. This driveway leads to the parking structure behind the 333 Continental Boulevard building, and also provides a connection to a small traffic circle and surface parking to the north.
- The middle driveway on Continental Boulevard is a right-in/right-out only driveway that leads directly to the traffic circle in front of the 333 Continental Boulevard building, and to surface parking.
- The northernmost driveway on Continental Boulevard is located at the north end of the 455 Continental Boulevard parcel. All turning movements are allowed at this driveway, however, under current conditions, the driveway is closed off with a swinging gate.
- The driveway on Grand Avenue is located at the west edge of the 333 Continental Boulevard parcel, and is a full-movement, joint access driveway that also serves the Doubletree Hotel. Left turns are allowed due to a break in the median on Grand Avenue, although the median does not currently provide a left-turn pocket for eastbound left-turning traffic. This is discussed in more detail later in this report.

Access to the parking for the 1955 East Grand Avenue building is provided via two driveways on Grand Avenue:

- The main driveway is located at the west edge of the project site, and leads directly to the surface parking lot behind the building. It is a right-in/right-out only driveway, due to the raised median on Grand Avenue.

- A minor entry drive located near the east edge of the project site provides one-way, inbound-only access to the small visitor parking area along the front of the 1955 Grand Avenue building, with a connection to the main driveway at the west edge of the site.

There are no vehicular connections between the 1955 East Grand Avenue parcel and the 333 and 455 Continental Boulevard parcels.

Proposed Project

A copy of the project site plan is provided on Figure 2. The proposed development would consist of two main components:

- Development on the 455 Continental Boulevard parcel would consist of a new 14-story building on the landscaped area with the Mattel logo. The new building would provide 328,612 square feet of office, research, and development space. This new building will house the Mattel Corporate Headquarters offices, and research and development functions. In addition, a new eight-story parking structure will be constructed on the site of the outdoor recreational area. The parking structure will provide 1,087 parking spaces, and will connect with the existing parking structure.
- On the 1955 East Grand Avenue parcel, the existing two-story building will be demolished and a new six-story office building with 174,236 square feet will be constructed. The surface parking to the north of the building will remain. There are currently 365 parking spaces in the surface parking lot. The project will increase the parking supply to a total of 465 parking spaces.

ANALYSIS METHODOLOGY

This traffic study includes documentation of existing conditions, analysis of cumulative traffic conditions, and identification of project-related impacts for the following analysis scenarios:

- Existing Conditions
- Existing Plus Project
- Opening Year 2022 Without Project
- Opening Year 2022 With Phase 1
- Opening Year 2023 Without Project
- Opening Year 2023 With Phase 1 and Phase 2

Analysis scenarios and study intersections were selected based on discussions with City of El Segundo staff and the project team.



LEGEND

	EXISTING BUILDING
	PROPOSED BUILDING
	EXISTING LANDSCAPE AREA
	PROPOSED LANDSCAPE AREA
	EXISTING CIRCULATION AREA
	PROPOSED CIRCULATION AREA
	BIOSWALE - LOW IMPACT DRAINAGE DESIGN
	PARCEL BOUNDARY
S	STANDARD PARKING STALL
C	COMPACT PARKING STALL

 NOT TO SCALE

**FIGURE 2
PROJECT SITE PLAN**

SOURCE: SALAS O'BRIEN ARCHITECTS & ENGINEERS



Weekday morning and evening peak hours will be evaluated at the following study intersections:

1. Pacific Coast Highway at Imperial Highway *
2. Pacific Coast Highway at Walnut Avenue *
3. Pacific Coast Highway at Maple Avenue *
4. Pacific Coast Highway at Mariposa Avenue *
5. Pacific Coast Highway at Grand Avenue *
6. Pacific Coast Highway at El Segundo Boulevard *
7. Pacific Coast Highway at Rosecrans Boulevard *
8. Continental Boulevard at Mariposa Avenue
9. Continental Boulevard at Grand Avenue
10. Continental Boulevard at El Segundo Boulevard
11. Nash Street at Imperial Highway
12. Nash Street at Mariposa Avenue
13. Nash Street at Grand Avenue
14. Nash Street at El Segundo Boulevard
15. Douglas Street at El Segundo Boulevard
16. Aviation Boulevard at El Segundo Boulevard
17. El Segundo Boulevard at Isis Avenue**
18. El Segundo Boulevard at I-405 Southbound Ramps *
19. El Segundo Boulevard at La Cienega**
20. El Segundo Boulevard at I-405 Northbound Ramps *

* Caltrans intersection

**City of Hawthorne intersection

Intersection Capacity Utilization (ICU) Methodology

All of the study intersections for this analysis are signalized. Peak hour operating conditions at signalized intersections are evaluated using the Intersection Capacity Utilization (ICU) methodology, in accordance with the City of El Segundo and LA County Congestion Management Program (CMP) requirements. The ICU methodology provides a comparison of the number of vehicles passing through an intersection to the theoretical hourly vehicular capacity of that intersection during a given hour.

The ICU calculation assumes a per-lane capacity of 1,600 vehicles per hour (vph) for each travel lane (through or turning lane) through the intersection. A separate, "unofficial" de facto right-turn lane is assumed where there is no separately striped right-turn lane, if the width of the outside through lane is 19 feet or more, and parking is prohibited during the peak period. A clearance factor of 0.05 (5%) of the total intersection capacity is included in the ICU calculation to account for the effect of the yellow and all-red phases of the signal cycle.

The ICU calculation returns a volume-to-capacity (V/C) ratio that translates into a corresponding Level of Service (LOS) measure, ranging from LOS A, representing uncongested, free-flowing conditions; to

LOS F, representing over-capacity conditions. A summary description of each Level of Service and the corresponding V/C ratio is provided on the chart on the following page.

LEVEL OF SERVICE DESCRIPTIONS: ICU METHODOLOGY		
Level of Service	ICU Value	Description
A	0.00 - 0.60	EXCELLENT – No vehicle waits longer than one red light and no approach phase is fully used.
B	0.61 - 0.70	VERY GOOD – An occasional approach phase is fully utilized; many drivers begin to feel somewhat restricted within groups of vehicles.
C	0.71 - 0.80	GOOD – Occasionally drivers may have to wait through more than one red light; back-ups may develop behind turning vehicles.
D	0.81 - 0.90	FAIR – Delays may be substantial during portions of the rush hours, but enough lower volume periods occur to permit clearing of developing lines, preventing excessive back-ups.
E	0.91 - 1.00	POOR – Represents the most vehicles that the intersection approaches can accommodate; may be long lines of waiting vehicles through several signal cycles.
F	> 1.00	FAILURE – Back-ups from nearby locations or on cross streets may restrict or prevent movement of vehicles out of the intersection approaches. Long delays with continuously increasing queue lengths.

Highway Capacity Manual (HCM) Methodology

Peak hour operating conditions at the unsignalized project driveway intersections and at intersections that are under Caltrans' jurisdiction are analyzed using the Highway Capacity Manual (HCM) delay methodology in accordance with the Caltrans *Guide for the Preparation of Traffic Impact Studies*. Pacific Coast Highway is a Caltrans facility; therefore, all intersections along Pacific Coast Highway, and all freeway ramp intersections will also be analyzed using the HCM methodology.

For signalized intersections, the HCM methodology estimates the average delay (in average seconds per vehicle) for each of the movements through the intersection, taking into account a number of factors, including number of lanes, volume of traffic, and signal timing and phasing.

For unsignalized intersections, the HCM methodology analysis determines the average delay for each vehicle making any movement from the stop-controlled minor street, as well as left turns from the major street. Delay values are calculated based on the relationship between the traffic on the major street and the availability of acceptable gaps in the traffic stream through which conflicting traffic movements can be made.

The HCM delay values correspond to Level of Service designations, also ranging from LOS A to LOS F. A summary of the delay ranges for each Level of Service is provided in the following chart.

HCM-BASED LEVEL OF SERVICE AND DELAY RANGES FOR SIGNALIZED AND UNSIGNALIZED INTERSECTIONS		
Level of Service	Signalized Intersection (Average delay per vehicle, in seconds) ¹	Unsignalized Intersections (Average delay per vehicle, in seconds) ²
A	≤ 10	0 – 10
B	> 10 – 20	> 10 – 15
C	> 20 – 35	> 15 – 25
D	> 35 – 55	> 25 – 35
E	> 55 – 80	> 35 – 50
F	> 80	> 50

¹ Source: Highway Capacity Manual (HCM 2010), Exhibit 18-4.

² Source: Highway Capacity Manual (HCM 2010), Exhibits 19-1 and 20-2.

Traffic Impact Criteria

The minimum acceptable level of service for signalized intersections in the City of El Segundo, per the City's Circulation Element, is LOS D. The project impact at an intersection would be considered to be significant if the project's traffic results in a change in Level of Service from LOS D or better to LOS E or F, or if there is an increase in intersection capacity utilization (ICU) value of 0.020 or more, when the "Without Project" intersection level of service is already at LOS E or F (ICU = 0.901 or more).

For Caltrans intersections, Level of Service standards and impact criteria specified by Caltrans will apply. The *Caltrans Guide for the Preparation of Traffic Impact Studies* states that "Caltrans endeavors to maintain a target Level of Service at the transition between LOS C and LOS D on State highway facilities. If an existing State highway facility is operating at less than the target LOS, the existing Level of Service is to be maintained."

EXISTING TRANSPORTATION SYSTEM

Roadway System

Regional access to the project site is provided by the Century Freeway (I-105), which is oriented in an east-west direction approximately ¾-mile north of the project site. Regional access is also provided via the San Diego Freeway (I-405) which is a north-south major travel corridor approximately 1.5 miles east of the project site, with a full interchange at Imperial Highway and at El Segundo Boulevard. Local access to the project site is provided by several arterial and commuter roadways.

Pacific Coast Highway (State Highway 1) is a north-south arterial located approximately 1,200 feet west of the project site. This roadway provides four travel lanes in each direction with a raised landscaped median in the project vicinity. Sidewalks are provided, and parking is prohibited along both sides of the street. The posted speed limit in the project vicinity is 40 miles per hour (mph). Pacific Coast Highway is classified as a Major Arterial and is a designated truck route on the City of El Segundo

Circulation Element of the General Plan. *Note:* The portion of Pacific Coast Highway through the study area was previously named Sepulveda Boulevard. It was renamed Pacific Coast Highway in 2017.

Continental Boulevard is a north-south street that forms the eastern boundary of the existing Mattel property and the project site. It has three lanes in each direction with a landscaped median from Mariposa Avenue on the north to El Segundo Boulevard on the south. Sidewalks are provided and parking is prohibited along both sides of the street, and the posted speed limit is 30 mph. Continental Boulevard is classified as a Secondary Arterial.

Nash Street is a north-south street located approximately 1,200 feet east of the project site. It has two lanes in each direction and connects Imperial Highway on the north to El Segundo Boulevard on the south. Sidewalks are provided along both sides of the street. Nash Street terminates at the westbound I-105 (Glenn Anderson Freeway) off-ramp at Imperial Highway. Parking is prohibited along both sides of Nash Street and the posted speed limit is 35 mph. Nash Street is classified as a Secondary Arterial.

Douglas Street is a six-lane north-south arterial located approximately one-half mile east of the project site. Douglas Street provides a connection between Imperial Highway and Rosecrans Avenue through the industrial/ manufacturing/aerospace area of El Segundo. Sidewalks are provided along both sides of the street. The posted speed limit on Douglas Street is 40 mph. South of El Segundo Boulevard, Douglas Street narrows to four lanes and the speed limit is reduced to 25 mph north of Rosecrans Avenue. Douglas Street is classified as a Secondary Arterial.

Aviation Boulevard is a north-south arterial located approximately 3/4 of a mile east of the project site. A sidewalk is provided along the east side of Aviation Boulevard. Parking is prohibited along both sides of the street. The posted speed limit is 40 mph. Aviation Boulevard is classified as a Major Arterial and is a designated truck route.

Imperial Highway is an east-west arterial extending from the City of El Segundo eastward into Orange County. Imperial Highway forms the southern boundary of the Los Angeles International Airport, and runs under and parallel to the Century Freeway (I-105). In the project vicinity, Imperial Highway provides three travel lanes in each direction, separated by a raised median. The roadway narrows to two lanes in each direction approximately 1/2-mile west of Pacific Coast Highway. Sidewalks are provided along both sides of the street. The speed limit on Imperial Highway in the project vicinity is posted at 40 (mph). Imperial Highway is classified as a Secondary Arterial and is a designated truck route on the Circulation Element of the General Plan.

Walnut Avenue is an east-west street located approximately one-half mile north of the project site. Walnut Avenue provides one travel lane in each direction. Sidewalks are provided along both sides of the street. Parking is allowed on both sides of Walnut Avenue. To the east of Pacific Coast Highway, Walnut Avenue terminates at Selby Street. Walnut Avenue is classified as a Secondary Arterial.

Maple Avenue is an east-west street located approximately 2,000 feet north of the project site. Maple Avenue provides one lane in each direction to the west of Pacific Coast Highway, and two lanes in each direction to the east of Pacific Coast Highway. Sidewalks are provided and on-street parking is allowed

on both sides of the street. Maple Avenue is classified as a Collector to the east of Pacific Coast Highway and a Local Street to the west of Pacific Coast Highway.

Mariposa Avenue is a four-lane east-west arterial located approximately 1,100 feet north of the project site. Mariposa Avenue connects Douglas Street on the east to the residential area of El Segundo on the west side of the city. Sidewalks are provided along both sides of the street. The posted speed limit is 40 mph. Mariposa Avenue is classified as a Secondary Arterial east of Pacific Coast Highway and a two-lane Collector west of Pacific Coast Highway.

Grand Avenue is an east-west arterial that forms the southern border of the project site. Grand Avenue begins at Duley Road on the east and extends westerly through the City of El Segundo downtown area to Vista del Mar, near the Pacific Ocean. In the project vicinity, Grand Avenue has two lanes east of Nash Street and six lanes west of Nash Street. Sidewalks are provided along both sides of the street. The posted speed limit on Grand Avenue is 35 mph. Grand Avenue is classified as a Secondary Arterial and is a designated truck route west of Pacific Coast Highway.

El Segundo Boulevard is an east-west arterial located approximately one-quarter mile south of the project site. El Segundo Boulevard extends from near the Pacific Ocean through the City of El Segundo to the San Diego Freeway and beyond. The posted speed limit in the project vicinity is 40 mph. Sidewalks are provided along both sides of the street. El Segundo Boulevard is classified as a Secondary Arterial west of Pacific Coast Highway and a Major Arterial east of Pacific Coast Highway; and is a designated truck route.

Isis Avenue is a north-south local street located in the City of Hawthorne and County of Los Angeles. Isis Avenue extends from El Segundo Boulevard to 16th Street and has one lane in each direction. The posted speed limit is 25 mph. Parking is allowed on both sides of the street.

La Cienega Boulevard is a north-south arterial located in the City of Hawthorne and County of Los Angeles. La Cienega Boulevard runs from the City boundary to the north to El Segundo Boulevard to the south. The posted speed limit is 40 mph, and parking is restricted on both sides of the street.

Existing Transit Service

Public transportation services for the project area are provided by the Los Angeles County Metropolitan Transportation Authority (LACMTA), the Los Angeles Department of Transportation (LADOT), and other local transit services, as described below.

Los Angeles County Metropolitan Transportation Authority (Metro)

Metro Bus Line 232 travels mainly north-south along Pacific Coast Highway (PCH) in the project vicinity, with a one-way loop via Mariposa Avenue, Nash Street, and Grand Avenue. Line 232 originates at LAX and travels south on PCH through the cities of Manhattan Beach, Hermosa Beach, and Redondo Beach, then turns eastward on PCH, terminating at the Transit Mall in the City of Long Beach. Line 232 operates with headways (the interval between arrivals) of 10-15 minutes during the weekday peak

commuting hours, and 20-60 minutes during other hours. Line 232 operates on the weekends with headways of 30 minutes during the day and 40-60 minutes in the evenings. The bus stop closest to the project site is located on Grand Avenue west of Continental Boulevard, adjacent to the project site.

The Metro Green Line is a light rail system that travels between Redondo Beach and Norwalk every day of the week with headways of 6-8 minutes during weekday peak hours and 15-20 minutes during non-peak hours and weekends. The Green Line stations in the vicinity of the project are the El Segundo Station, located near the intersection of El Segundo Boulevard at Nash Street (approximately 1/2 mile from the project site); the Mariposa Station, located at the intersection of Mariposa Avenue at Nash Street (approximately 1/2 mile from the project site); and the Aviation/LAX Station, located at the intersection of Aviation Boulevard at Imperial Highway (approximately 1-1/2 mile from the project).

Los Angeles Department of Transportation (LADOT)

The Los Angeles Department of Transportation (LADOT) operates Commuter Express (CE) lines to facilitate commuter travel to downtown Los Angeles and other employment destinations during the morning and afternoon commute hours.

Commuter Express 574 (CE 574) serves the communities of El Segundo, Manhattan Beach, Redondo Beach, and Hermosa Beach via Pacific Coast Highway, El Segundo Boulevard, and Aviation Boulevard. CE 574 operates southbound only during weekday mornings and northbound during the evenings, and travels non-stop via the I-405 Freeway between Space Park Drive at Aviation Boulevard in El Segundo, and the Sylmar / Encino area. CE 574 operates on 30- to 60-minute headways during the morning and afternoon commute periods (5:20 to 8:56 AM and 3:35 to 7:42 PM) on weekdays only. CE 574 stops at the bus stop located at the corner of Grand Avenue and Continental Boulevard.

Torrance Transit

Torrance Transit Line 8 (T8) originates at the LAX Transit Center and travels south via Pacific Coast Highway, Nash Street, and Aviation Boulevard to the City of Torrance. Line 8 has headways of approximately 30 minutes on weekdays and provides limited service on weekends with 30- to 60-minute headways. The nearest bus stop is located near the corner of Grand Avenue at Nash Street.

City of Redondo Beach – Beach Cities Transit

Beach Cities Transit Line 109 (BCT 109) operates between the cities of El Segundo and Redondo Beach, and provides service to Downtown Manhattan Beach, Downtown El Segundo, Plaza El Segundo, the Douglas and Aviation Green Line Stations, the LAX City Bus Center, and other areas. BCT 109 travels along Imperial Avenue, Main Street, Grand Avenue, and Pacific Coast Highway in the vicinity of the project site. This bus line operates with headways of 30 to 45 minutes on weekdays and one hour on weekends.

City of El Segundo

Lunchtime Shuttle: The City of El Segundo operates a Lunchtime Shuttle to connect the corporate business area on the east side of the city with the downtown area on the west side of the city. The shuttle operates free of charge, Monday through Friday from 11:30 AM to 2:15 PM, with 10-minute headways. The shuttle does not run on weekends or holidays. The Lunchtime Shuttle stops closest to the project site are located on Continental Boulevard between Mariposa Avenue and Grand Avenue; and on Grand Avenue, between Continental Boulevard and Nash Street.

EXISTING TRAFFIC CONDITIONS

Existing Traffic Volumes

Morning and evening peak hour turning movement counts were collected for the study intersections in October, 2015 and May, 2016. These counts were collected on a typical weekday, while local schools were in session. Counts collected in 2015 were grown 0.26%, per the Los Angeles County Congestion Management Program (CMP), to be consistent with 2016 counts. Additionally, morning and evening peak hour turning movement counts for intersections within the City of Hawthorne were collected in April, 2018. Existing lane configurations and traffic control at the study intersections are shown on Figure 3. The existing morning and evening peak hour traffic volumes are shown on Figure 4. Copies of the traffic count data worksheets are provided in *Appendix A*.

Existing Intersection Operating Conditions

Existing intersection operations were evaluated using the ICU and HCM methodologies described earlier. The results of the analysis are summarized on Table 1. ICU intersection analysis worksheets are provided in *Appendix B* and HCM intersection analysis worksheets are provided in *Appendix C*. Review of Table 1 indicates that all study intersections currently operate at an acceptable Level of Service D or better during both peak hours, with the exception of the following:

- #1 – Pacific Coast Highway at Imperial Highway (ICU) – PM LOS E
- #16 – Aviation Boulevard at El Segundo Boulevard (ICU) – PM LOS E

PROJECT TRAFFIC

Project Trip Generation

Trip generation estimates for the proposed Continental Grand Campus Specific Plan project are based on the Institute of Transportation Engineers (ITE) Trip Generation Manual. The following ITE land use categories were used:

- General Office Building (Land Use 710)
- Corporate Headquarters Building (Land Use 714)
- Research and Development Center (Land Use 760)



NOT TO SCALE

1. Pacific Coast Hwy at Imperial Hwy	2. Pacific Coast Hwy at Walnut Ave	3. Pacific Coast Hwy at Maple Ave	4. Pacific Coast Hwy at Mariposa Ave
5. Pacific Coast Hwy at Grand Ave	6. Pacific Coast Hwy at El Segundo Blvd	7. Pacific Coast Hwy at Rosecrans Blvd	8. Continental Blvd at Mariposa Ave
9. Continental Blvd at Grand Ave	10. Continental Blvd at El Segundo Blvd	11. Nash St at Imperial Hwy	12. Nash St at Mariposa Ave
13. Nash St at Grand Ave	14. Nash St at El Segundo Blvd	15. Douglas St at El Segundo Blvd	16. Aviation Blvd at El Segundo Blvd
17. El Segundo Blvd at Isis Ave	18. El Segundo Blvd at I-405 SB Ramps	19. El Segundo Blvd at La Cienega Blvd	20. El Segundo Blvd at I-405 NB Ramps

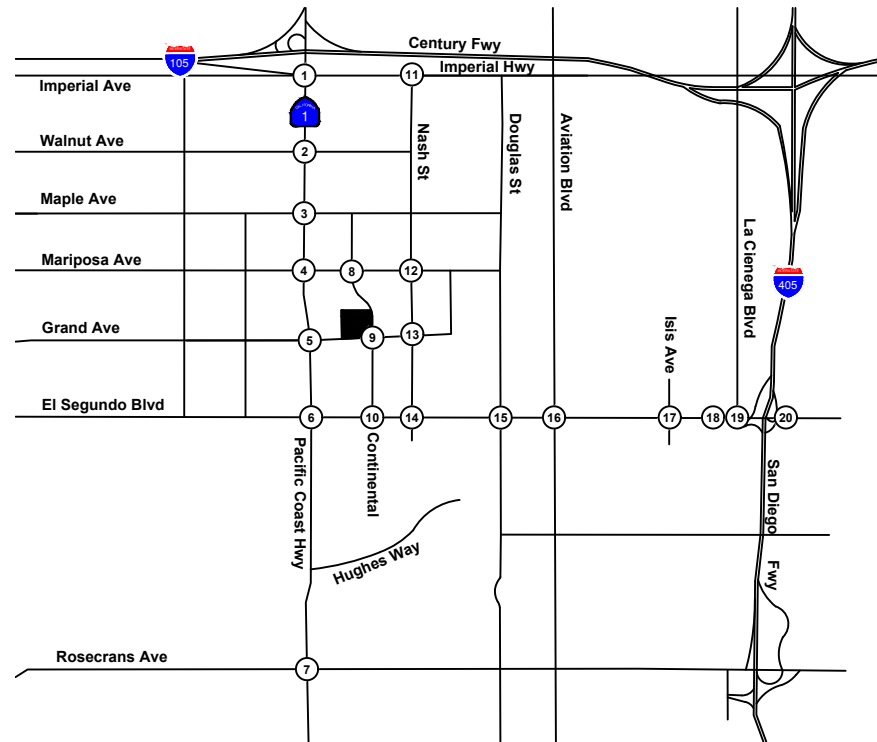

LEGEND:

- = Project Site
- = Study Intersection
- = Traffic Signal
- OVL = Right-Turn Overlap Phasing
- D = Defacto Right-Turn Lane
- Free = Free Right-Turn Lane

**FIGURE 3
EXISTING LANE CONFIGURATION AND TRAFFIC CONTROL**





1. Pacific Coast Hwy at Imperial Hwy 	2. Pacific Coast Hwy at Walnut Ave 	3. Pacific Coast Hwy at Maple Ave 	4. Pacific Coast Hwy at Mariposa Ave
5. Pacific Coast Hwy at Grand Ave 	6. Pacific Coast Hwy at El Segundo Blvd 	7. Pacific Coast Hwy at Rosecrans Blvd 	8. Continental Blvd at Mariposa Ave
9. Continental Blvd at Grand Ave 	10. Continental Blvd at El Segundo Blvd 	11. Nash St at Imperial Hwy 	12. Nash St at Mariposa Ave
13. Nash St at Grand Ave 	14. Nash St at El Segundo Blvd 	15. Douglas St at El Segundo Blvd 	16. Aviation Blvd at El Segundo Blvd
17. El Segundo Blvd at Isis Ave 	18. El Segundo Blvd at I-405 SB Ramps 	19. El Segundo Blvd at La Cienega Blvd 	20. El Segundo Blvd at I-405 NB Ramps

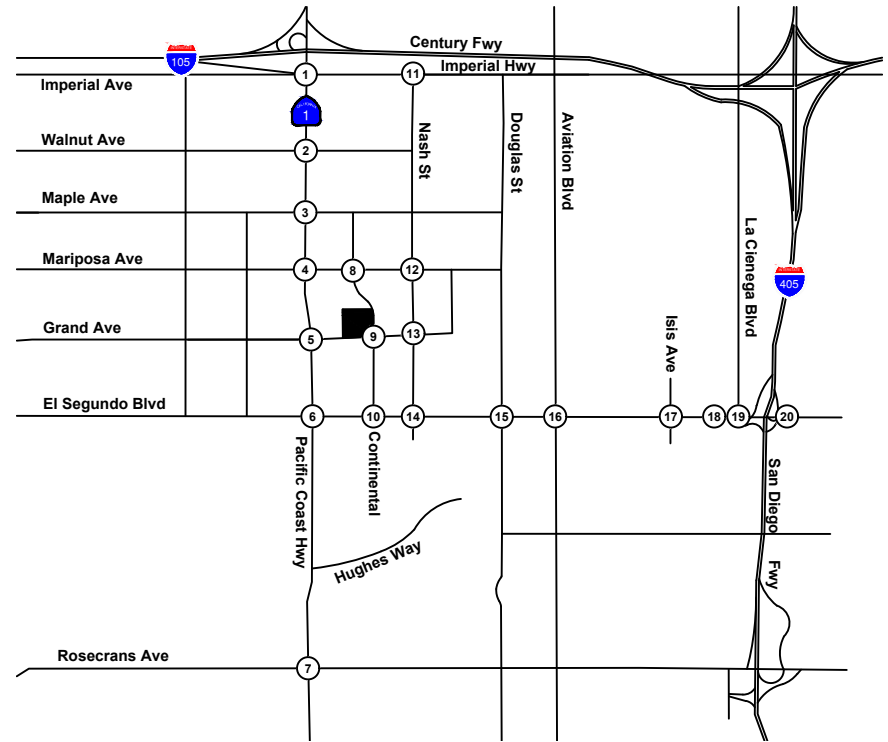

LEGEND:

- = Project Site
- = Study Intersection
- XX/YY = AM/PM Peak Hour Turning Movement Volumes

**FIGURE 4
EXISTING PEAK HOUR TRAFFIC VOLUMES**



**TABLE 1
SUMMARY OF INTERSECTION OPERATION
EXISTING CONDITIONS**

ICU Methodology						
Int. #	Intersection	Traffic Control	AM Peak Hour		PM Peak Hour	
			V/C	LOS	V/C	LOS
1	Pacific Coast Highway at Imperial Hwy	S	0.798	C	0.957	E
2	Pacific Coast Highway at Walnut Ave	S	0.561	A	0.564	A
3	Pacific Coast Highway at Maple Ave	S	0.575	A	0.629	B
4	Pacific Coast Highway at Mariposa Ave	S	0.675	B	0.684	B
5	Pacific Coast Highway at Grand Ave	S	0.737	C	0.781	C
6	Pacific Coast Highway at El Segundo Blvd	S	0.760	C	0.883	D
7	Pacific Coast Highway at Rosecrans Blvd	S	0.797	C	0.879	D
8	Continental Blvd at Mariposa Ave	S	0.383	A	0.366	A
9	Continental Blvd at Grand Ave	S	0.311	A	0.317	A
10	Continental Blvd at El Segundo Blvd	S	0.395	A	0.419	A
11	Nash St at Imperial Hwy	S	0.631	B	0.474	A
12	Nash St at Mariposa Ave	S	0.462	A	0.554	A
13	Nash St at Grand Ave	S	0.480	A	0.527	A
14	Nash St at El Segundo Blvd	S	0.457	A	0.546	A
15	Douglas St at El Segundo Blvd	S	0.699	B	0.881	D
16	Aviation Blvd at El Segundo Blvd	S	0.811	D	0.943	E
17	El Segundo Blvd at Isis Avenue	S	0.577	A	0.632	B
18	El Segundo Blvd at I-405 SB Ramps	S	0.522	A	0.874	D
19	El Segundo Blvd at La Cienega	S	0.570	A	0.643	B
20	El Segundo Blvd at I-405 NB Ramps	S	0.700	C	0.681	B
HCM Methodology						
Int. #	Intersection	Traffic Control	AM Peak Hour		PM Peak Hour	
			Delay	LOS	Delay	LOS
1	Pacific Coast Highway at Imperial Hwy	S	29.5	C	37.4	D
2	Pacific Coast Highway at Walnut Ave	S	7.8	A	9.8	A
3	Pacific Coast Highway at Maple Ave	S	10.6	B	12.4	B
4	Pacific Coast Highway at Mariposa Ave	S	18.2	B	19.9	B
5	Pacific Coast Highway at Grand Ave	S	22.2	C	30.0	C
6	Pacific Coast Highway at El Segundo Blvd	S	26.2	C	36.0	D
7	Pacific Coast Highway at Rosecrans Blvd	S	27.2	C	31.8	C
18	El Segundo Blvd at I-405 SB Ramps	S	17.7	B	26.8	C
20	El Segundo Blvd at I-405 NB Ramps	S	17.8	B	11.7	B

LOS shown in **Bold** and shaded indicates unacceptable Level of Service.
 ICU = Intersection Capacity Utilization
 HCM = Highway Capacity Manual
 LOS = Level of Service
 Intersection operation is expressed in volume-to-capacity (v/c) ratio for the ICU methodology.
 Intersection operation is expressed in average seconds of delay (sec/veh) for the HCM methodology.

The project will be constructed in two phases:

- Phase 1 will consist of the construction of a 14-story, 328,612-square-foot building on the 455 Continental Boulevard parcel. The building will include 246,459 gross square feet of Corporate Headquarters use and 82,153 gross square feet of Research and Development use. Phase 1 Opening Year is anticipated to be 2022.
- Phase 2 will include the demolition of the existing 1955 East Grand Avenue building and the construction of a six-story, 174,236-square-foot General Office Building. As discussed earlier, the existing 1955 East Grand Avenue building is not regularly used, therefore, no trip credits were taken for the existing use. Phase 2 Opening Year is anticipated to be 2023.

Trip generation rates and the resulting trip generation estimates for Phase 1 and Phase 2 of the Continental Grand Campus Specific Plan are summarized on Table 2. The project is estimated to generate a total of 4,555 trips on a daily basis, with 746 trips in the morning peak hour, and 696 trips in the evening peak hour.

Project Trip Distribution and Assignment

Trip distribution assumptions for the project were developed, taking into account the project access, the surrounding land uses and the area roadway system. Trip distribution assumptions for the project are shown on Figure 5. The resulting peak hour project trips at the study intersections are shown on Figure 6 for Phase 1, Figure 7 for Phase 2, and Figure 8 for the total project.

EXISTING PLUS PROJECT CONDITIONS

The Existing Plus Project analysis scenario is a hypothetical scenario that assumes completion of the project and full absorption of the project traffic on the surrounding street network at the current time, with no other changes in traffic conditions. The Existing Plus Project scenario is required by the California Environmental Quality Act (CEQA).

The project-related peak hour trips were added to the existing peak hour volumes to evaluate Existing Plus Project conditions. The resulting traffic volumes are shown on Figure 9. Existing Plus Project intersection results are shown on Table 3. As this table indicates, with the addition of project traffic, all study intersections would continue to operate at an acceptable Level of Service D or better, with the following exceptions:

The two intersections currently operating at a deficient Level of Service would continue to do so with the addition of project traffic:

- #1 – Pacific Coast Highway at Imperial Highway (ICU) – PM LOS F
- #16 – Aviation Boulevard at El Segundo Boulevard (ICU) – PM LOS E

TABLE 2
SUMMARY OF PROJECT TRIP GENERATION

Land Use	ITE Code	Unit	Trip Generation Rates ¹						
			Daily	AM Peak Hour			PM Peak Hour		
				In	Out	Total	In	Out	Total
Corporate Headquarters Building	714	KSF	7.980	1.414	0.106	1.520	0.141	1.269	1.410
Research and Development Center	760	KSF	8.110	1.013	0.207	1.220	0.161	0.910	1.070
General Office Building	710	KSF	11.030	1.373	0.187	1.560	0.253	1.237	1.490
Trip Generation Estimates									
Land Use	Quantity	Unit	Daily	AM Peak Hour			PM Peak Hour		
				In	Out	Total	In	Out	Total
			Phase 1: 455 Continental Avenue						
Corporate Headquarters Building	246.459	KSF	1,967	348	26	374	35	313	348
Research and Development Center	82.153	KSF	666	83	17	100	13	75	88
Subtotal			2,633	431	43	474	48	388	436
Phase 2: 1955 Grand Avenue									
General Office Building	174.236	KSF	1,922	239	33	272	44	216	260
Total Project Trips			4,555	670	76	746	92	604	696

¹ Source: Institute of Transportation Engineers (ITE) Trip Generation Manual, 9th Edition



NOT TO SCALE

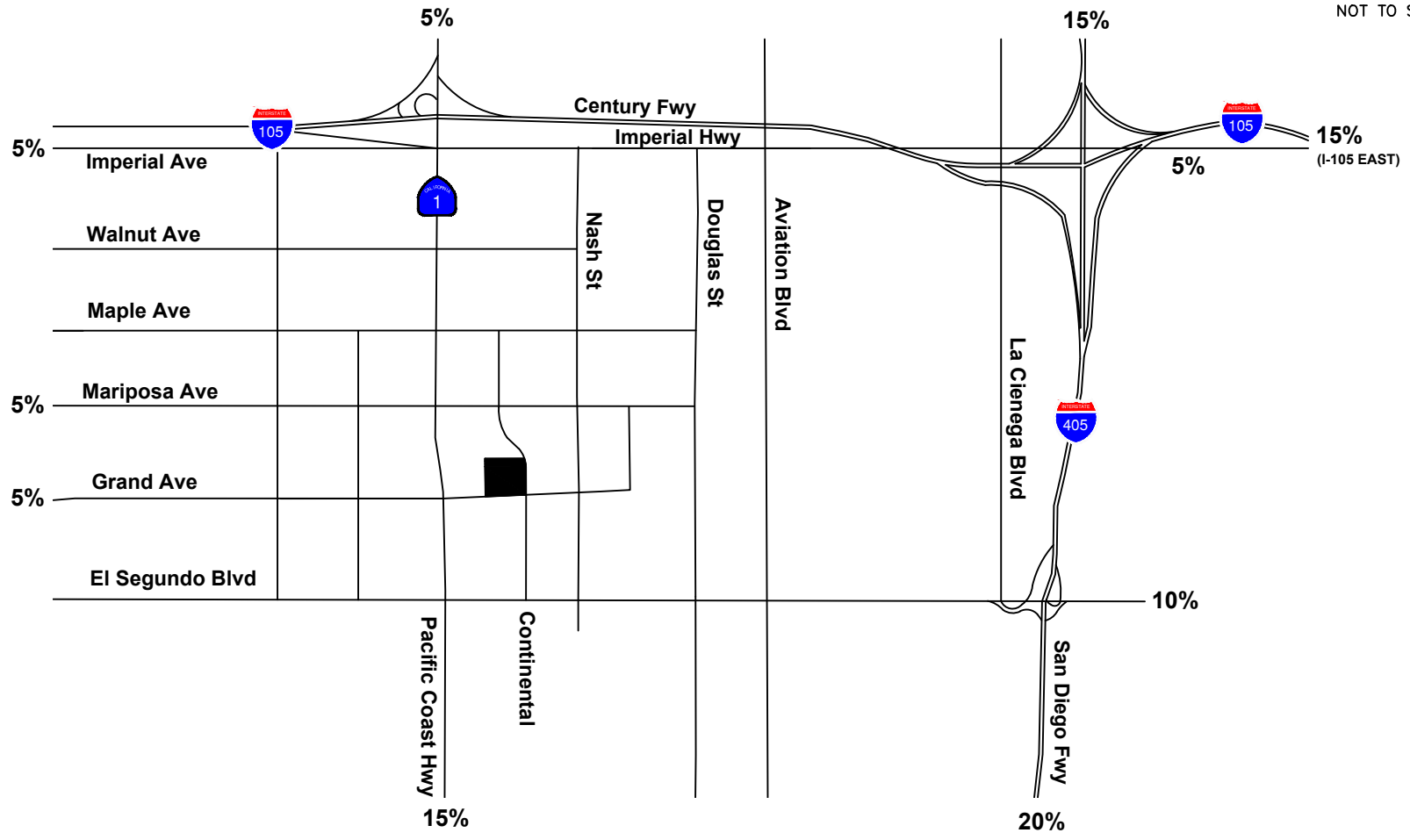

**FIGURE 5
PROJECT TRIP DISTRIBUTION**

LEGEND:

-  = Project Site
- XX%** = Trip Distribution Percentage



1. Pacific Coast Hwy at Imperial Hwy	2. Pacific Coast Hwy at Walnut Ave	3. Pacific Coast Hwy at Maple Ave	4. Pacific Coast Hwy at Mariposa Ave
5. Pacific Coast Hwy at Grand Ave	6. Pacific Coast Hwy at El Segundo Blvd	7. Pacific Coast Hwy at Rosecrans Blvd	8. Continental Blvd at Mariposa Ave
9. Continental Blvd at Grand Ave	10. Continental Blvd at El Segundo Blvd	11. Nash St at Imperial Hwy	12. Nash St at Mariposa Ave
13. Nash St at Grand Ave	14. Nash St at El Segundo Blvd	15. Douglas St at El Segundo Blvd	16. Aviation Blvd at El Segundo Blvd
17. El Segundo Blvd at Isis Ave	18. El Segundo Blvd at I-405 SB Ramps	19. El Segundo Blvd at La Cienega Blvd	20. El Segundo Blvd at I-405 NB Ramps

D1. Driveway 1 at Grand Ave	D2. Driveway 2 at Grand Ave	D3. Driveway 3 at Continental Blvd	D4. Driveway 4 at Continental Blvd

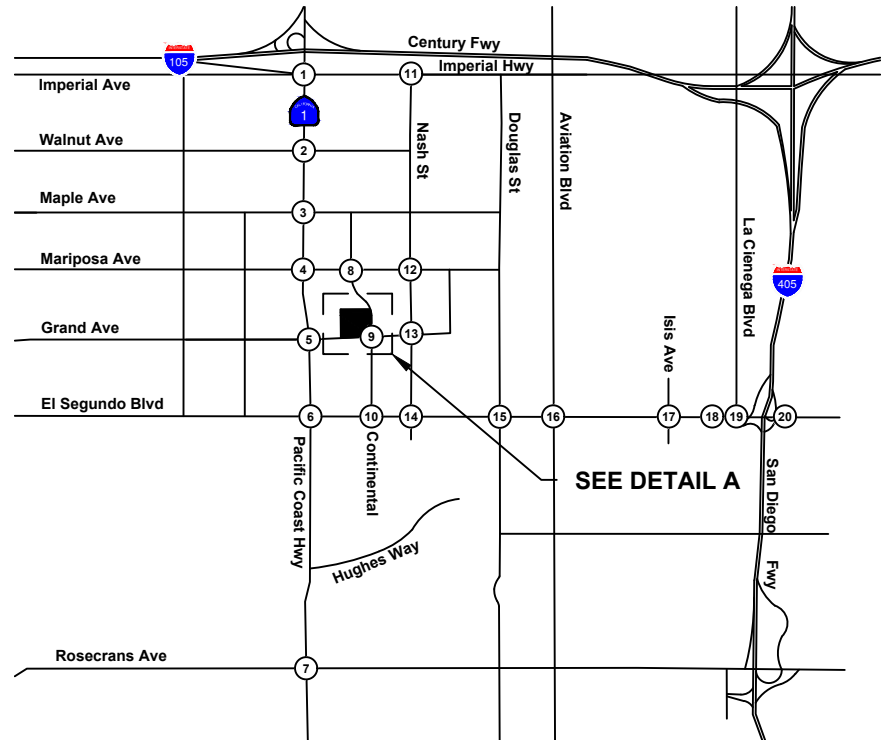

NOT TO SCALE

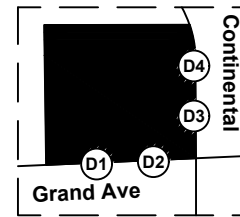

DETAIL A

LEGEND:

- = Project Site
- = Study Intersection
- XX/YY = AM/PM Peak Hour Turning Movement Volumes

**FIGURE 6
PHASE 1 PROJECT-RELATED TRAFFIC**

1. Pacific Coast Hwy at Imperial Hwy	2. Pacific Coast Hwy at Walnut Ave	3. Pacific Coast Hwy at Maple Ave	4. Pacific Coast Hwy at Mariposa Ave
5. Pacific Coast Hwy at Grand Ave	6. Pacific Coast Hwy at El Segundo Blvd	7. Pacific Coast Hwy at Rosecrans Blvd	8. Continental Blvd at Mariposa Ave
9. Continental Blvd at Grand Ave	10. Continental Blvd at El Segundo Blvd	11. Nash St at Imperial Hwy	12. Nash St at Mariposa Ave
13. Nash St at Grand Ave	14. Nash St at El Segundo Blvd	15. Douglas St at El Segundo Blvd	16. Aviation Blvd at El Segundo Blvd
17. El Segundo Blvd at Isis Ave	18. El Segundo Blvd at I-405 SB Ramps	19. El Segundo Blvd at La Cienega Blvd	20. El Segundo Blvd at I-405 NB Ramps

**FIGURE 7
PHASE 2 PROJECT-RELATED TRAFFIC**

D1. Driveway 1 at Grand Ave	D2. Driveway 2 at Grand Ave	D3. Driveway 3 at Continental Blvd	D4. Driveway 4 at Continental Blvd

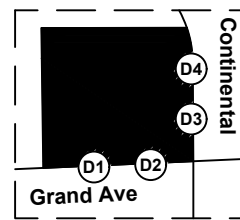
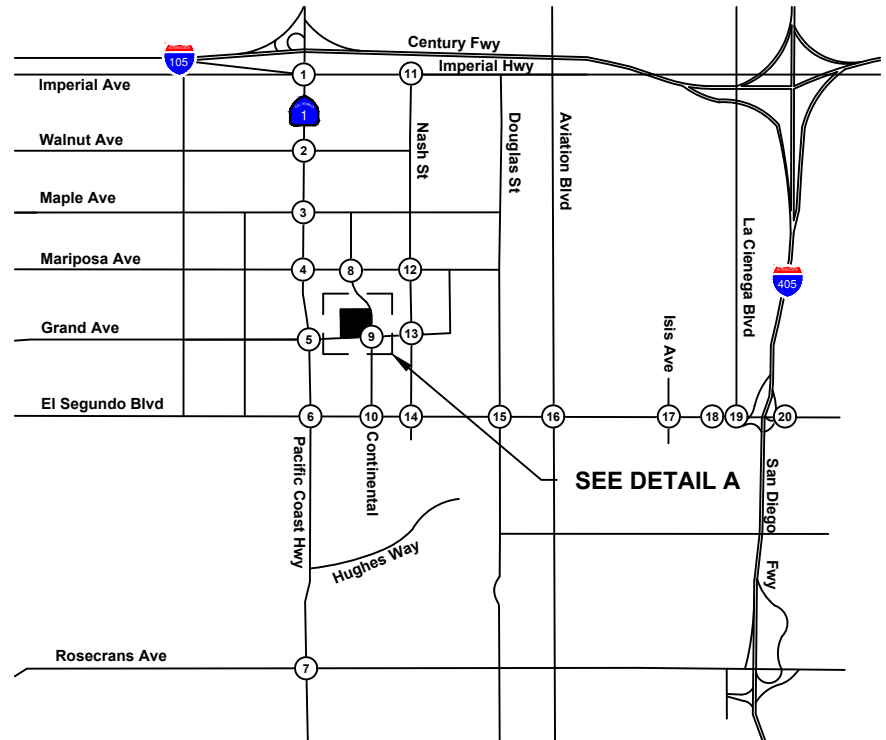

DETAIL A

LEGEND:

- = Project Site
- = Study Intersection
- XX/YY = AM/PM Peak Hour Turning Movement Volumes



1. Pacific Coast Hwy at Imperial Hwy	2. Pacific Coast Hwy at Walnut Ave	3. Pacific Coast Hwy at Maple Ave	4. Pacific Coast Hwy at Mariposa Ave
5. Pacific Coast Hwy at Grand Ave	6. Pacific Coast Hwy at El Segundo Blvd	7. Pacific Coast Hwy at Rosecrans Blvd	8. Continental Blvd at Mariposa Ave
9. Continental Blvd at Grand Ave	10. Continental Blvd at El Segundo Blvd	11. Nash St at Imperial Hwy	12. Nash St at Mariposa Ave
13. Nash St at Grand Ave	14. Nash St at El Segundo Blvd	15. Douglas St at El Segundo Blvd	16. Aviation Blvd at El Segundo Blvd
17. El Segundo Blvd at Isis Ave	18. El Segundo Blvd at I-405 SB Ramps	19. El Segundo Blvd at La Cienega Blvd	20. El Segundo Blvd at I-405 NB Ramps

**FIGURE 8
TOTAL PROJECT-RELATED TRAFFIC**

D1. Driveway 1 at Grand Ave	D2. Driveway 2 at Grand Ave	D3. Driveway 3 at Continental Blvd	D4. Driveway 4 at Continental Blvd

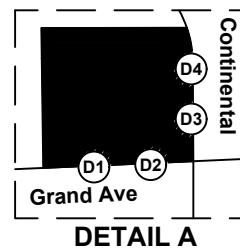
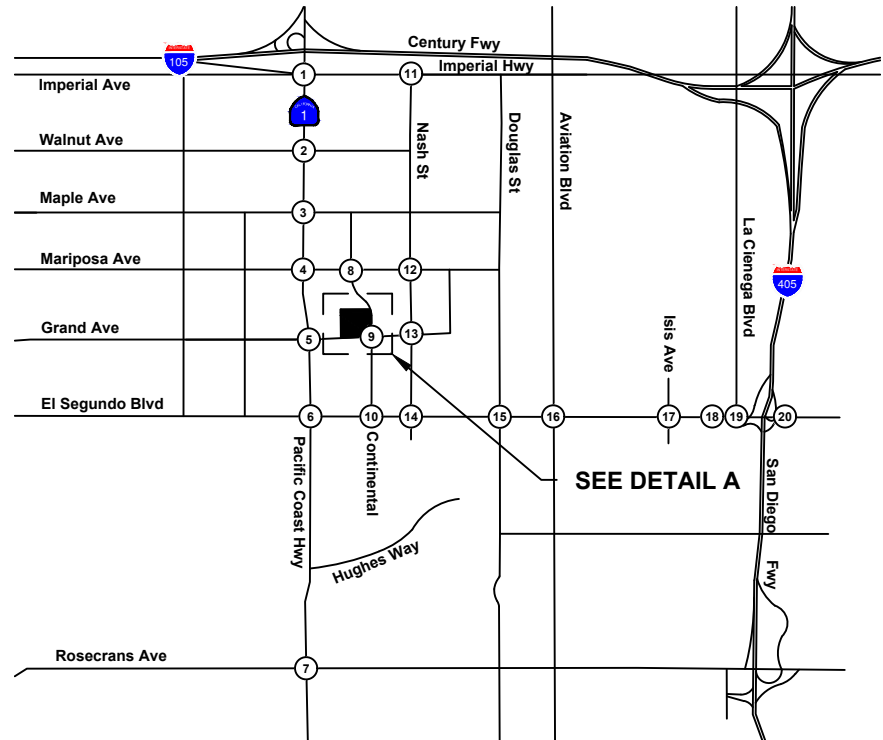

LEGEND:

- = Project Site
- = Study Intersection
- XX/YY = AM/PM Peak Hour Turning Movement Volumes



1. Pacific Coast Hwy at Imperial Hwy 	2. Pacific Coast Hwy at Walnut Ave 	3. Pacific Coast Hwy at Maple Ave 	4. Pacific Coast Hwy at Mariposa Ave
5. Pacific Coast Hwy at Grand Ave 	6. Pacific Coast Hwy at El Segundo Blvd 	7. Pacific Coast Hwy at Rosecrans Blvd 	8. Continental Blvd at Mariposa Ave
9. Continental Blvd at Grand Ave 	10. Continental Blvd at El Segundo Blvd 	11. Nash St at Imperial Hwy 	12. Nash St at Mariposa Ave
13. Nash St at Grand Ave 	14. Nash St at El Segundo Blvd 	15. Douglas St at El Segundo Blvd 	16. Aviation Blvd at El Segundo Blvd
17. El Segundo Blvd at Isis Ave 	18. El Segundo Blvd at I-405 SB Ramps 	19. El Segundo Blvd at La Cienega Blvd 	20. El Segundo Blvd at I-405 NB Ramps

D1. Driveway 1 at Grand Ave 	D2. Driveway 2 at Grand Ave 	D3. Driveway 3 at Continental Blvd 	D4. Driveway 4 at Continental Blvd
--	--	---	---

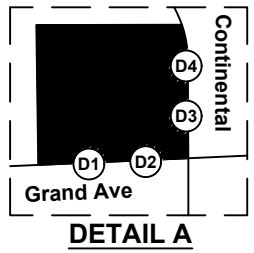
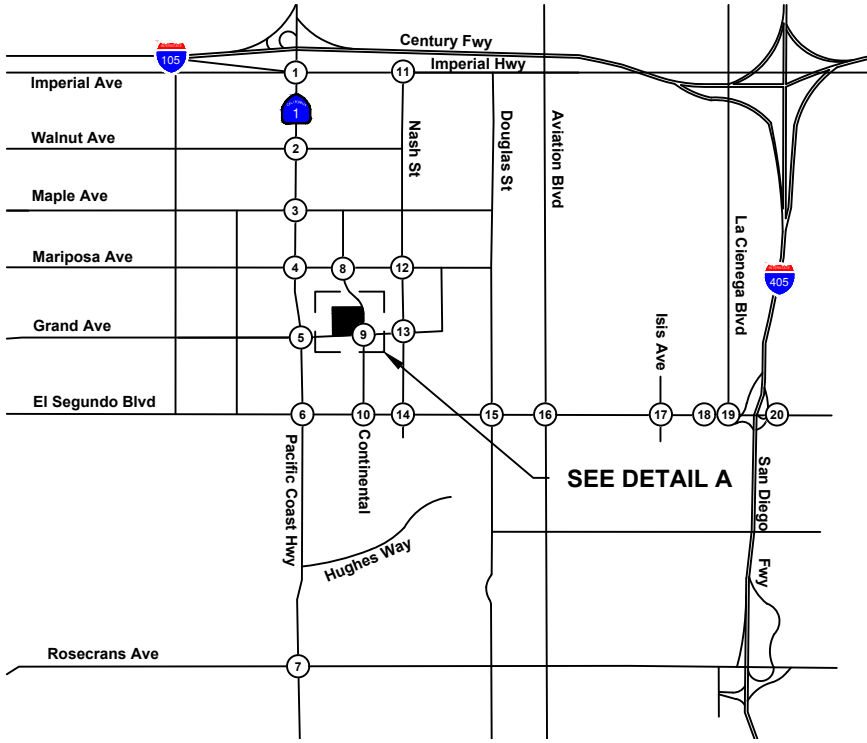

LEGEND:

- = Project Site
- = Study Intersection
- XX/YY = AM/PM Peak Hour Turning Movement Volumes

**FIGURE 9
EXISTING PLUS PROJECT
PEAK HOUR TRAFFIC VOLUMES**



**TABLE 3
SUMMARY OF INTERSECTION OPERATION
EXISTING PLUS PROJECT CONDITIONS**

ICU Methodology													
Int. #	Intersection	AM Peak Hour						PM Peak Hour					
		Without Project		With Project		Project Impact	Impact Sig?	Without Project		With Project		Project Impact	Impact Sig?
		V/C	LOS	V/C	LOS			V/C	LOS	V/C	LOS		
1	Pacific Coast Highway at Imperial Hwy	0.798	C	0.799	C	0.001	No	0.957	E	1.004	F	0.047	Yes
2	Pacific Coast Highway at Walnut Ave	0.561	A	0.571	A	0.010	No	0.564	A	0.585	A	0.021	No
3	Pacific Coast Highway at Maple Ave	0.575	A	0.578	A	0.003	No	0.629	B	0.630	B	0.001	No
4	Pacific Coast Highway at Mariposa Ave	0.675	B	0.713	C	0.038	No	0.684	B	0.703	B	0.019	No
5	Pacific Coast Highway at Grand Ave	0.737	C	0.820	D	0.083	No	0.781	C	0.862	D	0.081	No
6	Pacific Coast Highway at El Segundo Blvd	0.760	C	0.779	C	0.019	No	0.883	D	0.898	D	0.015	No
7	Pacific Coast Highway at Rosecrans Blvd	0.797	C	0.812	D	0.015	No	0.879	D	0.898	D	0.019	No
8	Continental Blvd at Mariposa Ave	0.383	A	0.516	A	0.133	No	0.366	A	0.401	A	0.035	No
9	Continental Blvd at Grand Ave	0.311	A	0.498	A	0.187	No	0.317	A	0.364	A	0.047	No
10	Continental Blvd at El Segundo Blvd	0.395	A	0.466	A	0.071	No	0.419	A	0.469	A	0.050	No
11	Nash St at Imperial Hwy	0.631	B	0.705	C	0.074	No	0.474	A	0.488	A	0.014	No
12	Nash St at Mariposa Ave	0.462	A	0.544	A	0.082	No	0.554	A	0.639	B	0.085	No
13	Nash St at Grand Ave	0.480	A	0.546	A	0.066	No	0.527	A	0.533	A	0.006	No
14	Nash St at El Segundo Blvd	0.457	A	0.499	A	0.042	No	0.546	A	0.584	A	0.038	No
15	Douglas St at El Segundo Blvd	0.699	B	0.724	C	0.025	No	0.881	D	0.918	E	0.037	Yes
16	Aviation Blvd at El Segundo Blvd	0.811	D	0.853	D	0.042	No	0.943	E	0.971	E	0.028	Yes
17	El Segundo Blvd at Isis Avenue	0.577	A	0.619	B	0.042	No	0.632	B	0.660	B	0.028	No
18	El Segundo Blvd at I-405 SB Ramps	0.522	A	0.564	A	0.042	No	0.874	D	0.949	E	0.075	Yes
19	El Segundo Blvd at La Cienega	0.570	A	0.612	B	0.042	No	0.643	B	0.656	B	0.013	No
20	El Segundo Blvd at I-405 NB Ramps	0.700	C	0.742	C	0.042	No	0.681	B	0.694	B	0.013	No
D1	Driveway 1 at Grand Ave			9.9	A	N/A	N/A			14.0	B	N/A	N/A
D2	Driveway 2 at Grand Ave			15.6	C	N/A	N/A			16.1	C	N/A	N/A
D3	Driveway 3 at Continental			17.0	C	N/A	N/A			13.4	B	N/A	N/A
D4	Driveway 4 at Continental			12.9	B	N/A	N/A			13.0	B	N/A	N/A
HCM Methodology													
Int. #	Intersection	AM Peak Hour						PM Peak Hour					
		Without Project		With Project		Project Impact	Impact Sig?	Without Project		With Project		Project Impact	Impact Sig?
		Delay	LOS	Delay	LOS			Delay	LOS	Delay	LOS		
1	Pacific Coast Highway at Imperial Hwy	29.5	C	29.7	C	0.2	No	37.4	D	43.3	D	5.9	No
2	Pacific Coast Highway at Walnut Ave	7.8	A	7.7	A	-0.1	No	9.8	A	9.5	A	-0.3	No
3	Pacific Coast Highway at Maple Ave	10.6	B	10.5	B	-0.1	No	12.4	B	12.4	B	0.0	No
4	Pacific Coast Highway at Mariposa Ave	18.2	B	19.6	B	1.4	No	19.9	B	20.5	C	0.6	No
5	Pacific Coast Highway at Grand Ave	22.2	C	23.5	C	1.3	No	30.0	C	34.6	C	4.6	No
6	Pacific Coast Highway at El Segundo Blvd	26.2	C	26.4	C	0.2	No	36.0	D	37.3	D	1.3	No
7	Pacific Coast Highway at Rosecrans Blvd	27.2	C	27.3	C	0.1	No	31.8	C	32.5	C	0.7	No
18	El Segundo Blvd at I-405 SB Ramps	17.7	B	17.1	B	-0.6	No	26.8	C	36.9	D	10.1	No
20	El Segundo Blvd at I-405 NB Ramps	17.8	B	19.5	B	1.7	No	11.7	B	11.8	B	0.1	No
<p>LOS shown in Bold and shaded indicates unacceptable Level of Service. ICU = Intersection Capacity Utilization HCM = Highway Capacity Manual LOS = Level of Service Intersection operation is expressed in volume-to-capacity (v/c) ratio for the ICU methodology. Intersection operation is expressed in average seconds of delay (sec/veh) ratio for the HCM methodology.</p>													

Both intersections would experience a significant impact per the City's significance thresholds. The intersection of Pacific Coast Highway at Imperial Highway would deteriorate from LOS E to LOS F in the evening peak hour.

In addition, two intersections would worsen from acceptable to unacceptable with the addition of project traffic, which would be considered a significant impact per the City's significance thresholds:

- #15 – Douglas Street at El Segundo Boulevard (ICU) – PM LOS E
- #18 – El Segundo Boulevard at I-405 SB Ramps (ICU) – PM LOS E

FUTURE TRAFFIC CONDITIONS

Near-term future traffic forecasts have been developed to evaluate Cumulative Conditions for the anticipated project opening year. Phase 1 Opening Year is estimated to be Year 2022, and Phase 2 Opening Year is anticipated to be Year 2023. The surrounding transportation network, intersection lane configurations, and traffic control are assumed to be the same as existing. Near-Term traffic forecast volumes were developed using the “build-up” process, starting with existing traffic volumes, and adding a background growth factor and traffic from cumulative projects.

Ambient Growth

Based on the Los Angeles County Congestion Management Program (CMP), the traffic growth factor for the South Bay / LAX area is estimated to be 0.26% per year between years 2016 and 2020, and 0.18% between years 2020 and 2025. The proposed project is expected to be completed in two phases, with Phase 1 completion in 2022 and Phase 2 completion in 2023, therefore, a growth factor of 1.014 is applied for Phase 1 and a factor of 1.0158 is applied for Phase 2.

Cumulative Projects Traffic

Information about cumulative projects (approved and pending projects) was obtained from the City of El Segundo Planning Department and the Cities of Manhattan Beach and Los Angeles. The cumulative projects are listed on Table 4, along with approved/proposed land uses, and estimated peak hour trips. The cumulative projects locations are shown on Figure 10. Trip generation estimates and trip distribution assumptions for the Cumulative Projects were derived from approved traffic studies, where available; and developed by Kimley-Horn if approved traffic studies were not available. Cumulative project turning movement volumes at the study intersections are shown on Figure 11.

**TABLE 4
CUMULATIVE PROJECTS TRIP GENERATION**

Proj. No.	EA#	Project Address	Land Use	Quantity	Unit	Project Trips			
						AM Peak Hour		PM Peak Hour	
						In	Out	In	Out
City of El Segundo									
1	784	445 N. Douglas Street	Data Center Expansion ¹	173,513	KSF	8	8	3	13
2	844	199 Continental Blvd	Hotel	152	Rooms	48	33	46	45
3	890	540 E. Imperial Ave	Senior Housing	304	DU	23	44	50	32
4	905	2100 E. El Segundo Blvd	Light Industrial/Office (Raytheon)	2,142,457	KSF	2,634	408	631	2,489
5	997	888 Pacific Coast Highway	Hotel	190	Rooms	57	36	60	41
6	N/A	201 North Douglas	Manufacturing (to be removed)	-170	KSF	-191	-54	-88	-157
			High School	1,200	Students	351	165	73	83
			District office	12.00	KSF	20	2	3	18
7	1040	400 Duley Road	General Office	73,000	KSF	100	14	18	90
8	1061	525 Pacific Coast Highway	Hotel (to be removed)	-23	Rooms	-7	-5	-7	-7
9	1079	750 South Douglas	Industrial	4,986	KSF	4	1	1	4
10	1082	2275 Mariposa Ave	Lakers Training Facility	131,443	KSF	136	13	103	85
11	1086	500 S Douglas St and 2330 Utah Ave	Industrial (to be removed)	-52,000	KSF	-42	-6	-6	-44
			Office	78,000	KSF	107	15	20	96
12	1097	123 Nevada Street	Industrial (to be removed)	1,700	KSF	-2	0	0	-2
			General Office	14,998	KSF	20	3	4	18
13	1098	2125 Campus Drive	General Office	63,550	KSF	87	12	16	79
			Hotel	140	Rooms	44	30	43	41
14	1103	1700 East Imperial Avenue	General Office	96,898	KSF	133	18	25	120
15	1111	535 Indiana Street	Single-Family Detached Housing	4,000	DU	1	2	3	1
16	1116	123 Lomita	Light Industrial	10,764	KSF	9	1	1	9
17	1125	2130 East Maple Drive	General Office	20,955	KSF	29	4	5	26
18	1126	140 Sheldon Street	Research and Development	7,692	KSF	8	2	1	7
19	1135	400 Pacific Coast Highway	Driving Range	37,991	KSF	9	6	21	26
20	1143	2171-2191 Rosecrans	Restaurant	13,570	KSF	81	66	80	53
21	1181	740 N. Pacific Coast Highway	Fast-Food Restaurant w/ D.T.	4,996	KSF	54	58	84	92
22	1185	700-860 Pacific Coast Highway 2001-2015 E. Park Pl 700-740 Allied Way	Shopping Center	18,850	KSF	11	7	34	37
23	1186	707 Pacific Coast Highway	Hotel and Lounge	116	Room	32	23	36	34
				1,660	KSF	9	8	10	6
24	1197	1301 East El Segundo Boulevard	Warehouse	5,879	KSF	1	0	0	1
25	1201	2121 E. Rosecrans Ave	Office	240,000	KSF	274	37	47	233
			Studio	66,000	KSF	15	4	5	15
			Retail	7,000	KSF	2	1	4	5
City of El Segundo Total						4,065	956	1,326	3,589
City of Manhattan Beach									
26	N/A	3200 N. Sepulveda Blvd	Manhattan Village Mall Expansion	123.7	KSF	29	19	97	79
27	N/A	2205 Sepulveda Blvd	Hair Salon (to be removed)	1,040	KSF	-1	0	0	-2
			General Office	4,700	KSF	6	1	1	6
City of Manhattan Beach Total						34	20	98	83
City of Los Angeles									
28	N/A	11604 Aviation Blvd	Aviation Station Commercial Retail Conversion	26.5	KSF	28	143	48	35
29	N/A	LAX Landside Access Modernization Program ²	N/A	-	-	-	-	-	-
30	N/A	Chick-fil-A	Fast-Food Restaurant w/ D.T.	3,999	KSF	25	28	11	15
31	N/A	OTIS College Consolidation & Relocation	Junior/Community College (To be Consolidated)	-	-	4	1	-10	4
City of Los Angeles Total						28	143	48	35
Total						4,127	1,119	1,472	3,707
¹ Renovation/expansion to 332,137 SF of Data Center (158,624 SF complete and already operating under Phase 1) ² LAX Landside Access Modernization Program (LAMP) envisions a redistribution of existing traffic patterns in the vicinity of LAX. Traffic volumes have been included from the LAX LAMP DEIR.									



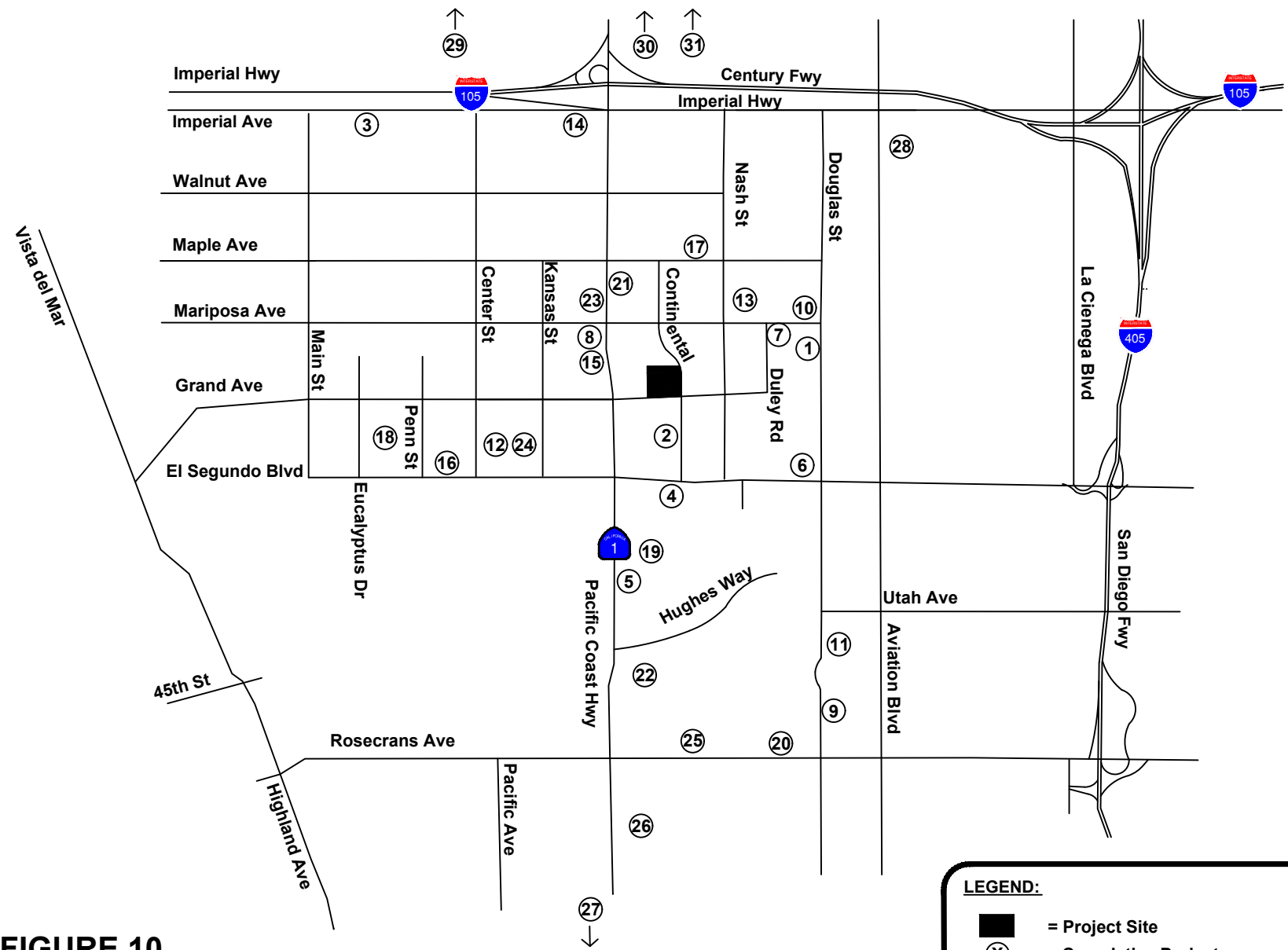

NOT TO SCALE



**FIGURE 10
LOCATION OF CUMULATIVE PROJECTS**

LEGEND:

-  = Project Site
-  = Cumulative Projects

Note: Project identification numbers correspond to project numbers on Table 4.





1. Pacific Coast Hwy at Imperial Hwy 	2. Pacific Coast Hwy at Walnut Ave 	3. Pacific Coast Hwy at Maple Ave 	4. Pacific Coast Hwy at Mariposa Ave
5. Pacific Coast Hwy at Grand Ave 	6. Pacific Coast Hwy at El Segundo Blvd 	7. Pacific Coast Hwy at Rosecrans Blvd 	8. Continental Blvd at Mariposa Ave
9. Continental Blvd at Grand Ave 	10. Continental Blvd at El Segundo Blvd 	11. Nash St at Imperial Hwy 	12. Nash St at Mariposa Ave
13. Nash St at Grand Ave 	14. Nash St at El Segundo Blvd 	15. Douglas St at El Segundo Blvd 	16. Aviation Blvd at El Segundo Blvd
17. El Segundo Blvd at Isis Ave 	18. El Segundo Blvd at I-405 SB Ramps 	19. El Segundo Blvd at La Cienega Blvd 	20. El Segundo Blvd at I-405 NB Ramps

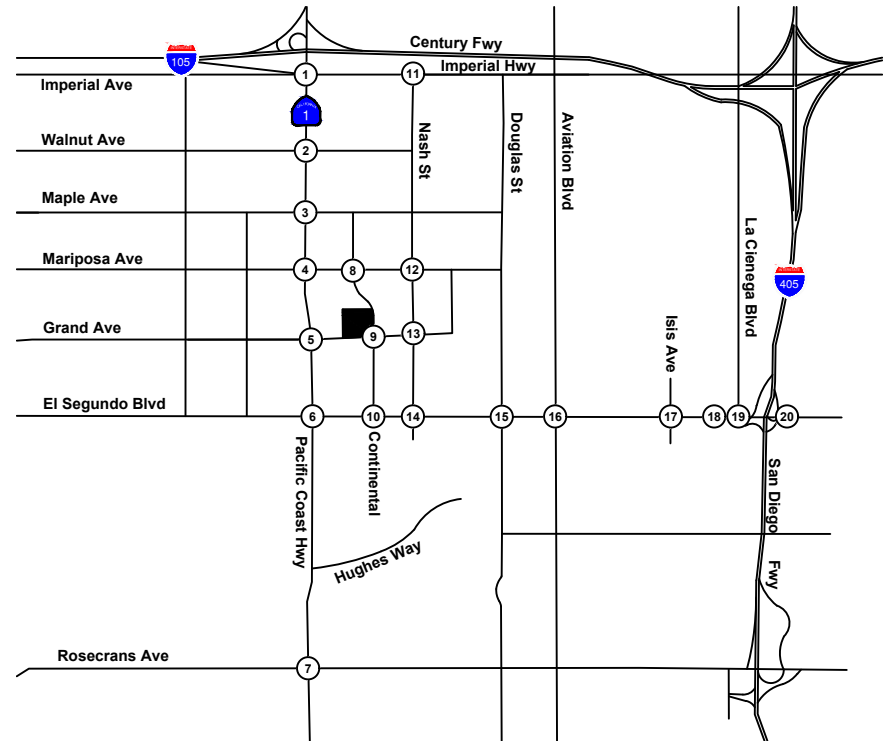

LEGEND:

- = Project Site
- = Study Intersection
- XX/YY = AM/PM Peak Hour Turning Movement Volumes

**FIGURE 11
CUMULATIVE PROJECT
PEAK HOUR TRAFFIC VOLUMES**



Opening Year 2022 Without Project Conditions

The ambient traffic growth and cumulative project traffic volumes were added to existing traffic volumes to develop the Opening Year 2022 Without Project peak hour forecasts. Forecasted peak hour volumes are shown on Figure 12. Each intersection was re-analyzed with these traffic volumes, and the results are shown on Table 5. ICU intersection analysis worksheets are provided in *Appendix B* and HCM intersection worksheets are provided in *Appendix C*.

The results show that the addition of ambient traffic growth and cumulative project traffic would cause the Level of Service at the following intersections to deteriorate to an unacceptable Level of Service in one or both peak hours under Opening Year 2022 Without Project Conditions:

- #1 – Pacific Coast Highway at Imperial Highway (ICU) – PM LOS F
- #6 – Pacific Coast Highway at El Segundo Boulevard
 - (ICU) – AM and PM LOS F
 - (HCM) – AM and PM LOS E
- #7 – Pacific Coast Highway at Rosecrans Boulevard (ICU) – AM LOS E, PM LOS F
- #14 – Nash Street at El Segundo Boulevard (ICU) – PM LOS F
- #15 – Douglas Street at El Segundo Boulevard (ICU) – AM LOS E, PM LOS F
- #16 – Aviation Boulevard at El Segundo Boulevard (ICU) – AM and PM LOS F
- #18 – El Segundo Boulevard at I-405 SB Ramps
 - (ICU) – PM LOS F
 - (HCM) – PM LOS E

Opening Year 2022 With Phase 1 Conditions

Phase 1 project traffic was added to the Opening Year 2022 Without Project traffic volumes to develop Opening Year 2022 With Phase 1 forecasts, which are shown on Figure 13. The results of the analysis are summarized on Table 6. The ICU intersection analysis worksheets are provided in *Appendix B* and HCM intersection worksheets are provided in *Appendix C*.

In the Opening Year 2022 With Phase 1 scenario, the same intersections that were forecasted to operate at an unacceptable Level of Service in the Opening Year 2022 Without Project scenario will continue to do so with the addition of project traffic.

This table also shows the project impact at each study intersection, calculated as the change in V/C ratio or in the seconds of delay as a result of the project traffic. The addition of project traffic would cause one additional intersection to worsen to an unacceptable Level of Service:

- #20 – El Segundo Boulevard at I-405 NB Ramps (ICU) – AM LOS E.



1. Pacific Coast Hwy at Imperial Hwy 	2. Pacific Coast Hwy at Walnut Ave 	3. Pacific Coast Hwy at Maple Ave 	4. Pacific Coast Hwy at Mariposa Ave
5. Pacific Coast Hwy at Grand Ave 	6. Pacific Coast Hwy at El Segundo Blvd 	7. Pacific Coast Hwy at Rosecrans Blvd 	8. Continental Blvd at Mariposa Ave
9. Continental Blvd at Grand Ave 	10. Continental Blvd at El Segundo Blvd 	11. Nash St at Imperial Hwy 	12. Nash St at Mariposa Ave
13. Nash St at Grand Ave 	14. Nash St at El Segundo Blvd 	15. Douglas St at El Segundo Blvd 	16. Aviation Blvd at El Segundo Blvd
17. El Segundo Blvd at Isis Ave 	18. El Segundo Blvd at I-405 SB Ramps 	19. El Segundo Blvd at La Cienega Blvd 	20. El Segundo Blvd at I-405 NB Ramps

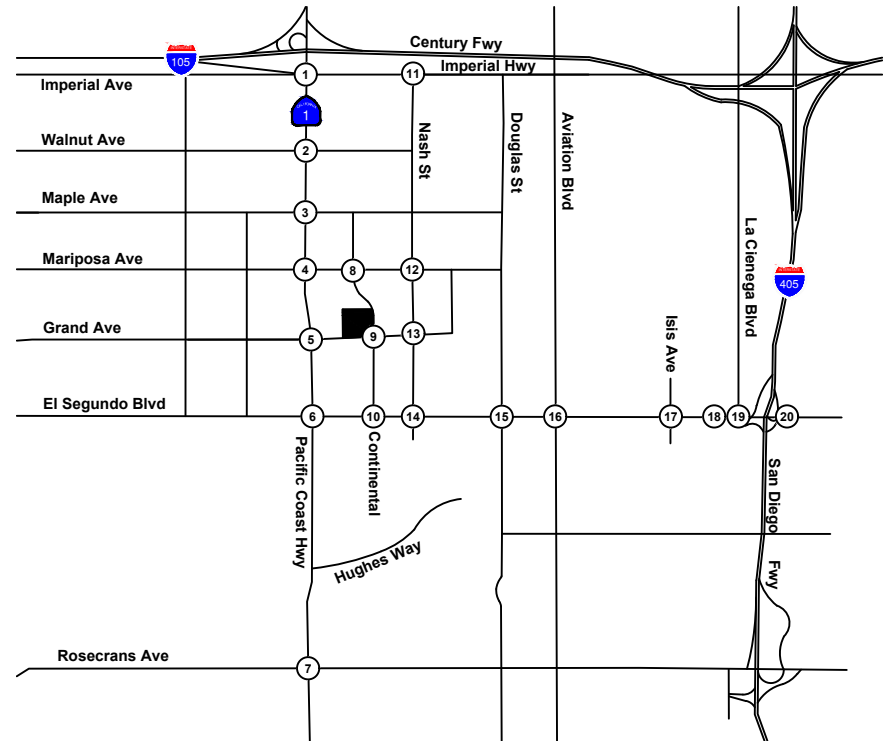

LEGEND:

- = Project Site
- = Study Intersection
- XX/YY = AM/PM Peak Hour Turning Movement Volumes

**FIGURE 12
OPENING YEAR 2022 WITHOUT PROJECT
PEAK HOUR TRAFFIC VOLUMES**



**TABLE 5
SUMMARY OF INTERSECTION OPERATION
OPENING YEAR 2022 WITHOUT PROJECT**

ICU Methodology						
Int. #	Intersection	Traffic Control	AM Peak Hour		PM Peak Hour	
			V/C	LOS	V/C	LOS
1	Pacific Coast Highway at Imperial Hwy	S	0.868	D	1.036	F
2	Pacific Coast Highway at Walnut Ave	S	0.727	C	0.754	C
3	Pacific Coast Highway at Maple Ave	S	0.725	C	0.756	C
4	Pacific Coast Highway at Mariposa Ave	S	0.764	C	0.830	D
5	Pacific Coast Highway at Grand Ave	S	0.852	D	0.886	D
6	Pacific Coast Highway at El Segundo Blvd	S	1.069	F	1.080	F
7	Pacific Coast Highway at Rosecrans Blvd	S	0.924	E	1.003	F
8	Continental Blvd at Mariposa Ave	S	0.390	A	0.370	A
9	Continental Blvd at Grand Ave	S	0.329	A	0.344	A
10	Continental Blvd at El Segundo Blvd	S	0.547	A	0.640	B
11	Nash St at Imperial Hwy	S	0.773	C	0.521	A
12	Nash St at Mariposa Ave	S	0.605	B	0.698	B
13	Nash St at Grand Ave	S	0.547	A	0.612	B
14	Nash St at El Segundo Blvd	S	0.729	C	1.038	F
15	Douglas St at El Segundo Blvd	S	0.988	E	1.179	F
16	Aviation Blvd at El Segundo Blvd	S	1.165	F	1.159	F
17	El Segundo Blvd at Isis Avenue	S	0.826	D	0.785	C
18	El Segundo Blvd at I-405 SB Ramps	S	0.771	C	1.187	F
19	El Segundo Blvd at La Cienega	S	0.847	D	0.753	C
20	El Segundo Blvd at I-405 NB Ramps	S	0.880	D	0.730	C
HCM Methodology						
Int. #	Intersection	Traffic Control	AM Peak Hour		PM Peak Hour	
			Delay	LOS	Delay	LOS
1	Pacific Coast Highway at Imperial Hwy	S	29.6	C	45.1	D
2	Pacific Coast Highway at Walnut Ave	S	9.0	A	15.6	B
3	Pacific Coast Highway at Maple Ave	S	15.4	B	17.1	B
4	Pacific Coast Highway at Mariposa Ave	S	19.8	B	23.2	C
5	Pacific Coast Highway at Grand Ave	S	25.8	C	35.7	D
6	Pacific Coast Highway at El Segundo Blvd	S	64.5	E	78.6	E
7	Pacific Coast Highway at Rosecrans Blvd	S	33.8	C	42.1	D
18	El Segundo Blvd at I-405 SB Ramps	S	17.8	B	74.7	E
20	El Segundo Blvd at I-405 NB Ramps	S	27.2	C	12.5	B
<p>LOS shown in Bold and shaded indicates unacceptable Level of Service. ICU = Intersection Capacity Utilization HCM = Highway Capacity Manual LOS = Level of Service Intersection operation is expressed in volume-to-capacity (v/c) ratio for the ICU methodology. Intersection operation is expressed in average seconds of delay (sec/veh) for the HCM methodology.</p>						

1. Pacific Coast Hwy at Imperial Hwy 	2. Pacific Coast Hwy at Walnut Ave 	3. Pacific Coast Hwy at Maple Ave 	4. Pacific Coast Hwy at Mariposa Ave
5. Pacific Coast Hwy at Grand Ave 	6. Pacific Coast Hwy at El Segundo Blvd 	7. Pacific Coast Hwy at Rosecrans Blvd 	8. Continental Blvd at Mariposa Ave
9. Continental Blvd at Grand Ave 	10. Continental Blvd at El Segundo Blvd 	11. Nash St at Imperial Hwy 	12. Nash St at Mariposa Ave
13. Nash St at Grand Ave 	14. Nash St at El Segundo Blvd 	15. Douglas St at El Segundo Blvd 	16. Aviation Blvd at El Segundo Blvd
17. El Segundo Blvd at Isis Ave 	18. El Segundo Blvd at I-405 SB Ramps 	19. El Segundo Blvd at La Cienega Blvd 	20. El Segundo Blvd at I-405 NB Ramps

**FIGURE 13
OPENING YEAR 2022 WITH PHASE 1
PEAK HOUR TRAFFIC VOLUMES**

D1. Driveway 1 at Grand Ave 	D2. Driveway 2 at Grand Ave 	D3. Driveway 3 at Continental Blvd 	D4. Driveway 4 at Continental Blvd
--	--	---	---

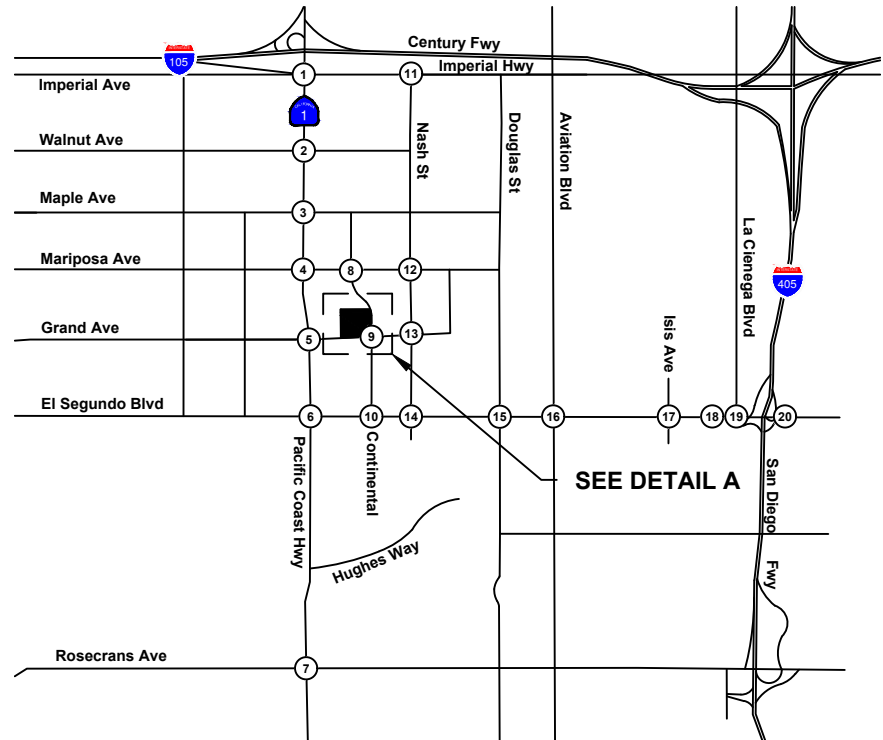

NOT TO SCALE

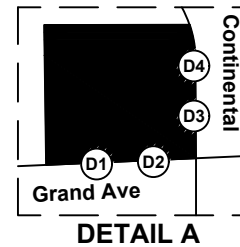

DETAIL A

LEGEND:

- = Project Site
- = Study Intersection
- XX/YY = AM/PM Peak Hour Turning Movement Volumes



**TABLE 6
SUMMARY OF INTERSECTION OPERATION
OPENING YEAR 2022 WITH PHASE 1**

ICU Methodology

Int. #	Intersection	AM Peak Hour						PM Peak Hour					
		Without Project		With Project		Project Impact	Impact Sig?	Without Project		With Project		Project Impact	Impact Sig?
		V/C	LOS	V/C	LOS			V/C	LOS	V/C	LOS		
1	Pacific Coast Highway at Imperial Hwy	0.868	D	0.872	D	0.004	No	1.036	F	1.036	F	0.000	No
2	Pacific Coast Highway at Walnut Ave	0.727	C	0.734	C	0.007	No	0.754	C	0.760	C	0.006	No
3	Pacific Coast Highway at Maple Ave	0.725	C	0.726	C	0.001	No	0.756	C	0.771	C	0.015	No
4	Pacific Coast Highway at Mariposa Ave	0.764	C	0.785	C	0.021	No	0.830	D	0.835	D	0.005	No
5	Pacific Coast Highway at Grand Ave	0.852	D	0.841	D	-0.011	No	0.886	D	0.898	D	0.012	No
6	Pacific Coast Highway at El Segundo Blvd	1.069	F	1.079	F	0.010	No	1.080	F	1.089	F	0.009	No
7	Pacific Coast Highway at Rosecrans Blvd	0.924	E	0.934	E	0.010	No	1.003	F	1.015	F	0.012	No
8	Continental Blvd at Mariposa Ave	0.390	A	0.500	A	0.110	No	0.370	A	0.405	A	0.035	No
9	Continental Blvd at Grand Ave	0.329	A	0.402	A	0.073	No	0.344	A	0.378	A	0.034	No
10	Continental Blvd at El Segundo Blvd	0.547	A	0.551	A	0.004	No	0.640	B	0.676	B	0.036	No
11	Nash St at Imperial Hwy	0.773	C	0.820	D	0.047	No	0.521	A	0.530	A	0.009	No
12	Nash St at Mariposa Ave	0.605	B	0.662	B	0.057	No	0.698	B	0.783	C	0.085	No
13	Nash St at Grand Ave	0.547	A	0.553	A	0.006	No	0.612	B	0.612	B	0.000	No
14	Nash St at El Segundo Blvd	0.729	C	0.729	C	0.000	No	1.038	F	1.062	F	0.024	Yes
15	Douglas St at El Segundo Blvd	0.988	E	1.015	F	0.027	Yes	1.179	F	1.203	F	0.024	Yes
16	Aviation Blvd at El Segundo Blvd	1.165	F	1.192	F	0.027	Yes	1.159	F	1.177	F	0.018	No
17	El Segundo Blvd at Isis Avenue	0.826	D	0.853	D	0.027	No	0.785	C	0.803	C	0.018	No
18	El Segundo Blvd at I-405 SB Ramps	0.771	C	0.798	C	0.027	No	1.187	F	1.236	F	0.049	Yes
19	El Segundo Blvd at La Cienega	0.847	D	0.873	D	0.026	No	0.753	C	0.761	C	0.008	No
20	El Segundo Blvd at I-405 NB Ramps	0.880	D	0.916	E	0.036	Yes	0.730	C	0.741	C	0.011	No
D1	Driveway 1 at Grand Ave			9.0	A	N/A	N/A			10.9	B	N/A	N/A
D2	Driveway 2 at Grand Ave			13.1	B	N/A	N/A			17.0	C	N/A	N/A
D3	Driveway 3 at Continental			16.6	C	N/A	N/A			13.5	B	N/A	N/A
D4	Driveway 4 at Continental			12.6	B	N/A	N/A			13.0	B	N/A	N/A

HCM Methodology

Int. #	Intersection	AM Peak Hour						PM Peak Hour					
		Without Project		With Project		Project Impact	Impact Sig?	Without Project		With Project		Project Impact	Impact Sig?
		Delay	LOS	Delay	LOS			Delay	LOS	Delay	LOS		
1	Pacific Coast Highway at Imperial Hwy	29.6	C	29.8	C	0.2	No	45.1	D	45.4	D	0.3	No
2	Pacific Coast Highway at Walnut Ave	9.0	A	9.1	A	0.1	No	15.6	B	15.6	B	0.0	No
3	Pacific Coast Highway at Maple Ave	15.4	B	15.4	B	0.0	No	17.1	B	17.1	B	0.0	No
4	Pacific Coast Highway at Mariposa Ave	19.8	B	20.7	C	0.9	No	23.2	C	23.6	C	0.4	No
5	Pacific Coast Highway at Grand Ave	25.8	C	23.7	C	-2.1	No	35.7	D	37.0	D	1.3	No
6	Pacific Coast Highway at El Segundo Blvd	64.5	E	67.2	E	2.7	No	78.6	E	79.4	E	0.8	No
7	Pacific Coast Highway at Rosecrans Blvd	33.8	C	34.4	C	0.6	No	42.1	D	43.9	D	1.8	No
18	El Segundo Blvd at I-405 SB Ramps	17.8	B	18.5	B	0.7	No	74.7	E	84.0	F	9.3	Yes
20	El Segundo Blvd at I-405 NB Ramps	27.2	C	30.3	C	3.1	No	12.5	B	12.7	B	0.2	No

LOS shown in **Bold** and shaded indicates unacceptable Level of Service.
 ICU = Intersection Capacity Utilization
 HCM = Highway Capacity Manual
 LOS = Level of Service
 Intersection operation is expressed in volume-to-capacity (v/c) ratio for the ICU methodology.
 Intersection operation is expressed in average seconds of delay (sec/veh) ratio for the HCM methodology.

The Phase 1 project would cause the ICU value at an already-deficient intersection to worsen by 0.02 V/C or more at the following intersections:

- #14 – Nash Street at El Segundo Boulevard (ICU) – PM LOS F, Impact +0.024
- #15 – Douglas Street at El Segundo Boulevard (ICU) – AM LOS F, Impact +0.027;
PM LOS F, Impact +0.024
- #16 – Aviation Boulevard at El Segundo Boulevard (ICU) – AM LOS F, Impact +0.027
- #18 – El Segundo Boulevard at I-405 SB Ramps
 - (ICU) PM LOS F, Impact +0.049
 - (HCM) PM LOS E to LOS F, Impact + 9.4 seconds
- #20 – El Segundo Boulevard at I-405 NB Ramps
 - (ICU) AM LOS E, Impact +0.036

Based on the significance criteria presented earlier, the project impact at these study intersections would be considered to be a significant impact.

Opening Year 2023 Without Project Conditions

The ambient growth rate and cumulative project traffic volumes were added to existing traffic volumes to develop Opening Year 2023 Without Project peak hour forecasts. Forecasted peak hour volumes are shown on Figure 14. Each intersection was re-analyzed with these traffic volumes, and the results are shown on Table 7. ICU intersection analysis worksheets are provided in *Appendix B* and HCM intersection worksheets are provided in *Appendix C*.

The results show that the same intersections that were forecasted to operate at an unacceptable Level of Service in the Opening Year 2022 without Project scenario will continue to do so in the Opening Year 2023 without Project scenario:

- #1 – Pacific Coast Highway at Imperial Highway (ICU) – PM LOS F
- #6 – Pacific Coast Highway at El Segundo Boulevard
 - (ICU) – AM and PM LOS F
 - (HCM) – AM and PM LOS E
- #7 – Pacific Coast Highway at Rosecrans Boulevard (ICU) – AM LOS E, PM LOS F
- #14 – Nash Street at El Segundo Boulevard (ICU) – PM LOS F
- #15 – Douglas Street at El Segundo Boulevard (ICU) – AM LOS E, PM LOS F
- #16 – Aviation Boulevard at El Segundo Boulevard (ICU) – AM and PM LOS F
- #18 – El Segundo Boulevard at I-405 SB Ramps
 - (ICU) – PM LOS F
 - (HCM) – PM LOS E



NOT TO SCALE

<p>1. Pacific Coast Hwy at Imperial Hwy</p>	<p>2. Pacific Coast Hwy at Walnut Ave</p>	<p>3. Pacific Coast Hwy at Maple Ave</p>	<p>4. Pacific Coast Hwy at Mariposa Ave</p>
<p>5. Pacific Coast Hwy at Grand Ave</p>	<p>6. Pacific Coast Hwy at El Segundo Blvd</p>	<p>7. Pacific Coast Hwy at Rosecrans Blvd</p>	<p>8. Continental Blvd at Mariposa Ave</p>
<p>9. Continental Blvd at Grand Ave</p>	<p>10. Continental Blvd at El Segundo Blvd</p>	<p>11. Nash St at Imperial Hwy</p>	<p>12. Nash St at Mariposa Ave</p>
<p>13. Nash St at Grand Ave</p>	<p>14. Nash St at El Segundo Blvd</p>	<p>15. Douglas St at El Segundo Blvd</p>	<p>16. Aviation Blvd at El Segundo Blvd</p>
<p>17. El Segundo Blvd at Isis Ave</p>	<p>18. El Segundo Blvd at I-405 SB Ramps</p>	<p>19. El Segundo Blvd at La Cienega Blvd</p>	<p>20. El Segundo Blvd at I-405 NB Ramps</p>

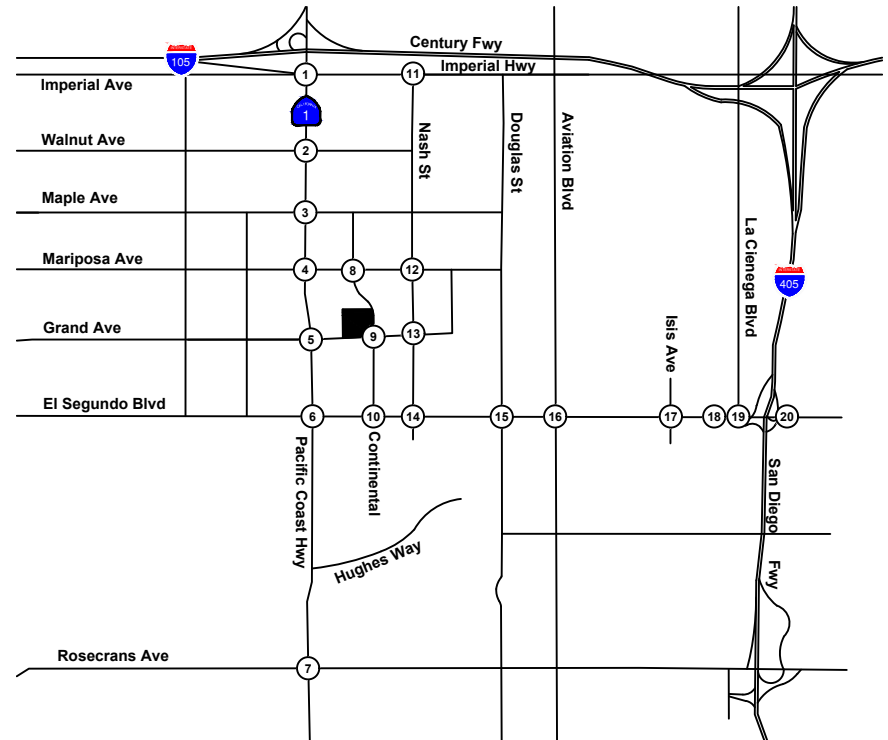

LEGEND:

- = Project Site
- = Study Intersection
- XX/YY = AM/PM Peak Hour Turning Movement Volumes



**FIGURE 14
OPENING YEAR 2023 WITHOUT PROJECT
PEAK HOUR TRAFFIC VOLUMES**

**TABLE 7
SUMMARY OF INTERSECTION OPERATION
OPENING YEAR 2023 WITHOUT PROJECT**

ICU Methodology						
Int. #	Intersection	Traffic Control	AM Peak Hour		PM Peak Hour	
			V/C	LOS	V/C	LOS
1	Pacific Coast Highway at Imperial Hwy	S	0.869	D	1.038	F
2	Pacific Coast Highway at Walnut Ave	S	0.728	C	0.755	C
3	Pacific Coast Highway at Maple Ave	S	0.726	C	0.757	C
4	Pacific Coast Highway at Mariposa Ave	S	0.766	C	0.832	D
5	Pacific Coast Highway at Grand Ave	S	0.853	D	0.887	D
6	Pacific Coast Highway at El Segundo Blvd	S	1.070	F	1.081	F
7	Pacific Coast Highway at Rosecrans Blvd	S	0.925	E	1.004	F
8	Continental Blvd at Mariposa Ave	S	0.391	A	0.371	A
9	Continental Blvd at Grand Ave	S	0.328	A	0.345	A
10	Continental Blvd at El Segundo Blvd	S	0.547	A	0.640	B
11	Nash St at Imperial Hwy	S	0.774	C	0.522	A
12	Nash St at Mariposa Ave	S	0.606	B	0.699	B
13	Nash St at Grand Ave	S	0.547	A	0.612	B
14	Nash St at El Segundo Blvd	S	0.729	C	1.039	F
15	Douglas St at El Segundo Blvd	S	0.989	E	1.181	F
16	Aviation Blvd at El Segundo Blvd	S	1.166	F	1.161	F
17	El Segundo Blvd at Isis Avenue	S	0.827	D	0.786	C
18	El Segundo Blvd at I-405 SB Ramps	S	0.772	C	1.189	F
19	El Segundo Blvd at La Cienega	S	0.847	D	0.754	C
20	El Segundo Blvd at I-405 NB Ramps	S	0.881	D	0.731	C
HCM Methodology						
Int. #	Intersection	Traffic Control	AM Peak Hour		PM Peak Hour	
			Delay	LOS	Delay	LOS
1	Pacific Coast Highway at Imperial Hwy	S	29.6	C	45.3	D
2	Pacific Coast Highway at Walnut Ave	S	9.1	A	15.7	B
3	Pacific Coast Highway at Maple Ave	S	15.4	B	17.2	B
4	Pacific Coast Highway at Mariposa Ave	S	19.9	B	23.2	C
5	Pacific Coast Highway at Grand Ave	S	25.9	C	35.8	D
6	Pacific Coast Highway at El Segundo Blvd	S	64.8	E	78.9	E
7	Pacific Coast Highway at Rosecrans Blvd	S	33.9	C	42.3	D
18	El Segundo Blvd at I-405 SB Ramps	S	17.8	B	75.0	E
20	El Segundo Blvd at I-405 NB Ramps	S	27.2	C	12.6	B

LOS shown in **Bold** and shaded indicates unacceptable Level of Service.
 ICU = Intersection Capacity Utilization
 HCM = Highway Capacity Manual
 LOS = Level of Service
 Intersection operation is expressed in volume-to-capacity (v/c) ratio for the ICU methodology.
 Intersection operation is expressed in average seconds of delay (sec/veh) for the HCM methodology.

Opening Year 2023 With Phase 1 and Phase 2 Conditions

Phase 1 and Phase 2 project traffic was added to Opening Year 2023 Without Project traffic volumes to develop Opening Year 2023 With Phase 1 and Phase 2 forecasts, as shown on Figure 15. The results are summarized on Table 8. ICU intersection analysis worksheets are provided in *Appendix B* and HCM intersection worksheets are provided in *Appendix C*.

In the Opening Year 2023 With Phase 1 and Phase 2 scenario, the same intersections that were forecasted to operate at an unacceptable Level of Service in the Opening Year 2023 Without Project scenario will continue to do so with the addition of project traffic.

The addition of project traffic would cause two additional intersections to worsen to an unacceptable Level of Service:

- #5 – Pacific Coast Highway at Grand Avenue (ICU) – PM LOS E
- #20 – El Segundo Boulevard at I-405 NB Ramps (ICU) – AM LOS E.

This table also shows the project impact at each study intersection. The project would cause one intersection to operate at an unacceptable Level of Service, and would cause the ICU value at an already-deficient intersection to worsen by 0.02 V/C or more at the following intersections:

- #1 – Pacific Coast Highway at Imperial Highway – (ICU) – PM LOS F, Impact +0.047
- #5 – Pacific Coast Highway at Grand Avenue (ICU) – Project causes PM LOS E
- #14 – Nash Street at El Segundo Boulevard (ICU) – PM LOS F, Impact +0.037
- #15 – Douglas Street at El Segundo Boulevard (ICU) – AM LOS F, Impact +0.042; PM LOS F, Impact +0.037
- #16 – Aviation Boulevard at El Segundo Boulevard (ICU) – AM LOS F, Impact +0.042; PM LOS F, Impact +0.028
- #18 – El Segundo Boulevard at I-405 SB Ramps (ICU) – PM LOS F, Impact +0.075
- #20 – El Segundo Boulevard at I-405 NB Ramps (ICU) – Project causes AM LOS E

In addition, based on the HCM delay methodology, the project would cause two intersections already operating at a deficient Level of Service to worsen from LOS E to LOS F:

- #6 – Pacific Coast Highway at El Segundo Boulevard (HCM) – PM LOS E worsens to LOS F.
- #18 – El Segundo Boulevard at I-405 SB Ramps (HCM) – PM LOS E worsens to LOS F.

1. Pacific Coast Hwy at Imperial Hwy 	2. Pacific Coast Hwy at Walnut Ave 	3. Pacific Coast Hwy at Maple Ave 	4. Pacific Coast Hwy at Mariposa Ave
5. Pacific Coast Hwy at Grand Ave 	6. Pacific Coast Hwy at El Segundo Blvd 	7. Pacific Coast Hwy at Rosecrans Blvd 	8. Continental Blvd at Mariposa Ave
9. Continental Blvd at Grand Ave 	10. Continental Blvd at El Segundo Blvd 	11. Nash St at Imperial Hwy 	12. Nash St at Mariposa Ave
13. Nash St at Grand Ave 	14. Nash St at El Segundo Blvd 	15. Douglas St at El Segundo Blvd 	16. Aviation Blvd at El Segundo Blvd
17. El Segundo Blvd at Isis Ave 	18. El Segundo Blvd at I-405 SB Ramps 	19. El Segundo Blvd at La Cienega Blvd 	20. El Segundo Blvd at I-405 NB Ramps

**FIGURE 15
OPENING YEAR 2023 WITH PHASE 1 AND
PHASE 2 PEAK HOUR TRAFFIC VOLUMES**

D1. Driveway 1 at Grand Ave 	D2. Driveway 2 at Grand Ave 	D3. Driveway 3 at Continental Blvd 	D4. Driveway 4 at Continental Blvd
--	--	---	---

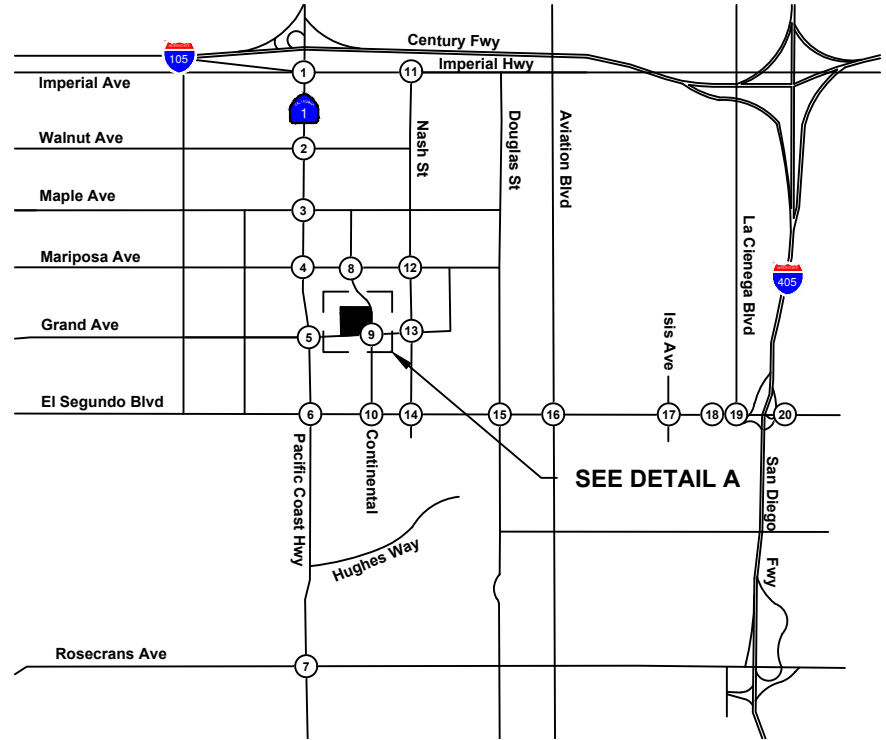

NOT TO SCALE

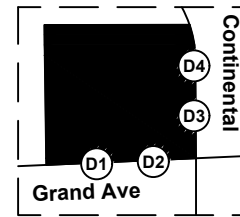

DETAIL A

LEGEND:

- = Project Site
- = Study Intersection
- XX/YY = AM/PM Peak Hour Turning Movement Volumes



**TABLE 8
SUMMARY OF INTERSECTION OPERATION
OPENING YEAR 2023 WITH PHASE 1 AND PHASE 2**

ICU Methodology

Int. #	Intersection	AM Peak Hour						PM Peak Hour					
		Without Project		With Project		Project	Impact	Without Project		With Project		Project	Impact
		V/C	LOS	V/C	LOS	Impact	Sig?	V/C	LOS	V/C	LOS	Impact	Sig?
1	Pacific Coast Highway at Imperial Hwy	0.869	D	0.877	D	0.008	No	1.038	F	1.085	F	0.047	Yes
2	Pacific Coast Highway at Walnut Ave	0.728	C	0.739	C	0.011	No	0.755	C	0.776	C	0.021	No
3	Pacific Coast Highway at Maple Ave	0.726	C	0.729	C	0.003	No	0.757	C	0.787	C	0.030	No
4	Pacific Coast Highway at Mariposa Ave	0.766	C	0.803	C	0.037	No	0.832	D	0.855	D	0.023	No
5	Pacific Coast Highway at Grand Ave	0.853	D	0.867	D	0.014	No	0.887	D	0.967	E	0.080	Yes
6	Pacific Coast Highway at El Segundo Blvd	1.070	F	1.089	F	0.019	No	1.081	F	1.095	F	0.014	No
7	Pacific Coast Highway at Rosecrans Blvd	0.925	E	0.941	E	0.016	No	1.004	F	1.023	F	0.019	No
8	Continental Blvd at Mariposa Ave	0.391	A	0.523	A	0.132	No	0.371	A	0.407	A	0.036	No
9	Continental Blvd at Grand Ave	0.328	A	0.517	A	0.189	No	0.345	A	0.391	A	0.046	No
10	Continental Blvd at El Segundo Blvd	0.547	A	0.552	A	0.005	No	0.640	B	0.690	B	0.050	No
11	Nash St at Imperial Hwy	0.774	C	0.848	D	0.074	No	0.522	A	0.535	A	0.013	No
12	Nash St at Mariposa Ave	0.606	B	0.689	B	0.083	No	0.699	B	0.784	C	0.085	No
13	Nash St at Grand Ave	0.547	A	0.580	A	0.033	No	0.612	B	0.612	B	0.000	No
14	Nash St at El Segundo Blvd	0.729	C	0.729	C	0.000	No	1.039	F	1.076	F	0.037	Yes
15	Douglas St at El Segundo Blvd	0.989	E	1.031	F	0.042	Yes	1.181	F	1.218	F	0.037	Yes
16	Aviation Blvd at El Segundo Blvd	1.166	F	1.208	F	0.042	Yes	1.161	F	1.189	F	0.028	Yes
17	El Segundo Blvd at Isis Avenue	0.827	D	0.869	D	0.042	No	0.786	C	0.814	D	0.028	No
18	El Segundo Blvd at I-405 SB Ramps	0.772	C	0.814	D	0.042	No	1.189	F	1.264	F	0.075	Yes
19	El Segundo Blvd at La Cienega	0.847	D	0.889	D	0.042	No	0.754	C	0.767	C	0.013	No
20	El Segundo Blvd at I-405 NB Ramps	0.881	D	0.937	E	0.056	Yes	0.731	C	0.749	C	0.018	No
D1	Driveway 1 at Grand Ave			9.9	A	N/A	N/A			14.7	B	N/A	N/A
D2	Driveway 2 at Grand Ave			16.4	C	N/A	N/A			18.2	C	N/A	N/A
D3	Driveway 3 at Continental			17.3	C	N/A	N/A			13.6	B	N/A	N/A
D4	Driveway 4 at Continental			13.0	B	N/A	N/A			13.1	B	N/A	N/A

HCM Methodology

Int. #	Intersection	AM Peak Hour						PM Peak Hour					
		Without Project		With Project		Project	Impact	Without Project		With Project		Project	Impact
		Delay	LOS	Delay	LOS	Impact	Sig?	Delay	LOS	Delay	LOS	Impact	Sig?
1	Pacific Coast Highway at Imperial Hwy	29.6	C	30.2	C	0.6	No	45.3	D	51.9	D	6.6	No
2	Pacific Coast Highway at Walnut Ave	9.1	A	9.1	A	0.0	No	15.7	B	15.6	B	-0.1	No
3	Pacific Coast Highway at Maple Ave	15.4	B	15.4	B	0.0	No	17.2	B	17.2	B	0.0	No
4	Pacific Coast Highway at Mariposa Ave	19.9	B	21.4	C	1.5	No	23.2	C	24.2	C	1.0	No
5	Pacific Coast Highway at Grand Ave	25.9	C	24.3	C	-1.6	No	35.8	D	47.8	D	12.0	No
6	Pacific Coast Highway at El Segundo Blvd	64.8	E	69.9	E	5.1	No	78.9	E	88.1	F	9.2	Yes
7	Pacific Coast Highway at Rosecrans Blvd	33.9	C	34.9	C	1.0	No	42.3	D	45.3	D	3.0	No
18	El Segundo Blvd at I-405 SB Ramps	17.8	B	19.2	B	1.4	No	75.0	E	89.5	F	14.5	Yes
20	El Segundo Blvd at I-405 NB Ramps	27.2	C	33.0	C	5.8	No	12.6	B	12.9	B	0.3	No

LOS shown in **Bold** and shaded indicates unacceptable Level of Service.
 ICU = Intersection Capacity Utilization
 HCM = Highway Capacity Manual
 LOS = Level of Service
 Intersection operation is expressed in volume-to-capacity (v/c) ratio for the ICU methodology.
 Intersection operation is expressed in average seconds of delay (sec/veh) ratio for the HCM methodology.

MITIGATION MEASURES

Based on the impact criteria outlined above, the project-related impact would be considered significant at these intersections, and project mitigation would be required.

#1 – Pacific Coast Highway at Imperial Highway: Re-stripe the northbound approach to provide a second northbound right-turn lane. This improvement would provide additional capacity for the heavy northbound right-turn movement, and would improve the Level of Service from LOS F to LOS D in the evening peak hour, which would mitigate the project impact.

#5 – Pacific Coast Highway at Grand Avenue: Re-stripe the westbound approach to convert the number 1 through lane to a shared through/right-turn lane. This improvement would provide additional capacity for the heavy westbound right-turn movement, and would improve the Level of Service from LOS E to LOS D in the evening peak hour, which would mitigate the project impact.

#6 – Pacific Coast Highway at El Segundo Boulevard: Re-stripe the westbound approach to convert the number 1 through lane to a shared through/right-turn lane. This improvement would provide additional capacity for the heavy westbound right-turn movement, and would improve the Level of Service from LOS F to LOS D in the evening peak hour, which would mitigate the project impact.

#14 – Nash Street at El Segundo Boulevard: The south leg of this intersection is one of the primary driveways for the Raytheon development. The Raytheon South Campus Specific Plan TIA (RBF, May 27, 2014) identified the following improvement for this intersection: Widen the northbound approach from two left-turn lanes, one shared through/right-turn lane, and one right-turn lane with right-turn overlap signal phasing to consist of two left-turn lanes, one through lane, and two right-turn lanes with right-turn overlap signal phasing. This improvement would provide additional capacity for the heavy northbound right-turn movement, and would improve the Level of Service from LOS F to LOS E in the evening peak hour, which would mitigate the project impact.

#15 – Douglas Street at El Segundo Boulevard: Mitigation measures at this intersection are considered to be infeasible, due to right-of-way constraints, and the impact that intersection widening would have on existing infrastructure and adjacent developed private property. Therefore, the project impact at this intersection would remain significant and unavoidable.

#16 – Aviation Boulevard at El Segundo Boulevard: Mitigation measures at this intersection are considered to be infeasible, due to right-of-way constraints and the impact that intersection widening would have on existing infrastructure and adjacent developed private property. Therefore, the project impact at this intersection would remain significant and unavoidable.

#18 – El Segundo Boulevard at I-405 SB Ramps: Add right-turn overlap phasing to the eastbound approach of the intersection. This improvement would provide additional signal green time for the heavy eastbound right-turn movement, and would improve the Level of Service from LOS F to LOS E in the evening peak hour, which would mitigate the project impact.

#20 – El Segundo Boulevard at I-405 NB Ramps: Re-stripe the northbound right-turn lane to a shared left/right-turn lane. This improvement would provide additional capacity for the northbound left-turn

movement, and would improve the Level of Service from LOS E to LOS C in the morning peak hour, which would mitigate the project impact.

While implementation of the mitigation measures at Intersection Nos. 1, 5, 6, 18, and 20 would reduce impacts to a less-than-significant level, the intersections are under Caltrans jurisdiction. Since the implementation of these improvements are outside the City's jurisdiction and there is uncertainty regarding the ability to implement these improvements, the City determines that there is a potential for a significant and unavoidable impact to occur at Intersection Nos. 1, 5, 6, 18, and 20 as a result of buildout of the Project.

A summary of the intersection operation before and after implementation of these mitigation measures is provided on Table 9.

FREEWAY MAINLINE ANALYSIS

Analysis of freeway mainline segments in the vicinity of the project was conducted in accordance with the *Caltrans Guide for the Preparation of Traffic Impact Studies*, which specifies application of the HCM methodology for freeway analysis. Freeway analysis results are expressed in terms of density, which measures the number of passenger cars per lane mile (pc/mi/ln) on the freeway mainline. The target Level of Service (LOS) for freeway mainline segments is LOS D, which is a density between 26 and 35 pc/mi/ln. If the existing density exceeds the target LOS, the existing Level of Service is to be maintained.

Freeway mainline analysis was conducted on the I-405 Freeway between Century Boulevard and Rosecrans Avenue, and on the I-105 Freeway between Pacific Coast Highway and Hawthorne Boulevard. Peak hour freeway volumes were obtained from the Caltrans website. The most recent data available was 2015. A conservative growth factor of 1.0% per year was applied to the traffic volumes to derive Existing and Future Year volumes. A summary of the results of the freeway mainline analysis for each study scenario are presented below.

Existing Conditions

Existing peak hour freeway volumes and analysis results for the morning and evening peak hours, by segment, and by direction are summarized on Table 10 for the I-405 segments, and Table 11 for the I-105 segments. Review of these tables indicates that each freeway segment currently operates at LOS D or better in each direction, and in both peak hours, with the exception of the I-405 southbound segment between El Segundo Boulevard and Rosecrans Avenue, which is currently operating at LOS E in the evening peak hour.

Existing Plus Project

Existing Plus Project results are summarized on Table 12 for the I-405 segments, and on Table 13 for the I-105 segments. Review of these tables indicates that each freeway segment will continue operating at LOS D or better in each direction, and in both peak hours, with the exception of the I-405 southbound segment between El Segundo Boulevard and Rosecrans Avenue, which would continue to operate at LOS E in the evening peak hour with the addition of project traffic.

TABLE 9
SUMMARY OF INTERSECTION OPERATION
WITH PROPOSED MITIGATION MEASURES

Intersection and Mitigation	Methodology	Impacted Condition Peak Hour	Without Mitigation		With Mitigation	
			ICU/Delay	LOS	ICU/Delay	LOS
<i>1. Pacific Coast Highway at Imperial Highway:</i> Stripe an additional northbound right-turn lane to provide dual northbound right-turn lanes	ICU	PM	1.085	F	0.899	D
<i>5. Pacific Coast Highway at Grand Avenue:</i> Restripe westbound through lane to be a shared through-right lane to provide dual right-turn capacity	ICU	PM	0.967	E	0.826	D
<i>6. Pacific Coast Highway at El Segundo Boulevard:</i> Restripe westbound through lane to be a shared through-right lane to provide dual right-turn capacity	HCM	PM	88.1	F	55.3	E
<i>14. Nash Street at El Segundo Boulevard:</i> Widen the northbound approach to consist of two left-turn lanes, one through lane, and two right-turn lanes with right-turn overlap signal phasing	ICU	PM	1.076	F	0.917	E
<i>15. Douglas Street at El Segundo Boulevard:</i> No Feasible Mitigation	ICU	AM	1.031	F	No Feasible Mitigation	
		PM	1.218	F		
<i>16. Aviation Boulevard at El Segundo Boulevard:</i> No Feasible Mitigation	ICU	AM	1.208	F	No Feasible Mitigation	
		PM	1.189	F		
<i>18. El Segundo Boulevard at I-405 SB Ramps</i> Add eastbound right-turn overlap	ICU	PM	1.264	F	1.137	F
	HCM		89.5	F	42.0	D
<i>20. El Segundo Boulevard at I-405 NB Ramps</i> Add 3rd northbound left-turn lane	ICU	AM	0.937	E	0.776	C
Notes: Bold and shaded values indicate intersections operating at LOS E or F.						

**TABLE 10
SUMMARY OF I-405 FREEWAY MAINLINE OPERATION
EXISTING CONDITIONS**

Freeway: I-405							
Freeway Segment	Lanes	AM Peak Hour			PM Peak Hour		
		Volume	Density (pc/mi/ln)	LOS	Volume	Density (pc/mi/ln)	LOS
Southbound							
Century Blvd to I-105	7	7,508	15.5	B	12,789	26.5	D
I-105 to El Segundo Blvd	5	5,811	16.8	B	9,899	28.7	D
El Segundo Blvd to Rosecrans Ave	5	7,182	20.8	C	12,235	35.5	E
Northbound							
Rosecrans Ave to El Segundo Blvd	5	11,382	33.0	D	9,355	27.1	D
El Segundo Blvd to I-105	5	9,209	26.7	D	7,569	21.9	C
I-105 to Century Blvd	7	11,897	24.6	C	9,779	20.2	C

**TABLE 11
SUMMARY OF I-105 FREEWAY MAINLINE OPERATION
EXISTING CONDITIONS**

Freeway: I-105							
Freeway Segment	Lanes	AM Peak Hour			PM Peak Hour		
		Volume	Density (pc/mi/ln)	LOS	Volume	Density (pc/mi/ln)	LOS
Westbound							
Hawthorne Boulevard to I-405	4	5,475	19.8	C	6,995	25.3	C
I-405 to Douglas Street	4	3,709	13.4	B	4,738	17.2	B
Douglas Street to Pacific Coast Highway	4	2,927	10.6	A	3,739	13.5	B
Eastbound							
Pacific Coast Highway to Douglas Street	4	3,545	12.8	B	3,526	12.8	B
Douglas Street to I-405	4	4,493	16.3	B	4,468	16.2	B
I-405 to Hawthorne Boulevard	4	6,632	24.0	C	6,595	23.9	C

**TABLE 12
SUMMARY OF I-405 FREEWAY MAINLINE OPERATION
EXISTING PLUS PROJECT**

Freeway: I-405								
Freeway Segment	Lanes	AM Peak Hour			PM Peak Hour			
		Volume	Density (pc/mi/ln)	LOS	Volume	Density (pc/mi/ln)	LOS	
Southbound								
Century Blvd to I-105	7	7,523	15.6	B	12,816	26.5	D	
I-105 to El Segundo Blvd	5	5,811	16.8	B	9,899	28.7	D	
El Segundo Blvd to Rosecrans Ave	5	7,203	20.9	C	12,270	35.6	E	
Northbound								
Rosecrans Ave to El Segundo Blvd	5	11,415	33.1	D	9,382	27.2	D	
El Segundo Blvd to I-105	5	9,209	26.7	D	7,569	21.9	C	
I-105 to Century Blvd	7	11,922	24.7	C	9,799	20.3	C	

**TABLE 13
SUMMARY OF I-105 FREEWAY MAINLINE OPERATION
EXISTING PLUS PROJECT**

Freeway: I-105							
Freeway Segment	Lanes	AM Peak Hour			PM Peak Hour		
		Volume	Density (pc/mi/ln)	LOS	Volume	Density (pc/mi/ln)	LOS
Westbound							
Hawthorne Boulevard to I-405	4	5,492	19.9	C	7,016	25.4	C
I-405 to Douglas Street	4	3,742	13.6	B	4,782	17.3	B
Douglas Street to Pacific Coast Highway	4	2,961	10.7	A	3,783	13.7	B
Eastbound							
Pacific Coast Highway to Douglas Street	4	3,586	13.0	B	3,566	12.9	B
Douglas Street to I-405	4	4,534	16.4	B	4,508	16.3	B
I-405 to Hawthorne Boulevard	4	6,653	24.1	C	6,616	24.0	C

Opening Year 2022

Freeway analysis results for the Opening Year 2022 Without Project scenario are summarized on Table 14 for the I-405 segments, and on Table 15 for the I-105 segments. Results for the Opening Year 2022 With Project (Phase 1) scenario are summarized on Table 16 for the I-405 segments, and on Table 17 for the I-105 segments.

Review of these tables indicates that the freeway segments would continue operating at LOS D or better in each direction, and in both peak hours, with the exception of:

- I-405 southbound, between El Segundo Boulevard and Rosecrans Avenue, PM LOS E
- I-405 northbound, between Rosecrans Avenue and El Segundo Boulevard, AM LOS E

Opening Year 2023

Freeway analysis results for the Opening Year 2023 Without Project Conditions are summarized on Table 18 for the I-405 segments, and on Table 19 for the I-105 segments. Results for the With Project (Phase 1 and Phase 2) scenario are summarized on Table 20 for the I-405 segments, and on Table 21 for the I-105 segments. Review of these tables indicates that the freeway segments would continue operating at LOS D or better in each direction, and in both peak hours, with the exception of:

- I-405 southbound, between El Segundo Boulevard and Rosecrans Avenue, PM LOS E
- I-405 northbound, between Rosecrans Avenue and El Segundo Boulevard, AM LOS E

The addition of project traffic to the freeway mainline system would not cause a freeway segment to worsen from acceptable to unacceptable, and would not cause a freeway segment that is already operating at a deficient Level of Service to deteriorate to a worse Level of Service.

CONSTRUCTION TRAFFIC

Construction of the Continental Grand Campus Specific Plan Project would occur over two phases and would add construction-related trips to and from the site. These trips are associated with construction activities, including construction workers, grading, and construction of structures and site features. Large construction equipment such as bulldozers, loaders, scrapers, and pavers would be required during various construction phases. Large equipment is generally brought to the site at the start of the construction phase, and kept on site until its term of use ends. A staging area would be designated on-site to store construction equipment and supplies during construction.

Throughout construction, the size of the work crew reporting to the site each day would vary, depending on the construction phase and the different construction activities taking place at the time. Parking for workers would be provided on-site during all phases of construction. Construction workers would not be allowed to park on local streets. If needed during the peak construction periods, off-site parking will be provided, and workers will carpool or be shuttled to the worksite.

**TABLE 14
SUMMARY OF I-405 FREEWAY MAINLINE OPERATION
OPENING YEAR 2022 WITHOUT PROJECT**

Freeway: I-405								
Freeway Segment	Lanes	AM Peak Hour			PM Peak Hour			
		Volume	Density (pc/mi/ln)	LOS	Volume	Density (pc/mi/ln)	LOS	
Southbound								
Century Blvd to I-105	7	8,455	17.5	B	14,403	29.8	D	
I-105 to El Segundo Blvd	5	6,544	19.0	C	11,148	32.3	D	
El Segundo Blvd to Rosecrans Ave	5	8,089	23.4	C	13,779	39.9	E	
Northbound								
Rosecrans Ave to El Segundo Blvd	5	12,817	37.2	E	10,535	30.5	D	
El Segundo Blvd to I-105	5	10,370	30.1	D	8,523	24.7	C	
I-105 to Century Blvd	7	13,398	27.7	D	11,012	22.8	C	

**TABLE 15
SUMMARY OF I-105 FREEWAY MAINLINE OPERATION
OPENING YEAR 2022 WITHOUT PROJECT**

Freeway: I-105							
Freeway Segment	Lanes	AM Peak Hour			PM Peak Hour		
		Volume	Density (pc/mi/ln)	LOS	Volume	Density (pc/mi/ln)	LOS
Westbound							
Hawthorne Boulevard to I-405	4	6,166	22.3	C	7,877	28.5	D
I-405 to Douglas Street	4	4,177	15.1	B	5,336	19.3	C
Douglas Street to Pacific Coast Highway	4	3,296	11.9	B	4,211	15.3	B
Eastbound							
Pacific Coast Highway to Douglas Street	4	3,993	14.5	B	3,970	14.4	B
Douglas Street to I-405	4	5,059	18.3	C	5,032	18.2	C
I-405 to Hawthorne Boulevard	4	7,469	27.1	D	7,428	26.9	D

**TABLE 16
SUMMARY OF I-405 FREEWAY MAINLINE OPERATION
OPENING YEAR 2022 WITH PHASE 1**

Freeway: I-405								
Freeway Segment	Lanes	AM Peak Hour			PM Peak Hour			
		Volume	Density (pc/mi/ln)	LOS	Volume	Density (pc/mi/ln)	LOS	
Southbound								
Century Blvd to I-105	7	8,464	17.5	B	14,418	29.9	D	
I-105 to El Segundo Blvd	5	6,544	19.0	C	11,148	32.3	D	
El Segundo Blvd to Rosecrans Ave	5	8,101	23.5	C	13,799	40.0	E	
Northbound								
Rosecrans Ave to El Segundo Blvd	5	12,836	37.2	E	10,551	30.6	D	
El Segundo Blvd to I-105	5	10,370	30.1	D	8,523	24.7	C	
I-105 to Century Blvd	7	13,413	27.8	D	11,024	22.8	C	

TABLE 17
SUMMARY OF I-105 FREEWAY MAINLINE OPERATION
OPENING YEAR 2022 WITH PHASE 1

Freeway: I-105							
Freeway Segment	Lanes	AM Peak Hour			PM Peak Hour		
		Volume	Density (pc/mi/ln)	LOS	Volume	Density (pc/mi/ln)	LOS
Westbound							
Hawthorne Boulevard to I-405	4	6,175	22.4	C	7,890	28.6	D
I-405 to Douglas Street	4	4,196	15.2	B	5,361	19.4	C
Douglas Street to Pacific Coast Highway	4	3,316	12.0	B	4,236	15.4	B
Eastbound							
Pacific Coast Highway to Douglas Street	4	4,016	14.6	B	3,994	14.5	B
Douglas Street to I-405	4	5,084	18.4	C	5,055	18.3	C
I-405 to Hawthorne Boulevard	4	7,481	27.1	D	7,439	27.0	D

**TABLE 18
SUMMARY OF I-405 FREEWAY MAINLINE OPERATION
OPENING YEAR 2023 WITHOUT PROJECT**

Freeway: I-405								
Freeway Segment	Lanes	AM Peak Hour			PM Peak Hour			
		Volume	Density (pc/mi/ln)	LOS	Volume	Density (pc/mi/ln)	LOS	
Southbound								
Century Blvd to I-105	7	8,624	17.9	B	14,691	30.4	D	
I-105 to El Segundo Blvd	5	6,675	19.3	C	11,371	33.0	D	
El Segundo Blvd to Rosecrans Ave	5	8,250	23.9	C	14,054	40.7	E	
Northbound								
Rosecrans Ave to El Segundo Blvd	5	13,074	37.9	E	10,746	31.1	D	
El Segundo Blvd to I-105	5	10,578	30.7	D	8,694	25.2	C	
I-105 to Century Blvd	7	13,666	28.3	D	11,233	23.3	C	

TABLE 19
SUMMARY OF I-105 FREEWAY MAINLINE OPERATION
OPENING YEAR 2023 WITHOUT PROJECT

Freeway: I-105								
Freeway Segment	Lanes	AM Peak Hour			PM Peak Hour			
		Volume	Density (pc/mi/ln)	LOS	Volume	Density (pc/mi/ln)	LOS	
Westbound								
Hawthorne Boulevard to I-405	4	6,289	22.8	C	8,035	29.1	D	
I-405 to Douglas Street	4	4,260	15.4	B	5,443	19.7	C	
Douglas Street to Sepulveda Boulevard	4	3,362	12.2	B	4,295	15.6	B	
Eastbound								
Sepulveda Boulevard to Douglas Street	4	4,072	14.8	B	4,050	14.7	B	
Douglas Street to I-405	4	5,161	18.7	C	5,132	18.6	C	
I-405 to Hawthorne Boulevard	4	7,618	27.6	D	7,576	27.5	D	

TABLE 20
SUMMARY OF I-405 FREEWAY MAINLINE OPERATION
OPENING YEAR 2023 WITH PROJECT

Freeway: I-405								
Freeway Segment	Lanes	AM Peak Hour			PM Peak Hour			
		Volume	Density (pc/mi/ln)	LOS	Volume	Density (pc/mi/ln)	LOS	
Southbound								
Century Blvd to I-105	7	8,640	17.9	B	14,717	30.5	D	
I-105 to El Segundo Blvd	5	6,675	19.3	C	11,371	33.0	D	
El Segundo Blvd to Rosecrans Ave	5	8,271	24.0	C	14,089	40.8	E	
Northbound								
Rosecrans Ave to El Segundo Blvd	5	13,107	38.0	E	10,773	31.2	D	
El Segundo Blvd to I-105	5	10,578	30.7	D	8,694	25.2	C	
I-105 to Century Blvd	7	13,691	28.4	D	11,253	23.3	C	

**TABLE 21
SUMMARY OF I-105 FREEWAY MAINLINE OPERATION
OPENING YEAR 2023 WITH FULL PROJECT**

Freeway: I-105							
Freeway Segment	Lanes	AM Peak Hour			PM Peak Hour		
		Volume	Density (pc/mi/ln)	LOS	Volume	Density (pc/mi/ln)	LOS
Westbound							
Hawthorne Boulevard to I-405	4	6,306	22.9	C	8,057	29.2	D
I-405 to Douglas Street	4	4,294	15.6	B	5,486	19.9	C
Douglas Street to Pacific Coast Highway	4	3,396	12.3	B	4,338	15.7	B
Eastbound							
Pacific Coast Highway to Douglas Street	4	4,113	14.9	B	4,091	14.8	B
Douglas Street to I-405	4	5,202	18.8	C	5,173	18.8	C
I-405 to Hawthorne Boulevard	4	7,639	27.7	D	7,596	27.5	D

Phase 1 will include the construction of the 455 Continental Boulevard building. Phase 1 would consist of three stages of construction activity: demolition, excavation, and construction. Demolition and excavation activities would require the removal of approximately 4,000 cubic yards of dirt over the course of three to five months. Assuming a capacity of 9 cubic yards per truckload, grading activities will require approximately 445 truckloads of material. In a conservative scenario in which excavation is completed in three months (65 working days), an average of 7 truckloads of material will need to be moved per day. This would equate to 7 inbound trucks and 7 outbound trucks per day.

Phase 2 would include the construction of the 1955 Grand Avenue building. Phase 2 would also consist of three stages of activity: demolition, excavation, and construction. Demolition and excavation activities would require the removal of approximately 23,200 cubic yards of dirt over the course of three to five months. Assuming a capacity of 9 cubic yards per truckload, grading activities will require approximately 2,578 truckloads of cut material. In a conservative scenario in which demolition and excavation is completed in five months (109 working days), an average of 24 truckloads of material will need to be moved per day. This would equate to 24 inbound trucks and 24 outbound trucks per day.

Heavy vehicles associated with construction would use the existing regional and local truck route network to approach the site, getting as close to the destination site as possible before turning off the designated truck route. The applicant will be required to identify planned travel patterns for haul vehicles, and obtain a haul route permit from the City. Designated truck routes serving the project area include Pacific Coast Highway and El Segundo Boulevard. Approach and departure routes for construction vehicles, therefore, would most likely be via Pacific Coast Highway or El Segundo Boulevard. Depending on the origin/destination (the nearest landfill, or the deposit site identified for cut material), trucks will either arrive and depart on Pacific Coast Highway via the I-105 Freeway, to the north of the site; or El Segundo Boulevard via the I-405 Freeway, to the east of the site.

Temporary delays in traffic may occasionally occur due to oversized vehicles traveling at lower speeds on local streets. Such delays would be occasional, and of short duration. These temporary delays would be considered less than significant. The project will be required to prepare a construction traffic management plan, which could include such things as requiring an encroachment permit for work in the public right-of-way, limiting heavy truck activity during peak hours, using flag men to manage short-term traffic control, requiring a formal traffic control plan for extended street and lane closures, limiting time and duration of closures, or requiring a minimum number of lanes be open for travel during peak hours.

SITE ACCESS

Access to the parcels making up the Continental Grand Specific Plan is currently provided by three driveways on Continental Boulevard, and three driveways on Grand Avenue. A detailed description of the existing site access for the three project parcels was provided in the Project Description section of this report.

The site driveways will remain in place, and will generally continue to serve the same functions they serve currently. The northernmost driveway on Continental Boulevard, which is a full-movement driveway, is currently gated under typical operating conditions. This driveway would be opened upon completion of the 455 Continental Boulevard portion of the project. The driveway would be extended to the west to connect to the entrance to the new parking structure, on the north end of the structure.

The analysis indicates that, upon completion of the project, each driveway would operate at Level of Service C or better in both peak hours as unsignalized intersections. Therefore, all project driveways will continue to be unsignalized driveways.

Pedestrian access to the site is facilitated by existing sidewalks on both sides of Grand Avenue and Continental Boulevard, and crosswalks on all four legs of the intersection. There are no bicycle routes in the project area. The project would not make any changes to reduce or inhibit pedestrian access to the site, and will not add bicycle routes.

Grand Avenue Median

As mentioned previously, the existing Grand Avenue driveway for 333 Continental Boulevard is located at the west edge of the parcel, and is a full-movement, joint access driveway that also serves the Doubletree Hotel. Left turns are allowed due to a break in the median on Grand Avenue, although the median does not currently provide a left-turn pocket for eastbound left-turning traffic. As a result, left-turning vehicles must turn from the Number 1 through lane (the left-most lane closest to the median). A left-turn pocket at this location would allow left-turning vehicles to wait for a gap in oncoming traffic from the refuge of the pocket, and would allow through vehicles in the lane closest to the median to proceed straight, without being delayed by turning vehicles.

The lack of a left-turn pocket at the median break on Grand Avenue and the Mattel driveway does not cause a deficient condition from a peak hour Level of Service standpoint. Currently, approximately 100 vehicles enter the driveway via a left turn from the Number 1 through lane on eastbound Grand Avenue during the AM peak hour. The intersection currently operates at LOS B. The addition of project traffic would increase the left-turn volume to approximately 200 AM peak hour vehicles. The intersection is forecasted to operate at LOS C in the future With Project condition, without an eastbound left-turn pocket.

Although the driveway intersection with Grand Avenue would not operate at a deficient Level of Service, the presence of a median break on a 6-lane roadway without a left-turn pocket is an unusual and potentially unsafe condition. This condition was further evaluated based on the industry standards and criteria for left-turn lanes at unsignalized intersections.

Two of the primary industry resources for roadway design policies are the American Association of State Highway and Transportation Officials (AASHTO): *A Policy on Geometric Design of Highways and Streets*; and the National Cooperative Highway Research Program (NCHRP) Report 279 – *Intersection Channelization Design Guide*. These resources provide “sliding scale” thresholds, based on the through and left-turn volumes at the intersection, to determine whether or not an unsignalized intersection warrants installation of a left-turn lane. Based on the policies and thresholds published in these two reference documents, the existing left-turn and through volumes on Grand Avenue at the Mattel driveway currently meet the warrant for a left-turn pocket. The existing volumes are well over the minimum thresholds, and with the addition of project traffic, future traffic volumes at this location would exceed the thresholds by an even greater margin.

Based on the industry standards for geometric design of streets and intersections, it is recommended that the City consider requiring an improvement to the median to provide a left-turn pocket as a condition of the project approval.

A prior traffic study for the project site (*Traffic Study for Mattel, Incorporated; Phase II of the Grand Way Project & 1955 East Grand Avenue*, Crain & Associates, August 15, 2003) identified the following median features that would require relocation, reconstruction, or replacement as a result of construction of a left-turn pocket:

“Currently the island has streetlights, electrical boxes, electrical and sewer access manholes and landscaping with trees and grass. . . . improvements will be conducted so as to disturb the existing landscaping as little as possible. However, one to two trees may need to be removed. The two manholes in the island will need to be dropped to street grade level within the new pocket. In addition, street lights may need to be moved.”

LOS ANGELES COUNTY CONGESTION MANAGEMENT PROGRAM

The Los Angeles County CMP was established to reduce traffic congestion and to provide a mechanism for coordinating land use and development decisions. Compliance with CMP requirements ensures a city's eligibility to compete for State gas tax funds for local transportation projects. The following intersections in the vicinity of the project site are listed as a CMP Arterial Monitoring Station:

- Pacific Coast Highway at El Segundo Boulevard
- Pacific Coast Highway at Rosecrans Avenue

Los Angeles County CMP determines the geographic area for study with the following criteria:

“ . . . all CMP arterial monitoring intersections, including monitored freeway on- or off-ramp intersections, where the proposed project will add 50 or more trips during either the AM or PM weekday peak hours”.

The project is forecasted to contribute 50 or more project trips to the two CMP intersections. Both intersections were included as study intersections. CMP significance thresholds are the same as the thresholds used by the City. The project's impacts were identified at these intersections, and where necessary, mitigation measures were identified, in compliance with Los Angeles County CMP requirements.

SUMMARY OF FINDINGS AND CONCLUSIONS

- The project site consists of three contiguous parcels at 333 Continental Boulevard, 455 Continental Boulevard, and 1955 East Grand Avenue.
- The 333 Continental Boulevard parcel is located on the south side of the project site and is currently occupied by a 14-story, 328,612-square-foot office building which houses the Mattel corporate headquarters offices.
- Development on the 455 Continental Boulevard parcel would consist of a new 14-story building on the landscaped area with the Mattel logo. The new building would provide 328,612 square feet of office, research, and development space.
- On the 1955 East Grand Avenue parcel, the existing two-story building will be demolished and a new six-story office building with 174,236 square feet will be constructed. The surface parking to the north of the building will remain.
- This traffic study includes documentation of existing conditions, analysis of cumulative traffic conditions, and identification of project-related impacts for the following analysis scenarios:
 - Existing Conditions
 - Existing Plus Project
 - Opening Year 2022 Without Project
 - Opening Year 2022 With Phase 1
 - Opening Year 2023 Without Project
 - Opening Year 2023 With Phase 1 and Phase 2

- The project will be constructed in two phases:
 - Phase 1 will include the construction of a 14-story, 328,612-square-foot building on the 455 Continental Boulevard parcel. The building will include 246,459 gross square feet of Corporate Headquarters use and 82,153 gross square feet of Research and Development use. Phase 1 Opening Year is anticipated to be 2022.
 - Phase 2 will include the demolition of the existing 1955 East Grand Avenue building and the construction of a six-story, 174,236-square-foot General Office Building. As discussed earlier, the existing 1955 East Grand Avenue building is not regularly used, therefore, no trip credits were taken for the existing use. Phase 2 Opening Year is anticipated to be 2023.
- The project is estimated to generate a total of 4,555 trips on a daily basis, with 746 trips in the morning peak hour, and 696 trips in the evening peak hour.
- Twenty study intersections in the project vicinity were evaluated for project traffic impacts.
- All study intersections currently operate at an acceptable Level of Service D during both peak hours, with the exception of the following:
 - #1 – Pacific Coast Highway at Imperial Highway (PM LOS E)
 - #16 – Aviation Boulevard at El Segundo Boulevard (PM LOS E)
- Project-related peak hour trips were added to the existing peak hour volumes to evaluate Existing Plus Project Conditions. With the addition of project traffic, all study intersections would continue to operate at an acceptable Level of Service D or better, with the following exceptions:
 - #1 – Pacific Coast Highway at Imperial Highway (ICU) – PM LOS F
 - #16 – Aviation Boulevard at El Segundo Boulevard (ICU) – PM LOS E
- Both intersections would experience a significant impact per the City's significance thresholds. The intersection of Pacific Coast Highway at Imperial Highway would deteriorate from LOS E to LOS F in the evening peak hour.
- In addition, two intersections would worsen from acceptable to unacceptable with the addition of project traffic, which would be considered a significant impact per the City's significance thresholds:
 - #15 – Douglas Street at El Segundo Boulevard (ICU) – PM LOS E
 - #18 – El Segundo Boulevard at I-405 SB Ramps (ICU) – PM LOS E

- Near-term future traffic forecasts have been developed to evaluate Cumulative Conditions for the anticipated project opening year. Phase 1 Opening Year is estimated to be Year 2022, and Phase 2 Opening Year is anticipated to be Year 2023. The future traffic forecasts include ambient growth as well as traffic from cumulative projects in the area.
- With the addition of ambient growth and cumulative project traffic, the Level of Service at the following intersections would deteriorate to an unacceptable Level of Service in one or both peak hours under Opening Year 2022 Without Project Conditions:
 - #1 – Pacific Coast Highway at Imperial Highway (ICU) – PM LOS F
 - #6 – Pacific Coast Highway at El Segundo Boulevard
 - (ICU) – AM LOS F, PM LOS F
 - (HCM) – AM and PM LOS E
 - #7 – Pacific Coast Highway at Rosecrans Boulevard (ICU) – AM LOS E, PM LOS F
 - #14 – Nash Street at El Segundo Boulevard (ICU) – PM LOS F
 - #15 – Douglas Street at El Segundo Boulevard (ICU) – AM LOS E, PM LOS F
 - #16 – Aviation Boulevard at El Segundo Boulevard (ICU) – AM LOS F, PM LOS F
 - #18 – El Segundo Boulevard at I-405 SB Ramps
 - (ICU) – PM LOS F
 - (HCM) – PM LOS E
- Phase 1 project traffic was added to the Opening Year 2022 Without Project traffic volumes to develop Opening Year 2022 With Phase 1 forecasts.
- In the Opening Year 2022 With Phase 1 scenario, the same intersections that were forecasted to operate at an unacceptable Level of Service in the Opening Year 2022 Without Project scenario will continue to do so with the addition of project traffic:
- The Phase 1 project would cause the ICU value at an already-deficient intersection to worsen by 0.02 V/C or more at the following intersections:
 - #14 – Nash Street at El Segundo Boulevard (ICU) – PM LOS F, Impact +0.024
 - #15 – Douglas Street at El Segundo Boulevard (ICU) – AM LOS F, Impact +0.027; PM LOS F, Impact +0.024
 - #16 – Aviation Boulevard at El Segundo Boulevard (ICU) – AM LOS F, Impact +0.027
 - #18 – El Segundo Boulevard at I-405 SB Ramps
 - (ICU) PM LOS F, Impact +0.049
 - (HCM) PM LOS E to LOS F, Impact + 9.4 seconds
 - #20 – El Segundo Boulevard at I-405 NB Ramps
 - (ICU) AM LOS E, Impact +0.036

- Phase 1 and Phase 2 project traffic was added to the Opening Year 2023 Without Project traffic volumes to develop Opening Year 2023 With Phase 1 and Phase 2 forecasts.
- In the Opening Year 2023 With Phase 1 and Phase 2 scenario, the same intersections that were forecasted to operate at an unacceptable Level of Service in the Opening Year 2023 Without Project scenario will continue to do so with the addition of project traffic.
- Based on the ICU Methodology, the following intersections would experience significant impacts per the City of El Segundo's significance criteria:
 - #1 – Pacific Coast Highway at Imperial Highway – (ICU) – PM LOS F, Impact +0.047
 - #5 – Pacific Coast Highway at Grand Avenue (ICU) – Project causes PM LOS E
 - #14 – Nash Street at El Segundo Boulevard (ICU) – PM LOS F, Impact +0.037
 - #15 – Douglas Street at El Segundo Boulevard (ICU) – AM LOS F, Impact +0.042; PM LOS F, Impact +0.037
 - #16 – Aviation Boulevard at El Segundo Boulevard (ICU) – AM LOS F, Impact +0.042; PM LOS F, Impact +0.028
 - #18 – El Segundo Boulevard at I-405 SB Ramps (ICU) – PM LOS F, Impact +0.075
 - #20 – El Segundo Boulevard at I-405 NB Ramps (ICU) – AM LOS E, Impact +0.056
- In addition, based on the HCM delay methodology, the project would cause two intersections already operating at a deficient Level of Service to worsen from LOS E to LOS F:
 - #6 – Pacific Coast Hwy at El Segundo Boulevard (HCM) – PM LOS E worsens to LOS F.
 - #18 – El Segundo Boulevard at I-405 SB Ramps (HCM) – PM LOS E worsens to LOS F.
- Mitigation measures were identified to mitigate the project impacts. Mitigation measures at Intersections #15 and #16 are considered to be infeasible, due to right-of-way constraints and the impact that intersection widening would have on existing infrastructure and densely developed private property. Therefore, the project impact at these intersections would remain significant and unavoidable.
- While implementation of the remaining mitigation measures at Intersection #1, 5, 6, 18, and 20 would reduce impacts to a less-than-significant level, the intersections are under Caltrans jurisdiction. Since the implementation of these improvements are outside the City's jurisdiction and there is uncertainty regarding the ability to implement these improvements, the City determines that there is a potential for a significant and unavoidable impact to occur at Intersection #1, 5, 6, 18, and 20 as a result of buildout of the Project.
- Heavy vehicles associated with construction would use the existing regional and local truck route network to approach the site. Designated truck routes serving the project area include Pacific Coast Highway and El Segundo Boulevard.
- Temporary delays in traffic may occasionally occur during construction due to oversized

vehicles traveling at lower speeds on local streets. Such delays would be occasional, and of short duration. These temporary delays would be considered less than significant. The project will be required to prepare a construction traffic management plan, to be reviewed and approved by the City.

- Upon completion of the project, each site driveway would operate at Level of Service C or better in both peak hours as unsignalized intersections. Therefore, all project driveways will continue to be unsignalized driveways.
- The existing Grand Avenue driveway for 333 Continental Boulevard is a full-movement, joint access driveway that also serves the Doubletree Hotel. Left turns are allowed due to a break in the median on Grand Avenue, although the median does not currently provide a left-turn pocket for eastbound left-turning traffic.
- The lack of a left-turn pocket at the median break on Grand Avenue at the Mattel driveway does not cause a deficient condition from a peak hour Level of Service standpoint.
- Although the driveway intersection with Grand Avenue would not operate at a deficient Level of Service, the presence of a median break on a 6-lane roadway without a left-turn pocket is an unusual and potentially unsafe condition.
- Based on the policies and thresholds published by the American Association of State Highway and Transportation Officials (AASHTO): *A Policy on Geometric Design of Highways and Streets*; and the National Cooperative Highway Research Program (NCHRP) Report 279 – *Intersection Channelization Design Guide*, the existing left-turn and through volumes on Grand Avenue at the Mattel driveway currently meet the warrant for a left-turn pocket. The existing volumes are well over the minimum thresholds, and with the addition of project traffic, future traffic volumes at this location would exceed the thresholds by an even greater margin.
- Based on the industry standards for geometric design of streets and intersections, it is recommended that the City consider requiring an improvement to the median to provide a left-turn pocket as a condition of the project approval.
- The project is forecasted to contribute 50 or more project trips to two CMP intersections: Pacific Coast Highway at Rosecrans Avenue and Pacific Coast Highway at El Segundo Boulevard. Both intersections were included as study intersections. The project's impacts were identified at these intersections, and where necessary, mitigation measures were identified, in compliance with Los Angeles County CMP requirements.

APPENDIX A

TRAFFIC DATA
COLLECTION
WORKSHEETS

ITM Peak Hour Summary

Prepared by:



National Data & Surveying Services

Sepulveda Blvd and Walnut Ave, El Segundo

Date: 10/21/2015

Day: Wednesday

Project #: Historical

City: El Segundo

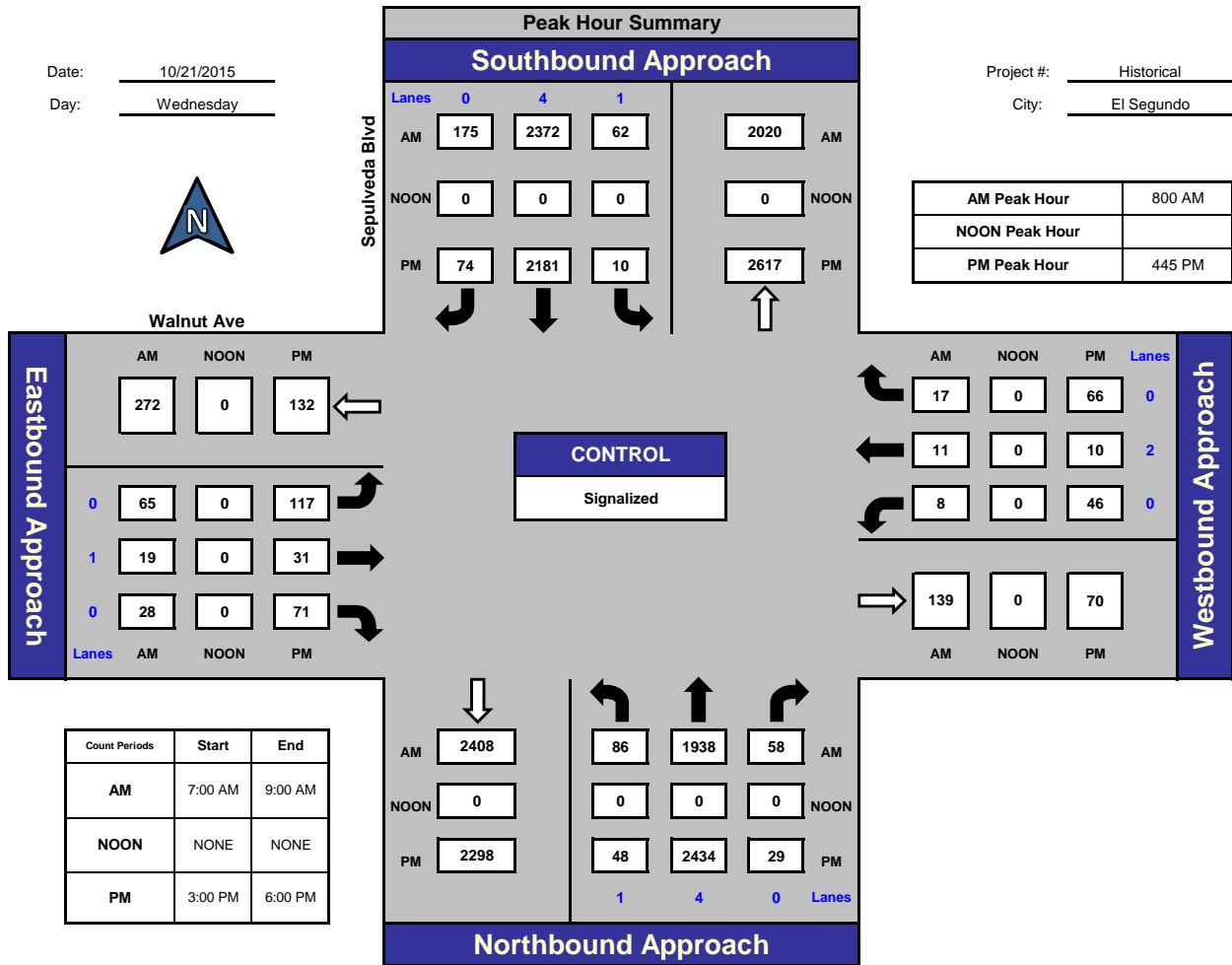

Total Ins & Outs

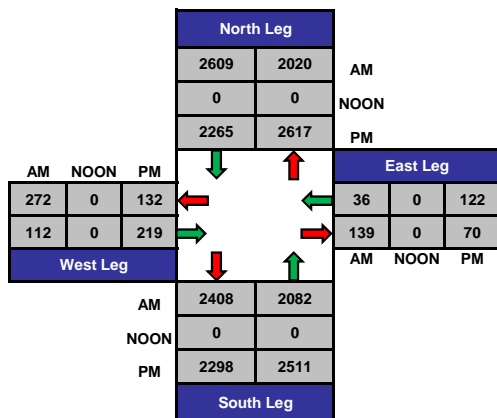

Total Volume Per Leg

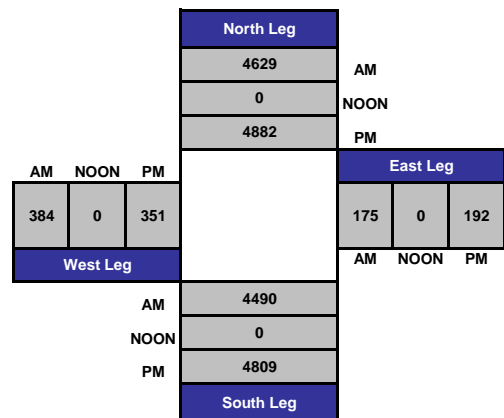

ITM Peak Hour Summary

Prepared by:



National Data & Surveying Services

Sepulveda Blvd and Maple Ave, El Segundo

Date: 5/3/2016
Day: Tuesday

Project #: 16-5278-003
City: El Segundo



Maple Ave

		Peak Hour Summary				
		Southbound Approach				
Sepulveda Blvd	Lanes	0	4	1		
	AM	36	2130	104	2216	AM
	NOON	0	0	0	0	NOON
PM	42	2439	57	2390	PM	

AM Peak Hour	745 AM
NOON Peak Hour	
PM Peak Hour	445 PM

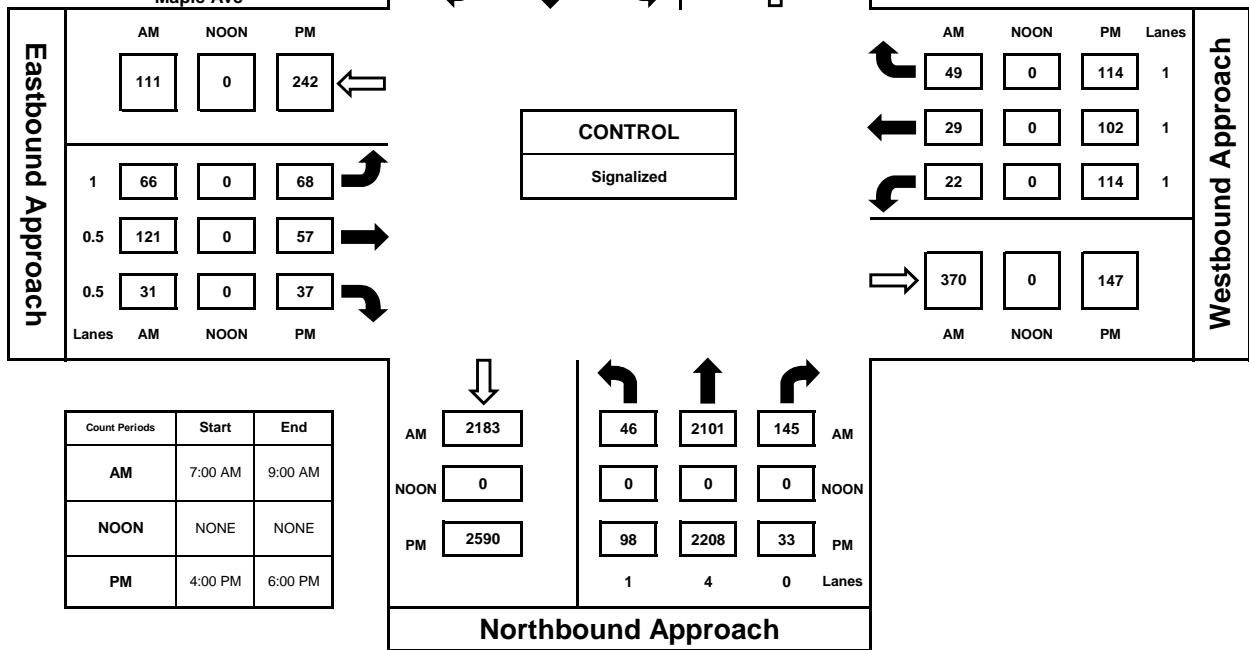

Count Periods	Start	End
AM	7:00 AM	9:00 AM
NOON	NONE	NONE
PM	4:00 PM	6:00 PM

Total Ins & Outs

		North Leg			
		2270	2216	AM	
		0	0	NOON	
		2538	2390	PM	
AM	NOON	PM	East Leg		
111	0	242	100	0	330
218	0	162	370	0	147
West Leg			AM	NOON	PM
			2183	0	2292
			0	0	0
			2590	0	2339
		South Leg			

Total Volume Per Leg

		North Leg			
		4486		AM	
		0		NOON	
		4928		PM	
AM	NOON	PM	East Leg		
329	0	404	470	0	477
West Leg			AM	NOON	PM
			4475	0	4929
			0	0	0
			4929	0	2339
		South Leg			

ITM Peak Hour Summary

Prepared by:



National Data & Surveying Services

Sepulveda Blvd and Mariposa Ave, El Segundo

Date: 10/21/2015

Day: Wednesday

Project #: Historical

City: El Segundo

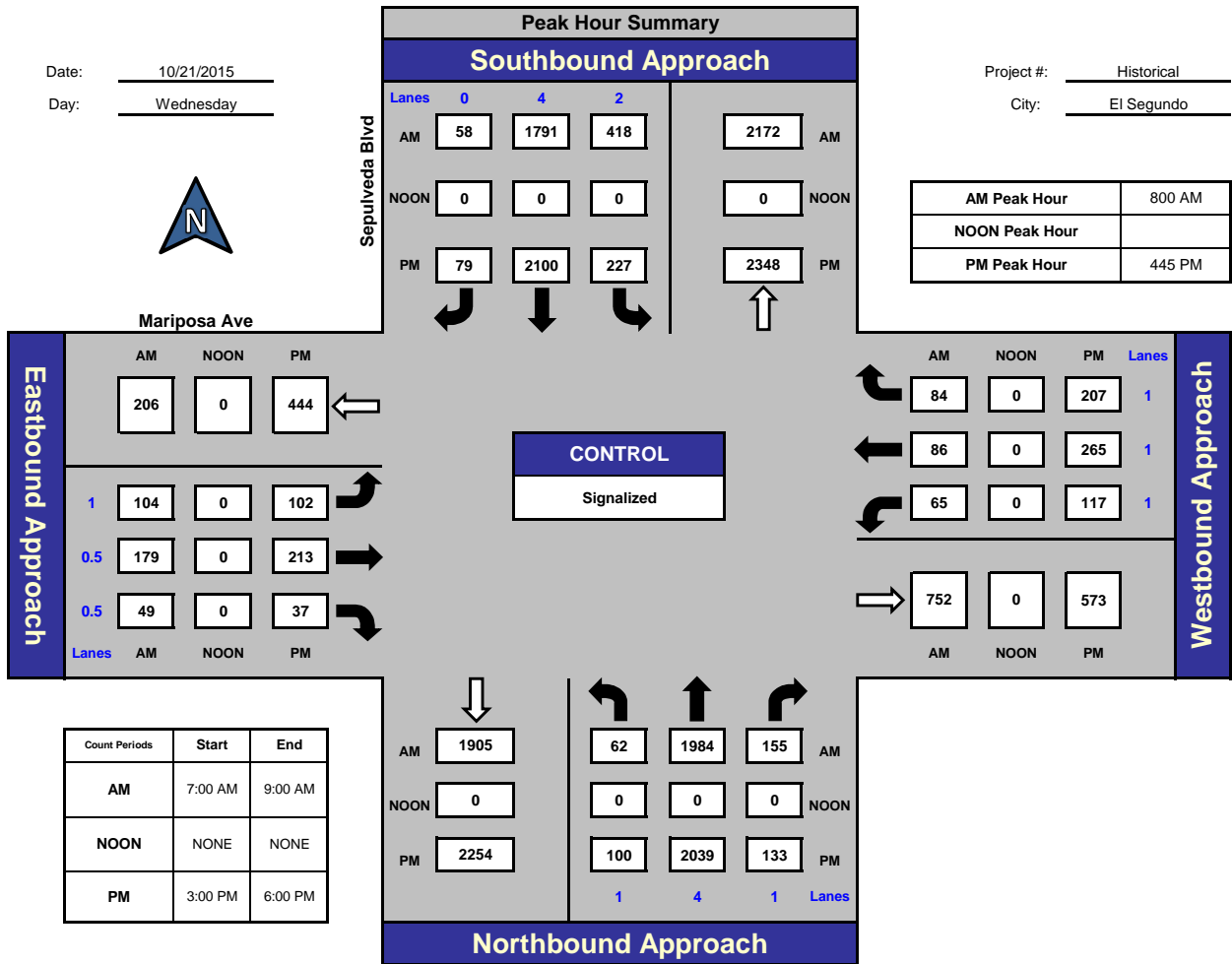

Total Ins & Outs

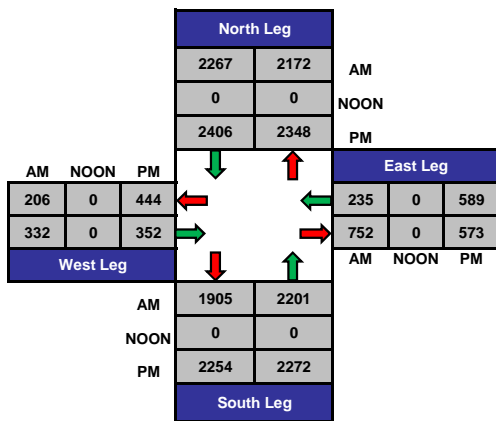

Total Volume Per Leg

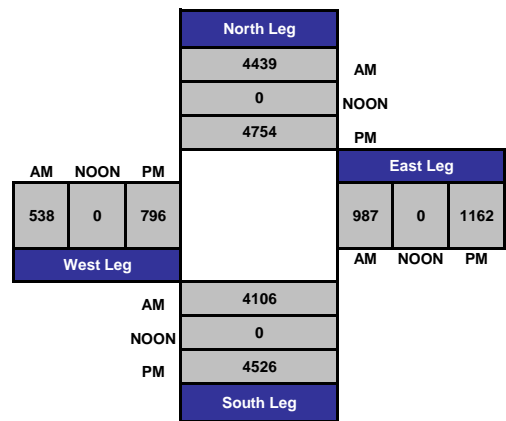

ITM Peak Hour Summary



Prepared by:
National Data & Surveying Services

Sepulveda Blvd and Grand Ave, El Segundo

Date: 10/21/2015
Day: Wednesday

Project #: Historical
City: El Segundo

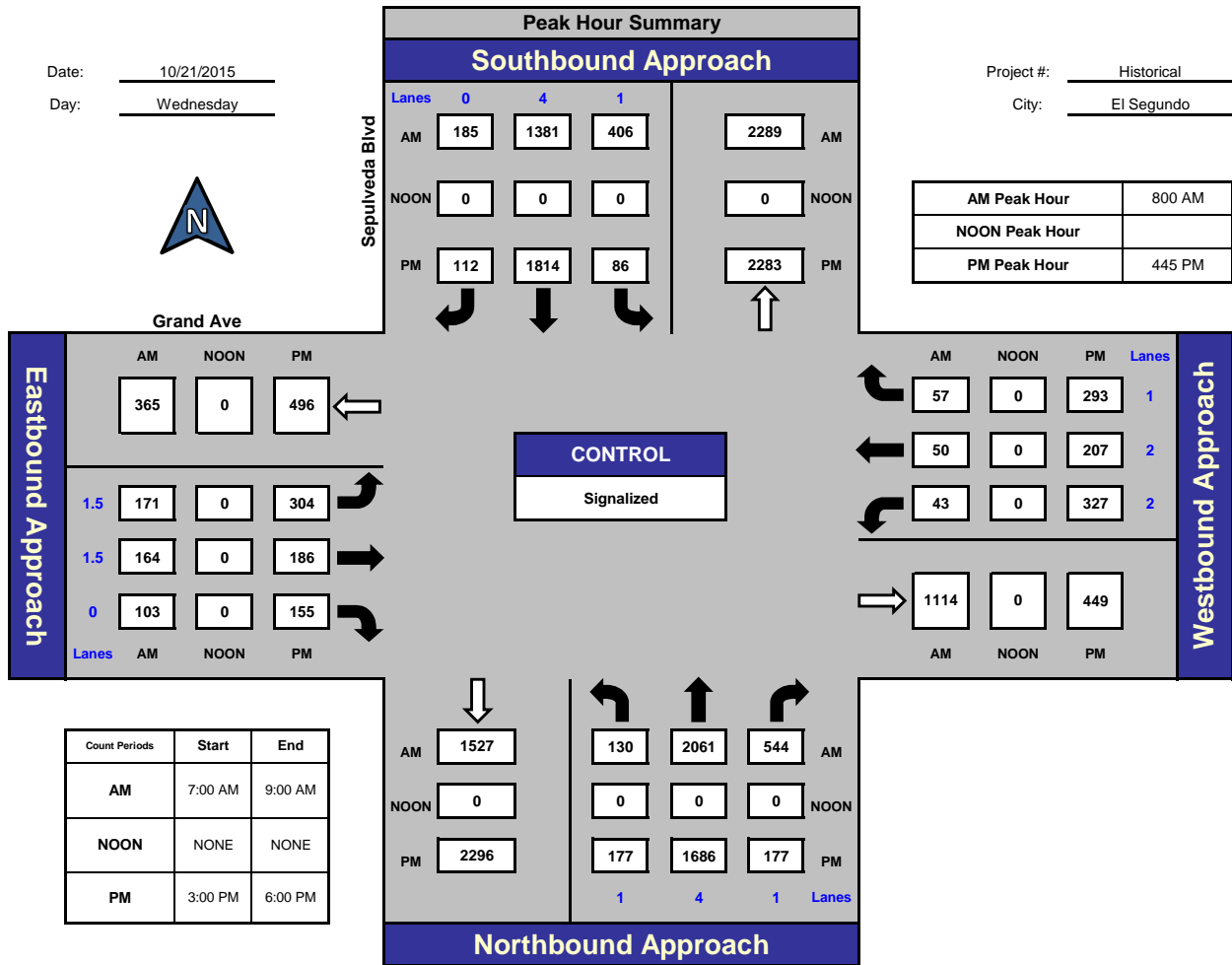

Total Ins & Outs

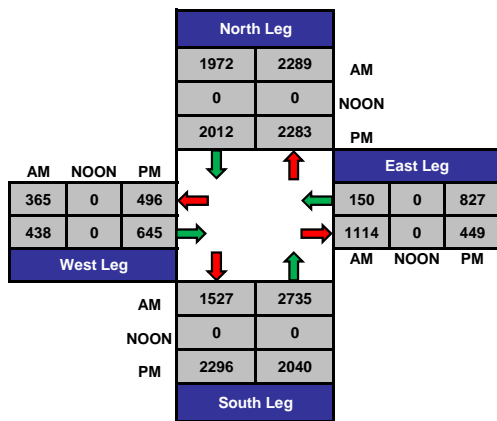

Total Volume Per Leg

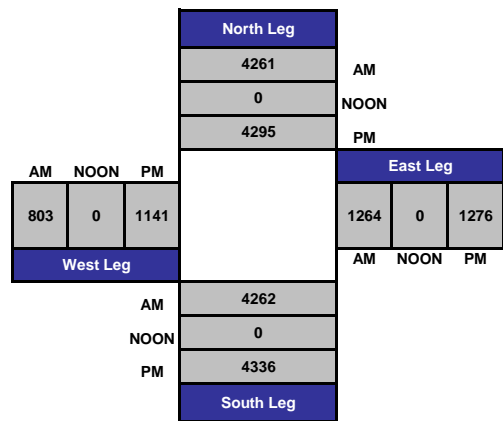

ITM Peak Hour Summary



Prepared by:
National Data & Surveying Services

Sepulveda Blvd and El Segundo Blvd, El Segundo

Date: 10/21/2015
Day: Wednesday

Project #: Historical
City: El Segundo

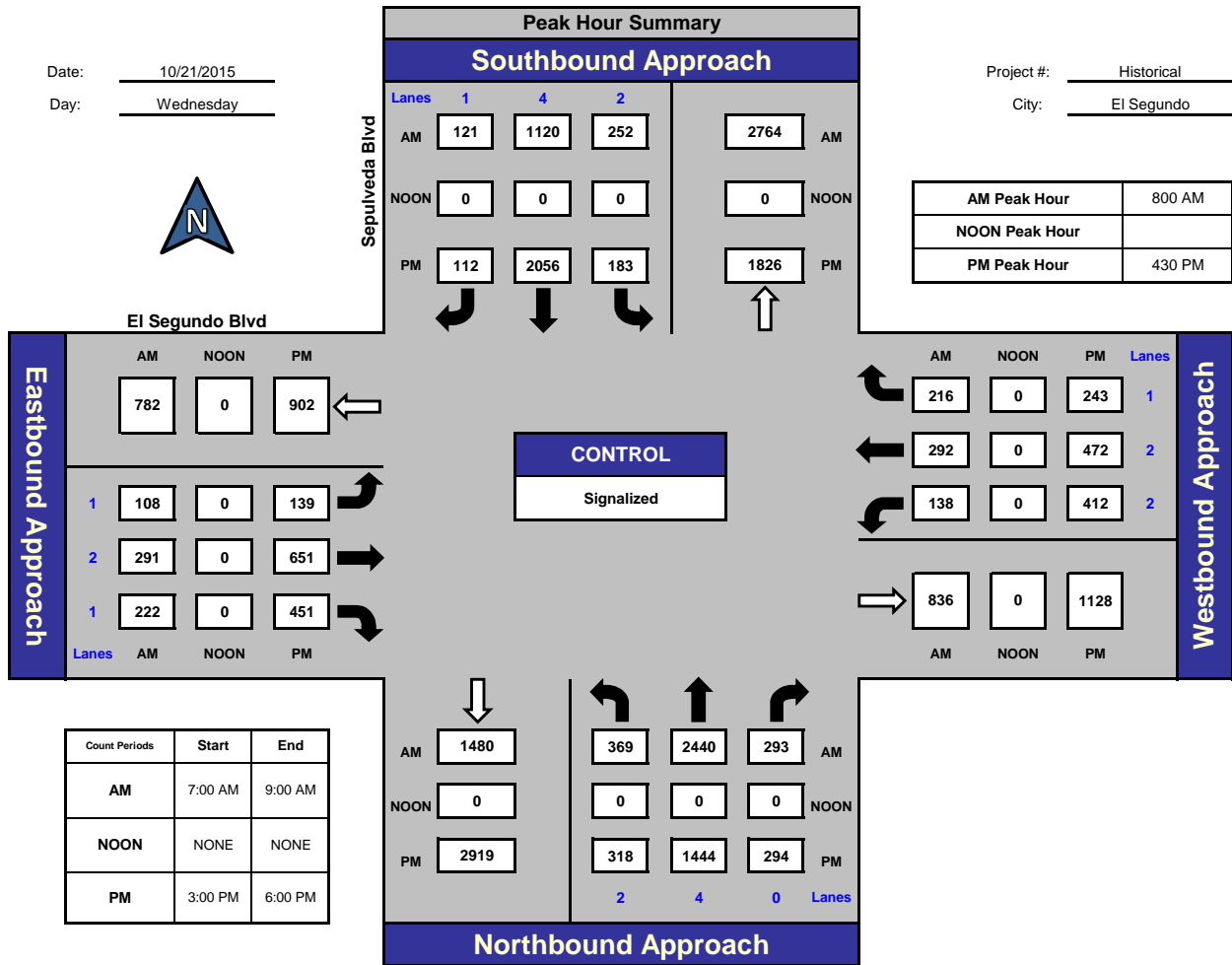

Total Ins & Outs

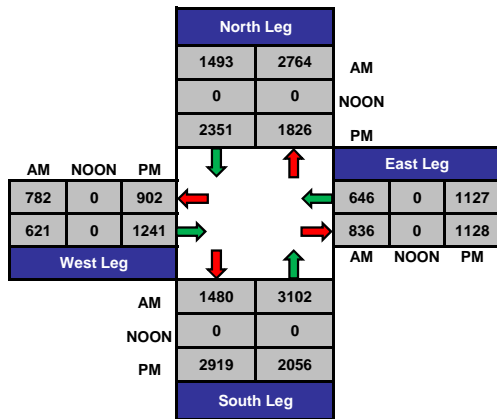

Total Volume Per Leg

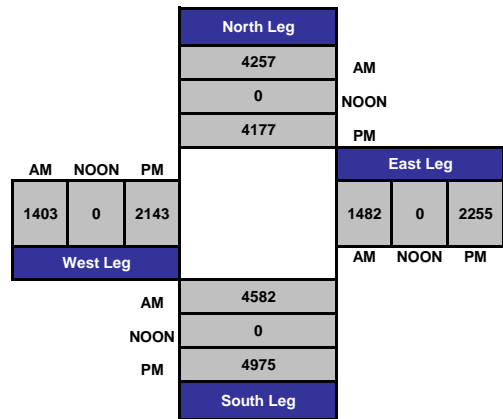

ITM Peak Hour Summary



Prepared by:
National Data & Surveying Services

Sepulveda Blvd and Rosecrans Blvd, El Segundo

Date: 5/3/2016
Day: Tuesday

Project #: 16-5278-007
City: El Segundo

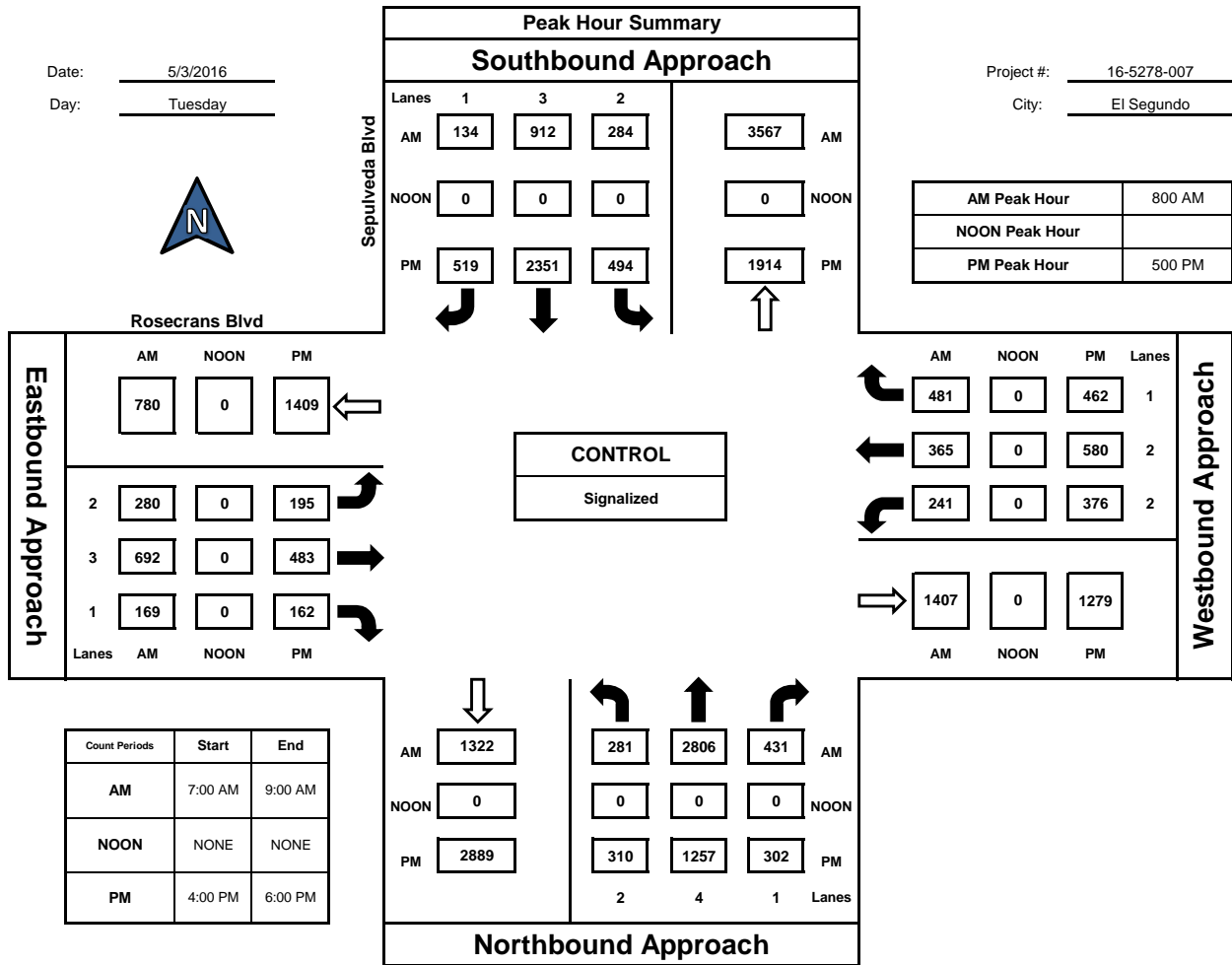

Total Ins & Outs

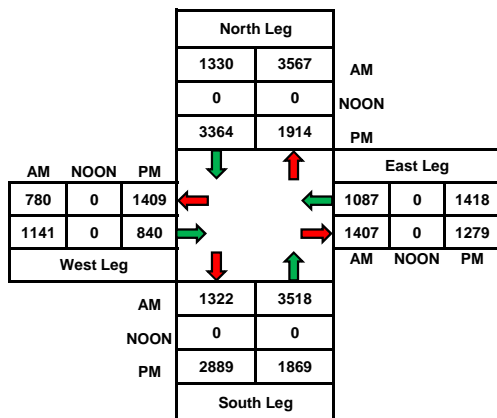

Total Volume Per Leg

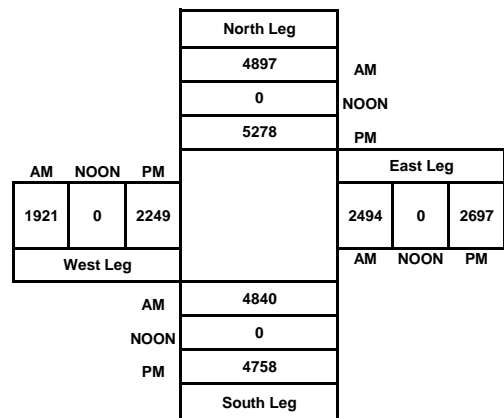

ITM Peak Hour Summary



Prepared by:
National Data & Surveying Services

Continental Blvd and Mariposa Ave, El Segundo

Date: 5/3/2016
Day: Tuesday

Project #: 16-5278-008
City: El Segundo



Mariposa Ave

Peak Hour Summary							
Southbound Approach							
Continental Blvd	Lanes	0.5	0.5	1			
	AM	16	77	6	95	AM	
	NOON	0	0	0	0	NOON	
PM	28	56	9	106	PM		

AM Peak Hour	745 AM
NOON Peak Hour	
PM Peak Hour	500 PM

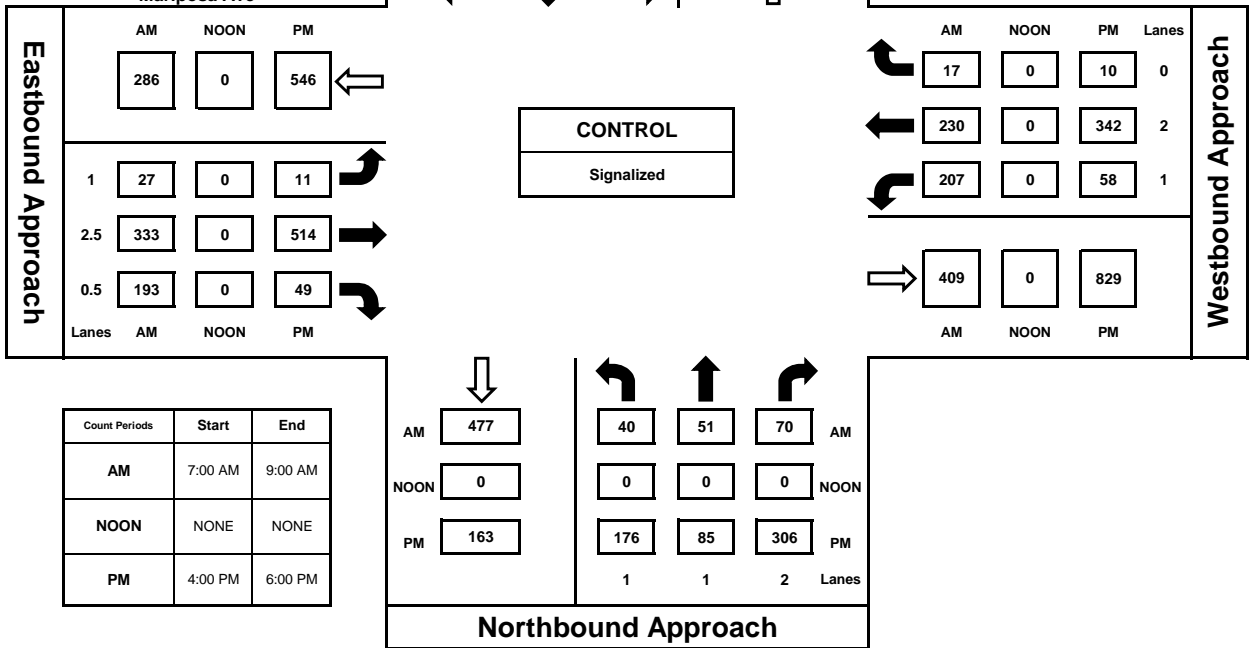

Count Periods	Start	End
AM	7:00 AM	9:00 AM
NOON	NONE	NONE
PM	4:00 PM	6:00 PM

Total Ins & Outs

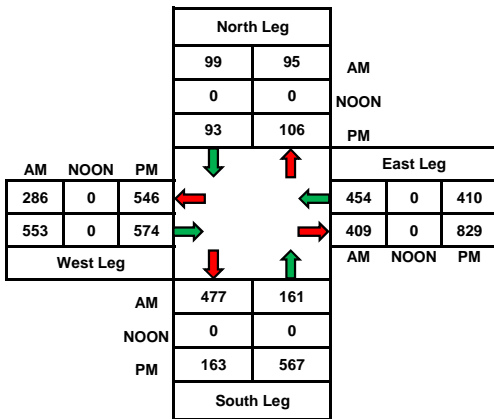

Total Volume Per Leg

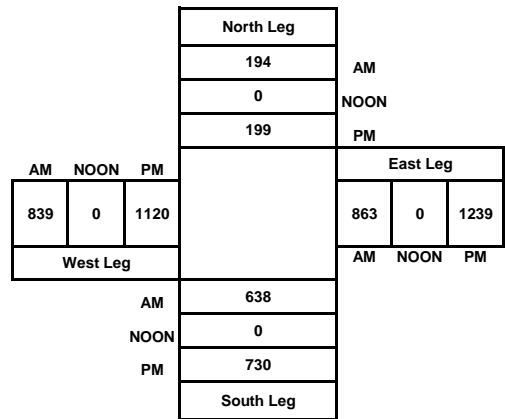

ITM Peak Hour Summary

Prepared by:



National Data & Surveying Services

Continental Blvd and Grand Ave, El Segundo

Date: 5/3/2016
Day: Tuesday

Project #: 16-5278-009
City: El Segundo



Peak Hour Summary							
Southbound Approach							
Continental Blvd	Lanes	0.5	2.5	1			
	AM	78	77	15	316	AM	
	NOON	0	0	0	0	NOON	
	PM	108	172	40	227	PM	

AM Peak Hour	800 AM
NOON Peak Hour	
PM Peak Hour	500 PM

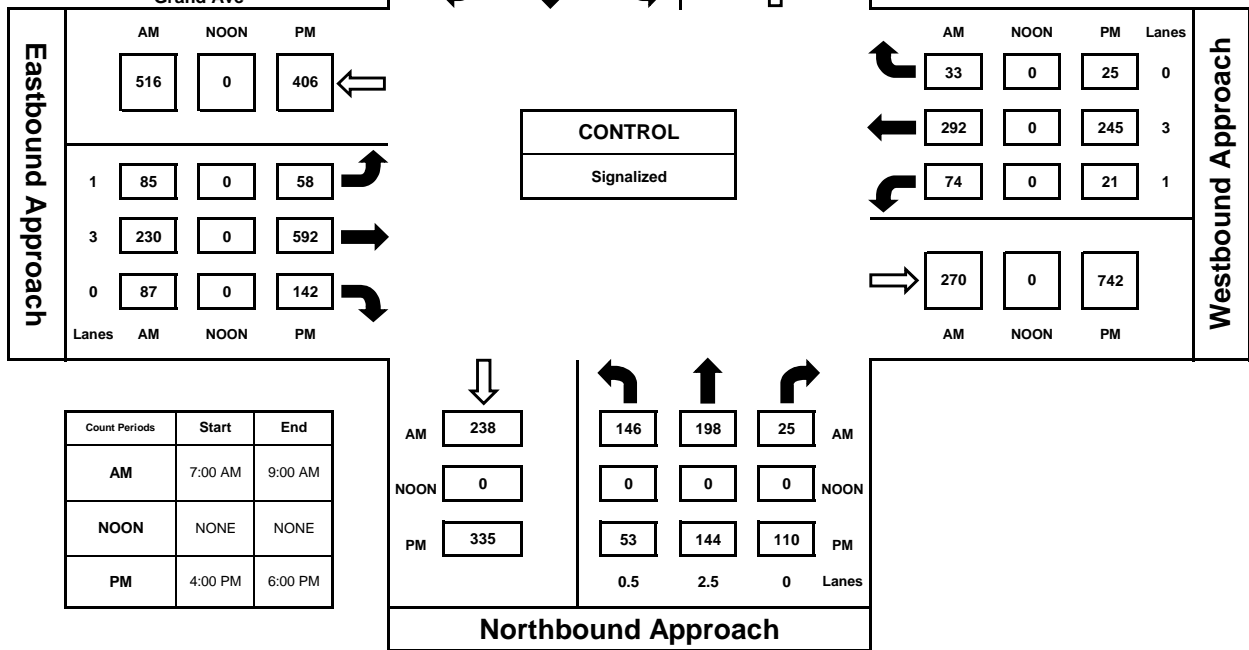

Count Periods	Start	End
AM	7:00 AM	9:00 AM
NOON	NONE	NONE
PM	4:00 PM	6:00 PM

Total Ins & Outs

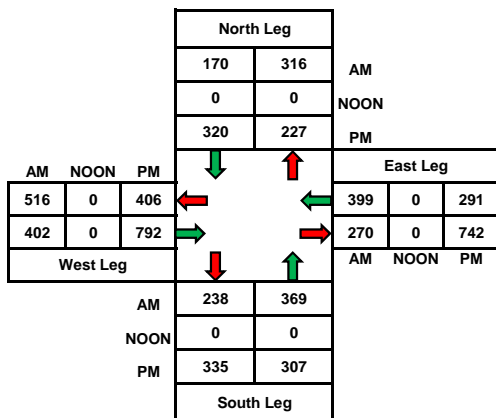

Total Volume Per Leg

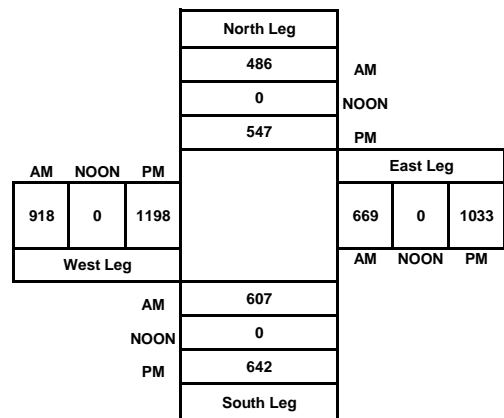

ITM Peak Hour Summary



Prepared by:
National Data & Surveying Services

Continental Blvd and El Segundo Blvd, El Segundo

Date: 5/3/2016
Day: Tuesday

Project #: 16-5278-010
City: El Segundo

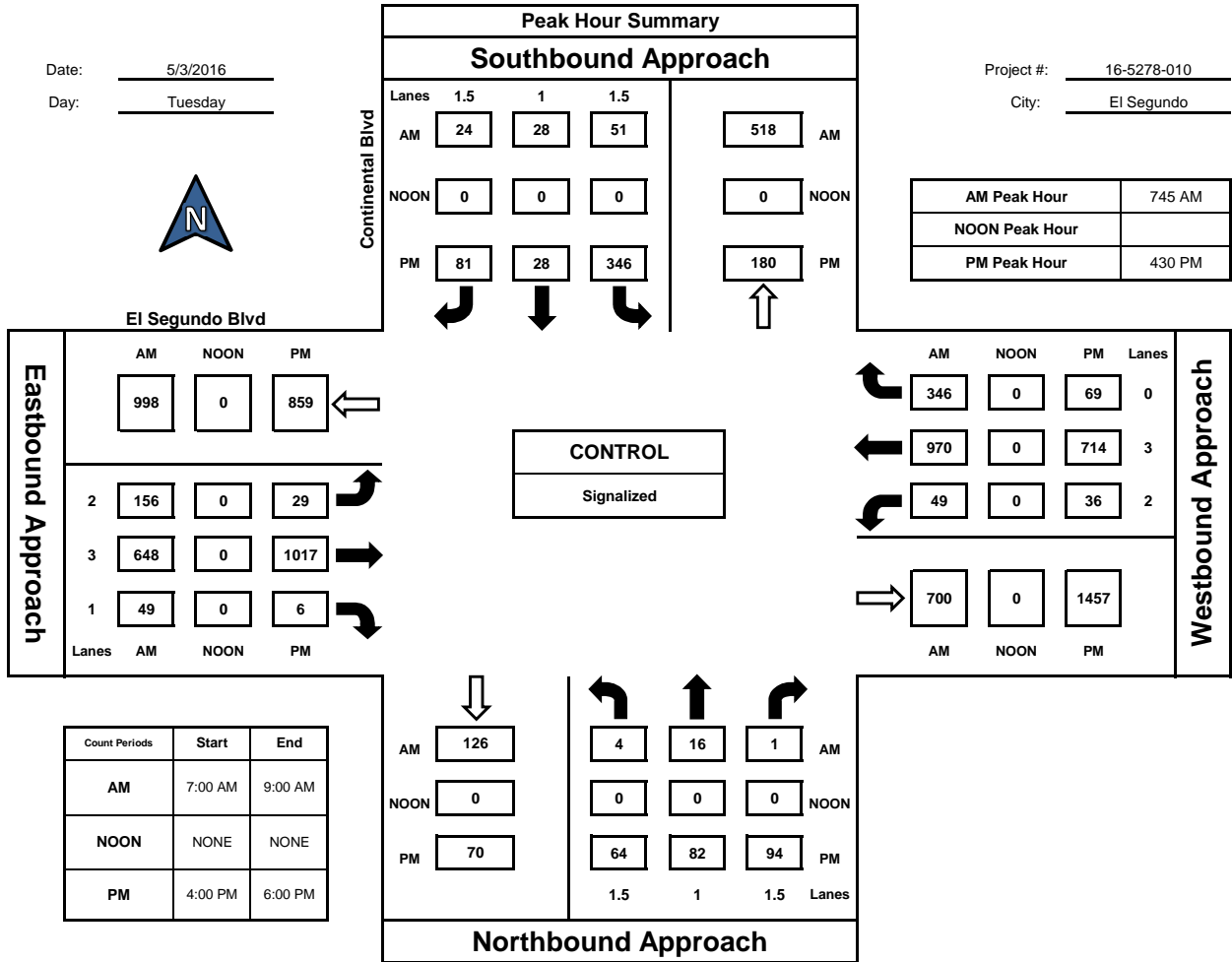

Total Ins & Outs

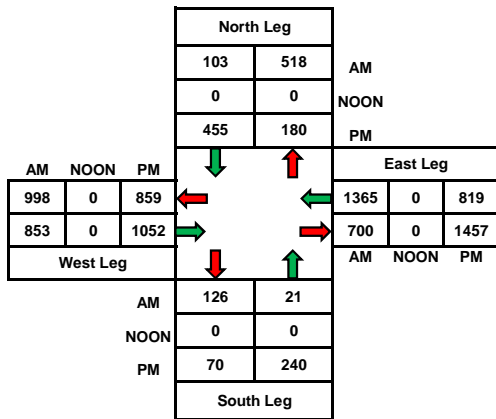

Total Volume Per Leg

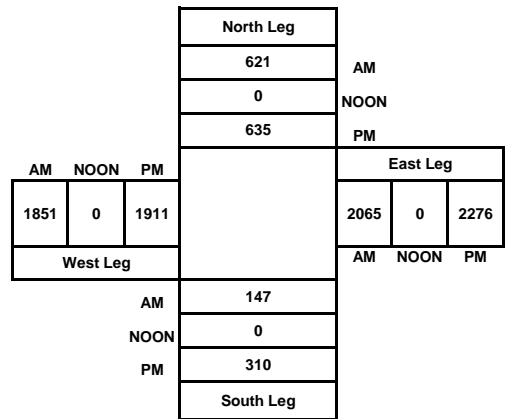

ITM Peak Hour Summary

Prepared by:



National Data & Surveying Services

Nash St and Imperial Hwy, El Segundo

Date: 5/3/2016
Day: Tuesday

Project #: 16-5278-011
City: El Segundo

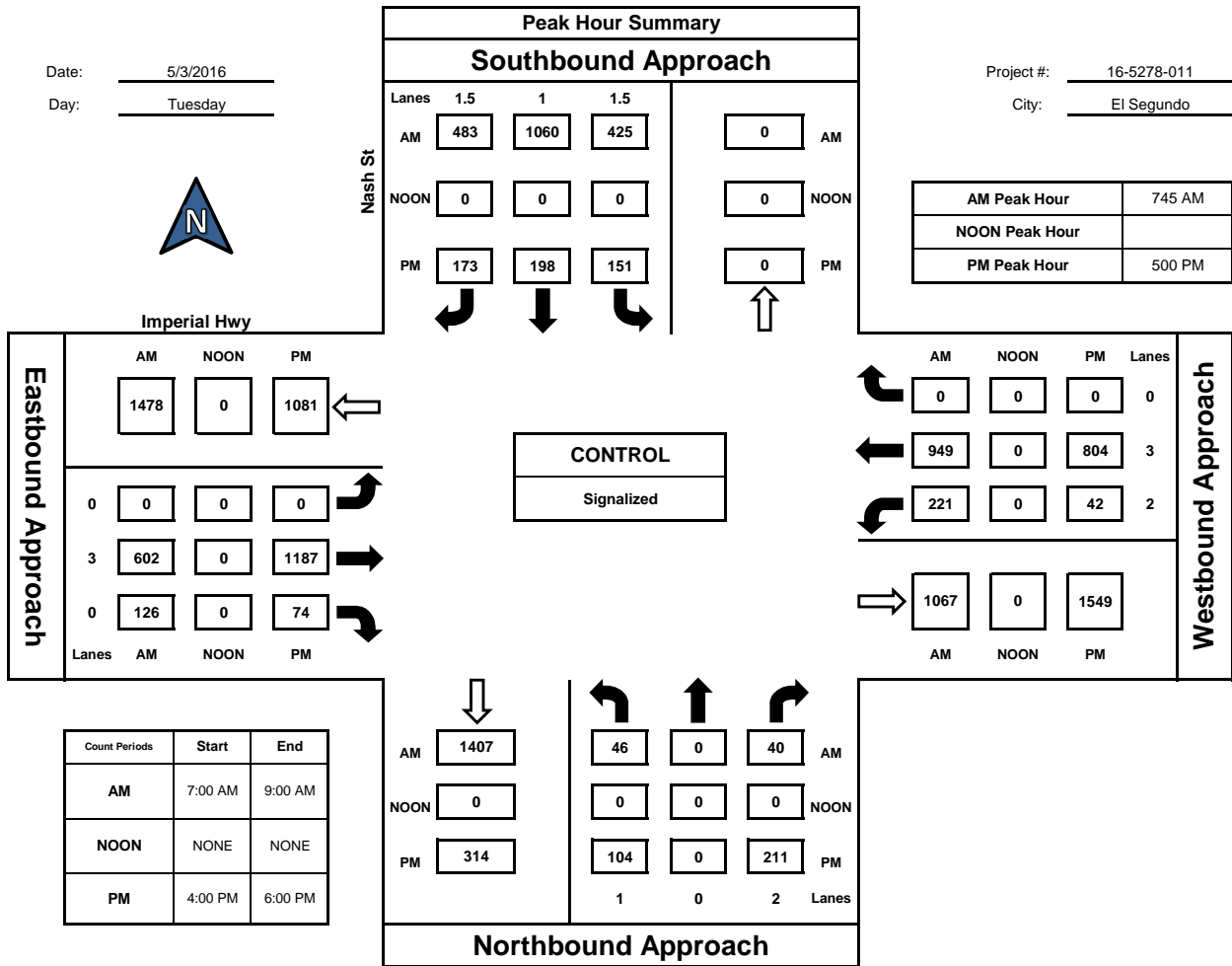

Total Ins & Outs

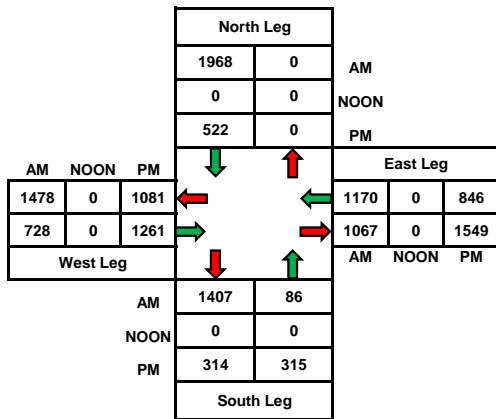

Total Volume Per Leg

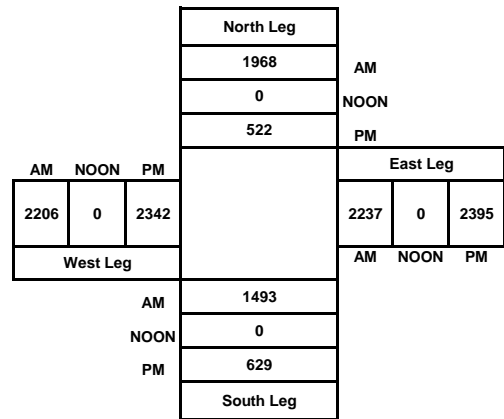

ITM Peak Hour Summary

Prepared by:



National Data & Surveying Services

Nash St and Mariposa Ave, El Segundo

Date: 5/3/2016

Day: Tuesday

Project #: 16-5278-012

City: El Segundo



Mariposa Ave

Peak Hour Summary						
Southbound Approach						
Lanes	0	2	1			
AM	232	555	25	322	AM	
NOON	0	0	0	0	NOON	
PM	80	272	54	891	PM	

AM Peak Hour	745 AM
NOON Peak Hour	
PM Peak Hour	500 PM

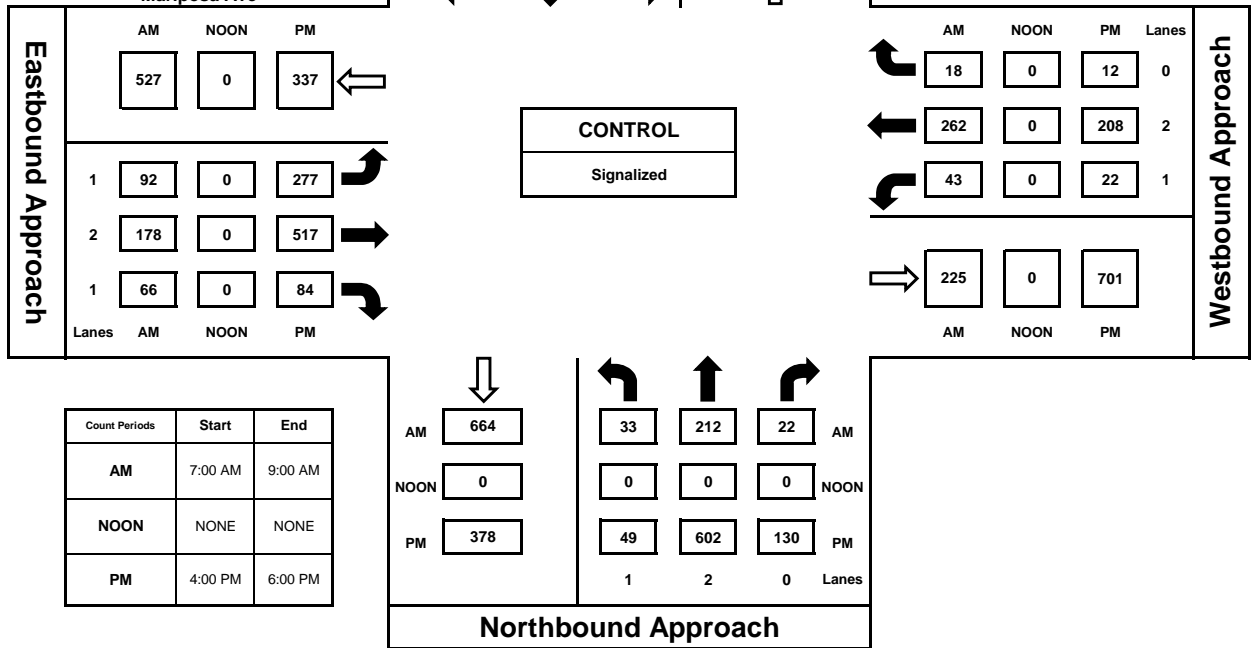

Count Periods	Start	End
AM	7:00 AM	9:00 AM
NOON	NONE	NONE
PM	4:00 PM	6:00 PM

Total Ins & Outs

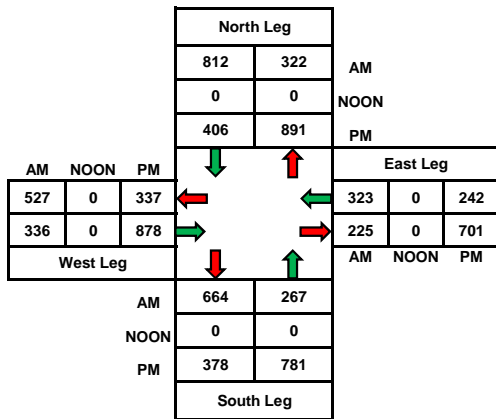

Total Volume Per Leg

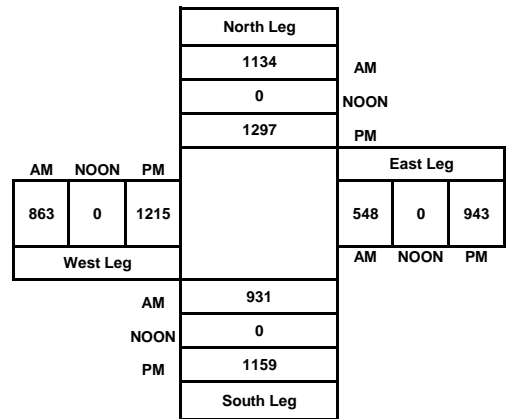

ITM Peak Hour Summary

Prepared by:



National Data & Surveying Services

Nash St and Grand Ave, El Segundo

Date: 5/3/2016
Day: Tuesday

Project #: 16-5278-013
City: El Segundo



Grand Ave

Peak Hour Summary						
Southbound Approach						
Lanes	0	2	1			
AM	368	192	43	284	AM	
NOON	0	0	0	0	NOON	
PM	151	203	50	701	PM	

AM Peak Hour	800 AM
NOON Peak Hour	
PM Peak Hour	500 PM

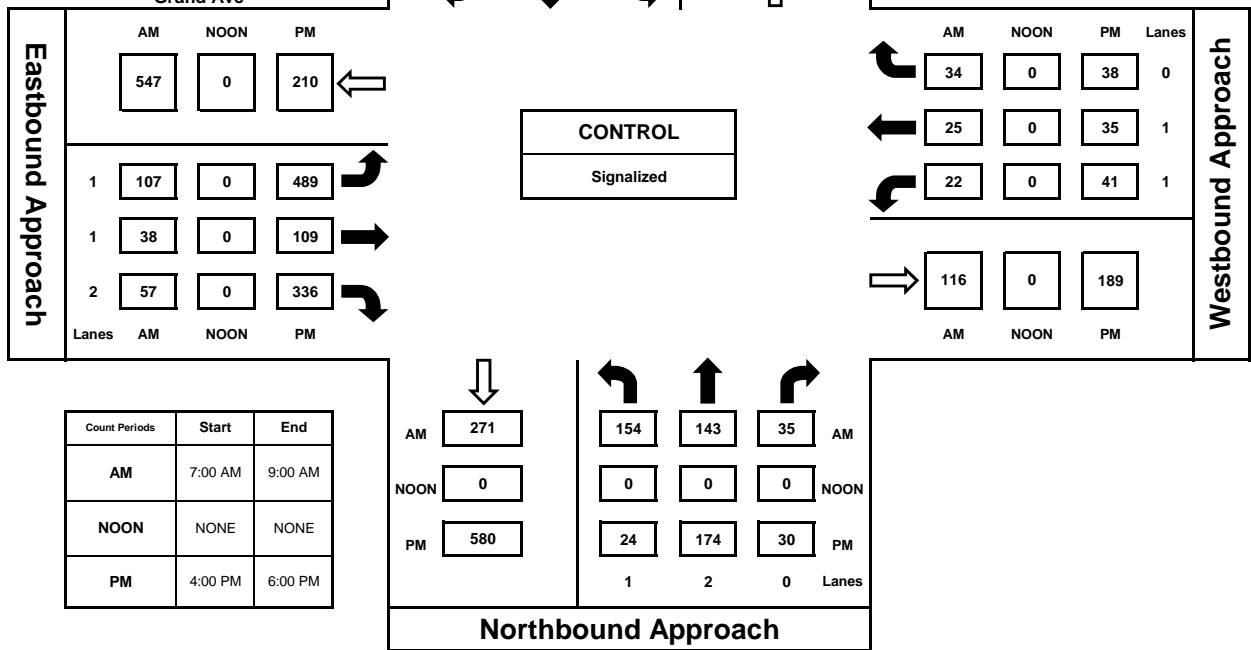

Count Periods	Start	End
AM	7:00 AM	9:00 AM
NOON	NONE	NONE
PM	4:00 PM	6:00 PM

Total Ins & Outs

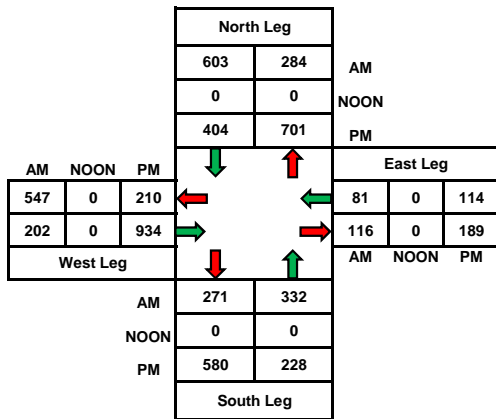

Total Volume Per Leg

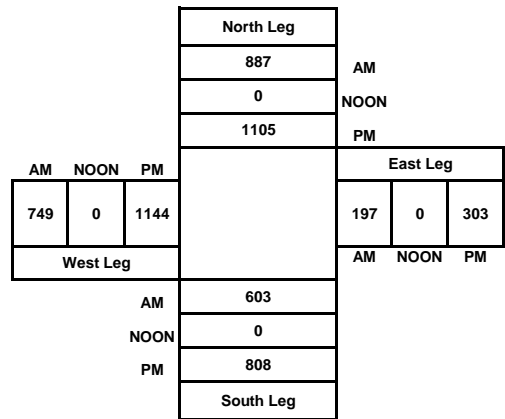

ITM Peak Hour Summary

Prepared by:



National Data & Surveying Services

Nash St and El Segundo Blvd, El Segundo

Date: 5/3/2016

Day: Tuesday

Project #: 16-5278-014

City: El Segundo

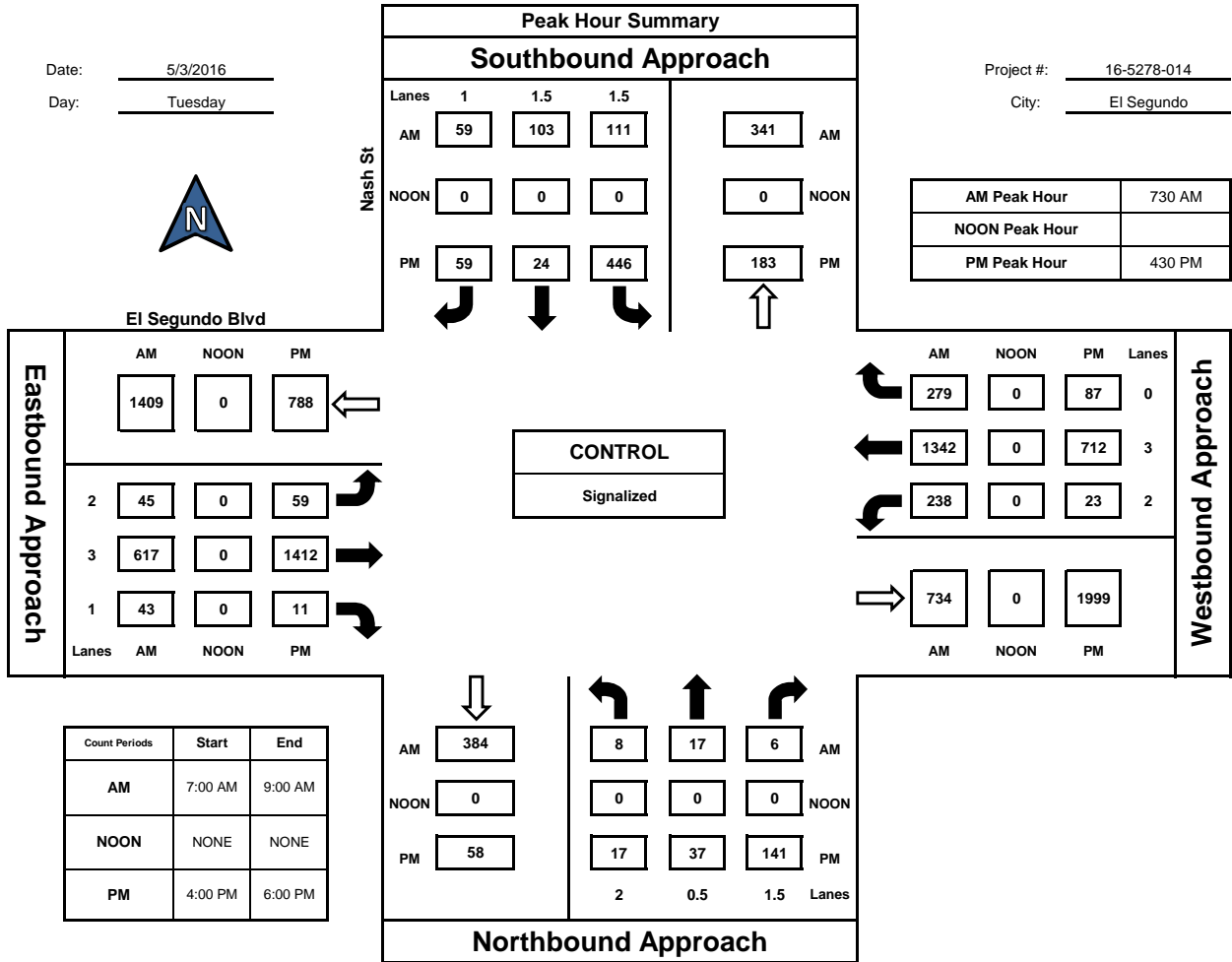

Total Ins & Outs

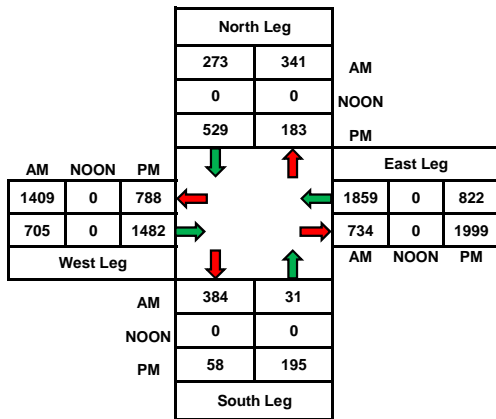

Total Volume Per Leg

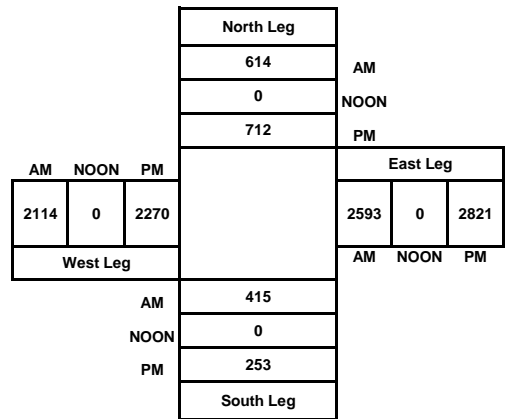

ITM Peak Hour Summary

Prepared by:



National Data & Surveying Services

Douglas St and El Segundo Blvd , El Segundo

Date: 5/3/2016
Day: Tuesday

Project #: 16-5278-015
City: El Segundo

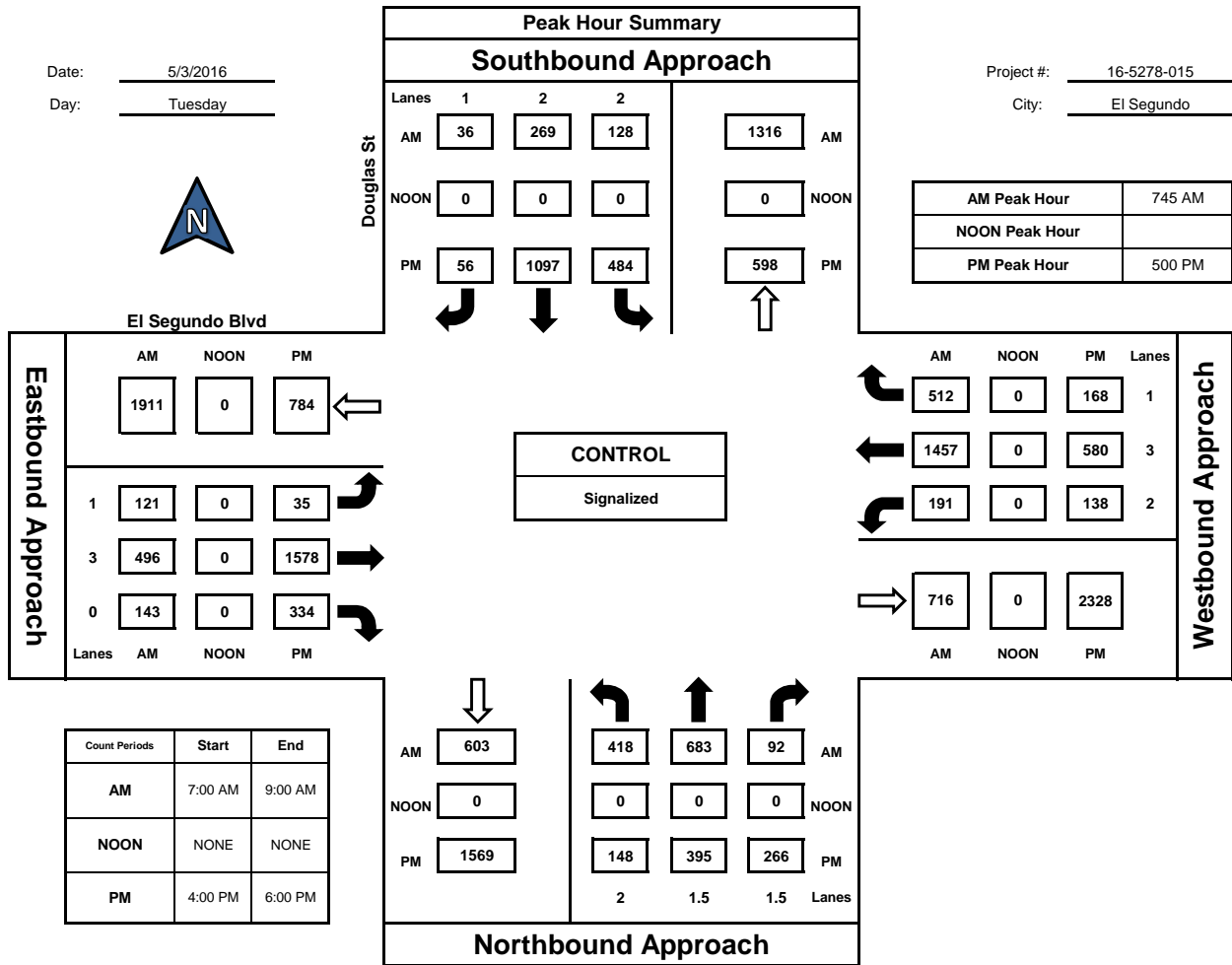

Total Ins & Outs

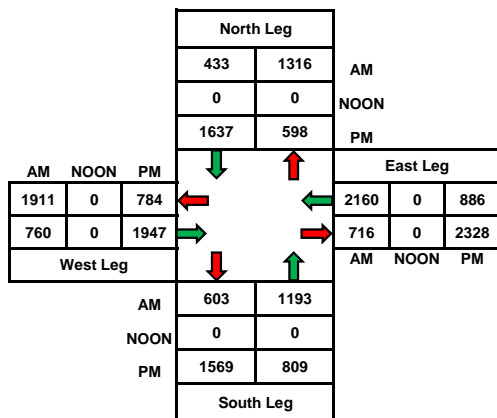

Total Volume Per Leg

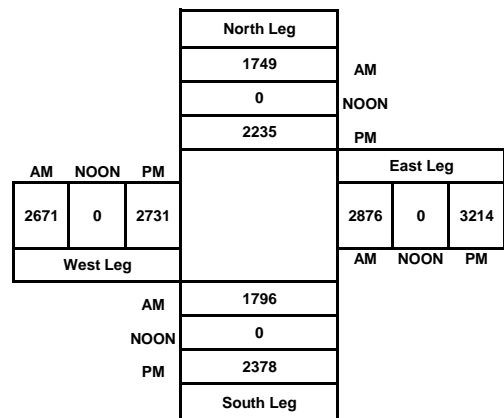

ITM Peak Hour Summary



Prepared by:
National Data & Surveying Services

Aviation Blvd and El Segundo Blvd, El Segundo

Date: 5/3/2016
Day: Tuesday

Project #: 16-5278-016
City: El Segundo

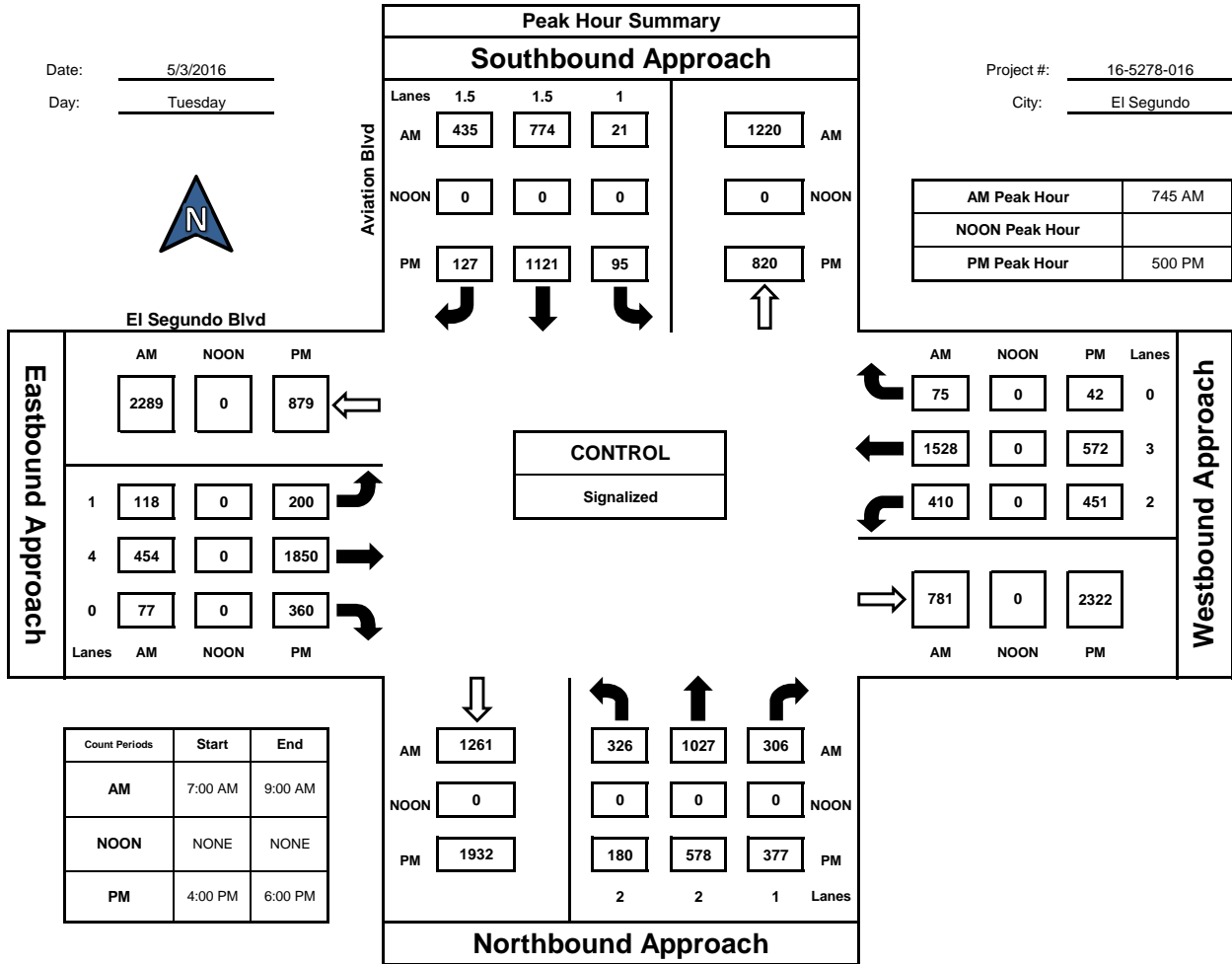

Total Ins & Outs

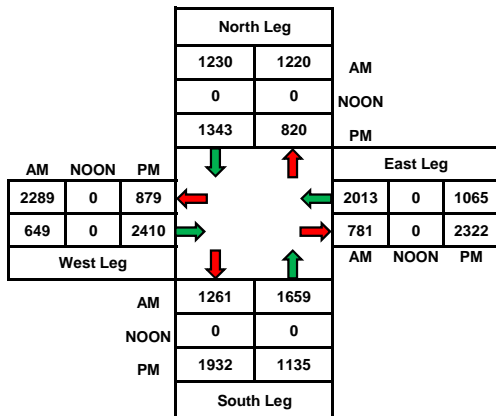

Total Volume Per Leg

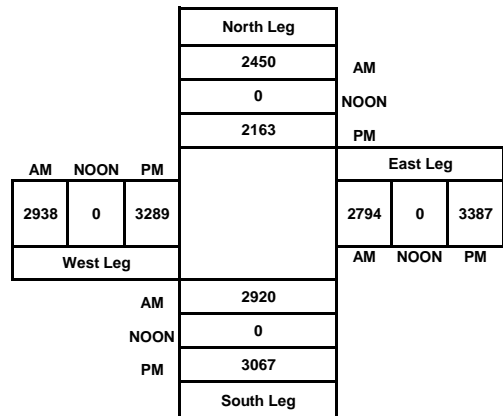

Isis Ave & El Segundo Blvd

Peak Hour Turning Movement Count

ID: 18-05233-001
City: El Segundo

Day: Tuesday
Date: 04/10/2018

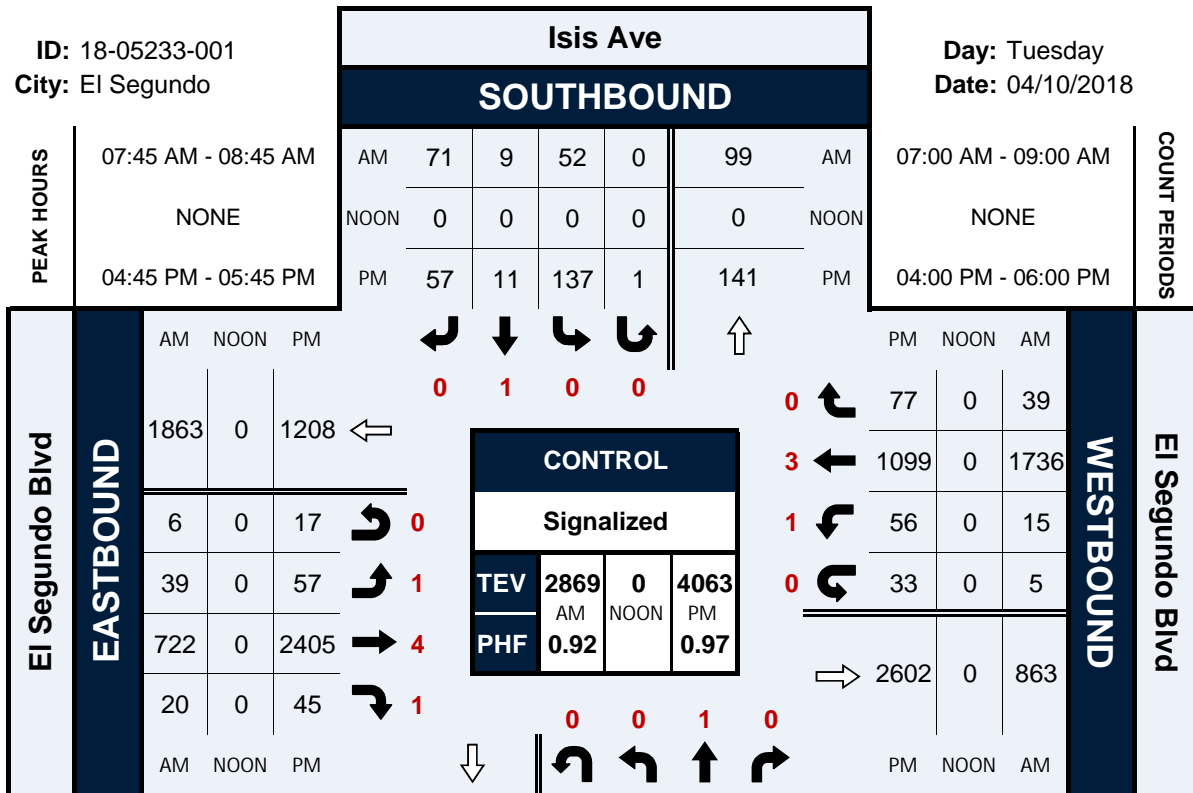

Total Vehicles (AM)

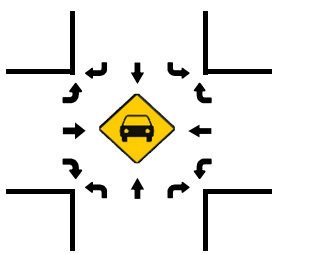

Total Vehicles (NOON)

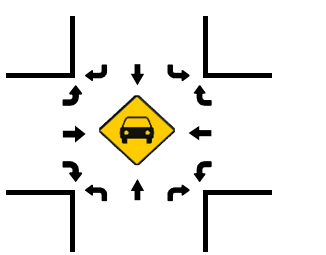

Total Vehicles (PM)

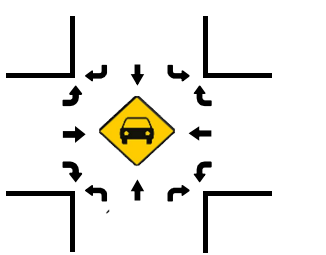

PM	112	0	35	6	27	PM
NOON	0	0	0	0	0	NOON
AM	44	0	50	21	84	AM

Isis Ave NORTHBOUND

Total Vehicles (AM)

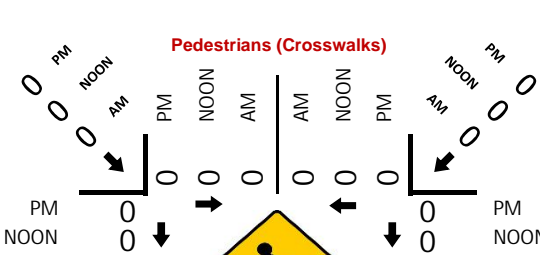

Total Vehicles (NOON)

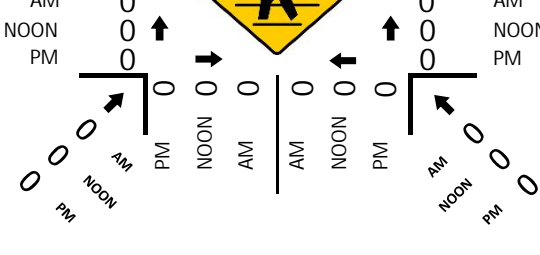

Total Vehicles (PM)

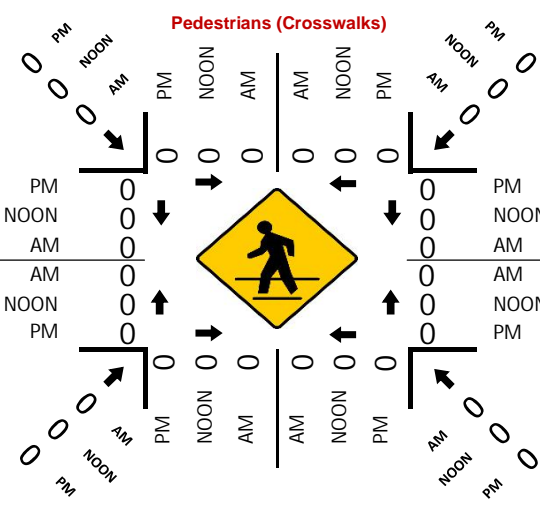

I-405 SB Ramps & El Segundo Blvd

Peak Hour Turning Movement Count

ID: 18-05233-002
City: El Segundo

Day: Tuesday
Date: 04/10/2018

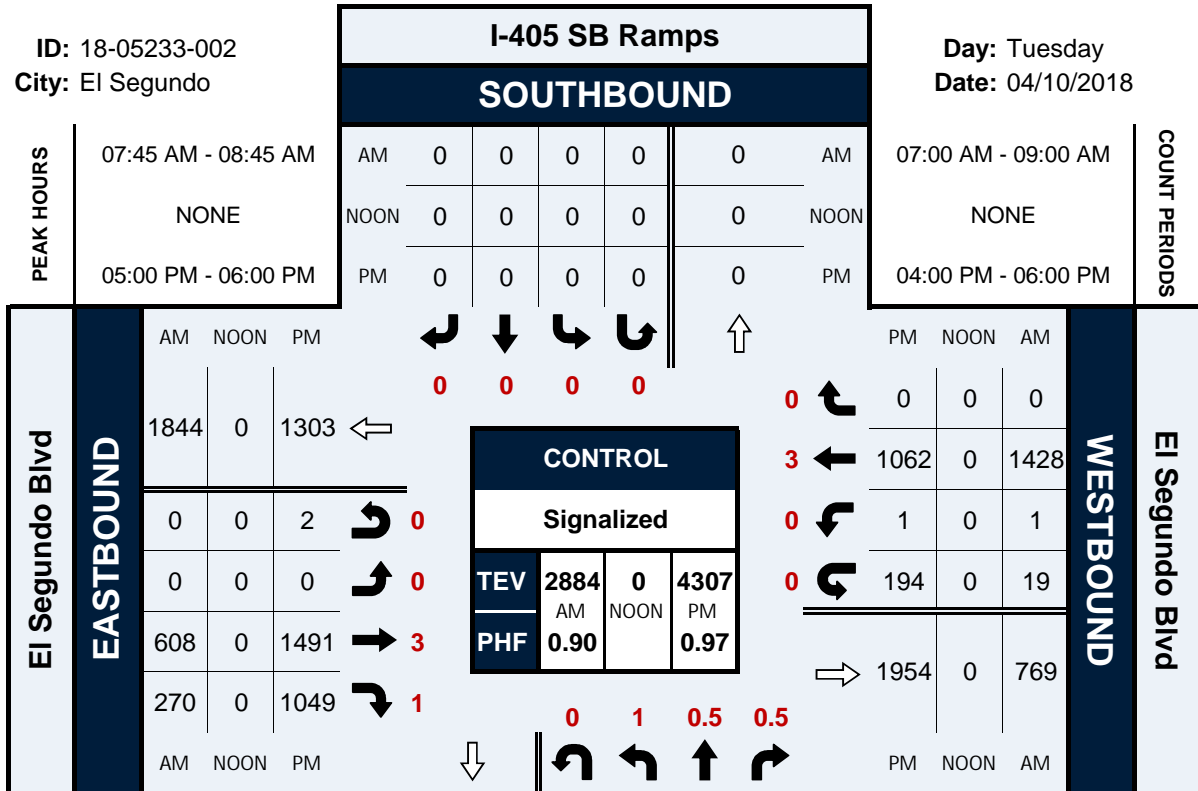

Total Vehicles (AM)

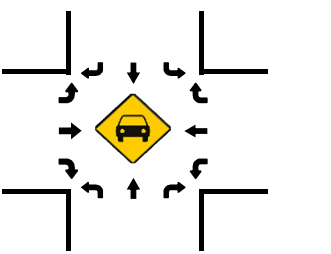

Total Vehicles (NOON)

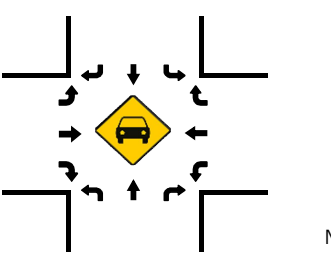

Total Vehicles (PM)

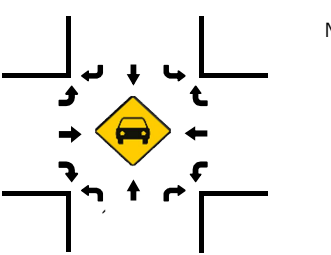

		PM	NOON	AM	PM
PM		1050	0	239	0
NOON		0	0	0	0
AM		271	0	416	0

NORTHBOUND

I-405 SB Ramps

Total Vehicles (AM)

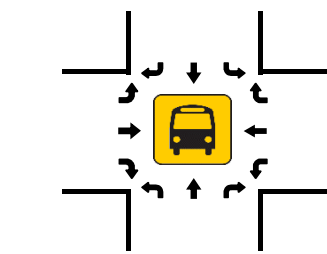

Total Vehicles (NOON)

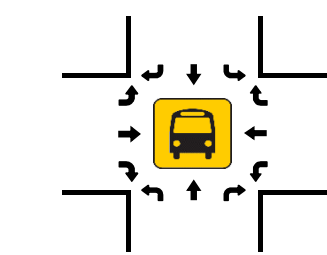

Total Vehicles (PM)

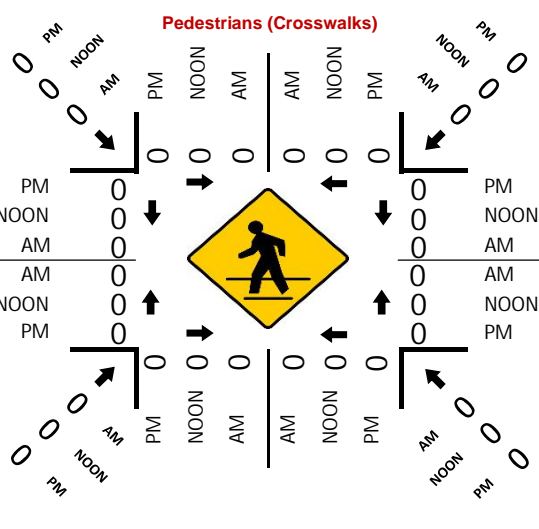
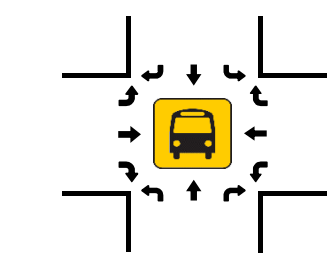

La Cienega Blvd & El Segundo Blvd

Peak Hour Turning Movement Count

ID: 18-05233-003
City: El Segundo

Day: Tuesday
Date: 04/10/2018

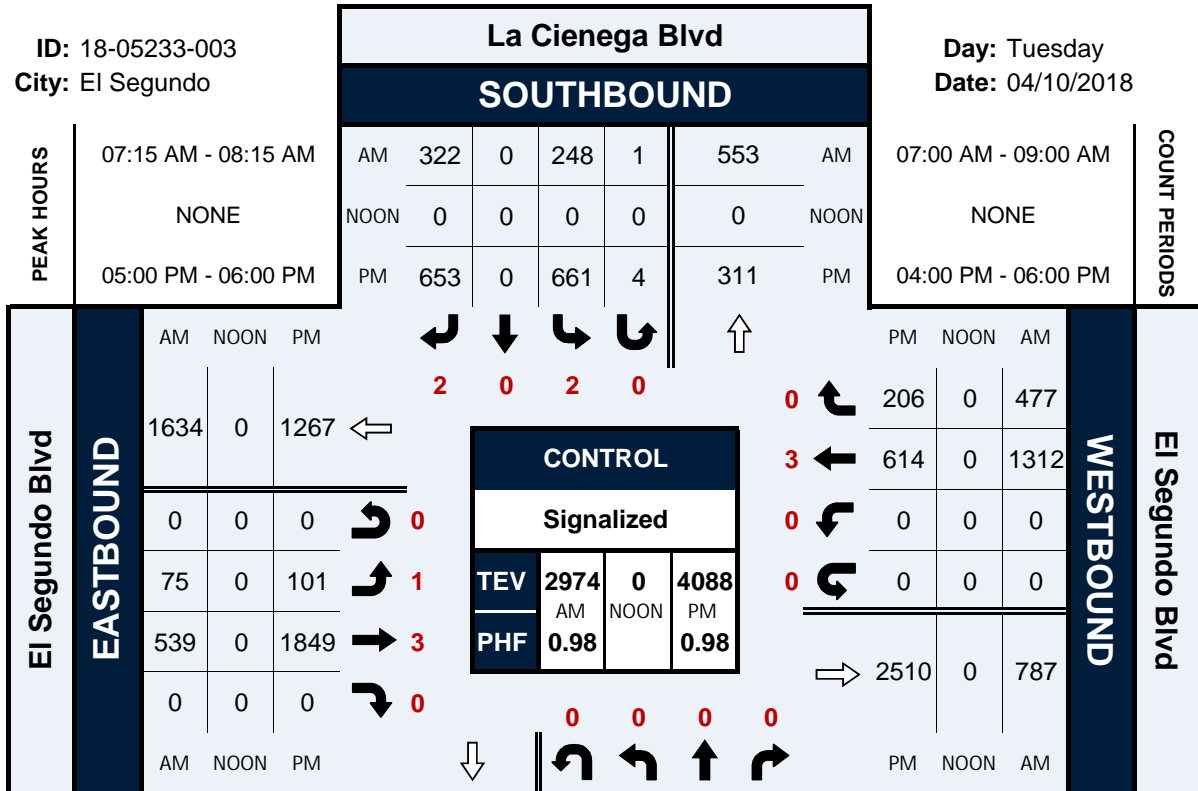

Total Vehicles (AM)

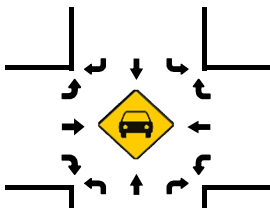

Total Vehicles (NOON)

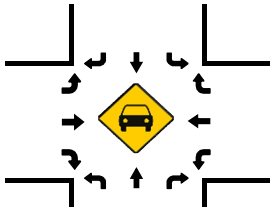

Total Vehicles (PM)

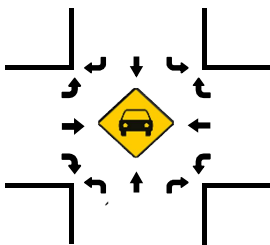

Total Vehicles (AM)

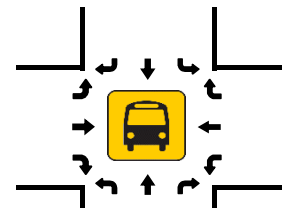

Total Vehicles (NOON)

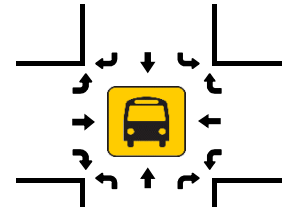

Total Vehicles (PM)

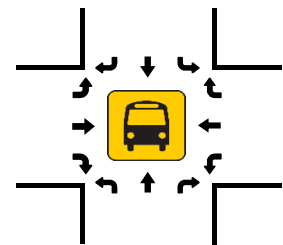

Pedestrians (Crosswalks)

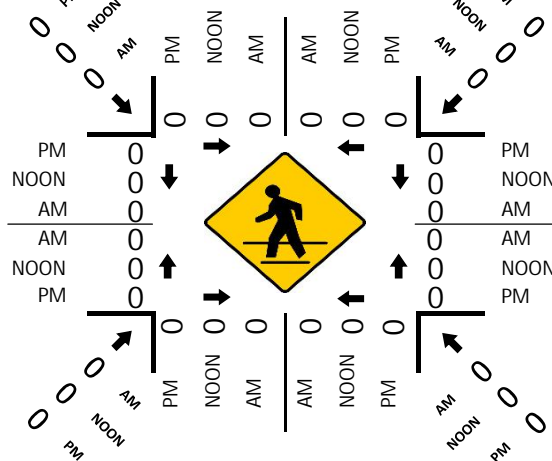

I-405 NB Ramps & El Segundo Blvd

Peak Hour Turning Movement Count

ID: 18-05233-004
City: El Segundo

Day: Tuesday
Date: 04/10/2018

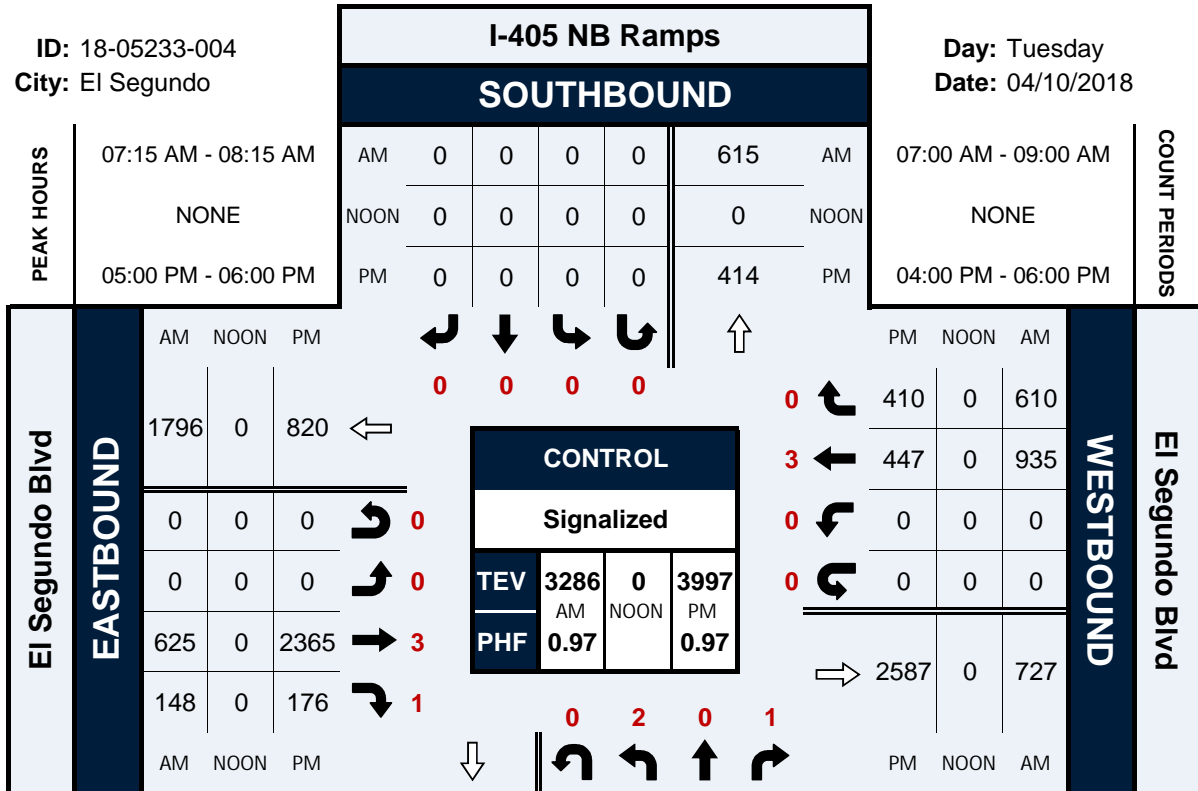

Total Vehicles (AM)

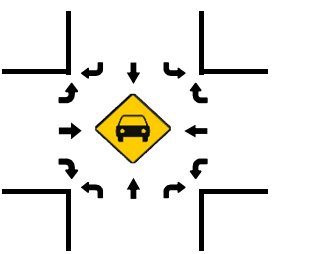

Total Vehicles (NOON)

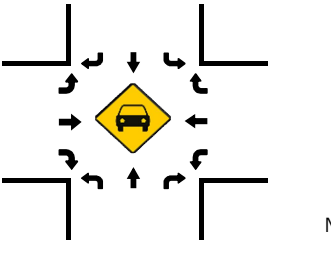

Total Vehicles (PM)

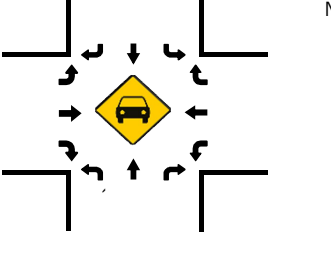

PM	176	0	373	4	222	PM
NOON	0	0	0	0	0	NOON
AM	148	0	861	5	102	AM

I-405 NB Ramps NORTHBOUND

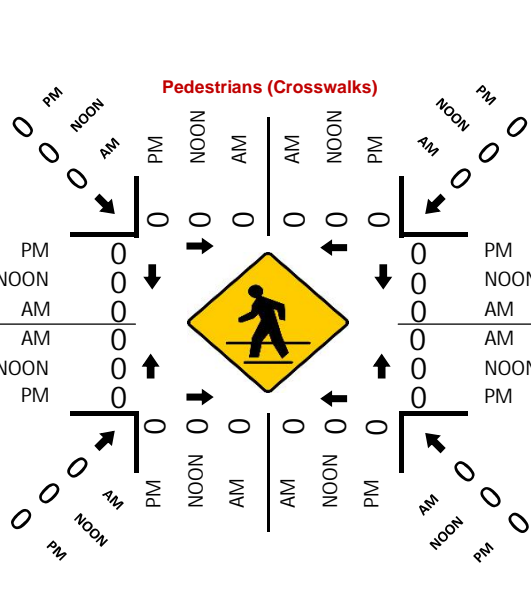

Total Vehicles (AM)

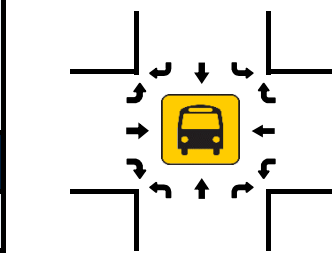

Total Vehicles (NOON)

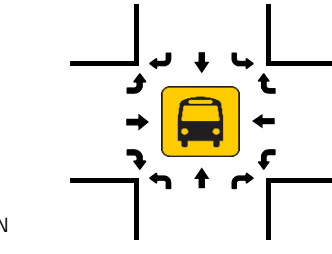

Total Vehicles (PM)

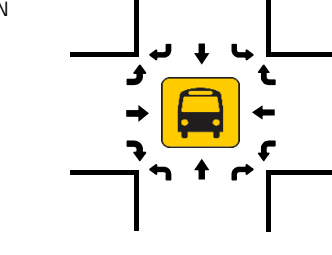

ITM Peak Hour Summary



Prepared by:
National Data & Surveying Services

Sepulveda Blvd and Imperial Hwy, El Segundo

Date: 10/21/2015
Day: Wednesday

Project #: Historical
City: El Segundo

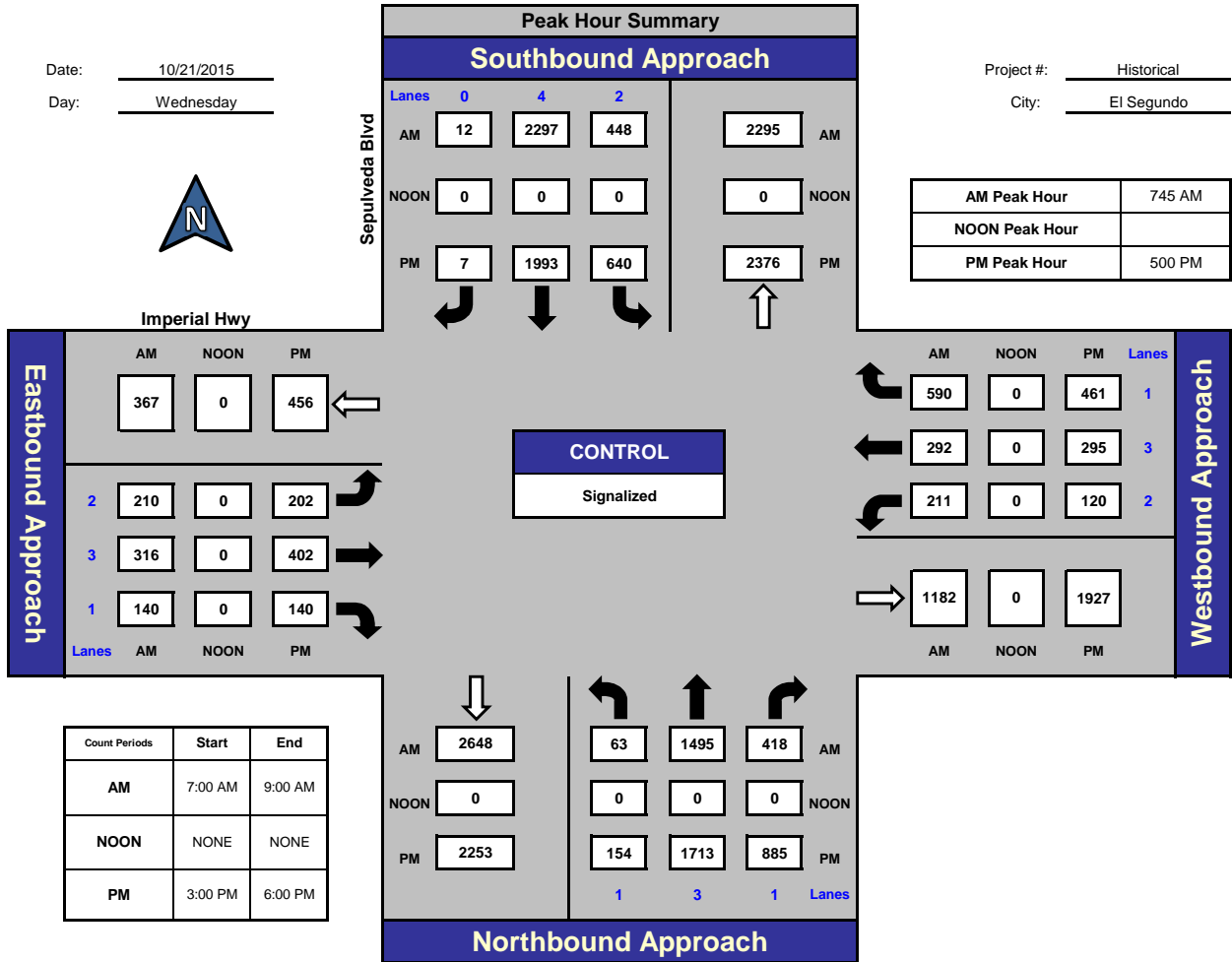

Total Ins & Outs

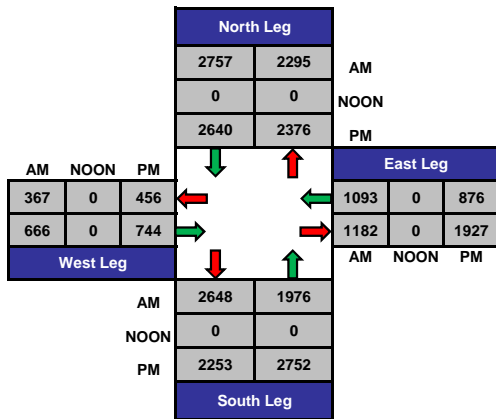

Total Volume Per Leg

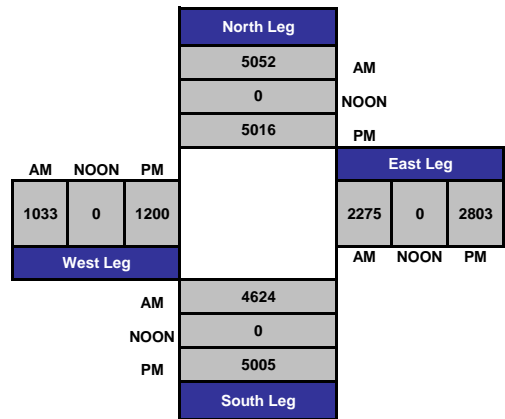

APPENDIX B

INTERSECTION ANALYSIS WORKSHEETS – ICU METHODOLOGY

 Continental Grand Campus Specific Plan
 City of El Segundo
 Existing AM Peak Hour (ICU)

Scenario Report

Scenario: Existing AM
 Command: Ex AM
 Volume: Ex AM
 Geometry: Existing
 Impact Fee: Default Impact Fee
 Trip Generation: none
 Trip Distribution: none
 Paths: Project
 Routes: Default Route
 Configuration: Ex AM

 Continental Grand Campus Specific Plan
 City of El Segundo
 Existing AM Peak Hour (ICU)

Impact Analysis Report
Level Of Service

Intersection	Base		Future		Change in
	Del/	V/	Del/	V/	
	LOS Veh	C	LOS Veh	C	
# 1 Sepulveda Blvd at Imperial Hwy	C	xxxxx 0.798	C	xxxxx 0.798	+ 0.000 V/C
# 2 Sepulveda Blvd at Walnut St	A	xxxxx 0.561	A	xxxxx 0.561	+ 0.000 V/C
# 3 Sepulveda Blvd at Maple Ave	A	xxxxx 0.575	A	xxxxx 0.575	+ 0.000 V/C
# 4 Sepulveda Blvd at Mariposa Ave	B	xxxxx 0.675	B	xxxxx 0.675	+ 0.000 V/C
# 5 Sepulveda Blvd at Grand Ave	C	xxxxx 0.737	C	xxxxx 0.737	+ 0.000 V/C
# 6 Sepulveda Blvd at El Segundo B	C	xxxxx 0.760	C	xxxxx 0.760	+ 0.000 V/C
# 7 Sepulveda Blvd at Rosecrans Bl	C	xxxxx 0.797	C	xxxxx 0.797	+ 0.000 V/C
# 8 Continental Boulevard at Marip	A	xxxxx 0.383	A	xxxxx 0.383	+ 0.000 V/C
# 9 Continental Boulevard at Grand	A	xxxxx 0.311	A	xxxxx 0.311	+ 0.000 V/C
# 10 Continental Boulevard at El Se	A	xxxxx 0.395	A	xxxxx 0.395	+ 0.000 V/C
# 11 Nash St and Imperial Hwy	B	xxxxx 0.631	B	xxxxx 0.631	+ 0.000 V/C
# 12 Nash St at Mariposa Ave	A	xxxxx 0.462	A	xxxxx 0.462	+ 0.000 V/C
# 13 Nash St at Grand Ave	A	xxxxx 0.480	A	xxxxx 0.480	+ 0.000 V/C
# 14 Nash St at El Segundo Blvd	A	xxxxx 0.457	A	xxxxx 0.457	+ 0.000 V/C
# 15 Douglas Street at El Segundo B	B	xxxxx 0.699	B	xxxxx 0.699	+ 0.000 V/C
# 16 Aviation Boulevard at El Segun	D	xxxxx 0.811	D	xxxxx 0.811	+ 0.000 V/C
# 17 El Segundo Boulevard and Isis	A	xxxxx 0.577	A	xxxxx 0.577	+ 0.000 V/C
# 18 El Segundo Blvd at I-405 SB Ra	A	xxxxx 0.522	A	xxxxx 0.522	+ 0.000 V/C
# 19 El Segundo Blvd at La Cienega	A	xxxxx 0.570	A	xxxxx 0.570	+ 0.000 V/C
# 20 El Segundo Blvd at I-405 NB Ra	C	xxxxx 0.700	C	xxxxx 0.700	+ 0.000 V/C

Continental Grand Campus Specific Plan
City of El Segundo
Existing AM Peak Hour (ICU)

Level of Service Computation Report

ICU 1(Loss as Cycle Length %) Method (Base Volume Alternative)

Intersection #1 Sepulveda Blvd at Imperial Hwy

Cycle (sec): 100 Critical Vol./Cap.(X): 0.798
Loss Time (sec): 5 Average Delay (sec/veh): xxxxxx
Optimal Cycle: 52 Level of Service: C

Table with columns for Street Name, Approach, Movement, Control, Rights, Min. Green, Y+R, Lanes. Rows for Sepulveda Blvd and Imperial Hwy.

Volume Module table with columns for Base Vol, Growth Adj, Initial Bse, User Adj, PHF Adj, PHF Volume, Reduct Vol, Reduced Vol, PCE Adj, MLF Adj, Final Volume, OvlAdjVol.

Saturation Flow Module table with columns for Sat/Lane, Adjustment, Lanes, Final Sat.

Capacity Analysis Module table with columns for Vol/Sat, OvlAdjV/S, Crit Moves.

Continental Grand Campus Specific Plan
City of El Segundo
Existing AM Peak Hour (ICU)

Level of Service Computation Report

ICU 1(Loss as Cycle Length %) Method (Base Volume Alternative)

Intersection #2 Sepulveda Blvd at Walnut St

Cycle (sec): 100 Critical Vol./Cap.(X): 0.561
Loss Time (sec): 5 Average Delay (sec/veh): xxxxxx
Optimal Cycle: 27 Level of Service: A

Table with columns for Street Name, Approach, Movement, Control, Rights, Min. Green, Y+R, Lanes. Rows for Sepulveda Blvd and Walnut St.

Volume Module table with columns for Base Vol, Growth Adj, Initial Bse, User Adj, PHF Adj, PHF Volume, Reduct Vol, Reduced Vol, PCE Adj, MLF Adj, Final Volume.

Saturation Flow Module table with columns for Sat/Lane, Adjustment, Lanes, Final Sat.

Capacity Analysis Module table with columns for Vol/Sat, Crit Moves.

Continental Grand Campus Specific Plan
City of El Segundo
Existing AM Peak Hour (ICU)

Level of Service Computation Report

ICU 1(Loss as Cycle Length %) Method (Base Volume Alternative)

Intersection #3 Sepulveda Blvd at Maple Ave

Cycle (sec): 100 Critical Vol./Cap.(X): 0.575
Loss Time (sec): 5 Average Delay (sec/veh): xxxxxx
Optimal Cycle: 27 Level of Service: A

Table with columns for Street Name (Sepulveda Blvd, Maple Ave), Approach (North Bound, South Bound, East Bound, West Bound), Movement (L, T, R), Control (Protected, Permitted), Rights (Include), and traffic volume data (Min. Green, Y+R, Lanes).

Volume Module table showing Base Vol, Growth Adj, Initial Bse, User Adj, PHF Adj, PHF Volume, Reduct Vol, Reduced Vol, PCE Adj, MLF Adj, and Final Volume for various approaches.

Saturation Flow Module table showing Sat/Lane, Adjustment, Lanes, and Final Sat. for various approaches.

Capacity Analysis Module table showing Vol/Sat and Crit Moves for various approaches.

Continental Grand Campus Specific Plan
City of El Segundo
Existing AM Peak Hour (ICU)

Level of Service Computation Report

ICU 1(Loss as Cycle Length %) Method (Base Volume Alternative)

Intersection #4 Sepulveda Blvd at Mariposa Ave

Cycle (sec): 100 Critical Vol./Cap.(X): 0.675
Loss Time (sec): 5 Average Delay (sec/veh): xxxxxx
Optimal Cycle: 35 Level of Service: B

Table with columns for Street Name (Sepulveda Blvd, Mariposa Ave), Approach (North Bound, South Bound, East Bound, West Bound), Movement (L, T, R), Control (Protected, Permitted), Rights (Include), and traffic volume data (Min. Green, Y+R, Lanes).

Volume Module table showing Base Vol, Growth Adj, Initial Bse, User Adj, PHF Adj, PHF Volume, Reduct Vol, Reduced Vol, PCE Adj, MLF Adj, and Final Volume for various approaches.

Saturation Flow Module table showing Sat/Lane, Adjustment, Lanes, and Final Sat. for various approaches.

Capacity Analysis Module table showing Vol/Sat and Crit Moves for various approaches.

Continental Grand Campus Specific Plan
City of El Segundo
Existing AM Peak Hour (ICU)

Level Of Service Computation Report

ICU 1(Loss as Cycle Length %) Method (Base Volume Alternative)

Intersection #5 Sepulveda Blvd at Grand Ave

Cycle (sec): 100 Critical Vol./Cap.(X): 0.737
Loss Time (sec): 5 Average Delay (sec/veh): xxxxxx
Optimal Cycle: 42 Level Of Service: C

Table with columns for Street Name (Sepulveda Blvd, Grand Ave), Approach (North Bound, South Bound, East Bound, West Bound), Movement (L, T, R), Control (Protected, Split Phase), Rights (Ovl, Include), and traffic volume data (Min. Green, Y+R, Lanes).

Volume Module table showing Base Vol, Growth Adj, Initial Bse, User Adj, PHF Adj, PHF Volume, Reduct Vol, Reduced Vol, PCE Adj, MLF Adj, Final Volume, and OvlAdjVol for various traffic scenarios.

Saturation Flow Module table showing Sat/Lane, Adjustment, Lanes, and Final Sat. values.

Capacity Analysis Module table showing Vol/Sat, OvlAdjV/S, and Crit Moves for different approaches.

Continental Grand Campus Specific Plan
City of El Segundo
Existing AM Peak Hour (ICU)

Level Of Service Computation Report

ICU 1(Loss as Cycle Length %) Method (Base Volume Alternative)

Intersection #6 Sepulveda Blvd at El Segundo Blvd

Cycle (sec): 100 Critical Vol./Cap.(X): 0.760
Loss Time (sec): 5 Average Delay (sec/veh): xxxxxx
Optimal Cycle: 45 Level Of Service: C

Table with columns for Street Name (Sepulveda Blvd, El Segundo Blvd), Approach (North Bound, South Bound, East Bound, West Bound), Movement (L, T, R), Control (Protected), Rights (Include), and traffic volume data (Min. Green, Y+R, Lanes).

Volume Module table showing Base Vol, Growth Adj, Initial Bse, User Adj, PHF Adj, PHF Volume, Reduct Vol, Reduced Vol, PCE Adj, MLF Adj, Final Volume, and OvlAdjVol for various traffic scenarios.

Saturation Flow Module table showing Sat/Lane, Adjustment, Lanes, and Final Sat. values.

Capacity Analysis Module table showing Vol/Sat, Crit Moves, and other capacity-related metrics.

Continental Grand Campus Specific Plan
City of El Segundo
Existing AM Peak Hour (ICU)

Level Of Service Computation Report

ICU 1(Loss as Cycle Length %) Method (Base Volume Alternative)

Intersection #7 Sepulveda Blvd at Rosecrans Blvd

Cycle (sec): 100 Critical Vol./Cap.(X): 0.797
Loss Time (sec): 5 Average Delay (sec/veh): xxxxxx
Optimal Cycle: 51 Level Of Service: C

Table with columns for Street Name (Sepulveda Blvd, Rosecrans Blvd), Approach (North Bound, South Bound, East Bound, West Bound), Movement (L, T, R), Control (Protected, Permitted), Rights (Ovl, Include, Ignore), and traffic volume metrics (Min. Green, Y+R, Lanes).

Volume Module table showing Base Vol, Growth Adj, Initial Bse, User Adj, PHF Adj, PHF Volume, Reduct Vol, Reduced Vol, PCE Adj, MLF Adj, Final Volume, and OvlAdjVol for various approaches.

Saturation Flow Module table showing Sat/Lane, Adjustment, Lanes, and Final Sat. for different movements.

Capacity Analysis Module table showing Vol/Sat, OvlAdjV/S, and Crit Moves for various approaches.

Continental Grand Campus Specific Plan
City of El Segundo
Existing AM Peak Hour (ICU)

Level Of Service Computation Report

ICU 1(Loss as Cycle Length %) Method (Base Volume Alternative)

Intersection #8 Continental Boulevard at Mariposa Ave

Cycle (sec): 100 Critical Vol./Cap.(X): 0.383
Loss Time (sec): 5 Average Delay (sec/veh): xxxxxx
Optimal Cycle: 19 Level Of Service: A

Table with columns for Street Name (Continental Boulevard, Mariposa Avenue), Approach (North Bound, South Bound, East Bound, West Bound), Movement (L, T, R), Control (Permitted), Rights (Include), and traffic volume metrics (Min. Green, Y+R, Lanes).

Volume Module table showing Base Vol, Growth Adj, Initial Bse, User Adj, PHF Adj, PHF Volume, Reduct Vol, Reduced Vol, PCE Adj, MLF Adj, Final Volume, and OvlAdjVol for various approaches.

Saturation Flow Module table showing Sat/Lane, Adjustment, Lanes, and Final Sat. for different movements.

Capacity Analysis Module table showing Vol/Sat, Crit Moves, and other metrics for various approaches.

Continental Grand Campus Specific Plan
City of El Segundo
Existing AM Peak Hour (ICU)

Level of Service Computation Report

ICU 1(Loss as Cycle Length %) Method (Base Volume Alternative)

Intersection #9 Continental Boulevard at Grand Avenue

Cycle (sec): 100 Critical Vol./Cap.(X): 0.311
Loss Time (sec): 5 Average Delay (sec/veh): xxxxxx
Optimal Cycle: 18 Level Of Service: A

Table with columns for Street Name, Approach, Movement, Control, Rights, Min. Green, Y+R, Lanes. Rows include Continental Boulevard and Grand Avenue with various movement types.

Volume Module table with columns for Base Vol, Growth Adj, Initial Bse, User Adj, PHF Adj, PHF Volume, Reduct Vol, Reduced Vol, PCE Adj, MLF Adj, Final Volume.

Saturation Flow Module table with columns for Sat/Lane, Adjustment, Lanes, Final Sat.

Capacity Analysis Module table with columns for Vol/Sat, Crit Moves.

Continental Grand Campus Specific Plan
City of El Segundo
Existing AM Peak Hour (ICU)

Level of Service Computation Report

ICU 1(Loss as Cycle Length %) Method (Base Volume Alternative)

Intersection #10 Continental Boulevard at El Segundo Boulevard

Cycle (sec): 100 Critical Vol./Cap.(X): 0.395
Loss Time (sec): 5 Average Delay (sec/veh): xxxxxx
Optimal Cycle: 20 Level Of Service: A

Table with columns for Street Name, Approach, Movement, Control, Rights, Min. Green, Y+R, Lanes. Rows include Continental Boulevard and El Segundo Boulevard with various movement types.

Volume Module table with columns for Base Vol, Growth Adj, Initial Bse, User Adj, PHF Adj, PHF Volume, Reduct Vol, Reduced Vol, PCE Adj, MLF Adj, Final Volume.

Saturation Flow Module table with columns for Sat/Lane, Adjustment, Lanes, Final Sat.

Capacity Analysis Module table with columns for Vol/Sat, Crit Moves.

Continental Grand Campus Specific Plan
City of El Segundo
Existing AM Peak Hour (ICU)

Level of Service Computation Report

ICU 1(Loss as Cycle Length %) Method (Base Volume Alternative)

Intersection #11 Nash St and Imperial Hwy

Cycle (sec): 100 Critical Vol./Cap.(X): 0.631
Loss Time (sec): 5 Average Delay (sec/veh): xxxxxx
Optimal Cycle: 31 Level of Service: B

Table with columns for Street Name (Nash St, Imperial Hwy), Approach (North Bound, South Bound, East Bound, West Bound), Movement (L, T, R), Control (Split Phase, Protected), Rights (Include), and traffic volume data (Min. Green, Y+R, Lanes).

Volume Module table showing Base Vol, Growth Adj, Initial Bse, User Adj, PHF Adj, PHF Volume, Reduct Vol, Reduced Vol, PCE Adj, MLF Adj, and Final Volume for various approaches.

Saturation Flow Module table showing Sat/Lane, Adjustment, Lanes, and Final Sat. for various approaches.

Capacity Analysis Module table showing Vol/Sat and Crit Moves for various approaches.

Continental Grand Campus Specific Plan
City of El Segundo
Existing AM Peak Hour (ICU)

Level of Service Computation Report

ICU 1(Loss as Cycle Length %) Method (Base Volume Alternative)

Intersection #12 Nash St at Mariposa Ave

Cycle (sec): 100 Critical Vol./Cap.(X): 0.462
Loss Time (sec): 5 Average Delay (sec/veh): xxxxxx
Optimal Cycle: 22 Level of Service: A

Table with columns for Street Name (Nash St, Mariposa Ave), Approach (North Bound, South Bound, East Bound, West Bound), Movement (L, T, R), Control (Permitted), Rights (Include), and traffic volume data (Min. Green, Y+R, Lanes).

Volume Module table showing Base Vol, Growth Adj, Initial Bse, User Adj, PHF Adj, PHF Volume, Reduct Vol, Reduced Vol, PCE Adj, MLF Adj, and Final Volume for various approaches.

Saturation Flow Module table showing Sat/Lane, Adjustment, Lanes, and Final Sat. for various approaches.

Capacity Analysis Module table showing Vol/Sat and Crit Moves for various approaches.

Continental Grand Campus Specific Plan
City of El Segundo
Existing AM Peak Hour (ICU)

Level of Service Computation Report

ICU 1(Loss as Cycle Length %) Method (Base Volume Alternative)

Intersection #13 Nash St at Grand Ave

Cycle (sec): 100 Critical Vol./Cap.(X): 0.480
Loss Time (sec): 5 Average Delay (sec/veh): xxxxxx
Optimal Cycle: 23 Level of Service: A

Table with columns for Street Name (Nash St, Grand Ave), Approach (North Bound, South Bound, East Bound, West Bound), Movement (L, T, R), Control (Protected, Split Phase), Rights (Include), and traffic volume data (Min. Green, Y+R, Lanes).

Table for Volume Module showing Base Vol, Growth Adj, Initial Bse, User Adj, PHF Adj, PHF Volume, Reduct Vol, Reduced Vol, PCE Adj, MLF Adj, and Final Volume for various approaches.

Table for Saturation Flow Module showing Sat/Lane, Adjustment, Lanes, and Final Sat. for various approaches.

Table for Capacity Analysis Module showing Vol/Sat, Crit Moves, and OvlAdjV/S for various approaches.

Continental Grand Campus Specific Plan
City of El Segundo
Existing AM Peak Hour (ICU)

Level of Service Computation Report

ICU 1(Loss as Cycle Length %) Method (Base Volume Alternative)

Intersection #14 Nash St at El Segundo Blvd

Cycle (sec): 100 Critical Vol./Cap.(X): 0.457
Loss Time (sec): 5 Average Delay (sec/veh): xxxxxx
Optimal Cycle: 22 Level of Service: A

Table with columns for Street Name (Nash St, El Segundo Blvd), Approach (North Bound, South Bound, East Bound, West Bound), Movement (L, T, R), Control (Split Phase, Protected), Rights (Include), and traffic volume data (Min. Green, Y+R, Lanes).

Table for Volume Module showing Base Vol, Growth Adj, Initial Bse, User Adj, PHF Adj, PHF Volume, Reduct Vol, Reduced Vol, PCE Adj, MLF Adj, and Final Volume for various approaches.

Table for Saturation Flow Module showing Sat/Lane, Adjustment, Lanes, and Final Sat. for various approaches.

Table for Capacity Analysis Module showing Vol/Sat, Crit Moves, and OvlAdjV/S for various approaches.

Continental Grand Campus Specific Plan
City of El Segundo
Existing AM Peak Hour (ICU)

Level Of Service Computation Report

ICU 1(Loss as Cycle Length %) Method (Base Volume Alternative)

Intersection #15 Douglas Street at El Segundo Boulevard

Cycle (sec): 100 Critical Vol./Cap.(X): 0.699
Loss Time (sec): 5 Average Delay (sec/veh): xxxxxx
Optimal Cycle: 37 Level Of Service: B

Table with columns for Street Name (Douglas St, El Segundo Blvd), Approach (North Bound, South Bound, East Bound, West Bound), Movement (L, T, R), Control (Protected, Include), Rights, Min. Green, Y+R, Lanes.

Table with columns for Volume Module (Base Vol, Growth Adj, Initial Bse, User Adj, PHF Adj, PHF Volume, Reduct Vol, Reduced Vol, PCE Adj, MLF Adj, FinalVolume).

Table with columns for Saturation Flow Module (Sat/Lane, Adjustment, Lanes, Final Sat.).

Table with columns for Capacity Analysis Module (Vol/Sat, Crit Moves).

Continental Grand Campus Specific Plan
City of El Segundo
Existing AM Peak Hour (ICU)

Level Of Service Computation Report

ICU 1(Loss as Cycle Length %) Method (Base Volume Alternative)

Intersection #16 Aviation Boulevard at El Segundo Boulevard

Cycle (sec): 100 Critical Vol./Cap.(X): 0.811
Loss Time (sec): 5 Average Delay (sec/veh): xxxxxx
Optimal Cycle: 54 Level Of Service: D

Table with columns for Street Name (Aviatio Blvd, El Segundo Blvd), Approach (North Bound, South Bound, East Bound, West Bound), Movement (L, T, R), Control (Protected, Include), Rights, Min. Green, Y+R, Lanes.

Table with columns for Volume Module (Base Vol, Growth Adj, Initial Bse, User Adj, PHF Adj, PHF Volume, Reduct Vol, Reduced Vol, PCE Adj, MLF Adj, FinalVolume, OvlAdjVol).

Table with columns for Saturation Flow Module (Sat/Lane, Adjustment, Lanes, Final Sat.).

Table with columns for Capacity Analysis Module (Vol/Sat, OvlAdjV/S, Crit Moves).

Continental Grand Campus Specific Plan
City of El Segundo
Existing AM Peak Hour (ICU)

Level of Service Computation Report

ICU 1(Loss as Cycle Length %) Method (Base Volume Alternative)

Intersection #17 El Segundo Boulevard and Isis Avenue

Cycle (sec): 100 Critical Vol./Cap.(X): 0.577
Loss Time (sec): 5 Average Delay (sec/veh): xxxxxx
Optimal Cycle: 28 Level Of Service: A

Table with columns for Street Name (Isis Avenue, El Segundo Boulevard), Approach (North Bound, South Bound, East Bound, West Bound), Movement (L, T, R), Control, Rights, Min. Green, Y+R, Lanes.

Table with columns for Volume Module (Base Vol, Growth Adj, Initial Bse, User Adj, PHF Adj, PHF Volume, Reduct Vol, Reduced Vol, PCE Adj, MLF Adj, FinalVolume).

Table with columns for Saturation Flow Module (Sat/Lane, Adjustment, Lanes, Final Sat.).

Table with columns for Capacity Analysis Module (Vol/Sat, Crit Moves).

Continental Grand Campus Specific Plan
City of El Segundo
Existing AM Peak Hour (ICU)

Level of Service Computation Report

ICU 1(Loss as Cycle Length %) Method (Base Volume Alternative)

Intersection #18 El Segundo Blvd at I-405 SB Ramps

Cycle (sec): 100 Critical Vol./Cap.(X): 0.522
Loss Time (sec): 5 Average Delay (sec/veh): xxxxxx
Optimal Cycle: 25 Level Of Service: A

Table with columns for Street Name (I-405 SB Ramps, El Segundo Blvd), Approach (North Bound, South Bound, East Bound, West Bound), Movement (L, T, R), Control, Rights, Min. Green, Y+R, Lanes.

Table with columns for Volume Module (Base Vol, Growth Adj, Initial Bse, User Adj, PHF Adj, PHF Volume, Reduct Vol, Reduced Vol, PCE Adj, MLF Adj, FinalVolume).

Table with columns for Saturation Flow Module (Sat/Lane, Adjustment, Lanes, Final Sat.).

Table with columns for Capacity Analysis Module (Vol/Sat, Crit Moves).

Continental Grand Campus Specific Plan
City of El Segundo
Existing AM Peak Hour (ICU)

Level of Service Computation Report

ICU 1(Loss as Cycle Length %) Method (Base Volume Alternative)

Intersection #19 El Segundo Blvd at La Cienega Blvd

Cycle (sec): 100 Critical Vol./Cap.(X): 0.570
Loss Time (sec): 5 Average Delay (sec/veh): xxxxxx
Optimal Cycle: 27 Level Of Service: A

Street Name: La Cienega Blvd El Segundo Blvd
Approach: North Bound South Bound East Bound West Bound
Movement: L - T - R L - T - R L - T - R L - T - R
Control: Protected Protected Protected Protected
Rights: Include Include Include Include
Min. Green: 0 0 0 0 0 0 0 0 0 0 0 0
Y+R: 4.0 4.0 4.0 4.0 4.0 4.0 4.0 4.0 4.0 4.0 4.0 4.0
Lanes: 0 0 0 0 0 2 0 0 0 2 1 0 0 0

Volume Module:
Base Vol: 0 0 0 249 0 322 75 539 0 0 1312 477
Growth Adj: 1.00 1.00 1.00 1.00 1.00 1.00 1.00 1.00 1.00 1.00 1.00 1.00
Initial Bse: 0 0 0 249 0 322 75 539 0 0 1312 477
User Adj: 1.00 1.00 1.00 1.00 1.00 1.00 1.00 1.00 1.00 1.00 1.00 1.00
PHF Adj: 1.00 1.00 1.00 1.00 1.00 1.00 1.00 1.00 1.00 1.00 1.00 1.00
PHF Volume: 0 0 0 249 0 322 75 539 0 0 1312 477
Reduct Vol: 0 0 0 0 0 0 0 0 0 0 0 0
Reduced Vol: 0 0 0 249 0 322 75 539 0 0 1312 477
PCE Adj: 1.00 1.00 1.00 1.00 1.00 1.00 1.00 1.00 1.00 1.00 1.00 1.00
MLF Adj: 1.00 1.00 1.00 1.00 1.00 1.00 1.00 1.00 1.00 1.00 1.00 1.00
FinalVolume: 0 0 0 249 0 322 75 539 0 0 1312 477

Saturation Flow Module:
Sat/Lane: 1600 1600 1600 1600 1600 1600 1600 1600 1600 1600 1600 1600
Adjustment: 1.00 1.00 1.00 1.00 1.00 1.00 1.00 1.00 1.00 1.00 1.00 1.00
Lanes: 0.00 0.00 0.00 2.00 0.00 2.00 1.00 3.00 0.00 0.00 2.20 0.80
Final Sat.: 0 0 0 3200 0 3200 1600 4800 0 0 3520 1280

Capacity Analysis Module:
Vol/Sat: 0.00 0.00 0.00 0.08 0.00 0.10 0.05 0.11 0.00 0.00 0.37 0.37
Crit Moves: **** **

Continental Grand Campus Specific Plan
City of El Segundo
Existing AM Peak Hour (ICU)

Level of Service Computation Report

ICU 1(Loss as Cycle Length %) Method (Base Volume Alternative)

Intersection #20 El Segundo Blvd at I-405 NB Ramps

Cycle (sec): 100 Critical Vol./Cap.(X): 0.700
Loss Time (sec): 5 Average Delay (sec/veh): xxxxxx
Optimal Cycle: 37 Level Of Service: C

Street Name: I-405 NB Ramps El Segundo Blvd
Approach: North Bound South Bound East Bound West Bound
Movement: L - T - R L - T - R L - T - R L - T - R
Control: Protected Protected Protected Protected
Rights: Include Include Ignore Include
Min. Green: 0 0 0 0 0 0 0 0 0 0 0 0
Y+R: 4.0 4.0 4.0 4.0 4.0 4.0 4.0 4.0 4.0 4.0 4.0 4.0
Lanes: 2 0 0 0 1 0 0 0 0 0 0 0 0 0 2 1 1 0 0 2 1 0

Volume Module:
Base Vol: 861 0 102 0 0 0 0 625 148 0 935 610
Growth Adj: 1.00 1.00 1.00 1.00 1.00 1.00 1.00 1.00 1.00 1.00 1.00 1.00
Initial Bse: 861 0 102 0 0 0 0 625 148 0 935 610
User Adj: 1.00 1.00 1.00 1.00 1.00 1.00 1.00 1.00 0.00 1.00 1.00 1.00
PHF Adj: 1.00 1.00 1.00 1.00 1.00 1.00 1.00 1.00 0.00 1.00 1.00 1.00
PHF Volume: 861 0 102 0 0 0 0 625 0 0 935 610
Reduct Vol: 0 0 0 0 0 0 0 0 0 0 0 0
Reduced Vol: 861 0 102 0 0 0 0 625 0 0 935 610
PCE Adj: 1.00 1.00 1.00 1.00 1.00 1.00 1.00 1.00 0.00 1.00 1.00 1.00
MLF Adj: 1.00 1.00 1.00 1.00 1.00 1.00 1.00 1.00 0.00 1.00 1.00 1.00
FinalVolume: 861 0 102 0 0 0 0 625 0 0 935 610

Saturation Flow Module:
Sat/Lane: 1600 1600 1600 1600 1600 1600 1600 1600 1600 1600 1600 1600
Adjustment: 1.00 1.00 1.00 1.00 1.00 1.00 1.00 1.00 1.00 1.00 1.00 1.00
Lanes: 2.00 0.00 1.00 0.00 0.00 0.00 0.00 3.00 1.00 0.00 2.00 1.00
Final Sat.: 3200 0 1600 0 0 0 0 4800 1600 0 3200 1600

Capacity Analysis Module:
Vol/Sat: 0.27 0.00 0.06 0.00 0.00 0.00 0.00 0.13 0.00 0.00 0.29 0.38
Crit Moves: **** **

 Continental Grand Campus Specific Plan
 City of El Segundo
 Existing PM Peak Hour (ICU)

Scenario Report

Scenario: Existing PM
 Command: Ex PM
 Volume: Ex PM
 Geometry: Existing
 Impact Fee: Default Impact Fee
 Trip Generation: none
 Trip Distribution: none
 Paths: Project
 Routes: Default Route
 Configuration: Ex PM

 Continental Grand Campus Specific Plan
 City of El Segundo
 Existing PM Peak Hour (ICU)

Impact Analysis Report
Level Of Service

Intersection	Base		Future		Change in
	Del/	V/	Del/	V/	
	LOS Veh	C	LOS Veh	C	
# 1 Sepulveda Blvd at Imperial Hwy	E xxxxxx	0.957	E xxxxxx	0.957	+ 0.000 V/C
# 2 Sepulveda Blvd at Walnut St	A xxxxxx	0.564	A xxxxxx	0.564	+ 0.000 V/C
# 3 Sepulveda Blvd at Maple Ave	B xxxxxx	0.629	B xxxxxx	0.629	+ 0.000 V/C
# 4 Sepulveda Blvd at Mariposa Ave	B xxxxxx	0.684	B xxxxxx	0.684	+ 0.000 V/C
# 5 Sepulveda Blvd at Grand Ave	C xxxxxx	0.781	C xxxxxx	0.781	+ 0.000 V/C
# 6 Sepulveda Blvd at El Segundo B	D xxxxxx	0.883	D xxxxxx	0.883	+ 0.000 V/C
# 7 Sepulveda Blvd at Rosecrans Bl	D xxxxxx	0.879	D xxxxxx	0.879	+ 0.000 V/C
# 8 Continental Boulevard at Marip	A xxxxxx	0.366	A xxxxxx	0.366	+ 0.000 V/C
# 9 Continental Boulevard at Grand	A xxxxxx	0.317	A xxxxxx	0.317	+ 0.000 V/C
# 10 Continental Boulevard at El Se	A xxxxxx	0.419	A xxxxxx	0.419	+ 0.000 V/C
# 11 Nash St and Imperial Hwy	A xxxxxx	0.474	A xxxxxx	0.474	+ 0.000 V/C
# 12 Nash St at Mariposa Ave	A xxxxxx	0.554	A xxxxxx	0.554	+ 0.000 V/C
# 13 Nash St at Grand Ave	A xxxxxx	0.527	A xxxxxx	0.527	+ 0.000 V/C
# 14 Nash St at El Segundo Blvd	A xxxxxx	0.546	A xxxxxx	0.546	+ 0.000 V/C
# 15 Douglas Street at El Segundo B	D xxxxxx	0.881	D xxxxxx	0.881	+ 0.000 V/C
# 16 Aviation Boulevard at El Segun	E xxxxxx	0.943	E xxxxxx	0.943	+ 0.000 V/C
# 17 El Segundo Boulevard and Isis	B xxxxxx	0.632	B xxxxxx	0.632	+ 0.000 V/C
# 18 El Segundo Blvd at I-405 SB Ra	D xxxxxx	0.874	D xxxxxx	0.874	+ 0.000 V/C
# 19 El Segundo Blvd at La Cienega	B xxxxxx	0.643	B xxxxxx	0.643	+ 0.000 V/C
# 20 El Segundo Blvd at I-405 NB Ra	B xxxxxx	0.681	B xxxxxx	0.681	+ 0.000 V/C

Continental Grand Campus Specific Plan
City of El Segundo
Existing PM Peak Hour (ICU)

Level of Service Computation Report

ICU 1(Loss as Cycle Length %) Method (Base Volume Alternative)

Intersection #1 Sepulveda Blvd at Imperial Hwy

Cycle (sec): 100 Critical Vol./Cap.(X): 0.957
Loss Time (sec): 5 Average Delay (sec/veh): xxxxxx
Optimal Cycle: 139 Level of Service: E

Table with columns for Street Name, Approach, Movement, Control, Rights, Min. Green, Y+R, Lanes. Rows for Sepulveda Blvd (North/South Bound) and Imperial Hwy (East/West Bound).

Volume Module table with columns for Base Vol, Growth Adj, Initial Bse, User Adj, PHF Adj, PHF Volume, Reduct Vol, Reduced Vol, PCE Adj, MLF Adj, Final Volume, OvlAdjVol.

Saturation Flow Module table with columns for Sat/Lane, Adjustment, Lanes, Final Sat.

Capacity Analysis Module table with columns for Vol/Sat, OvlAdjV/S, Crit Moves.

Continental Grand Campus Specific Plan
City of El Segundo
Existing PM Peak Hour (ICU)

Level of Service Computation Report

ICU 1(Loss as Cycle Length %) Method (Base Volume Alternative)

Intersection #2 Sepulveda Blvd at Walnut St

Cycle (sec): 100 Critical Vol./Cap.(X): 0.564
Loss Time (sec): 5 Average Delay (sec/veh): xxxxxx
Optimal Cycle: 27 Level of Service: A

Table with columns for Street Name, Approach, Movement, Control, Rights, Min. Green, Y+R, Lanes. Rows for Sepulveda Blvd (North/South Bound) and Walnut St (East/West Bound).

Volume Module table with columns for Base Vol, Growth Adj, Initial Bse, User Adj, PHF Adj, PHF Volume, Reduct Vol, Reduced Vol, PCE Adj, MLF Adj, Final Volume.

Saturation Flow Module table with columns for Sat/Lane, Adjustment, Lanes, Final Sat.

Capacity Analysis Module table with columns for Vol/Sat, Crit Moves.

Continental Grand Campus Specific Plan
City of El Segundo
Existing PM Peak Hour (ICU)

Level of Service Computation Report

ICU 1(Loss as Cycle Length %) Method (Base Volume Alternative)

Intersection #3 Sepulveda Blvd at Maple Ave

Cycle (sec): 100 Critical Vol./Cap.(X): 0.629
Loss Time (sec): 5 Average Delay (sec/veh): xxxxxx
Optimal Cycle: 31 Level Of Service: B

Table with columns for Street Name (Sepulveda Blvd, Maple Ave), Approach (North Bound, South Bound, East Bound, West Bound), Movement (L, T, R), Control (Protected, Permitted), Rights (Include), and traffic volume data (Min. Green, Y+R, Lanes).

Volume Module table showing Base Vol, Growth Adj, Initial Bse, User Adj, PHF Adj, PHF Volume, Reduct Vol, Reduced Vol, PCE Adj, MLF Adj, and Final Volume for each approach.

Saturation Flow Module table showing Sat/Lane, Adjustment, Lanes, and Final Sat. for each approach.

Capacity Analysis Module table showing Vol/Sat and Crit Moves for each approach.

Continental Grand Campus Specific Plan
City of El Segundo
Existing PM Peak Hour (ICU)

Level of Service Computation Report

ICU 1(Loss as Cycle Length %) Method (Base Volume Alternative)

Intersection #4 Sepulveda Blvd at Mariposa Ave

Cycle (sec): 100 Critical Vol./Cap.(X): 0.684
Loss Time (sec): 5 Average Delay (sec/veh): xxxxxx
Optimal Cycle: 36 Level Of Service: B

Table with columns for Street Name (Sepulveda Blvd, Mariposa Ave), Approach (North Bound, South Bound, East Bound, West Bound), Movement (L, T, R), Control (Protected, Permitted), Rights (Include), and traffic volume data (Min. Green, Y+R, Lanes).

Volume Module table showing Base Vol, Growth Adj, Initial Bse, User Adj, PHF Adj, PHF Volume, Reduct Vol, Reduced Vol, PCE Adj, MLF Adj, and Final Volume for each approach.

Saturation Flow Module table showing Sat/Lane, Adjustment, Lanes, and Final Sat. for each approach.

Capacity Analysis Module table showing Vol/Sat and Crit Moves for each approach.

Continental Grand Campus Specific Plan
City of El Segundo
Existing PM Peak Hour (ICU)

Level Of Service Computation Report

ICU 1(Loss as Cycle Length %) Method (Base Volume Alternative)

Intersection #5 Sepulveda Blvd at Grand Ave

Cycle (sec): 100 Critical Vol./Cap.(X): 0.781
Loss Time (sec): 5 Average Delay (sec/veh): xxxxxx
Optimal Cycle: 48 Level Of Service: C

Table with columns for Street Name, Approach, Movement, Control, Rights, Min. Green, Y+R, Lanes. Rows for Sepulveda Blvd and Grand Ave.

Volume Module table with columns for Base Vol, Growth Adj, Initial Bse, User Adj, PHF Adj, PHF Volume, Reduct Vol, Reduced Vol, PCE Adj, MLF Adj, Final Volume, OvlAdjVol.

Saturation Flow Module table with columns for Sat/Lane, Adjustment, Lanes, Final Sat.

Capacity Analysis Module table with columns for Vol/Sat, OvlAdjV/S, Crit Moves.

Continental Grand Campus Specific Plan
City of El Segundo
Existing PM Peak Hour (ICU)

Level Of Service Computation Report

ICU 1(Loss as Cycle Length %) Method (Base Volume Alternative)

Intersection #6 Sepulveda Blvd at El Segundo Blvd

Cycle (sec): 100 Critical Vol./Cap.(X): 0.883
Loss Time (sec): 5 Average Delay (sec/veh): xxxxxx
Optimal Cycle: 78 Level Of Service: D

Table with columns for Street Name, Approach, Movement, Control, Rights, Min. Green, Y+R, Lanes. Rows for Sepulveda Blvd and El Segundo Blvd.

Volume Module table with columns for Base Vol, Growth Adj, Initial Bse, User Adj, PHF Adj, PHF Volume, Reduct Vol, Reduced Vol, PCE Adj, MLF Adj, Final Volume.

Saturation Flow Module table with columns for Sat/Lane, Adjustment, Lanes, Final Sat.

Capacity Analysis Module table with columns for Vol/Sat, Crit Moves.

Continental Grand Campus Specific Plan
City of El Segundo
Existing PM Peak Hour (ICU)

Level Of Service Computation Report

ICU 1(Loss as Cycle Length %) Method (Base Volume Alternative)

Intersection #7 Sepulveda Blvd at Rosecrans Blvd

Cycle (sec): 100 Critical Vol./Cap.(X): 0.879
Loss Time (sec): 5 Average Delay (sec/veh): xxxxxx
Optimal Cycle: 76 Level Of Service: D

Table with columns for Street Name (Sepulveda Blvd, Rosecrans Blvd), Approach (North Bound, South Bound, East Bound, West Bound), Movement (L, T, R), Control (Protected, Ignored), Rights (Ovl, Include), Min. Green, Y+R, and Lanes.

Volume Module table showing Base Vol, Growth Adj, Initial Bse, User Adj, PHF Adj, PHF Volume, Reduct Vol, Reduced Vol, PCE Adj, MLF Adj, Final Volume, and OvlAdjVol for various approaches.

Saturation Flow Module table showing Sat/Lane, Adjustment, Lanes, and Final Sat. for various approaches.

Capacity Analysis Module table showing Vol/Sat, OvlAdjV/S, and Crit Moves for various approaches.

Continental Grand Campus Specific Plan
City of El Segundo
Existing PM Peak Hour (ICU)

Level Of Service Computation Report

ICU 1(Loss as Cycle Length %) Method (Base Volume Alternative)

Intersection #8 Continental Boulevard at Mariposa Ave

Cycle (sec): 100 Critical Vol./Cap.(X): 0.366
Loss Time (sec): 5 Average Delay (sec/veh): xxxxxx
Optimal Cycle: 19 Level Of Service: A

Table with columns for Street Name (Continental Boulevard, Mariposa Avenue), Approach (North Bound, South Bound, East Bound, West Bound), Movement (L, T, R), Control (Permitted), Rights (Include), Min. Green, Y+R, and Lanes.

Volume Module table showing Base Vol, Growth Adj, Initial Bse, User Adj, PHF Adj, PHF Volume, Reduct Vol, Reduced Vol, PCE Adj, MLF Adj, Final Volume, and OvlAdjVol for various approaches.

Saturation Flow Module table showing Sat/Lane, Adjustment, Lanes, and Final Sat. for various approaches.

Capacity Analysis Module table showing Vol/Sat, Crit Moves, and other metrics for various approaches.

Continental Grand Campus Specific Plan
City of El Segundo
Existing PM Peak Hour (ICU)

Level of Service Computation Report

ICU 1(Loss as Cycle Length %) Method (Base Volume Alternative)

Intersection #9 Continental Boulevard at Grand Avenue

Cycle (sec): 100 Critical Vol./Cap.(X): 0.317
Loss Time (sec): 5 Average Delay (sec/veh): xxxxxx
Optimal Cycle: 18 Level Of Service: A

Table with columns for Street Name, Approach, Movement, Control, Rights, Min. Green, Y+R, Lanes. Rows include Continental Boulevard and Grand Avenue with various movement and control details.

Volume Module table with columns for Base Vol, Growth Adj, Initial Bse, User Adj, PHF Adj, PHF Volume, Reduct Vol, Reduced Vol, PCE Adj, MLF Adj, Final Volume. Rows include Continental Boulevard and Grand Avenue.

Saturation Flow Module table with columns for Sat/Lane, Adjustment, Lanes, Final Sat. Rows include Continental Boulevard and Grand Avenue.

Capacity Analysis Module table with columns for Vol/Sat, Crit Moves. Rows include Continental Boulevard and Grand Avenue.

Continental Grand Campus Specific Plan
City of El Segundo
Existing PM Peak Hour (ICU)

Level of Service Computation Report

ICU 1(Loss as Cycle Length %) Method (Base Volume Alternative)

Intersection #10 Continental Boulevard at El Segundo Boulevard

Cycle (sec): 100 Critical Vol./Cap.(X): 0.419
Loss Time (sec): 5 Average Delay (sec/veh): xxxxxx
Optimal Cycle: 21 Level Of Service: A

Table with columns for Street Name, Approach, Movement, Control, Rights, Min. Green, Y+R, Lanes. Rows include Continental Boulevard and El Segundo Boulevard with various movement and control details.

Volume Module table with columns for Base Vol, Growth Adj, Initial Bse, User Adj, PHF Adj, PHF Volume, Reduct Vol, Reduced Vol, PCE Adj, MLF Adj, Final Volume. Rows include Continental Boulevard and El Segundo Boulevard.

Saturation Flow Module table with columns for Sat/Lane, Adjustment, Lanes, Final Sat. Rows include Continental Boulevard and El Segundo Boulevard.

Capacity Analysis Module table with columns for Vol/Sat, Crit Moves. Rows include Continental Boulevard and El Segundo Boulevard.

Continental Grand Campus Specific Plan
City of El Segundo
Existing PM Peak Hour (ICU)

Level of Service Computation Report

ICU 1(Loss as Cycle Length %) Method (Base Volume Alternative)

Intersection #11 Nash St and Imperial Hwy

Cycle (sec): 100 Critical Vol./Cap.(X): 0.474
Loss Time (sec): 5 Average Delay (sec/veh): xxxxxx
Optimal Cycle: 23 Level Of Service: A

Table with columns for Street Name (Nash St, Imperial Hwy), Approach (North Bound, South Bound, East Bound, West Bound), Movement (L, T, R), Control (Split Phase, Protected), Rights (Include), Min. Green, Y+R, Lanes.

Volume Module table with columns for Base Vol, Growth Adj, Initial Bse, User Adj, PHF Adj, PHF Volume, Reduct Vol, Reduced Vol, PCE Adj, MLF Adj, Final Volume.

Saturation Flow Module table with columns for Sat/Lane, Adjustment, Lanes, Final Sat.

Capacity Analysis Module table with columns for Vol/Sat, Crit Moves.

Continental Grand Campus Specific Plan
City of El Segundo
Existing PM Peak Hour (ICU)

Level of Service Computation Report

ICU 1(Loss as Cycle Length %) Method (Base Volume Alternative)

Intersection #12 Nash St at Mariposa Ave

Cycle (sec): 100 Critical Vol./Cap.(X): 0.554
Loss Time (sec): 5 Average Delay (sec/veh): xxxxxx
Optimal Cycle: 26 Level Of Service: A

Table with columns for Street Name (Nash St, Mariposa Ave), Approach (North Bound, South Bound, East Bound, West Bound), Movement (L, T, R), Control (Permitted), Rights (Include), Min. Green, Y+R, Lanes.

Volume Module table with columns for Base Vol, Growth Adj, Initial Bse, User Adj, PHF Adj, PHF Volume, Reduct Vol, Reduced Vol, PCE Adj, MLF Adj, Final Volume.

Saturation Flow Module table with columns for Sat/Lane, Adjustment, Lanes, Final Sat.

Capacity Analysis Module table with columns for Vol/Sat, Crit Moves.

Continental Grand Campus Specific Plan
City of El Segundo
Existing PM Peak Hour (ICU)

Level of Service Computation Report

ICU 1(Loss as Cycle Length %) Method (Base Volume Alternative)

Intersection #13 Nash St at Grand Ave

Cycle (sec): 100 Critical Vol./Cap.(X): 0.527
Loss Time (sec): 5 Average Delay (sec/veh): xxxxxx
Optimal Cycle: 25 Level Of Service: A

Table with columns: Street Name, Approach, Movement, Control, Rights, Min. Green, Y+R, Lanes. Rows for Nash St and Grand Ave.

Table with columns: Volume Module, Base Vol, Growth Adj, Initial Bse, User Adj, PHF Adj, PHF Volume, Reduct Vol, Reduced Vol, PCE Adj, MLF Adj, Final Volume. Rows for Nash St and Grand Ave.

Table with columns: Sat/Lane, Adjustment, Lanes, Final Sat. Rows for Nash St and Grand Ave.

Table with columns: Vol/Sat, Crit Moves. Rows for Nash St and Grand Ave.

Continental Grand Campus Specific Plan
City of El Segundo
Existing PM Peak Hour (ICU)

Level of Service Computation Report

ICU 1(Loss as Cycle Length %) Method (Base Volume Alternative)

Intersection #14 Nash St at El Segundo Blvd

Cycle (sec): 100 Critical Vol./Cap.(X): 0.546
Loss Time (sec): 5 Average Delay (sec/veh): xxxxxx
Optimal Cycle: 26 Level Of Service: A

Table with columns: Street Name, Approach, Movement, Control, Rights, Min. Green, Y+R, Lanes. Rows for Nash St and El Segundo Blvd.

Table with columns: Volume Module, Base Vol, Growth Adj, Initial Bse, User Adj, PHF Adj, PHF Volume, Reduct Vol, Reduced Vol, PCE Adj, MLF Adj, Final Volume, OvlAdjVol. Rows for Nash St and El Segundo Blvd.

Table with columns: Sat/Lane, Adjustment, Lanes, Final Sat. Rows for Nash St and El Segundo Blvd.

Table with columns: Vol/Sat, OvlAdjV/S, Crit Moves. Rows for Nash St and El Segundo Blvd.

Continental Grand Campus Specific Plan
City of El Segundo
Existing PM Peak Hour (ICU)

Level Of Service Computation Report

ICU 1(Loss as Cycle Length %) Method (Base Volume Alternative)

Intersection #15 Douglas Street at El Segundo Boulevard

Cycle (sec): 100 Critical Vol./Cap.(X): 0.881
Loss Time (sec): 5 Average Delay (sec/veh): xxxxxx
Optimal Cycle: 77 Level Of Service: D

Table with columns for Street Name, Approach, Movement, Control, Rights, Min. Green, Y+R, Lanes. Rows for Douglas St and El Segundo Blvd.

Table with columns for Volume Module, Base Vol, Growth Adj, Initial Bse, User Adj, PHF Adj, PHF Volume, Reduct Vol, Reduced Vol, PCE Adj, MLF Adj, Final Volume.

Table with columns for Sat/Lane, Adjustment, Lanes, Final Sat. for Saturation Flow Module.

Table with columns for Vol/Sat, Crit Moves for Capacity Analysis Module.

Continental Grand Campus Specific Plan
City of El Segundo
Existing PM Peak Hour (ICU)

Level Of Service Computation Report

ICU 1(Loss as Cycle Length %) Method (Base Volume Alternative)

Intersection #16 Aviation Boulevard at El Segundo Boulevard

Cycle (sec): 100 Critical Vol./Cap.(X): 0.943
Loss Time (sec): 5 Average Delay (sec/veh): xxxxxx
Optimal Cycle: 121 Level Of Service: E

Table with columns for Street Name, Approach, Movement, Control, Rights, Min. Green, Y+R, Lanes. Rows for Aviation Blvd and El Segundo Blvd.

Table with columns for Volume Module, Base Vol, Growth Adj, Initial Bse, User Adj, PHF Adj, PHF Volume, Reduct Vol, Reduced Vol, PCE Adj, MLF Adj, Final Volume, OvlAdjVol.

Table with columns for Sat/Lane, Adjustment, Lanes, Final Sat. for Saturation Flow Module.

Table with columns for Vol/Sat, OvlAdjV/S, Crit Moves for Capacity Analysis Module.

Continental Grand Campus Specific Plan
City of El Segundo
Existing PM Peak Hour (ICU)

Level of Service Computation Report

ICU 1(Loss as Cycle Length %) Method (Base Volume Alternative)

Intersection #17 El Segundo Boulevard and Isis Avenue

Cycle (sec): 100 Critical Vol./Cap.(X): 0.632
Loss Time (sec): 5 Average Delay (sec/veh): xxxxxx
Optimal Cycle: 31 Level Of Service: B

Table with columns for Street Name (Isis Avenue, El Segundo Boulevard), Approach (North Bound, South Bound, East Bound, West Bound), Movement (L, T, R), Control (Permitted, Protected), Rights (Include, Exclude), and traffic volume data (Min. Green, Y+R, Lanes).

Volume Module table showing Base Vol, Growth Adj, Initial Bse, User Adj, PHF Adj, PHF Volume, Reduct Vol, Reduced Vol, PCE Adj, MLF Adj, and Final Volume for various approaches.

Saturation Flow Module table showing Sat/Lane, Adjustment, Lanes, and Final Sat. values for different movements.

Capacity Analysis Module table showing Vol/Sat and Crit Moves for various movements.

Continental Grand Campus Specific Plan
City of El Segundo
Existing PM Peak Hour (ICU)

Level of Service Computation Report

ICU 1(Loss as Cycle Length %) Method (Base Volume Alternative)

Intersection #18 El Segundo Blvd at I-405 SB Ramps

Cycle (sec): 100 Critical Vol./Cap.(X): 0.874
Loss Time (sec): 5 Average Delay (sec/veh): xxxxxx
Optimal Cycle: 74 Level Of Service: D

Table with columns for Street Name (I-405 SB Ramps, El Segundo Blvd), Approach (North Bound, South Bound, East Bound, West Bound), Movement (L, T, R), Control (Permitted), Rights (Include, Exclude), and traffic volume data (Min. Green, Y+R, Lanes).

Volume Module table showing Base Vol, Growth Adj, Initial Bse, User Adj, PHF Adj, PHF Volume, Reduct Vol, Reduced Vol, PCE Adj, MLF Adj, and Final Volume for various approaches.

Saturation Flow Module table showing Sat/Lane, Adjustment, Lanes, and Final Sat. values for different movements.

Capacity Analysis Module table showing Vol/Sat and Crit Moves for various movements.

Continental Grand Campus Specific Plan
City of El Segundo
Existing PM Peak Hour (ICU)

Level of Service Computation Report

ICU 1(Loss as Cycle Length %) Method (Base Volume Alternative)

Intersection #19 El Segundo Blvd at La Cienega Blvd

Cycle (sec): 100 Critical Vol./Cap.(X): 0.643
Loss Time (sec): 5 Average Delay (sec/veh): xxxxxx
Optimal Cycle: 32 Level Of Service: B

Street Name: La Cienega Blvd El Segundo Blvd
Approach: North Bound South Bound East Bound West Bound
Movement: L - T - R L - T - R L - T - R L - T - R
Control: Protected Protected Protected Protected
Rights: Include Include Include Include
Min. Green: 0 0 0 0 0 0 0 0 0 0 0 0
Y+R: 4.0 4.0 4.0 4.0 4.0 4.0 4.0 4.0 4.0 4.0 4.0 4.0
Lanes: 0 0 0 0 0 2 0 0 0 2 1 0 3 0 0 0 0 0 2 1 0

Volume Module:
Base Vol: 0 0 0 665 0 653 101 1849 0 0 614 206
Growth Adj: 1.00 1.00 1.00 1.00 1.00 1.00 1.00 1.00 1.00 1.00 1.00 1.00
Initial Bse: 0 0 0 665 0 653 101 1849 0 0 614 206
User Adj: 1.00 1.00 1.00 1.00 1.00 1.00 1.00 1.00 1.00 1.00 1.00 1.00
PHF Adj: 1.00 1.00 1.00 1.00 1.00 1.00 1.00 1.00 1.00 1.00 1.00 1.00
PHF Volume: 0 0 0 665 0 653 101 1849 0 0 614 206
Reduct Vol: 0 0 0 0 0 0 0 0 0 0 0 0
Reduced Vol: 0 0 0 665 0 653 101 1849 0 0 614 206
PCE Adj: 1.00 1.00 1.00 1.00 1.00 1.00 1.00 1.00 1.00 1.00 1.00 1.00
MLF Adj: 1.00 1.00 1.00 1.00 1.00 1.00 1.00 1.00 1.00 1.00 1.00 1.00
FinalVolume: 0 0 0 665 0 653 101 1849 0 0 614 206

Saturation Flow Module:
Sat/Lane: 1600 1600 1600 1600 1600 1600 1600 1600 1600 1600 1600 1600
Adjustment: 1.00 1.00 1.00 1.00 1.00 1.00 1.00 1.00 1.00 1.00 1.00 1.00
Lanes: 0.00 0.00 0.00 2.00 0.00 2.00 1.00 3.00 0.00 0.00 2.25 0.75
Final Sat.: 0 0 0 3200 0 3200 1600 4800 0 0 3594 1206

Capacity Analysis Module:
Vol/Sat: 0.00 0.00 0.00 0.21 0.00 0.20 0.06 0.39 0.00 0.00 0.17 0.17
Crit Moves: ****

Continental Grand Campus Specific Plan
City of El Segundo
Existing PM Peak Hour (ICU)

Level of Service Computation Report

ICU 1(Loss as Cycle Length %) Method (Base Volume Alternative)

Intersection #20 El Segundo Blvd at I-405 NB Ramps

Cycle (sec): 100 Critical Vol./Cap.(X): 0.681
Loss Time (sec): 5 Average Delay (sec/veh): xxxxxx
Optimal Cycle: 35 Level Of Service: B

Street Name: I-405 NB Ramps El Segundo Blvd
Approach: North Bound South Bound East Bound West Bound
Movement: L - T - R L - T - R L - T - R L - T - R
Control: Protected Protected Protected Protected
Rights: Include Include Ignore Include
Min. Green: 0 0 0 0 0 0 0 0 0 0 0 0
Y+R: 4.0 4.0 4.0 4.0 4.0 4.0 4.0 4.0 4.0 4.0 4.0 4.0
Lanes: 2 0 0 0 1 0 0 0 0 0 0 0 0 0 2 1 1 0 0 2 1 0

Volume Module:
Base Vol: 373 0 222 0 0 0 0 2365 176 0 447 410
Growth Adj: 1.00 1.00 1.00 1.00 1.00 1.00 1.00 1.00 1.00 1.00 1.00 1.00
Initial Bse: 373 0 222 0 0 0 0 2365 176 0 447 410
User Adj: 1.00 1.00 1.00 1.00 1.00 1.00 1.00 1.00 0.00 1.00 1.00 1.00
PHF Adj: 1.00 1.00 1.00 1.00 1.00 1.00 1.00 1.00 0.00 1.00 1.00 1.00
PHF Volume: 373 0 222 0 0 0 0 2365 0 0 447 410
Reduct Vol: 0 0 0 0 0 0 0 0 0 0 0 0
Reduced Vol: 373 0 222 0 0 0 0 2365 0 0 447 410
PCE Adj: 1.00 1.00 1.00 1.00 1.00 1.00 1.00 1.00 0.00 1.00 1.00 1.00
MLF Adj: 1.00 1.00 1.00 1.00 1.00 1.00 1.00 1.00 0.00 1.00 1.00 1.00
FinalVolume: 373 0 222 0 0 0 0 2365 0 0 447 410

Saturation Flow Module:
Sat/Lane: 1600 1600 1600 1600 1600 1600 1600 1600 1600 1600 1600 1600
Adjustment: 1.00 1.00 1.00 1.00 1.00 1.00 1.00 1.00 1.00 1.00 1.00 1.00
Lanes: 2.00 0.00 1.00 0.00 0.00 0.00 0.00 3.00 1.00 0.00 2.00 1.00
Final Sat.: 3200 0 1600 0 0 0 0 4800 1600 0 3200 1600

Capacity Analysis Module:
Vol/Sat: 0.12 0.00 0.14 0.00 0.00 0.00 0.00 0.49 0.00 0.00 0.14 0.26
Crit Moves: ****

 Continental Grand Campus Specific Plan
 City of El Segundo
 Existing With Project AM Peak Hour (ICU)

Scenario Report

Scenario: Ex With Proj AM
 Command: Ex With Proj AM
 Volume: Ex AM
 Geometry: Existing
 Impact Fee: Default Impact Fee
 Trip Generation: Proj AM
 Trip Distribution: Project
 Paths: Project
 Routes: Default Route
 Configuration: Ex With Proj AM

 Continental Grand Campus Specific Plan
 City of El Segundo
 Existing With Project AM Peak Hour (ICU)

Trip Generation Report

Forecast for Proj AM

Zone #	Subzone	Amount	Units	Rate In	Rate Out	Trips In	Trips Out	Total Trips	% Of Total
714 400	Duley -	1.00	Office	0.00	0.00	0	0	0	0.0
714 400	Duley -	1.00	Industrial	0.00	0.00	0	0	0	0.0
1002	Laker Facili	1.00	General Office	0.00	0.00	0	0	0	0.0
1004	1955 E Grand	1.00	Mattel	239.00	33.00	239	33	272	18.2
Zone 1004 Subtotal						239	33	272	18.2
1005	Mattel	1.00	Mattel	431.00	43.00	431	43	474	31.8
Zone 1005 Subtotal						431	43	474	31.8
1007	Mattel Proje	1.00	project	670.00	76.00	670	76	746	50.0
Zone 1007 Subtotal						670	76	746	50.0
TOTAL						1340	152	1492	100.0

Continental Grand Campus Specific Plan
 City of El Segundo
 Existing With Project AM Peak Hour (ICU)

Trip Distribution Report

Percent Of Trips Project

Zone	To Gates										
	1	2	3	4	5	7	8	9	10	11	12
306	0.0	0.0	0.0	0.0	0.0	0.0	0.0	0.0	0.0	0.0	0.0
307	0.0	0.0	0.0	0.0	0.0	0.0	0.0	0.0	0.0	0.0	0.0
311	0.0	0.0	0.0	0.0	0.0	0.0	0.0	0.0	0.0	0.0	0.0
313	0.0	0.0	0.0	0.0	0.0	0.0	0.0	0.0	0.0	0.0	0.0
314	0.0	0.0	0.0	0.0	0.0	0.0	0.0	0.0	0.0	0.0	0.0
704	0.0	0.0	0.0	0.0	0.0	0.0	0.0	0.0	0.0	0.0	0.0
706	0.0	0.0	0.0	0.0	0.0	0.0	0.0	0.0	0.0	0.0	0.0
710	0.0	0.0	0.0	0.0	0.0	0.0	0.0	0.0	0.0	0.0	0.0
714	0.0	0.0	0.0	0.0	0.0	0.0	0.0	0.0	0.0	0.0	0.0
717	0.0	0.0	0.0	0.0	0.0	0.0	0.0	0.0	0.0	0.0	0.0
718	0.0	0.0	0.0	0.0	0.0	0.0	0.0	0.0	0.0	0.0	0.0
719	0.0	0.0	0.0	0.0	0.0	0.0	0.0	0.0	0.0	0.0	0.0
1002	0.0	10.0	5.0	5.0	15.0	5.0	10.0	15.0	5.0	15.0	5.0
1004	5.0	15.0	10.0	5.0	30.0	0.0	5.0	20.0	0.0	0.0	5.0
1005	5.0	15.0	10.0	5.0	30.0	0.0	5.0	20.0	0.0	0.0	5.0
1007	0.0	0.0	0.0	0.0	0.0	0.0	0.0	0.0	0.0	0.0	0.0

Zone	To Gates				
	14	15	17	18	20
306	0.0	0.0	0.0	0.0	0.0
307	0.0	0.0	0.0	0.0	0.0
311	0.0	0.0	0.0	0.0	0.0
313	0.0	0.0	0.0	0.0	0.0
314	0.0	0.0	0.0	0.0	0.0
704	0.0	0.0	0.0	0.0	0.0
706	0.0	0.0	0.0	0.0	0.0
710	0.0	0.0	0.0	0.0	0.0
714	0.0	0.0	0.0	0.0	0.0
717	0.0	0.0	0.0	0.0	0.0
718	0.0	0.0	0.0	0.0	0.0
719	0.0	0.0	0.0	0.0	0.0
1002	5.0	5.0	0.0	0.0	0.0
1004	5.0	0.0	0.0	0.0	0.0
1005	5.0	0.0	0.0	0.0	0.0
1007	0.0	0.0	0.0	20.0	10.0

Continental Grand Campus Specific Plan
 City of El Segundo
 Existing With Project AM Peak Hour (ICU)

Impact Analysis Report
 Level Of Service

Intersection	Base		Future		Change in
	Del/ LOS	V/ Veh C	Del/ LOS	V/ Veh C	
# 1 Sepulveda Blvd at Imperial Hwy	C xxxxxx	0.798	C xxxxxx	0.799	+ 0.001 V/C
# 2 Sepulveda Blvd at Walnut St	A xxxxxx	0.561	A xxxxxx	0.571	+ 0.010 V/C
# 3 Sepulveda Blvd at Maple Ave	A xxxxxx	0.575	A xxxxxx	0.578	+ 0.003 V/C
# 4 Sepulveda Blvd at Mariposa Ave	B xxxxxx	0.675	C xxxxxx	0.713	+ 0.038 V/C
# 5 Sepulveda Blvd at Grand Ave	C xxxxxx	0.737	D xxxxxx	0.820	+ 0.083 V/C
# 6 Sepulveda Blvd at El Segundo B	C xxxxxx	0.760	C xxxxxx	0.779	+ 0.019 V/C
# 7 Sepulveda Blvd at Rosecrans Bl	C xxxxxx	0.797	D xxxxxx	0.812	+ 0.016 V/C
# 8 Continental Boulevard at Marip	A xxxxxx	0.383	A xxxxxx	0.516	+ 0.133 V/C
# 9 Continental Boulevard at Grand	A xxxxxx	0.311	A xxxxxx	0.498	+ 0.187 V/C
# 10 Continental Boulevard at El Se	A xxxxxx	0.395	A xxxxxx	0.466	+ 0.070 V/C
# 11 Nash St and Imperial Hwy	B xxxxxx	0.631	C xxxxxx	0.705	+ 0.074 V/C
# 12 Nash St at Mariposa Ave	A xxxxxx	0.462	A xxxxxx	0.544	+ 0.082 V/C
# 13 Nash St at Grand Ave	A xxxxxx	0.480	A xxxxxx	0.546	+ 0.066 V/C
# 14 Nash St at El Segundo Blvd	A xxxxxx	0.457	A xxxxxx	0.499	+ 0.042 V/C
# 15 Douglas Street at El Segundo B	B xxxxxx	0.699	C xxxxxx	0.724	+ 0.025 V/C
# 16 Aviation Boulevard at El Segun	D xxxxxx	0.811	D xxxxxx	0.853	+ 0.042 V/C
# 17 El Segundo Boulevard and Isis	A xxxxxx	0.577	B xxxxxx	0.619	+ 0.042 V/C
# 18 El Segundo Blvd at I-405 SB Ra	A xxxxxx	0.522	A xxxxxx	0.564	+ 0.042 V/C
# 19 El Segundo Blvd at La Cienega	A xxxxxx	0.570	B xxxxxx	0.612	+ 0.042 V/C
# 20 El Segundo Blvd at I-405 NB Ra	C xxxxxx	0.700	C xxxxxx	0.742	+ 0.042 V/C

Continental Grand Campus Specific Plan
City of El Segundo
Existing With Project AM Peak Hour (ICU)

Level Of Service Computation Report

ICU 1(Loss as Cycle Length %) Method (Future Volume Alternative)

Intersection #1 Sepulveda Blvd at Imperial Hwy

Cycle (sec): 100 Critical Vol./Cap.(X): 0.799
Loss Time (sec): 5 Average Delay (sec/veh): xxxxxx
Optimal Cycle: 52 Level Of Service: C

Table with columns for Street Name, Approach, Movement, Control, Rights, Min. Green, Y+R, Lanes. Rows for Sepulveda Blvd (North/South Bound) and Imperial Hwy (East/West Bound).

Volume Module:

Table with columns for Base Vol, Growth Adj, Initial Bse, Added Vol, PasserByVol, Initial Fut, User Adj, PHF Adj, PHF Volume, Reduct Vol, Reduced Vol, PCE Adj, MLF Adj, FinalVolume, OvlAdjVol.

Saturation Flow Module:

Table with columns for Sat/Lane, Adjustment, Lanes, Final Sat.

Capacity Analysis Module:

Table with columns for Vol/Sat, OvlAdjV/S, Crit Moves.

Continental Grand Campus Specific Plan
City of El Segundo
Existing With Project AM Peak Hour (ICU)

Level Of Service Computation Report

ICU 1(Loss as Cycle Length %) Method (Future Volume Alternative)

Intersection #2 Sepulveda Blvd at Walnut St

Cycle (sec): 100 Critical Vol./Cap.(X): 0.571
Loss Time (sec): 5 Average Delay (sec/veh): xxxxxx
Optimal Cycle: 27 Level Of Service: A

Table with columns for Street Name, Approach, Movement, Control, Rights, Min. Green, Y+R, Lanes. Rows for Sepulveda Blvd (North/South Bound) and Walnut St (East/West Bound).

Volume Module:

Table with columns for Base Vol, Growth Adj, Initial Bse, Added Vol, PasserByVol, Initial Fut, User Adj, PHF Adj, PHF Volume, Reduct Vol, Reduced Vol, PCE Adj, MLF Adj, FinalVolume.

Saturation Flow Module:

Table with columns for Sat/Lane, Adjustment, Lanes, Final Sat.

Capacity Analysis Module:

Table with columns for Vol/Sat, Crit Moves.

Continental Grand Campus Specific Plan
City of El Segundo
Existing With Project AM Peak Hour (ICU)

Level Of Service Computation Report

ICU 1(Loss as Cycle Length %) Method (Future Volume Alternative)

Intersection #3 Sepulveda Blvd at Maple Ave

Cycle (sec): 100 Critical Vol./Cap.(X): 0.578
Loss Time (sec): 5 Average Delay (sec/veh): xxxxxx
Optimal Cycle: 28 Level Of Service: A

Table with columns for Street Name (Sepulveda Blvd, Maple Ave), Approach (North Bound, South Bound, East Bound, West Bound), Movement (L, T, R), Control (Protected, Permitted), Rights (Include), and traffic volume data (Min. Green, Y+R, Lanes).

Volume Module table showing Base Vol, Growth Adj, Initial Bse, Added Vol, PasserByVol, Initial Fut, User Adj, PHF Adj, PHF Volume, Reduct Vol, Reduced Vol, PCE Adj, MLF Adj, and Final Volume for various approaches.

Saturation Flow Module table showing Sat/Lane, Adjustment, Lanes, and Final Sat. for various approaches.

Capacity Analysis Module table showing Vol/Sat and Crit Moves for various approaches.

Continental Grand Campus Specific Plan
City of El Segundo
Existing With Project AM Peak Hour (ICU)

Level Of Service Computation Report

ICU 1(Loss as Cycle Length %) Method (Future Volume Alternative)

Intersection #4 Sepulveda Blvd at Mariposa Ave

Cycle (sec): 100 Critical Vol./Cap.(X): 0.713
Loss Time (sec): 5 Average Delay (sec/veh): xxxxxx
Optimal Cycle: 39 Level Of Service: C

Table with columns for Street Name (Sepulveda Blvd, Mariposa Ave), Approach (North Bound, South Bound, East Bound, West Bound), Movement (L, T, R), Control (Protected, Permitted), Rights (Include), and traffic volume data (Min. Green, Y+R, Lanes).

Volume Module table showing Base Vol, Growth Adj, Initial Bse, Added Vol, PasserByVol, Initial Fut, User Adj, PHF Adj, PHF Volume, Reduct Vol, Reduced Vol, PCE Adj, MLF Adj, and Final Volume for various approaches.

Saturation Flow Module table showing Sat/Lane, Adjustment, Lanes, and Final Sat. for various approaches.

Capacity Analysis Module table showing Vol/Sat and Crit Moves for various approaches.

Continental Grand Campus Specific Plan
City of El Segundo
Existing With Project AM Peak Hour (ICU)

Level Of Service Computation Report

ICU 1(Loss as Cycle Length %) Method (Future Volume Alternative)

Intersection #5 Sepulveda Blvd at Grand Ave

Cycle (sec): 100 Critical Vol./Cap.(X): 0.820
Loss Time (sec): 5 Average Delay (sec/veh): xxxxxx
Optimal Cycle: 57 Level Of Service: D

Table with columns for Street Name (Sepulveda Blvd, Grand Ave), Approach (North Bound, South Bound, East Bound, West Bound), Movement (L-T-R), Control (Protected, Split Phase), Rights (Ovl, Include), and traffic volume metrics (Min. Green, Y+R, Lanes).

Volume Module table showing Base Vol, Growth Adj, Initial Bse, Added Vol, PasserByVol, Initial Fut, User Adj, PHF Adj, PHF Volume, Reduct Vol, Reduced Vol, PCE Adj, MLF Adj, FinalVolume, and OvlAdjVol.

Saturation Flow Module table showing Sat/Lane, Adjustment, Lanes, and Final Sat. values.

Capacity Analysis Module table showing Vol/Sat, OvlAdjV/S, and Crit Moves.

Continental Grand Campus Specific Plan
City of El Segundo
Existing With Project AM Peak Hour (ICU)

Level Of Service Computation Report

ICU 1(Loss as Cycle Length %) Method (Future Volume Alternative)

Intersection #6 Sepulveda Blvd at El Segundo Blvd

Cycle (sec): 100 Critical Vol./Cap.(X): 0.779
Loss Time (sec): 5 Average Delay (sec/veh): xxxxxx
Optimal Cycle: 48 Level Of Service: C

Table with columns for Street Name (Sepulveda Blvd, El Segundo Blvd), Approach (North Bound, South Bound, East Bound, West Bound), Movement (L-T-R), Control (Protected), Rights (Include), and traffic volume metrics (Min. Green, Y+R, Lanes).

Volume Module table showing Base Vol, Growth Adj, Initial Bse, Added Vol, PasserByVol, Initial Fut, User Adj, PHF Adj, PHF Volume, Reduct Vol, Reduced Vol, PCE Adj, MLF Adj, and FinalVolume.

Saturation Flow Module table showing Sat/Lane, Adjustment, Lanes, and Final Sat. values.

Capacity Analysis Module table showing Vol/Sat, Crit Moves, and other metrics.

Continental Grand Campus Specific Plan
City of El Segundo
Existing With Project AM Peak Hour (ICU)

Level Of Service Computation Report

ICU 1(Loss as Cycle Length %) Method (Future Volume Alternative)

Intersection #7 Sepulveda Blvd at Rosecrans Blvd

Cycle (sec): 100 Critical Vol./Cap.(X): 0.812
Loss Time (sec): 5 Average Delay (sec/veh): xxxxxx
Optimal Cycle: 55 Level Of Service: D

Table with columns for Street Name (Sepulveda Blvd, Rosecrans Blvd), Approach (North Bound, South Bound, East Bound, West Bound), Movement (L, T, R), Control (Protected, Permitted), Rights (Ovl, Include, Ignore), and traffic volume metrics (Min. Green, Y+R, Lanes).

Volume Module table showing Base Vol, Growth Adj, Initial Bse, Added Vol, PasserByVol, Initial Fut, User Adj, PHF Adj, PHF Volume, Reduct Vol, Reduced Vol, PCE Adj, MLF Adj, FinalVolume, and OvlAdjVol for various approaches.

Saturation Flow Module table showing Sat/Lane, Adjustment, Lanes, and Final Sat. for different approaches.

Capacity Analysis Module table showing Vol/Sat, OvlAdjV/S, and Crit Moves for various approaches.

Continental Grand Campus Specific Plan
City of El Segundo
Existing With Project AM Peak Hour (ICU)

Level Of Service Computation Report

ICU 1(Loss as Cycle Length %) Method (Future Volume Alternative)

Intersection #8 Continental Boulevard at Mariposa Ave

Cycle (sec): 100 Critical Vol./Cap.(X): 0.516
Loss Time (sec): 5 Average Delay (sec/veh): xxxxxx
Optimal Cycle: 24 Level Of Service: A

Table with columns for Street Name (Continental Boulevard, Mariposa Avenue), Approach (North Bound, South Bound, East Bound, West Bound), Movement (L, T, R), Control (Permitted), Rights (Include), and traffic volume metrics (Min. Green, Y+R, Lanes).

Volume Module table showing Base Vol, Growth Adj, Initial Bse, Added Vol, PasserByVol, Initial Fut, User Adj, PHF Adj, PHF Volume, Reduct Vol, Reduced Vol, PCE Adj, MLF Adj, FinalVolume, and OvlAdjVol for various approaches.

Saturation Flow Module table showing Sat/Lane, Adjustment, Lanes, and Final Sat. for different approaches.

Capacity Analysis Module table showing Vol/Sat, Crit Moves, and other metrics for various approaches.

Continental Grand Campus Specific Plan
City of El Segundo
Existing With Project AM Peak Hour (ICU)

Level Of Service Computation Report

ICU 1(Loss as Cycle Length %) Method (Future Volume Alternative)

Intersection #9 Continental Boulevard at Grand Avenue

Cycle (sec): 100 Critical Vol./Cap.(X): 0.498
Loss Time (sec): 5 Average Delay (sec/veh): xxxxxx
Optimal Cycle: 24 Level Of Service: A

Table with columns for Street Name, Approach, Movement, Control, Rights, Min. Green, Y+R, Lanes. Rows for Continental Boulevard and Grand Avenue.

Volume Module table with columns for Base Vol, Growth Adj, Initial Bse, Added Vol, PasserByVol, Initial Fut, User Adj, PHF Adj, PHF Volume, Reduct Vol, Reduced Vol, PCE Adj, MLF Adj, FinalVolume.

Saturation Flow Module table with columns for Sat/Lane, Adjustment, Lanes, Final Sat.

Capacity Analysis Module table with columns for Vol/Sat, Crit Moves.

Continental Grand Campus Specific Plan
City of El Segundo
Existing With Project AM Peak Hour (ICU)

Level Of Service Computation Report

ICU 1(Loss as Cycle Length %) Method (Future Volume Alternative)

Intersection #10 Continental Boulevard at El Segundo Boulevard

Cycle (sec): 100 Critical Vol./Cap.(X): 0.466
Loss Time (sec): 5 Average Delay (sec/veh): xxxxxx
Optimal Cycle: 22 Level Of Service: A

Table with columns for Street Name, Approach, Movement, Control, Rights, Min. Green, Y+R, Lanes. Rows for Continental Boulevard and El Segundo Boulevard.

Volume Module table with columns for Base Vol, Growth Adj, Initial Bse, Added Vol, PasserByVol, Initial Fut, User Adj, PHF Adj, PHF Volume, Reduct Vol, Reduced Vol, PCE Adj, MLF Adj, FinalVolume.

Saturation Flow Module table with columns for Sat/Lane, Adjustment, Lanes, Final Sat.

Capacity Analysis Module table with columns for Vol/Sat, Crit Moves.

Continental Grand Campus Specific Plan
City of El Segundo
Existing With Project AM Peak Hour (ICU)

Level Of Service Computation Report

ICU 1(Loss as Cycle Length %) Method (Future Volume Alternative)

Intersection #11 Nash St and Imperial Hwy

Cycle (sec): 100 Critical Vol./Cap.(X): 0.705
Loss Time (sec): 5 Average Delay (sec/veh): xxxxxx
Optimal Cycle: 38 Level Of Service: C

Table with columns for Street Name (Nash St, Imperial Hwy), Approach (North Bound, South Bound, East Bound, West Bound), Movement (L, T, R), Control (Split Phase, Protected), Rights (Include), and traffic volume data (Min. Green, Y+R, Lanes).

Volume Module table showing Base Vol, Growth Adj, Initial Bse, Added Vol, PasserByVol, Initial Fut, User Adj, PHF Adj, PHF Volume, Reduct Vol, Reduced Vol, PCE Adj, MLF Adj, and Final Volume for various approaches.

Saturation Flow Module table showing Sat/Lane, Adjustment, Lanes, and Final Sat. for different approaches.

Capacity Analysis Module table showing Vol/Sat and Crit Moves for various approaches.

Continental Grand Campus Specific Plan
City of El Segundo
Existing With Project AM Peak Hour (ICU)

Level Of Service Computation Report

ICU 1(Loss as Cycle Length %) Method (Future Volume Alternative)

Intersection #12 Nash St at Mariposa Ave

Cycle (sec): 100 Critical Vol./Cap.(X): 0.544
Loss Time (sec): 5 Average Delay (sec/veh): xxxxxx
Optimal Cycle: 26 Level Of Service: A

Table with columns for Street Name (Nash St, Mariposa Ave), Approach (North Bound, South Bound, East Bound, West Bound), Movement (L, T, R), Control (Permitted), Rights (Include), and traffic volume data (Min. Green, Y+R, Lanes).

Volume Module table showing Base Vol, Growth Adj, Initial Bse, Added Vol, PasserByVol, Initial Fut, User Adj, PHF Adj, PHF Volume, Reduct Vol, Reduced Vol, PCE Adj, MLF Adj, and Final Volume for various approaches.

Saturation Flow Module table showing Sat/Lane, Adjustment, Lanes, and Final Sat. for different approaches.

Capacity Analysis Module table showing Vol/Sat and Crit Moves for various approaches.

Continental Grand Campus Specific Plan
City of El Segundo
Existing With Project AM Peak Hour (ICU)

Level Of Service Computation Report

ICU 1(Loss as Cycle Length %) Method (Future Volume Alternative)

Intersection #13 Nash St at Grand Ave

Cycle (sec): 100 Critical Vol./Cap.(X): 0.546
Loss Time (sec): 5 Average Delay (sec/veh): xxxxxx
Optimal Cycle: 26 Level Of Service: A

Table with columns for Street Name (Nash St, Grand Ave), Approach (North Bound, South Bound, East Bound, West Bound), Movement (L, T, R), Control (Protected, Split Phase), Rights (Include), and traffic volume metrics (Min. Green, Y+R, Lanes).

Volume Module table showing Base Vol, Growth Adj, Initial Bse, Added Vol, PasserByVol, Initial Fut, User Adj, PHF Adj, PHF Volume, Reduct Vol, Reduced Vol, PCE Adj, MLF Adj, and Final Volume for various approaches.

Saturation Flow Module table showing Sat/Lane, Adjustment, Lanes, and Final Sat. for different approaches.

Capacity Analysis Module table showing Vol/Sat, Crit Moves, and OvlAdjV/S for various approaches.

Continental Grand Campus Specific Plan
City of El Segundo
Existing With Project AM Peak Hour (ICU)

Level Of Service Computation Report

ICU 1(Loss as Cycle Length %) Method (Future Volume Alternative)

Intersection #14 Nash St at El Segundo Blvd

Cycle (sec): 100 Critical Vol./Cap.(X): 0.499
Loss Time (sec): 5 Average Delay (sec/veh): xxxxxx
Optimal Cycle: 24 Level Of Service: A

Table with columns for Street Name (Nash St, El Segundo Blvd), Approach (North Bound, South Bound, East Bound, West Bound), Movement (L, T, R), Control (Split Phase, Protected), Rights (Include), and traffic volume metrics (Min. Green, Y+R, Lanes).

Volume Module table showing Base Vol, Growth Adj, Initial Bse, Added Vol, PasserByVol, Initial Fut, User Adj, PHF Adj, PHF Volume, Reduct Vol, Reduced Vol, PCE Adj, MLF Adj, and Final Volume for various approaches.

Saturation Flow Module table showing Sat/Lane, Adjustment, Lanes, and Final Sat. for different approaches.

Capacity Analysis Module table showing Vol/Sat, Crit Moves, and OvlAdjV/S for various approaches.

Continental Grand Campus Specific Plan
City of El Segundo
Existing With Project AM Peak Hour (ICU)

Level Of Service Computation Report

ICU 1(Loss as Cycle Length %) Method (Future Volume Alternative)

Intersection #15 Douglas Street at El Segundo Boulevard

Cycle (sec): 100 Critical Vol./Cap.(X): 0.724
Loss Time (sec): 5 Average Delay (sec/veh): xxxxxx
Optimal Cycle: 40 Level Of Service: C

Table with columns for Street Name, Approach, Movement, Control, Rights, Min. Green, Y+R, Lanes. Rows include Douglas St and El Segundo Blvd with various approach and movement details.

Volume Module table with columns for Base Vol, Growth Adj, Initial Bse, Added Vol, PasserByVol, Initial Fut, User Adj, PHF Adj, PHF Volume, Reduct Vol, Reduced Vol, PCE Adj, MLF Adj, FinalVolume.

Saturation Flow Module table with columns for Sat/Lane, Adjustment, Lanes, Final Sat.

Capacity Analysis Module table with columns for Vol/Sat, Crit Moves.

Continental Grand Campus Specific Plan
City of El Segundo
Existing With Project AM Peak Hour (ICU)

Level Of Service Computation Report

ICU 1(Loss as Cycle Length %) Method (Future Volume Alternative)

Intersection #16 Aviation Boulevard at El Segundo Boulevard

Cycle (sec): 100 Critical Vol./Cap.(X): 0.853
Loss Time (sec): 5 Average Delay (sec/veh): xxxxxx
Optimal Cycle: 66 Level Of Service: D

Table with columns for Street Name, Approach, Movement, Control, Rights, Min. Green, Y+R, Lanes. Rows include Aviation Blvd and El Segundo Blvd with various approach and movement details.

Volume Module table with columns for Base Vol, Growth Adj, Initial Bse, Added Vol, PasserByVol, Initial Fut, User Adj, PHF Adj, PHF Volume, Reduct Vol, Reduced Vol, PCE Adj, MLF Adj, FinalVolume, OvlAdjVol.

Saturation Flow Module table with columns for Sat/Lane, Adjustment, Lanes, Final Sat.

Capacity Analysis Module table with columns for Vol/Sat, OvlAdjV/S, Crit Moves.

Continental Grand Campus Specific Plan
City of El Segundo
Existing With Project AM Peak Hour (ICU)

Level Of Service Computation Report

ICU 1(Loss as Cycle Length %) Method (Future Volume Alternative)

Intersection #17 El Segundo Boulevard and Isis Avenue

Cycle (sec): 100 Critical Vol./Cap.(X): 0.619
Loss Time (sec): 5 Average Delay (sec/veh): xxxxxx
Optimal Cycle: 30 Level Of Service: B

Table with columns for Street Name, Approach, Movement, Control, Rights, Min. Green, Y+R, Lanes. Rows for Isis Avenue and El Segundo Boulevard.

Volume Module table with columns for Base Vol, Growth Adj, Initial Bse, Added Vol, PasserByVol, Initial Fut, User Adj, PHF Adj, PHF Volume, Reduct Vol, Reduced Vol, PCE Adj, MLF Adj, FinalVolume.

Saturation Flow Module table with columns for Sat/Lane, Adjustment, Lanes, Final Sat.

Capacity Analysis Module table with columns for Vol/Sat, Crit Moves.

Continental Grand Campus Specific Plan
City of El Segundo
Existing With Project AM Peak Hour (ICU)

Level Of Service Computation Report

ICU 1(Loss as Cycle Length %) Method (Future Volume Alternative)

Intersection #18 El Segundo Blvd at I-405 SB Ramps

Cycle (sec): 100 Critical Vol./Cap.(X): 0.564
Loss Time (sec): 5 Average Delay (sec/veh): xxxxxx
Optimal Cycle: 27 Level Of Service: A

Table with columns for Street Name, Approach, Movement, Control, Rights, Min. Green, Y+R, Lanes. Rows for I-405 SB Ramps and El Segundo Blvd.

Volume Module table with columns for Base Vol, Growth Adj, Initial Bse, Added Vol, PasserByVol, Initial Fut, User Adj, PHF Adj, PHF Volume, Reduct Vol, Reduced Vol, PCE Adj, MLF Adj, FinalVolume.

Saturation Flow Module table with columns for Sat/Lane, Adjustment, Lanes, Final Sat.

Capacity Analysis Module table with columns for Vol/Sat, Crit Moves.

Continental Grand Campus Specific Plan
City of El Segundo
Existing With Project AM Peak Hour (ICU)

Level of Service Computation Report

ICU 1(Loss as Cycle Length %) Method (Future Volume Alternative)

Intersection #19 El Segundo Blvd at La Cienega Blvd

Cycle (sec): 100 Critical Vol./Cap.(X): 0.612
Loss Time (sec): 5 Average Delay (sec/veh): xxxxxx
Optimal Cycle: 30 Level Of Service: B

Table with columns for Street Name, Approach, Movement, Control, Rights, Min. Green, Y+R, Lanes. Rows for La Cienega Blvd and El Segundo Blvd.

Table with columns for Volume Module, Base Vol, Growth Adj, Initial Bse, Added Vol, PasserByVol, Initial Fut, User Adj, PHF Adj, PHF Volume, Reduct Vol, Reduced Vol, PCE Adj, MLF Adj, FinalVolume.

Table with columns for Sat/Lane, Adjustment, Lanes, Final Sat. for Saturation Flow Module.

Table with columns for Vol/Sat, Crit Moves for Capacity Analysis Module.

Continental Grand Campus Specific Plan
City of El Segundo
Existing With Project AM Peak Hour (ICU)

Level of Service Computation Report

ICU 1(Loss as Cycle Length %) Method (Future Volume Alternative)

Intersection #20 El Segundo Blvd at I-405 NB Ramps

Cycle (sec): 100 Critical Vol./Cap.(X): 0.742
Loss Time (sec): 5 Average Delay (sec/veh): xxxxxx
Optimal Cycle: 42 Level Of Service: C

Table with columns for Street Name, Approach, Movement, Control, Rights, Min. Green, Y+R, Lanes. Rows for I-405 NB Ramps and El Segundo Blvd.

Table with columns for Volume Module, Base Vol, Growth Adj, Initial Bse, Added Vol, PasserByVol, Initial Fut, User Adj, PHF Adj, PHF Volume, Reduct Vol, Reduced Vol, PCE Adj, MLF Adj, FinalVolume.

Table with columns for Sat/Lane, Adjustment, Lanes, Final Sat. for Saturation Flow Module.

Table with columns for Vol/Sat, Crit Moves for Capacity Analysis Module.

 Continental Grand Campus Specific Plan
 City of El Segundo
 Existing With Project PM Peak Hour (ICU)

Scenario Report

Scenario: Ex With Proj PM
 Command: Ex With Proj PM
 Volume: Ex PM
 Geometry: Existing
 Impact Fee: Default Impact Fee
 Trip Generation: Proj PM
 Trip Distribution: Project
 Paths: Project
 Routes: Default Route
 Configuration: Ex With Proj PM

 Continental Grand Campus Specific Plan
 City of El Segundo
 Existing With Project PM Peak Hour (ICU)

Trip Generation Report

Forecast for Proj PM

Zone #	Subzone	Amount	Units	Rate In	Rate Out	Trips In	Trips Out	Total Trips	% Of Total
714 400	Duley -	1.00	Office	0.00	0.00	0	0	0	0.0
714 400	Duley -	1.00	Industrial	0.00	0.00	0	0	0	0.0
1002	Laker Facili	1.00	General Office	0.00	0.00	0	0	0	0.0
1004	1955 E Grand	1.00	Mattel	44.00	216.00	44	216	260	18.7
	Zone 1004 Subtotal					44	216	260	18.7
1005	Mattel	1.00	Mattel	48.00	388.00	48	388	436	31.3
	Zone 1005 Subtotal					48	388	436	31.3
1007	Mattel Proje	1.00	project	92.00	604.00	92	604	696	50.0
	Zone 1007 Subtotal					92	604	696	50.0
TOTAL						184	1208	1392	100.0

Continental Grand Campus Specific Plan
 City of El Segundo
 Existing With Project PM Peak Hour (ICU)

Trip Distribution Report

Percent Of Trips Project

Zone	To Gates										
	1	2	3	4	5	7	8	9	10	11	12
306	0.0	0.0	0.0	0.0	0.0	0.0	0.0	0.0	0.0	0.0	0.0
307	0.0	0.0	0.0	0.0	0.0	0.0	0.0	0.0	0.0	0.0	0.0
311	0.0	0.0	0.0	0.0	0.0	0.0	0.0	0.0	0.0	0.0	0.0
313	0.0	0.0	0.0	0.0	0.0	0.0	0.0	0.0	0.0	0.0	0.0
314	0.0	0.0	0.0	0.0	0.0	0.0	0.0	0.0	0.0	0.0	0.0
704	0.0	0.0	0.0	0.0	0.0	0.0	0.0	0.0	0.0	0.0	0.0
706	0.0	0.0	0.0	0.0	0.0	0.0	0.0	0.0	0.0	0.0	0.0
710	0.0	0.0	0.0	0.0	0.0	0.0	0.0	0.0	0.0	0.0	0.0
714	0.0	0.0	0.0	0.0	0.0	0.0	0.0	0.0	0.0	0.0	0.0
717	0.0	0.0	0.0	0.0	0.0	0.0	0.0	0.0	0.0	0.0	0.0
718	0.0	0.0	0.0	0.0	0.0	0.0	0.0	0.0	0.0	0.0	0.0
719	0.0	0.0	0.0	0.0	0.0	0.0	0.0	0.0	0.0	0.0	0.0
1002	0.0	10.0	5.0	5.0	15.0	5.0	10.0	15.0	5.0	15.0	5.0
1004	5.0	15.0	10.0	5.0	30.0	0.0	5.0	20.0	0.0	0.0	5.0
1005	5.0	15.0	10.0	5.0	30.0	0.0	5.0	20.0	0.0	0.0	5.0
1007	0.0	0.0	0.0	0.0	0.0	0.0	0.0	0.0	0.0	0.0	0.0

Zone	To Gates				
	14	15	17	18	20
306	0.0	0.0	0.0	0.0	0.0
307	0.0	0.0	0.0	0.0	0.0
311	0.0	0.0	0.0	0.0	0.0
313	0.0	0.0	0.0	0.0	0.0
314	0.0	0.0	0.0	0.0	0.0
704	0.0	0.0	0.0	0.0	0.0
706	0.0	0.0	0.0	0.0	0.0
710	0.0	0.0	0.0	0.0	0.0
714	0.0	0.0	0.0	0.0	0.0
717	0.0	0.0	0.0	0.0	0.0
718	0.0	0.0	0.0	0.0	0.0
719	0.0	0.0	0.0	0.0	0.0
1002	5.0	5.0	0.0	0.0	0.0
1004	5.0	0.0	0.0	0.0	0.0
1005	5.0	0.0	0.0	0.0	0.0
1007	0.0	0.0	0.0	20.0	10.0

Continental Grand Campus Specific Plan
 City of El Segundo
 Existing With Project PM Peak Hour (ICU)

Impact Analysis Report
 Level Of Service

Intersection	Base		Future		Change in
	Del/ LOS	V/ Veh	Del/ LOS	V/ Veh	
# 1 Sepulveda Blvd at Imperial Hwy	E	xxxxx 0.957	F	xxxxx 1.004	+ 0.047 V/C
# 2 Sepulveda Blvd at Walnut St	A	xxxxx 0.564	A	xxxxx 0.585	+ 0.021 V/C
# 3 Sepulveda Blvd at Maple Ave	B	xxxxx 0.629	B	xxxxx 0.630	+ 0.001 V/C
# 4 Sepulveda Blvd at Mariposa Ave	B	xxxxx 0.684	C	xxxxx 0.703	+ 0.019 V/C
# 5 Sepulveda Blvd at Grand Ave	C	xxxxx 0.781	D	xxxxx 0.862	+ 0.080 V/C
# 6 Sepulveda Blvd at El Segundo B	D	xxxxx 0.883	D	xxxxx 0.898	+ 0.014 V/C
# 7 Sepulveda Blvd at Rosecrans Bl	D	xxxxx 0.879	D	xxxxx 0.898	+ 0.019 V/C
# 8 Continental Boulevard at Marip	A	xxxxx 0.366	A	xxxxx 0.401	+ 0.035 V/C
# 9 Continental Boulevard at Grand	A	xxxxx 0.317	A	xxxxx 0.364	+ 0.047 V/C
# 10 Continental Boulevard at El Se	A	xxxxx 0.419	A	xxxxx 0.469	+ 0.050 V/C
# 11 Nash St and Imperial Hwy	A	xxxxx 0.474	A	xxxxx 0.488	+ 0.014 V/C
# 12 Nash St at Mariposa Ave	A	xxxxx 0.554	B	xxxxx 0.639	+ 0.085 V/C
# 13 Nash St at Grand Ave	A	xxxxx 0.527	A	xxxxx 0.533	+ 0.006 V/C
# 14 Nash St at El Segundo Blvd	A	xxxxx 0.546	A	xxxxx 0.584	+ 0.038 V/C
# 15 Douglas Street at El Segundo B	D	xxxxx 0.881	E	xxxxx 0.918	+ 0.038 V/C
# 16 Aviation Boulevard at El Segun	E	xxxxx 0.943	E	xxxxx 0.971	+ 0.028 V/C
# 17 El Segundo Boulevard and Isis	B	xxxxx 0.632	B	xxxxx 0.660	+ 0.028 V/C
# 18 El Segundo Blvd at I-405 SB Ra	D	xxxxx 0.874	E	xxxxx 0.949	+ 0.076 V/C
# 19 El Segundo Blvd at La Cienega	B	xxxxx 0.643	B	xxxxx 0.656	+ 0.012 V/C
# 20 El Segundo Blvd at I-405 NB Ra	B	xxxxx 0.681	B	xxxxx 0.694	+ 0.013 V/C

Continental Grand Campus Specific Plan
City of El Segundo
Existing With Project PM Peak Hour (ICU)

Level Of Service Computation Report

ICU 1(Loss as Cycle Length %) Method (Future Volume Alternative)

Intersection #1 Sepulveda Blvd at Imperial Hwy

Cycle (sec): 100 Critical Vol./Cap.(X): 1.004
Loss Time (sec): 5 Average Delay (sec/veh): xxxxxx
Optimal Cycle: 180 Level Of Service: F

Table with columns for Street Name, Approach, Movement, Control, Rights, Min. Green, Y+R, Lanes. Rows for Sepulveda Blvd and Imperial Hwy.

Volume Module table with columns for Base Vol, Growth Adj, Initial Bse, Added Vol, PasserByVol, Initial Fut, User Adj, PHF Adj, PHF Volume, Reduct Vol, Reduced Vol, PCE Adj, MLF Adj, FinalVolume, OvlAdjVol.

Saturation Flow Module table with columns for Sat/Lane, Adjustment, Lanes, Final Sat.

Capacity Analysis Module table with columns for Vol/Sat, OvlAdjV/S, Crit Moves.

Continental Grand Campus Specific Plan
City of El Segundo
Existing With Project PM Peak Hour (ICU)

Level Of Service Computation Report

ICU 1(Loss as Cycle Length %) Method (Future Volume Alternative)

Intersection #2 Sepulveda Blvd at Walnut St

Cycle (sec): 100 Critical Vol./Cap.(X): 0.585
Loss Time (sec): 5 Average Delay (sec/veh): xxxxxx
Optimal Cycle: 28 Level Of Service: A

Table with columns for Street Name, Approach, Movement, Control, Rights, Min. Green, Y+R, Lanes. Rows for Sepulveda Blvd and Walnut St.

Volume Module table with columns for Base Vol, Growth Adj, Initial Bse, Added Vol, PasserByVol, Initial Fut, User Adj, PHF Adj, PHF Volume, Reduct Vol, Reduced Vol, PCE Adj, MLF Adj, FinalVolume.

Saturation Flow Module table with columns for Sat/Lane, Adjustment, Lanes, Final Sat.

Capacity Analysis Module table with columns for Vol/Sat, Crit Moves.

Continental Grand Campus Specific Plan
City of El Segundo
Existing With Project PM Peak Hour (ICU)

Level Of Service Computation Report

ICU 1(Loss as Cycle Length %) Method (Future Volume Alternative)

Intersection #3 Sepulveda Blvd at Maple Ave

Cycle (sec): 100 Critical Vol./Cap.(X): 0.630
Loss Time (sec): 5 Average Delay (sec/veh): xxxxxx
Optimal Cycle: 31 Level Of Service: B

Table with columns for Street Name, Approach, Movement, Control, Rights, Min. Green, Y+R, Lanes. Rows for Sepulveda Blvd and Maple Ave.

Table with columns for Volume Module, Base Vol, Growth Adj, Initial Bse, Added Vol, PasserByVol, Initial Fut, User Adj, PHF Adj, PHF Volume, Reduct Vol, Reduced Vol, PCE Adj, MLF Adj, FinalVolume.

Table with columns for Sat/Lane, Adjustment, Lanes, Final Sat. for Saturation Flow Module.

Table with columns for Vol/Sat, Crit Moves for Capacity Analysis Module.

Continental Grand Campus Specific Plan
City of El Segundo
Existing With Project PM Peak Hour (ICU)

Level Of Service Computation Report

ICU 1(Loss as Cycle Length %) Method (Future Volume Alternative)

Intersection #4 Sepulveda Blvd at Mariposa Ave

Cycle (sec): 100 Critical Vol./Cap.(X): 0.703
Loss Time (sec): 5 Average Delay (sec/veh): xxxxxx
Optimal Cycle: 37 Level Of Service: C

Table with columns for Street Name, Approach, Movement, Control, Rights, Min. Green, Y+R, Lanes. Rows for Sepulveda Blvd and Mariposa Ave.

Table with columns for Volume Module, Base Vol, Growth Adj, Initial Bse, Added Vol, PasserByVol, Initial Fut, User Adj, PHF Adj, PHF Volume, Reduct Vol, Reduced Vol, PCE Adj, MLF Adj, FinalVolume.

Table with columns for Sat/Lane, Adjustment, Lanes, Final Sat. for Saturation Flow Module.

Table with columns for Vol/Sat, Crit Moves for Capacity Analysis Module.

Continental Grand Campus Specific Plan
City of El Segundo
Existing With Project PM Peak Hour (ICU)

Level Of Service Computation Report

ICU 1(Loss as Cycle Length %) Method (Future Volume Alternative)

Intersection #5 Sepulveda Blvd at Grand Ave

Cycle (sec): 100 Critical Vol./Cap.(X): 0.862
Loss Time (sec): 5 Average Delay (sec/veh): xxxxxx
Optimal Cycle: 69 Level Of Service: D

Table with columns for Street Name (Sepulveda Blvd, Grand Ave), Approach (North Bound, South Bound, East Bound, West Bound), Movement (L, T, R), Control (Protected, Split Phase), Rights (Ovl, Include), and traffic volume metrics (Min. Green, Y+R, Lanes).

Volume Module table showing Base Vol, Growth Adj, Initial Bse, Added Vol, PasserByVol, Initial Fut, User Adj, PHF Adj, PHF Volume, Reduct Vol, Reduced Vol, PCE Adj, MLF Adj, and Final Volume for various approaches.

Saturation Flow Module table showing Sat/Lane, Adjustment, Lanes, and Final Sat. for different movements.

Capacity Analysis Module table showing Vol/Sat, OvlAdjV/S, and Crit Moves for various movements.

Continental Grand Campus Specific Plan
City of El Segundo
Existing With Project PM Peak Hour (ICU)

Level Of Service Computation Report

ICU 1(Loss as Cycle Length %) Method (Future Volume Alternative)

Intersection #6 Sepulveda Blvd at El Segundo Blvd

Cycle (sec): 100 Critical Vol./Cap.(X): 0.898
Loss Time (sec): 5 Average Delay (sec/veh): xxxxxx
Optimal Cycle: 85 Level Of Service: D

Table with columns for Street Name (Sepulveda Blvd, El Segundo Blvd), Approach (North Bound, South Bound, East Bound, West Bound), Movement (L, T, R), Control (Protected), Rights (Include), and traffic volume metrics (Min. Green, Y+R, Lanes).

Volume Module table showing Base Vol, Growth Adj, Initial Bse, Added Vol, PasserByVol, Initial Fut, User Adj, PHF Adj, PHF Volume, Reduct Vol, Reduced Vol, PCE Adj, MLF Adj, and Final Volume for various approaches.

Saturation Flow Module table showing Sat/Lane, Adjustment, Lanes, and Final Sat. for different movements.

Capacity Analysis Module table showing Vol/Sat, Crit Moves for various movements.

Continental Grand Campus Specific Plan
City of El Segundo
Existing With Project PM Peak Hour (ICU)

Level Of Service Computation Report

ICU 1(Loss as Cycle Length %) Method (Future Volume Alternative)

Intersection #7 Sepulveda Blvd at Rosecrans Blvd

Cycle (sec): 100 Critical Vol./Cap.(X): 0.898
Loss Time (sec): 5 Average Delay (sec/veh): xxxxxx
Optimal Cycle: 85 Level Of Service: D

Table with columns for Street Name (Sepulveda Blvd, Rosecrans Blvd), Approach (North Bound, South Bound, East Bound, West Bound), Movement (L-T-R), Control (Protected, Permitted), Rights (Ovl, Include, Ignore), and traffic volume metrics (Min. Green, Y+R, Lanes).

Volume Module table showing Base Vol, Growth Adj, Initial Bse, Added Vol, PasserByVol, Initial Fut, User Adj, PHF Adj, PHF Volume, Reduct Vol, Reduced Vol, PCE Adj, MLF Adj, FinalVolume, and OvlAdjVol.

Saturation Flow Module table showing Sat/Lane, Adjustment, Lanes, and Final Sat. values.

Capacity Analysis Module table showing Vol/Sat, OvlAdjV/S, and Crit Moves.

Continental Grand Campus Specific Plan
City of El Segundo
Existing With Project PM Peak Hour (ICU)

Level Of Service Computation Report

ICU 1(Loss as Cycle Length %) Method (Future Volume Alternative)

Intersection #8 Continental Boulevard at Mariposa Ave

Cycle (sec): 100 Critical Vol./Cap.(X): 0.401
Loss Time (sec): 5 Average Delay (sec/veh): xxxxxx
Optimal Cycle: 20 Level Of Service: A

Table with columns for Street Name (Continental Boulevard, Mariposa Avenue), Approach (North Bound, South Bound, East Bound, West Bound), Movement (L-T-R), Control (Permitted), Rights (Include), and traffic volume metrics (Min. Green, Y+R, Lanes).

Volume Module table showing Base Vol, Growth Adj, Initial Bse, Added Vol, PasserByVol, Initial Fut, User Adj, PHF Adj, PHF Volume, Reduct Vol, Reduced Vol, PCE Adj, MLF Adj, FinalVolume, and OvlAdjVol.

Saturation Flow Module table showing Sat/Lane, Adjustment, Lanes, and Final Sat. values.

Capacity Analysis Module table showing Vol/Sat, Crit Moves, and other metrics.

Continental Grand Campus Specific Plan
City of El Segundo
Existing With Project PM Peak Hour (ICU)

Level Of Service Computation Report

ICU 1(Loss as Cycle Length %) Method (Future Volume Alternative)

Intersection #9 Continental Boulevard at Grand Avenue

Cycle (sec): 100 Critical Vol./Cap.(X): 0.364
Loss Time (sec): 5 Average Delay (sec/veh): xxxxxx
Optimal Cycle: 19 Level Of Service: A

Table with columns for Street Name, Approach, Movement, Control, Rights, Min. Green, Y+R, Lanes. Rows include Continental Boulevard and Grand Avenue with various approach and movement details.

Volume Module:

Table with columns for Base Vol, Growth Adj, Initial Bse, Added Vol, PasserByVol, Initial Fut, User Adj, PHF Adj, PHF Volume, Reduct Vol, Reduced Vol, PCE Adj, MLF Adj, FinalVolume. Rows include Continental Boulevard and Grand Avenue.

Saturation Flow Module:

Table with columns for Sat/Lane, Adjustment, Lanes, Final Sat. Rows include Continental Boulevard and Grand Avenue.

Capacity Analysis Module:

Table with columns for Vol/Sat, Crit Moves. Rows include Continental Boulevard and Grand Avenue.

Continental Grand Campus Specific Plan
City of El Segundo
Existing With Project PM Peak Hour (ICU)

Level Of Service Computation Report

ICU 1(Loss as Cycle Length %) Method (Future Volume Alternative)

Intersection #10 Continental Boulevard at El Segundo Boulevard

Cycle (sec): 100 Critical Vol./Cap.(X): 0.469
Loss Time (sec): 5 Average Delay (sec/veh): xxxxxx
Optimal Cycle: 22 Level Of Service: A

Table with columns for Street Name, Approach, Movement, Control, Rights, Min. Green, Y+R, Lanes. Rows include Continental Boulevard and El Segundo Boulevard with various approach and movement details.

Volume Module:

Table with columns for Base Vol, Growth Adj, Initial Bse, Added Vol, PasserByVol, Initial Fut, User Adj, PHF Adj, PHF Volume, Reduct Vol, Reduced Vol, PCE Adj, MLF Adj, FinalVolume. Rows include Continental Boulevard and El Segundo Boulevard.

Saturation Flow Module:

Table with columns for Sat/Lane, Adjustment, Lanes, Final Sat. Rows include Continental Boulevard and El Segundo Boulevard.

Capacity Analysis Module:

Table with columns for Vol/Sat, Crit Moves. Rows include Continental Boulevard and El Segundo Boulevard.

Continental Grand Campus Specific Plan
City of El Segundo
Existing With Project PM Peak Hour (ICU)

Level Of Service Computation Report

ICU 1(Loss as Cycle Length %) Method (Future Volume Alternative)

Intersection #11 Nash St and Imperial Hwy

Cycle (sec): 100 Critical Vol./Cap.(X): 0.488
Loss Time (sec): 5 Average Delay (sec/veh): xxxxxx
Optimal Cycle: 23 Level Of Service: A

Table with columns for Street Name (Nash St, Imperial Hwy), Approach (North Bound, South Bound, East Bound, West Bound), Movement (L, T, R), Control (Split Phase, Protected), Rights (Include), and traffic volume data (Min. Green, Y+R, Lanes).

Volume Module table showing Base Vol, Growth Adj, Initial Bse, Added Vol, PasserByVol, Initial Fut, User Adj, PHF Adj, PHF Volume, Reduct Vol, Reduced Vol, PCE Adj, MLF Adj, and Final Volume for various movements.

Saturation Flow Module table showing Sat/Lane, Adjustment, Lanes, and Final Sat. for various movements.

Capacity Analysis Module table showing Vol/Sat and Crit Moves for various movements.

Continental Grand Campus Specific Plan
City of El Segundo
Existing With Project PM Peak Hour (ICU)

Level Of Service Computation Report

ICU 1(Loss as Cycle Length %) Method (Future Volume Alternative)

Intersection #12 Nash St at Mariposa Ave

Cycle (sec): 100 Critical Vol./Cap.(X): 0.639
Loss Time (sec): 5 Average Delay (sec/veh): xxxxxx
Optimal Cycle: 32 Level Of Service: B

Table with columns for Street Name (Nash St, Mariposa Ave), Approach (North Bound, South Bound, East Bound, West Bound), Movement (L, T, R), Control (Permitted), Rights (Include), and traffic volume data (Min. Green, Y+R, Lanes).

Volume Module table showing Base Vol, Growth Adj, Initial Bse, Added Vol, PasserByVol, Initial Fut, User Adj, PHF Adj, PHF Volume, Reduct Vol, Reduced Vol, PCE Adj, MLF Adj, and Final Volume for various movements.

Saturation Flow Module table showing Sat/Lane, Adjustment, Lanes, and Final Sat. for various movements.

Capacity Analysis Module table showing Vol/Sat and Crit Moves for various movements.

Continental Grand Campus Specific Plan
City of El Segundo
Existing With Project PM Peak Hour (ICU)

Level Of Service Computation Report

ICU 1(Loss as Cycle Length %) Method (Future Volume Alternative)

Intersection #13 Nash St at Grand Ave

Cycle (sec): 100 Critical Vol./Cap.(X): 0.533
Loss Time (sec): 5 Average Delay (sec/veh): xxxxxx
Optimal Cycle: 25 Level Of Service: A

Table with columns for Street Name (Nash St, Grand Ave), Approach (North Bound, South Bound, East Bound, West Bound), Movement (L, T, R), Control (Protected, Split Phase), Rights (Include), and traffic volume metrics (Min. Green, Y+R, Lanes).

Volume Module table showing Base Vol, Growth Adj, Initial Bse, Added Vol, PasserByVol, Initial Fut, User Adj, PHF Adj, PHF Volume, Reduct Vol, Reduced Vol, PCE Adj, MLF Adj, and Final Volume for various movements.

Saturation Flow Module table showing Sat/Lane, Adjustment, Lanes, and Final Sat. for various movements.

Capacity Analysis Module table showing Vol/Sat, Crit Moves, and OvlAdjV/S for various movements.

Continental Grand Campus Specific Plan
City of El Segundo
Existing With Project PM Peak Hour (ICU)

Level Of Service Computation Report

ICU 1(Loss as Cycle Length %) Method (Future Volume Alternative)

Intersection #14 Nash St at El Segundo Blvd

Cycle (sec): 100 Critical Vol./Cap.(X): 0.584
Loss Time (sec): 5 Average Delay (sec/veh): xxxxxx
Optimal Cycle: 28 Level Of Service: A

Table with columns for Street Name (Nash St, El Segundo Blvd), Approach (North Bound, South Bound, East Bound, West Bound), Movement (L, T, R), Control (Split Phase, Protected), Rights (Include), and traffic volume metrics (Min. Green, Y+R, Lanes).

Volume Module table showing Base Vol, Growth Adj, Initial Bse, Added Vol, PasserByVol, Initial Fut, User Adj, PHF Adj, PHF Volume, Reduct Vol, Reduced Vol, PCE Adj, MLF Adj, and Final Volume for various movements.

Saturation Flow Module table showing Sat/Lane, Adjustment, Lanes, and Final Sat. for various movements.

Capacity Analysis Module table showing Vol/Sat, Crit Moves, and OvlAdjV/S for various movements.

Continental Grand Campus Specific Plan
City of El Segundo
Existing With Project PM Peak Hour (ICU)

Level Of Service Computation Report

ICU 1(Loss as Cycle Length %) Method (Future Volume Alternative)

Intersection #15 Douglas Street at El Segundo Boulevard

Cycle (sec): 100 Critical Vol./Cap.(X): 0.918
Loss Time (sec): 5 Average Delay (sec/veh): xxxxxx
Optimal Cycle: 99 Level Of Service: E

Table with columns: Street Name, Approach, Movement, Control, Rights, Min. Green, Y+R, Lanes. Rows for Douglas St and El Segundo Blvd.

Table with columns: Volume Module, Base Vol, Growth Adj, Initial Bse, Added Vol, PasserByVol, Initial Fut, User Adj, PHF Adj, PHF Volume, Reduct Vol, Reduced Vol, PCE Adj, MLF Adj, FinalVolume.

Table with columns: Sat/Lane, Adjustment, Lanes, Final Sat. for Saturation Flow Module.

Table with columns: Vol/Sat, Crit Moves for Capacity Analysis Module.

Continental Grand Campus Specific Plan
City of El Segundo
Existing With Project PM Peak Hour (ICU)

Level Of Service Computation Report

ICU 1(Loss as Cycle Length %) Method (Future Volume Alternative)

Intersection #16 Aviation Boulevard at El Segundo Boulevard

Cycle (sec): 100 Critical Vol./Cap.(X): 0.971
Loss Time (sec): 5 Average Delay (sec/veh): xxxxxx
Optimal Cycle: 165 Level Of Service: E

Table with columns: Street Name, Approach, Movement, Control, Rights, Min. Green, Y+R, Lanes. Rows for Aviation Blvd and El Segundo Blvd.

Table with columns: Volume Module, Base Vol, Growth Adj, Initial Bse, Added Vol, PasserByVol, Initial Fut, User Adj, PHF Adj, PHF Volume, Reduct Vol, Reduced Vol, PCE Adj, MLF Adj, FinalVolume, OvlAdjVol.

Table with columns: Sat/Lane, Adjustment, Lanes, Final Sat. for Saturation Flow Module.

Table with columns: Vol/Sat, OvlAdjV/S, Crit Moves for Capacity Analysis Module.

Continental Grand Campus Specific Plan
City of El Segundo
Existing With Project PM Peak Hour (ICU)

Level of Service Computation Report

ICU 1(Loss as Cycle Length %) Method (Future Volume Alternative)

Intersection #17 El Segundo Boulevard and Isis Avenue

Cycle (sec): 100 Critical Vol./Cap.(X): 0.660
Loss Time (sec): 5 Average Delay (sec/veh): xxxxxx
Optimal Cycle: 33 Level Of Service: B

Table with columns for Street Name, Approach, Movement, Control, Rights, Min. Green, Y+R, Lanes. Rows for Isis Avenue and El Segundo Boulevard.

Volume Module table with columns for Base Vol, Growth Adj, Initial Bse, Added Vol, PasserByVol, Initial Fut, User Adj, PHF Adj, PHF Volume, Reduct Vol, Reduced Vol, PCE Adj, MLF Adj, FinalVolume.

Saturation Flow Module table with columns for Sat/Lane, Adjustment, Lanes, Final Sat.

Capacity Analysis Module table with columns for Vol/Sat, Crit Moves.

Continental Grand Campus Specific Plan
City of El Segundo
Existing With Project PM Peak Hour (ICU)

Level of Service Computation Report

ICU 1(Loss as Cycle Length %) Method (Future Volume Alternative)

Intersection #18 El Segundo Blvd at I-405 SB Ramps

Cycle (sec): 100 Critical Vol./Cap.(X): 0.949
Loss Time (sec): 5 Average Delay (sec/veh): xxxxxx
Optimal Cycle: 129 Level Of Service: E

Table with columns for Street Name, Approach, Movement, Control, Rights, Min. Green, Y+R, Lanes. Rows for I-405 SB Ramps and El Segundo Blvd.

Volume Module table with columns for Base Vol, Growth Adj, Initial Bse, Added Vol, PasserByVol, Initial Fut, User Adj, PHF Adj, PHF Volume, Reduct Vol, Reduced Vol, PCE Adj, MLF Adj, FinalVolume.

Saturation Flow Module table with columns for Sat/Lane, Adjustment, Lanes, Final Sat.

Capacity Analysis Module table with columns for Vol/Sat, Crit Moves.

Continental Grand Campus Specific Plan
City of El Segundo
Existing With Project PM Peak Hour (ICU)

Level Of Service Computation Report

ICU 1(Loss as Cycle Length %) Method (Future Volume Alternative)

Intersection #19 El Segundo Blvd at La Cienega Blvd

Cycle (sec): 100 Critical Vol./Cap.(X): 0.656
Loss Time (sec): 5 Average Delay (sec/veh): xxxxxx
Optimal Cycle: 33 Level Of Service: B

Table with columns for Street Name, Approach, Movement, Control, Rights, Min. Green, Y+R, Lanes. Rows include La Cienega Blvd and El Segundo Blvd with various approach and movement details.

Table with columns for Volume Module, Base Vol, Growth Adj, Initial Bse, Added Vol, PasserByVol, Initial Fut, User Adj, PHF Adj, PHF Volume, Reduct Vol, Reduced Vol, PCE Adj, MLF Adj, FinalVolume. Rows include La Cienega Blvd and El Segundo Blvd.

Table with columns for Sat/Lane, Adjustment, Lanes, Final Sat. Rows include La Cienega Blvd and El Segundo Blvd.

Table with columns for Vol/Sat, Crit Moves. Rows include La Cienega Blvd and El Segundo Blvd.

Continental Grand Campus Specific Plan
City of El Segundo
Existing With Project PM Peak Hour (ICU)

Level Of Service Computation Report

ICU 1(Loss as Cycle Length %) Method (Future Volume Alternative)

Intersection #20 El Segundo Blvd at I-405 NB Ramps

Cycle (sec): 100 Critical Vol./Cap.(X): 0.694
Loss Time (sec): 5 Average Delay (sec/veh): xxxxxx
Optimal Cycle: 37 Level Of Service: B

Table with columns for Street Name, Approach, Movement, Control, Rights, Min. Green, Y+R, Lanes. Rows include I-405 NB Ramps and El Segundo Blvd with various approach and movement details.

Table with columns for Volume Module, Base Vol, Growth Adj, Initial Bse, Added Vol, PasserByVol, Initial Fut, User Adj, PHF Adj, PHF Volume, Reduct Vol, Reduced Vol, PCE Adj, MLF Adj, FinalVolume. Rows include I-405 NB Ramps and El Segundo Blvd.

Table with columns for Sat/Lane, Adjustment, Lanes, Final Sat. Rows include I-405 NB Ramps and El Segundo Blvd.

Table with columns for Vol/Sat, Crit Moves. Rows include I-405 NB Ramps and El Segundo Blvd.

 Continental Grand Campus Specific Plan
 City of El Segundo
 Phase 1 Opening Year (2022) Without Project AM Peak Hour (ICU)

Scenario: Phase 1 Op Yr W/o Proj AM
 Command: Phase 1 Op Yr W/o Proj AM
 Volume: OY AM
 Geometry: Existing
 Impact Fee: Default Impact Fee
 Trip Generation: Cum AM
 Trip Distribution: Cum + Proj
 Paths: Project
 Routes: Default Route
 Configuration: Phase 1 Op Yr W/o Proj AM

 Continental Grand Campus Specific Plan
 City of El Segundo
 Phase 1 Opening Year (2022) Without Project AM Peak Hour (ICU)

Trip Generation Report

Forecast for Cum AM

Zone #	Subzone	Amount	Units	Rate In	Rate Out	Trips In	Trips Out	Total Trips	% Of Total
306	525 N. Sepul	1.00	Residential	-6.00	-3.00	-6	-3	-9	-0.6
	Zone 306 Subtotal					-6	-3	-9	-0.6
307	540 Imperial	1.00	Residential	23.00	44.00	23	44	67	4.7
	Zone 307 Subtotal					23	44	67	4.7
311	199 Continen	1.00	Business Hotel	48.00	33.00	48	33	81	5.7
	Zone 311 Subtotal					48	33	81	5.7
313	445 N. Dougl	1.00	Equinix Data C	8.00	8.00	8	8	16	1.1
	Zone 313 Subtotal					8	8	16	1.1
314	123 Lomita a	1.00	Office	17.00	3.00	17	3	20	1.4
	Zone 314 Subtotal					17	3	20	1.4
704	2355 Utah Av	1.00	Office	150.00	76.00	150	76	226	15.9
	Zone 704 Subtotal					150	76	226	15.9
706	888 Sepulved	1.00	hotel	57.00	36.00	57	36	93	6.5
	Zone 706 Subtotal					57	36	93	6.5
710	201 North Do	1.00	High School	160.00	111.00	160	111	271	19.1
710	201 North Do	1.00	District Offic	20.00	2.00	20	2	22	1.5
	Zone 710 Subtotal					180	113	293	20.6
714	400 Duley -	1.00	Office	95.00	13.00	95	13	108	7.6
	Zone 714 Subtotal					95	13	108	7.6
717	1700 Imperia	1.00	Townhome Resid	133.00	18.00	133	18	151	10.6
	Zone 717 Subtotal					133	18	151	10.6
718	123 Nevada S	1.00	Office	18.00	3.00	18	3	21	1.5
718	123 Nevada S	0.00	123 Nevada	18.00	3.00	0	0	0	0.0
	Zone 718 Subtotal					18	3	21	1.5
719	2125 Campus	1.00	Office Retail	160.00	46.00	160	46	206	14.5
	Zone 719 Subtotal					160	46	206	14.5
1002	Laker Facili	1.00	General Office	136.00	13.00	136	13	149	10.5
	Zone 1002 Subtotal					136	13	149	10.5

 Continental Grand Campus Specific Plan
 City of El Segundo
 Phase 1 Opening Year (2022) Without Project AM Peak Hour (ICU)

Zone #	Subzone	Amount	Units	Rate In	Rate Out	Trips In	Trips Out	Total Trips	% Of Total
TOTAL						1019	403	1422	100.0

 Continental Grand Campus Specific Plan
 City of El Segundo
 Phase 1 Opening Year (2022) Without Project AM Peak Hour (ICU)

Trip Distribution Report

Percent Of Trips Cum + Project

Zone	To Gates											
	1	2	3	4	5	7	8	9	10	11	12	
306	10.0	15.0	10.0	5.0	0.0	5.0	5.0	25.0	0.0	25.0	0.0	
307	10.0	15.0	10.0	5.0	50.0	0.0	0.0	0.0	0.0	0.0	0.0	
311	40.0	10.0	10.0	10.0	0.0	5.0	5.0	10.0	0.0	10.0	0.0	
313	15.0	5.0	15.0	10.0	25.0	0.0	5.0	20.0	0.0	0.0	0.0	
314	40.0	10.0	10.0	10.0	0.0	5.0	5.0	10.0	0.0	10.0	0.0	
704	30.0	15.0	8.0	12.0	0.0	5.0	5.0	10.0	5.0	10.0	0.0	
706	25.0	20.0	10.0	25.0	0.0	0.0	0.0	0.0	0.0	0.0	10.0	
710	0.0	0.0	15.0	10.0	10.0	2.0	2.0	20.0	5.0	10.0	1.0	
714	5.0	10.0	5.0	5.0	20.0	5.0	10.0	15.0	5.0	15.0	0.0	
717	10.0	15.0	10.0	5.0	50.0	0.0	0.0	0.0	0.0	0.0	0.0	
718	10.0	10.0	10.0	10.0	20.0	0.0	0.0	20.0	10.0	0.0	0.0	
719	20.0	10.0	10.0	10.0	10.0	5.0	5.0	10.0	5.0	0.0	0.0	
1002	0.0	10.0	5.0	5.0	15.0	5.0	10.0	15.0	5.0	15.0	5.0	
1004	5.0	15.0	10.0	5.0	30.0	0.0	5.0	20.0	0.0	0.0	5.0	
1005	5.0	15.0	10.0	5.0	30.0	0.0	5.0	20.0	0.0	0.0	5.0	
1007	0.0	0.0	0.0	0.0	0.0	0.0	0.0	0.0	0.0	0.0	0.0	

Zone	To Gates						
	13	14	15	16	17	18	20
306	0.0	0.0	0.0	0.0	0.0	0.0	0.0
307	0.0	10.0	0.0	0.0	0.0	0.0	0.0
311	0.0	0.0	0.0	0.0	0.0	0.0	0.0
313	5.0	0.0	0.0	0.0	0.0	0.0	0.0
314	0.0	0.0	0.0	0.0	0.0	0.0	0.0
704	0.0	0.0	0.0	0.0	0.0	0.0	0.0
706	0.0	0.0	0.0	0.0	10.0	0.0	0.0
710	10.0	5.0	10.0	0.0	0.0	0.0	0.0
714	0.0	5.0	0.0	0.0	0.0	0.0	0.0
717	0.0	10.0	0.0	0.0	0.0	0.0	0.0
718	0.0	10.0	0.0	0.0	0.0	0.0	0.0
719	0.0	10.0	5.0	0.0	0.0	0.0	0.0
1002	0.0	5.0	5.0	0.0	0.0	0.0	0.0
1004	0.0	5.0	0.0	0.0	0.0	0.0	0.0
1005	0.0	5.0	0.0	0.0	0.0	0.0	0.0
1007	0.0	0.0	0.0	0.0	0.0	20.0	10.0

Continental Grand Campus Specific Plan
 City of El Segundo
 Phase 1 Opening Year (2022) Without Project AM Peak Hour (ICU)

Impact Analysis Report
 Level Of Service

Intersection	Base		Future		Change in
	Del/	V/	Del/	V/	
	LOS Veh	C	LOS Veh	C	
# 1 Sepulveda Blvd at Imperial Hwy	D xxxxx	0.808	D xxxxx	0.868	+ 0.060 V/C
# 2 Sepulveda Blvd at Walnut St	A xxxxx	0.568	C xxxxx	0.727	+ 0.160 V/C
# 3 Sepulveda Blvd at Maple Ave	A xxxxx	0.582	C xxxxx	0.725	+ 0.143 V/C
# 4 Sepulveda Blvd at Mariposa Ave	B xxxxx	0.684	C xxxxx	0.764	+ 0.080 V/C
# 5 Sepulveda Blvd at Grand Ave	C xxxxx	0.764	D xxxxx	0.852	+ 0.087 V/C
# 6 Sepulveda Blvd at El Segundo B	C xxxxx	0.770	F xxxxx	1.069	+ 0.299 V/C
# 7 Sepulveda Blvd at Rosecrans Bl	D xxxxx	0.807	E xxxxx	0.924	+ 0.117 V/C
# 8 Continental Boulevard at Marip	A xxxxx	0.388	A xxxxx	0.390	+ 0.002 V/C
# 9 Continental Boulevard at Grand	A xxxxx	0.314	A xxxxx	0.329	+ 0.014 V/C
# 10 Continental Boulevard at El Se	A xxxxx	0.400	A xxxxx	0.547	+ 0.147 V/C
# 11 Nash St and Imperial Hwy	B xxxxx	0.639	C xxxxx	0.773	+ 0.134 V/C
# 12 Nash St at Mariposa Ave	A xxxxx	0.467	B xxxxx	0.605	+ 0.138 V/C
# 13 Nash St at Grand Ave	A xxxxx	0.486	A xxxxx	0.547	+ 0.061 V/C
# 14 Nash St at El Segundo Blvd	A xxxxx	0.463	C xxxxx	0.729	+ 0.266 V/C
# 15 Douglas Street at El Segundo B	C xxxxx	0.708	E xxxxx	0.988	+ 0.279 V/C
# 16 Aviation Boulevard at El Segun	D xxxxx	0.822	F xxxxx	1.165	+ 0.343 V/C
# 17 El Segundo Boulevard and Isis	A xxxxx	0.585	D xxxxx	0.826	+ 0.242 V/C
# 18 El Segundo Blvd at I-405 SB Ra	A xxxxx	0.528	C xxxxx	0.771	+ 0.243 V/C
# 19 El Segundo Blvd at La Cienega	A xxxxx	0.577	D xxxxx	0.847	+ 0.269 V/C
# 20 El Segundo Blvd at I-405 NB Ra	C xxxxx	0.709	D xxxxx	0.880	+ 0.170 V/C

Continental Grand Campus Specific Plan
 City of El Segundo
 Phase 1 Opening Year (2022) Without Project AM Peak Hour (ICU)

Level Of Service Computation Report
 ICU 1(Loss as Cycle Length %) Method (Future Volume Alternative)

 Intersection #1 Sepulveda Blvd at Imperial Hwy

Cycle (sec):	100	Critical Vol./Cap.(X):	0.868
Loss Time (sec):	5	Average Delay (sec/veh):	xxxxxx
Optimal Cycle:	71	Level Of Service:	D

Street Name:	Sepulveda Blvd				Imperial Hwy					
Approach:	North Bound		South Bound		East Bound		West Bound			
Movement:	L - T - R	L - T - R	L - T - R	L - T - R	L - T - R	L - T - R	L - T - R			
Control:	Protected		Protected		Protected		Protected			
Rights:	Include		Include		Include		Ovl			
Min. Green:	0	0	0	0	0	0	0	0		
Y+R:	4.0	4.0	4.0	4.0	4.0	4.0	4.0	4.0		
Lanes:	1	0	3	0	1	2	0	3	0	1

Volume Module:

Base Vol:	63	1495	418	448	2297	12	210	316	140	211	292	590
Growth Adj:	1.02	1.02	1.02	1.02	1.02	1.02	1.02	1.02	1.02	1.02	1.02	1.02
Initial Bse:	64	1520	425	455	2335	12	213	321	142	215	297	600
Added Vol:	17	48	13	23	185	2	4	31	56	15	3	12
Related Pro:	9	130	38	-85	615	0	-5	25	30	6	5	-90
Initial Fut:	90	1698	476	393	3135	14	212	377	228	236	305	522
User Adj:	1.00	1.00	1.00	1.00	1.00	1.00	1.00	1.00	1.00	1.00	1.00	1.00
PHF Adj:	1.00	1.00	1.00	1.00	1.00	1.00	1.00	1.00	1.00	1.00	1.00	1.00
PHF Volume:	90	1698	476	393	3135	14	212	377	228	236	305	522
Reduct Vol:	0	0	0	0	0	0	0	0	0	0	0	0
Reduced Vol:	90	1698	476	393	3135	14	212	377	228	236	305	522
PCE Adj:	1.00	1.00	1.00	1.00	1.00	1.00	1.00	1.00	1.00	1.00	1.00	1.00
MLF Adj:	1.00	1.00	1.00	1.00	1.00	1.00	1.00	1.00	1.00	1.00	1.00	1.00
FinalVolume:	90	1698	476	393	3135	14	212	377	228	236	305	522
OvlAdjVol:												325

Saturation Flow Module:

Sat/Lane:	1600	1600	1600	1600	1600	1600	1600	1600	1600	1600	1600	1600
Adjustment:	1.00	1.00	1.00	1.00	1.00	1.00	1.00	1.00	1.00	1.00	1.00	1.00
Lanes:	1.00	3.00	1.00	2.00	3.98	0.02	2.00	3.00	1.00	2.00	3.00	1.00
Final Sat.:	1600	4800	1600	3200	6371	29	3200	4800	1600	3200	4800	1600

Capacity Analysis Module:

Vol/Sat:	0.06	0.35	0.30	0.12	0.49	0.49	0.07	0.08	0.14	0.07	0.06	0.33
OvlAdjV/S:												0.20
Crit Moves:	****			****			****					****

Continental Grand Campus Specific Plan
City of El Segundo

Phase 1 Opening Year (2022) Without Project AM Peak Hour (ICU)

Level Of Service Computation Report

ICU 1(Loss as Cycle Length %) Method (Future Volume Alternative)

Intersection #2 Sepulveda Blvd at Walnut St

Cycle (sec): 100 Critical Vol./Cap.(X): 0.727
Loss Time (sec): 5 Average Delay (sec/veh): xxxxxx
Optimal Cycle: 40 Level Of Service: C

Table with columns for Street Name, Approach, Movement, Control, Rights, Min. Green, Y+R, Lanes. Rows for Sepulveda Blvd and Walnut St.

Table with columns for Volume Module, Base Vol, Growth Adj, Initial Bse, Added Vol, Related Pro, Initial Fut, User Adj, PHF Adj, PHF Volume, Reduct Vol, Reduced Vol, PCE Adj, MLF Adj, Final Volume.

Table with columns for Sat/Lane, Adjustment, Lanes, Final Sat. for Saturation Flow Module.

Table with columns for Vol/Sat, Crit Moves for Capacity Analysis Module.

Continental Grand Campus Specific Plan
City of El Segundo

Phase 1 Opening Year (2022) Without Project AM Peak Hour (ICU)

Level Of Service Computation Report

ICU 1(Loss as Cycle Length %) Method (Future Volume Alternative)

Intersection #3 Sepulveda Blvd at Maple Ave

Cycle (sec): 100 Critical Vol./Cap.(X): 0.725
Loss Time (sec): 5 Average Delay (sec/veh): xxxxxx
Optimal Cycle: 40 Level Of Service: C

Table with columns for Street Name, Approach, Movement, Control, Rights, Min. Green, Y+R, Lanes. Rows for Sepulveda Blvd and Maple Ave.

Table with columns for Volume Module, Base Vol, Growth Adj, Initial Bse, Added Vol, Related Pro, Initial Fut, User Adj, PHF Adj, PHF Volume, Reduct Vol, Reduced Vol, PCE Adj, MLF Adj, Final Volume.

Table with columns for Sat/Lane, Adjustment, Lanes, Final Sat. for Saturation Flow Module.

Table with columns for Vol/Sat, Crit Moves for Capacity Analysis Module.

Continental Grand Campus Specific Plan
 City of El Segundo
 Phase 1 Opening Year (2022) Without Project AM Peak Hour (ICU)

Level Of Service Computation Report
 ICU 1(Loss as Cycle Length %) Method (Future Volume Alternative)

 Intersection #4 Sepulveda Blvd at Mariposa Ave

Cycle (sec): 100 Critical Vol./Cap.(X): 0.764
 Loss Time (sec): 5 Average Delay (sec/veh): xxxxxx
 Optimal Cycle: 46 Level Of Service: C

Street Name: Sepulveda Blvd Mariposa Ave

Approach: North Bound South Bound East Bound West Bound
 Movement: L - T - R L - T - R L - T - R L - T - R

Control: Protected Protected Permitted Permitted
 Rights: Include Include Include Include
 Min. Green: 0 0 0 0 0 0 0 0 0 0 0 0
 Y+R: 4.0 4.0 4.0 4.0 4.0 4.0 4.0 4.0 4.0 4.0 4.0
 Lanes: 1 0 4 0 1 2 0 3 1 0 1 0 0 1 1

Volume Module:
 Base Vol: 62 1984 155 418 1791 58 104 179 49 65 86 84
 Growth Adj: 1.02 1.02 1.02 1.02 1.02 1.02 1.02 1.02 1.02 1.02 1.02 1.02
 Initial Bse: 63 2017 158 425 1821 59 106 182 50 66 87 85
 Added Vol: 1 80 33 13 93 -1 0 35 9 8 7 7
 Related Pro: 6 186 -25 17 651 14 14 -10 30 -25 0 -8
 Initial Fut: 70 2283 166 455 2565 72 120 207 89 49 94 84
 User Adj: 1.00 1.00 1.00 1.00 1.00 1.00 1.00 1.00 1.00 1.00 1.00 1.00
 PHF Adj: 1.00 1.00 1.00 1.00 1.00 1.00 1.00 1.00 1.00 1.00 1.00 1.00
 PHF Volume: 70 2283 166 455 2565 72 120 207 89 49 94 84
 Reduct Vol: 0 0 0 0 0 0 0 0 0 0 0 0
 Reduced Vol: 70 2283 166 455 2565 72 120 207 89 49 94 84
 PCE Adj: 1.00 1.00 1.00 1.00 1.00 1.00 1.00 1.00 1.00 1.00 1.00 1.00
 MLF Adj: 1.00 1.00 1.00 1.00 1.00 1.00 1.00 1.00 1.00 1.00 1.00 1.00
 FinalVolume: 70 2283 166 455 2565 72 120 207 89 49 94 84

Saturation Flow Module:
 Sat/Lane: 1600 1600 1600 1600 1600 1600 1600 1600 1600 1600 1600 1600
 Adjustment: 1.00 1.00 1.00 1.00 1.00 1.00 1.00 1.00 1.00 1.00 1.00 1.00
 Lanes: 1.00 4.00 1.00 2.00 3.89 0.11 1.00 0.70 0.30 1.00 1.00 1.00
 Final Sat.: 1600 6400 1600 3200 6225 175 1600 1120 480 1600 1600 1600

Capacity Analysis Module:
 Vol/Sat: 0.04 0.36 0.10 0.14 0.41 0.41 0.07 0.18 0.18 0.03 0.06 0.05
 Crit Moves: ****

Continental Grand Campus Specific Plan
 City of El Segundo
 Phase 1 Opening Year (2022) Without Project AM Peak Hour (ICU)

Level Of Service Computation Report
 ICU 1(Loss as Cycle Length %) Method (Future Volume Alternative)

 Intersection #5 Sepulveda Blvd at Grand Ave

Cycle (sec): 100 Critical Vol./Cap.(X): 0.852
 Loss Time (sec): 5 Average Delay (sec/veh): xxxxxx
 Optimal Cycle: 66 Level Of Service: D

Street Name: Sepulveda Blvd Grand Ave

Approach: North Bound South Bound East Bound West Bound
 Movement: L - T - R L - T - R L - T - R L - T - R

Control: Protected Protected Split Phase Split Phase
 Rights: Ovl Include Include Include
 Min. Green: 0 0 0 0 0 0 0 0 0 0 0 0
 Y+R: 4.0 4.0 4.0 4.0 4.0 4.0 4.0 4.0 4.0 4.0 4.0
 Lanes: 1 0 4 0 1 1 0 3 1 0 1 1 0 1 1

Volume Module:
 Base Vol: 130 2061 544 406 1381 185 171 164 103 43 50 57
 Growth Adj: 1.02 1.02 1.02 1.02 1.02 1.02 1.02 1.02 1.02 1.02 1.02 1.02
 Initial Bse: 132 2095 553 413 1404 188 174 167 105 44 51 58
 Added Vol: 1 84 19 31 74 4 10 2 2 2 0 20
 Related Pro: 0 142 -15 5 662 10 10 0 27 0 0 10
 Initial Fut: 133 2321 557 449 2140 202 194 169 134 46 51 88
 User Adj: 1.00 1.00 1.00 1.00 1.00 1.00 1.00 1.00 1.00 1.00 1.00 1.00
 PHF Adj: 1.00 1.00 1.00 1.00 1.00 1.00 1.00 1.00 1.00 1.00 1.00 1.00
 PHF Volume: 133 2321 557 449 2140 202 194 169 134 46 51 88
 Reduct Vol: 0 0 0 0 0 0 0 0 0 0 0 0
 Reduced Vol: 133 2321 557 449 2140 202 194 169 134 46 51 88
 PCE Adj: 1.00 1.00 1.00 1.00 1.00 1.00 1.00 1.00 1.00 1.00 1.00 1.00
 MLF Adj: 1.00 1.00 1.00 1.00 1.00 1.00 1.00 1.00 1.00 1.00 1.00 1.00
 FinalVolume: 133 2321 557 449 2140 202 194 169 134 46 51 88
 OvlAdjVol: 469

Saturation Flow Module:
 Sat/Lane: 1600 1600 1600 1600 1600 1600 1600 1600 1600 1600 1600 1600
 Adjustment: 1.00 1.00 1.00 1.00 1.00 1.00 1.00 1.00 1.00 1.00 1.00 1.00
 Lanes: 1.00 4.00 1.00 1.00 3.65 0.35 1.17 1.02 0.81 2.00 2.00 1.00
 Final Sat.: 1600 6400 1600 1600 5848 552 1877 1633 1291 3200 3200 1600

Capacity Analysis Module:
 Vol/Sat: 0.08 0.36 0.35 0.28 0.37 0.37 0.10 0.10 0.10 0.01 0.02 0.05
 OvlAdjV/S: 0.29
 Crit Moves: ****

Continental Grand Campus Specific Plan
City of El Segundo

Phase 1 Opening Year (2022) Without Project AM Peak Hour (ICU)

Level Of Service Computation Report

ICU 1(Loss as Cycle Length %) Method (Future Volume Alternative)

Intersection #6 Sepulveda Blvd at El Segundo Blvd

Cycle (sec): 100 Critical Vol./Cap.(X): 1.069
Loss Time (sec): 5 Average Delay (sec/veh): xxxxxx
Optimal Cycle: 180 Level Of Service: F

Table with columns for Street Name, Approach, Movement, Control, Rights, Min. Green, Y+R, Lanes. Rows for Sepulveda Blvd and El Segundo Blvd.

Table with columns for Volume Module, Base Vol, Growth Adj, Initial Bse, Added Vol, Related Pro, Initial Fut, User Adj, PHF Adj, PHF Volume, Reduct Vol, Reduced Vol, PCE Adj, MLF Adj, Final Volume.

Table with columns for Sat/Lane, Adjustment, Lanes, Final Sat. for Saturation Flow Module.

Table with columns for Vol/Sat, Crit Moves for Capacity Analysis Module.

Continental Grand Campus Specific Plan
City of El Segundo

Phase 1 Opening Year (2022) Without Project AM Peak Hour (ICU)

Level Of Service Computation Report

ICU 1(Loss as Cycle Length %) Method (Future Volume Alternative)

Intersection #7 Sepulveda Blvd at Rosecrans Blvd

Cycle (sec): 100 Critical Vol./Cap.(X): 0.924
Loss Time (sec): 5 Average Delay (sec/veh): xxxxxx
Optimal Cycle: 103 Level Of Service: E

Table with columns for Street Name, Approach, Movement, Control, Rights, Min. Green, Y+R, Lanes. Rows for Sepulveda Blvd and Rosecrans Blvd.

Table with columns for Volume Module, Base Vol, Growth Adj, Initial Bse, Added Vol, Related Pro, Initial Fut, User Adj, PHF Adj, PHF Volume, Reduct Vol, Reduced Vol, PCE Adj, MLF Adj, Final Volume, OvlAdjVol.

Table with columns for Sat/Lane, Adjustment, Lanes, Final Sat. for Saturation Flow Module.

Table with columns for Vol/Sat, OvlAdjV/S, Crit Moves for Capacity Analysis Module.

Continental Grand Campus Specific Plan
City of El Segundo
Phase 1 Opening Year (2022) Without Project AM Peak Hour (ICU)

Level Of Service Computation Report
ICU 1(Loss as Cycle Length %) Method (Future Volume Alternative)

Intersection #8 Continental Boulevard at Mariposa Ave

Cycle (sec): 100 Critical Vol./Cap.(X): 0.390
Loss Time (sec): 5 Average Delay (sec/veh): xxxxxx
Optimal Cycle: 20 Level Of Service: A

Table with columns: Street Name, Approach, Movement, Control, Rights, Min. Green, Y+R, Lanes. Rows for Continental Boulevard and Mariposa Avenue.

Volume Module table with columns: Base Vol, Growth Adj, Initial Bse, Added Vol, Related Pro, Initial Fut, User Adj, PHF Adj, PHF Volume, Reduct Vol, Reduced Vol, PCE Adj, MLF Adj, Final Volume.

Saturation Flow Module table with columns: Sat/Lane, Adjustment, Lanes, Final Sat.

Capacity Analysis Module table with columns: Vol/Sat, Crit Moves.

Continental Grand Campus Specific Plan
City of El Segundo
Phase 1 Opening Year (2022) Without Project AM Peak Hour (ICU)

Level Of Service Computation Report
ICU 1(Loss as Cycle Length %) Method (Future Volume Alternative)

Intersection #9 Continental Boulevard at Grand Avenue

Cycle (sec): 100 Critical Vol./Cap.(X): 0.329
Loss Time (sec): 5 Average Delay (sec/veh): xxxxxx
Optimal Cycle: 18 Level Of Service: A

Table with columns: Street Name, Approach, Movement, Control, Rights, Min. Green, Y+R, Lanes. Rows for Continental Boulevard and Grand Avenue.

Volume Module table with columns: Base Vol, Growth Adj, Initial Bse, Added Vol, Related Pro, Initial Fut, User Adj, PHF Adj, PHF Volume, Reduct Vol, Reduced Vol, PCE Adj, MLF Adj, Final Volume.

Saturation Flow Module table with columns: Sat/Lane, Adjustment, Lanes, Final Sat.

Capacity Analysis Module table with columns: Vol/Sat, Crit Moves.

Continental Grand Campus Specific Plan
City of El Segundo
Phase 1 Opening Year (2022) Without Project AM Peak Hour (ICU)

Level Of Service Computation Report
ICU 1(Loss as Cycle Length %) Method (Future Volume Alternative)

Intersection #10 Continental Boulevard at El Segundo Boulevard

Cycle (sec): 100 Critical Vol./Cap.(X): 0.547
Loss Time (sec): 5 Average Delay (sec/veh): xxxxxx
Optimal Cycle: 26 Level Of Service: A

Table with columns for Street Name, Approach, Movement, Control, Rights, Min. Green, Y+R, Lanes. Rows for Continental Boulevard and El Segundo Boulevard.

Volume Module table with columns for Base Vol, Growth Adj, Initial Bse, Added Vol, Related Pro, Initial Fut, User Adj, PHF Adj, PHF Volume, Reduct Vol, Reduced Vol, PCE Adj, MLF Adj, Final Volume.

Saturation Flow Module table with columns for Sat/Lane, Adjustment, Lanes, Final Sat.

Capacity Analysis Module table with columns for Vol/Sat, Crit Moves.

Continental Grand Campus Specific Plan
City of El Segundo
Phase 1 Opening Year (2022) Without Project AM Peak Hour (ICU)

Level Of Service Computation Report
ICU 1(Loss as Cycle Length %) Method (Future Volume Alternative)

Intersection #11 Nash St and Imperial Hwy

Cycle (sec): 100 Critical Vol./Cap.(X): 0.773
Loss Time (sec): 5 Average Delay (sec/veh): xxxxxx
Optimal Cycle: 47 Level Of Service: C

Table with columns for Street Name, Approach, Movement, Control, Rights, Min. Green, Y+R, Lanes. Rows for Nash St and Imperial Hwy.

Volume Module table with columns for Base Vol, Growth Adj, Initial Bse, Added Vol, Related Pro, Initial Fut, User Adj, PHF Adj, PHF Volume, Reduct Vol, Reduced Vol, PCE Adj, MLF Adj, Final Volume.

Saturation Flow Module table with columns for Sat/Lane, Adjustment, Lanes, Final Sat.

Capacity Analysis Module table with columns for Vol/Sat, Crit Moves.

Continental Grand Campus Specific Plan
City of El Segundo

Phase 1 Opening Year (2022) Without Project AM Peak Hour (ICU)

Level of Service Computation Report

ICU 1(Loss as Cycle Length %) Method (Future Volume Alternative)

Intersection #12 Nash St at Mariposa Ave

Cycle (sec): 100 Critical Vol./Cap.(X): 0.605
Loss Time (sec): 5 Average Delay (sec/veh): xxxxxx
Optimal Cycle: 29 Level Of Service: B

Table with columns for Street Name (Nash St, Mariposa Ave), Approach (North Bound, South Bound, East Bound, West Bound), Movement (L, T, R), Control (Permitted, Include), Rights, Min. Green, Y+R, Lanes.

Table with columns for Volume Module: Base Vol, Growth Adj, Initial Bse, Added Vol, PasserByVol, Initial Fut, User Adj, PHF Adj, PHF Volume, Reduct Vol, Reduced Vol, PCE Adj, MLF Adj, FinalVolume.

Table with columns for Saturation Flow Module: Sat/Lane, Adjustment, Lanes, Final Sat.

Table with columns for Capacity Analysis Module: Vol/Sat, Crit Moves.

Continental Grand Campus Specific Plan
City of El Segundo

Phase 1 Opening Year (2022) Without Project AM Peak Hour (ICU)

Level of Service Computation Report

ICU 1(Loss as Cycle Length %) Method (Future Volume Alternative)

Intersection #13 Nash St at Grand Ave

Cycle (sec): 100 Critical Vol./Cap.(X): 0.547
Loss Time (sec): 5 Average Delay (sec/veh): xxxxxx
Optimal Cycle: 26 Level Of Service: A

Table with columns for Street Name (Nash St, Grand Ave), Approach (North Bound, South Bound, East Bound, West Bound), Movement (L, T, R), Control (Protected, Split Phase, Include), Rights, Min. Green, Y+R, Lanes.

Table with columns for Volume Module: Base Vol, Growth Adj, Initial Bse, Added Vol, Related Pro, Initial Fut, User Adj, PHF Adj, PHF Volume, Reduct Vol, Reduced Vol, PCE Adj, MLF Adj, FinalVolume.

Table with columns for Saturation Flow Module: Sat/Lane, Adjustment, Lanes, Final Sat.

Table with columns for Capacity Analysis Module: Vol/Sat, Crit Moves.

Continental Grand Campus Specific Plan
City of El Segundo
Phase 1 Opening Year (2022) Without Project AM Peak Hour (ICU)

Level Of Service Computation Report
ICU 1(Loss as Cycle Length %) Method (Future Volume Alternative)

Intersection #14 Nash St at El Segundo Blvd
Cycle (sec): 100 Critical Vol./Cap.(X): 0.729
Loss Time (sec): 5 Average Delay (sec/veh): xxxxxx
Optimal Cycle: 41 Level Of Service: C

Table with columns for Street Name (Nash St, El Segundo Blvd), Approach (North Bound, South Bound, East Bound, West Bound), Movement (L, T, R), Control (Split Phase, Protected, etc.), Rights (Ovl, Include), and various traffic metrics like Min. Green, Y+R, Lanes.

Volume Module table showing Base Vol, Growth Adj, Initial Bse, Added Vol, Related Pro, Initial Fut, User Adj, PHF Adj, PHF Volume, Reduct Vol, Reduced Vol, PCE Adj, MLF Adj, Final Volume, and OvlAdjVol across different movements.

Saturation Flow Module table showing Sat/Lane, Adjustment, Lanes, and Final Sat. for various movements.

Capacity Analysis Module table showing Vol/Sat, OvlAdjV/S, and Crit Moves for various movements.

Continental Grand Campus Specific Plan
City of El Segundo
Phase 1 Opening Year (2022) Without Project AM Peak Hour (ICU)

Level Of Service Computation Report
ICU 1(Loss as Cycle Length %) Method (Future Volume Alternative)

Intersection #15 Douglas Street at El Segundo Boulevard
Cycle (sec): 100 Critical Vol./Cap.(X): 0.988
Loss Time (sec): 5 Average Delay (sec/veh): xxxxxx
Optimal Cycle: 180 Level Of Service: E

Table with columns for Street Name (Douglas St, El Segundo Blvd), Approach (North Bound, South Bound, East Bound, West Bound), Movement (L, T, R), Control (Protected, etc.), Rights (Include), and various traffic metrics like Min. Green, Y+R, Lanes.

Volume Module table showing Base Vol, Growth Adj, Initial Bse, Added Vol, Related Pro, Initial Fut, User Adj, PHF Adj, PHF Volume, Reduct Vol, Reduced Vol, PCE Adj, MLF Adj, Final Volume, and OvlAdjVol across different movements.

Saturation Flow Module table showing Sat/Lane, Adjustment, Lanes, and Final Sat. for various movements.

Capacity Analysis Module table showing Vol/Sat, OvlAdjV/S, and Crit Moves for various movements.

Continental Grand Campus Specific Plan
City of El Segundo
Phase 1 Opening Year (2022) Without Project AM Peak Hour (ICU)

Level Of Service Computation Report
ICU 1(Loss as Cycle Length %) Method (Future Volume Alternative)

Intersection #16 Aviation Boulevard at El Segundo Boulevard

Cycle (sec): 100 Critical Vol./Cap.(X): 1.165
Loss Time (sec): 5 Average Delay (sec/veh): xxxxxx
Optimal Cycle: 180 Level Of Service: F

Street Name: Aviatio Blvd El Segundo Blvd
Approach: North Bound South Bound East Bound West Bound
Movement: L - T - R L - T - R L - T - R L - T - R

Control: Protected Protected Protected Protected
Rights: Ovl Include Include Include
Min. Green: 0 0 0 0 0 0 0 0 0 0 0 0
Y+R: 4.0 4.0 4.0 4.0 4.0 4.0 4.0 4.0 4.0 4.0 4.0
Lanes: 2 0 2 0 1 1 0 1 1 1 1 0

Volume Module:
Base Vol: 326 1027 306 21 774 435 118 454 77 410 1528 75
Growth Adj: 1.01 1.01 1.01 1.01 1.01 1.01 1.01 1.01 1.01 1.01 1.01
Initial Bse: 331 1041 310 21 785 441 120 460 78 416 1549 76
Added Vol: 33 0 0 2 0 10 5 109 14 0 280 1
Related Pro: 167 36 -28 0 49 48 22 94 35 2 887 -10
Initial Fut: 531 1077 282 23 834 499 147 663 127 418 2716 67
User Adj: 1.00 1.00 1.00 1.00 1.00 1.00 1.00 1.00 1.00 1.00 1.00
PHF Adj: 1.00 1.00 1.00 1.00 1.00 1.00 1.00 1.00 1.00 1.00 1.00
PHF Volume: 531 1077 282 23 834 499 147 663 127 418 2716 67
Reduct Vol: 0 0 0 0 0 0 0 0 0 0 0 0
Reduced Vol: 531 1077 282 23 834 499 147 663 127 418 2716 67
PCE Adj: 1.00 1.00 1.00 1.00 1.00 1.00 1.00 1.00 1.00 1.00 1.00
MLF Adj: 1.00 1.00 1.00 1.00 1.00 1.00 1.00 1.00 1.00 1.00 1.00
FinalVolume: 531 1077 282 23 834 499 147 663 127 418 2716 67
OvlAdjVol: 73

Saturation Flow Module:
Sat/Lane: 1600 1600 1600 1600 1600 1600 1600 1600 1600 1600
Adjustment: 1.00 1.00 1.00 1.00 1.00 1.00 1.00 1.00 1.00 1.00
Lanes: 2.00 2.00 1.00 1.00 1.88 1.12 1.00 3.36 0.64 2.00 2.93 0.07
Final Sat.: 3200 3200 1600 1600 3003 1797 1600 5371 1029 3200 4684 116

Capacity Analysis Module:
Vol/Sat: 0.17 0.34 0.18 0.01 0.28 0.28 0.09 0.12 0.12 0.13 0.58 0.58
OvlAdjV/S: 0.05
Crit Moves: **** **** **** ****

Continental Grand Campus Specific Plan
City of El Segundo
Phase 1 Opening Year (2022) Without Project AM Peak Hour (ICU)

Level Of Service Computation Report
ICU 1(Loss as Cycle Length %) Method (Future Volume Alternative)

Intersection #17 El Segundo Boulevard and Isis Avenue

Cycle (sec): 100 Critical Vol./Cap.(X): 0.826
Loss Time (sec): 5 Average Delay (sec/veh): xxxxxx
Optimal Cycle: 58 Level Of Service: D

Street Name: Isis Avenue El Segundo Boulevard
Approach: North Bound South Bound East Bound West Bound
Movement: L - T - R L - T - R L - T - R L - T - R

Control: Permitted Permitted Protected Protected
Rights: Include Include Include Include
Min. Green: 0 0 0 0 0 0 0 0 0 0 0 0
Y+R: 4.0 4.0 4.0 4.0 4.0 4.0 4.0 4.0 4.0 4.0 4.0
Lanes: 0 0 1 0 0 0 0 1 0 0 1 0

Volume Module:
Base Vol: 50 21 84 52 9 71 45 722 20 20 1736 39
Growth Adj: 1.01 1.01 1.01 1.01 1.01 1.01 1.01 1.01 1.01 1.01 1.01
Initial Bse: 51 21 85 53 9 72 46 732 20 20 1760 40
Added Vol: 0 0 0 0 0 0 0 0 0 0 0 0
Related Pro: 0 0 0 0 0 0 0 177 0 0 1160 0
Initial Fut: 51 21 85 53 9 72 46 909 20 20 2920 40
User Adj: 1.00 1.00 1.00 1.00 1.00 1.00 1.00 1.00 1.00 1.00 1.00
PHF Adj: 1.00 1.00 1.00 1.00 1.00 1.00 1.00 1.00 1.00 1.00 1.00
PHF Volume: 51 21 85 53 9 72 46 909 20 20 2920 40
Reduct Vol: 0 0 0 0 0 0 0 0 0 0 0 0
Reduced Vol: 51 21 85 53 9 72 46 909 20 20 2920 40
PCE Adj: 1.00 1.00 1.00 1.00 1.00 1.00 1.00 1.00 1.00 1.00 1.00
MLF Adj: 1.00 1.00 1.00 1.00 1.00 1.00 1.00 1.00 1.00 1.00 1.00
FinalVolume: 51 21 85 53 9 72 46 909 20 20 2920 40

Saturation Flow Module:
Sat/Lane: 1600 1600 1600 1600 1600 1600 1600 1600 1600 1600
Adjustment: 1.00 1.00 1.00 1.00 1.00 1.00 1.00 1.00 1.00 1.00
Lanes: 0.32 0.14 0.54 0.39 0.07 0.54 1.00 4.00 1.00 1.00 2.96 0.04
Final Sat.: 516 217 867 630 109 861 1600 6400 1600 1600 4736 64

Capacity Analysis Module:
Vol/Sat: 0.03 0.10 0.10 0.03 0.08 0.08 0.03 0.14 0.01 0.01 0.62 0.62
Crit Moves: **** **** **** ****

Continental Grand Campus Specific Plan
City of El Segundo

Phase 1 Opening Year (2022) Without Project AM Peak Hour (ICU)

Level Of Service Computation Report

ICU 1(Loss as Cycle Length %) Method (Future Volume Alternative)

Intersection #18 El Segundo Blvd at I-405 SB Ramps

Cycle (sec): 100 Critical Vol./Cap.(X): 0.771
Loss Time (sec): 5 Average Delay (sec/veh): xxxxxx
Optimal Cycle: 47 Level Of Service: C

Table with columns for Street Name, Approach, Movement, Control, Rights, Min. Green, Y+R, Lanes for I-405 SB Ramps and El Segundo Blvd.

Table with columns for Volume Module: Base Vol, Growth Adj, Initial Bse, Added Vol, Related Pro, Initial Fut, User Adj, PHF Adj, PHF Volume, Reduct Vol, Reduced Vol, PCE Adj, MLF Adj, Final Volume.

Table with columns for Sat/Lane, Adjustment, Lanes, Final Sat. for Saturation Flow Module.

Table with columns for Vol/Sat, Crit Moves for Capacity Analysis Module.

Continental Grand Campus Specific Plan
City of El Segundo

Phase 1 Opening Year (2022) Without Project AM Peak Hour (ICU)

Level Of Service Computation Report

ICU 1(Loss as Cycle Length %) Method (Future Volume Alternative)

Intersection #19 El Segundo Blvd at La Cienega Blvd

Cycle (sec): 100 Critical Vol./Cap.(X): 0.847
Loss Time (sec): 5 Average Delay (sec/veh): xxxxxx
Optimal Cycle: 64 Level Of Service: D

Table with columns for Street Name, Approach, Movement, Control, Rights, Min. Green, Y+R, Lanes for La Cienega Blvd and El Segundo Blvd.

Table with columns for Volume Module: Base Vol, Growth Adj, Initial Bse, Added Vol, Related Pro, Initial Fut, User Adj, PHF Adj, PHF Volume, Reduct Vol, Reduced Vol, PCE Adj, MLF Adj, Final Volume.

Table with columns for Sat/Lane, Adjustment, Lanes, Final Sat. for Saturation Flow Module.

Table with columns for Vol/Sat, Crit Moves for Capacity Analysis Module.

Continental Grand Campus Specific Plan
City of El Segundo

Phase 1 Opening Year (2022) Without Project AM Peak Hour (ICU)

Level Of Service Computation Report

ICU 1(Loss as Cycle Length %) Method (Future Volume Alternative)

Intersection #20 El Segundo Blvd at I-405 NB Ramps

Cycle (sec): 100 Critical Vol./Cap.(X): 0.880
Loss Time (sec): 5 Average Delay (sec/veh): xxxxxx
Optimal Cycle: 76 Level Of Service: D

Table with columns for Street Name, Approach, Movement, Control, Rights, Min. Green, Y+R, Lanes. Rows include I-405 NB Ramps and El Segundo Blvd with various movement and control details.

Volume Module: Table with columns for Base Vol, Growth Adj, Initial Bse, Added Vol, Related Pro, Initial Fut, User Adj, PHF Adj, PHF Volume, Reduct Vol, Reduced Vol, PCE Adj, MLF Adj, Final Volume. Rows include I-405 NB Ramps and El Segundo Blvd.

Saturation Flow Module: Table with columns for Sat/Lane, Adjustment, Lanes, Final Sat. Rows include I-405 NB Ramps and El Segundo Blvd.

Capacity Analysis Module: Table with columns for Vol/Sat, Crit Moves. Rows include I-405 NB Ramps and El Segundo Blvd.

 Continental Grand Campus Specific Plan
 City of El Segundo
 Phase 1 Opening Year (2022) Without Project PM Peak Hour (ICU)

Scenario: Phase 1 Op Yr W/o Proj PM

Command: Phase 1 Op Yr W/o Proj PM
 Volume: OY PM
 Geometry: Existing
 Impact Fee: Default Impact Fee
 Trip Generation: Cum PM
 Trip Distribution: Cum + Proj
 Paths: Project
 Routes: Default Route
 Configuration: Phase 1 Op Yr W/o Proj PM

 Continental Grand Campus Specific Plan
 City of El Segundo
 Phase 1 Opening Year (2022) Without Project PM Peak Hour (ICU)

Trip Generation Report

Forecast for Cum PM

Zone #	Subzone	Amount	Units	Rate In	Rate Out	Trips In	Trips Out	Total Trips	% Of Total
306	525 N. Sepul	1.00	Residential	-4.00	-6.00	-4	-6	-10	-0.9
	Zone 306 Subtotal					-4	-6	-10	-0.9
307	540 Imperial	1.00	Residential	50.00	32.00	50	32	82	7.4
	Zone 307 Subtotal					50	32	82	7.4
311	199 Continen	1.00	Business Hotel	46.00	45.00	46	45	91	8.3
	Zone 311 Subtotal					46	45	91	8.3
313	445 N. Dougl	1.00	Equinix Data C	3.00	13.00	3	13	16	1.5
	Zone 313 Subtotal					3	13	16	1.5
314	123 Lomita a	1.00	Office	2.00	16.00	2	16	18	1.6
	Zone 314 Subtotal					2	16	18	1.6
704	2355 Utah Av	1.00	Office	95.00	109.00	95	109	204	18.5
	Zone 704 Subtotal					95	109	204	18.5
706	888 Sepulved	1.00	hotel	60.00	41.00	60	41	101	9.2
	Zone 706 Subtotal					60	41	101	9.2
710	201 North Do	1.00	High School	-15.00	-74.00	-15	-74	-89	-8.1
710	201 North Do	1.00	District Offic	3.00	18.00	3	18	21	1.9
	Zone 710 Subtotal					-12	-56	-68	-6.2
714	400 Duley -	1.00	Office	18.00	87.00	18	87	105	9.5
	Zone 714 Subtotal					18	87	105	9.5
717	1700 Imperia	1.00	Townhome Resid	25.00	120.00	25	120	145	13.2
	Zone 717 Subtotal					25	120	145	13.2
718	123 Nevada S	1.00	Office	4.00	16.00	4	16	20	1.8
718	123 Nevada S	0.00	123 Nevada	4.00	16.00	0	0	0	0.0
	Zone 718 Subtotal					4	16	20	1.8
719	2125 Campus	1.00	Office Retail	64.00	146.00	64	146	210	19.1
	Zone 719 Subtotal					64	146	210	19.1
1002	Laker Facili	1.00	General Office	103.00	85.00	103	85	188	17.1
	Zone 1002 Subtotal					103	85	188	17.1

 Continental Grand Campus Specific Plan
 City of El Segundo
 Phase 1 Opening Year (2022) Without Project PM Peak Hour (ICU)

Zone #	Subzone	Amount	Units	Rate In	Rate Out	Trips In	Trips Out	Total Trips	% Of Total
TOTAL						454	648	1102	100.0

 Continental Grand Campus Specific Plan
 City of El Segundo
 Phase 1 Opening Year (2022) Without Project PM Peak Hour (ICU)

Trip Distribution Report

Percent Of Trips Cum + Project

Zone	To Gates											
	1	2	3	4	5	7	8	9	10	11	12	
306	10.0	15.0	10.0	5.0	0.0	5.0	5.0	25.0	0.0	25.0	0.0	
307	10.0	15.0	10.0	5.0	50.0	0.0	0.0	0.0	0.0	0.0	0.0	
311	40.0	10.0	10.0	10.0	0.0	5.0	5.0	10.0	0.0	10.0	0.0	
313	15.0	5.0	15.0	10.0	25.0	0.0	5.0	20.0	0.0	0.0	0.0	
314	40.0	10.0	10.0	10.0	0.0	5.0	5.0	10.0	0.0	10.0	0.0	
704	30.0	15.0	8.0	12.0	0.0	5.0	5.0	10.0	5.0	10.0	0.0	
706	25.0	20.0	10.0	25.0	0.0	0.0	0.0	0.0	0.0	0.0	10.0	
710	0.0	0.0	15.0	10.0	10.0	2.0	2.0	20.0	5.0	10.0	1.0	
714	5.0	10.0	5.0	5.0	20.0	5.0	10.0	15.0	5.0	15.0	0.0	
717	10.0	15.0	10.0	5.0	50.0	0.0	0.0	0.0	0.0	0.0	0.0	
718	10.0	10.0	10.0	10.0	20.0	0.0	0.0	20.0	10.0	0.0	0.0	
719	20.0	10.0	10.0	10.0	10.0	5.0	5.0	10.0	5.0	0.0	0.0	
1002	0.0	10.0	5.0	5.0	15.0	5.0	10.0	15.0	5.0	15.0	5.0	
1004	5.0	15.0	10.0	5.0	30.0	0.0	5.0	20.0	0.0	0.0	5.0	
1005	5.0	15.0	10.0	5.0	30.0	0.0	5.0	20.0	0.0	0.0	5.0	
1007	0.0	0.0	0.0	0.0	0.0	0.0	0.0	0.0	0.0	0.0	0.0	

Zone	To Gates						
	13	14	15	16	17	18	20
306	0.0	0.0	0.0	0.0	0.0	0.0	0.0
307	0.0	10.0	0.0	0.0	0.0	0.0	0.0
311	0.0	0.0	0.0	0.0	0.0	0.0	0.0
313	5.0	0.0	0.0	0.0	0.0	0.0	0.0
314	0.0	0.0	0.0	0.0	0.0	0.0	0.0
704	0.0	0.0	0.0	0.0	0.0	0.0	0.0
706	0.0	0.0	0.0	0.0	10.0	0.0	0.0
710	10.0	5.0	10.0	0.0	0.0	0.0	0.0
714	0.0	5.0	0.0	0.0	0.0	0.0	0.0
717	0.0	10.0	0.0	0.0	0.0	0.0	0.0
718	0.0	10.0	0.0	0.0	0.0	0.0	0.0
719	0.0	10.0	5.0	0.0	0.0	0.0	0.0
1002	0.0	5.0	5.0	0.0	0.0	0.0	0.0
1004	0.0	5.0	0.0	0.0	0.0	0.0	0.0
1005	0.0	5.0	0.0	0.0	0.0	0.0	0.0
1007	0.0	0.0	0.0	0.0	0.0	20.0	10.0

Continental Grand Campus Specific Plan
City of El Segundo
Phase 1 Opening Year (2022) Without Project PM Peak Hour (ICU)

Impact Analysis Report
Level Of Service

Table with columns: Intersection, Base (Del/V, LOS Veh, C), Future (Del/V, LOS Veh, C), Change in. Lists 20 intersections from Sepulveda Blvd at Imperial Hwy to El Segundo Blvd at I-405 NB Ra.

Continental Grand Campus Specific Plan
City of El Segundo
Phase 1 Opening Year (2022) Without Project PM Peak Hour (ICU)

Level Of Service Computation Report
ICU 1(Loss as Cycle Length %) Method (Future Volume Alternative)
Intersection #1 Sepulveda Blvd at Imperial Hwy
Cycle (sec): 100, Critical Vol./Cap.(X): 1.036, Loss Time (sec): 5, Average Delay (sec/veh): xxxxxx, Optimal Cycle: 180, Level Of Service: F
Street Name: Sepulveda Blvd, Imperial Hwy
Approach: North Bound, South Bound, East Bound, West Bound
Movement: L - T - R, L - T - R, L - T - R, L - T - R
Control: Protected, Protected, Protected, Protected
Rights: Include, Include, Include, Ovl
Min. Green: 0 0 0, 0 0 0, 0 0 0, 0 0 0
Y+R: 4.0 4.0 4.0, 4.0 4.0 4.0, 4.0 4.0 4.0, 4.0 4.0 4.0
Lanes: 1 0 3 0 1, 2 0 3 1 0, 2 0 3 0 1, 2 0 3 0 1
Volume Module: Base Vol, Growth Adj, Initial Bse, Added Vol, Related Pro, Initial Fut, User Adj, PHF Adj, PHF Volume, Reduct Vol, Reduced Vol, PCE Adj, MLF Adj, Final Volume, OvlAdjVol
Saturation Flow Module: Sat/Lane, Adjustment, Lanes, Final Sat.
Capacity Analysis Module: Vol/Sat, OvlAdjV/S, Crit Moves

Continental Grand Campus Specific Plan
City of El Segundo
Phase 1 Opening Year (2022) Without Project PM Peak Hour (ICU)

Level Of Service Computation Report
ICU 1(Loss as Cycle Length %) Method (Future Volume Alternative)

Intersection #2 Sepulveda Blvd at Walnut St

Cycle (sec): 100 Critical Vol./Cap.(X): 0.754
Loss Time (sec): 5 Average Delay (sec/veh): xxxxxx
Optimal Cycle: 44 Level Of Service: C

Table with columns for Street Name, Approach, Movement, Control, Rights, Min. Green, Y+R, Lanes. Rows for Sepulveda Blvd and Walnut St.

Volume Module table with columns for Base Vol, Growth Adj, Initial Bse, Added Vol, Related Pro, Initial Fut, User Adj, PHF Adj, PHF Volume, Reduct Vol, Reduced Vol, PCE Adj, MLF Adj, Final Volume.

Saturation Flow Module table with columns for Sat/Lane, Adjustment, Lanes, Final Sat.

Capacity Analysis Module table with columns for Vol/Sat, Crit Moves.

Continental Grand Campus Specific Plan
City of El Segundo
Phase 1 Opening Year (2022) Without Project PM Peak Hour (ICU)

Level Of Service Computation Report
ICU 1(Loss as Cycle Length %) Method (Future Volume Alternative)

Intersection #3 Sepulveda Blvd at Maple Ave

Cycle (sec): 100 Critical Vol./Cap.(X): 0.756
Loss Time (sec): 5 Average Delay (sec/veh): xxxxxx
Optimal Cycle: 44 Level Of Service: C

Table with columns for Street Name, Approach, Movement, Control, Rights, Min. Green, Y+R, Lanes. Rows for Sepulveda Blvd and Maple Ave.

Volume Module table with columns for Base Vol, Growth Adj, Initial Bse, Added Vol, Related Pro, Initial Fut, User Adj, PHF Adj, PHF Volume, Reduct Vol, Reduced Vol, PCE Adj, MLF Adj, Final Volume.

Saturation Flow Module table with columns for Sat/Lane, Adjustment, Lanes, Final Sat.

Capacity Analysis Module table with columns for Vol/Sat, Crit Moves.

Continental Grand Campus Specific Plan
City of El Segundo
Phase 1 Opening Year (2022) Without Project PM Peak Hour (ICU)

Level Of Service Computation Report
ICU 1(Loss as Cycle Length %) Method (Future Volume Alternative)

Intersection #4 Sepulveda Blvd at Mariposa Ave

Cycle (sec): 100 Critical Vol./Cap.(X): 0.830
Loss Time (sec): 5 Average Delay (sec/veh): xxxxxx
Optimal Cycle: 59 Level Of Service: D

Table with columns for Street Name (Sepulveda Blvd, Mariposa Ave), Approach (North Bound, South Bound, East Bound, West Bound), Movement (L, T, R), Control (Protected, Permitted), Rights (Include), and traffic volume metrics (Min. Green, Y+R, Lanes).

Volume Module table showing Base Vol, Growth Adj, Initial Bse, Added Vol, Related Pro, Initial Fut, User Adj, PHF Adj, PHF Volume, Reduct Vol, Reduced Vol, PCE Adj, MLF Adj, and Final Volume for various traffic movements.

Saturation Flow Module table showing Sat/Lane, Adjustment, Lanes, and Final Sat. for different approaches and movements.

Capacity Analysis Module table showing Vol/Sat, Crit Moves, and OvlAdjV/S for various traffic movements.

Continental Grand Campus Specific Plan
City of El Segundo
Phase 1 Opening Year (2022) Without Project PM Peak Hour (ICU)

Level Of Service Computation Report
ICU 1(Loss as Cycle Length %) Method (Future Volume Alternative)

Intersection #5 Sepulveda Blvd at Grand Ave

Cycle (sec): 100 Critical Vol./Cap.(X): 0.886
Loss Time (sec): 5 Average Delay (sec/veh): xxxxxx
Optimal Cycle: 79 Level Of Service: D

Table with columns for Street Name (Sepulveda Blvd, Grand Ave), Approach (North Bound, South Bound, East Bound, West Bound), Movement (L, T, R), Control (Protected, Split Phase), Rights (Include), and traffic volume metrics (Min. Green, Y+R, Lanes).

Volume Module table showing Base Vol, Growth Adj, Initial Bse, Added Vol, Related Pro, Initial Fut, User Adj, PHF Adj, PHF Volume, Reduct Vol, Reduced Vol, PCE Adj, MLF Adj, and Final Volume for various traffic movements.

Saturation Flow Module table showing Sat/Lane, Adjustment, Lanes, and Final Sat. for different approaches and movements.

Capacity Analysis Module table showing Vol/Sat, Crit Moves, and OvlAdjV/S for various traffic movements.

Continental Grand Campus Specific Plan
City of El Segundo

Phase 1 Opening Year (2022) Without Project PM Peak Hour (ICU)

Level Of Service Computation Report

ICU 1(Loss as Cycle Length %) Method (Future Volume Alternative)

Intersection #6 Sepulveda Blvd at El Segundo Blvd

Cycle (sec): 100 Critical Vol./Cap.(X): 1.080
Loss Time (sec): 5 Average Delay (sec/veh): xxxxxx
Optimal Cycle: 180 Level Of Service: F

Table with columns for Street Name, Approach, Movement, Control, Rights, Min. Green, Y+R, Lanes. Rows for Sepulveda Blvd and El Segundo Blvd.

Volume Module table with columns for Base Vol, Growth Adj, Initial Bse, Added Vol, Related Pro, Initial Fut, User Adj, PHF Adj, PHF Volume, Reduct Vol, Reduced Vol, PCE Adj, MLF Adj, Final Volume.

Saturation Flow Module table with columns for Sat/Lane, Adjustment, Lanes, Final Sat.

Capacity Analysis Module table with columns for Vol/Sat, Crit Moves.

Continental Grand Campus Specific Plan
City of El Segundo

Phase 1 Opening Year (2022) Without Project PM Peak Hour (ICU)

Level Of Service Computation Report

ICU 1(Loss as Cycle Length %) Method (Future Volume Alternative)

Intersection #7 Sepulveda Blvd at Rosecrans Blvd

Cycle (sec): 100 Critical Vol./Cap.(X): 1.003
Loss Time (sec): 5 Average Delay (sec/veh): xxxxxx
Optimal Cycle: 180 Level Of Service: F

Table with columns for Street Name, Approach, Movement, Control, Rights, Min. Green, Y+R, Lanes. Rows for Sepulveda Blvd and Rosecrans Blvd.

Volume Module table with columns for Base Vol, Growth Adj, Initial Bse, Added Vol, Related Pro, Initial Fut, User Adj, PHF Adj, PHF Volume, Reduct Vol, Reduced Vol, PCE Adj, MLF Adj, Final Volume, OvlAdjVol.

Saturation Flow Module table with columns for Sat/Lane, Adjustment, Lanes, Final Sat.

Capacity Analysis Module table with columns for Vol/Sat, OvlAdjV/S, Crit Moves.

Continental Grand Campus Specific Plan
City of El Segundo
Phase 1 Opening Year (2022) Without Project PM Peak Hour (ICU)

Level Of Service Computation Report
ICU 1(Loss as Cycle Length %) Method (Future Volume Alternative)

Intersection #8 Continental Boulevard at Mariposa Ave

Cycle (sec): 100 Critical Vol./Cap.(X): 0.370
Loss Time (sec): 5 Average Delay (sec/veh): xxxxxx
Optimal Cycle: 19 Level Of Service: A

Table with columns: Street Name, Approach, Movement, Control, Rights, Min. Green, Y+R, Lanes. Rows for Continental Boulevard and Mariposa Avenue.

Volume Module table with columns: Base Vol, Growth Adj, Initial Bse, Added Vol, Related Pro, Initial Fut, User Adj, PHF Adj, PHF Volume, Reduct Vol, Reduced Vol, PCE Adj, MLF Adj, Final Volume.

Saturation Flow Module table with columns: Sat/Lane, Adjustment, Lanes, Final Sat.

Capacity Analysis Module table with columns: Vol/Sat, Crit Moves.

Continental Grand Campus Specific Plan
City of El Segundo
Phase 1 Opening Year (2022) Without Project PM Peak Hour (ICU)

Level Of Service Computation Report
ICU 1(Loss as Cycle Length %) Method (Future Volume Alternative)

Intersection #9 Continental Boulevard at Grand Avenue

Cycle (sec): 100 Critical Vol./Cap.(X): 0.344
Loss Time (sec): 5 Average Delay (sec/veh): xxxxxx
Optimal Cycle: 18 Level Of Service: A

Table with columns: Street Name, Approach, Movement, Control, Rights, Min. Green, Y+R, Lanes. Rows for Continental Boulevard and Grand Avenue.

Volume Module table with columns: Base Vol, Growth Adj, Initial Bse, Added Vol, Related Pro, Initial Fut, User Adj, PHF Adj, PHF Volume, Reduct Vol, Reduced Vol, PCE Adj, MLF Adj, Final Volume.

Saturation Flow Module table with columns: Sat/Lane, Adjustment, Lanes, Final Sat.

Capacity Analysis Module table with columns: Vol/Sat, Crit Moves.

Continental Grand Campus Specific Plan
City of El Segundo
Phase 1 Opening Year (2022) Without Project PM Peak Hour (ICU)

Level Of Service Computation Report
ICU 1(Loss as Cycle Length %) Method (Future Volume Alternative)

Intersection #10 Continental Boulevard at El Segundo Boulevard
Cycle (sec): 100 Critical Vol./Cap.(X): 0.640
Loss Time (sec): 5 Average Delay (sec/veh): xxxxxx
Optimal Cycle: 32 Level Of Service: B

Table with columns for Street Name, Approach, Movement, Control, Rights, Min. Green, Y+R, Lanes. Rows for Continental Boulevard and El Segundo Boulevard.

Volume Module table with columns for Base Vol, Growth Adj, Initial Bse, Added Vol, Related Pro, Initial Fut, User Adj, PHF Adj, PHF Volume, Reduct Vol, Reduced Vol, PCE Adj, MLF Adj, Final Volume.

Saturation Flow Module table with columns for Sat/Lane, Adjustment, Lanes, Final Sat.

Capacity Analysis Module table with columns for Vol/Sat, Crit Moves.

Continental Grand Campus Specific Plan
City of El Segundo
Phase 1 Opening Year (2022) Without Project PM Peak Hour (ICU)

Level Of Service Computation Report
ICU 1(Loss as Cycle Length %) Method (Future Volume Alternative)

Intersection #11 Nash St and Imperial Hwy
Cycle (sec): 100 Critical Vol./Cap.(X): 0.521
Loss Time (sec): 5 Average Delay (sec/veh): xxxxxx
Optimal Cycle: 25 Level Of Service: A

Table with columns for Street Name, Approach, Movement, Control, Rights, Min. Green, Y+R, Lanes. Rows for Nash St and Imperial Hwy.

Volume Module table with columns for Base Vol, Growth Adj, Initial Bse, Added Vol, Related Pro, Initial Fut, User Adj, PHF Adj, PHF Volume, Reduct Vol, Reduced Vol, PCE Adj, MLF Adj, Final Volume.

Saturation Flow Module table with columns for Sat/Lane, Adjustment, Lanes, Final Sat.

Capacity Analysis Module table with columns for Vol/Sat, Crit Moves.

Continental Grand Campus Specific Plan
City of El Segundo

Phase 1 Opening Year (2022) Without Project PM Peak Hour (ICU)

Level Of Service Computation Report

ICU 1(Loss as Cycle Length %) Method (Future Volume Alternative)

Intersection #12 Nash St at Mariposa Ave

Cycle (sec): 100 Critical Vol./Cap.(X): 0.698
Loss Time (sec): 5 Average Delay (sec/veh): xxxxxx
Optimal Cycle: 37 Level Of Service: B

Table with columns for Street Name (Nash St, Mariposa Ave), Approach (North Bound, South Bound, East Bound, West Bound), Movement (L, T, R), Control (Permitted, Include), Rights, Min. Green, Y+R, Lanes.

Table with columns for Volume Module: Base Vol, Growth Adj, Initial Bse, Added Vol, Related Pro, Initial Fut, User Adj, PHF Adj, PHF Volume, Reduct Vol, Reduced Vol, PCE Adj, MLF Adj, Final Volume.

Table with columns for Saturation Flow Module: Sat/Lane, Adjustment, Lanes, Final Sat.

Table with columns for Capacity Analysis Module: Vol/Sat, Crit Moves.

Continental Grand Campus Specific Plan
City of El Segundo

Phase 1 Opening Year (2022) Without Project PM Peak Hour (ICU)

Level Of Service Computation Report

ICU 1(Loss as Cycle Length %) Method (Future Volume Alternative)

Intersection #13 Nash St at Grand Ave

Cycle (sec): 100 Critical Vol./Cap.(X): 0.612
Loss Time (sec): 5 Average Delay (sec/veh): xxxxxx
Optimal Cycle: 30 Level Of Service: B

Table with columns for Street Name (Nash St, Grand Ave), Approach (North Bound, South Bound, East Bound, West Bound), Movement (L, T, R), Control (Protected, Split Phase, Include), Rights, Min. Green, Y+R, Lanes.

Table with columns for Volume Module: Base Vol, Growth Adj, Initial Bse, Added Vol, Related Pro, Initial Fut, User Adj, PHF Adj, PHF Volume, Reduct Vol, Reduced Vol, PCE Adj, MLF Adj, Final Volume.

Table with columns for Saturation Flow Module: Sat/Lane, Adjustment, Lanes, Final Sat.

Table with columns for Capacity Analysis Module: Vol/Sat, Crit Moves.

Continental Grand Campus Specific Plan
City of El Segundo

Phase 1 Opening Year (2022) Without Project PM Peak Hour (ICU)

Level Of Service Computation Report

ICU 1(Loss as Cycle Length %) Method (Future Volume Alternative)

Intersection #14 Nash St at El Segundo Blvd

Cycle (sec): 100 Critical Vol./Cap.(X): 1.038
Loss Time (sec): 5 Average Delay (sec/veh): xxxxxx
Optimal Cycle: 180 Level Of Service: F

Table with columns for Street Name (Nash St, El Segundo Blvd), Approach (North Bound, South Bound, East Bound, West Bound), Movement (L, T, R), Control (Split Phase, Protected), Rights (Ovl, Include), and traffic volume metrics (Min. Green, Y+R, Lanes).

Volume Module table showing Base Vol, Growth Adj, Initial Bse, Added Vol, Related Pro, Initial Fut, User Adj, PHF Adj, PHF Volume, Reduct Vol, Reduced Vol, PCE Adj, MLF Adj, Final Volume, and OvlAdjVol.

Saturation Flow Module table showing Sat/Lane, Adjustment, Lanes, and Final Sat. values.

Capacity Analysis Module table showing Vol/Sat, OvlAdjV/S, and Crit Moves.

Continental Grand Campus Specific Plan
City of El Segundo

Phase 1 Opening Year (2022) Without Project PM Peak Hour (ICU)

Level Of Service Computation Report

ICU 1(Loss as Cycle Length %) Method (Future Volume Alternative)

Intersection #15 Douglas Street at El Segundo Boulevard

Cycle (sec): 100 Critical Vol./Cap.(X): 1.179
Loss Time (sec): 5 Average Delay (sec/veh): xxxxxx
Optimal Cycle: 180 Level Of Service: F

Table with columns for Street Name (Douglas St, El Segundo Blvd), Approach (North Bound, South Bound, East Bound, West Bound), Movement (L, T, R), Control (Protected), Rights (Include), and traffic volume metrics (Min. Green, Y+R, Lanes).

Volume Module table showing Base Vol, Growth Adj, Initial Bse, Added Vol, Related Pro, Initial Fut, User Adj, PHF Adj, PHF Volume, Reduct Vol, Reduced Vol, PCE Adj, MLF Adj, Final Volume, and OvlAdjVol.

Saturation Flow Module table showing Sat/Lane, Adjustment, Lanes, and Final Sat. values.

Capacity Analysis Module table showing Vol/Sat, OvlAdjV/S, and Crit Moves.

Continental Grand Campus Specific Plan
City of El Segundo

Phase 1 Opening Year (2022) Without Project PM Peak Hour (ICU)

Level Of Service Computation Report

ICU 1(Loss as Cycle Length %) Method (Future Volume Alternative)

Intersection #16 Aviation Boulevard at El Segundo Boulevard

Cycle (sec): 100 Critical Vol./Cap.(X): 1.159
Loss Time (sec): 5 Average Delay (sec/veh): xxxxxx
Optimal Cycle: 180 Level Of Service: F

Table with columns for Street Name, Approach, Movement, Control, Rights, Min. Green, Y+R, Lanes. Rows include Aviatio Blvd and El Segundo Blvd with various movement and control details.

Volume Module table with columns for Base Vol, Growth Adj, Initial Bse, Added Vol, Related Pro, Initial Fut, User Adj, PHF Adj, PHF Volume, Reduct Vol, Reduced Vol, PCE Adj, MLF Adj, Final Volume, OvlAdjVol.

Saturation Flow Module table with columns for Sat/Lane, Adjustment, Lanes, Final Sat.

Capacity Analysis Module table with columns for Vol/Sat, OvlAdjV/S, Crit Moves.

Continental Grand Campus Specific Plan
City of El Segundo

Phase 1 Opening Year (2022) Without Project PM Peak Hour (ICU)

Level Of Service Computation Report

ICU 1(Loss as Cycle Length %) Method (Future Volume Alternative)

Intersection #17 El Segundo Boulevard and Isis Avenue

Cycle (sec): 100 Critical Vol./Cap.(X): 0.785
Loss Time (sec): 5 Average Delay (sec/veh): xxxxxx
Optimal Cycle: 49 Level Of Service: C

Table with columns for Street Name, Approach, Movement, Control, Rights, Min. Green, Y+R, Lanes. Rows include Isis Avenue and El Segundo Boulevard with various movement and control details.

Volume Module table with columns for Base Vol, Growth Adj, Initial Bse, Added Vol, Related Pro, Initial Fut, User Adj, PHF Adj, PHF Volume, Reduct Vol, Reduced Vol, PCE Adj, MLF Adj, Final Volume.

Saturation Flow Module table with columns for Sat/Lane, Adjustment, Lanes, Final Sat.

Capacity Analysis Module table with columns for Vol/Sat, Crit Moves.

Continental Grand Campus Specific Plan
City of El Segundo

Phase 1 Opening Year (2022) Without Project PM Peak Hour (ICU)

Level Of Service Computation Report

ICU 1(Loss as Cycle Length %) Method (Future Volume Alternative)

Intersection #18 El Segundo Blvd at I-405 SB Ramps

Cycle (sec): 100 Critical Vol./Cap.(X): 1.187
Loss Time (sec): 5 Average Delay (sec/veh): xxxxxx
Optimal Cycle: 180 Level Of Service: F

Street Name:	I-405 SB Ramps						El Segundo Blvd												
	North Bound		South Bound		East Bound		West Bound		North Bound		South Bound								
Approach:	L	T	R	L	T	R	L	T	R	L	T	R	L	T	R				
Control:	Permitted		Permitted		Permitted		Permitted		Permitted		Permitted		Permitted		Permitted				
Rights:	Include		Include		Include		Include		Include		Include		Include		Include				
Min. Green:	0	0	0	0	0	0	0	0	0	0	0	0	0	0	0	0	0	0	
Y+R:	4.0	4.0	4.0	4.0	4.0	4.0	4.0	4.0	4.0	4.0	4.0	4.0	4.0	4.0	4.0	4.0	4.0	4.0	
Lanes:	1	0	1	0	0	0	0	0	0	0	0	0	0	0	0	0	0	0	0

Volume Module:

Base Vol:	239	0	269	0	0	0	0	1491	1049	0	1062	0
Growth Adj:	1.01	1.01	1.01	1.01	1.01	1.01	1.01	1.01	1.01	1.01	1.01	1.01
Initial Bse:	242	0	273	0	0	0	0	1512	1064	0	1077	0
Added Vol:	0	0	0	0	0	0	0	0	0	0	0	0
Related Pro:	2	0	0	0	0	0	0	442	483	0	290	0
Initial Fut:	244	0	273	0	0	0	0	1954	1547	0	1367	0
User Adj:	1.00	1.00	1.00	1.00	1.00	1.00	1.00	1.00	1.00	1.00	1.00	1.00
PHF Adj:	1.00	1.00	1.00	1.00	1.00	1.00	1.00	1.00	1.00	1.00	1.00	1.00
PHF Volume:	244	0	273	0	0	0	0	1954	1547	0	1367	0
Reduct Vol:	0	0	0	0	0	0	0	0	0	0	0	0
Reduced Vol:	244	0	273	0	0	0	0	1954	1547	0	1367	0
PCE Adj:	1.00	1.00	1.00	1.00	1.00	1.00	1.00	1.00	1.00	1.00	1.00	1.00
MLF Adj:	1.00	1.00	1.00	1.00	1.00	1.00	1.00	1.00	1.00	1.00	1.00	1.00
FinalVolume:	244	0	273	0	0	0	0	1954	1547	0	1367	0

Saturation Flow Module:

Sat/Lane:	1600	1600	1600	1600	1600	1600	1600	1600	1600	1600	1600	1600
Adjustment:	1.00	1.00	1.00	1.00	1.00	1.00	1.00	1.00	1.00	1.00	1.00	1.00
Lanes:	1.00	0.00	1.00	0.00	0.00	0.00	0.00	3.00	1.00	0.00	3.00	0.00
Final Sat.:	1600	0	1600	0	0	0	0	4800	1600	0	4800	0

Capacity Analysis Module:

Vol/Sat:	0.15	0.00	0.17	0.00	0.00	0.00	0.00	0.41	0.97	0.00	0.28	0.00
Crit Moves:	***			***			***			***		

Continental Grand Campus Specific Plan
City of El Segundo

Phase 1 Opening Year (2022) Without Project PM Peak Hour (ICU)

Level Of Service Computation Report

ICU 1(Loss as Cycle Length %) Method (Future Volume Alternative)

Intersection #19 El Segundo Blvd at La Cienega Blvd

Cycle (sec): 100 Critical Vol./Cap.(X): 0.753
Loss Time (sec): 5 Average Delay (sec/veh): xxxxxx
Optimal Cycle: 44 Level Of Service: C

Street Name:	La Cienega Blvd						El Segundo Blvd														
	North Bound		South Bound		East Bound		West Bound		North Bound		South Bound										
Approach:	L	T	R	L	T	R	L	T	R	L	T	R	L	T	R						
Control:	Protected		Protected		Protected		Protected		Protected		Protected		Protected		Protected						
Rights:	Include		Include		Include		Include		Include		Include		Include		Include						
Min. Green:	0	0	0	0	0	0	0	0	0	0	0	0	0	0	0	0	0	0			
Y+R:	4.0	4.0	4.0	4.0	4.0	4.0	4.0	4.0	4.0	4.0	4.0	4.0	4.0	4.0	4.0	4.0	4.0	4.0			
Lanes:	0	0	0	0	0	0	2	0	0	0	2	1	0	3	0	0	0	0	2	1	0

Volume Module:

Base Vol:	0	0	0	665	0	653	101	1849	0	0	614	206
Growth Adj:	1.01	1.01	1.01	1.01	1.01	1.01	1.01	1.01	1.01	1.01	1.01	1.01
Initial Bse:	0	0	0	674	0	662	102	1875	0	0	623	209
Added Vol:	0	0	0	0	0	0	0	0	0	0	0	0
Related Pro:	0	0	0	0	0	55	0	424	0	0	233	0
Initial Fut:	0	0	0	674	0	717	102	2299	0	0	856	209
User Adj:	1.00	1.00	1.00	1.00	1.00	1.00	1.00	1.00	1.00	1.00	1.00	1.00
PHF Adj:	1.00	1.00	1.00	1.00	1.00	1.00	1.00	1.00	1.00	1.00	1.00	1.00
PHF Volume:	0	0	0	674	0	717	102	2299	0	0	856	209
Reduct Vol:	0	0	0	0	0	0	0	0	0	0	0	0
Reduced Vol:	0	0	0	674	0	717	102	2299	0	0	856	209
PCE Adj:	1.00	1.00	1.00	1.00	1.00	1.00	1.00	1.00	1.00	1.00	1.00	1.00
MLF Adj:	1.00	1.00	1.00	1.00	1.00	1.00	1.00	1.00	1.00	1.00	1.00	1.00
FinalVolume:	0	0	0	674	0	717	102	2299	0	0	856	209

Saturation Flow Module:

Sat/Lane:	1600	1600	1600	1600	1600	1600	1600	1600	1600	1600	1600	1600
Adjustment:	1.00	1.00	1.00	1.00	1.00	1.00	1.00	1.00	1.00	1.00	1.00	1.00
Lanes:	0.00	0.00	0.00	2.00	0.00	2.00	1.00	3.00	0.00	0.00	2.41	0.59
Final Sat.:	0	0	0	3200	0	3200	1600	4800	0	0	3858	942

Capacity Analysis Module:

Vol/Sat:	0.00	0.00	0.00	0.21	0.00	0.22	0.06	0.48	0.00	0.00	0.22	0.22
Crit Moves:	***			***			***			***		

Continental Grand Campus Specific Plan
City of El Segundo

Phase 1 Opening Year (2022) Without Project PM Peak Hour (ICU)

Level Of Service Computation Report

ICU 1(Loss as Cycle Length %) Method (Future Volume Alternative)

Intersection #20 El Segundo Blvd at I-405 NB Ramps

Cycle (sec): 100 Critical Vol./Cap.(X): 0.730
Loss Time (sec): 5 Average Delay (sec/veh): xxxxxx
Optimal Cycle: 41 Level Of Service: C

Table with columns for Street Name, Approach, Movement, Control, Rights, Min. Green, Y+R, and Lanes. Rows include I-405 NB Ramps and El Segundo Blvd with various movement and control details.

Volume Module table showing Base Vol, Growth Adj, Initial Bse, Added Vol, Related Pro, Initial Fut, User Adj, PHF Adj, PHF Volume, Reduct Vol, Reduced Vol, PCE Adj, MLF Adj, and Final Volume across different approaches.

Saturation Flow Module table showing Sat/Lane, Adjustment, Lanes, and Final Sat. values for different approaches.

Capacity Analysis Module table showing Vol/Sat and Crit Moves values for different approaches.

 Continental Grand Campus Specific Plan
 City of El Segundo
 Phase 1 Opening Year(2022) With Project AM Peak Hour (ICU)

Scenario: Phase 1 Op Yr With Proj AM

Command: Phase 1 Op Yr With Proj AM
 Volume: OY AM
 Geometry: Existing
 Impact Fee: Default Impact Fee
 Trip Generation: Cum + Phase 1 AM
 Trip Distribution: Cum + Proj
 Paths: Project
 Routes: Default Route
 Configuration: Phase 1 Op Yr With Proj AM

 Continental Grand Campus Specific Plan
 City of El Segundo
 Phase 1 Opening Year(2022) With Project AM Peak Hour (ICU)

Trip Generation Report

Forecast for Cum + Phase 1 AM

Zone #	Subzone	Amount	Units	Rate In	Rate Out	Trips In	Trips Out	Total Trips	% Of Total
306	525 N. Sepul	1.00	Residential	-6.00	-3.00	-6	-3	-9	-0.4
	Zone 306 Subtotal					-6	-3	-9	-0.4
307	540 Imperial	1.00	Residential	23.00	44.00	23	44	67	2.8
	Zone 307 Subtotal					23	44	67	2.8
311	199 Continen	1.00	Business Hotel	48.00	33.00	48	33	81	3.4
	Zone 311 Subtotal					48	33	81	3.4
313	445 N. Dougl	1.00	Equinix Data C	8.00	8.00	8	8	16	0.7
	Zone 313 Subtotal					8	8	16	0.7
314	123 Lomita a	1.00	Office	17.00	3.00	17	3	20	0.8
	Zone 314 Subtotal					17	3	20	0.8
704	2355 Utah Av	1.00	Office	150.00	76.00	150	76	226	9.5
	Zone 704 Subtotal					150	76	226	9.5
706	888 Sepulved	1.00	hotel	57.00	36.00	57	36	93	3.9
	Zone 706 Subtotal					57	36	93	3.9
710	201 North Do	1.00	High School	160.00	111.00	160	111	271	11.4
710	201 North Do	1.00	District Offic	20.00	2.00	20	2	22	0.9
	Zone 710 Subtotal					180	113	293	12.4
714	400 Duley -	1.00	Office	95.00	13.00	95	13	108	4.6
714	400 Duley -	1.00	Industrial	0.00	0.00	0	0	0	0.0
	Zone 714 Subtotal					95	13	108	4.6
717	1700 Imperia	1.00	Townhome Resid	133.00	18.00	133	18	151	6.4
	Zone 717 Subtotal					133	18	151	6.4
718	123 Nevada S	1.00	Office	18.00	3.00	18	3	21	0.9
718	123 Nevada S	0.00	123 Nevada	18.00	3.00	0	0	0	0.0
	Zone 718 Subtotal					18	3	21	0.9
719	2125 Campus	1.00	Office Retail	160.00	46.00	160	46	206	8.7
	Zone 719 Subtotal					160	46	206	8.7
1002	Laker Facili	1.00	General Office	136.00	13.00	136	13	149	6.3
	Zone 1002 Subtotal					136	13	149	6.3
1005	Mattel	1.00	Mattel	431.00	43.00	431	43	474	20.0

Continental Grand Campus Specific Plan
 City of El Segundo
 Phase 1 Opening Year(2022) With Project AM Peak Hour (ICU)

Zone #	Subzone	Amount	Units	Rate In	Rate Out	Trips In	Trips Out	Total Trips	% Of Total
	Zone 1005 Subtotal					431	43	474	20.0
1007	Mattel Proje	1.00	project	431.00	43.00	431	43	474	20.0
	Zone 1007 Subtotal					431	43	474	20.0
TOTAL						1881	489	2370	100.0

Continental Grand Campus Specific Plan
 City of El Segundo
 Phase 1 Opening Year(2022) With Project AM Peak Hour (ICU)

Trip Distribution Report

Percent Of Trips Cum + Project

Zone	To Gates											
	1	2	3	4	5	7	8	9	10	11	12	
306	10.0	15.0	10.0	5.0	0.0	5.0	5.0	25.0	0.0	25.0	0.0	
307	10.0	15.0	10.0	5.0	50.0	0.0	0.0	0.0	0.0	0.0	0.0	
311	40.0	10.0	10.0	10.0	0.0	5.0	5.0	10.0	0.0	10.0	0.0	
313	15.0	5.0	15.0	10.0	25.0	0.0	5.0	20.0	0.0	0.0	0.0	
314	40.0	10.0	10.0	10.0	0.0	5.0	5.0	10.0	0.0	10.0	0.0	
704	30.0	15.0	8.0	12.0	0.0	5.0	5.0	10.0	5.0	10.0	0.0	
706	25.0	20.0	10.0	25.0	0.0	0.0	0.0	0.0	0.0	0.0	10.0	
710	0.0	0.0	15.0	10.0	10.0	2.0	2.0	20.0	5.0	10.0	1.0	
714	5.0	10.0	5.0	5.0	20.0	5.0	10.0	15.0	5.0	15.0	0.0	
717	10.0	15.0	10.0	5.0	50.0	0.0	0.0	0.0	0.0	0.0	0.0	
718	10.0	10.0	10.0	10.0	20.0	0.0	0.0	20.0	10.0	0.0	0.0	
719	20.0	10.0	10.0	10.0	10.0	5.0	5.0	10.0	5.0	0.0	0.0	
1002	0.0	10.0	5.0	5.0	15.0	5.0	10.0	15.0	5.0	15.0	5.0	
1004	5.0	15.0	10.0	5.0	30.0	0.0	5.0	20.0	0.0	0.0	5.0	
1005	5.0	15.0	10.0	5.0	30.0	0.0	5.0	20.0	0.0	0.0	5.0	
1007	0.0	0.0	0.0	0.0	0.0	0.0	0.0	0.0	0.0	0.0	0.0	

Zone	To Gates						
	13	14	15	16	17	18	20
306	0.0	0.0	0.0	0.0	0.0	0.0	0.0
307	0.0	10.0	0.0	0.0	0.0	0.0	0.0
311	0.0	0.0	0.0	0.0	0.0	0.0	0.0
313	5.0	0.0	0.0	0.0	0.0	0.0	0.0
314	0.0	0.0	0.0	0.0	0.0	0.0	0.0
704	0.0	0.0	0.0	0.0	0.0	0.0	0.0
706	0.0	0.0	0.0	0.0	10.0	0.0	0.0
710	10.0	5.0	10.0	0.0	0.0	0.0	0.0
714	0.0	5.0	0.0	0.0	0.0	0.0	0.0
717	0.0	10.0	0.0	0.0	0.0	0.0	0.0
718	0.0	10.0	0.0	0.0	0.0	0.0	0.0
719	0.0	10.0	5.0	0.0	0.0	0.0	0.0
1002	0.0	5.0	5.0	0.0	0.0	0.0	0.0
1004	0.0	5.0	0.0	0.0	0.0	0.0	0.0
1005	0.0	5.0	0.0	0.0	0.0	0.0	0.0
1007	0.0	0.0	0.0	0.0	0.0	20.0	10.0

Continental Grand Campus Specific Plan
City of El Segundo
Phase 1 Opening Year(2022) With Project AM Peak Hour (ICU)

Impact Analysis Report
Level Of Service

Table with 5 columns: Intersection, Base (Del/V, LOS Veh, C), Future (Del/V, LOS Veh, C), Change in, and V/C. Lists 20 intersections including Sepulveda Blvd at Imperial Hwy, Walnut St, Maple Ave, Mariposa Ave, Grand Ave, El Segundo B, Rosecrans Bl, Continental Boulevard at Marip, Grand, El Se, Nash St and Imperial Hwy, Nash St at Mariposa Ave, Grand Ave, El Segundo Blvd, Douglas Street at El Segundo B, Aviation Boulevard at El Segun, El Segundo Boulevard and Isis, El Segundo Blvd at I-405 SB Ra, El Segundo Blvd at La Cienega, and El Segundo Blvd at I-405 NB Ra.

Continental Grand Campus Specific Plan
City of El Segundo
Phase 1 Opening Year(2022) With Project AM Peak Hour (ICU)

Level Of Service Computation Report

ICU 1(Loss as Cycle Length %) Method (Future Volume Alternative)

Level of Service Computation Report for Intersection #1 Sepulveda Blvd at Imperial Hwy. Includes Cycle (sec): 100, Critical Vol./Cap.(X): 0.872, Loss Time (sec): 5, Average Delay (sec/veh): xxxxxx, Optimal Cycle: 73, Level Of Service: D. Detailed breakdown by approach (North/South/East/West Bound) and movement (L, T, R) for Control, Rights, Min. Green, Y+R, Lanes, Volume Module, Saturation Flow Module, and Capacity Analysis Module.

Continental Grand Campus Specific Plan
City of El Segundo
Phase 1 Opening Year(2022) With Project AM Peak Hour (ICU)

Level Of Service Computation Report

ICU 1(Loss as Cycle Length %) Method (Future Volume Alternative)

Intersection #2 Sepulveda Blvd at Walnut St

Cycle (sec): 100 Critical Vol./Cap.(X): 0.734
Loss Time (sec): 5 Average Delay (sec/veh): xxxxxx
Optimal Cycle: 41 Level Of Service: C

Table with columns for Street Name, Approach, Movement, Control, Rights, Min. Green, Y+R, Lanes. Rows for Sepulveda Blvd and Walnut St.

Table with columns for Volume Module, Base Vol, Growth Adj, Initial Bse, Added Vol, Related Pro, Initial Fut, User Adj, PHF Adj, PHF Volume, Reduct Vol, Reduced Vol, PCE Adj, MLF Adj, Final Volume.

Table with columns for Sat/Lane, Adjustment, Lanes, Final Sat. for Saturation Flow Module.

Table with columns for Vol/Sat, Crit Moves for Capacity Analysis Module.

Continental Grand Campus Specific Plan
City of El Segundo
Phase 1 Opening Year(2022) With Project AM Peak Hour (ICU)

Level Of Service Computation Report

ICU 1(Loss as Cycle Length %) Method (Future Volume Alternative)

Intersection #3 Sepulveda Blvd at Maple Ave

Cycle (sec): 100 Critical Vol./Cap.(X): 0.726
Loss Time (sec): 5 Average Delay (sec/veh): xxxxxx
Optimal Cycle: 40 Level Of Service: C

Table with columns for Street Name, Approach, Movement, Control, Rights, Min. Green, Y+R, Lanes. Rows for Sepulveda Blvd and Maple Ave.

Table with columns for Volume Module, Base Vol, Growth Adj, Initial Bse, Added Vol, Related Pro, Initial Fut, User Adj, PHF Adj, PHF Volume, Reduct Vol, Reduced Vol, PCE Adj, MLF Adj, Final Volume.

Table with columns for Sat/Lane, Adjustment, Lanes, Final Sat. for Saturation Flow Module.

Table with columns for Vol/Sat, Crit Moves for Capacity Analysis Module.

Continental Grand Campus Specific Plan
City of El Segundo
Phase 1 Opening Year(2022) With Project AM Peak Hour (ICU)

Level Of Service Computation Report
ICU 1(Loss as Cycle Length %) Method (Future Volume Alternative)

Intersection #4 Sepulveda Blvd at Mariposa Ave

Cycle (sec): 100 Critical Vol./Cap.(X): 0.785
Loss Time (sec): 5 Average Delay (sec/veh): xxxxxx
Optimal Cycle: 49 Level Of Service: C

Table with columns for Street Name (Sepulveda Blvd, Mariposa Ave), Approach (North Bound, South Bound, East Bound, West Bound), Movement (L, T, R), Control (Protected, Permitted), Rights (Include, Include), and traffic volume metrics (Min. Green, Y+R, Lanes).

Volume Module table showing Base Vol, Growth Adj, Initial Bse, Added Vol, Related Pro, Initial Fut, User Adj, PHF Adj, PHF Volume, Reduct Vol, Reduced Vol, PCE Adj, MLF Adj, and Final Volume across various traffic scenarios.

Saturation Flow Module table showing Sat/Lane, Adjustment, Lanes, and Final Sat. values for different traffic movements.

Capacity Analysis Module table showing Vol/Sat, Crit Moves, and other capacity-related metrics.

Continental Grand Campus Specific Plan
City of El Segundo
Phase 1 Opening Year(2022) With Project AM Peak Hour (ICU)

Level Of Service Computation Report
ICU 1(Loss as Cycle Length %) Method (Future Volume Alternative)

Intersection #5 Sepulveda Blvd at Grand Ave

Cycle (sec): 100 Critical Vol./Cap.(X): 0.841
Loss Time (sec): 5 Average Delay (sec/veh): xxxxxx
Optimal Cycle: 62 Level Of Service: D

Table with columns for Street Name (Sepulveda Blvd, Grand Ave), Approach (North Bound, South Bound, East Bound, West Bound), Movement (L, T, R), Control (Protected, Split Phase), Rights (Include, Include), and traffic volume metrics (Min. Green, Y+R, Lanes).

Volume Module table showing Base Vol, Growth Adj, Initial Bse, Added Vol, Related Pro, Initial Fut, User Adj, PHF Adj, PHF Volume, Reduct Vol, Reduced Vol, PCE Adj, MLF Adj, and Final Volume across various traffic scenarios.

Saturation Flow Module table showing Sat/Lane, Adjustment, Lanes, and Final Sat. values for different traffic movements.

Capacity Analysis Module table showing Vol/Sat, Crit Moves, and other capacity-related metrics.

Continental Grand Campus Specific Plan
City of El Segundo
Phase 1 Opening Year(2022) With Project AM Peak Hour (ICU)

Level Of Service Computation Report

ICU 1(Loss as Cycle Length %) Method (Future Volume Alternative)

Intersection #6 Sepulveda Blvd at El Segundo Blvd

Cycle (sec): 100 Critical Vol./Cap.(X): 1.079
Loss Time (sec): 5 Average Delay (sec/veh): xxxxxx
Optimal Cycle: 180 Level Of Service: F

Table with columns for Street Name, Approach, Movement, Control, Rights, Min. Green, Y+R, Lanes. Rows for Sepulveda Blvd and El Segundo Blvd.

Volume Module table with columns for Base Vol, Growth Adj, Initial Bse, Added Vol, Related Pro, Initial Fut, User Adj, PHF Adj, PHF Volume, Reduct Vol, Reduced Vol, PCE Adj, MLF Adj, Final Volume.

Saturation Flow Module table with columns for Sat/Lane, Adjustment, Lanes, Final Sat.

Capacity Analysis Module table with columns for Vol/Sat, Crit Moves.

Continental Grand Campus Specific Plan
City of El Segundo
Phase 1 Opening Year(2022) With Project AM Peak Hour (ICU)

Level Of Service Computation Report

ICU 1(Loss as Cycle Length %) Method (Future Volume Alternative)

Intersection #7 Sepulveda Blvd at Rosecrans Blvd

Cycle (sec): 100 Critical Vol./Cap.(X): 0.934
Loss Time (sec): 5 Average Delay (sec/veh): xxxxxx
Optimal Cycle: 112 Level Of Service: E

Table with columns for Street Name, Approach, Movement, Control, Rights, Min. Green, Y+R, Lanes. Rows for Sepulveda Blvd and Rosecrans Blvd.

Volume Module table with columns for Base Vol, Growth Adj, Initial Bse, Added Vol, Related Pro, Initial Fut, User Adj, PHF Adj, PHF Volume, Reduct Vol, Reduced Vol, PCE Adj, MLF Adj, Final Volume, OvlAdjVol.

Saturation Flow Module table with columns for Sat/Lane, Adjustment, Lanes, Final Sat.

Capacity Analysis Module table with columns for Vol/Sat, OvlAdjV/S, Crit Moves.

Continental Grand Campus Specific Plan
City of El Segundo
Phase 1 Opening Year(2022) With Project AM Peak Hour (ICU)

Level Of Service Computation Report

ICU 1(Loss as Cycle Length %) Method (Future Volume Alternative)

Intersection #8 Continental Boulevard at Mariposa Ave

Cycle (sec): 100 Critical Vol./Cap.(X): 0.500
Loss Time (sec): 5 Average Delay (sec/veh): xxxxxx
Optimal Cycle: 24 Level Of Service: A

Table with columns: Street Name, Approach, Movement, Control, Rights, Min. Green, Y+R, Lanes. Rows for Continental Boulevard and Mariposa Avenue.

Volume Module table with columns: Base Vol, Growth Adj, Initial Bse, Added Vol, Related Pro, Initial Fut, User Adj, PHF Adj, PHF Volume, Reduct Vol, Reduced Vol, PCE Adj, MLF Adj, Final Volume.

Saturation Flow Module table with columns: Sat/Lane, Adjustment, Lanes, Final Sat.

Capacity Analysis Module table with columns: Vol/Sat, Crit Moves.

Continental Grand Campus Specific Plan
City of El Segundo
Phase 1 Opening Year(2022) With Project AM Peak Hour (ICU)

Level Of Service Computation Report

ICU 1(Loss as Cycle Length %) Method (Future Volume Alternative)

Intersection #9 Continental Boulevard at Grand Avenue

Cycle (sec): 100 Critical Vol./Cap.(X): 0.402
Loss Time (sec): 5 Average Delay (sec/veh): xxxxxx
Optimal Cycle: 20 Level Of Service: A

Table with columns: Street Name, Approach, Movement, Control, Rights, Min. Green, Y+R, Lanes. Rows for Continental Boulevard and Grand Avenue.

Volume Module table with columns: Base Vol, Growth Adj, Initial Bse, Added Vol, Related Pro, Initial Fut, User Adj, PHF Adj, PHF Volume, Reduct Vol, Reduced Vol, PCE Adj, MLF Adj, Final Volume.

Saturation Flow Module table with columns: Sat/Lane, Adjustment, Lanes, Final Sat.

Capacity Analysis Module table with columns: Vol/Sat, Crit Moves.

Continental Grand Campus Specific Plan
City of El Segundo
Phase 1 Opening Year(2022) With Project AM Peak Hour (ICU)

Level Of Service Computation Report

ICU 1(Loss as Cycle Length %) Method (Future Volume Alternative)

Intersection #10 Continental Boulevard at El Segundo Boulevard

Cycle (sec): 100 Critical Vol./Cap.(X): 0.551
Loss Time (sec): 5 Average Delay (sec/veh): xxxxxx
Optimal Cycle: 26 Level Of Service: A

Table with columns for Street Name, Approach, Movement, Control, Rights, Min. Green, Y+R, and Lanes. Rows include Continental Boulevard and El Segundo Boulevard with various approach and movement details.

Volume Module:

Table showing traffic volume data including Base Vol, Growth Adj, Initial Bse, Added Vol, Related Pro, Initial Fut, User Adj, PHF Adj, PHF Volume, Reduct Vol, Reduced Vol, PCE Adj, MLF Adj, and Final Volume.

Saturation Flow Module:

Table showing saturation flow data including Sat/Lane, Adjustment, Lanes, and Final Sat.

Capacity Analysis Module:

Table showing capacity analysis data including Vol/Sat and Crit Moves.

Continental Grand Campus Specific Plan
City of El Segundo
Phase 1 Opening Year(2022) With Project AM Peak Hour (ICU)

Level Of Service Computation Report

ICU 1(Loss as Cycle Length %) Method (Future Volume Alternative)

Intersection #11 Nash St and Imperial Hwy

Cycle (sec): 100 Critical Vol./Cap.(X): 0.820
Loss Time (sec): 5 Average Delay (sec/veh): xxxxxx
Optimal Cycle: 57 Level Of Service: D

Table with columns for Street Name, Approach, Movement, Control, Rights, Min. Green, Y+R, and Lanes. Rows include Nash St and Imperial Hwy with various approach and movement details.

Volume Module:

Table showing traffic volume data including Base Vol, Growth Adj, Initial Bse, Added Vol, Related Pro, Initial Fut, User Adj, PHF Adj, PHF Volume, Reduct Vol, Reduced Vol, PCE Adj, MLF Adj, and Final Volume.

Saturation Flow Module:

Table showing saturation flow data including Sat/Lane, Adjustment, Lanes, and Final Sat.

Capacity Analysis Module:

Table showing capacity analysis data including Vol/Sat and Crit Moves.

Continental Grand Campus Specific Plan
City of El Segundo
Phase 1 Opening Year(2022) With Project AM Peak Hour (ICU)

Level Of Service Computation Report

ICU 1(Loss as Cycle Length %) Method (Future Volume Alternative)

Intersection #12 Nash St at Mariposa Ave

Cycle (sec): 100 Critical Vol./Cap.(X): 0.662
Loss Time (sec): 5 Average Delay (sec/veh): xxxxxx
Optimal Cycle: 34 Level Of Service: B

Table with columns for Street Name (Nash St, Mariposa Ave), Approach (North Bound, South Bound, East Bound, West Bound), Movement (L, T, R), Control (Permitted, Include), Rights, Min. Green, Y+R, Lanes.

Volume Module:

Table with columns for Base Vol, Growth Adj, Initial Bse, Added Vol, PasserByVol, Initial Fut, User Adj, PHF Adj, PHF Volume, Reduct Vol, Reduced Vol, PCE Adj, MLF Adj, FinalVolume.

Saturation Flow Module:

Table with columns for Sat/Lane, Adjustment, Lanes, Final Sat.

Capacity Analysis Module:

Table with columns for Vol/Sat, Crit Moves.

Continental Grand Campus Specific Plan
City of El Segundo
Phase 1 Opening Year(2022) With Project AM Peak Hour (ICU)

Level Of Service Computation Report

ICU 1(Loss as Cycle Length %) Method (Future Volume Alternative)

Intersection #13 Nash St at Grand Ave

Cycle (sec): 100 Critical Vol./Cap.(X): 0.553
Loss Time (sec): 5 Average Delay (sec/veh): xxxxxx
Optimal Cycle: 26 Level Of Service: A

Table with columns for Street Name (Nash St, Grand Ave), Approach (North Bound, South Bound, East Bound, West Bound), Movement (L, T, R), Control (Protected, Split Phase, Include), Rights, Min. Green, Y+R, Lanes.

Volume Module:

Table with columns for Base Vol, Growth Adj, Initial Bse, Added Vol, Related Pro, Initial Fut, User Adj, PHF Adj, PHF Volume, Reduct Vol, Reduced Vol, PCE Adj, MLF Adj, FinalVolume.

Saturation Flow Module:

Table with columns for Sat/Lane, Adjustment, Lanes, Final Sat.

Capacity Analysis Module:

Table with columns for Vol/Sat, Crit Moves.

Continental Grand Campus Specific Plan
City of El Segundo
Phase 1 Opening Year(2022) With Project AM Peak Hour (ICU)

Level Of Service Computation Report

ICU 1(Loss as Cycle Length %) Method (Future Volume Alternative)

Intersection #14 Nash St at El Segundo Blvd

Cycle (sec): 100 Critical Vol./Cap.(X): 0.729
Loss Time (sec): 5 Average Delay (sec/veh): xxxxxx
Optimal Cycle: 41 Level Of Service: C

Table with columns for Street Name (Nash St, El Segundo Blvd), Approach (North Bound, South Bound, East Bound, West Bound), Movement (L, T, R), Control (Split Phase, Protected), Rights (Ovl, Include), and various traffic metrics like Min. Green, Y+R, Lanes.

Volume Module table showing Base Vol, Growth Adj, Initial Bse, Added Vol, Related Pro, Initial Fut, User Adj, PHF Adj, PHF Volume, Reduct Vol, Reduced Vol, PCE Adj, MLF Adj, Final Volume, and OvlAdjVol.

Saturation Flow Module table showing Sat/Lane, Adjustment, Lanes, and Final Sat.

Capacity Analysis Module table showing Vol/Sat, OvlAdjV/S, and Crit Moves.

Continental Grand Campus Specific Plan
City of El Segundo
Phase 1 Opening Year(2022) With Project AM Peak Hour (ICU)

Level Of Service Computation Report

ICU 1(Loss as Cycle Length %) Method (Future Volume Alternative)

Intersection #15 Douglas Street at El Segundo Boulevard

Cycle (sec): 100 Critical Vol./Cap.(X): 1.015
Loss Time (sec): 5 Average Delay (sec/veh): xxxxxx
Optimal Cycle: 180 Level Of Service: F

Table with columns for Street Name (Douglas St, El Segundo Blvd), Approach (North Bound, South Bound, East Bound, West Bound), Movement (L, T, R), Control (Protected), Rights (Include), and various traffic metrics like Min. Green, Y+R, Lanes.

Volume Module table showing Base Vol, Growth Adj, Initial Bse, Added Vol, Related Pro, Initial Fut, User Adj, PHF Adj, PHF Volume, Reduct Vol, Reduced Vol, PCE Adj, MLF Adj, Final Volume, and OvlAdjVol.

Saturation Flow Module table showing Sat/Lane, Adjustment, Lanes, and Final Sat.

Capacity Analysis Module table showing Vol/Sat, Crit Moves.

Continental Grand Campus Specific Plan
City of El Segundo
Phase 1 Opening Year(2022) With Project AM Peak Hour (ICU)

Level Of Service Computation Report

ICU 1(Loss as Cycle Length %) Method (Future Volume Alternative)

Intersection #16 Aviation Boulevard at El Segundo Boulevard

Cycle (sec): 100 Critical Vol./Cap.(X): 1.192
Loss Time (sec): 5 Average Delay (sec/veh): xxxxxx
Optimal Cycle: 180 Level Of Service: F

Table with columns for Street Name, Approach, Movement, Control, Rights, Min. Green, Y+R, Lanes. Rows for Aviatio Blvd and El Segundo Blvd.

Volume Module table with columns for Base Vol, Growth Adj, Initial Bse, Added Vol, Related Pro, Initial Fut, User Adj, PHF Adj, PHF Volume, Reduct Vol, Reduced Vol, PCE Adj, MLF Adj, FinalVolume, OvlAdjVol.

Saturation Flow Module table with columns for Sat/Lane, Adjustment, Lanes, Final Sat.

Capacity Analysis Module table with columns for Vol/Sat, OvlAdjV/S, Crit Moves.

Continental Grand Campus Specific Plan
City of El Segundo
Phase 1 Opening Year(2022) With Project AM Peak Hour (ICU)

Level Of Service Computation Report

ICU 1(Loss as Cycle Length %) Method (Future Volume Alternative)

Intersection #17 El Segundo Boulevard and Isis Avenue

Cycle (sec): 100 Critical Vol./Cap.(X): 0.853
Loss Time (sec): 5 Average Delay (sec/veh): xxxxxx
Optimal Cycle: 66 Level Of Service: D

Table with columns for Street Name, Approach, Movement, Control, Rights, Min. Green, Y+R, Lanes. Rows for Isis Avenue and El Segundo Boulevard.

Volume Module table with columns for Base Vol, Growth Adj, Initial Bse, Added Vol, Related Pro, Initial Fut, User Adj, PHF Adj, PHF Volume, Reduct Vol, Reduced Vol, PCE Adj, MLF Adj, FinalVolume.

Saturation Flow Module table with columns for Sat/Lane, Adjustment, Lanes, Final Sat.

Capacity Analysis Module table with columns for Vol/Sat, Crit Moves.

Continental Grand Campus Specific Plan
City of El Segundo
Phase 1 Opening Year(2022) With Project AM Peak Hour (ICU)

Level Of Service Computation Report

ICU 1(Loss as Cycle Length %) Method (Future Volume Alternative)

Intersection #18 El Segundo Blvd at I-405 SB Ramps

Cycle (sec): 100 Critical Vol./Cap.(X): 0.798
Loss Time (sec): 5 Average Delay (sec/veh): xxxxxx
Optimal Cycle: 52 Level Of Service: C

Table with columns for Street Name, Approach, Movement, Control, Rights, Min. Green, Y+R, Lanes. Rows for I-405 SB Ramps and El Segundo Blvd.

Volume Module table with columns for Base Vol, Growth Adj, Initial Bse, Added Vol, Related Pro, Initial Fut, User Adj, PHF Adj, PHF Volume, Reduct Vol, Reduced Vol, PCE Adj, MLF Adj, Final Volume.

Saturation Flow Module table with columns for Sat/Lane, Adjustment, Lanes, Final Sat.

Capacity Analysis Module table with columns for Vol/Sat, Crit Moves.

Continental Grand Campus Specific Plan
City of El Segundo
Phase 1 Opening Year(2022) With Project AM Peak Hour (ICU)

Level Of Service Computation Report

ICU 1(Loss as Cycle Length %) Method (Future Volume Alternative)

Intersection #19 El Segundo Blvd at La Cienega Blvd

Cycle (sec): 100 Critical Vol./Cap.(X): 0.873
Loss Time (sec): 5 Average Delay (sec/veh): xxxxxx
Optimal Cycle: 74 Level Of Service: D

Table with columns for Street Name, Approach, Movement, Control, Rights, Min. Green, Y+R, Lanes. Rows for La Cienega Blvd and El Segundo Blvd.

Volume Module table with columns for Base Vol, Growth Adj, Initial Bse, Added Vol, Related Pro, Initial Fut, User Adj, PHF Adj, PHF Volume, Reduct Vol, Reduced Vol, PCE Adj, MLF Adj, Final Volume.

Saturation Flow Module table with columns for Sat/Lane, Adjustment, Lanes, Final Sat.

Capacity Analysis Module table with columns for Vol/Sat, Crit Moves.

Continental Grand Campus Specific Plan
City of El Segundo
Phase 1 Opening Year(2022) With Project AM Peak Hour (ICU)

Level Of Service Computation Report

ICU 1(Loss as Cycle Length %) Method (Future Volume Alternative)

Intersection #20 El Segundo Blvd at I-405 NB Ramps

Cycle (sec): 100 Critical Vol./Cap.(X): 0.916
Loss Time (sec): 5 Average Delay (sec/veh): xxxxxx
Optimal Cycle: 97 Level Of Service: E

Table with columns for Street Name, Approach, Movement, Control, Rights, Min. Green, Y+R, Lanes. Rows include I-405 NB Ramps and El Segundo Blvd with various movement and control details.

Volume Module table with columns for Base Vol, Growth Adj, Initial Bse, Added Vol, Related Pro, Initial Fut, User Adj, PHF Adj, PHF Volume, Reduct Vol, Reduced Vol, PCE Adj, MLF Adj, Final Volume. Rows include I-405 NB Ramps and El Segundo Blvd.

Saturation Flow Module table with columns for Sat/Lane, Adjustment, Lanes, Final Sat. Rows include I-405 NB Ramps and El Segundo Blvd.

Capacity Analysis Module table with columns for Vol/Sat, Crit Moves. Rows include I-405 NB Ramps and El Segundo Blvd.

 Continental Grand Campus Specific Plan
 City of El Segundo
 Phase 1 Opening Year(2022) With Project PM Peak Hour (ICU)

Scenario: Phase 1 Op Yr With Proj PM

Command: Phase 1 Op Yr With Proj PM
 Volume: OY PM
 Geometry: Existing
 Impact Fee: Default Impact Fee
 Trip Generation: Cum + Phase 1 PM
 Trip Distribution: Cum + Proj
 Paths: Project
 Routes: Default Route
 Configuration: Phase 1 Op Yr With Proj PM

 Continental Grand Campus Specific Plan
 City of El Segundo
 Phase 1 Opening Year(2022) With Project PM Peak Hour (ICU)

Trip Generation Report

Forecast for Cum + Phase 1 PM

Zone #	Subzone	Amount	Units	Rate In	Rate Out	Trips In	Trips Out	Total Trips	% Of Total
306	525 N. Sepul	1.00	Residential	-4.00	-6.00	-4	-6	-10	-0.5
	Zone 306 Subtotal					-4	-6	-10	-0.5
307	540 Imperial	1.00	Residential	50.00	32.00	50	32	82	4.2
	Zone 307 Subtotal					50	32	82	4.2
311	199 Continen	1.00	Business Hotel	46.00	45.00	46	45	91	4.6
	Zone 311 Subtotal					46	45	91	4.6
313	445 N. Dougl	1.00	Equinix Data C	3.00	13.00	3	13	16	0.8
	Zone 313 Subtotal					3	13	16	0.8
314	123 Lomita a	1.00	Office	2.00	16.00	2	16	18	0.9
	Zone 314 Subtotal					2	16	18	0.9
704	2355 Utah Av	1.00	Office	95.00	109.00	95	109	204	10.3
	Zone 704 Subtotal					95	109	204	10.3
706	888 Sepulved	1.00	hotel	60.00	41.00	60	41	101	5.1
	Zone 706 Subtotal					60	41	101	5.1
710	201 North Do	1.00	High School	-15.00	-74.00	-15	-74	-89	-4.5
710	201 North Do	1.00	District Offic	3.00	18.00	3	18	21	1.1
	Zone 710 Subtotal					-12	-56	-68	-3.4
714	400 Duley -	1.00	Office	18.00	87.00	18	87	105	5.3
714	400 Duley -	1.00	Industrial	0.00	0.00	0	0	0	0.0
	Zone 714 Subtotal					18	87	105	5.3
717	1700 Imperia	1.00	Townhome Resid	25.00	120.00	25	120	145	7.3
	Zone 717 Subtotal					25	120	145	7.3
718	123 Nevada S	1.00	Office	4.00	16.00	4	16	20	1.0
718	123 Nevada S	0.00	123 Nevada	4.00	16.00	0	0	0	0.0
	Zone 718 Subtotal					4	16	20	1.0
719	2125 Campus	1.00	Office Retail	64.00	146.00	64	146	210	10.6
	Zone 719 Subtotal					64	146	210	10.6
1002	Laker Facili	1.00	General Office	103.00	85.00	103	85	188	9.5
	Zone 1002 Subtotal					103	85	188	9.5
1005	Mattel	1.00	Mattel	48.00	388.00	48	388	436	22.1

 Continental Grand Campus Specific Plan
 City of El Segundo
 Phase 1 Opening Year(2022) With Project PM Peak Hour (ICU)

Zone #	Subzone	Amount	Units	Rate In	Rate Out	Trips In	Trips Out	Total Trips	% Of Total
	Zone 1005 Subtotal					48	388	436	22.1
1007	Mattel Proje	1.00	project	48.00	388.00	48	388	436	22.1
	Zone 1007 Subtotal					48	388	436	22.1

TOTAL						550	1424	1974	100.0

 Continental Grand Campus Specific Plan
 City of El Segundo
 Phase 1 Opening Year(2022) With Project PM Peak Hour (ICU)

Trip Distribution Report

Percent Of Trips Cum + Project

Zone	To Gates											
	1	2	3	4	5	7	8	9	10	11	12	
306	10.0	15.0	10.0	5.0	0.0	5.0	5.0	25.0	0.0	25.0	0.0	
307	10.0	15.0	10.0	5.0	50.0	0.0	0.0	0.0	0.0	0.0	0.0	
311	40.0	10.0	10.0	10.0	0.0	5.0	5.0	10.0	0.0	10.0	0.0	
313	15.0	5.0	15.0	10.0	25.0	0.0	5.0	20.0	0.0	0.0	0.0	
314	40.0	10.0	10.0	10.0	0.0	5.0	5.0	10.0	0.0	10.0	0.0	
704	30.0	15.0	8.0	12.0	0.0	5.0	5.0	10.0	5.0	10.0	0.0	
706	25.0	20.0	10.0	25.0	0.0	0.0	0.0	0.0	0.0	0.0	10.0	
710	0.0	0.0	15.0	10.0	10.0	2.0	2.0	20.0	5.0	10.0	1.0	
714	5.0	10.0	5.0	5.0	20.0	5.0	10.0	15.0	5.0	15.0	0.0	
717	10.0	15.0	10.0	5.0	50.0	0.0	0.0	0.0	0.0	0.0	0.0	
718	10.0	10.0	10.0	10.0	20.0	0.0	0.0	20.0	10.0	0.0	0.0	
719	20.0	10.0	10.0	10.0	10.0	5.0	5.0	10.0	5.0	0.0	0.0	
1002	0.0	10.0	5.0	5.0	15.0	5.0	10.0	15.0	5.0	15.0	5.0	
1004	5.0	15.0	10.0	5.0	30.0	0.0	5.0	20.0	0.0	0.0	5.0	
1005	5.0	15.0	10.0	5.0	30.0	0.0	5.0	20.0	0.0	0.0	5.0	
1007	0.0	0.0	0.0	0.0	0.0	0.0	0.0	0.0	0.0	0.0	0.0	

Zone	To Gates						
	13	14	15	16	17	18	20
306	0.0	0.0	0.0	0.0	0.0	0.0	0.0
307	0.0	10.0	0.0	0.0	0.0	0.0	0.0
311	0.0	0.0	0.0	0.0	0.0	0.0	0.0
313	5.0	0.0	0.0	0.0	0.0	0.0	0.0
314	0.0	0.0	0.0	0.0	0.0	0.0	0.0
704	0.0	0.0	0.0	0.0	0.0	0.0	0.0
706	0.0	0.0	0.0	0.0	10.0	0.0	0.0
710	10.0	5.0	10.0	0.0	0.0	0.0	0.0
714	0.0	5.0	0.0	0.0	0.0	0.0	0.0
717	0.0	10.0	0.0	0.0	0.0	0.0	0.0
718	0.0	10.0	0.0	0.0	0.0	0.0	0.0
719	0.0	10.0	5.0	0.0	0.0	0.0	0.0
1002	0.0	5.0	5.0	0.0	0.0	0.0	0.0
1004	0.0	5.0	0.0	0.0	0.0	0.0	0.0
1005	0.0	5.0	0.0	0.0	0.0	0.0	0.0
1007	0.0	0.0	0.0	0.0	0.0	20.0	10.0

Continental Grand Campus Specific Plan
City of El Segundo
Phase 1 Opening Year(2022) With Project PM Peak Hour (ICU)

Impact Analysis Report
Level Of Service

Table with columns: Intersection, Base (Del/V, LOS Veh, C), Future (Del/V, LOS Veh, C), Change in. Lists 20 intersections including Sepulveda Blvd at Imperial Hwy, Walnut St, Maple Ave, Mariposa Ave, Grand Ave, El Segundo B, Rosecrans Bl, Continental Boulevard at Marip, Grand, El Se, Nash St and Imperial Hwy, Nash St at Mariposa Ave, Grand Ave, El Segundo Blvd, Douglas Street at El Segundo B, Aviation Boulevard at El Segun, El Segundo Boulevard and Isis, El Segundo Blvd at I-405 SB Ra, El Segundo Blvd at La Cienega, El Segundo Blvd at I-405 NB Ra.

Continental Grand Campus Specific Plan
City of El Segundo
Phase 1 Opening Year(2022) With Project PM Peak Hour (ICU)

Level Of Service Computation Report

ICU 1(Loss as Cycle Length %) Method (Future Volume Alternative)

Level of Service Computation Report for Intersection #1 Sepulveda Blvd at Imperial Hwy. Includes Cycle (sec): 100, Critical Vol./Cap.(X): 1.036, Loss Time (sec): 5, Average Delay (sec/veh): xxxxxx, Optimal Cycle: 180, Level Of Service: F. Detailed table for Street Name: Sepulveda Blvd and Imperial Hwy, showing Approach, Movement, Control, Rights, Min. Green, Y+R, Lanes, Volume Module, Saturation Flow Module, and Capacity Analysis Module.

Continental Grand Campus Specific Plan
City of El Segundo
Phase 1 Opening Year(2022) With Project PM Peak Hour (ICU)

Level Of Service Computation Report
ICU 1(Loss as Cycle Length %) Method (Future Volume Alternative)

Intersection #2 Sepulveda Blvd at Walnut St

Cycle (sec): 100 Critical Vol./Cap.(X): 0.760
Loss Time (sec): 5 Average Delay (sec/veh): xxxxxx
Optimal Cycle: 45 Level Of Service: C

Table with columns for Street Name, Approach, Movement, Control, Rights, Min. Green, Y+R, Lanes for Sepulveda Blvd and Walnut St.

Volume Module table with columns for Base Vol, Growth Adj, Initial Bse, Added Vol, Related Pro, Initial Fut, User Adj, PHF Adj, PHF Volume, Reduct Vol, Reduced Vol, PCE Adj, MLF Adj, Final Volume.

Saturation Flow Module table with columns for Sat/Lane, Adjustment, Lanes, Final Sat.

Capacity Analysis Module table with columns for Vol/Sat, Crit Moves.

Continental Grand Campus Specific Plan
City of El Segundo
Phase 1 Opening Year(2022) With Project PM Peak Hour (ICU)

Level Of Service Computation Report
ICU 1(Loss as Cycle Length %) Method (Future Volume Alternative)

Intersection #3 Sepulveda Blvd at Maple Ave

Cycle (sec): 100 Critical Vol./Cap.(X): 0.771
Loss Time (sec): 5 Average Delay (sec/veh): xxxxxx
Optimal Cycle: 47 Level Of Service: C

Table with columns for Street Name, Approach, Movement, Control, Rights, Min. Green, Y+R, Lanes for Sepulveda Blvd and Maple Ave.

Volume Module table with columns for Base Vol, Growth Adj, Initial Bse, Added Vol, Related Pro, Initial Fut, User Adj, PHF Adj, PHF Volume, Reduct Vol, Reduced Vol, PCE Adj, MLF Adj, Final Volume.

Saturation Flow Module table with columns for Sat/Lane, Adjustment, Lanes, Final Sat.

Capacity Analysis Module table with columns for Vol/Sat, Crit Moves.

Continental Grand Campus Specific Plan
City of El Segundo
Phase 1 Opening Year(2022) With Project PM Peak Hour (ICU)

Level Of Service Computation Report
ICU 1(Loss as Cycle Length %) Method (Future Volume Alternative)

Intersection #4 Sepulveda Blvd at Mariposa Ave

Cycle (sec): 100 Critical Vol./Cap.(X): 0.835
Loss Time (sec): 5 Average Delay (sec/veh): xxxxxx
Optimal Cycle: 61 Level Of Service: D

Table with columns for Street Name (Sepulveda Blvd, Mariposa Ave), Approach (North Bound, South Bound, East Bound, West Bound), Movement (L, T, R), Control (Protected, Permitted), Rights (Include), and traffic volume metrics (Min. Green, Y+R, Lanes).

Volume Module table showing Base Vol, Growth Adj, Initial Bse, Added Vol, Related Pro, Initial Fut, User Adj, PHF Adj, PHF Volume, Reduct Vol, Reduced Vol, PCE Adj, MLF Adj, and Final Volume for various approaches.

Saturation Flow Module table showing Sat/Lane, Adjustment, Lanes, and Final Sat. for different approaches.

Capacity Analysis Module table showing Vol/Sat, Crit Moves, and OvlAdjV/S for various approaches.

Continental Grand Campus Specific Plan
City of El Segundo
Phase 1 Opening Year(2022) With Project PM Peak Hour (ICU)

Level Of Service Computation Report
ICU 1(Loss as Cycle Length %) Method (Future Volume Alternative)

Intersection #5 Sepulveda Blvd at Grand Ave

Cycle (sec): 100 Critical Vol./Cap.(X): 0.898
Loss Time (sec): 5 Average Delay (sec/veh): xxxxxx
Optimal Cycle: 85 Level Of Service: D

Table with columns for Street Name (Sepulveda Blvd, Grand Ave), Approach (North Bound, South Bound, East Bound, West Bound), Movement (L, T, R), Control (Protected, Split Phase), Rights (Include), and traffic volume metrics (Min. Green, Y+R, Lanes).

Volume Module table showing Base Vol, Growth Adj, Initial Bse, Added Vol, Related Pro, Initial Fut, User Adj, PHF Adj, PHF Volume, Reduct Vol, Reduced Vol, PCE Adj, MLF Adj, and Final Volume for various approaches.

Saturation Flow Module table showing Sat/Lane, Adjustment, Lanes, and Final Sat. for different approaches.

Capacity Analysis Module table showing Vol/Sat, Crit Moves, and OvlAdjV/S for various approaches.

Continental Grand Campus Specific Plan
City of El Segundo
Phase 1 Opening Year(2022) With Project PM Peak Hour (ICU)

Level Of Service Computation Report

ICU 1(Loss as Cycle Length %) Method (Future Volume Alternative)

Intersection #6 Sepulveda Blvd at El Segundo Blvd

Cycle (sec): 100 Critical Vol./Cap.(X): 1.089
Loss Time (sec): 5 Average Delay (sec/veh): xxxxxx
Optimal Cycle: 180 Level Of Service: F

Table with columns for Street Name, Approach, Movement, Control, Rights, Min. Green, Y+R, Lanes. Rows for Sepulveda Blvd and El Segundo Blvd.

Volume Module table with columns for Base Vol, Growth Adj, Initial Bse, Added Vol, Related Pro, Initial Fut, User Adj, PHF Adj, PHF Volume, Reduct Vol, Reduced Vol, PCE Adj, MLF Adj, Final Volume.

Saturation Flow Module table with columns for Sat/Lane, Adjustment, Lanes, Final Sat.

Capacity Analysis Module table with columns for Vol/Sat, Crit Moves.

Continental Grand Campus Specific Plan
City of El Segundo
Phase 1 Opening Year(2022) With Project PM Peak Hour (ICU)

Level Of Service Computation Report

ICU 1(Loss as Cycle Length %) Method (Future Volume Alternative)

Intersection #7 Sepulveda Blvd at Rosecrans Blvd

Cycle (sec): 100 Critical Vol./Cap.(X): 1.015
Loss Time (sec): 5 Average Delay (sec/veh): xxxxxx
Optimal Cycle: 180 Level Of Service: F

Table with columns for Street Name, Approach, Movement, Control, Rights, Min. Green, Y+R, Lanes. Rows for Sepulveda Blvd and Rosecrans Blvd.

Volume Module table with columns for Base Vol, Growth Adj, Initial Bse, Added Vol, Related Pro, Initial Fut, User Adj, PHF Adj, PHF Volume, Reduct Vol, Reduced Vol, PCE Adj, MLF Adj, Final Volume, OvlAdjVol.

Saturation Flow Module table with columns for Sat/Lane, Adjustment, Lanes, Final Sat.

Capacity Analysis Module table with columns for Vol/Sat, OvlAdjV/S, Crit Moves.

Continental Grand Campus Specific Plan
City of El Segundo
Phase 1 Opening Year(2022) With Project PM Peak Hour (ICU)

Level Of Service Computation Report
ICU 1(Loss as Cycle Length %) Method (Future Volume Alternative)

Intersection #8 Continental Boulevard at Mariposa Ave

Cycle (sec): 100 Critical Vol./Cap.(X): 0.405
Loss Time (sec): 5 Average Delay (sec/veh): xxxxxx
Optimal Cycle: 20 Level Of Service: A

Street Name: Continental Boulevard Mariposa Avenue

Table with columns for Approach (North Bound, South Bound, East Bound, West Bound) and Movement (L, T, R). Rows include Control, Rights, Min. Green, Y+R, and Lanes.

Volume Module table with columns for Base Vol, Growth Adj, Initial Bse, Added Vol, Related Pro, Initial Fut, User Adj, PHF Adj, PHF Volume, Reduct Vol, Reduced Vol, PCE Adj, MLF Adj, and Final Volume.

Saturation Flow Module table with columns for Sat/Lane, Adjustment, Lanes, and Final Sat.

Capacity Analysis Module table with columns for Vol/Sat and Crit Moves.

Continental Grand Campus Specific Plan
City of El Segundo
Phase 1 Opening Year(2022) With Project PM Peak Hour (ICU)

Level Of Service Computation Report
ICU 1(Loss as Cycle Length %) Method (Future Volume Alternative)

Intersection #9 Continental Boulevard at Grand Avenue

Cycle (sec): 100 Critical Vol./Cap.(X): 0.378
Loss Time (sec): 5 Average Delay (sec/veh): xxxxxx
Optimal Cycle: 19 Level Of Service: A

Street Name: Continental Boulevard Grand Avenue

Table with columns for Approach (North Bound, South Bound, East Bound, West Bound) and Movement (L, T, R). Rows include Control, Rights, Min. Green, Y+R, and Lanes.

Volume Module table with columns for Base Vol, Growth Adj, Initial Bse, Added Vol, Related Pro, Initial Fut, User Adj, PHF Adj, PHF Volume, Reduct Vol, Reduced Vol, PCE Adj, MLF Adj, and Final Volume.

Saturation Flow Module table with columns for Sat/Lane, Adjustment, Lanes, and Final Sat.

Capacity Analysis Module table with columns for Vol/Sat and Crit Moves.

Continental Grand Campus Specific Plan
City of El Segundo
Phase 1 Opening Year(2022) With Project PM Peak Hour (ICU)

Level Of Service Computation Report

ICU 1(Loss as Cycle Length %) Method (Future Volume Alternative)

Intersection #10 Continental Boulevard at El Segundo Boulevard

Cycle (sec): 100 Critical Vol./Cap.(X): 0.676
Loss Time (sec): 5 Average Delay (sec/veh): xxxxxx
Optimal Cycle: 35 Level Of Service: B

Table with columns for Street Name, Approach, Movement, Control, Rights, Min. Green, Y+R, Lanes. Rows for Continental Boulevard and El Segundo Boulevard.

Volume Module table with columns for Base Vol, Growth Adj, Initial Bse, Added Vol, Related Pro, Initial Fut, User Adj, PHF Adj, PHF Volume, Reduct Vol, Reduced Vol, PCE Adj, MLF Adj, Final Volume.

Saturation Flow Module table with columns for Sat/Lane, Adjustment, Lanes, Final Sat.

Capacity Analysis Module table with columns for Vol/Sat, Crit Moves.

Continental Grand Campus Specific Plan
City of El Segundo
Phase 1 Opening Year(2022) With Project PM Peak Hour (ICU)

Level Of Service Computation Report

ICU 1(Loss as Cycle Length %) Method (Future Volume Alternative)

Intersection #11 Nash St and Imperial Hwy

Cycle (sec): 100 Critical Vol./Cap.(X): 0.530
Loss Time (sec): 5 Average Delay (sec/veh): xxxxxx
Optimal Cycle: 25 Level Of Service: A

Table with columns for Street Name, Approach, Movement, Control, Rights, Min. Green, Y+R, Lanes. Rows for Nash St and Imperial Hwy.

Volume Module table with columns for Base Vol, Growth Adj, Initial Bse, Added Vol, Related Pro, Initial Fut, User Adj, PHF Adj, PHF Volume, Reduct Vol, Reduced Vol, PCE Adj, MLF Adj, Final Volume.

Saturation Flow Module table with columns for Sat/Lane, Adjustment, Lanes, Final Sat.

Capacity Analysis Module table with columns for Vol/Sat, Crit Moves.

Continental Grand Campus Specific Plan
City of El Segundo
Phase 1 Opening Year(2022) With Project PM Peak Hour (ICU)

Level Of Service Computation Report
ICU 1(Loss as Cycle Length %) Method (Future Volume Alternative)

Intersection #12 Nash St at Mariposa Ave

Cycle (sec): 100 Critical Vol./Cap.(X): 0.783
Loss Time (sec): 5 Average Delay (sec/veh): xxxxxx
Optimal Cycle: 49 Level Of Service: C

Table with columns for Street Name (Nash St, Mariposa Ave), Approach (North Bound, South Bound, East Bound, West Bound), Movement (L, T, R), Control (Permitted, Include), Rights, Min. Green, Y+R, Lanes.

Table with columns for Volume Module: Base Vol, Growth Adj, Initial Bse, Added Vol, Related Pro, Initial Fut, User Adj, PHF Adj, PHF Volume, Reduct Vol, Reduced Vol, PCE Adj, MLF Adj, Final Volume.

Table with columns for Saturation Flow Module: Sat/Lane, Adjustment, Lanes, Final Sat.

Table with columns for Capacity Analysis Module: Vol/Sat, Crit Moves.

Continental Grand Campus Specific Plan
City of El Segundo
Phase 1 Opening Year(2022) With Project PM Peak Hour (ICU)

Level Of Service Computation Report
ICU 1(Loss as Cycle Length %) Method (Future Volume Alternative)

Intersection #13 Nash St at Grand Ave

Cycle (sec): 100 Critical Vol./Cap.(X): 0.612
Loss Time (sec): 5 Average Delay (sec/veh): xxxxxx
Optimal Cycle: 30 Level Of Service: B

Table with columns for Street Name (Nash St, Grand Ave), Approach (North Bound, South Bound, East Bound, West Bound), Movement (L, T, R), Control (Protected, Split Phase, Include), Rights, Min. Green, Y+R, Lanes.

Table with columns for Volume Module: Base Vol, Growth Adj, Initial Bse, Added Vol, Related Pro, Initial Fut, User Adj, PHF Adj, PHF Volume, Reduct Vol, Reduced Vol, PCE Adj, MLF Adj, Final Volume.

Table with columns for Saturation Flow Module: Sat/Lane, Adjustment, Lanes, Final Sat.

Table with columns for Capacity Analysis Module: Vol/Sat, Crit Moves.

Continental Grand Campus Specific Plan
City of El Segundo
Phase 1 Opening Year(2022) With Project PM Peak Hour (ICU)

Level Of Service Computation Report

ICU 1(Loss as Cycle Length %) Method (Future Volume Alternative)

Intersection #14 Nash St at El Segundo Blvd

Cycle (sec): 100 Critical Vol./Cap.(X): 1.062
Loss Time (sec): 5 Average Delay (sec/veh): xxxxxx
Optimal Cycle: 180 Level Of Service: F

Table with columns for Street Name (Nash St, El Segundo Blvd), Approach (North Bound, South Bound, East Bound, West Bound), Movement (L, T, R), Control (Split Phase, Protected), Rights (Ovl, Include), and Volume (Min. Green, Y+R, Lanes).

Volume Module table with columns for Base Vol, Growth Adj, Initial Bse, Added Vol, Related Pro, Initial Fut, User Adj, PHF Adj, PHF Volume, Reduct Vol, Reduced Vol, PCE Adj, MLF Adj, Final Volume, and OvlAdjVol.

Saturation Flow Module table with columns for Sat/Lane, Adjustment, Lanes, and Final Sat.

Capacity Analysis Module table with columns for Vol/Sat, OvlAdjV/S, and Crit Moves.

Continental Grand Campus Specific Plan
City of El Segundo
Phase 1 Opening Year(2022) With Project PM Peak Hour (ICU)

Level Of Service Computation Report

ICU 1(Loss as Cycle Length %) Method (Future Volume Alternative)

Intersection #15 Douglas Street at El Segundo Boulevard

Cycle (sec): 100 Critical Vol./Cap.(X): 1.203
Loss Time (sec): 5 Average Delay (sec/veh): xxxxxx
Optimal Cycle: 180 Level Of Service: F

Table with columns for Street Name (Douglas St, El Segundo Blvd), Approach (North Bound, South Bound, East Bound, West Bound), Movement (L, T, R), Control (Protected), Rights (Include), and Volume (Min. Green, Y+R, Lanes).

Volume Module table with columns for Base Vol, Growth Adj, Initial Bse, Added Vol, Related Pro, Initial Fut, User Adj, PHF Adj, PHF Volume, Reduct Vol, Reduced Vol, PCE Adj, MLF Adj, Final Volume, and OvlAdjVol.

Saturation Flow Module table with columns for Sat/Lane, Adjustment, Lanes, and Final Sat.

Capacity Analysis Module table with columns for Vol/Sat, Crit Moves, and other metrics.

Continental Grand Campus Specific Plan
City of El Segundo
Phase 1 Opening Year(2022) With Project PM Peak Hour (ICU)

Level Of Service Computation Report

ICU 1(Loss as Cycle Length %) Method (Future Volume Alternative)

Intersection #16 Aviation Boulevard at El Segundo Boulevard

Cycle (sec): 100 Critical Vol./Cap.(X): 1.177
Loss Time (sec): 5 Average Delay (sec/veh): xxxxxx
Optimal Cycle: 180 Level Of Service: F

Table with columns for Street Name, Approach, Movement, Control, Rights, Min. Green, Y+R, Lanes. Rows for North Bound, South Bound, East Bound, West Bound.

Volume Module table with columns for Base Vol, Growth Adj, Initial Bse, Added Vol, Related Pro, Initial Fut, User Adj, PHF Adj, PHF Volume, Reduct Vol, Reduced Vol, PCE Adj, MLF Adj, Final Volume, OvlAdjVol.

Saturation Flow Module table with columns for Sat/Lane, Adjustment, Lanes, Final Sat.

Capacity Analysis Module table with columns for Vol/Sat, OvlAdjV/S, Crit Moves.

Continental Grand Campus Specific Plan
City of El Segundo
Phase 1 Opening Year(2022) With Project PM Peak Hour (ICU)

Level Of Service Computation Report

ICU 1(Loss as Cycle Length %) Method (Future Volume Alternative)

Intersection #17 El Segundo Boulevard and Isis Avenue

Cycle (sec): 100 Critical Vol./Cap.(X): 0.803
Loss Time (sec): 5 Average Delay (sec/veh): xxxxxx
Optimal Cycle: 53 Level Of Service: D

Table with columns for Street Name, Approach, Movement, Control, Rights, Min. Green, Y+R, Lanes. Rows for North Bound, South Bound, East Bound, West Bound.

Volume Module table with columns for Base Vol, Growth Adj, Initial Bse, Added Vol, Related Pro, Initial Fut, User Adj, PHF Adj, PHF Volume, Reduct Vol, Reduced Vol, PCE Adj, MLF Adj, Final Volume.

Saturation Flow Module table with columns for Sat/Lane, Adjustment, Lanes, Final Sat.

Capacity Analysis Module table with columns for Vol/Sat, Crit Moves.

Continental Grand Campus Specific Plan
City of El Segundo
Phase 1 Opening Year(2022) With Project PM Peak Hour (ICU)

Level Of Service Computation Report

ICU 1(Loss as Cycle Length %) Method (Future Volume Alternative)

Intersection #18 El Segundo Blvd at I-405 SB Ramps

Cycle (sec): 100 Critical Vol./Cap.(X): 1.236
Loss Time (sec): 5 Average Delay (sec/veh): xxxxxx
Optimal Cycle: 180 Level Of Service: F

Table with columns for Street Name, Approach, Movement, Control, Rights, Min. Green, Y+R, Lanes. Rows include I-405 SB Ramps and El Segundo Blvd with various movement and control details.

Volume Module table with columns for Base Vol, Growth Adj, Initial Bse, Added Vol, Related Pro, Initial Fut, User Adj, PHF Adj, PHF Volume, Reduct Vol, Reduced Vol, PCE Adj, MLF Adj, Final Volume.

Saturation Flow Module table with columns for Sat/Lane, Adjustment, Lanes, Final Sat.

Capacity Analysis Module table with columns for Vol/Sat, Crit Moves.

Continental Grand Campus Specific Plan
City of El Segundo
Phase 1 Opening Year(2022) With Project PM Peak Hour (ICU)

Level Of Service Computation Report

ICU 1(Loss as Cycle Length %) Method (Future Volume Alternative)

Intersection #19 El Segundo Blvd at La Cienega Blvd

Cycle (sec): 100 Critical Vol./Cap.(X): 0.761
Loss Time (sec): 5 Average Delay (sec/veh): xxxxxx
Optimal Cycle: 45 Level Of Service: C

Table with columns for Street Name, Approach, Movement, Control, Rights, Min. Green, Y+R, Lanes. Rows include La Cienega Blvd and El Segundo Blvd with various movement and control details.

Volume Module table with columns for Base Vol, Growth Adj, Initial Bse, Added Vol, Related Pro, Initial Fut, User Adj, PHF Adj, PHF Volume, Reduct Vol, Reduced Vol, PCE Adj, MLF Adj, Final Volume.

Saturation Flow Module table with columns for Sat/Lane, Adjustment, Lanes, Final Sat.

Capacity Analysis Module table with columns for Vol/Sat, Crit Moves.

Continental Grand Campus Specific Plan
City of El Segundo
Phase 1 Opening Year(2022) With Project PM Peak Hour (ICU)

Level Of Service Computation Report

ICU 1(Loss as Cycle Length %) Method (Future Volume Alternative)

Intersection #20 El Segundo Blvd at I-405 NB Ramps

Cycle (sec): 100 Critical Vol./Cap.(X): 0.741
Loss Time (sec): 5 Average Delay (sec/veh): xxxxxx
Optimal Cycle: 42 Level Of Service: C

Table with columns for Street Name, Approach, Movement, Control, Rights, Min. Green, Y+R, Lanes. Rows include I-405 NB Ramps and El Segundo Blvd with various movement and control details.

Volume Module table with columns for Base Vol, Growth Adj, Initial Bse, Added Vol, Related Pro, Initial Fut, User Adj, PHF Adj, PHF Volume, Reduct Vol, Reduced Vol, PCE Adj, MLF Adj, Final Volume. Rows include various volume and adjustment factors.

Saturation Flow Module table with columns for Sat/Lane, Adjustment, Lanes, Final Sat. Rows include saturation flow and adjustment factors.

Capacity Analysis Module table with columns for Vol/Sat, Crit Moves. Rows include volume to saturation ratio and critical moves.

 Continental Grand Campus Specific Plan
 City of El Segundo
 Phase 2 Opening Year (2023) Without Project AM Peak Hour (ICU)

Scenario: Phase 2 Op Yr W/o Proj AM

Command: Phase 2 Op Yr W/o Proj AM
 Volume: OY AM
 Geometry: Existing
 Impact Fee: Default Impact Fee
 Trip Generation: Cum AM
 Trip Distribution: Cum + Proj
 Paths: Project
 Routes: Default Route
 Configuration: Phase 2 Op Yr W/o Proj AM

 Continental Grand Campus Specific Plan
 City of El Segundo
 Phase 2 Opening Year (2023) Without Project AM Peak Hour (ICU)

Trip Generation Report

Forecast for Cum AM

Zone #	Subzone	Amount	Units	Rate In	Rate Out	Trips In	Trips Out	Total Trips	% Of Total
306	525 N. Sepul	1.00	Residential	-6.00	-3.00	-6	-3	-9	-0.6
	Zone 306 Subtotal					-6	-3	-9	-0.6
307	540 Imperial	1.00	Residential	23.00	44.00	23	44	67	4.7
	Zone 307 Subtotal					23	44	67	4.7
311	199 Continen	1.00	Business Hotel	48.00	33.00	48	33	81	5.7
	Zone 311 Subtotal					48	33	81	5.7
313	445 N. Dougl	1.00	Equinix Data C	8.00	8.00	8	8	16	1.1
	Zone 313 Subtotal					8	8	16	1.1
314	123 Lomita a	1.00	Office	17.00	3.00	17	3	20	1.4
	Zone 314 Subtotal					17	3	20	1.4
704	2355 Utah Av	1.00	Office	150.00	76.00	150	76	226	15.9
	Zone 704 Subtotal					150	76	226	15.9
706	888 Sepulved	1.00	hotel	57.00	36.00	57	36	93	6.5
	Zone 706 Subtotal					57	36	93	6.5
710	201 North Do	1.00	High School	160.00	111.00	160	111	271	19.1
710	201 North Do	1.00	District Offic	20.00	2.00	20	2	22	1.5
	Zone 710 Subtotal					180	113	293	20.6
714	400 Duley -	1.00	Office	95.00	13.00	95	13	108	7.6
	Zone 714 Subtotal					95	13	108	7.6
717	1700 Imperia	1.00	Townhome Resid	133.00	18.00	133	18	151	10.6
	Zone 717 Subtotal					133	18	151	10.6
718	123 Nevada S	1.00	Office	18.00	3.00	18	3	21	1.5
718	123 Nevada S	0.00	123 Nevada	18.00	3.00	0	0	0	0.0
	Zone 718 Subtotal					18	3	21	1.5
719	2125 Campus	1.00	Office Retail	160.00	46.00	160	46	206	14.5
	Zone 719 Subtotal					160	46	206	14.5
1002	Laker Facili	1.00	General Office	136.00	13.00	136	13	149	10.5
	Zone 1002 Subtotal					136	13	149	10.5

 Continental Grand Campus Specific Plan
 City of El Segundo
 Phase 2 Opening Year (2023) Without Project AM Peak Hour (ICU)

Zone #	Subzone	Amount	Units	Rate In	Rate Out	Trips In	Trips Out	Total Trips	% Of Total
TOTAL						1019	403	1422	100.0

 Continental Grand Campus Specific Plan
 City of El Segundo
 Phase 2 Opening Year (2023) Without Project AM Peak Hour (ICU)

Trip Distribution Report

Percent Of Trips Cum + Project

Zone	To Gates											
	1	2	3	4	5	7	8	9	10	11	12	
306	10.0	15.0	10.0	5.0	0.0	5.0	5.0	25.0	0.0	25.0	0.0	
307	10.0	15.0	10.0	5.0	50.0	0.0	0.0	0.0	0.0	0.0	0.0	
311	40.0	10.0	10.0	10.0	0.0	5.0	5.0	10.0	0.0	10.0	0.0	
313	15.0	5.0	15.0	10.0	25.0	0.0	5.0	20.0	0.0	0.0	0.0	
314	40.0	10.0	10.0	10.0	0.0	5.0	5.0	10.0	0.0	10.0	0.0	
704	30.0	15.0	8.0	12.0	0.0	5.0	5.0	10.0	5.0	10.0	0.0	
706	25.0	20.0	10.0	25.0	0.0	0.0	0.0	0.0	0.0	0.0	10.0	
710	0.0	0.0	15.0	10.0	10.0	2.0	2.0	20.0	5.0	10.0	1.0	
714	5.0	10.0	5.0	5.0	20.0	5.0	10.0	15.0	5.0	15.0	0.0	
717	10.0	15.0	10.0	5.0	50.0	0.0	0.0	0.0	0.0	0.0	0.0	
718	10.0	10.0	10.0	10.0	20.0	0.0	0.0	20.0	10.0	0.0	0.0	
719	20.0	10.0	10.0	10.0	10.0	5.0	5.0	10.0	5.0	0.0	0.0	
1002	0.0	10.0	5.0	5.0	15.0	5.0	10.0	15.0	5.0	15.0	5.0	
1004	5.0	15.0	10.0	5.0	30.0	0.0	5.0	20.0	0.0	0.0	5.0	
1005	5.0	15.0	10.0	5.0	30.0	0.0	5.0	20.0	0.0	0.0	5.0	
1007	0.0	0.0	0.0	0.0	0.0	0.0	0.0	0.0	0.0	0.0	0.0	

Zone	To Gates						
	13	14	15	16	17	18	20
306	0.0	0.0	0.0	0.0	0.0	0.0	0.0
307	0.0	10.0	0.0	0.0	0.0	0.0	0.0
311	0.0	0.0	0.0	0.0	0.0	0.0	0.0
313	5.0	0.0	0.0	0.0	0.0	0.0	0.0
314	0.0	0.0	0.0	0.0	0.0	0.0	0.0
704	0.0	0.0	0.0	0.0	0.0	0.0	0.0
706	0.0	0.0	0.0	0.0	10.0	0.0	0.0
710	10.0	5.0	10.0	0.0	0.0	0.0	0.0
714	0.0	5.0	0.0	0.0	0.0	0.0	0.0
717	0.0	10.0	0.0	0.0	0.0	0.0	0.0
718	0.0	10.0	0.0	0.0	0.0	0.0	0.0
719	0.0	10.0	5.0	0.0	0.0	0.0	0.0
1002	0.0	5.0	5.0	0.0	0.0	0.0	0.0
1004	0.0	5.0	0.0	0.0	0.0	0.0	0.0
1005	0.0	5.0	0.0	0.0	0.0	0.0	0.0
1007	0.0	0.0	0.0	0.0	0.0	20.0	10.0

Continental Grand Campus Specific Plan
 City of El Segundo
 Phase 2 Opening Year (2023) Without Project AM Peak Hour (ICU)

Impact Analysis Report
 Level Of Service

Intersection	Base		Future		Change in
	Del/	V/	Del/	V/	
# 1 Sepulveda Blvd at Imperial Hwy	D xxxxx	0.810	D xxxxx	0.869	+ 0.060 V/C
# 2 Sepulveda Blvd at Walnut St	A xxxxx	0.569	C xxxxx	0.728	+ 0.160 V/C
# 3 Sepulveda Blvd at Maple Ave	A xxxxx	0.583	C xxxxx	0.726	+ 0.143 V/C
# 4 Sepulveda Blvd at Mariposa Ave	B xxxxx	0.685	C xxxxx	0.766	+ 0.080 V/C
# 5 Sepulveda Blvd at Grand Ave	C xxxxx	0.766	D xxxxx	0.853	+ 0.087 V/C
# 6 Sepulveda Blvd at El Segundo B	C xxxxx	0.771	F xxxxx	1.070	+ 0.299 V/C
# 7 Sepulveda Blvd at Rosecrans Bl	D xxxxx	0.808	E xxxxx	0.925	+ 0.117 V/C
# 8 Continental Boulevard at Marip	A xxxxx	0.388	A xxxxx	0.391	+ 0.002 V/C
# 9 Continental Boulevard at Grand	A xxxxx	0.315	A xxxxx	0.328	+ 0.013 V/C
# 10 Continental Boulevard at El Se	A xxxxx	0.401	A xxxxx	0.547	+ 0.147 V/C
# 11 Nash St and Imperial Hwy	B xxxxx	0.640	C xxxxx	0.774	+ 0.134 V/C
# 12 Nash St at Mariposa Ave	A xxxxx	0.468	B xxxxx	0.606	+ 0.138 V/C
# 13 Nash St at Grand Ave	A xxxxx	0.487	A xxxxx	0.547	+ 0.061 V/C
# 14 Nash St at El Segundo Blvd	A xxxxx	0.463	C xxxxx	0.729	+ 0.266 V/C
# 15 Douglas Street at El Segundo B	C xxxxx	0.709	E xxxxx	0.989	+ 0.279 V/C
# 16 Aviation Boulevard at El Segun	D xxxxx	0.823	F xxxxx	1.166	+ 0.343 V/C
# 17 El Segundo Boulevard and Isis	A xxxxx	0.586	D xxxxx	0.827	+ 0.242 V/C
# 18 El Segundo Blvd at I-405 SB Ra	A xxxxx	0.529	C xxxxx	0.772	+ 0.243 V/C
# 19 El Segundo Blvd at La Cienega	A xxxxx	0.578	D xxxxx	0.847	+ 0.269 V/C
# 20 El Segundo Blvd at I-405 NB Ra	C xxxxx	0.711	D xxxxx	0.881	+ 0.170 V/C

Continental Grand Campus Specific Plan
 City of El Segundo
 Phase 2 Opening Year (2023) Without Project AM Peak Hour (ICU)

Level Of Service Computation Report
 ICU 1(Loss as Cycle Length %) Method (Future Volume Alternative)

 Intersection #1 Sepulveda Blvd at Imperial Hwy

 Cycle (sec): 100 Critical Vol./Cap.(X): 0.869
 Loss Time (sec): 5 Average Delay (sec/veh): xxxxxx
 Optimal Cycle: 72 Level Of Service: D

Street Name:	Sepulveda Blvd				Imperial Hwy										
	North Bound		South Bound		East Bound		West Bound								
Approach:	L - T - R	L - T - R	L - T - R	L - T - R	L - T - R	L - T - R	L - T - R	L - T - R							
Movement:															
Control:	Protected		Protected		Protected		Protected								
Rights:	Include		Include		Include		Ovl								
Min. Green:	0	0	0	0	0	0	0	0							
Y+R:	4.0	4.0	4.0	4.0	4.0	4.0	4.0	4.0							
Lanes:	1	0	3	0	1	2	0	3	0	1	2	0	3	0	1

Volume Module:
 Base Vol: 63 1495 418 448 2297 12 210 316 140 211 292 590
 Growth Adj: 1.02 1.02 1.02 1.02 1.02 1.02 1.02 1.02 1.02 1.02 1.02 1.02
 Initial Bse: 64 1523 426 456 2339 12 214 322 143 215 297 601
 Added Vol: 17 48 13 23 185 2 4 31 56 15 3 12
 Related Pro: 9 130 38 -85 615 0 -5 25 30 6 5 -90
 Initial Fut: 90 1701 477 394 3139 14 213 378 229 236 305 523
 User Adj: 1.00 1.00 1.00 1.00 1.00 1.00 1.00 1.00 1.00 1.00 1.00 1.00
 PHF Adj: 1.00 1.00 1.00 1.00 1.00 1.00 1.00 1.00 1.00 1.00 1.00 1.00
 PHF Volume: 90 1701 477 394 3139 14 213 378 229 236 305 523
 Reduct Vol: 0 0 0 0 0 0 0 0 0 0 0 0
 Reduced Vol: 90 1701 477 394 3139 14 213 378 229 236 305 523
 PCE Adj: 1.00 1.00 1.00 1.00 1.00 1.00 1.00 1.00 1.00 1.00 1.00 1.00
 MLF Adj: 1.00 1.00 1.00 1.00 1.00 1.00 1.00 1.00 1.00 1.00 1.00 1.00
 FinalVolume: 90 1701 477 394 3139 14 213 378 229 236 305 523
 OvlAdjVol: 326

Saturation Flow Module:
 Sat/Lane: 1600 1600 1600 1600 1600 1600 1600 1600 1600 1600 1600
 Adjustment: 1.00 1.00 1.00 1.00 1.00 1.00 1.00 1.00 1.00 1.00 1.00
 Lanes: 1.00 3.00 1.00 2.00 3.98 0.02 2.00 3.00 1.00 2.00 3.00 1.00
 Final Sat.: 1600 4800 1600 3200 6371 29 3200 4800 1600 3200 4800 1600

Capacity Analysis Module:
 Vol/Sat: 0.06 0.35 0.30 0.12 0.49 0.49 0.07 0.08 0.14 0.07 0.06 0.33
 OvlAdjV/S: 0.20
 Crit Moves: ****

Continental Grand Campus Specific Plan
City of El Segundo

Phase 2 Opening Year (2023) Without Project AM Peak Hour (ICU)

Level Of Service Computation Report

ICU 1(Loss as Cycle Length %) Method (Future Volume Alternative)

Intersection #2 Sepulveda Blvd at Walnut St

Cycle (sec): 100 Critical Vol./Cap.(X): 0.728
Loss Time (sec): 5 Average Delay (sec/veh): xxxxxx
Optimal Cycle: 40 Level Of Service: C

Table with columns for Street Name, Approach, Movement, Control, Rights, Min. Green, Y+R, Lanes. Rows for Sepulveda Blvd and Walnut St.

Table with columns for Volume Module, Base Vol, Growth Adj, Initial Bse, Added Vol, Related Pro, Initial Fut, User Adj, PHF Adj, PHF Volume, Reduct Vol, Reduced Vol, PCE Adj, MLF Adj, FinalVolume.

Table with columns for Sat/Lane, Adjustment, Lanes, Final Sat. for Saturation Flow Module.

Table with columns for Vol/Sat, Crit Moves for Capacity Analysis Module.

Continental Grand Campus Specific Plan
City of El Segundo

Phase 2 Opening Year (2023) Without Project AM Peak Hour (ICU)

Level Of Service Computation Report

ICU 1(Loss as Cycle Length %) Method (Future Volume Alternative)

Intersection #3 Sepulveda Blvd at Maple Ave

Cycle (sec): 100 Critical Vol./Cap.(X): 0.726
Loss Time (sec): 5 Average Delay (sec/veh): xxxxxx
Optimal Cycle: 40 Level Of Service: C

Table with columns for Street Name, Approach, Movement, Control, Rights, Min. Green, Y+R, Lanes. Rows for Sepulveda Blvd and Maple Ave.

Table with columns for Volume Module, Base Vol, Growth Adj, Initial Bse, Added Vol, Related Pro, Initial Fut, User Adj, PHF Adj, PHF Volume, Reduct Vol, Reduced Vol, PCE Adj, MLF Adj, FinalVolume.

Table with columns for Sat/Lane, Adjustment, Lanes, Final Sat. for Saturation Flow Module.

Table with columns for Vol/Sat, Crit Moves for Capacity Analysis Module.

Continental Grand Campus Specific Plan
City of El Segundo
Phase 2 Opening Year (2023) Without Project AM Peak Hour (ICU)

Level Of Service Computation Report
ICU 1(Loss as Cycle Length %) Method (Future Volume Alternative)

Intersection #4 Sepulveda Blvd at Mariposa Ave

Cycle (sec): 100 Critical Vol./Cap.(X): 0.766
Loss Time (sec): 5 Average Delay (sec/veh): xxxxxx
Optimal Cycle: 46 Level Of Service: C

Table with columns for Street Name (Sepulveda Blvd, Mariposa Ave), Approach (North Bound, South Bound, East Bound, West Bound), Movement (L-T-R), Control (Protected, Permitted), Rights (Include), and traffic volume metrics (Min. Green, Y+R, Lanes).

Volume Module table showing Base Vol, Growth Adj, Initial Bse, Added Vol, Related Pro, Initial Fut, User Adj, PHF Adj, PHF Volume, Reduct Vol, Reduced Vol, PCE Adj, MLF Adj, and Final Volume for various approaches.

Saturation Flow Module table showing Sat/Lane, Adjustment, Lanes, and Final Sat. for different approaches.

Capacity Analysis Module table showing Vol/Sat, Crit Moves, and OvlAdjV/S for various approaches.

Continental Grand Campus Specific Plan
City of El Segundo
Phase 2 Opening Year (2023) Without Project AM Peak Hour (ICU)

Level Of Service Computation Report
ICU 1(Loss as Cycle Length %) Method (Future Volume Alternative)

Intersection #5 Sepulveda Blvd at Grand Ave

Cycle (sec): 100 Critical Vol./Cap.(X): 0.853
Loss Time (sec): 5 Average Delay (sec/veh): xxxxxx
Optimal Cycle: 66 Level Of Service: D

Table with columns for Street Name (Sepulveda Blvd, Grand Ave), Approach (North Bound, South Bound, East Bound, West Bound), Movement (L-T-R), Control (Protected, Split Phase), Rights (Include), and traffic volume metrics (Min. Green, Y+R, Lanes).

Volume Module table showing Base Vol, Growth Adj, Initial Bse, Added Vol, Related Pro, Initial Fut, User Adj, PHF Adj, PHF Volume, Reduct Vol, Reduced Vol, PCE Adj, MLF Adj, and Final Volume for various approaches.

Saturation Flow Module table showing Sat/Lane, Adjustment, Lanes, and Final Sat. for different approaches.

Capacity Analysis Module table showing Vol/Sat, Crit Moves, and OvlAdjV/S for various approaches.

Continental Grand Campus Specific Plan
City of El Segundo
Phase 2 Opening Year (2023) Without Project AM Peak Hour (ICU)

Level Of Service Computation Report
ICU 1(Loss as Cycle Length %) Method (Future Volume Alternative)

Intersection #6 Sepulveda Blvd at El Segundo Blvd

Cycle (sec): 100 Critical Vol./Cap.(X): 1.070
Loss Time (sec): 5 Average Delay (sec/veh): xxxxxx
Optimal Cycle: 180 Level Of Service: F

Table with columns for Street Name, Approach, Movement, Control, Rights, Min. Green, Y+R, Lanes. Rows for North Bound, South Bound, East Bound, West Bound.

Volume Module table with columns for Base Vol, Growth Adj, Initial Bse, Added Vol, Related Pro, Initial Fut, User Adj, PHF Adj, PHF Volume, Reduct Vol, Reduced Vol, PCE Adj, MLF Adj, Final Volume.

Saturation Flow Module table with columns for Sat/Lane, Adjustment, Lanes, Final Sat.

Capacity Analysis Module table with columns for Vol/Sat, Crit Moves.

Continental Grand Campus Specific Plan
City of El Segundo
Phase 2 Opening Year (2023) Without Project AM Peak Hour (ICU)

Level Of Service Computation Report
ICU 1(Loss as Cycle Length %) Method (Future Volume Alternative)

Intersection #7 Sepulveda Blvd at Rosecrans Blvd

Cycle (sec): 100 Critical Vol./Cap.(X): 0.925
Loss Time (sec): 5 Average Delay (sec/veh): xxxxxx
Optimal Cycle: 104 Level Of Service: E

Table with columns for Street Name, Approach, Movement, Control, Rights, Min. Green, Y+R, Lanes. Rows for North Bound, South Bound, East Bound, West Bound.

Volume Module table with columns for Base Vol, Growth Adj, Initial Bse, Added Vol, Related Pro, Initial Fut, User Adj, PHF Adj, PHF Volume, Reduct Vol, Reduced Vol, PCE Adj, MLF Adj, Final Volume, OvlAdjVol.

Saturation Flow Module table with columns for Sat/Lane, Adjustment, Lanes, Final Sat.

Capacity Analysis Module table with columns for Vol/Sat, OvlAdjV/S, Crit Moves.

Continental Grand Campus Specific Plan
City of El Segundo
Phase 2 Opening Year (2023) Without Project AM Peak Hour (ICU)

Level Of Service Computation Report
ICU 1(Loss as Cycle Length %) Method (Future Volume Alternative)

Intersection #8 Continental Boulevard at Mariposa Ave

Cycle (sec): 100 Critical Vol./Cap.(X): 0.391
Loss Time (sec): 5 Average Delay (sec/veh): xxxxxx
Optimal Cycle: 20 Level Of Service: A

Table with columns: Street Name, Approach, Movement, Control, Rights, Min. Green, Y+R, Lanes. Rows for Continental Boulevard and Mariposa Avenue.

Table with columns: Volume Module, Base Vol, Growth Adj, Initial Bse, Added Vol, Related Pro, Initial Fut, User Adj, PHF Adj, PHF Volume, Reduct Vol, Reduced Vol, PCE Adj, MLF Adj, Final Volume.

Table with columns: Saturation Flow Module, Sat/Lane, Adjustment, Lanes, Final Sat.

Table with columns: Capacity Analysis Module, Vol/Sat, Crit Moves.

Continental Grand Campus Specific Plan
City of El Segundo
Phase 2 Opening Year (2023) Without Project AM Peak Hour (ICU)

Level Of Service Computation Report
ICU 1(Loss as Cycle Length %) Method (Future Volume Alternative)

Intersection #9 Continental Boulevard at Grand Avenue

Cycle (sec): 100 Critical Vol./Cap.(X): 0.328
Loss Time (sec): 5 Average Delay (sec/veh): xxxxxx
Optimal Cycle: 18 Level Of Service: A

Table with columns: Street Name, Approach, Movement, Control, Rights, Min. Green, Y+R, Lanes. Rows for Continental Boulevard and Grand Avenue.

Table with columns: Volume Module, Base Vol, Growth Adj, Initial Bse, Added Vol, Related Pro, Initial Fut, User Adj, PHF Adj, PHF Volume, Reduct Vol, Reduced Vol, PCE Adj, MLF Adj, Final Volume.

Table with columns: Saturation Flow Module, Sat/Lane, Adjustment, Lanes, Final Sat.

Table with columns: Capacity Analysis Module, Vol/Sat, Crit Moves.

Continental Grand Campus Specific Plan
City of El Segundo
Phase 2 Opening Year (2023) Without Project AM Peak Hour (ICU)

Level Of Service Computation Report
ICU 1(Loss as Cycle Length %) Method (Future Volume Alternative)

Intersection #10 Continental Boulevard at El Segundo Boulevard

Cycle (sec): 100 Critical Vol./Cap.(X): 0.547
Loss Time (sec): 5 Average Delay (sec/veh): xxxxxx
Optimal Cycle: 26 Level Of Service: A

Table with columns for Street Name, Approach, Movement, Control, Rights, Min. Green, Y+R, Lanes. Rows for Continental Boulevard and El Segundo Boulevard.

Volume Module table with columns for Base Vol, Growth Adj, Initial Bse, Added Vol, Related Pro, Initial Fut, User Adj, PHF Adj, PHF Volume, Reduct Vol, Reduced Vol, PCE Adj, MLF Adj, Final Volume.

Saturation Flow Module table with columns for Sat/Lane, Adjustment, Lanes, Final Sat.

Capacity Analysis Module table with columns for Vol/Sat, Crit Moves.

Continental Grand Campus Specific Plan
City of El Segundo
Phase 2 Opening Year (2023) Without Project AM Peak Hour (ICU)

Level Of Service Computation Report
ICU 1(Loss as Cycle Length %) Method (Future Volume Alternative)

Intersection #11 Nash St and Imperial Hwy

Cycle (sec): 100 Critical Vol./Cap.(X): 0.774
Loss Time (sec): 5 Average Delay (sec/veh): xxxxxx
Optimal Cycle: 47 Level Of Service: C

Table with columns for Street Name, Approach, Movement, Control, Rights, Min. Green, Y+R, Lanes. Rows for Nash St and Imperial Hwy.

Volume Module table with columns for Base Vol, Growth Adj, Initial Bse, Added Vol, Related Pro, Initial Fut, User Adj, PHF Adj, PHF Volume, Reduct Vol, Reduced Vol, PCE Adj, MLF Adj, Final Volume.

Saturation Flow Module table with columns for Sat/Lane, Adjustment, Lanes, Final Sat.

Capacity Analysis Module table with columns for Vol/Sat, Crit Moves.

Continental Grand Campus Specific Plan
City of El Segundo

Phase 2 Opening Year (2023) Without Project AM Peak Hour (ICU)

Level of Service Computation Report

ICU 1(Loss as Cycle Length %) Method (Future Volume Alternative)

Intersection #12 Nash St at Mariposa Ave

Cycle (sec): 100 Critical Vol./Cap.(X): 0.606
Loss Time (sec): 5 Average Delay (sec/veh): xxxxxx
Optimal Cycle: 29 Level Of Service: B

Table with columns for Street Name (Nash St, Mariposa Ave), Approach (North Bound, South Bound, East Bound, West Bound), Movement (L, T, R), Control (Permitted, Include), Rights, Min. Green, Y+R, Lanes.

Table with columns for Volume Module: Base Vol, Growth Adj, Initial Bse, Added Vol, PasserByVol, Initial Fut, User Adj, PHF Adj, PHF Volume, Reduct Vol, Reduced Vol, PCE Adj, MLF Adj, FinalVolume.

Table with columns for Saturation Flow Module: Sat/Lane, Adjustment, Lanes, Final Sat.

Table with columns for Capacity Analysis Module: Vol/Sat, Crit Moves.

Continental Grand Campus Specific Plan
City of El Segundo

Phase 2 Opening Year (2023) Without Project AM Peak Hour (ICU)

Level of Service Computation Report

ICU 1(Loss as Cycle Length %) Method (Future Volume Alternative)

Intersection #13 Nash St at Grand Ave

Cycle (sec): 100 Critical Vol./Cap.(X): 0.547
Loss Time (sec): 5 Average Delay (sec/veh): xxxxxx
Optimal Cycle: 26 Level Of Service: A

Table with columns for Street Name (Nash St, Grand Ave), Approach (North Bound, South Bound, East Bound, West Bound), Movement (L, T, R), Control (Protected, Split Phase, Include), Rights, Min. Green, Y+R, Lanes.

Table with columns for Volume Module: Base Vol, Growth Adj, Initial Bse, Added Vol, Related Pro, Initial Fut, User Adj, PHF Adj, PHF Volume, Reduct Vol, Reduced Vol, PCE Adj, MLF Adj, FinalVolume.

Table with columns for Saturation Flow Module: Sat/Lane, Adjustment, Lanes, Final Sat.

Table with columns for Capacity Analysis Module: Vol/Sat, Crit Moves.

Continental Grand Campus Specific Plan
City of El Segundo

Phase 2 Opening Year (2023) Without Project AM Peak Hour (ICU)

Level Of Service Computation Report

ICU 1(Loss as Cycle Length %) Method (Future Volume Alternative)

Intersection #14 Nash St at El Segundo Blvd

Cycle (sec): 100 Critical Vol./Cap.(X): 0.729
Loss Time (sec): 5 Average Delay (sec/veh): xxxxxx
Optimal Cycle: 41 Level Of Service: C

Table with columns for Street Name (Nash St, El Segundo Blvd), Approach (North Bound, South Bound, East Bound, West Bound), Movement (L-T-R), Control (Split Phase, Protected), Rights (Ovl, Include), and Volume (Min. Green, Y+R, Lanes).

Volume Module table with columns for Base Vol, Growth Adj, Initial Bse, Added Vol, Related Pro, Initial Fut, User Adj, PHF Adj, PHF Volume, Reduct Vol, Reduced Vol, PCE Adj, MLF Adj, Final Volume, and OvlAdjVol.

Saturation Flow Module table with columns for Sat/Lane, Adjustment, Lanes, and Final Sat.

Capacity Analysis Module table with columns for Vol/Sat, OvlAdjV/S, and Crit Moves.

Continental Grand Campus Specific Plan
City of El Segundo

Phase 2 Opening Year (2023) Without Project AM Peak Hour (ICU)

Level Of Service Computation Report

ICU 1(Loss as Cycle Length %) Method (Future Volume Alternative)

Intersection #15 Douglas Street at El Segundo Boulevard

Cycle (sec): 100 Critical Vol./Cap.(X): 0.989
Loss Time (sec): 5 Average Delay (sec/veh): xxxxxx
Optimal Cycle: 180 Level Of Service: E

Table with columns for Street Name (Douglas St, El Segundo Blvd), Approach (North Bound, South Bound, East Bound, West Bound), Movement (L-T-R), Control (Protected), Rights (Include), and Volume (Min. Green, Y+R, Lanes).

Volume Module table with columns for Base Vol, Growth Adj, Initial Bse, Added Vol, Related Pro, Initial Fut, User Adj, PHF Adj, PHF Volume, Reduct Vol, Reduced Vol, PCE Adj, MLF Adj, Final Volume, and OvlAdjVol.

Saturation Flow Module table with columns for Sat/Lane, Adjustment, Lanes, and Final Sat.

Capacity Analysis Module table with columns for Vol/Sat, Crit Moves, and other metrics.

Continental Grand Campus Specific Plan
City of El Segundo

Phase 2 Opening Year (2023) Without Project AM Peak Hour (ICU)

Level of Service Computation Report

ICU 1(Loss as Cycle Length %) Method (Future Volume Alternative)

Intersection #16 Aviation Boulevard at El Segundo Boulevard

Cycle (sec): 100 Critical Vol./Cap.(X): 1.166
Loss Time (sec): 5 Average Delay (sec/veh): xxxxxx
Optimal Cycle: 180 Level of Service: F

Table with columns for Street Name, Approach, Movement, Control, Rights, Min. Green, Y+R, Lanes. Rows for Aviatio Blvd and El Segundo Blvd.

Volume Module table with columns for Base Vol, Growth Adj, Initial Bse, Added Vol, Related Pro, Initial Fut, User Adj, PHF Adj, PHF Volume, Reduct Vol, Reduced Vol, PCE Adj, MLF Adj, Final Volume, OvlAdjVol.

Saturation Flow Module table with columns for Sat/Lane, Adjustment, Lanes, Final Sat.

Capacity Analysis Module table with columns for Vol/Sat, OvlAdjV/S, Crit Moves.

Continental Grand Campus Specific Plan
City of El Segundo

Phase 2 Opening Year (2023) Without Project AM Peak Hour (ICU)

Level of Service Computation Report

ICU 1(Loss as Cycle Length %) Method (Future Volume Alternative)

Intersection #17 El Segundo Boulevard and Isis Avenue

Cycle (sec): 100 Critical Vol./Cap.(X): 0.827
Loss Time (sec): 5 Average Delay (sec/veh): xxxxxx
Optimal Cycle: 58 Level of Service: D

Table with columns for Street Name, Approach, Movement, Control, Rights, Min. Green, Y+R, Lanes. Rows for Isis Avenue and El Segundo Boulevard.

Volume Module table with columns for Base Vol, Growth Adj, Initial Bse, Added Vol, Related Pro, Initial Fut, User Adj, PHF Adj, PHF Volume, Reduct Vol, Reduced Vol, PCE Adj, MLF Adj, Final Volume.

Saturation Flow Module table with columns for Sat/Lane, Adjustment, Lanes, Final Sat.

Capacity Analysis Module table with columns for Vol/Sat, Crit Moves.

Continental Grand Campus Specific Plan
City of El Segundo
Phase 2 Opening Year (2023) Without Project AM Peak Hour (ICU)

Level Of Service Computation Report
ICU 1(Loss as Cycle Length %) Method (Future Volume Alternative)

Intersection #18 El Segundo Blvd at I-405 SB Ramps

Cycle (sec): 100 Critical Vol./Cap.(X): 0.772
Loss Time (sec): 5 Average Delay (sec/veh): xxxxxx
Optimal Cycle: 47 Level Of Service: C

Table with columns for Street Name, Approach, Movement, Control, Rights, Min. Green, Y+R, Lanes. Rows for I-405 SB Ramps and El Segundo Blvd.

Volume Module table with columns for Base Vol, Growth Adj, Initial Bse, Added Vol, Related Pro, Initial Fut, User Adj, PHF Adj, PHF Volume, Reduct Vol, Reduced Vol, PCE Adj, MLF Adj, Final Volume.

Saturation Flow Module table with columns for Sat/Lane, Adjustment, Lanes, Final Sat.

Capacity Analysis Module table with columns for Vol/Sat, Crit Moves.

Continental Grand Campus Specific Plan
City of El Segundo
Phase 2 Opening Year (2023) Without Project AM Peak Hour (ICU)

Level Of Service Computation Report
ICU 1(Loss as Cycle Length %) Method (Future Volume Alternative)

Intersection #19 El Segundo Blvd at La Cienega Blvd

Cycle (sec): 100 Critical Vol./Cap.(X): 0.847
Loss Time (sec): 5 Average Delay (sec/veh): xxxxxx
Optimal Cycle: 64 Level Of Service: D

Table with columns for Street Name, Approach, Movement, Control, Rights, Min. Green, Y+R, Lanes. Rows for La Cienega Blvd and El Segundo Blvd.

Volume Module table with columns for Base Vol, Growth Adj, Initial Bse, Added Vol, Related Pro, Initial Fut, User Adj, PHF Adj, PHF Volume, Reduct Vol, Reduced Vol, PCE Adj, MLF Adj, Final Volume.

Saturation Flow Module table with columns for Sat/Lane, Adjustment, Lanes, Final Sat.

Capacity Analysis Module table with columns for Vol/Sat, Crit Moves.

Continental Grand Campus Specific Plan
City of El Segundo

Phase 2 Opening Year (2023) Without Project AM Peak Hour (ICU)

Level Of Service Computation Report

ICU 1(Loss as Cycle Length %) Method (Future Volume Alternative)

Intersection #20 El Segundo Blvd at I-405 NB Ramps

Cycle (sec): 100 Critical Vol./Cap.(X): 0.881
Loss Time (sec): 5 Average Delay (sec/veh): xxxxxx
Optimal Cycle: 77 Level Of Service: D

Table with columns for Street Name, Approach, Movement, Control, Rights, Min. Green, Y+R, and Lanes. Rows include I-405 NB Ramps and El Segundo Blvd with various movement and control details.

Volume Module table showing Base Vol, Growth Adj, Initial Bse, Added Vol, Related Pro, Initial Fut, User Adj, PHF Adj, PHF Volume, Reduct Vol, Reduced Vol, PCE Adj, MLF Adj, and Final Volume for various approaches.

Saturation Flow Module table showing Sat/Lane, Adjustment, Lanes, and Final Sat. values for different approaches.

Capacity Analysis Module table showing Vol/Sat and Crit Moves for different approaches.

 Continental Grand Campus Specific Plan
 City of El Segundo
 Phase 2 Opening Year (2023) Without Project PM Peak Hour (ICU)

Scenario: Phase 2 Op Yr W/o Proj PM
 Command: Phase 2 Op Yr W/o Proj PM
 Volume: OY PM
 Geometry: Existing
 Impact Fee: Default Impact Fee
 Trip Generation: Cum PM
 Trip Distribution: Cum + Proj
 Paths: Project
 Routes: Default Route
 Configuration: Phase 2 Op Yr W/o Proj PM

 Continental Grand Campus Specific Plan
 City of El Segundo
 Phase 2 Opening Year (2023) Without Project PM Peak Hour (ICU)

Trip Generation Report

Forecast for Cum PM

Zone #	Subzone	Amount	Units	Rate In	Rate Out	Trips In	Trips Out	Total Trips	% Of Total
306	525 N. Sepul	1.00	Residential	-4.00	-6.00	-4	-6	-10	-0.9
	Zone 306 Subtotal					-4	-6	-10	-0.9
307	540 Imperial	1.00	Residential	50.00	32.00	50	32	82	7.4
	Zone 307 Subtotal					50	32	82	7.4
311	199 Continen	1.00	Business Hotel	46.00	45.00	46	45	91	8.3
	Zone 311 Subtotal					46	45	91	8.3
313	445 N. Dougl	1.00	Equinix Data C	3.00	13.00	3	13	16	1.5
	Zone 313 Subtotal					3	13	16	1.5
314	123 Lomita a	1.00	Office	2.00	16.00	2	16	18	1.6
	Zone 314 Subtotal					2	16	18	1.6
704	2355 Utah Av	1.00	Office	95.00	109.00	95	109	204	18.5
	Zone 704 Subtotal					95	109	204	18.5
706	888 Sepulved	1.00	hotel	60.00	41.00	60	41	101	9.2
	Zone 706 Subtotal					60	41	101	9.2
710	201 North Do	1.00	High School	-15.00	-74.00	-15	-74	-89	-8.1
710	201 North Do	1.00	District Offic	3.00	18.00	3	18	21	1.9
	Zone 710 Subtotal					-12	-56	-68	-6.2
714	400 Duley -	1.00	Office	18.00	87.00	18	87	105	9.5
	Zone 714 Subtotal					18	87	105	9.5
717	1700 Imperia	1.00	Townhome Resid	25.00	120.00	25	120	145	13.2
	Zone 717 Subtotal					25	120	145	13.2
718	123 Nevada S	1.00	Office	4.00	16.00	4	16	20	1.8
718	123 Nevada S	0.00	123 Nevada	4.00	16.00	0	0	0	0.0
	Zone 718 Subtotal					4	16	20	1.8
719	2125 Campus	1.00	Office Retail	64.00	146.00	64	146	210	19.1
	Zone 719 Subtotal					64	146	210	19.1
1002	Laker Facili	1.00	General Office	103.00	85.00	103	85	188	17.1
	Zone 1002 Subtotal					103	85	188	17.1

 Continental Grand Campus Specific Plan
 City of El Segundo
 Phase 2 Opening Year (2023) Without Project PM Peak Hour (ICU)

Zone #	Subzone	Amount	Units	Rate In	Rate Out	Trips In	Trips Out	Total Trips	% Of Total
TOTAL						454	648	1102	100.0

 Continental Grand Campus Specific Plan
 City of El Segundo
 Phase 2 Opening Year (2023) Without Project PM Peak Hour (ICU)

Trip Distribution Report

Percent Of Trips Cum + Project

Zone	To Gates											
	1	2	3	4	5	7	8	9	10	11	12	
306	10.0	15.0	10.0	5.0	0.0	5.0	5.0	25.0	0.0	25.0	0.0	
307	10.0	15.0	10.0	5.0	50.0	0.0	0.0	0.0	0.0	0.0	0.0	
311	40.0	10.0	10.0	10.0	0.0	5.0	5.0	10.0	0.0	10.0	0.0	
313	15.0	5.0	15.0	10.0	25.0	0.0	5.0	20.0	0.0	0.0	0.0	
314	40.0	10.0	10.0	10.0	0.0	5.0	5.0	10.0	0.0	10.0	0.0	
704	30.0	15.0	8.0	12.0	0.0	5.0	5.0	10.0	5.0	10.0	0.0	
706	25.0	20.0	10.0	25.0	0.0	0.0	0.0	0.0	0.0	0.0	10.0	
710	0.0	0.0	15.0	10.0	10.0	2.0	2.0	20.0	5.0	10.0	1.0	
714	5.0	10.0	5.0	5.0	20.0	5.0	10.0	15.0	5.0	15.0	0.0	
717	10.0	15.0	10.0	5.0	50.0	0.0	0.0	0.0	0.0	0.0	0.0	
718	10.0	10.0	10.0	10.0	20.0	0.0	0.0	20.0	10.0	0.0	0.0	
719	20.0	10.0	10.0	10.0	10.0	5.0	5.0	10.0	5.0	0.0	0.0	
1002	0.0	10.0	5.0	5.0	15.0	5.0	10.0	15.0	5.0	15.0	5.0	
1004	5.0	15.0	10.0	5.0	30.0	0.0	5.0	20.0	0.0	0.0	5.0	
1005	5.0	15.0	10.0	5.0	30.0	0.0	5.0	20.0	0.0	0.0	5.0	
1007	0.0	0.0	0.0	0.0	0.0	0.0	0.0	0.0	0.0	0.0	0.0	

Zone	To Gates						
	13	14	15	16	17	18	20
306	0.0	0.0	0.0	0.0	0.0	0.0	0.0
307	0.0	10.0	0.0	0.0	0.0	0.0	0.0
311	0.0	0.0	0.0	0.0	0.0	0.0	0.0
313	5.0	0.0	0.0	0.0	0.0	0.0	0.0
314	0.0	0.0	0.0	0.0	0.0	0.0	0.0
704	0.0	0.0	0.0	0.0	0.0	0.0	0.0
706	0.0	0.0	0.0	0.0	10.0	0.0	0.0
710	10.0	5.0	10.0	0.0	0.0	0.0	0.0
714	0.0	5.0	0.0	0.0	0.0	0.0	0.0
717	0.0	10.0	0.0	0.0	0.0	0.0	0.0
718	0.0	10.0	0.0	0.0	0.0	0.0	0.0
719	0.0	10.0	5.0	0.0	0.0	0.0	0.0
1002	0.0	5.0	5.0	0.0	0.0	0.0	0.0
1004	0.0	5.0	0.0	0.0	0.0	0.0	0.0
1005	0.0	5.0	0.0	0.0	0.0	0.0	0.0
1007	0.0	0.0	0.0	0.0	0.0	20.0	10.0

Continental Grand Campus Specific Plan
 City of El Segundo
 Phase 2 Opening Year (2023) Without Project PM Peak Hour (ICU)

Impact Analysis Report
 Level Of Service

Intersection	Base		Future		Change in
	Del/	V/	Del/	V/	
	LOS Veh	C	LOS Veh	C	
# 1 Sepulveda Blvd at Imperial Hwy	E xxxxx	0.971	F xxxxx	1.038	+ 0.067 V/C
# 2 Sepulveda Blvd at Walnut St	A xxxxx	0.572	C xxxxx	0.755	+ 0.183 V/C
# 3 Sepulveda Blvd at Maple Ave	B xxxxx	0.638	C xxxxx	0.757	+ 0.119 V/C
# 4 Sepulveda Blvd at Mariposa Ave	B xxxxx	0.694	D xxxxx	0.832	+ 0.138 V/C
# 5 Sepulveda Blvd at Grand Ave	C xxxxx	0.793	D xxxxx	0.887	+ 0.094 V/C
# 6 Sepulveda Blvd at El Segundo B	D xxxxx	0.897	F xxxxx	1.081	+ 0.184 V/C
# 7 Sepulveda Blvd at Rosecrans Bl	D xxxxx	0.892	F xxxxx	1.004	+ 0.112 V/C
# 8 Continental Boulevard at Marip	A xxxxx	0.371	A xxxxx	0.371	-0.000 V/C
# 9 Continental Boulevard at Grand	A xxxxx	0.321	A xxxxx	0.345	+ 0.024 V/C
# 10 Continental Boulevard at El Se	A xxxxx	0.425	B xxxxx	0.640	+ 0.215 V/C
# 11 Nash St and Imperial Hwy	A xxxxx	0.480	A xxxxx	0.522	+ 0.041 V/C
# 12 Nash St at Mariposa Ave	A xxxxx	0.562	B xxxxx	0.699	+ 0.136 V/C
# 13 Nash St at Grand Ave	A xxxxx	0.534	B xxxxx	0.612	+ 0.078 V/C
# 14 Nash St at El Segundo Blvd	A xxxxx	0.554	F xxxxx	1.039	+ 0.484 V/C
# 15 Douglas Street at El Segundo B	D xxxxx	0.894	F xxxxx	1.181	+ 0.287 V/C
# 16 Aviation Boulevard at El Segun	E xxxxx	0.957	F xxxxx	1.161	+ 0.204 V/C
# 17 El Segundo Boulevard and Isis	B xxxxx	0.641	C xxxxx	0.786	+ 0.145 V/C
# 18 El Segundo Blvd at I-405 SB Ra	D xxxxx	0.887	F xxxxx	1.189	+ 0.302 V/C
# 19 El Segundo Blvd at La Cienega	B xxxxx	0.652	C xxxxx	0.754	+ 0.102 V/C
# 20 El Segundo Blvd at I-405 NB Ra	B xxxxx	0.691	C xxxxx	0.731	+ 0.039 V/C

Continental Grand Campus Specific Plan
 City of El Segundo
 Phase 2 Opening Year (2023) Without Project PM Peak Hour (ICU)

Level Of Service Computation Report
 ICU 1(Loss as Cycle Length %) Method (Future Volume Alternative)

Intersection #1 Sepulveda Blvd at Imperial Hwy

Cycle (sec): 100 Critical Vol./Cap.(X): 1.038
 Loss Time (sec): 5 Average Delay (sec/veh): xxxxxx
 Optimal Cycle: 180 Level Of Service: F

Street Name:	Sepulveda Blvd				Imperial Hwy			
	North Bound		South Bound		East Bound		West Bound	
Movement:	L - T - R	L - T - R	L - T - R	L - T - R	L - T - R	L - T - R	L - T - R	
Control:	Protected		Protected		Protected		Protected	
Rights:	Include		Include		Include		Ovl	
Min. Green:	0 0 0	0 0 0	0 0 0	0 0 0	0 0 0	0 0 0	0 0 0	
Y+R:	4.0 4.0 4.0	4.0 4.0 4.0	4.0 4.0 4.0	4.0 4.0 4.0	4.0 4.0 4.0	4.0 4.0 4.0	4.0 4.0 4.0	
Lanes:	1 0 3 0 1	2 0 3 1 0	2 0 3 0 1	2 0 3 0 1	2 0 3 0 1	2 0 3 0 1	2 0 3 0 1	

Volume Module:

Base Vol:	154 1713 885	640 1993 7	202 402 140	120 295 461
Growth Adj:	1.02 1.02 1.02	1.02 1.02 1.02	1.02 1.02 1.02	1.02 1.02 1.02
Initial Bse:	157 1745 901	652 2030 7	206 409 143	122 300 470
Added Vol:	35 103 73	14 78 5	3 23 17	9 9 17
Related Pro:	30 569 63	-165 159 0	-15 15 11	40 -20 -40
Initial Fut:	222 2417 1037	501 2267 12	194 447 171	171 289 447
User Adj:	1.00 1.00 1.00	1.00 1.00 1.00	1.00 1.00 1.00	1.00 1.00 1.00
PHF Adj:	1.00 1.00 1.00	1.00 1.00 1.00	1.00 1.00 1.00	1.00 1.00 1.00
PHF Volume:	222 2417 1037	501 2267 12	194 447 171	171 289 447
Reduct Vol:	0 0 0	0 0 0	0 0 0	0 0 0
Reduced Vol:	222 2417 1037	501 2267 12	194 447 171	171 289 447
PCE Adj:	1.00 1.00 1.00	1.00 1.00 1.00	1.00 1.00 1.00	1.00 1.00 1.00
MLF Adj:	1.00 1.00 1.00	1.00 1.00 1.00	1.00 1.00 1.00	1.00 1.00 1.00
FinalVolume:	222 2417 1037	501 2267 12	194 447 171	171 289 447
OvlAdjVol:				196

Saturation Flow Module:

Sat/Lane:	1600 1600 1600	1600 1600 1600	1600 1600 1600	1600 1600 1600
Adjustment:	1.00 1.00 1.00	1.00 1.00 1.00	1.00 1.00 1.00	1.00 1.00 1.00
Lanes:	1.00 3.00 1.00	2.00 3.98 0.02	2.00 3.00 1.00	2.00 3.00 1.00
Final Sat.:	1600 4800 1600	3200 6366 34	3200 4800 1600	3200 4800 1600

Capacity Analysis Module:

Vol/Sat:	0.14 0.50 0.65	0.16 0.36 0.36	0.06 0.09 0.11	0.05 0.06 0.28
OvlAdjV/S:				0.12
Crit Moves:	****	****	****	****

Continental Grand Campus Specific Plan
City of El Segundo

Phase 2 Opening Year (2023) Without Project PM Peak Hour (ICU)

Level Of Service Computation Report

ICU 1(Loss as Cycle Length %) Method (Future Volume Alternative)

Intersection #2 Sepulveda Blvd at Walnut St

Cycle (sec): 100 Critical Vol./Cap.(X): 0.755
Loss Time (sec): 5 Average Delay (sec/veh): xxxxxx
Optimal Cycle: 44 Level Of Service: C

Table with columns for Street Name, Approach, Movement, Control, Rights, Min. Green, Y+R, Lanes. Rows for Sepulveda Blvd and Walnut St.

Volume Module table with columns for Base Vol, Growth Adj, Initial Bse, Added Vol, Related Pro, Initial Fut, User Adj, PHF Adj, PHF Volume, Reduct Vol, Reduced Vol, PCE Adj, MLF Adj, Final Volume.

Saturation Flow Module table with columns for Sat/Lane, Adjustment, Lanes, Final Sat.

Capacity Analysis Module table with columns for Vol/Sat, Crit Moves.

Continental Grand Campus Specific Plan
City of El Segundo

Phase 2 Opening Year (2023) Without Project PM Peak Hour (ICU)

Level Of Service Computation Report

ICU 1(Loss as Cycle Length %) Method (Future Volume Alternative)

Intersection #3 Sepulveda Blvd at Maple Ave

Cycle (sec): 100 Critical Vol./Cap.(X): 0.757
Loss Time (sec): 5 Average Delay (sec/veh): xxxxxx
Optimal Cycle: 44 Level Of Service: C

Table with columns for Street Name, Approach, Movement, Control, Rights, Min. Green, Y+R, Lanes. Rows for Sepulveda Blvd and Maple Ave.

Volume Module table with columns for Base Vol, Growth Adj, Initial Bse, Added Vol, Related Pro, Initial Fut, User Adj, PHF Adj, PHF Volume, Reduct Vol, Reduced Vol, PCE Adj, MLF Adj, Final Volume.

Saturation Flow Module table with columns for Sat/Lane, Adjustment, Lanes, Final Sat.

Capacity Analysis Module table with columns for Vol/Sat, Crit Moves.

Continental Grand Campus Specific Plan
City of El Segundo
Phase 2 Opening Year (2023) Without Project PM Peak Hour (ICU)

Level Of Service Computation Report
ICU 1(Loss as Cycle Length %) Method (Future Volume Alternative)

Intersection #4 Sepulveda Blvd at Mariposa Ave

Cycle (sec): 100 Critical Vol./Cap.(X): 0.832
Loss Time (sec): 5 Average Delay (sec/veh): xxxxxx
Optimal Cycle: 60 Level Of Service: D

Table with columns for Street Name (Sepulveda Blvd, Mariposa Ave), Approach (North Bound, South Bound, East Bound, West Bound), Movement (L, T, R), Control (Protected, Permitted), Rights (Include), and traffic volume metrics (Min. Green, Y+R, Lanes).

Volume Module table showing Base Vol, Growth Adj, Initial Bse, Added Vol, Related Pro, Initial Fut, User Adj, PHF Adj, PHF Volume, Reduct Vol, Reduced Vol, PCE Adj, MLF Adj, and Final Volume for various approaches.

Saturation Flow Module table showing Sat/Lane, Adjustment, Lanes, and Final Sat. for different approaches.

Capacity Analysis Module table showing Vol/Sat, Crit Moves, and OvlAdjV/S for various approaches.

Continental Grand Campus Specific Plan
City of El Segundo
Phase 2 Opening Year (2023) Without Project PM Peak Hour (ICU)

Level Of Service Computation Report
ICU 1(Loss as Cycle Length %) Method (Future Volume Alternative)

Intersection #5 Sepulveda Blvd at Grand Ave

Cycle (sec): 100 Critical Vol./Cap.(X): 0.887
Loss Time (sec): 5 Average Delay (sec/veh): xxxxxx
Optimal Cycle: 80 Level Of Service: D

Table with columns for Street Name (Sepulveda Blvd, Grand Ave), Approach (North Bound, South Bound, East Bound, West Bound), Movement (L, T, R), Control (Protected, Split Phase), Rights (Include), and traffic volume metrics (Min. Green, Y+R, Lanes).

Volume Module table showing Base Vol, Growth Adj, Initial Bse, Added Vol, Related Pro, Initial Fut, User Adj, PHF Adj, PHF Volume, Reduct Vol, Reduced Vol, PCE Adj, MLF Adj, and Final Volume for various approaches.

Saturation Flow Module table showing Sat/Lane, Adjustment, Lanes, and Final Sat. for different approaches.

Capacity Analysis Module table showing Vol/Sat, Crit Moves, and OvlAdjV/S for various approaches.

Continental Grand Campus Specific Plan
City of El Segundo
Phase 2 Opening Year (2023) Without Project PM Peak Hour (ICU)

Level Of Service Computation Report
ICU 1(Loss as Cycle Length %) Method (Future Volume Alternative)

Intersection #6 Sepulveda Blvd at El Segundo Blvd

Cycle (sec): 100 Critical Vol./Cap.(X): 1.081
Loss Time (sec): 5 Average Delay (sec/veh): xxxxxx
Optimal Cycle: 180 Level Of Service: F

Table with columns for Street Name, Approach, Movement, Control, Rights, Min. Green, Y+R, Lanes. Rows for Sepulveda Blvd and El Segundo Blvd.

Volume Module table with columns for Base Vol, Growth Adj, Initial Bse, Added Vol, Related Pro, Initial Fut, User Adj, PHF Adj, PHF Volume, Reduct Vol, Reduced Vol, PCE Adj, MLF Adj, Final Volume.

Saturation Flow Module table with columns for Sat/Lane, Adjustment, Lanes, Final Sat.

Capacity Analysis Module table with columns for Vol/Sat, Crit Moves.

Continental Grand Campus Specific Plan
City of El Segundo
Phase 2 Opening Year (2023) Without Project PM Peak Hour (ICU)

Level Of Service Computation Report
ICU 1(Loss as Cycle Length %) Method (Future Volume Alternative)

Intersection #7 Sepulveda Blvd at Rosecrans Blvd

Cycle (sec): 100 Critical Vol./Cap.(X): 1.004
Loss Time (sec): 5 Average Delay (sec/veh): xxxxxx
Optimal Cycle: 180 Level Of Service: F

Table with columns for Street Name, Approach, Movement, Control, Rights, Min. Green, Y+R, Lanes. Rows for Sepulveda Blvd and Rosecrans Blvd.

Volume Module table with columns for Base Vol, Growth Adj, Initial Bse, Added Vol, Related Pro, Initial Fut, User Adj, PHF Adj, PHF Volume, Reduct Vol, Reduced Vol, PCE Adj, MLF Adj, Final Volume, OvlAdjVol.

Saturation Flow Module table with columns for Sat/Lane, Adjustment, Lanes, Final Sat.

Capacity Analysis Module table with columns for Vol/Sat, OvlAdjV/S, Crit Moves.

Continental Grand Campus Specific Plan
City of El Segundo
Phase 2 Opening Year (2023) Without Project PM Peak Hour (ICU)

Level Of Service Computation Report
ICU 1(Loss as Cycle Length %) Method (Future Volume Alternative)

Intersection #8 Continental Boulevard at Mariposa Ave
Cycle (sec): 100 Critical Vol./Cap.(X): 0.371
Loss Time (sec): 5 Average Delay (sec/veh): xxxxxx
Optimal Cycle: 19 Level Of Service: A

Table with columns: Street Name, Approach, Movement, Control, Rights, Min. Green, Y+R, Lanes. Rows for Continental Boulevard and Mariposa Avenue.

Volume Module table with columns: Base Vol, Growth Adj, Initial Bse, Added Vol, Related Pro, Initial Fut, User Adj, PHF Adj, PHF Volume, Reduct Vol, Reduced Vol, PCE Adj, MLF Adj, Final Volume.

Saturation Flow Module table with columns: Sat/Lane, Adjustment, Lanes, Final Sat.

Capacity Analysis Module table with columns: Vol/Sat, Crit Moves.

Continental Grand Campus Specific Plan
City of El Segundo
Phase 2 Opening Year (2023) Without Project PM Peak Hour (ICU)

Level Of Service Computation Report
ICU 1(Loss as Cycle Length %) Method (Future Volume Alternative)

Intersection #9 Continental Boulevard at Grand Avenue
Cycle (sec): 100 Critical Vol./Cap.(X): 0.345
Loss Time (sec): 5 Average Delay (sec/veh): xxxxxx
Optimal Cycle: 18 Level Of Service: A

Table with columns: Street Name, Approach, Movement, Control, Rights, Min. Green, Y+R, Lanes. Rows for Continental Boulevard and Grand Avenue.

Volume Module table with columns: Base Vol, Growth Adj, Initial Bse, Added Vol, Related Pro, Initial Fut, User Adj, PHF Adj, PHF Volume, Reduct Vol, Reduced Vol, PCE Adj, MLF Adj, Final Volume.

Saturation Flow Module table with columns: Sat/Lane, Adjustment, Lanes, Final Sat.

Capacity Analysis Module table with columns: Vol/Sat, Crit Moves.

Continental Grand Campus Specific Plan
City of El Segundo
Phase 2 Opening Year (2023) Without Project PM Peak Hour (ICU)

Level Of Service Computation Report
ICU 1(Loss as Cycle Length %) Method (Future Volume Alternative)

Intersection #10 Continental Boulevard at El Segundo Boulevard

Cycle (sec): 100 Critical Vol./Cap.(X): 0.640
Loss Time (sec): 5 Average Delay (sec/veh): xxxxxx
Optimal Cycle: 32 Level Of Service: B

Table with columns for Street Name, Approach, Movement, Control, Rights, Min. Green, Y+R, Lanes. Rows for Continental Boulevard and El Segundo Boulevard.

Volume Module table with columns for Base Vol, Growth Adj, Initial Bse, Added Vol, Related Pro, Initial Fut, User Adj, PHF Adj, PHF Volume, Reduct Vol, Reduced Vol, PCE Adj, MLF Adj, Final Volume.

Saturation Flow Module table with columns for Sat/Lane, Adjustment, Lanes, Final Sat.

Capacity Analysis Module table with columns for Vol/Sat, Crit Moves.

Continental Grand Campus Specific Plan
City of El Segundo
Phase 2 Opening Year (2023) Without Project PM Peak Hour (ICU)

Level Of Service Computation Report
ICU 1(Loss as Cycle Length %) Method (Future Volume Alternative)

Intersection #11 Nash St and Imperial Hwy

Cycle (sec): 100 Critical Vol./Cap.(X): 0.522
Loss Time (sec): 5 Average Delay (sec/veh): xxxxxx
Optimal Cycle: 25 Level Of Service: A

Table with columns for Street Name, Approach, Movement, Control, Rights, Min. Green, Y+R, Lanes. Rows for Nash St and Imperial Hwy.

Volume Module table with columns for Base Vol, Growth Adj, Initial Bse, Added Vol, Related Pro, Initial Fut, User Adj, PHF Adj, PHF Volume, Reduct Vol, Reduced Vol, PCE Adj, MLF Adj, Final Volume.

Saturation Flow Module table with columns for Sat/Lane, Adjustment, Lanes, Final Sat.

Capacity Analysis Module table with columns for Vol/Sat, Crit Moves.

Continental Grand Campus Specific Plan
City of El Segundo

Phase 2 Opening Year (2023) Without Project PM Peak Hour (ICU)

Level Of Service Computation Report

ICU 1(Loss as Cycle Length %) Method (Future Volume Alternative)

Intersection #12 Nash St at Mariposa Ave

Cycle (sec): 100 Critical Vol./Cap.(X): 0.699
Loss Time (sec): 5 Average Delay (sec/veh): xxxxxx
Optimal Cycle: 37 Level Of Service: B

Table with columns for Street Name (Nash St, Mariposa Ave), Approach (North Bound, South Bound, East Bound, West Bound), Movement (L, T, R), Control (Permitted, Include), Rights, Min. Green, Y+R, Lanes.

Volume Module table with columns for Base Vol, Growth Adj, Initial Bse, Added Vol, Related Pro, Initial Fut, User Adj, PHF Adj, PHF Volume, Reduct Vol, Reduced Vol, PCE Adj, MLF Adj, Final Volume.

Saturation Flow Module table with columns for Sat/Lane, Adjustment, Lanes, Final Sat.

Capacity Analysis Module table with columns for Vol/Sat, Crit Moves.

Continental Grand Campus Specific Plan
City of El Segundo

Phase 2 Opening Year (2023) Without Project PM Peak Hour (ICU)

Level Of Service Computation Report

ICU 1(Loss as Cycle Length %) Method (Future Volume Alternative)

Intersection #13 Nash St at Grand Ave

Cycle (sec): 100 Critical Vol./Cap.(X): 0.612
Loss Time (sec): 5 Average Delay (sec/veh): xxxxxx
Optimal Cycle: 30 Level Of Service: B

Table with columns for Street Name (Nash St, Grand Ave), Approach (North Bound, South Bound, East Bound, West Bound), Movement (L, T, R), Control (Protected, Split Phase, Include), Rights, Min. Green, Y+R, Lanes.

Volume Module table with columns for Base Vol, Growth Adj, Initial Bse, Added Vol, Related Pro, Initial Fut, User Adj, PHF Adj, PHF Volume, Reduct Vol, Reduced Vol, PCE Adj, MLF Adj, Final Volume.

Saturation Flow Module table with columns for Sat/Lane, Adjustment, Lanes, Final Sat.

Capacity Analysis Module table with columns for Vol/Sat, Crit Moves.

Continental Grand Campus Specific Plan
City of El Segundo

Phase 2 Opening Year (2023) Without Project PM Peak Hour (ICU)

Level of Service Computation Report

ICU 1(Loss as Cycle Length %) Method (Future Volume Alternative)

Intersection #14 Nash St at El Segundo Blvd

Cycle (sec): 100 Critical Vol./Cap.(X): 1.039
Loss Time (sec): 5 Average Delay (sec/veh): xxxxxx
Optimal Cycle: 180 Level of Service: F

Table with columns for Street Name (Nash St, El Segundo Blvd), Approach (North Bound, South Bound, East Bound, West Bound), Movement (L, T, R), Control (Split Phase, Protected), Rights (Ovl, Include), and Volume (Min. Green, Y+R, Lanes).

Volume Module table with columns for Base Vol, Growth Adj, Initial Bse, Added Vol, Related Pro, Initial Fut, User Adj, PHF Adj, PHF Volume, Reduct Vol, Reduced Vol, PCE Adj, MLF Adj, Final Volume, and OvlAdjVol.

Saturation Flow Module table with columns for Sat/Lane, Adjustment, Lanes, and Final Sat.

Capacity Analysis Module table with columns for Vol/Sat, OvlAdjV/S, and Crit Moves.

Continental Grand Campus Specific Plan
City of El Segundo

Phase 2 Opening Year (2023) Without Project PM Peak Hour (ICU)

Level of Service Computation Report

ICU 1(Loss as Cycle Length %) Method (Future Volume Alternative)

Intersection #15 Douglas Street at El Segundo Boulevard

Cycle (sec): 100 Critical Vol./Cap.(X): 1.181
Loss Time (sec): 5 Average Delay (sec/veh): xxxxxx
Optimal Cycle: 180 Level of Service: F

Table with columns for Street Name (Douglas St, El Segundo Blvd), Approach (North Bound, South Bound, East Bound, West Bound), Movement (L, T, R), Control (Protected), Rights (Include), and Volume (Min. Green, Y+R, Lanes).

Volume Module table with columns for Base Vol, Growth Adj, Initial Bse, Added Vol, Related Pro, Initial Fut, User Adj, PHF Adj, PHF Volume, Reduct Vol, Reduced Vol, PCE Adj, MLF Adj, Final Volume, and OvlAdjVol.

Saturation Flow Module table with columns for Sat/Lane, Adjustment, Lanes, and Final Sat.

Capacity Analysis Module table with columns for Vol/Sat, Crit Moves, and other metrics.

Continental Grand Campus Specific Plan
City of El Segundo

Phase 2 Opening Year (2023) Without Project PM Peak Hour (ICU)

Level Of Service Computation Report

ICU 1(Loss as Cycle Length %) Method (Future Volume Alternative)

Intersection #16 Aviation Boulevard at El Segundo Boulevard

Cycle (sec): 100 Critical Vol./Cap.(X): 1.161
Loss Time (sec): 5 Average Delay (sec/veh): xxxxxx
Optimal Cycle: 180 Level Of Service: F

Table with columns for Street Name, Approach, Movement, Control, Rights, Min. Green, Y+R, Lanes. Rows for North Bound, South Bound, East Bound, West Bound.

Volume Module table with columns for Base Vol, Growth Adj, Initial Bse, Added Vol, Related Pro, Initial Fut, User Adj, PHF Adj, PHF Volume, Reduct Vol, Reduced Vol, PCE Adj, MLF Adj, Final Volume, OvlAdjVol.

Saturation Flow Module table with columns for Sat/Lane, Adjustment, Lanes, Final Sat.

Capacity Analysis Module table with columns for Vol/Sat, OvlAdjV/S, Crit Moves.

Continental Grand Campus Specific Plan
City of El Segundo

Phase 2 Opening Year (2023) Without Project PM Peak Hour (ICU)

Level Of Service Computation Report

ICU 1(Loss as Cycle Length %) Method (Future Volume Alternative)

Intersection #17 El Segundo Boulevard and Isis Avenue

Cycle (sec): 100 Critical Vol./Cap.(X): 0.786
Loss Time (sec): 5 Average Delay (sec/veh): xxxxxx
Optimal Cycle: 49 Level Of Service: C

Table with columns for Street Name, Approach, Movement, Control, Rights, Min. Green, Y+R, Lanes. Rows for North Bound, South Bound, East Bound, West Bound.

Volume Module table with columns for Base Vol, Growth Adj, Initial Bse, Added Vol, Related Pro, Initial Fut, User Adj, PHF Adj, PHF Volume, Reduct Vol, Reduced Vol, PCE Adj, MLF Adj, Final Volume.

Saturation Flow Module table with columns for Sat/Lane, Adjustment, Lanes, Final Sat.

Capacity Analysis Module table with columns for Vol/Sat, Crit Moves.

Continental Grand Campus Specific Plan
City of El Segundo

Phase 2 Opening Year (2023) Without Project PM Peak Hour (ICU)

Level Of Service Computation Report

ICU 1(Loss as Cycle Length %) Method (Future Volume Alternative)

Intersection #18 El Segundo Blvd at I-405 SB Ramps

Cycle (sec): 100 Critical Vol./Cap.(X): 1.189
Loss Time (sec): 5 Average Delay (sec/veh): xxxxxx
Optimal Cycle: 180 Level Of Service: F

Table with columns for Street Name, Approach, Movement, Control, Rights, Min. Green, Y+R, Lanes. Rows include I-405 SB Ramps and El Segundo Blvd.

Volume Module table with columns for Base Vol, Growth Adj, Initial Bse, Added Vol, Related Pro, Initial Fut, User Adj, PHF Adj, PHF Volume, Reduct Vol, Reduced Vol, PCE Adj, MLF Adj, Final Volume.

Saturation Flow Module table with columns for Sat/Lane, Adjustment, Lanes, Final Sat.

Capacity Analysis Module table with columns for Vol/Sat, Crit Moves.

Continental Grand Campus Specific Plan
City of El Segundo

Phase 2 Opening Year (2023) Without Project PM Peak Hour (ICU)

Level Of Service Computation Report

ICU 1(Loss as Cycle Length %) Method (Future Volume Alternative)

Intersection #19 El Segundo Blvd at La Cienega Blvd

Cycle (sec): 100 Critical Vol./Cap.(X): 0.754
Loss Time (sec): 5 Average Delay (sec/veh): xxxxxx
Optimal Cycle: 44 Level Of Service: C

Table with columns for Street Name, Approach, Movement, Control, Rights, Min. Green, Y+R, Lanes. Rows include La Cienega Blvd and El Segundo Blvd.

Volume Module table with columns for Base Vol, Growth Adj, Initial Bse, Added Vol, Related Pro, Initial Fut, User Adj, PHF Adj, PHF Volume, Reduct Vol, Reduced Vol, PCE Adj, MLF Adj, Final Volume.

Saturation Flow Module table with columns for Sat/Lane, Adjustment, Lanes, Final Sat.

Capacity Analysis Module table with columns for Vol/Sat, Crit Moves.

Continental Grand Campus Specific Plan
City of El Segundo

Phase 2 Opening Year (2023) Without Project PM Peak Hour (ICU)

Level Of Service Computation Report

ICU 1(Loss as Cycle Length %) Method (Future Volume Alternative)

Intersection #20 El Segundo Blvd at I-405 NB Ramps

Cycle (sec): 100 Critical Vol./Cap.(X): 0.731
Loss Time (sec): 5 Average Delay (sec/veh): xxxxxx
Optimal Cycle: 41 Level Of Service: C

Table with columns for Street Name, Approach, Movement, Control, Rights, Min. Green, Y+R, and Lanes. Rows include I-405 NB Ramps and El Segundo Blvd with various movement and control details.

Volume Module table with columns for Base Vol, Growth Adj, Initial Bse, Added Vol, Related Pro, Initial Fut, User Adj, PHF Adj, PHF Volume, Reduct Vol, Reduced Vol, PCE Adj, MLF Adj, and Final Volume. Rows include various volume and adjustment factors.

Saturation Flow Module table with columns for Sat/Lane, Adjustment, Lanes, and Final Sat. Rows include saturation flow and adjustment factors.

Capacity Analysis Module table with columns for Vol/Sat and Crit Moves. Rows include volume to saturation ratio and critical moves.

 Continental Grand Campus Specific Plan
 City of El Segundo
 Phase 2 Opening Year (2023) With Project AM Peak Hour (ICU)

Scenario: Phase 2 Op Yr With Proj AM

Command: Phase 2 Op Yr With Proj AM
 Volume: OY AM
 Geometry: Existing
 Impact Fee: Default Impact Fee
 Trip Generation: Cum + Phase 2 AM
 Trip Distribution: Cum + Proj
 Paths: Project
 Routes: Default Route
 Configuration: Phase 2 Op Yr With Proj AM

 Continental Grand Campus Specific Plan
 City of El Segundo
 Phase 2 Opening Year (2023) With Project AM Peak Hour (ICU)

Trip Generation Report

Forecast for Cum + Phase 2 AM

Zone #	Subzone	Amount	Units	Rate In	Rate Out	Trips In	Trips Out	Total Trips	% Of Total
306	525 N. Sepul	1.00	Residential	-6.00	-3.00	-6	-3	-9	-0.3
	Zone 306 Subtotal					-6	-3	-9	-0.3
307	540 Imperial	1.00	Residential	23.00	44.00	23	44	67	2.3
	Zone 307 Subtotal					23	44	67	2.3
311	199 Continen	1.00	Business Hotel	48.00	33.00	48	33	81	2.8
	Zone 311 Subtotal					48	33	81	2.8
313	445 N. Dougl	1.00	Equinix Data C	8.00	8.00	8	8	16	0.5
	Zone 313 Subtotal					8	8	16	0.5
314	123 Lomita a	1.00	Office	17.00	3.00	17	3	20	0.7
	Zone 314 Subtotal					17	3	20	0.7
704	2355 Utah Av	1.00	Office	150.00	76.00	150	76	226	7.8
	Zone 704 Subtotal					150	76	226	7.8
706	888 Sepulved	1.00	hotel	57.00	36.00	57	36	93	3.2
	Zone 706 Subtotal					57	36	93	3.2
710	201 North Do	1.00	High School	160.00	111.00	160	111	271	9.3
710	201 North Do	1.00	District Offic	20.00	2.00	20	2	22	0.8
	Zone 710 Subtotal					180	113	293	10.1
714	400 Duley -	1.00	Office	95.00	13.00	95	13	108	3.7
	Zone 714 Subtotal					95	13	108	3.7
717	1700 Imperia	1.00	Townhome Resid	133.00	18.00	133	18	151	5.2
	Zone 717 Subtotal					133	18	151	5.2
718	123 Nevada S	1.00	Office	18.00	3.00	18	3	21	0.7
	Zone 718 Subtotal					18	3	21	0.7
719	2125 Campus	1.00	Office Retail	160.00	46.00	160	46	206	7.1
	Zone 719 Subtotal					160	46	206	7.1
1002	Laker Facili	1.00	General Office	136.00	13.00	136	13	149	5.1
	Zone 1002 Subtotal					136	13	149	5.1
1004	1955 E Grand	1.00	Mattel	239.00	33.00	239	33	272	9.3
	Zone 1004 Subtotal					239	33	272	9.3

 Continental Grand Campus Specific Plan
 City of El Segundo
 Phase 2 Opening Year (2023) With Project AM Peak Hour (ICU)

Zone #	Subzone	Amount	Units	Rate In	Rate Out	Trips In	Trips Out	Total Trips	% Of Total
1005	Mattel	1.00	Mattel	431.00	43.00	431	43	474	16.3
	Zone 1005 Subtotal					431	43	474	16.3
1007	Mattel Proje	1.00	project	670.00	76.00	670	76	746	25.6
	Zone 1007 Subtotal					670	76	746	25.6

TOTAL						2359	555	2914	100.0

 Continental Grand Campus Specific Plan
 City of El Segundo
 Phase 2 Opening Year (2023) With Project AM Peak Hour (ICU)

Trip Distribution Report

Percent Of Trips Cum + Project

Zone	To Gates											
	1	2	3	4	5	7	8	9	10	11	12	
306	10.0	15.0	10.0	5.0	0.0	5.0	5.0	25.0	0.0	25.0	0.0	
307	10.0	15.0	10.0	5.0	50.0	0.0	0.0	0.0	0.0	0.0	0.0	
311	40.0	10.0	10.0	10.0	0.0	5.0	5.0	10.0	0.0	10.0	0.0	
313	15.0	5.0	15.0	10.0	25.0	0.0	5.0	20.0	0.0	0.0	0.0	
314	40.0	10.0	10.0	10.0	0.0	5.0	5.0	10.0	0.0	10.0	0.0	
704	30.0	15.0	8.0	12.0	0.0	5.0	5.0	10.0	5.0	10.0	0.0	
706	25.0	20.0	10.0	25.0	0.0	0.0	0.0	0.0	0.0	0.0	10.0	
710	0.0	0.0	15.0	10.0	10.0	2.0	2.0	20.0	5.0	10.0	1.0	
714	5.0	10.0	5.0	5.0	20.0	5.0	10.0	15.0	5.0	15.0	0.0	
717	10.0	15.0	10.0	5.0	50.0	0.0	0.0	0.0	0.0	0.0	0.0	
718	10.0	10.0	10.0	10.0	20.0	0.0	0.0	20.0	10.0	0.0	0.0	
719	20.0	10.0	10.0	10.0	10.0	5.0	5.0	10.0	5.0	0.0	0.0	
1002	0.0	10.0	5.0	5.0	15.0	5.0	10.0	15.0	5.0	15.0	5.0	
1004	5.0	15.0	10.0	5.0	30.0	0.0	5.0	20.0	0.0	0.0	5.0	
1005	5.0	15.0	10.0	5.0	30.0	0.0	5.0	20.0	0.0	0.0	5.0	
1007	0.0	0.0	0.0	0.0	0.0	0.0	0.0	0.0	0.0	0.0	0.0	

Zone	To Gates						
	13	14	15	16	17	18	20
306	0.0	0.0	0.0	0.0	0.0	0.0	0.0
307	0.0	10.0	0.0	0.0	0.0	0.0	0.0
311	0.0	0.0	0.0	0.0	0.0	0.0	0.0
313	5.0	0.0	0.0	0.0	0.0	0.0	0.0
314	0.0	0.0	0.0	0.0	0.0	0.0	0.0
704	0.0	0.0	0.0	0.0	0.0	0.0	0.0
706	0.0	0.0	0.0	0.0	10.0	0.0	0.0
710	10.0	5.0	10.0	0.0	0.0	0.0	0.0
714	0.0	5.0	0.0	0.0	0.0	0.0	0.0
717	0.0	10.0	0.0	0.0	0.0	0.0	0.0
718	0.0	10.0	0.0	0.0	0.0	0.0	0.0
719	0.0	10.0	5.0	0.0	0.0	0.0	0.0
1002	0.0	5.0	5.0	0.0	0.0	0.0	0.0
1004	0.0	5.0	0.0	0.0	0.0	0.0	0.0
1005	0.0	5.0	0.0	0.0	0.0	0.0	0.0
1007	0.0	0.0	0.0	0.0	0.0	20.0	10.0

Continental Grand Campus Specific Plan
City of El Segundo
Phase 2 Opening Year (2023) With Project AM Peak Hour (ICU)

Impact Analysis Report
Level Of Service

Table with columns: Intersection, Base (Del/V, LOS Veh, C), Future (Del/V, LOS Veh, C), Change in. Lists 20 intersections including Sepulveda Blvd at Imperial Hwy, Walnut St, Maple Ave, Mariposa Ave, Grand Ave, El Segundo B, Rosecrans Bl, Continental Boulevard at Marip, Grand, El Se, Nash St and Imperial Hwy, Nash St at Mariposa Ave, Grand Ave, El Segundo Blvd, Douglas Street at El Segundo B, Aviation Boulevard at El Segun, El Segundo Boulevard and Isis, El Segundo Blvd at I-405 SB Ra, El Segundo Blvd at La Cienega, El Segundo Blvd at I-405 NB Ra.

Continental Grand Campus Specific Plan
City of El Segundo
Phase 2 Opening Year (2023) With Project AM Peak Hour (ICU)

Level Of Service Computation Report

ICU 1(Loss as Cycle Length %) Method (Future Volume Alternative)

Level of Service Computation Report for Intersection #1 Sepulveda Blvd at Imperial Hwy. Includes Cycle (sec), Loss Time (sec), Optimal Cycle, Critical Vol./Cap.(X), Average Delay (sec/veh), Level Of Service (D). Detailed table for Street Name: Sepulveda Blvd and Imperial Hwy, showing Approach (North/South/East/West Bound), Movement (L-T-R), Control (Protected/Include/Ovl), and Volume Module (Base Vol, Growth Adj, Initial Bse, Added Vol, Related Pro, Initial Fut, User Adj, PHF Adj, PHF Volume, Reduct Vol, Reduced Vol, PCE Adj, MLF Adj, Final Volume, OvlAdjVol). Also includes Saturation Flow Module and Capacity Analysis Module.

Continental Grand Campus Specific Plan
City of El Segundo
Phase 2 Opening Year (2023) With Project AM Peak Hour (ICU)

Level Of Service Computation Report

ICU 1(Loss as Cycle Length %) Method (Future Volume Alternative)

Intersection #2 Sepulveda Blvd at Walnut St

Cycle (sec): 100 Critical Vol./Cap.(X): 0.739
Loss Time (sec): 5 Average Delay (sec/veh): xxxxxx
Optimal Cycle: 42 Level Of Service: C

Table with columns for Street Name, Approach, Movement, Control, Rights, Min. Green, Y+R, Lanes. Rows for Sepulveda Blvd and Walnut St.

Table with columns for Volume Module, Base Vol, Growth Adj, Initial Bse, Added Vol, Related Pro, Initial Fut, User Adj, PHF Adj, PHF Volume, Reduct Vol, Reduced Vol, PCE Adj, MLF Adj, Final Volume.

Table with columns for Sat/Lane, Adjustment, Lanes, Final Sat. for Saturation Flow Module.

Table with columns for Vol/Sat, Crit Moves for Capacity Analysis Module.

Continental Grand Campus Specific Plan
City of El Segundo
Phase 2 Opening Year (2023) With Project AM Peak Hour (ICU)

Level Of Service Computation Report

ICU 1(Loss as Cycle Length %) Method (Future Volume Alternative)

Intersection #3 Sepulveda Blvd at Maple Ave

Cycle (sec): 100 Critical Vol./Cap.(X): 0.729
Loss Time (sec): 5 Average Delay (sec/veh): xxxxxx
Optimal Cycle: 41 Level Of Service: C

Table with columns for Street Name, Approach, Movement, Control, Rights, Min. Green, Y+R, Lanes. Rows for Sepulveda Blvd and Maple Ave.

Table with columns for Volume Module, Base Vol, Growth Adj, Initial Bse, Added Vol, Related Pro, Initial Fut, User Adj, PHF Adj, PHF Volume, Reduct Vol, Reduced Vol, PCE Adj, MLF Adj, Final Volume.

Table with columns for Sat/Lane, Adjustment, Lanes, Final Sat. for Saturation Flow Module.

Table with columns for Vol/Sat, Crit Moves for Capacity Analysis Module.

Continental Grand Campus Specific Plan
City of El Segundo
Phase 2 Opening Year (2023) With Project AM Peak Hour (ICU)

Level Of Service Computation Report

ICU 1(Loss as Cycle Length %) Method (Future Volume Alternative)

Intersection #4 Sepulveda Blvd at Mariposa Ave

Cycle (sec): 100 Critical Vol./Cap.(X): 0.803
Loss Time (sec): 5 Average Delay (sec/veh): xxxxxx
Optimal Cycle: 53 Level Of Service: D

Table with columns for Street Name (Sepulveda Blvd, Mariposa Ave), Approach (North Bound, South Bound, East Bound, West Bound), Movement (L, T, R), Control (Protected, Permitted), Rights (Include), and Volume (Min. Green, Y+R, Lanes).

Volume Module table with columns for Base Vol, Growth Adj, Initial Bse, Added Vol, Related Pro, Initial Fut, User Adj, PHF Adj, PHF Volume, Reduct Vol, Reduced Vol, PCE Adj, MLF Adj, and Final Volume.

Saturation Flow Module table with columns for Sat/Lane, Adjustment, Lanes, and Final Sat.

Capacity Analysis Module table with columns for Vol/Sat, Crit Moves, and OvlAdjV/S.

Continental Grand Campus Specific Plan
City of El Segundo
Phase 2 Opening Year (2023) With Project AM Peak Hour (ICU)

Level Of Service Computation Report

ICU 1(Loss as Cycle Length %) Method (Future Volume Alternative)

Intersection #5 Sepulveda Blvd at Grand Ave

Cycle (sec): 100 Critical Vol./Cap.(X): 0.867
Loss Time (sec): 5 Average Delay (sec/veh): xxxxxx
Optimal Cycle: 71 Level Of Service: D

Table with columns for Street Name (Sepulveda Blvd, Grand Ave), Approach (North Bound, South Bound, East Bound, West Bound), Movement (L, T, R), Control (Protected, Split Phase), Rights (Include), and Volume (Min. Green, Y+R, Lanes).

Volume Module table with columns for Base Vol, Growth Adj, Initial Bse, Added Vol, Related Pro, Initial Fut, User Adj, PHF Adj, PHF Volume, Reduct Vol, Reduced Vol, PCE Adj, MLF Adj, and Final Volume.

Saturation Flow Module table with columns for Sat/Lane, Adjustment, Lanes, and Final Sat.

Capacity Analysis Module table with columns for Vol/Sat, Crit Moves, and OvlAdjV/S.

Continental Grand Campus Specific Plan
City of El Segundo
Phase 2 Opening Year (2023) With Project AM Peak Hour (ICU)

Level Of Service Computation Report
ICU 1(Loss as Cycle Length %) Method (Future Volume Alternative)

Intersection #6 Sepulveda Blvd at El Segundo Blvd

Cycle (sec): 100 Critical Vol./Cap.(X): 1.089
Loss Time (sec): 5 Average Delay (sec/veh): xxxxxx
Optimal Cycle: 180 Level Of Service: F

Table with columns for Street Name, Approach, Movement, Control, Rights, Min. Green, Y+R, Lanes. Rows for Sepulveda Blvd and El Segundo Blvd.

Volume Module table with columns for Base Vol, Growth Adj, Initial Bse, Added Vol, Related Pro, Initial Fut, User Adj, PHF Adj, PHF Volume, Reduct Vol, Reduced Vol, PCE Adj, MLF Adj, Final Volume.

Saturation Flow Module table with columns for Sat/Lane, Adjustment, Lanes, Final Sat.

Capacity Analysis Module table with columns for Vol/Sat, Crit Moves.

Continental Grand Campus Specific Plan
City of El Segundo
Phase 2 Opening Year (2023) With Project AM Peak Hour (ICU)

Level Of Service Computation Report
ICU 1(Loss as Cycle Length %) Method (Future Volume Alternative)

Intersection #7 Sepulveda Blvd at Rosecrans Blvd

Cycle (sec): 100 Critical Vol./Cap.(X): 0.941
Loss Time (sec): 5 Average Delay (sec/veh): xxxxxx
Optimal Cycle: 119 Level Of Service: E

Table with columns for Street Name, Approach, Movement, Control, Rights, Min. Green, Y+R, Lanes. Rows for Sepulveda Blvd and Rosecrans Blvd.

Volume Module table with columns for Base Vol, Growth Adj, Initial Bse, Added Vol, Related Pro, Initial Fut, User Adj, PHF Adj, PHF Volume, Reduct Vol, Reduced Vol, PCE Adj, MLF Adj, Final Volume, OvlAdjVol.

Saturation Flow Module table with columns for Sat/Lane, Adjustment, Lanes, Final Sat.

Capacity Analysis Module table with columns for Vol/Sat, OvlAdjV/S, Crit Moves.

Continental Grand Campus Specific Plan
City of El Segundo
Phase 2 Opening Year (2023) With Project AM Peak Hour (ICU)

Level Of Service Computation Report

ICU 1(Loss as Cycle Length %) Method (Future Volume Alternative)

Intersection #8 Continental Boulevard at Mariposa Ave

Cycle (sec): 100 Critical Vol./Cap.(X): 0.523
Loss Time (sec): 5 Average Delay (sec/veh): xxxxxx
Optimal Cycle: 25 Level Of Service: A

Table with columns for Street Name, Approach, Movement, Control, Rights, Min. Green, Y+R, Lanes. Rows include Continental Boulevard and Mariposa Avenue with various movement and control details.

Volume Module table with columns for Base Vol, Growth Adj, Initial Bse, Added Vol, Related Pro, Initial Fut, User Adj, PHF Adj, PHF Volume, Reduct Vol, Reduced Vol, PCE Adj, MLF Adj, Final Volume.

Saturation Flow Module table with columns for Sat/Lane, Adjustment, Lanes, Final Sat.

Capacity Analysis Module table with columns for Vol/Sat, Crit Moves.

Continental Grand Campus Specific Plan
City of El Segundo
Phase 2 Opening Year (2023) With Project AM Peak Hour (ICU)

Level Of Service Computation Report

ICU 1(Loss as Cycle Length %) Method (Future Volume Alternative)

Intersection #9 Continental Boulevard at Grand Avenue

Cycle (sec): 100 Critical Vol./Cap.(X): 0.517
Loss Time (sec): 5 Average Delay (sec/veh): xxxxxx
Optimal Cycle: 24 Level Of Service: A

Table with columns for Street Name, Approach, Movement, Control, Rights, Min. Green, Y+R, Lanes. Rows include Continental Boulevard and Grand Avenue with various movement and control details.

Volume Module table with columns for Base Vol, Growth Adj, Initial Bse, Added Vol, Related Pro, Initial Fut, User Adj, PHF Adj, PHF Volume, Reduct Vol, Reduced Vol, PCE Adj, MLF Adj, Final Volume.

Saturation Flow Module table with columns for Sat/Lane, Adjustment, Lanes, Final Sat.

Capacity Analysis Module table with columns for Vol/Sat, Crit Moves.

Continental Grand Campus Specific Plan
City of El Segundo
Phase 2 Opening Year (2023) With Project AM Peak Hour (ICU)

Level of Service Computation Report

ICU 1(Loss as Cycle Length %) Method (Future Volume Alternative)

Intersection #10 Continental Boulevard at El Segundo Boulevard

Cycle (sec): 100 Critical Vol./Cap.(X): 0.552
Loss Time (sec): 5 Average Delay (sec/veh): xxxxxx
Optimal Cycle: 26 Level Of Service: A

Table with columns for Street Name, Approach, Movement, Control, Rights, Min. Green, Y+R, Lanes. Rows for Continental Boulevard and El Segundo Boulevard.

Volume Module table with columns for Base Vol, Growth Adj, Initial Bse, Added Vol, Related Pro, Initial Fut, User Adj, PHF Adj, PHF Volume, Reduct Vol, Reduced Vol, PCE Adj, MLF Adj, Final Volume.

Saturation Flow Module table with columns for Sat/Lane, Adjustment, Lanes, Final Sat.

Capacity Analysis Module table with columns for Vol/Sat, Crit Moves.

Continental Grand Campus Specific Plan
City of El Segundo
Phase 2 Opening Year (2023) With Project AM Peak Hour (ICU)

Level of Service Computation Report

ICU 1(Loss as Cycle Length %) Method (Future Volume Alternative)

Intersection #11 Nash St and Imperial Hwy

Cycle (sec): 100 Critical Vol./Cap.(X): 0.848
Loss Time (sec): 5 Average Delay (sec/veh): xxxxxx
Optimal Cycle: 64 Level Of Service: D

Table with columns for Street Name, Approach, Movement, Control, Rights, Min. Green, Y+R, Lanes. Rows for Nash St and Imperial Hwy.

Volume Module table with columns for Base Vol, Growth Adj, Initial Bse, Added Vol, Related Pro, Initial Fut, User Adj, PHF Adj, PHF Volume, Reduct Vol, Reduced Vol, PCE Adj, MLF Adj, Final Volume.

Saturation Flow Module table with columns for Sat/Lane, Adjustment, Lanes, Final Sat.

Capacity Analysis Module table with columns for Vol/Sat, Crit Moves.

Continental Grand Campus Specific Plan
City of El Segundo
Phase 2 Opening Year (2023) With Project AM Peak Hour (ICU)

Level Of Service Computation Report
ICU 1(Loss as Cycle Length %) Method (Future Volume Alternative)

Intersection #12 Nash St at Mariposa Ave

Cycle (sec): 100 Critical Vol./Cap.(X): 0.689
Loss Time (sec): 5 Average Delay (sec/veh): xxxxxx
Optimal Cycle: 36 Level Of Service: B

Table with columns for Street Name (Nash St, Mariposa Ave), Approach (North Bound, South Bound, East Bound, West Bound), Movement (L, T, R), Control (Permitted, Include), Rights, Min. Green, Y+R, Lanes.

Volume Module table with columns for Base Vol, Growth Adj, Initial Bse, Added Vol, PasserByVol, Initial Fut, User Adj, PHF Adj, PHF Volume, Reduct Vol, Reduced Vol, PCE Adj, MLF Adj, FinalVolume.

Saturation Flow Module table with columns for Sat/Lane, Adjustment, Lanes, Final Sat.

Capacity Analysis Module table with columns for Vol/Sat, Crit Moves.

Continental Grand Campus Specific Plan
City of El Segundo
Phase 2 Opening Year (2023) With Project AM Peak Hour (ICU)

Level Of Service Computation Report
ICU 1(Loss as Cycle Length %) Method (Future Volume Alternative)

Intersection #13 Nash St at Grand Ave

Cycle (sec): 100 Critical Vol./Cap.(X): 0.580
Loss Time (sec): 5 Average Delay (sec/veh): xxxxxx
Optimal Cycle: 28 Level Of Service: A

Table with columns for Street Name (Nash St, Grand Ave), Approach (North Bound, South Bound, East Bound, West Bound), Movement (L, T, R), Control (Protected, Split Phase, Include), Rights, Min. Green, Y+R, Lanes.

Volume Module table with columns for Base Vol, Growth Adj, Initial Bse, Added Vol, Related Pro, Initial Fut, User Adj, PHF Adj, PHF Volume, Reduct Vol, Reduced Vol, PCE Adj, MLF Adj, FinalVolume.

Saturation Flow Module table with columns for Sat/Lane, Adjustment, Lanes, Final Sat.

Capacity Analysis Module table with columns for Vol/Sat, Crit Moves.

Continental Grand Campus Specific Plan
City of El Segundo
Phase 2 Opening Year (2023) With Project AM Peak Hour (ICU)

Level of Service Computation Report

ICU 1(Loss as Cycle Length %) Method (Future Volume Alternative)

Intersection #14 Nash St at El Segundo Blvd

Cycle (sec): 100 Critical Vol./Cap.(X): 0.729
Loss Time (sec): 5 Average Delay (sec/veh): xxxxxx
Optimal Cycle: 41 Level of Service: C

Table with columns for Street Name (Nash St, El Segundo Blvd), Approach (North Bound, South Bound, East Bound, West Bound), Movement (L, T, R), Control (Split Phase, Protected), Rights (Ovl, Include), and Volume (Min. Green, Y+R, Lanes).

Volume Module table with columns for Base Vol, Growth Adj, Initial Bse, Added Vol, Related Pro, Initial Fut, User Adj, PHF Adj, PHF Volume, Reduct Vol, Reduced Vol, PCE Adj, MLF Adj, Final Volume, and OvlAdjVol.

Saturation Flow Module table with columns for Sat/Lane, Adjustment, Lanes, and Final Sat.

Capacity Analysis Module table with columns for Vol/Sat, OvlAdjV/S, and Crit Moves.

Continental Grand Campus Specific Plan
City of El Segundo
Phase 2 Opening Year (2023) With Project AM Peak Hour (ICU)

Level of Service Computation Report

ICU 1(Loss as Cycle Length %) Method (Future Volume Alternative)

Intersection #15 Douglas Street at El Segundo Boulevard

Cycle (sec): 100 Critical Vol./Cap.(X): 1.031
Loss Time (sec): 5 Average Delay (sec/veh): xxxxxx
Optimal Cycle: 180 Level of Service: F

Table with columns for Street Name (Douglas St, El Segundo Blvd), Approach (North Bound, South Bound, East Bound, West Bound), Movement (L, T, R), Control (Protected), Rights (Include), and Volume (Min. Green, Y+R, Lanes).

Volume Module table with columns for Base Vol, Growth Adj, Initial Bse, Added Vol, Related Pro, Initial Fut, User Adj, PHF Adj, PHF Volume, Reduct Vol, Reduced Vol, PCE Adj, MLF Adj, Final Volume, and OvlAdjVol.

Saturation Flow Module table with columns for Sat/Lane, Adjustment, Lanes, and Final Sat.

Capacity Analysis Module table with columns for Vol/Sat, Crit Moves, and other metrics.

Continental Grand Campus Specific Plan
City of El Segundo
Phase 2 Opening Year (2023) With Project AM Peak Hour (ICU)

Level of Service Computation Report

ICU 1(Loss as Cycle Length %) Method (Future Volume Alternative)

Intersection #16 Aviation Boulevard at El Segundo Boulevard

Cycle (sec): 100 Critical Vol./Cap.(X): 1.208
Loss Time (sec): 5 Average Delay (sec/veh): xxxxxx
Optimal Cycle: 180 Level Of Service: F

Table with columns for Street Name, Approach, Movement, Control, Rights, Min. Green, Y+R, Lanes. Rows for Aviatio Blvd and El Segundo Blvd.

Volume Module table with columns for Base Vol, Growth Adj, Initial Bse, Added Vol, Related Pro, Initial Fut, User Adj, PHF Adj, PHF Volume, Reduct Vol, Reduced Vol, PCE Adj, MLF Adj, FinalVolume, OvlAdjVol.

Saturation Flow Module table with columns for Sat/Lane, Adjustment, Lanes, Final Sat.

Capacity Analysis Module table with columns for Vol/Sat, OvlAdjV/S, Crit Moves.

Continental Grand Campus Specific Plan
City of El Segundo
Phase 2 Opening Year (2023) With Project AM Peak Hour (ICU)

Level of Service Computation Report

ICU 1(Loss as Cycle Length %) Method (Future Volume Alternative)

Intersection #17 El Segundo Boulevard and Isis Avenue

Cycle (sec): 100 Critical Vol./Cap.(X): 0.869
Loss Time (sec): 5 Average Delay (sec/veh): xxxxxx
Optimal Cycle: 72 Level Of Service: D

Table with columns for Street Name, Approach, Movement, Control, Rights, Min. Green, Y+R, Lanes. Rows for Isis Avenue and El Segundo Boulevard.

Volume Module table with columns for Base Vol, Growth Adj, Initial Bse, Added Vol, Related Pro, Initial Fut, User Adj, PHF Adj, PHF Volume, Reduct Vol, Reduced Vol, PCE Adj, MLF Adj, FinalVolume.

Saturation Flow Module table with columns for Sat/Lane, Adjustment, Lanes, Final Sat.

Capacity Analysis Module table with columns for Vol/Sat, Crit Moves.

Continental Grand Campus Specific Plan
City of El Segundo
Phase 2 Opening Year (2023) With Project AM Peak Hour (ICU)

Level Of Service Computation Report

ICU 1(Loss as Cycle Length %) Method (Future Volume Alternative)

Intersection #18 El Segundo Blvd at I-405 SB Ramps

Cycle (sec): 100 Critical Vol./Cap.(X): 0.814
Loss Time (sec): 5 Average Delay (sec/veh): xxxxxx
Optimal Cycle: 55 Level Of Service: D

Table with columns for Street Name, Approach, Movement, Control, Rights, Min. Green, Y+R, Lanes. Rows include I-405 SB Ramps and El Segundo Blvd.

Table with columns for Volume Module, Base Vol, Growth Adj, Initial Bse, Added Vol, Related Pro, Initial Fut, User Adj, PHF Adj, PHF Volume, Reduct Vol, Reduced Vol, PCE Adj, MLF Adj, Final Volume.

Table with columns for Sat/Lane, Adjustment, Lanes, Final Sat. for Saturation Flow Module.

Table with columns for Vol/Sat, Crit Moves for Capacity Analysis Module.

Continental Grand Campus Specific Plan
City of El Segundo
Phase 2 Opening Year (2023) With Project AM Peak Hour (ICU)

Level Of Service Computation Report

ICU 1(Loss as Cycle Length %) Method (Future Volume Alternative)

Intersection #19 El Segundo Blvd at La Cienega Blvd

Cycle (sec): 100 Critical Vol./Cap.(X): 0.889
Loss Time (sec): 5 Average Delay (sec/veh): xxxxxx
Optimal Cycle: 81 Level Of Service: D

Table with columns for Street Name, Approach, Movement, Control, Rights, Min. Green, Y+R, Lanes. Rows include La Cienega Blvd and El Segundo Blvd.

Table with columns for Volume Module, Base Vol, Growth Adj, Initial Bse, Added Vol, Related Pro, Initial Fut, User Adj, PHF Adj, PHF Volume, Reduct Vol, Reduced Vol, PCE Adj, MLF Adj, Final Volume.

Table with columns for Sat/Lane, Adjustment, Lanes, Final Sat. for Saturation Flow Module.

Table with columns for Vol/Sat, Crit Moves for Capacity Analysis Module.

Continental Grand Campus Specific Plan
City of El Segundo
Phase 2 Opening Year (2023) With Project AM Peak Hour (ICU)

Level Of Service Computation Report

ICU 1(Loss as Cycle Length %) Method (Future Volume Alternative)

Intersection #20 El Segundo Blvd at I-405 NB Ramps

Cycle (sec): 100 Critical Vol./Cap.(X): 0.937
Loss Time (sec): 5 Average Delay (sec/veh): xxxxxx
Optimal Cycle: 115 Level Of Service: E

Table with columns for Street Name, Approach, Movement, Control, Rights, Min. Green, Y+R, Lanes. Rows include I-405 NB Ramps and El Segundo Blvd with various movement and control details.

Volume Module table with columns for Base Vol, Growth Adj, Initial Bse, Added Vol, Related Pro, Initial Fut, User Adj, PHF Adj, PHF Volume, Reduct Vol, Reduced Vol, PCE Adj, MLF Adj, Final Volume. Rows include I-405 NB Ramps and El Segundo Blvd.

Saturation Flow Module table with columns for Sat/Lane, Adjustment, Lanes, Final Sat. Rows include I-405 NB Ramps and El Segundo Blvd.

Capacity Analysis Module table with columns for Vol/Sat, Crit Moves. Rows include I-405 NB Ramps and El Segundo Blvd.

 Continental Grand Campus Specific Plan
 City of El Segundo
 Phase 2 Opening Year (2023) With Project PM Peak Hour (ICU)

Scenario: Phase 2 Op Yr With Proj PM

Command: Phase 2 Op Yr With Proj PM
 Volume: OY PM
 Geometry: Existing
 Impact Fee: Default Impact Fee
 Trip Generation: Cum + Phase 2 PM
 Trip Distribution: Cum + Proj
 Paths: Project
 Routes: Default Route
 Configuration: Phase 2 Op Yr With Proj PM

 Continental Grand Campus Specific Plan
 City of El Segundo
 Phase 2 Opening Year (2023) With Project PM Peak Hour (ICU)

Trip Generation Report

Forecast for Cum + Phase 2 PM

Zone #	Subzone	Amount	Units	Rate In	Rate Out	Trips In	Trips Out	Total Trips	% Of Total
306	525 N. Sepul	1.00	Residential	-4.00	-6.00	-4	-6	-10	-0.4
	Zone 306 Subtotal					-4	-6	-10	-0.4
307	540 Imperial	1.00	Residential	50.00	32.00	50	32	82	3.3
	Zone 307 Subtotal					50	32	82	3.3
311	199 Continen	1.00	Business Hotel	46.00	45.00	46	45	91	3.6
	Zone 311 Subtotal					46	45	91	3.6
313	445 N. Dougl	1.00	Equinix Data C	3.00	13.00	3	13	16	0.6
	Zone 313 Subtotal					3	13	16	0.6
314	123 Lomita a	1.00	Office	2.00	16.00	2	16	18	0.7
	Zone 314 Subtotal					2	16	18	0.7
704	2355 Utah Av	1.00	Office	95.00	109.00	95	109	204	8.2
	Zone 704 Subtotal					95	109	204	8.2
706	888 Sepulved	1.00	hotel	60.00	41.00	60	41	101	4.0
	Zone 706 Subtotal					60	41	101	4.0
710	201 North Do	1.00	High School	-15.00	-74.00	-15	-74	-89	-3.6
710	201 North Do	1.00	District Offic	3.00	18.00	3	18	21	0.8
	Zone 710 Subtotal					-12	-56	-68	-2.7
714	400 Duley -	1.00	Office	18.00	87.00	18	87	105	4.2
	Zone 714 Subtotal					18	87	105	4.2
717	1700 Imperia	1.00	Townhome Resid	25.00	120.00	25	120	145	5.8
	Zone 717 Subtotal					25	120	145	5.8
718	123 Nevada S	1.00	Office	4.00	16.00	4	16	20	0.8
	Zone 718 Subtotal					4	16	20	0.8
719	2125 Campus	1.00	Office Retail	64.00	146.00	64	146	210	8.4
	Zone 719 Subtotal					64	146	210	8.4
1002	Laker Facili	1.00	General Office	103.00	85.00	103	85	188	7.5
	Zone 1002 Subtotal					103	85	188	7.5
1004	1955 E Grand	1.00	Mattel	44.00	216.00	44	216	260	10.4
	Zone 1004 Subtotal					44	216	260	10.4

Continental Grand Campus Specific Plan
 City of El Segundo
 Phase 2 Opening Year (2023) With Project PM Peak Hour (ICU)

Zone #	Subzone	Amount	Units	Rate In	Rate Out	Trips In	Trips Out	Total Trips	% Of Total
1005	Mattel	1.00	Mattel	48.00	388.00	48	388	436	17.5
	Zone 1005 Subtotal					48	388	436	17.5
1007	Mattel Proje	1.00	project	92.00	604.00	92	604	696	27.9
	Zone 1007 Subtotal					92	604	696	27.9
TOTAL						638	1856	2494	100.0

Continental Grand Campus Specific Plan
 City of El Segundo
 Phase 2 Opening Year (2023) With Project PM Peak Hour (ICU)

Trip Distribution Report

Percent Of Trips Cum + Project

Zone	To Gates											
	1	2	3	4	5	7	8	9	10	11	12	
306	10.0	15.0	10.0	5.0	0.0	5.0	5.0	25.0	0.0	25.0	0.0	
307	10.0	15.0	10.0	5.0	50.0	0.0	0.0	0.0	0.0	0.0	0.0	
311	40.0	10.0	10.0	10.0	0.0	5.0	5.0	10.0	0.0	10.0	0.0	
313	15.0	5.0	15.0	10.0	25.0	0.0	5.0	20.0	0.0	0.0	0.0	
314	40.0	10.0	10.0	10.0	0.0	5.0	5.0	10.0	0.0	10.0	0.0	
704	30.0	15.0	8.0	12.0	0.0	5.0	5.0	10.0	5.0	10.0	0.0	
706	25.0	20.0	10.0	25.0	0.0	0.0	0.0	0.0	0.0	0.0	10.0	
710	0.0	0.0	15.0	10.0	10.0	2.0	2.0	20.0	5.0	10.0	1.0	
714	5.0	10.0	5.0	5.0	20.0	5.0	10.0	15.0	5.0	15.0	0.0	
717	10.0	15.0	10.0	5.0	50.0	0.0	0.0	0.0	0.0	0.0	0.0	
718	10.0	10.0	10.0	10.0	20.0	0.0	0.0	20.0	10.0	0.0	0.0	
719	20.0	10.0	10.0	10.0	10.0	5.0	5.0	10.0	5.0	0.0	0.0	
1002	0.0	10.0	5.0	5.0	15.0	5.0	10.0	15.0	5.0	15.0	5.0	
1004	5.0	15.0	10.0	5.0	30.0	0.0	5.0	20.0	0.0	0.0	5.0	
1005	5.0	15.0	10.0	5.0	30.0	0.0	5.0	20.0	0.0	0.0	5.0	
1007	0.0	0.0	0.0	0.0	0.0	0.0	0.0	0.0	0.0	0.0	0.0	

Zone	To Gates						
	13	14	15	16	17	18	20
306	0.0	0.0	0.0	0.0	0.0	0.0	0.0
307	0.0	10.0	0.0	0.0	0.0	0.0	0.0
311	0.0	0.0	0.0	0.0	0.0	0.0	0.0
313	5.0	0.0	0.0	0.0	0.0	0.0	0.0
314	0.0	0.0	0.0	0.0	0.0	0.0	0.0
704	0.0	0.0	0.0	0.0	0.0	0.0	0.0
706	0.0	0.0	0.0	0.0	10.0	0.0	0.0
710	10.0	5.0	10.0	0.0	0.0	0.0	0.0
714	0.0	5.0	0.0	0.0	0.0	0.0	0.0
717	0.0	10.0	0.0	0.0	0.0	0.0	0.0
718	0.0	10.0	0.0	0.0	0.0	0.0	0.0
719	0.0	10.0	5.0	0.0	0.0	0.0	0.0
1002	0.0	5.0	5.0	0.0	0.0	0.0	0.0
1004	0.0	5.0	0.0	0.0	0.0	0.0	0.0
1005	0.0	5.0	0.0	0.0	0.0	0.0	0.0
1007	0.0	0.0	0.0	0.0	0.0	20.0	10.0

Continental Grand Campus Specific Plan
City of El Segundo
Phase 2 Opening Year (2023) With Project PM Peak Hour (ICU)

Impact Analysis Report
Level Of Service

Table with 5 columns: Intersection, Base (Del/V, LOS Veh, C), Future (Del/V, LOS Veh, C), Change in, and a final column with values like V/C. Lists 20 intersections from Sepulveda Blvd at Imperial Hwy to El Segundo Blvd at I-405 NB Ra.

Continental Grand Campus Specific Plan
City of El Segundo
Phase 2 Opening Year (2023) With Project PM Peak Hour (ICU)

Level Of Service Computation Report
ICU 1(Loss as Cycle Length %) Method (Future Volume Alternative)

Level of Service Computation Report for Intersection #1 Sepulveda Blvd at Imperial Hwy. Includes Cycle (sec), Critical Vol./Cap.(X), Loss Time (sec), Average Delay (sec/veh), Optimal Cycle, Level Of Service, Street Name, Approach, Movement, Control, Rights, Min. Green, Y+R, Lanes, Volume Module, Saturation Flow Module, Capacity Analysis Module.

Continental Grand Campus Specific Plan
City of El Segundo
Phase 2 Opening Year (2023) With Project PM Peak Hour (ICU)

Level Of Service Computation Report
ICU 1(Loss as Cycle Length %) Method (Future Volume Alternative)

Intersection #2 Sepulveda Blvd at Walnut St

Cycle (sec): 100 Critical Vol./Cap.(X): 0.776
Loss Time (sec): 5 Average Delay (sec/veh): xxxxxx
Optimal Cycle: 47 Level Of Service: C

Table with columns for Street Name, Approach, Movement, Control, Rights, Min. Green, Y+R, Lanes. Rows for Sepulveda Blvd and Walnut St.

Volume Module table with columns for Base Vol, Growth Adj, Initial Bse, Added Vol, Related Pro, Initial Fut, User Adj, PHF Adj, PHF Volume, Reduct Vol, Reduced Vol, PCE Adj, MLF Adj, Final Volume.

Saturation Flow Module table with columns for Sat/Lane, Adjustment, Lanes, Final Sat.

Capacity Analysis Module table with columns for Vol/Sat, Crit Moves.

Continental Grand Campus Specific Plan
City of El Segundo
Phase 2 Opening Year (2023) With Project PM Peak Hour (ICU)

Level Of Service Computation Report
ICU 1(Loss as Cycle Length %) Method (Future Volume Alternative)

Intersection #3 Sepulveda Blvd at Maple Ave

Cycle (sec): 100 Critical Vol./Cap.(X): 0.787
Loss Time (sec): 5 Average Delay (sec/veh): xxxxxx
Optimal Cycle: 49 Level Of Service: C

Table with columns for Street Name, Approach, Movement, Control, Rights, Min. Green, Y+R, Lanes. Rows for Sepulveda Blvd and Maple Ave.

Volume Module table with columns for Base Vol, Growth Adj, Initial Bse, Added Vol, Related Pro, Initial Fut, User Adj, PHF Adj, PHF Volume, Reduct Vol, Reduced Vol, PCE Adj, MLF Adj, Final Volume.

Saturation Flow Module table with columns for Sat/Lane, Adjustment, Lanes, Final Sat.

Capacity Analysis Module table with columns for Vol/Sat, Crit Moves.

Continental Grand Campus Specific Plan
City of El Segundo
Phase 2 Opening Year (2023) With Project PM Peak Hour (ICU)

Level Of Service Computation Report
ICU 1(Loss as Cycle Length %) Method (Future Volume Alternative)

Intersection #4 Sepulveda Blvd at Mariposa Ave

Cycle (sec): 100 Critical Vol./Cap.(X): 0.855
Loss Time (sec): 5 Average Delay (sec/veh): xxxxxx
Optimal Cycle: 67 Level Of Service: D

Table with columns for Street Name (Sepulveda Blvd, Mariposa Ave), Approach (North Bound, South Bound, East Bound, West Bound), Movement (L, T, R), Control (Protected, Permitted), Rights (Include), and traffic volume data (Min. Green, Y+R, Lanes).

Volume Module table showing Base Vol, Growth Adj, Initial Bse, Added Vol, Related Pro, Initial Fut, User Adj, PHF Adj, PHF Volume, Reduct Vol, Reduced Vol, PCE Adj, MLF Adj, and Final Volume for various approaches.

Saturation Flow Module table showing Sat/Lane, Adjustment, Lanes, and Final Sat. for various approaches.

Capacity Analysis Module table showing Vol/Sat, Crit Moves, and OvlAdjV/S for various approaches.

Continental Grand Campus Specific Plan
City of El Segundo
Phase 2 Opening Year (2023) With Project PM Peak Hour (ICU)

Level Of Service Computation Report
ICU 1(Loss as Cycle Length %) Method (Future Volume Alternative)

Intersection #5 Sepulveda Blvd at Grand Ave

Cycle (sec): 100 Critical Vol./Cap.(X): 0.967
Loss Time (sec): 5 Average Delay (sec/veh): xxxxxx
Optimal Cycle: 157 Level Of Service: E

Table with columns for Street Name (Sepulveda Blvd, Grand Ave), Approach (North Bound, South Bound, East Bound, West Bound), Movement (L, T, R), Control (Protected, Split Phase), Rights (Include), and traffic volume data (Min. Green, Y+R, Lanes).

Volume Module table showing Base Vol, Growth Adj, Initial Bse, Added Vol, Related Pro, Initial Fut, User Adj, PHF Adj, PHF Volume, Reduct Vol, Reduced Vol, PCE Adj, MLF Adj, and Final Volume for various approaches.

Saturation Flow Module table showing Sat/Lane, Adjustment, Lanes, and Final Sat. for various approaches.

Capacity Analysis Module table showing Vol/Sat, Crit Moves, and OvlAdjV/S for various approaches.

Continental Grand Campus Specific Plan
City of El Segundo
Phase 2 Opening Year (2023) With Project PM Peak Hour (ICU)

Level Of Service Computation Report

ICU 1(Loss as Cycle Length %) Method (Future Volume Alternative)

Intersection #6 Sepulveda Blvd at El Segundo Blvd

Cycle (sec): 100 Critical Vol./Cap.(X): 1.095
Loss Time (sec): 5 Average Delay (sec/veh): xxxxxx
Optimal Cycle: 180 Level Of Service: F

Table with columns for Street Name, Approach, Movement, Control, Rights, Min. Green, Y+R, Lanes for Sepulveda Blvd and El Segundo Blvd.

Volume Module table with columns for Base Vol, Growth Adj, Initial Bse, Added Vol, Related Pro, Initial Fut, User Adj, PHF Adj, PHF Volume, Reduct Vol, Reduced Vol, PCE Adj, MLF Adj, Final Volume.

Saturation Flow Module table with columns for Sat/Lane, Adjustment, Lanes, Final Sat.

Capacity Analysis Module table with columns for Vol/Sat, Crit Moves.

Continental Grand Campus Specific Plan
City of El Segundo
Phase 2 Opening Year (2023) With Project PM Peak Hour (ICU)

Level Of Service Computation Report

ICU 1(Loss as Cycle Length %) Method (Future Volume Alternative)

Intersection #7 Sepulveda Blvd at Rosecrans Blvd

Cycle (sec): 100 Critical Vol./Cap.(X): 1.023
Loss Time (sec): 5 Average Delay (sec/veh): xxxxxx
Optimal Cycle: 180 Level Of Service: F

Table with columns for Street Name, Approach, Movement, Control, Rights, Min. Green, Y+R, Lanes for Sepulveda Blvd and Rosecrans Blvd.

Volume Module table with columns for Base Vol, Growth Adj, Initial Bse, Added Vol, Related Pro, Initial Fut, User Adj, PHF Adj, PHF Volume, Reduct Vol, Reduced Vol, PCE Adj, MLF Adj, Final Volume, OvlAdjVol.

Saturation Flow Module table with columns for Sat/Lane, Adjustment, Lanes, Final Sat.

Capacity Analysis Module table with columns for Vol/Sat, OvlAdjV/S, Crit Moves.

Continental Grand Campus Specific Plan
City of El Segundo
Phase 2 Opening Year (2023) With Project PM Peak Hour (ICU)

Level Of Service Computation Report

ICU 1(Loss as Cycle Length %) Method (Future Volume Alternative)

Intersection #8 Continental Boulevard at Mariposa Ave

Cycle (sec): 100 Critical Vol./Cap.(X): 0.407
Loss Time (sec): 5 Average Delay (sec/veh): xxxxxx
Optimal Cycle: 20 Level Of Service: A

Table with columns for Street Name, Approach, Movement, Control, Rights, Min. Green, Y+R, Lanes. Rows include Continental Boulevard and Mariposa Avenue with various movement and control details.

Volume Module:

Table with columns for Base Vol, Growth Adj, Initial Bse, Added Vol, Related Pro, Initial Fut, User Adj, PHF Adj, PHF Volume, Reduct Vol, Reduced Vol, PCE Adj, MLF Adj, Final Volume.

Saturation Flow Module:

Table with columns for Sat/Lane, Adjustment, Lanes, Final Sat.

Capacity Analysis Module:

Table with columns for Vol/Sat, Crit Moves.

Continental Grand Campus Specific Plan
City of El Segundo
Phase 2 Opening Year (2023) With Project PM Peak Hour (ICU)

Level Of Service Computation Report

ICU 1(Loss as Cycle Length %) Method (Future Volume Alternative)

Intersection #9 Continental Boulevard at Grand Avenue

Cycle (sec): 100 Critical Vol./Cap.(X): 0.391
Loss Time (sec): 5 Average Delay (sec/veh): xxxxxx
Optimal Cycle: 20 Level Of Service: A

Table with columns for Street Name, Approach, Movement, Control, Rights, Min. Green, Y+R, Lanes. Rows include Continental Boulevard and Grand Avenue with various movement and control details.

Volume Module:

Table with columns for Base Vol, Growth Adj, Initial Bse, Added Vol, Related Pro, Initial Fut, User Adj, PHF Adj, PHF Volume, Reduct Vol, Reduced Vol, PCE Adj, MLF Adj, Final Volume.

Saturation Flow Module:

Table with columns for Sat/Lane, Adjustment, Lanes, Final Sat.

Capacity Analysis Module:

Table with columns for Vol/Sat, Crit Moves.

Continental Grand Campus Specific Plan
City of El Segundo
Phase 2 Opening Year (2023) With Project PM Peak Hour (ICU)

Level Of Service Computation Report

ICU 1(Loss as Cycle Length %) Method (Future Volume Alternative)

Intersection #10 Continental Boulevard at El Segundo Boulevard

Cycle (sec): 100 Critical Vol./Cap.(X): 0.690
Loss Time (sec): 5 Average Delay (sec/veh): xxxxxx
Optimal Cycle: 36 Level Of Service: B

Table with columns for Street Name, Approach, Movement, Control, Rights, Min. Green, Y+R, Lanes. Rows for Continental Boulevard and El Segundo Boulevard.

Volume Module table with columns for Base Vol, Growth Adj, Initial Bse, Added Vol, Related Pro, Initial Fut, User Adj, PHF Adj, PHF Volume, Reduct Vol, Reduced Vol, PCE Adj, MLF Adj, Final Volume.

Saturation Flow Module table with columns for Sat/Lane, Adjustment, Lanes, Final Sat.

Capacity Analysis Module table with columns for Vol/Sat, Crit Moves.

Continental Grand Campus Specific Plan
City of El Segundo
Phase 2 Opening Year (2023) With Project PM Peak Hour (ICU)

Level Of Service Computation Report

ICU 1(Loss as Cycle Length %) Method (Future Volume Alternative)

Intersection #11 Nash St and Imperial Hwy

Cycle (sec): 100 Critical Vol./Cap.(X): 0.535
Loss Time (sec): 5 Average Delay (sec/veh): xxxxxx
Optimal Cycle: 25 Level Of Service: A

Table with columns for Street Name, Approach, Movement, Control, Rights, Min. Green, Y+R, Lanes. Rows for Nash St and Imperial Hwy.

Volume Module table with columns for Base Vol, Growth Adj, Initial Bse, Added Vol, Related Pro, Initial Fut, User Adj, PHF Adj, PHF Volume, Reduct Vol, Reduced Vol, PCE Adj, MLF Adj, Final Volume.

Saturation Flow Module table with columns for Sat/Lane, Adjustment, Lanes, Final Sat.

Capacity Analysis Module table with columns for Vol/Sat, Crit Moves.

Continental Grand Campus Specific Plan
City of El Segundo
Phase 2 Opening Year (2023) With Project PM Peak Hour (ICU)

Level Of Service Computation Report
ICU 1(Loss as Cycle Length %) Method (Future Volume Alternative)

Intersection #12 Nash St at Mariposa Ave

Cycle (sec): 100 Critical Vol./Cap.(X): 0.784
Loss Time (sec): 5 Average Delay (sec/veh): xxxxxx
Optimal Cycle: 49 Level Of Service: C

Table with columns for Street Name (Nash St, Mariposa Ave), Approach (North Bound, South Bound, East Bound, West Bound), Movement (L, T, R), Control (Permitted, Include), Rights, Min. Green, Y+R, Lanes.

Table with columns for Volume Module: Base Vol, Growth Adj, Initial Bse, Added Vol, Related Pro, Initial Fut, User Adj, PHF Adj, PHF Volume, Reduct Vol, Reduced Vol, PCE Adj, MLF Adj, Final Volume.

Table with columns for Saturation Flow Module: Sat/Lane, Adjustment, Lanes, Final Sat.

Table with columns for Capacity Analysis Module: Vol/Sat, Crit Moves.

Continental Grand Campus Specific Plan
City of El Segundo
Phase 2 Opening Year (2023) With Project PM Peak Hour (ICU)

Level Of Service Computation Report
ICU 1(Loss as Cycle Length %) Method (Future Volume Alternative)

Intersection #13 Nash St at Grand Ave

Cycle (sec): 100 Critical Vol./Cap.(X): 0.612
Loss Time (sec): 5 Average Delay (sec/veh): xxxxxx
Optimal Cycle: 30 Level Of Service: B

Table with columns for Street Name (Nash St, Grand Ave), Approach (North Bound, South Bound, East Bound, West Bound), Movement (L, T, R), Control (Protected, Split Phase, Include), Rights, Min. Green, Y+R, Lanes.

Table with columns for Volume Module: Base Vol, Growth Adj, Initial Bse, Added Vol, Related Pro, Initial Fut, User Adj, PHF Adj, PHF Volume, Reduct Vol, Reduced Vol, PCE Adj, MLF Adj, Final Volume.

Table with columns for Saturation Flow Module: Sat/Lane, Adjustment, Lanes, Final Sat.

Table with columns for Capacity Analysis Module: Vol/Sat, Crit Moves.

Continental Grand Campus Specific Plan
City of El Segundo
Phase 2 Opening Year (2023) With Project PM Peak Hour (ICU)

Level of Service Computation Report

ICU 1(Loss as Cycle Length %) Method (Future Volume Alternative)

Intersection #14 Nash St at El Segundo Blvd

Cycle (sec): 100 Critical Vol./Cap.(X): 1.076
Loss Time (sec): 5 Average Delay (sec/veh): xxxxxx
Optimal Cycle: 180 Level Of Service: F

Table with columns for Street Name (Nash St, El Segundo Blvd), Approach (North Bound, South Bound, East Bound, West Bound), Movement (L, T, R), Control (Split Phase, Protected), Rights (Ovl, Include), and Volume (Min. Green, Y+R, Lanes).

Volume Module table with columns for Base Vol, Growth Adj, Initial Bse, Added Vol, Related Pro, Initial Fut, User Adj, PHF Adj, PHF Volume, Reduct Vol, Reduced Vol, PCE Adj, MLF Adj, Final Volume, and OvlAdjVol.

Saturation Flow Module table with columns for Sat/Lane, Adjustment, Lanes, and Final Sat.

Capacity Analysis Module table with columns for Vol/Sat, OvlAdjV/S, and Crit Moves.

Continental Grand Campus Specific Plan
City of El Segundo
Phase 2 Opening Year (2023) With Project PM Peak Hour (ICU)

Level of Service Computation Report

ICU 1(Loss as Cycle Length %) Method (Future Volume Alternative)

Intersection #15 Douglas Street at El Segundo Boulevard

Cycle (sec): 100 Critical Vol./Cap.(X): 1.218
Loss Time (sec): 5 Average Delay (sec/veh): xxxxxx
Optimal Cycle: 180 Level Of Service: F

Table with columns for Street Name (Douglas St, El Segundo Blvd), Approach (North Bound, South Bound, East Bound, West Bound), Movement (L, T, R), Control (Protected), Rights (Include), and Volume (Min. Green, Y+R, Lanes).

Volume Module table with columns for Base Vol, Growth Adj, Initial Bse, Added Vol, Related Pro, Initial Fut, User Adj, PHF Adj, PHF Volume, Reduct Vol, Reduced Vol, PCE Adj, MLF Adj, Final Volume, and OvlAdjVol.

Saturation Flow Module table with columns for Sat/Lane, Adjustment, Lanes, and Final Sat.

Capacity Analysis Module table with columns for Vol/Sat, Crit Moves, and other metrics.

Continental Grand Campus Specific Plan
City of El Segundo
Phase 2 Opening Year (2023) With Project PM Peak Hour (ICU)

Level Of Service Computation Report

ICU 1(Loss as Cycle Length %) Method (Future Volume Alternative)

Intersection #16 Aviation Boulevard at El Segundo Boulevard

Cycle (sec): 100 Critical Vol./Cap.(X): 1.189
Loss Time (sec): 5 Average Delay (sec/veh): xxxxxx
Optimal Cycle: 180 Level Of Service: F

Table with columns for Street Name, Approach, Movement, Control, Rights, Min. Green, Y+R, Lanes. Rows for North Bound, South Bound, East Bound, West Bound.

Volume Module table with columns for Base Vol, Growth Adj, Initial Bse, Added Vol, Related Pro, Initial Fut, User Adj, PHF Adj, PHF Volume, Reduct Vol, Reduced Vol, PCE Adj, MLF Adj, Final Volume, OvlAdjVol.

Saturation Flow Module table with columns for Sat/Lane, Adjustment, Lanes, Final Sat.

Capacity Analysis Module table with columns for Vol/Sat, OvlAdjV/S, Crit Moves.

Continental Grand Campus Specific Plan
City of El Segundo
Phase 2 Opening Year (2023) With Project PM Peak Hour (ICU)

Level Of Service Computation Report

ICU 1(Loss as Cycle Length %) Method (Future Volume Alternative)

Intersection #17 El Segundo Boulevard and Isis Avenue

Cycle (sec): 100 Critical Vol./Cap.(X): 0.814
Loss Time (sec): 5 Average Delay (sec/veh): xxxxxx
Optimal Cycle: 55 Level Of Service: D

Table with columns for Street Name, Approach, Movement, Control, Rights, Min. Green, Y+R, Lanes. Rows for North Bound, South Bound, East Bound, West Bound.

Volume Module table with columns for Base Vol, Growth Adj, Initial Bse, Added Vol, Related Pro, Initial Fut, User Adj, PHF Adj, PHF Volume, Reduct Vol, Reduced Vol, PCE Adj, MLF Adj, Final Volume.

Saturation Flow Module table with columns for Sat/Lane, Adjustment, Lanes, Final Sat.

Capacity Analysis Module table with columns for Vol/Sat, Crit Moves.

Continental Grand Campus Specific Plan
City of El Segundo
Phase 2 Opening Year (2023) With Project PM Peak Hour (ICU)

Level Of Service Computation Report

ICU 1(Loss as Cycle Length %) Method (Future Volume Alternative)

Intersection #18 El Segundo Blvd at I-405 SB Ramps

Cycle (sec): 100 Critical Vol./Cap.(X): 1.264
Loss Time (sec): 5 Average Delay (sec/veh): xxxxxx
Optimal Cycle: 180 Level Of Service: F

Table with columns for Street Name, Approach, Movement, Control, Rights, Min. Green, Y+R, Lanes for I-405 SB Ramps and El Segundo Blvd.

Table with columns for Volume Module: Base Vol, Growth Adj, Initial Bse, Added Vol, Related Pro, Initial Fut, User Adj, PHF Adj, PHF Volume, Reduct Vol, Reduced Vol, PCE Adj, MLF Adj, Final Volume.

Table with columns for Saturation Flow Module: Sat/Lane, Adjustment, Lanes, Final Sat.

Table with columns for Capacity Analysis Module: Vol/Sat, Crit Moves.

Continental Grand Campus Specific Plan
City of El Segundo
Phase 2 Opening Year (2023) With Project PM Peak Hour (ICU)

Level Of Service Computation Report

ICU 1(Loss as Cycle Length %) Method (Future Volume Alternative)

Intersection #19 El Segundo Blvd at La Cienega Blvd

Cycle (sec): 100 Critical Vol./Cap.(X): 0.767
Loss Time (sec): 5 Average Delay (sec/veh): xxxxxx
Optimal Cycle: 46 Level Of Service: C

Table with columns for Street Name, Approach, Movement, Control, Rights, Min. Green, Y+R, Lanes for La Cienega Blvd and El Segundo Blvd.

Table with columns for Volume Module: Base Vol, Growth Adj, Initial Bse, Added Vol, Related Pro, Initial Fut, User Adj, PHF Adj, PHF Volume, Reduct Vol, Reduced Vol, PCE Adj, MLF Adj, Final Volume.

Table with columns for Saturation Flow Module: Sat/Lane, Adjustment, Lanes, Final Sat.

Table with columns for Capacity Analysis Module: Vol/Sat, Crit Moves.

Continental Grand Campus Specific Plan
City of El Segundo
Phase 2 Opening Year (2023) With Project PM Peak Hour (ICU)

Level Of Service Computation Report

ICU 1(Loss as Cycle Length %) Method (Future Volume Alternative)

Intersection #20 El Segundo Blvd at I-405 NB Ramps

Cycle (sec): 100 Critical Vol./Cap.(X): 0.749
Loss Time (sec): 5 Average Delay (sec/veh): xxxxxx
Optimal Cycle: 43 Level Of Service: C

Table with columns for Street Name, Approach, Movement, Control, Rights, Min. Green, Y+R, Lanes. Rows include I-405 NB Ramps and El Segundo Blvd with various movement and control details.

Volume Module table showing Base Vol, Growth Adj, Initial Bse, Added Vol, Related Pro, Initial Fut, User Adj, PHF Adj, PHF Volume, Reduct Vol, Reduced Vol, PCE Adj, MLF Adj, Final Volume for various approaches.

Saturation Flow Module table showing Sat/Lane, Adjustment, Lanes, Final Sat. for various approaches.

Capacity Analysis Module table showing Vol/Sat, Crit Moves for various approaches.

Continental Grand Campus Specific Plan
Phase 2 Opening Year (2023) With Project PM Peak Hour (HCM)

Level Of Service Computation Report
2000 HCM Operations Method (Future Volume Alternative)

Intersection #6 Sepulveda Blvd at El Segundo Blvd

Cycle (sec): 100 Critical Vol./Cap.(X): 1.009
Loss Time (sec): 5 Average Delay (sec/veh): 55.3
Optimal Cycle: 180 Level Of Service: E

Table with columns for Street Name (Sepulveda Blvd, El Segundo Blvd), Approach (North Bound, South Bound, East Bound, West Bound), Movement (L, T, R), Control, Rights, Min. Green, Y+R, and Lanes.

Volume Module: Table with columns for Base Vol, Growth Adj, Initial Bse, Added Vol, Related Pro, Initial Fut, User Adj, PHF Adj, PHF Volume, Reduct Vol, Reduced Vol, PCE Adj, MLF Adj, and Final Volume.

Saturation Flow Module: Table with columns for Sat/Lane, Adjustment, Lanes, and Final Sat.

Capacity Analysis Module: Table with columns for Vol/Sat, Crit Moves, Green/Cycle, Volume/Cap, Delay/Veh, User DelAdj, AdjDel/Veh, LOS by Move, and HCM2kAvgQ.

Note: Queue reported is the number of cars per lane.

Continental Grand Campus Specific Plan
City of El Segundo
Phase 2 Opening Year (2023) With Project PM Peak Hour (ICU)

Level of Service Computation Report

ICU 1(Loss as Cycle Length %) Method (Future Volume Alternative)

Intersection #14 Nash St at El Segundo Blvd

Cycle (sec): 100 Critical Vol./Cap.(X): 0.917
Loss Time (sec): 5 Average Delay (sec/veh): xxxxxx
Optimal Cycle: 97 Level Of Service: E

Table with columns for Street Name (Nash St, El Segundo Blvd), Approach (North Bound, South Bound, East Bound, West Bound), Movement (L, T, R), Control, Rights, Min. Green, Y+R, and Lanes.

Volume Module: Base Vol, Growth Adj, Initial Bse, Added Vol, Related Pro, Initial Fut, User Adj, PHF Adj, PHF Volume, Reduct Vol, Reduced Vol, PCE Adj, MLF Adj, Final Volume, OvlAdjVol.

Saturation Flow Module: Sat/Lane, Adjustment, Lanes, Final Sat.

Capacity Analysis Module: Vol/Sat, OvlAdjV/S, Crit Moves.

 Continental Grand Campus Specific Plan
 City of El Segundo
 Phase 2 Opening Year (2023) With Project PM Peak Hour (ICU)

Level Of Service Computation Report
 ICU 1(Loss as Cycle Length %) Method (Future Volume Alternative)

 Intersection #18 El Segundo Blvd at I-405 SB Ramps

 Cycle (sec): 100 Critical Vol./Cap.(X): 1.137
 Loss Time (sec): 5 Average Delay (sec/veh): xxxxxx
 Optimal Cycle: 180 Level Of Service: F

 Street Name: I-405 SB Ramps El Segundo Blvd
 Approach: North Bound South Bound East Bound West Bound
 Movement: L - T - R L - T - R L - T - R L - T - R
 -----|-----|-----|-----|
 Control: Split Phase Split Phase Permitted Permitted
 Rights: Include Include Ovl Include
 Min. Green: 0 0 0 0 0 0 0 0 0 0 0 0 0
 Y+R: 4.0 4.0 4.0 4.0 4.0 4.0 4.0 4.0 4.0 4.0 4.0 4.0
 Lanes: 1 0 1! 0 0 0 0 0 0 0 3 0 1 0 1 2 0 0
 -----|-----|-----|-----|
 Volume Module:
 Base Vol: 239 0 269 0 0 0 0 1491 1049 0 1062 0
 Growth Adj: 1.02 1.02 1.02 1.02 1.02 1.02 1.02 1.02 1.02 1.02 1.02 1.02
 Initial Bse: 243 0 273 0 0 0 0 1515 1066 0 1079 0
 Added Vol: 0 0 0 0 0 0 0 0 0 121 70 18 0
 Related Pro: 2 0 0 0 0 0 0 0 442 483 0 290 0
 Initial Fut: 245 0 273 0 0 0 0 1957 1670 70 1387 0
 User Adj: 1.00 1.00 1.00 1.00 1.00 1.00 1.00 1.00 1.00 1.00 1.00 1.00
 PHF Adj: 1.00 1.00 1.00 1.00 1.00 1.00 1.00 1.00 1.00 1.00 1.00 1.00
 PHF Volume: 245 0 273 0 0 0 0 1957 1670 70 1387 0
 Reduct Vol: 0 0 0 0 0 0 0 0 0 0 0 0 0
 Reduced Vol: 245 0 273 0 0 0 0 1957 1670 70 1387 0
 PCE Adj: 1.00 1.00 1.00 1.00 1.00 1.00 1.00 1.00 1.00 1.00 1.00 1.00
 MLF Adj: 1.00 1.00 1.00 1.00 1.00 1.00 1.00 1.00 1.00 1.00 1.00 1.00
 FinalVolume: 245 0 273 0 0 0 0 1957 1670 70 1387 0
 OvlAdjVol: 1396
 -----|-----|-----|-----|
 Saturation Flow Module:
 Sat/Lane: 1600 1600 1600 1600 1600 1600 1600 1600 1600 1600 1600 1600
 Adjustment: 1.00 1.00 1.00 1.00 1.00 1.00 1.00 1.00 1.00 1.00 1.00 1.00
 Lanes: 1.00 0.00 1.00 0.00 0.00 0.00 0.00 3.00 1.00 0.14 2.86 0.00
 Final Sat.: 1600 0 1600 0 0 0 0 4800 1600 231 4569 0
 -----|-----|-----|-----|
 Capacity Analysis Module:
 Vol/Sat: 0.15 0.00 0.17 0.00 0.00 0.00 0.00 0.41 1.04 0.04 0.30 0.00
 OvlAdjV/S: 0.87
 Crit Moves: **** *

Continental Grand Campus Specific Plan
City of El Segundo
Phase 2 Opening Year (2023) With Project AM Peak Hour (ICU)

Level Of Service Computation Report

ICU 1(Loss as Cycle Length %) Method (Future Volume Alternative)

Intersection #20 El Segundo Blvd at I-405 NB Ramps

Cycle (sec): 100 Critical Vol./Cap.(X): 0.776
Loss Time (sec): 5 Average Delay (sec/veh): xxxxxx
Optimal Cycle: 47 Level Of Service: C

Table with columns for Street Name (I-405 NB Ramps, El Segundo Blvd), Approach (North Bound, South Bound, East Bound, West Bound), Movement (L, T, R), Control, Rights, Min. Green, Y+R, and Lanes.

Volume Module:

Table with columns for Base Vol, Growth Adj, Initial Bse, Added Vol, Related Pro, Initial Fut, User Adj, PHF Adj, PHF Volume, Reduct Vol, Reduced Vol, PCE Adj, MLF Adj, and Final Volume.

Saturation Flow Module:

Table with columns for Sat/Lane, Adjustment, Lanes, and Final Sat.

Capacity Analysis Module:

Table with columns for Vol/Sat and Crit Moves.

 Continental Grand Campus Specific Plan
 City of El Segundo
 Phase 2 Opening Year (2023) With Project PM Peak Hour (ICU)

Level Of Service Computation Report
 ICU 1(Loss as Cycle Length %) Method (Future Volume Alternative)

 Intersection #1 Sepulveda Blvd at Imperial Hwy

 Cycle (sec): 100 Critical Vol./Cap.(X): 0.899
 Loss Time (sec): 5 Average Delay (sec/veh): xxxxxx
 Optimal Cycle: 86 Level Of Service: D

 Street Name: Sepulveda Blvd Imperial Hwy
 Approach: North Bound South Bound East Bound West Bound
 Movement: L - T - R L - T - R L - T - R L - T - R

 Control: Protected Protected Protected Protected
 Rights: Include Include Include Ovl
 Min. Green: 0 0 0 0 0 0 0 0 0 0 0 0
 Y+R: 4.0 4.0 4.0 4.0 4.0 4.0 4.0 4.0 4.0 4.0 4.0 4.0
 Lanes: 1 0 3 0 2 2 0 3 1 0 2 0 3 0 1 2 0 3 0 1

 Volume Module:
 Base Vol: 154 1713 885 640 1993 7 202 402 140 120 295 461
 Growth Adj: 1.02 1.02 1.02 1.02 1.02 1.02 1.02 1.02 1.02 1.02 1.02 1.02
 Initial Bse: 157 1745 901 652 2030 7 206 409 143 122 300 470
 Added Vol: 66 133 148 14 83 5 3 23 22 9 9 17
 Related Pro: 30 569 63 -165 159 0 -15 15 11 40 -20 -40
 Initial Fut: 253 2447 1112 501 2272 12 194 447 176 171 289 447
 User Adj: 1.00 1.00 1.00 1.00 1.00 1.00 1.00 1.00 1.00 1.00 1.00 1.00
 PHF Adj: 1.00 1.00 1.00 1.00 1.00 1.00 1.00 1.00 1.00 1.00 1.00 1.00
 PHF Volume: 253 2447 1112 501 2272 12 194 447 176 171 289 447
 Reduct Vol: 0 0 0 0 0 0 0 0 0 0 0 0
 Reduced Vol: 253 2447 1112 501 2272 12 194 447 176 171 289 447
 PCE Adj: 1.00 1.00 1.00 1.00 1.00 1.00 1.00 1.00 1.00 1.00 1.00 1.00
 MLF Adj: 1.00 1.00 1.00 1.00 1.00 1.00 1.00 1.00 1.00 1.00 1.00 1.00
 FinalVolume: 253 2447 1112 501 2272 12 194 447 176 171 289 447
 OvlAdjVol: 196

 Saturation Flow Module:
 Sat/Lane: 1600 1600 1600 1600 1600 1600 1600 1600 1600 1600 1600 1600
 Adjustment: 1.00 1.00 1.00 1.00 1.00 1.00 1.00 1.00 1.00 1.00 1.00 1.00
 Lanes: 1.00 3.00 2.00 2.00 3.98 0.02 2.00 3.00 1.00 2.00 3.00 1.00
 Final Sat.: 1600 4800 3200 3200 6366 34 3200 4800 1600 3200 4800 1600

 Capacity Analysis Module:
 Vol/Sat: 0.16 0.51 0.35 0.16 0.36 0.36 0.06 0.09 0.11 0.05 0.06 0.28
 OvlAdjV/S: 0.12
 Crit Moves: **** **** **** ****

Continental Grand Campus Specific Plan
City of El Segundo
Phase 2 Opening Year (2023) With Project PM Peak Hour (ICU)

Level of Service Computation Report

ICU 1(Loss as Cycle Length %) Method (Future Volume Alternative)

Intersection #5 Sepulveda Blvd at Grand Ave

Cycle (sec): 100 Critical Vol./Cap.(X): 0.826
Loss Time (sec): 5 Average Delay (sec/veh): xxxxxx
Optimal Cycle: 58 Level Of Service: D

Table with columns for Street Name (Sepulveda Blvd, Grand Ave), Approach (North Bound, South Bound, East Bound, West Bound), Movement (L, T, R), Control, Rights, Min. Green, Y+R, and Lanes.

Volume Module:

Table with columns for Base Vol, Growth Adj, Initial Bse, Added Vol, Related Pro, Initial Fut, User Adj, PHF Adj, PHF Volume, Reduct Vol, Reduced Vol, PCE Adj, MLF Adj, Final Volume, and OvlAdjVol.

Saturation Flow Module:

Table with columns for Sat/Lane, Adjustment, Lanes, and Final Sat.

Capacity Analysis Module:

Table with columns for Vol/Sat, OvlAdjV/S, and Crit Moves.

APPENDIX C

INTERSECTION ANALYSIS WORKSHEETS – HCM METHODOLOGY

 Continental Grand Campus Specific Plan
 Phase 2 Opening Year (2023) With Project PM Peak Hour (HCM)

Scenario Report

Scenario: Phase 2 Op Yr With Proj PM HCM
 Command: Phase 2 Op Yr With Proj PM HCM
 Volume: OY PM
 Geometry: Existing
 Impact Fee: Default Impact Fee
 Trip Generation: Cum + Phase 2 PM
 Trip Distribution: Cum + Proj
 Paths: Project
 Routes: Default Route
 Configuration: Phase 2 Op Yr With Proj PM HCM

 Continental Grand Campus Specific Plan
 Phase 2 Opening Year (2023) With Project PM Peak Hour (HCM)

Trip Generation Report

Forecast for Cum + Phase 2 PM

Zone #	Subzone	Amount	Units	Rate In	Rate Out	Trips In	Trips Out	Total Trips	% Of Total
306	525 N. Sepul	1.00	Residential	-4.00	-6.00	-4	-6	-10	-0.4
	Zone 306 Subtotal					-4	-6	-10	-0.4
307	540 Imperial	1.00	Residential	50.00	32.00	50	32	82	3.3
	Zone 307 Subtotal					50	32	82	3.3
311	199 Continen	1.00	Business Hotel	46.00	45.00	46	45	91	3.6
	Zone 311 Subtotal					46	45	91	3.6
313	445 N. Dougl	1.00	Equinix Data C	3.00	13.00	3	13	16	0.6
	Zone 313 Subtotal					3	13	16	0.6
314	123 Lomita a	1.00	Office	2.00	16.00	2	16	18	0.7
	Zone 314 Subtotal					2	16	18	0.7
704	2355 Utah Av	1.00	Office	95.00	109.00	95	109	204	8.2
	Zone 704 Subtotal					95	109	204	8.2
706	888 Sepulved	1.00	hotel	60.00	41.00	60	41	101	4.0
	Zone 706 Subtotal					60	41	101	4.0
710	201 North Do	1.00	High School	-15.00	-74.00	-15	-74	-89	-3.6
710	201 North Do	1.00	District Offic	3.00	18.00	3	18	21	0.8
	Zone 710 Subtotal					-12	-56	-68	-2.7
714	400 Duley -	1.00	Office	18.00	87.00	18	87	105	4.2
	Zone 714 Subtotal					18	87	105	4.2
717	1700 Imperia	1.00	Townhome Resid	25.00	120.00	25	120	145	5.8
	Zone 717 Subtotal					25	120	145	5.8
718	123 Nevada S	1.00	Office	4.00	16.00	4	16	20	0.8
	Zone 718 Subtotal					4	16	20	0.8
719	2125 Campus	1.00	Office Retail	64.00	146.00	64	146	210	8.4
	Zone 719 Subtotal					64	146	210	8.4
1002	Laker Facili	1.00	General Office	103.00	85.00	103	85	188	7.5
	Zone 1002 Subtotal					103	85	188	7.5
1004	1955 E Grand	1.00	Mattel	44.00	216.00	44	216	260	10.4
	Zone 1004 Subtotal					44	216	260	10.4
1005	Mattel	1.00	Mattel	48.00	388.00	48	388	436	17.5

Continental Grand Campus Specific Plan
Phase 2 Opening Year (2023) With Project PM Peak Hour (HCM)

Zone #	Subzone	Amount	Units	Rate In	Rate Out	Trips In	Trips Out	Total Trips	% Of Total
	Zone 1005 Subtotal					48	388	436	17.5
1007	Mattel Proje	1.00	project	92.00	604.00	92	604	696	27.9
	Zone 1007 Subtotal					92	604	696	27.9
TOTAL						638	1856	2494	100.0

Continental Grand Campus Specific Plan
Phase 2 Opening Year (2023) With Project PM Peak Hour (HCM)

Trip Distribution Report

Percent Of Trips Cum + Project

Zone	To Gates											
	1	2	3	4	5	7	8	9	10	11	12	
306	10.0	15.0	10.0	5.0	0.0	5.0	5.0	25.0	0.0	25.0	0.0	
307	10.0	15.0	10.0	5.0	50.0	0.0	0.0	0.0	0.0	0.0	0.0	
311	40.0	10.0	10.0	10.0	0.0	5.0	5.0	10.0	0.0	10.0	0.0	
313	15.0	5.0	15.0	10.0	25.0	0.0	5.0	20.0	0.0	0.0	0.0	
314	40.0	10.0	10.0	10.0	0.0	5.0	5.0	10.0	0.0	10.0	0.0	
704	30.0	15.0	8.0	12.0	0.0	5.0	5.0	10.0	5.0	10.0	0.0	
706	25.0	20.0	10.0	25.0	0.0	0.0	0.0	0.0	0.0	0.0	10.0	
710	0.0	0.0	15.0	10.0	10.0	2.0	2.0	20.0	5.0	10.0	1.0	
714	5.0	10.0	5.0	5.0	20.0	5.0	10.0	15.0	5.0	15.0	0.0	
717	10.0	15.0	10.0	5.0	50.0	0.0	0.0	0.0	0.0	0.0	0.0	
718	10.0	10.0	10.0	10.0	20.0	0.0	0.0	20.0	10.0	0.0	0.0	
719	20.0	10.0	10.0	10.0	10.0	5.0	5.0	10.0	5.0	0.0	0.0	
1002	0.0	10.0	5.0	5.0	15.0	5.0	10.0	15.0	5.0	15.0	5.0	
1004	5.0	15.0	10.0	5.0	30.0	0.0	5.0	20.0	0.0	0.0	5.0	
1005	5.0	15.0	10.0	5.0	30.0	0.0	5.0	20.0	0.0	0.0	5.0	
1007	0.0	0.0	0.0	0.0	0.0	0.0	0.0	0.0	0.0	0.0	0.0	

Zone	To Gates						
	13	14	15	16	17	18	20
306	0.0	0.0	0.0	0.0	0.0	0.0	0.0
307	0.0	10.0	0.0	0.0	0.0	0.0	0.0
311	0.0	0.0	0.0	0.0	0.0	0.0	0.0
313	5.0	0.0	0.0	0.0	0.0	0.0	0.0
314	0.0	0.0	0.0	0.0	0.0	0.0	0.0
704	0.0	0.0	0.0	0.0	0.0	0.0	0.0
706	0.0	0.0	0.0	0.0	10.0	0.0	0.0
710	10.0	5.0	10.0	0.0	0.0	0.0	0.0
714	0.0	5.0	0.0	0.0	0.0	0.0	0.0
717	0.0	10.0	0.0	0.0	0.0	0.0	0.0
718	0.0	10.0	0.0	0.0	0.0	0.0	0.0
719	0.0	10.0	5.0	0.0	0.0	0.0	0.0
1002	0.0	5.0	5.0	0.0	0.0	0.0	0.0
1004	0.0	5.0	0.0	0.0	0.0	0.0	0.0
1005	0.0	5.0	0.0	0.0	0.0	0.0	0.0
1007	0.0	0.0	0.0	0.0	0.0	20.0	10.0

Continental Grand Campus Specific Plan
Phase 2 Opening Year (2023) With Project PM Peak Hour (HCM)

Impact Analysis Report
Level Of Service

Intersection	Base	Future	Change	Del/ V/		Del/ V/	
				LOS	Veh C	LOS	Veh C
# 1 Sepulveda Blvd at Imperial Hwy	D 38.9 1.038	D 51.9 1.168	+12.949 D/V				
# 2 Sepulveda Blvd at Walnut St	A 9.9 0.551	B 15.6 0.794	+ 5.740 D/V				
# 3 Sepulveda Blvd at Maple Ave	B 12.6 0.604	B 17.2 0.764	+ 4.593 D/V				
# 4 Sepulveda Blvd at Mariposa Ave	C 20.1 0.630	C 24.2 0.832	+ 4.100 D/V				
# 5 Sepulveda Blvd at Grand Ave	C 30.3 0.801	D 47.8 0.993	+17.524 D/V				
# 6 Sepulveda Blvd at El Segundo B	D 36.9 0.915	F 88.1 1.129	+51.201 D/V				
# 7 Sepulveda Blvd at Rosecrans Bl	C 32.5 0.881	D 45.3 1.020	+12.794 D/V				
# 8 Continental Boulevard at Marip	B 16.3 0.283	B 17.0 0.322	+ 0.699 D/V				
# 9 Continental Boulevard at Grand	B 18.4 0.276	B 18.8 0.324	+ 0.485 D/V				
# 10 Continental Boulevard at El Se	B 19.6 0.400	C 29.8 0.690	+10.169 D/V				
# 11 Nash St and Imperial Hwy	B 19.5 0.475	C 22.9 0.535	+ 3.387 D/V				
# 12 Nash St at Mariposa Ave	B 17.3 0.534	C 24.1 0.882	+ 6.773 D/V				
# 13 Nash St at Grand Ave	C 22.7 0.501	C 25.4 0.573	+ 2.732 D/V				
# 14 Nash St at El Segundo Blvd	B 19.8 0.536	E 63.7 1.099	+43.920 D/V				
# 15 Douglas Street at El Segundo B	C 33.9 0.888	F 105.9 1.233	+71.973 D/V				
# 16 Aviation Boulevard at El Segun	D 41.2 0.956	F 99.9 1.210	+58.671 D/V				
# 17 El Segundo Boulevard and Isis	B xxxxxx 0.693	D xxxxxx 0.880	+ 0.188 V/C				
# 18 El Segundo Blvd at I-405 SB Ra	C 28.6 1.065	F 89.5 1.493	+60.882 D/V				
# 19 El Segundo Blvd at La Cienega	C 20.6 0.681	C 21.7 0.810	+ 1.144 D/V				
# 20 El Segundo Blvd at I-405 NB Ra	B 11.8 0.690	B 12.9 0.738	+ 1.075 D/V				

Continental Grand Campus Specific Plan
Phase 2 Opening Year (2023) With Project PM Peak Hour (HCM)

Level Of Service Computation Report
2000 HCM Operations Method (Future Volume Alternative)

Intersection #1 Sepulveda Blvd at Imperial Hwy

Cycle (sec):	100	Critical Vol./Cap.(X):	1.168
Loss Time (sec):	5	Average Delay (sec/veh):	51.9
Optimal Cycle:	180	Level Of Service:	D

Street Name:	Sepulveda Blvd		Imperial Hwy	
Approach:	North Bound	South Bound	East Bound	West Bound
Movement:	L - T - R	L - T - R	L - T - R	L - T - R
Control:	Protected	Protected	Protected	Protected
Rights:	Include	Include	Include	Ovl
Min. Green:	0 0 0	0 0 0	0 0 0	0 0 0
Y+R:	4.0 4.0 4.0	4.0 4.0 4.0	4.0 4.0 4.0	4.0 4.0 4.0
Lanes:	1 0 3 0 1	2 0 3 1 0	2 0 3 0 1	2 0 3 0 1

Volume Module:												
Base Vol:	154	1713	885	640	1993	7	202	402	140	120	295	461
Growth Adj:	1.02	1.02	1.02	1.02	1.02	1.02	1.02	1.02	1.02	1.02	1.02	1.02
Initial Bse:	157	1745	901	652	2030	7	206	409	143	122	300	470
Added Vol:	66	133	148	14	83	5	3	23	22	9	9	17
Related Pro:	30	569	63	-165	159	0	-15	15	11	40	-20	-40
Initial Fut:	253	2447	1112	501	2272	12	194	447	176	171	289	447
User Adj:	1.00	1.00	1.00	1.00	1.00	1.00	1.00	1.00	1.00	1.00	1.00	1.00
PHF Adj:	0.92	0.92	0.92	0.92	0.92	0.92	0.92	0.92	0.92	0.92	0.92	0.92
PHF Volume:	275	2659	1209	544	2469	13	211	486	191	186	315	485
Reduct Vol:	0	0	0	0	0	0	0	0	0	0	0	0
Reduced Vol:	275	2659	1209	544	2469	13	211	486	191	186	315	485
PCE Adj:	1.00	1.00	1.00	1.00	1.00	1.00	1.00	1.00	1.00	1.00	1.00	1.00
MLF Adj:	1.00	1.00	1.00	1.00	1.00	1.00	1.00	1.00	1.00	1.00	1.00	1.00
FinalVolume:	275	2659	1209	544	2469	13	211	486	191	186	315	485

Saturation Flow Module:												
Sat/Lane:	1900	1900	1900	1900	1900	1900	1900	1900	1900	1900	1900	1900
Adjustment:	0.95	0.91	0.85	0.92	0.91	0.91	0.92	0.91	0.85	0.92	0.91	0.85
Lanes:	1.00	3.00	1.00	2.00	3.98	0.02	2.00	3.00	1.00	2.00	3.00	1.00
Final Sat.:	1805	5187	1615	3502	6872	37	3502	5187	1615	3502	5187	1615

Capacity Analysis Module:												
Vol/Sat:	0.15	0.51	0.75	0.16	0.36	0.36	0.06	0.09	0.12	0.05	0.06	0.30
Crit Moves:		****	****				****					****
Green/Cycle:	0.23	0.64	0.64	0.13	0.54	0.54	0.05	0.12	0.12	0.05	0.12	0.26
Volume/Cap:	0.66	0.80	1.17	1.17	0.66	0.66	1.17	0.77	0.97	0.97	0.49	1.17
Delay/Veh:	38.8	14.7	104.0	139.8	16.7	16.7	166.8	48.5	100.6	104.8	41.4	135.7
User DelAdj:	1.00	1.00	1.00	1.00	1.00	1.00	1.00	1.00	1.00	1.00	1.00	1.00
AdjDel/Veh:	38.8	14.7	104.0	139.8	16.7	16.7	166.8	48.5	100.6	104.8	41.4	135.7
LOS by Move:	D	B	F	F	B	B	F	D	F	F	D	F
HCM2kAvgQ:	7	22	58	17	15	15	6	6	7	4	3	24

Note: Queue reported is the number of cars per lane.

Continental Grand Campus Specific Plan
Phase 2 Opening Year (2023) With Project PM Peak Hour (HCM)

Level of Service Computation Report
2000 HCM Operations Method (Future Volume Alternative)

Intersection #2 Sepulveda Blvd at Walnut St

Cycle (sec): 100 Critical Vol./Cap.(X): 0.794
Loss Time (sec): 5 Average Delay (sec/veh): 15.6
Optimal Cycle: 53 Level Of Service: B

Street Name: Sepulveda Blvd Walnut St

Approach: North Bound South Bound East Bound West Bound
Movement: L - T - R L - T - R L - T - R L - T - R

Control: Protected Protected Permitted Permitted
Rights: Include Include Include Include
Min. Green: 0 0 0 0 0 0 0 0 0 0 0 0
Y+R: 4.0 4.0 4.0 4.0 4.0 4.0 4.0 4.0 4.0 4.0 4.0 4.0
Lanes: 1 0 3 1 0 1 0 3 1 0 0 1 0 0 1

Volume Module:

Base Vol: 48 2434 29 10 2181 74 117 31 71 46 10 66
Growth Adj: 1.02 1.02 1.02 1.02 1.02 1.02 1.02 1.02 1.02 1.02 1.02 1.02
Initial Bse: 49 2479 30 10 2221 75 119 32 72 47 10 67
Added Vol: 12 253 12 6 89 19 90 0 0 8 0 4
Related Pro: 28 627 0 0 210 0 0 0 9 0 0 0
Initial Fut: 89 3359 42 16 2520 94 209 32 81 55 10 71
User Adj: 1.00 1.00 1.00 1.00 1.00 1.00 1.00 1.00 1.00 1.00 1.00 1.00
PHF Adj: 0.92 0.92 0.92 0.92 0.92 0.92 0.92 0.92 0.92 0.92 0.92 0.92
PHF Volume: 97 3651 45 18 2739 103 227 34 88 60 11 77
Reduct Vol: 0 0 0 0 0 0 0 0 0 0 0 0
Reduced Vol: 97 3651 45 18 2739 103 227 34 88 60 11 77
PCE Adj: 1.00 1.00 1.00 1.00 1.00 1.00 1.00 1.00 1.00 1.00 1.00 1.00
MLF Adj: 1.00 1.00 1.00 1.00 1.00 1.00 1.00 1.00 1.00 1.00 1.00 1.00
FinalVolume: 97 3651 45 18 2739 103 227 34 88 60 11 77

Saturation Flow Module:

Sat/Lane: 1900 1900 1900 1900 1900 1900 1900 1900 1900 1900 1900 1900
Adjustment: 0.95 0.91 0.91 0.95 0.91 0.91 0.66 0.66 0.85 0.54 0.54 0.85
Lanes: 1.00 3.95 0.05 1.00 3.86 0.14 0.87 0.13 1.00 0.84 0.16 1.00
Final Sat.: 1805 6818 84 1805 6633 248 1086 164 1615 865 161 1615

Capacity Analysis Module:

Vol/Sat: 0.05 0.54 0.54 0.01 0.41 0.41 0.21 0.21 0.05 0.07 0.07 0.05
Crit Moves: ****
Green/Cycle: 0.08 0.67 0.67 0.01 0.61 0.61 0.26 0.26 0.26 0.26 0.26 0.26
Volume/Cap: 0.68 0.79 0.79 0.79 0.68 0.68 0.79 0.79 0.21 0.26 0.26 0.18
Delay/Veh: 57.4 12.4 12.4 150.1 13.6 13.6 46.8 46.8 28.9 29.6 29.6 28.7
User DelAdj: 1.00 1.00 1.00 1.00 1.00 1.00 1.00 1.00 1.00 1.00 1.00 1.00
AdjDel/Veh: 57.4 12.4 12.4 150.1 13.6 13.6 46.8 46.8 28.9 29.6 29.6 28.7
LOS by Move: E B B F B B D D C C C C
HCM2kAvgQ: 4 23 23 1 16 16 10 10 2 2 2 2

Note: Queue reported is the number of cars per lane.

Continental Grand Campus Specific Plan
Phase 2 Opening Year (2023) With Project PM Peak Hour (HCM)

Level of Service Computation Report
2000 HCM Operations Method (Future Volume Alternative)

Intersection #3 Sepulveda Blvd at Maple Ave

Cycle (sec): 100 Critical Vol./Cap.(X): 0.764
Loss Time (sec): 5 Average Delay (sec/veh): 17.2
Optimal Cycle: 47 Level Of Service: B

Street Name: Sepulveda Blvd Maple Ave

Approach: North Bound South Bound East Bound West Bound
Movement: L - T - R L - T - R L - T - R L - T - R

Control: Protected Protected Permitted Permitted
Rights: Include Include Include Include
Min. Green: 0 0 0 0 0 0 0 0 0 0 0 0
Y+R: 4.0 4.0 4.0 4.0 4.0 4.0 4.0 4.0 4.0 4.0 4.0 4.0
Lanes: 1 0 3 1 0 1 0 3 1 0 1 0 0 1 0 1

Volume Module:

Base Vol: 98 2208 33 57 2439 42 68 57 37 114 102 114
Growth Adj: 1.02 1.02 1.02 1.02 1.02 1.02 1.02 1.02 1.02 1.02 1.02 1.02
Initial Bse: 100 2243 34 58 2478 43 69 58 38 116 104 116
Added Vol: 13 228 0 37 102 0 0 8 8 0 12 44
Related Pro: 56 687 30 25 226 0 0 8 13 5 0 0
Initial Fut: 169 3158 64 120 2806 43 69 74 59 121 116 160
User Adj: 1.00 1.00 1.00 1.00 1.00 1.00 1.00 1.00 1.00 1.00 1.00 1.00
PHF Adj: 0.92 0.92 0.92 0.92 0.92 0.92 0.92 0.92 0.92 0.92 0.92 0.92
PHF Volume: 183 3432 69 130 3049 46 75 80 64 131 126 174
Reduct Vol: 0 0 0 0 0 0 0 0 0 0 0 0
Reduced Vol: 183 3432 69 130 3049 46 75 80 64 131 126 174
PCE Adj: 1.00 1.00 1.00 1.00 1.00 1.00 1.00 1.00 1.00 1.00 1.00 1.00
MLF Adj: 1.00 1.00 1.00 1.00 1.00 1.00 1.00 1.00 1.00 1.00 1.00 1.00
FinalVolume: 183 3432 69 130 3049 46 75 80 64 131 126 174

Saturation Flow Module:

Sat/Lane: 1900 1900 1900 1900 1900 1900 1900 1900 1900 1900 1900 1900
Adjustment: 0.95 0.91 0.91 0.95 0.91 0.91 0.52 0.93 0.93 0.47 1.00 0.85
Lanes: 1.00 3.92 0.08 1.00 3.94 0.06 1.00 0.56 0.44 1.00 1.00 1.00
Final Sat.: 1805 6759 136 1805 6799 103 980 990 785 901 1900 1615

Capacity Analysis Module:

Vol/Sat: 0.10 0.51 0.51 0.07 0.45 0.45 0.08 0.08 0.08 0.15 0.07 0.11
Crit Moves: ****
Green/Cycle: 0.14 0.66 0.66 0.09 0.62 0.62 0.19 0.19 0.19 0.19 0.19 0.19
Volume/Cap: 0.72 0.76 0.76 0.76 0.72 0.72 0.40 0.43 0.43 0.76 0.35 0.56
Delay/Veh: 51.1 12.2 12.2 62.5 13.8 13.8 36.9 36.5 36.5 56.5 35.6 39.1
User DelAdj: 1.00 1.00 1.00 1.00 1.00 1.00 1.00 1.00 1.00 1.00 1.00 1.00
AdjDel/Veh: 51.1 12.2 12.2 62.5 13.8 13.8 36.9 36.5 36.5 56.5 35.6 39.1
LOS by Move: D B B E B B D D D E D D
HCM2kAvgQ: 7 21 21 6 19 19 2 4 4 6 4 6

Note: Queue reported is the number of cars per lane.

Continental Grand Campus Specific Plan
Phase 2 Opening Year (2023) With Project PM Peak Hour (HCM)

Level of Service Computation Report
2000 HCM Operations Method (Future Volume Alternative)

Intersection #4 Sepulveda Blvd at Mariposa Ave
Cycle (sec): 100 Critical Vol./Cap.(X): 0.832
Loss Time (sec): 5 Average Delay (sec/veh): 24.2
Optimal Cycle: 62 Level Of Service: C

Street Name: Sepulveda Blvd Mariposa Ave
Approach: North Bound South Bound East Bound West Bound
Movement: L - T - R L - T - R L - T - R L - T - R
Control: Protected Protected Permitted Permitted
Rights: Include Include Include Include
Min. Green: 0 0 0 0 0 0 0 0 0 0 0 0
Y+R: 4.0 4.0 4.0 4.0 4.0 4.0 4.0 4.0 4.0 4.0 4.0 4.0
Lanes: 1 0 4 0 1 2 0 3 1 0 1 0 0 1 0 1 0 1 0 1

Volume Module:
Base Vol: 100 2039 133 227 2100 79 102 213 37 117 265 207
Growth Adj: 1.02 1.02 1.02 1.02 1.02 1.02 1.02 1.02 1.02 1.02 1.02 1.02
Initial Bse: 102 2077 135 231 2139 80 104 217 38 119 270 211
Added Vol: 16 211 17 24 86 -1 -1 20 3 28 43 31
Related Pro: 32 688 -15 -23 232 11 10 -5 13 -5 5 0
Initial Fut: 150 2976 137 232 2457 90 113 232 54 142 318 242
User Adj: 1.00 1.00 1.00 1.00 1.00 1.00 1.00 1.00 1.00 1.00 1.00 1.00
PHF Adj: 0.92 0.92 0.92 0.92 0.92 0.92 0.92 0.92 0.92 0.92 0.92 0.92
PHF Volume: 163 3234 149 252 2670 98 123 252 58 155 346 263
Reduct Vol: 0 0 0 0 0 0 0 0 0 0 0 0
Reduced Vol: 163 3234 149 252 2670 98 123 252 58 155 346 263
PCE Adj: 1.00 1.00 1.00 1.00 1.00 1.00 1.00 1.00 1.00 1.00 1.00 1.00
MLF Adj: 1.00 1.00 1.00 1.00 1.00 1.00 1.00 1.00 1.00 1.00 1.00 1.00
FinalVolume: 163 3234 149 252 2670 98 123 252 58 155 346 263

Saturation Flow Module:
Sat/Lane: 1900 1900 1900 1900 1900 1900 1900 1900 1900 1900 1900
Adjustment: 0.95 0.91 0.85 0.92 0.91 0.91 0.28 0.97 0.97 0.32 1.00 0.85
Lanes: 1.00 4.00 1.00 2.00 3.86 0.14 1.00 0.81 0.19 1.00 1.00 1.00
Final Sat.: 1805 6916 1615 3502 6637 244 526 1500 347 616 1900 1615

Capacity Analysis Module:
Vol/Sat: 0.09 0.47 0.09 0.07 0.40 0.40 0.23 0.17 0.17 0.25 0.18 0.16
Crit Moves: ****
Green/Cycle: 0.12 0.56 0.56 0.09 0.53 0.53 0.30 0.30 0.30 0.30 0.30 0.30
Volume/Cap: 0.76 0.83 0.16 0.83 0.76 0.76 0.77 0.56 0.56 0.83 0.60 0.54
Delay/Veh: 57.3 19.7 10.7 62.5 19.5 19.5 52.5 30.6 30.6 58.7 31.6 30.4
User DelAdj: 1.00 1.00 1.00 1.00 1.00 1.00 1.00 1.00 1.00 1.00 1.00 1.00
AdjDel/Veh: 57.3 19.7 10.7 62.5 19.5 19.5 52.5 30.6 30.6 58.7 31.6 30.4
LOS by Move: E B B E B B D C C E C C
HCM2kAvgQ: 5 21 2 6 20 20 5 8 8 7 10 7

Note: Queue reported is the number of cars per lane.

Continental Grand Campus Specific Plan
Phase 2 Opening Year (2023) With Project PM Peak Hour (HCM)

Level of Service Computation Report
2000 HCM Operations Method (Future Volume Alternative)

Intersection #5 Sepulveda Blvd at Grand Ave
Cycle (sec): 100 Critical Vol./Cap.(X): 0.993
Loss Time (sec): 5 Average Delay (sec/veh): 47.8
Optimal Cycle: 180 Level Of Service: D

Street Name: Sepulveda Blvd Grand Ave
Approach: North Bound South Bound East Bound West Bound
Movement: L - T - R L - T - R L - T - R L - T - R
Control: Protected Protected Split Phase Split Phase
Rights: Ovl Include Include Include
Min. Green: 0 0 0 0 0 0 0 0 0 0 0 0
Y+R: 4.0 4.0 4.0 4.0 4.0 4.0 4.0 4.0 4.0 4.0 4.0 4.0
Lanes: 1 0 4 0 1 1 0 3 1 0 1 1 0 1 0 2 0 2 0 1

Volume Module:
Base Vol: 177 1686 177 86 1814 112 304 186 155 327 207 293
Growth Adj: 1.02 1.02 1.02 1.02 1.02 1.02 1.02 1.02 1.02 1.02 1.02 1.02
Initial Bse: 180 1717 180 88 1847 114 310 189 158 333 211 298
Added Vol: -1 79 23 30 80 6 9 6 0 171 32 155
Related Pro: 17 656 -5 2 197 7 11 -5 8 5 5 26
Initial Fut: 196 2452 198 120 2124 127 330 190 166 509 248 479
User Adj: 1.00 1.00 1.00 1.00 1.00 1.00 1.00 1.00 1.00 1.00 1.00 1.00
PHF Adj: 0.92 0.92 0.92 0.92 0.92 0.92 0.92 0.92 0.92 0.92 0.92 0.92
PHF Volume: 213 2665 216 130 2309 138 358 207 180 553 269 521
Reduct Vol: 0 0 0 0 0 0 0 0 0 0 0 0
Reduced Vol: 213 2665 216 130 2309 138 358 207 180 553 269 521
PCE Adj: 1.00 1.00 1.00 1.00 1.00 1.00 1.00 1.00 1.00 1.00 1.00 1.00
MLF Adj: 1.00 1.00 1.00 1.00 1.00 1.00 1.00 1.00 1.00 1.00 1.00 1.00
FinalVolume: 213 2665 216 130 2309 138 358 207 180 553 269 521

Saturation Flow Module:
Sat/Lane: 1900 1900 1900 1900 1900 1900 1900 1900 1900 1900 1900
Adjustment: 0.95 0.91 0.85 0.95 0.90 0.90 0.89 0.89 0.89 0.92 0.95 0.85
Lanes: 1.00 4.00 1.00 1.00 3.77 0.23 1.44 0.83 0.73 2.00 2.00 1.00
Final Sat.: 1805 6916 1615 1805 6473 387 2451 1416 1233 3502 3610 1615

Capacity Analysis Module:
Vol/Sat: 0.12 0.39 0.13 0.07 0.36 0.36 0.15 0.15 0.15 0.16 0.07 0.32
Crit Moves: ****
Green/Cycle: 0.12 0.40 0.73 0.08 0.36 0.36 0.15 0.15 0.15 0.32 0.32 0.32
Volume/Cap: 0.99 0.96 0.18 0.96 0.99 0.99 0.99 0.99 0.99 0.49 0.23 0.99
Delay/Veh: 103.4 38.1 4.4 109.9 48.5 48.5 73.7 73.7 73.7 27.4 24.7 71.2
User DelAdj: 1.00 1.00 1.00 1.00 1.00 1.00 1.00 1.00 1.00 1.00 1.00 1.00
AdjDel/Veh: 103.4 38.1 4.4 109.9 48.5 48.5 73.7 73.7 73.7 27.4 24.7 71.2
LOS by Move: F D A F D D E E E C C E
HCM2kAvgQ: 7 21 2 5 24 24 13 13 13 7 3 22

Note: Queue reported is the number of cars per lane.

Continental Grand Campus Specific Plan
Phase 2 Opening Year (2023) With Project PM Peak Hour (HCM)

Level of Service Computation Report
2000 HCM Operations Method (Future Volume Alternative)

Intersection #6 Sepulveda Blvd at El Segundo Blvd

Cycle (sec): 100 Critical Vol./Cap.(X): 1.129
Loss Time (sec): 5 Average Delay (sec/veh): 88.1
Optimal Cycle: 180 Level Of Service: F

Table with columns for Street Name, Approach, Movement, Control, Rights, Min. Green, Y+R, Lanes for Sepulveda Blvd and El Segundo Blvd.

Table with columns for Volume Module: Base Vol, Growth Adj, Initial Bse, Added Vol, Related Pro, Initial Fut, User Adj, PHF Adj, PHF Volume, Reduct Vol, Reduced Vol, PCE Adj, MLF Adj, Final Volume.

Table with columns for Saturation Flow Module: Sat/Lane, Adjustment, Lanes, Final Sat.

Table with columns for Capacity Analysis Module: Vol/Sat, Crit Moves, Green/Cycle, Volume/Cap, Delay/Veh, User DelAdj, AdjDel/Veh, LOS by Move, HCM2kAvgQ.

Note: Queue reported is the number of cars per lane.

Continental Grand Campus Specific Plan
Phase 2 Opening Year (2023) With Project PM Peak Hour (HCM)

Level of Service Computation Report
2000 HCM Operations Method (Future Volume Alternative)

Intersection #7 Sepulveda Blvd at Rosecrans Blvd

Cycle (sec): 100 Critical Vol./Cap.(X): 1.020
Loss Time (sec): 5 Average Delay (sec/veh): 45.3
Optimal Cycle: 180 Level Of Service: D

Table with columns for Street Name, Approach, Movement, Control, Rights, Min. Green, Y+R, Lanes for Sepulveda Blvd and Rosecrans Blvd.

Table with columns for Volume Module: Base Vol, Growth Adj, Initial Bse, Added Vol, Related Pro, Initial Fut, User Adj, PHF Adj, PHF Volume, Reduct Vol, Reduced Vol, PCE Adj, MLF Adj, Final Volume.

Table with columns for Saturation Flow Module: Sat/Lane, Adjustment, Lanes, Final Sat.

Table with columns for Capacity Analysis Module: Vol/Sat, Crit Moves, Green/Cycle, Volume/Cap, Delay/Veh, User DelAdj, AdjDel/Veh, LOS by Move, HCM2kAvgQ.

Note: Queue reported is the number of cars per lane.

Continental Grand Campus Specific Plan
Phase 2 Opening Year (2023) With Project PM Peak Hour (HCM)

Level of Service Computation Report
2000 HCM Operations Method (Future Volume Alternative)

Intersection #8 Continental Boulevard at Mariposa Ave

Cycle (sec): 100 Critical Vol./Cap.(X): 0.322
Loss Time (sec): 5 Average Delay (sec/veh): 17.0
Optimal Cycle: 19 Level Of Service: B

Table with columns: Street Name, Approach, Movement, Control, Rights, Min. Green, Y+R, Lanes. Rows for Continental Boulevard and Mariposa Avenue.

Table with columns: Volume Module, Base Vol, Growth Adj, Initial Bse, Added Vol, Related Pro, Initial Fut, User Adj, PHF Adj, PHF Volume, Reduct Vol, Reduced Vol, PCE Adj, MLF Adj, FinalVolume.

Table with columns: Sat/Lane, Adjustment, Lanes, Final Sat. Rows for Saturation Flow Module.

Table with columns: Vol/Sat, Crit Moves, Green/Cycle, Volume/Cap, Delay/Veh, User DelAdj, AdjDel/Veh, LOS by Move, HCM2kAvgQ.

Note: Queue reported is the number of cars per lane.

Continental Grand Campus Specific Plan
Phase 2 Opening Year (2023) With Project PM Peak Hour (HCM)

Level of Service Computation Report
2000 HCM Operations Method (Future Volume Alternative)

Intersection #9 Continental Boulevard at Grand Avenue

Cycle (sec): 100 Critical Vol./Cap.(X): 0.324
Loss Time (sec): 5 Average Delay (sec/veh): 18.8
Optimal Cycle: 19 Level Of Service: B

Table with columns: Street Name, Approach, Movement, Control, Rights, Min. Green, Y+R, Lanes. Rows for Continental Boulevard and Grand Avenue.

Table with columns: Volume Module, Base Vol, Growth Adj, Initial Bse, Added Vol, Related Pro, Initial Fut, User Adj, PHF Adj, PHF Volume, Reduct Vol, Reduced Vol, PCE Adj, MLF Adj, FinalVolume.

Table with columns: Sat/Lane, Adjustment, Lanes, Final Sat. Rows for Saturation Flow Module.

Table with columns: Vol/Sat, Crit Moves, Green/Cycle, Volume/Cap, Delay/Veh, User DelAdj, AdjDel/Veh, LOS by Move, HCM2kAvgQ.

Note: Queue reported is the number of cars per lane.

Continental Grand Campus Specific Plan
Phase 2 Opening Year (2023) With Project PM Peak Hour (HCM)

Level of Service Computation Report

2000 HCM Operations Method (Future Volume Alternative)

Intersection #10 Continental Boulevard at El Segundo Boulevard

Cycle (sec): 100 Critical Vol./Cap.(X): 0.690
Loss Time (sec): 5 Average Delay (sec/veh): 29.8
Optimal Cycle: 38 Level Of Service: C

Table with columns for Street Name, Approach, Movement, Control, Rights, Min. Green, Y+R, Lanes. Rows include Continental Boulevard and El Segundo Boulevard with various movement and control details.

Volume Module table with columns for Base Vol, Growth Adj, Initial Bse, Added Vol, Related Pro, Initial Fut, User Adj, PHF Adj, PHF Volume, Reduct Vol, Reduced Vol, PCE Adj, MLF Adj, Final Volume. Rows include Continental Boulevard and El Segundo Boulevard.

Saturation Flow Module table with columns for Sat/Lane, Adjustment, Lanes, Final Sat. Rows include Continental Boulevard and El Segundo Boulevard.

Capacity Analysis Module table with columns for Vol/Sat, Crit Moves, Green/Cycle, Volume/Cap, Delay/Veh, User DelAdj, AdjDel/Veh, LOS by Move, HCM2kAvgQ. Rows include Continental Boulevard and El Segundo Boulevard.

Note: Queue reported is the number of cars per lane.

Continental Grand Campus Specific Plan
Phase 2 Opening Year (2023) With Project PM Peak Hour (HCM)

Level of Service Computation Report

2000 HCM Operations Method (Future Volume Alternative)

Intersection #11 Nash St and Imperial Hwy

Cycle (sec): 100 Critical Vol./Cap.(X): 0.535
Loss Time (sec): 5 Average Delay (sec/veh): 22.9
Optimal Cycle: 26 Level Of Service: C

Table with columns for Street Name, Approach, Movement, Control, Rights, Min. Green, Y+R, Lanes. Rows include Nash St and Imperial Hwy with various movement and control details.

Volume Module table with columns for Base Vol, Growth Adj, Initial Bse, Added Vol, Related Pro, Initial Fut, User Adj, PHF Adj, PHF Volume, Reduct Vol, Reduced Vol, PCE Adj, MLF Adj, Final Volume. Rows include Nash St and Imperial Hwy.

Saturation Flow Module table with columns for Sat/Lane, Adjustment, Lanes, Final Sat. Rows include Nash St and Imperial Hwy.

Capacity Analysis Module table with columns for Vol/Sat, Crit Moves, Green/Cycle, Volume/Cap, Delay/Veh, User DelAdj, AdjDel/Veh, LOS by Move, HCM2kAvgQ. Rows include Nash St and Imperial Hwy.

Note: Queue reported is the number of cars per lane.

Continental Grand Campus Specific Plan
Phase 2 Opening Year (2023) With Project PM Peak Hour (HCM)

Level of Service Computation Report
2000 HCM Operations Method (Future Volume Alternative)

Intersection #12 Nash St at Mariposa Ave

Cycle (sec): 100 Critical Vol./Cap.(X): 0.882
Loss Time (sec): 5 Average Delay (sec/veh): 24.1
Optimal Cycle: 80 Level Of Service: C

Table with columns for Street Name (Nash St, Mariposa Ave), Approach (North Bound, South Bound, East Bound, West Bound), Movement (L, T, R), Control, Rights, Min. Green, Y+R, and Lanes.

Table with columns for Volume Module (Base Vol, Growth Adj, Initial Bse, Added Vol, Related Pro, Initial Fut, User Adj, PHF Adj, PHF Volume, Reduct Vol, Reduced Vol, PCE Adj, MLF Adj, FinalVolume).

Table with columns for Saturation Flow Module (Sat/Lane, Adjustment, Lanes, Final Sat).

Table with columns for Capacity Analysis Module (Vol/Sat, Crit Moves, Green/Cycle, Volume/Cap, Delay/Veh, User DelAdj, AdjDel/Veh, LOS by Move, HCM2kAvgQ).

Note: Queue reported is the number of cars per lane.

Continental Grand Campus Specific Plan
Phase 2 Opening Year (2023) With Project PM Peak Hour (HCM)

Level of Service Computation Report
2000 HCM Operations Method (Future Volume Alternative)

Intersection #13 Nash St at Grand Ave

Cycle (sec): 100 Critical Vol./Cap.(X): 0.573
Loss Time (sec): 5 Average Delay (sec/veh): 25.4
Optimal Cycle: 29 Level Of Service: C

Table with columns for Street Name (Nash St, Grand Ave), Approach (North Bound, South Bound, East Bound, West Bound), Movement (L, T, R), Control, Rights, Min. Green, Y+R, and Lanes.

Table with columns for Volume Module (Base Vol, Growth Adj, Initial Bse, Added Vol, Related Pro, Initial Fut, User Adj, PHF Adj, PHF Volume, Reduct Vol, Reduced Vol, PCE Adj, MLF Adj, FinalVolume).

Table with columns for Saturation Flow Module (Sat/Lane, Adjustment, Lanes, Final Sat).

Table with columns for Capacity Analysis Module (Vol/Sat, Crit Moves, Green/Cycle, Volume/Cap, Delay/Veh, User DelAdj, AdjDel/Veh, LOS by Move, HCM2kAvgQ).

Note: Queue reported is the number of cars per lane.

Continental Grand Campus Specific Plan
Phase 2 Opening Year (2023) With Project PM Peak Hour (HCM)

Level of Service Computation Report
2000 HCM Operations Method (Future Volume Alternative)

Intersection #14 Nash St at El Segundo Blvd

Cycle (sec): 100 Critical Vol./Cap.(X): 1.099
Loss Time (sec): 5 Average Delay (sec/veh): 63.7
Optimal Cycle: 180 Level Of Service: E

Street Name: Nash St El Segundo Blvd

Approach: North Bound South Bound East Bound West Bound
Movement: L - T - R L - T - R L - T - R L - T - R

Control: Split Phase Split Phase Protected Protected
Rights: Ovl Include Include Include
Min. Green: 0 0 0 0 0 0 0 0 0 0 0 0
Y+R: 4.0 4.0 4.0 4.0 4.0 4.0 4.0 4.0 4.0 4.0 4.0 4.0
Lanes: 2 0 0 1 1 1 1 1 0 1 2 0 3 0 1 2 0 2 1 0

Volume Module:

Base Vol: 17 37 141 446 24 59 59 1412 11 23 712 87
Growth Adj: 1.02 1.02 1.02 1.02 1.02 1.02 1.02 1.02 1.02 1.02 1.02 1.02
Initial Bse: 17 38 143 453 24 60 60 1434 11 23 723 88
Added Vol: 0 0 0 37 0 6 3 254 0 0 98 16
Related Pro: 251 212 803 -20 44 20 93 335 64 246 93 -5
Initial Fut: 268 250 946 470 68 86 156 2023 75 269 914 99
User Adj: 1.00 1.00 1.00 1.00 1.00 1.00 1.00 1.00 1.00 1.00 1.00 1.00
PHF Adj: 0.92 0.92 0.92 0.92 0.92 0.92 0.92 0.92 0.92 0.92 0.92 0.92
PHF Volume: 292 271 1029 511 74 93 169 2199 82 293 994 108
Reduct Vol: 0 0 0 0 0 0 0 0 0 0 0 0
Reduced Vol: 292 271 1029 511 74 93 169 2199 82 293 994 108
PCE Adj: 1.00 1.00 1.00 1.00 1.00 1.00 1.00 1.00 1.00 1.00 1.00 1.00
MLF Adj: 1.00 1.00 1.00 1.00 1.00 1.00 1.00 1.00 1.00 1.00 1.00 1.00
FinalVolume: 292 271 1029 511 74 93 169 2199 82 293 994 108

Saturation Flow Module:

Sat/Lane: 1900 1900 1900 1900 1900 1900 1900 1900 1900 1900 1900 1900
Adjustment: 0.92 0.88 0.88 0.91 0.91 0.85 0.92 0.91 0.85 0.92 0.90 0.90
Lanes: 2.00 0.42 1.58 2.00 1.00 1.00 2.00 3.00 1.00 2.00 2.71 0.29
Final Sat.: 3502 699 2649 3458 1729 1615 3502 5187 1615 3502 4608 501

Capacity Analysis Module:

Vol/Sat: 0.08 0.39 0.39 0.15 0.04 0.06 0.05 0.42 0.05 0.08 0.22 0.22
Crit Moves: ****
Green/Cycle: 0.35 0.35 0.43 0.13 0.13 0.13 0.08 0.39 0.39 0.08 0.38 0.38
Volume/Cap: 0.24 1.10 0.90 1.10 0.32 0.43 0.57 1.10 0.13 1.10 0.57 0.57
Delay/Veh: 22.9 89.8 34.9 111.9 39.2 41.1 46.7 83.5 20.0 130.2 25.1 25.1
User DelAdj: 1.00 1.00 1.00 1.00 1.00 1.00 1.00 1.00 1.00 1.00 1.00 1.00
AdjDel/Veh: 22.9 89.8 34.9 111.9 39.2 41.1 46.7 83.5 20.0 130.2 25.1 25.1
LOS by Move: C F C F D D D F B F C C
HCM2kAvgQ: 3 31 23 12 2 3 3 35 2 9 10 10

Note: Queue reported is the number of cars per lane.

Continental Grand Campus Specific Plan
Phase 2 Opening Year (2023) With Project PM Peak Hour (HCM)

Level of Service Computation Report
2000 HCM Operations Method (Future Volume Alternative)

Intersection #15 Douglas Street at El Segundo Boulevard

Cycle (sec): 100 Critical Vol./Cap.(X): 1.233
Loss Time (sec): 5 Average Delay (sec/veh): 105.9
Optimal Cycle: 180 Level Of Service: F

Street Name: Douglas St El Segundo Blvd

Approach: North Bound South Bound East Bound West Bound
Movement: L - T - R L - T - R L - T - R L - T - R

Control: Protected Protected Protected Protected
Rights: Include Include Include Include
Min. Green: 0 0 0 0 0 0 0 0 0 0 0 0
Y+R: 4.0 4.0 4.0 4.0 4.0 4.0 4.0 4.0 4.0 4.0 4.0 4.0
Lanes: 2 0 1 1 1 2 0 2 0 1 1 0 2 1 0 2 0 3 0 1

Volume Module:

Base Vol: 148 395 266 484 1097 56 35 1578 334 138 580 168
Growth Adj: 1.02 1.02 1.02 1.02 1.02 1.02 1.02 1.02 1.02 1.02 1.02 1.02
Initial Bse: 150 401 270 492 1114 57 36 1603 339 140 589 171
Added Vol: 49 22 37 38 9 -3 4 244 43 32 68 42
Related Pro: 31 8 8 0 12 -10 -10 1049 12 7 261 5
Initial Fut: 230 431 315 530 1135 44 30 2896 394 179 918 218
User Adj: 1.00 1.00 1.00 1.00 1.00 1.00 1.00 1.00 1.00 1.00 1.00 1.00
PHF Adj: 0.92 0.92 0.92 0.92 0.92 0.92 0.92 0.92 0.92 0.92 0.92 0.92
PHF Volume: 250 469 343 576 1234 48 32 3148 429 195 998 237
Reduct Vol: 0 0 0 0 0 0 0 0 0 0 0 0
Reduced Vol: 250 469 343 576 1234 48 32 3148 429 195 998 237
PCE Adj: 1.00 1.00 1.00 1.00 1.00 1.00 1.00 1.00 1.00 1.00 1.00 1.00
MLF Adj: 1.00 1.00 1.00 1.00 1.00 1.00 1.00 1.00 1.00 1.00 1.00 1.00
FinalVolume: 250 469 343 576 1234 48 32 3148 429 195 998 237

Saturation Flow Module:

Sat/Lane: 1900 1900 1900 1900 1900 1900 1900 1900 1900 1900 1900 1900
Adjustment: 0.92 0.89 0.89 0.92 0.95 0.85 0.95 0.89 0.89 0.92 0.91 0.85
Lanes: 2.00 1.73 1.27 2.00 2.00 1.00 1.00 2.64 0.36 2.00 3.00 1.00
Final Sat.: 3502 2931 2143 3502 3610 1615 1805 4483 610 3502 5187 1615

Capacity Analysis Module:

Vol/Sat: 0.07 0.16 0.16 0.16 0.34 0.03 0.02 0.70 0.70 0.06 0.19 0.15
Crit Moves: ****
Green/Cycle: 0.06 0.17 0.17 0.17 0.28 0.28 0.05 0.57 0.57 0.05 0.56 0.56
Volume/Cap: 1.23 0.97 0.97 0.97 1.23 0.11 0.34 1.23 1.23 1.23 0.34 0.26
Delay/Veh: 187.0 64.7 64.7 69.9 150 27.0 47.9 129 129.4 195.3 11.9 11.4
User DelAdj: 1.00 1.00 1.00 1.00 1.00 1.00 1.00 1.00 1.00 1.00 1.00 1.00
AdjDel/Veh: 187.0 64.7 64.7 69.9 150 27.0 47.9 129 129.4 195.3 11.9 11.4
LOS by Move: F E E E F C D F F F B B
HCM2kAvgQ: 9 13 13 14 38 1 1 72 72 8 6 4

Note: Queue reported is the number of cars per lane.

Continental Grand Campus Specific Plan
Phase 2 Opening Year (2023) With Project PM Peak Hour (HCM)

Level of Service Computation Report

2000 HCM Operations Method (Future Volume Alternative)

Intersection #16 Aviation Boulevard at El Segundo Boulevard

Cycle (sec): 100 Critical Vol./Cap.(X): 1.210
Loss Time (sec): 5 Average Delay (sec/veh): 99.9
Optimal Cycle: 180 Level Of Service: F

Table with columns: Street Name, Approach, Movement, Control, Rights, Min. Green, Y+R, Lanes. Rows for North and South BOUND, East and West BOUND.

Table with columns: Volume Module, Base Vol, Growth Adj, Initial Bse, Added Vol, Related Pro, Initial Fut, User Adj, PHF Adj, PHF Volume, Reduct Vol, Reduced Vol, PCE Adj, MLF Adj, Final Volume.

Table with columns: Saturation Flow Module, Sat/Lane, Adjustment, Lanes, Final Sat.

Table with columns: Capacity Analysis Module, Vol/Sat, Crit Moves, Green/Cycle, Volume/Cap, Delay/Veh, User DelAdj, AdjDel/Veh, LOS by Move, HCM2kAvgQ.

Note: Queue reported is the number of cars per lane.

Continental Grand Campus Specific Plan
Phase 2 Opening Year (2023) With Project PM Peak Hour (HCM)

Level of Service Computation Report

ICU 1(Loss as Cycle Length %) Method (Future Volume Alternative)

Intersection #17 El Segundo Boulevard and Isis Avenue

Cycle (sec): 100 Critical Vol./Cap.(X): 0.880
Loss Time (sec): 5 Average Delay (sec/veh): xxxxxx
Optimal Cycle: 77 Level Of Service: D

Table with columns: Street Name, Approach, Movement, Control, Rights, Min. Green, Y+R, Lanes. Rows for North and South BOUND, East and West BOUND.

Table with columns: Volume Module, Base Vol, Growth Adj, Initial Bse, Added Vol, Related Pro, Initial Fut, User Adj, PHF Adj, PHF Volume, Reduct Vol, Reduced Vol, PCE Adj, MLF Adj, Final Volume.

Table with columns: Saturation Flow Module, Sat/Lane, Adjustment, Lanes, Final Sat.

Table with columns: Capacity Analysis Module, Vol/Sat, Crit Moves.

Continental Grand Campus Specific Plan
Phase 2 Opening Year (2023) With Project PM Peak Hour (HCM)

Level of Service Computation Report

2000 HCM Operations Method (Future Volume Alternative)

Intersection #18 El Segundo Blvd at I-405 SB Ramps

Cycle (sec): 100 Critical Vol./Cap.(X): 1.493
Loss Time (sec): 5 Average Delay (sec/veh): 89.5
Optimal Cycle: 180 Level Of Service: F

Street Name: I-405 SB Ramps El Segundo Blvd

Approach: North Bound South Bound East Bound West Bound

Movement: L - T - R L - T - R L - T - R L - T - R

Control: Permitted Permitted Permitted Permitted

Rights: Include Include Include Include

Min. Green: 0 0 0 0 0 0 0 0 0 0 0 0

Y+R: 4.0 4.0 4.0 4.0 4.0 4.0 4.0 4.0 4.0 4.0 4.0 4.0

Lanes: 1 0 1 0 0 0 0 0 3 0 1 0 0 3 0 0

Volume Module:

Base Vol: 239 0 269 0 0 0 1491 1049 0 1062 0
Growth Adj: 1.02 1.02 1.02 1.02 1.02 1.02 1.02 1.02 1.02 1.02 1.02
Initial Bse: 243 0 273 0 0 0 1515 1066 0 1079 0
Added Vol: 0 0 0 0 0 0 60 121 0 28 0
Related Pro: 2 0 0 0 0 0 442 483 0 290 0
Initial Fut: 245 0 273 0 0 0 2017 1670 0 1397 0
User Adj: 1.00 1.00 1.00 1.00 1.00 1.00 1.00 1.00 1.00 1.00 1.00
PHF Adj: 0.92 0.92 0.92 0.92 0.92 0.92 0.92 0.92 0.92 0.92 0.92
PHF Volume: 266 0 297 0 0 0 2192 1815 0 1518 0
Reduct Vol: 0 0 0 0 0 0 0 0 0 0 0 0
Reduced Vol: 266 0 297 0 0 0 2192 1815 0 1518 0
PCE Adj: 1.00 1.00 1.00 1.00 1.00 1.00 1.00 1.00 1.00 1.00 1.00
MLF Adj: 1.00 1.00 1.00 1.00 1.00 1.00 1.00 1.00 1.00 1.00 1.00
FinalVolume: 266 0 297 0 0 0 2192 1815 0 1518 0

Saturation Flow Module:

Sat/Lane: 1900 1900 1900 1900 1900 1900 1900 1900 1900 1900 1900
Adjustment: 0.75 1.00 0.78 1.00 1.00 1.00 0.91 0.85 1.00 0.91 1.00
Lanes: 1.32 0.00 0.68 0.00 0.00 0.00 0.00 3.00 1.00 0.00 3.00 0.00
Final Sat.: 1875 0 1007 0 0 0 5187 1615 0 5187 0

Capacity Analysis Module:

Vol/Sat: 0.14 0.00 0.29 0.00 0.00 0.00 0.42 1.12 0.00 0.29 0.00
Crit Moves: ****
Green/Cycle: 0.20 0.00 0.20 0.00 0.00 0.00 0.75 0.75 0.00 0.75 0.00
Volume/Cap: 0.72 0.00 1.49 0.00 0.00 0.00 0.56 1.49 0.00 0.39 0.00
Delay/Veh: 40.7 0.0 275.7 0.0 0.0 0.0 5.5 238.8 0.0 4.4 0.0
User DelAdj: 1.00 1.00 1.00 1.00 1.00 1.00 1.00 1.00 1.00 1.00 1.00
AdjDel/Veh: 40.7 0.0 275.7 0.0 0.0 0.0 5.5 238.8 0.0 4.4 0.0
LOS by Move: D A F A A A A A F A A A
HCM2kAvgQ: 7 0 33 0 0 0 10 126 0 6 0

Note: Queue reported is the number of cars per lane.

Continental Grand Campus Specific Plan
Phase 2 Opening Year (2023) With Project PM Peak Hour (HCM)

Level of Service Computation Report

2000 HCM Operations Method (Future Volume Alternative)

Intersection #19 El Segundo Blvd at La Cienega Blvd

Cycle (sec): 100 Critical Vol./Cap.(X): 0.810
Loss Time (sec): 5 Average Delay (sec/veh): 21.7
Optimal Cycle: 56 Level Of Service: C

Street Name: La Cienega Blvd El Segundo Blvd

Approach: North Bound South Bound East Bound West Bound

Movement: L - T - R L - T - R L - T - R L - T - R

Control: Protected Protected Protected Protected

Rights: Include Include Include Include

Min. Green: 0 0 0 0 0 0 0 0 0 0 0 0

Y+R: 4.0 4.0 4.0 4.0 4.0 4.0 4.0 4.0 4.0 4.0 4.0 4.0

Lanes: 0 0 0 0 0 2 0 0 0 2 1 0 3 0 0 0 0 2 1 0

Volume Module:

Base Vol: 0 0 0 665 0 653 101 1849 0 0 614 206
Growth Adj: 1.02 1.02 1.02 1.02 1.02 1.02 1.02 1.02 1.02 1.02 1.02 1.02
Initial Bse: 0 0 0 676 0 663 103 1878 0 0 624 209
Added Vol: 0 0 0 0 0 0 0 60 0 0 28 0
Related Pro: 0 0 0 0 0 55 0 424 0 0 233 0
Initial Fut: 0 0 0 676 0 718 103 2362 0 0 885 209
User Adj: 1.00 1.00 1.00 1.00 1.00 1.00 1.00 1.00 1.00 1.00 1.00 1.00
PHF Adj: 0.92 0.92 0.92 0.92 0.92 0.92 0.92 0.92 0.92 0.92 0.92 0.92
PHF Volume: 0 0 0 734 0 781 112 2568 0 0 962 227
Reduct Vol: 0 0 0 0 0 0 0 0 0 0 0 0
Reduced Vol: 0 0 0 734 0 781 112 2568 0 0 962 227
PCE Adj: 1.00 1.00 1.00 1.00 1.00 1.00 1.00 1.00 1.00 1.00 1.00 1.00
MLF Adj: 1.00 1.00 1.00 1.00 1.00 1.00 1.00 1.00 1.00 1.00 1.00 1.00
FinalVolume: 0 0 0 734 0 781 112 2568 0 0 962 227

Saturation Flow Module:

Sat/Lane: 1900 1900 1900 1900 1900 1900 1900 1900 1900 1900 1900
Adjustment: 1.00 1.00 1.00 0.92 1.00 0.75 0.95 0.91 1.00 1.00 0.88 0.88
Lanes: 0.00 0.00 0.00 2.00 0.00 2.00 1.00 3.00 0.00 0.00 2.43 0.57
Final Sat.: 0 0 0 3502 0 2842 1805 5187 0 0 4073 963

Capacity Analysis Module:

Vol/Sat: 0.00 0.00 0.00 0.21 0.00 0.27 0.06 0.50 0.00 0.00 0.24 0.24
Crit Moves: ****
Green/Cycle: 0.00 0.00 0.00 0.34 0.00 0.34 0.13 0.61 0.00 0.00 0.48 0.48
Volume/Cap: 0.00 0.00 0.00 0.62 0.00 0.81 0.49 0.81 0.00 0.00 0.49 0.49
Delay/Veh: 0.0 0.0 0.0 28.6 0.0 35.3 42.3 16.6 0.0 0.0 17.6 17.6
User DelAdj: 1.00 1.00 1.00 1.00 1.00 1.00 1.00 1.00 1.00 1.00 1.00 1.00
AdjDel/Veh: 0.0 0.0 0.0 28.6 0.0 35.3 42.3 16.6 0.0 0.0 17.6 17.6
LOS by Move: A A A C A D D B A A B B
HCM2kAvgQ: 0 0 0 10 0 15 3 23 0 0 9 9

Note: Queue reported is the number of cars per lane.

Continental Grand Campus Specific Plan
Phase 2 Opening Year (2023) With Project PM Peak Hour (HCM)

Level of Service Computation Report

2000 HCM Operations Method (Future Volume Alternative)

Intersection #20 El Segundo Blvd at I-405 NB Ramps

Cycle (sec): 100 Critical Vol./Cap.(X): 0.738
Loss Time (sec): 5 Average Delay (sec/veh): 12.9
Optimal Cycle: 43 Level Of Service: B

Street Name: I-405 NB Ramps El Segundo Blvd
Approach: North Bound South Bound East Bound West Bound
Movement: L - T - R L - T - R L - T - R L - T - R

Control: Protected Protected Protected Protected
Rights: Include Include Ignore Include
Min. Green: 0 0 0 0 0 0 0 0 0 0 0 0
Y+R: 4.0 4.0 4.0 4.0 4.0 4.0 4.0 4.0 4.0 4.0 4.0 4.0
Lanes: 2 0 0 0 1 0 0 0 0 0 0 0 2 1 1 0 0 2 1 0

Volume Module:
Base Vol: 373 0 222 0 0 0 0 2365 176 0 447 410
Growth Adj: 1.02 1.02 1.02 1.02 1.02 1.02 1.02 1.02 1.02 1.02 1.02 1.02
Initial Bse: 379 0 226 0 0 0 0 2402 179 0 454 416
Added Vol: 18 0 0 0 0 0 0 60 0 0 9 0
Related Pro: 96 0 0 0 0 0 0 153 289 0 138 0
Initial Fut: 493 0 226 0 0 0 0 2615 468 0 601 416
User Adj: 1.00 1.00 1.00 1.00 1.00 1.00 1.00 1.00 0.00 1.00 1.00 1.00
PHF Adj: 0.92 0.92 0.92 0.92 0.92 0.92 0.92 0.92 0.00 0.92 0.92 0.92
PHF Volume: 536 0 245 0 0 0 0 2843 0 0 653 453
Reduct Vol: 0 0 0 0 0 0 0 0 0 0 0 0
Reduced Vol: 536 0 245 0 0 0 0 2843 0 0 653 453
PCE Adj: 1.00 1.00 1.00 1.00 1.00 1.00 1.00 1.00 0.00 1.00 1.00 1.00
MLF Adj: 1.00 1.00 1.00 1.00 1.00 1.00 1.00 1.00 0.00 1.00 1.00 1.00
FinalVolume: 536 0 245 0 0 0 0 2843 0 0 653 453

Saturation Flow Module:
Sat/Lane: 1900 1900 1900 1900 1900 1900 1900 1900 1900 1900 1900 1900
Adjustment: 0.92 1.00 0.85 1.00 1.00 1.00 1.00 0.91 0.91 1.00 0.85 0.85
Lanes: 2.00 0.00 1.00 0.00 0.00 0.00 0.00 3.00 1.00 0.00 2.00 1.00
Final Sat.: 3502 0 1615 0 0 0 0 5187 1729 0 3247 1624

Capacity Analysis Module:
Vol/Sat: 0.15 0.00 0.15 0.00 0.00 0.00 0.00 0.55 0.00 0.00 0.20 0.28
Crit Moves: **** ****
Green/Cycle: 0.21 0.00 0.21 0.00 0.00 0.00 0.00 0.74 0.00 0.00 0.74 0.74
Volume/Cap: 0.74 0.00 0.73 0.00 0.00 0.00 0.00 0.74 0.00 0.00 0.27 0.38
Delay/Veh: 41.1 0.0 45.1 0.0 0.0 0.0 0.0 8.1 0.0 0.0 4.2 4.7
User DelAdj: 1.00 1.00 1.00 1.00 1.00 1.00 1.00 1.00 1.00 1.00 1.00 1.00
AdjDel/Veh: 41.1 0.0 45.1 0.0 0.0 0.0 0.0 8.1 0.0 0.0 4.2 4.7
LOS by Move: D A D A A A A A A A A
HCM2kAvgQ: 10 0 9 0 0 0 0 18 0 0 4 6

Note: Queue reported is the number of cars per lane.

 Continental Grand Campus Specific Plan
 Existing AM Peak Hour (HCM)

Scenario Report

Scenario: Existing AM HCM

Command: Ex AM HCM
 Volume: Ex AM
 Geometry: Existing
 Impact Fee: Default Impact Fee
 Trip Generation: none
 Trip Distribution: none
 Paths: Project
 Routes: Default Route
 Configuration: Ex AM HCM

 Continental Grand Campus Specific Plan
 Existing AM Peak Hour (HCM)

Impact Analysis Report
Level Of Service

Intersection		Base		Future		Change in
		Del/ LOS	V/ Veh C	Del/ LOS	V/ Veh C	
# 1 Sepulveda Blvd at Imperial Hwy	C	29.5	0.819	C 29.5	0.819	+ 0.000 D/V
# 2 Sepulveda Blvd at Walnut St	A	7.8	0.548	A 7.8	0.548	+ 0.000 D/V
# 3 Sepulveda Blvd at Maple Ave	B	10.6	0.536	B 10.6	0.536	+ 0.000 D/V
# 4 Sepulveda Blvd at Mariposa Ave	B	18.2	0.608	B 18.2	0.608	+ 0.000 D/V
# 5 Sepulveda Blvd at Grand Ave	C	22.2	0.742	C 22.2	0.742	+ 0.000 D/V
# 6 Sepulveda Blvd at El Segundo B	C	26.2	0.765	C 26.2	0.765	+ 0.000 D/V
# 7 Sepulveda Blvd at Rosecrans Bl	C	27.2	0.788	C 27.2	0.788	+ 0.000 D/V
# 8 Continental Boulevard at Marip	A	9.7	0.345	A 9.7	0.345	+ 0.000 D/V
# 9 Continental Boulevard at Grand	C	23.5	0.252	C 23.5	0.252	+ 0.000 D/V
# 10 Continental Boulevard at El Se	A	9.0	0.376	A 9.0	0.376	+ 0.000 D/V
# 11 Nash St and Imperial Hwy	C	23.9	0.619	C 23.9	0.619	+ 0.000 D/V
# 12 Nash St at Mariposa Ave	B	15.0	0.377	B 15.0	0.377	+ 0.000 D/V
# 13 Nash St at Grand Ave	C	23.7	0.463	C 23.7	0.463	+ 0.000 D/V
# 14 Nash St at El Segundo Blvd	B	12.4	0.439	B 12.4	0.439	+ 0.000 D/V
# 15 Douglas Street at El Segundo B	C	27.7	0.702	C 27.7	0.702	+ 0.000 D/V
# 16 Aviation Boulevard at El Segun	C	31.0	0.807	C 31.0	0.807	+ 0.000 D/V
# 17 El Segundo Boulevard and Isis	B xxxxx	0.623		B xxxxx	0.623	+ 0.000 V/C
# 18 El Segundo Blvd at I-405 SB Ra	B	17.7	0.603	B 17.7	0.603	+ 0.000 D/V
# 19 El Segundo Blvd at La Cienega	B	14.6	0.588	B 14.6	0.588	+ 0.000 D/V
# 20 El Segundo Blvd at I-405 NB Ra	B	17.8	0.710	B 17.8	0.710	+ 0.000 D/V

Continental Grand Campus Specific Plan
Existing AM Peak Hour (HCM)

Level of Service Computation Report
2000 HCM Operations Method (Future Volume Alternative)

Intersection #1 Sepulveda Blvd at Imperial Hwy

Cycle (sec): 100 Critical Vol./Cap.(X): 0.819
Loss Time (sec): 5 Average Delay (sec/veh): 29.5
Optimal Cycle: 58 Level Of Service: C

Street Name: Sepulveda Blvd Imperial Hwy
Approach: North Bound South Bound East Bound West Bound
Movement: L - T - R L - T - R L - T - R L - T - R
Control: Protected Protected Protected Protected
Rights: Include Include Include Ovl
Min. Green: 0 0 0 0 0 0 0 0 0 0 0 0
Y+R: 4.0 4.0 4.0 4.0 4.0 4.0 4.0 4.0 4.0 4.0 4.0 4.0
Lanes: 1 0 3 0 1 2 0 3 1 0 2 0 3 0 1 2 0 3 0 1

Volume Module:
Base Vol: 63 1495 418 448 2297 12 210 316 140 211 292 590
Growth Adj: 1.00 1.00 1.00 1.00 1.00 1.00 1.00 1.00 1.00 1.00 1.00 1.00
Initial Bse: 63 1499 419 449 2303 12 211 317 140 212 293 592
Added Vol: 0 0 0 0 0 0 0 0 0 0 0 0
PasserByVol: 0 0 0 0 0 0 0 0 0 0 0 0
Initial Fut: 63 1499 419 449 2303 12 211 317 140 212 293 592
User Adj: 1.00 1.00 1.00 1.00 1.00 1.00 1.00 1.00 1.00 1.00 1.00 1.00
PHF Adj: 0.92 0.92 0.92 0.92 0.92 0.92 0.92 0.92 0.92 0.92 0.92 0.92
PHF Volume: 69 1629 456 488 2503 13 229 344 153 230 318 643
Reduct Vol: 0 0 0 0 0 0 0 0 0 0 0 0
Reduced Vol: 69 1629 456 488 2503 13 229 344 153 230 318 643
PCE Adj: 1.00 1.00 1.00 1.00 1.00 1.00 1.00 1.00 1.00 1.00 1.00 1.00
MLF Adj: 1.00 1.00 1.00 1.00 1.00 1.00 1.00 1.00 1.00 1.00 1.00 1.00
FinalVolume: 69 1629 456 488 2503 13 229 344 153 230 318 643

Saturation Flow Module:
Sat/Lane: 1900 1900 1900 1900 1900 1900 1900 1900 1900 1900 1900 1900
Adjustment: 0.95 0.91 0.85 0.92 0.91 0.91 0.92 0.91 0.85 0.92 0.91 0.85
Lanes: 1.00 3.00 1.00 2.00 3.98 0.02 2.00 3.00 1.00 2.00 3.00 1.00
Final Sat.: 1805 5187 1615 3502 6873 36 3502 5187 1615 3502 5187 1615

Capacity Analysis Module:
Vol/Sat: 0.04 0.31 0.28 0.14 0.36 0.36 0.07 0.07 0.09 0.07 0.06 0.40
Crit Moves: **** **** **** ****
Green/Cycle: 0.05 0.38 0.38 0.17 0.50 0.50 0.08 0.23 0.23 0.16 0.32 0.49
Volume/Cap: 0.73 0.82 0.74 0.82 0.73 0.73 0.82 0.28 0.40 0.40 0.19 0.82
Delay/Veh: 71.0 30.5 31.0 48.7 20.3 20.3 62.3 31.6 33.1 38.0 25.0 28.7
User DelAdj: 1.00 1.00 1.00 1.00 1.00 1.00 1.00 1.00 1.00 1.00 1.00 1.00
AdjDel/Veh: 71.0 30.5 31.0 48.7 20.3 20.3 62.3 31.6 33.1 38.0 25.0 28.7
LOS by Move: E C C D C C E C C D C C
HCM2kAvgQ: 2 17 12 10 18 18 4 3 4 3 2 17

Note: Queue reported is the number of cars per lane.

Continental Grand Campus Specific Plan
Existing AM Peak Hour (HCM)

Level of Service Computation Report
2000 HCM Operations Method (Future Volume Alternative)

Intersection #2 Sepulveda Blvd at Walnut St

Cycle (sec): 100 Critical Vol./Cap.(X): 0.548
Loss Time (sec): 5 Average Delay (sec/veh): 7.8
Optimal Cycle: 27 Level Of Service: A

Street Name: Sepulveda Blvd Walnut St
Approach: North Bound South Bound East Bound West Bound
Movement: L - T - R L - T - R L - T - R L - T - R
Control: Protected Protected Permitted Permitted
Rights: Include Include Include Include
Min. Green: 0 0 0 0 0 0 0 0 0 0 0 0
Y+R: 4.0 4.0 4.0 4.0 4.0 4.0 4.0 4.0 4.0 4.0 4.0 4.0
Lanes: 1 0 3 1 0 1 0 3 1 0 0 1 0 0 1 0 1 0 0 1

Volume Module:
Base Vol: 86 1938 58 62 2372 175 65 19 28 8 11 17
Growth Adj: 1.00 1.00 1.00 1.00 1.00 1.00 1.00 1.00 1.00 1.00 1.00 1.00
Initial Bse: 86 1943 58 62 2378 175 65 19 28 8 11 17
Added Vol: 0 0 0 0 0 0 0 0 0 0 0 0
PasserByVol: 0 0 0 0 0 0 0 0 0 0 0 0
Initial Fut: 86 1943 58 62 2378 175 65 19 28 8 11 17
User Adj: 1.00 1.00 1.00 1.00 1.00 1.00 1.00 1.00 1.00 1.00 1.00 1.00
PHF Adj: 0.92 0.92 0.92 0.92 0.92 0.92 0.92 0.92 0.92 0.92 0.92 0.92
PHF Volume: 94 2112 63 68 2585 191 71 21 31 9 12 19
Reduct Vol: 0 0 0 0 0 0 0 0 0 0 0 0
Reduced Vol: 94 2112 63 68 2585 191 71 21 31 9 12 19
PCE Adj: 1.00 1.00 1.00 1.00 1.00 1.00 1.00 1.00 1.00 1.00 1.00 1.00
MLF Adj: 1.00 1.00 1.00 1.00 1.00 1.00 1.00 1.00 1.00 1.00 1.00 1.00
FinalVolume: 94 2112 63 68 2585 191 71 21 31 9 12 19

Saturation Flow Module:
Sat/Lane: 1900 1900 1900 1900 1900 1900 1900 1900 1900 1900 1900 1900
Adjustment: 0.95 0.91 0.91 0.95 0.90 0.90 0.76 0.76 0.85 0.90 0.90 0.85
Lanes: 1.00 3.88 0.12 1.00 3.73 0.27 0.77 0.23 1.00 0.42 0.58 1.00
Final Sat.: 1805 6688 200 1805 6376 470 1120 327 1615 717 986 1615

Capacity Analysis Module:
Vol/Sat: 0.05 0.32 0.32 0.04 0.41 0.41 0.06 0.06 0.02 0.01 0.01 0.01
Crit Moves: **** **** **** ****
Green/Cycle: 0.09 0.75 0.75 0.09 0.74 0.74 0.12 0.12 0.12 0.12 0.12 0.12
Volume/Cap: 0.55 0.42 0.42 0.42 0.55 0.55 0.55 0.55 0.16 0.11 0.11 0.10
Delay/Veh: 46.9 4.8 4.8 45.0 5.8 5.8 45.6 45.6 40.3 39.8 39.8 39.8
User DelAdj: 1.00 1.00 1.00 1.00 1.00 1.00 1.00 1.00 1.00 1.00 1.00 1.00
AdjDel/Veh: 46.9 4.8 4.8 45.0 5.8 5.8 45.6 45.6 40.3 39.8 39.8 39.8
LOS by Move: D A A D A A D D D D D D
HCM2kAvgQ: 4 7 7 2 10 10 3 3 1 1 1 1

Note: Queue reported is the number of cars per lane.

Continental Grand Campus Specific Plan
Existing AM Peak Hour (HCM)

Level of Service Computation Report
2000 HCM Operations Method (Future Volume Alternative)

Intersection #3 Sepulveda Blvd at Maple Ave

Cycle (sec): 100 Critical Vol./Cap.(X): 0.536
Loss Time (sec): 5 Average Delay (sec/veh): 10.6
Optimal Cycle: 26 Level Of Service: B

Street Name: Sepulveda Blvd Maple Ave

Approach: North Bound South Bound East Bound West Bound
Movement: L - T - R L - T - R L - T - R L - T - R

Control: Protected Protected Permitted Permitted
Rights: Include Include Include Include
Min. Green: 0 0 0 0 0 0 0 0 0 0 0 0
Y+R: 4.0 4.0 4.0 4.0 4.0 4.0 4.0 4.0 4.0 4.0 4.0
Lanes: 1 0 3 1 0 1 0 3 1 0 1 0 0 1 0 1

Volume Module:

Base Vol: 46 2101 145 104 2130 36 66 121 31 22 29 49
Growth Adj: 1.00 1.00 1.00 1.00 1.00 1.00 1.00 1.00 1.00 1.00 1.00
Initial Bse: 46 2101 145 104 2130 36 66 121 31 22 29 49
Added Vol: 0 0 0 0 0 0 0 0 0 0 0 0
PasserByVol: 0 0 0 0 0 0 0 0 0 0 0 0
Initial Fut: 46 2101 145 104 2130 36 66 121 31 22 29 49
User Adj: 1.00 1.00 1.00 1.00 1.00 1.00 1.00 1.00 1.00 1.00 1.00
PHF Adj: 0.92 0.92 0.92 0.92 0.92 0.92 0.92 0.92 0.92 0.92 0.92
PHF Volume: 50 2284 158 113 2315 39 72 132 34 24 32 53
Reduct Vol: 0 0 0 0 0 0 0 0 0 0 0 0
Reduced Vol: 50 2284 158 113 2315 39 72 132 34 24 32 53
PCE Adj: 1.00 1.00 1.00 1.00 1.00 1.00 1.00 1.00 1.00 1.00 1.00
MLF Adj: 1.00 1.00 1.00 1.00 1.00 1.00 1.00 1.00 1.00 1.00 1.00
FinalVolume: 50 2284 158 113 2315 39 72 132 34 24 32 53

Saturation Flow Module:

Sat/Lane: 1900 1900 1900 1900 1900 1900 1900 1900 1900 1900 1900
Adjustment: 0.95 0.90 0.90 0.95 0.91 0.91 0.74 0.97 0.97 0.39 1.00 0.85
Lanes: 1.00 3.74 0.26 1.00 3.93 0.07 1.00 0.80 0.20 1.00 1.00 1.00
Final Sat.: 1805 6405 442 1805 6781 115 1410 1466 375 735 1900 1615

Capacity Analysis Module:

Vol/Sat: 0.03 0.36 0.36 0.06 0.34 0.34 0.05 0.09 0.09 0.03 0.02 0.03
Crit Moves: ****
Green/Cycle: 0.06 0.67 0.67 0.12 0.72 0.72 0.17 0.17 0.17 0.17 0.17 0.17
Volume/Cap: 0.47 0.54 0.54 0.54 0.47 0.47 0.30 0.54 0.54 0.19 0.10 0.20
Delay/Veh: 48.9 8.8 8.8 44.3 5.9 5.9 37.2 39.9 39.9 36.6 35.4 36.2
User DelAdj: 1.00 1.00 1.00 1.00 1.00 1.00 1.00 1.00 1.00 1.00 1.00 1.00
AdjDel/Veh: 48.9 8.8 8.8 44.3 5.9 5.9 37.2 39.9 39.9 36.6 35.4 36.2
LOS by Move: D A A D A A D D D D D D
HCM2kAvgQ: 2 11 11 4 8 8 2 5 5 1 1 2

Note: Queue reported is the number of cars per lane.

Continental Grand Campus Specific Plan
Existing AM Peak Hour (HCM)

Level of Service Computation Report
2000 HCM Operations Method (Future Volume Alternative)

Intersection #4 Sepulveda Blvd at Mariposa Ave

Cycle (sec): 100 Critical Vol./Cap.(X): 0.608
Loss Time (sec): 5 Average Delay (sec/veh): 18.2
Optimal Cycle: 31 Level Of Service: B

Street Name: Sepulveda Blvd Mariposa Ave

Approach: North Bound South Bound East Bound West Bound
Movement: L - T - R L - T - R L - T - R L - T - R

Control: Protected Protected Permitted Permitted
Rights: Include Include Include Include
Min. Green: 0 0 0 0 0 0 0 0 0 0 0 0
Y+R: 4.0 4.0 4.0 4.0 4.0 4.0 4.0 4.0 4.0 4.0 4.0
Lanes: 1 0 4 0 1 2 0 3 1 0 1 0 0 1 0 1

Volume Module:

Base Vol: 62 1984 155 418 1791 58 104 179 49 65 86 84
Growth Adj: 1.00 1.00 1.00 1.00 1.00 1.00 1.00 1.00 1.00 1.00 1.00 1.00
Initial Bse: 62 1989 155 419 1796 58 104 179 49 65 86 84
Added Vol: 0 0 0 0 0 0 0 0 0 0 0 0
PasserByVol: 0 0 0 0 0 0 0 0 0 0 0 0
Initial Fut: 62 1989 155 419 1796 58 104 179 49 65 86 84
User Adj: 1.00 1.00 1.00 1.00 1.00 1.00 1.00 1.00 1.00 1.00 1.00 1.00
PHF Adj: 0.92 0.92 0.92 0.92 0.92 0.92 0.92 0.92 0.92 0.92 0.92 0.92
PHF Volume: 68 2162 169 456 1952 63 113 195 53 71 94 92
Reduct Vol: 0 0 0 0 0 0 0 0 0 0 0 0
Reduced Vol: 68 2162 169 456 1952 63 113 195 53 71 94 92
PCE Adj: 1.00 1.00 1.00 1.00 1.00 1.00 1.00 1.00 1.00 1.00 1.00 1.00
MLF Adj: 1.00 1.00 1.00 1.00 1.00 1.00 1.00 1.00 1.00 1.00 1.00 1.00
FinalVolume: 68 2162 169 456 1952 63 113 195 53 71 94 92

Saturation Flow Module:

Sat/Lane: 1900 1900 1900 1900 1900 1900 1900 1900 1900 1900 1900
Adjustment: 0.95 0.91 0.85 0.92 0.91 0.91 0.61 0.97 0.97 0.31 1.00 0.85
Lanes: 1.00 4.00 1.00 2.00 3.87 0.13 1.00 0.79 0.21 1.00 1.00 1.00
Final Sat.: 1805 6916 1615 3502 6666 216 1163 1444 395 585 1900 1615

Capacity Analysis Module:

Vol/Sat: 0.04 0.31 0.10 0.13 0.29 0.29 0.10 0.14 0.14 0.12 0.05 0.06
Crit Moves: ****
Green/Cycle: 0.08 0.51 0.51 0.21 0.65 0.65 0.22 0.22 0.22 0.22 0.22 0.22
Volume/Cap: 0.45 0.61 0.20 0.61 0.45 0.45 0.44 0.61 0.61 0.54 0.22 0.26
Delay/Veh: 45.9 17.5 13.3 37.0 9.0 9.0 34.7 37.6 37.6 39.2 32.1 32.5
User DelAdj: 1.00 1.00 1.00 1.00 1.00 1.00 1.00 1.00 1.00 1.00 1.00 1.00
AdjDel/Veh: 45.9 17.5 13.3 37.0 9.0 9.0 34.7 37.6 37.6 39.2 32.1 32.5
LOS by Move: D B B D A A C D D D C C
HCM2kAvgQ: 2 12 3 7 9 9 3 8 8 3 2 2

Note: Queue reported is the number of cars per lane.

Continental Grand Campus Specific Plan
Existing AM Peak Hour (HCM)

Level of Service Computation Report
2000 HCM Operations Method (Future Volume Alternative)

Intersection #5 Sepulveda Blvd at Grand Ave

Cycle (sec): 100 Critical Vol./Cap.(X): 0.742
Loss Time (sec): 5 Average Delay (sec/veh): 22.2
Optimal Cycle: 44 Level Of Service: C

Street Name: Sepulveda Blvd Grand Ave

Approach: North Bound South Bound East Bound West Bound
Movement: L - T - R L - T - R L - T - R L - T - R

Control: Protected Protected Split Phase Split Phase
Rights: Ovl Include Include Include
Min. Green: 0 0 0 0 0 0 0 0 0 0 0 0
Y+R: 4.0 4.0 4.0 4.0 4.0 4.0 4.0 4.0 4.0 4.0 4.0 4.0
Lanes: 1 0 4 0 1 1 0 3 1 0 1 1 0 1 0 2 0 2 0 1

Volume Module:

Base Vol: 130 2061 544 406 1381 185 171 164 103 43 50 57
Growth Adj: 1.00 1.00 1.00 1.00 1.00 1.00 1.00 1.00 1.00 1.00 1.00 1.00
Initial Bse: 130 2066 545 407 1385 185 171 164 103 43 50 57
Added Vol: 0 0 0 0 0 0 0 0 0 0 0 0
PasserByVol: 0 0 0 0 0 0 0 0 0 0 0 0
Initial Fut: 130 2066 545 407 1385 185 171 164 103 43 50 57
User Adj: 1.00 1.00 1.00 1.00 1.00 1.00 1.00 1.00 1.00 1.00 1.00 1.00
PHF Adj: 0.92 0.92 0.92 0.92 0.92 0.92 0.92 0.92 0.92 0.92 0.92 0.92
PHF Volume: 142 2246 593 442 1505 202 186 179 112 47 54 62
Reduct Vol: 0 0 0 0 0 0 0 0 0 0 0 0
Reduced Vol: 142 2246 593 442 1505 202 186 179 112 47 54 62
PCE Adj: 1.00 1.00 1.00 1.00 1.00 1.00 1.00 1.00 1.00 1.00 1.00 1.00
MLF Adj: 1.00 1.00 1.00 1.00 1.00 1.00 1.00 1.00 1.00 1.00 1.00 1.00
FinalVolume: 142 2246 593 442 1505 202 186 179 112 47 54 62

Saturation Flow Module:

Sat/Lane: 1900 1900 1900 1900 1900 1900 1900 1900 1900 1900 1900 1900
Adjustment: 0.95 0.91 0.85 0.95 0.89 0.89 0.90 0.90 0.90 0.92 0.95 0.85
Lanes: 1.00 4.00 1.00 1.00 3.53 0.47 1.17 1.12 0.71 2.00 2.00 1.00
Final Sat.: 1805 6916 1615 1805 5989 802 2001 1919 1205 3502 3610 1615

Capacity Analysis Module:

Vol/Sat: 0.08 0.32 0.37 0.25 0.25 0.25 0.09 0.09 0.09 0.01 0.02 0.04
Crit Moves: ****
Green/Cycle: 0.19 0.48 0.53 0.33 0.61 0.61 0.13 0.13 0.13 0.05 0.05 0.05
Volume/Cap: 0.41 0.68 0.69 0.74 0.41 0.41 0.74 0.74 0.74 0.26 0.29 0.74
Delay/Veh: 36.2 20.9 20.1 34.7 10.0 10.0 46.8 46.8 46.8 46.3 46.5 76.4
User DelAdj: 1.00 1.00 1.00 1.00 1.00 1.00 1.00 1.00 1.00 1.00 1.00 1.00
AdjDel/Veh: 36.2 20.9 20.1 34.7 10.0 10.0 46.8 46.8 46.8 46.3 46.5 76.4
LOS by Move: D C C C A A D D D D D E
HCM2kAvgQ: 4 14 13 12 7 7 7 7 7 1 1 3

Note: Queue reported is the number of cars per lane.

Continental Grand Campus Specific Plan
Existing AM Peak Hour (HCM)

Level of Service Computation Report
2000 HCM Operations Method (Future Volume Alternative)

Intersection #6 Sepulveda Blvd at El Segundo Blvd

Cycle (sec): 100 Critical Vol./Cap.(X): 0.765
Loss Time (sec): 5 Average Delay (sec/veh): 26.2
Optimal Cycle: 48 Level Of Service: C

Street Name: Sepulveda Blvd El Segundo Blvd

Approach: North Bound South Bound East Bound West Bound
Movement: L - T - R L - T - R L - T - R L - T - R

Control: Protected Protected Protected Protected
Rights: Include Include Include Include
Min. Green: 0 0 0 0 0 0 0 0 0 0 0 0
Y+R: 4.0 4.0 4.0 4.0 4.0 4.0 4.0 4.0 4.0 4.0 4.0 4.0
Lanes: 2 0 3 1 0 2 0 4 0 1 1 0 2 0 1 2 0 2 0 1

Volume Module:

Base Vol: 369 2440 293 252 1120 121 108 291 222 138 292 216
Growth Adj: 1.00 1.00 1.00 1.00 1.00 1.00 1.00 1.00 1.00 1.00 1.00 1.00
Initial Bse: 370 2446 294 253 1123 121 108 292 223 138 293 217
Added Vol: 0 0 0 0 0 0 0 0 0 0 0 0
PasserByVol: 0 0 0 0 0 0 0 0 0 0 0 0
Initial Fut: 370 2446 294 253 1123 121 108 292 223 138 293 217
User Adj: 1.00 1.00 1.00 1.00 1.00 1.00 1.00 1.00 1.00 1.00 1.00 1.00
PHF Adj: 0.92 0.92 0.92 0.92 0.92 0.92 0.92 0.92 0.92 0.92 0.92 0.92
PHF Volume: 402 2659 319 275 1221 132 118 317 242 150 318 235
Reduct Vol: 0 0 0 0 0 0 0 0 0 0 0 0
Reduced Vol: 402 2659 319 275 1221 132 118 317 242 150 318 235
PCE Adj: 1.00 1.00 1.00 1.00 1.00 1.00 1.00 1.00 1.00 1.00 1.00 1.00
MLF Adj: 1.00 1.00 1.00 1.00 1.00 1.00 1.00 1.00 1.00 1.00 1.00 1.00
FinalVolume: 402 2659 319 275 1221 132 118 317 242 150 318 235

Saturation Flow Module:

Sat/Lane: 1900 1900 1900 1900 1900 1900 1900 1900 1900 1900 1900 1900
Adjustment: 0.92 0.90 0.90 0.92 0.91 0.85 0.95 0.95 0.85 0.92 0.95 0.85
Lanes: 2.00 3.57 0.43 2.00 4.00 1.00 1.00 2.00 1.00 2.00 2.00 1.00
Final Sat.: 3502 6076 730 3502 6916 1615 1805 3610 1615 3502 3610 1615

Capacity Analysis Module:

Vol/Sat: 0.11 0.44 0.44 0.08 0.18 0.08 0.07 0.09 0.15 0.04 0.09 0.15
Crit Moves: ****
Green/Cycle: 0.27 0.57 0.57 0.10 0.41 0.41 0.09 0.21 0.21 0.06 0.19 0.19
Volume/Cap: 0.43 0.77 0.77 0.77 0.43 0.20 0.77 0.41 0.70 0.70 0.46 0.77
Delay/Veh: 30.8 17.2 17.2 53.2 21.3 19.2 65.0 34.2 42.5 55.8 36.4 49.3
User DelAdj: 1.00 1.00 1.00 1.00 1.00 1.00 1.00 1.00 1.00 1.00 1.00 1.00
AdjDel/Veh: 30.8 17.2 17.2 53.2 21.3 19.2 65.0 34.2 42.5 55.8 36.4 49.3
LOS by Move: C B B D C B E C D E D D
HCM2kAvgQ: 6 20 20 5 7 2 5 5 8 4 5 9

Note: Queue reported is the number of cars per lane.

Continental Grand Campus Specific Plan
Existing AM Peak Hour (HCM)

Level of Service Computation Report
2000 HCM Operations Method (Future Volume Alternative)

Intersection #7 Sepulveda Blvd at Rosecrans Blvd

Cycle (sec): 100 Critical Vol./Cap.(X): 0.788
Loss Time (sec): 5 Average Delay (sec/veh): 27.2
Optimal Cycle: 52 Level Of Service: C

Street Name: Sepulveda Blvd Rosecrans Blvd
Approach: North Bound South Bound East Bound West Bound
Movement: L - T - R L - T - R L - T - R L - T - R
Control: Protected Protected Protected Protected
Rights: Ovl Include Include Ignore
Min. Green: 0 0 0 0 0 0 0 0 0 0 0 0
Y+R: 4.0 4.0 4.0 4.0 4.0 4.0 4.0 4.0 4.0 4.0 4.0 4.0
Lanes: 2 0 4 0 1 2 0 3 0 1 2 0 3 0 1 2 0 2 0 1

Volume Module:
Base Vol: 281 2806 431 284 912 134 280 692 169 241 365 481
Growth Adj: 1.00 1.00 1.00 1.00 1.00 1.00 1.00 1.00 1.00 1.00 1.00 1.00
Initial Bse: 281 2806 431 284 912 134 280 692 169 241 365 481
Added Vol: 0 0 0 0 0 0 0 0 0 0 0 0
PasserByVol: 0 0 0 0 0 0 0 0 0 0 0 0
Initial Fut: 281 2806 431 284 912 134 280 692 169 241 365 481
User Adj: 1.00 1.00 1.00 1.00 1.00 1.00 1.00 1.00 1.00 1.00 1.00 1.00
PHF Adj: 0.92 0.92 0.92 0.92 0.92 0.92 0.92 0.92 0.92 0.92 0.92 0.92
PHF Volume: 305 3050 468 309 991 146 304 752 184 262 397 0
Reduct Vol: 0 0 0 0 0 0 0 0 0 0 0 0
Reduced Vol: 305 3050 468 309 991 146 304 752 184 262 397 0
PCE Adj: 1.00 1.00 1.00 1.00 1.00 1.00 1.00 1.00 1.00 1.00 1.00 1.00
MLF Adj: 1.00 1.00 1.00 1.00 1.00 1.00 1.00 1.00 1.00 1.00 1.00 1.00
FinalVolume: 305 3050 468 309 991 146 304 752 184 262 397 0

Saturation Flow Module:
Sat/Lane: 1900 1900 1900 1900 1900 1900 1900 1900 1900 1900 1900 1900
Adjustment: 0.92 0.91 0.85 0.92 0.91 0.85 0.92 0.91 0.85 0.92 0.95 1.00
Lanes: 2.00 4.00 1.00 2.00 3.00 1.00 2.00 3.00 1.00 2.00 2.00 1.00
Final Sat.: 3502 6916 1615 3502 5187 1615 3502 5187 1615 3502 3610 1900

Capacity Analysis Module:
Vol/Sat: 0.09 0.44 0.29 0.09 0.19 0.09 0.09 0.15 0.11 0.07 0.11 0.00
Crit Moves: ****
Green/Cycle: 0.21 0.56 0.65 0.11 0.46 0.46 0.12 0.18 0.18 0.09 0.16 0.00
Volume/Cap: 0.41 0.79 0.44 0.79 0.41 0.20 0.71 0.79 0.62 0.79 0.71 0.00
Delay/Veh: 34.5 18.5 8.7 53.5 18.1 16.1 47.4 43.4 41.5 56.2 44.1 0.0
User DelAdj: 1.00 1.00 1.00 1.00 1.00 1.00 1.00 1.00 1.00 1.00 1.00 1.00
AdjDel/Veh: 34.5 18.5 8.7 53.5 18.1 16.1 47.4 43.4 41.5 56.2 44.1 0.0
LOS by Move: C B A D B B D D E D A
HCM2kAvgQ: 4 22 7 7 7 3 6 10 6 6 8 0

Note: Queue reported is the number of cars per lane.

Continental Grand Campus Specific Plan
Existing AM Peak Hour (HCM)

Level of Service Computation Report
2000 HCM Operations Method (Future Volume Alternative)

Intersection #8 Continental Boulevard at Mariposa Ave

Cycle (sec): 100 Critical Vol./Cap.(X): 0.345
Loss Time (sec): 5 Average Delay (sec/veh): 9.7
Optimal Cycle: 19 Level Of Service: A

Street Name: Continental Boulevard Mariposa Avenue
Approach: North Bound South Bound East Bound West Bound
Movement: L - T - R L - T - R L - T - R L - T - R
Control: Permitted Permitted Permitted Permitted
Rights: Include Include Include Include
Min. Green: 0 0 0 0 0 0 0 0 0 0 0 0
Y+R: 4.0 4.0 4.0 4.0 4.0 4.0 4.0 4.0 4.0 4.0 4.0 4.0
Lanes: 1 0 1 0 2 1 0 0 1 0 1 0 2 1 0 1 0 1 1 0

Volume Module:
Base Vol: 40 51 70 6 77 16 27 333 193 207 230 17
Growth Adj: 1.00 1.00 1.00 1.00 1.00 1.00 1.00 1.00 1.00 1.00 1.00 1.00
Initial Bse: 40 51 70 6 77 16 27 333 193 207 230 17
Added Vol: 0 0 0 0 0 0 0 0 0 0 0 0
PasserByVol: 0 0 0 0 0 0 0 0 0 0 0 0
Initial Fut: 40 51 70 6 77 16 27 333 193 207 230 17
User Adj: 1.00 1.00 1.00 1.00 1.00 1.00 1.00 1.00 1.00 1.00 1.00 1.00
PHF Adj: 0.92 0.92 0.92 0.92 0.92 0.92 0.92 0.92 0.92 0.92 0.92 0.92
PHF Volume: 43 55 76 7 84 17 29 362 210 225 250 18
Reduct Vol: 0 0 0 0 0 0 0 0 0 0 0 0
Reduced Vol: 43 55 76 7 84 17 29 362 210 225 250 18
PCE Adj: 1.00 1.00 1.00 1.00 1.00 1.00 1.00 1.00 1.00 1.00 1.00 1.00
MLF Adj: 1.00 1.00 1.00 1.00 1.00 1.00 1.00 1.00 1.00 1.00 1.00 1.00
FinalVolume: 43 55 76 7 84 17 29 362 210 225 250 18

Saturation Flow Module:
Sat/Lane: 1900 1900 1900 1900 1900 1900 1900 1900 1900 1900 1900 1900
Adjustment: 0.58 1.00 0.75 0.72 0.97 0.97 0.57 0.86 0.86 0.43 0.94 0.94
Lanes: 1.00 1.00 2.00 1.00 0.83 0.17 1.00 2.00 1.00 1.00 1.86 0.14
Final Sat.: 1102 1900 2842 1360 1532 318 1091 3268 1634 823 3328 246

Capacity Analysis Module:
Vol/Sat: 0.04 0.03 0.03 0.00 0.05 0.05 0.03 0.11 0.13 0.27 0.08 0.08
Crit Moves: ****
Green/Cycle: 0.16 0.16 0.16 0.16 0.16 0.16 0.79 0.79 0.79 0.79 0.79 0.79
Volume/Cap: 0.25 0.18 0.17 0.03 0.35 0.35 0.03 0.14 0.16 0.35 0.09 0.09
Delay/Veh: 37.6 36.8 36.6 35.7 38.2 38.2 2.2 2.5 2.5 3.3 2.4 2.4
User DelAdj: 1.00 1.00 1.00 1.00 1.00 1.00 1.00 1.00 1.00 1.00 1.00 1.00
AdjDel/Veh: 37.6 36.8 36.6 35.7 38.2 38.2 2.2 2.5 2.5 3.3 2.4 2.4
LOS by Move: D D D D D D A A A A A A
HCM2kAvgQ: 1 2 1 0 3 3 0 1 2 2 1 1

Note: Queue reported is the number of cars per lane.

Continental Grand Campus Specific Plan
Existing AM Peak Hour (HCM)

Level of Service Computation Report
2000 HCM Operations Method (Future Volume Alternative)

Intersection #9 Continental Boulevard at Grand Avenue

Cycle (sec): 100 Critical Vol./Cap.(X): 0.252
Loss Time (sec): 5 Average Delay (sec/veh): 23.5
Optimal Cycle: 17 Level Of Service: C

Street Name: Continental Boulevard Grand Avenue
Approach: North Bound South Bound East Bound West Bound
Movement: L - T - R L - T - R L - T - R L - T - R
Control: Permitted Permitted Protected Protected
Rights: Include Include Include Include
Min. Green: 0 0 0 0 0 0 0 0 0 0 0 0
Y+R: 4.0 4.0 4.0 4.0 4.0 4.0 4.0 4.0 4.0 4.0 4.0
Lanes: 0 1 1 1 0 1 0 2 1 0 1 0 2 1 0

Volume Module:
Base Vol: 146 198 25 15 77 78 85 230 87 74 292 33
Growth Adj: 1.00 1.00 1.00 1.00 1.00 1.00 1.00 1.00 1.00 1.00 1.00 1.00
Initial Bse: 146 198 25 15 77 78 85 230 87 74 292 33
Added Vol: 0 0 0 0 0 0 0 0 0 0 0 0
PasserByVol: 0 0 0 0 0 0 0 0 0 0 0 0
Initial Fut: 146 198 25 15 77 78 85 230 87 74 292 33
User Adj: 1.00 1.00 1.00 1.00 1.00 1.00 1.00 1.00 1.00 1.00 1.00
PHF Adj: 0.92 0.92 0.92 0.92 0.92 0.92 0.92 0.92 0.92 0.92 0.92
PHF Volume: 159 215 27 16 84 85 92 250 95 80 317 36
Reduct Vol: 0 0 0 0 0 0 0 0 0 0 0 0
Reduced Vol: 159 215 27 16 84 85 92 250 95 80 317 36
PCE Adj: 1.00 1.00 1.00 1.00 1.00 1.00 1.00 1.00 1.00 1.00 1.00
MLF Adj: 1.00 1.00 1.00 1.00 1.00 1.00 1.00 1.00 1.00 1.00 1.00
FinalVolume: 159 215 27 16 84 85 92 250 95 80 317 36

Saturation Flow Module:
Sat/Lane: 1900 1900 1900 1900 1900 1900 1900 1900 1900 1900 1900
Adjustment: 0.70 0.70 0.70 0.47 0.84 0.84 0.95 0.87 0.87 0.95 0.90 0.90
Lanes: 1.00 1.78 0.22 1.00 2.00 1.00 1.00 2.18 0.82 1.00 2.70 0.30
Final Sat.: 1330 2362 298 897 3199 1599 1805 3609 1365 1805 4590 519

Capacity Analysis Module:
Vol/Sat: 0.12 0.09 0.09 0.02 0.03 0.05 0.05 0.07 0.07 0.04 0.07 0.07
Crit Moves: ****
Green/Cycle: 0.47 0.47 0.47 0.47 0.47 0.47 0.20 0.29 0.29 0.19 0.27 0.27
Volume/Cap: 0.25 0.19 0.19 0.04 0.06 0.11 0.25 0.24 0.24 0.24 0.25 0.25
Delay/Veh: 15.9 15.3 15.3 14.2 14.3 14.7 33.8 27.1 27.1 35.0 28.4 28.4
User DelAdj: 1.00 1.00 1.00 1.00 1.00 1.00 1.00 1.00 1.00 1.00 1.00 1.00
AdjDel/Veh: 15.9 15.3 15.3 14.2 14.3 14.7 33.8 27.1 27.1 35.0 28.4 28.4
LOS by Move: B B B B B C C C C C C
HCM2kAvgQ: 3 2 2 0 1 2 2 3 3 2 3 3

Note: Queue reported is the number of cars per lane.

Continental Grand Campus Specific Plan
Existing AM Peak Hour (HCM)

Level of Service Computation Report
2000 HCM Operations Method (Future Volume Alternative)

Intersection #10 Continental Boulevard at El Segundo Boulevard

Cycle (sec): 100 Critical Vol./Cap.(X): 0.376
Loss Time (sec): 5 Average Delay (sec/veh): 9.0
Optimal Cycle: 20 Level Of Service: A

Street Name: Continental Boulevard El Segundo Boulevard
Approach: North Bound South Bound East Bound West Bound
Movement: L - T - R L - T - R L - T - R L - T - R
Control: Split Phase Split Phase Protected Protected
Rights: Include Include Include Include
Min. Green: 0 0 0 0 0 0 0 0 0 0 0 0
Y+R: 4.0 4.0 4.0 4.0 4.0 4.0 4.0 4.0 4.0 4.0 4.0
Lanes: 1 1 0 1 1 1 1 0 1 1 2 0 3 0 1 2 0 2 1 0

Volume Module:
Base Vol: 4 16 1 51 28 24 156 648 49 49 970 346
Growth Adj: 1.00 1.00 1.00 1.00 1.00 1.00 1.00 1.00 1.00 1.00 1.00 1.00
Initial Bse: 4 16 1 51 28 24 156 648 49 49 970 346
Added Vol: 0 0 0 0 0 0 0 0 0 0 0 0
PasserByVol: 0 0 0 0 0 0 0 0 0 0 0 0
Initial Fut: 4 16 1 51 28 24 156 648 49 49 970 346
User Adj: 1.00 1.00 1.00 1.00 1.00 1.00 1.00 1.00 1.00 1.00 1.00 1.00
PHF Adj: 0.92 0.92 0.92 0.92 0.92 0.92 0.92 0.92 0.92 0.92 0.92 0.92
PHF Volume: 4 17 1 55 30 26 170 704 53 53 1054 376
Reduct Vol: 0 0 0 0 0 0 0 0 0 0 0 0
Reduced Vol: 4 17 1 55 30 26 170 704 53 53 1054 376
PCE Adj: 1.00 1.00 1.00 1.00 1.00 1.00 1.00 1.00 1.00 1.00 1.00 1.00
MLF Adj: 1.00 1.00 1.00 1.00 1.00 1.00 1.00 1.00 1.00 1.00 1.00 1.00
FinalVolume: 4 17 1 55 30 26 170 704 53 53 1054 376

Saturation Flow Module:
Sat/Lane: 1900 1900 1900 1900 1900 1900 1900 1900 1900 1900 1900
Adjustment: 0.93 0.93 0.93 0.89 0.89 0.89 0.92 0.91 0.85 0.92 0.87 0.87
Lanes: 1.00 2.00 1.00 1.94 1.06 1.00 2.00 3.00 1.00 2.00 2.21 0.79
Final Sat.: 1776 3552 1776 3292 1808 1700 3502 5187 1615 3502 3674 1311

Capacity Analysis Module:
Vol/Sat: 0.00 0.00 0.00 0.02 0.02 0.02 0.05 0.14 0.03 0.02 0.29 0.29
Crit Moves: ****
Green/Cycle: 0.01 0.01 0.01 0.04 0.04 0.04 0.13 0.80 0.80 0.09 0.76 0.76
Volume/Cap: 0.19 0.38 0.05 0.38 0.38 0.34 0.38 0.17 0.04 0.17 0.38 0.38
Delay/Veh: 49.6 52.8 48.8 47.2 47.2 47.0 40.4 2.3 2.0 42.3 4.0 4.0
User DelAdj: 1.00 1.00 1.00 1.00 1.00 1.00 1.00 1.00 1.00 1.00 1.00 1.00
AdjDel/Veh: 49.6 52.8 48.8 47.2 47.2 47.0 40.4 2.3 2.0 42.3 4.0 4.0
LOS by Move: D D D D D D A A D A A
HCM2kAvgQ: 0 1 0 1 1 1 3 2 0 1 5 5

Note: Queue reported is the number of cars per lane.

Continental Grand Campus Specific Plan
Existing AM Peak Hour (HCM)

Level of Service Computation Report
2000 HCM Operations Method (Future Volume Alternative)

Intersection #11 Nash St and Imperial Hwy

Cycle (sec): 100 Critical Vol./Cap.(X): 0.619
Loss Time (sec): 5 Average Delay (sec/veh): 23.9
Optimal Cycle: 32 Level Of Service: C

Table with columns: Street Name, Approach, Movement, Control, Rights, Min. Green, Y+R, Lanes. Rows for Nash St and Imperial Hwy.

Table with columns: Volume Module, Base Vol, Growth Adj, Initial Bse, Added Vol, PasserByVol, Initial Fut, User Adj, PHF Adj, PHF Volume, Reduct Vol, Reduced Vol, PCE Adj, MLF Adj, FinalVolume.

Table with columns: Sat/Lane, Adjustment, Lanes, Final Sat. for Saturation Flow Module.

Table with columns: Vol/Sat, Crit Moves, Green/Cycle, Volume/Cap, Delay/Veh, User DelAdj, AdjDel/Veh, LOS by Move, HCM2kAvgQ for Capacity Analysis Module.

Note: Queue reported is the number of cars per lane.

Continental Grand Campus Specific Plan
Existing AM Peak Hour (HCM)

Level of Service Computation Report
2000 HCM Operations Method (Future Volume Alternative)

Intersection #12 Nash St at Mariposa Ave

Cycle (sec): 100 Critical Vol./Cap.(X): 0.377
Loss Time (sec): 5 Average Delay (sec/veh): 15.0
Optimal Cycle: 20 Level Of Service: B

Table with columns: Street Name, Approach, Movement, Control, Rights, Min. Green, Y+R, Lanes. Rows for Nash St and Mariposa Ave.

Table with columns: Volume Module, Base Vol, Growth Adj, Initial Bse, Added Vol, PasserByVol, Initial Fut, User Adj, PHF Adj, PHF Volume, Reduct Vol, Reduced Vol, PCE Adj, MLF Adj, FinalVolume.

Table with columns: Sat/Lane, Adjustment, Lanes, Final Sat. for Saturation Flow Module.

Table with columns: Vol/Sat, Crit Moves, Green/Cycle, Volume/Cap, Delay/Veh, User DelAdj, AdjDel/Veh, LOS by Move, HCM2kAvgQ for Capacity Analysis Module.

Note: Queue reported is the number of cars per lane.

Continental Grand Campus Specific Plan
Existing AM Peak Hour (HCM)

Level of Service Computation Report
2000 HCM Operations Method (Future Volume Alternative)

Intersection #13 Nash St at Grand Ave

Cycle (sec): 100 Critical Vol./Cap.(X): 0.463
Loss Time (sec): 5 Average Delay (sec/veh): 23.7
Optimal Cycle: 23 Level Of Service: C

Table with columns for Street Name (Nash St, Grand Ave), Approach (North Bound, South Bound, East Bound, West Bound), Movement (L, T, R), Control (Protected, Split Phase), Rights (Include), Min. Green, Y+R, and Lanes.

Table with columns for Volume Module (Base Vol, Growth Adj, Initial Bse, Added Vol, PasserByVol, Initial Fut, User Adj, PHF Adj, PHF Volume, Reduct Vol, Reduced Vol, PCE Adj, MLF Adj, FinalVolume).

Table with columns for Saturation Flow Module (Sat/Lane, Adjustment, Lanes, Final Sat).

Table with columns for Capacity Analysis Module (Vol/Sat, Crit Moves, Green/Cycle, Volume/Cap, Delay/Veh, User DelAdj, AdjDel/Veh, LOS by Move, HCM2kAvgQ).

Note: Queue reported is the number of cars per lane.

Continental Grand Campus Specific Plan
Existing AM Peak Hour (HCM)

Level of Service Computation Report
2000 HCM Operations Method (Future Volume Alternative)

Intersection #14 Nash St at El Segundo Blvd

Cycle (sec): 100 Critical Vol./Cap.(X): 0.439
Loss Time (sec): 5 Average Delay (sec/veh): 12.4
Optimal Cycle: 22 Level Of Service: B

Table with columns for Street Name (Nash St, El Segundo Blvd), Approach (North Bound, South Bound, East Bound, West Bound), Movement (L, T, R), Control (Split Phase, Protected), Rights (Ovl, Include), Min. Green, Y+R, and Lanes.

Table with columns for Volume Module (Base Vol, Growth Adj, Initial Bse, Added Vol, PasserByVol, Initial Fut, User Adj, PHF Adj, PHF Volume, Reduct Vol, Reduced Vol, PCE Adj, MLF Adj, FinalVolume).

Table with columns for Saturation Flow Module (Sat/Lane, Adjustment, Lanes, Final Sat).

Table with columns for Capacity Analysis Module (Vol/Sat, Crit Moves, Green/Cycle, Volume/Cap, Delay/Veh, User DelAdj, AdjDel/Veh, LOS by Move, HCM2kAvgQ).

Note: Queue reported is the number of cars per lane.

Continental Grand Campus Specific Plan
Existing AM Peak Hour (HCM)

Level of Service Computation Report
2000 HCM Operations Method (Future Volume Alternative)

Intersection #15 Douglas Street at El Segundo Boulevard

Cycle (sec): 100 Critical Vol./Cap.(X): 0.702
Loss Time (sec): 5 Average Delay (sec/veh): 27.7
Optimal Cycle: 39 Level Of Service: C

Street Name: Douglas St El Segundo Blvd

Approach: North Bound South Bound East Bound West Bound
Movement: L - T - R L - T - R L - T - R L - T - R

Control: Protected Protected Protected Protected
Rights: Include Include Include Include
Min. Green: 0 0 0 0 0 0 0 0 0 0 0 0
Y+R: 4.0 4.0 4.0 4.0 4.0 4.0 4.0 4.0 4.0 4.0 4.0
Lanes: 2 0 1 1 1 2 0 2 0 1 1 0 2 1 0 2 0 3 0 1

Volume Module:
Base Vol: 418 683 92 128 269 36 121 496 143 191 1457 512
Growth Adj: 1.00 1.00 1.00 1.00 1.00 1.00 1.00 1.00 1.00 1.00 1.00 1.00
Initial Bse: 418 683 92 128 269 36 121 496 143 191 1457 512
Added Vol: 0 0 0 0 0 0 0 0 0 0 0 0
PasserByVol: 0 0 0 0 0 0 0 0 0 0 0 0
Initial Fut: 418 683 92 128 269 36 121 496 143 191 1457 512
User Adj: 1.00 1.00 1.00 1.00 1.00 1.00 1.00 1.00 1.00 1.00 1.00 1.00
PHF Adj: 0.92 0.92 0.92 0.92 0.92 0.92 0.92 0.92 0.92 0.92 0.92 0.92
PHF Volume: 454 742 100 139 292 39 132 539 155 208 1584 557
Reduct Vol: 0 0 0 0 0 0 0 0 0 0 0 0
Reduced Vol: 454 742 100 139 292 39 132 539 155 208 1584 557
PCE Adj: 1.00 1.00 1.00 1.00 1.00 1.00 1.00 1.00 1.00 1.00 1.00 1.00
MLF Adj: 1.00 1.00 1.00 1.00 1.00 1.00 1.00 1.00 1.00 1.00 1.00 1.00
FinalVolume: 454 742 100 139 292 39 132 539 155 208 1584 557

Saturation Flow Module:
Sat/Lane: 1900 1900 1900 1900 1900 1900 1900 1900 1900 1900 1900 1900
Adjustment: 0.92 0.93 0.93 0.92 0.95 0.85 0.95 0.88 0.88 0.92 0.91 0.85
Lanes: 2.00 2.00 1.00 2.00 2.00 1.00 1.00 2.33 0.67 2.00 3.00 1.00
Final Sat.: 3502 3545 1773 3502 3610 1615 1805 3889 1121 3502 5187 1615

Capacity Analysis Module:
Vol/Sat: 0.13 0.21 0.06 0.04 0.08 0.02 0.07 0.14 0.14 0.06 0.31 0.34
Crit Moves: ****
Green/Cycle: 0.22 0.30 0.30 0.06 0.14 0.14 0.10 0.42 0.42 0.18 0.49 0.49
Volume/Cap: 0.59 0.70 0.19 0.70 0.59 0.18 0.70 0.33 0.33 0.33 0.62 0.70
Delay/Veh: 36.3 33.0 26.1 57.1 42.5 38.6 54.6 19.8 19.8 36.2 19.1 22.6
User DelAdj: 1.00 1.00 1.00 1.00 1.00 1.00 1.00 1.00 1.00 1.00 1.00 1.00
AdjDel/Veh: 36.3 33.0 26.1 57.1 42.5 38.6 54.6 19.8 19.8 36.2 19.1 22.6
LOS by Move: D C C E D D D B B D B C
HCM2kAvgQ: 7 12 2 4 5 1 5 5 5 3 13 14

Note: Queue reported is the number of cars per lane.

Continental Grand Campus Specific Plan
Existing AM Peak Hour (HCM)

Level of Service Computation Report
2000 HCM Operations Method (Future Volume Alternative)

Intersection #16 Aviation Boulevard at El Segundo Boulevard

Cycle (sec): 100 Critical Vol./Cap.(X): 0.807
Loss Time (sec): 5 Average Delay (sec/veh): 31.0
Optimal Cycle: 56 Level Of Service: C

Street Name: Aviation Blvd El Segundo Blvd

Approach: North Bound South Bound East Bound West Bound
Movement: L - T - R L - T - R L - T - R L - T - R

Control: Protected Protected Protected Protected
Rights: Ovl Include Include Include
Min. Green: 0 0 0 0 0 0 0 0 0 0 0 0
Y+R: 4.0 4.0 4.0 4.0 4.0 4.0 4.0 4.0 4.0 4.0 4.0 4.0
Lanes: 2 0 2 0 1 1 0 1 1 1 1 0 3 1 0 2 0 2 1 0

Volume Module:
Base Vol: 326 1027 306 21 774 435 118 454 77 410 1528 75
Growth Adj: 1.00 1.00 1.00 1.00 1.00 1.00 1.00 1.00 1.00 1.00 1.00 1.00
Initial Bse: 326 1027 306 21 774 435 118 454 77 410 1528 75
Added Vol: 0 0 0 0 0 0 0 0 0 0 0 0
PasserByVol: 0 0 0 0 0 0 0 0 0 0 0 0
Initial Fut: 326 1027 306 21 774 435 118 454 77 410 1528 75
User Adj: 1.00 1.00 1.00 1.00 1.00 1.00 1.00 1.00 1.00 1.00 1.00 1.00
PHF Adj: 0.92 0.92 0.92 0.92 0.92 0.92 0.92 0.92 0.92 0.92 0.92 0.92
PHF Volume: 354 1116 333 23 841 473 128 493 84 446 1661 82
Reduct Vol: 0 0 0 0 0 0 0 0 0 0 0 0
Reduced Vol: 354 1116 333 23 841 473 128 493 84 446 1661 82
PCE Adj: 1.00 1.00 1.00 1.00 1.00 1.00 1.00 1.00 1.00 1.00 1.00 1.00
MLF Adj: 1.00 1.00 1.00 1.00 1.00 1.00 1.00 1.00 1.00 1.00 1.00 1.00
FinalVolume: 354 1116 333 23 841 473 128 493 84 446 1661 82

Saturation Flow Module:
Sat/Lane: 1900 1900 1900 1900 1900 1900 1900 1900 1900 1900 1900 1900
Adjustment: 0.92 0.95 0.85 0.95 0.90 0.90 0.95 0.89 0.89 0.92 0.90 0.90
Lanes: 2.00 2.00 1.00 1.00 1.92 1.08 1.00 3.42 0.58 2.00 2.86 0.14
Final Sat.: 3502 3610 1615 1805 3279 1843 1805 5783 981 3502 4910 241

Capacity Analysis Module:
Vol/Sat: 0.10 0.31 0.21 0.01 0.26 0.26 0.07 0.09 0.09 0.13 0.34 0.34
Crit Moves: ****
Green/Cycle: 0.13 0.43 0.73 0.02 0.32 0.32 0.09 0.20 0.20 0.30 0.42 0.42
Volume/Cap: 0.81 0.73 0.28 0.73 0.81 0.81 0.81 0.42 0.42 0.42 0.81 0.81
Delay/Veh: 53.2 25.6 4.8 108.2 34.4 34.4 70.2 34.9 34.9 28.1 27.9 27.9
User DelAdj: 1.00 1.00 1.00 1.00 1.00 1.00 1.00 1.00 1.00 1.00 1.00 1.00
AdjDel/Veh: 53.2 25.6 4.8 108.2 34.4 34.4 70.2 34.9 34.9 28.1 27.9 27.9
LOS by Move: D C A F C C E C C C C C
HCM2kAvgQ: 8 16 4 1 14 14 6 5 5 6 19 19

Note: Queue reported is the number of cars per lane.

Continental Grand Campus Specific Plan
Existing AM Peak Hour (HCM)

Level of Service Computation Report

ICU 1(Loss as Cycle Length %) Method (Future Volume Alternative)

Intersection #17 El Segundo Boulevard and Isis Avenue

Cycle (sec): 100 Critical Vol./Cap.(X): 0.623
Loss Time (sec): 5 Average Delay (sec/veh): xxxxxx
Optimal Cycle: 30 Level Of Service: B

Street Name: Isis Avenue El Segundo Boulevard
Approach: North Bound South Bound East Bound West Bound
Movement: L - T - R L - T - R L - T - R L - T - R
Control: Permitted Permitted Protected Protected
Rights: Include Include Include Include
Min. Green: 0 0 0 0 0 0 0 0 0 0 0 0
Y+R: 4.0 4.0 4.0 4.0 4.0 4.0 4.0 4.0 4.0 4.0 4.0
Lanes: 0 0 1! 0 0 0 0 1! 0 0 1 0 4 0 1 1 0 2 1 0

Volume Module:
Base Vol: 50 21 84 52 9 71 45 722 20 20 1736 39
Growth Adj: 1.00 1.00 1.00 1.00 1.00 1.00 1.00 1.00 1.00 1.00 1.00 1.00
Initial Bse: 50 21 84 52 9 71 45 722 20 20 1736 39
Added Vol: 0 0 0 0 0 0 0 0 0 0 0 0
PasserByVol: 0 0 0 0 0 0 0 0 0 0 0 0
Initial Fut: 50 21 84 52 9 71 45 722 20 20 1736 39
User Adj: 1.00 1.00 1.00 1.00 1.00 1.00 1.00 1.00 1.00 1.00 1.00 1.00
PHF Adj: 0.92 0.92 0.92 0.92 0.92 0.92 0.92 0.92 0.92 0.92 0.92 0.92
PHF Volume: 54 23 91 57 10 77 49 785 22 22 1887 42
Reduct Vol: 0 0 0 0 0 0 0 0 0 0 0 0
Reduced Vol: 54 23 91 57 10 77 49 785 22 22 1887 42
PCE Adj: 1.00 1.00 1.00 1.00 1.00 1.00 1.00 1.00 1.00 1.00 1.00 1.00
MLF Adj: 1.00 1.00 1.00 1.00 1.00 1.00 1.00 1.00 1.00 1.00 1.00 1.00
FinalVolume: 54 23 91 57 10 77 49 785 22 22 1887 42

Saturation Flow Module:
Sat/Lane: 1600 1600 1600 1600 1600 1600 1600 1600 1600 1600 1600 1600
Adjustment: 1.00 1.00 1.00 1.00 1.00 1.00 1.00 1.00 1.00 1.00 1.00 1.00
Lanes: 0.32 0.14 0.54 0.39 0.07 0.54 1.00 4.00 1.00 1.00 2.93 0.07
Final Sat.: 516 217 867 630 109 861 1600 6400 1600 1600 4695 105

Capacity Analysis Module:
Vol/Sat: 0.03 0.11 0.11 0.04 0.09 0.09 0.03 0.12 0.01 0.01 0.40 0.40
Crit Moves: **** **** **** ****

Continental Grand Campus Specific Plan
Existing AM Peak Hour (HCM)

Level of Service Computation Report

2000 HCM Operations Method (Future Volume Alternative)

Intersection #18 El Segundo Blvd at I-405 SB Ramps

Cycle (sec): 100 Critical Vol./Cap.(X): 0.603
Loss Time (sec): 5 Average Delay (sec/veh): 17.7
Optimal Cycle: 30 Level Of Service: B

Street Name: I-405 SB Ramps El Segundo Blvd
Approach: North Bound South Bound East Bound West Bound
Movement: L - T - R L - T - R L - T - R L - T - R
Control: Permitted Permitted Permitted Permitted
Rights: Include Include Include Include
Min. Green: 0 0 0 0 0 0 0 0 0 0 0 0
Y+R: 4.0 4.0 4.0 4.0 4.0 4.0 4.0 4.0 4.0 4.0 4.0 4.0
Lanes: 1 0 1! 0 0 0 0 0 0 0 0 0 3 0 1 0 0 3 0 0

Volume Module:
Base Vol: 416 0 142 0 0 0 0 608 270 0 1428 0
Growth Adj: 1.00 1.00 1.00 1.00 1.00 1.00 1.00 1.00 1.00 1.00 1.00 1.00
Initial Bse: 416 0 142 0 0 0 0 608 270 0 1428 0
Added Vol: 0 0 0 0 0 0 0 0 0 0 0 0
PasserByVol: 0 0 0 0 0 0 0 0 0 0 0 0
Initial Fut: 416 0 142 0 0 0 0 608 270 0 1428 0
User Adj: 1.00 1.00 1.00 1.00 1.00 1.00 1.00 1.00 1.00 1.00 1.00 1.00
PHF Adj: 0.92 0.92 0.92 0.92 0.92 0.92 0.92 0.92 0.92 0.92 0.92 0.92
PHF Volume: 452 0 154 0 0 0 0 661 293 0 1552 0
Reduct Vol: 0 0 0 0 0 0 0 0 0 0 0 0
Reduced Vol: 452 0 154 0 0 0 0 661 293 0 1552 0
PCE Adj: 1.00 1.00 1.00 1.00 1.00 1.00 1.00 1.00 1.00 1.00 1.00 1.00
MLF Adj: 1.00 1.00 1.00 1.00 1.00 1.00 1.00 1.00 1.00 1.00 1.00 1.00
FinalVolume: 452 0 154 0 0 0 0 661 293 0 1552 0

Saturation Flow Module:
Sat/Lane: 1900 1900 1900 1900 1900 1900 1900 1900 1900 1900 1900 1900
Adjustment: 0.73 1.00 0.74 1.00 1.00 1.00 1.00 0.91 0.85 1.00 0.91 1.00
Lanes: 1.60 0.00 0.40 0.00 0.00 0.00 0.00 3.00 1.00 0.00 3.00 0.00
Final Sat.: 2206 0 564 0 0 0 0 5187 1615 0 5187 0

Capacity Analysis Module:
Vol/Sat: 0.20 0.00 0.27 0.00 0.00 0.00 0.00 0.13 0.18 0.00 0.30 0.00
Crit Moves: **** ****

Green/Cycle: 0.45 0.00 0.45 0.00 0.00 0.00 0.00 0.50 0.50 0.00 0.50 0.00
Volume/Cap: 0.45 0.00 0.60 0.00 0.00 0.00 0.00 0.26 0.37 0.00 0.60 0.00
Delay/Veh: 19.0 0.0 21.6 0.0 0.0 0.0 0.0 14.6 15.8 0.0 18.5 0.0
User DelAdj: 1.00 1.00 1.00 1.00 1.00 1.00 1.00 1.00 1.00 1.00 1.00 1.00
AdjDel/Veh: 19.0 0.0 21.6 0.0 0.0 0.0 0.0 14.6 15.8 0.0 18.5 0.0
LOS by Move: B A C A A A A B B A B A
HCM2kAvgQ: 6 0 9 0 0 0 0 4 5 0 12 0

Note: Queue reported is the number of cars per lane.

Continental Grand Campus Specific Plan
Existing AM Peak Hour (HCM)

Level of Service Computation Report
2000 HCM Operations Method (Future Volume Alternative)

Intersection #19 El Segundo Blvd at La Cienega Blvd

Cycle (sec): 100 Critical Vol./Cap.(X): 0.588
Loss Time (sec): 5 Average Delay (sec/veh): 14.6
Optimal Cycle: 29 Level Of Service: B

Street Name: La Cienega Blvd El Segundo Blvd

Approach: North Bound South Bound East Bound West Bound
Movement: L - T - R L - T - R L - T - R L - T - R

Control: Protected Protected Protected Protected
Rights: Include Include Include Include
Min. Green: 0 0 0 0 0 0 0 0 0 0 0 0
Y+R: 4.0 4.0 4.0 4.0 4.0 4.0 4.0 4.0 4.0 4.0 4.0
Lanes: 0 0 0 0 0 2 0 0 0 2 1 0 3 0 0 0 0 2 1 0

Volume Module:

Base Vol: 0 0 0 249 0 322 75 539 0 0 1312 477
Growth Adj: 1.00 1.00 1.00 1.00 1.00 1.00 1.00 1.00 1.00 1.00 1.00 1.00
Initial Bse: 0 0 0 249 0 322 75 539 0 0 1312 477
Added Vol: 0 0 0 0 0 0 0 0 0 0 0 0
PasserByVol: 0 0 0 0 0 0 0 0 0 0 0 0
Initial Fut: 0 0 0 249 0 322 75 539 0 0 1312 477
User Adj: 1.00 1.00 1.00 1.00 1.00 1.00 1.00 1.00 1.00 1.00 1.00 1.00
PHF Adj: 0.92 0.92 0.92 0.92 0.92 0.92 0.92 0.92 0.92 0.92 0.92 0.92
PHF Volume: 0 0 0 271 0 350 82 586 0 0 1426 518
Reduct Vol: 0 0 0 0 0 0 0 0 0 0 0 0
Reduced Vol: 0 0 0 271 0 350 82 586 0 0 1426 518
PCE Adj: 1.00 1.00 1.00 1.00 1.00 1.00 1.00 1.00 1.00 1.00 1.00 1.00
MLF Adj: 1.00 1.00 1.00 1.00 1.00 1.00 1.00 1.00 1.00 1.00 1.00 1.00
FinalVolume: 0 0 0 271 0 350 82 586 0 0 1426 518

Saturation Flow Module:

Sat/Lane: 1900 1900 1900 1900 1900 1900 1900 1900 1900 1900 1900 1900
Adjustment: 1.00 1.00 1.00 0.92 1.00 0.75 0.95 0.91 1.00 1.00 0.87 0.87
Lanes: 0.00 0.00 0.00 2.00 0.00 2.00 1.00 3.00 0.00 0.00 2.20 0.80
Final Sat.: 0 0 0 3502 0 2842 1805 5187 0 0 3652 1328

Capacity Analysis Module:

Vol/Sat: 0.00 0.00 0.00 0.08 0.00 0.12 0.05 0.11 0.00 0.00 0.39 0.39
Crit Moves: **** **
Green/Cycle: 0.00 0.00 0.00 0.21 0.00 0.21 0.08 0.74 0.00 0.00 0.66 0.66
Volume/Cap: 0.00 0.00 0.00 0.37 0.00 0.59 0.59 0.15 0.00 0.00 0.59 0.59
Delay/Veh: 0.0 0.0 0.0 34.2 0.0 37.2 51.1 3.8 0.0 0.0 9.5 9.5
User DelAdj: 1.00 1.00 1.00 1.00 1.00 1.00 1.00 1.00 1.00 1.00 1.00 1.00
AdjDel/Veh: 0.0 0.0 0.0 34.2 0.0 37.2 51.1 3.8 0.0 0.0 9.5 9.5
LOS by Move: A A A C A D D A A A A A
HCM2kAvgQ: 0 0 0 4 0 6 2 2 0 0 12 12

Note: Queue reported is the number of cars per lane.

Continental Grand Campus Specific Plan
Existing AM Peak Hour (HCM)

Level of Service Computation Report
2000 HCM Operations Method (Future Volume Alternative)

Intersection #20 El Segundo Blvd at I-405 NB Ramps

Cycle (sec): 100 Critical Vol./Cap.(X): 0.710
Loss Time (sec): 5 Average Delay (sec/veh): 17.8
Optimal Cycle: 40 Level Of Service: B

Street Name: I-405 NB Ramps El Segundo Blvd

Approach: North Bound South Bound East Bound West Bound
Movement: L - T - R L - T - R L - T - R L - T - R

Control: Protected Protected Protected Protected
Rights: Include Include Ignore Include
Min. Green: 0 0 0 0 0 0 0 0 0 0 0 0
Y+R: 4.0 4.0 4.0 4.0 4.0 4.0 4.0 4.0 4.0 4.0 4.0 4.0
Lanes: 2 0 0 0 1 0 0 0 0 0 0 0 2 1 1 0 0 2 1 0

Volume Module:

Base Vol: 861 0 102 0 0 0 0 625 148 0 935 610
Growth Adj: 1.00 1.00 1.00 1.00 1.00 1.00 1.00 1.00 1.00 1.00 1.00 1.00
Initial Bse: 861 0 102 0 0 0 0 625 148 0 935 610
Added Vol: 0 0 0 0 0 0 0 0 0 0 0 0
PasserByVol: 0 0 0 0 0 0 0 0 0 0 0 0
Initial Fut: 861 0 102 0 0 0 0 625 148 0 935 610
User Adj: 1.00 1.00 1.00 1.00 1.00 1.00 1.00 1.00 0.00 1.00 1.00 1.00
PHF Adj: 0.92 0.92 0.92 0.92 0.92 0.92 0.92 0.92 0.00 0.92 0.92 0.92
PHF Volume: 936 0 111 0 0 0 0 679 0 0 1016 663
Reduct Vol: 0 0 0 0 0 0 0 0 0 0 0 0
Reduced Vol: 936 0 111 0 0 0 0 679 0 0 1016 663
PCE Adj: 1.00 1.00 1.00 1.00 1.00 1.00 1.00 1.00 0.00 1.00 1.00 1.00
MLF Adj: 1.00 1.00 1.00 1.00 1.00 1.00 1.00 1.00 0.00 1.00 1.00 1.00
FinalVolume: 936 0 111 0 0 0 0 679 0 0 1016 663

Saturation Flow Module:

Sat/Lane: 1900 1900 1900 1900 1900 1900 1900 1900 1900 1900 1900 1900
Adjustment: 0.92 1.00 0.85 1.00 1.00 1.00 1.00 0.91 0.91 1.00 0.86 0.86
Lanes: 2.00 0.00 1.00 0.00 0.00 0.00 0.00 3.00 1.00 0.00 2.00 1.00
Final Sat.: 3502 0 1615 0 0 0 0 5187 1729 0 3254 1627

Capacity Analysis Module:

Vol/Sat: 0.27 0.00 0.07 0.00 0.00 0.00 0.00 0.13 0.00 0.00 0.31 0.41
Crit Moves: **** **
Green/Cycle: 0.38 0.00 0.38 0.00 0.00 0.00 0.00 0.57 0.00 0.00 0.57 0.57
Volume/Cap: 0.71 0.00 0.18 0.00 0.00 0.00 0.00 0.23 0.00 0.00 0.54 0.71
Delay/Veh: 28.4 0.0 21.0 0.0 0.0 0.0 0.0 10.5 0.0 0.0 13.4 16.4
User DelAdj: 1.00 1.00 1.00 1.00 1.00 1.00 1.00 1.00 1.00 1.00 1.00 1.00
AdjDel/Veh: 28.4 0.0 21.0 0.0 0.0 0.0 0.0 10.5 0.0 0.0 13.4 16.4
LOS by Move: C A C A A A A B A A B B
HCM2kAvgQ: 14 0 2 0 0 0 0 4 0 0 11 17

Note: Queue reported is the number of cars per lane.

 Continental Grand Campus Specific Plan
 Existing PM Peak Hour (HCM)

Scenario Report

Scenario: Existing PM HCM

Command: Ex PM HCM
 Volume: Ex PM
 Geometry: Existing
 Impact Fee: Default Impact Fee
 Trip Generation: none
 Trip Distribution: none
 Paths: Project
 Routes: Default Route
 Configuration: Ex PM HCM

 Continental Grand Campus Specific Plan
 Existing PM Peak Hour (HCM)

Impact Analysis Report
Level Of Service

Intersection		Base		Future		Change in
		Del/ LOS	V/ Veh C	Del/ LOS	V/ Veh C	
# 1 Sepulveda Blvd at Imperial Hwy	D	37.4	1.022	D 37.4	1.022	+ 0.000 D/V
# 2 Sepulveda Blvd at Walnut St	A	9.8	0.541	A 9.8	0.541	+ 0.000 D/V
# 3 Sepulveda Blvd at Maple Ave	B	12.4	0.593	B 12.4	0.593	+ 0.000 D/V
# 4 Sepulveda Blvd at Mariposa Ave	B	19.9	0.618	B 19.9	0.618	+ 0.000 D/V
# 5 Sepulveda Blvd at Grand Ave	C	30.0	0.788	C 30.0	0.788	+ 0.000 D/V
# 6 Sepulveda Blvd at El Segundo B	D	36.0	0.901	D 36.0	0.901	+ 0.000 D/V
# 7 Sepulveda Blvd at Rosecrans Bl	C	31.8	0.867	C 31.8	0.867	+ 0.000 D/V
# 8 Continental Boulevard at Marip	B	16.2	0.278	B 16.2	0.278	+ 0.000 D/V
# 9 Continental Boulevard at Grand	B	18.3	0.272	B 18.3	0.272	+ 0.000 D/V
# 10 Continental Boulevard at El Se	B	19.6	0.394	B 19.6	0.394	+ 0.000 D/V
# 11 Nash St and Imperial Hwy	B	19.4	0.468	B 19.4	0.468	+ 0.000 D/V
# 12 Nash St at Mariposa Ave	B	17.2	0.525	B 17.2	0.525	+ 0.000 D/V
# 13 Nash St at Grand Ave	C	22.6	0.493	C 22.6	0.493	+ 0.000 D/V
# 14 Nash St at El Segundo Blvd	B	19.7	0.528	B 19.7	0.528	+ 0.000 D/V
# 15 Douglas Street at El Segundo B	C	33.1	0.874	C 33.1	0.874	+ 0.000 D/V
# 16 Aviation Boulevard at El Segun	D	39.6	0.941	D 39.6	0.941	+ 0.000 D/V
# 17 El Segundo Boulevard and Isis	B xxxxx	0.683		B xxxxx	0.683	+ 0.000 V/C
# 18 El Segundo Blvd at I-405 SB Ra	C	26.8	1.048	C 26.8	1.048	+ 0.000 D/V
# 19 El Segundo Blvd at La Cienega	C	20.4	0.671	C 20.4	0.671	+ 0.000 D/V
# 20 El Segundo Blvd at I-405 NB Ra	B	11.7	0.679	B 11.7	0.679	+ 0.000 D/V

Continental Grand Campus Specific Plan
Existing PM Peak Hour (HCM)

Level of Service Computation Report
2000 HCM Operations Method (Future Volume Alternative)

Intersection #1 Sepulveda Blvd at Imperial Hwy

Cycle (sec): 100 Critical Vol./Cap.(X): 1.022
Loss Time (sec): 5 Average Delay (sec/veh): 37.4
Optimal Cycle: 180 Level Of Service: D

Street Name: Sepulveda Blvd Imperial Hwy

Approach: North Bound South Bound East Bound West Bound
Movement: L - T - R L - T - R L - T - R L - T - R

Control: Protected Protected Protected Protected
Rights: Include Include Include Ovl
Min. Green: 0 0 0 0 0 0 0 0 0 0 0 0
Y+R: 4.0 4.0 4.0 4.0 4.0 4.0 4.0 4.0 4.0 4.0 4.0
Lanes: 1 0 3 0 1 2 0 3 1 0 2 0 3 0 1 2 0 3 0 1

Volume Module:

Base Vol: 154 1713 885 640 1993 7 202 402 140 120 295 461
Growth Adj: 1.00 1.00 1.00 1.00 1.00 1.00 1.00 1.00 1.00 1.00 1.00 1.00
Initial Bse: 154 1717 887 642 1998 7 203 403 140 120 296 462
Added Vol: 0 0 0 0 0 0 0 0 0 0 0 0
PasserByVol: 0 0 0 0 0 0 0 0 0 0 0 0
Initial Fut: 154 1717 887 642 1998 7 203 403 140 120 296 462
User Adj: 1.00 1.00 1.00 1.00 1.00 1.00 1.00 1.00 1.00 1.00 1.00 1.00
PHF Adj: 0.92 0.92 0.92 0.92 0.92 0.92 0.92 0.92 0.92 0.92 0.92 0.92
PHF Volume: 168 1867 964 697 2172 8 220 438 153 131 321 502
Reduct Vol: 0 0 0 0 0 0 0 0 0 0 0 0
Reduced Vol: 168 1867 964 697 2172 8 220 438 153 131 321 502
PCE Adj: 1.00 1.00 1.00 1.00 1.00 1.00 1.00 1.00 1.00 1.00 1.00 1.00
MLF Adj: 1.00 1.00 1.00 1.00 1.00 1.00 1.00 1.00 1.00 1.00 1.00 1.00
FinalVolume: 168 1867 964 697 2172 8 220 438 153 131 321 502

Saturation Flow Module:

Sat/Lane: 1900 1900 1900 1900 1900 1900 1900 1900 1900 1900 1900
Adjustment: 0.95 0.91 0.85 0.92 0.91 0.91 0.92 0.91 0.85 0.92 0.91 0.85
Lanes: 1.00 3.00 1.00 2.00 3.99 0.01 2.00 3.00 1.00 2.00 3.00 1.00
Final Sat.: 1805 5187 1615 3502 6885 24 3502 5187 1615 3502 5187 1615

Capacity Analysis Module:

Vol/Sat: 0.09 0.36 0.60 0.20 0.32 0.32 0.06 0.08 0.09 0.04 0.06 0.31
Crit Moves: **** **** **** ****
Green/Cycle: 0.18 0.58 0.58 0.19 0.60 0.60 0.06 0.12 0.12 0.05 0.11 0.30
Volume/Cap: 0.52 0.62 1.02 1.02 0.52 0.52 1.02 0.69 0.77 0.77 0.57 1.02
Delay/Veh: 38.9 13.9 55.8 80.5 11.7 11.7 114.1 45.3 59.3 66.3 43.6 81.1
User DelAdj: 1.00 1.00 1.00 1.00 1.00 1.00 1.00 1.00 1.00 1.00 1.00 1.00
AdjDel/Veh: 38.9 13.9 55.8 80.5 11.7 11.7 114.1 45.3 59.3 66.3 43.6 81.1
LOS by Move: D B E F B B F D E D F
HCM2kAvgQ: 5 13 37 17 11 11 5 5 5 2 3 20

Note: Queue reported is the number of cars per lane.

Continental Grand Campus Specific Plan
Existing PM Peak Hour (HCM)

Level of Service Computation Report
2000 HCM Operations Method (Future Volume Alternative)

Intersection #2 Sepulveda Blvd at Walnut St

Cycle (sec): 100 Critical Vol./Cap.(X): 0.541
Loss Time (sec): 5 Average Delay (sec/veh): 9.8
Optimal Cycle: 27 Level Of Service: A

Street Name: Sepulveda Blvd Walnut St

Approach: North Bound South Bound East Bound West Bound
Movement: L - T - R L - T - R L - T - R L - T - R

Control: Protected Protected Permitted Permitted
Rights: Include Include Include Include
Min. Green: 0 0 0 0 0 0 0 0 0 0 0 0
Y+R: 4.0 4.0 4.0 4.0 4.0 4.0 4.0 4.0 4.0 4.0 4.0 4.0
Lanes: 1 0 3 1 0 1 0 3 1 0 0 1 0 0 1 0 1 0 0 1

Volume Module:

Base Vol: 48 2434 29 10 2181 74 117 31 71 46 10 66
Growth Adj: 1.00 1.00 1.00 1.00 1.00 1.00 1.00 1.00 1.00 1.00 1.00 1.00
Initial Bse: 48 2440 29 10 2187 74 117 31 71 46 10 66
Added Vol: 0 0 0 0 0 0 0 0 0 0 0 0
PasserByVol: 0 0 0 0 0 0 0 0 0 0 0 0
Initial Fut: 48 2440 29 10 2187 74 117 31 71 46 10 66
User Adj: 1.00 1.00 1.00 1.00 1.00 1.00 1.00 1.00 1.00 1.00 1.00 1.00
PHF Adj: 0.92 0.92 0.92 0.92 0.92 0.92 0.92 0.92 0.92 0.92 0.92 0.92
PHF Volume: 52 2653 32 11 2377 81 128 34 77 50 11 72
Reduct Vol: 0 0 0 0 0 0 0 0 0 0 0 0
Reduced Vol: 52 2653 32 11 2377 81 128 34 77 50 11 72
PCE Adj: 1.00 1.00 1.00 1.00 1.00 1.00 1.00 1.00 1.00 1.00 1.00 1.00
MLF Adj: 1.00 1.00 1.00 1.00 1.00 1.00 1.00 1.00 1.00 1.00 1.00 1.00
FinalVolume: 52 2653 32 11 2377 81 128 34 77 50 11 72

Saturation Flow Module:

Sat/Lane: 1900 1900 1900 1900 1900 1900 1900 1900 1900 1900 1900
Adjustment: 0.95 0.91 0.91 0.95 0.91 0.91 0.71 0.71 0.85 0.69 0.69 0.85
Lanes: 1.00 3.95 0.05 1.00 3.87 0.13 0.79 0.21 1.00 0.82 0.18 1.00
Final Sat.: 1805 6821 81 1805 6656 226 1068 283 1615 1083 235 1615

Capacity Analysis Module:

Vol/Sat: 0.03 0.39 0.39 0.01 0.36 0.36 0.12 0.12 0.05 0.05 0.05 0.04
Crit Moves: **** **** **** ****
Green/Cycle: 0.05 0.72 0.72 0.01 0.67 0.67 0.22 0.22 0.22 0.22 0.22 0.22
Volume/Cap: 0.53 0.54 0.54 0.54 0.53 0.53 0.54 0.54 0.22 0.21 0.21 0.20
Delay/Veh: 51.3 6.6 6.6 75.9 8.3 8.3 36.5 36.5 32.2 32.2 32.2 32.1
User DelAdj: 1.00 1.00 1.00 1.00 1.00 1.00 1.00 1.00 1.00 1.00 1.00 1.00
AdjDel/Veh: 51.3 6.6 6.6 75.9 8.3 8.3 36.5 36.5 32.2 32.2 32.2 32.1
LOS by Move: D A A E A A D D C C C C
HCM2kAvgQ: 2 11 11 0 10 10 5 5 2 2 2 2

Note: Queue reported is the number of cars per lane.

Continental Grand Campus Specific Plan
Existing PM Peak Hour (HCM)

Level of Service Computation Report
2000 HCM Operations Method (Future Volume Alternative)

Intersection #3 Sepulveda Blvd at Maple Ave

Cycle (sec): 100 Critical Vol./Cap.(X): 0.593
Loss Time (sec): 5 Average Delay (sec/veh): 12.4
Optimal Cycle: 30 Level Of Service: B

Street Name: Sepulveda Blvd Maple Ave
Approach: North Bound South Bound East Bound West Bound
Movement: L - T - R L - T - R L - T - R L - T - R
Control: Protected Protected Permitted Permitted
Rights: Include Include Include Include
Min. Green: 0 0 0 0 0 0 0 0 0 0 0 0
Y+R: 4.0 4.0 4.0 4.0 4.0 4.0 4.0 4.0 4.0 4.0 4.0 4.0
Lanes: 1 0 3 1 0 1 0 3 1 0 1 0 0 1 0 1 1 0 1 1

Volume Module:
Base Vol: 98 2208 33 57 2439 42 68 57 37 114 102 114
Growth Adj: 1.00 1.00 1.00 1.00 1.00 1.00 1.00 1.00 1.00 1.00 1.00 1.00
Initial Bse: 98 2208 33 57 2439 42 68 57 37 114 102 114
Added Vol: 0 0 0 0 0 0 0 0 0 0 0 0
PasserByVol: 0 0 0 0 0 0 0 0 0 0 0 0
Initial Fut: 98 2208 33 57 2439 42 68 57 37 114 102 114
User Adj: 1.00 1.00 1.00 1.00 1.00 1.00 1.00 1.00 1.00 1.00 1.00 1.00
PHF Adj: 0.92 0.92 0.92 0.92 0.92 0.92 0.92 0.92 0.92 0.92 0.92 0.92
PHF Volume: 107 2400 36 62 2651 46 74 62 40 124 111 124
Reduct Vol: 0 0 0 0 0 0 0 0 0 0 0 0
Reduced Vol: 107 2400 36 62 2651 46 74 62 40 124 111 124
PCE Adj: 1.00 1.00 1.00 1.00 1.00 1.00 1.00 1.00 1.00 1.00 1.00 1.00
MLF Adj: 1.00 1.00 1.00 1.00 1.00 1.00 1.00 1.00 1.00 1.00 1.00 1.00
FinalVolume: 107 2400 36 62 2651 46 74 62 40 124 111 124

Saturation Flow Module:
Sat/Lane: 1900 1900 1900 1900 1900 1900 1900 1900 1900 1900 1900 1900
Adjustment: 0.95 0.91 0.91 0.95 0.91 0.91 0.55 0.94 0.94 0.57 1.00 0.85
Lanes: 1.00 3.94 0.06 1.00 3.93 0.07 1.00 0.61 0.39 1.00 1.00 1.00
Final Sat.: 1805 6801 102 1805 6779 117 1049 1084 704 1091 1900 1615

Capacity Analysis Module:
Vol/Sat: 0.06 0.35 0.35 0.03 0.39 0.39 0.07 0.06 0.06 0.11 0.06 0.08
Crit Moves: ****
Green/Cycle: 0.10 0.69 0.69 0.07 0.66 0.66 0.19 0.19 0.19 0.19 0.19 0.19
Volume/Cap: 0.59 0.51 0.51 0.51 0.59 0.59 0.37 0.30 0.30 0.59 0.30 0.40
Delay/Veh: 48.3 7.5 7.5 48.7 9.8 9.8 36.3 35.2 35.2 41.4 35.2 36.3
User DelAdj: 1.00 1.00 1.00 1.00 1.00 1.00 1.00 1.00 1.00 1.00 1.00 1.00
AdjDel/Veh: 48.3 7.5 7.5 48.7 9.8 9.8 36.3 35.2 35.2 41.4 35.2 36.3
LOS by Move: D A A D A A D D D D D D
HCM2kAvgQ: 4 10 10 3 13 13 2 3 3 4 3 4

Note: Queue reported is the number of cars per lane.

Continental Grand Campus Specific Plan
Existing PM Peak Hour (HCM)

Level of Service Computation Report
2000 HCM Operations Method (Future Volume Alternative)

Intersection #4 Sepulveda Blvd at Mariposa Ave

Cycle (sec): 100 Critical Vol./Cap.(X): 0.618
Loss Time (sec): 5 Average Delay (sec/veh): 19.9
Optimal Cycle: 32 Level Of Service: B

Street Name: Sepulveda Blvd Mariposa Ave
Approach: North Bound South Bound East Bound West Bound
Movement: L - T - R L - T - R L - T - R L - T - R
Control: Protected Protected Permitted Permitted
Rights: Include Include Include Include
Min. Green: 0 0 0 0 0 0 0 0 0 0 0 0
Y+R: 4.0 4.0 4.0 4.0 4.0 4.0 4.0 4.0 4.0 4.0 4.0 4.0
Lanes: 1 0 4 0 1 2 0 3 1 0 1 0 0 1 0 1 0 1 0 1

Volume Module:
Base Vol: 100 2039 133 227 2100 79 102 213 37 117 265 207
Growth Adj: 1.00 1.00 1.00 1.00 1.00 1.00 1.00 1.00 1.00 1.00 1.00 1.00
Initial Bse: 100 2044 133 228 2105 79 102 214 37 117 266 208
Added Vol: 0 0 0 0 0 0 0 0 0 0 0 0
PasserByVol: 0 0 0 0 0 0 0 0 0 0 0 0
Initial Fut: 100 2044 133 228 2105 79 102 214 37 117 266 208
User Adj: 1.00 1.00 1.00 1.00 1.00 1.00 1.00 1.00 1.00 1.00 1.00 1.00
PHF Adj: 0.92 0.92 0.92 0.92 0.92 0.92 0.92 0.92 0.92 0.92 0.92 0.92
PHF Volume: 109 2222 145 247 2289 86 111 232 40 128 289 226
Reduct Vol: 0 0 0 0 0 0 0 0 0 0 0 0
Reduced Vol: 109 2222 145 247 2289 86 111 232 40 128 289 226
PCE Adj: 1.00 1.00 1.00 1.00 1.00 1.00 1.00 1.00 1.00 1.00 1.00 1.00
MLF Adj: 1.00 1.00 1.00 1.00 1.00 1.00 1.00 1.00 1.00 1.00 1.00 1.00
FinalVolume: 109 2222 145 247 2289 86 111 232 40 128 289 226

Saturation Flow Module:
Sat/Lane: 1900 1900 1900 1900 1900 1900 1900 1900 1900 1900 1900 1900
Adjustment: 0.95 0.91 0.85 0.92 0.91 0.91 0.34 0.98 0.98 0.37 1.00 0.85
Lanes: 1.00 4.00 1.00 2.00 3.85 0.15 1.00 0.85 0.15 1.00 1.00 1.00
Final Sat.: 1805 6916 1615 3502 6632 249 656 1583 275 701 1900 1615

Capacity Analysis Module:
Vol/Sat: 0.06 0.32 0.09 0.07 0.35 0.35 0.17 0.15 0.15 0.18 0.15 0.14
Crit Moves: ****
Green/Cycle: 0.10 0.54 0.54 0.12 0.56 0.56 0.29 0.29 0.29 0.29 0.29 0.29
Volume/Cap: 0.62 0.60 0.17 0.60 0.62 0.62 0.58 0.50 0.50 0.62 0.52 0.47
Delay/Veh: 49.8 16.0 11.8 44.2 15.2 15.2 34.3 29.9 29.9 36.0 30.2 29.7
User DelAdj: 1.00 1.00 1.00 1.00 1.00 1.00 1.00 1.00 1.00 1.00 1.00 1.00
AdjDel/Veh: 49.8 16.0 11.8 44.2 15.2 15.2 34.3 29.9 29.9 36.0 30.2 29.7
LOS by Move: D B B D B B C C C D C C
HCM2kAvgQ: 3 12 2 5 14 14 4 7 7 4 8 6

Note: Queue reported is the number of cars per lane.

Continental Grand Campus Specific Plan
Existing PM Peak Hour (HCM)

Level of Service Computation Report
2000 HCM Operations Method (Future Volume Alternative)

Intersection #5 Sepulveda Blvd at Grand Ave

Cycle (sec): 100 Critical Vol./Cap.(X): 0.788
Loss Time (sec): 5 Average Delay (sec/veh): 30.0
Optimal Cycle: 52 Level Of Service: C

Street Name: Sepulveda Blvd Grand Ave

Approach: North Bound South Bound East Bound West Bound
Movement: L - T - R L - T - R L - T - R L - T - R

Control: Protected Protected Split Phase Split Phase
Rights: Ovl Include Include Include
Min. Green: 0 0 0 0 0 0 0 0 0 0 0 0
Y+R: 4.0 4.0 4.0 4.0 4.0 4.0 4.0 4.0 4.0 4.0 4.0 4.0
Lanes: 1 0 4 0 1 1 0 3 1 0 1 1 0 1 0 2 0 2 0 1

Volume Module:

Base Vol: 177 1686 177 86 1814 112 304 186 155 327 207 293
Growth Adj: 1.00 1.00 1.00 1.00 1.00 1.00 1.00 1.00 1.00 1.00 1.00 1.00
Initial Bse: 177 1690 177 86 1819 112 305 186 155 328 208 294
Added Vol: 0 0 0 0 0 0 0 0 0 0 0 0
PasserByVol: 0 0 0 0 0 0 0 0 0 0 0 0
Initial Fut: 177 1690 177 86 1819 112 305 186 155 328 208 294
User Adj: 1.00 1.00 1.00 1.00 1.00 1.00 1.00 1.00 1.00 1.00 1.00 1.00
PHF Adj: 0.92 0.92 0.92 0.92 0.92 0.92 0.92 0.92 0.92 0.92 0.92 0.92
PHF Volume: 193 1837 193 94 1977 122 331 203 169 356 226 319
Reduct Vol: 0 0 0 0 0 0 0 0 0 0 0 0
Reduced Vol: 193 1837 193 94 1977 122 331 203 169 356 226 319
PCE Adj: 1.00 1.00 1.00 1.00 1.00 1.00 1.00 1.00 1.00 1.00 1.00 1.00
MLF Adj: 1.00 1.00 1.00 1.00 1.00 1.00 1.00 1.00 1.00 1.00 1.00 1.00
FinalVolume: 193 1837 193 94 1977 122 331 203 169 356 226 319

Saturation Flow Module:

Sat/Lane: 1900 1900 1900 1900 1900 1900 1900 1900 1900 1900 1900 1900
Adjustment: 0.95 0.91 0.85 0.95 0.90 0.90 0.89 0.89 0.89 0.92 0.95 0.85
Lanes: 1.00 4.00 1.00 1.00 3.77 0.23 1.41 0.87 0.72 2.00 2.00 1.00
Final Sat.: 1805 6916 1615 1805 6455 399 2404 1471 1226 3502 3610 1615

Capacity Analysis Module:

Vol/Sat: 0.11 0.27 0.12 0.05 0.31 0.31 0.14 0.14 0.14 0.10 0.06 0.20
Crit Moves: **** **** **** ****
Green/Cycle: 0.14 0.44 0.69 0.09 0.39 0.39 0.17 0.17 0.17 0.25 0.25 0.25
Volume/Cap: 0.79 0.61 0.17 0.61 0.79 0.79 0.79 0.79 0.79 0.41 0.25 0.79
Delay/Veh: 57.4 21.8 5.6 50.8 28.6 28.6 44.2 44.2 44.2 31.5 30.1 44.9
User DelAdj: 1.00 1.00 1.00 1.00 1.00 1.00 1.00 1.00 1.00 1.00 1.00 1.00
AdjDel/Veh: 57.4 21.8 5.6 50.8 28.6 28.6 44.2 44.2 44.2 31.5 30.1 44.9
LOS by Move: E C A D C C D D D C C D
HCM2kAvgQ: 6 11 2 3 16 16 9 9 9 5 3 11

Note: Queue reported is the number of cars per lane.

Continental Grand Campus Specific Plan
Existing PM Peak Hour (HCM)

Level of Service Computation Report
2000 HCM Operations Method (Future Volume Alternative)

Intersection #6 Sepulveda Blvd at El Segundo Blvd

Cycle (sec): 100 Critical Vol./Cap.(X): 0.901
Loss Time (sec): 5 Average Delay (sec/veh): 36.0
Optimal Cycle: 90 Level Of Service: D

Street Name: Sepulveda Blvd El Segundo Blvd

Approach: North Bound South Bound East Bound West Bound
Movement: L - T - R L - T - R L - T - R L - T - R

Control: Protected Protected Protected Protected
Rights: Include Include Include Include
Min. Green: 0 0 0 0 0 0 0 0 0 0 0 0
Y+R: 4.0 4.0 4.0 4.0 4.0 4.0 4.0 4.0 4.0 4.0 4.0 4.0
Lanes: 2 0 3 1 0 2 0 4 0 1 1 0 2 0 1 2 0 2 0 1

Volume Module:

Base Vol: 318 1444 294 183 2056 112 139 651 451 412 472 243
Growth Adj: 1.00 1.00 1.00 1.00 1.00 1.00 1.00 1.00 1.00 1.00 1.00 1.00
Initial Bse: 319 1448 295 183 2061 112 139 653 452 413 473 244
Added Vol: 0 0 0 0 0 0 0 0 0 0 0 0
PasserByVol: 0 0 0 0 0 0 0 0 0 0 0 0
Initial Fut: 319 1448 295 183 2061 112 139 653 452 413 473 244
User Adj: 1.00 1.00 1.00 1.00 1.00 1.00 1.00 1.00 1.00 1.00 1.00 1.00
PHF Adj: 0.92 0.92 0.92 0.92 0.92 0.92 0.92 0.92 0.92 0.92 0.92 0.92
PHF Volume: 347 1574 320 199 2241 122 151 709 491 449 514 265
Reduct Vol: 0 0 0 0 0 0 0 0 0 0 0 0
Reduced Vol: 347 1574 320 199 2241 122 151 709 491 449 514 265
PCE Adj: 1.00 1.00 1.00 1.00 1.00 1.00 1.00 1.00 1.00 1.00 1.00 1.00
MLF Adj: 1.00 1.00 1.00 1.00 1.00 1.00 1.00 1.00 1.00 1.00 1.00 1.00
FinalVolume: 347 1574 320 199 2241 122 151 709 491 449 514 265

Saturation Flow Module:

Sat/Lane: 1900 1900 1900 1900 1900 1900 1900 1900 1900 1900 1900 1900
Adjustment: 0.92 0.89 0.89 0.92 0.91 0.85 0.95 0.95 0.85 0.92 0.95 0.85
Lanes: 2.00 3.32 0.68 2.00 4.00 1.00 1.00 2.00 1.00 2.00 2.00 1.00
Final Sat.: 3502 5602 1141 3502 6916 1615 1805 3610 1615 3502 3610 1615

Capacity Analysis Module:

Vol/Sat: 0.10 0.28 0.28 0.06 0.32 0.08 0.08 0.20 0.30 0.13 0.14 0.16
Crit Moves: **** **** **** ****
Green/Cycle: 0.11 0.39 0.39 0.08 0.36 0.36 0.16 0.34 0.34 0.14 0.32 0.32
Volume/Cap: 0.90 0.72 0.72 0.72 0.90 0.21 0.52 0.58 0.90 0.90 0.45 0.52
Delay/Veh: 67.3 26.8 26.8 53.8 35.3 22.4 39.9 28.0 49.4 61.4 27.4 28.8
User DelAdj: 1.00 1.00 1.00 1.00 1.00 1.00 1.00 1.00 1.00 1.00 1.00 1.00
AdjDel/Veh: 67.3 26.8 26.8 53.8 35.3 22.4 39.9 28.0 49.4 61.4 27.4 28.8
LOS by Move: E C C D D C D C D E C C
HCM2kAvgQ: 9 15 15 3 18 2 5 10 18 10 7 7

Note: Queue reported is the number of cars per lane.

Continental Grand Campus Specific Plan
Existing PM Peak Hour (HCM)

Level of Service Computation Report
2000 HCM Operations Method (Future Volume Alternative)

Intersection #7 Sepulveda Blvd at Rosecrans Blvd

Cycle (sec): 100 Critical Vol./Cap.(X): 0.867
Loss Time (sec): 5 Average Delay (sec/veh): 31.8
Optimal Cycle: 74 Level Of Service: C

Street Name: Sepulveda Blvd Rosecrans Blvd
Approach: North Bound South Bound East Bound West Bound
Movement: L - T - R L - T - R L - T - R L - T - R

Control: Protected Protected Protected Protected
Rights: Ovl Include Include Ignore
Min. Green: 0 0 0 0 0 0 0 0 0 0 0 0
Y+R: 4.0 4.0 4.0 4.0 4.0 4.0 4.0 4.0 4.0 4.0 4.0
Lanes: 2 0 4 0 1 2 0 3 0 1 2 0 3 0 1 2 0 2 0 1

Volume Module:
Base Vol: 310 1257 302 494 2351 519 195 483 162 376 580 462
Growth Adj: 1.00 1.00 1.00 1.00 1.00 1.00 1.00 1.00 1.00 1.00 1.00 1.00
Initial Bse: 310 1257 302 494 2351 519 195 483 162 376 580 462
Added Vol: 0 0 0 0 0 0 0 0 0 0 0 0
PasserByVol: 0 0 0 0 0 0 0 0 0 0 0 0
Initial Fut: 310 1257 302 494 2351 519 195 483 162 376 580 462
User Adj: 1.00 1.00 1.00 1.00 1.00 1.00 1.00 1.00 1.00 1.00 1.00 0.00
PHF Adj: 0.92 0.92 0.92 0.92 0.92 0.92 0.92 0.92 0.92 0.92 0.92 0.00
PHF Volume: 337 1366 328 537 2555 564 212 525 176 409 630 0
Reduct Vol: 0 0 0 0 0 0 0 0 0 0 0 0
Reduced Vol: 337 1366 328 537 2555 564 212 525 176 409 630 0
PCE Adj: 1.00 1.00 1.00 1.00 1.00 1.00 1.00 1.00 1.00 1.00 1.00 0.00
MLF Adj: 1.00 1.00 1.00 1.00 1.00 1.00 1.00 1.00 1.00 1.00 1.00 0.00
FinalVolume: 337 1366 328 537 2555 564 212 525 176 409 630 0

Saturation Flow Module:
Sat/Lane: 1900 1900 1900 1900 1900 1900 1900 1900 1900 1900 1900 1900
Adjustment: 0.92 0.91 0.85 0.92 0.91 0.85 0.92 0.91 0.85 0.92 0.95 1.00
Lanes: 2.00 4.00 1.00 2.00 3.00 1.00 2.00 3.00 1.00 2.00 2.00 1.00
Final Sat.: 3502 6916 1615 3502 5187 1615 3502 5187 1615 3502 3610 1900

Capacity Analysis Module:
Vol/Sat: 0.10 0.20 0.20 0.15 0.49 0.35 0.06 0.10 0.11 0.12 0.17 0.00
Crit Moves: ****
Green/Cycle: 0.11 0.38 0.52 0.30 0.57 0.57 0.07 0.13 0.13 0.14 0.20 0.00
Volume/Cap: 0.87 0.52 0.39 0.52 0.87 0.62 0.87 0.77 0.83 0.83 0.87 0.00
Delay/Veh: 62.0 24.0 14.6 29.7 21.4 15.6 72.4 47.5 66.0 53.4 49.5 0.0
User DelAdj: 1.00 1.00 1.00 1.00 1.00 1.00 1.00 1.00 1.00 1.00 1.00 1.00
AdjDel/Veh: 62.0 24.0 14.6 29.7 21.4 15.6 72.4 47.5 66.0 53.4 49.5 0.0
LOS by Move: E C B C C B E D E D D A
HCM2kAvgQ: 8 9 6 7 27 12 6 8 8 9 13 0

Note: Queue reported is the number of cars per lane.

Continental Grand Campus Specific Plan
Existing PM Peak Hour (HCM)

Level of Service Computation Report
2000 HCM Operations Method (Future Volume Alternative)

Intersection #8 Continental Boulevard at Mariposa Ave

Cycle (sec): 100 Critical Vol./Cap.(X): 0.278
Loss Time (sec): 5 Average Delay (sec/veh): 16.2
Optimal Cycle: 18 Level Of Service: B

Street Name: Continental Boulevard Mariposa Avenue
Approach: North Bound South Bound East Bound West Bound
Movement: L - T - R L - T - R L - T - R L - T - R

Control: Permitted Permitted Permitted Permitted
Rights: Include Include Include Include
Min. Green: 0 0 0 0 0 0 0 0 0 0 0 0
Y+R: 4.0 4.0 4.0 4.0 4.0 4.0 4.0 4.0 4.0 4.0 4.0 4.0
Lanes: 1 0 1 0 2 1 0 0 1 0 1 0 2 1 0 1 0 1 1 0

Volume Module:
Base Vol: 176 85 306 9 56 28 11 514 49 58 342 10
Growth Adj: 1.00 1.00 1.00 1.00 1.00 1.00 1.00 1.00 1.00 1.00 1.00 1.00
Initial Bse: 176 85 306 9 56 28 11 514 49 58 342 10
Added Vol: 0 0 0 0 0 0 0 0 0 0 0 0
PasserByVol: 0 0 0 0 0 0 0 0 0 0 0 0
Initial Fut: 176 85 306 9 56 28 11 514 49 58 342 10
User Adj: 1.00 1.00 1.00 1.00 1.00 1.00 1.00 1.00 1.00 1.00 1.00 1.00
PHF Adj: 0.92 0.92 0.92 0.92 0.92 0.92 0.92 0.92 0.92 0.92 0.92 0.00
PHF Volume: 191 92 333 10 61 30 12 559 53 63 372 11
Reduct Vol: 0 0 0 0 0 0 0 0 0 0 0 0
Reduced Vol: 191 92 333 10 61 30 12 559 53 63 372 11
PCE Adj: 1.00 1.00 1.00 1.00 1.00 1.00 1.00 1.00 1.00 1.00 1.00 1.00
MLF Adj: 1.00 1.00 1.00 1.00 1.00 1.00 1.00 1.00 1.00 1.00 1.00 1.00
FinalVolume: 191 92 333 10 61 30 12 559 53 63 372 11

Saturation Flow Module:
Sat/Lane: 1900 1900 1900 1900 1900 1900 1900 1900 1900 1900 1900 1900
Adjustment: 0.69 1.00 0.75 0.69 0.95 0.95 0.45 0.90 0.90 0.36 0.95 0.95
Lanes: 1.00 1.00 2.00 1.00 0.67 0.33 1.00 2.74 0.26 1.00 1.94 0.06
Final Sat.: 1321 1900 2842 1319 1203 602 863 4674 446 692 3493 102

Capacity Analysis Module:
Vol/Sat: 0.14 0.05 0.12 0.01 0.05 0.05 0.01 0.12 0.12 0.09 0.11 0.11
Crit Moves: ****
Green/Cycle: 0.52 0.52 0.52 0.52 0.52 0.52 0.43 0.43 0.43 0.43 0.43 0.43
Volume/Cap: 0.28 0.09 0.22 0.01 0.10 0.10 0.03 0.28 0.28 0.21 0.25 0.25
Delay/Veh: 13.7 12.1 13.1 11.6 12.2 12.2 16.5 18.6 18.6 18.3 18.3 18.3
User DelAdj: 1.00 1.00 1.00 1.00 1.00 1.00 1.00 1.00 1.00 1.00 1.00 1.00
AdjDel/Veh: 13.7 12.1 13.1 11.6 12.2 12.2 16.5 18.6 18.6 18.3 18.3 18.3
LOS by Move: B B B B B B B B B B B B
HCM2kAvgQ: 3 1 3 0 1 1 0 4 4 1 4 4

Note: Queue reported is the number of cars per lane.

Continental Grand Campus Specific Plan Existing PM Peak Hour (HCM)

Level of Service Computation Report 2000 HCM Operations Method (Future Volume Alternative)

Intersection #9 Continental Boulevard at Grand Avenue

Cycle (sec): 100 Critical Vol./Cap.(X): 0.272
Loss Time (sec): 5 Average Delay (sec/veh): 18.3
Optimal Cycle: 18 Level Of Service: B

Table with columns for Street Name, Approach, Movement, Control, Rights, Min. Green, Y+R, Lanes. Rows for Continental Boulevard and Grand Avenue.

Table with columns for Volume Module, Base Vol, Growth Adj, Initial Bse, Added Vol, PasserByVol, Initial Fut, User Adj, PHF Adj, PHF Volume, Reduct Vol, Reduced Vol, PCE Adj, MLF Adj, FinalVolume.

Table with columns for Sat/Lane, Adjustment, Lanes, Final Sat. for Saturation Flow Module.

Table with columns for Vol/Sat, Crit Moves, Green/Cycle, Volume/Cap, Delay/Veh, User DelAdj, AdjDel/Veh, LOS by Move, HCM2kAvgQ for Capacity Analysis Module.

Note: Queue reported is the number of cars per lane.

Continental Grand Campus Specific Plan Existing PM Peak Hour (HCM)

Level of Service Computation Report 2000 HCM Operations Method (Future Volume Alternative)

Intersection #10 Continental Boulevard at El Segundo Boulevard

Cycle (sec): 100 Critical Vol./Cap.(X): 0.394
Loss Time (sec): 5 Average Delay (sec/veh): 19.6
Optimal Cycle: 21 Level Of Service: B

Table with columns for Street Name, Approach, Movement, Control, Rights, Min. Green, Y+R, Lanes. Rows for Continental Boulevard and El Segundo Boulevard.

Table with columns for Volume Module, Base Vol, Growth Adj, Initial Bse, Added Vol, PasserByVol, Initial Fut, User Adj, PHF Adj, PHF Volume, Reduct Vol, Reduced Vol, PCE Adj, MLF Adj, FinalVolume.

Table with columns for Sat/Lane, Adjustment, Lanes, Final Sat. for Saturation Flow Module.

Table with columns for Vol/Sat, Crit Moves, Green/Cycle, Volume/Cap, Delay/Veh, User DelAdj, AdjDel/Veh, LOS by Move, HCM2kAvgQ for Capacity Analysis Module.

Note: Queue reported is the number of cars per lane.

Continental Grand Campus Specific Plan
Existing PM Peak Hour (HCM)

Level of Service Computation Report
2000 HCM Operations Method (Future Volume Alternative)

Intersection #11 Nash St and Imperial Hwy
Cycle (sec): 100 Critical Vol./Cap.(X): 0.468
Loss Time (sec): 5 Average Delay (sec/veh): 19.4
Optimal Cycle: 23 Level Of Service: B

Table with columns for Street Name (Nash St, Imperial Hwy), Approach (North Bound, South Bound, East Bound, West Bound), Movement (L, T, R), Control (Split Phase, Protected), Rights (Include), Min. Green, Y+R, Lanes.

Table with columns for Volume Module (Base Vol, Growth Adj, Initial Bse, Added Vol, PasserByVol, Initial Fut, User Adj, PHF Adj, PHF Volume, Reduct Vol, Reduced Vol, PCE Adj, MLF Adj, FinalVolume).

Table with columns for Saturation Flow Module (Sat/Lane, Adjustment, Lanes, Final Sat).

Table with columns for Capacity Analysis Module (Vol/Sat, Crit Moves, Green/Cycle, Volume/Cap, Delay/Veh, User DelAdj, AdjDel/Veh, LOS by Move, HCM2kAvgQ).

Note: Queue reported is the number of cars per lane.

Continental Grand Campus Specific Plan
Existing PM Peak Hour (HCM)

Level of Service Computation Report
2000 HCM Operations Method (Future Volume Alternative)

Intersection #12 Nash St at Mariposa Ave
Cycle (sec): 100 Critical Vol./Cap.(X): 0.525
Loss Time (sec): 5 Average Delay (sec/veh): 17.2
Optimal Cycle: 26 Level Of Service: B

Table with columns for Street Name (Nash St, Mariposa Ave), Approach (North Bound, South Bound, East Bound, West Bound), Movement (L, T, R), Control (Permitted), Rights (Include), Min. Green, Y+R, Lanes.

Table with columns for Volume Module (Base Vol, Growth Adj, Initial Bse, Added Vol, PasserByVol, Initial Fut, User Adj, PHF Adj, PHF Volume, Reduct Vol, Reduced Vol, PCE Adj, MLF Adj, FinalVolume).

Table with columns for Saturation Flow Module (Sat/Lane, Adjustment, Lanes, Final Sat).

Table with columns for Capacity Analysis Module (Vol/Sat, Crit Moves, Green/Cycle, Volume/Cap, Delay/Veh, User DelAdj, AdjDel/Veh, LOS by Move, HCM2kAvgQ).

Note: Queue reported is the number of cars per lane.

Continental Grand Campus Specific Plan
Existing PM Peak Hour (HCM)

Level of Service Computation Report
2000 HCM Operations Method (Future Volume Alternative)

Intersection #13 Nash St at Grand Ave

Cycle (sec): 100 Critical Vol./Cap.(X): 0.493
Loss Time (sec): 5 Average Delay (sec/veh): 22.6
Optimal Cycle: 24 Level Of Service: C

Street Name: Nash St Grand Ave

Approach: North Bound South Bound East Bound West Bound
Movement: L - T - R L - T - R L - T - R L - T - R

Control: Protected Protected Split Phase Split Phase
Rights: Include Include Include Include
Min. Green: 0 0 0 0 0 0 0 0 0 0 0 0
Y+R: 4.0 4.0 4.0 4.0 4.0 4.0 4.0 4.0 4.0 4.0 4.0 4.0
Lanes: 1 0 1 1 0 1 0 1 1 0 2 1 0 0 1 0

Volume Module:
Base Vol: 24 174 30 50 203 151 489 109 336 41 35 38
Growth Adj: 1.00 1.00 1.00 1.00 1.00 1.00 1.00 1.00 1.00 1.00 1.00 1.00
Initial Bse: 24 174 30 50 203 151 489 109 336 41 35 38
Added Vol: 0 0 0 0 0 0 0 0 0 0 0 0
PasserByVol: 0 0 0 0 0 0 0 0 0 0 0 0
Initial Fut: 24 174 30 50 203 151 489 109 336 41 35 38
User Adj: 1.00 1.00 1.00 1.00 1.00 1.00 1.00 1.00 1.00 1.00 1.00 1.00
PHF Adj: 0.92 0.92 0.92 0.92 0.92 0.92 0.92 0.92 0.92 0.92 0.92 0.92
PHF Volume: 26 189 33 54 221 164 532 118 365 45 38 41
Reduct Vol: 0 0 0 0 0 0 0 0 0 0 0 0
Reduced Vol: 26 189 33 54 221 164 532 118 365 45 38 41
PCE Adj: 1.00 1.00 1.00 1.00 1.00 1.00 1.00 1.00 1.00 1.00 1.00 1.00
MLF Adj: 1.00 1.00 1.00 1.00 1.00 1.00 1.00 1.00 1.00 1.00 1.00 1.00
FinalVolume: 26 189 33 54 221 164 532 118 365 45 38 41

Saturation Flow Module:
Sat/Lane: 1900 1900 1900 1900 1900 1900 1900 1900 1900 1900 1900 1900
Adjustment: 0.95 0.93 0.93 0.95 0.89 0.89 0.95 1.00 0.75 0.95 0.92 0.92
Lanes: 1.00 1.71 0.29 1.00 1.15 0.85 1.00 1.00 2.00 1.00 0.48 0.52
Final Sat.: 1805 3011 519 1805 1938 1441 1805 1900 2842 1805 840 912

Capacity Analysis Module:
Vol/Sat: 0.01 0.06 0.06 0.03 0.11 0.11 0.29 0.06 0.13 0.02 0.05 0.05
Crit Moves: ****
Green/Cycle: 0.03 0.18 0.18 0.08 0.23 0.23 0.60 0.60 0.60 0.09 0.09 0.09
Volume/Cap: 0.49 0.36 0.36 0.36 0.49 0.49 0.49 0.10 0.21 0.27 0.49 0.49
Delay/Veh: 54.8 36.6 36.6 44.7 33.8 33.8 11.8 8.7 9.4 43.1 45.6 45.6
User DelAdj: 1.00 1.00 1.00 1.00 1.00 1.00 1.00 1.00 1.00 1.00 1.00 1.00
AdjDel/Veh: 54.8 36.6 36.6 44.7 33.8 33.8 11.8 8.7 9.4 43.1 45.6 45.6
LOS by Move: D D D D C C B A A D D D
HCM2kAvgQ: 1 3 3 2 6 6 9 2 3 2 3 3

Note: Queue reported is the number of cars per lane.

Continental Grand Campus Specific Plan
Existing PM Peak Hour (HCM)

Level of Service Computation Report
2000 HCM Operations Method (Future Volume Alternative)

Intersection #14 Nash St at El Segundo Blvd

Cycle (sec): 100 Critical Vol./Cap.(X): 0.528
Loss Time (sec): 5 Average Delay (sec/veh): 19.7
Optimal Cycle: 26 Level Of Service: B

Street Name: Nash St El Segundo Blvd

Approach: North Bound South Bound East Bound West Bound
Movement: L - T - R L - T - R L - T - R L - T - R

Control: Split Phase Split Phase Protected Protected
Rights: Ovl Include Include Include
Min. Green: 0 0 0 0 0 0 0 0 0 0 0 0
Y+R: 4.0 4.0 4.0 4.0 4.0 4.0 4.0 4.0 4.0 4.0 4.0 4.0
Lanes: 2 0 0 1 1 1 1 1 0 1 2 0 3 0 1 2 0 2 1 0

Volume Module:
Base Vol: 17 37 141 446 24 59 59 1412 11 23 712 87
Growth Adj: 1.00 1.00 1.00 1.00 1.00 1.00 1.00 1.00 1.00 1.00 1.00 1.00
Initial Bse: 17 37 141 446 24 59 59 1412 11 23 712 87
Added Vol: 0 0 0 0 0 0 0 0 0 0 0 0
PasserByVol: 0 0 0 0 0 0 0 0 0 0 0 0
Initial Fut: 17 37 141 446 24 59 59 1412 11 23 712 87
User Adj: 1.00 1.00 1.00 1.00 1.00 1.00 1.00 1.00 1.00 1.00 1.00 1.00
PHF Adj: 0.92 0.92 0.92 0.92 0.92 0.92 0.92 0.92 0.92 0.92 0.92 0.92
PHF Volume: 18 40 153 485 26 64 64 1535 12 25 774 95
Reduct Vol: 0 0 0 0 0 0 0 0 0 0 0 0
Reduced Vol: 18 40 153 485 26 64 64 1535 12 25 774 95
PCE Adj: 1.00 1.00 1.00 1.00 1.00 1.00 1.00 1.00 1.00 1.00 1.00 1.00
MLF Adj: 1.00 1.00 1.00 1.00 1.00 1.00 1.00 1.00 1.00 1.00 1.00 1.00
FinalVolume: 18 40 153 485 26 64 64 1535 12 25 774 95

Saturation Flow Module:
Sat/Lane: 1900 1900 1900 1900 1900 1900 1900 1900 1900 1900 1900 1900
Adjustment: 0.92 0.88 0.88 0.91 0.91 0.85 0.92 0.91 0.85 0.92 0.90 0.90
Lanes: 2.00 0.42 1.58 2.00 1.00 1.00 2.00 3.00 1.00 2.00 2.67 0.33
Final Sat.: 3502 696 2652 3448 1724 1615 3502 5187 1615 3502 4548 556

Capacity Analysis Module:
Vol/Sat: 0.01 0.06 0.06 0.14 0.02 0.04 0.02 0.30 0.01 0.01 0.17 0.17
Crit Moves: ****
Green/Cycle: 0.11 0.11 0.12 0.27 0.27 0.27 0.06 0.56 0.56 0.01 0.52 0.52
Volume/Cap: 0.05 0.53 0.47 0.53 0.06 0.15 0.33 0.53 0.01 0.53 0.33 0.33
Delay/Veh: 39.9 43.5 41.7 31.9 27.3 28.2 46.4 13.9 9.7 59.7 14.1 14.1
User DelAdj: 1.00 1.00 1.00 1.00 1.00 1.00 1.00 1.00 1.00 1.00 1.00 1.00
AdjDel/Veh: 39.9 43.5 41.7 31.9 27.3 28.2 46.4 13.9 9.7 59.7 14.1 14.1
LOS by Move: D D D C C C D B A E B B
HCM2kAvgQ: 0 4 3 7 1 1 1 11 0 1 6 6

Note: Queue reported is the number of cars per lane.

Continental Grand Campus Specific Plan
Existing PM Peak Hour (HCM)

Level of Service Computation Report
2000 HCM Operations Method (Future Volume Alternative)

Intersection #15 Douglas Street at El Segundo Boulevard

Cycle (sec): 100 Critical Vol./Cap.(X): 0.874
Loss Time (sec): 5 Average Delay (sec/veh): 33.1
Optimal Cycle: 77 Level Of Service: C

Street Name: Douglas St El Segundo Blvd

Table with columns for Street Name, Approach (North Bound, South Bound, East Bound, West Bound), Movement (L, T, R), Control, Rights, Min. Green, Y+R, and Lanes.

Volume Module:

Table with columns for Base Vol, Growth Adj, Initial Bse, Added Vol, PasserByVol, Initial Fut, User Adj, PHF Adj, PHF Volume, Reduct Vol, Reduced Vol, PCE Adj, MLF Adj, and FinalVolume.

Saturation Flow Module:

Table with columns for Sat/Lane, Adjustment, Lanes, and Final Sat.

Capacity Analysis Module:

Table with columns for Vol/Sat, Crit Moves, Green/Cycle, Volume/Cap, Delay/Veh, User DelAdj, AdjDel/Veh, LOS by Move, and HCM2kAvgQ.

Note: Queue reported is the number of cars per lane.

Continental Grand Campus Specific Plan
Existing PM Peak Hour (HCM)

Level of Service Computation Report
2000 HCM Operations Method (Future Volume Alternative)

Intersection #16 Aviation Boulevard at El Segundo Boulevard

Cycle (sec): 100 Critical Vol./Cap.(X): 0.941
Loss Time (sec): 5 Average Delay (sec/veh): 39.6
Optimal Cycle: 123 Level Of Service: D

Street Name: Aviation Blvd El Segundo Blvd

Table with columns for Street Name, Approach (North Bound, South Bound, East Bound, West Bound), Movement (L, T, R), Control, Rights, Min. Green, Y+R, and Lanes.

Volume Module:

Table with columns for Base Vol, Growth Adj, Initial Bse, Added Vol, PasserByVol, Initial Fut, User Adj, PHF Adj, PHF Volume, Reduct Vol, Reduced Vol, PCE Adj, MLF Adj, and FinalVolume.

Saturation Flow Module:

Table with columns for Sat/Lane, Adjustment, Lanes, and Final Sat.

Capacity Analysis Module:

Table with columns for Vol/Sat, Crit Moves, Green/Cycle, Volume/Cap, Delay/Veh, User DelAdj, AdjDel/Veh, LOS by Move, and HCM2kAvgQ.

Note: Queue reported is the number of cars per lane.

Continental Grand Campus Specific Plan
Existing PM Peak Hour (HCM)

Level of Service Computation Report

ICU 1(Loss as Cycle Length %) Method (Future Volume Alternative)

Intersection #17 El Segundo Boulevard and Isis Avenue

Cycle (sec): 100 Critical Vol./Cap.(X): 0.683
Loss Time (sec): 5 Average Delay (sec/veh): xxxxxx
Optimal Cycle: 35 Level Of Service: B

Street Name: Isis Avenue El Segundo Boulevard
Approach: North Bound South Bound East Bound West Bound
Movement: L - T - R L - T - R L - T - R L - T - R
Control: Permitted Permitted Protected Protected
Rights: Include Include Include Include
Min. Green: 0 0 0 0 0 0 0 0 0 0 0 0
Y+R: 4.0 4.0 4.0 4.0 4.0 4.0 4.0 4.0 4.0 4.0 4.0
Lanes: 0 0 1 0 0 0 0 1 0 0 1 1 0 2 1 0

Volume Module:
Base Vol: 35 6 27 138 11 57 74 2405 45 89 1099 77
Growth Adj: 1.00 1.00 1.00 1.00 1.00 1.00 1.00 1.00 1.00 1.00 1.00 1.00
Initial Bse: 35 6 27 138 11 57 74 2405 45 89 1099 77
Added Vol: 0 0 0 0 0 0 0 0 0 0 0 0
PasserByVol: 0 0 0 0 0 0 0 0 0 0 0 0
Initial Fut: 35 6 27 138 11 57 74 2405 45 89 1099 77
User Adj: 1.00 1.00 1.00 1.00 1.00 1.00 1.00 1.00 1.00 1.00 1.00
PHF Adj: 0.92 0.92 0.92 0.92 0.92 0.92 0.92 0.92 0.92 0.92 0.92
PHF Volume: 38 7 29 150 12 62 80 2614 49 97 1195 84
Reduct Vol: 0 0 0 0 0 0 0 0 0 0 0 0
Reduced Vol: 38 7 29 150 12 62 80 2614 49 97 1195 84
PCE Adj: 1.00 1.00 1.00 1.00 1.00 1.00 1.00 1.00 1.00 1.00 1.00
MLF Adj: 1.00 1.00 1.00 1.00 1.00 1.00 1.00 1.00 1.00 1.00 1.00
FinalVolume: 38 7 29 150 12 62 80 2614 49 97 1195 84

Saturation Flow Module:
Sat/Lane: 1600 1600 1600 1600 1600 1600 1600 1600 1600 1600 1600
Adjustment: 1.00 1.00 1.00 1.00 1.00 1.00 1.00 1.00 1.00 1.00 1.00
Lanes: 0.51 0.09 0.40 0.67 0.05 0.28 1.00 4.00 1.00 1.00 2.80 0.20
Final Sat.: 824 141 635 1072 85 443 1600 6400 1600 1600 4486 314

Capacity Analysis Module:
Vol/Sat: 0.02 0.05 0.05 0.09 0.14 0.14 0.05 0.41 0.03 0.06 0.27 0.27
Crit Moves: ****

Continental Grand Campus Specific Plan
Existing PM Peak Hour (HCM)

Level of Service Computation Report

2000 HCM Operations Method (Future Volume Alternative)

Intersection #18 El Segundo Blvd at I-405 SB Ramps

Cycle (sec): 100 Critical Vol./Cap.(X): 1.048
Loss Time (sec): 5 Average Delay (sec/veh): 26.8
Optimal Cycle: 180 Level Of Service: C

Street Name: I-405 SB Ramps El Segundo Blvd
Approach: North Bound South Bound East Bound West Bound
Movement: L - T - R L - T - R L - T - R L - T - R
Control: Permitted Permitted Permitted Permitted
Rights: Include Include Include Include
Min. Green: 0 0 0 0 0 0 0 0 0 0 0 0
Y+R: 4.0 4.0 4.0 4.0 4.0 4.0 4.0 4.0 4.0 4.0 4.0
Lanes: 1 0 1 0 0 0 0 0 0 0 0 0 3 0 1 0 0 3 0 0

Volume Module:
Base Vol: 239 0 269 0 0 0 0 1491 1049 0 1062 0
Growth Adj: 1.00 1.00 1.00 1.00 1.00 1.00 1.00 1.00 1.00 1.00 1.00 1.00
Initial Bse: 239 0 269 0 0 0 0 1491 1049 0 1062 0
Added Vol: 0 0 0 0 0 0 0 0 0 0 0 0
PasserByVol: 0 0 0 0 0 0 0 0 0 0 0 0
Initial Fut: 239 0 269 0 0 0 0 1491 1049 0 1062 0
User Adj: 1.00 1.00 1.00 1.00 1.00 1.00 1.00 1.00 1.00 1.00 1.00 1.00
PHF Adj: 0.92 0.92 0.92 0.92 0.92 0.92 0.92 0.92 0.92 0.92 0.92 0.92
PHF Volume: 260 0 292 0 0 0 0 1621 1140 0 1154 0
Reduct Vol: 0 0 0 0 0 0 0 0 0 0 0 0
Reduced Vol: 260 0 292 0 0 0 0 1621 1140 0 1154 0
PCE Adj: 1.00 1.00 1.00 1.00 1.00 1.00 1.00 1.00 1.00 1.00 1.00 1.00
MLF Adj: 1.00 1.00 1.00 1.00 1.00 1.00 1.00 1.00 1.00 1.00 1.00 1.00
FinalVolume: 260 0 292 0 0 0 0 1621 1140 0 1154 0

Saturation Flow Module:
Sat/Lane: 1900 1900 1900 1900 1900 1900 1900 1900 1900 1900 1900
Adjustment: 0.75 1.00 0.78 1.00 1.00 1.00 1.00 0.91 0.85 1.00 0.91 1.00
Lanes: 1.32 0.00 0.68 0.00 0.00 0.00 0.00 3.00 1.00 0.00 3.00 0.00
Final Sat.: 1867 0 1008 0 0 0 0 5187 1615 0 5187 0

Capacity Analysis Module:
Vol/Sat: 0.14 0.00 0.29 0.00 0.00 0.00 0.00 0.31 0.71 0.00 0.22 0.00
Crit Moves: ****

Green/Cycle: 0.28 0.00 0.28 0.00 0.00 0.00 0.00 0.67 0.67 0.00 0.67 0.00
Volume/Cap: 0.50 0.00 1.05 0.00 0.00 0.00 0.00 0.46 1.05 0.00 0.33 0.00
Delay/Veh: 30.8 0.0 88.7 0.0 0.0 0.0 0.0 7.9 57.2 0.0 6.9 0.0
User DelAdj: 1.00 1.00 1.00 1.00 1.00 1.00 1.00 1.00 1.00 1.00 1.00 1.00
AdjDel/Veh: 30.8 0.0 88.7 0.0 0.0 0.0 0.0 7.9 57.2 0.0 6.9 0.0
LOS by Move: C A F A A A A A E A A A
HCM2kAvgQ: 6 0 21 0 0 0 0 8 44 0 5 0

Note: Queue reported is the number of cars per lane.

Continental Grand Campus Specific Plan
Existing PM Peak Hour (HCM)

Level of Service Computation Report
2000 HCM Operations Method (Future Volume Alternative)

Intersection #19 El Segundo Blvd at La Cienega Blvd

Cycle (sec): 100 Critical Vol./Cap.(X): 0.671
Loss Time (sec): 5 Average Delay (sec/veh): 20.4
Optimal Cycle: 36 Level Of Service: C

Street Name: La Cienega Blvd El Segundo Blvd
Approach: North Bound South Bound East Bound West Bound
Movement: L - T - R L - T - R L - T - R L - T - R

Control: Protected Protected Protected Protected
Rights: Include Include Include Include
Min. Green: 0 0 0 0 0 0 0 0 0 0 0 0
Y+R: 4.0 4.0 4.0 4.0 4.0 4.0 4.0 4.0 4.0 4.0 4.0
Lanes: 0 0 0 0 0 2 0 0 0 2 1 0 3 0 0 0 0 0 2 1 0

Volume Module:
Base Vol: 0 0 0 665 0 653 101 1849 0 0 614 206
Growth Adj: 1.00 1.00 1.00 1.00 1.00 1.00 1.00 1.00 1.00 1.00 1.00 1.00
Initial Bse: 0 0 0 665 0 653 101 1849 0 0 614 206
Added Vol: 0 0 0 0 0 0 0 0 0 0 0 0
PasserByVol: 0 0 0 0 0 0 0 0 0 0 0 0
Initial Fut: 0 0 0 665 0 653 101 1849 0 0 614 206
User Adj: 1.00 1.00 1.00 1.00 1.00 1.00 1.00 1.00 1.00 1.00 1.00 1.00
PHF Adj: 0.92 0.92 0.92 0.92 0.92 0.92 0.92 0.92 0.92 0.92 0.92 0.92
PHF Volume: 0 0 0 723 0 710 110 2010 0 0 667 224
Reduct Vol: 0 0 0 0 0 0 0 0 0 0 0 0
Reduced Vol: 0 0 0 723 0 710 110 2010 0 0 667 224
PCE Adj: 1.00 1.00 1.00 1.00 1.00 1.00 1.00 1.00 1.00 1.00 1.00 1.00
MLF Adj: 1.00 1.00 1.00 1.00 1.00 1.00 1.00 1.00 1.00 1.00 1.00 1.00
FinalVolume: 0 0 0 723 0 710 110 2010 0 0 667 224

Saturation Flow Module:
Sat/Lane: 1900 1900 1900 1900 1900 1900 1900 1900 1900 1900 1900 1900
Adjustment: 1.00 1.00 1.00 0.92 1.00 0.75 0.95 0.91 1.00 1.00 0.88 0.88
Lanes: 0.00 0.00 0.00 2.00 0.00 2.00 1.00 3.00 0.00 0.00 2.25 0.75
Final Sat.: 0 0 0 3502 0 2842 1805 5187 0 0 3736 1254

Capacity Analysis Module:
Vol/Sat: 0.00 0.00 0.00 0.21 0.00 0.25 0.06 0.39 0.00 0.00 0.18 0.18
Crit Moves: ****
Green/Cycle: 0.00 0.00 0.00 0.37 0.00 0.37 0.15 0.58 0.00 0.00 0.43 0.43
Volume/Cap: 0.00 0.00 0.00 0.55 0.00 0.67 0.41 0.67 0.00 0.00 0.41 0.41
Delay/Veh: 0.0 0.0 0.0 25.4 0.0 27.9 39.8 15.2 0.0 0.0 19.8 19.8
User DelAdj: 1.00 1.00 1.00 1.00 1.00 1.00 1.00 1.00 1.00 1.00 1.00 1.00
AdjDel/Veh: 0.0 0.0 0.0 25.4 0.0 27.9 39.8 15.2 0.0 0.0 19.8 19.8
LOS by Move: A A A C A C D B A A B B
HCM2kAvgQ: 0 0 0 9 0 11 3 15 0 0 7 7

Note: Queue reported is the number of cars per lane.

Continental Grand Campus Specific Plan
Existing PM Peak Hour (HCM)

Level of Service Computation Report
2000 HCM Operations Method (Future Volume Alternative)

Intersection #20 El Segundo Blvd at I-405 NB Ramps

Cycle (sec): 100 Critical Vol./Cap.(X): 0.679
Loss Time (sec): 5 Average Delay (sec/veh): 11.7
Optimal Cycle: 37 Level Of Service: B

Street Name: I-405 NB Ramps El Segundo Blvd
Approach: North Bound South Bound East Bound West Bound
Movement: L - T - R L - T - R L - T - R L - T - R

Control: Protected Protected Protected Protected
Rights: Include Include Ignore Include
Min. Green: 0 0 0 0 0 0 0 0 0 0 0 0
Y+R: 4.0 4.0 4.0 4.0 4.0 4.0 4.0 4.0 4.0 4.0 4.0 4.0
Lanes: 2 0 0 0 1 0 0 0 0 0 0 0 0 2 1 1 0 0 2 1 0

Volume Module:
Base Vol: 373 0 222 0 0 0 0 2365 176 0 447 410
Growth Adj: 1.00 1.00 1.00 1.00 1.00 1.00 1.00 1.00 1.00 1.00 1.00 1.00
Initial Bse: 373 0 222 0 0 0 0 2365 176 0 447 410
Added Vol: 0 0 0 0 0 0 0 0 0 0 0 0
PasserByVol: 0 0 0 0 0 0 0 0 0 0 0 0
Initial Fut: 373 0 222 0 0 0 0 2365 176 0 447 410
User Adj: 1.00 1.00 1.00 1.00 1.00 1.00 1.00 1.00 0.00 1.00 1.00 1.00
PHF Adj: 0.92 0.92 0.92 0.92 0.92 0.92 0.92 0.92 0.00 0.92 0.92 0.92
PHF Volume: 405 0 241 0 0 0 0 2571 0 0 486 446
Reduct Vol: 0 0 0 0 0 0 0 0 0 0 0 0
Reduced Vol: 405 0 241 0 0 0 0 2571 0 0 486 446
PCE Adj: 1.00 1.00 1.00 1.00 1.00 1.00 1.00 1.00 0.00 1.00 1.00 1.00
MLF Adj: 1.00 1.00 1.00 1.00 1.00 1.00 1.00 1.00 0.00 1.00 1.00 1.00
FinalVolume: 405 0 241 0 0 0 0 2571 0 0 486 446

Saturation Flow Module:
Sat/Lane: 1900 1900 1900 1900 1900 1900 1900 1900 1900 1900 1900 1900
Adjustment: 0.92 1.00 0.85 1.00 1.00 1.00 1.00 0.91 0.91 1.00 0.84 0.84
Lanes: 2.00 0.00 1.00 0.00 0.00 0.00 0.00 3.00 1.00 0.00 2.00 1.00
Final Sat.: 3502 0 1615 0 0 0 0 5187 1729 0 3209 1605

Capacity Analysis Module:
Vol/Sat: 0.12 0.00 0.15 0.00 0.00 0.00 0.00 0.50 0.00 0.00 0.15 0.28
Crit Moves: ****
Green/Cycle: 0.22 0.00 0.22 0.00 0.00 0.00 0.00 0.73 0.00 0.00 0.73 0.73
Volume/Cap: 0.53 0.00 0.68 0.00 0.00 0.00 0.00 0.68 0.00 0.00 0.21 0.38
Delay/Veh: 35.1 0.0 41.0 0.0 0.0 0.0 0.0 7.7 0.0 0.0 4.3 5.1
User DelAdj: 1.00 1.00 1.00 1.00 1.00 1.00 1.00 1.00 1.00 1.00 1.00 1.00
AdjDel/Veh: 35.1 0.0 41.0 0.0 0.0 0.0 0.0 7.7 0.0 0.0 4.3 5.1
LOS by Move: D A D A A A A A A A A A
HCM2kAvgQ: 6 0 8 0 0 0 0 15 0 0 3 6

Note: Queue reported is the number of cars per lane.

 Continental Grand Campus Specific Plan
 Existing With Project AM Peak Hour (HCM)

Scenario Report

Scenario: Ex With Proj AM HCM
 Command: Ex With Proj AM HCM
 Volume: Ex AM
 Geometry: Existing
 Impact Fee: Default Impact Fee
 Trip Generation: Proj AM
 Trip Distribution: Project
 Paths: Project
 Routes: Default Route
 Configuration: Ex With Proj AM HCM

 Continental Grand Campus Specific Plan
 Existing With Project AM Peak Hour (HCM)

Trip Generation Report

Forecast for Proj AM

Zone #	Subzone	Amount	Units	Rate In	Rate Out	Trips In	Trips Out	Total Trips	% Of Total
714	400 Duley -	1.00	Office	0.00	0.00	0	0	0	0.0
714	400 Duley -	1.00	Industrial	0.00	0.00	0	0	0	0.0
1002	Laker Facili	1.00	General Office	0.00	0.00	0	0	0	0.0
1004	1955 E Grand	1.00	Mattel	239.00	33.00	239	33	272	18.2
	Zone 1004 Subtotal					239	33	272	18.2
1005	Mattel	1.00	Mattel	431.00	43.00	431	43	474	31.8
	Zone 1005 Subtotal					431	43	474	31.8
1007	Mattel Proje	1.00	project	670.00	76.00	670	76	746	50.0
	Zone 1007 Subtotal					670	76	746	50.0
TOTAL						1340	152	1492	100.0

Continental Grand Campus Specific Plan
Existing With Project AM Peak Hour (HCM)

Trip Distribution Report

Percent Of Trips Project

Zone	To Gates											
	1	2	3	4	5	7	8	9	10	11	12	
306	0.0	0.0	0.0	0.0	0.0	0.0	0.0	0.0	0.0	0.0	0.0	0.0
307	0.0	0.0	0.0	0.0	0.0	0.0	0.0	0.0	0.0	0.0	0.0	0.0
311	0.0	0.0	0.0	0.0	0.0	0.0	0.0	0.0	0.0	0.0	0.0	0.0
313	0.0	0.0	0.0	0.0	0.0	0.0	0.0	0.0	0.0	0.0	0.0	0.0
314	0.0	0.0	0.0	0.0	0.0	0.0	0.0	0.0	0.0	0.0	0.0	0.0
704	0.0	0.0	0.0	0.0	0.0	0.0	0.0	0.0	0.0	0.0	0.0	0.0
706	0.0	0.0	0.0	0.0	0.0	0.0	0.0	0.0	0.0	0.0	0.0	0.0
710	0.0	0.0	0.0	0.0	0.0	0.0	0.0	0.0	0.0	0.0	0.0	0.0
714	0.0	0.0	0.0	0.0	0.0	0.0	0.0	0.0	0.0	0.0	0.0	0.0
717	0.0	0.0	0.0	0.0	0.0	0.0	0.0	0.0	0.0	0.0	0.0	0.0
718	0.0	0.0	0.0	0.0	0.0	0.0	0.0	0.0	0.0	0.0	0.0	0.0
719	0.0	0.0	0.0	0.0	0.0	0.0	0.0	0.0	0.0	0.0	0.0	0.0
1002	0.0	10.0	5.0	5.0	15.0	5.0	10.0	15.0	5.0	15.0	5.0	5.0
1004	5.0	15.0	10.0	5.0	30.0	0.0	5.0	20.0	0.0	0.0	5.0	5.0
1005	5.0	15.0	10.0	5.0	30.0	0.0	5.0	20.0	0.0	0.0	5.0	5.0
1007	0.0	0.0	0.0	0.0	0.0	0.0	0.0	0.0	0.0	0.0	0.0	0.0

Zone	To Gates				
	14	15	17	18	20
306	0.0	0.0	0.0	0.0	0.0
307	0.0	0.0	0.0	0.0	0.0
311	0.0	0.0	0.0	0.0	0.0
313	0.0	0.0	0.0	0.0	0.0
314	0.0	0.0	0.0	0.0	0.0
704	0.0	0.0	0.0	0.0	0.0
706	0.0	0.0	0.0	0.0	0.0
710	0.0	0.0	0.0	0.0	0.0
714	0.0	0.0	0.0	0.0	0.0
717	0.0	0.0	0.0	0.0	0.0
718	0.0	0.0	0.0	0.0	0.0
719	0.0	0.0	0.0	0.0	0.0
1002	5.0	5.0	0.0	0.0	0.0
1004	5.0	0.0	0.0	0.0	0.0
1005	5.0	0.0	0.0	0.0	0.0
1007	0.0	0.0	0.0	20.0	10.0

Continental Grand Campus Specific Plan
Existing With Project AM Peak Hour (HCM)

Impact Analysis Report
Level Of Service

Intersection		Base		Future		Change in	
		Del/ LOS	V/ C	Del/ LOS	V/ C		
# 1 Sepulveda Blvd at Imperial Hwy	C	29.5	0.819	C	29.7	0.819	+ 0.199 D/V
# 2 Sepulveda Blvd at Walnut St	A	7.8	0.548	A	7.7	0.559	-0.077 D/V
# 3 Sepulveda Blvd at Maple Ave	B	10.6	0.536	B	10.5	0.539	-0.079 D/V
# 4 Sepulveda Blvd at Mariposa Ave	B	18.2	0.608	B	19.6	0.646	+ 1.399 D/V
# 5 Sepulveda Blvd at Grand Ave	C	22.2	0.742	C	23.5	0.835	+ 1.286 D/V
# 6 Sepulveda Blvd at El Segundo B	C	26.2	0.765	C	26.4	0.785	+ 0.224 D/V
# 7 Sepulveda Blvd at Rosecrans Bl	C	27.2	0.788	C	27.3	0.805	+ 0.143 D/V
# 8 Continental Boulevard at Marip	A	9.7	0.345	A	10.0	0.570	+ 0.245 D/V
# 9 Continental Boulevard at Grand	C	23.5	0.252	C	24.6	0.472	+ 1.065 D/V
# 10 Continental Boulevard at El Se	A	9.0	0.376	A	8.6	0.460	-0.394 D/V
# 11 Nash St and Imperial Hwy	C	23.9	0.619	C	24.6	0.695	+ 0.716 D/V
# 12 Nash St at Mariposa Ave	B	15.0	0.377	B	14.7	0.480	-0.246 D/V
# 13 Nash St at Grand Ave	C	23.7	0.463	C	22.6	0.540	-1.073 D/V
# 14 Nash St at El Segundo Blvd	B	12.4	0.439	B	11.7	0.483	-0.732 D/V
# 15 Douglas Street at El Segundo B	C	27.7	0.702	C	27.8	0.705	+ 0.130 D/V
# 16 Aviation Boulevard at El Segun	C	31.0	0.807	C	32.5	0.852	+ 1.498 D/V
# 17 El Segundo Boulevard and Isis	A	xxxxx	0.571	B	xxxxx	0.612	+ 0.041 V/C
# 18 El Segundo Blvd at I-405 SB Ra	B	17.7	0.603	B	17.1	0.647	-0.552 D/V
# 19 El Segundo Blvd at La Cienega	B	14.6	0.588	B	14.4	0.633	-0.224 D/V
# 20 El Segundo Blvd at I-405 NB Ra	B	17.8	0.710	B	19.5	0.753	+ 1.717 D/V

Continental Grand Campus Specific Plan
Existing With Project AM Peak Hour (HCM)

Level of Service Computation Report

2000 HCM Operations Method (Future Volume Alternative)

Intersection #1 Sepulveda Blvd at Imperial Hwy

Cycle (sec): 100 Critical Vol./Cap.(X): 0.819
Loss Time (sec): 5 Average Delay (sec/veh): 29.7
Optimal Cycle: 59 Level Of Service: C

Street Name: Sepulveda Blvd Imperial Hwy

Approach: North Bound South Bound East Bound West Bound
Movement: L - T - R L - T - R L - T - R L - T - R

Control: Protected Protected Protected Protected
Rights: Include Include Include Ovl
Min. Green: 0 0 0 0 0 0 0 0 0 0 0 0
Y+R: 4.0 4.0 4.0 4.0 4.0 4.0 4.0 4.0 4.0 4.0 4.0 4.0
Lanes: 1 0 3 0 1 2 0 3 1 0 2 0 3 0 1 2 0 3 0 1

Volume Module:

Base Vol: 63 1495 418 448 2297 12 210 316 140 211 292 590
Growth Adj: 1.00 1.00 1.00 1.00 1.00 1.00 1.00 1.00 1.00 1.00 1.00 1.00
Initial Bse: 63 1499 419 449 2303 12 211 317 140 212 293 592
Added Vol: 4 4 12 0 34 0 0 0 0 34 0 0 0
PasserByVol: 0 0 0 0 0 0 0 0 0 0 0 0 0
Initial Fut: 67 1503 431 449 2337 12 211 317 174 212 293 592
User Adj: 1.00 1.00 1.00 1.00 1.00 1.00 1.00 1.00 1.00 1.00 1.00 1.00
PHF Adj: 0.92 0.92 0.92 0.92 0.92 0.92 0.92 0.92 0.92 0.92 0.92 0.92
PHF Volume: 73 1634 469 488 2540 13 229 344 190 230 318 643
Reduct Vol: 0 0 0 0 0 0 0 0 0 0 0 0
Reduced Vol: 73 1634 469 488 2540 13 229 344 190 230 318 643
PCE Adj: 1.00 1.00 1.00 1.00 1.00 1.00 1.00 1.00 1.00 1.00 1.00 1.00
MLF Adj: 1.00 1.00 1.00 1.00 1.00 1.00 1.00 1.00 1.00 1.00 1.00 1.00
FinalVolume: 73 1634 469 488 2540 13 229 344 190 230 318 643

Saturation Flow Module:

Sat/Lane: 1900 1900 1900 1900 1900 1900 1900 1900 1900 1900 1900 1900
Adjustment: 0.95 0.91 0.85 0.92 0.91 0.91 0.92 0.91 0.85 0.92 0.91 0.85
Lanes: 1.00 3.00 1.00 2.00 3.98 0.02 2.00 3.00 1.00 2.00 3.00 1.00
Final Sat.: 1805 5187 1615 3502 6874 35 3502 5187 1615 3502 5187 1615

Capacity Analysis Module:

Vol/Sat: 0.04 0.31 0.29 0.14 0.37 0.37 0.07 0.07 0.12 0.07 0.06 0.40
Crit Moves: **** **** **** ****
Green/Cycle: 0.05 0.38 0.38 0.17 0.50 0.50 0.08 0.25 0.25 0.14 0.32 0.49
Volume/Cap: 0.74 0.82 0.75 0.82 0.74 0.74 0.82 0.26 0.46 0.46 0.19 0.82
Delay/Veh: 71.9 30.5 32.0 48.8 20.7 20.7 62.5 29.9 32.4 40.1 25.0 28.8
User DelAdj: 1.00 1.00 1.00 1.00 1.00 1.00 1.00 1.00 1.00 1.00 1.00 1.00
AdjDel/Veh: 71.9 30.5 32.0 48.8 20.7 20.7 62.5 29.9 32.4 40.1 25.0 28.8
LOS by Move: E C C D C C E C C D C C
HCM2kAvgQ: 2 17 13 10 18 18 4 3 5 3 2 18

Note: Queue reported is the number of cars per lane.

Continental Grand Campus Specific Plan
Existing With Project AM Peak Hour (HCM)

Level of Service Computation Report

2000 HCM Operations Method (Future Volume Alternative)

Intersection #2 Sepulveda Blvd at Walnut St

Cycle (sec): 100 Critical Vol./Cap.(X): 0.559
Loss Time (sec): 5 Average Delay (sec/veh): 7.7
Optimal Cycle: 28 Level Of Service: A

Street Name: Sepulveda Blvd Walnut St

Approach: North Bound South Bound East Bound West Bound
Movement: L - T - R L - T - R L - T - R L - T - R

Control: Protected Protected Permitted Permitted
Rights: Include Include Include Include
Min. Green: 0 0 0 0 0 0 0 0 0 0 0 0
Y+R: 4.0 4.0 4.0 4.0 4.0 4.0 4.0 4.0 4.0 4.0 4.0 4.0
Lanes: 1 0 3 1 0 1 0 3 1 0 0 1 0 0 1 0 1 0 0 1

Volume Module:

Base Vol: 86 1938 58 62 2372 175 65 19 28 8 11 17
Growth Adj: 1.00 1.00 1.00 1.00 1.00 1.00 1.00 1.00 1.00 1.00 1.00 1.00
Initial Bse: 86 1943 58 62 2378 175 65 19 28 8 11 17
Added Vol: 0 19 0 0 67 0 0 0 0 0 0 0
PasserByVol: 0 0 0 0 0 0 0 0 0 0 0 0
Initial Fut: 86 1962 58 62 2445 175 65 19 28 8 11 17
User Adj: 1.00 1.00 1.00 1.00 1.00 1.00 1.00 1.00 1.00 1.00 1.00 1.00
PHF Adj: 0.92 0.92 0.92 0.92 0.92 0.92 0.92 0.92 0.92 0.92 0.92 0.92
PHF Volume: 94 2133 63 68 2658 191 71 21 31 9 12 19
Reduct Vol: 0 0 0 0 0 0 0 0 0 0 0 0
Reduced Vol: 94 2133 63 68 2658 191 71 21 31 9 12 19
PCE Adj: 1.00 1.00 1.00 1.00 1.00 1.00 1.00 1.00 1.00 1.00 1.00 1.00
MLF Adj: 1.00 1.00 1.00 1.00 1.00 1.00 1.00 1.00 1.00 1.00 1.00 1.00
FinalVolume: 94 2133 63 68 2658 191 71 21 31 9 12 19

Saturation Flow Module:

Sat/Lane: 1900 1900 1900 1900 1900 1900 1900 1900 1900 1900 1900 1900
Adjustment: 0.95 0.91 0.91 0.95 0.90 0.90 0.76 0.76 0.85 0.90 0.90 0.85
Lanes: 1.00 3.88 0.12 1.00 3.73 0.27 0.77 0.23 1.00 0.42 0.58 1.00
Final Sat.: 1805 6690 198 1805 6388 458 1119 327 1615 716 985 1615

Capacity Analysis Module:

Vol/Sat: 0.05 0.32 0.32 0.04 0.42 0.42 0.06 0.06 0.02 0.01 0.01 0.01
Crit Moves: **** **** **** ****
Green/Cycle: 0.09 0.75 0.75 0.09 0.74 0.74 0.11 0.11 0.11 0.11 0.11 0.11
Volume/Cap: 0.56 0.43 0.43 0.43 0.56 0.56 0.56 0.56 0.17 0.11 0.11 0.10
Delay/Veh: 47.6 4.7 4.7 45.0 5.8 5.8 46.3 46.3 40.5 40.1 40.1 40.0
User DelAdj: 1.00 1.00 1.00 1.00 1.00 1.00 1.00 1.00 1.00 1.00 1.00 1.00
AdjDel/Veh: 47.6 4.7 4.7 45.0 5.8 5.8 46.3 46.3 40.5 40.1 40.1 40.0
LOS by Move: D A A D A A D D D D D D
HCM2kAvgQ: 4 7 7 2 10 10 4 4 1 1 1 1

Note: Queue reported is the number of cars per lane.

Continental Grand Campus Specific Plan
Existing With Project AM Peak Hour (HCM)

Level of Service Computation Report
2000 HCM Operations Method (Future Volume Alternative)

Intersection #3 Sepulveda Blvd at Maple Ave

Cycle (sec): 100 Critical Vol./Cap.(X): 0.539
Loss Time (sec): 5 Average Delay (sec/veh): 10.5
Optimal Cycle: 27 Level Of Service: B

Street Name: Sepulveda Blvd Maple Ave

Approach: North Bound South Bound East Bound West Bound
Movement: L - T - R L - T - R L - T - R L - T - R

Control: Protected Protected Permitted Permitted
Rights: Include Include Include Include
Min. Green: 0 0 0 0 0 0 0 0 0 0 0 0
Y+R: 4.0 4.0 4.0 4.0 4.0 4.0 4.0 4.0 4.0 4.0 4.0 4.0
Lanes: 1 0 3 1 0 1 0 3 1 0 1 0 0 1 0 1

Volume Module:

Base Vol: 46 2101 145 104 2130 36 66 121 31 22 29 49
Growth Adj: 1.00 1.00 1.00 1.00 1.00 1.00 1.00 1.00 1.00 1.00 1.00 1.00
Initial Bse: 46 2101 145 104 2130 36 66 121 31 22 29 49
Added Vol: 0 19 0 0 67 0 0 0 0 0 0 0 0
PasserByVol: 0 0 0 0 0 0 0 0 0 0 0 0 0
Initial Fut: 46 2120 145 104 2197 36 66 121 31 22 29 49
User Adj: 1.00 1.00 1.00 1.00 1.00 1.00 1.00 1.00 1.00 1.00 1.00 1.00
PHF Adj: 0.92 0.92 0.92 0.92 0.92 0.92 0.92 0.92 0.92 0.92 0.92 0.92
PHF Volume: 50 2304 158 113 2388 39 72 132 34 24 32 53
Reduct Vol: 0 0 0 0 0 0 0 0 0 0 0 0 0
Reduced Vol: 50 2304 158 113 2388 39 72 132 34 24 32 53
PCE Adj: 1.00 1.00 1.00 1.00 1.00 1.00 1.00 1.00 1.00 1.00 1.00 1.00
MLF Adj: 1.00 1.00 1.00 1.00 1.00 1.00 1.00 1.00 1.00 1.00 1.00 1.00
FinalVolume: 50 2304 158 113 2388 39 72 132 34 24 32 53

Saturation Flow Module:

Sat/Lane: 1900 1900 1900 1900 1900 1900 1900 1900 1900 1900 1900
Adjustment: 0.95 0.90 0.90 0.95 0.91 0.91 0.74 0.97 0.97 0.39 1.00 0.85
Lanes: 1.00 3.74 0.26 1.00 3.94 0.06 1.00 0.80 0.20 1.00 1.00 1.00
Final Sat.: 1805 6409 438 1805 6791 111 1410 1466 375 732 1900 1615

Capacity Analysis Module:

Vol/Sat: 0.03 0.36 0.36 0.06 0.35 0.35 0.05 0.09 0.09 0.03 0.02 0.03
Crit Moves: ****
Green/Cycle: 0.06 0.67 0.67 0.12 0.73 0.73 0.17 0.17 0.17 0.17 0.17 0.17
Volume/Cap: 0.48 0.54 0.54 0.54 0.48 0.48 0.31 0.54 0.54 0.20 0.10 0.20
Delay/Veh: 49.3 8.8 8.8 44.5 5.9 5.9 37.3 40.1 40.1 36.7 35.5 36.3
User DelAdj: 1.00 1.00 1.00 1.00 1.00 1.00 1.00 1.00 1.00 1.00 1.00 1.00
AdjDel/Veh: 49.3 8.8 8.8 44.5 5.9 5.9 37.3 40.1 40.1 36.7 35.5 36.3
LOS by Move: D A A D A A D D D D D D
HCM2kAvgQ: 2 11 11 4 9 9 2 5 5 1 1 2

Note: Queue reported is the number of cars per lane.

Continental Grand Campus Specific Plan
Existing With Project AM Peak Hour (HCM)

Level of Service Computation Report
2000 HCM Operations Method (Future Volume Alternative)

Intersection #4 Sepulveda Blvd at Mariposa Ave

Cycle (sec): 100 Critical Vol./Cap.(X): 0.646
Loss Time (sec): 5 Average Delay (sec/veh): 19.6
Optimal Cycle: 34 Level Of Service: B

Street Name: Sepulveda Blvd Mariposa Ave

Approach: North Bound South Bound East Bound West Bound
Movement: L - T - R L - T - R L - T - R L - T - R

Control: Protected Protected Permitted Permitted
Rights: Include Include Include Include
Min. Green: 0 0 0 0 0 0 0 0 0 0 0 0
Y+R: 4.0 4.0 4.0 4.0 4.0 4.0 4.0 4.0 4.0 4.0 4.0 4.0
Lanes: 1 0 4 0 1 2 0 3 1 0 1 0 0 1 0 1

Volume Module:

Base Vol: 62 1984 155 418 1791 58 104 179 49 65 86 84
Growth Adj: 1.00 1.00 1.00 1.00 1.00 1.00 1.00 1.00 1.00 1.00 1.00 1.00
Initial Bse: 62 1989 155 419 1796 58 104 179 49 65 86 84
Added Vol: 2 17 0 45 22 0 0 34 0 0 2 2
PasserByVol: 0 0 0 0 0 0 0 0 0 0 0 0 0
Initial Fut: 64 2006 155 464 1818 58 104 213 49 65 88 86
User Adj: 1.00 1.00 1.00 1.00 1.00 1.00 1.00 1.00 1.00 1.00 1.00 1.00
PHF Adj: 0.92 0.92 0.92 0.92 0.92 0.92 0.92 0.92 0.92 0.92 0.92 0.92
PHF Volume: 70 2181 169 504 1976 63 113 232 53 71 96 94
Reduct Vol: 0 0 0 0 0 0 0 0 0 0 0 0 0
Reduced Vol: 70 2181 169 504 1976 63 113 232 53 71 96 94
PCE Adj: 1.00 1.00 1.00 1.00 1.00 1.00 1.00 1.00 1.00 1.00 1.00 1.00
MLF Adj: 1.00 1.00 1.00 1.00 1.00 1.00 1.00 1.00 1.00 1.00 1.00 1.00
FinalVolume: 70 2181 169 504 1976 63 113 232 53 71 96 94

Saturation Flow Module:

Sat/Lane: 1900 1900 1900 1900 1900 1900 1900 1900 1900 1900 1900
Adjustment: 0.95 0.91 0.85 0.92 0.91 0.91 0.62 0.97 0.97 0.27 1.00 0.85
Lanes: 1.00 4.00 1.00 2.00 3.88 0.12 1.00 0.81 0.19 1.00 1.00 1.00
Final Sat.: 1805 6916 1615 3502 6668 213 1172 1501 346 519 1900 1615

Capacity Analysis Module:

Vol/Sat: 0.04 0.32 0.10 0.14 0.30 0.30 0.10 0.15 0.15 0.14 0.05 0.06
Crit Moves: ****
Green/Cycle: 0.08 0.49 0.49 0.22 0.63 0.63 0.24 0.24 0.24 0.24 0.24 0.24
Volume/Cap: 0.47 0.65 0.21 0.65 0.47 0.47 0.40 0.65 0.65 0.57 0.21 0.24
Delay/Veh: 46.2 19.6 14.8 37.2 9.9 9.9 33.0 37.5 37.5 39.8 30.7 31.1
User DelAdj: 1.00 1.00 1.00 1.00 1.00 1.00 1.00 1.00 1.00 1.00 1.00 1.00
AdjDel/Veh: 46.2 19.6 14.8 37.2 9.9 9.9 33.0 37.5 37.5 39.8 30.7 31.1
LOS by Move: D B B D A A C D D D C C
HCM2kAvgQ: 2 13 3 8 9 9 3 9 9 3 2 2

Note: Queue reported is the number of cars per lane.

Continental Grand Campus Specific Plan
Existing With Project AM Peak Hour (HCM)

Level of Service Computation Report

2000 HCM Operations Method (Future Volume Alternative)

Intersection #5 Sepulveda Blvd at Grand Ave

Cycle (sec): 100 Critical Vol./Cap.(X): 0.835
Loss Time (sec): 5 Average Delay (sec/veh): 23.5
Optimal Cycle: 63 Level Of Service: C

Street Name: Sepulveda Blvd Grand Ave

Approach: North Bound South Bound East Bound West Bound

Movement: L - T - R L - T - R L - T - R L - T - R

Control: Protected Protected Split Phase Split Phase

Rights: Ovl Include Include Include

Min. Green: 0 0 0 0 0 0 0 0 0 0 0 0

Y+R: 4.0 4.0 4.0 4.0 4.0 4.0 4.0 4.0 4.0 4.0 4.0 4.0

Lanes: 1 0 4 0 1 1 0 3 1 0 1 1 0 1 0 2 0 2 0 1

Volume Module:

Base Vol: 130 2061 544 406 1381 185 171 164 103 43 50 57

Growth Adj: 1.00 1.00 1.00 1.00 1.00 1.00 1.00 1.00 1.00 1.00 1.00 1.00

Initial Bse: 130 2066 545 407 1385 185 171 164 103 43 50 57

Added Vol: 0 0 100 22 0 0 0 0 34 0 21 4 19

PasserByVol: 0 0 0 0 0 0 0 0 0 0 0 0 0

Initial Fut: 130 2066 645 429 1385 185 171 198 103 64 54 76

User Adj: 1.00 1.00 1.00 1.00 1.00 1.00 1.00 1.00 1.00 1.00 1.00 1.00

PHF Adj: 0.92 0.92 0.92 0.92 0.92 0.92 0.92 0.92 0.92 0.92 0.92 0.92

PHF Volume: 142 2246 702 466 1505 202 186 216 112 70 59 83

Reduct Vol: 0 0 0 0 0 0 0 0 0 0 0 0

Reduced Vol: 142 2246 702 466 1505 202 186 216 112 70 59 83

PCE Adj: 1.00 1.00 1.00 1.00 1.00 1.00 1.00 1.00 1.00 1.00 1.00 1.00

MLF Adj: 1.00 1.00 1.00 1.00 1.00 1.00 1.00 1.00 1.00 1.00 1.00 1.00

FinalVolume: 142 2246 702 466 1505 202 186 216 112 70 59 83

Saturation Flow Module:

Sat/Lane: 1900 1900 1900 1900 1900 1900 1900 1900 1900 1900 1900 1900

Adjustment: 0.95 0.91 0.85 0.95 0.89 0.89 0.90 0.90 0.90 0.92 0.95 0.85

Lanes: 1.00 4.00 1.00 1.00 3.53 0.47 1.09 1.26 0.65 2.00 2.00 1.00

Final Sat.: 1805 6916 1615 1805 5989 802 1863 2156 1122 3502 3610 1615

Capacity Analysis Module:

Vol/Sat: 0.08 0.32 0.43 0.26 0.25 0.25 0.10 0.10 0.10 0.02 0.02 0.05

Crit Moves: **** **

Green/Cycle: 0.19 0.50 0.56 0.31 0.61 0.61 0.12 0.12 0.12 0.06 0.06 0.06

Volume/Cap: 0.41 0.65 0.78 0.83 0.41 0.41 0.83 0.83 0.83 0.32 0.27 0.83

Delay/Veh: 36.2 19.2 21.6 42.6 10.0 10.0 52.6 52.6 52.6 45.8 45.4 89.2

User DelAdj: 1.00 1.00 1.00 1.00 1.00 1.00 1.00 1.00 1.00 1.00 1.00 1.00

AdjDel/Veh: 36.2 19.2 21.6 42.6 10.0 10.0 52.6 52.6 52.6 45.8 45.4 89.2

LOS by Move: D B C D A A D D D D D F

HCM2kAvgQ: 4 13 16 14 7 7 8 8 8 1 1 5

Note: Queue reported is the number of cars per lane.

Continental Grand Campus Specific Plan
Existing With Project AM Peak Hour (HCM)

Level of Service Computation Report

2000 HCM Operations Method (Future Volume Alternative)

Intersection #6 Sepulveda Blvd at El Segundo Blvd

Cycle (sec): 100 Critical Vol./Cap.(X): 0.785
Loss Time (sec): 5 Average Delay (sec/veh): 26.4
Optimal Cycle: 51 Level Of Service: C

Street Name: Sepulveda Blvd El Segundo Blvd

Approach: North Bound South Bound East Bound West Bound

Movement: L - T - R L - T - R L - T - R L - T - R

Control: Protected Protected Protected Protected

Rights: Include Include Include Include

Min. Green: 0 0 0 0 0 0 0 0 0 0 0 0

Y+R: 4.0 4.0 4.0 4.0 4.0 4.0 4.0 4.0 4.0 4.0 4.0 4.0

Lanes: 2 0 3 1 0 2 0 4 0 1 1 0 2 0 1 2 0 2 0 1

Volume Module:

Base Vol: 369 2440 293 252 1120 121 108 291 222 138 292 216

Growth Adj: 1.00 1.00 1.00 1.00 1.00 1.00 1.00 1.00 1.00 1.00 1.00 1.00

Initial Bse: 370 2446 294 253 1123 121 108 292 223 138 293 217

Added Vol: 0 100 0 10 11 0 0 0 0 0 0 0

PasserByVol: 0 0 0 0 0 0 0 0 0 0 0 0

Initial Fut: 370 2546 294 263 1134 121 108 292 223 138 293 217

User Adj: 1.00 1.00 1.00 1.00 1.00 1.00 1.00 1.00 1.00 1.00 1.00 1.00

PHF Adj: 0.92 0.92 0.92 0.92 0.92 0.92 0.92 0.92 0.92 0.92 0.92 0.92

PHF Volume: 402 2768 319 285 1233 132 118 317 242 150 318 235

Reduct Vol: 0 0 0 0 0 0 0 0 0 0 0 0

Reduced Vol: 402 2768 319 285 1233 132 118 317 242 150 318 235

PCE Adj: 1.00 1.00 1.00 1.00 1.00 1.00 1.00 1.00 1.00 1.00 1.00 1.00

MLF Adj: 1.00 1.00 1.00 1.00 1.00 1.00 1.00 1.00 1.00 1.00 1.00 1.00

FinalVolume: 402 2768 319 285 1233 132 118 317 242 150 318 235

Saturation Flow Module:

Sat/Lane: 1900 1900 1900 1900 1900 1900 1900 1900 1900 1900 1900 1900

Adjustment: 0.92 0.90 0.90 0.92 0.91 0.85 0.95 0.95 0.85 0.92 0.95 0.85

Lanes: 2.00 3.59 0.41 2.00 4.00 1.00 1.00 2.00 1.00 2.00 2.00 1.00

Final Sat.: 3502 6108 705 3502 6916 1615 1805 3610 1615 3502 3610 1615

Capacity Analysis Module:

Vol/Sat: 0.11 0.45 0.45 0.08 0.18 0.08 0.07 0.09 0.15 0.04 0.09 0.15

Crit Moves: **** **

Green/Cycle: 0.27 0.58 0.58 0.10 0.41 0.41 0.08 0.21 0.21 0.06 0.19 0.19

Volume/Cap: 0.43 0.78 0.78 0.78 0.43 0.20 0.78 0.42 0.72 0.72 0.47 0.78

Delay/Veh: 30.7 17.4 17.4 54.4 21.0 18.8 68.2 34.7 44.0 57.4 36.9 51.6

User DelAdj: 1.00 1.00 1.00 1.00 1.00 1.00 1.00 1.00 1.00 1.00 1.00 1.00

AdjDel/Veh: 30.7 17.4 17.4 54.4 21.0 18.8 68.2 34.7 44.0 57.4 36.9 51.6

LOS by Move: C B B D C B E C D E D D

HCM2kAvgQ: 6 21 21 5 7 2 6 5 8 4 5 9

Note: Queue reported is the number of cars per lane.

Continental Grand Campus Specific Plan
Existing With Project AM Peak Hour (HCM)

Level of Service Computation Report
2000 HCM Operations Method (Future Volume Alternative)

Intersection #7 Sepulveda Blvd at Rosecrans Blvd

Cycle (sec): 100 Critical Vol./Cap.(X): 0.805
Loss Time (sec): 5 Average Delay (sec/veh): 27.3
Optimal Cycle: 55 Level Of Service: C

Table with columns for Street Name, Approach, Movement, Control, Rights, Min. Green, Y+R, Lanes. Rows for Sepulveda Blvd and Rosecrans Blvd.

Table with columns for Volume Module, Base Vol, Growth Adj, Initial Bse, Added Vol, PasserByVol, Initial Fut, User Adj, PHF Adj, PHF Volume, Reduct Vol, Reduced Vol, PCE Adj, MLF Adj, FinalVolume.

Table with columns for Saturation Flow Module, Sat/Lane, Adjustment, Lanes, Final Sat.

Table with columns for Capacity Analysis Module, Vol/Sat, Crit Moves, Green/Cycle, Volume/Cap, Delay/Veh, User DelAdj, AdjDel/Veh, LOS by Move, HCM2kAvgQ.

Note: Queue reported is the number of cars per lane.

Continental Grand Campus Specific Plan
Existing With Project AM Peak Hour (HCM)

Level of Service Computation Report
2000 HCM Operations Method (Future Volume Alternative)

Intersection #8 Continental Boulevard at Mariposa Ave

Cycle (sec): 100 Critical Vol./Cap.(X): 0.570
Loss Time (sec): 5 Average Delay (sec/veh): 10.0
Optimal Cycle: 28 Level Of Service: A

Table with columns for Street Name, Approach, Movement, Control, Rights, Min. Green, Y+R, Lanes. Rows for Continental Boulevard and Mariposa Avenue.

Table with columns for Volume Module, Base Vol, Growth Adj, Initial Bse, Added Vol, PasserByVol, Initial Fut, User Adj, PHF Adj, PHF Volume, Reduct Vol, Reduced Vol, PCE Adj, MLF Adj, FinalVolume.

Table with columns for Saturation Flow Module, Sat/Lane, Adjustment, Lanes, Final Sat.

Table with columns for Capacity Analysis Module, Vol/Sat, Crit Moves, Green/Cycle, Volume/Cap, Delay/Veh, User DelAdj, AdjDel/Veh, LOS by Move, HCM2kAvgQ.

Note: Queue reported is the number of cars per lane.

Continental Grand Campus Specific Plan
Existing With Project AM Peak Hour (HCM)

Level of Service Computation Report

2000 HCM Operations Method (Future Volume Alternative)

Intersection #9 Continental Boulevard at Grand Avenue

Cycle (sec): 100 Critical Vol./Cap.(X): 0.472
Loss Time (sec): 5 Average Delay (sec/veh): 24.6
Optimal Cycle: 24 Level Of Service: C

Table with columns: Street Name, Approach, Movement, Control, Rights, Min. Green, Y+R, Lanes. Rows for Continental Boulevard and Grand Avenue.

Table with columns: Volume Module, Base Vol, Growth Adj, Initial Bse, Added Vol, PasserByVol, Initial Fut, User Adj, PHF Adj, PHF Volume, Reduct Vol, Reduced Vol, PCE Adj, MLF Adj, FinalVolume.

Table with columns: Saturation Flow Module, Sat/Lane, Adjustment, Lanes, Final Sat.

Table with columns: Capacity Analysis Module, Vol/Sat, Crit Moves, Green/Cycle, Volume/Cap, Delay/Veh, User DelAdj, AdjDel/Veh, LOS by Move, HCM2kAvgQ.

Note: Queue reported is the number of cars per lane.

Continental Grand Campus Specific Plan
Existing With Project AM Peak Hour (HCM)

Level of Service Computation Report

2000 HCM Operations Method (Future Volume Alternative)

Intersection #10 Continental Boulevard at El Segundo Boulevard

Cycle (sec): 100 Critical Vol./Cap.(X): 0.460
Loss Time (sec): 5 Average Delay (sec/veh): 8.6
Optimal Cycle: 23 Level Of Service: A

Table with columns: Street Name, Approach, Movement, Control, Rights, Min. Green, Y+R, Lanes. Rows for Continental Boulevard and El Segundo Boulevard.

Table with columns: Volume Module, Base Vol, Growth Adj, Initial Bse, Added Vol, PasserByVol, Initial Fut, User Adj, PHF Adj, PHF Volume, Reduct Vol, Reduced Vol, PCE Adj, MLF Adj, FinalVolume.

Table with columns: Saturation Flow Module, Sat/Lane, Adjustment, Lanes, Final Sat.

Table with columns: Capacity Analysis Module, Vol/Sat, Crit Moves, Green/Cycle, Volume/Cap, Delay/Veh, User DelAdj, AdjDel/Veh, LOS by Move, HCM2kAvgQ.

Note: Queue reported is the number of cars per lane.

Continental Grand Campus Specific Plan
Existing With Project AM Peak Hour (HCM)

Level of Service Computation Report
2000 HCM Operations Method (Future Volume Alternative)

Intersection #11 Nash St and Imperial Hwy
Cycle (sec): 100 Critical Vol./Cap.(X): 0.695
Loss Time (sec): 5 Average Delay (sec/veh): 24.6
Optimal Cycle: 38 Level Of Service: C

Table with columns for Street Name (Nash St, Imperial Hwy), Approach (North Bound, South Bound, East Bound, West Bound), Movement (L, T, R), Control, Rights, Min. Green, Y+R, and Lanes.

Table with columns for Volume Module (Base Vol, Growth Adj, Initial Bse, Added Vol, PasserByVol, Initial Fut, User Adj, PHF Adj, PHF Volume, Reduct Vol, Reduced Vol, PCE Adj, MLF Adj, FinalVolume).

Table with columns for Saturation Flow Module (Sat/Lane, Adjustment, Lanes, Final Sat).

Table with columns for Capacity Analysis Module (Vol/Sat, Crit Moves, Green/Cycle, Volume/Cap, Delay/Veh, User DelAdj, AdjDel/Veh, LOS by Move, HCM2kAvgQ).

Note: Queue reported is the number of cars per lane.

Continental Grand Campus Specific Plan
Existing With Project AM Peak Hour (HCM)

Level of Service Computation Report
2000 HCM Operations Method (Future Volume Alternative)

Intersection #12 Nash St at Mariposa Ave
Cycle (sec): 100 Critical Vol./Cap.(X): 0.480
Loss Time (sec): 5 Average Delay (sec/veh): 14.7
Optimal Cycle: 24 Level Of Service: B

Table with columns for Street Name (Nash St, Mariposa Ave), Approach (North Bound, South Bound, East Bound, West Bound), Movement (L, T, R), Control, Rights, Min. Green, Y+R, and Lanes.

Table with columns for Volume Module (Base Vol, Growth Adj, Initial Bse, Added Vol, PasserByVol, Initial Fut, User Adj, PHF Adj, PHF Volume, Reduct Vol, Reduced Vol, PCE Adj, MLF Adj, FinalVolume).

Table with columns for Saturation Flow Module (Sat/Lane, Adjustment, Lanes, Final Sat).

Table with columns for Capacity Analysis Module (Vol/Sat, Crit Moves, Green/Cycle, Volume/Cap, Delay/Veh, User DelAdj, AdjDel/Veh, LOS by Move, HCM2kAvgQ).

Note: Queue reported is the number of cars per lane.

Continental Grand Campus Specific Plan
Existing With Project AM Peak Hour (HCM)

Level of Service Computation Report
2000 HCM Operations Method (Future Volume Alternative)

Intersection #13 Nash St at Grand Ave

Cycle (sec): 100 Critical Vol./Cap.(X): 0.540
Loss Time (sec): 5 Average Delay (sec/veh): 22.6
Optimal Cycle: 27 Level Of Service: C

Table with columns for Street Name (Nash St, Grand Ave), Approach (North Bound, South Bound, East Bound, West Bound), Movement (L, T, R), Control (Protected, Split Phase), Rights (Include), and various traffic metrics like Min. Green, Y+R, Lanes.

Volume Module table showing Base Vol, Growth Adj, Initial Bse, Added Vol, PasserByVol, Initial Fut, User Adj, PHF Adj, PHF Volume, Reduct Vol, Reduced Vol, PCE Adj, MLF Adj, and Final Volume for each movement.

Saturation Flow Module table showing Sat/Lane, Adjustment, Lanes, and Final Sat for each movement.

Capacity Analysis Module table showing Vol/Sat, Crit Moves, Green/Cycle, Volume/Cap, Delay/Veh, User DelAdj, AdjDel/Veh, LOS by Move, and HCM2kAvgQ.

Note: Queue reported is the number of cars per lane.

Continental Grand Campus Specific Plan
Existing With Project AM Peak Hour (HCM)

Level of Service Computation Report
2000 HCM Operations Method (Future Volume Alternative)

Intersection #14 Nash St at El Segundo Blvd

Cycle (sec): 100 Critical Vol./Cap.(X): 0.483
Loss Time (sec): 5 Average Delay (sec/veh): 11.7
Optimal Cycle: 24 Level Of Service: B

Table with columns for Street Name (Nash St, El Segundo Blvd), Approach (North Bound, South Bound, East Bound, West Bound), Movement (L, T, R), Control (Split Phase, Protected), Rights (Include), and various traffic metrics like Min. Green, Y+R, Lanes.

Volume Module table showing Base Vol, Growth Adj, Initial Bse, Added Vol, PasserByVol, Initial Fut, User Adj, PHF Adj, PHF Volume, Reduct Vol, Reduced Vol, PCE Adj, MLF Adj, and Final Volume for each movement.

Saturation Flow Module table showing Sat/Lane, Adjustment, Lanes, and Final Sat for each movement.

Capacity Analysis Module table showing Vol/Sat, Crit Moves, Green/Cycle, Volume/Cap, Delay/Veh, User DelAdj, AdjDel/Veh, LOS by Move, and HCM2kAvgQ.

Note: Queue reported is the number of cars per lane.

Continental Grand Campus Specific Plan
Existing With Project AM Peak Hour (HCM)

Level of Service Computation Report

2000 HCM Operations Method (Future Volume Alternative)

Intersection #15 Douglas Street at El Segundo Boulevard

Cycle (sec): 100 Critical Vol./Cap.(X): 0.705
Loss Time (sec): 5 Average Delay (sec/veh): 27.8
Optimal Cycle: 39 Level Of Service: C

Street Name: Douglas St El Segundo Blvd

Approach: North Bound South Bound East Bound West Bound
Movement: L - T - R L - T - R L - T - R L - T - R

Control: Protected Protected Protected Protected
Rights: Include Include Include Include
Min. Green: 0 0 0 0 0 0 0 0 0 0 0 0
Y+R: 4.0 4.0 4.0 4.0 4.0 4.0 4.0 4.0 4.0 4.0 4.0 4.0
Lanes: 2 0 1 1 1 2 0 2 0 1 1 0 2 1 0 2 0 3 0 1

Volume Module:

Base Vol: 418 683 92 128 269 36 121 496 143 191 1457 512
Growth Adj: 1.00 1.00 1.00 1.00 1.00 1.00 1.00 1.00 1.00 1.00 1.00 1.00
Initial Bse: 418 683 92 128 269 36 121 496 143 191 1457 512
Added Vol: 0 0 0 0 0 0 0 23 0 0 201 0
PasserByVol: 0 0 0 0 0 0 0 0 0 0 0 0
Initial Fut: 418 683 92 128 269 36 121 519 143 191 1658 512
User Adj: 1.00 1.00 1.00 1.00 1.00 1.00 1.00 1.00 1.00 1.00 1.00 1.00
PHF Adj: 0.92 0.92 0.92 0.92 0.92 0.92 0.92 0.92 0.92 0.92 0.92 0.92
PHF Volume: 454 742 100 139 292 39 132 564 155 208 1802 557
Reduct Vol: 0 0 0 0 0 0 0 0 0 0 0 0
Reduced Vol: 454 742 100 139 292 39 132 564 155 208 1802 557
PCE Adj: 1.00 1.00 1.00 1.00 1.00 1.00 1.00 1.00 1.00 1.00 1.00 1.00
MLF Adj: 1.00 1.00 1.00 1.00 1.00 1.00 1.00 1.00 1.00 1.00 1.00 1.00
FinalVolume: 454 742 100 139 292 39 132 564 155 208 1802 557

Saturation Flow Module:

Sat/Lane: 1900 1900 1900 1900 1900 1900 1900 1900 1900 1900 1900 1900
Adjustment: 0.92 0.93 0.93 0.92 0.95 0.85 0.95 0.88 0.88 0.92 0.91 0.85
Lanes: 2.00 2.00 1.00 2.00 2.00 1.00 1.00 2.35 0.65 2.00 3.00 1.00
Final Sat.: 3502 3545 1773 3502 3610 1615 1805 3936 1085 3502 5187 1615

Capacity Analysis Module:

Vol/Sat: 0.13 0.21 0.06 0.04 0.08 0.02 0.07 0.14 0.14 0.06 0.35 0.34
Crit Moves: ****
Green/Cycle: 0.22 0.30 0.30 0.06 0.14 0.14 0.10 0.42 0.42 0.17 0.49 0.49
Volume/Cap: 0.60 0.70 0.19 0.70 0.60 0.18 0.70 0.34 0.34 0.34 0.70 0.70
Delay/Veh: 36.5 33.2 26.2 57.3 42.6 38.7 54.9 19.6 19.6 36.5 20.6 22.4
User DelAdj: 1.00 1.00 1.00 1.00 1.00 1.00 1.00 1.00 1.00 1.00 1.00 1.00
AdjDel/Veh: 36.5 33.2 26.2 57.3 42.6 38.7 54.9 19.6 19.6 36.5 20.6 22.4
LOS by Move: D C C E D D D B B D C C
HCM2kAvgQ: 7 12 2 4 5 1 5 5 5 3 16 14

Note: Queue reported is the number of cars per lane.

Continental Grand Campus Specific Plan
Existing With Project AM Peak Hour (HCM)

Level of Service Computation Report

2000 HCM Operations Method (Future Volume Alternative)

Intersection #16 Aviation Boulevard at El Segundo Boulevard

Cycle (sec): 100 Critical Vol./Cap.(X): 0.852
Loss Time (sec): 5 Average Delay (sec/veh): 32.5
Optimal Cycle: 68 Level Of Service: C

Street Name: Aviation Blvd El Segundo Blvd

Approach: North Bound South Bound East Bound West Bound
Movement: L - T - R L - T - R L - T - R L - T - R

Control: Protected Protected Protected Protected
Rights: Ovl Include Include Include
Min. Green: 0 0 0 0 0 0 0 0 0 0 0 0
Y+R: 4.0 4.0 4.0 4.0 4.0 4.0 4.0 4.0 4.0 4.0 4.0 4.0
Lanes: 2 0 2 0 1 1 0 1 1 1 1 0 3 1 0 2 0 2 1 0

Volume Module:

Base Vol: 326 1027 306 21 774 435 118 454 77 410 1528 75
Growth Adj: 1.00 1.00 1.00 1.00 1.00 1.00 1.00 1.00 1.00 1.00 1.00 1.00
Initial Bse: 326 1027 306 21 774 435 118 454 77 410 1528 75
Added Vol: 0 0 0 0 0 0 0 23 0 0 201 0
PasserByVol: 0 0 0 0 0 0 0 0 0 0 0 0
Initial Fut: 326 1027 306 21 774 435 118 477 77 410 1729 75
User Adj: 1.00 1.00 1.00 1.00 1.00 1.00 1.00 1.00 1.00 1.00 1.00 1.00
PHF Adj: 0.92 0.92 0.92 0.92 0.92 0.92 0.92 0.92 0.92 0.92 0.92 0.92
PHF Volume: 354 1116 333 23 841 473 128 518 84 446 1879 82
Reduct Vol: 0 0 0 0 0 0 0 0 0 0 0 0
Reduced Vol: 354 1116 333 23 841 473 128 518 84 446 1879 82
PCE Adj: 1.00 1.00 1.00 1.00 1.00 1.00 1.00 1.00 1.00 1.00 1.00 1.00
MLF Adj: 1.00 1.00 1.00 1.00 1.00 1.00 1.00 1.00 1.00 1.00 1.00 1.00
FinalVolume: 354 1116 333 23 841 473 128 518 84 446 1879 82

Saturation Flow Module:

Sat/Lane: 1900 1900 1900 1900 1900 1900 1900 1900 1900 1900 1900 1900
Adjustment: 0.92 0.95 0.85 0.95 0.90 0.90 0.95 0.89 0.89 0.92 0.90 0.90
Lanes: 2.00 2.00 1.00 1.00 1.92 1.08 1.00 3.44 0.56 2.00 2.88 0.12
Final Sat.: 3502 3610 1615 1805 3279 1843 1805 5830 941 3502 4942 214

Capacity Analysis Module:

Vol/Sat: 0.10 0.31 0.21 0.01 0.26 0.26 0.07 0.09 0.09 0.13 0.38 0.38
Crit Moves: ****
Green/Cycle: 0.12 0.40 0.72 0.02 0.30 0.30 0.08 0.22 0.22 0.31 0.45 0.45
Volume/Cap: 0.85 0.77 0.29 0.77 0.85 0.85 0.85 0.41 0.41 0.41 0.85 0.85
Delay/Veh: 58.6 28.3 5.2 122.7 37.6 37.6 79.7 33.7 33.7 27.4 28.0 28.0
User DelAdj: 1.00 1.00 1.00 1.00 1.00 1.00 1.00 1.00 1.00 1.00 1.00 1.00
AdjDel/Veh: 58.6 28.3 5.2 122.7 37.6 37.6 79.7 33.7 33.7 27.4 28.0 28.0
LOS by Move: E C A F D D E C C C C C
HCM2kAvgQ: 8 17 4 1 14 14 6 5 5 6 22 22

Note: Queue reported is the number of cars per lane.

Continental Grand Campus Specific Plan
Existing With Project AM Peak Hour (HCM)

Level of Service Computation Report

ICU 1(Loss as Cycle Length %) Method (Future Volume Alternative)

Intersection #17 El Segundo Boulevard and Isis Avenue

Cycle (sec): 100 Critical Vol./Cap.(X): 0.612
Loss Time (sec): 5 Average Delay (sec/veh): xxxxxx
Optimal Cycle: 30 Level Of Service: B

Street Name: Isis Avenue El Segundo Boulevard
Approach: North Bound South Bound East Bound West Bound
Movement: L - T - R L - T - R L - T - R L - T - R
Control: Permitted Permitted Protected Protected
Rights: Include Include Include Include
Min. Green: 0 0 0 0 0 0 0 0 0 0 0 0
Y+R: 4.0 4.0 4.0 4.0 4.0 4.0 4.0 4.0 4.0 4.0 4.0
Lanes: 0 0 1! 0 0 0 0 1! 0 0 1 0 4 0 1 1 0 2 1 0

Volume Module:
Base Vol: 50 21 84 52 9 71 45 722 20 20 1736 39
Growth Adj: 1.00 1.00 1.00 1.00 1.00 1.00 1.00 1.00 1.00 1.00 1.00 1.00
Initial Bse: 50 21 84 52 9 71 45 722 20 20 1736 39
Added Vol: 0 0 0 0 0 0 0 0 23 0 0 201 0
PasserByVol: 0 0 0 0 0 0 0 0 0 0 0 0 0
Initial Fut: 50 21 84 52 9 71 45 745 20 20 1937 39
User Adj: 1.00 1.00 1.00 1.00 1.00 1.00 1.00 1.00 1.00 1.00 1.00 1.00
PHF Adj: 0.92 0.92 0.92 0.92 0.92 0.92 0.92 0.92 0.92 0.92 0.92 0.92
PHF Volume: 54 23 91 57 10 77 49 810 22 22 2105 42
Reduct Vol: 0 0 0 0 0 0 0 0 0 0 0 0 0
Reduced Vol: 54 23 91 57 10 77 49 810 22 22 2105 42
PCE Adj: 1.00 1.00 1.00 1.00 1.00 1.00 1.00 1.00 1.00 1.00 1.00 1.00
MLF Adj: 1.00 1.00 1.00 1.00 1.00 1.00 1.00 1.00 1.00 1.00 1.00 1.00
FinalVolume: 54 23 91 57 10 77 49 810 22 22 2105 42

Saturation Flow Module:
Sat/Lane: 1760 1760 1760 1760 1760 1760 1760 1760 1760 1760 1760 1760
Adjustment: 1.00 1.00 1.00 1.00 1.00 1.00 1.00 1.00 1.00 1.00 1.00 1.00
Lanes: 0.32 0.14 0.54 0.39 0.07 0.54 1.00 4.00 1.00 1.00 2.94 0.06
Final Sat.: 568 238 954 693 120 947 1760 7040 1760 1760 5176 104

Capacity Analysis Module:
Vol/Sat: 0.03 0.10 0.10 0.03 0.08 0.08 0.03 0.12 0.01 0.01 0.41 0.41
Crit Moves: **** **** **** ****

Green/Cycle: 0.42 0.00 0.42 0.00 0.00 0.00 0.00 0.53 0.53 0.00 0.53 0.00
Volume/Cap: 0.48 0.00 0.65 0.00 0.00 0.00 0.00 0.24 0.36 0.00 0.65 0.00
Delay/Veh: 21.3 0.0 24.5 0.0 0.0 0.0 0.0 12.9 14.1 0.0 17.5 0.0
User DelAdj: 1.00 1.00 1.00 1.00 1.00 1.00 1.00 1.00 1.00 1.00 1.00 1.00
AdjDel/Veh: 21.3 0.0 24.5 0.0 0.0 0.0 0.0 12.9 14.1 0.0 17.5 0.0
LOS by Move: C A C A A A A B B A B A
HCM2kAvgQ: 7 0 10 0 0 0 0 4 5 0 14 0

Continental Grand Campus Specific Plan
Existing With Project AM Peak Hour (HCM)

Level of Service Computation Report

2000 HCM Operations Method (Future Volume Alternative)

Intersection #18 El Segundo Blvd at I-405 SB Ramps

Cycle (sec): 100 Critical Vol./Cap.(X): 0.647
Loss Time (sec): 5 Average Delay (sec/veh): 17.1
Optimal Cycle: 34 Level Of Service: B

Street Name: I-405 SB Ramps El Segundo Blvd
Approach: North Bound South Bound East Bound West Bound
Movement: L - T - R L - T - R L - T - R L - T - R
Control: Permitted Permitted Permitted Permitted
Rights: Include Include Include Include
Min. Green: 0 0 0 0 0 0 0 0 0 0 0 0
Y+R: 4.0 4.0 4.0 4.0 4.0 4.0 4.0 4.0 4.0 4.0 4.0
Lanes: 1 0 1! 0 0 0 0 0 0 0 0 0 3 0 1 0 0 3 0 0

Volume Module:
Base Vol: 416 0 142 0 0 0 0 608 270 0 1428 0
Growth Adj: 1.00 1.00 1.00 1.00 1.00 1.00 1.00 1.00 1.00 1.00 1.00 1.00
Initial Bse: 416 0 142 0 0 0 0 608 270 0 1428 0
Added Vol: 0 0 0 0 0 0 0 8 15 0 201 0
PasserByVol: 0 0 0 0 0 0 0 0 0 0 0 0 0
Initial Fut: 416 0 142 0 0 0 0 616 285 0 1629 0
User Adj: 1.00 1.00 1.00 1.00 1.00 1.00 1.00 1.00 1.00 1.00 1.00 1.00
PHF Adj: 0.92 0.92 0.92 0.92 0.92 0.92 0.92 0.92 0.92 0.92 0.92 0.92
PHF Volume: 452 0 154 0 0 0 0 670 310 0 1771 0
Reduct Vol: 0 0 0 0 0 0 0 0 0 0 0 0 0
Reduced Vol: 452 0 154 0 0 0 0 670 310 0 1771 0
PCE Adj: 1.00 1.00 1.00 1.00 1.00 1.00 1.00 1.00 1.00 1.00 1.00 1.00
MLF Adj: 1.00 1.00 1.00 1.00 1.00 1.00 1.00 1.00 1.00 1.00 1.00 1.00
FinalVolume: 452 0 154 0 0 0 0 670 310 0 1771 0

Saturation Flow Module:
Sat/Lane: 1900 1900 1900 1900 1900 1900 1900 1900 1900 1900 1900 1900
Adjustment: 0.73 1.00 0.74 1.00 1.00 1.00 1.00 0.91 0.85 1.00 0.91 1.00
Lanes: 1.60 0.00 0.40 0.00 0.00 0.00 0.00 3.00 1.00 0.00 3.00 0.00
Final Sat.: 2206 0 564 0 0 0 0 5187 1615 0 5187 0

Capacity Analysis Module:
Vol/Sat: 0.20 0.00 0.27 0.00 0.00 0.00 0.00 0.13 0.19 0.00 0.34 0.00
Crit Moves: **** **** ****

Green/Cycle: 0.42 0.00 0.42 0.00 0.00 0.00 0.00 0.53 0.53 0.00 0.53 0.00
Volume/Cap: 0.48 0.00 0.65 0.00 0.00 0.00 0.00 0.24 0.36 0.00 0.65 0.00
Delay/Veh: 21.3 0.0 24.5 0.0 0.0 0.0 0.0 12.9 14.1 0.0 17.5 0.0
User DelAdj: 1.00 1.00 1.00 1.00 1.00 1.00 1.00 1.00 1.00 1.00 1.00 1.00
AdjDel/Veh: 21.3 0.0 24.5 0.0 0.0 0.0 0.0 12.9 14.1 0.0 17.5 0.0
LOS by Move: C A C A A A A B B A B A
HCM2kAvgQ: 7 0 10 0 0 0 0 4 5 0 14 0

Note: Queue reported is the number of cars per lane.

Continental Grand Campus Specific Plan
Existing With Project AM Peak Hour (HCM)

Level of Service Computation Report

2000 HCM Operations Method (Future Volume Alternative)

Intersection #19 El Segundo Blvd at La Cienega Blvd

Cycle (sec): 100 Critical Vol./Cap.(X): 0.633
Loss Time (sec): 5 Average Delay (sec/veh): 14.4
Optimal Cycle: 33 Level Of Service: B

Street Name: La Cienega Blvd El Segundo Blvd

Approach: North Bound South Bound East Bound West Bound

Movement: L - T - R L - T - R L - T - R L - T - R

Control: Protected Protected Protected Protected
Rights: Include Include Include Include
Min. Green: 0 0 0 0 0 0 0 0 0 0 0 0
Y+R: 4.0 4.0 4.0 4.0 4.0 4.0 4.0 4.0 4.0 4.0 4.0
Lanes: 0 0 0 0 0 2 0 0 0 2 1 0 3 0 0 0 0 2 1 0

Volume Module:

Base Vol: 0 0 0 249 0 322 75 539 0 0 1312 477
Growth Adj: 1.00 1.00 1.00 1.00 1.00 1.00 1.00 1.00 1.00 1.00 1.00 1.00
Initial Bse: 0 0 0 249 0 322 75 539 0 0 1312 477
Added Vol: 0 0 0 0 0 0 0 8 0 0 201 0
PasserByVol: 0 0 0 0 0 0 0 0 0 0 0 0
Initial Fut: 0 0 0 249 0 322 75 547 0 0 1513 477
User Adj: 1.00 1.00 1.00 1.00 1.00 1.00 1.00 1.00 1.00 1.00 1.00 1.00
PHF Adj: 0.92 0.92 0.92 0.92 0.92 0.92 0.92 0.92 0.92 0.92 0.92 0.92
PHF Volume: 0 0 0 271 0 350 82 595 0 0 1645 518
Reduct Vol: 0 0 0 0 0 0 0 0 0 0 0 0
Reduced Vol: 0 0 0 271 0 350 82 595 0 0 1645 518
PCE Adj: 1.00 1.00 1.00 1.00 1.00 1.00 1.00 1.00 1.00 1.00 1.00 1.00
MLF Adj: 1.00 1.00 1.00 1.00 1.00 1.00 1.00 1.00 1.00 1.00 1.00 1.00
FinalVolume: 0 0 0 271 0 350 82 595 0 0 1645 518

Saturation Flow Module:

Sat/Lane: 1900 1900 1900 1900 1900 1900 1900 1900 1900 1900 1900 1900
Adjustment: 1.00 1.00 1.00 0.92 1.00 0.75 0.95 0.91 1.00 1.00 0.88 0.88
Lanes: 0.00 0.00 0.00 2.00 0.00 2.00 1.00 3.00 0.00 0.00 2.28 0.72
Final Sat.: 0 0 0 3502 0 2842 1805 5187 0 0 3802 1199

Capacity Analysis Module:

Vol/Sat: 0.00 0.00 0.00 0.08 0.00 0.12 0.05 0.11 0.00 0.00 0.43 0.43
Crit Moves: ****
Green/Cycle: 0.00 0.00 0.00 0.19 0.00 0.19 0.07 0.76 0.00 0.00 0.68 0.68
Volume/Cap: 0.00 0.00 0.00 0.40 0.00 0.63 0.63 0.15 0.00 0.00 0.63 0.63
Delay/Veh: 0.0 0.0 0.0 35.5 0.0 39.4 55.0 3.4 0.0 0.0 9.2 9.2
User DelAdj: 1.00 1.00 1.00 1.00 1.00 1.00 1.00 1.00 1.00 1.00 1.00 1.00
AdjDel/Veh: 0.0 0.0 0.0 35.5 0.0 39.4 55.0 3.4 0.0 0.0 9.2 9.2
LOS by Move: A A A D A D D A A A A A
HCM2kAvgQ: 0 0 0 4 0 7 3 2 0 0 13 13

Note: Queue reported is the number of cars per lane.

Continental Grand Campus Specific Plan
Existing With Project AM Peak Hour (HCM)

Level of Service Computation Report

2000 HCM Operations Method (Future Volume Alternative)

Intersection #20 El Segundo Blvd at I-405 NB Ramps

Cycle (sec): 100 Critical Vol./Cap.(X): 0.753
Loss Time (sec): 5 Average Delay (sec/veh): 19.5
Optimal Cycle: 46 Level Of Service: B

Street Name: I-405 NB Ramps El Segundo Blvd

Approach: North Bound South Bound East Bound West Bound

Movement: L - T - R L - T - R L - T - R L - T - R

Control: Protected Protected Protected Protected
Rights: Include Include Ignore Include
Min. Green: 0 0 0 0 0 0 0 0 0 0 0 0
Y+R: 4.0 4.0 4.0 4.0 4.0 4.0 4.0 4.0 4.0 4.0 4.0 4.0
Lanes: 2 0 0 0 1 0 0 0 0 0 0 0 2 1 1 0 0 2 1 0

Volume Module:

Base Vol: 861 0 102 0 0 0 0 625 148 0 935 610
Growth Adj: 1.00 1.00 1.00 1.00 1.00 1.00 1.00 1.00 1.00 1.00 1.00 1.00
Initial Bse: 861 0 102 0 0 0 0 625 148 0 935 610
Added Vol: 134 0 0 0 0 0 0 8 0 0 67 0
PasserByVol: 0 0 0 0 0 0 0 0 0 0 0 0
Initial Fut: 995 0 102 0 0 0 0 633 148 0 1002 610
User Adj: 1.00 1.00 1.00 1.00 1.00 1.00 1.00 1.00 0.00 1.00 1.00 1.00
PHF Adj: 0.92 0.92 0.92 0.92 0.92 0.92 0.92 0.92 0.00 0.92 0.92 0.92
PHF Volume: 1082 0 111 0 0 0 0 688 0 0 1089 663
Reduct Vol: 0 0 0 0 0 0 0 0 0 0 0 0
Reduced Vol: 1082 0 111 0 0 0 0 688 0 0 1089 663
PCE Adj: 1.00 1.00 1.00 1.00 1.00 1.00 1.00 1.00 0.00 1.00 1.00 1.00
MLF Adj: 1.00 1.00 1.00 1.00 1.00 1.00 1.00 1.00 0.00 1.00 1.00 1.00
FinalVolume: 1082 0 111 0 0 0 0 688 0 0 1089 663

Saturation Flow Module:

Sat/Lane: 1900 1900 1900 1900 1900 1900 1900 1900 1900 1900 1900 1900
Adjustment: 0.92 1.00 0.85 1.00 1.00 1.00 1.00 0.91 0.91 1.00 0.86 0.86
Lanes: 2.00 0.00 1.00 0.00 0.00 0.00 0.00 3.00 1.00 0.00 2.00 1.00
Final Sat.: 3502 0 1615 0 0 0 0 5187 1729 0 3261 1630

Capacity Analysis Module:

Vol/Sat: 0.31 0.00 0.07 0.00 0.00 0.00 0.00 0.13 0.00 0.00 0.33 0.41
Crit Moves: ****
Green/Cycle: 0.41 0.00 0.41 0.00 0.00 0.00 0.00 0.54 0.00 0.00 0.54 0.54
Volume/Cap: 0.75 0.00 0.17 0.00 0.00 0.00 0.00 0.25 0.00 0.00 0.62 0.75
Delay/Veh: 27.5 0.0 18.8 0.0 0.0 0.0 0.0 12.2 0.0 0.0 16.3 19.3
User DelAdj: 1.00 1.00 1.00 1.00 1.00 1.00 1.00 1.00 1.00 1.00 1.00 1.00
AdjDel/Veh: 27.5 0.0 18.8 0.0 0.0 0.0 0.0 12.2 0.0 0.0 16.3 19.3
LOS by Move: C A B A A A A B A A B B
HCM2kAvgQ: 16 0 2 0 0 0 0 4 0 0 13 18

Note: Queue reported is the number of cars per lane.

 Continental Grand Campus Specific Plan
 Existing With Project PM Peak Hour (HCM)

Scenario Report

Scenario: Ex With Proj PM HCM
 Command: Ex With Proj PM HCM
 Volume: Ex PM
 Geometry: Existing
 Impact Fee: Default Impact Fee
 Trip Generation: Proj PM
 Trip Distribution: Project
 Paths: Project
 Routes: Default Route
 Configuration: Ex With Proj PM HCM

 Continental Grand Campus Specific Plan
 Existing With Project PM Peak Hour (HCM)

Trip Generation Report

Forecast for Proj PM

Zone #	Subzone	Amount	Units	Rate In	Rate Out	Trips In	Trips Out	Total Trips	% Of Total
714	400 Duley -	1.00	Office	0.00	0.00	0	0	0	0.0
714	400 Duley -	1.00	Industrial	0.00	0.00	0	0	0	0.0
1002	Laker Facili	1.00	General Office	0.00	0.00	0	0	0	0.0
1004	1955 E Grand	1.00	Mattel	44.00	216.00	44	216	260	18.7
	Zone 1004 Subtotal					44	216	260	18.7
1005	Mattel	1.00	Mattel	48.00	388.00	48	388	436	31.3
	Zone 1005 Subtotal					48	388	436	31.3
1007	Mattel Proje	1.00	project	92.00	604.00	92	604	696	50.0
	Zone 1007 Subtotal					92	604	696	50.0
TOTAL						184	1208	1392	100.0

Continental Grand Campus Specific Plan
Existing With Project PM Peak Hour (HCM)

Trip Distribution Report

Percent Of Trips Project

Zone	To Gates											
	1	2	3	4	5	7	8	9	10	11	12	
306	0.0	0.0	0.0	0.0	0.0	0.0	0.0	0.0	0.0	0.0	0.0	0.0
307	0.0	0.0	0.0	0.0	0.0	0.0	0.0	0.0	0.0	0.0	0.0	0.0
311	0.0	0.0	0.0	0.0	0.0	0.0	0.0	0.0	0.0	0.0	0.0	0.0
313	0.0	0.0	0.0	0.0	0.0	0.0	0.0	0.0	0.0	0.0	0.0	0.0
314	0.0	0.0	0.0	0.0	0.0	0.0	0.0	0.0	0.0	0.0	0.0	0.0
704	0.0	0.0	0.0	0.0	0.0	0.0	0.0	0.0	0.0	0.0	0.0	0.0
706	0.0	0.0	0.0	0.0	0.0	0.0	0.0	0.0	0.0	0.0	0.0	0.0
710	0.0	0.0	0.0	0.0	0.0	0.0	0.0	0.0	0.0	0.0	0.0	0.0
714	0.0	0.0	0.0	0.0	0.0	0.0	0.0	0.0	0.0	0.0	0.0	0.0
717	0.0	0.0	0.0	0.0	0.0	0.0	0.0	0.0	0.0	0.0	0.0	0.0
718	0.0	0.0	0.0	0.0	0.0	0.0	0.0	0.0	0.0	0.0	0.0	0.0
719	0.0	0.0	0.0	0.0	0.0	0.0	0.0	0.0	0.0	0.0	0.0	0.0
1002	0.0	10.0	5.0	5.0	15.0	5.0	10.0	15.0	5.0	15.0	5.0	5.0
1004	5.0	15.0	10.0	5.0	30.0	0.0	5.0	20.0	0.0	0.0	5.0	5.0
1005	5.0	15.0	10.0	5.0	30.0	0.0	5.0	20.0	0.0	0.0	5.0	5.0
1007	0.0	0.0	0.0	0.0	0.0	0.0	0.0	0.0	0.0	0.0	0.0	0.0

Zone	To Gates				
	14	15	17	18	20
306	0.0	0.0	0.0	0.0	0.0
307	0.0	0.0	0.0	0.0	0.0
311	0.0	0.0	0.0	0.0	0.0
313	0.0	0.0	0.0	0.0	0.0
314	0.0	0.0	0.0	0.0	0.0
704	0.0	0.0	0.0	0.0	0.0
706	0.0	0.0	0.0	0.0	0.0
710	0.0	0.0	0.0	0.0	0.0
714	0.0	0.0	0.0	0.0	0.0
717	0.0	0.0	0.0	0.0	0.0
718	0.0	0.0	0.0	0.0	0.0
719	0.0	0.0	0.0	0.0	0.0
1002	5.0	5.0	0.0	0.0	0.0
1004	5.0	0.0	0.0	0.0	0.0
1005	5.0	0.0	0.0	0.0	0.0
1007	0.0	0.0	0.0	20.0	10.0

Continental Grand Campus Specific Plan
Existing With Project PM Peak Hour (HCM)

Impact Analysis Report
Level Of Service

Intersection		Base		Future		Change in	
		Del/ LOS	V/ C	Del/ LOS	V/ C		
# 1 Sepulveda Blvd at Imperial Hwy	D	37.4	1.022	D	43.3	1.076	+ 5.970 D/V
# 2 Sepulveda Blvd at Walnut St	A	9.8	0.541	A	9.5	0.565	-0.222 D/V
# 3 Sepulveda Blvd at Maple Ave	B	12.4	0.593	B	12.4	0.595	-0.061 D/V
# 4 Sepulveda Blvd at Mariposa Ave	B	19.9	0.618	C	20.5	0.630	+ 0.655 D/V
# 5 Sepulveda Blvd at Grand Ave	C	30.0	0.788	C	34.6	0.879	+ 4.618 D/V
# 6 Sepulveda Blvd at El Segundo B	D	36.0	0.901	D	37.3	0.916	+ 1.291 D/V
# 7 Sepulveda Blvd at Rosecrans Bl	C	31.8	0.867	C	32.5	0.887	+ 0.713 D/V
# 8 Continental Boulevard at Marip	B	16.2	0.278	B	16.8	0.315	+ 0.571 D/V
# 9 Continental Boulevard at Grand	B	18.3	0.272	B	18.7	0.298	+ 0.379 D/V
# 10 Continental Boulevard at El Se	B	19.6	0.394	C	20.8	0.447	+ 1.262 D/V
# 11 Nash St and Imperial Hwy	B	19.4	0.468	C	20.2	0.484	+ 0.763 D/V
# 12 Nash St at Mariposa Ave	B	17.2	0.525	B	19.2	0.659	+ 1.964 D/V
# 13 Nash St at Grand Ave	C	22.6	0.493	C	22.8	0.499	+ 0.157 D/V
# 14 Nash St at El Segundo Blvd	B	19.7	0.528	B	19.0	0.568	-0.761 D/V
# 15 Douglas Street at El Segundo B	C	33.1	0.874	D	35.2	0.914	+ 2.043 D/V
# 16 Aviation Boulevard at El Segun	D	39.6	0.941	D	42.9	0.972	+ 3.286 D/V
# 17 El Segundo Boulevard and Isis	B	xxxxx	0.625	B	xxxxx	0.653	+ 0.028 V/C
# 18 El Segundo Blvd at I-405 SB Ra	C	26.8	1.048	D	36.9	1.134	+10.102 D/V
# 19 El Segundo Blvd at La Cienega	C	20.4	0.671	C	20.4	0.684	-0.005 D/V
# 20 El Segundo Blvd at I-405 NB Ra	B	11.7	0.679	B	11.8	0.692	+ 0.152 D/V

Continental Grand Campus Specific Plan
Existing With Project PM Peak Hour (HCM)

Level of Service Computation Report
2000 HCM Operations Method (Future Volume Alternative)

Intersection #1 Sepulveda Blvd at Imperial Hwy

Cycle (sec): 100 Critical Vol./Cap.(X): 1.076
Loss Time (sec): 5 Average Delay (sec/veh): 43.3
Optimal Cycle: 180 Level Of Service: D

Street Name: Sepulveda Blvd Imperial Hwy

Approach: North Bound South Bound East Bound West Bound
Movement: L - T - R L - T - R L - T - R L - T - R

Control: Protected Protected Protected Protected
Rights: Include Include Include Ovl
Min. Green: 0 0 0 0 0 0 0 0 0 0 0 0
Y+R: 4.0 4.0 4.0 4.0 4.0 4.0 4.0 4.0 4.0 4.0 4.0 4.0
Lanes: 1 0 3 0 1 2 0 3 1 0 2 0 3 0 1 2 0 3 0 1

Volume Module:

Base Vol: 154 1713 885 640 1993 7 202 402 140 120 295 461
Growth Adj: 1.00 1.00 1.00 1.00 1.00 1.00 1.00 1.00 1.00 1.00 1.00 1.00
Initial Bse: 154 1717 887 642 1998 7 203 403 140 120 296 462
Added Vol: 30 30 76 0 5 0 0 0 5 0 0 0
PasserByVol: 0 0 0 0 0 0 0 0 0 0 0 0
Initial Fut: 184 1747 963 642 2003 7 203 403 145 120 296 462
User Adj: 1.00 1.00 1.00 1.00 1.00 1.00 1.00 1.00 1.00 1.00 1.00 1.00
PHF Adj: 0.92 0.92 0.92 0.92 0.92 0.92 0.92 0.92 0.92 0.92 0.92 0.92
PHF Volume: 200 1899 1047 697 2177 8 220 438 158 131 321 502
Reduct Vol: 0 0 0 0 0 0 0 0 0 0 0 0
Reduced Vol: 200 1899 1047 697 2177 8 220 438 158 131 321 502
PCE Adj: 1.00 1.00 1.00 1.00 1.00 1.00 1.00 1.00 1.00 1.00 1.00 1.00
MLF Adj: 1.00 1.00 1.00 1.00 1.00 1.00 1.00 1.00 1.00 1.00 1.00 1.00
FinalVolume: 200 1899 1047 697 2177 8 220 438 158 131 321 502

Saturation Flow Module:

Sat/Lane: 1900 1900 1900 1900 1900 1900 1900 1900 1900 1900 1900 1900
Adjustment: 0.95 0.91 0.85 0.92 0.91 0.91 0.92 0.91 0.85 0.92 0.91 0.85
Lanes: 1.00 3.00 1.00 2.00 3.99 0.01 2.00 3.00 1.00 2.00 3.00 1.00
Final Sat.: 1805 5187 1615 3502 6892 24 3502 5187 1615 3502 5187 1615

Capacity Analysis Module:

Vol/Sat: 0.11 0.37 0.65 0.20 0.32 0.32 0.06 0.08 0.10 0.04 0.06 0.31
Crit Moves: **** **** **** ****
Green/Cycle: 0.20 0.60 0.60 0.19 0.58 0.58 0.06 0.12 0.12 0.04 0.10 0.29
Volume/Cap: 0.54 0.61 1.08 1.08 0.54 0.54 1.08 0.72 0.83 0.83 0.60 1.08
Delay/Veh: 37.2 12.8 71.5 98.3 12.9 12.9 131.7 46.7 68.9 77.2 44.6 99.1
User DelAdj: 1.00 1.00 1.00 1.00 1.00 1.00 1.00 1.00 1.00 1.00 1.00 1.00
AdjDel/Veh: 37.2 12.8 71.5 98.3 12.9 12.9 131.7 46.7 68.9 77.2 44.6 99.1
LOS by Move: D B E F B B F D E D F
HCM2kAvgQ: 5 13 44 18 11 11 5 5 5 2 3 22

Note: Queue reported is the number of cars per lane.

Continental Grand Campus Specific Plan
Existing With Project PM Peak Hour (HCM)

Level of Service Computation Report
2000 HCM Operations Method (Future Volume Alternative)

Intersection #2 Sepulveda Blvd at Walnut St

Cycle (sec): 100 Critical Vol./Cap.(X): 0.565
Loss Time (sec): 5 Average Delay (sec/veh): 9.5
Optimal Cycle: 28 Level Of Service: A

Street Name: Sepulveda Blvd Walnut St

Approach: North Bound South Bound East Bound West Bound
Movement: L - T - R L - T - R L - T - R L - T - R

Control: Protected Protected Permitted Permitted
Rights: Include Include Include Include
Min. Green: 0 0 0 0 0 0 0 0 0 0 0 0
Y+R: 4.0 4.0 4.0 4.0 4.0 4.0 4.0 4.0 4.0 4.0 4.0 4.0
Lanes: 1 0 3 1 0 1 0 3 1 0 0 1 0 0 1 0 1 0 0 1

Volume Module:

Base Vol: 48 2434 29 10 2181 74 117 31 71 46 10 66
Growth Adj: 1.00 1.00 1.00 1.00 1.00 1.00 1.00 1.00 1.00 1.00 1.00 1.00
Initial Bse: 48 2440 29 10 2187 74 117 31 71 46 10 66
Added Vol: 0 136 0 0 9 0 0 0 0 0 0 0
PasserByVol: 0 0 0 0 0 0 0 0 0 0 0 0
Initial Fut: 48 2576 29 10 2196 74 117 31 71 46 10 66
User Adj: 1.00 1.00 1.00 1.00 1.00 1.00 1.00 1.00 1.00 1.00 1.00 1.00
PHF Adj: 0.92 0.92 0.92 0.92 0.92 0.92 0.92 0.92 0.92 0.92 0.92 0.92
PHF Volume: 52 2800 32 11 2387 81 128 34 77 50 11 72
Reduct Vol: 0 0 0 0 0 0 0 0 0 0 0 0
Reduced Vol: 52 2800 32 11 2387 81 128 34 77 50 11 72
PCE Adj: 1.00 1.00 1.00 1.00 1.00 1.00 1.00 1.00 1.00 1.00 1.00 1.00
MLF Adj: 1.00 1.00 1.00 1.00 1.00 1.00 1.00 1.00 1.00 1.00 1.00 1.00
FinalVolume: 52 2800 32 11 2387 81 128 34 77 50 11 72

Saturation Flow Module:

Sat/Lane: 1900 1900 1900 1900 1900 1900 1900 1900 1900 1900 1900 1900
Adjustment: 0.95 0.91 0.91 0.95 0.91 0.91 0.71 0.71 0.85 0.68 0.68 0.85
Lanes: 1.00 3.96 0.04 1.00 3.87 0.13 0.79 0.21 1.00 0.82 0.18 1.00
Final Sat.: 1805 6825 77 1805 6656 225 1060 281 1615 1064 231 1615

Capacity Analysis Module:

Vol/Sat: 0.03 0.41 0.41 0.01 0.36 0.36 0.12 0.12 0.05 0.05 0.05 0.04
Crit Moves: **** **** **** ****
Green/Cycle: 0.06 0.73 0.73 0.01 0.68 0.68 0.21 0.21 0.21 0.21 0.21 0.21
Volume/Cap: 0.53 0.56 0.56 0.56 0.53 0.53 0.56 0.56 0.23 0.22 0.22 0.21
Delay/Veh: 51.1 6.5 6.5 82.7 8.0 8.0 37.8 37.8 32.9 32.9 32.9 32.7
User DelAdj: 1.00 1.00 1.00 1.00 1.00 1.00 1.00 1.00 1.00 1.00 1.00 1.00
AdjDel/Veh: 51.1 6.5 6.5 82.7 8.0 8.0 37.8 37.8 32.9 32.9 32.9 32.7
LOS by Move: D A A F A A D D C C C C
HCM2kAvgQ: 2 11 11 0 10 10 5 5 2 2 2 2

Note: Queue reported is the number of cars per lane.

Continental Grand Campus Specific Plan
Existing With Project PM Peak Hour (HCM)

Level of Service Computation Report
2000 HCM Operations Method (Future Volume Alternative)

Intersection #3 Sepulveda Blvd at Maple Ave

Cycle (sec): 100 Critical Vol./Cap.(X): 0.595
Loss Time (sec): 5 Average Delay (sec/veh): 12.4
Optimal Cycle: 30 Level Of Service: B

Street Name: Sepulveda Blvd Maple Ave

Approach: North Bound South Bound East Bound West Bound
Movement: L - T - R L - T - R L - T - R L - T - R

Control: Protected Protected Permitted Permitted
Rights: Include Include Include Include
Min. Green: 0 0 0 0 0 0 0 0 0 0 0 0
Y+R: 4.0 4.0 4.0 4.0 4.0 4.0 4.0 4.0 4.0 4.0 4.0
Lanes: 1 0 3 1 0 1 0 3 1 0 1 0 0 1 0 1

Volume Module:

Base Vol: 98 2208 33 57 2439 42 68 57 37 114 102 114
Growth Adj: 1.00 1.00 1.00 1.00 1.00 1.00 1.00 1.00 1.00 1.00 1.00 1.00
Initial Bse: 98 2208 33 57 2439 42 68 57 37 114 102 114
Added Vol: 0 136 0 0 9 0 0 0 0 0 0 0 0
PasserByVol: 0 0 0 0 0 0 0 0 0 0 0 0 0
Initial Fut: 98 2344 33 57 2448 42 68 57 37 114 102 114
User Adj: 1.00 1.00 1.00 1.00 1.00 1.00 1.00 1.00 1.00 1.00 1.00 1.00
PHF Adj: 0.92 0.92 0.92 0.92 0.92 0.92 0.92 0.92 0.92 0.92 0.92 0.92
PHF Volume: 107 2548 36 62 2661 46 74 62 40 124 111 124
Reduct Vol: 0 0 0 0 0 0 0 0 0 0 0 0 0
Reduced Vol: 107 2548 36 62 2661 46 74 62 40 124 111 124
PCE Adj: 1.00 1.00 1.00 1.00 1.00 1.00 1.00 1.00 1.00 1.00 1.00 1.00
MLF Adj: 1.00 1.00 1.00 1.00 1.00 1.00 1.00 1.00 1.00 1.00 1.00 1.00
FinalVolume: 107 2548 36 62 2661 46 74 62 40 124 111 124

Saturation Flow Module:

Sat/Lane: 1900 1900 1900 1900 1900 1900 1900 1900 1900 1900 1900 1900
Adjustment: 0.95 0.91 0.91 0.95 0.91 0.91 0.55 0.94 0.94 0.57 1.00 0.85
Lanes: 1.00 3.94 0.06 1.00 3.93 0.07 1.00 0.61 0.39 1.00 1.00 1.00
Final Sat.: 1805 6806 96 1805 6779 116 1049 1084 704 1089 1900 1615

Capacity Analysis Module:

Vol/Sat: 0.06 0.37 0.37 0.03 0.39 0.39 0.07 0.06 0.06 0.11 0.06 0.08
Crit Moves: ****
Green/Cycle: 0.10 0.70 0.70 0.06 0.66 0.66 0.19 0.19 0.19 0.19 0.19 0.19
Volume/Cap: 0.60 0.54 0.54 0.54 0.60 0.60 0.37 0.30 0.30 0.60 0.31 0.40
Delay/Veh: 48.5 7.6 7.6 50.4 9.8 9.8 36.3 35.2 35.2 41.5 35.2 36.3
User DelAdj: 1.00 1.00 1.00 1.00 1.00 1.00 1.00 1.00 1.00 1.00 1.00 1.00
AdjDel/Veh: 48.5 7.6 7.6 50.4 9.8 9.8 36.3 35.2 35.2 41.5 35.2 36.3
LOS by Move: D A A D A A D D D D D D
HCM2kAvgQ: 4 11 11 3 13 13 2 3 3 4 3 4

Note: Queue reported is the number of cars per lane.

Continental Grand Campus Specific Plan
Existing With Project PM Peak Hour (HCM)

Level of Service Computation Report
2000 HCM Operations Method (Future Volume Alternative)

Intersection #4 Sepulveda Blvd at Mariposa Ave

Cycle (sec): 100 Critical Vol./Cap.(X): 0.630
Loss Time (sec): 5 Average Delay (sec/veh): 20.5
Optimal Cycle: 32 Level Of Service: C

Street Name: Sepulveda Blvd Mariposa Ave

Approach: North Bound South Bound East Bound West Bound
Movement: L - T - R L - T - R L - T - R L - T - R

Control: Protected Protected Permitted Permitted
Rights: Include Include Include Include
Min. Green: 0 0 0 0 0 0 0 0 0 0 0 0
Y+R: 4.0 4.0 4.0 4.0 4.0 4.0 4.0 4.0 4.0 4.0 4.0
Lanes: 1 0 4 0 1 2 0 3 1 0 1 0 0 1 0 1

Volume Module:

Base Vol: 100 2039 133 227 2100 79 102 213 37 117 265 207
Growth Adj: 1.00 1.00 1.00 1.00 1.00 1.00 1.00 1.00 1.00 1.00 1.00 1.00
Initial Bse: 100 2044 133 228 2105 79 102 214 37 117 266 208
Added Vol: 11 117 0 7 2 0 0 5 0 0 19 19
PasserByVol: 0 0 0 0 0 0 0 0 0 0 0 0 0
Initial Fut: 111 2161 133 235 2107 79 102 219 37 117 285 227
User Adj: 1.00 1.00 1.00 1.00 1.00 1.00 1.00 1.00 1.00 1.00 1.00 1.00
PHF Adj: 0.92 0.92 0.92 0.92 0.92 0.92 0.92 0.92 0.92 0.92 0.92 0.92
PHF Volume: 121 2349 145 255 2291 86 111 238 40 128 309 246
Reduct Vol: 0 0 0 0 0 0 0 0 0 0 0 0 0
Reduced Vol: 121 2349 145 255 2291 86 111 238 40 128 309 246
PCE Adj: 1.00 1.00 1.00 1.00 1.00 1.00 1.00 1.00 1.00 1.00 1.00 1.00
MLF Adj: 1.00 1.00 1.00 1.00 1.00 1.00 1.00 1.00 1.00 1.00 1.00 1.00
FinalVolume: 121 2349 145 255 2291 86 111 238 40 128 309 246

Saturation Flow Module:

Sat/Lane: 1900 1900 1900 1900 1900 1900 1900 1900 1900 1900 1900 1900
Adjustment: 0.95 0.91 0.85 0.92 0.91 0.91 0.32 0.98 0.98 0.36 1.00 0.85
Lanes: 1.00 4.00 1.00 2.00 3.86 0.14 1.00 0.85 0.15 1.00 1.00 1.00
Final Sat.: 1805 6916 1615 3502 6632 249 604 1589 270 686 1900 1615

Capacity Analysis Module:

Vol/Sat: 0.07 0.34 0.09 0.07 0.35 0.35 0.18 0.15 0.15 0.19 0.16 0.15
Crit Moves: ****
Green/Cycle: 0.11 0.54 0.54 0.12 0.55 0.55 0.30 0.30 0.30 0.30 0.30 0.30
Volume/Cap: 0.63 0.63 0.17 0.63 0.63 0.63 0.62 0.51 0.51 0.63 0.55 0.52
Delay/Veh: 49.4 16.4 11.8 45.4 15.9 15.9 37.1 30.0 30.0 36.7 30.9 30.3
User DelAdj: 1.00 1.00 1.00 1.00 1.00 1.00 1.00 1.00 1.00 1.00 1.00 1.00
AdjDel/Veh: 49.4 16.4 11.8 45.4 15.9 15.9 37.1 30.0 30.0 36.7 30.9 30.3
LOS by Move: D B B D B B D C C D C C
HCM2kAvgQ: 4 13 2 5 14 14 4 7 7 5 8 7

Note: Queue reported is the number of cars per lane.

Continental Grand Campus Specific Plan
Existing With Project PM Peak Hour (HCM)

Level of Service Computation Report
2000 HCM Operations Method (Future Volume Alternative)

Intersection #5 Sepulveda Blvd at Grand Ave

Cycle (sec): 100 Critical Vol./Cap.(X): 0.879
Loss Time (sec): 5 Average Delay (sec/veh): 34.6
Optimal Cycle: 79 Level Of Service: C

Street Name: Sepulveda Blvd Grand Ave

Approach: North Bound South Bound East Bound West Bound
Movement: L - T - R L - T - R L - T - R L - T - R

Control: Protected Protected Split Phase Split Phase
Rights: Ovl Include Include Include
Min. Green: 0 0 0 0 0 0 0 0 0 0 0 0
Y+R: 4.0 4.0 4.0 4.0 4.0 4.0 4.0 4.0 4.0 4.0 4.0 4.0
Lanes: 1 0 4 0 1 1 0 3 1 0 1 1 0 1 0 2 0 2 0 1

Volume Module:

Base Vol: 177 1686 177 86 1814 112 304 186 155 327 207 293
Growth Adj: 1.00 1.00 1.00 1.00 1.00 1.00 1.00 1.00 1.00 1.00 1.00 1.00
Initial Bse: 177 1690 177 86 1819 112 305 186 155 328 208 294
Added Vol: 0 0 14 2 0 0 0 5 0 155 30 127
PasserByVol: 0 0 0 0 0 0 0 0 0 0 0 0
Initial Fut: 177 1690 191 88 1819 112 305 191 155 483 238 421
User Adj: 1.00 1.00 1.00 1.00 1.00 1.00 1.00 1.00 1.00 1.00 1.00 1.00
PHF Adj: 0.92 0.92 0.92 0.92 0.92 0.92 0.92 0.92 0.92 0.92 0.92 0.92
PHF Volume: 193 1837 208 96 1977 122 331 208 169 525 258 457
Reduct Vol: 0 0 0 0 0 0 0 0 0 0 0 0
Reduced Vol: 193 1837 208 96 1977 122 331 208 169 525 258 457
PCE Adj: 1.00 1.00 1.00 1.00 1.00 1.00 1.00 1.00 1.00 1.00 1.00 1.00
MLF Adj: 1.00 1.00 1.00 1.00 1.00 1.00 1.00 1.00 1.00 1.00 1.00 1.00
FinalVolume: 193 1837 208 96 1977 122 331 208 169 525 258 457

Saturation Flow Module:

Sat/Lane: 1900 1900 1900 1900 1900 1900 1900 1900 1900 1900 1900 1900
Adjustment: 0.95 0.91 0.85 0.95 0.90 0.90 0.89 0.89 0.89 0.92 0.95 0.85
Lanes: 1.00 4.00 1.00 1.00 3.77 0.23 1.40 0.88 0.72 2.00 2.00 1.00
Final Sat.: 1805 6916 1615 1805 6455 399 2385 1499 1216 3502 3610 1615

Capacity Analysis Module:

Vol/Sat: 0.11 0.27 0.13 0.05 0.31 0.31 0.14 0.14 0.14 0.15 0.07 0.28
Crit Moves: ****
Green/Cycle: 0.12 0.39 0.71 0.08 0.35 0.35 0.16 0.16 0.16 0.32 0.32 0.32
Volume/Cap: 0.88 0.68 0.18 0.68 0.88 0.88 0.88 0.88 0.88 0.47 0.22 0.88
Delay/Veh: 74.0 25.9 4.8 57.4 34.7 34.7 52.1 52.1 52.1 27.3 24.8 47.8
User DelAdj: 1.00 1.00 1.00 1.00 1.00 1.00 1.00 1.00 1.00 1.00 1.00 1.00
AdjDel/Veh: 74.0 25.9 4.8 57.4 34.7 34.7 52.1 52.1 52.1 27.3 24.8 47.8
LOS by Move: E C A E C C D D D C C D
HCM2kAvgQ: 6 12 2 3 17 17 11 11 11 7 3 17

Note: Queue reported is the number of cars per lane.

Continental Grand Campus Specific Plan
Existing With Project PM Peak Hour (HCM)

Level of Service Computation Report
2000 HCM Operations Method (Future Volume Alternative)

Intersection #6 Sepulveda Blvd at El Segundo Blvd

Cycle (sec): 100 Critical Vol./Cap.(X): 0.916
Loss Time (sec): 5 Average Delay (sec/veh): 37.3
Optimal Cycle: 100 Level Of Service: D

Street Name: Sepulveda Blvd El Segundo Blvd

Approach: North Bound South Bound East Bound West Bound
Movement: L - T - R L - T - R L - T - R L - T - R

Control: Protected Protected Protected Protected
Rights: Include Include Include Include
Min. Green: 0 0 0 0 0 0 0 0 0 0 0 0
Y+R: 4.0 4.0 4.0 4.0 4.0 4.0 4.0 4.0 4.0 4.0 4.0 4.0
Lanes: 2 0 3 1 0 2 0 4 0 1 1 0 2 0 1 2 0 2 0 1

Volume Module:

Base Vol: 318 1444 294 183 2056 112 139 651 451 412 472 243
Growth Adj: 1.00 1.00 1.00 1.00 1.00 1.00 1.00 1.00 1.00 1.00 1.00 1.00
Initial Bse: 319 1448 295 183 2061 112 139 653 452 413 473 244
Added Vol: 0 14 0 65 91 0 0 0 0 0 0 0
PasserByVol: 0 0 0 0 0 0 0 0 0 0 0 0
Initial Fut: 319 1462 295 248 2152 112 139 653 452 413 473 244
User Adj: 1.00 1.00 1.00 1.00 1.00 1.00 1.00 1.00 1.00 1.00 1.00 1.00
PHF Adj: 0.92 0.92 0.92 0.92 0.92 0.92 0.92 0.92 0.92 0.92 0.92 0.92
PHF Volume: 347 1589 320 270 2340 122 151 709 491 449 514 265
Reduct Vol: 0 0 0 0 0 0 0 0 0 0 0 0
Reduced Vol: 347 1589 320 270 2340 122 151 709 491 449 514 265
PCE Adj: 1.00 1.00 1.00 1.00 1.00 1.00 1.00 1.00 1.00 1.00 1.00 1.00
MLF Adj: 1.00 1.00 1.00 1.00 1.00 1.00 1.00 1.00 1.00 1.00 1.00 1.00
FinalVolume: 347 1589 320 270 2340 122 151 709 491 449 514 265

Saturation Flow Module:

Sat/Lane: 1900 1900 1900 1900 1900 1900 1900 1900 1900 1900 1900 1900
Adjustment: 0.92 0.89 0.89 0.92 0.91 0.85 0.95 0.95 0.85 0.92 0.95 0.85
Lanes: 2.00 3.33 0.67 2.00 4.00 1.00 1.00 2.00 1.00 2.00 2.00 1.00
Final Sat.: 3502 5612 1132 3502 6916 1615 1805 3610 1615 3502 3610 1615

Capacity Analysis Module:

Vol/Sat: 0.10 0.28 0.28 0.08 0.34 0.08 0.08 0.20 0.30 0.13 0.14 0.16
Crit Moves: ****
Green/Cycle: 0.11 0.38 0.38 0.10 0.37 0.37 0.16 0.33 0.33 0.14 0.31 0.31
Volume/Cap: 0.92 0.75 0.75 0.75 0.92 0.20 0.52 0.59 0.92 0.92 0.46 0.52
Delay/Veh: 70.5 28.5 28.5 52.5 35.8 21.7 40.3 28.5 52.5 64.3 27.9 29.3
User DelAdj: 1.00 1.00 1.00 1.00 1.00 1.00 1.00 1.00 1.00 1.00 1.00 1.00
AdjDel/Veh: 70.5 28.5 28.5 52.5 35.8 21.7 40.3 28.5 52.5 64.3 27.9 29.3
LOS by Move: E C C D D C D C D E C C
HCM2kAvgQ: 9 15 15 4 19 2 5 10 19 11 7 7

Note: Queue reported is the number of cars per lane.

Continental Grand Campus Specific Plan
Existing With Project PM Peak Hour (HCM)

Level of Service Computation Report

2000 HCM Operations Method (Future Volume Alternative)

Intersection #7 Sepulveda Blvd at Rosecrans Blvd

Cycle (sec): 100 Critical Vol./Cap.(X): 0.887
Loss Time (sec): 5 Average Delay (sec/veh): 32.5
Optimal Cycle: 83 Level Of Service: C

Street Name: Sepulveda Blvd Rosecrans Blvd

Approach: North Bound South Bound East Bound West Bound

Movement: L - T - R L - T - R L - T - R L - T - R

Control: Protected Protected Protected Protected

Rights: Ovl Include Include Ignore

Min. Green: 0 0 0 0 0 0 0 0 0 0 0 0

Y+R: 4.0 4.0 4.0 4.0 4.0 4.0 4.0 4.0 4.0 4.0 4.0 4.0

Lanes: 2 0 4 0 1 2 0 3 0 1 2 0 3 0 1 2 0 2 0 1

Volume Module:

Base Vol: 310 1257 302 494 2351 519 195 483 162 376 580 462
Growth Adj: 1.00 1.00 1.00 1.00 1.00 1.00 1.00 1.00 1.00 1.00 1.00 1.00
Initial Bse: 310 1257 302 494 2351 519 195 483 162 376 580 462
Added Vol: 0 14 0 0 91 0 0 0 0 0 0 0
PasserByVol: 0 0 0 0 0 0 0 0 0 0 0 0
Initial Fut: 310 1271 302 494 2442 519 195 483 162 376 580 462
User Adj: 1.00 1.00 1.00 1.00 1.00 1.00 1.00 1.00 1.00 1.00 1.00 0.00
PHF Adj: 0.92 0.92 0.92 0.92 0.92 0.92 0.92 0.92 0.92 0.92 0.92 0.00
PHF Volume: 337 1382 328 537 2654 564 212 525 176 409 630 0
Reduct Vol: 0 0 0 0 0 0 0 0 0 0 0 0
Reduced Vol: 337 1382 328 537 2654 564 212 525 176 409 630 0
PCE Adj: 1.00 1.00 1.00 1.00 1.00 1.00 1.00 1.00 1.00 1.00 1.00 0.00
MLF Adj: 1.00 1.00 1.00 1.00 1.00 1.00 1.00 1.00 1.00 1.00 1.00 0.00
FinalVolume: 337 1382 328 537 2654 564 212 525 176 409 630 0

Saturation Flow Module:

Sat/Lane: 1900 1900 1900 1900 1900 1900 1900 1900 1900 1900 1900 1900
Adjustment: 0.92 0.91 0.85 0.92 0.91 0.85 0.92 0.91 0.85 0.92 0.95 1.00
Lanes: 2.00 4.00 1.00 2.00 3.00 1.00 2.00 3.00 1.00 2.00 2.00 1.00
Final Sat.: 3502 6916 1615 3502 5187 1615 3502 5187 1615 3502 3610 1900

Capacity Analysis Module:

Vol/Sat: 0.10 0.20 0.20 0.15 0.51 0.35 0.06 0.10 0.11 0.12 0.17 0.00
Crit Moves: ****
Green/Cycle: 0.11 0.39 0.52 0.30 0.58 0.58 0.07 0.13 0.13 0.14 0.20 0.00
Volume/Cap: 0.89 0.52 0.39 0.52 0.89 0.61 0.89 0.79 0.85 0.85 0.89 0.00
Delay/Veh: 65.5 23.6 14.5 29.6 22.0 14.9 76.7 48.7 69.8 55.8 52.1 0.0
User DelAdj: 1.00 1.00 1.00 1.00 1.00 1.00 1.00 1.00 1.00 1.00 1.00 1.00
AdjDel/Veh: 65.5 23.6 14.5 29.6 22.0 14.9 76.7 48.7 69.8 55.8 52.1 0.0
LOS by Move: E C B C C B E D E D A
HCM2kAvgQ: 8 9 6 7 29 12 6 8 8 9 13 0

Note: Queue reported is the number of cars per lane.

Continental Grand Campus Specific Plan
Existing With Project PM Peak Hour (HCM)

Level of Service Computation Report

2000 HCM Operations Method (Future Volume Alternative)

Intersection #8 Continental Boulevard at Mariposa Ave

Cycle (sec): 100 Critical Vol./Cap.(X): 0.315
Loss Time (sec): 5 Average Delay (sec/veh): 16.8
Optimal Cycle: 19 Level Of Service: B

Street Name: Continental Boulevard Mariposa Avenue

Approach: North Bound South Bound East Bound West Bound

Movement: L - T - R L - T - R L - T - R L - T - R

Control: Permitted Permitted Permitted Permitted

Rights: Include Include Include Include

Min. Green: 0 0 0 0 0 0 0 0 0 0 0 0

Y+R: 4.0 4.0 4.0 4.0 4.0 4.0 4.0 4.0 4.0 4.0 4.0 4.0

Lanes: 1 0 1 0 2 1 0 0 1 0 1 0 2 1 0 1 0 1 1 0

Volume Module:

Base Vol: 176 85 306 9 56 28 11 514 49 58 342 10
Growth Adj: 1.00 1.00 1.00 1.00 1.00 1.00 1.00 1.00 1.00 1.00 1.00 1.00
Initial Bse: 176 85 306 9 56 28 11 514 49 58 342 10
Added Vol: 39 0 136 0 0 0 0 0 0 11 14 0 0
PasserByVol: 0 0 0 0 0 0 0 0 0 0 0 0
Initial Fut: 215 85 442 9 56 28 11 514 60 72 342 10
User Adj: 1.00 1.00 1.00 1.00 1.00 1.00 1.00 1.00 1.00 1.00 1.00 1.00
PHF Adj: 0.92 0.92 0.92 0.92 0.92 0.92 0.92 0.92 0.92 0.92 0.92 0.00
PHF Volume: 234 92 480 10 61 30 12 559 65 78 372 11
Reduct Vol: 0 0 0 0 0 0 0 0 0 0 0 0
Reduced Vol: 234 92 480 10 61 30 12 559 65 78 372 11
PCE Adj: 1.00 1.00 1.00 1.00 1.00 1.00 1.00 1.00 1.00 1.00 1.00 1.00
MLF Adj: 1.00 1.00 1.00 1.00 1.00 1.00 1.00 1.00 1.00 1.00 1.00 1.00
FinalVolume: 234 92 480 10 61 30 12 559 65 78 372 11

Saturation Flow Module:

Sat/Lane: 1900 1900 1900 1900 1900 1900 1900 1900 1900 1900 1900 1900
Adjustment: 0.70 1.00 0.75 0.69 0.95 0.95 0.44 0.90 0.90 0.35 0.95 0.95
Lanes: 1.00 1.00 2.00 1.00 0.67 0.33 1.00 2.69 0.31 1.00 1.94 0.06
Final Sat.: 1322 1900 2842 1321 1203 602 838 4570 534 659 3493 102

Capacity Analysis Module:

Vol/Sat: 0.18 0.05 0.17 0.01 0.05 0.05 0.01 0.12 0.12 0.12 0.11 0.11
Crit Moves: ****
Green/Cycle: 0.56 0.56 0.56 0.56 0.56 0.56 0.39 0.39 0.39 0.39 0.39 0.39
Volume/Cap: 0.31 0.09 0.30 0.01 0.09 0.09 0.04 0.31 0.31 0.31 0.27 0.27
Delay/Veh: 11.9 10.1 11.7 9.7 10.2 10.2 19.0 21.4 21.4 21.9 21.0 21.0
User DelAdj: 1.00 1.00 1.00 1.00 1.00 1.00 1.00 1.00 1.00 1.00 1.00 1.00
AdjDel/Veh: 11.9 10.1 11.7 9.7 10.2 10.2 19.0 21.4 21.4 21.9 21.0 21.0
LOS by Move: B B B A B B B C C C C C
HCM2kAvgQ: 4 1 4 0 1 1 0 5 5 2 4 4

Note: Queue reported is the number of cars per lane.

Continental Grand Campus Specific Plan
Existing With Project PM Peak Hour (HCM)

Level of Service Computation Report
2000 HCM Operations Method (Future Volume Alternative)

Intersection #9 Continental Boulevard at Grand Avenue

Cycle (sec): 100 Critical Vol./Cap.(X): 0.298
Loss Time (sec): 5 Average Delay (sec/veh): 18.7
Optimal Cycle: 18 Level Of Service: B

Street Name: Continental Boulevard Grand Avenue
Approach: North Bound South Bound East Bound West Bound
Movement: L - T - R L - T - R L - T - R L - T - R

Control: Permitted Permitted Protected Protected
Rights: Include Include Include Include
Min. Green: 0 0 0 0 0 0 0 0 0 0 0 0
Y+R: 4.0 4.0 4.0 4.0 4.0 4.0 4.0 4.0 4.0 4.0 4.0 4.0
Lanes: 0 1 1 1 0 1 0 2 1 0 1 0 2 1 0

Volume Module:
Base Vol: 53 144 110 40 172 108 58 592 142 21 245 25
Growth Adj: 1.00 1.00 1.00 1.00 1.00 1.00 1.00 1.00 1.00 1.00 1.00 1.00
Initial Bse: 53 144 110 40 172 108 58 592 142 21 245 25
Added Vol: 23 5 0 0 39 26 11 0 78 0 18 0
PasserByVol: 0 0 0 0 0 0 0 0 0 0 0 0
Initial Fut: 76 149 110 40 211 134 69 592 220 21 263 25
User Adj: 1.00 1.00 1.00 1.00 1.00 1.00 1.00 1.00 1.00 1.00 1.00 1.00
PHF Adj: 0.92 0.92 0.92 0.92 0.92 0.92 0.92 0.92 0.92 0.92 0.92 0.92
PHF Volume: 83 162 120 43 229 146 75 643 239 23 286 27
Reduct Vol: 0 0 0 0 0 0 0 0 0 0 0 0
Reduced Vol: 83 162 120 43 229 146 75 643 239 23 286 27
PCE Adj: 1.00 1.00 1.00 1.00 1.00 1.00 1.00 1.00 1.00 1.00 1.00 1.00
MLF Adj: 1.00 1.00 1.00 1.00 1.00 1.00 1.00 1.00 1.00 1.00 1.00 1.00
FinalVolume: 83 162 120 43 229 146 75 643 239 23 286 27

Saturation Flow Module:
Sat/Lane: 1900 1900 1900 1900 1900 1900 1900 1900 1900 1900 1900 1900
Adjustment: 0.69 0.69 0.69 0.46 0.86 0.86 0.95 0.87 0.87 0.95 0.90 0.90
Lanes: 0.68 1.33 0.99 1.00 2.00 1.00 1.00 2.19 0.81 1.00 2.74 0.26
Final Sat.: 890 1744 1288 876 3257 1629 1805 3627 1348 1805 4675 444

Capacity Analysis Module:
Vol/Sat: 0.09 0.09 0.09 0.05 0.07 0.09 0.04 0.18 0.18 0.01 0.06 0.06
Crit Moves: ****
Green/Cycle: 0.31 0.31 0.31 0.31 0.31 0.31 0.26 0.60 0.60 0.04 0.38 0.38
Volume/Cap: 0.30 0.30 0.30 0.16 0.23 0.29 0.16 0.30 0.30 0.30 0.16 0.16
Delay/Veh: 26.2 26.2 26.2 25.2 25.5 26.1 28.9 10.0 10.0 48.6 20.5 20.5
User DelAdj: 1.00 1.00 1.00 1.00 1.00 1.00 1.00 1.00 1.00 1.00 1.00 1.00
AdjDel/Veh: 26.2 26.2 26.2 25.2 25.5 26.1 28.9 10.0 10.0 48.6 20.5 20.5
LOS by Move: C C C C C C C A A D C C
HCM2kAvgQ: 3 3 3 1 3 4 2 5 5 1 2 2

Note: Queue reported is the number of cars per lane.

Continental Grand Campus Specific Plan
Existing With Project PM Peak Hour (HCM)

Level of Service Computation Report
2000 HCM Operations Method (Future Volume Alternative)

Intersection #10 Continental Boulevard at El Segundo Boulevard

Cycle (sec): 100 Critical Vol./Cap.(X): 0.447
Loss Time (sec): 5 Average Delay (sec/veh): 20.8
Optimal Cycle: 23 Level Of Service: C

Street Name: Continental Boulevard El Segundo Boulevard
Approach: North Bound South Bound East Bound West Bound
Movement: L - T - R L - T - R L - T - R L - T - R

Control: Split Phase Split Phase Protected Protected
Rights: Include Include Include Include
Min. Green: 0 0 0 0 0 0 0 0 0 0 0 0
Y+R: 4.0 4.0 4.0 4.0 4.0 4.0 4.0 4.0 4.0 4.0 4.0 4.0
Lanes: 1 1 0 1 1 1 1 0 1 1 2 0 3 0 1 2 0 2 1 0

Volume Module:
Base Vol: 64 82 94 346 28 81 29 1017 6 36 714 69
Growth Adj: 1.00 1.00 1.00 1.00 1.00 1.00 1.00 1.00 1.00 1.00 1.00 1.00
Initial Bse: 64 82 94 346 28 81 29 1017 6 36 714 69
Added Vol: 0 0 0 116 0 0 0 65 0 0 0 0 28
PasserByVol: 0 0 0 0 0 0 0 0 0 0 0 0 0
Initial Fut: 64 82 94 462 28 81 29 1082 6 36 714 97
User Adj: 1.00 1.00 1.00 1.00 1.00 1.00 1.00 1.00 1.00 1.00 1.00 1.00
PHF Adj: 0.92 0.92 0.92 0.92 0.92 0.92 0.92 0.92 0.92 0.92 0.92 0.92
PHF Volume: 70 89 102 502 30 88 32 1176 7 39 776 105
Reduct Vol: 0 0 0 0 0 0 0 0 0 0 0 0
Reduced Vol: 70 89 102 502 30 88 32 1176 7 39 776 105
PCE Adj: 1.00 1.00 1.00 1.00 1.00 1.00 1.00 1.00 1.00 1.00 1.00 1.00
MLF Adj: 1.00 1.00 1.00 1.00 1.00 1.00 1.00 1.00 1.00 1.00 1.00 1.00
FinalVolume: 70 89 102 502 30 88 32 1176 7 39 776 105

Saturation Flow Module:
Sat/Lane: 1900 1900 1900 1900 1900 1900 1900 1900 1900 1900 1900 1900
Adjustment: 0.88 0.88 0.88 0.89 0.89 0.89 0.92 0.91 0.85 0.92 0.89 0.89
Lanes: 1.07 1.36 1.57 2.00 0.51 1.49 2.00 3.00 1.00 2.00 2.64 0.36
Final Sat.: 1788 2291 2626 3396 872 2524 3502 5187 1615 3502 4484 609

Capacity Analysis Module:
Vol/Sat: 0.04 0.04 0.04 0.15 0.03 0.03 0.01 0.23 0.00 0.01 0.17 0.17
Crit Moves: ****
Green/Cycle: 0.09 0.09 0.09 0.33 0.33 0.33 0.03 0.51 0.51 0.02 0.51 0.51
Volume/Cap: 0.45 0.45 0.45 0.45 0.11 0.11 0.34 0.45 0.01 0.45 0.34 0.34
Delay/Veh: 43.9 43.9 43.9 26.5 23.2 23.2 50.1 15.8 12.2 51.7 14.8 14.8
User DelAdj: 1.00 1.00 1.00 1.00 1.00 1.00 1.00 1.00 1.00 1.00 1.00 1.00
AdjDel/Veh: 43.9 43.9 43.9 26.5 23.2 23.2 50.1 15.8 12.2 51.7 14.8 14.8
LOS by Move: D D D C C C D B B D B B
HCM2kAvgQ: 3 3 3 7 1 1 1 8 0 1 6 6

Note: Queue reported is the number of cars per lane.

Continental Grand Campus Specific Plan
Existing With Project PM Peak Hour (HCM)

Level of Service Computation Report
2000 HCM Operations Method (Future Volume Alternative)

Intersection #11 Nash St and Imperial Hwy
Cycle (sec): 100 Critical Vol./Cap.(X): 0.484
Loss Time (sec): 5 Average Delay (sec/veh): 20.2
Optimal Cycle: 24 Level Of Service: C

Table with columns: Street Name, Approach, Movement, Control, Rights, Min. Green, Y+R, Lanes. Rows for Nash St and Imperial Hwy.

Table with columns: Volume Module, Base Vol, Growth Adj, Initial Bse, Added Vol, PasserByVol, Initial Fut, User Adj, PHF Adj, PHF Volume, Reduct Vol, Reduced Vol, PCE Adj, MLF Adj, FinalVolume.

Table with columns: Sat/Lane, Adjustment, Lanes, Final Sat. Rows for Nash St and Imperial Hwy.

Table with columns: Capacity Analysis Module, Vol/Sat, Crit Moves, Green/Cycle, Volume/Cap, Delay/Veh, User DelAdj, AdjDel/Veh, LOS by Move, HCM2kAvgQ.

Note: Queue reported is the number of cars per lane.

Continental Grand Campus Specific Plan
Existing With Project PM Peak Hour (HCM)

Level of Service Computation Report
2000 HCM Operations Method (Future Volume Alternative)

Intersection #12 Nash St at Mariposa Ave
Cycle (sec): 100 Critical Vol./Cap.(X): 0.659
Loss Time (sec): 5 Average Delay (sec/veh): 19.2
Optimal Cycle: 35 Level Of Service: B

Table with columns: Street Name, Approach, Movement, Control, Rights, Min. Green, Y+R, Lanes. Rows for Nash St and Mariposa Ave.

Table with columns: Volume Module, Base Vol, Growth Adj, Initial Bse, Added Vol, PasserByVol, Initial Fut, User Adj, PHF Adj, PHF Volume, Reduct Vol, Reduced Vol, PCE Adj, MLF Adj, FinalVolume.

Table with columns: Sat/Lane, Adjustment, Lanes, Final Sat. Rows for Nash St and Mariposa Ave.

Table with columns: Capacity Analysis Module, Vol/Sat, Crit Moves, Green/Cycle, Volume/Cap, Delay/Veh, User DelAdj, AdjDel/Veh, LOS by Move, HCM2kAvgQ.

Note: Queue reported is the number of cars per lane.

Continental Grand Campus Specific Plan
Existing With Project PM Peak Hour (HCM)

Level of Service Computation Report
2000 HCM Operations Method (Future Volume Alternative)

Intersection #13 Nash St at Grand Ave

Cycle (sec): 100 Critical Vol./Cap.(X): 0.499
Loss Time (sec): 5 Average Delay (sec/veh): 22.8
Optimal Cycle: 25 Level Of Service: C

Table with columns for Street Name (Nash St, Grand Ave), Approach (North Bound, South Bound, East Bound, West Bound), Movement (L, T, R), Control (Protected, Split Phase), Rights (Include), Min. Green, Y+R, and Lanes.

Table with columns for Volume Module (Base Vol, Growth Adj, Initial Bse, Added Vol, PasserByVol, Initial Fut, User Adj, PHF Adj, PHF Volume, Reduct Vol, Reduced Vol, PCE Adj, MLF Adj, FinalVolume).

Table with columns for Sat/Lane, Adjustment, Lanes, and Final Sat. for Saturation Flow Module.

Table with columns for Vol/Sat, Crit Moves, Green/Cycle, Volume/Cap, Delay/Veh, User DelAdj, AdjDel/Veh, LOS by Move, and HCM2kAvgQ for Capacity Analysis Module.

Note: Queue reported is the number of cars per lane.

Continental Grand Campus Specific Plan
Existing With Project PM Peak Hour (HCM)

Level of Service Computation Report
2000 HCM Operations Method (Future Volume Alternative)

Intersection #14 Nash St at El Segundo Blvd

Cycle (sec): 100 Critical Vol./Cap.(X): 0.568
Loss Time (sec): 5 Average Delay (sec/veh): 19.0
Optimal Cycle: 28 Level Of Service: B

Table with columns for Street Name (Nash St, El Segundo Blvd), Approach (North Bound, South Bound, East Bound, West Bound), Movement (L, T, R), Control (Split Phase, Protected), Rights (Ovl, Include), Min. Green, Y+R, and Lanes.

Table with columns for Volume Module (Base Vol, Growth Adj, Initial Bse, Added Vol, PasserByVol, Initial Fut, User Adj, PHF Adj, PHF Volume, Reduct Vol, Reduced Vol, PCE Adj, MLF Adj, FinalVolume).

Table with columns for Sat/Lane, Adjustment, Lanes, and Final Sat. for Saturation Flow Module.

Table with columns for Vol/Sat, Crit Moves, Green/Cycle, Volume/Cap, Delay/Veh, User DelAdj, AdjDel/Veh, LOS by Move, and HCM2kAvgQ for Capacity Analysis Module.

Note: Queue reported is the number of cars per lane.

Continental Grand Campus Specific Plan
Existing With Project PM Peak Hour (HCM)

Level of Service Computation Report

2000 HCM Operations Method (Future Volume Alternative)

Intersection #15 Douglas Street at El Segundo Boulevard

Cycle (sec): 100 Critical Vol./Cap.(X): 0.914
Loss Time (sec): 5 Average Delay (sec/veh): 35.2
Optimal Cycle: 99 Level Of Service: D

Street Name: Douglas St El Segundo Blvd

Approach: North Bound South Bound East Bound West Bound
Movement: L - T - R L - T - R L - T - R L - T - R

Control: Protected Protected Protected Protected
Rights: Include Include Include Include
Min. Green: 0 0 0 0 0 0 0 0 0 0 0 0
Y+R: 4.0 4.0 4.0 4.0 4.0 4.0 4.0 4.0 4.0 4.0 4.0 4.0
Lanes: 2 0 1 1 1 2 0 2 0 1 1 0 2 1 0 2 0 3 0 1

Volume Module:

Base Vol: 148 395 266 484 1097 56 35 1578 334 138 580 168
Growth Adj: 1.00 1.00 1.00 1.00 1.00 1.00 1.00 1.00 1.00 1.00 1.00 1.00
Initial Bse: 148 395 266 484 1097 56 35 1578 334 138 580 168
Added Vol: 0 0 0 0 0 0 0 0 181 0 0 28 0
PasserByVol: 0
Initial Fut: 148 395 266 484 1097 56 35 1759 334 138 608 168
User Adj: 1.00 1.00 1.00 1.00 1.00 1.00 1.00 1.00 1.00 1.00 1.00 1.00
PHF Adj: 0.92 0.92 0.92 0.92 0.92 0.92 0.92 0.92 0.92 0.92 0.92 0.92
PHF Volume: 161 429 289 526 1192 61 38 1912 363 150 661 183
Reduct Vol: 0
Reduced Vol: 161 429 289 526 1192 61 38 1912 363 150 661 183
PCE Adj: 1.00 1.00 1.00 1.00 1.00 1.00 1.00 1.00 1.00 1.00 1.00 1.00
MLF Adj: 1.00 1.00 1.00 1.00 1.00 1.00 1.00 1.00 1.00 1.00 1.00 1.00
FinalVolume: 161 429 289 526 1192 61 38 1912 363 150 661 183

Saturation Flow Module:

Sat/Lane: 1900 1900 1900 1900 1900 1900 1900 1900 1900 1900 1900 1900
Adjustment: 0.92 0.89 0.89 0.92 0.95 0.85 0.95 0.89 0.89 0.92 0.91 0.85
Lanes: 2.00 1.79 1.21 2.00 2.00 1.00 1.00 2.52 0.48 2.00 3.00 1.00
Final Sat.: 3502 3042 2048 3502 3610 1615 1805 4255 808 3502 5187 1615

Capacity Analysis Module:

Vol/Sat: 0.05 0.14 0.14 0.15 0.33 0.04 0.02 0.45 0.45 0.04 0.13 0.11
Crit Moves: ****
Green/Cycle: 0.05 0.20 0.20 0.21 0.36 0.36 0.08 0.49 0.49 0.05 0.46 0.46
Volume/Cap: 0.91 0.71 0.71 0.71 0.91 0.10 0.28 0.91 0.91 0.91 0.28 0.24
Delay/Veh: 91.2 39.6 39.6 39.7 40.5 21.3 44.7 29.3 29.3 93.5 16.6 16.5
User DelAdj: 1.00 1.00 1.00 1.00 1.00 1.00 1.00 1.00 1.00 1.00 1.00 1.00
AdjDel/Veh: 91.2 39.6 39.6 39.7 40.5 21.3 44.7 29.3 29.3 93.5 16.6 16.5
LOS by Move: F D D D C D C C F B B
HCM2kAvgQ: 5 9 9 9 23 1 1 28 28 5 5 3

Note: Queue reported is the number of cars per lane.

Continental Grand Campus Specific Plan
Existing With Project PM Peak Hour (HCM)

Level of Service Computation Report

2000 HCM Operations Method (Future Volume Alternative)

Intersection #16 Aviation Boulevard at El Segundo Boulevard

Cycle (sec): 100 Critical Vol./Cap.(X): 0.972
Loss Time (sec): 5 Average Delay (sec/veh): 42.9
Optimal Cycle: 169 Level Of Service: D

Street Name: Aviation Blvd El Segundo Blvd

Approach: North Bound South Bound East Bound West Bound
Movement: L - T - R L - T - R L - T - R L - T - R

Control: Protected Protected Protected Protected
Rights: Ovl Include Include Include
Min. Green: 0 0 0 0 0 0 0 0 0 0 0 0 0 0 0 0
Y+R: 4.0 4.0 4.0 4.0 4.0 4.0 4.0 4.0 4.0 4.0 4.0 4.0 4.0 4.0 4.0 4.0
Lanes: 2 0 2 0 1 1 0 1 1 1 1 0 3 1 0 2 0 2 1 0

Volume Module:

Base Vol: 180 578 377 95 1121 127 200 1850 360 451 572 42
Growth Adj: 1.00 1.00 1.00 1.00 1.00 1.00 1.00 1.00 1.00 1.00 1.00 1.00
Initial Bse: 180 578 377 95 1121 127 200 1850 360 451 572 42
Added Vol: 0 0 0 0 0 0 0 0 181 0 0 28 0
PasserByVol: 0
Initial Fut: 180 578 377 95 1121 127 200 2031 360 451 600 42
User Adj: 1.00 1.00 1.00 1.00 1.00 1.00 1.00 1.00 1.00 1.00 1.00 1.00
PHF Adj: 0.92 0.92 0.92 0.92 0.92 0.92 0.92 0.92 0.92 0.92 0.92 0.92
PHF Volume: 196 628 410 103 1218 138 217 2208 391 490 652 46
Reduct Vol: 0
Reduced Vol: 196 628 410 103 1218 138 217 2208 391 490 652 46
PCE Adj: 1.00 1.00 1.00 1.00 1.00 1.00 1.00 1.00 1.00 1.00 1.00 1.00
MLF Adj: 1.00 1.00 1.00 1.00 1.00 1.00 1.00 1.00 1.00 1.00 1.00 1.00
FinalVolume: 196 628 410 103 1218 138 217 2208 391 490 652 46

Saturation Flow Module:

Sat/Lane: 1900 1900 1900 1900 1900 1900 1900 1900 1900 1900 1900 1900
Adjustment: 0.92 0.95 0.85 0.95 0.94 0.94 0.95 0.89 0.89 0.92 0.90 0.90
Lanes: 2.00 2.00 1.00 1.00 2.00 1.00 1.00 3.40 0.60 2.00 2.80 0.20
Final Sat.: 3502 3610 1615 1805 3556 1778 1805 5740 1017 3502 4799 336

Capacity Analysis Module:

Vol/Sat: 0.06 0.17 0.25 0.06 0.34 0.08 0.12 0.38 0.38 0.14 0.14 0.14
Crit Moves: ****
Green/Cycle: 0.06 0.31 0.45 0.10 0.35 0.35 0.25 0.40 0.40 0.14 0.29 0.29
Volume/Cap: 0.97 0.56 0.56 0.56 0.97 0.22 0.47 0.97 0.97 0.97 0.47 0.47
Delay/Veh: 102.1 29.6 21.1 46.8 49.6 22.7 32.4 41.2 41.2 75.4 29.7 29.7
User DelAdj: 1.00 1.00 1.00 1.00 1.00 1.00 1.00 1.00 1.00 1.00 1.00 1.00
AdjDel/Veh: 102.1 29.6 21.1 46.8 49.6 22.7 32.4 41.2 41.2 75.4 29.7 29.7
LOS by Move: F C C D D C C D E C C
HCM2kAvgQ: 6 9 10 3 23 3 6 28 28 12 7 7

Note: Queue reported is the number of cars per lane.

Continental Grand Campus Specific Plan
Existing With Project PM Peak Hour (HCM)

Level of Service Computation Report

ICU 1(Loss as Cycle Length %) Method (Future Volume Alternative)

Intersection #17 El Segundo Boulevard and Isis Avenue

Cycle (sec): 100 Critical Vol./Cap.(X): 0.653
Loss Time (sec): 5 Average Delay (sec/veh): xxxxxx
Optimal Cycle: 33 Level Of Service: B

Table with columns for Street Name, Approach, Movement, Control, Rights, Min. Green, Y+R, Lanes. Rows for Isis Avenue and El Segundo Boulevard.

Table with columns for Volume Module, Base Vol, Growth Adj, Initial Bse, Added Vol, PasserByVol, Initial Fut, User Adj, PHF Adj, PHF Volume, Reduct Vol, Reduced Vol, PCE Adj, MLF Adj, FinalVolume.

Table with columns for Saturation Flow Module, Sat/Lane, Adjustment, Lanes, Final Sat.

Table with columns for Capacity Analysis Module, Vol/Sat, Crit Moves.

Continental Grand Campus Specific Plan
Existing With Project PM Peak Hour (HCM)

Level of Service Computation Report

2000 HCM Operations Method (Future Volume Alternative)

Intersection #18 El Segundo Blvd at I-405 SB Ramps

Cycle (sec): 100 Critical Vol./Cap.(X): 1.134
Loss Time (sec): 5 Average Delay (sec/veh): 36.9
Optimal Cycle: 180 Level Of Service: D

Table with columns for Street Name, Approach, Movement, Control, Rights, Min. Green, Y+R, Lanes. Rows for I-405 SB Ramps and El Segundo Blvd.

Table with columns for Volume Module, Base Vol, Growth Adj, Initial Bse, Added Vol, PasserByVol, Initial Fut, User Adj, PHF Adj, PHF Volume, Reduct Vol, Reduced Vol, PCE Adj, MLF Adj, FinalVolume.

Table with columns for Saturation Flow Module, Sat/Lane, Adjustment, Lanes, Final Sat.

Table with columns for Capacity Analysis Module, Vol/Sat, Crit Moves.

Green/Cycle: 0.26 0.00 0.26 0.00 0.00 0.00 0.00 0.69 0.69 0.00 0.69 0.00
Volume/Cap: 0.54 0.00 1.13 0.00 0.00 0.00 0.00 0.47 1.13 0.00 0.33 0.00
Delay/Veh: 32.8 0.0 120.2 0.0 0.0 0.0 0.0 7.0 87.0 0.0 6.1 0.0
User DelAdj: 1.00 1.00 1.00 1.00 1.00 1.00 1.00 1.00 1.00 1.00 1.00 1.00
AdjDel/Veh: 32.8 0.0 120.2 0.0 0.0 0.0 0.0 7.0 87.0 0.0 6.1 0.0
LOS by Move: C A F A A A A A F A A A
HCM2kAvgQ: 6 0 23 0 0 0 0 8 58 0 5 0

Note: Queue reported is the number of cars per lane.

Continental Grand Campus Specific Plan
Existing With Project PM Peak Hour (HCM)

Level of Service Computation Report

2000 HCM Operations Method (Future Volume Alternative)

Intersection #19 El Segundo Blvd at La Cienega Blvd

Cycle (sec): 100 Critical Vol./Cap.(X): 0.684
Loss Time (sec): 5 Average Delay (sec/veh): 20.4
Optimal Cycle: 37 Level Of Service: C

Street Name: La Cienega Blvd El Segundo Blvd

Approach: North Bound South Bound East Bound West Bound

Movement: L - T - R L - T - R L - T - R L - T - R

Control: Protected Protected Protected Protected

Rights: Include Include Include Include

Min. Green: 0 0 0 0 0 0 0 0 0 0 0 0 0

Y+R: 4.0 4.0 4.0 4.0 4.0 4.0 4.0 4.0 4.0 4.0 4.0 4.0

Lanes: 0 0 0 0 0 2 0 0 0 2 1 0 3 0 0 0 0 0 2 1 0

Volume Module:

Base Vol: 0 0 0 665 0 653 101 1849 0 0 614 206
Growth Adj: 1.00 1.00 1.00 1.00 1.00 1.00 1.00 1.00 1.00 1.00 1.00 1.00
Initial Bse: 0 0 0 665 0 653 101 1849 0 0 614 206
Added Vol: 0 0 0 0 0 0 0 60 0 0 28 0
PasserByVol: 0 0 0 0 0 0 0 0 0 0 0 0 0
Initial Fut: 0 0 0 665 0 653 101 1909 0 0 642 206
User Adj: 1.00 1.00 1.00 1.00 1.00 1.00 1.00 1.00 1.00 1.00 1.00 1.00
PHF Adj: 0.92 0.92 0.92 0.92 0.92 0.92 0.92 0.92 0.92 0.92 0.92 0.92
PHF Volume: 0 0 0 723 0 710 110 2075 0 0 698 224
Reduct Vol: 0 0 0 0 0 0 0 0 0 0 0 0 0
Reduced Vol: 0 0 0 723 0 710 110 2075 0 0 698 224
PCE Adj: 1.00 1.00 1.00 1.00 1.00 1.00 1.00 1.00 1.00 1.00 1.00 1.00
MLF Adj: 1.00 1.00 1.00 1.00 1.00 1.00 1.00 1.00 1.00 1.00 1.00 1.00
FinalVolume: 0 0 0 723 0 710 110 2075 0 0 698 224

Saturation Flow Module:

Sat/Lane: 1900 1900 1900 1900 1900 1900 1900 1900 1900 1900 1900 1900
Adjustment: 1.00 1.00 1.00 0.92 1.00 0.75 0.95 0.91 1.00 1.00 0.88 0.88
Lanes: 0.00 0.00 0.00 2.00 0.00 2.00 1.00 3.00 0.00 0.00 2.27 0.73
Final Sat.: 0 0 0 3502 0 2842 1805 5187 0 0 3786 1215

Capacity Analysis Module:

Vol/Sat: 0.00 0.00 0.00 0.21 0.00 0.25 0.06 0.40 0.00 0.00 0.18 0.18
Crit Moves: ****
Green/Cycle: 0.00 0.00 0.00 0.37 0.00 0.37 0.15 0.58 0.00 0.00 0.44 0.44
Volume/Cap: 0.00 0.00 0.00 0.57 0.00 0.68 0.42 0.68 0.00 0.00 0.42 0.42
Delay/Veh: 0.0 0.0 0.0 26.0 0.0 28.8 40.0 15.0 0.0 0.0 19.4 19.4
User DelAdj: 1.00 1.00 1.00 1.00 1.00 1.00 1.00 1.00 1.00 1.00 1.00 1.00
AdjDel/Veh: 0.0 0.0 0.0 26.0 0.0 28.8 40.0 15.0 0.0 0.0 19.4 19.4
LOS by Move: A A A C A C D B A A B B
HCM2kAvgQ: 0 0 0 10 0 11 3 16 0 0 7 7

Note: Queue reported is the number of cars per lane.

Continental Grand Campus Specific Plan
Existing With Project PM Peak Hour (HCM)

Level of Service Computation Report

2000 HCM Operations Method (Future Volume Alternative)

Intersection #20 El Segundo Blvd at I-405 NB Ramps

Cycle (sec): 100 Critical Vol./Cap.(X): 0.692
Loss Time (sec): 5 Average Delay (sec/veh): 11.8
Optimal Cycle: 38 Level Of Service: B

Street Name: I-405 NB Ramps El Segundo Blvd

Approach: North Bound South Bound East Bound West Bound

Movement: L - T - R L - T - R L - T - R L - T - R

Control: Protected Protected Protected Protected

Rights: Include Include Ignore Include

Min. Green: 0 0 0 0 0 0 0 0 0 0 0 0 0

Y+R: 4.0 4.0 4.0 4.0 4.0 4.0 4.0 4.0 4.0 4.0 4.0 4.0

Lanes: 2 0 0 0 1 0 0 0 0 0 0 0 0 2 1 1 0 0 2 1 0

Volume Module:

Base Vol: 373 0 222 0 0 0 0 2365 176 0 447 410
Growth Adj: 1.00 1.00 1.00 1.00 1.00 1.00 1.00 1.00 1.00 1.00 1.00 1.00
Initial Bse: 373 0 222 0 0 0 0 2365 176 0 447 410
Added Vol: 18 0 0 0 0 0 0 60 0 0 9 0
PasserByVol: 0 0 0 0 0 0 0 0 0 0 0 0 0
Initial Fut: 391 0 222 0 0 0 0 2425 176 0 456 410
User Adj: 1.00 1.00 1.00 1.00 1.00 1.00 1.00 1.00 0.00 1.00 1.00 1.00
PHF Adj: 0.92 0.92 0.92 0.92 0.92 0.92 0.92 0.92 0.00 0.92 0.92 0.92
PHF Volume: 425 0 241 0 0 0 0 2636 0 0 496 446
Reduct Vol: 0 0 0 0 0 0 0 0 0 0 0 0 0
Reduced Vol: 425 0 241 0 0 0 0 2636 0 0 496 446
PCE Adj: 1.00 1.00 1.00 1.00 1.00 1.00 1.00 1.00 0.00 1.00 1.00 1.00
MLF Adj: 1.00 1.00 1.00 1.00 1.00 1.00 1.00 1.00 0.00 1.00 1.00 1.00
FinalVolume: 425 0 241 0 0 0 0 2636 0 0 496 446

Saturation Flow Module:

Sat/Lane: 1900 1900 1900 1900 1900 1900 1900 1900 1900 1900 1900 1900
Adjustment: 0.92 1.00 0.85 1.00 1.00 1.00 1.00 0.91 0.91 1.00 0.85 0.85
Lanes: 2.00 0.00 1.00 0.00 0.00 0.00 0.00 3.00 1.00 0.00 2.00 1.00
Final Sat.: 3502 0 1615 0 0 0 0 5187 1729 0 3212 1606

Capacity Analysis Module:

Vol/Sat: 0.12 0.00 0.15 0.00 0.00 0.00 0.00 0.51 0.00 0.00 0.15 0.28
Crit Moves: ****
Green/Cycle: 0.22 0.00 0.22 0.00 0.00 0.00 0.00 0.73 0.00 0.00 0.73 0.73
Volume/Cap: 0.56 0.00 0.69 0.00 0.00 0.00 0.00 0.69 0.00 0.00 0.21 0.38
Delay/Veh: 36.0 0.0 42.0 0.0 0.0 0.0 0.0 7.7 0.0 0.0 4.2 5.0
User DelAdj: 1.00 1.00 1.00 1.00 1.00 1.00 1.00 1.00 1.00 1.00 1.00 1.00
AdjDel/Veh: 36.0 0.0 42.0 0.0 0.0 0.0 0.0 7.7 0.0 0.0 4.2 5.0
LOS by Move: D A D A A A A A A A A A
HCM2kAvgQ: 7 0 8 0 0 0 0 16 0 0 3 6

Note: Queue reported is the number of cars per lane.

Continental Grand Campus Specific Plan
Phase 1 Opening Year (2022) Without Project AM Peak Hour (HCM)

Scenario Report

Scenario: Phase 1 Op Yr W/o Proj AM HCM
 Command: Phase 1 Op Yr W/o Proj AM HCM
 Volume: OY AM
 Geometry: Existing
 Impact Fee: Default Impact Fee
 Trip Generation: Cum AM
 Trip Distribution: Cum + Proj
 Paths: Project
 Routes: Default Route
 Configuration: Phase 1 Op Yr W/o Proj AM HCM

Continental Grand Campus Specific Plan
Phase 1 Opening Year (2022) Without Project AM Peak Hour (HCM)

Trip Generation Report

Forecast for Cum AM

Zone #	Subzone	Amount	Units	Rate In	Rate Out	Trips In	Trips Out	Total Trips	% Of Total
306	525 N. Sepul	1.00	Residential	-6.00	-3.00	-6	-3	-9	-0.6
	Zone 306 Subtotal					-6	-3	-9	-0.6
307	540 Imperial	1.00	Residential	23.00	44.00	23	44	67	4.7
	Zone 307 Subtotal					23	44	67	4.7
311	199 Continen	1.00	Business Hotel	48.00	33.00	48	33	81	5.7
	Zone 311 Subtotal					48	33	81	5.7
313	445 N. Dougl	1.00	Equinix Data C	8.00	8.00	8	8	16	1.1
	Zone 313 Subtotal					8	8	16	1.1
314	123 Lomita a	1.00	Office	17.00	3.00	17	3	20	1.4
	Zone 314 Subtotal					17	3	20	1.4
704	2355 Utah Av	1.00	Office	150.00	76.00	150	76	226	15.9
	Zone 704 Subtotal					150	76	226	15.9
706	888 Sepulved	1.00	hotel	57.00	36.00	57	36	93	6.5
	Zone 706 Subtotal					57	36	93	6.5
710	201 North Do	1.00	High School	160.00	111.00	160	111	271	19.1
710	201 North Do	1.00	District Offic	20.00	2.00	20	2	22	1.5
	Zone 710 Subtotal					180	113	293	20.6
714	400 Duley -	1.00	Office	95.00	13.00	95	13	108	7.6
	Zone 714 Subtotal					95	13	108	7.6
717	1700 Imperia	1.00	Townhome Resid	133.00	18.00	133	18	151	10.6
	Zone 717 Subtotal					133	18	151	10.6
718	123 Nevada S	1.00	Office	18.00	3.00	18	3	21	1.5
718	123 Nevada S	0.00	123 Nevada	18.00	3.00	0	0	0	0.0
	Zone 718 Subtotal					18	3	21	1.5
719	2125 Campus	1.00	Office Retail	160.00	46.00	160	46	206	14.5
	Zone 719 Subtotal					160	46	206	14.5
1002	Laker Facili	1.00	General Office	136.00	13.00	136	13	149	10.5
	Zone 1002 Subtotal					136	13	149	10.5
TOTAL						1019	403	1422	100.0

Continental Grand Campus Specific Plan
Phase 1 Opening Year (2022) Without Project AM Peak Hour (HCM)

Trip Distribution Report

Percent Of Trips Cum + Project

Zone	To Gates											
	1	2	3	4	5	7	8	9	10	11	12	
306	10.0	15.0	10.0	5.0	0.0	5.0	5.0	25.0	0.0	25.0	0.0	
307	10.0	15.0	10.0	5.0	50.0	0.0	0.0	0.0	0.0	0.0	0.0	
311	40.0	10.0	10.0	10.0	0.0	5.0	5.0	10.0	0.0	10.0	0.0	
313	15.0	5.0	15.0	10.0	25.0	0.0	5.0	20.0	0.0	0.0	0.0	
314	40.0	10.0	10.0	10.0	0.0	5.0	5.0	10.0	0.0	10.0	0.0	
704	30.0	15.0	8.0	12.0	0.0	5.0	5.0	10.0	5.0	10.0	0.0	
706	25.0	20.0	10.0	25.0	0.0	0.0	0.0	0.0	0.0	0.0	10.0	
710	0.0	0.0	15.0	10.0	10.0	2.0	2.0	20.0	5.0	10.0	1.0	
714	5.0	10.0	5.0	5.0	20.0	5.0	10.0	15.0	5.0	15.0	0.0	
717	10.0	15.0	10.0	5.0	50.0	0.0	0.0	0.0	0.0	0.0	0.0	
718	10.0	10.0	10.0	10.0	20.0	0.0	0.0	20.0	10.0	0.0	0.0	
719	20.0	10.0	10.0	10.0	10.0	5.0	5.0	10.0	5.0	0.0	0.0	
1002	0.0	10.0	5.0	5.0	15.0	5.0	10.0	15.0	5.0	15.0	5.0	
1004	5.0	15.0	10.0	5.0	30.0	0.0	5.0	20.0	0.0	0.0	5.0	
1005	5.0	15.0	10.0	5.0	30.0	0.0	5.0	20.0	0.0	0.0	5.0	
1007	0.0	0.0	0.0	0.0	0.0	0.0	0.0	0.0	0.0	0.0	0.0	

Zone	To Gates						
	13	14	15	16	17	18	20
306	0.0	0.0	0.0	0.0	0.0	0.0	0.0
307	0.0	10.0	0.0	0.0	0.0	0.0	0.0
311	0.0	0.0	0.0	0.0	0.0	0.0	0.0
313	5.0	0.0	0.0	0.0	0.0	0.0	0.0
314	0.0	0.0	0.0	0.0	0.0	0.0	0.0
704	0.0	0.0	0.0	0.0	0.0	0.0	0.0
706	0.0	0.0	0.0	0.0	10.0	0.0	0.0
710	10.0	5.0	10.0	0.0	0.0	0.0	0.0
714	0.0	5.0	0.0	0.0	0.0	0.0	0.0
717	0.0	10.0	0.0	0.0	0.0	0.0	0.0
718	0.0	10.0	0.0	0.0	0.0	0.0	0.0
719	0.0	10.0	5.0	0.0	0.0	0.0	0.0
1002	0.0	5.0	5.0	0.0	0.0	0.0	0.0
1004	0.0	5.0	0.0	0.0	0.0	0.0	0.0
1005	0.0	5.0	0.0	0.0	0.0	0.0	0.0
1007	0.0	0.0	0.0	0.0	0.0	20.0	10.0

Continental Grand Campus Specific Plan
Phase 1 Opening Year (2022) Without Project AM Peak Hour (HCM)

Impact Analysis Report
Level Of Service

Intersection		Base		Future		Change in	
		Del/ LOS	V/ Veh C	Del/ LOS	V/ Veh C		
# 1 Sepulveda Blvd at Imperial Hwy	C	30.0	0.830	C	29.6	0.889	-0.386 D/V
# 2 Sepulveda Blvd at Walnut St	A	7.8	0.556	A	9.0	0.732	+ 1.226 D/V
# 3 Sepulveda Blvd at Maple Ave	B	10.6	0.543	B	15.4	0.691	+ 4.732 D/V
# 4 Sepulveda Blvd at Mariposa Ave	B	18.4	0.617	B	19.8	0.713	+ 1.478 D/V
# 5 Sepulveda Blvd at Grand Ave	C	22.4	0.753	C	25.8	0.842	+ 3.420 D/V
# 6 Sepulveda Blvd at El Segundo B	C	26.5	0.776	E	64.5	1.099	+38.055 D/V
# 7 Sepulveda Blvd at Rosecrans Bl	C	27.5	0.799	C	33.8	0.923	+ 6.296 D/V
# 8 Continental Boulevard at Marip	A	9.8	0.353	A	9.8	0.378	+ 0.054 D/V
# 9 Continental Boulevard at Grand	C	23.5	0.256	C	23.6	0.279	+ 0.062 D/V
# 10 Continental Boulevard at El Se	A	9.1	0.381	B	15.8	0.548	+ 6.773 D/V
# 11 Nash St and Imperial Hwy	C	24.1	0.628	C	24.9	0.766	+ 0.803 D/V
# 12 Nash St at Mariposa Ave	B	15.0	0.383	B	15.1	0.546	+ 0.071 D/V
# 13 Nash St at Grand Ave	C	23.7	0.470	C	21.4	0.525	-2.354 D/V
# 14 Nash St at El Segundo Blvd	B	12.5	0.445	C	23.3	0.729	+10.876 D/V
# 15 Douglas Street at El Segundo B	C	27.9	0.712	D	39.7	0.982	+11.781 D/V
# 16 Aviation Boulevard at El Segun	C	31.4	0.819	F	90.1	1.181	+58.763 D/V
# 17 El Segundo Boulevard and Isis	B	xxxxx	0.631	D	xxxxx	0.894	+ 0.263 V/C
# 18 El Segundo Blvd at I-405 SB Ra	B	17.8	0.611	B	17.8	0.868	+ 0.017 D/V
# 19 El Segundo Blvd at La Cienega	B	14.7	0.596	C	24.3	0.903	+ 9.563 D/V
# 20 El Segundo Blvd at I-405 NB Ra	B	17.9	0.720	C	27.2	0.894	+ 9.240 D/V

Continental Grand Campus Specific Plan
Phase 1 Opening Year (2022) Without Project AM Peak Hour (HCM)

Level of Service Computation Report
2000 HCM Operations Method (Future Volume Alternative)

Intersection #1 Sepulveda Blvd at Imperial Hwy

Cycle (sec): 100 Critical Vol./Cap.(X): 0.889
Loss Time (sec): 5 Average Delay (sec/veh): 29.6
Optimal Cycle: 84 Level Of Service: C

Street Name: Sepulveda Blvd Imperial Hwy

Approach: North Bound South Bound East Bound West Bound
Movement: L - T - R L - T - R L - T - R L - T - R

Control: Protected Protected Protected Protected
Rights: Include Include Include Ovl
Min. Green: 0 0 0 0 0 0 0 0 0 0 0 0
Y+R: 4.0 4.0 4.0 4.0 4.0 4.0 4.0 4.0 4.0 4.0 4.0
Lanes: 1 0 3 0 1 2 0 3 1 0 2 0 3 0 1 2 0 3 0 1

Volume Module:

Base Vol: 63 1495 418 448 2297 12 210 316 140 211 292 590
Growth Adj: 1.02 1.02 1.02 1.02 1.02 1.02 1.02 1.02 1.02 1.02 1.02 1.02
Initial Bse: 64 1520 425 455 2335 12 213 321 142 215 297 600
Added Vol: 17 48 13 23 185 2 4 31 56 15 3 12
Related Pro: 9 130 38 -85 615 0 -5 25 30 6 5 -90
Initial Fut: 90 1698 476 393 3135 14 212 377 228 236 305 522
User Adj: 1.00 1.00 1.00 1.00 1.00 1.00 1.00 1.00 1.00 1.00 1.00 1.00
PHF Adj: 0.92 0.92 0.92 0.92 0.92 0.92 0.92 0.92 0.92 0.92 0.92 0.92
PHF Volume: 98 1846 517 428 3408 15 231 410 248 256 331 567
Reduct Vol: 0 0 0 0 0 0 0 0 0 0 0 0
Reduced Vol: 98 1846 517 428 3408 15 231 410 248 256 331 567
PCE Adj: 1.00 1.00 1.00 1.00 1.00 1.00 1.00 1.00 1.00 1.00 1.00 1.00
MLF Adj: 1.00 1.00 1.00 1.00 1.00 1.00 1.00 1.00 1.00 1.00 1.00 1.00
FinalVolume: 98 1846 517 428 3408 15 231 410 248 256 331 567

Saturation Flow Module:

Sat/Lane: 1900 1900 1900 1900 1900 1900 1900 1900 1900 1900 1900
Adjustment: 0.95 0.91 0.85 0.92 0.91 0.91 0.92 0.91 0.85 0.92 0.91 0.85
Lanes: 1.00 3.00 1.00 2.00 3.98 0.02 2.00 3.00 1.00 2.00 3.00 1.00
Final Sat.: 1805 5187 1615 3502 6878 31 3502 5187 1615 3502 5187 1615

Capacity Analysis Module:

Vol/Sat: 0.05 0.36 0.32 0.12 0.50 0.50 0.07 0.08 0.15 0.07 0.06 0.35
Crit Moves: ****
Green/Cycle: 0.06 0.46 0.46 0.16 0.56 0.56 0.07 0.22 0.22 0.11 0.26 0.42
Volume/Cap: 0.89 0.77 0.70 0.77 0.89 0.89 0.89 0.35 0.68 0.68 0.25 0.85
Delay/Veh: 99.2 24.2 24.3 47.1 22.3 22.3 74.8 32.8 40.8 48.2 29.5 36.0
User DelAdj: 1.00 1.00 1.00 1.00 1.00 1.00 1.00 1.00 1.00 1.00 1.00 1.00
AdjDel/Veh: 99.2 24.2 24.3 47.1 22.3 22.3 74.8 32.8 40.8 48.2 29.5 36.0
LOS by Move: F C C D C C E C D D C D
HCM2kAvgQ: 4 18 13 8 29 29 4 4 7 4 3 16

Note: Queue reported is the number of cars per lane.

Continental Grand Campus Specific Plan
Phase 1 Opening Year (2022) Without Project AM Peak Hour (HCM)

Level of Service Computation Report
2000 HCM Operations Method (Future Volume Alternative)

Intersection #2 Sepulveda Blvd at Walnut St

Cycle (sec): 100 Critical Vol./Cap.(X): 0.732
Loss Time (sec): 5 Average Delay (sec/veh): 9.0
Optimal Cycle: 43 Level Of Service: A

Street Name: Sepulveda Blvd Walnut St

Approach: North Bound South Bound East Bound West Bound
Movement: L - T - R L - T - R L - T - R L - T - R

Control: Protected Protected Permitted Permitted
Rights: Include Include Include Include
Min. Green: 0 0 0 0 0 0 0 0 0 0 0 0
Y+R: 4.0 4.0 4.0 4.0 4.0 4.0 4.0 4.0 4.0 4.0 4.0 4.0
Lanes: 1 0 3 1 0 1 0 3 1 0 0 1 0 0 1 0 1 0 0 1

Volume Module:

Base Vol: 86 1938 58 62 2372 175 65 19 28 8 11 17
Growth Adj: 1.02 1.02 1.02 1.02 1.02 1.02 1.02 1.02 1.02 1.02 1.02 1.02
Initial Bse: 87 1970 59 63 2411 178 66 19 28 8 11 17
Added Vol: 11 60 11 6 149 100 14 0 0 7 0 4
Related Pro: 7 163 0 0 650 0 0 0 28 0 0 0
Initial Fut: 105 2193 70 69 3210 278 80 19 56 15 11 21
User Adj: 1.00 1.00 1.00 1.00 1.00 1.00 1.00 1.00 1.00 1.00 1.00 1.00
PHF Adj: 0.92 0.92 0.92 0.92 0.92 0.92 0.92 0.92 0.92 0.92 0.92 0.92
PHF Volume: 115 2384 76 75 3490 302 87 21 61 16 12 23
Reduct Vol: 0 0 0 0 0 0 0 0 0 0 0 0
Reduced Vol: 115 2384 76 75 3490 302 87 21 61 16 12 23
PCE Adj: 1.00 1.00 1.00 1.00 1.00 1.00 1.00 1.00 1.00 1.00 1.00 1.00
MLF Adj: 1.00 1.00 1.00 1.00 1.00 1.00 1.00 1.00 1.00 1.00 1.00 1.00
FinalVolume: 115 2384 76 75 3490 302 87 21 61 16 12 23

Saturation Flow Module:

Sat/Lane: 1900 1900 1900 1900 1900 1900 1900 1900 1900 1900 1900
Adjustment: 0.95 0.91 0.91 0.95 0.90 0.90 0.74 0.74 0.85 0.78 0.78 0.85
Lanes: 1.00 3.88 0.12 1.00 3.68 0.32 0.81 0.19 1.00 0.58 0.42 1.00
Final Sat.: 1805 6669 213 1805 6289 544 1127 272 1615 852 630 1615

Capacity Analysis Module:

Vol/Sat: 0.06 0.36 0.36 0.04 0.55 0.55 0.08 0.08 0.04 0.02 0.02 0.01
Crit Moves: ****
Green/Cycle: 0.09 0.76 0.76 0.09 0.76 0.76 0.11 0.11 0.11 0.11 0.11 0.11
Volume/Cap: 0.73 0.47 0.47 0.47 0.73 0.73 0.73 0.73 0.36 0.18 0.18 0.14
Delay/Veh: 60.8 4.7 4.7 45.6 7.1 7.1 60.5 60.5 42.9 41.4 41.4 41.0
User DelAdj: 1.00 1.00 1.00 1.00 1.00 1.00 1.00 1.00 1.00 1.00 1.00 1.00
AdjDel/Veh: 60.8 4.7 4.7 45.6 7.1 7.1 60.5 60.5 42.9 41.4 41.4 41.0
LOS by Move: E A A D A A E E D D D D
HCM2kAvgQ: 5 8 8 2 17 17 5 5 2 1 1 1

Note: Queue reported is the number of cars per lane.

Continental Grand Campus Specific Plan
Phase 1 Opening Year (2022) Without Project AM Peak Hour (HCM)

Level of Service Computation Report
2000 HCM Operations Method (Future Volume Alternative)

Intersection #3 Sepulveda Blvd at Maple Ave

Cycle (sec): 100 Critical Vol./Cap.(X): 0.691
Loss Time (sec): 5 Average Delay (sec/veh): 15.4
Optimal Cycle: 38 Level Of Service: B

Street Name: Sepulveda Blvd Maple Ave

Table with columns for Approach (North Bound, South Bound, East Bound, West Bound) and Movement (L, T, R). Rows include Control, Rights, Min. Green, Y+R, and Lanes.

Volume Module:

Table with columns for Base Vol, Growth Adj, Initial Bse, Added Vol, Related Pro, Initial Fut, User Adj, PHF Adj, PHF Volume, Reduct Vol, Reduced Vol, PCE Adj, MLF Adj, and Final Volume.

Saturation Flow Module:

Table with columns for Sat/Lane, Adjustment, Lanes, and Final Sat.

Capacity Analysis Module:

Table with columns for Vol/Sat, Crit Moves, Green/Cycle, Volume/Cap, Delay/Veh, User DelAdj, AdjDel/Veh, LOS by Move, and HCM2kAvgQ.

Note: Queue reported is the number of cars per lane.

Continental Grand Campus Specific Plan
Phase 1 Opening Year (2022) Without Project AM Peak Hour (HCM)

Level of Service Computation Report
2000 HCM Operations Method (Future Volume Alternative)

Intersection #4 Sepulveda Blvd at Mariposa Ave

Cycle (sec): 100 Critical Vol./Cap.(X): 0.713
Loss Time (sec): 5 Average Delay (sec/veh): 19.8
Optimal Cycle: 40 Level Of Service: B

Street Name: Sepulveda Blvd Mariposa Ave

Table with columns for Approach (North Bound, South Bound, East Bound, West Bound) and Movement (L, T, R). Rows include Control, Rights, Min. Green, Y+R, and Lanes.

Volume Module:

Table with columns for Base Vol, Growth Adj, Initial Bse, Added Vol, Related Pro, Initial Fut, User Adj, PHF Adj, PHF Volume, Reduct Vol, Reduced Vol, PCE Adj, MLF Adj, and Final Volume.

Saturation Flow Module:

Table with columns for Sat/Lane, Adjustment, Lanes, and Final Sat.

Capacity Analysis Module:

Table with columns for Vol/Sat, Crit Moves, Green/Cycle, Volume/Cap, Delay/Veh, User DelAdj, AdjDel/Veh, LOS by Move, and HCM2kAvgQ.

Note: Queue reported is the number of cars per lane.

Continental Grand Campus Specific Plan
Phase 1 Opening Year (2022) Without Project AM Peak Hour (HCM)

Level of Service Computation Report
2000 HCM Operations Method (Future Volume Alternative)

Intersection #5 Sepulveda Blvd at Grand Ave

Cycle (sec): 100 Critical Vol./Cap.(X): 0.842
Loss Time (sec): 5 Average Delay (sec/veh): 25.8
Optimal Cycle: 65 Level Of Service: C

Street Name: Sepulveda Blvd Grand Ave
Approach: North Bound South Bound East Bound West Bound
Movement: L - T - R L - T - R L - T - R L - T - R
Control: Protected Protected Split Phase Split Phase
Rights: Ovl Include Include Include
Min. Green: 0 0 0 0 0 0 0 0 0 0 0 0
Y+R: 4.0 4.0 4.0 4.0 4.0 4.0 4.0 4.0 4.0 4.0 4.0 4.0
Lanes: 1 0 4 0 1 1 0 3 1 0 1 1 0 1 0 2 0 2 0 1

Volume Module:
Base Vol: 130 2061 544 406 1381 185 171 164 103 43 50 57
Growth Adj: 1.02 1.02 1.02 1.02 1.02 1.02 1.02 1.02 1.02 1.02 1.02 1.02
Initial Bse: 132 2095 553 413 1404 188 174 167 105 44 51 58
Added Vol: 1 84 19 31 74 4 10 2 2 2 0 20
Related Pro: 0 142 -15 5 662 10 10 0 27 0 0 10
Initial Fut: 133 2321 557 449 2140 202 194 169 134 46 51 88
User Adj: 1.00 1.00 1.00 1.00 1.00 1.00 1.00 1.00 1.00 1.00 1.00 1.00
PHF Adj: 0.92 0.92 0.92 0.92 0.92 0.92 0.92 0.92 0.92 0.92 0.92 0.92
PHF Volume: 145 2523 605 488 2326 220 211 183 145 50 55 96
Reduct Vol: 0 0 0 0 0 0 0 0 0 0 0 0
Reduced Vol: 145 2523 605 488 2326 220 211 183 145 50 55 96
PCE Adj: 1.00 1.00 1.00 1.00 1.00 1.00 1.00 1.00 1.00 1.00 1.00 1.00
MLF Adj: 1.00 1.00 1.00 1.00 1.00 1.00 1.00 1.00 1.00 1.00 1.00 1.00
FinalVolume: 145 2523 605 488 2326 220 211 183 145 50 55 96

Saturation Flow Module:
Sat/Lane: 1900 1900 1900 1900 1900 1900 1900 1900 1900 1900 1900 1900
Adjustment: 0.95 0.91 0.85 0.95 0.90 0.90 0.89 0.89 0.89 0.92 0.95 0.85
Lanes: 1.00 4.00 1.00 1.00 3.65 0.35 1.17 1.02 0.81 2.00 2.00 1.00
Final Sat.: 1805 6916 1615 1805 6237 589 1992 1734 1374 3502 3610 1615

Capacity Analysis Module:
Vol/Sat: 0.08 0.36 0.37 0.27 0.37 0.37 0.11 0.11 0.11 0.01 0.02 0.06
Crit Moves: ****
Green/Cycle: 0.13 0.43 0.50 0.32 0.62 0.62 0.13 0.13 0.13 0.07 0.07 0.07
Volume/Cap: 0.60 0.84 0.74 0.84 0.60 0.60 0.84 0.84 0.84 0.20 0.22 0.84
Delay/Veh: 45.0 27.6 23.5 42.4 11.7 11.7 52.6 52.6 52.6 44.2 44.3 86.3
User DelAdj: 1.00 1.00 1.00 1.00 1.00 1.00 1.00 1.00 1.00 1.00 1.00 1.00
AdjDel/Veh: 45.0 27.6 23.5 42.4 11.7 11.7 52.6 52.6 52.6 44.2 44.3 86.3
LOS by Move: D C C D B B D D D D D F
HCM2kAvgQ: 4 17 14 14 13 13 8 8 8 1 1 5

Note: Queue reported is the number of cars per lane.

Continental Grand Campus Specific Plan
Phase 1 Opening Year (2022) Without Project AM Peak Hour (HCM)

Level of Service Computation Report
2000 HCM Operations Method (Future Volume Alternative)

Intersection #6 Sepulveda Blvd at El Segundo Blvd

Cycle (sec): 100 Critical Vol./Cap.(X): 1.099
Loss Time (sec): 5 Average Delay (sec/veh): 64.5
Optimal Cycle: 180 Level Of Service: E

Street Name: Sepulveda Blvd El Segundo Blvd
Approach: North Bound South Bound East Bound West Bound
Movement: L - T - R L - T - R L - T - R L - T - R
Control: Protected Protected Protected Protected
Rights: Include Include Include Include
Min. Green: 0 0 0 0 0 0 0 0 0 0 0 0
Y+R: 4.0 4.0 4.0 4.0 4.0 4.0 4.0 4.0 4.0 4.0 4.0 4.0
Lanes: 2 0 3 1 0 2 0 4 0 1 1 0 2 0 1 2 0 2 0 1

Volume Module:
Base Vol: 369 2440 293 252 1120 121 108 291 222 138 292 216
Growth Adj: 1.02 1.02 1.02 1.02 1.02 1.02 1.02 1.02 1.02 1.02 1.02 1.02
Initial Bse: 375 2481 298 256 1139 123 110 296 226 140 297 220
Added Vol: 4 69 32 36 23 19 16 25 1 15 22 20
Related Pro: 1 27 169 527 178 3 3 4 6 27 13 83
Initial Fut: 380 2577 499 819 1340 145 129 325 233 182 332 323
User Adj: 1.00 1.00 1.00 1.00 1.00 1.00 1.00 1.00 1.00 1.00 1.00 1.00
PHF Adj: 0.92 0.92 0.92 0.92 0.92 0.92 0.92 0.92 0.92 0.92 0.92 0.92
PHF Volume: 413 2801 542 890 1456 158 140 353 253 198 361 351
Reduct Vol: 0 0 0 0 0 0 0 0 0 0 0 0
Reduced Vol: 413 2801 542 890 1456 158 140 353 253 198 361 351
PCE Adj: 1.00 1.00 1.00 1.00 1.00 1.00 1.00 1.00 1.00 1.00 1.00 1.00
MLF Adj: 1.00 1.00 1.00 1.00 1.00 1.00 1.00 1.00 1.00 1.00 1.00 1.00
FinalVolume: 413 2801 542 890 1456 158 140 353 253 198 361 351

Saturation Flow Module:
Sat/Lane: 1900 1900 1900 1900 1900 1900 1900 1900 1900 1900 1900 1900
Adjustment: 0.92 0.89 0.89 0.92 0.91 0.85 0.95 0.95 0.85 0.92 0.95 0.85
Lanes: 2.00 3.35 0.65 2.00 4.00 1.00 1.00 2.00 1.00 2.00 2.00 1.00
Final Sat.: 3502 5655 1095 3502 6916 1615 1805 3610 1615 3502 3610 1615

Capacity Analysis Module:
Vol/Sat: 0.12 0.50 0.50 0.25 0.21 0.10 0.08 0.10 0.16 0.06 0.10 0.22
Crit Moves: ****
Green/Cycle: 0.24 0.45 0.45 0.23 0.44 0.44 0.07 0.20 0.20 0.07 0.20 0.20
Volume/Cap: 0.48 1.10 1.10 1.10 0.48 0.22 1.10 0.50 0.80 0.80 0.51 1.10
Delay/Veh: 32.8 77.9 77.9 100.7 20.2 17.7 155.3 36.3 51.2 61.8 36.4 119.8
User DelAdj: 1.00 1.00 1.00 1.00 1.00 1.00 1.00 1.00 1.00 1.00 1.00 1.00
AdjDel/Veh: 32.8 77.9 77.9 100.7 20.2 17.7 155.3 36.3 51.2 61.8 36.4 119.8
LOS by Move: C E E F C B F D D E D F
HCM2kAvgQ: 6 43 43 20 8 3 9 6 10 5 6 19

Note: Queue reported is the number of cars per lane.

Continental Grand Campus Specific Plan
Phase 1 Opening Year (2022) Without Project AM Peak Hour (HCM)

Level of Service Computation Report
2000 HCM Operations Method (Future Volume Alternative)

Intersection #7 Sepulveda Blvd at Rosecrans Blvd
Cycle (sec): 100 Critical Vol./Cap.(X): 0.923
Loss Time (sec): 5 Average Delay (sec/veh): 33.8
Optimal Cycle: 105 Level Of Service: C

Table with columns for Street Name, Approach, Movement, Control, Rights, Min. Green, Y+R, Lanes. Rows for Sepulveda Blvd and Rosecrans Blvd.

Table with columns for Volume Module, Base Vol, Growth Adj, Initial Bse, Added Vol, Related Pro, Initial Fut, User Adj, PHF Adj, PHF Volume, Reduct Vol, Reduced Vol, PCE Adj, MLF Adj, Final Volume.

Table with columns for Sat/Lane, Adjustment, Lanes, Final Sat. for Saturation Flow Module.

Table with columns for Vol/Sat, Crit Moves, Green/Cycle, Volume/Cap, Delay/Veh, User DelAdj, AdjDel/Veh, LOS by Move, HCM2kAvgQ for Capacity Analysis Module.

Note: Queue reported is the number of cars per lane.

Continental Grand Campus Specific Plan
Phase 1 Opening Year (2022) Without Project AM Peak Hour (HCM)

Level of Service Computation Report
2000 HCM Operations Method (Future Volume Alternative)

Intersection #8 Continental Boulevard at Mariposa Ave
Cycle (sec): 100 Critical Vol./Cap.(X): 0.378
Loss Time (sec): 5 Average Delay (sec/veh): 9.8
Optimal Cycle: 20 Level Of Service: A

Table with columns for Street Name, Approach, Movement, Control, Rights, Min. Green, Y+R, Lanes. Rows for Continental Boulevard and Mariposa Avenue.

Table with columns for Volume Module, Base Vol, Growth Adj, Initial Bse, Added Vol, Related Pro, Initial Fut, User Adj, PHF Adj, PHF Volume, Reduct Vol, Reduced Vol, PCE Adj, MLF Adj, Final Volume.

Table with columns for Sat/Lane, Adjustment, Lanes, Final Sat. for Saturation Flow Module.

Table with columns for Vol/Sat, Crit Moves, Green/Cycle, Volume/Cap, Delay/Veh, User DelAdj, AdjDel/Veh, LOS by Move, HCM2kAvgQ for Capacity Analysis Module.

Note: Queue reported is the number of cars per lane.

Continental Grand Campus Specific Plan
Phase 1 Opening Year (2022) Without Project AM Peak Hour (HCM)

Level of Service Computation Report
2000 HCM Operations Method (Future Volume Alternative)

Intersection #9 Continental Boulevard at Grand Avenue

Cycle (sec): 100 Critical Vol./Cap.(X): 0.279
Loss Time (sec): 5 Average Delay (sec/veh): 23.6
Optimal Cycle: 18 Level Of Service: C

Table with columns: Street Name, Approach, Movement, Control, Rights, Min. Green, Y+R, Lanes. Rows for Continental Boulevard and Grand Avenue.

Table with columns: Volume Module, Base Vol, Growth Adj, Initial Bse, Added Vol, Related Pro, Initial Fut, User Adj, PHF Adj, PHF Volume, Reduct Vol, Reduced Vol, PCE Adj, MLF Adj, Final Volume.

Table with columns: Sat/Lane, Adjustment, Lanes, Final Sat. for Saturation Flow Module.

Table with columns: Vol/Sat, Crit Moves, Green/Cycle, Volume/Cap, Delay/Veh, User DelAdj, AdjDel/Veh, LOS by Move, HCM2kAvgQ for Capacity Analysis Module.

Note: Queue reported is the number of cars per lane.

Continental Grand Campus Specific Plan
Phase 1 Opening Year (2022) Without Project AM Peak Hour (HCM)

Level of Service Computation Report
2000 HCM Operations Method (Future Volume Alternative)

Intersection #10 Continental Boulevard at El Segundo Boulevard

Cycle (sec): 100 Critical Vol./Cap.(X): 0.548
Loss Time (sec): 5 Average Delay (sec/veh): 15.8
Optimal Cycle: 27 Level Of Service: B

Table with columns: Street Name, Approach, Movement, Control, Rights, Min. Green, Y+R, Lanes. Rows for Continental Boulevard and El Segundo Boulevard.

Table with columns: Volume Module, Base Vol, Growth Adj, Initial Bse, Added Vol, Related Pro, Initial Fut, User Adj, PHF Adj, PHF Volume, Reduct Vol, Reduced Vol, PCE Adj, MLF Adj, Final Volume.

Table with columns: Sat/Lane, Adjustment, Lanes, Final Sat. for Saturation Flow Module.

Table with columns: Vol/Sat, Crit Moves, Green/Cycle, Volume/Cap, Delay/Veh, User DelAdj, AdjDel/Veh, LOS by Move, HCM2kAvgQ for Capacity Analysis Module.

Note: Queue reported is the number of cars per lane.

Continental Grand Campus Specific Plan
Phase 1 Opening Year (2022) Without Project AM Peak Hour (HCM)

Level of Service Computation Report
2000 HCM Operations Method (Future Volume Alternative)

Intersection #11 Nash St and Imperial Hwy
Cycle (sec): 100 Critical Vol./Cap.(X): 0.766
Loss Time (sec): 5 Average Delay (sec/veh): 24.9
Optimal Cycle: 48 Level Of Service: C

Table with columns for Street Name (Nash St, Imperial Hwy), Approach (North Bound, South Bound, East Bound, West Bound), Movement (L, T, R), Control, Rights, Min. Green, Y+R, Lanes.

Table with columns for Volume Module: Base Vol, Growth Adj, Initial Bse, Added Vol, Related Pro, Initial Fut, User Adj, PHF Adj, PHF Volume, Reduct Vol, Reduced Vol, PCE Adj, MLF Adj, Final Volume.

Table with columns for Saturation Flow Module: Sat/Lane, Adjustment, Lanes, Final Sat.

Table with columns for Capacity Analysis Module: Vol/Sat, Crit Moves, Green/Cycle, Volume/Cap, Delay/Veh, User DelAdj, AdjDel/Veh, LOS by Move, HCM2kAvgQ.

Note: Queue reported is the number of cars per lane.

Continental Grand Campus Specific Plan
Phase 1 Opening Year (2022) Without Project AM Peak Hour (HCM)

Level of Service Computation Report
2000 HCM Operations Method (Future Volume Alternative)

Intersection #12 Nash St at Mariposa Ave
Cycle (sec): 100 Critical Vol./Cap.(X): 0.546
Loss Time (sec): 5 Average Delay (sec/veh): 15.1
Optimal Cycle: 27 Level Of Service: B

Table with columns for Street Name (Nash St, Mariposa Ave), Approach (North Bound, South Bound, East Bound, West Bound), Movement (L, T, R), Control, Rights, Min. Green, Y+R, Lanes.

Table with columns for Volume Module: Base Vol, Growth Adj, Initial Bse, Added Vol, PasserByVol, Initial Fut, User Adj, PHF Adj, PHF Volume, Reduct Vol, Reduced Vol, PCE Adj, MLF Adj, Final Volume.

Table with columns for Saturation Flow Module: Sat/Lane, Adjustment, Lanes, Final Sat.

Table with columns for Capacity Analysis Module: Vol/Sat, Crit Moves, Green/Cycle, Volume/Cap, Delay/Veh, User DelAdj, AdjDel/Veh, LOS by Move, HCM2kAvgQ.

Note: Queue reported is the number of cars per lane.

Continental Grand Campus Specific Plan
Phase 1 Opening Year (2022) Without Project AM Peak Hour (HCM)

Level of Service Computation Report
2000 HCM Operations Method (Future Volume Alternative)

Intersection #13 Nash St at Grand Ave

Cycle (sec): 100 Critical Vol./Cap.(X): 0.525
Loss Time (sec): 5 Average Delay (sec/veh): 21.4
Optimal Cycle: 26 Level Of Service: C

Table with columns for Street Name (Nash St, Grand Ave), Approach (North Bound, South Bound, East Bound, West Bound), Movement (L, T, R), Control (Protected, Split Phase), Rights (Include), and various traffic metrics like Min. Green, Y+R, Lanes.

Volume Module table showing Base Vol, Growth Adj, Initial Bse, Added Vol, Related Pro, Initial Fut, User Adj, PHF Adj, PHF Volume, Reduct Vol, Reduced Vol, PCE Adj, MLF Adj, Final Volume for various movements.

Saturation Flow Module table showing Sat/Lane, Adjustment, Lanes, Final Sat for various movements.

Capacity Analysis Module table showing Vol/Sat, Crit Moves, Green/Cycle, Volume/Cap, Delay/Veh, User DelAdj, AdjDel/Veh, LOS by Move, HCM2kAvgQ for various movements.

Note: Queue reported is the number of cars per lane.

Continental Grand Campus Specific Plan
Phase 1 Opening Year (2022) Without Project AM Peak Hour (HCM)

Level of Service Computation Report
2000 HCM Operations Method (Future Volume Alternative)

Intersection #14 Nash St at El Segundo Blvd

Cycle (sec): 100 Critical Vol./Cap.(X): 0.729
Loss Time (sec): 5 Average Delay (sec/veh): 23.3
Optimal Cycle: 42 Level Of Service: C

Table with columns for Street Name (Nash St, El Segundo Blvd), Approach (North Bound, South Bound, East Bound, West Bound), Movement (L, T, R), Control (Split Phase, Protected), Rights (Include), and various traffic metrics like Min. Green, Y+R, Lanes.

Volume Module table showing Base Vol, Growth Adj, Initial Bse, Added Vol, Related Pro, Initial Fut, User Adj, PHF Adj, PHF Volume, Reduct Vol, Reduced Vol, PCE Adj, MLF Adj, Final Volume for various movements.

Saturation Flow Module table showing Sat/Lane, Adjustment, Lanes, Final Sat for various movements.

Capacity Analysis Module table showing Vol/Sat, Crit Moves, Green/Cycle, Volume/Cap, Delay/Veh, User DelAdj, AdjDel/Veh, LOS by Move, HCM2kAvgQ for various movements.

Note: Queue reported is the number of cars per lane.

Continental Grand Campus Specific Plan
Phase 1 Opening Year (2022) Without Project AM Peak Hour (HCM)

Level of Service Computation Report
2000 HCM Operations Method (Future Volume Alternative)

Intersection #15 Douglas Street at El Segundo Boulevard

Cycle (sec): 100 Critical Vol./Cap.(X): 0.982
Loss Time (sec): 5 Average Delay (sec/veh): 39.7
Optimal Cycle: 180 Level Of Service: D

Table with columns: Street Name, Approach, Movement, Control, Rights, Min. Green, Y+R, Lanes. Rows for Douglas St and El Segundo Blvd.

Table with columns: Volume Module, Base Vol, Growth Adj, Initial Bse, Added Vol, Related Pro, Initial Fut, User Adj, PHF Adj, PHF Volume, Reduct Vol, Reduced Vol, PCE Adj, MLF Adj, Final Volume.

Table with columns: Saturation Flow Module, Sat/Lane, Adjustment, Lanes, Final Sat.

Table with columns: Capacity Analysis Module, Vol/Sat, Crit Moves, Green/Cycle, Volume/Cap, Delay/Veh, User DelAdj, AdjDel/Veh, LOS by Move, HCM2kAvgQ.

Note: Queue reported is the number of cars per lane.

Continental Grand Campus Specific Plan
Phase 1 Opening Year (2022) Without Project AM Peak Hour (HCM)

Level of Service Computation Report
2000 HCM Operations Method (Future Volume Alternative)

Intersection #16 Aviation Boulevard at El Segundo Boulevard

Cycle (sec): 100 Critical Vol./Cap.(X): 1.181
Loss Time (sec): 5 Average Delay (sec/veh): 90.1
Optimal Cycle: 180 Level Of Service: F

Table with columns: Street Name, Approach, Movement, Control, Rights, Min. Green, Y+R, Lanes. Rows for Aviation Blvd and El Segundo Blvd.

Table with columns: Volume Module, Base Vol, Growth Adj, Initial Bse, Added Vol, Related Pro, Initial Fut, User Adj, PHF Adj, PHF Volume, Reduct Vol, Reduced Vol, PCE Adj, MLF Adj, Final Volume.

Table with columns: Saturation Flow Module, Sat/Lane, Adjustment, Lanes, Final Sat.

Table with columns: Capacity Analysis Module, Vol/Sat, Crit Moves, Green/Cycle, Volume/Cap, Delay/Veh, User DelAdj, AdjDel/Veh, LOS by Move, HCM2kAvgQ.

Note: Queue reported is the number of cars per lane.

Continental Grand Campus Specific Plan
Phase 1 Opening Year (2022) Without Project AM Peak Hour (HCM)

Level of Service Computation Report

ICU 1(Loss as Cycle Length %) Method (Future Volume Alternative)

Intersection #17 El Segundo Boulevard and Isis Avenue

Cycle (sec): 100 Critical Vol./Cap.(X): 0.894
Loss Time (sec): 5 Average Delay (sec/veh): xxxxxx
Optimal Cycle: 83 Level Of Service: D

Table with columns for Street Name, Approach, Movement, Control, Rights, Min. Green, Y+R, Lanes. Rows for North and South Bounding streets.

Table with columns for Volume Module, Base Vol, Growth Adj, Initial Bse, Added Vol, Related Pro, Initial Fut, User Adj, PHF Adj, PHF Volume, Reduct Vol, Reduced Vol, PCE Adj, MLF Adj, Final Volume.

Table with columns for Sat/Lane, Adjustment, Lanes, Final Sat. for Saturation Flow Module.

Table with columns for Vol/Sat, Crit Moves for Capacity Analysis Module.

Table with columns for Green/Cycle, Volume/Cap, Delay/Veh, User DelAdj, AdjDel/Veh, LOS by Move, HCM2kAvgQ.

Continental Grand Campus Specific Plan
Phase 1 Opening Year (2022) Without Project AM Peak Hour (HCM)

Level of Service Computation Report

2000 HCM Operations Method (Future Volume Alternative)

Intersection #18 El Segundo Blvd at I-405 SB Ramps

Cycle (sec): 100 Critical Vol./Cap.(X): 0.868
Loss Time (sec): 5 Average Delay (sec/veh): 17.8
Optimal Cycle: 74 Level Of Service: B

Table with columns for Street Name, Approach, Movement, Control, Rights, Min. Green, Y+R, Lanes. Rows for I-405 SB Ramps and El Segundo Blvd.

Table with columns for Volume Module, Base Vol, Growth Adj, Initial Bse, Added Vol, Related Pro, Initial Fut, User Adj, PHF Adj, PHF Volume, Reduct Vol, Reduced Vol, PCE Adj, MLF Adj, Final Volume.

Table with columns for Sat/Lane, Adjustment, Lanes, Final Sat. for Saturation Flow Module.

Table with columns for Vol/Sat, Crit Moves for Capacity Analysis Module.

Table with columns for Green/Cycle, Volume/Cap, Delay/Veh, User DelAdj, AdjDel/Veh, LOS by Move, HCM2kAvgQ.

Note: Queue reported is the number of cars per lane.

Continental Grand Campus Specific Plan
Phase 1 Opening Year (2022) Without Project AM Peak Hour (HCM)

Level of Service Computation Report
2000 HCM Operations Method (Future Volume Alternative)

Intersection #19 El Segundo Blvd at La Cienega Blvd

Cycle (sec): 100 Critical Vol./Cap.(X): 0.903
Loss Time (sec): 5 Average Delay (sec/veh): 24.3
Optimal Cycle: 91 Level Of Service: C

Street Name: La Cienega Blvd El Segundo Blvd
Approach: North Bound South Bound East Bound West Bound
Movement: L - T - R L - T - R L - T - R L - T - R

Control: Protected Protected Protected Protected
Rights: Include Include Include Include
Min. Green: 0 0 0 0 0 0 0 0 0 0 0 0
Y+R: 4.0 4.0 4.0 4.0 4.0 4.0 4.0 4.0 4.0 4.0 4.0
Lanes: 0 0 0 0 0 2 0 0 0 2 1 0 3 0 0 0 0 2 1 0

Volume Module:
Base Vol: 0 0 0 249 0 322 75 539 0 0 1312 477
Growth Adj: 1.01 1.01 1.01 1.01 1.01 1.01 1.01 1.01 1.01 1.01 1.01 1.01
Initial Bse: 0 0 0 252 0 327 76 547 0 0 1330 484
Added Vol: 0 0 0 0 0 0 0 0 0 0 0 0
Related Pro: 0 0 0 0 0 305 0 100 0 0 834 0
Initial Fut: 0 0 0 252 0 632 76 647 0 0 2164 484
User Adj: 1.00 1.00 1.00 1.00 1.00 1.00 1.00 1.00 1.00 1.00 1.00 1.00
PHF Adj: 0.92 0.92 0.92 0.92 0.92 0.92 0.92 0.92 0.92 0.92 0.92 0.92
PHF Volume: 0 0 0 274 0 686 83 703 0 0 2353 526
Reduct Vol: 0 0 0 0 0 0 0 0 0 0 0 0
Reduced Vol: 0 0 0 274 0 686 83 703 0 0 2353 526
PCE Adj: 1.00 1.00 1.00 1.00 1.00 1.00 1.00 1.00 1.00 1.00 1.00 1.00
MLF Adj: 1.00 1.00 1.00 1.00 1.00 1.00 1.00 1.00 1.00 1.00 1.00 1.00
FinalVolume: 0 0 0 274 0 686 83 703 0 0 2353 526

Saturation Flow Module:
Sat/Lane: 1900 1900 1900 1900 1900 1900 1900 1900 1900 1900 1900 1900
Adjustment: 1.00 1.00 1.00 0.92 1.00 0.75 0.95 0.91 1.00 1.00 0.89 0.89
Lanes: 0.00 0.00 0.00 2.00 0.00 2.00 1.00 3.00 0.00 0.00 2.45 0.55
Final Sat.: 0 0 0 3502 0 2842 1805 5187 0 0 4125 922

Capacity Analysis Module:
Vol/Sat: 0.00 0.00 0.00 0.08 0.00 0.24 0.05 0.14 0.00 0.00 0.57 0.57
Crit Moves: **** **** ****
Green/Cycle: 0.00 0.00 0.00 0.27 0.00 0.27 0.05 0.68 0.00 0.00 0.63 0.63
Volume/Cap: 0.00 0.00 0.00 0.29 0.00 0.90 0.90 0.20 0.00 0.00 0.90 0.90
Delay/Veh: 0.0 0.0 0.0 29.3 0.0 49.4 110.3 5.9 0.0 0.0 19.8 19.8
User DelAdj: 1.00 1.00 1.00 1.00 1.00 1.00 1.00 1.00 1.00 1.00 1.00 1.00
AdjDel/Veh: 0.0 0.0 0.0 29.3 0.0 49.4 110.3 5.9 0.0 0.0 19.8 19.8
LOS by Move: A A A C A D F A A A B B
HCM2kAvgQ: 0 0 0 4 0 15 3 3 0 0 27 27

Note: Queue reported is the number of cars per lane.

Continental Grand Campus Specific Plan
Phase 1 Opening Year (2022) Without Project AM Peak Hour (HCM)

Level of Service Computation Report
2000 HCM Operations Method (Future Volume Alternative)

Intersection #20 El Segundo Blvd at I-405 NB Ramps

Cycle (sec): 100 Critical Vol./Cap.(X): 0.894
Loss Time (sec): 5 Average Delay (sec/veh): 27.2
Optimal Cycle: 86 Level Of Service: C

Street Name: I-405 NB Ramps El Segundo Blvd
Approach: North Bound South Bound East Bound West Bound
Movement: L - T - R L - T - R L - T - R L - T - R

Control: Protected Protected Protected Protected
Rights: Include Include Ignore Include
Min. Green: 0 0 0 0 0 0 0 0 0 0 0 0
Y+R: 4.0 4.0 4.0 4.0 4.0 4.0 4.0 4.0 4.0 4.0 4.0 4.0
Lanes: 2 0 0 0 1 0 0 0 0 0 0 0 2 1 1 0 0 2 1 0

Volume Module:
Base Vol: 861 0 102 0 0 0 0 625 148 0 935 610
Growth Adj: 1.01 1.01 1.01 1.01 1.01 1.01 1.01 1.01 1.01 1.01 1.01 1.01
Initial Bse: 873 0 103 0 0 0 0 634 150 0 948 619
Added Vol: 0 0 0 0 0 0 0 0 0 0 0 0
Related Pro: 534 0 0 0 0 0 0 59 44 0 306 0
Initial Fut: 1407 0 103 0 0 0 0 693 194 0 1254 619
User Adj: 1.00 1.00 1.00 1.00 1.00 1.00 1.00 1.00 0.00 1.00 1.00 1.00
PHF Adj: 0.92 0.92 0.92 0.92 0.92 0.92 0.92 0.92 0.00 0.92 0.92 0.92
PHF Volume: 1529 0 112 0 0 0 0 753 0 0 1363 672
Reduct Vol: 0 0 0 0 0 0 0 0 0 0 0 0
Reduced Vol: 1529 0 112 0 0 0 0 753 0 0 1363 672
PCE Adj: 1.00 1.00 1.00 1.00 1.00 1.00 1.00 1.00 0.00 1.00 1.00 1.00
MLF Adj: 1.00 1.00 1.00 1.00 1.00 1.00 1.00 1.00 0.00 1.00 1.00 1.00
FinalVolume: 1529 0 112 0 0 0 0 753 0 0 1363 672

Saturation Flow Module:
Sat/Lane: 1900 1900 1900 1900 1900 1900 1900 1900 1900 1900 1900 1900
Adjustment: 0.92 1.00 0.85 1.00 1.00 1.00 1.00 0.91 0.91 1.00 0.87 0.87
Lanes: 2.00 0.00 1.00 0.00 0.00 0.00 0.00 3.00 1.00 0.00 2.01 0.99
Final Sat.: 3502 0 1615 0 0 0 0 5187 1729 0 3303 1629

Capacity Analysis Module:
Vol/Sat: 0.44 0.00 0.07 0.00 0.00 0.00 0.00 0.15 0.00 0.00 0.41 0.41
Crit Moves: **** **** ****
Green/Cycle: 0.49 0.00 0.49 0.00 0.00 0.00 0.00 0.46 0.00 0.00 0.46 0.46
Volume/Cap: 0.89 0.00 0.14 0.00 0.00 0.00 0.00 0.31 0.00 0.00 0.89 0.89
Delay/Veh: 29.7 0.0 14.1 0.0 0.0 0.0 0.0 17.0 0.0 0.0 29.7 29.7
User DelAdj: 1.00 1.00 1.00 1.00 1.00 1.00 1.00 1.00 1.00 1.00 1.00 1.00
AdjDel/Veh: 29.7 0.0 14.1 0.0 0.0 0.0 0.0 17.0 0.0 0.0 29.7 29.7
LOS by Move: C A B A A A A B A A C C
HCM2kAvgQ: 26 0 2 0 0 0 0 5 0 0 25 25

Note: Queue reported is the number of cars per lane.

Continental Grand Campus Specific Plan
Phase 1 Opening Year (2022) Without Project PM Peak Hour (HCM)

Scenario Report

Scenario: Phase 1 Op Yr W/o Proj PM HCM
 Command: Phase 1 Op Yr W/o Proj PM HCM
 Volume: OY PM
 Geometry: Existing
 Impact Fee: Default Impact Fee
 Trip Generation: Cum PM
 Trip Distribution: Cum + Proj
 Paths: Project
 Routes: Default Route
 Configuration: Phase 1 Op Yr W/o Proj PM HCM

Continental Grand Campus Specific Plan
Phase 1 Opening Year (2022) Without Project PM Peak Hour (HCM)

Trip Generation Report

Forecast for Cum PM

Zone #	Subzone	Amount	Units	Rate In	Rate Out	Trips In	Trips Out	Total Trips	% Of Total
306	525 N. Sepul	1.00	Residential	-4.00	-6.00	-4	-6	-10	-0.9
	Zone 306 Subtotal					-4	-6	-10	-0.9
307	540 Imperial	1.00	Residential	50.00	32.00	50	32	82	7.4
	Zone 307 Subtotal					50	32	82	7.4
311	199 Continen	1.00	Business Hotel	46.00	45.00	46	45	91	8.3
	Zone 311 Subtotal					46	45	91	8.3
313	445 N. Dougl	1.00	Equinix Data C	3.00	13.00	3	13	16	1.5
	Zone 313 Subtotal					3	13	16	1.5
314	123 Lomita a	1.00	Office	2.00	16.00	2	16	18	1.6
	Zone 314 Subtotal					2	16	18	1.6
704	2355 Utah Av	1.00	Office	95.00	109.00	95	109	204	18.5
	Zone 704 Subtotal					95	109	204	18.5
706	888 Sepulved	1.00	hotel	60.00	41.00	60	41	101	9.2
	Zone 706 Subtotal					60	41	101	9.2
710	201 North Do	1.00	High School	-15.00	-74.00	-15	-74	-89	-8.1
710	201 North Do	1.00	District Offic	3.00	18.00	3	18	21	1.9
	Zone 710 Subtotal					-12	-56	-68	-6.2
714	400 Duley -	1.00	Office	18.00	87.00	18	87	105	9.5
	Zone 714 Subtotal					18	87	105	9.5
717	1700 Imperia	1.00	Townhome Resid	25.00	120.00	25	120	145	13.2
	Zone 717 Subtotal					25	120	145	13.2
718	123 Nevada S	1.00	Office	4.00	16.00	4	16	20	1.8
718	123 Nevada S	0.00	123 Nevada	4.00	16.00	0	0	0	0.0
	Zone 718 Subtotal					4	16	20	1.8
719	2125 Campus	1.00	Office Retail	64.00	146.00	64	146	210	19.1
	Zone 719 Subtotal					64	146	210	19.1
1002	Laker Facili	1.00	General Office	103.00	85.00	103	85	188	17.1
	Zone 1002 Subtotal					103	85	188	17.1
TOTAL						454	648	1102	100.0

Continental Grand Campus Specific Plan
Phase 1 Opening Year (2022) Without Project PM Peak Hour (HCM)

Trip Distribution Report

Percent Of Trips Cum + Project

Zone	To Gates											
	1	2	3	4	5	7	8	9	10	11	12	
306	10.0	15.0	10.0	5.0	0.0	5.0	5.0	25.0	0.0	25.0	0.0	
307	10.0	15.0	10.0	5.0	50.0	0.0	0.0	0.0	0.0	0.0	0.0	
311	40.0	10.0	10.0	10.0	0.0	5.0	5.0	10.0	0.0	10.0	0.0	
313	15.0	5.0	15.0	10.0	25.0	0.0	5.0	20.0	0.0	0.0	0.0	
314	40.0	10.0	10.0	10.0	0.0	5.0	5.0	10.0	0.0	10.0	0.0	
704	30.0	15.0	8.0	12.0	0.0	5.0	5.0	10.0	5.0	10.0	0.0	
706	25.0	20.0	10.0	25.0	0.0	0.0	0.0	0.0	0.0	0.0	10.0	
710	0.0	0.0	15.0	10.0	10.0	2.0	2.0	20.0	5.0	10.0	1.0	
714	5.0	10.0	5.0	5.0	20.0	5.0	10.0	15.0	5.0	15.0	0.0	
717	10.0	15.0	10.0	5.0	50.0	0.0	0.0	0.0	0.0	0.0	0.0	
718	10.0	10.0	10.0	10.0	20.0	0.0	0.0	20.0	10.0	0.0	0.0	
719	20.0	10.0	10.0	10.0	10.0	5.0	5.0	10.0	5.0	0.0	0.0	
1002	0.0	10.0	5.0	5.0	15.0	5.0	10.0	15.0	5.0	15.0	5.0	
1004	5.0	15.0	10.0	5.0	30.0	0.0	5.0	20.0	0.0	0.0	5.0	
1005	5.0	15.0	10.0	5.0	30.0	0.0	5.0	20.0	0.0	0.0	5.0	
1007	0.0	0.0	0.0	0.0	0.0	0.0	0.0	0.0	0.0	0.0	0.0	

Zone	To Gates						
	13	14	15	16	17	18	20
306	0.0	0.0	0.0	0.0	0.0	0.0	0.0
307	0.0	10.0	0.0	0.0	0.0	0.0	0.0
311	0.0	0.0	0.0	0.0	0.0	0.0	0.0
313	5.0	0.0	0.0	0.0	0.0	0.0	0.0
314	0.0	0.0	0.0	0.0	0.0	0.0	0.0
704	0.0	0.0	0.0	0.0	0.0	0.0	0.0
706	0.0	0.0	0.0	0.0	10.0	0.0	0.0
710	10.0	5.0	10.0	0.0	0.0	0.0	0.0
714	0.0	5.0	0.0	0.0	0.0	0.0	0.0
717	0.0	10.0	0.0	0.0	0.0	0.0	0.0
718	0.0	10.0	0.0	0.0	0.0	0.0	0.0
719	0.0	10.0	5.0	0.0	0.0	0.0	0.0
1002	0.0	5.0	5.0	0.0	0.0	0.0	0.0
1004	0.0	5.0	0.0	0.0	0.0	0.0	0.0
1005	0.0	5.0	0.0	0.0	0.0	0.0	0.0
1007	0.0	0.0	0.0	0.0	0.0	20.0	10.0

Continental Grand Campus Specific Plan
Phase 1 Opening Year (2022) Without Project PM Peak Hour (HCM)

Impact Analysis Report
Level Of Service

Intersection		Base		Future		Change in
		Del/ LOS	V/ Veh C	Del/ LOS	V/ Veh C	
# 1 Sepulveda Blvd at Imperial Hwy	D	38.8	1.037	D	45.1 1.113	+ 6.329 D/V
# 2 Sepulveda Blvd at Walnut St	A	9.9	0.550	B	15.6 0.770	+ 5.754 D/V
# 3 Sepulveda Blvd at Maple Ave	B	12.5	0.603	B	17.1 0.739	+ 4.577 D/V
# 4 Sepulveda Blvd at Mariposa Ave	C	20.1	0.629	C	23.2 0.802	+ 3.059 D/V
# 5 Sepulveda Blvd at Grand Ave	C	30.3	0.799	D	35.7 0.901	+ 5.414 D/V
# 6 Sepulveda Blvd at El Segundo B	D	36.8	0.913	E	78.6 1.120	+41.805 D/V
# 7 Sepulveda Blvd at Rosecrans Bl	C	32.4	0.880	D	42.1 0.998	+ 9.639 D/V
# 8 Continental Boulevard at Marip	B	16.3	0.283	B	16.3 0.288	-0.027 D/V
# 9 Continental Boulevard at Grand	B	18.4	0.276	B	18.4 0.290	+ 0.086 D/V
# 10 Continental Boulevard at El Se	B	19.6	0.400	C	28.2 0.636	+ 8.592 D/V
# 11 Nash St and Imperial Hwy	B	19.5	0.474	C	22.2 0.519	+ 2.714 D/V
# 12 Nash St at Mariposa Ave	B	17.3	0.533	B	19.3 0.682	+ 1.961 D/V
# 13 Nash St at Grand Ave	C	22.7	0.500	C	25.3 0.572	+ 2.640 D/V
# 14 Nash St at El Segundo Blvd	B	19.8	0.535	E	55.4 1.058	+35.578 D/V
# 15 Douglas Street at El Segundo B	C	33.8	0.886	F	93.0 1.191	+59.133 D/V
# 16 Aviation Boulevard at El Segun	D	41.0	0.955	F	90.4 1.178	+49.377 D/V
# 17 El Segundo Boulevard and Isis	B	xxxxx	0.691	D	xxxxx 0.849	+ 0.157 V/C
# 18 El Segundo Blvd at I-405 SB Ra	C	28.4	1.063	E	74.7 1.406	+46.338 D/V
# 19 El Segundo Blvd at La Cienega	C	20.6	0.680	C	21.6 0.796	+ 1.001 D/V
# 20 El Segundo Blvd at I-405 NB Ra	B	11.8	0.688	B	12.5 0.718	+ 0.746 D/V

Continental Grand Campus Specific Plan
Phase 1 Opening Year (2022) Without Project PM Peak Hour (HCM)

Level of Service Computation Report
2000 HCM Operations Method (Future Volume Alternative)

Intersection #1 Sepulveda Blvd at Imperial Hwy

Cycle (sec): 100 Critical Vol./Cap.(X): 1.113
Loss Time (sec): 5 Average Delay (sec/veh): 45.1
Optimal Cycle: 180 Level Of Service: D

Street Name: Sepulveda Blvd Imperial Hwy
Approach: North Bound South Bound East Bound West Bound
Movement: L - T - R L - T - R L - T - R L - T - R

Control: Protected Protected Protected Protected
Rights: Include Include Include Ovl
Min. Green: 0 0 0 0 0 0 0 0 0 0 0 0
Y+R: 4.0 4.0 4.0 4.0 4.0 4.0 4.0 4.0 4.0 4.0 4.0 4.0
Lanes: 1 0 3 0 1 2 0 3 1 0 2 0 3 0 1 2 0 3 0 1

Volume Module:
Base Vol: 154 1713 885 640 1993 7 202 402 140 120 295 461
Growth Adj: 1.02 1.02 1.02 1.02 1.02 1.02 1.02 1.02 1.02 1.02 1.02 1.02
Initial Bse: 157 1741 900 651 2026 7 205 409 142 122 300 469
Added Vol: 35 103 73 14 78 5 3 23 17 9 9 17
Related Pro: 30 569 63 -165 159 0 -15 15 11 40 -20 -40
Initial Fut: 222 2413 1036 500 2263 12 193 447 170 171 289 446
User Adj: 1.00 1.00 1.00 1.00 1.00 1.00 1.00 1.00 1.00 1.00 1.00 1.00
PHF Adj: 0.92 0.92 0.92 0.92 0.92 0.92 0.92 0.92 0.92 0.92 0.92 0.92
PHF Volume: 241 2623 1126 543 2460 13 210 486 185 186 314 484
Reduct Vol: 0 0 0 0 0 0 0 0 0 0 0 0
Reduced Vol: 241 2623 1126 543 2460 13 210 486 185 186 314 484
PCE Adj: 1.00 1.00 1.00 1.00 1.00 1.00 1.00 1.00 1.00 1.00 1.00 1.00
MLF Adj: 1.00 1.00 1.00 1.00 1.00 1.00 1.00 1.00 1.00 1.00 1.00 1.00
FinalVolume: 241 2623 1126 543 2460 13 210 486 185 186 314 484

Saturation Flow Module:
Sat/Lane: 1900 1900 1900 1900 1900 1900 1900 1900 1900 1900 1900 1900
Adjustment: 0.95 0.91 0.85 0.92 0.91 0.91 0.92 0.91 0.85 0.92 0.91 0.85
Lanes: 1.00 3.00 1.00 2.00 3.98 0.02 2.00 3.00 1.00 2.00 3.00 1.00
Final Sat.: 1805 5187 1615 3502 6872 37 3502 5187 1615 3502 5187 1615

Capacity Analysis Module:
Vol/Sat: 0.13 0.51 0.70 0.16 0.36 0.36 0.06 0.09 0.11 0.05 0.06 0.30
Crit Moves: **** **** **** ****
Green/Cycle: 0.21 0.63 0.63 0.14 0.56 0.56 0.05 0.13 0.13 0.06 0.13 0.27
Volume/Cap: 0.64 0.81 1.11 1.11 0.64 0.64 1.11 0.74 0.91 0.91 0.47 1.11
Delay/Veh: 39.9 15.7 83.2 118.3 15.6 15.6 146.2 46.8 82.4 86.0 40.8 114.0
User DelAdj: 1.00 1.00 1.00 1.00 1.00 1.00 1.00 1.00 1.00 1.00 1.00 1.00
AdjDel/Veh: 39.9 15.7 83.2 118.3 15.6 15.6 146.2 46.8 82.4 86.0 40.8 114.0
LOS by Move: D B F F B B F D F F D F
HCM2kAvgQ: 7 22 49 16 15 15 5 5 6 4 3 22

Note: Queue reported is the number of cars per lane.

Continental Grand Campus Specific Plan
Phase 1 Opening Year (2022) Without Project PM Peak Hour (HCM)

Level of Service Computation Report
2000 HCM Operations Method (Future Volume Alternative)

Intersection #2 Sepulveda Blvd at Walnut St

Cycle (sec): 100 Critical Vol./Cap.(X): 0.770
Loss Time (sec): 5 Average Delay (sec/veh): 15.6
Optimal Cycle: 48 Level Of Service: B

Street Name: Sepulveda Blvd Walnut St
Approach: North Bound South Bound East Bound West Bound
Movement: L - T - R L - T - R L - T - R L - T - R

Control: Protected Protected Permitted Permitted
Rights: Include Include Include Include
Min. Green: 0 0 0 0 0 0 0 0 0 0 0 0
Y+R: 4.0 4.0 4.0 4.0 4.0 4.0 4.0 4.0 4.0 4.0 4.0 4.0
Lanes: 1 0 3 1 0 1 0 3 1 0 0 1 0 0 1 0 1 0 0 1

Volume Module:
Base Vol: 48 2434 29 10 2181 74 117 31 71 46 10 66
Growth Adj: 1.02 1.02 1.02 1.02 1.02 1.02 1.02 1.02 1.02 1.02 1.02 1.02
Initial Bse: 49 2474 29 10 2217 75 119 32 72 47 10 67
Added Vol: 12 117 12 6 80 19 90 0 0 8 0 4
Related Pro: 28 627 0 0 210 0 0 0 9 0 0 0
Initial Fut: 89 3218 41 16 2507 94 209 32 81 55 10 71
User Adj: 1.00 1.00 1.00 1.00 1.00 1.00 1.00 1.00 1.00 1.00 1.00 1.00
PHF Adj: 0.92 0.92 0.92 0.92 0.92 0.92 0.92 0.92 0.92 0.92 0.92 0.92
PHF Volume: 97 3498 45 18 2725 102 227 34 88 60 11 77
Reduct Vol: 0 0 0 0 0 0 0 0 0 0 0 0
Reduced Vol: 97 3498 45 18 2725 102 227 34 88 60 11 77
PCE Adj: 1.00 1.00 1.00 1.00 1.00 1.00 1.00 1.00 1.00 1.00 1.00 1.00
MLF Adj: 1.00 1.00 1.00 1.00 1.00 1.00 1.00 1.00 1.00 1.00 1.00 1.00
FinalVolume: 97 3498 45 18 2725 102 227 34 88 60 11 77

Saturation Flow Module:
Sat/Lane: 1900 1900 1900 1900 1900 1900 1900 1900 1900 1900 1900 1900
Adjustment: 0.95 0.91 0.91 0.95 0.91 0.91 0.66 0.66 0.85 0.55 0.55 0.85
Lanes: 1.00 3.95 0.05 1.00 3.86 0.14 0.87 0.13 1.00 0.84 0.16 1.00
Final Sat.: 1805 6814 88 1805 6632 249 1090 164 1615 888 165 1615

Capacity Analysis Module:
Vol/Sat: 0.05 0.51 0.51 0.01 0.41 0.41 0.21 0.21 0.05 0.07 0.07 0.05
Crit Moves: **** **** **** ****
Green/Cycle: 0.08 0.67 0.67 0.01 0.60 0.60 0.27 0.27 0.27 0.27 0.27 0.27
Volume/Cap: 0.68 0.77 0.77 0.77 0.68 0.68 0.77 0.77 0.20 0.25 0.25 0.18
Delay/Veh: 57.9 12.2 12.2 139.3 14.0 14.0 43.9 43.9 28.4 29.0 29.0 28.1
User DelAdj: 1.00 1.00 1.00 1.00 1.00 1.00 1.00 1.00 1.00 1.00 1.00 1.00
AdjDel/Veh: 57.9 12.2 12.2 139.3 14.0 14.0 43.9 43.9 28.4 29.0 29.0 28.1
LOS by Move: E B B F B B D D C C C C
HCM2kAvgQ: 4 22 22 1 16 16 9 9 2 2 2 2

Note: Queue reported is the number of cars per lane.

Continental Grand Campus Specific Plan
Phase 1 Opening Year (2022) Without Project PM Peak Hour (HCM)

Level of Service Computation Report
2000 HCM Operations Method (Future Volume Alternative)

Intersection #3 Sepulveda Blvd at Maple Ave

Cycle (sec): 100 Critical Vol./Cap.(X): 0.739
Loss Time (sec): 5 Average Delay (sec/veh): 17.1
Optimal Cycle: 44 Level Of Service: B

Street Name: Sepulveda Blvd Maple Ave

Approach: North Bound South Bound East Bound West Bound
Movement: L - T - R L - T - R L - T - R L - T - R

Control: Protected Protected Permitted Permitted
Rights: Include Include Include Include
Min. Green: 0 0 0 0 0 0 0 0 0 0 0 0
Y+R: 4.0 4.0 4.0 4.0 4.0 4.0 4.0 4.0 4.0 4.0 4.0 4.0
Lanes: 1 0 3 1 0 1 0 3 1 0 1 0 0 1 0 1

Volume Module:

Base Vol: 98 2208 33 57 2439 42 68 57 37 114 102 114
Growth Adj: 1.01 1.01 1.01 1.01 1.01 1.01 1.01 1.01 1.01 1.01 1.01 1.01
Initial Bse: 99 2239 33 58 2473 43 69 58 38 116 103 116
Added Vol: 13 92 0 37 92 0 0 8 8 0 12 44
Related Pro: 56 687 30 25 226 0 0 8 13 5 0 0
Initial Fut: 168 3018 63 120 2791 43 69 74 59 121 115 160
User Adj: 1.00 1.00 1.00 1.00 1.00 1.00 1.00 1.00 1.00 1.00 1.00 1.00
PHF Adj: 0.92 0.92 0.92 0.92 0.92 0.92 0.92 0.92 0.92 0.92 0.92 0.92
PHF Volume: 183 3280 69 130 3034 46 75 80 64 131 125 173
Reduct Vol: 0 0 0 0 0 0 0 0 0 0 0 0
Reduced Vol: 183 3280 69 130 3034 46 75 80 64 131 125 173
PCE Adj: 1.00 1.00 1.00 1.00 1.00 1.00 1.00 1.00 1.00 1.00 1.00 1.00
MLF Adj: 1.00 1.00 1.00 1.00 1.00 1.00 1.00 1.00 1.00 1.00 1.00 1.00
FinalVolume: 183 3280 69 130 3034 46 75 80 64 131 125 173

Saturation Flow Module:

Sat/Lane: 1900 1900 1900 1900 1900 1900 1900 1900 1900 1900 1900 1900
Adjustment: 0.95 0.91 0.91 0.95 0.91 0.91 0.52 0.93 0.93 0.48 1.00 0.85
Lanes: 1.00 3.92 0.08 1.00 3.94 0.06 1.00 0.56 0.44 1.00 1.00 1.00
Final Sat.: 1805 6753 142 1805 6798 104 994 990 785 910 1900 1615

Capacity Analysis Module:

Vol/Sat: 0.10 0.49 0.49 0.07 0.45 0.45 0.08 0.08 0.08 0.14 0.07 0.11
Crit Moves: ****
Green/Cycle: 0.14 0.66 0.66 0.10 0.62 0.62 0.19 0.19 0.19 0.19 0.19 0.19
Volume/Cap: 0.73 0.74 0.74 0.74 0.73 0.73 0.39 0.42 0.42 0.74 0.34 0.55
Delay/Veh: 51.2 12.1 12.1 59.1 14.0 14.0 36.3 36.1 36.1 53.0 35.2 38.4
User DelAdj: 1.00 1.00 1.00 1.00 1.00 1.00 1.00 1.00 1.00 1.00 1.00 1.00
AdjDel/Veh: 51.2 12.1 12.1 59.1 14.0 14.0 36.3 36.1 36.1 53.0 35.2 38.4
LOS by Move: D B B E B B D D D D D D
HCM2kAvgQ: 7 20 20 6 19 19 2 4 4 6 4 5

Note: Queue reported is the number of cars per lane.

Continental Grand Campus Specific Plan
Phase 1 Opening Year (2022) Without Project PM Peak Hour (HCM)

Level of Service Computation Report
2000 HCM Operations Method (Future Volume Alternative)

Intersection #4 Sepulveda Blvd at Mariposa Ave

Cycle (sec): 100 Critical Vol./Cap.(X): 0.802
Loss Time (sec): 5 Average Delay (sec/veh): 23.2
Optimal Cycle: 55 Level Of Service: C

Street Name: Sepulveda Blvd Mariposa Ave

Approach: North Bound South Bound East Bound West Bound
Movement: L - T - R L - T - R L - T - R L - T - R

Control: Protected Protected Permitted Permitted
Rights: Include Include Include Include
Min. Green: 0 0 0 0 0 0 0 0 0 0 0 0
Y+R: 4.0 4.0 4.0 4.0 4.0 4.0 4.0 4.0 4.0 4.0 4.0 4.0
Lanes: 1 0 4 0 1 2 0 3 1 0 1 0 0 1 0 1

Volume Module:

Base Vol: 100 2039 133 227 2100 79 102 213 37 117 265 207
Growth Adj: 1.02 1.02 1.02 1.02 1.02 1.02 1.02 1.02 1.02 1.02 1.02 1.02
Initial Bse: 102 2073 135 231 2135 80 104 217 38 119 269 210
Added Vol: 6 94 17 18 83 -1 -1 15 3 28 24 11
Related Pro: 32 688 -15 -23 232 11 10 -5 13 -5 5 0
Initial Fut: 140 2855 137 226 2450 90 113 227 54 142 298 221
User Adj: 1.00 1.00 1.00 1.00 1.00 1.00 1.00 1.00 1.00 1.00 1.00 1.00
PHF Adj: 0.92 0.92 0.92 0.92 0.92 0.92 0.92 0.92 0.92 0.92 0.92 0.92
PHF Volume: 152 3103 149 245 2663 98 122 246 58 154 324 241
Reduct Vol: 0 0 0 0 0 0 0 0 0 0 0 0
Reduced Vol: 152 3103 149 245 2663 98 122 246 58 154 324 241
PCE Adj: 1.00 1.00 1.00 1.00 1.00 1.00 1.00 1.00 1.00 1.00 1.00 1.00
MLF Adj: 1.00 1.00 1.00 1.00 1.00 1.00 1.00 1.00 1.00 1.00 1.00 1.00
FinalVolume: 152 3103 149 245 2663 98 122 246 58 154 324 241

Saturation Flow Module:

Sat/Lane: 1900 1900 1900 1900 1900 1900 1900 1900 1900 1900 1900 1900
Adjustment: 0.95 0.91 0.85 0.92 0.91 0.91 0.31 0.97 0.97 0.33 1.00 0.85
Lanes: 1.00 4.00 1.00 2.00 3.86 0.14 1.00 0.81 0.19 1.00 1.00 1.00
Final Sat.: 1805 6916 1615 3502 6637 245 587 1492 353 635 1900 1615

Capacity Analysis Module:

Vol/Sat: 0.08 0.45 0.09 0.07 0.40 0.40 0.21 0.17 0.17 0.24 0.17 0.15
Crit Moves: ****
Green/Cycle: 0.11 0.56 0.56 0.09 0.53 0.53 0.30 0.30 0.30 0.30 0.30 0.30
Volume/Cap: 0.75 0.80 0.17 0.80 0.75 0.75 0.69 0.54 0.54 0.80 0.56 0.49
Delay/Veh: 57.5 18.9 10.8 58.8 19.0 19.0 41.5 30.2 30.2 53.0 30.6 29.3
User DelAdj: 1.00 1.00 1.00 1.00 1.00 1.00 1.00 1.00 1.00 1.00 1.00 1.00
AdjDel/Veh: 57.5 18.9 10.8 58.8 19.0 19.0 41.5 30.2 30.2 53.0 30.6 29.3
LOS by Move: E B B E B B D C C D C C
HCM2kAvgQ: 4 20 2 6 19 19 5 8 8 7 9 6

Note: Queue reported is the number of cars per lane.

Continental Grand Campus Specific Plan
Phase 1 Opening Year (2022) Without Project PM Peak Hour (HCM)

Level of Service Computation Report
2000 HCM Operations Method (Future Volume Alternative)

Intersection #5 Sepulveda Blvd at Grand Ave

Cycle (sec): 100 Critical Vol./Cap.(X): 0.901
Loss Time (sec): 5 Average Delay (sec/veh): 35.7
Optimal Cycle: 90 Level Of Service: D

Street Name: Sepulveda Blvd Grand Ave

Approach: North Bound South Bound East Bound West Bound
Movement: L - T - R L - T - R L - T - R L - T - R

Control: Protected Protected Split Phase Split Phase
Rights: Ovl Include Include Include
Min. Green: 0 0 0 0 0 0 0 0 0 0 0 0
Y+R: 4.0 4.0 4.0 4.0 4.0 4.0 4.0 4.0 4.0 4.0 4.0 4.0
Lanes: 1 0 4 0 1 1 0 3 1 0 1 1 0 1 0 2 0 2 0 1

Volume Module:

Base Vol: 177 1686 177 86 1814 112 304 186 155 327 207 293
Growth Adj: 1.02 1.02 1.02 1.02 1.02 1.02 1.02 1.02 1.02 1.02 1.02 1.02
Initial Bse: 180 1714 180 87 1844 114 309 189 158 332 210 298
Added Vol: -1 79 9 28 80 6 9 2 0 16 2 28
Related Pro: 17 656 -5 2 197 7 11 -5 8 5 5 26
Initial Fut: 196 2449 184 117 2121 127 329 186 166 353 217 352
User Adj: 1.00 1.00 1.00 1.00 1.00 1.00 1.00 1.00 1.00 1.00 1.00 1.00
PHF Adj: 0.92 0.92 0.92 0.92 0.92 0.92 0.92 0.92 0.92 0.92 0.92 0.92
PHF Volume: 213 2662 200 128 2306 138 358 202 180 384 236 382
Reduct Vol: 0 0 0 0 0 0 0 0 0 0 0 0
Reduced Vol: 213 2662 200 128 2306 138 358 202 180 384 236 382
PCE Adj: 1.00 1.00 1.00 1.00 1.00 1.00 1.00 1.00 1.00 1.00 1.00 1.00
MLF Adj: 1.00 1.00 1.00 1.00 1.00 1.00 1.00 1.00 1.00 1.00 1.00 1.00
FinalVolume: 213 2662 200 128 2306 138 358 202 180 384 236 382

Saturation Flow Module:

Sat/Lane: 1900 1900 1900 1900 1900 1900 1900 1900 1900 1900 1900 1900
Adjustment: 0.95 0.91 0.85 0.95 0.90 0.90 0.89 0.89 0.89 0.92 0.95 0.85
Lanes: 1.00 4.00 1.00 1.00 3.77 0.23 1.45 0.82 0.73 2.00 2.00 1.00
Final Sat.: 1805 6916 1615 1805 6474 387 2463 1393 1239 3502 3610 1615

Capacity Analysis Module:

Vol/Sat: 0.12 0.38 0.12 0.07 0.36 0.36 0.15 0.15 0.15 0.11 0.07 0.24
Crit Moves: ****
Green/Cycle: 0.13 0.44 0.71 0.08 0.40 0.40 0.16 0.16 0.16 0.26 0.26 0.26
Volume/Cap: 0.90 0.87 0.18 0.87 0.90 0.90 0.90 0.90 0.90 0.42 0.25 0.90
Delay/Veh: 76.2 27.9 5.0 83.4 33.0 33.0 54.2 54.2 54.2 30.8 29.2 57.5
User DelAdj: 1.00 1.00 1.00 1.00 1.00 1.00 1.00 1.00 1.00 1.00 1.00 1.00
AdjDel/Veh: 76.2 27.9 5.0 83.4 33.0 33.0 54.2 54.2 54.2 30.8 29.2 57.5
LOS by Move: E C A F C C D D D C C E
HCM2kAvgQ: 6 19 2 4 20 20 11 11 11 5 3 15

Note: Queue reported is the number of cars per lane.

Continental Grand Campus Specific Plan
Phase 1 Opening Year (2022) Without Project PM Peak Hour (HCM)

Level of Service Computation Report
2000 HCM Operations Method (Future Volume Alternative)

Intersection #6 Sepulveda Blvd at El Segundo Blvd

Cycle (sec): 100 Critical Vol./Cap.(X): 1.120
Loss Time (sec): 5 Average Delay (sec/veh): 78.6
Optimal Cycle: 180 Level Of Service: E

Street Name: Sepulveda Blvd El Segundo Blvd

Approach: North Bound South Bound East Bound West Bound
Movement: L - T - R L - T - R L - T - R L - T - R

Control: Protected Protected Protected Protected
Rights: Include Include Include Include
Min. Green: 0 0 0 0 0 0 0 0 0 0 0 0
Y+R: 4.0 4.0 4.0 4.0 4.0 4.0 4.0 4.0 4.0 4.0 4.0 4.0
Lanes: 2 0 3 1 0 2 0 4 0 1 1 0 2 0 1 2 0 2 0 1

Volume Module:

Base Vol: 318 1444 294 183 2056 112 139 651 451 412 472 243
Growth Adj: 1.02 1.02 1.02 1.02 1.02 1.02 1.02 1.02 1.02 1.02 1.02 1.02
Initial Bse: 323 1468 299 186 2090 114 141 662 459 419 480 247
Added Vol: 1 38 22 21 62 13 22 19 3 22 11 27
Related Pro: 6 192 52 125 73 5 4 9 2 145 14 485
Initial Fut: 330 1698 373 332 2225 132 167 690 464 586 505 759
User Adj: 1.00 1.00 1.00 1.00 1.00 1.00 1.00 1.00 1.00 1.00 1.00 1.00
PHF Adj: 0.92 0.92 0.92 0.92 0.92 0.92 0.92 0.92 0.92 0.92 0.92 0.92
PHF Volume: 359 1846 405 361 2419 143 182 750 504 637 549 825
Reduct Vol: 0 0 0 0 0 0 0 0 0 0 0 0
Reduced Vol: 359 1846 405 361 2419 143 182 750 504 637 549 825
PCE Adj: 1.00 1.00 1.00 1.00 1.00 1.00 1.00 1.00 1.00 1.00 1.00 1.00
MLF Adj: 1.00 1.00 1.00 1.00 1.00 1.00 1.00 1.00 1.00 1.00 1.00 1.00
FinalVolume: 359 1846 405 361 2419 143 182 750 504 637 549 825

Saturation Flow Module:

Sat/Lane: 1900 1900 1900 1900 1900 1900 1900 1900 1900 1900 1900 1900
Adjustment: 0.92 0.89 0.89 0.92 0.91 0.85 0.95 0.95 0.85 0.92 0.95 0.85
Lanes: 2.00 3.28 0.72 2.00 4.00 1.00 1.00 2.00 1.00 2.00 2.00 1.00
Final Sat.: 3502 5518 1212 3502 6916 1615 1805 3610 1615 3502 3610 1615

Capacity Analysis Module:

Vol/Sat: 0.10 0.33 0.33 0.10 0.35 0.09 0.10 0.21 0.31 0.18 0.15 0.51
Crit Moves: ****
Green/Cycle: 0.09 0.31 0.31 0.10 0.31 0.31 0.09 0.35 0.35 0.20 0.46 0.46
Volume/Cap: 1.12 1.08 1.08 1.08 1.12 0.28 1.12 0.60 0.90 0.90 0.33 1.12
Delay/Veh: 132.0 81.2 81.2 118.7 95.2 26.3 151.9 27.9 49.3 54.1 17.6 98.4
User DelAdj: 1.00 1.00 1.00 1.00 1.00 1.00 1.00 1.00 1.00 1.00 1.00 1.00
AdjDel/Veh: 132.0 81.2 81.2 118.7 95.2 26.3 151.9 27.9 49.3 54.1 17.6 98.4
LOS by Move: F F F F F C F C D D B F
HCM2kAvgQ: 11 29 29 8 29 3 11 11 19 13 6 40

Note: Queue reported is the number of cars per lane.

Continental Grand Campus Specific Plan
Phase 1 Opening Year (2022) Without Project PM Peak Hour (HCM)

Level of Service Computation Report
2000 HCM Operations Method (Future Volume Alternative)

Intersection #7 Sepulveda Blvd at Rosecrans Blvd

Cycle (sec): 100 Critical Vol./Cap.(X): 0.998
Loss Time (sec): 5 Average Delay (sec/veh): 42.1
Optimal Cycle: 180 Level Of Service: D

Street Name: Sepulveda Blvd Rosecrans Blvd

Approach: North Bound South Bound East Bound West Bound
Movement: L - T - R L - T - R L - T - R L - T - R

Control: Protected Protected Protected Protected
Rights: Ovl Include Include Ignore
Min. Green: 0 0 0 0 0 0 0 0 0 0 0 0
Y+R: 4.0 4.0 4.0 4.0 4.0 4.0 4.0 4.0 4.0 4.0 4.0 4.0
Lanes: 2 0 4 0 1 2 0 3 0 1 2 0 3 0 1 2 0 2 0 1

Volume Module:

Base Vol: 310 1257 302 494 2351 519 195 483 162 376 580 462
Growth Adj: 1.01 1.01 1.01 1.01 1.01 1.01 1.01 1.01 1.01 1.01 1.01 1.01
Initial Bse: 314 1275 306 501 2384 526 198 490 164 381 588 468
Added Vol: 0 61 0 0 87 0 0 0 0 0 0 0
Related Pro: 0 112 5 19 447 4 3 0 0 4 0 16
Initial Fut: 314 1448 311 520 2918 530 201 490 164 385 588 484
User Adj: 1.00 1.00 1.00 1.00 1.00 1.00 1.00 1.00 1.00 1.00 1.00 0.00
PHF Adj: 0.92 0.92 0.92 0.92 0.92 0.92 0.92 0.92 0.92 0.92 0.92 0.00
PHF Volume: 342 1573 338 565 3172 576 218 532 179 419 639 0
Reduct Vol: 0 0 0 0 0 0 0 0 0 0 0 0
Reduced Vol: 342 1573 338 565 3172 576 218 532 179 419 639 0
PCE Adj: 1.00 1.00 1.00 1.00 1.00 1.00 1.00 1.00 1.00 1.00 1.00 0.00
MLF Adj: 1.00 1.00 1.00 1.00 1.00 1.00 1.00 1.00 1.00 1.00 1.00 0.00
FinalVolume: 342 1573 338 565 3172 576 218 532 179 419 639 0

Saturation Flow Module:

Sat/Lane: 1900 1900 1900 1900 1900 1900 1900 1900 1900 1900 1900 1900
Adjustment: 0.92 0.91 0.85 0.92 0.91 0.85 0.92 0.91 0.85 0.92 0.95 1.00
Lanes: 2.00 4.00 1.00 2.00 3.00 1.00 2.00 3.00 1.00 2.00 2.00 1.00
Final Sat.: 3502 6916 1615 3502 5187 1615 3502 5187 1615 3502 3610 1900

Capacity Analysis Module:

Vol/Sat: 0.10 0.23 0.21 0.16 0.61 0.36 0.06 0.10 0.11 0.12 0.18 0.00
Crit Moves: ****
Green/Cycle: 0.10 0.42 0.54 0.29 0.61 0.61 0.06 0.12 0.12 0.12 0.18 0.00
Volume/Cap: 1.00 0.55 0.39 0.55 1.00 0.58 1.00 0.89 0.96 0.96 1.00 0.00
Delay/Veh: 93.3 22.3 13.7 30.3 34.9 12.6 107.2 59.1 98.1 76.3 76.2 0.0
User DelAdj: 1.00 1.00 1.00 1.00 1.00 1.00 1.00 1.00 1.00 1.00 1.00 1.00
AdjDel/Veh: 93.3 22.3 13.7 30.3 34.9 12.6 107.2 59.1 98.1 76.3 76.2 0.0
LOS by Move: F C B C C B F E F E E A
HCM2kAvgQ: 10 10 6 8 44 11 7 9 9 11 16 0

Note: Queue reported is the number of cars per lane.

Continental Grand Campus Specific Plan
Phase 1 Opening Year (2022) Without Project PM Peak Hour (HCM)

Level of Service Computation Report
2000 HCM Operations Method (Future Volume Alternative)

Intersection #8 Continental Boulevard at Mariposa Ave

Cycle (sec): 100 Critical Vol./Cap.(X): 0.288
Loss Time (sec): 5 Average Delay (sec/veh): 16.3
Optimal Cycle: 18 Level Of Service: B

Street Name: Continental Boulevard Mariposa Avenue

Approach: North Bound South Bound East Bound West Bound
Movement: L - T - R L - T - R L - T - R L - T - R

Control: Permitted Permitted Permitted Permitted
Rights: Include Include Include Include
Min. Green: 0 0 0 0 0 0 0 0 0 0 0 0
Y+R: 4.0 4.0 4.0 4.0 4.0 4.0 4.0 4.0 4.0 4.0 4.0 4.0
Lanes: 1 0 1 0 2 1 0 0 1 0 1 0 2 1 0 1 0 1 1 0

Volume Module:

Base Vol: 176 85 306 9 56 28 11 514 49 58 342 10
Growth Adj: 1.01 1.01 1.01 1.01 1.01 1.01 1.01 1.01 1.01 1.01 1.01 1.01
Initial Bse: 178 86 310 9 57 28 11 521 50 59 347 10
Added Vol: 0 0 2 3 0 0 0 0 37 0 2 63 6
Related Pro: 0 0 0 0 0 0 0 0 -45 0 0 -10 0
Initial Fut: 178 86 312 12 57 28 11 513 50 61 400 16
User Adj: 1.00 1.00 1.00 1.00 1.00 1.00 1.00 1.00 1.00 1.00 1.00 1.00
PHF Adj: 0.92 0.92 0.92 0.92 0.92 0.92 0.92 0.92 0.92 0.92 0.92 0.00
PHF Volume: 194 94 339 13 62 31 12 558 54 66 435 18
Reduct Vol: 0 0 0 0 0 0 0 0 0 0 0 0
Reduced Vol: 194 94 339 13 62 31 12 558 54 66 435 18
PCE Adj: 1.00 1.00 1.00 1.00 1.00 1.00 1.00 1.00 1.00 1.00 1.00 1.00
MLF Adj: 1.00 1.00 1.00 1.00 1.00 1.00 1.00 1.00 1.00 1.00 1.00 1.00
FinalVolume: 194 94 339 13 62 31 12 558 54 66 435 18

Saturation Flow Module:

Sat/Lane: 1900 1900 1900 1900 1900 1900 1900 1900 1900 1900 1900 1900
Adjustment: 0.69 1.00 0.75 0.69 0.95 0.95 0.41 0.90 0.90 0.37 0.94 0.94
Lanes: 1.00 1.00 2.00 1.00 0.67 0.33 1.00 2.74 0.26 1.00 1.92 0.08
Final Sat.: 1317 1900 2842 1313 1203 602 773 4668 452 695 3449 139

Capacity Analysis Module:

Vol/Sat: 0.15 0.05 0.12 0.01 0.05 0.05 0.02 0.12 0.12 0.10 0.13 0.13
Crit Moves: ****
Green/Cycle: 0.51 0.51 0.51 0.51 0.51 0.51 0.44 0.44 0.44 0.44 0.44 0.44
Volume/Cap: 0.29 0.10 0.23 0.02 0.10 0.10 0.04 0.27 0.27 0.22 0.29 0.29
Delay/Veh: 14.2 12.6 13.6 12.0 12.6 12.6 16.1 18.0 18.0 17.8 18.2 18.2
User DelAdj: 1.00 1.00 1.00 1.00 1.00 1.00 1.00 1.00 1.00 1.00 1.00 1.00
AdjDel/Veh: 14.2 12.6 13.6 12.0 12.6 12.6 16.1 18.0 18.0 17.8 18.2 18.2
LOS by Move: B B B B B B B B B B B B
HCM2kAvgQ: 3 1 3 0 1 1 0 4 4 1 5 5

Note: Queue reported is the number of cars per lane.

Continental Grand Campus Specific Plan
Phase 1 Opening Year (2022) Without Project PM Peak Hour (HCM)

Level of Service Computation Report

2000 HCM Operations Method (Future Volume Alternative)

Intersection #9 Continental Boulevard at Grand Avenue

Cycle (sec): 100 Critical Vol./Cap.(X): 0.290
Loss Time (sec): 5 Average Delay (sec/veh): 18.4
Optimal Cycle: 18 Level Of Service: B

Street Name: Continental Boulevard Grand Avenue
Approach: North Bound South Bound East Bound West Bound
Movement: L - T - R L - T - R L - T - R L - T - R
Control: Permitted Permitted Protected Protected
Rights: Include Include Include Include
Min. Green: 0 0 0 0 0 0 0 0 0 0 0 0
Y+R: 4.0 4.0 4.0 4.0 4.0 4.0 4.0 4.0 4.0 4.0 4.0 4.0
Lanes: 0 1 1 1 0 1 0 2 1 0 1 0 2 1 0

Volume Module:
Base Vol: 53 144 110 40 172 108 58 592 142 21 245 25
Growth Adj: 1.01 1.01 1.01 1.01 1.01 1.01 1.01 1.01 1.01 1.01 1.01 1.01
Initial Bse: 54 146 112 41 174 110 59 600 144 21 248 25
Added Vol: 28 2 2 0 2 0 0 11 28 2 18 0
Related Pro: 0 0 0 0 0 0 0 -15 0 0 30 0
Initial Fut: 82 148 114 41 176 110 59 596 172 23 296 25
User Adj: 1.00 1.00 1.00 1.00 1.00 1.00 1.00 1.00 1.00 1.00 1.00 1.00
PHF Adj: 0.92 0.92 0.92 0.92 0.92 0.92 0.92 0.92 0.92 0.92 0.92 0.92
PHF Volume: 89 161 123 44 192 119 64 648 187 25 322 28
Reduct Vol: 0 0 0 0 0 0 0 0 0 0 0 0
Reduced Vol: 89 161 123 44 192 119 64 648 187 25 322 28
PCE Adj: 1.00 1.00 1.00 1.00 1.00 1.00 1.00 1.00 1.00 1.00 1.00 1.00
MLF Adj: 1.00 1.00 1.00 1.00 1.00 1.00 1.00 1.00 1.00 1.00 1.00 1.00
FinalVolume: 89 161 123 44 192 119 64 648 187 25 322 28

Saturation Flow Module:
Sat/Lane: 1900 1900 1900 1900 1900 1900 1900 1900 1900 1900 1900 1900
Adjustment: 0.69 0.69 0.69 0.46 0.86 0.86 0.95 0.88 0.88 0.95 0.90 0.90
Lanes: 0.71 1.30 0.99 1.00 2.00 1.00 1.00 2.33 0.67 1.00 2.76 0.24
Final Sat.: 940 1702 1305 872 3261 1630 1805 3889 1122 1805 4721 404

Capacity Analysis Module:
Vol/Sat: 0.09 0.09 0.09 0.05 0.06 0.07 0.04 0.17 0.17 0.01 0.07 0.07
Crit Moves: ****
Green/Cycle: 0.33 0.33 0.33 0.33 0.33 0.33 0.21 0.58 0.58 0.05 0.41 0.41
Volume/Cap: 0.29 0.29 0.29 0.15 0.18 0.22 0.17 0.29 0.29 0.29 0.17 0.17
Delay/Veh: 25.2 25.2 25.2 24.2 24.2 24.6 32.3 10.9 10.9 47.8 18.7 18.7
User DelAdj: 1.00 1.00 1.00 1.00 1.00 1.00 1.00 1.00 1.00 1.00 1.00 1.00
AdjDel/Veh: 25.2 25.2 25.2 24.2 24.2 24.6 32.3 10.9 10.9 47.8 18.7 18.7
LOS by Move: C C C C C C C B B D B B
HCM2kAvgQ: 3 3 3 1 2 3 2 5 5 1 2 2

Note: Queue reported is the number of cars per lane.

Continental Grand Campus Specific Plan
Phase 1 Opening Year (2022) Without Project PM Peak Hour (HCM)

Level of Service Computation Report

2000 HCM Operations Method (Future Volume Alternative)

Intersection #10 Continental Boulevard at El Segundo Boulevard

Cycle (sec): 100 Critical Vol./Cap.(X): 0.636
Loss Time (sec): 5 Average Delay (sec/veh): 28.2
Optimal Cycle: 33 Level Of Service: C

Street Name: Continental Boulevard El Segundo Boulevard
Approach: North Bound South Bound East Bound West Bound
Movement: L - T - R L - T - R L - T - R L - T - R
Control: Split Phase Split Phase Protected Protected
Rights: Include Include Include Include
Min. Green: 0 0 0 0 0 0 0 0 0 0 0 0
Y+R: 4.0 4.0 4.0 4.0 4.0 4.0 4.0 4.0 4.0 4.0 4.0 4.0
Lanes: 1 1 0 1 1 1 1 0 1 1 2 0 3 0 1 2 0 2 1 0

Volume Module:
Base Vol: 64 82 94 346 28 81 29 1017 6 36 714 69
Growth Adj: 1.01 1.01 1.01 1.01 1.01 1.01 1.01 1.01 1.01 1.01 1.01 1.01
Initial Bse: 65 83 95 351 28 82 29 1031 6 37 724 70
Added Vol: 0 0 0 18 0 5 5 57 0 0 55 22
Related Pro: 417 0 459 0 0 0 0 78 121 142 223 0
Initial Fut: 482 83 554 369 28 87 34 1166 127 179 1002 92
User Adj: 1.00 1.00 1.00 1.00 1.00 1.00 1.00 1.00 1.00 1.00 1.00 1.00
PHF Adj: 0.92 0.92 0.92 0.92 0.92 0.92 0.92 0.92 0.92 0.92 0.92 0.92
PHF Volume: 524 90 603 401 31 95 37 1268 138 194 1089 100
Reduct Vol: 0 0 0 0 0 0 0 0 0 0 0 0
Reduced Vol: 524 90 603 401 31 95 37 1268 138 194 1089 100
PCE Adj: 1.00 1.00 1.00 1.00 1.00 1.00 1.00 1.00 1.00 1.00 1.00 1.00
MLF Adj: 1.00 1.00 1.00 1.00 1.00 1.00 1.00 1.00 1.00 1.00 1.00 1.00
FinalVolume: 524 90 603 401 31 95 37 1268 138 194 1089 100

Saturation Flow Module:
Sat/Lane: 1900 1900 1900 1900 1900 1900 1900 1900 1900 1900 1900 1900
Adjustment: 0.86 0.86 0.86 0.89 0.89 0.89 0.92 0.91 0.85 0.92 0.90 0.90
Lanes: 1.72 0.30 1.98 2.00 0.49 1.51 2.00 3.00 1.00 2.00 2.75 0.25
Final Sat.: 2818 486 3241 3383 831 2551 3502 5187 1615 3502 4689 430

Capacity Analysis Module:
Vol/Sat: 0.19 0.19 0.19 0.12 0.04 0.04 0.01 0.24 0.09 0.06 0.23 0.23
Crit Moves: ****
Green/Cycle: 0.29 0.29 0.29 0.19 0.19 0.19 0.02 0.38 0.38 0.09 0.45 0.45
Volume/Cap: 0.64 0.64 0.64 0.64 0.20 0.20 0.52 0.64 0.22 0.64 0.52 0.52
Delay/Veh: 31.5 31.5 31.5 39.2 34.4 34.4 54.7 25.8 20.9 48.5 19.9 19.9
User DelAdj: 1.00 1.00 1.00 1.00 1.00 1.00 1.00 1.00 1.00 1.00 1.00 1.00
AdjDel/Veh: 31.5 31.5 31.5 39.2 34.4 34.4 54.7 25.8 20.9 48.5 19.9 19.9
LOS by Move: C C C D C C D C C D B B
HCM2kAvgQ: 9 9 9 7 2 2 1 12 3 3 9 9

Note: Queue reported is the number of cars per lane.

Continental Grand Campus Specific Plan
Phase 1 Opening Year (2022) Without Project PM Peak Hour (HCM)

Level of Service Computation Report
2000 HCM Operations Method (Future Volume Alternative)

Intersection #11 Nash St and Imperial Hwy
Cycle (sec): 100 Critical Vol./Cap.(X): 0.519
Loss Time (sec): 5 Average Delay (sec/veh): 22.2
Optimal Cycle: 26 Level Of Service: C

Table with columns for Street Name (Nash St, Imperial Hwy), Approach (North Bound, South Bound, East Bound, West Bound), Movement (L, T, R), Control (Split Phase, Protected), Rights (Include), Min. Green, Y+R, and Lanes.

Table for Volume Module showing Base Vol, Growth Adj, Initial Bse, Added Vol, Related Pro, Initial Fut, User Adj, PHF Adj, PHF Volume, Reduct Vol, Reduced Vol, PCE Adj, MLF Adj, and Final Volume for various movements.

Table for Saturation Flow Module showing Sat/Lane, Adjustment, Lanes, and Final Sat for various movements.

Table for Capacity Analysis Module showing Vol/Sat, Crit Moves, Green/Cycle, Volume/Cap, Delay/Veh, User DelAdj, AdjDel/Veh, LOS by Move, and HCM2kAvgQ for various movements.

Note: Queue reported is the number of cars per lane.

Continental Grand Campus Specific Plan
Phase 1 Opening Year (2022) Without Project PM Peak Hour (HCM)

Level of Service Computation Report
2000 HCM Operations Method (Future Volume Alternative)

Intersection #12 Nash St at Mariposa Ave
Cycle (sec): 100 Critical Vol./Cap.(X): 0.682
Loss Time (sec): 5 Average Delay (sec/veh): 19.3
Optimal Cycle: 37 Level Of Service: B

Table with columns for Street Name (Nash St, Mariposa Ave), Approach (North Bound, South Bound, East Bound, West Bound), Movement (L, T, R), Control (Permitted), Rights (Include), Min. Green, Y+R, and Lanes.

Table for Volume Module showing Base Vol, Growth Adj, Initial Bse, Added Vol, Related Pro, Initial Fut, User Adj, PHF Adj, PHF Volume, Reduct Vol, Reduced Vol, PCE Adj, MLF Adj, and Final Volume for various movements.

Table for Saturation Flow Module showing Sat/Lane, Adjustment, Lanes, and Final Sat for various movements.

Table for Capacity Analysis Module showing Vol/Sat, Crit Moves, Green/Cycle, Volume/Cap, Delay/Veh, User DelAdj, AdjDel/Veh, LOS by Move, and HCM2kAvgQ for various movements.

Note: Queue reported is the number of cars per lane.

Continental Grand Campus Specific Plan
Phase 1 Opening Year (2022) Without Project PM Peak Hour (HCM)

Level of Service Computation Report
2000 HCM Operations Method (Future Volume Alternative)

Intersection #13 Nash St at Grand Ave

Cycle (sec): 100 Critical Vol./Cap.(X): 0.572
Loss Time (sec): 5 Average Delay (sec/veh): 25.3
Optimal Cycle: 28 Level Of Service: C

Table with columns for Street Name (Nash St, Grand Ave), Approach (North Bound, South Bound, East Bound, West Bound), Movement (L, T, R), Control (Protected, Split Phase), Rights (Include), Min. Green, Y+R, and Lanes.

Table with columns for Volume Module (Base Vol, Growth Adj, Initial Bse, Added Vol, Related Pro, Initial Fut, User Adj, PHF Adj, PHF Volume, Reduct Vol, Reduced Vol, PCE Adj, MLF Adj, FinalVolume) and rows for Nash St and Grand Ave.

Table with columns for Sat/Lane, Adjustment, Lanes, and Final Sat. for Nash St and Grand Ave.

Table with columns for Vol/Sat, Crit Moves, Green/Cycle, Volume/Cap, Delay/Veh, User DelAdj, AdjDel/Veh, LOS by Move, and HCM2kAvgQ for Nash St and Grand Ave.

Note: Queue reported is the number of cars per lane.

Continental Grand Campus Specific Plan
Phase 1 Opening Year (2022) Without Project PM Peak Hour (HCM)

Level of Service Computation Report
2000 HCM Operations Method (Future Volume Alternative)

Intersection #14 Nash St at El Segundo Blvd

Cycle (sec): 100 Critical Vol./Cap.(X): 1.058
Loss Time (sec): 5 Average Delay (sec/veh): 55.4
Optimal Cycle: 180 Level Of Service: E

Table with columns for Street Name (Nash St, El Segundo Blvd), Approach (North Bound, South Bound, East Bound, West Bound), Movement (L, T, R), Control (Split Phase, Protected), Rights (Ovl, Include), Min. Green, Y+R, and Lanes.

Table with columns for Volume Module (Base Vol, Growth Adj, Initial Bse, Added Vol, Related Pro, Initial Fut, User Adj, PHF Adj, PHF Volume, Reduct Vol, Reduced Vol, PCE Adj, MLF Adj, FinalVolume) and rows for Nash St and El Segundo Blvd.

Table with columns for Sat/Lane, Adjustment, Lanes, and Final Sat. for Nash St and El Segundo Blvd.

Table with columns for Vol/Sat, Crit Moves, Green/Cycle, Volume/Cap, Delay/Veh, User DelAdj, AdjDel/Veh, LOS by Move, and HCM2kAvgQ for Nash St and El Segundo Blvd.

Note: Queue reported is the number of cars per lane.

Continental Grand Campus Specific Plan
Phase 1 Opening Year (2022) Without Project PM Peak Hour (HCM)

Level of Service Computation Report
2000 HCM Operations Method (Future Volume Alternative)

Intersection #15 Douglas Street at El Segundo Boulevard

Cycle (sec): 100 Critical Vol./Cap.(X): 1.191
Loss Time (sec): 5 Average Delay (sec/veh): 93.0
Optimal Cycle: 180 Level Of Service: F

Street Name: Douglas St El Segundo Blvd
Approach: North Bound South Bound East Bound West Bound
Movement: L - T - R L - T - R L - T - R L - T - R
Control: Protected Protected Protected Protected
Rights: Include Include Include Include
Min. Green: 0 0 0 0 0 0 0 0 0 0 0 0
Y+R: 4.0 4.0 4.0 4.0 4.0 4.0 4.0 4.0 4.0 4.0 4.0 4.0
Lanes: 2 0 1 1 1 2 0 2 0 1 1 0 2 1 0 2 0 3 0 1

Volume Module:
Base Vol: 148 395 266 484 1097 56 35 1578 334 138 580 168
Growth Adj: 1.01 1.01 1.01 1.01 1.01 1.01 1.01 1.01 1.01 1.01 1.01 1.01
Initial Bse: 150 401 270 491 1112 57 35 1600 339 140 588 170
Added Vol: 49 22 37 38 9 -3 4 63 43 32 40 42
Related Pro: 31 8 8 0 12 -10 -10 1049 12 7 261 5
Initial Fut: 230 431 315 529 1133 44 29 2712 394 179 889 217
User Adj: 1.00 1.00 1.00 1.00 1.00 1.00 1.00 1.00 1.00 1.00 1.00 1.00
PHF Adj: 0.92 0.92 0.92 0.92 0.92 0.92 0.92 0.92 0.92 0.92 0.92 0.92
PHF Volume: 250 468 342 575 1232 48 32 2948 428 194 966 236
Reduct Vol: 0 0 0 0 0 0 0 0 0 0 0 0
Reduced Vol: 250 468 342 575 1232 48 32 2948 428 194 966 236
PCE Adj: 1.00 1.00 1.00 1.00 1.00 1.00 1.00 1.00 1.00 1.00 1.00 1.00
MLF Adj: 1.00 1.00 1.00 1.00 1.00 1.00 1.00 1.00 1.00 1.00 1.00 1.00
FinalVolume: 250 468 342 575 1232 48 32 2948 428 194 966 236

Saturation Flow Module:
Sat/Lane: 1900 1900 1900 1900 1900 1900 1900 1900 1900 1900 1900 1900
Adjustment: 0.92 0.89 0.89 0.92 0.95 0.85 0.95 0.89 0.89 0.92 0.91 0.85
Lanes: 2.00 1.73 1.27 2.00 2.00 1.00 1.00 2.62 0.38 2.00 3.00 1.00
Final Sat.: 3502 2931 2143 3502 3610 1615 1805 4443 645 3502 5187 1615

Capacity Analysis Module:
Vol/Sat: 0.07 0.16 0.16 0.16 0.34 0.03 0.02 0.66 0.66 0.06 0.19 0.15
Crit Moves: ****
Green/Cycle: 0.06 0.17 0.17 0.18 0.29 0.29 0.05 0.56 0.56 0.05 0.55 0.55
Volume/Cap: 1.19 0.93 0.93 0.93 1.19 0.10 0.34 1.19 1.19 1.19 0.34 0.27
Delay/Veh: 170.3 57.8 57.8 62.3 131 26.3 47.8 112 112.0 178.8 12.5 12.0
User DelAdj: 1.00 1.00 1.00 1.00 1.00 1.00 1.00 1.00 1.00 1.00 1.00 1.00
AdjDel/Veh: 170.3 57.8 57.8 62.3 131 26.3 47.8 112 112.0 178.8 12.5 12.0
LOS by Move: F E E E F C D F F F B B
HCM2kAvgQ: 9 13 13 13 36 1 1 64 64 7 6 4

Note: Queue reported is the number of cars per lane.

Continental Grand Campus Specific Plan
Phase 1 Opening Year (2022) Without Project PM Peak Hour (HCM)

Level of Service Computation Report
2000 HCM Operations Method (Future Volume Alternative)

Intersection #16 Aviation Boulevard at El Segundo Boulevard

Cycle (sec): 100 Critical Vol./Cap.(X): 1.178
Loss Time (sec): 5 Average Delay (sec/veh): 90.4
Optimal Cycle: 180 Level Of Service: F

Street Name: Aviation Blvd El Segundo Blvd
Approach: North Bound South Bound East Bound West Bound
Movement: L - T - R L - T - R L - T - R L - T - R
Control: Protected Protected Protected Protected
Rights: Ovl Include Include Include
Min. Green: 0 0 0 0 0 0 0 0 0 0 0 0
Y+R: 4.0 4.0 4.0 4.0 4.0 4.0 4.0 4.0 4.0 4.0 4.0 4.0
Lanes: 2 0 2 0 1 1 0 1 1 1 1 0 3 1 0 2 0 2 1 0

Volume Module:
Base Vol: 180 578 377 95 1121 127 200 1850 360 451 572 42
Growth Adj: 1.01 1.01 1.01 1.01 1.01 1.01 1.01 1.01 1.01 1.01 1.01 1.01
Initial Bse: 183 586 382 96 1137 129 203 1876 365 457 580 43
Added Vol: 7 0 0 2 0 6 7 124 6 0 102 3
Related Pro: 55 46 0 -20 45 88 20 819 168 -13 205 -5
Initial Fut: 245 632 382 78 1182 223 230 2819 539 444 887 41
User Adj: 1.00 1.00 1.00 1.00 1.00 1.00 1.00 1.00 1.00 1.00 1.00 1.00
PHF Adj: 0.92 0.92 0.92 0.92 0.92 0.92 0.92 0.92 0.92 0.92 0.92 0.92
PHF Volume: 266 687 416 85 1284 242 250 3064 586 483 964 44
Reduct Vol: 0 0 0 0 0 0 0 0 0 0 0 0
Reduced Vol: 266 687 416 85 1284 242 250 3064 586 483 964 44
PCE Adj: 1.00 1.00 1.00 1.00 1.00 1.00 1.00 1.00 1.00 1.00 1.00 1.00
MLF Adj: 1.00 1.00 1.00 1.00 1.00 1.00 1.00 1.00 1.00 1.00 1.00 1.00
FinalVolume: 266 687 416 85 1284 242 250 3064 586 483 964 44

Saturation Flow Module:
Sat/Lane: 1900 1900 1900 1900 1900 1900 1900 1900 1900 1900 1900 1900
Adjustment: 0.92 0.95 0.85 0.95 0.93 0.93 0.95 0.89 0.89 0.92 0.90 0.90
Lanes: 2.00 2.00 1.00 1.00 2.00 1.00 1.00 3.36 0.64 2.00 2.87 0.13
Final Sat.: 3502 3610 1615 1805 3523 1762 1805 5666 1084 3502 4925 225

Capacity Analysis Module:
Vol/Sat: 0.08 0.19 0.26 0.05 0.36 0.14 0.14 0.54 0.54 0.14 0.20 0.20
Crit Moves: ****
Green/Cycle: 0.06 0.30 0.42 0.07 0.31 0.31 0.24 0.46 0.46 0.12 0.34 0.34
Volume/Cap: 1.18 0.64 0.62 0.64 1.18 0.44 0.58 1.18 1.18 1.18 0.58 0.58
Delay/Veh: 163.2 31.5 24.6 54.6 123 27.7 35.6 111 110.8 146.9 27.8 27.8
User DelAdj: 1.00 1.00 1.00 1.00 1.00 1.00 1.00 1.00 1.00 1.00 1.00 1.00
AdjDel/Veh: 163.2 31.5 24.6 54.6 123 27.7 35.6 111 110.8 146.9 27.8 27.8
LOS by Move: F C C D F C D F F C C
HCM2kAvgQ: 9 10 11 3 34 6 7 52 52 15 10 10

Note: Queue reported is the number of cars per lane.

Continental Grand Campus Specific Plan
Phase 1 Opening Year (2022) Without Project PM Peak Hour (HCM)

Level of Service Computation Report

ICU 1(Loss as Cycle Length %) Method (Future Volume Alternative)

Intersection #17 El Segundo Boulevard and Isis Avenue

Cycle (sec): 100 Critical Vol./Cap.(X): 0.849
Loss Time (sec): 5 Average Delay (sec/veh): xxxxxx
Optimal Cycle: 65 Level Of Service: D

Table with columns for Street Name, Approach, Movement, Control, Rights, Min. Green, Y+R, Lanes. Rows for Isis Avenue and El Segundo Boulevard.

Table with columns for Volume Module, Base Vol, Growth Adj, Initial Bse, Added Vol, Related Pro, Initial Fut, User Adj, PHF Adj, PHF Volume, Reduct Vol, Reduced Vol, PCE Adj, MLF Adj, Final Volume.

Table with columns for Sat/Lane, Adjustment, Lanes, Final Sat. for Saturation Flow Module.

Table with columns for Vol/Sat, Crit Moves for Capacity Analysis Module.

Table with columns for Green/Cycle, Volume/Cap, Delay/Veh, User DelAdj, AdjDel/Veh, LOS by Move, HCM2kAvgQ.

Continental Grand Campus Specific Plan
Phase 1 Opening Year (2022) Without Project PM Peak Hour (HCM)

Level of Service Computation Report

2000 HCM Operations Method (Future Volume Alternative)

Intersection #18 El Segundo Blvd at I-405 SB Ramps

Cycle (sec): 100 Critical Vol./Cap.(X): 1.406
Loss Time (sec): 5 Average Delay (sec/veh): 74.7
Optimal Cycle: 180 Level Of Service: E

Table with columns for Street Name, Approach, Movement, Control, Rights, Min. Green, Y+R, Lanes. Rows for I-405 SB Ramps and El Segundo Blvd.

Table with columns for Volume Module, Base Vol, Growth Adj, Initial Bse, Added Vol, Related Pro, Initial Fut, User Adj, PHF Adj, PHF Volume, Reduct Vol, Reduced Vol, PCE Adj, MLF Adj, Final Volume.

Table with columns for Sat/Lane, Adjustment, Lanes, Final Sat. for Saturation Flow Module.

Table with columns for Vol/Sat, Crit Moves for Capacity Analysis Module.

Table with columns for Green/Cycle, Volume/Cap, Delay/Veh, User DelAdj, AdjDel/Veh, LOS by Move, HCM2kAvgQ.

Note: Queue reported is the number of cars per lane.

Continental Grand Campus Specific Plan
Phase 1 Opening Year (2022) Without Project PM Peak Hour (HCM)

Level of Service Computation Report
2000 HCM Operations Method (Future Volume Alternative)

Intersection #19 El Segundo Blvd at La Cienega Blvd

Cycle (sec): 100 Critical Vol./Cap.(X): 0.796
Loss Time (sec): 5 Average Delay (sec/veh): 21.6
Optimal Cycle: 53 Level Of Service: C

Table with columns: Street Name, Approach, Movement, Control, Rights, Min. Green, Y+R, Lanes. Rows for North Bound, South Bound, East Bound, West Bound.

Table with columns: Volume Module, Base Vol, Growth Adj, Initial Bse, Added Vol, Related Pro, Initial Fut, User Adj, PHF Adj, PHF Volume, Reduct Vol, Reduced Vol, PCE Adj, MLF Adj, Final Volume.

Table with columns: Sat/Lane, Adjustment, Lanes, Final Sat. for Saturation Flow Module.

Table with columns: Vol/Sat, Crit Moves, Green/Cycle, Volume/Cap, Delay/Veh, User DelAdj, AdjDel/Veh, LOS by Move, HCM2kAvgQ for Capacity Analysis Module.

Note: Queue reported is the number of cars per lane.

Continental Grand Campus Specific Plan
Phase 1 Opening Year (2022) Without Project PM Peak Hour (HCM)

Level of Service Computation Report
2000 HCM Operations Method (Future Volume Alternative)

Intersection #20 El Segundo Blvd at I-405 NB Ramps

Cycle (sec): 100 Critical Vol./Cap.(X): 0.718
Loss Time (sec): 5 Average Delay (sec/veh): 12.5
Optimal Cycle: 41 Level Of Service: B

Table with columns: Street Name, Approach, Movement, Control, Rights, Min. Green, Y+R, Lanes. Rows for North Bound, South Bound, East Bound, West Bound.

Table with columns: Volume Module, Base Vol, Growth Adj, Initial Bse, Added Vol, Related Pro, Initial Fut, User Adj, PHF Adj, PHF Volume, Reduct Vol, Reduced Vol, PCE Adj, MLF Adj, Final Volume.

Table with columns: Sat/Lane, Adjustment, Lanes, Final Sat. for Saturation Flow Module.

Table with columns: Vol/Sat, Crit Moves, Green/Cycle, Volume/Cap, Delay/Veh, User DelAdj, AdjDel/Veh, LOS by Move, HCM2kAvgQ for Capacity Analysis Module.

Note: Queue reported is the number of cars per lane.

 Continental Grand Campus Specific Plan
 Phase 1 Opening Year(2022) With Project AM Peak Hour (HCM)

Scenario Report

Scenario: Phase 1 Op Yr With Proj AM HCM
 Command: Phase 1 Op Yr With Proj AM HCM
 Volume: OY AM
 Geometry: Existing
 Impact Fee: Default Impact Fee
 Trip Generation: Cum + Phase 1 AM
 Trip Distribution: Cum + Proj
 Paths: Project
 Routes: Default Route
 Configuration: Phase 1 Op Yr With Proj AM HCM

 Continental Grand Campus Specific Plan
 Phase 1 Opening Year(2022) With Project AM Peak Hour (HCM)

Trip Generation Report

Forecast for Cum + Phase 1 AM

Zone #	Subzone	Amount	Units	Rate In	Rate Out	Trips In	Trips Out	Total Trips	% Of Total
306	525 N. Sepul	1.00	Residential	-6.00	-3.00	-6	-3	-9	-0.4
	Zone 306 Subtotal					-6	-3	-9	-0.4
307	540 Imperial	1.00	Residential	23.00	44.00	23	44	67	2.8
	Zone 307 Subtotal					23	44	67	2.8
311	199 Continen	1.00	Business Hotel	48.00	33.00	48	33	81	3.4
	Zone 311 Subtotal					48	33	81	3.4
313	445 N. Dougl	1.00	Equinix Data C	8.00	8.00	8	8	16	0.7
	Zone 313 Subtotal					8	8	16	0.7
314	123 Lomita a	1.00	Office	17.00	3.00	17	3	20	0.8
	Zone 314 Subtotal					17	3	20	0.8
704	2355 Utah Av	1.00	Office	150.00	76.00	150	76	226	9.5
	Zone 704 Subtotal					150	76	226	9.5
706	888 Sepulved	1.00	hotel	57.00	36.00	57	36	93	3.9
	Zone 706 Subtotal					57	36	93	3.9
710	201 North Do	1.00	High School	160.00	111.00	160	111	271	11.4
710	201 North Do	1.00	District Offic	20.00	2.00	20	2	22	0.9
	Zone 710 Subtotal					180	113	293	12.4
714	400 Duley -	1.00	Office	95.00	13.00	95	13	108	4.6
714	400 Duley -	1.00	Industrial	0.00	0.00	0	0	0	0.0
	Zone 714 Subtotal					95	13	108	4.6
717	1700 Imperia	1.00	Townhome Resid	133.00	18.00	133	18	151	6.4
	Zone 717 Subtotal					133	18	151	6.4
718	123 Nevada S	1.00	Office	18.00	3.00	18	3	21	0.9
718	123 Nevada S	0.00	123 Nevada	18.00	3.00	0	0	0	0.0
	Zone 718 Subtotal					18	3	21	0.9
719	2125 Campus	1.00	Office Retail	160.00	46.00	160	46	206	8.7
	Zone 719 Subtotal					160	46	206	8.7
1002	Laker Facili	1.00	General Office	136.00	13.00	136	13	149	6.3
	Zone 1002 Subtotal					136	13	149	6.3
1005	Mattel	1.00	Mattel	431.00	43.00	431	43	474	20.0
	Zone 1005 Subtotal					431	43	474	20.0

Continental Grand Campus Specific Plan
Phase 1 Opening Year(2022) With Project AM Peak Hour (HCM)

Zone #	Subzone	Amount	Units	Rate In	Rate Out	Trips In	Trips Out	Total Trips	% Of Total
1007	Mattel Proje	1.00	project	431.00	43.00	431	43	474	20.0
	Zone 1007 Subtotal					431	43	474	20.0
TOTAL						1881	489	2370	100.0

Continental Grand Campus Specific Plan
Phase 1 Opening Year(2022) With Project AM Peak Hour (HCM)

Trip Distribution Report

Percent Of Trips Cum + Project

Zone	To Gates											
	1	2	3	4	5	7	8	9	10	11	12	
306	10.0	15.0	10.0	5.0	0.0	5.0	5.0	25.0	0.0	25.0	0.0	
307	10.0	15.0	10.0	5.0	50.0	0.0	0.0	0.0	0.0	0.0	0.0	
311	40.0	10.0	10.0	10.0	0.0	5.0	5.0	10.0	0.0	10.0	0.0	
313	15.0	5.0	15.0	10.0	25.0	0.0	5.0	20.0	0.0	0.0	0.0	
314	40.0	10.0	10.0	10.0	0.0	5.0	5.0	10.0	0.0	10.0	0.0	
704	30.0	15.0	8.0	12.0	0.0	5.0	5.0	10.0	5.0	10.0	0.0	
706	25.0	20.0	10.0	25.0	0.0	0.0	0.0	0.0	0.0	0.0	10.0	
710	0.0	0.0	15.0	10.0	10.0	2.0	2.0	20.0	5.0	10.0	1.0	
714	5.0	10.0	5.0	5.0	20.0	5.0	10.0	15.0	5.0	15.0	0.0	
717	10.0	15.0	10.0	5.0	50.0	0.0	0.0	0.0	0.0	0.0	0.0	
718	10.0	10.0	10.0	10.0	20.0	0.0	0.0	20.0	10.0	0.0	0.0	
719	20.0	10.0	10.0	10.0	10.0	5.0	5.0	10.0	5.0	0.0	0.0	
1002	0.0	10.0	5.0	5.0	15.0	5.0	10.0	15.0	5.0	15.0	5.0	
1004	5.0	15.0	10.0	5.0	30.0	0.0	5.0	20.0	0.0	0.0	5.0	
1005	5.0	15.0	10.0	5.0	30.0	0.0	5.0	20.0	0.0	0.0	5.0	
1007	0.0	0.0	0.0	0.0	0.0	0.0	0.0	0.0	0.0	0.0	0.0	

Zone	To Gates						
	13	14	15	16	17	18	20
306	0.0	0.0	0.0	0.0	0.0	0.0	0.0
307	0.0	10.0	0.0	0.0	0.0	0.0	0.0
311	0.0	0.0	0.0	0.0	0.0	0.0	0.0
313	5.0	0.0	0.0	0.0	0.0	0.0	0.0
314	0.0	0.0	0.0	0.0	0.0	0.0	0.0
704	0.0	0.0	0.0	0.0	0.0	0.0	0.0
706	0.0	0.0	0.0	0.0	10.0	0.0	0.0
710	10.0	5.0	10.0	0.0	0.0	0.0	0.0
714	0.0	5.0	0.0	0.0	0.0	0.0	0.0
717	0.0	10.0	0.0	0.0	0.0	0.0	0.0
718	0.0	10.0	0.0	0.0	0.0	0.0	0.0
719	0.0	10.0	5.0	0.0	0.0	0.0	0.0
1002	0.0	5.0	5.0	0.0	0.0	0.0	0.0
1004	0.0	5.0	0.0	0.0	0.0	0.0	0.0
1005	0.0	5.0	0.0	0.0	0.0	0.0	0.0
1007	0.0	0.0	0.0	0.0	0.0	20.0	10.0

Continental Grand Campus Specific Plan
Phase 1 Opening Year(2022) With Project AM Peak Hour (HCM)

Impact Analysis Report
Level Of Service

Intersection	Base	Future	Change	Del/ V/		Del/ V/		in
				LOS	Veh	LOS	Veh	
# 1 Sepulveda Blvd at Imperial Hwy	C 30.0 0.830	C 29.8 0.894	-0.116 D/V					
# 2 Sepulveda Blvd at Walnut St	A 7.8 0.556	A 9.1 0.740	+ 1.249 D/V					
# 3 Sepulveda Blvd at Maple Ave	B 10.6 0.543	B 15.4 0.691	+ 4.748 D/V					
# 4 Sepulveda Blvd at Mariposa Ave	B 18.4 0.617	C 20.7 0.734	+ 2.369 D/V					
# 5 Sepulveda Blvd at Grand Ave	C 22.4 0.753	C 23.7 0.855	+ 1.222 D/V					
# 6 Sepulveda Blvd at El Segundo B	C 26.5 0.776	E 67.2 1.110	+40.711 D/V					
# 7 Sepulveda Blvd at Rosecrans Bl	C 27.5 0.799	C 34.4 0.934	+ 6.924 D/V					
# 8 Continental Boulevard at Marip	A 9.8 0.353	B 10.5 0.597	+ 0.778 D/V					
# 9 Continental Boulevard at Grand	C 23.5 0.256	C 23.8 0.376	+ 0.294 D/V					
# 10 Continental Boulevard at El Se	A 9.1 0.381	B 15.8 0.553	+ 6.728 D/V					
# 11 Nash St and Imperial Hwy	C 24.1 0.628	C 26.0 0.815	+ 1.963 D/V					
# 12 Nash St at Mariposa Ave	B 15.0 0.383	B 15.5 0.621	+ 0.515 D/V					
# 13 Nash St at Grand Ave	C 23.7 0.470	C 21.3 0.532	-2.476 D/V					
# 14 Nash St at El Segundo Blvd	B 12.5 0.445	C 23.3 0.729	+10.840 D/V					
# 15 Douglas Street at El Segundo B	C 27.9 0.712	D 43.7 1.011	+15.763 D/V					
# 16 Aviation Boulevard at El Segun	C 31.4 0.819	F 98.4 1.209	+67.052 D/V					
# 17 El Segundo Boulevard and Isis	B xxxxxx 0.631	E xxxxxx 0.923	+ 0.292 V/C					
# 18 El Segundo Blvd at I-405 SB Ra	B 17.8 0.611	B 18.5 0.897	+ 0.754 D/V					
# 19 El Segundo Blvd at La Cienega	B 14.7 0.596	C 26.2 0.931	+11.472 D/V					
# 20 El Segundo Blvd at I-405 NB Ra	B 17.9 0.720	C 30.3 0.932	+12.425 D/V					

Continental Grand Campus Specific Plan
Phase 1 Opening Year(2022) With Project AM Peak Hour (HCM)

Level Of Service Computation Report
2000 HCM Operations Method (Future Volume Alternative)

Intersection #1 Sepulveda Blvd at Imperial Hwy

Cycle (sec):	100	Critical Vol./Cap.(X):	0.894
Loss Time (sec):	5	Average Delay (sec/veh):	29.8
Optimal Cycle:	86	Level Of Service:	C

Street Name:	Sepulveda Blvd		Imperial Hwy	
Approach:	North Bound	South Bound	East Bound	West Bound
Movement:	L - T - R	L - T - R	L - T - R	L - T - R
Control:	Protected	Protected	Protected	Protected
Rights:	Include	Include	Include	Ovl
Min. Green:	0 0 0	0 0 0	0 0 0	0 0 0
Y+R:	4.0 4.0 4.0	4.0 4.0 4.0	4.0 4.0 4.0	4.0 4.0 4.0
Lanes:	1 0 3 0 1	2 0 3 1 0	2 0 3 0 1	2 0 3 0 1

Volume Module:

Base Vol:	63 1495	418	448 2297	12	210 316	140	211 292	590
Growth Adj:	1.02 1.02	1.02	1.02 1.02	1.02	1.02 1.02	1.02	1.02 1.02	1.02
Initial Bse:	64 1520	425	455 2335	12	213 321	142	215 297	600
Added Vol:	19 50	13	23 206	2	4 31	77	15 3	12
Related Pro:	9 130	38	-85 615	0	-5 25	30	6 5	-90
Initial Fut:	92 1700	476	393 3156	14	212 377	249	236 305	522
User Adj:	1.00 1.00	1.00	1.00 1.00	1.00	1.00 1.00	1.00	1.00 1.00	1.00
PHF Adj:	0.92 0.92	0.92	0.92 0.92	0.92	0.92 0.92	0.92	0.92 0.92	0.92
PHF Volume:	100 1848	517	428 3431	15	231 410	271	256 331	567
Reduct Vol:	0 0 0	0	0 0 0	0	0 0 0	0	0 0 0	0
Reduced Vol:	100 1848	517	428 3431	15	231 410	271	256 331	567
PCE Adj:	1.00 1.00	1.00	1.00 1.00	1.00	1.00 1.00	1.00	1.00 1.00	1.00
MLF Adj:	1.00 1.00	1.00	1.00 1.00	1.00	1.00 1.00	1.00	1.00 1.00	1.00
FinalVolume:	100 1848	517	428 3431	15	231 410	271	256 331	567

Saturation Flow Module:

Sat/Lane:	1900 1900	1900	1900 1900	1900	1900 1900	1900	1900 1900	1900
Adjustment:	0.95 0.91	0.85	0.92 0.91	0.91	0.92 0.91	0.85	0.92 0.91	0.85
Lanes:	1.00 3.00	1.00	2.00 3.98	0.02	2.00 3.00	1.00	2.00 3.00	1.00
Final Sat.:	1805 5187	1615	3502 6878	31	3502 5187	1615	3502 5187	1615

Capacity Analysis Module:

Vol/Sat:	0.06 0.36	0.32	0.12 0.50	0.50	0.07 0.08	0.17	0.07 0.06	0.35
Crit Moves:	****		****		****			****
Green/Cycle:	0.06 0.46	0.46	0.16 0.56	0.56	0.07 0.23	0.23	0.10 0.26	0.41
Volume/Cap:	0.89 0.77	0.69	0.77 0.89	0.89	0.89 0.34	0.73	0.73 0.25	0.85
Delay/Veh:	99.8 24.1	24.2	47.0 22.6	22.6	75.9 32.4	42.8	51.3 29.6	36.3
User DelAdj:	1.00 1.00	1.00	1.00 1.00	1.00	1.00 1.00	1.00	1.00 1.00	1.00
AdjDel/Veh:	99.8 24.1	24.2	47.0 22.6	22.6	75.9 32.4	42.8	51.3 29.6	36.3
LOS by Move:	F C	C	D C	C	E C	D	D C	D
HCM2kAvgQ:	4 18	13	8 29	29	4 4	8	4 3	17

Note: Queue reported is the number of cars per lane.

Continental Grand Campus Specific Plan
Phase 1 Opening Year(2022) With Project AM Peak Hour (HCM)

Level of Service Computation Report
2000 HCM Operations Method (Future Volume Alternative)

Intersection #2 Sepulveda Blvd at Walnut St

Cycle (sec): 100 Critical Vol./Cap.(X): 0.740
Loss Time (sec): 5 Average Delay (sec/veh): 9.1
Optimal Cycle: 44 Level Of Service: A

Table with columns: Street Name, Approach, Movement, Control, Rights, Min. Green, Y+R, Lanes. Rows for Sepulveda Blvd and Walnut St.

Table with columns: Volume Module, Base Vol, Growth Adj, Initial Bse, Added Vol, Related Pro, Initial Fut, User Adj, PHF Adj, PHF Volume, Reduct Vol, Reduced Vol, PCE Adj, MLF Adj, Final Volume. Rows for Sepulveda Blvd and Walnut St.

Table with columns: Sat/Lane, Adjustment, Lanes, Final Sat. Rows for Sepulveda Blvd and Walnut St.

Table with columns: Vol/Sat, Crit Moves, Green/Cycle, Volume/Cap, Delay/Veh, User DelAdj, AdjDel/Veh, LOS by Move, HCM2kAvgQ. Rows for Sepulveda Blvd and Walnut St.

Note: Queue reported is the number of cars per lane.

Continental Grand Campus Specific Plan
Phase 1 Opening Year(2022) With Project AM Peak Hour (HCM)

Level of Service Computation Report
2000 HCM Operations Method (Future Volume Alternative)

Intersection #3 Sepulveda Blvd at Maple Ave

Cycle (sec): 100 Critical Vol./Cap.(X): 0.691
Loss Time (sec): 5 Average Delay (sec/veh): 15.4
Optimal Cycle: 38 Level Of Service: B

Table with columns: Street Name, Approach, Movement, Control, Rights, Min. Green, Y+R, Lanes. Rows for Sepulveda Blvd and Maple Ave.

Table with columns: Volume Module, Base Vol, Growth Adj, Initial Bse, Added Vol, Related Pro, Initial Fut, User Adj, PHF Adj, PHF Volume, Reduct Vol, Reduced Vol, PCE Adj, MLF Adj, Final Volume. Rows for Sepulveda Blvd and Maple Ave.

Table with columns: Sat/Lane, Adjustment, Lanes, Final Sat. Rows for Sepulveda Blvd and Maple Ave.

Table with columns: Vol/Sat, Crit Moves, Green/Cycle, Volume/Cap, Delay/Veh, User DelAdj, AdjDel/Veh, LOS by Move, HCM2kAvgQ. Rows for Sepulveda Blvd and Maple Ave.

Note: Queue reported is the number of cars per lane.

Continental Grand Campus Specific Plan
Phase 1 Opening Year(2022) With Project AM Peak Hour (HCM)

Level of Service Computation Report
2000 HCM Operations Method (Future Volume Alternative)

Intersection #4 Sepulveda Blvd at Mariposa Ave

Cycle (sec): 100 Critical Vol./Cap.(X): 0.734
Loss Time (sec): 5 Average Delay (sec/veh): 20.7
Optimal Cycle: 43 Level Of Service: C

Table with columns: Street Name, Approach, Movement, Control, Rights, Min. Green, Y+R, Lanes. Rows for Sepulveda Blvd and Mariposa Ave.

Table with columns: Volume Module, Base Vol, Growth Adj, Initial Bse, Added Vol, Related Pro, Initial Fut, User Adj, PHF Adj, PHF Volume, Reduct Vol, Reduced Vol, PCE Adj, MLF Adj, FinalVolume.

Table with columns: Saturation Flow Module, Sat/Lane, Adjustment, Lanes, Final Sat.

Table with columns: Capacity Analysis Module, Vol/Sat, Crit Moves, Green/Cycle, Volume/Cap, Delay/Veh, User DelAdj, AdjDel/Veh, LOS by Move, HCM2kAvgQ.

Note: Queue reported is the number of cars per lane.

Continental Grand Campus Specific Plan
Phase 1 Opening Year(2022) With Project AM Peak Hour (HCM)

Level of Service Computation Report
2000 HCM Operations Method (Future Volume Alternative)

Intersection #5 Sepulveda Blvd at Grand Ave

Cycle (sec): 100 Critical Vol./Cap.(X): 0.855
Loss Time (sec): 5 Average Delay (sec/veh): 23.7
Optimal Cycle: 69 Level Of Service: C

Table with columns: Street Name, Approach, Movement, Control, Rights, Min. Green, Y+R, Lanes. Rows for Sepulveda Blvd and Grand Ave.

Table with columns: Volume Module, Base Vol, Growth Adj, Initial Bse, Added Vol, Related Pro, Initial Fut, User Adj, PHF Adj, PHF Volume, Reduct Vol, Reduced Vol, PCE Adj, MLF Adj, FinalVolume.

Table with columns: Saturation Flow Module, Sat/Lane, Adjustment, Lanes, Final Sat.

Table with columns: Capacity Analysis Module, Vol/Sat, Crit Moves, Green/Cycle, Volume/Cap, Delay/Veh, User DelAdj, AdjDel/Veh, LOS by Move, HCM2kAvgQ.

Note: Queue reported is the number of cars per lane.

Continental Grand Campus Specific Plan
Phase 1 Opening Year(2022) With Project AM Peak Hour (HCM)

Level of Service Computation Report
2000 HCM Operations Method (Future Volume Alternative)

Intersection #6 Sepulveda Blvd at El Segundo Blvd

Cycle (sec): 100 Critical Vol./Cap.(X): 1.110
Loss Time (sec): 5 Average Delay (sec/veh): 67.2
Optimal Cycle: 180 Level Of Service: E

Table with columns: Street Name, Approach, Movement, Control, Rights, Min. Green, Y+R, Lanes. Rows for Sepulveda Blvd and El Segundo Blvd.

Table with columns: Volume Module, Base Vol, Growth Adj, Initial Bse, Added Vol, Related Pro, Initial Fut, User Adj, PHF Adj, PHF Volume, Reduct Vol, Reduced Vol, PCE Adj, MLF Adj, FinalVolume.

Table with columns: Saturation Flow Module, Sat/Lane, Adjustment, Lanes, Final Sat.

Table with columns: Capacity Analysis Module, Vol/Sat, Crit Moves, Green/Cycle, Volume/Cap, Delay/Veh, User DelAdj, AdjDel/Veh, LOS by Move, HCM2kAvgQ.

Note: Queue reported is the number of cars per lane.

Continental Grand Campus Specific Plan
Phase 1 Opening Year(2022) With Project AM Peak Hour (HCM)

Level of Service Computation Report
2000 HCM Operations Method (Future Volume Alternative)

Intersection #7 Sepulveda Blvd at Rosecrans Blvd

Cycle (sec): 100 Critical Vol./Cap.(X): 0.934
Loss Time (sec): 5 Average Delay (sec/veh): 34.4
Optimal Cycle: 115 Level Of Service: C

Table with columns: Street Name, Approach, Movement, Control, Rights, Min. Green, Y+R, Lanes. Rows for Sepulveda Blvd and Rosecrans Blvd.

Table with columns: Volume Module, Base Vol, Growth Adj, Initial Bse, Added Vol, Related Pro, Initial Fut, User Adj, PHF Adj, PHF Volume, Reduct Vol, Reduced Vol, PCE Adj, MLF Adj, FinalVolume.

Table with columns: Saturation Flow Module, Sat/Lane, Adjustment, Lanes, Final Sat.

Table with columns: Capacity Analysis Module, Vol/Sat, Crit Moves, Green/Cycle, Volume/Cap, Delay/Veh, User DelAdj, AdjDel/Veh, LOS by Move, HCM2kAvgQ.

Note: Queue reported is the number of cars per lane.

Continental Grand Campus Specific Plan
Phase 1 Opening Year(2022) With Project AM Peak Hour (HCM)

Level of Service Computation Report
2000 HCM Operations Method (Future Volume Alternative)

Intersection #8 Continental Boulevard at Mariposa Ave

Cycle (sec): 100 Critical Vol./Cap.(X): 0.597
Loss Time (sec): 5 Average Delay (sec/veh): 10.5
Optimal Cycle: 30 Level Of Service: B

Table with columns: Street Name, Approach, Movement, Control, Rights, Min. Green, Y+R, Lanes. Rows for Continental Boulevard and Mariposa Avenue.

Table with columns: Volume Module, Base Vol, Growth Adj, Initial Bse, Added Vol, Related Pro, Initial Fut, User Adj, PHF Adj, PHF Volume, Reduct Vol, Reduced Vol, PCE Adj, MLF Adj, Final Volume.

Table with columns: Sat/Lane, Adjustment, Lanes, Final Sat. for Saturation Flow Module.

Table with columns: Vol/Sat, Crit Moves, Green/Cycle, Volume/Cap, Delay/Veh, User DelAdj, AdjDel/Veh, LOS by Move, HCM2kAvgQ for Capacity Analysis Module.

Note: Queue reported is the number of cars per lane.

Continental Grand Campus Specific Plan
Phase 1 Opening Year(2022) With Project AM Peak Hour (HCM)

Level of Service Computation Report
2000 HCM Operations Method (Future Volume Alternative)

Intersection #9 Continental Boulevard at Grand Avenue

Cycle (sec): 100 Critical Vol./Cap.(X): 0.376
Loss Time (sec): 5 Average Delay (sec/veh): 23.8
Optimal Cycle: 20 Level Of Service: C

Table with columns: Street Name, Approach, Movement, Control, Rights, Min. Green, Y+R, Lanes. Rows for Continental Boulevard and Grand Avenue.

Table with columns: Volume Module, Base Vol, Growth Adj, Initial Bse, Added Vol, Related Pro, Initial Fut, User Adj, PHF Adj, PHF Volume, Reduct Vol, Reduced Vol, PCE Adj, MLF Adj, Final Volume.

Table with columns: Sat/Lane, Adjustment, Lanes, Final Sat. for Saturation Flow Module.

Table with columns: Vol/Sat, Crit Moves, Green/Cycle, Volume/Cap, Delay/Veh, User DelAdj, AdjDel/Veh, LOS by Move, HCM2kAvgQ for Capacity Analysis Module.

Note: Queue reported is the number of cars per lane.

Continental Grand Campus Specific Plan
Phase 1 Opening Year(2022) With Project AM Peak Hour (HCM)

Level of Service Computation Report

2000 HCM Operations Method (Future Volume Alternative)

Intersection #10 Continental Boulevard at El Segundo Boulevard

Cycle (sec): 100 Critical Vol./Cap.(X): 0.553
Loss Time (sec): 5 Average Delay (sec/veh): 15.8
Optimal Cycle: 27 Level Of Service: B

Street Name: Continental Boulevard El Segundo Boulevard
Approach: North Bound South Bound East Bound West Bound
Movement: L - T - R L - T - R L - T - R L - T - R

Control: Split Phase Split Phase Protected Protected
Rights: Include Include Include Include
Min. Green: 0 0 0 0 0 0 0 0 0 0 0 0
Y+R: 4.0 4.0 4.0 4.0 4.0 4.0 4.0 4.0 4.0 4.0 4.0 4.0
Lanes: 1 1 0 1 1 1 1 0 1 1 2 0 3 0 1 2 0 2 1 0

Volume Module:
Base Vol: 4 16 1 51 28 24 156 648 49 49 970 346
Growth Adj: 1.01 1.01 1.01 1.01 1.01 1.01 1.01 1.01 1.01 1.01 1.01 1.01
Initial Bse: 4 16 1 52 28 24 158 657 50 50 984 351
Added Vol: 0 0 0 30 0 3 5 88 0 0 53 161
Related Pro: 67 0 73 0 0 0 0 273 421 451 26 0
Initial Fut: 71 16 74 82 28 27 163 1018 471 501 1063 512
User Adj: 1.00 1.00 1.00 1.00 1.00 1.00 1.00 1.00 1.00 1.00 1.00 1.00
PHF Adj: 0.92 0.92 0.92 0.92 0.92 0.92 0.92 0.92 0.92 0.92 0.92 0.92
PHF Volume: 77 18 80 89 31 30 177 1107 512 544 1155 556
Reduct Vol: 0 0 0 0 0 0 0 0 0 0 0 0
Reduced Vol: 77 18 80 89 31 30 177 1107 512 544 1155 556
PCE Adj: 1.00 1.00 1.00 1.00 1.00 1.00 1.00 1.00 1.00 1.00 1.00 1.00
MLF Adj: 1.00 1.00 1.00 1.00 1.00 1.00 1.00 1.00 1.00 1.00 1.00 1.00
FinalVolume: 77 18 80 89 31 30 177 1107 512 544 1155 556

Saturation Flow Module:
Sat/Lane: 1900 1900 1900 1900 1900 1900 1900 1900 1900 1900 1900 1900
Adjustment: 0.86 0.86 0.86 0.89 0.89 0.89 0.92 0.91 0.85 0.92 0.87 0.87
Lanes: 1.76 0.40 1.84 2.00 1.00 1.00 2.00 3.00 1.00 2.00 2.02 0.98
Final Sat.: 2896 661 3017 3400 1700 1700 3502 5187 1615 3502 3329 1604

Capacity Analysis Module:
Vol/Sat: 0.03 0.03 0.03 0.03 0.02 0.02 0.05 0.21 0.32 0.16 0.35 0.35
Crit Moves: ****
Green/Cycle: 0.05 0.05 0.05 0.05 0.05 0.05 0.11 0.57 0.57 0.28 0.75 0.75
Volume/Cap: 0.55 0.55 0.55 0.55 0.38 0.37 0.47 0.37 0.55 0.55 0.47 0.47
Delay/Veh: 48.6 48.6 48.6 49.1 46.9 46.8 42.7 11.7 14.1 31.3 5.0 5.0
User DelAdj: 1.00 1.00 1.00 1.00 1.00 1.00 1.00 1.00 1.00 1.00 1.00 1.00
AdjDel/Veh: 48.6 48.6 48.6 49.1 46.9 46.8 42.7 11.7 14.1 31.3 5.0 5.0
LOS by Move: D D D D D D B B C A A
HCM2kAvgQ: 2 2 2 2 1 1 3 7 10 7 7 7

Note: Queue reported is the number of cars per lane.

Continental Grand Campus Specific Plan
Phase 1 Opening Year(2022) With Project AM Peak Hour (HCM)

Level of Service Computation Report

2000 HCM Operations Method (Future Volume Alternative)

Intersection #11 Nash St and Imperial Hwy

Cycle (sec): 100 Critical Vol./Cap.(X): 0.815
Loss Time (sec): 5 Average Delay (sec/veh): 26.0
Optimal Cycle: 57 Level Of Service: C

Street Name: Nash St Imperial Hwy
Approach: North Bound South Bound East Bound West Bound
Movement: L - T - R L - T - R L - T - R L - T - R

Control: Split Phase Split Phase Protected Protected
Rights: Include Include Include Include
Min. Green: 0 0 0 0 0 0 0 0 0 0 0 0
Y+R: 4.0 4.0 4.0 4.0 4.0 4.0 4.0 4.0 4.0 4.0 4.0 4.0
Lanes: 1 0 0 0 2 1 1 0 1 1 0 0 2 1 0 2 0 3 0 0

Volume Module:
Base Vol: 46 0 40 425 1060 483 0 602 126 221 949 0
Growth Adj: 1.01 1.01 1.01 1.01 1.01 1.01 1.01 1.01 1.01 1.01 1.01 1.01
Initial Bse: 47 0 41 431 1075 490 0 610 128 224 962 0
Added Vol: 1 0 8 0 205 0 0 37 5 40 35 0
Related Pro: -25 0 -20 40 331 -40 0 10 -10 25 -25 0
Initial Fut: 23 0 29 471 1611 450 0 657 123 289 972 0
User Adj: 1.00 1.00 1.00 1.00 1.00 1.00 1.00 1.00 1.00 1.00 1.00 1.00
PHF Adj: 0.92 0.92 0.92 0.92 0.92 0.92 0.92 0.92 0.92 0.92 0.92 0.92
PHF Volume: 25 0 31 512 1751 489 0 715 133 314 1057 0
Reduct Vol: 0 0 0 0 0 0 0 0 0 0 0 0
Reduced Vol: 25 0 31 512 1751 489 0 715 133 314 1057 0
PCE Adj: 1.00 1.00 1.00 1.00 1.00 1.00 1.00 1.00 1.00 1.00 1.00 1.00
MLF Adj: 1.00 1.00 1.00 1.00 1.00 1.00 1.00 1.00 1.00 1.00 1.00 1.00
FinalVolume: 25 0 31 512 1751 489 0 715 133 314 1057 0

Saturation Flow Module:
Sat/Lane: 1900 1900 1900 1900 1900 1900 1900 1900 1900 1900 1900 1900
Adjustment: 0.95 1.00 0.75 0.92 0.92 0.92 1.00 0.89 0.89 0.92 0.91 1.00
Lanes: 1.00 0.00 2.00 1.00 2.00 1.00 0.00 2.53 0.47 2.00 3.00 0.00
Final Sat.: 1805 0 2842 1740 3481 1740 0 4266 797 3502 5187 0

Capacity Analysis Module:
Vol/Sat: 0.01 0.00 0.01 0.29 0.50 0.28 0.00 0.17 0.17 0.09 0.20 0.00
Crit Moves: ****
Green/Cycle: 0.02 0.00 0.02 0.62 0.62 0.62 0.00 0.21 0.21 0.11 0.32 0.00
Volume/Cap: 0.81 0.00 0.65 0.48 0.81 0.45 0.00 0.81 0.81 0.81 0.65 0.00
Delay/Veh: 138.1 0.0 76.8 10.4 16.3 10.2 0.0 42.9 42.9 56.0 30.3 0.0
User DelAdj: 1.00 1.00 1.00 1.00 1.00 1.00 1.00 1.00 1.00 1.00 1.00 1.00
AdjDel/Veh: 138.1 0.0 76.8 10.4 16.3 10.2 0.0 42.9 42.9 56.0 30.3 0.0
LOS by Move: F A E B B B A D D E C A
HCM2kAvgQ: 1 0 1 9 24 8 0 11 11 5 10 0

Note: Queue reported is the number of cars per lane.

Continental Grand Campus Specific Plan
Phase 1 Opening Year(2022) With Project AM Peak Hour (HCM)

Level of Service Computation Report
2000 HCM Operations Method (Future Volume Alternative)

Intersection #12 Nash St at Mariposa Ave

Cycle (sec): 100 Critical Vol./Cap.(X): 0.621
Loss Time (sec): 5 Average Delay (sec/veh): 15.5
Optimal Cycle: 32 Level Of Service: B

Table with columns: Street Name, Approach, Movement, Control, Rights, Min. Green, Y+R, Lanes. Rows for Nash St and Mariposa Ave.

Table with columns: Volume Module, Base Vol, Growth Adj, Initial Bse, Added Vol, PasserByVol, Initial Fut, User Adj, PHF Adj, PHF Volume, Reduct Vol, Reduced Vol, PCE Adj, MLF Adj, FinalVolume.

Table with columns: Sat/Lane, Adjustment, Lanes, Final Sat. Rows for Saturation Flow Module.

Table with columns: Vol/Sat, Crit Moves, Green/Cycle, Volume/Cap, Delay/Veh, User DelAdj, AdjDel/Veh, LOS by Move, HCM2kAvgQ.

Note: Queue reported is the number of cars per lane.

Continental Grand Campus Specific Plan
Phase 1 Opening Year(2022) With Project AM Peak Hour (HCM)

Level of Service Computation Report
2000 HCM Operations Method (Future Volume Alternative)

Intersection #13 Nash St at Grand Ave

Cycle (sec): 100 Critical Vol./Cap.(X): 0.532
Loss Time (sec): 5 Average Delay (sec/veh): 21.3
Optimal Cycle: 26 Level Of Service: C

Table with columns: Street Name, Approach, Movement, Control, Rights, Min. Green, Y+R, Lanes. Rows for Nash St and Grand Ave.

Table with columns: Volume Module, Base Vol, Growth Adj, Initial Bse, Added Vol, Related Pro, Initial Fut, User Adj, PHF Adj, PHF Volume, Reduct Vol, Reduced Vol, PCE Adj, MLF Adj, FinalVolume.

Table with columns: Sat/Lane, Adjustment, Lanes, Final Sat. Rows for Saturation Flow Module.

Table with columns: Vol/Sat, Crit Moves, Green/Cycle, Volume/Cap, Delay/Veh, User DelAdj, AdjDel/Veh, LOS by Move, HCM2kAvgQ.

Note: Queue reported is the number of cars per lane.

Continental Grand Campus Specific Plan
Phase 1 Opening Year(2022) With Project AM Peak Hour (HCM)

Level of Service Computation Report
2000 HCM Operations Method (Future Volume Alternative)

Intersection #14 Nash St at El Segundo Blvd

Cycle (sec): 100 Critical Vol./Cap.(X): 0.729
Loss Time (sec): 5 Average Delay (sec/veh): 23.3
Optimal Cycle: 42 Level Of Service: C

Table with columns for Street Name, Approach, Movement, Control, Rights, Min. Green, Y+R, Lanes. Rows for Nash St and El Segundo Blvd.

Table with columns for Volume Module, Base Vol, Growth Adj, Initial Bse, Added Vol, Related Pro, Initial Fut, User Adj, PHF Adj, PHF Volume, Reduct Vol, Reduced Vol, PCE Adj, MLF Adj, Final Volume.

Table with columns for Saturation Flow Module, Sat/Lane, Adjustment, Lanes, Final Sat.

Table with columns for Capacity Analysis Module, Vol/Sat, Crit Moves, Green/Cycle, Volume/Cap, Delay/Veh, User DelAdj, AdjDel/Veh, LOS by Move, HCM2kAvgQ.

Note: Queue reported is the number of cars per lane.

Continental Grand Campus Specific Plan
Phase 1 Opening Year(2022) With Project AM Peak Hour (HCM)

Level of Service Computation Report
2000 HCM Operations Method (Future Volume Alternative)

Intersection #15 Douglas Street at El Segundo Boulevard

Cycle (sec): 100 Critical Vol./Cap.(X): 1.011
Loss Time (sec): 5 Average Delay (sec/veh): 43.7
Optimal Cycle: 180 Level Of Service: D

Table with columns for Street Name, Approach, Movement, Control, Rights, Min. Green, Y+R, Lanes. Rows for Douglas St and El Segundo Blvd.

Table with columns for Volume Module, Base Vol, Growth Adj, Initial Bse, Added Vol, Related Pro, Initial Fut, User Adj, PHF Adj, PHF Volume, Reduct Vol, Reduced Vol, PCE Adj, MLF Adj, Final Volume.

Table with columns for Saturation Flow Module, Sat/Lane, Adjustment, Lanes, Final Sat.

Table with columns for Capacity Analysis Module, Vol/Sat, Crit Moves, Green/Cycle, Volume/Cap, Delay/Veh, User DelAdj, AdjDel/Veh, LOS by Move, HCM2kAvgQ.

Note: Queue reported is the number of cars per lane.

Continental Grand Campus Specific Plan
Phase 1 Opening Year(2022) With Project AM Peak Hour (HCM)

Level of Service Computation Report

2000 HCM Operations Method (Future Volume Alternative)

Intersection #16 Aviation Boulevard at El Segundo Boulevard

Cycle (sec): 100 Critical Vol./Cap.(X): 1.209
Loss Time (sec): 5 Average Delay (sec/veh): 98.4
Optimal Cycle: 180 Level Of Service: F

Street Name: Aviatio Blvd El Segundo Blvd

Approach: North Bound South Bound East Bound West Bound
Movement: L - T - R L - T - R L - T - R L - T - R

Control: Protected Protected Protected Protected
Rights: Ovl Include Include Include
Min. Green: 0 0 0 0 0 0 0 0 0 0 0 0
Y+R: 4.0 4.0 4.0 4.0 4.0 4.0 4.0 4.0 4.0 4.0 4.0 4.0
Lanes: 2 0 2 0 1 1 0 1 1 1 1 1 0 3 1 0 2 0 2 1 0

Volume Module:

Base Vol: 326 1027 306 21 774 435 118 454 77 410 1528 75
Growth Adj: 1.01 1.01 1.01 1.01 1.01 1.01 1.01 1.01 1.01 1.01 1.01 1.01
Initial Bse: 331 1041 310 21 785 441 120 460 78 416 1549 76
Added Vol: 33 0 0 2 0 10 5 122 14 0 409 1
Related Pro: 167 36 -28 0 49 48 22 94 35 2 887 -10
Initial Fut: 531 1077 282 23 834 499 147 676 127 418 2845 67
User Adj: 1.00 1.00 1.00 1.00 1.00 1.00 1.00 1.00 1.00 1.00 1.00 1.00
PHF Adj: 0.92 0.92 0.92 0.92 0.92 0.92 0.92 0.92 0.92 0.92 0.92 0.92
PHF Volume: 577 1171 307 25 906 542 159 735 138 454 3093 73
Reduct Vol: 0 0 0 0 0 0 0 0 0 0 0 0
Reduced Vol: 577 1171 307 25 906 542 159 735 138 454 3093 73
PCE Adj: 1.00 1.00 1.00 1.00 1.00 1.00 1.00 1.00 1.00 1.00 1.00 1.00
MLF Adj: 1.00 1.00 1.00 1.00 1.00 1.00 1.00 1.00 1.00 1.00 1.00 1.00
FinalVolume: 577 1171 307 25 906 542 159 735 138 454 3093 73

Saturation Flow Module:

Sat/Lane: 1900 1900 1900 1900 1900 1900 1900 1900 1900 1900 1900 1900
Adjustment: 0.92 0.95 0.85 0.95 0.90 0.90 0.95 0.89 0.89 0.92 0.91 0.91
Lanes: 2.00 2.00 1.00 1.00 1.88 1.12 1.00 3.37 0.63 2.00 2.93 0.07
Final Sat.: 3502 3610 1615 1805 3198 1914 1805 5682 1068 3502 5052 119

Capacity Analysis Module:

Vol/Sat: 0.16 0.32 0.19 0.01 0.28 0.28 0.09 0.13 0.13 0.13 0.61 0.61
Crit Moves: ****
Green/Cycle: 0.14 0.36 0.65 0.02 0.23 0.23 0.07 0.29 0.29 0.29 0.51 0.51
Volume/Cap: 1.21 0.91 0.29 0.91 1.21 1.21 1.21 0.45 0.45 0.45 1.21 1.21
Delay/Veh: 155.5 40.9 7.9 182.4 140 140.4 191.6 29.2 29.2 29.3 123 122.6
User DelAdj: 1.00 1.00 1.00 1.00 1.00 1.00 1.00 1.00 1.00 1.00 1.00 1.00
AdjDel/Veh: 155.5 40.9 7.9 182.4 140 140.4 191.6 29.2 29.2 29.3 123 122.6
LOS by Move: F D A F F F F C C C F F
HCM2kAvgQ: 18 22 4 1 27 27 11 6 6 6 62 62

Note: Queue reported is the number of cars per lane.

Continental Grand Campus Specific Plan
Phase 1 Opening Year(2022) With Project AM Peak Hour (HCM)

Level of Service Computation Report

ICU 1(Loss as Cycle Length %) Method (Future Volume Alternative)

Intersection #17 El Segundo Boulevard and Isis Avenue

Cycle (sec): 100 Critical Vol./Cap.(X): 0.923
Loss Time (sec): 5 Average Delay (sec/veh): xxxxxx
Optimal Cycle: 102 Level Of Service: E

Street Name: Isis Avenue El Segundo Boulevard

Approach: North Bound South Bound East Bound West Bound
Movement: L - T - R L - T - R L - T - R L - T - R

Control: Permitted Permitted Protected Protected
Rights: Include Include Include Include
Min. Green: 0 0 0 0 0 0 0 0 0 0 0 0
Y+R: 4.0 4.0 4.0 4.0 4.0 4.0 4.0 4.0 4.0 4.0 4.0 4.0
Lanes: 0 0 1! 0 0 0 0 1! 0 0 1 0 4 0 1 1 0 2 1 0

Volume Module:

Base Vol: 50 21 84 52 9 71 45 722 20 20 1736 39
Growth Adj: 1.01 1.01 1.01 1.01 1.01 1.01 1.01 1.01 1.01 1.01 1.01 1.01
Initial Bse: 51 21 85 53 9 72 46 732 20 20 1760 40
Added Vol: 0 0 0 0 0 0 0 0 13 0 0 129 0
Related Pro: 0 0 0 0 0 0 0 0 177 0 0 1160 0
Initial Fut: 51 21 85 53 9 72 46 922 20 20 3049 40
User Adj: 1.00 1.00 1.00 1.00 1.00 1.00 1.00 1.00 1.00 1.00 1.00 1.00
PHF Adj: 0.92 0.92 0.92 0.92 0.92 0.92 0.92 0.92 0.92 0.92 0.92 0.92
PHF Volume: 55 23 93 57 10 78 50 1002 22 22 3314 43
Reduct Vol: 0 0 0 0 0 0 0 0 0 0 0 0 0
Reduced Vol: 55 23 93 57 10 78 50 1002 22 22 3314 43
PCE Adj: 1.00 1.00 1.00 1.00 1.00 1.00 1.00 1.00 1.00 1.00 1.00 1.00
MLF Adj: 1.00 1.00 1.00 1.00 1.00 1.00 1.00 1.00 1.00 1.00 1.00 1.00
FinalVolume: 55 23 93 57 10 78 50 1002 22 22 3314 43

Saturation Flow Module:

Sat/Lane: 1600 1600 1600 1600 1600 1600 1600 1600 1600 1600 1600 1600
Adjustment: 1.00 1.00 1.00 1.00 1.00 1.00 1.00 1.00 1.00 1.00 1.00 1.00
Lanes: 0.32 0.14 0.54 0.39 0.07 0.54 1.00 4.00 1.00 1.00 2.96 0.04
Final Sat.: 516 217 867 630 109 861 1600 6400 1600 1600 4739 61

Capacity Analysis Module:

Vol/Sat: 0.03 0.11 0.11 0.04 0.09 0.09 0.03 0.16 0.01 0.01 0.70 0.70
Crit Moves: ****

Continental Grand Campus Specific Plan
Phase 1 Opening Year(2022) With Project AM Peak Hour (HCM)

Level of Service Computation Report
2000 HCM Operations Method (Future Volume Alternative)

Intersection #18 El Segundo Blvd at I-405 SB Ramps

Cycle (sec): 100 Critical Vol./Cap.(X): 0.897
Loss Time (sec): 5 Average Delay (sec/veh): 18.5
Optimal Cycle: 88 Level Of Service: B

Table with columns: Street Name, Approach, Movement, Control, Rights, Min. Green, Y+R, Lanes. Rows for North, South, East, West bounds.

Table with columns: Volume Module, Base Vol, Growth Adj, Initial Bse, Added Vol, Related Pro, Initial Fut, User Adj, PHF Adj, PHF Volume, Reduct Vol, Reduced Vol, PCE Adj, MLF Adj, FinalVolume.

Table with columns: Saturation Flow Module, Sat/Lane, Adjustment, Lanes, Final Sat.

Table with columns: Capacity Analysis Module, Vol/Sat, Crit Moves, Green/Cycle, Volume/Cap, Delay/Veh, User DelAdj, AdjDel/Veh, LOS by Move, HCM2kAvgQ.

Note: Queue reported is the number of cars per lane.

Continental Grand Campus Specific Plan
Phase 1 Opening Year(2022) With Project AM Peak Hour (HCM)

Level of Service Computation Report
2000 HCM Operations Method (Future Volume Alternative)

Intersection #19 El Segundo Blvd at La Cienega Blvd

Cycle (sec): 100 Critical Vol./Cap.(X): 0.931
Loss Time (sec): 5 Average Delay (sec/veh): 26.2
Optimal Cycle: 113 Level Of Service: C

Table with columns: Street Name, Approach, Movement, Control, Rights, Min. Green, Y+R, Lanes. Rows for North, South, East, West bounds.

Table with columns: Volume Module, Base Vol, Growth Adj, Initial Bse, Added Vol, Related Pro, Initial Fut, User Adj, PHF Adj, PHF Volume, Reduct Vol, Reduced Vol, PCE Adj, MLF Adj, FinalVolume.

Table with columns: Saturation Flow Module, Sat/Lane, Adjustment, Lanes, Final Sat.

Table with columns: Capacity Analysis Module, Vol/Sat, Crit Moves, Green/Cycle, Volume/Cap, Delay/Veh, User DelAdj, AdjDel/Veh, LOS by Move, HCM2kAvgQ.

Note: Queue reported is the number of cars per lane.

Continental Grand Campus Specific Plan
Phase 1 Opening Year(2022) With Project AM Peak Hour (HCM)

Level Of Service Computation Report
2000 HCM Operations Method (Future Volume Alternative)

Intersection #20 El Segundo Blvd at I-405 NB Ramps

Cycle (sec): 100 Critical Vol./Cap.(X): 0.932
Loss Time (sec): 5 Average Delay (sec/veh): 30.3
Optimal Cycle: 113 Level Of Service: C

Street Name: I-405 NB Ramps El Segundo Blvd
Approach: North Bound South Bound East Bound West Bound
Movement: L - T - R L - T - R L - T - R L - T - R
Control: Protected Protected Protected Protected
Rights: Include Include Ignore Include
Min. Green: 0 0 0 0 0 0 0 0 0 0 0 0
Y+R: 4.0 4.0 4.0 4.0 4.0 4.0 4.0 4.0 4.0 4.0 4.0 4.0
Lanes: 2 0 0 0 1 0 0 0 0 0 0 0 2 1 1 0 0 2 1 0

Volume Module:
Base Vol: 861 0 102 0 0 0 0 625 148 0 935 610
Growth Adj: 1.01 1.01 1.01 1.01 1.01 1.01 1.01 1.01 1.01 1.01 1.01 1.01
Initial Bse: 873 0 103 0 0 0 0 634 150 0 948 619
Added Vol: 86 0 0 0 0 0 0 4 0 0 43 0
Related Pro: 534 0 0 0 0 0 0 59 44 0 306 0
Initial Fut: 1493 0 103 0 0 0 0 697 194 0 1297 619
User Adj: 1.00 1.00 1.00 1.00 1.00 1.00 1.00 1.00 0.00 1.00 1.00 1.00
PHF Adj: 0.92 0.92 0.92 0.92 0.92 0.92 0.92 0.92 0.00 0.92 0.92 0.92
PHF Volume: 1623 0 112 0 0 0 0 757 0 0 1410 672
Reduct Vol: 0 0 0 0 0 0 0 0 0 0 0 0
Reduced Vol: 1623 0 112 0 0 0 0 757 0 0 1410 672
PCE Adj: 1.00 1.00 1.00 1.00 1.00 1.00 1.00 1.00 0.00 1.00 1.00 1.00
MLF Adj: 1.00 1.00 1.00 1.00 1.00 1.00 1.00 1.00 0.00 1.00 1.00 1.00
FinalVolume: 1623 0 112 0 0 0 0 757 0 0 1410 672

Saturation Flow Module:
Sat/Lane: 1900 1900 1900 1900 1900 1900 1900 1900 1900 1900 1900 1900
Adjustment: 0.92 1.00 0.85 1.00 1.00 1.00 1.00 0.91 0.91 1.00 0.87 0.87
Lanes: 2.00 0.00 1.00 0.00 0.00 0.00 0.00 3.00 1.00 0.00 2.03 0.97
Final Sat.: 3502 0 1615 0 0 0 0 5187 1729 0 3344 1594

Capacity Analysis Module:
Vol/Sat: 0.46 0.00 0.07 0.00 0.00 0.00 0.00 0.15 0.00 0.00 0.42 0.42
Crit Moves: **** ****
Green/Cycle: 0.50 0.00 0.50 0.00 0.00 0.00 0.00 0.45 0.00 0.00 0.45 0.45
Volume/Cap: 0.93 0.00 0.14 0.00 0.00 0.00 0.00 0.32 0.00 0.00 0.93 0.93
Delay/Veh: 33.1 0.0 13.7 0.0 0.0 0.0 0.0 17.6 0.0 0.0 33.7 33.7
User DelAdj: 1.00 1.00 1.00 1.00 1.00 1.00 1.00 1.00 1.00 1.00 1.00 1.00
AdjDel/Veh: 33.1 0.0 13.7 0.0 0.0 0.0 0.0 17.6 0.0 0.0 33.7 33.7
LOS by Move: C A B A A A A B A A C C
HCM2kAvgQ: 29 0 2 0 0 0 0 5 0 0 27 27

Note: Queue reported is the number of cars per lane.

 Continental Grand Campus Specific Plan
 Phase 1 Opening Year(2022) With Project PM Peak Hour (HCM)

Scenario Report

Scenario: Phase 1 Op Yr With Proj PM HCM
 Command: Phase 1 Op Yr With Proj PM HCM
 Volume: OY PM
 Geometry: Existing
 Impact Fee: Default Impact Fee
 Trip Generation: Cum + Phase 1 PM
 Trip Distribution: Cum + Proj
 Paths: Project
 Routes: Default Route
 Configuration: Phase 1 Op Yr With Proj PM HCM

 Continental Grand Campus Specific Plan
 Phase 1 Opening Year(2022) With Project PM Peak Hour (HCM)

Trip Generation Report

Forecast for Cum + Phase 1 PM

Zone #	Subzone	Amount	Units	Rate In	Rate Out	Trips In	Trips Out	Total Trips	% Of Total
306	525 N. Sepul	1.00	Residential	-4.00	-6.00	-4	-6	-10	-0.5
	Zone 306 Subtotal					-4	-6	-10	-0.5
307	540 Imperial	1.00	Residential	50.00	32.00	50	32	82	4.2
	Zone 307 Subtotal					50	32	82	4.2
311	199 Continen	1.00	Business Hotel	46.00	45.00	46	45	91	4.6
	Zone 311 Subtotal					46	45	91	4.6
313	445 N. Dougl	1.00	Equinix Data C	3.00	13.00	3	13	16	0.8
	Zone 313 Subtotal					3	13	16	0.8
314	123 Lomita a	1.00	Office	2.00	16.00	2	16	18	0.9
	Zone 314 Subtotal					2	16	18	0.9
704	2355 Utah Av	1.00	Office	95.00	109.00	95	109	204	10.3
	Zone 704 Subtotal					95	109	204	10.3
706	888 Sepulved	1.00	hotel	60.00	41.00	60	41	101	5.1
	Zone 706 Subtotal					60	41	101	5.1
710	201 North Do	1.00	High School	-15.00	-74.00	-15	-74	-89	-4.5
710	201 North Do	1.00	District Offic	3.00	18.00	3	18	21	1.1
	Zone 710 Subtotal					-12	-56	-68	-3.4
714	400 Duley -	1.00	Office	18.00	87.00	18	87	105	5.3
714	400 Duley -	1.00	Industrial	0.00	0.00	0	0	0	0.0
	Zone 714 Subtotal					18	87	105	5.3
717	1700 Imperia	1.00	Townhome Resid	25.00	120.00	25	120	145	7.3
	Zone 717 Subtotal					25	120	145	7.3
718	123 Nevada S	1.00	Office	4.00	16.00	4	16	20	1.0
718	123 Nevada S	0.00	123 Nevada	4.00	16.00	0	0	0	0.0
	Zone 718 Subtotal					4	16	20	1.0
719	2125 Campus	1.00	Office Retail	64.00	146.00	64	146	210	10.6
	Zone 719 Subtotal					64	146	210	10.6
1002	Laker Facili	1.00	General Office	103.00	85.00	103	85	188	9.5
	Zone 1002 Subtotal					103	85	188	9.5
1005	Mattel	1.00	Mattel	48.00	388.00	48	388	436	22.1
	Zone 1005 Subtotal					48	388	436	22.1

Continental Grand Campus Specific Plan
Phase 1 Opening Year(2022) With Project PM Peak Hour (HCM)

Zone #	Subzone	Amount	Units	Rate In	Rate Out	Trips In	Trips Out	Total Trips	% Of Total
1007	Mattel Proje	1.00	project	48.00	388.00	48	388	436	22.1
	Zone 1007 Subtotal					48	388	436	22.1
TOTAL						550	1424	1974	100.0

Continental Grand Campus Specific Plan
Phase 1 Opening Year(2022) With Project PM Peak Hour (HCM)

Trip Distribution Report

Percent Of Trips Cum + Project

Zone	To Gates											
	1	2	3	4	5	7	8	9	10	11	12	
306	10.0	15.0	10.0	5.0	0.0	5.0	5.0	25.0	0.0	25.0	0.0	
307	10.0	15.0	10.0	5.0	50.0	0.0	0.0	0.0	0.0	0.0	0.0	
311	40.0	10.0	10.0	10.0	0.0	5.0	5.0	10.0	0.0	10.0	0.0	
313	15.0	5.0	15.0	10.0	25.0	0.0	5.0	20.0	0.0	0.0	0.0	
314	40.0	10.0	10.0	10.0	0.0	5.0	5.0	10.0	0.0	10.0	0.0	
704	30.0	15.0	8.0	12.0	0.0	5.0	5.0	10.0	5.0	10.0	0.0	
706	25.0	20.0	10.0	25.0	0.0	0.0	0.0	0.0	0.0	0.0	10.0	
710	0.0	0.0	15.0	10.0	10.0	2.0	2.0	20.0	5.0	10.0	1.0	
714	5.0	10.0	5.0	5.0	20.0	5.0	10.0	15.0	5.0	15.0	0.0	
717	10.0	15.0	10.0	5.0	50.0	0.0	0.0	0.0	0.0	0.0	0.0	
718	10.0	10.0	10.0	10.0	20.0	0.0	0.0	20.0	10.0	0.0	0.0	
719	20.0	10.0	10.0	10.0	10.0	5.0	5.0	10.0	5.0	0.0	0.0	
1002	0.0	10.0	5.0	5.0	15.0	5.0	10.0	15.0	5.0	15.0	5.0	
1004	5.0	15.0	10.0	5.0	30.0	0.0	5.0	20.0	0.0	0.0	5.0	
1005	5.0	15.0	10.0	5.0	30.0	0.0	5.0	20.0	0.0	0.0	5.0	
1007	0.0	0.0	0.0	0.0	0.0	0.0	0.0	0.0	0.0	0.0	0.0	

Zone	To Gates						
	13	14	15	16	17	18	20
306	0.0	0.0	0.0	0.0	0.0	0.0	0.0
307	0.0	10.0	0.0	0.0	0.0	0.0	0.0
311	0.0	0.0	0.0	0.0	0.0	0.0	0.0
313	5.0	0.0	0.0	0.0	0.0	0.0	0.0
314	0.0	0.0	0.0	0.0	0.0	0.0	0.0
704	0.0	0.0	0.0	0.0	0.0	0.0	0.0
706	0.0	0.0	0.0	0.0	10.0	0.0	0.0
710	10.0	5.0	10.0	0.0	0.0	0.0	0.0
714	0.0	5.0	0.0	0.0	0.0	0.0	0.0
717	0.0	10.0	0.0	0.0	0.0	0.0	0.0
718	0.0	10.0	0.0	0.0	0.0	0.0	0.0
719	0.0	10.0	5.0	0.0	0.0	0.0	0.0
1002	0.0	5.0	5.0	0.0	0.0	0.0	0.0
1004	0.0	5.0	0.0	0.0	0.0	0.0	0.0
1005	0.0	5.0	0.0	0.0	0.0	0.0	0.0
1007	0.0	0.0	0.0	0.0	0.0	20.0	10.0

Continental Grand Campus Specific Plan
Phase 1 Opening Year(2022) With Project PM Peak Hour (HCM)

Impact Analysis Report
Level Of Service

Intersection	Base	Future	Change	Del/ V/		Del/ V/		in
				LOS	Veh	C	LOS	
# 1 Sepulveda Blvd at Imperial Hwy	D 38.8 1.037	D 45.4 1.113	+ 6.673 D/V					
# 2 Sepulveda Blvd at Walnut St	A 9.9 0.550	B 15.6 0.777	+ 5.751 D/V					
# 3 Sepulveda Blvd at Maple Ave	B 12.5 0.603	B 17.1 0.746	+ 4.566 D/V					
# 4 Sepulveda Blvd at Mariposa Ave	C 20.1 0.629	C 23.6 0.808	+ 3.437 D/V					
# 5 Sepulveda Blvd at Grand Ave	C 30.3 0.799	D 37.0 0.915	+ 6.729 D/V					
# 6 Sepulveda Blvd at El Segundo B	D 36.8 0.913	E 79.4 1.129	+42.582 D/V					
# 7 Sepulveda Blvd at Rosecrans Bl	C 32.4 0.880	D 43.9 1.011	+11.498 D/V					
# 8 Continental Boulevard at Marip	B 16.3 0.283	B 17.0 0.321	+ 0.672 D/V					
# 9 Continental Boulevard at Grand	B 18.4 0.276	B 18.5 0.317	+ 0.184 D/V					
# 10 Continental Boulevard at El Se	B 19.6 0.400	C 29.9 0.675	+10.262 D/V					
# 11 Nash St and Imperial Hwy	B 19.5 0.474	C 22.8 0.529	+ 3.272 D/V					
# 12 Nash St at Mariposa Ave	B 17.3 0.533	C 24.4 0.911	+ 7.145 D/V					
# 13 Nash St at Grand Ave	C 22.7 0.500	C 25.3 0.572	+ 2.647 D/V					
# 14 Nash St at El Segundo Blvd	B 19.8 0.535	E 60.5 1.083	+40.658 D/V					
# 15 Douglas Street at El Segundo B	C 33.8 0.886	F 100.8 1.217	+66.995 D/V					
# 16 Aviation Boulevard at El Segun	D 41.0 0.955	F 96.1 1.197	+55.095 D/V					
# 17 El Segundo Boulevard and Isis	B xxxxx 0.691	D xxxxx 0.868	+ 0.177 V/C					
# 18 El Segundo Blvd at I-405 SB Ra	C 28.4 1.063	F 84.0 1.461	+55.627 D/V					
# 19 El Segundo Blvd at La Cienega	C 20.6 0.680	C 21.6 0.804	+ 1.084 D/V					
# 20 El Segundo Blvd at I-405 NB Ra	B 11.8 0.688	B 12.7 0.730	+ 0.931 D/V					

Continental Grand Campus Specific Plan
Phase 1 Opening Year(2022) With Project PM Peak Hour (HCM)

Level Of Service Computation Report
2000 HCM Operations Method (Future Volume Alternative)

Intersection #1 Sepulveda Blvd at Imperial Hwy

Cycle (sec):	100	Critical Vol./Cap.(X):	1.113
Loss Time (sec):	5	Average Delay (sec/veh):	45.4
Optimal Cycle:	180	Level Of Service:	D

Street Name:	Sepulveda Blvd	Imperial Hwy		
Approach:	North Bound	South Bound	East Bound	West Bound
Movement:	L - T - R	L - T - R	L - T - R	L - T - R
Control:	Protected	Protected	Protected	Protected
Rights:	Include	Include	Include	Ovl
Min. Green:	0 0 0	0 0 0	0 0 0	0 0 0
Y+R:	4.0 4.0 4.0	4.0 4.0 4.0	4.0 4.0 4.0	4.0 4.0 4.0
Lanes:	1 0 3 0 1	2 0 3 1 0	2 0 3 0 1	2 0 3 0 1

Volume Module:												
Base Vol:	154	1713	885	640	1993	7	202	402	140	120	295	461
Growth Adj:	1.02	1.02	1.02	1.02	1.02	1.02	1.02	1.02	1.02	1.02	1.02	1.02
Initial Bse:	157	1741	900	651	2026	7	205	409	142	122	300	469
Added Vol:	55	122	73	14	81	5	3	23	20	9	9	17
Related Pro:	30	569	63	-165	159	0	-15	15	11	40	-20	-40
Initial Fut:	242	2432	1036	500	2266	12	193	447	173	171	289	446
User Adj:	1.00	1.00	1.00	1.00	1.00	1.00	1.00	1.00	1.00	1.00	1.00	1.00
PHF Adj:	0.92	0.92	0.92	0.92	0.92	0.92	0.92	0.92	0.92	0.92	0.92	0.92
PHF Volume:	263	2644	1126	543	2463	13	210	486	188	186	314	484
Reduct Vol:	0	0	0	0	0	0	0	0	0	0	0	0
Reduced Vol:	263	2644	1126	543	2463	13	210	486	188	186	314	484
PCE Adj:	1.00	1.00	1.00	1.00	1.00	1.00	1.00	1.00	1.00	1.00	1.00	1.00
MLF Adj:	1.00	1.00	1.00	1.00	1.00	1.00	1.00	1.00	1.00	1.00	1.00	1.00
FinalVolume:	263	2644	1126	543	2463	13	210	486	188	186	314	484

Saturation Flow Module:												
Sat/Lane:	1900	1900	1900	1900	1900	1900	1900	1900	1900	1900	1900	1900
Adjustment:	0.95	0.91	0.85	0.92	0.91	0.91	0.92	0.91	0.85	0.92	0.91	0.85
Lanes:	1.00	3.00	1.00	2.00	3.98	0.02	2.00	3.00	1.00	2.00	3.00	1.00
Final Sat.:	1805	5187	1615	3502	6872	37	3502	5187	1615	3502	5187	1615

Capacity Analysis Module:												
Vol/Sat:	0.15	0.51	0.70	0.16	0.36	0.36	0.06	0.09	0.12	0.05	0.06	0.30
Crit Moves:		****	****				****					****
Green/Cycle:	0.22	0.63	0.63	0.14	0.54	0.54	0.05	0.13	0.13	0.06	0.13	0.27
Volume/Cap:	0.66	0.81	1.11	1.11	0.66	0.66	1.11	0.74	0.92	0.92	0.47	1.11
Delay/Veh:	39.5	15.9	83.2	118.3	16.6	16.6	146.2	46.6	84.8	88.9	40.8	114.0
User DelAdj:	1.00	1.00	1.00	1.00	1.00	1.00	1.00	1.00	1.00	1.00	1.00	1.00
AdjDel/Veh:	39.5	15.9	83.2	118.3	16.6	16.6	146.2	46.6	84.8	88.9	40.8	114.0
LOS by Move:	D	B	F	F	B	B	F	D	F	F	D	F
HCM2kAvgQ:	7	22	49	16	15	15	5	5	7	4	3	22

Note: Queue reported is the number of cars per lane.

Continental Grand Campus Specific Plan
Phase 1 Opening Year(2022) With Project PM Peak Hour (HCM)

Level of Service Computation Report
2000 HCM Operations Method (Future Volume Alternative)

Intersection #2 Sepulveda Blvd at Walnut St

Cycle (sec): 100 Critical Vol./Cap.(X): 0.777
Loss Time (sec): 5 Average Delay (sec/veh): 15.6
Optimal Cycle: 50 Level Of Service: B

Street Name: Sepulveda Blvd Walnut St
Approach: North Bound South Bound East Bound West Bound
Movement: L - T - R L - T - R L - T - R L - T - R
Control: Protected Protected Permitted Permitted
Rights: Include Include Include Include
Min. Green: 0 0 0 0 0 0 0 0 0 0 0 0
Y+R: 4.0 4.0 4.0 4.0 4.0 4.0 4.0 4.0 4.0 4.0 4.0 4.0
Lanes: 1 0 3 1 0 1 0 3 1 0 0 1 0 0 1

Volume Module:
Base Vol: 48 2434 29 10 2181 74 117 31 71 46 10 66
Growth Adj: 1.02 1.02 1.02 1.02 1.02 1.02 1.02 1.02 1.02 1.02 1.02 1.02
Initial Bse: 49 2474 29 10 2217 75 119 32 72 47 10 67
Added Vol: 12 156 12 6 85 19 90 0 0 8 0 4
Related Pro: 28 627 0 0 210 0 0 0 9 0 0 0
Initial Fut: 89 3257 41 16 2512 94 209 32 81 55 10 71
User Adj: 1.00 1.00 1.00 1.00 1.00 1.00 1.00 1.00 1.00 1.00 1.00 1.00
PHF Adj: 0.92 0.92 0.92 0.92 0.92 0.92 0.92 0.92 0.92 0.92 0.92 0.92
PHF Volume: 97 3541 45 18 2731 102 227 34 88 60 11 77
Reduct Vol: 0 0 0 0 0 0 0 0 0 0 0 0
Reduced Vol: 97 3541 45 18 2731 102 227 34 88 60 11 77
PCE Adj: 1.00 1.00 1.00 1.00 1.00 1.00 1.00 1.00 1.00 1.00 1.00 1.00
MLF Adj: 1.00 1.00 1.00 1.00 1.00 1.00 1.00 1.00 1.00 1.00 1.00 1.00
FinalVolume: 97 3541 45 18 2731 102 227 34 88 60 11 77

Saturation Flow Module:
Sat/Lane: 1900 1900 1900 1900 1900 1900 1900 1900 1900 1900 1900 1900
Adjustment: 0.95 0.91 0.91 0.95 0.91 0.91 0.66 0.66 0.85 0.55 0.55 0.85
Lanes: 1.00 3.95 0.05 1.00 3.86 0.14 0.87 0.13 1.00 0.84 0.16 1.00
Final Sat.: 1805 6815 87 1805 6633 249 1088 164 1615 883 164 1615

Capacity Analysis Module:
Vol/Sat: 0.05 0.52 0.52 0.01 0.41 0.41 0.21 0.21 0.05 0.07 0.07 0.05
Crit Moves: **** **** ****
Green/Cycle: 0.08 0.67 0.67 0.01 0.60 0.60 0.27 0.27 0.27 0.27 0.27 0.27
Volume/Cap: 0.68 0.78 0.78 0.78 0.68 0.68 0.78 0.78 0.20 0.25 0.25 0.18
Delay/Veh: 57.8 12.3 12.3 142.3 13.9 13.9 44.7 44.7 28.5 29.1 29.1 28.3
User DelAdj: 1.00 1.00 1.00 1.00 1.00 1.00 1.00 1.00 1.00 1.00 1.00 1.00
AdjDel/Veh: 57.8 12.3 12.3 142.3 13.9 13.9 44.7 44.7 28.5 29.1 29.1 28.3
LOS by Move: E B B F B B D D C C C C
HCM2kAvgQ: 4 22 22 1 16 16 9 9 2 2 2 2

Note: Queue reported is the number of cars per lane.

Continental Grand Campus Specific Plan
Phase 1 Opening Year(2022) With Project PM Peak Hour (HCM)

Level of Service Computation Report
2000 HCM Operations Method (Future Volume Alternative)

Intersection #3 Sepulveda Blvd at Maple Ave

Cycle (sec): 100 Critical Vol./Cap.(X): 0.746
Loss Time (sec): 5 Average Delay (sec/veh): 17.1
Optimal Cycle: 45 Level Of Service: B

Street Name: Sepulveda Blvd Maple Ave
Approach: North Bound South Bound East Bound West Bound
Movement: L - T - R L - T - R L - T - R L - T - R
Control: Protected Protected Permitted Permitted
Rights: Include Include Include Include
Min. Green: 0 0 0 0 0 0 0 0 0 0 0 0
Y+R: 4.0 4.0 4.0 4.0 4.0 4.0 4.0 4.0 4.0 4.0 4.0 4.0
Lanes: 1 0 3 1 0 1 0 3 1 0 1 0 0 1 0 1

Volume Module:
Base Vol: 98 2208 33 57 2439 42 68 57 37 114 102 114
Growth Adj: 1.01 1.01 1.01 1.01 1.01 1.01 1.01 1.01 1.01 1.01 1.01 1.01
Initial Bse: 99 2239 33 58 2473 43 69 58 38 116 103 116
Added Vol: 13 131 0 37 97 0 0 8 8 0 12 44
Related Pro: 56 687 30 25 226 0 0 8 13 5 0 0
Initial Fut: 168 3057 63 120 2796 43 69 74 59 121 115 160
User Adj: 1.00 1.00 1.00 1.00 1.00 1.00 1.00 1.00 1.00 1.00 1.00 1.00
PHF Adj: 0.92 0.92 0.92 0.92 0.92 0.92 0.92 0.92 0.92 0.92 0.92 0.92
PHF Volume: 183 3323 69 130 3039 46 75 80 64 131 125 173
Reduct Vol: 0 0 0 0 0 0 0 0 0 0 0 0
Reduced Vol: 183 3323 69 130 3039 46 75 80 64 131 125 173
PCE Adj: 1.00 1.00 1.00 1.00 1.00 1.00 1.00 1.00 1.00 1.00 1.00 1.00
MLF Adj: 1.00 1.00 1.00 1.00 1.00 1.00 1.00 1.00 1.00 1.00 1.00 1.00
FinalVolume: 183 3323 69 130 3039 46 75 80 64 131 125 173

Saturation Flow Module:
Sat/Lane: 1900 1900 1900 1900 1900 1900 1900 1900 1900 1900 1900 1900
Adjustment: 0.95 0.91 0.91 0.95 0.91 0.91 0.52 0.93 0.93 0.48 1.00 0.85
Lanes: 1.00 3.92 0.08 1.00 3.94 0.06 1.00 0.56 0.44 1.00 1.00 1.00
Final Sat.: 1805 6755 140 1805 6799 104 990 990 785 908 1900 1615

Capacity Analysis Module:
Vol/Sat: 0.10 0.49 0.49 0.07 0.45 0.45 0.08 0.08 0.08 0.14 0.07 0.11
Crit Moves: **** **** ****
Green/Cycle: 0.14 0.66 0.66 0.10 0.62 0.62 0.19 0.19 0.19 0.19 0.19 0.19
Volume/Cap: 0.73 0.75 0.75 0.75 0.73 0.73 0.39 0.42 0.42 0.75 0.34 0.55
Delay/Veh: 51.2 12.1 12.1 60.0 13.9 13.9 36.5 36.2 36.2 53.9 35.4 38.6
User DelAdj: 1.00 1.00 1.00 1.00 1.00 1.00 1.00 1.00 1.00 1.00 1.00 1.00
AdjDel/Veh: 51.2 12.1 12.1 60.0 13.9 13.9 36.5 36.2 36.2 53.9 35.4 38.6
LOS by Move: D B B E B B D D D D D D
HCM2kAvgQ: 7 20 20 6 19 19 2 4 4 6 4 6

Note: Queue reported is the number of cars per lane.

Continental Grand Campus Specific Plan
Phase 1 Opening Year(2022) With Project PM Peak Hour (HCM)

Level of Service Computation Report
2000 HCM Operations Method (Future Volume Alternative)

Intersection #4 Sepulveda Blvd at Mariposa Ave

Cycle (sec): 100 Critical Vol./Cap.(X): 0.808
Loss Time (sec): 5 Average Delay (sec/veh): 23.6
Optimal Cycle: 56 Level Of Service: C

Street Name: Sepulveda Blvd Mariposa Ave
Approach: North Bound South Bound East Bound West Bound
Movement: L - T - R L - T - R L - T - R L - T - R
Control: Protected Protected Permitted Permitted
Rights: Include Include Include Include
Min. Green: 0 0 0 0 0 0 0 0 0 0 0 0
Y+R: 4.0 4.0 4.0 4.0 4.0 4.0 4.0 4.0 4.0 4.0 4.0
Lanes: 1 0 4 0 1 2 0 3 1 0 1 0 0 1 0 1 0 1 0 1

Volume Module:
Base Vol: 100 2039 133 227 2100 79 102 213 37 117 265 207
Growth Adj: 1.02 1.02 1.02 1.02 1.02 1.02 1.02 1.02 1.02 1.02 1.02 1.02
Initial Bse: 102 2073 135 231 2135 80 104 217 38 119 269 210
Added Vol: 6 114 17 20 86 -1 -1 17 3 28 43 31
Related Pro: 32 688 -15 -23 232 11 10 -5 13 -5 5 0
Initial Fut: 140 2875 137 228 2453 90 113 229 54 142 317 241
User Adj: 1.00 1.00 1.00 1.00 1.00 1.00 1.00 1.00 1.00 1.00 1.00 1.00
PHF Adj: 0.92 0.92 0.92 0.92 0.92 0.92 0.92 0.92 0.92 0.92 0.92 0.92
PHF Volume: 152 3125 149 248 2666 98 122 248 58 154 345 262
Reduct Vol: 0 0 0 0 0 0 0 0 0 0 0 0
Reduced Vol: 152 3125 149 248 2666 98 122 248 58 154 345 262
PCE Adj: 1.00 1.00 1.00 1.00 1.00 1.00 1.00 1.00 1.00 1.00 1.00 1.00
MLF Adj: 1.00 1.00 1.00 1.00 1.00 1.00 1.00 1.00 1.00 1.00 1.00 1.00
FinalVolume: 152 3125 149 248 2666 98 122 248 58 154 345 262

Saturation Flow Module:
Sat/Lane: 1900 1900 1900 1900 1900 1900 1900 1900 1900 1900 1900
Adjustment: 0.95 0.91 0.85 0.92 0.91 0.91 0.28 0.97 0.97 0.33 1.00 0.85
Lanes: 1.00 4.00 1.00 2.00 3.86 0.14 1.00 0.81 0.19 1.00 1.00 1.00
Final Sat.: 1805 6916 1615 3502 6637 244 534 1496 351 629 1900 1615

Capacity Analysis Module:
Vol/Sat: 0.08 0.45 0.09 0.07 0.40 0.40 0.23 0.17 0.17 0.25 0.18 0.16
Crit Moves: ****
Green/Cycle: 0.11 0.56 0.56 0.09 0.53 0.53 0.30 0.30 0.30 0.30 0.30 0.30
Volume/Cap: 0.75 0.81 0.17 0.81 0.75 0.75 0.76 0.55 0.55 0.81 0.60 0.54
Delay/Veh: 57.6 19.1 10.8 59.5 19.0 19.0 49.7 30.2 30.2 54.1 31.4 30.1
User DelAdj: 1.00 1.00 1.00 1.00 1.00 1.00 1.00 1.00 1.00 1.00 1.00 1.00
AdjDel/Veh: 57.6 19.1 10.8 59.5 19.0 19.0 49.7 30.2 30.2 54.1 31.4 30.1
LOS by Move: E B B E B B D C C D C C
HCM2kAvgQ: 4 20 2 6 19 19 5 8 8 7 10 7

Note: Queue reported is the number of cars per lane.

Continental Grand Campus Specific Plan
Phase 1 Opening Year(2022) With Project PM Peak Hour (HCM)

Level of Service Computation Report
2000 HCM Operations Method (Future Volume Alternative)

Intersection #5 Sepulveda Blvd at Grand Ave

Cycle (sec): 100 Critical Vol./Cap.(X): 0.915
Loss Time (sec): 5 Average Delay (sec/veh): 37.0
Optimal Cycle: 100 Level Of Service: D

Street Name: Sepulveda Blvd Grand Ave
Approach: North Bound South Bound East Bound West Bound
Movement: L - T - R L - T - R L - T - R L - T - R
Control: Protected Protected Split Phase Split Phase
Rights: Ovl Include Include Include
Min. Green: 0 0 0 0 0 0 0 0 0 0 0 0
Y+R: 4.0 4.0 4.0 4.0 4.0 4.0 4.0 4.0 4.0 4.0 4.0 4.0
Lanes: 1 0 4 0 1 1 0 3 1 0 1 1 0 1 0 2 0 2 0 1

Volume Module:
Base Vol: 177 1686 177 86 1814 112 304 186 155 327 207 293
Growth Adj: 1.02 1.02 1.02 1.02 1.02 1.02 1.02 1.02 1.02 1.02 1.02 1.02
Initial Bse: 180 1714 180 87 1844 114 309 189 158 332 210 298
Added Vol: -1 79 16 30 80 6 9 4 0 74 22 47
Related Pro: 17 656 -5 2 197 7 11 -5 8 5 5 26
Initial Fut: 196 2449 191 119 2121 127 329 188 166 411 237 371
User Adj: 1.00 1.00 1.00 1.00 1.00 1.00 1.00 1.00 1.00 1.00 1.00 1.00
PHF Adj: 0.92 0.92 0.92 0.92 0.92 0.92 0.92 0.92 0.92 0.92 0.92 0.92
PHF Volume: 213 2662 208 130 2306 138 358 204 180 447 258 403
Reduct Vol: 0 0 0 0 0 0 0 0 0 0 0 0
Reduced Vol: 213 2662 208 130 2306 138 358 204 180 447 258 403
PCE Adj: 1.00 1.00 1.00 1.00 1.00 1.00 1.00 1.00 1.00 1.00 1.00 1.00
MLF Adj: 1.00 1.00 1.00 1.00 1.00 1.00 1.00 1.00 1.00 1.00 1.00 1.00
FinalVolume: 213 2662 208 130 2306 138 358 204 180 447 258 403

Saturation Flow Module:
Sat/Lane: 1900 1900 1900 1900 1900 1900 1900 1900 1900 1900 1900
Adjustment: 0.95 0.91 0.85 0.95 0.90 0.90 0.89 0.89 0.89 0.92 0.95 0.85
Lanes: 1.00 4.00 1.00 1.00 3.77 0.23 1.44 0.83 0.73 2.00 2.00 1.00
Final Sat.: 1805 6916 1615 1805 6474 387 2456 1404 1236 3502 3610 1615

Capacity Analysis Module:
Vol/Sat: 0.12 0.38 0.13 0.07 0.36 0.36 0.15 0.15 0.15 0.13 0.07 0.25
Crit Moves: ****
Green/Cycle: 0.13 0.44 0.71 0.08 0.39 0.39 0.16 0.16 0.16 0.27 0.27 0.27
Volume/Cap: 0.92 0.88 0.18 0.88 0.92 0.92 0.92 0.92 0.92 0.47 0.26 0.92
Delay/Veh: 79.8 29.2 4.9 87.0 34.5 34.5 56.3 56.3 56.3 30.7 28.6 58.8
User DelAdj: 1.00 1.00 1.00 1.00 1.00 1.00 1.00 1.00 1.00 1.00 1.00 1.00
AdjDel/Veh: 79.8 29.2 4.9 87.0 34.5 34.5 56.3 56.3 56.3 30.7 28.6 58.8
LOS by Move: E C A F C C E E E C C E
HCM2kAvgQ: 6 19 2 4 20 20 12 12 12 6 3 16

Note: Queue reported is the number of cars per lane.

Continental Grand Campus Specific Plan
Phase 1 Opening Year(2022) With Project PM Peak Hour (HCM)

Level of Service Computation Report
2000 HCM Operations Method (Future Volume Alternative)

Intersection #6 Sepulveda Blvd at El Segundo Blvd

Cycle (sec): 100 Critical Vol./Cap.(X): 1.129
Loss Time (sec): 5 Average Delay (sec/veh): 79.4
Optimal Cycle: 180 Level Of Service: E

Table with columns: Street Name, Approach, Movement, Control, Rights, Min. Green, Y+R, Lanes. Rows for Sepulveda Blvd and El Segundo Blvd.

Table with columns: Volume Module, Base Vol, Growth Adj, Initial Bse, Added Vol, Related Pro, Initial Fut, User Adj, PHF Adj, PHF Volume, Reduct Vol, Reduced Vol, PCE Adj, MLF Adj, Final Volume.

Table with columns: Saturation Flow Module, Sat/Lane, Adjustment, Lanes, Final Sat.

Table with columns: Capacity Analysis Module, Vol/Sat, Crit Moves, Green/Cycle, Volume/Cap, Delay/Veh, User DelAdj, AdjDel/Veh, LOS by Move, HCM2kAvgQ.

Note: Queue reported is the number of cars per lane.

Continental Grand Campus Specific Plan
Phase 1 Opening Year(2022) With Project PM Peak Hour (HCM)

Level of Service Computation Report
2000 HCM Operations Method (Future Volume Alternative)

Intersection #7 Sepulveda Blvd at Rosecrans Blvd

Cycle (sec): 100 Critical Vol./Cap.(X): 1.011
Loss Time (sec): 5 Average Delay (sec/veh): 43.9
Optimal Cycle: 180 Level Of Service: D

Table with columns: Street Name, Approach, Movement, Control, Rights, Min. Green, Y+R, Lanes. Rows for Sepulveda Blvd and Rosecrans Blvd.

Table with columns: Volume Module, Base Vol, Growth Adj, Initial Bse, Added Vol, Related Pro, Initial Fut, User Adj, PHF Adj, PHF Volume, Reduct Vol, Reduced Vol, PCE Adj, MLF Adj, Final Volume.

Table with columns: Saturation Flow Module, Sat/Lane, Adjustment, Lanes, Final Sat.

Table with columns: Capacity Analysis Module, Vol/Sat, Crit Moves, Green/Cycle, Volume/Cap, Delay/Veh, User DelAdj, AdjDel/Veh, LOS by Move, HCM2kAvgQ.

Note: Queue reported is the number of cars per lane.

Continental Grand Campus Specific Plan
Phase 1 Opening Year(2022) With Project PM Peak Hour (HCM)

Level of Service Computation Report
2000 HCM Operations Method (Future Volume Alternative)

Intersection #8 Continental Boulevard at Mariposa Ave

Cycle (sec): 100 Critical Vol./Cap.(X): 0.321
Loss Time (sec): 5 Average Delay (sec/veh): 17.0
Optimal Cycle: 19 Level Of Service: B

Street Name: Continental Boulevard Mariposa Avenue

Approach: North Bound South Bound East Bound West Bound
Movement: L - T - R L - T - R L - T - R L - T - R

Control: Permitted Permitted Permitted Permitted
Rights: Include Include Include Include
Min. Green: 0 0 0 0 0 0 0 0 0 0 0 0
Y+R: 4.0 4.0 4.0 4.0 4.0 4.0 4.0 4.0 4.0 4.0 4.0
Lanes: 1 0 1 0 2 1 0 0 1 0 1 0 1 0

Volume Module:

Base Vol: 176 85 306 9 56 28 11 514 49 58 342 10
Growth Adj: 1.01 1.01 1.01 1.01 1.01 1.01 1.01 1.01 1.01 1.01 1.01 1.01
Initial Bse: 178 86 310 9 57 28 11 521 50 59 347 10
Added Vol: 39 0 138 3 0 0 0 37 5 17 63 6
Related Pro: 0 0 0 0 0 0 0 -45 0 0 -10 0
Initial Fut: 217 86 448 12 57 28 11 513 55 76 400 16
User Adj: 1.00 1.00 1.00 1.00 1.00 1.00 1.00 1.00 1.00 1.00 1.00
PHF Adj: 0.92 0.92 0.92 0.92 0.92 0.92 0.92 0.92 0.92 0.92 0.92
PHF Volume: 236 94 487 13 62 31 12 558 59 82 435 18
Reduct Vol: 0 0 0 0 0 0 0 0 0 0 0 0
Reduced Vol: 236 94 487 13 62 31 12 558 59 82 435 18
PCE Adj: 1.00 1.00 1.00 1.00 1.00 1.00 1.00 1.00 1.00 1.00 1.00
MLF Adj: 1.00 1.00 1.00 1.00 1.00 1.00 1.00 1.00 1.00 1.00 1.00
FinalVolume: 236 94 487 13 62 31 12 558 59 82 435 18

Saturation Flow Module:

Sat/Lane: 1900 1900 1900 1900 1900 1900 1900 1900 1900 1900 1900
Adjustment: 0.69 1.00 0.75 0.69 0.95 0.95 0.39 0.90 0.90 0.35 0.94 0.94
Lanes: 1.00 1.00 2.00 1.00 0.67 0.33 1.00 2.71 0.29 1.00 1.92 0.08
Final Sat.: 1321 1900 2842 1319 1203 602 741 4622 493 669 3449 139

Capacity Analysis Module:

Vol/Sat: 0.18 0.05 0.17 0.01 0.05 0.05 0.02 0.12 0.12 0.12 0.13 0.13
Crit Moves: ****
Green/Cycle: 0.56 0.56 0.56 0.56 0.56 0.56 0.39 0.39 0.39 0.39 0.39 0.39
Volume/Cap: 0.32 0.09 0.31 0.02 0.09 0.09 0.04 0.31 0.31 0.31 0.32 0.32
Delay/Veh: 12.2 10.3 11.9 9.9 10.4 10.4 18.8 21.1 21.1 21.7 21.3 21.3
User DelAdj: 1.00 1.00 1.00 1.00 1.00 1.00 1.00 1.00 1.00 1.00 1.00 1.00
AdjDel/Veh: 12.2 10.3 11.9 9.9 10.4 10.4 18.8 21.1 21.1 21.7 21.3 21.3
LOS by Move: B B B A B B B C C C C C
HCM2kAvgQ: 4 1 5 0 1 1 0 5 5 2 5 5

Note: Queue reported is the number of cars per lane.

Continental Grand Campus Specific Plan
Phase 1 Opening Year(2022) With Project PM Peak Hour (HCM)

Level of Service Computation Report
2000 HCM Operations Method (Future Volume Alternative)

Intersection #9 Continental Boulevard at Grand Avenue

Cycle (sec): 100 Critical Vol./Cap.(X): 0.317
Loss Time (sec): 5 Average Delay (sec/veh): 18.5
Optimal Cycle: 19 Level Of Service: B

Street Name: Continental Boulevard Grand Avenue

Approach: North Bound South Bound East Bound West Bound
Movement: L - T - R L - T - R L - T - R L - T - R

Control: Permitted Permitted Protected Protected
Rights: Include Include Include Include
Min. Green: 0 0 0 0 0 0 0 0 0 0 0 0
Y+R: 4.0 4.0 4.0 4.0 4.0 4.0 4.0 4.0 4.0 4.0 4.0 4.0
Lanes: 0 1 1 1 0 1 0 2 1 0 1 0 2 1 0

Volume Module:

Base Vol: 53 144 110 40 172 108 58 592 142 21 245 25
Growth Adj: 1.01 1.01 1.01 1.01 1.01 1.01 1.01 1.01 1.01 1.01 1.01 1.01
Initial Bse: 54 146 112 41 174 110 59 600 144 21 248 25
Added Vol: 38 7 2 0 41 19 2 11 105 2 20 0
Related Pro: 0 0 0 0 0 0 0 -15 0 0 30 0
Initial Fut: 92 153 114 41 215 129 61 596 249 23 298 25
User Adj: 1.00 1.00 1.00 1.00 1.00 1.00 1.00 1.00 1.00 1.00 1.00 1.00
PHF Adj: 0.92 0.92 0.92 0.92 0.92 0.92 0.92 0.92 0.92 0.92 0.92 0.92
PHF Volume: 100 166 123 44 234 140 66 648 271 25 324 28
Reduct Vol: 0 0 0 0 0 0 0 0 0 0 0 0
Reduced Vol: 100 166 123 44 234 140 66 648 271 25 324 28
PCE Adj: 1.00 1.00 1.00 1.00 1.00 1.00 1.00 1.00 1.00 1.00 1.00 1.00
MLF Adj: 1.00 1.00 1.00 1.00 1.00 1.00 1.00 1.00 1.00 1.00 1.00 1.00
FinalVolume: 100 166 123 44 234 140 66 648 271 25 324 28

Saturation Flow Module:

Sat/Lane: 1900 1900 1900 1900 1900 1900 1900 1900 1900 1900 1900
Adjustment: 0.67 0.67 0.67 0.45 0.86 0.86 0.95 0.87 0.87 0.95 0.90 0.90
Lanes: 0.77 1.28 0.95 1.00 2.00 1.00 1.00 2.12 0.88 1.00 2.77 0.23
Final Sat.: 977 1630 1210 846 3264 1632 1805 3498 1461 1805 4724 401

Capacity Analysis Module:

Vol/Sat: 0.10 0.10 0.10 0.05 0.07 0.09 0.04 0.19 0.19 0.01 0.07 0.07
Crit Moves: ****
Green/Cycle: 0.32 0.32 0.32 0.32 0.32 0.32 0.22 0.58 0.58 0.04 0.41 0.41
Volume/Cap: 0.32 0.32 0.32 0.16 0.22 0.27 0.17 0.32 0.32 0.32 0.17 0.17
Delay/Veh: 25.8 25.8 25.8 24.6 24.9 25.3 31.9 10.7 10.7 48.6 18.7 18.7
User DelAdj: 1.00 1.00 1.00 1.00 1.00 1.00 1.00 1.00 1.00 1.00 1.00 1.00
AdjDel/Veh: 25.8 25.8 25.8 24.6 24.9 25.3 31.9 10.7 10.7 48.6 18.7 18.7
LOS by Move: C C C C C C C B B D B B
HCM2kAvgQ: 3 3 3 1 3 4 2 5 5 1 2 2

Note: Queue reported is the number of cars per lane.

Continental Grand Campus Specific Plan
Phase 1 Opening Year(2022) With Project PM Peak Hour (HCM)

Level of Service Computation Report
2000 HCM Operations Method (Future Volume Alternative)

Intersection #10 Continental Boulevard at El Segundo Boulevard

Cycle (sec): 100 Critical Vol./Cap.(X): 0.675
Loss Time (sec): 5 Average Delay (sec/veh): 29.9
Optimal Cycle: 36 Level Of Service: C

Table with columns for Street Name, Approach, Movement, Control, Rights, Min. Green, Y+R, Lanes. Rows for Continental and El Segundo boulevards.

Table with columns for Volume Module, Base Vol, Growth Adj, Initial Bse, Added Vol, Related Pro, Initial Fut, User Adj, PHF Adj, PHF Volume, Reduct Vol, Reduced Vol, PCE Adj, MLF Adj, Final Volume.

Table with columns for Sat/Lane, Adjustment, Lanes, Final Sat. for Saturation Flow Module.

Table with columns for Vol/Sat, Crit Moves, Green/Cycle, Volume/Cap, Delay/Veh, User DelAdj, AdjDel/Veh, LOS by Move, HCM2kAvgQ for Capacity Analysis Module.

Note: Queue reported is the number of cars per lane.

Continental Grand Campus Specific Plan
Phase 1 Opening Year(2022) With Project PM Peak Hour (HCM)

Level of Service Computation Report
2000 HCM Operations Method (Future Volume Alternative)

Intersection #11 Nash St and Imperial Hwy

Cycle (sec): 100 Critical Vol./Cap.(X): 0.529
Loss Time (sec): 5 Average Delay (sec/veh): 22.8
Optimal Cycle: 26 Level Of Service: C

Table with columns for Street Name, Approach, Movement, Control, Rights, Min. Green, Y+R, Lanes. Rows for Nash St and Imperial Hwy.

Table with columns for Volume Module, Base Vol, Growth Adj, Initial Bse, Added Vol, Related Pro, Initial Fut, User Adj, PHF Adj, PHF Volume, Reduct Vol, Reduced Vol, PCE Adj, MLF Adj, Final Volume.

Table with columns for Sat/Lane, Adjustment, Lanes, Final Sat. for Saturation Flow Module.

Table with columns for Vol/Sat, Crit Moves, Green/Cycle, Volume/Cap, Delay/Veh, User DelAdj, AdjDel/Veh, LOS by Move, HCM2kAvgQ for Capacity Analysis Module.

Note: Queue reported is the number of cars per lane.

Continental Grand Campus Specific Plan
Phase 1 Opening Year(2022) With Project PM Peak Hour (HCM)

Level of Service Computation Report
2000 HCM Operations Method (Future Volume Alternative)

Intersection #12 Nash St at Mariposa Ave

Cycle (sec): 100 Critical Vol./Cap.(X): 0.911
Loss Time (sec): 5 Average Delay (sec/veh): 24.4
Optimal Cycle: 97 Level Of Service: C

Table with columns: Street Name, Approach, Movement, Control, Rights, Min. Green, Y+R, Lanes. Rows for Nash St and Mariposa Ave.

Table with columns: Volume Module, Base Vol, Growth Adj, Initial Bse, Added Vol, Related Pro, Initial Fut, User Adj, PHF Adj, PHF Volume, Reduct Vol, Reduced Vol, PCE Adj, MLF Adj, FinalVolume. Rows for Nash St and Mariposa Ave.

Table with columns: Saturation Flow Module, Sat/Lane, Adjustment, Lanes, Final Sat. Rows for Nash St and Mariposa Ave.

Table with columns: Capacity Analysis Module, Vol/Sat, Crit Moves, Green/Cycle, Volume/Cap, Delay/Veh, User DelAdj, AdjDel/Veh, LOS by Move, HCM2kAvgQ. Rows for Nash St and Mariposa Ave.

Note: Queue reported is the number of cars per lane.

Continental Grand Campus Specific Plan
Phase 1 Opening Year(2022) With Project PM Peak Hour (HCM)

Level of Service Computation Report
2000 HCM Operations Method (Future Volume Alternative)

Intersection #13 Nash St at Grand Ave

Cycle (sec): 100 Critical Vol./Cap.(X): 0.572
Loss Time (sec): 5 Average Delay (sec/veh): 25.3
Optimal Cycle: 28 Level Of Service: C

Table with columns: Street Name, Approach, Movement, Control, Rights, Min. Green, Y+R, Lanes. Rows for Nash St and Grand Ave.

Table with columns: Volume Module, Base Vol, Growth Adj, Initial Bse, Added Vol, Related Pro, Initial Fut, User Adj, PHF Adj, PHF Volume, Reduct Vol, Reduced Vol, PCE Adj, MLF Adj, FinalVolume. Rows for Nash St and Grand Ave.

Table with columns: Saturation Flow Module, Sat/Lane, Adjustment, Lanes, Final Sat. Rows for Nash St and Grand Ave.

Table with columns: Capacity Analysis Module, Vol/Sat, Crit Moves, Green/Cycle, Volume/Cap, Delay/Veh, User DelAdj, AdjDel/Veh, LOS by Move, HCM2kAvgQ. Rows for Nash St and Grand Ave.

Note: Queue reported is the number of cars per lane.

Continental Grand Campus Specific Plan
Phase 1 Opening Year(2022) With Project PM Peak Hour (HCM)

Level of Service Computation Report
2000 HCM Operations Method (Future Volume Alternative)

Intersection #14 Nash St at El Segundo Blvd

Cycle (sec): 100 Critical Vol./Cap.(X): 1.083
Loss Time (sec): 5 Average Delay (sec/veh): 60.5
Optimal Cycle: 180 Level Of Service: E

Table with columns: Street Name, Approach, Movement, Control, Rights, Min. Green, Y+R, Lanes. Rows for Nash St and El Segundo Blvd.

Table with columns: Volume Module, Base Vol, Growth Adj, Initial Bse, Added Vol, Related Pro, Initial Fut, User Adj, PHF Adj, PHF Volume, Reduct Vol, Reduced Vol, PCE Adj, MLF Adj, Final Volume.

Table with columns: Saturation Flow Module, Sat/Lane, Adjustment, Lanes, Final Sat.

Table with columns: Capacity Analysis Module, Vol/Sat, Crit Moves, Green/Cycle, Volume/Cap, Delay/Veh, User DelAdj, AdjDel/Veh, LOS by Move, HCM2kAvgQ.

Note: Queue reported is the number of cars per lane.

Continental Grand Campus Specific Plan
Phase 1 Opening Year(2022) With Project PM Peak Hour (HCM)

Level of Service Computation Report
2000 HCM Operations Method (Future Volume Alternative)

Intersection #15 Douglas Street at El Segundo Boulevard

Cycle (sec): 100 Critical Vol./Cap.(X): 1.217
Loss Time (sec): 5 Average Delay (sec/veh): 100.8
Optimal Cycle: 180 Level Of Service: F

Table with columns: Street Name, Approach, Movement, Control, Rights, Min. Green, Y+R, Lanes. Rows for Douglas St and El Segundo Blvd.

Table with columns: Volume Module, Base Vol, Growth Adj, Initial Bse, Added Vol, Related Pro, Initial Fut, User Adj, PHF Adj, PHF Volume, Reduct Vol, Reduced Vol, PCE Adj, MLF Adj, Final Volume.

Table with columns: Saturation Flow Module, Sat/Lane, Adjustment, Lanes, Final Sat.

Table with columns: Capacity Analysis Module, Vol/Sat, Crit Moves, Green/Cycle, Volume/Cap, Delay/Veh, User DelAdj, AdjDel/Veh, LOS by Move, HCM2kAvgQ.

Note: Queue reported is the number of cars per lane.

Continental Grand Campus Specific Plan
Phase 1 Opening Year(2022) With Project PM Peak Hour (HCM)

Level of Service Computation Report

2000 HCM Operations Method (Future Volume Alternative)

Intersection #16 Aviation Boulevard at El Segundo Boulevard

Cycle (sec): 100 Critical Vol./Cap.(X): 1.197
Loss Time (sec): 5 Average Delay (sec/veh): 96.1
Optimal Cycle: 180 Level Of Service: F

Street Name: Aviatio Blvd El Segundo Blvd

Approach: North Bound South Bound East Bound West Bound
Movement: L - T - R L - T - R L - T - R L - T - R

Control: Protected Protected Protected Protected
Rights: Ovl Include Include Include
Min. Green: 0 0 0 0 0 0 0 0 0 0 0 0
Y+R: 4.0 4.0 4.0 4.0 4.0 4.0 4.0 4.0 4.0 4.0 4.0 4.0
Lanes: 2 0 2 0 1 1 0 1 1 1 1 1 0 3 1 0 2 0 2 1 0

Volume Module:

Base Vol: 180 578 377 95 1121 127 200 1850 360 451 572 42
Growth Adj: 1.01 1.01 1.01 1.01 1.01 1.01 1.01 1.01 1.01 1.01 1.01 1.01
Initial Bse: 183 586 382 96 1137 129 203 1876 365 457 580 43
Added Vol: 7 0 0 2 0 6 7 241 6 0 116 3
Related Pro: 55 46 0 -20 45 88 20 819 168 -13 205 -5
Initial Fut: 245 632 382 78 1182 223 230 2936 539 444 901 41
User Adj: 1.00 1.00 1.00 1.00 1.00 1.00 1.00 1.00 1.00 1.00 1.00 1.00
PHF Adj: 0.92 0.92 0.92 0.92 0.92 0.92 0.92 0.92 0.92 0.92 0.92 0.92
PHF Volume: 266 687 416 85 1284 242 250 3191 586 483 979 44
Reduct Vol: 0 0 0 0 0 0 0 0 0 0 0 0
Reduced Vol: 266 687 416 85 1284 242 250 3191 586 483 979 44
PCE Adj: 1.00 1.00 1.00 1.00 1.00 1.00 1.00 1.00 1.00 1.00 1.00 1.00
MLF Adj: 1.00 1.00 1.00 1.00 1.00 1.00 1.00 1.00 1.00 1.00 1.00 1.00
FinalVolume: 266 687 416 85 1284 242 250 3191 586 483 979 44

Saturation Flow Module:

Sat/Lane: 1900 1900 1900 1900 1900 1900 1900 1900 1900 1900 1900 1900
Adjustment: 0.92 0.95 0.85 0.95 0.93 0.93 0.95 0.89 0.89 0.92 0.90 0.90
Lanes: 2.00 2.00 1.00 1.00 2.00 1.00 1.00 3.38 0.62 2.00 2.87 0.13
Final Sat.: 3502 3610 1615 1805 3523 1762 1805 5709 1048 3502 4934 222

Capacity Analysis Module:

Vol/Sat: 0.08 0.19 0.26 0.05 0.36 0.14 0.14 0.56 0.56 0.14 0.20 0.20
Crit Moves: ****
Green/Cycle: 0.06 0.29 0.41 0.07 0.30 0.30 0.24 0.47 0.47 0.12 0.34 0.34
Volume/Cap: 1.20 0.65 0.63 0.65 1.20 0.45 0.58 1.20 1.20 1.20 0.58 0.58
Delay/Veh: 170.8 32.1 25.4 55.6 131 28.1 35.6 119 118.7 154.7 27.4 27.4
User DelAdj: 1.00 1.00 1.00 1.00 1.00 1.00 1.00 1.00 1.00 1.00 1.00 1.00
AdjDel/Veh: 170.8 32.1 25.4 55.6 131 28.1 35.6 119 118.7 154.7 27.4 27.4
LOS by Move: F C C E F C D F F F C C
HCM2kAvgQ: 10 10 11 3 35 6 7 55 55 16 10 10

Note: Queue reported is the number of cars per lane.

Continental Grand Campus Specific Plan
Phase 1 Opening Year(2022) With Project PM Peak Hour (HCM)

Level of Service Computation Report

ICU 1(Loss as Cycle Length %) Method (Future Volume Alternative)

Intersection #17 El Segundo Boulevard and Isis Avenue

Cycle (sec): 100 Critical Vol./Cap.(X): 0.868
Loss Time (sec): 5 Average Delay (sec/veh): xxxxxx
Optimal Cycle: 72 Level Of Service: D

Street Name: Isis Avenue El Segundo Boulevard

Approach: North Bound South Bound East Bound West Bound
Movement: L - T - R L - T - R L - T - R L - T - R

Control: Permitted Permitted Protected Protected
Rights: Include Include Include Include
Min. Green: 0 0 0 0 0 0 0 0 0 0 0 0
Y+R: 4.0 4.0 4.0 4.0 4.0 4.0 4.0 4.0 4.0 4.0 4.0 4.0
Lanes: 0 0 1! 0 0 0 0 1! 0 0 1 0 4 0 1 1 0 2 1 0

Volume Module:

Base Vol: 35 6 27 138 11 57 74 2405 45 89 1099 77
Growth Adj: 1.01 1.01 1.01 1.01 1.01 1.01 1.01 1.01 1.01 1.01 1.01 1.01
Initial Bse: 35 6 27 140 11 58 75 2439 46 90 1114 78
Added Vol: 0 0 0 0 0 0 0 0 116 0 0 14 0
Related Pro: 0 0 0 0 0 0 0 0 925 0 0 292 0
Initial Fut: 35 6 27 140 11 58 75 3480 46 90 1420 78
User Adj: 1.00 1.00 1.00 1.00 1.00 1.00 1.00 1.00 1.00 1.00 1.00 1.00
PHF Adj: 0.92 0.92 0.92 0.92 0.92 0.92 0.92 0.92 0.92 0.92 0.92 0.92
PHF Volume: 39 7 30 152 12 63 82 3782 50 98 1544 85
Reduct Vol: 0 0 0 0 0 0 0 0 0 0 0 0 0
Reduced Vol: 39 7 30 152 12 63 82 3782 50 98 1544 85
PCE Adj: 1.00 1.00 1.00 1.00 1.00 1.00 1.00 1.00 1.00 1.00 1.00 1.00
MLF Adj: 1.00 1.00 1.00 1.00 1.00 1.00 1.00 1.00 1.00 1.00 1.00 1.00
FinalVolume: 39 7 30 152 12 63 82 3782 50 98 1544 85

Saturation Flow Module:

Sat/Lane: 1600 1600 1600 1600 1600 1600 1600 1600 1600 1600 1600 1600
Adjustment: 1.00 1.00 1.00 1.00 1.00 1.00 1.00 1.00 1.00 1.00 1.00 1.00
Lanes: 0.51 0.09 0.40 0.67 0.05 0.28 1.00 4.00 1.00 1.00 2.84 0.16
Final Sat.: 824 141 635 1072 85 443 1600 6400 1600 1600 4550 250

Capacity Analysis Module:

Vol/Sat: 0.02 0.05 0.05 0.10 0.14 0.14 0.05 0.59 0.03 0.06 0.34 0.34
Crit Moves: ****

Continental Grand Campus Specific Plan
Phase 1 Opening Year(2022) With Project PM Peak Hour (HCM)

Level of Service Computation Report
2000 HCM Operations Method (Future Volume Alternative)

Intersection #18 El Segundo Blvd at I-405 SB Ramps

Cycle (sec): 100 Critical Vol./Cap.(X): 1.461
Loss Time (sec): 5 Average Delay (sec/veh): 84.0
Optimal Cycle: 180 Level Of Service: F

Table with columns for Street Name, Approach, Movement, Control, Rights, Min. Green, Y+R, Lanes. Rows for North Bound, South Bound, East Bound, West Bound.

Table with columns for Volume Module, Base Vol, Growth Adj, Initial Bse, Added Vol, Related Pro, Initial Fut, User Adj, PHF Adj, PHF Volume, Reduct Vol, Reduced Vol, PCE Adj, MLF Adj, FinalVolume.

Table with columns for Sat/Lane, Adjustment, Lanes, Final Sat. for Saturation Flow Module.

Table with columns for Vol/Sat, Crit Moves, Green/Cycle, Volume/Cap, Delay/Veh, User DelAdj, AdjDel/Veh, LOS by Move, HCM2kAvgQ for Capacity Analysis Module.

Note: Queue reported is the number of cars per lane.

Continental Grand Campus Specific Plan
Phase 1 Opening Year(2022) With Project PM Peak Hour (HCM)

Level of Service Computation Report
2000 HCM Operations Method (Future Volume Alternative)

Intersection #19 El Segundo Blvd at La Cienega Blvd

Cycle (sec): 100 Critical Vol./Cap.(X): 0.804
Loss Time (sec): 5 Average Delay (sec/veh): 21.6
Optimal Cycle: 55 Level Of Service: C

Table with columns for Street Name, Approach, Movement, Control, Rights, Min. Green, Y+R, Lanes. Rows for North Bound, South Bound, East Bound, West Bound.

Table with columns for Volume Module, Base Vol, Growth Adj, Initial Bse, Added Vol, Related Pro, Initial Fut, User Adj, PHF Adj, PHF Volume, Reduct Vol, Reduced Vol, PCE Adj, MLF Adj, FinalVolume.

Table with columns for Sat/Lane, Adjustment, Lanes, Final Sat. for Saturation Flow Module.

Table with columns for Vol/Sat, Crit Moves, Green/Cycle, Volume/Cap, Delay/Veh, User DelAdj, AdjDel/Veh, LOS by Move, HCM2kAvgQ for Capacity Analysis Module.

Note: Queue reported is the number of cars per lane.

Continental Grand Campus Specific Plan
Phase 1 Opening Year(2022) With Project PM Peak Hour (HCM)

Level of Service Computation Report

2000 HCM Operations Method (Future Volume Alternative)

Intersection #20 El Segundo Blvd at I-405 NB Ramps

Cycle (sec): 100 Critical Vol./Cap.(X): 0.730
Loss Time (sec): 5 Average Delay (sec/veh): 12.7
Optimal Cycle: 42 Level Of Service: B

Street Name: I-405 NB Ramps El Segundo Blvd
Approach: North Bound South Bound East Bound West Bound
Movement: L - T - R L - T - R L - T - R L - T - R

Control: Protected Protected Protected Protected
Rights: Include Include Ignore Include
Min. Green: 0 0 0 0 0 0 0 0 0 0 0 0
Y+R: 4.0 4.0 4.0 4.0 4.0 4.0 4.0 4.0 4.0 4.0 4.0 4.0
Lanes: 2 0 0 0 1 0 0 0 0 0 0 0 2 1 1 0 0 2 1 0

Volume Module:
Base Vol: 373 0 222 0 0 0 0 2365 176 0 447 410
Growth Adj: 1.01 1.01 1.01 1.01 1.01 1.01 1.01 1.01 1.01 1.01 1.01 1.01
Initial Bse: 378 0 225 0 0 0 0 2398 178 0 453 416
Added Vol: 10 0 0 0 0 0 0 39 0 0 5 0
Related Pro: 96 0 0 0 0 0 0 153 289 0 138 0
Initial Fut: 484 0 225 0 0 0 0 2590 467 0 596 416
User Adj: 1.00 1.00 1.00 1.00 1.00 1.00 1.00 1.00 0.00 1.00 1.00 1.00
PHF Adj: 0.92 0.92 0.92 0.92 0.92 0.92 0.92 0.92 0.00 0.92 0.92 0.92
PHF Volume: 526 0 245 0 0 0 0 2815 0 0 648 452
Reduct Vol: 0 0 0 0 0 0 0 0 0 0 0 0
Reduced Vol: 526 0 245 0 0 0 0 2815 0 0 648 452
PCE Adj: 1.00 1.00 1.00 1.00 1.00 1.00 1.00 1.00 0.00 1.00 1.00 1.00
MLF Adj: 1.00 1.00 1.00 1.00 1.00 1.00 1.00 1.00 0.00 1.00 1.00 1.00
FinalVolume: 526 0 245 0 0 0 0 2815 0 0 648 452

Saturation Flow Module:
Sat/Lane: 1900 1900 1900 1900 1900 1900 1900 1900 1900 1900 1900 1900
Adjustment: 0.92 1.00 0.85 1.00 1.00 1.00 1.00 0.91 0.91 1.00 0.85 0.85
Lanes: 2.00 0.00 1.00 0.00 0.00 0.00 0.00 3.00 1.00 0.00 2.00 1.00
Final Sat.: 3502 0 1615 0 0 0 0 5187 1729 0 3244 1622

Capacity Analysis Module:
Vol/Sat: 0.15 0.00 0.15 0.00 0.00 0.00 0.00 0.54 0.00 0.00 0.20 0.28
Crit Moves: ****
Green/Cycle: 0.21 0.00 0.21 0.00 0.00 0.00 0.00 0.74 0.00 0.00 0.74 0.74
Volume/Cap: 0.73 0.00 0.74 0.00 0.00 0.00 0.00 0.73 0.00 0.00 0.27 0.37
Delay/Veh: 40.9 0.0 45.4 0.0 0.0 0.0 0.0 7.9 0.0 0.0 4.1 4.6
User DelAdj: 1.00 1.00 1.00 1.00 1.00 1.00 1.00 1.00 1.00 1.00 1.00 1.00
AdjDel/Veh: 40.9 0.0 45.4 0.0 0.0 0.0 0.0 7.9 0.0 0.0 4.1 4.6
LOS by Move: D A D A A A A A A A A
HCM2kAvgQ: 9 0 9 0 0 0 0 17 0 0 4 5

Note: Queue reported is the number of cars per lane.

 Continental Grand Campus Specific Plan
 Phase 2 Opening Year (2023) Without Project AM Peak Hour (HCM)

Scenario Report

Scenario: Phase 2 Op Yr W/o Proj AM HCM
 Command: Phase 2 Op Yr W/o Proj AM HCM
 Volume: OY AM
 Geometry: Existing
 Impact Fee: Default Impact Fee
 Trip Generation: Cum AM
 Trip Distribution: Cum + Proj
 Paths: Project
 Routes: Default Route
 Configuration: Phase 2 Op Yr W/o Proj AM HCM

 Continental Grand Campus Specific Plan
 Phase 2 Opening Year (2023) Without Project AM Peak Hour (HCM)

Trip Generation Report

Forecast for Cum AM

Zone #	Subzone	Amount	Units	Rate In	Rate Out	Trips In	Trips Out	Total Trips	% Of Total
306	525 N. Sepul	1.00	Residential	-6.00	-3.00	-6	-3	-9	-0.6
	Zone 306 Subtotal					-6	-3	-9	-0.6
307	540 Imperial	1.00	Residential	23.00	44.00	23	44	67	4.7
	Zone 307 Subtotal					23	44	67	4.7
311	199 Continen	1.00	Business Hotel	48.00	33.00	48	33	81	5.7
	Zone 311 Subtotal					48	33	81	5.7
313	445 N. Dougl	1.00	Equinix Data C	8.00	8.00	8	8	16	1.1
	Zone 313 Subtotal					8	8	16	1.1
314	123 Lomita a	1.00	Office	17.00	3.00	17	3	20	1.4
	Zone 314 Subtotal					17	3	20	1.4
704	2355 Utah Av	1.00	Office	150.00	76.00	150	76	226	15.9
	Zone 704 Subtotal					150	76	226	15.9
706	888 Sepulved	1.00	hotel	57.00	36.00	57	36	93	6.5
	Zone 706 Subtotal					57	36	93	6.5
710	201 North Do	1.00	High School	160.00	111.00	160	111	271	19.1
710	201 North Do	1.00	District Offic	20.00	2.00	20	2	22	1.5
	Zone 710 Subtotal					180	113	293	20.6
714	400 Duley -	1.00	Office	95.00	13.00	95	13	108	7.6
	Zone 714 Subtotal					95	13	108	7.6
717	1700 Imperia	1.00	Townhome Resid	133.00	18.00	133	18	151	10.6
	Zone 717 Subtotal					133	18	151	10.6
718	123 Nevada S	1.00	Office	18.00	3.00	18	3	21	1.5
718	123 Nevada S	0.00	123 Nevada	18.00	3.00	0	0	0	0.0
	Zone 718 Subtotal					18	3	21	1.5
719	2125 Campus	1.00	Office Retail	160.00	46.00	160	46	206	14.5
	Zone 719 Subtotal					160	46	206	14.5
1002	Laker Facili	1.00	General Office	136.00	13.00	136	13	149	10.5
	Zone 1002 Subtotal					136	13	149	10.5
TOTAL						1019	403	1422	100.0

Continental Grand Campus Specific Plan
Phase 2 Opening Year (2023) Without Project AM Peak Hour (HCM)

Trip Distribution Report

Percent Of Trips Cum + Project

Zone	To Gates											
	1	2	3	4	5	7	8	9	10	11	12	
306	10.0	15.0	10.0	5.0	0.0	5.0	5.0	25.0	0.0	25.0	0.0	
307	10.0	15.0	10.0	5.0	50.0	0.0	0.0	0.0	0.0	0.0	0.0	
311	40.0	10.0	10.0	10.0	0.0	5.0	5.0	10.0	0.0	10.0	0.0	
313	15.0	5.0	15.0	10.0	25.0	0.0	5.0	20.0	0.0	0.0	0.0	
314	40.0	10.0	10.0	10.0	0.0	5.0	5.0	10.0	0.0	10.0	0.0	
704	30.0	15.0	8.0	12.0	0.0	5.0	5.0	10.0	5.0	10.0	0.0	
706	25.0	20.0	10.0	25.0	0.0	0.0	0.0	0.0	0.0	0.0	10.0	
710	0.0	0.0	15.0	10.0	10.0	2.0	2.0	20.0	5.0	10.0	1.0	
714	5.0	10.0	5.0	5.0	20.0	5.0	10.0	15.0	5.0	15.0	0.0	
717	10.0	15.0	10.0	5.0	50.0	0.0	0.0	0.0	0.0	0.0	0.0	
718	10.0	10.0	10.0	10.0	20.0	0.0	0.0	20.0	10.0	0.0	0.0	
719	20.0	10.0	10.0	10.0	10.0	5.0	5.0	10.0	5.0	0.0	0.0	
1002	0.0	10.0	5.0	5.0	15.0	5.0	10.0	15.0	5.0	15.0	5.0	
1004	5.0	15.0	10.0	5.0	30.0	0.0	5.0	20.0	0.0	0.0	5.0	
1005	5.0	15.0	10.0	5.0	30.0	0.0	5.0	20.0	0.0	0.0	5.0	
1007	0.0	0.0	0.0	0.0	0.0	0.0	0.0	0.0	0.0	0.0	0.0	

Zone	To Gates						
	13	14	15	16	17	18	20
306	0.0	0.0	0.0	0.0	0.0	0.0	0.0
307	0.0	10.0	0.0	0.0	0.0	0.0	0.0
311	0.0	0.0	0.0	0.0	0.0	0.0	0.0
313	5.0	0.0	0.0	0.0	0.0	0.0	0.0
314	0.0	0.0	0.0	0.0	0.0	0.0	0.0
704	0.0	0.0	0.0	0.0	0.0	0.0	0.0
706	0.0	0.0	0.0	0.0	10.0	0.0	0.0
710	10.0	5.0	10.0	0.0	0.0	0.0	0.0
714	0.0	5.0	0.0	0.0	0.0	0.0	0.0
717	0.0	10.0	0.0	0.0	0.0	0.0	0.0
718	0.0	10.0	0.0	0.0	0.0	0.0	0.0
719	0.0	10.0	5.0	0.0	0.0	0.0	0.0
1002	0.0	5.0	5.0	0.0	0.0	0.0	0.0
1004	0.0	5.0	0.0	0.0	0.0	0.0	0.0
1005	0.0	5.0	0.0	0.0	0.0	0.0	0.0
1007	0.0	0.0	0.0	0.0	0.0	20.0	10.0

Continental Grand Campus Specific Plan
Phase 2 Opening Year (2023) Without Project AM Peak Hour (HCM)

Impact Analysis Report
Level Of Service

Intersection		Base		Future		Change in	
		Del/ LOS	V/ Veh C	Del/ LOS	V/ Veh C		
# 1 Sepulveda Blvd at Imperial Hwy	C	30.0	0.831	C	29.6	0.891	-0.368 D/V
# 2 Sepulveda Blvd at Walnut St	A	7.8	0.557	A	9.1	0.733	+ 1.233 D/V
# 3 Sepulveda Blvd at Maple Ave	B	10.6	0.544	B	15.4	0.692	+ 4.738 D/V
# 4 Sepulveda Blvd at Mariposa Ave	B	18.4	0.618	B	19.9	0.714	+ 1.484 D/V
# 5 Sepulveda Blvd at Grand Ave	C	22.5	0.754	C	25.9	0.843	+ 3.444 D/V
# 6 Sepulveda Blvd at El Segundo B	C	26.5	0.777	E	64.8	1.101	+38.347 D/V
# 7 Sepulveda Blvd at Rosecrans Bl	C	27.5	0.801	C	33.9	0.924	+ 6.353 D/V
# 8 Continental Boulevard at Marip	A	9.8	0.354	A	9.8	0.379	+ 0.053 D/V
# 9 Continental Boulevard at Grand	C	23.5	0.256	C	23.6	0.279	+ 0.062 D/V
# 10 Continental Boulevard at El Se	A	9.1	0.382	B	15.8	0.548	+ 6.771 D/V
# 11 Nash St and Imperial Hwy	C	24.1	0.629	C	24.9	0.767	+ 0.814 D/V
# 12 Nash St at Mariposa Ave	B	15.0	0.384	B	15.1	0.547	+ 0.079 D/V
# 13 Nash St at Grand Ave	C	23.7	0.471	C	21.4	0.525	-2.344 D/V
# 14 Nash St at El Segundo Blvd	B	12.5	0.446	C	23.3	0.730	+10.882 D/V
# 15 Douglas Street at El Segundo B	C	27.9	0.713	D	39.9	0.984	+11.939 D/V
# 16 Aviation Boulevard at El Segun	C	31.4	0.820	F	90.6	1.183	+59.123 D/V
# 17 El Segundo Boulevard and Isis	B	xxxxx	0.632	D	xxxxx	0.895	+ 0.263 V/C
# 18 El Segundo Blvd at I-405 SB Ra	B	17.8	0.613	B	17.8	0.869	+ 0.053 D/V
# 19 El Segundo Blvd at La Cienega	B	14.7	0.598	C	24.3	0.904	+ 9.621 D/V
# 20 El Segundo Blvd at I-405 NB Ra	B	17.9	0.722	C	27.2	0.895	+ 9.292 D/V

Continental Grand Campus Specific Plan
Phase 2 Opening Year (2023) Without Project AM Peak Hour (HCM)

Level of Service Computation Report
2000 HCM Operations Method (Future Volume Alternative)

Intersection #1 Sepulveda Blvd at Imperial Hwy

Cycle (sec): 100 Critical Vol./Cap.(X): 0.891
Loss Time (sec): 5 Average Delay (sec/veh): 29.6
Optimal Cycle: 84 Level Of Service: C

Street Name: Sepulveda Blvd Imperial Hwy
Approach: North Bound South Bound East Bound West Bound
Movement: L - T - R L - T - R L - T - R L - T - R

Control: Protected Protected Protected Protected
Rights: Include Include Include Ovl
Min. Green: 0 0 0 0 0 0 0 0 0 0 0 0
Y+R: 4.0 4.0 4.0 4.0 4.0 4.0 4.0 4.0 4.0 4.0 4.0
Lanes: 1 0 3 0 1 2 0 3 1 0 2 0 3 0 1 2 0 3 0 1

Volume Module:
Base Vol: 63 1495 418 448 2297 12 210 316 140 211 292 590
Growth Adj: 1.02 1.02 1.02 1.02 1.02 1.02 1.02 1.02 1.02 1.02 1.02 1.02
Initial Bse: 64 1523 426 456 2339 12 214 322 143 215 297 601
Added Vol: 17 48 13 23 185 2 4 31 56 15 3 12
Related Pro: 9 130 38 -85 615 0 -5 25 30 6 5 -90
Initial Fut: 90 1701 477 394 3139 14 213 378 229 236 305 523
User Adj: 1.00 1.00 1.00 1.00 1.00 1.00 1.00 1.00 1.00 1.00 1.00 1.00
PHF Adj: 0.92 0.92 0.92 0.92 0.92 0.92 0.92 0.92 0.92 0.92 0.92 0.92
PHF Volume: 98 1848 518 429 3412 15 231 411 248 256 332 568
Reduct Vol: 0 0 0 0 0 0 0 0 0 0 0 0
Reduced Vol: 98 1848 518 429 3412 15 231 411 248 256 332 568
PCE Adj: 1.00 1.00 1.00 1.00 1.00 1.00 1.00 1.00 1.00 1.00 1.00 1.00
MLF Adj: 1.00 1.00 1.00 1.00 1.00 1.00 1.00 1.00 1.00 1.00 1.00 1.00
FinalVolume: 98 1848 518 429 3412 15 231 411 248 256 332 568

Saturation Flow Module:
Sat/Lane: 1900 1900 1900 1900 1900 1900 1900 1900 1900 1900 1900
Adjustment: 0.95 0.91 0.85 0.92 0.91 0.91 0.92 0.91 0.85 0.92 0.91 0.85
Lanes: 1.00 3.00 1.00 2.00 3.98 0.02 2.00 3.00 1.00 2.00 3.00 1.00
Final Sat.: 1805 5187 1615 3502 6878 31 3502 5187 1615 3502 5187 1615

Capacity Analysis Module:
Vol/Sat: 0.05 0.36 0.32 0.12 0.50 0.50 0.07 0.08 0.15 0.07 0.06 0.35
Crit Moves: ****
Green/Cycle: 0.06 0.46 0.46 0.16 0.56 0.56 0.07 0.22 0.22 0.11 0.26 0.42
Volume/Cap: 0.89 0.77 0.70 0.77 0.89 0.89 0.89 0.35 0.68 0.68 0.25 0.85
Delay/Veh: 99.5 24.3 24.4 47.1 22.4 22.4 75.1 32.8 40.8 48.2 29.5 36.1
User DelAdj: 1.00 1.00 1.00 1.00 1.00 1.00 1.00 1.00 1.00 1.00 1.00 1.00
AdjDel/Veh: 99.5 24.3 24.4 47.1 22.4 22.4 75.1 32.8 40.8 48.2 29.5 36.1
LOS by Move: F C C D C C E C D D C D
HCM2kAvgQ: 4 18 13 8 29 29 4 4 7 4 3 17

Note: Queue reported is the number of cars per lane.

Continental Grand Campus Specific Plan
Phase 2 Opening Year (2023) Without Project AM Peak Hour (HCM)

Level of Service Computation Report
2000 HCM Operations Method (Future Volume Alternative)

Intersection #2 Sepulveda Blvd at Walnut St

Cycle (sec): 100 Critical Vol./Cap.(X): 0.733
Loss Time (sec): 5 Average Delay (sec/veh): 9.1
Optimal Cycle: 43 Level Of Service: A

Street Name: Sepulveda Blvd Walnut St
Approach: North Bound South Bound East Bound West Bound
Movement: L - T - R L - T - R L - T - R L - T - R

Control: Protected Protected Permitted Permitted
Rights: Include Include Include Include
Min. Green: 0 0 0 0 0 0 0 0 0 0 0 0
Y+R: 4.0 4.0 4.0 4.0 4.0 4.0 4.0 4.0 4.0 4.0 4.0 4.0
Lanes: 1 0 3 1 0 1 0 3 1 0 0 1 0 0 1 0 1 0 0 1

Volume Module:
Base Vol: 86 1938 58 62 2372 175 65 19 28 8 11 17
Growth Adj: 1.02 1.02 1.02 1.02 1.02 1.02 1.02 1.02 1.02 1.02 1.02 1.02
Initial Bse: 88 1974 59 63 2416 178 66 19 29 8 11 17
Added Vol: 11 60 11 6 149 100 14 0 0 7 0 4
Related Pro: 7 163 0 0 650 0 0 0 28 0 0 0
Initial Fut: 106 2197 70 69 3215 278 80 19 57 15 11 21
User Adj: 1.00 1.00 1.00 1.00 1.00 1.00 1.00 1.00 1.00 1.00 1.00 1.00
PHF Adj: 0.92 0.92 0.92 0.92 0.92 0.92 0.92 0.92 0.92 0.92 0.92 0.92
PHF Volume: 115 2388 76 75 3494 302 87 21 61 16 12 23
Reduct Vol: 0 0 0 0 0 0 0 0 0 0 0 0
Reduced Vol: 115 2388 76 75 3494 302 87 21 61 16 12 23
PCE Adj: 1.00 1.00 1.00 1.00 1.00 1.00 1.00 1.00 1.00 1.00 1.00 1.00
MLF Adj: 1.00 1.00 1.00 1.00 1.00 1.00 1.00 1.00 1.00 1.00 1.00 1.00
FinalVolume: 115 2388 76 75 3494 302 87 21 61 16 12 23

Saturation Flow Module:
Sat/Lane: 1900 1900 1900 1900 1900 1900 1900 1900 1900 1900 1900
Adjustment: 0.95 0.91 0.91 0.95 0.90 0.90 0.74 0.74 0.85 0.78 0.78 0.85
Lanes: 1.00 3.88 0.12 1.00 3.68 0.32 0.81 0.19 1.00 0.57 0.43 1.00
Final Sat.: 1805 6669 213 1805 6289 544 1127 272 1615 852 630 1615

Capacity Analysis Module:
Vol/Sat: 0.06 0.36 0.36 0.04 0.56 0.56 0.08 0.08 0.04 0.02 0.02 0.01
Crit Moves: ****
Green/Cycle: 0.09 0.76 0.76 0.09 0.76 0.76 0.11 0.11 0.11 0.11 0.11 0.11
Volume/Cap: 0.73 0.47 0.47 0.47 0.73 0.73 0.73 0.73 0.36 0.18 0.18 0.14
Delay/Veh: 60.9 4.7 4.7 45.6 7.2 7.2 60.6 60.6 42.9 41.4 41.4 41.0
User DelAdj: 1.00 1.00 1.00 1.00 1.00 1.00 1.00 1.00 1.00 1.00 1.00 1.00
AdjDel/Veh: 60.9 4.7 4.7 45.6 7.2 7.2 60.6 60.6 42.9 41.4 41.4 41.0
LOS by Move: E A A D A A E E D D D D
HCM2kAvgQ: 5 8 8 2 17 17 5 5 2 1 1 1

Note: Queue reported is the number of cars per lane.

Continental Grand Campus Specific Plan
Phase 2 Opening Year (2023) Without Project AM Peak Hour (HCM)

Level of Service Computation Report
2000 HCM Operations Method (Future Volume Alternative)

Intersection #3 Sepulveda Blvd at Maple Ave

Cycle (sec): 100 Critical Vol./Cap.(X): 0.692
Loss Time (sec): 5 Average Delay (sec/veh): 15.4
Optimal Cycle: 38 Level Of Service: B

Street Name: Sepulveda Blvd Maple Ave

Approach: North Bound South Bound East Bound West Bound
Movement: L - T - R L - T - R L - T - R L - T - R

Control: Protected Protected Permitted Permitted
Rights: Include Include Include Include
Min. Green: 0 0 0 0 0 0 0 0 0 0 0 0
Y+R: 4.0 4.0 4.0 4.0 4.0 4.0 4.0 4.0 4.0 4.0 4.0 4.0
Lanes: 1 0 3 1 0 1 0 3 1 0 1 0 0 1 1

Volume Module:

Base Vol: 46 2101 145 104 2130 36 66 121 31 22 29 49
Growth Adj: 1.02 1.02 1.02 1.02 1.02 1.02 1.02 1.02 1.02 1.02 1.02 1.02
Initial Bse: 47 2134 147 106 2164 37 67 123 31 22 29 50
Added Vol: 6 81 0 66 90 0 0 18 15 0 3 14
Related Pro: 25 199 20 16 684 0 0 5 30 4 0 0
Initial Fut: 78 2414 167 188 2938 37 67 146 76 26 32 64
User Adj: 1.00 1.00 1.00 1.00 1.00 1.00 1.00 1.00 1.00 1.00 1.00 1.00
PHF Adj: 0.92 0.92 0.92 0.92 0.92 0.92 0.92 0.92 0.92 0.92 0.92 0.92
PHF Volume: 84 2624 182 204 3193 40 73 159 83 29 35 69
Reduct Vol: 0 0 0 0 0 0 0 0 0 0 0 0
Reduced Vol: 84 2624 182 204 3193 40 73 159 83 29 35 69
PCE Adj: 1.00 1.00 1.00 1.00 1.00 1.00 1.00 1.00 1.00 1.00 1.00 1.00
MLF Adj: 1.00 1.00 1.00 1.00 1.00 1.00 1.00 1.00 1.00 1.00 1.00 1.00
FinalVolume: 84 2624 182 204 3193 40 73 159 83 29 35 69

Saturation Flow Module:

Sat/Lane: 1900 1900 1900 1900 1900 1900 1900 1900 1900 1900 1900 1900
Adjustment: 0.95 0.90 0.90 0.95 0.91 0.91 0.74 0.95 0.95 0.27 1.00 0.85
Lanes: 1.00 3.74 0.26 1.00 3.95 0.05 1.00 0.66 0.34 1.00 1.00 1.00
Final Sat.: 1805 6403 444 1805 6817 85 1404 1182 619 504 1900 1615

Capacity Analysis Module:

Vol/Sat: 0.05 0.41 0.41 0.11 0.47 0.47 0.05 0.13 0.13 0.06 0.02 0.04
Crit Moves: ****
Green/Cycle: 0.07 0.59 0.59 0.16 0.69 0.69 0.19 0.19 0.19 0.19 0.19 0.19
Volume/Cap: 0.68 0.69 0.69 0.69 0.68 0.68 0.27 0.69 0.69 0.29 0.10 0.22
Delay/Veh: 59.9 14.6 14.6 46.3 9.6 9.6 34.8 43.3 43.3 36.1 33.2 34.3
User DelAdj: 1.00 1.00 1.00 1.00 1.00 1.00 1.00 1.00 1.00 1.00 1.00 1.00
AdjDel/Veh: 59.9 14.6 14.6 46.3 9.6 9.6 34.8 43.3 43.3 36.1 33.2 34.3
LOS by Move: E B B D A A C D D D C C
HCM2kAvgQ: 4 17 17 7 17 17 2 8 8 1 1 2

Note: Queue reported is the number of cars per lane.

Continental Grand Campus Specific Plan
Phase 2 Opening Year (2023) Without Project AM Peak Hour (HCM)

Level of Service Computation Report
2000 HCM Operations Method (Future Volume Alternative)

Intersection #4 Sepulveda Blvd at Mariposa Ave

Cycle (sec): 100 Critical Vol./Cap.(X): 0.714
Loss Time (sec): 5 Average Delay (sec/veh): 19.9
Optimal Cycle: 40 Level Of Service: B

Street Name: Sepulveda Blvd Mariposa Ave

Approach: North Bound South Bound East Bound West Bound
Movement: L - T - R L - T - R L - T - R L - T - R

Control: Protected Protected Permitted Permitted
Rights: Include Include Include Include
Min. Green: 0 0 0 0 0 0 0 0 0 0 0 0
Y+R: 4.0 4.0 4.0 4.0 4.0 4.0 4.0 4.0 4.0 4.0 4.0 4.0
Lanes: 1 0 4 0 1 2 0 3 1 0 1 0 0 1 1

Volume Module:

Base Vol: 62 1984 155 418 1791 58 104 179 49 65 86 84
Growth Adj: 1.02 1.02 1.02 1.02 1.02 1.02 1.02 1.02 1.02 1.02 1.02 1.02
Initial Bse: 63 2021 158 426 1824 59 106 182 50 66 88 86
Added Vol: 1 80 33 13 93 -1 0 35 9 8 7 7
Related Pro: 6 186 -25 17 651 14 14 -10 30 -25 0 -8
Initial Fut: 70 2287 166 456 2568 72 120 207 89 49 95 85
User Adj: 1.00 1.00 1.00 1.00 1.00 1.00 1.00 1.00 1.00 1.00 1.00 1.00
PHF Adj: 0.92 0.92 0.92 0.92 0.92 0.92 0.92 0.92 0.92 0.92 0.92 0.92
PHF Volume: 76 2485 180 495 2791 78 130 225 97 53 103 92
Reduct Vol: 0 0 0 0 0 0 0 0 0 0 0 0
Reduced Vol: 76 2485 180 495 2791 78 130 225 97 53 103 92
PCE Adj: 1.00 1.00 1.00 1.00 1.00 1.00 1.00 1.00 1.00 1.00 1.00 1.00
MLF Adj: 1.00 1.00 1.00 1.00 1.00 1.00 1.00 1.00 1.00 1.00 1.00 1.00
FinalVolume: 76 2485 180 495 2791 78 130 225 97 53 103 92

Saturation Flow Module:

Sat/Lane: 1900 1900 1900 1900 1900 1900 1900 1900 1900 1900 1900 1900
Adjustment: 0.95 0.91 0.85 0.92 0.91 0.91 0.61 0.96 0.96 0.23 1.00 0.85
Lanes: 1.00 4.00 1.00 2.00 3.89 0.11 1.00 0.70 0.30 1.00 1.00 1.00
Final Sat.: 1805 6916 1615 3502 6700 188 1155 1270 545 435 1900 1615

Capacity Analysis Module:

Vol/Sat: 0.04 0.36 0.11 0.14 0.42 0.42 0.11 0.18 0.18 0.12 0.05 0.06
Crit Moves: ****
Green/Cycle: 0.06 0.50 0.50 0.20 0.64 0.64 0.25 0.25 0.25 0.25 0.25 0.25
Volume/Cap: 0.65 0.71 0.22 0.71 0.65 0.65 0.45 0.71 0.71 0.49 0.22 0.23
Delay/Veh: 58.3 20.0 14.0 41.0 11.7 11.7 33.0 39.7 39.7 35.7 30.1 30.2
User DelAdj: 1.00 1.00 1.00 1.00 1.00 1.00 1.00 1.00 1.00 1.00 1.00 1.00
AdjDel/Veh: 58.3 20.0 14.0 41.0 11.7 11.7 33.0 39.7 39.7 35.7 30.1 30.2
LOS by Move: E B B D B B C D D D C C
HCM2kAvgQ: 2 15 3 9 15 15 4 10 10 2 3 2

Note: Queue reported is the number of cars per lane.

Continental Grand Campus Specific Plan
Phase 2 Opening Year (2023) Without Project AM Peak Hour (HCM)

Level of Service Computation Report
2000 HCM Operations Method (Future Volume Alternative)

Intersection #5 Sepulveda Blvd at Grand Ave

Cycle (sec): 100 Critical Vol./Cap.(X): 0.843
Loss Time (sec): 5 Average Delay (sec/veh): 25.9
Optimal Cycle: 65 Level Of Service: C

Table with columns for Street Name, Approach, Movement, Control, Rights, Min. Green, Y+R, Lanes. Rows for Sepulveda Blvd and Grand Ave.

Table with columns for Volume Module, Base Vol, Growth Adj, Initial Bse, Added Vol, Related Pro, Initial Fut, User Adj, PHF Adj, PHF Volume, Reduct Vol, Reduced Vol, PCE Adj, MLF Adj, Final Volume.

Table with columns for Saturation Flow Module, Sat/Lane, Adjustment, Lanes, Final Sat.

Table with columns for Capacity Analysis Module, Vol/Sat, Crit Moves, Green/Cycle, Volume/Cap, Delay/Veh, User DelAdj, AdjDel/Veh, LOS by Move, HCM2kAvgQ.

Note: Queue reported is the number of cars per lane.

Continental Grand Campus Specific Plan
Phase 2 Opening Year (2023) Without Project AM Peak Hour (HCM)

Level of Service Computation Report
2000 HCM Operations Method (Future Volume Alternative)

Intersection #6 Sepulveda Blvd at El Segundo Blvd

Cycle (sec): 100 Critical Vol./Cap.(X): 1.101
Loss Time (sec): 5 Average Delay (sec/veh): 64.8
Optimal Cycle: 180 Level Of Service: E

Table with columns for Street Name, Approach, Movement, Control, Rights, Min. Green, Y+R, Lanes. Rows for Sepulveda Blvd and El Segundo Blvd.

Table with columns for Volume Module, Base Vol, Growth Adj, Initial Bse, Added Vol, Related Pro, Initial Fut, User Adj, PHF Adj, PHF Volume, Reduct Vol, Reduced Vol, PCE Adj, MLF Adj, Final Volume.

Table with columns for Saturation Flow Module, Sat/Lane, Adjustment, Lanes, Final Sat.

Table with columns for Capacity Analysis Module, Vol/Sat, Crit Moves, Green/Cycle, Volume/Cap, Delay/Veh, User DelAdj, AdjDel/Veh, LOS by Move, HCM2kAvgQ.

Note: Queue reported is the number of cars per lane.

Continental Grand Campus Specific Plan
Phase 2 Opening Year (2023) Without Project AM Peak Hour (HCM)

Level of Service Computation Report
2000 HCM Operations Method (Future Volume Alternative)

Intersection #7 Sepulveda Blvd at Rosecrans Blvd

Cycle (sec): 100 Critical Vol./Cap.(X): 0.924
Loss Time (sec): 5 Average Delay (sec/veh): 33.9
Optimal Cycle: 107 Level Of Service: C

Table with columns for Street Name, Approach, Movement, Control, Rights, Min. Green, Y+R, Lanes. Rows for Sepulveda Blvd and Rosecrans Blvd.

Table with columns for Volume Module, Base Vol, Growth Adj, Initial Bse, Added Vol, Related Pro, Initial Fut, User Adj, PHF Adj, PHF Volume, Reduct Vol, Reduced Vol, PCE Adj, MLF Adj, FinalVolume.

Table with columns for Sat/Lane, Adjustment, Lanes, Final Sat. for Saturation Flow Module.

Table with columns for Vol/Sat, Crit Moves, Green/Cycle, Volume/Cap, Delay/Veh, User DelAdj, AdjDel/Veh, LOS by Move, HCM2kAvgQ for Capacity Analysis Module.

Note: Queue reported is the number of cars per lane.

Continental Grand Campus Specific Plan
Phase 2 Opening Year (2023) Without Project AM Peak Hour (HCM)

Level of Service Computation Report
2000 HCM Operations Method (Future Volume Alternative)

Intersection #8 Continental Boulevard at Mariposa Ave

Cycle (sec): 100 Critical Vol./Cap.(X): 0.379
Loss Time (sec): 5 Average Delay (sec/veh): 9.8
Optimal Cycle: 20 Level Of Service: A

Table with columns for Street Name, Approach, Movement, Control, Rights, Min. Green, Y+R, Lanes. Rows for Continental Boulevard and Mariposa Avenue.

Table with columns for Volume Module, Base Vol, Growth Adj, Initial Bse, Added Vol, Related Pro, Initial Fut, User Adj, PHF Adj, PHF Volume, Reduct Vol, Reduced Vol, PCE Adj, MLF Adj, FinalVolume.

Table with columns for Sat/Lane, Adjustment, Lanes, Final Sat. for Saturation Flow Module.

Table with columns for Vol/Sat, Crit Moves, Green/Cycle, Volume/Cap, Delay/Veh, User DelAdj, AdjDel/Veh, LOS by Move, HCM2kAvgQ for Capacity Analysis Module.

Note: Queue reported is the number of cars per lane.

Continental Grand Campus Specific Plan
Phase 2 Opening Year (2023) Without Project AM Peak Hour (HCM)

Level of Service Computation Report
2000 HCM Operations Method (Future Volume Alternative)

Intersection #9 Continental Boulevard at Grand Avenue

Cycle (sec): 100 Critical Vol./Cap.(X): 0.279
Loss Time (sec): 5 Average Delay (sec/veh): 23.6
Optimal Cycle: 18 Level Of Service: C

Table with columns: Street Name, Approach, Movement, Control, Rights, Min. Green, Y+R, Lanes. Rows for Continental Boulevard and Grand Avenue.

Table with columns: Volume Module, Base Vol, Growth Adj, Initial Bse, Added Vol, Related Pro, Initial Fut, User Adj, PHF Adj, PHF Volume, Reduct Vol, Reduced Vol, PCE Adj, MLF Adj, Final Volume.

Table with columns: Sat/Lane, Adjustment, Lanes, Final Sat. for Saturation Flow Module.

Table with columns: Vol/Sat, Crit Moves, Green/Cycle, Volume/Cap, Delay/Veh, User DelAdj, AdjDel/Veh, LOS by Move, HCM2kAvgQ for Capacity Analysis Module.

Note: Queue reported is the number of cars per lane.

Continental Grand Campus Specific Plan
Phase 2 Opening Year (2023) Without Project AM Peak Hour (HCM)

Level of Service Computation Report
2000 HCM Operations Method (Future Volume Alternative)

Intersection #10 Continental Boulevard at El Segundo Boulevard

Cycle (sec): 100 Critical Vol./Cap.(X): 0.548
Loss Time (sec): 5 Average Delay (sec/veh): 15.8
Optimal Cycle: 27 Level Of Service: B

Table with columns: Street Name, Approach, Movement, Control, Rights, Min. Green, Y+R, Lanes. Rows for Continental Boulevard and El Segundo Boulevard.

Table with columns: Volume Module, Base Vol, Growth Adj, Initial Bse, Added Vol, Related Pro, Initial Fut, User Adj, PHF Adj, PHF Volume, Reduct Vol, Reduced Vol, PCE Adj, MLF Adj, Final Volume.

Table with columns: Sat/Lane, Adjustment, Lanes, Final Sat. for Saturation Flow Module.

Table with columns: Vol/Sat, Crit Moves, Green/Cycle, Volume/Cap, Delay/Veh, User DelAdj, AdjDel/Veh, LOS by Move, HCM2kAvgQ for Capacity Analysis Module.

Note: Queue reported is the number of cars per lane.

Continental Grand Campus Specific Plan
Phase 2 Opening Year (2023) Without Project AM Peak Hour (HCM)

Level of Service Computation Report
2000 HCM Operations Method (Future Volume Alternative)

Intersection #11 Nash St and Imperial Hwy
Cycle (sec): 100 Critical Vol./Cap.(X): 0.767
Loss Time (sec): 5 Average Delay (sec/veh): 24.9
Optimal Cycle: 48 Level Of Service: C

Table with columns for Street Name (Nash St, Imperial Hwy), Approach (North Bound, South Bound, East Bound, West Bound), Movement (L, T, R), Control, Rights, Min. Green, Y+R, and Lanes.

Table for Volume Module showing Base Vol, Growth Adj, Initial Bse, Added Vol, Related Pro, Initial Fut, User Adj, PHF Adj, PHF Volume, Reduct Vol, Reduced Vol, PCE Adj, MLF Adj, and Final Volume.

Table for Saturation Flow Module showing Sat/Lane, Adjustment, Lanes, and Final Sat.

Table for Capacity Analysis Module showing Vol/Sat, Crit Moves, Green/Cycle, Volume/Cap, Delay/Veh, User DelAdj, AdjDel/Veh, LOS by Move, and HCM2kAvgQ.

Note: Queue reported is the number of cars per lane.

Continental Grand Campus Specific Plan
Phase 2 Opening Year (2023) Without Project AM Peak Hour (HCM)

Level of Service Computation Report
2000 HCM Operations Method (Future Volume Alternative)

Intersection #12 Nash St at Mariposa Ave
Cycle (sec): 100 Critical Vol./Cap.(X): 0.547
Loss Time (sec): 5 Average Delay (sec/veh): 15.1
Optimal Cycle: 27 Level Of Service: B

Table with columns for Street Name (Nash St, Mariposa Ave), Approach (North Bound, South Bound, East Bound, West Bound), Movement (L, T, R), Control, Rights, Min. Green, Y+R, and Lanes.

Table for Volume Module showing Base Vol, Growth Adj, Initial Bse, Added Vol, PasserByVol, Initial Fut, User Adj, PHF Adj, PHF Volume, Reduct Vol, Reduced Vol, PCE Adj, MLF Adj, and Final Volume.

Table for Saturation Flow Module showing Sat/Lane, Adjustment, Lanes, and Final Sat.

Table for Capacity Analysis Module showing Vol/Sat, Crit Moves, Green/Cycle, Volume/Cap, Delay/Veh, User DelAdj, AdjDel/Veh, LOS by Move, and HCM2kAvgQ.

Note: Queue reported is the number of cars per lane.

Continental Grand Campus Specific Plan
Phase 2 Opening Year (2023) Without Project AM Peak Hour (HCM)

Level of Service Computation Report
2000 HCM Operations Method (Future Volume Alternative)

Intersection #13 Nash St at Grand Ave
Cycle (sec): 100 Critical Vol./Cap.(X): 0.525
Loss Time (sec): 5 Average Delay (sec/veh): 21.4
Optimal Cycle: 26 Level Of Service: C

Table with columns for Street Name (Nash St, Grand Ave), Approach (North Bound, South Bound, East Bound, West Bound), Movement (L, T, R), Control (Protected, Split Phase), Rights (Include), and various traffic metrics like Min. Green, Y+R, Lanes.

Table for Volume Module showing Base Vol, Growth Adj, Initial Bse, Added Vol, Related Pro, Initial Fut, User Adj, PHF Adj, PHF Volume, Reduct Vol, Reduced Vol, PCE Adj, MLF Adj, and Final Volume across different movements.

Table for Saturation Flow Module showing Sat/Lane, Adjustment, Lanes, and Final Sat. values for each movement.

Table for Capacity Analysis Module showing Vol/Sat, Crit Moves, Green/Cycle, Volume/Cap, Delay/Veh, User DelAdj, AdjDel/Veh, LOS by Move, and HCM2kAvgQ.

Note: Queue reported is the number of cars per lane.

Continental Grand Campus Specific Plan
Phase 2 Opening Year (2023) Without Project AM Peak Hour (HCM)

Level of Service Computation Report
2000 HCM Operations Method (Future Volume Alternative)

Intersection #14 Nash St at El Segundo Blvd
Cycle (sec): 100 Critical Vol./Cap.(X): 0.730
Loss Time (sec): 5 Average Delay (sec/veh): 23.3
Optimal Cycle: 42 Level Of Service: C

Table with columns for Street Name (Nash St, El Segundo Blvd), Approach (North Bound, South Bound, East Bound, West Bound), Movement (L, T, R), Control (Split Phase, Protected), Rights (Include), and various traffic metrics like Min. Green, Y+R, Lanes.

Table for Volume Module showing Base Vol, Growth Adj, Initial Bse, Added Vol, Related Pro, Initial Fut, User Adj, PHF Adj, PHF Volume, Reduct Vol, Reduced Vol, PCE Adj, MLF Adj, and Final Volume across different movements.

Table for Saturation Flow Module showing Sat/Lane, Adjustment, Lanes, and Final Sat. values for each movement.

Table for Capacity Analysis Module showing Vol/Sat, Crit Moves, Green/Cycle, Volume/Cap, Delay/Veh, User DelAdj, AdjDel/Veh, LOS by Move, and HCM2kAvgQ.

Note: Queue reported is the number of cars per lane.

Continental Grand Campus Specific Plan
Phase 2 Opening Year (2023) Without Project AM Peak Hour (HCM)

Level of Service Computation Report
2000 HCM Operations Method (Future Volume Alternative)

Intersection #15 Douglas Street at El Segundo Boulevard

Cycle (sec): 100 Critical Vol./Cap.(X): 0.984
Loss Time (sec): 5 Average Delay (sec/veh): 39.9
Optimal Cycle: 180 Level Of Service: D

Street Name: Douglas St El Segundo Blvd
Approach: North Bound South Bound East Bound West Bound
Movement: L - T - R L - T - R L - T - R L - T - R
Control: Protected Protected Protected Protected
Rights: Include Include Include Include
Min. Green: 0 0 0 0 0 0 0 0 0 0 0 0
Y+R: 4.0 4.0 4.0 4.0 4.0 4.0 4.0 4.0 4.0 4.0 4.0 4.0
Lanes: 2 0 1 1 1 2 0 2 0 1 1 0 2 1 0 2 0 3 0 1

Volume Module:
Base Vol: 418 683 92 128 269 36 121 496 143 191 1457 512
Growth Adj: 1.02 1.02 1.02 1.02 1.02 1.02 1.02 1.02 1.02 1.02 1.02 1.02
Initial Bse: 425 694 93 130 273 37 123 504 145 194 1480 520
Added Vol: 34 34 26 75 34 7 15 27 68 51 82 189
Related Pro: 13 6 -4 0 9 0 5 179 5 -6 1107 -10
Initial Fut: 472 734 115 205 316 44 143 710 218 239 2669 699
User Adj: 1.00 1.00 1.00 1.00 1.00 1.00 1.00 1.00 1.00 1.00 1.00 1.00
PHF Adj: 0.92 0.92 0.92 0.92 0.92 0.92 0.92 0.92 0.92 0.92 0.92 0.92
PHF Volume: 513 798 125 223 344 47 155 772 237 260 2901 760
Reduct Vol: 0 0 0 0 0 0 0 0 0 0 0 0
Reduced Vol: 513 798 125 223 344 47 155 772 237 260 2901 760
PCE Adj: 1.00 1.00 1.00 1.00 1.00 1.00 1.00 1.00 1.00 1.00 1.00 1.00
MLF Adj: 1.00 1.00 1.00 1.00 1.00 1.00 1.00 1.00 1.00 1.00 1.00 1.00
FinalVolume: 513 798 125 223 344 47 155 772 237 260 2901 760

Saturation Flow Module:
Sat/Lane: 1900 1900 1900 1900 1900 1900 1900 1900 1900 1900 1900 1900
Adjustment: 0.92 0.93 0.93 0.92 0.95 0.85 0.95 0.88 0.88 0.92 0.91 0.85
Lanes: 2.00 2.00 1.00 2.00 2.00 1.00 1.00 2.29 0.71 2.00 3.00 1.00
Final Sat.: 3502 3538 1769 3502 3610 1615 1805 3828 1177 3502 5187 1615

Capacity Analysis Module:
Vol/Sat: 0.15 0.23 0.07 0.06 0.10 0.03 0.09 0.20 0.20 0.07 0.56 0.47
Crit Moves: ****
Green/Cycle: 0.18 0.23 0.23 0.06 0.12 0.12 0.09 0.48 0.48 0.18 0.57 0.57
Volume/Cap: 0.82 0.98 0.31 0.98 0.82 0.25 0.98 0.42 0.42 0.42 0.98 0.83
Delay/Veh: 48.2 63.7 32.0 101.7 55.5 41.0 112.1 17.1 17.1 37.1 34.1 23.9
User DelAdj: 1.00 1.00 1.00 1.00 1.00 1.00 1.00 1.00 1.00 1.00 1.00 1.00
AdjDel/Veh: 48.2 63.7 32.0 101.7 55.5 41.0 112.1 17.1 17.1 37.1 34.1 23.9
LOS by Move: D E C F E D F B B D C C
HCM2kAvgQ: 10 18 3 7 8 2 9 7 7 4 39 21

Note: Queue reported is the number of cars per lane.

Continental Grand Campus Specific Plan
Phase 2 Opening Year (2023) Without Project AM Peak Hour (HCM)

Level of Service Computation Report
2000 HCM Operations Method (Future Volume Alternative)

Intersection #16 Aviation Boulevard at El Segundo Boulevard

Cycle (sec): 100 Critical Vol./Cap.(X): 1.183
Loss Time (sec): 5 Average Delay (sec/veh): 90.6
Optimal Cycle: 180 Level Of Service: F

Street Name: Aviation Blvd El Segundo Blvd
Approach: North Bound South Bound East Bound West Bound
Movement: L - T - R L - T - R L - T - R L - T - R
Control: Protected Protected Protected Protected
Rights: Ovl Include Include Include
Min. Green: 0 0 0 0 0 0 0 0 0 0 0 0
Y+R: 4.0 4.0 4.0 4.0 4.0 4.0 4.0 4.0 4.0 4.0 4.0 4.0
Lanes: 2 0 2 0 1 1 0 1 1 1 1 0 3 1 0 2 0 2 1 0

Volume Module:
Base Vol: 326 1027 306 21 774 435 118 454 77 410 1528 75
Growth Adj: 1.02 1.02 1.02 1.02 1.02 1.02 1.02 1.02 1.02 1.02 1.02 1.02
Initial Bse: 331 1043 311 21 786 442 120 461 78 416 1552 76
Added Vol: 33 0 0 2 0 10 5 109 14 0 280 1
Related Pro: 167 36 -28 0 49 48 22 94 35 2 887 -10
Initial Fut: 531 1079 283 23 835 500 147 664 127 418 2719 67
User Adj: 1.00 1.00 1.00 1.00 1.00 1.00 1.00 1.00 1.00 1.00 1.00 1.00
PHF Adj: 0.92 0.92 0.92 0.92 0.92 0.92 0.92 0.92 0.92 0.92 0.92 0.92
PHF Volume: 577 1173 307 25 908 543 160 722 138 455 2956 73
Reduct Vol: 0 0 0 0 0 0 0 0 0 0 0 0
Reduced Vol: 577 1173 307 25 908 543 160 722 138 455 2956 73
PCE Adj: 1.00 1.00 1.00 1.00 1.00 1.00 1.00 1.00 1.00 1.00 1.00 1.00
MLF Adj: 1.00 1.00 1.00 1.00 1.00 1.00 1.00 1.00 1.00 1.00 1.00 1.00
FinalVolume: 577 1173 307 25 908 543 160 722 138 455 2956 73

Saturation Flow Module:
Sat/Lane: 1900 1900 1900 1900 1900 1900 1900 1900 1900 1900 1900 1900
Adjustment: 0.92 0.95 0.85 0.95 0.90 0.90 0.95 0.89 0.89 0.92 0.91 0.91
Lanes: 2.00 2.00 1.00 1.00 1.88 1.12 1.00 3.36 0.64 2.00 2.93 0.07
Final Sat.: 3502 3610 1615 1805 3198 1914 1805 5665 1085 3502 5042 125

Capacity Analysis Module:
Vol/Sat: 0.16 0.32 0.19 0.01 0.28 0.28 0.09 0.13 0.13 0.13 0.59 0.59
Crit Moves: ****
Green/Cycle: 0.14 0.36 0.65 0.02 0.24 0.24 0.07 0.28 0.28 0.29 0.50 0.50
Volume/Cap: 1.18 0.89 0.29 0.89 1.18 1.18 1.18 0.45 0.45 0.45 1.18 1.18
Delay/Veh: 144.5 38.1 7.6 172.5 129 128.8 181.1 29.7 29.7 29.5 112 111.7
User DelAdj: 1.00 1.00 1.00 1.00 1.00 1.00 1.00 1.00 1.00 1.00 1.00 1.00
AdjDel/Veh: 144.5 38.1 7.6 172.5 129 128.8 181.1 29.7 29.7 29.5 112 111.7
LOS by Move: F D A F F F F C C C F F
HCM2kAvgQ: 18 21 4 1 26 26 11 6 6 6 57 57

Note: Queue reported is the number of cars per lane.

Continental Grand Campus Specific Plan
Phase 2 Opening Year (2023) Without Project AM Peak Hour (HCM)

Level of Service Computation Report

ICU 1(Loss as Cycle Length %) Method (Future Volume Alternative)

Intersection #17 El Segundo Boulevard and Isis Avenue

Cycle (sec): 100 Critical Vol./Cap.(X): 0.895
Loss Time (sec): 5 Average Delay (sec/veh): xxxxxx
Optimal Cycle: 84 Level Of Service: D

Table with columns for Street Name, Approach, Movement, Control, Rights, Min. Green, Y+R, Lanes. Rows for North and South Bound of Isis Avenue and East and West Bound of El Segundo Boulevard.

Volume Module table with columns for Base Vol, Growth Adj, Initial Bse, Added Vol, Related Pro, Initial Fut, User Adj, PHF Adj, PHF Volume, Reduct Vol, Reduced Vol, PCE Adj, MLF Adj, Final Volume.

Saturation Flow Module table with columns for Sat/Lane, Adjustment, Lanes, Final Sat.

Capacity Analysis Module table with columns for Vol/Sat, Crit Moves.

Continental Grand Campus Specific Plan
Phase 2 Opening Year (2023) Without Project AM Peak Hour (HCM)

Level of Service Computation Report

2000 HCM Operations Method (Future Volume Alternative)

Intersection #18 El Segundo Blvd at I-405 SB Ramps

Cycle (sec): 100 Critical Vol./Cap.(X): 0.869
Loss Time (sec): 5 Average Delay (sec/veh): 17.8
Optimal Cycle: 75 Level Of Service: B

Table with columns for Street Name, Approach, Movement, Control, Rights, Min. Green, Y+R, Lanes. Rows for North and South Bound of I-405 SB Ramps and East and West Bound of El Segundo Blvd.

Volume Module table with columns for Base Vol, Growth Adj, Initial Bse, Added Vol, Related Pro, Initial Fut, User Adj, PHF Adj, PHF Volume, Reduct Vol, Reduced Vol, PCE Adj, MLF Adj, Final Volume.

Saturation Flow Module table with columns for Sat/Lane, Adjustment, Lanes, Final Sat.

Capacity Analysis Module table with columns for Vol/Sat, Crit Moves.

Green/Cycle: 0.32 0.00 0.32 0.00 0.00 0.00 0.00 0.63 0.63 0.00 0.63 0.00
Volume/Cap: 0.65 0.00 0.87 0.00 0.00 0.00 0.00 0.24 0.37 0.00 0.87 0.00
Delay/Veh: 30.7 0.0 43.0 0.0 0.0 0.0 0.0 8.2 9.3 0.0 18.1 0.0
User DelAdj: 1.00 1.00 1.00 1.00 1.00 1.00 1.00 1.00 1.00 1.00 1.00 1.00
AdjDel/Veh: 30.7 0.0 43.0 0.0 0.0 0.0 0.0 8.2 9.3 0.0 18.1 0.0
LOS by Move: C A D A A A A A A B A
HCM2kAvgQ: 9 0 15 0 0 0 0 4 6 0 25 0

Note: Queue reported is the number of cars per lane.

Continental Grand Campus Specific Plan
Phase 2 Opening Year (2023) Without Project AM Peak Hour (HCM)

Level of Service Computation Report
2000 HCM Operations Method (Future Volume Alternative)

Intersection #19 El Segundo Blvd at La Cienega Blvd

Cycle (sec): 100 Critical Vol./Cap.(X): 0.904
Loss Time (sec): 5 Average Delay (sec/veh): 24.3
Optimal Cycle: 92 Level Of Service: C

Table with columns for Street Name, Approach, Movement, Control, Rights, Min. Green, Y+R, Lanes. Rows for North and South Bound movements.

Table with columns for Volume Module, Base Vol, Growth Adj, Initial Bse, Added Vol, Related Pro, Initial Fut, User Adj, PHF Adj, PHF Volume, Reduct Vol, Reduced Vol, PCE Adj, MLF Adj, Final Volume.

Table with columns for Sat/Lane, Adjustment, Lanes, Final Sat.

Table with columns for Capacity Analysis Module, Vol/Sat, Crit Moves, Green/Cycle, Volume/Cap, Delay/Veh, User DelAdj, AdjDel/Veh, LOS by Move, HCM2kAvgQ.

Note: Queue reported is the number of cars per lane.

Continental Grand Campus Specific Plan
Phase 2 Opening Year (2023) Without Project AM Peak Hour (HCM)

Level of Service Computation Report
2000 HCM Operations Method (Future Volume Alternative)

Intersection #20 El Segundo Blvd at I-405 NB Ramps

Cycle (sec): 100 Critical Vol./Cap.(X): 0.895
Loss Time (sec): 5 Average Delay (sec/veh): 27.2
Optimal Cycle: 87 Level Of Service: C

Table with columns for Street Name, Approach, Movement, Control, Rights, Min. Green, Y+R, Lanes. Rows for North and South Bound movements.

Table with columns for Volume Module, Base Vol, Growth Adj, Initial Bse, Added Vol, Related Pro, Initial Fut, User Adj, PHF Adj, PHF Volume, Reduct Vol, Reduced Vol, PCE Adj, MLF Adj, Final Volume.

Table with columns for Sat/Lane, Adjustment, Lanes, Final Sat.

Table with columns for Capacity Analysis Module, Vol/Sat, Crit Moves, Green/Cycle, Volume/Cap, Delay/Veh, User DelAdj, AdjDel/Veh, LOS by Move, HCM2kAvgQ.

Note: Queue reported is the number of cars per lane.

 Continental Grand Campus Specific Plan
 Phase 2 Opening Year (2023) Without Project PM Peak Hour (HCM)

Scenario Report

Scenario: Phase 2 Op Yr W/o Proj PM HCM
 Command: Phase 2 Op Yr W/o Proj PM HCM
 Volume: OY PM
 Geometry: Existing
 Impact Fee: Default Impact Fee
 Trip Generation: Cum PM
 Trip Distribution: Cum + Proj
 Paths: Project
 Routes: Default Route
 Configuration: Phase 2 Op Yr W/o Proj PM HCM

 Continental Grand Campus Specific Plan
 Phase 2 Opening Year (2023) Without Project PM Peak Hour (HCM)

Trip Generation Report

Forecast for Cum PM

Zone #	Subzone	Amount	Units	Rate In	Rate Out	Trips In	Trips Out	Total Trips	% Of Total
306	525 N. Sepul	1.00	Residential	-4.00	-6.00	-4	-6	-10	-0.9
	Zone 306 Subtotal					-4	-6	-10	-0.9
307	540 Imperial	1.00	Residential	50.00	32.00	50	32	82	7.4
	Zone 307 Subtotal					50	32	82	7.4
311	199 Continen	1.00	Business Hotel	46.00	45.00	46	45	91	8.3
	Zone 311 Subtotal					46	45	91	8.3
313	445 N. Dougl	1.00	Equinix Data C	3.00	13.00	3	13	16	1.5
	Zone 313 Subtotal					3	13	16	1.5
314	123 Lomita a	1.00	Office	2.00	16.00	2	16	18	1.6
	Zone 314 Subtotal					2	16	18	1.6
704	2355 Utah Av	1.00	Office	95.00	109.00	95	109	204	18.5
	Zone 704 Subtotal					95	109	204	18.5
706	888 Sepulved	1.00	hotel	60.00	41.00	60	41	101	9.2
	Zone 706 Subtotal					60	41	101	9.2
710	201 North Do	1.00	High School	-15.00	-74.00	-15	-74	-89	-8.1
710	201 North Do	1.00	District Offic	3.00	18.00	3	18	21	1.9
	Zone 710 Subtotal					-12	-56	-68	-6.2
714	400 Duley -	1.00	Office	18.00	87.00	18	87	105	9.5
	Zone 714 Subtotal					18	87	105	9.5
717	1700 Imperia	1.00	Townhome Resid	25.00	120.00	25	120	145	13.2
	Zone 717 Subtotal					25	120	145	13.2
718	123 Nevada S	1.00	Office	4.00	16.00	4	16	20	1.8
718	123 Nevada S	0.00	123 Nevada	4.00	16.00	0	0	0	0.0
	Zone 718 Subtotal					4	16	20	1.8
719	2125 Campus	1.00	Office Retail	64.00	146.00	64	146	210	19.1
	Zone 719 Subtotal					64	146	210	19.1
1002	Laker Facili	1.00	General Office	103.00	85.00	103	85	188	17.1
	Zone 1002 Subtotal					103	85	188	17.1
TOTAL						454	648	1102	100.0

Continental Grand Campus Specific Plan
Phase 2 Opening Year (2023) Without Project PM Peak Hour (HCM)

Trip Distribution Report

Percent Of Trips Cum + Project

Zone	To Gates											
	1	2	3	4	5	7	8	9	10	11	12	
306	10.0	15.0	10.0	5.0	0.0	5.0	5.0	25.0	0.0	25.0	0.0	
307	10.0	15.0	10.0	5.0	50.0	0.0	0.0	0.0	0.0	0.0	0.0	
311	40.0	10.0	10.0	10.0	0.0	5.0	5.0	10.0	0.0	10.0	0.0	
313	15.0	5.0	15.0	10.0	25.0	0.0	5.0	20.0	0.0	0.0	0.0	
314	40.0	10.0	10.0	10.0	0.0	5.0	5.0	10.0	0.0	10.0	0.0	
704	30.0	15.0	8.0	12.0	0.0	5.0	5.0	10.0	5.0	10.0	0.0	
706	25.0	20.0	10.0	25.0	0.0	0.0	0.0	0.0	0.0	0.0	10.0	
710	0.0	0.0	15.0	10.0	10.0	2.0	2.0	20.0	5.0	10.0	1.0	
714	5.0	10.0	5.0	5.0	20.0	5.0	10.0	15.0	5.0	15.0	0.0	
717	10.0	15.0	10.0	5.0	50.0	0.0	0.0	0.0	0.0	0.0	0.0	
718	10.0	10.0	10.0	10.0	20.0	0.0	0.0	20.0	10.0	0.0	0.0	
719	20.0	10.0	10.0	10.0	10.0	5.0	5.0	10.0	5.0	0.0	0.0	
1002	0.0	10.0	5.0	5.0	15.0	5.0	10.0	15.0	5.0	15.0	5.0	
1004	5.0	15.0	10.0	5.0	30.0	0.0	5.0	20.0	0.0	0.0	5.0	
1005	5.0	15.0	10.0	5.0	30.0	0.0	5.0	20.0	0.0	0.0	5.0	
1007	0.0	0.0	0.0	0.0	0.0	0.0	0.0	0.0	0.0	0.0	0.0	

Zone	To Gates						
	13	14	15	16	17	18	20
306	0.0	0.0	0.0	0.0	0.0	0.0	0.0
307	0.0	10.0	0.0	0.0	0.0	0.0	0.0
311	0.0	0.0	0.0	0.0	0.0	0.0	0.0
313	5.0	0.0	0.0	0.0	0.0	0.0	0.0
314	0.0	0.0	0.0	0.0	0.0	0.0	0.0
704	0.0	0.0	0.0	0.0	0.0	0.0	0.0
706	0.0	0.0	0.0	0.0	10.0	0.0	0.0
710	10.0	5.0	10.0	0.0	0.0	0.0	0.0
714	0.0	5.0	0.0	0.0	0.0	0.0	0.0
717	0.0	10.0	0.0	0.0	0.0	0.0	0.0
718	0.0	10.0	0.0	0.0	0.0	0.0	0.0
719	0.0	10.0	5.0	0.0	0.0	0.0	0.0
1002	0.0	5.0	5.0	0.0	0.0	0.0	0.0
1004	0.0	5.0	0.0	0.0	0.0	0.0	0.0
1005	0.0	5.0	0.0	0.0	0.0	0.0	0.0
1007	0.0	0.0	0.0	0.0	0.0	20.0	10.0

Continental Grand Campus Specific Plan
Phase 2 Opening Year (2023) Without Project PM Peak Hour (HCM)

Impact Analysis Report
Level Of Service

Intersection		Base		Future		Change in
		Del/ LOS	V/ Veh C	Del/ LOS	V/ Veh C	
# 1 Sepulveda Blvd at Imperial Hwy	D	38.9	1.038	D	45.3	+ 6.360 D/V
# 2 Sepulveda Blvd at Walnut St	A	9.9	0.551	B	15.7	+ 5.764 D/V
# 3 Sepulveda Blvd at Maple Ave	B	12.6	0.604	B	17.2	+ 4.589 D/V
# 4 Sepulveda Blvd at Mariposa Ave	C	20.1	0.630	C	23.2	+ 3.084 D/V
# 5 Sepulveda Blvd at Grand Ave	C	30.3	0.801	D	35.8	+ 5.468 D/V
# 6 Sepulveda Blvd at El Segundo B	D	36.9	0.915	E	78.9	+42.041 D/V
# 7 Sepulveda Blvd at Rosecrans Bl	C	32.5	0.881	D	42.3	+ 9.819 D/V
# 8 Continental Boulevard at Marip	B	16.3	0.283	B	16.3	-0.026 D/V
# 9 Continental Boulevard at Grand	B	18.4	0.276	B	18.4	+ 0.086 D/V
# 10 Continental Boulevard at El Se	B	19.6	0.400	C	28.2	+ 8.595 D/V
# 11 Nash St and Imperial Hwy	B	19.5	0.475	C	22.2	+ 2.712 D/V
# 12 Nash St at Mariposa Ave	B	17.3	0.534	B	19.3	+ 1.980 D/V
# 13 Nash St at Grand Ave	C	22.7	0.501	C	25.3	+ 2.643 D/V
# 14 Nash St at El Segundo Blvd	B	19.8	0.536	E	55.6	+35.750 D/V
# 15 Douglas Street at El Segundo B	C	33.9	0.888	F	93.4	+59.515 D/V
# 16 Aviation Boulevard at El Segun	D	41.2	0.956	F	90.9	+49.676 D/V
# 17 El Segundo Boulevard and Isis	B	xxxxx	0.693	D	xxxxx	+ 0.157 V/C
# 18 El Segundo Blvd at I-405 SB Ra	C	28.6	1.065	E	75.0	+46.415 D/V
# 19 El Segundo Blvd at La Cienega	C	20.6	0.681	C	21.6	+ 1.014 D/V
# 20 El Segundo Blvd at I-405 NB Ra	B	11.8	0.690	B	12.6	+ 0.750 D/V

Continental Grand Campus Specific Plan
Phase 2 Opening Year (2023) Without Project PM Peak Hour (HCM)

Level of Service Computation Report
2000 HCM Operations Method (Future Volume Alternative)

Intersection #1 Sepulveda Blvd at Imperial Hwy

Cycle (sec): 100 Critical Vol./Cap.(X): 1.115
Loss Time (sec): 5 Average Delay (sec/veh): 45.3
Optimal Cycle: 180 Level Of Service: D

Street Name: Sepulveda Blvd Imperial Hwy

Approach: North Bound South Bound East Bound West Bound
Movement: L - T - R L - T - R L - T - R L - T - R

Control: Protected Protected Protected Protected
Rights: Include Include Include Ovl
Min. Green: 0 0 0 0 0 0 0 0 0 0 0 0
Y+R: 4.0 4.0 4.0 4.0 4.0 4.0 4.0 4.0 4.0 4.0 4.0 4.0
Lanes: 1 0 3 0 1 2 0 3 1 0 2 0 3 0 1 2 0 3 0 1

Volume Module:

Base Vol: 154 1713 885 640 1993 7 202 402 140 120 295 461
Growth Adj: 1.02 1.02 1.02 1.02 1.02 1.02 1.02 1.02 1.02 1.02 1.02 1.02
Initial Bse: 157 1745 901 652 2030 7 206 409 143 122 300 470
Added Vol: 35 103 73 14 78 5 3 23 17 9 9 17
Related Pro: 30 569 63 -165 159 0 -15 15 11 40 -20 -40
Initial Fut: 222 2417 1037 501 2267 12 194 447 171 171 289 447
User Adj: 1.00 1.00 1.00 1.00 1.00 1.00 1.00 1.00 1.00 1.00 1.00 1.00
PHF Adj: 0.92 0.92 0.92 0.92 0.92 0.92 0.92 0.92 0.92 0.92 0.92 0.92
PHF Volume: 241 2627 1128 544 2464 13 211 486 185 186 315 485
Reduct Vol: 0 0 0 0 0 0 0 0 0 0 0 0
Reduced Vol: 241 2627 1128 544 2464 13 211 486 185 186 315 485
PCE Adj: 1.00 1.00 1.00 1.00 1.00 1.00 1.00 1.00 1.00 1.00 1.00 1.00
MLF Adj: 1.00 1.00 1.00 1.00 1.00 1.00 1.00 1.00 1.00 1.00 1.00 1.00
FinalVolume: 241 2627 1128 544 2464 13 211 486 185 186 315 485

Saturation Flow Module:

Sat/Lane: 1900 1900 1900 1900 1900 1900 1900 1900 1900 1900 1900 1900
Adjustment: 0.95 0.91 0.85 0.92 0.91 0.91 0.92 0.91 0.85 0.92 0.91 0.85
Lanes: 1.00 3.00 1.00 2.00 3.98 0.02 2.00 3.00 1.00 2.00 3.00 1.00
Final Sat.: 1805 5187 1615 3502 6872 37 3502 5187 1615 3502 5187 1615

Capacity Analysis Module:

Vol/Sat: 0.13 0.51 0.70 0.16 0.36 0.36 0.06 0.09 0.11 0.05 0.06 0.30
Crit Moves: **** **** **** ****
Green/Cycle: 0.21 0.63 0.63 0.14 0.56 0.56 0.05 0.13 0.13 0.06 0.13 0.27
Volume/Cap: 0.64 0.81 1.11 1.11 0.64 0.64 1.11 0.74 0.91 0.91 0.47 1.11
Delay/Veh: 40.0 15.7 83.9 118.9 15.6 15.6 146.8 46.8 82.7 86.3 40.8 114.6
User DelAdj: 1.00 1.00 1.00 1.00 1.00 1.00 1.00 1.00 1.00 1.00 1.00 1.00
AdjDel/Veh: 40.0 15.7 83.9 118.9 15.6 15.6 146.8 46.8 82.7 86.3 40.8 114.6
LOS by Move: D B F F B B F D F D F
HCM2kAvgQ: 7 22 49 16 15 15 5 5 7 4 3 22

Note: Queue reported is the number of cars per lane.

Continental Grand Campus Specific Plan
Phase 2 Opening Year (2023) Without Project PM Peak Hour (HCM)

Level of Service Computation Report
2000 HCM Operations Method (Future Volume Alternative)

Intersection #2 Sepulveda Blvd at Walnut St

Cycle (sec): 100 Critical Vol./Cap.(X): 0.771
Loss Time (sec): 5 Average Delay (sec/veh): 15.7
Optimal Cycle: 49 Level Of Service: B

Street Name: Sepulveda Blvd Walnut St

Approach: North Bound South Bound East Bound West Bound
Movement: L - T - R L - T - R L - T - R L - T - R

Control: Protected Protected Permitted Permitted
Rights: Include Include Include Include
Min. Green: 0 0 0 0 0 0 0 0 0 0 0 0
Y+R: 4.0 4.0 4.0 4.0 4.0 4.0 4.0 4.0 4.0 4.0 4.0 4.0
Lanes: 1 0 3 1 0 1 0 3 1 0 0 1 0 0 1 0 1 0 0 1

Volume Module:

Base Vol: 48 2434 29 10 2181 74 117 31 71 46 10 66
Growth Adj: 1.02 1.02 1.02 1.02 1.02 1.02 1.02 1.02 1.02 1.02 1.02 1.02
Initial Bse: 49 2479 30 10 2221 75 119 32 72 47 10 67
Added Vol: 12 117 12 6 80 19 90 0 0 8 0 4
Related Pro: 28 627 0 0 210 0 0 0 9 0 0 0
Initial Fut: 89 3223 42 16 2511 94 209 32 81 55 10 71
User Adj: 1.00 1.00 1.00 1.00 1.00 1.00 1.00 1.00 1.00 1.00 1.00 1.00
PHF Adj: 0.92 0.92 0.92 0.92 0.92 0.92 0.92 0.92 0.92 0.92 0.92 0.92
PHF Volume: 97 3503 45 18 2730 103 227 34 88 60 11 77
Reduct Vol: 0 0 0 0 0 0 0 0 0 0 0 0
Reduced Vol: 97 3503 45 18 2730 103 227 34 88 60 11 77
PCE Adj: 1.00 1.00 1.00 1.00 1.00 1.00 1.00 1.00 1.00 1.00 1.00 1.00
MLF Adj: 1.00 1.00 1.00 1.00 1.00 1.00 1.00 1.00 1.00 1.00 1.00 1.00
FinalVolume: 97 3503 45 18 2730 103 227 34 88 60 11 77

Saturation Flow Module:

Sat/Lane: 1900 1900 1900 1900 1900 1900 1900 1900 1900 1900 1900 1900
Adjustment: 0.95 0.91 0.91 0.95 0.91 0.91 0.66 0.66 0.85 0.55 0.55 0.85
Lanes: 1.00 3.95 0.05 1.00 3.86 0.14 0.87 0.13 1.00 0.84 0.16 1.00
Final Sat.: 1805 6814 88 1805 6632 249 1090 164 1615 885 164 1615

Capacity Analysis Module:

Vol/Sat: 0.05 0.51 0.51 0.01 0.41 0.41 0.21 0.21 0.05 0.07 0.07 0.05
Crit Moves: **** **** **** ****
Green/Cycle: 0.08 0.67 0.67 0.01 0.60 0.60 0.27 0.27 0.27 0.27 0.27 0.27
Volume/Cap: 0.68 0.77 0.77 0.77 0.68 0.68 0.77 0.77 0.20 0.25 0.25 0.18
Delay/Veh: 58.0 12.3 12.3 139.7 14.0 14.0 44.0 44.0 28.4 29.0 29.0 28.1
User DelAdj: 1.00 1.00 1.00 1.00 1.00 1.00 1.00 1.00 1.00 1.00 1.00 1.00
AdjDel/Veh: 58.0 12.3 12.3 139.7 14.0 14.0 44.0 44.0 28.4 29.0 29.0 28.1
LOS by Move: E B B F B B D D C C C C
HCM2kAvgQ: 4 22 22 1 16 16 9 9 2 2 2 2

Note: Queue reported is the number of cars per lane.

Continental Grand Campus Specific Plan
Phase 2 Opening Year (2023) Without Project PM Peak Hour (HCM)

Level of Service Computation Report
2000 HCM Operations Method (Future Volume Alternative)

Intersection #3 Sepulveda Blvd at Maple Ave

Cycle (sec): 100 Critical Vol./Cap.(X): 0.740
Loss Time (sec): 5 Average Delay (sec/veh): 17.2
Optimal Cycle: 44 Level Of Service: B

Street Name: Sepulveda Blvd Maple Ave

Approach: North Bound South Bound East Bound West Bound
Movement: L - T - R L - T - R L - T - R L - T - R

Control: Protected Protected Permitted Permitted
Rights: Include Include Include Include
Min. Green: 0 0 0 0 0 0 0 0 0 0 0 0
Y+R: 4.0 4.0 4.0 4.0 4.0 4.0 4.0 4.0 4.0 4.0 4.0 4.0
Lanes: 1 0 3 1 0 1 0 3 1 0 1 0 0 1 0 1

Volume Module:

Base Vol: 98 2208 33 57 2439 42 68 57 37 114 102 114
Growth Adj: 1.02 1.02 1.02 1.02 1.02 1.02 1.02 1.02 1.02 1.02 1.02 1.02
Initial Bse: 100 2243 34 58 2478 43 69 58 38 116 104 116
Added Vol: 13 92 0 37 92 0 0 8 8 0 12 44
Related Pro: 56 687 30 25 226 0 0 8 13 5 0 0
Initial Fut: 169 3022 64 120 2796 43 69 74 59 121 116 160
User Adj: 1.00 1.00 1.00 1.00 1.00 1.00 1.00 1.00 1.00 1.00 1.00 1.00
PHF Adj: 0.92 0.92 0.92 0.92 0.92 0.92 0.92 0.92 0.92 0.92 0.92 0.92
PHF Volume: 183 3285 69 130 3039 46 75 80 64 131 126 174
Reduct Vol: 0 0 0 0 0 0 0 0 0 0 0 0
Reduced Vol: 183 3285 69 130 3039 46 75 80 64 131 126 174
PCE Adj: 1.00 1.00 1.00 1.00 1.00 1.00 1.00 1.00 1.00 1.00 1.00 1.00
MLF Adj: 1.00 1.00 1.00 1.00 1.00 1.00 1.00 1.00 1.00 1.00 1.00 1.00
FinalVolume: 183 3285 69 130 3039 46 75 80 64 131 126 174

Saturation Flow Module:

Sat/Lane: 1900 1900 1900 1900 1900 1900 1900 1900 1900 1900 1900 1900
Adjustment: 0.95 0.91 0.91 0.95 0.91 0.91 0.52 0.93 0.93 0.48 1.00 0.85
Lanes: 1.00 3.92 0.08 1.00 3.94 0.06 1.00 0.56 0.44 1.00 1.00 1.00
Final Sat.: 1805 6753 142 1805 6798 104 988 990 785 910 1900 1615

Capacity Analysis Module:

Vol/Sat: 0.10 0.49 0.49 0.07 0.45 0.45 0.08 0.08 0.08 0.14 0.07 0.11
Crit Moves: ****
Green/Cycle: 0.14 0.66 0.66 0.10 0.62 0.62 0.20 0.20 0.20 0.20 0.20 0.20
Volume/Cap: 0.73 0.74 0.74 0.74 0.73 0.73 0.39 0.42 0.42 0.74 0.34 0.55
Delay/Veh: 51.3 12.1 12.1 59.2 14.0 14.0 36.4 36.1 36.1 53.1 35.2 38.4
User DelAdj: 1.00 1.00 1.00 1.00 1.00 1.00 1.00 1.00 1.00 1.00 1.00 1.00
AdjDel/Veh: 51.3 12.1 12.1 59.2 14.0 14.0 36.4 36.1 36.1 53.1 35.2 38.4
LOS by Move: D B B E B B D D D D D D
HCM2kAvgQ: 7 20 20 6 19 19 2 4 4 6 4 6

Note: Queue reported is the number of cars per lane.

Continental Grand Campus Specific Plan
Phase 2 Opening Year (2023) Without Project PM Peak Hour (HCM)

Level of Service Computation Report
2000 HCM Operations Method (Future Volume Alternative)

Intersection #4 Sepulveda Blvd at Mariposa Ave

Cycle (sec): 100 Critical Vol./Cap.(X): 0.803
Loss Time (sec): 5 Average Delay (sec/veh): 23.2
Optimal Cycle: 55 Level Of Service: C

Street Name: Sepulveda Blvd Mariposa Ave

Approach: North Bound South Bound East Bound West Bound
Movement: L - T - R L - T - R L - T - R L - T - R

Control: Protected Protected Permitted Permitted
Rights: Include Include Include Include
Min. Green: 0 0 0 0 0 0 0 0 0 0 0 0
Y+R: 4.0 4.0 4.0 4.0 4.0 4.0 4.0 4.0 4.0 4.0 4.0 4.0
Lanes: 1 0 4 0 1 2 0 3 1 0 1 0 0 1 0 1

Volume Module:

Base Vol: 100 2039 133 227 2100 79 102 213 37 117 265 207
Growth Adj: 1.02 1.02 1.02 1.02 1.02 1.02 1.02 1.02 1.02 1.02 1.02 1.02
Initial Bse: 102 2077 135 231 2139 80 104 217 38 119 270 211
Added Vol: 6 94 17 18 83 -1 -1 15 3 28 24 11
Related Pro: 32 688 -15 -23 232 11 10 -5 13 -5 5 0
Initial Fut: 140 2859 137 226 2454 90 113 227 54 142 299 222
User Adj: 1.00 1.00 1.00 1.00 1.00 1.00 1.00 1.00 1.00 1.00 1.00 1.00
PHF Adj: 0.92 0.92 0.92 0.92 0.92 0.92 0.92 0.92 0.92 0.92 0.92 0.92
PHF Volume: 152 3107 149 246 2667 98 123 247 58 155 325 241
Reduct Vol: 0 0 0 0 0 0 0 0 0 0 0 0
Reduced Vol: 152 3107 149 246 2667 98 123 247 58 155 325 241
PCE Adj: 1.00 1.00 1.00 1.00 1.00 1.00 1.00 1.00 1.00 1.00 1.00 1.00
MLF Adj: 1.00 1.00 1.00 1.00 1.00 1.00 1.00 1.00 1.00 1.00 1.00 1.00
FinalVolume: 152 3107 149 246 2667 98 123 247 58 155 325 241

Saturation Flow Module:

Sat/Lane: 1900 1900 1900 1900 1900 1900 1900 1900 1900 1900 1900 1900
Adjustment: 0.95 0.91 0.85 0.92 0.91 0.91 0.31 0.97 0.97 0.33 1.00 0.85
Lanes: 1.00 4.00 1.00 2.00 3.86 0.14 1.00 0.81 0.19 1.00 1.00 1.00
Final Sat.: 1805 6916 1615 3502 6637 245 583 1492 353 635 1900 1615

Capacity Analysis Module:

Vol/Sat: 0.08 0.45 0.09 0.07 0.40 0.40 0.21 0.17 0.17 0.24 0.17 0.15
Crit Moves: ****
Green/Cycle: 0.11 0.56 0.56 0.09 0.53 0.53 0.30 0.30 0.30 0.30 0.30 0.30
Volume/Cap: 0.75 0.80 0.17 0.80 0.75 0.75 0.69 0.55 0.55 0.80 0.56 0.49
Delay/Veh: 57.6 18.9 10.8 59.0 19.0 19.0 42.0 30.2 30.2 53.2 30.6 29.3
User DelAdj: 1.00 1.00 1.00 1.00 1.00 1.00 1.00 1.00 1.00 1.00 1.00 1.00
AdjDel/Veh: 57.6 18.9 10.8 59.0 19.0 19.0 42.0 30.2 30.2 53.2 30.6 29.3
LOS by Move: E B B E B B D C C D C C
HCM2kAvgQ: 4 20 2 6 19 19 5 8 8 7 9 6

Note: Queue reported is the number of cars per lane.

Continental Grand Campus Specific Plan
Phase 2 Opening Year (2023) Without Project PM Peak Hour (HCM)

Level of Service Computation Report
2000 HCM Operations Method (Future Volume Alternative)

Intersection #5 Sepulveda Blvd at Grand Ave

Cycle (sec): 100 Critical Vol./Cap.(X): 0.903
Loss Time (sec): 5 Average Delay (sec/veh): 35.8
Optimal Cycle: 91 Level Of Service: D

Table with columns for Street Name, Approach, Movement, Control, Rights, Min. Green, Y+R, Lanes. Rows for North Bound, South Bound, East Bound, West Bound.

Table with columns for Volume Module, Base Vol, Growth Adj, Initial Bse, Added Vol, Related Pro, Initial Fut, User Adj, PHF Adj, PHF Volume, Reduct Vol, Reduced Vol, PCE Adj, MLF Adj, Final Volume.

Table with columns for Saturation Flow Module, Sat/Lane, Adjustment, Lanes, Final Sat.

Table with columns for Capacity Analysis Module, Vol/Sat, Crit Moves, Green/Cycle, Volume/Cap, Delay/Veh, User DelAdj, AdjDel/Veh, LOS by Move, HCM2kAvgQ.

Note: Queue reported is the number of cars per lane.

Continental Grand Campus Specific Plan
Phase 2 Opening Year (2023) Without Project PM Peak Hour (HCM)

Level of Service Computation Report
2000 HCM Operations Method (Future Volume Alternative)

Intersection #6 Sepulveda Blvd at El Segundo Blvd

Cycle (sec): 100 Critical Vol./Cap.(X): 1.121
Loss Time (sec): 5 Average Delay (sec/veh): 78.9
Optimal Cycle: 180 Level Of Service: E

Table with columns for Street Name, Approach, Movement, Control, Rights, Min. Green, Y+R, Lanes. Rows for North Bound, South Bound, East Bound, West Bound.

Table with columns for Volume Module, Base Vol, Growth Adj, Initial Bse, Added Vol, Related Pro, Initial Fut, User Adj, PHF Adj, PHF Volume, Reduct Vol, Reduced Vol, PCE Adj, MLF Adj, Final Volume.

Table with columns for Saturation Flow Module, Sat/Lane, Adjustment, Lanes, Final Sat.

Table with columns for Capacity Analysis Module, Vol/Sat, Crit Moves, Green/Cycle, Volume/Cap, Delay/Veh, User DelAdj, AdjDel/Veh, LOS by Move, HCM2kAvgQ.

Note: Queue reported is the number of cars per lane.

Continental Grand Campus Specific Plan
Phase 2 Opening Year (2023) Without Project PM Peak Hour (HCM)

Level of Service Computation Report
2000 HCM Operations Method (Future Volume Alternative)

Intersection #7 Sepulveda Blvd at Rosecrans Blvd

Cycle (sec): 100 Critical Vol./Cap.(X): 1.000
Loss Time (sec): 5 Average Delay (sec/veh): 42.3
Optimal Cycle: 180 Level Of Service: D

Street Name: Sepulveda Blvd Rosecrans Blvd
Approach: North Bound South Bound East Bound West Bound
Movement: L - T - R L - T - R L - T - R L - T - R
Control: Protected Protected Protected Protected
Rights: Ovl Include Include Ignore
Min. Green: 0 0 0 0 0 0 0 0 0 0 0 0
Y+R: 4.0 4.0 4.0 4.0 4.0 4.0 4.0 4.0 4.0 4.0 4.0 4.0
Lanes: 2 0 4 0 1 2 0 3 0 1 2 0 3 0 1 2 0 2 0 1

Volume Module:
Base Vol: 310 1257 302 494 2351 519 195 483 162 376 580 462
Growth Adj: 1.02 1.02 1.02 1.02 1.02 1.02 1.02 1.02 1.02 1.02 1.02 1.02
Initial Bse: 315 1277 307 502 2388 527 198 491 165 382 589 469
Added Vol: 0 61 0 0 87 0 0 0 0 0 0 0
Related Pro: 0 112 5 19 447 4 3 0 0 4 0 16
Initial Fut: 315 1450 312 521 2922 531 201 491 165 386 589 485
User Adj: 1.00 1.00 1.00 1.00 1.00 1.00 1.00 1.00 1.00 1.00 1.00 0.00
PHF Adj: 0.92 0.92 0.92 0.92 0.92 0.92 0.92 0.92 0.92 0.92 0.92 0.00
PHF Volume: 342 1576 339 566 3176 577 219 533 179 420 640 0
Reduct Vol: 0 0 0 0 0 0 0 0 0 0 0 0
Reduced Vol: 342 1576 339 566 3176 577 219 533 179 420 640 0
PCE Adj: 1.00 1.00 1.00 1.00 1.00 1.00 1.00 1.00 1.00 1.00 1.00 0.00
MLF Adj: 1.00 1.00 1.00 1.00 1.00 1.00 1.00 1.00 1.00 1.00 1.00 0.00
FinalVolume: 342 1576 339 566 3176 577 219 533 179 420 640 0

Saturation Flow Module:
Sat/Lane: 1900 1900 1900 1900 1900 1900 1900 1900 1900 1900 1900 1900
Adjustment: 0.92 0.91 0.85 0.92 0.91 0.85 0.92 0.91 0.85 0.92 0.95 1.00
Lanes: 2.00 4.00 1.00 2.00 3.00 1.00 2.00 3.00 1.00 2.00 2.00 1.00
Final Sat.: 3502 6916 1615 3502 5187 1615 3502 5187 1615 3502 3610 1900

Capacity Analysis Module:
Vol/Sat: 0.10 0.23 0.21 0.16 0.61 0.36 0.06 0.10 0.11 0.12 0.18 0.00
Crit Moves: ****
Green/Cycle: 0.10 0.42 0.54 0.29 0.61 0.61 0.06 0.12 0.12 0.12 0.18 0.00
Volume/Cap: 1.00 0.55 0.39 0.55 1.00 0.58 1.00 0.89 0.96 0.96 1.00 0.00
Delay/Veh: 93.7 22.4 13.7 30.3 35.3 12.6 107.7 59.3 98.6 76.7 76.7 0.0
User DelAdj: 1.00 1.00 1.00 1.00 1.00 1.00 1.00 1.00 1.00 1.00 1.00 1.00
AdjDel/Veh: 93.7 22.4 13.7 30.3 35.3 12.6 107.7 59.3 98.6 76.7 76.7 0.0
LOS by Move: F C B C D B F E F E E A
HCM2kAvgQ: 10 10 6 8 44 11 7 9 9 11 16 0

Note: Queue reported is the number of cars per lane.

Continental Grand Campus Specific Plan
Phase 2 Opening Year (2023) Without Project PM Peak Hour (HCM)

Level of Service Computation Report
2000 HCM Operations Method (Future Volume Alternative)

Intersection #8 Continental Boulevard at Mariposa Ave

Cycle (sec): 100 Critical Vol./Cap.(X): 0.288
Loss Time (sec): 5 Average Delay (sec/veh): 16.3
Optimal Cycle: 18 Level Of Service: B

Street Name: Continental Boulevard Mariposa Avenue
Approach: North Bound South Bound East Bound West Bound
Movement: L - T - R L - T - R L - T - R L - T - R
Control: Permitted Permitted Permitted Permitted
Rights: Include Include Include Include
Min. Green: 0 0 0 0 0 0 0 0 0 0 0 0
Y+R: 4.0 4.0 4.0 4.0 4.0 4.0 4.0 4.0 4.0 4.0 4.0 4.0
Lanes: 1 0 1 0 2 1 0 0 1 0 1 0 2 1 0 1 0 1 1 0

Volume Module:
Base Vol: 176 85 306 9 56 28 11 514 49 58 342 10
Growth Adj: 1.02 1.02 1.02 1.02 1.02 1.02 1.02 1.02 1.02 1.02 1.02 1.02
Initial Bse: 179 86 311 9 57 28 11 522 50 59 347 10
Added Vol: 0 0 2 3 0 0 0 0 37 0 2 63 6
Related Pro: 0 0 0 0 0 0 0 0 -45 0 0 -10 0
Initial Fut: 179 86 313 12 57 28 11 514 50 61 400 16
User Adj: 1.00 1.00 1.00 1.00 1.00 1.00 1.00 1.00 1.00 1.00 1.00 1.00
PHF Adj: 0.92 0.92 0.92 0.92 0.92 0.92 0.92 0.92 0.92 0.92 0.92 0.00
PHF Volume: 194 94 340 13 62 31 12 559 54 66 435 18
Reduct Vol: 0 0 0 0 0 0 0 0 0 0 0 0
Reduced Vol: 194 94 340 13 62 31 12 559 54 66 435 18
PCE Adj: 1.00 1.00 1.00 1.00 1.00 1.00 1.00 1.00 1.00 1.00 1.00 1.00
MLF Adj: 1.00 1.00 1.00 1.00 1.00 1.00 1.00 1.00 1.00 1.00 1.00 1.00
FinalVolume: 194 94 340 13 62 31 12 559 54 66 435 18

Saturation Flow Module:
Sat/Lane: 1900 1900 1900 1900 1900 1900 1900 1900 1900 1900 1900 1900
Adjustment: 0.69 1.00 0.75 0.69 0.95 0.95 0.41 0.90 0.90 0.37 0.94 0.94
Lanes: 1.00 1.00 2.00 1.00 0.67 0.33 1.00 2.74 0.26 1.00 1.92 0.08
Final Sat.: 1317 1900 2842 1313 1203 602 771 4668 452 695 3449 139

Capacity Analysis Module:
Vol/Sat: 0.15 0.05 0.12 0.01 0.05 0.05 0.02 0.12 0.12 0.10 0.13 0.13
Crit Moves: ****
Green/Cycle: 0.51 0.51 0.51 0.51 0.51 0.51 0.44 0.44 0.44 0.44 0.44 0.44
Volume/Cap: 0.29 0.10 0.23 0.02 0.10 0.10 0.04 0.27 0.27 0.22 0.29 0.29
Delay/Veh: 14.2 12.6 13.6 12.0 12.6 12.6 16.1 18.0 18.0 17.8 18.2 18.2
User DelAdj: 1.00 1.00 1.00 1.00 1.00 1.00 1.00 1.00 1.00 1.00 1.00 1.00
AdjDel/Veh: 14.2 12.6 13.6 12.0 12.6 12.6 16.1 18.0 18.0 17.8 18.2 18.2
LOS by Move: B B B B B B B B B B B B
HCM2kAvgQ: 3 1 3 0 1 1 0 4 4 1 5 5

Note: Queue reported is the number of cars per lane.

Continental Grand Campus Specific Plan
Phase 2 Opening Year (2023) Without Project PM Peak Hour (HCM)

Level of Service Computation Report
2000 HCM Operations Method (Future Volume Alternative)

Intersection #9 Continental Boulevard at Grand Avenue

Cycle (sec): 100 Critical Vol./Cap.(X): 0.290
Loss Time (sec): 5 Average Delay (sec/veh): 18.4
Optimal Cycle: 18 Level Of Service: B

Table with columns: Street Name, Approach, Movement, Control, Rights, Min. Green, Y+R, Lanes. Rows for North and South Bound movements.

Table with columns: Volume Module, Base Vol, Growth Adj, Initial Bse, Added Vol, Related Pro, Initial Fut, User Adj, PHF Adj, PHF Volume, Reduct Vol, Reduced Vol, PCE Adj, MLF Adj, Final Volume.

Table with columns: Saturation Flow Module, Sat/Lane, Adjustment, Lanes, Final Sat.

Table with columns: Capacity Analysis Module, Vol/Sat, Crit Moves, Green/Cycle, Volume/Cap, Delay/Veh, User DelAdj, AdjDel/Veh, LOS by Move, HCM2kAvgQ.

Note: Queue reported is the number of cars per lane.

Continental Grand Campus Specific Plan
Phase 2 Opening Year (2023) Without Project PM Peak Hour (HCM)

Level of Service Computation Report
2000 HCM Operations Method (Future Volume Alternative)

Intersection #10 Continental Boulevard at El Segundo Boulevard

Cycle (sec): 100 Critical Vol./Cap.(X): 0.637
Loss Time (sec): 5 Average Delay (sec/veh): 28.2
Optimal Cycle: 33 Level Of Service: C

Table with columns: Street Name, Approach, Movement, Control, Rights, Min. Green, Y+R, Lanes. Rows for North and South Bound movements.

Table with columns: Volume Module, Base Vol, Growth Adj, Initial Bse, Added Vol, Related Pro, Initial Fut, User Adj, PHF Adj, PHF Volume, Reduct Vol, Reduced Vol, PCE Adj, MLF Adj, Final Volume.

Table with columns: Saturation Flow Module, Sat/Lane, Adjustment, Lanes, Final Sat.

Table with columns: Capacity Analysis Module, Vol/Sat, Crit Moves, Green/Cycle, Volume/Cap, Delay/Veh, User DelAdj, AdjDel/Veh, LOS by Move, HCM2kAvgQ.

Note: Queue reported is the number of cars per lane.

Continental Grand Campus Specific Plan
Phase 2 Opening Year (2023) Without Project PM Peak Hour (HCM)

Level of Service Computation Report
2000 HCM Operations Method (Future Volume Alternative)

Intersection #11 Nash St and Imperial Hwy
Cycle (sec): 100 Critical Vol./Cap.(X): 0.520
Loss Time (sec): 5 Average Delay (sec/veh): 22.2
Optimal Cycle: 26 Level Of Service: C

Table with columns for Street Name (Nash St, Imperial Hwy), Approach (North Bound, South Bound, East Bound, West Bound), Movement (L, T, R), Control, Rights, Min. Green, Y+R, and Lanes.

Table for Volume Module showing Base Vol, Growth Adj, Initial Bse, Added Vol, Related Pro, Initial Fut, User Adj, PHF Adj, PHF Volume, Reduct Vol, Reduced Vol, PCE Adj, MLF Adj, and Final Volume.

Table for Saturation Flow Module showing Sat/Lane, Adjustment, Lanes, and Final Sat.

Table for Capacity Analysis Module showing Vol/Sat, Crit Moves, Green/Cycle, Volume/Cap, Delay/Veh, User DelAdj, AdjDel/Veh, LOS by Move, and HCM2kAvgQ.

Note: Queue reported is the number of cars per lane.

Continental Grand Campus Specific Plan
Phase 2 Opening Year (2023) Without Project PM Peak Hour (HCM)

Level of Service Computation Report
2000 HCM Operations Method (Future Volume Alternative)

Intersection #12 Nash St at Mariposa Ave
Cycle (sec): 100 Critical Vol./Cap.(X): 0.683
Loss Time (sec): 5 Average Delay (sec/veh): 19.3
Optimal Cycle: 37 Level Of Service: B

Table with columns for Street Name (Nash St, Mariposa Ave), Approach (North Bound, South Bound, East Bound, West Bound), Movement (L, T, R), Control, Rights, Min. Green, Y+R, and Lanes.

Table for Volume Module showing Base Vol, Growth Adj, Initial Bse, Added Vol, Related Pro, Initial Fut, User Adj, PHF Adj, PHF Volume, Reduct Vol, Reduced Vol, PCE Adj, MLF Adj, and Final Volume.

Table for Saturation Flow Module showing Sat/Lane, Adjustment, Lanes, and Final Sat.

Table for Capacity Analysis Module showing Vol/Sat, Crit Moves, Green/Cycle, Volume/Cap, Delay/Veh, User DelAdj, AdjDel/Veh, LOS by Move, and HCM2kAvgQ.

Note: Queue reported is the number of cars per lane.

Continental Grand Campus Specific Plan
Phase 2 Opening Year (2023) Without Project PM Peak Hour (HCM)

Level of Service Computation Report
2000 HCM Operations Method (Future Volume Alternative)

Intersection #13 Nash St at Grand Ave

Cycle (sec): 100 Critical Vol./Cap.(X): 0.573
Loss Time (sec): 5 Average Delay (sec/veh): 25.3
Optimal Cycle: 29 Level Of Service: C

Table with columns: Street Name, Approach, Movement, Control, Rights, Min. Green, Y+R, Lanes. Rows for Nash St and Grand Ave.

Table with columns: Volume Module, Base Vol, Growth Adj, Initial Bse, Added Vol, Related Pro, Initial Fut, User Adj, PHF Adj, PHF Volume, Reduct Vol, Reduced Vol, PCE Adj, MLF Adj, Final Volume.

Table with columns: Sat/Lane, Adjustment, Lanes, Final Sat. for Saturation Flow Module.

Table with columns: Vol/Sat, Crit Moves, Green/Cycle, Volume/Cap, Delay/Veh, User DelAdj, AdjDel/Veh, LOS by Move, HCM2kAvgQ for Capacity Analysis Module.

Note: Queue reported is the number of cars per lane.

Continental Grand Campus Specific Plan
Phase 2 Opening Year (2023) Without Project PM Peak Hour (HCM)

Level of Service Computation Report
2000 HCM Operations Method (Future Volume Alternative)

Intersection #14 Nash St at El Segundo Blvd

Cycle (sec): 100 Critical Vol./Cap.(X): 1.059
Loss Time (sec): 5 Average Delay (sec/veh): 55.6
Optimal Cycle: 180 Level Of Service: E

Table with columns: Street Name, Approach, Movement, Control, Rights, Min. Green, Y+R, Lanes. Rows for Nash St and El Segundo Blvd.

Table with columns: Volume Module, Base Vol, Growth Adj, Initial Bse, Added Vol, Related Pro, Initial Fut, User Adj, PHF Adj, PHF Volume, Reduct Vol, Reduced Vol, PCE Adj, MLF Adj, Final Volume.

Table with columns: Sat/Lane, Adjustment, Lanes, Final Sat. for Saturation Flow Module.

Table with columns: Vol/Sat, Crit Moves, Green/Cycle, Volume/Cap, Delay/Veh, User DelAdj, AdjDel/Veh, LOS by Move, HCM2kAvgQ for Capacity Analysis Module.

Note: Queue reported is the number of cars per lane.

Continental Grand Campus Specific Plan
Phase 2 Opening Year (2023) Without Project PM Peak Hour (HCM)

Level of Service Computation Report
2000 HCM Operations Method (Future Volume Alternative)

Intersection #15 Douglas Street at El Segundo Boulevard

Cycle (sec): 100 Critical Vol./Cap.(X): 1.193
Loss Time (sec): 5 Average Delay (sec/veh): 93.4
Optimal Cycle: 180 Level Of Service: F

Table with columns for Street Name, Approach, Movement, Control, Rights, Min. Green, Y+R, Lanes. Rows for Douglas St and El Segundo Blvd.

Table with columns for Volume Module, Base Vol, Growth Adj, Initial Bse, Added Vol, Related Pro, Initial Fut, User Adj, PHF Adj, PHF Volume, Reduct Vol, Reduced Vol, PCE Adj, MLF Adj, Final Volume.

Table with columns for Saturation Flow Module, Sat/Lane, Adjustment, Lanes, Final Sat.

Table with columns for Capacity Analysis Module, Vol/Sat, Crit Moves, Green/Cycle, Volume/Cap, Delay/Veh, User DelAdj, AdjDel/Veh, LOS by Move, HCM2kAvgQ.

Note: Queue reported is the number of cars per lane.

Continental Grand Campus Specific Plan
Phase 2 Opening Year (2023) Without Project PM Peak Hour (HCM)

Level of Service Computation Report
2000 HCM Operations Method (Future Volume Alternative)

Intersection #16 Aviation Boulevard at El Segundo Boulevard

Cycle (sec): 100 Critical Vol./Cap.(X): 1.180
Loss Time (sec): 5 Average Delay (sec/veh): 90.9
Optimal Cycle: 180 Level Of Service: F

Table with columns for Street Name, Approach, Movement, Control, Rights, Min. Green, Y+R, Lanes. Rows for Aviation Blvd and El Segundo Blvd.

Table with columns for Volume Module, Base Vol, Growth Adj, Initial Bse, Added Vol, Related Pro, Initial Fut, User Adj, PHF Adj, PHF Volume, Reduct Vol, Reduced Vol, PCE Adj, MLF Adj, Final Volume.

Table with columns for Saturation Flow Module, Sat/Lane, Adjustment, Lanes, Final Sat.

Table with columns for Capacity Analysis Module, Vol/Sat, Crit Moves, Green/Cycle, Volume/Cap, Delay/Veh, User DelAdj, AdjDel/Veh, LOS by Move, HCM2kAvgQ.

Note: Queue reported is the number of cars per lane.

Continental Grand Campus Specific Plan
Phase 2 Opening Year (2023) Without Project PM Peak Hour (HCM)

Level of Service Computation Report

ICU 1(Loss as Cycle Length %) Method (Future Volume Alternative)

Intersection #17 El Segundo Boulevard and Isis Avenue

Cycle (sec): 100 Critical Vol./Cap.(X): 0.850
Loss Time (sec): 5 Average Delay (sec/veh): xxxxxx
Optimal Cycle: 65 Level Of Service: D

Street Name: Isis Avenue El Segundo Boulevard
Approach: North Bound South Bound East Bound West Bound
Movement: L - T - R L - T - R L - T - R L - T - R

Control: Permitted Permitted Protected Protected
Rights: Include Include Include Include
Min. Green: 0 0 0 0 0 0 0 0 0 0 0 0
Y+R: 4.0 4.0 4.0 4.0 4.0 4.0 4.0 4.0 4.0 4.0 4.0
Lanes: 0 0 1 0 0 0 0 1 0 4 0 1 1 0 2 1 0

Volume Module:
Base Vol: 35 6 27 138 11 57 74 2405 45 89 1099 77
Growth Adj: 1.02 1.02 1.02 1.02 1.02 1.02 1.02 1.02 1.02 1.02 1.02 1.02
Initial Bse: 36 6 27 140 11 58 75 2443 46 90 1116 78
Added Vol: 0 0 0 0 0 0 0 0 0 0 0 0
Related Pro: 0 0 0 0 0 0 0 0 925 0 0 292 0
Initial Fut: 36 6 27 140 11 58 75 3368 46 90 1408 78
User Adj: 1.00 1.00 1.00 1.00 1.00 1.00 1.00 1.00 1.00 1.00 1.00 1.00
PHF Adj: 0.92 0.92 0.92 0.92 0.92 0.92 0.92 0.92 0.92 0.92 0.92 0.92
PHF Volume: 39 7 30 152 12 63 82 3661 50 98 1531 85
Reduct Vol: 0 0 0 0 0 0 0 0 0 0 0 0
Reduced Vol: 39 7 30 152 12 63 82 3661 50 98 1531 85
PCE Adj: 1.00 1.00 1.00 1.00 1.00 1.00 1.00 1.00 1.00 1.00 1.00 1.00
MLF Adj: 1.00 1.00 1.00 1.00 1.00 1.00 1.00 1.00 1.00 1.00 1.00 1.00
FinalVolume: 39 7 30 152 12 63 82 3661 50 98 1531 85

Saturation Flow Module:
Sat/Lane: 1600 1600 1600 1600 1600 1600 1600 1600 1600 1600 1600 1600
Adjustment: 1.00 1.00 1.00 1.00 1.00 1.00 1.00 1.00 1.00 1.00 1.00 1.00
Lanes: 0.51 0.09 0.40 0.67 0.05 0.28 1.00 4.00 1.00 1.00 2.84 0.16
Final Sat.: 824 141 635 1072 85 443 1600 6400 1600 1600 4547 253

Capacity Analysis Module:
Vol/Sat: 0.02 0.05 0.05 0.10 0.14 0.14 0.05 0.57 0.03 0.06 0.34 0.34
Crit Moves: ****

Green/Cycle: 0.21 0.00 0.21 0.00 0.00 0.00 0.00 0.74 0.74 0.00 0.74 0.00
Volume/Cap: 0.68 0.00 1.41 0.00 0.00 0.00 0.00 0.55 1.41 0.00 0.39 0.00
Delay/Veh: 38.7 0.0 237.4 0.0 0.0 0.0 0.0 5.9 201.5 0.0 4.8 0.0
User DelAdj: 1.00 1.00 1.00 1.00 1.00 1.00 1.00 1.00 1.00 1.00 1.00 1.00
AdjDel/Veh: 38.7 0.0 237.4 0.0 0.0 0.0 0.0 5.9 201.5 0.0 4.8 0.0
LOS by Move: D A F A A A A A F A A A
HCM2kAvgQ: 7 0 31 0 0 0 0 10 109 0 6 0

Continental Grand Campus Specific Plan
Phase 2 Opening Year (2023) Without Project PM Peak Hour (HCM)

Level of Service Computation Report

2000 HCM Operations Method (Future Volume Alternative)

Intersection #18 El Segundo Blvd at I-405 SB Ramps

Cycle (sec): 100 Critical Vol./Cap.(X): 1.408
Loss Time (sec): 5 Average Delay (sec/veh): 75.0
Optimal Cycle: 180 Level Of Service: E

Street Name: I-405 SB Ramps El Segundo Blvd
Approach: North Bound South Bound East Bound West Bound
Movement: L - T - R L - T - R L - T - R L - T - R

Control: Permitted Permitted Permitted Permitted
Rights: Include Include Include Include
Min. Green: 0 0 0 0 0 0 0 0 0 0 0 0
Y+R: 4.0 4.0 4.0 4.0 4.0 4.0 4.0 4.0 4.0 4.0 4.0
Lanes: 1 0 1 0 0 0 0 0 0 0 0 0 0 0 3 0 1 0 0 3 0 0

Volume Module:
Base Vol: 239 0 269 0 0 0 0 1491 1049 0 1062 0
Growth Adj: 1.02 1.02 1.02 1.02 1.02 1.02 1.02 1.02 1.02 1.02 1.02 1.02
Initial Bse: 243 0 273 0 0 0 0 1515 1066 0 1079 0
Added Vol: 0 0 0 0 0 0 0 0 0 0 0 0
Related Pro: 2 0 0 0 0 0 0 0 442 483 0 290 0
Initial Fut: 245 0 273 0 0 0 0 1957 1549 0 1369 0
User Adj: 1.00 1.00 1.00 1.00 1.00 1.00 1.00 1.00 1.00 1.00 1.00 1.00
PHF Adj: 0.92 0.92 0.92 0.92 0.92 0.92 0.92 0.92 0.92 0.92 0.92 0.92
PHF Volume: 266 0 297 0 0 0 0 2127 1683 0 1488 0
Reduct Vol: 0 0 0 0 0 0 0 0 0 0 0 0
Reduced Vol: 266 0 297 0 0 0 0 2127 1683 0 1488 0
PCE Adj: 1.00 1.00 1.00 1.00 1.00 1.00 1.00 1.00 1.00 1.00 1.00 1.00
MLF Adj: 1.00 1.00 1.00 1.00 1.00 1.00 1.00 1.00 1.00 1.00 1.00 1.00
FinalVolume: 266 0 297 0 0 0 0 2127 1683 0 1488 0

Saturation Flow Module:
Sat/Lane: 1900 1900 1900 1900 1900 1900 1900 1900 1900 1900 1900 1900
Adjustment: 0.75 1.00 0.78 1.00 1.00 1.00 1.00 0.91 0.85 1.00 0.91 1.00
Lanes: 1.32 0.00 0.68 0.00 0.00 0.00 0.00 3.00 1.00 0.00 3.00 0.00
Final Sat.: 1873 0 1007 0 0 0 0 5187 1615 0 5187 0

Capacity Analysis Module:
Vol/Sat: 0.14 0.00 0.30 0.00 0.00 0.00 0.00 0.41 1.04 0.00 0.29 0.00
Crit Moves: ****

Green/Cycle: 0.21 0.00 0.21 0.00 0.00 0.00 0.00 0.74 0.74 0.00 0.74 0.00
Volume/Cap: 0.68 0.00 1.41 0.00 0.00 0.00 0.00 0.55 1.41 0.00 0.39 0.00
Delay/Veh: 38.7 0.0 237.4 0.0 0.0 0.0 0.0 5.9 201.5 0.0 4.8 0.0
User DelAdj: 1.00 1.00 1.00 1.00 1.00 1.00 1.00 1.00 1.00 1.00 1.00 1.00
AdjDel/Veh: 38.7 0.0 237.4 0.0 0.0 0.0 0.0 5.9 201.5 0.0 4.8 0.0
LOS by Move: D A F A A A A A F A A A
HCM2kAvgQ: 7 0 31 0 0 0 0 10 109 0 6 0

Note: Queue reported is the number of cars per lane.

Continental Grand Campus Specific Plan
Phase 2 Opening Year (2023) Without Project PM Peak Hour (HCM)

Level of Service Computation Report

2000 HCM Operations Method (Future Volume Alternative)

Intersection #19 El Segundo Blvd at La Cienega Blvd

Cycle (sec): 100 Critical Vol./Cap.(X): 0.797
Loss Time (sec): 5 Average Delay (sec/veh): 21.6
Optimal Cycle: 54 Level Of Service: C

Street Name: La Cienega Blvd El Segundo Blvd
Approach: North Bound South Bound East Bound West Bound
Movement: L - T - R L - T - R L - T - R L - T - R

Control: Protected Protected Protected Protected
Rights: Include Include Include Include
Min. Green: 0 0 0 0 0 0 0 0 0 0 0 0
Y+R: 4.0 4.0 4.0 4.0 4.0 4.0 4.0 4.0 4.0 4.0 4.0
Lanes: 0 0 0 0 0 2 0 0 0 2 1 0 3 0 0 0 0 2 1 0

Volume Module:
Base Vol: 0 0 0 665 0 653 101 1849 0 0 614 206
Growth Adj: 1.02 1.02 1.02 1.02 1.02 1.02 1.02 1.02 1.02 1.02 1.02 1.02
Initial Bse: 0 0 0 676 0 663 103 1878 0 0 624 209
Added Vol: 0 0 0 0 0 0 0 0 0 0 0 0
Related Pro: 0 0 0 0 0 0 55 0 424 0 0 233 0
Initial Fut: 0 0 0 676 0 718 103 2302 0 0 857 209
User Adj: 1.00 1.00 1.00 1.00 1.00 1.00 1.00 1.00 1.00 1.00 1.00 1.00
PHF Adj: 0.92 0.92 0.92 0.92 0.92 0.92 0.92 0.92 0.92 0.92 0.92 0.92
PHF Volume: 0 0 0 734 0 781 112 2502 0 0 931 227
Reduct Vol: 0 0 0 0 0 0 0 0 0 0 0 0
Reduced Vol: 0 0 0 734 0 781 112 2502 0 0 931 227
PCE Adj: 1.00 1.00 1.00 1.00 1.00 1.00 1.00 1.00 1.00 1.00 1.00 1.00
MLF Adj: 1.00 1.00 1.00 1.00 1.00 1.00 1.00 1.00 1.00 1.00 1.00 1.00
FinalVolume: 0 0 0 734 0 781 112 2502 0 0 931 227

Saturation Flow Module:
Sat/Lane: 1900 1900 1900 1900 1900 1900 1900 1900 1900 1900 1900 1900
Adjustment: 1.00 1.00 1.00 0.92 1.00 0.75 0.95 0.91 1.00 1.00 0.88 0.88
Lanes: 0.00 0.00 0.00 2.00 0.00 2.00 1.00 3.00 0.00 0.00 2.41 0.59
Final Sat.: 0 0 0 3502 0 2842 1805 5187 0 0 4048 989

Capacity Analysis Module:
Vol/Sat: 0.00 0.00 0.00 0.21 0.00 0.27 0.06 0.48 0.00 0.00 0.23 0.23
Crit Moves: ****
Green/Cycle: 0.00 0.00 0.00 0.34 0.00 0.34 0.13 0.61 0.00 0.00 0.48 0.48
Volume/Cap: 0.00 0.00 0.00 0.61 0.00 0.80 0.48 0.80 0.00 0.00 0.48 0.48
Delay/Veh: 0.0 0.0 0.0 28.1 0.0 34.2 42.1 16.5 0.0 0.0 17.9 17.9
User DelAdj: 1.00 1.00 1.00 1.00 1.00 1.00 1.00 1.00 1.00 1.00 1.00 1.00
AdjDel/Veh: 0.0 0.0 0.0 28.1 0.0 34.2 42.1 16.5 0.0 0.0 17.9 17.9
LOS by Move: A A A C A C D B A A B B
HCM2kAvgQ: 0 0 0 10 0 14 3 22 0 0 9 9

Note: Queue reported is the number of cars per lane.

Continental Grand Campus Specific Plan
Phase 2 Opening Year (2023) Without Project PM Peak Hour (HCM)

Level of Service Computation Report

2000 HCM Operations Method (Future Volume Alternative)

Intersection #20 El Segundo Blvd at I-405 NB Ramps

Cycle (sec): 100 Critical Vol./Cap.(X): 0.719
Loss Time (sec): 5 Average Delay (sec/veh): 12.6
Optimal Cycle: 41 Level Of Service: B

Street Name: I-405 NB Ramps El Segundo Blvd
Approach: North Bound South Bound East Bound West Bound
Movement: L - T - R L - T - R L - T - R L - T - R

Control: Protected Protected Protected Protected
Rights: Include Include Ignore Include
Min. Green: 0 0 0 0 0 0 0 0 0 0 0 0
Y+R: 4.0 4.0 4.0 4.0 4.0 4.0 4.0 4.0 4.0 4.0 4.0 4.0
Lanes: 2 0 0 0 1 0 0 0 0 0 0 0 0 2 1 1 0 0 2 1 0

Volume Module:
Base Vol: 373 0 222 0 0 0 0 2365 176 0 447 410
Growth Adj: 1.02 1.02 1.02 1.02 1.02 1.02 1.02 1.02 1.02 1.02 1.02 1.02
Initial Bse: 379 0 226 0 0 0 0 2402 179 0 454 416
Added Vol: 0 0 0 0 0 0 0 0 0 0 0 0
Related Pro: 96 0 0 0 0 0 0 153 289 0 138 0
Initial Fut: 475 0 226 0 0 0 0 2555 468 0 592 416
User Adj: 1.00 1.00 1.00 1.00 1.00 1.00 1.00 1.00 0.00 1.00 1.00 1.00
PHF Adj: 0.92 0.92 0.92 0.92 0.92 0.92 0.92 0.92 0.92 0.92 0.92 0.92
PHF Volume: 516 0 245 0 0 0 0 2778 0 0 644 453
Reduct Vol: 0 0 0 0 0 0 0 0 0 0 0 0
Reduced Vol: 516 0 245 0 0 0 0 2778 0 0 644 453
PCE Adj: 1.00 1.00 1.00 1.00 1.00 1.00 1.00 1.00 0.00 1.00 1.00 1.00
MLF Adj: 1.00 1.00 1.00 1.00 1.00 1.00 1.00 1.00 0.00 1.00 1.00 1.00
FinalVolume: 516 0 245 0 0 0 0 2778 0 0 644 453

Saturation Flow Module:
Sat/Lane: 1900 1900 1900 1900 1900 1900 1900 1900 1900 1900 1900 1900
Adjustment: 0.92 1.00 0.85 1.00 1.00 1.00 1.00 0.91 0.91 1.00 0.85 0.85
Lanes: 2.00 0.00 1.00 0.00 0.00 0.00 0.00 3.00 1.00 0.00 2.00 1.00
Final Sat.: 3502 0 1615 0 0 0 0 5187 1729 0 3244 1622

Capacity Analysis Module:
Vol/Sat: 0.15 0.00 0.15 0.00 0.00 0.00 0.00 0.54 0.00 0.00 0.20 0.28
Crit Moves: ****
Green/Cycle: 0.21 0.00 0.21 0.00 0.00 0.00 0.00 0.74 0.00 0.00 0.74 0.74
Volume/Cap: 0.72 0.00 0.74 0.00 0.00 0.00 0.00 0.72 0.00 0.00 0.27 0.37
Delay/Veh: 40.6 0.0 45.8 0.0 0.0 0.0 0.0 7.7 0.0 0.0 4.1 4.6
User DelAdj: 1.00 1.00 1.00 1.00 1.00 1.00 1.00 1.00 1.00 1.00 1.00 1.00
AdjDel/Veh: 40.6 0.0 45.8 0.0 0.0 0.0 0.0 7.7 0.0 0.0 4.1 4.6
LOS by Move: D A D A A A A A A A A A
HCM2kAvgQ: 9 0 9 0 0 0 0 17 0 0 3 5

Note: Queue reported is the number of cars per lane.

 Continental Grand Campus Specific Plan
 Phase 2 Opening Year (2023) With Project AM Peak Hour (HCM)

Scenario Report

Scenario: Phase 2 Op Yr With Proj AM HCM
 Command: Phase 2 Op Yr With Proj AM HCM
 Volume: OY AM
 Geometry: Existing
 Impact Fee: Default Impact Fee
 Trip Generation: Cum + Phase 2 AM
 Trip Distribution: Cum + Proj
 Paths: Project
 Routes: Default Route
 Configuration: Phase 2 Op Yr With Proj AM HCM

 Continental Grand Campus Specific Plan
 Phase 2 Opening Year (2023) With Project AM Peak Hour (HCM)

Trip Generation Report

Forecast for Cum + Phase 2 AM

Zone #	Subzone	Amount	Units	Rate In	Rate Out	Trips In	Trips Out	Total Trips	% Of Total
306	525 N. Sepul	1.00	Residential	-6.00	-3.00	-6	-3	-9	-0.3
	Zone 306 Subtotal					-6	-3	-9	-0.3
307	540 Imperial	1.00	Residential	23.00	44.00	23	44	67	2.3
	Zone 307 Subtotal					23	44	67	2.3
311	199 Continen	1.00	Business Hotel	48.00	33.00	48	33	81	2.8
	Zone 311 Subtotal					48	33	81	2.8
313	445 N. Dougl	1.00	Equinix Data C	8.00	8.00	8	8	16	0.5
	Zone 313 Subtotal					8	8	16	0.5
314	123 Lomita a	1.00	Office	17.00	3.00	17	3	20	0.7
	Zone 314 Subtotal					17	3	20	0.7
704	2355 Utah Av	1.00	Office	150.00	76.00	150	76	226	7.8
	Zone 704 Subtotal					150	76	226	7.8
706	888 Sepulved	1.00	hotel	57.00	36.00	57	36	93	3.2
	Zone 706 Subtotal					57	36	93	3.2
710	201 North Do	1.00	High School	160.00	111.00	160	111	271	9.3
710	201 North Do	1.00	District Offic	20.00	2.00	20	2	22	0.8
	Zone 710 Subtotal					180	113	293	10.1
714	400 Duley -	1.00	Office	95.00	13.00	95	13	108	3.7
	Zone 714 Subtotal					95	13	108	3.7
717	1700 Imperia	1.00	Townhome Resid	133.00	18.00	133	18	151	5.2
	Zone 717 Subtotal					133	18	151	5.2
718	123 Nevada S	1.00	Office	18.00	3.00	18	3	21	0.7
	Zone 718 Subtotal					18	3	21	0.7
719	2125 Campus	1.00	Office Retail	160.00	46.00	160	46	206	7.1
	Zone 719 Subtotal					160	46	206	7.1
1002	Laker Facili	1.00	General Office	136.00	13.00	136	13	149	5.1
	Zone 1002 Subtotal					136	13	149	5.1
1004	1955 E Grand	1.00	Mattel	239.00	33.00	239	33	272	9.3
	Zone 1004 Subtotal					239	33	272	9.3
1005	Mattel	1.00	Mattel	431.00	43.00	431	43	474	16.3

Continental Grand Campus Specific Plan
Phase 2 Opening Year (2023) With Project AM Peak Hour (HCM)

Zone #	Subzone	Amount	Units	Rate In	Rate Out	Trips In	Trips Out	Total Trips	% Of Total
	Zone 1005 Subtotal					431	43	474	16.3
1007	Mattel Proje	1.00	project	670.00	76.00	670	76	746	25.6
	Zone 1007 Subtotal					670	76	746	25.6
TOTAL						2359	555	2914	100.0

Continental Grand Campus Specific Plan
Phase 2 Opening Year (2023) With Project AM Peak Hour (HCM)

Trip Distribution Report

Percent Of Trips Cum + Project

Zone	To Gates											
	1	2	3	4	5	7	8	9	10	11	12	
306	10.0	15.0	10.0	5.0	0.0	5.0	5.0	25.0	0.0	25.0	0.0	
307	10.0	15.0	10.0	5.0	50.0	0.0	0.0	0.0	0.0	0.0	0.0	
311	40.0	10.0	10.0	10.0	0.0	5.0	5.0	10.0	0.0	10.0	0.0	
313	15.0	5.0	15.0	10.0	25.0	0.0	5.0	20.0	0.0	0.0	0.0	
314	40.0	10.0	10.0	10.0	0.0	5.0	5.0	10.0	0.0	10.0	0.0	
704	30.0	15.0	8.0	12.0	0.0	5.0	5.0	10.0	5.0	10.0	0.0	
706	25.0	20.0	10.0	25.0	0.0	0.0	0.0	0.0	0.0	0.0	10.0	
710	0.0	0.0	15.0	10.0	10.0	2.0	2.0	20.0	5.0	10.0	1.0	
714	5.0	10.0	5.0	5.0	20.0	5.0	10.0	15.0	5.0	15.0	0.0	
717	10.0	15.0	10.0	5.0	50.0	0.0	0.0	0.0	0.0	0.0	0.0	
718	10.0	10.0	10.0	10.0	20.0	0.0	0.0	20.0	10.0	0.0	0.0	
719	20.0	10.0	10.0	10.0	10.0	5.0	5.0	10.0	5.0	0.0	0.0	
1002	0.0	10.0	5.0	5.0	15.0	5.0	10.0	15.0	5.0	15.0	5.0	
1004	5.0	15.0	10.0	5.0	30.0	0.0	5.0	20.0	0.0	0.0	5.0	
1005	5.0	15.0	10.0	5.0	30.0	0.0	5.0	20.0	0.0	0.0	5.0	
1007	0.0	0.0	0.0	0.0	0.0	0.0	0.0	0.0	0.0	0.0	0.0	

Zone	To Gates						
	13	14	15	16	17	18	20
306	0.0	0.0	0.0	0.0	0.0	0.0	0.0
307	0.0	10.0	0.0	0.0	0.0	0.0	0.0
311	0.0	0.0	0.0	0.0	0.0	0.0	0.0
313	5.0	0.0	0.0	0.0	0.0	0.0	0.0
314	0.0	0.0	0.0	0.0	0.0	0.0	0.0
704	0.0	0.0	0.0	0.0	0.0	0.0	0.0
706	0.0	0.0	0.0	0.0	10.0	0.0	0.0
710	10.0	5.0	10.0	0.0	0.0	0.0	0.0
714	0.0	5.0	0.0	0.0	0.0	0.0	0.0
717	0.0	10.0	0.0	0.0	0.0	0.0	0.0
718	0.0	10.0	0.0	0.0	0.0	0.0	0.0
719	0.0	10.0	5.0	0.0	0.0	0.0	0.0
1002	0.0	5.0	5.0	0.0	0.0	0.0	0.0
1004	0.0	5.0	0.0	0.0	0.0	0.0	0.0
1005	0.0	5.0	0.0	0.0	0.0	0.0	0.0
1007	0.0	0.0	0.0	0.0	0.0	20.0	10.0

Continental Grand Campus Specific Plan
Phase 2 Opening Year (2023) With Project AM Peak Hour (HCM)

Impact Analysis Report
Level Of Service

Intersection	Base	Future	Change	Del/ V/		Del/ V/		in
				LOS	Veh	LOS	Veh	
# 1 Sepulveda Blvd at Imperial Hwy	C 30.0 0.831	C 30.2 0.899	+ 0.153 D/V					
# 2 Sepulveda Blvd at Walnut St	A 7.8 0.557	A 9.1 0.744	+ 1.262 D/V					
# 3 Sepulveda Blvd at Maple Ave	B 10.6 0.544	B 15.4 0.695	+ 4.751 D/V					
# 4 Sepulveda Blvd at Mariposa Ave	B 18.4 0.618	C 21.4 0.752	+ 2.986 D/V					
# 5 Sepulveda Blvd at Grand Ave	C 22.5 0.754	C 24.3 0.885	+ 1.860 D/V					
# 6 Sepulveda Blvd at El Segundo B	C 26.5 0.777	E 69.9 1.121	+43.386 D/V					
# 7 Sepulveda Blvd at Rosecrans Bl	C 27.5 0.801	C 34.9 0.941	+ 7.393 D/V					
# 8 Continental Boulevard at Marip	A 9.8 0.354	B 10.6 0.620	+ 0.851 D/V					
# 9 Continental Boulevard at Grand	C 23.5 0.256	C 24.7 0.497	+ 1.146 D/V					
# 10 Continental Boulevard at El Se	A 9.1 0.382	B 15.5 0.553	+ 6.495 D/V					
# 11 Nash St and Imperial Hwy	C 24.1 0.629	C 26.9 0.843	+ 2.819 D/V					
# 12 Nash St at Mariposa Ave	B 15.0 0.384	B 15.6 0.651	+ 0.624 D/V					
# 13 Nash St at Grand Ave	C 23.7 0.471	C 20.9 0.564	-2.883 D/V					
# 14 Nash St at El Segundo Blvd	B 12.5 0.446	C 23.3 0.730	+10.868 D/V					
# 15 Douglas Street at El Segundo B	C 27.9 0.713	D 46.4 1.028	+18.491 D/V					
# 16 Aviation Boulevard at El Segun	C 31.4 0.820	F 103.7 1.226	+72.245 D/V					
# 17 El Segundo Boulevard and Isis	B xxxxxx 0.632	E xxxxxx 0.940	+ 0.308 V/C					
# 18 El Segundo Blvd at I-405 SB Ra	B 17.8 0.613	B 19.2 0.914	+ 1.420 D/V					
# 19 El Segundo Blvd at La Cienega	B 14.7 0.598	C 27.7 0.948	+12.978 D/V					
# 20 El Segundo Blvd at I-405 NB Ra	B 17.9 0.722	C 33.0 0.954	+15.075 D/V					

Continental Grand Campus Specific Plan
Phase 2 Opening Year (2023) With Project AM Peak Hour (HCM)

Level Of Service Computation Report
2000 HCM Operations Method (Future Volume Alternative)

Intersection #1 Sepulveda Blvd at Imperial Hwy

Cycle (sec):	100	Critical Vol./Cap.(X):	0.899
Loss Time (sec):	5	Average Delay (sec/veh):	30.2
Optimal Cycle:	89	Level Of Service:	C

Street Name:	Sepulveda Blvd			Imperial Hwy		
	North Bound		South Bound	East Bound		West Bound
Approach:	L	T	R	L	T	R
Movement:	L	T	R	L	T	R
Control:	Protected		Protected	Protected		Protected
Rights:	Include		Include	Include		Ovl
Min. Green:	0	0	0	0	0	0
Y+R:	4.0	4.0	4.0	4.0	4.0	4.0
Lanes:	1	0	3	0	1	2
	0	1	0	2	0	3
	0	1	0	2	0	3
	0	1	0	2	0	3

Volume Module:

Base Vol:	63	1495	418	448	2297	12	210	316	140	211	292	590
Growth Adj:	1.02	1.02	1.02	1.02	1.02	1.02	1.02	1.02	1.02	1.02	1.02	1.02
Initial Bse:	64	1523	426	456	2339	12	214	322	143	215	297	601
Added Vol:	21	52	24	23	218	2	4	31	89	15	3	12
Related Pro:	9	130	38	-85	615	0	-5	25	30	6	5	-90
Initial Fut:	94	1705	488	394	3172	14	213	378	262	236	305	523
User Adj:	1.00	1.00	1.00	1.00	1.00	1.00	1.00	1.00	1.00	1.00	1.00	1.00
PHF Adj:	0.92	0.92	0.92	0.92	0.92	0.92	0.92	0.92	0.92	0.92	0.92	0.92
PHF Volume:	102	1853	530	429	3448	15	231	411	284	256	332	568
Reduct Vol:	0	0	0	0	0	0	0	0	0	0	0	0
Reduced Vol:	102	1853	530	429	3448	15	231	411	284	256	332	568
PCE Adj:	1.00	1.00	1.00	1.00	1.00	1.00	1.00	1.00	1.00	1.00	1.00	1.00
MLF Adj:	1.00	1.00	1.00	1.00	1.00	1.00	1.00	1.00	1.00	1.00	1.00	1.00
FinalVolume:	102	1853	530	429	3448	15	231	411	284	256	332	568

Saturation Flow Module:

Sat/Lane:	1900	1900	1900	1900	1900	1900	1900	1900	1900	1900	1900	1900
Adjustment:	0.95	0.91	0.85	0.92	0.91	0.91	0.92	0.91	0.85	0.92	0.91	0.85
Lanes:	1.00	3.00	1.00	2.00	3.98	0.02	2.00	3.00	1.00	2.00	3.00	1.00
Final Sat.:	1805	5187	1615	3502	6878	31	3502	5187	1615	3502	5187	1615

Capacity Analysis Module:

Vol/Sat:	0.06	0.36	0.33	0.12	0.50	0.50	0.07	0.08	0.18	0.07	0.06	0.35
Crit Moves:	****			****			****					****
Green/Cycle:	0.06	0.46	0.46	0.16	0.56	0.56	0.07	0.23	0.23	0.10	0.26	0.41
Volume/Cap:	0.90	0.77	0.71	0.77	0.90	0.90	0.90	0.34	0.76	0.76	0.25	0.85
Delay/Veh:	100.3	24.1	24.7	47.0	22.8	22.8	76.9	32.2	44.4	53.5	29.7	36.6
User DelAdj:	1.00	1.00	1.00	1.00	1.00	1.00	1.00	1.00	1.00	1.00	1.00	1.00
AdjDel/Veh:	100.3	24.1	24.7	47.0	22.8	22.8	76.9	32.2	44.4	53.5	29.7	36.6
LOS by Move:	F	C	C	D	C	C	E	C	D	D	C	D
HCM2kAvgQ:	4	18	13	8	30	30	4	4	8	4	3	17

Note: Queue reported is the number of cars per lane.

Continental Grand Campus Specific Plan
Phase 2 Opening Year (2023) With Project AM Peak Hour (HCM)

Level of Service Computation Report

2000 HCM Operations Method (Future Volume Alternative)

Intersection #2 Sepulveda Blvd at Walnut St

Cycle (sec): 100 Critical Vol./Cap.(X): 0.744
Loss Time (sec): 5 Average Delay (sec/veh): 9.1
Optimal Cycle: 44 Level Of Service: A

Street Name: Sepulveda Blvd Walnut St

Approach: North Bound South Bound East Bound West Bound
Movement: L - T - R L - T - R L - T - R L - T - R

Control: Protected Protected Permitted Permitted
Rights: Include Include Include Include
Min. Green: 0 0 0 0 0 0 0 0 0 0 0 0
Y+R: 4.0 4.0 4.0 4.0 4.0 4.0 4.0 4.0 4.0 4.0 4.0
Lanes: 1 0 3 1 0 1 0 3 1 0 0 1 0 0 1

Volume Module:

Base Vol: 86 1938 58 62 2372 175 65 19 28 8 11 17
Growth Adj: 1.02 1.02 1.02 1.02 1.02 1.02 1.02 1.02 1.02 1.02 1.02 1.02
Initial Bse: 88 1974 59 63 2416 178 66 19 29 8 11 17
Added Vol: 11 80 11 6 216 100 14 0 0 7 0 4
Related Pro: 7 163 0 0 650 0 0 0 28 0 0 0
Initial Fut: 106 2217 70 69 3282 278 80 19 57 15 11 21
User Adj: 1.00 1.00 1.00 1.00 1.00 1.00 1.00 1.00 1.00 1.00 1.00 1.00
PHF Adj: 0.92 0.92 0.92 0.92 0.92 0.92 0.92 0.92 0.92 0.92 0.92 0.92
PHF Volume: 115 2409 76 75 3567 302 87 21 61 16 12 23
Reduct Vol: 0 0 0 0 0 0 0 0 0 0 0 0
Reduced Vol: 115 2409 76 75 3567 302 87 21 61 16 12 23
PCE Adj: 1.00 1.00 1.00 1.00 1.00 1.00 1.00 1.00 1.00 1.00 1.00 1.00
MLF Adj: 1.00 1.00 1.00 1.00 1.00 1.00 1.00 1.00 1.00 1.00 1.00 1.00
FinalVolume: 115 2409 76 75 3567 302 87 21 61 16 12 23

Saturation Flow Module:

Sat/Lane: 1900 1900 1900 1900 1900 1900 1900 1900 1900 1900 1900
Adjustment: 0.95 0.91 0.91 0.95 0.90 0.90 0.74 0.74 0.85 0.77 0.77 0.85
Lanes: 1.00 3.74 0.26 1.00 3.95 0.31 0.81 0.19 1.00 0.57 0.43 1.00
Final Sat.: 1805 6671 211 1805 6299 534 1127 272 1615 842 623 1615

Capacity Analysis Module:

Vol/Sat: 0.06 0.36 0.36 0.04 0.57 0.57 0.08 0.08 0.04 0.02 0.02 0.01
Crit Moves: ****
Green/Cycle: 0.09 0.76 0.76 0.09 0.76 0.76 0.10 0.10 0.10 0.10 0.10 0.10
Volume/Cap: 0.74 0.48 0.48 0.48 0.74 0.74 0.74 0.74 0.37 0.19 0.19 0.14
Delay/Veh: 62.4 4.6 4.6 45.7 7.2 7.2 62.2 62.2 43.1 41.5 41.5 41.1
User DelAdj: 1.00 1.00 1.00 1.00 1.00 1.00 1.00 1.00 1.00 1.00 1.00 1.00
AdjDel/Veh: 62.4 4.6 4.6 45.7 7.2 7.2 62.2 62.2 43.1 41.5 41.5 41.1
LOS by Move: E A A D A A E E D D D D
HCM2kAvgQ: 5 8 8 2 17 17 5 5 2 1 1 1

Note: Queue reported is the number of cars per lane.

Continental Grand Campus Specific Plan
Phase 2 Opening Year (2023) With Project AM Peak Hour (HCM)

Level of Service Computation Report

2000 HCM Operations Method (Future Volume Alternative)

Intersection #3 Sepulveda Blvd at Maple Ave

Cycle (sec): 100 Critical Vol./Cap.(X): 0.695
Loss Time (sec): 5 Average Delay (sec/veh): 15.4
Optimal Cycle: 38 Level Of Service: B

Street Name: Sepulveda Blvd Maple Ave

Approach: North Bound South Bound East Bound West Bound
Movement: L - T - R L - T - R L - T - R L - T - R

Control: Protected Protected Permitted Permitted
Rights: Include Include Include Include
Min. Green: 0 0 0 0 0 0 0 0 0 0 0 0
Y+R: 4.0 4.0 4.0 4.0 4.0 4.0 4.0 4.0 4.0 4.0 4.0 4.0
Lanes: 1 0 3 1 0 1 0 3 1 0 1 0 1 0 1

Volume Module:

Base Vol: 46 2101 145 104 2130 36 66 121 31 22 29 49
Growth Adj: 1.02 1.02 1.02 1.02 1.02 1.02 1.02 1.02 1.02 1.02 1.02 1.02
Initial Bse: 47 2134 147 106 2164 37 67 123 31 22 29 50
Added Vol: 6 100 0 66 157 0 0 18 15 0 3 14
Related Pro: 25 199 20 16 684 0 0 5 30 4 0 0
Initial Fut: 78 2433 167 188 3005 37 67 146 76 26 32 64
User Adj: 1.00 1.00 1.00 1.00 1.00 1.00 1.00 1.00 1.00 1.00 1.00 1.00
PHF Adj: 0.92 0.92 0.92 0.92 0.92 0.92 0.92 0.92 0.92 0.92 0.92 0.92
PHF Volume: 84 2645 182 204 3266 40 73 159 83 29 35 69
Reduct Vol: 0 0 0 0 0 0 0 0 0 0 0 0
Reduced Vol: 84 2645 182 204 3266 40 73 159 83 29 35 69
PCE Adj: 1.00 1.00 1.00 1.00 1.00 1.00 1.00 1.00 1.00 1.00 1.00 1.00
MLF Adj: 1.00 1.00 1.00 1.00 1.00 1.00 1.00 1.00 1.00 1.00 1.00 1.00
FinalVolume: 84 2645 182 204 3266 40 73 159 83 29 35 69

Saturation Flow Module:

Sat/Lane: 1900 1900 1900 1900 1900 1900 1900 1900 1900 1900 1900
Adjustment: 0.95 0.90 0.90 0.95 0.91 0.91 0.74 0.95 0.95 0.26 1.00 0.85
Lanes: 1.00 3.74 0.26 1.00 3.95 0.05 1.00 0.66 0.34 1.00 1.00 1.00
Final Sat.: 1805 6406 440 1805 6819 83 1404 1182 619 500 1900 1615

Capacity Analysis Module:

Vol/Sat: 0.05 0.41 0.41 0.11 0.48 0.48 0.05 0.13 0.13 0.06 0.02 0.04
Crit Moves: ****
Green/Cycle: 0.07 0.59 0.59 0.16 0.69 0.69 0.19 0.19 0.19 0.19 0.19 0.19
Volume/Cap: 0.69 0.69 0.69 0.69 0.69 0.69 0.27 0.69 0.69 0.30 0.10 0.22
Delay/Veh: 61.7 14.6 14.6 46.6 9.7 9.7 34.9 43.6 43.6 36.2 33.3 34.4
User DelAdj: 1.00 1.00 1.00 1.00 1.00 1.00 1.00 1.00 1.00 1.00 1.00 1.00
AdjDel/Veh: 61.7 14.6 14.6 46.6 9.7 9.7 34.9 43.6 43.6 36.2 33.3 34.4
LOS by Move: E B B D A A C D D D C C
HCM2kAvgQ: 4 17 17 7 17 17 2 8 8 1 1 2

Note: Queue reported is the number of cars per lane.

Continental Grand Campus Specific Plan
Phase 2 Opening Year (2023) With Project AM Peak Hour (HCM)

Level of Service Computation Report
2000 HCM Operations Method (Future Volume Alternative)

Intersection #4 Sepulveda Blvd at Mariposa Ave

Cycle (sec): 100 Critical Vol./Cap.(X): 0.752
Loss Time (sec): 5 Average Delay (sec/veh): 21.4
Optimal Cycle: 45 Level Of Service: C

Street Name: Sepulveda Blvd Mariposa Ave

Approach: North Bound South Bound East Bound West Bound
Movement: L - T - R L - T - R L - T - R L - T - R

Control: Protected Protected Permitted Permitted
Rights: Include Include Include Include
Min. Green: 0 0 0 0 0 0 0 0 0 0 0 0
Y+R: 4.0 4.0 4.0 4.0 4.0 4.0 4.0 4.0 4.0 4.0 4.0 4.0
Lanes: 1 0 4 0 1 2 0 3 1 0 1 0 0 1 0 1 0 1 0 1

Volume Module:

Base Vol: 62 1984 155 418 1791 58 104 179 49 65 86 84
Growth Adj: 1.02 1.02 1.02 1.02 1.02 1.02 1.02 1.02 1.02 1.02 1.02 1.02
Initial Bse: 63 2021 158 426 1824 59 106 182 50 66 88 86
Added Vol: 3 97 33 59 115 -1 0 68 9 8 9 9
Related Pro: 6 186 -25 17 651 14 14 -10 30 -25 0 -8
Initial Fut: 72 2304 166 502 2590 72 120 240 89 49 97 87
User Adj: 1.00 1.00 1.00 1.00 1.00 1.00 1.00 1.00 1.00 1.00 1.00 1.00
PHF Adj: 0.92 0.92 0.92 0.92 0.92 0.92 0.92 0.92 0.92 0.92 0.92 0.92
PHF Volume: 78 2504 180 545 2815 78 130 261 97 53 105 94
Reduct Vol: 0 0 0 0 0 0 0 0 0 0 0 0
Reduced Vol: 78 2504 180 545 2815 78 130 261 97 53 105 94
PCE Adj: 1.00 1.00 1.00 1.00 1.00 1.00 1.00 1.00 1.00 1.00 1.00 1.00
MLF Adj: 1.00 1.00 1.00 1.00 1.00 1.00 1.00 1.00 1.00 1.00 1.00 1.00
FinalVolume: 78 2504 180 545 2815 78 130 261 97 53 105 94

Saturation Flow Module:

Sat/Lane: 1900 1900 1900 1900 1900 1900 1900 1900 1900 1900 1900 1900
Adjustment: 0.95 0.91 0.85 0.92 0.91 0.91 0.61 0.96 0.96 0.20 1.00 0.85
Lanes: 1.00 4.00 1.00 2.00 3.89 0.11 1.00 0.73 0.27 1.00 1.00 1.00
Final Sat.: 1805 6916 1615 3502 6702 186 1159 1331 493 372 1900 1615

Capacity Analysis Module:

Vol/Sat: 0.04 0.36 0.11 0.16 0.42 0.42 0.11 0.20 0.20 0.14 0.06 0.06
Crit Moves: ****
Green/Cycle: 0.06 0.48 0.48 0.21 0.62 0.62 0.26 0.26 0.26 0.26 0.26 0.26
Volume/Cap: 0.67 0.75 0.23 0.75 0.67 0.67 0.43 0.75 0.75 0.55 0.21 0.22
Delay/Veh: 60.1 22.0 15.3 41.6 12.6 12.6 31.7 40.6 40.6 38.5 29.1 29.3
User DelAdj: 1.00 1.00 1.00 1.00 1.00 1.00 1.00 1.00 1.00 1.00 1.00 1.00
AdjDel/Veh: 60.1 22.0 15.3 41.6 12.6 12.6 31.7 40.6 40.6 38.5 29.1 29.3
LOS by Move: E C B D B B C D D D C C
HCM2kAvgQ: 2 17 3 10 16 16 4 12 12 2 3 2

Note: Queue reported is the number of cars per lane.

Continental Grand Campus Specific Plan
Phase 2 Opening Year (2023) With Project AM Peak Hour (HCM)

Level of Service Computation Report
2000 HCM Operations Method (Future Volume Alternative)

Intersection #5 Sepulveda Blvd at Grand Ave

Cycle (sec): 100 Critical Vol./Cap.(X): 0.885
Loss Time (sec): 5 Average Delay (sec/veh): 24.3
Optimal Cycle: 81 Level Of Service: C

Street Name: Sepulveda Blvd Grand Ave

Approach: North Bound South Bound East Bound West Bound
Movement: L - T - R L - T - R L - T - R L - T - R

Control: Protected Protected Split Phase Split Phase
Rights: Ovl Include Include Include
Min. Green: 0 0 0 0 0 0 0 0 0 0 0 0
Y+R: 4.0 4.0 4.0 4.0 4.0 4.0 4.0 4.0 4.0 4.0 4.0 4.0
Lanes: 1 0 4 0 1 1 0 3 1 0 1 1 0 1 0 2 0 2 0 1

Volume Module:

Base Vol: 130 2061 544 406 1381 185 171 164 103 43 50 57
Growth Adj: 1.02 1.02 1.02 1.02 1.02 1.02 1.02 1.02 1.02 1.02 1.02 1.02
Initial Bse: 132 2099 554 413 1406 188 174 167 105 44 51 58
Added Vol: 1 84 120 53 74 4 10 36 2 24 4 39
Related Pro: 0 142 -15 5 662 10 10 0 27 0 0 10
Initial Fut: 133 2325 659 471 2142 202 194 203 134 68 55 107
User Adj: 1.00 1.00 1.00 1.00 1.00 1.00 1.00 1.00 1.00 1.00 1.00 1.00
PHF Adj: 0.92 0.92 0.92 0.92 0.92 0.92 0.92 0.92 0.92 0.92 0.92 0.92
PHF Volume: 145 2527 716 512 2329 220 211 221 146 74 60 116
Reduct Vol: 0 0 0 0 0 0 0 0 0 0 0 0
Reduced Vol: 145 2527 716 512 2329 220 211 221 146 74 60 116
PCE Adj: 1.00 1.00 1.00 1.00 1.00 1.00 1.00 1.00 1.00 1.00 1.00 1.00
MLF Adj: 1.00 1.00 1.00 1.00 1.00 1.00 1.00 1.00 1.00 1.00 1.00 1.00
FinalVolume: 145 2527 716 512 2329 220 211 221 146 74 60 116

Saturation Flow Module:

Sat/Lane: 1900 1900 1900 1900 1900 1900 1900 1900 1900 1900 1900 1900
Adjustment: 0.95 0.91 0.85 0.95 0.90 0.90 0.90 0.90 0.90 0.92 0.95 0.85
Lanes: 1.00 4.00 1.00 1.00 3.65 0.35 1.10 1.15 0.75 2.00 2.00 1.00
Final Sat.: 1805 6916 1615 1805 6237 589 1870 1956 1290 3502 3610 1615

Capacity Analysis Module:

Vol/Sat: 0.08 0.37 0.44 0.28 0.37 0.37 0.11 0.11 0.11 0.02 0.02 0.07
Crit Moves: ****
Green/Cycle: 0.14 0.48 0.56 0.32 0.66 0.66 0.13 0.13 0.13 0.08 0.08 0.08
Volume/Cap: 0.57 0.77 0.79 0.88 0.57 0.57 0.88 0.88 0.88 0.26 0.20 0.88
Delay/Veh: 43.1 22.6 22.3 47.2 9.5 9.5 56.5 56.5 56.5 43.6 43.2 91.0
User DelAdj: 1.00 1.00 1.00 1.00 1.00 1.00 1.00 1.00 1.00 1.00 1.00 1.00
AdjDel/Veh: 43.1 22.6 22.3 47.2 9.5 9.5 56.5 56.5 56.5 43.6 43.2 91.0
LOS by Move: D C C D A A E E E D D F
HCM2kAvgQ: 4 16 16 16 11 11 9 9 9 1 1 6

Note: Queue reported is the number of cars per lane.

Continental Grand Campus Specific Plan
Phase 2 Opening Year (2023) With Project AM Peak Hour (HCM)

Level of Service Computation Report
2000 HCM Operations Method (Future Volume Alternative)

Intersection #6 Sepulveda Blvd at El Segundo Blvd

Cycle (sec): 100 Critical Vol./Cap.(X): 1.121
Loss Time (sec): 5 Average Delay (sec/veh): 69.9
Optimal Cycle: 180 Level Of Service: E

Street Name: Sepulveda Blvd El Segundo Blvd

Approach: North Bound South Bound East Bound West Bound
Movement: L - T - R L - T - R L - T - R L - T - R

Control: Protected Protected Protected Protected
Rights: Include Include Include Include
Min. Green: 0 0 0 0 0 0 0 0 0 0 0 0
Y+R: 4.0 4.0 4.0 4.0 4.0 4.0 4.0 4.0 4.0 4.0 4.0
Lanes: 2 0 3 1 0 2 0 4 0 1 1 0 2 0 1 2 0 2 0 1

Volume Module:

Base Vol: 369 2440 293 252 1120 121 108 291 222 138 292 216
Growth Adj: 1.02 1.02 1.02 1.02 1.02 1.02 1.02 1.02 1.02 1.02 1.02 1.02
Initial Bse: 376 2485 298 257 1141 123 110 296 226 141 297 220
Added Vol: 4 170 32 46 35 19 16 25 1 15 22 20
Related Pro: 1 27 169 527 178 3 3 4 6 27 13 83
Initial Fut: 381 2682 499 830 1354 145 129 325 233 183 332 323
User Adj: 1.00 1.00 1.00 1.00 1.00 1.00 1.00 1.00 1.00 1.00 1.00 1.00
PHF Adj: 0.92 0.92 0.92 0.92 0.92 0.92 0.92 0.92 0.92 0.92 0.92 0.92
PHF Volume: 414 2915 543 902 1471 158 140 354 253 198 361 351
Reduct Vol: 0 0 0 0 0 0 0 0 0 0 0 0
Reduced Vol: 414 2915 543 902 1471 158 140 354 253 198 361 351
PCE Adj: 1.00 1.00 1.00 1.00 1.00 1.00 1.00 1.00 1.00 1.00 1.00 1.00
MLF Adj: 1.00 1.00 1.00 1.00 1.00 1.00 1.00 1.00 1.00 1.00 1.00 1.00
FinalVolume: 414 2915 543 902 1471 158 140 354 253 198 361 351

Saturation Flow Module:

Sat/Lane: 1900 1900 1900 1900 1900 1900 1900 1900 1900 1900 1900 1900
Adjustment: 0.92 0.89 0.89 0.92 0.91 0.85 0.95 0.95 0.85 0.92 0.95 0.85
Lanes: 2.00 3.37 0.63 2.00 4.00 1.00 1.00 2.00 1.00 2.00 2.00 1.00
Final Sat.: 3502 5690 1060 3502 6916 1615 1805 3610 1615 3502 3610 1615

Capacity Analysis Module:

Vol/Sat: 0.12 0.51 0.51 0.26 0.21 0.10 0.08 0.10 0.16 0.06 0.10 0.22
Crit Moves: ****
Green/Cycle: 0.25 0.46 0.46 0.23 0.44 0.44 0.07 0.19 0.19 0.07 0.19 0.19
Volume/Cap: 0.48 1.12 1.12 1.12 0.48 0.22 1.12 0.51 0.81 0.81 0.52 1.12
Delay/Veh: 32.7 86.5 86.5 109.0 19.9 17.4 163.2 36.7 53.3 64.0 36.8 127.8
User DelAdj: 1.00 1.00 1.00 1.00 1.00 1.00 1.00 1.00 1.00 1.00 1.00 1.00
AdjDel/Veh: 32.7 86.5 86.5 109.0 19.9 17.4 163.2 36.7 53.3 64.0 36.8 127.8
LOS by Move: C F F F B B F D D E D F
HCM2kAvgQ: 6 45 45 22 8 3 9 6 10 5 6 19

Note: Queue reported is the number of cars per lane.

Continental Grand Campus Specific Plan
Phase 2 Opening Year (2023) With Project AM Peak Hour (HCM)

Level of Service Computation Report
2000 HCM Operations Method (Future Volume Alternative)

Intersection #7 Sepulveda Blvd at Rosecrans Blvd

Cycle (sec): 100 Critical Vol./Cap.(X): 0.941
Loss Time (sec): 5 Average Delay (sec/veh): 34.9
Optimal Cycle: 123 Level Of Service: C

Street Name: Sepulveda Blvd Rosecrans Blvd

Approach: North Bound South Bound East Bound West Bound
Movement: L - T - R L - T - R L - T - R L - T - R

Control: Protected Protected Protected Protected
Rights: Ovl Include Include Ignore
Min. Green: 0 0 0 0 0 0 0 0 0 0 0 0
Y+R: 4.0 4.0 4.0 4.0 4.0 4.0 4.0 4.0 4.0 4.0 4.0 4.0
Lanes: 2 0 4 0 1 2 0 3 0 1 2 0 3 0 1 2 0 2 0 1

Volume Module:

Base Vol: 281 2806 431 284 912 134 280 692 169 241 365 481
Growth Adj: 1.02 1.02 1.02 1.02 1.02 1.02 1.02 1.02 1.02 1.02 1.02 1.02
Initial Bse: 285 2850 438 288 926 136 284 703 172 245 371 489
Added Vol: 0 205 0 0 50 0 0 0 0 0 0 0
Related Pro: 2 0 0 0 6 56 1 0 471 0 1 0 4
Initial Fut: 287 3055 438 294 1032 137 284 1174 172 246 371 493
User Adj: 1.00 1.00 1.00 1.00 1.00 1.00 1.00 1.00 1.00 1.00 1.00 1.00
PHF Adj: 0.92 0.92 0.92 0.92 0.92 0.92 0.92 0.92 0.92 0.92 0.92 0.92
PHF Volume: 312 3321 476 320 1122 149 309 1276 187 267 403 0
Reduct Vol: 0 0 0 0 0 0 0 0 0 0 0 0
Reduced Vol: 312 3321 476 320 1122 149 309 1276 187 267 403 0
PCE Adj: 1.00 1.00 1.00 1.00 1.00 1.00 1.00 1.00 1.00 1.00 1.00 1.00
MLF Adj: 1.00 1.00 1.00 1.00 1.00 1.00 1.00 1.00 1.00 1.00 1.00 1.00
FinalVolume: 312 3321 476 320 1122 149 309 1276 187 267 403 0

Saturation Flow Module:

Sat/Lane: 1900 1900 1900 1900 1900 1900 1900 1900 1900 1900 1900 1900
Adjustment: 0.92 0.91 0.85 0.92 0.91 0.85 0.92 0.91 0.85 0.92 0.95 1.00
Lanes: 2.00 4.00 1.00 2.00 3.00 1.00 2.00 3.00 1.00 2.00 2.00 1.00
Final Sat.: 3502 6916 1615 3502 5187 1615 3502 5187 1615 3502 3610 1900

Capacity Analysis Module:

Vol/Sat: 0.09 0.48 0.29 0.09 0.22 0.09 0.09 0.25 0.12 0.08 0.11 0.00
Crit Moves: ****
Green/Cycle: 0.18 0.51 0.59 0.10 0.43 0.43 0.15 0.26 0.26 0.08 0.19 0.00
Volume/Cap: 0.50 0.94 0.50 0.94 0.50 0.21 0.58 0.94 0.44 0.94 0.58 0.00
Delay/Veh: 37.8 29.1 12.2 78.5 20.9 18.0 41.2 49.1 31.6 83.5 38.1 0.0
User DelAdj: 1.00 1.00 1.00 1.00 1.00 1.00 1.00 1.00 1.00 1.00 1.00 1.00
AdjDel/Veh: 37.8 29.1 12.2 78.5 20.9 18.0 41.2 49.1 31.6 83.5 38.1 0.0
LOS by Move: D C B E C B D D C F D A
HCM2kAvgQ: 5 32 9 8 9 3 5 19 5 7 7 0

Note: Queue reported is the number of cars per lane.

Continental Grand Campus Specific Plan
Phase 2 Opening Year (2023) With Project AM Peak Hour (HCM)

Level of Service Computation Report
2000 HCM Operations Method (Future Volume Alternative)

Intersection #8 Continental Boulevard at Mariposa Ave

Cycle (sec): 100 Critical Vol./Cap.(X): 0.620
Loss Time (sec): 5 Average Delay (sec/veh): 10.6
Optimal Cycle: 32 Level Of Service: B

Street Name: Continental Boulevard Mariposa Avenue
Approach: North Bound South Bound East Bound West Bound
Movement: L - T - R L - T - R L - T - R L - T - R
Control: Permitted Permitted Permitted Permitted
Rights: Include Include Include Include
Min. Green: 0 0 0 0 0 0 0 0 0 0 0 0
Y+R: 4.0 4.0 4.0 4.0 4.0 4.0 4.0 4.0 4.0 4.0 4.0
Lanes: 1 0 1 0 2 1 0 0 1 0 1 0 2 1 0 1 0 1 1 0

Volume Module:
Base Vol: 40 51 70 6 77 16 27 333 193 207 230 17
Growth Adj: 1.02 1.02 1.02 1.02 1.02 1.02 1.02 1.02 1.02 1.02 1.02 1.02
Initial Bse: 41 52 71 6 78 16 27 338 196 210 234 17
Added Vol: 4 0 17 10 0 0 0 79 79 132 22 1
Related Pro: 0 0 0 0 0 0 0 -20 0 0 -40 0
Initial Fut: 45 52 88 16 78 16 27 397 275 342 216 18
User Adj: 1.00 1.00 1.00 1.00 1.00 1.00 1.00 1.00 1.00 1.00 1.00
PHF Adj: 0.92 0.92 0.92 0.92 0.92 0.92 0.92 0.92 0.92 0.92 0.92
PHF Volume: 49 56 96 17 85 18 30 432 299 372 234 20
Reduct Vol: 0 0 0 0 0 0 0 0 0 0 0 0
Reduced Vol: 49 56 96 17 85 18 30 432 299 372 234 20
PCE Adj: 1.00 1.00 1.00 1.00 1.00 1.00 1.00 1.00 1.00 1.00 1.00
MLF Adj: 1.00 1.00 1.00 1.00 1.00 1.00 1.00 1.00 1.00 1.00 1.00
FinalVolume: 49 56 96 17 85 18 30 432 299 372 234 20

Saturation Flow Module:
Sat/Lane: 1900 1900 1900 1900 1900 1900 1900 1900 1900 1900 1900 1900
Adjustment: 0.46 1.00 0.75 0.69 0.97 0.97 0.58 0.85 0.85 0.37 0.94 0.94
Lanes: 1.00 1.00 2.00 1.00 0.83 0.17 1.00 2.00 1.00 1.00 1.84 0.16
Final Sat.: 868 1900 2842 1309 1532 318 1106 3247 1624 697 3288 279

Capacity Analysis Module:
Vol/Sat: 0.06 0.03 0.03 0.01 0.06 0.06 0.03 0.13 0.18 0.53 0.07 0.07
Crit Moves: ****
Green/Cycle: 0.09 0.09 0.09 0.09 0.09 0.09 0.86 0.86 0.86 0.86 0.86 0.86
Volume/Cap: 0.62 0.33 0.37 0.15 0.62 0.62 0.03 0.15 0.21 0.62 0.08 0.08
Delay/Veh: 58.2 43.8 43.8 42.5 50.6 50.6 1.0 1.1 1.2 4.1 1.1 1.1
User DelAdj: 1.00 1.00 1.00 1.00 1.00 1.00 1.00 1.00 1.00 1.00 1.00 1.00
AdjDel/Veh: 58.2 43.8 43.8 42.5 50.6 50.6 1.0 1.1 1.2 4.1 1.1 1.1
LOS by Move: E D D D D A A A A A A
HCM2kAvgQ: 3 2 2 1 4 4 0 1 2 4 1 1

Note: Queue reported is the number of cars per lane.

Continental Grand Campus Specific Plan
Phase 2 Opening Year (2023) With Project AM Peak Hour (HCM)

Level of Service Computation Report
2000 HCM Operations Method (Future Volume Alternative)

Intersection #9 Continental Boulevard at Grand Avenue

Cycle (sec): 100 Critical Vol./Cap.(X): 0.497
Loss Time (sec): 5 Average Delay (sec/veh): 24.7
Optimal Cycle: 25 Level Of Service: C

Street Name: Continental Boulevard Grand Avenue
Approach: North Bound South Bound East Bound West Bound
Movement: L - T - R L - T - R L - T - R L - T - R
Control: Permitted Permitted Protected Protected
Rights: Include Include Include Include
Min. Green: 0 0 0 0 0 0 0 0 0 0 0 0
Y+R: 4.0 4.0 4.0 4.0 4.0 4.0 4.0 4.0 4.0 4.0 4.0 4.0
Lanes: 0 1 1 1 0 1 0 2 1 0 1 0 2 1 0 1 0 2 1 0

Volume Module:
Base Vol: 146 198 25 15 77 78 85 230 87 74 292 33
Growth Adj: 1.02 1.02 1.02 1.02 1.02 1.02 1.02 1.02 1.02 1.02 1.02 1.02
Initial Bse: 148 201 25 15 78 79 86 234 88 75 297 34
Added Vol: 178 45 2 0 7 38 69 22 40 2 108 0
Related Pro: 0 0 0 0 0 0 0 -15 0 0 5 0
Initial Fut: 326 246 27 15 85 117 155 241 128 77 410 34
User Adj: 1.00 1.00 1.00 1.00 1.00 1.00 1.00 1.00 1.00 1.00 1.00 1.00
PHF Adj: 0.92 0.92 0.92 0.92 0.92 0.92 0.92 0.92 0.92 0.92 0.92 0.92
PHF Volume: 355 268 30 17 93 127 169 262 140 84 445 36
Reduct Vol: 0 0 0 0 0 0 0 0 0 0 0 0
Reduced Vol: 355 268 30 17 93 127 169 262 140 84 445 36
PCE Adj: 1.00 1.00 1.00 1.00 1.00 1.00 1.00 1.00 1.00 1.00 1.00 1.00
MLF Adj: 1.00 1.00 1.00 1.00 1.00 1.00 1.00 1.00 1.00 1.00 1.00 1.00
FinalVolume: 355 268 30 17 93 127 169 262 140 84 445 36

Saturation Flow Module:
Sat/Lane: 1900 1900 1900 1900 1900 1900 1900 1900 1900 1900 1900 1900
Adjustment: 0.66 0.66 0.66 0.35 0.83 0.83 0.95 0.86 0.86 0.95 0.90 0.90
Lanes: 1.00 1.80 0.20 1.00 2.00 1.00 1.00 2.00 1.00 1.00 2.77 0.23
Final Sat.: 1246 2243 250 671 3157 1579 1805 3278 1639 1805 4742 388

Capacity Analysis Module:
Vol/Sat: 0.28 0.12 0.12 0.02 0.03 0.08 0.09 0.08 0.09 0.05 0.09 0.09
Crit Moves: ****
Green/Cycle: 0.57 0.57 0.57 0.57 0.57 0.57 0.19 0.24 0.24 0.13 0.19 0.19
Volume/Cap: 0.50 0.21 0.21 0.04 0.05 0.14 0.50 0.33 0.35 0.35 0.50 0.50
Delay/Veh: 13.1 10.4 10.4 9.4 9.4 10.0 37.5 31.2 31.4 40.3 36.7 36.7
User DelAdj: 1.00 1.00 1.00 1.00 1.00 1.00 1.00 1.00 1.00 1.00 1.00 1.00
AdjDel/Veh: 13.1 10.4 10.4 9.4 9.4 10.0 37.5 31.2 31.4 40.3 36.7 36.7
LOS by Move: B B B A A A D C C D D D
HCM2kAvgQ: 7 2 2 0 1 2 5 4 4 2 5 5

Note: Queue reported is the number of cars per lane.

Continental Grand Campus Specific Plan
Phase 2 Opening Year (2023) With Project AM Peak Hour (HCM)

Level of Service Computation Report

2000 HCM Operations Method (Future Volume Alternative)

Intersection #10 Continental Boulevard at El Segundo Boulevard

Cycle (sec): 100 Critical Vol./Cap.(X): 0.553
Loss Time (sec): 5 Average Delay (sec/veh): 15.5
Optimal Cycle: 27 Level Of Service: B

Table with columns for Street Name, Approach, Movement, Control, Rights, Min. Green, Y+R, Lanes for Continental and El Segundo Boulevards.

Table with columns for Volume Module metrics: Base Vol, Growth Adj, Initial Bse, Added Vol, Related Pro, Initial Fut, User Adj, PHF Adj, PHF Volume, Reduct Vol, Reduced Vol, PCE Adj, MLF Adj, Final Volume.

Table with columns for Saturation Flow Module metrics: Sat/Lane, Adjustment, Lanes, Final Sat.

Table with columns for Capacity Analysis Module metrics: Vol/Sat, Crit Moves, Green/Cycle, Volume/Cap, Delay/Veh, User DelAdj, AdjDel/Veh, LOS by Move, HCM2kAvgQ.

Note: Queue reported is the number of cars per lane.

Continental Grand Campus Specific Plan
Phase 2 Opening Year (2023) With Project AM Peak Hour (HCM)

Level of Service Computation Report

2000 HCM Operations Method (Future Volume Alternative)

Intersection #11 Nash St and Imperial Hwy

Cycle (sec): 100 Critical Vol./Cap.(X): 0.843
Loss Time (sec): 5 Average Delay (sec/veh): 26.9
Optimal Cycle: 65 Level Of Service: C

Table with columns for Street Name, Approach, Movement, Control, Rights, Min. Green, Y+R, Lanes for Nash St and Imperial Hwy.

Table with columns for Volume Module metrics: Base Vol, Growth Adj, Initial Bse, Added Vol, Related Pro, Initial Fut, User Adj, PHF Adj, PHF Volume, Reduct Vol, Reduced Vol, PCE Adj, MLF Adj, Final Volume.

Table with columns for Saturation Flow Module metrics: Sat/Lane, Adjustment, Lanes, Final Sat.

Table with columns for Capacity Analysis Module metrics: Vol/Sat, Crit Moves, Green/Cycle, Volume/Cap, Delay/Veh, User DelAdj, AdjDel/Veh, LOS by Move, HCM2kAvgQ.

Note: Queue reported is the number of cars per lane.

Continental Grand Campus Specific Plan
Phase 2 Opening Year (2023) With Project AM Peak Hour (HCM)

Level of Service Computation Report
2000 HCM Operations Method (Future Volume Alternative)

Intersection #12 Nash St at Mariposa Ave
Cycle (sec): 100 Critical Vol./Cap.(X): 0.651
Loss Time (sec): 5 Average Delay (sec/veh): 15.6
Optimal Cycle: 34 Level Of Service: B

Table with columns for Street Name (Nash St, Mariposa Ave), Approach (North Bound, South Bound, East Bound, West Bound), Movement (L, T, R), Control, Rights, Min. Green, Y+R, and Lanes.

Table with columns for Volume Module (Base Vol, Growth Adj, Initial Bse, Added Vol, PasserByVol, Initial Fut, User Adj, PHF Adj, PHF Volume, Reduct Vol, Reduced Vol, PCE Adj, MLF Adj, FinalVolume).

Table with columns for Saturation Flow Module (Sat/Lane, Adjustment, Lanes, Final Sat).

Table with columns for Capacity Analysis Module (Vol/Sat, Crit Moves, Green/Cycle, Volume/Cap, Delay/Veh, User DelAdj, AdjDel/Veh, LOS by Move, HCM2kAvgQ).

Note: Queue reported is the number of cars per lane.

Continental Grand Campus Specific Plan
Phase 2 Opening Year (2023) With Project AM Peak Hour (HCM)

Level of Service Computation Report
2000 HCM Operations Method (Future Volume Alternative)

Intersection #13 Nash St at Grand Ave
Cycle (sec): 100 Critical Vol./Cap.(X): 0.564
Loss Time (sec): 5 Average Delay (sec/veh): 20.9
Optimal Cycle: 28 Level Of Service: C

Table with columns for Street Name (Nash St, Grand Ave), Approach (North Bound, South Bound, East Bound, West Bound), Movement (L, T, R), Control, Rights, Min. Green, Y+R, and Lanes.

Table with columns for Volume Module (Base Vol, Growth Adj, Initial Bse, Added Vol, Related Pro, Initial Fut, User Adj, PHF Adj, PHF Volume, Reduct Vol, Reduced Vol, PCE Adj, MLF Adj, FinalVolume).

Table with columns for Saturation Flow Module (Sat/Lane, Adjustment, Lanes, Final Sat).

Table with columns for Capacity Analysis Module (Vol/Sat, Crit Moves, Green/Cycle, Volume/Cap, Delay/Veh, User DelAdj, AdjDel/Veh, LOS by Move, HCM2kAvgQ).

Note: Queue reported is the number of cars per lane.

Continental Grand Campus Specific Plan
Phase 2 Opening Year (2023) With Project AM Peak Hour (HCM)

Level of Service Computation Report
2000 HCM Operations Method (Future Volume Alternative)

Intersection #14 Nash St at El Segundo Blvd

Cycle (sec): 100 Critical Vol./Cap.(X): 0.730
Loss Time (sec): 5 Average Delay (sec/veh): 23.3
Optimal Cycle: 42 Level Of Service: C

Street Name: Nash St El Segundo Blvd
Approach: North Bound South Bound East Bound West Bound
Movement: L - T - R L - T - R L - T - R L - T - R
Control: Split Phase Split Phase Protected Protected
Rights: Ovl Include Include Include
Min. Green: 0 0 0 0 0 0 0 0 0 0 0 0
Y+R: 4.0 4.0 4.0 4.0 4.0 4.0 4.0 4.0 4.0 4.0 4.0 4.0
Lanes: 2 0 0 1 1 1 1 1 0 1 2 0 3 0 1 2 0 2 1 0

Volume Module:
Base Vol: 8 17 6 111 103 59 45 617 43 238 1342 279
Growth Adj: 1.02 1.02 1.02 1.02 1.02 1.02 1.02 1.02 1.02 1.02 1.02 1.02
Initial Bse: 8 17 6 113 105 60 46 627 44 242 1363 283
Added Vol: 0 0 0 12 0 1 7 122 0 0 285 40
Related Pro: 38 33 129 5 232 95 19 60 261 801 344 -15
Initial Fut: 46 50 135 130 337 156 72 809 305 1043 1992 308
User Adj: 1.00 1.00 1.00 1.00 1.00 1.00 1.00 1.00 1.00 1.00 1.00 1.00
PHF Adj: 0.92 0.92 0.92 0.92 0.92 0.92 0.92 0.92 0.92 0.92 0.92 0.92
PHF Volume: 50 55 147 141 366 169 78 879 331 1133 2165 335
Reduct Vol: 0 0 0 0 0 0 0 0 0 0 0 0
Reduced Vol: 50 55 147 141 366 169 78 879 331 1133 2165 335
PCE Adj: 1.00 1.00 1.00 1.00 1.00 1.00 1.00 1.00 1.00 1.00 1.00 1.00
MLF Adj: 1.00 1.00 1.00 1.00 1.00 1.00 1.00 1.00 1.00 1.00 1.00 1.00
FinalVolume: 50 55 147 141 366 169 78 879 331 1133 2165 335

Saturation Flow Module:
Sat/Lane: 1900 1900 1900 1900 1900 1900 1900 1900 1900 1900 1900 1900
Adjustment: 0.92 0.89 0.89 0.94 0.94 0.85 0.92 0.91 0.85 0.92 0.89 0.89
Lanes: 2.00 0.54 1.46 1.00 2.00 1.00 2.00 3.00 1.00 2.00 2.60 0.40
Final Sat.: 3502 918 2468 1780 3559 1615 3502 5187 1615 3502 4402 681

Capacity Analysis Module:
Vol/Sat: 0.01 0.06 0.06 0.08 0.10 0.10 0.02 0.17 0.21 0.32 0.49 0.49
Crit Moves: ****
Green/Cycle: 0.08 0.08 0.53 0.14 0.14 0.14 0.03 0.28 0.28 0.44 0.69 0.69
Volume/Cap: 0.18 0.73 0.11 0.55 0.71 0.73 0.71 0.60 0.73 0.73 0.71 0.71
Delay/Veh: 43.1 54.3 12.0 40.5 44.3 52.1 67.3 31.8 38.4 24.7 9.9 9.9
User DelAdj: 1.00 1.00 1.00 1.00 1.00 1.00 1.00 1.00 1.00 1.00 1.00 1.00
AdjDel/Veh: 43.1 54.3 12.0 40.5 44.3 52.1 67.3 31.8 38.4 24.7 9.9 9.9
LOS by Move: D D B D D D E C D C A A
HCM2kAvgQ: 1 5 2 4 6 5 1 8 9 16 18 18

Note: Queue reported is the number of cars per lane.

Continental Grand Campus Specific Plan
Phase 2 Opening Year (2023) With Project AM Peak Hour (HCM)

Level of Service Computation Report
2000 HCM Operations Method (Future Volume Alternative)

Intersection #15 Douglas Street at El Segundo Boulevard

Cycle (sec): 100 Critical Vol./Cap.(X): 1.028
Loss Time (sec): 5 Average Delay (sec/veh): 46.4
Optimal Cycle: 180 Level Of Service: D

Street Name: Douglas St El Segundo Blvd
Approach: North Bound South Bound East Bound West Bound
Movement: L - T - R L - T - R L - T - R L - T - R
Control: Protected Protected Protected Protected
Rights: Include Include Include Include
Min. Green: 0 0 0 0 0 0 0 0 0 0 0 0
Y+R: 4.0 4.0 4.0 4.0 4.0 4.0 4.0 4.0 4.0 4.0 4.0 4.0
Lanes: 2 0 1 1 1 2 0 2 0 1 1 0 2 1 0 2 0 3 0 1

Volume Module:
Base Vol: 418 683 92 128 269 36 121 496 143 191 1457 512
Growth Adj: 1.02 1.02 1.02 1.02 1.02 1.02 1.02 1.02 1.02 1.02 1.02 1.02
Initial Bse: 425 694 93 130 273 37 123 504 145 194 1480 520
Added Vol: 34 34 26 75 34 7 15 50 68 51 283 189
Related Pro: 13 6 -4 0 9 0 5 179 5 -6 1107 -10
Initial Fut: 472 734 115 205 316 44 143 733 218 239 2870 699
User Adj: 1.00 1.00 1.00 1.00 1.00 1.00 1.00 1.00 1.00 1.00 1.00 1.00
PHF Adj: 0.92 0.92 0.92 0.92 0.92 0.92 0.92 0.92 0.92 0.92 0.92 0.92
PHF Volume: 513 798 125 223 344 47 155 797 237 260 3120 760
Reduct Vol: 0 0 0 0 0 0 0 0 0 0 0 0
Reduced Vol: 513 798 125 223 344 47 155 797 237 260 3120 760
PCE Adj: 1.00 1.00 1.00 1.00 1.00 1.00 1.00 1.00 1.00 1.00 1.00 1.00
MLF Adj: 1.00 1.00 1.00 1.00 1.00 1.00 1.00 1.00 1.00 1.00 1.00 1.00
FinalVolume: 513 798 125 223 344 47 155 797 237 260 3120 760

Saturation Flow Module:
Sat/Lane: 1900 1900 1900 1900 1900 1900 1900 1900 1900 1900 1900 1900
Adjustment: 0.92 0.93 0.93 0.92 0.95 0.85 0.95 0.88 0.88 0.92 0.91 0.85
Lanes: 2.00 2.00 1.00 2.00 2.00 1.00 1.00 2.31 0.69 2.00 3.00 1.00
Final Sat.: 3502 3538 1769 3502 3610 1615 1805 3861 1150 3502 5187 1615

Capacity Analysis Module:
Vol/Sat: 0.15 0.23 0.07 0.06 0.10 0.03 0.09 0.21 0.21 0.07 0.60 0.47
Crit Moves: ****
Green/Cycle: 0.17 0.22 0.22 0.06 0.11 0.11 0.08 0.49 0.49 0.18 0.59 0.59
Volume/Cap: 0.86 1.03 0.32 1.03 0.86 0.26 1.03 0.42 0.42 0.42 1.03 0.80
Delay/Veh: 52.3 76.4 32.9 115.5 60.5 41.5 126.6 16.4 16.4 37.1 44.8 21.3
User DelAdj: 1.00 1.00 1.00 1.00 1.00 1.00 1.00 1.00 1.00 1.00 1.00 1.00
AdjDel/Veh: 52.3 76.4 32.9 115.5 60.5 41.5 126.6 16.4 16.4 37.1 44.8 21.3
LOS by Move: D E C F E D F B B D D C
HCM2kAvgQ: 11 20 4 7 8 2 9 7 7 4 46 20

Note: Queue reported is the number of cars per lane.

Continental Grand Campus Specific Plan
Phase 2 Opening Year (2023) With Project AM Peak Hour (HCM)

Level of Service Computation Report

2000 HCM Operations Method (Future Volume Alternative)

Intersection #16 Aviation Boulevard at El Segundo Boulevard

Cycle (sec): 100 Critical Vol./Cap.(X): 1.226
Loss Time (sec): 5 Average Delay (sec/veh): 103.7
Optimal Cycle: 180 Level Of Service: F

Street Name: Aviatio Blvd El Segundo Blvd
Approach: North Bound South Bound East Bound West Bound
Movement: L - T - R L - T - R L - T - R L - T - R

Control: Protected Protected Protected Protected
Rights: Ovl Include Include Include
Min. Green: 0 0 0 0 0 0 0 0 0 0 0 0
Y+R: 4.0 4.0 4.0 4.0 4.0 4.0 4.0 4.0 4.0 4.0 4.0
Lanes: 2 0 2 0 1 1 0 1 1 1 1 0 3 1 0 2 0 2 1 0

Volume Module:
Base Vol: 326 1027 306 21 774 435 118 454 77 410 1528 75
Growth Adj: 1.02 1.02 1.02 1.02 1.02 1.02 1.02 1.02 1.02 1.02 1.02 1.02
Initial Bse: 331 1043 311 21 786 442 120 461 78 416 1552 76
Added Vol: 33 0 0 2 0 10 5 132 14 0 481 1
Related Pro: 167 36 -28 0 49 48 22 94 35 2 887 -10
Initial Fut: 531 1079 283 23 835 500 147 687 127 418 2920 67
User Adj: 1.00 1.00 1.00 1.00 1.00 1.00 1.00 1.00 1.00 1.00 1.00 1.00
PHF Adj: 0.92 0.92 0.92 0.92 0.92 0.92 0.92 0.92 0.92 0.92 0.92 0.92
PHF Volume: 577 1173 307 25 908 543 160 747 138 455 3174 73
Reduct Vol: 0 0 0 0 0 0 0 0 0 0 0 0
Reduced Vol: 577 1173 307 25 908 543 160 747 138 455 3174 73
PCE Adj: 1.00 1.00 1.00 1.00 1.00 1.00 1.00 1.00 1.00 1.00 1.00 1.00
MLF Adj: 1.00 1.00 1.00 1.00 1.00 1.00 1.00 1.00 1.00 1.00 1.00 1.00
FinalVolume: 577 1173 307 25 908 543 160 747 138 455 3174 73

Saturation Flow Module:
Sat/Lane: 1900 1900 1900 1900 1900 1900 1900 1900 1900 1900 1900 1900
Adjustment: 0.92 0.95 0.85 0.95 0.90 0.90 0.95 0.89 0.89 0.92 0.91 0.91
Lanes: 2.00 2.00 1.00 1.00 1.88 1.12 1.00 3.38 0.62 2.00 2.93 0.07
Final Sat.: 3502 3610 1615 1805 3198 1914 1805 5701 1056 3502 5055 116

Capacity Analysis Module:
Vol/Sat: 0.16 0.32 0.19 0.01 0.28 0.28 0.09 0.13 0.13 0.13 0.63 0.63
Crit Moves: ****
Green/Cycle: 0.13 0.35 0.64 0.02 0.23 0.23 0.07 0.29 0.29 0.29 0.51 0.51
Volume/Cap: 1.23 0.93 0.30 0.93 1.23 1.23 1.23 0.45 0.45 0.45 1.23 1.23
Delay/Veh: 162.8 42.9 8.1 189.0 148 148.0 198.5 28.9 28.9 29.2 130 129.8
User DelAdj: 1.00 1.00 1.00 1.00 1.00 1.00 1.00 1.00 1.00 1.00 1.00 1.00
AdjDel/Veh: 162.8 42.9 8.1 189.0 148 148.0 198.5 28.9 28.9 29.2 130 129.8
LOS by Move: F D A F F F F C C C F F
HCM2kAvgQ: 19 23 4 1 28 28 11 6 6 6 65 65

Note: Queue reported is the number of cars per lane.

Continental Grand Campus Specific Plan
Phase 2 Opening Year (2023) With Project AM Peak Hour (HCM)

Level of Service Computation Report

ICU 1(Loss as Cycle Length %) Method (Future Volume Alternative)

Intersection #17 El Segundo Boulevard and Isis Avenue

Cycle (sec): 100 Critical Vol./Cap.(X): 0.940
Loss Time (sec): 5 Average Delay (sec/veh): xxxxxx
Optimal Cycle: 119 Level Of Service: E

Street Name: Isis Avenue El Segundo Boulevard
Approach: North Bound South Bound East Bound West Bound
Movement: L - T - R L - T - R L - T - R L - T - R

Control: Permitted Permitted Protected Protected
Rights: Include Include Include Include
Min. Green: 0 0 0 0 0 0 0 0 0 0 0 0
Y+R: 4.0 4.0 4.0 4.0 4.0 4.0 4.0 4.0 4.0 4.0 4.0 4.0
Lanes: 0 0 1! 0 0 0 0 1! 0 0 1 0 4 0 1 1 0 2 1 0

Volume Module:
Base Vol: 50 21 84 52 9 71 45 722 20 20 1736 39
Growth Adj: 1.02 1.02 1.02 1.02 1.02 1.02 1.02 1.02 1.02 1.02 1.02 1.02
Initial Bse: 51 21 85 53 9 72 46 733 20 20 1763 40
Added Vol: 0 0 0 0 0 0 0 23 0 0 201 0
Related Pro: 0 0 0 0 0 0 0 177 0 0 1160 0
Initial Fut: 51 21 85 53 9 72 46 933 20 20 3124 40
User Adj: 1.00 1.00 1.00 1.00 1.00 1.00 1.00 1.00 1.00 1.00 1.00 1.00
PHF Adj: 0.92 0.92 0.92 0.92 0.92 0.92 0.92 0.92 0.92 0.92 0.92 0.92
PHF Volume: 55 23 93 57 10 78 50 1015 22 22 3396 43
Reduct Vol: 0 0 0 0 0 0 0 0 0 0 0 0
Reduced Vol: 55 23 93 57 10 78 50 1015 22 22 3396 43
PCE Adj: 1.00 1.00 1.00 1.00 1.00 1.00 1.00 1.00 1.00 1.00 1.00 1.00
MLF Adj: 1.00 1.00 1.00 1.00 1.00 1.00 1.00 1.00 1.00 1.00 1.00 1.00
FinalVolume: 55 23 93 57 10 78 50 1015 22 22 3396 43

Saturation Flow Module:
Sat/Lane: 1600 1600 1600 1600 1600 1600 1600 1600 1600 1600 1600 1600
Adjustment: 1.00 1.00 1.00 1.00 1.00 1.00 1.00 1.00 1.00 1.00 1.00 1.00
Lanes: 0.32 0.14 0.54 0.39 0.07 0.54 1.00 4.00 1.00 1.00 2.96 0.04
Final Sat.: 516 217 867 630 109 861 1600 6400 1600 1600 4740 60

Capacity Analysis Module:
Vol/Sat: 0.03 0.11 0.11 0.04 0.09 0.09 0.03 0.16 0.01 0.01 0.72 0.72
Crit Moves: ****

Continental Grand Campus Specific Plan
Phase 2 Opening Year (2023) With Project AM Peak Hour (HCM)

Level of Service Computation Report

2000 HCM Operations Method (Future Volume Alternative)

Intersection #18 El Segundo Blvd at I-405 SB Ramps

Cycle (sec): 100 Critical Vol./Cap.(X): 0.914
Loss Time (sec): 5 Average Delay (sec/veh): 19.2
Optimal Cycle: 99 Level Of Service: B

Street Name: I-405 SB Ramps El Segundo Blvd

Approach: North Bound South Bound East Bound West Bound

Movement: L - T - R L - T - R L - T - R L - T - R

Control: Permitted Permitted Permitted Permitted

Rights: Include Include Include Include

Min. Green: 0 0 0 0 0 0 0 0 0 0 0 0

Y+R: 4.0 4.0 4.0 4.0 4.0 4.0 4.0 4.0 4.0 4.0 4.0 4.0

Lanes: 1 0 1 0 0 0 0 0 0 0 0 0

Volume Module:

Base Vol: 416 0 142 0 0 0 0 608 270 0 1428 0

Growth Adj: 1.02 1.02 1.02 1.02 1.02 1.02 1.02 1.02 1.02 1.02 1.02 1.02

Initial Bse: 423 0 144 0 0 0 0 618 274 0 1451 0

Added Vol: 0 0 0 0 0 0 0 8 15 0 201 0

Related Pro: 9 0 0 0 0 0 0 103 74 0 1151 0

Initial Fut: 432 0 144 0 0 0 0 729 363 0 2803 0

User Adj: 1.00 1.00 1.00 1.00 1.00 1.00 1.00 1.00 1.00 1.00 1.00 1.00

PHF Adj: 0.92 0.92 0.92 0.92 0.92 0.92 0.92 0.92 0.92 0.92 0.92 0.92

PHF Volume: 469 0 157 0 0 0 0 792 395 0 3046 0

Reduct Vol: 0 0 0 0 0 0 0 0 0 0 0 0

Reduced Vol: 469 0 157 0 0 0 0 792 395 0 3046 0

PCE Adj: 1.00 1.00 1.00 1.00 1.00 1.00 1.00 1.00 1.00 1.00 1.00 1.00

MLF Adj: 1.00 1.00 1.00 1.00 1.00 1.00 1.00 1.00 1.00 1.00 1.00 1.00

FinalVolume: 469 0 157 0 0 0 0 792 395 0 3046 0

Saturation Flow Module:

Sat/Lane: 1900 1900 1900 1900 1900 1900 1900 1900 1900 1900 1900 1900

Adjustment: 0.73 1.00 0.74 1.00 1.00 1.00 1.00 0.91 0.85 1.00 0.91 1.00

Lanes: 1.60 0.00 0.40 0.00 0.00 0.00 0.00 3.00 1.00 0.00 3.00 0.00

Final Sat.: 2221 0 558 0 0 0 0 5187 1615 0 5187 0

Capacity Analysis Module:

Vol/Sat: 0.21 0.00 0.28 0.00 0.00 0.00 0.00 0.15 0.24 0.00 0.59 0.00

Crit Moves: ****

Green/Cycle: 0.31 0.00 0.31 0.00 0.00 0.00 0.00 0.64 0.64 0.00 0.64 0.00

Volume/Cap: 0.69 0.00 0.91 0.00 0.00 0.00 0.00 0.24 0.38 0.00 0.91 0.00

Delay/Veh: 32.6 0.0 50.1 0.0 0.0 0.0 0.0 7.6 8.7 0.0 19.9 0.0

User DelAdj: 1.00 1.00 1.00 1.00 1.00 1.00 1.00 1.00 1.00 1.00 1.00 1.00

AdjDel/Veh: 32.6 0.0 50.1 0.0 0.0 0.0 0.0 7.6 8.7 0.0 19.9 0.0

LOS by Move: C A D A A A A A B A

HCM2kAvgQ: 9 0 16 0 0 0 0 4 6 0 28 0

Note: Queue reported is the number of cars per lane.

Continental Grand Campus Specific Plan
Phase 2 Opening Year (2023) With Project AM Peak Hour (HCM)

Level of Service Computation Report

2000 HCM Operations Method (Future Volume Alternative)

Intersection #19 El Segundo Blvd at La Cienega Blvd

Cycle (sec): 100 Critical Vol./Cap.(X): 0.948
Loss Time (sec): 5 Average Delay (sec/veh): 27.7
Optimal Cycle: 131 Level Of Service: C

Street Name: La Cienega Blvd El Segundo Blvd

Approach: North Bound South Bound East Bound West Bound

Movement: L - T - R L - T - R L - T - R L - T - R

Control: Protected Protected Protected Protected

Rights: Include Include Include Include

Min. Green: 0 0 0 0 0 0 0 0 0 0 0 0

Y+R: 4.0 4.0 4.0 4.0 4.0 4.0 4.0 4.0 4.0 4.0 4.0 4.0

Lanes: 0 0 0 0 0 2 0 0 0 2 1 0 3 0 0 0 0 2 1 0

Volume Module:

Base Vol: 0 0 0 249 0 322 75 539 0 0 1312 477

Growth Adj: 1.02 1.02 1.02 1.02 1.02 1.02 1.02 1.02 1.02 1.02 1.02 1.02

Initial Bse: 0 0 0 253 0 327 76 548 0 0 1333 485

Added Vol: 0 0 0 0 0 0 0 8 0 0 201 0

Related Pro: 0 0 0 0 0 0 305 0 100 0 0 834 0

Initial Fut: 0 0 0 253 0 632 76 656 0 0 2368 485

User Adj: 1.00 1.00 1.00 1.00 1.00 1.00 1.00 1.00 1.00 1.00 1.00 1.00

PHF Adj: 0.92 0.92 0.92 0.92 0.92 0.92 0.92 0.92 0.92 0.92 0.92 0.92

PHF Volume: 0 0 0 275 0 687 83 713 0 0 2574 527

Reduct Vol: 0 0 0 0 0 0 0 0 0 0 0 0

Reduced Vol: 0 0 0 275 0 687 83 713 0 0 2574 527

PCE Adj: 1.00 1.00 1.00 1.00 1.00 1.00 1.00 1.00 1.00 1.00 1.00 1.00

MLF Adj: 1.00 1.00 1.00 1.00 1.00 1.00 1.00 1.00 1.00 1.00 1.00 1.00

FinalVolume: 0 0 0 275 0 687 83 713 0 0 2574 527

Saturation Flow Module:

Sat/Lane: 1900 1900 1900 1900 1900 1900 1900 1900 1900 1900 1900 1900

Adjustment: 1.00 1.00 1.00 0.92 1.00 0.75 0.95 0.91 1.00 1.00 0.89 0.89

Lanes: 0.00 0.00 0.00 2.00 0.00 2.00 1.00 3.00 0.00 0.00 2.49 0.51

Final Sat.: 0 0 0 3502 0 2842 1805 5187 0 0 4198 859

Capacity Analysis Module:

Vol/Sat: 0.00 0.00 0.00 0.08 0.00 0.24 0.05 0.14 0.00 0.00 0.61 0.61

Crit Moves: ****

Green/Cycle: 0.00 0.00 0.00 0.25 0.00 0.25 0.05 0.70 0.00 0.00 0.65 0.65

Volume/Cap: 0.00 0.00 0.00 0.31 0.00 0.95 0.95 0.20 0.00 0.00 0.95 0.95

Delay/Veh: 0.0 0.0 0.0 30.3 0.0 58.2 126.3 5.4 0.0 0.0 23.2 23.2

User DelAdj: 1.00 1.00 1.00 1.00 1.00 1.00 1.00 1.00 1.00 1.00 1.00 1.00

AdjDel/Veh: 0.0 0.0 0.0 30.3 0.0 58.2 126.3 5.4 0.0 0.0 23.2 23.2

LOS by Move: A A A C A E F A A A C C

HCM2kAvgQ: 0 0 0 4 0 16 3 3 0 0 31 31

Note: Queue reported is the number of cars per lane.

Continental Grand Campus Specific Plan
Phase 2 Opening Year (2023) With Project AM Peak Hour (HCM)

Level of Service Computation Report

2000 HCM Operations Method (Future Volume Alternative)

Intersection #20 El Segundo Blvd at I-405 NB Ramps

Cycle (sec): 100 Critical Vol./Cap.(X): 0.954
Loss Time (sec): 5 Average Delay (sec/veh): 33.0
Optimal Cycle: 139 Level Of Service: C

Street Name: I-405 NB Ramps El Segundo Blvd
Approach: North Bound South Bound East Bound West Bound
Movement: L - T - R L - T - R L - T - R L - T - R

Control: Protected Protected Protected Protected
Rights: Include Include Ignore Include
Min. Green: 0 0 0 0 0 0 0 0 0 0 0 0
Y+R: 4.0 4.0 4.0 4.0 4.0 4.0 4.0 4.0 4.0 4.0 4.0 4.0
Lanes: 2 0 0 0 1 0 0 0 0 0 0 0 2 1 1 0 0 2 1 0

Volume Module:
Base Vol: 861 0 102 0 0 0 0 625 148 0 935 610
Growth Adj: 1.02 1.02 1.02 1.02 1.02 1.02 1.02 1.02 1.02 1.02 1.02 1.02
Initial Bse: 875 0 104 0 0 0 0 635 150 0 950 620
Added Vol: 134 0 0 0 0 0 0 8 0 0 67 0
Related Pro: 534 0 0 0 0 0 0 59 44 0 306 0
Initial Fut: 1543 0 104 0 0 0 0 702 194 0 1323 620
User Adj: 1.00 1.00 1.00 1.00 1.00 1.00 1.00 1.00 0.00 1.00 1.00 1.00
PHF Adj: 0.92 0.92 0.92 0.92 0.92 0.92 0.92 0.92 0.00 0.92 0.92 0.92
PHF Volume: 1677 0 113 0 0 0 0 763 0 0 1438 674
Reduct Vol: 0 0 0 0 0 0 0 0 0 0 0 0
Reduced Vol: 1677 0 113 0 0 0 0 763 0 0 1438 674
PCE Adj: 1.00 1.00 1.00 1.00 1.00 1.00 1.00 1.00 0.00 1.00 1.00 1.00
MLF Adj: 1.00 1.00 1.00 1.00 1.00 1.00 1.00 1.00 0.00 1.00 1.00 1.00
FinalVolume: 1677 0 113 0 0 0 0 763 0 0 1438 674

Saturation Flow Module:
Sat/Lane: 1900 1900 1900 1900 1900 1900 1900 1900 1900 1900 1900 1900
Adjustment: 0.92 1.00 0.85 1.00 1.00 1.00 1.00 0.91 0.91 1.00 0.87 0.87
Lanes: 2.00 0.00 1.00 0.00 0.00 0.00 0.00 3.00 1.00 0.00 2.04 0.96
Final Sat.: 3502 0 1615 0 0 0 0 5187 1729 0 3363 1575

Capacity Analysis Module:
Vol/Sat: 0.48 0.00 0.07 0.00 0.00 0.00 0.00 0.15 0.00 0.00 0.43 0.43
Crit Moves: **** ****
Green/Cycle: 0.50 0.00 0.50 0.00 0.00 0.00 0.00 0.45 0.00 0.00 0.45 0.45
Volume/Cap: 0.95 0.00 0.14 0.00 0.00 0.00 0.00 0.33 0.00 0.00 0.95 0.95
Delay/Veh: 36.2 0.0 13.4 0.0 0.0 0.0 0.0 17.9 0.0 0.0 37.0 37.0
User DelAdj: 1.00 1.00 1.00 1.00 1.00 1.00 1.00 1.00 1.00 1.00 1.00 1.00
AdjDel/Veh: 36.2 0.0 13.4 0.0 0.0 0.0 0.0 17.9 0.0 0.0 37.0 37.0
LOS by Move: D A B A A A A B A A D D
HCM2kAvgQ: 31 0 2 0 0 0 0 5 0 0 28 28

Note: Queue reported is the number of cars per lane.

 Continental Grand Campus Specific Plan
 Phase 2 Opening Year (2023) With Project PM Peak Hour (HCM)

Level Of Service Computation Report
 2000 HCM Operations Method (Future Volume Alternative)

```

*****
Intersection #18 El Segundo Blvd at I-405 SB Ramps
*****
Cycle (sec):          100          Critical Vol./Cap.(X):          1.183
Loss Time (sec):      5           Average Delay (sec/veh):        42.0
Optimal Cycle:        180          Level Of Service:              D
*****
Street Name:          I-405 SB Ramps          El Segundo Blvd
Approach:             North Bound          South Bound          East Bound          West Bound
Movement:            L - T - R          L - T - R          L - T - R          L - T - R
-----|-----|-----|-----|
Control:             Split Phase          Split Phase          Permitted          Permitted
Rights:              Include             Include             Ovl               Include
Min. Green:          0   0   0           0   0   0           0   0   0           0   0   0
Y+R:                 4.0 4.0 4.0         4.0 4.0 4.0         4.0 4.0 4.0         4.0 4.0 4.0
Lanes:               1 0 1! 0 0         0 0 0 0 0         0 0 3 0 1         0 1 2 0 0
-----|-----|-----|-----|
Volume Module:
Base Vol:            239   0   269         0   0   0           0 1491 1049         0 1062   0
Growth Adj:          1.02 1.02 1.02       1.02 1.02 1.02       1.02 1.02 1.02       1.02 1.02 1.02
Initial Bse:          243   0   273         0   0   0           0 1515 1066         0 1079   0
Added Vol:           0   0   0           0   0   0           0   0  121         70  18   0
Related Pro:         2   0   0           0   0   0           0  442  483         0  290   0
Initial Fut:          245   0   273         0   0   0           0 1957 1670         70 1387   0
User Adj:            1.00 1.00 1.00       1.00 1.00 1.00       1.00 1.00 1.00       1.00 1.00 1.00
PHF Adj:             0.92 0.92 0.92       0.92 0.92 0.92       0.92 0.92 0.92       0.92 0.92 0.92
PHF Volume:          266   0   297         0   0   0           0 2127 1815         76 1507   0
Reduct Vol:          0   0   0           0   0   0           0   0   0           0   0   0
Reduced Vol:         266   0   297         0   0   0           0 2127 1815         76 1507   0
PCE Adj:            1.00 1.00 1.00       1.00 1.00 1.00       1.00 1.00 1.00       1.00 1.00 1.00
MLF Adj:            1.00 1.00 1.00       1.00 1.00 1.00       1.00 1.00 1.00       1.00 1.00 1.00
FinalVolume:         266   0   297         0   0   0           0 2127 1815         76 1507   0
-----|-----|-----|-----|
Saturation Flow Module:
Sat/Lane:            1900 1900 1900       1900 1900 1900       1900 1900 1900       1900 1900 1900
Adjustment:          0.90 1.00 0.90       1.00 1.00 1.00       1.00 0.91 0.85       0.65 0.65 1.00
Lanes:              1.31 0.00 0.69       0.00 0.00 0.00       0.00 3.00 1.00       0.14 2.86 0.00
Final Sat.:         2239   0  1181         0   0   0           0 5187 1615         179 3550   0
-----|-----|-----|-----|
Capacity Analysis Module:
Vol/Sat:            0.12 0.00 0.25       0.00 0.00 0.00       0.00 0.41 1.12       0.42 0.42 0.00
Crit Moves:                ****                ****
Green/Cycle:        0.19 0.00 0.19       0.00 0.00 0.00       0.00 0.76 0.95       0.76 0.76 0.00
Volume/Cap:         0.62 0.00 1.32       0.00 0.00 0.00       0.00 0.54 1.18       0.56 0.56 0.00
Delay/Veh:          38.6 0.0 201.3       0.0 0.0 0.0           0.0 5.0 91.8       5.3 5.3 0.0
User DelAdj:        1.00 1.00 1.00       1.00 1.00 1.00       1.00 1.00 1.00       1.00 1.00 1.00
AdjDel/Veh:         38.6 0.0 201.3       0.0 0.0 0.0           0.0 5.0 91.8       5.3 5.3 0.0
LOS by Move:         D   A   F           A   A   A           A   A   F           A   A   A
HCM2kAvgQ:          7   0   28         0   0   0           0   9   88         8   8   0
*****

```

Note: Queue reported is the number of cars per lane.