



California State University
MONTEREY BAY



California State University, Monterey Bay Master Plan

Final Environmental Impact Report - Volume II **APPENDICES**

Prepared for California State University, Monterey Bay
May 2022 - SCH No. 2017051042

FINAL

**Environmental Impact Report
California State University Monterey Bay
Master Plan
SCH No. 2017051042**

**VOLUME II
APPENDICES**

Prepared for:

California State University Monterey Bay
100 Campus Center
Seaside, California 93955
Contact: Anya Spear, LEED AP, AICP

Prepared by:

DUDEK

725 Front Street, Suite 400
Santa Cruz, California 95060

MAY 2022

APPENDIX A

**Notice of Preparation (NOP) & Revision to
Previously Issued Notice of Preparation**

INTENTIONALLY LEFT BLANK

**Notice of
Preparation**

May 12, 2017

INTENTIONALLY LEFT BLANK

Campus Planning & Development
100 Campus Center
Mountain Hall A
Seaside, CA 93955-8001

[831] 582-3709
FAX [831] 582-4436

NOTICE OF PREPARATION

ENVIRONMENTAL IMPACT REPORT FOR THE CALIFORNIA STATE UNIVERSITY MONTEREY BAY MASTER PLAN

DATE: May 12, 2017

TO: Agencies, Organizations, and Interested Parties

PROJECT TITLE: California State University Monterey Bay Master Plan

LEAD AGENCY: The Board of Trustees of the California State University
401 Golden Shore
Long Beach, California 90802-4210

California State University Monterey Bay (CSUMB)
100 Campus Center
Seaside, California 93955

SUBJECT: Notice of Preparation of an Environmental Impact Report for the CSUMB Master Plan

The Board of Trustees of the California State University (Trustees) is the lead agency for the preparation of an environmental impact report (EIR) in accordance with the California Environmental Quality Act (CEQA) (California Public Resources Code, Section 21000 et seq.) and the CEQA Guidelines (Title 14 of the California Code of Regulations [CCR] 15000 et seq.). Per California Education Code Section 66606, the Board of Trustee is the governing body and owner of the California State University Monterey Bay (CSUMB) campus, and has the authority to certify the EIR, adopt the Master Plan, and provide for schematic design approvals. CSUMB will act as point of contact for the CEQA process.

The Trustees prepared this Notice of Preparation (NOP) in accordance with CEQA Guidelines (14 CCR 15082 and 15375). The EIR will address the environmental effects of the proposed CSUMB Master Plan (project) at a program level. Implementation of the proposed Master Plan would

include space and facility needs to support planned growth to 12,700 full-time-equivalent (FTE) students, with housing for 60% of students and 65% of faculty and staff. Overall, the proposed Master Plan identifies 3.0 million gross square feet of approved and new building space, 4,500 new student beds, and 460 units of faculty and staff housing that would be converted from existing student housing. The project location, project background, project description, and the potential environmental effects are contained in the attached materials. The EIR will also assess environmental impacts of six “near-term projects” at a project level of analysis.

Agencies: The Trustees request agencies’ views on the scope and content of the environmental information that is germane to an agency’s statutory responsibilities in connection with the project, in accordance with CEQA Guidelines Sections 15082(b) and 15103. Agencies may need to use the EIR to consider permits or other approvals.

Organizations and Interested Parties: The Trustees request comments and concerns regarding the scope and evaluation of potential environmental issues associated with the project.

Public Review Period: The Trustees have issued this NOP for public review and comment pursuant to the CEQA Guidelines (14 CCR 15082 and 15375). The Trustees have established a 30-day public review and scoping period from **May 12, 2017** through **June 12, 2017**, in accordance with the CEQA Guidelines (14 CCR 15082). During this period, the NOP will be available for review online here: <https://csumb.edu/campusplanning/proposed-projects>.

Scoping Comments: At this time, the Trustees are soliciting comments on the scope and content of the EIR. Comments may be submitted by mail, email, or fax, or by attending the Public Scoping Meeting (see details below) and submitting a written comment. All comments should indicate a contact person for the agency or organization, if applicable. All comments should be sent to the following address, to arrive no later than 5 p.m. on **June 12, 2017**:

Anya Spear, LEED AP
Associate Director of Campus Planning
CSUMB, Campus Planning & Development
100 Campus Center
Seaside, California 93955
T: 831.582.5098
F: 831-582-3545
aspear@csumb.edu

Public Scoping Meeting: The Trustees will hold Scoping Meetings to give the public an opportunity to receive more information on the proposed Master Plan, and to provide comments and suggestions on the scope of the EIR. All members of the public and interested persons are welcome to attend and provide comments. The meetings will be held on **May 23, 2017**, starting at both 4 p.m. and 6 p.m. at the Student Center West Lounge (next to Starbucks) on the CSUMB campus. See the campus map

provided at the following location for details about the meeting location: <https://csumb.edu/sites/default/files/images/st-block-156-1431028320687-raw-studentcenter.pdf>.

Further Information: For environmental review information or questions about the project, please contact Anya Spear (831.582.5098 or aspear@csumb.edu).

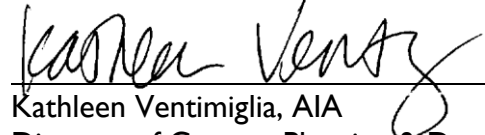

Kathleen Ventimiglia, AIA
Director of Campus Planning & Development
California State University Monterey Bay

May 11, 2017
Date

INTENTIONALLY LEFT BLANK

NOTICE OF PREPARATION

CSUMB MASTER PLAN ENVIRONMENTAL IMPACT REPORT

1 INTRODUCTION

The purpose of an environmental impact report (EIR) is to inform decision makers and the general public of the potential environmental effects of a proposed project. The environmental review process is intended to provide public agencies with the environmental information required to evaluate a proposed project to determine whether it may have a significant effect on the environment, to establish methods for reducing adverse environmental impacts, and to consider alternatives prior to approval. This section provides a project overview, location of the project, and project background.

1.1 Project and CEQA Overview

The EIR addresses the potential environmental effects of implementation of the proposed California State University Monterey Bay (CSUMB) Master Plan (Master Plan or project). The proposed Master Plan provides a guide for the physical development of the +1,350-acre campus.

The proposed Master Plan would include projects identified in the CSUMB's 5-Year Capital Improvement Program 2016/2017 through 2020/2021, plus the additional space and facility needs to support planned growth to 12,700 full-time-equivalent (FTE) students, with on-campus housing for 60% of students and 65% of faculty and staff. Growth anticipated in the proposed Master Plan will be evaluated at a program level. The project would also include six "near-term projects" that are expected to be developed within the next 3 to 7 years. The EIR for the proposed Master Plan will provide the description of these projects and evaluate them at a project-specific level. The distinctions between a "program" and a "project" EIR and associated analyses are provided below:

- **Program EIR:** Under state and California State University California Environmental Quality Act (CEQA) Guidelines, the EIR is being prepared as a "program" EIR. A program EIR may be prepared for a series of actions that are related geographically, or as part of a series of actions for adopting rules, regulations, plans, or general criteria for a continuing program or for individual activities carried out under the same authorizing law or regulation. CEQA environmental review conducted for future individual projects that are proposed in accordance with the proposed Master Plan will be tiered from the EIR to the extent that this program-level analysis remains adequate for such purposes in accordance with Section 15152(b) of the State CEQA Guidelines.
- **Project EIR:** Under state and California State University CEQA Guidelines, a portion of the EIR is being prepared as a "project" EIR. A project EIR examines the environmental impacts of a specific development project. This portion of the EIR will focus primarily on the changes in the environment that would result from the six near-term projects

proposed as part of the campus development. The EIR will examine all phases of these projects at a site-specific level, including planning, construction, and operation.

1.2 Project Location

The project site is located at the existing CSUMB campus, on the former U.S. Department of the Army (Army) military facility known as Fort Ord. The CSUMB campus is approximately 100 miles south of San Francisco and is located north of the Monterey Peninsula and west of the Salinas Valley, as shown in Figure 1. Portions of the existing CSUMB campus are within the city boundaries of Seaside and Marina, and within the unincorporated Monterey County, as shown in Figure 2.

1.3 Project Background

Three prior Master Plans for the CSUMB campus were prepared and adopted by the Board of Trustees of the California State University (Trustees) in 1998, 2004, and 2007. Previous environmental review of the project area includes four EIRs that were certified by the Trustees: the Campus Acquisition EIR, based on the Fort Ord Disposal and Reuse Environmental Impact Statement prepared by the United States government, and a Master Plan EIR for each of the three prior Master Plans. The most recent 2007 Master Plan and EIR considered land uses and space requirements commensurate with enrollment projections for three planning horizons: Planning Horizon I (2005–2014), Planning Horizon II (2015–2024), and Planning Horizon III (beyond 2025). The 2007 Master Plan projected an on-campus traditional student enrollment of 8,500 FTE students, with an additional 3,500 FTE non-traditional, primarily off-campus students, for a total of 12,000 FTE students at buildout (2025), with 1,900 faculty, staff, and management personnel. There were approximately 6,731 FTE on-campus students in 2015–2016.

In 2015, CSUMB initiated a process to update the 2007 Master Plan. This initiative was driven by several factors: new leadership, a new academic plan, revised growth projections, and university goals for carbon neutrality, among other issues. Many of the assumptions and priorities underlying the plan had evolved, and a further update to the Master Plan was needed. The proposed Master Plan was prepared to address these issues, and is available for review at https://csumb.edu/campusplanning/campus-master-plan-2016?_search=Master%20Plan.

2 PROJECT DESCRIPTION

2.1 Master Plan

The vision for the proposed Master Plan is distilled into three core sustainability tenets: placemaking, stewardship, and partnership. These tenets are reflected in the nine sustainability elements and the accompanying objectives that were prioritized as part of the Master Plan outreach.

The proposed Master Plan program outlines the space and facility needs for the campus' academic, student life, administration, residential, athletics, recreation, and support functions. It

includes the projects identified in the CSUMB's 5-Year Capital Improvement Program 2016/2017 through 2020/2021, plus the additional space and facility needs to support planned growth to 12,700 FTE students and associated growth to 1,490 FTE faculty and staff. As there were approximately 6,731 FTE students on campus in 2015–2016, the proposed Master Plan would increase enrollment by 4,200 FTE students over the existing on-campus enrollment ceiling of 8,500 FTE students from the adopted 2007 Master Plan, and by approximately 5,969 FTE students over existing enrollment levels.

The proposed Master Plan program includes academic and administrative support, residential, campus life, recreation, institutional partnerships, and operations and maintenance space. This includes accommodation of residence halls and classroom buildings, and also a mix of amenities such as museums, performing arts centers, ethnic centers, faculty lounges and work space, child care centers, greenhouses, and other uses that would contribute toward a diverse and dynamic campus life. On-campus housing would be provided for 60% of students (a total of 7,620 beds), and 65% of faculty and staff (a total of 970 units). This would be accomplished through new student housing construction on the main campus, and reallocation of existing student housing to provide for the faculty and staff units.

Table I summarizes the development planned in the 5-Year Capital Improvement Plan to serve existing enrollment and the development planned to serve additional growth contemplated in the proposed Master Plan. According to the proposed Master Plan Implementation Plan, of the approximately 3.0 million gross square feet (GSF) of approved and new development, approximately 1.7 million GSF would occur in Horizon I (2016–2025) and approximately 1.2 million GSF would occur in Horizon II (2026–2035). The proposed Master Plan program also accounts for growth in outdoor athletics and recreation, with space for various fields, courts, and a pool. Figure 3 shows a plan of the location of existing and future buildings on the campus. The future building locations and orientations are illustrative only, and may be refined through the proposed Master Plan development process.

The proposed Master Plan Land Use Plan builds on and densifies the existing pattern of land uses while shifting the overall campus center of gravity toward the north to better integrate housing with the campus core. The proposed Master Plan Land Use Plan is shown in Figure 4. Cars and parking would be separated from the pedestrian-oriented campus core by creating two multimodal parking hubs on the east and west side of campus, while still preserving some visitor and ADA parking in the core. Academic and student life uses would be further consolidated in the campus core to enhance vitality in this area by increasing the opportunity for student interactions. The existing and inherited student housing in the campus core remains for the foreseeable future as part of a mixed-use core where students live, study, and socialize. The plan expands the existing student housing clusters at North Quad Housing and Promontory to create residential neighborhoods; a third residential neighborhood is sited east of 6th Avenue. The athletics and recreation areas would be expanded and reorganized. Future development sites beyond the scope of this proposed Master Plan, as well as areas for future institutional partnership sites, are also identified. The proposed

Master Plan suggests development around and connected to open spaces. The open space framework calls for improving existing open spaces and adding new spaces to enhance community interaction and connection with the natural environment. Several areas on campus are designated as natural open space.

**TABLE 1
 PROPOSED MASTER PLAN BUILDING PROGRAM**

Campus Space	Beds/Units	Gross Square Feet
EXISTING OCCUPIED SPACE		
Main Campus Facilities	—	1,270,000
Student Housing	3,254 beds	895,081
Faculty, Staff, and Community Partners Housing	742 units	840,666
Total Existing Space	3,254 beds / 742 units	3,005,747
PENDING OR APPROVED BUT NOT YET CONSTRUCTED PROJECTS		
Academic III	—	50,800
Student Union	—	80,000
Facilities Buildings	—	50,000
Monterey Bay Charter School	—	60,000
Total Pending or Approved Space	—	240,800
MASTER PLAN BUILDING PROGRAM		
Academic and Support Buildings	—	380,360
Institutional Partnership Buildings	—	63,695
Administration Buildings	—	77,454
Campus Life Buildings	—	250,764
Recreation Buildings and Facilities	—	165,343
Facilities Buildings	—	23,590
Housing	4,500 beds/460 units*	1,800,000
Total New Master Plan Space	4,500 beds/460 units*	2,761,206
TOTAL APPROVED & NEW MASTER PLAN SPACE	4,500 beds/460 units*	3,002,006

Note:

* The 460 units for faculty and staff housing will be provided by reallocating existing student housing for faculty and staff housing units. No new faculty and staff housing units would be constructed with the proposed Master Plan.

The proposed Master Plan includes the pursuit of an “ambitious” Transportation Scenario to strengthen and expand the campus’ Transportation Demand Management (TDM) strategies. The scenario’s 2016–2026 goal (Horizon 1) is a mode split of 28% drive alone, 22% shared ride, 25% transit, 13% walk, 10% bicycle, and 2% other. To reach this mode split goal, many TDM strategies will need to be employed. The proposed Master Plan is built on the following assumptions: pedestrian travel will be prioritized over other modes of travel; the transit program will continue to offer unlimited free rides for CSUMB ID card holders; CSUMB will house 60% of students and 65% of staff and faculty on campus; parking will be limited and consolidated to the campus periphery; vehicle travel will be separated from bicycles and pedestrians where possible; academic buildings will be concentrated in the campus core within a 0.25-mile walking distance; ADA accessibility will be improved on existing streets and corridors, and be a primary consideration for new facilities; and new TDM strategies will be introduced and proposed for funding. The mobility goals and plans in the proposed Master Plan are designed to meet the above, and include plans for vehicle, shuttle, bicycle, and pedestrian circulation. The plan includes restricting and/or limiting vehicle access through the campus core; providing for a new extension of Fifth Street toward Eight Street; providing for improved shuttle service, frequency, and routing; creating two multimodal hubs and designation of other peripheral surface parking locations; providing for transit infrastructure; and creating specific trail and path improvements. Once finalized, the Mobility chapter of the proposed Master Plan will serve as the TDM Plan for the campus.

The proposed Master Plan identifies infrastructure improvements to serve campus growth. The Marina Coast Water District, which provides potable water and wastewater collection services to the campus, has plans for water line and storage improvements at the campus, and replacement of older sewer lines, although the plan notes that the existing water distribution and sanitary sewer collection infrastructure is generally adequate to service the proposed Master Plan improvements. Development outside of areas currently served by existing trunk mains could require extension of trunk mains at the university’s expense. According to the proposed Master Plan, the campus aspires to sustainably manage all stormwater on campus through a combination of decentralized and centralized “low-impact development” stormwater drainage features that are integrated into open space and public space areas. For energy use and utilities, the proposed Master Plan seeks to reduce demand for energy through energy-efficient design and efficient technologies, and developing campus energy supply and distribution systems that enable the campus to meet its carbon neutrality goals as the population and campus building square footage increases.

2.2 Near-Term Projects

The EIR will also address specific development projects expected to be constructed in the next 3 to 7 years that are referred to as “near-term projects.” These projects are included in the building space program presented in Table I and shown in Figure 3. The EIR will include environmental analysis for the following near-term projects at a project-specific level. The dates provided are the anticipated construction start date.

I. Student Housing Phase III – 600 beds (2020)

2. Panetta Institute for Public Policy – 37,600 square feet (2020)
3. Academic IV – 72,200 square feet (2021)
4. Student Recreation Center – 70,000 square feet (2021)
5. Student Housing IIB – 400 beds (2022)
6. Academic V – 76,704 square feet (2024)

3 ENVIRONMENTAL ISSUES AND PROBABLE EFFECTS TO BE ADDRESSED IN EIR

The following key environmental issues are proposed to be addressed at a program level for the proposed Master Plan and a project-specific level for the near-term projects. Direct and indirect impacts will be analyzed for the short term (construction) and long term (life of project) based on thresholds of significance that meet state guidelines and accepted professional standards and practice. Mitigation measures will be identified for impacts determined to be significant. The EIR will include a section that identifies other issues that were found to not result in significant impacts.

Aesthetics. The existing visual characteristics of the campus and surrounding area will be described. The EIR will review potential impacts on the visual character of the campus and surrounding areas based on the proposed Master Plan land uses and building sites. If potentially significant visual impacts are identified, feasible mitigation measures will be included in the EIR.

Air Quality. This section of the EIR will be based on estimates of emissions and associated changes in air quality that are likely to occur based on activities that result from the development accommodated by the proposed Master Plan and near-term projects. The EIR will update and summarize recent revisions to air quality regulations and ambient air pollutant data from the local monitoring station and other stations representative of regional air quality conditions. Pollutants of concern will include criteria pollutants and toxic air contaminants. An assessment of the air quality impacts will be conducted, and emissions will be estimated using the California Emissions Estimator Model (CalEEMod) land use and air quality model. The results will be compared to significance thresholds developed by the Monterey Bay Air Resources District.¹

Biological Resources. The EIR will identify, characterize, and evaluate biological resource issues, including sensitive habitats, special-status species, and wildlife nesting/breeding. Existing biological resources will be described based on previous and new biological studies conducted for CSUMB. The proposed areas of planned development and open space and conservation areas will be reviewed to determine potential impacts to biological resources, including sensitive habitats, special-status species, and wildlife nesting/breeding.

¹ Formally referred to as the Monterey Bay Unified Air Pollution Control District.

In addition, the EIR will describe the Habitat Management Plan prepared by the U.S. Army Corps of Engineers and the Draft Habitat Conservation Plan being prepared by FORA as they relate to the campus property. Although all campus property is considered Designated Development or Borderlands (there are no designated Habitat Management Areas on campus), the proposed Master Plan indicates that the campus has designated its own natural open space areas. It is understood that the ultimate completion and approval of the Habitat Conservation Plan for Fort Ord is intended to cover future CSUMB activities that may result in take of listed species covered by the Habitat Conservation Plan. The EIR will identify mitigation measures to reduce the significance of identified biological resources impacts.

Cultural Resources. The 2007 Master Plan EIR provides an overview of regional history and archaeological and historic resources in the former Fort Ord area. Studies conducted for the U.S. Army Corps of Engineers as part of the Fort Ord base closure and reuse planning process identified archeological sensitivity areas and historic structures potentially eligible for listing in the National Register of Historic Places. Based on these studies and as reported in the 2007 Master Plan EIR, the campus is not located in an area that has a high potential for archaeological resources. According to the Record of Decision for acquisition of the campus, there are no historic sites on the campus that have been identified as being eligible or potentially eligible for listing in the National Register in past studies. The EIR will use existing documentation, supplemented with updated records searches and field reconnaissance surveys, to evaluate potential impacts of development accommodated by the proposed Master Plan and near-term projects on cultural resources. The EIR section will address all archaeological, historical, and cultural resource issues. Tribal cultural resources will be addressed in accordance with changes in state law since the 2007 Master Plan EIR was certified. The EIR will identify mitigation measures to ensure that cultural resources that may be unexpectedly found during construction are protected.

Geology/Soils. Geologic and soils impacts resulting from future development will be assessed based on previous geologic and soils studies conducted in the previous Master Plan EIRs, which included identification of soils, faults, and subsurface characteristics within the campus boundaries. The EIR will determine whether implementation of the proposed Master Plan or near-term projects would result in potential significant impacts. Mitigation measures will be identified to reduce potentially significant geology and soils impacts.

Greenhouse Gas Emissions. The EIR will include a setting and background discussion consisting of a summary of the greenhouse effect and global climate change; potential changes to the global climate system and to California; and emissions inventories at the national, state, and local levels, including the CSUMB greenhouse gas (GHG) emissions inventory and future projections. It will also include a summary of the key regulatory measures at the federal and state levels as the regulatory setting for this topic. GHG emissions resulting from the proposed Master Plan and near-term projects will be estimated using the CalEEMod emissions model. The net change in operational GHG emissions relative to those under the baseline scenario will be calculated. Impact significance

will be assessed in accordance state and regional guidelines and standards. Mitigation measures will be identified to reduce potentially significant GHG impacts.

Hazards and Hazardous Materials. The campus is located within the former Fort Ord. The EIR will review past and present land use practices and operations to identify potential hazardous conditions. Existing studies will be used to identify hazardous materials and emergency response issues, including the current status of cleanup sites, munitions response sites (at East Campus Open Space Zone parcel), groundwater contamination, and asbestos-containing materials and lead-based-paint hazards. Where potentially significant impacts are identified, mitigation measures to reduce impacts will be presented.

Hydrology and Water Quality. Drainage and water quality impacts will be evaluated, taking into account campus stormwater plans and state requirements. The EIR will include a review of the project's regulatory context, development standards pertaining to water quality, and their applicability to campus improvements. Potential impacts will be compared against existing conditions, and additional mitigation measures will be identified, where necessary, to avoid or substantially reduce impacts.

Land Use and Planning. The EIR will evaluate the proposed Master Plan to determine whether the project would physically divide an established community or conflict with any applicable land use plan, policy, or regulation of an agency with jurisdiction over the project, per Appendix G of the CEQA Guidelines. Conflicts with existing or planned land uses adjacent to the campus will also be evaluated where such conflicts could result in environmental impacts. The EIR will summarize and address relevant provisions of the Fort Ord Base Reuse Plan as it relates to CSUMB development and resource management.

Noise and Vibration. As part of the EIR for the project, Dudek will prepare an acoustical analysis evaluating noise impacts resulting from project-generated traffic and other on-site operations activities associated with buildout under the proposed Master Plan and near-term projects. The EIR will also evaluate noise exposure levels for proposed noise-sensitive project components (i.e., student residential buildings). Noise measurements will be conducted to determine existing noise levels. Future on-site traffic noise levels at the proposed noise-sensitive facilities will be determined based on the results of the noise measurements and modeling of future traffic volumes using Federal Highway Administration models. Off-site traffic noise impacts associated with project-generated traffic along the adjoining roads will also be evaluated. Future noise levels at noise-sensitive receptors on campus and off campus will be reviewed. Noise mitigation measures will be recommended as necessary.

Population and Housing. The EIR will evaluate the proposed Master Plan to determine whether implementation would induce substantial population growth, create a substantial new demand for housing that exceeds existing or planned supply, or displace a substantial number of existing housing or people requiring the construction of replacement housing. Campus population growth and

housing demand will be reviewed, and the EIR analysis will address the growth of campus population and its implications for housing demand. Regional population and housing forecasts and local adopted Housing Elements of General Plans will be reviewed and considered as relevant as part of the housing analysis.

Public Services and Recreation. Existing conditions related to fire protection service, police protection service, parks and recreation, and schools will be described. The increase in campus population as a result of the project will be reviewed to determine whether the project would result in potentially significant impacts to performance levels of these public services, and thus result in substantial physical impacts associated with the provision of new or physically altered governmental facilities, consistent with CEQA Guidelines Appendix G guidance. The EIR will consider impacts related to recreation and the potential for increased demand for parks and recreation facilities as a result of on-campus housing and population.

Transportation and Traffic. A traffic impact analysis will be prepared for the EIR to evaluate potential impacts of the proposed Master Plan and the near-term projects on intersection and freeway levels of service and campus access and circulation systems based on updated traffic counts. Using data from the CSUMB Annual Traffic Generation Study, peak-hour trip generation data from other California State University campus surveys, and other relevant information, trip rates will be estimated and project impacts will be assessed. The campus has committed to a sustainable campus Master Plan, which includes recommendations for a robust TDM program and a parking management plan as a means to reduce vehicle trips to the campus. The transportation analysis will account for implementation of the TDM program and parking management plan, and through the analysis process, additional TDM and parking management strategies may be considered. The analysis will also consider changes in land use on the campus under the proposed Master Plan and in the immediate vicinity of the campus, including increases in on-campus housing and the availability of increased student amenities.

Utilities and Service Systems. The EIR will address water supply, wastewater treatment, solid waste, and electrical and natural gas utility services. Stormwater drainage utilities will be addressed in the hydrology section of the EIR. The EIR will document and update existing conditions, and provide impact assessments for these utilities.

Other CEQA-Required Sections. In accordance with CEQA requirements, cumulative impacts, alternatives, and growth-inducement effects of the proposed Master Plan and near-term projects will be analyzed.

INTENTIONALLY LEFT BLANK

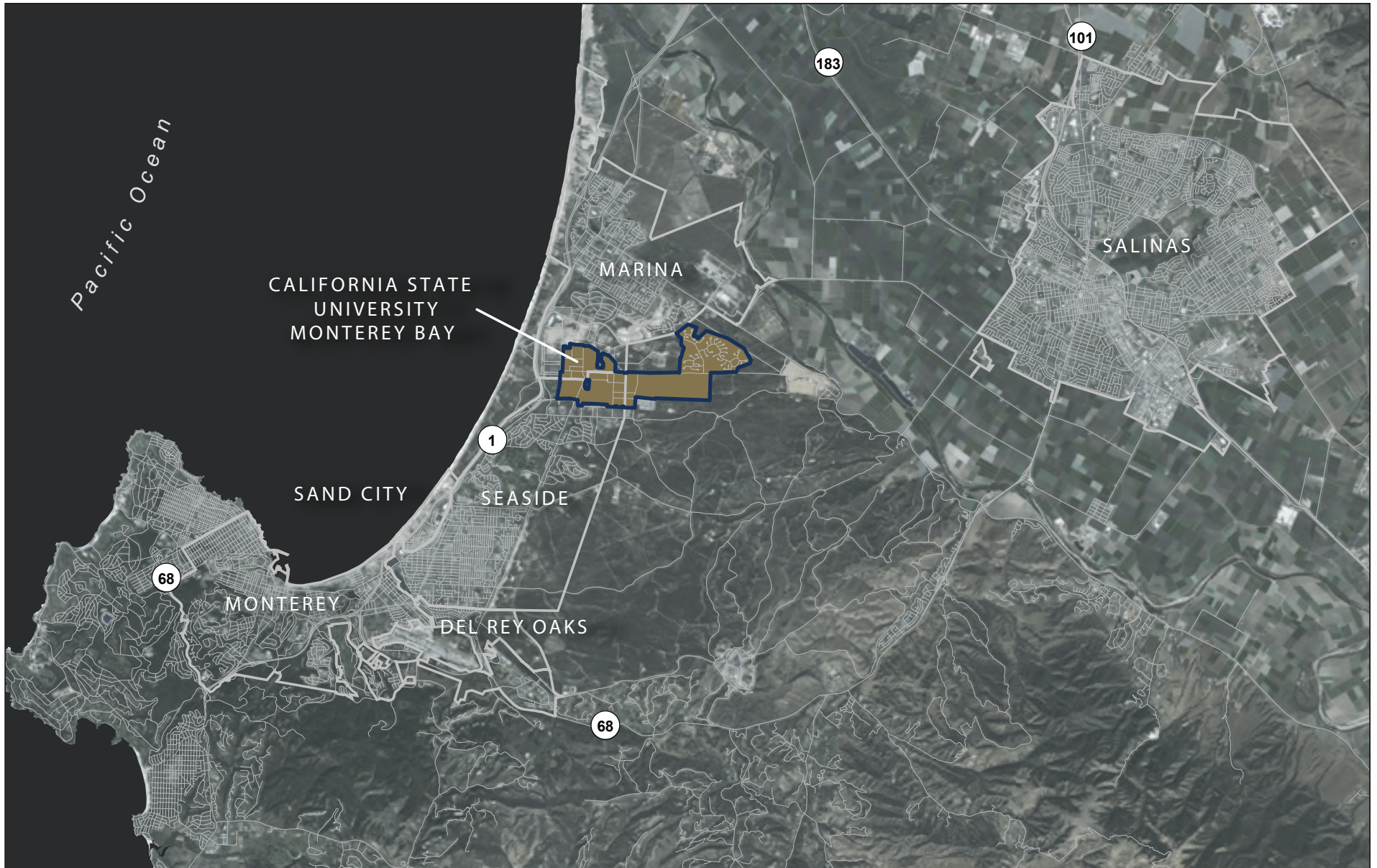

SOURCE: Page/BMS Design Group (2017)

DUDEK

CSU Monterey Bay Master Plan EIR

FIGURE 1
Regional Location

INTENTIONALLY LEFT BLANK

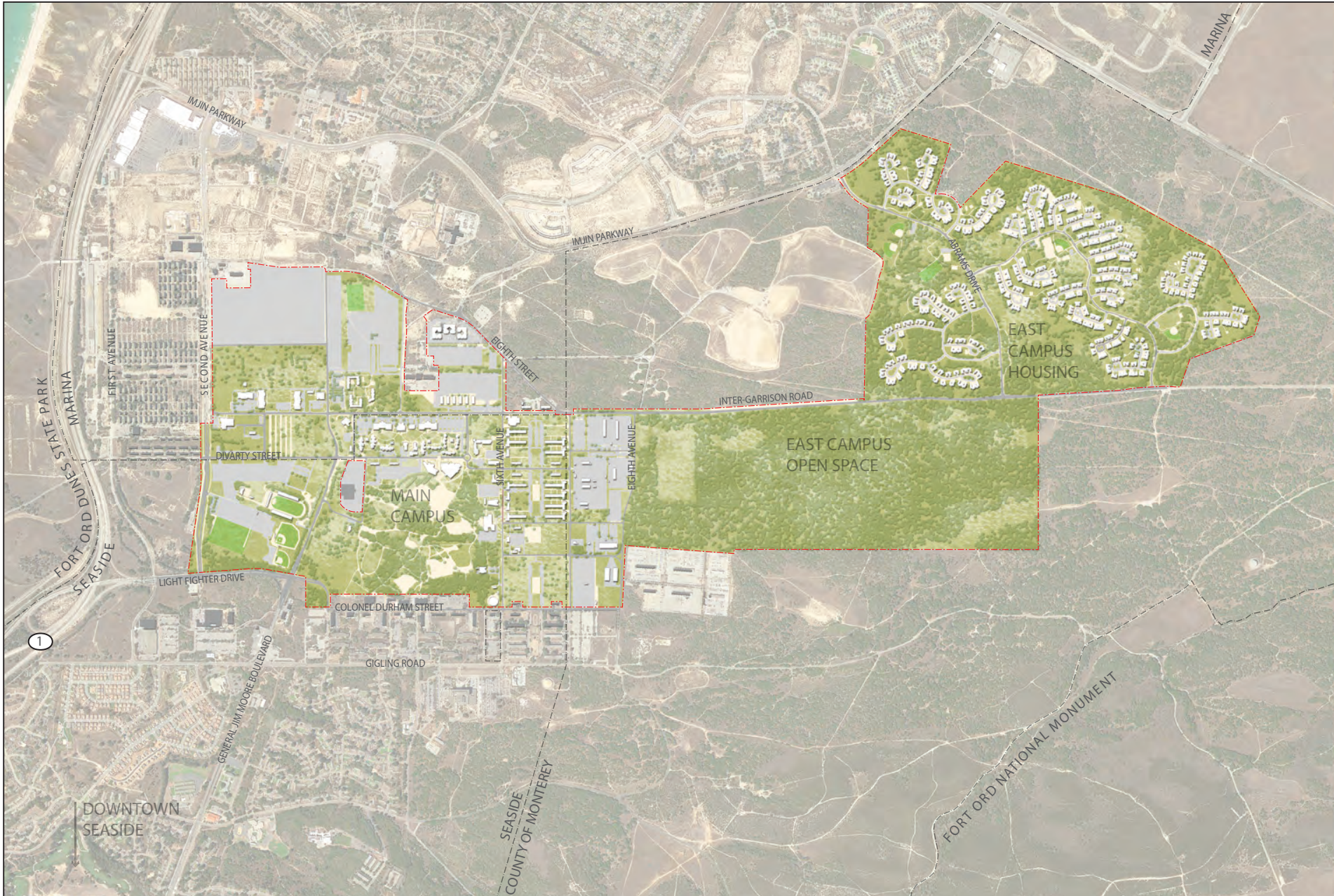

SOURCE: Page/BMS Design Group (2017)

DUDEK

CSU Monterey Bay Master Plan EIR

FIGURE 2
CSUMB Campus

INTENTIONALLY LEFT BLANK

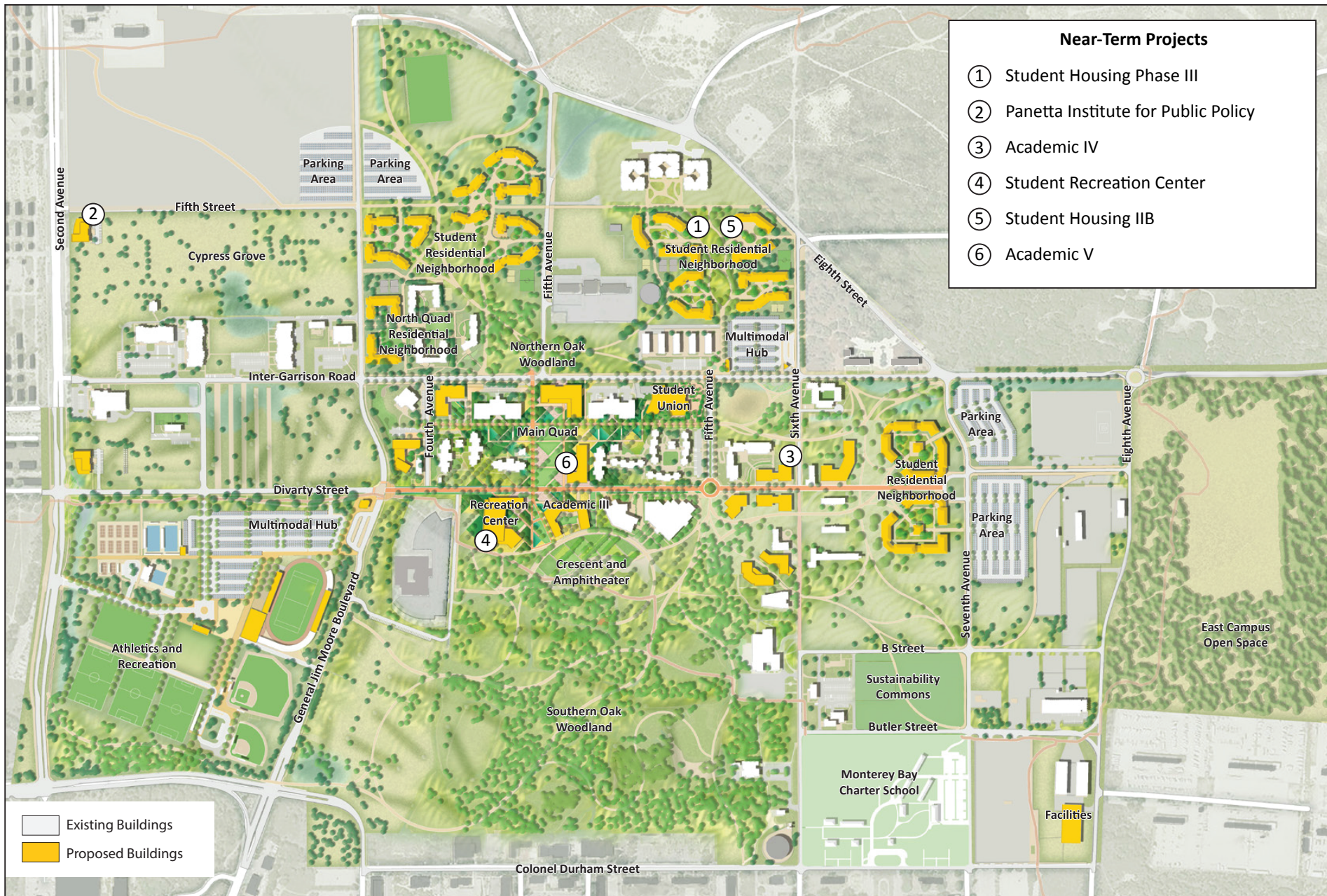

SOURCE: Page/BMS Design Group, as modified by Dudek (2017)

DUDEK

CSU Monterey Bay Master Plan EIR

FIGURE 3
Illustrative Plan

INTENTIONALLY LEFT BLANK

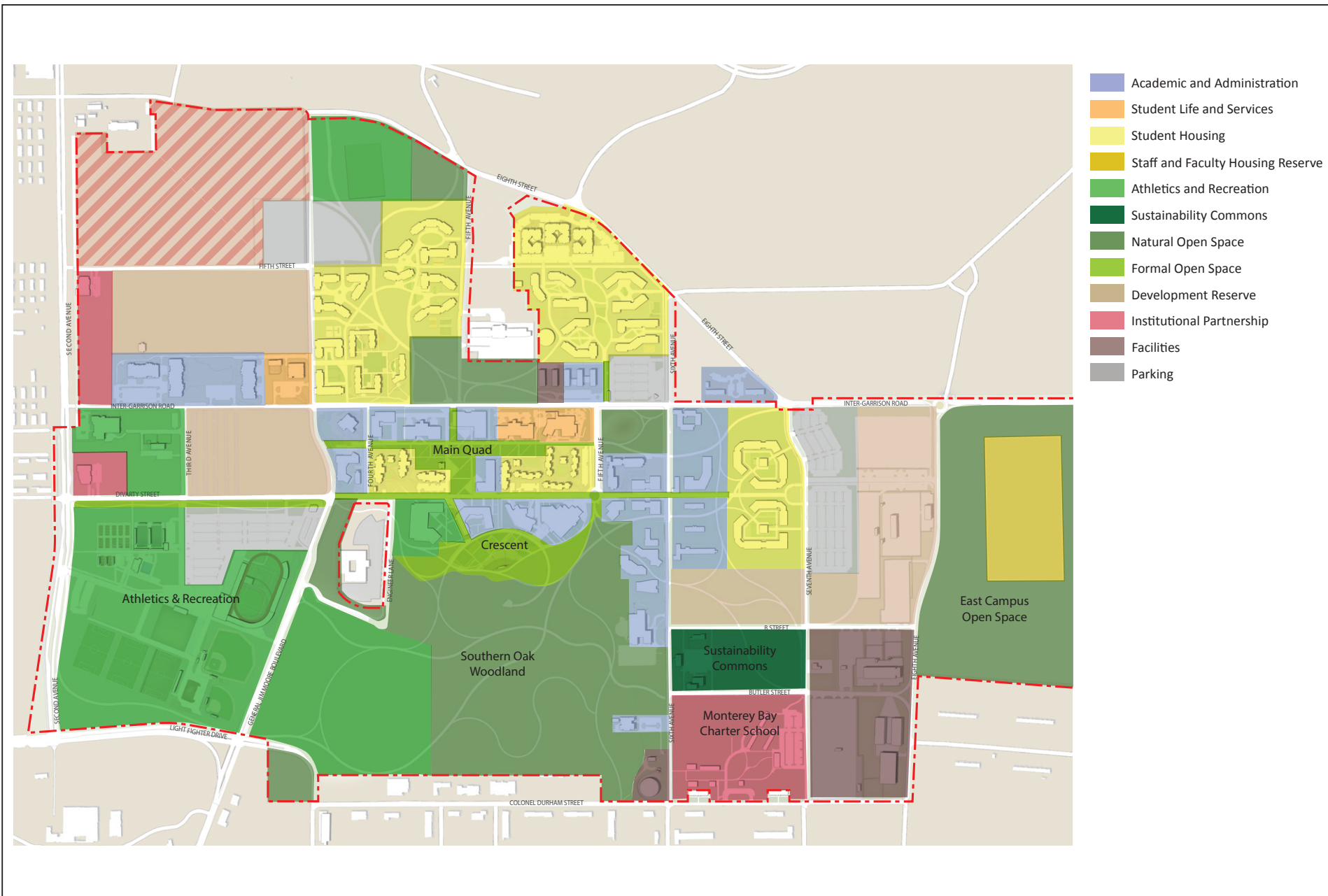

SOURCE: Page/BMS Design Group (2017)

DUDEK

CSU Monterey Bay Master Plan EIR

FIGURE 4
Land Use Plan

INTENTIONALLY LEFT BLANK

**Revision to
Previously Issued
Notice of Preparation**

August 9, 2019

INTENTIONALLY LEFT BLANK

Campus Planning & Development
100 Campus Center
Mountain Hall A
Seaside, CA 93955-8001

(831) 582-3709
FAX (831) 582-4436

REVISION TO PREVIOUSLY ISSUED NOTICE OF PREPARATION

ENVIRONMENTAL IMPACT REPORT FOR THE CALIFORNIA STATE UNIVERSITY MONTEREY BAY MASTER PLAN

DATE: August 9, 2019

TO: Agencies, Organizations, and Interested Parties

PROJECT TITLE: California State University Monterey Bay Master Plan (Project)

LEAD AGENCY: The Board of Trustees of the California State University (Trustees)
401 Golden Shore
Long Beach, California 90802-4210

On behalf of California State University Monterey Bay (CSUMB)
100 Campus Center
Seaside, California 93955

SUBJECT: Revised Notice of Preparation of an Environmental Impact Report for the CSUMB Master Plan

A Notice of Preparation (NOP) for the pending CSUMB Master Plan Environmental Impact Report (EIR) was issued by the Board of Trustees of the California State University (Trustees) on May 17, 2017 and is located at <https://csumb.edu/campusplanning/draft-campus-master-plan-2017>. Per California Education Code (Cal. Code Regs. tit. 3, §66606), the Trustees is the governing body and owner of the California State University Monterey Bay (CSUMB) campus, and has the authority to certify the EIR, adopt the Master Plan, and provide for schematic design approvals. CSUMB is acting as point of contact for the CEQA process.

As the lead agency for the preparation of the EIR for the Project, the Trustees prepared this Revision to Previously Issued NOP to notify agencies, organizations, and other interested parties that the methodology to be used in the EIR in assessing potential transportation-related impacts has been modified from that indicated in the original NOP. Specifically, the original NOP indicates that intersection and freeway levels of service (LOS) would be the basis for the evaluation of potential

transportation impacts related to vehicle travel in the EIR. However, in response to Senate Bill 743 and the associated revisions to the CEQA Guidelines that became effective December 28, 2018, after release of the original NOP, the proposed analysis methodology has been modified, as further explained below. In all other respects, the NOP issued May 17, 2017, is unchanged.

NOP Revision – Transportation and Traffic: NOP page 9 is revised to read as follows: A transportation impact analysis will be prepared as part of the EIR to evaluate potential impacts of the proposed Master Plan and the near-term projects relative to vehicle miles traveled (VMT) and other applicable transportation criteria, consistent with the December 2018 revisions to the CEQA Guidelines. The analysis will consider campus growth and land use changes anticipated under the proposed Master Plan, including increases in on-campus housing and the availability of increased student amenities. The campus has committed to a sustainable campus Master Plan, which includes recommendations for a transportation demand management (TDM) program and a parking management plan as a means to manage vehicle trips to the campus and parking demand. While the transportation analysis will acknowledge the implementation of the TDM program and parking management plan as part of the Project, the estimates of vehicle travel in the transportation analysis are based on observed existing travel behavior to provide for a reasonable worst-case estimate of likely transportation conditions with the Project. Intersection and freeway LOS analysis will be provided for information and campus planning purposes only; significant impact determinations relative to vehicular travel and mitigation, if applicable, will be identified based upon the 2018 CEQA Guidelines, which require VMT analysis.

Organizations and Interested Parties: The Trustees request comments and concerns regarding the proposed revised analytical methodology, as described in this Revision to Previously Issued NOP, to be applied in the transportation impact analysis associated with the Project.

Public Review Period: The Trustees have issued this Revision to Previously Issued NOP for public review and comment pursuant to the CEQA Guidelines (Cal. Code Regs. tit. 14, §15082 and §15375). The Trustees have established a 30-day public scoping period from **August 12, 2019** through **September 10, 2019**, in accordance with the CEQA Guidelines (Cal. Code Regs. tit. 14, §15082). The Revision to Previously Issued NOP, along with the original NOP dated May 17, 2017, is available for review online at the following location: <https://csumb.edu/campusplanning/draft-campus-master-plan-2017>.

Scoping Comments: The Trustees are soliciting comments only on the revised analytical methodology to be applied in the transportation impact analysis of the pending EIR as described in this Revision to Previously Issued NOP. All prior scoping comments will be disclosed and considered in the pending EIR and do not need to be resubmitted. Comments on the transportation impact analysis may be submitted by mail, email, or fax. All comments should indicate a contact person for the agency or organization, if applicable. All comments should be sent to the following address, to arrive no later than 5:00 p.m. on **September 10, 2019**:

Anya Spear, LEED AP
Associate Director of Campus Planning
CSUMB, Campus Planning & Development
100 Campus Center, Seaside, California 93955
T: 831.582.5098 F: 831.582.3545 aspear@csumb.edu

Public Scoping Meeting: Two scoping meetings were previously held in May of 2017. The Trustees will hold one additional Scoping Meeting to give the public an opportunity to receive more information about the revised analytical methodology to be applied in the transportation impact analysis of the pending EIR, and to provide comments and suggestions related thereto. All members of the public and interested persons are welcome to attend and provide written comments. The Scoping Meeting will be held on **August 27, 2019**, from **5:00 p.m. to 6:30 p.m.** at the Student Center West Lounge (next to Starbucks) on the CSUMB campus. See the campus map at the following location: <https://csumb.edu/directory/building/12>.

Further Information: For environmental review information or questions about the Project, please contact Anya Spear (831.582.5098 or aspear@csumb.edu).

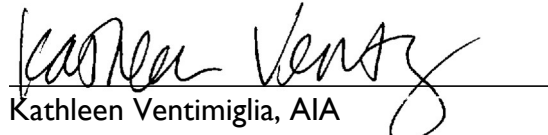
Kathleen Ventimiglia, AIA
Director of Campus Planning & Development
California State University Monterey Bay

August 9, 2019
Date

INTENTIONALLY LEFT BLANK

APPENDIX B

Comment Letters Received During Scoping Periods

INTENTIONALLY LEFT BLANK

**Notice of
Preparation**

May 12, 2017

INTENTIONALLY LEFT BLANK

CSUMB Master Plan EIR - scoping comments

Inbox x



Guidi, Robert G CIV USARMY IMCOM CENTRAL (US)

11:39 AM (2 hours ago)

to me, Joelle

Good day Anya,

Hope all is going well. Thank you for the opportunity to provide input on the CSUMB Master Plan EIR scoping process. Please consider the comments for in-depth environmental analyses as follows:

1. **WATER RESOURCES** - A solid evaluation should be made when addressing sustainable water sources required to support future growth of the CSUMB Campus. Efforts to bring about a "regional" water solution are finally being realized after decades of planning. Nonetheless, the "regional solution" should not be viewed as the panacea for water needs. There are several local and site specific measures that should be addressed in the forthcoming EIR. Those measures include but are not limited to water conservation programs in graywater treatment/recycling, storm water diversion for reuse, low-flow water fixtures and developing a separate water works system.
2. **STORM WATER MANAGEMENT** - There should be a significant effort made to address Low-Impact Development (LID) measures and on-site water management. There could be opportunities to lessen or eliminate environmental impacts from storm water runoff by sharing facilities with others such as developers and neighboring property owners. Possible ways to reduce environmental impacts of storm water runoff should be examined.
3. **ALTERNATIVE MODES OF TRANSPORTATION** - CSUMB and MST continue to partner in providing additional transportation services. The EIR should address potential mitigations measures designed to further reduce the need for motorized vehicle use within the interior campus areas (e.g. enhancing shuttle bus services, providing incentives to bolster usage of bicycles or pedestrian activity.)
4. **TRANSPORTATION CIRCULATION** - CSUMB continues its positive efforts to create a uniform traffic flow and minimize the amount of motorized vehicles moving within inner campus areas. Extending the environmental impact analysis beyond the campus is strongly encouraged. Arterial roads and intersections now on the periphery still experience low Levels of Service (LOS) during peaking traffic times. Those areas now located on the outer limits many very well be within the main campus as it expands over time. The overall sphere of influence associated with transportation circulation/traffic flow should be part of the environmental analysis.

Please contact me if you require any clarification or have questions about the comments submitted. I look forward to participating in future meetings/workshops and reviewing the draft of this important environmental document.

Robert Guidi
Directorate of Public Works
Master Planning Division
Presidio of Monterey, CA
[831-242-7928](tel:831-242-7928) (M-F 8 A.M. to 6 P.M. Pacific)

DEPARTMENT OF TRANSPORTATION

50 HIGUERA STREET
SAN LUIS OBISPO, CA 93401-5415
PHONE (805) 549-3101
FAX (805) 549-3329
TTY 711
<http://www.dot.ca.gov/dist05/>



*Serious drought
Help save water!*

June 8, 2017

MON-1-R83.4
SCH#2017051042

Ms. Anya Spear
California State University Monterey Bay Master Plan
100 Campus Center
Seaside, CA 93955

Dear Ms. Spear:

COMMENTS FOR THE NOTICE OF PREPARATION (NOP) FOR THE CALIFORNIA STATE UNIVERSITY MONTEREY BAY MASTER PLAN DRAFT ENVIRONMENTAL IMPACT REPORT (DEIR) – (2ND AVENUE/INTER-GARRISON) MONTEREY, CA

The California Department of Transportation (Caltrans), District 5, Development Review, has reviewed the NOP for the California State University Monterey Bay Master Plan DEIR including projects identified in the university's Five-Year Capital Improvement Program 2016/2017 through 2020/2021 located adjacent to Highway 1. Caltrans supports local development that is consistent with State planning priorities intended to promote equity, strengthen the economy, protect the environment, and promote public health and safety. We accomplish this by working with local jurisdictions to achieve a shared vision of how the transportation system should and can accommodate interregional and local travel and development. Projects that support smart growth principles which include improvements to pedestrian, bicycle, and transit infrastructure (or other key Transportation Demand Strategies) are supported by Caltrans and are consistent with our mission, vision, and goals.

Further, we seek to reduce vehicle trips and new vehicle miles traveled associated with the development by appropriate measures that avoid, minimize, or mitigate impacts through smart mobility community design and multimodal demand strategies. Caltrans offers the following comments in response to the NOP for the California State University Monterey Bay Master Plan DEIR:

1. The Transportation Agency for Monterey County (TAMC) collects development impact fees to help fund transportation projects of regional significance to address project long-range traffic impacts. Caltrans supports payment of the adopted TAMC development impact fees as required to mitigate any cumulative impacts.

Ms. Spear
June 8, 2017
Page 2

2. Please be aware that if any work is completed in the State's right-of-way it will require an encroachment permit from Caltrans, and must be done to our engineering and environmental standards, and at no cost to the State. The conditions of approval and the requirements for the encroachment permit are issued at the sole discretion of the Permits Office, and nothing in this letter shall be implied as limiting those future conditioned and requirements. For more information regarding the encroachment permit process, please visit our Encroachment Permit Website at: <http://www.dot.ca.gov/trafficops/ep/index.html>.
3. At any time during the environmental review and approval process, Caltrans retains the statutory right to request a formal scoping meeting to resolve any issues of concern. Such formal scoping meeting requests are allowed per the provisions of the California Public Resources Code Section 21083.9 [a] [1].
4. Since the master plan is proposing an increase of full time student population, Caltrans looks forward to reviewing the detailed traffic analysis provided when the EIR document is circulated. With early coordination, we hope to identify the university's off campus traffic impacts and work together to develop the mitigation package to mitigate these consistent with CEQA and other current case-law relative to university expansion.

Thank you for the opportunity to review and comment on the proposed project. If you have any questions, or need further clarification on items discussed above, please contact me at (805) 549-3282 or email jill.morales@dot.ca.gov.

Sincerely,



JILLIAN R. LEAL-MORALES
Associate Transportation Planner, District 5
jill.morales@dot.ca.gov

cc: Orchid Monroy-Ochoa (D5)
Grant Leonard (TAMC)
Heather Adamson (AMBAG)

NATIVE AMERICAN HERITAGE COMMISSION

Environmental and Cultural Department
1550 Harbor Blvd., Suite 100
West Sacramento, CA 95691
Phone (916) 373-3710
Fax (916) 373-5471
Email: nahc@nahc.ca.gov
Website: <http://www.nahc.ca.gov>
Twitter: @CA_NAHC



May 17, 2017

Anya Spear
California State University, Monterey Bay
100 Campus Center
Seaside, CA 93955

RE: SCH#2017051042 California State University Monterey Bay Master Plan, Monterey County

Dear Ms. Spear:

The Native American Heritage Commission has received the Notice of Preparation (NOP), Draft Environmental Impact Report (DEIR) or Early Consultation for the project referenced above. The California Environmental Quality Act (CEQA) (Pub. Resources Code § 21000 et seq.), specifically Public Resources Code section 21084.1, states that a project that may cause a substantial adverse change in the significance of an historical resource is a project that may have a significant effect on the environment. (Pub. Resources Code § 21084.1; Cal. Code Regs., tit.14, § 15064.5 (b) (CEQA Guidelines Section 15064.5 (b)). If there is substantial evidence, in light of the whole record before a lead agency, that a project may have a significant effect on the environment, an environmental impact report (EIR) shall be prepared. (Pub. Resources Code § 21080 (d); Cal. Code Regs., tit. 14, § 15064 subd.(a)(1) (CEQA Guidelines § 15064 (a)(1)). In order to determine whether a project will cause a substantial adverse change in the significance of a historical resource, a lead agency will need to determine whether there are historical resources with the area of project effect (APE).

CEQA was amended significantly in 2014. Assembly Bill 52 (Gatto, Chapter 532, Statutes of 2014) (AB 52) amended CEQA to create a separate category of cultural resources, "tribal cultural resources" (Pub. Resources Code § 21074) and provides that a project with an effect that may cause a substantial adverse change in the significance of a tribal cultural resource is a project that may have a significant effect on the environment. (Pub. Resources Code § 21084.2). Public agencies shall, when feasible, avoid damaging effects to any tribal cultural resource. (Pub. Resources Code § 21084.3 (a)). **AB 52 applies to any project for which a notice of preparation or a notice of negative declaration or mitigated negative declaration is filed on or after July 1, 2015.** If your project involves the adoption of or amendment to a general plan or a specific plan, or the designation or proposed designation of open space, on or after March 1, 2005, it may also be subject to Senate Bill 18 (Burton, Chapter 905, Statutes of 2004) (SB 18). **Both SB 18 and AB 52 have tribal consultation requirements.** If your project is also subject to the federal National Environmental Policy Act (42 U.S.C. § 4321 et seq.) (NEPA), the tribal consultation requirements of Section 106 of the National Historic Preservation Act of 1966 (154 U.S.C. 300101, 36 C.F.R. § 800 et seq.) may also apply.

The NAHC recommends consultation with California Native American tribes that are traditionally and culturally affiliated with the geographic area of your proposed project as early as possible in order to avoid inadvertent discoveries of Native American human remains and best protect tribal cultural resources. Below is a brief summary of portions of AB 52 and SB 18 as well as the NAHC's recommendations for conducting cultural resources assessments. **Consult your legal counsel about compliance with AB 52 and SB 18 as well as compliance with any other applicable laws.**

AB 52 has added to CEQA the additional requirements listed below, along with many other requirements:

1. Fourteen Day Period to Provide Notice of Completion of an Application/Decision to Undertake a Project: Within fourteen (14) days of determining that an application for a project is complete or of a decision by a public agency to undertake a project, a lead agency shall provide formal notification to a designated contact of, or tribal representative of, traditionally and culturally affiliated California Native American tribes that have requested notice, to be accomplished by at least one written notice that includes:
 - a. A brief description of the project.
 - b. The lead agency contact information.
 - c. Notification that the California Native American tribe has 30 days to request consultation. (Pub. Resources Code § 21080.3.1 (d)).
 - d. A "California Native American tribe" is defined as a Native American tribe located in California that is on the contact list maintained by the NAHC for the purposes of Chapter 905 of Statutes of 2004 (SB 18). (Pub. Resources Code § 21073).
2. Begin Consultation Within 30 Days of Receiving a Tribe's Request for Consultation and Before Releasing a Negative Declaration, Mitigated Negative Declaration, or Environmental Impact Report: A lead agency shall begin the consultation process within 30 days of receiving a request for consultation from a California Native American tribe that is traditionally and culturally affiliated with the geographic area of the proposed project. (Pub. Resources Code § 21080.3.1, subds. (d) and (e)) and prior to the release of a negative declaration, mitigated negative declaration or environmental impact report. (Pub. Resources Code § 21080.3.1(b)).
 - a. For purposes of AB 52, "consultation shall have the same meaning as provided in Gov. Code § 65352.4 (SB 18). (Pub. Resources Code § 21080.3.1 (b)).
3. Mandatory Topics of Consultation If Requested by a Tribe: The following topics of consultation, if a tribe requests to discuss them, are mandatory topics of consultation:
 - a. Alternatives to the project.
 - b. Recommended mitigation measures.
 - c. Significant effects. (Pub. Resources Code § 21080.3.2 (a)).
4. Discretionary Topics of Consultation: The following topics are discretionary topics of consultation:
 - a. Type of environmental review necessary.
 - b. Significance of the tribal cultural resources.
 - c. Significance of the project's impacts on tribal cultural resources.
 - d. If necessary, project alternatives or appropriate measures for preservation or mitigation that the tribe may recommend to the lead agency. (Pub. Resources Code § 21080.3.2 (a)).
5. Confidentiality of Information Submitted by a Tribe During the Environmental Review Process: With some exceptions, any information, including but not limited to, the location, description, and use of tribal cultural resources submitted by a California Native American tribe during the environmental review process shall not be included in the environmental document or otherwise disclosed by the lead agency or any other public agency to the public, consistent with Government Code sections 6254 (r) and 6254.10. Any information submitted by a California Native American tribe during the consultation or environmental review process shall be published in a confidential appendix to the environmental document unless the tribe that provided the information consents, in writing, to the disclosure of some or all of the information to the public. (Pub. Resources Code § 21082.3 (c)(1)).
6. Discussion of Impacts to Tribal Cultural Resources in the Environmental Document: If a project may have a significant impact on a tribal cultural resource, the lead agency's environmental document shall discuss both of the following:
 - a. Whether the proposed project has a significant impact on an identified tribal cultural resource.
 - b. Whether feasible alternatives or mitigation measures, including those measures that may be agreed to pursuant to Public Resources Code section 21082.3, subdivision (a), avoid or substantially lessen the impact on the identified tribal cultural resource. (Pub. Resources Code § 21082.3 (b)).
7. Conclusion of Consultation: Consultation with a tribe shall be considered concluded when either of the following occurs:

- a. The parties agree to measures to mitigate or avoid a significant effect, if a significant effect exists, on a tribal cultural resource; or
 - b. A party, acting in good faith and after reasonable effort, concludes that mutual agreement cannot be reached. (Pub. Resources Code § 21080.3.2 (b)).
8. Recommending Mitigation Measures Agreed Upon in Consultation in the Environmental Document: Any mitigation measures agreed upon in the consultation conducted pursuant to Public Resources Code section 21080.3.2 shall be recommended for inclusion in the environmental document and in an adopted mitigation monitoring and reporting program, if determined to avoid or lessen the impact pursuant to Public Resources Code section 21082.3, subdivision (b), paragraph 2, and shall be fully enforceable. (Pub. Resources Code § 21082.3 (a)).
9. Required Consideration of Feasible Mitigation: If mitigation measures recommended by the staff of the lead agency as a result of the consultation process are not included in the environmental document or if there are no agreed upon mitigation measures at the conclusion of consultation, or if consultation does not occur, and if substantial evidence demonstrates that a project will cause a significant effect to a tribal cultural resource, the lead agency shall consider feasible mitigation pursuant to Public Resources Code section 21084.3 (b). (Pub. Resources Code § 21082.3 (e)).
10. Examples of Mitigation Measures That, If Feasible, May Be Considered to Avoid or Minimize Significant Adverse Impacts to Tribal Cultural Resources:
- a. Avoidance and preservation of the resources in place, including, but not limited to:
 - i. Planning and construction to avoid the resources and protect the cultural and natural context.
 - ii. Planning greenspace, parks, or other open space, to incorporate the resources with culturally appropriate protection and management criteria.
 - b. Treating the resource with culturally appropriate dignity, taking into account the tribal cultural values and meaning of the resource, including, but not limited to, the following:
 - i. Protecting the cultural character and integrity of the resource.
 - ii. Protecting the traditional use of the resource.
 - iii. Protecting the confidentiality of the resource.
 - c. Permanent conservation easements or other interests in real property, with culturally appropriate management criteria for the purposes of preserving or utilizing the resources or places.
 - d. Protecting the resource. (Pub. Resource Code § 21084.3 (b)).
 - e. Please note that a federally recognized California Native American tribe or a nonfederally recognized California Native American tribe that is on the contact list maintained by the NAHC to protect a California prehistoric, archaeological, cultural, spiritual, or ceremonial place may acquire and hold conservation easements if the conservation easement is voluntarily conveyed. (Civ. Code § 815.3 (c)).
 - f. Please note that it is the policy of the state that Native American remains and associated grave artifacts shall be repatriated. (Pub. Resources Code § 5097.991).
11. Prerequisites for Certifying an Environmental Impact Report or Adopting a Mitigated Negative Declaration or Negative Declaration with a Significant Impact on an Identified Tribal Cultural Resource: An environmental impact report may not be certified, nor may a mitigated negative declaration or a negative declaration be adopted unless one of the following occurs:
- a. The consultation process between the tribes and the lead agency has occurred as provided in Public Resources Code sections 21080.3.1 and 21080.3.2 and concluded pursuant to Public Resources Code section 21080.3.2.
 - b. The tribe that requested consultation failed to provide comments to the lead agency or otherwise failed to engage in the consultation process.
 - c. The lead agency provided notice of the project to the tribe in compliance with Public Resources Code section 21080.3.1 (d) and the tribe failed to request consultation within 30 days. (Pub. Resources Code § 21082.3 (d)).

The NAHC's PowerPoint presentation titled, "Tribal Consultation Under AB 52: Requirements and Best Practices" may be found online at: http://nahc.ca.gov/wp-content/uploads/2015/10/AB52TribalConsultation_CalEPAPDF.pdf

SB 18 applies to local governments and requires local governments to contact, provide notice to, refer plans to, and consult with tribes prior to the adoption or amendment of a general plan or a specific plan, or the designation of open space. (Gov. Code § 65352.3). Local governments should consult the Governor's Office of Planning and Research's "Tribal Consultation Guidelines," which can be found online at: https://www.opr.ca.gov/docs/09_14_05_Updated_Guidelines_922.pdf

Some of SB 18's provisions include:

1. **Tribal Consultation:** If a local government considers a proposal to adopt or amend a general plan or a specific plan, or to designate open space it is required to contact the appropriate tribes identified by the NAHC by requesting a "Tribal Consultation List." If a tribe, once contacted, requests consultation the local government must consult with the tribe on the plan proposal. **A tribe has 90 days from the date of receipt of notification to request consultation unless a shorter timeframe has been agreed to by the tribe.** (Gov. Code § 65352.3 (a)(2)).
2. **No Statutory Time Limit on SB 18 Tribal Consultation.** There is no statutory time limit on SB 18 tribal consultation.
3. **Confidentiality:** Consistent with the guidelines developed and adopted by the Office of Planning and Research pursuant to Gov. Code section 65040.2, the city or county shall protect the confidentiality of the information concerning the specific identity, location, character, and use of places, features and objects described in Public Resources Code sections 5097.9 and 5097.993 that are within the city's or county's jurisdiction. (Gov. Code § 65352.3 (b)).
4. **Conclusion of SB 18 Tribal Consultation:** Consultation should be concluded at the point in which:
 - a. The parties to the consultation come to a mutual agreement concerning the appropriate measures for preservation or mitigation; or
 - b. Either the local government or the tribe, acting in good faith and after reasonable effort, concludes that mutual agreement cannot be reached concerning the appropriate measures of preservation or mitigation. (Tribal Consultation Guidelines, Governor's Office of Planning and Research (2005) at p. 18).

Agencies should be aware that neither AB 52 nor SB 18 precludes agencies from initiating tribal consultation with tribes that are traditionally and culturally affiliated with their jurisdictions before the timeframes provided in AB 52 and SB 18. For that reason, we urge you to continue to request Native American Tribal Contact Lists and "Sacred Lands File" searches from the NAHC. The request forms can be found online at: <http://nahc.ca.gov/resources/forms/>

NAHC Recommendations for Cultural Resources Assessments

To adequately assess the existence and significance of tribal cultural resources and plan for avoidance, preservation in place, or barring both, mitigation of project-related impacts to tribal cultural resources, the NAHC recommends the following actions:

1. Contact the appropriate regional California Historical Research Information System (CHRIS) Center (http://ohp.parks.ca.gov/?page_id=1068) for an archaeological records search. The records search will determine:
 - a. If part or all of the APE has been previously surveyed for cultural resources.
 - b. If any known cultural resources have been already been recorded on or adjacent to the APE.
 - c. If the probability is low, moderate, or high that cultural resources are located in the APE.
 - d. If a survey is required to determine whether previously unrecorded cultural resources are present.
2. If an archaeological inventory survey is required, the final stage is the preparation of a professional report detailing the findings and recommendations of the records search and field survey.
 - a. The final report containing site forms, site significance, and mitigation measures should be submitted immediately to the planning department. All information regarding site locations, Native American human remains, and associated funerary objects should be in a separate confidential addendum and not be made available for public disclosure.
 - b. The final written report should be submitted within 3 months after work has been completed to the appropriate regional CHRIS center.

3. Contact the NAHC for:
 - a. A Sacred Lands File search. Remember that tribes do not always record their sacred sites in the Sacred Lands File, nor are they required to do so. A Sacred Lands File search is not a substitute for consultation with tribes that are traditionally and culturally affiliated with the geographic area of the project's APE.
 - b. A Native American Tribal Consultation List of appropriate tribes for consultation concerning the project site and to assist in planning for avoidance, preservation in place, or, failing both, mitigation measures.
4. Remember that the lack of surface evidence of archaeological resources (including tribal cultural resources) does not preclude their subsurface existence.
 - a. Lead agencies should include in their mitigation and monitoring reporting program plan provisions for the identification and evaluation of inadvertently discovered archaeological resources per Cal. Code Regs., tit. 14, section 15064.5(f) (CEQA Guidelines section 15064.5(f)). In areas of identified archaeological sensitivity, a certified archaeologist and a culturally affiliated Native American with knowledge of cultural resources should monitor all ground-disturbing activities.
 - b. Lead agencies should include in their mitigation and monitoring reporting program plans provisions for the disposition of recovered cultural items that are not burial associated in consultation with culturally affiliated Native Americans.
 - c. Lead agencies should include in their mitigation and monitoring reporting program plans provisions for the treatment and disposition of inadvertently discovered Native American human remains. Health and Safety Code section 7050.5, Public Resources Code section 5097.98, and Cal. Code Regs., tit. 14, section 15064.5, subdivisions (d) and (e) (CEQA Guidelines section 15064.5, subs. (d) and (e)) address the processes to be followed in the event of an inadvertent discovery of any Native American human remains and associated grave goods in a location other than a dedicated cemetery.

If you have any questions, please contact me at my email address: frank.lienert@nahc.ca.gov

Sincerely,



for Frank Lienert
Associate Governmental Program Analyst

cc: State Clearinghouse



FORT ORD REUSE AUTHORITY

920 2nd Avenue, Suite A, Marina, CA 93933

Phone: (831) 883-3672 | Fax: (831) 883-3675 | www.fora.org

June 9, 2017

Anya Spear, LEED AP
Associate Director of Campus Planning
California State University Monterey Bay, Campus Planning & Development
100 Campus Center, Seaside, California 93955

Re: Notice of Preparation dated May 11, 2017 for an Environmental Impact Report for the California State University Monterey Bay Master Plan

Dear Ms. Spear:

We are in receipt of the Notice of Preparation document dated May 11, 2017 for an Environmental Impact Report (EIR) for the California State University Monterey Bay Master Plan (CSUMB Plan). In that regard, we are providing the following comments and concerns about the impacts the Master Plan could have on the environment in the future from the perspective of the Fort Ord Reuse Authority's (FORA's) overall mission of regional recovery.

A primary concern and mandate of FORA is to minimize the increase in demand for transportation infrastructure and services both within the base area and the region. The Base Reuse Plan Circulation Concept for the former Fort Ord includes strategies and improvements for the system within the base, as well as for those regionally significant facilities that provide access to the former Fort Ord. This plan includes building or improving roadway facilities and a demand management network that consists of strategies and actions that can be used to minimize the demand for vehicle trips as an alternative to increasing roadway capacity. In developing the CSUMB Plan EIR, traffic volumes on roadways must be evaluated. FORA recently conducted a fee reallocation study; we urge your team to use the information gained from our study in your analysis. Furthermore, we applaud your effort to eliminate or reduce traffic-related impacts and anticipate that the transition to the scenario's 2016-2026 goals of modes (28% drive alone, 22% shared ride, 25% transit, 13% walk, 10% bicycle, 2% other) will be gradual. We recommend your team evaluate traffic flow and load in phases from road closures and extensions, so that traffic impacts during the transition are precisely measured and mitigated appropriately in each phase. In addition, discuss how you can maximize your transit options in coordination with Monterey Salinas Transit during this gradual transition.

FORA is currently invested in helping the lead jurisdictions, Monterey County and City of Seaside, work collaboratively to plan for regional Oak Woodland protection on former Fort Ord. They are completing several policies and programs that the Base Reuse Plan requires to preserve contiguous areas of native Oak Woodland habitat. Your offices have been offered the opportunity to plan with them so that some 40 to 70 acres of

CSUMB's native Oak Woodland can be included in the regional corridor connecting Habitat Management Areas (HMAs) southeast of the CSUMB campus to the Landfill HMA to the north. The area in discussion is "East Campus Open Space." We find these policies to be aligned with your Master Plan's objective to retain Oak Woodlands. They also relate to your need to offset your project-related impacts. We urge you to embrace the opportunity to be a part of the Oak Woodland Conservation Area and to grant these agencies the opportunity to set aside conservation easements. The EIR should address how these specific areas are defined as mitigation for Oak Woodlands impacted by activities of the Master Plan and serve as components of regional mitigation areas. Also, coordinate with the County and Seaside to refer to related measures to be taken to protect and manage Oak Woodland habitat values. It is an excellent opportunity to align with the historic Fort Ord jurisdictions toward cohesive regional conservation planning.

In closing, we appreciate the opportunity to provide these comments. FORA is supportive of CSU's efforts to complete the promise of the Monterey Bay campus and look forward to the campus' central role in the regional recovery from the Fort Ord closure.

Sincerely,

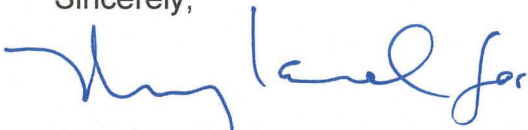
A handwritten signature in blue ink, appearing to read "Jonathan Brinkmann".

Jonathan Brinkmann
Principal Planner

cc: Michael Houlemard, Executive Officer

State Clearinghouse
P.O. Box 3044
Sacramento, CA 95812-3044

MONTEREY COUNTY RESOURCE MANAGEMENT AGENCY

Carl P. Holm, AICP, Director



Building Services / Environmental Services / Planning Services / Public Works & Facilities
168 W. Alisal Street, 2nd Floor (831)755-4800
Salinas, California 93901 www.co.monterey.ca.us/rma

June 12, 2017

Anya Spear
CSUMB Campus Planning and Development
100 Campus Center
Seaside, CA 93955

Subject: NOP for CSUMB Master Plan

Dear Ms. Spear,

Thank you for the opportunity to review the NOP for the CSUMB Master Plan. Monterey County land use departments have reviewed the NOP and have the following comments:

Office of the Sheriff

The area of the project/construction is not in the actual jurisdiction of the Monterey County Sheriff's Office. (MCSO).

However, there are areas on the Former Ft. Ord property that fall under the jurisdiction of the MCSO (Beat areas 6C and 4C).

These areas are near the borders of the CSUMB campus.

Due to this project, with the increase in housing, the population will increase. This does have the potential to increase calls for service in the surrounding areas of the campus, and thus could impact those areas in the jurisdiction of MCSO.

Also, in the event of a major crime/emergency, the CSUMB Police Department could request the assistance of MCSO.

At this time, even with these factors considered, the impact to MCSO services would be **less than significant**.

Thank you again for the opportunity to comment on the NOP.

Sincerely,

A handwritten signature in cursive script that reads 'Bob Schubert'.

Bob Schubert, AICP
Senior Planner

MONTEREY COUNTY RESOURCE MANAGEMENT AGENCY

Carl P. Holm, AICP, Director



LAND USE & COMMUNITY DEVELOPMENT | PUBLIC WORKS & FACILITIES | PARKS
1441 Schilling Place, South 2nd Floor (831)755-4800
Salinas, California 93901-4527 www.co.monterey.ca.us/rma

June 12, 2017

Anya Spear, LEED AP
Associate Director of Campus Planning
CSUMB, Campus Planning & Development
100 Campus Center
Seaside, California 93955

**SUBJECT: COMMENTS TO NOTICE OF PREPARATION OF AN ENVIRONMENTAL
IMPACT REPORT FOR THE CALIFORNIA STATE UNIVERSITY
MONTEREY BAY MASTER PLAN**

Dear Ms. Spear,

Monterey County Resource Management Agency - Public Works (RMA-PW) has reviewed the Notice of Preparation (NOP) of an EIR for the CSUMB Master Plan, dated May 12, 2017. Based on the NOP, the proposed Master Plan would include projects identified in the CSUMB's 5-Year Capital Improvement Program, plus the additional space and facility needs to support planned growth to 12,700 full-time-equivalent (FTE) students, with on-campus housing for students, faculty and staff. The project would also include six "near-term projects." The RMA-PW is very interested to know about the project's potential impacts to County Roads and the surrounding traffic circulation network, especially given the severe congestion currently experienced in the vicinity of the campus.

We offer the following information and recommendations to aid you with the environmental review process:

- Any mitigation measure(s) proposed by the project should conform to regional planning documents, such as the Monterey County General Plan and TAMC's Regional Transportation Plan.
- The methodologies used to calculate the Levels of Service (LOS) should be consistent with the methods in the latest edition of the Highway Capacity Manual (2010 HCM). The analysis should use the latest Institute of Transportation Engineers (ITE) trip generation manual for trip rates (please refer to the County of Monterey's guide for the preparation of traffic impact studies <http://www.co.monterey.ca.us/home/showdocument?id=3846>).
- The Traffic Study should identify mitigation measures for all traffic circulation impacts on County roads. The significance criteria for County roads is described as follows:
 - Signalized Intersection: A significant impact would occur if an intersection operating at LOS A, B, C, or D degrades to E, F. For intersections already operating at unacceptable levels E, a significant impact would occur if a project adds 0.01 during peak hour or more to the critical movement's volume-to-capacity ratio. If the intersection is already operating at LOS F any increase (one vehicle) in the critical movement's volume-to-capacity ratio is considered significant.

- Unsignalized Intersections: A significant impact would occur if any traffic movement has LOS F or any traffic signal warrant is met.
- Road segments: A significant impact would occur if a roadway segment operating at A through E degrades to a lower level of service of E, or F. If a segment is already operating at LOS F any increase during peak hour (one vehicle) is considered significant.
- The EIR/Traffic Study should address the project's impacts on all county, regional, and city roadways. The geographic area covered in the scope of the traffic study should be of sufficient size to adequately identify all of the project's impacts. The traffic report should disclose all projects' access points and analyze the effects on county, cities, and regional roadway systems.
- In developing the cumulative scenarios for the traffic forecasts, trip distributions and traffic analysis, should be consistent with regional traffic model projections, i.e. AMBAG model.
- At a minimum, the following project scenarios should be analyzed: Existing Conditions, Existing plus Project, Background, Background plus project, Cumulative No Project, and Cumulative plus Project.
- As noted in the NOP, the campus is committed to a sustainable campus master plan, which includes plans and recommendations to reduce vehicle trips to campus. The report should provide details for the implementation of effectiveness of such vehicle trip reduction strategies. Also, the report should include the needs and benefits of providing pedestrian/bicycle facilities.
- In order to identify the project's potential impacts to the roadway system, the EIR will require:
 - Level of Service Analysis (LOS) for the following intersections:
 - Inter-Garrison Rd/Reservation Rd
 - Reservation Rd/Davis Rd
 - Davis Rd/Blanco Rd.
 - Level of Service Analysis (LOS) for the following road segment:
 - Reservation Rd from Inter-Garrison Rd to Davis Rd
 - Davis Rd from Reservation Rd to Blanco Rd
 - Davis Rd from Blanco Rd to Market St.
 - Blanco Rd from Reservation Rd to Davis Rd.
- The report needs to consider traffic while school is in regular and summer sessions and consider all planned development within the vicinity of the project.

We welcome the opportunity to participate and consult with you in developing the scope of the traffic analysis. We also look forward to reviewing and commenting on the Draft Environmental Impact Report. Should you have any further questions please contact me at (831) 755-4628, or email at martinezrr@co.monterey.ca.us.

Sincerely,



**Raul Martinez, Assistant Engineer.
Resource Management Agency, Public Works & Facilities Division
Traffic Section**



May 17, 2017

Ms. Anya Spear, LEED AP
Associate Director of Campus Planning
CSUMB, Campus Planning & Development
100 Campus Center
Seaside, California 93955

Subject: Notice of Preparation – Environmental Impact Report for the California State University Monterey Bay Master Plan

Dear Ms. Spear:

The Monterey Peninsula Water Management District (MPWMD or District) appreciates the opportunity to comment on the Environmental Impact Report (EIR) dated May 2017 for California State University Monterey Bay's (CSUMB) Master Plan. The California State University Monterey Bay campus is physically located on the former Fort Ord.

The CSUMB campus is outside of the MPWMD's boundaries and is not subject to our Rules and Regulations. The project will be served by Marina Coast Water District, a Water Distribution System not regulated by MPWMD. Inquiries regarding construction at the CSUMB campus should be addressed to Marina Coast Water District.

Thank you for the opportunity to review and provide feedback on the Environmental Impact Report for California State University Monterey Bay's Master Plan. If you have questions, please contact me at gabby@mpwmd.net or 831-658-5601

Sincerely,

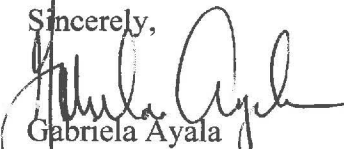
Gabriela Ayala
Conservation Analyst

U:\demand\CEQA Docs\20170517_CSUMB_MasterPlanEIR_Ayala.docx

RECEIVED

MAY 24 2017

CSUMB CP&D



RESOURCE MANAGEMENT SERVICES

440 Harcourt Avenue
Seaside, CA 93955

Telephone (831) 899-6737
FAX (831) 899-6211
TDD (831) 899-6207

June 9, 2017

Anya Spear, LEED AP
CSMUB, Campus Planning and Development
100 Campus Center
Seaside, CA 93955

RE: Notice of Preparation CSUMB Master Plan EIR

The City of Seaside is submitting the following comments on the scope and content of the CSUMB Master Plan EIR.

Section	Comments
2.1, Page 3	Provide explanation and/or example of type of institutional partnerships CSUMB can enter into with the City of Seaside.
2.1, Page 3	Provide explanation how athletics and recreation areas would be expanded near Seaside Municipal Boundaries.
2.1, Page 5	Identify development outside of areas currently served by existing trunk mains on CUMB Campus that could require extension of trunk mains at the university's expense.
Section 3, Hydrology and Water Quality, Page 8	Has CSUMB identified locations for potential bio swale treatment areas.
Section 3, Population Housing, Page 8	The City of Seaside would encourage CSUMB to develop higher density residential structures on the south side of the campus at heights of four stories or more to match the housing development on the "Promnitory" project site
Section 3, Public Services and Recreation, Page 9	Identify whether the EIR should evaluate wildland fire maintenance and fire protection services. Identify how mutual aid would be coordinated between adjacent municipal jurisdictions.

The City of Seaside wants to thank CSUMB and its consultants for providing the City of Seaside with the opportunity to provide its written comments on the CSUMB Master Plan EIR.

Sincerely

Rick Medina
Senior Planner



June 12, 2017

Anya Spear
Associate Director of Campus Planning
CSUMB, Campus Planning and Development
100 Campus Center
Seaside, CA 93955

SUBJECT: Comments on the Notice of Preparation for the CSUMB Master Plan

Dear Ms. Spear:

The Transportation Agency for Monterey County is the Regional Transportation Planning and Congestion Management Agency for Monterey County. Agency staff has reviewed the Notice of Preparation for the CSUMB Master plan Environmental Impact Report and offers the following comments:

1. The Agency supports the development of a detailed Traffic Impact Analysis to inform the EIR about the impacts to local and regional road networks. In particular, we support the detailed analysis of the Master Plan's proposed Travel Demand Management (TDM) strategies.
2. The Agency looks forward to providing comments on the draft environmental impact report.

Thank you for the opportunity to comment on the proposed project. If you have any questions, please contact Grant Leonard of my staff at 831-775-0903.

Sincerely,

Debra L. Hale
Executive Director

NOP EIR Master Plan

Inbox x

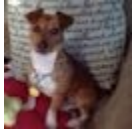

Mark Lasnik

11:33 AM (23 minutes ago)

to me

Hi Anya. I hope that you and your family are well.

My initial feedback about the pursuit of an "ambitious" Transportation Scenario is:

due to the fact that parking will be limited and consolidated to the campus periphery, there is no stated plan to encourage employees to use active transportation. I'd like to see in print a plan that CSUMB management has to create a positive employment environment between supervisor and line staff, in regards to the impact that using active transportation has on start and end time. Let's not re-invent the wheel. How do universities and private employers handle start and end times where active transportation is the primary source?

If management does not initiate the conversation with staff to utilize active transportation, the vast majority of staff will not initiate that conversation. An "improved shuttle service" needs definition...will the arrival time at the multimodal hubs qualify as arriving to work "on time"? Will transit and shuttle schedules be so coordinated that our culture will eliminate supervisors' need to pay attention to work start and end times?

My best to you,
M

Thank you.

Mark Lasnik, LEED® AP

[831-582-5216](tel:831-582-5216)

CSU Monterey Bay

Please do not print this email unless absolutely necessary.

**Revision to
Previously Issued
Notice of Preparation**

August 9, 2019

INTENTIONALLY LEFT BLANK

NATIVE AMERICAN HERITAGE COMMISSION
Cultural and Environmental Department
1550 Harbor Blvd., Suite 100
West Sacramento, CA 95691 Phone: (916) 373-3710
Email: nahc@nahc.ca.gov
Website: <http://www.nahc.ca.gov>



RECEIVED
AUG 22 2019
CSUMB CP&D

August 15, 2019

Anya Spear
California State University, Monterey Bay
100 Campus Center
Seaside, CA 93955

RE: SCH# 2017051042, California State University Monterey Bay Master Plan Project, Monterey County

Dear Ms. Spear:

The Native American Heritage Commission (NAHC) has received the Notice of Preparation (NOP) for the project referenced above. The California Environmental Quality Act (CEQA) (Pub. Resources Code §21000 et seq.), specifically Public Resources Code §21084.1, states that a project that may cause a substantial adverse change in the significance of a historical resource, is a project that may have a significant effect on the environment. (Pub. Resources Code § 21084.1; Cal. Code Regs., tit.14, §15064.5 (b) (CEQA Guidelines §15064.5 (b)). If there is substantial evidence, in light of the whole record before a lead agency, that a project may have a significant effect on the environment, an Environmental Impact Report (EIR) shall be prepared. (Pub. Resources Code §21080 (d); Cal. Code Regs., tit. 14, § 5064 subd.(a)(1) (CEQA Guidelines §15064 (a)(1)). In order to determine whether a project will cause a substantial adverse change in the significance of a historical resource, a lead agency will need to determine whether there are historical resources within the area of potential effect (APE).

CEQA was amended significantly in 2014. Assembly Bill 52 (Gatto, Chapter 532, Statutes of 2014) (AB 52) amended CEQA to create a separate category of cultural resources, "tribal cultural resources" (Pub. Resources Code §21074) and provides that a project with an effect that may cause a substantial adverse change in the significance of a tribal cultural resource is a project that may have a significant effect on the environment. (Pub. Resources Code §21084.2). Public agencies shall, when feasible, avoid damaging effects to any tribal cultural resource. (Pub. Resources Code §21084.3 (a)). **AB 52 applies to any project for which a notice of preparation, a notice of negative declaration, or a mitigated negative declaration is filed on or after July 1, 2015.** If your project involves the adoption of or amendment to a general plan or a specific plan, or the designation or proposed designation of open space, on or after March 1, 2005, it may also be subject to Senate Bill 18 (Burton, Chapter 905, Statutes of 2004) (SB 18). **Both SB 18 and AB 52 have tribal consultation requirements.** If your project is also subject to the federal National Environmental Policy Act (42 U.S.C. § 4321 et seq.) (NEPA), the tribal consultation requirements of Section 106 of the National Historic Preservation Act of 1966 (154 U.S.C. 300101, 36 C.F.R. §800 et seq.) may also apply.

The NAHC recommends consultation with California Native American tribes that are traditionally and culturally affiliated with the geographic area of your proposed project as early as possible in order to avoid inadvertent discoveries of Native American human remains and best protect tribal cultural resources. Below is a brief summary of portions of AB 52 and SB 18 as well as the NAHC's recommendations for conducting cultural resources assessments.

Consult your legal counsel about compliance with AB 52 and SB 18 as well as compliance with any other applicable laws.

AB 52 has added to CEQA the additional requirements listed below, along with many other requirements:

1. Fourteen Day Period to Provide Notice of Completion of an Application/Decision to Undertake a Project: Within fourteen (14) days of determining that an application for a project is complete or of a decision by a public agency to undertake a project, a lead agency shall provide formal notification to a designated contact of, or tribal representative of, traditionally and culturally affiliated California Native American tribes that have requested notice, to be accomplished by at least one written notice that includes:
 - a. A brief description of the project.
 - b. The lead agency contact information.
 - c. Notification that the California Native American tribe has 30 days to request consultation. (Pub. Resources Code §21080.3.1 (d)).
 - d. A "California Native American tribe" is defined as a Native American tribe located in California that is on the contact list maintained by the NAHC for the purposes of Chapter 905 of Statutes of 2004 (SB 18). (Pub. Resources Code §21073).
2. Begin Consultation Within 30 Days of Receiving a Tribe's Request for Consultation and Before Releasing a Negative Declaration, Mitigated Negative Declaration, or Environmental Impact Report: A lead agency shall begin the consultation process within 30 days of receiving a request for consultation from a California Native American tribe that is traditionally and culturally affiliated with the geographic area of the proposed project. (Pub. Resources Code §21080.3.1, subs. (d) and (e)) and prior to the release of a negative declaration, mitigated negative declaration or Environmental Impact Report. (Pub. Resources Code §21080.3.1(b)).
 - a. For purposes of AB 52, "consultation shall have the same meaning as provided in Gov. Code §65352.4 (SB 18). (Pub. Resources Code §21080.3.1 (b)).
3. Mandatory Topics of Consultation If Requested by a Tribe: The following topics of consultation, if a tribe requests to discuss them, are mandatory topics of consultation:
 - a. Alternatives to the project.
 - b. Recommended mitigation measures.
 - c. Significant effects. (Pub. Resources Code §21080.3.2 (a)).
4. Discretionary Topics of Consultation: The following topics are discretionary topics of consultation:
 - a. Type of environmental review necessary.
 - b. Significance of the tribal cultural resources.
 - c. Significance of the project's impacts on tribal cultural resources.
 - d. If necessary, project alternatives or appropriate measures for preservation or mitigation that the tribe may recommend to the lead agency. (Pub. Resources Code §21080.3.2 (a)).
5. Confidentiality of Information Submitted by a Tribe During the Environmental Review Process: With some exceptions, any information, including but not limited to, the location, description, and use of tribal cultural resources submitted by a California Native American tribe during the environmental review process shall not be included in the environmental document or otherwise disclosed by the lead agency or any other public agency to the public, consistent with Government Code §6254 (r) and §6254.10. Any information submitted by a California Native American tribe during the consultation or environmental review process shall be published in a confidential appendix to the environmental document unless the tribe that provided the information consents, in writing, to the disclosure of some or all of the information to the public. (Pub. Resources Code §21082.3 (c)(1)).
6. Discussion of Impacts to Tribal Cultural Resources in the Environmental Document: If a project may have a significant impact on a tribal cultural resource, the lead agency's environmental document shall discuss both of the following:
 - a. Whether the proposed project has a significant impact on an identified tribal cultural resource.
 - b. Whether feasible alternatives or mitigation measures, including those measures that may be agreed to pursuant to Public Resources Code §21082.3, subdivision (a), avoid or substantially lessen the impact on the identified tribal cultural resource. (Pub. Resources Code §21082.3 (b)).

7. Conclusion of Consultation: Consultation with a tribe shall be considered concluded when either of the following occurs:
 - a. The parties agree to measures to mitigate or avoid a significant effect, if a significant effect exists, on a tribal cultural resource; or
 - b. A party, acting in good faith and after reasonable effort, concludes that mutual agreement cannot be reached. (Pub. Resources Code §21080.3.2 (b)).
8. Recommending Mitigation Measures Agreed Upon in Consultation in the Environmental Document: Any mitigation measures agreed upon in the consultation conducted pursuant to Public Resources Code §21080.3.2 shall be recommended for inclusion in the environmental document and in an adopted mitigation monitoring and reporting program, if determined to avoid or lessen the impact pursuant to Public Resources Code §21082.3, subdivision (b), paragraph 2, and shall be fully enforceable. (Pub. Resources Code §21082.3 (a)).
9. Required Consideration of Feasible Mitigation: If mitigation measures recommended by the staff of the lead agency as a result of the consultation process are not included in the environmental document or if there are no agreed upon mitigation measures at the conclusion of consultation, or if consultation does not occur, and if substantial evidence demonstrates that a project will cause a significant effect to a tribal cultural resource, the lead agency shall consider feasible mitigation pursuant to Public Resources Code §21084.3 (b). (Pub. Resources Code §21082.3 (e)).
10. Examples of Mitigation Measures That, If Feasible, May Be Considered to Avoid or Minimize Significant Adverse Impacts to Tribal Cultural Resources:
 - a. Avoidance and preservation of the resources in place, including, but not limited to:
 - i. Planning and construction to avoid the resources and protect the cultural and natural context.
 - ii. Planning greenspace, parks, or other open space, to incorporate the resources with culturally appropriate protection and management criteria.
 - b. Treating the resource with culturally appropriate dignity, taking into account the tribal cultural values and meaning of the resource, including, but not limited to, the following:
 - i. Protecting the cultural character and integrity of the resource.
 - ii. Protecting the traditional use of the resource.
 - iii. Protecting the confidentiality of the resource.
 - c. Permanent conservation easements or other interests in real property, with culturally appropriate management criteria for the purposes of preserving or utilizing the resources or places.
 - d. Protecting the resource. (Pub. Resource Code §21084.3 (b)).
 - e. Please note that a federally recognized California Native American tribe or a non-federally recognized California Native American tribe that is on the contact list maintained by the NAHC to protect a California prehistoric, archaeological, cultural, spiritual, or ceremonial place may acquire and hold conservation easements if the conservation easement is voluntarily conveyed. (Civ. Code §815.3 (c)).
 - f. Please note that it is the policy of the state that Native American remains and associated grave artifacts shall be repatriated. (Pub. Resources Code §5097.991).
11. Prerequisites for Certifying an Environmental Impact Report or Adopting a Mitigated Negative Declaration or Negative Declaration with a Significant Impact on an Identified Tribal Cultural Resource: An Environmental Impact Report may not be certified, nor may a mitigated negative declaration or a negative declaration be adopted unless one of the following occurs:
 - a. The consultation process between the tribes and the lead agency has occurred as provided in Public Resources Code §21080.3.1 and §21080.3.2 and concluded pursuant to Public Resources Code §21080.3.2.
 - b. The tribe that requested consultation failed to provide comments to the lead agency or otherwise failed to engage in the consultation process.
 - c. The lead agency provided notice of the project to the tribe in compliance with Public Resources Code §21080.3.1 (d) and the tribe failed to request consultation within 30 days. (Pub. Resources Code §21082.3 (d)).

The NAHC's PowerPoint presentation titled, "Tribal Consultation Under AB 52: Requirements and Best Practices" may be found online at: http://nahc.ca.gov/wp-content/uploads/2015/10/AB52TribalConsultation_CalEPAPDF.pdf

SB 18

SB 18 applies to local governments and requires local governments to contact, provide notice to, refer plans to, and consult with tribes prior to the adoption or amendment of a general plan or a specific plan, or the designation of open space. (Gov. Code §65352.3). Local governments should consult the Governor's Office of Planning and Research's "Tribal Consultation Guidelines," which can be found online at: https://www.opr.ca.gov/docs/09_14_05_Updated_Guidelines_922.pdf.

Some of SB 18's provisions include:

1. **Tribal Consultation**: If a local government considers a proposal to adopt or amend a general plan or a specific plan, or to designate open space it is required to contact the appropriate tribes identified by the NAHC by requesting a "Tribal Consultation List." If a tribe, once contacted, requests consultation the local government must consult with the tribe on the plan proposal. **A tribe has 90 days from the date of receipt of notification to request consultation unless a shorter timeframe has been agreed to by the tribe.** (Gov. Code §65352.3 (a)(2)).
2. **No Statutory Time Limit on SB 18 Tribal Consultation**. There is no statutory time limit on SB 18 tribal consultation.
3. **Confidentiality**: Consistent with the guidelines developed and adopted by the Office of Planning and Research pursuant to Gov. Code §65040.2, the city or county shall protect the confidentiality of the information concerning the specific identity, location, character, and use of places, features and objects described in Public Resources Code §5097.9 and §5097.993 that are within the city's or county's jurisdiction. (Gov. Code §65352.3 (b)).
4. **Conclusion of SB 18 Tribal Consultation**: Consultation should be concluded at the point in which:
 - a. The parties to the consultation come to a mutual agreement concerning the appropriate measures for preservation or mitigation; or
 - b. Either the local government or the tribe, acting in good faith and after reasonable effort, concludes that mutual agreement cannot be reached concerning the appropriate measures of preservation or mitigation. (Tribal Consultation Guidelines, Governor's Office of Planning and Research (2005) at p. 18).

Agencies should be aware that neither AB 52 nor SB 18 precludes agencies from initiating tribal consultation with tribes that are traditionally and culturally affiliated with their jurisdictions before the timeframes provided in AB 52 and SB 18. For that reason, we urge you to continue to request Native American Tribal Contact Lists and "Sacred Lands File" searches from the NAHC. The request forms can be found online at: <http://nahc.ca.gov/resources/forms/>

NAHC Recommendations for Cultural Resources Assessments

To adequately assess the existence and significance of tribal cultural resources and plan for avoidance, preservation in place, or barring both, mitigation of project-related impacts to tribal cultural resources, the NAHC recommends the following actions:

1. Contact the appropriate regional California Historical Research Information System (CHRIS) Center (http://ohp.parks.ca.gov/?page_id=1068) for an archaeological records search. The records search will determine:
 - a. If part or all of the APE has been previously surveyed for cultural resources.
 - b. If any known cultural resources have already been recorded on or adjacent to the APE.
 - c. If the probability is low, moderate, or high that cultural resources are located in the APE.
 - d. If a survey is required to determine whether previously unrecorded cultural resources are present.
2. If an archaeological inventory survey is required, the final stage is the preparation of a professional report detailing the findings and recommendations of the records search and field survey.
 - a. The final report containing site forms, site significance, and mitigation measures should be submitted immediately to the planning department. All information regarding site locations, Native American human remains, and associated funerary objects should be in a separate confidential addendum and not be made available for public disclosure.
 - b. The final written report should be submitted within 3 months after work has been completed to the appropriate regional CHRIS center.

3. Contact the NAHC for:
 - a. A Sacred Lands File search. Remember that tribes do not always record their sacred sites in the Sacred Lands File, nor are they required to do so. A Sacred Lands File search is not a substitute for consultation with tribes that are traditionally and culturally affiliated with the geographic area of the project's APE.
 - b. A Native American Tribal Consultation List of appropriate tribes for consultation concerning the project site and to assist in planning for avoidance, preservation in place, or, failing both, mitigation measures.
4. Remember that the lack of surface evidence of archaeological resources (including tribal cultural resources) does not preclude their subsurface existence.
 - a. Lead agencies should include in their mitigation and monitoring reporting program plan provisions for the identification and evaluation of inadvertently discovered archaeological resources per Cal. Code Regs., tit. 14, §15064.5(f) (CEQA Guidelines §15064.5(f)). In areas of identified archaeological sensitivity, a certified archaeologist and a culturally affiliated Native American with knowledge of cultural resources should monitor all ground-disturbing activities.
 - b. Lead agencies should include in their mitigation and monitoring reporting program plans provisions for the disposition of recovered cultural items that are not burial associated in consultation with culturally affiliated Native Americans.
 - c. Lead agencies should include in their mitigation and monitoring reporting program plans provisions for the treatment and disposition of inadvertently discovered Native American human remains. Health and Safety Code §7050.5, Public Resources Code §5097.98, and Cal. Code Regs., tit. 14, §15064.5, subdivisions (d) and (e) (CEQA Guidelines §15064.5, subds. (d) and (e)) address the processes to be followed in the event of an inadvertent discovery of any Native American human remains and associated grave goods in a location other than a dedicated cemetery.

If you have any questions or need additional information, please contact me at my email address:
Andrew.Green@nahc.ca.gov.

Sincerely,



Andrew Green
Staff Services Analyst

cc: State Clearinghouse



September 5, 2019

Anya Spear, LEED AP
Associate Director of Campus Planning
CSUMB, Campus Planning & Development
100 Campus Center
Seaside, CA 93955

SUBJECT: Comments on the Revised Notice of Preparation for the Environmental Impact Report for the CSUMB Master Plan

Dear Anya Spear:

The Transportation Agency for Monterey County (TAMC) is the Regional Transportation Planning and Congestion Management Agency for Monterey County. TAMC staff have reviewed the CSUMB Master Plan and revised Notice of Preparation and offer the following comments:

1. As TAMC indicated in our comment letter on the original NOP dated June 12, 2017, the Agency supports the development of a detailed Traffic Impact Analysis to inform the EIR about the impacts to local and regional road networks. In particular, we support the detailed analysis of the Master Plan's proposed Transportation Demand Management (TDM) strategies.
2. Although not expressly stated, the proposed TDM measures identified in the Master Plan are either currently provided through TAMC's Go831 program or in line with Go831 regional trip reduction goals. Because student travel is not confined to CSUMB's jurisdictional boundary, and because big life changes (like starting a new school or new job) are critical opportunities for travel behavior change, please consider including the following information in the Mobility chapter:
 - Under "TDM Resources" consider adding:
 - i. Regional TDM Coordination with TAMC's Go831 program – The Go831 program operates in Monterey County and provides resources to employers and schools to develop or enhance their own TDM programs.
 - ii. New Student & Staff Transportation Orientation – integrate TDM resources into new student orientation activities and provide hands-on opportunities to try a variety of transportation options. Example: a

lunchtime workshop where students can learn about benefits, tips and resources to carpool, while meeting potential carpool buddies.

- iii. Personal Trip Reduction Plans – provide personal trip reduction plans to new student and faculty as part of their orientation. Personal trip reduction plans allow for new students and staff to receive more specific TDM information that is relevant to their needs and interests instead of overwhelming them with all of the transportation options available.
3. TAMC encourages the use of Intersections Control Evaluations (ICE analysis) when determining intersection control type for primary intersections. The Agency recommends including ICE analyses in the EIR traffic and circulation technical study for the intersections identified in the Master Plan as “Campus Entry” points:
 - Inter-Garrison Rd / 7th Ave / 8th St
 - 8th St / 6th Ave / Engineering Equipment Rd
 - Divarty St. / General Jim Moore Blvd
 - General Jim Moore Blvd / Lightfighter Drive.
 4. Please consider a roundabout at 2nd Ave and the CSUMB Sports Complex, between Divarty Street and Lightfighter Drive.
 5. Please consider coordination between the CSUMB Master Plan and the adjacent Seaside Campus Town Project.
 6. TAMC strongly supports the Master Plan’s prioritization and proposal of increased bicycles and pedestrian access on the CSUMB campus. TAMC supports the Master Plan’s prioritization of pedestrian travel as the primary mode of travel on campus, and the Master Plan’s vision of a bicycle share program, and covered bicycle parking with supporting Fix-it stations. We encourage consideration of the connectivity of the proposed bicycle and pedestrian paths with the neighboring communities
 7. TAMC is grateful for CSUMB’s ongoing consideration and coordination with the proposed Fort Ord Regional Trail and Greenway (FORTAG) trail alignment in relation to the CSUMB campus, with specific emphasis on bicycle and pedestrian connections to the proposed trail.
 8. The Transportation Agency recommends coordination with Monterey-Salinas Transit (MST) about the Master Plan’s vision for transit. Monterey-Salinas Transit’s *Designing for Transit* Guideline Manual should be used as a resource for accommodating the existing (16, 18, 19, 25, 26, 74) and potential future transit access to the project site.
 9. TAMC supports the Master Plan’s goal to improve wayfinding to promote pedestrian and bicycle travel within the CSUMB campus and throughout neighboring communities. TAMC encourages utilizing the Agency’s *Wayfinding Plan* and *Wayfinding Sign Design Package* as resources.

Additionally, the Agency offers the following minor edit:

Figure 7.10 and 7.11 of the Master Plan should use the recently updated Fort Ord Regional Trail and Greenway (FORTAG) alignment. Enclosed is a geographic file (.kmz) containing the current alignment. TAMC recommends coordination regarding FORTAG with Stefania Castillo, Transportation Planner, at stefania@tamcmonterey.org.

Thank you for the opportunity to comment on the proposed project. TAMC looks forward to providing comments on the draft environmental impact report.

If you have any questions, please contact Madilyn Jacobsen of my staff at 831-775-4402 or madilyn@tamcmonterey.org.

Sincerely,

A handwritten signature in blue ink, appearing to read 'DLH', with a long horizontal flourish extending to the right.

Debra L. Hale
Executive Director

Enclosures:

- FORTAG Alignment (.kmz)
- FORTAG Alignment (.pdf)

Figure 1 FORTAG Alignment

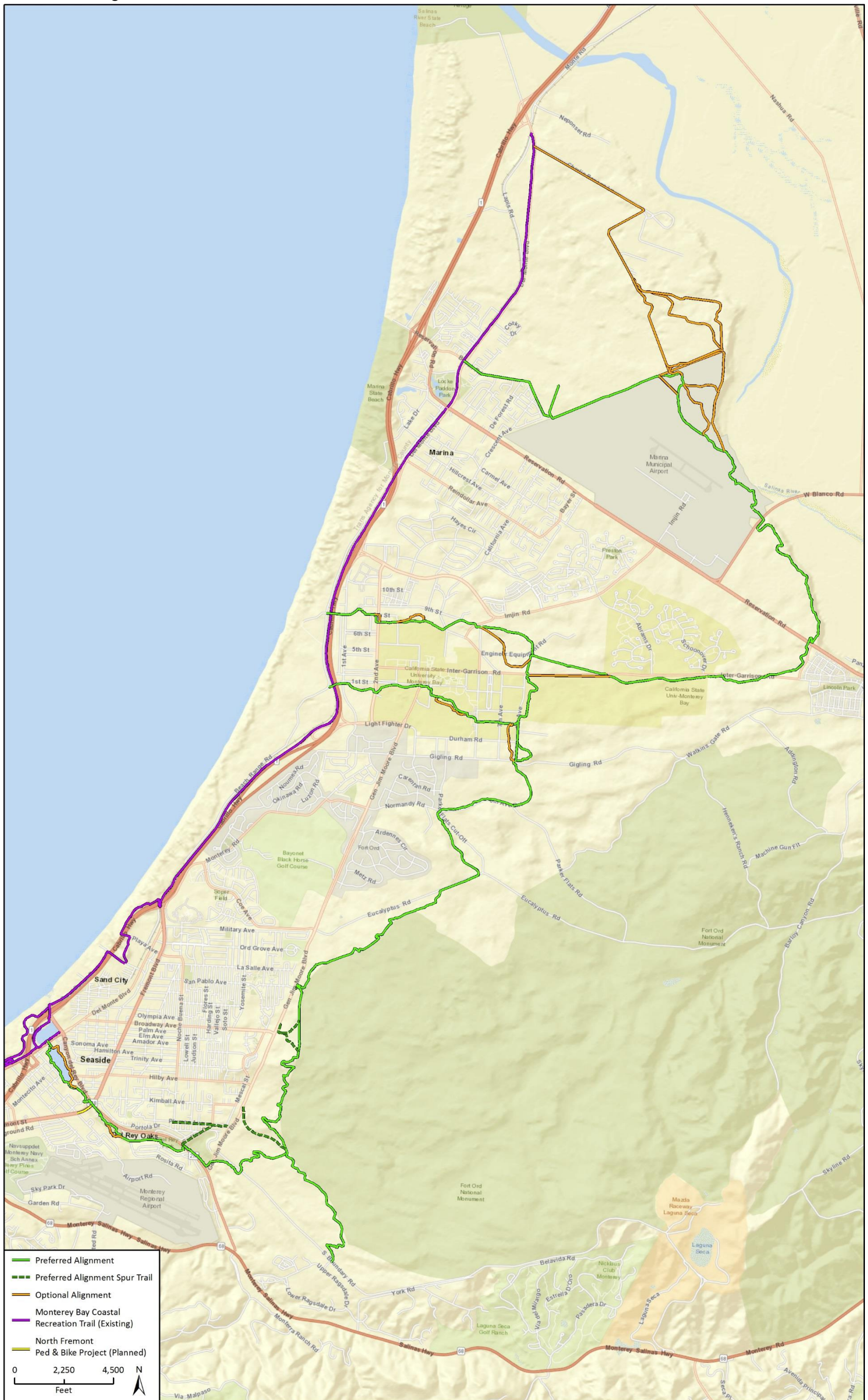

Imagery provided by ESRI and its licensors © 2019. Additional data provided by Alta, 2019.

Fig 1 FORTAG Proposed Alignment

INTENTIONALLY LEFT BLANK

APPENDIX C
**CSUMB Student Housing and
Parking Guidelines**

INTENTIONALLY LEFT BLANK



California State University
MONTEREY BAY

California State University, Monterey Bay Student Housing & Parking Management Guidelines

February 2022

Introduction

The primary goals of this California State University, Monterey Bay (CSUMB) Student Housing and Parking Management Guidelines (Guidelines) are to:

1. Ensure that at least 60% of the student population lives on campus; and
2. Reduce vehicle traffic both on and off campus.

These goals will be met by implementing transportation planning elements identified in the 2007 Campus Master Plan and proposed Master Plan Guidelines documents, as well as by implementing an existing International Programs on-campus housing goal.

These Housing and Parking Management Guidelines require the following:

1. Freshman and sophomore students¹ are to live in on-campus housing.
2. 90% of International Program students² are to live in on-campus housing.

¹ **On-campus residency requirement exemptions** from this policy may include: living in the tri-county area prior to acceptance, marital, parental, military and health status. Exemption/waiver requests are reviewed on a case-by-case basis.

² **International Students** are full time undergraduate semester, year or degree seeking students. Not included within this directive are upper-division, graduate or students enrolled in extended education language programs.

3. All freshman and sophomore on-campus residents³ are prohibited from parking or maintaining personal automobiles⁴ on campus and purchasing parking permits.⁵

These measures will be implemented at a time determined by the President, based upon key milestones,⁶ and before 12,700 Full Time Equivalent Students are enrolled.

Directives and Rationale

1. Freshman and sophomore students will live on campus.

Rationale:

- **Precedent:** CSUMB has required full-time freshmen and sophomores to live on-campus since its inception in 1994 when the CSU acquired 1,253 East Campus Housing apartment style units and 1,811 beds on the Main Campus. This is consistent with research indicating that on-campus students are significantly more likely than their off-campus peers to succeed academically, to be involved in campus activities, to graduate, and to feel positive about their college experience. Furthermore, in 2018, the Monterey Bay Corporation adopted its own Student Housing policy⁷ which required full time freshmen and sophomores to live on- campus.
- **Master Plan goal to house 60% of students:** The last three versions of the campus Master Plan (2004, 2007, current proposed) have included goals to house 60% of students on campus. The requirement takes advantage of the large housing stock, and the adopted good planning practices to co-locate housing, jobs and school. As of the fall 2016 semester, approximately 60% of the enrolled 6,634 Full Time Equivalent Students resided in on-campus housing. As the campus continues to grow, implementing these guidelines will

⁴ **Automobile** – Includes

⁵ **Parking permits** - Include all permit types

⁶ **Milestones** – Will be determined based on data indicating the campus’ progress toward meeting its transportation and housing goals.

⁷ University Corporation at Monterey Bay Student Housing Policy 410-001-A
https://gallery.mailchimp.com/3a9bc2d0b4b7b35594002815a/files/5d12d933-02a5-4666-b3d8-7f8a22c6f50c/410_001A_Student_Housing_Policy2_draft_1_.pdf

maintain this percentage and will require commitment to ensure students remain a primary focus of future housing development.

- **Response to the housing crisis:** Providing on-campus housing reduces competition between students and residents for limited affordable housing. Furthermore, students coming to the Monterey Area from outside the area often have trouble finding off-campus affordable housing.
- **Transportation Demand Management (TDM) programs address transportation challenges:** Attending class while living on campus does not require car ownership. The campus currently provides, and is in the process of expanding, TDM programs (ex. car-share, scooter-share, universal transit access pass, bike parking, etc.), which increasingly meet the mobility needs of those who do not have the financial means or desire to own a car. Therefore, living on campus is a car-free option and alternative transportation programs allow students to access off-campus commitments and resources such as Service Learning or employment.

2. 90% of International Program students will live on-campus

Rationale:

- **Precedent:** International Students (IS) have generally been guaranteed on-campus housing if they apply by posted deadlines. As of the fall of 2017, approximately 87%⁸ of IS enrolled at CSUMB already lived on campus.
- **International Programs housing goal:** International Programs has a goal to house 90% of full time undergraduate IS on campus.
- **Response to the housing crisis:** Acquiring off-campus housing can be especially challenging for IS living abroad, due to limited financial resources, language or cultural barriers, and lack of knowledge of the Monterey area.
- **Community:** Living on campus provides a built-in community with target resources close at hand, which help IS start their CSUMB career off on the right footing.
- **TDM programs address transportation challenges:** IS typically do not have access to an automobile once they arrive in the area. Living on campus provides access to campus TDM programs to meet their needs.

⁸ Email from Brian Childs, Director of International Student and Scholar Services on 07/16/2018

3. All freshman and sophomore student residents will be prohibited from bringing personal automobiles and motor vehicles to campus, and from purchasing parking permits.

Rationale:

- **TDM definition:** Managing demand is about providing travelers, regardless of whether they drive alone, with travel choices, such as work location, route, time of travel and mode. In the broadest sense, demand management is defined as providing travelers with effective choices to improve travel reliability.
 - **TDM requirement:** The CSU Transportation and Parking Policy requires e
- 10
- **Cost effectiveness:** TDM programs can be more cost effective¹¹ than increasing parking facilities.
 - **Parking permit TDM strategy:** Parking permits encourage driving and do not incentivize sustainable travel modes. Parking management (restrictions, locations and pricing) is a TDM strategy that can reduce on- and off-campus traffic by requiring or encouraging people to choose other transportation modes (ride-share, car-share, bike-share, scooter-share, etc.). As the presence and visibility of sustainable transportation modes increase, so will the adoption of these programs as the primary modes of transportation.
 - **Equity:** Resident students do not require a car to fulfill their academic commitments. Parking spaces should be made available to commuter students, staff and faculty, those with a disability or documented exemption/waiver from the parking permit guidelines requirements.
 - **Land use, transportation and safety strategy:** The proposed Master Plan Guidelines place new buildings on existing centrally located parking lots and reallocates space

⁹ US Department of Transportation – Organizing and Planning for Operations - https://ops.fhwa.dot.gov/plan4ops/trans_demand.htm

¹⁰ California State University Transportation and Parking Policy <https://calstate.policystat.com/policy/9869842/latest/>

¹¹ Innovative Parking Management Strategies for Universities: Accommodating Multiple Objectives in a Constrained Environment https://www.researchgate.net/publication/305720913_Innovative_Parking_Management_Strategies_for_Universities_Accommodating_Multiple_Objectives_in_a_Constrained_Environment

previously used for car storage, to use by people in support of their academic success (academic buildings, pathways, gathering spaces, etc.). Utilizing existing parking quantities efficiently throughout the buildout of the proposed Master Plan will allow the campus to develop a car-free and safer central campus for walking and biking and protect our natural open spaces from being developed.

APPENDIX D

Revised Air Quality, Greenhouse Gas Emissions, and Energy Calculations

INTENTIONALLY LEFT BLANK

REVISED APPENDIX D CLARIFICATIONS¹

Mobile Sources

Following re-evaluation of the Draft EIR's mobile source emissions calculations in response to comments, the vehicle miles traveled (VMT) inputs for the California Emissions Estimator Model (CalEEMod) were revised, which resulted in changes to the emissions outputs for the air quality and GHG analyses, as well as the fuel consumption data for the energy analysis. The re-calculation effort was undertaken because the Draft EIR mis-applied the daily VMT estimates for both the existing conditions and the Project provided in the Fehr & Peers Transportation Analysis prepared for the Project (see EIR Appendix H) and, therefore, underestimated both existing conditions and Project emissions. As revised, the existing conditions and Project emissions incrementally increased in a proportional fashion. The revised GHG emissions generated for the Project would still be expected to result in a potentially significant impact prior to application of mitigation, as previously presented in the Draft EIR (Section 4.6, Greenhouse Gas Emissions). Further discussion of the refinements made to the mobile source component of the emissions inventories is provided below.

As discussed in EIR Section 4.2, Air Quality and incorporated by reference in EIR Section 4.6, Greenhouse Gas Emissions, mobile sources for the Project would primarily be motor vehicles (automobiles and light-duty trucks) traveling to and from the campus. Motor vehicles may be fueled with gasoline, diesel, or alternative fuels. The default vehicle mix provided in CalEEMod 2020.4.0, which is based on CARB's Mobile Source Emissions Inventory model, EMFAC, version 2017, was applied for both existing and Project conditions. Emission factors representing the vehicle mix and emissions for 2035 (the first full year of operation) were used to estimate emissions associated with the Project. For the existing scenario, 2018 was assumed for the vehicle emissions factors and vehicle fleet mix.

Trip generation rates for existing and Project conditions were based on the Transportation Analysis. As such, default weekday vehicle trip generation rates included in CalEEMod were adjusted to mathematically match the existing campus and the Project's weekday trip generation estimates (28,181 weekday trips for existing conditions and 39,873 weekday trips for the Project) from the Transportation Analysis. Saturday and Sunday trip rates for both the existing campus and the Project were adjusted in proportion to the CalEEMod weekday trip rates because weekend trip-generation rates were not provided in the Transportation Analysis.

For the revised calculations, the default vehicle trip lengths included in CalEEMod also were adjusted to match the daily VMT for the existing campus (178,500 miles) and the Project (295,500

¹ Given that the modeling was updated in this appendix as part of the Final EIR and this revised appendix replaces Appendix D included in the Draft EIR, ~~underline/strikethrough~~ is not used in this revised appendix.

miles), as taken from EIR Section 4.13, Transportation, Tables 4.13-2 and 4.13-8. For the existing conditions, the revised trip length was estimated to be 6.33 miles (178,500 miles ÷ 28,181 trips = 6.33 miles) while the Project's revised trip length was estimated to be 7.41 miles (295,500 miles ÷ 39,873 trips = 7.41 miles).

In addition to trip rates and trip lengths, the trip purpose is also a factor in the calculation of vehicle-generated emissions. In general, CalEEMod determines an overall average trip length for primary, diverted, and pass-by trip link types where primary trips are 100 percent of the trip length, diverted trips are 25 percent of the primary trip length, and pass-by trips are 0.1 mile (CAPCOA 2021). For this Project analysis, the CalEEMod default trip type percentages were adjusted to assume 100 percent primary trips so that the CalEEMod-generated VMT would mathematically match the overall weekday VMT data provided in the Project's Transportation Analysis. This approach is consistent with the transportation modeling, which accounts for a full inventory of trip categories; that is, both primary and shorter trips are already assessed in the model (i.e., the modeled VMT estimates provided in the Transportation Analysis reflect primary trip, diverted trips, and pass-by trips).

The VMT estimates discussed above include students, faculty/staff, and guests, which are considered in one trip rate (under the University/College land use sub type in CalEEMod) rather than separated. Specifically, the Project's estimated VMT includes the 2,446 faculty and staff and the 12,700 students since it is based on the trip generation and VMT assessment provided by Fehr & Peers.

Solid Waste

The Project would generate solid waste, and therefore, result in CO₂e emissions associated with landfill off-gassing. CalEEMod default values for solid waste generation were used to estimate GHG emissions associated with solid waste for the Project. For the Project, CalEEMod inputs were revised to account for the 90 percent solid waste diversion rate for non-construction and demolition waste per the CSUMB Campus Sustainability Plan and CSUMB Materials Management and Conservation Plan.

Water Supply and Wastewater

Supply, conveyance, treatment, and distribution of water require the use of electricity, which would result in associated indirect GHG emissions. Similarly, wastewater generated by the Project requires the use of electricity for conveyance and treatment, along with GHG emissions generated during wastewater treatment. CalEEMod default values were revised based on the consumption and future forecast data provided by CSUMB, as presented in EIR Section 4.14, Utilities and Energy (Table 4.14-7). At buildout, the Project would result in 716 AFY, of which 427 AFY would be related to building use and 290 AFY would be related to irrigation.

References

CAPCOA (California Air Pollution Control Officers Association). 2021. California Emissions Estimator Model® (CalEEMod). <http://www.caleemod.com/>.

GHG Threshold - Carbon Neutral by 2045 Using STARS Baseline Inventory

State Reduction Targets

Milestone Year	Statewide Existing and Target Emissions (MMT CO ₂ e)	Target Percent Reduction from 2018	Notes
1990	311	NA	Based on baseline GHG inventory in CARB's 2017 Scoping Plan. Excludes industrial, agriculture, and high global warming potential sources.
2018	283	NA	From CARB 2018 GHG Inventory
2030	187	34%	SB 32 - 40% below 1990 level
2035	124	56%	2035 is planning horizon for proposed Master Plan
2040	62	78%	Estimated by applying a linear regression between the 2030 and 2045 GHG inventory state goals.
2045	0	100%	EO B-55-18 - Carbon neutrality

Note: CARB state inventory for 2018 excludes industrial, agriculture, and High GWP sources

	Unit	
CSUMB 2018 Inventory	13,399 MT CO ₂ e/year	GHG emissions from STARS 2018 Annual Report
CSUMB 2035 Emissions Limit	5,893 MT CO ₂ e/year	
2035 Population (students+employees)	15,790 Total Population (students + employees)	
Per Capita (students+employees)	0.37 2035 MT CO ₂ e/capita	
Total New Students	6,323 Students	
Total New Faculty	1,036 Faculty	
Total New Student and Faculty	7,359 Students + Faculty	
Mass Emission Limit	2,747 MT CO₂e/year	

Note:

STARS 2018 Annual Report located at: <https://reports.aashe.org/institutions/california-state-university-monterey-bay-ca/report/2019-05-20/OP/air-climate/OP-1/>
 GHG inventory for 1990 is from the California Air Resources Board 2017 Scoping Plan and 2018 inventory is from <https://ww2.arb.ca.gov/ghg-inventory-data>

2018 STARS Inventory

Fiscal Year	Scope	Source	CO2 (kg)	CO2 (MTCDE)	CH4 (kg)	CH4 (MTCDE)	N2O (kg)	N2O (MTCDE)	GHG MTCDE
2018	1	Other On-Campus Stationary	3,620,895	3,620.89	360	10.09	7	1.91	3,632.89
2018	1	Direct Transportation	232,321	232.32	46	1.3	16	4.14	237.76
2018	1	Fertilizer & Animals	0	0	0	0	4	1.13	1.13
2018	2	Purchased Electricity	3,313,610	3,313.61	193	5.4	24	6.23	3,325.24
2018	3	Faculty Commuting	277,630	277.63	55	1.55	19	4.95	284.13
2018	3	Staff Commuting	969,930	969.93	201	5.64	68	17.89	993.47
2018	3	Student Commuting	4,647,819	4,647.82	930	26.03	313	82.98	4,756.83
2018	3	T&D Losses	166,707	166.71	10	0.27	1	0.31	167.29

Fiscal Year	Scope	CO2 (kg)	CH4 (kg)	N2O (kg)	GHG MTCDE
2018	1	3,853,216	407	27	3,871.78
2018	2	3,313,610	193	24	3,325.24
2018	3	6,062,087	1,196	401	6,201.72

Fiscal Year	CO2 (kg)	CH4 (kg)	N2O (kg)	Gross MTCDE	Offsets (MTCDE)	Compost (MTCDE)	Non-Addition	Biogenic (MTCDE)	Net MTCDE
2018	13,228,913	1,796	451	13,398.75	0	0	0	0	13,398.75

1990 GHG Emissions by Scoping Plan Category

Scoping Plan Category	1990 Emissions (MMT CO ₂ e)
Transportation	152
Industrial uses	98
Electricity generation	108
Residential and commercial uses	44
Agriculture	26
High GWP substances	3
Recycling and waste	7
Total	311

*Total excludes High GWP, industrial, and agriculture uses.

Source: California Air Resources Board 2017 Scoping Plan.

2018 GHG Emissions by Scoping Plan Category

Scoping Plan Category	2018 Emissions (MMT CO ₂ e)
Transportation	170
Industrial uses	89
Electricity generation	63
Residential and commercial uses	41
Agriculture	33
High GWP substances	20
Recycling and waste	9
Total	283

*Total excludes High GWP, industrial, and agriculture uses.

Source: California Air Resources Board (2021). <https://ww2.arb.ca.gov/ghg-inventory-data>

Land Use	Energy Use (From CSUMB) Electricity (MWh/yr)	Natural Gas Breakdown (MMBtu/yr) (Breakdown Percentages From CallEModel)					Natural Gas Breakdown (MMBtu/yr) (Conversion Only)					New Electricity Mixes (from Removed Natural Gas (MWh/yr))					Existing Electricity plus New Electricity (MMBtu/yr)	Remaining Natural Gas Usage (MMBtu/yr)	Existing Electricity plus New Electricity (MT CO2e/year)	Remaining Natural Gas Usage (MT CO2e/year)		
		Natural Gas (MMBtu/yr)	Space Heating	Water Heating	Space Cooling	Other	Space Heating	Water Heating	Space Cooling	Cooking	Other	Space Heating	Water Heating	Space Cooling	Cooking	Other						
Nonresidential	ACAD III	310	850	245	254	45	26	262	71	22	13	10	17	54	46	12	10	21	516	25	20.24	3.17
Nonresidential	College Facility	155	884	253	234	47	37	273	74	80	14	11	40	85	80	11	24	24	540	24	41.27	3.37
Nonresidential	ACAD IV	500	1,484	486	527	90	17	524	144	164	26	5	144	148	95	26	5	143	585	144	24.52	6.18
Nonresidential	Resilient for Public Policy	480	1,407	323	344	49	47	342	93	149	17	13	100	83	42	16	12	83	576	78	51.28	3.46
Nonresidential	Student Union	470	1,200	365	400	67	75	388	106	114	20	22	114	95	71	18	20	106	508	100	60.45	4.81
Nonresidential	Chandler School	394	1,054	304	329	56	48	327	82	96	17	14	96	80	59	15	13	89	450	74	49.85	4.00
Nonresidential	Health Center	146	417	107	116	20	17	116	31	28	6	17	34	28	21	5	16	20	348	29	20.85	1.87
Nonresidential	Bus Center Phase 1	193	537	160	174	30	0	173	47	51	9	0	51	49	31	6	0	47	320	38	24.51	2.02
Nonresidential	ACAD V	478	1,126	351	380	65	1	378	103	111	19	0	111	92	69	18	0	103	740	82	58.29	4.42
Nonresidential	ACAD VI	395	1,109	320	338	61	3	356	92	105	18	1	104	82	65	17	1	92	642	78	50.71	4.17
Nonresidential	ACAD VII	388	1,072	317	344	59	13	342	93	101	17	4	100	83	62	16	4	93	646	75	49.56	4.05
Nonresidential	ACAD VIII	303	1,013	298	324	56	11	322	82	95	16	3	94	78	58	15	3	88	606	71	46.45	3.80
Nonresidential	Bus Center Phase II	213	576	165	176	31	25	176	48	52	9	7	52	43	32	8	7	48	352	45	26.85	2.16
Nonresidential	Greenhouses	44	76	7	7	1	53	7	2	2	0	16	2	2	1	0	14	2	64	5	4.89	0.39
Nonresidential	Admin Building	860	1,487	361	391	67	17	360	106	115	20	17	114	90	71	18	16	106	774	80	59.48	4.76
Nonresidential	Student Union II	193	289	86	93	16	1	93	25	27	5	0	27	25	17	4	0	25	173	20	13.25	1.00
Nonresidential	Compass Arts & Auditorium	441	1,215	354	384	66	29	382	104	113	19	8	112	93	69	18	8	104	733	85	56.22	4.56
Nonresidential	Student Union	288	673	184	190	34	48	188	54	58	10	17	58	48	36	0	16	55	421	47	33.28	2.53
Nonresidential	Over Retail Space	47	126	48	52	9	15	52	14	15	3	4	15	14	9	7	4	14	110	12	8.67	0.66
Nonresidential	Aquatics Center Expansion	56	130	30	32	5	34	32	9	9	2	9	8	6	1	9	9	89	9	6.79	0.49	
Nonresidential	Student Housing I	131	32	10	10	0	10	3	1	0	3	1	0	3	2	0	0	3	18	2	1.48	0.12
Nonresidential	Student Life Spaces PH	372	894	280	303	52	57	303	82	89	15	17	88	73	55	14	16	78	612	70	46.40	3.73
Nonresidential	Student Life Spaces PH2	334	911	283	285	49	30	284	77	84	14	9	83	69	52	13	8	77	533	64	42.45	3.42
Nonresidential	Bus Center Addition	350	959	278	301	52	29	300	81	88	15	8	88	70	54	14	8	80	581	67	44.56	3.60
Nonresidential	Wellness Center	209	593	141	153	26	61	152	41	46	8	18	44	37	28	7	17	41	339	37	25.96	2.00
Nonresidential	Faculty Building	120	260	106	115	20	5	114	31	28	0	1	28	21	5	1	31	216	25	16.53	1.35	
Nonresidential	Faculty House	35	92	0	35	0	0	35	0	0	0	0	0	0	0	0	0	15	4	4.15	0.31	
Residential	Student Housing Phase III	1,495	6,444	2,327	2,662	4	888	766	682	780	0	246	225	412	481	0	242	209	3,023	465	232.45	24.86
Residential	Student Housing Phase IIIB	962	4,227	1,490	1,704	0	892	691	422	499	0	173	144	262	308	0	161	134	1,622	289	156.89	16.07
Residential	Student Housing Phase IV	1,213	5,402	1,825	2,088	0	888	601	535	432	0	240	176	480	372	0	242	164	2,474	378	189.83	20.30
Residential	Student Housing Phase V	1,173	5,224	1,753	2,005	0	888	577	514	588	0	240	169	461	362	0	242	157	2,395	366	183.42	19.43
Residential	Student Housing Phase VI	1,173	5,224	1,753	2,005	0	888	577	514	588	0	240	169	461	362	0	242	157	2,395	366	183.42	19.43
Residential	Student Housing Phase VII	1,278	4,286	1,718	1,965	0	532	566	504	576	0	157	166	451	355	0	146	134	2,186	339	167.05	17.08
Residential	Student Housing Phase VIII	1,022	4,136	1,417	1,849	0	532	533	474	542	0	157	156	435	334	0	146	145	2,072	318	158.87	17.04
Residential	Household Class X	968	4,301	1,520	1,781	0	532	501	446	510	0	157	147	400	315	0	146	137	1,966	301	150.71	16.16
Residential	Household Class Y	918	4,029	1,430	1,638	0	532	472	420	480	0	157	138	376	286	0	146	129	1,866	286	143.02	15.33
Nonresidential	Total	2,581.44	20,452.20	6,091	6,607	1,133	852	6,295	2,721	2,485	118	230	1,645	1,534	1,144	296	232	1,726	12,507.80	1,498.19	688.80	76.47
Residential	Residential Total	10,000.55	41,671.80	13,264	14,801	2,430	2,202	2,086	4,226	3,416	0	1,884	1,406	4,087	3,126	0	1,728	1,286	20,100.80	1,111.69	1,000.00	102.41
	Project Total	12,581.99	62,124.00	19,355	21,408	3,563	3,054	8,381	6,947	6,901	318	2,014	3,335	5,591	4,335	296	1,947	3,102	32,608.64	2,610.88	1,788.80	178.88

1. Note that the project-generated electricity remains at a minimum of 17,588 MWh/yr as shown above as that was the electricity demand provided by CSUMB. Additional electricity from natural gas converted to electricity depends on the inputs below.

2. Total GHG Emissions for new development assuming no conversion of natural gas to electricity (MT CO2e)

	Electricity (MWh/yr)	Natural Gas (MMBtu/yr)
Existing Energy Use	11,468	55,271
Total Existing Associated GHG Emissions (MT CO2e/year)	1,061	2,983
Total Project Energy Use	27,006	110,683
Total Project Associated GHG Emissions (MT CO2e/year)	2,070	5,042
Total Adjusted Associated GHG Emissions (MT CO2e/year)	3,131	8,025
MT CO2e reduction from reduced NG	2,068.02	

Nonresidential (Remaining and Converted NG)

	Natural Gas (NG remaining as NG)	Electricity (NG converted to Electricity)	93.00%
Only change cell C5B	1,033.58	76.67	93.00%
93% Electricity & 7% Natural Gas	1,033.58	76.67	93.00%
MT CO2e/yr from energy use			
MT CO2e/yr from NG			
93% Electricity & 7% Natural Gas	1,033.58	76.67	93.00%
MT CO2e/yr from energy use			
MT CO2e/yr from electricity			
93% Electricity & 7% Natural Gas	1,033.58	76.67	93.00%

Residential (Remaining and Converted NG)

	Natural Gas (NG remaining as NG)	Electricity (NG converted to Electricity)	93.00%
Only change cell C67	1,677.31	167.11	93.00%
93% Electricity & 7% Natural Gas	1,677.31	167.11	93.00%
MT CO2e/yr from energy use			
MT CO2e/yr from NG			
93% Electricity & 7% Natural Gas	1,677.31	167.11	93.00%
MT CO2e/yr from energy use			
MT CO2e/yr from electricity			
93% Electricity & 7% Natural Gas	1,677.31	167.11	93.00%

EMFAC Off-Model Adjustment Factors for Gasoline Light Duty Vehicle to Account for the SAFE Vehicle Rule Not Applied

**CSUMB Master Plan - Construction
Monterey Bay Unified APCD Air District, Annual**

1.0 Project Characteristics

1.1 Land Usage

Land Uses	Size	Metric	Lot Acreage	Floor Surface Area	Population
University/College (4yr)	1,634.00	Student	6.89	300,000.00	0
Other Non-Asphalt Surfaces	1.80	Acre	1.80	78,408.00	0

1.2 Other Project Characteristics

Urbanization	Urban	Wind Speed (m/s)	2.8	Precipitation Freq (Days)	53
Climate Zone	4			Operational Year	2024
Utility Company	Pacific Gas and Electric Company				
CO2 Intensity (lb/MWhr)	203.98	CH4 Intensity (lb/MWhr)	0.033	N2O Intensity (lb/MWhr)	0.004

1.3 User Entered Comments & Non-Default Data

Project Characteristics - CSU Monterey Bay Master Plan. MBARD. Construction Scenario.

Land Use - Maximum development of approximately 300 GSF and 1.8 acres of paving.

Construction Phase - Default schedule assumed.

Off-road Equipment - Default equipment

Off-road Equipment - Default equipment

Off-road Equipment - Default equipment

Off-road Equipment - Default equipment

EMFAC Off-Model Adjustment Factors for Gasoline Light Duty Vehicle to Account for the SAFE Vehicle Rule Not Applied

Off-road Equipment - Default equipment

Off-road Equipment - Default equipment

Demolition - Assume demolition of 10,500 SF.

Grading -

Trips and VMT - Default trips

Construction Off-road Equipment Mitigation - Water twice daily

Architectural Coating - MBARD Rule 426 - interior 50 g/L, exterior 100 g/L

Table Name	Column Name	Default Value	New Value
tblArchitecturalCoating	EF_Nonresidential_Exterior	150.00	100.00
tblArchitecturalCoating	EF_Nonresidential_Interior	150.00	50.00
tblArchitecturalCoating	EF_Parking	150.00	100.00
tblLandUse	LandUseSquareFeet	300,325.06	300,000.00
tblTripsAndVMT	HaulingTripNumber	48.00	200.00

EMFAC Off-Model Adjustment Factors for Gasoline Light Duty Vehicle to Account for the SAFE Vehicle Rule Not Applied

2.0 Emissions Summary

2.1 Overall Construction

Unmitigated Construction

	ROG	NOx	CO	SO2	Fugitive PM10	Exhaust PM10	PM10 Total	Fugitive PM2.5	Exhaust PM2.5	PM2.5 Total	Bio- CO2	NBio- CO2	Total CO2	CH4	N2O	CO2e
Year	tons/yr										MT/yr					
2022	0.3166	2.7313	2.8206	6.4300e-003	0.3550	0.1201	0.4751	0.1346	0.1125	0.2471	0.0000	576.3589	576.3589	0.0876	0.0245	585.8618
2023	0.9155	0.2955	0.3940	8.0000e-004	0.0205	0.0131	0.0336	5.5400e-003	0.0123	0.0178	0.0000	71.7031	71.7031	0.0127	2.2400e-003	72.6901
Maximum	0.9155	2.7313	2.8206	6.4300e-003	0.3550	0.1201	0.4751	0.1346	0.1125	0.2471	0.0000	576.3589	576.3589	0.0876	0.0245	585.8618

Mitigated Construction

	ROG	NOx	CO	SO2	Fugitive PM10	Exhaust PM10	PM10 Total	Fugitive PM2.5	Exhaust PM2.5	PM2.5 Total	Bio- CO2	NBio- CO2	Total CO2	CH4	N2O	CO2e
Year	tons/yr										MT/yr					
2022	0.3166	2.7313	2.8206	6.4300e-003	0.2591	0.1201	0.3792	0.0875	0.1125	0.2001	0.0000	576.3585	576.3585	0.0876	0.0245	585.8614
2023	0.9155	0.2955	0.3940	8.0000e-004	0.0205	0.0131	0.0336	5.5400e-003	0.0123	0.0178	0.0000	71.7031	71.7031	0.0127	2.2400e-003	72.6900
Maximum	0.9155	2.7313	2.8206	6.4300e-003	0.2591	0.1201	0.3792	0.0875	0.1125	0.2001	0.0000	576.3585	576.3585	0.0876	0.0245	585.8614

EMFAC Off-Model Adjustment Factors for Gasoline Light Duty Vehicle to Account for the SAFE Vehicle Rule Not Applied

	ROG	NOx	CO	SO2	Fugitive PM10	Exhaust PM10	PM10 Total	Fugitive PM2.5	Exhaust PM2.5	PM2.5 Total	Bio- CO2	NBio-CO2	Total CO2	CH4	N2O	CO2e
Percent Reduction	0.00	0.00	0.00	0.00	25.54	0.00	18.85	33.59	0.00	17.76	0.00	0.00	0.00	0.00	0.00	0.00

3.0 Construction Detail

Construction Phase

Phase Number	Phase Name	Phase Type	Start Date	End Date	Num Days Week	Num Days	Phase Description
1	Demolition	Demolition	1/3/2022	1/28/2022	5	20	
2	Site Preparation	Site Preparation	1/29/2022	2/11/2022	5	10	
3	Grading	Grading	2/12/2022	3/11/2022	5	20	
4	Building Construction	Building Construction	3/12/2022	1/27/2023	5	230	
5	Paving	Paving	1/28/2023	2/24/2023	5	20	
6	Architectural Coating	Architectural Coating	2/25/2023	3/24/2023	5	20	

Acres of Grading (Site Preparation Phase): 15

Acres of Grading (Grading Phase): 20

Acres of Paving: 1.8

Residential Indoor: 0; Residential Outdoor: 0; Non-Residential Indoor: 450,000; Non-Residential Outdoor: 150,000; Striped Parking Area: 4,704

EMFAC Off-Model Adjustment Factors for Gasoline Light Duty Vehicle to Account for the SAFE Vehicle Rule Not Applied**OffRoad Equipment**

Phase Name	Offroad Equipment Type	Amount	Usage Hours	Horse Power	Load Factor
Demolition	Concrete/Industrial Saws	1	8.00	81	0.73
Demolition	Excavators	3	8.00	158	0.38
Demolition	Rubber Tired Dozers	2	8.00	247	0.40
Site Preparation	Rubber Tired Dozers	3	8.00	247	0.40
Site Preparation	Tractors/Loaders/Backhoes	4	8.00	97	0.37
Grading	Excavators	1	8.00	158	0.38
Grading	Graders	1	8.00	187	0.41
Grading	Rubber Tired Dozers	1	8.00	247	0.40
Grading	Tractors/Loaders/Backhoes	3	8.00	97	0.37
Building Construction	Cranes	1	7.00	231	0.29
Building Construction	Forklifts	3	8.00	89	0.20
Building Construction	Generator Sets	1	8.00	84	0.74
Building Construction	Tractors/Loaders/Backhoes	3	7.00	97	0.37
Building Construction	Welders	1	8.00	46	0.45
Paving	Pavers	2	8.00	130	0.42
Paving	Paving Equipment	2	8.00	132	0.36
Paving	Rollers	2	8.00	80	0.38
Architectural Coating	Air Compressors	1	6.00	78	0.48

EMFAC Off-Model Adjustment Factors for Gasoline Light Duty Vehicle to Account for the SAFE Vehicle Rule Not Applied**Trips and VMT**

Phase Name	Offroad Equipment Count	Worker Trip Number	Vendor Trip Number	Hauling Trip Number	Worker Trip Length	Vendor Trip Length	Hauling Trip Length	Worker Vehicle Class	Vendor Vehicle Class	Hauling Vehicle Class
Demolition	6	15.00	0.00	200.00	10.80	7.30	20.00	LD_Mix	HDT_Mix	HHDT
Site Preparation	7	18.00	0.00	0.00	10.80	7.30	20.00	LD_Mix	HDT_Mix	HHDT
Grading	6	15.00	0.00	0.00	10.80	7.30	20.00	LD_Mix	HDT_Mix	HHDT
Building Construction	9	159.00	62.00	0.00	10.80	7.30	20.00	LD_Mix	HDT_Mix	HHDT
Paving	6	15.00	0.00	0.00	10.80	7.30	20.00	LD_Mix	HDT_Mix	HHDT
Architectural Coating	1	32.00	0.00	0.00	10.80	7.30	20.00	LD_Mix	HDT_Mix	HHDT

3.1 Mitigation Measures Construction

Water Exposed Area

EMFAC Off-Model Adjustment Factors for Gasoline Light Duty Vehicle to Account for the SAFE Vehicle Rule Not Applied

3.2 Demolition - 2022

Unmitigated Construction On-Site

	ROG	NOx	CO	SO2	Fugitive PM10	Exhaust PM10	PM10 Total	Fugitive PM2.5	Exhaust PM2.5	PM2.5 Total	Bio- CO2	NBio- CO2	Total CO2	CH4	N2O	CO2e
Category	tons/yr										MT/yr					
Fugitive Dust					5.2700e-003	0.0000	5.2700e-003	8.0000e-004	0.0000	8.0000e-004	0.0000	0.0000	0.0000	0.0000	0.0000	0.0000
Off-Road	0.0264	0.2572	0.2059	3.9000e-004		0.0124	0.0124		0.0116	0.0116	0.0000	33.9902	33.9902	9.5500e-003	0.0000	34.2289
Total	0.0264	0.2572	0.2059	3.9000e-004	5.2700e-003	0.0124	0.0177	8.0000e-004	0.0116	0.0124	0.0000	33.9902	33.9902	9.5500e-003	0.0000	34.2289

Unmitigated Construction Off-Site

	ROG	NOx	CO	SO2	Fugitive PM10	Exhaust PM10	PM10 Total	Fugitive PM2.5	Exhaust PM2.5	PM2.5 Total	Bio- CO2	NBio- CO2	Total CO2	CH4	N2O	CO2e
Category	tons/yr										MT/yr					
Hauling	3.9000e-004	0.0170	3.2500e-003	6.0000e-005	1.7000e-003	1.6000e-004	1.8600e-003	4.7000e-004	1.6000e-004	6.2000e-004	0.0000	6.0472	6.0472	7.0000e-005	9.5000e-004	6.3330
Vendor	0.0000	0.0000	0.0000	0.0000	0.0000	0.0000	0.0000	0.0000	0.0000	0.0000	0.0000	0.0000	0.0000	0.0000	0.0000	0.0000
Worker	5.3000e-004	4.3000e-004	4.5800e-003	1.0000e-005	1.1900e-003	1.0000e-005	1.2000e-003	3.2000e-004	1.0000e-005	3.2000e-004	0.0000	1.0222	1.0222	4.0000e-005	3.0000e-005	1.0334
Total	9.2000e-004	0.0174	7.8300e-003	7.0000e-005	2.8900e-003	1.7000e-004	3.0600e-003	7.9000e-004	1.7000e-004	9.4000e-004	0.0000	7.0695	7.0695	1.1000e-004	9.8000e-004	7.3664

EMFAC Off-Model Adjustment Factors for Gasoline Light Duty Vehicle to Account for the SAFE Vehicle Rule Not Applied

Mitigated Construction On-Site

	ROG	NOx	CO	SO2	Fugitive PM10	Exhaust PM10	PM10 Total	Fugitive PM2.5	Exhaust PM2.5	PM2.5 Total	Bio- CO2	NBio- CO2	Total CO2	CH4	N2O	CO2e
Category	tons/yr										MT/yr					
Fugitive Dust					2.3700e-003	0.0000	2.3700e-003	3.6000e-004	0.0000	3.6000e-004	0.0000	0.0000	0.0000	0.0000	0.0000	0.0000
Off-Road	0.0264	0.2572	0.2059	3.9000e-004		0.0124	0.0124		0.0116	0.0116	0.0000	33.9902	33.9902	9.5500e-003	0.0000	34.2289
Total	0.0264	0.2572	0.2059	3.9000e-004	2.3700e-003	0.0124	0.0148	3.6000e-004	0.0116	0.0119	0.0000	33.9902	33.9902	9.5500e-003	0.0000	34.2289

Mitigated Construction Off-Site

	ROG	NOx	CO	SO2	Fugitive PM10	Exhaust PM10	PM10 Total	Fugitive PM2.5	Exhaust PM2.5	PM2.5 Total	Bio- CO2	NBio- CO2	Total CO2	CH4	N2O	CO2e
Category	tons/yr										MT/yr					
Hauling	3.9000e-004	0.0170	3.2500e-003	6.0000e-005	1.7000e-003	1.6000e-004	1.8600e-003	4.7000e-004	1.6000e-004	6.2000e-004	0.0000	6.0472	6.0472	7.0000e-005	9.5000e-004	6.3330
Vendor	0.0000	0.0000	0.0000	0.0000	0.0000	0.0000	0.0000	0.0000	0.0000	0.0000	0.0000	0.0000	0.0000	0.0000	0.0000	0.0000
Worker	5.3000e-004	4.3000e-004	4.5800e-003	1.0000e-005	1.1900e-003	1.0000e-005	1.2000e-003	3.2000e-004	1.0000e-005	3.2000e-004	0.0000	1.0222	1.0222	4.0000e-005	3.0000e-005	1.0334
Total	9.2000e-004	0.0174	7.8300e-003	7.0000e-005	2.8900e-003	1.7000e-004	3.0600e-003	7.9000e-004	1.7000e-004	9.4000e-004	0.0000	7.0695	7.0695	1.1000e-004	9.8000e-004	7.3664

EMFAC Off-Model Adjustment Factors for Gasoline Light Duty Vehicle to Account for the SAFE Vehicle Rule Not Applied

3.3 Site Preparation - 2022

Unmitigated Construction On-Site

	ROG	NOx	CO	SO2	Fugitive PM10	Exhaust PM10	PM10 Total	Fugitive PM2.5	Exhaust PM2.5	PM2.5 Total	Bio- CO2	NBio- CO2	Total CO2	CH4	N2O	CO2e
Category	tons/yr										MT/yr					
Fugitive Dust					0.0983	0.0000	0.0983	0.0505	0.0000	0.0505	0.0000	0.0000	0.0000	0.0000	0.0000	0.0000
Off-Road	0.0159	0.1654	0.0985	1.9000e-004		8.0600e-003	8.0600e-003		7.4200e-003	7.4200e-003	0.0000	16.7197	16.7197	5.4100e-003	0.0000	16.8549
Total	0.0159	0.1654	0.0985	1.9000e-004	0.0983	8.0600e-003	0.1064	0.0505	7.4200e-003	0.0579	0.0000	16.7197	16.7197	5.4100e-003	0.0000	16.8549

Unmitigated Construction Off-Site

	ROG	NOx	CO	SO2	Fugitive PM10	Exhaust PM10	PM10 Total	Fugitive PM2.5	Exhaust PM2.5	PM2.5 Total	Bio- CO2	NBio- CO2	Total CO2	CH4	N2O	CO2e
Category	tons/yr										MT/yr					
Hauling	0.0000	0.0000	0.0000	0.0000	0.0000	0.0000	0.0000	0.0000	0.0000	0.0000	0.0000	0.0000	0.0000	0.0000	0.0000	0.0000
Vendor	0.0000	0.0000	0.0000	0.0000	0.0000	0.0000	0.0000	0.0000	0.0000	0.0000	0.0000	0.0000	0.0000	0.0000	0.0000	0.0000
Worker	3.2000e-004	2.6000e-004	2.7500e-003	1.0000e-005	7.2000e-004	0.0000	7.2000e-004	1.9000e-004	0.0000	1.9000e-004	0.0000	0.6133	0.6133	2.0000e-005	2.0000e-005	0.6200
Total	3.2000e-004	2.6000e-004	2.7500e-003	1.0000e-005	7.2000e-004	0.0000	7.2000e-004	1.9000e-004	0.0000	1.9000e-004	0.0000	0.6133	0.6133	2.0000e-005	2.0000e-005	0.6200

EMFAC Off-Model Adjustment Factors for Gasoline Light Duty Vehicle to Account for the SAFE Vehicle Rule Not Applied

Mitigated Construction On-Site

	ROG	NOx	CO	SO2	Fugitive PM10	Exhaust PM10	PM10 Total	Fugitive PM2.5	Exhaust PM2.5	PM2.5 Total	Bio- CO2	NBio- CO2	Total CO2	CH4	N2O	CO2e
Category	tons/yr										MT/yr					
Fugitive Dust					0.0442	0.0000	0.0442	0.0227	0.0000	0.0227	0.0000	0.0000	0.0000	0.0000	0.0000	0.0000
Off-Road	0.0159	0.1654	0.0985	1.9000e-004		8.0600e-003	8.0600e-003		7.4200e-003	7.4200e-003	0.0000	16.7197	16.7197	5.4100e-003	0.0000	16.8549
Total	0.0159	0.1654	0.0985	1.9000e-004	0.0442	8.0600e-003	0.0523	0.0227	7.4200e-003	0.0302	0.0000	16.7197	16.7197	5.4100e-003	0.0000	16.8549

Mitigated Construction Off-Site

	ROG	NOx	CO	SO2	Fugitive PM10	Exhaust PM10	PM10 Total	Fugitive PM2.5	Exhaust PM2.5	PM2.5 Total	Bio- CO2	NBio- CO2	Total CO2	CH4	N2O	CO2e
Category	tons/yr										MT/yr					
Hauling	0.0000	0.0000	0.0000	0.0000	0.0000	0.0000	0.0000	0.0000	0.0000	0.0000	0.0000	0.0000	0.0000	0.0000	0.0000	0.0000
Vendor	0.0000	0.0000	0.0000	0.0000	0.0000	0.0000	0.0000	0.0000	0.0000	0.0000	0.0000	0.0000	0.0000	0.0000	0.0000	0.0000
Worker	3.2000e-004	2.6000e-004	2.7500e-003	1.0000e-005	7.2000e-004	0.0000	7.2000e-004	1.9000e-004	0.0000	1.9000e-004	0.0000	0.6133	0.6133	2.0000e-005	2.0000e-005	0.6200
Total	3.2000e-004	2.6000e-004	2.7500e-003	1.0000e-005	7.2000e-004	0.0000	7.2000e-004	1.9000e-004	0.0000	1.9000e-004	0.0000	0.6133	0.6133	2.0000e-005	2.0000e-005	0.6200

EMFAC Off-Model Adjustment Factors for Gasoline Light Duty Vehicle to Account for the SAFE Vehicle Rule Not Applied

3.4 Grading - 2022

Unmitigated Construction On-Site

	ROG	NOx	CO	SO2	Fugitive PM10	Exhaust PM10	PM10 Total	Fugitive PM2.5	Exhaust PM2.5	PM2.5 Total	Bio- CO2	NBio- CO2	Total CO2	CH4	N2O	CO2e
Category	tons/yr										MT/yr					
Fugitive Dust					0.0708	0.0000	0.0708	0.0343	0.0000	0.0343	0.0000	0.0000	0.0000	0.0000	0.0000	0.0000
Off-Road	0.0195	0.2086	0.1527	3.0000e-004		9.4100e-003	9.4100e-003		8.6600e-003	8.6600e-003	0.0000	26.0548	26.0548	8.4300e-003	0.0000	26.2654
Total	0.0195	0.2086	0.1527	3.0000e-004	0.0708	9.4100e-003	0.0802	0.0343	8.6600e-003	0.0429	0.0000	26.0548	26.0548	8.4300e-003	0.0000	26.2654

Unmitigated Construction Off-Site

	ROG	NOx	CO	SO2	Fugitive PM10	Exhaust PM10	PM10 Total	Fugitive PM2.5	Exhaust PM2.5	PM2.5 Total	Bio- CO2	NBio- CO2	Total CO2	CH4	N2O	CO2e
Category	tons/yr										MT/yr					
Hauling	0.0000	0.0000	0.0000	0.0000	0.0000	0.0000	0.0000	0.0000	0.0000	0.0000	0.0000	0.0000	0.0000	0.0000	0.0000	0.0000
Vendor	0.0000	0.0000	0.0000	0.0000	0.0000	0.0000	0.0000	0.0000	0.0000	0.0000	0.0000	0.0000	0.0000	0.0000	0.0000	0.0000
Worker	5.3000e-004	4.3000e-004	4.5800e-003	1.0000e-005	1.1900e-003	1.0000e-005	1.2000e-003	3.2000e-004	1.0000e-005	3.2000e-004	0.0000	1.0222	1.0222	4.0000e-005	3.0000e-005	1.0334
Total	5.3000e-004	4.3000e-004	4.5800e-003	1.0000e-005	1.1900e-003	1.0000e-005	1.2000e-003	3.2000e-004	1.0000e-005	3.2000e-004	0.0000	1.0222	1.0222	4.0000e-005	3.0000e-005	1.0334

EMFAC Off-Model Adjustment Factors for Gasoline Light Duty Vehicle to Account for the SAFE Vehicle Rule Not Applied

Mitigated Construction On-Site

	ROG	NOx	CO	SO2	Fugitive PM10	Exhaust PM10	PM10 Total	Fugitive PM2.5	Exhaust PM2.5	PM2.5 Total	Bio- CO2	NBio- CO2	Total CO2	CH4	N2O	CO2e
Category	tons/yr										MT/yr					
Fugitive Dust					0.0319	0.0000	0.0319	0.0154	0.0000	0.0154	0.0000	0.0000	0.0000	0.0000	0.0000	0.0000
Off-Road	0.0195	0.2086	0.1527	3.0000e-004		9.4100e-003	9.4100e-003		8.6600e-003	8.6600e-003	0.0000	26.0547	26.0547	8.4300e-003	0.0000	26.2654
Total	0.0195	0.2086	0.1527	3.0000e-004	0.0319	9.4100e-003	0.0413	0.0154	8.6600e-003	0.0241	0.0000	26.0547	26.0547	8.4300e-003	0.0000	26.2654

Mitigated Construction Off-Site

	ROG	NOx	CO	SO2	Fugitive PM10	Exhaust PM10	PM10 Total	Fugitive PM2.5	Exhaust PM2.5	PM2.5 Total	Bio- CO2	NBio- CO2	Total CO2	CH4	N2O	CO2e
Category	tons/yr										MT/yr					
Hauling	0.0000	0.0000	0.0000	0.0000	0.0000	0.0000	0.0000	0.0000	0.0000	0.0000	0.0000	0.0000	0.0000	0.0000	0.0000	0.0000
Vendor	0.0000	0.0000	0.0000	0.0000	0.0000	0.0000	0.0000	0.0000	0.0000	0.0000	0.0000	0.0000	0.0000	0.0000	0.0000	0.0000
Worker	5.3000e-004	4.3000e-004	4.5800e-003	1.0000e-005	1.1900e-003	1.0000e-005	1.2000e-003	3.2000e-004	1.0000e-005	3.2000e-004	0.0000	1.0222	1.0222	4.0000e-005	3.0000e-005	1.0334
Total	5.3000e-004	4.3000e-004	4.5800e-003	1.0000e-005	1.1900e-003	1.0000e-005	1.2000e-003	3.2000e-004	1.0000e-005	3.2000e-004	0.0000	1.0222	1.0222	4.0000e-005	3.0000e-005	1.0334

EMFAC Off-Model Adjustment Factors for Gasoline Light Duty Vehicle to Account for the SAFE Vehicle Rule Not Applied

3.5 Building Construction - 2022

Unmitigated Construction On-Site

	ROG	NOx	CO	SO2	Fugitive PM10	Exhaust PM10	PM10 Total	Fugitive PM2.5	Exhaust PM2.5	PM2.5 Total	Bio- CO2	NBio- CO2	Total CO2	CH4	N2O	CO2e
Category	tons/yr										MT/yr					
Off-Road	0.1792	1.6396	1.7182	2.8300e-003		0.0850	0.0850		0.0799	0.0799	0.0000	243.3115	243.3115	0.0583	0.0000	244.7688
Total	0.1792	1.6396	1.7182	2.8300e-003		0.0850	0.0850		0.0799	0.0799	0.0000	243.3115	243.3115	0.0583	0.0000	244.7688

Unmitigated Construction Off-Site

	ROG	NOx	CO	SO2	Fugitive PM10	Exhaust PM10	PM10 Total	Fugitive PM2.5	Exhaust PM2.5	PM2.5 Total	Bio- CO2	NBio- CO2	Total CO2	CH4	N2O	CO2e
Category	tons/yr										MT/yr					
Hauling	0.0000	0.0000	0.0000	0.0000	0.0000	0.0000	0.0000	0.0000	0.0000	0.0000	0.0000	0.0000	0.0000	0.0000	0.0000	0.0000
Vendor	0.0153	0.3950	0.1198	1.3900e-003	0.0430	4.1500e-003	0.0471	0.0124	3.9700e-003	0.0164	0.0000	133.8062	133.8062	1.4000e-003	0.0197	139.7078
Worker	0.0587	0.0474	0.5103	1.2400e-003	0.1328	9.2000e-004	0.1337	0.0353	8.5000e-004	0.0362	0.0000	113.7715	113.7715	4.3700e-003	3.8100e-003	115.0161
Total	0.0739	0.4424	0.6301	2.6300e-003	0.1758	5.0700e-003	0.1809	0.0477	4.8200e-003	0.0526	0.0000	247.5778	247.5778	5.7700e-003	0.0235	254.7240

EMFAC Off-Model Adjustment Factors for Gasoline Light Duty Vehicle to Account for the SAFE Vehicle Rule Not Applied

Mitigated Construction On-Site

	ROG	NOx	CO	SO2	Fugitive PM10	Exhaust PM10	PM10 Total	Fugitive PM2.5	Exhaust PM2.5	PM2.5 Total	Bio- CO2	NBio- CO2	Total CO2	CH4	N2O	CO2e
Category	tons/yr										MT/yr					
Off-Road	0.1792	1.6396	1.7182	2.8300e-003		0.0850	0.0850		0.0799	0.0799	0.0000	243.3112	243.3112	0.0583	0.0000	244.7685
Total	0.1792	1.6396	1.7182	2.8300e-003		0.0850	0.0850		0.0799	0.0799	0.0000	243.3112	243.3112	0.0583	0.0000	244.7685

Mitigated Construction Off-Site

	ROG	NOx	CO	SO2	Fugitive PM10	Exhaust PM10	PM10 Total	Fugitive PM2.5	Exhaust PM2.5	PM2.5 Total	Bio- CO2	NBio- CO2	Total CO2	CH4	N2O	CO2e
Category	tons/yr										MT/yr					
Hauling	0.0000	0.0000	0.0000	0.0000	0.0000	0.0000	0.0000	0.0000	0.0000	0.0000	0.0000	0.0000	0.0000	0.0000	0.0000	0.0000
Vendor	0.0153	0.3950	0.1198	1.3900e-003	0.0430	4.1500e-003	0.0471	0.0124	3.9700e-003	0.0164	0.0000	133.8062	133.8062	1.4000e-003	0.0197	139.7078
Worker	0.0587	0.0474	0.5103	1.2400e-003	0.1328	9.2000e-004	0.1337	0.0353	8.5000e-004	0.0362	0.0000	113.7715	113.7715	4.3700e-003	3.8100e-003	115.0161
Total	0.0739	0.4424	0.6301	2.6300e-003	0.1758	5.0700e-003	0.1809	0.0477	4.8200e-003	0.0526	0.0000	247.5778	247.5778	5.7700e-003	0.0235	254.7240

EMFAC Off-Model Adjustment Factors for Gasoline Light Duty Vehicle to Account for the SAFE Vehicle Rule Not Applied

3.5 Building Construction - 2023

Unmitigated Construction On-Site

	ROG	NOx	CO	SO2	Fugitive PM10	Exhaust PM10	PM10 Total	Fugitive PM2.5	Exhaust PM2.5	PM2.5 Total	Bio- CO2	NBio- CO2	Total CO2	CH4	N2O	CO2e
Category	tons/yr										MT/yr					
Off-Road	0.0157	0.1439	0.1624	2.7000e-004		7.0000e-003	7.0000e-003		6.5800e-003	6.5800e-003	0.0000	23.1805	23.1805	5.5100e-003	0.0000	23.3183
Total	0.0157	0.1439	0.1624	2.7000e-004		7.0000e-003	7.0000e-003		6.5800e-003	6.5800e-003	0.0000	23.1805	23.1805	5.5100e-003	0.0000	23.3183

Unmitigated Construction Off-Site

	ROG	NOx	CO	SO2	Fugitive PM10	Exhaust PM10	PM10 Total	Fugitive PM2.5	Exhaust PM2.5	PM2.5 Total	Bio- CO2	NBio- CO2	Total CO2	CH4	N2O	CO2e
Category	tons/yr										MT/yr					
Hauling	0.0000	0.0000	0.0000	0.0000	0.0000	0.0000	0.0000	0.0000	0.0000	0.0000	0.0000	0.0000	0.0000	0.0000	0.0000	0.0000
Vendor	8.8000e-004	0.0316	9.9500e-003	1.3000e-004	4.0900e-003	2.0000e-004	4.2900e-003	1.1800e-003	1.9000e-004	1.3800e-003	0.0000	12.3300	12.3300	1.1000e-004	1.8100e-003	12.8724
Worker	5.1900e-003	3.9800e-003	0.0445	1.1000e-004	0.0127	8.0000e-005	0.0127	3.3600e-003	8.0000e-005	3.4400e-003	0.0000	10.5068	10.5068	3.7000e-004	3.3000e-004	10.6155
Total	6.0700e-003	0.0355	0.0544	2.4000e-004	0.0167	2.8000e-004	0.0170	4.5400e-003	2.7000e-004	4.8200e-003	0.0000	22.8368	22.8368	4.8000e-004	2.1400e-003	23.4879

EMFAC Off-Model Adjustment Factors for Gasoline Light Duty Vehicle to Account for the SAFE Vehicle Rule Not Applied

Mitigated Construction On-Site

	ROG	NOx	CO	SO2	Fugitive PM10	Exhaust PM10	PM10 Total	Fugitive PM2.5	Exhaust PM2.5	PM2.5 Total	Bio- CO2	NBio- CO2	Total CO2	CH4	N2O	CO2e
Category	tons/yr										MT/yr					
Off-Road	0.0157	0.1439	0.1624	2.7000e-004		7.0000e-003	7.0000e-003		6.5800e-003	6.5800e-003	0.0000	23.1805	23.1805	5.5100e-003	0.0000	23.3183
Total	0.0157	0.1439	0.1624	2.7000e-004		7.0000e-003	7.0000e-003		6.5800e-003	6.5800e-003	0.0000	23.1805	23.1805	5.5100e-003	0.0000	23.3183

Mitigated Construction Off-Site

	ROG	NOx	CO	SO2	Fugitive PM10	Exhaust PM10	PM10 Total	Fugitive PM2.5	Exhaust PM2.5	PM2.5 Total	Bio- CO2	NBio- CO2	Total CO2	CH4	N2O	CO2e
Category	tons/yr										MT/yr					
Hauling	0.0000	0.0000	0.0000	0.0000	0.0000	0.0000	0.0000	0.0000	0.0000	0.0000	0.0000	0.0000	0.0000	0.0000	0.0000	0.0000
Vendor	8.8000e-004	0.0316	9.9500e-003	1.3000e-004	4.0900e-003	2.0000e-004	4.2900e-003	1.1800e-003	1.9000e-004	1.3800e-003	0.0000	12.3300	12.3300	1.1000e-004	1.8100e-003	12.8724
Worker	5.1900e-003	3.9800e-003	0.0445	1.1000e-004	0.0127	8.0000e-005	0.0127	3.3600e-003	8.0000e-005	3.4400e-003	0.0000	10.5068	10.5068	3.7000e-004	3.3000e-004	10.6155
Total	6.0700e-003	0.0355	0.0544	2.4000e-004	0.0167	2.8000e-004	0.0170	4.5400e-003	2.7000e-004	4.8200e-003	0.0000	22.8368	22.8368	4.8000e-004	2.1400e-003	23.4879

EMFAC Off-Model Adjustment Factors for Gasoline Light Duty Vehicle to Account for the SAFE Vehicle Rule Not Applied

3.6 Paving - 2023

Unmitigated Construction On-Site

	ROG	NOx	CO	SO2	Fugitive PM10	Exhaust PM10	PM10 Total	Fugitive PM2.5	Exhaust PM2.5	PM2.5 Total	Bio- CO2	NBio- CO2	Total CO2	CH4	N2O	CO2e
Category	tons/yr										MT/yr					
Off-Road	0.0103	0.1019	0.1458	2.3000e-004		5.1000e-003	5.1000e-003		4.6900e-003	4.6900e-003	0.0000	20.0269	20.0269	6.4800e-003	0.0000	20.1888
Paving	0.0000					0.0000	0.0000		0.0000	0.0000	0.0000	0.0000	0.0000	0.0000	0.0000	0.0000
Total	0.0103	0.1019	0.1458	2.3000e-004		5.1000e-003	5.1000e-003		4.6900e-003	4.6900e-003	0.0000	20.0269	20.0269	6.4800e-003	0.0000	20.1888

Unmitigated Construction Off-Site

	ROG	NOx	CO	SO2	Fugitive PM10	Exhaust PM10	PM10 Total	Fugitive PM2.5	Exhaust PM2.5	PM2.5 Total	Bio- CO2	NBio- CO2	Total CO2	CH4	N2O	CO2e
Category	tons/yr										MT/yr					
Hauling	0.0000	0.0000	0.0000	0.0000	0.0000	0.0000	0.0000	0.0000	0.0000	0.0000	0.0000	0.0000	0.0000	0.0000	0.0000	0.0000
Vendor	0.0000	0.0000	0.0000	0.0000	0.0000	0.0000	0.0000	0.0000	0.0000	0.0000	0.0000	0.0000	0.0000	0.0000	0.0000	0.0000
Worker	4.9000e-004	3.8000e-004	4.2000e-003	1.0000e-005	1.1900e-003	1.0000e-005	1.2000e-003	3.2000e-004	1.0000e-005	3.2000e-004	0.0000	0.9912	0.9912	4.0000e-005	3.0000e-005	1.0015
Total	4.9000e-004	3.8000e-004	4.2000e-003	1.0000e-005	1.1900e-003	1.0000e-005	1.2000e-003	3.2000e-004	1.0000e-005	3.2000e-004	0.0000	0.9912	0.9912	4.0000e-005	3.0000e-005	1.0015

EMFAC Off-Model Adjustment Factors for Gasoline Light Duty Vehicle to Account for the SAFE Vehicle Rule Not Applied

Mitigated Construction On-Site

	ROG	NOx	CO	SO2	Fugitive PM10	Exhaust PM10	PM10 Total	Fugitive PM2.5	Exhaust PM2.5	PM2.5 Total	Bio- CO2	NBio- CO2	Total CO2	CH4	N2O	CO2e
Category	tons/yr										MT/yr					
Off-Road	0.0103	0.1019	0.1458	2.3000e-004		5.1000e-003	5.1000e-003		4.6900e-003	4.6900e-003	0.0000	20.0268	20.0268	6.4800e-003	0.0000	20.1888
Paving	0.0000					0.0000	0.0000		0.0000	0.0000	0.0000	0.0000	0.0000	0.0000	0.0000	0.0000
Total	0.0103	0.1019	0.1458	2.3000e-004		5.1000e-003	5.1000e-003		4.6900e-003	4.6900e-003	0.0000	20.0268	20.0268	6.4800e-003	0.0000	20.1888

Mitigated Construction Off-Site

	ROG	NOx	CO	SO2	Fugitive PM10	Exhaust PM10	PM10 Total	Fugitive PM2.5	Exhaust PM2.5	PM2.5 Total	Bio- CO2	NBio- CO2	Total CO2	CH4	N2O	CO2e
Category	tons/yr										MT/yr					
Hauling	0.0000	0.0000	0.0000	0.0000	0.0000	0.0000	0.0000	0.0000	0.0000	0.0000	0.0000	0.0000	0.0000	0.0000	0.0000	0.0000
Vendor	0.0000	0.0000	0.0000	0.0000	0.0000	0.0000	0.0000	0.0000	0.0000	0.0000	0.0000	0.0000	0.0000	0.0000	0.0000	0.0000
Worker	4.9000e-004	3.8000e-004	4.2000e-003	1.0000e-005	1.1900e-003	1.0000e-005	1.2000e-003	3.2000e-004	1.0000e-005	3.2000e-004	0.0000	0.9912	0.9912	4.0000e-005	3.0000e-005	1.0015
Total	4.9000e-004	3.8000e-004	4.2000e-003	1.0000e-005	1.1900e-003	1.0000e-005	1.2000e-003	3.2000e-004	1.0000e-005	3.2000e-004	0.0000	0.9912	0.9912	4.0000e-005	3.0000e-005	1.0015

EMFAC Off-Model Adjustment Factors for Gasoline Light Duty Vehicle to Account for the SAFE Vehicle Rule Not Applied

3.7 Architectural Coating - 2023

Unmitigated Construction On-Site

	ROG	NOx	CO	SO2	Fugitive PM10	Exhaust PM10	PM10 Total	Fugitive PM2.5	Exhaust PM2.5	PM2.5 Total	Bio- CO2	NBio- CO2	Total CO2	CH4	N2O	CO2e
Category	tons/yr										MT/yr					
Archit. Coating	0.8800					0.0000	0.0000		0.0000	0.0000	0.0000	0.0000	0.0000	0.0000	0.0000	0.0000
Off-Road	1.9200e-003	0.0130	0.0181	3.0000e-005		7.1000e-004	7.1000e-004		7.1000e-004	7.1000e-004	0.0000	2.5533	2.5533	1.5000e-004	0.0000	2.5571
Total	0.8819	0.0130	0.0181	3.0000e-005		7.1000e-004	7.1000e-004		7.1000e-004	7.1000e-004	0.0000	2.5533	2.5533	1.5000e-004	0.0000	2.5571

Unmitigated Construction Off-Site

	ROG	NOx	CO	SO2	Fugitive PM10	Exhaust PM10	PM10 Total	Fugitive PM2.5	Exhaust PM2.5	PM2.5 Total	Bio- CO2	NBio- CO2	Total CO2	CH4	N2O	CO2e
Category	tons/yr										MT/yr					
Hauling	0.0000	0.0000	0.0000	0.0000	0.0000	0.0000	0.0000	0.0000	0.0000	0.0000	0.0000	0.0000	0.0000	0.0000	0.0000	0.0000
Vendor	0.0000	0.0000	0.0000	0.0000	0.0000	0.0000	0.0000	0.0000	0.0000	0.0000	0.0000	0.0000	0.0000	0.0000	0.0000	0.0000
Worker	1.0400e-003	8.0000e-004	8.9500e-003	2.0000e-005	2.5500e-003	2.0000e-005	2.5600e-003	6.8000e-004	2.0000e-005	6.9000e-004	0.0000	2.1146	2.1146	8.0000e-005	7.0000e-005	2.1365
Total	1.0400e-003	8.0000e-004	8.9500e-003	2.0000e-005	2.5500e-003	2.0000e-005	2.5600e-003	6.8000e-004	2.0000e-005	6.9000e-004	0.0000	2.1146	2.1146	8.0000e-005	7.0000e-005	2.1365

EMFAC Off-Model Adjustment Factors for Gasoline Light Duty Vehicle to Account for the SAFE Vehicle Rule Not Applied

Mitigated Construction On-Site

	ROG	NOx	CO	SO2	Fugitive PM10	Exhaust PM10	PM10 Total	Fugitive PM2.5	Exhaust PM2.5	PM2.5 Total	Bio- CO2	NBio- CO2	Total CO2	CH4	N2O	CO2e
Category	tons/yr										MT/yr					
Archit. Coating	0.8800					0.0000	0.0000		0.0000	0.0000	0.0000	0.0000	0.0000	0.0000	0.0000	0.0000
Off-Road	1.9200e-003	0.0130	0.0181	3.0000e-005		7.1000e-004	7.1000e-004		7.1000e-004	7.1000e-004	0.0000	2.5533	2.5533	1.5000e-004	0.0000	2.5571
Total	0.8819	0.0130	0.0181	3.0000e-005		7.1000e-004	7.1000e-004		7.1000e-004	7.1000e-004	0.0000	2.5533	2.5533	1.5000e-004	0.0000	2.5571

Mitigated Construction Off-Site

	ROG	NOx	CO	SO2	Fugitive PM10	Exhaust PM10	PM10 Total	Fugitive PM2.5	Exhaust PM2.5	PM2.5 Total	Bio- CO2	NBio- CO2	Total CO2	CH4	N2O	CO2e
Category	tons/yr										MT/yr					
Hauling	0.0000	0.0000	0.0000	0.0000	0.0000	0.0000	0.0000	0.0000	0.0000	0.0000	0.0000	0.0000	0.0000	0.0000	0.0000	0.0000
Vendor	0.0000	0.0000	0.0000	0.0000	0.0000	0.0000	0.0000	0.0000	0.0000	0.0000	0.0000	0.0000	0.0000	0.0000	0.0000	0.0000
Worker	1.0400e-003	8.0000e-004	8.9500e-003	2.0000e-005	2.5500e-003	2.0000e-005	2.5600e-003	6.8000e-004	2.0000e-005	6.9000e-004	0.0000	2.1146	2.1146	8.0000e-005	7.0000e-005	2.1365
Total	1.0400e-003	8.0000e-004	8.9500e-003	2.0000e-005	2.5500e-003	2.0000e-005	2.5600e-003	6.8000e-004	2.0000e-005	6.9000e-004	0.0000	2.1146	2.1146	8.0000e-005	7.0000e-005	2.1365

EMFAC Off-Model Adjustment Factors for Gasoline Light Duty Vehicle to Account for the SAFE Vehicle Rule Not Applied

**CSUMB Master Plan - Construction
Monterey Bay Unified APCD Air District, Summer**

1.0 Project Characteristics

1.1 Land Usage

Land Uses	Size	Metric	Lot Acreage	Floor Surface Area	Population
University/College (4yr)	1,634.00	Student	6.89	300,000.00	0
Other Non-Asphalt Surfaces	1.80	Acre	1.80	78,408.00	0

1.2 Other Project Characteristics

Urbanization	Urban	Wind Speed (m/s)	2.8	Precipitation Freq (Days)	53
Climate Zone	4			Operational Year	2024
Utility Company	Pacific Gas and Electric Company				
CO2 Intensity (lb/MWhr)	203.98	CH4 Intensity (lb/MWhr)	0.033	N2O Intensity (lb/MWhr)	0.004

1.3 User Entered Comments & Non-Default Data

Project Characteristics - CSU Monterey Bay Master Plan. MBARD. Construction Scenario.

Land Use - Maximum development of approximately 300 GSF and 1.8 acres of paving.

Construction Phase - Default schedule assumed.

Off-road Equipment - Default equipment

Off-road Equipment - Default equipment

Off-road Equipment - Default equipment

Off-road Equipment - Default equipment

EMFAC Off-Model Adjustment Factors for Gasoline Light Duty Vehicle to Account for the SAFE Vehicle Rule Not Applied

Off-road Equipment - Default equipment

Off-road Equipment - Default equipment

Demolition - Assume demolition of 10,500 SF.

Grading -

Trips and VMT - Default trips

Construction Off-road Equipment Mitigation - Water twice daily

Architectural Coating - MBARD Rule 426 - interior 50 g/L, exterior 100 g/L

Table Name	Column Name	Default Value	New Value
tblArchitecturalCoating	EF_Nonresidential_Exterior	150.00	100.00
tblArchitecturalCoating	EF_Nonresidential_Interior	150.00	50.00
tblArchitecturalCoating	EF_Parking	150.00	100.00
tblLandUse	LandUseSquareFeet	300,325.06	300,000.00
tblTripsAndVMT	HaulingTripNumber	48.00	200.00

EMFAC Off-Model Adjustment Factors for Gasoline Light Duty Vehicle to Account for the SAFE Vehicle Rule Not Applied

2.0 Emissions Summary

2.1 Overall Construction (Maximum Daily Emission)

Unmitigated Construction

	ROG	NOx	CO	SO2	Fugitive PM10	Exhaust PM10	PM10 Total	Fugitive PM2.5	Exhaust PM2.5	PM2.5 Total	Bio- CO2	NBio- CO2	Total CO2	CH4	N2O	CO2e
Year	lb/day										lb/day					
2022	3.2345	33.1284	22.6069	0.0526	19.8049	1.6136	21.4184	10.1417	1.4845	11.6262	0.0000	5,216.0934	5,216.0934	1.1971	0.2430	5,305.2635
2023	88.2941	17.7732	21.8987	0.0518	1.7261	0.7281	2.4542	0.4674	0.6853	1.1526	0.0000	5,132.5254	5,132.5254	0.7177	0.2330	5,218.4241
Maximum	88.2941	33.1284	22.6069	0.0526	19.8049	1.6136	21.4184	10.1417	1.4845	11.6262	0.0000	5,216.0934	5,216.0934	1.1971	0.2430	5,305.2635

Mitigated Construction

	ROG	NOx	CO	SO2	Fugitive PM10	Exhaust PM10	PM10 Total	Fugitive PM2.5	Exhaust PM2.5	PM2.5 Total	Bio- CO2	NBio- CO2	Total CO2	CH4	N2O	CO2e
Year	lb/day										lb/day					
2022	3.2345	33.1284	22.6069	0.0526	8.9935	1.6136	10.6071	4.5853	1.4845	6.0698	0.0000	5,216.0934	5,216.0934	1.1971	0.2430	5,305.2635
2023	88.2941	17.7732	21.8987	0.0518	1.7261	0.7281	2.4542	0.4674	0.6853	1.1526	0.0000	5,132.5254	5,132.5254	0.7177	0.2330	5,218.4241
Maximum	88.2941	33.1284	22.6069	0.0526	8.9935	1.6136	10.6071	4.5853	1.4845	6.0698	0.0000	5,216.0934	5,216.0934	1.1971	0.2430	5,305.2635

EMFAC Off-Model Adjustment Factors for Gasoline Light Duty Vehicle to Account for the SAFE Vehicle Rule Not Applied

	ROG	NOx	CO	SO2	Fugitive PM10	Exhaust PM10	PM10 Total	Fugitive PM2.5	Exhaust PM2.5	PM2.5 Total	Bio- CO2	NBio-CO2	Total CO2	CH4	N2O	CO2e
Percent Reduction	0.00	0.00	0.00	0.00	50.21	0.00	45.29	52.37	0.00	43.48	0.00	0.00	0.00	0.00	0.00	0.00

3.0 Construction Detail

Construction Phase

Phase Number	Phase Name	Phase Type	Start Date	End Date	Num Days Week	Num Days	Phase Description
1	Demolition	Demolition	1/3/2022	1/28/2022	5	20	
2	Site Preparation	Site Preparation	1/29/2022	2/11/2022	5	10	
3	Grading	Grading	2/12/2022	3/11/2022	5	20	
4	Building Construction	Building Construction	3/12/2022	1/27/2023	5	230	
5	Paving	Paving	1/28/2023	2/24/2023	5	20	
6	Architectural Coating	Architectural Coating	2/25/2023	3/24/2023	5	20	

Acres of Grading (Site Preparation Phase): 15

Acres of Grading (Grading Phase): 20

Acres of Paving: 1.8

Residential Indoor: 0; Residential Outdoor: 0; Non-Residential Indoor: 450,000; Non-Residential Outdoor: 150,000; Striped Parking Area: 4,704

EMFAC Off-Model Adjustment Factors for Gasoline Light Duty Vehicle to Account for the SAFE Vehicle Rule Not Applied**OffRoad Equipment**

Phase Name	Offroad Equipment Type	Amount	Usage Hours	Horse Power	Load Factor
Demolition	Concrete/Industrial Saws	1	8.00	81	0.73
Demolition	Excavators	3	8.00	158	0.38
Demolition	Rubber Tired Dozers	2	8.00	247	0.40
Site Preparation	Rubber Tired Dozers	3	8.00	247	0.40
Site Preparation	Tractors/Loaders/Backhoes	4	8.00	97	0.37
Grading	Excavators	1	8.00	158	0.38
Grading	Graders	1	8.00	187	0.41
Grading	Rubber Tired Dozers	1	8.00	247	0.40
Grading	Tractors/Loaders/Backhoes	3	8.00	97	0.37
Building Construction	Cranes	1	7.00	231	0.29
Building Construction	Forklifts	3	8.00	89	0.20
Building Construction	Generator Sets	1	8.00	84	0.74
Building Construction	Tractors/Loaders/Backhoes	3	7.00	97	0.37
Building Construction	Welders	1	8.00	46	0.45
Paving	Pavers	2	8.00	130	0.42
Paving	Paving Equipment	2	8.00	132	0.36
Paving	Rollers	2	8.00	80	0.38
Architectural Coating	Air Compressors	1	6.00	78	0.48

EMFAC Off-Model Adjustment Factors for Gasoline Light Duty Vehicle to Account for the SAFE Vehicle Rule Not Applied

Trips and VMT

Phase Name	Offroad Equipment Count	Worker Trip Number	Vendor Trip Number	Hauling Trip Number	Worker Trip Length	Vendor Trip Length	Hauling Trip Length	Worker Vehicle Class	Vendor Vehicle Class	Hauling Vehicle Class
Demolition	6	15.00	0.00	200.00	10.80	7.30	20.00	LD_Mix	HDT_Mix	HHDT
Site Preparation	7	18.00	0.00	0.00	10.80	7.30	20.00	LD_Mix	HDT_Mix	HHDT
Grading	6	15.00	0.00	0.00	10.80	7.30	20.00	LD_Mix	HDT_Mix	HHDT
Building Construction	9	159.00	62.00	0.00	10.80	7.30	20.00	LD_Mix	HDT_Mix	HHDT
Paving	6	15.00	0.00	0.00	10.80	7.30	20.00	LD_Mix	HDT_Mix	HHDT
Architectural Coating	1	32.00	0.00	0.00	10.80	7.30	20.00	LD_Mix	HDT_Mix	HHDT

3.1 Mitigation Measures Construction

Water Exposed Area

EMFAC Off-Model Adjustment Factors for Gasoline Light Duty Vehicle to Account for the SAFE Vehicle Rule Not Applied

3.2 Demolition - 2022

Unmitigated Construction On-Site

	ROG	NOx	CO	SO2	Fugitive PM10	Exhaust PM10	PM10 Total	Fugitive PM2.5	Exhaust PM2.5	PM2.5 Total	Bio- CO2	NBio- CO2	Total CO2	CH4	N2O	CO2e
Category	lb/day										lb/day					
Fugitive Dust					0.5266	0.0000	0.5266	0.0797	0.0000	0.0797			0.0000			0.0000
Off-Road	2.6392	25.7194	20.5941	0.0388		1.2427	1.2427		1.1553	1.1553		3,746.7812	3,746.7812	1.0524		3,773.0920
Total	2.6392	25.7194	20.5941	0.0388	0.5266	1.2427	1.7692	0.0797	1.1553	1.2350		3,746.7812	3,746.7812	1.0524		3,773.0920

Unmitigated Construction Off-Site

	ROG	NOx	CO	SO2	Fugitive PM10	Exhaust PM10	PM10 Total	Fugitive PM2.5	Exhaust PM2.5	PM2.5 Total	Bio- CO2	NBio- CO2	Total CO2	CH4	N2O	CO2e
Category	lb/day										lb/day					
Hauling	0.0397	1.6368	0.3215	6.2400e-003	0.1750	0.0162	0.1912	0.0480	0.0155	0.0635		666.4063	666.4063	7.8400e-003	0.1050	697.9010
Vendor	0.0000	0.0000	0.0000	0.0000	0.0000	0.0000	0.0000	0.0000	0.0000	0.0000		0.0000	0.0000	0.0000	0.0000	0.0000
Worker	0.0536	0.0374	0.4828	1.1700e-003	0.1232	8.2000e-004	0.1241	0.0327	7.6000e-004	0.0334		118.6349	118.6349	4.1000e-003	3.4500e-003	119.7671
Total	0.0933	1.6742	0.8043	7.4100e-003	0.2982	0.0170	0.3152	0.0806	0.0163	0.0969		785.0412	785.0412	0.0119	0.1085	817.6681

EMFAC Off-Model Adjustment Factors for Gasoline Light Duty Vehicle to Account for the SAFE Vehicle Rule Not Applied

Mitigated Construction On-Site

	ROG	NOx	CO	SO2	Fugitive PM10	Exhaust PM10	PM10 Total	Fugitive PM2.5	Exhaust PM2.5	PM2.5 Total	Bio- CO2	NBio- CO2	Total CO2	CH4	N2O	CO2e
Category	lb/day										lb/day					
Fugitive Dust					0.2370	0.0000	0.2370	0.0359	0.0000	0.0359			0.0000			0.0000
Off-Road	2.6392	25.7194	20.5941	0.0388		1.2427	1.2427		1.1553	1.1553	0.0000	3,746.7812	3,746.7812	1.0524		3,773.0920
Total	2.6392	25.7194	20.5941	0.0388	0.2370	1.2427	1.4796	0.0359	1.1553	1.1911	0.0000	3,746.7812	3,746.7812	1.0524		3,773.0920

Mitigated Construction Off-Site

	ROG	NOx	CO	SO2	Fugitive PM10	Exhaust PM10	PM10 Total	Fugitive PM2.5	Exhaust PM2.5	PM2.5 Total	Bio- CO2	NBio- CO2	Total CO2	CH4	N2O	CO2e
Category	lb/day										lb/day					
Hauling	0.0397	1.6368	0.3215	6.2400e-003	0.1750	0.0162	0.1912	0.0480	0.0155	0.0635		666.4063	666.4063	7.8400e-003	0.1050	697.9010
Vendor	0.0000	0.0000	0.0000	0.0000	0.0000	0.0000	0.0000	0.0000	0.0000	0.0000		0.0000	0.0000	0.0000	0.0000	0.0000
Worker	0.0536	0.0374	0.4828	1.1700e-003	0.1232	8.2000e-004	0.1241	0.0327	7.6000e-004	0.0334		118.6349	118.6349	4.1000e-003	3.4500e-003	119.7671
Total	0.0933	1.6742	0.8043	7.4100e-003	0.2982	0.0170	0.3152	0.0806	0.0163	0.0969		785.0412	785.0412	0.0119	0.1085	817.6681

EMFAC Off-Model Adjustment Factors for Gasoline Light Duty Vehicle to Account for the SAFE Vehicle Rule Not Applied

3.3 Site Preparation - 2022

Unmitigated Construction On-Site

	ROG	NOx	CO	SO2	Fugitive PM10	Exhaust PM10	PM10 Total	Fugitive PM2.5	Exhaust PM2.5	PM2.5 Total	Bio- CO2	NBio- CO2	Total CO2	CH4	N2O	CO2e
Category	lb/day										lb/day					
Fugitive Dust					19.6570	0.0000	19.6570	10.1025	0.0000	10.1025			0.0000			0.0000
Off-Road	3.1701	33.0835	19.6978	0.0380		1.6126	1.6126		1.4836	1.4836		3,686.0619	3,686.0619	1.1922		3,715.8655
Total	3.1701	33.0835	19.6978	0.0380	19.6570	1.6126	21.2696	10.1025	1.4836	11.5860		3,686.0619	3,686.0619	1.1922		3,715.8655

Unmitigated Construction Off-Site

	ROG	NOx	CO	SO2	Fugitive PM10	Exhaust PM10	PM10 Total	Fugitive PM2.5	Exhaust PM2.5	PM2.5 Total	Bio- CO2	NBio- CO2	Total CO2	CH4	N2O	CO2e
Category	lb/day										lb/day					
Hauling	0.0000	0.0000	0.0000	0.0000	0.0000	0.0000	0.0000	0.0000	0.0000	0.0000		0.0000	0.0000	0.0000	0.0000	0.0000
Vendor	0.0000	0.0000	0.0000	0.0000	0.0000	0.0000	0.0000	0.0000	0.0000	0.0000		0.0000	0.0000	0.0000	0.0000	0.0000
Worker	0.0643	0.0449	0.5793	1.4100e-003	0.1479	9.9000e-004	0.1489	0.0392	9.1000e-004	0.0401		142.3619	142.3619	4.9200e-003	4.1500e-003	143.7205
Total	0.0643	0.0449	0.5793	1.4100e-003	0.1479	9.9000e-004	0.1489	0.0392	9.1000e-004	0.0401		142.3619	142.3619	4.9200e-003	4.1500e-003	143.7205

EMFAC Off-Model Adjustment Factors for Gasoline Light Duty Vehicle to Account for the SAFE Vehicle Rule Not Applied**Mitigated Construction On-Site**

	ROG	NOx	CO	SO2	Fugitive PM10	Exhaust PM10	PM10 Total	Fugitive PM2.5	Exhaust PM2.5	PM2.5 Total	Bio- CO2	NBio- CO2	Total CO2	CH4	N2O	CO2e
Category	lb/day										lb/day					
Fugitive Dust					8.8457	0.0000	8.8457	4.5461	0.0000	4.5461			0.0000			0.0000
Off-Road	3.1701	33.0835	19.6978	0.0380		1.6126	1.6126		1.4836	1.4836	0.0000	3,686.0619	3,686.0619	1.1922		3,715.8655
Total	3.1701	33.0835	19.6978	0.0380	8.8457	1.6126	10.4582	4.5461	1.4836	6.0297	0.0000	3,686.0619	3,686.0619	1.1922		3,715.8655

Mitigated Construction Off-Site

	ROG	NOx	CO	SO2	Fugitive PM10	Exhaust PM10	PM10 Total	Fugitive PM2.5	Exhaust PM2.5	PM2.5 Total	Bio- CO2	NBio- CO2	Total CO2	CH4	N2O	CO2e
Category	lb/day										lb/day					
Hauling	0.0000	0.0000	0.0000	0.0000	0.0000	0.0000	0.0000	0.0000	0.0000	0.0000		0.0000	0.0000	0.0000	0.0000	0.0000
Vendor	0.0000	0.0000	0.0000	0.0000	0.0000	0.0000	0.0000	0.0000	0.0000	0.0000		0.0000	0.0000	0.0000	0.0000	0.0000
Worker	0.0643	0.0449	0.5793	1.4100e-003	0.1479	9.9000e-004	0.1489	0.0392	9.1000e-004	0.0401		142.3619	142.3619	4.9200e-003	4.1500e-003	143.7205
Total	0.0643	0.0449	0.5793	1.4100e-003	0.1479	9.9000e-004	0.1489	0.0392	9.1000e-004	0.0401		142.3619	142.3619	4.9200e-003	4.1500e-003	143.7205

EMFAC Off-Model Adjustment Factors for Gasoline Light Duty Vehicle to Account for the SAFE Vehicle Rule Not Applied

3.4 Grading - 2022

Unmitigated Construction On-Site

	ROG	NOx	CO	SO2	Fugitive PM10	Exhaust PM10	PM10 Total	Fugitive PM2.5	Exhaust PM2.5	PM2.5 Total	Bio- CO2	NBio- CO2	Total CO2	CH4	N2O	CO2e
Category	lb/day										lb/day					
Fugitive Dust					7.0826	0.0000	7.0826	3.4247	0.0000	3.4247			0.0000			0.0000
Off-Road	1.9486	20.8551	15.2727	0.0297		0.9409	0.9409		0.8656	0.8656		2,872.0464	2,872.0464	0.9289		2,895.2684
Total	1.9486	20.8551	15.2727	0.0297	7.0826	0.9409	8.0234	3.4247	0.8656	4.2903		2,872.0464	2,872.0464	0.9289		2,895.2684

Unmitigated Construction Off-Site

	ROG	NOx	CO	SO2	Fugitive PM10	Exhaust PM10	PM10 Total	Fugitive PM2.5	Exhaust PM2.5	PM2.5 Total	Bio- CO2	NBio- CO2	Total CO2	CH4	N2O	CO2e
Category	lb/day										lb/day					
Hauling	0.0000	0.0000	0.0000	0.0000	0.0000	0.0000	0.0000	0.0000	0.0000	0.0000		0.0000	0.0000	0.0000	0.0000	0.0000
Vendor	0.0000	0.0000	0.0000	0.0000	0.0000	0.0000	0.0000	0.0000	0.0000	0.0000		0.0000	0.0000	0.0000	0.0000	0.0000
Worker	0.0536	0.0374	0.4828	1.1700e-003	0.1232	8.2000e-004	0.1241	0.0327	7.6000e-004	0.0334		118.6349	118.6349	4.1000e-003	3.4500e-003	119.7671
Total	0.0536	0.0374	0.4828	1.1700e-003	0.1232	8.2000e-004	0.1241	0.0327	7.6000e-004	0.0334		118.6349	118.6349	4.1000e-003	3.4500e-003	119.7671

EMFAC Off-Model Adjustment Factors for Gasoline Light Duty Vehicle to Account for the SAFE Vehicle Rule Not Applied

Mitigated Construction On-Site

	ROG	NOx	CO	SO2	Fugitive PM10	Exhaust PM10	PM10 Total	Fugitive PM2.5	Exhaust PM2.5	PM2.5 Total	Bio- CO2	NBio- CO2	Total CO2	CH4	N2O	CO2e
Category	lb/day										lb/day					
Fugitive Dust					3.1872	0.0000	3.1872	1.5411	0.0000	1.5411			0.0000			0.0000
Off-Road	1.9486	20.8551	15.2727	0.0297		0.9409	0.9409		0.8656	0.8656	0.0000	2,872.0464	2,872.0464	0.9289		2,895.2684
Total	1.9486	20.8551	15.2727	0.0297	3.1872	0.9409	4.1280	1.5411	0.8656	2.4067	0.0000	2,872.0464	2,872.0464	0.9289		2,895.2684

Mitigated Construction Off-Site

	ROG	NOx	CO	SO2	Fugitive PM10	Exhaust PM10	PM10 Total	Fugitive PM2.5	Exhaust PM2.5	PM2.5 Total	Bio- CO2	NBio- CO2	Total CO2	CH4	N2O	CO2e
Category	lb/day										lb/day					
Hauling	0.0000	0.0000	0.0000	0.0000	0.0000	0.0000	0.0000	0.0000	0.0000	0.0000		0.0000	0.0000	0.0000	0.0000	0.0000
Vendor	0.0000	0.0000	0.0000	0.0000	0.0000	0.0000	0.0000	0.0000	0.0000	0.0000		0.0000	0.0000	0.0000	0.0000	0.0000
Worker	0.0536	0.0374	0.4828	1.1700e-003	0.1232	8.2000e-004	0.1241	0.0327	7.6000e-004	0.0334		118.6349	118.6349	4.1000e-003	3.4500e-003	119.7671
Total	0.0536	0.0374	0.4828	1.1700e-003	0.1232	8.2000e-004	0.1241	0.0327	7.6000e-004	0.0334		118.6349	118.6349	4.1000e-003	3.4500e-003	119.7671

EMFAC Off-Model Adjustment Factors for Gasoline Light Duty Vehicle to Account for the SAFE Vehicle Rule Not Applied

3.5 Building Construction - 2022

Unmitigated Construction On-Site

	ROG	NOx	CO	SO2	Fugitive PM10	Exhaust PM10	PM10 Total	Fugitive PM2.5	Exhaust PM2.5	PM2.5 Total	Bio- CO2	NBio- CO2	Total CO2	CH4	N2O	CO2e
Category	lb/day										lb/day					
Off-Road	1.7062	15.6156	16.3634	0.0269		0.8090	0.8090		0.7612	0.7612		2,554.3336	2,554.3336	0.6120		2,569.6322
Total	1.7062	15.6156	16.3634	0.0269		0.8090	0.8090		0.7612	0.7612		2,554.3336	2,554.3336	0.6120		2,569.6322

Unmitigated Construction Off-Site

	ROG	NOx	CO	SO2	Fugitive PM10	Exhaust PM10	PM10 Total	Fugitive PM2.5	Exhaust PM2.5	PM2.5 Total	Bio- CO2	NBio- CO2	Total CO2	CH4	N2O	CO2e
Category	lb/day										lb/day					
Hauling	0.0000	0.0000	0.0000	0.0000	0.0000	0.0000	0.0000	0.0000	0.0000	0.0000		0.0000	0.0000	0.0000	0.0000	0.0000
Vendor	0.1466	3.6264	1.1263	0.0132	0.4200	0.0395	0.4595	0.1209	0.0378	0.1587		1,404.2295	1,404.2295	0.0148	0.2064	1,466.1003
Worker	0.5683	0.3962	5.1172	0.0124	1.3062	8.7400e-003	1.3149	0.3465	8.0600e-003	0.3545		1,257.5303	1,257.5303	0.0435	0.0366	1,269.5309
Total	0.7149	4.0226	6.2435	0.0257	1.7261	0.0483	1.7744	0.4674	0.0459	0.5132		2,661.7598	2,661.7598	0.0583	0.2430	2,735.6313

EMFAC Off-Model Adjustment Factors for Gasoline Light Duty Vehicle to Account for the SAFE Vehicle Rule Not Applied

Mitigated Construction On-Site

	ROG	NOx	CO	SO2	Fugitive PM10	Exhaust PM10	PM10 Total	Fugitive PM2.5	Exhaust PM2.5	PM2.5 Total	Bio- CO2	NBio- CO2	Total CO2	CH4	N2O	CO2e
Category	lb/day										lb/day					
Off-Road	1.7062	15.6156	16.3634	0.0269		0.8090	0.8090		0.7612	0.7612	0.0000	2,554.3336	2,554.3336	0.6120		2,569.6322
Total	1.7062	15.6156	16.3634	0.0269		0.8090	0.8090		0.7612	0.7612	0.0000	2,554.3336	2,554.3336	0.6120		2,569.6322

Mitigated Construction Off-Site

	ROG	NOx	CO	SO2	Fugitive PM10	Exhaust PM10	PM10 Total	Fugitive PM2.5	Exhaust PM2.5	PM2.5 Total	Bio- CO2	NBio- CO2	Total CO2	CH4	N2O	CO2e
Category	lb/day										lb/day					
Hauling	0.0000	0.0000	0.0000	0.0000	0.0000	0.0000	0.0000	0.0000	0.0000	0.0000		0.0000	0.0000	0.0000	0.0000	0.0000
Vendor	0.1466	3.6264	1.1263	0.0132	0.4200	0.0395	0.4595	0.1209	0.0378	0.1587		1,404.2295	1,404.2295	0.0148	0.2064	1,466.1003
Worker	0.5683	0.3962	5.1172	0.0124	1.3062	8.7400e-003	1.3149	0.3465	8.0600e-003	0.3545		1,257.5303	1,257.5303	0.0435	0.0366	1,269.5309
Total	0.7149	4.0226	6.2435	0.0257	1.7261	0.0483	1.7744	0.4674	0.0459	0.5132		2,661.7598	2,661.7598	0.0583	0.2430	2,735.6313

EMFAC Off-Model Adjustment Factors for Gasoline Light Duty Vehicle to Account for the SAFE Vehicle Rule Not Applied

3.5 Building Construction - 2023

Unmitigated Construction On-Site

	ROG	NOx	CO	SO2	Fugitive PM10	Exhaust PM10	PM10 Total	Fugitive PM2.5	Exhaust PM2.5	PM2.5 Total	Bio- CO2	NBio- CO2	Total CO2	CH4	N2O	CO2e
Category	lb/day										lb/day					
Off-Road	1.5728	14.3849	16.2440	0.0269		0.6997	0.6997		0.6584	0.6584		2,555.2099	2,555.2099	0.6079		2,570.4061
Total	1.5728	14.3849	16.2440	0.0269		0.6997	0.6997		0.6584	0.6584		2,555.2099	2,555.2099	0.6079		2,570.4061

Unmitigated Construction Off-Site

	ROG	NOx	CO	SO2	Fugitive PM10	Exhaust PM10	PM10 Total	Fugitive PM2.5	Exhaust PM2.5	PM2.5 Total	Bio- CO2	NBio- CO2	Total CO2	CH4	N2O	CO2e
Category	lb/day										lb/day					
Hauling	0.0000	0.0000	0.0000	0.0000	0.0000	0.0000	0.0000	0.0000	0.0000	0.0000		0.0000	0.0000	0.0000	0.0000	0.0000
Vendor	0.0896	3.0392	0.9817	0.0128	0.4200	0.0201	0.4401	0.1209	0.0193	0.1402		1,358.1176	1,358.1176	0.0119	0.1993	1,417.8112
Worker	0.5270	0.3491	4.6730	0.0121	1.3062	8.2300e-003	1.3144	0.3465	7.5800e-003	0.3540		1,219.1979	1,219.1979	0.0390	0.0337	1,230.2069
Total	0.6166	3.3883	5.6547	0.0249	1.7261	0.0284	1.7545	0.4674	0.0268	0.4942		2,577.3155	2,577.3155	0.0509	0.2330	2,648.0180

EMFAC Off-Model Adjustment Factors for Gasoline Light Duty Vehicle to Account for the SAFE Vehicle Rule Not Applied

Mitigated Construction On-Site

	ROG	NOx	CO	SO2	Fugitive PM10	Exhaust PM10	PM10 Total	Fugitive PM2.5	Exhaust PM2.5	PM2.5 Total	Bio- CO2	NBio- CO2	Total CO2	CH4	N2O	CO2e
Category	lb/day										lb/day					
Off-Road	1.5728	14.3849	16.2440	0.0269		0.6997	0.6997		0.6584	0.6584	0.0000	2,555.2099	2,555.2099	0.6079		2,570.4061
Total	1.5728	14.3849	16.2440	0.0269		0.6997	0.6997		0.6584	0.6584	0.0000	2,555.2099	2,555.2099	0.6079		2,570.4061

Mitigated Construction Off-Site

	ROG	NOx	CO	SO2	Fugitive PM10	Exhaust PM10	PM10 Total	Fugitive PM2.5	Exhaust PM2.5	PM2.5 Total	Bio- CO2	NBio- CO2	Total CO2	CH4	N2O	CO2e
Category	lb/day										lb/day					
Hauling	0.0000	0.0000	0.0000	0.0000	0.0000	0.0000	0.0000	0.0000	0.0000	0.0000		0.0000	0.0000	0.0000	0.0000	0.0000
Vendor	0.0896	3.0392	0.9817	0.0128	0.4200	0.0201	0.4401	0.1209	0.0193	0.1402		1,358.1176	1,358.1176	0.0119	0.1993	1,417.8112
Worker	0.5270	0.3491	4.6730	0.0121	1.3062	8.2300e-003	1.3144	0.3465	7.5800e-003	0.3540		1,219.1979	1,219.1979	0.0390	0.0337	1,230.2069
Total	0.6166	3.3883	5.6547	0.0249	1.7261	0.0284	1.7545	0.4674	0.0268	0.4942		2,577.3155	2,577.3155	0.0509	0.2330	2,648.0180

EMFAC Off-Model Adjustment Factors for Gasoline Light Duty Vehicle to Account for the SAFE Vehicle Rule Not Applied

3.6 Paving - 2023

Unmitigated Construction On-Site

	ROG	NOx	CO	SO2	Fugitive PM10	Exhaust PM10	PM10 Total	Fugitive PM2.5	Exhaust PM2.5	PM2.5 Total	Bio- CO2	NBio- CO2	Total CO2	CH4	N2O	CO2e
Category	lb/day										lb/day					
Off-Road	1.0327	10.1917	14.5842	0.0228		0.5102	0.5102		0.4694	0.4694		2,207.5841	2,207.5841	0.7140		2,225.4336
Paving	0.0000					0.0000	0.0000		0.0000	0.0000			0.0000			0.0000
Total	1.0327	10.1917	14.5842	0.0228		0.5102	0.5102		0.4694	0.4694		2,207.5841	2,207.5841	0.7140		2,225.4336

Unmitigated Construction Off-Site

	ROG	NOx	CO	SO2	Fugitive PM10	Exhaust PM10	PM10 Total	Fugitive PM2.5	Exhaust PM2.5	PM2.5 Total	Bio- CO2	NBio- CO2	Total CO2	CH4	N2O	CO2e
Category	lb/day										lb/day					
Hauling	0.0000	0.0000	0.0000	0.0000	0.0000	0.0000	0.0000	0.0000	0.0000	0.0000		0.0000	0.0000	0.0000	0.0000	0.0000
Vendor	0.0000	0.0000	0.0000	0.0000	0.0000	0.0000	0.0000	0.0000	0.0000	0.0000		0.0000	0.0000	0.0000	0.0000	0.0000
Worker	0.0497	0.0329	0.4409	1.1400e-003	0.1232	7.8000e-004	0.1240	0.0327	7.2000e-004	0.0334		115.0187	115.0187	3.6800e-003	3.1800e-003	116.0573
Total	0.0497	0.0329	0.4409	1.1400e-003	0.1232	7.8000e-004	0.1240	0.0327	7.2000e-004	0.0334		115.0187	115.0187	3.6800e-003	3.1800e-003	116.0573

EMFAC Off-Model Adjustment Factors for Gasoline Light Duty Vehicle to Account for the SAFE Vehicle Rule Not Applied

Mitigated Construction On-Site

	ROG	NOx	CO	SO2	Fugitive PM10	Exhaust PM10	PM10 Total	Fugitive PM2.5	Exhaust PM2.5	PM2.5 Total	Bio- CO2	NBio- CO2	Total CO2	CH4	N2O	CO2e
Category	lb/day										lb/day					
Off-Road	1.0327	10.1917	14.5842	0.0228		0.5102	0.5102		0.4694	0.4694	0.0000	2,207.5841	2,207.5841	0.7140		2,225.4336
Paving	0.0000					0.0000	0.0000		0.0000	0.0000			0.0000			0.0000
Total	1.0327	10.1917	14.5842	0.0228		0.5102	0.5102		0.4694	0.4694	0.0000	2,207.5841	2,207.5841	0.7140		2,225.4336

Mitigated Construction Off-Site

	ROG	NOx	CO	SO2	Fugitive PM10	Exhaust PM10	PM10 Total	Fugitive PM2.5	Exhaust PM2.5	PM2.5 Total	Bio- CO2	NBio- CO2	Total CO2	CH4	N2O	CO2e
Category	lb/day										lb/day					
Hauling	0.0000	0.0000	0.0000	0.0000	0.0000	0.0000	0.0000	0.0000	0.0000	0.0000		0.0000	0.0000	0.0000	0.0000	0.0000
Vendor	0.0000	0.0000	0.0000	0.0000	0.0000	0.0000	0.0000	0.0000	0.0000	0.0000		0.0000	0.0000	0.0000	0.0000	0.0000
Worker	0.0497	0.0329	0.4409	1.1400e-003	0.1232	7.8000e-004	0.1240	0.0327	7.2000e-004	0.0334		115.0187	115.0187	3.6800e-003	3.1800e-003	116.0573
Total	0.0497	0.0329	0.4409	1.1400e-003	0.1232	7.8000e-004	0.1240	0.0327	7.2000e-004	0.0334		115.0187	115.0187	3.6800e-003	3.1800e-003	116.0573

EMFAC Off-Model Adjustment Factors for Gasoline Light Duty Vehicle to Account for the SAFE Vehicle Rule Not Applied

3.7 Architectural Coating - 2023

Unmitigated Construction On-Site

	ROG	NOx	CO	SO2	Fugitive PM10	Exhaust PM10	PM10 Total	Fugitive PM2.5	Exhaust PM2.5	PM2.5 Total	Bio- CO2	NBio- CO2	Total CO2	CH4	N2O	CO2e
Category	lb/day										lb/day					
Archit. Coating	87.9964					0.0000	0.0000		0.0000	0.0000			0.0000			0.0000
Off-Road	0.1917	1.3030	1.8111	2.9700e-003		0.0708	0.0708		0.0708	0.0708		281.4481	281.4481	0.0168		281.8690
Total	88.1881	1.3030	1.8111	2.9700e-003		0.0708	0.0708		0.0708	0.0708		281.4481	281.4481	0.0168		281.8690

Unmitigated Construction Off-Site

	ROG	NOx	CO	SO2	Fugitive PM10	Exhaust PM10	PM10 Total	Fugitive PM2.5	Exhaust PM2.5	PM2.5 Total	Bio- CO2	NBio- CO2	Total CO2	CH4	N2O	CO2e
Category	lb/day										lb/day					
Hauling	0.0000	0.0000	0.0000	0.0000	0.0000	0.0000	0.0000	0.0000	0.0000	0.0000		0.0000	0.0000	0.0000	0.0000	0.0000
Vendor	0.0000	0.0000	0.0000	0.0000	0.0000	0.0000	0.0000	0.0000	0.0000	0.0000		0.0000	0.0000	0.0000	0.0000	0.0000
Worker	0.1061	0.0703	0.9405	2.4300e-003	0.2629	1.6600e-003	0.2645	0.0697	1.5300e-003	0.0713		245.3732	245.3732	7.8500e-003	6.7800e-003	247.5888
Total	0.1061	0.0703	0.9405	2.4300e-003	0.2629	1.6600e-003	0.2645	0.0697	1.5300e-003	0.0713		245.3732	245.3732	7.8500e-003	6.7800e-003	247.5888

EMFAC Off-Model Adjustment Factors for Gasoline Light Duty Vehicle to Account for the SAFE Vehicle Rule Not Applied

Mitigated Construction On-Site

	ROG	NOx	CO	SO2	Fugitive PM10	Exhaust PM10	PM10 Total	Fugitive PM2.5	Exhaust PM2.5	PM2.5 Total	Bio- CO2	NBio- CO2	Total CO2	CH4	N2O	CO2e
Category	lb/day										lb/day					
Archit. Coating	87.9964					0.0000	0.0000		0.0000	0.0000			0.0000			0.0000
Off-Road	0.1917	1.3030	1.8111	2.9700e-003		0.0708	0.0708		0.0708	0.0708	0.0000	281.4481	281.4481	0.0168		281.8690
Total	88.1881	1.3030	1.8111	2.9700e-003		0.0708	0.0708		0.0708	0.0708	0.0000	281.4481	281.4481	0.0168		281.8690

Mitigated Construction Off-Site

	ROG	NOx	CO	SO2	Fugitive PM10	Exhaust PM10	PM10 Total	Fugitive PM2.5	Exhaust PM2.5	PM2.5 Total	Bio- CO2	NBio- CO2	Total CO2	CH4	N2O	CO2e
Category	lb/day										lb/day					
Hauling	0.0000	0.0000	0.0000	0.0000	0.0000	0.0000	0.0000	0.0000	0.0000	0.0000		0.0000	0.0000	0.0000	0.0000	0.0000
Vendor	0.0000	0.0000	0.0000	0.0000	0.0000	0.0000	0.0000	0.0000	0.0000	0.0000		0.0000	0.0000	0.0000	0.0000	0.0000
Worker	0.1061	0.0703	0.9405	2.4300e-003	0.2629	1.6600e-003	0.2645	0.0697	1.5300e-003	0.0713		245.3732	245.3732	7.8500e-003	6.7800e-003	247.5888
Total	0.1061	0.0703	0.9405	2.4300e-003	0.2629	1.6600e-003	0.2645	0.0697	1.5300e-003	0.0713		245.3732	245.3732	7.8500e-003	6.7800e-003	247.5888

EMFAC Off-Model Adjustment Factors for Gasoline Light Duty Vehicle to Account for the SAFE Vehicle Rule Not Applied

**CSUMB Master Plan - Construction
Monterey Bay Unified APCD Air District, Winter**

1.0 Project Characteristics

1.1 Land Usage

Land Uses	Size	Metric	Lot Acreage	Floor Surface Area	Population
University/College (4yr)	1,634.00	Student	6.89	300,000.00	0
Other Non-Asphalt Surfaces	1.80	Acre	1.80	78,408.00	0

1.2 Other Project Characteristics

Urbanization	Urban	Wind Speed (m/s)	2.8	Precipitation Freq (Days)	53
Climate Zone	4			Operational Year	2024
Utility Company	Pacific Gas and Electric Company				
CO2 Intensity (lb/MWhr)	203.98	CH4 Intensity (lb/MWhr)	0.033	N2O Intensity (lb/MWhr)	0.004

1.3 User Entered Comments & Non-Default Data

Project Characteristics - CSU Monterey Bay Master Plan. MBARD. Construction Scenario.

Land Use - Maximum development of approximately 300 GSF and 1.8 acres of paving.

Construction Phase - Default schedule assumed.

Off-road Equipment - Default equipment

Off-road Equipment - Default equipment

Off-road Equipment - Default equipment

Off-road Equipment - Default equipment

EMFAC Off-Model Adjustment Factors for Gasoline Light Duty Vehicle to Account for the SAFE Vehicle Rule Not Applied

Off-road Equipment - Default equipment

Off-road Equipment - Default equipment

Demolition - Assume demolition of 10,500 SF.

Grading -

Trips and VMT - Default trips

Construction Off-road Equipment Mitigation - Water twice daily

Architectural Coating - MBARD Rule 426 - interior 50 g/L, exterior 100 g/L

Table Name	Column Name	Default Value	New Value
tblArchitecturalCoating	EF_Nonresidential_Exterior	150.00	100.00
tblArchitecturalCoating	EF_Nonresidential_Interior	150.00	50.00
tblArchitecturalCoating	EF_Parking	150.00	100.00
tblLandUse	LandUseSquareFeet	300,325.06	300,000.00
tblTripsAndVMT	HaulingTripNumber	48.00	200.00

EMFAC Off-Model Adjustment Factors for Gasoline Light Duty Vehicle to Account for the SAFE Vehicle Rule Not Applied

2.0 Emissions Summary

2.1 Overall Construction (Maximum Daily Emission)

Unmitigated Construction

	ROG	NOx	CO	SO2	Fugitive PM10	Exhaust PM10	PM10 Total	Fugitive PM2.5	Exhaust PM2.5	PM2.5 Total	Bio- CO2	NBio- CO2	Total CO2	CH4	N2O	CO2e
Year	lb/day										lb/day					
2022	3.2384	33.1397	22.5728	0.0520	19.8049	1.6136	21.4184	10.1417	1.4845	11.6262	0.0000	5,149.6884	5,149.6884	1.1977	0.2495	5,240.9286
2023	88.3009	18.0400	21.8829	0.0512	1.7261	0.7282	2.4543	0.4674	0.6853	1.1527	0.0000	5,069.6292	5,069.6292	0.7181	0.2392	5,157.4826
Maximum	88.3009	33.1397	22.5728	0.0520	19.8049	1.6136	21.4184	10.1417	1.4845	11.6262	0.0000	5,149.6884	5,149.6884	1.1977	0.2495	5,240.9286

Mitigated Construction

	ROG	NOx	CO	SO2	Fugitive PM10	Exhaust PM10	PM10 Total	Fugitive PM2.5	Exhaust PM2.5	PM2.5 Total	Bio- CO2	NBio- CO2	Total CO2	CH4	N2O	CO2e
Year	lb/day										lb/day					
2022	3.2384	33.1397	22.5728	0.0520	8.9935	1.6136	10.6071	4.5853	1.4845	6.0698	0.0000	5,149.6884	5,149.6884	1.1977	0.2495	5,240.9286
2023	88.3009	18.0400	21.8829	0.0512	1.7261	0.7282	2.4543	0.4674	0.6853	1.1527	0.0000	5,069.6292	5,069.6292	0.7181	0.2392	5,157.4825
Maximum	88.3009	33.1397	22.5728	0.0520	8.9935	1.6136	10.6071	4.5853	1.4845	6.0698	0.0000	5,149.6884	5,149.6884	1.1977	0.2495	5,240.9286

EMFAC Off-Model Adjustment Factors for Gasoline Light Duty Vehicle to Account for the SAFE Vehicle Rule Not Applied

	ROG	NOx	CO	SO2	Fugitive PM10	Exhaust PM10	PM10 Total	Fugitive PM2.5	Exhaust PM2.5	PM2.5 Total	Bio- CO2	NBio-CO2	Total CO2	CH4	N2O	CO2e
Percent Reduction	0.00	0.00	0.00	0.00	50.21	0.00	45.29	52.37	0.00	43.48	0.00	0.00	0.00	0.00	0.00	0.00

3.0 Construction Detail

Construction Phase

Phase Number	Phase Name	Phase Type	Start Date	End Date	Num Days Week	Num Days	Phase Description
1	Demolition	Demolition	1/3/2022	1/28/2022	5	20	
2	Site Preparation	Site Preparation	1/29/2022	2/11/2022	5	10	
3	Grading	Grading	2/12/2022	3/11/2022	5	20	
4	Building Construction	Building Construction	3/12/2022	1/27/2023	5	230	
5	Paving	Paving	1/28/2023	2/24/2023	5	20	
6	Architectural Coating	Architectural Coating	2/25/2023	3/24/2023	5	20	

Acres of Grading (Site Preparation Phase): 15

Acres of Grading (Grading Phase): 20

Acres of Paving: 1.8

Residential Indoor: 0; Residential Outdoor: 0; Non-Residential Indoor: 450,000; Non-Residential Outdoor: 150,000; Striped Parking Area: 4,704

EMFAC Off-Model Adjustment Factors for Gasoline Light Duty Vehicle to Account for the SAFE Vehicle Rule Not Applied**OffRoad Equipment**

Phase Name	Offroad Equipment Type	Amount	Usage Hours	Horse Power	Load Factor
Demolition	Concrete/Industrial Saws	1	8.00	81	0.73
Demolition	Excavators	3	8.00	158	0.38
Demolition	Rubber Tired Dozers	2	8.00	247	0.40
Site Preparation	Rubber Tired Dozers	3	8.00	247	0.40
Site Preparation	Tractors/Loaders/Backhoes	4	8.00	97	0.37
Grading	Excavators	1	8.00	158	0.38
Grading	Graders	1	8.00	187	0.41
Grading	Rubber Tired Dozers	1	8.00	247	0.40
Grading	Tractors/Loaders/Backhoes	3	8.00	97	0.37
Building Construction	Cranes	1	7.00	231	0.29
Building Construction	Forklifts	3	8.00	89	0.20
Building Construction	Generator Sets	1	8.00	84	0.74
Building Construction	Tractors/Loaders/Backhoes	3	7.00	97	0.37
Building Construction	Welders	1	8.00	46	0.45
Paving	Pavers	2	8.00	130	0.42
Paving	Paving Equipment	2	8.00	132	0.36
Paving	Rollers	2	8.00	80	0.38
Architectural Coating	Air Compressors	1	6.00	78	0.48

EMFAC Off-Model Adjustment Factors for Gasoline Light Duty Vehicle to Account for the SAFE Vehicle Rule Not Applied

Trips and VMT

Phase Name	Offroad Equipment Count	Worker Trip Number	Vendor Trip Number	Hauling Trip Number	Worker Trip Length	Vendor Trip Length	Hauling Trip Length	Worker Vehicle Class	Vendor Vehicle Class	Hauling Vehicle Class
Demolition	6	15.00	0.00	200.00	10.80	7.30	20.00	LD_Mix	HDT_Mix	HHDT
Site Preparation	7	18.00	0.00	0.00	10.80	7.30	20.00	LD_Mix	HDT_Mix	HHDT
Grading	6	15.00	0.00	0.00	10.80	7.30	20.00	LD_Mix	HDT_Mix	HHDT
Building Construction	9	159.00	62.00	0.00	10.80	7.30	20.00	LD_Mix	HDT_Mix	HHDT
Paving	6	15.00	0.00	0.00	10.80	7.30	20.00	LD_Mix	HDT_Mix	HHDT
Architectural Coating	1	32.00	0.00	0.00	10.80	7.30	20.00	LD_Mix	HDT_Mix	HHDT

3.1 Mitigation Measures Construction

Water Exposed Area

EMFAC Off-Model Adjustment Factors for Gasoline Light Duty Vehicle to Account for the SAFE Vehicle Rule Not Applied

3.2 Demolition - 2022

Unmitigated Construction On-Site

	ROG	NOx	CO	SO2	Fugitive PM10	Exhaust PM10	PM10 Total	Fugitive PM2.5	Exhaust PM2.5	PM2.5 Total	Bio- CO2	NBio- CO2	Total CO2	CH4	N2O	CO2e
Category	lb/day										lb/day					
Fugitive Dust					0.5266	0.0000	0.5266	0.0797	0.0000	0.0797			0.0000			0.0000
Off-Road	2.6392	25.7194	20.5941	0.0388		1.2427	1.2427		1.1553	1.1553		3,746.7812	3,746.7812	1.0524		3,773.0920
Total	2.6392	25.7194	20.5941	0.0388	0.5266	1.2427	1.7692	0.0797	1.1553	1.2350		3,746.7812	3,746.7812	1.0524		3,773.0920

Unmitigated Construction Off-Site

	ROG	NOx	CO	SO2	Fugitive PM10	Exhaust PM10	PM10 Total	Fugitive PM2.5	Exhaust PM2.5	PM2.5 Total	Bio- CO2	NBio- CO2	Total CO2	CH4	N2O	CO2e
Category	lb/day										lb/day					
Hauling	0.0382	1.7269	0.3288	6.2400e-003	0.1750	0.0162	0.1912	0.0480	0.0155	0.0635		666.8525	666.8525	7.7700e-003	0.1051	698.3671
Vendor	0.0000	0.0000	0.0000	0.0000	0.0000	0.0000	0.0000	0.0000	0.0000	0.0000		0.0000	0.0000	0.0000	0.0000	0.0000
Worker	0.0569	0.0468	0.4763	1.1100e-003	0.1232	8.2000e-004	0.1241	0.0327	7.6000e-004	0.0334		112.2572	112.2572	4.6000e-003	4.0200e-003	113.5704
Total	0.0951	1.7737	0.8051	7.3500e-003	0.2982	0.0171	0.3152	0.0806	0.0163	0.0969		779.1097	779.1097	0.0124	0.1091	811.9375

EMFAC Off-Model Adjustment Factors for Gasoline Light Duty Vehicle to Account for the SAFE Vehicle Rule Not Applied

Mitigated Construction On-Site

	ROG	NOx	CO	SO2	Fugitive PM10	Exhaust PM10	PM10 Total	Fugitive PM2.5	Exhaust PM2.5	PM2.5 Total	Bio- CO2	NBio- CO2	Total CO2	CH4	N2O	CO2e
Category	lb/day										lb/day					
Fugitive Dust					0.2370	0.0000	0.2370	0.0359	0.0000	0.0359			0.0000			0.0000
Off-Road	2.6392	25.7194	20.5941	0.0388		1.2427	1.2427		1.1553	1.1553	0.0000	3,746.7812	3,746.7812	1.0524		3,773.0920
Total	2.6392	25.7194	20.5941	0.0388	0.2370	1.2427	1.4796	0.0359	1.1553	1.1911	0.0000	3,746.7812	3,746.7812	1.0524		3,773.0920

Mitigated Construction Off-Site

	ROG	NOx	CO	SO2	Fugitive PM10	Exhaust PM10	PM10 Total	Fugitive PM2.5	Exhaust PM2.5	PM2.5 Total	Bio- CO2	NBio- CO2	Total CO2	CH4	N2O	CO2e
Category	lb/day										lb/day					
Hauling	0.0382	1.7269	0.3288	6.2400e-003	0.1750	0.0162	0.1912	0.0480	0.0155	0.0635		666.8525	666.8525	7.7700e-003	0.1051	698.3671
Vendor	0.0000	0.0000	0.0000	0.0000	0.0000	0.0000	0.0000	0.0000	0.0000	0.0000		0.0000	0.0000	0.0000	0.0000	0.0000
Worker	0.0569	0.0468	0.4763	1.1100e-003	0.1232	8.2000e-004	0.1241	0.0327	7.6000e-004	0.0334		112.2572	112.2572	4.6000e-003	4.0200e-003	113.5704
Total	0.0951	1.7737	0.8051	7.3500e-003	0.2982	0.0171	0.3152	0.0806	0.0163	0.0969		779.1097	779.1097	0.0124	0.1091	811.9375

EMFAC Off-Model Adjustment Factors for Gasoline Light Duty Vehicle to Account for the SAFE Vehicle Rule Not Applied

3.3 Site Preparation - 2022

Unmitigated Construction On-Site

	ROG	NOx	CO	SO2	Fugitive PM10	Exhaust PM10	PM10 Total	Fugitive PM2.5	Exhaust PM2.5	PM2.5 Total	Bio- CO2	NBio- CO2	Total CO2	CH4	N2O	CO2e
Category	lb/day										lb/day					
Fugitive Dust					19.6570	0.0000	19.6570	10.1025	0.0000	10.1025			0.0000			0.0000
Off-Road	3.1701	33.0835	19.6978	0.0380		1.6126	1.6126		1.4836	1.4836		3,686.0619	3,686.0619	1.1922		3,715.8655
Total	3.1701	33.0835	19.6978	0.0380	19.6570	1.6126	21.2696	10.1025	1.4836	11.5860		3,686.0619	3,686.0619	1.1922		3,715.8655

	ROG	NOx	CO	SO2	Fugitive PM10	Exhaust PM10	PM10 Total	Fugitive PM2.5	Exhaust PM2.5	PM2.5 Total	Bio- CO2	NBio- CO2	Total CO2	CH4	N2O	CO2e
Category	lb/day										lb/day					
Hauling	0.0000	0.0000	0.0000	0.0000	0.0000	0.0000	0.0000	0.0000	0.0000	0.0000		0.0000	0.0000	0.0000	0.0000	0.0000
Vendor	0.0000	0.0000	0.0000	0.0000	0.0000	0.0000	0.0000	0.0000	0.0000	0.0000		0.0000	0.0000	0.0000	0.0000	0.0000
Worker	0.0682	0.0561	0.5715	1.3300e-003	0.1479	9.9000e-004	0.1489	0.0392	9.1000e-004	0.0401		134.7087	134.7087	5.5200e-003	4.8200e-003	136.2844
Total	0.0682	0.0561	0.5715	1.3300e-003	0.1479	9.9000e-004	0.1489	0.0392	9.1000e-004	0.0401		134.7087	134.7087	5.5200e-003	4.8200e-003	136.2844

EMFAC Off-Model Adjustment Factors for Gasoline Light Duty Vehicle to Account for the SAFE Vehicle Rule Not Applied

Mitigated Construction On-Site

	ROG	NOx	CO	SO2	Fugitive PM10	Exhaust PM10	PM10 Total	Fugitive PM2.5	Exhaust PM2.5	PM2.5 Total	Bio- CO2	NBio- CO2	Total CO2	CH4	N2O	CO2e
Category	lb/day										lb/day					
Fugitive Dust					8.8457	0.0000	8.8457	4.5461	0.0000	4.5461			0.0000			0.0000
Off-Road	3.1701	33.0835	19.6978	0.0380		1.6126	1.6126		1.4836	1.4836	0.0000	3,686.0619	3,686.0619	1.1922		3,715.8655
Total	3.1701	33.0835	19.6978	0.0380	8.8457	1.6126	10.4582	4.5461	1.4836	6.0297	0.0000	3,686.0619	3,686.0619	1.1922		3,715.8655

Mitigated Construction Off-Site

	ROG	NOx	CO	SO2	Fugitive PM10	Exhaust PM10	PM10 Total	Fugitive PM2.5	Exhaust PM2.5	PM2.5 Total	Bio- CO2	NBio- CO2	Total CO2	CH4	N2O	CO2e
Category	lb/day										lb/day					
Hauling	0.0000	0.0000	0.0000	0.0000	0.0000	0.0000	0.0000	0.0000	0.0000	0.0000		0.0000	0.0000	0.0000	0.0000	0.0000
Vendor	0.0000	0.0000	0.0000	0.0000	0.0000	0.0000	0.0000	0.0000	0.0000	0.0000		0.0000	0.0000	0.0000	0.0000	0.0000
Worker	0.0682	0.0561	0.5715	1.3300e-003	0.1479	9.9000e-004	0.1489	0.0392	9.1000e-004	0.0401		134.7087	134.7087	5.5200e-003	4.8200e-003	136.2844
Total	0.0682	0.0561	0.5715	1.3300e-003	0.1479	9.9000e-004	0.1489	0.0392	9.1000e-004	0.0401		134.7087	134.7087	5.5200e-003	4.8200e-003	136.2844

EMFAC Off-Model Adjustment Factors for Gasoline Light Duty Vehicle to Account for the SAFE Vehicle Rule Not Applied

3.4 Grading - 2022

Unmitigated Construction On-Site

	ROG	NOx	CO	SO2	Fugitive PM10	Exhaust PM10	PM10 Total	Fugitive PM2.5	Exhaust PM2.5	PM2.5 Total	Bio- CO2	NBio- CO2	Total CO2	CH4	N2O	CO2e
Category	lb/day										lb/day					
Fugitive Dust					7.0826	0.0000	7.0826	3.4247	0.0000	3.4247			0.0000			0.0000
Off-Road	1.9486	20.8551	15.2727	0.0297		0.9409	0.9409		0.8656	0.8656		2,872.0464	2,872.0464	0.9289		2,895.2684
Total	1.9486	20.8551	15.2727	0.0297	7.0826	0.9409	8.0234	3.4247	0.8656	4.2903		2,872.0464	2,872.0464	0.9289		2,895.2684

Unmitigated Construction Off-Site

	ROG	NOx	CO	SO2	Fugitive PM10	Exhaust PM10	PM10 Total	Fugitive PM2.5	Exhaust PM2.5	PM2.5 Total	Bio- CO2	NBio- CO2	Total CO2	CH4	N2O	CO2e
Category	lb/day										lb/day					
Hauling	0.0000	0.0000	0.0000	0.0000	0.0000	0.0000	0.0000	0.0000	0.0000	0.0000		0.0000	0.0000	0.0000	0.0000	0.0000
Vendor	0.0000	0.0000	0.0000	0.0000	0.0000	0.0000	0.0000	0.0000	0.0000	0.0000		0.0000	0.0000	0.0000	0.0000	0.0000
Worker	0.0569	0.0468	0.4763	1.1100e-003	0.1232	8.2000e-004	0.1241	0.0327	7.6000e-004	0.0334		112.2572	112.2572	4.6000e-003	4.0200e-003	113.5704
Total	0.0569	0.0468	0.4763	1.1100e-003	0.1232	8.2000e-004	0.1241	0.0327	7.6000e-004	0.0334		112.2572	112.2572	4.6000e-003	4.0200e-003	113.5704

EMFAC Off-Model Adjustment Factors for Gasoline Light Duty Vehicle to Account for the SAFE Vehicle Rule Not Applied

Mitigated Construction On-Site

	ROG	NOx	CO	SO2	Fugitive PM10	Exhaust PM10	PM10 Total	Fugitive PM2.5	Exhaust PM2.5	PM2.5 Total	Bio- CO2	NBio- CO2	Total CO2	CH4	N2O	CO2e
Category	lb/day										lb/day					
Fugitive Dust					3.1872	0.0000	3.1872	1.5411	0.0000	1.5411			0.0000			0.0000
Off-Road	1.9486	20.8551	15.2727	0.0297		0.9409	0.9409		0.8656	0.8656	0.0000	2,872.0464	2,872.0464	0.9289		2,895.2684
Total	1.9486	20.8551	15.2727	0.0297	3.1872	0.9409	4.1280	1.5411	0.8656	2.4067	0.0000	2,872.0464	2,872.0464	0.9289		2,895.2684

Mitigated Construction Off-Site

	ROG	NOx	CO	SO2	Fugitive PM10	Exhaust PM10	PM10 Total	Fugitive PM2.5	Exhaust PM2.5	PM2.5 Total	Bio- CO2	NBio- CO2	Total CO2	CH4	N2O	CO2e
Category	lb/day										lb/day					
Hauling	0.0000	0.0000	0.0000	0.0000	0.0000	0.0000	0.0000	0.0000	0.0000	0.0000		0.0000	0.0000	0.0000	0.0000	0.0000
Vendor	0.0000	0.0000	0.0000	0.0000	0.0000	0.0000	0.0000	0.0000	0.0000	0.0000		0.0000	0.0000	0.0000	0.0000	0.0000
Worker	0.0569	0.0468	0.4763	1.1100e-003	0.1232	8.2000e-004	0.1241	0.0327	7.6000e-004	0.0334		112.2572	112.2572	4.6000e-003	4.0200e-003	113.5704
Total	0.0569	0.0468	0.4763	1.1100e-003	0.1232	8.2000e-004	0.1241	0.0327	7.6000e-004	0.0334		112.2572	112.2572	4.6000e-003	4.0200e-003	113.5704

EMFAC Off-Model Adjustment Factors for Gasoline Light Duty Vehicle to Account for the SAFE Vehicle Rule Not Applied

3.5 Building Construction - 2022

Unmitigated Construction On-Site

	ROG	NOx	CO	SO2	Fugitive PM10	Exhaust PM10	PM10 Total	Fugitive PM2.5	Exhaust PM2.5	PM2.5 Total	Bio- CO2	NBio- CO2	Total CO2	CH4	N2O	CO2e
Category	lb/day										lb/day					
Off-Road	1.7062	15.6156	16.3634	0.0269		0.8090	0.8090		0.7612	0.7612		2,554.3336	2,554.3336	0.6120		2,569.6322
Total	1.7062	15.6156	16.3634	0.0269		0.8090	0.8090		0.7612	0.7612		2,554.3336	2,554.3336	0.6120		2,569.6322

Unmitigated Construction Off-Site

	ROG	NOx	CO	SO2	Fugitive PM10	Exhaust PM10	PM10 Total	Fugitive PM2.5	Exhaust PM2.5	PM2.5 Total	Bio- CO2	NBio- CO2	Total CO2	CH4	N2O	CO2e
Category	lb/day										lb/day					
Hauling	0.0000	0.0000	0.0000	0.0000	0.0000	0.0000	0.0000	0.0000	0.0000	0.0000		0.0000	0.0000	0.0000	0.0000	0.0000
Vendor	0.1450	3.8285	1.1611	0.0133	0.4200	0.0397	0.4596	0.1209	0.0379	0.1588		1,405.4282	1,405.4282	0.0145	0.2069	1,467.4505
Worker	0.6028	0.4958	5.0483	0.0118	1.3062	8.7400e-003	1.3149	0.3465	8.0600e-003	0.3545		1,189.9266	1,189.9266	0.0488	0.0426	1,203.8458
Total	0.7478	4.3244	6.2094	0.0250	1.7261	0.0484	1.7745	0.4674	0.0460	0.5133		2,595.3548	2,595.3548	0.0633	0.2495	2,671.2964

EMFAC Off-Model Adjustment Factors for Gasoline Light Duty Vehicle to Account for the SAFE Vehicle Rule Not Applied

Mitigated Construction On-Site

	ROG	NOx	CO	SO2	Fugitive PM10	Exhaust PM10	PM10 Total	Fugitive PM2.5	Exhaust PM2.5	PM2.5 Total	Bio- CO2	NBio- CO2	Total CO2	CH4	N2O	CO2e
Category	lb/day										lb/day					
Off-Road	1.7062	15.6156	16.3634	0.0269		0.8090	0.8090		0.7612	0.7612	0.0000	2,554.3336	2,554.3336	0.6120		2,569.6322
Total	1.7062	15.6156	16.3634	0.0269		0.8090	0.8090		0.7612	0.7612	0.0000	2,554.3336	2,554.3336	0.6120		2,569.6322

Mitigated Construction Off-Site

	ROG	NOx	CO	SO2	Fugitive PM10	Exhaust PM10	PM10 Total	Fugitive PM2.5	Exhaust PM2.5	PM2.5 Total	Bio- CO2	NBio- CO2	Total CO2	CH4	N2O	CO2e
Category	lb/day										lb/day					
Hauling	0.0000	0.0000	0.0000	0.0000	0.0000	0.0000	0.0000	0.0000	0.0000	0.0000		0.0000	0.0000	0.0000	0.0000	0.0000
Vendor	0.1450	3.8285	1.1611	0.0133	0.4200	0.0397	0.4596	0.1209	0.0379	0.1588		1,405.4282	1,405.4282	0.0145	0.2069	1,467.4505
Worker	0.6028	0.4958	5.0483	0.0118	1.3062	8.7400e-003	1.3149	0.3465	8.0600e-003	0.3545		1,189.9266	1,189.9266	0.0488	0.0426	1,203.8458
Total	0.7478	4.3244	6.2094	0.0250	1.7261	0.0484	1.7745	0.4674	0.0460	0.5133		2,595.3548	2,595.3548	0.0633	0.2495	2,671.2964

EMFAC Off-Model Adjustment Factors for Gasoline Light Duty Vehicle to Account for the SAFE Vehicle Rule Not Applied

3.5 Building Construction - 2023

Unmitigated Construction On-Site

	ROG	NOx	CO	SO2	Fugitive PM10	Exhaust PM10	PM10 Total	Fugitive PM2.5	Exhaust PM2.5	PM2.5 Total	Bio- CO2	NBio- CO2	Total CO2	CH4	N2O	CO2e
Category	lb/day										lb/day					
Off-Road	1.5728	14.3849	16.2440	0.0269		0.6997	0.6997		0.6584	0.6584		2,555.2099	2,555.2099	0.6079		2,570.4061
Total	1.5728	14.3849	16.2440	0.0269		0.6997	0.6997		0.6584	0.6584		2,555.2099	2,555.2099	0.6079		2,570.4061

Unmitigated Construction Off-Site

	ROG	NOx	CO	SO2	Fugitive PM10	Exhaust PM10	PM10 Total	Fugitive PM2.5	Exhaust PM2.5	PM2.5 Total	Bio- CO2	NBio- CO2	Total CO2	CH4	N2O	CO2e
Category	lb/day										lb/day					
Hauling	0.0000	0.0000	0.0000	0.0000	0.0000	0.0000	0.0000	0.0000	0.0000	0.0000		0.0000	0.0000	0.0000	0.0000	0.0000
Vendor	0.0871	3.2184	1.0115	0.0128	0.4200	0.0202	0.4402	0.1209	0.0193	0.1402		1,360.5808	1,360.5808	0.0117	0.2000	1,420.4704
Worker	0.5604	0.4367	4.6274	0.0114	1.3062	8.2300e-003	1.3144	0.3465	7.5800e-003	0.3540		1,153.8385	1,153.8385	0.0439	0.0392	1,166.6061
Total	0.6475	3.6551	5.6389	0.0242	1.7261	0.0284	1.7546	0.4674	0.0269	0.4943		2,514.4192	2,514.4192	0.0556	0.2392	2,587.0765

EMFAC Off-Model Adjustment Factors for Gasoline Light Duty Vehicle to Account for the SAFE Vehicle Rule Not Applied

Mitigated Construction On-Site

	ROG	NOx	CO	SO2	Fugitive PM10	Exhaust PM10	PM10 Total	Fugitive PM2.5	Exhaust PM2.5	PM2.5 Total	Bio- CO2	NBio- CO2	Total CO2	CH4	N2O	CO2e
Category	lb/day										lb/day					
Off-Road	1.5728	14.3849	16.2440	0.0269		0.6997	0.6997		0.6584	0.6584	0.0000	2,555.2099	2,555.2099	0.6079		2,570.4061
Total	1.5728	14.3849	16.2440	0.0269		0.6997	0.6997		0.6584	0.6584	0.0000	2,555.2099	2,555.2099	0.6079		2,570.4061

Mitigated Construction Off-Site

	ROG	NOx	CO	SO2	Fugitive PM10	Exhaust PM10	PM10 Total	Fugitive PM2.5	Exhaust PM2.5	PM2.5 Total	Bio- CO2	NBio- CO2	Total CO2	CH4	N2O	CO2e
Category	lb/day										lb/day					
Hauling	0.0000	0.0000	0.0000	0.0000	0.0000	0.0000	0.0000	0.0000	0.0000	0.0000		0.0000	0.0000	0.0000	0.0000	0.0000
Vendor	0.0871	3.2184	1.0115	0.0128	0.4200	0.0202	0.4402	0.1209	0.0193	0.1402		1,360.5808	1,360.5808	0.0117	0.2000	1,420.4704
Worker	0.5604	0.4367	4.6274	0.0114	1.3062	8.2300e-003	1.3144	0.3465	7.5800e-003	0.3540		1,153.8385	1,153.8385	0.0439	0.0392	1,166.6061
Total	0.6475	3.6551	5.6389	0.0242	1.7261	0.0284	1.7546	0.4674	0.0269	0.4943		2,514.4192	2,514.4192	0.0556	0.2392	2,587.0765

EMFAC Off-Model Adjustment Factors for Gasoline Light Duty Vehicle to Account for the SAFE Vehicle Rule Not Applied

3.6 Paving - 2023

Unmitigated Construction On-Site

	ROG	NOx	CO	SO2	Fugitive PM10	Exhaust PM10	PM10 Total	Fugitive PM2.5	Exhaust PM2.5	PM2.5 Total	Bio- CO2	NBio- CO2	Total CO2	CH4	N2O	CO2e
Category	lb/day										lb/day					
Off-Road	1.0327	10.1917	14.5842	0.0228		0.5102	0.5102		0.4694	0.4694		2,207.5841	2,207.5841	0.7140		2,225.4336
Paving	0.0000					0.0000	0.0000		0.0000	0.0000			0.0000			0.0000
Total	1.0327	10.1917	14.5842	0.0228		0.5102	0.5102		0.4694	0.4694		2,207.5841	2,207.5841	0.7140		2,225.4336

Unmitigated Construction Off-Site

	ROG	NOx	CO	SO2	Fugitive PM10	Exhaust PM10	PM10 Total	Fugitive PM2.5	Exhaust PM2.5	PM2.5 Total	Bio- CO2	NBio- CO2	Total CO2	CH4	N2O	CO2e
Category	lb/day										lb/day					
Hauling	0.0000	0.0000	0.0000	0.0000	0.0000	0.0000	0.0000	0.0000	0.0000	0.0000		0.0000	0.0000	0.0000	0.0000	0.0000
Vendor	0.0000	0.0000	0.0000	0.0000	0.0000	0.0000	0.0000	0.0000	0.0000	0.0000		0.0000	0.0000	0.0000	0.0000	0.0000
Worker	0.0529	0.0412	0.4366	1.0800e-003	0.1232	7.8000e-004	0.1240	0.0327	7.2000e-004	0.0334		108.8527	108.8527	4.1400e-003	3.6900e-003	110.0572
Total	0.0529	0.0412	0.4366	1.0800e-003	0.1232	7.8000e-004	0.1240	0.0327	7.2000e-004	0.0334		108.8527	108.8527	4.1400e-003	3.6900e-003	110.0572

EMFAC Off-Model Adjustment Factors for Gasoline Light Duty Vehicle to Account for the SAFE Vehicle Rule Not Applied

Mitigated Construction On-Site

	ROG	NOx	CO	SO2	Fugitive PM10	Exhaust PM10	PM10 Total	Fugitive PM2.5	Exhaust PM2.5	PM2.5 Total	Bio- CO2	NBio- CO2	Total CO2	CH4	N2O	CO2e
Category	lb/day										lb/day					
Off-Road	1.0327	10.1917	14.5842	0.0228		0.5102	0.5102		0.4694	0.4694	0.0000	2,207.5841	2,207.5841	0.7140		2,225.4336
Paving	0.0000					0.0000	0.0000		0.0000	0.0000			0.0000			0.0000
Total	1.0327	10.1917	14.5842	0.0228		0.5102	0.5102		0.4694	0.4694	0.0000	2,207.5841	2,207.5841	0.7140		2,225.4336

Mitigated Construction Off-Site

	ROG	NOx	CO	SO2	Fugitive PM10	Exhaust PM10	PM10 Total	Fugitive PM2.5	Exhaust PM2.5	PM2.5 Total	Bio- CO2	NBio- CO2	Total CO2	CH4	N2O	CO2e
Category	lb/day										lb/day					
Hauling	0.0000	0.0000	0.0000	0.0000	0.0000	0.0000	0.0000	0.0000	0.0000	0.0000		0.0000	0.0000	0.0000	0.0000	0.0000
Vendor	0.0000	0.0000	0.0000	0.0000	0.0000	0.0000	0.0000	0.0000	0.0000	0.0000		0.0000	0.0000	0.0000	0.0000	0.0000
Worker	0.0529	0.0412	0.4366	1.0800e-003	0.1232	7.8000e-004	0.1240	0.0327	7.2000e-004	0.0334		108.8527	108.8527	4.1400e-003	3.6900e-003	110.0572
Total	0.0529	0.0412	0.4366	1.0800e-003	0.1232	7.8000e-004	0.1240	0.0327	7.2000e-004	0.0334		108.8527	108.8527	4.1400e-003	3.6900e-003	110.0572

EMFAC Off-Model Adjustment Factors for Gasoline Light Duty Vehicle to Account for the SAFE Vehicle Rule Not Applied

3.7 Architectural Coating - 2023

Unmitigated Construction On-Site

	ROG	NOx	CO	SO2	Fugitive PM10	Exhaust PM10	PM10 Total	Fugitive PM2.5	Exhaust PM2.5	PM2.5 Total	Bio- CO2	NBio- CO2	Total CO2	CH4	N2O	CO2e
Category	lb/day										lb/day					
Archit. Coating	87.9964					0.0000	0.0000		0.0000	0.0000			0.0000			0.0000
Off-Road	0.1917	1.3030	1.8111	2.9700e-003		0.0708	0.0708		0.0708	0.0708		281.4481	281.4481	0.0168		281.8690
Total	88.1881	1.3030	1.8111	2.9700e-003		0.0708	0.0708		0.0708	0.0708		281.4481	281.4481	0.0168		281.8690

Unmitigated Construction Off-Site

	ROG	NOx	CO	SO2	Fugitive PM10	Exhaust PM10	PM10 Total	Fugitive PM2.5	Exhaust PM2.5	PM2.5 Total	Bio- CO2	NBio- CO2	Total CO2	CH4	N2O	CO2e
Category	lb/day										lb/day					
Hauling	0.0000	0.0000	0.0000	0.0000	0.0000	0.0000	0.0000	0.0000	0.0000	0.0000		0.0000	0.0000	0.0000	0.0000	0.0000
Vendor	0.0000	0.0000	0.0000	0.0000	0.0000	0.0000	0.0000	0.0000	0.0000	0.0000		0.0000	0.0000	0.0000	0.0000	0.0000
Worker	0.1128	0.0879	0.9313	2.3000e-003	0.2629	1.6600e-003	0.2645	0.0697	1.5300e-003	0.0713		232.2191	232.2191	8.8300e-003	7.8800e-003	234.7886
Total	0.1128	0.0879	0.9313	2.3000e-003	0.2629	1.6600e-003	0.2645	0.0697	1.5300e-003	0.0713		232.2191	232.2191	8.8300e-003	7.8800e-003	234.7886

EMFAC Off-Model Adjustment Factors for Gasoline Light Duty Vehicle to Account for the SAFE Vehicle Rule Not Applied

Mitigated Construction On-Site

	ROG	NOx	CO	SO2	Fugitive PM10	Exhaust PM10	PM10 Total	Fugitive PM2.5	Exhaust PM2.5	PM2.5 Total	Bio- CO2	NBio- CO2	Total CO2	CH4	N2O	CO2e
Category	lb/day										lb/day					
Archit. Coating	87.9964					0.0000	0.0000		0.0000	0.0000			0.0000			0.0000
Off-Road	0.1917	1.3030	1.8111	2.9700e-003		0.0708	0.0708		0.0708	0.0708	0.0000	281.4481	281.4481	0.0168		281.8690
Total	88.1881	1.3030	1.8111	2.9700e-003		0.0708	0.0708		0.0708	0.0708	0.0000	281.4481	281.4481	0.0168		281.8690

Mitigated Construction Off-Site

	ROG	NOx	CO	SO2	Fugitive PM10	Exhaust PM10	PM10 Total	Fugitive PM2.5	Exhaust PM2.5	PM2.5 Total	Bio- CO2	NBio- CO2	Total CO2	CH4	N2O	CO2e
Category	lb/day										lb/day					
Hauling	0.0000	0.0000	0.0000	0.0000	0.0000	0.0000	0.0000	0.0000	0.0000	0.0000		0.0000	0.0000	0.0000	0.0000	0.0000
Vendor	0.0000	0.0000	0.0000	0.0000	0.0000	0.0000	0.0000	0.0000	0.0000	0.0000		0.0000	0.0000	0.0000	0.0000	0.0000
Worker	0.1128	0.0879	0.9313	2.3000e-003	0.2629	1.6600e-003	0.2645	0.0697	1.5300e-003	0.0713		232.2191	232.2191	8.8300e-003	7.8800e-003	234.7886
Total	0.1128	0.0879	0.9313	2.3000e-003	0.2629	1.6600e-003	0.2645	0.0697	1.5300e-003	0.0713		232.2191	232.2191	8.8300e-003	7.8800e-003	234.7886

EMFAC Off-Model Adjustment Factors for Gasoline Light Duty Vehicle to Account for the SAFE Vehicle Rule Applied

**CSUMB - Master Plan Buildout (Annual)
Monterey Bay Unified APCD Air District, Annual**

1.0 Project Characteristics

1.1 Land Usage

Land Uses	Size	Metric	Lot Acreage	Floor Surface Area	Population
University/College (4yr)	12,700.00	Student	53.59	2,060,401.00	0
Apartments Mid Rise	9,020.00	Dwelling Unit	237.37	3,807,779.00	13920

1.2 Other Project Characteristics

Urbanization	Urban	Wind Speed (m/s)	2.8	Precipitation Freq (Days)	53
Climate Zone	4			Operational Year	2035
Utility Company	Pacific Gas and Electric Company				
CO2 Intensity (lb/MWhr)	167	CH4 Intensity (lb/MWhr)	0.033	N2O Intensity (lb/MWhr)	0.004

1.3 User Entered Comments & Non-Default Data

Project Characteristics - CSUMB Master Plan. MBUAPCD.

Land Use - Total Master Plan (Campus: 2,256,767 and Student housing 3,807,779) and approved buildings (60,000) minus demolition (256,366) also includes 3,820 beds/1,220 DU. 12,700 FTE students and 1,220 DU occuied by staff/faculty.

Construction Phase - Modeling operations only.

Vehicle Trips - Update trip rate and trip length per TRA for annual emissions. Assumed 100% primary trips. Based Sunday trip rates from Junior College land use since since University default is 0. Adjusted calculated trip rate to match annual VMT.

Woodstoves - Assumed no fireplaces.

Area Coating - Use of low-VOC (50 g/L) arch coatings.

EMFAC Off-Model Adjustment Factors for Gasoline Light Duty Vehicle to Account for the SAFE Vehicle Rule Applied

Energy Use - Updated energy intensities based on date provided.

Water And Wastewater - Revised water and wastewater based on projections provided by CSUMB. Total demand in 2035 would be 427 AF building use and 290 AF for irrigation

Solid Waste - Default solid waste generation rates assumed.

Sequestration - Plant 2,030 new trees on campus.

Water Mitigation - RUWAP irrigation would account for 32% of outdoor irrigation water.

Waste Mitigation - Update per campus waste reduction goal.

Table Name	Column Name	Default Value	New Value
tblAreaCoating	Area_EF_Nonresidential_Exterior	150	50
tblAreaCoating	Area_EF_Nonresidential_Interior	150	50
tblAreaCoating	Area_EF_Residential_Exterior	100	50
tblAreaCoating	Area_EF_Residential_Interior	100	50
tblAreaCoating	Area_Nonresidential_Exterior	1030200	1079895
tblAreaCoating	Area_Nonresidential_Interior	3090600	3239685
tblAreaCoating	Area_Residential_Exterior	2570252	2597252
tblAreaCoating	Area_Residential_Interior	7710755	7791755
tblEnergyUse	LightingElect	741.44	0.00
tblEnergyUse	LightingElect	2.91	5.01
tblEnergyUse	NT24E	3,054.10	0.00
tblEnergyUse	NT24E	2.27	3.90
tblEnergyUse	NT24NG	3,155.00	0.00
tblEnergyUse	NT24NG	3.30	7.41
tblEnergyUse	T24E	70.89	0.00
tblEnergyUse	T24E	2.44	4.20
tblEnergyUse	T24NG	5,226.68	0.00
tblEnergyUse	T24NG	20.62	46.31

EMFAC Off-Model Adjustment Factors for Gasoline Light Duty Vehicle to Account for the SAFE Vehicle Rule Applied

tblFireplaces	NumberGas	9,020.00	0.00
tblFireplaces	NumberNoFireplace	0.00	9,020.00
tblLandUse	LandUseSquareFeet	2,334,227.85	2,060,401.00
tblLandUse	LandUseSquareFeet	9,020,000.00	3,807,779.00
tblLandUse	Population	25,797.00	13,920.00
tblProjectCharacteristics	CO2IntensityFactor	203.98	167
tblSequestration	NumberOfNewTrees	0.00	2,030.00
tblVehicleTrips	CC_TL	7.30	5.45
tblVehicleTrips	CNW_TL	7.30	5.45
tblVehicleTrips	CW_TL	9.50	5.45
tblVehicleTrips	DV_TP	9.00	0.00
tblVehicleTrips	HO_TL	7.50	0.00
tblVehicleTrips	HS_TL	7.30	0.00
tblVehicleTrips	HW_TL	10.80	0.00
tblVehicleTrips	PR_TP	91.00	100.00
tblVehicleTrips	ST_TR	4.91	0.00
tblVehicleTrips	ST_TR	1.30	2.62
tblVehicleTrips	SU_TR	4.09	0.00
tblVehicleTrips	SU_TR	0.00	0.19
tblVehicleTrips	WD_TR	5.44	0.00
tblVehicleTrips	WD_TR	1.56	3.14
tblWater	IndoorWaterUseRate	587,689,311.11	0.00
tblWater	IndoorWaterUseRate	27,191,970.00	139,138,377.00
tblWater	OutdoorWaterUseRate	370,499,783.09	0.00
tblWater	OutdoorWaterUseRate	42,531,030.00	94,496,790.00

EMFAC Off-Model Adjustment Factors for Gasoline Light Duty Vehicle to Account for the SAFE Vehicle Rule Applied

tblWaterMitigation	UseWaterEfficientIrrigationSystemPercentReduction	6.1	32
--------------------	---	-----	----

2.0 Emissions Summary

2.2 Overall Operational

Unmitigated Operational

	ROG	NOx	CO	SO2	Fugitive PM10	Exhaust PM10	PM10 Total	Fugitive PM2.5	Exhaust PM2.5	PM2.5 Total	Bio- CO2	NBio- CO2	Total CO2	CH4	N2O	CO2e
Category	tons/yr										MT/yr					
Area	27.4088	1.0709	92.8544	4.9200e-003		0.5164	0.5164		0.5164	0.5164	0.0000	152.2620	152.2620	0.1455	0.0000	155.8984
Energy	0.5968	5.4256	4.5575	0.0326		0.4124	0.4124		0.4124	0.4124	0.0000	7,952.1695	7,952.1695	0.5175	0.1573	8,011.9764
Mobile	10.3717	11.1493	95.4557	0.1921	24.7229	0.1298	24.8527	6.6013	0.1212	6.7224	0.0000	19,156.5259	19,156.5259	1.2318	0.8981	19,454.9370
Waste						0.0000	0.0000		0.0000	0.0000	1,312.7324	0.0000	1,312.7324	77.5803	0.0000	3,252.2390
Water						0.0000	0.0000		0.0000	0.0000	44.1422	82.0839	126.2261	4.5501	0.1090	272.4650
Total	38.3772	17.6458	192.8676	0.2295	24.7229	1.0586	25.7815	6.6013	1.0499	7.6512	1,356.8746	27,343.0413	28,699.9159	84.0250	1.1644	31,147.5159

EMFAC Off-Model Adjustment Factors for Gasoline Light Duty Vehicle to Account for the SAFE Vehicle Rule Applied

Mitigated Operational

	ROG	NOx	CO	SO2	Fugitive PM10	Exhaust PM10	PM10 Total	Fugitive PM2.5	Exhaust PM2.5	PM2.5 Total	Bio- CO2	NBio- CO2	Total CO2	CH4	N2O	CO2e
Category	tons/yr										MT/yr					
Area	27.4088	1.0709	92.8544	4.9200e-003		0.5164	0.5164		0.5164	0.5164	0.0000	152.2620	152.2620	0.1455	0.0000	155.8984
Energy	0.5968	5.4256	4.5575	0.0326		0.4124	0.4124		0.4124	0.4124	0.0000	7,952.1695	7,952.1695	0.5175	0.1573	8,011.9764
Mobile	10.3717	11.1493	95.4557	0.1921	24.7229	0.1298	24.8527	6.6013	0.1212	6.7224	0.0000	19,156.5259	19,156.5259	1.2318	0.8981	19,454.9370
Waste						0.0000	0.0000		0.0000	0.0000	131.2732	0.0000	131.2732	7.7580	0.0000	325.2239
Water						0.0000	0.0000		0.0000	0.0000	44.1422	74.0668	118.2090	4.5485	0.1088	264.3511
Total	38.3772	17.6458	192.8676	0.2295	24.7229	1.0586	25.7815	6.6013	1.0499	7.6512	175.4154	27,335.0242	27,510.4396	14.2012	1.1642	28,212.3869

	ROG	NOx	CO	SO2	Fugitive PM10	Exhaust PM10	PM10 Total	Fugitive PM2.5	Exhaust PM2.5	PM2.5 Total	Bio- CO2	NBio- CO2	Total CO2	CH4	N2O	CO2e
Percent Reduction	0.00	0.00	0.00	0.00	0.00	0.00	0.00	0.00	0.00	0.00	87.07	0.03	4.14	83.10	0.02	9.42

EMFAC Off-Model Adjustment Factors for Gasoline Light Duty Vehicle to Account for the SAFE Vehicle Rule Applied

2.3 Vegetation

Vegetation

	CO2e
Category	MT
New Trees	1,437.2400
Total	1,437.2400

EMFAC Off-Model Adjustment Factors for Gasoline Light Duty Vehicle to Account for the SAFE Vehicle Rule Applied

4.0 Operational Detail - Mobile

4.1 Mitigation Measures Mobile

	ROG	NOx	CO	SO2	Fugitive PM10	Exhaust PM10	PM10 Total	Fugitive PM2.5	Exhaust PM2.5	PM2.5 Total	Bio- CO2	NBio- CO2	Total CO2	CH4	N2O	CO2e
Category	tons/yr										MT/yr					
Mitigated	10.3717	11.1493	95.4557	0.1921	24.7229	0.1298	24.8527	6.6013	0.1212	6.7224	0.0000	19,156.5259	19,156.5259	1.2318	0.8981	19,454.9370
Unmitigated	10.3717	11.1493	95.4557	0.1921	24.7229	0.1298	24.8527	6.6013	0.1212	6.7224	0.0000	19,156.5259	19,156.5259	1.2318	0.8981	19,454.9370

4.2 Trip Summary Information

Land Use	Average Daily Trip Rate			Unmitigated	Mitigated
	Weekday	Saturday	Sunday	Annual VMT	Annual VMT
Apartments Mid Rise	0.00	0.00	0.00		
University/College (4yr)	39,878.00	33,274.00	2,413.00	66,620,822	66,620,822
Total	39,878.00	33,274.00	2,413.00	66,620,822	66,620,822

4.3 Trip Type Information

Land Use	Miles			Trip %			Trip Purpose %		
	H-W or C-W	H-S or C-C	H-O or C-NW	H-W or C-W	H-S or C-C	H-O or C-NW	Primary	Diverted	Pass-by
Apartments Mid Rise	0.00	0.00	0.00	44.00	18.80	37.20	86	11	3
University/College (4yr)	5.45	5.45	5.45	6.40	88.60	5.00	100	0	0

EMFAC Off-Model Adjustment Factors for Gasoline Light Duty Vehicle to Account for the SAFE Vehicle Rule Applied

4.4 Fleet Mix

Land Use	LDA	LDT1	LDT2	MDV	LHD1	LHD2	MHD	HHD	OBUS	UBUS	MCY	SBUS	MH
Apartments Mid Rise	0.555052	0.055883	0.188820	0.126929	0.020456	0.005379	0.009845	0.008677	0.000965	0.000515	0.024108	0.001007	0.002365
University/College (4yr)	0.555052	0.055883	0.188820	0.126929	0.020456	0.005379	0.009845	0.008677	0.000965	0.000515	0.024108	0.001007	0.002365

5.0 Energy Detail

Historical Energy Use: N

5.1 Mitigation Measures Energy

	ROG	NOx	CO	SO2	Fugitive PM10	Exhaust PM10	PM10 Total	Fugitive PM2.5	Exhaust PM2.5	PM2.5 Total	Bio- CO2	NBio- CO2	Total CO2	CH4	N2O	CO2e
Category	tons/yr										MT/yr					
Electricity Mitigated						0.0000	0.0000		0.0000	0.0000	0.0000	2,045.7092	2,045.7092	0.4042	0.0490	2,070.4169
Electricity Unmitigated						0.0000	0.0000		0.0000	0.0000	0.0000	2,045.7092	2,045.7092	0.4042	0.0490	2,070.4169
Natural Gas Mitigated	0.5968	5.4256	4.5575	0.0326		0.4124	0.4124		0.4124	0.4124	0.0000	5,906.4604	5,906.4604	0.1132	0.1083	5,941.5595
Natural Gas Unmitigated	0.5968	5.4256	4.5575	0.0326		0.4124	0.4124		0.4124	0.4124	0.0000	5,906.4604	5,906.4604	0.1132	0.1083	5,941.5595

EMFAC Off-Model Adjustment Factors for Gasoline Light Duty Vehicle to Account for the SAFE Vehicle Rule Applied

5.2 Energy by Land Use - NaturalGas

Unmitigated

	NaturalGas Use	ROG	NOx	CO	SO2	Fugitive PM10	Exhaust PM10	PM10 Total	Fugitive PM2.5	Exhaust PM2.5	PM2.5 Total	Bio- CO2	NBio- CO2	Total CO2	CH4	N2O	CO2e
Land Use	kBTU/yr	tons/yr										MT/yr					
Apartments Mid Rise	0	0.0000	0.0000	0.0000	0.0000		0.0000	0.0000		0.0000	0.0000	0.0000	0.0000	0.0000	0.0000	0.0000	0.0000
University/College (4yr)	1.10683e+008	0.5968	5.4256	4.5575	0.0326		0.4124	0.4124		0.4124	0.4124	0.0000	5,906.4604	5,906.4604	0.1132	0.1083	5,941.5595
Total		0.5968	5.4256	4.5575	0.0326		0.4124	0.4124		0.4124	0.4124	0.0000	5,906.4604	5,906.4604	0.1132	0.1083	5,941.5595

Mitigated

	NaturalGas Use	ROG	NOx	CO	SO2	Fugitive PM10	Exhaust PM10	PM10 Total	Fugitive PM2.5	Exhaust PM2.5	PM2.5 Total	Bio- CO2	NBio- CO2	Total CO2	CH4	N2O	CO2e
Land Use	kBTU/yr	tons/yr										MT/yr					
Apartments Mid Rise	0	0.0000	0.0000	0.0000	0.0000		0.0000	0.0000		0.0000	0.0000	0.0000	0.0000	0.0000	0.0000	0.0000	0.0000
University/College (4yr)	1.10683e+008	0.5968	5.4256	4.5575	0.0326		0.4124	0.4124		0.4124	0.4124	0.0000	5,906.4604	5,906.4604	0.1132	0.1083	5,941.5595
Total		0.5968	5.4256	4.5575	0.0326		0.4124	0.4124		0.4124	0.4124	0.0000	5,906.4604	5,906.4604	0.1132	0.1083	5,941.5595

EMFAC Off-Model Adjustment Factors for Gasoline Light Duty Vehicle to Account for the SAFE Vehicle Rule Applied

5.3 Energy by Land Use - Electricity

Unmitigated

	Electricity Use	Total CO2	CH4	N2O	CO2e
Land Use	kWh/yr	MT/yr			
Apartments Mid Rise	0	0.0000	0.0000	0.0000	0.0000
University/College (4yr)	2.70061e+007	2,045.7092	0.4042	0.0490	2,070.4169
Total		2,045.7092	0.4042	0.0490	2,070.4169

Mitigated

	Electricity Use	Total CO2	CH4	N2O	CO2e
Land Use	kWh/yr	MT/yr			
Apartments Mid Rise	0	0.0000	0.0000	0.0000	0.0000
University/College (4yr)	2.70061e+007	2,045.7092	0.4042	0.0490	2,070.4169
Total		2,045.7092	0.4042	0.0490	2,070.4169

EMFAC Off-Model Adjustment Factors for Gasoline Light Duty Vehicle to Account for the SAFE Vehicle Rule Applied

6.0 Area Detail

6.1 Mitigation Measures Area

	ROG	NOx	CO	SO2	Fugitive PM10	Exhaust PM10	PM10 Total	Fugitive PM2.5	Exhaust PM2.5	PM2.5 Total	Bio- CO2	NBio- CO2	Total CO2	CH4	N2O	CO2e
Category	tons/yr										MT/yr					
Mitigated	27.4088	1.0709	92.8544	4.9200e-003		0.5164	0.5164		0.5164	0.5164	0.0000	152.2620	152.2620	0.1455	0.0000	155.8984
Unmitigated	27.4088	1.0709	92.8544	4.9200e-003		0.5164	0.5164		0.5164	0.5164	0.0000	152.2620	152.2620	0.1455	0.0000	155.8984

6.2 Area by SubCategory

Unmitigated

	ROG	NOx	CO	SO2	Fugitive PM10	Exhaust PM10	PM10 Total	Fugitive PM2.5	Exhaust PM2.5	PM2.5 Total	Bio- CO2	NBio- CO2	Total CO2	CH4	N2O	CO2e
SubCategory	tons/yr										MT/yr					
Architectural Coating	1.7044					0.0000	0.0000		0.0000	0.0000	0.0000	0.0000	0.0000	0.0000	0.0000	0.0000
Consumer Products	22.9182					0.0000	0.0000		0.0000	0.0000	0.0000	0.0000	0.0000	0.0000	0.0000	0.0000
Hearth	0.0000	0.0000	0.0000	0.0000		0.0000	0.0000		0.0000	0.0000	0.0000	0.0000	0.0000	0.0000	0.0000	0.0000
Landscaping	2.7862	1.0709	92.8544	4.9200e-003		0.5164	0.5164		0.5164	0.5164	0.0000	152.2620	152.2620	0.1455	0.0000	155.8984
Total	27.4088	1.0709	92.8544	4.9200e-003		0.5164	0.5164		0.5164	0.5164	0.0000	152.2620	152.2620	0.1455	0.0000	155.8984

EMFAC Off-Model Adjustment Factors for Gasoline Light Duty Vehicle to Account for the SAFE Vehicle Rule Applied

Mitigated

	ROG	NOx	CO	SO2	Fugitive PM10	Exhaust PM10	PM10 Total	Fugitive PM2.5	Exhaust PM2.5	PM2.5 Total	Bio- CO2	NBio- CO2	Total CO2	CH4	N2O	CO2e
SubCategory	tons/yr										MT/yr					
Architectural Coating	1.7044					0.0000	0.0000		0.0000	0.0000	0.0000	0.0000	0.0000	0.0000	0.0000	0.0000
Consumer Products	22.9182					0.0000	0.0000		0.0000	0.0000	0.0000	0.0000	0.0000	0.0000	0.0000	0.0000
Hearth	0.0000	0.0000	0.0000	0.0000		0.0000	0.0000		0.0000	0.0000	0.0000	0.0000	0.0000	0.0000	0.0000	0.0000
Landscaping	2.7862	1.0709	92.8544	4.9200e-003		0.5164	0.5164		0.5164	0.5164	0.0000	152.2620	152.2620	0.1455	0.0000	155.8984
Total	27.4088	1.0709	92.8544	4.9200e-003		0.5164	0.5164		0.5164	0.5164	0.0000	152.2620	152.2620	0.1455	0.0000	155.8984

7.0 Water Detail

7.1 Mitigation Measures Water

Use Water Efficient Irrigation System

EMFAC Off-Model Adjustment Factors for Gasoline Light Duty Vehicle to Account for the SAFE Vehicle Rule Applied

	Total CO2	CH4	N2O	CO2e
Category	MT/yr			
Mitigated	118.2090	4.5485	0.1088	264.3511
Unmitigated	126.2261	4.5501	0.1090	272.4650

7.2 Water by Land Use

Unmitigated

	Indoor/Outdoor Use	Total CO2	CH4	N2O	CO2e
Land Use	Mgal	MT/yr			
Apartments Mid Rise	0 / 0	0.0000	0.0000	0.0000	0.0000
University/College (4yr)	139.138 / 94.4968	126.2261	4.5501	0.1090	272.4650
Total		126.2261	4.5501	0.1090	272.4650

EMFAC Off-Model Adjustment Factors for Gasoline Light Duty Vehicle to Account for the SAFE Vehicle Rule Applied

Mitigated

Indoor/Outdoor Use		Total CO2	CH4	N2O	CO2e
Land Use	Mgal	MT/yr			
Apartments Mid Rise	0 / 0	0.0000	0.0000	0.0000	0.0000
University/College (4yr)	139.138 / 64.2578	118.2090	4.5485	0.1088	264.3511
Total		118.2090	4.5485	0.1088	264.3511

8.0 Waste Detail

8.1 Mitigation Measures Waste

Institute Recycling and Composting Services

Category/Year

	Total CO2	CH4	N2O	CO2e
	MT/yr			
Mitigated	131.2732	7.7580	0.0000	325.2239
Unmitigated	1,312.7324	77.5803	0.0000	3,252.2390

EMFAC Off-Model Adjustment Factors for Gasoline Light Duty Vehicle to Account for the SAFE Vehicle Rule Applied

8.2 Waste by Land Use

Unmitigated

	Waste Disposed	Total CO2	CH4	N2O	CO2e
Land Use	tons	MT/yr			
Apartments Mid Rise	4149.2	842.2501	49.7756	0.0000	2,086.6390
University/College (4yr)	2317.75	470.4823	27.8047	0.0000	1,165.6000
Total		1,312.7324	77.5803	0.0000	3,252.2390

Mitigated

	Waste Disposed	Total CO2	CH4	N2O	CO2e
Land Use	tons	MT/yr			
Apartments Mid Rise	414.92	84.2250	4.9776	0.0000	208.6639
University/College (4yr)	231.775	47.0482	2.7805	0.0000	116.5600
Total		131.2732	7.7580	0.0000	325.2239

EMFAC Off-Model Adjustment Factors for Gasoline Light Duty Vehicle to Account for the SAFE Vehicle Rule Applied

11.0 Vegetation

	Total CO2	CH4	N2O	CO2e
Category	MT			
Unmitigated	1,437.2400	0.0000	0.0000	1,437.2400

11.2 Net New Trees

Species Class

	Number of Trees	Total CO2	CH4	N2O	CO2e
		MT			
Miscellaneous	2030	1,437.2400	0.0000	0.0000	1,437.2400
Total		1,437.2400	0.0000	0.0000	1,437.2400

EMFAC Off-Model Adjustment Factors for Gasoline Light Duty Vehicle to Account for the SAFE Vehicle Rule Applied

**CSUMB - Master Plan Buildout (Daily)
Monterey Bay Unified APCD Air District, Summer**

1.0 Project Characteristics

1.1 Land Usage

Land Uses	Size	Metric	Lot Acreage	Floor Surface Area	Population
University/College (4yr)	12,700.00	Student	53.59	2,060,401.00	0
Apartments Mid Rise	9,020.00	Dwelling Unit	237.37	3,807,779.00	13920

1.2 Other Project Characteristics

Urbanization	Urban	Wind Speed (m/s)	2.8	Precipitation Freq (Days)	53
Climate Zone	4			Operational Year	2035
Utility Company	Pacific Gas and Electric Company				
CO2 Intensity (lb/MWhr)	167	CH4 Intensity (lb/MWhr)	0.033	N2O Intensity (lb/MWhr)	0.004

1.3 User Entered Comments & Non-Default Data

Project Characteristics - CSUMB Master Plan. MBUAPCD.

Land Use - Total Master Plan (Campus: 2,256,767 and Student housing 3,807,779) and approved buildings (60,000) minus demolition (256,366) also includes 3,820 beds/1,220 DU. 12,700 FTE students and 1,220 DU occuied by staff/faculty.

Construction Phase - Modeling operations only.

Vehicle Trips - Update trip rate and trip length per TRA. Assumed 100% primary trips. Based Sunday trip rates from Junior College land use since since University default is 0.

Woodstoves - Assumed no fireplaces.

Area Coating - Use of low-VOC (50 g/L) arch coatings.

EMFAC Off-Model Adjustment Factors for Gasoline Light Duty Vehicle to Account for the SAFE Vehicle Rule Applied

Energy Use - Revised energy intensities based on consumption projections provided by CSUMB.

Water And Wastewater - Revised water and wastewater based on projections provided by CSUMB. Total demand in 2035 would be 427 AF building use and 290 AF for irrigation

Solid Waste - Default solid waste generation rates assumed.

Sequestration - Plant 2,030 new trees on campus.

Water Mitigation - RUWAP irrigation would account for 32% of outdoor irrigation water.

Waste Mitigation - Update per campus waste reduction goal.

Table Name	Column Name	Default Value	New Value
tblAreaCoating	Area_EF_Nonresidential_Exterior	150	50
tblAreaCoating	Area_EF_Nonresidential_Interior	150	50
tblAreaCoating	Area_EF_Residential_Exterior	100	50
tblAreaCoating	Area_EF_Residential_Interior	100	50
tblAreaCoating	Area_Nonresidential_Exterior	1030200	1079895
tblAreaCoating	Area_Nonresidential_Interior	3090600	3239685
tblAreaCoating	Area_Residential_Exterior	2570252	2597252
tblAreaCoating	Area_Residential_Interior	7710755	7791755
tblEnergyUse	LightingElect	741.44	0.00
tblEnergyUse	LightingElect	2.91	5.01
tblEnergyUse	NT24E	3,054.10	0.00
tblEnergyUse	NT24E	2.27	3.90
tblEnergyUse	NT24NG	3,155.00	0.00
tblEnergyUse	NT24NG	3.30	7.41
tblEnergyUse	T24E	70.89	0.00
tblEnergyUse	T24E	2.44	4.20
tblEnergyUse	T24NG	5,226.68	0.00
tblEnergyUse	T24NG	20.62	46.31

EMFAC Off-Model Adjustment Factors for Gasoline Light Duty Vehicle to Account for the SAFE Vehicle Rule Applied

tblFireplaces	NumberGas	9,020.00	0.00
tblFireplaces	NumberNoFireplace	0.00	9,020.00
tblLandUse	LandUseSquareFeet	2,334,227.85	2,060,401.00
tblLandUse	LandUseSquareFeet	9,020,000.00	3,807,779.00
tblLandUse	Population	25,797.00	13,920.00
tblProjectCharacteristics	CO2IntensityFactor	203.98	167
tblSequestration	NumberOfNewTrees	0.00	2,030.00
tblVehicleTrips	CC_TL	7.30	7.41
tblVehicleTrips	CNW_TL	7.30	7.41
tblVehicleTrips	CW_TL	9.50	7.41
tblVehicleTrips	DV_TP	9.00	0.00
tblVehicleTrips	HO_TL	7.50	0.00
tblVehicleTrips	HS_TL	7.30	0.00
tblVehicleTrips	HW_TL	10.80	0.00
tblVehicleTrips	PR_TP	91.00	100.00
tblVehicleTrips	ST_TR	4.91	0.00
tblVehicleTrips	ST_TR	1.30	2.62
tblVehicleTrips	SU_TR	4.09	0.00
tblVehicleTrips	SU_TR	0.00	0.19
tblVehicleTrips	WD_TR	5.44	0.00
tblVehicleTrips	WD_TR	1.56	3.14
tblWater	IndoorWaterUseRate	587,689,311.11	0.00
tblWater	IndoorWaterUseRate	27,191,970.00	139,138,377.00
tblWater	OutdoorWaterUseRate	370,499,783.09	0.00
tblWater	OutdoorWaterUseRate	42,531,030.00	94,496,790.00

EMFAC Off-Model Adjustment Factors for Gasoline Light Duty Vehicle to Account for the SAFE Vehicle Rule Applied

Water Mitigation	Use Water Efficient Irrigation System Percent Reduction	6.1	32
------------------	---	-----	----

2.0 Emissions Summary

2.2 Overall Operational

Unmitigated Operational

	ROG	NOx	CO	SO2	Fugitive PM10	Exhaust PM10	PM10 Total	Fugitive PM2.5	Exhaust PM2.5	PM2.5 Total	Bio- CO2	NBio- CO2	Total CO2	CH4	N2O	CO2e
Category	lb/day										lb/day					
Area	157.2079	8.5669	742.8350	0.0394		4.1313	4.1313		4.1313	4.1313	0.0000	1,342.7212	1,342.7212	1.2827	0.0000	1,374.7889
Energy	3.2703	29.7300	24.9732	0.1784		2.2595	2.2595		2.2595	2.2595		35,675.9844	35,675.9844	0.6838	0.6541	35,887.9890
Mobile	84.6892	83.7632	762.6182	1.7575	193.2585	1.1164	194.3749	52.1636	1.0426	53.2062		193,365.2128	193,365.2128	10.3833	7.6894	195,916.2342
Total	245.1673	122.0601	1,530.4264	1.9752	193.2585	7.5072	200.7657	52.1636	7.4334	59.5970	0.0000	230,383.9184	230,383.9184	12.3498	8.3435	233,179.0121

EMFAC Off-Model Adjustment Factors for Gasoline Light Duty Vehicle to Account for the SAFE Vehicle Rule Applied

4.0 Operational Detail - Mobile

4.1 Mitigation Measures Mobile

Category	ROG	NOx	CO	SO2	Fugitive PM10	Exhaust PM10	PM10 Total	Fugitive PM2.5	Exhaust PM2.5	PM2.5 Total	Bio- CO2	NBio- CO2	Total CO2	CH4	N2O	CO2e
lb/day											lb/day					
Mitigated	84.6892	83.7632	762.6182	1.7575	193.2585	1.1164	194.3749	52.1636	1.0426	53.2062		193,365.212	193,365.21	10.3833	7.6894	195,916.234
Unmitigated	84.6892	83.7632	762.6182	1.7575	193.2585	1.1164	194.3749	52.1636	1.0426	53.2062		193,365.212	193,365.21	10.3833	7.6894	195,916.234

4.2 Trip Summary Information

Land Use	Average Daily Trip Rate			Unmitigated	Mitigated
	Weekday	Saturday	Sunday	Annual VMT	Annual VMT
Apartments Mid Rise	0.00	0.00	0.00		
University/College (4yr)	39,878.00	33,274.00	2,413.00	90,579,870	90,579,870
Total	39,878.00	33,274.00	2,413.00	90,579,870	90,579,870

4.3 Trip Type Information

Land Use	Miles			Trip %			Trip Purpose %		
	H-W or C-W	H-S or C-C	H-O or C-NW	H-W or C-W	H-S or C-C	H-O or C-NW	Primary	Diverted	Pass-by
Apartments Mid Rise	0.00	0.00	0.00	44.00	18.80	37.20	86	11	3
University/College (4yr)	7.41	7.41	7.41	6.40	88.60	5.00	100	0	0

4.4 Fleet Mix

Land Use	LDA	LDT1	LDT2	MDV	LHD1	LHD2	MHD	HHD	OBUS	UBUS	MCY	SBUS	MH
Apartments Mid Rise	0.555052	0.055883	0.188820	0.126929	0.020456	0.005379	0.009845	0.008677	0.000965	0.000515	0.024108	0.001007	0.002365
University/College (4yr)	0.555052	0.055883	0.188820	0.126929	0.020456	0.005379	0.009845	0.008677	0.000965	0.000515	0.024108	0.001007	0.002365

EMFAC Off-Model Adjustment Factors for Gasoline Light Duty Vehicle to Account for the SAFE Vehicle Rule Applied

5.0 Energy Detail

Historical Energy Use: N

5.1 Mitigation Measures Energy

	ROG	NOx	CO	SO2	Fugitive PM10	Exhaust PM10	PM10 Total	Fugitive PM2.5	Exhaust PM2.5	PM2.5 Total	Bio- CO2	NBio- CO2	Total CO2	CH4	N2O	CO2e
Category	lb/day										lb/day					
NaturalGas Mitigated	3.2703	29.7300	24.9732	0.1784		2.2595	2.2595		2.2595	2.2595		35,675.9844	35,675.9844	0.6838	0.6541	35,887.9890
NaturalGas Unmitigated	3.2703	29.7300	24.9732	0.1784		2.2595	2.2595		2.2595	2.2595		35,675.9844	35,675.9844	0.6838	0.6541	35,887.9890

5.2 Energy by Land Use - NaturalGas

Unmitigated

	NaturalGas Use	ROG	NOx	CO	SO2	Fugitive PM10	Exhaust PM10	PM10 Total	Fugitive PM2.5	Exhaust PM2.5	PM2.5 Total	Bio- CO2	NBio- CO2	Total CO2	CH4	N2O	CO2e
Land Use	kBTU/yr	lb/day										lb/day					
Apartments Mid Rise	0	0.0000	0.0000	0.0000	0.0000		0.0000	0.0000		0.0000	0.0000		0.0000	0.0000	0.0000	0.0000	0.0000
University/College (4yr)	303246	3.2703	29.7300	24.9732	0.1784		2.2595	2.2595		2.2595	2.2595		35,675.9844	35,675.9844	0.6838	0.6541	35,887.9890
Total		3.2703	29.7300	24.9732	0.1784		2.2595	2.2595		2.2595	2.2595		35,675.9844	35,675.9844	0.6838	0.6541	35,887.9890

EMFAC Off-Model Adjustment Factors for Gasoline Light Duty Vehicle to Account for the SAFE Vehicle Rule Applied

Mitigated

	Natural Gas Use	ROG	NOx	CO	SO2	Fugitive PM10	Exhaust PM10	PM10 Total	Fugitive PM2.5	Exhaust PM2.5	PM2.5 Total	Bio- CO2	NBio- CO2	Total CO2	CH4	N2O	CO2e
Land Use	kBTU/yr	lb/day										lb/day					
Apartments Mid Rise	0	0.0000	0.0000	0.0000	0.0000		0.0000	0.0000		0.0000	0.0000		0.0000	0.0000	0.0000	0.0000	0.0000
University/College (4yr)	303.246	3.2703	29.7300	24.9732	0.1784		2.2595	2.2595		2.2595	2.2595		35,675.984 4	35,675.984 4	0.6838	0.6541	35,887.989 0
Total		3.2703	29.7300	24.9732	0.1784		2.2595	2.2595		2.2595	2.2595		35,675.984 4	35,675.984 4	0.6838	0.6541	35,887.989 0

6.0 Area Detail

6.1 Mitigation Measures Area

	ROG	NOx	CO	SO2	Fugitive PM10	Exhaust PM10	PM10 Total	Fugitive PM2.5	Exhaust PM2.5	PM2.5 Total	Bio- CO2	NBio- CO2	Total CO2	CH4	N2O	CO2e
Category	lb/day										lb/day					
Mitigated	157.2079	8.5669	742.8350	0.0394		4.1313	4.1313		4.1313	4.1313	0.0000	1,342.7212	1,342.7212	1.2827	0.0000	1,374.7889
Unmitigated	157.2079	8.5669	742.8350	0.0394		4.1313	4.1313		4.1313	4.1313	0.0000	1,342.7212	1,342.7212	1.2827	0.0000	1,374.7889

EMFAC Off-Model Adjustment Factors for Gasoline Light Duty Vehicle to Account for the SAFE Vehicle Rule Applied

6.2 Area by SubCategory

Unmitigated

	ROG	NOx	CO	SO2	Fugitive PM10	Exhaust PM10	PM10 Total	Fugitive PM2.5	Exhaust PM2.5	PM2.5 Total	Bio- CO2	NBio- CO2	Total CO2	CH4	N2O	CO2e
SubCategory	lb/day										lb/day					
Architectural Coating	9.3390					0.0000	0.0000		0.0000	0.0000			0.0000			0.0000
Consumer Products	125.5791					0.0000	0.0000		0.0000	0.0000			0.0000			0.0000
Hearth	0.0000	0.0000	0.0000	0.0000		0.0000	0.0000		0.0000	0.0000	0.0000	0.0000	0.0000	0.0000	0.0000	0.0000
Landscaping	22.2899	8.5669	742.8350	0.0394		4.1313	4.1313		4.1313	4.1313		1,342.7212	1,342.7212	1.2827		1,374.7889
Total	157.2079	8.5669	742.8350	0.0394		4.1313	4.1313		4.1313	4.1313	0.0000	1,342.7212	1,342.7212	1.2827	0.0000	1,374.7889

EMFAC Off-Model Adjustment Factors for Gasoline Light Duty Vehicle to Account for the SAFE Vehicle Rule Applied

Mitigated

	ROG	NOx	CO	SO2	Fugitive PM10	Exhaust PM10	PM10 Total	Fugitive PM2.5	Exhaust PM2.5	PM2.5 Total	Bio- CO2	NBio- CO2	Total CO2	CH4	N2O	CO2e
SubCategory	lb/day										lb/day					
Architectural Coating	9.3390					0.0000	0.0000		0.0000	0.0000			0.0000			0.0000
Consumer Products	125.5791					0.0000	0.0000		0.0000	0.0000			0.0000			0.0000
Hearth	0.0000	0.0000	0.0000	0.0000		0.0000	0.0000		0.0000	0.0000	0.0000	0.0000	0.0000	0.0000	0.0000	0.0000
Landscaping	22.2899	8.5669	742.8350	0.0394		4.1313	4.1313		4.1313	4.1313		1,342.7212	1,342.7212	1.2827		1,374.7889
Total	157.2079	8.5669	742.8350	0.0394		4.1313	4.1313		4.1313	4.1313	0.0000	1,342.7212	1,342.7212	1.2827	0.0000	1,374.7889

EMFAC Off-Model Adjustment Factors for Gasoline Light Duty Vehicle to Account for the SAFE Vehicle Rule Applied

**CSUMB - Master Plan Buildout (Daily)
Monterey Bay Unified APCD Air District, Winter**

1.0 Project Characteristics

1.1 Land Usage

Land Uses	Size	Metric	Lot Acreage	Floor Surface Area	Population
University/College (4yr)	12,700.00	Student	53.59	2,060,401.00	0
Apartments Mid Rise	9,020.00	Dwelling Unit	237.37	3,807,779.00	13920

1.2 Other Project Characteristics

Urbanization	Urban	Wind Speed (m/s)	2.8	Precipitation Freq (Days)	53
Climate Zone	4			Operational Year	2035
Utility Company	Pacific Gas and Electric Company				
CO2 Intensity (lb/MWhr)	167	CH4 Intensity (lb/MWhr)	0.033	N2O Intensity (lb/MWhr)	0.004

1.3 User Entered Comments & Non-Default Data

Project Characteristics - CSUMB Master Plan. MBUAPCD.

Land Use - Total Master Plan (Campus: 2,256,767 and Student housing 3,807,779) and approved buildings (60,000) minus demolition (256,366) also includes 3,820 beds/1,220 DU. 12,700 FTE students and 1,220 DU occuied by staff/faculty.

Construction Phase - Modeling operations only.

Vehicle Trips - Update trip rate and trip length per TRA. Assumed 100% primary trips. Based Sunday trip rates from Junior College land use since since University default is 0.

Woodstoves - Assumed no fireplaces.

Area Coating - Use of low-VOC (50 g/L) arch coatings.

EMFAC Off-Model Adjustment Factors for Gasoline Light Duty Vehicle to Account for the SAFE Vehicle Rule Applied

Energy Use - Revised energy intensities based on consumption projections provided by CSUMB.

Water And Wastewater - Revised water and wastewater based on projections provided by CSUMB. Total demand in 2035 would be 427 AF building use and 290 AF for irrigation

Solid Waste - Default solid waste generation rates assumed.

Sequestration - Plant 2,030 new trees on campus.

Water Mitigation - RUWAP irrigation would account for 32% of outdoor irrigation water.

Waste Mitigation - Update per campus waste reduction goal.

Table Name	Column Name	Default Value	New Value
tblAreaCoating	Area_EF_Nonresidential_Exterior	150	50
tblAreaCoating	Area_EF_Nonresidential_Interior	150	50
tblAreaCoating	Area_EF_Residential_Exterior	100	50
tblAreaCoating	Area_EF_Residential_Interior	100	50
tblAreaCoating	Area_Nonresidential_Exterior	1030200	1079895
tblAreaCoating	Area_Nonresidential_Interior	3090600	3239685
tblAreaCoating	Area_Residential_Exterior	2570252	2597252
tblAreaCoating	Area_Residential_Interior	7710755	7791755
tblEnergyUse	LightingElect	741.44	0.00
tblEnergyUse	LightingElect	2.91	5.01
tblEnergyUse	NT24E	3,054.10	0.00
tblEnergyUse	NT24E	2.27	3.90
tblEnergyUse	NT24NG	3,155.00	0.00
tblEnergyUse	NT24NG	3.30	7.41
tblEnergyUse	T24E	70.89	0.00
tblEnergyUse	T24E	2.44	4.20
tblEnergyUse	T24NG	5,226.68	0.00
tblEnergyUse	T24NG	20.62	46.31

EMFAC Off-Model Adjustment Factors for Gasoline Light Duty Vehicle to Account for the SAFE Vehicle Rule Applied

tblFireplaces	NumberGas	9,020.00	0.00
tblFireplaces	NumberNoFireplace	0.00	9,020.00
tblLandUse	LandUseSquareFeet	2,334,227.85	2,060,401.00
tblLandUse	LandUseSquareFeet	9,020,000.00	3,807,779.00
tblLandUse	Population	25,797.00	13,920.00
tblProjectCharacteristics	CO2IntensityFactor	203.98	167
tblSequestration	NumberOfNewTrees	0.00	2,030.00
tblVehicleTrips	CC_TL	7.30	7.41
tblVehicleTrips	CNW_TL	7.30	7.41
tblVehicleTrips	CW_TL	9.50	7.41
tblVehicleTrips	DV_TP	9.00	0.00
tblVehicleTrips	HO_TL	7.50	0.00
tblVehicleTrips	HS_TL	7.30	0.00
tblVehicleTrips	HW_TL	10.80	0.00
tblVehicleTrips	PR_TP	91.00	100.00
tblVehicleTrips	ST_TR	4.91	0.00
tblVehicleTrips	ST_TR	1.30	2.62
tblVehicleTrips	SU_TR	4.09	0.00
tblVehicleTrips	SU_TR	0.00	0.19
tblVehicleTrips	WD_TR	5.44	0.00
tblVehicleTrips	WD_TR	1.56	3.14
tblWater	IndoorWaterUseRate	587,689,311.11	0.00
tblWater	IndoorWaterUseRate	27,191,970.00	139,138,377.00
tblWater	OutdoorWaterUseRate	370,499,783.09	0.00
tblWater	OutdoorWaterUseRate	42,531,030.00	94,496,790.00

EMFAC Off-Model Adjustment Factors for Gasoline Light Duty Vehicle to Account for the SAFE Vehicle Rule Applied

tbWaterMitigation	UseWaterEfficientIrrigationSystemPercentReduction	6.1	32
-------------------	---	-----	----

2.0 Emissions Summary

**2.2 Overall Operational
Unmitigated Operational**

	ROG	NOx	CO	SO2	Fugitive PM10	Exhaust PM10	PM10 Total	Fugitive PM2.5	Exhaust PM2.5	PM2.5 Total	Bio- CO2	NBio- CO2	Total CO2	CH4	N2O	CO2e
Category	lb/day										lb/day					
Area	157.2079	8.5669	742.8350	0.0394		4.1313	4.1313		4.1313	4.1313	0.0000	1,342.7212	1,342.7212	1.2827	0.0000	1,374.7889
Energy	3.2703	29.7300	24.9732	0.1784		2.2595	2.2595		2.2595	2.2595		35,675.9844	35,675.9844	0.6838	0.6541	35,887.9890
Mobile	79.1788	95.9374	838.4702	1.6841	193.2585	1.1170	194.3755	52.1636	1.0432	53.2068		185,205.7079	185,205.7079	11.4968	8.4160	188,001.0976
Total	239.6569	134.2343	1,606.2784	1.9019	193.2585	7.5078	200.7663	52.1636	7.4340	59.5976	0.0000	222,224.4136	222,224.4136	13.4633	9.0701	225,263.8755

EMFAC Off-Model Adjustment Factors for Gasoline Light Duty Vehicle to Account for the SAFE Vehicle Rule Applied

Mitigated Operational

	ROG	NOx	CO	SO2	Fugitive PM10	Exhaust PM10	PM10 Total	Fugitive PM2.5	Exhaust PM2.5	PM2.5 Total	Bio- CO2	NBio- CO2	Total CO2	CH4	N2O	CO2e
Category	lb/day										lb/day					
Area	157.2079	8.5669	742.8350	0.0394		4.1313	4.1313		4.1313	4.1313	0.0000	1,342.7212	1,342.7212	1.2827	0.0000	1,374.7889
Energy	3.2703	29.7300	24.9732	0.1784		2.2595	2.2595		2.2595	2.2595		35,675.9844	35,675.9844	0.6838	0.6541	35,887.9890
Mobile	79.1788	95.9374	838.4702	1.6841	193.2585	1.1170	194.3755	52.1636	1.0432	53.2068		185,205.7079	185,205.7079	11.4968	8.4160	188,001.0976
Total	239.6569	134.2343	1,606.2784	1.9019	193.2585	7.5078	200.7663	52.1636	7.4340	59.5976	0.0000	222,224.4136	222,224.4136	13.4633	9.0701	225,263.8755

	ROG	NOx	CO	SO2	Fugitive PM10	Exhaust PM10	PM10 Total	Fugitive PM2.5	Exhaust PM2.5	PM2.5 Total	Bio- CO2	NBio- CO2	Total CO2	CH4	N2O	CO2e
Percent Reduction	0.00	0.00	0.00	0.00	0.00	0.00	0.00	0.00	0.00	0.00	0.00	0.00	0.00	0.00	0.00	0.00

4.0 Operational Detail - Mobile

4.1 Mitigation Measures Mobile

	ROG	NOx	CO	SO2	Fugitive PM10	Exhaust PM10	PM10 Total	Fugitive PM2.5	Exhaust PM2.5	PM2.5 Total	Bio- CO2	NBio- CO2	Total CO2	CH4	N2O	CO2e
Category	lb/day										lb/day					
Mitigated	79.1788	95.9374	838.4702	1.6841	193.2585	1.1170	194.3755	52.1636	1.0432	53.2068		185,205.7079	185,205.7079	11.4968	8.4160	188,001.0976
Unmitigated	79.1788	95.9374	838.4702	1.6841	193.2585	1.1170	194.3755	52.1636	1.0432	53.2068		185,205.7079	185,205.7079	11.4968	8.4160	188,001.0976

EMFAC Off-Model Adjustment Factors for Gasoline Light Duty Vehicle to Account for the SAFE Vehicle Rule Applied

4.2 Trip Summary Information

Land Use	Average Daily Trip Rate			Unmitigated	Mitigated
	Weekday	Saturday	Sunday	Annual VMT	Annual VMT
Apartments Mid Rise	0.00	0.00	0.00		
University/College (4yr)	39,878.00	33,274.00	2,413.00	90,579,870	90,579,870
Total	39,878.00	33,274.00	2,413.00	90,579,870	90,579,870

4.3 Trip Type Information

Land Use	Miles			Trip %			Trip Purpose %		
	H-W or C-W	H-S or C-C	H-O or C-NW	H-W or C-W	H-S or C-C	H-O or C-NW	Primary	Diverted	Pass-by
Apartments Mid Rise	0.00	0.00	0.00	44.00	18.80	37.20	86	11	3
University/College (4yr)	7.41	7.41	7.41	6.40	88.60	5.00	100	0	0

4.4 Fleet Mix

Land Use	LDA	LDT1	LDT2	MDV	LHD1	LHD2	MHD	HHD	OBUS	UBUS	MCY	SBUS	MH
Apartments Mid Rise	0.555052	0.055883	0.188820	0.126929	0.020456	0.005379	0.009845	0.008677	0.000965	0.000515	0.024108	0.001007	0.002365
University/College (4yr)	0.555052	0.055883	0.188820	0.126929	0.020456	0.005379	0.009845	0.008677	0.000965	0.000515	0.024108	0.001007	0.002365

5.0 Energy Detail

Historical Energy Use: N

5.1 Mitigation Measures Energy

EMFAC Off-Model Adjustment Factors for Gasoline Light Duty Vehicle to Account for the SAFE Vehicle Rule Applied

	ROG	NOx	CO	SO2	Fugitive PM10	Exhaust PM10	PM10 Total	Fugitive PM2.5	Exhaust PM2.5	PM2.5 Total	Bio- CO2	NBio- CO2	Total CO2	CH4	N2O	CO2e
Category	lb/day										lb/day					
NaturalGas Mitigated	3.2703	29.7300	24.9732	0.1784		2.2595	2.2595		2.2595	2.2595		35,675.9844	35,675.9844	0.6838	0.6541	35,887.9890
NaturalGas Unmitigated	3.2703	29.7300	24.9732	0.1784		2.2595	2.2595		2.2595	2.2595		35,675.9844	35,675.9844	0.6838	0.6541	35,887.9890

5.2 Energy by Land Use - NaturalGas

Unmitigated

	NaturalGas Use	ROG	NOx	CO	SO2	Fugitive PM10	Exhaust PM10	PM10 Total	Fugitive PM2.5	Exhaust PM2.5	PM2.5 Total	Bio- CO2	NBio- CO2	Total CO2	CH4	N2O	CO2e
Land Use	kBTU/yr	lb/day										lb/day					
Apartments Mid Rise	0	0.0000	0.0000	0.0000	0.0000		0.0000	0.0000		0.0000	0.0000		0.0000	0.0000	0.0000	0.0000	0.0000
University/College (4yr)	303246	3.2703	29.7300	24.9732	0.1784		2.2595	2.2595		2.2595	2.2595		35,675.9844	35,675.9844	0.6838	0.6541	35,887.9890
Total		3.2703	29.7300	24.9732	0.1784		2.2595	2.2595		2.2595	2.2595		35,675.9844	35,675.9844	0.6838	0.6541	35,887.9890

EMFAC Off-Model Adjustment Factors for Gasoline Light Duty Vehicle to Account for the SAFE Vehicle Rule Applied

Mitigated

	Natural Gas Use	ROG	NOx	CO	SO2	Fugitive PM10	Exhaust PM10	PM10 Total	Fugitive PM2.5	Exhaust PM2.5	PM2.5 Total	Bio- CO2	NBio- CO2	Total CO2	CH4	N2O	CO2e
Land Use	kBTU/yr	lb/day										lb/day					
Apartments Mid Rise	0	0.0000	0.0000	0.0000	0.0000		0.0000	0.0000		0.0000	0.0000		0.0000	0.0000	0.0000	0.0000	0.0000
University/College (4yr)	303.246	3.2703	29.7300	24.9732	0.1784		2.2595	2.2595		2.2595	2.2595		35,675.9844	35,675.9844	0.6838	0.6541	35,887.9890
Total		3.2703	29.7300	24.9732	0.1784		2.2595	2.2595		2.2595	2.2595		35,675.9844	35,675.9844	0.6838	0.6541	35,887.9890

6.0 Area Detail

6.1 Mitigation Measures Area

	ROG	NOx	CO	SO2	Fugitive PM10	Exhaust PM10	PM10 Total	Fugitive PM2.5	Exhaust PM2.5	PM2.5 Total	Bio- CO2	NBio- CO2	Total CO2	CH4	N2O	CO2e
Category	lb/day										lb/day					
Mitigated	157.2079	8.5669	742.8350	0.0394		4.1313	4.1313		4.1313	4.1313	0.0000	1,342.7212	1,342.7212	1.2827	0.0000	1,374.7889
Unmitigated	157.2079	8.5669	742.8350	0.0394		4.1313	4.1313		4.1313	4.1313	0.0000	1,342.7212	1,342.7212	1.2827	0.0000	1,374.7889

EMFAC Off-Model Adjustment Factors for Gasoline Light Duty Vehicle to Account for the SAFE Vehicle Rule Applied

6.2 Area by SubCategory

Unmitigated

	ROG	NOx	CO	SO2	Fugitive PM10	Exhaust PM10	PM10 Total	Fugitive PM2.5	Exhaust PM2.5	PM2.5 Total	Bio- CO2	NBio- CO2	Total CO2	CH4	N2O	CO2e
SubCategory	lb/day										lb/day					
Architectural Coating	9.3390					0.0000	0.0000		0.0000	0.0000			0.0000			0.0000
Consumer Products	125.5791					0.0000	0.0000		0.0000	0.0000			0.0000			0.0000
Hearth	0.0000	0.0000	0.0000	0.0000		0.0000	0.0000		0.0000	0.0000	0.0000	0.0000	0.0000	0.0000	0.0000	0.0000
Landscaping	22.2899	8.5669	742.8350	0.0394		4.1313	4.1313		4.1313	4.1313		1,342.7212	1,342.7212	1.2827		1,374.7889
Total	157.2079	8.5669	742.8350	0.0394		4.1313	4.1313		4.1313	4.1313	0.0000	1,342.7212	1,342.7212	1.2827	0.0000	1,374.7889

EMFAC Off-Model Adjustment Factors for Gasoline Light Duty Vehicle to Account for the SAFE Vehicle Rule Applied

Mitigated

	ROG	NOx	CO	SO2	Fugitive PM10	Exhaust PM10	PM10 Total	Fugitive PM2.5	Exhaust PM2.5	PM2.5 Total	Bio- CO2	NBio- CO2	Total CO2	CH4	N2O	CO2e
SubCategory	lb/day										lb/day					
Architectural Coating	9.3390					0.0000	0.0000		0.0000	0.0000			0.0000			0.0000
Consumer Products	125.5791					0.0000	0.0000		0.0000	0.0000			0.0000			0.0000
Hearth	0.0000	0.0000	0.0000	0.0000		0.0000	0.0000		0.0000	0.0000	0.0000	0.0000	0.0000	0.0000	0.0000	0.0000
Landscaping	22.2899	8.5669	742.8350	0.0394		4.1313	4.1313		4.1313	4.1313		1,342.7212	1,342.7212	1.2827		1,374.7889
Total	157.2079	8.5669	742.8350	0.0394		4.1313	4.1313		4.1313	4.1313	0.0000	1,342.7212	1,342.7212	1.2827	0.0000	1,374.7889

EMFAC Off-Model Adjustment Factors for Gasoline Light Duty Vehicle to Account for the SAFE Vehicle Rule Applied

**CSUMB - Existing Campus (Annual)
Monterey Bay Unified APCD Air District, Annual**

1.0 Project Characteristics

1.1 Land Usage

Land Uses	Size	Metric	Lot Acreage	Floor Surface Area	Population
University/College (4yr)	6,634.00	Student	27.99	1,142,777.00	0
Apartments Mid Rise	5,200.00	Dwelling Unit	136.84	2,047,779.00	7097

1.2 Other Project Characteristics

Urbanization	Urban	Wind Speed (m/s)	2.8	Precipitation Freq (Days)	53
Climate Zone	4			Operational Year	2018
Utility Company	Pacific Gas and Electric Company				
CO2 Intensity (lb/MWhr)	203.98	CH4 Intensity (lb/MWhr)	0.033	N2O Intensity (lb/MWhr)	0.004

1.3 User Entered Comments & Non-Default Data

Project Characteristics - CSUMB Master Plan. MBUAPCD.

Land Use - Existing campus includes 1,142,777 SF of campus facilities and 3,980 beds/1,220 DU. 6,634 FTE students in 2016-17 and 463 DU occuied by staff/faculty.

Construction Phase - Modeling operations only.

Vehicle Trips - Update trip rate and trip length per TRA for annual emissions. Adjusted calculated trip rate tp match annual VMT. Assumed 100% primary trips. Based Sunday trip rates from Junior College land use since Univeristy default is 0.

Woodstoves - Assumed no fireplaces.

Area Coating - Use of low-VOC (50 g/L) arch coatings.

Energy Use - Updated energy intensities based on data provided.

EMFAC Off-Model Adjustment Factors for Gasoline Light Duty Vehicle to Account for the SAFE Vehicle Rule Applied

Water And Wastewater - Revised water and wastewater based on consumption data provided by CSUMB.

Solid Waste - Default solid waste generation rates assumed.

Table Name	Column Name	Default Value	New Value
tblAreaCoating	Area_EF_Nonresidential_Exterior	150	50
tblAreaCoating	Area_EF_Nonresidential_Interior	150	50
tblAreaCoating	Area_EF_Residential_Exterior	100	50
tblAreaCoating	Area_EF_Residential_Interior	100	50
tblAreaCoating	Area_Nonresidential_Exterior	571390	609655
tblAreaCoating	Area_Nonresidential_Interior	1714170	1828965
tblAreaCoating	Area_Residential_Exterior	1382252	3142800
tblAreaCoating	Area_Residential_Interior	4146755	9428400
tblEnergyUse	LightingElect	741.44	0.00
tblEnergyUse	LightingElect	2.91	3.83
tblEnergyUse	NT24E	3,054.10	0.00
tblEnergyUse	NT24E	2.27	2.99
tblEnergyUse	NT24NG	3,155.00	0.00
tblEnergyUse	NT24NG	3.30	6.71
tblEnergyUse	T24E	70.89	0.00
tblEnergyUse	T24E	2.44	3.21
tblEnergyUse	T24NG	5,226.68	0.00
tblEnergyUse	T24NG	20.62	41.92
tblFireplaces	NumberGas	5,200.00	0.00
tblFireplaces	NumberNoFireplace	0.00	5,200.00
tblLandUse	LandUseSquareFeet	1,219,312.41	1,142,777.00
tblLandUse	LandUseSquareFeet	5,200,000.00	2,047,779.00

EMFAC Off-Model Adjustment Factors for Gasoline Light Duty Vehicle to Account for the SAFE Vehicle Rule Applied

tblLandUse	Population	14,872.00	7,097.00
tblProjectCharacteristics	CH4IntensityFactor	0.033	0
tblProjectCharacteristics	N2OIntensityFactor	0.004	0
tblSolidWaste	SolidWasteGenerationRate	2,392.00	2,141.76
tblVehicleTrips	CC_TL	7.30	4.65
tblVehicleTrips	CNW_TL	7.30	4.65
tblVehicleTrips	CW_TL	9.50	4.65
tblVehicleTrips	DV_TP	9.00	0.00
tblVehicleTrips	HO_TL	7.50	0.00
tblVehicleTrips	HS_TL	7.30	0.00
tblVehicleTrips	HW_TL	10.80	0.00
tblVehicleTrips	PR_TP	91.00	100.00
tblVehicleTrips	ST_TR	4.91	0.00
tblVehicleTrips	ST_TR	1.30	3.54
tblVehicleTrips	SU_TR	4.09	0.00
tblVehicleTrips	SU_TR	0.00	0.25
tblVehicleTrips	WD_TR	5.44	0.00
tblVehicleTrips	WD_TR	1.56	4.25
tblWater	IndoorWaterUseRate	338,800,933.23	0.00
tblWater	IndoorWaterUseRate	14,204,057.40	32,827,469.00
tblWater	OutdoorWaterUseRate	213,591,892.69	0.00
tblWater	OutdoorWaterUseRate	22,216,602.60	21,879,743.00

EMFAC Off-Model Adjustment Factors for Gasoline Light Duty Vehicle to Account for the SAFE Vehicle Rule Applied

2.0 Emissions Summary

**2.2 Overall Operational
Unmitigated Operational**

	ROG	NOx	CO	SO2	Fugitive PM10	Exhaust PM10	PM10 Total	Fugitive PM2.5	Exhaust PM2.5	PM2.5 Total	Bio- CO2	NBio- CO2	Total CO2	CH4	N2O	CO2e
Category	tons/yr										MT/yr					
Area	15.8729	0.6276	54.0909	2.8400e-003		0.2951	0.2951		0.2951	0.2951	0.0000	87.7615	87.7615	0.0873	0.0000	89.9431
Energy	0.2997	2.7242	2.2883	0.0164		0.2070	0.2070		0.2070	0.2070	0.0000	4,026.1124	4,026.1124	0.0568	0.0544	4,043.7355
Mobile	16.3233	23.2635	132.8500	0.1868	14.9725	0.3091	15.2816	4.0083	0.2916	4.2999	0.0000	17,244.2846	17,244.2846	1.8595	1.1840	17,643.6091
Waste						0.0000	0.0000		0.0000	0.0000	680.5191	0.0000	680.5191	40.2175	0.0000	1,685.9572
Water						0.0000	0.0000		0.0000	0.0000	10.4146	23.5203	33.9350	1.0697	0.0253	68.2038
Total	32.4959	26.6153	189.2292	0.2060	14.9725	0.8112	15.7837	4.0083	0.7937	4.8020	690.9337	21,381.6788	22,072.6126	43.2908	1.2637	23,531.4487

EMFAC Off-Model Adjustment Factors for Gasoline Light Duty Vehicle to Account for the SAFE Vehicle Rule Applied

4.0 Operational Detail - Mobile

4.1 Mitigation Measures Mobile

	ROG	NOx	CO	SO2	Fugitive PM10	Exhaust PM10	PM10 Total	Fugitive PM2.5	Exhaust PM2.5	PM2.5 Total	Bio- CO2	NBio- CO2	Total CO2	CH4	N2O	CO2e
Category	tons/yr										MT/yr					
Mitigated	16.3233	23.2635	132.8500	0.1868	14.9725	0.3091	15.2816	4.0083	0.2916	4.2999	0.0000	17,244.2846	17,244.2846	1.8595	1.1840	17,643.6091
Unmitigated	16.3233	23.2635	132.8500	0.1868	14.9725	0.3091	15.2816	4.0083	0.2916	4.2999	0.0000	17,244.2846	17,244.2846	1.8595	1.1840	17,643.6091

4.2 Trip Summary Information

Land Use	Average Daily Trip Rate			Unmitigated	Mitigated
	Weekday	Saturday	Sunday	Annual VMT	Annual VMT
Apartments Mid Rise	0.00	0.00	0.00		
University/College (4yr)	28,194.50	23,484.36	1,658.50	40,166,694	40,166,694
Total	28,194.50	23,484.36	1,658.50	40,166,694	40,166,694

4.3 Trip Type Information

Land Use	Miles			Trip %			Trip Purpose %		
	H-W or C-W	H-S or C-C	H-O or C-NW	H-W or C-W	H-S or C-C	H-O or C-NW	Primary	Diverted	Pass-by
Apartments Mid Rise	0.00	0.00	0.00	44.00	18.80	37.20	86	11	3
University/College (4yr)	4.65	4.65	4.65	6.40	88.60	5.00	100	0	0

EMFAC Off-Model Adjustment Factors for Gasoline Light Duty Vehicle to Account for the SAFE Vehicle Rule Applied

4.4 Fleet Mix

Land Use	LDA	LDT1	LDT2	MDV	LHD1	LHD2	MHD	HHD	OBUS	UBUS	MCY	SBUS	MH
Apartments Mid Rise	0.472891	0.048916	0.201626	0.172765	0.037062	0.008202	0.011598	0.008545	0.001485	0.000584	0.029640	0.001456	0.005230
University/College (4yr)	0.472891	0.048916	0.201626	0.172765	0.037062	0.008202	0.011598	0.008545	0.001485	0.000584	0.029640	0.001456	0.005230

5.0 Energy Detail

Historical Energy Use: N

5.1 Mitigation Measures Energy

Category	ROG	NOx	CO	SO2	Fugitive PM10	Exhaust PM10	PM10 Total	Fugitive PM2.5	Exhaust PM2.5	PM2.5 Total	Bio- CO2	NBio- CO2	Total CO2	CH4	N2O	CO2e
	tons/yr										MT/yr					
Electricity Mitigated						0.0000	0.0000		0.0000	0.0000	0.0000	1,060.5124	1,060.5124	0.0000	0.0000	1,060.5124
Electricity Unmitigated						0.0000	0.0000		0.0000	0.0000	0.0000	1,060.5124	1,060.5124	0.0000	0.0000	1,060.5124
NaturalGas Mitigated	0.2997	2.7242	2.2883	0.0164		0.2070	0.2070		0.2070	0.2070	0.0000	2,965.6000	2,965.6000	0.0568	0.0544	2,983.2231
NaturalGas Unmitigated	0.2997	2.7242	2.2883	0.0164		0.2070	0.2070		0.2070	0.2070	0.0000	2,965.6000	2,965.6000	0.0568	0.0544	2,983.2231

EMFAC Off-Model Adjustment Factors for Gasoline Light Duty Vehicle to Account for the SAFE Vehicle Rule Applied

5.2 Energy by Land Use - NaturalGas

Unmitigated

	NaturalGas Use	ROG	NOx	CO	SO2	Fugitive PM10	Exhaust PM10	PM10 Total	Fugitive PM2.5	Exhaust PM2.5	PM2.5 Total	Bio- CO2	NBio- CO2	Total CO2	CH4	N2O	CO2e
Land Use	kBTU/yr	tons/yr										MT/yr					
Apartments Mid Rise	0	0.0000	0.0000	0.0000	0.0000		0.0000	0.0000		0.0000	0.0000	0.0000	0.0000	0.0000	0.0000	0.0000	0.0000
University/College (4yr)	5.55732e+007	0.2997	2.7242	2.2883	0.0164		0.2070	0.2070		0.2070	0.2070	0.0000	2,965.6000	2,965.6000	0.0568	0.0544	2,983.2231
Total		0.2997	2.7242	2.2883	0.0164		0.2070	0.2070		0.2070	0.2070	0.0000	2,965.6000	2,965.6000	0.0568	0.0544	2,983.2231

Mitigated

	NaturalGas Use	ROG	NOx	CO	SO2	Fugitive PM10	Exhaust PM10	PM10 Total	Fugitive PM2.5	Exhaust PM2.5	PM2.5 Total	Bio- CO2	NBio- CO2	Total CO2	CH4	N2O	CO2e
Land Use	kBTU/yr	tons/yr										MT/yr					
Apartments Mid Rise	0	0.0000	0.0000	0.0000	0.0000		0.0000	0.0000		0.0000	0.0000	0.0000	0.0000	0.0000	0.0000	0.0000	0.0000
University/College (4yr)	5.55732e+007	0.2997	2.7242	2.2883	0.0164		0.2070	0.2070		0.2070	0.2070	0.0000	2,965.6000	2,965.6000	0.0568	0.0544	2,983.2231
Total		0.2997	2.7242	2.2883	0.0164		0.2070	0.2070		0.2070	0.2070	0.0000	2,965.6000	2,965.6000	0.0568	0.0544	2,983.2231

EMFAC Off-Model Adjustment Factors for Gasoline Light Duty Vehicle to Account for the SAFE Vehicle Rule Applied

5.3 Energy by Land Use - Electricity

Unmitigated

	Electricity Use	Total CO2	CH4	N2O	CO2e
Land Use	kWh/yr	MT/yr			
Apartments Mid Rise	0	0.0000	0.0000	0.0000	0.0000
University/College (4yr)	1.14621e+007	1,060.5124	0.0000	0.0000	1,060.5124
Total		1,060.5124	0.0000	0.0000	1,060.5124

Mitigated

	Electricity Use	Total CO2	CH4	N2O	CO2e
Land Use	kWh/yr	MT/yr			
Apartments Mid Rise	0	0.0000	0.0000	0.0000	0.0000
University/College (4yr)	1.14621e+007	1,060.5124	0.0000	0.0000	1,060.5124
Total		1,060.5124	0.0000	0.0000	1,060.5124

EMFAC Off-Model Adjustment Factors for Gasoline Light Duty Vehicle to Account for the SAFE Vehicle Rule Applied

6.0 Area Detail

6.1 Mitigation Measures Area

	ROG	NOx	CO	SO2	Fugitive PM10	Exhaust PM10	PM10 Total	Fugitive PM2.5	Exhaust PM2.5	PM2.5 Total	Bio- CO2	NBio- CO2	Total CO2	CH4	N2O	CO2e
Category	tons/yr										MT/yr					
Mitigated	15.8729	0.6276	54.0909	2.8400e-003		0.2951	0.2951		0.2951	0.2951	0.0000	87.7615	87.7615	0.0873	0.0000	89.9431
Unmitigated	15.8729	0.6276	54.0909	2.8400e-003		0.2951	0.2951		0.2951	0.2951	0.0000	87.7615	87.7615	0.0873	0.0000	89.9431

EMFAC Off-Model Adjustment Factors for Gasoline Light Duty Vehicle to Account for the SAFE Vehicle Rule Applied

6.2 Area by SubCategory

Unmitigated

	ROG	NOx	CO	SO2	Fugitive PM10	Exhaust PM10	PM10 Total	Fugitive PM2.5	Exhaust PM2.5	PM2.5 Total	Bio- CO2	NBio- CO2	Total CO2	CH4	N2O	CO2e
SubCategory	tons/yr										MT/yr					
Architectural Coating	1.7393					0.0000	0.0000		0.0000	0.0000	0.0000	0.0000	0.0000	0.0000	0.0000	0.0000
Consumer Products	12.4607					0.0000	0.0000		0.0000	0.0000	0.0000	0.0000	0.0000	0.0000	0.0000	0.0000
Hearth	0.0000	0.0000	0.0000	0.0000		0.0000	0.0000		0.0000	0.0000	0.0000	0.0000	0.0000	0.0000	0.0000	0.0000
Landscaping	1.6730	0.6276	54.0909	2.8400e-003		0.2951	0.2951		0.2951	0.2951	0.0000	87.7615	87.7615	0.0873	0.0000	89.9431
Total	15.8729	0.6276	54.0909	2.8400e-003		0.2951	0.2951		0.2951	0.2951	0.0000	87.7615	87.7615	0.0873	0.0000	89.9431

EMFAC Off-Model Adjustment Factors for Gasoline Light Duty Vehicle to Account for the SAFE Vehicle Rule Applied

Mitigated

	ROG	NOx	CO	SO2	Fugitive PM10	Exhaust PM10	PM10 Total	Fugitive PM2.5	Exhaust PM2.5	PM2.5 Total	Bio- CO2	NBio- CO2	Total CO2	CH4	N2O	CO2e
SubCategory	tons/yr										MT/yr					
Architectural Coating	1.7393					0.0000	0.0000		0.0000	0.0000	0.0000	0.0000	0.0000	0.0000	0.0000	0.0000
Consumer Products	12.4607					0.0000	0.0000		0.0000	0.0000	0.0000	0.0000	0.0000	0.0000	0.0000	0.0000
Hearth	0.0000	0.0000	0.0000	0.0000		0.0000	0.0000		0.0000	0.0000	0.0000	0.0000	0.0000	0.0000	0.0000	0.0000
Landscaping	1.6730	0.6276	54.0909	2.8400e-003		0.2951	0.2951		0.2951	0.2951	0.0000	87.7615	87.7615	0.0873	0.0000	89.9431
Total	15.8729	0.6276	54.0909	2.8400e-003		0.2951	0.2951		0.2951	0.2951	0.0000	87.7615	87.7615	0.0873	0.0000	89.9431

7.0 Water Detail

7.1 Mitigation Measures Water

	Total CO2	CH4	N2O	CO2e
Category	MT/yr			
Mitigated	33.9350	1.0697	0.0253	68.2038
Unmitigated	33.9350	1.0697	0.0253	68.2038

EMFAC Off-Model Adjustment Factors for Gasoline Light Duty Vehicle to Account for the SAFE Vehicle Rule Applied

7.2 Water by Land Use

Unmitigated

Indoor/Outdoor Use		Total CO2	CH4	N2O	CO2e
Land Use	Mgal	MT/yr			
Apartments Mid Rise	0 / 0	0.0000	0.0000	0.0000	0.0000
University/College (4yr)	32.8275 / 21.8797	33.9350	1.0697	0.0253	68.2038
Total		33.9350	1.0697	0.0253	68.2038

Mitigated

Indoor/Outdoor Use		Total CO2	CH4	N2O	CO2e
Land Use	Mgal	MT/yr			
Apartments Mid Rise	0 / 0	0.0000	0.0000	0.0000	0.0000
University/College (4yr)	32.8275 / 21.8797	33.9350	1.0697	0.0253	68.4438
Total		33.9350	1.0697	0.0253	68.4438

EMFAC Off-Model Adjustment Factors for Gasoline Light Duty Vehicle to Account for the SAFE Vehicle Rule Applied

8.0 Waste Detail

8.1 Mitigation Measures Waste

Category/Year

	Total CO2	CH4	N2O	CO2e
	MT/yr			
Mitigated	680.5191	40.2175	0.0000	1,685.9572
Unmitigated	680.5191	40.2175	0.0000	1,685.9572

8.2 Waste by Land Use

Unmitigated

	Waste Disposed	Total CO2	CH4	N2O	CO2e
Land Use	tons	MT/yr			
Apartments Mid Rise	2141.76	434.7579	25.6935	0.0000	1,077.0944
University/College (4yr)	1210.7	245.7612	14.5241	0.0000	608.8629
Total		680.5191	40.2175	0.0000	1,685.9572

EMFAC Off-Model Adjustment Factors for Gasoline Light Duty Vehicle to Account for the SAFE Vehicle Rule Applied**Mitigated**

	Waste Disposed	Total CO2	CH4	N2O	CO2e
Land Use	tons	MT/yr			
Apartments Mid Rise	2141.76	434.7579	25.6935	0.0000	1,077.0944
University/College (4yr)	1210.7	245.7612	14.5241	0.0000	608.8629
Total		680.5191	40.2175	0.0000	1,685.9572

EMFAC Off-Model Adjustment Factors for Gasoline Light Duty Vehicle to Account for the SAFE Vehicle Rule Applied

**CSUMB - Existing Campus (Daily)
Monterey Bay Unified APCD Air District, Summer**

1.0 Project Characteristics

1.1 Land Usage

Land Uses	Size	Metric	Lot Acreage	Floor Surface Area	Population
University/College (4yr)	6,634.00	Student	27.99	1,142,777.00	0
Apartments Mid Rise	5,200.00	Dwelling Unit	136.84	2,047,779.00	7097

1.2 Other Project Characteristics

Urbanization	Urban	Wind Speed (m/s)	2.8	Precipitation Freq (Days)	53
Climate Zone	4			Operational Year	2018
Utility Company	Pacific Gas and Electric Company				
CO2 Intensity (lb/MWhr)	203.98	CH4 Intensity (lb/MWhr)	0.033	N2O Intensity (lb/MWhr)	0.004

1.3 User Entered Comments & Non-Default Data

Project Characteristics - CSUMB Master Plan. MBUAPCD.

Land Use - Existing campus includes 1,142,777 SF of campus facilities and 3,980 beds/1,220 DU. 6,634 FTE students in 2016-17 and 463 DU occuied by staff/faculty.

Construction Phase - Modeling operations only.

Vehicle Trips - Update trip rate and trip length per TRA. Assumed 100% primary trips. Based Sunday trip rates from Junior College land use since Univeristy default is 0.

Woodstoves - Assumed no fireplaces.

Area Coating - Use of low-VOC (50 g/L) arch coatings.

Energy Use - Updated energy intensities per provided consumption data.

EMFAC Off-Model Adjustment Factors for Gasoline Light Duty Vehicle to Account for the SAFE Vehicle Rule Applied

Water And Wastewater - Revised water and wastewater based on consumption data provided by CSUMB.

Solid Waste - Default solid waste generation rates assumed.

Table Name	Column Name	Default Value	New Value
tblAreaCoating	Area_EF_Nonresidential_Exterior	150	50
tblAreaCoating	Area_EF_Nonresidential_Interior	150	50
tblAreaCoating	Area_EF_Residential_Exterior	100	50
tblAreaCoating	Area_EF_Residential_Interior	100	50
tblAreaCoating	Area_Nonresidential_Exterior	571390	609655
tblAreaCoating	Area_Nonresidential_Interior	1714170	1828965
tblAreaCoating	Area_Residential_Exterior	1382252	3142800
tblAreaCoating	Area_Residential_Interior	4146755	9428400
tblEnergyUse	LightingElect	741.44	0.00
tblEnergyUse	LightingElect	2.91	3.83
tblEnergyUse	NT24E	3,054.10	0.00
tblEnergyUse	NT24E	2.27	2.99
tblEnergyUse	NT24NG	3,155.00	0.00
tblEnergyUse	NT24NG	3.30	6.71
tblEnergyUse	T24E	70.89	0.00
tblEnergyUse	T24E	2.44	3.21
tblEnergyUse	T24NG	5,226.68	0.00
tblEnergyUse	T24NG	20.62	41.92
tblFireplaces	NumberGas	5,200.00	0.00
tblFireplaces	NumberNoFireplace	0.00	5,200.00
tblLandUse	LandUseSquareFeet	1,219,312.41	1,142,777.00
tblLandUse	LandUseSquareFeet	5,200,000.00	2,047,779.00

EMFAC Off-Model Adjustment Factors for Gasoline Light Duty Vehicle to Account for the SAFE Vehicle Rule Applied

tblLandUse	Population	14,872.00	7,097.00
tblSolidWaste	SolidWasteGenerationRate	2,392.00	2,141.76
tblVehicleTrips	CC_TL	7.30	6.33
tblVehicleTrips	CNW_TL	7.30	6.33
tblVehicleTrips	CW_TL	9.50	6.33
tblVehicleTrips	DV_TP	9.00	0.00
tblVehicleTrips	HO_TL	7.50	0.00
tblVehicleTrips	HS_TL	7.30	0.00
tblVehicleTrips	HW_TL	10.80	0.00
tblVehicleTrips	PR_TP	91.00	100.00
tblVehicleTrips	ST_TR	4.91	0.00
tblVehicleTrips	ST_TR	1.30	3.54
tblVehicleTrips	SU_TR	4.09	0.00
tblVehicleTrips	SU_TR	0.00	0.25
tblVehicleTrips	WD_TR	5.44	0.00
tblVehicleTrips	WD_TR	1.56	4.25
tblWater	IndoorWaterUseRate	338,800,933.23	0.00
tblWater	IndoorWaterUseRate	14,204,057.40	32,827,469.00
tblWater	OutdoorWaterUseRate	213,591,892.69	0.00
tblWater	OutdoorWaterUseRate	22,216,602.60	21,879,743.00

EMFAC Off-Model Adjustment Factors for Gasoline Light Duty Vehicle to Account for the SAFE Vehicle Rule Applied

2.0 Emissions Summary

2.2 Overall Operational

Unmitigated Operational

	ROG	NOx	CO	SO2	Fugitive PM10	Exhaust PM10	PM10 Total	Fugitive PM2.5	Exhaust PM2.5	PM2.5 Total	Bio- CO2	NBio- CO2	Total CO2	CH4	N2O	CO2e
Category	lb/day										lb/day					
Area	91.1918	5.0210	432.7271	0.0227		2.3605	2.3605		2.3605	2.3605	0.0000	773.9238	773.9238	0.7695	0.0000	793.1619
Energy	1.6420	14.9270	12.5387	0.0896		1.1345	1.1345		1.1345	1.1345		17,912.4079	17,912.4079	0.3433	0.3284	18,018.8524
Mobile	127.0859	179.2398	1,100.7519	1.7100	137.3367	2.6868	140.0235	36.6709	2.5359	39.2068		173,920.1369	173,920.1369	14.7665	10.0779	177,292.4988
Total	219.9197	199.1879	1,546.0177	1.8222	137.3367	6.1817	143.5184	36.6709	6.0309	42.7017	0.0000	192,606.4687	192,606.4687	15.8793	10.4062	196,104.5131

Mitigated Operational

	ROG	NOx	CO	SO2	Fugitive PM10	Exhaust PM10	PM10 Total	Fugitive PM2.5	Exhaust PM2.5	PM2.5 Total	Bio- CO2	NBio- CO2	Total CO2	CH4	N2O	CO2e
Category	lb/day										lb/day					
Area	91.1918	5.0210	432.7271	0.0227		2.3605	2.3605		2.3605	2.3605	0.0000	773.9238	773.9238	0.7695	0.0000	793.1619
Energy	1.6420	14.9270	12.5387	0.0896		1.1345	1.1345		1.1345	1.1345		17,912.4079	17,912.4079	0.3433	0.3284	18,018.8524
Mobile	127.0859	179.2398	1,100.7519	1.7100	137.3367	2.6868	140.0235	36.6709	2.5359	39.2068		173,920.1369	173,920.1369	14.7665	10.0779	177,292.4988
Total	219.9197	199.1879	1,546.0177	1.8222	137.3367	6.1817	143.5184	36.6709	6.0309	42.7017	0.0000	192,606.4687	192,606.4687	15.8793	10.4062	196,104.5131

EMFAC Off-Model Adjustment Factors for Gasoline Light Duty Vehicle to Account for the SAFE Vehicle Rule Applied

	ROG	NOx	CO	SO2	Fugitive PM10	Exhaust PM10	PM10 Total	Fugitive PM2.5	Exhaust PM2.5	PM2.5 Total	Bio- CO2	NBio-CO2	Total CO2	CH4	N2O	CO2e
Percent Reduction	0.00	0.00	0.00	0.00	0.00	0.00	0.00	0.00	0.00	0.00	0.00	0.00	0.00	0.00	0.00	0.00

4.0 Operational Detail - Mobile

4.1 Mitigation Measures Mobile

	ROG	NOx	CO	SO2	Fugitive PM10	Exhaust PM10	PM10 Total	Fugitive PM2.5	Exhaust PM2.5	PM2.5 Total	Bio- CO2	NBio- CO2	Total CO2	CH4	N2O	CO2e
Category	lb/day										lb/day					
Mitigated	127.0859	179.2398	1,100.7519	1.7100	137.3367	2.6868	140.0235	36.6709	2.5359	39.2068		173,920.136	173,920.13	14.7665	10.0779	177,292.498
Unmitigated	127.0859	179.2398	1,100.7519	1.7100	137.3367	2.6868	140.0235	36.6709	2.5359	39.2068		173,920.136	173,920.13	14.7665	10.0779	177,292.498

4.2 Trip Summary Information

Land Use	Average Daily Trip Rate			Unmitigated Annual VMT	Mitigated Annual VMT
	Weekday	Saturday	Sunday		
Apartments Mid Rise	0.00	0.00	0.00		
University/College (4yr)	28,194.50	23,484.36	1,658.50	54,678,532	54,678,532
Total	28,194.50	23,484.36	1,658.50	54,678,532	54,678,532

EMFAC Off-Model Adjustment Factors for Gasoline Light Duty Vehicle to Account for the SAFE Vehicle Rule Applied

4.3 Trip Type Information

Land Use	Miles			Trip %			Trip Purpose %		
	H-W or C-W	H-S or C-C	H-O or C-NW	H-W or C-W	H-S or C-C	H-O or C-NW	Primary	Diverted	Pass-by
Apartments Mid Rise	0.00	0.00	0.00	44.00	18.80	37.20	86	11	3
University/College (4yr)	6.33	6.33	6.33	6.40	88.60	5.00	100	0	0

4.4 Fleet Mix

Land Use	LDA	LDT1	LDT2	MDV	LHD1	LHD2	MHD	HHD	OBUS	UBUS	MCY	SBUS	MH
Apartments Mid Rise	0.472891	0.048916	0.201626	0.172765	0.037062	0.008202	0.011598	0.008545	0.001485	0.000584	0.029640	0.001456	0.005230
University/College (4yr)	0.472891	0.048916	0.201626	0.172765	0.037062	0.008202	0.011598	0.008545	0.001485	0.000584	0.029640	0.001456	0.005230

5.0 Energy Detail

Historical Energy Use: N

5.1 Mitigation Measures Energy

Category	ROG	NOx	CO	SO2	Fugitive PM10	Exhaust PM10	PM10 Total	Fugitive PM2.5	Exhaust PM2.5	PM2.5 Total	Bio- CO2	NBio- CO2	Total CO2	CH4	N2O	CO2e
	lb/day										lb/day					
NaturalGas Mitigated	1.6420	14.9270	12.5387	0.0896		1.1345	1.1345		1.1345	1.1345		17,912.4079	17,912.4079	0.3433	0.3284	18,018.8524
NaturalGas Unmitigated	1.6420	14.9270	12.5387	0.0896		1.1345	1.1345		1.1345	1.1345		17,912.4079	17,912.4079	0.3433	0.3284	18,018.8524

EMFAC Off-Model Adjustment Factors for Gasoline Light Duty Vehicle to Account for the SAFE Vehicle Rule Applied

5.2 Energy by Land Use - NaturalGas

Unmitigated

	NaturalGas Use	ROG	NOx	CO	SO2	Fugitive PM10	Exhaust PM10	PM10 Total	Fugitive PM2.5	Exhaust PM2.5	PM2.5 Total	Bio- CO2	NBio- CO2	Total CO2	CH4	N2O	CO2e
Land Use	kBTU/yr	lb/day										lb/day					
Apartments Mid Rise	0	0.0000	0.0000	0.0000	0.0000		0.0000	0.0000		0.0000	0.0000		0.0000	0.0000	0.0000	0.0000	0.0000
University/College (4yr)	152255	1.6420	14.9270	12.5387	0.0896		1.1345	1.1345		1.1345	1.1345		17,912.4079	17,912.4079	0.3433	0.3284	18,018.8524
Total		1.6420	14.9270	12.5387	0.0896		1.1345	1.1345		1.1345	1.1345		17,912.4079	17,912.4079	0.3433	0.3284	18,018.8524

Mitigated

	NaturalGas Use	ROG	NOx	CO	SO2	Fugitive PM10	Exhaust PM10	PM10 Total	Fugitive PM2.5	Exhaust PM2.5	PM2.5 Total	Bio- CO2	NBio- CO2	Total CO2	CH4	N2O	CO2e
Land Use	kBTU/yr	lb/day										lb/day					
Apartments Mid Rise	0	0.0000	0.0000	0.0000	0.0000		0.0000	0.0000		0.0000	0.0000		0.0000	0.0000	0.0000	0.0000	0.0000
University/College (4yr)	152.255	1.6420	14.9270	12.5387	0.0896		1.1345	1.1345		1.1345	1.1345		17,912.4079	17,912.4079	0.3433	0.3284	18,018.8524
Total		1.6420	14.9270	12.5387	0.0896		1.1345	1.1345		1.1345	1.1345		17,912.4079	17,912.4079	0.3433	0.3284	18,018.8524

EMFAC Off-Model Adjustment Factors for Gasoline Light Duty Vehicle to Account for the SAFE Vehicle Rule Applied

6.0 Area Detail

6.1 Mitigation Measures Area

	ROG	NOx	CO	SO2	Fugitive PM10	Exhaust PM10	PM10 Total	Fugitive PM2.5	Exhaust PM2.5	PM2.5 Total	Bio- CO2	NBio- CO2	Total CO2	CH4	N2O	CO2e
Category	lb/day										lb/day					
Mitigated	91.1918	5.0210	432.7271	0.0227		2.3605	2.3605		2.3605	2.3605	0.0000	773.9238	773.9238	0.7695	0.0000	793.1619
Unmitigated	91.1918	5.0210	432.7271	0.0227		2.3605	2.3605		2.3605	2.3605	0.0000	773.9238	773.9238	0.7695	0.0000	793.1619

6.2 Area by SubCategory

Unmitigated

	ROG	NOx	CO	SO2	Fugitive PM10	Exhaust PM10	PM10 Total	Fugitive PM2.5	Exhaust PM2.5	PM2.5 Total	Bio- CO2	NBio- CO2	Total CO2	CH4	N2O	CO2e
SubCategory	lb/day										lb/day					
Architectural Coating	9.5302					0.0000	0.0000		0.0000	0.0000			0.0000			0.0000
Consumer Products	68.2779					0.0000	0.0000		0.0000	0.0000			0.0000			0.0000
Hearth	0.0000	0.0000	0.0000	0.0000		0.0000	0.0000		0.0000	0.0000	0.0000	0.0000	0.0000	0.0000	0.0000	0.0000
Landscaping	13.3837	5.0210	432.7271	0.0227		2.3605	2.3605		2.3605	2.3605		773.9238	773.9238	0.7695		793.1619
Total	91.1918	5.0210	432.7271	0.0227		2.3605	2.3605		2.3605	2.3605	0.0000	773.9238	773.9238	0.7695	0.0000	793.1619

EMFAC Off-Model Adjustment Factors for Gasoline Light Duty Vehicle to Account for the SAFE Vehicle Rule Applied

Mitigated

	ROG	NOx	CO	SO2	Fugitive PM10	Exhaust PM10	PM10 Total	Fugitive PM2.5	Exhaust PM2.5	PM2.5 Total	Bio- CO2	NBio- CO2	Total CO2	CH4	N2O	CO2e
SubCategory	lb/day										lb/day					
Architectural Coating	9.5302					0.0000	0.0000		0.0000	0.0000			0.0000			0.0000
Consumer Products	68.2779					0.0000	0.0000		0.0000	0.0000			0.0000			0.0000
Hearth	0.0000	0.0000	0.0000	0.0000		0.0000	0.0000		0.0000	0.0000	0.0000	0.0000	0.0000	0.0000	0.0000	0.0000
Landscaping	13.3837	5.0210	432.7271	0.0227		2.3605	2.3605		2.3605	2.3605		773.9238	773.9238	0.7695		793.1619
Total	91.1918	5.0210	432.7271	0.0227		2.3605	2.3605		2.3605	2.3605	0.0000	773.9238	773.9238	0.7695	0.0000	793.1619

EMFAC Off-Model Adjustment Factors for Gasoline Light Duty Vehicle to Account for the SAFE Vehicle Rule Applied

**CSUMB - Existing Campus
Monterey Bay Unified APCD Air District, Winter**

1.0 Project Characteristics

1.1 Land Usage

Land Uses	Size	Metric	Lot Acreage	Floor Surface Area	Population
University/College (4yr)	6,634.00	Student	27.99	1,142,777.00	0
Apartments Mid Rise	5,200.00	Dwelling Unit	136.84	2,047,779.00	7097

1.2 Other Project Characteristics

Urbanization	Urban	Wind Speed (m/s)	2.8	Precipitation Freq (Days)	53
Climate Zone	4			Operational Year	2018
Utility Company	Pacific Gas and Electric Company				
CO2 Intensity (lb/MWhr)	203.98	CH4 Intensity (lb/MWhr)	0.033	N2O Intensity (lb/MWhr)	0.004

1.3 User Entered Comments & Non-Default Data

Project Characteristics - CSUMB Master Plan. MBUAPCD.

Land Use - Existing campus includes 1,142,777 SF of campus facilities and 3,980 beds/1,220 DU. 6,634 FTE students in 2016-17 and 463 DU occuied by staff/faculty.

Construction Phase - Modeling operations only.

Vehicle Trips - Update trip rate and trip length per TRA. Assumed 100% primary trips. Based Sunday trip rates from Junior College land use since Univeristy default is 0.

Woodstoves - Assumed no fireplaces.

Area Coating - Use of low-VOC (50 g/L) arch coatings.

Energy Use - Updated energy intensities per provided consumption data.

EMFAC Off-Model Adjustment Factors for Gasoline Light Duty Vehicle to Account for the SAFE Vehicle Rule Applied

Water And Wastewater - Revised water and wastewater based on consumption data provided by CSUMB.

Solid Waste - Default solid waste generation rates assumed.

Table Name	Column Name	Default Value	New Value
tblAreaCoating	Area_EF_Nonresidential_Exterior	150	50
tblAreaCoating	Area_EF_Nonresidential_Interior	150	50
tblAreaCoating	Area_EF_Residential_Exterior	100	50
tblAreaCoating	Area_EF_Residential_Interior	100	50
tblAreaCoating	Area_Nonresidential_Exterior	571390	609655
tblAreaCoating	Area_Nonresidential_Interior	1714170	1828965
tblAreaCoating	Area_Residential_Exterior	1382252	3142800
tblAreaCoating	Area_Residential_Interior	4146755	9428400
tblEnergyUse	LightingElect	741.44	0.00
tblEnergyUse	LightingElect	2.91	3.83
tblEnergyUse	NT24E	3,054.10	0.00
tblEnergyUse	NT24E	2.27	2.99
tblEnergyUse	NT24NG	3,155.00	0.00
tblEnergyUse	NT24NG	3.30	6.71
tblEnergyUse	T24E	70.89	0.00
tblEnergyUse	T24E	2.44	3.21
tblEnergyUse	T24NG	5,226.68	0.00
tblEnergyUse	T24NG	20.62	41.92
tblFireplaces	NumberGas	5,200.00	0.00
tblFireplaces	NumberNoFireplace	0.00	5,200.00
tblLandUse	LandUseSquareFeet	1,219,312.41	1,142,777.00
tblLandUse	LandUseSquareFeet	5,200,000.00	2,047,779.00

EMFAC Off-Model Adjustment Factors for Gasoline Light Duty Vehicle to Account for the SAFE Vehicle Rule Applied

tblLandUse	Population	14,872.00	7,097.00
tblSolidWaste	SolidWasteGenerationRate	2,392.00	2,141.76
tblVehicleTrips	CC_TL	7.30	6.33
tblVehicleTrips	CNW_TL	7.30	6.33
tblVehicleTrips	CW_TL	9.50	6.33
tblVehicleTrips	DV_TP	9.00	0.00
tblVehicleTrips	HO_TL	7.50	0.00
tblVehicleTrips	HS_TL	7.30	0.00
tblVehicleTrips	HW_TL	10.80	0.00
tblVehicleTrips	PR_TP	91.00	100.00
tblVehicleTrips	ST_TR	4.91	0.00
tblVehicleTrips	ST_TR	1.30	3.54
tblVehicleTrips	SU_TR	4.09	0.00
tblVehicleTrips	SU_TR	0.00	0.25
tblVehicleTrips	WD_TR	5.44	0.00
tblVehicleTrips	WD_TR	1.56	4.25
tblWater	IndoorWaterUseRate	338,800,933.23	0.00
tblWater	IndoorWaterUseRate	14,204,057.40	32,827,469.00
tblWater	OutdoorWaterUseRate	213,591,892.69	0.00
tblWater	OutdoorWaterUseRate	22,216,602.60	21,879,743.00

EMFAC Off-Model Adjustment Factors for Gasoline Light Duty Vehicle to Account for the SAFE Vehicle Rule Applied

2.0 Emissions Summary

2.2 Overall Operational

Unmitigated Operational

	ROG	NOx	CO	SO2	Fugitive PM10	Exhaust PM10	PM10 Total	Fugitive PM2.5	Exhaust PM2.5	PM2.5 Total	Bio- CO2	NBio- CO2	Total CO2	CH4	N2O	CO2e
Category	lb/day										lb/day					
Area	91.1918	5.0210	432.7271	0.0227		2.3605	2.3605		2.3605	2.3605	0.0000	773.9238	773.9238	0.7695	0.0000	793.1619
Energy	1.6420	14.9270	12.5387	0.0896		1.1345	1.1345		1.1345	1.1345		17,912.4079	17,912.4079	0.3433	0.3284	18,018.8524
Mobile	123.3493	206.2309	1,176.0031	1.6402	137.3367	2.6904	140.0271	36.6709	2.5394	39.2102		166,874.4053	166,874.4053	16.8836	11.2223	170,640.7408
Total	216.1830	226.1789	1,621.2689	1.7524	137.3367	6.1853	143.5220	36.6709	6.0343	42.7052	0.0000	185,560.7371	185,560.7371	17.9965	11.5507	189,452.7551

Mitigated Operational

	ROG	NOx	CO	SO2	Fugitive PM10	Exhaust PM10	PM10 Total	Fugitive PM2.5	Exhaust PM2.5	PM2.5 Total	Bio- CO2	NBio- CO2	Total CO2	CH4	N2O	CO2e
Category	lb/day										lb/day					
Area	91.1918	5.0210	432.7271	0.0227		2.3605	2.3605		2.3605	2.3605	0.0000	773.9238	773.9238	0.7695	0.0000	793.1619
Energy	1.6420	14.9270	12.5387	0.0896		1.1345	1.1345		1.1345	1.1345		17,912.4079	17,912.4079	0.3433	0.3284	18,018.8524
Mobile	123.3493	206.2309	1,176.0031	1.6402	137.3367	2.6904	140.0271	36.6709	2.5394	39.2102		166,874.4053	166,874.4053	16.8836	11.2223	170,640.7408
Total	216.1830	226.1789	1,621.2689	1.7524	137.3367	6.1853	143.5220	36.6709	6.0343	42.7052	0.0000	185,560.7371	185,560.7371	17.9965	11.5507	189,452.7551

EMFAC Off-Model Adjustment Factors for Gasoline Light Duty Vehicle to Account for the SAFE Vehicle Rule Applied

4.0 Operational Detail - Mobile

4.1 Mitigation Measures Mobile

Category	ROG	NOx	CO	SO2	Fugitive PM10	Exhaust PM10	PM10 Total	Fugitive PM2.5	Exhaust PM2.5	PM2.5 Total	Bio- CO2	NBio- CO2	Total CO2	CH4	N2O	CO2e
lb/day											lb/day					
Mitigated	123.3493	206.2309	1,176.0031	1.6402	137.3367	2.6904	140.0271	36.6709	2.5394	39.2102		166,874.405	166,874.40	16.8836	11.2223	170,640.740
Unmitigated	123.3493	206.2309	1,176.0031	1.6402	137.3367	2.6904	140.0271	36.6709	2.5394	39.2102		166,874.405	166,874.40	16.8836	11.2223	170,640.740

4.2 Trip Summary Information

Land Use	Average Daily Trip Rate			Unmitigated	Mitigated
	Weekday	Saturday	Sunday	Annual VMT	Annual VMT
Apartments Mid Rise	0.00	0.00	0.00		
University/College (4yr)	28,194.50	23,484.36	1,658.50	54,678,532	54,678,532
Total	28,194.50	23,484.36	1,658.50	54,678,532	54,678,532

4.3 Trip Type Information

Land Use	Miles			Trip %			Trip Purpose %		
	H-W or C-W	H-S or C-C	H-O or C-NW	H-W or C-W	H-S or C-C	H-O or C-NW	Primary	Diverted	Pass-by
Apartments Mid Rise	0.00	0.00	0.00	44.00	18.80	37.20	86	11	3
University/College (4yr)	6.33	6.33	6.33	6.40	88.60	5.00	100	0	0

4.4 Fleet Mix

Land Use	LDA	LDT1	LDT2	MDV	LHD1	LHD2	MHD	HHD	OBUS	UBUS	MCY	SBUS	MH
Apartments Mid Rise	0.472891	0.048916	0.201626	0.172765	0.037062	0.008202	0.011598	0.008545	0.001485	0.000584	0.029640	0.001456	0.005230
University/College (4yr)	0.472891	0.048916	0.201626	0.172765	0.037062	0.008202	0.011598	0.008545	0.001485	0.000584	0.029640	0.001456	0.005230

EMFAC Off-Model Adjustment Factors for Gasoline Light Duty Vehicle to Account for the SAFE Vehicle Rule Applied

5.0 Energy Detail

Historical Energy Use: N

5.1 Mitigation Measures Energy

	ROG	NOx	CO	SO2	Fugitive PM10	Exhaust PM10	PM10 Total	Fugitive PM2.5	Exhaust PM2.5	PM2.5 Total	Bio- CO2	NBio- CO2	Total CO2	CH4	N2O	CO2e
Category	lb/day										lb/day					
NaturalGas Mitigated	1.6420	14.9270	12.5387	0.0896		1.1345	1.1345		1.1345	1.1345		17,912.4079	17,912.4079	0.3433	0.3284	18,018.8524
NaturalGas Unmitigated	1.6420	14.9270	12.5387	0.0896		1.1345	1.1345		1.1345	1.1345		17,912.4079	17,912.4079	0.3433	0.3284	18,018.8524

EMFAC Off-Model Adjustment Factors for Gasoline Light Duty Vehicle to Account for the SAFE Vehicle Rule Applied

5.2 Energy by Land Use - NaturalGas

Unmitigated

	NaturalGas Use	ROG	NOx	CO	SO2	Fugitive PM10	Exhaust PM10	PM10 Total	Fugitive PM2.5	Exhaust PM2.5	PM2.5 Total	Bio- CO2	NBio- CO2	Total CO2	CH4	N2O	CO2e	
Land Use	kBTU/yr	lb/day										lb/day						
Apartments Mid Rise	0	0.0000	0.0000	0.0000	0.0000		0.0000	0.0000		0.0000	0.0000		0.0000	0.0000	0.0000	0.0000	0.0000	0.0000
University/College (4yr)	152255	1.6420	14.9270	12.5387	0.0896		1.1345	1.1345		1.1345	1.1345		17,912.4079	17,912.4079	0.3433	0.3284	18,018.8524	
Total		1.6420	14.9270	12.5387	0.0896		1.1345	1.1345		1.1345	1.1345		17,912.4079	17,912.4079	0.3433	0.3284	18,018.8524	

Mitigated

	NaturalGas Use	ROG	NOx	CO	SO2	Fugitive PM10	Exhaust PM10	PM10 Total	Fugitive PM2.5	Exhaust PM2.5	PM2.5 Total	Bio- CO2	NBio- CO2	Total CO2	CH4	N2O	CO2e	
Land Use	kBTU/yr	lb/day										lb/day						
Apartments Mid Rise	0	0.0000	0.0000	0.0000	0.0000		0.0000	0.0000		0.0000	0.0000		0.0000	0.0000	0.0000	0.0000	0.0000	0.0000
University/College (4yr)	152.255	1.6420	14.9270	12.5387	0.0896		1.1345	1.1345		1.1345	1.1345		17,912.4079	17,912.4079	0.3433	0.3284	18,018.8524	
Total		1.6420	14.9270	12.5387	0.0896		1.1345	1.1345		1.1345	1.1345		17,912.4079	17,912.4079	0.3433	0.3284	18,018.8524	

EMFAC Off-Model Adjustment Factors for Gasoline Light Duty Vehicle to Account for the SAFE Vehicle Rule Applied

6.0 Area Detail

6.1 Mitigation Measures Area

	ROG	NOx	CO	SO2	Fugitive PM10	Exhaust PM10	PM10 Total	Fugitive PM2.5	Exhaust PM2.5	PM2.5 Total	Bio- CO2	NBio- CO2	Total CO2	CH4	N2O	CO2e
Category	lb/day										lb/day					
Mitigated	91.1918	5.0210	432.7271	0.0227		2.3605	2.3605		2.3605	2.3605	0.0000	773.9238	773.9238	0.7695	0.0000	793.1619
Unmitigated	91.1918	5.0210	432.7271	0.0227		2.3605	2.3605		2.3605	2.3605	0.0000	773.9238	773.9238	0.7695	0.0000	793.1619

6.2 Area by SubCategory

Unmitigated

	ROG	NOx	CO	SO2	Fugitive PM10	Exhaust PM10	PM10 Total	Fugitive PM2.5	Exhaust PM2.5	PM2.5 Total	Bio- CO2	NBio- CO2	Total CO2	CH4	N2O	CO2e
SubCategory	lb/day										lb/day					
Architectural Coating	9.5302					0.0000	0.0000		0.0000	0.0000			0.0000			0.0000
Consumer Products	68.2779					0.0000	0.0000		0.0000	0.0000			0.0000			0.0000
Hearth	0.0000	0.0000	0.0000	0.0000		0.0000	0.0000		0.0000	0.0000	0.0000	0.0000	0.0000	0.0000	0.0000	0.0000
Landscaping	13.3837	5.0210	432.7271	0.0227		2.3605	2.3605		2.3605	2.3605		773.9238	773.9238	0.7695		793.1619
Total	91.1918	5.0210	432.7271	0.0227		2.3605	2.3605		2.3605	2.3605	0.0000	773.9238	773.9238	0.7695	0.0000	793.1619

EMFAC Off-Model Adjustment Factors for Gasoline Light Duty Vehicle to Account for the SAFE Vehicle Rule Applied

Mitigated

	ROG	NOx	CO	SO2	Fugitive PM10	Exhaust PM10	PM10 Total	Fugitive PM2.5	Exhaust PM2.5	PM2.5 Total	Bio- CO2	NBio- CO2	Total CO2	CH4	N2O	CO2e
SubCategory	lb/day										lb/day					
Architectural Coating	9.5302					0.0000	0.0000		0.0000	0.0000			0.0000			0.0000
Consumer Products	68.2779					0.0000	0.0000		0.0000	0.0000			0.0000			0.0000
Hearth	0.0000	0.0000	0.0000	0.0000		0.0000	0.0000		0.0000	0.0000	0.0000	0.0000	0.0000	0.0000	0.0000	0.0000
Landscaping	13.3837	5.0210	432.7271	0.0227		2.3605	2.3605		2.3605	2.3605		773.9238	773.9238	0.7695		793.1619
Total	91.1918	5.0210	432.7271	0.0227		2.3605	2.3605		2.3605	2.3605	0.0000	773.9238	773.9238	0.7695	0.0000	793.1619

Hours of Operation for Construction Equipment

Phase	Equipment Type	Number of Equipment	Hours/day	Phase Duration	Hours of Equipment Use	Phase Hours Subtotals	Total Hours Over Buildout
Demolition	Concrete/Industrial Saws	1	8		20	160	
Demolition	Excavators	3	8		20	480	
Demolition	Rubber Tired Dozers	2	8		20	320	960 4,800
Site Preparation	Rubber Tired Dozers	3	8		10	240	
Site Preparation	Tractors/Loaders/Backhoes	4	8		10	320	560 2,800
Grading	Graders	1	8		20	160	
Grading	Rubber Tired Dozers	1	8		20	160	
Grading	Tractors/Loaders/Backhoes	2	7		20	280	
Grading	Trenchers	1	8		20	160	760 3,800
Building Construction	Cranes	1	7		230	1,610	
Building Construction	Forklifts	3	8		230	5,520	
Building Construction	Generator Sets	1	8		230	1,840	
Building Construction	Tractors/Loaders/Backhoes	3	7		230	4,830	
Building Construction	Welders	3	7		230	4,830	18,630 93,150
Paving	Pavers	2	8		20	320	
Paving	Paving Equipment	2	8		20	320	
Paving	Rollers	2	8		20	320	960 4,800
Architectural Coating	Air Compressors	1	6		20	120	120 600
Total					21,990		109,950

Construction Equipment Diesel Demand

Phase	Pieces of Equipment	Equipment CO2 (MT)	Kg/CO2/Gallon	Gallons (2022-2023)	Gallons (Buildout)
Demolition	6	33.99	10.21	3,329.09	16,645.45
Site Preparation	7	16.72	10.21	1,637.58	8,187.90
Grading	5	26.05	10.21	2,551.89	12,759.45
Building Construction	11	266.49	10.21	26,101.08	130,505.39
Paving	6	20.03	10.21	1,961.50	9,807.49
Architectural Coating	1	2.55	10.21	250.08	1,250.39
Total				35,831.21	179,156.07

Construction Worker Gasoline Demand

Phase	Trips	Vehicle CO2 (MT)	Kg/CO2/Gallon	Gallons (2022-2023)	Gallons (Buildout)
Demolition	300	1.02	8.78	116.42	582.12
Site Preparation	180	0.61	8.78	69.85	349.26
Grading	300	1.02	8.78	116.42	582.12
Building Construction	36,570	124.28	8.78	14,154.70	70,773.52
Paving	300	0.99	8.78	112.89	564.46
Architectural Coating	640	2.11	8.78	240.84	1,204.21
Total				14,811.14	74,055.69

Construction Vendor Truck Diesel Demand

Phase	Trips	Vehicle CO2 (MT)	Kg/CO2/Gallon	Gallons (2022-2023)	Gallons (Buildout)
Demolition	0	0.00	10.21	0.00	0.00
Site Preparation	0	0.00	10.21	0.00	0.00
Grading	0	0.00	10.21	0.00	0.00
Building Construction	14,260	146.14	10.21	14,313.05	71,565.23
Paving	0	0.00	10.21	0.00	0.00
Architectural Coating	0	0.00	10.21	0.00	0.00
Total				14,313.05	71,565.23

Construction Haul Truck Diesel Demand

Phase	Trips	Vehicle CO2 (MT)	Kg/CO2/Gallon	Gallons (2022-2023)	Gallons (Buildout)
Demolition	200	6.05	10.21	592.28	2,961.41
Site Preparation	0	0.00	10.21	0.00	0.00
Grading	0	0.00	10.21	0.00	0.00
Paving	0	0.00	10.21	0.00	0.00
Building Construction	0	0.00	10.21	0.00	0.00
Architectural Coating	0	0.00	10.21	0.00	0.00
Total				592.28	2,961.41

CSUMB - Operational Petroleum Consumption

	Annual CO2 MT	% GAS	% DSL	MT CO2 GAS	MT CO2 DSL	Diesel kg CO2/Gallons	Gasoline kg CO2/Gallons	Diesel Gallons/yr	Gasoline Gallons/yr	Petro Gallons/yr
Project - Buildout	19,156.53	92.58%	7.42%	17,735.84	1,420.69	10.21	8.78	139,146.55	2,020,027.29	2,159,173.84
Project - Existing	17,244.28	95.08%	4.92%	16,395.73	848.56	10.21	8.78	83,110.36	1,867,394.97	1,950,505.33
									Net Increase	208,668.51

APPENDIX E
Biological Resources Report

INTENTIONALLY LEFT BLANK

DRAFT BIOLOGICAL RESOURCES REPORT

PROPOSED CALIFORNIA STATE UNIVERSITY, MONTEREY BAY MASTER PLAN AND NEAR-TERM DEVELOPMENT COMPONENTS

FEBRUARY 2022



PREPARED BY:



Denise Duffy & Associates, Inc.
Contact: Erin Harwayne, AICP
947 Cass Street, Suite 5
Monterey, California 93940

PREPARED FOR:

California State University, Monterey Bay
Contact: Anya Spear
Director of Strategic Initiatives, CSUMB Office of the President
100 Campus Center, Building 1
Seaside, California 93955

This page left intentionally blank

TABLE OF CONTENTS

1.0 PROJECT SUMMARY	3
1.1 Summary of Results	3
2.0 INTRODUCTION	7
2.1 Project Location and Area	7
2.2 Project Description	7
3.0 METHODS	18
3.1 Personnel and Survey Dates	18
3.2 Special-Status Species	20
3.3 Sensitive Habitats	21
3.4 Data Sources	21
3.5 Regulatory Setting	23
4.0 RESULTS	30
4.1 Vegetation Types	30
4.2 Special-Status Species	38
4.3 Sensitive Habitats	60
5.0 IMPACTS AND MITIGATION	62
5.1 Impact Analysis Approach	62
5.2 Impacts and Mitigation Measures – Master Plan	64
5.3 Impacts and Mitigation Measures – Near-Term Development Components	73
6.0 REFERENCES	78
APPENDIX A: SPECIAL-STATUS SPECIES TABLE	
APPENDIX B: CNDDDB OCCURRENCE REPORT	
APPENDIX C: IPAC RESOURCES LIST FOR CSUMB CAMPUS	
APPENDIX D: THE BIRDS OF FORT ORD EAST OF ROUTE 1	

FIGURES

Figure 1. Project Location.....	10
Figure 2. CSUMB Campus	11
Figure 3. Implementation Plan and Near-Term Project Sites	12
Figure 4. Near-Term Development Component Sites	14
Figure 5. Survey Areas	19
Figure 6. Vegetation Types.....	31
Figure 7. Special-Status Plants Observed	33
Figure 8. Former Fort Ord CTS Aquatic Resources	42
Figure 9. CTS Upland Habitat – USFWS Analysis	44
Figure 10. CTS Upland Habitat – CDFW Analysis.....	45
Figure 11. CRLF Aquatic Resources	49
Figure 12. Smith’s Blue Butterfly Potential Habitat Observed.....	50
Figure 13. Special-Status Plant CNDDDB Occurrences within Project Site.....	55

TABLES

Table 3-1. Biological Survey Dates within the Project Site.....	18
Table 4-1. Vegetation Types within the Project Site ¹	30
Table 4-2. Vegetation Types within the Near-Term Development Sites and Staging Areas.....	30
Table 4-2. Potential for Special-Status Wildlife Species Presence within the Project Site	39
Table 4-3. Area of Potential CTS Habitat within the Project Site	43
Table 4-4. Potential for Special-Status Plant Species Presence within the Project Site	52
Table 4-5. Area of Special-Status Plant Species within the Survey Area.....	53

1.0 PROJECT SUMMARY

The Project consists of the proposed California State University Monterey Bay (CSUMB) Master Plan (proposed Master Plan), including Project Design Features (PDFs) drawn from the 2019 CSUMB Master Plan Guidelines (Master Plan Guidelines¹), and five “near-term” development components to be constructed pursuant to the proposed Master Plan (collectively, the Project). The Project would provide a blueprint for land uses and building and facility space requirements to support a campus enrollment of 12,700 full-time-equivalent (FTE) students and 1,776 FTE faculty and staff by the year 2035. The campus is located on approximately 1,396 acres of land within the former Fort Ord military base, in Monterey County, California. This report presents the findings of a biological resources assessment conducted by Denise Duffy & Associates, Inc. (DD&A) for the Project. The emphasis of this study is to describe existing and potential biological resources within and surrounding the Project site, assess potential impacts to biological resources that may result from implementation of the proposed Master Plan, and recommend appropriate mitigation measures necessary to reduce those impacts in accordance with the California Environmental Quality Act (CEQA). This analysis evaluates potential impacts to sensitive biological resources within the Project site at a programmatic-level commensurate with the conceptual level of project information available and the approval being considered. In addition, this analysis addresses specific development projects expected to be constructed in the next ten years, which are referred to as “near-term development components.” The five near-term development components are described and evaluated at a project-specific level in this study.

1.1 Summary of Results

Five vegetation types were observed within the Project site: coast live oak woodland, central maritime chaparral, central coastal scrub, non-native grassland, and ruderal/disturbed. In addition, several areas were identified where these vegetation types intergrade with one another and some areas are developed. Central maritime chaparral habitat (including the central maritime chaparral/non-native grassland, central maritime chaparral/central coastal scrub, and central maritime chaparral/coast live oak woodland mix habitats) are listed as sensitive on the California Department of Fish and Wildlife’s (CDFW’s) *Natural Communities List* (CDFW, 2010).

Several special-status plant species are known or have the potential to occur within the Project site based on observations, presence of appropriate habitat, and known occurrences within the vicinity. Please refer to **Appendix A** and **Section 4.0 “Results”** for an analysis of each species within the Project site. All other species evaluated have a low potential to occur but are unlikely to be impacted, are assumed “unlikely to occur,” or were determined “not present” within the Project site for the species-specific reasons presented in **Appendix A**.

The special-status wildlife species that are known to or have been determined to have a moderate or high potential to occur within or immediately adjacent the Project site are discussed below. All other species presented in **Appendix A** are assumed “unlikely to occur” or have a low potential to occur but are unlikely to be impacted for the species-specific reasons presented. Although the likelihood for California red-legged

¹ The Master Plan Guidelines were made available to the general public and local agencies for review and comment in 2017 under the title CSUMB Comprehensive Master Plan. Since that time the title has been changed to Master Plan Guidelines.

frog (CRLF) to occur within the Project site is unlikely, a discussion of this species is included below as this is a federally listed species that is known to occur in other portions of the former Fort Ord.

The following special-status wildlife species are known or have been determined to have a moderate or high potential to occur within or immediately adjacent the Project site:

- Townsend’s big-eared bat (*Corynorhinus townsendii*) – CSC²,
- Hoary bat (*Lasiurus cinereus*) – CNDDDB,
- Monterey dusky-footed woodrat (*Neotoma macrotis fuscipes*) – CSC,
- Monterey shrew (*Sorex ornatus salarius*) – CSC/HMP,
- American badger (*Taxidea taxus*) – CSC,
- California tiger salamander (CTS, *Ambystoma californiense*) – FT/ST/HMP,
- Northern California legless lizard (*Anniella pulchra*) – CSC/HMP,
- Coast horned lizard (*Phrynosoma blainvillii*) – CSC,
- Obscure bumble bee (*Bombus caliginosus*) – CNDDDB,
- Western bumble bee (*Bombus occidentalis*) – CNDDDB,
- Smith’s blue butterfly (SBB, *Euphilotes enoptes smithi*) – FE/HMP, and
- Nesting raptors and other protected avian species, including:
 - Burrowing owl (*Athene cunicularia*) – CSC,
 - White-tailed kite (*Elanus leucurus*) – CFP, and
 - California horned lark (*Eremophila alpestris actia*) – CNDDDB.

The following special-status plant species are known or have been determined to have a moderate or high potential to occur within or immediately adjacent the Project site:

- Toro manzanita (*Arctostaphylos montereyensis*) – CRPR 1B/HMP,
- Sandmat manzanita (*A. pumila*) – CRPR 1B/HMP,
- Pajaro manzanita (*A. pajaorensis*) – CRPR 1B,
- Hooker’s manzanita (*A. hookeri*) – CRPR 1B/HMP,
- Monterey ceanothus (*Ceanothus rigidus*) – CRPR 4/HMP,
- Fort Ord spineflower (*Chorizanthe minutiflora*) – CRPR 1B,
- Monterey spineflower (*C. pungens* var. *pungens*) – FT/CRPR 1B/HMP,
- Seaside bird’s-beak (*Cordylanthus rigidus* ssp. *littoralis*) – SE/CRPR 1B/HMP,
- Eastwood’s goldenbush (*Ericameria fasciculata*) – CRPR 1B/HMP,
- Sand-loving wallflower (*Erysimum ammophilum*) – CRPR 1B/HMP,
- Sand gilia (*Gilia tenuiflora* ssp. *arenaria*) – FE/ST/CRPR 1B/HMP,
- Kellogg’s horkelia (*Horkelia cuneata* var. *sericea*) – CRPR 1B,
- Point Reyes horkelia (*H. marinensis*) – CRPR 1B,
- Marsh microseris (*Microseris paludosa*) – CRPR 1B,
- Northern curly-leaved monardella (*Monardella sinuata* ssp. *nigrescens*) – CRPR 1B,

² Status Definitions – FE – Federally endangered, FT: Federally threatened; ST: State threatened; CSC: California Species of Concern; CFP: California Fully Protected Species; HMP: Fort Ord Habitat Management Plan Species; CRPR 1B: California Native Plant Society (CNPS) California Rare Plant Rank (CRPR) 1B Species (rare, threatened, or endangered in California and elsewhere); CRPR 4: CNPS CRPR 4 Species (plants of limited distribution – a watch list); CNDDDB: animal species on the CNDDDB “Special Animals” list that are not assigned any of the other status designations but the CDFW considers to be those of greatest conservation need, regardless of their legal or protection status.

- Woodland woollythreads (*Monolopia gracilens*) – CRPR 1B,
- Yadon’s piperia (*Piperia yadonii*) – FE/CRPR 1B/HMP,
- Santa Cruz microseris (*Stebbinsoseris decipiens*) – CRPR 1B,
- Santa Cruz clover (*Trifolium buckwestiorum*) – CRPR 1B, and
- Pacific Grove clover (*T. polyodon*) – CRPR 1B.

The proposed near-term development components are generally located on sites that have been disturbed and are mostly developed. However, the construction of the near-term development components may result in direct loss of individuals and habitat for a number of special-status wildlife species, including special-status bat species, Monterey dusky-footed woodrat, Northern California legless lizard, and nesting raptors and other protected avian species. In addition, the construction of the near-term development components may also result in direct loss of individuals and habitat for Monterey spineflower.

The implementation of the proposed Master Plan or near-term development components would not result in significant impacts to any sensitive biological resources known or with the potential to occur within the Project site with implementation of the mitigation identified in **Sections 5.2** and **5.3**.

This page left intentionally blank

2.0 INTRODUCTION

The Project consists of the proposed Master Plan, including PDFs drawn from the CSUMB Master Plan Guidelines (Master Plan Guidelines), and more detailed evaluation of five “near-term” development components to be constructed pursuant to the proposed Master Plan (collectively, the Project). The Project would provide a blueprint for land uses and building and facility space requirements to support a campus enrollment of 12,700 FTE students and 1,776 FTE faculty and staff by the year 2035. The campus is located on approximately 1,396 acres of land within the former Fort Ord military base, in Monterey County, California (**Figure 1**). This report presents the findings of a biological resources assessment conducted by DD&A for the Project. The emphasis of this study is to describe existing and potential biological resources within and surrounding the Project, assess potential impacts to biological resources that may result from implementation of the proposed Master Plan, and recommend appropriate mitigation measures necessary to reduce those impacts in accordance with CEQA. This analysis evaluates potential impacts to sensitive biological resources within the Project site at a programmatic level commensurate with the conceptual level of project information available and the approval being considered. In addition, this analysis addresses specific development projects expected to be constructed in the next ten years, which are referred to as “near-term Development components.” The five near-term development components are described and evaluated at a project-specific level in this study.

2.1 Project Location and Area

The Project site is located at the existing CSUMB campus, on the former U.S. Department of the Army (Army) military facility known as Fort Ord. The CSUMB campus is approximately 100 miles south of San Francisco and is located north of the Monterey Peninsula and west of the Salinas Valley, as shown in **Figure 1**. Portions of the existing CSUMB campus are within the city boundaries of Seaside and Marina, and within the unincorporated Monterey County, as shown in **Figure 2**.

2.2 Project Description

2.2.1 Master Plan

As indicated previously, the Project would provide a blueprint for land uses and building and facility space requirements to support an on-campus enrollment of 12,700 full-time-equivalent students (FTES³) and 1,776 FTE faculty and staff by the year 2035. Achieving this growth would result in an increase of approximately 6,066 FTES and 752 FTE faculty/staff over existing levels in academic year 2016-2017, which were 6,634 FTES and 1,024 FTE faculty/staff.

The Project also would result in a net increase of approximately 2.6 million gross square feet (GSF) of new academic, administration, student life, athletic and recreational, and institutional partnership⁴ facilities, and housing (see **Table 2-1**). On-campus housing would be constructed sufficient to continue to accommodate 60 percent of FTES and existing housing would accommodate 65 percent of FTE faculty and staff, with a projected increase of 3,820 student beds and 757 converted residential units for faculty

³ Full-time equivalent student (FTES) is the unit of measurement used to convert class load to student enrollment. At CSUMB, one FTES is equal to 15 units. Thus, one FTES is equal to one student enrolled in 15 units or three students each enrolled in 5 units. A related unit of measurement is “headcount.” In the case of one student taking 15 units, the headcount is 1; in the case of three students collectively taking 15 units, the headcount is 3.

⁴ Institutional partnerships are projects involving public-public or public-private partnerships and long-term contractual relationships that use or develop CSU real property to further the educational mission of the campus.

and staff. The Project also would accommodate redevelopment and growth in outdoor athletics and recreation facilities to serve campus needs, with space set aside for additional athletic fields, tennis courts, and pools, as well as for replacement of the existing stadium, field house, and pool house.

Table 2-1. Proposed Master Plan Development

Campus Space	Beds/Units	GSF ¹	Implementation	
			Horizon I	Horizon II
<i>Existing Space (2016-2017)</i>				
Main Campus Facilities (Non-Residential) ²	—	1,142,777	NA	
Student Housing Main Campus	2,600 beds	1,171,264	NA	
Student Housing East Campus Housing ³	1,380 beds / 466 units			
Faculty, Staff & Community Partners Housing (East Campus Housing) ⁴	754 units	876,515	NA	
Total Existing Space	3,980 beds / 1,220 units	3,190,556	NA	
<i>Approved but not Constructed Project</i>				
Monterey Bay Charter School	—	60,000	✓	
Total Pending or Approved Space	—	60,000	✓	
<i>Proposed Master Plan - New Development⁵</i>				
Academic Space		403,160		
• Academic IV		95,000	✓	
• Academic V		76,704	✓	
• Academic VI	—	76,704		✓
• Academic VII		76,704		✓
• Academic VIII		76,704		✓
• Greenhouses ⁶		1,344	✓	
Institutional Partnerships - Panetta Institute	—	64,000	✓	
Administration Buildings	—	77,454	✓	
“Student Life” Buildings		270,764		
• Childcare Center		23,000	✓	
• Student Life Space (Phase I and II) ⁶	—	145,473	✓	
• Campus Arts & Auditorium		82,291		✓
• Student Union Phase II		20,000		✓
Indoor Recreation Buildings and Facilities		165,343		
• Recreation Center (Phase I and II)	—	70,000	✓	
• Recreation Center Addition (Phase III)		64,574		✓
• Wellness Center		30,769	✓	
Outdoor Athletics & Recreation Support	—	59,679		
• Stadium House		40,177	✓	
• Otter Retail Space		10,502	✓	
• Aquatics Center	—	7,000		✓
• Field House		2,000	✓	
Facilities Building		73,590		
• Facilities Building	—	23,590	✓	
• Facilities Storage Buildings		50,000	✓	
Housing	3,820 beds / 757 units	1,760,000		
• East Campus Housing Conversion ⁷	-1,380 beds / 757 units	NA	✓	

Table 2-1. Proposed Master Plan Development



Campus Space	Beds/Units	GSF ¹	Implementation	
			Horizon I	Horizon II
• Student Housing Phase IIB	400 beds	160,000	✓	
• Student Housing Phase III	600 beds	200,000	✓	
• Student Housing Phase IV	600 beds	200,000	✓	
• Student Housing Phase V	600 beds	200,000	✓	
• Student Housing Phase VI	600 beds	200,000	✓	
• Student Housing Phase VII	600 beds	200,000		✓
• Student Housing Phase VIII	600 beds	200,000		✓
• Student Housing Phase IX	600 beds	200,000		✓
• Student Housing Phase X	600 beds	200,000		✓
Total New Space with Master Plan⁷	3,820 beds / 757 units	2,873,990	NA	
Existing Building	3,980 beds / 1,220 units	3,190,556	NA	
Approved and Pending Building Projects	NA	60,000	NA	
Total New Building Space with Master Plan⁷	3,820 beds / 757 units	2,873,990	NA	
Total Building Space to be Demolished	NA	-256,366	NA	
Net Increase in Building Space with Master Plan⁶	3,820 beds / 757 units	2,617,624	NA	
TOTAL FUTURE BUILDING SPACE	7,800 beds / 1,220 units	5,868,180	NA	

As part of the Project, numerous PDFs are included that address various topics including open space, transportation, water and wastewater systems, energy systems and greenhouse gas reduction, and design. For example, transportation PDFs will enhance and expand the campus’ existing Transportation Demand Management (TDM) program in order to further reduce vehicle trips and prioritize pedestrian and bicycle movement.

As noted above, the Project includes specific development components identified in the proposed Master Plan and expected to be constructed in the next 10 years; these Project components are referred to throughout this EIR as “near-term development components.” These near-term development components include: (1) Student Housing Phase III (600 student housing beds); (2) Academic IV (95,000 GSF of classroom/instructional space); (3) Student Recreation Center (70,000 GSF of recreation space); (4) Student Housing Phase IIB (400 student housing beds); and (5) Academic V (76,700 GSF of classroom/instructional space).

Portions of the campus not currently proposed for development under this Project could be the subject of future development proposals. Such development proposals could be institutional partnerships or campus projects. Environmental review under CEQA would be pursued if and when such development proposals are pursued.

See CSUMB Master Plan Draft EIR Chapter 3, Project Description for additional details for the Project.

 Former Fort Ord Boundary
 CSUMB Campus

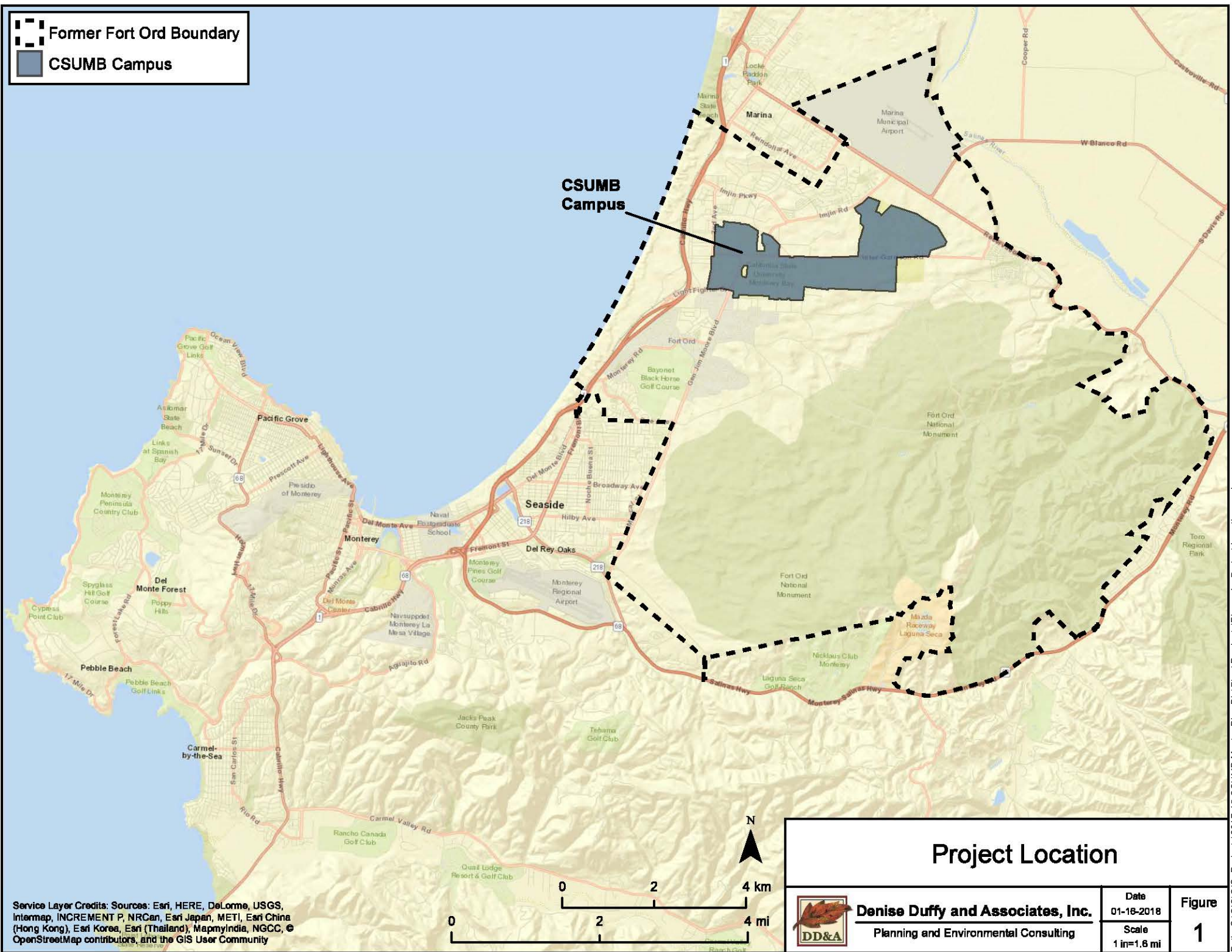

CSUMB Campus

Project Location

	Denise Duffy and Associates, Inc.		Date 01-16-2018	Figure 1
	Planning and Environmental Consulting		Scale 1 in=1.6 mi	

Service Layer Credits: Sources: Esri, HERE, DeLorme, USGS, Intermap, INCREMENT P, NRCan, Esri Japan, METI, Esri China (Hong Kong), Esri Korea, Esri (Thailand), MapmyIndia, NGCC, OpenStreetMap contributors, and the GIS User Community

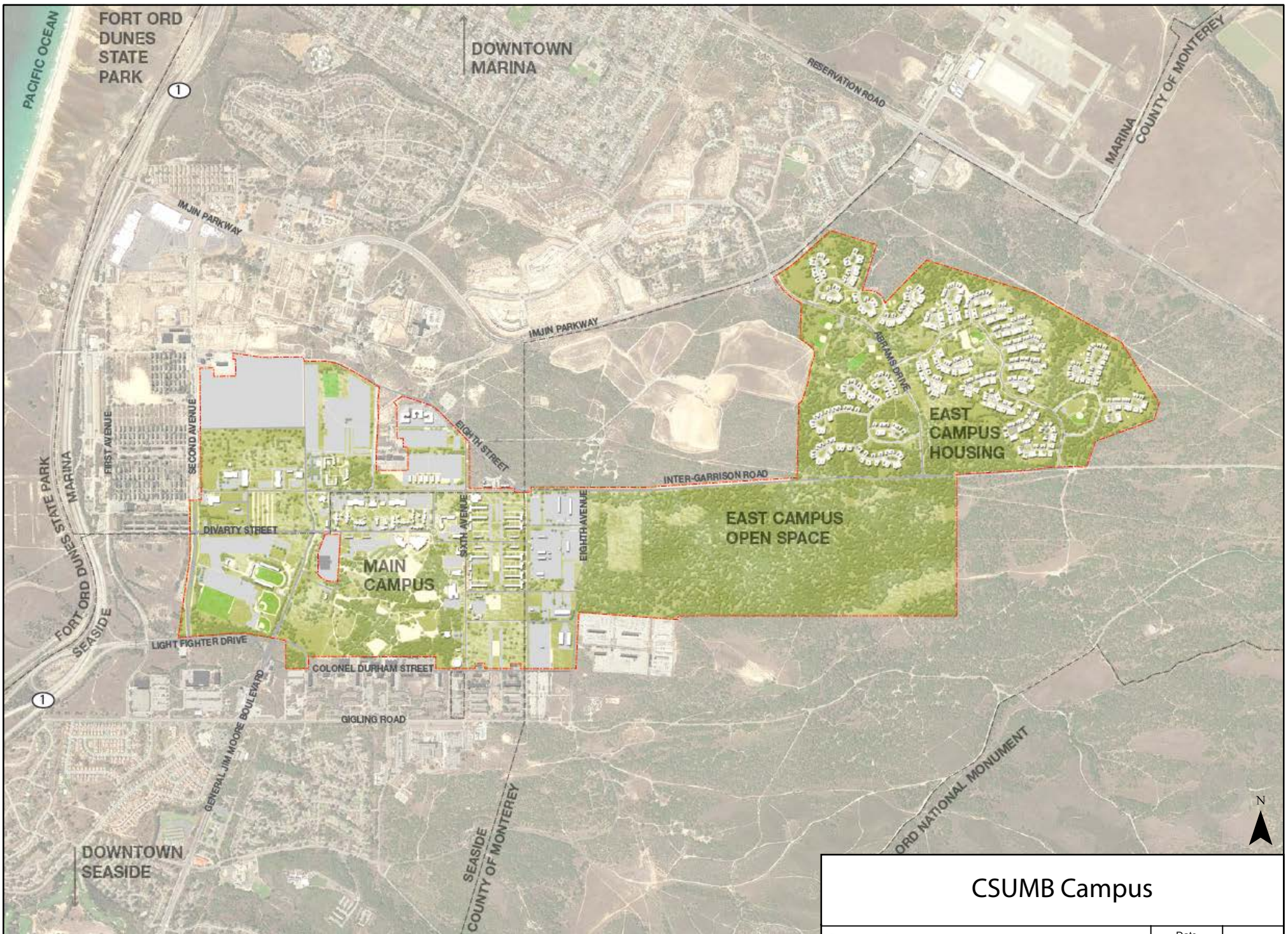

Source: CSUMB Comprehensive Master Plan, Draft June 2017

<h2>CSUMB Campus</h2>		
	Denise Duffy and Associates, Inc.	
	Planning and Environmental Consulting	
	Date 09-08-2017	Figure 2
	Scale 1 in=1.6 mi	

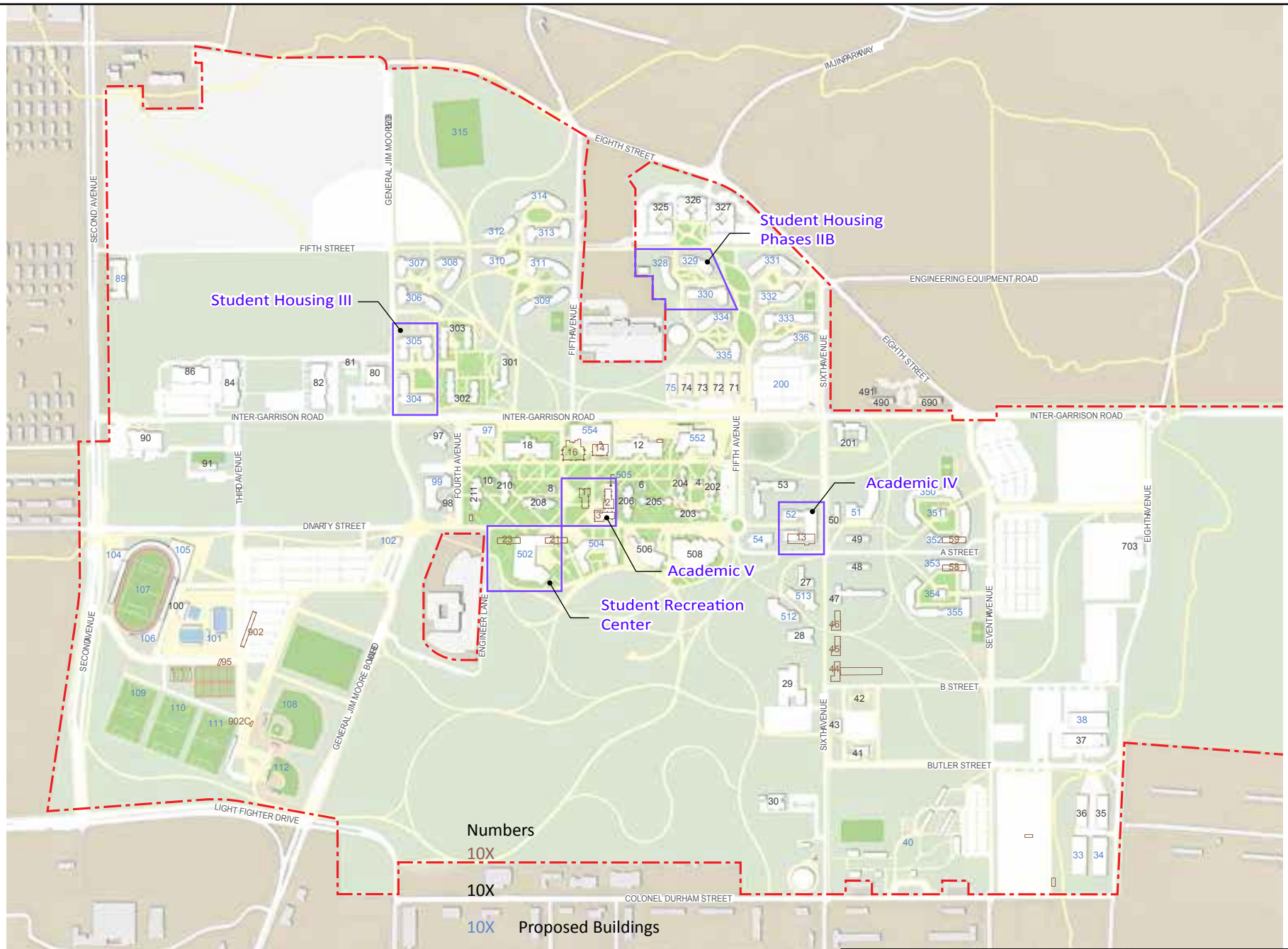

- | | | |
|---------|------------------------------|----------------------------|
| Numbers | | |
| 10X | Existing Buildings Removed | Existing Buildings Removed |
| 10X | Existing Buildings to Remain | Near-Term Projects |
| 10X | Proposed Buildings | |

Implementation Plan and Near-Term Project Sites



Denise Duffy and Associates, Inc.
 Planning and Environmental Consulting

Date
 01-17-2018
 Scale
 1 in=1.6 mi

Figure
3

2.2.2 Near-Term Development Components

In addition to providing a framework for the development of facilities to accommodate the proposed student, faculty and staff growth, the Project includes near-term development components. A brief description of each project is provided below, including anticipated year of construction; site locations are shown on **Figures 3, 4a, and 4b**.





1. **Student Housing Phase III.** Student Housing Phase III would provide an approximately 200,000-square-foot residential building complex with 600 beds on an approximately 6.4-acre site in the North Quad on an existing parking lot. The planned four-story buildings would provide a range of housing types. At least one apartment in each building would be dedicated to CSUMB Housing staff/student staff space.

Amenities would include: multi-purpose rooms and AV-connected classroom space,⁵ laundry, indoor bike parking, lounges/communal rooms, half courts outside (basketball and/or sand volleyball), picnic tables, urban agriculture/garden, outdoor social spaces, art, and connections to pedestrian/bicycle paths and trails. An approximately 7,600-square-foot dining facility would be located on the ground floor.

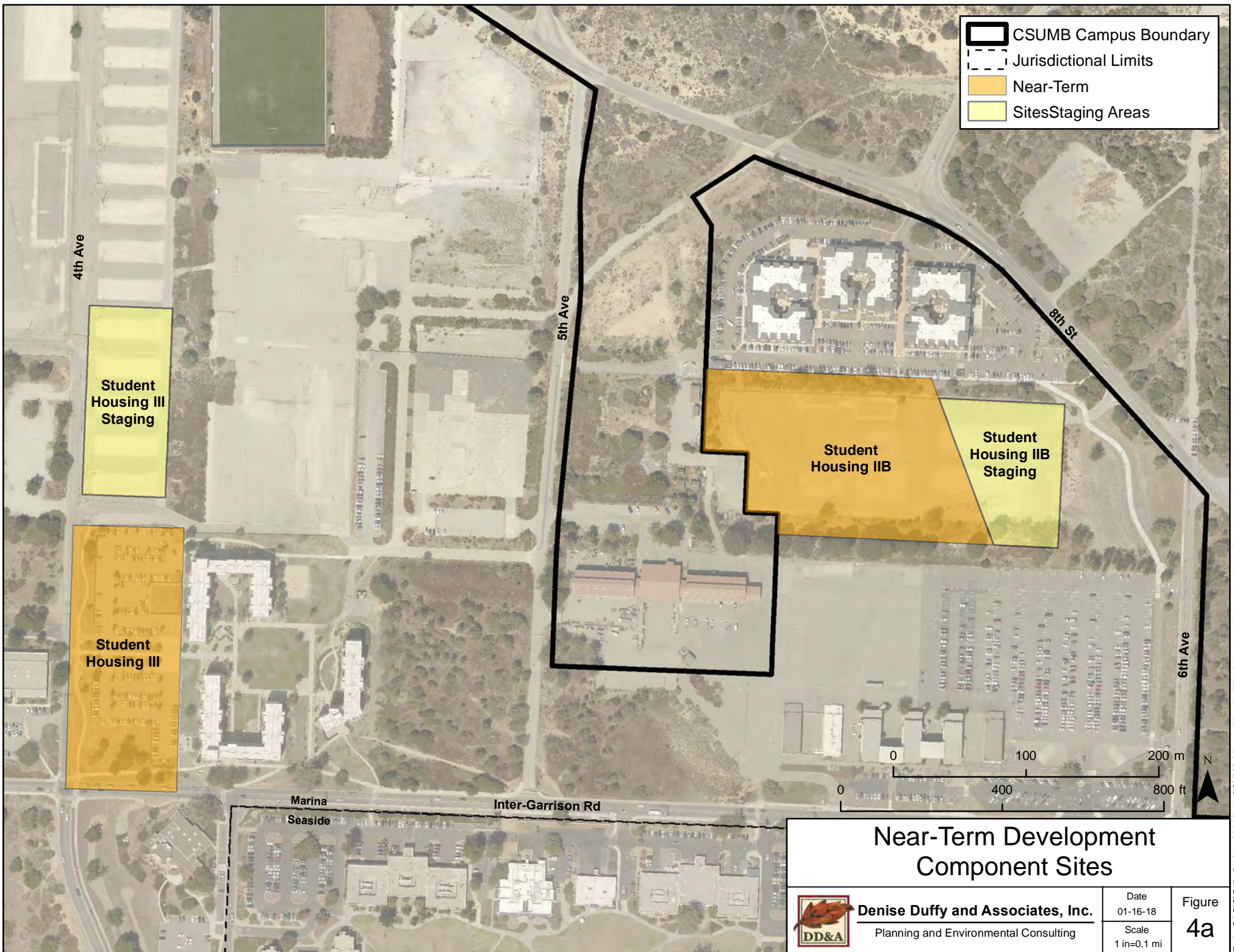
New utility connections to adjacent services would be installed with this development. Additionally, appropriate building/site scale LID BMPs would be implemented. Construction staging would occur north of the North Quad in existing paved area.

⁵ Multipurpose space could be used as classroom space during the day and for housing programs at other times.



 CSUMB Campus Boundary
 Jurisdictional Limits
 Near-Term
 Sites Staging Areas

Near-Term Development Component Sites



Denise Duffy and Associates, Inc.
 Planning and Environmental Consulting

Date
01-16-18
 Scale
1 in=0.1 mi

Figure
4a

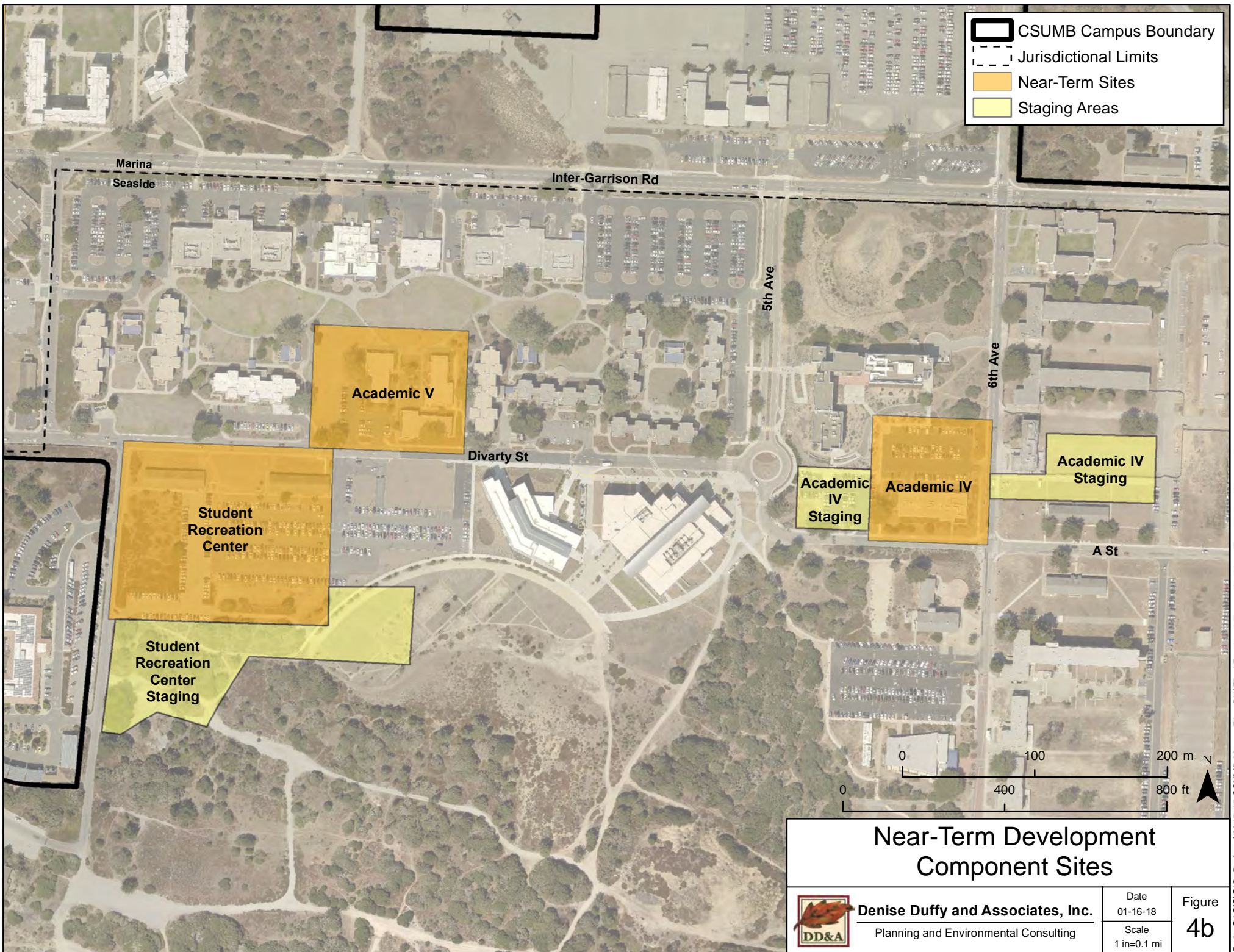

Near-Term Development Component Sites



Denise Duffy and Associates, Inc.
 Planning and Environmental Consulting

Date
01-16-18
 Scale
1 in=0.1 mi

Figure
4b

- 2. Academic IV Building.** Academic IV would provide an approximately 95,000-square-foot science building devoted to laboratory, lecture, and office space located in the campus core on an approximately 4.0-acre site. The building would be up to four stories and would include an on-site emergency generator. Future construction would require demolition of existing Building 13 (Science Research Lab Annex) and portions of parking lot areas 13 and 19. The development would include construction of a pedestrian/bike path north of existing Building 53 (Chapman Science Academic Center) for improved connectivity to the multimodal hub and parking to the east.

New utility connections to adjacent services would be installed with this development. Additionally, appropriate building/site scale LID BMPs would be implemented. Construction and staging would likely use parking lots 13 and 19 and/or close A Street between 5th and 6th Avenues.

- 3. Student Recreation Center.** The approximately 70,000-square-foot Student Recreation Center would be located on an approximately 8.5-acre site south of the Main Quad and Divarty Street and includes demolition of Building 21 (Beach Hall) and Building 23 (Tide Hall), and portions of parking lots 23 and 508. This facility would primarily house recreation (potentially up to 75 percent) and the remaining space allocated to the Kinesiology department. Kinesiology has demonstrated steady growth in the last 5 years and lacks appropriate teaching spaces to support the curriculum.

The building would be up to two stories and would be constructed in two phases (Phase I – 2021, approximately 33,000 square feet; Phase II – 2026, approximately 36,000 square feet). The building would include multi-use indoor courts (for uses such as intramural basketball, soccer and volleyball), including bleachers/seating, weight room (free weights and machines), a climbing wall, fitness rooms, cardio-dance studios indoor, lockers and restrooms, laundry rooms, equipment check out area, storage, Kinesiology department special instruction rooms, Kinesiology department faculty office, administrative office space and conference room, and outdoor court areas. Only intramural sports would occur in the Recreation Center, not indoor athletic team competitions.

New utility connections to adjacent services would be installed with this development. Additionally, appropriate building/site scale LID BMPs would be implemented. Construction staging would take place south of the building site and within the Crescent in previously disturbed open space areas with little or no habitat value.

4. **Student Housing Phase IIB.** Student Housing Phase IIB would provide an approximately 160,000-square-foot, student residential building complex south of the Promontory on a vacant paved lot approximately 7.2-acres in size. The planned four-story buildings would provide approximately 400 beds in apartments or suites for sophomores, juniors, and seniors. At least one apartment in each building would be dedicated to CSUMB Housing staff/student staff space. Planned amenities include laundry, indoor bike parking, lounges/communal rooms, half courts outside (basketball or sand volleyball), picnic tables, urban agriculture/garden, outdoor social spaces, art, and connections to pedestrian/bicycle paths and nature. A convenience store would be included.

New utility connections to adjacent services would be installed with this development. Additionally, appropriate building/site scale LID BMPs would be implemented. Construction staging is planned just east of the building in already paved areas.

5. **Academic V.** Academic V would provide an approximately 76,700-square-foot academic building on an approximately 2.7-acre site in the Main Quad and includes demolition of existing Buildings 1, 2, and 3 (Administration, Playa, and Del Mar buildings) and parking lot 18. The development would involve temporary relocation of the administration offices until the new Administration Building, another new building identified on the proposed Master Plan, is constructed. The building would support academic uses, i.e., learning and meeting spaces. The building would be up to four stories.

New utility connections to adjacent services would be installed with this development. Appropriate building/site scale LID BMPs would also be implemented. Construction staging would be conducted within the site boundaries on the Main Quad, and if necessary, in previously disturbed open space areas south of the Crescent

3.0 METHODS

3.1 Personnel and Survey Dates

Reconnaissance-level wildlife and general habitat surveys were completed by DD&A biologists Matthew Johnson (Senior Environmental Scientist), Jami Colley (Associate Environmental Scientist), Shaelyn Hession (Assistant Environmental Scientist), and Patric Krabacher (Assistant Environmental Scientist) in December 2016 (for a separate, overlapping project under contract with the Fort Ord Reuse Authority [FORA]) that included the Main Campus and East Campus Open Space areas (**Figure 5**). Focused botanical surveys were conducted within a designated survey area within the Project site in April and June 2016 by DD&A biologists. Reconnaissance-level wildlife and general habitat surveys were completed by DD&A biologists in August 2017 within the East Campus Housing area and portions of Main Campus that were not surveyed during previous surveys. Reconnaissance-level surveys for special-status plant and wildlife species habitat were conducted by DD&A biologists in January 2018 within the five Near-Term Development sites and proposed associated staging areas. An additional focused survey for SBB habitat was conducted in March 2019 at the Academic IV site and staging areas based on information that habitat had previously been observed by CSUMB faculty at this site. The focused botanical survey area and Near-Term Development sites were defined by maps provided by the CSUMB Campus Planning & Development (CPD) Department, which included portions of the Main Campus and East Campus Open Space areas. The dates for each of these surveys are outlined in **Table 3-1**.





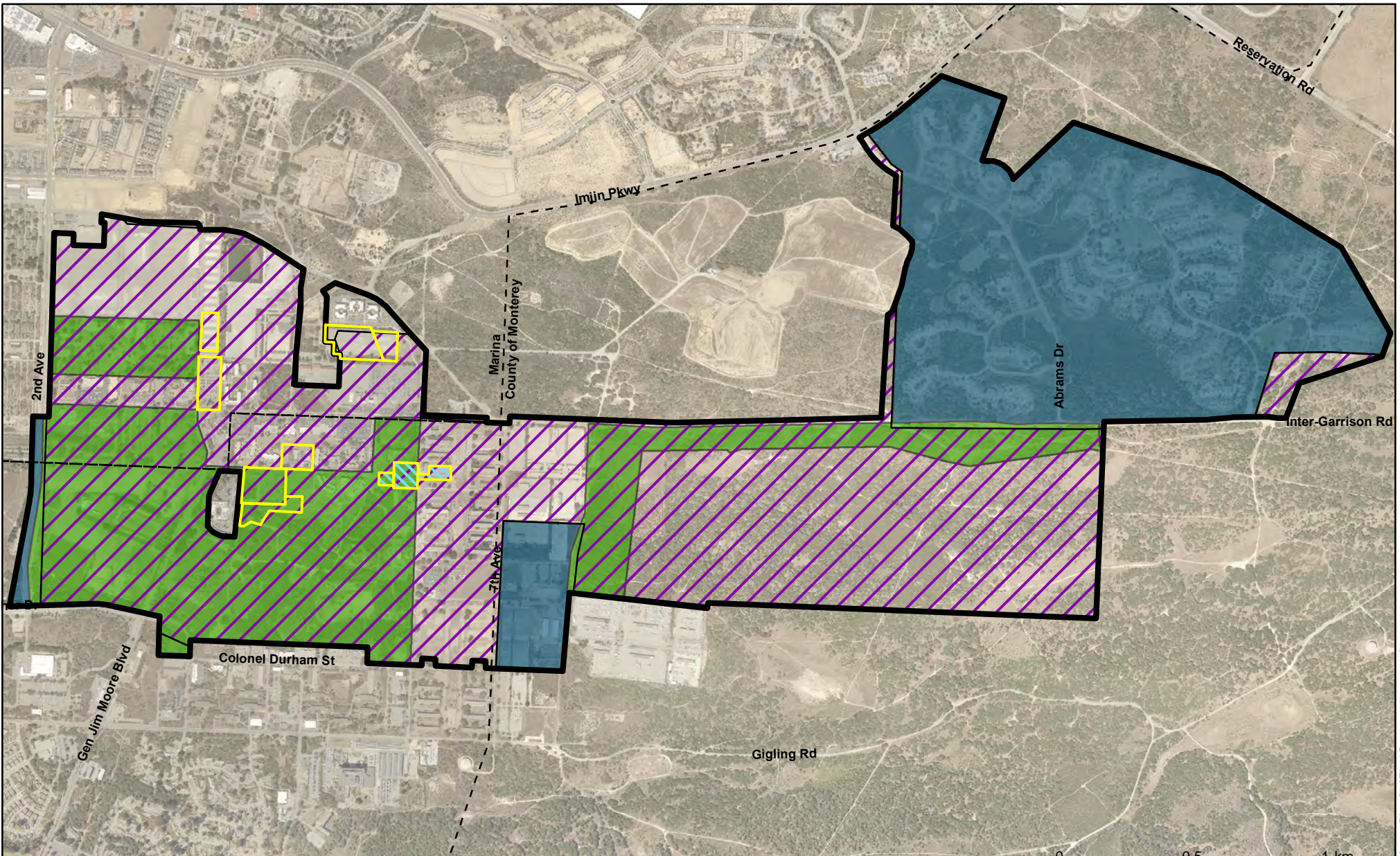

Table 3-1. Biological Survey Dates within the Project Site

Survey Type	Location	Date(s)
Focused spring-flowering plant species survey	Survey Area	April 2016
Focused summer-flowering plant species survey	Survey Area	July 2016
Reconnaissance-level wildlife and general habitat survey	Main Campus and East Campus Open Space	December 2016 ⁶
Reconnaissance-level wildlife and general habitat survey	East Campus Housing and Portions of Main Campus	August 2017
Reconnaissance-level special-status plant and wildlife species habitat survey	Near-Term Development Sites	January 2018
Focused Smith's blue butterfly habitat survey	Academic IV and Staging sites	March 2019

Prior to surveys in 2016, local reference populations of Monterey spineflower and sand gilia were checked on an approximately weekly basis from mid-March until the time of the survey to ensure these species would be in peak bloom during the time of the survey. In 2016, local reference populations for seaside bird's-beak and Yadon's piperia were checked on an approximately weekly basis for two to three weeks prior to the surveys.

⁶ Surveys completed in December 2016 for the Oak Woodlands Conservation Area Project under contract with FORA.



-  CSUMB Campus Boundary
-  Jurisdictional Limits
-  Reconnaissance-Level Wildlife and Habitat Surveys (August 2017)
-  Focused Botanical Surveys (April and July 2016)
-  Reconnaissance-Level Wildlife and Habitat Surveys (December 2017)
-  Reconnaissance-Level Special-Status Species Habitat Surveys (January 2018)
-  Focused Smith's Blue Butterfly Habitat Survey (March 2018)

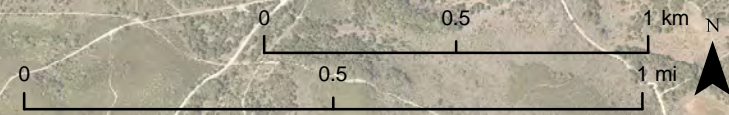

<h2>Survey Areas</h2>		Date 03-13-2019	Figure 5
 Denise Duffy and Associates, Inc.		Scale 1 in=0.3 mi	
Planning and Environmental Consulting			

Reconnaissance-level wildlife and general habitat survey methods included using aerial maps to identify general habitat types and potential sensitive habitats and verifying conditions in the field. General habitat types were mapped using a combination of GPS and hand drawing on aerial maps, which were later digitized using ArcGIS software.

Available reference materials were reviewed prior to conducting the field surveys, including the California Department of Fish and Wildlife's (CDFW's) California Natural Diversity Database (CNDDDB) occurrence reports (**Appendix B**, CDFW, 2017a), current agency status information from the U.S. Fish and Wildlife Service (USFWS or Service) and CDFW for species listed, proposed for listing, or candidates for listing as threatened or endangered under the federal Endangered Species Act (ESA) or California ESA (CESA), and those considered CDFW "species of special concern" (**Appendix C**, Service, 2017a; **Appendix B**, CDFW, 2017a and 2017b), aerial photographs of the Project site, and numerous biological reports prepared for the former Fort Ord (see "Data Sources" below).

Portions of the campus were surveyed for botanical resources following the applicable guidelines outlined in: *Guidelines for Conducting and Reporting Botanical Inventories for Federally listed, Proposed and Candidate Plants* (Service, 2000), *Protocols for Surveying and Evaluating Impacts to Special Status Native Plant Populations and Natural Communities* (CDFW, 2009), and *CNPS Botanical Survey Guidelines* (CNPS, 2001). All special-status plant species identified were mapped using a Trimble Pro XH GPS unit, which were later digitized using ArcGIS software. Populations of plants with greater than six individuals were mapped as a polygon and the density of the population was documented. Densities were recorded as low (1-33% cover), medium (34-66% cover) and high (67-100% cover). Individual plants or populations of less than six individuals were mapped as a point and a count of the number of individual plants was documented. Populations included all individuals within approximately three feet of another individual; individual plants further away than three feet were mapped as a separate polygon or point. Data collected during the surveys was used to assess the environmental conditions of the Project site and its surroundings, evaluate environmental constraints at the site and within the local vicinity, and provide a basis for recommendations to minimize and avoid impacts.

3.2 Special-Status Species

Special-status species are those plants and animals that have been formally listed or proposed for listing as endangered or threatened, or are candidates for such listing under the ESA or CESA. Listed species are afforded legal protection under the ESA and CESA. Species that meet the definition of rare or endangered under the CEQA Section 15380 are also considered special-status species. Animals on the CDFW's list of "species of special concern" (most of which are species whose breeding populations in California may face extirpation if current population trends continue) meet this definition and are typically provided management consideration through the CEQA process, although they are not legally protected under the ESA or CESA. Additionally, the CDFW also includes some animal species that are not assigned any of the other status designations on their "Special Animals" list (CDFW, 2017b). The CDFW considers the taxa on this list to be those of greatest conservation need, regardless of their legal or protection status.

Plants listed as rare under the California Native Plant Protection Act (CNPPA) or included in California Native Plant Society (CNPS) California Rare Plant Ranks (CRPR)⁷ 1A, 1B, 2A, and 2B are also treated as special-status species as they meet the definitions of Sections 2062 and 2067 of the CESA and in accordance with CEQA Guidelines Section 15380. In general, the CDFW requires that CRPR 1A species (Plants presumed extirpated in California and Either Rare or Extinct Elsewhere), CRPR 1B species (Plants rare, threatened, or endangered in California and elsewhere), CRPR 2A species (Plants presumed extirpated in California, but more common elsewhere); and CRPR 2B species (Plants rare, threatened, or endangered in California, but more common elsewhere) of the CNPS *Inventory of Rare and Endangered Vascular Plants of California* (CNPS, 2017) be fully considered during the preparation of environmental documents relating to CEQA.⁸ In addition, species of vascular plants, bryophytes, and lichens listed as having special-status by CDFW are considered special-status plant species (CDFW, 2017a).

Raptors (e.g., eagles, hawks, and owls) and their nests are protected under both federal and state laws and regulations. The federal Migratory Bird Treaty Act (MBTA) of 1918 and California Fish and Game Code (FGC) Section 3513 prohibit killing, possessing, or trading migratory birds except in accordance with regulation prescribed by the Secretary of the Interior. Birds of prey are protected in California under FGC Section 3503.5. Section 3503.5 states that it is “unlawful to take, possess, or destroy the nest or eggs of any such bird except otherwise provided by this code or any regulation adopted pursuant thereto.” In addition, fully protected species under the FGC Section 3511 (birds), Section 4700 (mammals), Section 5515 (fish), and Section 5050 (reptiles and amphibians) are also considered special-status animal species. Species with no formal special-status designation but thought by experts to be rare or in serious decline are also considered special-status animal species (CDFW, 2017a).

3.3 Sensitive Habitats

Sensitive habitats include riparian corridors, wetlands, habitats for legally protected species, areas of high biological diversity, areas supporting rare or special-status wildlife habitat, and unusual or regionally restricted habitat types. Habitat types considered sensitive include those listed as sensitive on the on CDFW’s *Natural Communities List* (CDFW, 2010), those that are occupied by species listed under ESA or are critical habitat in accordance with ESA, and those that are defined as Environmentally Sensitive Habitat Areas (ESHA) under the California Coastal Act (CCA). Specific habitats may also be identified as sensitive in city or county general plans or ordinances. Sensitive habitats are regulated under federal regulations (such as the Clean Water Act [CWA] and Executive Order 11990 – Protection of Wetlands), state regulations (such as CEQA and FGC Section 1600-1616), or local ordinances or policies (such as city or county tree ordinances and general plan policies).

3.4 Data Sources

The primary literature and data sources reviewed in order to determine the occurrence or potential for occurrence of special-status species at the Project site are as follows: current agency status information from the Service and CDFW for species listed, proposed for listing, or candidates for listing as threatened

⁷ Formerly known as CNPS Lists. CNPS initially created five CRPR in an effort to categorize degrees of concern; however, in order to better define and categorize rarity in California’s flora, the CNPS Rare Plant Program and Rare Plant Program Committee have developed the new CRPR 2A and CRPR 2B.

⁸ Species on CRPR 3 (Plants about which we need more information - a review list) and CRPR 4 (Plants of limited distribution - a watch list) may, but generally do not, meet the definitions of Sections 2062 and 2067 of CESA, and are not typically considered in environmental documents relating to CEQA.

or endangered under ESA or CESA and those considered CDFW “species of special concern” (**Appendix C**, Service, 2017a; **Appendix B**, CDFW, 2017a and 2017b); the CNPS *Inventory of Rare and Endangered Vascular Plants of California* (CNPS, 2017); CNDDDB occurrence reports (**Appendix B**, CDFW, 2017a); the Service’s Critical Habitat Mapper (2017b); *Flora and Fauna Baseline Study of Fort Ord* (U.S. Army Corps of Engineers [ACOE], 1992); and the *Installation-Wide Multispecies Habitat Management Plan for Former Fort Ord* (HMP) (ACOE, 1997). The U.S. Geological Survey (USGS) Marina quadrangle and the six surrounding quadrangles (Monterey, Moss Landing, Prunedale, Salinas, Seaside, and Spreckels) from the CNDDDB were reviewed for documented special-status species occurrences in the vicinity of the Project site.

In addition, all of the comment letters received in response to the Notice of Preparation (NOP) for the Project’s Environmental Impact Report (EIR) were reviewed to ensure all potential biological resources known or with the potential to occur were evaluated and concerns were addressed in accordance with CEQA.

From these resources, a list of special-status plant and wildlife species known or with the potential to occur in the vicinity of the Project site was created (**Appendix A**). The list presents these species along with their legal status, habitat requirements, and a brief statement of the likelihood to occur.

3.4.1 Botany

The classification and characterization of the vegetation of the Project site is based on field observations and the *Manual of California Vegetation* (Sawyer et.al., 2009). A generalized nomenclature for vegetation types is used within this document for ease of reference; however, each vegetation type description also lists the *Manual of California Vegetation* (Sawyer et.al. 2009) vegetation type(s) in order to provide a crosswalk to the *Natural Communities List* (CDFW, 2010).

Information regarding the distribution and habitats of local and state vascular plants was also reviewed (Howitt and Howell, 1964 and 1973; Munz and Keck, 1973; Matthews and Mitchell, 2015; Baldwin, et. al, 2012; Jepson Flora Project, 2017; ACOE, 1992; ACOE, 1997). All plants observed within the Project site were identified to species or intraspecific taxon using keys and descriptions in Baldwin, et. al, (2012) and Matthews and Mitchell (2015). Scientific nomenclature for plants in this report follows Baldwin, et.al., (2012) and common names follow Matthews and Mitchell (2015). A full botanical inventory was not recorded for the Project site; however, the dominant species within each habitat were recorded and all plant species encountered were identified to species or intraspecific taxon necessary to eliminate them as being special-status species. Dominant plant species are those which are more numerous than its competitors in an ecological community or makes up more of the biomass; generally, the species that are most abundant. Most ecological communities are defined by their dominant species.

3.4.2 Wildlife

The following literature and data sources were reviewed: CDFW reports on special-status wildlife (Remsen, 1978; Williams, 1986; Jennings and Hayes, 1994; Thelander, 1994); *Monterey Birds* (Roberson 2002); California Wildlife Habitat Relationships Program species-habitat models (CDFW, 2008; Zeiner et al., 1988 and 1990); *Flora and Fauna Baseline Study of Fort Ord* (ACOE, 1992); and the HMP (ACOE, 1997); and general wildlife references (Stebbins, 1985).

3.5 Regulatory Setting

3.5.1 Federal Regulations

Federal Endangered Species Act

Provisions of the ESA of 1973 (16 USC 1532 et seq., as amended) protect federally-listed threatened or endangered species and their habitats from unlawful take. Listed species include those for which proposed and final rules have been published in the Federal Register (FR). The ESA is administered by the Service or the National Oceanic and Atmospheric Administration National Marine Fisheries Service (NMFS). In general, the NMFS is responsible for the protection of ESA-listed marine species and anadromous fish, whereas other listed species are under Service jurisdiction.

Section 9 of ESA prohibits the take of any fish or wildlife species listed under ESA as endangered or threatened. Take, as defined by ESA, is “to harass, harm, pursue, hunt, shoot, wound, kill, trap, capture, or collect, or attempt to engage in any such conduct.” Harm is defined as “any act that kills or injures the fish or wildlife...including significant habitat modification or degradation that significantly impairs essential behavioral patterns of fish or wildlife.” In addition, Section 9 prohibits removing, digging up, and maliciously damaging or destroying federally-listed plants on sites under federal jurisdiction. Section 9 does not prohibit take of federally-listed plants on sites not under federal jurisdiction. If there is the potential for incidental take of a federally-listed fish or wildlife species, take of listed species can be authorized through either the Section 7 consultation process for federal actions or a Section 10 incidental take permit process for non-federal actions. Federal agency actions include activities that are on federal land, conducted by a federal agency, funded by a federal agency, or authorized by a federal agency (including issuance of federal permits).

Critical Habitat

Critical habitat is a term defined and used in the ESA. It is a specific geographic area(s) that contains features essential for the conservation of a threatened or endangered species and that may require special management and protection. Critical habitat may include an area that is not currently occupied by the species but that will be needed for its recovery. An area is designated as "critical habitat" after the Service publishes a proposed federal regulation in the Federal Register and then public comments are received and considered on the proposal. The final boundaries of the critical habitat area are also published in the Federal Register. Federal agencies are required to consult with the Service on actions they carry out, fund, or authorize to ensure that their actions will not destroy or adversely modify critical habitat. In this way, a critical habitat designation protects areas that are necessary for the conservation of the species. No critical habitat for federally listed species is designated within the Project site.

Recovery Plans

The ultimate goal of the ESA is the recovery (and subsequent conservation) of endangered and threatened species and the ecosystems on which they depend. A variety of methods and procedures are used to recover listed species, such as protective measures to prevent extinction or further decline, consultation to avoid adverse impacts of federal activities, habitat acquisition and restoration, and other on-the-ground activities for managing and monitoring endangered and threatened species. The collaborative efforts of the Service and its many partners (federal, state, and local agencies, tribal governments, conservation organizations,

the business community, landowners, and other concerned citizens) are critical to the recovery of listed species.

Two recovery plans have been prepared for listed species known or with the potential to occur within the Project site:

- Recovery Plan for the Central California Distinct Population Segment of the California Tiger Salamander (*Ambystoma californiense*) (Service, 2017c) and
- Smith’s Blue Butterfly Recovery Plan (Service, 1984).

Migratory Bird Treaty Act

The MBTA (16 USC 703 et seq.) of 1918 prohibits killing, possessing, or trading migratory birds except in accordance with regulation prescribed by the Secretary of the Interior. Most actions that result in taking or in permanent or temporary possession of a protected species constitute violations of the MBTA. The Service is responsible for overseeing compliance with the MBTA and implements Conventions (treaties) between the United States and four countries for the protection of migratory birds – Canada, Mexico, Japan, and Russia. The Service maintains a list of migratory bird species that are protected under the MBTA, which was updated in 2010 to: 1) correct previous mistakes, such as misspellings or removing species no longer known to occur within the United States; 2) add species, as a result of expanding the geographic scope to include Hawaii and U.S. territories and new evidence of occurrence in the United States or U.S. territories; and 3) update name changes based on new taxonomy (Service, 2013).

Clean Water Act

The ACOE and Environmental Protection Agency (EPA) regulate discharge of dredged and fill material into “Waters of the United States” (waters of the U.S.) under Section 404 of the CWA (33 USC 1344). Waters of the U.S. are defined broadly as waters susceptible to use in commerce (including waters subject to tides, interstate waters, and interstate wetlands) and other waters (such as interstate lakes, rivers, streams, mudflats, sandflats, wetlands, sloughs, prairie potholes, wet meadows, playa lakes, or natural ponds) (33 CFR 328.3). Potential wetland areas are identified as “those areas that are inundated or saturated by surface or ground water at a frequency and duration sufficient to support, and that under normal circumstances do support, a prevalence of vegetation typically adapted for life in saturated soils conditions.”

Under Section 401 of the CWA (33 USC 1341), any applicant receiving a Section 404 permit from the ACOE must also obtain a Section 401 Water Quality Certification from the Regional Water Quality Control Board (RWQCB). A Section 401 Water Quality Certification is issued when a project is demonstrated to comply with state water quality standards and other aquatic resource protection requirements.

Executive Order 11990 - Protection of Wetlands

Executive Order 11990 - Protection of Wetlands (42 FR 26961) calls for no net loss of wetlands. For the regulatory process, the ACOE and EPA jointly define wetlands as follows: "Those areas that are inundated or saturated by surface or ground water at a frequency and duration sufficient to support, and that under normal circumstances do support, a prevalence of vegetation typically adapted for life in saturated soil conditions." Federal agencies are required to implement the following procedures for any federal action that involves wetlands: 1) provide an opportunity for early public involvement; 2) consider alternatives that

would avoid wetlands, and if avoidance is not possible, measures to minimize harm to wetlands must be included in the action; 3) prepare a “Wetlands Only Practicable Alternative Finding” for actions that require an Environmental Impact Study.

Executive Order 13112-Invasive Species

Executive Order 13112 - Invasive Species (64 FR 6183) requires the prevention of introduction and spread of invasive species. Invasive species are defined as “alien species whose introduction does or is likely to cause economic or environmental harm or harm to human health.” Each federal agency whose actions may affect the status of invasive species on a project site shall, to the extent practicable and permitted by law, subject to the availability of appropriations, use relevant programs and authorities to: 1) prevent the introduction of invasive species; 2) detect and respond rapidly to and control populations of such species in a cost-effective and environmentally sound manner; 3) monitor invasive species populations accurately and reliably; 4) provide for restoration of native species and habitat conditions in ecosystems that have been invaded; 5) conduct research on invasive species and develop technologies to prevent introduction and provide for environmentally sound control of invasive species; and 6) promote public education on invasive species and the means to address them. A national invasive species management plan was prepared by the National Invasive Species Council and the Invasive Species Advisory Committee that recommends objectives and measures to implement the Executive Order. The California Invasive Plant Council (Cal-IPC) Inventory categorizes non-native invasive plants that threaten California’s wildlands. Categorization is based on an assessment of the ecological impacts of each plant. The Cal-IPC Inventory represents the best available knowledge of invasive plant experts in the state. Although the impact of each plant varies regionally, its rating represents cumulative impacts statewide. Therefore, a plant whose statewide impacts are categorized as Limited may have more severe impacts in a particular region. Conversely, a plant categorized as having a High cumulative impact across California may have very little impact in some regions.

3.5.2 State Regulations

California Endangered Species Act

The CESA (FGC 2050 et seq.) was enacted in 1984. The California Code of Regulations (14 CCR 670.5) lists animal species considered endangered or threatened by the state. Section 2090 of CESA requires state agencies to comply with endangered species protection and recovery and to promote conservation of these species. Section 2080 of the FGC prohibits “take” of any species that the commission determines to be an endangered species or a threatened species. “Take” is defined in Section 86 of the FGC as “hunt, pursue, catch, capture, or kill, or attempt to hunt, pursue, catch, capture, or kill.” A Section 2081 Incidental Take Permit from the CDFW may be obtained to authorize “take” of any state listed species.

California Fish and Game Code

Birds: Section 3503 of the FGC states that it is “unlawful to take, possess, or destroy the nest or eggs of any such bird except as otherwise provided by this code or any regulation adopted pursuant thereto.” Section 3503.5 prohibits the killing, possession, or destruction of any birds in the orders Falconiformes or Strigiformes (birds-of-prey). Section 3511 prohibits take or possession of fully protected birds. Section 3513 prohibits the take or possession of any migratory nongame birds designated under the federal MBTA. Section 3800 prohibits take of nongame birds.

Fully Protected Species: The classification of fully protected was the state's initial effort in the 1960's to identify and provide additional protection to those animals that were rare or faced possible extinction. Lists were created for fish (Section 5515), mammals (Section 4700), amphibians and reptiles (Section 5050), and birds (Section 3511). Most fully protected species have also been listed as threatened or endangered species under the more recent endangered species laws and regulations. Fully protected species may not be taken or possessed at any time and no licenses or permits may be issued for their take except for collecting these species for necessary scientific research and relocation of the bird species for the protection of livestock.

Species of Special Concern: As noted above, CDFW also maintains a list of animal “species of special concern.” Although these species have no legal status, CDFW recommends considering these species during analysis of project impacts to protect declining populations and avoid the need to list them as endangered in the future.

Lake and Streambeds: Under Sections 1600-1616 of the California Fish and Game Code, the CDFW regulates activities that would alter the flow, bed, channel, or bank of streams and lakes. The limits of CDFW’s jurisdiction are defined in the code as the “... bed, channel or bank of any river, stream, or lake designated by the department in which there is at any time an existing fish or wildlife resource or from which these resources derive benefit ...” (Section 1601). In practice, the CDFW usually marks its jurisdictional limit at the top of the stream or bank, or at the outer edge of the riparian vegetation, whichever is wider.

Native Plant Protection Act

The CNPPA (FGC 1900 et seq.) of 1977 directed the CDFW to carry out the legislature’s intent to “preserve, protect and enhance rare and endangered plants in the state.” The CNPPA prohibits importing rare and endangered plants into California, taking rare and endangered plants, and selling rare and endangered plants. The CESA and CNPPA authorized the Fish and Game Commission to designate endangered, threatened and rare species and to regulate the taking of these species (FGC Section 2050-2098). Plants listed as rare under the CNPPA are not protected under CESA.

Porter-Cologne Water Quality Control Act

The Porter-Cologne Water Quality Control Act of 1969 (Porter-Cologne; California Water Code [CWC] 13000 et seq.) is California’s statutory authority for the protection of water quality and applies to surface waters, wetlands, and groundwater, and to both point and nonpoint sources. Under the Porter-Cologne, the State Water Resources Control Board (State Board) has the ultimate authority over State water rights and water quality policy. However, Porter-Cologne also establishes nine RWQCBs to oversee water quality on a day-to-day basis at the local/regional level. The Project site is located within Region 3 – Central Coast RWQCB. Porter-Cologne incorporates many provisions of the federal CWA, such as delegation to the State Board and RWQCBs of the National Pollutant Discharge Elimination System (NPDES) permitting program.

Under Porter-Cologne, the state must adopt water quality policies, plans, and objectives that protect the state’s waters for the use and enjoyment of the people. Regional authority for planning, permitting, and enforcement is delegate to the nine RWQCBs. The regional boards are required to formulate and adopt water quality control plans for all areas in the region and establish water quality objectives in the plans.

The Porter-Cologne sets forth the obligations of the State Board and RWQCBs to adopt and periodically update water quality control plans (basin plans). The act also requires waste dischargers to notify the RWQCBs of such activities through filing of Reports of Waste Discharge (RWD) and authorizes the State Board and RWQCBs to issue and enforce waste discharge requirements (WDRs), NPDES permits, Section 401 water quality certifications, or other approvals. The RWQCBs also have authority to issue waivers to RWD requirements and WDRs for broad categories of “low threat” discharge activities that have minimal potential for adverse water quality effects, when implemented according to prescribed terms and conditions.

The term “Waters of the State” is defined by Porter-Cologne as “any surface water or groundwater, including saline waters, within the boundaries of the state.” The RWQCB protects all waters in its regulatory scope but has special responsibility for wetlands, riparian areas, and headwaters, including isolated wetlands, and waters that many not be regulated by the ACOE under Section 404 of the CWA. Waters of the State are regulated by the RWQCB under the State Water Quality Certification Program, which regulates discharges of fill and dredged material under Section 401 of the CWA and the Porter-Cologne.

CSUMB Tree Restoration Program

CSUMB has established a tree restoration program for impacts to coast live oak and other trees resulting from projects that take place on campus. This program requires that for every tree greater than 4” diameter breast height (dbh) removed, two coast live oak trees would be replanted, and assumed to survive, in the identified restoration area on campus. In some cases, more than two trees would need to be planted to achieve this survival rate. The implementation of this program is required for all projects that would result in impacts to trees 4” dbh or greater.

3.5.3 Local Regulations

As a state entity, CSUMB is not subject to local government planning or ordinances, such as the general plans and ordinances for the cities of Marina and Seaside and the County of Monterey. Accordingly, because neither local general plans or any other local land use plans or ordinances are applicable to CSUMB, such local plans and ordinances are not summarized here or further analyzed in this section. However, there are a number of local plans that have come out of the former Fort Ord Base Reuse process, which are summarized below.

Fort Ord Habitat Management Plan

The U.S. Army’s decision to close and dispose of the Fort Ord military base was considered a major federal action that could affect listed species under the ESA. The Service issued a Final Biological Opinion (BO) on the disposal and reuse of former Fort Ord requiring that an HMP be developed and implemented to reduce the incidental take of listed species and loss of habitat that supports these species (October 19, 1993). The HMP was prepared to assess impacts on vegetation and wildlife resources and provide mitigation for their loss associated with the disposal and reuse of former Fort Ord (ACOE, 1997).

The HMP establishes guidelines for the conservation and management of HMP species and their habitats on former Fort Ord lands by identifying lands that are available for development, lands that have some restrictions with development, and habitat reserve areas. The intent of the plan is to establish large, contiguous habitat conservation areas and corridors to compensate for future development in other areas of

the former base. The HMP establishes a habitat conservation area and corridor system with parcel-specific land use categories and management requirements for all lands on former Fort Ord. The HMP identifies what type of activities can occur on each parcel at former Fort Ord and parcels are designated as “development with no restrictions,” “habitat reserves with management requirements,” or “habitat reserves with development restrictions.” Within these land use designations, parcels may also be identified as Borderlands with specific requirements for lands adjacent to BLM and contain future road corridors, easements, and rights of way. The HMP sets the standards to assure the long-term viability of former Fort Ord's biological resources in the context of base reuse so that no further mitigation should be necessary for impacts to species and habitats considered in the HMP. This plan has been approved by the Service; the HMP, deed restrictions, and Memoranda of Agreement between the Army and various land recipients, including the Board of Trustees of the California State University, provide the legal mechanism to assure HMP implementation. It is a legally binding document, and all recipients of former Fort Ord lands are required to abide by its management requirements and procedures.

The HMP anticipates some losses to HMP special-status species and HMP sensitive habitats as a result of redevelopment of the former Fort Ord. With the designated reserves and corridors and habitat management requirements in place, the losses of individuals of species and sensitive habitats considered in the HMP are not expected to jeopardize the long-term viability of those species, their populations, or sensitive habitats on former Fort Ord. Recipients of disposed land with restrictions or management guidelines designated by the HMP will be obligated to implement those specific measures through the HMP and through deed covenants.

The Coordinated Resource Management and Planning (CRMP) process is a multi-agency multi-jurisdictional land use planning effort developed under the sponsorship of the California CRMP Memorandum of Understanding (MOU). This MOU has been signed by 14 federal and state agencies, including the Bureau of Land Management (BLM), CDFW, Service, Monterey County, and University of California. The CRMP program provides a mechanism for public agencies to share resources to deliver the most efficient habitat protection and public services for the money expended.

However, the HMP does not provide specific authorization for incidental take of federal or state listed species to existing or future non-federal land recipients under the ESA or CESA. In compliance with the ESA and CESA, the Fort Ord Reuse Authority (FORA) is currently in the process of obtaining a Section 10(a)(1)(B) Incidental Take Permit from the Service and Section 2081 Incidental Take Permit from the CDFW, which will provide base-wide coverage for the take of federal and state listed wildlife and plant species to all non-federal entities receiving land on the former Fort Ord. This process involves the preparation of a Habitat Conservation Plan (HCP) and Implementing Agreement (IA). The Administrative Draft Fort Ord HCP (ICF International, Inc., 2017) and IA are currently in draft form and being reviewed by the resource agencies. The base-wide Incidental Take Permits are expected to be issued by the Service and CDFW in summer of 2019.

The entire Project site is located within designated “development” parcels under the HMP. Additionally, a portion of the campus, along the southeastern boundary of the East Campus Open Space parcel (Army parcel number S1.3.2), is designated in the HMP as having Borderlands requirements. Borderlands are designated development parcels or habitat reserve parcels at the urban/wildland interface where specific design considerations and management activities are required to minimize effects of development on HMP

species and natural communities. For the East Campus Open Space parcel, these activities include interim management activities, including but not limited to, the installation and maintenance of firebreaks and vehicle barriers where appropriate to separate developed and developing area from natural lands. To minimize the possibility of fire damage to the adjacent habitat reserve as well as structures on the development parcels, parking lots, greenbelts, or other nonflammable or fire-resistant land uses will be located as a buffer between the habitat reserve and development. Measures will also be taken to reduce potential for erosion in these parcels so as not to affect the adjacent habitat reserve from stormwater runoff that may originate in this parcel. This parcel is to be conserved and managed until development occurs. Non-native species (i.e., iceplant, scotch broom, and pampas grass) controls will also be in place to avoid spreading to the adjacent habitat reserve.

Parcels designated as “development” do not have management requirements relative to HMP species. However, the BO and HMP require the identification of sensitive biological resources within the development parcels that may be salvaged for use in restoration activities in reserve areas. In addition, the campus is required to implement the Borderlands requirements within the East Campus Open Space parcel.

Habitat Conservation Plans or NCCP

There are no adopted HCPs or Natural Community Conservation Plans (NCCP) associated with the Project site. Please refer to the discussion of the Draft HCP currently in progress in the Fort Ord Habitat Management Plan section above.

Fort Ord Oak Woodland Conservation Requirements

FORA is assisting the City of Seaside and Monterey County in preparing an Oak Woodland Conservation Area Map and an Oak Woodlands Management and Monitoring Plan on the former Fort Ord Property. The map and plan will address oak woodland areas in the City of Seaside and Monterey County, and has proposed including the use of CSUMB property to connect key oak woodland areas on Fort Ord. These agencies are obligated to comply with Oak Woodland Policy B-2 and Programs B-2.1 and B-2.2, which are described in the 1997 Base Reuse Plan (BRP) (EDAW and EMC 1996), and 2012 BRP Reassessment Report (FORA and EMC 2012).

CSUMB is involved in meeting with these agencies on the in-progress map and plan related to conservation areas that may ultimately be identified on the CSUMB campus (A. Spear, personal communication 2019).

4.0 RESULTS

4.1 Vegetation Types

The survey results include mapping and quantification of the acreage of five vegetation types within the Project site (**Figure 6**). Several areas were identified where these vegetation types intergrade with one another; these areas are identified as “mix” habitats and the dominant species from each of the two separate vegetation types are approximately evenly distributed throughout these areas. Additionally, some areas of the project site are developed. **Table 4-1** provides the acreages of these vegetation types and developed areas within the Project site and **Table 4-2** provides the acreages within the Near-Term Development sites. A brief description of each of these vegetation types and developed areas can be found below, along with a statement of the presence or potential presence of special-status species within each, and identification of whether the vegetation type is considered a sensitive habitat. In addition, each description identifies the *Manual of California Vegetation* (Sawyer et.al. 2009) vegetation type(s).

Table 4-1. Vegetation Types within the Project Site¹

Vegetation Types	Total Area (Acres)
<i>Coast Live Oak Woodland</i>	336.4
<i>Ruderal/Disturbed</i>	327.6
<i>Central Maritime Chaparral</i>	74.9
<i>Central Maritime Chaparral/Coast Live Oak Woodland Mix</i>	46.3
<i>Coast Live Oak Woodland/Non-Native Grassland Mix</i>	23.5
<i>Non-Native Grassland</i>	33.9
<i>Coast Live Oak Woodland/Central Coastal Scrub Mix</i>	10.4
<i>Central Coastal Scrub</i>	8.6
<i>Central Coastal Scrub/Non-Native Grassland Mix</i>	4.6
<i>Central Maritime Chaparral/Central Coastal Scrub Mix</i>	3.1
<i>Developed</i>	526.5
Total	1,395.8

¹ **Bold** indicates sensitive habitat addressed in the Fort Ord HMP.

Table 4-2. Vegetation Types within Near-Term Development Component Sites and Staging Areas

Vegetation Types	Student Housing Phase III (Acres)		Academic IV Building (Acres)		Student Recreation Center (Acres)		Student Housing Phase IIB (Acres)		Academic V Building (Acres)	
	Site	Staging	Site	Staging	Site	Staging	Site	Staging	Site	Staging
<i>Coast Live Oak Woodland</i>	0	0	0	0	0	0.01	0	0	0	0
<i>Ruderal/Disturbed</i>	0	0.1	0.5	0.9	2.5	2.0	1.4	0.2	0	0
<i>Developed</i>	4.1	2.2	1.6	1.0	2.9	1.1	3.9	1.7	2.7	0
Total	4.1	2.3	2.1	1.9	5.4	3.1	5.3	1.9	2.7	0

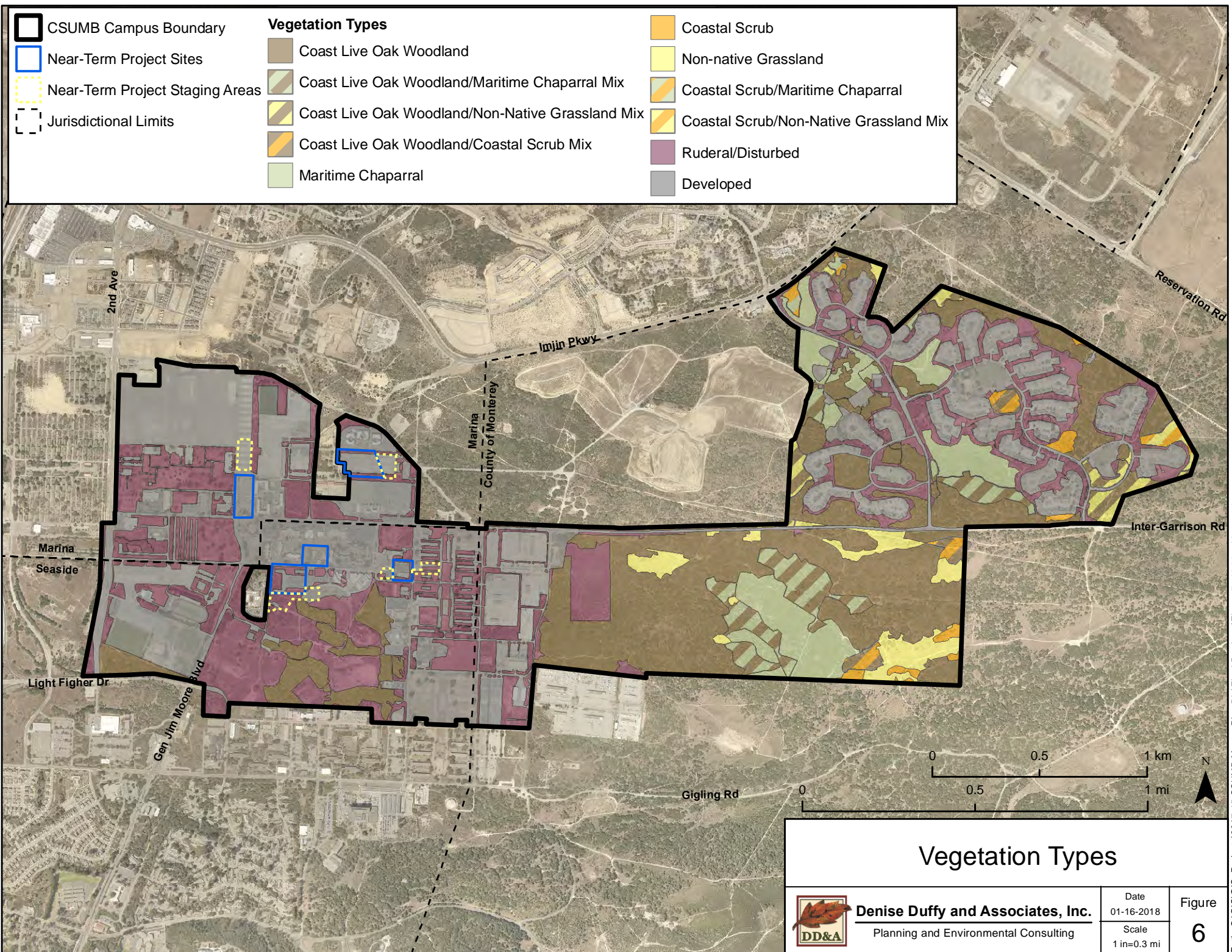

- CSUMB Campus Boundary
- Near-Term Project Sites
- Near-Term Project Staging Areas
- Jurisdictional Limits

- Vegetation Types**
- Coast Live Oak Woodland
 - Coast Live Oak Woodland/Maritime Chaparral Mix
 - Coast Live Oak Woodland/Non-Native Grassland Mix
 - Coast Live Oak Woodland/Coastal Scrub Mix
 - Maritime Chaparral

- Coastal Scrub
- Non-native Grassland
- Coastal Scrub/Maritime Chaparral
- Coastal Scrub/Non-Native Grassland Mix
- Ruderal/Disturbed
- Developed

Vegetation Types

	Denise Duffy and Associates, Inc. Planning and Environmental Consulting	Date 01-16-2018	Figure 6
		Scale 1 in=0.3 mi	

4.1.1 Coast Live Oak Woodland

- **A Manual of California Vegetation classification:** coast live oak woodland (*Quercus agrifolia*/*Toxicodendron diversilobum*/grass association)

Coast live oak woodland is the dominant habitat type within the Project site (**Figure 6**). Coast live oak woodland is an open-canopied to nearly closed-canopied community with a grass or sparsely scattered shrub understory. Three coast live oak communities, each with different growth characteristics, understory associates, and canopy cover, have been recognized on the former Fort Ord: coastal coast live oak woodland, inland coast live oak woodland, and coast live oak savanna (ACOE, 1992). “Coastal” coast live oak woodland is the dominant vegetation type within the project site (**Figure 7**). The distinction of “coastal” is given based on the proximity of the coast live oak woodland to the coast. In coastal coast live oak woodland, coast live oaks grow in unprotected sites and are exposed to the combined stresses of strong winds, salt spray, and sterile, sandy soils, which are often referred to as “sand hills.” These environmental factors create an oak woodland characterized by short, wind-pruned trees that intergrades with the surrounding coastal scrub and maritime chaparral communities.

Oak woodlands within the project site are largely homogeneous, in species composition. Within the project site, the coast live oak (*Quercus agrifolia*) canopy is quite dense in many areas with an understory dominated by poison oak or, in some areas, invasive ice plant. Other plant species observed within the coast live oak woodland include hedge-nettle (*Stachys* sp.), slender wild oat (*Avena barbata*), sheep sorrel (*Rumex acetosella*), fiesta flower (*Pholistoma auritum*), and scattered shrubs such as fuchsia-flowered gooseberry (*Ribes speciosum*), California coffeeberry (*Frangula californica*), and sticky monkey flower (*Mimulus aurantiacus*).

In several areas, the coast live oak woodland intergrades with other vegetative communities, including maritime chaparral, coastal scrub, and non-native grassland. Where these vegetative communities comprise of approximately half of the dominant species, the areas have been mapped as coast live oak mixes (**Figure 7**). The dominant plant species and the common wildlife found in these mixed vegetation types are generally the same as those described for the individual vegetation types.

Coast live oak woodland is important habitat to many wildlife species. Oaks provide nesting sites for many avian species and cover for a variety of mammals, including mourning dove (*Zenaidura macroura*), American kestrel (*Falco sparverius*), California ground squirrel (*Spermophilus beecheyi*), and California pocket mouse (*Chaetodipus californicus*). Acorns provide an important food source for acorn woodpecker (*Melanerpes formicivorus*), western scrub jay (*Aphelocoma californica*), and black-tailed deer (*Odocoileus hemionus columbianus*). Other common wildlife species found in the coast live oak woodland are raccoon (*Procyon lotor*), Nuttall’s woodpecker (*Picoides nuttallii*), northern flicker (*Colaptes auratus*), bobcat (*Lynx rufus*), and coyote (*Canis latrans*). Generally, red-tailed hawks (*Buteo jamaicensis*) and great-horned owls (*Bubo virginianus*) nest and roost in the coast live oaks. Additional avian species that may be found within the oak woodland habitat are presented in **Appendix D**.

Special-status plant species were identified within some grassy openings of the coast live oak woodland habitat, mostly at the edges in transition areas with other habitats, within the area surveyed in 2016, including Monterey spineflower, Kellogg’s horkelia, sandmat manzanita, and Toro manzanita (**Figure 7**). Additional special-status plant species that may occur within the coast live oak woodland habitat, outside

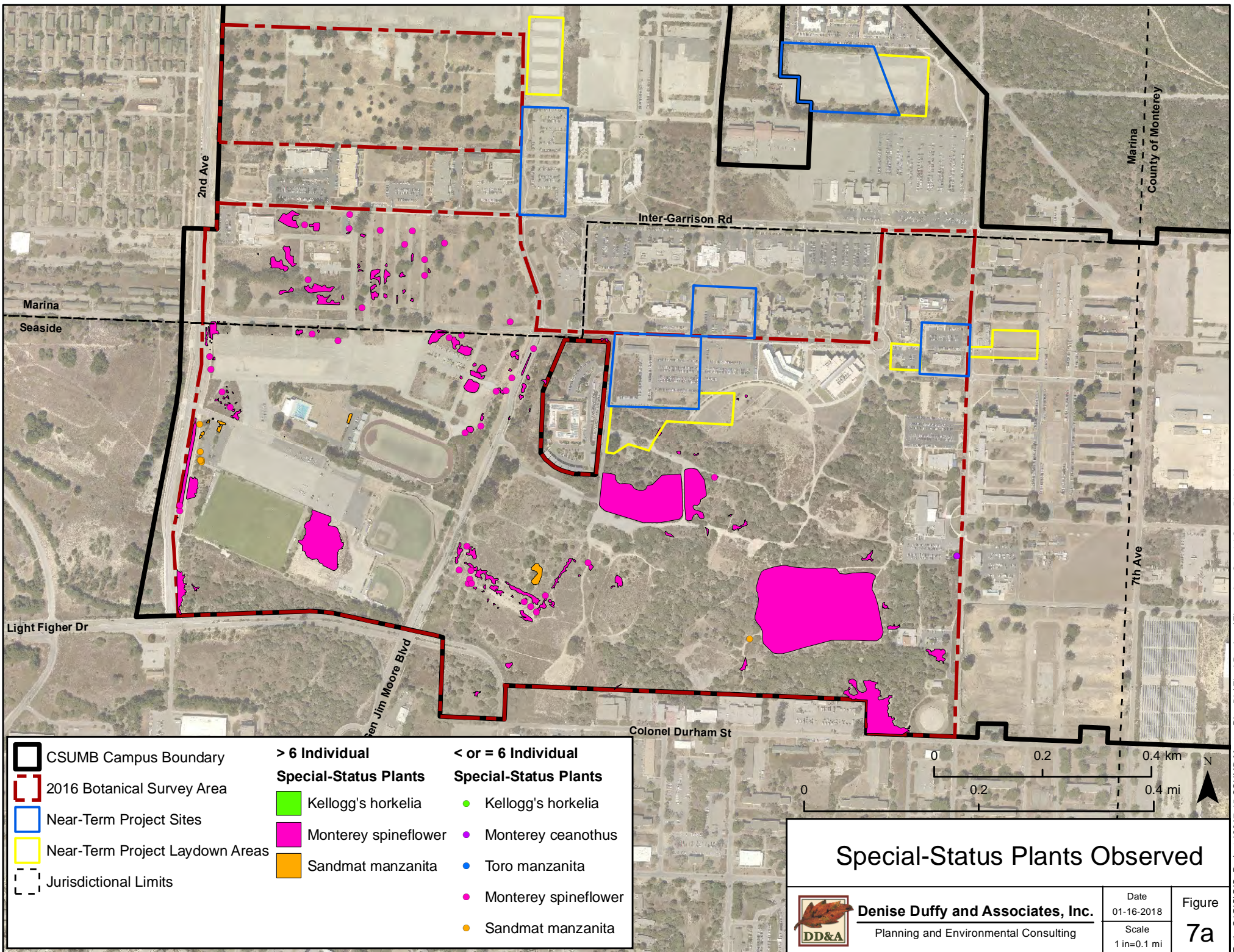

- CSUMB Campus Boundary
- 2016 Botanical Survey Area
- Near-Term Project Sites
- Near-Term Project Laydown Areas
- Jurisdictional Limits

- | | | | |
|--|----------------------|---|----------------------|
| > 6 Individual Special-Status Plants | | < or = 6 Individual Special-Status Plants | |
| | Kellogg's horkelia | | Kellogg's horkelia |
| | Monterey spineflower | | Monterey ceanothus |
| | Sandmat manzanita | | Toro manzanita |
| | | | Monterey spineflower |
| | | | Sandmat manzanita |



Special-Status Plants Observed

Denise Duffy and Associates, Inc. Planning and Environmental Consulting	Date 01-16-2018	Figure 7a
	Scale 1 in=0.1 mi	

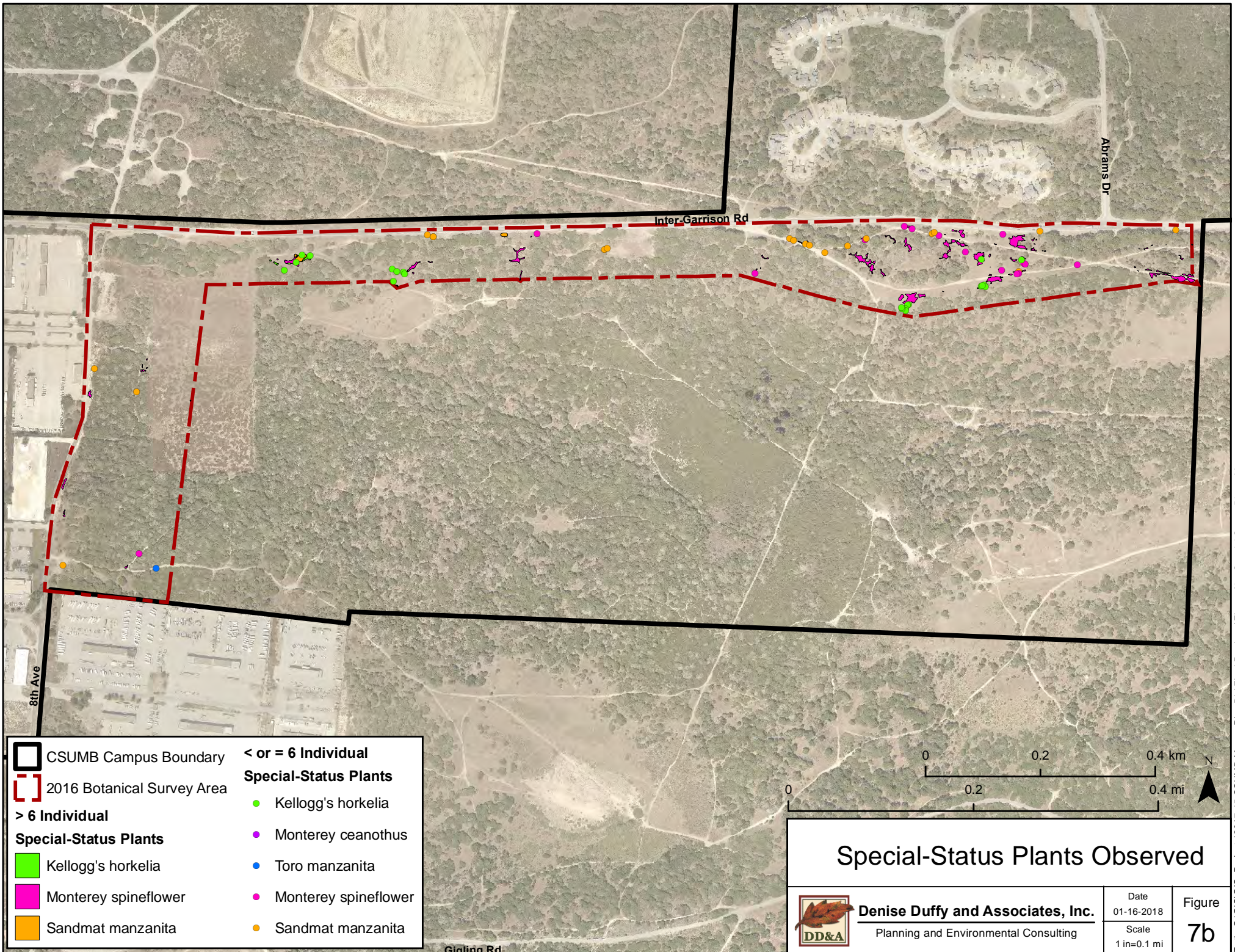

	CSUMB Campus Boundary	< or = 6 Individual Special-Status Plants		Kellogg's horkelia
	2016 Botanical Survey Area	> 6 Individual Special-Status Plants		Monterey ceanothus
				Toro manzanita
				Monterey spineflower
				Sandmat manzanita

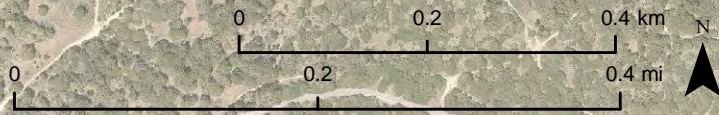

Special-Status Plants Observed

Denise Duffy and Associates, Inc. Planning and Environmental Consulting	Date 01-16-2018	Figure 7b
	Scale 1 in=0.1 mi	

of the area surveyed in 2016, include Hooker's manzanita, seaside bird's-beak, woodland woollythreads, and Santa Cruz clover.

No special-status wildlife species were observed within the coast live oak woodland habitat; however, the presence of several large woodrat nests indicates the presence of Monterey dusky-footed woodrats within the Project site. The Northern California legless lizard may use this habitat type for foraging and cover, and white-tailed kite, other raptors and protected avian species, and special-status bat species may nest or roost within the coast live oak trees. Figure B-18 in the HMP identifies this habitat type as potential habitat for the Monterey ornate shrew. Additionally, most of coast live oak woodland habitat within the Project site is within the known dispersal range of the CTS and may be used as upland aestivation and dispersal habitat for this species.

Oak woodlands are considered important natural communities because they provide a variety of ecological, aesthetic, and economical values. The extent of oak woodland in California has declined due to agricultural conversion, urban development, fuelwood harvesting, and grazing activities. Coast live oak woodland is not considered a sensitive habitat by CDFW (CDFW, 2010); however, as a native tree and habitat, impacts to coast live oak trees and woodland are typically addressed and mitigated under CEQA.

4.1.2 Central Maritime Chaparral

- ***A Manual of California Vegetation classifications:*** brittle leaf-wooly leaf manzanita chaparral (*Arctostaphylos* [crustacea, tomentosa] shrubland alliance) and sandmat manzanita chaparral (*Arctostaphylos pumila* provisional shrubland alliance)

Central maritime chaparral within the Project site (**Figure 6**) is dominated by shaggy-barked manzanita, sandmat manzanita, dwarf ceanothus, coyote brush (*Baccharis pilularis*), chamise, and sticky monkey flower. Additional species within this habitat type include California coffeeberry, fuchsia-flowered gooseberry, chaparral currant (*Ribes malvaceum*), poison oak, black sage (*Salvia mellifera*), sticky cinquefoil (*Drymocallis glandulosa*), and creeping snowberry (*Symphoricarpos mollis*).

Common wildlife species that occur within central maritime chaparral habitat include California quail (*Callipepla californica*), California towhee (*Melospiza crissalis*), California thrasher (*Toxostoma redivivum*), common poorwill (*Phalaenoptilus nuttallii*), Anna's hummingbird (*Calypte anna*), wrentit (*Chamaea fasciata*), western scrub jay, northern pacific rattlesnake (*Crotalus oreganus* ssp. *oreganus*), coast range fence lizard (*Sceloporus occidentalis bocourtii*), gopher snake (*Pituophis catenifer catenifer*), coast gartersnake (*Thamnophis elegans terrestris*), and brush rabbit (*Sylvilagus bachmani*). Additional avian species that may be found within the central maritime chaparral habitat are presented in **Appendix D**.

No special-status plant species were observed within the maritime chaparral habitat within the area surveyed in 2016. However, special-status plant species that may occur or are assumed present within this habitat type outside of the surveyed area include: Hooker's manzanita, Toro manzanita, Pajaro manzanita, sandmat manzanita, Monterey ceanothus, Fort Ord spineflower, Monterey spineflower, seaside bird's-beak, Eastwood's goldenbush, sand-loving wallflower, sand gilia, Kellogg's horkelia, Northern curly-leaved monardella, Yadon's piperia, and Santa Cruz microseris.

No special-status wildlife species were observed within the central maritime chaparral habitat; however, the presence of several large woodrat nests distributed throughout this habitat type indicates the presence

of Monterey dusky-footed woodrats within the Project site. Northern California legless lizard and coast horned lizard may occur throughout this habitat type. Special-status raptor and bat species may also forage within this habitat type, including white-tailed kite, Townsend's big-eared bat, and hoary bat. Figure B-18 in the HMP also identifies this habitat type as potential habitat for the Monterey ornate shrew. Additionally, most of the central maritime chaparral within the project site is within the known dispersal range of the CTS and may be used as upland aestivation and dispersal habitat for this species.

4.1.3 Central Coastal Scrub

- ***A Manual of California Vegetation classifications:*** coyote brush scrub (*Baccharis pilularis* shrubland alliance) and black sage scrub (*Salvia mellifera* shrubland alliance)

Holland (1986) describes central coastal scrub habitat as an area with dense shrubs, approximately one to two meters tall, which lacks grassy openings and is often integrated with other habitat types. Dominant shrub species in the central coastal scrub habitat within the Project site (**Figure 6**) include black sage, coyote brush, poison oak, sticky monkey flower, and coast sagebrush (*Artemisia californica*).

Central coastal scrub habitats provide cover and food for a number of wildlife species, including songbirds, snakes, lizards, rodents, and other small mammals. Common species that may occur within the central coastal scrub habitat include California quail, blue-gray gnatcatcher (*Polioptila caerulea*), Anna's hummingbird, coast range fence lizard, northern pacific rattlesnake, gopher snake, brush rabbit, and California ground squirrel. Additional avian species that may be found within the central coastal scrub habitat are presented in **Appendix D**.

Monterey spineflower and sandmat manzanita were identified within central coastal scrub habitat, within the area surveyed in 2016 (**Figure 7**). Additionally, special-status plant species that may occur or are assumed present within this habitat type, outside of the surveyed area, include: Hooker's manzanita, Toro manzanita, Monterey ceanothus, Fort Ord spineflower, seaside bird's-beak, Eastwood's goldenbush, sand-loving wallflower, sand gilia, Kellogg's horkelia, Point Reyes horkelia, Northern curly-leaved monardella, and Santa Cruz microseris.

No special-status wildlife species were observed within this habitat type; however, Northern California legless lizard and coast horned lizard may occur throughout the central coastal scrub on the Project site. Figure B-18 in the HMP also identifies this habitat type as potential habitat for the Monterey ornate shrew. Special-status raptor and bat species may also forage within this habitat type, including white-tailed kite, Townsend's big-eared bat, and hoary bat. The CTS may use the central coastal scrub as upland and dispersal habitat. Additionally, most of the central coastal scrub within the project site is within the known dispersal range of the CTS and may be used as upland aestivation and dispersal habitat for this species.

4.1.4 Non-Native Grassland

- ***A Manual of California Vegetation classification:*** annual brome grasslands (*Bromus diandrus*-*Avena* spp. Association)

Throughout California, non-native grasslands typically occur in open areas of valleys and foothills, usually on fine-textured clay or loam soils that are somewhat poorly drained (Holland, 1986). Non-native grasslands are often dominated by non-native annual grasses and forbs along with scattered native grasses and wildflowers. The dominant species observed in this habitat within the Project site (**Figure 6**) include

slender oat, ripgut grass (*Bromus diandrus*), soft chess (*Bromus hordeaceus*), rat-tail fescue (*Festuca myuros*), slender wild oat (*Avena barbata*), and long-beaked filaree (*Erodium botrys*). Additional species found within this habitat include needlegrass (*Stipa* sp.), sky lupine (*Lupinus nanus*), California poppy (*Eschscholzia californica*), wedge-leaved horkelia (*Horkelia cuneata*), sheep sorrel, and telegraphweed (*Heterotheca grandiflora*).

Non-native grasslands provide habitat to a number of common wildlife species. Botta's pocket gopher (*Thomomys bottae*), California ground squirrel, American badger, and several rodent species use non-native grasslands for foraging and cover. Raptors are also known to forage in this habitat, including red-tailed hawk. Reptiles, such as northern pacific rattlesnake, gopher snake, and coast range fence lizard, are also common non-native grassland species. Avian species that may be found within the non-native grassland habitat include grasshopper sparrow (*Ammodramus savannarum*), savannah sparrow (*Passerculus sandwichensis*), western kingbird (*Tyrannus verticalis*), and red-tailed hawk. Additional avian species are presented in **Appendix D**.

Monterey spineflower, Kellogg's horkelia, and sandmat manzanita were identified within non-native grassland habitat, within the area surveyed in 2016 (**Figure 7**). Additionally, special-status plant species that may occur or are assumed present within this habitat type, outside of the surveyed area, include: Point Reyes horkelia, woodland woollythreads, Santa Cruz microseris, Santa Cruz clover, and Pacific Grove clover.

No special-status wildlife was observed within the non-native grassland during field visits. However, special-status raptor and bat species may forage within this habitat type, including white-tailed kite, Townsend's big-eared bat, and hoary bat. Additionally, burrowing owl and California horned lark may nest and forage within the non-native grassland habitat. The American badger and Northern California legless lizard may use this habitat type for foraging and cover while coast horned lizard may utilize open, sandy areas within the non-native grassland for basking. Figure B-18 in the HMP also identifies this habitat type as potential habitat for the Monterey ornate shrew. Additionally, most of the non-native grassland within the project site is within the known dispersal range of the CTS and may be used as upland aestivation and dispersal habitat for this species.

4.1.5 Ruderal/Disturbed

- ***A Manual of California Vegetation classification:*** none

Ruderal, disturbed areas are those areas which have been disturbed by human activities and are dominated by non-native annual grasses and other "weedy" species. Ruderal areas within the project site includes areas around the developed areas that are regularly disturbed and other areas of historic disturbance (**Figure 6**). The ruderal areas include vegetation dominated by hottentot fig, ripgut grass, slender oat, cut-leaved plantain (*Plantago coronopus*), English plantain (*P. lanceolata*), sand mat (*Cardionema ramosissimum*), long-beaked filaree, and telegraphweed.

Common wildlife species which do well in urbanized and disturbed areas can utilize this habitat, such as the American crow (*Corvus brachyrhynchos*), California ground squirrel, raccoon, striped skunk (*Mephitis mephitis*), western scrub jay, European starling (*Sturnus vulgaris*), coast range fence lizard, and rock pigeon (*Columba livia*). This habitat type is considered to have low biological value, as it generally dominated by

non-native plant species and consists of relatively low-quality habitat from a wildlife perspective. Additional avian species are presented in **Appendix D**.

Two special-status plant species were observed within ruderal habitat in the area surveyed in 2016: Monterey spineflower and sandmat manzanita (**Figure 7**). Additionally, special-status plant species that may occur or are assumed present within this habitat type, outside of the surveyed area, include: Monterey spineflower, sandmat manzanita, Monterey ceanothus, Eastwood's goldenbush, sand-loving wallflower, sand gilia, Kellogg's horkelia, woodland woollythreads, and Yadon's piperia.

No special-status wildlife species were observed within the ruderal areas; however, some special-status wildlife species may occur. Coast horned lizards often occupy open, sandy areas and may be present within this habitat type. The presence of shrubs throughout may provide habitat for the Northern California legless lizard. American badgers may also forage within portions of this habitat type in proximity to more commonly used habitat types, such as non-native grassland. A portion of the ruderal areas within the project site is also within the known dispersal range of the CTS and may be used as upland aestivation and dispersal habitat for this species.

4.1.6 Developed

- *A Manual of California Vegetation* classification: none

Developed areas comprise the majority of the project site (**Figure 6**). These areas include paved roads and parking lots, structures, and landscaping. Very little natural vegetation is present within these areas and they are considered to have little biological value. However, some common wildlife species that do well in urbanized areas may be found foraging within the developed areas, including American crow, California ground squirrel, raccoon, striped skunk, western scrub jay, European starling, and rock pigeon.

No special-status plant species were identified within the developed areas within the areas surveyed in 2016 and none are expected to occur within developed areas outside of the survey area.

No special-status wildlife species were observed within the developed areas of the Project; however, raptors, other migratory birds, and Townsend's big-eared bat may nest/roost within the abandoned buildings or mature trees within the developed areas.

4.2 Special-Status Species

Published occurrence data within the Project area and surrounding USGS Quads were evaluated to compile a table of special-status species known to occur in the vicinity of the Project site (please refer to **Section 3 "Methods"** and **Appendix A**). Each of these species was evaluated for their likelihood to occur within and immediately adjacent to the Project site (**Appendix A**).⁹ The special-status species that are known to or have been determined to have a moderate or high potential to occur within or immediately adjacent the Project site are discussed below. All other species presented in **Appendix A** are assumed "unlikely to occur" or have a low potential to occur but are unlikely to be impacted for the species-specific reasons presented. Please note that only those species that are known or have a moderate or high potential to occur within the proposed Project site are discussed in the impacts and mitigation section of this document.

⁹ Please see **Appendix A** for the evaluation standards for the potential for species to occur.

4.2.1 Special-Status Wildlife Species

The Project site and adjacent areas were evaluated for the presence or potential presence of a variety of special-status wildlife species (**Appendix A**). The following species are discussed due to their moderate or high potential to occur or known presence within the Project site and potential to be impacted by the Project. **Table 4-2** summarizes the potential for these species to occur within the Project site. Although the likelihood for CRLF to occur within the Project site is unlikely, a discussion of this species is included below as this is a federally listed species that is known to occur in other portions of the former Fort Ord.

Table 4-2. Potential for Special-Status Wildlife Species Presence within the Project Site

Species	Potential Occurrence within Project Site	Potential Occurrence within Near-Term Development Sites				
		Student Housing Phase III	Academic IV Building	Student Recreation Center	Student Housing Phase IIB	Academic V Building
Townsend’s big-eared bat	Moderate	Unlikely	Moderate	Moderate	Moderate	Unlikely
Hoary bat	Moderate	Unlikely	Unlikely	Moderate	Moderate	Unlikely
Monterey dusky-footed woodrat	Present	Unlikely	Unlikely	Moderate	Unlikely	Unlikely
Monterey ornate shrew	High	Unlikely	Unlikely	Unlikely	Unlikely	Unlikely
American badger	High	Unlikely	Unlikely	Unlikely	Unlikely	Unlikely
California tiger salamander	Present	Unlikely	Unlikely	Unlikely	Unlikely	Unlikely
Northern California legless lizard	High	Moderate	Moderate	Moderate	Moderate	Unlikely
Coast horned lizard	High	Low	Low	Low	Low	Unlikely
California red-legged frog	Unlikely	Unlikely	Unlikely	Unlikely	Unlikely	Unlikely
Smith’s blue butterfly	Moderate	Not Present	Moderate	Not Present	Not Present	Not Present
Obscure bumble bee	Moderate	Unlikely	Unlikely	Unlikely	Unlikely	Unlikely
Western bumble bee	Moderate	Unlikely	Unlikely	Unlikely	Unlikely	Unlikely
Burrowing owl	Moderate	Unlikely	Unlikely	Unlikely	Unlikely	Unlikely
Nesting Raptors, Migratory Birds, & Other Protected Avian Species	Moderate - High	Moderate	Moderate	Moderate	Moderate	Moderate

³ **Bold** indicates Fort Ord HMP Species.

Special-Status Bat Species

Special-status bat species with the potential to occur in the vicinity that use oak woodland, central coastal scrub, and central maritime chaparral habitats and abandoned buildings as either maternity, migratory, or foraging roosts include the Townsends’s big-eared bat and hoary bat.

These species may utilize some of the coast live oak trees within the Project site for night roosts and may forage over all undeveloped areas of the Project site. Any abandoned buildings within the Project site may also provide day roost or maternity roost habitat for Townsends’s big-eared bat. Special-status bat species have a moderate potential to occur within these areas at the Project site.

Monterey Dusky-Footed Woodrat

The Monterey dusky-footed woodrat is a CDFW species of special concern. This is a subspecies of the dusky-footed woodrat (*Neotoma macrotis*), which is common to oak woodlands and other forest types throughout California. Dusky-footed woodrats are frequently found in forest habitats with moderate canopy cover and a moderate to dense understory, including riparian forests; however, they may also be found in

chaparral communities. Relatively large nests are constructed of grass, leaves, sticks, and feathers and are built in protected spots, such as rocky outcrops or dense brambles of blackberry and/or poison oak. Typical food sources for this species include leaves, flowers, nuts, berries, and truffles. Dusky-footed woodrats may be a significant food source for small- to medium-sized predators. Populations of this species may be limited by the availability of nest material. Within suitable habitat, nests are often found in close proximity to each other.

The CNDDDB does not report any occurrences of Monterey dusky-footed woodrat within the seven quadrangles reviewed. However, this species is known to occur throughout the former Fort Ord and woodrat nests were observed within the Project site during field surveys. Therefore, the Monterey dusky-footed woodrat is assumed present within suitable habitat areas.

Monterey Ornate Shrew

The Monterey ornate shrew, also known as the Salinas ornate shrew, is a CDFW species of special concern and HMP species. In general, this shrew is common in the southern two-thirds of California west of the Sierra Nevada, from Mendocino to Butte counties, south to the Mexican border. It occupies a variety of mostly moist or riparian woodland habitats and also occurs within chaparral, grassland, and emergent wetland habitats where there is thick duff or downed logs. The breeding season is long; while most pregnancies occur in March and April, they may occur from February through October. The litter size is about six and females may have more than one litter per year. Most individuals do not live to breed a second year. Foraging occurs under logs rocks and leaf litter, and prey items are mostly insects and some other invertebrates.

The CNDDDB does not report any occurrences of the Monterey ornate shrew within the seven quadrangles reviewed; however, Figure B-18 in the HMP identifies the project site as containing potential habitat for this species (ACOE, 1997). As with most shrews, little is known about their ecology since they are hard to locate and do not survive well in traps due to very high metabolic rates. However, field surveys on the UC Fort Ord Natural Reserve found that habitats within the Project site (e.g., non-native grassland, coast live oak woodland, central coastal scrub, central maritime chaparral, riparian, and mixes of these habitats) are likely considered suitable habitat for the shrew. Therefore, there is a high potential for the Monterey ornate shrew to occur within these habitats in the project site.

American Badger

The American badger is a CDFW species of special concern. Badgers occupy a diversity of habitats within California. The principal requirements seem to be sufficient food, friable soils, and relatively open, uncultivated grounds. Grasslands, savannas, and mountain meadows near timberline are preferred. Badgers feed primarily of burrowing rodents, such as gophers, squirrels, mice, and kangaroo rats, as well as some insects and reptiles. Badgers also break open beehives to eat both the brood and honey. They are active all year long and are nocturnal and diurnal. Mating occurs in summer and early fall and two to five young are born in burrows dug in relatively dry, often sandy soil, usually with sparse overstory cover.

The CNDDDB reports eight occurrences of American badger within the seven quadrangles reviewed, the nearest of which located within the eastern portion of the project site, near Inter-Garrison Road. Additionally, this species is known to occur throughout the former Fort Ord. Suitable habitat is present

within the non-native grassland, central maritime chaparral/non-native grassland mix, and central coastal scrub/non-native grassland mix, and within ruderal habitat in close proximity to the aforementioned more commonly used habitats within the project site. As such, the American badger has a high potential to occur within suitable habitat areas.

California Tiger Salamander

The CTS was listed as a federally threatened species on August 4, 2004 (69 FR 47211-47248). Critical habitat was designated for CTS on August 23, 2005 (70 FR 49379-49458), and went into effect on September 22, 2005. Additionally, CTS was listed as a state threatened species on March 3, 2010.

The CTS is a large, stocky salamander most commonly found in annual grassland habitat, but also occurring in the grassy understory of valley-foothill hardwood and chaparral habitats, and uncommonly along stream courses in valley-foothill riparian habitats (Service, 2004). Adults spend most of their lives underground, typically in burrows of ground squirrels and other animals (Service, 2004). The CTS has been eliminated from an estimated 55 percent of its documented historic breeding sites. Currently, about 150 known populations of CTS remain. The CTS persists in disjunct remnant vernal pool complexes in Sonoma County and Santa Barbara County, in vernal pool complexes and isolated stockpools scattered along a narrow strip of rangeland on the fringes of the Central Valley from southern Colusa County south to northern Kern County, and in sag ponds and human-maintained stockpools in the coast ranges from the San Francisco Bay Area south to the Temblor Range.

Above-ground migratory and breeding activity may occur under suitable environmental conditions from mid-October through May. Adults may travel long distances between upland and breeding sites; adults have been found more than two kilometers (1.24 miles) from breeding sites (Service, 2004). Breeding occurs from November to February, following relatively warm rains (Stebbins, 2003). The CTS breeds and lays eggs primarily in vernal pools and other temporary rainwater ponds. Permanent human-made ponds are sometimes utilized if predatory fishes are absent; streams are rarely used for reproduction. Eggs are laid singly or in clumps on both submerged and emergent vegetation and on submerged debris in shallow water (Stebbins, 1972; Jennings and Hayes, 1994). Males typically spend 6-8 weeks at breeding ponds, while females typically spend only 1-2 weeks (Loredo et al., 1996). Eggs hatch within 10-14 days (Service, 2004) and a minimum of 10 weeks is required to complete development through metamorphosis (Jennings and Hayes, 1994), although the larval stage may last up to six months and some larvae in Contra Costa and Alameda Counties may remain in their breeding sites over the summer (Service, 2004).

The project site is not located within designated critical habitat for CTS. The CNDDDB reports 49 occurrences of CTS within the seven quadrangles evaluated, 25 of which occur within the former Fort Ord. Extensive surveys have been conducted within the former Fort Ord to determine the aquatic resources that are known or have the potential to be occupied by CTS (**Figure 8**). No potential or known CTS breeding (aquatic) habitat is present within the Project site. The nearest known CTS-occupied pond is 0.4 mile (0.6 km) from the project site (Pond 101 East).

The Service considers suitable upland aestivation habitat within two kilometers of known or potential breeding locations for CTS as occupied habitat unless protocol-level surveys are conducted with negative results pursuant to the *Interim Guidance on Site Assessment and Field Surveys for Determining Presence or a Negative Finding of the California Tiger Salamander* (Service and CDFW, 2003). Portions of the

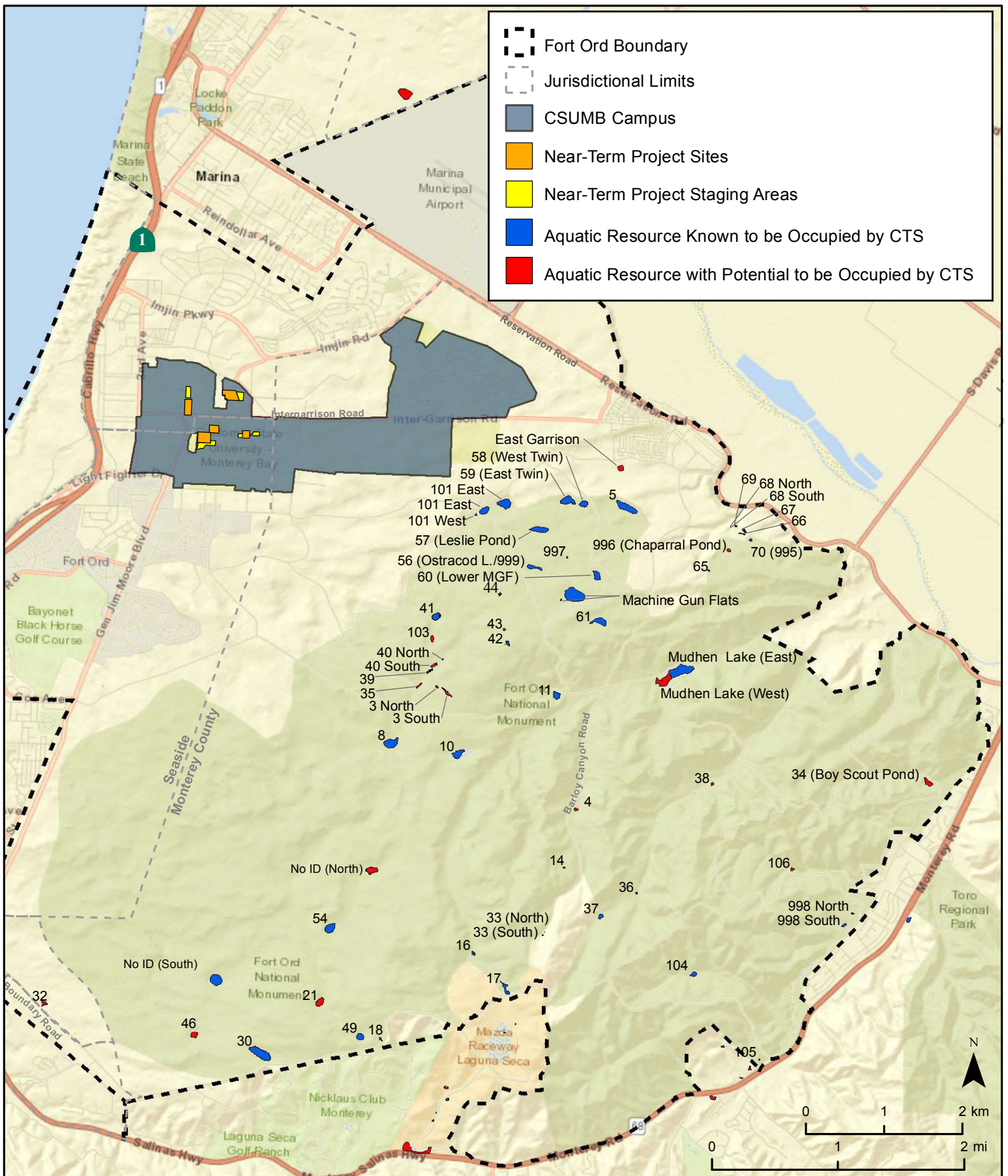

Service Layer Credits: Sources: Esri, HERE, DeLorme, USGS, Intermap, INCREMENT P, NRCan, Esri Japan, METI, Esri China (Hong Kong), Esri Korea, Esri (Thailand), MapmyIndia, NGCC, © OpenStreetMap contributors, and the GIS User Community



Denise Duffy and Associates, Inc.

Planning and Environmental Consulting

Date
01-16-2017

Scale
1 in = 1 mi

Figure

8

Project site are within two kilometers of several aquatic resources known or with the potential to be occupied by CTS. **Figure 9** and **Table 4-3** present the area of habitats within the Project site assumed by the Service as occupied by CTS in the absence of protocol-level surveys. Please note that areas designated as “developed” are not included in these calculations as it is assumed these areas do not provide CTS upland habitat.

The CDFW uses a four-zone methodology to determine the relative impact of a project to CTS. The zones are as follows:

- Zone 1: 380 meters (0.24 mile) –the distance that greater than 50% of dispersing CTS adults and approximately 50% of dispersing CTS sub-adults will travel from the breeding pond;
- Zone 2: 630 meters (0.39 mile) – the distance within which greater than 95% of dispersing CTS are found;
- Zone 3: 1 km (0.62 mile) – the distance that ongoing studies have shown that adults and juveniles routinely move; and
- Zone 4: 2.2 km (1.3 miles) – the greatest distance adults have been found to move from a breeding site.





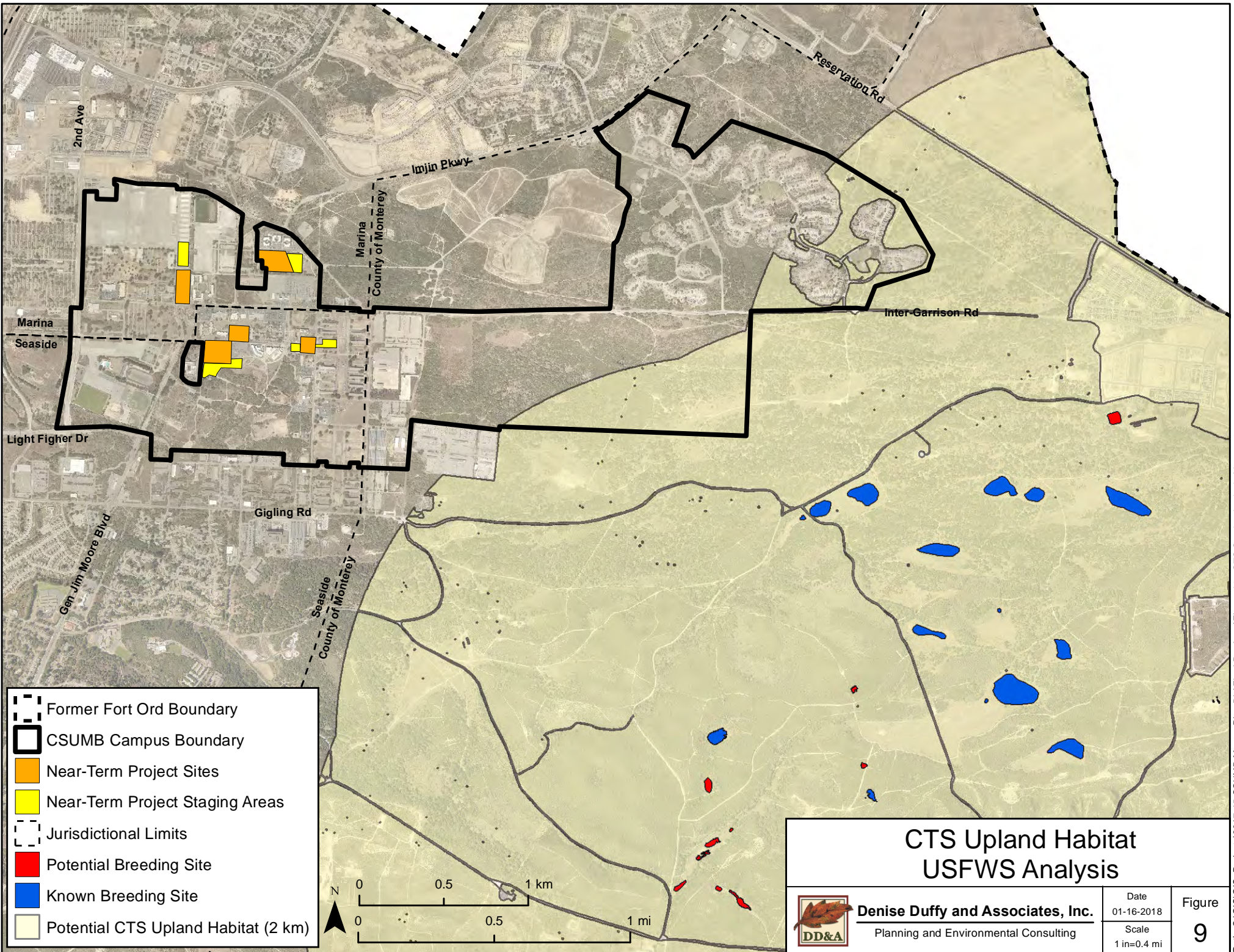

Portions of the Project site fall within the Zone 2, Zone 3, and Zone 4 distances from aquatic resources known or with the potential to be occupied by CTS. **Figure 10** and **Table 4-3** present the area of habitats within the Project site that fall within these zones. Please note that areas designated as “developed” are not included in these calculations as it is assumed these areas do not provide CTS upland habitat. Additionally, none of the Near-Term Development sites fall within potential CTS Habitat.

Table 4-3. Area of Potential CTS Habitat within the Project Site

Habitat	<i>Service (2km)</i>	<i>DFW Zone 2 (630 m)</i>	<i>DFW Zone 3 (1km)</i>	<i>DFW Zone 4 (2.2km)</i>
<i>Coast Live Oak Woodland</i>	89.1	0.9	19.4	236.1
<i>Central Maritime Chaparral</i>	31.6	0	0	65.4
<i>Central Coastal Scrub</i>	7.8	0	4.8	3.1
<i>Non-native Grassland</i>	18.0	0	14.4	18.0
<i>Central Coastal Scrub/ Non-Native Grassland Mix</i>	4.5	0	0	4.5
<i>Central Maritime Chaparral/ Coast Live Oak Woodland Mix</i>	19.9	0	0	45.8
<i>Central Coastal Scrub/ Coast Live Oak Woodland Mix</i>	5.1	0	2.7	7.5
<i>Non-Native Grassland/ Coast Live Oak Woodland Mix</i>	11.9	0	0	18.2
<i>Ruderal</i>	10.5	0	0	35.9
Total	198.4	0.9	41.3	434.5

In addition to the potential CTS upland habitat within the Project site, DD&A biologists encountered an individual CTS within the compound used for the Army’s Munitions and Explosives of Concern (MEC) remediation project, located immediately adjacent to the Project site (ITSI Gilbane Company, 2014). In the absence of protocol-level surveys, it is assumed that CTS are present within suitable upland habitat within the Project site.



-  Former Fort Ord Boundary
-  CSUMB Campus Boundary
-  Near-Term Project Sites
-  Near-Term Project Staging Areas
-  Jurisdictional Limits
-  Potential Breeding Site
-  Known Breeding Site
-  Potential CTS Upland Habitat (2 km)

<h2>CTS Upland Habitat USFWS Analysis</h2>		
	Denise Duffy and Associates, Inc.	Date 01-16-2018
	Planning and Environmental Consulting	Scale 1 in=0.4 mi
		Figure 9

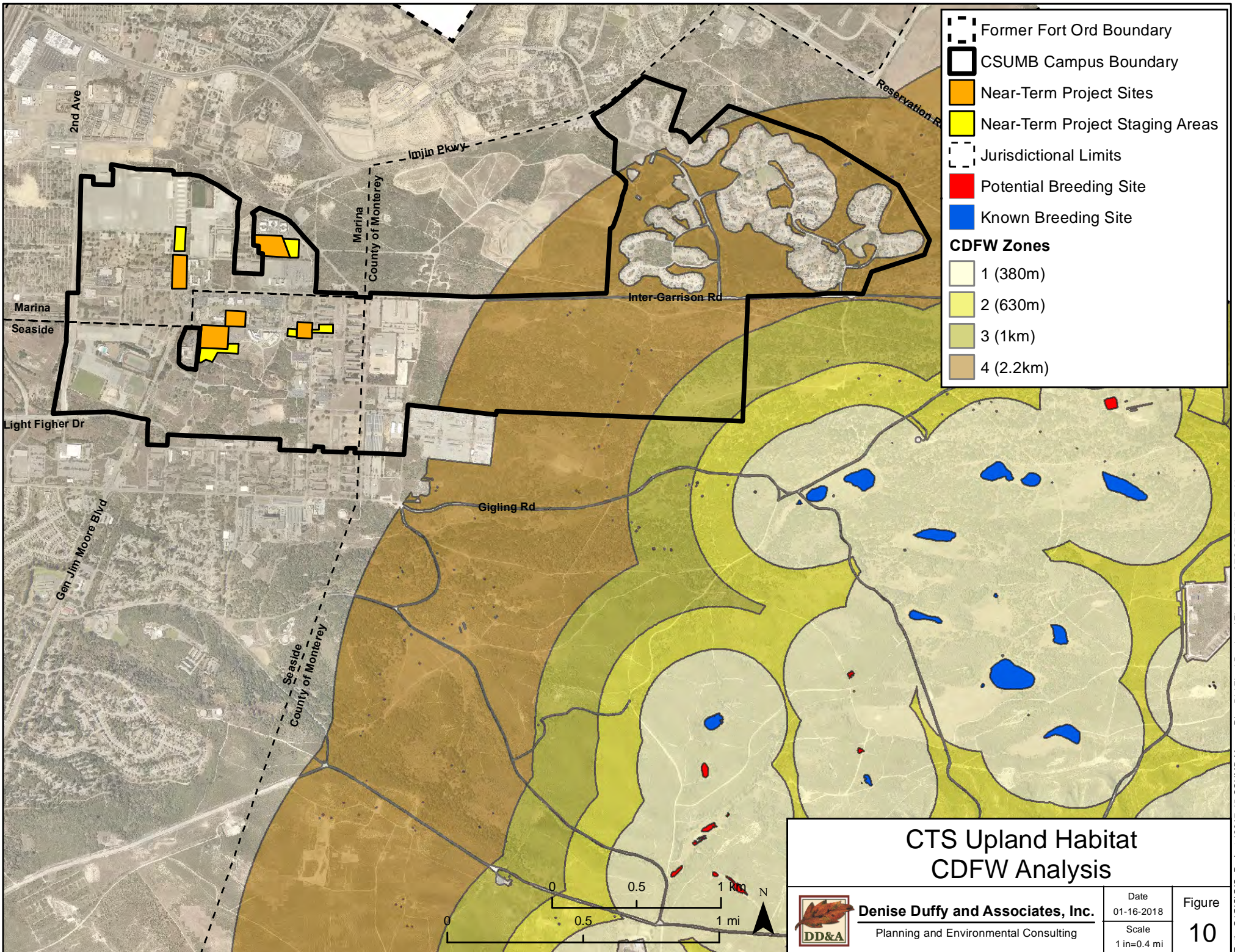

CTS Upland Habitat CDFW Analysis



Denise Duffy and Associates, Inc.
Planning and Environmental Consulting

Date	01-16-2018
Scale	1 in=0.4 mi

Figure
10

Northern California Legless Lizard

The Northern California legless lizard is a CDFW species of special concern, as well as an HMP species.¹⁰ This fossorial (burrowing) species typically inhabits sandy or loose (friable) soils. Habitats known to support Northern California legless lizard include (but are not limited to) coastal dunes, valley and foothill grasslands, chaparral, and coastal scrub at elevations from near sea level to approximately 1,800 meters (6,000 feet). The Northern California legless lizard forages on invertebrates beneath the leaf litter or duff layer at the base of bushes and trees or under wood, rocks, and slash in appropriate habitats. The diet of this species likely overlaps to some extent with that of juvenile alligator lizards and perhaps some other salamanders. This species may be preyed upon by alligator lizards, snakes, birds, and small mammals. Little is known about the specific habitat requirements for courtship and breeding; however, the mating season for this species is believed to begin late spring or early summer, with one to four live young born between September and November.

The CNDDDB reports 38 occurrences of Northern California legless lizard within the seven quadrangles reviewed, including one occurrence that includes the northeastern portion of the Project site. An additional CNDDDB occurrence is located immediately north of the western portion of the Project site. Suitable habitat for Northern California legless lizard is present throughout all undeveloped areas of the Project site where appropriate cover conditions occur. Therefore, the Northern California legless lizard has a high potential to occur within the project site.

Coast Horned Lizard

The coast horned lizard is a CDFW species of special concern. Horned lizards occur in valley-foothill hardwood, conifer, and riparian habitats, as well as in pine-cypress, juniper, chaparral, and annual grass habitats. This species generally inhabits open country, especially sandy areas, washes, flood plains, and wind-blown deposits in a wide variety of habitats. Coast horned lizards rely on camouflage for protection and will often lay motionless when approached. Horned lizards often bask in the early morning on the ground or on elevated objects such as low boulders or rocks. Predators and extreme heat are avoided by burrowing into loose soil. Periods of inactivity and winter hibernation are spent burrowed into the soil or under surface objects. Little is known about the habitat requirements for breeding and egg-laying of this species. Prey species include ants, beetles, wasps, grasshoppers, flies, and caterpillars.

The CNDDDB reports five occurrences of the coast horned lizard within the seven quadrangles reviewed, one occurrence within the northeastern portion of the Project site. Additionally, this species has been observed throughout Fort Ord by DD&A biologists. Suitable habitat for this species is present within the Project site within the central maritime chaparral and central coastal scrub habitats, including the mixed

¹⁰ The HMP identifies this species as black-legless lizard (*Anniella pulchra* ssp. *nigra*) in order to differentiate it from the previously identified silvery-legless lizard (*A. p.* ssp. *pulchra*). These subspecies are based primarily on phenotypic differences (black-legless lizard being much darker, having fewer scales on the back, and a relatively shorter tail) and very limited genetic work. Further, the range of the black-legless lizard has historically been classified as “restricted to coastal and interior dune sand other areas of sandy soils in the vicinity of Monterey Bay and the Monterey Peninsula” (Service, 1998), while the range of silvery-legless lizard has been classified as widespread throughout central California (Parham and Papenfuss, 2008). However, recent genetic studies have revealed five lineages of this species that correspond with different geographic areas of California (Parham and Papenfuss, 2008). These studies do not, however, identify the legless lizards occurring on the coast of Monterey Bay (i.e. the currently designated black-legless lizard) as a separate lineage. Currently, CDFW identifies both subspecies as the Northern California legless lizard and this document, therefore, follows the current regulatory identification.

habitats, and may utilize open sandy areas of the non-native grassland and ruderal habitats. Therefore, there is a high potential for the coast horned lizard to occur within these habitats within the Project site.

California Red-Legged Frog

The CRLF was listed as a federally threatened species on June 24, 1996 (61 FR 25813-25833) and is also a CDFW species of special concern. Critical habitat was designated for CRLF on April 13, 2006 (71 FR 19244-19346) and revised on March 17, 2010 (75 FR 12816-12959). The revised critical habitat went into effect on April 16, 2010.

The CRLF is the largest native frog in California (44-131 mm snout-vent length) and was historically widely distributed in the central and southern portions of the state (Jennings & Hayes, 1994). Adults generally inhabit aquatic habitats with riparian vegetation, overhanging banks, or plunge pools for cover, especially during the breeding season (Jennings and Hayes, 1988). They may take refuge in small mammal burrows, leaf litter, or other moist areas during periods of inactivity or to avoid desiccation (Rathbun, et al., 1993; Jennings and Hayes, 1994). Radiotelemetry data indicates that adults engage in straight-line breeding season movements irrespective of riparian corridors or topography and they may move up to two miles between non-breeding and breeding sites (Bulger et. al., 2003). During the non-breeding season, a wider variety of aquatic habitats are used including small pools in coastal streams, springs, water traps, and other ephemeral water bodies (Service, 1996). CRLF may also move up to 300 feet from aquatic habitats into surrounding uplands, especially following rains, where individuals may spend days or weeks (Bulger et al., 2003).

This species requires still or slow-moving water during the breeding season where it can deposit large egg masses, which are most often attached to submergent or emergent vegetation. Breeding typically occurs between December and April depending on annual environmental conditions and locality. Eggs require six to 12 days to hatch and metamorphosis generally occurs after 3.5 to seven months, although larvae are also capable of over-wintering. Following metamorphosis, generally between July and September, juveniles are 25-35 mm in size. Juvenile CRLF appear to have different habitat needs than adults. Jennings and Hayes (1988) recorded juvenile frogs mostly from sites with shallow water and limited shoreline or emergent vegetation. Additionally, it was important that there be small one-meter breaks in the vegetation or clearings in the dense riparian cover to allow juveniles to sun themselves and forage, but to also have close escape cover from predators. Jennings and Hayes also noted that tadpoles have different habitat needs and that in addition to vegetation cover, tadpoles use mud. It is speculated that CRLF larvae are algae grazers, however, foraging larval ecology remains unknown (Jennings, et. al., 1993).

It has been shown that occurrences of CRLF are negatively correlated with presence of non-native bullfrogs (Moyle, 1973; Jennings and Hayes, 1986 and 1988), although both species are able to persist at certain locations, particularly in the coastal zone. It is estimated that CRLF has disappeared from approximately 75% of its former range and has been nearly extirpated from the Sierra Nevada, Central Valley, and much of southern California (Service, 1996).

The project site is not located within designated critical habitat for CRLF. The CNDDDB reports 52 occurrences of CRLF within the seven quadrangles reviewed, the nearest of which is located approximately three miles north of the Project site, within the Salinas River riparian corridor. No aquatic breeding, aquatic non-breeding, or optimal dispersal habitat is present within the Project site. The nearest known breeding

pond on former Fort Ord is approximately 4.7 miles southeast of the Project site (**Figure 11**). The Project site is within one mile (1.6 km) of several potential CRLF breeding ponds, the general distance provided by the Service for CRLF site assessments (Service and CDFW, 2005). These ponds are located east and south of the Project site, no potential breeding ponds are present north or west of the Project site on Fort Ord, and the availability of non-breeding aquatic resources to the north and west of the Project site is little to none. The nearest potential breeding pond to the Project site is 0.4 mile (0.6 km) away (Pond 101 East). As such, there is a very low potential for CRLF to disperse through the Project site. As noted above, CRLF may move up to 300 feet from aquatic habitats into surrounding uplands (Bulger et al., 2003); however, no aquatic resources are present within 300 feet of the Project site. Additionally, CRLF have not been observed breeding in this pond since the initial detection and there have been recent observations of large goldfish in the pond, which may inhibit further use by CRLF. Therefore, this species is unlikely to occur within the Project site.









Smith's Blue Butterfly

The SBB was listed as a federally Endangered species on June 1, 1976 (41 FR 22041-22044). This species historically ranged along the California coast from Monterey Bay south through Big Sur to near Point Gorda, occurring in scattered populations in association with coastal dune, coastal scrub, chaparral, and grassland vegetation types. The primary limiting factor for SBB populations is the occurrence of their host plants, dune buckwheat (*Eriogonum parvifolium*) and coast buckwheat (*E. latifolium*), in which they are associated with for their entire life span. There is also a potential for SBB to use naked buckwheat (*E. nudum*) within a range of the obligate host species (pers. comm. Dave Dixon, State Parks).

The presence of the host plant, however, is not always an indication of the occurrence of the butterfly, as the host plant distribution is much more extensive than that of the butterfly.

Individual adult males and females live approximately one week. Adult emergence and seasonal activity are synchronized with the blooming period of the particular buckwheat used at a given site. Dispersal data from capture-recapture studies (Arnold, 1983) indicate that most adults are quite sedentary, with home ranges no more than a few acres. The SBB has only one generation per year. Females lay single eggs into buckwheat flower heads, which hatch in approximately one week. Caterpillars mature over a span of approximately three to four weeks, feeding on petals and seeds of the buckwheat plant. Chrysalis formation then takes place in the buckwheat flower head and the chrysalis eventually falls into the leaf litter and topsoil beneath the plant where it remains for approximately 47 weeks until the cycle begins again (Dixon, 1999).

The CNDDDB reports 17 occurrences of SBB within the quadrangles reviewed, the nearest of which is located approximately 0.7 mile from the Project site, within the Monterey Dunes State Park. Small areas of dune buckwheat were identified within the survey area near the intersection of 6th Avenue and Butler Street (0.1 ac and 6 individuals) and the intersection of 6th Avenue and A Street (23 individuals). Additionally, a small area of dune buckwheat (0.02 ac and 1 individual) is known from previous surveys conducted for the Fort Ord HCP, along Inter-Garrison Road near the main campus quad. Four dune buckwheat individuals were identified within the Academic IV project site. These areas may provide habitat for SBB (**Figure 12**). Host plant species for SBB may also occur within the unsurveyed areas of the Project site. Therefore, this species has a moderate potential to occur within the Project site. No buckwheat plant

-  Former Fort Ord Boundary
-  Jurisdictional Limits
-  CSUMB Campus
-  1.6 km Buffer of Known and Potential CRLF Breeding Sites
-  Near-Term Project Sites
-  Aquatic Resource Known to be Occupied by CRLF
-  Near-Term Project Staging Areas
-  Aquatic Resource with Potential to be Occupied by CRLF

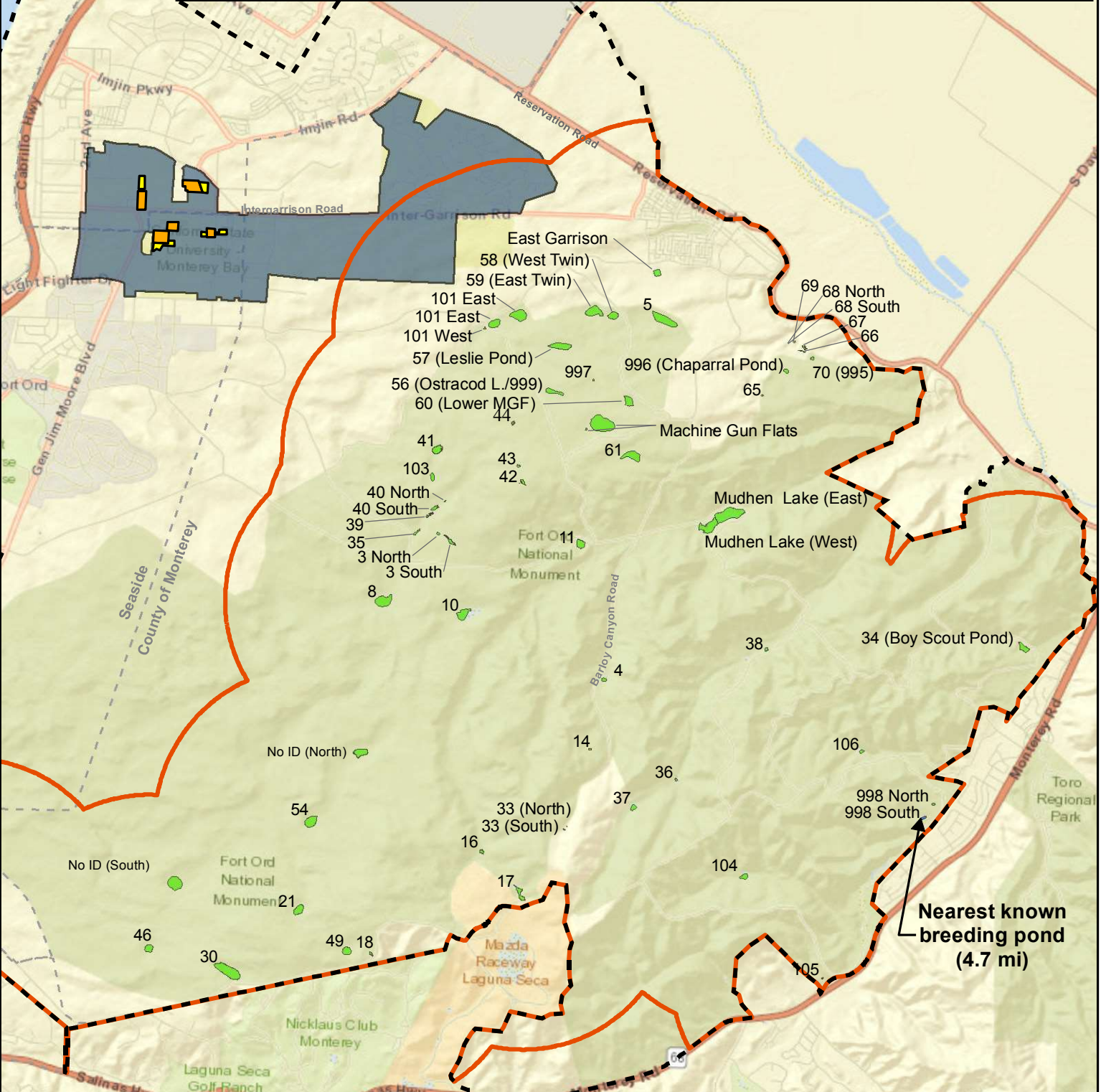

Service Layer Credits: Sources: Esri, HERE, DeLorme, USGS, Intermap, INCREMENT P, NRCan, Esri Japan, METI, Esri China (Hong Kong), Esri Korea, Esri (Thailand), MapmyIndia, NGCC, © OpenStreetMap contributors, and the GIS User Community

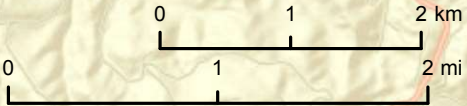

Denise Duffy and Associates, Inc.
Planning and Environmental Consulting

Date: 01-16-2018
Scale: 1 in = 0.9 mi

Figure
11

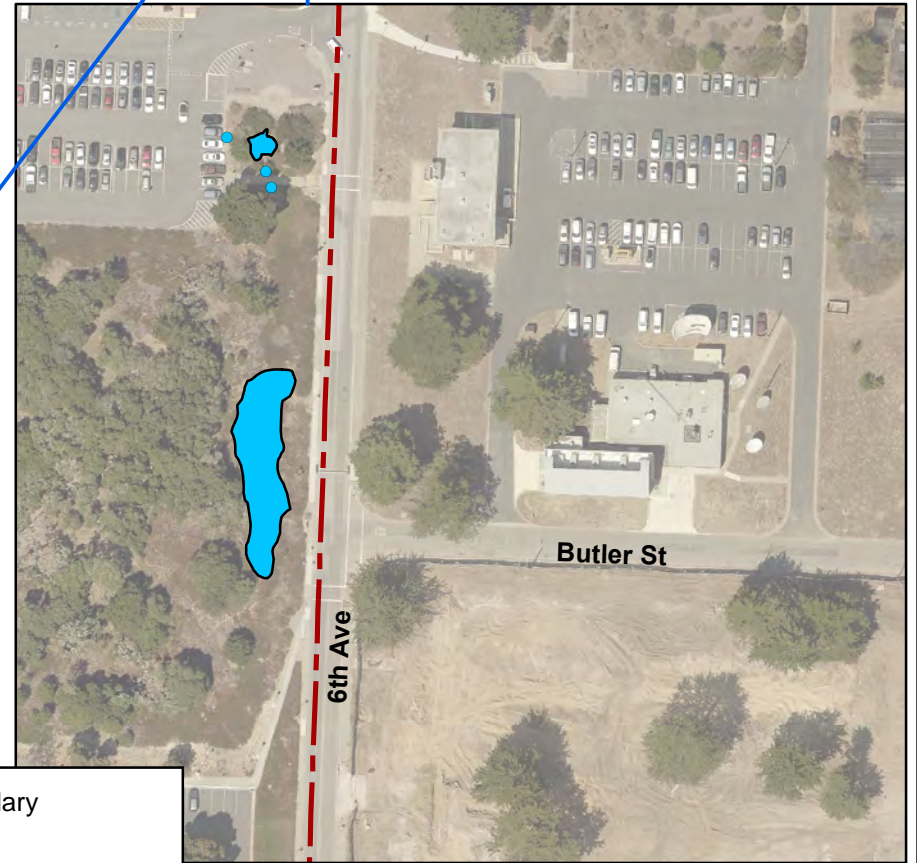
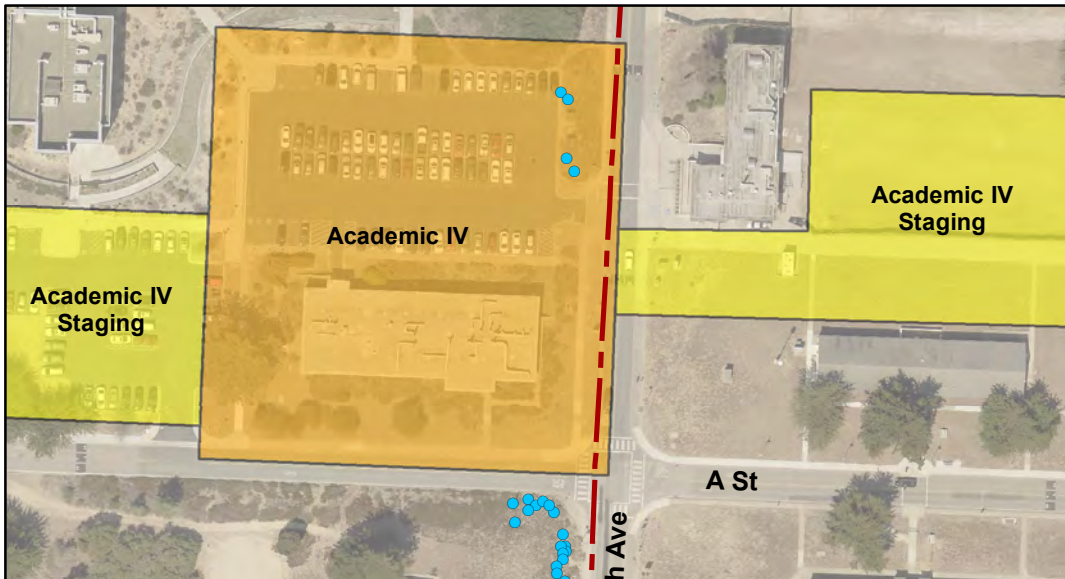
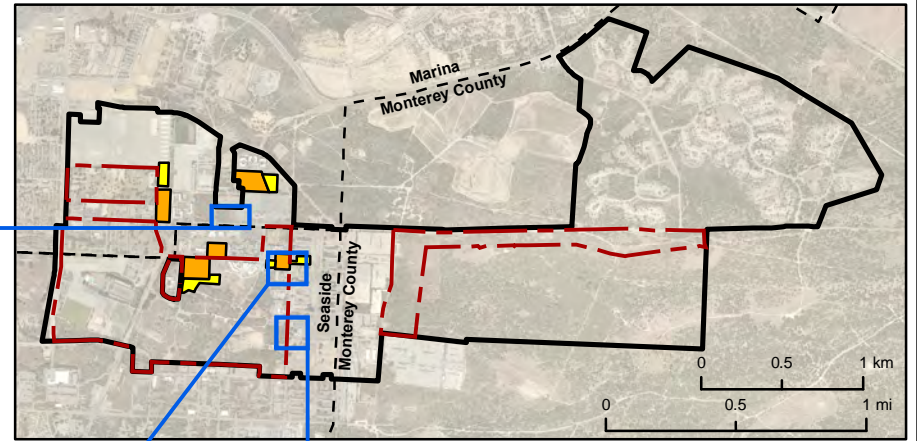
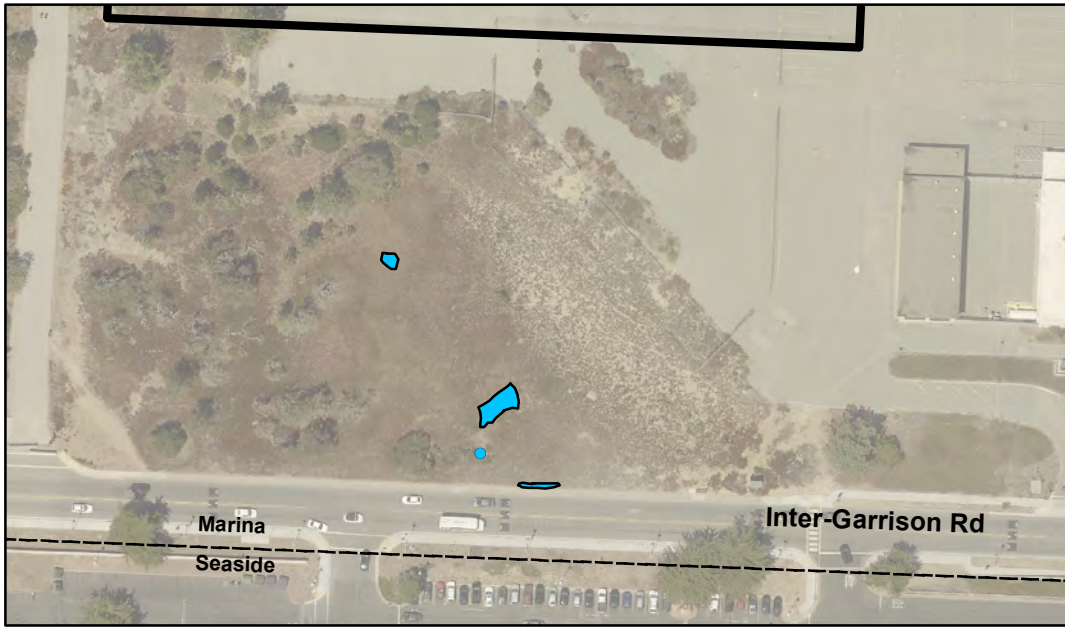

- CSUMB Campus Boundary
- Near-Term Project Sites
- Near-Term Project Staging Areas
- 2016 Botanical Survey Area
- Jurisdictional Limits
- Potential Smith's Blue Butterfly Habitat

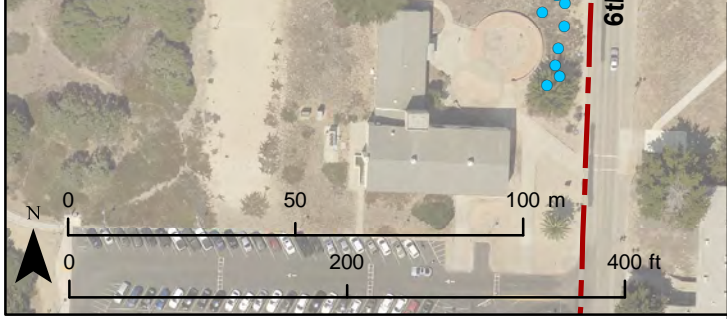

Smith's Blue Butterfly Potential Habitat Observed		
	Denise Duffy and Associates, Inc.	Date 03-13-2019
	Planning and Environmental Consulting	Scale 1 in=0 mi
		Figure 12

species suitable for SBB habitat were observed within the other Near-Term Development sites or proposed staging areas.

Obscure Bumble Bee

The obscure bumble bee occurs in Mediterranean California and along the Pacific Coast from southern California to southern British Columbia in Canada (Williams et. al., 2014). This species occurs primarily along the coast in grassy prairies and meadows. Select food genera include *Baccharis*, *Cirsium*, *Lupinus*, *Lotus*, *Grindelia*, and *Phacelia* (Pollinator Partnership and U.S. Forest Service [USFS], 2012). The obscure bumble bee nests both underground and above ground (abandoned bird nests are often utilized).

The CNDDDB reports four occurrences of the obscure bumble bee within the quads evaluated. The nearest CNDDDB occurrence of obscure bumble bee is approximately 5.8 miles from the Project site. Suitable habitat for this species may be present within the non-native grassland, non-native grassland mix habitats, and portions of the ruderal habitat within the Project site. This species has a moderate potential to occur within suitable habitat at the Project site.

Western Bumble Bee

The western bumble bee was formerly common from the Pacific coast to the Colorado Rocky Mountains; however, populations from central California to southern British Columbia, Canada and west of the Sierra-Cascade Ranges have declined sharply since the late 1990s (Pollinator Partnership and USFS, 2012; Williams et. al., 2014). Select food genera include *Melilotus*, *Cirsium*, *Trifolium*, *Centaurea*, *Chrysothamnus*, and *Eriogonum* (Pollinator Partnership and USFS, 2012). The western bumble bee generally nests underground.

The CNDDDB reports six occurrences of the western bumble bee within the quads evaluated. The nearest CNDDDB occurrence of this species is approximately 4.6 miles from the Project site. Suitable habitat for this species may be present within the non-native grassland, non-native grassland/coast live oak woodland mix, non-native grassland/central coastal scrub, and portions of the ruderal areas within the Project site. This species has a moderate potential to occur within suitable habitat at the Project site.

Nesting Raptors, Migratory Birds, and Other Protected Avian Species

Raptors and their nests and migratory birds are protected under FGC and the MBTA. While the life histories of these species vary, overlapping nesting and foraging similarities (approximately February through August) allow for their concurrent discussion. Most raptors are breeding residents throughout most of the wooded portions of the state. Stands of live oak, riparian deciduous, or other forest habitats, as well as open grasslands, are used most frequently for nesting. Breeding occurs February through August, with peak activity May through July. Prey for these species includes small birds, small mammals, and some reptiles and amphibians. Many raptor species hunt in open woodland and habitat edges. Various species of raptors (such as red-tailed hawk, red-shouldered hawk [*Buteo lineatus*], great horned owl, American kestrel, and turkey vulture [*Cathartes aura*]) have a potential to nest within any of the large coast live oak, Monterey pine, or Monterey cypress trees present within the Project site. Additionally, migratory bird species that may be present within the Project site include, but is not limited to, common poorwill, blue-gray gnatcatcher, Townsend's warbler (*Setophaga townsendii*), western tanager (*Piranga ludoviciana*),

savannah sparrow, ash-throated fly catcher (*Myiarchus cinerascens*), and violet-green swallow (*Tachycineta thalassina*).

Avian species identified as CDFW species of special concern or Fully Protected Species (such as the white-tailed kite, western burrowing owl, and California horned lark) have the potential to occur within the Project site. Suitable nesting habitat for the white-tailed kite is present within the coast live oak woodland habitat. This species may also forage over any of the undeveloped areas within the Project site. In addition, marginally suitable nesting and foraging habitat for the western burrowing owl and California horned lark is present within the non-native grassland habitat. Therefore, nesting raptors, migratory birds, and other protected avian species have a moderate to high potential to occur within the Project site.

4.2.2 Special-Status Plant Species

The Project site and adjacent areas were evaluated for the presence or potential presence of a variety of special-status plant species (**Appendix A**). Focused surveys were conducted within a portion of the Project site; this area is identified as the “survey area” on **Figure 6**. The following special-status plant species are discussed due to their known presence within the Project site, as observed during the focused botanical surveys (**Figure 7**), or for their moderate to high potential to occur in the un-surveyed areas of the Project site, based on known occurrences in the vicinity and presence of suitable habitat. **Table 4-4** summarizes the potential for these species to occur within the Project site. **Figure 7** and **Table 4-5** identifies the area of each of species observed within the survey area. All other species presented in **Appendix A** are assumed “unlikely to occur” based on the lack of suitable habitat within un-surveyed portions of the Project site and/or the results of the focused surveys within the survey area, or have a low potential to occur but are unlikely to be impacted. Please note that only those special-status plant species that are known or have the potential to occur within the Project site are discussed in the impacts and mitigation section of this document.

Table 4-4. Potential for Special-Status Plant Species Presence within the Project Site

Species	Potential Occurrence within Project Site	Potential Occurrence within Near-Term Development Component Sites and Staging Areas				
		Student Housing Phase III	Academic IV Building ¹¹	Student Recreation Center	Student Housing Phase IIB	Academic V Building
Hooker’s manzanita	Moderate	Not Present	Not Present	Not Present	Not Present	Not Present
Toro manzanita	Present	Not Present	Not Present	Not Present	Not Present	Not Present
Pajaro manzanita	Moderate	Not Present	Not Present	Not Present	Not Present	Not Present
Sandmat manzanita	Present	Not Present	Not Present	Not Present	Not Present	Not Present
Monterey ceanothus	Present	Not Present	Not Present	Not Present	Not Present	Not Present
Fort Ord spineflower	Moderate	Unlikely	Unlikely	Not Present	Unlikely	Unlikely
Monterey spineflower	Present	Low	Low	Present	Low	Unlikely
Seaside bird’s-beak	High	Unlikely	Unlikely	Not Present	Unlikely	Unlikely
Eastwood’s goldenbush	High	Not Present	Not Present	Not Present	Not Present	Not Present
Sand-loving wallflower	High	Unlikely	Unlikely	Not Present	Unlikely	Unlikely

¹¹ The Academic IV Building site and a portion of the staging area was included in the survey area for botanical surveys conducted in 2017; however, a portion of the staging area was not included. Therefore, special-status plant species listed with potential to occur for this site may occur only within the unsurveyed portions of the staging area. No special-status plant species were observed within the surveyed areas of the Academic IV Building site in 2017.

Species	Potential Occurrence within Project Site	Potential Occurrence within Near-Term Development				
		Student Housing Phase III	Academic IV Building ¹¹	Student Recreation Center	Student Housing Phase IIB	Academic V Building
Sand gilia	High	Low	Low	Not Present	Low	Unlikely
Kellogg's horkelia	Present	Not Present	Not Present	Not Present	Not Present	Not Present
Point Reyes horkelia	Moderate	Unlikely	Unlikely	Not Present	Unlikely	Unlikely
Marsh microseris	Moderate	Unlikely	Unlikely	Not Present	Unlikely	Unlikely
Northern curly-leaved monardella	Moderate	Unlikely	Unlikely	Not Present	Unlikely	Unlikely
Woodland woolythreads	Moderate	Unlikely	Unlikely	Not Present	Unlikely	Unlikely
Yadon's piperia	High	Unlikely	Unlikely	Not Present	Low	Unlikely
Santa Cruz microseris	Moderate	Unlikely	Unlikely	Not Present	Unlikely	Unlikely
Santa Cruz clover	Moderate	Unlikely	Unlikely	Not Present	Unlikely	Unlikely
Pacific Grove clover	Moderate	Unlikely	Unlikely	Not Present	Unlikely	Unlikely

³ **Bold** indicates Fort Ord HMP Species.

Table 4-5. Area of Special-Status Plant Species within the Survey Area¹²

Species	Area (acres)			Individuals
	Low	Medium	High	
Toro Manzanita	0	0	0	1
Sandmat Manzanita	0.01	0.02	0.3	30
Monterey Ceanothus	0	0	0	2
Monterey Spineflower	16.5	1.1	0.1	120
Kellogg's Horkelia	0.03	0.003	0	48

Hooker's Manzanita

Hooker's manzanita is a CNPS CRPR 1B and HMP species in the Ericaceae family. This evergreen shrub is associated with closed-cone coniferous forest, chaparral, cismontane woodland and coastal scrub habitats on sandy soils at a range of 85-536 meters in elevation. The blooming period is from January to June.

The CNDDDB reports 19 occurrences of this species within the quads evaluated, the nearest of which is located approximately 0.2 mile south of the Project site. This species was not observed within the survey area during surveys in 2016; however, suitable habitat for this species is present within the unsurveyed portions of the Project site. Therefore, this species has a moderate potential to occur within the Project site.

Toro Manzanita

Toro manzanita (also often referred to as Monterey manzanita) is a CNPS CRPR 1B and HMP species. This evergreen shrub in the Ericaceae family blooms from February-March. Toro manzanita is associated with maritime chaparral, cismontane woodland, and coastal scrub on sandy soils at elevations of 30-730 meters.

¹² Please note that the areas presented in Table 4-4 only represent the areas of the Project site where focused special-status plant surveys were completed in 2016. **Bold** indicates Fort Ord HMP Species.

The CNDDDB reports an occurrence of this species within the project site (**Figure 14**). One individual Toro manzanita was identified within the survey area during the 2016 botanical surveys (**Figure 7**). This species may also occur within the unsurveyed portions of the Project site.

Pajaro Manzanita

Pajaro manzanita is a CNPS CRPR 1B species in the Ericaceae family. This evergreen shrub is associated with chaparral on sandy soils at a range of 30-760 meters in elevation. The blooming period is December to March.

The CNDDDB reports 18 occurrences of this species within the quads evaluated, the nearest of which includes a very small portion of the southwestern corner of the Project site (**Figure 13**). This occurrence is associated with the main entrance to Fort Ord and the Highway 1 overpass, and is, therefore, unlikely within the Project site. This species was not observed within the survey area during surveys in 2016; however, Pajaro manzanita is known to occur in other areas of the Former Fort Ord and suitable habitat is present within the unsurveyed portions of the Project site. Therefore, this species has a moderate potential to occur within the Project site.

Sandmat Manzanita

Sandmat manzanita is a CNPS CRPR 1B and HMP species. This evergreen shrub in the Ericaceae family blooms from February to May. Sandmat manzanita is associated with openings in chaparral, coastal scrub, closed cone coniferous forest, coastal dunes, and cismontane woodland habitats on sandy soils at elevations between 3-205 meters.

The CNDDDB reports 17 occurrences of this species within the quads evaluated, including two specific occurrences within project site (**Figure 13**). Sandmat manzanita was identified within the survey area during the 2016 botanical surveys (**Figure 7**). This species may also occur within the unsurveyed portions of the Project site.

Monterey Ceanothus

Monterey ceanothus is a CNPS CRPR 4 and HMP species. This evergreen shrub in the Rhamnaceae family blooms from February to April (sometimes through June). This species is associated with closed-cone coniferous forests, chaparral, and coastal scrub on sandy soils at elevations between 3-550 meters.

The CNDDDB does not report any occurrences of this species; however, it is known to occur throughout the former Fort Ord. Two individual Monterey ceanothus were identified within the survey area during the 2016 botanical surveys (**Figure 7**). This species may also occur within the unsurveyed portions of the Project site.

Service Layer Credits: Sources: Earl, HERE, DeLorme, TomTom, Intermap, Increment P Corp., GEBCO, USGS, FAO, NPS, NRCAN, GeoBase, IGN, Kadaster NL, Ordnance

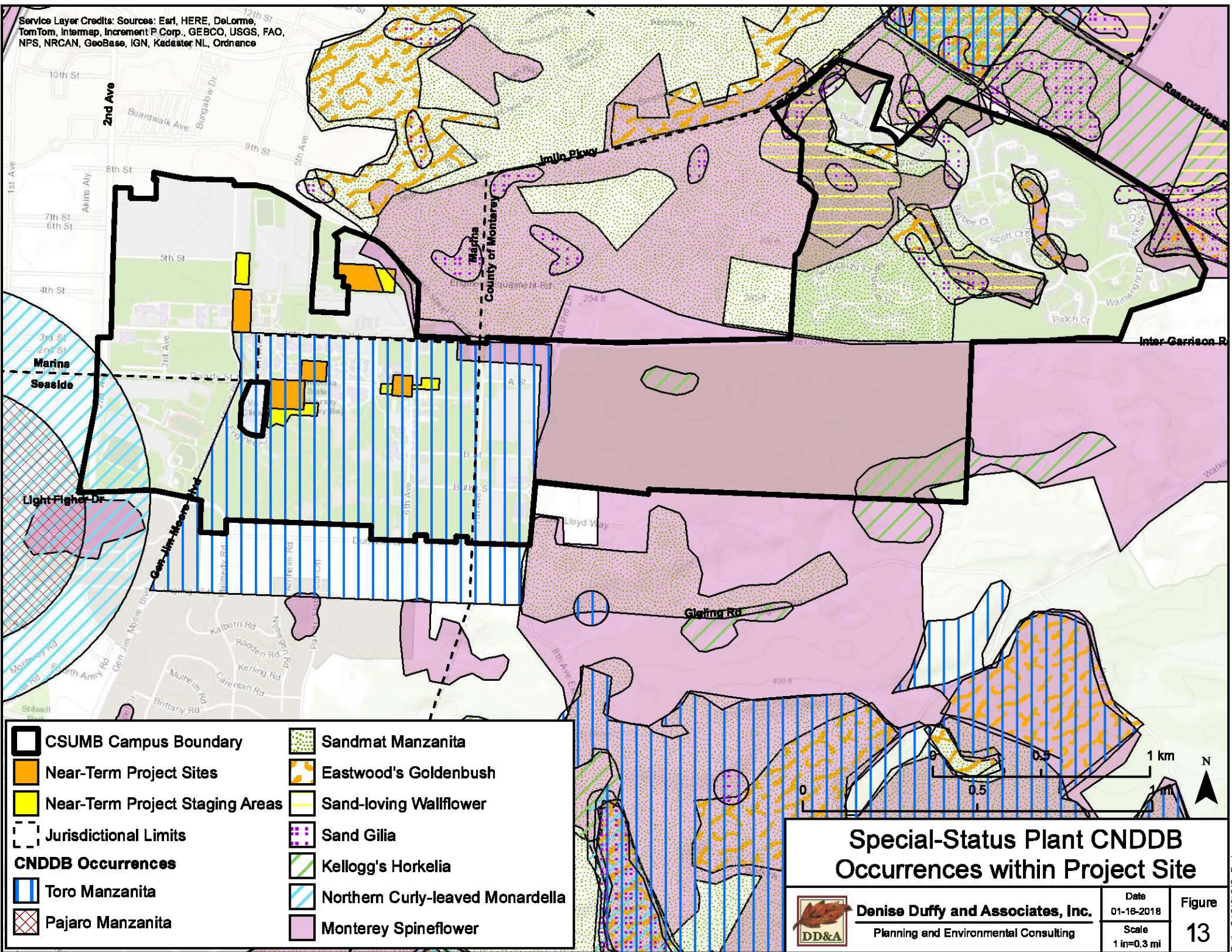

Special-Status Plant CNDDB Occurrences within Project Site



Denise Duffy and Associates, Inc.
 Planning and Environmental Consulting

Date
 01-16-2018
 Scale
 1 in=0.3 mi

Figure
 13

Fort Ord Spineflower

Fort Ord spineflower is a CNPS CRPR 1B species. This annual herb in the Polygonaceae family is associated with sandy openings of maritime chaparral and coastal scrub at elevations of 55-150 meters. The blooming period is April to July.

The CNDDDB reports five occurrences of this species within the quads evaluated, the nearest of which is located 0.3 mile south of the Project site. This species was not observed within the survey area during surveys in 2016; however, Fort Ord spineflower is known to occur in other areas of the Former Fort Ord and suitable habitat is present within the unsurveyed portions of the Project site. Therefore, this species has a moderate potential to occur within the Project site.

Monterey Spineflower

Monterey spineflower and is a federally threatened, CNPS CRPR 1B, and HMP species. It is a small, prostrate annual herb in the Polygonaceae family that blooms from April to June. The white to rose floral tube of Monterey spineflower distinguishes it from the more common, but closely related, diffuse spineflower (*Chorizanthe diffusa*), which has a lemon-yellow floral tube. Monterey spineflower typically occurs on open sandy or gravelly soils on relic dunes in coastal dune, coastal scrub, and maritime chaparral habitats, though it can also be associated with cismontane woodlands and valley and foothill grasslands, within a range of 3-450 meters in elevation.

The CNDDDB reports an occurrence of this species that includes the majority of Project site (**Figure 13**). Monterey spineflower was identified within the survey area during the 2016 botanical surveys, including a small population that overlaps with the Student Recreation Center proposed staging area (**Figure 7**). This species may also occur within the unsurveyed portions of the Project site.

Seaside Bird's-Beak

Seaside bird's-beak is a state endangered, CNPS CRPR 1B, and HMP species. It is a hemiparasitic annual in the Scrophulariaceae family and blooms April through October. Seaside bird's-beak is typically associated with closed-cone coniferous forest, chaparral, cismontane woodlands, coastal dunes, and coastal scrub in sandy soils and often in disturbed areas, within the range of 0-425 meters in elevation.

The CNDDDB reports 17 occurrences of this species within the quads evaluated, the nearest of which is located approximately 0.3 mile from the Project site (**Figure 13**). This species was not observed within the survey area during surveys in 2016; however, seaside bird's-beak is known to occur in other areas of the Former Fort Ord and suitable habitat is present within the unsurveyed portions of the Project site. Therefore, this species has a high potential to occur within the Project site.

Eastwood's Goldenbush

Eastwood's goldenbush (also often referred to as Eastwood's goldenfleece) is a CNPS CRPR 1B and HMP species. This evergreen shrub in the Asteraceae is associated with openings in closed-cone coniferous forest, maritime chaparral, coastal dunes, and coastal scrub on sandy soils at elevations of 30-275 meters. The blooming period is from July-October.

The CNDDDB reports 17 occurrences of this species within the quads evaluated, including a specific occurrence in the northeastern portion of the Project site (**Figure 13**). This species was not observed within the survey area during surveys in 2016; however, suitable habitat is present within the unsurveyed portions of the Project site. Based on this information, Eastwood's goldenbush has a high potential to occur within the Project site, outside of the survey area.

Sand-loving Wallflower

Sand-loving wallflower is a CNPS CRPR 1B and HMP species in the Brassicaceae family. This perennial herb is associated with openings in maritime chaparral, coastal dunes, and coastal scrub on sandy soils at elevations of 0-60 meters. The blooming period is February to June.

The CNDDDB reports 16 occurrences of this species within the quads evaluated, including a specific occurrence in the northeastern portion of the Project site (**Figure 13**). This species was not observed within the survey area during surveys in 2016; however, suitable habitat is present within the unsurveyed portions of the Project site. Based on this information, sand-loving wallflower has a high potential to occur within the Project site, outside of the survey area.

Sand Gilia

Sand gilia is a federally Endangered, state Threatened, CNPS CRPR 1B, and HMP species. This annual herb in the Polemoniaceae blooms from April through June and is found in sandy openings of maritime chaparral, cismontane woodland, coastal dune and coastal scrub habitats within the range of 0-45 meters in elevation.

The CNDDDB reports 30 occurrences of this species within the quads evaluated, including a specific occurrence in the northeastern portion of the Project site (**Figure 13**). This species was not observed within the survey area during surveys in 2016; however, suitable habitat is present within the unsurveyed portions of the Project site. Based on this information, sand gilia has a high potential to occur within the Project site, outside of the survey area.

Kellogg's Horkelia

Kellogg's horkelia is a CNPS CRPR 1B species. It is a perennial herb in the Rosaceae family and blooms April through June. Kellogg's horkelia is typically associated with openings in closed cone coniferous forest, maritime chaparral, and coastal scrub in sandy or gravelly soils on relic dunes, within a range of 10 to 200 meters in elevation.

The CNDDDB reports three occurrences of this species that overlap with the Project site (**Figure 13**). This species was identified within the survey area during the 2016 botanical surveys (**Figure 7**). This species may also occur within the unsurveyed portions of the Project site.

Point Reyes Horkelia

Point Reyes horkelia is a CNPS CRPR 1B species. It is a perennial herb in the Rosaceae family and blooms May through September. Point Reyes horkelia is typically associated with coastal dunes, coastal prairie, and coastal scrub in sandy soils, within a range of 5-755 meters in elevation.

The CNDDDB reports one occurrence of this species within the quads evaluated, located approximately 1.5 miles northwest of the Project site. This species was not observed within the survey area during surveys in 2016; however, suitable habitat is present within the unsurveyed portions of the Project site. Based on this information, Point Reyes horkelia has a moderate potential to occur within the Project site.

Marsh Microseris

Marsh microseris is a CNPS CRPR 1B species in the Asteraceae family. This rhizomatous, perennial herb is found in closed-cone coniferous forest, cismontane woodland, coastal scrub, and valley and foothill grassland habitats at elevations from 5-300 meters. The blooming period is from April through July.

The CNDDDB reports 10 occurrences of this species within the quads evaluated, the nearest of which is located approximately 0.9 mile southeast of the Project site. This species was not observed within the survey area during surveys in 2016; however, suitable habitat may be present within the unsurveyed portions of the Project site. Therefore, marsh microseris has a moderate potential to occur within the Project site.

Northern Curly-leaved Monardella

Northern curly-leaved monardella is a CNPS CRPR 1B species in the Lamiaceae family. This annual herb is found in chaparral, coastal dunes, and coastal scrub at elevations of 0-300 meters. This species may also be found in ponderosa pine sandhills in Santa Cruz County and valley and foothill grassland habitats at elevations from 5-300 meters. The blooming period is from April through September.

The CNDDDB reports eight occurrences of this species within the quads evaluated, the nearest of which includes a portion of the southwestern corner of the Project site (**Figure 13**). This occurrence is a non-specific occurrence based on collections from 1908 to 1919 and the exact location is unknown. This species was not observed within this portion of the project site or any other portions of the survey area during surveys in 2016. However, Northern curly-leaved monardella is known to occur in other areas of the Former Fort Ord and suitable habitat is present within the unsurveyed portions of the Project site. Therefore, this species has a moderate potential to occur within the Project site.

Woodland Woollythreads

Woodland woollythreads is a CNPS CRPR 1B species. It is an annual herb in the Asteraceae family and blooms between March and July. This species is typically associated with openings in broadleaved upland forest, chaparral, cismontane woodland, north coast coniferous forest and valley and foothill grasslands on serpentine soils, within a range of 100-1,200 meters in elevation. This species may occur within the non-native grassland habitat on the Project site.

The CNDDDB reports two occurrences of this species within the quads evaluated, the nearest of which is located approximately 5.1 miles southwest of the Project site. This species was not observed within the survey area during surveys in 2016; however, suitable habitat is present within the unsurveyed portions of the Project site. Based on this information, woodland woollythreads has a moderate potential to within the Project site.

Yadon's Piperia

Yadon's piperia is a federally endangered, CNPS CRPR 1B, and HMP species. This perennial herb in the Orchidaceae family blooms from May to August and is found in closed-cone coniferous forest, maritime chaparral on sandy soils, and coastal bluff scrub at elevations from 10-510 meters. Overall, this species favors a well-drained, sandy soil substrate with podzolic conditions, and areas that retain moisture during the rainy season but are not subject to inundation (V.Yadon in litt. 2002). As in some other plant taxa, individual orchids that flower in one year may not have the necessary energy reserves to flower in the following year. As a result, an unknown proportion of a population may be dormant in any given year, thus making it difficult to track population dynamics through monitoring of population size (Wells, 1981; Rasmussen, 1995; A. Graff in litt., 2002). However, it would be expected that some percentage of a resident population would flower in any given year. As a result, while it may be difficult to track population dynamics in any given year, determining presence or absence for a specific area is not.

The CNDDDB reports 22 occurrences of this species within the quads evaluated, the nearest of which is located approximately 0.9 mile north of the Project site. DD&A biologists have also found Yadon's piperia approximately 0.1 mile west of the Project site on 1st Street. This species was not observed within the survey area during surveys in 2016; however, suitable habitat is present within the unsurveyed portions of the Project site and this species is known to occur within other portions of the Former Fort Ord. Based on this information, Yadon's piperia has a high potential to within the Project site.

Santa Cruz Microseris

Santa Cruz microseris is a CNPS CRPR 1B species. This annual herb in the Asteraceae family is found in broadleaved upland forest, closed cone coniferous forest, chaparral, coastal prairie, coastal scrub, and valley and foothill grasslands in open areas, sometimes on serpentinite soils. The elevation range for Santa Cruz microseris is 10-500 meters and the blooming period is from April to May.

The CNDDDB reports two occurrences of this species within the quads evaluated, the nearest of which is located approximately 4.6 miles south of the Project site. This species was not observed within the survey area during surveys in 2016; however, suitable habitat is present within the unsurveyed portions of the Project site. Based on this information, Santa Cruz microseris has a moderate potential to within the Project site.

Santa Cruz Clover

Santa Cruz clover is a CNPS CRPR 1B species in the Fabaceae family. This annual herb is associated with broad-leaved upland forest, cismontane woodland, and margins of coastal prairie on gravelly soils, at elevations of 105-610 meters. The blooming period is from April-October.

The CNDDDB reports four occurrences of this species within the quads evaluated, the nearest of which is located approximately 0.5 miles southeast of the Project site. This species was not observed within the survey area during surveys in 2016; however, suitable habitat is present within the unsurveyed portions of the Project site. Based on this information, Santa Cruz clover has a moderate potential to within the Project site.

Pacific Grove Clover

Pacific Grove clover is a CNPS CRPR 1B species in the Fabaceae family. This annual herb is found in closed-cone coniferous forest, coastal prairie, meadows, seeps, and mesic areas in valley and foothill grassland at elevations of 5-120 meters. The blooming period is from April-June.

The CNDDDB reports 12 occurrences of this species within the quads evaluated, the nearest of which is located approximately 4.9 miles south of the Project site. This species was not observed within the survey area during surveys in 2016; however, suitable habitat may be present within the unsurveyed portions of the Project site. Based on this information, Pacific Grove clover has a moderate potential to within the Project site.

4.3 Sensitive Habitats

One sensitive habitat was identified within the Project site: central maritime chaparral (which includes the central maritime chaparral mix habitats).

4.3.1 Central Maritime Chaparral

Central maritime chaparral habitat (**Figure 6**), including the central maritime chaparral/central coastal scrub and central maritime chaparral/coast live oak woodland mix habitats, is identified as a sensitive habitat on the CDFW's *Natural Communities List* (CDFW, 2010). Central maritime chaparral is also identified as a sensitive habitat in the HMP. Approximately 124.3 acres of central maritime chaparral habitat, including mix habitats, occurs within the Project site. No central maritime chaparral or mix habitats occur within the Near-Term Development sites.

This page left intentionally blank

5.0 IMPACTS AND MITIGATION

5.1 Impact Analysis Approach

The biological analysis herein includes two levels of analysis: program-level for the Master Plan (**Section 5.2 “Impacts and Mitigation Measures – Master Plan”**), and project-level for the Near-Term Development Components (**Section 5.3 “Impacts and Mitigation Measures – Near-Term Development Components”**). Specific subsequent projects, their associated locations, and physical effects on the environment from the implementation of the proposed Master Plan are not known at this time. Thus, this analysis uses a programmatic approach to evaluating potential impacts to sensitive biological resources that may result from implementation of the proposed Master Plan, commensurate with the conceptual level of project information available and the approval being considered (i.e., CSU BOT approval of the proposed Master Plan).

A project-level approach was used to evaluate the potential impacts to sensitive biological resources that may result from implementation of the proposed Near-Term Developments, commensurate with the site- and project-specific detail available. The Proposed Master Plan Project and Mitigation Measures identified in **Section 5.2** for the Master Plan remain applicable and are not repeated. Additional mitigation measures also are included, where warranted, to respond to project-specific impacts.

5.1.1 HMP Species and Habitat Impact Analysis

The entire proposed Project site is located within parcels designated by the HMP as “development” and no uses beyond what is permissible by the HMP are proposed with the Project. As described above, parcels designated as “development” do not have management requirements. However, CSUMB is required to implement Borderlands requirements within the East Campus Open Space parcel and required to identify sensitive biological resources within development parcels that may be salvaged for use in restoration activities in habitat reserve areas. Through implementation of the HMP, impacts to HMP species and habitats occurring within the designated development parcels were anticipated and mitigated off campus through the establishment of habitat reserves and corridors and the implementation of habitat management requirements within habitat reserve parcels on former Fort Ord.

The HMP species known or with the potential to occur within the Project site include: Monterey spineflower, sand gilia, sandmat manzanita, Hooker’s manzanita, Toro manzanita, Monterey ceanothus, seaside bird’s-beak, sand-loving wallflower, Eastwood’s goldenbush, Yadon’s piperia, CTS, SBB, Northern California legless lizard, and Monterey ornate shrew (Appendix A). With the designated off campus habitat reserves and corridors and habitat management requirements of the HMP in place, the loss of these species associated with development in the Fort Ord area is not expected to jeopardize the long-term viability of these species and their populations on the former Fort Ord (Service, 1993). This is such because the recipients of disposed land with habitat management requirements and development restrictions designated by the HMP will be obligated to implement those specific measures through the HMP and deed covenants.

In addition to the HMP species identified, impacts to sensitive central maritime chaparral habitat are also addressed in the HMP and, therefore, impacts to this habitat are also considered mitigated through the implementation of the HMP based on the same conclusions: because the Project is: 1) only proposing

development activities within designated development parcels; 2) required to comply with the HMP; and 3) would not result in any additional impacts to HMP species and habitats beyond those anticipated in the HMP, no additional mitigation measures for these HMP species or central maritime chaparral habitat are required. Impacts to these special-status species and central maritime chaparral are considered less than significant.

The HMP, as well as the BO, require the identification of sensitive biological resources within development parcels that may be salvaged for use in restoration activities in habitat reserve areas. In addition, CSUMB is required to implement Borderlands requirements in the East Campus Open Space parcel. CSUMB is required to implement HMP requirements in accordance with the deed covenants, which apply to all parcels within the campus boundaries. Therefore, this analysis assumes that salvage of HMP species will be conducted in accordance with this requirement.

However, as described earlier in this report, the HMP does not exempt existing or future land recipients from the federal and state requirements of ESA and CESA. Of the 14 HMP species known or with the potential to occur within the Project site, there are six federal and/or state listed species that have the potential to be impacted by the Project and may require take authorization from the resource agencies (Service and/or CDFW): Monterey spineflower, federally threatened; sand gilia, federally endangered and state threatened; seaside bird's-beak, state endangered; Yadon's piperia, federally endangered; CTS, federal and state threatened; and SBB, federally endangered. Therefore, although these species are HMP species, the take of these species is prohibited under the ESA and/or CESA. Development resulting in take of these species would need to be authorized by the Service and/or CDFW through the issuance of incidental take permits from the applicable agency to avoid violation of the ESA and/or CESA.

It is also important to note that these four species are currently being considered for take coverage under a base-wide Draft HCP. The Project is included in the Draft HCP as a covered activity, and, therefore, the incidental take of these four species would be authorized under the base-wide Incidental Take Permits issued by the Service and CDFW once the HCP and IA are approved. In the event that the HCP and IA are approved prior to construction of the Project, no additional mitigation measures would be required. However, if specific projects under the proposed Master Plan are initiated prior to HCP and IA approval, implementation of the specific projects may require take authorization from the Service and/or CDFW at an individual project level to avoid violation of the ESA and/or CESA.

5.1.2 Applicable Project Design Features

The PDFs drawn from the Master Plan Guidelines identify numerous measures that would reduce impacts to sensitive biological resources (see CSUMB Master Plan Draft EIR Chapter 3, Project Description). The impact analysis assumes that these measures will be implemented; however, additional mitigation measures are identified to reduce impacts to sensitive biological resources identified herein to a less-than-significant level, where necessary.

5.1.3 Thresholds of Significance

Based on the significance criteria contained in Appendix G of the CEQA Guidelines, a project may have a significant adverse impact on the environment if it will:

- (a) Have a substantial adverse effect, either directly or through habitat modifications, on any species identified as a candidate, sensitive, or special status species in local or regional plans, policies, or regulations, or by the California Department of Fish and Wildlife or U.S. Fish and Wildlife Service;
- (b) Have a substantial adverse effect on any riparian habitat or other sensitive natural community identified in local or regional plans, policies, or regulations or by the California Department of Fish and Wildlife or US Fish and Wildlife Service;
- (c) Have a substantial adverse effect on state or federally protected wetlands (including, but not limited to, marsh, vernal pool, coastal, etc.) through direct removal, filling, hydrological interruption, or other means;
- (d) Interfere substantially with the movement of any native resident or migratory fish or wildlife species or with established native resident or migratory wildlife corridors, or impede the use of native wildlife nursery sites;
- (e) Conflict with any local policies or ordinances protecting biological resources, such as a tree preservation policy or ordinance; or
- (f) Conflict with the provisions of an adopted Habitat Conservation Plan, Natural Community Conservation Plan, or other approved local, regional, or state habitat conservation plan.

5.2 **Impacts and Mitigation Measures – Master Plan**

Impact BIO-1: Impacts to Special-Status Species and Habitat. *Implementation of the proposed Master Plan could result in removal of special-status plant and wildlife species and their habitat. This is a potentially significant impact that can be reduced to a less-than-significant level with the implementation of the mitigation measures identified below.*

Future development on the CSUMB campus could result in direct loss of individuals and habitat for a number of special-status wildlife species, including special-status bat species, Monterey dusky-footed woodrat, Monterey ornate shrew, American badger, Northern California legless lizard, coast horned lizard, CTS, SBB, obscure bumble bee, western bumble bee, and nesting raptors and other protected avian species. In addition, future development within the Project site could also result in direct loss of individuals and habitat for a number of special-status plant species, including Toro manzanita, Hooker's manzanita, Pajaro manzanita, sandmat manzanita, Monterey ceanothus, Fort Ord spineflower, Monterey spineflower, seaside bird's beak, Eastwood's goldenbush, sand-loving wallflower, sand gilia, Kellogg's horkelia, Point Reyes horkelia, marsh microseris, Northern curly-leaved monardella, woodland woollythreads, Yadon's piperia, Santa Cruz microseris, Santa Cruz clover, and Pacific Grove clover.

As described in the Impact Analysis Approach section above, impacts to HMP plant and wildlife species are considered less than significant. These species include: CTS, SBB, Northern California legless lizard, Monterey ornate shrew, Monterey spineflower, sand gilia, sandmat manzanita, Hooker's manzanita, Toro manzanita, Monterey ceanothus, seaside bird's-beak, sand-loving wallflower, Eastwood's goldenbush and Yadon's piperia (Appendix A). While not required to reduce a significant impact, Mitigation BIO-1.1 will be implemented to further reduce the less-than-significant impact. This measure would ensure that sensitive biological resources are identified on development sites in advance of construction and that take authorization is obtained, were needed. Per the HMP and the BO requirements in deed covenants, **Mitigation BIO-1.1** acknowledges that CSUMB will identify sensitive biological resources within all development parcels prior to any future construction to determine whether salvage is feasible and if so, seed and topsoil salvage would occur to support reseeded and restoration efforts on- or off-site. In addition, CSUMB is required to implement Borderlands requirements in the East Campus Open Space parcel. Implementation of these requirements are included in **Mitigation BIO-1d**, which includes measures to avoid and minimize impacts to biological resources in adjacent open space areas. Additionally, in the absence of an approved based-wide incidental take permit, Project impacts to species listed as threatened or endangered by CDFW and/or the Service may also require agency consultation and/or incidental take permits. These species include: Monterey spineflower, federally threatened; sand gilia, federally endangered and state threatened; seaside bird's-beak, state endangered; Yadon's piperia, federally endangered; CTS, federal and state threatened; and SBB, federally endangered. Therefore, although these species are HMP species, the take of these species is prohibited under the ESA and/or CESA. Impacts resulting in take of these species would need to be authorized by the Service and/or CDFW through the issuance of incidental take permits from the applicable agency to avoid violation of the ESA and/or CESA.

If a project would result in impacts to special-status species not included in the HMP, such impacts would be potentially significant and mitigation will be required. Special-status species not included in the HMP that would require mitigation include: Kellogg's horkelia, Pajaro manzanita, Fort Ord spineflower, Point Reyes horkelia, marsh microseris, Northern curly-leaved monardella, woodland woolythreads, Santa Cruz microseris, Santa Cruz clover, Pacific Grove Clover, special-status bat species, Monterey dusky-footed woodrat, American badger, coast horned lizard, western bumble bee, and obscure bumble bee (Appendix A). These species are not listed under ESA or CESA and take authorization from the Service or CDFW is not required; however, impacts to these species would be considered potentially significant under CEQA. This potentially significant impact can be reduced to a less-than-significant level with implementation of **Mitigation Measure BIO-1.2** provided below, which includes project-specific biological assessments for future development to determine presence/absence of special-status species and identification of measures necessary to avoid, minimize, and/or compensate for any identified impacts.

The MBTA protects the majority of migrating birds breeding in the U.S., regardless of their official federal or state listing status under the ESA or CESA. The law applies to the disturbance or removal of active nests occupied by migratory birds during their breeding season. It is specifically a violation of the MBTA to directly kill or destroy an occupied nest of any bird species covered by the MBTA. CDFW Code Section 3503 protects the nest and eggs of native non-game birds. Under this law, it is unlawful to take, possess, or destroy any such birds or to take, possess, or destroy the nests or eggs of any such bird. FGC Section 86 defines "take" as "hunt, pursue, catch, capture, or kill, or attempt to hunt, pursue, catch, capture, or kill." Most of the birds observed or with the potential to occur within the Project site are protected under both the MBTA and FGC Section 3503, and, in addition, birds may be designated as California species of special

concern. Construction-related activities (e.g., trimming and removal of vegetation, and equipment noise, vibration, and lighting) that result in harm, injury, or death of individuals, or abandonment of an active nest is a potentially significant impact that can be reduced to a less-than-significant level with implementation of **Mitigation Measure BIO-1.3** identified below, which includes surveys to identify the presence of active nests prior to construction and measures to avoid active nests if found.

New development proposed adjacent to open space areas has the potential to adversely affect special-status species and natural communities within the open space areas. Damaging effects may include vandalism, dumping of trash, trampling, mountain bike use, equestrian use, and off-road vehicle use; runoff from adjacent streets and landscaped areas containing lawn fertilizer, pesticides, and vehicle waste (petroleum byproducts); introduction of invasive non-native species; off-trail activity resulting in habitat destruction and/or fragmentation and spread of invasive species; lights and noise from nearby development; unregulated movement of domestic animals; and a lack of barriers to special-status species that may enter developed areas, which may result in individual mortality. These adverse effects may be the result of activities occurring within development areas and indirectly affecting the adjacent habitat areas (e.g., water runoff), or result of increased public access and use of the open space areas due to the increase in local population and availability of open space recreational amenities. This is considered a potentially significant impact that can be reduced to a less-than-significant level with implementation of **Mitigation Measure BIO-1.4** provided below, which includes implementation of open space requirements.

Mitigation Measures for Impacts to Special-Status Species

Implementation of the following mitigation measures will reduce the potentially significant impacts to special-status species to a less-than-significant level. Mitigation measures may be refined as part of EIR preparation. Additionally, although impacts to HMP plant and wildlife species are considered less than significant, **Mitigation BIO-1.1** below will be implemented to further reduce the less-than-significant impact consistent with the HMP and the BO requirements in deed covenants.

BIO-1.1: Project-Specific Biological Assessments (HMP Species). The CSUMB CPD Department shall require that a biological survey of development sites be conducted by a qualified biologist to determine if the development could potentially impact HMP species of potential habitat. A report describing the results of the surveys will be provided to the CSUMB CPD Department prior to any ground disturbing activities. The report will include, but not be limited to: 1) a description of the biological conditions at the site; 2) identification of the potential for HMP species to occur or HMP species observed, if any; and 3) maps of the locations of HMP species or potential habitat, if observed.

If HMP species that do not require take authorization from the Service or CDFW are identified within the development site, salvage efforts for these species will be evaluated by a qualified biologist in coordination with CSUMB CPD Department to further reduce impacts per the requirements of the HMP and BO. Where salvage is determined feasible and proposed, seed collection should occur from plants within the development site and/or topsoil should be salvaged within occupied areas to be disturbed. Seeds should be collected during the appropriate time of year for each species by qualified biologists. The collected seeds and topsoil should be used to revegetate temporarily disturbed construction areas and reseeded and restoration efforts on- or off-site, as determined appropriate by the qualified biologist and CSUMB CPD Department.

If HMP species that require take authorization from the Service and/or CDFW are identified within the development site, the CSUMB CPD Department will comply with ESA and CESA and obtain necessary permits prior to construction.

BIO-1.2: Project-Specific Biological Assessments (Non-HMP Species). The CSUMB CPD Department shall require that a biological survey of development sites be conducted by a qualified biologist to determine if the development could potentially impact a special-status species or their habitat. A report describing the results of the surveys will be provided to the CSUMB CPD Department prior to any ground disturbing activities. The report will include, but not be limited to: 1) a description of the biological conditions at the site; 2) identification of the potential for special-status species to occur or special-status species observed, if any; 3) maps of the locations of special-status species or potential habitat, if observed; and 4) recommended mitigation measures, if applicable.

If special-status species are determined not to occur at the development site, no additional mitigation is necessary.

If special-status species are observed or determined to have the potential to occur, the project biologist shall recommend measures necessary to avoid, minimize, and/or compensate for identified impacts. Measures may include, but are not limited to, revisions to the project design and project modifications, pre-construction surveys, construction buffers, construction best management practices, monitoring, non-native species control, restoration and preservation, and salvage and relocation.

BIO-1.3: Pre-Construction Surveys for Protected Avian Species. Construction activities that may directly (e.g., vegetation removal) or indirectly (e.g., noise/ground disturbance) affect protected nesting avian species will be timed to avoid the breeding and nesting season. Specifically, vegetation and/or tree removal can be scheduled after September 16 and before January 31. Alternatively, a qualified biologist will be retained by the CSUMB CPD Department to conduct pre-construction surveys for nesting raptors and other protected avian species within 500 feet of proposed construction activities if construction occurs between February 1 and September 15. Pre-construction surveys will be conducted no more than 14 days prior to the start of construction activities during the early part of the breeding season (February through April) and no more than 30 days prior to the initiation

of these activities during the late part of the breeding season (May through August). Because some bird species nest early in spring and others nest later in summer, surveys for nesting birds may be required to continue during construction to address new arrivals, and because some species breed multiple times in a season. The necessity and timing of these continued surveys will be determined by the qualified biologist based on review of the final construction plans and in coordination with the Service and CDFW, as needed.

If raptors or other protected avian species nests are identified during the pre-construction surveys, the qualified biologist will notify the CSUMB CPD Department and an appropriate no-disturbance buffer will be imposed within which no construction activities or disturbance shall take place (generally 500 feet in all directions for raptors; other avian species may have species-specific requirements) until the young of the year have fledged and are no longer reliant upon the nest or parental care for survival, as determined by a qualified biologist.

BIO-1.4: Implement Open Space Protection Requirements. For open space areas adjacent to the campus development, the following measures shall be implemented:

- Conduct an access assessment to identify necessary access controls. In some cases, structures including fences or other appropriate barriers may be required within the new development parcel to control access into the habitat areas. An assessment of access issues and necessary controls will be completed as part of planning for the development and submitted to the CSUMB CPD Department for review and approval, prior to development.
- Signs, interpretive displays, trailhead markers, or other information will be installed and maintained at identified urban/wildland interface that illustrate the importance of the adjacent habitat area and prohibit trespass, motor vehicle entry, dumping of trash or yard wastes, pets off-leash, capture or harassment of wildlife, impacts to special-status species, and other unauthorized activities.
- Incorporate non-native species control features into site design. Detention ponds or other water features associated with new development will be sited as far from the urban/wildland interface as possible. Suitable barriers will be located between these features and the habitat area boundary to prevent these features from becoming “sinks” for special-status wildlife species, as well as sources for invasive non-natives that could then move into the adjacent habitat area.

If detention ponds or other waterbodies must be located at the urban/wildland interface, a specific management program addressing control of non-native animals (e.g., bullfrogs) must be prepared and submitted for review and approval by the CSUMB CPD Department, prior to development.

- Landscaping within the areas adjacent to open space areas will consist of native or non-native plant species that will not colonize reserve areas in the former Fort Ord

outside the campus boundaries. Any landscaping or replanting required for the project will not use species listed as noxious by the CDFA. All landscape plans will be reviewed by the CSUMB CPD Department.

- Limit artificial lighting at the urban/wildland interface. Outdoor lighting associated with new development will be low intensity, focused, and directional to preclude night illumination of the adjacent habitat area. Outdoor lighting will be placed as far from the urban/wildland interface as possible given safety constraints. Facilities such as ball parks and fields that require high intensity night lighting (i.e., flood lights) will be sited as far from the urban/wildland interface as possible. High-intensity lighting facing the habitat areas will be directional and as low to the ground as possible to minimize long distance glare.
- Develop and implement erosion control measures to prevent sediment transport into and within habitat areas. Erosion control measures will be required where vegetation removal or soil disturbance occurs as a result of all facility construction and maintenance, including trail, road, or fuelbreak construction/maintenance, access controls, or stormwater management, consistent with existing stormwater management plans. Specific measures to be implemented shall be detailed in an erosion control plan. The erosion control plan will include, at a minimum, the following measures.
 - Re-contour eroded areas.
 - Maintain and grade areas along the reserve perimeter and main roads as appropriate to avoid washouts. Gullies will be repaired as needed.
 - Install drainage features such as outlet ditches, rolling dips (similar to waterbars), and berms as needed to facilitate the proper drainage of storm runoff.
 - Add soil amendments such as fertilizers and gypsum for designated development areas only.
 - Prevent sediments from entering basins or swales that could be used by HCP species during erosion control activities.
 - Design and conduct erosion control measures to minimize the footprint of the structures and repairs, and design structures to minimize potential impacts on CTS that may be moving between breeding and upland habitats.
 - Use weed-free mulch, weed-free rice, sterile barley straw, or other similar functioning product where needed for erosion control. Seed native plant species to stabilize soils disturbed by erosion control activities and prevent colonization by invasive weeds. Incorporate native plant species to the extent practicable.

Impact BIO-2: Impacts to Riparian Habitat, State or Federally Protected Wetlands, or other Sensitive Natural Community. *Implementation of the proposed Master Plan could result in removal of riparian habitat or other sensitive community as identified in local or regional plans, policies, or regulations or by the California Department of Fish and Wildlife or US Fish and Wildlife Service, or state or federally protected wetlands (including, but not limited to, marsh, vernal pool, coastal, etc.) through direct removal, filling, hydrological interruption, or other means. This is a potentially significant impact that can be reduced to a less-than-significant level with implementation of the mitigation measures below.*

Vegetation types occurring within the Project site that are listed as sensitive on the CDFW's *Natural Communities List* (CDFW, 2010) include central maritime chaparral and central maritime chaparral mix types. Approximately 124.3 acres of central maritime chaparral (including central maritime chaparral mix types) are present within the Project site. The proposed Master Plan does not site new development in the areas where central maritime chaparral is located; however, these sensitive vegetation types could be impacted if trail or other similar development occurs in the East Campus Housing or East Campus Open Space areas.

As described in the Impact Analysis Approach, the implementation of the HMP mitigates for the loss of central maritime chaparral by preserving the same habitat within the habitat reserve areas on the former Fort Ord. Therefore, impacts to central maritime chaparral are considered less than significant with the implementation of the HMP.

Although not observed on the Project site during the surveys in 2016 and 2017, there is a low potential for future establishment of riparian habitat, state or federally protected wetlands, and/or other sensitive communities within the campus boundaries. Development that occurs within or adjacent to sensitive natural communities may result in a significant impact. The presence of sensitive natural communities on a development site must be evaluated prior to approval of the development. Any impacts to sensitive natural communities are considered a significant impact that can be reduced to a less-than-significant level with implementation of **Mitigation Measure BIO 1.5** identified below, which includes project-specific biological assessments for future development to determine presence/absence of sensitive habitats and identification of measures necessary to avoid, minimize, and/or compensate for any identified impacts.

Mitigation Measures for Impacts to Sensitive Natural Communities

Implementation of the following mitigation measure will reduce the potentially significant impacts to sensitive natural communities to a less-than-significant level. Mitigation measures may be refined as part of EIR preparation.

BIO-1.5: Project-Specific Sensitive Natural Community Assessments. The CSUMB CPD Department shall require that any development that could potentially impact a sensitive natural community shall be required to conduct a survey of the site by a qualified biologist. A report describing the results of the survey will be provided to the CSUMB CPD Department prior to any ground disturbing activities. The report will include, but is not limited to: 1) a description of the biological conditions at the site; 2) identification of the potential for sensitive habitats or sensitive habitats observed, if any; 3) maps of the locations of sensitive habitats or potential sensitive habitat, if observed; and 4) recommended avoidance and minimization measures, if applicable. If a potential state or

federally protected wetland is newly identified to be present on the site, a formal wetland delineation will be conducted in accordance to ACOE methodology.

If a proposed development cannot avoid impacts to sensitive habitat areas, the CSUMB CPD Department shall require a compensatory habitat-based mitigation to reduce impacts. Compensatory mitigation must involve the preservation, restoration, or purchase of off-site mitigation credits for impacts to sensitive habitats. Mitigation must be conducted in-kind or within an approved mitigation bank in the region. The specific mitigation ratio for habitat-based mitigation will be determined through consultation with the appropriate agency (i.e., CDFW, Service, or ACOE) on a project-by-project basis.

Impacts to sensitive habitats, including but not limited to, vernal pools, streambeds, waterways, or riparian habitat, protected under Section 1600 of Fish and Wildlife Code and Sections 401 and 404 of the CWA, require regulatory permitting to reduce impacts. Acquisition of permits and implementation of the approved mitigation strategy would ensure impacts are fully mitigated and “no net loss” of wetland habitat would occur.

Impact BIO-3: Impacts to Movement of Wildlife. *Implementation of the proposed Master Plan would not result in interference with wildlife migration or corridors. No impact will occur.*

Wildlife movement corridors are pathways or habitat linkages that connect discrete areas of natural open space otherwise separated or fragmented by topography, changes in vegetation, and other natural or man-made factors, such as urbanization. The fragmentation of natural habitat creates isolated “islands” of vegetation that may not provide sufficient area or resources to accommodate sustainable populations for a number of species, and therefore, adversely affect both genetic and species diversity. Corridors often partially or largely mitigate the adverse effects of fragmentation by: 1) allowing animals to move between remaining habitats to replenish depleted populations and increase the gene pool available; 2) providing escape routes from fire, predators, and human disturbances, thus, reducing the risk that catastrophic events (e.g., fire and disease) will result in population or species extinction; and 3) serving as travel paths for individual animals moving throughout their home range in search of food, water, mates, and other needs, or for dispersing juveniles in search of new home ranges.

The East Campus Open Space connects with other planned habitat areas to the east, south, and north and is considered an important area for wildlife movement. The majority of the area is proposed to be retained in Open Space and the remainder of the area is designated as a Development Reserve and is not proposed for development as part of the proposed Master Plan, thus maintaining wildlife movement through this area. No other areas of the campus contain significant open space areas that would support wildlife movement. Therefore, no impacts to movement of wildlife would result from implementation of the proposed Master Plan.

Mitigation Measures for Impacts to Movement of Wildlife

As no impacts to movement of wildlife resulting from implementation of the proposed Master Plan would occur, no additional mitigation measures are required.

Impact BIO-4: Conflicts with Local Biological Policies and Ordinances. *Implementation of the proposed Master Plan would not conflict with local policies and ordinances protecting biological resources, including tree preservation policies. This is a less-than-significant impact.*

Implementation of the proposed Master Plan may result in impacts to trees within the campus boundaries. However, CSUMB has established a tree restoration program for impacts to coast live oak and other trees resulting from projects that take place on campus. This program requires that for every tree greater than 4” dbh removed, a minimum of two coast live oak trees would be replanted in the identified restoration area on campus. The implementation of this program is required for all development that would result in impacts to trees at least 4” dbh. The replanting specifications would be required in subsequent project plans and permits. Proposed PDF OS-4, continues and expands this program to maximize the health and stability of existing and replacement trees. Therefore, implementation of the proposed Master Plan would not conflict with the CSUMB tree restoration program and the impact would be less than significant.

Mitigation Measures for Impacts Related to Conflict with Local Policies

As impacts related to conflicts with local policies would be less than significant, no additional mitigation measures are required.

Impact BIO-5: Conflicts with any Adopted HCP, NCCP, or Other Approved Conservation Plan. *Implementation of the proposed Master Plan would not conflict with any adopted HCP, NCCP, or other approved conservation plan. No impact will occur.*

As described in **Section 3.5.3**, the Project site is not located within an approved HCP or NCCP area. However, the Project site is located within the approved Fort Ord HMP area. The entire Project site is located within parcels designated by the HMP as “development.” As described above in the Regulatory section, parcels designated as “development” do not have habitat requirements. Additionally, a portion of the campus, along the southeastern boundary of the East Campus Open Space parcel (Army parcel number S1.3.2), is designated in the HMP as having Borderlands requirements. Borderlands are designated development parcels or habitat reserve parcels at the urban/wildland interface where specific design considerations and management activities are required to minimize effects of development on HMP species and natural communities.

CSUMB is required to implement HMP requirements in accordance with the deed covenants, which apply to all parcels within the campus boundaries. Therefore, although impacts to HMP plant and wildlife species are considered less than significant, **Mitigation BIO-1.1** will be implemented to further reduce the less-than-significant impact. Therefore, implementation of the proposed Master Plan would not conflict with the approved HMP and no impact would occur.

Mitigation Measures for Impacts Related to Conflict with an Adopted HCP

As no impacts related to conflicts with an adopted HCP would occur, no additional mitigation measures are required. However, although impacts to HMP plant and wildlife species are considered less than significant, **Mitigation BIO-1.1** (see above) will be implemented to further reduce the less-than-significant impact consistent with the HMP and the BO requirements in deed covenants.

5.3 Impacts and Mitigation Measures – Near-Term Development Components

Impact BIO-1: Impacts to Special-Status Species and Habitat. *Implementation of the proposed near-term development components could result in removal of special-status plant and wildlife species and their habitat. This is a potentially significant impact that can be reduced to a less-than-significant level with the implementation of the mitigation measures identified below.*

The proposed near-term development components are generally located on disturbed and mostly developed sites. However, the construction of the near-term development components may result in direct loss of individuals and habitat for a number of special-status wildlife species, including special-status bat species, Monterey dusky-footed woodrat, SBB, Northern California legless lizard, and nesting raptors and other protected avian species. In addition, construction of the near-term development components may also result in direct loss of individuals and habitat for Monterey spineflower. The known and potential special-status species and habitat within each of the near-term development component sites are described below.

1. Near-Term Development Component #1 (Student Housing Phase III)

This development site is primarily developed, but the site does contain some suitable habitat for the Northern California legless lizard. In addition, trees within and adjacent to the site may provide nesting habitat for raptors, migratory birds, and other protected avian species.

2. Near-Term Development Component #2 (Academic IV Building)

This development site contains mostly developed areas with some ruderal/disturbed areas and would require building demolition. Four dune buckwheat individuals were identified within this site. These areas may provide habitat for this species (**Figure 12**). Therefore, this species has a moderate potential to occur within the Project site. In areas not surveyed (i.e., the staging area, see Figure 6), the ruderal/disturbed habitat may provide suitable habitat for Northern California legless lizard. In addition, mature trees and existing buildings within and adjacent to the site may provide nesting habitat for raptors, migratory birds, and other protected avian species and Townsend's big-eared bat. No special-status plant species were observed within the development site and staging area, and none are expected to occur in these areas.

3. Near-Term Development Component #3 (Student Recreation Center)

The ruderal/disturbed habitat within the site may provide suitable habitat for Northern California legless lizard. In addition, mature trees and existing buildings within and adjacent to the site may provide nesting habitat for raptors, migratory birds, and other protected avian species, as well as the Townsend's big-eared bat and hoary bat. Although the hoary bat may roost and forage within some of the oak trees during the winter, they are not known to breed in California. Therefore, impacts to hoary bat are unlikely. The oak trees may provide suitable habitat for the Monterey dusky-footed woodrat. Additionally, approximately 0.01 acre of Monterey spineflower was observed within the development site.

4. Near-Term Development Component #4 (Student Housing Phase IIB)

This development site is primarily developed with some ruderal/disturbed areas. The ruderal/disturbed habitat within the site may provide suitable habitat for Northern California legless lizard. In addition, mature trees within and adjacent to the site may provide nesting habitat for raptors, migratory birds, and other protected avian species, as well as the Townsend's big-eared bat and hoary bat. However, for the same reasons as identified for Near-Term Development #3, impacts to hoary bat are unlikely.

5. Near-Term Development Component #5 (Academic V Building)

This development site is completely developed; however, trees within and adjacent to the site may provide nesting habitat for raptors, migratory birds, and other protected avian species.

As described in the Impact Analysis Approach section above, impacts to HMP plant and wildlife species are considered less than significant unless take authorization is required from the Service and/or CDFW. Since impacts to the Northern California legless lizard and Monterey spineflower would not require take authorization from the Service and/or CDFW, no additional mitigation is required for these two species. However, near-term development component #2 has the potential to impact SBB habitat, which would require take authorization from the Service to avoid violation of ESA. Implementation of **Mitigation Measure BIO-1.6** identified below would reduce the potential impacts to SBB to a less-than-significant level by avoiding SBB habitat if possible, and if not possible, requiring compliance with ESA in advance of construction.

Per the discussions above, near-term development components #1-5 have the potential to impact nesting habitat for raptors, migratory birds, and other protected avian species. Implementation of **Mitigation Measure BIO-1.3** identified in **Section 5.2** above would reduce the potential impacts to nesting raptors, migratory birds, and other protected avian species to a less-than-significant level. No additional project-specific mitigation is required.

Near-term development components #3, 4, and 5 have the potential to impact Townsend's big-eared bat. Implementation of **Mitigation Measures BIO-1.2** and **BIO-1.4** identified above and **Mitigation Measure BIO-1.7** identified below would reduce the potential impacts to Townsend's big-eared bat to a less-than-significant level by conducting pre-construction survey and implementing avoidance and minimization measures if any Townsend's big-eared bats or their roosts are found. No additional project-specific mitigation is required.

Near-term development component #3 has the potential to impact Monterey dusky-footed woodrat. Implementation of **Mitigation Measures BIO-1.2** and **BIO-1.4** identified above and **Mitigation Measure BIO-1.8** identified below would reduce the potential impacts to Monterey dusky-footed woodrat to a less-than-significant level by conducting pre-construction survey and implementing avoidance and minimization measures if any Monterey dusky-footed woodrats or their nests are found. No additional project-specific mitigation is required.

Mitigation Measures for Impacts to Special-Status Species

Implementation of **Mitigation Measures BIO-1.2** through **BIO-1.4** and the following mitigation measures will reduce the potential impacts to special-status species associated with the near-term development components to a less-than-significant level.

BIO-1.6: Smith's Blue Butterfly Habitat Avoidance/ESA Compliance. SBB habitat (i.e. dune buckwheat) shall be avoided to the greatest extent feasible. SBB habitat that will not be impacted by the project shall be protected prior to and during construction to the maximum possible through the use of exclusionary fencing and/or flagging. A biological monitor will supervise the installation of protective fencing/flagging and monitor at least once per week until construction is complete to ensure that the protective fencing/flagging remains intact.

If all SBB habitat is avoided, no additional mitigation is necessary. If the project will impact SBB habitat, CSUMB will comply with the FESA and obtain necessary authorizations prior to construction due to the assumed presence of the Federally listed SBB. CSUMB shall be required to initiate consultation with the Service to receive take authorization. Take authorization would be granted through the issuance of an individual, project-specific incidental take permit. Mitigation for take likely would require restoration at a 3:1 ratio of impacted habitat. Dune buckwheat plants and/or seed salvage may also be required prior to ground disturbing activities.

BIO-1.7: Pre-Construction Bat Assessment and Surveys. To avoid and reduce impacts to Townsend's big-eared bat, a qualified bat specialist or wildlife biologist shall conduct site surveys during the reproductive season (May 1 through September 15) to characterize bat utilization of the site and potential species present (techniques utilized to be determined by the biologist) prior to structure removal. Based on the results of these initial surveys, one or more of the following will occur:

- If it is determined that bats are not present at the site, no additional mitigation is required.
- If it is determined that bats are utilizing the site and may be impacted by the development, pre-construction surveys will be conducted no more than 30 days prior to any structure removal. If, according to the bat specialist, no bats or bat signs are observed in the course of the pre-construction surveys, structure removal may proceed. If bats and/or bat signs are observed during the pre-construction surveys, the biologist will determine if disturbance will jeopardize the roost (i.e., maternity, day, or night).
- If a single bat and/or only adult bats are roosting, removal of buildings may proceed after the bats have been safely excluded from the roost. Exclusion techniques will be determined by the biologist and depend on the roost type; the biologist will prepare a mitigation plan for provision of alternative habitat to be approved by the CDFW.
- If an active maternity roost is detected, avoidance is preferred. Work in the vicinity of the roost (buffer to be determined by biologist) will be postponed until

the biologist monitoring the roost(s) determines that the young are no longer dependent on the roost. The monitor will ensure that all bats have left the area of disturbance prior to initiation of structure removal. If avoidance is not possible and a maternity roost must be disrupted, a depredation permit would be required prior to removal of the roost.

BIO-1.8: Pre-Construction Monterey Dusky-Footed Woodrat Surveys. Not more than thirty (30) days prior to the start of construction (including vegetation removal), a qualified biologist shall conduct a survey of the development sites to locate existing Monterey dusky-footed woodrat nests. All Monterey dusky-footed woodrat nests shall be mapped and flagged for avoidance. Graphics depicting all Monterey dusky-footed woodrat nests shall be provided to CSUMB and the construction contractor. Any Monterey dusky-footed woodrat nests that cannot be avoided shall be relocated according to the following procedures.

Each active nest shall be disturbed by the qualified biologist to the degree that the woodrats leave the nest and seek refuge elsewhere. After the nests have been disturbed, the nest sticks shall be removed from the impact areas and placed outside of areas planned for impacts. Nests shall be dismantled during the non-breeding season (between October 1 and December 31), if possible. If a litter of young is found or suspected, nest material shall be replaced and the nest left alone for 2-3 weeks, after this time the nest will be rechecked to verify that young are capable of independent survival before proceeding with nest dismantling.

Impact BIO-2: Impacts to Riparian Habitat, State or Federally Protected Wetlands, or other Sensitive Natural Community. *Implementation of the proposed near-term development components would not result in removal of riparian habitat or other sensitive community as identified in local or regional plans, policies, or regulations or by the California Department of Fish and Wildlife or US Fish and Wildlife Service, or state or federally protected wetlands (including, but not limited to, marsh, vernal pool, coastal, etc.) through direct removal, filling, hydrological interruption, or other means. No impact would occur.*

The proposed near-term development components are generally located on sites that have been disturbed and are mostly developed. No sensitive communities occur within the near-term development component sites; therefore, no impacts would occur.

Impact BIO-3: Impacts to Movement of Wildlife. *Implementation of the proposed near-term development components would not result in interference with wildlife migration or corridors. No impacts would occur.*

The proposed near-term development components are generally located on sites that have been disturbed and are mostly developed. These sites do not contain significant wildlife habitat used for migration or movement corridor; therefore, no impacts would occur.

Impact BIO-4: Conflicts with Local Biological Policies and Ordinances. *Implementation of the proposed near-term development components would not conflict with local policies and ordinances protecting biological resources, including tree preservation policies. This is a less-than-significant impact.*

Implementation of the proposed near-term development component #3 (Student Recreation Center) may result in impacts to trees within the campus boundaries; other near-term developments would not result in tree removal. However, CSUMB has established a tree restoration program for impacts to coast live oak and other trees resulting from projects that take place on campus. This program requires that for tree 4” dbh or greater removed, a minimum of two coast live oak trees would be replanted in the identified restoration area on campus. The implementation of this program is required for all projects that would result in impacts to trees. Further, proposed PDF OS-4 continues and expands this program to maximize the health and stability of existing and replacement tree species, including replacement of all removed trees 4” dbh or greater at a minimum 2:1 ratio. Therefore, as a feature of the project design, two coast live oak trees would be replanted for every tree greater than 4” dbh removed. The replanting specifications would be required in final project plans. Therefore, the potential to conflict with the CSUMB tree restoration program is less than significant.

Impact BIO-5: Conflicts with any Adopted HCP, NCCP, or Other Approved Conservation Plan. *Implementation of the proposed near-term development components would not conflict with any adopted HCP, NCCP, or other approved conservation plan. No impact will occur.*

As described in **Section 3.5.3**, the campus is not located within an approved HCP or NCCP area. However, the campus is located within the approved Fort Ord HMP area. All of the proposed near-term development component sites are located within parcels designated by the HMP as “development.” CSUMB is required to implement HMP requirements, applicable to all parcels within the campus boundaries, which is acknowledged and described in Mitigation BIO-1.1 (see Impact BIO-1). Therefore, as described above in **Section 5.2**, implementation of the proposed near-term development components would not conflict with the approved HMP and no impact would occur.

6.0 REFERENCES

- Arnold, R.A., 1983. Ecological studies of six endangered butterflies (Lepidoptera: Lycaenidae): Island biogeography, patch dynamics, and design of habitat preserves. University of California Publications in Entomology, Vol. 99. Pp. 1-161.
- Baldwin, B. G, et. al. 2012. The Jepson Manual – Vascular Plants of California, Second Edition, Thoroughly Revised and Expanded. University of California Press. Berkeley, CA. 1600 pp.
- Bulger, J.B., N.J. Scott Jr., and R.B. Seymour. 2003. Terrestrial activity and conservation of adult California red-legged frog *Rana aurora draytonii* in coastal forests and grasslands. Biological Conservation, Vol. 110. Pp. 85-95.
- California Department of Fish and Wildlife (CDFW). 2008. California Wildlife Relationships System: Life History Accounts. Database Version 8.2.
- CDFW. 2009. Protocols for Surveying and Evaluating Impacts to Special Status Native Plant Populations and Natural Communities. Available online at: http://www.dfg.ca.gov/biogeodata/cnddb/pdfs/Protocols_for_Surveying_and_Evaluating_Impacts.pdf
- CDFW. 2010. List of Vegetation Alliances and Associations (Natural Communities List). Available online at: <https://www.wildlife.ca.gov/Data/VegCAMP/Natural-Communities/List>.
- CDFW. 2017a. California Natural Diversity Data Base Rare Find Report (August, 2017).
- CDFW. 2017b. Special Animals List. Available online at: <http://www.dfg.ca.gov/biogeodata/cnddb/pdfs/SPAnimals.pdf> (January 2011).
- California Native Plant Society (CNPS). 2001. Botanical Survey Guidelines. Available Online at: http://www.cnps.org/cnps/rareplants/pdf/cnps_survey_guidelines.pdf
- CNPS. 2017. Inventory of Rare and Endangered Plants (online edition, v8-03 0.39). California Native Plant Society. Sacramento, CA. Available online at: <http://www.rareplants.cnps.org/>
- Dixon, Dave. 1999. Dunes Alive-The endangered Smith's blue and marina blue butterflies. A closer look at coastal dune wildlife of south Monterey Bay. Tideline, Vol. 19 (3). Pp. 1-3.
- Holland, R.F. 1986. Preliminary descriptions of the terrestrial natural communities of California. Nongame-Heritage Program, California Department of Fish and Wildlife, Sacramento, CA. 156 pp.
- Howitt, B.F. and J.T. Howell. 1964. The vascular plants of Monterey County, California.
- Howitt, B.F. and J.T. Howell. 1973. Supplement to the vascular plants of Monterey County, California. Pacific Grove Museum of Natural History Association, Pacific Grove, CA. 60 pp.
- ICF International, Inc. 2017. Administrative Draft Fort Ord Habitat Conservation Plan. August. San Francisco, CA. Prepared for the Fort Ord Reuse Authority, Marina, CA. Unpublished.
- ITSI Gilbane. 2014. 2013 Annual Biological Monitoring Report, Former Fort Ord, California, Worldwide Environmental Remediation Services Contract No. W912DY-10-D-0024. Available online at: http://docs.fortordcleanup.com/ar_pdfs/AR-BW-2686//BW-2686.pdf

- Jennings, M.R. and M.P. Hayes. 1986. Decline of ranid frog species in western North America: are bullfrogs (*Rana catesbeiana*) responsible? *Journal of Herpetology* Vol. 20 (4). Pp. 490-509.
- Jennings, M.R. and M.P. Hayes. 1988. Habitat correlates of distribution of the California red-legged frog (*Rana draytonii*) and the foothill yellow-legged frog (*Rana boylei*): implications for management. *Proceedings from Management of Amphibians, Reptiles and Small Mammals in North America Symposium 1988*.
- Jennings, M.R. and M.P. Hayes. 1994. Amphibian and reptile species of special concern in California. Final report to the California Department of Fish and Wildlife, Inland Fisheries Division. 255 pp.
- Jepson Flora Project. 2017. Jepson Online Interchange for California floristics. Available online at: <http://ucjeps.berkeley.edu/interchange.html>
- Loredo et al. 1996. Habitat use and migration behavior of the California tiger salamander. *Journal of Herpetology*, Vol. 30(2). Pp. 282-285.
- Matthews, M.A and M. Mitchell. 2015. *The Plants of Monterey County; an Illustrated Field Key (Second Edition)*. California Native Plant Society, Sacramento, California. 446 pp.
- Moyle, P.B. 1973. Effects of introduced bullfrogs, *Rana catesbeiana*, on the native frogs of the San Joaquin Valley, California. *Copeia* 1973. Pp. 18-22.
- Munz, P. A. and D. D. Keck. 1973. *A California flora and supplement*. University of California Press, Berkeley, CA. 1681 pp., + 224 pp. supplement.
- Parham, J.F. and T.J. Papenfuss. 2008. High genetic diversity among fossorial lizard populations (*Anniella pulchra*) in a rapidly developing landscape (Central California). *Conservation Genetics*, Vol 10. Pp. 169-176.
- Pollinator Partnership and U.S. Forest Service [USFS], 2012. *Bumble Bees of the Western United States*. Available online at: <http://www.pollinator.org/PDFs/BumbleBee.GuideWestern.FINAL.pdf>
- Rathbun, G.B., M.R. Jennings, T.G. Murphey, and N.R. Siepel. 1993. Status and ecology of sensitive aquatic vertebrates in lower San Simeon and Pico Creeks, San Luis Obispo County, California. Unpublished report, National Ecology Research Center, Pederast Blancas Research Station, San Simeon, California. 103 pp.
- Remsen, J.V. Jr. 1978. Bird species of special concern in California. California Dept. of Fish and Wildlife, Nongame Wildlife Investigations, Wildlife Management Branch Administrative Report No. 78-1.
- Roberson, D. 2002. *Monterey Birds*. Monterey Peninsula Audubon Society, Carmel, CA. 536 pp.
- Sawyer, J.O., T. Keeler-Wolf, and J.M. Evens. 2009. *A manual of California vegetation 2nd Edition*. California Native Plant Society, Sacramento, CA. 1300 pp.
- Stebbins, R.C. 1972. *California Amphibians and Reptiles*. University of California Press, Berkeley. 152 pp.
- Stebbins, R.C. 1985. *Western reptiles and amphibians*. Houghton Mifflin Company, Boston, MA. 336 pp.

- Stebbins, R.C. 2003. Western reptiles and amphibians, 3rd edition. Houghton Mifflin Company, New York, NY. 533 pp.
- Thelander, C. (ed.). 1994. Life on the edge: A guide to California's endangered natural resources: wildlife. BioSystems Books, Santa Cruz, CA.
- U.S. Army Corps of Engineers (ACOE), Sacramento District. 1992. Flora and Fauna Baseline Study of Fort Ord, California. With technical assistance from Jones and Stokes Associates, Inc. Sacramento, California.
- ACOE, Sacramento District. 1997. Installation-Wide Multispecies Habitat Management Plan for Former Fort Ord, California. April 1997. Sacramento, CA.
- U.S. Fish and Wildlife Service (Service). 1976. Determination That Six Species of Butterflies are Endangered Species; 41 FR 22041-22044 (Lotis blue, *Lycaeides argyrognomon lotis*; El Segundo blue, *Shijimiaeoides battoides allyni*; Smith's blue, *Shijimiaeoides enoptes smithi*; Mission blue, *Icaricia icarioides missionensis*; San Bruno elfin, *Callophrys mossi bayensis*; Lange's metalmark, *Apodemia mormo langei*). Federal Register, Vol. 41(106). Pp. 22041-22044.
- Service. 1984. Smith's Blue Butterfly Recovery Plan. Available Online at: https://ecos.fws.gov/docs/recovery_plan/841109.pdf
- Service. 1993. Biological Opinion for the Disposal and Reuse of Fort Ord, Monterey County, California (1-8-93-F-14).
- Service. 1996. Endangered and Threatened Wildlife and Plants; Determination of Threatened Status for the California Red-legged Frog; Final Rule. Federal Register, Vol. 61(101). Pp. 25813-25833.
- Service. 1998. Endangered and threatened wildlife and plants; Withdrawal of Proposed Rule to List the Black Legless Lizard, Proposed rule. Federal Register, Vol. 69(149). Pp. 47211-47248.
- Service. 2000. Guidelines for Conducting and Reporting Botanical Inventories for Federally Listed, Proposed, and Candidate Plants. Available online at: http://www.fws.gov/ventura/speciesinfo/protocols_guidelines/docs/botanicalinventories.pdf
- Service. 2004. Endangered and threatened wildlife and plants; Determination of threatened status for the California Tiger Salamander; and special rule exemption for existing routine ranching activities; Final rule. Federal Register, Vol. 69(149). Pp. 47211-47248.
- Service. 2005. Endangered and Threatened Wildlife and Plants; Designation of Critical Habitat for the California Tiger Salamander; Central Population; Final Rule. Federal Register, Vol. 70(162). Pp 49379-49458.
- Service. 2006. Endangered and Threatened Wildlife and Plants; Designation of Critical Habitat for the California Red-legged Frog and Special Rule Exemption Associated with Final Listing for Existing Routine Ranching Activities; Final rule. Federal Register, Vol. 71(71). Pp. 19244-19346.
- Service. 2010. Endangered and Threatened Wildlife and Plants; Revised Designation of Critical Habitat for the California Red-legged Frog; Final rule. Federal Register, Vol. 75(51). Pp. 12816-12959.

- Service. 2013. Birds Protected by the Migratory Bird Treaty Act. Available online at: <http://www.fws.gov/migratorybirds/RegulationsPolicies/mbta/mbtintro.html>
- Service. 2017a. Information Planning and Consultation (IPaC) Resources List for the CSUMB Master Plan Project site.
- Service, 2017b. Critical Habitat Mapper. Available online at: <https://ecos.fws.gov/ecp/report/table/critical-habitat.html>
- Service. 2017c. Recovery Plan for the Central California Distinct Population Segment of the California Tiger Salamander (*Ambystoma californiense*). Available online at: <https://ecos.fws.gov/ecp0/profile/speciesProfile?spcode=D01T>
- U.S. Fish and Wildlife Service and California Department of Fish and Wildlife. 2003. Interim guidance on site assessment and field surveys for determining presence of a negative finding of the California tiger salamander.
- United States Fish and Wildlife Service and California Department of Fish and Wildlife. 2005. Revised guidance on site assessments and field surveys for the California red-legged frog. Available online at: http://www.fws.gov/sacramento/es/Survey-Protocols-Guidelines/Documents/crf_survey_guidance_aug2005.pdf
- Williams, D. 1986. Mammalian species of special concern in California. California Department of Fish and Wildlife Report 86-1. 112 pp.
- Williams, P., R. Thorp, L. Richardson, and S. Colla. 2014. Bumble Bees of North America: An Identification Guide. Princeton University Press, Princeton, New Jersey. 209 pp.
- Zeiner, D. C., W. F. Laudenslayer, Jr., K. E. Mayer, and M. White (eds.). 1988. California's wildlife, Volume I: Amphibians and reptiles. California Department of Fish and Wildlife, Sacramento, California. 272 pp.
- Zeiner, D. C., W. F. Laudenslayer, Jr., K. E. Mayer, and M. White (eds.). 1990. California's Wildlife, Volume II: Birds. California Department of Fish and Wildlife, Sacramento, California. 731 pp.

APPENDIX A.

Table of Special-Status Species Known or With the Potential to Occur in the vicinity of the
Monterey Downs Specific Plan Project Site

(CNDDDB Rare Plant Report from the Marina quadrangle and the six surrounding quadrangles
[Monterey, Moss Landing, Prunedale, Salinas, Seaside, and Spreckels])

This page left intentionally blank

Special-Status Species Known or With the Potential to Occur in the Vicinity of the CSUMB Proposed Master Plan Project

Species	Status (Service/ CDFW/CNPS)	General Habitat	Potential Occurrence within Project Vicinity
MAMMALS			
<i>Corynorhinus townsendii</i> Townsend's big-eared bat	-- / CSC / --	Found primarily in rural settings from inland deserts to coastal redwoods, oak woodland of the inner Coast Ranges and Sierra foothills, and low to mid-elevation mixed coniferous-deciduous forests. Typically roost during the day in limestone caves, lava tubes, and mines, but can roost in buildings that offer suitable conditions. Night roosts are in more open settings and include bridges, rock crevices, and trees.	Moderate: The abandoned buildings within the Project site may provide low quality day roost or maternity roost habitat. Additionally, this species may forage over all other areas of the Project site. The nearest CNDDDB occurrence is approximately 1.2 miles east of the Project site within the East Garrison development area.
<i>Enhydra lutris nereis</i> Southern sea otter	FT / CFP / --	Found in nearshore marine habitats environments of California from Ano Nuevo to Point Sal. Often associated with giant kelp and bull kelp, these opportunistic foragers eat mainly abalones, sea urchins, crabs, and clams.	Not Present: No suitable habitat present within Project site.
<i>Lasiurus cinereus</i> Hoary bat	-- / CNDDDB / --	Prefers open habitats or habitat mosaics with access to trees for cover and open areas or edge for feeding. Generally roost in dense foliage of trees; does not use buildings for roosting. Winters in California and Mexico and often migrates towards summer quarters in the north and east during the spring. Young are born and reared in summer grounds, which is unlikely to occur in California.	Moderate: May roost within some of the trees within the oak woodland habitat and may forage over all undeveloped areas of the Project site. However, while the species may utilize the Project site as winter grounds, they are unlikely to occur during the summer months and it is unlikely that birth and rearing occur on the site. The nearest CNDDDB occurrence is approximately 5.0 miles southwest of the Project site.
<i>Neotoma macrotis luciana</i> Monterey dusky-footed woodrat	-- / CSC / --	Forest and oak woodland habitats of moderate canopy with moderate to dense understory. Also occurs in chaparral habitats.	Present: Numerous woodrat nests were observed throughout the Project site. This species is known to occur throughout Fort Ord. Therefore, this species is assumed present within the Project site.
<i>Reithrodontomys megalotis distichlis</i> Salinas harvest mouse	-- / CNDDDB / --	Known only to occur from the Monterey Bay region. Occurs in fresh and brackish water wetlands and probably in the adjacent uplands around the mouth of the Salinas River.	Unlikely: No suitable habitat present within Project site.
<i>Sorex ornatus salarius</i> * Monterey ornate shrew	-- / CSC / --	Mostly moist or riparian woodland habitats and within chaparral, grassland, and emergent wetland habitats where there is a thick duff or downed logs.	High: Suitable habitat is present within the Project site. The CNDDDB does not report any occurrences of this species; however Figure B-18 in the HMP identifies the Project site as containing potential habitat for this species and recent studies on the Fort Ord Natural Reserve have identified Monterey ornate shrew in the same habitat types on the former Fort Ord.
<i>Taxidea taxus</i> American badger	-- / CSC / --	Dry, open grasslands, fields, pastures savannas, and mountain meadows near timberline are preferred. The principal requirements seem to be sufficient food, friable soils, and relatively open, uncultivated grounds.	High: The CNDDDB reports one occurrence of this species within the eastern portion of the Project site, near Inter-Garrison Rd. Suitable habitat for this species is present within the non-native grassland habitat on the Project site.
BIRDS			
<i>Agelaius tricolor</i> Tricolored blackbird (nesting colony)	-- / SC&CSC / --	Nest in colonies in dense riparian vegetation, along rivers, lagoons, lakes, and ponds. Forages over grassland or aquatic habitats.	Unlikely: No suitable nesting habitat is present within the Project site.

Species	Status (Service/ CDFW/CNPS)	General Habitat	Potential Occurrence within Project Vicinity
<i>Asio flammeus</i> Short-eared owl (nesting)	-- / CSC / --	Usually found in open areas with few trees, such as annual and perennial grasslands, prairies, meadows, dunes, irrigated lands, and saline and freshwater emergent marshes. Dense vegetation is required for roosting and nesting cover. This includes tall grasses, brush, ditches, and wetlands. Open, treeless areas containing elevated sites for perching, such as fence posts or small mounds, are also needed. Some individuals breed in northern California.	Unlikely: No suitable nesting habitat is present within the Project site.
<i>Athene cucularia</i> Burrowing owl (burrow sites & some wintering sites)	-- / CSC / --	Year round resident of open, dry grassland and desert habitats, and in grass, forb and open shrub stages of pinyon-juniper and ponderosa pine habitats. Frequent open grasslands and shrublands with perches and burrows. Use rodent burrows (often California ground squirrel) for roosting and nesting cover. Pipes, culverts, and nest boxes may be substituted for burrows in areas where burrows are not available.	Moderate: Marginally suitable habitat is present within the Project site within the non-native grassland habitat and some portions of the ruderal areas. The nearest CNDDDB occurrence is 0.6 miles north of the Project site.
<i>Brachyramphus marmoratus</i> Marbled murrelet	FT / SE / --	Occur year-round in marine subtidal and pelagic habitats from the Oregon border to Point Sal. Partial to coastlines with stands of mature redwood and Douglas-fir. Require dense old growth forests of redwood and/or Douglas-fir in higher elevations for breeding and nesting.	Not Present: No suitable habitat is present within the Project site.
<i>Buteo regalis</i> Ferruginous hawk (wintering)	-- / CNDDDB / --	An uncommon winter resident and migrant at lower elevations and open grasslands in the Modoc Plateau, Central Valley, and Coast Ranges and a fairly common winter resident of grassland and agricultural areas in southwestern California. Frequent open grasslands, sagebrush flats, desert scrub, low foothills surrounding valleys, and fringes of pinyon-juniper habitats. Does not breed in California.	Low: Only poor quality wintering habitat present within Project site. No breeding habitat present within Project site. The nearest CNDDDB occurrence is 2.0 miles north of the Project site at the Armstrong Ranch.
<i>Charadrius nivosus</i> Western snowy plover	FT / CSC / --	Sandy beaches on marine and estuarine shores, also salt pond levees and the shores of large alkali lakes. Requires sandy, gravelly or friable soil substrate for nesting.	Not Present: No suitable habitat present within Project site.
<i>Cypseloides niger</i> Black swift (nesting)	-- / CSC / --	Regularly nests in moist crevice or cave on sea cliffs above the surf, or on cliffs behind, or adjacent to, waterfalls in deep canyons. Forages widely over many habitats.	Not Present: No suitable nesting habitat present within Project site.
<i>Elanus leucurus</i> White-tailed kite (nesting)	-- / CFP / --	Open groves, river valleys, marshes, and grasslands. Prefer such area with low roosts (fences etc.). Nest in shrubs and trees adjacent to grasslands.	High: Suitable nesting and foraging habitat present within Project site. The nearest CNDDDB occurrence is 10 miles north of the Project site; however, this species has also been observed by DD&A biologists 0.5 mile east of the Project site, on the north side of Reservation Road.
<i>Empidonax traillii extimus</i> Southerwestern willow flycatcher	FE / SE / --	Dense willow thickets are required for nesting and roosting. Low, exposed branches are used for singing posts and hunting perches. Open, cup nest is placed in an upright fork of willow or other shrub, or occasionally on a horizontal limb. Most numerous where extensive thickets of low, dense willows edge on wet meadows, ponds, or backwaters.	Not Present: No suitable habitat present within Project site.
<i>Eremophila alpestris actia</i> California horned lark	-- / CNDDDB / --	Variety of open habitats, usually where large trees and/or shrubs are absent. Found from grasslands along the coast to deserts at sea-level and alpine dwarf-shrub habitats are higher elevations. Builds open cup-like nests on the ground.	High: Suitable habitat is present within the non-native grassland habitat on the Project site. The nearest CNDDDB occurrence is 1.0 mile from the Project site. This species has also been observed by DD&A biologists 3.5 miles south of the Project site, within the Former Fort Ord Impact Area.

Species	Status (Service/ CDFW/CNPS)	General Habitat	Potential Occurrence within Project Vicinity
<i>Falco mexicanus</i> Prairie falcon (nesting)	-- / CNDDDB / --	Associated primarily with perennial grasslands, savannahs, rangeland, some agricultural fields, and desert scrub areas. Nests in open terrain with canyons, cliffs, escarpments, and rock outcrops.	Low: Although this species may forage within the Project site, no suitable nesting habitat present.
<i>Falco peregrinus anatum</i> American peregrine falcon	-- / CFP / --	Forages for other birds over a variety of habitats. Breeds primarily on rocky cliffs.	Low: Although this species may forage within the Project site, no suitable nesting habitat present.
<i>Gymnogyps californianus</i> California condor	FE / SE / --	Roosting sites in isolated rocky cliffs, rugged chaparral, and pine covered mountains 2000-6000 ft above sea level. Foraging area removed from nesting/roosting site (includes rangeland and coastal area - up to 19 mile commute one way). Nest sites in cliffs, crevices, and potholes.	Not Present: No suitable habitat present within Project site.
<i>Laterallus jamaicensis coturniculus</i> California black rail	-- / ST & CFP / --	Inhabits freshwater marshes, wet meadows & shallow margins of saltwater marshes bordering larger bays. Needs water depths of about 1 inch that does not fluctuate during the year & dense vegetation for nesting habitat.	Not Present: No suitable habitat present within Project site.
<i>Pelecanus occidentalis californicus</i> California brown pelican (nesting colony & communal roosts)	-- / CFP / --	Found in estuarine, marine subtidal, and marine pelagic waters along the California coast. Usually rests on water or inaccessible rocks, but also uses mudflats, sandy beaches, wharfs, and jetties.	Not Present: No suitable habitat present within Project site.
<i>Rallus obsoletus obsoletus</i> California Ridgeway's rail	FE / SE & CFP / --	Salt and brackish marshes.	Not Present: No suitable habitat present within Project site.
<i>Riparia riparia</i> Bank swallow (nesting)	-- / ST / --	Nest colonially in sand banks. Found near water; fields, marshes, streams, and lakes.	Not Present: No suitable habitat present within Project site.
<i>Sterna antillarum browni</i> California least tern	FE / SE / --	Prefers undisturbed nest sites on open, sandy/gravelly shores near shallow-water feeding areas in estuaries. Sea beaches, bays, large rivers, bars.	Not Present: No suitable habitat present within Project site.
<i>Vireo bellii pusillus</i> Least Bell's vireo	FE / SE / --	Riparian areas and drainages. Primarily found in Southern California.	Not Present: No suitable habitat present within Project site.
REPTILES AND AMPHIBIANS			
<i>Ambystoma californiense</i> California tiger salamander	FT / ST / --	Annual grassland and grassy understory of valley-foothill hardwood habitats in central and northern California. Need underground refuges and vernal pools or other seasonal water sources.	Present: No aquatic breeding habitat is present within the Project site; however, potential upland habitat (i.e., suitable habitat within 2.2 km of known and potential breeding ponds) is present. The nearest CNDDDB occurrence is within the eastern portion of the Project site. Additionally, DD&A biologists encountered this species immediately adjacent to the Project site, and relocated the individual to the nearest suitable upland habitat, which was located within the Project site.

Species	Status (Service/ CDFW/CNPS)	General Habitat	Potential Occurrence within Project Vicinity
<i>Ambystoma macrodactylum croceum</i> Santa Cruz long-toed salamander	FE / SE&CFP / --	Preferred habitats include ponderosa pine, montane hardwood-conifer, mixed conifer, montane riparian, red fir and wet meadows. Occurs in a small number of localities in Santa Cruz and Monterey Counties. Adults spend the majority of the time in underground burrows and beneath objects. Larvae prefer shallow water with clumps of vegetation.	Unlikely: Project site is outside of the known range for this species.
<i>Anniella pulchra</i> Northern California legless lizard (includes <i>A. p. nigra</i> as recognized by the HMP)	-- / CSC / --	Requires moist, warm habitats with loose soil for burrowing and prostrate plant cover, often forages in leaf litter at plant bases; may be found on beaches, sandy washes, and in woodland, chaparral, and riparian areas.	High: Suitable habitat is present within the Project site. The CNDDDB an occurrence that includes the eastern portion of the Project site and an occurrence immediately north of the western portion of the Project site. This species has been observed in several areas of Fort Ord.
<i>Emys marmorata</i> Western pond turtle	UR / CSC / --	Associated with permanent or nearly permanent water in a wide variety of habitats including streams, lakes, ponds, irrigation ditches, etc. Require basking sites such as partially submerged logs, rocks, mats of vegetation, or open banks.	Not Present: No suitable habitat present within Project site.
<i>Phrynosoma blainvillii</i> Coast horned lizard	-- / CSC / --	Associated with open patches of sandy soils in washes, chaparral, scrub, and grasslands.	High: Suitable habitat is present within the coastal scrub, maritime chaparral, grassland, and ruderal habitats within the Project site. This species is known to occur and has been observed by DD&A biologists throughout Fort Ord. The CNDDDB also reports an occurrence of this species within the northeastern portion of the Project site.
<i>Rana boylei</i> Foothill yellow-legged frog	-- / SC / --	Partly-shaded, shallow streams and riffles with a rocky substrate in a variety of habitats, including hardwood, pine, and riparian forests, scrub, chaparral, and wet meadows. Rarely encountered far from permanent water.	Unlikely: Project site is outside of the known range for this species.
<i>Rana draytonii</i> California red-legged frog	FT / CSC / --	Lowlands and foothills in or near permanent or late-season sources of deep water with dense, shrubby, or emergent riparian vegetation. During late summer or fall adults are known to utilize a variety of upland habitats with leaf litter or mammal burrows.	Unlikely: No breeding habitat is present within the Project site; however, portions of the Project site are within 1.6 km of potential breeding ponds. The nearest CNDDDB occurrence is approximately 3.0 miles north of the Project site at the Salinas River. The nearest known breeding pond on Fort Ord is 4.7 miles, and the nearest potential breeding pond is 0.4 mile from the Project site. Although the species has the potential to spread to the ponds near the Project site, the potential for CRLF to occur within the Project site at this time is unlikely based on the proximity to the known breeding locations.
<i>Taricha torosa torosa</i> Coast Range newt (Monterey County south only)	-- / CSC / --	Occurs mainly in valley-foothill hardwood, valley-foothill hardwood-conifer, coastal scrub, and mixed chaparral but is known to occur in grasslands and mixed conifer types. Seek cover under rocks and logs, in mammal burrows, rock fissures, or man-made structures such as wells. Breed in intermittent ponds, streams, lakes, and reservoir.	Low: No suitable breeding habitat within the Project site. Although suitable upland habitat for this species is present within the Project site, this species has only been documented to breed within one pond on Fort Ord, located approximately 2.2 miles south of the Project site within the Former Fort Ord Impact Area. The nearest CNDDDB occurrence is approximately 10 miles from the Project site at Palo Corona Regional Park.
<i>Thamnophis hammondi</i> Two-striped garter snake	-- / CSC / --	Associated with permanent or semi-permanent bodies of water bordered by dense vegetation in a variety of habitats from sea level to 2400m elevation.	Not Present: No suitable habitat present within Project site.

Species	Status (Service/ CDFW/CNPS)	General Habitat	Potential Occurrence within Project Vicinity
FISH			
<i>Eucyclogobius newberryi</i> Tidewater goby	FE / CSC / --	Brackish water habitats, found in shallow lagoons and lower stream reaches.	Not Present: No suitable habitat present within Project site.
<i>Oncorhynchus mykiss irideus</i> Steelhead (South/Central California Coast ESU)	FT / -- / --	Coastal perennial and near perennial streams, with suitable spawning and rearing habitat and no major barriers.	Not Present: No suitable habitat present within Project site.
<i>Spirinchus thaleichthys</i> Longfin smelt	FC / ST / --	Euryhaline, nektonic & anadromous. Found in open waters of estuaries, mostly in middle or bottom of water column. Prefers salinities of 15-30 PPT, but can be found in completely freshwater to almost pure seawater.	Not Present: No suitable habitat present within Project site.
INVERTEBRATES			
<i>Bombus caliginosus</i> Obscure bumble bee	-- / CNDDDB / --	Native to the West Coast of the United States. Occurs primarily along the coast in grassy prairies and meadows within the Coast Range. This species can nest both under and above ground. When nesting above ground the species may utilize abandoned bird nests. Found in areas that are relatively humid including areas that are frequently foggy.	Moderate: Marginally suitable habitat is present within the Project site within the non-native grassland habitat and some portions of the ruderal areas. The nearest CNDDDB occurrence is 5.8 miles west of the Project site.
<i>Bombus occidentalis</i> Western bumble bee	-- / CNDDDB / --	Occurs in open grassy areas, urban parks, urban gardens, chaparral, and meadows. This species generally nest underground.	Moderate: Marginally suitable habitat is present within the Project site within the non-native grassland and chaparral habitats, and some portions of the ruderal areas. The nearest CNDDDB occurrence is 4.6 miles east of the Project site.
<i>Brachminecta lynchi</i> Vernal pool fairy shrimp	FT / -- / --	Require ephemeral pools with no flow. Associated with vernal pools/grasslands from near Red Bluff (Shasta County), through the central valley, and into the south Coast Mountains region.	Not Present: No suitable habitat present within Project site.
<i>Coelus globosus</i> Globose dune beetle	-- / CNDDDB / --	Coastal dunes. These beetles are primarily subterranean, tunneling through sand underneath dune vegetation.	Not Present: No suitable habitat present within Project site.
<i>Danaus plexippus</i> Monarch butterfly	-- / CNDDDB / --	Overwinters in coastal California using colonial roosts generally found in Eucalyptus, pine, and acacia trees. Overwintering habitat for this species within the Coastal Zone represents ESHA. Local ordinances often protect this species as well.	Low: Although a small grove of Eucalyptus trees are present within the western portion of the Project site, no occurrences of this species are known to use these trees. The density of the Eucalyptus trees are unlikely to provide suitable wintering habitat for this species, and while a few individuals may occur within the Project site during the overwintering season, aggregations of monarch butterfly are unlikely to occur.
<i>Euphilotes enoptes smithi</i> Smith's blue butterfly	FE / -- / --	Most commonly associated with coastal dunes and coastal sage scrub plant communities in Monterey and Santa Cruz Counties. Plant hosts are <i>Eriogonum latifolium</i> and <i>E. parvifolium</i> .	Moderate: <i>E. parvifolium</i> is present at three locations within the Project site and may occur in other unsurveyed areas. This species may provide suitable habitat for Smith's blue butterfly.
<i>Linderiella occidentalis</i> California linderiella	-- / CNDDDB / --	Ephemeral ponds with no flow. Generally associated with hardpans.	Unlikely: No suitable habitat present within Project site.
<i>Tryonia imitator</i> Mimic tryonia (California brackishwater snail)	-- / CNDDDB / --	Inhabits coastal lagoons, estuaries and salt marshes. Found only in permanently submerged areas in a variety of sediment types. Tolerant of a wide range of salinities.	Not Present: No suitable habitat present within Project site.

Species	Status (Service/ CDFW/CNPS)	General Habitat	Potential Occurrence within Project Vicinity
PLANTS			
<i>Agrostis lacuna-vernalis</i> Vernal pool bent grass	-- / -- / 1B	Vernal pools (mima mounds) at elevations of 115-145 meters. Annual herb in the Poaceae family; blooms April-May.	Unlikely: Not identified within survey area in 2016. No suitable habitat present within Project site.
<i>Allium hickmanii</i> Hickman's onion	-- / -- / 1B	Closed-cone coniferous forests, maritime chaparral, coastal prairie, coastal scrub, and valley and foothill grasslands at elevations of 5-200 meters. Bulbiferous perennial herb in the Alliaceae family; blooms March-May.	Unlikely: Not identified within survey area in 2016. No suitable habitat present within Project site.
<i>Arctostaphylos hookeri</i> ssp. <i>hookeri</i> Hooker's manzanita	-- / -- / 1B	Closed-cone coniferous forest, chaparral, cismontane woodland, and coastal scrub on sandy soils at elevations of 85-536 meters. Evergreen shrub in the Ericaceae family; blooms January-June.	Moderate: Not identified within survey area in 2016; however, this species may occur within the Project site, outside of the survey area.
<i>Arctostaphylos montereyensis</i> Toro manzanita	-- / -- / 1B	Maritime chaparral, cismontane woodland, and coastal scrub on sandy soils at elevations of 30-730 meters. Evergreen shrub in the Ericaceae family; blooms February-March.	Present: Identified within survey area in 2016. May also occur within the Project site, outside of survey area.
<i>Arctostaphylos pajaroensis</i> Pajaro manzanita	-- / -- / 1B	Chaparral on sandy soils at elevations of 30-760 meters. Evergreen shrub in the Ericaceae family; blooms December-March.	Moderate: Not identified within survey area in 2016; however, this species may occur within the Project site, outside of the survey area.
<i>Arctostaphylos pumila</i> Sandmat manzanita	-- / -- / 1B	Openings of closed-cone coniferous forests, maritime chaparral, cismontane woodland, coastal dunes, and coastal scrub on sandy soils at elevations of 3-205 meters. Evergreen shrub in the Ericaceae family; blooms February-May.	Present: Identified within survey area in 2016. May also occur within the Project site, outside of survey area.
<i>Arenaria paludicola</i> Marsh sandwort	FE / SE 1B	Known from only two natural occurrences in Black Lake Canyon and at Oso Flaco Lake. Sandy openings of freshwater or brackish marshes and swamps at elevations of 3-170 meters. Stoloniferous perennial herb in the Caryophyllaceae family; blooms May-August.	Unlikely: Not identified within survey area in 2016. No suitable habitat present within Project site. Project site is outside of the currently known range for this species.
<i>Astragalus tener</i> var. <i>tener</i> Alkali milk-vetch	-- / -- / 1B	Playas, valley and foothill grassland on adobe clay, and vernal pools on alkaline soils at elevations of 1-60 meters. Annual herb in the Fabaceae family; blooms March-June.	Unlikely: Not identified within survey area in 2016. No suitable habitat present within Project site.
<i>Astragalus tener</i> var. <i>titi</i> Coastal dunes milk-vetch	FE / SE / 1B	Vernally mesic, sandy areas of coastal bluff scrub, coastal dunes, and coastal prairie at elevations of 1-50 meters. Annual herb in the Fabaceae family; blooms March-May.	Unlikely: Not identified within survey area in 2016. No suitable habitat present within Project site.
<i>Bryoria spiralis</i> Twisted horsehair lichen	-- / -- / 1B	California North Coast coniferous forest at elevations of 0-30 meters. Often found on conifers, including <i>Picea sitchensis</i> , <i>Pinus contorta</i> var. <i>contorta</i> , <i>Pseudotsuga menziesii</i> , <i>Abies grandis</i> , and <i>Tsuga heterophylla</i> . Fruticose lichen in the Parmeliaceae family.	Unlikely: Not identified within survey area in 2016. No suitable habitat present within Project site.
<i>Castilleja ambigua</i> ssp. <i>insalutata</i> Pink johnny-nip	-- / -- / 1B	Coastal prairie and coastal scrub at elevations of 0-100 meters. Annual herb in the Orobanchaceae family; blooms May-August.	Low: Not identified within survey area during in 2016. Low quality habitat present within the coastal scrub habitat within the Project site, outside of the survey area. The CNDDDB reports a non-specific occurrence within the Project site; however, the CNDDDB identifies that the species was found in the "mima mounds" area of Fort Ord, which does not occur within the Project site.

Species	Status (Service/ CDFW/CNPS)	General Habitat	Potential Occurrence within Project Vicinity
<i>Ceanothus cuneatus</i> ssp. <i>rigidus</i> Monterey ceanothus	-- / -- / List 4	Closed cone coniferous forest, chaparral, and coastal scrub on sandy soils at elevations of 3-550 meters. Evergreen shrub in the Rhamnaceae family; blooms February-June.	Present: Identified within survey area in 2016. May also occur within the Project site, outside of survey area.
<i>Centromadia parryi</i> ssp. <i>congdonii</i> Congdon's tarplant	-- / -- / 1B	Mesic areas of valley and foothill grassland on alkaline soils at elevations of 0-230 meters. Annual herb in the Asteraceae family; blooms May-November.	Unlikely: Not identified within survey area in 2016. No suitable habitat present within Project site, outside of survey area.
<i>Chorizanthe minutiflora</i> Fort Ord spineflower	-- / -- / 1B	Sandy openings of maritime chaparral and coastal scrub at elevations of 55-150 meters. Annual herb in the Polygonaceae family; blooms April-July.	Moderate: Suitable habitat for this species is present within the maritime chaparral and coastal scrub habitats within Project site ¹ .
<i>Chorizanthe pungens</i> var. <i>pungens</i> Monterey spineflower	FT / -- / 1B	Maritime chaparral, cismontane woodland, coastal dunes, coastal scrub, and valley and foothill grassland on sandy soils at elevations of 3-450 meters. Annual herb in the Polygonaceae family; blooms April-July.	Present: Identified within survey area in 2016. May also occur within the Project site, outside of survey area.
<i>Chorizanthe robusta</i> var. <i>robusta</i> Robust spineflower	FE / -- / 1B	Openings in cismontane woodland, coastal dunes, maritime chaparral, and coastal scrub on sandy or gravelly soils at elevations of 3-300 meters. Annual herb in the Polygonaceae family; blooms April-September.	Unlikely: Not identified during surveys in 2016. Although suitable habitat is present within the Project site, outside of survey area, the Project site is outside of the currently known range for this species.
<i>Clarkia jolonensis</i> Jolon clarkia	-- / -- / 1B	Cismontane woodland, chaparral, riparian woodland, and coastal scrub at elevations of 20-660 meters. Annual herb in the Onagraceae family; blooms April-June.	Low: Not identified during surveys in 2016. Low quality habitat present within the coast live oak woodland and coastal scrub habitats within the Project site, outside of the survey area. No occurrences of this species are known on the Former Fort Ord.
<i>Collinsia multicolor</i> San Francisco collinsia	-- / -- / 1B	Closed-cone coniferous forest and coastal scrub, sometimes on serpentinite soils, at elevations of 30-250 meters. Annual herb in the Plantaginaceae family; blooms March-May.	Unlikely: Not identified within survey area in 2016. No suitable habitat present within Project site, outside of survey area.
<i>Cordylanthus rigidus</i> ssp. <i>littoralis</i> Seaside bird's-beak	-- / SE / 1B	Closed-cone coniferous forests, maritime chaparral, cismontane woodlands, coastal dunes, and coastal scrub on sandy soils, often on disturbed sites, at elevations of 0-425 meters. Annual hemi-parasitic herb in the Orobanchaceae family; blooms April-October.	High: Not identified within survey area in 2016; however, this species may occur within the Project site, outside of the survey area. The nearest CNDDDB occurrence is approximately 0.3 mile from the Project site.
<i>Delphinium californicum</i> ssp. <i>interius</i> Hospital Canyon California larkspur	-- / -- / 1B	Openings in chaparral, coastal scrub, and mesic areas of cismontane woodland at elevations of 230-1095 meters. Perennial herb in the Ranunculaceae family; blooms April-June.	Unlikely: Not identified within survey area in 2016. No suitable habitat present within Project site. Project site is below the known elevation range for this species.
<i>Delphinium hutchinsoniae</i> Hutchinson's larkspur	-- / -- / 1B	Broadleaved upland forest, chaparral, coastal scrub, and coastal prairie at elevations of 0-427 meters. Perennial herb in the Ranunculaceae family; blooms March-June.	Unlikely: Not identified within survey area in 2016. No suitable habitat present within Project site, outside of the survey area.
<i>Ericameria fasciculata</i> Eastwood's goldenbush	-- / -- / 1B	Openings in closed-cone coniferous forest, maritime chaparral, coastal dunes, and coastal scrub on sandy soils at elevations of 30-275 meters. Evergreen shrub in the Asteraceae family; blooms July-October.	High: Not identified within survey area in 2016; however, the CNDDDB reports and occurrence of this species outside of the survey area and suitable habitat is present.
<i>Erysimum ammophilum</i> Sand-loving wallflower	-- / -- / 1B	Openings in maritime chaparral, coastal dunes, and coastal scrub on sandy soils at elevations of 0-60 meters. Perennial herb in the Brassicaceae family; blooms February-June.	High: Not identified within survey area in 2016; however, this species may occur within the Project site, outside of the survey area.

¹ Occurrences of this species were not identified in the CNDDDB search conducted prior to the surveys in 2016. Therefore, this species was not included in the 2016 surveys.

Species	Status (Service/ CDFW/CNPS)	General Habitat	Potential Occurrence within Project Vicinity
<i>Erysimum menziesii</i> Menzies' wallflower	FE / SE / 1B	Coastal dunes at elevations of 0-35 meters. Perennial herb in the Brassicaceae family; blooms March-June.	Unlikely: Not identified during surveys in 2016. No suitable habitat present within Project site.
<i>Fritillaria liliacea</i> Fragrant fritillaria	-- / -- / 1B	Cismontane woodland, coastal prairie, coastal scrub, and valley and foothill grassland, often serpentine, at elevations of 3-410 meters. Bulbiferous perennial herb in the Liliaceae family; blooms February-April.	Unlikely: Not identified within survey area in 2016. No suitable habitat present within Project site, outside of the survey area.
<i>Gilia tenuiflora</i> ssp. <i>arenaria</i> Sand gilia	FE / ST / 1B	Sandy openings of maritime chaparral, cismontane woodland, coastal dunes, and coastal scrub at elevations of 0-45 meters. Annual herb in the Polemoniaceae family; blooms April-June.	High: Not identified within survey area in 2016; however, the CNDDDB reports and occurrence of this species outside of the survey area and suitable habitat is present.
<i>Hesperocyparis goveniana</i> Gowen cypress	FT / -- / 1B	Closed-cone coniferous forest and maritime chaparral at elevations of 30-300 meters. Evergreen tree in the Cupressaceae family. Natively occurring only at Point Lobos near Gibson Creek and the Huckleberry Hill Nature Preserve near Highway 68.	Not Present: Not identified within survey area in 2016. No suitable habitat present within Project site, outside of the survey area. Project site is outside of the highly endemic range for this species.
<i>Hesperocyparis macrocarpa</i> Monterey cypress	-- / -- / 1B	Closed-cone coniferous forest at elevations of 10-30 meters. Evergreen tree in the Cupressaceae family. Natively occurring only at Cypress Point in Pebble Beach and Point Lobos State Park; widely planted and naturalized elsewhere.	Not Present: Although Monterey cypress trees are present within the Project site, these individuals were planted and are from unknown genetic stock. The Project site is outside of the known native range for this species, and thus the individuals within the Project site are not considered special-status species.
<i>Holocarpha macradenia</i> Santa Cruz tarplant	FT / SE / 1B	Coastal prairies and valley foothill grasslands, often clay or sandy soils, at elevations of 10-220 meters. Annual herb in the Asteraceae family; blooms June-October.	Unlikely: Not identified during surveys in 2016. Although suitable habitat is present within the Project site, outside of survey area, the Project site is outside of the currently known range for this species.
<i>Horkelia cuneata</i> ssp. <i>sericea</i> Kellogg's horkelia	-- / -- / 1B	Openings of closed-cone coniferous forests, maritime chaparral, coastal dunes, and coastal scrub on sandy or gravelly soils at elevations of 10-200 meters. Perennial herb in the Rosaceae family; blooms April-September.	Present: Identified within survey area in 2016. May also occur within the Project site, outside of survey area
<i>Horkelia marinensis</i> Point Reyes horkelia	-- / -- / 1B	Coastal dunes, coastal prairie, and coastal scrub on sandy soils at elevations of 5-350 meters. Perennial herb in the Rosaceae family; blooms May-September.	Moderate: Not identified within survey area in 2016; however, this species may occur within the Project site, outside of the survey area.
<i>Lasthenia conjugens</i> Contra Costa goldfields	FE / -- / 1B	Mesic areas of valley and foothill grassland, alkaline playas, cismontane woodland, and vernal pools at elevations of 0-470 meters. Annual herb in the Asteraceae family; blooms March-June.	Unlikely: Not identified within survey area in 2016. No suitable habitat present within Project site, outside of the survey area; this species is only known to occur within a few vernal pools on the Former Fort Ord.
<i>Layia carnosa</i> Beach layia	FE / SE / 1B	Coastal dunes and coastal scrub on sandy soils at elevations of 0-60 meters. Annual herb in the Asteraceae family; blooms March-July.	Unlikely: Not identified within survey area in 2016. No suitable habitat present within Project site, outside of the survey area.
<i>Legenere limosa</i> Legenere	-- / -- / 1B	Vernal pools at elevations of 1-880 meters. Annual herb in the Campanulaceae family; blooms April-June.	Unlikely: Not identified within survey area in 2016. No suitable habitat present within Project site, outside of the survey area.
<i>Lupinus tidestromii</i> Tidestrom's lupine	FE / SE / 1B	Coastal dunes at elevations of 0-100 meters. Perennial rhizomatous herb in the Fabaceae family; blooms April-June.	Unlikely: Not identified within survey area in 2016. No suitable habitat present within Project site, outside of the survey area.

Species	Status (Service/ CDFW/CNPS)	General Habitat	Potential Occurrence within Project Vicinity
<i>Malacothamnus palmeri</i> var. <i>involutus</i> Carmel Valley bush-mallow	-- / -- / 1B	Chaparral, cismontane woodland, and coastal scrub at elevations of 30-1100 meters. Deciduous shrub in the Malvaceae family; blooms May-August.	Unlikely: Not identified within survey area in 2016. Although suitable habitat for this species is present within the Project site, outside of the survey area, all known CNDDDB occurrences are located south of the Former Fort Ord and the Project site is likely outside of the range for this species.
<i>Malacothrix saxatilis</i> var. <i>arachnoidea</i> Carmel Valley macrothrix	-- / -- / 1B	Chaparral and coastal scrub on rocky soils at elevations of 25-1036 meters. Perennial rhizomatous herb in the Asteraceae family; blooms June-December.	Unlikely: Not identified within survey area in 2016. Although suitable habitat for this species is present within the Project site, outside of the survey area, all known CNDDDB occurrences are located south of the Former Fort Ord and the Project site is likely outside of the range for this species.
<i>Meconella oregana</i> Oregon meconella	-- / -- / 1B	Coastal prairie and coastal scrub at elevations of 250-620 meters. Annual herb in the Papaveraceae Family; blooms March-April.	Unlikely: Not identified within survey area in 2016. Although suitable habitat for this species is present within the Project site, outside of the survey area, the Project site is below the known elevation range for this species.
<i>Microseris paludosa</i> Marsh microseris	-- / -- / 1B	Mesic areas of closed-cone coniferous forest cismontane woodland, coastal scrub, and valley and foothill grasslands at elevations of 3-300 meters. Perennial herb in the Asteraceae family; blooms April-July.	Moderate: Not identified within survey area in 2016; however, this species may occur within the Project site, outside of the survey area.
<i>Monardella sinuata</i> ssp. <i>nigrescens</i> Northern curly-leaved monardella	-- / -- / 1B	Chaparral, coastal dunes, coastal scrub, and lower montane coniferous forest (ponderosa pine sandhills) on sandy soils at elevations of 0-300 meters. Annual herb in the Lamiaceae family; blooms April-September.	Moderate: Not identified within survey area in 2016; however, this species may occur within the Project site, outside of the survey area.
<i>Monolopia gracilens</i> Woodland woollythreads	-- / -- / 1B	Openings of broadleaved upland forest, chaparral, cismontane woodland, North Coast coniferous forest, and valley and foothill grassland on serpentinite soils at elevations of 100-1200 meters. Annual herb in the Asteraceae family; blooms February-July.	Moderate: Not identified within survey area in 2016; however, this species may occur within the Project site, outside of the survey area.
<i>Pinus radiata</i> Monterey pine	-- / -- / 1B	Closed-cone coniferous forest and cismontane woodland at elevations of 25-185 meters. Evergreen tree in the Pinaceae family. Only three native stands in CA, at Ano Nuevo, Cambria, and the Monterey Peninsula; introduced in many areas.	Not Present: Although Monterey pine trees are present within the Project site, these individuals were planted and are from unknown genetic stock. The Project site is outside of the known native range for this species, and thus the individuals within the Project site are not considered special status species.
<i>Piperia yadonii</i> Yadon's piperia	FE / -- / 1B	Sandy soils in coastal bluff scrub, closed-cone coniferous forest, and maritime chaparral at elevations of 10-510 meters. Annual herb in the Orchidaceae family; blooms May-August.	High: Not identified within survey area in 2016; however, this species may occur within the Project site, outside of the survey area.
<i>Plagiobothrys chorisianus</i> var. <i>chorisianus</i> Choris' popcornflower	-- / -- / 1B	Mesic areas of chaparral, coastal prairie, and coastal scrub at elevations of 15-160 meters. Annual herb in the Boraginaceae family; blooms March-June.	Unlikely: Not identified within survey area in 2016. No suitable habitat present within Project site, outside of the survey area; this species is only known to occur within a few vernal pools on the Former Fort Ord.
<i>Potentilla hickmanii</i> Hickman's cinquefoil	FE / SE / 1B	Coastal bluff scrub, closed-cone coniferous forests, vernal mesic meadows, and freshwater marshes and swamps at elevations of 10-149 meters. Perennial herb in the Rosaceae family; blooms April-August.	Unlikely: Not identified within survey area in 2016. No suitable habitat present within Project site, outside of the survey area.

Species	Status (Service/ CDFW/CNPS)	General Habitat	Potential Occurrence within Project Vicinity
<i>Ramalina thrausta</i> Angel's hair lichen	-- / -- / 2B	North coast coniferous forest on dead twigs and other lichens. Epiphytic fructose lichen in the Ramalinaceae family. In northern CA it is usually found on dead twigs, and has been found on <i>Alnus rubra</i> , <i>Calocedrus decurrens</i> , <i>Pseudotsuga menziesii</i> , <i>Quercus garryana</i> , and <i>Rubus spectabilis</i> . In Sonoma County it grows on and among dangling mats of <i>R. menziesii</i> and <i>Usnea</i> spp.	Unlikely: Not identified within survey area in 2016. No suitable habitat present within Project site, outside of the survey area.
<i>Rosa pinetorum</i> Pine rose	-- / -- / 1B	Closed-cone coniferous forest at elevations of 2-300 meters. Perennial shrub in the Rosaceae family; blooms May-July. Possible hybrid of <i>R. spithamea</i> , <i>R. gymnocarpa</i> , or others; further study needed.	Unlikely: Not identified within survey area in 2016. No suitable habitat present within Project site, outside of the survey area.
<i>Stebbinsoseris decipiens</i> Santa Cruz microseris	-- / -- / 1B	Broadleaved upland forest, closed-cone coniferous forest, chaparral, coastal prairie, coastal scrub, and openings in valley and foothill grassland, sometimes on serpentinite, at elevations of 10-500 meters. Annual herb in the Asteraceae family; blooms April-May.	Moderate: Not identified within survey area in 2016; however, this species may occur within the Project site, outside of the survey area.
<i>Trifolium buckwestiorum</i> Santa Cruz clover	-- / -- / 1B	Broadleaved upland forest, cismontane woodland, and margins of coastal prairie on gravelly soils at elevations of 105-610 meters. Annual herb in the Fabaceae family; blooms April-October.	Moderate: Not identified within survey area in 2016; however, this species may occur within the Project site, outside of the survey area.
<i>Trifolium hydrophilum</i> Saline clover	-- / -- / 1B	Marshes and swamps, mesic and alkaline valley and foothill grassland, and vernal pools at elevations of 0-300 meters. Annual herb in the Fabaceae family; blooms April-June.	Unlikely: Not identified within survey area in 2016. No suitable habitat present within Project site, outside of the survey area.
<i>Trifolium polyodon</i> Pacific Grove clover	-- / SR / 1B	Mesic areas of closed-cone coniferous forest, coastal prairie, meadows and seeps, and valley and foothill grassland at elevations of 5-120 meters. Annual herb in the Fabaceae family; blooms April-June.	Moderate: Not identified within survey area in 2016; however, this species may occur within the Project site, outside of the survey area.
<i>Trifolium trichocalyx</i> Monterey clover	FE / SE / 1B	Sandy openings and burned areas of closed-cone coniferous forest at elevations of 30-240 meters. Annual herb in the Fabaceae family; blooms April-June.	Unlikely: Not identified within survey area in 2016. No suitable habitat present within Project site, outside of the survey area.

Species	Status (Service/ CDFW/CNPS)	General Habitat	Potential Occurrence within Project Vicinity
<p>STATUS DEFINITIONS:</p> <p>Federal</p> <p>FE = listed as Endangered under the federal Endangered Species Act FT = listed as Threatened under the federal Endangered Species Act FC = Candidate for listing under the federal Endangered Species Act UR = Species that have been petitioned for listing under the ESA and for which a 90 day and/or 12 Month finding has not been published in the Federal Register, as well as species being reviewed through the candidate process but the CNOR has not yet been signed -- = no listing</p> <p>State</p> <p>SE = listed as Endangered under the California Endangered Species Act ST = listed as Threatened under the California Endangered Species Act SC = Candidate for listing under the California Endangered Species Act SR = listed as Rare under the California Endangered Species Act CFP = California Fully Protected Species CSC = California Department of Fish and Wildlife Species of Concern CNDDDB = This designation is being assigned to animal species that are not assigned any of the other status designations defined in this table. These animal species are included in CDFW's CNDDDB "Special Animals" list (2017b), which includes all taxa the CNDDDB is interested in tracking, regardless of their legal or protection status. This list is also referred to as the list of "species at risk" or "special-status species." The California Department of Fish and Wildlife considers the taxa on this list to be those of greatest conservation need. -- = no listing</p> <p>California Native Plant Society</p> <p>1B = California Rare Plant Rank 1B species; plants rare, threatened, or endangered in California and elsewhere 2B = California Rare Plant Rank 2B species; plants rare, threatened, or endangered in California, but more common elsewhere -- = no listing</p> <p>*Bold font indicates Fort Ord HMP Species</p> <p><u>POTENTIAL TO OCCUR:</u></p> <p>Present – known occurrence of species within the site; presence of suitable habitat conditions; or observed during field surveys High – known occurrence of species in the vicinity from the CNDDDB or other documentation; presence of suitable habitat conditions Moderate – known occurrence of species in the vicinity from the CNDDDB or other documentation; presence of marginal habitat conditions Low – species known to occur in the vicinity from the CNDDDB or other documentation; presence of low quality habitat conditions Unlikely – species not known to occur in the vicinity from the CNDDDB or other documentation; no suitable habitat is present Not Present – species not observed during surveys</p>			

This page left intentionally blank

APPENDIX B.

CNDDDB Occurrence Report

This page left intentionally blank



Selected Elements by Scientific Name

California Department of Fish and Wildlife

California Natural Diversity Database



Query Criteria: Quad (Seaside (3612157) OR Monterey (3612158) OR Marina (3612167) OR Spreckels (3612156) OR Salinas (3612166) OR Moss Landing (3612177) OR Prunedale (3612176)) AND Taxonomic Group (Fish OR Amphibians OR Reptiles OR Birds OR Mammals OR Mollusks OR Arachnids OR Crustaceans OR Insects OR Ferns OR Gymnosperms OR Monocots OR Dicots OR Lichens OR Bryophytes)

Species	Element Code	Federal Status	State Status	Global Rank	State Rank	Rare Plant Rank/CDFW SSC or FP
<i>Agelaius tricolor</i> tricolored blackbird	ABPBXB0020	None	Candidate Endangered	G2G3	S1S2	SSC
<i>Agrostis lacuna-vernalis</i> vernal pool bent grass	PMPOA041N0	None	None	G1	S1	1B.1
<i>Allium hickmanii</i> Hickman's onion	PMLIL02140	None	None	G2	S2	1B.2
<i>Ambystoma californiense</i> California tiger salamander	AAAAA01180	Threatened	Threatened	G2G3	S2S3	WL
<i>Ambystoma macrodactylum croceum</i> Santa Cruz long-toed salamander	AAAAA01082	Endangered	Endangered	G5T1T2	S1S2	FP
<i>Anniella pulchra</i> northern California legless lizard	ARACC01020	None	None	G3	S3	SSC
<i>Arctostaphylos hookeri ssp. hookeri</i> Hooker's manzanita	PDERI040J1	None	None	G3T2	S2	1B.2
<i>Arctostaphylos montereyensis</i> Toro manzanita	PDERI040R0	None	None	G2G3	S2S3	1B.2
<i>Arctostaphylos pajaroensis</i> Pajaro manzanita	PDERI04100	None	None	G1	S1	1B.1
<i>Arctostaphylos pumila</i> sandmat manzanita	PDERI04180	None	None	G1	S1	1B.2
<i>Asio flammeus</i> short-eared owl	ABNSB13040	None	None	G5	S3	SSC
<i>Astragalus tener var. tener</i> alkali milk-vetch	PDFAB0F8R1	None	None	G2T2	S2	1B.2
<i>Astragalus tener var. titi</i> coastal dunes milk-vetch	PDFAB0F8R2	Endangered	Endangered	G2T1	S1	1B.1
<i>Athene cunicularia</i> burrowing owl	ABNSB10010	None	None	G4	S3	SSC
<i>Bombus caliginosus</i> obscure bumble bee	IIHYM24380	None	None	G4?	S1S2	
<i>Bombus occidentalis</i> western bumble bee	IIHYM24250	None	None	G2G3	S1	
<i>Bryoria spiralifera</i> twisted horsehair lichen	NLTEST5460	None	None	G3	S1S2	1B.1



Selected Elements by Scientific Name
California Department of Fish and Wildlife
California Natural Diversity Database



Species	Element Code	Federal Status	State Status	Global Rank	State Rank	Rare Plant Rank/CDFW SSC or FP
<i>Buteo regalis</i> ferruginous hawk	ABNKC19120	None	None	G4	S3S4	WL
<i>Castilleja ambigua</i> var. <i>insalutata</i> pink Johnny-nip	PDSCR0D403	None	None	G4T2	S2	1B.1
<i>Centromadia parryi</i> ssp. <i>congdonii</i> Congdon's tarplant	PDAST4R0P1	None	None	G3T2	S2	1B.1
<i>Charadrius alexandrinus nivosus</i> western snowy plover	ABNNB03031	Threatened	None	G3T3	S2S3	SSC
<i>Chorizanthe minutiflora</i> Fort Ord spineflower	PDPGN04100	None	None	G1	S1	1B.2
<i>Chorizanthe pungens</i> var. <i>pungens</i> Monterey spineflower	PDPGN040M2	Threatened	None	G2T2	S2	1B.2
<i>Chorizanthe robusta</i> var. <i>robusta</i> robust spineflower	PDPGN040Q2	Endangered	None	G2T1	S1	1B.1
<i>Clarkia jolonensis</i> Jolon clarkia	PDONA050L0	None	None	G2	S2	1B.2
<i>Coelus globosus</i> globose dune beetle	IICOL4A010	None	None	G1G2	S1S2	
<i>Collinsia multicolor</i> San Francisco collinsia	PDSCR0H0B0	None	None	G2	S2	1B.2
<i>Cordylanthus rigidus</i> ssp. <i>littoralis</i> seaside bird's-beak	PDSCR0J0P2	None	Endangered	G5T2	S2	1B.1
<i>Corynorhinus townsendii</i> Townsend's big-eared bat	AMACC08010	None	None	G3G4	S2	SSC
<i>Cypseloides niger</i> black swift	ABNUA01010	None	None	G4	S2	SSC
<i>Danaus plexippus</i> pop. 1 monarch - California overwintering population	IILEPP2012	None	None	G4T2T3	S2S3	
<i>Delphinium californicum</i> ssp. <i>interius</i> Hospital Canyon larkspur	PDRAN0B0A2	None	None	G3T3	S3	1B.2
<i>Delphinium hutchinsoniae</i> Hutchinson's larkspur	PDRAN0B0V0	None	None	G2	S2	1B.2
<i>Delphinium umbraculorum</i> umbrella larkspur	PDRAN0B1W0	None	None	G3	S3	1B.3
<i>Elanus leucurus</i> white-tailed kite	ABNKC06010	None	None	G5	S3S4	FP
<i>Emys marmorata</i> western pond turtle	ARAAD02030	None	None	G3G4	S3	SSC
<i>Eremophila alpestris actia</i> California horned lark	ABPAT02011	None	None	G5T4Q	S4	WL
<i>Ericameria fasciculata</i> Eastwood's goldenbush	PDAST3L080	None	None	G2	S2	1B.1



Selected Elements by Scientific Name
California Department of Fish and Wildlife
California Natural Diversity Database



Species	Element Code	Federal Status	State Status	Global Rank	State Rank	Rare Plant Rank/CDFW SSC or FP
<i>Erysimum ammophilum</i> sand-loving wallflower	PDBRA16010	None	None	G2	S2	1B.2
<i>Erysimum menziesii</i> Menzies' wallflower	PDBRA160R0	Endangered	Endangered	G1	S1	1B.1
<i>Eucyclogobius newberryi</i> tidewater goby	AFCQN04010	Endangered	None	G3	S3	SSC
<i>Euphilotes enoptes smithi</i> Smith's blue butterfly	IILEPG2026	Endangered	None	G5T1T2	S1S2	
<i>Falco mexicanus</i> prairie falcon	ABNKD06090	None	None	G5	S4	WL
<i>Falco peregrinus anatum</i> American peregrine falcon	ABNKD06071	Delisted	Delisted	G4T4	S3S4	FP
<i>Fritillaria liliacea</i> fragrant fritillary	PMLIL0V0C0	None	None	G2	S2	1B.2
<i>Gilia tenuiflora ssp. arenaria</i> Monterey gilia	PDPLM041P2	Endangered	Threatened	G3G4T2	S2	1B.2
<i>Hesperocyparis goveniana</i> Gowen cypress	PGCUP04031	Threatened	None	G1	S1	1B.2
<i>Hesperocyparis macrocarpa</i> Monterey cypress	PGCUP04060	None	None	G1	S1	1B.2
<i>Holocarpha macradenia</i> Santa Cruz tarplant	PDAST4X020	Threatened	Endangered	G1	S1	1B.1
<i>Horkelia cuneata var. sericea</i> Kellogg's horkelia	PDROS0W043	None	None	G4T1?	S1?	1B.1
<i>Horkelia marinensis</i> Point Reyes horkelia	PDROS0W0B0	None	None	G2	S2	1B.2
<i>Lasiurus cinereus</i> hoary bat	AMACC05030	None	None	G5	S4	
<i>Lasthenia conjugens</i> Contra Costa goldfields	PDAST5L040	Endangered	None	G1	S1	1B.1
<i>Laterallus jamaicensis coturniculus</i> California black rail	ABNME03041	None	Threatened	G3G4T1	S1	FP
<i>Layia carnosa</i> beach layia	PDAST5N010	Endangered	Endangered	G2	S2	1B.1
<i>Legenere limosa</i> legenere	PDCAM0C010	None	None	G2	S2	1B.1
<i>Linderiella occidentalis</i> California linderiella	ICBRA06010	None	None	G2G3	S2S3	
<i>Lupinus tidestromii</i> Tidestrom's lupine	PDFAB2B3Y0	Endangered	Endangered	G1	S1	1B.1
<i>Malacothamnus palmeri var. involucratus</i> Carmel Valley bush-mallow	PDMAL0Q0B1	None	None	G3T2Q	S2	1B.2



Selected Elements by Scientific Name
California Department of Fish and Wildlife
California Natural Diversity Database



Species	Element Code	Federal Status	State Status	Global Rank	State Rank	Rare Plant Rank/CDFW SSC or FP
<i>Malacothrix saxatilis</i> var. <i>arachnoidea</i> Carmel Valley malacothrix	PDAST660C2	None	None	G5T2	S2	1B.2
<i>Meconella oregana</i> Oregon meconella	PDPAP0G030	None	None	G2G3	S2	1B.1
<i>Microseris paludosa</i> marsh microseris	PDAST6E0D0	None	None	G2	S2	1B.2
<i>Monardella sinuata</i> ssp. <i>nigrescens</i> northern curly-leaved monardella	PDLAM18162	None	None	G3T2	S2	1B.2
<i>Monolopia gracilens</i> woodland woollythreads	PDAST6G010	None	None	G3	S3	1B.2
<i>Oncorhynchus mykiss irideus</i> steelhead - south-central California coast DPS	AFCHA0209H	Threatened	None	G5T2Q	S2	
<i>Pelecanus occidentalis californicus</i> California brown pelican	ABNFC01021	Delisted	Delisted	G4T3	S3	FP
<i>Phrynosoma blainvillii</i> coast horned lizard	ARACF12100	None	None	G3G4	S3S4	SSC
<i>Pinus radiata</i> Monterey pine	PGPIN040V0	None	None	G1	S1	1B.1
<i>Piperia yadonii</i> Yadon's rein orchid	PMORC1X070	Endangered	None	G1	S1	1B.1
<i>Plagiobothrys chorisianus</i> var. <i>chorisianus</i> Choris' popcornflower	PDBOR0V061	None	None	G3T2Q	S2	1B.2
<i>Potentilla hickmanii</i> Hickman's cinquefoil	PDROS1B0U0	Endangered	Endangered	G1	S1	1B.1
<i>Rallus obsoletus obsoletus</i> California Ridgway's rail	ABNME05016	Endangered	Endangered	G5T1	S1	FP
<i>Ramalina thrausta</i> angel's hair lichen	NLLEC3S340	None	None	G5	S2?	2B.1
<i>Rana boylei</i> foothill yellow-legged frog	AAABH01050	None	Candidate Threatened	G3	S3	SSC
<i>Rana draytonii</i> California red-legged frog	AAABH01022	Threatened	None	G2G3	S2S3	SSC
<i>Reithrodontomys megalotis distichlis</i> Salinas harvest mouse	AMAFF02032	None	None	G5T1	S1	
<i>Riparia riparia</i> bank swallow	ABPAU08010	None	Threatened	G5	S2	
<i>Rosa pinetorum</i> pine rose	PDROS1J0W0	None	None	G2	S2	1B.2
<i>Sidalcea malachroides</i> maple-leaved checkerbloom	PDMAL110E0	None	None	G3	S3	4.2
<i>Spirinchus thaleichthys</i> longfin smelt	AFCHB03010	Candidate	Threatened	G5	S1	SSC



Selected Elements by Scientific Name
California Department of Fish and Wildlife
California Natural Diversity Database



Species	Element Code	Federal Status	State Status	Global Rank	State Rank	Rare Plant Rank/CDFW SSC or FP
<i>Stebbinsoseris decipiens</i> Santa Cruz microseris	PDAST6E050	None	None	G2	S2	1B.2
<i>Taricha torosa</i> Coast Range newt	AAAAF02032	None	None	G4	S4	SSC
<i>Taxidea taxus</i> American badger	AMAJF04010	None	None	G5	S3	SSC
<i>Thamnophis hammondi</i> two-striped gartersnake	ARADB36160	None	None	G4	S3S4	SSC
<i>Trifolium buckwestiorum</i> Santa Cruz clover	PDFAB402W0	None	None	G2	S2	1B.1
<i>Trifolium hydrophilum</i> saline clover	PDFAB400R5	None	None	G2	S2	1B.2
<i>Trifolium polyodon</i> Pacific Grove clover	PDFAB402H0	None	Rare	G1	S1	1B.1
<i>Trifolium trichocalyx</i> Monterey clover	PDFAB402J0	Endangered	Endangered	G1	S1	1B.1
<i>Tryonia imitator</i> mimic tryonia (=California brackishwater snail)	IMGASJ7040	None	None	G2	S2	

Record Count: 89

This page left intentionally blank

APPENDIX C.

IPAC Resources List for CSUMB Campus

This page left intentionally blank



United States Department of the Interior



FISH AND WILDLIFE SERVICE

Ventura Fish And Wildlife Office
2493 Portola Road, Suite B
Ventura, CA 93003-7726
Phone: (805) 644-1766 Fax: (805) 644-3958

In Reply Refer To:

August 04, 2017

Consultation Code: 08EVEN00-2017-SLI-0573

Event Code: 08EVEN00-2017-E-01268

Project Name: CSUMB Master Plan

Subject: List of threatened and endangered species that may occur in your proposed project location, and/or may be affected by your proposed project

To Whom It May Concern:

The enclosed list identifies species listed as threatened and endangered, species proposed for listing as threatened or endangered, designated and proposed critical habitat, and species that are candidates for listing that may occur within the boundary of the area you have indicated using the U.S. Fish and Wildlife Service's (Service) Information Planning and Conservation System (IPaC). The species list fulfills the requirements under section 7(c) of the Endangered Species Act (Act) of 1973, as amended (16 U.S.C. 1531 et seq.). Please note that under 50 CFR 402.12(e) of the regulations implementing section 7 of the Act, the species list should be verified after 90 days. We recommend that verification be completed by visiting the IPaC website at regular intervals during project planning and implementation for updates to species lists following the same process you used to receive the enclosed list. Please include the Consultation Tracking Number in the header of this letter with any correspondence about the species list.

Due to staff shortages and excessive workload, we are unable to provide an official list more specific to your area. Numerous other sources of information are available for you to narrow the list to the habitats and conditions of the site in which you are interested. For example, we recommend conducting a biological site assessment or surveys for plants and animals that could help refine the list.

If a Federal agency is involved in the project, that agency has the responsibility to review its proposed activities and determine whether any listed species may be affected. If the project is a major construction project*, the Federal agency has the responsibility to prepare a biological assessment to make a determination of the effects of the action on the listed species or critical habitat. If the Federal agency determines that a listed species or critical habitat is likely to be adversely affected, it should request, in writing through our office, formal consultation pursuant to section 7 of the Act. Informal consultation may be used to exchange information and resolve conflicts with respect to threatened or endangered species or their critical habitat prior to a

written request for formal consultation. During this review process, the Federal agency may engage in planning efforts but may not make any irreversible commitment of resources. Such a commitment could constitute a violation of section 7(d) of the Act.

Federal agencies are required to confer with the Service, pursuant to section 7(a)(4) of the Act, when an agency action is likely to jeopardize the continued existence of any proposed species or result in the destruction or adverse modification of proposed critical habitat (50 CFR 402.10(a)). A request for formal conference must be in writing and should include the same information that would be provided for a request for formal consultation. Conferences can also include discussions between the Service and the Federal agency to identify and resolve potential conflicts between an action and proposed species or proposed critical habitat early in the decision-making process. The Service recommends ways to minimize or avoid adverse effects of the action. These recommendations are advisory because the jeopardy prohibition of section 7(a)(2) of the Act does not apply until the species is listed or the proposed critical habitat is designated. The conference process fulfills the need to inform Federal agencies of possible steps that an agency might take at an early stage to adjust its actions to avoid jeopardizing a proposed species.

When a proposed species or proposed critical habitat may be affected by an action, the lead Federal agency may elect to enter into formal conference with the Service even if the action is not likely to jeopardize or result in the destruction or adverse modification of proposed critical habitat. If the proposed species is listed or the proposed critical habitat is designated after completion of the conference, the Federal agency may ask the Service, in writing, to confirm the conference as a formal consultation. If the Service reviews the proposed action and finds that no significant changes in the action as planned or in the information used during the conference have occurred, the Service will confirm the conference as a formal consultation on the project and no further section 7 consultation will be necessary. Use of the formal conference process in this manner can prevent delays in the event the proposed species is listed or the proposed critical habitat is designated during project development or implementation.

Candidate species are those species presently under review by the Service for consideration for Federal listing. Candidate species should be considered in the planning process because they may become listed or proposed for listing prior to project completion. Preparation of a biological assessment, as described in section 7(c) of the Act, is not required for candidate species. If early evaluation of your project indicates that it is likely to affect a candidate species, you may wish to request technical assistance from this office.

Only listed species receive protection under the Act. However, sensitive species should be considered in the planning process in the event they become listed or proposed for listing prior to project completion. We recommend that you review information in the California Department of Fish and Wildlife's Natural Diversity Data Base. You can contact the California Department of Fish and Wildlife at (916) 324-3812 for information on other sensitive species that may occur in this area.

[*A Biological Assessment is required for construction projects (or other undertakings having

similar physical impacts) that are major Federal actions significantly affecting the quality of the human environment as defined in the National Environmental Policy Act (42 U.S.C. 4332(2) (c)). For projects other than major construction activities, the Service suggests that a biological evaluation similar to a Biological Assessment be prepared to determine whether the project may affect listed or proposed species and/or designated or proposed critical habitat. Recommended contents of a Biological Assessment are described at 50 CFR 402.12.]

Attachment(s):

- Official Species List

Official Species List

This list is provided pursuant to Section 7 of the Endangered Species Act, and fulfills the requirement for Federal agencies to "request of the Secretary of the Interior information whether any species which is listed or proposed to be listed may be present in the area of a proposed action".

This species list is provided by:

Ventura Fish And Wildlife Office

2493 Portola Road, Suite B

Ventura, CA 93003-7726

(805) 644-1766

Project Summary

Consultation Code: 08EVEN00-2017-SLI-0573

Event Code: 08EVEN00-2017-E-01268

Project Name: CSUMB Master Plan

Project Type: ** OTHER **

Project Description: Master Plan for California State University Monterey Bay

Project Location:

Approximate location of the project can be viewed in Google Maps:

<https://www.google.com/maps/place/36.65656217050322N121.7652391355764W>

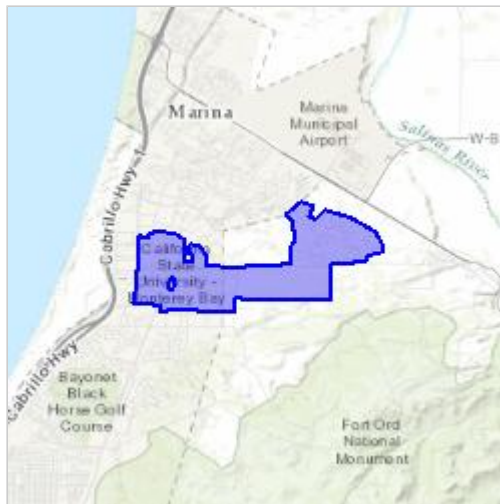

Counties: Monterey, CA

Endangered Species Act Species

There is a total of 19 threatened, endangered, or candidate species on this species list. Species on this list should be considered in an effects analysis for your project and could include species that exist in another geographic area. For example, certain fish may appear on the species list because a project could affect downstream species. See the "Critical habitats" section below for those critical habitats that lie wholly or partially within your project area under this office's jurisdiction. Please contact the designated FWS office if you have questions.

Mammals

NAME	STATUS
Southern Sea Otter <i>Enhydra lutris nereis</i> No critical habitat has been designated for this species. Species profile: https://ecos.fws.gov/ecp/species/8560	Threatened

Birds

NAME	STATUS
<p>California Condor <i>Gymnogyps californianus</i> Population: U.S.A. only, except where listed as an experimental population There is a final critical habitat designated for this species. Your location is outside the designated critical habitat. Species profile: https://ecos.fws.gov/ecp/species/8193</p>	Endangered
<p>California Least Tern <i>Sterna antillarum browni</i> No critical habitat has been designated for this species. Species profile: https://ecos.fws.gov/ecp/species/8104</p>	Endangered
<p>Least Bell's Vireo <i>Vireo bellii pusillus</i> There is a final critical habitat designated for this species. Your location is outside the designated critical habitat. Species profile: https://ecos.fws.gov/ecp/species/5945</p>	Endangered
<p>Marbled Murrelet <i>Brachyramphus marmoratus</i> Population: U.S.A. (CA, OR, WA) There is a final critical habitat designated for this species. Your location is outside the designated critical habitat. Species profile: https://ecos.fws.gov/ecp/species/4467</p>	Threatened
<p>Southwestern Willow Flycatcher <i>Empidonax traillii extimus</i> There is a final critical habitat designated for this species. Your location is outside the designated critical habitat. Species profile: https://ecos.fws.gov/ecp/species/6749</p>	Endangered
<p>Western Snowy Plover <i>Charadrius alexandrinus nivosus</i> Population: Pacific Coast population DPS-U.S.A. (CA, OR, WA), Mexico (within 50 miles of Pacific coast) There is a final critical habitat designated for this species. Your location is outside the designated critical habitat. Species profile: https://ecos.fws.gov/ecp/species/8035</p>	Threatened

Amphibians

NAME	STATUS
<p>California Red-legged Frog <i>Rana draytonii</i></p> <p>There is a final critical habitat designated for this species. Your location is outside the designated critical habitat.</p> <p>Species profile: https://ecos.fws.gov/ecp/species/2891</p>	Threatened
<p>California Tiger Salamander <i>Ambystoma californiense</i></p> <p>Population: U.S.A. (Central CA DPS)</p> <p>There is a final critical habitat designated for this species. Your location is outside the designated critical habitat.</p> <p>Species profile: https://ecos.fws.gov/ecp/species/2076</p>	Threatened
<p>Santa Cruz Long-toed Salamander <i>Ambystoma macrodactylum croceum</i></p> <p>No critical habitat has been designated for this species.</p> <p>Species profile: https://ecos.fws.gov/ecp/species/7405</p>	Endangered

Fishes

NAME	STATUS
<p>Tidewater Goby <i>Eucyclogobius newberryi</i></p> <p>There is a final critical habitat designated for this species. Your location is outside the designated critical habitat.</p> <p>Species profile: https://ecos.fws.gov/ecp/species/57</p>	Endangered

Insects

NAME	STATUS
<p>Smith's Blue Butterfly <i>Euphilotes enoptes smithi</i></p> <p>No critical habitat has been designated for this species.</p> <p>Species profile: https://ecos.fws.gov/ecp/species/4418</p>	Endangered

Crustaceans

NAME	STATUS
<p>Vernal Pool Fairy Shrimp <i>Branchinecta lynchi</i></p> <p>There is a final critical habitat designated for this species. Your location is outside the designated critical habitat.</p> <p>Species profile: https://ecos.fws.gov/ecp/species/498</p>	Threatened

Flowering Plants

NAME	STATUS
<p>Contra Costa Goldfields <i>Lasthenia conjugens</i></p> <p>There is a final critical habitat designated for this species. Your location is outside the designated critical habitat.</p> <p>Species profile: https://ecos.fws.gov/ecp/species/7058</p>	Endangered
<p>Marsh Sandwort <i>Arenaria paludicola</i></p> <p>No critical habitat has been designated for this species.</p> <p>Species profile: https://ecos.fws.gov/ecp/species/2229</p>	Endangered
<p>Menzies' Wallflower <i>Erysimum menziesii</i></p> <p>No critical habitat has been designated for this species.</p> <p>Species profile: https://ecos.fws.gov/ecp/species/2935</p>	Endangered
<p>Monterey Gilia <i>Gilia tenuiflora ssp. arenaria</i></p> <p>No critical habitat has been designated for this species.</p> <p>Species profile: https://ecos.fws.gov/ecp/species/856</p>	Endangered
<p>Monterey Spineflower <i>Chorizanthe pungens var. pungens</i></p> <p>There is a final critical habitat designated for this species. Your location overlaps the designated critical habitat.</p> <p>Species profile: https://ecos.fws.gov/ecp/species/396</p>	Threatened
<p>Yadon's Piperia <i>Piperia yadonii</i></p> <p>There is a final critical habitat designated for this species. Your location is outside the designated critical habitat.</p> <p>Species profile: https://ecos.fws.gov/ecp/species/4205</p>	Endangered

Critical habitats

There is 1 critical habitat wholly or partially within your project area under this office's jurisdiction.

NAME	STATUS
<p>Monterey Spineflower <i>Chorizanthe pungens var. pungens</i></p> <p>https://ecos.fws.gov/ecp/species/396#crithab</p>	Final designated

This page left intentionally blank

APPENDIX D.

The Birds of Fort Ord East of Route 1

This page left intentionally blank

THE BIRDS OF FORT ORD EAST OF ROUTE 1

Revised 5 Feb 07

David Styer with historic data provided by Don Roberson

An asterisk (*) after a bird's name means that the species was probably breeding, or confirmed breeding on Fort Ord east of Route 1. This list is based almost entirely on my own inventories. These have taken place during the following time periods: 25 Feb - 16 Jun 96, 9 Jul - 16 Aug 97, 27 Jun - 16 Aug 98, 27 Jul - 19 Aug 99, 7 Jun - 28 Jun 00, 5 Feb 01 - 3 Mar 01, 17 Sep 01 - 2 Nov 01, 13 Dec - 31 Dec 01, and most of 2002 and 2003. In 2004–2006 only the more outstanding sightings were noted. The few records based on other people's sightings are noted. All collective references to Christmas Bird Counts (CBCs) refer to the nine Monterey CBCs provided by Roberson. This count takes place in a 15-mile diameter circle that includes the southwest portion of Ft. Ord.

1. Cackling Goose 1 record: 1 seen by D. Roberson's CBC group on 29 Dec 00.
2. Canada Goose* Seen in small numbers. Nested, but unsuccessfully in 2002. Successfully nested at Machine Gun Flats in 2005.
3. Wood Duck The first record was 5 males at Boy Scout Lake on 12 Oct 05. Some were seen there until 7 Dec 05.
4. Gadwall* The first record was five seen on 8 Aug 98 on a vernal pond. Expected in small numbers. In 2002 there were 3 records from 12 Mar to 24 Mar, and 5 records from 29 Aug to 29 Oct, all at Mudhen Lake. Seen in January and December in 2003. Nested on Machine Gun Flats in 2005; young noted on 22 May 05.
5. American Wigeon Winter visitor. A pair was on Mudhen Lake on 18 Feb 01; 3 were there on 23 Mar 02, and 1 to 2 pairs were there from 23 Nov 02 through 31 Jan 03. Seen regularly at the vernal pools 29 Jan 05 through 2 Apr 05. Also, seen regularly at Boy Scout Lake Nov and Dec 05, with approximately 10 there on 13 Dec.
6. Mallard* Seen on ponds through year. Young seen on Mudhen Lake 6 Jun 96 and on Boy Scout Pond on 2 Jun 96. Young seen on several ponds in 1998. One hundred to three hundred regularly visited Mudhen Lake in the fall of 2001. There were 87 visiting the vernal pool at Machine Gun Flats on 2 Mar 04. Bill Collins saw around 500 on the pond behind Range 37 in the fall of 2000. Ronnie L. Ryno found young at Mudhen Lake on 9 Jun 89 during the Monterey County Breeding Bird Atlas project.
7. Cinnamon Teal First record: 1 male on the pond behind Range 37 on 31 Mar 96. Two spent most of Aug 99 on Fox Pond. There were several records in Mar 05, and 3 were on Mudhen Lake on 21 Jul 05. In early 2006 they were seen on Boy Scout Lake: 2 on 24 Jan and 4 on 21 Feb.
8. Northern Shoveler A pair was at Mudhen Lake on 29 Oct 01, 6 were there 6 Oct 02 and 3 were there on 25 Oct 05.
9. Northern Pintail First record: 3 females on Mudhen Lake on 22 Oct 01. Six were there, including a male, on 2 Nov 01, 2 were there on 22 Oct 02, and a pair was at Boy Scout Lake on 13 Dec 05.

10. Green-winged Teal
A pair was at Mudhen Lake from 30 Mar to 7 Apr 96. They visited Mudhen Lake in early Nov 02, and 20 were there on 5 Nov 02. On 12 Dec 05 19 males were on Mudhen Lake. The next day a flock of 35 (males and females) were on Boy Scout Lake. They were seen there in dwindling numbers up until 21 Feb 06.
11. Redhead
A male was seen at Mudhen Lake from 13 Dec 01 through 4 Feb 02.
12. Ring-necked Duck
An occasional fall and winter visitor. 1st record: 1 male in holding pond near west end of Eucalyptus Rd. on 28 Jun 98. There were 5 females on Mudhen Lake on 20 and 27 Nov, and 1 male there on 1 Dec 06. Notably, Bill Collins saw around 35 in the pond behind Range 37 in the fall of 2000.
13. Greater Scaup
1 record: 1 female in the holding pond at the west end of Eucalyptus Road on 26 Oct 01.
14. Bufflehead
One female spent the entire summer of 1998 on the same pond (see ring-necked Duck). 2 females were on the same pond in Jan 03. A pair was on Machine Gun Flats on 22 Feb 05.
15. Common Goldeneye
Seen in winter 1996 on above-mentioned pond before inventory started, and in Dec 01.
16. Hooded Merganser
2 records: One immature male on Mudhen Lake 25 Feb - 24 Mar 96, and 1 female on Mudhen Lake on 24 Nov 06.
17. Common Merganser
1 record: seen in the Salinas River on 30 Apr 05.
18. Ruddy Duck
Occasional visitor. 2 males on the vernal pool on Machine Gun Flats on 17 Jul 98, and 1 female on the Catfish Pond on 18 Oct 02. Two females spent much of Dec 05 on Mudhen Lake. A resident of Mudhen Lake beginning 9 Oct 06.
19. Wild Turkey*
Seen irregularly during the inventory. Dick Pitschka and I saw 3 adult females and 7 young across Jacks Road from Mudhen Lake on 21 Jun 00. Noticeably more common by 2001 than in the past. In 2003 and 2004, 2 or 3 flocks of up to 20 were seen, and they continue to have young.
20. California Quail*
Seen, except in the most open grassland, throughout Ft. Ord, throughout the inventory. Possibly increasing: in 1996 most coveys with 10 or fewer birds. In 2001 many coveys with 10 to 20 birds. They continue roughly the same size through 2006. I have been told that coveys with a 100 California Quail were common in the past.
21. Loon species
2 flew over the BLM office area on 2 Nov 01.
22. Pied-billed Grebe*
Seen throughout the year on permanent ponds. In 1996 and 1997 young produced only on Mudhen Lake. In 1998 young were produced on at least four vernal ponds.
23. Eared Grebe
2 records: 1 stayed at the holding pond on the west end of Eucalyptus Road from 4 Oct to 11 Oct 01, and 1 was on Mudhen lake from 15 Nov 05 through 29 Nov 05.

24. Double-crested Cormorant Winter visitor to Mudhen Lake. Seen late December through March, irregularly until May. Up to 5 have been seen at once. On 30 Nov 06 30 flew over Mudhen Lake.
25. American Bittern 1 record: 1 seen at Mudhen Lake on and around 7 Aug 99.
26. Great Blue Heron One or two regularly visit the permanent ponds.
27. Great Egret Occasional visitor to the permanent ponds. 1 frequently seen at the dwindling Mudhen Lake in 2003. One at a puddle in East Garrison on 22 Mar 05 was a surprise.
28. Green Heron 4 records prior to 2006: 1 seen by Sam Fitton on 6 Apr 98, 1 seen at Mudhen Lake 11 Jun 02, 1 seen by Steve Moore at the pond on Crescent Bluff Road on 25 Apr 03, and 1 flew from Toro Creek Pond on 7 Jul 05. Bruce Gerow saw them regularly at the mouth of El Toro Creek, just off Ft. Ord. There were 5 records at Mudhen Lake and Boy Scout Lake in 2006.
29. Turkey Vulture Seen throughout Ft. Ord throughout the year, although uncommon in the backcountry in the fall. Possibly breeding, but not confirmed, although evidence continues to build. Numbers on CBCs have increased almost steadily from 1 in 1984 to 17 in 2001.
30. Osprey 1st record: 1 eating on top of high-tension tower by Range 45 on 6 Apr 96. 1 flew over Mudhen Lake on 19 Oct 01. In 2002 Osprey were seen on 4 Jan, 8 Jan, and 11 Apr. In 2003 there were 3 records: 1 on 3 Jan at Mudhen Lake, 1 in April flying over Ingman Court, and 1 on 3 May at El Toro Creek. Again, one was seen at Mudhen Lake on 3 Jan 04.
31. White-tailed Kite* Seen in small numbers (1 or 2) over grasslands and vernal pools. In the spring of 1998 Roberto Maceira saw approximately 10 spending the day by one pool, and in the summer of 2006 Tim Buhl saw a group of 11, including young.
32. Bald Eagle An immature bird was seen at Mudhen Lake in the spring of 1999. On 4 Mar 02 Bill Collins saw 1 subadult on Machine Gun Flats.
33. Northern Harrier A winter resident on the grasslands, and an occasional migrant elsewhere. 1 to 3 are usually seen in grasslands. One summer record: 1 on 8 Jul 98.
34. Sharp-shinned Hawk Fairly common fall migrant, arriving in Sep, and uncommon spring migrant. Also seen on 1 and 2 Aug 99. A winter resident in 2003 and 2004.
35. Cooper's Hawk* Seen throughout the inventory, and widely, but thinly spread over Ft. Ord.
36. Red-shouldered Hawk* Common year-round in the "front" of Ft. Ord, near housing. Seen less in other locations. Ronnie L Ryno observed an occupied nest near Mudhen Lake 16 Apr 86.

37. Red-tailed Hawk* Seen throughout Ft. Ord throughout the year. Eleven Red-tailed Hawks wheeling over the BLM office on 25 Jul 98 was an extraordinary sight. Nests are seen regularly; for example, Ronnie L. Ryno saw on occupied nest on 16 Apr 86. Usually around 10 are seen on CBCs, but on 28 Dec 84 there were 25 counted.
38. Ferruginous Hawk 2 records: Don Roberson saw one in the Grasslands on 28 Dec 84, and I saw 1 near Imjin Rd. on 14 Apr 02.
39. Golden Eagle 1st record: 1 over grassland, Oil Well Rd., on 6 Apr 96. An uncommon fall migrant, rare in other seasons. Seen in February, March, and September in 2003. One was seen on the CBC on 29 Dec 00, and on Lightfighter Road during the CBC on 27 Dec 05.
40. Crested Caracara 1 record: Tim Buhl saw 1 fly across Highway 1 on 11 Sep 06.
41. American Kestrel* Seen throughout the year. Perhaps 4 to 8 pairs breed on Ft. Ord. Especially visible on the grasslands. On the 9 CBCs the low count was 4 and the high count was 14.
42. Merlin Uncommon migrant or winter visitor: 1 was seen near Laguna Seca during the CBC on 27 Dec 89. 1 at Machine Gun Flats on 9 Mar 96 and on 11 Jan 02, 1 on First Ave. on 19 Oct 01, 1 at Parker Flats on 30 Dec 03, and 1 by Fox Pond on 9 Dec 04. 1 was seen at El Toro Creek on 26 Feb 05, and another was seen at Machine Gun Flats on 25 Mar 05.
43. Peregrine Falcon One seen circling over First Ave. on 4 Oct 01.
44. Prairie Falcon 3 records: 1 seen at Machine Gun Flats on 19 Oct 01, 1 seen by Bill Reese on 27 Dec 04, and 1 was seen flying over Old Reservation Rd. on 30 Aug 06.
45. Virginia Rail 1 record: 1 first heard on 28 Oct responded repeatedly to a taped call on 30 Oct 06.
46. Sora Few records: 1 on pond behind Range 37 on 31 Mar 96; 1 seen on Mudhen Lake on 1 and 2 Mar 01, and 1 was at the Catfish Pond much of Oct 04. They were heard from 21 Oct to 13 Nov 06 on Mudhen Lake, with a maximum of 3 heard on 26 Oct.
47. Common Moorhen 2 records of single individuals on Mudhen Lake: on 23 Oct 01, and seen from 16 Oct to 23 Oct 06.
48. American Coot* In 1996 common through April, then most gone. Approximately 2 young produced in 1996 and 1997. In 1998 seen in summer on at least 6 ponds, with at least 25 young produced. In the dry year, 2001, only a pair at the Catfish Pond produced young (5). By summer 2004 all ponds except the Catfish Pond had dried, so Coots could only be seen there. Coots returned to the refilled Mudhen Lake by 25 Mar 05, and approximately 40 were seen there on 14 Nov 06.

49. Killdeer
Seen at Mudhen Lake through Mar 96, but not later that year. Up to 8 seen at the vernal pool behind the BLM buildings in July and August of 1998. Larger numbers, e.g., 26 on 11 Dec 02, seen in fall or winter in fields such as Parker Flats.
50. Spotted Sandpiper
1 record: 2 in breeding plumage at Fox Pond on 4 Jul 98.
51. Solitary Sandpiper
3 records: 1 bird at vernal pond behind BLM headquarters on 1 Aug 98, 1 at the Catfish Pond on 29 Jul 03, and there was also 1 on the Salinas River at the mouth of El Toro Creek on 3 May 03.
52. Greater Yellowlegs
2 March records in 1996: 6 on Reserve 12 on 9 Mar and 1 heard at Mudhen Lake on 24 Mar. Seen visiting the mud-flats behind the BLM buildings in July and August of 1998, at Fox Pond in Aug 99, 3 on Machine Gun Flats on 11 Jan 02. Visited Mudhen Lake and Machine Gun Flats in March, April, October, and November in 2003. There were 14 on Machine Gun Flats on 2 Mar 04, and 22 on 14 Mar 05. 1 flew over South Boundary Road during the CBC on 29 Dec 00.
53. Whimbrel
1 record: on 29 Jul 03 one flew over me on Parker Flats Road, and circled around and called.
54. Western Sandpiper
1 record: 1 at Fox Pond on 14 Aug 99.
55. Least Sandpiper
1 stayed at Fox Pond in 1999. First record: 31 Jul 99. Mary Paul saw 2 at Boy Scout Lake on 19 Dec 05, and 1 was seen at the pond by Riso Ridge Road on 13 Nov 06.
56. Long-billed Dowitcher
Visitors to Fox Pond in 1999. I saw 1 on 5 Aug, the first record, and 10 or more on 18 Aug.
57. Wilson's Snipe
Steve Moore and Suzy Worcester have seen several at vernal pools; e.g., they saw 1 at Twin Pond on 6 Apr 03. In 2004 there was 1 at Machine Gun Flats on 22 Apr, and there were 2 at the Catfish Pond on 16 and 21 Oct. 3 records in 2005: 10 were counted at Machine Gun Flats on 29 Jan, 2 at Mudhen Lake on 29 Oct, and 1 at Toro Creek Pond on 23 Nov. One was at Machine Gun Flats on 23 Jan 06.
58. Wilson's Phalarope
First record: 1 immature bird on pond behind BLM office on 2 Aug 98. There were 3 on Fox Pond in Aug 99.
59. Red-necked Phalarope
3 on the pond on Reserve 5 on 26 Jul 97, up to 19 on Fox Pond in Aug 99, and up to 6 on Mudhen Lake in Aug 06.
60. Red Phalarope
1 record: 1 seen by Bill Reese's CBC group on Mudhen Lake on 27 Dec 05.
61. Mew Gull
1 record: a large and varied group of gulls were on top of the Commissary building during the CBC count on 28 Dec 84, when Ft. Ord was an active military base. There were 130 of these gulls.
62. California Gull
Several are regularly seen flying over Ft. Ord and visiting such places as Burger King in fall and winter. Don Roberson saw 1105 on the commissary roof during the CBC on 28 Dec 84.
63. Herring Gull
1 record: 38 on 28 Dec 84 (see comment at Mew Gull).

64. Thayer's Gull 1 record: 1 adult on 28 Dec84 (see comment at Mew Gull).
65. Western Gull 2 records: Don Roberson counted 159 on the Commissary roof during the 28 Dec 84 CBC, and a flock of approximately 6 were seen flying over CSUMB on 19 Jul 98.
66. Glaucous-winged Gull 1 record: 1 on 28 Dec84 (see comment at Mew Gull).
67. Black-legged Kittiwake 1 record: an exhausted individual found by Shirley Tudor in the Inland Ranges on 25 Feb 11.
68. Elegant Tern 2 records: Sam Fitton heard 1 on 26 Jul 97, and Bruce Gerow heard 1 on 1 Aug 98.
69. Rock Pigeon* In spite of being common in the housing areas of Ft. Ord, they are infrequently seen in the interior backcountry. There are a few records each year.
70. Band-tailed Pigeon Chuck Haugen had seen them along El Toro Creek. Charlie Saunders and I saw 5 on 18 Mar 03 flying over Trail 22. Following that, I saw 24 on 9 May, 7 on 16 Jun, and 3 on 11 Nov 03. In 2006 there were 6 at the BLM Offices on 4 Jan, 10 at Engineer Canyon Road on 8 Mar, and 30 down from Mudhen Lake on 5 Apr. Fifteen were seen on the CBC on 27 Dec 96.
71. Eurasian Collared-Dove
72. Mourning Dove* Seen, usually 1 to 4 at a time, throughout the inventory and in all areas. On 24 Jul 97, Robin Whatley and I counted over 60 in one spot along Oil Well Road, and I saw approximately 60 by Eucalyptus Road on 15 Oct 06. Less common in the dry years of 2002 and 2003, but a flock of 30 was seen in the grasslands on 2 Dec 03.
73. Greater Roadrunner* Few records: near Mudhen Lake: 1 heard on 6 Apr 96 and 1 heard on 2 Nov 01. Also seen by Barloy Canyon Road and Trail 22 in the spring of 2002. People have said they see them down Crescent Bluff Road, and Engineering Canyon Road. Steve Moore and Eric Morgan independently saw 1 at Machine Gun Flats on 19 Apr 03, our only 2003 record. A Roadrunner on Eucalyptus Road entertained the volunteers on 18 May 04. Tammy Jakl saw 1 on Trail 10 on 26 Oct 05. Ronnie Ryno saw 1 near Mudhen Lake on 16 Apr 89. Don Roberson saw 2 on the CBC on 28 Dec 84, and 1 on the CBC on 28 Dec 99.
74. Barn Owl* Resident, but few seen. In Aug 98 they were found to come out at dusk over the grasslands at Skyline and Oil Well Roads, and hover like Red-tailed Hawks. [Id. aided by Sam Fitton.] In Jul 06 Wendi Wendt showed us a cliff-side nest with 4 young.
75. Western Screech-Owl* Resident. Seen once or twice each year, including an adult and 1 young on 26 Jul 97.
76. Great Horned Owl* A permanent resident, and breeding bird, seen throughout Ft. Ord. At least 5 pairs live in the vicinity of Eucalyptus Road. Mark Littlefield observed a nest with young on 25 Feb 91.

77. Burrowing Owl
 Jack Massera reported that they used to live in the grasslands. Bruce Delgado saw 2 in Nov 97. The Fittons and I looked for them on 15 Aug 98, and we found pellets that were no more than a week old [fida Sam Fitton]. The volunteer group saw 1 on 4 Feb 03 near the corner of Skyline and Guidotti Roads. In late Oct 05 Jessie Quinn saw 3 or 4, and Phil Smith found 1 that stood by its hole under a Coyote Brush bush. Smith reported at least 12 on a subsequent trip that winter (2005-06). Observed on the 1993, 1994, 1998, 2005, and 2006 CBCs.
78. Common Poorwill*
 In the chaparral throughout the inventory. Infrequently calls in July and August. Heard calling as early as 31 Jan 03. In fall they are seen but not heard. Late records: 6 on 20 Oct 01, and 4 on 28 Oct 06.
79. Vaux's Swift
80. White-throated Swift
 Appears to be nesting under the highway bridges adjacent to Ft. Ord. Seen widely over Ft. Ord on 19 Feb 01, as in a migration. Seen throughout the year, but usually scarce in winter. One was seen on the CBC of 29 Dec 94. They were common on the Reservation Road bridge over El Toro Creek in the fall of 2006, with at least 28 seen on 16 Nov, and seen until my last trip to the area on 24 Dec.
81. Anna's Hummingbird*
 One to several seen everywhere except pure grassland throughout the year. Most actively breeding in winter. Ronnie Ryno saw an occupied nest on 8 May 89, and I watched nest activity at the BLM office area from 5 Jan to 16 Feb 06. Usually between 40 and 70 individuals have been counted on the CBCs, but 179 were noted on the 1984 CBC.
82. Rufous Hummingbird
 Bruce Gerow said that a big migratory wave of Rufous Hummingbirds passed through Ft. Ord in April 1989.
83. Allen's Hummingbird*
 Seen at BLM compound in 1996 and at the Catfish Pond from 16 Mar to 8 Jun 03, and again in 2004, starting 15 Feb. In 2004, also noted in the BLM office area on 11 Feb, and along El Toro Creek on 10 Mar.
84. Belted Kingfisher
 One or two seem to visit Ft. Ord regularly, except during the breeding season. Seen most regularly at Mudhen Lake. They are more regular, and possibly nesting, in the Salinas River area, a region not inventoried prior to 2006.
85. Lewis's Woodpecker
 From 20 Dec 93 to 6 May 94 there were "dozens" on eastern Ft. Ord. For example, 5 were seen on the CBC on 28 Dec 93. [See Don Roberson, *Monterey Birds*, 2nd Edition, 2002.] Tim Buhl saw 1 at the Catfish Pond on 2 Oct 03. It was still there the next day.
86. Acorn Woodpecker*
 In 1996 most individuals were along El Toro Creek. In 1998 there was a small colony next to Mudhen Lake. In the falls of 2001 and 2005, strong acorn years, Acorn Woodpeckers were widely distributed all over Ft. Ord. One to five could be seen in many places. By the end of the dry, low yield year, 2002, Acorn Woodpeckers were again scarce on Ft. Ord, with a total of 2 at Mudhen Lake.

87. Red-breasted Sapsucker 3 records of 1 near Mudhen Lake: 7 Apr 96, 12 Nov 02, and 21 Oct 06. In 2003 there were 3 records of 1 in the BLM office area: 4 Mar, 18 Mar, and 31 Dec. Not seen on CBCs.
88. Nuttall's Woodpecker* Seen in oak trees throughout the year. Usually just 1 or 2 seen. Perhaps more easily seen in sycamore trees along El Toro Creek. Anywhere from 1 to 8 have been seen on CBCs.
89. Downy Woodpecker* Thinly spread over riparian locations throughout the year. At most 2 have been seen on any CBC, but the count circle excludes most of the riparian areas of Ft. Ord.
90. Hairy Woodpecker* Widely distributed on Ft. Ord in very small numbers. For example, a pair can usually be seen at Mudhen Lake. Much more widely distributed in the fall of 2001. At most 3 have been noted on any CBC.
91. Northern Flicker* Seen throughout oak savannah throughout the inventory. Up to 10 seen per field trip. From 10 to 20 have been noted on most CBCs.
92. Olive-sided Flycatcher* Uncommon spring migrant; 3 records of 1 each: on Crescent Bluff Rd. on 28 Apr 96, at El Toro Creek on 7 May 02, and Machine Gun Flats on 14 May 03. In 2004 through 2006 a pair nested in the BLM office area. On 13 Jul 04 an adult was seen with 2 fledglings.
93. Western Wood-Pewee 4 records: 1 seen at the camp ground by West Camp Street on 15 Aug 99, and 1 May 03 (singing), 2 at the BLM office area on 8 May 03, and Bruce Gerow saw 1 at Mudhen Lake on 21 Apr 04.
94. Gray Flycatcher 1 record: Jane Styer and I saw one near Skyline Road on 2 May 03.
95. Pacific-slope Flycatcher* Summer resident in trees in riparian locations. First spring record: 17 Mar 04. In 1998 nested under eaves at front entrance to BLM main building. The latest annual record was 1 seen 27 Sep 01. Early arrival in 2004 with 3 March records; and in 2005 with arrival noted on 25 Mar.
96. Black Phoebe* 1 or 2 pairs are seen at most riparian locations throughout the year. On CBCs prior to 1999 fewer than 8 individuals were noted per count; from 1999 on 10 or more have been noted per count
97. Say's Phoebe Winter resident on grasslands: last seen on 7 May 02. First fall record: 10 Sep 02. Usually fewer than 5 seen on one field trip. Usually 5 to 15 individuals have been seen per CBC.
98. Ash-throated Flycatcher* Summer resident throughout oak-chaparral. First spring record: 2 Apr 05. Infrequently seen in August. Latest record: 13 Aug 02.
99. Cassin's Kingbird Bruce Gerow saw 1 very vocal bird on Ft. Ord near the Toro Estates Entrance from 19 to 21 May 01. Another vocal bird was seen at Boy Scout Lake on 19 Aug 05.

100. Western Kingbird* 1 or 2 pairs breed on the grasslands near El Toro Creek. The 1st spring records are usually in early April. Seen on 27 Mar 04. A “fall” migrant was on Machine Gun Flats on 2 Aug 99. Bruce Gerow confirmed breeding in 2001.
101. Loggerhead Shrike Not seen in 1996. Uncommon, but widely distributed in somewhat open areas since then.
102. Hutton’s Vireo* Year-round resident in the Coast Live Oaks. When they are singing I can usually detect 1 to 4 individuals in one place. Most CBCs have recorded between 2 and 7 individuals.
103. Warbling Vireo* Likely breeding in dense willow locations. Seen only in spring, and in drier years likely only a migrant. Earliest records: 27 Apr 02, 21 Apr 04, and 18 Apr 05. I was surprised that there was one at the Dam Crossing on 22 Jun 04.
104. Steller’s Jay Usually associated with El Toro Creek community, first recorded on Ft. Ord on 27 Jul 97. Widely distributed over Ft. Ord in the fall of 2001, a good acorn year. Noted around Mudhen Lake in November and December 05.
105. Western Scrub-Jay* Highly visible common bird throughout the oak-chaparral throughout the inventory. The CBCs have recorded between 32 and 90 individuals.
106. American Crow* Although abundant in the housing areas on Ft. Ord, it is uncommon in the backcountry. The CBCs have recorded between 16 and 90 individuals.
107. Common Raven Infrequent visitor. Bruce Gerow saw two fly over the vicinity of Mudhen Lake in the spring of 1999. From then through 2003 I have widely scattered records: 10 Jun 00, 21 Oct 01, 3 May 02, 8 Aug 02, 17 Nov 02, 21 May 03, and 11 Sep 03. The six records in 2004 of up to 5 individuals suggest a population increase. In 2005 there were 4 records, and in 2006 there were 11 records of 1 to 4 individuals.
108. Horned Lark* Seen in high grassland throughout the year. Young birds observed in June and July. They appear to be much more common in winter. They were uncommon in 2002. Five of the 9 CBCs have recorded no Horned Larks. The 28 Dec 93 CBC recorded 69 larks, far more than any other Ft. Ord count.
109. Purple Martin 1 record: four flew west over Mudhen Lake on 14 Aug 99.
110. Tree Swallow* Seen at ponds in small numbers. In 1996 first seen on 9 Mar, in 2001 on 12 Feb, in 2002 on 8 Feb, and in 2003 on 9 Mar. In July/August inventories, not seen in 1997, and last seen on 12 Jul 98, 1 Oct 01, 15 Jun 02, and 8 Jun 03. A possible migration peak in April. Three were seen on the 29 Dec 98 CBC.

111. Violet-green Swallow* At ponds in small numbers during the winter/spring inventory of 1996. Early record: 10 Feb 01. Around 60 birds seen on 2 Mar 01. Rarely seen in summer. In 2002 seen regularly from 6 Mar until 11 Jun, but not otherwise. In 2003 and 2004 seen until mid-June, probably nesting in a cliff face on Barloy Canyon Road. Also, 4 seen on the 29 Dec 98 CBC, and 3 were at Mudhen Lake on 30 Dec 03.
112. Northern Rough-winged Swallow Seen in small numbers from early March (5 Mar 02) to early July (8 Jul 98). Seen as early as 12 Feb 01.
113. Cliff Swallow* Summer resident. Until 2003 the early inventory date was 2 May 02. In 2003 approximately 50 were flying along El Toro Creek on 6 Apr, and in 2004 they were seen as early as 15 Mar. The most common swallow into August. Not seen in Sep 01, and last seen on 7 Aug 02, 12 Aug 03, and 19 Aug 05.
114. Barn Swallow* Summer resident with nests observed. Usually first seen in March. One individual was seen on 20 Jan 06. Seen over the grasslands as well as over ponds. The 20 Barn Swallows seen over the vernal pond behind the BLM office appeared migratory. In Aug 04 a flock settled around the corner of Eucalyptus and Parker Flats Roads. Approximately 60 were seen there on the 20th. Some last records for the year are: 22 Sep 01, 12 Sep 02, and 12 Aug 03. One was seen on the 29 Dec 98 CBC.
115. Chestnut-backed Chickadee* Seen throughout the inventory in scattered localities where there are oak trees. Up to 10 may be seen in a given location. The 1993 CBC reported 43 individuals, but the count has usually seen fewer than 15.
116. Oak Titmouse* Common in the oaks and riparian woods throughout the year. Usually fewer than 10 are seen. The 1993 CBC reported 54 titmice, all other CBCs found 17 or fewer individuals.
117. Bushtit* Common throughout the year wherever there are trees or chaparral. Usually seen in flocks (of up to 30 birds). Usually 100–200 are seen during CBCs, but 326 were counted on 28 Dec 84.
118. Red-breasted Nuthatch Infrequent winter resident, noted on several CBCs.: 1 in '96, 2 on the golf course in '98, 3 in '00, and 1 seen near BLM office on 28 Dec 01. A small "wave" came through in the fall of 2004, with the 1st heard in Coast Live Oaks on 29 Sep., and one wintered in the BLM office area and was last seen on 30 Apr 05.
119. White-breasted Nuthatch 5 records: 1 or 2 in the Valley Oaks near El Toro Creek on 27 Jul 97, 15 Aug 99, and 28 Oct 03; one was seen near El Toro Creek on 18 Sep 01. One was in the Coast Live Oaks at Boy Scout Lake on 16 Nov 05
120. Pygmy Nuthatch* 1 record prior to 2006: Don Roberson saw 2 on the golf course on the CBC on 28 Dec 99. On 6 Mar 06 a pair was seen mating in the pine planting along South Boundary Road. On 5 Jun they were seen feeding fledglings in the same location.

121. Brown Creeper Uncommon winter resident. They have been seen at the golf course on several CBCs: 1998, 2000, and 2005. There was 1 at BLM offices from 11 Dec 02 until 28 Jan 03.
122. Rock Wren One was in an eroded area not far from the top of Oil Well Road, seen on 21 and 27 Oct 01.
123. Bewick's Wren* Common in the trees, brush, and chaparral throughout the inventory. During the height of song one may hear roughly 10 singing. On CBCs anywhere from the teens to the 30s have usually been recorded. On 28 Dec 93 52 were counted.
124. House Wren* Seen in riparian locations from March until July. Latest records: 19 Aug 99, 13 Oct 02, and 17 Oct 06. Less frequent, and last noted on 17 May, in the dry year 2004.
125. Marsh Wren One singing on Mudhen Lake 25 Feb to 2 Mar 01, and 1 at the Catfish Pond in the fall (8 Oct) of 2002, in Mar 03, and Oct 04. Previously seen by Bill Collins in the pond near Range 36. They were seen at Mudhen Lake from 26 Oct to 15 Dec 06, with a maximum of 4 seen on 13 Dec.
126. Golden-crowned Kinglet Few winter records. There were 2 noted on the golf course on the 1998 CBC. Seen in Dec 01 until 10 Mar 02. Not seen again until 12 Dec 02.
127. Ruby-crowned Kinglet Winter resident in trees. Last seen on 6 Apr 96, 12 Apr 02, and 6 Apr 03. Main fall arrival in early October, e.g. 3 Oct 02, 6 Oct 03. Usually fewer than 10 are seen, but in the fall of 2006 up to 30 could be seen at a single place. Usually 15–30 are seen on the CBCs.
128. Blue-gray Gnatcatcher* Recorded from 30 Mar 96 and 10 Mar 02 through spring in oak-chaparral areas. Last records: 7 Jul 98, 19 Aug 99, 2 seen in chaparral on the 2001 CBC, and 20 Aug 02. Robert Horn saw 1 near Creekside on 1 Nov 03.
129. Western Bluebird* Seen throughout the year, although recorded on a minority of the stops. The flocks usually have 5 or fewer individuals. Bluebirds may have become more common on Ft. Ord between 1996 and 2006.
130. Mountain Bluebird 7 seen on Camp Ord on 3 Jan 37. [See Don Roberson, *Monterey Birds*, 2nd Edition, 2002.]
131. Townsend's Solitaire 1 record: 1 seen and photographed by the BLM Office on 22 Oct 07.
132. Swainson's Thrush First heard singing in dense willows along Crescent Bluff Road on 4 May 96. Heard singing on 8 and 16 Jun 96 near Guidotti Gate. Migrant heard singing on 14 May 02. In 2003 a May migrant. Noted 23 to 30 Apr 05. Just 1 or 2 seen per day.
133. Hermit Thrush Widely spread fall records of 1 to 3 birds starting 18 Oct 01, 13 Oct 02, and 14 Oct 03. A winter resident; most have left by the end of February. Sporadic records up to 6 Apr (2003). A surprising 9 seen at once at the Huffman Tank on 23 Nov 02. On the 9 CBCs a high of 22 were counted on 28 Dec 99 and a low of 3 were noted on 27 Dec 96.

134. American Robin* A few present in certain locations, e.g. Mudhen Lake, and the BLM compound. Seen throughout the year. On 15 Aug 98 there was a "fall" flock of ten by the BLM office. Only 1 record from 18 Sep through 18 Oct 01. After that, more frequently seen. In 2003 seen on 6 Jun, and not again until 7 Nov. On 3 Feb 04 there was a winter flock of 32 at the corner of Eucalyptus and Barloy Canyon Roads. An outstanding record was the 1190 counted on the 1994 CBC.
135. Varied Thrush Seen by Don Roberson at Lower Pilarcitos Pond on 2 CBCs: 1 seen on 28 Dec 92 and 3 seen on 28 Dec 99. Also seen, 1 each, on 24 Nov and 25 Dec 06 at the BLM office area, and on 1 Dec 06 near Lower Pilarcitos Pond. The 24 Nov and 1 Dec birds were singing.
136. Wrentit* Seen (heard) throughout the chaparral throughout the year.
137. Northern Mockingbird* Small numbers usually seen near housing areas, but also seen around trees or shrubs in the grasslands.
138. Brown Thrasher 1 seen near Mudhen Lake on 14 Oct 84. [See Don Roberson, *Monterey Birds*, 2nd Edition, 2002.]
139. California Thrasher* Seen (heard) throughout the chaparral throughout the year, but with lower frequency than the Wrentit.
140. European Starling Seen in many locations throughout the year. Common along El Toro Creek; however, infrequently seen at many places. In 2006 they were more common throughout Ft. Ord.
141. American Pipit Winter visitor: 7 at Fox Pond on 14 Feb 01; 39 not far from the top of Oil Well Road on 17 Feb 01. In 2003 last seen on 21 Mar, and in 2004 on 12 Apr.
142. Cedar Waxwing Winter resident. First fall record: 10 seen on 3 Oct 01. On 26 Feb 01 there were 44 by El Toro Creek. Late records: on 7 May 02 there were about 10 by El Toro Creek, and on 25 May 03 there were 32 in the same location; in 2004 there were 50 seen on 19 May and 7 seen on 4 Jun. In 2005 seen mainly in April. Seen just 3 times in 2006.
143. Phainopepla 2 seen along Crescent Bluff Road on 12 Apr 02. Reported by Chuck Haugen in July 2002. Up to 3 seen visiting elderberries along El Toro Creek on 25 and 26 Jul 02. Next seen 28 and 29 Sep 06, when 2 visited an elderberry on the corner of Eucalyptus and Barloy Canyon Roads. Previously reported by Bruce Gerow as a non-breeding visitor during the Monterey Breeding Bird Atlas project.
144. Orange-crowned Warbler* First annual records: 9 Mar 96, 1 Mar 01, 9 Mar 03, 15 Feb 04, 18 Feb 05. On 9 Mar 03, 16 were heard singing. Frequently recorded in chaparral/oaks from 14 Apr on. Infrequently recorded in July and August. In 2001 a noticeable fall migration in September and October, and 2 were seen on 1 Nov. In 2003 later individuals included 1 on 22 Oct and 1 on 4 Dec, both near water. They have been seen on approximately half of the CBCs.
145. Nashville Warbler Migrant. 1st record: 1 at El Toro Creek on 17 Sep 01. Other records of 1 individual from 6 to 9 Oct 01, 11 Mar 03, and 21 Apr 03.

146. Northern Parula
1 sure record: 1 on 5 Oct 01 on 7th Street. Also, likely an immature female seen on Parker Flats Cutoff on 27 Oct 02.
147. Yellow Warbler
Spring records: 1 heard near Mudhen Lake on 21 Apr 96, and ones seen on 14 May and 16 May 02, 17 Apr 03, and 17 and 25 Apr 04. In 2001 one to three were regularly seen from mid-September to mid-October.
148. Yellow-rumped Warbler
Winter resident. Peak on 6 Apr 96, and last seen on 20 Apr 96 and 12 Apr 02. First seen on 27 Sep 01, 1 Oct 02, and 26 Sep 06. Also, there was an isolated record of 1 on Ingman Ct. on 15 Aug 02. Nearly all are of the Audubon's race. I saw 1 bird of the Myrtle race on 2 Nov 01, and 2 on 19 Nov 03. On 9 CBCs a low of 27 were seen in 1989 and a high of 104 were seen in 1993. The 1993 CBC count included 12 of the Myrtle race.
149. Black-throated Gray Warbler
4 spring records: 20 Apr, 28 Apr, 4 May 96, and 28 Apr 03. A female was seen on the golf course during the CBC on 29 Dec 98.
150. Townsend's Warbler
Winter resident. Earliest fall record 20 Sep 01. Seen through February in 2001. Six or fewer seen per field trip. Spring records: a female seen on 1 Jun 96 and 3 males on 23 Mar 02; in 2003 seen from 9 Mar until 8 May. On 9 CBCs fewer than 10 were noted on 4 years, and more than 10 on 5 years, with a maximum of 33 in 1993.
151. Hermit Warbler
3 records, all at the BLM office area: 1 on 5 May 03, 5 seen on 8 May 03, and 1 on 28 Apr 05.
152. Black-and-white Warbler
1 record: 1 seen by Don Roberson on the 28 Dec 84 CBC.
153. MacGillivray's Warbler
In the spring of 1999 Bruce Gerow encountered a singing male in the chaparral on Crescent Bluff.
154. Common Yellowthroat*
Probably to be found all year at the corner of Barloy Canyon and Eucalyptus Roads and/or Mudhen Lake prior to the 2003 burn. In 2003 not seen in these areas following the July fire. In the dry year of 2004, just a few records from 21 Apr to 30 Jun. Mainly noted around Mudhen Lake in 2006.
155. Wilson's Warbler*
Summer resident some years along upper El Toro Creek. Earliest records: 7 Apr 96 and 27 Mar 04. Latest record: 2 Aug 97. A migratory flock of 10 at the BLM office on 8 May 03 was unusual.
156. Yellow-breasted Chat
1 record: 1 heard singing in a tangle along Crescent Bluff Rd. on
157. Western Tanager
Spring migrants recorded on 4 May and 1 Jun 96, and from 1 to 8 May 03. In 2005 the early record was 24 Apr, and by 30 Apr a flock of 3 was seen. Two flocks noted in May 03, with a maximum of 10 at the BLM office on the 8th. Fall migrants on 25 Jul to 2 Aug 98, and until 20 Sep 01. A late bird was seen near Parker Flats Cut-off on 29 Oct 05.
158. [Green-tailed Towhee
1 seen on 28 Feb 02 on Parker Flats Road near Eucalyptus Road. Efforts to find the bird later failed.]

159. Spotted Towhee* A permanent resident seen throughout the chaparral. In comparison with the California Towhee, this bird is more restricted in habitat and fewer are seen.
160. California Towhee* Common throughout the year, and widely distributed. Seen on virtually all trips, although not in large flocks. On 9 CBCs a low of 18 were seen in 1989 and a high of 63 were noted in 1993.
161. Rufous-crowned Sparrow* In April of 2000 Sam Fitton found 2 singing by the big washout into Mudhen Lake. One was still there at least as late as 21 Jun 00. Seen along Barloy Canyon Road on 9 and 14 May 02, and from 13 Feb until 18 Mar in 2003.
162. Chipping Sparrow* 1 record prior to 2004: 2 at the campground on Watkins Gate Rd. on 11 May 03. Regularly seen in the burn area in the spring of 2004, with nesting probable. Seen there again in 2005.
163. Lark Sparrow* Seen all year, but infrequently in the winter. Most commonly seen in the grasslands, but also apparently breeding in or near the chaparral areas. Regularly seen at the BLM compound.
164. (Bell's) Sage Sparrow* Resident. Thinly spread over the burned chaparral areas. I likely overlooked them before Bruce Gerow pointed out that they were there. My first record: 4 Jul 98. Birds with young fledgling seen on 3 Jul 06. Don Roberson noted between 1 and 4 individuals on the CBCs in 1993, 1996, 1998, and 2000.
165. Savannah Sparrow Winter resident in the grasslands. Approximately 60 seen high in the grasslands on 17 Dec 06. Last spring record: 28 Apr 96. First fall records: 26 Sep 01, and 22 Oct 02.
166. Grasshopper Sparrow* Breeding bird of the grasslands. First seen on 14 Apr 96, on 27 Apr 02, on 21 Mar 03, on 9 Mar 04, and 16 Mar 05. Approximately 30 singing birds detected in 1996, 5 or 6 of these were on Machine Gun Flats. Bird in juvenal plumage seen on 16 Jun 96. Seen until the end of the inventory in 1996. There were 35 or more singing birds on Ft. Ord in Jun 00. There were likely as many in Jun 02, but likely fewer in 2003.
167. Fox Sparrow Winter resident, but much more common in fall. First noted in chaparral on 5 Oct 01, 1 Oct 02, 30 Sep 03, and 29 Sep 05. Last seen on 25 Jan 02 and 14 Mar 03. Usually 1 or 2 seen, but 10 to 20 were at the Huffman Tank on 29 Oct 02. 84 were seen on the 28 Dec 84 CBC. All Fox Sparrows seen have been of the 'Sooty' race.
168. Song Sparrow* There are 2 to 6 individuals at nearly every pond throughout the inventory.
169. Lincoln's Sparrow Mostly a spring and fall migrant, but few recorded per year. The 2 that Sam Fitton and I saw at Fox Pond on 11 Aug 99 were unusually early.
170. White-throated Sparrow 1 record: 1, perhaps immature, at Mudhen Lake 15 Oct 01.
171. Harris's Sparrow One immature seen on Trail 22 on 16 Jan and 25 Jan 02.

172. White-crowned Sparrow Winter resident in backcountry Ft. Ord. Last seen on 29 Apr 05. Earliest fall record: 2 at Fox Pond on 13 Aug 99. In the fall of 2001 the main migration arrived by 26 Sep. I usually record fewer than 10, but I saw approximately 50 along El Toro Creek on 30 Nov 03.
173. Golden-crowned Sparrow Common winter resident, October through April. Last seen on 21 Apr 96, and on 2 May 02. Seen in good numbers, around 20, by 5 Oct 01 (and 6 Oct 03). First noted in fall on 1 Oct 02 and 30 Sep 03.
174. Dark-eyed Junco* Common breeding bird in oak woods and at the BLM compound. Seen throughout the year. In 2003 flocks of 50 were seen in October, but in other seasons 20 or fewer were seen.
175. Black-headed Grosbeak* Summer resident near Guidotti Gate. Seen as early as 16 Apr 02 and 7 Apr 03, and as late as 1 Aug 99.
176. Lazuli Bunting* 4 records prior to 2002: 28 Apr 96, 4 May 96, and 28 Jun 98, 1 Aug 99. The June record was of a singing male at Mudhen Lake. Strong migration in 2002, seen from 23 Apr to 25 May, with a peak of around 15 seen on 7 May. Weak migration in 2003, seen from 1 May until 6 Jun. A strong migration again in 2004; noted 19 Apr to 30 Jun, with around 30 individuals in the burn area alone. Probable breeding in the burn area followed the migration. In 2006 they probably bred in the 2005 burn area off Parker Flats Road.
177. Red-winged Blackbird* Concentrated near ponds and also seen elsewhere throughout the year, although scarce in August, except, possibly, at the roost at the pond on Watkins Gate Road near West Camp Street.
178. Tricolored Blackbird* The known colony on Oil Well Road has been active most years. The colony has maintained over 50 birds. On 26 Jul 98 I watched them come to feed at the play fields of El Toro Creek community. Ten or more visit the Equestrian Center in winter. They were seen there up to 28 Feb 02. 120 were counted on the 27 Dec 89 CBC, and 200 on the 28 Dec 93 CBC.
179. Western Meadowlark* Small numbers on grassland and Machine Gun Flats in the spring and summer. Larger, more widespread groups of up to 50 seen in the fall and winter. Usually seen in double digits on the CBCs; a low of 8 was seen on the 29 Dec 01 count, and a high of 323 on 28 Dec 93.
180. Brewer's Blackbird* Present throughout the inventory. Especially common at the BLM compound, prior to the fall of 2001. Common in residential areas. 850 were noted on the 27 Dec 89 CBC.
181. Brown-headed Cowbird 5 records: 22 Mar 96, 30 May 02, 23 May 03, 29 Apr and 30 Apr 05.
182. Hooded Oriole* Added to inventory on 11 Jul 98. Sam Fitton pointed out that they were near El Toro Creek. I found at least 3 pairs breeding in Fan Palms in El Toro community, and using Ft. Ord to feed. They continue to be seen only in this area.

183. Bullock's Oriole* Summer resident. Earliest records: 20 Apr 02 and 2 Apr 03. Breeding along El Toro Creek, and possibly other riparian areas with tall (Eucalyptus) trees. Not seen after mid-August. Bruce Gerow noted especially large numbers of both oriole species nesting in the El Toro Creek area in 2001.
184. Purple Finch* Present in the oaks and at the BLM compound throughout the inventory. Usually no more than 5, but sometimes 10 or 20 are in a flock.
185. House Finch* Seen in small numbers throughout Ft. Ord throughout the inventory. Seen at the BLM compound in larger numbers. Abundant in the housing areas of Ft. Ord.
186. Pine Siskin* At BLM compound from first inventory until 2001. However, not encountered in the fall (inventory in 2001). Seen Jan 02 through 23 Apr 02, and then gone: perhaps sensitive to drought. In the drought year of 2003 seen only from 23 Jan to 28 Apr. No Siskins noted in the dry year of 2004, and a few were noted in 2005 or 2006.
187. Lesser Goldfinch* Seen throughout the inventory wherever there are trees. Uncommon in the backcountry in the dry season of 2002. Hardly seen after Jul 03, another dry season, and in 2006 not noted after 7 Dec.
188. Lawrence's Goldfinch* Seen at the BLM compound and in riparian locations in the chaparral. First seen on 24 Mar 96. Not seen at all in 1998. In 2000 last seen on 15 Jun. The 2002 records span 14 Apr to 20 Aug. In 2003 just 2 records of 2 each on 23 May and 16 Jun. The year 2004 was a strong one with records regularly from 19 Apr to 10 Sep, especially in the burn area where they probably bred. Two fall records: 2 near El Toro Creek on 27 Oct 01, and 1 at recent burn on 19 Oct 06.
189. American Goldfinch Fall and winter resident. 1st record: approximately 50 near El Toro Creek on 9 Feb 01. Smaller numbers seen in fall starting 24 Oct 01, 22 Oct 03, and 1 Nov 05. Usually the first fall records are in October.
190. House Sparrow* Common in the housing areas on Ft. Ord. Barely seen in Backcountry Ft. Ord.

APPENDIX F

Cultural Resources and Built Environment Reports

INTENTIONALLY LEFT BLANK

APPENDIX F1

Cultural Resources Inventory, Evaluation, and Finding of Effect Report

INTENTIONALLY LEFT BLANK

July 5, 2019

Anya Spear
Associate Director of Campus Planning
CSU Monterey Bay, Campus Planning and Development
100 Campus Center
Seaside, California 93955-8001

Subject: Cultural Resource Inventory for the CSU Monterey Bay EIR Master Plan Project, Monterey County, California

Dear Ms. Spear:

This memorandum presents data from the cultural resources records search and survey conducted in compliance with Section 15064.5(a)(2)-(3) of the California Environmental Quality Act (CEQA) Guidelines for California State University Monterey Bay's (CSUMB) proposed EIR Master Plan Project (Project). The Project is located on the campus of CSUMB near the southern-central portion of the Monterey Bay, northeast of the Monterey Peninsula (Figure 1). The campus covers 1,396 acres that compose the northwestern portion of the U. S. Department of Army Fort Ord Military Reservation, and includes portions of the cities of Seaside and Marina, as well as unincorporated portions of Monterey County. The Project is composed of Proposed CSUMB 2019 Project Design Features described in the 2019 CSUMB Master Plan Guidelines, along with five "near-term" projects that are to be constructed within the next 3 to 7 years. Overall, the Project includes work that will demolish several buildings, build new structures, and provide new infrastructure to allow for expected on-campus growth and improve usability of space within the core campus area. Attachment 1 summarizes this study in a National Archaeology Database Information form.

SUMMARY OF WORK

Researchers at the Northwest Information Center (NWIC) of the California Historical Resources Information System (CHRIS) at Sonoma State University, Rohnert Park, conducted a records search on September 20, 2017 (NWIC File No. 17-0608). The records search encompassed the proposed Project Area along with a one-mile radius buffer (Attachment 2). The results of the records search indicated the approximate location of one previously recorded archaeological site (P-27-000385), which could be within the Project Area. However, the site record provides no

locational data other than “On the Fort Ord Military Reservation,” which extends well beyond the Project Area (Pilling 1950). Furthermore, the site’s recorder, Pilling, described that the site was “destroyed by bulldozing in ca. 1940” (Pilling 1950). The results of the record search also indicate two historic sites within a one-mile radius of the Project Area. One is a historic ranch (P-27-001724) and one is a World War II era military site (P-27-002915). Sixteen Built Environment resources exist within one mile of the Project Area, but it is beyond the scope of this project to address them. Thirteen previously conducted studies include portions of the Project Area. Twenty-nine additional studies have occurred within a one-mile radius of the Project Area.

Dudek archaeologists Ryan Brady, MA, RPA, and Sarah Brewer, BA, surveyed of the location of the proposed Project Area on November 22, 2017. The archaeologists applied a mixed-intensity strategy for the survey, using intensive-level 15-meter transects when possible, and adopting a less intensive reconnaissance-level approach in highly developed areas. The archaeologists focused intensive-level survey in areas that will be affected by “near-term” projects. Dudek archaeologists conducted a supplemental on February 6, 2019 to investigate additional potential resources. Dudek archaeologists did not identify any new archaeological resources. Dudek’s level of effort and findings on this project fulfills the CEQA requirements for cultural resource investigations. By applying standard mitigation measures for the treatment of unanticipated discoveries, Dudek recommends that the proposed Project will have no significant effect on Historic Resources.

PROJECT LOCATION AND DESCRIPTION

CSUMB is located approximately 100 miles south of San Francisco near the southern-central portion of the Monterey Bay, northeast of the Monterey Peninsula. The campus covers 1,396 acres that compose the northwestern portion of the U.S. Department of Army Fort Ord Military Reservation, and includes portions of the cities of Seaside and Marina, as well as unincorporated portions of Monterey County (Figure 1).

The Project consists of the proposed California State University Monterey Bay (CSUMB) Master Plan (proposed Master Plan), including Project Design Features (PDFs) drawn from the CSUMB Master Plan Guidelines (Master Plan Guidelines). In addition to a program level evaluation of the entire Master Plan and PDFs, the pending EIR will provide project-level evaluation of 5 “near-term” developments to be constructed pursuant to the proposed Master Plan within the next 10 years (Figure 2). Overall, the Project includes work that will demolish numerous buildings, build new buildings and structures, and provide new infrastructure to allow for expected on-campus growth and improve usability of space within the core campus area. The near-term projects include construction of the following buildings and associated landscapes:

1. Student Recreation Center (70,000 square feet)
2. Student Housing Phase IIB (400 beds);

3. Student Housing Phase III (600 beds);
4. Academic IV (72,200 square feet);
5. Academic V (76,7000 square feet)

REGULATORY SETTING

The Project is funded by California State University, which also serves as the lead agency; therefore, the current project must comply with State environmental regulations, which are addressed in broad scope under the California Environmental Quality Act (CEQA).

State of California

The California Register of Historical Resources

In California, the term “historical resource” includes “any object, building, structure, site, area, place, record, or manuscript which is historically or archaeologically significant, or is significant in the architectural, engineering, scientific, economic, agricultural, educational, social, political, military, or cultural annals of California” (Public Resources Code (PRC) Section 5020.1(j)). In 1992, the California legislature established the California Register of Historical Resources (CRHR) “to be used by state and local agencies, private groups, and citizens to identify the state’s historical resources and to indicate what properties are to be protected, to the extent prudent and feasible, from substantial adverse change” (PRC Section 5024.1(a)). The criteria for listing resources on the CRHR, enumerated in the following text, were developed to be in accordance with previously established criteria developed for listing in the NRHP. According to PRC Section 5024.1(c)(1–4), a resource is considered historically significant if it (i) retains “substantial integrity,” and (ii) meets at least one of the following criteria:

1. Is associated with events that have made a significant contribution to the broad patterns of California’s history and cultural heritage
2. Is associated with the lives of persons important in our past
3. Embodies the distinctive characteristics of a type, period, region, or method of construction, or represents the work of an important creative individual, or possesses high artistic values
4. Has yielded, or may be likely to yield, information important in prehistory or history

To understand the historic importance of a resource, sufficient time must have passed to obtain a scholarly perspective on the events or individuals associated with the resource. A resource less than 50 years old may be considered for listing in the CRHR if it can be demonstrated that sufficient time has passed to understand its historical importance (see 14 CCR 4852(d)(2)).

The CRHR protects cultural resources by requiring evaluations of the significance of prehistoric and historic resources. The criteria for the CRHR are nearly identical to those for the NRHP, and properties listed or formally designated as eligible for listing in the NRHP are automatically listed in the CRHR, as are state landmarks and points of interest. The CRHR also includes properties designated under local ordinances or identified through local historical resource surveys.

California Environmental Quality Act

As described further in the following text, the following CEQA statutes and CEQA Guidelines are of relevance to the analysis of archaeological, historic, and tribal cultural resources:

PRC Section 21083.2(g) defines “unique archaeological resource.”

PRC Section 21084.1 and CEQA Guidelines Section 15064.5(a) define “historical resources.”

In addition, CEQA Guidelines Section 15064.5(b) defines the phrase “substantial adverse change in the significance of an historical resource.” It also defines the circumstances when a project would materially impair the significance of a historical resource.

PRC Section 21074(a) defines “tribal cultural resources.”

PRC Section 5097.98 and CEQA Guidelines Section 15064.5(e) set forth standards and steps to be employed following the accidental discovery of human remains in any location other than a dedicated ceremony.

PRC Sections 21083.2(b)–(c) and CEQA Guidelines Section 15126.4 provide information regarding the mitigation framework for archaeological and historic resources, including examples of preservation-in-place mitigation measures; preservation-in-place is the preferred manner of mitigating impacts to significant archaeological sites because it maintains the relationship between artifacts and the archaeological context, and may also help avoid conflict with religious or cultural values of groups associated with the archaeological site(s).

Under CEQA, a project may have a significant effect on the environment if it may cause “a substantial adverse change in the significance of an historical resource” (PRC Section 21084.1; CEQA Guidelines Section 15064.5(b)). A site is considered to be a “historical resource” if it is either determined to be listed or is eligible for listing in the CRHR, included in a local register of historic resources, or identified as significant in a historical resources survey (meeting the requirements of PRC Section 5024.1(q)). If a resource is determined to be a “historical resource,” it is historically or culturally significant for purposes of CEQA (PRC Section 21084.1; CEQA Guidelines Section 15064.5(a)). The lead agency is not precluded from determining that a resource is a historical resource, even if it does not fall within this presumption (PRC Section 21084.1; CEQA Guidelines Section 15064.5(a)).

A “substantial adverse change in the significance of an historical resource” reflecting a significant effect under CEQA means “physical demolition, destruction, relocation, or alteration of the resource or its immediate surroundings such that the significance of an historical resource would be materially impaired” (CEQA Guidelines Section 15064.5(b)(1); PRC Section 5020.1(q)). In turn, the significance of a historical resource is materially impaired when a project does any of the following:

1. Demolishes or materially alters in an adverse manner those physical characteristics of an historical resource that convey its historical significance and that justify its inclusion in, or eligibility for, inclusion in the California Register; or
2. Demolishes or materially alters in an adverse manner those physical characteristics that account for its inclusion in a local register of historical resources pursuant to Section 5020.1(k) of the PRC or its identification in an historical resources survey meeting the requirements of Section 5024.1(g) of the PRC, unless the public agency reviewing the effects of the project establishes by a preponderance of evidence that the resource is not historically or culturally significant; or
3. Demolishes or materially alters in an adverse manner those physical characteristics of a historical resource that convey its historical significance and that justify its eligibility for inclusion in the California Register as determined by a lead agency for purposes of CEQA [CEQA Guidelines Section 15064.5(b)(2)].

Pursuant to these sections, the CEQA inquiry begins with evaluating whether a project site contains any “historical resources,” then evaluates whether that project will cause a substantial adverse change in the significance of a historical resource such that the resource’s historical significance is materially impaired.

If it can be demonstrated that a project will cause damage to a unique archaeological resource, the lead agency may require reasonable efforts be made to permit any or all of these resources to be preserved in place or left in an undisturbed state. To the extent that they cannot be left undisturbed, mitigation measures are required (Section 21083.2(a), (b), and (c)).

Section 21083.2(g) defines a unique archaeological resource as an archaeological artifact, object, or site about which it can be clearly demonstrated that without merely adding to the current body of knowledge, there is a high probability that it meets any of the following criteria:

1. Contains information needed to answer important scientific research questions and that there is a demonstrable public interest in that information

*Subject: Cultural Resource Inventory for the CSU Monterey Bay EIR Master Plan Project,
Monterey County, California*

2. Has a special and particular quality such as being the oldest of its type or the best available example of its type
3. Is directly associated with a scientifically recognized important prehistoric or historic event or person

Impacts to non-unique archaeological resources are generally not considered a significant environmental impact (PRC Section 21083.2(a); CEQA Guidelines Section 15064.5(c)(4)). However, if a non-unique archaeological resource qualifies as tribal cultural resource (PRC 21074(c); 21083.2(h)), further consideration of significant impacts is required.

CEQA Guidelines Section 15064.5 assigns special importance to human remains and specifies procedures to be used when Native American remains are discovered. As described in the following text, these procedures are detailed in PRC Section 5097.98.

California State Assembly Bill 52

AB 52 of 2014 amended PRC Section 5097.94 and added PRC Sections 21073, 21074, 21080.3.1, 21080.3.2, 21082.3, 21083.09, 21084.2, and 21084.3. AB 52 established that TCRs must be considered under CEQA and also provided for additional Native American consultation requirements for the lead agency. Section 21074 describes a TCR as a site, feature, place, cultural landscape, sacred place, or object that is considered of cultural value to a California Native American Tribe and that is either:

- On or determined to be eligible for the California Register of Historical Resources or a local historic register; or
- A resource determined by the lead agency, in its discretion and supported by substantial evidence, to be significant pursuant to criteria set forth in subdivision (c) of Section 5024.1.

AB 52 formalizes the lead agency–tribal consultation process, requiring the lead agency to initiate consultation with California Native American groups that are traditionally and culturally affiliated with the project site, including tribes that may not be federally recognized. Lead agencies are required to begin consultation prior to the release of a negative declaration, mitigated negative declaration, or environmental impact report.

Section 1 (a)(9) of AB 52 establishes that “a substantial adverse change to a tribal cultural resource has a significant effect on the environment.” Effects on TCRs should be considered under CEQA. Section 6 of AB 52 adds Section 21080.3.2 to the PRC, which states that parties may propose mitigation measures “capable of avoiding or substantially lessening potential significant impacts to a tribal cultural resource or alternatives that would avoid significant impacts to a tribal cultural

resource.” Further, if a California Native American tribe requests consultation regarding project alternatives, mitigation measures, or significant effects to tribal cultural resources, the consultation shall include those topics (PRC Section 21080.3.2[a]). The environmental document and the mitigation monitoring and reporting program (where applicable) shall include any mitigation measures that are adopted (PRC Section 21082.3[a]).

Native American Historic Cultural Sites

State law (PRC Section 5097 et seq.) addresses the disposition of Native American burials in archaeological sites and protects such remains from disturbance, vandalism, or inadvertent destruction; establishes procedures to be implemented if Native American skeletal remains are discovered during construction of a project; and established the Native American Heritage Commission (NAHC) to resolve disputes regarding the disposition of such remains. In addition, the Native American Historic Resource Protection Act makes it a misdemeanor punishable by up to 1 year in jail to deface or destroy an Indian historic or cultural site that is listed or may be eligible for listing in the CRHR.

Additionally, PRC Section 5097.9 mandates that public agencies or private parties may not interfere with free expression of Native American religion or cause severe or irreparable damage to a Native American place of worship, ceremonial site, or sanctified cemetery.

California Health and Safety Code Section 7050.5

In the event that Native American human remains or related cultural material are encountered, Section 15064.5(e) of the CEQA Guidelines (as incorporated from PRC Section 5097.98) and California Health and Safety Code Section 7050.5 define the subsequent protocol. If human remains are encountered, excavation or other disturbances shall be suspended of the site or any nearby area reasonably suspected to overlie adjacent human remains or related material. Protocol requires that a county-approved coroner be contacted in order to determine if the remains are of Native American origin. Should the coroner determine the remains to be Native American, the coroner must contact the NAHC within 24 hours. The most likely descendent may make recommendations to the landowner or the person responsible for the excavation work, for means of treating, with appropriate dignity, the human remains and any associated grave goods as provided in PRC Section 5097.98 (14 CCR 15064.5(e)).

NATURAL AND CULTURAL CONTEXT

Environmental Context

CSUMB is located approximately 100 miles south of San Francisco near the southern-central portion of the Monterey Bay, northeast of the Monterey Peninsula. The CSUMB campus, 0.75 miles east of the Pacific Ocean shoreline, is situated on a sandy substrate that comprises leveled dune landforms. Geology of the Project Area is classified as Quaternary sand deposits (USGS 2018). Soils are predominantly Baywood sand with 2-15 percent slopes with portions of the southern and western campus comprising Oceano loamy sand with 2-15 percent slopes (USDA NRCS 2018). Neither soil type typically contains buried A-horizons. The vegetation community of the campus is categorized as Northern seashore community (Elymus-Baccharis) (Küchler 1977). This plant community includes dune shrubs and grasses, as well as Monterey Pine and other trees. The climate is characterized as Mediterranean with mild summers and cooler wet winters. Mean annual temperature ranges between 46.4°F and 62.7°F, with 14.9 inches of annual rainfall (Western Regional Climate Center 2018). The proximity of the Pacific Ocean mediates dramatic temperature fluctuations throughout the year.

Cultural Setting

Prehistoric

The Project Area lies within the territory prehistorically occupied by the Costanoan or Ohlone people. Costanoan refers to eight separate Penutian-stock language groups situated roughly from modern-day Richmond in the north to Big Sur in the south. The Rumsen tribelet occupied the Monterey area (Levy 1978). Of the Rumsen-speaking groups, Milliken and Johnson (2010) identifies four local groups in the area, of which, the *Calenda Ruc* inhabited the project vicinity.

Glimpses into the ways of life for prehistoric Californians continue to be pieced together through studies of ethnography and archaeology. Early European explorers from the 16th and 18th centuries provided the first written descriptions about the native Californians they encountered, although details are sparse. Attempts at systematic ethnographies did not occur until the early 20th century, generations after the effects of missionization and integration had altered Costanoan/Ohlone lifestyles drastically. Much of these studies focused on recording Native languages before they fell into disuse. Archaeologists extrapolate trends in tool use, trade, diet and migration from studies on archaeological sites. Costanoan/Ohlone descendants are often invited to participate in decisions about their ancestral sites as well as educate others about their traditional lifeways.

Information from the archaeological record continues to fill in the gaps of our understanding of prehistoric lifeways. Prehistoric research in the Monterey Bay dates back to the early 1900s,

although the bulk of archaeological excavations date to the 1960s and later. Early research was conducted by Beardsley (1946). More recent excavations and surveys include the work of Cartier (1993), Dietz and Jackson (1981), Dietz et al. (1988), Hildebrandt and Mikkelsen (1993), Hylkema (1991), Jones (1993), Jones and Ferneau (2002a), Jones et al. (1996) and Milliken et al. (1999) among others referenced below. Jones et al. (2007) presents a synthetic overview of prehistoric adaptive change in the Central Coast. This temporal framework, for the prehistoric era of greater Central California coast, spans a period of approximately 10,000–12,000 years, and divides into six different periods. Researchers distinguish these periods by perceived changes in prehistoric settlement patterns, subsistence practices, and technological advances. These adaptive shifts identify differences in temporally discrete artifact assemblages, site locations, and site types. Table 1 summarizes the cultural chronology presented by Jones et al. (2007).

Table 1
California Central Coast Chronology

Temporal Period	Date Range*
Paleo-Indian	pre-8000 cal B.C.
Millingstone (or Early Archaic)	8000 to 3500 cal B.C.
Early	3500 to 600 cal B.C.
Middle	600 cal B.C. to cal A.D. 1000
Middle-Late Transition	cal A.D. 1000-1250
Late	cal A.D. to 1250-1769

Source: Jones et al. (2007).

Paleo-Indian

The Paleo-Indian era represents people’s initial occupation of the region and is quite sparse across the Monterey Bay region. Evidence of this era is generally expressed through isolated artifacts or sparse lithic scatters (Bertrando 2004). Further south, in the San Luis Obispo area, fluted points characterizing this era are documented near the town of Nipomo (Mills et al. 2005) and Santa Margarita (Gibson 1996). No points of this type have been found yet in the Monterey Bay. Possible occupation dating to the Paleo-Indian period is reported at CA-SCR-38/123, at Wilder Ranch (Bryne 2002), and in CA-SCR-177 in Scotts Valley (Cartier 1993). The traditional interpretation is that people living during this time were highly mobile hunters who focused subsistence efforts on large mammals. In contrast, Erlandson et al. (2007) proposes a “kelp highway” hypothesis for the peopling of the Americas. Proponents of this model argue that the earliest inhabitants of the region focused their economic pursuits on coastal resources. Archaeological sites that support this hypothesis are mainly from the Santa Barbara Channel Islands. Some scholars hypothesize that Paleo-Indian sites in the Bay Area may exist but are inundated due to rising ocean levels throughout the Holocene (Jones 1992).

Millingstone

Settlement in the Monterey Bay appears with more frequency in the Millingstone Period. Sites of this era have been discovered in Big Sur (Jones 2003; Fitzgerald and Jones 1999) and Moss Landing (Jones and Jones 1992; Milliken et al. 1999). Assemblages are characterized by abundant millingstones and handstones, core and core-cobble tools, thick rectangular (L-series) *Olivella* beads, and a low incidence of projectile points, generally lanceolate or large side-notched varieties (Jones et al. 2007). Eccentric crescents are also found in Millingstone components. Sites are often associated with shellfish remains and small mammal bone, which suggest a collecting-focused economy. Newsome et al. (2004) report that stable isotope studies on human bone, from a Millingstone component, indicate a diet composed of 70%–84% marine resources. Contrary to these findings, deer remains are abundant at some Millingstone sites (cf. Jones et al. 2008), which suggests a flexible subsistence focus. People living during the Millingstone era are thought to have been highly mobile.

Early

The Early Period corresponds with the earliest era of what Rogers (1929) called the “Hunting Culture.” According to Rogers, the “Hunting Culture” continues through to the Middle-Late Transition in the present framework. The Early Period is marked by a greater emphasis on formalized flaked stone tools, such as projectile points and bifaces, and the initial use of mortar and pestle technology. Early Period sites are located in more varied environmental contexts than millingstone sites, suggesting more intensive use of the landscape than previous evidence suggested (Jones and Waugh 1997).

Early Period artifact assemblages are characterized by Large Side-notched points, Rossi Square-stemmed points, Spire-lopped (A), End-ground (B2b and B2c), Cap (B4), and Rectangular (L-series) *Olivella* beads. Other artifacts include less temporally diagnostic Contracting-stemmed and Año Nuevo long-stemmed points, and bone gorges.

Early Period sites are common and often found in estuary settings along the coast or along river terraces inland and are present in both Monterey and Santa Cruz Counties. Coastal sites dating to this period include CA-MNT-108 (Breschini and Haversat 1992a), CA-SCR-7 (Jones and Hildebrandt 1990), and CA-SCR-38/123 (Jones and Hildebrandt 1994).

Archaeologists have long debated whether the shift in site locations and artifact assemblages during this time represent either population intrusion as a result of mid-Holocene warming trends, or an in-situ adaptive shift (cf. Mikkelsen et al. 2000). The initial use of mortars and pestles during this time appears to reflect a more labor intensive economy associated with the adoption of acorn processing (cf. Basgall 1987)

Middle

The trend toward greater labor investment is apparent in the Middle Period. During this time, there is increased use of plant resources, more long-term occupation at habitation sites, and a greater variety of smaller “use-specific” localities. Artifacts common to this era include Contracting-stemmed projectile points, a greater variety of *Olivella* shell beads and *Haliotis* ornaments that include discs and rings (Jones 2003). Bone tools and ornaments are also common, especially in the richer coastal contexts (Jones and Ferneau 2002a; Jones and Waugh 1995), and circular shell fishhooks are present for the first time. Grooved stone net sinkers are also found in coastal sites. Mortars and pestles become more common than millstones and handstones at some sites (Jones et al. 2007). Important Middle Period sites include CA-MNT-282 at Willow Creek (Jones 2003; Pohorecky 1976), and CA-MNT-229 at Elkhorn Slough (Dietz et al. 1988). Middle Period sites north of the Monterey Bay include CA-SCR-9 and CA-SMA 218 at Año Nuevo (Hylkema 1991).

Jones et al. (2007) discuss the Middle Period in the context of Rogers’ “Hunting Culture” because it is seen as a continuation of the pattern that begins in the Early Period. The pattern reflects a greater emphasis on labor-intensive technologies that include projectile and plant processing. Additionally, faunal evidence highlight a shift toward prey species that are more labor intensive to capture, either by search and processing time or technological needs. These labor-intensive species include small schooling fishes, sea otters, rabbits, and plants such as acorn. Jones and Haney (2005) offer that Early and Middle Period sites are difficult to distinguish without shell beads due to the similarity of artifact assemblages.

Middle-Late Transition

The Middle-Late Transition also marks the end of Rogers’ “Hunting Culture,” which seems to occur sometime during this era. Artifacts associated with the Middle-Late Transition include contracting-stemmed, double side-notched, and small leaf-shaped projectile points. The latter are thought to represent the introduction of bow and arrow technology to the region. A variety of *Olivella* shell bead types are found in these deposits and include B2, B3, G1, G2, G6, and K1 varieties (Jones 1995), notched line sinkers, hopper mortars, and circular shell fishhooks (Jones et al. 2007). Sites in Monterey County that correspond with this time are CA-MNT-1233 and -281 at Willow Creek (Pohorecky 1976), CA-MNT-1754, and CA-MNT-745 in Priest Valley (Hildebrandt 2006).

The Middle-Late Transition is a time that appears to correspond with social reorganization across the region. This era is also a period of rapid climatic change known as the Medieval Climatic Anomaly (cf. Stine 1994). The Medieval Climatic Anomaly is proposed as an impetus for the cultural change that was a response to fluctuations between cool-wet and warm-dry conditions that

characterize the event (Jones et al. 1999). Archaeological sites are rarer during this period, which may reflect a decline in regional population (Jones and Ferneau 2002b).

Late

Late Period sites are found in a variety of environmental conditions and include newly occupied task sites and encampments, as well as previously occupied localities. Artifacts associated with this era include Cottonwood and Desert Side-notched arrow points, flaked stone drills, steatite and clamshell disc beads, *Haliotis* disc beads, *Olivella* bead types E1 and E2, and earlier used B2, B3, G1, G6, and K1 types. Millingstones, handstones, mortars, pestles, and circular shell fishhooks also continue to be used (Jones et al. 2007). Sites dating to this era are found in coastal and interior contexts. In the Monterey Bay area, Late Period sites include CA-MNT-143 at Asilomar State Beach (Brady et al. 2009), CA-MNT-1765 at Moro Cojo Slough (Fitzgerald et al. 1995), CA-MNT-1485/H and -1486/H at Rancho San Carlos (Breschini and Haversat 1992b), and CA-SCR-177 at Davenport Landing (Fitzgerald and Ruby 1997).

Coastal sites dating to the Late Period tend to be more resource acquisition or processing sites, while residential occupation is more common inland (Jones et al. 2007).

Historic

The first European to explore the Monterey Bay was Sebastián Vizcaíno, who, in 1602, was sent by the Spanish government to map the Californian coastline (Holm et al. 2013). It was Vizcaíno who named the area “Puerto de Monterey” after the viceroy of New Spain. The location of Vizcaíno’s landing (and later Junipero Serra) lies within the Lower Presidio Park in downtown Monterey. The Gaspar de Portolá expedition traveled through the region in 1769 and returned again in 1770 to establish both the Monterey Presidio, Spain’s first military base in Alta California, and Mission San Carlos Borreméo de Carmelo.

The establishment of the Spanish missions drastically altered the lifeways of the Native Americans. The Spanish conscripted members of local Native American communities to move to the Mission San Carlos Borreméo de Carmelo, where they were indoctrinated as Catholic neophytes.

Mexico gained independence from Spain in 1821. In 1834, the Mexican government secularized the mission lands releasing the Native Americans from control of the mission-system. The City of Monterey continued as the capital of Alta California and the *Californios*, the Mexicans who settled in the region, were given land grants. The United States of America acquired Alta California after landing at Monterey in the 1848 during the Mexican-American War. California became a state in 1850.

Fort Ord

The CSUMB campus is located on a portion of Fort Ord, a military training installation. The Fort was established in 1917, originally called Camp Gigling. Prior to decommissioning, Fort Ord covered 28,000 acres. The Fort was originally used to train cavalry troops stationed at Presidio of Monterey. The Army did not make permanent improvements, which included administrative buildings, barracks, mess halls, tent pads and a sewage treatment plant, on the land until the 1930s. By 1939, the location became known as Camp Ord, then Fort Ord in 1940. From 1940 to 1975, Fort Ord served as a basic training center, then by light infantry troops of the 7th Infantry Division. The base began the transition to closure in 1990 and was decommissioned in 1994 (Rughe 2016).

Records Search

In order to identify cultural resources potentially affected by the proposed undertaking, Dudek defined a Study Area, which includes the location of the proposed CSU Monterey Bay EIR Master Plan Project and a one-mile buffer. Dudek submitted a records search request to the Northwest Information Center (NWIC) of the California Historical Resources Information System (CHRIS) at Sonoma State University on August 27, 2017. The Records Search request included lands within one mile of the study area and reviewed:

- Archaeological and non-archaeological resource records and reports on file at NWIC
- OHP Historic Properties Directory
- OHP Archaeological Determinations of Eligibility
- California Inventory of Historical Resources (1976)
- Historical Maps
- Local Inventories
- GLO and/or rancho Plat Maps

Previously Recorded Resources

Researchers at the Northwest Information Center (NWIC) of the California Historical Resources Information System (CHRIS) at Sonoma State University conducted a records search on September 20, 2017 (Attachment 2). The results of the records search indicated the approximate location of one previously recorded prehistoric site on the former Fort Ord, potentially within the Project Area; two historic sites and sixteen Built Environment resources are located within a one-mile radius of the Project Area (Table 2). The location of prehistoric site (P-27-000385) is unknown; the site record provides no locational data other than “On the Fort Ord Military Reservation”, which extends well beyond the Project Area (Pilling 1950). Furthermore, the site was described as “destroyed by bulldozing in ca. 1940” (Pilling 1950). The two historic sites within

Subject: Cultural Resource Inventory for the CSU Monterey Bay EIR Master Plan Project, Monterey County, California

a one-mile radius of the Project Area are a historic ranch (P-27-001724) and a World War II era military site (P-27-002915). Sixteen Built Environment resources exist within one mile of the Project Area, but it is beyond the scope of this project to address them. Thirteen previously conducted studies include portions of the Project Area; twenty-nine additional studies have occurred within a one-mile radius of the Project Area (Table 3).

Table 2. Cultural Resources within a One-Mile Radius of CSUMB

Primary	Trinomial	Resource Name	Res Type	Age	Recording Events	NRHP Eligibility
P-27-000385	CA-MNT-280	[none]	Site	Prehistoric	1950 (A.R. Pilling, UCAS)	Unlikely eligible
P-27-001724	CA-MNT-1818H	Henneken	Site	Historic	1993 (David Fee, Harding Lawson Associates); 1993 (David W. Babson, [none]); 1994 (David W. Babson, Tri-Services Cultural Resource Center, USA-CERL)	Strong potential for NRHP eligibility, Criterion D
P-27-002717		CA-1025A	Structure	Historic	2001 (Lorna Billat, Earth Touch, Inc.)	Unknown
P-27-002749		Auto Shop	Building	Historic	2003 (Jody R. Stock, Architectural Resources Group); 2007 (Ian Alexander, Juan Cervantes, Matthew Clark, Holman & Associates)	Unknown
P-27-002880		Building 2019, latrine, former Fort Ord	Building	Historic	2007 (Matt Bischoff, CSP, Monterey District)	Unknown
P-27-002881		Building TR9070, office, former Fort Ord	Building	Historic	2007 (Matt Bischoff, CSP, Monterey District)	Unknown
P-27-002882		Building 2066, warehouse, former Fort Ord	Building	Historic	2007 (Matt Bischoff, CSP, Monterey District)	Unknown
P-27-002883		Building 2079, former Fort Ord	Building	Historic	2007 (Matt Bischoff, CSP, Monterey District)	Unknown
P-27-002891		Building 924, metal storage, former Fort Ord	Structure	Historic	2007 (Matt Bischoff, CSP, Monterey District)	Unknown
P-27-002892		Building 1A39, office, former Fort Ord	Structure	Historic	2007 (Matt Bischoff, CSP, Monterey District)	Unknown
P-27-002893		Building 1A99, office, former Fort Ord	Structure	Historic	2007 (Matt Bischoff, CSP, Monterey District)	Unknown
P-27-002894		Building 2026Z, storehouse, former Fort Ord	Building	Historic	2007 (Matt Bischoff, CSP, Monterey District)	Unknown
P-27-002895		Building TR9080, former Fort Ord	Building	Historic	2007 (Matt Bischoff, CSP, Monterey District)	Unknown
P-27-002896		Building TR9081, former Fort Ord	Building	Historic	2007 (Matt Bischoff, CSP, Monterey District)	Unknown
P-27-002913		Feature EGP-2	Structure	Historic	2007 (Ian Alexander, Juan Cervantes, Matthew Clark, Holman and Associates)	Unknown
P-27-002915		Feature EGP-4, WWII Tent Area	Site	Historic	2007 (Matthew Clark, Holman and Associates)	Unknown
P-27-002916		Feature EGP-5	Structure	Historic	2007 (Matthew Clark, Holman and Associates)	Unknown

*Subject: Cultural Resource Inventory for the CSU Monterey Bay EIR Master Plan Project,
Monterey County, California*

Primary	Trinomial	Resource Name	Res Type	Age	Recording Events	NRHP Eligibility
P-27-003170		Marina Municipal Airport Tower	Building	Historic	2012 (Dana E. Supernowicz, Historic Resource Associates)	Unknown
P-27-003383		PG&E Sal-Del Transmission Tower No. 4/62	Structure	Historic	2013 (Dana E. Supernowicz, Historic Resources Associates)	Unknown

P-27-000385 (CA-MNT-280)

A. R. Pilling (1950) recorded this site as an “Occupation site” on the Fort Ord Military Reservation. There is no specific description of the location of the site nor the characteristics of the site, other than it was “destroyed by bull-dozing in ca. 1940”. Due to the vast size of the Fort Ord Military Reservation, at 19,220 acres, and the destroyed site condition, it is difficult to speculate more about the precise location or characteristics of the site.

Previously Conducted Studies

A review of NWIC records indicates that thirteen previously-conducted studies included portions of the Project area. Twenty-nine other previous technical studies have been conducted within a mile radius of the Project Area (Table 3).

Table 3. Prior Cultural Resource Studies Conducted within a One-Mile Radius of CSUMB

Report Number	Authors	Year	Title	Publisher	Report Type	Within Project APE
S-003345	Tony F. Weber and Ann S. Peak	1976	Monterey Peninsula Regional Wastewater Treatment System Expansion Project	Ann S. Peak & Associates	Archaeological, Excavation, Field study	No
S-003345a	Ann S. Peak	1976	Appendix I Cultural Resource Assessment of the Interceptor Line -- East of Blanco Road and West of Davis Road (Augmentation of Monterey Peninsula Regional Wastewater Treatment System)	Ann S. Peak & Associates	Archaeological, Field study	No
S-003345b	Ann S. Peak and Melinda A. Peak	1978	Cultural Resource Assessment of the Selected Alternative of the Monterey Regional Wastewater Treatment System, Monterey County, California.	Ann S. Peak and Associates	Archaeological, Field study	No
S-003418		1978	Cultural Resource Assessment of the Proposed Effluent Disposal System, Fort Ord, Monterey County, California	Ann S. Peak & Associates	Archaeological, Field study	Yes
S-003441		1975	Archeological Survey, Fort Ord, Monterey County		Archaeological, Field study	Yes
S-005210	Michael Swernoff	1982	A Reconnaissance Cultural Resources Survey of Fort Ord, California.	Professional Analysts	Archaeological, Architectural/historical, Field study, Management/planning	Yes
S-005210a	Michael Swernoff	1981	A Reconnaissance Cultural Resources Survey of Fort Ord, California, Draft Report	Professional Analysts	Archaeological, Architectural/historical, Field study	Yes

Subject: Cultural Resource Inventory for the CSU Monterey Bay EIR Master Plan Project, Monterey County, California

Report Number	Authors	Year	Title	Publisher	Report Type	Within Project APE
S-014001	Anna Runnings and Gary S. Breschini	1992	Preliminary Cultural Resources Reconnaissance for the MPWMD Desalinization Pipeline, Monterey County, California	Archaeological Consulting	Archaeological, Field study	No
S-016225	James E. Bowman and Robert Chenier	1994	Report on the Historic Period Archaeological Survey at Henneken's Ranch and the Windmill Site, Fort Ord, Monterey County, California	Tri-Services Cultural Resources Research Center, U.S. Army Corps of Engineers, Construction Engineering Research Laboratories	Archaeological, Excavation, Field study	No
S-018372	Philip R. Waite	1995	A Cultural Resources Survey of 783 Hectares, Fort Ord, Monterey County, California	Geo-Marine, Inc.	Archaeological, Architectural/historical, Field study	Yes
S-020626	Sunshine Psota	1998	Review of Historic Resources for Site SF-754-01, New Monopole at 1st Ave. and 2nd St., Fort Ord, Monterey County, CA (letter report)	Anthropological Studies Center, Sonoma State University	Literature search	No
S-020626a	Sunshine Psota	1998	Review of Historic Resources for Site SF754-01, New Monopole at 6th Army Avenue, Fort Ord, Monterey County, CA (letter report)	Anthropological Studies Center, Sonoma State University	Archaeological, Field study	No
S-022537	Kelda Wilson	2000	Negative Archaeological Survey Report, 05-MON-1 PM R80.7-R85.3 CU 05-168 EA 05-0A3301, Proposal to Place an Asphalt Concrete Overlay on the Class 1 Bike Path on State Route 1 in Seaside and Marina, Monterey County	Caltrans	Archaeological, Field study	No
S-022657	Izaak Sawyer, Laurie Pfeiffer, Karen Rasmussen, and Judy Berryman	2000	Phase 1 Archaeological Survey Along Onshore Portions of the Global West Fiber Optic Cable Project	Science Applications International Corporation	Archaeological, Field study	No
S-022738	Mary Doane and Trudy Haversat	2000	Preliminary Archaeological Reconnaissance of the MBEST 18" Water Pipeline Project, Marina, Monterey County, California	Archaeological Consulting	Archaeological, Field study	Yes
S-023023	Mary Doane and Trudy Haversat	2000	Preliminary Archaeological Reconnaissance of the 2nd Avenue/12th Street Project, in the Former Fort Ord, Monterey County, California	Archaeological Consulting	Archaeological, Field study	Yes
S-023331	Mary Doane and Trudy Haversat	2000	Preliminary Archaeological Reconnaissance of the Seaside Resort Project on the Former Fort Ord Golf Courses, Seaside, Monterey County, California	Archaeological Consulting	Archaeological, Field study	No
S-024030	Loma Billat	2001	Proposed Telecommunications Facility; Nextel Site CA-1025A "Fort Ord" (letter report)	Earth Touch, LLC	Archaeological, Field study	No
S-025416	Mary Doane and Trudy Haversat	2002	Preliminary Archaeological Reconnaissance for the First Tee Project and Two Separate Recreational Facility Sites in the Former Fort Ord, Monterey County, California	Archaeological Consulting	Archaeological, Field study	Yes
S-025535	Colin I. Busby	2001	Negative Archaeological Survey Report, signal and other roadway improvements at the intersection of Reservation Road and Imjin Road, City of Marina, Monterey County	Basin Research Associates, Inc.	Archaeological, Field study	No

***Subject: Cultural Resource Inventory for the CSU Monterey Bay EIR Master Plan Project,
Monterey County, California***

Report Number	Authors	Year	Title	Publisher	Report Type	Within Project APE
S-028012	Colin I. Busby	2002	Cultural Resources Assessment - Three Inundation Areas, Fort Ord Reuse Authority, Monterey County, California (letter report)	Basin Research Associates, Inc.	Archaeological, Field study	No
S-029425	Scott Billat	2004	Construction of a 70 foot Monopole and New Equipment Shelter, Mars/SF-1036 (resubmittal), 599 DX Road, Marina Ca.	EarthTouch, Inc.	Architectural/historical, Management/planning	No
S-029425a	Erika Thal	2004	Cultural Resource Assessment for the Mars (SF-1036) Cellular Facility on 599 DX Road, Marina, Monterey County, California	EarthTouch Inc.	Archaeological, Field study	No
S-029932	Michael Darcangelo and Laura Leach-Palm	2004	Archaeological Survey Report on the University Villages Specific Plan, 390 Acre Project Area, at Former Fort Ord, Monterey County, California.	Far Western Anthropological Research Group, Inc.	Archaeological, Field study	No
S-031953	Wayne H. Bonner and James M. Keasling	2006	Cultural Resource Records Search Results and Site Visit for T-Mobile Telecommunications Facility Candidate SF15153 (Metro Marina Monopine/Amateur Radio Club), 599 DX Drive, Marina, Monterey County, California (letter report)	Michael Brandman Associates	Archaeological, Architectural/historical, Field study	No
S-032063		2004	Fort Ord, East Garrison Historic Resources Assessment	Architectural Resources Group	Architectural/historical, Field study, Management/planning	No
S-032063a		2003	Draft: Fort Ord, East Garrison, Historic Resources Assessment; July 28, 2003	Architectural Resources Group	Architectural/historical, Field study, Management/planning	No
S-032063b		2006	East Garrison Preservation Plan, Fort Ord, Monterey County	Architectural Resources Group	Architectural/historical, Management/planning	No
S-032063c		2004	Guidelines for Rehabilitating Buildings at the East Garrison, Fort Ord, Monterey County, California	Architectural Resources Group	Architectural/historical, Management/planning	No
S-032063d		2006	Mothball Plan and Existing Conditions Survey for Fort Ord, East Garrison, Monterey, California	Architectural Resources Group	Architectural/historical, Management/planning	No
S-033596	Mary L. Manieri and Cindy L. Baker	2007	Cultural Resource Inventory and Evaluation of United States Army Reserve 63D Regional Readiness Command Facilities; Contract No. W912C8-05-P-0052	PAR Environmental Services, Inc.	Archaeological, Architectural/historical, Field study	No
S-033596a	U.S. Army Reserve and PAR Environmental Services, Inc.	2007	Cultural Resources Inventory and Evaluation of the United States Army Reserve Heroic War Dead USAR Center/Area Maintenance Support Activity 85 (G), Oakland, California; P-01-[010831], 63D Regional Readiness Command Facility CA036, Contract No. W912C8-05-P	U.S. Army Reserve; PAR Environmental Services, Inc.	Architectural/historical, Evaluation, Field study	No
S-033596b	U.S. Army Reserve and PAR Environmental Services, Inc.	2007	Cultural Resources Inventory and Evaluation of the United States Army Reserve Oakland USAR Center #2, Oakland, California; P-01-01830, 63D Regional Readiness Command Facility CA-125, Contract No. W912C8-05-P-0052	U.S. Army Reserve; PAR Environmental Services, Inc.	Architectural/historical, Evaluation, Field study	No

Subject: Cultural Resource Inventory for the CSU Monterey Bay EIR Master Plan Project, Monterey County, California

Report Number	Authors	Year	Title	Publisher	Report Type	Within Project APE
S-033596c	U.S. Army Reserve and PAR Environmental Services, Inc.	2007	Cultural Resources Inventory and Evaluation of the United States Army Reserve PFC Bacciglieri Armed Forces Reserve Center, Concord, California; P-07-002752, 63 D Regional Readiness Command Facility CA007, Contract No. W912C8-P-0052	U.S. Army Reserve; PAR Environmental Services, Inc.	Architectural/historical, Evaluation, Field study	No
S-033596d	U.S. Army Reserve and PAR Environmental Services, Inc.	2007	Cultural Resources Inventory and Evaluation of the United States Army Reserve Col. Hunter Hall USAR Center, San Pablo, California; P-07-002753, 63D Regional Readiness Command Facility CA 070, Contract No. W912C8-05-P-0052	U.S. Army Reserve; PAR Environmental Services, Inc.	Architectural/historical, Evaluation, Field study	No
S-033596e	U.S. Army Reserve and PAR Environmental Services, Inc.	2007	Cultural Resources Inventory and Evaluation of the United States Army Reserve Fort Ord USAR Center, Marina, California; 63D Regional Readiness Command Facility CA012, Contract No. W912C8-05-P-0052	U.S. Army Reserve; PAR Environmental Services, Inc.	Architectural/historical, Evaluation, Field study	No
S-033596f	U.S. Army Reserve and PAR Environmental Services, Inc.	2007	Cultural Resources Inventory and Evaluation of the United States Army Reserve Moss Landing Local Training Area, Moss Landing, California; 63D Regional Readiness Command Facility CA189, Contract No. W912C8-05-P-0052	U.S. Army Reserve; PAR Environmental Services, Inc.	Architectural/historical, Evaluation, Field study	No
S-033596g	U.S. Army Reserve and PAR Environmental Services, Inc.	2007	Cultural Resources Inventory and Evaluation of the United States Army Reserve Jones Hall USAR Center, Mountain View, California; P-43-001836, 63D Regional Readiness Command Facility CA031, Contract No. W912C8-05-P-0052	U.S. Army Reserve; PAR Environmental Services, Inc.	Architectural/historical, Evaluation, Field study	No
S-033596h	U.S. Army Reserve and PAR Environmental Services, Inc.	2007	Cultural Resources Inventory and Evaluation of the United States Army Reserve Richey Hall USAR Center, San Jose, California; P-43-000728, 63D Regional Readiness Command Facility CA069, Contract No. W912C8-05-P-0052	U.S. Army Reserve; PAR Environmental Services, Inc.	Architectural/historical, Evaluation, Field study	No
S-033596i	U.S. Army Reserve and PAR Environmental Services, Inc.	2007	Cultural Resources Inventory and Evaluation of the United States Army Reserve Moffett USAR Center, Mountain View, California; P-43-001837, 63D Regional Readiness Command Facility CA120, Contract No. W912C8-05-P-0052	U.S. Army Reserve; PAR Environmental Services, Inc.	Architectural/historical, Evaluation, Field study	No
S-033596j	U.S. Army Reserve and PAR Environmental Services, Inc.	2007	Cultural Resources Inventory and Evaluation of the United States Army Reserve PFC Young USAR Center, Vallejo, California; P-[48-000752], 63D Regional Readiness Command Facility CA-090, Contract No. W912C8-05-P-0052	U.S. Army Reserve; PAR Environmental Services, Inc.	Architectural/historical, Evaluation, Field study	No
S-033596k	Milford Wayne Donaldson and James O. Anderson	2007	USA070613A; Inventory and Evaluation of Historic Resources at 63D Regional Readiness Command, US Army Reserve Center in California	Office of Historic Preservation; US Army	OHP Correspondence	No
S-033677	Mary Doane and Trudy Haversat	1999	Preliminary Archaeological Reconnaissance of the Marina Coast Water District Recycled Water Pipeline Project, Monterey County, California	Archaeological Consulting	Archaeological, Field study	Yes
S-033677a	Mary Doane and Trudy Haversat	2006	Phase 1 Archaeological Reconnaissance for the Marina Coast Water District Regional Urban Water Augmentation Project, Recycled Water Component, Northern Segment, In Marina and Seaside, Monterey County, California	Archaeological Consulting	Archaeological, Field study	Yes

Subject: Cultural Resource Inventory for the CSU Monterey Bay EIR Master Plan Project, Monterey County, California

Report Number	Authors	Year	Title	Publisher	Report Type	Within Project APE
S-033677b	Mary Doane and Gary S. Breschini	2007	Phase I Archaeological Reconnaissance for the Marina Coast Water District Regional Urban Water Augmentation Project, Recycled Water Component, in Marina, Ord Community, Seaside and Monterey, Monterey County, California (Revised May 22, 2007)	Archaeological Consulting	Archaeological, Field study	Yes
S-033677c	Mary Doane and Gary S. Breschini	2006	Phase 1 Archaeological Reconnaissance for the Marina Coast Water District Regional Urban Water Augmentation Project, Recycled Water Component, in Marina, Ord Community, Seaside and Monterey, Monterey County, California	Archaeological Consulting	Archaeological, Field study	Yes
S-033677d	Mary Doane and Gary S. Breschini	2007	Phase 1 Archaeological Reconnaissance for Two Additional Alignments for the Marina Coast Water District Regional Urban Water Augmentation Project, Recycled Water Component, In Marina, Monterey County, California	Archaeological Consulting	Archaeological, Field study	Yes
S-033677e	Mary Doane and Gary S. Breschini	2007	Preliminary Archaeological Reconnaissance for the Marina Coast Water District Well 34 Project, In Marina, Monterey County, California	Archaeological Consulting	Archaeological, Field study	Yes
S-034302	James Keasling	2008	Cultural Resource Records Search and Site Visit Results for Sprint Nextel Candidate MO45XCO18 (Fort Ord), 4251 General Jim Moore Boulevard, Seaside, Monterey County, California	Michael Brandman and Associates	Archaeological, Field study	No
S-034406	Scott Billat	2007	New Tower ("NT") Submission Packet FCC Form 620, Fort Ord Seaside, SF-18350A	EarthTouch, Inc.	Archaeological, Field study	No
S-035060	Mary Doane and Gary Breschini	2008	Preliminary Archaeological Reconnaissance for the Projects at Main Gate in the Former Fort Ord, Seaside, Monterey County, California	Archaeological Consulting	Archaeological, Field study	Yes
S-035143	Matthew Clark	2006	Archaeological Surface and Subsurface Reconnaissance and Historic Feature Recording for the East Garrison Project Area, Monterey County, California	Holman and Associates	Archaeological, Evaluation, Excavation, Field study	No
S-035143a	Matthew Clark	2006	Archaeological Monitoring Plan for the East Garrison Project, Monterey County, California	Holman & Associates	Archaeological, Management/ planning	No
S-035143b	Matthew R. Clark and Juan Cervantes	2007	Archaeological Monitoring for the East Garrison Project, Monterey County, California	Holman & Associates	Archaeological, Field study, Management/ planning	No
S-035143c	Matthew R. Clark	2005	Archaeological Surface and Subsurface Reconnaissance and Historic Feature Recording for the East Garrison Project Area, Monterey Count, California [original]	Holman & Associates	Archaeological, Architectural/ historical, Excavation, Field study	No
S-035979	Susan Morley	2009	Preliminary Cultural Resources Reconnaissance of Assessor's Parcel Number 031-251-004 in the City of Marina, County of Monterey, California	Achasta Archaeological Services	Archaeological, Field study	No
S-036412	Mary Doane and Gary Breschini	2009	Preliminary Archaeological Reconnaissance for the Marina Middle School, High School, and Joint Use Community Recreational Facilities Project in Marina, Monterey County, California	Archaeological Consulting	Archaeological, Field study	No
S-036412a	Mary Doane and Gary S. Breschini	2009	Phase 1 Archaeological Survey Report for the Marina Middle School, High School, and Joint Use Community Recreational Facilities Project in Marina, Monterey County, California	Archaeological Consulting	Archaeological, Field study	No
S-037693	Mary Doane and Gary S. Breschini	2010	Phase I Archaeological Survey for the Central Coast California Veterans Cemetery and Eastside Road Infrastructure Projects, Seaside, Monterey County, California	Archaeological Consulting	Archaeological, Field study	Yes

Subject: Cultural Resource Inventory for the CSU Monterey Bay EIR Master Plan Project, Monterey County, California

Report Number	Authors	Year	Title	Publisher	Report Type	Within Project APE
S-037725	Allika Ruby	2010	Archaeological Survey Report for the Monterey Light Rail Transit Project	Far Western Anthropological Research Services, Inc.	Archaeological, Field study	No
S-038840	Mary Doane and Gary S. Breschini	2012	Phase 1 Archaeological Survey for the Fort Ord Dunes State Park Project Near Seaside, Monterey County, California	Archaeological Consulting	Archaeological, Field study	No
S-039072		2009	Cultural Resources Review, Gigling Road and South Boundary Road Improvements, Within Former Fort Ord, Monterey County, California	Basin Research Associates	Archaeological, Architectural/historical, Field study	No
S-039246	Tobin Rodman	2012	Cultural Resources Constraints Study for the Replacement of the Marina, 6th Street Wood Pole Replacement Project, Monterey County, California, PG&E No. 30787086/7690	Parus Consulting	Archaeological, Architectural/historical, Field study	No
S-040206	Mary Doane and Gary Breschini	2013	Preliminary Archaeological Reconnaissance for the MRWPCA Salinas Pump Station Capacity Enhancement Project Between Salinas and Marina, Monterey County, California	Archaeological Consulting	Archaeological, Field study	No
S-042969	Carolyn Losee	2012	Cultural Resources Investigation for AT&T Mobility CNU3562 "W Blanco Road LTE", 3262 Imjin Road, Marina, Monterey County, California 93933 (letter report)	Archaeological Resources Technology	Architectural/historical, Field study	No
S-042969a	Carol Roland-Nawi and Carolyn Losee	2012	FCC_2012_1106_005; CNU3562, W Blanco Road TLTE, 3262 Imjin Road, Marina, Collocation	Office of Historic Preservation; Archaeological Resources Technology	OHP Correspondence	No
S-044195	Lawrence Moore	2010	Cultural Resource Inventory, ASR Wells Location, Ord Military Community, Monterey County, CA	Dept of Public Works, Environmental Division, US Army Garrison, Presidio of Monterey	Archaeological, Architectural/historical, Field study	No
S-044238	Aniela Travers	2013	Cultural Resources Survey, California State University Monterey Bay/CN3776, NWC Eighth Avenue and A Street, Seaside, Monterey County, California, 93955, Unsectioned	EBI Consulting	Archaeological, Field study	Yes
S-045823	Mary Doane and Gary S. Breschini	2014	Phase I Archaeology Survey for the Proposed Monterey Peninsula Groundwater Replenishment Project, Northern Monterey County, California	Archaeological Consulting	Archaeological, Field study	Yes
S-046930	Roderic McLean	2014	FCC Form 620 New Tower ("NT") Submission Packet, Verizon Wireless Imjin and Abrams Facility, 2700 Imjin Parkway, Marina, CA 93933	Bureau Veritas	Architectural/historical, Management/planning	No
S-046930a		2014	Cultural Resource Assessment Class III Inventory, Verizon Wireless Services, Imjin and Abrams Facility, City of Marina, County of Monterey, California	LSA Associates, Inc.	Archaeological, Field study	No
S-047095	Allika Ruby	2015	Archaeological Survey Report for the PG&E Salinas #1 and Salinas #2 Pole Replacement Project, Monterey County, California	Far Western Anthropological Research Group, Inc.	Archaeological, Field study	Yes

Subject: Cultural Resource Inventory for the CSU Monterey Bay EIR Master Plan Project, Monterey County, California

Report Number	Authors	Year	Title	Publisher	Report Type	Within Project APE
S-048445	Dana E. Supernowicz	2013	Archaeological Survey Study of the PG&E Ardennes Project, AT&T Mobility Site No. CNU6074, 207 Ardennes Circle, Seaside, Monterey County, California 93955	Historic Resource Associates	Archaeological, Field study	No
S-048445a	Milford Wayne Donaldson	2013	Collocation Submission Packet; PG&E ARDENNES; AT&T- CNU6074.	Office Of Historic Preservation	Management/ planning	No
S-048445b	Carol Roland-Navi	2014	FCC_2013_1218_001: CNU6074 (PG&E ARDENNES) 207 ARDENNES CIRCLE, SEASIDE, Collocation	Office Of Historic Preservation	OHP Correspondence	No

The following studies occurred within portions of the Project Area.

S-003418 Cultural Resource Assessment of the Proposed Effluent Disposal System, Fort Ord, Monterey County, California (Peak 1978)

This study crosses the Project Area in the southwest corner. It relates to an upgrade in the sewage system along the western portion of Fort Ord. No cultural resources were identified.

S-003441 Appendix D: Archeological Survey, Fort Ord, Monterey County (Unknown 1975)

This study took place in the northeastern portion of the Project Area. The survey was conducted for a proposed expansion of housing facilities. No cultural resources were encountered.

S-005210 Predictive Model of Cultural Resources at Fort Ord: A Reconnaissance Cultural Survey of Fort Ord, California (Michael Swernoff of Professional Analysts 1982)

Professional Analysts surveyed over a thousand acres of the Fort Ord property and analyzed previous surveys and overviews to create a predictive map of cultural sensitivity. The survey was stratified by vegetation type, which included: grassland, live oak savannah, dense brush (manzanita), light brush (sage brush), and coastal strand. Areas of high sensitivity were identified in the eastern and southern portions of the Fort in areas where water drains from high relief areas, there is available surface water, concentrated variability in ecological zone, presence of buckeye trees, and degree of protection from the elements. Additionally, Swernoff reported on four previously recorded historic buildings and one newly recorded historic cairn. Moreover, they report that a single bedrock mortar site, CA-MNT-416, is located in a buffer zone east of Fort Ord.

S-018372 A Cultural Resources Survey of 783 Hectares, Fort Ord, Monterey County, California (Waite 1995)

This study was a cultural resources survey sampling of 783 hectares (1,935.4 acres) within the Fort Ord related to the closure of the military base. The survey was stratified by environmental zones, which included: beach strand, active dunes, stabilized dunes (Holocene), stabilized dunes (ancient), and dissected uplands. High probability areas included areas within 100 meters of a water source and a 300-meter wide area along the bluff overlooking the Salinas River on the eastern edge of the Fort Ord. The effort included the recording of a historic site and an examination of two prehistoric sites, which included excavating shovel test pits. Portions of the survey included segments within the eastern half of the Project Area. None of the resources addressed in the report are within the Project Area or one-mile buffer.

S-22738 Preliminary Archaeological Reconnaissance of the MBEST 18' Water Pipeline Project, Marina, Monterey County, California (Doane and Haversat 2000)

This study included a survey and records search related to a proposed waterline project in Marina. The survey crosses the Project Area in the northeastern portion. No cultural resources were encountered in the records search or survey for this study.

S-23023 Preliminary Archaeological Reconnaissance of the 2nd Avenue/12th Street Project, in the Former Fort Ord, Monterey County, California (Doane and Haversat 2000)

This study, located along 12th Street, 2nd Avenue and Lightfighter Drive on the grounds of former Fort Ord, makes up 2/3 of the western boundary of the Project Area on the north end and enters the Project Area approximately 800 meters from the western boundary. This study did not encounter any cultural resources from the survey or record search efforts.

S-25416 Preliminary Archaeological Reconnaissance for the First Tee Project and Two Separate Recreational Facility Sites in the Former Fort Ord, Monterey County, California (Doane and Haversat 2002)

This study is related to the construction of a golf course and two recreational facilities on the grounds of the former Fort Ord. The northernmost recreational facility grazes the southern boundary of the Project Area in the western portion. The records search did not indicate any cultural resources within 1 km of the study and no cultural resources were encountered during the survey.

S-33677a-d Phase 1 Archaeological Reconnaissance for the Marina Coast Water District Regional Urban Water Augmentation Project, Recycled Water Component, Northern Segment, In Marina and Seaside, Monterey County, California (Doane and Haversat 2006 and 2007)

This study is linked to a waterline project that spans from northeast of the City of Marina through the former Fort Ord to downtown Monterey. It connects reservoirs, pump stations, laterals and several pipelines. This linear study lines several existing streets in the western portion of the Project Area. One historic site was found within the confines of former Fort Ord, but was not affected by their project and does not exist within the Project Area or one-mile buffer. Any other archaeological sites within the concern of the study were located farther to the south, beyond the extent of the former Fort Ord and outside the one-mile buffer of this Project.

S-33677e Preliminary Archaeological Reconnaissance for the Marina Coast Water District Well 34 Project, In Marina, Monterey County, California (Doane and Breschini 2007)

This study discusses drilling for a well for the Marina Coast Water District in the East Garrison area of the Ord Community. This portion of the study is outside the Project Area.

S-35060 Preliminary Archaeological Reconnaissance for the Projects at Main Gate in the Former Fort Ord, Seaside, Monterey County, California (Doane and Breschini 2008)

This study involves a proposed development project at the Main Gate of the former Fort Ord. The study intersects the Project Area on the southern portion of the western boundary. Neither the records search nor the survey produced any evidence of cultural resources within 1 km of the study area.

S-37693 Phase 1 Archaeological Survey for the Central Coast California Veterans Cemetery and Eastside Road Infrastructure Projects Seaside, Monterey County, California (Doane and Breschini 2010)

The study involves an assessment of a cemetery for veterans, as well as a new road alignment and improvements eastward on Inter Garrison Road to Old County Road. The study intersects with the Project Area in the southeastern portion. Records search indicated one historic site (not within the Project Area). Survey yielded the discovery of no additional cultural resources.

S-44238 Cultural Resources Survey California State University Monterey Bay/CN3776 NWC Eighth Avenue and A Street Seaside, Monterey County, California 93955 Unsectioned (EBI Consulting 2013)

Subject: Cultural Resource Inventory for the CSU Monterey Bay EIR Master Plan Project, Monterey County, California

This study is for a proposed telecommunications tower at the intersection of Eighth Avenue and A Street at the former Fort Ord property. The study is within the Project Area in the central region to the north. No cultural resources were encountered in the records search or survey.

S-45823 Phase 1 Archaeological Survey for the Proposed Monterey Peninsula Groundwater Replenishment Project, Northern Monterey County, California (Doane and Breschini 2014)

This study is a water resources improvement project, which would inject treated water from a new water treatment plant into the Seaside Groundwater Basin. The study area is vast and involves lands in Marina, Seaside, Monterey and Pacific Grove, as well as unincorporated lands around Marina, Salinas and Castroville. The study bisects the Project Area in the western portion. Although the study contained prehistoric and historic resources, none were located within the Project Area and none encountered during the survey.

S-47095 Archaeological Survey Report for the PG&E Salinas #1 and Salinas #2 Pole Replacement Project, Monterey County, California (Ruby 2015)

This study relates to PG&E poles being replaced in Salinas and on the property of former Fort Ord. One pole is within the Project Area and two within the one-mile buffer. Access roads between the poles are also part of the study. No cultural resources discovered during the course of the survey nor in the records search.

Native American Consultation

On behalf of CSUMB, Dudek submitted a Sacred Lands File (SLF) search and request for a list of Native American contacts with NAHC on August 28, 2017 (Attachment 3). NAHC responded on September 6, 2017 with negative results for the SLF search. NAHC provided contacts for 8 separate groups. Pursuant to AB52 requirements, all NAHC-listed California Native American tribes who have requested project notification from CSUMB were contacted.

AB 52 consultation

A project with an effect that may cause a substantial adverse change in the significance of a tribal cultural resource is a project that may have a significant effect on the environment (Pub. Resources Code, § 21084.2.). CSUMB initiated AB 52 consultation on this project through the following process. Two Native American groups, the Ohlone/Costanoan-Esselen Nation (OCEN) and the Torres Martinez Desert Cahuilla Indians, contacted CSUMB requesting consultation under AB52 for new projects initiated by CSUMB meeting requirements for consultation under CEQA. The Torres Martinez Desert Cahuilla Indians are geographically located in the vicinity of Imperial and

Riverside counties, California. Due to the geographic distance and lack of traditional and cultural affiliation with the geographic area surrounding CSUMB, CSUMB responded to Torres Martinez on July 18, 2017 that AB52 consultation would not be initiated unless additional information supporting cultural affiliation was provided. Also on July 18, 2017, CSUMB sent a letter to OCEN notifying them of the intent to prepare an Environmental Impact Report for the proposed CSUMB Master Plan. The letter described a general overview of the Project and included maps. Attachment 4 presents the record of AB 52 consultation, which is summarized below.

OCEN responded to CSUMB in a letter dated August 4, 2017 requesting consultation and outlining a series of requests as a component of consultation. Their requests included the following: to be provided with copies of reports, to establish a procedure for addressing disturbance to known and unknown sites, and to complete a CHRIS records search at NWIC and with the Native American Heritage Commission (NAHC). CSUMB initiated AB52 consultation with OCEN by a letter dated August 31, 2017. OCEN responded in a letter dated September 11, 2017 requesting no disturbance of cultural lands and implementation of procedures to follow when known or unknown cultural resources are identified, among other points. CSUMB followed up with a letter dated September 5, 2018 providing summary results of the NWIC and NAHC searches and the surface survey. CSUMB met with OCEN on December 17, 2018 and January 29, 2019 to discuss the project.

OCEN brought up several points about cultural sensitivity on the campus and identified various contacts who may have more information about tribal or archaeological cultural resources on the campus. On behalf of CSUMB, Dudek followed up with several of the leads. CSUMB followed up with a letter dated April 18, 2019 summarizing the results of the two meetings, providing OCEN with a copy of the draft cultural report, summarizing supplemental investigations and research completed to attempt to identify TCRs on the campus, and offering to continue consultation with OCEN by holding a field meeting to obtain additional information from OCEN about potential resources. OCEN did not respond to this letter and CSUMB concluded consultation on May 17, 2019. A summary of the additional communications is presented in Attachment 4.

AB 52 requires a TCR to have tangible, geographically defined properties that can be impacted by a project. No known TCRs have been identified through consultation with OCEN. In the future, should one or more TCRs be identified that may be affected, CSUMB will work with tribal representatives that have requested consultation under AB 52 to establish a feasible and appropriate mitigation approach.

Cultural Resources Survey

Dudek archaeologists Ryan Brady, MA, RPA, and Sarah Brewer, BA, performed a survey of the proposed Project Area on November 22, 2017 (Figure 3). The focus of the survey was to characterize existing conditions and identify whether archaeological resources were located at, or

had the potential to be located within, the Project area. The archaeologists applied a mixed-intensity strategy for the survey, using 15-meter transects when possible, and adopting a more opportunistic approach in highly developed areas. More care was given to areas that will be affected by “near-term” projects.

1. Student Recreation Center

Dudek archaeologists inspected the exposed sand north of the parking area, but the southern area was fenced off for construction activities. The trail south of Area 1 was surveyed eastward. This zone was within an oak-pine woodland with ice plant ground cover. The partially-landscaped area south of the construction area was also surveyed. Visibility was good in non-developed areas.

2. Student Housing Phase IIB

Although most of this area was paved, there were some open areas with moderate visibility revealing a sandy substrate. Vegetation in this area included pines, eucalyptus and ice plant.

3. Student Housing Phase III

The south end of this survey area was a paved parking lot. The northwestern portion was also paved or covered in ice plant. Buildings formerly located in this area have been removed. Dudek archaeologists inspected the ground surface in all visible areas. Vegetation in this area included oak, eucalyptus and ice plant.

4. Academic IV

Buildings in the southeastern portion of this survey area were fenced off and in the process of being demolished. Other construction was ongoing and included recently-constructed buildings. The ground surface provided moderate to low visibility.

5. Academic V

The north end of this survey area was fully developed with buildings, grass and a paved parking lot. Ground surface visibility was poor.

6. Athletics Field

The eastern portion of this survey area was heavily disturbed with a fair surface visibility. The western portion was developed with a baseball field, a track, a pool and a parking lot. Some areas are open and show past disturbance.

7. Southeast and Northwest New Buildings

In the southeast block, the northern portion was paved and fenced off. There was thick ice plant in unpaved areas. West of the solar array was an open area with good surface visibility and a high level of disturbance.

The northwestern block was undeveloped with moderate to poor surface visibility. Ice plant covered the ground surface, which was a sandy substrate.

8. Outlying Trails and Infrastructure

In the eastern portion of the Project Area, Dudek archaeologists surveyed a portion of the proposed FORTAG trail from Inter Garrison Road south. The trail was graded with aggregate in areas and was within a disturbed context. Visibility was moderate to poor in the central portion that has been cleared in the past. The thick forested area south of the previously cleared area was not passable.

Dudek archaeologists surveyed all areas of near-term projects and did not identify new archaeological resources in any of the areas surveyed.

SUMMARY AND RECOMMENDATIONS

All cultural resource fieldwork and reporting for this project has been conducted by archaeologists meeting the Secretary of the Interior's Professional Qualifications Standards. A cultural resources records search of the California Historical Resources Information System (CHRIS) at the Northwest Information Center (NWIC) records search found one potential previously recorded prehistoric site within the 19,220 acre former Fort Ord Military Reserve, but no specific locational data was provided in the site record so the exact location remains unknown. This site was recorded as destroyed in 1940 (Pilling 1950). Two other historical archaeological sites and 16 Built Environment resources exist within one mile of the Project Area. A mixed-intensity field survey of the Project Area was conducted on November 22, 2017 and a supplemental survey was conducted on February 6, 2019; the surveys did not identify any unrecorded archaeological resources.

General archaeological sensitivity of the CSUMB campus can be assessed by reviewing the archaeological survey and sensitivity model presented by Swernoff (1982). The study identified high sensitivity for prehistoric resources where:

1. Drainages empty from high relief areas onto the Salinas River floodplain or Toro Creek watershed
2. Surface water is available
3. There is concentrated ecological zone diversity

4. Presence of buckeye trees
5. Protection from the elements

Areas meeting those characteristics are found in the eastern and southern areas of Fort Ord, beyond the current CSUMB boundary.

Dudek has worked with CSUMB to facilitate consultation with Native American tribes who are traditionally and culturally affiliated to the geographic area of the project pursuant to AB 52. This process has included letters sent to Native American tribes who have previously requested notification of projects within this area, a follow-up letter initiating consultation with OCEN, then an additional letter documenting the results of the records search and survey. Further, CSUMB met with OCEN on December 17, 2018 and on January 29, 2019 as part of the government-to-government consultation in order to discuss the project and receive feedback. CSUMB followed up with a letter dated April 18, 2019 summarizing the results of the two meetings, providing OCEN with a copy of the draft cultural report, summarizing supplemental investigations and research completed to attempt to identify TCRs on the campus, and offering to continue consultation with OCEN by holding a field meeting to obtain additional information from OCEN about potential resources. OCEN did not respond to this letter and CSUMB concluded consultation on May 17, 2019.

An appropriate approach to determining potential impacts to TCRs is developed in response to verifying the identified presence of a TCR by a California Native American Tribe through the process of consultation. Government-to-government consultation initiated by CSUMB, acting in good faith and after a reasonable effort, has not resulted in the identification of a TCR within or near the project area. Based on the results of these efforts, the proposed Master Plan Project does not appear to threaten impacts to known archaeological sites or TCRs. Nevertheless, CSUMB will implement the following mitigation measures in the event that unknown resources are uncovered during the course of development.

Mitigation Measure CULT-1: CSUMB shall include a standard inadvertent discovery clause in every construction contract for the Project, which requires that in the event that an archaeological resource is discovered during construction (whether or not an archaeologist is present), all soil disturbing work within 100 feet of the find shall cease until a qualified archaeologist can evaluate the find and make a recommendation for how to proceed. For an archaeological resource that is encountered during construction, the campus shall:

- Retain a qualified archaeologist to determine whether the resource has potential to qualify as a historical resource or a unique archaeological resource as outlined in the California Environmental Quality Act (CEQA)(PRC 21083.2).

- If the resource has potential to be a historical resource or a unique archaeological resource, the qualified archaeologist, in consultation with CSUMB, shall prepare a research design and archaeological evaluation plan to assess whether the resource should be considered significant under CEQA criteria.
- If the resource is determined significant, in consultation with CSUMB, a qualified archaeologist will prepare a data recovery plan for retrieving data relevant to the site's significance. The data recovery plan shall be implemented prior to, or during site development (with a 100 foot buffer around the resource). The archaeologist shall also perform appropriate technical analyses, prepare a full written report and file it with the Northwest Information Center, and provide for the permanent curation of recovered materials.

Mitigation Measure CULT-2: A Native American and archaeological monitor shall be present for earth-disturbing work in native soils within 750 feet of a documented archaeological resource or TCR, if such resources are discovered and documented in the future. Depth to native soils on particular project sites is typically identified in project-specific geotechnical investigations.

Mitigation Measure CULT-3: CSUMB shall include a standard clause in every construction contract for the Project, which requires cultural resource sensitivity training for workers prior to conducting earth disturbance in the vicinity of a documented cultural resource-sensitive area, should one be identified in the future. Additionally, campus staff involved in earth-disturbing work in the vicinity of a documented resource sensitive area will also receive such training.

Mitigation Measure CULT-4: Should human remains be discovered at any time, work will halt in that area and procedures set forth in the California Public Resources Code (Section 5097.98) and State Health and Safety Code (Section 7050.5) will be followed, beginning with notification to CSUMB and the County Coroner. If Native American remains are determined to be present, the County Coroner will contact the Native American Heritage Commission to designate a Most Likely Descendent, who will arrange for the dignified disposition and treatment of the remains. OCEN shall be notified of the discovery even if not assigned as MLD.

Should you have any questions relating to this report and its findings please do not hesitate to contact me directly.

Respectfully Submitted,

*Subject: Cultural Resource Inventory for the CSU Monterey Bay EIR Master Plan Project,
Monterey County, California*



Ryan Brady, MA, R.P.A.
Archaeologist

DUDEK

Office: (831) 600-1414

Email: rbrady@dudek.com

cc: Micah Hale, Dudek

Att: *Figure 1. Regional/Vicinity Map*
Figure 2. Implementation Plan and Near-Term Project Sites
Figure 3. Cultural Survey Coverage
Attachment 1: National Archaeological Database Information
Attachment 2: NWIC Records Search (Confidential)
Attachment 3: Native American Heritage Commission Sacred Lands File Search (Confidential)
Attachment 4: Record of Native American Consultation (Confidential)

REFERENCES CITED

- Basgall, M.E. 1987. Resource Intensification Among Hunter-Gatherers: Acorn Economies in Prehistoric California. *Research in Economic Anthropology* 9:21–52.
- Beardsley, R.K. 1946. The Monterey Custom Flag Pole: Archaeological Findings. *California Historical Society Quarterly* 25(3):204-218
- Bertrando, E. 2004. Evidence and Models for Late Pleistocene Chronology and Settlement Along California’s Central Coast. In *Emerging from the Ice Age: Early Holocene Occupations on the California Central Coast*, edited by Ethan Bertrando and V.A. Levulett, pp. 93–105. San Luis Obispo County Archaeological Society Occasional Papers no. 17.
- Brady, R., J. Farquhar, T. Garlinghouse, and C. Peterson. 2009. *Archaeological Evaluation of CA-MNT-143 for the Asilomar Boardwalk Replacement Project, Asilomar State Beach, Pacific Grove, California*. Albion Environmental, Inc., Santa Cruz. Copies available from the Northwest Information Center, Department of Anthropology, Sonoma State University, Rohnert Park.
- Breschini, G. and T. Haversat. 1992a. Preliminary Excavations at CA-MNT-108, Fisherman’s Wharf, Monterey County, California. In *Archaeological Investigations of Some Significant Sites on the Central Coast of California*, edited by H. Dallas, Jr. and G.S. Breschini, pp. 39–47. Coyote Press Archives of California Prehistory No. 37, Salinas.
- Breschini, G. and T. Haversat. 1992b. Baseline Archaeological Studies at Rancho San Carlos, Carmel Valley, Monterey County, California. Coyote Press Archives of California Prehistory No. 36, Salinas.
- Bryne, S. 2002. *Archaeological Monitoring of the Wilder Ranch Bike Path Construction and Mitigation Related to Archaeological Site CA-SCR-38/123/H*. Garcia and Associates, San Anselmo. Copies available from Northwest Archaeological Information Center, Department of Anthropology, Sonoma State University, Rohnert Park, California.
- Cartier, R. 1993. *The Scotts Valley Site: CA-SCR-177*. The Santa Cruz Archaeological Society, Santa Cruz.
- Dietz, S.A., W.R. Hildebrandt, and T. Jones 1988. *Archaeological Investigations at Elkhorn Slough: CA-MNT-229 A Middle Period Site on the Central California Coast*. Papers in Northern California Anthropology, Number 3.

*Subject: Cultural Resource Inventory for the CSU Monterey Bay EIR Master Plan Project,
Monterey County, California*

- Dietz, S.A and T.L. Jackson 1981. *Report of Archaeological Excavations at Nineteen Archaeological Sites for the Stage 1 Pacific Grove-Monterey Consolidation Project Regional Sewerage System*. Coyote Press, Salinas, CA
- Erlandson, J.M., M.H. Graham, B.J. Bourque, D. Corbett, J.A. Estes, and R.S. Steneck. 2007. The Kelp Highway Hypothesis: Marine Ecology, the Coastal Migration Theory, and the Peopling of the Americas. *The Journal of Island and Coastal Archaeology* 2(2): 161–174.
- Fitzgerald, R.T., J.L. Edwards, J.M. Farquhar, and K. Loeffler. 1995. *Archaeological Test Excavation at CA-MNT-1765, for the Moro Cojo Standard Subdivision Project (SH93001), Monterey County, California*. Biosystems Analysis, Inc., Santa Cruz. Report on file Northwest Information Center, Department of Anthropology, Sonoma State University, Rohnert Park.
- Fitzgerald, R.T. and T.L. Jones 1999. The Milling Stone Horizon Revisited: New Perspectives from Northern and Central California. *Journal of California and Great Basin Anthropology* 21:65-93.
- Fitzgerald, R.T. and A. Ruby. 1997. *Archaeological Test Excavations at CA-SCR-117, the Davenport Landing Site*. Garcia and Associates, San Anselmo. Report on file Northwest Information Center, Department of Anthropology, Sonoma State University, Rohnert Park.
- Gibson, R.O. 1996. *Results of Archaeological Monitoring for Unocal Soil Testing Program along Pipelines near Santa Margarita, San Luis Obispo County, California*. Gibson's Archaeological Consulting, Paso Robles. Report submitted to UNOCAL CERT, San Luis Obispo. Copies available from the Central Coast Information Center, Department of Anthropology, University of California, Santa Barbara.
- Hildebrandt, W.R. 2006. *Archaeological Evaluation of the Priest Valley Knoll Sites (CA-MNT-745), Eastern Monterey County, California*. Far Western Anthropological Research Group, Inc., Davis. Copies available from the Northwest Information Center, Department of Anthropology, Sonoma State University, Rohnert Park.
- Hildebrandt, W.R., and P. Mikkelsen. 1993. *Archaeological Test Excavations at Fourteen Sites Along Highways 101 and 152, Santa Clara and San Benito Counties, California Volume 1: Prehistory*. Prepared for Caltrans District 4, Oakland. Copies available from Northwest Information Center, Department of Anthropology, Sonoma State University, Rohnert Park.

*Subject: Cultural Resource Inventory for the CSU Monterey Bay EIR Master Plan Project,
Monterey County, California*

- Holm, L., K. Chao and J. Holson. 2013. *Archaeological Assessment for the City of Monterey 2013 Sewer Rehabilitation Project, Monterey County, California PL-2616-21 (Updated July 2013)*. Report on file at the Northwest Information Center, Sonoma State University, Rohnert Park.
- Hylkema, M.G. 1991. *Prehistoric Native American Adaptations Along the Central California Coast of San Mateo and Santa Cruz Counties*. Master's thesis, Department of Anthropology, San Jose State University. University Microfilms, Ann Arbor.
- Jones, T.L. 1993. Big Sur: A Keystone in Central California Culture History. *Pacific Coast Archaeological Quarterly*.
- Jones, T.L. 1995. *Transitions in Prehistoric Diet, Mobility, Exchange, and Social Organization Along California's Big Sur Coast*. Unpublished Ph.D. Dissertation, Department of Anthropology, University of California, Davis.
- Jones, T.L. 2003. *Prehistoric Human Ecology of the Big Sur Coast, California*. Contributions of the University of California Archaeological Research Facility, Berkeley.
- Jones, T.L., G. M. Brown, L.M. Raab, J.L. McVickar, W.G. Spaulding, D.J. Kennett, A. York, and P.L. Walker. 1999. Environmental Imperatives Reconsidered: Demographic Crises in Western North America During the Medieval Climatic Anomaly. *Current Anthropology* 40:137-170.
- Jones, T.L. and J.A. Ferneau 2002a. Prehistory at San Simeon Reef: Archaeological Data Recovery at CA-SLO-179 and -267, San Luis Obispo, California. *San Luis Obispo Archaeological Society Occasional Paper No. 16*.
- Jones, T.L., and J.A. Ferneau. 2002b. Deintensification along the Central Coast. In *Catalysts to Complexity: Late Holocene Societies of the California Coast*, edited by J.M. Erlandson and T.L. Jones, pp. 205-232. Perspectives in California Archaeology, Vol. 6. Cotsen Institute of Archaeology, University of California, Los Angeles.
- Jones, T.L. and J. Haney. 2005. Archaeological Evaluation of CA-MNT-910, -1748/H, -1919, and -2182, Fort Hunter Liggett Military Installation, Monterey County, California. California Polytechnic State University, San Luis Obispo.

- Jones, D., and W.R. Hildebrandt. 1990. *Archaeological Investigation at Sand Hill Bluff: Portions of Prehistoric Site CA-SCr-7, Santa Cruz County, California*. Far Western Anthropological Research Group, Inc., Davis. Copies available from Northwest Information Center, Department of Anthropology, Sonoma State University, Rohnert Park.
- Jones, D., and W.R. Hildebrandt. 1994. *Archaeological Investigations at Sites CA-SCR-10, CA-SCR-17, CA-SCR-304, and CA-SCR-38/123 for the North Coast Treated Water Main Project, Santa Cruz County, California*. Far Western Anthropological Research Group, Inc. Copies available from Northwest Information Center, Department of Anthropology, Sonoma State University, Rohnert Park.
- Jones, T.L., and D. Jones. 1992. Elkhorn Slough Revisited: Reassessing the Chronology of CA-MNT-229. *Journal of California and Great Basin Anthropology* 14:159-179.
- Jones, T.L., J.F. Porcasi, J.W. Gaeta, and B.F. Coddig. 2008. The Diablo Canyon Fauna: A Coarse-grained Record of Trans-Holocene Foraging from the Central California Mainland Coast. *American Antiquity* 73:289–316.
- Jones, T. L., N. E. Stevens, D. A. Jones, R. T. Fitzgerald, and M. G. Hylkema. 2007. The Central Coast: A Midlatitude Milieu. In *California Prehistory Colonization, Culture, and Complexity*, edited by Terry L. Jones and Kathryn A. Klar, pp: 125-146. Altamira Press, Lanham.
- Jones, T.L., T. Van Bueren, S. Grantham, J. Huddleson, and T.W. Fung. 1996. *Archaeological Test Excavations for the State Highway 1 Widening Project Near Castroville, Monterey County, California*. Office of Cultural Studies, California Department of Transportation. Prepared for Caltrans, District 5, San Luis Obispo. Copies available from Northwest Information Center, Department of Anthropology, Sonoma State University, Rohnert Park.
- Jones, T.L. and G. Waugh 1995. Central California Coastal Prehistory: A View from Little Pico Creek. *Perspectives in California Archaeology* No. 3, Institute of Archaeology, University of California, Los Angeles.
- Jones, T.L. and G. Waugh 1997. Climatic Consequences or Population Pragmatism? A Middle Holocene Prehistory of the Central California Coast. In *Archaeology of the California Coast During the Middle Holocene*, edited by J.M. Erlandson and M.A. Glassow, pp. 111-128. *Perspectives in California Archaeology* 4. Institute of Archaeology, University of California, Los Angeles.

*Subject: Cultural Resource Inventory for the CSU Monterey Bay EIR Master Plan Project,
Monterey County, California*

- Levy, R. 1978. Costanoan. *Handbook of North American Indians*. Vol. 8. Edited by Robert F. Heizer. Smithsonian Institution, Washington.
- Mikkelsen, P., W.R. Hildebrandt and D.A. Jones. 2000. *Prehistoric Adaptations on the Shores of Morro Bay Estuary: Excavations at Site CA-SLO-165, Morro Bay, California*. Occasional Paper No. 14, San Luis Obispo County Archaeological Society, San Luis Obispo, California.
- Milliken, R. J. and J.R. Johnson. 2010. South Coast Ranges Analytical Zone. In *The Contact-Period Native California Community Distribution Model: A Dynamic Digital Atlas and Wiki Encyclopedia 10*. Far Western Anthropological Research Group, Inc., Davis, California. Report submitted to Caltrans District 6, Fresno, California.
- Milliken, R., J. Nelson, W.R. Hildebrandt, and P. Mikkelsen. 1999. *The Moss Landing Hill Site: A Technical Report on Archaeological Studies at CA-MNT-234 in 1991 and 1997-1998*. Far Western Anthropological Research Group, Inc., Davis. Copies available from the Northwest Information Center, Department of Anthropology, Sonoma State University, Rohnert Park.
- Mills, W.W., M.F. Rondeau, and T.L. Jones. 2005. A Fluted Point from Nipomo, San Luis Obispo County, California. *Journal of California and Great Basin Anthropology* 25:214-220.
- Newsome, S.D., D.L. Phillips, B.J. Culleton, T.P. Guilderson, P. Koch. 2004. Dietary Reconstruction of an Early to Middle Holocene Human Population from the Central California Coast: Insights from Advanced Stable Isotope Mixing Models. *Journal of Archaeological Science* 31:1101-1115.
- Pilling, A. R. 1950. Site record for CA-MNT-280 (P-27-000385). On file, Northwest Information Center, Rohnert Park, California.
- Pohorecky, Z.S. 1976. Archaeology of the South Coast Ranges of California. *University of Archaeological Research Facility* 34, Berkeley.
- Rogers, D.B. 1929. *Prehistoric Man of the Santa Barbara Coast*. Museum of Natural History, Santa Barbara.
- Rughe, J. 2016. Fort Ord History. From <http://www.militarymuseum.org/FtOrd.html> accessed Sept. 4, 2018.

*Subject: Cultural Resource Inventory for the CSU Monterey Bay EIR Master Plan Project,
Monterey County, California*

Stine, S. 1994. Extreme and Persistent Drought in California and Patagonia during Medieval Time. *Nature* 369:546-549.

United State Department of Agriculture (USDA), National Resource Conservation Service (NRCS) 2018 Soil Map for Santa Cruz County, California. Accessed online, February 12, 2018. <https://websoilsurvey.sc.egov.usda.gov>

United States Geological Survey (USGS). 1997. Open-file Report 97-489. Geologic Map of Santa Cruz County, California: A Digital Database. Compiled by E. E. Brabb. Electronic document, <https://pubs.usgs.gov/of/1997/of97-489/scruzmap.pdf> accessed February 12, 2018.

Western Regional Climate Center. 2018. Monthly Climate Summary for Fritzsche AAF, California (Fort Ord). Period of Record 04/04/1960 to 11/30/1978. Electronic document: <https://wrcc.dri.edu/summary/Climsmcca.html>. Accessed February 12, 2018.

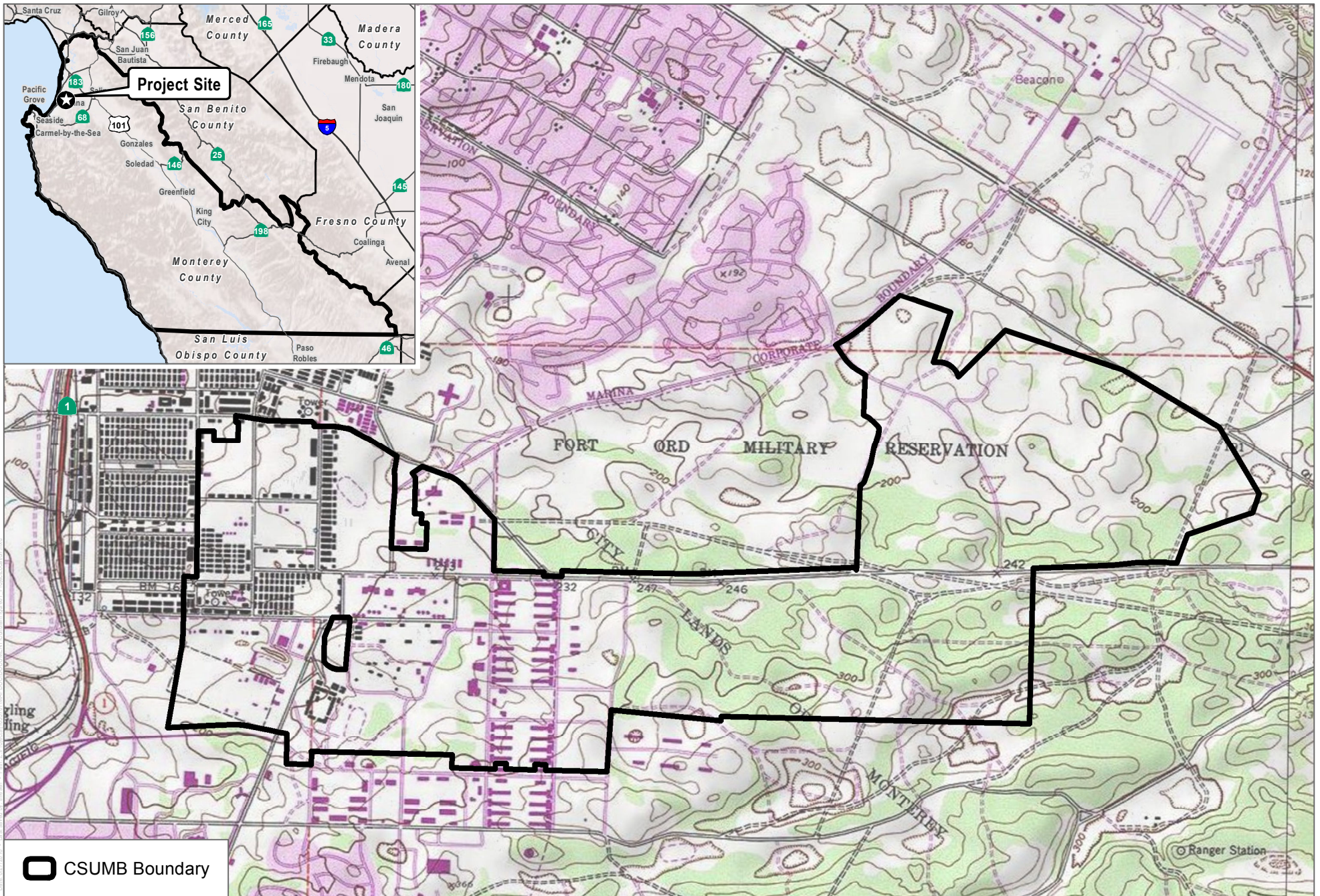

SOURCE: USGS 7.5-Minute Series Marina Quadrangle,
 Township 14S / Range 2E / Sections 32 & 33, Township 15S / Range 1E / Section 01,
 Township 15S / Range 2E / Sections 04, 05 & 06



FIGURE 1

Project Location

Numbers

10X Existing Buildings Removed

10X Existing Buildings to Remain

10X Proposed Buildings

Existing Buildings Removed

Near-Term Projects

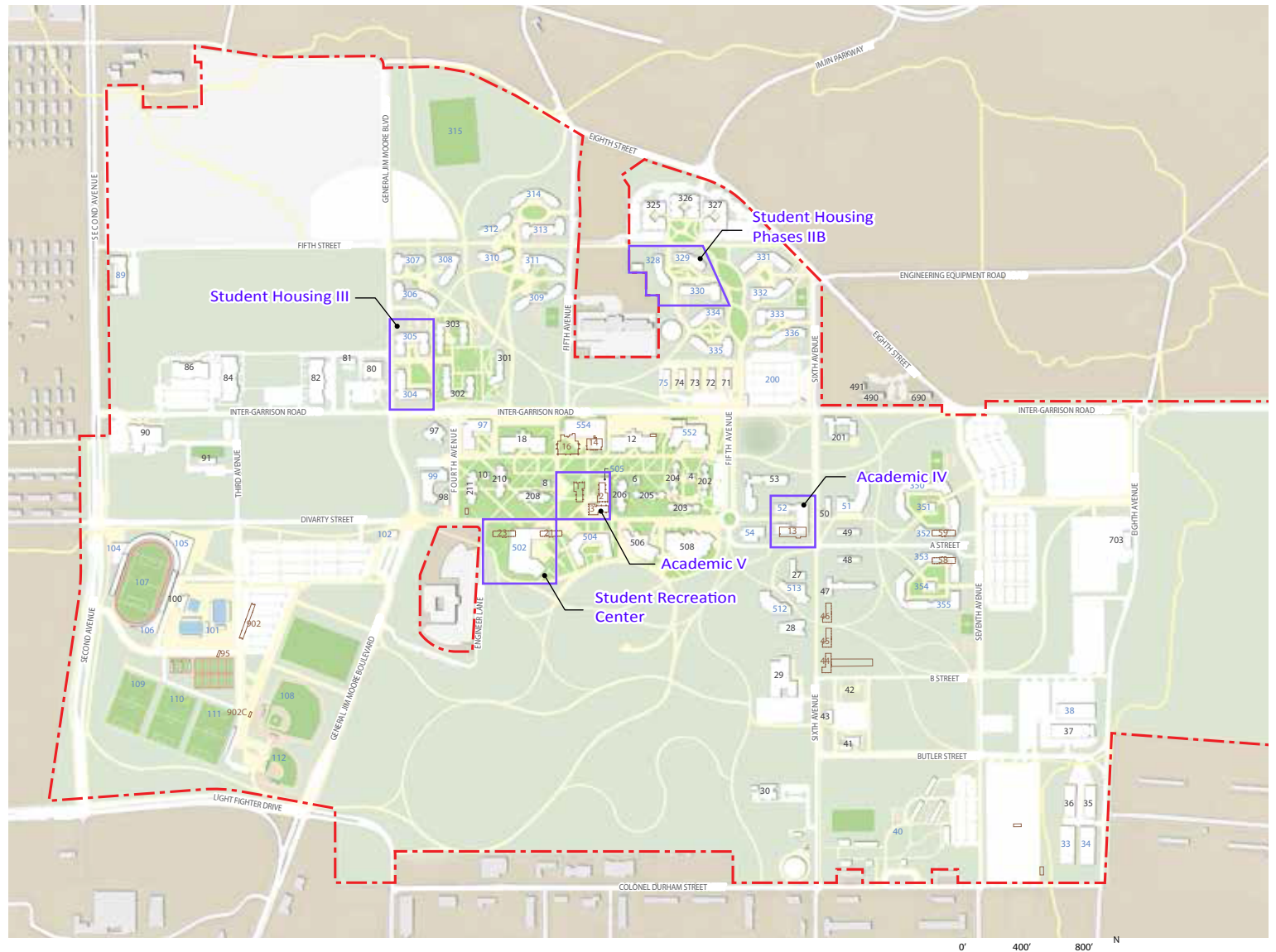

SOURCE: Page / BMS Design Group (2017)

DUDEK

FIGURE 2
Implementation Plan and Near-Term Project Sites

Cultural Resource Inventory for the CSU Monterey Bay Master Plan EIR

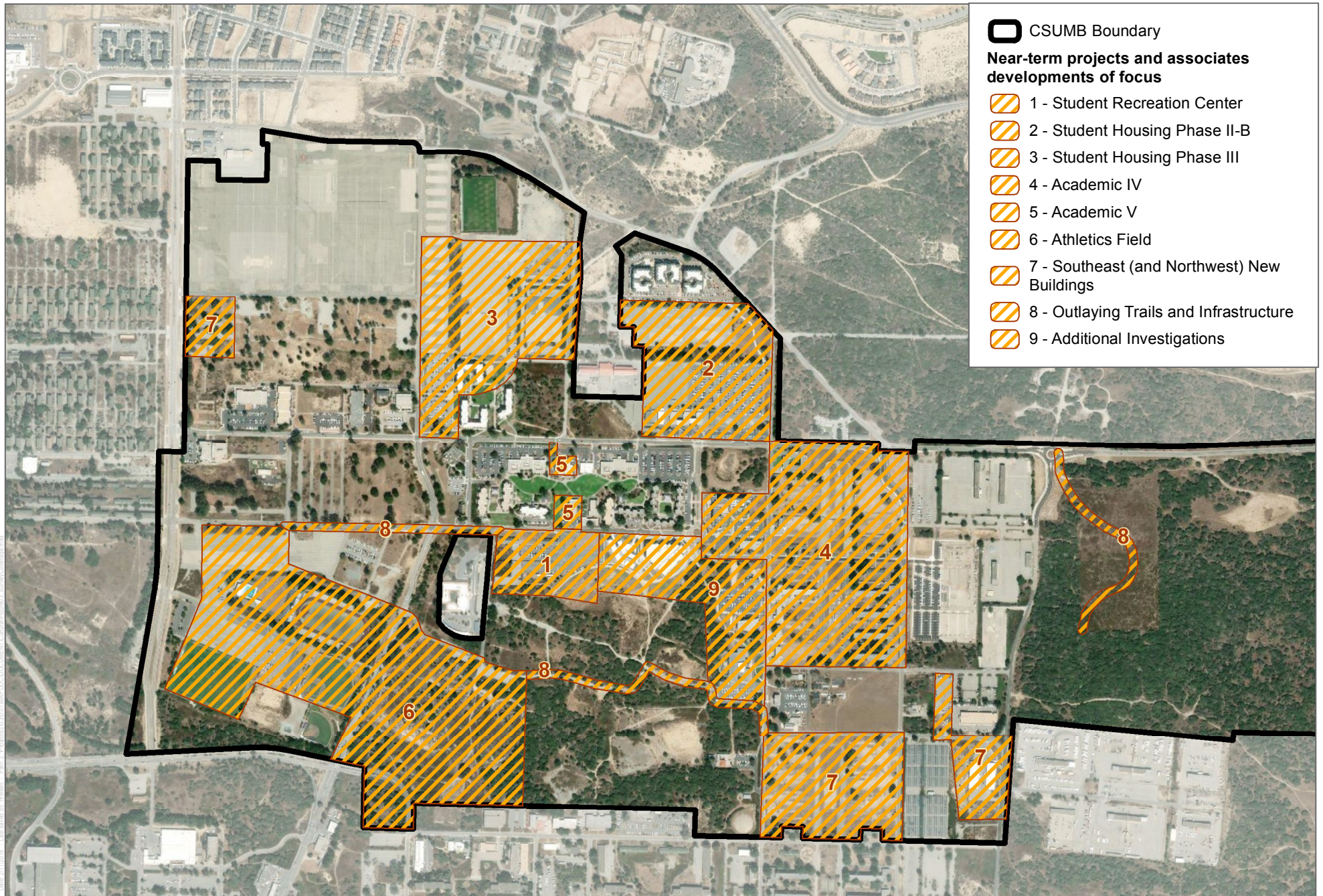

SOURCE: Bing Maps 2019

Attachment 1
National Archaeological Database Information

NATIONAL ARCHAEOLOGICAL DATABASE (NADB) INFORMATION

Authors: Ryan Brady, MA, RPA and Sarah Brewer, BA

Firm: Dudek

Project Proponent: California State University Monterey Bay

Report Date: January 2019

Report Title: Cultural Resource Inventory for the CSU Monterey Bay EIR Master Plan Project, Monterey County, California

Type of Study: Archaeological Inventory

Resources: P-27-000385

USGS Quads: Marina, CA 1:24,000 Salinas, CA 1:24,000; T14S, 15S; R2E, 1E

Acreage: 1,396 acres

Permit Numbers: Permit Pending

Keywords: CSU Monterey Bay, Fort Ord, Marina,

Attachment 2
NWIC Records Search Results (Confidential)

Attachment 3
***Native American Heritage Commission Sacred
Lands File Search (Confidential)***

Attachment 4
Record of AB 52 Consultation
(Confidential)

APPENDIX F2

Built Environment Inventory and Evaluation Report

INTENTIONALLY LEFT BLANK

Built Environment Inventory and Evaluation Report for The California State University, Monterey Bay Master Plan

Prepared for:

California State University, Monterey Bay

100 Campus Center

Seaside, California 93955

Contact: Anya Spear, LEED BD+C, AICP

Associate Director of Regional Environmental Planning

Prepared by:

Sarah Corder, MFA; Adrienne Donovan Boyd, MSHP; and Laura Carias, MA

DUDEK

725 Front Street, Suite 400

Santa Cruz, California 95060

SEPTEMBER 2021

Table of Contents

<u>SECTION</u>	<u>PAGE NO.</u>
EXECUTIVE SUMMARY	V
1 INTRODUCTION	1
1.1 Project Location and Setting.....	1
1.2 Project Description	1
1.3 Project Team.....	5
1.4 Regulatory Setting	11
1.5 Master Plan Study Area and Areas of Direct Impact for Built Environment Resources	18
2 METHODS	19
2.1 Records Search and Other Sources	19
2.1.1 California Historical Resource Information System Record Search	19
2.1.2 Built Environment Resource Database Search.....	24
2.1.3 Additional Studies.....	24
2.2 Building Development and Archival Research.....	26
2.3 Built Environment Field Methods	27
3 HISTORIC CONTEXT.....	29
3.1 Historical Overview of Monterey County	29
3.2 Historical Overview of Marina	30
3.3 Historical Overview of Seaside	31
3.4 Historical Overview of Fort Ord	32
3.4.1 Camp Gigling to Camp Ord (1917-1940).....	32
3.4.2 Fort Ord and the 7th Infantry Division (1940-1945).....	34
3.4.3 Cold War and Vietnam Eras at Fort Ord (1946-1976).....	35
3.4.4 Built Environment ADI Buildings Constructed During the Cold War and Vietnam Era (1946-1976)	38
3.4.5 The Volunteer Army - and the Base Realignment and Closure (BRAC) (1974-1994)	49
3.5 Notable Fort Ord Architects and Builders	53
3.5.1 Del E. Webb Construction Company	53
3.5.2 Milton T. Pflueger.....	53
3.5.3 Robert Stanton.....	54
3.6 Notable Fort Ord Military Personnel	54
3.6.1 General Joseph “Vinegar Joe” Stilwell.....	54
3.6.2 Lt. James (Jim) E. Moore	55
3.7 Fort Ord Building Typology and Character-Defining Features.....	55
3.7.1 Support Services Buildings	55
3.7.2 Medical Buildings.....	57

3.7.3	Hammerhead Buildings/Barracks	59
3.7.4	Recreational Facilities	60
3.8	Historical Overview California State University Monterey Bay	62
3.8.1	Higher Public Education in California	62
3.8.2	Historical Overview of CSUMB (1991-present)	63
4	RESULTS OF IDENTIFICATION EFFORTS AND BUILDING DESCRIPTIONS.....	67
5	SIGNIFICANCE EVALUATION FINDINGS	75
6	SUMMARY OF FINDINGS AND MANAGEMENT RECOMMENDATIONS	79
6.1	Summary of Findings	79
7	REFERENCES	81

APPENDICES

- A Preparer’s Qualifications
- B DPR Forms

FIGURES

1	Project Location.....	7
2	Built Environment Study Area.....	9
3	Impermanent, temporary tents and buildings at Fort Ord c. 1939 (CSUMB 2021: Image 121).	33
4	Fort Ord picture showing semi-permanent buildings and tents, 1940 (CSUMB 2021: Image 131).	34
5	Fort Ord, after construction of main garrison and infrastructure, such as roads, date unknown (DLIFLC 2021).	35
6	Fort Ord, Specialist 4, Abil Abdallah Mughannam at the new Fort Ord barracks in November of 1960 (DLIFLC 2021).	37
7	Fort Ord base, aerial image showing the completed barracks, c. 1970. The barracks are described as “Old Permanent Barracks, looking south” (DLIFLC 2021).	38
8	Fort Ord 1953 architectural drawing of the Permanent Troop Spaces and Supporting Facilities Classrooms (Buildings 21, 23, 58, 59) (CSUMB Facilities 2021).	40
9	Fort Ord 1995 architectural drawing of changes made to some of the buildings that used the Permanent Troop Spaces and Supporting Facilities Classroom building plan (CSUMB Facilities 2021). ..	40
10	Fort Ord 1963 architectural drawing of the Science Research Lab Annex (Building 13) (CSUMB Facilities 2021).	42
11	Photograph (c. 1990) of the Science Research Lab Annex (Building 13) after its conversion to the Stone Army Dental Clinic (DLIFLC 2021).	42
12	Fort Ord 1956 architectural drawing of the Watershed Institute (Building 42) (front elevation) (CSUMB Facilities 2021).	43
13	Fort Ord 1956 architectural drawing of the Watershed Institute (Building 42) (rear elevation) (CSUMB Facilities 2021).	43

14	Fort Ord, after construction of new barracks between 1952 and 1954 (The Webb Spinner 1952-54, Vol 8. No. 5:6).....	44
15	Fort Ord 1952 Conceptual drawing of the new barracks at Fort Ord (The Web Spinner 1952-54, Vol 6. No. 3:1).....	45
16	Fort Ord architectural site plan of the Hammerhead Buildings/Barracks (CSUMB Facilities 2021).....	45
17	Fort Ord 1951 conceptual drawing of the Stadium (CSUMB Facilities 2021).	48
18	Fort Ord 1949 architectural drawing the Field House (CSUMB Facilities 2021).	48
19	1987 Aerial showing the current main campus boundary with intact Fort Ord buildings	51
20	2021 Aerial showing the current main campus boundary with areas of extensive demolition of Fort Ord buildings and significant changes in paths of circulation.....	51
21	Building 58, Green Hall, View facing southeast at the north elevation (IMG_0566).....	56
22	Building 13, the Science Research Lab Annex, View facing northwest at the south elevation (IMG_0715).	57
23	Building 44, Pacific Hall, View facing east at the west elevation (IMG_0602).	59
24	Building 902, Freeman Stadium, View facing northeast at the west elevation (IMG_0431).....	61

TABLES

1	Proposed Master Plan Development	2
2	Proposed Master Plan Building Removal.....	4
3	Previously Conducted Technical Studies.....	19
4	Previously Recorded Built Environment Resources	23
5	Character-Defining Features: Fort Ord Support Services Buildings.....	56
6	Character-Defining Features: Fort Ord Medical Buildings	58
7	Character-Defining Features: The Hammerhead Buildings/Barracks	59
8	Character-defining features: Fort Ord Recreational Facilities	61
9	Properties Surveyed	69
10	Individual Significance Findings for CSUMB Buildings within the ADI	76

INTENTIONALLY LEFT BLANK

Executive Summary

As part of cultural resources investigations for the CSUMB Master Plan Environmental Impact Report (EIR), Dudek was retained by California State University, Monterey Bay (CSUMB) to conduct a built environment inventory and evaluation study.

This built environment inventory and evaluation report included a records search of the campus and a one-mile radius around its boundary; an intensive level survey of the campus; archival and building development research for buildings located within the campus boundaries; evaluation of buildings for the National Register of Historic Places (NRHP), California Register of Historical Resources (CRHR), California Historical Landmark (CHL), and local eligibility criteria and integrity requirements; and an assessment of impacts to historical resources in compliance with the California Environmental Quality Act (CEQA) and Public Resources Code (PRC) Sections 5024 and 5024.5 for state-owned resources.

In order to identify potential built environment historical resources that may sustain significant impacts through implementation of the CSUMB Master Plan (Project), a California Historical Resource Information System (CHRIS) record search of the campus and buffer was completed by the Northwest Information Center (NWIC) at Sonoma State University on August 27, 2017. The 2017 records search included a review of the following: Archaeological and non-archaeological resource records and reports on file at NWIC; Office of Historic Preservation (OHP) Historic Properties Directory; OHP Archaeological Determinations of Eligibility; California Inventory of Historical Resources (1976); Historical Maps; Local Inventories; and General Land Office (GLO) and/or rancho Plat Maps.

In addition, all 11 properties located within the CSUMB campus Areas of Direct Impact for Built Environment Resources (ADI) that were constructed at least 45 years ago as of 2021 (i.e., on or before 1976) and proposed for demolition or substantial alteration as part of the Project were photographed, researched, and evaluated in consideration of NRHP, CRHR, CHL, and local designation criteria and integrity requirements, and in consideration of potential impacts to historical resources under CEQA and PRC Sections 5024 and 5024.5.

Dudek formally recorded and evaluated 11 properties over 45 years old located within the ADI proposed for renovation, alteration, or demolition as part of the Project. All 11 of these built environment properties were identified as not eligible for national, state, or local designation. Consequently, all 11 built environment properties evaluated for the purposes of the Project are not considered historical resources under CEQA.

INTENTIONALLY LEFT BLANK

1 Introduction

Dudek was retained by California State University, Monterey Bay (CSUMB) to conduct a built environment inventory and evaluation study and report for the proposed CSUMB Master Plan (Project) (Figure 1). Only buildings and structures (properties) over 45 years old and proposed for renovation or demolition as part the proposed Project were included in the historic built environment study of the CSUMB campus (campus). This report includes the following components: (1) a California Historical Resources Information System (CHRIS) records search covering the campus and a one-mile radius around its boundary; (2) results of an intensive-level survey of the campus for built environment resources; (3) archival and building development research for properties located within the campus boundaries; (4) the evaluation of properties for the National Register of Historic Places (NRHP); California Register of Historical Resources (CRHR), California Historical Landmark (CHL), and local eligibility criteria and integrity requirements; and (5) consideration of impacts to cultural resources in compliance with the California Environmental Quality Act (CEQA) and Public Resources Code (PRC) Sections 5024 and 5024.5 for state-owned resources. This chapter provides an overview of the Project, qualifications of Dudek staff that prepared this report, regulatory setting, and a description of the Built Environment Study Area (Figure 2).

1.1 Project Location and Setting

The campus is located approximately 100 miles south of San Francisco, in Seaside, California, north of the Monterey Peninsula, and near the southern-central portion of Monterey Bay. The campus covers 1,396 acres, which were historically part of the northwestern portion of the U.S. Department of Army Fort Ord Military Reservation (Figure 1). The campus lies within three separate governmental jurisdictions: The City of Marina, the City of Seaside, and unincorporated Monterey County. Primary access to the campus is available from Highway 1, via the main entrance at Lightfighter Drive to the south and from Imjin Parkway to the north. Access is also provided via Second Avenue from the north, General Jim Moore Boulevard from the south, and Inter-Garrison Road and Divarty Street from the east. Inter-Garrison Road connects the East Campus Housing area to the Main Campus.

1.2 Project Description

The Project is the proposed California State University, Monterey Bay (CSUMB) Master Plan (proposed Master Plan), including Project Design Features (PDFs) drawn from the CSUMB Master Plan Guidelines (Master Plan Guidelines), and five “near-term” development components to be constructed pursuant to the proposed Master Plan within the next 10 years (collectively, the Project). The Project would provide the basis for the physical development of the CSUMB campus consistent with the vision identified in the Master Plan Guidelines and the mission of the University.

The Project would provide a blueprint for land uses and building and facility space requirements to support an on-campus enrollment of 12,700 full-time-equivalent students (FTES¹) and 1,776 FTE faculty and staff by the year 2035. Achieving this growth would result in an increase of approximately 6,066 FTES and 752 FTE faculty/staff over existing levels (academic year 2016-2017).

¹ Full-time equivalent student (FTES) is the unit of measurement used to convert class load to student enrollment. At CSUMB, one FTES is equal to 15 units. Thus, one FTES is equal to one student enrolled in 15 units or three students each enrolled in 5 units. A related unit of measurement is “headcount.” In the case of one student taking 15 units, the headcount is 1; in the case of three students collectively taking 15 units, the headcount is 3.

The Project also would result in approximately 2.9 million gross square feet (GSF) of total new academic, administration, student life, athletic and recreational, and institutional partnership² facilities, and housing development and a net increase of approximately 2.6 million GSF, when considering the demolition of existing buildings (see Table 1). Some of the future building development would include demolition of existing buildings that are currently being used for academic and/or student purposes. The proposed Master Plan anticipates that up to 24 buildings, totaling approximately 256,400 GSF, would be demolished as part of the construction of new buildings (see Table 2).

On-campus housing would be constructed sufficient to continue to accommodate 60 percent of FTES and existing housing would accommodate 65 percent of FTE faculty and staff, with a projected increase of 3,820 student beds and 757 converted residential units for faculty and staff. The Project also would accommodate redevelopment and growth in outdoor athletics and recreation facilities to serve campus needs, with space set aside for additional athletic fields, tennis courts, and pools, as well as for replacement of the existing stadium, field house, and pool house. A stadium and field house renovation project is the subject of separate CEQA review underway in 2021.

As noted above, the Project includes specific development components identified in the proposed Master Plan and expected to be constructed in the next 10 years; these Project components are referred to throughout this EIR as “near-term development components.” These near-term development components include: 1) Student Housing Phase III (600 student housing beds); 2) Academic IV (95,000 GSF of classroom/instructional space); 3) Student Recreation Center (70,000 GSF of recreation space); 4) Student Housing Phase IIB (400 student housing beds); and 5) Academic V (76,700 GSF of classroom/instructional space).

Table 1. Proposed Master Plan Development

Campus Space	Beds/Units	GSF ¹	Implementation	
			Horizon I	Horizon II
EXISTING SPACE (2016-2017)				
Main Campus Facilities (Non-Residential) ²	—	1,142,777	NA	
Student Housing Main Campus	2,600 beds	1,171,264	NA	
Student Housing East Campus Housing ³	1,380 beds / 466 units			
Faculty, Staff & Community Partners Housing (East Campus Housing) ⁴	754 units	876,515	NA	
Total Existing Space	3,980 beds / 1,220 units	3,190,556	NA	
APPROVED BUT NOT YET CONSTRUCTED PROJECT				
Monterey Bay Charter School	—	60,000	✓	
Total Pending or Approved Space	—	60,000	✓	
MASTER PLAN - NEW DEVELOPMENT⁵				
Academic Space		403,160		
• Academic IV	—	95,000	✓	
• Academic V		76,704	✓	
• Academic VI		76,704		✓

² Institutional Partnerships are projects involving public-public or public-private partnerships and long-term contractual relationships that use or develop CSU real property to further the educational mission of the campus.

Table 1. Proposed Master Plan Development

Campus Space	Beds/Units	GSF1	Implementation	
			Horizon I	Horizon II
<ul style="list-style-type: none"> Academic VII Academic VIII Greenhouses 		76,704		✓
		76,704		✓
		1,344	✓	
Institutional Partnerships - Panetta Institute	—	64,000	✓	
Administration Buildings	—	77,454	✓	
“Student Life” Buildings		270,764		
<ul style="list-style-type: none"> Childcare Center 		23,000	✓	
<ul style="list-style-type: none"> Student Life Space (Phase I and II)⁶ 	—	145,473	✓	
<ul style="list-style-type: none"> Campus Arts & Auditorium 		82,291		✓
<ul style="list-style-type: none"> Student Union Phase II 		20,000		✓
Indoor Recreation Buildings and Facilities		165,343		
<ul style="list-style-type: none"> Recreation Center (Phase I and II) 	—	70,000	✓	
<ul style="list-style-type: none"> Recreation Center Addition (Phase III) 		64,574		✓
<ul style="list-style-type: none"> Wellness Center 		30,769	✓	
Outdoor Athletics & Recreation Support Buildings	—	59,679		
<ul style="list-style-type: none"> Stadium House 		40,177	✓	
<ul style="list-style-type: none"> Otter Retail Space 		10,502	✓	
<ul style="list-style-type: none"> Aquatics Center 	—	7,000		✓
<ul style="list-style-type: none"> Field House 		2,000	✓	
Facilities Building		73,590		
<ul style="list-style-type: none"> Facilities Building 	—	23,590	✓	
<ul style="list-style-type: none"> Facilities Storage Buildings 		50,000	✓	
Housing	3,820 beds / 757 units	1,760,000		
<ul style="list-style-type: none"> East Campus Housing Conversion⁷ 	-1,380 beds / 757 units	NA	✓	
<ul style="list-style-type: none"> Student Housing Phase IIB 	400 beds	160,000	✓	
<ul style="list-style-type: none"> Student Housing Phase III 	600 beds	200,000	✓	
<ul style="list-style-type: none"> Student Housing Phase IV 	600 beds	200,000	✓	
<ul style="list-style-type: none"> Student Housing Phase V 	600 beds	200,000	✓	
<ul style="list-style-type: none"> Student Housing Phase VI 	600 beds	200,000	✓	
<ul style="list-style-type: none"> Student Housing Phase VII 	600 beds	200,000		✓
<ul style="list-style-type: none"> Student Housing Phase VIII 	600 beds	200,000		✓
<ul style="list-style-type: none"> Student Housing Phase IX 	600 beds	200,000		✓
<ul style="list-style-type: none"> Student Housing Phase X 	600 beds	200,000		✓
Total New Space with Master Plan⁷	3,820 beds / 757 units	2,873,990		NA
Existing Building	3,980 beds / 1,220 units	3,190,556		NA
Approved and Pending Building Projects	NA	60,000		NA

Table 1. Proposed Master Plan Development

Campus Space	Beds/Units	GSF1	Implementation	
			Horizon I	Horizon II
Total New Building Space with Master Plan ⁷	3,820 beds / 757units	2,873,990	NA	
Total Building Space to be Demolished	NA	-256,366	NA	
Net Increase in Building Space with Master Plan ⁶	3,820 beds / 757 units	2,617,624	NA	
Total Future Building Space	7,800 Beds / 1,220 Units	5,868,180	Na	

Notes:

1. GSF = gross square feet
2. Excludes existing baseball, softball, soccer and recreation fields and stadiums seating = 596,375 GSF.
3. Of the 466 units in East Campus Housing (Frederick Park I & II) for student housing, 460 units currently house 1,380 student beds and the remaining 6 units are used for offices.
4. Of the 754 units in East Campus Housing (Schoonover Park I & II) for faculty, staff, and Community Housing Partners, 676 units are currently rented or owned.
5. New Master Plan development does not include development on the faculty and staff housing reserve site or the potential athletics expansion area, as development in these areas is not part of the Project. Likewise, Institutional Partnership development beyond the Panetta Institute and the Monterey Bay Charter School is also not part of the Project.
6. To support mixed use development, Student Life space will be allocated within future buildings, as needed.
7. The 757 units for faculty and staff housing would be provided by reallocating and converting existing student housing to faculty and staff housing units and by converting units that are currently not rentable and units occupied by Community Housing Partners. No new faculty and staff housing units would be constructed under the proposed Master Plan.

Table 2. Proposed Master Plan Building Removal

Building #	Building Name	Square Footage (GSF)
1	Administration	5,820
2	Playa Hall	5,829
3	Del Mar Hall	5,820
13	Science Research Lab Annex	12,743
14	Otter Express	7,191
16	Dining Commons	14,080
21	Beach Hall	5,627
23	Tide Hall	5,627
42	Watershed Institute	3,772
44	Pacific Hall	5,000
45	Coast Hall	5,000
46	Harbor Hall	5,000
58	Green Hall	5,627
59	Reading Center	5,627
70	Visual & Public Arts - Far East (Potential Removal)	4,816
87	Panetta Institute Storage	2,695
95	Soccer Field Restrooms	525
100	Aquatics Center Pump House	1,322
902	Field House	5,250
903	Stadium Track and Field	137,400
903A	Stadium Seats North	5,364
903B	Stadium Seats South	5,364
903C	Field Electrical	150

Table 2. Proposed Master Plan Building Removal

Building #	Building Name	Square Footage (GSF)
904	Field Office	385
Total Gross Square Footage		256,366

1.3 Project Team

The Dudek project team responsible for this report include Historic Built Environment Lead and Task Manager Sarah Corder, MFA, and Dudek Architectural Historians Adrienne Donovan-Boyd, MSHP, and Laura G. Carias, MA. The report was reviewed for quality assurance/quality control by Dudek Senior Architectural Historians Allison Lyons, MSHP, and Kathryn Haley, MA. All authors and reviewers meet the Secretary of the Interior’s Professional Qualification Standards (36 CFR Part 61) for architectural history. Preparer’s qualifications are located in Appendix A.

INTENTIONALLY LEFT BLANK

Figure 1. Project Location

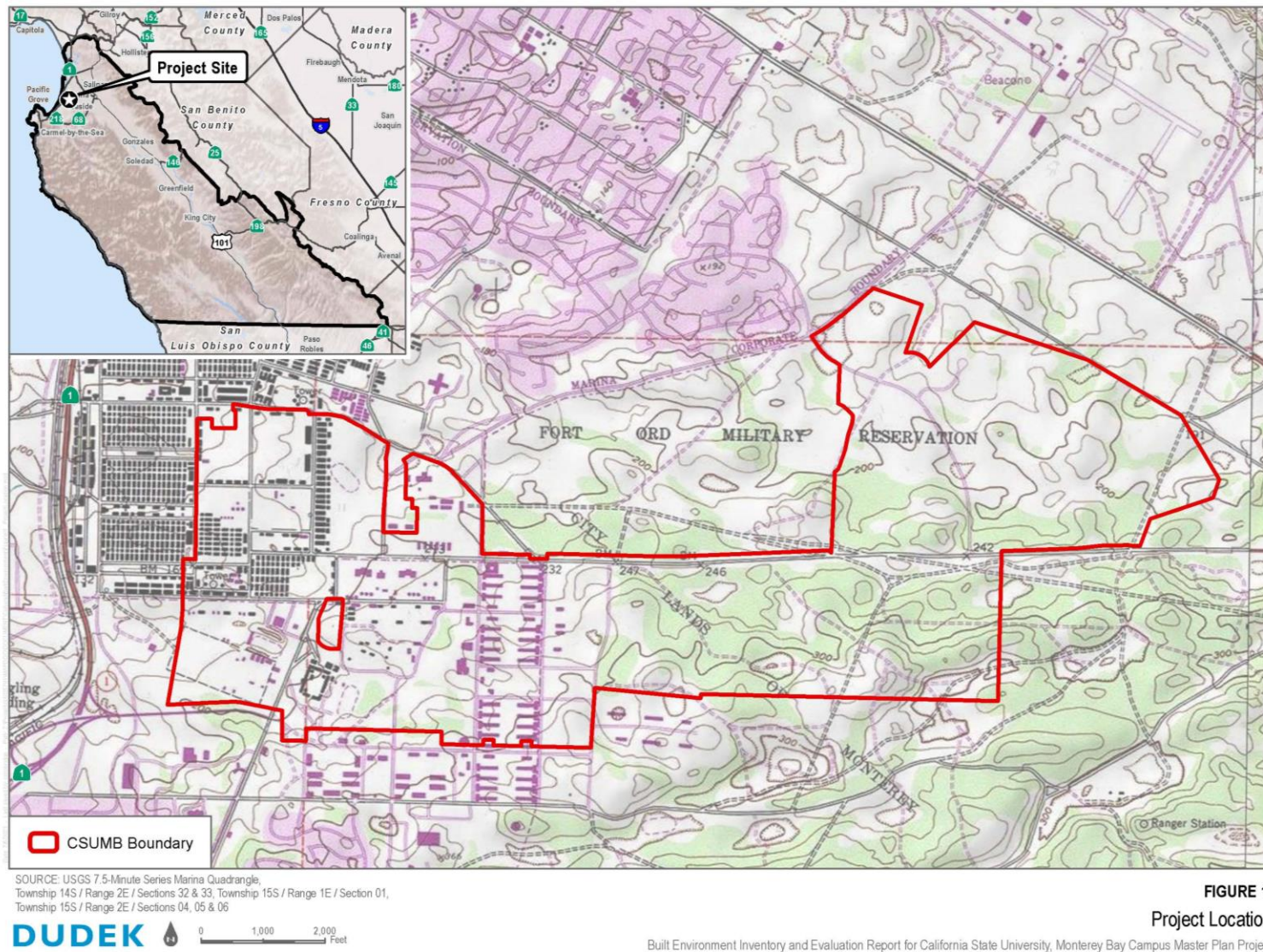

FIGURE 1
Project Location

Built Environment Inventory and Evaluation Report for California State University, Monterey Bay Campus Master Plan Project

INTENTIONALLY LEFT BLANK

Figure 2. Built Environment Study Area



SOURCE: Bing Vise 2021



FIGURE 2

Built Environment Study Area

Built Environment Inventory and Evaluation Report for California State University, Monterey Bay Campus Master Plan Project

INTENTIONALLY LEFT BLANK

1.4 Regulatory Setting

Federal

National Register of Historic Places

Although there is no federal nexus for this project, the subject properties were evaluated in consideration of the NRHP designation criteria and integrity requirements to comply with Public Resources Code (PRC) Sections 5024 and 5024.5. The NRHP is the United States' official list of districts, sites, buildings, structures, and objects worthy of preservation. Overseen by the National Park Service under the U.S. Department of the Interior, the NRHP was authorized under the National Historic Preservation Act, as amended. Its listings encompass all National Historic Landmarks, as well as historic areas administered by the National Park Service.

NRHP guidelines for the evaluation of historic significance were developed to be flexible and to recognize the accomplishments of all who have made significant contributions to the nation's history and heritage. Its criteria are designed to guide state and local governments, federal agencies, and others in evaluating potential entries in the NRHP. For a property to be listed in or determined eligible for listing, it must be demonstrated to possess integrity and to meet at least one of the following criteria:

The quality of significance in American history, architecture, archaeology, engineering, and culture is present in districts, sites, buildings, structures, and objects that possess integrity of location, design, setting, materials, workmanship, feeling, and association, and:

- A. That are associated with events that have made a significant contribution to the broad patterns of our history; or
- B. That are associated with the lives of persons significant in our past; or
- C. That embody the distinctive characteristics of a type, period, or method of construction, or that represent the work of a master, or that possess high artistic values, or that represent a significant and distinguishable entity whose components may lack individual distinction; or
- D. That have yielded, or may be likely to yield, information important in prehistory or history.

Integrity is defined in NRHP guidance, "How to Apply the National Register Criteria," as "the ability of a property to convey its significance. To be listed in the NRHP, a property must not only be shown to be significant under the NRHP criteria, but it also must have integrity" (NPS 1995). NRHP guidance further asserts that properties be completed at least 50 years ago to be considered for eligibility. Properties completed fewer than 50 years before evaluation must be proven to be "exceptionally important" (criteria consideration to be considered for listing).

State

Public Resources Code Sections 5024 and 5024.5

PRC Sections 5024 and 5024.5 provide the following guidance:

- 5024 (a-h): Describes the process of inventorying and evaluating state-owned historical resources in consultation with the State Historic Preservation Officer (SHPO).
- 5024.5 (a-g): Describes the process of identifying adverse effects and development of alternatives and mitigation for state-owned historical resources in consultation with, and as determined by, the SHPO.

Review of Projects Affecting State-Owned Historical Resources

Under PRC Sections 5024(f) and 5024.5, state agencies must provide notification and submit documentation to the SHPO early in the planning process for any project having the potential to affect state-owned historical resources on or eligible for inclusion in the Master List (buildings, structures, landscapes, archaeological sites, and other nonstructural resources). Under PRC Section 5024(f), state agencies request the SHPO's comments on the project.

Under PRC Section 5024.5, it is the SHPO's responsibility to comment on the project and to determine if it may cause an adverse effect (PRC Section 5024.5), defined as a substantial adverse change in the significance of a historical resource (PRC Section 5020.1(q)). In this case, historical resources are defined as resources eligible for or listed in the NRHP and/or resources registered for or eligible for registering as a CHL.

California Historical Landmarks

CHLs are buildings, structures, sites, or places that have been determined to have statewide historical significance by meeting at least one of the criteria listed below (OHP 2019).

- The first, last, only, or most significant of its type in the state or within a large geographic region (Northern, Central, or Southern California).
- Associated with an individual or group having a profound influence on the history of California.
- A prototype of, or an outstanding example of, a period, style, architectural movement or construction or is one of the more notable works or the best surviving work in a region of a pioneer architect, designer or master builder.

The resource also must have written consent of the property owner, be recommended by the State Historical Resources Commission, and be officially designated by the Director of California State Parks. CHLs #770 and above are automatically listed in the CRHR (OHP 2019).

California Register of Historical Resources

In California, the term "historical resource" includes but is not limited to "any object, building, structure, site, area, place, record, or manuscript which is historically or archaeologically significant, or is significant in the architectural, engineering, scientific, economic, agricultural, educational, social, political, military, or cultural annals of California" (California Public Resources Code Section 5020.1(j)). In 1992, the California legislature established the California Register of Historical Resources (CRHR) "to be used by state and local agencies, private groups, and citizens to identify the state's historical resources and to indicate what properties are to be protected, to the extent prudent and feasible, from substantial adverse change" (California Public Resources Code Section 5024.1(a)). The criteria for listing resources on the CRHR were expressly developed to be in accordance with previously established criteria developed for listing in the NRHP, enumerated below. According to California Public Resources Code Section 5024.1(c)(1-4), a resource is considered historically significant if it (i) retains "substantial integrity," and (ii) meets at least one of the following criteria:

1. Is associated with events that have made a significant contribution to the broad patterns of California's history and cultural heritage.
2. Is associated with the lives of persons important in our past.

3. Embodies the distinctive characteristics of a type, period, region, or method of construction, or represents the work of an important creative individual, or possesses high artistic values.
4. Has yielded, or may be likely to yield, information important in prehistory or history.

In order to understand the historic importance of a resource, sufficient time must have passed to obtain a scholarly perspective on the events or individuals associated with the resource. A resource less than 50 years old may be considered for listing in the CRHR if it can be demonstrated that sufficient time has passed to understand its historical importance (see 14 CCR 4852(d)(2)).

The CRHR protects cultural resources by requiring evaluations of the significance of prehistoric and historic resources. The criteria for the CRHR are nearly identical to those for the NRHP, and properties listed or formally designated as eligible for listing in the NRHP are automatically listed in the CRHR, as are the state landmarks and points of interest. The CRHR also includes properties designated under local ordinances or identified through local historical resource surveys.

California Environmental Quality Act

As described further below, the following CEQA statutes and CEQA Guidelines are of relevance to the analysis of archaeological, historic, and tribal cultural resources:

- California Public Resources Code Section 21083.2(g) defines “unique archaeological resource.”
- California Public Resources Code Section 21084.1 and CEQA Guidelines Section 15064.5(a) define “historical resources.” In addition, CEQA Guidelines Section 15064.5(b) defines the phrase “substantial adverse change in the significance of an historical resource.” It also defines the circumstances when a project would materially impair the significance of an historical resource.
- California Public Resources Code Section 21074(a) defines “tribal cultural resources.”
- California Public Resources Code Section 5097.98 and CEQA Guidelines Section 15064.5(e) set forth standards and steps to be employed following the accidental discovery of human remains in any location other than a dedicated ceremony.
- California Public Resources Code Sections 21083.2(b)-(c) and CEQA Guidelines Section 15126.4 provide information regarding the mitigation framework for archaeological and historic resources, including examples of preservation-in-place mitigation measures; preservation-in-place is the preferred manner of mitigating impacts to significant archaeological sites because it maintains the relationship between artifacts and the archaeological context and may also help avoid conflict with religious or cultural values of groups associated with the archaeological site(s).

More specifically, under CEQA, a project may have a significant effect on the environment if it may cause “a substantial adverse change in the significance of an historical resource” (California Public Resources Code Section 21084.1; CEQA Guidelines Section 15064.5(b).) If a site is either listed or eligible for listing in the CRHR, or if it is included in a local register of historic resources or identified as significant in a historical resources survey (meeting the requirements of California Public Resources Code Section 5024.1(q)), it is a “historical resource” and is presumed to be historically or culturally significant for purposes of CEQA (California Public Resources Code Section 21084.1; CEQA Guidelines Section 15064.5(a)). The lead agency is not precluded from determining that a resource is a historical resource even if it does not fall within this presumption (California Public Resources Code Section 21084.1; CEQA Guidelines Section 15064.5(a)).

A “substantial adverse change in the significance of an historical resource” reflecting a significant effect under CEQA means “physical demolition, destruction, relocation, or alteration of the resource or its immediate surroundings such that the significance of an historical resource would be materially impaired” (CEQA Guidelines Section 15064.5(b)(1); California Public Resources Code Section 5020.1(q)). In turn, CEQA Guidelines Section 15064.5(b)(2) states the significance of an historical resource is materially impaired when a project:

1. Demolishes or materially alters in an adverse manner those physical characteristics of an historical resource that convey its historical significance and that justify its inclusion in, or eligibility for, inclusion in the California Register of Historical Resources; or
5. Demolishes or materially alters in an adverse manner those physical characteristics that account for its inclusion in a local register of historical resources pursuant to Section 5020.1(k) of the Public Resources Code or its identification in an historical resources survey meeting the requirements of Section 5024.1(g) of the Public Resources Code, unless the public agency reviewing the effects of the project establishes by a preponderance of evidence that the resource is not historically or culturally significant; or
6. Demolishes or materially alters in an adverse manner those physical characteristics of a historical resource that convey its historical significance and that justify its eligibility for inclusion in the California Register of Historical Resources as determined by a lead agency for purposes of CEQA.

Pursuant to these sections, the CEQA inquiry begins with evaluating whether a project site contains any “historical resources,” then evaluates whether that project will cause a substantial adverse change in the significance of a historical resource such that the resource’s historical significance is materially impaired.

Local

County of Monterey

Preservation of Historic Resources Code of the County of Monterey

Chapter 18.25 of the Monterey County Code of ordinances enumerates the “protection, enhancement, perpetuation, and use of structures and districts of historic, archaeological, architectural, and engineering significance, located within the County (18.25.020 - Intent and Purpose).”

- 18.25.030 – Definitions:

"Cultural resource" means buildings, structures, signs, features, sites, places, areas, or other objects of scientific, aesthetic, educational, cultural, architectural, or historic significance to the residents of the County.”

“Historic district" means an area, which may include public rights-of-way, within the County having special historic and architectural worth and designated as such by the Board of Supervisors pursuant to the provisions of this Chapter. The area may predominantly, though not exclusively, contain historic resources.”

"Historic resource" means any structure, object, fence, site, or portion of a site which has a significant historic, archaeological, architectural, engineering or cultural value, real property or improvement thereon such as a structure, archaeological excavation, or object that is unique or significant because of its location, design, setting, materials, workmanship, or aesthetic feeling and is designated as such by the Board of Supervisors pursuant to the provisions of this Chapter.”

- 18.25.060 - Designation of historic resources and districts:
 - A. Designation of historic resources and districts may be initiated by the Board of Supervisors, the Planning Commission, the Review Board, the Secretary, or upon application of the owner of the property for which designation is requested, or the authorized representative of the owner. No property shall be designated pursuant to this Chapter without the consent of the property owner. Any such proposal shall be filed with the Secretary and may include the following information:
 1. Assessor's parcel number of site of the structure proposed for designation or legal description of the district proposed for designation;
 2. Description detailing the structure or district proposed for designation;
 3. Description of special aesthetic, cultural, architectural, or engineering qualities which justify such designation;
 4. Sketches, drawings, photographs, or other descriptive material;
 5. Statement of condition of structure or district;
 6. Statement of architectural and historic significance of the structure or district; and,
 7. Other information requested by the Secretary or the Historic Resources Review Board.
 - B. All applications by property owners for historical designation shall be filed with the Secretary on forms prescribed by the Secretary and shall be accompanied by all data required pursuant to Subsection A of this Section. Where such application is submitted for designation of an historic district, the application must be subscribed by, or on behalf of, a majority of the property owners in the proposed district.
 - C. No building, alteration, demolition, or removal permits for any improvement, building, or structure relative to any proposal for designation as an historical resource or within an area proposed for designation as an historical district shall be issued between the date on which the proposal was initiated and date the Board of Supervisors takes final action on such proposal, unless a permit pursuant to Chapter 18.26 has been secured.
- 18.25.070 - Review criteria.
 - A. Historical and Cultural Significance.
 1. The resource or district proposed for designation is particularly representative of a distinct historical period, type, style, region, or way of life.
 2. The resource or district proposed for designation is, or contains, a type of building or buildings which was once common but is now rare.
 3. The resource or district proposed for designation was connected with someone renowned.
 4. The resource or district proposed for designation is connected with a business or use which was once common but is now rare.
 5. The resource or district proposed for designation represents the work of a master builder, engineer, designer, artist, or architect whose talent influenced a particular architectural style or way of life.
 6. The resource or district proposed for designation is the site of an important historic event or is associated with events that have made a meaningful contribution to the nation, State, or community.

7. The resource or district proposed for designation has a high potential of yielding information of archaeological interest
- B. Historic, Architectural, and Engineering Significance.
1. The resource or district proposed for designation exemplifies a particular architectural style or way of life important to the County.
 2. The resource or district proposed for designation exemplifies the best remaining architectural type of a community.
 3. The construction materials or engineering methods used in the resource or district proposed for designation embody elements of outstanding attention to architectural or engineering design, detail, material, or craftsmanship.
- C. Community and Geographic Setting.
1. The proposed resource materially benefits the historic character of the community.
 2. The unique location or singular physical characteristic of the resource or district proposed for designation represents an established and familiar visual feature of the community, area, or county.
 3. The district is a geographically definable area, urban or rural possessing a significant concentration or continuity of site, buildings, structures, or objects unified by past events, or aesthetically by plan or physical development.
 4. The preservation of a resource or resources is essential to the integrity of the district.

City of Marina

This study was completed in consideration of all sections of the City of Marina municipal code related to historical resources.

15.48.020 Definitions:

Historic structure” means any structure that is:

1. Listed individually in the National Register of Historic Places (a listing maintained by the Department of Interior) or preliminarily determined by the Secretary of the Interior as meeting the requirements for individual listing on the National Register;
2. Certified or preliminarily determined by the Secretary of the Interior as contributing to the historical significance of a registered historic district;
3. Individually listed on a state inventory of historic places in states with historic preservation programs which have been approved by the Secretary of Interior;
4. Individually listed on a local inventory of historic places in communities with historic preservation programs that have been certified either: (a) by an approved state program as determined by the Secretary of the Interior or (b) directly by the Secretary of the Interior in states with approved programs.

The city of Marina follows the guidelines set forth by the California Environmental Quality Act (CEQA) of 1970, for governmental agencies at all levels to develop standards and procedures necessary to protect environmental quality, and setting forth regulations for environmental impact reports (EIR).

City of Seaside

This study was completed in consideration of all sections of the City of Seaside, California - Code of Ordinances related to Historic Preservation (Chapter 17.68). The most recent version of this ordinance was adopted by the City in 2020. Sections most relevant to this study are enumerated in Sections A, B, and C in Chapter 17.68.030 Historic Landmark Designation. In addition, Dudek consulted the most current City of Seaside General Plan (completed in 2004) for additional historic preservation guidance. These sections are provided below.

17.68.030 Historic Landmark Designation

The Council may designate an improvement, natural feature, or site as an historic landmark and any area within the City as an historic district in compliance with this section, based on the Council's evaluation of the age of the affected structures, distinguishing characteristics, distinct geographical area, familiar visual feature, significant achievement, and/or other distinctive feature.

- A. **Procedure.** The designation of an historic landmark or district, or the removal of the designation of an historic landmark or district, shall comply with the procedure established by this Zoning Ordinance for amendments in Chapter 17.74, including public notice and a hearing in compliance with state law, and a final decision by the Council.
- B. **Permit issuance during nomination process.** No permit for any improvement or structure within a proposed historic district or relative to a nominated historic landmark shall be issued while the nomination process is pending.
- C. **Placement on historic register.** The nominated district, site, or structure shall be placed on the City's historic register after being officially accepted by the Council, and the designation shall be recorded for each affected parcel in the office of the Monterey County recorder.

City of Seaside General Plan (2004)

In addition, the City of Seaside General Plan's Historic Preservation Element contains the following goals and policies relating to cultural resources that are relevant and/or applicable to the Project:

Historical Resources: Historically significant sites are located within the community. Stilwell Hall and 35 other structures in the East Garrison area are the only properties in North Seaside that are eligible for the National Register of Historic Places. The City's approved Local Coastal Program Land Use Plan requires that design and architectural guidelines be prepared for buildings and related facilities constructed in the Coastal Zone. The City's goal is to identify all significant archaeological, architectural, and historic resources within Seaside and preserve them in accordance with the California Environmental Quality Act (CEQA) (City of Seaside 2004, p. COS-12)

Goal COS-5. Protect high sensitivity archaeological resources, architecturally significant buildings, and historic places (City of Seaside 2004, p. COS-26).

Policy COS-5.1. Identify and conserve archeological, architectural, and historic resources within Seaside (City of Seaside 2004, p. COS-26).

Implementation Plan COS-5.1.1 Assess and Mitigate Impacts to Cultural Resources. Continue to assess development proposals for potential impacts to sensitive historic, archaeological, and paleontological resources pursuant to the California Environmental Quality Act (CEQA) (City of Seaside 2004, p. COS-26).

Implementation Plan COS-5.1.1a. For structures that potentially have historic significance, require that a study be conducted by a professional archaeologist or historian to determine the actual significance of the structure and potential impacts of the proposed development in accordance with CEQA Guidelines Section 15064.5. The City may require modification of the project and/or mitigation measures to avoid any impact to a historic structure, when feasible (City of Seaside 2004, p. COS-26).

1.5 Master Plan Study Area and Areas of Direct Impact for Built Environment Resources

The Study Area for built environment resources takes into account the boundary of the Master Plan area, which includes the campus. Since much of the proposed Master Plan consists of future projects that are still in early conceptual planning stages, the primary focus of this built environment technical study is on buildings or facilities that are 45 years or older that could be subject to demolition or substantial alteration under the Project.

Built Environment ADI-Study Area

Figure 2 shows the Built Environment ADI within the campus. The Built Environment ADI includes the campus where implementation of the Project may result in impacts to CEQA historical resources. This includes properties (buildings or structures) that were found to be at least 45 years old and were evaluated for significance as part of this study because a proposed Near-Term Project would potentially affect these properties. The ADI consists of the project footprints, which includes areas of demolition, new construction, building renovation, and areas used for staging, if known. The ADI also takes into consideration the maximum extent of potential visual and noise-related impacts that the Project could have on historic built environment resources. Figure 2 shows the locations of the 11 properties evaluated for significance within the campus ADI.

2 Methods

The effort to identify previously recorded and/or evaluated built environment properties on the campus included a records search and a review of historical literature; examination of historic maps; archival research; and field surveys. Each of these methods and their results is described below.

2.1 Records Search and Other Sources

2.1.1 California Historical Resource Information System Record Search

In order to identify cultural resources potentially affected by the Project, a California Historical Resource Information System (CHRIS) record search was completed by Northwest Information Center (NWIC) at Sonoma State University on August 27, 2017. The 2017 records search included the campus and a one-mile buffer. As part of this process Dudek reviewed archaeological and built environment site records and reports on file at NWIC; OHP Historic Properties Directory; OHP Archaeological Determinations of Eligibility; California Inventory of Historical Resources (1976); Historical Maps; Local Inventories; and GLO and/or rancho Plat Maps.

For the purposes of this study, the following records search summary is focused on the built environment. A complete discussion of this records search and results, including archaeological resources and relevant reports, is included in *Cultural Resource Inventory for the CSU Monterey Bay EIR Master Plan Project, Monterey County, California*, a memorandum prepared by Dudek on July 5, 2019 (Brady 2019, pp. 19-27).

Previously Conducted Technical Studies

NWIC records indicate that a total of 42 previous cultural resources technical investigations have been conducted within one mile of the campus. Of these, a total of 29 studies cover the built environment. Among the built environment studies, three intersect the campus and 26 studies fall within the one-mile buffer (Table 3). Below Table 3, a short description of each study that fell within the campus boundaries is provided.

Table 3. Previously Conducted Technical Studies

Report ID	Authors, Publisher	Year	Title
<i>Previous Technical Studies Intersecting the campus</i>			
S-005210	Michael Swernoff, Professional Analysts	1982	A Reconnaissance Cultural Resources Survey of Fort Ord, California.
S-005210a	Michael Swernoff, Professional Analysts	1981	A Reconnaissance Cultural Resources Survey of Fort Ord, California, Draft Report
S-018372	Philip R. Waite, Geo-Marine, Inc.	1995	A Cultural Resources Survey of 783 Hectares, Fort Ord, Monterey County, California
<i>Previous Technical Studies within one mile of the campus</i>			
S-029425	Scott Billat, EarthTouch, Inc.	2004	Construction of a 70-foot Monopole and New Equipment Shelter, Mars/SF-1036 (resubmittal), 599 DX Road, Marina Ca.

Table 3. Previously Conducted Technical Studies

Report ID	Authors, Publisher	Year	Title
S-031953	Wayne H. Bonner and James M. Keasling, Michael Brandman Associates	2006	Cultural Resource Records Search Results and Site Visit for T-Mobile Telecommunications Facility Candidate SF15153 (Metro Marina Monopine/Amateur Radio Club), 599 DX Drive, Marina, Monterey County, California (letter report)
S-032063	Architectural Resources Group	2004	Fort Ord, East Garrison Historic Resources Assessment
S-032063a	Architectural Resources Group	2003	Draft: Fort Ord, East Garrison, Historic Resources Assessment; July 28, 2003
S-032063b	Architectural Resources Group	2006	East Garrison Preservation Plan, Fort Ord, Monterey County
S-032063c	Architectural Resources Group	2004	Guidelines for Rehabilitating Buildings at the East Garrison, Fort Ord, Monterey County, California
S-032063d	Architectural Resources Group	2006	Mothball Plan and Existing Conditions Survey for Fort Ord, East Garrison, Monterey, California
S-033596	Mary L. Maniery and Cindy L. Baker	2007	Cultural Resource Inventory and Evaluation of United States Army Reserve 63D Regional Readiness Command Facilities; Contract No. W912C8-05-P-0052
S-033596a	U.S. Army Reserve and PAR Environmental Services, Inc.	2007	Cultural Resources Inventory and Evaluation of the United States Army Reserve Heroic War Dead USAR Center/Area Maintenance Support Activity 85 (G), Oakland, California; P-01-[010831], 63D Regional Readiness Command Facility CA036, Contract No. W912C8-05-P
S-033596b	U.S. Army Reserve and PAR Environmental Services, Inc.	2007	Cultural Resources Inventory and Evaluation of the United States Army Reserve Oakland USAR Center #2, Oakland, California; P-01-01830, 63D Regional Readiness Command Facility CA-125, Contract No. W912C8-05-P-0052
S-033596c	U.S. Army Reserve and PAR Environmental Services, Inc.	2007	Cultural Resources Inventory and Evaluation of the United States Army Reserve PFC Bacciglieri Armed Forces Reserve Center, Concord, California; P-07-002752, 63 D Regional Readiness Command Facility CA007, Contract No. W912C8-P-0052
S-033596d	U.S. Army Reserve and PAR Environmental Services, Inc.	2007	Cultural Resources Inventory and Evaluation of the United States Army Reserve Col. Hunter Hall USAR Center, San Pablo, California; P-07-002753, 63D Regional Readiness Command Facility CA 070, Contract No. W912C8-05-P-0052
S-033596e	U.S. Army Reserve and PAR Environmental Services, Inc.	2007	Cultural Resources Inventory and Evaluation of the United States Army Reserve Fort Ord USAR Center, Marina, California; 63D Regional Readiness Command Facility CA012, Contract No. W912C8-05-P-0052
S-033596f	U.S. Army Reserve and PAR Environmental Services, Inc.	2007	Cultural Resources Inventory and Evaluation of the United States Army Reserve Moss Landing Local Training Area, Moss Landing, California; 63D Regional Readiness Command Facility CA189, Contract No. W912C8-05-P-0052

Table 3. Previously Conducted Technical Studies

Report ID	Authors, Publisher	Year	Title
S-033596g	U.S. Army Reserve and PAR Environmental Services, Inc.	2007	Cultural Resources Inventory and Evaluation of the United States Army Reserve Jones Hall USAR Center, Mountain View, California; P-43-001836, 63D Regional Readiness Command Facility CA031, Contract No. W912C8-05-P-0052
S-033596h	U.S. Army Reserve and PAR Environmental Services, Inc.	2007	Cultural Resources Inventory and Evaluation of the United States Army Reserve Richey Hall USAR Center, San Jose, California; P-43-000728, 63D Regional Readiness Command Facility CA069, Contract No. W912C8-05-P-0052
S-033596i	U.S. Army Reserve and PAR Environmental Services, Inc.	2007	Cultural Resources Inventory and Evaluation of the United States Army Reserve Moffett USAR Center, Mountain View, California; P-43-001837, 63D Regional Readiness Command Facility CA120, Contract No. W912C8-05-P-0052
S-033596j	U.S. Army Reserve and PAR Environmental Services, Inc.	2007	Cultural Resources Inventory and Evaluation of the United States Army Reserve PFC Young USAR Center, Vallejo, California; P-[48-000752], 63D Regional Readiness Command Facility CA-090, Contract No. W912C8-05-P-0052
S-033596k	Milford Wayne Donaldson and James O. Anderson; Office of Historic Preservation and US Army	2007	USA070613A; Inventory and Evaluation of Historic Resources at 63D Regional Readiness Command, US Army Reserve Center in California
S-035143c	Matthew R. Clark, Holman & Associates	2005	Archaeological Surface and Subsurface Reconnaissance and Historic Feature Recording for the East Garrison Project Area, Monterey County, California [original]
S-039072	Basin Research Associates	2009	Cultural Resources Review, Gigling Road and South Boundary Road Improvements, Within Former Fort Ord, Monterey County, California
S-039246	Tobin Rodman, Parus Consulting	2012	Cultural Resources Constraints Study for the Replacement of the Marina, 6th Street Wood Pole Replacement Project, Monterey County, California, PG&E No. 30787086/7690
S-042969	Carolyn Losee, Archaeological Resources Technology	2012	Cultural Resources Investigation for AT&T Mobility CNU3562 "W Blanco Road LTE", 3262 Imjin Road, Marina, Monterey County, California 93933 (letter report)
S-042969a	Carol Roland-Nawi and Carolyn Losee; Office of Historic Preservation; Archaeological Resources Technology	2012	FCC_2012_1106_005; CNU3562, W Blanco Road TLTE, 3262 Imjin Road, Marina, Collocation

Table 3. Previously Conducted Technical Studies

Report ID	Authors, Publisher	Year	Title
S-044195	Lawrence Moore; Dept of Public Works, Environmental Division, US Army Garrison, Presidio of Monterey	2010	Cultural Resource Inventory, ASR Wells Location, Ord Military Community, Monterey County, CA
S-046930	Roderic McLean; Bureau Veritas	2014	FCC Form 620 New Tower (“NT”) Submission Packet, Verizon Wireless Imjin and Abrams Facility, 2700 Imjin Parkway, Marina, CA 93933

S-005210: Predictive Model of Cultural Resources at Fort Ord: A Reconnaissance Cultural Survey of Fort Ord, California (Swernoff 1982)

Professional Analysts conducted a stratified sample survey of Fort Ord in 1982 and analyzed previous surveys and overviews to create a predictive map of cultural resource sensitivity. Areas of high sensitivity for archaeological sites were identified in the eastern and southern portions of Fort Ord. Additionally, Swernoff recorded four historic built environment resources: Whitcher Cemetery, Martinez Hill, Stillwell Hall, and the East Garrison Mess Hall Complex. All were recommended eligible for the NRHP by Swernoff, and the Whitcher Cemetery nomination was recommended to submit to the NRHP as a result of the survey (Swernoff 1982, pp. 8-3 to 9-9).

S-005210a: A Reconnaissance Cultural Resources Survey of Fort Ord, California, Draft Report

This report is an unfinalized draft version of the Swernoff 1982 report, described above.

S-018372: A Cultural Resources Survey of 783 Hectares, Fort Ord, Monterey County, California (Waite 1995)

This study was a cultural resources survey sampling of 783 hectares (1,935.4 acres) within Fort Ord related to the closure of the military base. The survey was stratified by environmental zones, which included: beach strand, active dunes, stabilized dunes (Holocene), stabilized dunes (ancient), and dissected uplands. High probability areas included areas within 100 meters of a water source and a 300-meter-wide area along the bluff overlooking the Salinas River on the eastern edge of Fort Ord. The effort included the recording of a historic site and an examination of two prehistoric sites, which included excavating shovel test pits. None of the resources addressed in the report are within the campus boundaries or a one-mile buffer.

Previously Recorded Cultural Resources

The NWIC records search results did not identify any previously recorded built environment resources within the campus boundaries. The record search also identified sixteen built environment resources within a one-mile radius of the campus, but it was beyond the scope of this project to address them. All built environment resources discovered in the record search are included below in Table 4, including their California Historical Resource Status Codes which indicate their eligibility status.

Table 4. Previously Recorded Built Environment Resources

Primary ID	Name	Type	Age	Recording event	California Historical Resource Status Code
<i>Previously Recorded Resources Intersecting the campus</i>					
None					
<i>Previously Recorded Resources within One Mile of the campus</i>					
P-27-002717	CA-1025A	Structure	Historic	2001 (Lorna Billat, Earth Touch, Inc.)	Unknown
P-27-002749	Auto Shop	Building	Historic	2003 (Jody R. Stock, Architectural Resources Group); 2007 (Ian Alexander, Juan Cervantes, Matthew Clark, Holman & Associates)	Unknown
P-27-002880	Building 2019, latrine, former Fort Ord	Building	Historic	2007 (Matt Bischoff, CSP, Monterey District)	Unknown
P-27-002881	Building TR9070, office, former Fort Ord	Building	Historic	2007 (Matt Bischoff, CSP, Monterey District)	Unknown
P-27-002882	Building 2066, warehouse, former Fort Ord	Building	Historic	2007 (Matt Bischoff, CSP, Monterey District)	Unknown
P-27-002883	Building 2079, former Fort Ord	Building	Historic	2007 (Matt Bischoff, CSP, Monterey District)	Unknown
P-27-002891	Building 924, metal storage, former Fort Ord	Structure	Historic	2007 (Matt Bischoff, CSP, Monterey District)	Unknown
P-27-002892	Building 1A39, office, former Fort Ord	Structure	Historic	2007 (Matt Bischoff, CSP, Monterey District)	Unknown
P-27-002893	Building 1A99, office, former Fort Ord	Structure	Historic	2007 (Matt Bischoff, CSP, Monterey District)	Unknown
P-27-002894	Building 2026Z, storehouse, former Fort Ord	Building	Historic	2007 (Matt Bischoff, CSP, Monterey District)	Unknown
P-27-002895	Building TR9080, former Fort Ord	Building	Historic	2007 (Matt Bischoff, CSP, Monterey District)	Unknown
P-27-002896	Building TR9081, former Fort Ord	Building	Historic	2007 (Matt Bischoff, CSP, Monterey District)	Unknown
P-27-002913	Feature EGP-2	Structure	Historic	2007 (Ian Alexander, Juan Cervantes, Matthew Clark, Holman and Associates)	Unknown
P-27-002915	Feature EGP-4, WWII Tent Area	Site	Historic	2007 (Matthew Clark, Holman and Associates)	Unknown
P-27-002916	Feature EGP-5	Structure	Historic	2007 (Matthew Clark, Holman and Associates)	Unknown

Table 4. Previously Recorded Built Environment Resources

Primary ID	Name	Type	Age	Recording event	California Historical Resource Status Code
P-27-003170	Marina Municipal Airport Tower	Building	Historic	2012 (Dana E. Supernowicz, Historic Resource Associates)	Unknown

2.1.2 Built Environment Resource Database Search

The Built Environment Resources Directory (BERD) provides information, organized by county, regarding non-archaeological resources in the Office of Historic Preservation’s (OHP) inventory. The BERD inventory only contains information that has been processed through OHP and includes resources reviewed for eligibility to the National Register of Historic Places and the California Historical Landmarks programs through federal and state environmental compliance laws, and resources nominated under federal and state registration programs.

For the purposes of this study, the Monterey County BERD spreadsheet was accessed. In this spreadsheet, multiple resources in the City of Marina and the City of Seaside were noted, including Fort Ord Veterinary Hospital (now Fort Ord Equestrian Center) 1D, 2013, and Fort Ord US Army Reserve Center (6Y). Despite these resources’ close proximity, no historical resources listed in the BERD were noted within the campus.

2.1.3 Additional Studies

In addition to studies and site records procured by the CHRIS record search, Dudek also received additional reports from CSUMB and found other reports through various municipal and digital repositories for environmental compliance studies. For the purposes of this study, included below is a brief summary of reports pertaining to the built environment within and immediately adjacent to the campus.

Fort Ord, California: Base-Wide Remedial Investigations/Feasibility Study. Volume 1 (1991).

EA Engineering, Science, and Technology prepared an investigation and feasibility study for the U.S. Army Corps of Engineers (USACE) after the site was placed on the National Priorities List of Hazardous Waste Sites (NPL). In October of 1990, EA Engineering completed a literature review and site inventory as part of their Remedial Investigation/Feasibility Study. The report delineated 21 study zones to review past land use for the purpose of discovering environmental contaminants at Fort Ord. EA Engineering, Science, and Technology also conducted a literature review and provided a history of the site (EA Engineering, Science, and Technology 1991:1-1).

Environmental Impact Statement Fort Ord Disposal and Reuse (1993).

USACE prepared an Environmental Impact Statement to address Fort Ord’s closure and reuse. The document supported creating a 1,500-acre Presidio of Monterey to provide operations support for the remaining Army uses in the area, retaining a 12-acre reserve center on Fort Ord, and disposing of excess property at Fort Ord. The document responds to comments in the following subjects: alternatives, land use, socioeconomics, soils, geology, topography, and seismicity, public services and utilities, water resources, traffic and circulation, air quality,

hazardous and toxic waste site remediations, vegetation, wildlife, and wetland resources, visual resource, new issues, and other concerns. (Fort Ord Disposal and Reuse: EIS. 1993:3-1).

California Military Base Reuse Task Force: A Strategic Response to Base Reuse Opportunities (1994).

Governor Pete Wilson appointed the California Military Base Reuse Task Force to explore and mitigate economic, community, and land use issues at military base closures in California. The report outlines barriers and recommendations to potential components of reuse plans including the need to comply with City, County, and other agencies, as well as compliance with CEQA and NEPA in an effort to improve the prospects for a “smooth reuse process, expedited base clean ups, and the protection of natural and cultural resources (California Military Base Reuse Task Force 1994:xxi).

Final Environmental Impact Report (EIR) Fort Ord, Monterey County, California (1997).

In June 1997, EMC Planning Group, Inc. and EDAW, Inc. prepared a Fort Ord Reuse Plan Environmental Impact Report for the former Fort Ord Base located in Seaside, Monterey County, California. The EIR was prepared to evaluate the potential impacts to the environment under CEQA that may result from implementing the proposed Fort Ord Reuse Plan. The EIR was prepared to focus on the additional elements needed for CEQA analysis beyond the previously completed studies, Fort Ord Disposal and Reuse Final Environmental Impact Statement (FEIS) and Fort Ord Disposal and Reuse Draft Supplemental Environmental Impact Statement (DSEIS) (EMC Planning Group, Inc Republished 1997:1-2).

Historic Resources Evaluation Memorandum for Hammerhead Barracks at Fort Ord, Monterey County, California (2019).

In November 2019, Rincon Consultants, Inc. prepared historic resource evaluations for eight hammerhead buildings at Ford Ord located in Seaside, Monterey County, California. These hammerhead buildings are identical in design, materials, and plan to campus Buildings 44 (Pacific Hall), 45 (Coast Hall), 46 (Harbor Hall), and 47 (Student Services). Rincon recommended that all eight buildings were ineligible for both individual listings in the NRHP, CRHR, or for designation as a City of Seaside Historical Landmarks, or as contributors to a historic district, due to a lack of architectural distinction and lack of important historical associations within the broader context of Cold War military base establishment or a narrower context of military unaccompanied personnel housing (Madsen and Treffers 2019, pp. 13-15).

Previous Campus Master Plans

Three prior Campus Master Plans were prepared the campus and adopted by the Board of Trustees of the California State University in 1998, 2004, and 2007. The 2007 Master Plan was updated in 2015.

The 1998 CSUMB Campus Master Plan was the first step by the university to create a “city of learning.” The 1998 Master Plan described the broad steps the university planned to physically guide the development of the campus for the next 30 years. The 1998 Master Plan also addressed the broad physical framework for land use, development intensity, open space, circulation, and linkages to the surrounding community. The document provided a framework to ensure that physical developments to the campus reflect the long-range planning goals (CSUMB 1998).

The most recent 2007 CSUMB Campus Master Plan and EIR considered land uses and space requirements commensurate with enrollment projections for three planning horizons: Planning Horizon I (2005-2014), Planning Horizon II (2015-2024), and Planning Horizon III (beyond 2025) (CSUMB 2007:1-1). The 2007 CSUMB Master Plan projected an on-campus, traditional student enrollment of 8,500 full time equivalent (FTE) students, with an additional 3,500 FTE non-traditional, primarily off-campus students, for a total of 12,000 FTE students at buildout (2025), with 1,900 faculty, staff, and management personnel. There were approximately 6,731 FTE on-campus students in 2015-2016 (CSUMB 2007:1-1).

2.2 Building Development and Archival Research

The following text provides a summary of additional background research conducted by Dudek to arrive at a general understanding of the settlement and development of the campus and to gather information on the development of properties evaluated in this study.

Chamberlain Library, Defense Language Institute Foreign Language Center

Dudek obtained access to the Chamberlain Library on June 15, 2021. Dudek staff reviewed documentation relating to the transfer of Fort Ord ownership to the California State University system. This included newspaper clippings, reports, and historic maps. All information obtained from the Chamberlain Library was used in the preparation of the historic context sections of this study.

University Archives, California State University Monterey Bay

Dudek obtained access to CSUMB's archives on June 16, 2021. The archives provided a variety of primary documents, including copies of historic campus maps, campus master plans, and newspaper articles. All information obtained from the CSUMB archives was used in the preparation of the historic context sections of this study.

Facilities Plan Room, California State University Monterey Bay

Dudek obtained access to CSUMB's Facilities Plan Room on June 15-16, 2021. Dudek reviewed the historic as-built drawings and renovation drawings for the campus properties included in this study. Dudek used the information obtained during this visit to develop the construction history of each property and to prepare the historic context sections of this study.

Historical Aerial Photographs

A review of historical aerial photographs was conducted as part of the archival research effort from the following years: 1941, 1956, 1968, 1971, 1981, 1987, 1998, 2005, 2009, 2010, 2012, 2014, 2016, and 2018. (NETR 2021; UCSB 2021).

Sanborn Fire Insurance Company Map Review

Archival research failed to indicate any Sanborn Fire Insurance Company maps for the campus.

2.3 Built Environment Field Methods

Dudek Architectural Historian Sarah Corder, MFA conducted an intensive level survey of the campus between June 14 and June 16, 2021. The survey focused on documenting the built environment properties potentially affected by the Project. The survey entailed walking the entire campus and documenting the exterior conditions of all properties proposed for demolition or renovation as part of the Project. Each property was documented with notes and photographs, specifically noting character-defining features, spatial relationships, observed alterations, and examining any historic landscape features on the campus. Dudek documented the fieldwork using field notes, digital photography, close-scale field maps, and aerial photographs. Photographs of the campus were taken with a digital camera. All field notes, photographs, and records related to the current study are on file at Dudek's Santa Cruz, California, office.

INTENTIONALLY LEFT BLANK

3 Historic Context

The following historic context addresses relevant themes concerning the history and development of CSUMB. It begins with a general overview of Monterey County, the City of Marina, and the City of Seaside and the development of Fort Ord. This is followed by a discussion of CSUMB's development, including a discussion of higher public education in California. The section concludes with a discussion of the historical development periods of the campus including its buildings, structures, architects, and building types.

3.1 Historical Overview of Monterey County

One of the earliest known European explorations of the Monterey Bay was a Spanish envoy mission led by Sebastián Vizcaíno in 1602. The purpose of the voyage was to survey the California coastline to locate feasible ports for shipping. Finding Monterey Bay to be commodious, fertile, and extremely favorable for anchorage between Spanish-held Manila and Acapulco, Vizcaíno named the bay "Monterey" after the Conde de Monterey, the present Viceroy in Mexico (Chapman 1920; Hoover et al. 2002). Spanish settlement was limited until the 1770s, when Don Gaspar de Portolá, the Governor of Baja, embarked on a voyage in 1769 to establish military and religious control over the area and established a Presidio to guard the port at Monterey Bay Mission San Carlos Borromeo de Carmelo. The area developed slowly with limited land grants, primarily given to members of the Spanish armed forces (Breschini 1996a; Hoover et al. 2002).

After more than a decade of intermittent rebellion and warfare, New Spain (Mexico and the California territory) won independence from Spain in 1821. In 1822, the Mexican legislative body in California ended isolationist policies designed to protect the Spanish monopoly on trade, and decreed the ports open to foreign merchants. As a result, dynamic trading communities developed along the present-day coastal areas of Monterey County where tallow and hides from the cattle raised in the area were traded for goods such as tea, coffee, spices, and fine leather goods (City 2008). During the Mexican period, land grants were distributed liberally throughout California to increase the population inland from the more settled coastal areas where the Spanish first concentrated their colonization efforts. The City of Monterey continued as the capital of Alta California and the *Californios*, the Mexicans who settled in the region, were given land grants.

The County of Monterey was designated as one of the 27 original counties of California on February 18, 1850, shortly before California officially became a state with the Compromise of 1850. The new state of California recognized the ownership of lands in the state distributed under the Mexican land grants of the previous several decades. As the Gold Rush was picking up steam in 1849, a massive influx of people seeking gold steadily flooded the rural counties of California. When the gold fields became overcrowded and unproductive, many later arrivals sought new sources of wealth altogether. For early arrivals in the relatively flat, fertile acreage of Monterey County, agriculture, cattle rearing, and dairy farming took hold as the leading economic ventures. This mirrored the use of the land in the area by early Spanish and Mexican settlers. Despite the promise of retaining their land, many Mexican families had difficulty proving ownership over their land in the face of new claimants who encroached on their land. Others were forced to sell off portions of their holdings to pay for the legal fees and taxes to maintain ownership (City 2008).

Gold, silver, granite, and lesser quality coal were mined with disappointing results from various locations throughout the County. In the 1870s, sand and gravel was mined from the beaches, with large mining companies securing the rights to haul away a certain quantity of sand per year from private properties along the shore beginning in 1888 (City 2008).

The introduction of the Southern Pacific Railroad (S.P.R.R.) beginning in 1872 with the completion of the Pajaro to Salinas line helped to promote the beauty of the coastal areas of the County for settlement. The S.P.R.R. made the remote areas of the County quickly accessible from San Francisco and other inland, Central Valley locations, which prompted the development of idyllic coastal retreat and vacation communities such as Pacific Grove (1878), Carmel (today, Carmel-By-The-Sea) (1888), and the secluded neighborhoods within the Del Monte Forest (Hoover et al. 2002).

Agriculture and tourism have endured into the present-day as the most substantial contributors to Monterey County's economy which helps to support a population of 434,061 residents. The rich farmland of the Salinas Valley farms in the heart of Monterey County have consistently made agriculture the top provider of employment in the County and have also helped to secure Monterey County as the third largest agricultural County in the State of California. In addition to the picturesque Monterey Bay, the County of Monterey features many tourist destinations of ecological, cultural, and historical value that attract in excess of three million visitors per year (County of Monterey 2021).

3.2 Historical Overview of Marina

The land that constitutes the modern-day City of Marina was once part of a 9,000-acre landholding owned by David Jacks and James Bardin dating to the 1860s. The Bardin's sold 2,800 acres of their holding to John Armstrong in 1885. Although Armstrong dubbed the area "Sand Hill Ranch" and used the acreage to grow potatoes, the area of today's Marina remained a largely desolate and undeveloped stretch of sand dunes until the 1910s. He sold 400 acres of his land near the ocean to the San Francisco Sand Company around 1900, who later constructed a sand plant in 1906. Builders utilized sand from the area as a primary source material for the rebuilding of San Francisco after a devastating 1906 earthquake (The Californian 1936; The Californian 1976).

While Southern Pacific railroad cut through the area, development in Marina lagged until about 1915, when San Francisco businessman William Locke-Paddon purchased 1,500 acres of present-day City land and it became known as "Locke-Paddon Colonies", then "Paddonville". Looking to develop his acreage into a townsite, Paddon convinced the Southern Pacific to create a flag stop and he sold five-acre lots for roughly \$75 per acre to stimulate development. Paddon built a community drinking well and created the first school out of a small cottage building in 1916 but found it difficult to attract buyers to his community in the early years. The first post office (also served as a general store) opened in 1919 as the "Marina Post Office", helping to establish Marina as the official town name (The Californian 1936; The Californian 1976).

By 1926, the community had grown to 70 families with surnames like Koenen, Cardoza, Smith, and Maddison among the early settlers. One of the community's oldest organizations, Grange Hall #518, established in 1933. Marina increasingly became a popular gathering place for off-duty soldiers and their families stationed at nearby Fort Ord, in part because of the well-liked Mortimer's restaurant. The town grew steadily after the construction of nearby Fort Ord in 1940 and reached a population of 6,000 by about 1950 (The City of Marina 2021).

During the 1950s, Reservation Road began to emerge as a commercial corridor and the community began to build more suburban-like retail and housing options. Both single-family developments and apartments soon sprung up near Reservation Road. By the mid-1960s the town boasted a new Safeway Supermarket and the "Marina Shopping Center" which was equipped with a bank, coffee shop, dry cleaners, drug store, laundry mat, and other options (The City of Marina 2021). Marina voters approved incorporation on November 5, 1975, by a 20 percent margin, and a

City Hall was established on Hillcrest Avenue. Since incorporation, the City had experience substantial growth with a number of single-family suburban tract developments, new shopping centers, and civic amenities being built in the 1980s. With the closure of Fort Ord in 1993, a major community employer, the City saw a population decline for a few years following its closure (The City of Marina 2021). Despite the brief population decline, the City has since attracted new employers, including aviation businesses at the Marina Municipal Airport and service sector retail jobs, and the population has grown to nearly 23,000 people as of 2020 (U.S. Census 2020).

3.3 Historical Overview of Seaside

Seaside, located in Monterey County, began in 1887 when Dr. John L.D. Roberts purchased land a mile to the northwest of the prominent Del Monte Hotel (opened in 1880). Roberts was a physician who had come to California at the age of 24 from New York and saw the development possibilities in creating a new subdivision northeast of Monterey. Roberts “bought 150 acres from his uncle, marketed it as a shoreline resort and in 6 months had repaid his loans, built a house, and expanded his subdivision to the north” (City of Seaside n.d.). The area was originally known as East Monterey. By 1891, the town had a post office, hot springs resort, schools, churches, and a railcar line, and had received the name Seaside (City of Seaside n.d.). The area attracted white, middle-class residents who considered the area a potential resort destination (McKibben 2009a; McKibben 2009b).

In 1910, while Roberts was acting as Monterey County Supervisor, he petitioned to establish the U.S. Army Base Fort Ord on the ranchland north of Seaside. The base quickly grew to house over 20,000 infantry members and civilian workers. With the establishment of Fort Ord, Seaside transformed from a resort destination to a military town. Many original residents left because of the change in the community’s character.

Seaside’s military-driven economy gradually declined with the end of World War I. The decline was compounded by the Great Depression, resulting in low property values. Frequently, people simply claimed a piece of land and built a home without formally purchasing the land. Demographically, the low property values, Dustbowl refugee influx, and military presence contributed to the community becoming one of the most racially diverse areas in the Central Coast (Whaley 2015; McKibben 2009a; McKibben 2009b).

During World War II, Fort Ord grew into one of the U.S. Army’s principal west coast training facilities and the town of Seaside continued to house most of the off-base workers and soldiers. In 1948, the U.S. Army became racially integrated with the signing of Executive Order 9981. Fort Ord became the first integrated training division (MacGregor 1981; McKibben 2009b). As a result, Seaside continued to be a town of ethnic and racial diversity unique in central California. The population of Seaside doubled between 1948 and 1954 from fewer than 10,000 to 21,750 (City of Seaside n.d.).

Seaside initially attempted to incorporate as a city in 1940, but as the process dragged on, half the town’s original acreage was ceded to the City of Monterey and Sand City. In 1954, Seaside finally won its battle and became an independent city. Despite the loss of the original sections of Seaside to neighboring cities, within remaining city boundaries Seaside was able to construct a high school and a City Hall designed by prominent architect Edward Durell Stone (City of Seaside n.d.).

By 1970, Seaside was the most populated city on the Monterey Peninsula, with a population of 35,940. The City had a notable concentration of African-American residents; 20 percent of the population in 1970 was African-American. (McKibben 2009b). By 1980, Seaside’s population was extremely diverse and had no ethnic majority.

The City had the most concentrated population of African-Americans in California between Los Angeles and Oakland. By the 1980s, the area's demographics began to shift with a mass immigration of people from Mexico and Central America. Latinos presently make up the majority of the City's population.

In 1991, the Base Realignment and Closure Commission recommended that Fort Ord be closed. The base was formally decommissioned in 1994. The City was able to sustain the closure of Fort Ord in 1994 and the population remained steady. The majority of the land comprising the base was returned to the State of California for further public use. Seaside continues to develop with recent projects including golf courses, resorts, conference centers, residential and commercial developments, and plans for a mixed-use, transit-oriented downtown (City of Seaside n.d.).

3.4 Historical Overview of Fort Ord

The history of Fort Ord has been extensively documented in newspaper articles, websites, academic journals, and books. From its creation in 1917 to its closure in 1994, the base grew to become one of the largest training centers in the country. Its location was also reported to be the most attractive U.S. Army post, with easy access to the ocean and beautiful California weather.

The development periods in the history of Fort Ord were defined by Harold E. Raugh, Jr, a U.S. Army lieutenant colonel and historian with the Department of Defense. Since his retirement, Raugh served as the Chief Historian, for the Defense Logistics Agency, for the Department of Defense and, from 2006-2013, Raugh served as the Command Historian at the Defense Language Institute Foreign Language Center (DLIFLC) and the Presidio of Monterey, California. He received his PhD in history from the University of California, Los Angeles (Walch 2004). Raugh has authored numerous books including, *Fort Ord* (2004); *Presidio of Monterey* (2004); *Operation Joint Endeavor: V Corps in Bosnia-Herzegovina, 1995-1996* (2013); *The Raugh Bibliography of the Indian Mutiny 1857-1859* (2016); and *Wavell in the Middle East, 1939-1941: A study in Generalship*. Raugh defined four periods for the historic development of Fort Ord:

- 1917-1940 Camp Gigling to Camp Ord
- 1940-1945 Fort Ord and the 7th Infantry Division
- 1946-1976 The Cold War and Vietnam Eras
- 1974-1994 The Volunteer Army

These periods correspond to distinct eras in the history of the base and the U.S. Army (Raugh 2004: ii). The following sections provide a summary overview of each of these periods of development and their relevance to the area of Fort Ord now known as the CSUMB campus.

3.4.1 Camp Gigling to Camp Ord (1917-1940)

Between 1917 and to 1940, just before the start of World War II, Fort Ord grew from an agricultural field to a bustling Army outpost filled with tents, mess halls, and enlisted soldiers training for foreign conflict.

Fort Ord, located on the Monterey Peninsula, was formally established in 1917 under the name “Fort Gigling.” The land was purchased from David Jacks, a local rancher who, along with the Gigling family, operated a dairy farm on the land (EA Engineering, 1991: 2-1). The site was purchased to create a training ground for field artillery and cavalry troops stationed at the Presidio of Monterey, located about eight miles to the southwest (Military Museum 2016). No formal land improvements or buildings were constructed at the site. The site remained primarily agricultural in use, though it was also used as an area for maneuver training (EA Engineering, 1991: 2-1).

In the late 1930s, after more than a decade of use, several facilities were constructed at the site, including “administrative buildings, barracks, mess halls, tent pads, and a sewage treatment plant” (Military Museum 2016). The work completed from 1938 to 1940 was primarily done by the Civilian Conservation Corps (CCC) and the Works Progress Administration (WPA). The area was named Camp Ord in 1939 and changed to Fort Ord in 1940 (The Californian 1940: 1). Fort Ord was placed under the command of General Joseph “Vinegar Joe” Stilwell. The original site encompassed 3,777 acres (Castle 1990: 4).

Building development during this period was temporary in nature, as the Fort was initially planned to be provisional. Tents of various sizes were erected in neat rows to house troops. In the 1930s, wood buildings were constructed. These buildings were considered impermanent, as they generally used simple wood construction techniques that could be easily moved or deconstructed if necessary.



Figure 3. Impermanent, temporary tents and buildings at Fort Ord c. 1939 (CSUMB 2021: Image 121).



Figure 4. Fort Ord picture showing semi-permanent buildings and tents, 1940 (CSUMB 2021: Image 131).

3.4.2 Fort Ord and the 7th Infantry Division (1940-1945)

The second period of development at Fort Ord was brief, but substantial. The Fort became a semi-permanent base with a massive population influx as operations trained and deployed soldiers for war. This period included the first large-scale development of semi-permanent housing and administration buildings and was the most substantial period of development in Fort Ord's history (Chamberlin Library 2021.).

In 1940, the *Salinas Morning Post* announced contracts for a total of \$2.7 million were awarded to Ford J. Twait and Morrison-Knudsen, Inc., both Los Angeles-based companies, to construct 564 structures on Fort Ord. The Barret & Hilp Company of San Francisco was awarded "\$35,000 to lay down two spur tracks from Southern Pacific lines into the Army reservations" (*Salinas Morning Post*, 1940: 1). The building program was appropriated by Congress to house the 7th Division that was being formed on the base under the command of Gen. Stilwell (*Salinas Morning Post*, 1940: 1). At this time, an additional \$4 million was devoted to making the site a "complete city" with utilities, paving, and sewage. Additionally, the WPA was awarded a \$1.4 million budget to construct buildings at Fort Ord (*Salinas Morning Post*, 1940:1).

By 1941, the Fort had over 28,514 acres of land, 27,000 men, and \$12 million invested to create a training base and staging area for the U.S. Army (Cavanaugh 2000: 9). The WPA and private contractors continued constructing wood frame buildings to accommodate the growing population. The main garrison was constructed between 1940 and the 1960s "starting in the northwest corner of the base and expanding southward and eastward." (Figure 5) (DLIFLC 2021; Military Museum 2016).

During World War II, the Army was changing training tactics. It was actively transitioning the cavalry from horses to tanks and trucks (Castle 1990: 4). Fort Ord also became a training site for amphibious warfare, which was essential for combat missions in the Pacific theater. Fort Ord became home to the amphibious training unit 18th Armored Group, taking advantage of the Fort's proximity to the beaches in Monterey Bay (Panorama, n.d.).

It was during this period that the National Defense Program began requiring Army housing to provide a variety of additional support buildings for soldiers beyond the “screened, framed, and floored tents for officers and men” (The Quartermaster Review 1940). Additional temporary buildings included mess halls, kitchens, lavatories, company supply, and administration buildings, supply and general utilities, medical infirmaries, and recreation facilities (Quartermaster Review 1940:37). Building development in this period was swift and simple. World War II created an immediate need for soldiers, all of whom needed housing. Emergency war construction took place on bases across America. Temporary construction was authorized at “post, camps, and stations where additional regular Army troops are assigned as soon as requirements are determined” and funding became available (The Quartermaster Review 1940: 37). The building program began quickly at Fort Ord. Buildings were constructed of wood, with slight eave overhangs with exposed rafter tails. They were clad in horizontal, wood siding finished with simple corner boards. The majority of the windows were multi-light double-hung wood windows. Most of the buildings appeared to sit on post and pier foundations, which was part of the semi-permanent nature of the construction.



Figure 5. Fort Ord, after construction of main garrison and infrastructure, such as roads, date unknown (DLIFLC 2021).

3.4.3 Cold War and Vietnam Eras at Fort Ord (1946-1976)

This period of development between 1946 and 1976 was characterized by a massive operation to move the base out of its semi-permanent status and create a permanent outpost for active military personnel who were retained due to ongoing foreign conflicts.

In July of 1948, Harry S Truman signed Executive Order 9981, which officially ended segregation in the armed forces. The order stated that “there shall be equality of treatment and opportunity for all persons in the armed forces without regard to race, color, religion, or national origin” (National Archives Foundation 2021). Fort Ord

became one of the first integrated training divisions in the United States. The Fort was touted as “pioneering to end all segregation” (The Pomona Progress Bulletin 1950: 4). In 1950, the *Pomona Progress Bulletin* reported that black and white soldiers at Fort Ord were “fighting side by side” and all the enlistees “trained together, slept in the same barracks, and eat the same messes” (The Pomona Progress Bulletin 1950: 4).

The end of World War II in 1945 did not bring lasting peace. The tenuous relationship between dominant nations in the communist East and free market West led to the beginning of the Cold War. The Department of Defense maintained a robust fighting force during the Cold War, with more than 900,000 Army personnel retained during the 1950s (ACHP 2006). The ongoing global tensions and the number of active U.S. military personnel created a need for new permanent buildings and expanded military housing at Fort Ord.

In 1949, the Soviet-supported communist government of North Korea invaded American-supported South Korea, initiating the Korean War. Fort Ord was a primary staging area for the training of troops departing for the war (Castle 1990:3). By the 1950s, Fort Ord had become one of the largest basic training camps in the United States. In 1952, the military began a multi-million dollar building program to transform Fort Ord into a permanent post, including the development of permanent troop housing, and the construction of a guard house, stockade, and multiple warehouses. In January of 1952, military authorities announced the new construction program at Fort Ord was underway, with an estimated cost of \$26,650,600. More than half of the funds that were approved by Congress were “earmarked for new permanent troop housing” for more than 7,000 soldiers (The Webb Spinner 1952-54, Vol 6. No. 3:1).

The new troop housing was to be constructed of reinforced concrete, a departure from the wood buildings constructed before and during World War II. The plan called for three types of massive barracks, twenty-two were to house 225 enlisted men each, seven were to accommodate 165 men each, and nine were to house 105 men each (The Webb Spinner 1952-54, Vol 6. No. 3:3). The San Francisco District of the U.S. Army Corps of Engineers oversaw the construction project to completion. An additional \$1,349,700 was earmarked for the expansion of classroom and training facilities at Fort Ord, including a new battalion and regimental headquarters (The Californian 1952a:1 and The Californian 1952b:18). By March of 1952, another phase of the permanent army post transformation began with the construction of a guard house, stockade, warehouse, and other buildings (The Webb Spinner 1952-54, Vol 6. No. 3:1). This addition of permanent buildings continued into the late 1950s, when the Army requested \$124 million to replace all the wood World War II infrastructure at Fort Ord with concrete block and reinforced concrete (Madsen and Treffers 2019:6; San Francisco Examiner 1958:2-4). While many of the wood buildings remain today, this period saw the continuous addition of reinforced concrete permanent buildings across the Fort (Madsen and Treffers 2019:6).

Following the Korean War through the end of the conflict in Vietnam, Fort Ord served as an important training facility. In 1957, Fort Ord was designated as a U.S. Army Training Center for Infantry (Castle 1990: 4). The 7th Infantry Division was based at Fort Ord in 1975 (Cavanaugh 2000: 9). Fort Ord produced thousands of combat-ready troops during the conflict in Vietnam.

With the establishment of Fort Ord as a permanent Army base during this period, there was substantial building construction that led to the modernization of the base and its services. This development is closely related to the history of the current CSUMB campus. All the properties that are included as part of this built environment study were constructed during the Cold War and Vietnam Era period. Building development during this period was a substantial departure from the styles and materials used in the buildings constructed before World War II. Building during the period between 1946 and 1976 used reinforced concrete and concrete masonry unit (CMU). The

buildings tended to be larger than those constructed in previous periods. Other development in this period included support service buildings and several types of medical buildings. Infrastructure was also improved at this time, with the introduction of paved streets and roadways, and the addition of several water tanks, water pumping plants, and warehouse buildings.



Figure 6. Fort Ord, Specialist 4, Abil Abdallah Mughannam at the new Fort Ord barracks in November of 1960 (DLIFLC 2021).



Figure 7. Fort Ord base, aerial image showing the completed barracks, c. 1970. The barracks are described as “Old Permanent Barracks, looking south” (DLIFLC 2021).

3.4.4 Built Environment ADI Buildings Constructed During the Cold War and Vietnam Era (1946-1976)

The following presents a discussion of the properties located within the Built Environment ADI and provides a brief overview of their types, original use, and changes over time. Four categories of building types were identified for the purposes of this study. These are the Support Services Buildings, Medical Buildings, Hammerhead Buildings/Barracks, and Recreational Facilities.

Support Services Buildings

Support services buildings at Fort Ord have a variety of uses and functions that have changed over the history of the base. One of the most common type of support services building from this period is classroom buildings. In alignment with the typical planning, design, and materials of buildings constructed during this period of Fort Ord’s history, these buildings are constructed from concrete and CMU and feature side-gabled roofs. Another support services building type is the auto repair buildings that were constructed during this period to support the repair and maintenance of military vehicles. These buildings were more industrial in design, with large openings and metal roll-up doors to support their function.

Beach Hall (21), Tide Hall (23), Green Hall (58), and Reading Center (59), are four support service buildings in the Built Environment ADI. The nearly identical buildings differ slightly due to renovations, but they all began with the same architectural design. The buildings were all constructed in 1954 and were designed by Robert Stanton,

architect for the United States Army Corps of Engineers (CSUMB Facilities 2021). The buildings were described on the architectural plans as “permanent troop spaces and supporting facilities/classrooms” (Figure 8) (CSUMB Facilities 2021). These support services buildings were designed by California architect, Robert Stanton, who designed a variety of residential, commercial, and public buildings in the San Joaquin Valley and Monterey, and Santa Cruz areas.

An auto repair support services building included in this study is Building 70. The building first appears in the 1956 aerial photograph as the east-most building in a group of six similarly sized buildings between 5th Avenue, 6th Avenue, Inter-Garrison Road, and a large parking area. A 1970 site plan of Fort Ord labels these buildings the “Motor Park” (CSUMB Facilities 2021). Archival research did not find any conclusive information on the original use of these buildings. No architectural drawings were available for this building type and the architect is unknown.

After Fort Ord closed in 1994, these support services buildings became part of the CSUMB campus. With the shift to campus use, many of the buildings were altered to fit the needs of CSUMB. Beach Hall and Tide Hall’s building footprints appear unchanged between 1956 and the present, however the circulation pattern of both building’s interior changed during a 1995 remodel when some windows were converted to doors on the north elevation, and a gable roof was added over the primary door (Figure 9) (CSUMB Facilities 2021; NETR 2021). No changes to Green Hall (58) or the Reading Center (59) were noted. Building 70’s footprint does not appear altered, and no additions appear between 1956 and 2016, according to aerial photographs (NETR 2021).

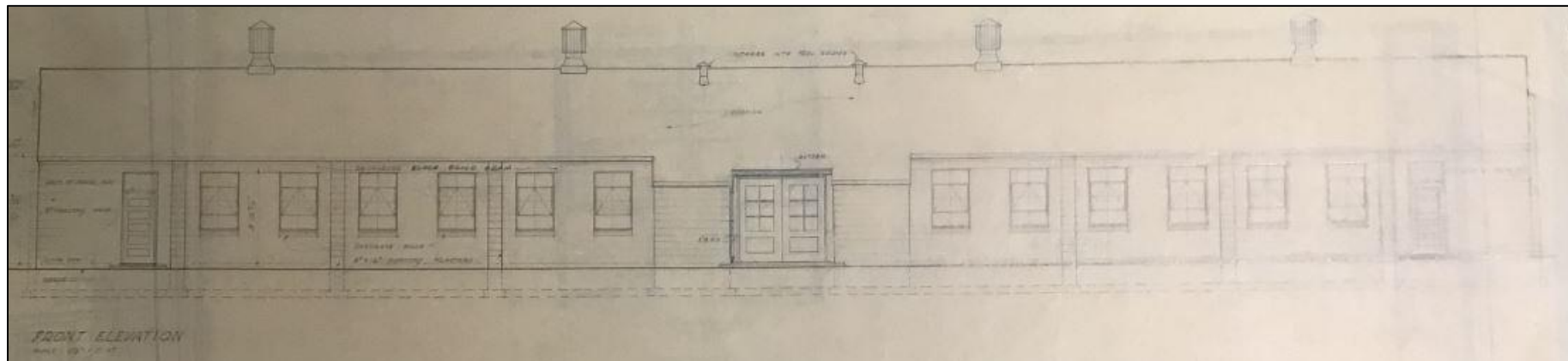

Figure 8. Fort Ord 1953 architectural drawing of the Permanent Troop Spaces and Supporting Facilities Classrooms (Buildings 21, 23, 58, 59) (CSUMB Facilities 2021).



Figure 9. Fort Ord 1995 architectural drawing of changes made to some of the buildings that used the Permanent Troop Spaces and Supporting Facilities Classroom building plan (CSUMB Facilities 2021).

Medical Buildings

Medical buildings at Fort Ord have a variety of uses and functions that changed over the history of the base. One of the most common medical building types during this period were clinic buildings. Examples of clinic buildings that are extant and part of the present-day CSUMB campus study area are the Science Research Lab Annex (13) and Watershed Institute (42) (more detail below). In alignment with the typical planning, design, and materials of buildings constructed during this period of Fort Ord's history, these buildings are constructed with reinforced concrete and CMU and feature flat roofs with multi-light windows with concrete sills. Building 13 was originally a dental clinic and Building 42 was one of the Fort's regimental dispensaries (pharmacies). The buildings were initially designed to have waiting areas near the front entrances, with patient rooms separated from the primary entrance by long hallways.

The Science Research Lab Annex (13), originally a dental clinic, was designed by the San Francisco architectural firm of Milton T. Pflueger in 1963 (CSUMB Facilities 2021). The original plans called for the interior space to have 28 dental chairs. It was the first permanent dental clinic at Fort Ord. Renovation architectural drawings from 1987 show many of the interior walls were demolished to divide the building into two clinics, the Stone Dental Clinic and a Blood Donation Center (Figure 10) (CSUMB Facilities 2021). In 1995, CSUMB facility plans show the building was converted to the university's science building (Figure 11) (CSUMB Facilities 2021).

The Watershed Institute building (42), originally a regimental dispensary, was designed in 1956 by the firm White, Noakes & Neubauer, Architects, and Engineers, located in Washington D. C. (CSUMB Facilities 2021). In 1959, The Californian reported two new regimental dispensaries were approved for construction at Fort Ord. Daniels and House Construction company of Monterey received the contract for \$197,964. Original plans called for the interior space to have a waiting room, clerk and records room, doctor's office, a resting room, examination and treatment room, surgical dressing room, a fan room, the boiler room, and coal storage (Figures 12 and 13). As-built changes were made to the drawings in January of 1960, suggesting the building was constructed by this time (CSUMB Facilities 2021).

After Fort Ord closed in 1994, the buildings became part of the CSUMB campus and both buildings were altered to serve as classroom space designed for academic study and instruction.

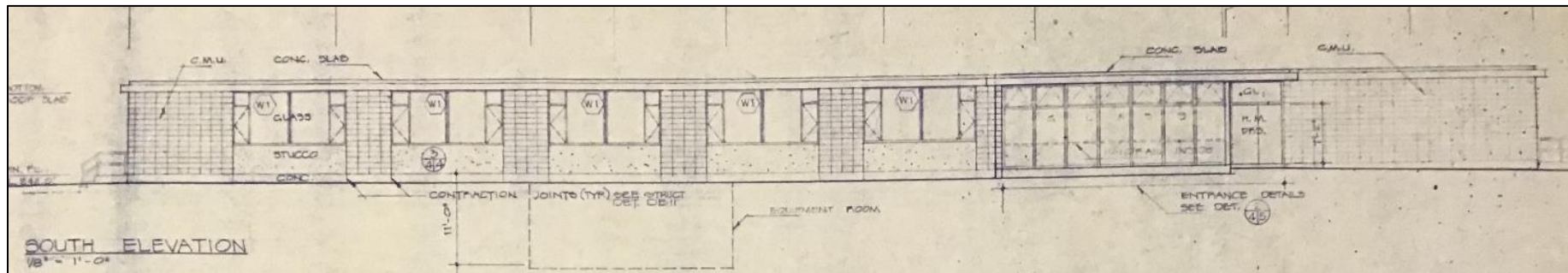

Figure 10. Fort Ord 1963 architectural drawing of the Science Research Lab Annex (Building 13) (CSUMB Facilities 2021).



Figure 11. Photograph (c. 1990) of the Science Research Lab Annex (Building 13) after its conversion to the Stone Army Dental Clinic (DLIFLC 2021).

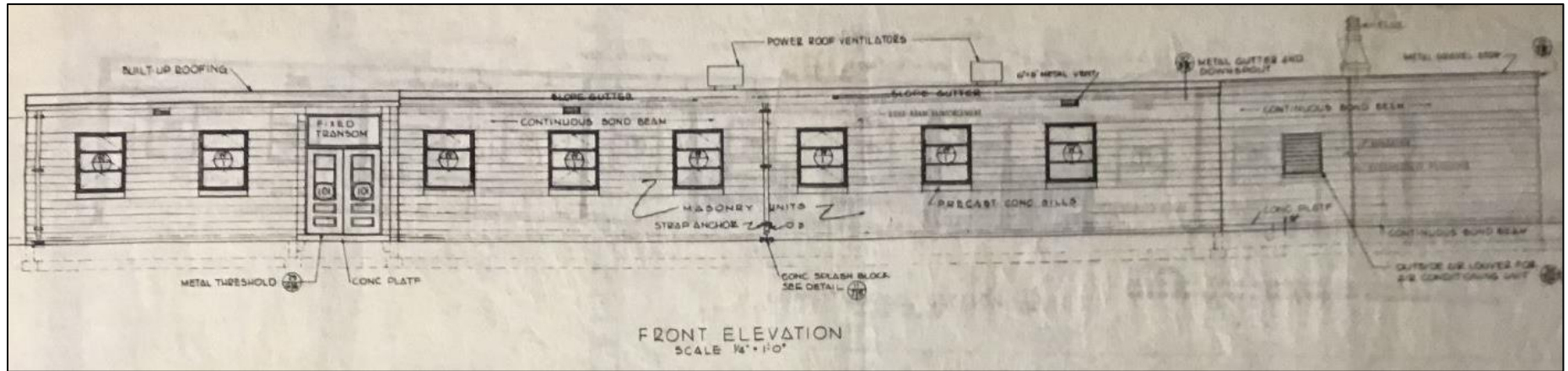

Figure 12. Fort Ord 1956 architectural drawing of the Watershed Institute (Building 42) (front elevation) (CSUMB Facilities 2021).

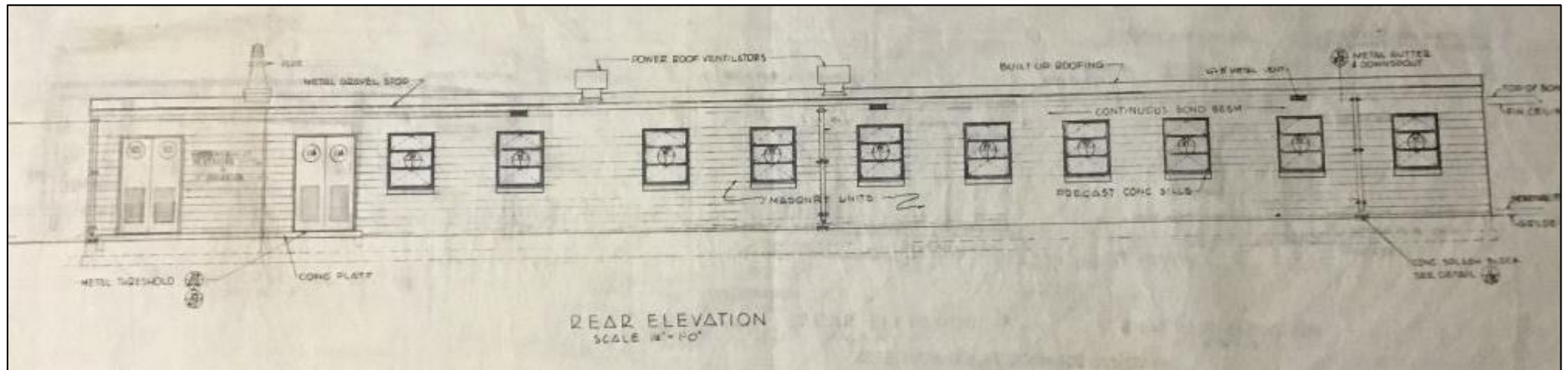

Figure 13. Fort Ord 1956 architectural drawing of the Watershed Institute (Building 42) (rear elevation) (CSUMB Facilities 2021).

Hammerhead Buildings/Barracks

Three buildings that are part of the CSUMB campus study area, Pacific Hall (44), Coast Hall (45), and Harbor Hall (46), first appear on a 1956 aerial photograph of the site on the western half of the base. They are part of a group of eight other similarly oriented buildings. These buildings were originally designed as new permanent barracks, commonly referred to as the “Hammerhead Buildings,” that were part of the \$26,650,600 construction program awarded by the military in 1952. More than \$17 million of these funds were used to construct 38 three-story barracks. These larger barracks were planned to house entire companies and serve all their needs in one space, with mess halls, lounges, day rooms, orderly rooms, supply rooms, and issue rooms, as well as administrative space (The Californian 1952a).

The Del Webb Construction Company won the work at Fort Ord with a low bid of \$12,614,832 (The Californian 1952b: 18). Groundbreaking for the project took place on February 19, 1952. The barracks were featured in the Del Webb Construction Company’s newsletter, *The Webb Spinner*, in the June/July/August edition. The paper described the new military dormitories as “sleek” (The Web Spinner 1952-54, Vol 6. No. 3:6). The buildings were a departure from the “old, white-painted barracks” constructed 12 years earlier. The new barracks were erected of steel and concrete with large glass areas (Figures 14-16). The concrete construction was praised as both vermin and fire-proof (The Web Spinner 1952-54, Vol 8. No. 5:6).

After Fort Ord closed in 1994, the buildings became part of the CSUMB campus. There were no notable changes to the footprint of the buildings until sometime between 2012 and 2014 when the east, multi-story wings were demolished on Coast Hall (45) and Harbor Hall (46). Pacific Hall’s east multi-story wing was demolished sometime between 2016 and 2021.



Figure 14. Fort Ord, after construction of new barracks between 1952 and 1954 (The Webb Spinner 1952-54, Vol 8. No. 5:6).



Figure 15. Fort Ord 1952 Conceptual drawing of the new barracks at Fort Ord (The Web Spinner 1952-54, Vol 6. No. 3:1).

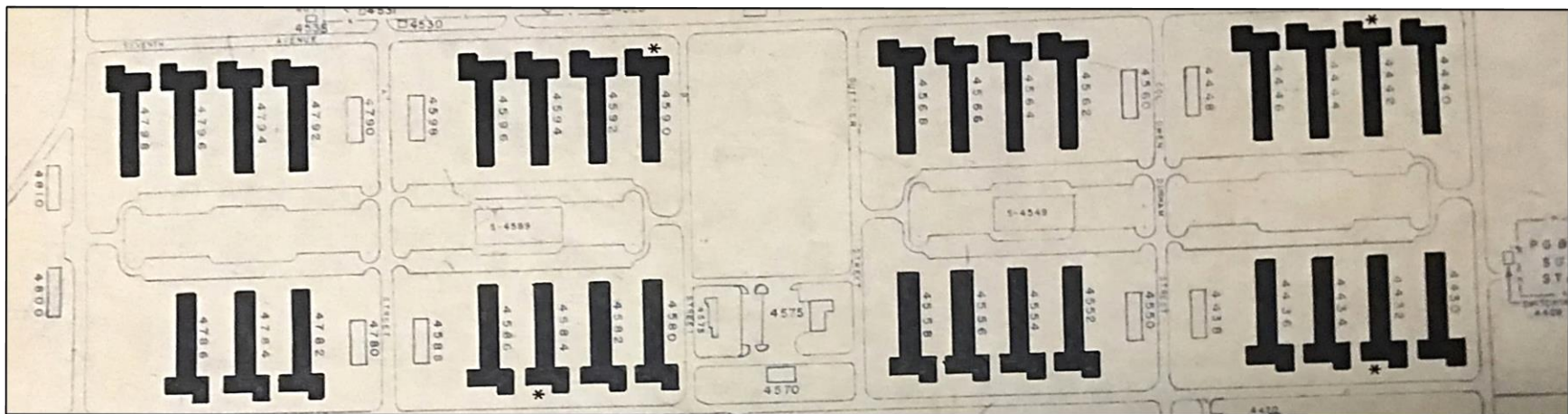

Figure 16. Fort Ord architectural site plan of the Hammerhead Buildings/Barracks (CSUMB Facilities 2021).

Recreation Facilities

During the Cold War and Vietnam Eras at Fort Ord (1946-1976) recreational opportunities increased substantially on the base. Initially, the U.S. Armed Forces focused solely on training programs that led to the production and establishment of a robust fighting force. Recreation for enlisted soldiers was often provided by civilian groups, not through formal programs run through any branch of the military. This began to change after World War I. The 1940 plan for the development of Fort Ord called for all the buildings necessary to train, house, and care for the infantry, as well as the construction of recreation related facilities such as post exchanges, regimental recreational facilities, moving picture tents, and service clubs (Quartermaster Review 1940: 37). During World War II, the military vastly expanded recreational offerings for enlisted personnel to boost morale and to align with more modern concepts of free-time and leisure (Gates 1957: 99). Morale, it was said, was “just as important as ammunition” and newer, more modern thinking saw recreation as a “vital force in self-development and the art of living” (Gates 1957: 100).

Early recreation activities at the Fort included band concerts, live theater, orchestra shows, and choir performances often organized by the enlisted men (Park 2015: 25). Track and field meets were organized with field days throughout World War II. Boxing was also noted as a popular spectator sport at the base in its early years (Park 2015:25). Fort Ord’s first football team, the Presidio Dons, was organized in October 1940. The team initially practiced and played at nearby Del Monte Polo Field. During World War II, the Fort Ord Athletic and Recreation Officer designed a plan to keep soldiers “fit to fight” by developing a more extensive plan for football, baseball, softball, boxing, and other recreational activities. Soon after, games and tournaments were arranged between Fort Ord teams, nearby military bases, and other organized teams (Gates 1957: 100). After the war ended in 1945, Fort Ord introduced an athletic program that gave service members “an opportunity to take part in any recreational activity they wish” (Park 2015: 33). In 1951, a report completed by the Committee on Religion and Welfare in the Armed Forces found that the availability of “wholesome free time activities” were essential for shaping character, increasing job performance, and for the national support of the Armed Forces” (Gates 1957: 100).

The recreation opportunities available at Fort Ord continued to expand in the post-World War II era with the construction of the stadium and other outdoor athletic fields in the 1950s and 1960s. By 1977, the main garrison area included a wide variety of recreation facilities, including a snack bar, bowling center, softball field, baseball field, service club, library, handball courts, tennis courts, a commissary, the theater, and parade grounds, as well as the Football and Track Stadium (U. S. Army 1977). It was believed that these recreation opportunities created better leaders and would better prepare soldiers for successful civilian lives after their service (Gates 1957: 104).

The Freeman Stadium, originally called Warrior Stadium, is the only Recreation Facility type in the campus study area. Freeman Stadium is made up of the following components: the field, track, bleachers, electrical building, and Field House. This grouping is referred to throughout this report as the “Freeman Stadium.” In January of 1949, the Army prepared plans and specifications for a new Football and Track Stadium (Fresno Bee 1951b:27). The plans were finalized in December 1949 by Fort Ord Engineer Office (CSUMB Facilities 2021). They called for the development of the new stadium at the site of the base’s existing amphitheater, just north of the parade grounds. In January 1951, the Army requested bids for a \$200,000, 6,000-seat, concrete football and track stadium at Fort Ord. The design called for the stadium seating to be reinforced concrete, set into the existing dirt embankment of the base’s amphitheater (Fresno Bee 1951a: 13).

The plan to develop a stadium at Fort Ord was immediately met with criticism, as President Truman had previously ordered a freeze on new government construction projects to direct funds to the Korean War effort. The Army argued that the stadium was planned “long before the present emergency” and would be constructed of non-critical

materials. The planned stadium seating was designed to be constructed of “concrete steel blocks” and concrete slab flooring. In February 1951, it was announced that the stadium would use steel water pipes and cast-iron conduits for construction in an effort to preserve copper (Fresno Bee 1951b:27). Ultimately, the ban on unnecessary construction was ignored, citing the need for recreational facilities to boost morale, and because the growth of Fort Ord was placing a “severe strain on the recreational facilities in the Monterey-Salinas area” (San Francisco Examiner 1951:4). The stadium was considered a necessary facility to “keep pace with the growth of the tent-soldier population” and the athletics field would help to reinforce the Army’s rigorous training program (San Francisco Examiner 1951:4). The contract was awarded to construct the stadium and Field House in March 1951 to F. V. Hampshire Contracting Company of Salinas. They bid \$146,346 for the project. Construction was set to begin soon after the contract was awarded and was planned to be completed by September 1951 (Figures 17 and 18) (The Californian 1951: 1).

After Fort Ord closed in 1994, Warrior Stadium became part of the CSUMB campus. The stadium was rebranded as Freeman Stadium and has not been used for athletic purposes in some time; instead it is used for graduation ceremonies and other gatherings.

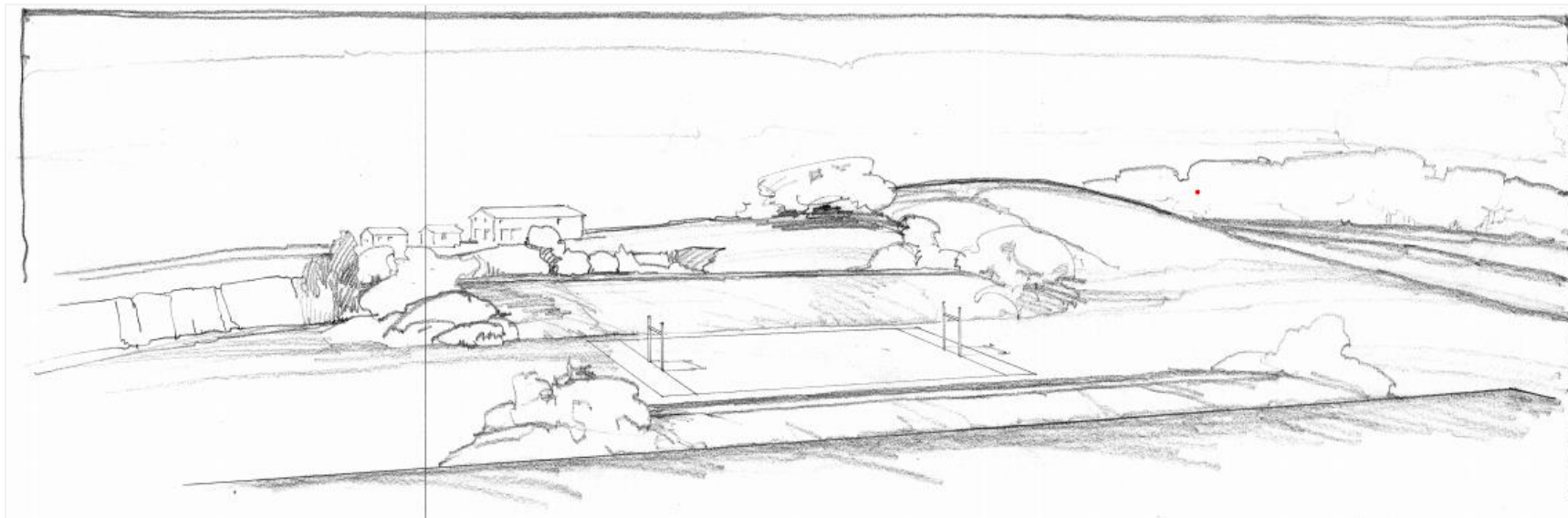

Figure 17. Fort Ord 1951 conceptual drawing of the Stadium (CSUMB Facilities 2021).

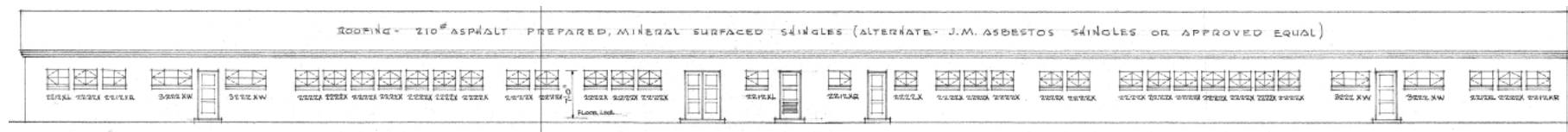

Figure 18. Fort Ord 1949 architectural drawing the Field House (CSUMB Facilities 2021).

3.4.5 The Volunteer Army - and the Base Realignment and Closure (BRAC) (1974-1994)

The expiration of the draft authority in 1973 created an all-volunteer Army for the first time since 1948 (Moore 1975: iii). During this era, the Army worked to increase the enlistment men and women, to raise the quality of Army life, and to improve professionalism throughout the rank and file (more 1975: iii). Lieutenant General Harold G. Moore described the program at Fort Ord as one focused on improving conditions, fostering racial harmony, enhancing morale, creating a better training regime to improve life in the Army, and encouraging enlistment (Moore 1975: 119, 121)

With the end of the Cold War in the 1980s, the government implemented programs to increase the efficiency of the Department of Defense. One of these programs included defense installation realignment and closures, including the downsizing of Fort Ord (Cavanaugh 2000: 9). The Base Realignment and Closure (BRAC) Commission determined which military installations would close. BRAC also established the framework for the transfer of ownership. Despite objections by the community to the closure of Fort Ord, the Secretary of Defense announced the closure of Fort Ord in April 1991 (Cavanaugh 2000: 9). The Fort was divided. A portion was retained by the Army, another was kept as a nature preserve, and another was set aside to establish CSUMB. Figures 19 and 20 show the newly established campus boundaries within Fort Ord. The newest installation of the California State University system opened on September 4, 1996 (Cavanaugh 2000: 29). President Bill Clinton was present for the dedication of the campus (Cavanaugh 2000: 28).

INTENTIONALLY LEFT BLANK

Figure 19. 1987 Aerial showing the current main campus boundary with intact Fort Ord buildings



Figure 20. 2021 Aerial showing the current main campus boundary with areas of extensive demolition of Fort Ord buildings and significant changes in paths of circulation



INTENTIONALLY LEFT BLANK

3.5 Notable Fort Ord Architects and Builders

3.5.1 Del E. Webb Construction Company

The Del E. Webb Company was founded by Delbert Eugene Webb in Phoenix in 1928. The company grew to develop a diverse range of projects across the United States during and was known for large-scale commercial, residential, and institutional projects (Del Webb and Pulte Homes 2021:1). During World War II, the company won many military and Navy contracts for housing projects. They specialized in streamlining massive construction projects across undeveloped land.

After World War II, Webb transitioned into many emerging development markets. In the late 1940s, Webb constructed a casino/hotel in Las Vegas for Benjamin “Bugsy” Siegel. Del Webb went on to become the “largest gaming operator and private employer in Nevada” (Del Webb and Pulte Homes 2021:1). In January of 1960, the Del Webb Corporation opened a community in Phoenix, Arizona aptly named “Sun City”. The community was known for its modestly priced housing and delivered a “highly desirable lifestyle.” Del Webb went on to construct “Sun Cities” in Florida and Southern California (Del Webb and Pulte Homes 2021:1). The company continued to focus on gaming and commercial operations until 1987 when the decision was made to sell these interests and focus on the development of “master-planned, active adult communities” (Del Webb and Pulte Homes 2021:2). By January of 2000, the company had planned and constructed 13 Sun Cities communities, selling more than 80,000 homes. In July 2001, Del Webb Company merged with Pulte Homes Inc. to create the largest homebuilding company in the nation (Del Webb and Pulte Homes 2021:3).

Webb was the lead contractor for several prominent buildings, campuses, and institutions. These included Madison Square Garden in New York City from 1964-1968 (New York, NY) and the Los Angeles County Museum of Art in 1963-1964 (Los Angeles, CA). Several buildings constructed by the company are listed on the NRHP, including many components of the Williams Air Force Base in Arizona (two Ammo Bunkers, the Civil Engineering Maintenance Shop, the Demountable Hangar, the flagpole, the Housing Storage Supply Warehouse, and the Water Pump Station and Water Tower). Additionally, Webb was the contractor for the 1938 addition to the Arizona State Capital Building, Hunts Tomb, and the Phoenix Towers, all in Phoenix, AZ. All three buildings are all listed on the NRHP.

The Del Webb Construction Company received the contract to construct forty-two buildings at Fort Ord in February of 1952. This contract included the construction of the Hammerhead Buildings/Barracks, buildings for the regional headquarters, and regimental supplies buildings (The Web Spinner 1952-54, Vol 6. No. 3:1). The company was also awarded the contract in March of 1952 to construct a guardhouse, stockade, warehouse, and other buildings and a contract to construct the utilities, including fencing, paving, railroads, water systems, water supply and storage (including reservoirs, well houses, equipment, and a water booster pump station), gas distributing system, and sanitary and storm sewer installations. (The Web Spinner 1952-54, Vol 6. No. 4:1; The Web Spinner 1952-54, Vol 6. No. 8:1).

3.5.2 Milton T. Pflueger

Milton Theodore Pflueger was born in San Francisco in 1907. From 1925 to 1929, Pflueger worked as a draftsman for the architectural firm Bakewell & Brown. Around 1930, Pflueger began working for his older brother, Timothy Pflueger, who was a partner of architect J. R. Miller (OAC 2021). In 1940, Milton Pflueger went into partnership with his brother Timothy for several years until Timothy Pflueger died in 1946 (PCAD 2021).

Milton Pflueger opened his own firm in the San Francisco Bay area. His more notable projects included: Richmond Memorial Civic Center (Richmond, CA), University of San Francisco Richard A. Gleeson Library (San Francisco, CA), the headquarters building for the Department of Motor Vehicles (Sacramento, CA), the Herbert C. Moffitt Hospital at the University of California Medical Center (San Francisco, CA), Alemany Housing Project (San Francisco, CA), the William F. Herrin laboratories, Herrin Hall, and Florence Moore Hall, all at Stanford University (Stanford, CA), Millberry Union UCSF Medical Center (San Francisco, CA), and Tulare Theater, (Tulare, CA) (OAC 2021 and PCAD 2021). Pflueger's firm is known to have designed the Science Research Annex building in the Built Environment ADI (CSUMB Facilities 2021).

3.5.3 Robert Stanton

Robert Stanton was born in Detroit, Michigan in 1900. He served briefly in the U.S. Navy during World War I and then graduated from high school in Los Angeles and went on to complete his education at University of California at Berkeley. After graduation he worked with renowned architect, Wallace Neff. Neff appointed Stanton as project supervisor on several projects and Stanton earned his architecture license in 1934. Stanton moved to Monterey Bay in 1935 and went on to design a variety of residential, commercial, and public buildings in the area. Two of his buildings, the Monterey County Courthouse and the King City High School Auditorium have been listed on the NRHP (Hiller 2007:8-4). Robert Stanton was known to have designed a plan for classroom buildings at Fort Ord that was used for at least four buildings on campus (CSUMB Facilities 2021).

3.6 Notable Fort Ord Military Personnel

3.6.1 General Joseph "Vinegar Joe" Stilwell

Joseph Warren Stilwell was born in 1883 in Palatka, Florida. He joined the Army and graduated from the United States Military Academy in West Point, New York in 1904 (Encyclopedia Britannica 2021). During World War I, he served as the Deputy Chief of Staff for Intelligence in the IV Corps of the American Expeditionary Forces. He served three times in China and could speak fluent Chinese (Chen n.d.). While serving his third posting in China, he acted as military attaché to the U.S. Legation in Beijing (now Beijing) in north China from 1935 and 1939 (Chen n.d.).

While teaching at the Infantry School at Fort Benning, Georgia, one of Stilwell's students drew a caricature of Stilwell rising out of a vinegar bottle, "portraying his sore personality, and the name 'Vinegar Joe' stuck with him for the rest of his career" (Chen n.d.). He was known to give malevolent nicknames to people he did not like and had a "no-nonsense attitude" (Chen n.d.).

In 1940, Stilwell was the commanding officer of the 7th Division at Fort Ord. While at Fort Ord, he started the Fort's newspaper, *Panorama*. He wanted "a weekly newspaper published by and for the officers and men of Fort Ord/Presidio of Monterey area" (Panorama 1990: 2). Stilwell also established Fort Ord Soldier's Club in 1943 (later renamed the Stilwell Community Center). "The cost was partially funded by enlisted soldiers who voluntarily contributed" (McPherson 1990: 18). The Club was located over the bluffs near the Pacific Ocean and was demolished in 2003 due to erosion.

Stilwell left Fort Ord in 1943 to command the American Troops in the China-Burma-India theater (Castle 1990: 3). He returned to the United States and served as the Sixth Army commander in San Francisco. Stilwell died in 1946 (Encyclopedia Britannica 2021).

3.6.2 Lt. James (Jim) E. Moore

James (Jim) E. Moore was born on June 28, 1931. He graduated from United States Military Academy in West Point, New York and was assigned to the 28th Infantry, in Heilbronn, Germany. In 1954, Moore married Joan Marie Phillips, and the couple had seven children. He was stationed at Ft. Bragg, Ft. Benning, and the Alliance Francaise. During the conflict in Vietnam, Moore was awarded both the Silver Star and Vietnamese Cross of Gallantry for his service (Moore Chiusano 2009).

After Vietnam, Moore attended the Army War College and was assigned to J-3 Headquarters, U.S. European Command. Moore was selected to command two Fort Ord brigades, the 3rd BCT Brigade, and the 1st Brigade, 7th Infantry Division (Cavanaugh 2000: preface). He later commanded the 7th Infantry Division. He is credited with saying, “take care of soldiers, and they will take care of the mission” (Moore Chiusano 2009). Moore was awarded the Distinguished Service Medal. He was promoted to lieutenant general in 1985. Moore died in 1999 and the North-South Road at Fort Ord was renamed after him in 2000 (Moore Chiusano 2009).

3.7 Fort Ord Building Typology and Character-Defining Features

The following presents a discussion of the building typology found on the campus and provides a detailed account of the specific character-defining features of buildings and structures on site. Four categories of building types were identified for the purposes of this study. These are the Support Services Buildings, Medical Buildings, Hammerhead Buildings/Barracks, and Recreational Facilities. The numbering system used throughout the following discussion represents the current building numbers and building names as shown on the official campus master plan map unless otherwise specified.

3.7.1 Support Services Buildings

The Support Services Buildings on the campus were originally constructed in the late 1950s and the early 1960s. The buildings tended to have central entryways that opened into hallways, with classrooms lining the halls. These buildings have a uniform design, like many of the other buildings at Fort Ord. The buildings that fall under this category for the Built Environment ADI include Green Hall (58), the Reading Center (59), Beach Hall (21), and Tide Hall (23).



Figure 21. Building 58, Green Hall, View facing southeast at the north elevation (IMG_0566).

Character-Defining Features for the Support Services Buildings

The Support Services Buildings originally exhibited the following specific character-defining features (Table 5):

Table 5. Character-Defining Features: Fort Ord Support Services Buildings

Character Aspect	Primary Character-Defining Features	Character-defining features
Shape and Plan	<ul style="list-style-type: none"> • Simple rectangular form • Single story 	The overall shape and mass of the building are considered a primary character-defining feature of the support services buildings. The plan should be rectangular in form.
Roof	<ul style="list-style-type: none"> • Flat or gable roof • small eave overhangs • No exposed rafters 	Support service buildings from this period have gable roof forms, with slight eave overhangs.
Openings	<ul style="list-style-type: none"> • Public entrances and circulation patterns 	Window openings are generally uniform in size and placement, windows are multi-light, and set into concrete openings. Replaced windows are not considered character-defining features as they fall outside the period of significance.
Exterior Ornamentation	<ul style="list-style-type: none"> • Minimal exterior ornamentation 	The support services buildings were designed to be quickly constructed. They have little to no decorative ornamentation, with windows being set evenly apart and CMU pillars being the only decorative element.
Materials	<ul style="list-style-type: none"> • Mass-produced and cost-effective materials • Concrete and CMU • Reinforced Concrete construction 	The support services buildings have simple, utilitarian designs. Buildings were constructed using mass-produced and cost-effective building materials that were readily available at the time of construction. For instance, buildings under the support services buildings type were constructed with reinforced concrete and CMU and were minimally decorated.

Alterations and demolitions over time have compromised the overall architectural integrity of this building type. The most common alterations observed for this building type include the following:

- Replacement windows
- ADA compliance measures such as ramps and doors
- HVAC systems and window units
- Infill of openings
- Addition of front gable over doorways
- Interior renovations

3.7.2 Medical Buildings

The Medical Buildings on the campus were originally constructed in the late 1950s and the early 1960s. The Medical Buildings tended to have central entryways that opened into waiting areas, with smaller exam rooms behind reception desks. These buildings did not have a uniform design, unlike many of the other buildings at Fort Ord. The buildings that fall under this category for the campus include The Science Research Lab Annex (13) and the Watershed Institute (42).



Figure 22. Building 13, the Science Research Lab Annex, View facing northwest at the south elevation (IMG_0715).

Character-Defining Features for the Medical Buildings

The Medical Buildings originally exhibited the following specific character-defining features (Table 6):

Table 6. Character-Defining Features: Fort Ord Medical Buildings

Character Aspect	Primary Character-Defining Features	Character-Defining Features
Shape and Plan	<ul style="list-style-type: none"> • Simple rectangular form • Single story 	The overall shape and mass of the building with a central entrance opening to waiting areas.
Roof	<ul style="list-style-type: none"> • Flat roof • Moderate or slight eave openings • No exposed rafters 	The Medical Buildings have flat roofs, with moderate or slight eave overhangs.
Openings	<ul style="list-style-type: none"> • Entrances on the ground level • Multi-light windows or modern windows with protruding metal frames set on concrete sills • Public entrances and circulation patterns 	Window openings are uniform in size and placement, windows are multi-light, and set into concrete openings. Replaced windows are not considered character-defining features as they fall outside the period of significance.
Exterior Ornamentation	<ul style="list-style-type: none"> • Minimal exterior ornamentation • Glass windows used as ornamentation 	The Medical Buildings were often specifically designed to serve specific functions. They have little to no decorative ornamentation, with windows in ribbons, or evenly spaced windows being the only decorative element.
Materials	<ul style="list-style-type: none"> • Mass-produced and cost-effective materials • Concrete and CMU • Reinforced Concrete construction 	Medical Buildings have simple, utilitarian designs. Buildings were constructed using mass-produced and cost-effective building materials that were readily available at the time of construction. Buildings under the Medical Building type were constructed with reinforced concrete and CMU and were minimally decorated.

Alterations and demolitions over time have compromised the overall architectural integrity of this building type. The most common alterations observed for this building type include the following.

- Replacement windows
- ADA compliance measures such as ramps and doors
- HVAC systems and window units
- Infill of openings
- Interior renovations

3.7.3 Hammerhead Buildings/Barracks

The Hammerhead Buildings/Barracks were originally constructed between 1952 and 1954, and historically served as a barracks for housing troops. These buildings were commonly called the Hammerhead Buildings because of the “hammer”-like plan. Buildings within the Built Environment ADI that fall under this category include Pacific Hall (44), Coast Hall (45), and Harbor Hall (46).



Figure 23. Building 44, Pacific Hall, View facing east at the west elevation (IMG_0602).

Character-Defining Features of the Hammerhead Buildings

The Hammerhead Buildings/Barracks originally exhibited the following specific character-defining features (Table 7):

Table 7. Character-Defining Features: The Hammerhead Buildings/Barracks

Character Aspect	Primary Character-Defining Features	Character-Defining Features
Shape and Plan	<ul style="list-style-type: none"> • Hammerhead shape • Single story wing and multi-story wing 	The overall shape and mass of the building are considered a primary character-defining feature of the Hammerhead Buildings/Barracks. The plan should include a multi-story wing.
Roof	<ul style="list-style-type: none"> • Flat roof • Wide eave overhangs • No exposed rafters 	The Hammerhead Buildings/Barracks have flat roofs, with moderate eave overhangs.
Openings	<ul style="list-style-type: none"> • Entrances on the first story • Multi-light windows 	Window openings are uniform in size and placement, windows are multi-light, and set into concrete openings. Replaced windows are not considered character-defining features as they fall outside the period of significance.

Table 7. Character-Defining Features: The Hammerhead Buildings/Barracks

Character Aspect	Primary Character-Defining Features	Character-Defining Features
Exterior Ornamentation	<ul style="list-style-type: none"> Minimal exterior ornamentation Glass windows used as ornamentation 	Hammerhead Buildings/Barracks were designed to be quickly constructed. They have little to no decorative ornamentation, with windows in ribbons being the only decorative element.
Materials	<ul style="list-style-type: none"> Mass-produced and cost-effective materials Concrete and CMU Reinforced concrete construction 	Hammerhead Buildings/Barracks have simple, utilitarian designs. Buildings were constructed using mass-produced and cost-effective building materials that were readily available at the time of construction. For instance, buildings under the Hammerhead type were constructed with reinforced concrete and CMU and were minimally decorated.

Alterations and demolitions over time have compromised the overall architectural integrity of this building type. The most common alterations observed for this building type include the following.

- Replacement windows
- ADA compliance measures such as ramps and doors
- HVAC systems and window units
- Infill of openings
- Interior renovations

3.7.4 Recreational Facilities

The only Recreation Facilities in the Built Environment ADI, Freeman Stadium, was originally constructed in 1951. As previously discussed, the stadium was constructed at the site of Fort Ord’s existing amphitheater, just north of the former parade grounds. The 6,000-seat stadium seating was constructed of reinforced concrete, set into the existing dirt embarkment (Fresno Bee 1951a: 13). The Field House was also constructed of concrete, as a building ban was in effect and concrete was not a restricted material.



Figure 24. Building 902, Freeman Stadium, View facing northeast at the west elevation (IMG_0431).

Character-Defining Features for the Recreational Facilities

The Recreation Facilities originally exhibited the following specific character-defining features (Table 8):

Table 8. Character-defining features: Fort Ord Recreational Facilities

Character Aspect	Primary character-defining features	Character-defining features
Shape and Plan	<ul style="list-style-type: none"> • Arena form • Track • Field • Bleachers • Field House 	The overall shape and mass of the building as well as circulation and arrangement of the bleachers relative to the field are considered primary character-defining features of Recreational Facilities.
Roof	<ul style="list-style-type: none"> • Various roof forms • Slight eave overhangs 	Recreational Facilities have varied roof structures, but the retention of the form is a primary character-defining feature
Openings	<ul style="list-style-type: none"> • Multi-light windows • Concession windows 	Window openings are uniform in size and placement, windows are multi-light, and set into concrete openings. Replaced windows are not considered character-defining features as they fall outside the period of significance.
Exterior Ornamentation	<ul style="list-style-type: none"> • Minimal exterior ornamentation • Glass windows and glass block used as ornamentation 	Recreation Facilities were designed to be the backdrop to athletic competitions and events. They have little to no decorative ornamentation, with evenly spaced windows being the only decorative element.

Table 8. Character-defining features: Fort Ord Recreational Facilities

Character Aspect	Primary character-defining features	Character-defining features
Materials	<ul style="list-style-type: none"> • Mass-produced and cost-effective materials • Concrete and CMU • Reinforced Concrete construction 	Recreation Facilities have simple, utilitarian designs. Buildings were constructed using mass-produced and cost-effective building materials that were readily available at the time of construction. For instance, buildings under the Recreational Facility type were constructed with reinforced concrete and were minimally decorated.

Alterations and demolitions over time have compromised the overall architectural integrity of this building type. The most common alterations observed for this building type include the following.

- Replacement windows
- Barrel roof additions
- Infill of openings
- HVAC systems and window units
- ADA compliance measures such as ramps and doors

3.8 Historical Overview California State University Monterey Bay

3.8.1 Higher Public Education in California

The following section discusses the expansion of the State Normal School system in California and the circumstances that caused the early campuses to become the foundation of the Nation’s largest public four-year university system.

The Normal School system began in 18th century Europe as a training school for teachers to establish a standard approach to elementary school curriculum in public institutions. As the notion of consistent teacher-training spread beyond Europe, the first Normal School was established in the United States in Lexington, Massachusetts in 1839 (Encyclopedia Britannica 2002). Nearly twenty years later in 1857, the San Francisco Board of Education established Minns Evening Normal School in San Francisco, named after the school’s first principal, George Minns. It was not only the first Normal School in the state but also the first public institution of higher education in operation within the new State of California (Vasche 1959: 5; CSUC 2021a).

Following a vote of basis by the State Legislature, Minns Evening Normal School became the California State Normal School in 1862. In 1871, the State Legislature voted to relocate the campus from San Francisco to San Jose, where it opened in time for the 1872 term. This campus continues to this day as San Jose State University (CSUC 2021a).

Subsequent State Normal School campuses were established in other cities throughout the State during the remainder of the 19th century, including Los Angeles (1882), Chico (1889), San Diego (1897), and another in San Francisco (1899) (Vasche 1959: 5).

Following the turn of the 20th century, the California State Normal School system established several campuses that offered new educational opportunities. The California Polytechnic School in San Luis Obispo opened as a State-funded, vocational co-ed high school in 1903. The Santa Barbara State Normal School of Manual Arts and Home Economics opened in 1909 as a public institution that adopted the Finnish Sloyd, or education through manual training. The first public junior college opened in Fresno in 1910. Two additional Normal Schools were established during the early 20th century in Fresno (1911) and Arcata (1913) before the State Legislature voted to change all “Normal Schools” in the State system to “Teachers Colleges” in 1921. The State Teachers Colleges were authorized to offer a B.A. of Education in 1923, which was followed by the approval to offer courses beyond teacher training when the Legislature voted to rename “Teachers Colleges” to “State Colleges” in 1935. At this time, the State College system was serving approximately 8,230 students per year (Vasche 1959: 5).

Prompted by massive post-World War II population growth in California, ten (10) new campuses were in place by 1961 when the Donahoe Higher Education Act of 1960 formally established the “California State Colleges” (CSC) system. The newest campuses in Los Angeles (1947), Sacramento (1947), Long Beach (1949), Fullerton (1957), Hayward (1957), Stanislaus (1957), San Fernando Valley (1958), Sonoma (1960), San Bernardino (1960), and Dominguez Hills (1960) helped the burgeoning State system educate roughly 105,900 students annually throughout the state (CSUC 2021a). To construct the facilities necessary to serve the students on the new and expanding CSC campuses, in some cases, the State of California Public Works, Division of Architecture modified standardized designs to fit the needs of individual campuses to save money and expedite construction schedules.

In 1972, the State College System was renamed “The California State University and Colleges” which included criteria by which 14 state campuses were henceforth deemed a ‘University’ while the remaining five retained their designation as a ‘College’. In 1982, the system schools became “The California State University” (CSU) system. Today, the CSU system is one of the widest-ranging public education systems in the United States and presently includes twenty-three (23) participating campuses throughout the state, which serve an estimated 481,000 students every year (Encyclopedia Britannica 2006; CSUC 2021b).

3.8.2 Historical Overview of CSUMB (1991-present)

The establishment of CSUMB began in 1991 when news of Ford Ord’s closing was released. Following the announcement of Fort Ord’s closure, plans for a new university were organized through CSU San Jose, with the goal of opening a new CSU campus on the former Fort by August 1995. In May of 1994, the CSU system was given 1,350 acres of former Fort Ord land to establish the CSUMB campus (CSUMB 1998: 19). Administrators set up three temporary facilities in August 1994 and by early 1995 several former military buildings were in the process of rehabilitation for educational use. When the school opened in August, only “two of the twenty-two facilities under renovation were completed, and classes began on the campus and in a nearby vacant elementary school on a temporary basis” (CSUMB 1998: 21). CSUMB was the first university created on what was previously an active military installation. President Bill Clinton was present on September 4, 1995, for the dedication ceremony of the 21st school in the California State University system (CSUMB 1998: 21). In 1995, CSUMB had 633 students with the first phase of construction focusing on renovating military buildings into the key elements of a college campus, including lecture halls and classrooms, faculty offices, dormitories, an auditorium, a student dining hall, a gymnasium, and a library (CSUMB 1998).

The first campus Master Plan was prepared in 1998 and presented the development history of the campus and planned development for the coming years. The 1998 plan stated that two of the three original phases of construction were completed with funding coming from the “military to education” defense conversion project. The plan also stipulated that by the fall of 1997 the campus would have 42 buildings with approximately 500,000 gross square feet of space for campus use (CSUMB 1998).

The college’s first period of development revealed design issues with conversion efforts from a structured and highly organized military design into the interdisciplinary requirement of higher education with an emphasis on freedom of movement (Cavanaugh 2000: 28; CSUMB 1998). The following excerpt from the 1998 plan clearly defines the design challenge presented to the University in the initial phase of campus development:

The campus’s previous use as a military installation serves as the basis for the campus’s community design. The existing buildings, road systems, and landscape spaces were built quickly over specific time periods. Building development is located in clusters over large areas. In addition to the nature and period of development, the political hierarchy of the military is expressed in the organization and placement of the buildings. The building clusters are oriented inward, away from the street, to control their function and use. In imposing this sense of hierarchy, the military formed an environment that, for the University, inherently limit opportunities of use by restricting the social aspects of the built environment that buildings and streets normally offer to a community (CSUMB 1998: 97).

Unlike many colleges in California, CSUMB began with a pre-constructed campus of buildings remaining from the decommissioned military installation. The Army buildings that the university inherited in 1994 were organized in efficient, easy to monitor, gridded developments that were separated by large, paved areas to store military vehicles (Moore 2007: 3-4). The college not only needed to convert buildings constructed for military use into usable education spaces, but they also needed to deformalize the spaces by including roads, landscaping, and pedestrian pathways to make them conducive to be used by students, faculty, and workers (CSUMB 1998; NETR 2021).

Some of the first major modifications to the military buildings occurred as the campus pursued its mobility initiative with a comprehensive ADA compliance plan in the late 1990s. During this time, all of the buildings on the campus were modified for ADA compliance to fulfill a new purpose as an education facility. Such alterations included the installation of ramps and the replacement of original entry and exit points with ADA-accessible doors (CSUMB 1998; CSUMB Plan Room 2021).

This first phase of construction was focused around the Main Quad (Freshman Quad), which became the first significant open space created on campus. Construction was also focused along Sixth Avenue with the renovation of some of the Hammerhead Buildings/Barracks to house academics and support facilities. By 1998, the Main Quad was formalized with curved pedestrian pathways connecting the buildings and surface parking lots along Fifth Avenue. The parking lot to the north of the Main Quad along Inter-Garrison Road retained its same general shape and structure, providing student and faculty parking. This section of the campus became the college’s core and allowed for future planning efforts to utilize it as a centralized location (CSUMB 1998; NETR 2021).

The early 2000s brought additional changes to the college, including the infill of open spaces with the development of North Quad along Inter-Garrison Road and the construction of Chapman Science Academic Center in 2003. These two construction projects followed along the college’s developing main corridors to the southwest of the intersection of Inter-Garrison Road and Sixth Avenue. The Fort Ord buildings, roads, and parking lots east of Sixth Avenue were largely unused, and the school’s development was focused west of Sixth Avenue. With the construction of Chapman

Science Academic Center, a pedestrian zone was developed between 2005 and 2009 connecting A Street to Divarty Street and the Main Quad. A three-street roundabout allowed for an improved flow of traffic and generated a more cohesive campus plan (NETR 2021). These changes facilitated the consolidation of academic spaces in an attempt to generate a reasonable, pedestrian scale circulation pattern (Moore 2007: 4-1). Parking lots from Fort Ord continued to be utilized into the 2000s, north of the Visual and Public Art Center (Building 70) and south of Beach Hall and Tide Hall (Buildings 21 and 23). The large lot on the southern side of Divarty Street by 2007 had undergone a large-scale redevelopment project with the construction of the Tanimura & Antle Family Memorial Library, the Business & Information Technology Building, and the Crescent walkway. This series of redevelopments eliminated half of the parking lot on the southern side of Divarty Street and redirected pedestrian traffic along the large open space to the direct south of the college along the Crescent walkway. The 2007 project reinforced the campus's developing centralized core and worked to further pedestrian corridors (CSUMB 2007; NETR 2021).

Unlike the majority of colleges in California that continue to grow in size based on the influx of new students, CSUMB required a continuous removal of buildings or portions of buildings located onsite. Between 2012 and 2014, the eastern wings of Coast Hall (Building 45) and Harbor Hall (Building 46) were demolished. Exposed openings were enclosed with CMU. Similarly, between 2016 and 2018, the college demolished nine of the Hammerhead Buildings/Barracks between Inter Garrison Road and B Street and the eastern wing of Pacific Hall (Building 44). This section of the college transitioned from a formalized double row of Hammerhead Buildings/Barracks, repeating in design, plan, and spacing arranged around a centered roadway, into a row of academic buildings easily accessed from Sixth Avenue and A Street (NETR 2021). Throughout the 2000s and 2010s, CSUMB constructed new facilities closer to the Main Quad. Over time the rigid military planning was disrupted with pedestrian pathways, replacement of open lots or parking lots with buildings, and the demolition of Fort Ord buildings (Figures 19 and 20).

INTENTIONALLY LEFT BLANK

4 Results of Identification Efforts and Building Descriptions

As stated in the field methods (Section 2.3), campus buildings not included in the survey included those that have no renovation or demolition proposed under the Project; buildings of recent construction that lack historical associations; buildings less than 45 years old, portable/temporary buildings; or buildings that were recently moved onto the campus from a different location. Furthermore, at this time it does not appear that any of the post-1976 buildings located on the campus rise to the level of exceptional importance required for buildings and structures of the recent past to be considered historically significant.

A total of 11 properties are located within the Built Environment ADI (Figure 2). The properties were constructed between 1951 to 1964 and were documented and evaluated in consideration of NRHP, CRHR, CHL, and local criteria and integrity requirements as part of this study. These properties required recordation and evaluation for historical significance because they are over 45 years old and will potentially be impacted by Near-Term Projects. The tables below provide survey results for the 11 properties, including a photograph of each building/structure, current name, year built (if known), a general physical description of the building/structure, and any alterations identified either through building development research or during the historic built environment resources survey. Dates and details of construction and alterations were confirmed through building development research conducted at the CSUMB Facilities office and archival research.

INTENTIONALLY LEFT BLANK

Table 9. Properties Surveyed



Building Number	Current Building Name	Year Built	Descriptions	Identified Alternations	Architectural Style	Architect (if known)
13	Science Research Lab Annex  View facing south at the north elevation (IMG_0715)	1964	The one-story, utilitarian building with modern stylistic details has a rectangular floor plan with several small projections. The building appears to sit on a concrete slab foundation and the primary construction materials are CMU and cement. The perimeter of the building has simple native landscaping on the east, west, and south elevations. A parking lot is located to the north of the building. The primary elevation faces south with a concrete path leading to the main entrance from A Street. The primary entrance is located offset to the east on the south elevation. The building has a flat roof with small eave overhangs. The main entrance consists of a pair of recently added metal-framed glazed doors, with a large, fixed transom. A fully glazed wall of windows is located to the west of the primary entrance. The exterior walls are varied, with the majority of the building constructed of CMU, with some concrete sections and some floor-to-ceiling windows. Fenestration is irregular and includes horizontal pane 1/1 metal-framed, and metal-framed picture windows, and metal-framed casement windows. An ADA-accessible ramp is located on the north elevation leading to the parking area on the north elevation and a second ADA ramp and entrance are on the east elevation. Metal vents are located below the windows on the north elevation.	<ul style="list-style-type: none"> • 1987 (Fort Ord): Remodel to move the dental clinic to the west side of the building and retrofit east side for proposed blood donor's clinic. Renovations include the demolition of interior walls and finishes, installation of new doors and finishes, construction of loading dock at northwest corner and addition of ramp to parking, new concrete exit porch and stairs. • 1995 (CSUMB): New ramp on east and west elevations, new vents on north elevation, and new window wall added to south elevation, west of primary entrance, new lath, and plaster to match existing on window alteration on north elevation. • 1995 (CSUMB): Change in use from medical/dental building to Science Research Lab 	Utilitarian	1964: Milton T. Pflueger Architect, San Francisco, CA
21	Beach Hall  View facing north at the south elevation (IMG_0302)	1954	The one-story utilitarian building has a rectangular floor plan and a concrete block structural system. The south-facing main elevation is symmetrical. It is covered by a moderately pitched side-gabled roof clad with composition shingles. The south main entrance is located centrally and is flanked by two squared projections and capped by a gabled, glazed dormer. The main entrance consists of recently added metal-framed double-glazed doors with sidelights and topped with a transom. Secondary doors are located to the far east and west ends of the main elevation. Windows are recently added metal-framed, one-over-one, fixed, and awning windows. A single column of cinderblocks is located between every other window on the main and rear north elevation. The fenestration pattern is repeated on the rear elevation. It appears that the westernmost window at the rear elevation was once a door as a pedestrian walkway leads directly up to it. Other alterations include the infill of a centrally located door and windows that flanked it on the rear elevation, added central gabled projection on the main elevation, and recently added main door and all windows.	<ul style="list-style-type: none"> • Replaced original windows with metal sash fixed and awning windows (1995) • Replaced original windows with recently added glazed double doors, sidelights, and transom window (1995) • Various filled in windows and doors (1995) • Added gable projection on south elevation (1995) • Change of circulation within building as doorways were converted to windows (1995) 	Utilitarian	Robert Stanton

Table 9. Properties Surveyed



Building Number	Current Building Name	Year Built	Descriptions	Identified Alternations	Architectural Style	Architect (if known)
23	Tide Hall  <p>View facing north at the south elevation (IMG_0292)</p>	1954	The one-story utilitarian building has a rectangular floor plan and a concrete block structural system. The south-facing main elevation is symmetrical. It is covered by a moderately pitched side-gabled roof clad with composition shingles. The main entrance is located centrally and is flanked by two squared projections and capped by a gabled, glazed dormer. The main entrance consists of recently added metal-framed sliding doors. Secondary doors are recently added and located to the far east and west ends of the main elevation. Windows are recently added metal-framed, one-over-one, fixed, and awning windows. Single columns of cinderblocks are located between every other window on the main and rear north elevation. The westernmost and easternmost recently added windows on the rear elevation appear to have been originally been doorways as concrete and asphalt pedestrian walkway lead directly up to it. The fenestration pattern is repeated on the north (rear) elevation. Alterations include the infill of centrally located windows on the rear elevation, conversion of doors to windows on rear elevation, added central gabled projection on the main elevation, and recently added doors.	<ul style="list-style-type: none"> Replaced original windows with metal sash fixed and awning windows (Date Unknown) Various filled in windows and doors (Date Unknown) Added gable projection on south elevation (Date Unknown) Replaced original doors Change of circulation within building as doorways were converted to windows	Utilitarian	Robert Stanton
42	Watershed Institute  <p>View facing south at the north elevation (IMG_0683)</p>	c. 1959	The one-story utilitarian building with modern stylistic details has a primarily rectangular floor plan with a rectangular projection on the west facade. The building appears to sit on a concrete slab foundation and the primary construction material is CMU. The building has a flat roof with small, concrete eave overhangs. The primary elevation faces north with a concrete path leading to the main door from B Street. Planted areas with native landscaping surround the building. A parking lot is located to the south. A concrete path leads from the parking lot to an entrance on the west end of the south elevation. The primary entrance is located offset to the east on the north elevation. The entrance consists of a pair of recently added metal-framed glazed doors, with a large, fixed transom. The north, primary, elevation has six, evenly spaced windows to the east of the entrance and two evenly spaced windows to the west. Fenestration is varied and includes fixed metal-framed picture windows and 1/1 metal. All windowsills appear to be precast concrete.	<ul style="list-style-type: none"> Several original windows on primary facade replaced with fixed picture windows (Date Unknown) Exterior walls repainted (Date Unknown) Entry doors replaced with modern, ADA-accessible doors (Date Unknown) 	Utilitarian	1956: Noakes & Neubauer, Architects, and Engineers, Washington D. C.

Table 9. Properties Surveyed



Building Number	Current Building Name	Year Built	Descriptions	Identified Alternations	Architectural Style	Architect (if known)
44	<p>Pacific Hall</p>  <p>View facing southeast at the west elevation (IMG_0602)</p>	1952-1954	The utilitarian building with modern stylistic details is constructed of board-formed concrete. The single-story building has an L-shaped plan with a flat roof and concrete eave overhangs. The primary, west, elevation has the main entrance at the corner of the "L." Fenestration includes bands of rectangular fixed glass windows in protruding metal frames set on concrete sills. Above the rectangular windows are square metal-framed decorative white panels. The east elevation shows changes to the plan, with a concrete framed door filled with CMUs and a change in exterior cladding. An ADA-accessible ramp leads to a secondary entrance with an arched metal awning on the east facade. The south elevation mirrors other elevations in style and materials. A CMU-filled window opening, and a door repurposed as a window are on the west end of the south elevation. The building appears to sit on a concrete foundation.	<ul style="list-style-type: none"> • Demolition of east, multi-story wing, and infill of opening with CMU (between 2016 and 2021). • Infill of multiple openings and fenestration changes. • Addition of mosaic mural near primary entrance on west façade (Date Unknown). • Addition of ADA ramps (Date Unknown). • Replacement of original windows throughout. 	Utilitarian	Unknown
45	<p>Coast Hall</p>  <p>View facing southeast at the west elevation (IMG_0645)</p>	1952-1954	The utilitarian building with modern stylistic details is constructed of board-formed concrete. The single-story building has an L-shaped plan with a flat roof and concrete eave overhangs. The primary, west, elevation has the main entrance at the corner of the "L." Fenestration includes bands of rectangular fixed glass windows in protruding metal frames set on concrete sills. Above the rectangular windows are square metal-framed decorative white panels. Below the windows is a section of concrete block. The east elevation shows changes to the plan, with a concrete framed door filled with CMUs and a change in exterior cladding. ADA-accessible ramps are located on the east and west sides of the building. The south and north elevations mirror other elevations in style and materials. Extensive changes to fenestration and door openings are visible on the south elevation. Several wall sections throughout the building are filled with CMU, showing changes to fenestration, pedestrian entrances, and plan. The building appears to sit on a concrete foundation.	<ul style="list-style-type: none"> • Demolition of east, multi-story wing, and infill of opening with CMU (between 2012 and 2014). • Infill of multiple openings and fenestration changes (between 2016 and 2021) • Addition of ADA ramps (Date Unknown) • Replacement of original windows throughout. 	Utilitarian	Unknown

Table 9. Properties Surveyed



Building Number	Current Building Name	Year Built	Descriptions	Identified Alternations	Architectural Style	Architect (if known)
46	Harbor Hall 	1952-1954	The utilitarian building with modern stylistic details is primarily constructed of board-formed concrete. The single-story building has an L-shaped plan with a flat roof and moderate concrete eave overhangs. The primary, west, elevation has the main entrance at the corner of the “L.” Fenestration includes bands of rectangular fixed glass windows in protruding metal frames set on concrete sills. Above the rectangular windows are square metal-framed decorative white panels. The east elevation shows changes to plan, with a concrete framed door filled with CMUs and a change in exterior cladding. An ADA-accessible ramp leads to a secondary entrance with an arched metal awning on the east facade. A below-grade basement is accessed on the east façade with stairs leading north under the ADA ramp. The south and north elevations mirror other elevations in style and materials. A CMU-filled window opening, and a door repurposed as a window are on the west end of the south elevation. The building appears to sit on a concrete foundation.	<ul style="list-style-type: none"> • Demolition of east, multi-story wing, and infill of opening with CMU (between 2012 and 2014). • Infill of multiple openings and fenestration changes (between 2016 and 2021) • Addition of ADA ramps (Date Unknown). • Addition of HVAC unit to east side of building. • Replacement of original windows throughout. 	Utilitarian	Unknown
58	Green Hall 	1954	The one-story utilitarian building has a rectangular floor plan and a concrete block structural system. The north-facing main elevation is symmetrical. It is covered by a moderately pitched side-gabled roof clad with composition shingles. The main entrance is located centrally and is flanked by two squared projections. The main entrance consists of a single metal-framed, half-glazed door topped with a transom. Secondary doors are located to the far east and west ends of the main elevation and appear to have been sealed off as doorknobs have been removed. Windows are metal-framed, multi-light awning windows. A single column of cinderblocks is located between every other window on the main and rear south elevation. The fenestration pattern is repeated on the rear elevation. Two central windows have been replaced with recently added windows. Alterations include the sealing doors shut and replacement windows at the rear elevation.	<ul style="list-style-type: none"> • Replacement windows at rear elevation (Date Unknown) 	Utilitarian	Robert Stanton

Table 9. Properties Surveyed





Building Number	Current Building Name	Year Built	Descriptions	Identified Alternations	Architectural Style	Architect (if known)
59	Reading Center  View facing north at the south elevation (IMG_0581)	1954	The one-story utilitarian building has a rectangular floor plan and a concrete block structural system. The south-facing main elevation is symmetrical. It is covered by a moderately pitched side-gabled roof clad with composition shingles. The main entrance is located centrally and is flanked by two squared projections. The main entrance consists of recently added metal-framed double doors with sidelights and transom window. Secondary doors are located to the far east and west ends of the main elevation. These doors are alterations and appear to have been placed within existing windows frames. Windows are recently added, metal-framed, one-over-one, fixed, and awning windows. A single column of cinderblocks is located between every other window on the main and rear north elevation. The fenestration pattern is repeated on the rear elevation. Alterations include the infill of several window frames with doors, replacement windows, and a recently added main door.	<ul style="list-style-type: none"> Replaced original windows with metal sash fixed and awning windows (Date Unknown) Various filled in windows and doors (Date Unknown) 	Utilitarian	Robert Stanton
70	Visual and Public Art  View facing north at the south elevation (IMG_0335)	1958	The one-and-a-half-story utilitarian building, with a one-story portion on the north (rear) elevation, is located on the north side of Inter-Garrison Road with a west-facing main elevation. It has a rectangular floor plan and a poured-in-place concrete and steel structural system. The building is capped by a flat roof with slightly overhanging eaves. The main elevation once consisted of five garage doors that have been infilled with anodized aluminum framed, fully glazed bays, glazed doors, and filled in completely except for a row of aluminum-framed fixed windows. The main elevation features a quarter-arch canopy clad in corrugated metal and supported by steel brackets. Windows on the south elevation consist of steel-framed, multi-light, hopper, and awning windows. The fenestration pattern on the east elevation has also been altered as a car garage door and original window frames have been infilled and left with a single row of fixed aluminum sash windows. The one-story portion to the rear retains the original steel sash, multi-light windows. Two large air ducts are located at the rear.	<ul style="list-style-type: none"> Added arched awnings over windows on the south and west elevations (Date Unknown). Infill of multiple garage openings and fenestration changes on the east and west elevations (Date Unknown). Exterior walls repainted (Date Unknown). Addition of HVAC unit to north side of building. Replaced original doors. Replacement of some original windows 	Utilitarian	Architect Unknown

Table 9. Properties Surveyed

Building Number	Current Building Name	Year Built	Descriptions	Identified Alternations	Architectural Style	Architect (if known)
902/903	<p>Hammerhead Buildings/Barracks</p>  <p>View facing northeast at the west elevation of the track and Field House. Coated field and bleachers visible on right. (IMG_0437)</p>  <p>View facing northeast at the west elevation Field House (IMG_0425)</p>	1951	<p>Freeman Stadium is located at a low grade, with the bleachers following the slope of the hillside. A chain-link fence encloses the field, track, and bleachers, with gates on the west, near the Field House, and on the east side of the field for ADA accessibility. Deciduous and evergreen trees and shrubs are planted around the perimeter of the chain-link fence. Freeman Stadium is made up of the following components: the field, track, bleachers, electrical building, and Field House. Freeman Stadium field is oval, paved, and has a white coating. A paved track encircles the field, but track markings are no longer delineated on the pavement. Concrete, stepped bleachers are located on the north and south side of the track and field. They each measure approximately 342 feet by 48 feet and contain 15, board-formed, concrete bleachers with concrete stairs on both the north and south ends and four sets of stairs evenly spaced throughout the bleachers, creating distinct aisleways. Additional concrete stairs lead from the track on the east and west sides of bleachers. A welded 1½ inch metal railing is located along the perimeter of each section of bleachers with openings at each stairwell. The electrical building is located on a berm west of the track. The small, windowless building is constructed of CMU and sits on a concrete foundation. The building has a low-pitched cement shed roof with small eave overhangs. The two-story, Field House building sits at the west end of the field and track (Figure 1 and 2). The building is rectangular in plan with a side-gable roof sheathed in standing seam metal. The roof has round skylights evenly spaced throughout and small eave overhangs. Three, two-story, barrel roofed sections are evenly spaced on the façade, one of which is a larger central section. Two, smaller, two-story barrel roof sections are located on the north and the southern portions of the building. The concession area is in the central two-story section. This section has square pillars supporting an overhanging barrel roof. The pillars are primarily clad in stucco fiber cement siding panels, with the lower portion clad in manufactured stone veneer. The west elevation has windows located at irregular intervals, all of which appear to be the side-sliding vinyl variety, except for the windows in the barrel roof gable ends, which appear to be fixed, multi-light windows with protruding metal frames.</p>	<ul style="list-style-type: none"> • Minor changes and upgrades were completed in 1953, 1974, 1982, 1987, and 1998. • Major renovations were completed to the Field House in 2006, including the addition of three, barrel roof, two-story additions to the south, center, and north portions of the building, removal of original doors, windows, and substantial changes to fenestration (CSUMB Facilities 2021). • The field was paved in 2018 (Google Earth 2021) 	Altered; no longer reflects an architectural style	<p>Architect: Fort Ord Engineer Office</p> <p>Builder: F. V. Hampshire Contracting Company of Salinas</p>

5 Significance Evaluation Findings

A total of 11 properties over 45 years old are located within the campus ADI. Each property was photographed, researched, and recorded on the appropriate DPR forms. Each property was evaluated for historical significance in consideration of NRHP, CRHR, CHL, and local designation criteria and integrity requirements. All of the 11 properties surveyed and evaluated do not appear eligible for inclusion in the NRHP, CRHR, CHL, or local register due to a lack of significant historical associations and compromised integrity.

Table below provides a list of the 11 built environment properties that appear not eligible for listing in the NRHP, CRHR, or CHL as a result of the property significance evaluations. None of the 11 buildings presented in this table are considered historical resources under CEQA or historic resources under PRC 5024 and 5024.5. The summary table below provides the following information: building number(s), current building name, year built, architectural style, property types, significance criteria if applicable, and applicable California Historical Resource Status Code (CHRS code). **Detailed individual property evaluations are provided on the DPR 523 forms, located in Appendix B.** The DPRs provide detailed information on the properties, including applicable NRHP/CRHR/CHL and local eligibility criteria, periods of significance, historic boundary, and character-defining features, if applicable.

Table 10. Individual Significance Findings for CSUMB Buildings within the ADI

Table 10 Number	Campus Building Number(s)	Current Building Name	Year Built	Architectural Style	Historic Property Type	Current Property Type	Current CHRS Status Code	Eligibility Criteria (if applicable)
1	13	Science Research Lab Annex	1964	Utilitarian	Military Building	Educational Building	6Z	n/a
2	21	Beach Hall	1954	Utilitarian	Military Building	Educational Building	6Z	n/a
3	23	Tide Hall	1954	Utilitarian	Military Building	Educational Building	6Z	n/a
4	42	Watershed Institute	1959	Utilitarian	Military Building	Educational Building	6Z	n/a
5	44	Pacific Hall	1952-1954	Utilitarian	Military Building	Educational Building	6Z	n/a
6	45	Coast Hall	1952-1954	Utilitarian	Military Building	Educational Building	6Z	n/a
7	46	Harbor Hall	1952-1954	Utilitarian	Military Building	Educational Building	6Z	n/a
8	58	Green Hall	1954	Utilitarian	Military Building	Educational Building	6Z	n/a
9	59	Reading Center	1954	Utilitarian	Military Building	Educational Building	6Z	n/a
10	70	Visual & Public Arts	1958	Utilitarian	Military Building	Educational Building	6Z	n/a
11	902-903C	Freeman Stadium	1951	Utilitarian	Military Building	Athletic Complex	6Z	n/a

While the focus of the built environment study was to determine significance for individual buildings proposed for demolition or renovation in the Master Plan, Dudek's architectural historians also reviewed the CSUMB campus for its potential as a historic district. According to National Register Bulletin 15, a historic district is defined as a resource that "possesses a significant concentration, linkage, or continuity of sites, buildings, structures, or objects united historically or aesthetically by plan or physical development" (USDOJ 1995: 5). Unlike other CSU (California State University) campuses, CSUMB was originally a military base known as Fort Ord. The history of Fort Ord dates back to 1917 and continued a growth and development trajectory until it was formally decommissioned in 1994 by the Base Realignment and Closure Commission. At the time of the closure, the land once belonging to the Army was divided, including the section that was set aside for the establishment of CSUMB. For the purposes of evaluating the CSUMB campus and its individual buildings, it was necessary to use the previously defined periods of significance for Fort Ord established by military historian Harold E. Raugh, Jr. listed below:

- Camp Gigling to Camp Ord (1917-1940)
- Fort Ord and the 7th Infantry Division (1940-1945)
- The Cold War and Vietnam Eras (1946-1976)
- The Volunteer Army (1974-1994)

In addition to the currently established military periods of significance, Dudek also evaluated the campus in consideration of the history of the CSU system and the CSUMB development period that began in the 1990s.

Given that all of the properties included within the campus ADI were constructed between 1951 and 1964, their potential for significance as a historic district would fall under the period defined as the Cold War and Vietnam Eras (1946-1976) at Fort Ord. While these buildings are of historic age and were constructed during this important period of development in Fort Ord's history, they no longer retain enough integrity to convey significance as a historic district. One of the most notable elements of integrity that is compromised is the integrity of setting. Significant demolition, changes to circulation patterns, introduction of new buildings, and changes in use, all impact the CSUMB campus's ability to convey significance from its time as an active Cold War and Vietnam Era military installation. Additionally, the subdivision of Fort Ord following its closure has also greatly impacted the integrity of feeling, association, and setting of the Cold War and Vietnam Era portions of the installation. In summary, the portion of Fort Ord that is now the CSUMB campus no longer retains the requisite integrity to convey significance and Dudek finds that there is no potential for the campus to be a historic district at the national, state, or local level.

INTENTIONALLY LEFT BLANK

6 Summary of Findings and Management Recommendations

6.1 Summary of Findings

Dudek formally recorded and evaluated 11 properties located within the Built Environment ADI over 45 years old proposed for renovation, alteration, or demolition as part of the Project. All built environment properties were identified as not eligible for national, state, or local designation. Therefore, it is not necessary to examine potential impacts to these properties resulting from the implementation of the proposed Master Plan. In summary, the Project will not result in significant impacts to CEQA built environment historical resources. The finding for the Project related to built environment historical resources is no impact.

INTENTIONALLY LEFT BLANK

7 References

- Advisory Council on Historic Preservation (ACHP). 2006. "Draft Program Comment Regarding Cold War Era Unaccompanied Personnel Housing." Federal Register: The Daily Journal of the United States Government. 12 April 2016. Accessed June 30, 2021 Available at: <https://www.federalregister.gov/documents/2006/04/12/06-3509/draft-program-comment-regarding-cold-war-era-unaccompanied-personnel-housing>
- Boland n.d. "Guidelines for Evaluating and Nominating Properties Associated with Significant Persons." National Register Bulletin 32. U.S. Department of the Interior, National Park Service. <https://www.nps.gov/nr/publications/bulletins/nrb32/>.
- Brady, Ryan. 2019. *Cultural Resource Inventory for the CSU Monterey Bay EIR Master Plan Project, Monterey County, California*. Memorandum prepared July 5, 2019 by Dudek for CSU Monterey Bay, Campus Planning and Development.
- Breschini, G. and T. Haversat. 1992a. Preliminary Excavations at CA-MNT-108, Fisherman's Wharf, Monterey County, California. In *Archaeological Investigations of Some Significant Sites on the Central Coast of California*, edited by H. Dallas, Jr. and G.S. Breschini, pp. 39–47. Coyote Press Archives of California Prehistory No. 37, Salinas.
- California Military Base Reuse Task Force, "Report of the California Military Base Reuse Task Force to Governor Pete Wilson: a strategic response to base reuse opportunities" (1994). California Agencies. Paper 71. Accessed July 12, 2021. Available at: http://digitalcommons.law.ggu.edu/caldocs_agencies/71
- Californian, The. 1936. Paddon Tells of Marina's History. July 21, 1936. Page 2. Salinas, California. Accessed September 10, 2021. Available at: <https://www.newspapers.com>
- Californian, The. 1940. "No More Camp Ord! It's Fort Ord Now! Stilwell in Command: Headquarters of General Located on Salinas Side." July 13, 1940. Salinas, California, pg. 1.
- Californian, The. 1951. Stadium Field House—Sixth Army Lets Ord Contract. March 20, 1951. P1. Accessed June 17, 2021. Available at: [Newspapers.com](https://www.newspapers.com).
- Californian, The. 1952a. Proposed New Fort Ord Barracks. January 22, 1952. Page 1. Salinas, California. Accessed June 25, 2021. Available at: <https://www.newspapers.com>
- Californian, The. 1952b Phoenix Arizona Firm. January 22, 1952. Page 18. Salinas, California. Accessed June 25, 2021. Available at: <https://www.newspapers.com>.
- Californian, The. 1959. Work Starts on 3 New Buildings at Fort Ord. January 24, 1952. Page 18. Salinas, California. Accessed June 25, 2021. Available at: <https://www.newspapers.com>
- Californian, The. 1976. Marina's history: \$20 an acre and a promise. July 3, 1976. Page 32. Salinas, California. Accessed September 10, 2021. Available at: <https://www.newspapers.com>
- Castle, Ted. 1990. "The March of Time." Fort Ord Panorama. September 21, 1990.

- Cavanaugh, Joe. 2000. *The Peace Dividend: Defense Conversion Through Higher Education*. The Leon Panetta Institute.
- Chamberlin Library. 2021. Fort Ord Working Papers. CSUMB Special Collections Box 6.42-01. Available at the Chamberlin Library, Seaside, California.
- Chapman, Charles. 1920. "Sebastian Vizcaino: Exploration of California." *The Southwestern Historical Quarterly* 23(4). April 1920. Accessed January 21, 2021. <http://www.jstor.org/stable/27794572>.
- Chen, C. Peter. n.d. "Joseph Stilwell" World War II Database. Accessed online July 1, 2021: https://ww2db.com/person_bio.php?person_id=18
- City (City of Carmel-By-The-Sea). 2008. *Historic Context Statement Carmel-By-The-Sea*. Prepared for the City of Carmel-By-The-Sea. 1st ed. Leslie Heumann and Associates, 1994. 2nd ed. Archives and Architecture, 1996. Update, Architectural Resource Group, Inc., 2008.
- City of Marina. n.d. "City of Marina History" Accessed online September 10, 2021: <https://cityofmarina.org/DocumentCenter/View/143/Marina-History?bidId=>
- City of Seaside. 2004. "Conservation/Open Space Element." City of Seaside General Plan. Adopted by City Council resolution 04-59, August 5, 2004. <https://www.ci.seaside.ca.us/DocumentCenter/View/368/Seaside-General-Plan-Full-Text-PDF?bidId=>
- City of Seaside. n.d. "Seaside History" Accessed online July 1, 2021: <https://www.ci.seaside.ca.us/166/Seaside-History>
- County of Monterey. 2021. "At a Glance: Monterey County." County of Monterey Website. Accessed January 18, 2021. <https://www.co.monterey.ca.us/government/departments-i-z/resource-management-agency-rma/economic-development/at-a-glance-county-facts>.
- CSUC (California State University, Chico). 2021a. "State Normal School at Chico." Accessed July 8, 2021. <https://www.csuchico.edu/traditions/history/normal-school.shtml>.
- CSUC. 2021b. "Chico State Teachers College." Accessed July 8, 2021. <https://www.csuchico.edu/traditions/history/teachers-college.shtml>
- CSUMB (California State University, Monterey Bay). 1998. CSUMB Master Plan.
- CSUMB. 2007. CSUMB Master Plan.
- CSUMB Enrollment Facts. N.d. Accessed online: <https://csumb.edu/iar/enrollment-fast-facts-most-recent-term/>
- CSUMB Facilities. 2021. Original As built and renovation architectural drawings on file with CSUMB facilities department. Accessed in person June 15-16, 2021.
- CSUMB. 2021. Images 121 and 131. Fort Ord Images: Historical Photographs and Postcards. Accessed on July 15, 2021. Available: https://digitalcommons.csUMB.edu/fortord_images/
- Del Webb and Pulte Homes 2021. Del Web History. Accessed July 9, 2021. Available at: http://media.corporate-ir.net/media_files/irol/14/147717/DelWebb/DelWebbHistory.pdf

- DLIFLC (Defense Language Institute Foreign Language Center). 2021. Command History Program. Accessed in person on June 15, 2021 and accessed online database collection online July 2021. Available at: <https://adli.pastperfectonline.com/>
- EA Engineering. 1991. Draft Final Fort Ord, California Base wide Remedial Investigation Feasibility Study. Volume 1 Literature Review and Base Inventory Report. Accessed on July 13, 2021. Available at: <https://www.fortordcleanup.com/documents/search/>
- EMC Planning Group Inc and EDAW, Inc. 1997 (Republished in 2001). Fort Ord Reuse Plan. Accessed July 12, 2021. Available at: https://www.fora.org/Reports/BRP/BRP_v4_FinalEIR_1997.pdf
- Fort Ord Disposal and Reuse: EIS. 1993. Vol IV Final. Environmental Impact Statement Fort Ord Disposal and Reuse. Accessed July 12, 2021. Available at: https://www.google.com/books/edition/Fort_Ord_Disposal_and_Reuse/CdY3AQAAAMAJ?hl=en&gbpv=1
- Fresno Bee, The. 1951a. "Army Spokesman Are Defending Building of Fort Ord Stadium." January 12, 1951. Page 13. Accessed June 17, 2021.
- Fresno Bee, The. 1951b. "Army Spokesman Are Defending Building of Fort Ord Stadium." February 4, 1951. Page 27. Accessed June 17, 2021. Available at: [Newspapers.com](https://www.newspapers.com/).
- Gates, S., & Williams, H. 1957. The Armed Forces. The Annals of the American Academy of Political and Social Science, 313, 99-104. Accessed June 17, 2021. <http://proxy.multcolib.org:2052/stable/1031762>
- Google Earth. 2021. Historic Aerial Imagery Historic Aerial Photographs of CSUMB Campus, 100 Campus Center, Seaside, CA 93955, dating from 1998, 2004, 2005, 2006, 2007, 2009, 2011, 1012, 2013, 2016, 2018, 2019, 2020. <https://earth.google.com/web/>
- Hiller, Peter. 2007. NRHP Nomination Form. Monterey County Court House. National Parks Service. Accessed July 18, 2021. Available at: https://npgallery.nps.gov/NRHP/GetAsset/NRHP/08000878_text
- Hoover, Mildred B., Hero Eugene Rensch, Ethel G. Rensch, and William N. Abeloe. 2002. Historic Spots in California. 5th ed. Stanford, California: Stanford University Press.
- Encyclopedia Britannica. 2016. "Normal school." Encyclopedia Britannica, April 20, 2016. <https://www.britannica.com/topic/normal-school>. Accessed September 16, 2019.
- Encyclopedia Britannica. 2020. "California State University." Encyclopedia Britannica, January 26, 2020. <https://www.britannica.com/topic/California-State-University-system-California>. Accessed September 16, 2019.
- Encyclopedia Britannica. 2021. "Joseph W. Stilwell". Encyclopedia Britannica, March 15, 2021, <https://www.britannica.com/biography/Joseph-W-Stilwell>. Accessed July 7, 2021.
- MacGregor Jr., Morris J. 1981. Integration of the Armed Forces, 1940-1965. Center of Military History, United States Army: Washington, D.C.

- Madsen, Alexandra and Steven Treffers. 2019. *Historic Resources Evaluation Memorandum for Hammerhead Barracks at Fort Ord, Monterey County, California*. Prepared by Rincon Consultants, Inc for City of Seaside, Community and Economic Development Department. November 4, 2019. Accessed June 28, 2021. https://www.ci.seaside.ca.us/DocumentCenter/View/10674/9_App-S--HRE-Memo
- McKibben, Carol Lynn and the Seaside History Project. 2009a. *Image of America: Seaside*. Charleston, SC: Arcadia Publishing.
- McKibben, Carol Lynn. 2009b. "Race and Color in A California Coastal Community: The Seaside Story." *BlackPast.org*. Accessed online: <https://www.blackpast.org/african-american-history/race-and-color-california-coastal-community-seaside-story/>.
- McPherson, Stephanie. 1990. "Ord Commanders: Training, community programs have made Ord a dynamic place to work and live." September 21, 1990, pg. 18.
- Military Construction Appropriations (MCA) for 1979: Hearings Before a Subcommittee of the Committee on Appropriations, House of Representatives, Ninety-fifth Congress, Second Session. 1978. United States: U.S. Government Printing Office. Digitized by Google. Accessed June 25, 2021. Available at: https://www.google.com/books/edition/Military_Construction_Appropriations_for/cv06AAAAMAAJ?hl=en&gbpv=1&dq=Fort+Ord+Dental+clinic&pg=PA109&printsec=frontcover
- Military Museum. 2016. "Historic California Posts, Camps, Stations, and Airfields: Fort Ord." Accessed on June 19, 2021. <http://www.militarymuseum.org/FtOrd.html>
- Moore Chiusano, Elizabeth. 2009. James E. Moore, Class of 1954. Grip Hands Memorials. Accessed June 30, 2021. Available at: http://www.usma1954.org/Grip_Hands/memorials/19733jem.htm
- Moore Iacofano Goltsman, Inc. 2007. Master Plan, Volume I, Design Plan.
- Moore, Harold G. Lieutenant General. 1975. *Building a Volunteer Army: The Fort Ord Contribution*. Department of the Army. Washington D.C. Accessed June 30, 2021. Available at: https://history.army.mil/html/books/090/90-3/CMH_Pub_90-3.pdf
- National Archives Foundation. 2021. Executive Order 9981. Accessed June 29, 2021. Available at: <https://www.archivesfoundation.org/documents/executive-order-9981-ending-segregation-armed-forces/>
- NETR (Nationwide Environmental Title Research LLC). 2021. Historic Aerial Photographs of 100 Campus Center, Seaside, CA 93955 dating from 1956, 1968, 1981, 1998, 2005, 2009, 2010, 2012, 2014, 2016, and 2018. Accessed June 10, 2021. <https://www.historicaerials.com/viewer>
- NPS (National Park Service). 1990. National Register Bulletin: Technical Information on the National Register of Historic Places: Survey, Evaluation, Registration, and Preservation of Cultural Resources. How to Apply the National Register Criteria for Evaluation. <https://www.nps.gov/nr/publications/bulletins/pdfs/nrb15.pdf>.
- NPS. 1995. "How to Apply the National Register Criteria for Evaluation." National Register Bulletin 15. Accessed January 27, 2021. <https://www.nps.gov/nr/publications/bulletins/pdfs/nrb15.pdf>

- OAC (Online Archives of California). 2021. Finding Aid for the Milton Pflueger drawings of the University of California, Berkeley Radiation Laboratory addition, 1961 0000276. <https://oac.cdlib.org/findaid/ark:/13030/c86w9bq9/>.
- OHP (California Office of Historic Preservation). 2019. "California Historical Landmarks." Accessed July 2019. https://ohp.parks.ca.gov/?page_id=21441
- Panorama. 1990. "50 Years and Counting.." September 21, 1990, pg. 2.
- Panorama. n.d. "Ford Ord in World War II." Historic California Posts: Fort Ord. Accessed on June 19, 2021. <http://www.militarymuseum.org/FtOrd.html>
- Park, R. 2015. "Happy and Cheerful in This Fine Camp": Sports, Recreation, and the United States Army at Fort Ord and Camp Roberts, 1940 to 1945. *Journal of Sport History*, 42(1), 21-37. Accessed on June 18, 2021, from <https://www.jstor.org/stable/10.5406/jsporthistory.42.1.21>
- PCAD (Pacific Coast Architecture Database). 2021. Database information for Milton Theodore Pflueger and Timothy Pflueger. Accessed July 7, 2021. <http://pcad.lib.washington.edu>
- Pomona Progress Bulletin. 1950. War Solving Racial Problems. August 24, 1950. Page 4. Accessed June 29, 2021. Available at: Newspapers.com.
- Quartermaster Review, The. 1940. "Army Construction Underway at Camp Ord, California." Volume XX. No 3. November-December. On file at the Chamberlin Library, Ord Military Community.
- Raugh, Harold E. 2004. Fort Ord. Charleston, SC: Arcadia.
- Salinas Morning Post. 1940. "\$2,766,000 in Building Authorized—Ord Contracts Let." August 21, 1940. Salinas, CA. pg. 1.
- San Francisco Examiner. 1951. Fort Ord Will Get Stadium. San Francisco Page 4. · 3 Feb 1951. Pages 1 and 4 A Available on www.Newspapers.com. Accessed on Jun 11, 2021.
- San Francisco Examiner. 1958. Army Asks OK on \$124,000,000 for Fort Ord Buildings. San Francisco. Section 2. Page. 4. Available on www.Newspapers.com. Accessed July 18, 2021.
- Swernoff, Michael. 1982. *Predictive Model of Cultural Resources at Fort Ord: A Reconnaissance Cultural Survey of Fort Ord, California*. Prepared under the Direction of the Department of the Army, Sacramento District Corps of Engineers, Contract #DACA05-800-C-0228, by Professional Analysts. Report on file as S-005210 at the CHRIS Northwest Information Center, Sonoma State University, Rohnert Park, CA.
- U.S. Army. 1977. Post Map Main Garrison Area. Fort Ord, California. Drawing number G-950. Accessed in person at the Chamberlain Library on June 15, 2021.
- U.S. Census. US. Census Quick Facts. "Marina, CA". Accessed September 10, 2021: <https://www.census.gov/quickfacts/marinacalifornia>

UCSB (University of California, Santa Barbara). 2021. Historic Aerial Photographs of 100 Campus Center, Seaside, CA 93955 dating from 1941, 1956, 1971, 1987, and 1998. Map & Imagery Laboratory (MIL) UCSB Library, Electronic Resource. Accessed June 10, 2021. http://mil.library.ucsb.edu/ap_indexes/FrameFinder.

Vasche, J. Burton. 1959. "The California State Colleges: Their History, Organization, Purposes, and Programs." in California

Waite, Philip R. 1995. *A Cultural Resources Survey of 783 Hectares, Fort Ord, Monterey County, California*. Prepared by Geo-Marine, Inc. for Tri-Services Cultural Resources Research Center, Construction Engineering Research laboratory. Miscellaneous Report of Investigations No. 67. Report on file as S-018372 at the CHRIS Northwest Information Center, Sonoma State University, Rohnert Park, CA.

Walch, Bob. 2004. An Army Historian's Pictorial Take on Fort Ord. Monterey County NOW. Accessed July 12, 2021. Available at: https://www.montereycountyweekly.com/news/local_news/an-army-historian-s-pictorial-take-on-fort-ord/article_6e8b0250-9c38-5ca4-a4a4-f93d42d65a11.html.

Webb Spinner, The. 1952-1954. Webb Spinner Volume for 1952-1954. Del Webb Sun Cities Museum Collection. Accessed June 30, 2021. Accessed at: <https://delwebbsuncitiesmuseum.org/newsletters-webb-spinners/>

Whaley, Derek. 2015. "East Monterey & Seaside." Santa Cruz Trains: Railroads of the Monterey Bay Area. July 20, 2015. Accessed online: <https://www.santacruztrains.com/2015/07/east-monterey-seaside.html>.

Appendix A

Preparer's Qualifications

Sarah Corder, MFA

Historic Built Environment Lead

Sarah Corder (*SARE-uh COR-der; she/her*) is an architectural historian with 17 years' experience throughout the United States in all elements of cultural resources management, including project management, intensive-level field investigations, architectural history studies, and historical significance evaluations in consideration of the California Register of Historical Resources (CRHR), the National Register of Historic Places (NRHP), and local-level evaluation criteria. Ms. Corder has conducted hundreds of historical resource evaluations and developed detailed historic context statements for a multitude of property types and architectural styles, including private residential, commercial, industrial, educational, and agricultural properties. She has also provided expertise on numerous projects requiring conformance with the Secretary of the Interior's Standards for the Treatment of Historic Properties.

Ms. Corder meets the Secretary of the Interior's Professional Qualification Standards for both Architectural History and History. She has experience preparing environmental compliance documentation in support of projects that fall under the California Environmental Quality Act (CEQA)/National Environmental Policy Act (NEPA), and Sections 106 and 110 of the National Historic Preservation Act.

Relevant Experience

Riverside City College Life Science/Physical Science Reconstruction Project, Riverside Community College District, Riverside, California. Dudek was retained by the Riverside Community College District to complete a cultural resources technical report for the Life Science/Physical Science Reconstruction Project in the City of Riverside, California. The report included the results of a California Historical Resources Information System (CHRIS) records search; a pedestrian survey of the project site by a qualified architectural historian; building development and archival research; development of an appropriate historic context for the project site; and recordation and evaluation of two (2) educational/institutional properties and one (1) mural over 45 years old for historical significance and integrity in consideration NRHP, CRHR, and local designation criteria and integrity requirements. Responsibilities for the project include archival research, co-authorship of the report, and preparation of Department of Parks and Recreation Series 523 Forms (DPR forms), and quality assurance/quality control of work products. (2020)

Integrity Assessment and Comparative Analysis for Confidential Education Project, Confidential Client, Santa Barbara, California. Dudek prepared a memorandum that provides a comparative analysis and detailed account of alterations made to a confidential educational property located in the City of Santa Barbara, California. This analysis was designed to facilitate future significance evaluations with regard to the property's physical integrity and architectural merit. Responsibilities included project management, field survey, archival research, and preparation of the technical memorandum. (2019-2020)

Education

Savannah College of Art and Design

MFA, Historic Preservation, 2004

Bridgewater College

BA, History, 2002

Professional Affiliations

National Trust for

Historic Preservation

Los Angeles Conservancy

California Preservation Foundation

Society for Architectural Historians

San Francisco State University Master Plan EIR, San Francisco State University, City of San Francisco, California. Dudek was retained to evaluate all buildings and structures on campus over 45 years old that were proposed for demolition or substantial alteration as part of the proposed Master Plan Program. The study entailed conducting archival and building development research, a records search, detailed impacts assessment, and development of mitigation measures for project conformance with the Secretary of the Interior's Standards for Rehabilitation. Responsibilities included field survey leadership, archival research, evaluation of built environment resources, co-authorship of the technical report, and preparation of DPR forms. (2019)

Castilleja Master Plan and Conditional Use Permit Project, City of Palo Alto, California. Dudek was retained by the City of Palo Alto to conduct a cultural resources study for the Castilleja Master Plan and Conditional Use Permit project. The proposed project would allow for an increase in student enrollment and expand the existing campus by demolishing existing buildings, constructing a new building and a new below-grade parking structure, and increasing the amount of open space. The study included a historical significance evaluation of the campus and related buildings and structures for the private all-girls school for grades 6–12. The school has been educating 6th- to 12th-grade girls since 1907 and has been located at the current site since 1910. The school's facilities include administrative buildings, a chapel theater, classrooms, a gymnasium, a pool, an aboveground parking area, a playing area, and a track. All buildings and structures within the proposed project site that were constructed at least 45 years ago were photographed, researched, and evaluated in consideration of CRHR and City designation criteria and integrity requirements. Responsibilities included field survey, background research, preparation of DPR forms for the evaluation of built resources, and co-authorship of the cultural resources report. (2019)

CSU Chico College Park Demolition Project, CSU Chico, Butte County, California. Dudek was retained by CSU Chico to complete a cultural resources study for a project that proposes demolition of 10 single-family residences near the CSU Chico campus. The study involved completion of a CHRIS records search; a pedestrian survey of the project area for built-environment resources; archival and building development research for each property; outreach with local libraries, historical societies, and advocacy groups; and a historic context and evaluation of 10 properties for historical significance. Responsibilities included co-authorship of the technical report, evaluation of built environment resources, field survey, archival research, and preparation of DPR forms. (2018)

Castilleja School Project, City of Palo Alto, California. Dudek was retained by the City of Palo Alto to conduct a cultural resources study for the Castilleja Master Plan and Conditional Use Permit project. The study included a historical significance evaluation of the campus and related buildings and structures. Responsibilities included field survey, background research, preparation of DPR forms for the evaluation of built resources, and co-authorship of the cultural resources report. (2017)

CSU Chico Siskiyou Hall Project, CSU Chico, Butte County, California. Dudek was retained by CSU Chico to complete a historic resources technical report for Siskiyou Hall. The study involved a pedestrian survey of the project area for built-environment resources, conducting archival and building development research, and completing a historic context and evaluation of the property for historical significance. Responsibilities included field survey, contributions to the technical report, and archival research. (2017)

Fullerton College Facilities Master Plan Program EIR, North Orange County Community College District, City of Fullerton, California. The district contracted Dudek to evaluate all buildings and structures on campus over 45 years old that were proposed for demolition or substantial alteration as part of the proposed Master Plan Program. The study entailed conducting archival and building development research, a records search, detailed impacts assessment, and development of mitigation measures for project conformance with the Secretary of the Interior's Standards for Rehabilitation. As a result of the significance evaluation, three historic districts and one individually eligible building were identified within the project area. Responsibilities included archival research, field survey, and co-authorship the technical report. (2017)

Adrienne Donovan Boyd, MSHP

Architectural Historian

Adrienne Donovan-Boyd (*AY-dree-en DON-uh-vin BOID; she/her*) is an architectural historian with significant experience in Oregon and the Pacific Northwest. Ms. Donovan-Boyd has 15 years' experience in all elements of cultural resources management, including intensive- and reconnaissance-level field investigations, architectural history studies, and historical significance evaluations for compliance projects, the National Register of Historic Places (NRHP), and local landmark designations. She is a very skilled researcher, adept at evaluation of historic properties and an experienced author of historical resources evaluation reports, findings of effect documentation for Sections 106 and 110 of the National Historic Preservation Act, historic context statements, and management plans for historic properties. Ms. Donovan-Boyd meets the Secretary of the Interior's Professional Qualification Standards for architectural history and also maintains a strong professional relationship with State Historic Preservation Office staff in Washington and Oregon.

Education

*University of Oregon
MS, Historic Preservation, 2009*

*Portland State University
BA, Community Development, 2006*

Ms. Donovan-Boyd has completed numerous projects requiring compliance with the Secretary of the Interior's Standards for the Treatment of Historic Properties. Her recent work at the University of Oregon's The Shire, a John Yeon-designed historic landscape in the Columbia River Gorge National Scenic Area, has focused on completing a cultural landscape report, including preparing a historic context statement, evaluation and analysis, and treatment protocols and procedures. Ms. Donovan-Boyd's National Register Nomination for the mid-century modern Amundsen House in Gresham, Oregon, was recently approved by the State Advisory Committee for Historic Preservation.

Project Experience

Cultural Resource Inventory and Evaluation

Cultural Resources Report, Horning Tree Seed Orchard, Bureau of Land Management, Washington County, Oregon. Served on an interdisciplinary team. Attended project meetings and contributed archival research, in-field research, geographic information system (GIS) data, and sections of the report including landscape descriptions, historic context section, significance evaluations, and recommendations. The project proposed that the site was eligible at the local and state level for the NRHP. (2020)

Class III Inventory and Cultural Resources Report, Fish Springs Ranch, NextEra Energy, Washoe County, Nevada. Served on a multidisciplinary team working on a Class III Inventory for the Fish Springs Ranch property. Contributed to archival research and co-authored the report, including the historic context section, significance evaluations, and recommendations. The project proposed that the historic period buildings remaining were not eligible for the NRHP. (2020)

Cultural Landscape Report, The Shire, University of Oregon, Skamania County, Washington. Served on a multidisciplinary team working for the University of Oregon on a Cultural Landscape Inventory for John Yeon's Columbia River Gorge property, The Shire. Contributed archival research, in-field research, GIS data, and sections of the report, including landscape descriptions, historic context section, existing conditions, significance

evaluations, and treatment recommendations. The project proposed that the site was eligible at the local and state level for the NRHP. (2019–2020)

Cultural Resources Inventory, The Shire First Bay Shoreline Restoration Project, Skamania County, Washington.

Served as architectural historian for the University of Oregon's project to conduct shoreline and habitat restoration at The Shire property in Skamania County. The project was subject to Section 106 review (lead agency: Federal Emergency Management Agency). Led the aboveground survey, conducted archival research, and co-authored the report with recommended determinations of eligibility and findings of effect. (2018–2019)

Cultural Resources Services, U.S. Army Corps of Engineers (ACOE) Master Planning IDIQ, Portland District, Oregon.

Served as architectural historian for the ACOE Portland District's Master Plan and integrated Environmental Assessment for the Mid-Columbia (Bonneville, The Dalles, John Day, and Willow Creek) and Rogue River (Lost Creek, Elk Creek, and Applegate) basin regions. Attended project meetings, conducted site visit reconnaissance surveys within the Lost Creek Project, and prepared the historic properties management plan for the Lost Creek Project. (2018)

Cultural Resources Investigations, Mouth of the Columbia River South Jetty Rehabilitation Project, Clatsop County, Oregon.

Served as architectural historian for the ACOE's proposed South Jetty rehabilitation within Fort Stevens State Park. The investigations involved inventorying and evaluating the South Jetty and a historic trails system. Evaluated the identified resources for the NRHP and co-authored the report. (2018)

Intensive-Level Survey, Port of Portland World War II Hangers, Portland International Airport. Conducted an intensive-level survey for two World War II Airport Hangers at the Portland International Airport and completed a cultural resource report with recommendations for the potential to list the structures on the NRHP. The hangers were significant for being the last remaining World War II constructed hangers on the Portland Airport Site. (2017)

Lower Snake River Programmatic Environmental Impact Statement; Washington, Oregon, Idaho; ACOE.

Researched and reported on historic built environment resources for the cultural resource sections for a programmatic Environmental Impact Statement related to the ACOE sediment management plan. The project area includes the Lower Snake River and four associated sub-basins: Clearwater River, Salmon River, Grande Ronde River, and Hells Canyon Reach of the Snake River. Made eligibility recommendation and co-authored the report. (2014)

Reconnaissance-Level Inventory, Gresham, Oregon. Conducted reconnaissance-level surveys for approximately 450 properties in the Centennial and Rockwood neighborhoods in Gresham, Oregon. Properties will be recorded in the Oregon State Historic Preservation Office's Historic Sites Database. (2020–Present)

Reconnaissance-Level Inventory, Gresham, Oregon. Conducted two reconnaissance-level surveys for approximately 57 properties in the Mt. Hood neighborhood and approximately 177 properties in the Kelly Creek neighborhood of Gresham, Oregon. Recorded all information in the Oregon State Historic Preservation Office's Historic Sites Database. (2017)

Intensive-Level Inventory, Enterprise Cemetery, Enterprise, Oregon. Conducted an intensive-level survey of the Enterprise Cemetery in Enterprise, Oregon. Conducted all field work, authored the report, and completed all necessary archival research to outline the cemetery's historic context. (2017)

Intensive-Level Inventory, Roslyn, Washington. Conducted intensive-level surveys of historic properties in Roslyn, Washington, in stages from 2012–2014. Recorded all information in the Washington Department of Archeology and Historic Preservation Office's online WISAARD Database. (2012–2014)

Laura G. Carias, MA

Architectural Historian

Laura Carias has over fifteen years of experience in the field of historic and cultural resources evaluation, identification, documentation, and preservation. Ms. Carias specializes in historic resources assessments including historic significance evaluations in consideration of the California Register of Historical Resources (CRHR) Register, and the National Register of Historic Places (NRHP), and local-level evaluation criteria. She also has experience in intensive-level field surveys, historic structure reports, design consultation, Historic American Buildings Survey and Historic American Engineering Record documentation, local Mills Act contracts, and local, state and nation landmark designations.

Ms. Carias meets the Secretary of the Interior's Professional Qualification Standards for Architectural History. She has experience preparing environmental compliance documentation in support of projects that fall under the California Environmental Quality Act (CEQA)/National Environmental Policy Act (NEPA), and Sections 106 of the National Historic Preservation Act (NHPA).

Education

*California State University,
Sacramento
MA, Public History, 2004
California State University,
Dominguez Hills
BA, History and Chicano Studies,
2003*

Professional Affiliations

*National Trust for Historic
Preservation
Los Angeles Conservancy
California Preservation Foundation
Society for Architectural Historians*

Dudek Project Experience (2020-Present)

123 Independence Drive Mixed-Use Project, Menlo Park, California. (2021). Served as architectural historian and co-author of the Historical Resources Evaluation Report (report). The Sobrato Organization retained Dudek to prepare a cultural resources study in support of the 123 Independence Drive Mixed-Use Project located in the City of Menlo Park. The study included a pedestrian survey of the subject properties for buildings and structures over 45 years of age; building development and archival research for the identified properties located within the project site; recordation and evaluation of cultural resources identified within the study area for the National Register of Historic Places (NRHP), California Register of Historical Resources (CRHR), and local eligibility criteria and integrity requirements; and an assessment of potential impacts to historical resources in conformance with CEQA and all applicable local municipal code and planning documents. Responsibilities included site specific background research, co-authoring the historic context covering the development of the site over time and preparation of significance evaluation.

Historic Built Environment Evaluation Report for the Sycuan Fee to Trust Project, Sycuan Band of the Kumeyaay Nation Reservation, San Diego County, California (2020). Dudek was retained by the Sycuan Band of the Kumeyaay Nation Reservation (Sycuan) to complete a Historic Properties Inventory and Evaluation Report for the proposed Sycuan Fee to Trust Project (Project), located on the within the vicinity of El Cajon, California in unincorporated San Diego County. The Project proposes a fee-to-trust transfer of five (5) parcels that cumulatively total approximately 40 acres. The transfer of land from Sycuan to the Bureau of Indian Affairs (BIA), the federal lead agency. Responsibilities for the project included: background research and authoring the cultural resources report.

Mothballing Plan, Fort MacArthur World War I Cantonment Historic District, Los Angeles, California. Dudek was retained to prepare a mothballing plan for the former military facility known as Fort MacArthur. The purpose of this Mothballing Plan was to document the existing conditions of the contributing buildings and to provide guidance and recommendations that LAUSD can employ for mothballing the district-contributing buildings that are not in active use in a manner consistent with National Park Service (NPS) Preservation Brief No. 31, *Mothballing Historic Buildings*. Responsible for field survey, recordation and documentation of existing conditions, and shared authorship of the Mothballing Plan. (2020-2021)

Additional Work Experience (2004-2009)

Historic American Engineering Record

San Juan Bautista, California

Authored Historic American Engineering Record for a former Southern California Edison 1917 substation. Documentation was successfully submitted to the Library of Congress. Prior to DUDEK, Chattel, Inc.

Department of Veterans Affairs West Los Angeles, Building 500 Building Replacement Project

Los Angeles, California

Authored Finding of Effects report to satisfy Section 106 compliance for the West Los Angeles Veterans Affairs Historic District. The proposed project includes the addition of a new hospital and associated support buildings as well as the demolition of several non-contributing buildings. Prior to DUDEK, Chattel, Inc.

Second Church of Christ, Scientist, Historic Structure Report

Long Beach, California

Compiled a Historic Structure Report to assist current owner in obtaining much needed funds for rehabilitation of 1914 church with extensive water damage. Prior to DUDEK, Chattel, Inc.

Sears Boyle Heights, Los Angeles, Federal Investment Tax Credit

Los Angeles, California

Submitted and received conditional approvals on Part II Federal Investment Tax Credit application for former Sears, Roebuck and Company retail store and warehouse in Boyle Heights. Participated in design collaboration on rehabilitation of subject property as a mixed-use property with retail, creative office, and residential space. Prior to DUDEK, Chattel, Inc.

1311-1317 North Hayworth Avenue

West Hollywood, California

Successfully designated a multi-family residence as a Cultural Resource and entered the property owner into a Mills Act historical property contract. Prior to DUDEK, Chattel, Inc.

Los Angeles Unified School District, Lincoln High School Small Learning Community Improvements

Los Angeles, California

Historic resources assessment for Lincoln High School as part of the environmental compliance work performed for proposed landscaping and American Disabilities Act (ADA) compliance. Work was completed to confirm historic significance of school and character-defining features and document project conformance with the Secretary's Standards for Rehabilitation in support of Work compliance with California Environmental Quality Act (CEQA). Prior to DUDEK, Sapphos Environmental, Inc.

Appendix B

DPR Forms

State of California & The Resources Agency
DEPARTMENT OF PARKS AND RECREATION
PRIMARY RECORD

Primary #
HRI #
Trinomial
NRHP Status Code 6Z

Other Listings
Review Code

Reviewer

Date

Page 1 of 15 *Resource Name or #: (Assigned by recorder) Science Research Lab Annex

P1. Other Identifier: CSUMB Building 13

*P2. Location: Not for Publication Unrestricted

*a. County Monterey County and (P2c, P2e, and P2b or P2d. Attach a Location Map as necessary.)

*b. USGS 7.5' Quad Marina, CA Date 1995 T 15S; R 1E; NW ¼ of SW ¼ of Sec 6; Mount Diablo B.M.

c. Address 3700 6TH Avenue Seaside Zip 93955

d. UTM: (Give more than one for large and/or linear resources) Zone 10S, 607801 mE/ 4057011 mN

e. Other Locational Data: (e.g., parcel #, directions to resource, elevation, decimal degrees, etc., as appropriate)

The Science Research Lab Annex sits north of A Street, between 5th Avenue and 6th Avenue.

*P3a. Description: (Describe resource and its major elements. Include design, materials, condition, alterations, size, setting, and boundaries)

The Science Research Lab Annex (CSUMB Building 13) is clustered with other classroom buildings southeast of the Main Quad on the California State University, Monterey Bay (CSUMB) campus. The one-story, utilitarian building with modern stylistic details has a rectangular floor plan with several small projections. The building appears to sit on a concrete slab foundation and the primary construction materials are CMU and cement. The perimeter of the building has simple landscaping on the east, west, and south elevations. A parking lot is located to the north of the building.

See Continuation Sheet.

*P3b. Resource Attributes: (List attributes and codes) HP15. Educational building, HP34. Military property

P5a. Photograph or Drawing (Photograph required for buildings, structures, and objects.)



*P4. Resources Present: Building
 Structure Object Site District
Element of District Other (Isolates, etc.)

P5b. Description of Photo: (view, date, accession #) south
elevation, view looking
northwest, Dudek(IMG 0716)

*P6. Date Constructed/Age and Source: Historic Prehistoric Both
1963 (CSUMB Facilities)

*P7. Owner and Address:
CSUMB, 100 Campus Center,
Seaside, CA. 93955

*P8. Recorded by: (Name, affiliation, and address) Sarah Corder,
Dudek, 725 Front St #400,
Santa Cruz, CA 95060

*P9. Date Recorded: 6/14/2021

*P10. Survey Type: (Describe)
Intensive level

*P11. Report Citation: (Cite survey report and other sources or enter none)

Dudek 2021. Built Environment Inventory and Evaluation Report for California State
University, Monterey Bay

*Attachments: NONE Location Map Continuation Sheet Building, Structure, and Object Record
 Archaeological Record District Record Linear Feature Record Milling Station Record Rock Art Record
 Artifact Record Photograph Record Other (List):

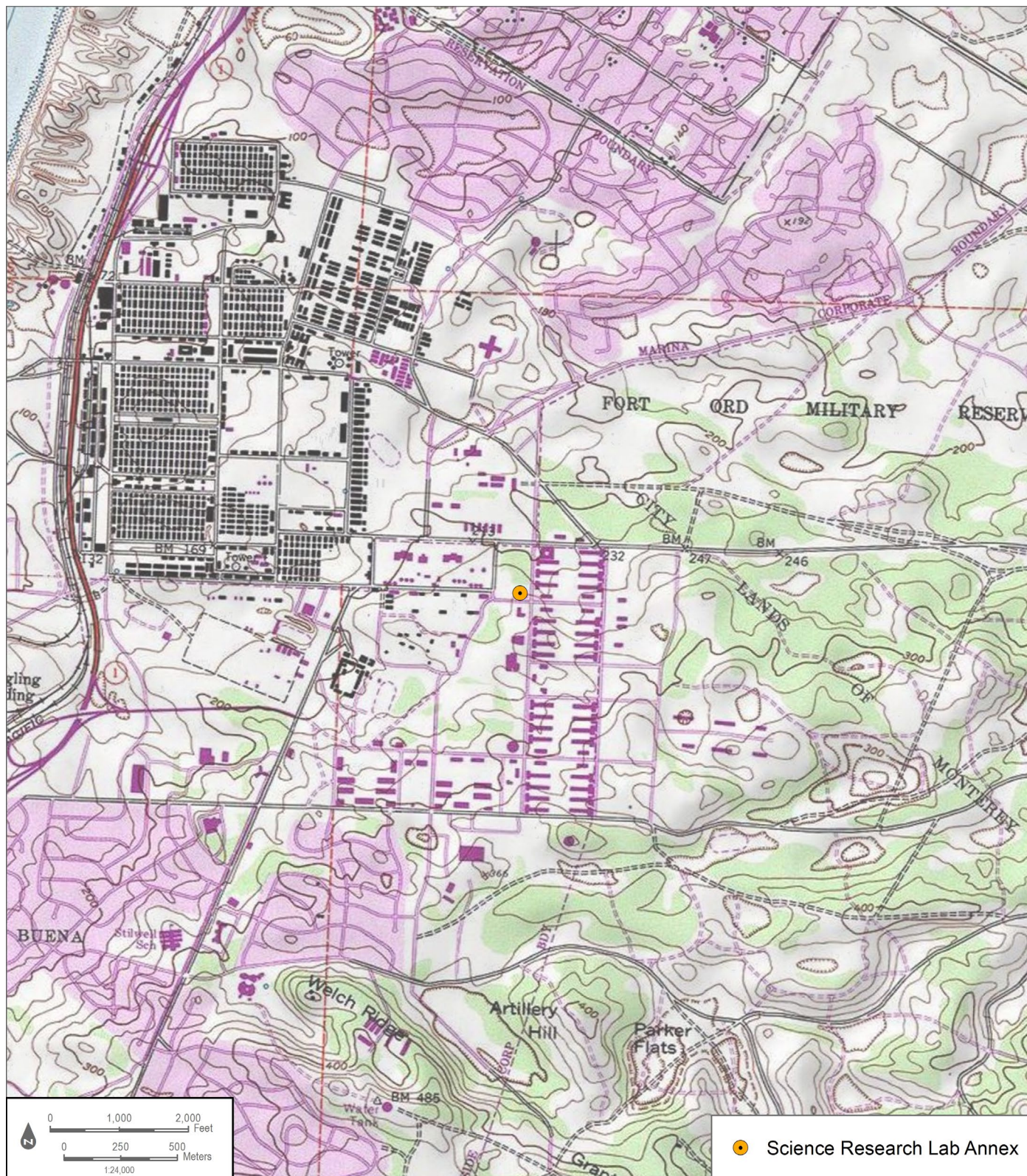

BUILDING, STRUCTURE, AND OBJECT RECORD

*Resource Name or # (Assigned by recorder) Science Research Lab Annex *NRHP Status Code 6Z

Page 3 of 15

B1. Historic Name: Fort Ord Dental Clinic, Stone Dental Clinic

B2. Common Name: Science Research Lab Annex, CSUMB Building 13

B3. Original Use: Military Medical Clinic 4. Present Use: Classroom/Science Lab

*B5. Architectural Style: Utilitarian

*B6. Construction History: (Construction date, alterations, and date of alterations)

Designed in 1963 and completed in 1964, the Science Research Lab Annex has been altered since its construction. Renovation and as-built drawings show alterations to the building took place in 1987 and 1995 (CSUMB Facilities 2021). In 1987, Fort Ord remodeled the building to move the dental clinic to the west side of the building and retrofit the east side of the building to accommodate a proposed blood donation clinic. Renovations included the demolition of interior walls and finishes, installation of new doors, the construction of a loading dock at the northwest corner, an addition of a ramp to the parking area, and the construction of a new concrete exit porch and stairs. In 1995, CSUMB installed a ramp on the east and west facades, new vents on the north elevation, a new window wall on the south elevation to the west of primary entrance and completed window alterations on the north elevation. At this time the building's use changed from a medical/dental building to a CSUMB classroom building with science labs (CSUMB Facilities 2021).

*B7. Moved? No Yes Unknown Date: _____ Original Location: _____ *B8. Related Features:

B9a. Architect: Milton T. Pflueger b. Builder: N/A

*B10. Significance: Theme N/A Area N/A
Period of Significance N/A Property Type N/A Applicable Criteria N/A

(Discuss importance in terms of historical or architectural context as defined by theme, period, and geographic scope. Also address integrity.)

See Continuation Sheet.

B11. Additional Resource Attributes: (List attributes and codes) _____

*B12. References: See Continuation Sheet.

B13. Remarks:

*B14. Evaluator: Adrienne Donovan-Boyd, MSHP

*Date of Evaluation: July 20, 2021

(This space reserved for official comments.)

(Sketch Map with north arrow required.)

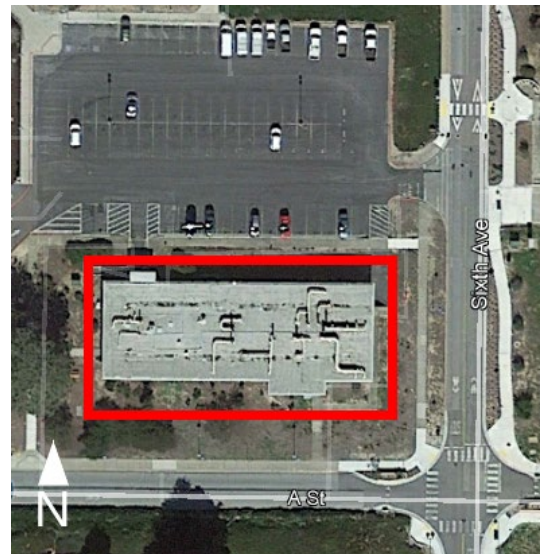

CONTINUATION SHEET

Property Name: Science Research Lab Annex

Page 4 of 15

*P3a. Description (continued):

The primary elevation faces south with a concrete path leading to the main entrance from A Street. The primary entrance is located offset to the east on the south elevation. The building has a flat roof with small eave overhangs. The main entrance consists of a pair of recently added metal-framed glazed doors, with a large, fixed transom. A fully glazed wall of windows is located to the west of the primary entrance. The exterior walls are varied, with the majority of the building constructed of CMU, with some concrete sections and some floor-to-ceiling windows.

Fenestration is irregular and includes horizontal pane 1/1 metal-framed, and metal-framed picture windows, and metal-framed casement windows. An ADA-accessible ramp is located on the north elevation leading to the parking area on the north elevation and a second ADA ramp and entrance are on the east elevation. Metal vents are located below the windows on the north elevation.



Figure 1. Main (south) elevation and entrance, looking northwest (IMG_0715)

CONTINUATION SHEET

Property Name: Science Research Lab Annex

Page 5 of 15



Figure 2. North elevation, looking southeast (IMG_0746)

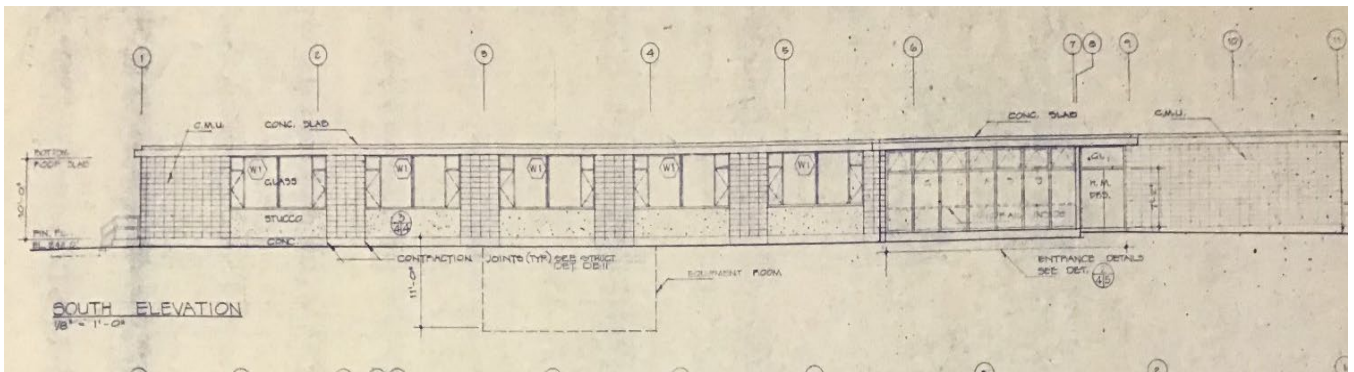

Figure 3. 1963 architectural drawing of the south elevation Science Research Lab Annex (CSUMB Facilities 2021)

Alterations:

- Remodel to move the dental clinic to the west side of the building and retrofit the east side for the proposed blood donor's clinic. Renovations include the demolition of interior walls and finishes, installation of new doors and finishes, construction of loading dock at northwest corner and addition of ramp to parking, new concrete exit porch and stairs. (1987)
- New ramp on east and west elevations, new vents on north elevation, and new window wall added to south elevation, west of primary entrance, new lath, and plaster to match existing, window alteration on north elevation, replacement of window bank on south elevation (1995)
- Change in use from medical/dental building to Science Research Lab (1995)

CONTINUATION SHEET

Property Name: Science Research Lab Annex

Page 6 of 15

*B10. Significance (continued):

Historical Overview of Fort Ord

The history of Fort Ord has been extensively documented in newspaper articles, websites, academic journals, and books. From its creation in 1917 to its closure in 1994, the base grew to become one of the largest training centers in the country. Its location was also reported to be the most attractive U.S. Army post, with easy access to the ocean and beautiful California weather.

The development periods in the history of Fort Ord were defined by Harold E. Raugh, Jr, a U.S. Army lieutenant colonel and historian with the Department of Defense. Since his retirement, Raugh served as the Chief Historian, for the Defense Logistics Agency, for the Department of Defense and, from 2006-2013, Raugh served as the Command Historian at the Defense Language Institute Foreign Language Center (DLIFLC) and the Presidio of Monterey, California. He received his PhD in history from the University of California, Los Angeles (Walch 2004). Raugh has authored numerous books including, *Fort Ord* (2004); *Presidio of Monterey* (2004); *Operation Joint Endeavor: V Corps in Bosnia-Herzegovina, 1995-1996* (2013); *The Raugh Bibliography of the Indian Mutiny 1857-1859* (2016); and *Wavell in the Middle East, 1939-1941: A study in Generalship*. Raugh defined four periods for the historic development of Fort Ord:

- 1917-1940 Camp Gigling to Camp Ord
- 1940-1945 Fort Ord and the 7th Infantry Division
- 1946-1976 The Cold War and Vietnam Eras
- 1974-1994 The Volunteer Army

These periods correspond to distinct eras in the history of the base and the U.S. Army (Raugh 2004: ii). The following sections provide a summary overview of each of these periods of development and their relevance to the area of Fort Ord now known as the CSUMB campus.

The full historic context of Fort Ord is represented in the report, *Built Environment Inventory and Evaluation Report for California State University, Monterey Bay* (Dudek 2021). The following presents only relevant historical and building typology information pertaining to the development of the Science Research Lab Annex.

Cold War and Vietnam Eras at Fort Ord (1946-1976)

This period of development between 1946 and 1976 was characterized by a massive operation to move the base out of its semi-permanent status and create a permanent outpost for active military personnel who were retained due to ongoing foreign conflicts.

In July of 1948, Harry S Truman signed Executive Order 9981, which officially ended segregation in the armed forces. The order stated that "there shall be equality of treatment and opportunity for all persons in the armed forces without regard to race, color, religion, or national origin" (National Archives Foundation 2021). Fort Ord became one of the first integrated training divisions in the United States. The Fort was touted as "pioneering to end all segregation" (The Pomona Progress Bulletin 1950: 4). In 1950, the Pomona Progress Bulletin reported that black and white soldiers at Fort Ord were "fighting side by side" and all the enlistees "trained together, slept in the same barracks, and eat the same messes" (The Pomona Progress Bulletin 1950: 4).

The end of World War II in 1945 did not bring lasting peace. The tenuous relationship between dominant nations in the communist East and free market West led to the beginning

CONTINUATION SHEET

Property Name: Science Research Lab Annex

Page 7 of 15

of the Cold War. The Department of Defense maintained a robust fighting force during the Cold War, with more than 900,000 Army personnel retained during the 1950s (ACHP 2006). The ongoing global tensions and the number of active U.S. military personnel created a need for new permanent buildings and expanded military housing at Fort Ord.

In 1949, the Soviet-supported communist government of North Korea invaded American-supported South Korea, initiating the Korean War. Fort Ord was a primary staging area for the training of troops departing for the war (Castle 1990:3). By the 1950s, Fort Ord had become one of the largest basic training camps in the United States. In 1952, the military began a multi-million dollar building program to transform Fort Ord into a permanent post, including the development of permanent troop housing, and the construction of a guard house, stockade, and multiple warehouses. In January of 1952, military authorities announced the new construction program at Fort Ord was underway, with an estimated cost of \$26,650,600. More than half of the funds that were approved by Congress were "earmarked for new permanent troop housing" for more than 7,000 soldiers (The Webb Spinner 1952-54, Vol 6. No. 3:1).

The new troop housing was to be constructed of reinforced concrete, a departure from the wood buildings constructed before and during World War II. The plan called for three types of massive barracks, twenty-two were to house 225 enlisted men each, seven were to accommodate 165 men each, and nine were to house 105 men each (The Webb Spinner 1952-54, Vol 6. No. 3:3). The San Francisco District of the U.S. Army Corps of Engineers oversaw the construction project to completion. An additional \$1,349,700 was earmarked for the expansion of classroom and training facilities at Fort Ord, including a new battalion and regimental headquarters (The Californian 1952a:1 and The Californian 1952b:18). By March of 1952, another phase of the permanent army post transformation began with the construction of a guard house, stockade, warehouse, and other buildings (The Webb Spinner 1952-54, Vol 6. No. 3:1). This addition of permanent buildings continued into the late 1950s, when the Army requested \$124 million to replace all the wood World War II infrastructure at Fort Ord with concrete block and reinforced concrete (Madsen and Treffers 2019:6; San Francisco Examiner 1958:2-4). While many of the wood buildings remain today, this period saw the continuous addition of reinforced concrete permanent buildings across the Fort (Madsen and Treffers 2019:6).

Following the Korean War through the end of the conflict in Vietnam, Fort Ord served as an important training facility. In 1957, Fort Ord was designated as a U.S. Army Training Center for Infantry (Castle 1990: 4). The 7th Infantry Division was based at Fort Ord in 1975 (Cavanaugh 2000: 9). Fort Ord produced thousands of combat-ready troops during the conflict in Vietnam.

With the establishment of Fort Ord as a permanent Army base during this period, there was substantial building construction that led to the modernization of the base and its services. This development is closely related to the history of the current CSUMB campus. All the properties that are included as part of this built environment study were constructed during the Cold War and Vietnam Era period. Building development during this period was a substantial departure from the styles and materials used in the buildings constructed before World War II. Building during the period between 1946 and 1976 used reinforced concrete and concrete masonry unit (CMU). The buildings tended to be larger than those constructed in previous periods. Other development in this period included support service buildings and several types of medical buildings. Infrastructure was also improved at this time, with the introduction of paved streets and roadways, and the addition of several water tanks, water pumping plants, and warehouse buildings.

CONTINUATION SHEET

Property Name: Science Research Lab Annex

Page 8 of 15

Science Research Lab Annex, 1964

The Science Research Lab Annex building was designed by the San Francisco architectural firm of Milton T. Pflueger in 1963. The plan lists the building designer as "JRS" and "LBM" and notes the design was prepared under the direction of H.N. Turner (CSUMB Facilities 2021). The building was constructed in 1964. The original plans called for the interior space to have 28 dental chairs and was the first permanent dental clinic at Fort Ord. Additional permanent dental clinics were constructed at Fort Ord in 1964, 1970, and 1977, with additional funds for further clinic space requested in 1979 (MCA 1979:109). Renovation architectural drawings from 1987 show many of the interior walls were demolished to divide the building into two clinics, the Stone Dental Clinic and a blood donation center (CSUMB Facilities 2021). After Fort Ord closed in 1994, the building became part of the CSUMB campus and was altered to serve as classroom space designed for academic study and instruction. CSUMB facility plans show in 1995, the building was converted to a university science building and named the Science Research Lab Annex (CSUMB Facilities 2021).

Milton Pflueger

Milton Theodore Pflueger was born in San Francisco in 1907. From 1925 to 1929, Pflueger worked as a draftsman for the architectural firm Bakewell & Brown. Around 1930, Pflueger began working for his older brother, Timothy Pflueger, who was a partner of architect J. R. Miller (OAC 2021). In 1940, Milton Pflueger went into partnership with his brother Timothy for several years until Timothy Pflueger died in 1946 (PCAD 2021). Milton Pflueger opened his own firm in the San Francisco Bay area. His more notable projects included: Richmond Memorial Civic Center (Richmond, CA), University of San Francisco Richard A. Gleeson Library (San Francisco, CA), the headquarters building for the Department of Motor Vehicles (Sacramento, CA), the Herbert C. Moffitt Hospital at the University of California Medical Center (San Francisco, CA), Alemany Housing Project (San Francisco, CA), the William F. Herrin laboratories, Herrin Hall, and Florence Moore Hall, all at Stanford University (Stanford, CA), Millberry Union UCSF Medical Center (San Francisco, CA), and Tulare Theater, (Tulare, CA) (OAC 2021 and PCAD 2021). Pflueger's firm is known to have designed the Science Research Annex building in the Built Environment ADI (CSUMB Facilities 2021).

Fort Ord Building Typology and Character-Defining Features

Four categories of building types were identified for the purposes of this study. These are the Support Services Buildings, Medical Buildings, Hammerhead Buildings/Barracks, and Recreational Buildings. The following presents a discussion of the Medical building typology, as the Science Research Lab Annex is classified in this category. This section provides an overview and a detailed account of the specific character-defining features of Fort Ord's Cold War and Vietnam Era (1946-1976) medical buildings.

Medical Buildings

Medical buildings constructed during the Cold War and Vietnam Eras (1946-1976) at Fort Ord have a variety of uses and functions that changed over the history of the base. One of the most common medical building types during this period were clinic buildings. In alignment with the typical planning, design, and materials of buildings constructed during this period of Fort Ord's history, these buildings are constructed with reinforced concrete and CMU and feature flat roofs with multi-light windows set on concrete sills. The Medical Buildings tended to have central entryways that opened into waiting areas, with smaller exam rooms behind reception areas. These buildings did not have a uniform design, unlike many of the other buildings at Fort Ord.

CONTINUATION SHEET

Property Name: Science Research Lab Annex

Page 9 of 15

Character-Defining Features for the Medical Buildings

The Medical Buildings originally exhibited the following specific character-defining features:

Character Aspect	Primary Character-Defining Features	Character-Defining Features
Shape and Plan	<ul style="list-style-type: none"> • Simple rectangular form • Single story 	The overall shape and mass of the building with a central entrance opening to waiting areas.
Roof	<ul style="list-style-type: none"> • Flat roof • Moderate or slight eave openings • No exposed rafters 	The Medical Buildings have flat roofs, with moderate or slight eave overhangs.
Openings	<ul style="list-style-type: none"> • Entrances on the ground level • Multi-light windows or modern windows with protruding metal frames set on concrete sills • Public entrances and circulation patterns 	Window openings are uniform in size and placement, windows are multi-light, and set into concrete openings. Replaced windows are not considered character-defining features as they fall outside the period of significance.
Exterior Ornamentation	<ul style="list-style-type: none"> • Minimal exterior ornamentation • Glass windows used as ornamentation 	The Medical Buildings were often specifically designed to serve specific functions. They have little to no decorative ornamentation, with windows in ribbons, or evenly spaced windows being the only decorative element.
Materials	<ul style="list-style-type: none"> • Mass-produced and cost-effective materials • Concrete and CMU • Reinforced Concrete construction 	Medical Buildings have simple, utilitarian designs. Buildings were constructed using mass-produced and cost-effective building materials that were readily available at the time of construction. Buildings under the Medical Building type were constructed with reinforced concrete and CMU and were minimally decorated.

Alterations and demolitions over time have compromised the overall architectural integrity of this building type. The most common alterations observed for this building type include the following.

- Replacement windows
- ADA compliance measures such as ramps and doors
- HVAC systems and window units
- Infill of openings
- Interior renovations

CONTINUATION SHEET

Property Name: Science Research Lab Annex

Page 10 of 15

NRHP/CRHR Designation Criteria

In consideration of the Science Research Lab Annex's history and requisite integrity, Dudek recommends the building not eligible for listing in the NRHP and CRHR based on the following significance evaluation and in consideration of national and state eligibility criteria:

Criterion A/1: That are associated with events that have made a significant contribution to the broad patterns of our history.

The Science Research Lab Annex was constructed in 1964 during the period defined as the Cold War and Vietnam Eras (1946-1976) at Ford Ord. While this building is of historic age and was constructed during this important period of development in Fort Ord's history, it no longer retains enough integrity to convey its significance. One of the most notable elements of integrity that is compromised is the integrity of setting. Significant demolition, changes to circulation patterns, introduction of new buildings, and changes in use, all impact the campus's ability to convey significance from its time as an active Cold War and Vietnam Era military base. The loss of this overall integrity of setting adversely effects the Science Research Lab Annex, as individual buildings are no longer able to convey their collective history. Additionally, the subdivision of Fort Ord following its closure has also greatly impacted the integrity of feeling, association, and setting of the Cold War and Vietnam Era portions of the installation. In summary, the Science Research Lab Annex, is not able to convey its association with any extraordinary events or events occurring within the context of Cold War and Vietnam military Medical Buildings, the CSUMB Campus, or has an association with the broad patterns of history in Monterey County, the State of California, or the Nation. Dudek recommends the building is not eligible under NRHP/CRHR Criterion A/1.

Criterion B/2: That are associated with the lives of persons significant in our past.

To be found eligible under B/2 the building must be directly tied to an important person and the place where that individual conducted or produced the work for which he or she is known. Milton T. Pflueger was found to be the architecture firm responsible for the design, but the utilitarian building does not reflect on of his remarkable works. Archival research indicated that the Science Research Lab Annex building, originally called the Fort Ord Dental Clinic, was not directly associated with any other significant person or persons. As such this building is not known to have any historical associations with people important to the nation's or state's past. Due to a lack of identified significant associations with important persons in history, Dudek recommends the building is not eligible under NRHP/CRHR Criterion B/2.

Criterion C/3: That embody the distinctive characteristics of a type, period, or method of construction, or that represent the work of a master, or that possess high artistic values, or that represent a significant and distinguishable entity whose components may lack individual distinction.

The Science Research Lab Annex was added to Fort Ord in 1964. The building was designed by the Milton T. Pflueger Architectural Firm, of San Francisco, CA. The plan lists the building designer as "JRS" and "LBM" and notes the design was prepared under the direction of H. N. Turner (CSUMB Facilities 2021). Milton Theodore Pflueger lead a notable San Francisco architectural firm. He designed many distinguished buildings during his career, first with his older brother, and then as the head of his own firm.

While Pflueger may be a master architect, the Science Research Lab Annex, designed by his firm, is not one of the firm's notable buildings, nor was it a defining moment in the firm's career. The Science Research Lab Annex is a smaller, utilitarian building, with minimal detailing, and few stylistic features. The building appears to have been designed by "JRS" and "LBM" under the direction of H.N. Turner (CSUMB Facilities 2021). No further information was discovered during archival research about these designers.

CONTINUATION SHEET

Property Name: Science Research Lab Annex

Page 11 of 15

The building is a ubiquitous building type that lacks high style components to set it apart from other buildings constructed throughout the State of California in the 1960s. Additionally, the Science Research Lab Annex, has undergone numerous alterations and changes to notable character-defining features including many replacement windows, enclosed openings, and changes to circulation patterns and use. Due to a lack of high artistic value, a lack of evidence suggesting this is a notable work of the Milton T. Pflueger Firm, and substantial alterations, Dudek recommends the building is not eligible under NRHP/CRHR Criterion C/3.

Criterion D/4: That have yielded, or may be likely to yield, information important in prehistory or history.

There is no evidence to suggest that this building has the potential to yield information important to state or local history. Therefore, Dudek recommends the building is not eligible under NRHP/CRHR Criterion D/4.

California Historic Landmark Statement of Significance

In consideration of the Science Research Lab Annex's history and requisite integrity, Dudek recommends the building not eligible for designation as a California Historic Landmark based on the following significance evaluation and in consideration of state eligibility criteria:

The first, last, only, or most significant of its type in the state or within a large geographic region (Northern, Central, or Southern California).

The Science Research Lab Annex was designed in 1963 and constructed in 1964. The building was constructed during the Cold War and Vietnam Eras (1946-1976) at Fort Ord. The Science Research Lab Annex appears to have been conceptualized by architects who worked for Milton Theodore Pflueger, a notable San Francisco architect. The building is a ubiquitous building type that lacks high style components to set it apart from other buildings constructed throughout the State of California in the 1960s. Therefore, Dudek recommends the building is not eligible for listing as a CHL under this criterion.

Associated with an individual or group having a profound influence on the history of California.

Archival research failed to indicate any significant associations between the Science Research Lab Annex and individuals or groups that profoundly influenced the history of California. The Science Research Lab Annex building was originally the Fort Ord Dental Clinic, to provide a service for military personnel. Milton T. Pflueger was found to be the architecture firm responsible for the design, but the utilitarian building does not reflect a remarkable project for the firm. No other individuals are known to have influenced the construction or use of this building. Therefore, Dudek recommends the building is not eligible for listing as a CHL under this criterion.

A prototype of, or an outstanding example of, a period, style, architectural movement or construction or is one of the more notable works or the best surviving work in a region of a pioneer architect, designer or master builder.

The Science Research Lab Annex is neither a prototype or an outstanding example of a period, style, or architectural movement. It is a typical example of utilitarian military design and was constructed well after these designs had become popular in the 1950s. The building was designed to serve a utilitarian purpose. There are no identifying features on the building that would establish the connection to the notable work of a master architect in the State of California. Additionally, the building has been altered and it fails to sufficiently convey its significance. Therefore, Dudek recommends the building is not eligible for listing as a CHL under this criterion.

CONTINUATION SHEET

Property Name: Science Research Lab Annex

Page 12 of 15

Local Designation Criteria

Portions of the CSUMB campus are located within the boundaries of two cities, City of Seaside and the City of Marina, both of which evaluate historical resources in accordance with CEQA Guidelines. as presented above. The subject property, as discussed in the NRHP/CRHR/CHL criteria discussion above, does not rise to the necessary level of significance for local, state, or national designation. For these reasons, the subject property is recommended not eligible individually or as a component of a historic district under any of the NRHP/CRHR/CHL/local criteria.

Additionally, portions of the CSUMB campus are located in the County of Monterey and the campus is therefore subject to the regulations set forth in Chapter 18.25 of the Monterey County Code. The subject property, as discussed in the NRHP/CRHR/CHL criteria discussion above, does not rise to the necessary level of significance for state or national designation. For these same reasons, the subject property is also recommended not eligible individually or as a component of a historic district under any of the delineated County of Monterey review criteria categories that are addressed with the NRHP/CRHR/CHL criteria discussed above: A. Historical and Cultural Significance; B. Historic, Architectural, and Engineering Significance; or C. Community and Geographic Setting.

Integrity Discussion

The Science Research Lab Annex was analyzed against the seven aspects of integrity: location, design, setting, materials, workmanship, feeling, and association. The building retains its integrity of location, as it has not been relocated. However, the integrity of setting has been compromised with the demolition of adjacent buildings, new constructions, and changes in paths of circulation throughout the campus. This change of use, from a Cold War and Vietnam Era military dental clinic to a classroom building for CSUMB also adversely effects the integrity of setting. The integrity of design, materials and workmanship are compromised, as replacement materials have been added throughout the building since its completion in 1964, including replacement of most of the original windows. As a result, the integrity of feeling is not intact, as the building is unable to convey the feeling of a 1960s military dental clinic. As the building does not possess historic significance, there is no historic association. While the building is in good condition, it does not possess integrity to convey significance or its temporal period.

Summary of Evaluation Findings

Based on the significance evaluations and integrity analysis presented above, the Science Research Lab Annex does not appear to meet the NRHP, CRHR, CHL or local designation criteria. Therefore, Science Research Lab Annex is not considered a historical resource for purposes of CEQA.

CONTINUATION SHEET

Property Name: Science Research Lab Annex

Page 13 of 15

*B12. References (continued):

- ACHP (Advisory Council on Historic Preservation). 2006. "Draft Program Comment Regarding Cold War Era Unaccompanied Personnel Housing." Federal Register: The Daily Journal of the United States Government. 12 April 2016. Accessed June 30, 2021 Available at: <https://www.federalregister.gov/documents/2006/04/12/06-3509/draft-program-comment-regarding-cold-war-era-unaccompanied-personnel-housing>
- Californian, The. 1940. "No More Camp Ord! It's Fort Ord Now! Stilwell in Command: Headquarters of General Located on Salinas Side." July 13, 1940. Salinas, California, pg. 1.
- Californian, The. 1951. Stadium Field House—Sixth Army Lets Ord Contract. March 20, 1951. P1. Accessed June 17, 2021. Available at: Newspapers.com.
- Castle, Ted. 1990. "The March of Time." Fort Ord Panorama. September 21, 1990.
- Cavanaugh, Joe. 2000. *The Peace Dividend: Defense Conversion Through Higher Education*. The Leon Panetta Institute.
- Chamberlin Library. 2021. Fort Ord Working Papers. CSUMB Special Collections Box 6.42-01. Available at the Chamberlin Library, Seaside, California.
- CSUC (California State University, Chico). 2021a. "State Normal School at Chico." Accessed July 8, 2021. <https://www.csuchico.edu/traditions/history/normal-school.shtml>.
- CSUC. 2021b. "Chico State Teachers College." Accessed July 8, 2021. <https://www.csuchico.edu/traditions/history/teachers-college.shtml>
- CSUMB Facilities. 2021. Original As built and renovation architectural drawings on file with CSUMB facilities department. Accessed in person June 15-16, 2021.
- DLIFLC (Defense Language Institute Foreign Language Center). 2021. Command History Program. Accessed in person on June 15, 2021 and accessed online database collection online July 2021. Available at: <https://adli.pastperfectonline.com/>
- EA Engineering. 1991. Draft Final Fort Ord, California Base wide Remedial Investigation Feasibility Study. Volume 1 Literature Review and Base Inventory Report. Accessed on July 13, 2021. Available at: <https://www.fortordcleanup.com/documents/search/>
- Fresno Bee, The. 1951a. "Army Spokesman Are Defending Building of Fort Ord Stadium." January 12, 1951. Page 13. Accessed June 17, 2021.
- Fresno Bee, The. 1951b. "Army Spokesman Are Defending Building of Fort Ord Stadium." February 4, 1951. Page 27. Accessed June 17, 2021. Available at: Newspapers.com.
- Gates, S., & Williams, H. 1957. The Armed Forces. The Annals of the American Academy of Political and Social Science, 313, 99-104. Accessed June 17, 2021. <http://proxy.multcolib.org:2052/stable/1031762>

CONTINUATION SHEET

Property Name: Science Research Lab Annex

Page 14 of 15

- MacGregor Jr., Morris J. 1981. Integration of the Armed Forces, 1940-1965. Center of Military History, United States Army: Washington, D.C.
- Madsen, Alexandra and Steven Treffers. 2019. *Historic Resources Evaluation Memorandum for Hammerhead Barracks at Fort Ord, Monterey County, California*. Prepared by Rincon Consultants, Inc for City of Seaside, Community and Economic Development Department. November 4, 2019. Accessed June 28, 2021.
https://www.ci.seaside.ca.us/DocumentCenter/View/10674/9_App-S---HRE-Memo
- Military Museum. 2016. "Historic California Posts, Camps, Stations, and Airfields: Fort Ord." Accessed on June 19, 2021. <http://www.militarymuseum.org/FtOrd.html>
- National Archives Foundation. 2021. Executive Order 9981. Accessed June 29, 2021. Available at: <https://www.archivesfoundation.org/documents/executive-order-9981-ending-segregation-armed-forces/>
- NETR (Nationwide Environmental Title Research LLC). 2021. Historic Aerial Photographs of 100 Campus Center, Seaside, CA 93955 dating from 1956, 1968, 1981, 1998, 2005, 2009, 2010, 2012, 2014, 2016, and 2018. Accessed June 10, 2021.
<https://www.historicaerials.com/viewer>
- OAC (Online Archives of California). 2021. Finding Aid for the Milton Pflueger drawings of the University of California, Berkeley Radiation Laboratory addition, 1961 0000276. <https://oac.cdlib.org/findaid/ark:/13030/c86w9bq9/>.
- PCAD (Pacific Coast Architecture Database). 2021. Database information for Milton Theodore Pflueger and Timothy Pflueger. Accessed July 7, 2021.
<http://pcad.lib.washington.edu>
- Panorama. 1990. "50 Years and Counting..." September 21, 1990, pg. 2.
- Panorama. n.d. "Ford Ord in World War II." Historic California Posts: Fort Ord. Accessed on June 19, 2021. <http://www.militarymuseum.org/FtOrd.html>
- Park, R. 2015. "Happy and Cheerful in This Fine Camp": Sports, Recreation, and the United States Army at Fort Ord and Camp Roberts, 1940 to 1945. *Journal of Sport History*, 42(1), 21-37. Accessed on June 18, 2021, from
<https://www.jstor.org/stable/10.5406/jsporhistory.42.1.21>
- Pomona Progress Bulletin. 1950. War Solving Racial Problems. August 24, 1950. Page 4. Accessed June 29, 2021. Available at: [Newspapers.com](http://www.newspapers.com).
- Quartermaster Review, The. 1940. "Army Construction Underway at Camp Ord, California." Volume XX. No 3. November-December. On file at the Chamberlin Library, Ord Military Community.
- Raugh, Harold E. 2004. Fort Ord. Charleston, SC: Arcadia.
- Salinas Morning Post. 1940. "\$2,766,000 in Building Authorized—Ord Contracts Let." August 21, 1940. Salinas, CA. pg. 1.
- San Francisco Examiner. 1951. Fort Ord Will Get Stadium. San Francisco Page 4. · 3 Feb 1951. Pages 1 and 4 A Available on [www.Newspapers.com](http://www.newspapers.com). Accessed on Jun 11, 2021.

CONTINUATION SHEET

Property Name: Science Research Lab Annex

Page 15 of 15

San Francisco Examiner. 1958. Army Asks OK on \$124,000,000 for Fort Ord Buildings. San Francisco. Section 2. Page. 4. Available on www.Newspapers.com. Accessed July 18, 2021.

Vasche, J. Burton. 1959. "The California State Colleges: Their History, Organization, Purposes, and Programs." in California

U.S. Army. 1977. Post Map Main Garrison Area. Fort Ord, California. Drawing number G-950. Accessed in person at the Chamberlain Library on June 15, 2021.

Walch, Bob. 2004. An Army Historian's Pictorial Take on Fort Ord. Monterey County NOW. Accessed July 12, 2021. Available at:
https://www.montereycountyweekly.com/news/local_news/an-army-historian-s-pictorial-take-on-fort-ord/article_6e8b0250-9c38-5ca4-a4a4-f93d42d65a11.html

State of California & The Resources Agency
DEPARTMENT OF PARKS AND RECREATION
PRIMARY RECORD

Primary #
HRI #
Trinomial
NRHP Status Code 6Z

Other Listings
Review Code

Reviewer

Date

Page 1 of 15 *Resource Name or #: (Assigned by recorder) Beach Hall

P1. Other Identifier: CSUMB Building 21

*P2. Location: Not for Publication Unrestricted

*a. County Monterey County and (P2c, P2e, and P2b or P2d. Attach a Location Map as necessary.)

*b. USGS 7.5' Quad Marina, CA Date 1995 T 15S; R 1E; NE ¼ ■ of SE ¼ ■ of Sec 1; Mount Diablo B.M.

c. Address 3716 First Street Seaside Zip 93955

d. UTM: (Give more than one for large and/or linear resources) Zone 10S, 607323 mE/ 4057010 mN

e. Other Locational Data: (e.g., parcel #, directions to resource, elevation, decimal degrees, etc., as appropriate)

Beach Hall sits south of Divarty Street, east of Engineer Lane.

*P3a. Description: (Describe resource and its major elements. Include design, materials, condition, alterations, size, setting, and boundaries)

Beach Hall (CSUMB Building 21) is a one-story utilitarian building has a rectangular floor plan and a concrete block structural system. The south-facing main elevation is symmetrical. It is covered by a moderately pitched side-gabled roof clad with composition shingles. The south main entrance is located centrally and is flanked by two squared projections and capped by a gabled, glazed dormer. The main entrance consists of recently added metal-framed double-glazed doors with sidelights and topped with a transom. Secondary doors are located to the far east and west ends of the main elevation.

Continuation Sheet

*P3b. Resource Attributes: (List attributes and codes) HP15. Educational building/HP34 Military property

*P4. Resources Present: Building

Structure Object Site District Element of District Other (Isolates, etc.)

P5b. Description of Photo: (view, date, accession #) south elevation, view looking north, Dudek (IMG 0302)

*P6. Date Constructed/Age and Source: Historic Prehistoric Other 1953 (CSUMB Facilities)

*P7. Owner and Address: CSUMB, 100 Campus Center, Seaside, CA. 93955

*P8. Recorded by: (Name, affiliation, and address) Sarah Corder, Dudek, 725 Front St #400, Santa Cruz, CA 95060

*P9. Date Recorded: 6/14/2021

*P10. Survey Type: (Describe) Intensive level

*P11. Report Citation: (Cite survey report and other sources or enter none) Dudek 2021. Built

P5a. Photograph or Drawing (Photograph required for buildings, structures, and objects.)



Environment Inventory and Evaluation Report for California State University, Monterey Bay.

*Attachments: NONE Location Map Continuation Sheet Building, Structure, and Object Record

Archaeological Record District Record Linear Feature Record Milling Station Record Rock Art Record

Artifact Record Photograph Record Other (List): _____

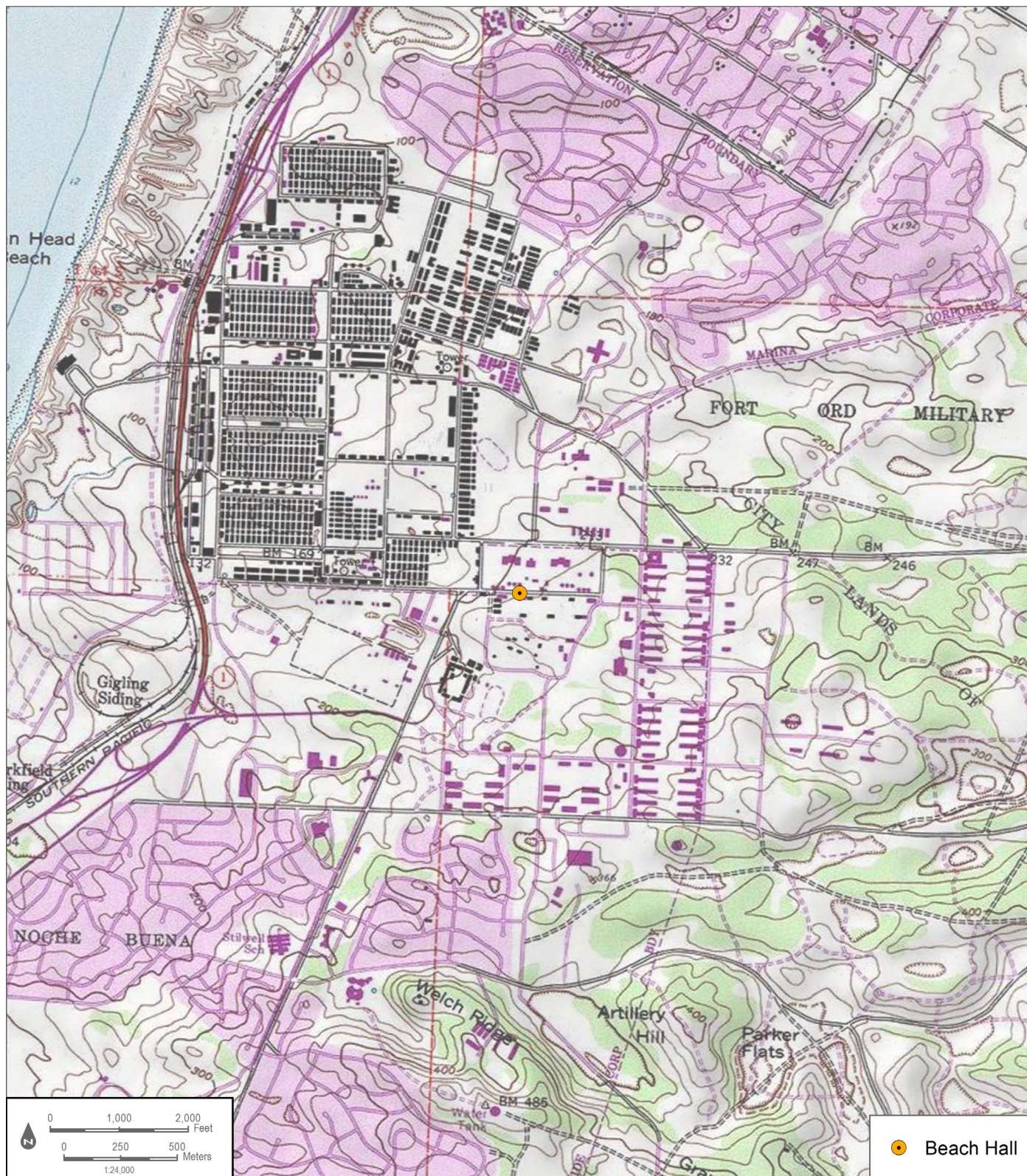

BUILDING, STRUCTURE, AND OBJECT RECORD

*Resource Name or # (Assigned by recorder) Beach Hall *NRHP Status Code 6Z
Page 3 of 15

B1. Historic Name: Permanent Troop Spaces and Support Facilities Classroom
B2. Common Name: Beach Hall (CSUMB Building 21)
B3. Original Use: Military Classroom 4. Present Use: Student Services

*B5. Architectural Style: Utilitarian

*B6. Construction History: (Construction date, alterations, and date of alterations)
Designed in 1953 and completed in 1954, Beach Hall has undergone several alterations. Renovation and as-built drawings show alterations to the Beach Hall took place in 1995. Changes include the addition of gabled roof to south elevation and substantial changes to fenestration (CSUMB Facilities 2021).

*B7. Moved? No Yes Unknown Date: _____ Original Location: _____ *B8. Related Features:

B9a. Architect: Robert Stanton b. Builder: Unknown

*B10. Significance: Theme N/A Area N/A
Period of Significance N/A Property Type N/A Applicable Criteria N/A
(Discuss importance in terms of historical or architectural context as defined by theme, period, and geographic scope. Also address integrity.)

See Continuation Sheet.

B11. Additional Resource Attributes: (List attributes and codes) _____

*B12. References: See Continuation Sheet.

B13. Remarks:

*B14. Evaluator: Laura Carias, MA

*Date of Evaluation: July 20, 2021

(This space reserved for official comments.)



CONTINUATION SHEET

Property Name: Beach Hall

Page 4 of 15

***P3a. Description (continued):**

Windows are recently added metal-framed, one-over-one, fixed, and awning windows. A single column of cinderblocks is located between every second window on the main (south) and rear (north) elevation. The fenestration pattern is repeated on the rear elevation. It appears that the westernmost window at the rear elevation was once a door as a pedestrian walkway leads directly up to it. Other alterations include the infill of a centrally located door and windows that flanked it on the rear elevation, added central gabled projection on the main elevation, and recently added main door and all windows.



Figure 1. Main (south) elevation, looking north (IMG_0302)

CONTINUATION SHEET

Property Name: Beach Hall

Page 5 of 15



Figure 2. North elevation, looking south (IMG_0314)

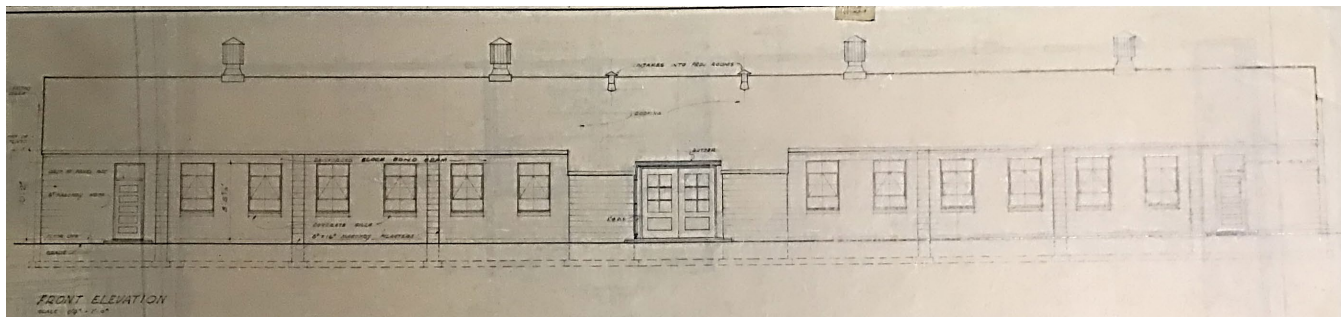

Figure 3. 1953 architectural drawing of the primary elevation of a typical Support Services Building, the design used for Beach Hall (CSUMB Facilities 2021)

Known and Observed Alterations:

- Replaced original windows with metal sash fixed and awning windows (1995)
- Replaced original windows with contemporary glazed double doors, sidelights and transom window (1995)
- Various filled in windows and doors (1995)
- Added gable projection on south elevation (1995)
- Change of circulation within building as doorways were converted to windows (1995)

CONTINUATION SHEET

Property Name: Beach Hall

Page 6 of 15

*B10. Significance (continued):

Historical Overview of Fort Ord

The history of Fort Ord has been extensively documented in newspaper articles, websites, academic journals, and books. From its creation in 1917 to its closure in 1994, the base grew to become one of the largest training centers in the country. Its location was also reported to be the most attractive U.S. Army post, with easy access to the ocean and beautiful California weather.

The development periods in the history of Fort Ord were defined by Harold E. Raugh, Jr, a U.S. Army lieutenant colonel and historian with the Department of Defense. Since his retirement, Raugh served as the Chief Historian, for the Defense Logistics Agency, for the Department of Defense and, from 2006-2013, Raugh served as the Command Historian at the Defense Language Institute Foreign Language Center (DLIFLC) and the Presidio of Monterey, California. He received his PhD in history from the University of California, Los Angeles (Walch 2004). Raugh has authored numerous books including, *Fort Ord* (2004); *Presidio of Monterey* (2004); *Operation Joint Endeavor: V Corps in Bosnia-Herzegovina, 1995-1996* (2013); *The Raugh Bibliography of the Indian Mutiny 1857-1859* (2016); and *Wavell in the Middle East, 1939-1941: A study in Generalship*. Raugh defined four periods for the historic development of Fort Ord:

- 1917-1940 Camp Gigling to Camp Ord
- 1940-1945 Fort Ord and the 7th Infantry Division
- 1946-1976 The Cold War and Vietnam Eras
- 1974-1994 The Volunteer Army

These periods correspond to distinct eras in the history of the base and the U.S. Army (Raugh 2004: ii).

The full historic context of Fort Ord is represented in the report, *Built Environment Inventory and Evaluation Report for California State University, Monterey Bay* (Dudek 2021). The following presents only relevant historical and building typology information pertaining to the development of Beach Hall.

Cold War and Vietnam Eras at Fort Ord (1946-1976)

This period of development between 1946 and 1976 was characterized by a massive operation to move the base out of its semi-permanent status and create a permanent outpost for active military personnel who were retained due to ongoing foreign conflicts.

In July of 1948, Harry S Truman signed Executive Order 9981, which officially ended segregation in the armed forces. The order stated that "there shall be equality of treatment and opportunity for all persons in the armed forces without regard to race, color, religion, or national origin" (National Archives Foundation 2021). Fort Ord became one of the first integrated training divisions in the United States. The Fort was touted as "pioneering to end all segregation" (The Pomona Progress Bulletin 1950: 4). In 1950, the Pomona Progress Bulletin reported that black and white soldiers at Fort Ord were "fighting side by side" and all the enlistees "trained together, slept in the same barracks, and eat the same messes" (The Pomona Progress Bulletin 1950: 4).

The end of World War II in 1945 did not bring lasting peace. The tenuous relationship between dominant nations in the communist East and free market West led to the beginning of the Cold War. The Department of Defense maintained a robust fighting force during the Cold War, with more than 900,000 Army personnel retained during the 1950s (ACHP 2006). The ongoing global tensions and the number of active U.S. military personnel created a

CONTINUATION SHEET

Property Name: Beach Hall

Page 7 of 15

need for new permanent buildings and expanded military housing at Fort Ord.

In 1949, the Soviet-supported communist government of North Korea invaded American-supported South Korea, initiating the Korean War. Fort Ord was a primary staging area for the training of troops departing for the war (Castle 1990:3). By the 1950s, Fort Ord had become one of the largest basic training camps in the United States. In 1952, the military began a multi-million dollar building program to transform Fort Ord into a permanent post, including the development of permanent troop housing, and the construction of a guard house, stockade, and multiple warehouses. In January of 1952, military authorities announced the new construction program at Fort Ord was underway, with an estimated cost of \$26,650,600. More than half of the funds that were approved by Congress were "earmarked for new permanent troop housing" for more than 7,000 soldiers (The Webb Spinner 1952-54, Vol 6. No. 3:1).

The new troop housing was to be constructed of reinforced concrete, a departure from the wood buildings constructed before and during World War II. The plan called for three types of massive barracks, twenty-two were to house 225 enlisted men each, seven were to accommodate 165 men each, and nine were to house 105 men each (The Webb Spinner 1952-54, Vol 6. No. 3:3). The San Francisco District of the U.S. Army Corps of Engineers oversaw the construction project to completion. An additional \$1,349,700 was earmarked for the expansion of classroom and training facilities at Fort Ord, including a new battalion and regimental headquarters (The Californian 1952a:1 and The Californian 1952b:18). By March of 1952, another phase of the permanent army post transformation began with the construction of a guard house, stockade, warehouse, and other buildings (The Webb Spinner 1952-54, Vol 6. No. 3:1). This addition of permanent buildings continued into the late 1950s, when the Army requested \$124 million to replace all the wood World War II infrastructure at Fort Ord with concrete block and reinforced concrete (Madsen and Treffers 2019:6; San Francisco Examiner 1958:2-4). While many of the wood buildings remain today, this period saw the continuous addition of reinforced concrete permanent buildings across the Fort (Madsen and Treffers 2019:6).

Following the Korean War through the end of the conflict in Vietnam, Fort Ord served as an important training facility. In 1957, Fort Ord was designated as a U.S. Army Training Center for Infantry (Castle 1990: 4). The 7th Infantry Division was based at Fort Ord in 1975 (Cavanaugh 2000: 9). Fort Ord produced thousands of combat-ready troops during the conflict in Vietnam.

With the establishment of Fort Ord as a permanent Army base during this period, there was substantial building construction that led to the modernization of the base and its services. This development is closely related to the history of the current CSUMB campus. All the properties that are included as part of this built environment study were constructed during the Cold War and Vietnam Era period. Building development during this period was a substantial departure from the styles and materials used in the buildings constructed before World War II. Building during the period between 1946 and 1976 used reinforced concrete and concrete masonry unit (CMU). The buildings tended to be larger than those constructed in previous periods. Other development in this period included support service buildings and several types of medical buildings. Infrastructure was also improved at this time, with the introduction of paved streets and roadways, and the addition of several water tanks, water pumping plants, and warehouse buildings.

Beach Hall, 1954

Constructed in 1954, Beach Hall (21) was designed by Robert Stanton, Monterey Bay architect (CSUMB Facilities 2021). It was one of several identical buildings described as "permanent troop spaces and supporting facilities/classrooms" designed for Fort Ord

CONTINUATION SHEET

Property Name: Beach Hall

Page 8 of 15

(CSUMB Facilities 2021). The building first appears in a 1956 aerial photograph as a long, rectangular plan, gable-ended building with a south-facing entrance on the south side of Divarty Street (UCSB 2021). This building floor plan appears unchanged between 1956 and 2005 (NETR 2021). The area surrounding this building appears to have changed, as all the buildings north of Divarty Street to the north were demolished circa 1971-81 (UCSB 2021, NETR 2021). Although parking lots south of Beach Hall appear unchanged since 1956, they have been repaved. Between 2005 and 2009, two buildings to the southwest, along Engineer Lane were demolished (NETR 2021). Between the 2014 and 2016 aerial photographs, the College of Arts, Humanities, and Social Sciences (504) building was erected, due east of Beach Hall (NETR 2021). The circulation pattern in and out of the building was likely changed during a 1995 interior remodel when windows were converted into doors on the north elevation. Before 2005, the gabled addition over the primary entrance was added (NETR 2021). No other changes were noted.

Robert Stanton

Robert Stanton was born in Detroit, Michigan in 1900. He served briefly in the U.S. Navy during World War I and then graduated from high school in Los Angeles and went on to complete his education at University of California at Berkeley. After graduation he worked with renowned architect, Wallace Neff. Neff appointed Stanton as project supervisor on several projects and Stanton earned his architecture license in 1934. Stanton moved to Monterey Bay in 1935 and went on to design a variety of residential, commercial, and public buildings in the area. Two of his buildings, the Monterey County Courthouse and the King City High School Auditorium have been listed on the NRHP (Hiller 2007:8-4). Robert Stanton was known to have designed a plan for classroom buildings at Fort Ord that was used for at least four buildings on campus (CSUMB Facilities 2021).

Fort Ord Building Typology and Character-Defining Features

Four categories of building types were identified for the purposes of this study. These are the Support Services Buildings, Medical Buildings, Hammerhead Buildings/Barracks, and Recreational Buildings. The following presents a discussion of the Support Services building typology, as Beach Hall is classified in this category. This section provides a detailed account of the specific character-defining features of Fort Ord Cold War and Vietnam Era (1946-1976) Support Services buildings.

Building Typology: Support Services Buildings

Support Services Buildings constructed during the Cold War and Vietnam Eras (1946-1976) at Fort Ord have a variety of uses and functions that changed over the history of the base. The buildings tended to have central entryways that opened into hallways, with classrooms lining the halls. In alignment with the typical planning, design, and materials of buildings from this period of Fort Ord's history, these buildings are constructed with reinforced concrete and CMU and feature gable roofs with multi-light windows with concrete sills. These buildings have a uniform design, like many of the other buildings at Fort Ord.

After Fort Ord closed in 1994, these support services buildings became part of the CSUMB campus. With the shift to campus use, many of the buildings were altered to fit the needs of CSUMB. Beach Hall's building footprint appears unchanged between 1956 and the present, however the circulation pattern of the building's interior changed during a 1995 remodel when some windows were converted to doors on the north elevation, and a gable roof was added over the primary door (CSUMB Facilities 2021; NETR 2021).

Character-Defining Features for the Support Services Buildings

The Support Services Buildings originally exhibited the following specific character-defining features:

CONTINUATION SHEET

Property Name: Beach Hall

Page 9 of 15

Character Aspect	Primary Character-Defining Features	Character-defining features
Shape and Plan	<ul style="list-style-type: none"> • Simple rectangular form • Single story 	The overall shape and mass of the building are considered a primary character-defining feature of the support services buildings. The plan should be rectangular in form.
Roof	<ul style="list-style-type: none"> • Flat or gable roof • small eave overhangs • No exposed rafters 	Support service buildings from this period have gable roof forms, with slight eave overhangs.
Openings	<ul style="list-style-type: none"> • Public entrances and circulation patterns 	Window openings are generally uniform in size and placement, windows are multi-light, and set into concrete openings. Replaced windows are not considered character-defining features as they fall outside the period of significance.
Exterior Ornamentation	<ul style="list-style-type: none"> • Minimal exterior ornamentation 	The support services buildings were designed to be quickly constructed. They have little to no decorative ornamentation, with windows being set evenly apart and CMU pillars being the only decorative element.
Materials	<ul style="list-style-type: none"> • Mass-produced and cost-effective materials • Concrete and CMU • Reinforced Concrete construction 	The support services buildings have simple, utilitarian designs. Buildings were constructed using mass-produced and cost-effective building materials that were readily available at the time of construction. For instance, buildings under the support services buildings type were constructed with reinforced concrete and CMU and were minimally decorated.

Alterations and demolitions over time have compromised the overall architectural integrity of this building type. The most common alterations observed for this building type include the following.

- Replacement windows
- ADA compliance measures such as ramps and doors
- HVAC systems and window units
- Infill of openings
- Addition of front gable over doorways
- Interior renovations

NRHP/CRHR Designation Criteria

In consideration of the Beach Hall's history and requisite integrity, Dudek recommends the building not eligible for listing in the NRHP and CRHR based on the following significance evaluation and in consideration of national and state eligibility criteria:

Criterion A/1: That are associated with events that have made a significant contribution to the broad patterns of our history.

Beach Hall was constructed in 1954 during the period defined as the Cold War and Vietnam Eras (1946-1976) at Ford Ord. While this building is of historic age and was constructed during an important period of development in Fort Ord's history, it no longer retains enough integrity to convey its significance. One of the most notable elements of integrity that is compromised is the integrity of setting. Significant demolition, changes to

CONTINUATION SHEET

Property Name: Beach Hall

Page 10 of 15

circulation patterns, introduction of new buildings, and changes in use, all impact the building's ability to convey significance from its time as an active Cold War and Vietnam Era military base. The loss of this overall integrity of setting adversely affects Beach Hall, as individual buildings are no longer able to convey their collective history. Additionally, the subdivision of Fort Ord following its closure has also greatly impacted the integrity of feeling, association, and setting of the remaining Cold War and Vietnam Era buildings. Beach Hall is not able to convey its association with any extraordinary events or events occurring within the context of Cold War and Vietnam military support service buildings, the CSUMB Campus, or has an association with the broad patterns of history locally, within the State of California, or the Nation. Therefore, the building is recommended not eligible under NRHP/CRHR Criterion A/1.

Criterion B/2: That are associated with the lives of persons significant in our past.

To be found eligible under B/2 Beach Hall must be directly tied to an important person and the place where that individual conducted or produced the work for which he or she is known. No person or persons were shown to be influential or directly associated with the building. As such this building is not known to have any historical associations with people important to the nation's or state's past. Due to a lack of identified significant associations with important persons in history, Dudek recommends the building is not eligible under NRHP/CRHR Criterion B/2.

Criterion C/3: That embody the distinctive characteristics of a type, period, or method of construction, or that represent the work of a master, or that possess high artistic values, or that represent a significant and distinguishable entity whose components may lack individual distinction.

Archival research indicates that Beach Hall was constructed in 1954 as one of several classroom/support buildings for Fort Ord. Although designed by architect, Robert Stanton, the building was not constructed in any obvious architectural style. The building is a ubiquitous building type that lacks high style components to set it apart from other buildings constructed in the 1950s. The building has been altered with the addition of a gable at the south main elevation, a majority of the original windows and doors have been replaced, and there have been changes to the fenestration pattern. Due to a lack of high artistic value, a lack of evidence suggesting this is a notable work of Robert Stanton, and because of alterations to character-defining features, Dudek recommends the building is not eligible under NRHP/CRHR Criterion C/3.

Criterion D/4: That have yielded, or may be likely to yield, information important in prehistory or history.

There is no evidence to suggest that Beach Hall has the potential to yield information important to state or local history. Therefore, the building is recommended not eligible under NRHP/CRHR Criterion D/4.

California Historic Landmark Statement of Significance

In consideration of the building's history and requisite integrity, Dudek recommends the building not eligible for designation as a California Historic Landmark based on the following significance evaluation and in consideration of state eligibility criteria:

The first, last, only, or most significant of its type in the state or within a large geographic region (Northern, Central, or Southern California).

Beach Hall was designed in 1953 and constructed in 1954. The building was constructed during the Cold War and Vietnam Eras (1946-1976) at Fort Ord. Beach Hall was designed by Robert Stanton. The building is a ubiquitous building type that lacks high style components to set it apart from other utilitarian buildings constructed throughout the State of California in the 1950s. Therefore, Dudek recommends the building is not eligible for listing as a CHL under this criterion.

CONTINUATION SHEET

Property Name: Beach Hall

Page 11 of 15

Associated with an individual or group having a profound influence on the history of California.

Archival research failed to indicate any significant associations between the Beach Hall and individuals or groups that profoundly influenced the history of California. Beach Hall was one of several support/classroom buildings constructed on the site. Robert Stanton was found to be the building's architect, but the utilitarian building does not reflect one of his remarkable designs. No other individuals are known to have influenced the construction or use of this building. Therefore, Dudek recommends the building is not eligible for listing as a CHL under this criterion.

A prototype of, or an outstanding example of, a period, style, architectural movement or construction or is one of the more notable works or the best surviving work in a region of a pioneer architect, designer or master builder.

Beach Hall is neither a prototype or an outstanding example of a period, style, or architectural movement. The building was designed to serve a utilitarian purpose. There are no remaining identifying features on Beach Hall that would establish the building as a notable work of a master architect, or a notable designer or builder working within the military, or in the State of California. Therefore, Dudek recommends the building is not eligible for listing as a CHL under this criterion.

Local Designation Criteria

Portions of the CSUMB campus are located within the boundaries of two cities, City of Seaside and the City of Marina, both of which evaluate historical resources in accordance with CEQA Guidelines. as presented above. The subject property, as discussed in the NRHP/CRHR/CHL criteria discussion above, does not rise to the necessary level of significance for local, state, or national designation. For these reasons, the subject property is recommended not eligible individually or as a component of a historic district under any of the NRHP/CRHR/CHL or local criteria.

Additionally, portions of the CSUMB campus are located in the County of Monterey and the campus is therefore subject to the regulations set forth in Chapter 18.25 of the Monterey County Code. The subject property, as discussed in the NRHP/CRHR/CHL criteria discussion above, does not rise to the necessary level of significance for state or national designation. For these same reasons, the subject property is also recommended not eligible individually or as a component of a historic district under any of the delineated County of Monterey review criteria categories that are addressed with the NRHP/CRHR/CHL criteria discussed above: A. Historical and Cultural Significance; B. Historic, Architectural, and Engineering Significance; or C. Community and Geographic Setting.

Integrity Discussion

Beach Hall was analyzed against the seven aspects of integrity: location, design, setting, materials, workmanship, feeling, and association. The building retains its integrity of location, as it has not been relocated. The integrity of setting has been compromised with the demolition of adjacent buildings, new constructions, and changes in paths of circulation throughout the campus. This change of use, from a Cold War and Vietnam Era military support services building to an education classroom building for CSUMB also adversely effects the integrity of setting and feeling. Replacement materials have been added throughout the building since its completion in 1954, including new windows, doors, change in fenestration pattern, and addition of roof gable at south elevation over the primary entrance. These alterations have compromised the building's integrity of design, materials, and workmanship. As the building does not possess

CONTINUATION SHEET

Property Name: Beach Hall

Page 12 of 15

historic significance, there is no historic association. While the building is in good condition, it does not possess integrity to convey significance or its temporal period.

Summary of Evaluation Findings

Beach Hall retains little historic integrity and lacks historical and architectural significance. Based on the significance evaluations presented above, the Beach Hall does not appear to meet the NRHP, CRHR, CHL or local designation criteria. Therefore, Beach Hall is not considered a historical resource for purposes of CEQA.

CONTINUATION SHEET

Property Name: Beach Hall

Page 13 of 15

*B12. References (continued):

- ACHP (Advisory Council on Historic Preservation). 2006. "Draft Program Comment Regarding Cold War Era Unaccompanied Personnel Housing." Federal Register: The Daily Journal of the United States Government. 12 April 2016. Accessed June 30, 2021 Available at: <https://www.federalregister.gov/documents/2006/04/12/06-3509/draft-program-comment-regarding-cold-war-era-unaccompanied-personnel-housing>
- Californian, The. 1940. "No More Camp Ord! It's Fort Ord Now! Stilwell in Command: Headquarters of General Located on Salinas Side." July 13, 1940. Salinas, California, pg. 1.
- Californian, The. 1951. Stadium Field House—Sixth Army Lets Ord Contract. March 20, 1951. P1. Accessed June 17, 2021. Available at: Newspapers.com.
- Castle, Ted. 1990. "The March of Time." Fort Ord Panorama. September 21, 1990.
- Cavanaugh, Joe. 2000. *The Peace Dividend: Defense Conversion Through Higher Education*. The Leon Panetta Institute.
- Chamberlin Library. 2021. Fort Ord Working Papers. CSUMB Special Collections Box 6.42-01. Available at the Chamberlin Library, Seaside, California.
- CSUMB Facilities. 2021. Original As built and renovation architectural drawings on file with CSUMB facilities department. Accessed in person June 15-16, 2021.
- DLIFLC (Defense Language Institute Foreign Language Center). 2021. Command History Program. Accessed in person on June 15, 2021 and accessed online database collection online July 2021. Available at: <https://adli.pastperfectonline.com/>
- EA Engineering. 1991. Draft Final Fort Ord, California Base wide Remedial Investigation Feasibility Study. Volume 1 Literature Review and Base Inventory Report. Accessed on July 13, 2021. Available at: <https://www.fortordcleanup.com/documents/search/>
- Fresno Bee, The. 1951a. "Army Spokesman Are Defending Building of Fort Ord Stadium." January 12, 1951. Page 13. Accessed June 17, 2021.
- Fresno Bee, The. 1951b. "Army Spokesman Are Defending Building of Fort Ord Stadium." February 4, 1951. Page 27. Accessed June 17, 2021. Available at: Newspapers.com.
- Gates, S., & Williams, H. 1957. The Armed Forces. The Annals of the American Academy of Political and Social Science, 313, 99-104. Accessed June 17, 2021. <http://proxy.multcolib.org:2052/stable/1031762>
- Hiller, Peter. 2007. NRHP Nomination Form. Monterey County Court House. National Parks Service. Accessed July 18, 2021. Available at: https://npgallery.nps.gov/NRHP/GetAsset/NRHP/08000878_text
- MacGregor Jr., Morris J. 1981. Integration of the Armed Forces, 1940-1965. Center of Military History, United States Army: Washington, D.C.

CONTINUATION SHEET

Property Name: Beach Hall

Page 14 of 15

- Madsen, Alexandra and Steven Treffers. 2019. *Historic Resources Evaluation Memorandum for Hammerhead Barracks at Fort Ord, Monterey County, California*. Prepared by Rincon Consultants, Inc for City of Seaside, Community and Economic Development Department. November 4, 2019. Accessed June 28, 2021.
https://www.ci.seaside.ca.us/DocumentCenter/View/10674/9_App-S---HRE-Memo
- Military Museum. 2016. "Historic California Posts, Camps, Stations, and Airfields: Fort Ord." Accessed on June 19, 2021. <http://www.militarymuseum.org/FtOrd.html>
- National Archives Foundation. 2021. Executive Order 9981. Accessed June 29, 2021. Available at: <https://www.archivesfoundation.org/documents/executive-order-9981-ending-segregation-armed-forces/>
- NETR (Nationwide Environmental Title Research LLC). 2021. Historic Aerial Photographs of 100 Campus Center, Seaside, CA 93955 dating from 1956, 1968, 1981, 1998, 2005, 2009, 2010, 2012, 2014, 2016, and 2018. Accessed June 10, 2021.
<https://www.historicaerials.com/viewer>
- Panorama. 1990. "50 Years and Counting..." September 21, 1990, pg. 2.
- Panorama. n.d. "Ford Ord in World War II." Historic California Posts: Fort Ord. Accessed on June 19, 2021. <http://www.militarymuseum.org/FtOrd.html>
- Park, R. 2015. "Happy and Cheerful in This Fine Camp": Sports, Recreation, and the United States Army at Fort Ord and Camp Roberts, 1940 to 1945. *Journal of Sport History*, 42(1), 21-37. Accessed on June 18, 2021, from
<https://www.jstor.org/stable/10.5406/jsporhistory.42.1.21>
- Pomona Progress Bulletin. 1950. War Solving Racial Problems. August 24, 1950. Page 4. Accessed June 29, 2021. Available at: [Newspapers.com](http://www.newspapers.com).
- Quartermaster Review, The. 1940. "Army Construction Underway at Camp Ord, California." Volume XX. No 3. November-December. On file at the Chamberlin Library, Ord Military Community.
- Raugh, Harold E. 2004. Fort Ord. Charleston, SC: Arcadia.
- Salinas Morning Post. 1940. "\$2,766,000 in Building Authorized—Ord Contracts Let." August 21, 1940. Salinas, CA. pg. 1.
- San Francisco Examiner. 1951. Fort Ord Will Get Stadium. San Francisco Page 4. . 3 Feb 1951. Pages 1 and 4 A Available on [www.Newspapers.com](http://www.newspapers.com). Accessed on Jun 11, 2021.
- San Francisco Examiner. 1958. Army Asks OK on \$124,000,000 for Fort Ord Buildings. San Francisco. Section 2. Page. 4. Available on [www.Newspapers.com](http://www.newspapers.com). Accessed July 18, 2021.
- Vasche, J. Burton. 1959. "The California State Colleges: Their History, Organization, Purposes, and Programs." in California
- U.S. Army. 1977. Post Map Main Garrison Area. Fort Ord, California. Drawing number G-950. Accessed in person at the Chamberlain Library on June 15, 2021.

CONTINUATION SHEET

Property Name: Beach Hall

Page 15 of 15

Walch, Bob. 2004. An Army Historian's Pictorial Take on Fort Ord. Monterey County NOW. Accessed July 12, 2021. Available at:
https://www.montereycountyweekly.com/news/local_news/an-army-historian-s-pictorial-take-on-fort-ord/article_6e8b0250-9c38-5ca4-a4a4-f93d42d65a11.html

Whaley, Derek. 2015. "East Monterey & Seaside." Santa Cruz Trains: Railroads of the Monterey Bay Area. July 20, 2015. Accessed online:
<https://www.santacruztrains.com/2015/07/east-monterey-seaside.html>.

Webb Spinner, The. 1952-1954. Webb Spinner Volume for 1952-1954. Del Webb Sun Cities Museum Collection. Accessed June 30, 2021. Accessed at:
<https://delwebbsuncitiesmuseum.org/newsletters-webb-spinners/>

State of California & The Resources Agency
DEPARTMENT OF PARKS AND RECREATION
PRIMARY RECORD

Primary #
HRI #
Trinomial
NRHP Status Code 6Z

Other Listings
Review Code

Reviewer

Date

Page 1 of 15 *Resource Name or #: (Assigned by recorder) Tide Hall

P1. Other Identifier: CSUMB Building 23

*P2. Location: Not for Publication Unrestricted

*a. County Monterey County and (P2c, P2e, and P2b or P2d. Attach a Location Map as necessary.)

*b. USGS 7.5' Quad Marina, CA Date 1995 T 15S; R 1E; NE ¼ of SE ¼ of Sec 1; Mount Diablo B.M.

c. Address 3719 Engineer Road Seaside Zip 93955

d. UTM: (Give more than one for large and/or linear resources) Zone 10S 607231 mE/ 4057011 mN

e. Other Locational Data: (e.g., parcel #, directions to resource, elevation, decimal degrees, etc., as appropriate)

Tide Hall sits south of Divarty Street, east of Engineer Lane

*P3a. Description: (Describe resource and its major elements. Include design, materials, condition, alterations, size, setting, and boundaries)

Tide Hall (CSUMB Building 23) is a one-story utilitarian building that has a rectangular floor plan and a concrete block structural system. The south facing main elevation is symmetrical. It is covered by a moderately pitched side gabled roof clad with composition shingles. The main entrance is located centrally and is flanked by two squared projections and capped by a gabled, glazed dormer. The main entrance consists of contemporary metal framed sliding doors. Secondary doors are contemporary and located on the far east and west ends of the main elevation. Windows are contemporary metal framed, one-over-one, fixed and awning windows.

See Continuation Sheet

*P3b. Resource Attributes: (List attributes and codes) HP15. Educational building/HP34 Military property

*P4. Resources Present: Building

Structure Object Site District Element of District Other (Isolates, etc.)

P5b. Description of Photo: (view, date, accession #) south elevation, view looking north, Dudek (IMG 0246).

*P6. Date Constructed/Age and Source: Historic Prehistoric Both 1953 (CSUMB Facilities)

*P7. Owner and Address: CSUMB, 100 Campus Center, Seaside, CA. 93955

*P8. Recorded by: (Name, affiliation, and address) Sarah Corder, Dudek, 725 Front St #400, Santa Cruz, CA 95060

*P9. Date Recorded: 7/9/2021

*P10. Survey Type: (Describe) Intensive level

*P11. Report Citation: (Cite survey report and other sources or enter none) Dudek 2021. Built

P5a. Photograph or Drawing (Photograph required for buildings, structures, and objects.)



Environment Inventory and Evaluation Report for California State University, Monterey Bay.

*Attachments: NONE Location Map Continuation Sheet Building, Structure, and Object Record

Archaeological Record District Record Linear Feature Record Milling Station Record Rock Art Record

Artifact Record Photograph Record Other (List): _____

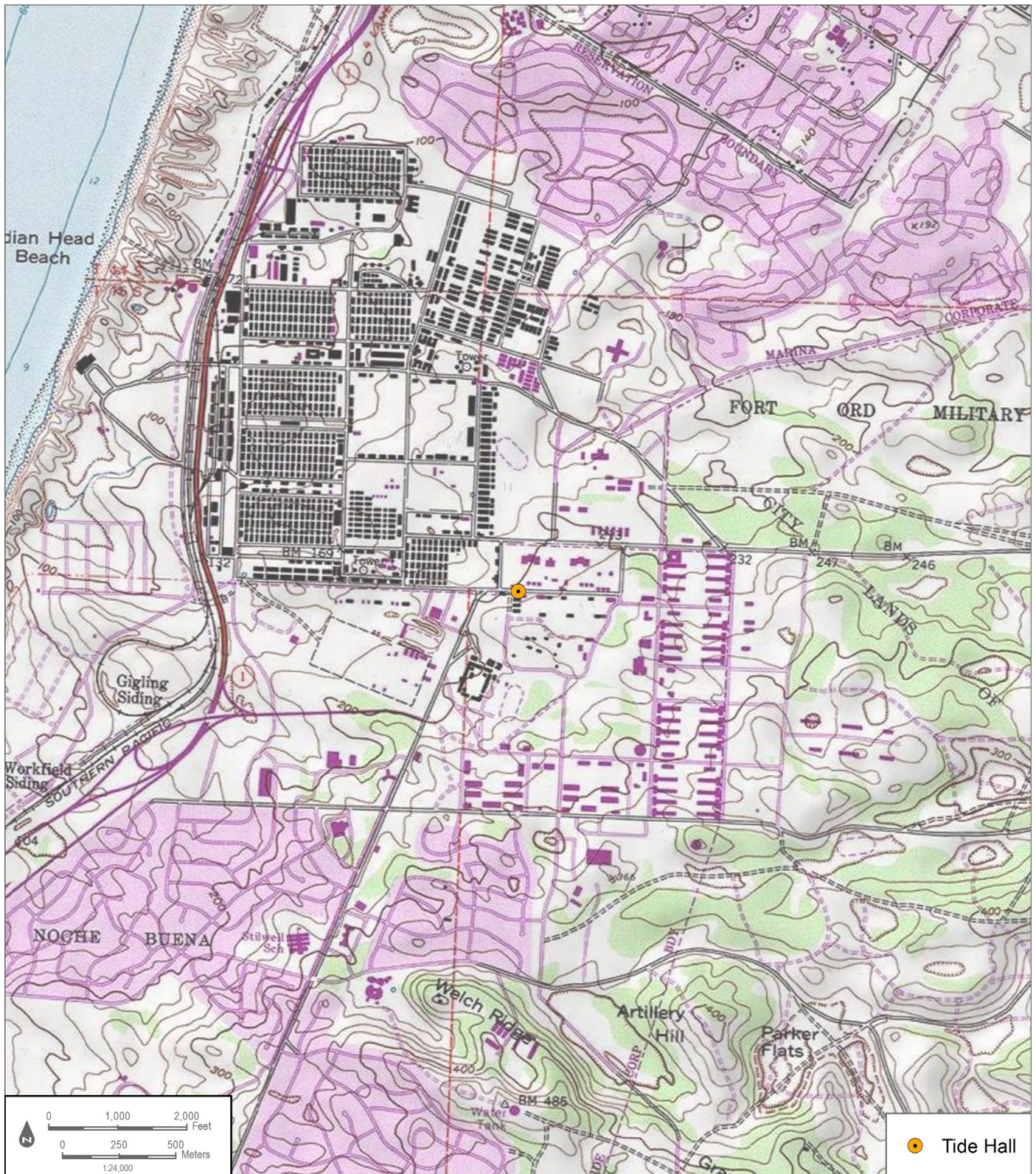

BUILDING, STRUCTURE, AND OBJECT RECORD

*Resource Name or # (Assigned by recorder) Tide Hall *NRHP Status Code 6Z
Page 3 of 15

B1. Historic Name: Permanent Troop Spaces and Support Facilities Classroom

B2. Common Name: Tide Hall

B3. Original Use: Educational building 4. Present Use: Administration

*B5. Architectural Style: Utilitarian

*B6. Construction History: (Construction date, alterations, and date of alterations)
Designed in 1953 and completed in 1954, Tide Hall has undergone several alterations. Renovation and as-built drawings show alterations to the building took place in 1995. Changes include the addition of gabled roof to south elevation and substantial changes to fenestration (CSUMB Facilities 2021).

*B7. Moved? No Yes Unknown Date: _____ Original Location: _____ *B8. Related Features:

B9a. Architect: Robert Stanton b. Builder: Unknown

*B10. Significance: Theme N/A Area N/A
Period of Significance N/A Property Type N/A Applicable Criteria N/A
(Discuss importance in terms of historical or architectural context as defined by theme, period, and geographic scope. Also address integrity.)

See Continuation Sheet.

B11. Additional Resource Attributes: (List attributes and codes) _____

*B12. References: See Continuation Sheet.

B13. Remarks:

*B14. Evaluator: Laura Carias, MA

*Date of Evaluation: July 9, 2021

(This space reserved for official comments.)

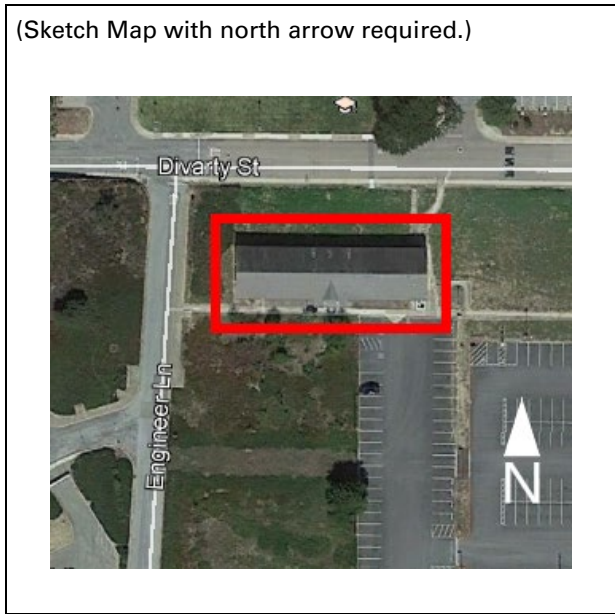

CONTINUATION SHEET

Property Name: Tide Hall

Page 4 of 15

***P3a. Description (continued):**

A single column of cinderblocks is located between every second window on the main (south) and rear (north) elevation. The westernmost and easternmost windows on the rear elevation appear have originally been doorways as concrete and asphalt pedestrian walkways lead directly up to them. Window fenestration is repeated on the north (rear) elevation. Alterations include the infill of a centrally located windows on the rear elevation, conversion of doors to windows on rear elevation, added central gabled projection on main elevation, and replacement doors.



Figure 1. Main (south) elevation, looking north (IMG_0292)

CONTINUATION SHEET

Property Name: Tide Hall

Page 5 of 15



Figure 2. North elevation, looking south (IMG_0314)

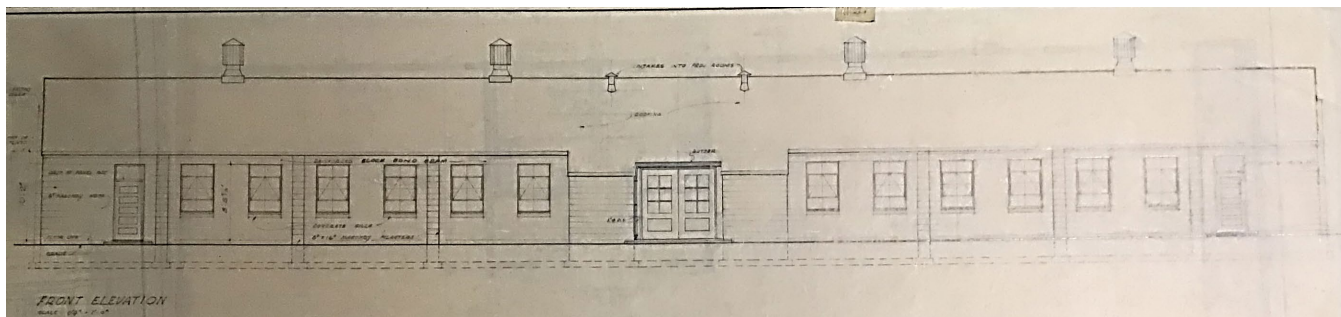

Figure 3. 1953 architectural drawing of a typical Support Services Building, the design used for Tide Hall (CSUMB Facilities 2021)

Alterations:

- Replaced original windows with metal sash fixed and awning windows (1995)
- Various filled in windows and doors (Date unknown)
- Added gable projection on south elevation (1995)
- Replaced original doors (Date unknown)
- Change of circulation within building as doorways were converted to windows (1995)

CONTINUATION SHEET

Property Name: Tide Hall

Page 6 of 15

*B10. Significance (continued):

Historical Overview of Fort Ord

The history of Fort Ord has been extensively documented in newspaper articles, websites, academic journals, and books. From its creation in 1917 to its closure in 1994, the base grew to become one of the largest training centers in the country. Its location was also reported to be the most attractive U.S. Army post, with easy access to the ocean and beautiful California weather.

The development periods in the history of Fort Ord were defined by Harold E. Raugh, Jr, a U.S. Army lieutenant colonel and historian with the Department of Defense. Since his retirement, Raugh served as the Chief Historian, for the Defense Logistics Agency, for the Department of Defense and, from 2006-2013, Raugh served as the Command Historian at the Defense Language Institute Foreign Language Center (DLIFLC) and the Presidio of Monterey, California. He received his PhD in history from the University of California, Los Angeles (Walch 2004). Raugh has authored numerous books including, *Fort Ord* (2004); *Presidio of Monterey* (2004); *Operation Joint Endeavor: V Corps in Bosnia-Herzegovina, 1995-1996* (2013); *The Raugh Bibliography of the Indian Mutiny 1857-1859* (2016); and *Wavell in the Middle East, 1939-1941: A study in Generalship*. Raugh defined four periods for the historic development of Fort Ord:

- 1917-1940 Camp Gigling to Camp Ord
- 1940-1945 Fort Ord and the 7th Infantry Division
- 1946-1976 The Cold War and Vietnam Eras
- 1974-1994 The Volunteer Army

These periods correspond to distinct eras in the history of the base and the U.S. Army (Raugh 2004: ii). The following sections provide a summary overview of each of these periods of development and their relevance to the area of Fort Ord now known as the CSUMB campus.

The full historic context of Fort Ord is represented in the report, *Built Environment Inventory and Evaluation Report for California State University, Monterey Bay* (Dudek 2021). The following presents only relevant historical and building typology information pertaining to the development of Tide Hall.

Cold War and Vietnam Eras at Fort Ord (1946-1976)

This period of development between 1946 and 1976 was characterized by a massive operation to move the base out of its semi-permanent status and create a permanent outpost for active military personnel who were retained due to ongoing foreign conflicts.

In July of 1948, Harry S Truman signed Executive Order 9981, which officially ended segregation in the armed forces. The order stated that "there shall be equality of treatment and opportunity for all persons in the armed forces without regard to race, color, religion, or national origin" (National Archives Foundation 2021). Fort Ord became one of the first integrated training divisions in the United States. The Fort was touted as "pioneering to end all segregation" (Pomona Progress Bulletin 1950: 4). In 1950, the Pomona Progress Bulletin reported that black and white soldiers at Fort Ord were "fighting side by side" and all the enlistees "trained together, slept in the same barracks, and eat the same messes" (Pomona Progress Bulletin 1950: 4).

The end of World War II in 1945 did not bring lasting peace. The tenuous relationship between dominant nations in the communist East and free market West led to the beginning of the Cold War. The Department of Defense maintained a robust fighting force during the Cold War, with more than 900,000 Army personnel retained during the 1950s (ACHP 2006).

CONTINUATION SHEET

Property Name: Tide Hall

Page 7 of 15

The ongoing global tensions and the number of active U.S. military personnel created a need for new permanent buildings and expanded military housing at Fort Ord.

In 1949, the Soviet-supported communist government of North Korea invaded American-supported South Korea, initiating the Korean War. Fort Ord was a primary staging area for the training of troops departing for the war (Castle 1990:3). By the 1950s, Fort Ord had become one of the largest basic training camps in the United States. In 1952, the military began a multi-million dollar building program to transform Fort Ord into a permanent post, including the development of permanent troop housing, and the construction of a guard house, stockade, and multiple warehouses. In January of 1952, military authorities announced the new construction program at Fort Ord was underway, with an estimated cost of \$26,650,600. More than half of the funds that were approved by Congress were "earmarked for new permanent troop housing" for more than 7,000 soldiers (The Webb Spinner 1952-54, Vol 6. No. 3:1).

The new troop housing was to be constructed of reinforced concrete, a departure from the wood buildings constructed before and during World War II. The plan called for three types of massive barracks, twenty-two were to house 225 enlisted men each, seven were to accommodate 165 men each, and nine were to house 105 men each (The Webb Spinner 1952-54, Vol 6. No. 3:3). The San Francisco District of the U.S. Army Corps of Engineers oversaw the construction project to completion. An additional \$1,349,700 was earmarked for the expansion of classroom and training facilities at Fort Ord, including a new battalion and regimental headquarters (The Californian 1952a:1 and The Californian 1952b:18). By March of 1952, another phase of the permanent army post transformation began with the construction of a guard house, stockade, warehouse, and other buildings (The Webb Spinner 1952-54, Vol 6. No. 3:1). This addition of permanent buildings continued into the late 1950s, when the Army requested \$124 million to replace all the wood World War II infrastructure at Fort Ord with concrete block and reinforced concrete (Madsen and Treffers 2019:6; San Francisco Examiner 1958:2-4). While many of the wood buildings remain today, this period saw the continuous addition of reinforced concrete permanent buildings across the Fort (Madsen and Treffers 2019:6).

Following the Korean War through the end of the conflict in Vietnam, Fort Ord served as an important training facility. In 1957, Fort Ord was designated as a U.S. Army Training Center for Infantry (Castle 1990: 4). The 7th Infantry Division was based at Fort Ord in 1975 (Cavanaugh 2000: 9). Fort Ord produced thousands of combat-ready troops during the conflict in Vietnam.

With the establishment of Fort Ord as a permanent Army base during this period, there was substantial building construction that led to the modernization of the base and its services. This development is closely related to the history of the current CSUMB campus. All the properties that are included as part of this built environment study were constructed during the Cold War and Vietnam Era period. Building development during this period was a substantial departure from the styles and materials used in the buildings constructed before World War II. Buildings constructed between 1946 and 1976 primarily used reinforced concrete and concrete masonry unit (CMU) in their design. The buildings tended to be larger than those constructed in previous periods. Other development in this period included support service buildings and several types of medical buildings. Infrastructure was also improved at this time, with the introduction of paved streets and roadways, and the addition of several water tanks, water pumping plants, and warehouse buildings.

Tide Hall (23)

Constructed in 1954, Tide Hall (23) was designed by Robert Stanton a local Monterey Bay

CONTINUATION SHEET

Property Name: Tide Hall

Page 8 of 15

architect (CSUMB Facilities 2021). It was one of several identical buildings described as “permanent troop spaces and supporting facilities/classrooms” designed for Fort Ord (CSUMB Facilities 2021). The building first appears in a 1956 aerial photograph as a long, rectangular plan, gable-ended building with a south-facing entrance, on the south side of Divarty Street (UCSB 2021). This building appears unchanged between 1956 and 2016, there are major changes to the surrounding area (NETR 2021). All the buildings north of Divarty Street to the north were demolished circa 1971-81 (UCSB 2021, NETR 2021). Between 1981 and 1987, the Veteran’s Administration building appears to the southwest across Engineer’s Lane 81 (NETR 2021, UCSB 2021). Between 2005 and 2009, two buildings immediately south of Tide Hall along Engineer Lane were demolished (NETR 2021). The circulation pattern in and out of the building was likely changed during a 1995 interior remodel when windows were converted into doors on the north elevation (CSUMB Facilities 2021). Before 2005, the gabled addition over the primary entrance was added (NETR 2021). No other changes were noted.

Robert Stanton

Robert Stanton was born in Detroit, Michigan in 1900. He served briefly in the U.S. Navy during World War I and then graduated from high school in Los Angeles and went on to complete his education at University of California at Berkeley. After graduation he worked with renowned architect, Wallace Neff. Neff appointed Stanton as project supervisor on several projects and Stanton earned his architecture license in 1934. Stanton moved to Monterey Bay in 1935 and went on to design a variety of residential, commercial, and public buildings in the area. Two of his buildings, the Monterey County Courthouse and the King City High School Auditorium have been listed on the NRHP (Hiller 2007:8-4). Robert Stanton was known to have designed a plan for classroom buildings at Fort Ord that was used for at least four buildings on campus (CSUMB Facilities 2021).

Fort Ord Building Typology

Four categories of building types were identified for the purposes of this study. These are the Support Services Buildings, Medical Buildings, Hammerhead Buildings/Barracks, and Recreational Buildings. The following presents a discussion of the Support Services building typology, as Tide Hall (23) is classified in this typology. This section provides a detailed account of the specific character-defining features of Fort Ord Cold War and Vietnam Era (1946-1976) Support Services buildings.

Building Typology: Support Services Buildings

Support Services Buildings constructed during the Cold War and Vietnam Eras (1946-1976) at Fort Ord have a variety of uses and functions that changed over the history of the base. In alignment with the typical planning, design, and materials of buildings constructed during this period of Fort Ord’s history, these buildings are constructed with reinforced concrete and CMU and feature moderately pitched gable roofs with multi-light windows with concrete sills. The buildings tended to have central entryways that opened into hallways, with classrooms lining the halls. In alignment with the typical planning, design, and materials of buildings from this period of Fort Ord’s history, these buildings are constructed with reinforced concrete and CMU and feature gable roofs with multi-light windows with concrete sills. These buildings have a uniform design, like many of the other buildings at Fort Ord.

After Fort Ord closed in 1994, these support services buildings became part of the CSUMB campus. With the shift to campus use, many of the buildings were altered to fit the needs of CSUMB. Tide Hall’s building footprints appears unchanged between 1956 and the present, however the circulation pattern of the building’s interior changed during a 1995 remodel when some windows were converted to doors on the north elevation, and a gable roof was added over the primary door (CSUMB Facilities 2021; NETR 2021).

CONTINUATION SHEET

Property Name: Tide Hall

Page 9 of 15

Character-Defining Features for the Support Services Buildings

The Support Services Buildings originally exhibited the following specific character-defining features:

Character Aspect	Primary Character-Defining Features	Character-defining features
Shape and Plan	<ul style="list-style-type: none"> • Simple rectangular form • Single story 	The overall shape and mass of the building are considered a primary character-defining feature of the support services buildings. The plan should be rectangular in form.
Roof	<ul style="list-style-type: none"> • Flat or gable roof • small eave overhangs • No exposed rafters 	Support service buildings from this period have gable roof forms, with slight eave overhangs.
Openings	<ul style="list-style-type: none"> • Public entrances and circulation patterns 	Window openings are generally uniform in size and placement, windows are multi-light, and set into concrete openings. Replaced windows are not considered character-defining features as they fall outside the period of significance.
Exterior Ornamentation	<ul style="list-style-type: none"> • Minimal exterior ornamentation 	The support services buildings were designed to be quickly constructed. They have little to no decorative ornamentation, with windows being set evenly apart and CMU pillars being the only decorative element.
Materials	<ul style="list-style-type: none"> • Mass-produced and cost-effective materials • Concrete and CMU • Reinforced Concrete construction 	The support services buildings have simple, utilitarian designs. Buildings were constructed using mass-produced and cost-effective building materials that were readily available at the time of construction. For instance, buildings under the support services buildings type were constructed with reinforced concrete and CMU and were minimally decorated.

Alterations and demolitions over time have compromised the overall architectural integrity of this building type. The most common alterations observed for this building type include the following:

- Replacement windows
- ADA compliance measures such as ramps and doors
- HVAC systems and window units
- Infill of openings
- Addition of front gable over doorways
- Interior renovations

NRHP/CRHR Designation Criteria

In consideration of Tide Hall's history and requisite integrity, Dudek recommends the building not eligible for listing in the NRHP and CRHR based on the following significance evaluation and in consideration of national and state eligibility criteria:

Criterion A/1: That are associated with events that have made a significant contribution to the broad patterns of our history.

Tide Hall was constructed in 1954 during the period defined as the Cold War and Vietnam

CONTINUATION SHEET

Property Name: Tide Hall

Page 10 of 15

Eras (1946-1976) at Ford Ord. While this building is of historic age and was constructed during an important period of development in Fort Ord's history, it no longer retains enough integrity to convey its significance. One of the most notable elements of integrity that is compromised is the integrity of setting. Significant demolition, changes to circulation patterns, introduction of new buildings, and changes in use, all impact the campus's ability to convey significance from its time as an active Cold War and Vietnam Era military base. The loss of this overall integrity of setting adversely affects Tide Hall, as individual buildings are no longer able to convey their collective history. Additionally, the subdivision of Fort Ord following its closure has also greatly impacted the integrity of feeling, association, and setting of the remaining Cold War and Vietnam Era buildings. Tide Hall is not able to convey its association with any extraordinary events or events occurring within the context of Cold War and Vietnam military support service buildings, the CSUMB Campus, or has an association with the broad patterns of history in Monterey County, the State of California, or the Nation. Therefore, the building is recommended not eligible under NRHP/CRHR Criterion A/1.

Criterion B/2: That are associated with the lives of persons significant in our past.

To be found eligible under B/2 the building must be directly tied to an important person and the place where that individual conducted or produced the work for which he or she is known. No other single person was shown to be influential or directly associated with the building. As such, this building is not known to have any historical associations with people important to the nation's or state's past. Due to a lack of identified significant associations with important persons in history, Dudek recommends the building is not eligible under NRHP/CRHR Criterion B/2.

Criterion C/3: That embody the distinctive characteristics of a type, period, or method of construction, or that represent the work of a master, or that possess high artistic values, or that represent a significant and distinguishable entity whose components may lack individual distinction.

Archival research indicates that Tide Hall was constructed in 1954 as one of several classroom/support buildings for Fort Ord. Although designed by architect, Robert Stanton, the building was not constructed in any obvious architectural style. The building is a ubiquitous building type that lacks high style components to set it apart from other buildings constructed in the 1960s. The building has been altered with the addition of a gable at the south main elevation and the removal of all original windows and doors as well as changes to the fenestration pattern. For these reasons, the building does not possess a high level of architectural merit to be considered for inclusion in the NRHP. For these reasons Dudek recommends Tide Hall is not eligible under NRHP/CRHR Criterion C/3.

Criterion D/4: That have yielded, or may be likely to yield, information important in prehistory or history.

There is no evidence to suggest that Tide Hall has the potential to yield information important to state or local history. Therefore, the building is recommended not eligible under NRHP/CRHR Criterion D/4.

California Historic Landmark Statement of Significance

In consideration of Tide Hall's history and requisite integrity, Dudek recommends the building is not eligible for designation as a California Historic Landmark based on the following significance evaluation and in consideration of state eligibility criteria:

The first, last, only, or most significant of its type in the state or within a large geographic region (Northern, Central, or Southern California).

Tide Hall was designed in 1953 and constructed in 1954. The building was constructed after the initial, core development period of Fort Ord in the 1940s. Tide Hall was

CONTINUATION SHEET

Property Name: Tide Hall

Page 11 of 15

designed by Robert Stanton. The building is a ubiquitous building type that lacks high style components to set it apart from other utilitarian buildings constructed throughout the State of California in the 1950s. Therefore, Dudek recommends the building is not eligible for listing as a CHL under this criterion.

Associated with an individual or group having a profound influence on the history of California.

Archival research failed to indicate any significant associations between Tide Hall and individuals or groups that profoundly influenced the history of California. Tide Hall was one of several support/classroom buildings constructed on the site. Robert Stanton was found to be the architect responsible for the design, but the utilitarian building does not reflect one of his remarkable designs. No other individuals are known to have influenced the construction or use of this building. Therefore, Dudek recommends the building is not eligible for listing as a CHL under this criterion.

A prototype of, or an outstanding example of, a period, style, architectural movement or construction or is one of the more notable works or the best surviving work in a region of a pioneer architect, designer or master builder.

Tide Hall is neither a prototype or an outstanding example of a period, style, or architectural movement. The building was designed to serve a utilitarian purpose. There are no remaining identifying features on Tide Hall that would establish the building as a notable work of a master architect, or a notable designer or builder working within the military, or in the State of California. Therefore, Dudek recommends the building is not eligible for listing as a CHL under this criterion.

Local Designation Criteria

Portions of the CSUMB campus are located within the boundaries of two cities, City of Seaside and the City of Marina, both of which evaluate historical resources in accordance with CEQA Guidelines. as presented above. The subject property, as discussed in the NRHP/CRHR/CHL criteria discussion above, does not rise to the necessary level of significance for local, state, or national designation. For these reasons, the subject property is recommended not eligible individually or as a component of a historic district under any of the NRHP/CRHR/CHL or local criteria.

Additionally, portions of the CSUMB campus are located in the County of Monterey and the campus is therefore subject to the regulations set forth in Chapter 18.25 of the Monterey County Code. The subject property, as discussed in the NRHP/CRHR/CHL criteria discussion above, does not rise to the necessary level of significance for state or national designation. For these same reasons, the subject property is also recommended not eligible individually or as a component of a historic district under any of the delineated County of Monterey review criteria categories that are addressed with the NRHP/CRHR/CHL criteria discussed above: A. Historical and Cultural Significance; B. Historic, Architectural, and Engineering Significance; or C. Community and Geographic Setting.

Integrity Discussion

Tide Hall was analyzed against the seven aspects of integrity: location, design, setting, materials, workmanship, feeling, and association. The building retains its integrity of location, as it has not been relocated; however, the integrity of setting has been compromised due to the change of use, from a Cold War and Vietnam Era military support services building to an educational classroom building for CSUMB. Changes to the surrounding area have further compromised the integrity of setting and feeling. Replacement materials have been added throughout the building since its completion in 1954, including new doors, changes in the fenestration pattern, and addition of roof gable at south elevation. These alterations have compromised the resource's integrity of

CONTINUATION SHEET

Property Name: Tide Hall

Page 12 of 15

design, materials, and workmanship. As the building does not possess historic significance, there is no historic association. While the building is in good condition, it does not possess integrity to convey significance or its temporal period.

Summary of Evaluation Findings

Tide Hall retains little historic integrity and lacks historical and architectural significance. Based on the significance evaluations presented above, Tide Hall does not appear to meet the NRHP, CRHR, CHL or local designation criteria. Therefore, Tide Hall is not considered a historical resource for purposes of CEQA.

CONTINUATION SHEET

Property Name: Tide Hall

Page 13 of 15

*B12. References (continued):

ACHP (Advisory Council on Historic Preservation). 2006. "Draft Program Comment Regarding Cold War Era Unaccompanied Personnel Housing." Federal Register: The Daily Journal of the United States Government. 12 April 2016. Accessed June 30, 2021 Available at: <https://www.federalregister.gov/documents/2006/04/12/06-3509/draft-program-comment-regarding-cold-war-era-unaccompanied-personnel-housing>

Californian, The. 1940. "No More Camp Ord! It's Fort Ord Now! Stilwell in Command: Headquarters of General Located on Salinas Side." July 13, 1940. Salinas, California, pg. 1.

Californian, The. 1951. Stadium Field House—Sixth Army Lets Ord Contract. March 20, 1951. P1. Accessed June 17, 2021. Available at: Newspapers.com.

Castle, Ted. 1990. "The March of Time." Fort Ord Panorama. September 21, 1990.

Cavanaugh, Joe. 2000. *The Peace Dividend: Defense Conversion Through Higher Education*. The Leon Panetta Institute.

Chamberlin Library. 2021. Fort Ord Working Papers. CSUMB Special Collections Box 6.42-01. Available at the Chamberlin Library, Seaside, California.

CSUMB Facilities. 2021. Original As built and renovation architectural drawings on file with CSUMB facilities department. Accessed in person June 15-16, 2021.

DLIFLC (Defense Language Institute Foreign Language Center). 2021. Command History Program. Accessed in person on June 15, 2021 and accessed online database collection online July 2021. Available at: <https://adli.pastperfectonline.com/>

EA Engineering. 1991. Draft Final Fort Ord, California Base wide Remedial Investigation Feasibility Study. Volume 1 Literature Review and Base Inventory Report. Accessed on July 13, 2021. Available at: <https://www.fortordcleanup.com/documents/search/>

Fresno Bee, The. 1951a. "Army Spokesman Are Defending Building of Fort Ord Stadium." January 12, 1951. Page 13. Accessed June 17, 2021.

Fresno Bee, The. 1951b. "Army Spokesman Are Defending Building of Fort Ord Stadium." February 4, 1951. Page 27. Accessed June 17, 2021. Available at: Newspapers.com.

Gates, S., & Williams, H. 1957. The Armed Forces. The Annals of the American Academy of Political and Social Science, 313, 99-104. Accessed June 17, 2021. <http://proxy.multcolib.org:2052/stable/1031762>

Hiller, Peter. 2007. NRHP Nomination Form. Monterey County Court House. National Parks Service. Accessed July 18, 2021. Available at: https://npgallery.nps.gov/NRHP/GetAsset/NRHP/08000878_text

CONTINUATION SHEET

Property Name: Tide Hall

Page 14 of 15

- MacGregor Jr., Morris J. 1981. *Integration of the Armed Forces, 1940-1965*. Center of Military History, United States Army: Washington, D.C.
- Madsen, Alexandra and Steven Treffers. 2019. *Historic Resources Evaluation Memorandum for Hammerhead Barracks at Fort Ord, Monterey County, California*. Prepared by Rincon Consultants, Inc for City of Seaside, Community and Economic Development Department. November 4, 2019. Accessed June 28, 2021.
https://www.ci.seaside.ca.us/DocumentCenter/View/10674/9_App-S---HRE-Memo
- Military Museum. 2016. "Historic California Posts, Camps, Stations, and Airfields: Fort Ord." Accessed on June 19, 2021. <http://www.militarymuseum.org/FtOrd.html>
- National Archives Foundation. 2021. Executive Order 9981. Accessed June 29, 2021. Available at: <https://www.archivesfoundation.org/documents/executive-order-9981-ending-segregation-armed-forces/>
- NETR (Nationwide Environmental Title Research LLC). 2021. Historic Aerial Photographs of 100 Campus Center, Seaside, CA 93955 dating from 1956, 1968, 1981, 1998, 2005, 2009, 2010, 2012, 2014, 2016, and 2018. Accessed June 10, 2021.
<https://www.historicaerials.com/viewer>
- Panorama. 1990. "50 Years and Counting..." September 21, 1990, pg. 2.
- Panorama. n.d. "Ford Ord in World War II." Historic California Posts: Fort Ord. Accessed on June 19, 2021. <http://www.militarymuseum.org/FtOrd.html>
- Park, R. 2015. "Happy and Cheerful in This Fine Camp": Sports, Recreation, and the United States Army at Fort Ord and Camp Roberts, 1940 to 1945. *Journal of Sport History*, 42(1), 21-37. Accessed on June 18, 2021, from
<https://www.jstor.org/stable/10.5406/jsporthistory.42.1.21>
- Pomona Progress Bulletin. 1950. War Solving Racial Problems. August 24, 1950. Page 4. Accessed June 29, 2021. Available at: [Newspapers.com](http://www.newspapers.com).
- Quartermaster Review, The. 1940. "Army Construction Underway at Camp Ord, California." Volume XX. No 3. November-December. On file at the Chamberlin Library, Ord Military Community.
- Raugh, Harold E. 2004. Fort Ord. Charleston, SC: Arcadia.
- Salinas Morning Post. 1940. "\$2,766,000 in Building Authorized—Ord Contracts Let." August 21, 1940. Salinas, CA. pg. 1.
- San Francisco Examiner. 1951. Fort Ord Will Get Stadium. San Francisco Page 4. · 3 Feb 1951. Pages 1 and 4 A Available on [www.Newspapers.com](http://www.newspapers.com). Accessed on Jun 11, 2021.
- San Francisco Examiner. 1958. Army Asks OK on \$124,000,000 for Fort Ord Buildings. San Francisco. Section 2. Page. 4. Available on [www.Newspapers.com](http://www.newspapers.com). Accessed July 18, 2021.

CONTINUATION SHEET

Property Name: Tide Hall

Page 15 of 15

Vasche, J. Burton. 1959. "The California State Colleges: Their History, Organization, Purposes, and Programs." in California

U.S. Army. 1977. Post Map Main Garrison Area. Fort Ord, California. Drawing number G-950. Accessed in person at the Chamberlain Library on June 15, 2021.

Walch, Bob. 2004. An Army Historian's Pictorial Take on Fort Ord. Monterey County NOW. Accessed July 12, 2021. Available at:
https://www.montereycountyweekly.com/news/local_news/an-army-historian-s-pictorial-take-on-fort-ord/article_6e8b0250-9c38-5ca4-a4a4-f93d42d65a11.html

Whaley, Derek. 2015. "East Monterey & Seaside." Santa Cruz Trains: Railroads of the Monterey Bay Area. July 20, 2015. Accessed online:
<https://www.santacruztrains.com/2015/07/east-monterey-seaside.html>.

Webb Spinner, The. 1952-1954. Webb Spinner Volume for 1952-1954. Del Webb Sun Cities Museum Collection. Accessed June 30, 2021. Accessed at:
<https://delwebbsuncitiesmuseum.org/newsletters-webb-spinners/>

State of California & The Resources Agency
 DEPARTMENT OF PARKS AND RECREATION
PRIMARY RECORD

Primary #
 HRI #
 Trinomial
NRHP Status Code 6Z

Other Listings
 Review Code

Reviewer

Date

Page 1 of 15 *Resource Name or #: (Assigned by recorder) Watershed Institute

P1. Other Identifier: CSUMB Building 42

*P2. Location: Not for Publication Unrestricted

*a. County Monterey County and (P2c, P2e, and P2b or P2d. Attach a Location Map as necessary.)

*b. USGS 7.5' Quad Marina, CA Date 1995 T 15S; R 1E; NE $\frac{1}{4}$ of SW $\frac{1}{4}$ of Sec 6; Mount Diablo B.M.

c. Address 4573 6th Avenue, Seaside Zip 93955

d. UTM: (Give more than one for large and/or linear resources) Zone 10S, 607912 mE/ 4056703 mN

e. Other Locational Data: (e.g., parcel #, directions to resource, elevation, decimal degrees, etc., as appropriate)

The Watershed Institute (CSUMB Building 42) sits south of B Street, between 6th Avenue and 7th Avenue.

*P3a. Description: (Describe resource and its major elements. Include design, materials, condition, alterations, size, setting, and boundaries)

The Watershed Institute (CSUMB Building 42) is located southeast of the Main Quad on the California State University, Monterey Bay (CSUMB) campus. The building is surrounded by simple plantings and to the east of the building are several greenhouses and planting areas, where native plant restoration is taught in an outdoor classroom setting. A parking area is to the south of the building. The one-story utilitarian building with modern stylistic details has a primarily rectangular floor plan with a rectangular projection on the west facade. The building appears to sit on a concrete slab foundation and the primary construction material is CMU.

See Continuation Sheet.

*P3b. Resource Attributes: (List attributes and codes) HP15. Educational building, HP34. Military property

*P4. Resources Present: Building

Structure Object Site District Element of District Other (Isolates, etc.)

P5b. Description of Photo: (view, date, accession #) north
elevation, view looking
southeast, Dudek
 (IMG 0682)

*P6. Date Constructed/Age and Source: Historic Prehistoric Both 1959 (CSUMB Facilities).

*P7. Owner and Address: CSUMB, 100 Campus Center, Seaside, CA. 93955

*P8. Recorded by: (Name, affiliation, and address) Sarah Corder, Dudek, 725 Front St #400, Santa Cruz, CA 95060

*P9. Date Recorded: 6/14/2021

*P10. Survey Type: (Describe) Intensive level

*P11. Report Citation: (Cite survey report and other sources or enter none)

P5a. Photograph or Drawing (Photograph required for buildings, structures, and objects.)



"Dudek 2021. Built Environment Inventory and Evaluation Report for California State University, Monterey Bay."

*Attachments: NONE Location Map Continuation Sheet Building, Structure, and Object Record

Archaeological Record District Record Linear Feature Record Milling Station Record Rock Art Record

Artifact Record Photograph Record Other (List): _____

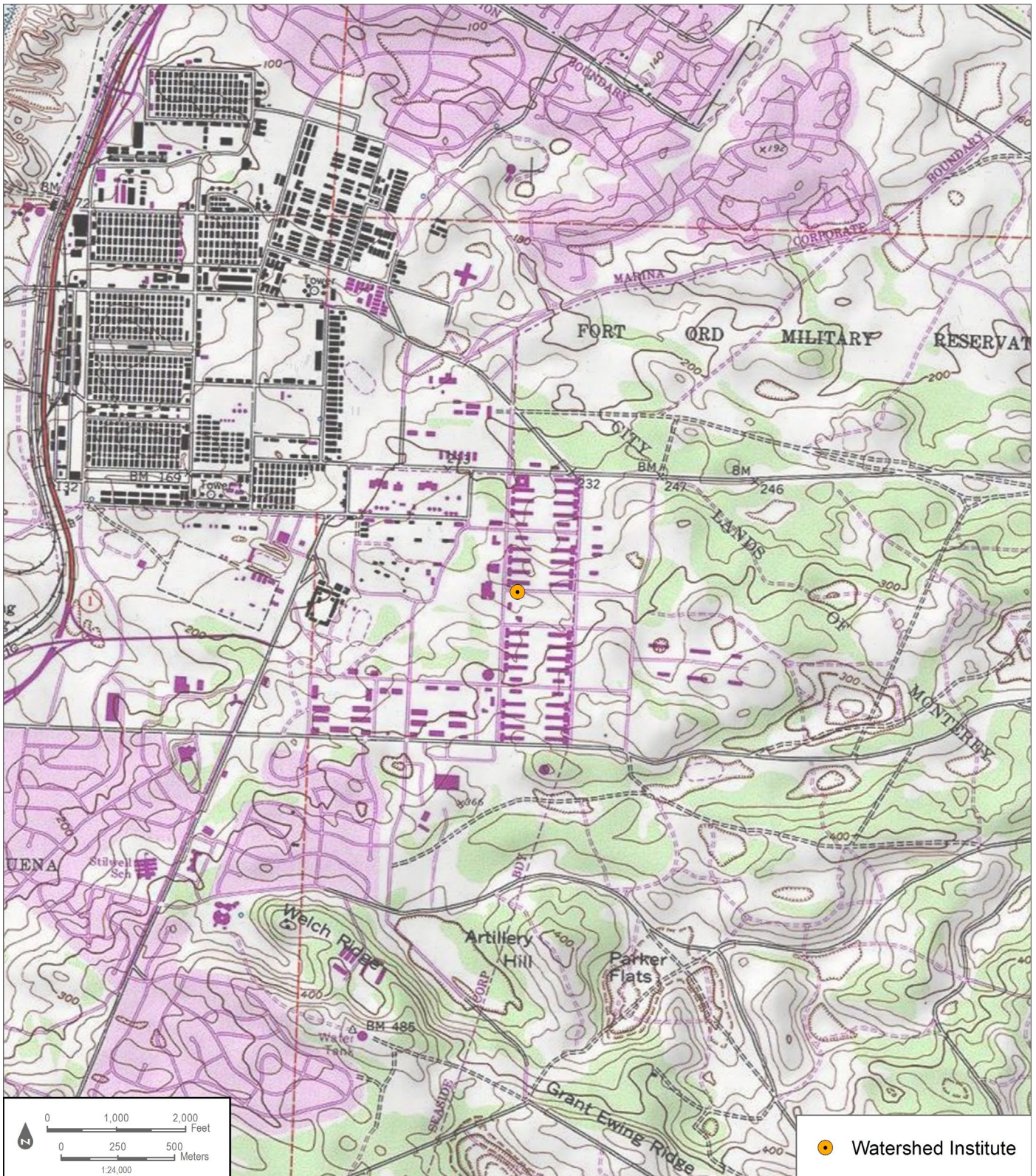

BUILDING, STRUCTURE, AND OBJECT RECORD

*Resource Name or # (Assigned by recorder) Watershed Institute *NRHP Status Code 6Z
Page 3 of 15

B1. Historic Name: Fort Ord Regimental Dispensary
B2. Common Name: Watershed Institute
B3. Original Use: Military Medical Clinic 4. Present Use: Classroom/Science Lab

*B5. Architectural Style: Mid-Century Modern

*B6. Construction History: (Construction date, alterations, and date of alterations)

Designed in 1956 and completed in 1959, the Watershed Institute is a utilitarian building with modern detailing. As-built drawings show alterations were made to the original plans by Fort Ord in 1958. The building became the Watershed Institute, an educational classroom building, after 1995, when the CSUMB Campus was established. The building is covered in a mural, likely applied after the building was adapted for the CSUMB. At this time, the entry doors were likely replaced with modern ADA accessible doors and some windows were also replaced with single, fixed panes.

*B7. Moved? No Yes Unknown Date: _____ Original Location: _____ *B8. Related Features:

B9a. Architect: Noakes & Neubauer, Architects and Engineers b. Builder: N/A

*B10. Significance: Theme N/A Area N/A
Period of Significance N/A Property Type N/A Applicable Criteria N/A
(Discuss importance in terms of historical or architectural context as defined by theme, period, and geographic scope. Also address integrity.)

See Continuation Sheet.

B11. Additional Resource Attributes: (List attributes and codes) _____

*B12. References: See Continuation Sheet.

B13. Remarks:

*B14. Evaluator: Adrienne Donovan-Boyd, MSHP

*Date of Evaluation: July 20, 2021

(This space reserved for official comments.)

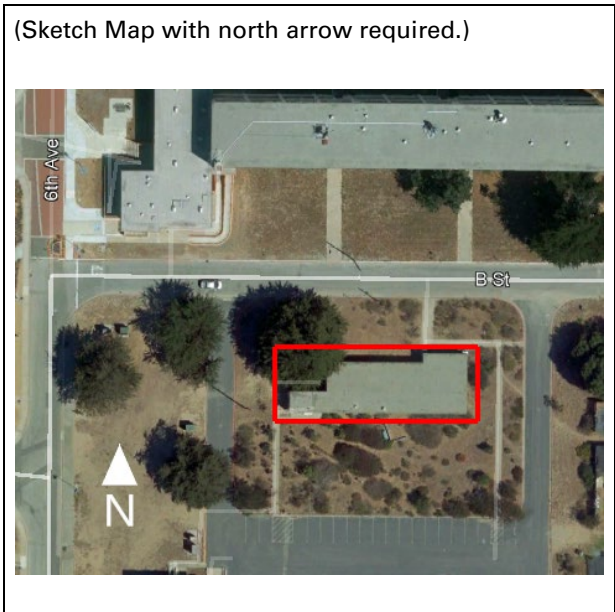

CONTINUATION SHEET

Property Name: Watershed Institute

Page 4 of 15

*P3a. Description (continued):

The building has a flat roof with small, concrete eave overhangs. The primary elevation faces north with a concrete path leading to the main door from B Street. Planted landscaping areas surround the building. A parking lot is located to the south. A concrete path leads from the parking lot to an entrance on the west end of the south elevation. The primary entrance is located offset to the east on the north elevation. The entrance consists of a pair of recently added metal-framed glazed doors, with a large, fixed transom. The north, primary, elevation has six, evenly spaced windows to the east of the entrance and two evenly spaced windows to the west. Fenestration is varied and includes fixed metal-framed picture windows and 1/1 metal. All windowsills appear to be precast concrete.



Figure 1. Main (north) elevation and entrance, looking southeast (IMG_0681)

CONTINUATION SHEET

Property Name: Watershed Institute
Page 5 of 15



Figure 2. West elevation, looking east (IMG_0675).

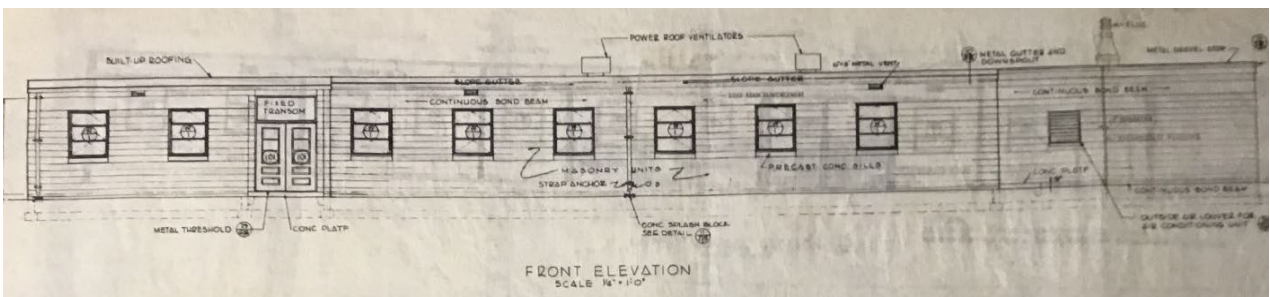

Figure 3. 1956 architectural drawing of the Watershed Institute (CSUMB Facilities 2021)

CONTINUATION SHEET

Property Name: Watershed Institute

Page 6 of 15

*B10. Significance (continued):

Historical Overview of Fort Ord

The history of Fort Ord has been extensively documented in newspaper articles, websites, academic journals, and books. From its creation in 1917 to its closure in 1994, the base grew to become one of the largest training centers in the country. Its location was also reported to be the most attractive U.S. Army post, with easy access to the ocean and beautiful California weather.

The development periods in the history of Fort Ord were defined by Harold E. Raugh, Jr, a U.S. Army lieutenant colonel and historian with the Department of Defense. Since his retirement, Raugh served as the Chief Historian, for the Defense Logistics Agency, for the Department of Defense and, from 2006-2013, Raugh served as the Command Historian at the Defense Language Institute Foreign Language Center (DLIFLC) and the Presidio of Monterey, California. He received his PhD in history from the University of California, Los Angeles (Walch 2004). Raugh has authored numerous books including, Fort Ord (2004); Presidio of Monterey (2004); Operation Joint Endeavor: V Corps in Bosnia-Herzegovina, 1995-1996 (2013); The Raugh Bibliography of the Indian Mutiny 1857-1859 (2016); and Wavell in the Middle East, 1939-1941: A study in Generalship. Raugh defined four periods for the historic development of Fort Ord:

1917-1940 Camp Gigling to Camp Ord

1940-1945 Fort Ord and the 7th Infantry Division

1946-1976 The Cold War and Vietnam Eras

1974-1994 The Volunteer Army

These periods correspond to distinct eras in the history of the base and the U.S. Army (Raugh 2004: ii). The following sections provide a summary overview of each of these periods of development and their relevance to the area of Fort Ord now known as the CSUMB campus.

The full historic context of Fort Ord is represented in the report, Built Environment Inventory and Evaluation Report for California State University, Monterey Bay (Dudek 2021). The following presents only relevant historical and building typology information pertaining to the development of the Watershed Institute.

Cold War and Vietnam Eras at Fort Ord (1946-1976)

This period of development between 1946 and 1976 was characterized by a massive operation to move the base out of its semi-permanent status and create a permanent outpost for active military personnel who were retained due to ongoing foreign conflicts.

In July of 1948, Harry S Truman signed Executive Order 9981, which officially ended segregation in the armed forces. The order stated that "there shall be equality of treatment and opportunity for all persons in the armed forces without regard to race, color, religion, or national origin" (National Archives Foundation 2021). Fort Ord became one of the first integrated training divisions in the United States. The Fort was touted as "pioneering to end all segregation" (Pomona Progress Bulletin 1950: 4). In 1950, the Pomona Progress Bulletin reported that black and white soldiers at Fort Ord were "fighting side by side" and all the enlistees "trained together, slept in the same barracks, and eat the same messes" (Pomona Progress Bulletin 1950: 4).

The end of World War II in 1945 did not bring lasting peace. The tenuous relationship

CONTINUATION SHEET

Property Name: Watershed Institute

Page 7 of 15

between dominant nations in the communist East and free market West led to the beginning of the Cold War. The Department of Defense maintained a robust fighting force during the Cold War, with more than 900,000 Army personnel retained during the 1950s (ACHP 2006). The ongoing global tensions and the number of active U.S. military personnel created a need for new permanent buildings and expanded military housing at Fort Ord.

In 1949, the Soviet-supported communist government of North Korea invaded American-supported South Korea, initiating the Korean War. Fort Ord was a primary staging area for the training of troops departing for the war (Castle 1990:3). By the 1950s, Fort Ord had become one of the largest basic training camps in the United States. In 1952, the military began a multi-million dollar building program to transform Fort Ord into a permanent post, including the development of permanent troop housing, and the construction of a guard house, stockade, and multiple warehouses. In January of 1952, military authorities announced the new construction program at Fort Ord was underway, with an estimated cost of \$26,650,600. More than half of the funds that were approved by Congress were "earmarked for new permanent troop housing" for more than 7,000 soldiers (The Webb Spinner 1952-54, Vol 6. No. 3:1).

The new troop housing was to be constructed of reinforced concrete, a departure from the wood buildings constructed before and during World War II. The plan called for three types of massive barracks, twenty-two were to house 225 enlisted men each, seven were to accommodate 165 men each, and nine were to house 105 men each (The Webb Spinner 1952-54, Vol 6. No. 3:3). The San Francisco District of the U.S. Army Corps of Engineers oversaw the construction project to completion. An additional \$1,349,700 was earmarked for the expansion of classroom and training facilities at Fort Ord, including a new battalion and regimental headquarters (The Californian 1952a:1 and The Californian 1952b:18). By March of 1952, another phase of the permanent army post transformation began with the construction of a guard house, stockade, warehouse, and other buildings (The Webb Spinner 1952-54, Vol 6. No. 3:1). This addition of permanent buildings continued into the late 1950s, when the Army requested \$124 million to replace all the wood World War II infrastructure at Fort Ord with concrete block and reinforced concrete (Madsen and Treffers 2019:6; San Francisco Examiner 1958:2-4). While many of the wood buildings remain today, this period saw the continuous addition of reinforced concrete permanent buildings across the Fort (Madsen and Treffers 2019:6).

Following the Korean War through the end of the conflict in Vietnam, Fort Ord served as an important training facility. In 1957, Fort Ord was designated as a U.S. Army Training Center for Infantry (Castle 1990: 4). The 7th Infantry Division was based at Fort Ord in 1975 (Cavanaugh 2000: 9). Fort Ord produced thousands of combat-ready troops during the conflict in Vietnam.

With the establishment of Fort Ord as a permanent Army base during this period, there was substantial building construction that led to the modernization of the base and its services. This development is closely related to the history of the current CSUMB campus. All the properties that are included as part of this built environment study were constructed during the Cold War and Vietnam Era period. Building development during this period was a substantial departure from the styles and materials used in the buildings constructed before World War II. Buildings constructed between 1946 and 1976 primarily used reinforced concrete and concrete masonry unit (CMU) in their design. The buildings tended to be larger than those constructed in previous periods. Other development in this period included support service buildings and several types of medical buildings. Infrastructure was also improved at this time, with the introduction of paved streets and roadways, and the addition of several water tanks, water pumping plants, and warehouse buildings.

CONTINUATION SHEET

Property Name: Watershed Institute

Page 8 of 15

Watershed Institute, 1958

The Watershed Institute building was designed 1956 by the firm White, Noakes & Neubauer, Architects and Engineers, located in Washington D. C. (Figure 3) (CSUMB Facilities: Building 42 1956). Very little information was found during archival research about this firm, with only one newspaper article found where Noakes & Neubauer were the noted architects for a new wing on a retirement home (The Morning Call 1959: 50). The plans were updated for Fort Ord in 1958. Originally the building served as one of the fort's regimental dispensaries. In 1959, The Californian, reported two new regimental dispensaries were approved for construction at Fort Ord. Daniels and House Construction company of Monterey received the contract for \$197,964. The dispensaries were to include facilities such as pharmacies, surgical dressing examination and waiting rooms. The completion of a new main road and parking area was planned to coincide with the construction of the buildings (The Californian 1959:14). The plan lists the building designer as "J.D.L" and checked by "R. A. P." and notes the design was prepared under the direction of the Chief Engineering Division of Military Contracts (CSUMB Facilities: Building 42 1956). As built changes were made to the drawings in January of 1960, suggesting the building was constructed by this time. Original plans called for the interior space to have a waiting room, clerk and records room, doctor's office, a resting room, examination and treatment room, surgical dressing room, a fan room, the boiler room, and coal storage. (CSUMB Facilities: Building 42 1956). Currently the building is used by the CSUMB as a classroom known as the Watershed Institute.

Fort Ord Building Typology and Character-Defining Features

Four categories of building types were identified for the purposes of this study. These are the Support Services Buildings, Medical Buildings, Hammerhead Buildings/Barracks, and Recreational Buildings. The following presents a discussion of the Medical building typology, as the Watershed Institute is classified in this category. This section provides an overview and a detailed account of the specific character-defining features of Fort Ord's Cold War and Vietnam Era (1946-1976) medical buildings.

Medical Buildings

Medical buildings constructed during the Cold War and Vietnam Eras (1946-1976) at Fort Ord have a variety of uses and functions that changed over the history of the base. One of the most common medical building types during this period were clinic buildings. In alignment with the typical planning, design, and materials of buildings constructed during this period of Fort Ord's history, these buildings are constructed with reinforced concrete and CMU and feature flat roofs with multi-light windows set on concrete sills. The Medical Buildings tended to have central entryways that opened into waiting areas, with smaller exam rooms behind reception areas. These buildings did not have a uniform design, unlike many of the other buildings at Fort Ord.

Character-Defining Features of Fort Ord Medical Buildings

This section provides a detailed account of the specific character-defining features of this type of building and noted alterations that are considered non-character defining features. This section provides a detailed account of the specific character-defining features of Fort Ord's Cold War and Vietnam Era (1946-1976) Medical Buildings.

CONTINUATION SHEET

Property Name: Watershed Institute
 Page 9 of 15

The Medical Buildings originally exhibited the following specific character-defining features:

Character-Defining Features: Fort Ord Medical Buildings

Character Aspect	Primary Character-Defining Features	Character-Defining Features
Shape and Plan	<ul style="list-style-type: none"> • Simple rectangular form • Single story 	The overall shape and mass of the building with a central entrance opening to waiting areas.
Roof	<ul style="list-style-type: none"> • Flat roof • Moderate or slight eave openings • No exposed rafters 	The Medical Buildings have flat roofs, with moderate or slight eave overhangs.
Openings	<ul style="list-style-type: none"> • Entrances on the ground level • Multi-light windows or modern windows with protruding metal frames set on concrete sills • Public entrances and circulation patterns 	Window openings are uniform in size and placement, windows are multi-light, and set into concrete openings. Replaced windows are not considered character-defining features as they fall outside the period of significance.
Exterior Ornamentation	<ul style="list-style-type: none"> • Minimal exterior ornamentation • Glass windows used as ornamentation 	The Medical Buildings were often specifically designed to serve specific functions. They have little to no decorative ornamentation, with windows in ribbons, or evenly spaced windows being the only decorative element.
Materials	<ul style="list-style-type: none"> • Mass-produced and cost-effective materials • Concrete and CMU • Reinforced Concrete construction 	Medical Buildings have simple, utilitarian designs. Buildings were constructed using mass-produced and cost-effective building materials that were readily available at the time of construction. Buildings under the Medical Building type were constructed with reinforced concrete and CMU and were minimally decorated.

Alterations and demolitions over time have compromised the overall architectural integrity of this building type. The most common alterations observed for this building type include the following.

- Replacement windows
- ADA compliance measures such as ramps and doors

CONTINUATION SHEET

Property Name: Watershed Institute

Page 10 of 15

- HVAC systems and window units
- Infill of openings
- Interior renovations

NRHP/CRHR Designation Criteria

In consideration of the project site's history and requisite integrity, Dudek recommends the property not eligible for listing in the NRHP and CRHR based on the following significance evaluation and in consideration of national and state eligibility criteria:

Criterion A/1: That are associated with events that have made a significant contribution to the broad patterns of our history.

The Watershed Institute was constructed in 1959 during the period defined as the Cold War and Vietnam Eras (1946-1976) at Fort Ord. While this building is of historic age and was constructed during this important period of development in Fort Ord's history, it no longer retains enough integrity to convey its significance. One of the most notable elements of integrity that is compromised is the integrity of setting. Significant demolition, changes to circulation patterns, introduction of new buildings, and changes in use, all impact the building's ability to convey significance from its time as an active Cold War and Vietnam Era military medical building. The loss of this overall integrity of setting adversely affects the Watershed Institute, as individual buildings are no longer able to convey their collective history. Additionally, the subdivision of Fort Ord following its closure in 1994 has also greatly impacted the integrity of feeling, association, and setting of the Cold War and Vietnam Era portions of the installation. In summary, the Watershed Institute is not able to convey its association with any extraordinary events or events occurring within the context of Cold War and Vietnam Era medical buildings, the CSUMB Campus, or has an association with the broad patterns of history in Monterey County, the State of California, or the Nation. Therefore, the building is recommended not eligible under NRHP/CRHR Criterion A/1.

Criterion B/2: That are associated with the lives of persons significant in our past.

To be found eligible under B/2 the property must be directly tied to an important person and the place where that individual conducted or produced the work for which he or she is known. Archival research indicated that the Watershed Institute building, originally one of Fort Ord's regimental dispensaries, was not associated with a single, significant person or persons. As such this property is not known to have any historical associations with people important to the nation's or state's past. Due to a lack of identified significant associations with important persons in history, Dudek recommends the building is not eligible under NRHP/CRHR Criterion B/2.

Criterion C/3: That embody the distinctive characteristics of a type, period, or method of construction, or that represent the work of a master, or that possess high artistic values, or that represent a significant and distinguishable entity whose components may lack individual distinction.

The Watershed Institute was constructed at Fort Ord in 1959. The building was designed by White, Noakes & Neubauer, Architects and Engineers, Washington D. C. The plan lists the building designer as "J.D.L" and checked by "R.A.P." (CSUMB Facilities 2021 Very little information was found during archival research about the firm of White, Noakes & Neubauer, or any further information about the noted designers. The Watershed Institute building is a smaller, utilitarian building, with minimal detailing, and few stylistic features. No further information was discovered during archival research about these designers. The building is a ubiquitous building type that lacks high style components to set it apart from other buildings constructed during this era. Additionally, the Watershed Institute, has undergone alterations, including changes to fenestration and

CONTINUATION SHEET

Property Name: Watershed Institute

Page 11 of 15

use. Due to a lack of high artistic value, a lack of evidence suggesting this is the work of a master, and its noted alterations, Dudek recommends the Watershed Institute is recommended not eligible under NRHP/CRHR Criterion C/3.

Criterion D/4: That have yielded, or may be likely to yield, information important in prehistory or history.

There is no evidence to suggest that this property has the potential to yield information important to state or local history. Therefore, the property is recommended not eligible under NRHP/CRHR Criterion D/4.

California Historic Landmark Statement of Significance

In consideration of the Watershed Institute's history and requisite integrity, Dudek recommends the property not eligible for designation as a California Historic Landmark based on the following significance evaluation and in consideration of state eligibility criteria:

The first, last, only, or most significant of its type in the state or within a large geographic region (Northern, Central, or Southern California).

The Watershed Institute was designed in 1956 and constructed in 1959. The building was constructed during the Cold War and Vietnam Eras (1946-1976) at Fort Ord. The building appears to have been conceptualized by architects who worked for White, Noakes & Neubauer, a Washington D.C. based architectural firm. The building is a ubiquitous building type that lacks high style components to set it apart from other buildings constructed throughout the State of California in the 1950s and 1960s. Therefore, the building is recommended not eligible for listing as a CHL under this criterion.

Associated with an individual or group having a profound influence on the history of California.

Archival research failed to indicate any significant associations between the Watershed Institute and individuals or groups that profoundly influenced the history of California. The Watershed Institute building was originally a Fort Ord Regimental Dispensary, constructed to provide a service for military personnel. White, Noakes & Neubauer, a Washington D.C. base architectural firm was responsible for the design. Very little information was found during archival research about the firm and no other buildings are known to have been designed by the firm. No other individuals are known to have influenced the construction or use of this building. Therefore, Dudek recommends the building is not eligible for listing as a CHL under this criterion.

A prototype of, or an outstanding example of, a period, style, architectural movement or construction or is one of the more notable works or the best surviving work in a region of a pioneer architect, designer or master builder.

The Watershed Institute building is neither a prototype or an outstanding example of a period, style, or architectural movement. It is a typical example of a utilitarian design. The building was designed to serve a utilitarian purpose for the military at Fort Ord. There are no identifying features on the Watershed Institute that would establish the connection to the notable work of a master architect in the State of California. Additionally, the Watershed Institute building has been altered and it fails to sufficiently convey its temporal period. Therefore, Dudek recommends the building is not eligible for listing as a CHL under this criterion.

Local Designation Criteria

Portions of the CSUMB campus are located within the boundaries of two cities, City of Seaside and the City of Marina, both of which evaluate historical resources in accordance with CEQA Guidelines. as presented above. The subject property, as discussed in the NRHP/CRHR/CHL criteria discussion above, does not rise to the necessary level of

CONTINUATION SHEET

Property Name: Watershed Institute

Page 12 of 15

significance for local, state, or national designation. For these reasons, the subject property is recommended not eligible individually or as a component of a historic district under any of the NRHP/CRHR/CHL criteria.

Additionally, portions of the CSUMB campus are located in the County of Monterey and the campus is therefore subject to the regulations set forth in Chapter 18.25 of the Monterey County Code. The subject property, as discussed in the NRHP/CRHR/CHL criteria discussion above, does not rise to the necessary level of significance for state or national designation. For these same reasons, the subject property is also recommended not eligible individually or as a component of a historic district under any of the delineated County of Monterey review criteria categories that are addressed with the NRHP/CRHR/CHL criteria discussed above: A. Historical and Cultural Significance; B. Historic, Architectural, and Engineering Significance; or C. Community and Geographic Setting.

Integrity Discussion

The Watershed Institute was analyzed against the seven aspects of integrity: location, design, setting, materials, workmanship, feeling, and association. The building retains its integrity of location, as it has not been relocated; however, the integrity of setting has been compromised due to the change of use, from a Cold War and Vietnam Era military support services building to an education classroom building for CSUMB. The building was designed with minimal elements typical of a utilitarian building. Some of the features of the original design, most notably the windows on the primary facade have been lost due to alterations. Therefore, the overall integrity of design has been compromised. A majority of the original materials appear to be intact, and such the building retains some integrity of materials. The techniques used in the construction of the Watershed Institute are still apparent, with the CMU construction and concrete windowsills, accordingly the building has retained some integrity of workmanship. The exterior of the Watershed Institute no longer conveys its original use as a 1950s military regimental dispensary. Therefore, the integrity of feeling has been lost. As the Watershed Institute does not possess historic significance, there is no historic association. While the building is in good condition, it does not possess adequate integrity to convey significance or its temporal period.

Summary of Evaluation Findings

The Watershed Institute building retains a diminished level of historic integrity and lacks historical and architectural significance. Based on the significance evaluations presented above, the Watershed Institute does not appear to meet the NRHP, CRHR, CHL or local designation criteria. Therefore, Watershed Institute building is not considered a historical resource for purposes of CEQA.

CONTINUATION SHEET

Property Name: Watershed Institute

Page 13 of 15

*B12. References (continued):

ACHP (Advisory Council on Historic Preservation). 2006. "Draft Program Comment Regarding Cold War Era Unaccompanied Personnel Housing." Federal Register: The Daily Journal of the United States Government. 12 April 2016. Accessed June 30, 2021 Available at: <https://www.federalregister.gov/documents/2006/04/12/06-3509/draft-program-comment-regarding-cold-war-era-unaccompanied-personnel-housing>

Californian, The. 1940. "No More Camp Ord! It's Fort Ord Now! Stilwell in Command: Headquarters of General Located on Salinas Side." July 13, 1940. Salinas, California, pg. 1.

Californian, The. 1951. Stadium Field House—Sixth Army Lets Ord Contract. March 20, 1951. P1. Accessed June 17, 2021. Available at: Newspapers.com.

Castle, Ted. 1990. "The March of Time." Fort Ord Panorama. September 21, 1990.

Cavanaugh, Joe. 2000. *The Peace Dividend: Defense Conversion Through Higher Education*. The Leon Panetta Institute.

Chamberlin Library. 2021. Fort Ord Working Papers. CSUMB Special Collections Box 6.42-01. Available at the Chamberlin Library, Seaside, California.

CSUMB Facilities. 2021. Original As built and renovation architectural drawings on file with CSUMB facilities department. Accessed in person June 15-16, 2021.

DLIFLC (Defense Language Institute Foreign Language Center). 2021. Command History Program. Accessed in person on June 15, 2021 and accessed online database collection online July 2021. Available at: <https://adli.pastperfectonline.com/>

EA Engineering. 1991. Draft Final Fort Ord, California Base wide Remedial Investigation Feasibility Study. Volume 1 Literature Review and Base Inventory Report. Accessed on July 13, 2021. Available at: <https://www.fortordcleanup.com/documents/search/>

Fresno Bee, The. 1951a. "Army Spokesman Are Defending Building of Fort Ord Stadium." January 12, 1951. Page 13. Accessed June 17, 2021.

Fresno Bee, The. 1951b. "Army Spokesman Are Defending Building of Fort Ord Stadium." February 4, 1951. Page 27. Accessed June 17, 2021. Available at: Newspapers.com.

Gates, S., & Williams, H. 1957. The Armed Forces. The Annals of the American Academy of Political and Social Science, 313, 99-104. Accessed June 17, 2021. <http://proxy.multcolib.org:2052/stable/1031762>

MacGregor Jr., Morris J. 1981. Integration of the Armed Forces, 1940-1965. Center of Military History, United States Army: Washington, D.C.

Madsen, Alexandra and Steven Treffers. 2019. *Historic Resources Evaluation Memorandum for Hammerhead Barracks at Fort Ord, Monterey County, California*. Prepared by

CONTINUATION SHEET

Property Name: Watershed Institute

Page 14 of 15

Rincon Consultants, Inc for City of Seaside, Community and Economic Development Department. November 4, 2019. Accessed June 28, 2021.
https://www.ci.seaside.ca.us/DocumentCenter/View/10674/9_App-S---HRE-Memo

Military Museum. 2016. "Historic California Posts, Camps, Stations, and Airfields: Fort Ord." Accessed on June 19, 2021. <http://www.militarymuseum.org/FtOrd.html>

National Archives Foundation. 2021. Executive Order 9981. Accessed June 29, 2021. Available at: <https://www.archivesfoundation.org/documents/executive-order-9981-ending-segregation-armed-forces/>

NETR (Nationwide Environmental Title Research LLC). 2021. Historic Aerial Photographs of 100 Campus Center, Seaside, CA 93955 dating from 1956, 1968, 1981, 1998, 2005, 2009, 2010, 2012, 2014, 2016, and 2018. Accessed June 10, 2021.
<https://www.historicaerials.com/viewer>

Panorama. 1990. "50 Years and Counting..." September 21, 1990, pg. 2.

Panorama. n.d. "Ford Ord in World War II." Historic California Posts: Fort Ord. Accessed on June 19, 2021. <http://www.militarymuseum.org/FtOrd.html>

Park, R. 2015. "Happy and Cheerful in This Fine Camp": Sports, Recreation, and the United States Army at Fort Ord and Camp Roberts, 1940 to 1945. *Journal of Sport History*, 42(1), 21-37. Accessed on June 18, 2021, from
<https://www.jstor.org/stable/10.5406/jsporhistory.42.1.21>

Pomona Progress Bulletin. 1950. War Solving Racial Problems. August 24, 1950. Page 4. Accessed June 29, 2021. Available at: [Newspapers.com](http://www.newspapers.com).

Quartermaster Review, The. 1940. "Army Construction Underway at Camp Ord, California." Volume XX. No 3. November-December. On file at the Chamberlin Library, Ord Military Community.

Raugh, Harold E. 2004. Fort Ord. Charleston, SC: Arcadia.

Salinas Morning Post. 1940. "\$2,766,000 in Building Authorized—Ord Contracts Let." August 21, 1940. Salinas, CA. pg. 1.

San Francisco Examiner. 1951. Fort Ord Will Get Stadium. San Francisco Page 4. · 3 Feb 1951. Pages 1 and 4 A Available on [www.Newspapers.com](http://www.newspapers.com). Accessed on Jun 11, 2021.

San Francisco Examiner. 1958. Army Asks OK on \$124,000,000 for Fort Ord Buildings. San Francisco. Section 2. Page. 4. Available on [www.Newspapers.com](http://www.newspapers.com). Accessed July 18, 2021.

Vasche, J. Burton. 1959. "The California State Colleges: Their History, Organization, Purposes, and Programs." in California

U.S. Army. 1977. Post Map Main Garrison Area. Fort Ord, California. Drawing number G-950. Accessed in person at the Chamberlain Library on June 15, 2021.

CONTINUATION SHEET

Property Name: Watershed Institute

Page 15 of 15

Walch, Bob. 2004. An Army Historian's Pictorial Take on Fort Ord. Monterey County NOW. Accessed July 12, 2021. Available at:
https://www.montereycountyweekly.com/news/local_news/an-army-historian-s-pictorial-take-on-fort-ord/article_6e8b0250-9c38-5ca4-a4a4-f93d42d65a11.html

Whaley, Derek. 2015. "East Monterey & Seaside." Santa Cruz Trains: Railroads of the Monterey Bay Area. July 20, 2015. Accessed online:
<https://www.santacruztrains.com/2015/07/east-monterey-seaside.html>.

Webb Spinner, The. 1952-1954. Webb Spinner Volume for 1952-1954. Del Webb Sun Cities Museum Collection. Accessed June 30, 2021. Accessed at:
<https://delwebbsuncitiesmuseum.org/newsletters-webb-spinners/>

State of California & The Resources Agency
DEPARTMENT OF PARKS AND RECREATION
PRIMARY RECORD

Primary #
HRI #
Trinomial
NRHP Status Code 6Z

Other Listings
Review Code

Reviewer

Date

Page 1 of 15 *Resource Name or #: (Assigned by recorder) Pacific Hall

P1. Other Identifier CSUMB Building 44

*P2. Location: Not for Publication Unrestricted

*a. County Monterey County and (P2c, P2e, and P2b or P2d. Attach a Location Map as necessary.)

*b. USGS 7.5' Quad Marina, CA Date 1995 T 15S; R 1E; NW ¼ ■ of SW ¼ ■ of Sec 6; Mount Diablo B.M.

c. Address 4580 6th Avenue, Seaside Zip 93955

d. UTM: (Give more than one for large and/or linear resources) Zone 10S, 607876 mE/ 4056754 mN

e. Other Locational Data: (e.g., parcel #, directions to resource, elevation, decimal degrees, etc., as appropriate)

Pacific Hall sits north of B Street, between 6th Avenue and 7th Avenue.

*P3a. Description: (Describe resource and its major elements. Include design, materials, condition, alterations, size, setting, and boundaries)

Pacific Hall (CSUMB Building 44) is a utilitarian building with modern stylistic details. The building is constructed of board-formed concrete. The single-story building has an L-shaped plan with a flat roof and concrete eave overhangs. The primary, west, elevation has the main entrance at the corner of the "L." Fenestration includes bands of rectangular fixed glass windows in protruding metal frames set on concrete sills. Concrete pillars divide the sets of windows.

See Continuation Sheet.

*P3b. Resource Attributes: (List attributes and codes) HP15. Educational Building, HP34. Military Property

P5a. Photograph or Drawing (Photograph required for buildings, structures, and objects.)



*P4. Resources Present: Building
 Structure Object Site District
Element of District Other (Isolates, etc.)

P5b. Description of Photo: (view, date, accession #) West elevation, view looking southeast, Dudek (IMG 0602).

*P6. Date Constructed/Age and Source: Historic Prehistoric Both 1952-1954 (The Webb Spinner).

*P7. Owner and Address:
CSUMB
100 Campus Center
Seaside, CA. 93955

*P8. Recorded by: (Name, affiliation, and address) Sarah Corder Dudek
725 Front St #400
Santa Cruz, CA 95060

*P9. Date Recorded: 6/14/2021

*P10. Survey Type: (Describe)
Intensive level

*P11. Report Citation: (Cite survey report and other sources or enter none) Dudek 2021. Built Environment Inventory and Evaluation Report for California State University, Monterey Bay

*Attachments: NONE Location Map Continuation Sheet Building, Structure, and Object Record
 Archaeological Record District Record Linear Feature Record Milling Station Record Rock Art Record
 Artifact Record Photograph Record Other (List): _____

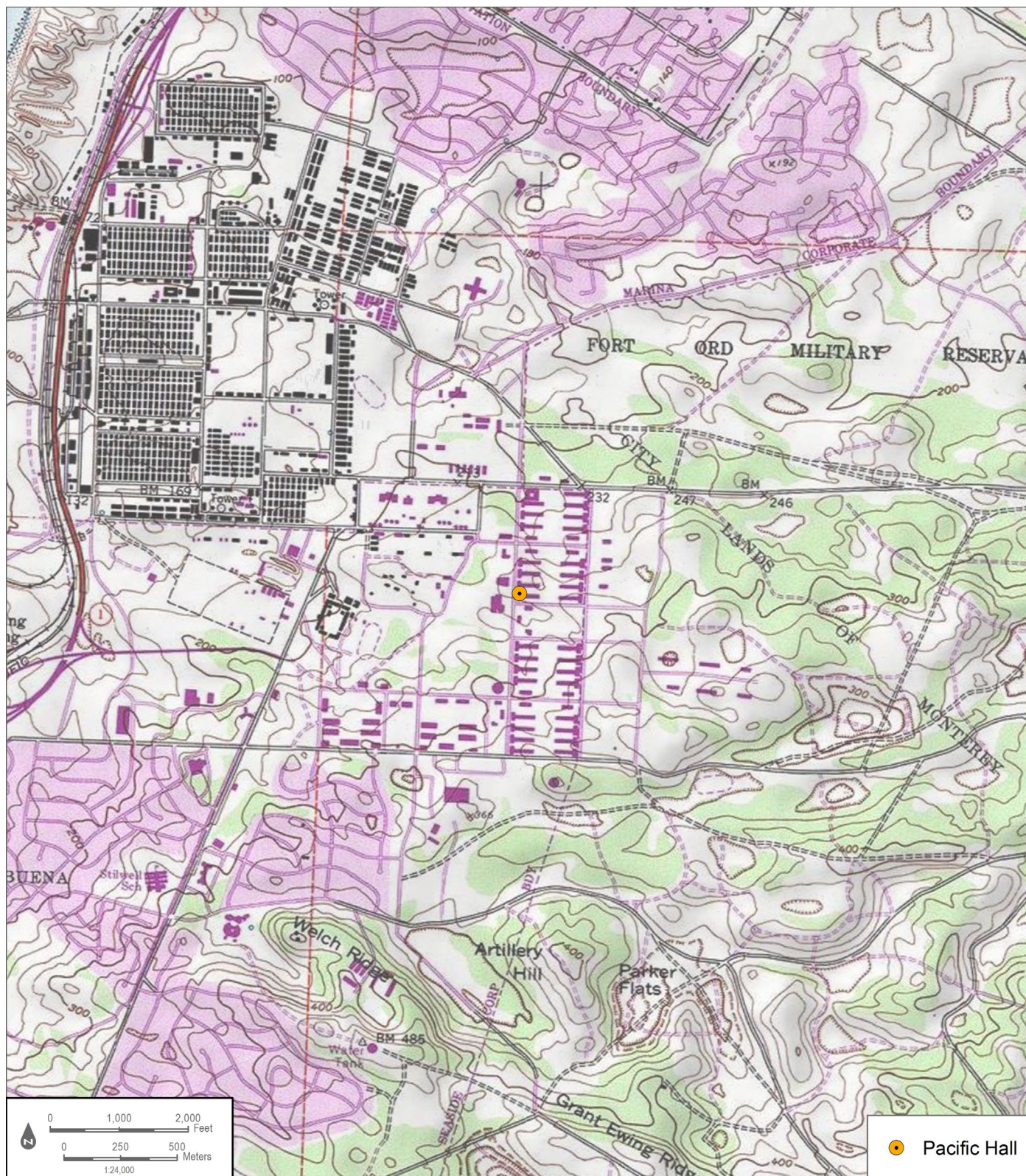

BUILDING, STRUCTURE, AND OBJECT RECORD

*Resource Name or # (Assigned by recorder) Pacific Hall *NRHP Status Code 6Z

Page 3 of 15

B1. Historic Name: Hammerhead Building, Hammerhead Barracks, Fort Ord Barracks

B2. Common Name: Pacific Hall, CSUMB Building 44

B3. Original Use: Military Barracks 4. Present Use: Educational Classroom

*B5. Architectural Style: Utilitarian

*B6. Construction History: (Construction date, alterations, and date of alterations)

Designed and constructed between 1952-1954, Pacific Hall (44) is a utilitarian building with modern design elements. Originally the building served as barracks at Fort Ord. At least 38 barracks were constructed by Del Webb Construction Company at a cost of \$12,614,832. Construction started in 1952 (The Californian 1952b:18). When CSUMB acquired the campus, the building became Pacific Hall, and has been in use as a classroom. It is likely the addition of the ADA ramps and the replacement of windows were completed during this transition. Between 2016 and 2021, the east, multi-story wing of the building was demolished and the opening to that wing was filled with CMU (NETR 2021).

*B7. Moved? No Yes Unknown Date: _____ Original Location: _____ *B8. Related Features:

B9a. Architect: unknown b. Builder: Del Webb Construction Company

*B10. Significance: Theme N/A Area N/A
Period of Significance N/A Property Type N/A Applicable Criteria N/A

(Discuss importance in terms of historical or architectural context as defined by theme, period, and geographic scope. Also address integrity.)

See Continuation Sheet.

B11. Additional Resource Attributes: (List attributes and codes) _____

*B12. References: See Continuation Sheet.

B13. Remarks:

*B14. Evaluator: Adrienne Donovan-Boyd, MSHP

*Date of Evaluation: July 20, 2021

(This space reserved for official comments.)

(Sketch Map with north arrow required.)

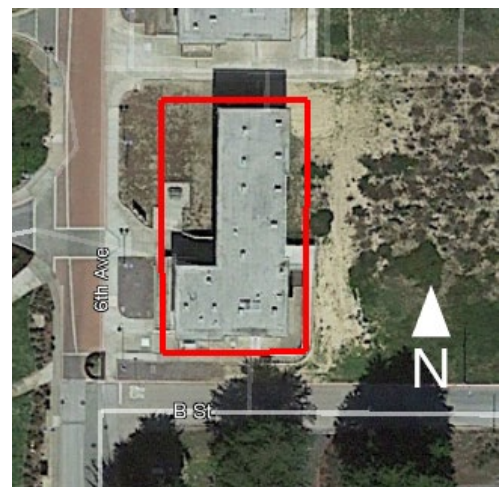

CONTINUATION SHEET

Property Name: Pacific Hall
Page 4 of 15

***P3a. Description (continued):**

Above the rectangular windows are square metal-framed decorative white panels. The east elevation shows changes to the plan, with a concrete framed door filled with CMUs and a change in exterior cladding. An ADA-accessible ramp leads to a secondary entrance with an arched metal awning on the east facade. The south elevation mirrors other elevations in style and materials. A CMU-filled window opening, and a door repurposed as a window are on the west end of the south elevation. The building appears to sit on a concrete foundation.



Figure 1. Main (west) elevation and north elevation, looking southeast (IMG_0604)



Figure 2. South elevation, looking north (IMG_0621)

CONTINUATION SHEET

Property Name: Pacific Hall

Page 5 of 15

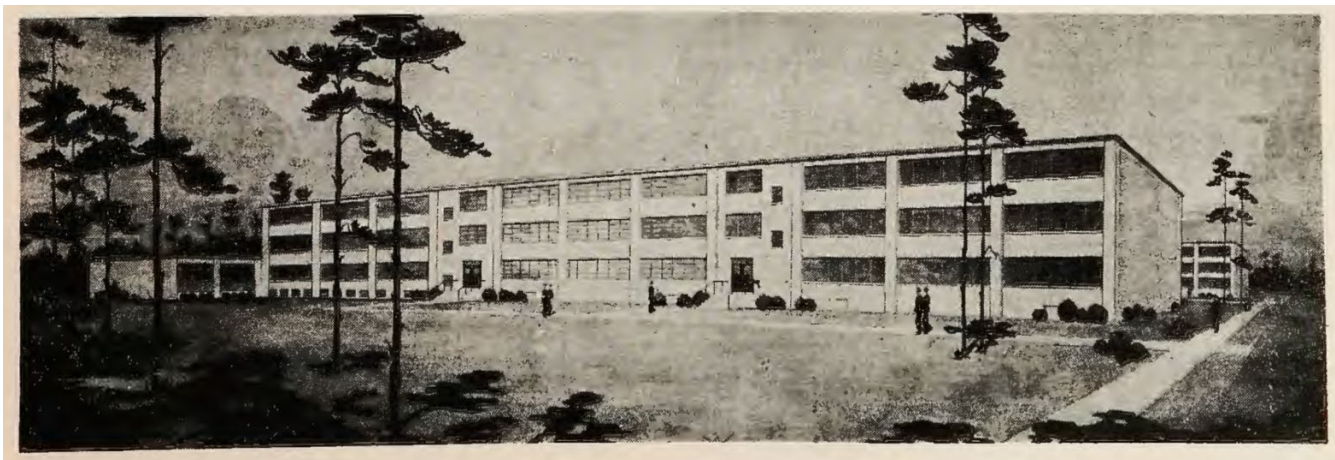

Figure 3. 1952 conceptual drawing of the new barracks to be constructed at Fort Ord
(The Webb Spinner 1952)

*B10. Significance (continued):

Historical Overview of Fort Ord

The history of Fort Ord has been extensively documented in newspaper articles, websites, academic journals, and books. From its creation in 1917 to its closure in 1994, the base grew to become one of the largest training centers in the country. Its location was also reported to be the most attractive U.S. Army post, with easy access to the ocean and beautiful California weather.

The development periods in the history of Fort Ord were defined by Harold E. Raugh, Jr, a U.S. Army lieutenant colonel and historian with the Department of Defense. Since his retirement, Raugh served as the Chief Historian, for the Defense Logistics Agency, for the Department of Defense and, from 2006-2013, Raugh served as the Command Historian at the Defense Language Institute Foreign Language Center (DLIFLC) and the Presidio of Monterey, California. He received his PhD in history from the University of California, Los Angeles (Walch 2004). Raugh has authored numerous books including, *Fort Ord* (2004); *Presidio of Monterey* (2004); *Operation Joint Endeavor: V Corps in Bosnia-Herzegovina, 1995-1996* (2013); *The Raugh Bibliography of the Indian Mutiny 1857-1859* (2016); and *Wavell in the Middle East, 1939-1941: A study in Generalship*. Raugh defined four periods for the historic development of Fort Ord:

- 1917-1940 Camp Gigling to Camp Ord
- 1940-1945 Fort Ord and the 7th Infantry Division
- 1946-1976 The Cold War and Vietnam Eras
- 1974-1994 The Volunteer Army

These periods correspond to distinct eras in the history of the base and the U.S. Army (Raugh 2004: ii). The following sections provide a summary overview of each of these periods of development and their relevance to the area of Fort Ord now known as the CSUMB campus.

The full historic context of Fort Ord is represented in the report, *Built Environment Inventory and Evaluation Report for California State University, Monterey Bay* (Dudek

CONTINUATION SHEET

Property Name: Pacific Hall
Page 6 of 15

2021). The following presents only relevant historical and building typology information pertaining to the development of Pacific Hall.

Cold War and Vietnam Eras at Fort Ord (1946-1976)

This period of development between 1946 and 1976 was characterized by a massive operation to move the base out of its semi-permanent status and create a permanent outpost for active military personnel who were retained due to ongoing foreign conflicts.

In July of 1948, Harry S Truman signed Executive Order 9981, which officially ended segregation in the armed forces. The order stated that "there shall be equality of treatment and opportunity for all persons in the armed forces without regard to race, color, religion, or national origin" (National Archives Foundation 2021). Fort Ord became one of the first integrated training divisions in the United States. The Fort was touted as "pioneering to end all segregation" (The Pomona Progress Bulletin 1950: 4). In 1950, the Pomona Progress Bulletin reported that black and white soldiers at Fort Ord were "fighting side by side" and all the enlistees "trained together, slept in the same barracks, and eat the same messes" (The Pomona Progress Bulletin 1950: 4).

The end of World War II in 1945 did not bring lasting peace. The tenuous relationship between dominant nations in the communist East and free market West led to the beginning of the Cold War. The Department of Defense maintained a robust fighting force during the Cold War, with more than 900,000 Army personnel retained during the 1950s (ACHP 2006). The ongoing global tensions and the number of active U.S. military personnel created a need for new permanent buildings and expanded military housing at Fort Ord.

In 1949, the Soviet-supported communist government of North Korea invaded American-supported South Korea, initiating the Korean War. Fort Ord was a primary staging area for the training of troops departing for the war (Castle 1990:3). By the 1950s, Fort Ord had become one of the largest basic training camps in the United States. In 1952, the military began a multi-million dollar building program to transform Fort Ord into a permanent post, including the development of permanent troop housing, and the construction of a guard house, stockade, and multiple warehouses. In January of 1952, military authorities announced the new construction program at Fort Ord was underway, with an estimated cost of \$26,650,600. More than half of the funds that were approved by Congress were "earmarked for new permanent troop housing" for more than 7,000 soldiers (The Webb Spinner 1952-54, Vol 6. No. 3:1).

The new troop housing was to be constructed of reinforced concrete, a departure from the wood buildings constructed before and during World War II. The plan called for three types of massive barracks, twenty-two were to house 225 enlisted men each, seven were to accommodate 165 men each, and nine were to house 105 men each (The Webb Spinner 1952-54, Vol 6. No. 3:3). The San Francisco District of the U.S. Army Corps of Engineers oversaw the construction project to completion. An additional \$1,349,700 was earmarked for the expansion of classroom and training facilities at Fort Ord, including a new battalion and regimental headquarters (The Californian 1952a:1 and The Californian 1952b:18). By March of 1952, another phase of the permanent army post transformation began with the construction of a guard house, stockade, warehouse, and other buildings (The Webb Spinner 1952-54, Vol 6. No. 3:1). This addition of permanent buildings continued into the late 1950s, when the Army requested \$124 million to replace all the wood World War II infrastructure at Fort Ord with concrete block and reinforced concrete (Madsen and Treffers 2019:6; San Francisco Examiner 1958:2-4). While many of the wood buildings

CONTINUATION SHEET

Property Name: Pacific Hall
Page 7 of 15

remain today, this period saw the continuous addition of reinforced concrete permanent buildings across the Fort (Madsen and Treffers 2019:6).

Following the Korean War through the end of the conflict in Vietnam, Fort Ord served as an important training facility. In 1957, Fort Ord was designated as a U.S. Army Training Center for Infantry (Castle 1990: 4). The 7th Infantry Division was based at Fort Ord in 1975 (Cavanaugh 2000: 9). Fort Ord produced thousands of combat-ready troops during the conflict in Vietnam.

With the establishment of Fort Ord as a permanent Army base during this period, there was substantial building construction that led to the modernization of the base and its services. This development is closely related to the history of the current CSUMB campus. All the properties that are included as part of this built environment study were constructed during the Cold War and Vietnam Era period. Building development during this period was a substantial departure from the styles and materials used in the buildings constructed before World War II. Building during the period between 1946 and 1976 used reinforced concrete and concrete masonry unit (CMU). The buildings tended to be larger than those constructed in previous periods. Other development in this period included support service buildings and several types of medical buildings. Infrastructure was also improved at this time, with the introduction of paved streets and roadways, and the addition of several water tanks, water pumping plants, and warehouse buildings.

Pacific Hall, 1952-1954

Pacific Hall first appears on a 1956 aerial photograph of the site in the western half, of a group of eight other similarly laid out buildings. These buildings were originally designed as new permanent barracks that were part of a \$26,650,000 construction program awarded by the military in 1952. More than \$17 million of these funds were used to construct 38, new, three-story barracks. These larger barracks were planned to house entire companies and serve all their needs in one space, with mess halls, lounges, day rooms, orderly rooms, supply rooms, and issue rooms, as well as administrative space (the Californian 1952a).

The Del Webb Construction Company won the bid for the work at Fort Ord with a low bid of \$12,614,832 (The Californian 1952b: 18). Groundbreaking for the project took place on February 19, 1952. The barracks were featured in Webb's newsletter, *The Webb Spinner*, in the June/July/August edition. The paper touted the new military dormitories as being "sleek" (The Webb Spinner 1954:6). The buildings were a departure from the "old, white-painted barracks" constructed 12 years earlier. The new barracks were erected of steel and concrete and features large glass areas. The concrete construction was lauded as both vermin- and fire-proof (The Webb Spinner 1954:6).

After Fort Ord closed in 1994, the buildings became part of the CSUMB campus. There are no notable changes to the footprint of Pacific Hall until sometime between 2016 and 2021, when the east multi-story wing was demolished.

Del Webb Construction Company

The Del E. Webb Company was founded by Delbert Eugene Webb in Phoenix in 1928. The company grew to develop a diverse range of projects across the United States during and was known for large-scale commercial, residential, and institutional projects (Del Webb and Pulte Homes 2021:1). During World War II, the company won many military and Navy contracts for housing projects. They specialized in streamlining massive construction projects across undeveloped land.

After World War II, Webb transitioned into many emerging development markets. In the

CONTINUATION SHEET

Property Name: Pacific Hall
Page 8 of 15

late 1940s, Webb constructed a casino/hotel in Las Vegas for Benjamin "Bugsy" Siegel. Del Webb went on to become the "largest gaming operator and private employer in Nevada" (Del Webb and Pulte Homes 2021:1). In January of 1960, the Del Webb Corporation opened a community in Phoenix, Arizona aptly named "Sun City". The community was known for its modestly priced housing and delivered a "highly desirable lifestyle." Del Webb went on to construct "Sun Cities" in Florida and Southern California (Del Webb and Pulte Homes 2021:1). The company continued to focus on gaming and commercial operations until 1987 when the decision was made to sell these interests and focus on the development of "master-planned, active adult communities" (Del Webb and Pulte Homes 2021:2). By January of 2000, the company had planned and constructed 13 Sun Cities communities, selling more than 80,000 homes. In July 2001, Del Webb Company merged with Pulte Homes Inc. to create the largest homebuilding company in the nation (Del Webb and Pulte Homes 2021:3).

Webb was the lead contractor for several prominent buildings, campuses, and institutions. These included Madison Square Garden in New York City from 1964-1968 (New York, NY) and the Los Angeles County Museum of Art in 1963-1964 (Los Angeles, CA). Several buildings constructed by the company are listed on the NRHP, including many components of the Williams Air Force Base in Arizona (two Ammo Bunkers, the Civil Engineering Maintenance Shop, the Demountable Hangar, the flagpole, the Housing Storage Supply Warehouse, and the Water Pump Station and Water Tower). Additionally, Webb was the contractor for the 1938 addition to the Arizona State Capital Building, Hunts Tomb, and the Phoenix Towers, all in Phoenix, AZ. All three buildings are all listed on the NRHP.

The Del Webb Construction Company received the contract to construct forty-two buildings at Fort Ord in February of 1952. This contract included the construction of the Hammerhead Buildings/Barracks, buildings for the regional headquarters, and regimental supplies buildings (The Web Spinner 1952-54, Vol 6. No. 3:1). The company was also awarded the contract in March of 1952 to construct a guardhouse, stockade, warehouse, and other buildings and a contract to construct the utilities, including fencing, paving, railroads, water systems, water supply and storage (including reservoirs, well houses, equipment, and a water booster pump station), gas distributing system, and sanitary and storm sewer installations. (The Web Spinner 1952-54, Vol 6. No. 4:1; The Web Spinner 1952-54, Vol 6. No. 8:1).

Fort Ord Building Typology and Character-Defining Features

Four categories of building types were identified for the purposes of this study. These are the Support Services Buildings, Medical Buildings, Hammerhead Buildings/Barracks, and Recreational Buildings. The following presents a discussion of the Hammerhead Buildings/Barracks building typology, as Pacific Hall is classified in this category. This section provides a detailed account of the specific character-defining features of Fort Ord Cold War and Vietnam Era (1946-1976) Hammerhead Buildings/Barracks.

Hammerhead Buildings/Barracks

The Hammerhead Buildings/Barracks were constructed to house troops at Fort Ord as it was expanding from a semi-permanent instillation to a permanent base. In alignment with the typical planning, design, and materials of buildings constructed during this period of Fort Ord's history, these buildings are constructed with reinforced concrete and CMU and feature flat roofs with multi-light windows with concrete sills.

Pacific Hall (44) first appears on a 1956 aerial photograph of the site on the western half of the base. It is part of a group of eight other similarly oriented buildings. No changes to the footprint were noted

After Fort Ord closed in 1994, the buildings became part of the CSUMB campus. There were

CONTINUATION SHEET

Property Name: Pacific Hall
 Page 9 of 15

no notable changes to the footprint of the building until sometime between 2016 and 2018 when the east, multi-story wing was demolished on Pacific Hall.

Character-Defining Features of the Hammerhead Buildings

The Hammerhead Buildings/Barracks originally exhibited the following specific character-defining features:

Character Aspect	Primary Character-Defining Features	Character-Defining Features
Shape and Plan	<ul style="list-style-type: none"> • Hammerhead shape • Single story wing and multi-story wing 	The overall shape and mass of the building are considered a primary character-defining feature of the Hammerhead Buildings/Barracks. The plan should include a multi-story wing.
Roof	<ul style="list-style-type: none"> • Flat roof • Wide eave overhangs • No exposed rafters 	The Hammerhead Buildings/Barracks have flat roofs, with moderate eave overhangs.
Openings	<ul style="list-style-type: none"> • Entrances on the first story • Multi-light windows 	Window openings are uniform in size and placement, windows are multi-light, and set into concrete openings. Replaced windows are not considered character-defining features as they fall outside the period of significance.
Exterior Ornamentation	<ul style="list-style-type: none"> • Minimal exterior ornamentation • Glass windows used as ornamentation 	Hammerhead Buildings/Barracks were designed to be quickly constructed. They have little to no decorative ornamentation, with windows in ribbons being the only decorative element.
Materials	<ul style="list-style-type: none"> • Mass-produced and cost-effective materials • Concrete and CMU • Reinforced concrete construction 	Hammerhead Buildings/Barracks have simple, utilitarian designs. Buildings were constructed using mass-produced and cost-effective building materials that were readily available at the time of construction. For instance, buildings under the Hammerhead type were constructed with reinforced concrete and CMU and were minimally decorated.

Alterations and demolitions over time have compromised the overall architectural integrity of this building type. The most common alterations observed for this building type include the following.

- Replacement windows
- ADA compliance measures such as ramps and doors
- HVAC systems and window units
- Infill of openings
- Interior renovations

CONTINUATION SHEET

Property Name: Pacific Hall
Page 10 of 15

NRHP/CRHR Designation Criteria

In consideration of the Pacific Hall's history and requisite integrity, Dudek recommends the building is not eligible for listing in the NRHP and CRHR based on the following significance evaluation and in consideration of national and state eligibility criteria:

Criterion A/1: That are associated with events that have made a significant contribution to the broad patterns of our history.

Pacific Hall was constructed in 1952-1954 during the period defined as the Cold War and Vietnam Eras (1946-1976) at Ford Ord. While this building is of historic age and was constructed during this important period of development in Fort Ord's history, it no longer retains enough integrity to convey its significance. One of the most notable elements of integrity that is compromised is the integrity of setting. Significant demolition, changes to circulation patterns, introduction of new buildings, and changes in use all impact the campus's ability to convey significance from its time as an active Cold War and Vietnam Era military base. The loss of this overall integrity of setting adversely effects Pacific Hall, as individual buildings are no longer able to convey their collective history. Additionally, the subdivision of Fort Ord following its closure has also greatly impacted the integrity of feeling, association, and setting of the Cold War and Vietnam Era portions of the installation. In summary, Pacific Hall, is not able to convey its association with any extraordinary events or events occurring within the context of Cold War and Vietnam military barracks, the CSUMB Campus, or has an association with the broad patterns of history in Monterey County, the State of California, or the Nation. Therefore, the building is recommended not eligible under NRHP/CRHR Criterion A/1.

Criterion B/2: That are associated with the lives of persons significant in our past.

To be found eligible under B/2 the building must be directly tied to an important person and the place where that individual conducted or produced the work for which he or she is known. Archival research failed to indicate any historical associations with people important to the nation's or state's past. Due to a lack of identified significant associations with important persons in history, Dudek recommends the building is not eligible under NRHP/CRHR Criterion B/2.

Criterion C/3: That embody the distinctive characteristics of a type, period, or method of construction, or that represent the work of a master, or that possess high artistic values, or that represent a significant and distinguishable entity whose components may lack individual distinction.

No original plans or designs for the 1952-1954 barracks were discovered during archival research. Newspaper articles from 1952, announced the contract was awarded to the Del Webb Company, of Phoenix, AZ (the Californian 1952a). The Webb Company was a notable building company that completed contracts for the government, commercial clients, and private individuals during its long period operation, beginning in 1929 and continuing to the present. The Webb Company designed many distinguished buildings including many that are listed on the NRHP. While Webb may be a master builder, Pacific Hall, was constructed during a period when the Webb company was completing many other large-scale projects, many at military bases. The company received many contracts during and after World War II to construct barracks and other military related buildings. The buildings at Fort Ord were common contracts for the company, and they had constructing buildings of this type at other bases.

Pacific Hall is a utilitarian building, with minimal detailing, and few stylistic features. Additionally, the building has undergone numerous, alterations, including changes to fenestration, materials, and the demolition of the east, multi-story wing.

CONTINUATION SHEET

Property Name: Pacific Hall
Page 11 of 15

Originally the building housed an entire infantry of troops, the remaining portion of the building is currently used for classroom space. While the building is associated with a master builder, the Del Webb Construction Company, it is not one of their more notable works. Furthermore, the building lacks high artistic value, and has undergone substantial alterations. For these reasons Dudek recommends Pacific Hall is not eligible under NRHP/CRHR Criterion C/3.

Criterion D/4: That have yielded, or may be likely to yield, information important in prehistory or history.

There is no evidence to suggest that this building has the potential to yield information important to state or local history. Therefore, the building is recommended not eligible under NRHP/CRHR Criterion D/4.

California Historic Landmark Statement of Significance

In consideration of Pacific Hall's history and requisite integrity, Dudek recommends the building is not eligible for designation as a California Historic Landmark based on the following significance evaluation and in consideration of state eligibility criteria:

The first, last, only, or most significant of its type in the state or within a large geographic region (Northern, Central, or Southern California).

Pacific Hall was constructed between 1952-1954. The building, along with at least 38 other barracks, were constructed during the fort's transition to a permanent base during the Cold War and Vietnam Eras (1946-1976) at Fort Ord. Pacific Hall was constructed by Del Webb Company, a company based in Phoenix Arizona. The building is a utilitarian building type that lacks high style components to set it apart from other buildings constructed throughout the State of California in the 1950s. Therefore, Dudek recommends Pacific Hall is not eligible for listing as a CHL under this criterion.

Associated with an individual or group having a profound influence on the history of California.

Pacific Hall was originally constructed to be one of Fort Ord's barracks, one of 38 such buildings to provide a housing for military personnel. The Del Webb Construction Company, a notable Phoenix, Arizona based company, was responsible for the construction of the building. While Pacific Hall is associated with a master builder with many known projects completed in California, this building is not one of the company's notable works. No other individuals are known to have influenced the construction or use of this building. Therefore, Dudek recommends Pacific Hall is not eligible for listing as a CHL under this criterion.

A prototype of, or an outstanding example of, a period, style, architectural movement or construction or is one of the more notable works or the best surviving work in a region of a pioneer architect, designer or master builder.

Pacific Hall is neither a prototype or an outstanding example of a period, style, or architectural movement. It is a typical example of a utilitarian design. The building was designed to serve a utilitarian purpose for the military at Fort Ord. There are no identifying features on Pacific Hall that would establish the connection to the notable work of the Del Webb Construction Company in the State of California. Additionally, Pacific Hall has been substantially altered and the large multi-story wing demolished making it unable to convey its temporal period or its historic context. Therefore, Dudek recommends Pacific Hall is not eligible for listing as a CHL under this criterion.

Local Designation Criteria

Portions of the CSUMB campus are located within the boundaries of two cities, City of

CONTINUATION SHEET

Property Name: Pacific Hall
Page 12 of 15

Seaside and the City of Marina, both of which evaluate historical resources in accordance with CEQA Guidelines. as presented above. The subject property, as discussed in the NRHP/CRHR/CHL criteria discussion above, does not rise to the necessary level of significance for local, state, or national designation. For these reasons, the subject property is recommended not eligible individually or as a component of a historic district under any of the NRHP/CRHR/CHL criteria.

Additionally, portions of the CSUMB campus are located in the County of Monterey and the campus is therefore subject to the regulations set forth in Chapter 18.25 of the Monterey County Code. The subject property, as discussed in the NRHP/CRHR/CHL criteria discussion above, does not rise to the necessary level of significance for state or national designation. For these same reasons, the subject property is also recommended not eligible individually or as a component of a historic district under any of the delineated County of Monterey review criteria categories that are addressed with the NRHP/CRHR/CHL criteria discussed above: A. Historical and Cultural Significance; B. Historic, Architectural, and Engineering Significance; or C. Community and Geographic Setting.

Integrity Discussion

Pacific Hall was analyzed against the seven aspects of integrity: location, design, setting, materials, workmanship, feeling, and association. The building retains its integrity of location, as it has not been relocated. The building was designed with minimal elements reflecting an architectural style. Some of the features reflecting the original design, most notably the windows and the demolition of the multi-story wing, have been lost, and the overall integrity of design has been compromised. The integrity of setting has been lost as with the change in use from its original use as barracks at Fort Ord to a classroom building for CSUMB. Therefore, the integrity of setting has been lost. While some of the original materials appear to be intact, the demolition of the multi-story wing and changes to original fenestration have compromised the integrity of materials. The techniques used in the construction of Pacific Hall are still apparent, with the CMU and concrete construction, but the demolition of more than half the building has adversely affected the integrity of workmanship. The exterior of Pacific Hall no longer conveys its original use. Therefore, the integrity of feeling has been lost. As Pacific Hall does not possess historic significance, there is no historic association. The building does not possess adequate integrity to convey significance.

Summary of Evaluation Findings

Pacific Hall has compromised historic integrity and lacks historical and architectural significance. Based on the significance evaluations presented above, Pacific Hall does not appear to meet the NRHP, CRHR, CHL or local designation criteria. Therefore, Pacific Hall is not considered a historical resource for purposes of CEQA.

CONTINUATION SHEET

Property Name: Pacific Hall

Page 13 of 15

*B12. References (continued):

- ACHP (Advisory Council on Historic Preservation). 2006. "Draft Program Comment Regarding Cold War Era Unaccompanied Personnel Housing." Federal Register: The Daily Journal of the United States Government. 12 April 2016. Accessed June 30, 2021 Available at: <https://www.federalregister.gov/documents/2006/04/12/06-3509/draft-program-comment-regarding-cold-war-era-unaccompanied-personnel-housing>
- Californian, The. 1940. "No More Camp Ord! It's Fort Ord Now! Stilwell in Command: Headquarters of General Located on Salinas Side." July 13, 1940. Salinas, California, pg. 1.
- Californian, The. 1951. Stadium Field House—Sixth Army Lets Ord Contract. March 20, 1951. P1. Accessed June 17, 2021. Available at: Newspapers.com.
- Castle, Ted. 1990. "The March of Time." Fort Ord Panorama. September 21, 1990.
- Cavanaugh, Joe. 2000. *The Peace Dividend: Defense Conversion Through Higher Education*. The Leon Panetta Institute.
- Chamberlin Library. 2021. Fort Ord Working Papers. CSUMB Special Collections Box 6.42-01. Available at the Chamberlin Library, Seaside, California.
- CSUMB Facilities. 2021. Original As built and renovation architectural drawings on file with CSUMB facilities department. Accessed in person June 15-16, 2021.
- Del Webb and Pulte Homes 2021. Del Webb History. Accessed July 9, 2021. Available at: http://media.corporate-ir.net/media_files/irol/14/147717/DelWebb/DelWebbHistory.pdf
- DLIFLC (Defense Language Institute Foreign Language Center). 2021. Command History Program. Accessed in person on June 15, 2021 and accessed online database collection online July 2021. Available at: <https://adli.pastperfectonline.com/>
- EA Engineering. 1991. Draft Final Fort Ord, California Base wide Remedial Investigation Feasibility Study. Volume 1 Literature Review and Base Inventory Report. Accessed on July 13, 2021. Available at: <https://www.fortordcleanup.com/documents/search/>
- Fresno Bee, The. 1951a. "Army Spokesman Are Defending Building of Fort Ord Stadium." January 12, 1951. Page 13. Accessed June 17, 2021.
- Fresno Bee, The. 1951b. "Army Spokesman Are Defending Building of Fort Ord Stadium." February 4, 1951. Page 27. Accessed June 17, 2021. Available at: Newspapers.com.
- Gates, S., & Williams, H. 1957. The Armed Forces. The Annals of the American Academy of Political and Social Science, 313, 99-104. Accessed June 17, 2021. <http://proxy.multcolib.org:2052/stable/1031762>

CONTINUATION SHEET

Property Name: Pacific Hall
Page 14 of 15

- MacGregor Jr., Morris J. 1981. *Integration of the Armed Forces, 1940-1965*. Center of Military History, United States Army: Washington, D.C.
- Madsen, Alexandra and Steven Treffers. 2019. *Historic Resources Evaluation Memorandum for Hammerhead Barracks at Fort Ord, Monterey County, California*. Prepared by Rincon Consultants, Inc for City of Seaside, Community and Economic Development Department. November 4, 2019. Accessed June 28, 2021.
https://www.ci.seaside.ca.us/DocumentCenter/View/10674/9_App-S---HRE-Memo
- Military Museum. 2016. "Historic California Posts, Camps, Stations, and Airfields: Fort Ord." Accessed on June 19, 2021. <http://www.militarymuseum.org/FtOrd.html>
- National Archives Foundation. 2021. Executive Order 9981. Accessed June 29, 2021. Available at: <https://www.archivesfoundation.org/documents/executive-order-9981-ending-segregation-armed-forces/>
- NETR (Nationwide Environmental Title Research LLC). 2021. Historic Aerial Photographs of 100 Campus Center, Seaside, CA 93955 dating from 1956, 1968, 1981, 1998, 2005, 2009, 2010, 2012, 2014, 2016, and 2018. Accessed June 10, 2021.
<https://www.historicaerials.com/viewer>
- Panorama. 1990. "50 Years and Counting..." September 21, 1990, pg. 2.
- Panorama. n.d. "Ford Ord in World War II." Historic California Posts: Fort Ord. Accessed on June 19, 2021. <http://www.militarymuseum.org/FtOrd.html>
- Park, R. 2015. "Happy and Cheerful in This Fine Camp": Sports, Recreation, and the United States Army at Fort Ord and Camp Roberts, 1940 to 1945. *Journal of Sport History*, 42(1), 21-37. Accessed on June 18, 2021, from
<https://www.jstor.org/stable/10.5406/jsporthistory.42.1.21>
- Pomona Progress Bulletin. 1950. War Solving Racial Problems. August 24, 1950. Page 4. Accessed June 29, 2021. Available at: [Newspapers.com](http://www.newspapers.com).
- Quartermaster Review, The. 1940. "Army Construction Underway at Camp Ord, California." Volume XX. No 3. November-December. On file at the Chamberlin Library, Ord Military Community.
- Raugh, Harold E. 2004. Fort Ord. Charleston, SC: Arcadia.
- Salinas Morning Post. 1940. "\$2,766,000 in Building Authorized—Ord Contracts Let." August 21, 1940. Salinas, CA. pg. 1.
- San Francisco Examiner. 1951. Fort Ord Will Get Stadium. San Francisco Page 4. · 3 Feb 1951. Pages 1 and 4 A Available on [www.Newspapers.com](http://www.newspapers.com). Accessed on Jun 11, 2021.
- San Francisco Examiner. 1958. Army Asks OK on \$124,000,000 for Fort Ord Buildings. San Francisco. Section 2. Page. 4. Available on [www.Newspapers.com](http://www.newspapers.com). Accessed July 18, 2021.

CONTINUATION SHEET

Property Name: Pacific Hall

Page 15 of 15

Vasche, J. Burton. 1959. "The California State Colleges: Their History, Organization, Purposes, and Programs." in California

U.S. Army. 1977. Post Map Main Garrison Area. Fort Ord, California. Drawing number G-950. Accessed in person at the Chamberlain Library on June 15, 2021.

Walch, Bob. 2004. An Army Historian's Pictorial Take on Fort Ord. Monterey County NOW. Accessed July 12, 2021. Available at:
https://www.montereycountyweekly.com/news/local_news/an-army-historian-s-pictorial-take-on-fort-ord/article_6e8b0250-9c38-5ca4-a4a4-f93d42d65a11.html

Whaley, Derek. 2015. "East Monterey & Seaside." Santa Cruz Trains: Railroads of the Monterey Bay Area. July 20, 2015. Accessed online:
<https://www.santacruztrains.com/2015/07/east-monterey-seaside.html>.

Webb Spinner, The. 1952-1954. Webb Spinner Volume for 1952-1954. Del Webb Sun Cities Museum Collection. Accessed June 30, 2021. Accessed at:
<https://delwebbsuncitiesmuseum.org/newsletters-webb-spinners/>

State of California & The Resources Agency
 DEPARTMENT OF PARKS AND RECREATION
PRIMARY RECORD

Primary #
 HRI #
 Trinomial
NRHP Status Code 6Z

Other Listings
 Review Code

Reviewer

Date

Page 1 of 16 *Resource Name or #: (Assigned by recorder) Coast Hall

P1. Other Identifier: CSUMB Building 45

*P2. Location: Not for Publication Unrestricted

*a. County Monterey County and (P2c, P2e, and P2b or P2d. Attach a Location Map as necessary.)

*b. USGS 7.5' Quad Marina, CA Date 1995 T 15S; R 2E; NW ¼ of SW ¼ of Sec 6; Mount Diablo B.M.

c. Address 4582 6th Avenue, Seaside Zip 93955

d. UTM: (Give more than one for large and/or linear resources) Zone 10S, 607875 mE/ 4056803 mN

e. Other Locational Data: (e.g., parcel #, directions to resource, elevation, decimal degrees, etc., as appropriate)

Coast Hall sits on 6th Avenue, between A Street and B Street.

APN: 031101005000

*P3a. Description: (Describe resource and its major elements. Include design, materials, condition, alterations, size, setting, and boundaries)

Coast Hall (CSUMB Building 45) is located southeast of the Main Quad on the California State University, Monterey Bay (CSUMB) campus. The utilitarian building with modern stylistic details is constructed of board-formed concrete. The single-story building has an L-shaped plan with a flat roof and concrete eave overhangs. The primary, west, elevation has the main entrance at the corner of the "L." Fenestration includes bands of rectangular fixed glass windows in protruding metal frames set on concrete sills.

See Continuation Sheet.

*P3b. Resource Attributes: (List attributes and codes) HP15. Educational building, HP34. Military property

P5a. Photograph or Drawing (Photograph required for buildings, structures, and objects.)



*P4. Resources Present: Building

Structure Object Site District Element of District Other (Isolates, etc.)

P5b. Description of Photo: (view, date, accession #) west elevation, view looking southeast, Dudek (IMG 0645)

*P6. Date Constructed/Age and Source: Historic Prehistoric Both 1952-1954 (The Webb Spinner).

*P7. Owner and Address:

CSUMB
100 Campus Center
Seaside, CA. 93955

*P8. Recorded by: (Name, affiliation, and address) Sarah Corder, Dudek, 725 Front St #400, Santa Cruz, CA 95060

*P9. Date Recorded: 6/14/2021

*P10. Survey Type: (Describe)

Intensive level

*P11. Report Citation: (Cite survey

report and other sources or enter none) Dudek 2021. Built Environment Inventory and Evaluation Report for California State

*Attachments: NONE Location Map Continuation Sheet Building, Structure, and Object Record

Archaeological Record District Record Linear Feature Record Milling Station Record Rock Art Record

Artifact Record Photograph Record Other (List): _____



BUILDING, STRUCTURE, AND OBJECT RECORD

*Resource Name or # (Assigned by recorder) Coast Hall *NRHP Status Code 6Z
Page 3 of 16

B1. Historic Name: Hammerhead Building, Hammerhead Barracks, Fort Ord Barracks
B2. Common Name: Coast Hall, CSUMB Building 45
B3. Original Use: Military Barracks 4. Present Use: Educational Classroom

*B5. Architectural Style: Utilitarian

*B6. Construction History: (Construction date, alterations, and date of alterations)

Designed and constructed between 1952-1954, Coast Hall is a utilitarian building with modern stylistic details. Originally the building served as barracks at Fort Ord. At least 38 barracks were constructed by Del Webb Construction Company at a cost of \$12,614,832. Construction started in 1952 (The Californian 1952b: 18). When California State University at Monterey Bay (CSUMB) acquired the campus, the building became Coast Hall, an educational classroom building. It is likely the addition of the ADA ramps and the replacement of windows was completed during this transition. Between 2006 and 2012, the east, multi-story wing of the building was demolished and the opening to that wing was filled with CMU.

*B7. Moved? No Yes Unknown Date: _____ Original Location: _____ *B8. Related Features:

B9a. Architect: unknown b. Builder: Del Webb Construction Company

*B10. Significance: Theme N/A Area N/A
Period of Significance N/A Property Type N/A Applicable Criteria N/A

(Discuss importance in terms of historical or architectural context as defined by theme, period, and geographic scope. Also address integrity.)

See Continuation Sheet.

B11. Additional Resource Attributes: (List attributes and codes) _____

*B12. References: See Continuation Sheet.

B13. Remarks:

*B14. Evaluator: Adrienne Donovan-Boyd, MSHP

*Date of Evaluation: July 9, 2021

(Sketch Map with north arrow required.)



(This space reserved for official comments.)

CONTINUATION SHEET

Property Name: Coast Hall
Page 4 of 16

*P3a. Description (continued):

Above the rectangular windows are square metal-framed decorative white panels. Below the windows is a section of concrete block. The east elevation shows changes to the plan, with a concrete framed door filled with CMUs and a change in exterior cladding. ADA-accessible ramps are located on the east and west sides of the building. The south and north elevations mirror other elevations in style and materials. Extensive changes to fenestration and door openings are visible on the south elevation. Several wall sections throughout the building are filled with CMU, showing changes to fenestration, pedestrian entrances, and plan. The building appears to sit on a concrete foundation.

Alterations:

- Demolition of east, multi-story wing, and infill of opening with CMU (between 2012 and 2014).
- Infill of multiple openings and fenestration changes (between 2016 and 2021)
- Addition of ADA ramps (Date Unknown)
- Replacement of original windows throughout.



Figure 1. Main (west) elevation, looking southeast (IMG_0644)

CONTINUATION SHEET

Property Name: Coast Hall
Page 5 of 16



Figure 2. East elevation, rear entrance, awning, and filled in area that originally connected to the multi-story wing, looking northwest. (IMG_0639)

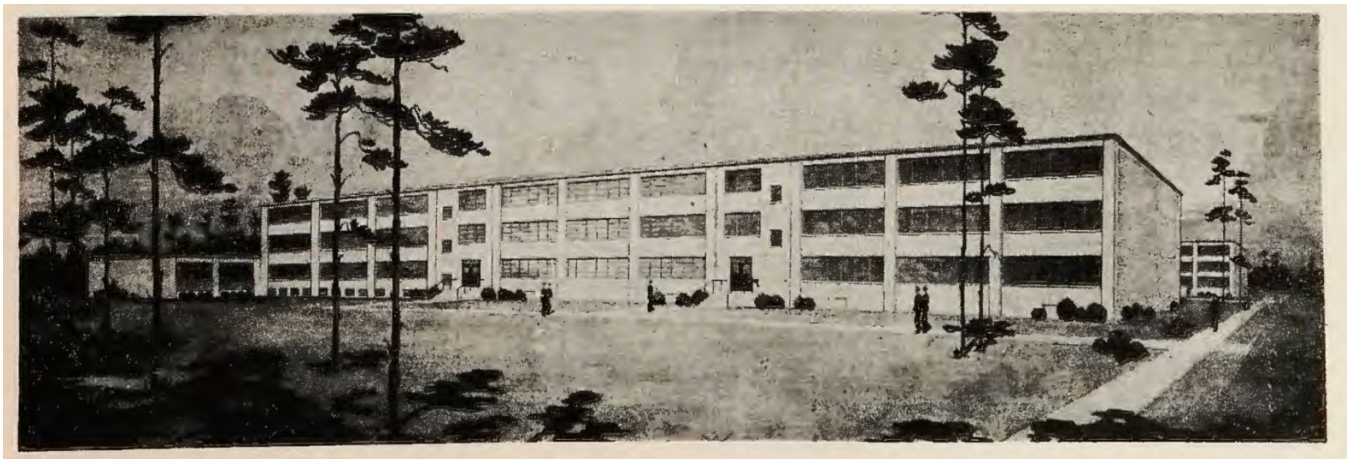

Figure 3. 1952 conceptual drawing of the new barracks to be constructed at Fort Ord. (The Webb Spinner 1952) (DPR Elevation)

CONTINUATION SHEET

Property Name: Coast Hall
Page 6 of 16

*B10. Significance (continued):

Historical Overview of Fort Ord

The history of Fort Ord has been extensively documented in newspaper articles, websites, academic journals, and books. From its creation in 1917 to its closure in 1994, the base grew to become one of the largest training centers in the country. Its location was also reported to be the most attractive U.S. Army post, with easy access to the ocean and beautiful California weather.

The development periods in the history of Fort Ord were defined by Harold E. Raugh, Jr, a U.S. Army lieutenant colonel and historian with the Department of Defense. Since his retirement, Raugh served as the Chief Historian, for the Defense Logistics Agency, for the Department of Defense and, from 2006-2013, Raugh served as the Command Historian at the Defense Language Institute Foreign Language Center (DLIFLC) and the Presidio of Monterey, California. He received his PhD in history from the University of California, Los Angeles (Walch 2004). Raugh has authored numerous books including, *Fort Ord* (2004); *Presidio of Monterey* (2004); *Operation Joint Endeavor: V Corps in Bosnia-Herzegovina, 1995-1996* (2013); *The Raugh Bibliography of the Indian Mutiny 1857-1859* (2016); and *Wavell in the Middle East, 1939-1941: A study in Generalship*. Raugh defined four periods for the historic development of Fort Ord:

- 1917-1940 Camp Gigling to Camp Ord
- 1940-1945 Fort Ord and the 7th Infantry Division
- 1946-1976 The Cold War and Vietnam Eras
- 1974-1994 The Volunteer Army

These periods correspond to distinct eras in the history of the base and the U.S. Army (Raugh 2004: ii). The following sections provide a summary overview of each of these periods of development and their relevance to the area of Fort Ord now known as the CSUMB campus.

The full historic context of Fort Ord is represented in the report, *Built Environment Inventory and Evaluation Report for California State University, Monterey Bay* (Dudek 2021). The following presents only relevant historical and building typology information pertaining to the development of Coast Hall.

Cold War and Vietnam Eras at Fort Ord (1946-1976)

This period of development between 1946 and 1976 was characterized by a massive operation to move the base out of its semi-permanent status and create a permanent outpost for active military personnel who were retained due to ongoing foreign conflicts.

In July of 1948, Harry S Truman signed Executive Order 9981, which officially ended segregation in the armed forces. The order stated that "there shall be equality of treatment and opportunity for all persons in the armed forces without regard to race, color, religion, or national origin" (National Archives Foundation 2021). Fort Ord became one of the first integrated training divisions in the United States. The Fort was touted as "pioneering to end all segregation" (The Pomona Progress Bulletin 1950: 4). In 1950, the Pomona Progress Bulletin reported that black and white soldiers at Fort Ord were "fighting side by side" and all the enlistees "trained together, slept in the same barracks, and eat the same messes" (The Pomona Progress Bulletin 1950: 4).

The end of World War II in 1945 did not bring lasting peace. The tenuous relationship between dominant nations in the communist East and free market West led to the beginning

CONTINUATION SHEET

Property Name: Coast Hall
Page 7 of 16

of the Cold War. The Department of Defense maintained a robust fighting force during the Cold War, with more than 900,000 Army personnel retained during the 1950s (ACHP 2006). The ongoing global tensions and the number of active U.S. military personnel created a need for new permanent buildings and expanded military housing at Fort Ord.

In 1949, the Soviet-supported communist government of North Korea invaded American-supported South Korea, initiating the Korean War. Fort Ord was a primary staging area for the training of troops departing for the war (Castle 1990:3). By the 1950s, Fort Ord had become one of the largest basic training camps in the United States. In 1952, the military began a multi-million dollar building program to transform Fort Ord into a permanent post, including the development of permanent troop housing, and the construction of a guard house, stockade, and multiple warehouses. In January of 1952, military authorities announced the new construction program at Fort Ord was underway, with an estimated cost of \$26,650,600. More than half of the funds that were approved by Congress were "earmarked for new permanent troop housing" for more than 7,000 soldiers (The Webb Spinner 1952-54, Vol 6. No. 3:1).

The new troop housing was to be constructed of reinforced concrete, a departure from the wood buildings constructed before and during World War II. The plan called for three types of massive barracks, twenty-two were to house 225 enlisted men each, seven were to accommodate 165 men each, and nine were to house 105 men each (The Webb Spinner 1952-54, Vol 6. No. 3:3). The San Francisco District of the U.S. Army Corps of Engineers oversaw the construction project to completion. An additional \$1,349,700 was earmarked for the expansion of classroom and training facilities at Fort Ord, including a new battalion and regimental headquarters (The Californian 1952a:1 and The Californian 1952b:18). By March of 1952, another phase of the permanent army post transformation began with the construction of a guard house, stockade, warehouse, and other buildings (The Webb Spinner 1952-54, Vol 6. No. 3:1). This addition of permanent buildings continued into the late 1950s, when the Army requested \$124 million to replace all the wood World War II infrastructure at Fort Ord with concrete block and reinforced concrete (Madsen and Treffers 2019:6; San Francisco Examiner 1958:2-4). While many of the wood buildings remain today, this period saw the continuous addition of reinforced concrete permanent buildings across the Fort (Madsen and Treffers 2019:6).

Following the Korean War through the end of the conflict in Vietnam, Fort Ord served as an important training facility. In 1957, Fort Ord was designated as a U.S. Army Training Center for Infantry (Castle 1990: 4). The 7th Infantry Division was based at Fort Ord in 1975 (Cavanaugh 2000: 9). Fort Ord produced thousands of combat-ready troops during the conflict in Vietnam.

With the establishment of Fort Ord as a permanent Army base during this period, there was substantial building construction that led to the modernization of the base and its services. This development is closely related to the history of the current CSUMB campus. All the properties that are included as part of this built environment study were constructed during the Cold War and Vietnam Era period. Building development during this period was a substantial departure from the styles and materials used in the buildings constructed before World War II. Building during the period between 1946 and 1976 used reinforced concrete and concrete masonry unit (CMU). The buildings tended to be larger than those constructed in previous periods. Other development in this period included support service buildings and several types of medical buildings. Infrastructure was

CONTINUATION SHEET

Property Name: Coast Hall
Page 8 of 16

also improved at this time, with the introduction of paved streets and roadways, and the addition of several water tanks, water pumping plants, and warehouse buildings.

Coast Hall, 1952-1954

Coast Hall (45) first appears on a 1956 aerial photograph of the site in the western half, of a group of eight other similarly laid out buildings. These buildings were originally designed as new permanent barracks that were part of a \$26,650,000 construction program awarded by the military in 1952. More than \$17 million of these funds were used to construct 38, new, three-story barracks. These larger barracks were planned to house entire companies and serve all their needs in one space, with mess halls, lounges, day rooms, orderly rooms, supply rooms, and issue rooms, as well as administrative space (the Californian 1952a).

The Del Webb Construction Company won the bid for the work at Fort Ord with a low bid of \$12,614,832 (The Californian 1952b: 18). Groundbreaking for the project took place on February 19, 1952. The barracks were featured in Webb's newsletter, The Webb Spinner, in the June/July/August edition. The paper touted the new military dormitories as being "sleek" (The Webb Spinner 1954:6). The buildings were a departure from the "old, white-painted barracks" constructed 12 years earlier. The new barracks were erected of steel and concrete and features large glass areas. The concrete construction was lauded as both vermin- and fire-proof (The Webb Spinner 1954:6). After Fort Ord closed in 1994, the buildings became part of the CSUMB campus.

Del Webb Construction Company

The Del Webb Construction Company was founded by Delbert Eugene Webb in Phoenix in 1928. The company would become known for its ability to develop profitable commercial and residential large-scale projects (Del Webb and Pulte Homes 2021:1). Webb was the lead contractor on Madison Square Garden and the L. A. County Museum of Art. During World War II, the company won many military and navy housing projects where the company streamlined development of housing on once barren land. In the late 1940s Webb constructed a casino/hotel in Las Vegas for Benjamin "Bugsy" Siegle. Over time Del Webb became the largest gaming operator and private employer in California.

The Del Webb Corporation opened a community, Sun City, in January of 1960. The community was known for its modestly priced housing and delivering a "highly desirable lifestyle" (Del Webb and Pulte Homes 2021:1). Del Webb went on to construct "Sun Cities" in Florida and Southern California, both of which were sold. The company continued to focus on gaming and commercial operations until 1987, when the decision was made to sell these interests and focus on the development of "master-planned, active adult communities" (Del Webb and Pulte Homes 2021:2). By January of 2000 the company had planned and constructed 13 Sun Cities Communities, selling more than 80,000 homes. In July 2001, Del Webb Company merged with Pulte Homes inc. to create the largest homebuilding company in the Nation (Del Webb and Pulte Homes 2021:3).

Several buildings on the Williams Air Force Base are listed on the NRHP including, two Ammo Bunkers, the Civil Engineering Maintenance Shop, the Demountable Hangar, the flagpole, the Housing Storage Supply Warehouse, and the Water Pump Station and Water Tower. Additionally, the 1938 addition to the Arizona State Capital Building, Hunts Tomb in Phoenix Arizona, and the Phoenix Towers in Phoenix are all individual listed on the NRHP. The Del Webb Construction Company has constructed thousands of buildings across the United States.

CONTINUATION SHEET

Property Name: Coast Hall
 Page 9 of 16

Fort Ord Building Typology and Character-Defining Features

Four categories of building types were identified for the purposes of this study. These are the Support Services Buildings, Medical Buildings, Hammerhead Buildings/Barracks, and Recreational Buildings. The following presents a discussion of the Hammerhead Buildings/Barracks building typology, as Coast Hall is classified in this category. This section provides a detailed account of the specific character-defining features of Fort Ord Cold War and Vietnam Era (1946-1976) Hammerhead Buildings/Barracks.

Hammerhead Buildings/Barracks

The Hammerhead Buildings/Barracks were constructed to house troops at Fort Ord as it was expanding from a semi-permanent installation to a permanent base. In alignment with the typical planning, design, and materials of buildings constructed during this period of Fort Ord’s history, these buildings are constructed with reinforced concrete and CMU and feature flat roofs with multi-light windows with concrete sills.

Coast Hall (45) first appears on a 1956 aerial photograph of the site on the western half of the base. It is part of a group of eight others similarly oriented buildings. No changes to the footprint were noted. After Fort Ord closed in 1994, the buildings became part of the CSUMB campus. There were no notable changes to the footprint of the building until sometime between 2016 and 2018 when the east, multi-story wing was demolished on Coast Hall.

Character-Defining Features of the Hammerhead Buildings

The Hammerhead Buildings/Barracks originally exhibited the following specific character-defining features:

Character-Defining Features: The Hammerhead Buildings/Barracks

Character Aspect	Primary Character-Defining Features	Character-Defining Features
Shape and Plan	<ul style="list-style-type: none"> Hammerhead shape Single story wing and multi-story wing 	The overall shape and mass of the building are considered a primary character-defining feature of the Hammerhead Buildings/Barracks. The plan should include a multi-story wing.
Roof	<ul style="list-style-type: none"> Flat roof Wide eave overhangs No exposed rafters 	The Hammerhead Buildings/Barracks have flat roofs, with moderate eave overhangs.
Openings	<ul style="list-style-type: none"> Entrances on the first story Multi-light windows 	Window openings are uniform in size and placement, windows are multi-light, and set into concrete openings. Replaced windows are not considered character-defining features as they fall outside the period of significance.
Exterior Ornamentation	<ul style="list-style-type: none"> Minimal exterior ornamentation Glass windows used as ornamentation 	Hammerhead Buildings/Barracks were designed to be quickly constructed. They have little to no decorative ornamentation, with windows in ribbons being the only decorative element.

CONTINUATION SHEET

Property Name: Coast Hall
 Page 10 of 16

Materials	<ul style="list-style-type: none"> • Mass-produced and cost-effective materials • Concrete and CMU • Reinforced concrete construction 	Hammerhead Buildings/Barracks have simple, utilitarian designs. Buildings were constructed using mass-produced and cost-effective building materials that were readily available at the time of construction. For instance, buildings under the Hammerhead type were constructed with reinforced concrete and CMU and were minimally decorated.
-----------	--	---

Alterations and demolitions over time have compromised the overall architectural integrity of this building type. The most common alterations observed for this building type include the following.

- Replacement windows
- ADA compliance measures such as ramps and doors
- HVAC systems and window units
- Infill of openings
- Interior renovations

NRHP/CRHR Designation Criteria

In consideration of the project site's history and requisite integrity, Dudek recommends the property not eligible for listing in the NRHP and CRHR based on the following significance evaluation and in consideration of national and state eligibility criteria:

Criterion A/1: That are associated with events that have made a significant contribution to the broad patterns of our history.

Coast Hall was constructed in 1952-1954 during the period defined as the Cold War and Vietnam Eras (1946-1976) at Ford Ord. While this building is of historic age and was constructed during this important period of development in Fort Ord's history, it no longer retains enough integrity to convey its significance. One of the most notable elements of integrity that is compromised is the integrity of setting. Significant demolition, changes to circulation patterns, introduction of new buildings, and changes in use, all impact the campus's ability to convey significance from its time as an active Cold War and Vietnam Era military base. The loss of this overall integrity of setting adversely effects Coast Hall, as individual buildings are no longer able to convey their collective history. Additionally, the subdivision of Fort Ord following its closure has also greatly impacted the integrity of feeling, association, and setting of the Cold War and Vietnam Era portions of the installation. In summary, Coast Hall, is not able to convey its association with any extraordinary events or events occurring within the context of Cold War and Vietnam military barracks, the CSUMB Campus, or has an association with the broad patterns of history in Monterey County, the State of California, or the Nation. Therefore, the building is recommended not eligible under NRHP/CRHR Criterion A/1.

Criterion B/2: That are associated with the lives of persons significant in our past.

To be found eligible under B/2 the building must be directly tied to an important person and the place where that individual conducted or produced the work for which he or she is known. Archival research failed to indicate any historical associations with people important to the nation's or state's past. Due to a lack of identified significant associations with important persons in history, the building does not appear eligible under NRHP/CRHR Criterion B/2.

Criterion C/3: That embody the distinctive characteristics of a type, period, or method

CONTINUATION SHEET

Property Name: Coast Hall

Page 11 of 16

of construction, or that represent the work of a master, or that possess high artistic values, or that represent a significant and distinguishable entity whose components may lack individual distinction.

No original plans or designs for the 1952-1954 barracks were discovered during archival research. Newspaper articles from 1952, announced the contract was awarded to the Del Webb Company, of Phoenix, AZ (the Californian 1952a). The Webb Company was a notable building company that completed contracts for the government, commercial clients, and private individuals during its long period operation, beginning in 1929 and continuing to the present. The Webb Company designed many distinguished buildings including many that are listed on the NRHP. While Webb may be a master builder, Coast Hall, was constructed during a period when the Webb company was completing many other large-scale projects, many at military bases. The company received many contracts during World War II to construct barracks and other military related buildings. The buildings at Fort Ord were common contracts for the company, and they had constructed buildings of this type at other bases.

Coast Hall is a utilitarian building, with minimal detailing, and few stylistic features. Additionally, Coast Hall, has undergone numerous, alterations, including changes to fenestration, materials, and the demolition of the east, multi-story wing. Originally the building housed an entire infantry of troops, the remaining portion of the building is currently used for classroom space. While the building is associated with a master builder, the Del Webb Construction Company, it is not one of their more notable works. Additionally, the building lacks high artistic value, and has undergone substantial alterations. For these reasons Coast Hall is recommended not eligible under NRHP/CRHR Criterion C/3.

Criterion D/4: That have yielded, or may be likely to yield, information important in prehistory or history.

There is no evidence to suggest that this property has the potential to yield information important to state or local history. Therefore, the property is recommended not eligible under NRHP/CRHR Criterion D/4.

California Historic Landmark Statement of Significance

In consideration of Coast Hall's history and requisite integrity, Dudek recommends the property not eligible for designation as a California Historic Landmark based on the following significance evaluation and in consideration of state eligibility criteria:

The first, last, only, or most significant of its type in the state or within a large geographic region (Northern, Central, or Southern California).

Coast Hall was constructed between 1952 and 1954. The building, along with at least 38 other barracks, was constructed after the initial, core development period of Fort Ord in the 1940s. The buildings were constructed during the fort's transition to a permanent base. Coast Hall was constructed by Del Webb Company, a company based in Phoenix Arizona. The building is a utilitarian building type that lacks high style components to set it apart from other buildings constructed throughout the State of California in the 1950s and 1960s. Therefore, Dudek recommends Coast Hall is not eligible for listing as a CHL under this criterion.

Associated with an individual or group having a profound influence on the history of California.

Coast Hall was originally constructed to be one of Fort Ord's barracks, one of 38 such buildings to provide a housing for military personnel. The Del Webb Construction Company, a notable Phoenix, Arizona based company, was responsible for the construction of the building. While Coast Hall is associated with a master builder with many known projects

CONTINUATION SHEET

Property Name: Coast Hall
Page 12 of 16

completed in California, this building is not one of the company's notable works. No other individuals are known to have influenced the construction or use of this building. Therefore, Dudek recommends Coast Hall is not eligible for listing as a CHL under this criterion.

A prototype of, or an outstanding example of, a period, style, architectural movement or construction or is one of the more notable works or the best surviving work in a region of a pioneer architect, designer or master builder.

Coast Hall is neither a prototype or an outstanding example of a period, style, or architectural movement. It is a typical example of a utilitarian design. The building was designed to serve a utilitarian purpose for the military at Fort Ord. There are no identifying features on Coast Hall that would establish the connection to the notable work of the Del Webb Construction Company in the State of California. Additionally, Coast Hall has been substantially altered and the large multi-story wing demolished making it unable to sufficiently convey its temporal period or its historic context. Therefore, Dudek recommends Coast Hall is not eligible for listing as a CHL under this criterion.

Local Designation Criteria

Portions of the CSUMB campus are located within the boundaries of two cities, City of Seaside and the City of Marina, both of which evaluate historical resources in accordance with CEQA Guidelines. as presented above. The subject property, as discussed in the NRHP/CRHR/CHL criteria discussion above, does not rise to the necessary level of significance for local, state, or national designation. For these reasons, the subject property is recommended not eligible individually or as a component of a historic district under any of the NRHP/CRHR/CHL criteria.

Additionally, portions of the CSUMB campus are located in the County of Monterey and the campus is therefore subject to the regulations set forth in Chapter 18.25 of the Monterey County Code. The subject property, as discussed in the NRHP/CRHR/CHL criteria discussion above, does not rise to the necessary level of significance for state or national designation. For these same reasons, the subject property is also recommended not eligible individually or as a component of a historic district under any of the delineated County of Monterey review criteria categories that are addressed with the NRHP/CRHR/CHL criteria discussed above: A. Historical and Cultural Significance; B. Historic, Architectural, and Engineering Significance; or C. Community and Geographic Setting.

Integrity Discussion

Coast Hall was analyzed against the seven aspects of integrity: location, design, setting, materials, workmanship, feeling, and association. The building retains its integrity of location, as it has not been relocated. The building was designed with minimal elements reflecting an architectural style. Some of the features reflecting the original design, most notably the windows and the demolition of the multi-story wing, have been lost, and the overall integrity of design has been compromised. The integrity of setting has been lost with the change in use from its original use as barracks at Fort Ord to a classroom building for CSUMB. Therefore, the integrity of setting has been lost. While some of the original materials appear to be intact, the demolition of the multi-story wing and changes to original fenestration have compromised the integrity of materials. The techniques used in the construction of Coast Hall are still apparent, with the CMU and concrete construction, but the demolition of more than half the building has adversely affected the integrity of workmanship. The exterior of Coast Hall no longer conveys its original use. Therefore, the integrity of feeling has been lost. As Coast Hall does not possess historic significance, there is no historic association. The building does not possess adequate integrity to convey significance.

CONTINUATION SHEET

Property Name: Coast Hall

Page 13 of 16

Summary of Evaluation Findings

Coast Hall has a compromised level of historic integrity and lacks historical and architectural significance. Based on the significance evaluations presented above, Coast Hall does not appear to meet the NRHP, CRHR, CHL or local designation criteria. Therefore, Coast Hall is not considered a historical resource for purposes of CEQA.

CONTINUATION SHEET

Property Name: Coast Hall

Page 14 of 16

*B12. References (continued):

ACHP (Advisory Council on Historic Preservation). 2006. "Draft Program Comment Regarding Cold War Era Unaccompanied Personnel Housing." Federal Register: The Daily Journal of the United States Government. 12 April 2016. Accessed June 30, 2021 Available at: <https://www.federalregister.gov/documents/2006/04/12/06-3509/draft-program-comment-regarding-cold-war-era-unaccompanied-personnel-housing>

Californian, The. 1940. "No More Camp Ord! It's Fort Ord Now! Stilwell in Command: Headquarters of General Located on Salinas Side." July 13, 1940. Salinas, California, pg. 1.

Californian, The. 1951. Stadium Field House—Sixth Army Lets Ord Contract. March 20, 1951. P1. Accessed June 17, 2021. Available at: Newspapers.com.

Castle, Ted. 1990. "The March of Time." Fort Ord Panorama. September 21, 1990.

Cavanaugh, Joe. 2000. *The Peace Dividend: Defense Conversion Through Higher Education*. The Leon Panetta Institute.

Chamberlin Library. 2021. Fort Ord Working Papers. CSUMB Special Collections Box 6.42-01. Available at the Chamberlin Library, Seaside, California.

CSUMB Facilities. 2021. Original As built and renovation architectural drawings on file with CSUMB facilities department. Accessed in person June 15-16, 2021.

Del Webb and Pulte Homes 2021. Del Webb History. Accessed July 9, 2021. Available at: http://media.corporate-ir.net/media_files/irol/14/147717/DelWebb/DelWebbHistory.pdf

DLIFLC (Defense Language Institute Foreign Language Center). 2021. Command History Program. Accessed in person on June 15, 2021 and accessed online database collection online July 2021. Available at: <https://adli.pastperfectonline.com/>

EA Engineering. 1991. Draft Final Fort Ord, California Base wide Remedial Investigation Feasibility Study. Volume 1 Literature Review and Base Inventory Report. Accessed on July 13, 2021. Available at: <https://www.fortordcleanup.com/documents/search/>

Fresno Bee, The. 1951a. "Army Spokesman Are Defending Building of Fort Ord Stadium." January 12, 1951. Page 13. Accessed June 17, 2021.

Fresno Bee, The. 1951b. "Army Spokesman Are Defending Building of Fort Ord Stadium." February 4, 1951. Page 27. Accessed June 17, 2021. Available at: Newspapers.com.

Gates, S., & Williams, H. 1957. The Armed Forces. The Annals of the American Academy of Political and Social Science, 313, 99-104. Accessed June 17, 2021. <http://proxy.multcolib.org:2052/stable/1031762>

CONTINUATION SHEET

Property Name: Coast Hall

Page 15 of 16

- MacGregor Jr., Morris J. 1981. *Integration of the Armed Forces, 1940-1965*. Center of Military History, United States Army: Washington, D.C.
- Madsen, Alexandra and Steven Treffers. 2019. *Historic Resources Evaluation Memorandum for Hammerhead Barracks at Fort Ord, Monterey County, California*. Prepared by Rincon Consultants, Inc for City of Seaside, Community and Economic Development Department. November 4, 2019. Accessed June 28, 2021.
https://www.ci.seaside.ca.us/DocumentCenter/View/10674/9_App-S---HRE-Memo
- Military Museum. 2016. "Historic California Posts, Camps, Stations, and Airfields: Fort Ord." Accessed on June 19, 2021. <http://www.militarymuseum.org/FtOrd.html>
- National Archives Foundation. 2021. Executive Order 9981. Accessed June 29, 2021. Available at: <https://www.archivesfoundation.org/documents/executive-order-9981-ending-segregation-armed-forces/>
- NETR (Nationwide Environmental Title Research LLC). 2021. Historic Aerial Photographs of 100 Campus Center, Seaside, CA 93955 dating from 1956, 1968, 1981, 1998, 2005, 2009, 2010, 2012, 2014, 2016, and 2018. Accessed June 10, 2021.
<https://www.historicaerials.com/viewer>
- Panorama. 1990. "50 Years and Counting..." September 21, 1990, pg. 2.
- Panorama. n.d. "Ford Ord in World War II." Historic California Posts: Fort Ord. Accessed on June 19, 2021. <http://www.militarymuseum.org/FtOrd.html>
- Park, R. 2015. "Happy and Cheerful in This Fine Camp": Sports, Recreation, and the United States Army at Fort Ord and Camp Roberts, 1940 to 1945. *Journal of Sport History*, 42(1), 21-37. Accessed on June 18, 2021, from
<https://www.jstor.org/stable/10.5406/jsporhistory.42.1.21>
- Pomona Progress Bulletin. 1950. War Solving Racial Problems. August 24, 1950. Page 4. Accessed June 29, 2021. Available at: [Newspapers.com](http://www.newspapers.com).
- Quartermaster Review, The. 1940. "Army Construction Underway at Camp Ord, California." Volume XX. No 3. November-December. On file at the Chamberlin Library, Ord Military Community.
- Raugh, Harold E. 2004. Fort Ord. Charleston, SC: Arcadia.
- Salinas Morning Post. 1940. "\$2,766,000 in Building Authorized—Ord Contracts Let." August 21, 1940. Salinas, CA. pg. 1.
- San Francisco Examiner. 1951. Fort Ord Will Get Stadium. San Francisco Page 4. · 3 Feb 1951. Pages 1 and 4 A Available on [www.Newspapers.com](http://www.newspapers.com). Accessed on Jun 11, 2021.
- San Francisco Examiner. 1958. Army Asks OK on \$124,000,000 for Fort Ord Buildings. San Francisco. Section 2. Page. 4. Available on [www.Newspapers.com](http://www.newspapers.com). Accessed July 18, 2021.

CONTINUATION SHEET

Property Name: Coast Hall

Page 16 of 16

Vasche, J. Burton. 1959. "The California State Colleges: Their History, Organization, Purposes, and Programs." in California

U.S. Army. 1977. Post Map Main Garrison Area. Fort Ord, California. Drawing number G-950. Accessed in person at the Chamberlain Library on June 15, 2021.

Walch, Bob. 2004. An Army Historian's Pictorial Take on Fort Ord. Monterey County NOW. Accessed July 12, 2021. Available at:
https://www.montereycountyweekly.com/news/local_news/an-army-historian-s-pictorial-take-on-fort-ord/article_6e8b0250-9c38-5ca4-a4a4-f93d42d65a11.html

Whaley, Derek. 2015. "East Monterey & Seaside." Santa Cruz Trains: Railroads of the Monterey Bay Area. July 20, 2015. Accessed online:
<https://www.santacruztrains.com/2015/07/east-monterey-seaside.html>.

Webb Spinner, The. 1952-1954. Webb Spinner Volume for 1952-1954. Del Webb Sun Cities Museum Collection. Accessed June 30, 2021. Accessed at:
<https://delwebbsuncitiesmuseum.org/newsletters-webb-spinners/>

State of California & The Resources Agency
DEPARTMENT OF PARKS AND RECREATION
PRIMARY RECORD

Primary #
HRI #
Trinomial
NRHP Status Code 6Z

Other Listings
Review Code

Reviewer

Date

Page 1 of 16 *Resource Name or #: (Assigned by recorder) Harbor Hall

P1. Other Identifier: CSUMB Building 46

*P2. Location: Not for Publication Unrestricted

*a. County Monterey County and (P2c, P2e, and P2b or P2d. Attach a Location Map as necessary.)

*b. USGS 7.5' Quad Marina, CA Date 1995 T 15S; R 2E; NW ¼ of SW ¼ of Sec 6; Mount Diablo B.M.

c. Address 4580 6th Avenue, Seaside Zip 93955

d. UTM: (Give more than one for large and/or linear resources) Zone 10S, 607876 mE/ 4056852 mN

e. Other Locational Data: (e.g., parcel #, directions to resource, elevation, decimal degrees, etc., as appropriate)

Harbor Hall sits north of B Street, between 6th Avenue and 7th Avenue.

*P3a. Description: (Describe resource and its major elements. Include design, materials, condition, alterations, size, setting, and boundaries)

Harbor Hall (CSUMB Building 46) is located southeast of the Main Quad on the California State University, Monterey Bay (CSUMB) campus. The utilitarian building with modern stylistic details is primarily constructed of board-formed concrete. The single-story building has an L-shaped plan with a flat roof and moderate concrete eave overhangs. The primary, west, elevation has the main entrance at the corner of the "L." Fenestration includes bands of rectangular fixed glass windows in protruding metal frames set on concrete sills. **See Continuation Sheet.**

*P3b. Resource Attributes: (List attributes and codes) HP15. Educational building, HP34. Military property

P5a. Photograph or Drawing (Photograph required for buildings, structures, and objects.)



*P4. Resources Present: Building
 Structure Object Site District
Element of District Other (Isolates, etc.)

P5b. Description of Photo: (view, date, accession #) West elevation, view looking east, Dudek (IMG 06520)

*P6. Date Constructed/Age and Source: Historic Prehistoric Both
1952-1954 (The Webb Spinner).

*P7. Owner and Address:

CSUMB
100 Campus Center
Seaside, CA. 93955

*P8. Recorded by: (Name, affiliation, and address) Sarah Corder Dudek
725 Front St #400
Santa Cruz, CA 95060

*P9. Date Recorded: 6/14/2021

*P10. Survey Type: (Describe)
Intensive level

*P11. Report Citation: (Cite survey report and other sources or enter none) Dudek 2021. Built Environment Inventory and Evaluation Report for California State Bay.

*Attachments: NONE Location Map Continuation Sheet Building, Structure, and Object Record
 Archaeological Record District Record Linear Feature Record Milling Station Record Rock Art Record
 Artifact Record Photograph Record Other (List): _____

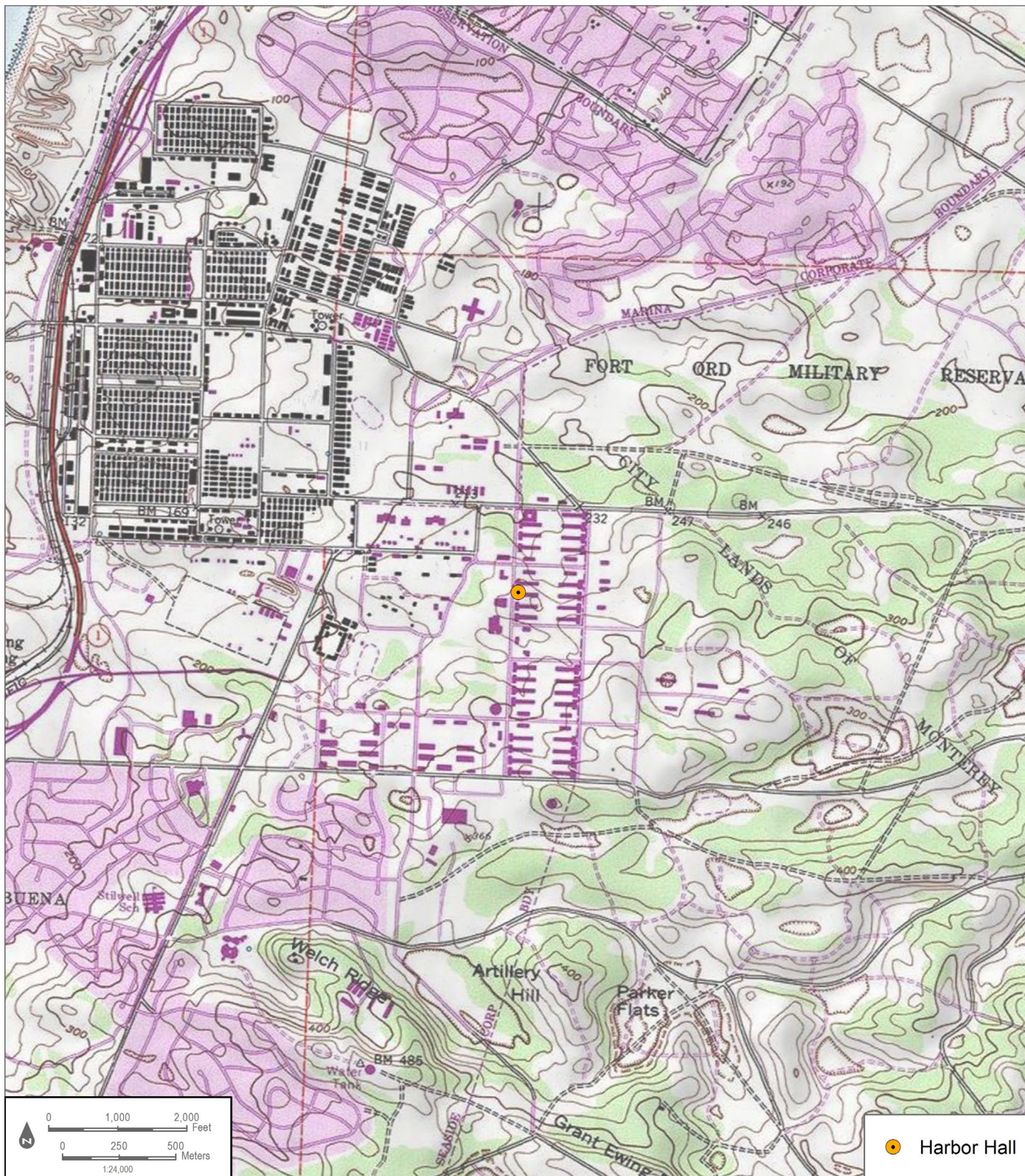

BUILDING, STRUCTURE, AND OBJECT RECORD

*Resource Name or # (Assigned by recorder) Harbor Hall *NRHP Status Code 6Z

Page 3 of 16

B1. Historic Name: Hammerhead Building, Hammerhead Barracks, Fort Ord Barracks

B2. Common Name: Harbor Hall, CSUMB Building 46

B3. Original Use: Military Barracks 4. Present Use: Educational Classroom

*B5. Architectural Style: Utilitarian

*B6. Construction History: (Construction date, alterations, and date of alterations)

Constructed in c. 1952, Harbor Hall (46) is a utilitarian building with modern design elements. Originally the building served as barracks at Fort Ord. At least 38 barracks were constructed by Del Webb Construction Company at a cost of \$12,614,832. Construction started in 1952 (The Californian 1952b: 18). When California State University at Monterey Bay (CSUMB) acquired the campus, the building became Harbor Hall, an educational classroom building. It is likely the addition of the ADA ramps and the replacement of windows were completed during this transition. There are no notable changes to Harbor Hall's surroundings until sometime between 1998 and 2005 when a landscaped green space also appears to join Harbor Hall to the Student Services building via their multi-story east wings. Sometime between 2012 and 2014, Harbor Hall's east multi-story wing was demolished.

*B7. Moved? No Yes Unknown Date: _____ Original Location: _____ *B8. Related Features:

B9a. Architect: unknown b. Builder: Del Webb Construction Company

*B10. Significance: Theme N/A Area N/A
Period of Significance N/A Property Type N/A Applicable Criteria N/A

(Discuss importance in terms of historical or architectural context as defined by theme, period, and geographic scope. Also address integrity.)

See Continuation Sheet.

B11. Additional Resource Attributes: (List attributes and codes) _____

*B12. References: See Continuation Sheet.

B13. Remarks:

*B14. Evaluator: Adrienne Donovan-Boyd, MSHP

*Date of Evaluation: July 20, 2021

(This space reserved for official comments.)



CONTINUATION SHEET

Property Name: Harbor Hall
Page 4 of 16

*P3a

Description (continued):

Above the rectangular windows are square metal-framed decorative white panels. The east elevation shows changes to plan, with a concrete framed door filled with CMUs and a change in exterior cladding. An ADA-accessible ramp leads to a secondary entrance with an arched metal awning on the east facade. A below-grade basement is accessed on the east façade with stairs leading north under the ADA ramp. The south and north elevations mirror other elevations in style and materials. A CMU-filled window opening, and a door repurposed as a window are on the west end of the south elevation. The building appears to sit on a concrete foundation.

Alterations:

- Demolition of east, multi-story wing, and infill of opening with CMU (between 2012 and 2014).
- Infill of multiple openings and fenestration changes (between 2016 and 2018)
- Addition of ADA ramps (Date Unknown).
- Addition of HVAC unit to east side of building (Date Unknown).
- Replacement of original windows throughout (Date Unknown).



3

Figure 1. Front entrance detail of Harbor Hall (west elevations), looking southeast, detail of ADA ramps (IMG_0671)

CONTINUATION SHEET

Property Name: Harbor Hall
Page 5 of 16



Figure 2. Main (west) elevation, looking northeast (IMG_0654)



Figure 3. 1952 conceptual drawing of the new barracks to be constructed at Fort Ord.
(The Webb Spinner 1952)

Historical Overview of Fort Ord

The history of Fort Ord has been extensively documented in newspaper articles, websites, academic journals, and books. From its creation in 1917 to its closure in 1994, the base grew to become one of the largest training centers in the country. Its location was also reported to be the most attractive U.S. Army post, with easy access to the ocean and beautiful California weather.

The development periods in the history of Fort Ord were defined by Harold E. Raugh, Jr, a U.S. Army lieutenant colonel and historian with the Department of Defense. Since his

CONTINUATION SHEET

Property Name: Harbor Hall
Page 6 of 16

retirement, Raugh served as the Chief Historian, for the Defense Logistics Agency, for the Department of Defense and, from 2006-2013, Raugh served as the Command Historian at the Defense Language Institute Foreign Language Center (DLIFLC) and the Presidio of Monterey, California. He received his PhD in history from the University of California, Los Angeles (Walch 2004). Raugh has authored numerous books including, *Fort Ord* (2004); *Presidio of Monterey* (2004); *Operation Joint Endeavor: V Corps in Bosnia-Herzegovina, 1995-1996* (2013); *The Raugh Bibliography of the Indian Mutiny 1857-1859* (2016); and *Wavell in the Middle East, 1939-1941: A study in Generalship*. Raugh defined four periods for the historic development of Fort Ord:

- 1917-1940 Camp Gigling to Camp Ord
- 1940-1945 Fort Ord and the 7th Infantry Division
- 1946-1976 The Cold War and Vietnam Eras
- 1974-1994 The Volunteer Army

These periods correspond to distinct eras in the history of the base and the U.S. Army (Raugh 2004: ii). The following sections provide a summary overview of each of these periods of development and their relevance to the area of Fort Ord now known as the CSUMB campus.

The full historic context of Fort Ord is represented in the report, *Built Environment Inventory and Evaluation Report for California State University, Monterey Bay* (Dudek 2021). The following presents only relevant historical and building typology information pertaining to the development of Harbor Hall.

Cold War and Vietnam Eras at Fort Ord (1946-1976)

This period of development between 1946 and 1976 was characterized by a massive operation to move the base out of its semi-permanent status and create a permanent outpost for active military personnel who were retained due to ongoing foreign conflicts.

In July of 1948, Harry S Truman signed Executive Order 9981, which officially ended segregation in the armed forces. The order stated that "there shall be equality of treatment and opportunity for all persons in the armed forces without regard to race, color, religion, or national origin" (National Archives Foundation 2021). Fort Ord became one of the first integrated training divisions in the United States. The Fort was touted as "pioneering to end all segregation" (The Pomona Progress Bulletin 1950: 4). In 1950, the *Pomona Progress Bulletin* reported that black and white soldiers at Fort Ord were "fighting side by side" and all the enlistees "trained together, slept in the same barracks, and eat the same messes" (The Pomona Progress Bulletin 1950: 4).

The end of World War II in 1945 did not bring lasting peace. The tenuous relationship between dominant nations in the communist East and free market West led to the beginning of the Cold War. The Department of Defense maintained a robust fighting force during the Cold War, with more than 900,000 Army personnel retained during the 1950s (ACHP 2006). The ongoing global tensions and the number of active U.S. military personnel created a need for new permanent buildings and expanded military housing at Fort Ord.

In 1949, the Soviet-supported communist government of North Korea invaded American-supported South Korea, initiating the Korean War. Fort Ord was a primary staging area for the training of troops departing for the war (Castle 1990:3). By the 1950s, Fort Ord had become one of the largest basic training camps in the United States. In 1952, the military began a multi-million dollar building program to transform Fort Ord into a

CONTINUATION SHEET

Property Name: Harbor Hall
Page 7 of 16

permanent post, including the development of permanent troop housing, and the construction of a guard house, stockade, and multiple warehouses. In January of 1952, military authorities announced the new construction program at Fort Ord was underway, with an estimated cost of \$26,650,600. More than half of the funds that were approved by Congress were "earmarked for new permanent troop housing" for more than 7,000 soldiers (The Webb Spinner 1952-54, Vol 6. No. 3:1).

The new troop housing was to be constructed of reinforced concrete, a departure from the wood buildings constructed before and during World War II. The plan called for three types of massive barracks, twenty-two were to house 225 enlisted men each, seven were to accommodate 165 men each, and nine were to house 105 men each (The Webb Spinner 1952-54, Vol 6. No. 3:3). The San Francisco District of the U.S. Army Corps of Engineers oversaw the construction project to completion. An additional \$1,349,700 was earmarked for the expansion of classroom and training facilities at Fort Ord, including a new battalion and regimental headquarters (The Californian 1952a:1 and The Californian 1952b:18). By March of 1952, another phase of the permanent army post transformation began with the construction of a guard house, stockade, warehouse, and other buildings (The Webb Spinner 1952-54, Vol 6. No. 3:1). This addition of permanent buildings continued into the late 1950s, when the Army requested \$124 million to replace all the wood World War II infrastructure at Fort Ord with concrete block and reinforced concrete (Madsen and Treffers 2019:6; San Francisco Examiner 1958:2-4). While many of the wood buildings remain today, this period saw the continuous addition of reinforced concrete permanent buildings across the Fort (Madsen and Treffers 2019:6).

Following the Korean War through the end of the conflict in Vietnam, Fort Ord served as an important training facility. In 1957, Fort Ord was designated as a U.S. Army Training Center for Infantry (Castle 1990: 4). The 7th Infantry Division was based at Fort Ord in 1975 (Cavanaugh 2000: 9). Fort Ord produced thousands of combat-ready troops during the conflict in Vietnam.

With the establishment of Fort Ord as a permanent Army base during this period, there was substantial building construction that led to the modernization of the base and its services. This development is closely related to the history of the current CSUMB campus. All the properties that are included as part of this built environment study were constructed during the Cold War and Vietnam Era period. Building development during this period was a substantial departure from the styles and materials used in the buildings constructed before World War II. Building during the period between 1946 and 1976 used reinforced concrete and concrete masonry unit (CMU). The buildings tended to be larger than those constructed in previous periods. Other development in this period included support service buildings and several types of medical buildings. Infrastructure was also improved at this time, with the introduction of paved streets and roadways, and the addition of several water tanks, water pumping plants, and warehouse buildings.

Harbor Hall, 1952-1954

Harbor Hall (46) first appears on a 1956 aerial photograph of the site in the western half, of a group of eight other similarly laid out buildings. These buildings were originally designed as new permanent barracks that were part of a \$26,650,000 construction program awarded by the military in 1952. More than \$17 million of these funds were used to construct 38, new, three-story barracks. These larger barracks were planned to house entire companies and serve all their needs in one space, with mess halls, lounges, day rooms, orderly rooms, supply rooms, and issue rooms, as well as administrative space (the Californian 1952a).

The Del Webb Construction Company won the bid for the work at Fort Ord with a low bid of

CONTINUATION SHEET

Property Name: Harbor Hall
Page 8 of 16

\$12,614,832 (The Californian 1952b: 18). Groundbreaking for the project took place on February 19, 1952. The barracks were featured in Webb's newsletter, The Webb Spinner, in the June/July/August edition. The paper touted the new military dormitories as being "sleek" (The Webb Spinner 1954:6). The buildings were a departure from the "old, white-painted barracks" constructed 12 years earlier. The new barracks were erected of steel and concrete and features large glass areas. The concrete construction was lauded as both vermin- and fire-proof (The Webb Spinner 1954:6).

After Fort Ord closed in 1994, the buildings became part of the CSUMB campus. There are no notable changes to the footprint of Harbor Hall until sometime between 2016 and 2021, when the east multi-story wing was demolished.

Del Webb Construction Company

The Del E. Webb Company was founded by Delbert Eugene Webb in Phoenix in 1928. The company grew to develop a diverse range of projects across the United States during and was known for large-scale commercial, residential, and institutional projects (Del Webb and Pulte Homes 2021:1). During World War II, the company won many military and Navy contracts for housing projects. They specialized in streamlining massive construction projects across undeveloped land.

After World War II, Webb transitioned into many emerging development markets. In the late 1940s, Webb constructed a casino/hotel in Las Vegas for Benjamin "Bugsy" Siegel. Del Webb went on to become the "largest gaming operator and private employer in Nevada" (Del Webb and Pulte Homes 2021:1). In January of 1960, the Del Webb Corporation opened a community in Phoenix, Arizona aptly named "Sun City". The community was known for its modestly priced housing and delivered a "highly desirable lifestyle." Del Webb went on to construct "Sun Cities" in Florida and Southern California (Del Webb and Pulte Homes 2021:1). The company continued to focus on gaming and commercial operations until 1987 when the decision was made to sell these interests and focus on the development of "master-planned, active adult communities" (Del Webb and Pulte Homes 2021:2). By January of 2000, the company had planned and constructed 13 Sun Cities communities, selling more than 80,000 homes. In July 2001, Del Webb Company merged with Pulte Homes Inc. to create the largest homebuilding company in the nation (Del Webb and Pulte Homes 2021:3).

Webb was the lead contractor for several prominent buildings, campuses, and institutions. These included Madison Square Garden in New York City from 1964-1968 (New York, NY) and the Los Angeles County Museum of Art in 1963-1964 (Los Angeles, CA). Several buildings constructed by the company are listed on the NRHP, including many components of the Williams Air Force Base in Arizona (two Ammo Bunkers, the Civil Engineering Maintenance Shop, the Demountable Hangar, the flagpole, the Housing Storage Supply Warehouse, and the Water Pump Station and Water Tower). Additionally, Webb was the contractor for the 1938 addition to the Arizona State Capital Building, Hunts Tomb, and the Phoenix Towers, all in Phoenix, AZ. All three buildings are all listed on the NRHP.

The Del Webb Construction Company received the contract to construct forty-two buildings at Fort Ord in February of 1952. This contract included the construction of the Hammerhead Buildings/Barracks, buildings for the regional headquarters, and regimental supplies buildings (The Web Spinner 1952-54, Vol 6. No. 3:1). The company was also awarded the contract in March of 1952 to construct a guardhouse, stockade, warehouse, and other buildings and a contract to construct the utilities, including fencing, paving, railroads, water systems, water supply and storage (including reservoirs, well houses, equipment, and a water booster pump station), gas distributing system, and sanitary and storm sewer installations. (The Web Spinner 1952-54, Vol 6. No. 4:1; The Web Spinner 1952-54, Vol 6. No. 8:1).

CONTINUATION SHEET

Property Name: Harbor Hall
 Page 9 of 16

Fort Ord Building Typology and Character-Defining Features

Four categories of building types were identified for the purposes of this study. These are the Support Services Buildings, Medical Buildings, Hammerhead Buildings/Barracks, and Recreational Buildings. The following presents a discussion of the Hammerhead Buildings/Barracks building typology, as Harbor Hall is classified in this category. This section provides a detailed account of the specific character-defining features of Fort Ord Cold War and Vietnam Era (1946-1976) Hammerhead Buildings/Barracks.

Hammerhead Buildings/Barracks

The Hammerhead Buildings/Barracks were constructed to house troops at Fort Ord as it was expanding from a semi-permanent instillation to a permanent base. In alignment with the typical planning, design, and materials of buildings constructed during this period of Fort Ord’s history, these buildings are constructed with reinforced concrete and CMU and feature flat roofs with multi-light windows with concrete sills.

Harbor Hall (46) first appears on a 1956 aerial photograph of the site on the western half of the base. It is part of a group of eight other similarly oriented buildings. No changes to the footprint were noted After Fort Ord closed in 1994, the buildings became part of the CSUMB campus. There were no notable changes to the footprint of the building until sometime between 2016 and 2018 when the east, multi-story wing was demolished on Harbor Hall.

The Hammerhead Buildings/Barracks originally exhibited the following specific character-defining features:

Character-Defining Features: The Hammerhead Buildings/Barracks

Character Aspect	Primary Character-Defining Features	Character-Defining Features
Shape and Plan	<ul style="list-style-type: none"> • Hammerhead shape • Single story wing and multi-story wing 	The overall shape and mass of the building are considered a primary character-defining feature of the Hammerhead Buildings/Barracks. The plan should include a multi-story wing.
Roof	<ul style="list-style-type: none"> • Flat roof • Wide eave overhangs • No exposed rafters 	The Hammerhead Buildings/Barracks have flat roofs, with moderate eave overhangs.
Openings	<ul style="list-style-type: none"> • Entrances on the first story • Multi-light windows 	Window openings are uniform in size and placement, windows are multi-light, and set into concrete openings. Replaced windows are not considered character-defining features as they fall outside the period of significance.
Exterior Ornamentation	<ul style="list-style-type: none"> • Minimal exterior ornamentation • Glass windows used as ornamentation 	Hammerhead Buildings/Barracks were designed to be quickly constructed. They have little to no decorative ornamentation, with windows in ribbons being the only decorative element.

CONTINUATION SHEET

Property Name: Harbor Hall
Page 10 of 16

Materials	<ul style="list-style-type: none">• Mass-produced and cost-effective materials• Concrete and CMU• Reinforced concrete construction	Hammerhead Buildings/Barracks have simple, utilitarian designs. Buildings were constructed using mass-produced and cost-effective building materials that were readily available at the time of construction. For instance, buildings under the Hammerhead type were constructed with reinforced concrete and CMU and were minimally decorated.
-----------	--	---

Alterations and demolitions over time have compromised the overall architectural integrity of this building type. The most common alterations observed for this building type include the following.

- Replacement windows
- ADA compliance measures such as ramps and doors
- HVAC systems and window units
- Infill of openings
- Interior renovations

NRHP/CRHR Designation Criteria

In consideration of the project site's history and requisite integrity, Dudek recommends the property not eligible for listing in the NRHP and CRHR based on the following significance evaluation and in consideration of national and state eligibility criteria:

Criterion A/1: That are associated with events that have made a significant contribution to the broad patterns of our history.

Harbor Hall was constructed in 1952-1954 during the period defined as the Cold War and Vietnam Eras (1946-1976) at Ford Ord. While this building is of historic age and was constructed during this important period of development in Fort Ord's history, it no longer retains enough integrity to convey its significance. One of the most notable elements of integrity that is compromised is the integrity of setting. Significant demolition, changes to circulation patterns, introduction of new buildings, and changes in use all impact the campus's ability to convey significance from its time as an active Cold War and Vietnam Era military base. The loss of this overall integrity of setting adversely affects Harbor Hall, as individual buildings are no longer able to convey their collective history. Additionally, the subdivision of Fort Ord following its closure has also greatly impacted the integrity of feeling, association, and setting of the Cold War and Vietnam Era portions of the installation. In summary, Harbor Hall, is not able to convey its association with any extraordinary events or events occurring within the context of Cold War and Vietnam military barracks, the CSUMB Campus, or has an association with the broad patterns of history in Monterey County, the State of California, or the Nation. Therefore, the building is recommended not eligible under NRHP/CRHR Criterion A/1.

Criterion B/2: That are associated with the lives of persons significant in our past.

To be found eligible under B/2 the property must be directly tied to an important person and the place where that individual conducted or produced the work for which he or she is known. Archival research failed to indicate any historical associations with people

CONTINUATION SHEET

Property Name: Harbor Hall
Page 11 of 16

important to the nation's or state's past. Due to a lack of identified significant associations with important persons in history, Dudek recommends the building is not eligible under NRHP/CRHR Criterion B/2.

Criterion C/3: That embody the distinctive characteristics of a type, period, or method of construction, or that represent the work of a master, or that possess high artistic values, or that represent a significant and distinguishable entity whose components may lack individual distinction.

No original plans or designs for the c. 1952 Barracks were discovered during archival research. Newspaper articles from 1952, announced the contract was awarded to the Del Webb Company, of Phoenix, AZ (the Californian 1952a). The Webb Company was a notable building company that completed contracts for the government, commercial clients, and private individuals during its long period operation, beginning in 1929 and continuing to the present. The Webb Company designed many distinguished buildings including many that are listed on the NRHP. While Webb may be a master builder, Harbor Hall, was constructed during a period when the Webb company was completing many other large-scale projects, many at military bases. The company received many contracts during World War II to construct barracks and other military related buildings. The buildings at Fort Ord were common contracts for the company, and they had constructed buildings of this type at other bases.

Harbor Hall is a utilitarian building, with minimal detailing, and few stylistic features. Additionally, Harbor Hall, has undergone numerous, alterations, including changes to fenestration, materials, and the demolition of the east, multi-story wing. Originally the building housed an entire infantry of troops, the remaining portion of the building is currently used for classroom space. While the building is associated with a master builder, the Del Webb Construction Company, it is not one of their more notable works. Additionally, the building lacks high artistic value, and has undergone substantial alterations, including the demolition of more than half the building. For these reasons Harbor Hall is recommended not eligible under NRHP/CRHR Criterion C/3.

Criterion D/4: That have yielded, or may be likely to yield, information important in prehistory or history.

There is no evidence to suggest that this property has the potential to yield information important to state or local history. Therefore, Harbor Hall is recommended not eligible under NRHP/CRHR Criterion D/4.

California Historic Landmark Statement of Significance

In consideration of Harbor Hall's history and requisite integrity, Dudek recommends the property not eligible for designation as a California Historic Landmark based on the following significance evaluation and in consideration of state eligibility criteria:

The first, last, only, or most significant of its type in the state or within a large geographic region (Northern, Central, or Southern California).

Harbor Hall was constructed between 1952-1954. The building, along with at least 38 other barracks, were constructed during the fort's transition to a permanent base during the Cold War and Vietnam Eras (1946-1976) at Ford Ord. The buildings were constructed during the fort's transition to a permanent base. The building is a utilitarian building type that lacks high style components to set it apart from other buildings constructed throughout the State of California in the 1950s. Harbor Hall was constructed by Del Webb Company, a company based in Phoenix Arizona. The building is a utilitarian building type that lacks high style components to set it apart from other buildings constructed throughout the State of California in the 1950s.

Associated with an individual or group having a profound influence on the history of California.

CONTINUATION SHEET

Property Name: Harbor Hall
Page 12 of 16

Harbor Hall was originally constructed to be one of Fort Ord's barracks, one of 38 such buildings to provide a housing for military personnel. The Del Webb Construction Company, a notable Phoenix, Arizona based company, was responsible for the construction of the building. While Harbor Hall is associated with a master builder with many known projects completed in California, this building is not one of the company's notable works. No other individuals are known to have influenced the construction or use of this building. Therefore, Dudek recommends Harbor Hall is not eligible for listing as a CHL under this criterion.

A prototype of, or an outstanding example of, a period, style, architectural movement or construction or is one of the more notable works or the best surviving work in a region of a pioneer architect, designer or master builder.

Harbor Hall is neither a prototype or an outstanding example of a period, style, or architectural movement. It is a typical example of a utilitarian design. The building was designed to serve a utilitarian purpose for the military at Fort Ord. There are no identifying features on Harbor Hall that would establish the connection to the notable work of the Del Webb Construction Company in the State of California. Additionally, Harbor Hall has been substantially altered and the large multi-story wing demolished making it unable to sufficiently convey its temporal period or its historic context. Therefore, the subject property is recommended not eligible for listing as a CHL under this criterion.

Local Designation Criteria

Portions of the CSUMB campus are located within the boundaries of two cities, City of Seaside and the City of Marina, both of which evaluate historical resources in accordance with CEQA Guidelines. as presented above. The subject property, as discussed in the NRHP/CRHR/CHL criteria discussion above, does not rise to the necessary level of significance for local, state, or national designation. For these reasons, the subject property is recommended not eligible individually or as a component of a historic district under any of the NRHP/CRHR/CHL criteria.

Additionally, portions of the CSUMB campus are located in the County of Monterey and the campus is therefore subject to the regulations set forth in Chapter 18.25 of the Monterey County Code. The subject property, as discussed in the NRHP/CRHR/CHL criteria discussion above, does not rise to the necessary level of significance for state or national designation. For these same reasons, the subject property is also recommended not eligible individually or as a component of a historic district under any of the delineated County of Monterey review criteria categories that are addressed with the NRHP/CRHR/CHL criteria discussed above: A. Historical and Cultural Significance; B. Historic, Architectural, and Engineering Significance; or C. Community and Geographic Setting.

Integrity Discussion

Harbor Hall was analyzed against the seven aspects of integrity: location, design, setting, materials, workmanship, feeling, and association. The building retains its integrity of location, as it has not been relocated. The building was designed with minimal elements reflecting an architectural style. Some of the features reflecting the original design, most notably the windows and the demolition of the multi-story wing, have been lost, and the overall integrity of design has been diminished. The integrity of setting has been diminished as with the change in use from its original use as barracks at Fort Ord to a classroom building for CSUMB. Therefore, the integrity of setting has been lost. Some of the original materials appear to be intact, but the demolition of the multi-story wing and changes to original fenestration has diminished the integrity of materials. The techniques used in the construction of Harbor Hall are still apparent, with the CMU construction and concrete, accordingly the building has retained some integrity of workmanship. The exterior of Harbor Hall no longer conveys its original

CONTINUATION SHEET

Property Name: Harbor Hall

Page 13 of 16

use. Therefore, the integrity of feeling has been lost. As Harbor Hall does not possess historic significance, there is no historic association. The building does not possess adequate integrity to convey significance.

Summary of Evaluation Findings

Harbor Hall retains a diminished level of historic integrity and lacks historical and architectural significance. Based on the significance evaluations presented above, Harbor Hall does not appear to meet the NRHP, CRHR, CHL or local designation criteria. Therefore, Harbor Hall is not considered a historical resource for purposes of CEQA.

CONTINUATION SHEET

Property Name: Harbor Hall
Page 14 of 16

*B12. References (continued):

- ACHP (Advisory Council on Historic Preservation). 2006. "Draft Program Comment Regarding Cold War Era Unaccompanied Personnel Housing." Federal Register: The Daily Journal of the United States Government. 12 April 2016. Accessed June 30, 2021 Available at: <https://www.federalregister.gov/documents/2006/04/12/06-3509/draft-program-comment-regarding-cold-war-era-unaccompanied-personnel-housing>
- Californian, The. 1940. "No More Camp Ord! It's Fort Ord Now! Stilwell in Command: Headquarters of General Located on Salinas Side." July 13, 1940. Salinas, California, pg. 1.
- Californian, The. 1951. Stadium Field House—Sixth Army Lets Ord Contract. March 20, 1951. P1. Accessed June 17, 2021. Available at: Newspapers.com.
- Castle, Ted. 1990. "The March of Time." Fort Ord Panorama. September 21, 1990.
- Cavanaugh, Joe. 2000. *The Peace Dividend: Defense Conversion Through Higher Education*. The Leon Panetta Institute.
- Chamberlin Library. 2021. Fort Ord Working Papers. CSUMB Special Collections Box 6.42-01. Available at the Chamberlin Library, Seaside, California.
- CSUMB Facilities. 2021. Original As built and renovation architectural drawings on file with CSUMB facilities department. Accessed in person June 15-16, 2021.
- Del Webb and Pulte Homes 2021. Del Webb History. Accessed July 9, 2021. Available at: http://media.corporate-ir.net/media_files/irol/14/147717/DelWebb/DelWebbHistory.pdf
- DLIFLC (Defense Language Institute Foreign Language Center). 2021. Command History Program. Accessed in person on June 15, 2021 and accessed online database collection online July 2021. Available at: <https://adli.pastperfectonline.com/>
- EA Engineering. 1991. Draft Final Fort Ord, California Base wide Remedial Investigation Feasibility Study. Volume 1 Literature Review and Base Inventory Report. Accessed on July 13, 2021. Available at: <https://www.fortordcleanup.com/documents/search/>
- Fresno Bee, The. 1951a. "Army Spokesman Are Defending Building of Fort Ord Stadium." January 12, 1951. Page 13. Accessed June 17, 2021.
- Fresno Bee, The. 1951b. "Army Spokesman Are Defending Building of Fort Ord Stadium." February 4, 1951. Page 27. Accessed June 17, 2021. Available at: Newspapers.com.
- Gates, S., & Williams, H. 1957. The Armed Forces. The Annals of the American Academy of Political and Social Science, 313, 99-104. Accessed June 17, 2021. <http://proxy.multcolib.org:2052/stable/1031762>

CONTINUATION SHEET

Property Name: Harbor Hall
Page 15 of 16

- MacGregor Jr., Morris J. 1981. *Integration of the Armed Forces, 1940-1965*. Center of Military History, United States Army: Washington, D.C.
- Madsen, Alexandra and Steven Treffers. 2019. *Historic Resources Evaluation Memorandum for Hammerhead Barracks at Fort Ord, Monterey County, California*. Prepared by Rincon Consultants, Inc for City of Seaside, Community and Economic Development Department. November 4, 2019. Accessed June 28, 2021.
https://www.ci.seaside.ca.us/DocumentCenter/View/10674/9_App-S---HRE-Memo
- Military Museum. 2016. "Historic California Posts, Camps, Stations, and Airfields: Fort Ord." Accessed on June 19, 2021. <http://www.militarymuseum.org/FtOrd.html>
- National Archives Foundation. 2021. Executive Order 9981. Accessed June 29, 2021. Available at: <https://www.archivesfoundation.org/documents/executive-order-9981-ending-segregation-armed-forces/>
- NETR (Nationwide Environmental Title Research LLC). 2021. Historic Aerial Photographs of 100 Campus Center, Seaside, CA 93955 dating from 1956, 1968, 1981, 1998, 2005, 2009, 2010, 2012, 2014, 2016, and 2018. Accessed June 10, 2021.
<https://www.historicaerials.com/viewer>
- Panorama. 1990. "50 Years and Counting..." September 21, 1990, pg. 2.
- Panorama. n.d. "Ford Ord in World War II." Historic California Posts: Fort Ord. Accessed on June 19, 2021. <http://www.militarymuseum.org/FtOrd.html>
- Park, R. 2015. "Happy and Cheerful in This Fine Camp": Sports, Recreation, and the United States Army at Fort Ord and Camp Roberts, 1940 to 1945. *Journal of Sport History*, 42(1), 21-37. Accessed on June 18, 2021, from
<https://www.jstor.org/stable/10.5406/jsporthistory.42.1.21>
- Pomona Progress Bulletin. 1950. War Solving Racial Problems. August 24, 1950. Page 4. Accessed June 29, 2021. Available at: [Newspapers.com](http://www.newspapers.com).
- Quartermaster Review, The. 1940. "Army Construction Underway at Camp Ord, California." Volume XX. No 3. November-December. On file at the Chamberlin Library, Ord Military Community.
- Raugh, Harold E. 2004. Fort Ord. Charleston, SC: Arcadia.
- Salinas Morning Post. 1940. "\$2,766,000 in Building Authorized—Ord Contracts Let." August 21, 1940. Salinas, CA. pg. 1.
- San Francisco Examiner. 1951. Fort Ord Will Get Stadium. San Francisco Page 4. . 3 Feb 1951. Pages 1 and 4 A Available on [www.Newspapers.com](http://www.newspapers.com). Accessed on Jun 11, 2021.
- San Francisco Examiner. 1958. Army Asks OK on \$124,000,000 for Fort Ord Buildings. San Francisco. Section 2. Page. 4. Available on [www.Newspapers.com](http://www.newspapers.com). Accessed July 18, 2021.

CONTINUATION SHEET

Property Name: Harbor Hall

Page 16 of 16

Vasche, J. Burton. 1959. "The California State Colleges: Their History, Organization, Purposes, and Programs." in California

U.S. Army. 1977. Post Map Main Garrison Area. Fort Ord, California. Drawing number G-950. Accessed in person at the Chamberlain Library on June 15, 2021.

Walch, Bob. 2004. An Army Historian's Pictorial Take on Fort Ord. Monterey County NOW. Accessed July 12, 2021. Available at:
https://www.montereycountyweekly.com/news/local_news/an-army-historian-s-pictorial-take-on-fort-ord/article_6e8b0250-9c38-5ca4-a4a4-f93d42d65a11.html

Whaley, Derek. 2015. "East Monterey & Seaside." Santa Cruz Trains: Railroads of the Monterey Bay Area. July 20, 2015. Accessed online:
<https://www.santacruztrains.com/2015/07/east-monterey-seaside.html>.

Webb Spinner, The. 1952-1954. Webb Spinner Volume for 1952-1954. Del Webb Sun Cities Museum Collection. Accessed June 30, 2021. Accessed at:
<https://delwebbsuncitiesmuseum.org/newsletters-webb-spinners/>

State of California & The Resources Agency
DEPARTMENT OF PARKS AND RECREATION
PRIMARY RECORD

Primary #
HRI #
Trinomial
NRHP Status Code 6Z

Other Listings
Review Code

Reviewer

Date

Page 1 of 14 *Resource Name or #: (Assigned by recorder) Green Hall

P1. Other Identifier: CSUMB Building 58

*P2. Location: Not for Publication Unrestricted

*a. County Monterey County and (P2c, P2e, and P2b or P2d. Attach a Location Map as necessary.)

*b. USGS 7.5' Quad Marina, CA Date 1995 T 15S; R 2E; NE ¼ of SW ¼ of Sec 6; Mount Diablo B.M.

c. Address 4598 7th Avenue Seaside Zip 93955

d. UTM: (Give more than one for large and/or linear resources) Zone 10S, 608100 mE/ 4056957 mN

e. Other Locational Data: (e.g., parcel #, directions to resource, elevation, decimal degrees, etc., as appropriate)

Green Hall sits south of A Street, west of 7th Avenue.

*P3a. Description: (Describe resource and its major elements. Include design, materials, condition, alterations, size, setting, and boundaries)

Green Hall (CSUMB Building 58) is a one-story utilitarian building with a rectangular floor plan and a concrete block structural system. The north-facing main elevation is symmetrical. It is covered by a moderately pitched side-gabled roof clad with composition shingles. The main entrance is located centrally and is flanked by two squared projections. The main entrance consists of a single metal-framed, half-glazed door topped with a transom. Secondary doors are located to the far east and west ends of the main elevation and appear to have been sealed off as doorknobs have been removed.

See Continuation Sheet

*P3b. Resource Attributes: (List attributes and codes) HP15. Educational building/HP34 Military property

P5a. Photograph or Drawing (Photograph required for buildings, structures, and objects.)



*P4. Resources Present: Building

Structure Object Site District Element of District Other (Isolates, etc.)

P5b. Description of Photo: (view, date, accession #) north elevation, view to the southeast, Dudek (IMG 0566)

*P6. Date Constructed/Age and Source: Historic Prehistoric Both 1953 (CSUMB Facilities)

*P7. Owner and Address:

CSUMB
100 Campus Center
Seaside, CA. 93955

*P8. Recorded by: (Name, affiliation, and address) Sarah Corder

Dudek
725 Front St #400
Santa Cruz, CA 95060

*P9. Date Recorded: 6/14/2021

*P10. Survey Type: (Describe)
Intensive level

*P11. Report Citation: (Cite survey report and other sources or enter none)

Dudek 2021. Built Environment Inventory and Evaluation Report for California State University, Monterey

*Attachments: NONE Location Map Continuation Sheet Building, Structure, and Object Record

Archaeological Record District Record Linear Feature Record Milling Station Record Rock Art Record

Artifact Record Photograph Record Other (List): _____

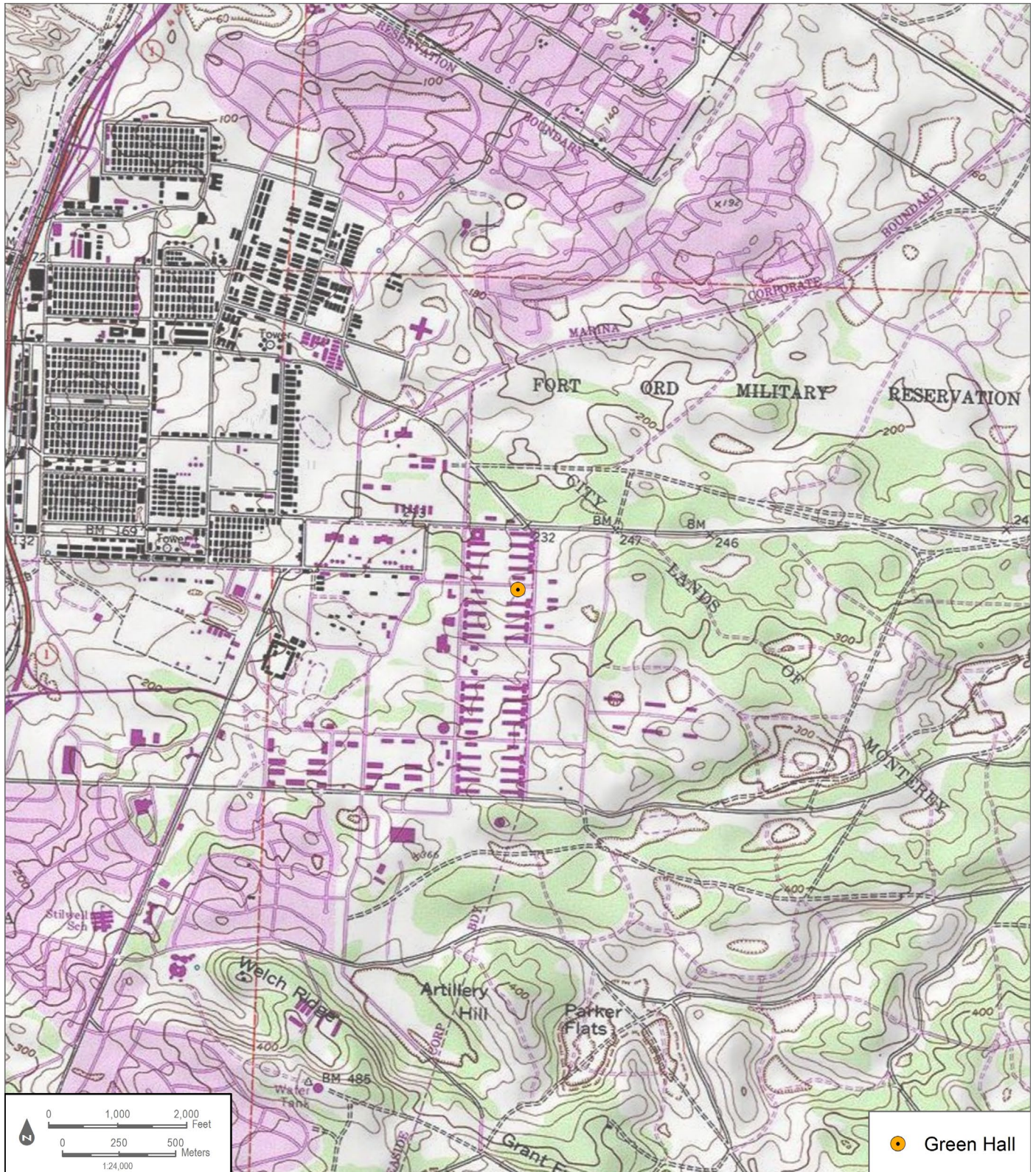

BUILDING, STRUCTURE, AND OBJECT RECORD

*Resource Name or # (Assigned by recorder) Green Hall *NRHP Status Code 6Z
Page 3 of 14

B1. Historic Name: Permanent Troop Spaces and Support Facilities Classroom
B2. Common Name: Green Hall (CSUMB Building 58)
B3. Original Use: Educational building 4. Present Use: Classroom

*B5. Architectural Style: Utilitarian

*B6. Construction History: (Construction date, alterations, and date of alterations)
Designed in 1953 and completed in 1954, Green Hall has undergone several alterations. As-built drawings show alterations to the building took place in 1995. Changes include the replacement of original windows on the south elevation (CSUMB Facilities 2021).

*B7. Moved? No Yes Unknown Date: _____ Original Location: _____ *B8. Related Features:

B9a. Architect: Robert Stanton b. Builder: Unknown

*B10. Significance: Theme N/A Area N/A
Period of Significance N/A Property Type N/A Applicable Criteria N/A

(Discuss importance in terms of historical or architectural context as defined by theme, period, and geographic scope. Also address integrity.)

See Continuation Sheet.

B11. Additional Resource Attributes: (List attributes and codes) _____

*B12. References: See Continuation Sheet.

B13. Remarks:

*B14. Evaluator: Laura Carias, MA

*Date of Evaluation: July 20, 2021

(This space reserved for official comments.)

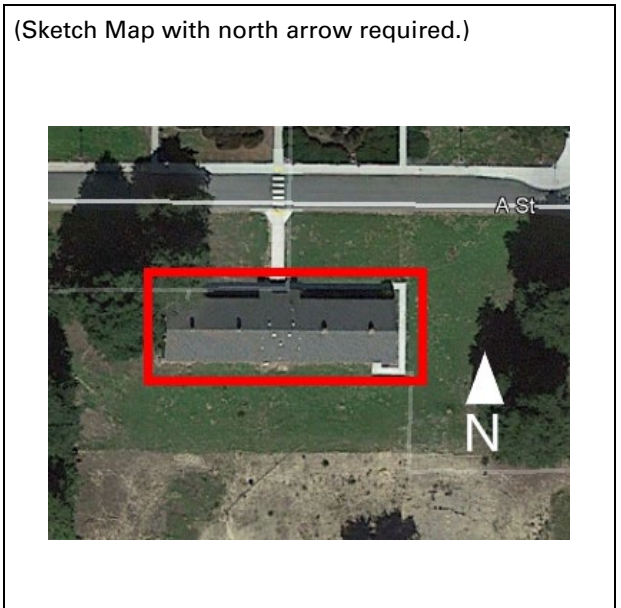

CONTINUATION SHEET

Property Name: Green Hall

Page 4 of 14

*P3a. Description (continued):

Windows are metal-framed, multi-light awning windows. A single column of cinderblocks is located between every other window on the main and rear south elevation. The fenestration pattern is repeated on the rear elevation. Two central windows have been replaced with recently added windows. Alterations include the sealing doors shut and replacement windows at the rear elevation.



Figure 1. Main (north) elevation, looking southeast (IMG_0566)



Figure 2. South elevation, looking northwest (IMG_0576)

Alterations:

- Replacement windows at rear elevation (1995)
- Replacement Roof (2005)

CONTINUATION SHEET

Property Name: Green Hall

Page 5 of 14

*B10. Significance (continued):

Historical Overview of Fort Ord

The history of Fort Ord has been extensively documented in newspaper articles, websites, academic journals, and books. From its creation in 1917 to its closure in 1994, the base grew to become one of the largest training centers in the country. Its location was also reported to be the most attractive U.S. Army post, with easy access to the ocean and beautiful California weather.

The development periods in the history of Fort Ord were defined by Harold E. Raugh, Jr, a U.S. Army lieutenant colonel and historian with the Department of Defense. Since his retirement, Raugh served as the Chief Historian, for the Defense Logistics Agency, for the Department of Defense and, from 2006-2013, Raugh served as the Command Historian at the Defense Language Institute Foreign Language Center (DLIFLC) and the Presidio of Monterey, California. He received his PhD in history from the University of California, Los Angeles (Walch 2004). Raugh has authored numerous books including, *Fort Ord* (2004); *Presidio of Monterey* (2004); *Operation Joint Endeavor: V Corps in Bosnia-Herzegovina, 1995-1996* (2013); *The Raugh Bibliography of the Indian Mutiny 1857-1859* (2016); and *Wavell in the Middle East, 1939-1941: A study in Generalship*. Raugh defined four periods for the historic development of Fort Ord:

- 1917-1940 Camp Gigling to Camp Ord
- 1940-1945 Fort Ord and the 7th Infantry Division
- 1946-1976 The Cold War and Vietnam Eras
- 1974-1994 The Volunteer Army

These periods correspond to distinct eras in the history of the base and the U.S. Army (Raugh 2004: ii).

The full historic context of Fort Ord is represented in the report, *Built Environment Inventory and Evaluation Report for California State University, Monterey Bay* (Dudek 2021). The following presents only relevant historical and building typology information pertaining to the development of Green Hall.

Cold War and Vietnam Eras at Fort Ord (1946-1976)

This period of development between 1946 and 1976 was characterized by a massive operation to move the base out of its semi-permanent status and create a permanent outpost for active military personnel who were retained due to ongoing foreign conflicts.

In July of 1948, Harry S Truman signed Executive Order 9981, which officially ended segregation in the armed forces. The order stated that "there shall be equality of treatment and opportunity for all persons in the armed forces without regard to race, color, religion, or national origin" (National Archives Foundation 2021). Fort Ord became one of the first integrated training divisions in the United States. The Fort was touted as "pioneering to end all segregation" (The Pomona Progress Bulletin 1950: 4). In 1950, the Pomona Progress Bulletin reported that black and white soldiers at Fort Ord were "fighting side by side" and all the enlistees "trained together, slept in the same barracks, and eat the same messes" (The Pomona Progress Bulletin 1950: 4).

The end of World War II in 1945 did not bring lasting peace. The tenuous relationship between dominant nations in the communist East and free market West led to the beginning of the Cold War. The Department of Defense maintained a robust fighting force during the Cold War, with more than 900,000 Army personnel retained during the 1950s (ACHP 2006). The

CONTINUATION SHEET

Property Name: Green Hall

Page 6 of 14

ongoing global tensions and the number of active U.S. military personnel created a need for new permanent buildings and expanded military housing at Fort Ord.

In 1949, the Soviet-supported communist government of North Korea invaded American-supported South Korea, initiating the Korean War. Fort Ord was a primary staging area for the training of troops departing for the war (Castle 1990:3). By the 1950s, Fort Ord had become one of the largest basic training camps in the United States. In 1952, the military began a multi-million dollar building program to transform Fort Ord into a permanent post, including the development of permanent troop housing, and the construction of a guard house, stockade, and multiple warehouses. In January of 1952, military authorities announced the new construction program at Fort Ord was underway, with an estimated cost of \$26,650,600. More than half of the funds that were approved by Congress were "earmarked for new permanent troop housing" for more than 7,000 soldiers (The Webb Spinner 1952-54, Vol 6. No. 3:1).

The new troop housing was to be constructed of reinforced concrete, a departure from the wood buildings constructed before and during World War II. The plan called for three types of massive barracks, twenty-two were to house 225 enlisted men each, seven were to accommodate 165 men each, and nine were to house 105 men each (The Webb Spinner 1952-54, Vol 6. No. 3:3). The San Francisco District of the U.S. Army Corps of Engineers oversaw the construction project to completion. An additional \$1,349,700 was earmarked for the expansion of classroom and training facilities at Fort Ord, including a new battalion and regimental headquarters (The Californian 1952a:1 and The Californian 1952b:18). By March of 1952, another phase of the permanent army post transformation began with the construction of a guard house, stockade, warehouse, and other buildings (The Webb Spinner 1952-54, Vol 6. No. 3:1). This addition of permanent buildings continued into the late 1950s, when the Army requested \$124 million to replace all the wood World War II infrastructure at Fort Ord with concrete block and reinforced concrete (Madsen and Treffers 2019:6; San Francisco Examiner 1958:2-4). While many of the wood buildings remain today, this period saw the continuous addition of reinforced concrete permanent buildings across the Fort (Madsen and Treffers 2019:6).

Following the Korean War through the end of the conflict in Vietnam, Fort Ord served as an important training facility. In 1957, Fort Ord was designated as a U.S. Army Training Center for Infantry (Castle 1990: 4). The 7th Infantry Division was based at Fort Ord in 1975 (Cavanaugh 2000: 9). Fort Ord produced thousands of combat-ready troops during the conflict in Vietnam.

With the establishment of Fort Ord as a permanent Army base during this period, there was substantial building construction that led to the modernization of the base and its services. This development is closely related to the history of the current CSUMB campus. All the properties that are included as part of this built environment study were constructed during the Cold War and Vietnam Era period. Building development during this period was a substantial departure from the styles and materials used in the buildings constructed before World War II. Building during the period between 1946 and 1976 used reinforced concrete and concrete masonry unit (CMU). The buildings tended to be larger than those constructed in previous periods. Other development in this period included support service buildings and several types of medical buildings. Infrastructure was also improved at this time, with the introduction of paved streets and roadways, and the addition of several water tanks, water pumping plants, and warehouse buildings.

Green Hall, 1954

Constructed in 1954, Green Hall (58) was designed by Robert Stanton, Monterey Bay architect (CSUMB Facilities 2021). It was one of several identical buildings described as "permanent troop spaces and supporting facilities/classrooms" designed for Fort Ord (CSUMB Facilities 2021). It first appears on a 1956 aerial photograph as a long, rectangular plan, gable-ended building on the south side of A Street (UCSB 2021). The

CONTINUATION SHEET

Property Name: Green Hall

Page 7 of 14

entrance faces north to A Street and is accessed by a formal path from the A Street sidewalk. It is surrounded on all sides by lawn. Replacement windows were installed during a 1995 renovation. The roof was replaced in 2005.

Robert Stanton

Robert Stanton was born in Detroit, Michigan in 1900. He served briefly in the U.S. Navy during World War I and then graduated from high school in Los Angeles and went on to complete his education at University of California at Berkeley. After graduation he worked with renowned architect, Wallace Neff. Neff appointed Stanton as project supervisor on several projects and Stanton earned his architecture license in 1934. Stanton moved to Monterey Bay in 1935 and went on to design a variety of residential, commercial, and public buildings in the area. Two of his buildings, the Monterey County Courthouse and the King City High School Auditorium have been listed on the NRHP (Hiller 2007:8-4). Robert Stanton was known to have designed a plan for classroom buildings at Fort Ord that was used for at least four buildings on campus (CSUMB Facilities 2021).

Fort Ord Building Typology and Character-Defining Features

Four categories of building types were identified for the purposes of this study. These are the Support Services Buildings, Medical Buildings, Hammerhead Buildings/Barracks, and Recreational Buildings. The following presents a discussion of the Support Services building typology, as Green Hall (58) is classified in this category. This section provides a detailed account of the specific character-defining features of Fort Ord Cold War and Vietnam Era (1946-1976) Support Services buildings.

Support Services Buildings

Support Services Buildings constructed during the Cold War and Vietnam Eras (1946-1976) at Fort Ord have a variety of uses and functions that changed over the history of the base. The buildings tended to have central entryways that opened into hallways, with classrooms lining the halls. In alignment with the typical planning, design, and materials of buildings from this period of Fort Ord's history, these buildings are constructed with reinforced concrete and CMU and feature gable roofs with multi-light windows with concrete sills. These buildings have a uniform design, like many of the other buildings at Fort Ord.

After Fort Ord closed in 1994, these support services buildings became part of the CSUMB campus. With the shift to campus use, many of the buildings were altered to fit the needs of CSUMB. No changes to the plan of Green Hall were noted.

Character-Defining Features for the Support Services Buildings

The Support Services Buildings originally exhibited the following specific character-defining features:

Character-Defining Features: Fort Ord Support Services Buildings

Character Aspect	Primary Character-Defining Features	Character-defining features
Shape and Plan	<ul style="list-style-type: none">Simple rectangular formSingle story	The overall shape and mass of the building are considered a primary character-defining feature of the support services buildings. The plan should be rectangular in form.

CONTINUATION SHEET

Property Name: Green Hall

Page 8 of 14

Roof	<ul style="list-style-type: none"> Flat or gable roof small eave overhangs No exposed rafters 	Support service buildings from this period have gable roof forms, with slight eave overhangs.
Openings	<ul style="list-style-type: none"> Public entrances and circulation patterns 	Window openings are generally uniform in size and placement, windows are multi-light, and set into concrete openings. Replaced windows are not considered character-defining features as they fall outside the period of significance.
Exterior Ornamentation	<ul style="list-style-type: none"> Minimal exterior ornamentation 	The support services buildings were designed to be quickly constructed. They have little to no decorative ornamentation, with windows being set evenly apart and CMU pillars being the only decorative element.
Materials	<ul style="list-style-type: none"> Mass-produced and cost-effective materials Concrete and CMU Reinforced Concrete construction 	The support services buildings have simple, utilitarian designs. Buildings were constructed using mass-produced and cost-effective building materials that were readily available at the time of construction. For instance, buildings under the support services buildings type were constructed with reinforced concrete and CMU and were minimally decorated.

Alterations and demolitions over time have compromised the overall architectural integrity of this building type. The most common alterations observed for this building type include the following.

- Replacement windows
- ADA compliance measures such as ramps and doors
- HVAC systems and window units
- Infill of openings
- Addition of front gable over doorways
- Interior renovations

NRHP/CRHR Designation Criteria

In consideration of the project site's history and requisite integrity, Dudek recommends the building not eligible for listing in the NRHP and CRHR based on the following significance evaluation and in consideration of national and state eligibility criteria:

Criterion A/1: That are associated with events that have made a significant contribution to the broad patterns of our history.

Green Hall was constructed in 1951 during the period defined as the Cold War and Vietnam Eras (1946-1976) at Ford Ord. While this building is of historic age and was constructed during an important period of development in Fort Ord's history, it no longer retains enough integrity to convey its significance. One of the most notable elements of integrity that is compromised is the integrity of setting. Significant demolition, changes to circulation patterns, introduction of new buildings, and changes in use, all impact the campus's ability to convey significance from its time as an active Cold War and Vietnam Era military base. The loss of this overall integrity of setting adversely effects Green

CONTINUATION SHEET

Property Name: Green Hall

Page 9 of 14

Hall, as individual buildings are no longer able to convey their collective history. Additionally, the subdivision of Fort Ord following its closure has also greatly impacted the integrity of feeling, association, and setting of the remaining Cold War and Vietnam Era buildings. Green Hall is not able to convey its association with any extraordinary events or events occurring within the context of Cold War and Vietnam military support service buildings, the CSUMB Campus, or has an association with the broad patterns of history in Monterey County, the State of California, or the Nation. Therefore, the building is recommended not eligible under NRHP/CRHR Criterion A/1.

Criterion B/2: That are associated with the lives of persons significant in our past.

To be found eligible under B/2 the building must be directly tied to an important person and the place where that individual conducted or produced the work for which he or she is known. Archival research found no significant or influential directly associated with the building. As such this building is not known to have any historical associations with people important to the nation's or state's past. Due to a lack of identified significant associations with important persons in history, Dudek recommends the building is not eligible under NRHP/CRHR Criterion B/2.

Criterion C/3: That embody the distinctive characteristics of a type, period, or method of construction, or that represent the work of a master, or that possess high artistic values, or that represent a significant and distinguishable entity whose components may lack individual distinction.

Archival research indicates that Green Hall was constructed in 1954 as one of several classroom/support buildings for Fort Ord. Although designed by architect, Robert Stanton, the building was not constructed in any obvious architectural style. The building is a ubiquitous building type that lacks high style components to set it apart from other buildings constructed in the 1950s. No further information on Stanton was identified during archival research. The building has been altered with the replacement of many of the original windows. Due to a lack of high artistic value, a lack of evidence suggesting this is a notable work of the Robert Stanton Firm, Dudek recommends the building is not eligible under NRHP/CRHR Criterion C/3.

Criterion D/4: That have yielded, or may be likely to yield, information important in prehistory or history.

There is no evidence to suggest that Green Hall has the potential to yield information important to state or local history. Therefore, Dudek recommends the building is not eligible under NRHP/CRHR Criterion D/4.

California Historic Landmark Statement of Significance

In consideration of Green Hall's history and requisite integrity, Dudek recommends the building not eligible for designation as a California Historic Landmark based on the following significance evaluation and in consideration of state eligibility criteria:

The first, last, only, or most significant of its type in the state or within a large geographic region (Northern, Central, or Southern California).

Green Hall was designed in 1953 and constructed in 1954. The building was constructed during the Cold War and Vietnam Eras (1946-1976) at Fort Ord. Green Hall was designed by Robert Stanton. The building is a ubiquitous building type that lacks high style components to set it apart from other utilitarian buildings constructed throughout the State of California in the 1950s. Therefore, Dudek recommends the building is not eligible for listing as a CHL under this criterion.

CONTINUATION SHEET

Property Name: Green Hall

Page 10 of 14

Associated with an individual or group having a profound influence on the history of California.

Archival research failed to indicate any significant associations between the Green Hall and individuals or groups that profoundly influenced the history of California. Green Hall was one of several support/classroom buildings constructed on site. Robert Stanton was found to be the architect responsible for the design, but the utilitarian building does not reflect a remarkable design of his. No other individuals are known to have influenced the construction or use of this building. Therefore, Dudek recommends the building is not eligible for listing as a CHL under this criterion.

A prototype of, or an outstanding example of, a period, style, architectural movement or construction or is one of the more notable works or the best surviving work in a region of a pioneer architect, designer or master builder.

Green Hall is neither a prototype or an outstanding example of a period, style, or architectural movement. The building was designed to serve a utilitarian purpose. There are no identifying features on Green Hall that would establish the building as a notable work of a master architect, or a notable designer or builder working within the military, or in the State of California. Therefore, Dudek recommends the building is not eligible for listing as a CHL under this criterion.

Local Designation Criteria

Portions of the CSUMB campus are located within the boundaries of two cities, City of Seaside and the City of Marina, both of which evaluate historical resources in accordance with CEQA Guidelines. as presented above. The subject property, as discussed in the NRHP/CRHR/CHL criteria discussion above, does not rise to the necessary level of significance for local, state, or national designation. For these reasons, the subject property is recommended not eligible individually or as a component of a historic district under any of the NRHP/CRHR/CHL criteria.

Additionally, portions of the CSUMB campus are also located in the County of Monterey and it is therefore subject to the regulations set forth in Chapter 18.25 of the Monterey County Code. The subject property, as discussed in the NRHP/CRHR/CHL criteria discussion above, does not rise to the necessary level of significance for state or national designation. For these same reasons, the subject property is also recommended not eligible individually or as a component of a historic district under any of the delineated County of Monterey review criteria categories that are addressed with the NRHP/CRHR/CHL criteria discussed above: A. Historical and Cultural Significance; B. Historic, Architectural, and Engineering Significance; or C. Community and Geographic Setting.

Integrity Discussion

Green Hall was analyzed against the seven aspects of integrity: location, design, setting, materials, workmanship, feeling, and association. The building retains its integrity of location, as it has not been relocated. However, the integrity of setting has been compromised with the demolition of adjacent buildings, new constructions, and changes in paths of circulation throughout the campus. This change of use, from a Cold War and Vietnam Era military support services building to a classroom building for CSUMB adversely effects the integrity of setting. A few windows have been replaced and a door closed off since its completion in 1954. These alterations have compromised the resource's integrity of design, materials, and workmanship. As a result, the integrity of feeling is not intact, as the building is unable to convey the feeling of a 1950s military support services building. As the building does not possess historic significance, there is no historic association. While the building is in good condition, it does not possess integrity to convey significance or its temporal period.

CONTINUATION SHEET

Property Name: Green Hall

Page 11 of 14

Summary of Evaluation Findings

Green Hall retains little historic integrity and lacks historical and architectural significance. Based on the significance evaluations presented above, Green Hall does not appear to meet the NRHP, CRHR, CHL or local designation criteria. Therefore, Green Hall is not considered a historical resource for purposes of CEQA.

CONTINUATION SHEET

Property Name: Green Hall

Page 12 of 14

*B12. References (continued):

- ACHP (Advisory Council on Historic Preservation). 2006. "Draft Program Comment Regarding Cold War Era Unaccompanied Personnel Housing." Federal Register: The Daily Journal of the United States Government. 12 April 2016. Accessed June 30, 2021 Available at: <https://www.federalregister.gov/documents/2006/04/12/06-3509/draft-program-comment-regarding-cold-war-era-unaccompanied-personnel-housing>
- Californian, The. 1940. "No More Camp Ord! It's Fort Ord Now! Stilwell in Command: Headquarters of General Located on Salinas Side." July 13, 1940. Salinas, California, pg. 1.
- Californian, The. 1951. Stadium Field House—Sixth Army Lets Ord Contract. March 20, 1951. P1. Accessed June 17, 2021. Available at: Newspapers.com.
- Castle, Ted. 1990. "The March of Time." Fort Ord Panorama. September 21, 1990.
- Cavanaugh, Joe. 2000. *The Peace Dividend: Defense Conversion Through Higher Education*. The Leon Panetta Institute.
- Chamberlin Library. 2021. Fort Ord Working Papers. CSUMB Special Collections Box 6.42-01. Available at the Chamberlin Library, Seaside, California.
- CSUMB Facilities. 2021. Original As built and renovation architectural drawings on file with CSUMB facilities department. Accessed in person June 15-16, 2021.
- DLIFLC (Defense Language Institute Foreign Language Center). 2021. Command History Program. Accessed in person on June 15, 2021 and accessed online database collection online July 2021. Available at: <https://adli.pastperfectonline.com/>
- EA Engineering. 1991. Draft Final Fort Ord, California Base wide Remedial Investigation Feasibility Study. Volume 1 Literature Review and Base Inventory Report. Accessed on July 13, 2021. Available at: <https://www.fortordcleanup.com/documents/search/>
- Fresno Bee, The. 1951a. "Army Spokesman Are Defending Building of Fort Ord Stadium." January 12, 1951. Page 13. Accessed June 17, 2021.
- Fresno Bee, The. 1951b. "Army Spokesman Are Defending Building of Fort Ord Stadium." February 4, 1951. Page 27. Accessed June 17, 2021. Available at: Newspapers.com.
- Gates, S., & Williams, H. 1957. The Armed Forces. The Annals of the American Academy of Political and Social Science, 313, 99-104. Accessed June 17, 2021. <http://proxy.multcolib.org:2052/stable/1031762>
- Hiller, Peter. 2007. NRHP Nomination Form. Monterey County Court House. National Parks Service. Accessed July 18, 2021. Available at: https://npgallery.nps.gov/NRHP/GetAsset/NRHP/08000878_text

CONTINUATION SHEET

Property Name: Green Hall

Page 13 of 14

- MacGregor Jr., Morris J. 1981. *Integration of the Armed Forces, 1940-1965*. Center of Military History, United States Army: Washington, D.C.
- Madsen, Alexandra and Steven Treffers. 2019. *Historic Resources Evaluation Memorandum for Hammerhead Barracks at Fort Ord, Monterey County, California*. Prepared by Rincon Consultants, Inc for City of Seaside, Community and Economic Development Department. November 4, 2019. Accessed June 28, 2021.
https://www.ci.seaside.ca.us/DocumentCenter/View/10674/9_App-S---HRE-Memo
- Military Museum. 2016. "Historic California Posts, Camps, Stations, and Airfields: Fort Ord." Accessed on June 19, 2021. <http://www.militarymuseum.org/FtOrd.html>
- National Archives Foundation. 2021. Executive Order 9981. Accessed June 29, 2021. Available at: <https://www.archivesfoundation.org/documents/executive-order-9981-ending-segregation-armed-forces/>
- NETR (Nationwide Environmental Title Research LLC). 2021. Historic Aerial Photographs of 100 Campus Center, Seaside, CA 93955 dating from 1956, 1968, 1981, 1998, 2005, 2009, 2010, 2012, 2014, 2016, and 2018. Accessed June 10, 2021.
<https://www.historicaerials.com/viewer>
- Panorama. 1990. "50 Years and Counting..." September 21, 1990, pg. 2.
- Panorama. n.d. "Ford Ord in World War II." Historic California Posts: Fort Ord. Accessed on June 19, 2021. <http://www.militarymuseum.org/FtOrd.html>
- Park, R. 2015. "Happy and Cheerful in This Fine Camp": Sports, Recreation, and the United States Army at Fort Ord and Camp Roberts, 1940 to 1945. *Journal of Sport History*, 42(1), 21-37. Accessed on June 18, 2021, from
<https://www.jstor.org/stable/10.5406/jsporhistory.42.1.21>
- Pomona Progress Bulletin. 1950. War Solving Racial Problems. August 24, 1950. Page 4. Accessed June 29, 2021. Available at: [Newspapers.com](http://www.newspapers.com).
- Quartermaster Review, The. 1940. "Army Construction Underway at Camp Ord, California." Volume XX. No 3. November-December. On file at the Chamberlin Library, Ord Military Community.
- Raugh, Harold E. 2004. Fort Ord. Charleston, SC: Arcadia.
- Salinas Morning Post. 1940. "\$2,766,000 in Building Authorized—Ord Contracts Let." August 21, 1940. Salinas, CA. pg. 1.
- San Francisco Examiner. 1951. Fort Ord Will Get Stadium. San Francisco Page 4. · 3 Feb 1951. Pages 1 and 4 A Available on [www.Newspapers.com](http://www.newspapers.com). Accessed on Jun 11, 2021.
- San Francisco Examiner. 1958. Army Asks OK on \$124,000,000 for Fort Ord Buildings. San Francisco. Section 2. Page. 4. Available on [www.Newspapers.com](http://www.newspapers.com). Accessed July 18, 2021.

CONTINUATION SHEET

Property Name: Green Hall

Page 14 of 14

Vasche, J. Burton. 1959. "The California State Colleges: Their History, Organization, Purposes, and Programs." in California

U.S. Army. 1977. Post Map Main Garrison Area. Fort Ord, California. Drawing number G-950. Accessed in person at the Chamberlain Library on June 15, 2021.

Walch, Bob. 2004. An Army Historian's Pictorial Take on Fort Ord. Monterey County NOW. Accessed July 12, 2021. Available at:
https://www.montereycountyweekly.com/news/local_news/an-army-historian-s-pictorial-take-on-fort-ord/article_6e8b0250-9c38-5ca4-a4a4-f93d42d65a11.html

Whaley, Derek. 2015. "East Monterey & Seaside." Santa Cruz Trains: Railroads of the Monterey Bay Area. July 20, 2015. Accessed online:
<https://www.santacruztrains.com/2015/07/east-monterey-seaside.html>.

Webb Spinner, The. 1952-1954. Webb Spinner Volume for 1952-1954. Del Webb Sun Cities Museum Collection. Accessed June 30, 2021. Accessed at:
<https://delwebbsuncitiesmuseum.org/newsletters-webb-spinners/>

State of California & The Resources Agency
DEPARTMENT OF PARKS AND RECREATION
PRIMARY RECORD

Primary #
HRI #
Trinomial
NRHP Status Code 6Z

Other Listings
Review Code

Reviewer

Date

Page 1 of 15 *Resource Name or #: (Assigned by recorder) Reading Center

P1. Other Identifier: CSUMB Building 59

*P2. Location: Not for Publication Unrestricted

*a. County Monterey County and (P2c, P2e, and P2b or P2d. Attach a Location Map as necessary.)

*b. USGS 7.5' Quad Marina, CA Date 1995 T 15S; R 2E; NE ¼ of SW ¼ of Sec 6; Mount Diablo B.M.

c. Address 4790 7th Avenue Seaside Zip 93955

d. UTM: (Give more than one for large and/or linear resources) Zone 10S, 608102 mE/ 4057011 mN

e. Other Locational Data: (e.g., parcel #, directions to resource, elevation, decimal degrees, etc., as appropriate)

The Reading Center sits north of A Street, west of 7th Avenue.

*P3a. Description: (Describe resource and its major elements. Include design, materials, condition, alterations, size, setting, and boundaries)

The Reading Center (CSUMB Building 59) is a one-story utilitarian building with a rectangular floor plan and a concrete block structural system. The south-facing main elevation is symmetrical. It is covered by a moderately pitched side-gabled roof clad with composition shingles. The main entrance is located centrally and is flanked by two squared projections. The main entrance consists of recently added metal-framed double doors with sidelights and transom window.

See Continuation Sheet

*P3b. Resource Attributes: (List attributes and codes) HP15. Educational building/HP34 Military property

P5a. Photograph or Drawing (Photograph required for buildings, structures, and objects.)



*P4. Resources Present: Building

Structure Object Site District Element of District Other (Isolates, etc.)

P5b. Description of Photo: (view, date, accession #) south elevation, view looking north, Dudek (IMG 0581)

*P6. Date Constructed/Age and Source: Historic Prehistoric Both 1953 (CSUMB Facilities)

*P7. Owner and Address: CSUMB, 100 Campus Center, Seaside, CA. 93955

*P8. Recorded by: (Name, affiliation, and address) Sarah Corder
Dudek

725 Front St #400
Santa Cruz, CA 95060

*P9. Date Recorded: 6/14/2021

*P10. Survey Type: (Describe)
Intensive level

*P11. Report Citation: (Cite survey report and other sources or enter none) Dudek 2021. Built Environment Inventory and Evaluation Report for California State University, Monterey

*Attachments: NONE Location Map Continuation Sheet Building, Structure, and Object Record

Archaeological Record District Record Linear Feature Record Milling Station Record Rock Art Record

Artifact Record Photograph Record Other (List): _____

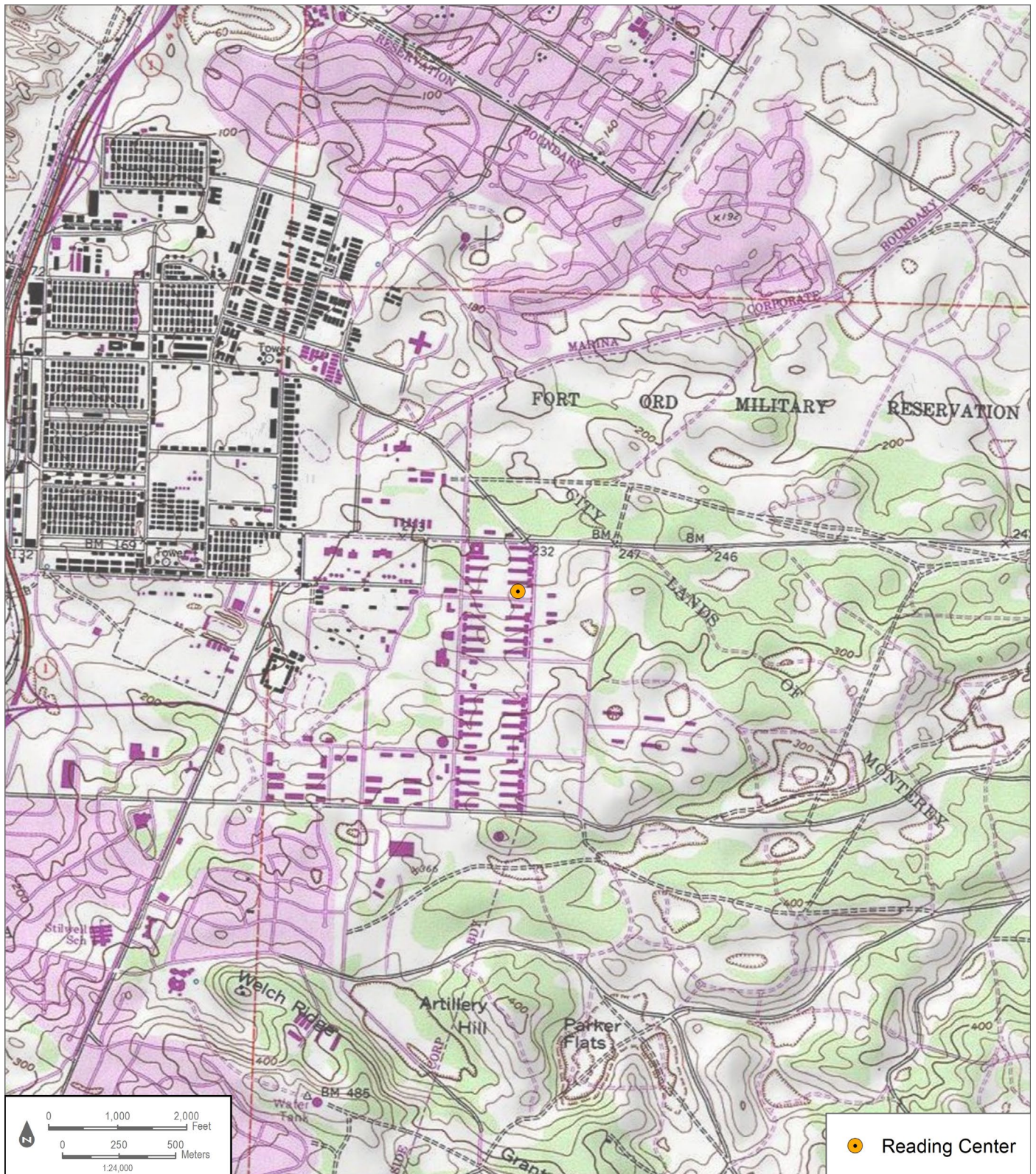

BUILDING, STRUCTURE, AND OBJECT RECORD

*Resource Name or # (Assigned by recorder) Reading Center *NRHP Status Code 6Z
Page 3 of 15

B1. Historic Name: Permanent Troop Spaces and Support Facilities Classroom
B2. Common Name: Reading Center, CSUMB Building 59
B3. Original Use: Educational building 4. Present Use: Administration

*B5. Architectural Style: Utilitarian

*B6. Construction History: (Construction date, alterations, and date of alterations)
The Reading Center was designed in 1953 and completed in 1954. As-built drawings show alterations to the subject property took place in 1995. Changes include the replacement of original windows and various infilled windows and doors (CSUMB Facilities 2021).

*B7. Moved? No Yes Unknown Date: _____ Original Location: _____ *B8. Related Features:

B9a. Architect: Robert Stanton b. Builder: Unknown

*B10. Significance: Theme N/A Area N/A
Period of Significance N/A Property Type N/A Applicable Criteria N/A

(Discuss importance in terms of historical or architectural context as defined by theme, period, and geographic scope. Also address integrity.)

See Continuation Sheet.

B11. Additional Resource Attributes: (List attributes and codes) _____

*B12. References: See Continuation Sheet.

B13. Remarks:

*B14. Evaluator: Laura Carias, MA

*Date of Evaluation: July 20, 2021

(This space reserved for official comments.)



CONTINUATION SHEET

Property Name: Reading Center

Page 4 of 15

***P3a. Description (continued):**

Secondary doors are located to the far east and west ends of the main elevation. These doors are alterations and appear to have been placed within existing window frames. Windows are recently added, metal-framed, one-over-one, fixed, and awning windows. A single column of cinderblocks is located between every second window on the main and rear north elevation. The fenestration pattern is repeated on the rear elevation. Alterations include the infill of several window frames with doors, replacement windows, and a recently added main door.



Figure 1. Main (south) elevation, looking north (IMG_0581)

CONTINUATION SHEET

Property Name: Reading Center

Page 5 of 15



Figure 2. north elevation, looking southwest (IMG_0598)

Alterations:

- Replaced original windows with metal sash fixed and awning windows (1995)
- Various filled in windows and doors (1995)

CONTINUATION SHEET

Property Name: Reading Center

Page 6 of 15

*B10. Significance (continued):

Historical Overview of Fort Ord

The history of Fort Ord has been extensively documented in newspaper articles, websites, academic journals, and books. From its creation in 1917 to its closure in 1994, the base grew to become one of the largest training centers in the country. Its location was also reported to be the most attractive U.S. Army post, with easy access to the ocean and beautiful California weather.

The development periods in the history of Fort Ord were defined by Harold E. Raugh, Jr, a U.S. Army lieutenant colonel and historian with the Department of Defense. Since his retirement, Raugh served as the Chief Historian, for the Defense Logistics Agency, for the Department of Defense and, from 2006-2013, Raugh served as the Command Historian at the Defense Language Institute Foreign Language Center (DLIFLC) and the Presidio of Monterey, California. He received his PhD in history from the University of California, Los Angeles (Walch 2004). Raugh has authored numerous books including, *Fort Ord* (2004); *Presidio of Monterey* (2004); *Operation Joint Endeavor: V Corps in Bosnia-Herzegovina, 1995-1996* (2013); *The Raugh Bibliography of the Indian Mutiny 1857-1859* (2016); and *Wavell in the Middle East, 1939-1941: A study in Generalship*. Raugh defined four periods for the historic development of Fort Ord:

- 1917-1940 Camp Gigling to Camp Ord
- 1940-1945 Fort Ord and the 7th Infantry Division
- 1946-1976 The Cold War and Vietnam Eras
- 1974-1994 The Volunteer Army

These periods correspond to distinct eras in the history of the base and the U.S. Army (Raugh 2004: ii).

The full historic context of Fort Ord is represented in the report, *Built Environment Inventory and Evaluation Report for California State University, Monterey Bay* (Dudek 2021). The following presents only relevant historical and building typology information pertaining to the development of the Reading Center.

Cold War and Vietnam Eras at Fort Ord (1946-1976)

This period of development between 1946 and 1976 was characterized by a massive operation to move the base out of its semi-permanent status and create a permanent outpost for active military personnel who were retained due to ongoing foreign conflicts.

In July of 1948, Harry S Truman signed Executive Order 9981, which officially ended segregation in the armed forces. The order stated that "there shall be equality of treatment and opportunity for all persons in the armed forces without regard to race, color, religion, or national origin" (National Archives Foundation 2021). Fort Ord became one of the first integrated training divisions in the United States. The Fort was touted as "pioneering to end all segregation" (The Pomona Progress Bulletin 1950: 4). In 1950, the *Pomona Progress Bulletin* reported that black and white soldiers at Fort Ord were "fighting side by side" and all the enlistees "trained together, slept in the same barracks, and eat the same messes" (The Pomona Progress Bulletin 1950: 4).

The end of World War II in 1945 did not bring lasting peace. The tenuous relationship between dominant nations in the communist East and free market West led to the beginning of the Cold War. The Department of Defense maintained a robust fighting force during the Cold War, with more than 900,000 Army personnel retained during the 1950s (ACHP 2006).

CONTINUATION SHEET

Property Name: Reading Center

Page 7 of 15

The ongoing global tensions and the number of active U.S. military personnel created a need for new permanent buildings and expanded military housing at Fort Ord.

In 1949, the Soviet-supported communist government of North Korea invaded American-supported South Korea, initiating the Korean War. Fort Ord was a primary staging area for the training of troops departing for the war (Castle 1990:3). By the 1950s, Fort Ord had become one of the largest basic training camps in the United States. In 1952, the military began a multi-million dollar building program to transform Fort Ord into a permanent post, including the development of permanent troop housing, and the construction of a guard house, stockade, and multiple warehouses. In January of 1952, military authorities announced the new construction program at Fort Ord was underway, with an estimated cost of \$26,650,600. More than half of the funds that were approved by Congress were "earmarked for new permanent troop housing" for more than 7,000 soldiers (The Webb Spinner 1952-54, Vol 6. No. 3:1).

The new troop housing was to be constructed of reinforced concrete, a departure from the wood buildings constructed before and during World War II. The plan called for three types of massive barracks, twenty-two were to house 225 enlisted men each, seven were to accommodate 165 men each, and nine were to house 105 men each (The Webb Spinner 1952-54, Vol 6. No. 3:3). The San Francisco District of the U.S. Army Corps of Engineers oversaw the construction project to completion. An additional \$1,349,700 was earmarked for the expansion of classroom and training facilities at Fort Ord, including a new battalion and regimental headquarters (The Californian 1952a:1 and The Californian 1952b:18). By March of 1952, another phase of the permanent army post transformation began with the construction of a guard house, stockade, warehouse, and other buildings (The Webb Spinner 1952-54, Vol 6. No. 3:1). This addition of permanent buildings continued into the late 1950s, when the Army requested \$124 million to replace all the wood World War II infrastructure at Fort Ord with concrete block and reinforced concrete (Madsen and Treffers 2019:6; San Francisco Examiner 1958:2-4). While many of the wood buildings remain today, this period saw the continuous addition of reinforced concrete permanent buildings across the Fort (Madsen and Treffers 2019:6).

Following the Korean War through the end of the conflict in Vietnam, Fort Ord served as an important training facility. In 1957, Fort Ord was designated as a U.S. Army Training Center for Infantry (Castle 1990: 4). The 7th Infantry Division was based at Fort Ord in 1975 (Cavanaugh 2000: 9). Fort Ord produced thousands of combat-ready troops during the conflict in Vietnam.

With the establishment of Fort Ord as a permanent Army base during this period, there was substantial building construction that led to the modernization of the base and its services. This development is closely related to the history of the current CSUMB campus. All the properties that are included as part of this built environment study were constructed during the Cold War and Vietnam Era period. Building development during this period was a substantial departure from the styles and materials used in the buildings constructed before World War II. Building during the period between 1946 and 1976 used reinforced concrete and concrete masonry unit (CMU). The buildings tended to be larger than those constructed in previous periods. Other development in this period included support service buildings and several types of medical buildings. Infrastructure was also improved at this time, with the introduction of paved streets and roadways, and the addition of several water tanks, water pumping plants, and warehouse buildings.

Reading Center, 1954

Constructed in 1954, the Reading Center (59) was designed by Robert Stanton, Monterey Bay architect (CSUMB Facilities 2021). It was one of several identical buildings described as "permanent troop spaces and supporting facilities/classrooms" designed for Fort Ord (CSUMB Facilities 1953). It first appears in the 1956 aerial photograph as a long, rectangular

CONTINUATION SHEET

Property Name: Reading Center

Page 8 of 15

plan, gable-ended building on the north side of A Street (UCSB 1956). The entrance faces south to A Street and is accessed by a formal path from the A Street sidewalk. It is surrounded on all sides by lawn. The Reading Center (59) is mirrored in plan, size, and position by Green Hall (58) south of A Street. It appears south of a group of four buildings similar in plan to Pacific Hall (44), Coast Hall (45) and Harbor Hall (46), however buildings in this group begin to be demolished in 2010, and demolition is complete by 2021. No changes to the Reading Center over time were noted.

Robert Stanton

Robert Stanton was born in Detroit, Michigan in 1900. He served briefly in the U.S. Navy during World War I and then graduated from high school in Los Angeles and went on to complete his education at University of California at Berkeley. After graduation he worked with renowned architect, Wallace Neff. Neff appointed Stanton as project supervisor on several projects and Stanton earned his architecture license in 1934. Stanton moved to Monterey Bay in 1935 and went on to design a variety of residential, commercial, and public buildings in the area. Two of his buildings, the Monterey County Courthouse and the King City High School Auditorium have been listed on the NRHP (Hiller 2007:8-4). Robert Stanton was known to have designed a plan for classroom buildings at Fort Ord that was used for at least four buildings on campus (CSUMB Facilities 2021).

Fort Ord Building Typology

Four categories of building types were identified for the purposes of this study. These are the Support Services Buildings, Medical Buildings, Hammerhead Buildings/Barracks, and Recreational Buildings. The following presents a discussion of the Support Services building typology, as the Reading Center (59) is classified in this typology. This section provides a detailed account of the specific character-defining features of Fort Ord Cold War and Vietnam Era (1946-1976) Support Services buildings.

Support Services Buildings

Support Services Buildings constructed during the Cold War and Vietnam Eras (1946-1976) at Fort Ord have a variety of uses and functions that changed over the history of the base. The buildings tended to have central entryways that opened into hallways, with classrooms lining the halls. In alignment with the typical planning, design, and materials of buildings from this period of Fort Ord's history, these buildings are constructed with reinforced concrete and CMU and feature gable roofs with multi-light windows with concrete sills. These buildings have a uniform design, like many of the other buildings at Fort Ord.

After Fort Ord closed in 1994, these support services buildings became part of the CSUMB campus. With the shift to campus use, many of the buildings were altered to fit the needs of CSUMB. No changes to the Reading Center were noted.

Character-Defining Features for the Support Services Buildings

The Support Services Buildings originally exhibited the following specific character-defining features:

CONTINUATION SHEET

Property Name: Reading Center

Page 9 of 15

Character-Defining Features: Fort Ord Support Services Buildings

Character Aspect	Primary Character-Defining Features	Character-defining features
Shape and Plan	<ul style="list-style-type: none"> Simple rectangular form Single story 	The overall shape and mass of the building are considered a primary character-defining feature of the support services buildings. The plan should be rectangular in form.
Roof	<ul style="list-style-type: none"> Flat or gable roof small eave overhangs No exposed rafters 	Support service buildings from this period have gable roof forms, with slight eave overhangs.
Openings	<ul style="list-style-type: none"> Public entrances and circulation patterns 	Window openings are generally uniform in size and placement, windows are multi-light, and set into concrete openings. Replaced windows are not considered character-defining features as they fall outside the period of significance.
Exterior Ornamentation	<ul style="list-style-type: none"> Minimal exterior ornamentation 	The support services buildings were designed to be quickly constructed. They have little to no decorative ornamentation, with windows being set evenly apart and CMU pillars being the only decorative element.
Materials	<ul style="list-style-type: none"> Mass-produced and cost-effective materials Concrete and CMU Reinforced Concrete construction 	The support services buildings have simple, utilitarian designs. Buildings were constructed using mass-produced and cost-effective building materials that were readily available at the time of construction. For instance, buildings under the support services buildings type were constructed with reinforced concrete and CMU and were minimally decorated.

Alterations and demolitions over time have compromised the overall architectural integrity of this building type. The most common alterations observed for this building type include the following.

- Replacement windows
- ADA compliance measures such as ramps and doors
- HVAC systems and window units
- Infill of openings
- Addition of front gable over doorways
- Interior renovations

NRHP/CRHR Designation Criteria

In consideration of the project site's history and requisite integrity, Dudek recommends the property not eligible for listing in the NRHP and CRHR based on the following significance evaluation and in consideration of national and state eligibility criteria:

CONTINUATION SHEET

Property Name: Reading Center

Page 10 of 15

Criterion A/1: That are associated with events that have made a significant contribution to the broad patterns of our history.

The Reading Center was designed in 1953 and constructed in 1954 during the period defined as the Cold War and Vietnam Eras (1946-1976) at Ford Ord. While this building is of historic age and was constructed during an important period of development in Fort Ord's history, it no longer retains enough integrity to convey its significance. One of the most notable elements of integrity that is compromised is the integrity of setting. Significant demolition, changes to circulation patterns, introduction of new buildings, and changes in use, all impact the building's ability to convey significance from its time as an active Cold War and Vietnam Era military base. The loss of this overall integrity of setting adversely affects Beach Hall, as individual buildings are no longer able to convey their collective history. Additionally, the subdivision of Fort Ord following its closure has also greatly impacted the integrity of feeling, association, and setting of the remaining Cold War and Vietnam Era buildings. Beach Hall is not able to convey its association with any extraordinary events or events occurring within the context of Cold War and Vietnam military support service buildings, the CSUMB Campus, or has an association with the broad patterns of history in Monterey County, the State of California, or the Nation. Therefore, the building is recommended not eligible under NRHP/CRHR Criterion A/1.

Criterion B/2: That are associated with the lives of persons significant in our past.

To be found eligible under B/2 the property must be directly tied to an important person and the place where that individual conducted or produced the work for which he or she is known. Archival research found no significant or influential people directly associated with the building. As such this property is not known to have any historical associations with people important to the nation's or state's past. Due to a lack of identified significant associations with important persons in history, Dudek recommends the building is not eligible under NRHP/CRHR Criterion B/2.

Criterion C/3: That embody the distinctive characteristics of a type, period, or method of construction, or that represent the work of a master, or that possess high artistic values, or that represent a significant and distinguishable entity whose components may lack individual distinction.

Archival research indicates that the Reading Center was constructed in 1954 as one of several classroom/support buildings for Fort Ord. Although designed by architect, Robert Stanton, the building was not constructed in any obvious architectural style. The building is a ubiquitous building type that lacks high style components to set it apart from other buildings constructed in the 1950s. The building has been altered by the removal of original windows and doors and there have been changes to the fenestration pattern. Due to a lack of high artistic value, a lack of evidence suggesting this is a notable work of Robert Stanton, and because of the alterations to character-defining features, Dudek recommends the building is not eligible under NRHP/CRHR Criterion C/3.

Criterion D/4: That have yielded, or may be likely to yield, information important in prehistory or history.

There is no evidence to suggest that this property has the potential to yield information important to state or local history. Therefore, the property is recommended not eligible under NRHP/CRHR Criterion D/4.

California Historic Landmark Statement of Significance

In consideration of the subject property's history and requisite integrity, Dudek

CONTINUATION SHEET

Property Name: Reading Center

Page 11 of 15

recommends the property not eligible for designation as a California Historic Landmark based on the following significance evaluation and in consideration of state eligibility criteria:

The first, last, only, or most significant of its type in the state or within a large geographic region (Northern, Central, or Southern California).

The Reading Center was designed in 1953 and constructed in 1954. The building was constructed after the initial, core development period of Fort Ord in the 1940s. Beach Hall was designed by Robert Stanton. The building is a ubiquitous building type that lacks high style components to set it apart from other utilitarian buildings constructed throughout the State of California in the 1950s. Therefore, the subject property is recommended not eligible for listing as a CHL under this criterion.

Associated with an individual or group having a profound influence on the history of California.

Archival research failed to indicate any significant associations between the subject property and individuals or groups that profoundly influenced the history of California. The Reading Center was one of several support/classroom buildings constructed on site. Robert Stanton was found to be the architect responsible for the design, but the utilitarian building does not reflect a remarkable design. No other individuals are known to have influenced the construction or use of this building. Therefore, the subject property is recommended not eligible for listing as a CHL under this criterion.

A prototype of, or an outstanding example of, a period, style, architectural movement or construction or is one of the more notable works or the best surviving work in a region of a pioneer architect, designer or master builder.

The Reading Center is neither a prototype or an outstanding example of a period, style, or architectural movement. The building was designed to serve a utilitarian purpose. There are no remaining identifying features on the Reading Center that would establish the building as a notable work of a master architect, or a notable designer or builder working within the military, or in the State of California. Therefore, the subject property is recommended not eligible for listing as a CHL under this criterion.

Local Designation Criteria

Portions of the CSUMB campus are located within the boundaries of two cities, City of Seaside and the City of Marina, both of which evaluate historical resources in accordance with CEQA Guidelines. as presented above. The subject property, as discussed in the NRHP/CRHR/CHL criteria discussion above, does not rise to the necessary level of significance for local, state, or national designation. For these reasons, the subject property is recommended not eligible individually or as a component of a historic district under any of the NRHP/CRHR/CHL criteria.

Additionally, portions of the CSUMB campus are located in the County of Monterey and it is therefore subject to the regulations set forth in Chapter 18.25 of the Monterey County Code. The subject property, as discussed in the NRHP/CRHR/CHL criteria discussion above, does not rise to the necessary level of significance for state or national designation. For these same reasons, the subject property is also recommended not eligible individually or as a component of a historic district under any of the delineated County of Monterey review criteria categories that are addressed with the NRHP/CRHR/CHL criteria discussed above: A. Historical and Cultural Significance; B. Historic, Architectural, and Engineering Significance; or C. Community and Geographic Setting.

CONTINUATION SHEET

Property Name: Reading Center

Page 12 of 15

Integrity Discussion

The Reading Center retains its integrity of location. Windows have been replaced and various windows and doors have been closed off since its completion in 1954. These alterations have diminished the resource's integrity of design, materials, and workmanship. Although the Reading Center is still used as a support building, the site, once a bustling army base, is now home to a California State University campus. These changes to the surrounding area have diminished the integrity of setting, feeling, and association. The changes to original materials prohibit the building from conveying its significance or its temporal period.

Summary of Evaluation Findings

The Reading Center retains little historic integrity and lacks historical and architectural significance. Based on the significance evaluations presented above, the Reading Center does not appear to meet the NRHP, CRHR, CHL or local designation criteria. Therefore, the Reading Center is not considered a historical resource for purposes of CEQA.

CONTINUATION SHEET

Property Name: Reading Center

Page 13 of 15

*B12. References (continued):

- ACHP (Advisory Council on Historic Preservation). 2006. "Draft Program Comment Regarding Cold War Era Unaccompanied Personnel Housing." Federal Register: The Daily Journal of the United States Government. 12 April 2016. Accessed June 30, 2021 Available at: <https://www.federalregister.gov/documents/2006/04/12/06-3509/draft-program-comment-regarding-cold-war-era-unaccompanied-personnel-housing>
- Californian, The. 1940. "No More Camp Ord! It's Fort Ord Now! Stilwell in Command: Headquarters of General Located on Salinas Side." July 13, 1940. Salinas, California, pg. 1.
- Californian, The. 1951. Stadium Field House—Sixth Army Lets Ord Contract. March 20, 1951. P1. Accessed June 17, 2021. Available at: Newspapers.com.
- Castle, Ted. 1990. "The March of Time." Fort Ord Panorama. September 21, 1990.
- Cavanaugh, Joe. 2000. *The Peace Dividend: Defense Conversion Through Higher Education*. The Leon Panetta Institute.
- Chamberlin Library. 2021. Fort Ord Working Papers. CSUMB Special Collections Box 6.42-01. Available at the Chamberlin Library, Seaside, California.
- CSUC (California State University, Chico). 2021a. "State Normal School at Chico." Accessed July 8, 2021. <https://www.csuchico.edu/traditions/history/normal-school.shtml>.
- CSUC. 2021b. "Chico State Teachers College." Accessed July 8, 2021. <https://www.csuchico.edu/traditions/history/teachers-college.shtml>
- CSUMB Facilities. 2021. Original As built and renovation architectural drawings on file with CSUMB facilities department. Accessed in person June 15-16, 2021.
- DLIFLC (Defense Language Institute Foreign Language Center). 2021. Command History Program. Accessed in person on June 15, 2021 and accessed online database collection online July 2021. Available at: <https://adli.pastperfectonline.com/>
- EA Engineering. 1991. Draft Final Fort Ord, California Base wide Remedial Investigation Feasibility Study. Volume 1 Literature Review and Base Inventory Report. Accessed on July 13, 2021. Available at: <https://www.fortordcleanup.com/documents/search/>
- Fresno Bee, The. 1951a. "Army Spokesman Are Defending Building of Fort Ord Stadium." January 12, 1951. Page 13. Accessed June 17, 2021.
- Fresno Bee, The. 1951b. "Army Spokesman Are Defending Building of Fort Ord Stadium." February 4, 1951. Page 27. Accessed June 17, 2021. Available at: Newspapers.com.
- Gates, S., & Williams, H. 1957. The Armed Forces. The Annals of the American Academy of Political and Social Science, 313, 99-104. Accessed June 17, 2021. <http://proxy.multcolib.org:2052/stable/1031762>

CONTINUATION SHEET

Property Name: Reading Center

Page 14 of 15

- MacGregor Jr., Morris J. 1981. Integration of the Armed Forces, 1940-1965. Center of Military History, United States Army: Washington, D.C.
- Madsen, Alexandra and Steven Treffers. 2019. *Historic Resources Evaluation Memorandum for Hammerhead Barracks at Fort Ord, Monterey County, California*. Prepared by Rincon Consultants, Inc for City of Seaside, Community and Economic Development Department. November 4, 2019. Accessed June 28, 2021.
https://www.ci.seaside.ca.us/DocumentCenter/View/10674/9_App-S---HRE-Memo
- Military Museum. 2016. "Historic California Posts, Camps, Stations, and Airfields: Fort Ord." Accessed on June 19, 2021. <http://www.militarymuseum.org/FtOrd.html>
- National Archives Foundation. 2021. Executive Order 9981. Accessed June 29, 2021. Available at: <https://www.archivesfoundation.org/documents/executive-order-9981-ending-segregation-armed-forces/>
- NETR (Nationwide Environmental Title Research LLC). 2021. Historic Aerial Photographs of 100 Campus Center, Seaside, CA 93955 dating from 1956, 1968, 1981, 1998, 2005, 2009, 2010, 2012, 2014, 2016, and 2018. Accessed June 10, 2021.
<https://www.historicaerials.com/viewer>
- OAC (Online Archives of California). 2021. Finding Aid for the Milton Pflueger drawings of the University of California, Berkeley Radiation Laboratory addition, 1961 0000276. <https://oac.cdlib.org/findaid/ark:/13030/c86w9bq9/>.
- PCAD (Pacific Coast Architecture Database). 2021. Database information for Milton Theodore Pflueger and Timothy Pflueger. Accessed July 7, 2021.
<http://pcad.lib.washington.edu>
- Panorama. 1990. "50 Years and Counting..." September 21, 1990, pg. 2.
- Panorama. n.d. "Ford Ord in World War II." Historic California Posts: Fort Ord. Accessed on June 19, 2021. <http://www.militarymuseum.org/FtOrd.html>
- Park, R. 2015. "Happy and Cheerful in This Fine Camp": Sports, Recreation, and the United States Army at Fort Ord and Camp Roberts, 1940 to 1945. *Journal of Sport History*, 42(1), 21-37. Accessed on June 18, 2021, from
<https://www.jstor.org/stable/10.5406/jsporhistory.42.1.21>
- Pomona Progress Bulletin. 1950. War Solving Racial Problems. August 24, 1950. Page 4. Accessed June 29, 2021. Available at: [Newspapers.com](http://www.newspapers.com).
- Quartermaster Review, The. 1940. "Army Construction Underway at Camp Ord, California." Volume XX. No 3. November-December. On file at the Chamberlin Library, Ord Military Community.
- Raugh, Harold E. 2004. Fort Ord. Charleston, SC: Arcadia.
- Salinas Morning Post. 1940. "\$2,766,000 in Building Authorized—Ord Contracts Let." August 21, 1940. Salinas, CA. pg. 1.
- San Francisco Examiner. 1951. Fort Ord Will Get Stadium. San Francisco Page 4. · 3 Feb 1951. Pages 1 and 4 A Available on [www.Newspapers.com](http://www.newspapers.com). Accessed on Jun 11, 2021.

CONTINUATION SHEET

Property Name: Reading Center

Page 15 of 15

San Francisco Examiner. 1958. Army Asks OK on \$124,000,000 for Fort Ord Buildings. San Francisco. Section 2. Page. 4. Available on www.Newspapers.com. Accessed July 18, 2021.

Vasche, J. Burton. 1959. "The California State Colleges: Their History, Organization, Purposes, and Programs." in California

U.S. Army. 1977. Post Map Main Garrison Area. Fort Ord, California. Drawing number G-950. Accessed in person at the Chamberlain Library on June 15, 2021.

Walch, Bob. 2004. An Army Historian's Pictorial Take on Fort Ord. Monterey County NOW. Accessed July 12, 2021. Available at:
https://www.montereycountyweekly.com/news/local_news/an-army-historian-s-pictorial-take-on-fort-ord/article_6e8b0250-9c38-5ca4-a4a4-f93d42d65a11.html

**State of California & The Resources Agency
DEPARTMENT OF PARKS AND RECREATION
PRIMARY RECORD**

Primary #
HRI #
Trinomial
NRHP Status Code 6Z

Other Listings
Review Code

Reviewer

Date

Page 1 of 15 *Resource Name or #: (Assigned by recorder) Visual & Public Arts

P1. Other Identifier: CSUMB Building 70

*P2. Location: Not for Publication Unrestricted

*a. County Monterey County and (P2c, P2e, and P2b or P2d. Attach a Location Map as necessary.)

*b. USGS 7.5' Quad Marina, CA Date 1995 T 15S; R 2E; SW ¼ of NW ¼ of Sec 6; Mount Diablo B.M.

c. Address 4855 3rd Avenue Seaside Zip 93955

d. UTM: (Give more than one for large and/or linear resources) Zone 10S, 607703 mE/ 4057310 mN

e. Other Locational Data: (e.g., parcel #, directions to resource, elevation, decimal degrees, etc., as appropriate)

The Visual & Public Art building sits north of 3rd Avenue and west of 6th Avenue

*P3a. Description: (Describe resource and its major elements. Include design, materials, condition, alterations, size, setting, and boundaries)

The Visual & Public Arts building (CSUMB Building 70) sits north east of the Main Quad on the California State University Monterey Bay Campus (CSUMB). The one-and-a-half-story utilitarian building, with a one-story portion on the north (rear) elevation, is located on the north side of Inter-Garrison Road with a west-facing main elevation. It has a rectangular floor plan and a poured-in-place concrete and steel structural system. The building is capped by a flat roof with slightly overhanging eaves. The main elevation once consisted of five garage doors that have been infilled with anodized aluminum framed, fully glazed bays, glazed doors, and filled in completely except for a row of aluminum-framed fixed windows. **See Continuation Sheet**

P5a. Photograph or Drawing (Photograph required for buildings, structures, and objects.)



*P3b. Resource Attributes: (List attributes and codes) HP15.

Educational building/HP34
Military property

*P4. Resources Present: Building
 Structure Object Site District
Element of District Other (Isolates, etc.)

P5b. Description of Photo: (view, date, accession #) south elevation, view looking north, Dudek, (IMG 0334)

*P6. Date Constructed/Age and Source: Historic Prehistoric Both
c. 1950 (NETR 2021)

*P7. Owner and Address:
CSUMB,
100 Campus Center
Seaside, CA. 93955

*P8. Recorded by: (Name, affiliation, and address) Sarah Corder
Dudek
725 Front St #400
Santa Cruz, CA 95060

*P9. Date Recorded: 7/9/2021

*P10. Survey Type: (Describe)

Intensive level

*P11. Report Citation: (Cite survey report and other sources or enter none) Dudek 2021. Built Environment Inventory and Evaluation Report for California State University, Monterey Bay

*Attachments: NONE Location Map Continuation Sheet Building, Structure, and Object Record

Archaeological Record District Record Linear Feature Record Milling Station Record Rock Art Record

Artifact Record Photograph Record Other (List): _____

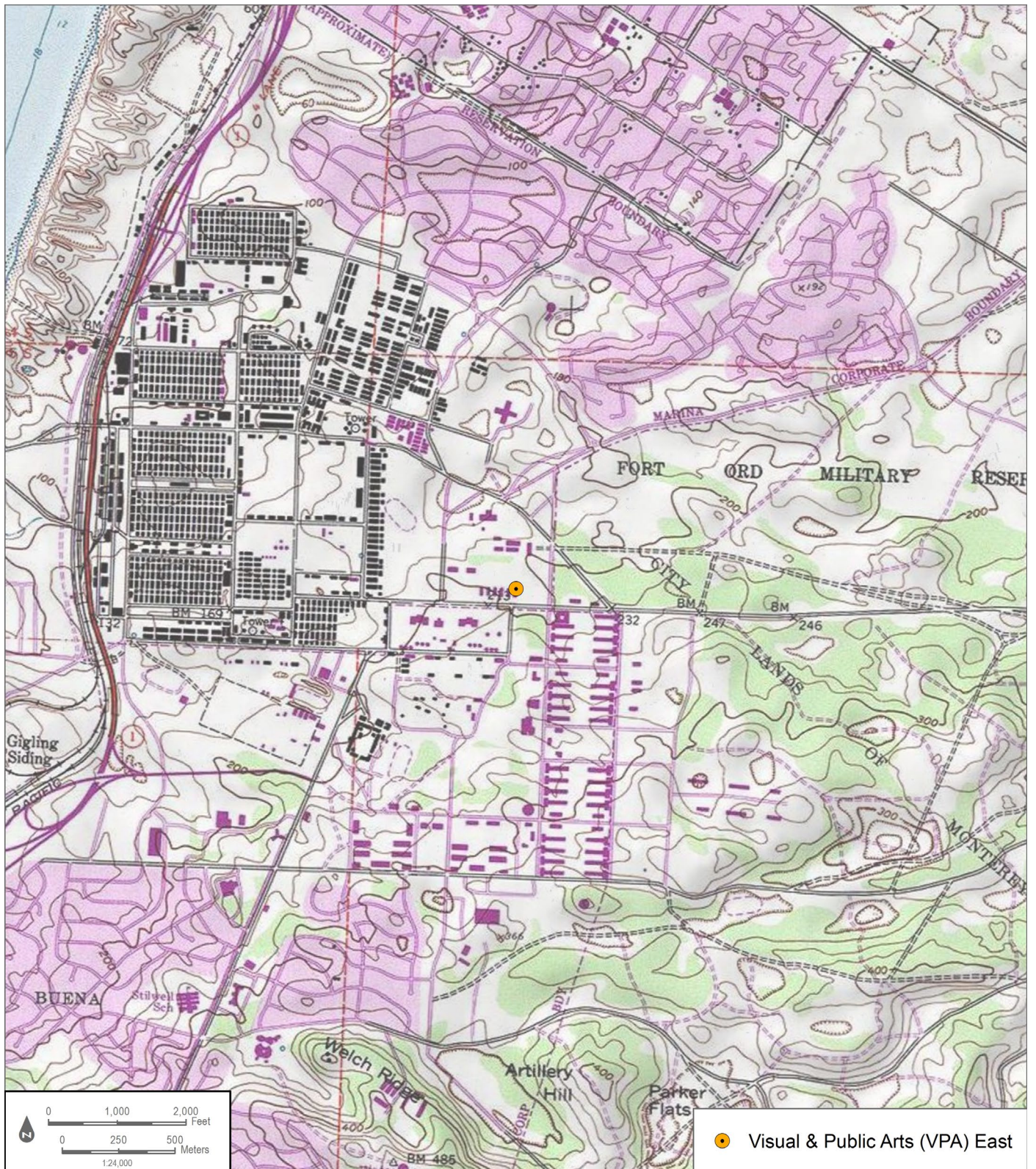

● Visual & Public Arts (VPA) East

BUILDING, STRUCTURE, AND OBJECT RECORD

*Resource Name or # (Assigned by recorder) Visual and Public Arts Building *NRHP Status Code 6Z
Page 3 of 15

B1. Historic Name: Fort Ord Motor Park
B2. Common Name Visual and Public Arts Building, CSUMB Building 70
B3. Original Use: Motor Park 4. Present Use: Classroom

*B5. Architectural Style: Utilitarian

*B6. Construction History: (Construction date, alterations, and date of alterations)
Built in circa 1950 the Visual and Public Arts Building has undergone several alterations since it's construction. No architectural drawings were located for this building. Observed alterations include the addition of arched awnings over the windows on the south and west elevations, the infill of multiple garage openings and fenestration changes on the east and west elevations, painting of the exterior, the addition of HVAC unit to north side of building, and the replacement of the original doors and some original windows.

*B7. Moved? No Yes Unknown Date: _____ Original Location: _____ *B8. Related Features:

B9a. Architect: Unknown b. Builder: Unknown

*B10. Significance: Theme N/A Area N/A
Period of Significance N/A Property Type N/A Applicable Criteria N/A
(Discuss importance in terms of historical or architectural context as defined by theme, period, and geographic scope. Also address integrity.)

See Continuation Sheet.

B11. Additional Resource Attributes: (List attributes and codes) _____

*B12. References: See Continuation Sheet.

B13. Remarks:

*B14. Evaluator: Laura Carias, MA
*Date of Evaluation: July 20, 2021

(This space reserved for official comments.)



CONTINUATION SHEET

Property Name: Visual and Public Arts 70

Page 4 of 15

***P3a. Description (continued):**

The main elevation features a quarter-arch canopy clad in corrugated metal and supported by steel brackets. Windows on the south elevation consist of steel-framed, multi-light, hopper, and awning windows. The fenestration pattern on the east elevation has also been altered as a garage door and original window frames have been infilled and left with a single row of fixed aluminum sash windows. The one-story portion to the rear retains the original steel sash, multi-light windows. Two large air ducts are located at the rear.



Figure 1. Main (south) elevation, looking north (IMG_0335)

CONTINUATION SHEET

Property Name: Visual and Public Arts 70

Page 5 of 15



Figure 2. North (right) and east (left) elevations, looking southwest (IMG_0348)

Alterations:

- Added arched awnings over windows on the south and west elevations (Date Unknown).
- Infill of multiple garage openings and fenestration changes on the east and west elevations (Date Unknown).
- Exterior walls repainted (Date Unknown).
- Addition of HVAC unit to north side of building (Date Unknown).
- Replacement of original doors (Date Unknown).
- Replacement of some original windows (Date Unknown).

CONTINUATION SHEET

Property Name: Visual and Public Arts 70

Page 6 of 15

*B10. Significance (continued):

Historical Overview of Fort Ord

The history of Fort Ord has been extensively documented in newspaper articles, websites, academic journals, and books. From its creation in 1917 to its closure in 1994, the base grew to become one of the largest training centers in the country. Its location was also reported to be the most attractive U.S. Army post, with easy access to the ocean and beautiful California weather.

The development periods in the history of Fort Ord were defined by Harold E. Raugh, Jr, a U.S. Army lieutenant colonel and historian with the Department of Defense. Since his retirement, Raugh served as the Chief Historian, for the Defense Logistics Agency, for the Department of Defense and, from 2006-2013, Raugh served as the Command Historian at the Defense Language Institute Foreign Language Center (DLIFLC) and the Presidio of Monterey, California. He received his PhD in history from the University of California, Los Angeles (Walch 2004). Raugh has authored numerous books including, Fort Ord (2004); Presidio of Monterey (2004); Operation Joint Endeavor: V Corps in Bosnia-Herzegovina, 1995-1996 (2013); The Raugh Bibliography of the Indian Mutiny 1857-1859 (2016); and Wavell in the Middle East, 1939-1941: A study in Generalship. Raugh defined four periods for the historic development of Fort Ord:

- 1917-1940 Camp Gigling to Camp Ord
- 1940-1945 Fort Ord and the 7th Infantry Division
- 1946-1976 The Cold War and Vietnam Eras
- 1974-1994 The Volunteer Army

These periods correspond to distinct eras in the history of the base and the U.S. Army (Raugh 2004: ii). The following sections provide a summary overview of each of these periods of development and their relevance to the area of Fort Ord now known as the CSUMB campus.

The full historic context of Fort Ord is represented in the report, Built Environment Inventory and Evaluation Report for California State University, Monterey Bay (Dudek 2021). The following presents only relevant historical and building typology information pertaining to the development of the Visual and Public Art building.

Cold War and Vietnam Eras at Fort Ord (1946-1976)

This period of development between 1946 and 1976 was characterized by a massive operation to move the base out of its semi-permanent status and create a permanent outpost for active military personnel who were retained due to ongoing foreign conflicts.

In July of 1948, Harry S Truman signed Executive Order 9981, which officially ended segregation in the armed forces. The order stated that "there shall be equality of treatment and opportunity for all persons in the armed forces without regard to race, color, religion, or national origin" (National Archives Foundation 2021). Fort Ord became one of the first integrated training divisions in the United States. The Fort was touted as "pioneering to end all segregation" (The Pomona Progress Bulletin 1950: 4). In 1950, the Pomona Progress Bulletin reported that black and white soldiers at Fort Ord were "fighting side by side" and all the enlistees "trained together, slept in the same barracks, and eat the same messes" (The Pomona Progress Bulletin 1950: 4).

The end of World War II in 1945 did not bring lasting peace. The tenuous relationship between dominant nations in the communist East and free market West led to the beginning

CONTINUATION SHEET

Property Name: Visual and Public Arts 70

Page 7 of 15

of the Cold War. The Department of Defense maintained a robust fighting force during the Cold War, with more than 900,000 Army personnel retained during the 1950s (ACHP 2006). The ongoing global tensions and the number of active U.S. military personnel created a need for new permanent buildings and expanded military housing at Fort Ord.

In 1949, the Soviet-supported communist government of North Korea invaded American-supported South Korea, initiating the Korean War. Fort Ord was a primary staging area for the training of troops departing for the war (Castle 1990:3). By the 1950s, Fort Ord had become one of the largest basic training camps in the United States. In 1952, the military began a multi-million dollar building program to transform Fort Ord into a permanent post, including the development of permanent troop housing, and the construction of a guard house, stockade, and multiple warehouses. In January of 1952, military authorities announced the new construction program at Fort Ord was underway, with an estimated cost of \$26,650,600. More than half of the funds that were approved by Congress were "earmarked for new permanent troop housing" for more than 7,000 soldiers (The Webb Spinner 1952-54, Vol 6. No. 3:1).

The new troop housing was to be constructed of reinforced concrete, a departure from the wood buildings constructed before and during World War II. The plan called for three types of massive barracks, twenty-two were to house 225 enlisted men each, seven were to accommodate 165 men each, and nine were to house 105 men each (The Webb Spinner 1952-54, Vol 6. No. 3:3). The San Francisco District of the U.S. Army Corps of Engineers oversaw the construction project to completion. An additional \$1,349,700 was earmarked for the expansion of classroom and training facilities at Fort Ord, including a new battalion and regimental headquarters (The Californian 1952a:1 and The Californian 1952b:18). By March of 1952, another phase of the permanent army post transformation began with the construction of a guard house, stockade, warehouse, and other buildings (The Webb Spinner 1952-54, Vol 6. No. 3:1). This addition of permanent buildings continued into the late 1950s, when the Army requested \$124 million to replace all the wood World War II infrastructure at Fort Ord with concrete block and reinforced concrete (Madsen and Treffers 2019:6; San Francisco Examiner 1958:2-4). While many of the wood buildings remain today, this period saw the continuous addition of reinforced concrete permanent buildings across the Fort (Madsen and Treffers 2019:6).

Following the Korean War through the end of the conflict in Vietnam, Fort Ord served as an important training facility. In 1957, Fort Ord was designated as a U.S. Army Training Center for Infantry (Castle 1990: 4). The 7th Infantry Division was based at Fort Ord in 1975 (Cavanaugh 2000: 9). Fort Ord produced thousands of combat-ready troops during the conflict in Vietnam.

With the establishment of Fort Ord as a permanent Army base during this period, there was substantial building construction that led to the modernization of the base and its services. This development is closely related to the history of the current CSUMB campus. All the properties that are included as part of this built environment study were constructed during the Cold War and Vietnam Era period. Building development during this period was a substantial departure from the styles and materials used in the buildings constructed before World War II. Building during the period between 1946 and 1976 used reinforced concrete and concrete masonry unit (CMU). The buildings tended to be larger than those constructed in previous periods. Other development in this period included support service buildings and several types of medical buildings. Infrastructure was also improved at this time, with the introduction of paved streets and roadways, and the addition of several water tanks, water pumping plants, and warehouse buildings.

CONTINUATION SHEET

Property Name: Visual and Public Arts 70
 Page 8 of 15

Visual & Public Arts Building - Far East (70)

The Visual & Public Arts building (70) first appears in the 1956 aerial photograph as the east-most building in a group of six similarly sized buildings between 5th Avenue, 6th Avenue, north of Inter-Garrison Road and south of a large parking area. This building group included Visual & Public Arts - East (71), Visual & Public Arts - Center (72), Visual & Public Arts - West (73), and the Central Plant buildings (74 - two buildings). The Visual & Public Arts building (70) does not appear to be enlarged between 1956 and 2016, according to aerial photographs. Between 1987 and 1998, two arched breezeway structures appear between the Visual & Public Arts - East (71), Visual & Public Arts - Center (72), and Visual & Public Arts - West (73) buildings. Sometime after 2016, one of the two Central Plant buildings (74) is demolished.

Fort Ord Building Typology

Four categories of building types were identified for the purposes of this study. These are the Support Services Buildings, Medical Buildings, Hammerhead Buildings/Barracks, and Recreational Buildings. The following presents a discussion of the Support Services building typology, as the Visual and Public Arts building (70) is classified as this type. This section provides a detailed account of the specific character-defining features of Fort Ord Cold War and Vietnam Era (1946-1976) Support Services buildings.

Building Typology: Support Services Buildings

Support Services Buildings constructed during the Cold War and Vietnam Eras (1946-1976) at Fort Ord have a variety of uses and functions that changed over the history of the base. In alignment with the typical planning, design, and materials of buildings constructed during this period of Fort Ord's history, these buildings are constructed with reinforced concrete and CMU and feature flat or gable roofs with multi-light windows with concrete sills. These buildings tended to have a uniform design, like many of the other buildings at Fort Ord.

After Fort Ord closed in 1994, these support services buildings became part of the CSUMB campus. With the shift to campus use, many of the buildings were altered to fit the needs of CSUMB. The Visual and Public Arts building footprints appears unchanged between 1956 and the present (NETR 2021).

Character-Defining Features for the Support Services Buildings

The Support Services Buildings originally exhibited the following specific character-defining features:

Character Aspect	Primary Character-Defining Features	Character-defining features
Shape and Plan	<ul style="list-style-type: none"> Simple rectangular form Single story 	The overall shape and mass of the building are considered a primary character-defining feature of the support services buildings. The plan should be rectangular in form.
Roof	<ul style="list-style-type: none"> Flat or gable roof small eave overhangs No exposed rafters 	Support service buildings from this period have gable roof forms, with slight eave overhangs.
Openings	<ul style="list-style-type: none"> Public entrances and circulation patterns 	Window openings are generally uniform in size and placement, windows are multi-light, and set into concrete openings. Replaced windows

CONTINUATION SHEET

Property Name: Visual and Public Arts 70

Page 9 of 15

		are not considered character-defining features as they fall outside the period of significance.
Exterior Ornamentation	<ul style="list-style-type: none"> Minimal exterior ornamentation 	The support services buildings were designed to be quickly constructed. They have little to no decorative ornamentation, with windows being set evenly apart and CMU pillars being the only decorative element.
Materials	<ul style="list-style-type: none"> Mass-produced and cost-effective materials Concrete and CMU Reinforced Concrete construction 	The support services buildings have simple, utilitarian designs. Buildings were constructed using mass-produced and cost-effective building materials that were readily available at the time of construction. For instance, buildings under the support services buildings type were constructed with reinforced concrete and CMU and were minimally decorated.

Alterations and demolitions over time have compromised the overall architectural integrity of this building type. The most common alterations observed for this building type include the following.

- Replacement windows
- ADA compliance measures such as ramps and doors
- HVAC systems and window units
- Infill of openings
- Addition of front gable over doorways
- Interior renovations

NRHP/CRHR Designation Criteria

In consideration of the Visual and Public Arts building's history and requisite integrity, Dudek recommends the building not eligible for listing in the NRHP and CRHR based on the following significance evaluation and in consideration of national and state eligibility criteria:

Criterion A/1: That are associated with events that have made a significant contribution to the broad patterns of our history.

The Visual and Public Arts building was constructed in c 1950 during the period defined as the Cold War and Vietnam Eras (1946-1976) at Ford Ord. While this building is of historic age and was constructed during an important period of development in Fort Ord's history, it no longer retains enough integrity to convey its significance. One of the most notable elements of integrity that is compromised is the integrity of setting. Significant demolition, changes to circulation patterns, introduction of new buildings, and changes in use, all impact the campus's ability to convey significance from its time as an active Cold War and Vietnam Era military base. The loss of this overall integrity of setting adversely effects the Visual and Public Arts building, as individual buildings are no longer able to convey their collective history. Additionally, the subdivision of Fort Ord following its closure has also greatly impacted the integrity of feeling, association, and setting of the remaining Cold War and Vietnam Era buildings. The Visual and Public Arts building is not able to convey its association with any extraordinary

CONTINUATION SHEET

Property Name: Visual and Public Arts 70

Page 10 of 15

events or events occurring within the context of Cold War and Vietnam military support service buildings, the CSUMB Campus, or has an association with the broad patterns of history in Monterey County, the State of California, or the Nation. Therefore, the building is recommended not eligible under NRHP/CRHR Criterion A/1.

Criterion B/2: That are associated with the lives of persons significant in our past.

To be found eligible under B/2 the building must be directly tied to an important person and the place where that individual conducted or produced the work for which he or she is known. Archival research did not find any notable persons associated with the Visual and Public Arts building. As such, this building is not known to have any historical associations with people important to the nation's or state's past. Due to a lack of identified significant associations with important persons in history, Dudek recommends the building is not eligible under NRHP/CRHR Criterion B/2.

Criterion C/3: That embody the distinctive characteristics of a type, period, or method of construction, or that represent the work of a master, or that possess high artistic values, or that represent a significant and distinguishable entity whose components may lack individual distinction.

Archival research indicates that the Visual and Public Arts building was constructed in c. 1950 as a motor park for Fort Ord. The building was not constructed in any obvious architectural style and is a ubiquitous building type that lacks high style components to set it apart from other buildings constructed in the 1950s. The building has been altered with the alteration of the fenestration pattern on the east elevation, the infill of a garage door, and the infill of the original window frames. For these reasons, the building does not possess a high level of architectural merit to be considered for inclusion in the NRHP. For these reasons Dudek recommends the Visual and Public Arts building is not eligible under NRHP/CRHR Criterion C/3.

Criterion D/4: That have yielded, or may be likely to yield, information important in prehistory or history.

There is no evidence to suggest that the Visual and Public Arts building has the potential to yield information important to state or local history. Therefore, the building is recommended not eligible under NRHP/CRHR Criterion D/4.

California Historic Landmark Statement of Significance

In consideration of the Visual and Public Arts building history and requisite integrity, Dudek recommends the building is not eligible for designation as a California Historic Landmark based on the following significance evaluation and in consideration of state eligibility criteria:

The first, last, only, or most significant of its type in the state or within a large geographic region (Northern, Central, or Southern California).

The Visual and Public Arts building was designed circa 1950. The building was constructed during the Cold War and Vietnam Eras (1946-1976) at Fort Ord. The Visual and Public Arts building is a utilitarian building type that lacks high style components to set it apart from other buildings constructed throughout the State of California in the 1950s. Therefore, Dudek recommends the building is not eligible for listing as a CHL under this criterion.

Associated with an individual or group having a profound influence on the history of California.

Archival research failed to indicate any significant associations between the Visual and Public Arts building and individuals or groups that profoundly influenced the history of California. The Visual and Public Arts building was one of several

CONTINUATION SHEET

Property Name: Visual and Public Arts 70

Page 11 of 15

support/classroom buildings constructed on the site. No architect or other individuals are known to have influenced the construction or use of this building. Therefore, Dudek recommends the Visual and Public Arts building is not eligible for listing as a CHL under this criterion.

A prototype of, or an outstanding example of, a period, style, architectural movement or construction or is one of the more notable works or the best surviving work in a region of a pioneer architect, designer or master builder.

The Visual and Public Arts building is neither a prototype or an outstanding example of a period, style, or architectural movement. The building was designed to serve a utilitarian purpose as Fort Ord's Motor Park. There are no remaining identifying features on the Visual and Public Arts building that would establish the building as a notable work of a master architect, or a notable designer or builder working within the military, or in the State of California. Therefore, Dudek recommends the building is not eligible for listing as a CHL under this criterion.

Local Designation Criteria

Portions of the CSUMB campus are located within the boundaries of two cities, City of Seaside and the City of Marina, both of which evaluate historical resources in accordance with CEQA Guidelines. as presented above. The subject property, as discussed in the NRHP/CRHR/CHL criteria discussion above, does not rise to the necessary level of significance for local, state, or national designation. For these reasons, the subject property is recommended not eligible individually or as a component of a historic district under any of the NRHP/CRHR/CHL criteria.

Additionally, portions of the CSUMB campus are located in the County of Monterey and the campus is therefore subject to the regulations set forth in Chapter 18.25 of the Monterey County Code. The subject property, as discussed in the NRHP/CRHR/CHL criteria discussion above, does not rise to the necessary level of significance for state or national designation. For these same reasons, the subject property is also recommended not eligible individually or as a component of a historic district under any of the delineated County of Monterey review criteria categories that are addressed with the NRHP/CRHR/CHL criteria discussed above: A. Historical and Cultural Significance; B. Historic, Architectural, and Engineering Significance; or C. Community and Geographic Setting.

Integrity Discussion

The Visual and Public Arts building was analyzed against the seven aspects of integrity: location, design, setting, materials, workmanship, feeling, and association. The building retains its integrity of location, as it has not been relocated; however, the integrity of setting has been compromised due to the change of use, from a Cold War and Vietnam Era military support services building to an educational classroom building for CSUMB. Changes to the surrounding area have further compromised the integrity of setting and feeling. Replacement materials have been added throughout the building since its completion in circa 1950, changes in the fenestration pattern and the infill of several openings. These alterations have compromised the resource's integrity of design, materials, and workmanship. As the building does not possess historic significance, there is no historic association. While the building is in good condition, it does not possess integrity to convey significance or its temporal period.

Summary of Evaluation Findings

The Visual and Public Arts building retains little historic integrity and lacks historical and architectural significance. Based on the significance evaluations presented above, the Visual and Public Arts building does not appear to meet the NRHP,

CONTINUATION SHEET

Property Name: Visual and Public Arts 70

Page 12 of 15

CRHR, CHL or local designation criteria. Therefore, the Visual and Public Arts building is not considered a historical resource for purposes of CEQA.

CONTINUATION SHEET

Property Name: Visual and Public Arts 70

Page 13 of 15

*B12. References (continued):

ACHP (Advisory Council on Historic Preservation). 2006. "Draft Program Comment Regarding Cold War Era Unaccompanied Personnel Housing." Federal Register: The Daily Journal of the United States Government. 12 April 2016. Accessed June 30, 2021 Available at: <https://www.federalregister.gov/documents/2006/04/12/06-3509/draft-program-comment-regarding-cold-war-era-unaccompanied-personnel-housing>

Californian, The. 1940. "No More Camp Ord! It's Fort Ord Now! Stilwell in Command: Headquarters of General Located on Salinas Side." July 13, 1940. Salinas, California, pg. 1.

Californian, The. 1951. Stadium Field House—Sixth Army Lets Ord Contract. March 20, 1951. P1. Accessed June 17, 2021. Available at: Newspapers.com.

Castle, Ted. 1990. "The March of Time." Fort Ord Panorama. September 21, 1990.

Cavanaugh, Joe. 2000. *The Peace Dividend: Defense Conversion Through Higher Education*. The Leon Panetta Institute.

Chamberlin Library. 2021. Fort Ord Working Papers. CSUMB Special Collections Box 6.42-01. Available at the Chamberlin Library, Seaside, California.

CSUMB Facilities. 2021. Original As built and renovation architectural drawings on file with CSUMB facilities department. Accessed in person June 15-16, 2021.

DLIFLC (Defense Language Institute Foreign Language Center). 2021. Command History Program. Accessed in person on June 15, 2021 and accessed online database collection online July 2021. Available at: <https://adli.pastperfectonline.com/>

EA Engineering. 1991. Draft Final Fort Ord, California Base wide Remedial Investigation Feasibility Study. Volume 1 Literature Review and Base Inventory Report. Accessed on July 13, 2021. Available at: <https://www.fortordcleanup.com/documents/search/>

Fresno Bee, The. 1951a. "Army Spokesman Are Defending Building of Fort Ord Stadium." January 12, 1951. Page 13. Accessed June 17, 2021.

Fresno Bee, The. 1951b. "Army Spokesman Are Defending Building of Fort Ord Stadium." February 4, 1951. Page 27. Accessed June 17, 2021. Available at: Newspapers.com.

Gates, S., & Williams, H. 1957. The Armed Forces. *The Annals of the American Academy of Political and Social Science*, 313, 99-104. Accessed June 17, 2021. <http://proxy.multcolib.org:2052/stable/1031762>

MacGregor Jr., Morris J. 1981. *Integration of the Armed Forces, 1940-1965*. Center of Military History, United States Army: Washington, D.C.

Madsen, Alexandra and Steven Treffers. 2019. *Historic Resources Evaluation Memorandum for Hammerhead Barracks at Fort Ord, Monterey County, California*. Prepared by

CONTINUATION SHEET

Property Name: Visual and Public Arts 70

Page 14 of 15

Rincon Consultants, Inc for City of Seaside, Community and Economic Development Department. November 4, 2019. Accessed June 28, 2021.
https://www.ci.seaside.ca.us/DocumentCenter/View/10674/9_App-S---HRE-Memo

Military Museum. 2016. "Historic California Posts, Camps, Stations, and Airfields: Fort Ord." Accessed on June 19, 2021. <http://www.militarymuseum.org/FtOrd.html>

National Archives Foundation. 2021. Executive Order 9981. Accessed June 29, 2021. Available at: <https://www.archivesfoundation.org/documents/executive-order-9981-ending-segregation-armed-forces/>

NETR (Nationwide Environmental Title Research LLC). 2021. Historic Aerial Photographs of 100 Campus Center, Seaside, CA 93955 dating from 1956, 1968, 1981, 1998, 2005, 2009, 2010, 2012, 2014, 2016, and 2018. Accessed June 10, 2021.
<https://www.historicaerials.com/viewer>

Panorama. 1990. "50 Years and Counting..." September 21, 1990, pg. 2.

Panorama. n.d. "Ford Ord in World War II." Historic California Posts: Fort Ord. Accessed on June 19, 2021. <http://www.militarymuseum.org/FtOrd.html>

Park, R. 2015. "Happy and Cheerful in This Fine Camp": Sports, Recreation, and the United States Army at Fort Ord and Camp Roberts, 1940 to 1945. *Journal of Sport History*, 42(1), 21-37. Accessed on June 18, 2021, from
<https://www.jstor.org/stable/10.5406/jsporhistory.42.1.21>

Pomona Progress Bulletin. 1950. War Solving Racial Problems. August 24, 1950. Page 4. Accessed June 29, 2021. Available at: [Newspapers.com](http://www.newspapers.com).

Quartermaster Review, The. 1940. "Army Construction Underway at Camp Ord, California." Volume XX. No 3. November-December. On file at the Chamberlin Library, Ord Military Community.

Raugh, Harold E. 2004. Fort Ord. Charleston, SC: Arcadia.

Salinas Morning Post. 1940. "\$2,766,000 in Building Authorized—Ord Contracts Let." August 21, 1940. Salinas, CA. pg. 1.

San Francisco Examiner. 1951. Fort Ord Will Get Stadium. San Francisco Page 4. . 3 Feb 1951. Pages 1 and 4 A Available on [www.Newspapers.com](http://www.newspapers.com). Accessed on Jun 11, 2021.

San Francisco Examiner. 1958. Army Asks OK on \$124,000,000 for Fort Ord Buildings. San Francisco. Section 2. Page. 4. Available on [www.Newspapers.com](http://www.newspapers.com). Accessed July 18, 2021.

Vasche, J. Burton. 1959. "The California State Colleges: Their History, Organization, Purposes, and Programs." in California

U.S. Army. 1977. Post Map Main Garrison Area. Fort Ord, California. Drawing number G-950. Accessed in person at the Chamberlain Library on June 15, 2021.

CONTINUATION SHEET

Property Name: Visual and Public Arts 70

Page 15 of 15

Walch, Bob. 2004. An Army Historian's Pictorial Take on Fort Ord. Monterey County NOW. Accessed July 12, 2021. Available at:
https://www.montereycountyweekly.com/news/local_news/an-army-historian-s-pictorial-take-on-fort-ord/article_6e8b0250-9c38-5ca4-a4a4-f93d42d65a11.html

Whaley, Derek. 2015. "East Monterey & Seaside." Santa Cruz Trains: Railroads of the Monterey Bay Area. July 20, 2015. Accessed online:
<https://www.santacruztrains.com/2015/07/east-monterey-seaside.html>.

Webb Spinner, The. 1952-1954. Webb Spinner Volume for 1952-1954. Del Webb Sun Cities Museum Collection. Accessed June 30, 2021. Accessed at:
<https://delwebbsuncitiesmuseum.org/newsletters-webb-spinners/>

State of California & The Resources Agency
DEPARTMENT OF PARKS AND RECREATION
PRIMARY RECORD

Primary #
HRI #
Trinomial
NRHP Status Code 6Z

Other Listings
Review Code

Reviewer

Date

Page 1 of 18 *Resource Name or #: (Assigned by recorder) Freeman Stadium

P1. Other Identifier: CSUMB Building 902/903

*P2. Location: Not for Publication Unrestricted

*a. County Monterey County and (P2c, P2e, and P2b or P2d. Attach a Location Map as necessary.)

*b. USGS 7.5' Quad Marina, CA Date 1995 T 15S; R 1E; NE $\frac{1}{4}$ of SE $\frac{1}{4}$ of Sec 1; Mount Diablo B.M.

c. Address 4111 2nd Ave Seaside Zip 93955

d. UTM: (Give more than one for large and/or linear resources) Zone 10S, 606812 mE/4056806 mN

e. Other Locational Data: (e.g., parcel #, directions to resource, elevation, decimal degrees, etc., as appropriate)

Freeman Stadium sits south of Divarty Street, between 2nd Avenue and General Jim Moore Boulevard.

*P3a. Description: (Describe resource and its major elements. Include design, materials, condition, alterations, size, setting, and boundaries)

Freeman Stadium (CSUMB Building 902/903) sits south of Divarty Street, between 2nd Avenue and General Jim Moore Boulevard. The stadium is clustered with other outdoor athletic facilities northeast of the Otter Sports Complex on the California State University, Monterey Bay (CSUMB) campus. Freeman Stadium is located at a low grade, with the bleachers following the slope of the hillside. A chain-link fence encloses the field, track, and bleachers, with gates on the west, near the Field House, and on the east side of the field for ADA accessibility. Deciduous and evergreen trees and shrubs are planted around the perimeter of the chain-link fence. See Continuation Sheet.

*P3b. Resource Attributes: (List attributes and codes) HP42. Stadium/Sports Field/HP34 Military property

P5a. Photograph or Drawing (Photograph required for buildings, structures, and objects.)



*P4. Resources Present: Building
 Structure Object Site District
Element of District Other (Isolates, etc.)

P5b. Description of Photo: (view, date, accession #) East elevation, view looking west, Dudek (IMG 0477)

*P6. Date Constructed/Age and Source: Historic Prehistoric Both
1951 (The Californian)

*P7. Owner and Address:
CSUMB, 100 Campus Center, Seaside, CA. 93955

*P8. Recorded by: (Name, affiliation, and address) Sarah Corder, Dudek, 725 Front St #400, Santa Cruz, CA 95060

*P9. Date Recorded: 6/14/2021

*P10. Survey Type: (Describe)
Intensive level

*P11. Report Citation: (Cite survey report and other sources or enter none)
Dudek 2021. Built

Environment Inventory and Evaluation Report for California State University, Monterey Bay

*Attachments: NONE Location Map Continuation Sheet Building, Structure, and Object Record

Archaeological Record District Record Linear Feature Record Milling Station Record Rock Art Record

Artifact Record Photograph Record Other (List): _____

Page 2 of 18 *Resource Name or # (Assigned by recorder) Freeman Stadium
Map Name: Marina Quadrangle *Scale: USGS 7.5-minute Series *Date of map: 1995



● Freeman Stadium

BUILDING, STRUCTURE, AND OBJECT RECORD

*Resource Name or # (Assigned by recorder) Freeman Stadium *NRHP Status Code 6Z
Page 3 of 18

B1. Historic Name: Warriors Stadium
B2. Common Name: Freeman Stadium
B3. Original Use: Stadium/Sports Field 4. Present Use: Outdoor Field/Athletic Complex
*B5. Architectural Style: Altered Beyond Recognition

*B6. Construction History: (Construction date, alterations, and date of alterations)
Designed in 1949 and completed in 1951, Freeman Stadium has been altered beyond recognition since its construction. Renovation and as-built drawings show alterations to the subject property took place in 1953, 1974, 1982, 1987, 1998, and 2006. Minor changes and upgrades were completed in 1953, 1974, 1982, 1987, and 1998. Major renovations were completed to the Field House in 2006, including the addition of three, barrel roof, two-story additions to the south, center, and north portions of the building, removal of original doors, windows, and substantial changes to fenestration (CSUMB Facilities 2021). The field was paved in 2018 (NETR 2021)

*B7. Moved? No Yes Unknown Date: _____ Original Location: _____ *B8. Related Features:

B9a. Architect: Fort Ord Engineering Office b. Builder: F. V. Hampshire Contracting Company

*B10. Significance: Theme N/A Area N/A
Period of Significance N/A Property Type N/A Applicable Criteria N/A
(Discuss importance in terms of historical or architectural context as defined by theme, period, and geographic scope. Also address integrity.)

See Continuation Sheet.

B11. Additional Resource Attributes: (List attributes and codes) _____

*B12. References: See Continuation Sheet.

B13. Remarks:

*B14. Evaluator: Adrienne Donovan-Boyd, MSHP

*Date of Evaluation: July 20, 2021

(This space reserved for official comments.)



CONTINUATION SHEET

Property Name: Freeman Stadium

Page 4 of 18

*P3a. Description (continued):

Freeman Stadium is made up of the following components: the field, track, bleachers, electrical building, and Field House. Freeman Stadium field is oval, paved, and has a white coating. A paved track encircles the field, but track markings are no longer delineated on the pavement. Concrete, stepped bleachers are located on the north and south side of the track and field. They each measure approximately 342 feet by 48 feet and contain 15, board-formed, concrete bleachers with concrete stairs on both the north and south ends and four sets of stairs evenly spaced throughout the bleachers, creating distinct aisleways. Additional concrete stairs lead from the track on the east and west sides of bleachers. A welded 1½ inch metal railing is located along the perimeter of each section of bleachers with openings at each stairwell.

The electrical building is located on a berm west of the track. The small, windowless building is constructed of CMU and sits on a concrete foundation. The building has a low-pitched cement shed roof with small eave overhangs.

The two-story, Field House building sits at the west end of the field and track. The building is rectangular in plan with a side-gable roof sheathed in standing seam metal. The roof has round skylights evenly spaced throughout and small eave overhangs. Three, two-story, barrel roofed sections are evenly spaced on the façade, one of which is a larger central section. Two, smaller, two-story barrel roof sections are located on the north and the southern portions of the building. The concession area is in the central two-story section. This section has square pillars supporting an overhanging barrel roof. The pillars are primarily clad in stucco fiber cement siding panels, with the lower portion clad in manufactured stone veneer. The west elevation has windows located at irregular intervals, all of which appear to be the side-sliding vinyl variety, except for the windows in the barrel roof gable ends, which appear to be fixed, multi-light windows with protruding metal frames.



Figure 1. Main (west) elevation, looking northeast (IMG_0431)

CONTINUATION SHEET

Property Name: Freeman Stadium

Page 5 of 18



Figure 2. East elevation, looking west (IMG_0477)

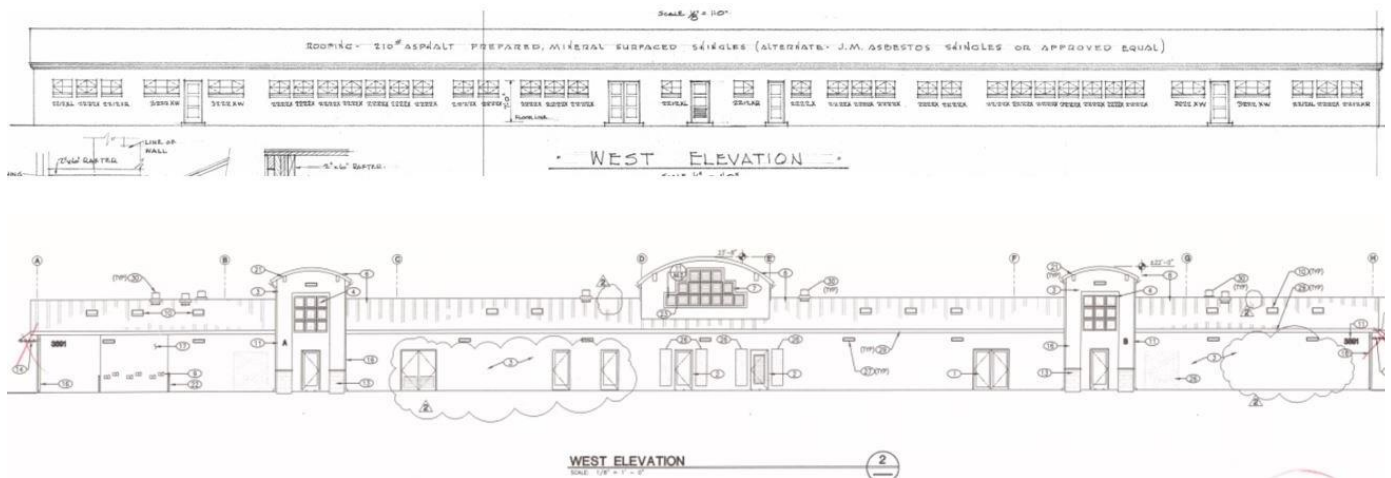

Figure 3. 1949 As-Built Drawing (top) 2006 Renovation Drawing (bottom) (DPR Elevations)

CONTINUATION SHEET

Property Name: Freeman Stadium

Page 6 of 18



Figure 4. South bleachers, looking southeast (IMG_0434)



Figure 5. Electrical building, looking east (IMG_0452)

CONTINUATION SHEET

Property Name: Freeman Stadium

Page 7 of 18



Figure 6. Track detail, looking northwest, Field House in background (IMG_0437)

*B10. Significance (continued):

Historical Overview of Fort Ord

The history of Fort Ord has been extensively documented in newspaper articles, websites, academic journals, and books. From its creation in 1917 to its closure in 1994, the base grew to become one of the largest training centers in the country. Its location was also reported to be the most attractive U.S. Army post, with easy access to the ocean and beautiful California weather.

The development periods in the history of Fort Ord were defined by Harold E. Raugh, Jr, a U.S. Army lieutenant colonel and historian with the Department of Defense. Since his retirement, Raugh served as the Chief Historian, for the Defense Logistics Agency, for the Department of Defense and, from 2006-2013, Raugh served as the Command Historian at the Defense Language Institute Foreign Language Center (DLIFLC) and the Presidio of Monterey, California. He received his PhD in history from the University of California, Los Angeles (Walch 2004). Raugh has authored numerous books including, Fort Ord (2004); Presidio of Monterey (2004); Operation Joint Endeavor: V Corps in Bosnia-Herzegovina, 1995-1996 (2013); The Raugh Bibliography of the Indian Mutiny 1857-1859 (2016); and Wavell in the Middle East, 1939-1941: A study in Generalship. Raugh defined four periods for the historic development of Fort Ord:

- 1917-1940 Camp Gigling to Camp Ord
- 1940-1945 Fort Ord and the 7th Infantry Division
- 1946-1976 The Cold War and Vietnam Eras
- 1974-1994 The Volunteer Army

These periods correspond to distinct eras in the history of the base and the U.S. Army (Raugh 2004: ii). The following sections provide a summary overview of each of these periods of development and their relevance to the area of Fort Ord now known as the CSUMB campus.

CONTINUATION SHEET

Property Name: Freeman Stadium

Page 8 of 18

The full historic context of Fort Ord is represented in the report, Built Environment Inventory and Evaluation Report for California State University, Monterey Bay (Dudek 2021). The following presents only relevant historical and building typology information pertaining to the development of Freeman Stadium.

Cold War and Vietnam Eras at Fort Ord (1946-1976)

This period of development between 1946 and 1976 was characterized by a massive operation to move the base out of its semi-permanent status and create a permanent outpost for active military personnel who were retained due to ongoing foreign conflicts.

In July of 1948, Harry S Truman signed Executive Order 9981, which officially ended segregation in the armed forces. The order stated that "there shall be equality of treatment and opportunity for all persons in the armed forces without regard to race, color, religion, or national origin" (National Archives Foundation 2021). Fort Ord became one of the first integrated training divisions in the United States. The Fort was touted as "pioneering to end all segregation" (The Pomona Progress Bulletin 1950: 4). In 1950, the Pomona Progress Bulletin reported that black and white soldiers at Fort Ord were "fighting side by side" and all the enlistees "trained together, slept in the same barracks, and eat the same messes" (The Pomona Progress Bulletin 1950: 4).

The end of World War II in 1945 did not bring lasting peace. The tenuous relationship between dominant nations in the communist East and free market West led to the beginning of the Cold War. The Department of Defense maintained a robust fighting force during the Cold War, with more than 900,000 Army personnel retained during the 1950s (ACHP 2006). The ongoing global tensions and the number of active U.S. military personnel created a need for new permanent buildings and expanded military housing at Fort Ord.

In 1949, the Soviet-supported communist government of North Korea invaded American-supported South Korea, initiating the Korean War. Fort Ord was a primary staging area for the training of troops departing for the war (Castle 1990:3). By the 1950s, Fort Ord had become one of the largest basic training camps in the United States. In 1952, the military began a multi-million dollar building program to transform Fort Ord into a permanent post, including the development of permanent troop housing, and the construction of a guard house, stockade, and multiple warehouses. In January of 1952, military authorities announced the new construction program at Fort Ord was underway, with an estimated cost of \$26,650,600. More than half of the funds that were approved by Congress were "earmarked for new permanent troop housing" for more than 7,000 soldiers (The Webb Spinner 1952-54, Vol 6. No. 3:1).

The new troop housing was to be constructed of reinforced concrete, a departure from the wood buildings constructed before and during World War II. The plan called for three types of massive barracks, twenty-two were to house 225 enlisted men each, seven were to accommodate 165 men each, and nine were to house 105 men each (The Webb Spinner 1952-54, Vol 6. No. 3:3). The San Francisco District of the U.S. Army Corps of Engineers oversaw the construction project to completion. An additional \$1,349,700 was earmarked for the expansion of classroom and training facilities at Fort Ord, including a new battalion and regimental headquarters (The Californian 1952a:1 and The Californian 1952b:18). By March of 1952, another phase of the permanent army post transformation began with the construction of a guard house, stockade, warehouse, and other buildings (The Webb Spinner 1952-54, Vol 6. No. 3:1). This addition of permanent buildings continued into the late 1950s, when the Army requested \$124 million to replace all the wood World War II infrastructure at Fort Ord with concrete block and reinforced concrete (Madsen and Treffers 2019:6; San Francisco Examiner 1958:2-4). While many of the wood buildings remain today, this period saw the continuous addition of reinforced concrete permanent buildings across the Fort (Madsen and Treffers 2019:6).

CONTINUATION SHEET

Property Name: Freeman Stadium

Page 9 of 18

Following the Korean War through the end of the conflict in Vietnam, Fort Ord served as an important training facility. In 1957, Fort Ord was designated as a U.S. Army Training Center for Infantry (Castle 1990: 4). The 7th Infantry Division was based at Fort Ord in 1975 (Cavanaugh 2000: 9). Fort Ord produced thousands of combat-ready troops during the conflict in Vietnam.

With the establishment of Fort Ord as a permanent Army base during this period, there was substantial building construction that led to the modernization of the base and its services. This development is closely related to the history of the current CSUMB campus. All the properties that are included as part of this built environment study were constructed during the Cold War and Vietnam Era period. Building development during this period was a substantial departure from the styles and materials used in the buildings constructed before World War II. Building during the period between 1946 and 1976 used reinforced concrete and concrete masonry unit (CMU). The buildings tended to be larger than those constructed in previous periods. Other development in this period included support service buildings and several types of medical buildings. Infrastructure was also improved at this time, with the introduction of paved streets and roadways, and the addition of several water tanks, water pumping plants, and warehouse buildings.

Recreation Opportunities at Fort Ord

During the Cold War and Vietnam Eras at Fort Ord (1946-1976) recreational opportunities increased substantially on the base. Initially, the U.S. Armed Forces focused solely on training programs that led to the production and establishment of a robust fighting force. Recreation for enlisted soldiers was often provided by civilian groups, not through formal programs run through any branch of the military. This began to change after World War I. The 1940 plan for the development of Fort Ord called for all the buildings necessary to train, house, and care for the infantry, as well as the construction of recreation related facilities such as post exchanges, regimental recreational facilities, moving picture tents, and service clubs (Quartermaster Review 1940: 37). During World War II, the military vastly expanded recreational offerings for enlisted personnel to boost morale and to align with more modern concepts of free-time and leisure (Gates 1957: 99). Morale, it was said, was "just as important as ammunition" and newer, more modern thinking saw recreation as a "vital force in self-development and the art of living" (Gates 1957: 100).

Early recreation activities at the Fort included band concerts, live theater, orchestra shows, and choir performances often organized by the enlisted men (Park 2015: 25). Track and field meets were organized with field days throughout World War II. Boxing was also noted as a popular spectator sport at the base in its early years (Park 2015:25). Fort Ord's first football team, the Presidio Dons, was organized in October 1940. The team initially practiced and played at nearby Del Monte Polo Field. During World War II, the Fort Ord Athletic and Recreation Officer designed a plan to keep soldiers "fit to fight" by developing a more extensive plan for football, baseball, softball, boxing, and other recreational activities. Soon after, games and tournaments were arranged between Fort Ord teams, nearby military bases, and other organized teams (Gates 1957: 100). After the war ended in 1945, Fort Ord introduced an athletic program that gave service members "an opportunity to take part in any recreational activity they wish" (Park 2015: 33). In 1951, a report completed by the Committee on Religion and Welfare in the Armed Forces found that the availability of "wholesome free time activities" were essential for shaping character, increasing job performance, and for the national support of the Armed Forces" (Gates 1957: 100).

The recreation opportunities available at Fort Ord continued to expand in the post-World War II era with the construction of the stadium and other outdoor athletic fields in the 1950s and 1960s. By 1977, the main garrison area included a wide variety of recreation

CONTINUATION SHEET

Property Name: Freeman Stadium

Page 10 of 18

facilities, including a snack bar, bowling center, softball field, baseball field, service club, library, handball courts, tennis courts, a commissary, the theater, and parade grounds, as well as the Football and Track Stadium (U. S. Army 1977). It was believed that these recreation opportunities created better leaders and would better prepare soldiers for successful civilian lives after their service (Gates 1957: 104).

The Freeman Stadium, originally called the Warrior Stadium, is the only Recreation Facility type in the campus study area. Freeman Stadium is made up of the following components: the field, track, bleachers, electrical building, and Field House. This grouping is referred to throughout this report as the "Freeman Stadium." In January of 1949, the Army prepared plans and specifications for a new Football and Track Stadium (Fresno Bee 1951b:27). The plans were finalized in December 1949 by Fort Ord Engineer Office (CSUMB Facilities 2021). They called for the development of the new stadium at the site of the base's existing amphitheater, just north of the parade grounds. In January 1951, the Army requested bids for a \$200,000, 6,000-seat, concrete football and track stadium at Fort Ord. The design called for the stadium seating to be reinforced concrete, set into the existing dirt embankment of the base's amphitheater (Fresno Bee 1951a: 13).

The plan to develop a stadium at Fort Ord was immediately met with criticism, as President Truman had previously ordered a freeze on new government construction projects to direct funds to the Korean War effort. The Army argued that the stadium was planned "long before the present emergency" and would be constructed of non-critical materials. The planned stadium seating was designed to be constructed of "concrete steel blocks" and concrete slab flooring. In February 1951, it was announced that the stadium would use steel water pipes and cast-iron conduits for construction in an effort to preserve copper (Fresno Bee 1951b:27). Ultimately, the ban on unnecessary construction was ignored, citing the need for recreational facilities to boost morale, and because the growth of Fort Ord was placing a "severe strain on the recreational facilities in the Monterey-Salinas area" (San Francisco Examiner 1951:4). The stadium was considered a necessary facility to "keep pace with the growth of the tent-soldier population" and the athletics field would help to reinforce the Army's rigorous training program (San Francisco Examiner 1951:4). The contract was awarded to construct the stadium and Field House in March 1951 to F. V. Hampshire Contracting Company of Salinas. They bid \$146,346 for the project. Construction was set to begin soon after the contract was awarded and was planned to be completed by September 1951 (Figures 17 and 18) (The Californian 1951: 1).

After Fort Ord closed in 1994, Warrior Stadium became part of the CSUMB campus. The stadium was rebranded as Freeman Stadium and has not been used for athletic purposes in some time; instead it is used for graduation ceremonies and other gatherings.

Fort Ord Football: The Warriors

The first football team at Fort Ord were named the Presidio Dons was organized in 1940. The team held practices at nearby fields and appeared to play other branches of the military. After the new stadium was constructed in 1951, the team's name changed to the Warriors and games were being played regularly between military units, but also against other college teams. By November of 1953 the Fort Ord's semi-professional football team made up of service members stationed at Fort Ord, were playing games in the newly completed "Warriors Stadium" (Sacramento Bee 1953:33). During the 1953 season, the Warriors played both the Los Angeles Rams and the San Francisco Forty Niners. The team was so well respected that in the 1950s, coaches from various colleges would visit Fort Ord at the end of the season in an effort to recruit players for college football (Hollaway 2021). The Warriors were the top-ranked service team in the country in the mid-1950s (Sports Press 2012). In 1953, Don Heinrich, who twice earned the All-American rating while quarterbacking for the Washington Huskies, and Ollie Matson, who played for the Chicago Cardinals and went on to play for the Los Angeles Rams were both playing for

CONTINUATION SHEET

Property Name: Freeman Stadium

Page 11 of 18

the Warriors during their tour of duty (Seattle Times 1953:73). The Fort Ord Warriors continued to have All Star and professional bound players through the 1950s and 1960s keeping them in the top of the ratings and making football one of Fort Ord's most prominent sports.

Freeman Stadium, 1951

In January of 1949, the Army prepared plans and specifications for a new Football and Track Stadium (Fresno Bee 1951b:27). The plans were finalized in December of 1949, by the Fort Ord Engineer Office (CSUMB Facilities 1949). They called for the development of the new stadium at the site of the base's existing amphitheater, just north of the parade grounds. In January of 1951, the Army put out a call for bids for the \$200,000, 6,000-seat, concrete football and track stadium at Fort Ord. The design called for the stadium seating to be reinforced concrete, set into the existing dirt embankment of the base's amphitheater (Fresno Bee 1951a:13).

The plan to develop a stadium at Fort Ord was immediately met with criticism, as President Truman had previously ordered a federal freeze on new government construction to aid the Korean War effort. The Army argued that the stadium was planned "long before the present emergency" and would be constructed of non-critical materials. The planned stadium seating was designed to be constructed of "concrete steel blocks" and concrete slab flooring. They announced in February of 1951, in an effort to preserve copper, the stadium would use steel water pipes and cast-iron conduits for construction (Fresno Bee 1951b:27). Ultimately, the ban on unnecessary building was ignored, citing the need for recreational facilities to boost morale, and because the growth of Fort Ord was placing a "severe strain on the recreational facilities in the Monterey-Salinas area" (San Francisco Examiner 1951:4). The stadium was considered a necessary facility to "keep pace with the growth of the tent-soldier population" and the athletics field would help to reinforce the Army's rigorous training program (San Francisco Examiner 1951:4).

The contract was awarded to construct the stadium and Field House in March of 1951 to F. V. Hampshire Contracting Company of Salinas. They bid \$146,346 for the project. Construction was set to begin soon after the contract was awarded and was planned to be completed by September of 1951 (The Californian 1951:1).

Fort Ord Building Typology

Four categories of building types were identified for the purposes of this study. These are the Support Services Buildings, Medical Buildings, Hammerhead Buildings/Barracks, and Recreational Facilities. The following presents a discussion of the Recreation Facilities typology, as Freeman Stadium is classified in this typology. This section provides a detailed account of the specific character-defining features of Fort Ord Cold War and Vietnam Era (1946-1976) Recreation Buildings.

Building Typology: Recreational Facilities

During the Cold War and Vietnam Eras at Fort Ord (1946-1976) recreational opportunities increased substantially on the base. In alignment with the typical planning, design, and materials of buildings constructed during this period of Fort Ord's history, these buildings are constructed with reinforced concrete and CMU and feature multi-light windows with concrete sills.

The only Recreation Facility in the Built Environment ADI, Freeman Stadium, was originally constructed in 1951. The stadium was constructed at the site of Fort Ord's existing amphitheater, just north of the parade grounds. The 6,000-seat stadium seating was constructed of reinforced concrete, set into the existing dirt embankment (Fresno Bee 1951a: 13). The Field House was also constructed of concrete, as a building ban was in effect and concrete was not a restricted material. After Fort Ord closed in 1994, Warrior Stadium became part of the CSUMB campus. The stadium was rebranded as Freeman

CONTINUATION SHEET

Property Name: Freeman Stadium
 Page 12 of 18

Stadium and has not been used for athletic purposes in some time, instead it is used for graduation ceremonies and other gatherings.

Character-Defining Features for the Recreational Facilities

The Recreation Facilities originally exhibited the following specific character-defining features:

Character Aspect	Primary character-defining features	Character-defining features
Shape and Plan	<ul style="list-style-type: none"> • Arena form • Track • Field • Bleachers • Field House 	The overall shape and mass of the facility as well as circulation and arrangement of the bleachers relative to the field are considered primary character-defining features of Recreational Facilities.
Roof	<ul style="list-style-type: none"> • Various roof forms • Slight eave overhangs 	Recreational Facilities have varied roof structures, but the retention of the form is a primary character-defining feature
Openings	<ul style="list-style-type: none"> • Multi-light windows • Concession windows 	Window openings are uniform in size and placement, windows are multi-light, and set into concrete openings. Replaced windows are not considered character-defining features as they fall outside the period of significance.
Exterior Ornamentation	<ul style="list-style-type: none"> • Minimal exterior ornamentation • Glass windows and glass block used as ornamentation 	Recreation Facilities were designed to be the backdrop to athletic competitions and events. They have little to no decorative ornamentation, with evenly spaced windows being the only decorative element.
Materials	<ul style="list-style-type: none"> • Mass-produced and cost-effective materials • Concrete and CMU • Reinforced Concrete construction 	Recreation Facilities have simple, utilitarian designs. Buildings were constructed using mass-produced and cost-effective building materials that were readily available at the time of construction. For instance, buildings under the Recreational Facility type were constructed with reinforced concrete and were minimally decorated.

Alterations and demolitions over time have compromised the overall architectural integrity of this building type. The most common alterations observed for Recreational Facilities typology include the following:

CONTINUATION SHEET

Property Name: Freeman Stadium

Page 13 of 18

- Replacement windows
- Barrel roof additions
- Infill of openings
- HVAC systems and window units
- ADA compliance measures such as ramps and doors

NRHP/CRHR Designation Criteria

In consideration of the project site's history and requisite integrity, Dudek recommends the property not eligible for listing in the NRHP and CRHR based on the following significance evaluation and in consideration of national and state eligibility criteria:

Criterion A/1: That are associated with events that have made a significant contribution to the broad patterns of our history.

Built in 1951, Freeman Stadium and associated buildings, were constructed for use by the fort's football team, the Warriors. The stadium was constructed after the core construction period of the base during a period when the military was working to increase recreational facilities and opportunities for service members. The initial base plan did not call for a stadium, with early practices and scrimmages taking place at nearby facilities. Both the increasing popularity of football and the desire to provide more avenues for athletic recreation, created a need for an on-site stadium at Fort Ord. This nationwide interest in sports and recreation resulted in numerous improvements to recreation facilities on army bases across America. While Freeman Stadium does reflect the post-war investment in recreation, that investment and subsequent infrastructure was not limited to or unique to Fort Ord. Utilitarian stadiums, such as these, were not uncommon. Freeman Stadium is not able to convey its association with any extraordinary events or events occurring within the context of Cold War and Vietnam military recreation buildings, the CSUMB Campus, or has an association with the broad patterns of history in Monterey County, the State of California, or the Nation. Therefore, the Dudek recommends the stadium is not eligible under NRHP/CRHR Criterion A/1.

Criterion B/2: That are associated with the lives of persons significant in our past.

To be found eligible under B/2 the property must be directly tied to an important person and the place where that individual conducted or produced the work for which he or she is known. Archival research indicated that Freeman Stadium, originally called the Warriors Stadium, was originally named after Fort Ord's football team, the Warriors. No single person was shown to be influential or directly associated with the stadium. As such this property is not known to have any historical associations with people important to the nation's or state's past. Due to a lack of identified significant associations with important persons in history, Dudek recommends the building is not eligible under NRHP/CRHR Criterion B/2.

Criterion C/3: That embody the distinctive characteristics of a type, period, or method of construction, or that represent the work of a master, or that possess high artistic values, or that represent a significant and distinguishable entity whose components may lack individual distinction.

Freeman Stadium was added to the Fort Ord in 1951. By 1952 the stadium included the track, football field, bleachers, electrical building, and the Field House. Research indicates that the stadium was designed using the amphitheater on the site and was designed by the Fort Ord Post Engineer Office.

CONTINUATION SHEET

Property Name: Freeman Stadium

Page 14 of 18

The original design for the stadium, bleachers, and Field House were completed by architects and/or engineers who were employed by the Fort Ord Engineering Office. The building drawings identify "ROWE" as the individual who drew the plans and shows the plans were checked by an individual with the initials "M.O.R". No further information on these individuals was identified during archival research. The drawings were approved by Lt. Col. Post Engineer Menon W. Whitsitt. No further information was uncovered during archival research about Whitsitt, or the other's listed on the plan. None of the research identified a significant architect for Freeman Stadium, as such, no master architect is found to be associated with the design.

Lastly, stadiums are a ubiquitous type of recreational facility. Archival research did not identify Freeman Stadium as being distinctive in its type, period, and method of construction. There is no artistic value to the present paved track or paved field. The concrete stadium bleachers are a simple, utilitarian design. The field and track have been altered beyond recognition with numerous additions and replacement of original materials including new surfacing on the track and the paving and surfacing of the field. Additionally, the Field House, has undergone numerous, extensive alterations, including substantial changes to the plan, exterior cladding, and fenestration. Due to a lack of high artistic value, a lack of evidence suggesting Freeman Stadium is associated with a master architect, and substantial alterations, Dudek recommends the stadium is not eligible under NRHP/CRHR Criterion C/3.

Criterion D/4: That have yielded, or may be likely to yield, information important in prehistory or history.

There is no evidence to suggest that Freeman Stadium has the potential to yield information important to state or local history. Therefore, Dudek recommends the stadium is not eligible under NRHP/CRHR Criterion D/4.

California Historic Landmark Statement of Significance

In consideration of the Freeman Stadium's history and requisite integrity, Dudek recommends the property not eligible for designation as a California Historic Landmark based on the following significance evaluation and in consideration of state eligibility criteria:

The first, last, only, or most significant of its type in the state or within a large geographic region (Northern, Central, or Southern California).

Freeman Stadium was designed in 1949 and constructed in 1951. The stadium and associated buildings were constructed after the initial, core development period of Fort Ord in the 1940s. The stadium was conceptualized by architects employed through the Fort Ord Engineering office and is a ubiquitous building type that lacks high style components to set it apart from other stadiums constructed throughout the State of California in the 1950s. Therefore, Dudek recommends the stadium is not eligible for listing as a CHL under this criterion.

Associated with an individual or group having a profound influence on the history of California.

Archival research failed to indicate any significant associations between the subject property and individuals or groups that profoundly influenced the history of California. Freeman Stadium was developed by the military, and no single individual was found to have influenced design, construction, or use of the building. Therefore, Dudek recommends the stadium is not eligible for listing as a CHL under this criterion.

A prototype of, or an outstanding example of, a period, style, architectural movement or construction or is one of the more notable works or the best surviving work in a region of a pioneer architect, designer or master builder.

Freeman Stadium is neither a prototype or an outstanding example of a period, style, or

CONTINUATION SHEET

Property Name: Freeman Stadium

Page 15 of 18

architectural movement. The stadium has been altered beyond recognition and it fails to convey either its style or its temporal period. It is a typical example of a sports arena, designed to serve a utilitarian purpose. There are no remaining identifying features on the Field House that would establish the building as a notable work of a master architect, or a notable designer or builder working within the military, or in the State of California. Therefore, Dudek recommends the stadium is not eligible for listing as a CHL under this criterion.

Local Designation Criteria

Portions of the CSUMB campus are located within the boundaries of two cities, City of Seaside and the City of Marina, both of which evaluate historical resources in accordance with CEQA Guidelines. as presented above. The subject property, as discussed in the NRHP/CRHR/CHL criteria discussion above, does not rise to the necessary level of significance for local, state, or national designation. For these reasons, the subject property is recommended not eligible individually or as a component of a historic district under any of the NRHP/CRHR/CHL criteria.

Additionally, portions of the CSUMB campus are located in the County of Monterey and the campus is therefore subject to the regulations set forth in Chapter 18.25 of the Monterey County Code. The subject property, as discussed in the NRHP/CRHR/CHL criteria discussion above, does not rise to the necessary level of significance for state or national designation. For these same reasons, the subject property is also recommended not eligible individually or as a component of a historic district under any of the delineated County of Monterey review criteria categories that are addressed with the NRHP/CRHR/CHL criteria discussed above: A. Historical and Cultural Significance; B. Historic, Architectural, and Engineering Significance; or C. Community and Geographic Setting.

Integrity Discussion

Freeman Stadium was analyzed against the seven aspects of integrity: location, design, setting, materials, workmanship, feeling, and association. The stadium retains its integrity of location, as it has not been relocated. However, the integrity of setting has been compromised with the demolition of adjacent buildings, new constructions, and changes in paths of circulation throughout the campus. Replacement materials have been added throughout the stadium since its completion in 1951, including new track materials, the paving of the field, removal of the goal posts, and extensive alterations and material changes to the Field House. These alterations have diminished the resource's integrity of design, materials, and workmanship. The stadium is no longer used as a football stadium and the site, once a bustling army base, is now home to a California State University campus. These changes to the surrounding area and the change of use, from a sports arena to an outdoor auditorium, have compromised the integrity of setting, feeling, and association. The changes to original materials and the change in original use prohibit the stadium from conveying significance or its temporal period.

Summary of Evaluation Findings

Freeman Stadium retains little to no historic integrity and lacks historical and architectural significance. Based on the significance evaluations presented above, Freeman Stadium does not appear to meet the NRHP, CRHR, CHL or local designation criteria. Therefore, Freeman Stadium is not considered a historical resource for purposes of CEQA.

CONTINUATION SHEET

Property Name: Freeman Stadium

Page 16 of 18

*B12. References (continued):

- ACHP (Advisory Council on Historic Preservation). 2006. "Draft Program Comment Regarding Cold War Era Unaccompanied Personnel Housing." Federal Register: The Daily Journal of the United States Government. 12 April 2016. Accessed June 30, 2021 Available at: <https://www.federalregister.gov/documents/2006/04/12/06-3509/draft-program-comment-regarding-cold-war-era-unaccompanied-personnel-housing>
- Californian, The. 1940. "No More Camp Ord! It's Fort Ord Now! Stilwell in Command: Headquarters of General Located on Salinas Side." July 13, 1940. Salinas, California, pg. 1.
- Californian, The. 1951. Stadium Field House—Sixth Army Lets Ord Contract. March 20, 1951. P1. Accessed June 17, 2021. Available at: Newspapers.com.
- Castle, Ted. 1990. "The March of Time." Fort Ord Panorama. September 21, 1990.
- Cavanaugh, Joe. 2000. *The Peace Dividend: Defense Conversion Through Higher Education*. The Leon Panetta Institute.
- Chamberlin Library. 2021. Fort Ord Working Papers. CSUMB Special Collections Box 6.42-01. Available at the Chamberlin Library, Seaside, California.
- CSUMB Facilities. 2021. Original As built and renovation architectural drawings on file with CSUMB facilities department. Accessed in person June 15-16, 2021.
- DLIFLC (Defense Language Institute Foreign Language Center). 2021. Command History Program. Accessed in person on June 15, 2021 and accessed online database collection online July 2021. Available at: <https://adli.pastperfectonline.com/>
- EA Engineering. 1991. Draft Final Fort Ord, California Base wide Remedial Investigation Feasibility Study. Volume 1 Literature Review and Base Inventory Report. Accessed on July 13, 2021. Available at: <https://www.fortordcleanup.com/documents/search/>
- Fresno Bee, The. 1951a. "Army Spokesman Are Defending Building of Fort Ord Stadium." January 12, 1951. Page 13. Accessed June 17, 2021.
- Fresno Bee, The. 1951b. "Army Spokesman Are Defending Building of Fort Ord Stadium." February 4, 1951. Page 27. Accessed June 17, 2021. Available at: Newspapers.com.
- Gates, S., & Williams, H. 1957. The Armed Forces. The Annals of the American Academy of Political and Social Science, 313, 99-104. Accessed June 17, 2021. <http://proxy.multcolib.org:2052/stable/1031762>
- Hollaway, Chuck. 2021. Chuck Hollaway Chronicles. Accessed June 18, 2021. <http://www.chuckhollaway.com/part-2>.
- MacGregor Jr., Morris J. 1981. Integration of the Armed Forces, 1940-1965. Center of Military History, United States Army: Washington, D.C.

CONTINUATION SHEET

Property Name: Freeman Stadium

Page 17 of 18

- Madsen, Alexandra and Steven Treffers. 2019. *Historic Resources Evaluation Memorandum for Hammerhead Barracks at Fort Ord, Monterey County, California*. Prepared by Rincon Consultants, Inc for City of Seaside, Community and Economic Development Department. November 4, 2019. Accessed June 28, 2021.
https://www.ci.seaside.ca.us/DocumentCenter/View/10674/9_App-S---HRE-Memo
- Military Museum. 2016. "Historic California Posts, Camps, Stations, and Airfields: Fort Ord." Accessed on June 19, 2021. <http://www.militarymuseum.org/FtOrd.html>
- National Archives Foundation. 2021. Executive Order 9981. Accessed June 29, 2021. Available at: <https://www.archivesfoundation.org/documents/executive-order-9981-ending-segregation-armed-forces/>
- NETR (Nationwide Environmental Title Research LLC). 2021. Historic Aerial Photographs of 100 Campus Center, Seaside, CA 93955 dating from 1956, 1968, 1981, 1998, 2005, 2009, 2010, 2012, 2014, 2016, and 2018. Accessed June 10, 2021.
<https://www.historicaerials.com/viewer>
- Panorama. 1990. "50 Years and Counting..." September 21, 1990, pg. 2.
- Panorama. n.d. "Ford Ord in World War II." Historic California Posts: Fort Ord. Accessed on June 19, 2021. <http://www.militarymuseum.org/FtOrd.html>
- Park, R. 2015. "Happy and Cheerful in This Fine Camp": Sports, Recreation, and the United States Army at Fort Ord and Camp Roberts, 1940 to 1945. *Journal of Sport History*, 42(1), 21-37. Accessed on June 18, 2021, from
<https://www.jstor.org/stable/10.5406/jsporthistory.42.1.21>
- Pomona Progress Bulletin. 1950. War Solving Racial Problems. August 24, 1950. Page 4. Accessed June 29, 2021. Available at: [Newspapers.com](http://www.newspapers.com).
- Quartermaster Review, The. 1940. "Army Construction Underway at Camp Ord, California." Volume XX. No 3. November-December. On file at the Chamberlin Library, Ord Military Community.
- Raugh, Harold E. 2004. Fort Ord. Charleston, SC: Arcadia.
- Salinas Morning Post. 1940. "\$2,766,000 in Building Authorized—Ord Contracts Let." August 21, 1940. Salinas, CA. pg. 1.
- San Francisco Examiner. 1951. Fort Ord Will Get Stadium. San Francisco Page 4. · 3 Feb 1951. Pages 1 and 4 A Available on [www.Newspapers.com](http://www.newspapers.com). Accessed on Jun 11, 2021.
- San Francisco Examiner. 1958. Army Asks OK on \$124,000,000 for Fort Ord Buildings. San Francisco. Section 2. Page. 4. Available on [www.Newspapers.com](http://www.newspapers.com). Accessed July 18, 2021.
- Seattle Times. 1953. "Fort Ord Will Be Ramblers' Next Foe" Sunday November 15, 1953. Seattle, Washington. Accessed on June 18, 2021. [www.Newsbank.com](http://www.newsbank.com).

CONTINUATION SHEET

Property Name: Freeman Stadium

Page 18 of 18

SportspressNW. 2012. Wayback Machine: 'Deadeye' Don Heinrich. Accessed on June 18, 2021. Available at: <http://sportspressnw.com/2140579/2012/wayback-machine-deadeye-don-heinrich>.

Vasche, J. Burton. 1959. "The California State Colleges: Their History, Organization, Purposes, and Programs." in California

U.S. Army. 1977. Post Map Main Garrison Area. Fort Ord, California. Drawing number G-950. Accessed in person at the Chamberlain Library on June 15, 2021.

Walch, Bob. 2004. An Army Historian's Pictorial Take on Fort Ord. Monterey County NOW. Accessed July 12, 2021. Available at: https://www.montereycountyweekly.com/news/local_news/an-army-historian-s-pictorial-take-on-fort-ord/article_6e8b0250-9c38-5ca4-a4a4-f93d42d65a11.html

Whaley, Derek. 2015. "East Monterey & Seaside." Santa Cruz Trains: Railroads of the Monterey Bay Area. July 20, 2015. Accessed online: <https://www.santacruztrains.com/2015/07/east-monterey-seaside.html>.

Webb Spinner, The. 1952-1954. Webb Spinner Volume for 1952-1954. Del Webb Sun Cities Museum Collection. Accessed June 30, 2021. Accessed at: <https://delwebbsuncitiesmuseum.org/newsletters-webb-spinners/>

APPENDIX G

Noise Measurements and Calculations

INTENTIONALLY LEFT BLANK

FIELD NOISE MEASUREMENT DATA

PROJECT C.SUMB CAMPUS MASTER PLAN PROJECT # 10357
 SITE ID ST-1
 SITE ADDRESS _____ OBSERVER(S) DAVID ORTEGA
 START DATE 5/23/19 END DATE 5/23/19
 START TIME 1005 END TIME 1025

METEOROLOGICAL CONDITIONS
 TEMP 62 F HUMIDITY 70 % R.H. WIND ALM LIGHT MODERATE
 WINDSPD 2 MPH DIR. N NE S SE S SW W NW VARIABLE STEADY GUSTY
 SKY SUNNY CLEAR OVERCAST PRTL CLDY FOG RAIN

ACOUSTIC MEASUREMENTS
 MEAS. INSTRUMENT Piccolo II TYPE 1 2 SERIAL # P0218020900
 CALIBRATOR _____ SERIAL # _____
 CALIBRATION CHECK PRE-MEASUREMENT 94 dBA SPL POST-MEASUREMENT _____ dBA SPL WINDSCRN Yes

SETTINGS A-WTD SLOW FAST FRONTAL RANDOM ANSI OTHER: _____

REC. #	BEGIN	END	Leq	Lmax	Lmin	L90	L50	L10	OTHER (SPECIFY METRIC)
	<u>1005</u>	<u>1025</u>	<u>55.7</u>	<u>74.2</u>	<u>45.4</u>	<u>49.2</u>	<u>52.6</u>	<u>59.1</u>	

COMMENTS _____

SOURCE INFO AND TRAFFIC COUNTS
 PRIMARY NOISE SOURCE TRAFFIC AIRCRAFT RAIL INDUSTRIAL OTHER: _____
 ROADWAY TYPE: ARTERIAL DIST. TO RDWY C/L OR EOP: 10 Feet

TRAFFIC COUNT DURATION: 20 MIN SPEED 35 mph MIN SPEED _____
 DIRECTION NB/EB SB/WB NB/EB SB/WB NB/EB SB/WB NB/EB SB/WB
 COUNT 1 (OR RDWY 1) AUTOS 75 _____ _____ IF COUNTING BOTH DIRECTIONS AS ONE, CHECK HERE _____
 MED TRKS 1 _____ _____ COUNT 2 (OR RDWY 2) _____
 HVY TRKS 1 _____ _____
 BUSES 0 _____ _____
 MOTRCLS 0 _____ _____

SPEEDS ESTIMATED BY: RADAR / DRIVING THE PACE
 POSTED SPEED LIMIT SIGNS SAY: 35 mph

OTHER NOISE SOURCES (BACKGROUND): DIST. AIRCRAFT RUSTLING LEAVES DIST. BARKING DOGS BIRDS DIST. INDUSTRIAL
 DIST. KIDS PLAYING DIST. CONVRSTNS / YELLING DIST. TRAFFIC (LIST RDWYS BELOW) DISTD GARDENERS/LANDSCAPING NOISE
 OTHER: _____

DESCRIPTION / SKETCH
 TERRAIN HARD SOFT MIXED FLAT OTHER: _____
 PHOTOS _____
 OTHER COMMENTS / SKETCH Tri-pod base is 6 inches higher than road (on top of curb)

FIELD NOISE MEASUREMENT DATA

PROJECT <u>CSUMB CAMPUS MASTER PLAN</u>	PROJECT # <u>10357</u>
SITE ID <u>ST-2</u>	OBSERVER(S) <u>DAVID ORTEGA</u>
SITE ADDRESS _____	
START DATE <u>5/23/19</u>	END DATE <u>5/23/19</u>
START TIME <u>1052</u>	END TIME <u>1112</u>

METEOROLOGICAL CONDITIONS

TEMP 62 F HUMIDITY 70 % R.H. WIND CALM LIGHT MODERATE
WINDSPD 2 MPH DIR. N NE S SE S SW W NW VARIABLE STEADY GUSTY
SKY SUNNY CLEAR OVERCAST PRTLY CLDY FOG RAIN

ACOUSTIC MEASUREMENTS

MEAS. INSTRUMENT PICCOLO II TYPE 1 2 SERIAL # P0218020906
CALIBRATOR _____ SERIAL # _____
CALIBRATION CHECK PRE-MEASUREMENT 94 dBA SPL POST-MEASUREMENT _____ dBA SPL WINDSCRN Yes

SETTINGS A-WTD SLOW FAST FRONTAL RANDOM ANSI OTHER: _____

REC. #	BEGIN	END	Leq	Lmax	Lmin	L90	L50	L10	OTHER (SPECIFY METRIC)
	<u>1052</u>	<u>1112</u>	<u>58.1</u>	<u>83.3</u>	<u>36.2</u>	<u>40</u>	<u>47.7</u>	<u>60.8</u>	

COMMENTS _____

SOURCE INFO AND TRAFFIC COUNTS

PRIMARY NOISE SOURCE TRAFFIC AIRCRAFT RAIL INDUSTRIAL OTHER: _____
ROADWAY TYPE: COLLECTOR DIST. TO RDWY C/L OR EDP: 5 Feet

TRAFFIC COUNT DURATION: 20 MIN SPEED 30 mph

COUNT 1 (OR RDWY 1)	DIRECTION		SPEED		IF COUNTING BOTH DIRECTIONS AS ONE, CHECK HERE	COUNT 2 (OR RDWY 2)	
	NB/EB	SB/WB	NB/EB	SB/WB		NB/EB	SB/WB
AUTOS	<u>33</u>				<u>X</u>		
MED TRKS	<u>6</u>						
HVY TRKS	<u>2</u>						
BUSES	<u>1</u>						
MOTRCLS	<u>0</u>						

SPEEDS ESTIMATED BY: RADAR / DRIVING THE PACE
POSTED SPEED LIMIT SIGNS SAY: _____

OTHER NOISE SOURCES (BACKGROUND): DIST. AIRCRAFT RUSTLING LEAVES DIST. BARKING DOGS BIRDS DIST. INDUSTRIAL
DIST. KIDS PLAYING DIST. CONVRSTNS / YELLING DIST. TRAFFIC (LIST RDWYS BELOW) DISTD GARDENERS/LANDSCAPING NOISE
OTHER: _____

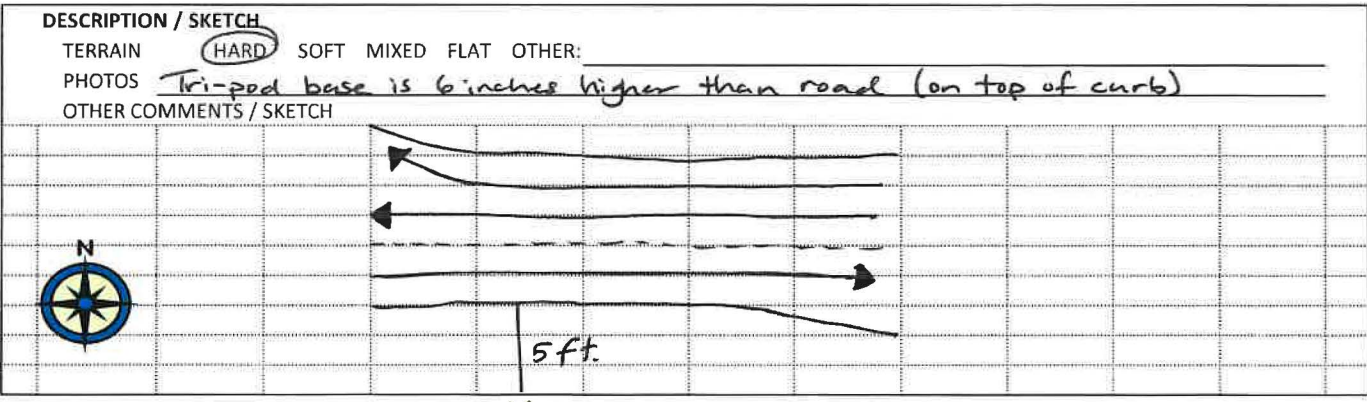

FIELD NOISE MEASUREMENT DATA

PROJECT CSUMB CAMPUS MASTER PLAN PROJECT # 10357
 SITE ID ST-3
 SITE ADDRESS _____ OBSERVER(S) DAVID ORTEGA
 START DATE 5/23/19 END DATE 5/23/19
 START TIME 1143 END TIME 1203

METEOROLOGICAL CONDITIONS
 TEMP 62 F HUMIDITY 70 % R.H. WIND CALM LIGHT MODERATE
 WINDSPD 2 MPH DIR. N NE S SE S SW W NW VARIABLE STEADY GUSTY
 SKY SUNNY CLEAR OVRCAST PRTLY CLDY FOG RAIN

ACOUSTIC MEASUREMENTS
 MEAS. INSTRUMENT Piccolo II TYPE 1 2 SERIAL # P0218020900
 CALIBRATOR _____ SERIAL # _____
 CALIBRATION CHECK PRE-MEASUREMENT 94 dBA SPL POST-MEASUREMENT _____ dBA SPL WINDSCRN YES

SETTINGS A-WTD SLOW FAST FRONTAL RANDOM ANSI OTHER: _____

REC. #	BEGIN	END	Leq	Lmax	Lmin	L90	L50	L10	OTHER (SPECIFY METRIC)
	<u>1143</u>	<u>1203</u>	<u>53.8</u>	<u>69.9</u>	<u>39</u>	<u>44</u>	<u>49.1</u>	<u>58.8</u>	

COMMENTS _____

SOURCE INFO AND TRAFFIC COUNTS
 PRIMARY NOISE SOURCE TRAFFIC AIRCRAFT RAIL INDUSTRIAL OTHER: _____
 ROADWAY TYPE: COLLECTOR DIST. TO RDWY C/L OR EOP: 10 Feet

TRAFFIC COUNT DURATION: 20 MIN SPEED 25 mph

COUNT 1 (OR RDWY 1)	DIRECTION		MIN	SPEED	IF COUNTING BOTH DIRECTIONS AS ONE, CHECK HERE	COUNT 2 (OR RDWY 2)	
	NB/EB	SB/WB				NB/EB	SB/WB
AUTOS	<u>41</u>				<u>X</u>		
MED TRKS	<u>4</u>						
HVY TRKS	<u>1</u>						
BUSES	<u>0</u>						
MOTRCLS	<u>0</u>						

SPEEDS ESTIMATED BY: RADAR / DRIVING THE PACE
 POSTED SPEED LIMIT SIGNS SAY: 25 mph

OTHER NOISE SOURCES (BACKGROUND): DIST. AIRCRAFT RUSTLING LEAVES DIST. BARKING DOGS BIRDS DIST. INDUSTRIAL
 DIST. KIDS PLAYING DIST. CONVRSTNS / YELLING DIST. TRAFFIC (LIST RDWYS BELOW) DISTD GARDENERS/LANDSCAPING NOISE
 OTHER: Construction vehicle beeping in distant background

DESCRIPTION / SKETCH
 TERRAIN HARD SOFT MIXED FLAT OTHER: _____
 PHOTOS Tri-pod base is 6 inches higher than road (on top of curb)
 OTHER COMMENTS / SKETCH

FIELD NOISE MEASUREMENT DATA

PROJECT CSUMB CAMPUS MASTER PLAN PROJECT # 10357
 SITE ID ST-4
 SITE ADDRESS _____ OBSERVER(S) DAVID ORTEGA
 START DATE 5/23/19 END DATE 5/23/19
 START TIME 1224 END TIME 1244

METEOROLOGICAL CONDITIONS
 TEMP 62 F HUMIDITY 70 % R.H. WIND CALM LIGHT MODERATE
 WINDSPD 2 MPH DIR. N NE S SE S SW W NW VARIABLE STEADY GUSTY
 SKY SUNNY CLEAR OVRCAST PRTLY CLDY FOG RAIN

ACOUSTIC MEASUREMENTS
 MEAS. INSTRUMENT Piccolo II TYPE 1 2 SERIAL # P0218020900
 CALIBRATOR _____ SERIAL # _____
 CALIBRATION CHECK PRE-MEASUREMENT 94 dBA SPL POST-MEASUREMENT _____ dBA SPL WINDSCRN yes

SETTINGS A-WTD SLOW FAST FRONTAL RANDOM ANSI OTHER: _____

REC. #	BEGIN	END	Leq	Lmax	Lmin	L90	L50	L10	OTHER (SPECIFY METRIC)
	<u>1224</u>	<u>1244</u>	<u>53.6</u>	<u>71.5</u>	<u>33.9</u>	<u>40.1</u>	<u>48</u>	<u>58.2</u>	

COMMENTS _____

SOURCE INFO AND TRAFFIC COUNTS
 PRIMARY NOISE SOURCE TRAFFIC AIRCRAFT RAIL INDUSTRIAL OTHER: _____
 ROADWAY TYPE: COLLECTOR DIST. TO RDWY C/L OR EOP 10 Feet
 TRAFFIC COUNT DURATION: 20 MIN SPEED 25 mph

COUNT 1 (OR RDWY 1)	DIRECTION	NB/EB		SB/WB		IF COUNTING BOTH DIRECTIONS AS ONE, CHECK HERE	COUNT 2 (OR RDWY 2)	NB/EB		SB/WB	
		NB/EB	SB/WB	NB/EB	SB/WB			NB/EB	SB/WB		
	AUTOS	<u>63</u>				<u>X</u>					
	MED TRKS	<u>1</u>									
	HVY TRKS	<u>0</u>									
	BUSES	<u>1</u>									
	MOTRCLS	<u>0</u>									

SPEEDS ESTIMATED BY: RADAR / DRIVING THE PACE
 POSTED SPEED LIMIT SIGNS SAY: 25 mph

OTHER NOISE SOURCES (BACKGROUND): DIST. AIRCRAFT RUSTLING LEAVES DIST. BARKING DOGS BIRDS DIST. INDUSTRIAL
 DIST. KIDS PLAYING DIST. CONVRSTNS / YELLING DIST. TRAFFIC (LIST RDWYS BELOW) DISTD GARDENERS/LANDSCAPING NOISE
 OTHER: _____

DESCRIPTION / SKETCH
 TERRAIN HARD SOFT MIXED FLAT OTHER: _____
 PHOTOS Tri-pod base is 6 inches higher than road (on top of curb)
 OTHER COMMENTS / SKETCH _____

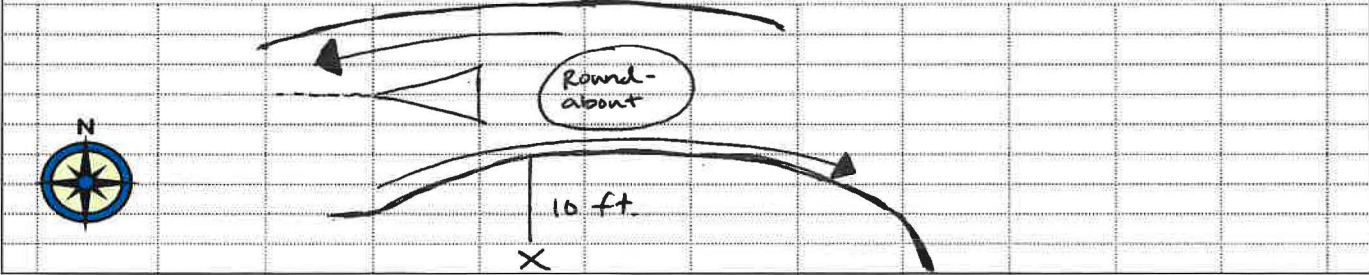

FIELD NOISE MEASUREMENT DATA

PROJECT <u>CSUMB CAMPUS MASTER PLAN</u>	PROJECT # <u>10357</u>
SITE ID <u>ST-5</u>	OBSERVER(S) <u>DAVID ORTEGA</u>
SITE ADDRESS _____	
START DATE <u>5/23/19</u> END DATE <u>5/23/19</u>	
START TIME <u>1312</u> END TIME <u>1332</u>	

METEOROLOGICAL CONDITIONS

TEMP 62 F HUMIDITY 70 % R.H. WIND ALM LIGHT MODERATE
WINDSPD 2 MPH DIR. N NE S SE S SW W NW VARIABLE STEADY GUSTY
SKY SUNNY CLEAR OVRCAST PRTLY CLDY FOG RAIN

ACOUSTIC MEASUREMENTS

MEAS. INSTRUMENT Piccolo II TYPE 1 2 SERIAL # P0218020900
CALIBRATOR _____ SERIAL # _____
CALIBRATION CHECK PRE-MEASUREMENT 94 dBA SPL POST-MEASUREMENT _____ dBA SPL WINDSCRN Yes

SETTINGS A-WTD SLOW FAST FRONTAL RANDOM ANSI OTHER: _____

REC. #	BEGIN	END	Leq	Lmax	Lmin	L90	L50	L10	OTHER (SPECIFY METRIC)
	<u>1312</u>	<u>1332</u>	<u>59.2</u>	<u>75.6</u>	<u>48.5</u>	<u>52.2</u>	<u>55.9</u>	<u>62.8</u>	

COMMENTS _____

SOURCE INFO AND TRAFFIC COUNTS

PRIMARY NOISE SOURCE TRAFFIC AIRCRAFT RAIL INDUSTRIAL OTHER: _____
ROADWAY TYPE: ARTERIAL DIST. TO RDWY C/L OR EOP 5 feet

	TRAFFIC COUNT DURATION: <u>20</u> MIN		SPEED <u>35 mph</u>		IF COUNTING BOTH DIRECTIONS AS ONE, CHECK HERE	MIN		SPEED	
	NB/EB	SB/WB	NB/EB	SB/WB		NB/EB	SB/WB	NB/EB	SB/WB
COUNT 1 (OR RDWY 1)									
AUTOS	<u>97</u>								
MED TRKS	<u>5</u>								
HVY TRKS	<u>2</u>								
BUSES	<u>0</u>								
MOTRCLS	<u>0</u>								
COUNT 2 (OR RDWY 2)									

SPEEDS ESTIMATED BY: RADAR / DRIVING THE PACE
POSTED SPEED LIMIT SIGNS SAY: 35 mph

OTHER NOISE SOURCES (BACKGROUND): DIST. AIRCRAFT RUSTLING LEAVES DIST. BARKING DOGS BIRDS DIST. INDUSTRIAL
DIST. KIDS PLAYING DIST. CONVRSTNS / YELLING DIST. TRAFFIC (LIST RDWYS BELOW) DISTD GARDENERS/LANDSCAPING NOISE
OTHER: _____

DESCRIPTION / SKETCH

TERRAIN HARD SOFT MIXED FLAT OTHER: _____
PHOTOS Tri-pod base is 6 inches higher than road (on top of curb)
OTHER COMMENTS / SKETCH

FIELD NOISE MEASUREMENT DATA

PROJECT <u>CSUMB CAMPUS MASTER PLAN</u>	PROJECT # <u>10357</u>
SITE ID <u>ST-6</u>	
SITE ADDRESS _____	OBSERVER(S) <u>DAVID ORTEGA</u>
START DATE <u>5/23/19</u>	END DATE <u>5/23/19</u>
START TIME <u>1355</u>	END TIME <u>1415</u>

METEOROLOGICAL CONDITIONS

TEMP <u>62</u> F	HUMIDITY <u>70</u> % R.H.	WIND <u>CALM</u> <u>LIGHT</u> MODERATE
WINDSPD <u>2</u> MPH	DIR. <u>N</u> NE S SE S SW W NW	VARIABLE STEADY GUSTY
SKY <u>SUNNY CLEAR</u>	<u>OVRCAST</u> PRTL CLDY FOG	RAIN

ACOUSTIC MEASUREMENTS

MEAS. INSTRUMENT Piccolo II TYPE 1 2 SERIAL # P028020900

CALIBRATOR _____ SERIAL # _____

CALIBRATION CHECK PRE-MEASUREMENT 94 dBA SPL POST-MEASUREMENT _____ dBA SPL WINDSCRN yes

SETTINGS A-WTD SLOW FAST FRONTAL RANDOM ANSI OTHER: _____

REC. #	BEGIN	END	Leq	Lmax	Lmin	L90	L50	L10	OTHER (SPECIFY METRIC)
	<u>1355</u>	<u>1415</u>	<u>55.9</u>	<u>75.3</u>	<u>38.3</u>	<u>44.4</u>	<u>50</u>	<u>59.5</u>	

COMMENTS _____

SOURCE INFO AND TRAFFIC COUNTS

PRIMARY NOISE SOURCE TRAFFIC AIRCRAFT RAIL INDUSTRIAL OTHER: _____

ROADWAY TYPE: COLLECTOR DIST. TO RDWY C/L OR EOP 1 Foot

TRAFFIC COUNT DURATION: 20 MIN SPEED 35 mph

	DIRECTION	COUNT 1 (OR RDWY 1)		COUNT 2 (OR RDWY 2)		IF COUNTING BOTH DIRECTIONS AS ONE, CHECK HERE	MIN		SPEED	
		NB/EB	SB/WB	NB/EB	SB/WB		NB/EB	SB/WB	NB/EB	SB/WB
AUTOS		<u>35</u>				<u>X</u>				
MED TRKS		<u>0</u>								
HVY TRKS		<u>0</u>								
BUSES		<u>0</u>								
MOTRCLS		<u>0</u>								

SPEEDS ESTIMATED BY: RADAR / DRIVING THE PACE
POSTED SPEED LIMIT SIGNS SAY: 35 mph

OTHER NOISE SOURCES (BACKGROUND): DIST. AIRCRAFT RUSTLING LEAVES DIST. BARKING DOGS BIRDS DIST. INDUSTRIAL
DIST. KIDS PLAYING DIST. CONVRSTNS / YELLING DIST. TRAFFIC (LIST RDWYS BELOW) DISTD GARDENERS/LANDSCAPING NOISE
OTHER: _____

DESCRIPTION / SKETCH

TERRAIN HARD SOFT MIXED FLAT OTHER: _____

PHOTOS Tri-pod base is 6 inches higher than road (on top of curb)

OTHER COMMENTS / SKETCH

FIELD NOISE MEASUREMENT DATA

PROJECT <u>CSUMB CAMPUS MASTER PLAN</u>	PROJECT # <u>10357</u>
SITE ID <u>ST-7</u>	
SITE ADDRESS _____	OBSERVER(S) <u>DAVID ORTEGA</u>
START DATE <u>5/23/19</u>	END DATE <u>5/23/19</u>
START TIME <u>1430</u>	END TIME <u>1450</u>

METEOROLOGICAL CONDITIONS

TEMP 62 F HUMIDITY 70 % R.H. WIND CALM LIGHT MODERATE
 WINDSPD 2 MPH DIR. N NE S SE S SW W NW VARIABLE STEADY GUSTY
 SKY SUNNY CLEAR OVRCAST PRTLY CLDY FOG RAIN

ACOUSTIC MEASUREMENTS

MEAS. INSTRUMENT PICCOLO II TYPE 1 2 SERIAL # P0218020900
 CALIBRATOR _____ SERIAL # _____
 CALIBRATION CHECK PRE-MEASUREMENT 94 dBA SPL POST-MEASUREMENT _____ dBA SPL WINDSCRN yes

SETTINGS A-WTD SLOW FAST FRONTAL RANDOM ANSI OTHER: _____

REC. #	BEGIN	END	Leq	Lmax	Lmin	L90	L50	L10	OTHER (SPECIFY METRIC)
	<u>1430</u>	<u>1450</u>	<u>63.5</u>	<u>87.7</u>	<u>38.8</u>	<u>50.3</u>	<u>56.6</u>	<u>66.1</u>	

COMMENTS _____

SOURCE INFO AND TRAFFIC COUNTS

PRIMARY NOISE SOURCE TRAFFIC AIRCRAFT RAIL INDUSTRIAL OTHER: _____
 ROADWAY TYPE: COLLECTOR DIST. TO RDWY C/L OR EOP: 3 Feet

TRAFFIC COUNT DURATION: 20 MIN SPEED 35 mph MIN SPEED _____

COUNT 1 (OR RDWY 1)	DIRECTION		SPEED	IF COUNTING BOTH DIRECTIONS AS ONE, CHECK HERE	COUNT 2 (OR RDWY 2)	DIRECTION		SPEED
	NB/EB	SB/WB				NB/EB	SB/WB	
AUTOS	<u>87</u>			<u>X</u>				
MED TRKS	<u>5</u>							
HVY TRKS	<u>0</u>							
BUSES	<u>0</u>							
MOTRCLS	<u>0</u>							

SPEEDS ESTIMATED BY: RADAR / DRIVING THE PACE
 POSTED SPEED LIMIT SIGNS SAY: 35 mph

OTHER NOISE SOURCES (BACKGROUND): DIST. AIRCRAFT RUSTLING LEAVES DIST. BARKING DOGS BIRDS DIST. INDUSTRIAL
 DIST. KIDS PLAYING DIST. CONVRSTNS / YELLING DIST. TRAFFIC (LIST RDWYS BELOW) DISTD GARDENERS/LANDSCAPING NOISE
 OTHER: Facility across the street had a buzzing gate that would sound when vehicles entered and left the facility

DESCRIPTION / SKETCH

TERRAIN HARD SOFT MIXED FLAT OTHER: _____
 PHOTOS Tri-pod base is 6 inches higher than road (on top of curb)
 OTHER COMMENTS / SKETCH

FIELD NOISE MEASUREMENT DATA

PROJECT CSUMB CAMPUS MASTER PLAN PROJECT # 10357
 SITE ID ST-8
 SITE ADDRESS _____ OBSERVER(S) DAVID ORTEGA
 START DATE 5/23/19 END DATE 5/23/19
 START TIME 1505 END TIME 1525

METEOROLOGICAL CONDITIONS
 TEMP 62 F HUMIDITY 70 % R.H. WIND CALM LIGHT MODERATE
 WINDSPD 2 MPH DIR. N NE S SE S SW W NW VARIABLE STEADY GUSTY
 SKY SUNNY CLEAR OVRCAST PRTLY CLDY FOG RAIN

ACOUSTIC MEASUREMENTS
 MEAS. INSTRUMENT Piccolo II TYPE 1 2 SERIAL # P0218020900
 CALIBRATOR _____ SERIAL # _____
 CALIBRATION CHECK PRE-MEASUREMENT 94 dBA SPL POST-MEASUREMENT _____ dBA SPL WINDSCRN YES

SETTINGS A-WTD SLOW FAST FRONTAL RANDOM ANSI OTHER: _____

REC. #	BEGIN	END	Leq	Lmax	Lmin	L90	L50	L10	OTHER (SPECIFY METRIC)
	<u>1505</u>	<u>1525</u>	<u>67.5</u>	<u>90.9</u>	<u>44.7</u>	<u>54.2</u>	<u>62.7</u>	<u>70.9</u>	

COMMENTS _____

SOURCE INFO AND TRAFFIC COUNTS
 PRIMARY NOISE SOURCE TRAFFIC AIRCRAFT RAIL INDUSTRIAL OTHER: _____
 ROADWAY TYPE: COLLECTOR DIST. TO RDWY C/L OR EOP: 3 Feet

TRAFFIC COUNT DURATION: 20 MIN SPEED ~40 mph
 MIN SPEED
 DIRECTION NB/EB SB/WB NB/EB SB/WB NB/EB SB/WB NB/EB SB/WB

COUNT 1 (OR RDWY 1)	DIRECTION		SPEED		IF COUNTING BOTH DIRECTIONS AS ONE, CHECK HERE	COUNT 2 (OR RDWY 2)	MIN		SPEED	
	NB/EB	SB/WB	NB/EB	SB/WB			NB/EB	SB/WB	NB/EB	SB/WB
AUTOS	<u>153</u>									
MED TRKS	<u>1</u>									
HVY TRKS	<u>0</u>									
BUSES	<u>1</u>									
MOTRCLS	<u>1</u>				<u>X</u>					

SPEEDS ESTIMATED BY: RADAR DRIVING THE PACE
 POSTED SPEED LIMIT SIGNS SAY: _____

OTHER NOISE SOURCES (BACKGROUND): DIST. AIRCRAFT RUSTLING LEAVES DIST. BARKING DOGS BIRDS DIST. INDUSTRIAL
 DIST. KIDS PLAYING DIST. CONVRSTNS / YELLING DIST. TRAFFIC (LIST RDWYS BELOW) DISTD GARDENERS/LANDSCAPING NOISE
 OTHER: _____

DESCRIPTION / SKETCH
 TERRAIN HARD SOFT MIXED FLAT OTHER: _____
 PHOTOS Tri-pod base is 6 inches higher than road (on top of curb)
 OTHER COMMENTS / SKETCH

To User: bordered cells are inputs, unbordered cells have formulae

noise level limit for construction phase, per FTA at residences = **80**
 allowable hours over which Leq is to be averaged (example: 8 per FTA guidance) = **8**

Construction Phase	Equipment	Total Equipment Qty	AUF % (from FHWA RCNM)	Reference Lmax @ 50 ft. from FHWA RCNM	Client Equipment Description, Data Source and/or Notes	Source to NSR Distance (ft.)	Distance-Adjusted Lmax	Allowable Operation Time (hours)	Allowable Operation Time (minutes)	Predicted 8-hour Leq
Demolition	Concrete Saw	1	20	90		125	82.0	8	480	75
	Dozer	1	40	82		125	74.0	8	480	70
	Backhoe	2	40	78		125	70.0	8	480	69
	Front End Loader	1	40	79		125	71.0	8	480	67
Total for Demolition Phase:										77.4
Site Preparation	Grader	1	40	85		125	77.0	8	480	73
	Scraper	1	40	84		125	76.0	8	480	72
	Front End Loader	1	40	79		125	71.0	8	480	67
Total for Site Preparation Phase:										76.2
Grading	Grader	1	40	85		125	77.0	8	480	73
	Dozer	1	40	82		125	74.0	8	480	70
	Tractor	1	40	84		125	76.0	8	480	72
	Backhoe	1	40	78		125	70.0	8	480	66
	Slurry Trenching Machine	1	50	80		125	72.0	8	480	69
Total for Grading Phase:										77.7
Building Construction	Crane	1	16	81		262	66.6	8	480	59
	Man Lift	2	20	75	Forklifts	262	60.6	8	480	57
	Generator	1	50	72		262	57.6	8	480	55
	Tractor	1	40	84		262	69.6	6	360	64
	Welder / Torch	3	40	73		262	58.6	8	480	59
Total for Building Construction Phase:										67.1
Paving	Concrete Mixer Truck	1	40	79		125	71.0	8	480	67
	Paver	1	50	77		125	69.0	8	480	66
	All Other Equipment > 5 HP	1	50	85		125	77.0	8	480	74
	Roller	2	20	80		125	72.0	8	480	68
	Tractor	1	40	84		125	76.0	8	480	72
Total for Paving Phase:										77.5
Architectural Coating	Compressor (Air)	1	40	78		262	63.6	8	480	60
Total for Architectural Coating Phase:										59.6

To User: bordered cells are inputs, unbordered cells have formulae

noise level limit for construction phase, per FTA at residences = **80**
 allowable hours over which Leq is to be averaged (example: 8 per FTA guidance) = **8**

Construction Phase	Equipment	Total Equipment Qty	AUF % (from FHWA RCNM)	Reference Lmax @ 50 ft. from FHWA RCNM	Client Equipment Description, Data Source and/or Notes	Source to NSR Distance (ft.)	Distance-Adjusted Lmax	Allowable Operation Time (hours)	Allowable Operation Time (minutes)	Predicted 8-hour Leq
Demolition	Concrete Saw	1	20	90		30	94.4	8	480	87
	Dozer	1	40	82		30	86.4	8	480	82
	Backhoe	2	40	78		30	82.4	8	480	81
	Front End Loader	1	40	79		30	83.4	8	480	79
Total for Demolition Phase:										89.8
Site Preparation	Grader	1	40	85		30	89.4	8	480	85
	Dozer	1	40	82		30	86.4	8	480	82
	Front End Loader	1	40	79		30	83.4	8	480	79
Total for Site Preparation Phase:										87.9
Grading	Grader	1	40	85		30	89.4	8	480	85
	Dozer	1	40	82		30	86.4	8	480	82
	Tractor	1	40	84		30	88.4	8	480	84
	Backhoe	1	40	78		30	82.4	8	480	78
	Slurry Trenching Machine	1	50	80		30	84.4	8	480	81
Total for Grading Phase:										90.1
Building Construction	Crane	1	16	81		136	72.3	8	480	64
	Man Lift	1	20	75	Forklifts	136	66.3	8	480	59
	Generator	1	50	72		136	63.3	8	480	60
	Tractor	1	40	84		136	75.3	8	480	71
	Welder / Torch	3	40	73		136	64.3	8	480	65
Total for Building Construction Phase:										73.3
Paving	Concrete Mixer Truck	1	40	79		30	83.4	8	480	79
	Paver	1	50	77		30	81.4	8	480	78
	All Other Equipment > 5 HP	1	50	85		30	89.4	8	480	86
	Roller	1	20	80		30	84.4	8	480	77
	Tractor	1	40	84		30	88.4	8	480	84
Total for Paving Phase:										89.7
Architectural Coating	Compressor (Air)	1	40	78		136	69.3	8	480	65
Total for Architectural Coating Phase:										65.3

To User: bordered cells are inputs, unbordered cells have formulae

noise level limit for construction phase, per FTA at residences = **80**
 allowable hours over which Leq is to be averaged (example: 8 per FTA guidance) = **8**

Construction Phase	Equipment	Total Equipment Qty	AUF % (from FHWA RCNM)	Reference Lmax @ 50 ft. from FHWA RCNM	Client Equipment Description, Data Source and/or Notes	Source to NSR Distance (ft.)	Distance-Adjusted Lmax	Allowable Operation Time (hours)	Allowable Operation Time (minutes)	Predicted 8-hour Leq
Demolition	Concrete Saw	1	20	90		75	86.5	8	480	79
	Dozer	1	40	82		75	78.5	8	480	74
	Backhoe	2	40	78		75	74.5	8	480	74
	Front End Loader	1	40	79		75	75.5	8	480	71
Total for Demolition Phase:										81.9
Site Preparation	Grader	1	40	85		75	81.5	8	480	77
	Dozer	1	40	82		75	78.5	8	480	74
	Front End Loader	1	40	79		75	75.5	8	480	71
Total for Site Preparation Phase:										79.9
Grading	Grader	1	40	85		75	81.5	8	480	77
	Dozer	1	40	82		75	78.5	8	480	74
	Tractor	1	40	84		75	80.5	8	480	76
	Backhoe	1	40	78		75	74.5	8	480	70
	Slurry Trenching Machine	1	50	80		75	76.5	8	480	73
Total for Grading Phase:										82.1
Building Construction	Crane	1	16	81		233	67.6	8	480	60
	Man Lift	1	20	75	Forklifts	233	61.6	8	480	55
	Generator	1	50	72		233	58.6	8	480	56
	Tractor	1	40	84		233	70.6	6	360	65
	Welder / Torch	3	40	73		233	59.6	8	480	60
Total for Building Construction Phase:										67.9
Paving	Concrete Mixer Truck	1	40	79		75	75.5	8	480	71
	Paver	1	50	77		75	73.5	8	480	70
	All Other Equipment > 5 HP	1	50	85		75	81.5	8	480	78
	Roller	1	20	80		75	76.5	8	480	69
	Tractor	1	40	84		75	80.5	8	480	76
Total for Paving Phase:										81.7
Architectural Coating	Compressor (Air)	1	40	78		233	64.6	8	480	61
Total for Architectural Coating Phase:										60.7

To User: bordered cells are inputs, unbordered cells have formulae

noise level limit for construction phase, per FTA at residences = **80**
 allowable hours over which Leq is to be averaged (example: 8 per FTA guidance) = **8**

Construction Phase	Equipment	Total Equipment Qty	AUF % (from FHWA RCNM)	Reference Lmax @ 50 ft. from FHWA RCNM	Client Equipment Description, Data Source and/or Notes	Source to NSR Distance (ft.)	Distance-Adjusted Lmax	Allowable Operation Time (hours)	Allowable Operation Time (minutes)	Predicted 8-hour Leq
Demolition	Concrete Saw	1	20	90		40	91.9	8	480	85
	Dozer	1	40	82		40	83.9	8	480	80
	Backhoe	2	40	78		40	79.9	8	480	79
	Front End Loader	1	40	79		40	80.9	8	480	77
Total for Demolition Phase:										87.3
Site Preparation	Grader	1	40	85		40	86.9	8	480	83
	Scraper	1	40	84		40	85.9	8	480	82
	Front End Loader	1	40	79		40	80.9	8	480	77
Total for Site Preparation Phase:										86.1
Grading	Grader	1	40	85		40	86.9	8	480	83
	Dozer	1	40	82		40	83.9	8	480	80
	Tractor	1	40	84		40	85.9	8	480	82
	Backhoe	1	40	78		40	79.9	8	480	76
	Slurry Trenching Machine	1	50	80		40	81.9	8	480	79
Total for Grading Phase:										87.6
Building Construction	Crane	1	16	81		134	72.4	8	480	64
	Man Lift	2	20	75	Forklifts	134	66.4	8	480	62
	Generator	1	50	72		134	63.4	8	480	60
	Tractor	1	40	84		134	75.4	6	360	70
	Welder / Torch	3	40	73		134	64.4	8	480	65
Total for Building Construction Phase:										72.9
Paving	Concrete Mixer Truck	1	40	79		40	80.9	8	480	77
	Paver	1	50	77		40	78.9	8	480	76
	All Other Equipment > 5 HP	1	50	85		40	86.9	8	480	84
	Roller	2	20	80		40	81.9	8	480	78
	Tractor	1	40	84		40	85.9	8	480	82
Total for Paving Phase:										87.4
Architectural Coating	Compressor (Air)	1	40	78		134	69.4	6	360	64
Total for Architectural Coating Phase:										64.2

To User: bordered cells are inputs, unbordered cells have formulae

noise level limit for construction phase, per FTA at residences = **85**
 allowable hours over which Leq is to be averaged (example: 8 per FTA guidance) = **8**

Construction Phase	Equipment	Total Equipment Qty	AUF % (from FHWA RCNM)	Reference Lmax @ 50 ft. from FHWA RCNM	Client Equipment Description, Data Source and/or Notes	Source to NSR Distance (ft.)	Distance-Adjusted Lmax	Allowable Operation Time (hours)	Allowable Operation Time (minutes)	Predicted 8-hour Leq
Demolition	Concrete Saw	1	20	90		80	85.9	8	480	79
	Dozer	1	40	82		80	77.9	8	480	74
	Backhoe	2	40	78		80	73.9	8	480	73
	Front End Loader	1	40	79		80	74.9	8	480	71
Total for Demolition Phase:										81.3
Site Preparation	Grader	1	40	85		80	80.9	8	480	77
	Scraper	1	40	84		80	79.9	8	480	76
	Front End Loader	1	40	79		80	74.9	8	480	71
Total for Site Preparation Phase:										80.0
Grading	Grader	1	40	85		80	80.9	8	480	77
	Dozer	1	40	82		80	77.9	8	480	74
	Tractor	1	40	84		80	79.9	8	480	76
	Backhoe	1	40	78		80	73.9	8	480	70
	Slurry Trenching Machine	1	50	80		80	75.9	8	480	73
Total for Grading Phase:										81.5
Building Construction	Crane	1	16	81		173	70.2	8	480	62
	Man Lift	2	20	75	Forklifts	173	64.2	8	480	60
	Generator	1	50	72		173	61.2	8	480	58
	Tractor	1	40	84		173	73.2	8	480	69
	Welder / Torch	3	40	73		173	62.2	8	480	63
Total for Building Construction Phase:										71.4
Paving	Concrete Mixer Truck	1	40	79		80	74.9	8	480	71
	Paver	1	50	77		80	72.9	8	480	70
	All Other Equipment > 5 HP	1	50	85		80	80.9	8	480	78
	Roller	2	20	80		80	75.9	8	480	72
	Tractor	1	40	84		80	79.9	8	480	76
Total for Paving Phase:										81.4

1/1-octave band center frequency	63	125	250	500	1000	2000	4000	8000
A-weighting adjustments	26	13	9	3	0	-1	-1	1

		specific sound power levels (dB)							
largest of values for the two fan diameter ranges, per <u>ENC</u> (Bies & Hansen 1996) -->	plug	36	38	36	34	33	28	20	12
largest of values for the two fan diameter ranges, per <u>ENC</u> (Bies & Hansen 1996) -->	tube	41	41	47	46	44	43	37	35
largest of values for the two fan diameter ranges, per <u>ENC</u> (Bies & Hansen 1996) -->	prop	56	57	56	55	55	52	48	46

AHUs (plenum-type return fan only, no condenser units [assume in-building chilled water or DX plant]):

Phase	Building Tag	GSF	m ²	facility function	CFM pksf	m ³ /s per 1,000		fanteype = plug, tube, or prop	unweighted PWL								OA dB	Q (cfm)	Distance to Nearest Receptor (feet)	Hourly dBA Leq	
						m ²	Pressure (Pa)		Q (m ³ /s)	63	125	250	500	1000	2000	4000					8000
<i>return air fans in building rooftop AHUs:</i>																					
	Student Housing Phase IIB	160000	14872	dormitory	100	0.51	625	8	plug	86	88	86	84	83	78	70	62	93	16000		
	Student Housing Phase III	240000	22308	dormitory	100	0.51	625	11	plug	87	89	87	85	84	79	71	63	94	24000		
	Student Recreation Center	70000	6507	sporting spectator area	1125	5.71	625	37	plug	93	95	93	91	90	85	77	69	100	79000		
	Academic V	76700	7129	classroom	250	1.27	625	9	plug	86	88	86	84	83	78	70	62	93	20000		
	Academic IV	72200	6711	classroom	250	1.27	625	9	plug	86	88	86	84	83	78	70	62	93	19000		
										A-weighted dB								OA			
										60	75	77	81	83	79	71	61	87		233	42
										61	76	78	82	84	80	72	62	88		136	48
										67	82	84	88	90	86	78	68	94		262	48
										60	75	77	81	83	79	71	61	87		134	47
										60	75	77	81	83	79	71	61	87		173	45

APPENDIX H

Revised Transportation Analysis

INTENTIONALLY LEFT BLANK



Prepared by

FEHR & PEERS

160 W Santa Clara St #675
San Jose, CA 95113
408.278.1700

May 2022

California State University Monterey Bay Master Plan

Transportation Analysis

Prepared for
**California State University, Monterey Bay
and DUDEK**

Transportation Analysis

California State University, Monterey Bay Master Plan

Prepared for:
California State University, Monterey Bay
and
Dudek

May 2022

SJ17-1728

FEHR  PEERS

Note to reader: Strike through and double underline text indicates text changes from November 2021. Additional information added to an appendix is noted with "Added to report since November 2021."



Table of Contents

EXECUTIVE SUMMARY	i
Project Description.....	i
CEQA Impacts and Mitigation Measures.....	iv
Operations Analysis Results.....	vi
1. INTRODUCTION AND PROJECT DESCRIPTION	1
Purpose.....	1
Project Description.....	6
Recent Changes to CEQA Transportation Analysis	13
SB 743 VMT Assessment Methods Decisions.....	13
Operations Analysis Study Area and Scenarios (For Information Purposes Only).....	18
Report Organization	22
EXISTING CONDITIONS AND RELEVANT PLANS	24
2. EXISTING CONDITIONS.....	25
Existing Campus Parking and Transportation Demand Management	25
Existing Street System.....	29
Existing Truck Routes	31
Existing Pedestrian Facilities.....	32
Existing Bicycle Facilities	34
Existing Transit Service	37
Existing Intersection Operations.....	42
Existing Freeway Segment Operations.....	50
Existing Freeway Ramp Operations	51
Field Observations.....	52
3. SUMMARY OF RELEVANT REGIONAL CIRCULATION AND TRANSPORTATION PLANS.....	56
AMBAG Regional Transportation Plan	56
Seaside General Plan	57
Marina General Plan	60
Monterey County General Plan.....	61

	TAMC Congestion Management Program	63
	2018 Monterey County Active Transportation Plan.....	63
	Fort Ord Reuse Authority Act.....	64
	Monterey-Salinas Transit Designing for Transit.....	65
	CEQA SIGNIFICANCE CRITERIA, VMT ANALYSIS METHODS, IMPACTS AND MITIGATION.....	66
4.	SIGNIFICANCE CRITERIA AND VMT ANALYSIS METHODS.....	67
	Significance Criteria	67
	Traffic Forecasting Methods.....	71
5.	CEQA SIGNIFICANT IMPACTS AND MITIGATION.....	77
	Plan Conflicts Analysis	77
	SB 743 VMT Analysis	85
	Hazards Evaluation Analysis	87
	Emergency Access Analysis	87
	Construction Impact Analysis	87
	PARKING MANAGEMENT AND TDM.....	89
6.	PARKING MANAGEMENT AND TDM.....	90
	Main Campus Parking Evaluation.....	90
	Main Campus Inbound AM peak Hour Mode Share	96
	Project PDFs to reduce Project Vehicle Trips and VMT.....	98
	OPERATIONS ANALYSIS (FOR INFORMATION PURPOSES ONLY)	102
7.	OPERATIONS ANALYSIS AND PROJECT TRAFFIC FORECASTING METHODS (FOR INFORMATION PURPOSES ONLY)	103
	Traffic Analysis Methods.....	103
	Project Traffic Volumes.....	107
8.	EXISTING WITH PROJECT CONDITIONS (FOR INFORMATION PURPOSES ONLY)	116
	Existing with Project Intersection Levels of Service.....	116
	Existing with Project Freeway Levels of Service.....	117
	Existing with Project Ramp Analysis.....	119

9.	CUMULATIVE WITHOUT EASTSIDE PARKWAY CONDITIONS (FOR INFORMATION PURPOSES ONLY)	121
	Cumulative without and with Project and without Eastside Parkway Conditions Traffic Volumes	121
	Cumulative without and with Project and without Eastside Parkway Conditions Roadway Improvements	121
	Cumulative without and with Project and without Eastside Parkway Conditions Intersection Levels of Service	126
	Cumulative without and with Project and without Eastside Parkway Conditions Freeway Levels of Service	126
	Cumulative without and with Project and without Eastside Parkway Conditions Ramp Levels of Service	129
10.	CUMULATIVE WITH EASTSIDE PARKWAY CONDITIONS (FOR INFORMATION PURPOSES ONLY)	131
	Cumulative without and with Project and with Eastside Parkway Conditions Roadway Improvements	131
	Cumulative without and with Project and with Eastside Parkway Conditions Intersection Levels of Service	132
	Cumulative without and with Project and with Eastside Parkway Conditions Freeway Levels of Service	133
	Cumulative without and with Project and with Eastside Parkway Conditions Ramp Levels of Service	135
11.	TRANSPORTATION FACILITY DEFICIENCIES AND POTENTIAL IMPROVEMENTS (FOR INFORMATION PURPOSES ONLY)	137
	Deficiencies Criteria	137
	Deficiencies Analysis and Potential Improvements	138

Appendices

- Appendix A: CSUMB Master Plan EIR – Trip Generation Evaluation Methods and Estimates
- Appendix B: California State University, Monterey Bay Master Plan EIR – Transportation Study Area Locations
- Appendix C: Existing Parking Inventory
- Appendix D: Existing Traffic Counts
- Appendix E: Intersection Level of Service Calculations
- Appendix F: Association of Monterey Bay Area Governments Travel Model Validation
- Appendix G: VMT Analysis for Greenhouse Gases and VMT Forecasting Outline
- Appendix H: CSUMB Draft Parking Supply Scenarios
- Appendix I: Parking Demand and Supply Calculations
- Appendix J: California State University, Monterey Bay Housing and Parking Management Guidelines
- Appendix K: Intersection Volume Figures
- Appendix L: Intersection Level of Service Tables
- Appendix M: Freeway Analysis
- Appendix N: Intersection Signal Warrant Analysis
- Appendix O: Intersection with Improvements Level of Service Calculations



List of Figures

Figure 1	Project Location	3
Figure 2	Project Location and Study Intersections	4
Figure 3	Project Location and Study Freeway Segments	5
Figure 4	CSUMB Proposed Bicycle Network	10
Figure 5	CSUMB Proposed Pedestrian Network.....	11
Figure 6	CSUMB Campus Streets and Parking Lots.....	12
Figure 7	Academic Parking Occupancy from 7:00 AM to 7:00 PM	27
Figure 8	Residential Parking Occupancy from 7:00 AM to 7:00 PM.....	27
Figure 9	Existing CSUMB and Regionally Planned Pedestrian Facilities.....	33
Figure 10	Existing CSUMB and Regionally Planned Bicycle Facilities	35
Figure 11	Existing Transit Service to CSUMB.....	41
Figure 12	Existing Conditions Peak Hour Traffic Volumes and Lane Configurations	47
Figure 13	Signalized Intersection Level of Service Examples	104
Figure 14	Parking Area Ingress/Egress Routes for External Trips.....	114
Figure 15	Parking Area Ingress/Egress Routes for Internal Trips	115

List of Tables

Table ES-1: CSUMB Population Type By Housing Location	ii
Table ES-2: Intersection Deficiency and Improvement Summary.....	vii
Table ES-3: Freeway Segment Deficiency and Improvement Summary.....	x
Table 1: CSUMB Population Type By Housing Location	7
Table 2: Existing Parking Spaces.....	26
Table 3: Existing Parking Demand Rates	26
Table 4: Existing Weekday MST Transit Service Summary	39
Table 5: Average Weekday MST Boarding Factors	40
Table 6: Existing Intersection Levels of Service.....	43
Table 7: Existing Freeway Segment Levels Of Service.....	50
Table 8: Existing Ramp AM Peak Hour Volumes and Capacities.....	51
Table 9: Existing Ramp PM Peak-Hour Volumes and Capacities.....	52
Table 10: Existing CSU TISM VMT Significance Thresholds.....	67
Table 11: Project Generated VMT Threshold Based on Existing Conditions for Monterey County	70
Table 12: Project’s Effect on VMT (Boundary VMT) Threshold based on Cumulative Conditions for Monterey County.....	70
Table 13: Roadway Improvements for Cumulative Conditions	73
Table 14: Service Populations	76
Table 15: Main Campus Transit Ridership Summary	79
Table 16: East Campus Transit Ridership Summary	79
Table 17: Weekday Peak Hour Bus Route Capacity Analysis.....	80
Table 18: Project Generated VMT for SB 743 VMT Assessment.....	86
Table 19: Project’s Effect on VMT (Boundary VMT) for SB 743 VMT Assessment.....	87
Table 20: Future Academic Parking Supply By Parking Zone – Base Scenario.....	93
Table 21: Future Residential Parking Supply By Parking Zone – Base Scenario	93
Table 22: Existing and Future (Base Scenario) Parking Supply Summary.....	94
Table 23: Future Parking Supply By Parking Zone (Land Area Allocation and Base Scenarios)	94
Table 24: Future Parking Supply Summary (Future Parking Supply Base Scenario, Land Area Allocation Parking Supply Scenario, and Master Plan Vision).....	95
Table 25: AM Peak Period Inbound Person Mode Share for All CSUMB Students, Faculty and Staff	96
Table 26: AM peak period Inbound Person Mode Share for CSUMB Students, Faculty and Staff Residents of East Campus And Off-Campus	98



Table 27:	Signalized Intersection Level of Service Definitions	105
Table 28:	Unsignalized Intersection and Roundabout Level of Service Definitions	106
Table 29:	Freeway Segment Level of Service Definitions	107
Table 30:	Existing Conditions Vehicle Trip Generation for CSUMB Campus.....	109
Table 31:	CSUMB Campus Vehicle Trip Generation for Project Conditions	110
Table 32:	CSUMB Campus Vehicle Trip Generation Results	111
Table 33:	Distribution of CSUMB External Vehicle Trips to Nearby Communities (AMBAG Model)	112
Table 34:	CSUMB Main Campus Total Daily Vehicle Trips.....	113
Table 35:	Existing without and with Project Conditions Freeway Segment LOS	118
Table 36:	Existing without and with Project Conditions Ramp AM Peak Hour Volumes and Capacities	119
Table 37:	Existing without and with Project Conditions Ramp PM Peak Hour Volumes and Capacities	120
Table 38:	Cumulative without and with Project and without Eastside Parkway Conditions Intersection Improvements.....	122
Table 39:	Cumulative without and with Project Conditions Freeway Segment Level of Service.....	128
Table 40:	Cumulative without and with Project Conditions Ramp AM Peak Hour Volumes and Capacities	129
Table 41:	Cumulative without and with Project Conditions Ramp PM Peak Hour Volumes and Capacities	130
Table 42:	Cumulative without and with Project and with Eastside Parkway Conditions Freeway Segment Level of Service.....	134
Table 43:	Cumulative without and with Project, and with Eastside Parkway Conditions Ramp AM Peak Hour Volumes and Capacities	135
Table 44:	Cumulative without and with Project, and with Eastside Parkway Conditions Ramp PM Peak Hour Volumes and Capacities	136
Table 45:	Existing with Project Conditions Intersection Improvements Summary	140
Table 46:	Cumulative with Project and without Eastside Parkway Conditions Intersection Improvements Summary.....	146
Table 47:	Roundabout Improvements Intersection Level of Service	149
Table 48:	Cumulative with Project and with Eastside Parkway Conditions Intersection Improvements Summary.....	152

EXECUTIVE SUMMARY

This report presents the results of the transportation analysis (TA) conducted for the *California State University, Monterey Bay (CSUMB) Master Plan*, also referred to as the Project. The purposes of the TA are two-fold:

- To present the transportation analysis for compliance with the California Environmental Quality Act (CEQA), including analysis of the Project’s vehicle miles traveled (VMT), the identification of significant impacts and mitigation, where applicable, for inclusion in the Environmental Impact Report (EIR),¹ and
- To present a traffic operations analysis for informational purposes only, intended to inform the reader of potential roadway operational deficiencies² resulting from the addition of Project traffic, and potential transportation improvements to reduce the identified deficient operations.

The analysis presented in this report was conducted based on the *California State University Transportation Impact Study Manual* (2019) to evaluate the effects of the Project on the transportation system on and near the campus.

PROJECT DESCRIPTION

The Project consists of the proposed CSUMB Master Plan, including Project Design Features (PDFs), as described in the Project Description (Chapter 3) of the CSUMB Master Plan Draft Environmental Impact Report (EIR) (Master Plan Draft EIR). Project elements that would affect the transportation system include the proposed increase in student enrollment and associated increase in faculty and staff; the added on-campus housing for students, faculty, and staff; and a Main Campus street and parking system that facilitates and prioritizes walking, bicycling, and transit use over vehicle travel.

¹ VMT refers to “Vehicle Miles Traveled,” a metric that accounts for the number of vehicle trips generated plus the length or distance of those trips. This report uses total VMT and boundary VMT metrics for specific geographic areas, which are defined in **Chapter 4**.

² Deficiencies are the Project’s potential effects to the study area’s transportation system and determined by the criteria described in **Chapter 11**.



CAMPUS POPULATION

Upon buildout, the Project would accommodate an increase in campus enrollment from the existing 6,634 full-time equivalent (FTE) students³ and 1,024 FTE faculty/staff,⁴ to 12,700 FTE students and 1,776 FTE faculty/staff. Based on academic year 2016-17, achieving this growth would result in an increase of approximately 6,066 FTE students and 752 FTE faculty/staff over existing levels.

LAND USE/CAMPUS HOUSING

Upon buildout, the Project is forecast to house at least 60 percent of enrolled students and 65 percent of faculty and staff on campus (refer to PDF-LU-5 and PDF-LU-6, as described in Chapter 3, Project Description, of the Master Plan Draft EIR).

Table ES-1 summarizes the number of students, faculty, and staff presently residing on- and off-campus (Existing Conditions), and the number forecasted to reside on- and off-campus under Project Conditions when FTE student enrollment and FTE faculty/staff employment reach a total of 14,476.

TABLE ES-1: CSUMB POPULATION TYPE BY HOUSING LOCATION

Population Component	Existing Conditions (FTE Students or Faculty/Staff) ¹	Project Conditions (FTE Students or Faculty/Staff) ¹	Change (Project – Existing) ²
Student Population	6,634	12,700	+6,066
Faculty/Staff Population	1,024	1,776	+752
Student, Faculty, and Staff Population (Campus Population)	7,658	14,476	+6,818
Campus Population with Community Housing Partners	7,938	14,542	+6,604

Notes:

1. FTE = Full-time equivalent students or faculty and staff
2. Change (Project - Existing) = Project Conditions column – Existing Conditions column.

Source: Fehr & Peers, 2019.

³ Full-time equivalent (FTE) is the unit of measurement used to convert class load to student enrollment. At CSUMB, one FTE is equal to 15 units. Thus, one FTE student is equal to one student enrolled in 15 units or three students each enrolled in 5 units. A related unit of measurement is “headcount.” In the case of one student taking 15 units, the headcount is 1; in the case of three students collectively taking 15 units, the headcount is 3.

⁴ According to CSUMB Institutional Assessment and Research, 1 FTE faculty/staff = full-time faculty or staff headcount + part time faculty or staff headcount then divided by 3. The faculty and staff category also includes affiliates, which are companies that have been contracted by the University Corporation at Monterey Bay or “Corporation” to provide services that the auxiliary has been asked to provide by the university (e.g., dining, bookstore, etc.), and the affiliate’s employees work full-time on campus in that capacity. They are also referred to as contractors. The auxiliary includes staff of the Corporation, Student Union, and Foundation.



As shown on **Table ES-1**, the total on-campus housed population (i.e., the number of students, faculty, and staff residing in either Main Campus or East Campus housing) is forecasted to increase from the existing 58 percent (4,443 of 7,658) to 61 percent (8,774 of 14,476). In terms of actual on-campus housing facilities, the Project would provide housing to accommodate an increase in student population from approximately 6,634 to 12,700 FTEs, and an increase in employees (i.e., faculty and staff) from approximately 1,024 to 1,776 FTEs.

CAMPUS TRANSPORTATION NETWORK

The Project includes modifications to existing campus parking and transportation facilities in order to create a more pedestrian- and bicycle-oriented campus core. Specific elements of the key PDFs identified in Chapter 3 of the Master Plan Draft EIR that influence existing and future vehicle traffic in and near the CSUMB campus include:

- Parking will be consolidated and relocated to select areas on the periphery of the campus core (PDF-MO-1[c]).
- Vehicle access will be limited to CSUMB students, faculty, and staff vehicles on General Jim Moore Boulevard between Eighth Street and Fifth Street (PDF-MO-3).
- Vehicle travel through the campus core will be restricted to shuttles, transit vehicles, service vehicles, and emergency vehicles at Inter-Garrison Road between General Jim Moore Boulevard and Sixth Avenue, Divarty Street between General Jim Moore Boulevard and Seventh Avenue, Fourth Avenue between Divarty Street and Inter-Garrison Road, Fifth Avenue between Divarty Street and Inter-Garrison, A Street between Divarty Street and Seventh Avenue, Sixth Avenue between B Street and north of Divarty Street, and Butler Street between Sixth Avenue and Seventh Avenue (PDF-MO-3).
- Seventh Avenue between Colonel Durham Street and Butler Street will be converted to one-way for vehicles traveling north from Colonel Durham Street to Inter-Garrison Road (PDF-MO-3).

PARKING MANAGEMENT AND TRANSPORTATION DEMAND MANAGEMENT

In addition to consolidating and relocating existing campus parking lots, parking management (PDF-MO-1[c]) would be aligned with the expansion of the existing transportation demand management (TDM) strategies (PDF-MO-1), as indicated in the PDFs in Chapter 3 of the Master Plan Draft EIR, to make parking more efficient and remove non-essential lots from the campus core. The TDM plan would address parking management and complement other multimodal infrastructure investments (PDF-MO-2), vehicle restrictions (PDF-MO-3), transit mobility (PDF-MO7 to -11), and active mode (bicycle and pedestrian) mobility (PDF-MO-12 and -13).



The trip generation and parking demand analysis presented in this report uses observed data (refer to **Appendix A**) and assumes the existing Parking Management and Transportation Demand Management (TDM) measures remain in place on the CSUMB campus, and those measures continue to be as effective in reducing vehicle trip-making and encouraging the use of other modes based on observed existing travel characteristics. The analysis furthermore assumes no increased effectiveness or growth in TDM and parking measures despite plans to expand these programs (refer to **Chapter 6** for TDM and parking demand reduction potential).

CEQA IMPACTS AND MITIGATION MEASURES

Recent legislation in California, Senate Bill (SB) 743, has changed the metric by which significant transportation impacts under CEQA are assessed from level of service, or LOS, to vehicle miles traveled, or “VMT.” In response to this recent legislation, the CSU Office of the Chancellor recently issued the *2019 California State University Transportation Impact Study Manual (2019 CSU TISM)*. The *2019 CSU TISM* establishes the following significance criteria for use in an environmental impact analysis in identifying a project’s potentially significant transportation-related impacts:

- **Plan Conflict:** The Project would conflict with a program, plan, ordinance, or policy addressing the circulation system, including transit, roadway, bicycle, and pedestrian facilities.
- **VMT Impacts:** The Project would result in a VMT-related impact in accordance with the CSU’s project-level or cumulative VMT Significance Thresholds.
- **Hazard Impact:** The Project would substantially increase hazards due to a geometric design feature (e.g., sharp curves or dangerous intersections) or incompatible uses (e.g., farm equipment).
- **Emergency Access Impact:** The Project would result in inadequate emergency vehicle access.

Each of these is further described below.

PLAN CONFLICTS

The Project’s consistency was evaluated against the relevant circulation and transportation plans considered. This evaluation is summarized by travel mode below.

- **Existing or planned transit systems** will not be significantly impacted by the Project. The Project does not propose changes to the transit system that will impact the *2040 Metropolitan Transportation Plan / Sustainable Communities Strategy (2018)* goals of expanding the role transit plays in meeting the region’s mobility needs such as investments in bus rapid transit, expansion of local services, and planned rail projects. Internal circulation changes will support core regional transit travel within the Campus. The Project is not anticipated to create demand for public transit



above the existing capacity, and therefore, the Project would not have an adverse effect on transit ridership and facilities, and no additional improvements would be required.

- **Existing or planned roadway facilities** will not be significantly impacted by the Project. The Project proposes to design Campus parking lots and local streets to promote a “park once” policy that limits vehicle circulation on local streets on or near the CSUMB campus. Parallel transportation improvements will serve the shifts in regional and local traffic through the CSUMB campus. The street modifications also would support a more walkable, bikeable, and transit-oriented Main Campus core.
- **Existing or planned bicycle facilities** will not be significantly impacted by the Project. The Project will not conflict with existing or planned bicycle facilities. The Project proposes to increase bicycle connections between the existing and planned facilities.
- **Existing or planned pedestrian facilities** will not be significantly impacted by the Project. The Project would enhance pedestrian circulation within the Main Campus core and connections to adjacent land uses, a beneficial effect on pedestrian circulation and access. Therefore, the Project would not interfere with existing or planned pedestrian facilities or conflict with applicable non-automotive transportation plans, guidelines, policies, or standards.

VEHICLE MILES TRAVELED (VMT)

The VMT impact analysis presented in this report considers the Project’s direct impacts relative to Project-generated VMT per service population, as well the Project’s long-term effect on VMT using boundary VMT per service population evaluated under Cumulative Conditions.

Project Generated VMT (Project Analysis)

The significance threshold for determining the Project generated VMT impact is a Total VMT per service population rate of 23.91, which is 15 percent below the Existing Conditions VMT per service population for Monterey County of 28.12. Under the Existing with Project Conditions, the CSUMB campus total VMT per service population rate of 20.30 is below the applicable threshold of 23.91. Therefore, the CSUMB campus total VMT per service population rate would not exceed the applicable thresholds under Existing with Project Conditions and the impact is less than significant.

Projects Effect on VMT (Cumulative Analysis)

This analysis evaluated whether the Project would result in an increase in the countywide boundary VMT per service population from “Cumulative Conditions” to “Cumulative with Project and without Eastside Parkway Conditions” or “Cumulative with Project and with Eastside Parkway Conditions.” The regional impact threshold for the Project’s effect on VMT is the Monterey County Cumulative Conditions boundary VMT per service population of 14.07.



The Project's effect on VMT under Cumulative with Project and without Eastside Parkway Conditions of 13.98 is below the threshold of 14.07. Therefore, the Project would not exceed the applicable thresholds relative to the Project's effect on VMT under Cumulative with Project and without Eastside Parkway Conditions and the impact is less than significant.

Under conditions assuming the Eastside Parkway is in place, the Project's effect on VMT under Cumulative with Project and with Eastside Parkway Conditions of 13.98 is below the threshold of 14.07. Therefore, the Project would not exceed the applicable thresholds under this scenario and the impact is less than significant.

HAZARDS

The Project would have a significant impact if it would substantially increase hazards due to a roadway geometric design feature (e.g., sharp curves or dangerous intersections) or incompatible uses (e.g., farm equipment). While the Project does include modifications that will change the design of parking lots and local streets and intersections, these modifications would not create hazards such as sharp curves or include otherwise dangerous features. Therefore, the impact is less than significant.

EMERGENCY ACCESS

For this analysis, a significant impact would occur if the Project or an element of the Project would result in inadequate emergency access. Future parking facilities and streets will be designed to accommodate emergency vehicles. Emergency and service vehicles will continue to have access to the campus and ability to circulate through streets restricted to other vehicles. Therefore, the impact is less than significant.

OPERATIONS ANALYSIS RESULTS

Operational deficiencies and improvements of intersections and freeway segments within the Project study area were analyzed not to determine environmental impacts within the meaning of CEQA but rather for informational purposes. Deficiency criteria presented in the California State University *Transportation Impact Study Manual* (2012) are used to identify the Project's deficiencies with a refinement to the freeway deficiency criteria: the criteria used is based on Caltrans guidance.

INTERSECTIONS

Intersections with deficiencies and improvements are summarized below in **Table ES-2**, along with a determination as to whether the intersection deficiency is addressed by the improvement.



TABLE ES-2: INTERSECTION DEFICIENCY AND IMPROVEMENT SUMMARY

Intersection ¹	Deficiency Identified?			Improvement	Deficiency Addressed?		
	Existing with Project Conditions	Cumulative with Project and without Eastside Parkway Conditions	Cumulative with Project and with Eastside Parkway Conditions		Existing with Project Conditions	Cumulative with Project and without Eastside Parkway Conditions	Cumulative with Project and with Eastside Parkway Conditions
3 SR 1 Southbound Ramps and Imjin Parkway (Cal)	Yes	Yes	Yes	Add WBL. Convert off-ramp to loop ramp equivalent.	Yes	Yes	Yes
5 Second Avenue and Imjin Parkway (M)	No	Yes	Yes	Add third NBL, second NBR. Add third WBL, two WBT, and convert shared WBT/R to WBR. Add second SBL, second SBT, convert shared SBT/R to SBR. Add second EBL, third EBT, convert shared EBT/R to two SBR.	N/A	Yes	Yes
10 Imjin Road and Imjin Parkway (M)	No	Yes	No	Add second WBL	N/A	Yes	N/A
12 Reservation Road and Imjin Parkway (M)	No	Yes	Yes	Add third SBT	N/A	No	Yes
14 Inter-Garrison Road and Reservation Road (MC)	No	Yes	Yes	Add second NBL	N/A	Yes	No
16 Second Avenue and Eighth Street (M)	Yes	No	No	Signalize intersection and optimize signal timings.	Yes	N/A	N/A
21 <u>Eighth Street/Seventh Avenue and Inter-Garrison Road</u>	<u>Yes</u>	<u>No</u>	<u>No</u>	<u>Add EB and WB left-turn pockets. Convert shared NBL/T/R to 1 left turn lane, 1 through lane and 1 right turn lane. Convert shared SBT/L and channelized NBR to 1 left turn lane, and 1 shared through-right lane. Signalize intersection and optimize signal timings.</u>	<u>Yes</u>	<u>N/A</u>	<u>N/A</u>



TABLE ES-2: INTERSECTION DEFICIENCY AND IMPROVEMENT SUMMARY

Intersection ¹	Deficiency Identified?			Improvement	Deficiency Addressed?		
	Existing with Project Conditions	Cumulative with Project and without Eastside Parkway Conditions	Cumulative with Project and with Eastside Parkway Conditions		Existing with Project Conditions	Cumulative with Project and without Eastside Parkway Conditions	Cumulative with Project and with Eastside Parkway Conditions
22 Eighth Avenue and Inter-Garrison Road (CSUMB)	Yes	Yes	Yes	<u>Option 1</u> - Signalize, optimize signal timings, and add two WBL	Yes	No	Yes
				<u>Option 2</u> - Add second circulating lane to roundabout and add WBL	Yes	No	Yes
23 Abrams Drive and Inter-Garrison Road (MC)	Yes	Yes	No	Existing Conditions Improvement: Signalize intersection, optimize signal timings, and add SBL Cumulative Conditions Improvement: Add second EBL	Yes	Yes	N/A
25 Inter-Garrison Road Connection and Inter-Garrison Road (MC)	No	Yes	Yes	Signalize intersection optimize cycle length and splits	N/A	Yes	No
28 Davis Road and Reservation Road (MC)	No	Yes	Yes	Add second EBL	N/A	No	No
29 Second Avenue and Divarty Street (M)	Yes	No	No	Convert NBR and SBR to shared NBT/R and SBT/R	Yes	N/A	N/A
33 General Jim Moore Boulevard and Lightfighter (S)	No	Yes	Yes	<u>Option 1</u> - Add third NBL, second NBT. Add SBR and overlap phase. Add second EBL. Add second WBL and second WBT. Optimize cycle length and splits	N/A	Yes	Yes
				<u>Option 2</u> - Roundabout design	N/A	Yes	Yes



TABLE ES-2: INTERSECTION DEFICIENCY AND IMPROVEMENT SUMMARY

Intersection ¹	Deficiency Identified?			Improvement	Deficiency Addressed?		
	Existing with Project Conditions	Cumulative with Project and without Eastside Parkway Conditions	Cumulative with Project and with Eastside Parkway Conditions		Existing with Project Conditions	Cumulative with Project and without Eastside Parkway Conditions	Cumulative with Project and with Eastside Parkway Conditions
39 General Jim Moore Boulevard and Gigling Road (S)	No	Yes	Yes	<u>Option 1</u> - Add second WBL	N/A	Yes	Yes
				<u>Option 2</u> - Roundabout design	N/A	Yes	Yes
46 General Jim Moore Boulevard and Normandy Road (S)	No	No	Yes	Add third NBT, third SBT, optimized cycle length and splits	N/A	N/A	No
47 General Jim Moore Boulevard and Coe Avenue (S)	Yes	Yes	No	Signalize intersection and optimize signal timings	Yes	Yes	N/A

Notes:

1. Intersection jurisdiction and associated LOS threshold applied.
 - i. City of Marina = M
 - ii. City of Seaside = S
 - iii. California State University, Monterey Bay = CSUMB
 - iv. Monterey County = MC
 - v. Caltrans = Cal

Source: Fehr & Peers, 2019.



FREEWAY SEGMENTS

Freeway segment deficiencies are summarized in **Table ES-3** below. These deficiencies on SR 1 would remain, as there is no assurance that funding will be available for the one planned improvement (widening SR 1 to six lanes from Fremont Boulevard-Del Monte Boulevard to Canyon Del Rey Boulevard), and there are no other planned widening improvements that would address the remainder of the deficiencies. Therefore, there are no feasible improvements available and the deficiencies in **Table ES-3** would remain.

TABLE ES-3: FREEWAY SEGMENT DEFICIENCY AND IMPROVEMENT SUMMARY

Freeway Segment	Deficiency Identified?		
	Existing with Project Conditions	Cumulative with Project and without Eastside Parkway Conditions	Cumulative with Project and with Eastside Parkway Conditions
Northbound SR 1 between Lightfighter Drive and Fremont Boulevard-Del Monte Boulevard	No	Yes	Yes
Southbound SR 1 between Lightfighter Drive and Fremont Boulevard-Del Monte Boulevard	Yes	Yes	No
Northbound SR 1 between Fremont Boulevard-Del Monte Boulevard and Canyon Del Rey	Yes	Yes	Yes
Southbound SR 1 between Fremont Boulevard-Del Monte Boulevard and Canyon Del Rey	Yes	Yes	Yes

Source: Fehr & Peers, 2019.

FREEWAY RAMPS

Freeway ramps analysis was conducted for the Existing with Project Condition and Cumulative with Project and without and with Eastside Parkway Conditions to assess changes in peak hour ramp volumes with the addition of Project traffic and its effects on freeway and local street operations. The freeway study ramps include the on- and off-ramps at SR 1 and Imjin Parkway, and SR 1 and Lightfighter Drive. The volumes for all the with Project conditions scenarios are expected to increase at each of the ramps without exceeding the ramp capacities, with the exception of the SR 1 and Imjin Parkway southbound on-ramp and the SR 1 and Imjin Parkway northbound off-ramp; therefore, no deficiencies were identified. Volumes are expected to decrease for the SR 1 and Imjin Parkway southbound on-ramp and the SR 1 and Imjin Parkway northbound off-ramp. Decreases in volumes under the with Project conditions are due to the displacement and reassignment of traffic when the Project volume is added to the roadway network.



1. INTRODUCTION AND PROJECT DESCRIPTION

This report presents the results of the Transportation Analysis (TA) conducted for the proposed *California State University, Monterey Bay (CSUMB) Master Plan* (the “Project”). The Project consists of the proposed Master Plan and Project Design Features (PDFs), as described in Chapter 3, Project Description, of the Master Plan Draft EIR. The trip generation and parking demand analysis presented in this report assumes the existing Parking Management and Transportation Demand Management (TDM) measures remain in place on the CSUMB campus, and those measures continue to be as effective in reducing vehicle trip-making and encouraging the use of other modes based on observed existing travel characteristics. It furthermore assumes no increased effectiveness or growth in TDM and parking measures despite plans to expand these programs (refer to **Chapter 6** for TDM and parking demand reduction potential). Therefore, this TA bases Project trip generation, parking demand, and roadway operations changes on observed data to the greatest extent possible.

The CSUMB Main Campus is located within the geographic boundaries of the cities of Marina, Seaside, and Monterey County, and is generally bounded by Eighth Street, Inter-Garrison Road, Eighth Avenue, Colonel Durham Street, Lightfighter Drive, and Second Avenue. The East Campus open space and housing is located east of Eighth Avenue on either side of Inter-Garrison Road. **Figure 1** shows the location of the Project site (Main Campus and East Campus) and the surrounding transportation network. **Figure 2** shows the Project site with study intersections. **Figure 3** shows the Project site (Main Campus and East Campus) and the surrounding transportation network with the freeway study segments.

This chapter discusses the report purpose, Project description, recent changes in the California Environmental Quality Act (CEQA) regarding transportation analyses, the study area/analysis scenarios/methods used in the operations analysis and the criteria used to identify deficiencies, and report organization.

PURPOSE

The primary purpose of this report is:

- To present the transportation analysis for compliance with the CEQA, including analysis of the Project’s vehicle miles traveled (VMT), the identification of significant impacts and recommended mitigation, where applicable, for inclusion in the Environmental Impact Report (EIR),⁵ and

⁵ VMT refers to “Vehicle Miles Traveled,” a metric that accounts for the number of vehicle trips generated plus the length or distance of those trips. This report uses total VMT and boundary VMT metrics for specific geographic areas, which are defined in **Chapter 4**.



- To present a traffic operations analysis for informational purposes only, intended to inform the reader of potential roadway operational deficiencies⁶ resulting from the addition of Project traffic, and potential transportation improvements to reduce the identified deficient operations.

This TA addresses the Project's effects on the roadway system and on the nearby bicycle, pedestrian, and transit networks. Project effects on the environment were evaluated following the CEQA Guidelines and the *California State University Transportation Impact Study Manual* (2019), which provides guidance on how to evaluate the effects of projects on the transportation system on and near a CSU campus. Guidance from the City of Marina, City of Seaside, Monterey County, and Caltrans was also considered.

⁶ Deficiencies are the Project's potential effects to the study area's transportation system and determined by the criteria described in **Chapter 11**.



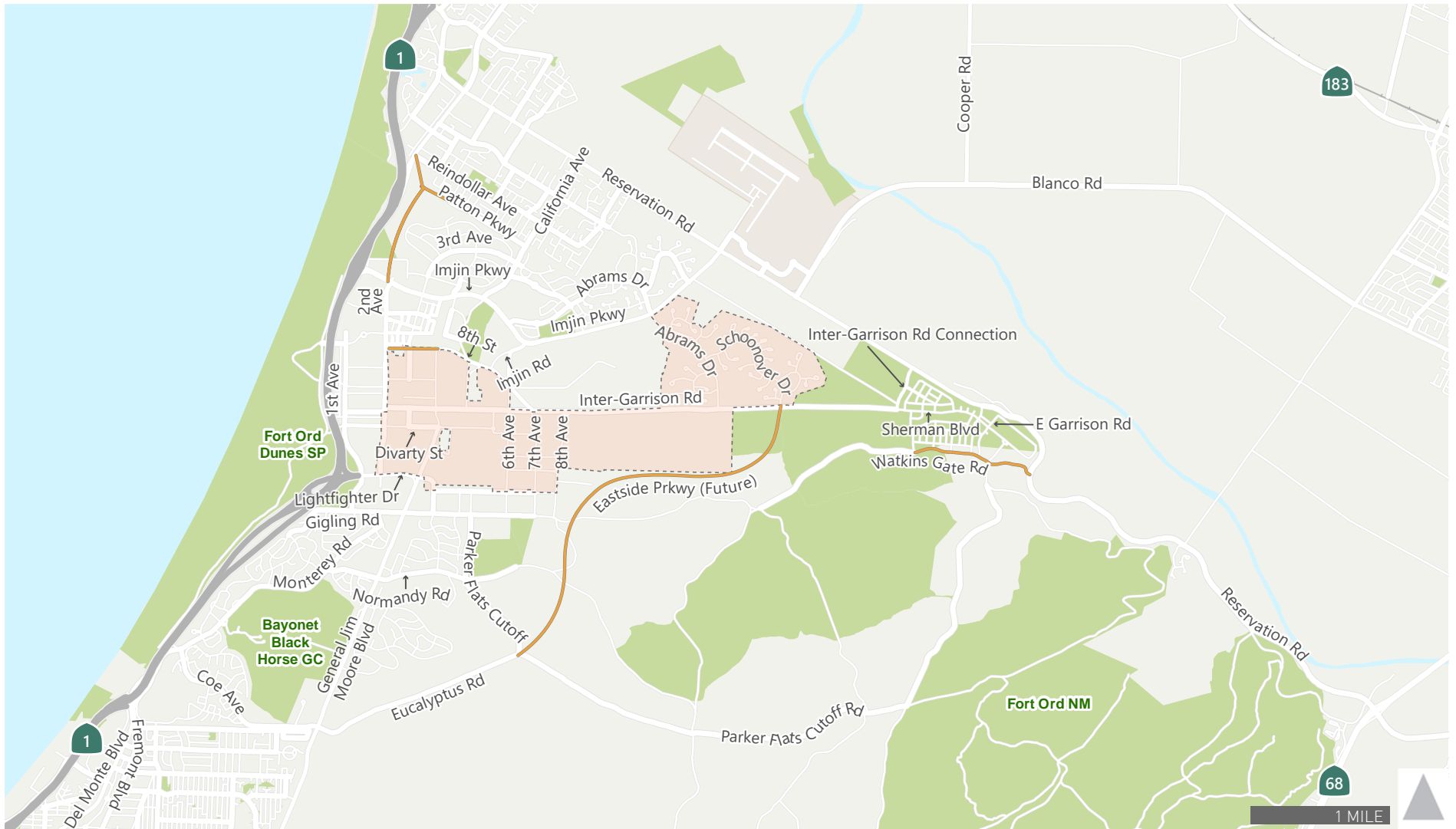

- California State University Monterey Bay Campus
- New/Extended Roadway



Figure 1
Project Location

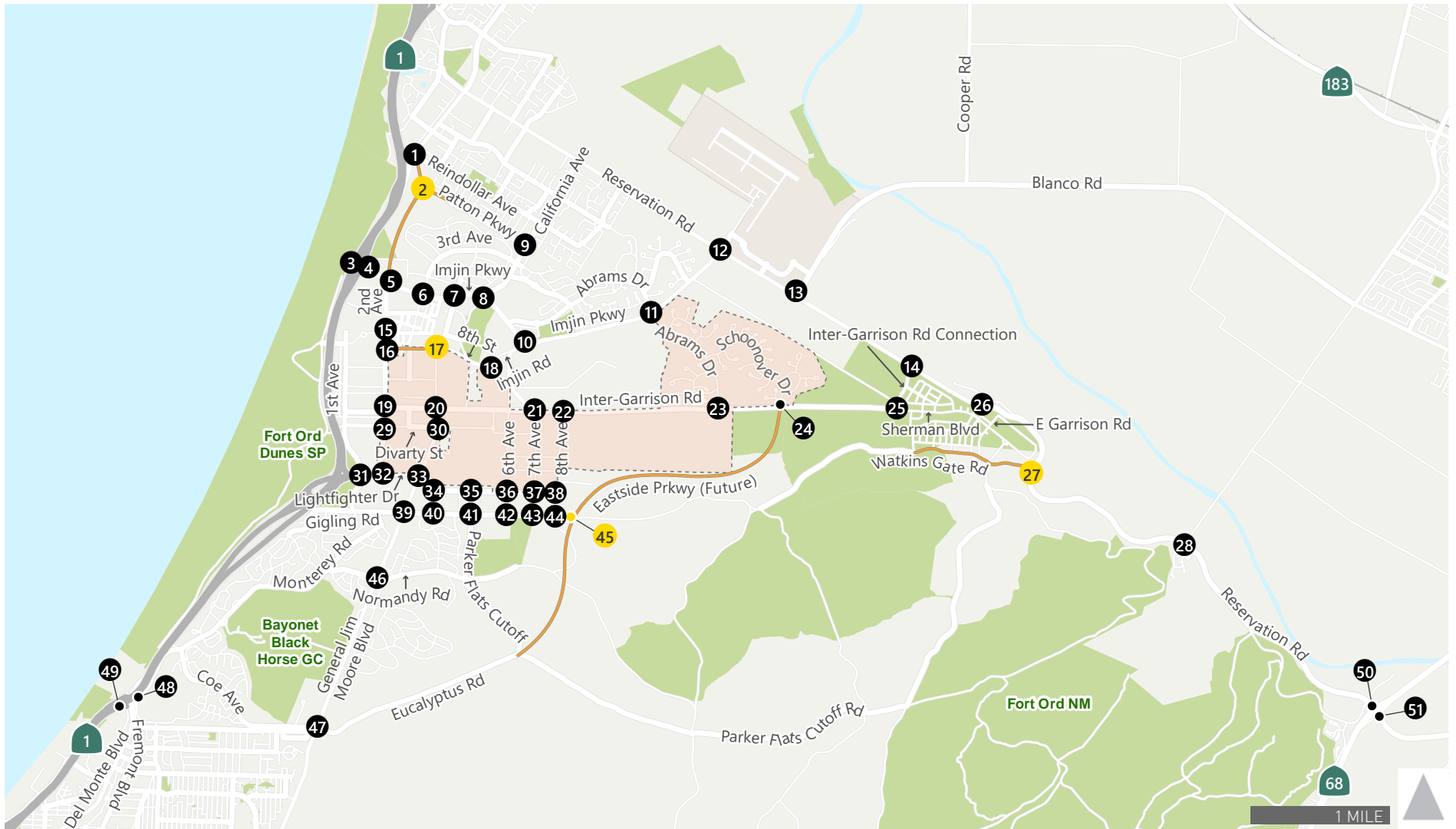

- California State University Monterey Bay Campus
- # Study Intersection
- # Future Intersection
- New/Extended Roadway



Figure 2
Project Location and Study Intersections

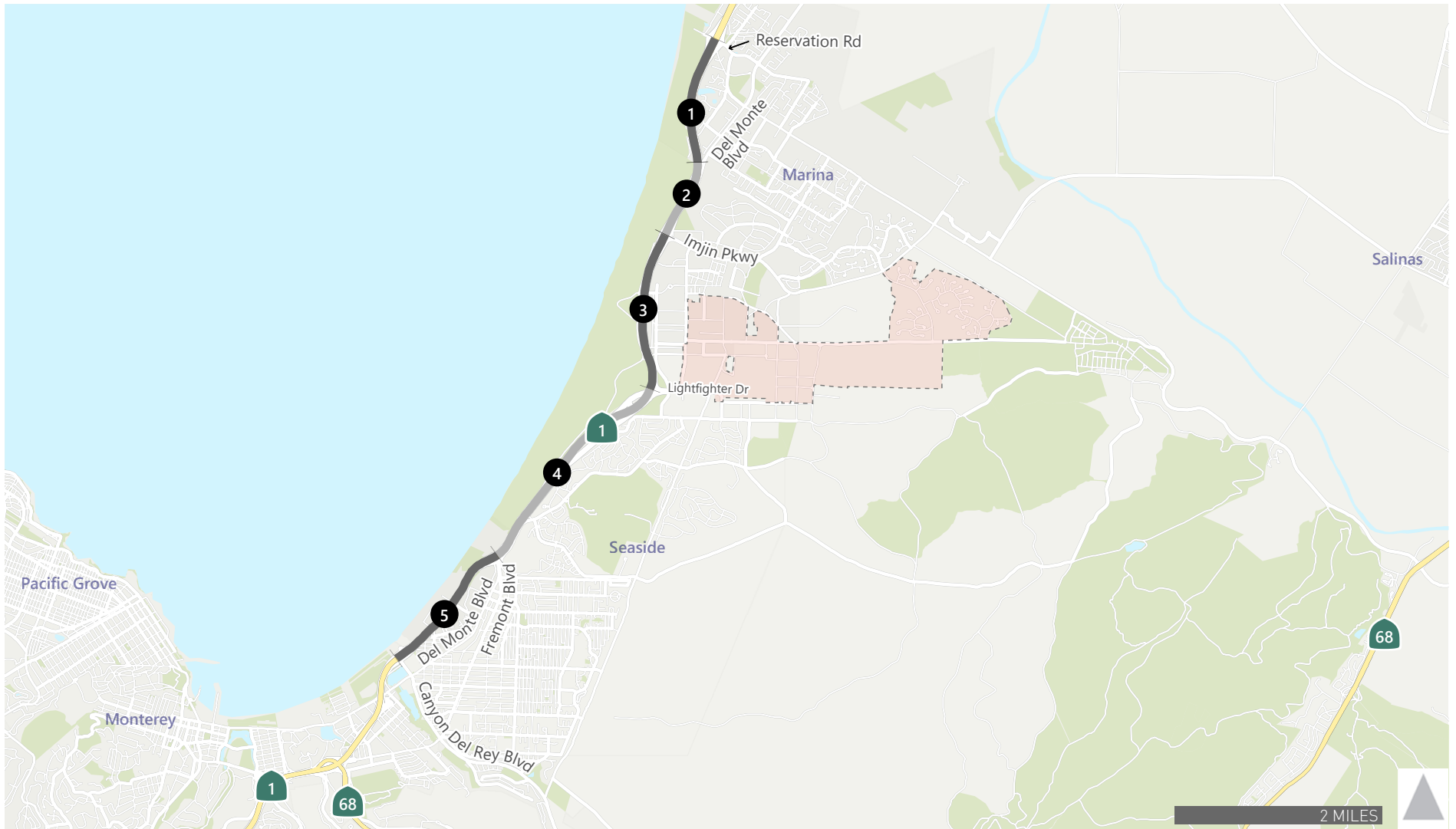



-  Study Freeway Segments
-  California State University Monterey Bay Campus



Figure 3
 Project Location and Study Freeway Segments

PROJECT DESCRIPTION

The Project is the proposed CSUMB Master Plan, including Project Design Features (PDFs), as described in Project Description (Chapter 3), of the CSUMB Master Plan Draft Environmental Impact Report (Master Plan Draft EIR). Project elements that would affect the transportation system include the proposed increase in student enrollment and associated increase in faculty and staff; the added on-campus housing for students, faculty, and staff; and a Main Campus street and parking system that facilitates and prioritizes walking, bicycling, and transit use over vehicle travel. Each of these Project elements is described below.

CAMPUS POPULATION

Upon buildout, the Project would accommodate an increase in campus enrollment from the existing (based on academic year 2016-2017) 6,634 full-time equivalent (FTE) students⁷ and 1,024 FTE faculty/staff,⁸ to 12,700 FTE students and 1,776 FTE faculty/staff. Achieving this growth would result in an increase of approximately 6,066 FTE students and 752 FTE faculty/staff over existing levels.

LAND USE/CAMPUS HOUSING

Upon buildout, the Project is forecast to house at least 60 percent of enrolled students and 65 percent of faculty and staff on campus (refer to PDF-LU-5 and PDF-LU-6, as described in Chapter 3 of the proposed CSUMB Master Plan Draft EIR [Master Plan Draft EIR]). Based on current and projected future conditions, at Project buildout the percentage of students housed on-campus is expected to be similar to the existing percentage, although the absolute number of students housed on campus will increase with planned enrollment growth, while the percentage of faculty and staff housed on campus is expected to increase as the result of the Project. Refer to *California State University, Monterey Bay Proposed Master Plan Housing Memorandum* (**Attachment A** of the trip generation memorandum in **Appendix A** of this TA report).

Table 1 summarizes the number and percentage of students, faculty, and staff presently residing on- and off-campus (Existing Conditions), and the number forecasted to reside on- and off-campus under Project Conditions when FTE student enrollment and FTE faculty/staff employment reach a total of 14,476.

⁷ Full-time equivalent (FTE) is the unit of measurement used to convert class load to student enrollment. At CSUMB, one FTE is equal to 15 units. Thus, one FTE student is equal to one student enrolled in 15 units or three students each enrolled in 5 units. A related unit of measurement is "headcount." In the case of one student taking 15 units, the headcount is 1; in the case of three students collectively taking 15 units, the headcount is 3.

⁸ According to CSUMB Institutional Assessment and Research, 1 FTE faculty/staff = full-time faculty or staff headcount + part time faculty or staff headcount then divided by 3. The faculty and staff category also includes affiliates, which are companies that have been contracted by the University Corporation at Monterey Bay or "Corporation" to provide services that the auxiliary has been asked to provide by the university (e.g., dining, bookstore, etc.), and the affiliate's employees work full-time on campus in that capacity. They are also referred to as contractors. The auxiliary includes staff of the Corporation, Student Union, and Foundation.



TABLE 1: CSUMB POPULATION TYPE BY HOUSING LOCATION

Housing Location	Existing Conditions (FTE Students or Faculty/Staff) ¹	Project Conditions (FTE Students or Faculty Staff) ¹	Change (Project – Existing) ²
Student Population			
Main Campus	2,600 (39.2%)	7,620 ³ (60.0%)	+5,020
East Campus ⁴	1,380 (20.8%)	0 (0%)	-1,380
Off-Campus	2,654 (40.0%)	5,080 (40.0%)	+2,426
<i>Subtotal [A]</i>	<i>6,634</i> <i>(100%)</i>	<i>12,700</i> <i>(100%)</i>	<i>+6,066</i>
Faculty/Staff Population			
East Campus ⁴	463 (45.2%)	1,154 ³ (65.0%)	+691
Off-Campus	561 (54.8%)	622 (35.0%)	+61
<i>Subtotal [B]</i>	<i>1,024</i> <i>(100%)</i>	<i>1,776</i> <i>(100%)</i>	<i>+752</i>
Student, Faculty, and Staff Population (Campus Population)			
Main Campus and East Campus (Students, Faculty and Staff)	4,443 (58.0%)	8,774 (60.6%)	+4,331
Off-Campus (Students, Faculty and Staff)	3,215 (42.0%)	5,702 (39.4%)	+2,487
Total [A + B = C]	7,658 (100%)	14,476 (100%)	+6,818
Campus Population with Community Housing Partners			
East Campus (Community Housing Partners) [D]	280	66	-214
Total [C+D = E]	7,938	14,542	+6,604

Notes:

1. FTE = Full-time equivalent students, faculty/staff or community housing partners.
2. Change (Project – Existing) = Project Conditions column – Existing Conditions column.
3. The transportation trip generation analysis uses a campus population that, meets but does not exceed the 60 percent student housing goal and the 65 faculty and staff housing goal under Project Conditions.
4. Under Existing Conditions 1,380 students, 463 faculty/staff, and 280 community housing partners live in the East Campus housing. Under Project Conditions 1,154 faculty/staff and 66 community housing partners live in the East Campus housing unless housing is needed by for campus employees.

Source: Fehr & Peers, 2019.



As shown in **Table 1**, the total population housed on-campus (i.e., the number of students, faculty, and staff residing in either Main Campus or East Campus housing) is forecasted to increase from the existing 58 percent (4,443 of 7,658) to 61 percent (8,774 of 14,476).⁹

CAMPUS TRANSPORTATION NETWORK

The Project includes physical modifications to existing campus parking and transportation facilities to create a more pedestrian and bicycle-oriented campus core. Specific elements (refer to **Figure 6**) of the key PDFs in Chapter 3 of the Master Plan Draft EIR that influence existing and future vehicle traffic in and near the CSUMB campus include the following:

- Parking will be consolidated and relocated to select areas on the periphery of the campus core (PDF-MO-1[c]).
- Vehicle access will be limited to CSUMB students, faculty, and staff vehicles on General Jim Moore Boulevard between Eighth Street and Fifth Street (PDF-MO-3).
- Vehicle travel through the campus core will be restricted to shuttles, transit vehicles, service vehicles, and emergency vehicles at the following locations (PDF-MO-3):
 - Inter-Garrison Road between General Jim Moore Boulevard and Sixth Avenue
 - Divarty Street between General Jim Moore Boulevard and Seventh Avenue
 - Fourth Avenue between Divarty Street and Inter-Garrison Road
 - Fifth Avenue between Divarty Street and Inter-Garrison Road
 - A Street between Divarty Street and Seventh Avenue
 - Sixth Avenue between B Street and north of Divarty Street
 - Butler Street between Sixth Avenue and Seventh Avenue
- Seventh Avenue between Colonel Durham Street and Butler Street will be converted to one-way for vehicles traveling north from Colonel Durham Street to Inter-Garrison Road.

CSUMB proposed on campus bicycle and pedestrian networks are presented in **Figure 4** and **Figure 5**.

⁹ As space permits, Community Housing Partners will also reside in the East Campus housing; Community Housing Partners are made up of affiliates (a subcategory of CSUMB staff), educational partners and military partners. While Community Housing Partners live on-campus, they are not associated with on-campus housing for students, faculty, and staff, and therefore are not included in the student, faculty, and staff population total but are included in the entire campus population total in **Table 1**.



TRANSPORTATION DEMAND MANAGEMENT AND PARKING MANAGEMENT

In addition to consolidating and relocating existing campus parking lots, parking management (PDF-MO-1[c]) would be aligned with the expansion of the existing transportation demand management (TDM) strategies (PDF-MO-1), as indicated in Chapter 3 of the Master Plan Draft EIR, to make parking more efficient and remove non-essential lots from the campus core. Parking for academic or residential lots would be consolidated as new development occurs. Continued use of a limited number of special-use parking stalls would be provided throughout campus to accommodate service vehicles, deliveries, loading and unloading activities, and trash pick-up. Appropriate numbers of accessible stalls would be allocated campus wide as required by state code. The TDM plan would address parking management and complement other multimodal infrastructure investments (PDF-MO-2), vehicle restrictions (PDF-MO-3), transit mobility (PDF-MO7 to 11), and active mode (bicycle and pedestrian) mobility (PDF-MO-12 and 13). The list of existing Parking Management and TDM strategies are listed in the Existing Conditions chapter (**Chapter 2**).



Figure 7.10:



Source: Page / BMS Design Group (2017)

SOURCE: Page / BMS Design Group (2017)



CSU Monterey Bay Master Plan EIR



CSU MONTEREY BAY CAMPUS MASTER PLAN

**FIGURE 3-11
Bicycle Circulation Plan**

Figure 4

CSUMB Proposed Bicycle Network

Figure 7.12:

- Proposed FORTAG Trail
- - - Bicycle/Pedestrian Path
- Sidewalk or Walkway
- Grades < 5%
-  Multimodal Hub
-  Parking Area

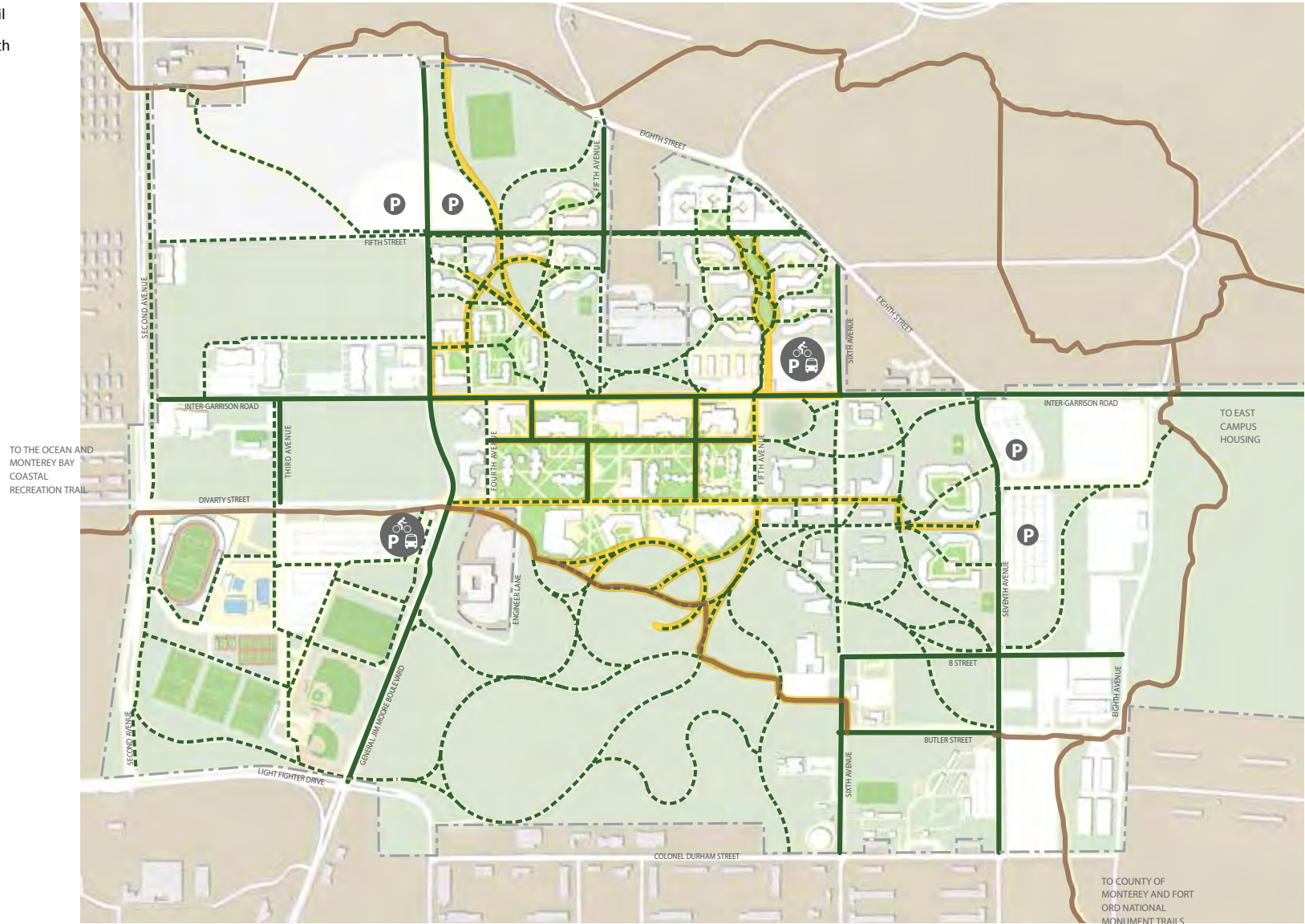

Source: Page / BMS Design Group (2017)

SOURCE: Page / BMS Design Group (2017)

CSU MONTEREY BAY CAMPUS MASTER PLAN
FIGURE 3-12
Pedestrian Circulation Plan

Figure 5

CSU Monterey Bay Master Plan EIR

CSUMB Proposed Pedestrian Network



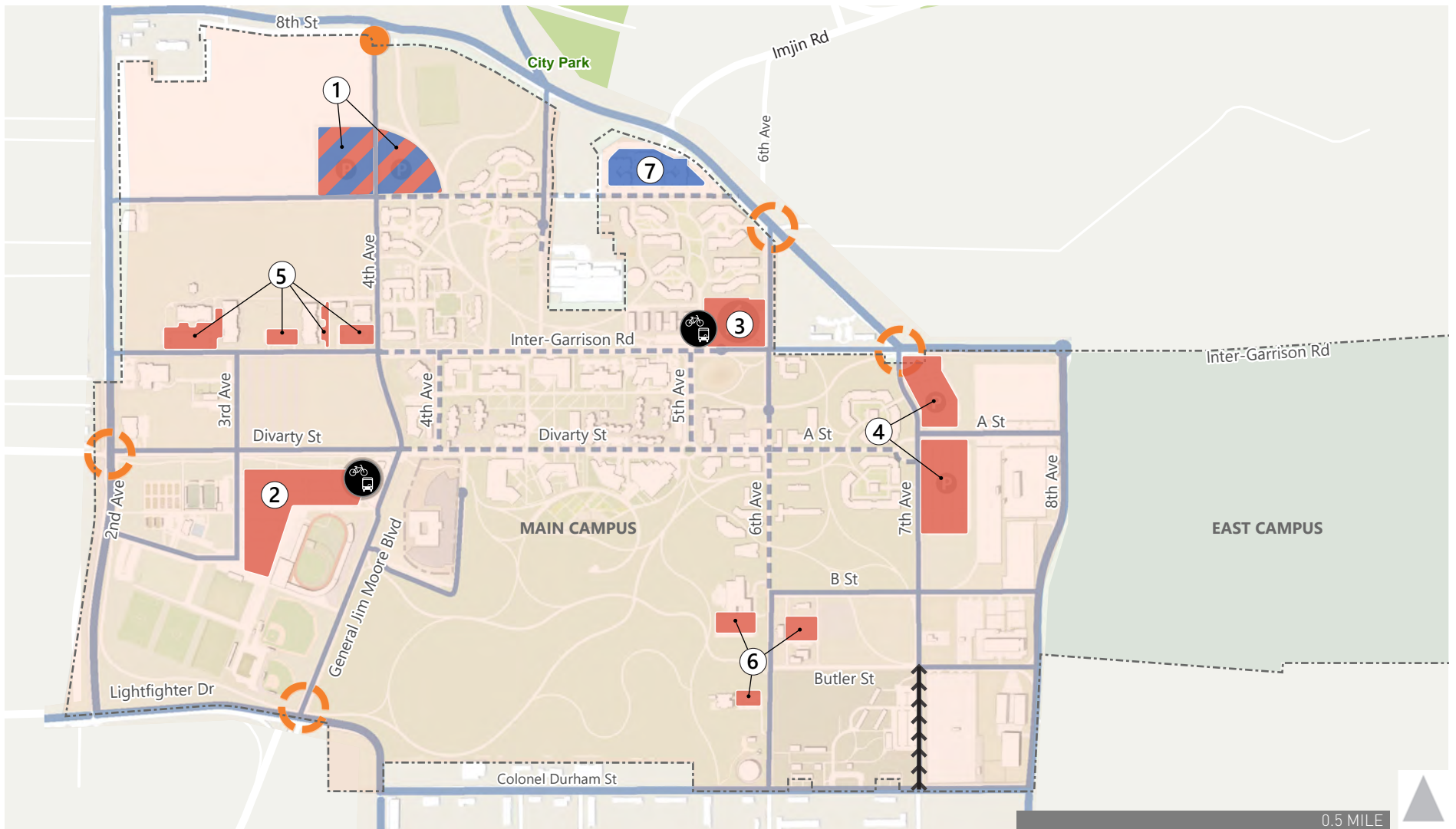

California State University Monterey Bay Main Campus
 California State University Monterey Bay East Campus

Peripheral Circulation Street
 Campus Vehicular Street
 Campus Restricted Access Street
 (Shuttle, Transit, Service and Emergency)
 Oneway Street
 Campus Entry
 Gated Entry
 (Restricted to CSUMB students, faculty and staff)

Academic Parking Area
 Residential Parking Area
 Academic and Residential Parking Area
 Multimodal Hub



Figure 6
 CSUMB Campus Streets and Parking Lots

RECENT CHANGES TO CEQA TRANSPORTATION ANALYSIS

Senate Bill (SB) 743, signed by Governor Jerry Brown in 2013, changed the way transportation impacts are identified under CEQA. Specifically, the legislation directed the State of California's Office of Planning and Research (OPR) to look at different metrics for identifying transportation impacts and make corresponding revisions to the CEQA Guidelines. Following several years of draft proposals and related public comments, OPR settled upon VMT¹⁰ as the preferred metric for assessing passenger vehicle-related impacts, and issued revised CEQA Guidelines in December 2018, along with a *Technical Advisory on Evaluating Transportation Impacts in CEQA* (December 2018) to assist practitioners in implementing the CEQA Guidelines revisions to use VMT as the new metric.

Under the revised Guidelines, vehicle level of service (LOS) is no longer used as a determinant of significant environmental impacts, and an analysis of a project's impacts relative to VMT is the new metric against which significant impacts are to be assessed. In response to this methodological change in required transportation analysis, the CSU Chancellors Office prepared the recently issued *2019 California State University Transportation Impact Study Manual (CSU TISM)*, which supersedes the *2012 CSU TISM*. The *2019 CSU TISM* provides guidance for the preparation of CEQA-compliant transportation impact analysis pursuant to SB 743 and is the operative TISM for the analysis presented here.

SB 743 VMT ASSESSMENT METHODS DECISIONS

As discussed below, the comprehensive VMT analysis (i.e., VMT including all vehicle trips, vehicle types, and trip purposes without separation by land use) presented in this report considers the Project's direct impacts, as well as a cumulative analysis that considers the Project's long-term effect on VMT.¹¹ The VMT analysis methods and thresholds used for this analysis go beyond the *Technical Advisory on Evaluating Transportation Impacts in CEQA* (December 2018) due to the unique characteristics of a university campus development project, which are not specifically addressed in the Technical Advisory. This is due to several reasons, including the Technical Advisory's focus on how to streamline or avoid VMT impact review for

¹⁰ VMT refers to "Vehicle Miles Traveled," a metric that accounts for the number of vehicle trips generated plus the length or travel distance of those trips. This report uses the total VMT and boundary VMT metrics for specific geographic areas. The VMT metrics are defined in **Chapter 4**. VMT is an accessibility performance metric that evaluates the changes in land use patterns, regional transportation systems, and other built environment characteristics. This is different from the previous performance metric, vehicle level of service, which measures vehicle mobility.

¹¹ This is in contrast with the OPR Technical Advisory recommendation to use Partial VMT for transportation impact analysis (Governor's Office of Planning and Research, *Technical Advisory: On Evaluating Transportation Impacts in CEQA*, pages 15 and 16). Using Partial VMT for Project generated VMT screening may not tell the full story of the project's benefits. For example, mixed-use projects help reduce VMT by shortening vehicle trip lengths or reducing vehicle trips because of the convenience of walking, bicycling, or using transit between project destinations. A comprehensive VMT analysis is a more complete evaluation.



projects the state considers to be desirable based on their type and location (i.e., infill projects near transit) and that include the most common land uses (i.e., office, industrial, residential, and retail).

Accordingly, after careful evaluation of the OPR Technical Advisory relative to a campus setting, the CSU Chancellor's Office prepared the *2019 CSU TISM* to provide guidance for CEQA compliant transportation impact analysis pursuant to SB 743 for all CSU campuses. The *2019 CSU TISM* was prepared by transportation engineers and support staff with a strong understanding of CEQA practice and focus on consistency and compliance with CEQA Guidelines.

The OPR Technical Advisory provides a blueprint for organizing key decisions regarding SB 743 methods: the decisions listed later in this section follow the basic structure of the *OPR Technical Advisory*. The *OPR Technical Advisory* recommends considering a project's short-term, long-term, and cumulative effects on VMT but provides limited recommendations on how to prepare a comprehensive VMT analysis for projects. The CSU Chancellor's Office and resulting *2019 CSU TISM* considers the substantial evidence presented in the OPR Technical Advisory to make key decisions about the VMT forecasting model, VMT accounting methods, calculation of the baseline and cumulative regional VMT estimates, and VMT thresholds required for a comprehensive analysis. Below are substantial evidence examples with specific citations of:

- using all Project generated VMT and Project's Effect on VMT (refer to the **Retail Projects** quote below),
- not truncating trip lengths based on model or political boundaries (refer to the **Consideration for All Projects** quote below), and
- accounting for the cumulative effects of a project (refer to **Cumulative Impacts** quote) used to create the *2019 CSU TISM*.

The quotes are listed below with highlights added to the most relevant portion of the quote.

Retail Projects. *Generally, lead agencies should analyze the effects of a retail project by assessing the change in total VMT¹¹ because retail projects typically reroute travel from other retail destinations. A retail project might lead to increases or decreases in VMT, depending on previously existing retail travel patterns.* (Quote from page 5 of the *Technical Advisory on Evaluating Transportation Impacts in CEQA*, December 2018; footnote 11 in this quote is a reference to see Appendix 1 of the OPR Technical Advisory, which discusses evaluation of Total VMT).

Considerations for All Projects. *Lead agencies should not truncate any VMT analysis because of jurisdictional or other boundaries, for example, by failing to count the portion of a trip that falls outside the jurisdiction or by discounting the VMT from a trip that crosses a jurisdictional boundary. CEQA requires environmental analyses to reflect a "good faith effort at full disclosure." (CEQA Guidelines, § 15151.) Thus, where methodologies exist that can estimate the full extent of vehicle travel from a project, the lead agency should apply them to do so. Where those VMT effects will grow over time,*



analyses should consider both a project's short-term and long-term effects on VMT. (Quote from page 6 of the *Technical Advisory: On Evaluating Transportation Impacts in CEQA*, December 2018).

Cumulative Impacts. *A project's cumulative impacts are based on an assessment of whether the "incremental effects of an individual project are considerable when viewed in connection with the effects of past projects, the effects of other current projects, and the effects of probable future projects." (Pub. Resources Code, § 21083, subd. (b)(2); see CEQA Guidelines, § 15064, subd. (h)(1).)* (Quote from page 6 of the *Technical Advisor: On Evaluating Transportation Impacts in CEQA*, December 2018).

The inclusion of Project's effect on VMT for retail projects in the OPR Technical Advisory is one of the reasons that the analysis presented here includes all trip purposes and vehicle types without separation of VMT by land use, and an evaluation of Project's Effects on VMT (i.e., Project generated VMT per service population and boundary VMT).

The expectations of a CEQA impact analysis to provide a complete picture of the VMT effects on the environment are highlighted within the CEQA Guidelines in the following sections.

- **CEQA Guidelines – Expectations for Environmental Impact Analysis**
 - § 15003 (F) = fullest possible protection of the environment...
 - § 15003 (I) = adequacy, completeness, and good-faith effort at full disclosure...
 - § 15125 (C) = EIR must demonstrate that the significant environmental impacts of the proposed project were adequately investigated...
 - § 15144 = an agency must use its best efforts to find out and disclose...
 - § 15151 = sufficient analysis to allow a decision which intelligently takes account of environmental consequences...

All of these suggest completeness (and accuracy) is important and have largely been recognized by the courts as the context for judging an adequate analysis. Furthermore, to understand the effects of a project, VMT inputs for air quality, greenhouse gas (GHG) emissions, and energy consumption already require a comprehensive analysis of 'project generated' and 'project's effect on VMT' using local or regional travel forecasting models:

- Project generated VMT per service population (Direct Impacts): The sum of the "VMT from" and "VMT to" and within a local jurisdiction under baseline conditions divided by the sum of the number of residents, employees, and students in the local jurisdiction.
- Project's effect on VMT per service population (Cumulative Impacts): An evaluation of the change in travel between without and with project conditions on all roadways within the local jurisdiction under Cumulative Conditions divided by the sum of the number of residents, employees, and students in the local jurisdiction.



Both 'project generated VMT' and the 'project's effect on VMT' are recommended in the *2019 CSU TISM* to fully account for VMT effects that may include changes to VMT generation from neighboring land uses. The importance of a comprehensive analysis using all VMT per service population and that considers the project's effect on VMT is that land use projects can influence the routing of existing trips and the VMT generation of surrounding land uses. Combined with the expectations established in the CEQA Guidelines and CEQA case law, ignoring the project's effect on VMT may result in an inadequate analysis.

With this in mind, implementation of an SB 743 VMT assessment requires that certain methodology decisions must be made prior to the assessment. The necessary decisions and selected tools used in this assessment are as follows (consistent with the *2019 CSU TISM*):

- Select a VMT calculation tool
 - Use the Association of Monterey Bay Area Governments (AMBAG) regional travel forecasting model.
- Select the VMT accounting method(s)
 - Total (Project generated)¹² VMT per service population (for Direct Impacts): The sum of the "VMT from" and "VMT to" and within a specific geographic area divided by the service population, which is the sum of the number of residents, employees, and students in the county.
 - Project's effect on VMT per service population (for Cumulative Impacts): An evaluation of the change in travel between without and with Project Conditions on all roadways within Monterey County under Cumulative Conditions divided by the sum of the number of residents, employees, and students in the county.
- Calculate the baseline and cumulative regional VMT estimates
 - The analysis presented here uses VMT from all trip purposes and vehicle types without separation of VMT by land use for Monterey County with a baseline set as Existing Conditions VMT generated by Monterey County and cumulative set as VMT on all roadways in Monterey County under Cumulative without Project Conditions. (Refer to the descriptions of Project generated VMT (Project Analysis) and Project's effect on VMT (Cumulative Analysis) presented in **Chapters 4** and **5** for more details.)

¹² For projects requiring a full VMT assessment, the *2019 California State University Transportation Impact Study Manual* describes the need to evaluate the project-generated VMT per service population. This analysis uses the total VMT metric. The Project's VMT is the difference between the CSUMB campus total VMT under Existing with Project Conditions and Existing Conditions. This approach of identifying the Project's total VMT is to capture the effects of increasing on-campus housing and shifting of student housing from East Campus Housing to Main Campus.



- Set VMT threshold(s)
 - The threshold to be applied in assessing Project-specific impacts is 15 percent below the existing total VMT per service population rate for Monterey County.¹³ (Refer to **Table 10** for additional details about this threshold)
 - The threshold to be applied in assessing cumulative impacts (Project's effect on VMT) is no change in the cumulative conditions (future) boundary VMT per service population (without and with Eastside Parkway) for Monterey County. (Refer to **Table 10** for additional details about this threshold)

As to direct impacts, total VMT per service population is the metric used to evaluate how the CSUMB campus VMT rate changes (increases or decreases) between the "without Project" and "with Project" scenarios, considering both VMT increases due to growth and VMT reductions due to changes in travel behavior.¹⁴ The "with Project" scenario results are divided by the number of full-time equivalent (FTE) students, FTE faculty, and staff (the change in service population due to the Project) to normalize the results; that is, to account for the differences in travel behavior among the different campus population types.¹⁵ Total VMT per service population is used to evaluate changes in the VMT rate due to the Project (i.e., the direct impacts); however, it does not evaluate a Project's effect on VMT on the entire roadway system,¹⁶ which is evaluated as part of the cumulative analysis.

Regarding the cumulative analysis, the CSUMB campus land use changes are relatively small in the context of Monterey County's residential population and employment; therefore, it is likely that the Project's effect on VMT (cumulative impact) would be localized, such as shifting some existing trips to/from other neighborhoods close to the CSUMB campus. Furthermore, the Project is likely to cause existing pass-through traffic to shift to alternate routes as more CSUMB campus-generated traffic occurs on the local streets within and near the CSUMB campus. Therefore, the Project's effect on VMT, as evaluated by the cumulative effects of the Project's land use and transportation changes, compares the changes in boundary

¹³ The CSU has selected the 15 percent reduction relative to Monterey County based on the OPR *Technical Advisory*, which states "... OPR recommends that a per capita or per employee VMT that is 15 percent below that of existing development may be a reasonable threshold." (Quote from page 10 of the *Technical Advisory on Evaluating Transportation Impacts in CEQA*, December 2018).

¹⁴ The trip generation approach and technical methods are unique because of the size of the CSUMB campus, the unique travel behavior of each portion of the CSUMB population, and varied housing locations of the CSUMB population. Rather than calculating the net increase in project VMT due to the net increase in land use intensity like most projects, the total VMT is prepared for the entire campus under Existing Conditions and Existing with Project Conditions to capture the effects of adding student on-campus housing to the Main Campus and shifting of student housing from East Campus to Main Campus, and increasing the portion of faculty and staff living in the East Campus.

¹⁵ For this analysis, service population is defined as the sum of all employees, residents, and students (Kindergarten through University).

¹⁶ An often-cited example of how a project can affect VMT is the addition of a grocery store in a food desert. Residents of a neighborhood without a grocery store have to travel a great distance to an existing grocery store. Adding a grocery store to that neighborhood will shorten many of the grocery shopping trips and reduce the VMT to/from the neighborhood. This concept is likely to occur with the addition of campus housing.



VMT per service population¹⁷ between the Cumulative and Cumulative with Project conditions, including with and without Eastside Parkway Conditions. Each scenario is described in detail later in this chapter.

For the reasons listed above, the analysis presented in this report focuses on the VMT for all trip purposes and vehicle types without separation of VMT by land use. For the project analysis, the Project generated VMT threshold was developed using the Existing Conditions total VMT for Monterey County because a substantial majority of the campus population (nearly 90 percent of students, faculty, and staff) lives within Monterey County. As a result, most of the CSUMB campus total VMT would be within Monterey County and, therefore, impacts assessed against the Monterey County baseline is the most appropriate assessment of a project's direct impact. Like the Project-generated VMT baseline rate, the boundary VMT baseline uses the Monterey County boundary VMT to evaluate the Project's effects on VMT because the Project effects are likely to be localized near the CSUMB campus and within Monterey County.

OPERATIONS ANALYSIS STUDY AREA AND SCENARIOS (FOR INFORMATION PURPOSES ONLY)

PROJECT STUDY AREA

The study area for the transportation operations analysis presented in this report was determined by using Project traffic volume estimates to identify intersections and freeway segments where the Project may contribute to deficient operations. The outer edges of the study area were defined first, followed by major intersections along local access routes to the campus that could potentially experience deficient operations with the addition of Project traffic and redistribution of traffic. Please refer to the memorandum *California State University, Monterey Bay (CSUMB) Master Plan EIR – Transportation Study Area Locations* in **Appendix A** of this report for additional details regarding the process used to determine the study area. The intersections and freeway segments within the study area are described below.

Study Intersections

A total of 51 intersections, as shown on **Figure 2** and listed here, were selected as study locations in consultation with CSUMB staff and reviewing agencies; the corresponding jurisdiction is noted in parentheses.

1. Del Monte Boulevard and Reindollar Avenue (City of Marina [M])
2. Second Avenue Extension and Patton Parkway (Future Intersection) (M)
3. State Route (SR) 1 Southbound Ramps and Imjin Parkway (Caltrans [Cal])

¹⁷ Boundary VMT captures all VMT on a roadway network within a specified geographic area, including local trips plus interregional travel, that does not have an origin or destination within the area.



4. SR 1 Northbound Ramps and Imjin Parkway (Cal)
5. Second Avenue and Imjin Parkway (M)
6. Third Avenue and Imjin Parkway (M)
7. Fourth Avenue and Imjin Parkway (M)
8. California Avenue and Imjin Parkway (M)
9. California Avenue and Patton Parkway (M)
10. Imjin Road and Imjin Parkway (M)
11. Abrams Drive and Imjin Parkway (M)
12. Reservation Road and Imjin Parkway (M)
13. Blanco Road and Reservation Road (Monterey County [MC])
14. Inter-Garrison Road Connection and Reservation Road (MC)
15. Second Avenue and Ninth Street (M)
16. Second Avenue and Eighth Street (M)
17. Fourth Avenue and Eighth Street (Future Intersection) (M / CSUMB)
18. Imjin Road and Eighth Street (M)
19. Second Avenue and Inter-Garrison Road (M)
20. General Jim Moore Boulevard and Inter-Garrison Road (M / CSUMB)
21. Eighth Street/Seventh Avenue and Inter-Garrison Road (MC / M / CSUMB)
22. Eighth Avenue and Inter-Garrison Road (CSUMB)
23. Abrams Drive and Inter-Garrison Road (MC / CSUMB)
24. Schoonover Road and Inter-Garrison Road (MC)
25. Inter-Garrison Road Connection and Inter-Garrison Road (MC)
26. East Garrison Road and Reservation Road (MC)
27. Reservation Road and Watkins Gate Road (MC)
28. Davis Road and Reservation Road (MC)
29. Second Avenue and Divarty Street (M / CSUMB)
30. General Jim Moore Boulevard and Divarty Street (M / CSUMB)
31. First Avenue and Lightfighter Drive (City of Seaside [S])
32. Second Avenue and Lightfighter Drive (S)
33. General Jim Moore Boulevard and Lightfighter Drive (S)
34. Malmedy Road and Colonel Durham Street (S)
35. Parker Flatts Cut Off Road and Colonel Durham Street (S)
36. Sixth Avenue and Colonel Durham Street (S)



37. Seventh Avenue and Colonel Durham Street (S)
38. Eighth Avenue and Colonel Durham Street (MC)
39. General Jim Moore Boulevard and Gigling Road (S)
40. Malmedy Road and Gigling Road (S)
41. Parker Flatts Cut Off Road and Gigling Road (S)
42. Sixth Avenue and Gigling Road (S)
43. Seventh Avenue and Gigling Road (S)
44. Eighth Avenue and Gigling Road (MC)
45. Eastside Parkway and Gigling Road (MC)
46. General Jim Moore Boulevard and Normandy Road (S)
47. General Jim Moore Boulevard and Coe Avenue (S)
48. Fremont Boulevard-Southbound SR 1 Off-Ramp and Monterey Road (Cal / Sand City)
49. California Avenue and Monterey Road-Northbound SR 1 Off-Ramp (Cal / S)
50. Reservation Road and State Route 68 Westbound Ramps (Cal / MC)
51. Reservation Road and State Route 68 Eastbound Ramps (Cal / MC)

Freeway Segments and Ramps

The freeway segments identified for analysis are those at which the Project is expected to add traffic equal to or greater than two percent of the freeway segment's capacity. Based on this criterion, the following ten freeway segments were selected:

1. State Route 1 between Reservation Road and Del Monte Boulevard (2 segments)
2. State Route 1 between Del Monte Boulevard and Imjin Parkway (2 segments)
3. State Route 1 between Imjin Parkway and Lightfighter Drive (2 segments)
4. State Route 1 between Lightfighter Drive and Fremont Boulevard-Del Monte Boulevard (2 segments)
5. State Route 1 between Fremont Boulevard-Del Monte Boulevard and Canyon Del Rey Boulevard (2 segments)

In addition to the above segments, the study area includes the following eight freeway on- and off-ramps:

1. State Route 1 and Imjin Parkway Interchange Ramps (4 ramps)
2. State Route 1 and Lightfighter Drive Interchange Ramps (4 ramps)



ANALYSIS SCENARIOS

The operations of the study intersections, freeway segments, and freeway ramps are evaluated during the weekday morning (AM) and weekday evening (PM) peak hours for the scenarios listed below. These scenarios include a description of the study area conditions at the time the Draft EIR Notice of Preparation was issued (Existing Conditions); Project changes to the existing transportation conditions for all travel modes in the study area (Existing with Project Conditions); and a description of the long-term cumulative setting, approximately 20 years in the future (Cumulative without Project and without Eastside Parkway Conditions and Cumulative with Project and without Eastside Parkway Conditions). Given the uncertainty of the Eastside Parkway project, two cumulative scenarios relating to Eastside Parkway are provided (Cumulative without and with Project and without Eastside Parkway Conditions, and Cumulative without and with Project and with Eastside Parkway Conditions).

- Scenario 1:** *Existing Conditions* – Existing traffic conditions based on existing volumes.
- Scenario 2:** *Existing with Project Conditions* – Scenario 1 volumes plus the combined effects of the CSUMB Master Plan including increased campus population and modifications to existing campus parking and transportation facilities.
- Scenario 3:** *Cumulative without Project and without Eastside Parkway Conditions* – Year 2035 cumulative traffic volumes based on forecasts from the AMBAG regional travel model without Eastside Parkway.¹⁸
- Scenario 4:** *Cumulative with Project and without Eastside Parkway Conditions* – Scenario 3 volumes plus effects of the CSUMB Master Plan including increased campus population and modifications to existing campus parking and transportation facilities.
- Scenario 5:** *Cumulative without Project and with Eastside Parkway Conditions* – Year 2035 cumulative traffic volumes based on forecasts from the AMBAG regional travel model with Eastside Parkway.
- Scenario 6:** *Cumulative with Project and with Eastside Parkway Conditions* – Scenario 5 volumes plus the combined effects of the CSUMB Master Plan including increased campus population and modifications to existing campus parking and transportation facilities.

¹⁸ As of this writing, the Eastside Parkway project does not have an identified funding source, nor has a final alignment been determined. Refer to **Figure 2** for alignment studied.



REPORT ORGANIZATION

This report is divided into five sections and 11 chapters:

- **Existing Conditions and Relevant Plans**
 - **Chapter 2 – Existing Conditions** describes the existing campus parking and transportation demand management and the transportation system near the Project site, including the surrounding roadway network, AM and PM peak hour driveway and intersection turning movement volumes, existing bicycle, pedestrian, and transit facilities, intersection levels of service, freeway segment levels of service, and ramp operations.
 - **Chapter 3 – Summary of Relevant Circulation and Transportation Plans** provides background information to be used for the plan consistency evaluation.
- **CEQA Significance Criteria, VMT Analysis Methods, Impacts and Mitigation**
 - **Chapter 4 – Significance Criteria and Analysis Methods** lists the significance criteria used for the environmental impact analysis. This chapter also discusses the traffic forecasting methods used to estimate total VMT per service population rate and the Project's effect on VMT using boundary VMT per service population.
 - **Chapter 5 – CEQA Impacts and Mitigation** evaluates the Project's impacts on the overall transportation system via the VMT analyses and to transit, bicycle, and pedestrian systems, and identifies mitigation measures, if warranted, to address significant impacts of the Project.
- **Parking Management and TDM**
 - **Chapter 6 – Parking Management and TDM** describes the parking supply and mode share assumptions used in the transportation analysis, which establishes the business as usual condition for the future Parking Management and TDM Plan. To assist with refining the proposed PDFs and implementation of the Master Plan, the Main Campus Parking Evaluation and Main Campus Inbound AM peak Hour Mode Share Evaluation was conducted using the parking demand and mode share data collected for this report.
- **Operations Analysis (For Information Purposes Only)**
 - *Chapter 7 – Operations Analysis and Project Traffic Forecasting Methods (For Information Purposes Only)* describes the traffic analysis methods and traffic volumes used for the operations analysis chapters.
 - *Chapter 8 – Existing with Project Conditions (For Information Purposes Only)* addresses intersection and freeway operations for Existing with Project Conditions. The relevant Project information and Project trip generation, distribution, and assignment is also discussed in this chapter.



- *Chapter 9 – Cumulative without Eastside Parkway Conditions (For Information Purposes Only)* addresses the cumulative intersection and freeway operations for conditions without and with the Project and without the Eastside Parkway.
- *Chapter 10 – Cumulative with Eastside Parkway Conditions (For Information Purposes Only)* addresses the cumulative intersection and freeway operations for conditions without and with the Project and with the Eastside Parkway.
- *Chapter 11 – Transportation Deficiencies and Improvements (For Information Purposes Only)* describes the Project's effects on intersection and freeway operations, and identifies improvements to address deficiencies caused by the Project. This chapter also includes an evaluation of potential secondary effects to bicycle and pedestrian facilities associated with the roadway system improvements.



2. EXISTING CONDITIONS

This chapter describes the Existing Conditions associated with roadways, truck routes, pedestrian facilities, bicycle facilities, and transit service near the Project site. It also presents existing vehicle volumes, and operations for the study intersections and freeway segments.

EXISTING CAMPUS PARKING AND TRANSPORTATION DEMAND MANAGEMENT

This section describes the existing parking conditions and transportation demand management (TDM) program currently in effect on the campus. The parking uses are described as academic parking and residential parking:

- Academic parking serves students (residing on- and off-campus), staff, employees, and visitors, and is not restricted to on-campus residents as is residential parking, described below. Academic parking also includes handicapped, electric vehicle, and motorcycle parking that serves all populations.
- Residential parking is parking reserved for on-campus residents only. Residential parking includes handicapped, electric vehicle, and motorcycle parking reserved for on-campus residents.

EXISTING PARKING INVENTORY AND DEMAND SURVEY

To assess the existing level of parking demand on-campus and the related available inventory, a parking occupancy survey was conducted over a three-day period for the academic and residential parking areas located within the Main Campus on typical non-holiday days (Tuesday, November 28, 2017; Wednesday, November 29, 2017; and Thursday, November 30, 2017). This parking occupancy survey also provided a parking inventory of the existing parking lots on the campus. The details of the survey results are provided in **Appendix C**.

Under Existing Conditions, the campus has 40 parking lots with a total of 4,721 academic and residential spaces. **Table 2** presents a summary of the number of existing parking spaces on the CSUMB Main Campus.



TABLE 2: EXISTING PARKING SPACES

Parking Type	Spaces ¹
Academic	3,730
Residential	991
Total	4,721

Notes:

1. Residential lots include both North Quad and Promontory Housing lots. Students who live in the Main Quad park in Academic lots.

Source: CSUMB data received May 2018. Fehr & Peers, 2019.

Table 3 presents the core campus peak parking demand rates, which are estimated as the total parking utilized on the campus divided by the existing campus population, for the academic and residential parking lots based on the survey results. For the academic parking lots, the peak parking occupancy period occurred at 11:00 AM at a demand rate of 0.31 parking spaces per FTE; for the residential parking lots the peak parking occupancy period occurred at 7:00 AM at a demand rate of 0.20 parking spaces per student. Academic and residential parking occupancy percentages depict the amount of existing parking utilized compared to the amount of existing parking available on the campus, and are shown for every half-hour from 7:00 AM to 7:00 PM in **Figure 7** and **Figure 8**.

TABLE 3: EXISTING PARKING DEMAND RATES

Item	Academic	Residential
Existing Peak Parking Demand	2,396 spaces	525 spaces
Existing Population	7,658 FTE	2,600 residents
Existing Parking Demand Rate	0.31 spaces/FTE	0.20 spaces per resident

Notes:

1. FTE = Full-time equivalent students, faculty, and staff

Source: CSUMB data received May 2018. Fehr & Peers, 2019.



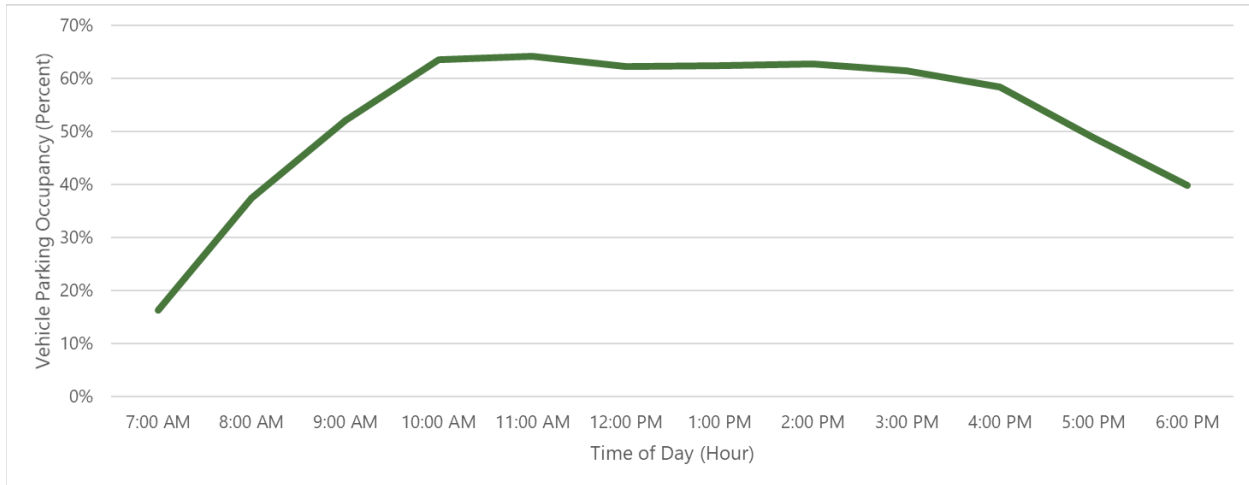

Figure 7 Academic Parking Occupancy from 7:00 AM to 7:00 PM

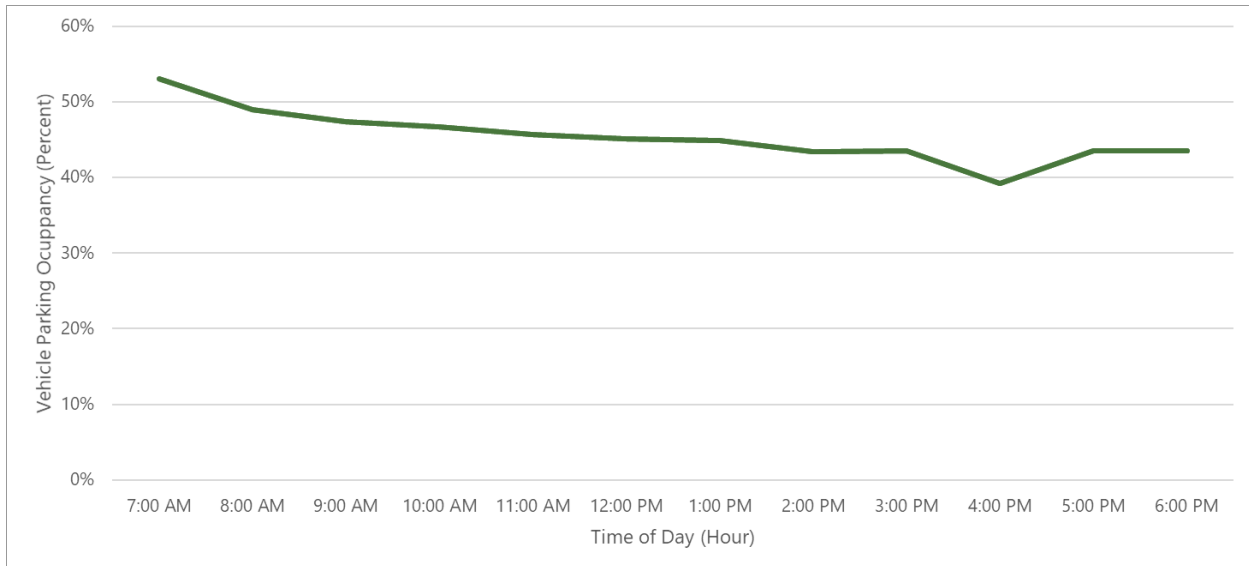

Figure 8 Residential Parking Occupancy from 7:00 AM to 7:00 PM

In terms of the direct observations, the peak observed academic parking demand for the entire campus was 2,396 vehicles, or 64 percent occupied, at 11:00 AM. The peak observed residential parking demand for the entire campus was 525 vehicles, or 53 percent occupied, at 7:00 AM. The overall academic and residential demand of 2,921 vehicles is lower than existing parking supply of 4,721 parking spaces and represents an overall occupancy rate of approximately 62 percent. Assuming a circulation factor of five percent, the estimated existing parking supply based on the existing demand would be 3,068 parking spaces, which is 1,653 spaces fewer than the actual existing parking supply.



EXISTING TRANSPORTATION DEMAND MANAGEMENT PROGRAM

The existing CSUMB TDM program complements the on-campus housing of students, faculty, and staff and enhances the quality of pedestrian, bicycle, and transit facilities on campus. Housing and high-quality transportation infrastructure helps to promote walking, bicycling, and transit use, which reduces vehicle trips to/from the campus. CSUMB's Master Plan Guidelines include the following existing TDM strategies intended to provide residents and off-campus students, faculty, and staff with transportation options that can reduce vehicle trip generation:

- Otter Cycle Center – on-campus bicycle repair shop that also offers bicycle rentals and other services to facilitate bicycle ridership.
- Bicycle Storage and Amenities – several hundred bicycle racks have been installed on campus outside of residence halls and popular academic, recreation and administrative buildings. Additionally, a secure bicycle bunker storage room has been installed, as well as two 'fix-it' stations that provide 24/7 access to bicycle repair tools and air pumps. Bicycle registration is also available through the University Police Department to simplify that process. Three skateboard storage racks also have been installed in the popular destinations on campus.
- Paid Parking – to discourage non-CSUMB related vehicle trips the campus manages parking on campus via a parking permit fee structure presently based upon campus, community, or vehicle type and parking timeframes. The fees have increased several times over the last two decades to more accurately match the true cost of providing managed parking.
- Monterey-Salinas Transit (MST) – the campus has entered into an agreement with MST that is annually renewed and provides universal access on the MST bus network for all active CSUMB ID card holders, three supplemental campus-serving and subsidized bus routes, and funding for a shared transit marketing student intern.
- Emergency Ride Home Program – campus community members can sign up for a program run by Transportation Agency for Monterey County (TAMC) that reimburses taxi or ridesharing trips home in emergency situations for commuters who use alternative means of transportation.
- Carsharing and Ridesharing – CSUMB hosts four cars for carsharing. These are cars stationed on the campus available for use by carshare members on the campus. Additionally, CSUMB students, faculty and staff can use Go831, a regional ride share program.
- Transportation Services Website – Information for most of the available TDM strategies is included on a campus website to facilitate information dissemination.
- Delivery Vehicle Limitations – to discourage delivery vehicle trips, drivers providing frequent delivery services to campus, such as office supply deliveries, have been instructed to limit their deliveries to campus to no more than three days per week.



- Bicyclist/Pedestrian Malls – to encourage pedestrian and bicycle use, a section of Divarty Street and a section of Sixth Avenue are closed to regular vehicular traffic to accommodate pedestrians and bicyclists.
- Traffic Calming – to discourage automobile use and provide increased safety, speed humps and flashing beacon crosswalk devices have been installed on several campus roadways to reduce vehicle speeds, particularly near high traffic pedestrian crosswalks.

EXISTING STREET SYSTEM

Regional access to the CSUMB Main Campus is provided by State Route (SR) 1. Primary local access to the CSUMB campus is provided by Imjin Road from the north, Inter-Garrison Road from the west and east, and General Jim Moore Boulevard from the south. The Main Campus entrance at Lightfighter Drive and General Jim Moore Boulevard is marked by a gateway entrance sign. Traffic from Seaside or the Monterey Peninsula access the campus from the General Jim Moore Boulevard entrance; traffic from Salinas or Marina accesses the campus via either the Second Avenue, Imjin Road, or Inter-Garrison Road entrances; and traffic from Santa Cruz County access the campus entrances at either Inter-Garrison and Second Avenue or Imjin Road. These roadways are described below and illustrated in **Figure 1**.

State Route 1 (SR 1) is a state highway within Monterey County, providing access to Watsonville and Santa Cruz to the north via Seaside, Marina, and Castroville, and to San Luis Obispo to the south via Monterey and Carmel. Through its connection to SR 156 in Castroville, SR 1 also provides access to US 101 and the greater San Francisco Bay Area. Through Marina and Seaside, SR 1 has a posted speed limit of 65 miles per hour (mph), and provides four lanes north of the Del Monte Boulevard interchange, six lanes south of Del Monte Boulevard interchange to the Fremont Boulevard/Del Monte Boulevard interchange, and returns to four lanes south of the Fremont Boulevard/Del Monte Boulevard interchange. SR 1 average daily traffic (ADT) counts range between 51,560 to 96,960 for the segments between Del Monte Boulevard and Canyon Del Rey Boulevard, with the highest ADT between Imjin Parkway and Del Monte Boulevard.

Reservation Road is a major arterial extending from the Pacific Ocean at Marina State Park west of Dunes Drive, through the City of Marina. East of Del Monte Boulevard, Reservation Road is a four-lane divided street. At East Garrison Road, east of Imjin Parkway, it narrows to a two-lane rural highway. Reservation Road is under the jurisdiction of the City of Marina west of Blanco Road and the County of Monterey east of Blanco Road. The ADT on Reservation Road ranges between 6,220 to 26,570 vehicles with the lowest ADT south of Blanco Road, and the highest ADT between Imjin Road and Blanco Road.

Imjin Parkway is an arterial street within the City of Marina limits. Imjin Parkway is a two-lane road at its interchange with SR 1 and a four-lane divided street with left-turn channelization east of the northbound SR 1 ramps and two lanes east of Imjin Road. Imjin Parkway has bike lanes on each side of the street starting east of Second Avenue with the eastbound bike lane ending at Reservation Road. The speed limit on Imjin Parkway is



45 mph. Imjin Parkway has an ADT of 22,500 east of Second Avenue and an ADT of 28,220 west of Second Avenue toward SR 1.

California Avenue/Fifth Avenue is a two-lane arterial from central Marina to Imjin Parkway, and a local street south of Imjin Parkway ending at Inter-Garrison Road. California Avenue connects Reservation Road with Imjin Parkway and CSUMB. Bicycle lanes are provided along California Avenue/Fifth Avenue between Imjin Parkway and Reservation Road. The speed limit on California Avenue is 25 mph. The ADT on California Avenue north of Imjin Parkway is 5,900.

Eighth Street is a two-lane arterial from First Avenue to Inter-Garrison Road that is currently closed (future extension is planned) between Third Avenue and Fifth Avenue. The speed limit along Eighth Street is 35 mph.

Inter-Garrison Road extends from Second Avenue to Reservation Road as a two-lane arterial. The extension of Inter-Garrison Road (referred to as the Inter-Garrison Road Connection in this analysis) to Reservation Road, completed in 2013, provides a regional connection from the Marina-Salinas area to SR 1. The speed limit on Inter-Garrison Road is 35 mph between Eighth Avenue and Schoonover Road and 25 mph between Second Avenue and Eighth Avenue. Inter-Garrison Road has an ADT of 8,450 between Eighth Avenue and Abrams Drive, and an ADT of 2,630 between Second Avenue and Third Avenue.

Lightfighter Drive starts from the SR 1 ramps as an east-west street that continues as the north-south street Malmedy Road at the intersection of Colonel Durham Street. From the SR 1 interchange to General Jim Moore Boulevard, the street is a four-lane divided major arterial with a speed limit of 40 mph. East of General Jim Moore Boulevard, Lightfighter Drive is a two-lane minor arterial with a speed limit of 25 mph. West of General Jim Moore Boulevard, the ADT on Lightfighter range between 13,250 and 15,000 vehicles.

Divarty Street is a two-lane local street from First Avenue to Fifth Avenue providing access to the core of the CSUMB campus. The speed limit along Divarty Street is 25 mph.

Colonel Durham Street is a two-lane local street that extends between Lightfighter Drive/Malmedy Road to the west and Eighth Avenue to the east. The street has pedestrian facilities along one or both sides west of Sixth Avenue, and although it is a local street, the speed limit is 35 mph along its entirety.

Gigling Road is a two-lane arterial that starts just east of SR 1 at Noumea Road and extends to Eighth Avenue. Gigling Road has a speed limit of 30 mph and an ADT of 6,300 vehicles.

Second Avenue connects Lightfighter Drive in Seaside with Imjin Parkway in Marina, along the western edge of CSUMB. Second Avenue is a north-south arterial street in Marina and Seaside with four lanes from Imjin Parkway to Tenth Street, two lanes from Tenth Street to Divarty Street, and returns to four lanes south of Divarty Street. Second Avenue has right-turn and left-turn channelization on the entire stretch of the street, and bike lanes north of Divarty Street to Imjin Parkway. The speed limit on Second Avenue is 35 mph. The lowest ADT on



Second Avenue is 2,500 vehicles south of Divarty Street. Second Avenue's ADT is highest north of Fifth Street, with ADT of 6,330 vehicles.

General Jim Moore Boulevard is a four-lane arterial that extends from Canyon del Rey Boulevard to Lightfighter Drive in Seaside. Once it enters the campus at Lightfighter Drive, the street becomes a two-lane arterial to Fifth Street with a posted speed limit of 25 mph on campus. The ADT on General Jim Moore Boulevard ranges between 5,230 to 9,600 vehicles, with the lowest ADT north of Lightfighter Drive (on campus) and highest ADT between Lightfighter Drive and Gigling Road (south of campus).

Sixth Avenue is a north-south local street that extends from Gigling Road to Eighth Street. The two-lane connector has restricted access from CSUMB's Student Services building, 250 feet south of A Street to B Street.

Seventh Avenue is a north-south two-lane local street that extends from Gigling Road to the south to Eighth Street/Inter-Garrison Road to the north.

Eighth Avenue is a north-south two-lane local street that extends from Gigling Road on the south to Inter-Garrison Road at in the north.

Abrams Drive is a two-lane connector between Imjin Parkway and Inter-Garrison Road, with a posted speed limit of 30 mph and ADT of 5,050. Abrams Drive is the main street through East Campus Housing and connects to Bunker Hill Drive, Manassas Drive, and Schoonover Road.

Schoonover Road is a two-lane connector between Abrams Drive and Inter-Garrison Road with a posted speed limit of 25 mph. The street travels through the eastern side of the East Campus Housing.

EXISTING TRUCK ROUTES

SR 1 is identified as part of the regional truck network. The freeway is intended to move goods efficiently within the cities of Marina and Seaside, between outlying agricultural uses, and packing/distribution centers. Additionally, the freeway serves to separate truck traffic from local streets where the larger vehicles may conflict with other uses.

Both the City of Marina and City of Seaside designate and describe streets that permit commercial vehicles exceeding three tons as truck routes with appropriate signage. Neither city has an existing truck route network, but in the Circulation Element of the Seaside General Plan, the City identified establishing a truck route network as an ongoing goal to reduce impacts on residential neighborhoods. In the City of Marina, commercial trucks are prohibited from entering local residential streets and collectors except for the purpose of local deliveries.



EXISTING PEDESTRIAN FACILITIES

The CSUMB campus has a variety of pedestrian accommodations, such as sidewalks, pedestrian malls, and trails. Some portions of the campus, such as existing pedestrian malls on Divarty Street and Sixth Avenue which are street segments reserved for primarily pedestrian use with limited transit and service vehicle usage, have a high-quality walking environment with many destinations within a close walking distance, while other areas of campus lack sidewalks. **Figure 9** shows the locations of existing sidewalks and sidewalk gaps on and near the CSUMB campus.

Arterial roads such as Lightfighter Drive, Second Avenue and Gigling Road have sidewalks on one or both sides of the street. Several local streets within and near the campus do not have sidewalks, creating gaps in the pedestrian network.

While CSUMB has made improvements to the on-campus pedestrian network, a limited number of direct, accessible, and protected pedestrian connections are in place through parking lots and to the existing sidewalk network. Additionally, there are no existing sidewalks along Inter-Garrison Road connecting the Main Campus to the East Campus Housing area east of Eighth Avenue. In many areas, the natural topography exceeds a five percent grade, making the construction of Americans with Disabilities Act (ADA)-accessible pathways difficult along some streets such as Fifth Avenue, Sixth Avenue, and portions of Inter-Garrison Road. Distances between major destinations that are more than a 10-minute walk, coupled with a mild yet windy and foggy coastal climate, can deter pedestrian movement.



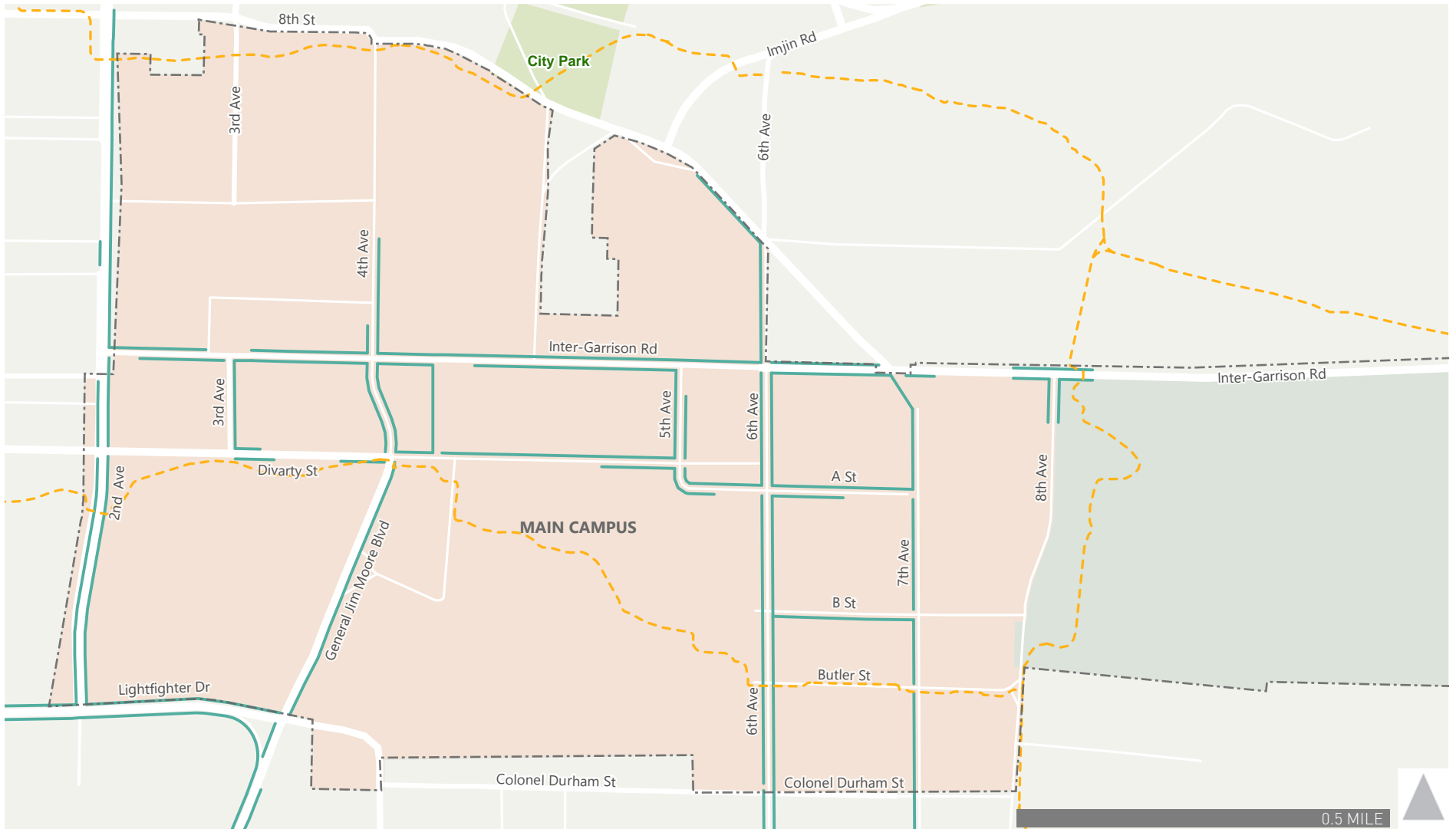

- California State University Monterey Bay Main Campus
- California State University Monterey Bay East Campus

- Existing Pedestrian Network**
- Existing Sidewalk

- Planned Pedestrian Network**
- Fort Ord Regional Trail & Greenway (FORTAG) Preferred Alignment



Figure 9
Existing CSUMB and Regionally Planned Pedestrian Facilities

EXISTING BICYCLE FACILITIES

There are several existing bicycle facilities on the CSUMB campus and in surrounding areas, comprised of bike routes or boulevards, bike lanes, and separated bike paths or trails. On campus and surrounding the campus, there are 3.8 miles of bike boulevards, which are low-speed and low-volume streets designated with pavement markings for shared bicycle use with motor vehicles, and other bike facilities along roadways. The campus has parking for 580 bicycles, which includes 36 secure indoor spots within the Bike Bunker parking facility, which are typically well-utilized during the academic year.

Figure 10 shows the existing and regionally planned bicycle facilities as described in the *2011 Transportation Agency for Monterey County (TAMC) Bicycle and Pedestrian Master Plan, 2016 for a Regional Urban Design Guidelines* and *2018 Monterey County Active Transportation Plan*.

Bikeway planning and design in California typically relies on guidelines and design standards established by the California Department of Transportation (Caltrans) in the *Highway Design Manual* (Caltrans 2020). The *Highway Design Manual* provides for three distinct types of bikeway facilities that are applicable to the campus, as described below and shown in the accompanying figures.

- Class I Bikeways (Shared-Use Paths) provide a completely separate right-of-way and are designated for the exclusive use of bicycles and pedestrians, with vehicle and pedestrian crossflow minimized. The campus recently constructed its first separated bike path, or a Class I facility, between the Promontory housing and Inter-Garrison Road. On the campus periphery, separated bicycle paths exist on the east side of Second Avenue between Lightfighter Drive and Imjin Parkway and off campus, along Imjin Parkway between Second Avenue and Imjin Road, at which point it transitions to an in-road shared bicycle route.

SHARED-USE PATH (CLASS I)

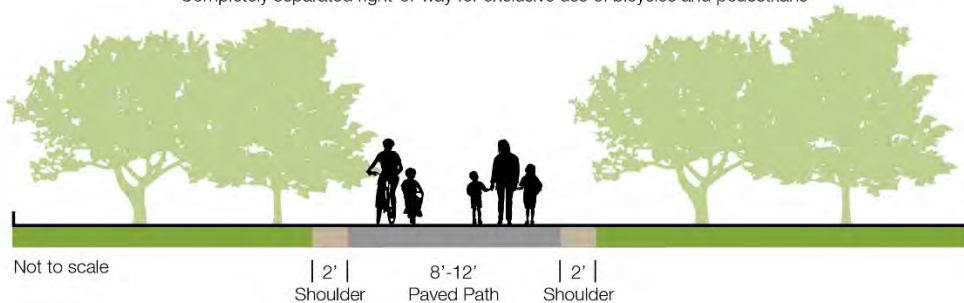

Completely separated right-of-way for exclusive use of bicycles and pedestrians

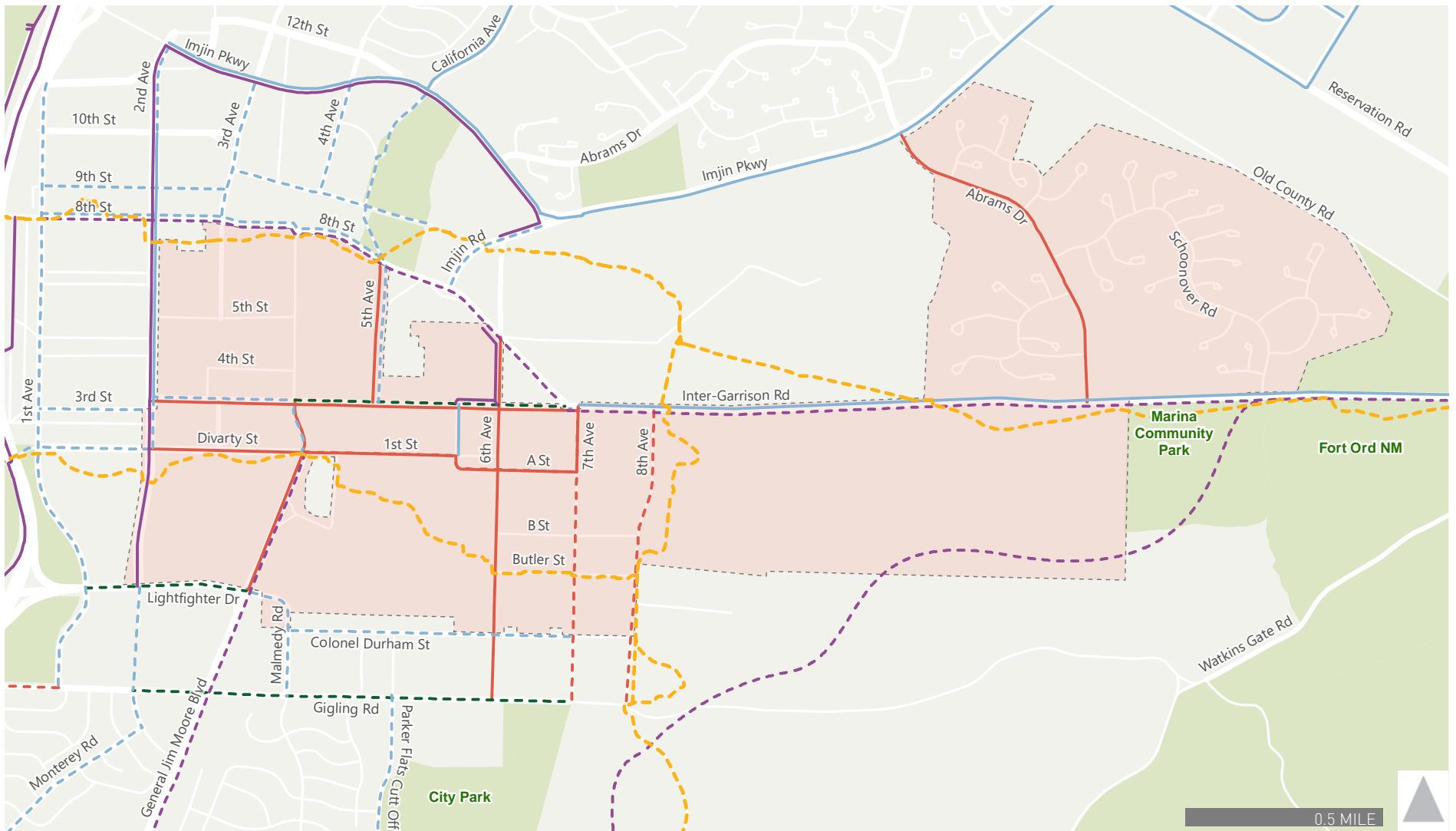



 California State University Monterey Bay Campus

Existing Bicycle Facilities

-  Class I - Shared Use Path
-  Class II - Bicycle Lane
-  Class III - Bicycle Route

Planned Bicycle Facilities

-  Fort Ord Regional Trail & Greenway (FORTAG) Preferred Alignment
-  Class I - Shared Use Path
-  Class II - Bicycle Lane
-  Class III - Bicycle Route
-  Class IV - Cycle Track/Separated Bikeway

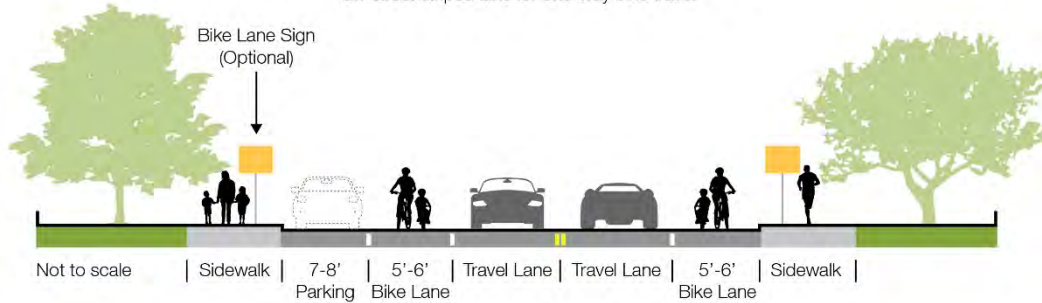

Figure 10
Existing CSUMB and Regionally Planned Bicycle Facilities

- ***Class II Bikeways (Bicycle Lanes)*** are dedicated lanes for bicyclists generally adjacent to the outer vehicle travel lanes, that have special lane markings, pavement legends, and signage. Bicycle lanes are at least five (5) feet wide. Bicycle lanes, also known as Class II facilities, are provided on Second Avenue, General Jim Moore Boulevard from Lightfighter Drive to Inter-Garrison Road, Fifth Avenue from Divarty Street to Inter-Garrison Road and Inter-Garrison Road from Seventh Avenue to Schoonover Drive.

BICYCLE LANE (CLASS II)

On-street striped lane for one-way bike travel



- ***Class III Bikeways (Bike Boulevards/Bicycle Routes)*** are designated by signs or pavement markings for shared use with motor vehicles but have no separated bike right-of-way or lane striping. On-campus bike routes, known as Class III facilities, include approximately 3.8 miles of bicycle boulevards on the following road segments: Divarty Street from Second Avenue to A Street, A Street from Divarty to Seventh Avenue, Seventh Avenue from Inter-Garrison Road Colonel Durham Street, and Inter-Garrison Road from Seventh Avenue to Second Avenue.

BICYCLE ROUTE (CLASS III)

Shared on-street facility

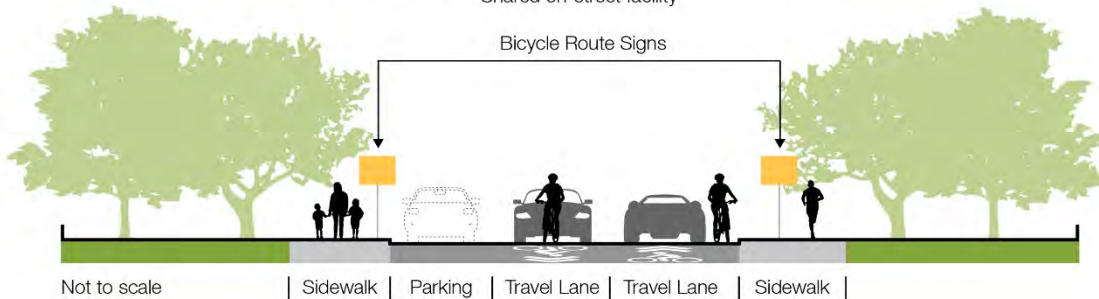

- Class IV Bikeways (Cycle Tracks or “Separated” Bikeways) provide a right-of-way designated exclusively for bicycle travel within a roadway and are protected from other vehicle traffic by physical barriers, including, but not limited to, grade separations, flexible posts, inflexible vertical barriers such as raised curbs or parked cars. None of the existing facilities in the study area classify as Class IV bikeways.

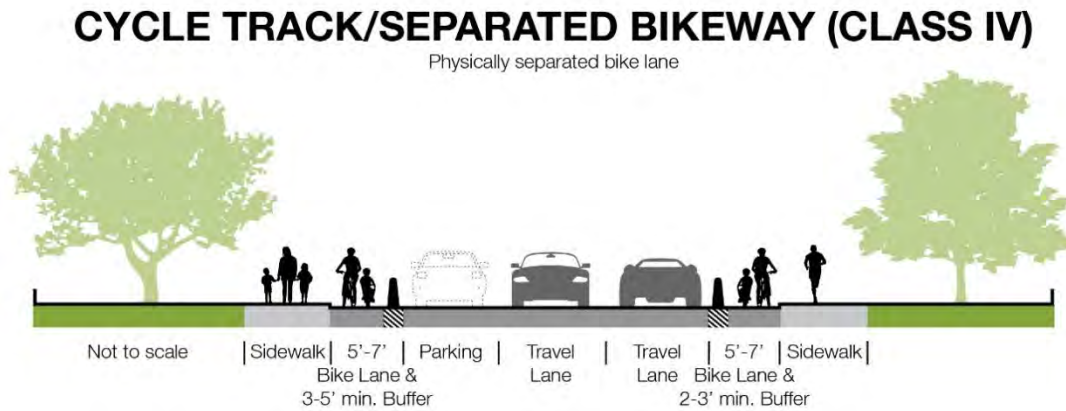

EXISTING TRANSIT SERVICE

The public transit system that connects the CSUMB campus to the greater Monterey and Salinas area is operated by the Monterey-Salinas Transit District (MST). Students, staff, and faculty receive free boarding and unlimited access on all MST regular bus routes with their CSUMB Otter ID card. Eight bus routes serve stops in or along the boundary of the CSUMB campus throughout the academic year: Routes 12, 16, 18, 19, 25, 26, 67, and 74. **Figure 11** shows the map of the transit services that run through the academic year, and **Table 4** describes weekday bus route information and route access from CSUMB to major points of interest throughout the region.

Seven bus routes travel along Fourth Avenue and connect with a main stop that is centrally located adjacent to CSUMB’s Alumni and Visitor Center and west of the Main Campus. Routes serve a total of 21 on-campus bus stops – 11 stops in the Main Campus and 10 stops in the East Campus. A majority of the stops are located along Inter-Garrison Road, Second Avenue, and Sixth Avenue. Routes 16, 19, 25, 26, and 74 travel through the campus and provide service to the stops located at the East Campus Housing.

Students, faculty, and staff with physical disabilities have access to the MST para-transit program, RIDES. This service operates on a point-to-point basis with no restrictions on purpose of the trip and appointments are required to guarantee service. The para-transit service accommodates travel to and from locations that are up to three-quarters of a mile from any of MST’s regular bus routes and the service is available during the hours of operation of MST’s regular fixed-route bus service. CSUMB also offers a wheelchair accessible cart that is



available for University Departments/Group tours, campus-wide orientations, and major events such as Commencement.

BUS ROUTE BOARDINGS

The boarding factors for all bus routes described in **Table 4**, including the number of buses, the capacity of each bus, and the number of passenger boardings (general and CSUMB) per bus, are provided for the AM and PM peak hours in **Table 5** (except Route 19 with a daily factor). Boarding factor is defined as the average number of passenger boardings relative to average bus capacity.

As shown on the table, Routes 12, 16, 18, and 74 run vehicles with a capacity between 46 to 59 passengers, and Routes 19, 25, and 26 run vehicles with a capacity of 21 passengers. Students make up more than 50 percent of the ridership on an average day for Routes 16, 19, 25, and 26. Route 16, which runs from The Dunes development at Second Avenue through the Main Campus and East Campus to the Marina Transit Exchange, has an estimated average boarding factor of 0.20 in the AM peak hour and 0.24 in the PM peak hour, with students making up 0.10 and 0.14 of those boarding factors, respectively. Route 19, which runs on Fridays and weekends, has a daily boarding factor of 0.29, with students making up most of that boarding factor (0.23). Routes 25 and 26, which primarily serve the campus, have estimated average weekday boarding factors greater than 0.20, with students making up most or all of the boardings. Route 74 has the highest boarding factor of 0.59 in the AM peak hour. Students make up a small percentage of the passengers of Route 74.



TABLE 4: EXISTING WEEKDAY MST TRANSIT SERVICE SUMMARY

Route	Description	From	To	Hours of Operation	Average Weekday Headway	Average Weekday Boardings ¹	CSUMB Weekday Boardings ¹
12	The Dunes - NPS	CSUMB Alumni & Visitor Center	Naval Postgraduate School	6:45 AM to 5:40 PM	Limited ²	37	10%
16	Marina – The Dunes	CSUMB Alumni & Visitor Center	Marina Transit Exchange	5:35 AM to 10:30 PM	Every 60 Minutes	376	60%
18	Monterey – The Dunes	CSUMB Alumni & Visitor Center	Monterey Transit Plaza	6:00 AM to 10:40 PM	Every 60 Minutes	383	43%
19	Del Monte Center – CSUMB East Campus	CSUMB Alumni & Visitor Center	Del Monte Center	Fridays & Saturdays: 1:00 PM to 2:55 AM Sundays: 6:00 PM to 11:50 PM	Every 60 Minutes before 7:00 PM Every 120 minutes after 7:00 PM ³	66	80%
25	CSUMB – Salinas	CSUMB Alumni & Visitor Center	Salinas Transit Center	6:20 AM to 10:35 PM	Every 60 Minutes	120	80%
26	CSUMB – East Campus Express	CSUMB Alumni & Visitor Center	East Campus	6:30 AM to 12:25 AM	Every 20 minutes	390	98%
67 ⁴	Presidio – Marina	Otter Sports Center	Reservation & Beach	Fridays: 2:15 PM to 10:10 PM Weekends: 10:15 AM to 10:10 PM	Every 120 minutes ⁵	-	-
74 ⁶	Presidio – Toro Park	CSUMB Alumni & Visitor Center	Portola and Anza	6:30 AM to 6:00 PM	Limited ²	89	3%

Notes:

1. Boardings collected for the CSUMB Spring 2017 Semester, from January 23, 2017 to May 12, 2017. Boardings based on average Tuesday to Thursday boardings for all routes except Route 19. Average boardings for Route 19 based on Friday and Saturday data.
 2. Headways for Route 12 range between 60 to 120 minutes. Route 74 runs one route in each direction in the morning and one evening route towards Toro Park.
 3. Route 19 only operates on Fridays and weekends, and headways are shown for Fridays and Saturdays, since the hours of operation are limited for Sunday.
 4. Route 67 service started operating in September 2017.
 5. Route 67 runs every 60 minutes on weekends.
 6. Regular service does not make a scheduled stop at CSUMB Alumni and Visitor Center. Express Service in the evening does not make a stop at CSUMB Alumni and Visitor Center.
- Source: Calculations based on boarding data provided by MST in August 2017. Route descriptions and hours of operation are based on printable map and schedules downloaded from MST.org in December 2017.



TABLE 5: AVERAGE WEEKDAY MST BOARDING FACTORS

Route ¹	Peak Hour ²	Average Number of Peak Period Buses [A]	Bus Capacity [B] ¹	Total Peak Hour Capacity [(A * B) / 2 = C]	Average Peak Hour Boardings [D] ²	Average Peak Hour CSUMB Boardings [E] ²	Boarding Factor [D/C = F]	CSUMB Boarding Factor [E/C = G]
12	AM	5	49	123	8	1	0.07	0.01
	PM	3	49	74	6	1	0.08	0.02
16	AM	5	47	118	23	12	0.20	0.10
	PM	5	47	118	28	16	0.24	0.14
18	AM	5	47	118	22	7	0.19	0.06
	PM	5	47	118	33	17	0.28	0.14
19	Daily ³	11	21	231	66	53	0.29	0.23
25	AM	3	21	32	8	6	0.25	0.19
	PM	3	21	32	7	6	0.22	0.19
26	AM	10	21	105	22	22	0.21	0.21
	PM	10	21	105	29	29	0.28	0.28
74	AM	2	56	56	33	1	0.59	0.02
	PM	1	56	56	7	1	0.13	0.02

Notes:

1. Bus capacity includes sitting and standing capacity.
2. Calculations based on Spring 2017 Tuesday through Thursday peak period ridership data provided by MST. Peak hour boardings were calculated by dividing the peak period capacity by two.
3. Route 19 only operates on Fridays and weekends. Boarding factor for Route 19 is based on average ridership on Friday and Saturday, since hours of operation are limited on Sundays.

Source: Calculations based on Spring 2017 Tuesday through Thursday peak period and daily ridership data provided by MST in August 2017.



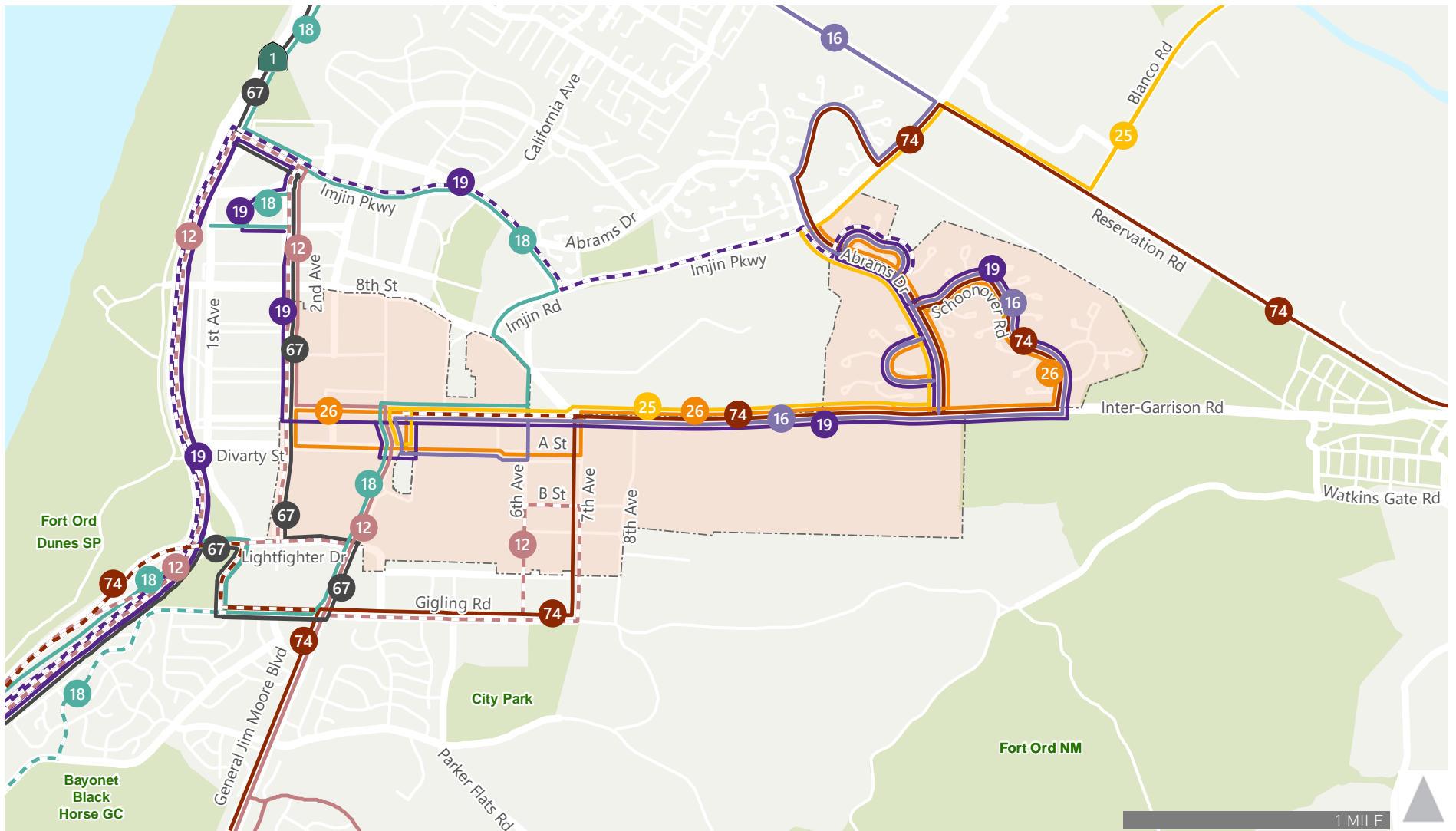



Note: Transit Routes shown for Academic Year, 2017

 California State University Monterey Bay Campus

Monterey-Salinas Transit (MST)

-  Regular Service Routes
-  Express/Select Trips

Headways

- 20 minutes: 26
- 60 minutes: 16, 18, 19, 25
- 120 minutes: 67
- Limited: 12, 74



Figure 11
Existing Transit Service to CSUMB

EXISTING INTERSECTION OPERATIONS

Intersection traffic operations were evaluated during a typical mid-week day during the morning (7:00 to 9:00 AM) and evening (4:00 to 6:00 PM) peak periods at the 51 study intersections. For the study intersections, the single hour with the highest traffic volumes during each count period was identified. In addition, counts of pedestrian and bicycle volumes were collected during the morning (AM) and evening (PM) peak periods at the study intersections. All counts were collected in May 2017 and April 2018 while CSU and local schools were in session; the data is shown in **Appendix D**.

Table 6 shows the existing level of service at each study intersection. (refer to **Chapter 7** for a description of the level of service (LOS) analysis method and relevant LOS standards for each jurisdiction.) **Appendix E** contains the analysis sheets documenting the intersection level of service calculations. The intersection volumes are shown in **Figure 12**.

The following intersections, with applicable peak hour noted, exceed their applicable level of service standard of the local jurisdiction under Existing Conditions (i.e., without Project, Conditions):

- Int 3. SR 1 Southbound Ramps and Imjin Parkway (AM peak hour)
- Int 4. SR 1 Northbound Ramps and Imjin Parkway (PM peak hour)
- Int 6. Third Avenue and Imjin Parkway (AM and PM peak hour)
- Int 7. Fourth Avenue and Imjin Parkway (AM and PM peak hour)
- Int 16. Second Avenue and Eighth Street (AM peak hour)
- Int 23. Abrams Drive and Inter-Garrison Road (AM peak hour)
- Int 47. General Jim Moore Boulevard and Coe Avenue (AM peak hour)
- Int 48. Fremont Boulevard/Southbound SR 1 Off-Ramp and Monterey Road (AM and PM peak hour)



TABLE 6: EXISTING INTERSECTION LEVELS OF SERVICE

#	Intersection	Count Date	Intersection Control ¹	Jurisdiction (LOS Standard) ²	Peak Hour ³	Delay ⁴	LOS ⁵
1	Del Monte Boulevard and Reindollar Avenue	4/25/2018	Signalized	M (D)	AM PM	11.6 8.9	B A
2	Second Avenue Extension and Patton Parkway	Future	Signalized	M (D)	AM PM	Future Intersection	
3	SR 1 Southbound Ramps and Imjin Parkway	5/3/2017	Signalized	for a (C)	AM PM	36.6 17.2	D B
4	SR 1 Northbound Ramps and Imjin Parkway	5/3/2017	Signalized		AM PM	0.0 (0.1) 0.2 (26.7)	A (A) A (D)
5	Second Avenue and Imjin Parkway	4/27/2017	Signalized	M (D)	AM PM	12.5 16.3	B B
6	Third Avenue and Imjin Parkway	4/27/2017	SSS	M (D)	AM PM	3.7 (103.6) 1.3 (43.2)	A (F) A (E)
7	Fourth Avenue and Imjin Parkway	5/3/2017	SSS	M (D)	AM PM	0.4 (88.9) 1.4 (>120)	A (F) A (F)
8	California Avenue and Imjin Parkway	4/27/2017	Signalized	M (D)	AM PM	20.2 10.0	C A
9	California Avenue and Patton Parkway	4/25/2018	SSS	M (D)	AM PM	1.4 (17.4) 0.4 (10.4)	A (C) A (B)
10	Imjin Road and Imjin Parkway	4/27/2017	Signalized	M (D)	AM PM	7.4 7.6	A A
11	Abrams Drive and Imjin Parkway	4/27/2017	Signalized	M (D)	AM PM	14.5 17.4	B B
12	Reservation Road and Imjin Parkway	4/27/2017	Signalized	M (D)	AM PM	22.5 32.9	C C
13	Blanco Road and Reservation Road	4/25/2018	Signalized	MC (D)	AM PM	13.1 11.0	B B
14	Inter-Garrison Road Connection and Reservation Road	4/27/2017	Signalized	MC (D)	AM PM ⁷	10.4 10.2	B B
15	Second Avenue and Ninth Street	4/27/2017	AWSC	M (D)	AM PM	21.9 11.4	C B
16	Second Avenue and Eighth Street	4/27/2017	AWSC	M (D)	AM PM	56.3 12.8	F B
17	Fourth Avenue and Eighth Street	Future	AWSC	M / CSUMB (D)	AM PM	Project Intersection ⁶	
18	Imjin Road and Eighth Street	4/27/2017	AWSC	M (D)	AM ⁷ PM	17.9 9.3	C A
19	Second Avenue and Inter-Garrison Road	4/27/2017	AWSC	M (D)	AM PM	26.5 9.8	D A



TABLE 6: EXISTING INTERSECTION LEVELS OF SERVICE

#	Intersection	Count Date	Intersection Control ¹	Jurisdiction (LOS Standard) ²	Peak Hour ³	Delay ⁴	LOS ⁵
20	General Jim Moore Boulevard and Inter-Garrison Road	4/25/2018	AWSC	M/ CSUMB (D)	AM ⁷ PM ⁷	8.5 9.9	A A
21	Eighth Street/Seventh Avenue and Inter-Garrison Road	4/25/2018	AWSC	MC / M / CSUMB (D)	AM ⁷ PM	12.9 8.9	B A
22	Eighth Avenue and Inter-Garrison Road	4/25/2018	Roundabout	CSUMB (D)	AM ⁷ PM	32.1 8.6	D A
23	Abrams Drive and Inter-Garrison Road	4/27/2017	AWSC	MC / CSUMB (D)	AM ⁷ PM	60.3 12.8	F B
24	Schoonover Road and Inter-Garrison Road	4/27/2017	AWSC	MC (D)	AM ⁷ PM	20.8 11.1	C B
25	Inter-Garrison Road Connection and Inter-Garrison Road	4/27/2017	AWSC	MC (D)	AM ⁷ PM	11.8 11.1	B B
26	East Garrison Road and Reservation Road	4/25/2018	Signalized	MC (D)	AM PM	5.0 5.6	A A
27	Reservation Road and Watkins Gate Road	Future	Signalized	MC (D)	AM PM	Future Intersection	
28	Davis Road and Reservation Road	4/25/2018	Signalized	MC (D)	AM PM	18.2 15.9	B B
29	Second Avenue and Divarty Street	4/27/2017	AWSC	M / CSUMB (D)	AM PM	31.1 9.4	D A
30	General Jim Moore Boulevard and Divarty Street	4/27/2017	AWSC	M / CSUMB (D)	AM PM ⁷	9.1 10.2	A B
31	First Avenue and Lightfighter Drive	4/27/2017	Signalized	S (C)	AM ⁷ PM	4.0 3.4	A A
32	Second Avenue and Lightfighter Drive	4/27/2017	Signalized	S (C)	AM PM	18.3 14.2	B B
33	General Jim Moore Boulevard and Lightfighter Drive	4/27/2017	Signalized	S (C)	AM PM	20.0 22.6	B C
34	Malmedy Road and Colonel Durham Street	4/25/2018	AWSC	S (C)	AM ⁷ PM	9.9 8.3	A A
35	Parker Flatts Cut Off Road and Colonel Durham Street	4/25/2018	SSS	S (C)	AM ⁷ PM ⁷	0.4 (10.9) 1.1 (10.1)	A (B) A (B)
36	Sixth Avenue and Colonel Durham Street	4/25/2018	AWSC	S (C)	AM ⁷ PM ⁷	8.9 7.8	A A
37	Seventh Avenue and Colonel Durham Street	4/25/2018	SSS	S (C)	AM ⁷ PM ⁷	6.6 (12.3) 7 (10.5)	A (B) A (B)
38	Eighth Avenue and Colonel Durham Street	4/25/2018	SSS	MC (D)	AM PM	0.6 (14.5) 2 (13.9)	A (B) A (B)



TABLE 6: EXISTING INTERSECTION LEVELS OF SERVICE

#	Intersection	Count Date	Intersection Control ¹	Jurisdiction (LOS Standard) ²	Peak Hour ³	Delay ⁴	LOS ⁵
39	General Jim Moore Boulevard and Gigling Road	4/27/2017	Signalized	S (C)	AM PM	25.9 14.8	C B
40	Malmedy Road and Gigling Road	4/25/2018	SSS	S (C)	AM PM	3.7 (24.9) 2.0 (18.0)	A (C) A (C)
41	Parker Flatts Cut Off Road and Gigling Road	4/25/2018	SSS	S (C)	AM ⁷ PM	2.0 (23.6) 2.8 (17.6)	A (C) A (C)
42	Sixth Avenue and Gigling Road	4/25/2018	AWSC	S (C)	AM PM	13.3 10.2	B B
43	Seventh Avenue and Gigling Road	4/25/2018	SSS	S (C)	AM PM	2.1 (12.7) 0.9 (9.0)	A (B) A (A)
44	Eighth Avenue and Gigling Road	4/25/2018	AWSC	MC (D)	AM ⁷ PM	9.9 10.3	A B
45	Eastside Parkway and Gigling Road	Future	AWSC	MC (D)	AM PM	Future Intersection	
46	General Jim Moore Boulevard and Normandy Road	4/25/2018	Signalized	S (C)	AM PM	22.0 9.9	C A
47	General Jim Moore Boulevard and Coe Avenue	4/25/2018	AWSC	S (C)	AM PM	92.2 18.4	F C
48	Fremont Boulevard - Southbound SR 1 Off-Ramp and Monterey Road	4/25/2018	Signalized	for a / Sand City (C)	AM PM	65.8 50.5	E D
49	California Avenue—and Monterey Road - Northbound SR 1 Off-Ramp	4/25/2018	Signalized	Cal / S (C)	AM PM	12.1 24.5	B C
50	Reservation Road and State Route 68 Westbound Ramps	4/25/2018	Signalized	Cal / MC (C)	AM PM	13.6 33.0	B C
51	Reservation Road and State Route 68 Eastbound Ramps	4/25/2018	Signalized	Cal / MC (C)	AM PM	11.4 12.2	B B

Notes: **Bold text** indicates intersection operates at unacceptable level of service.

- SSS = Side Street Stop Controlled, AWSC = All Way Stop Controlled, Signalized = Signalized intersection
- Intersection jurisdiction and associated LOS threshold applied.
 - City of Marina = M
 - City of Seaside = S
 - California State University, Monterey Bay = CSUMB
 - Monterey County = MC
 - Caltrans = Cal
- AM = AM peak hour, PM = PM peak hour.
- Whole intersection weighted average control delay expressed in seconds per vehicle calculated using methods described in the 2010 *Highway Capacity Manual* for signalized intersections and all-way stop-controlled intersections. For side-street stop-controlled intersections, average control delay and total delay for the worst movement are reported as "average control delay (worst movement total delay)."



5. LOS = Level of Service. LOS calculations conducted using the Synchro 10 analysis software packages, which apply the methods described in the 2010 *Highway Capacity Manual*. For side-street stop-controlled intersections, average control LOS and total LOS for the worst movement are reported as "average control LOS (worst movement total LOS)."
 6. Fourth Avenue and Eighth Street is currently closed by both the City of Marina and CSUMB. The Project proposes to make this a limited access gated entry, restricted to through traffic; therefore, the intersection is considered open in the with Project scenarios. The intersection is also proposed to be open in the future; therefore, open in the Cumulative without Project scenarios.
 7. For these intersections, the peak hour factor is below 0.85; therefore, the delay is calculated based on the peak of the peak 15 minutes, which results in delay calculations that vary from general peak hour observations.
- Source: Fehr & Peers, 2019.



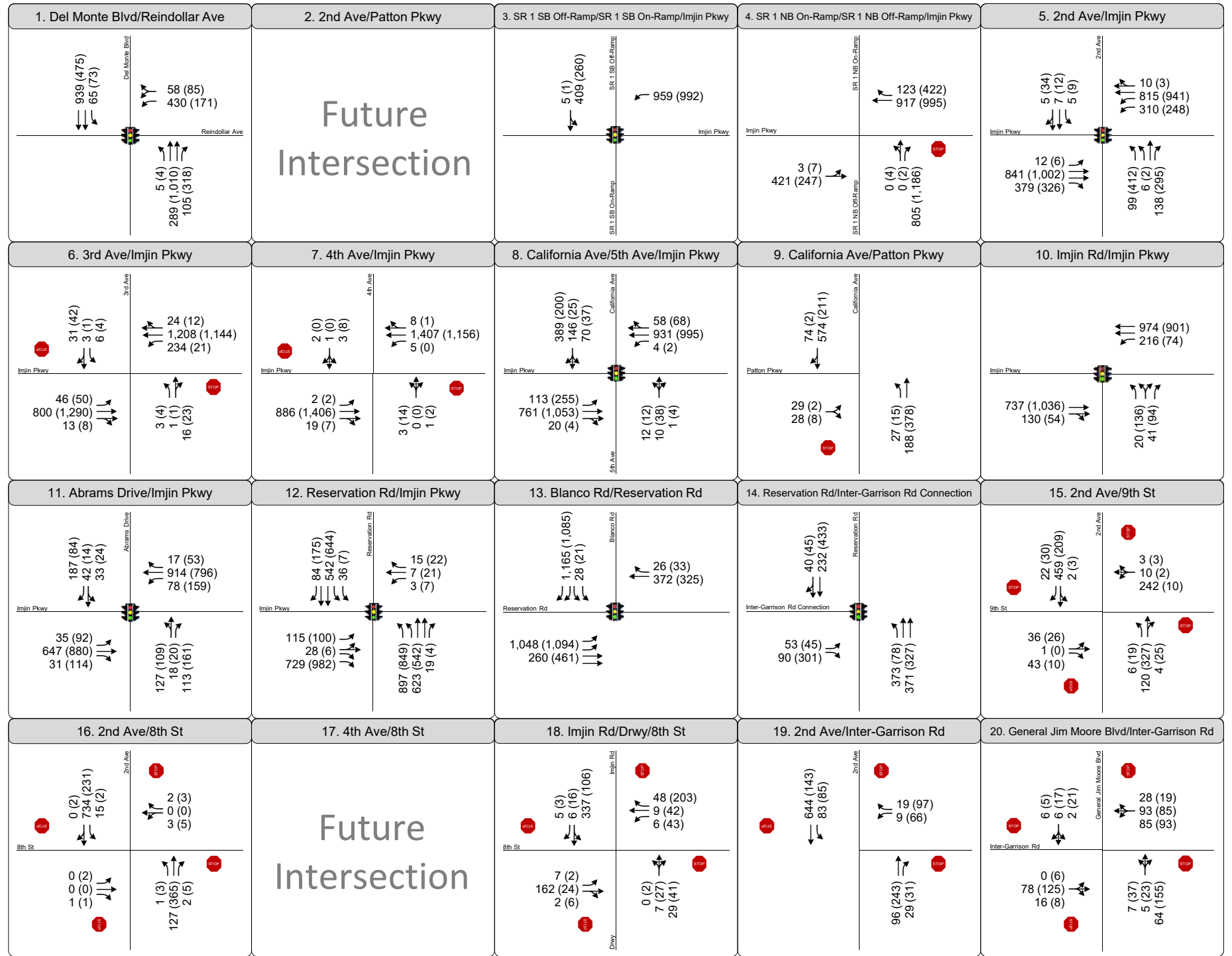
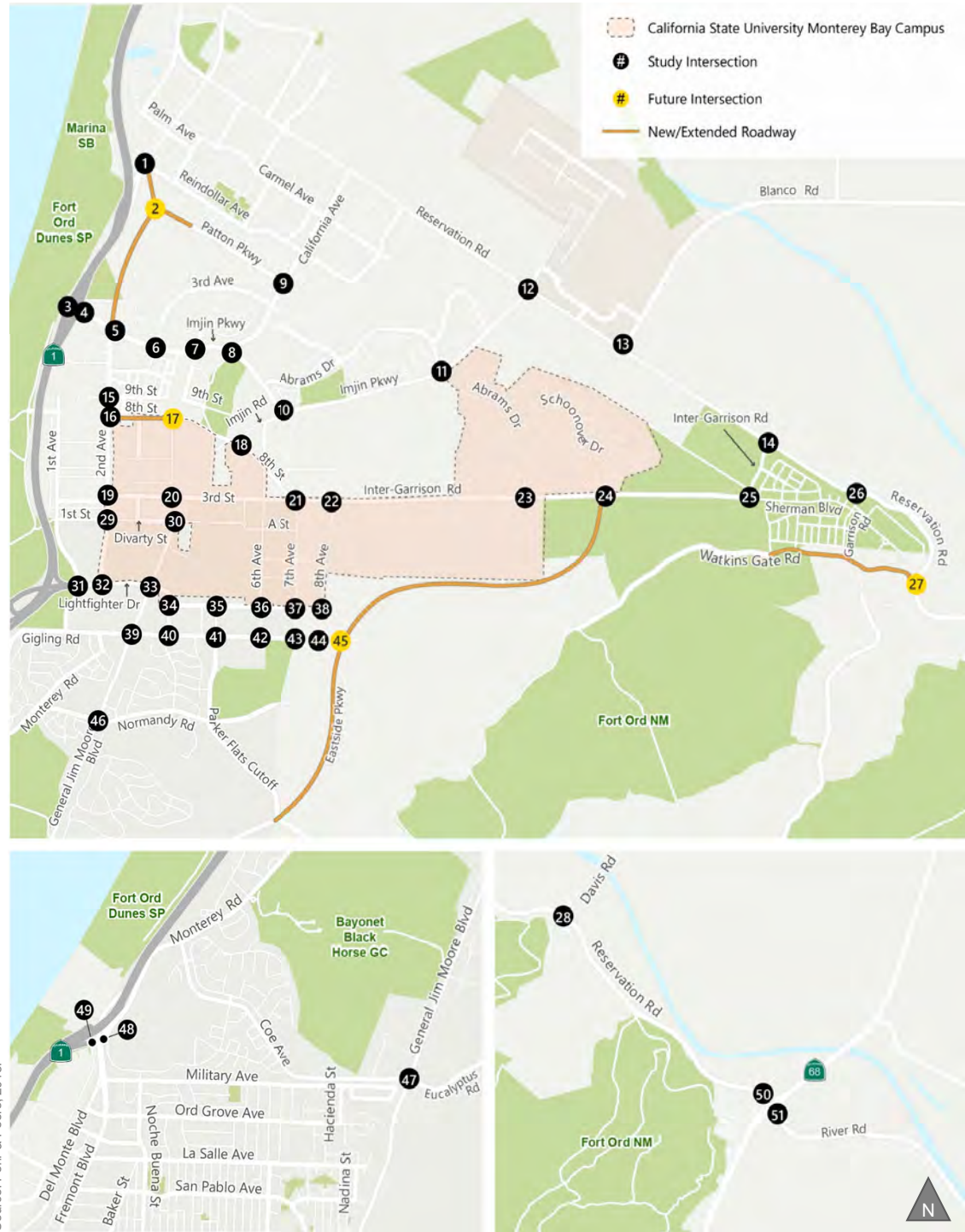

LEGEND

- AM (PM) Peak Hour Traffic Volume
- Lane Configuration
- Stop Sign Controlled
- Signalized
- Roundabout

Figure 12a
Study Intersection Peak Hour Traffic Volumes and Lane Configurations
Existing Conditions



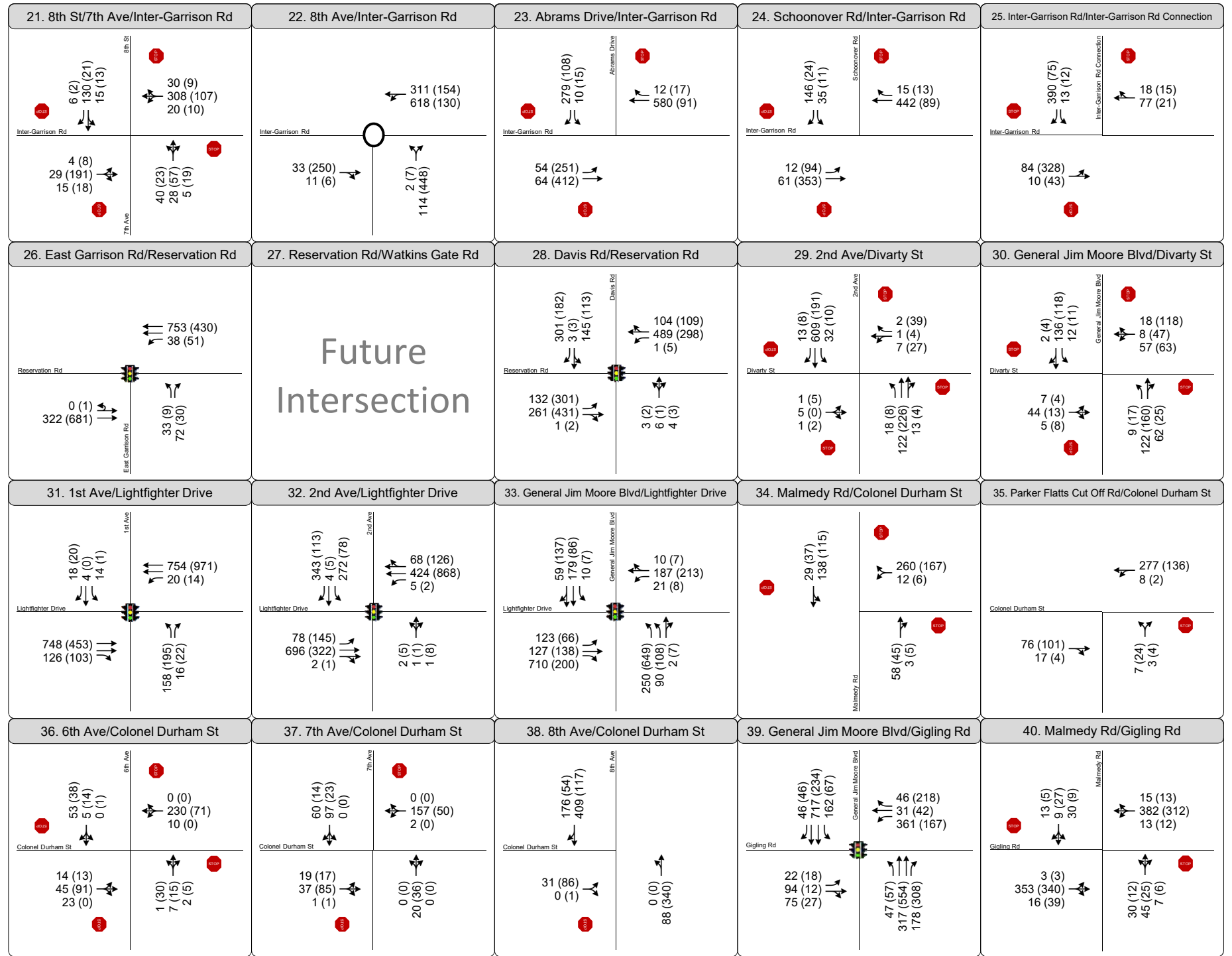
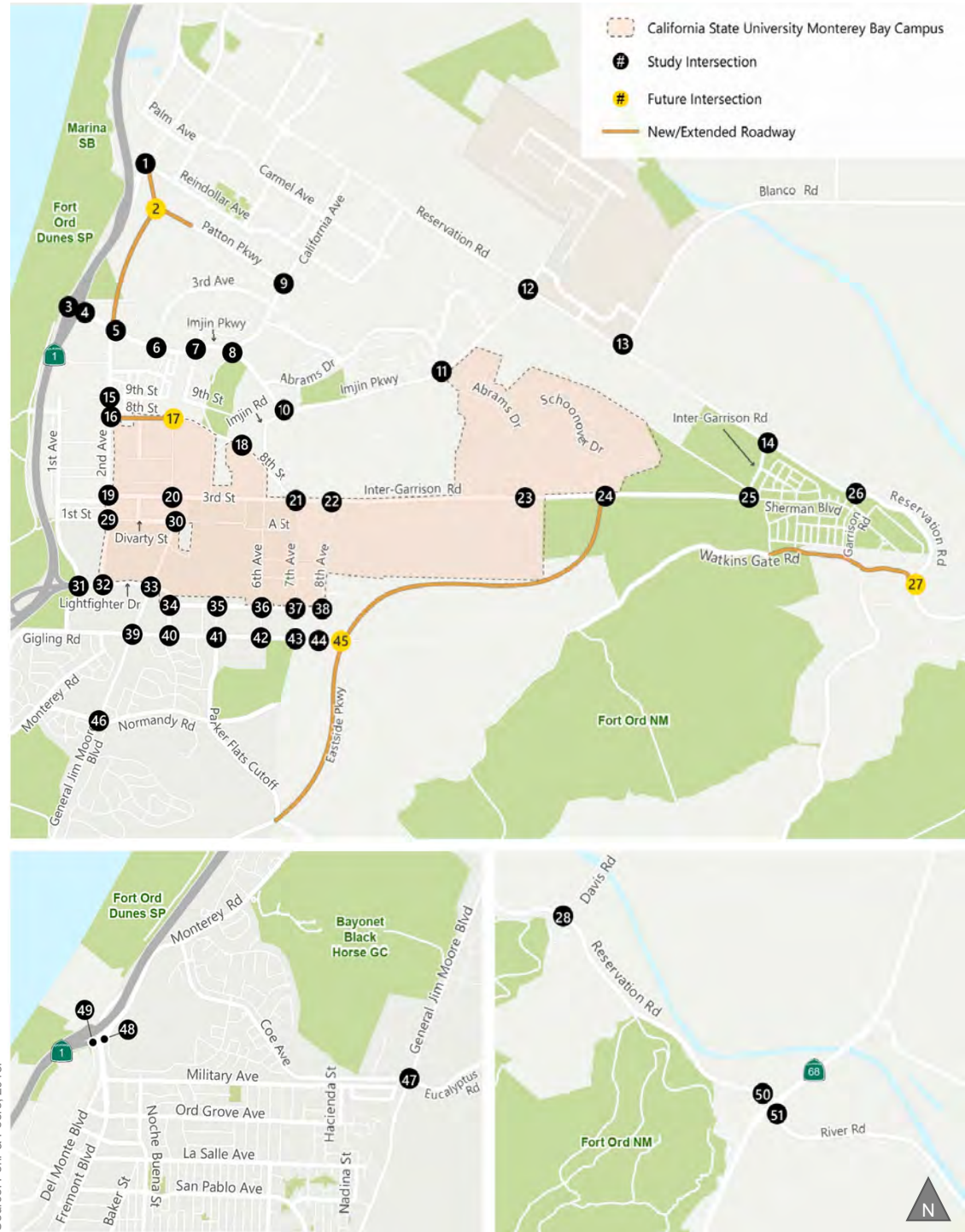

LEGEND

- AM (PM) Peak Hour Traffic Volume
- Lane Configuration
- Stop Sign Controlled
- Signalized
- Roundabout

Figure 12b
Study Intersection Peak Hour Traffic Volumes and Lane Configurations
Existing Conditions



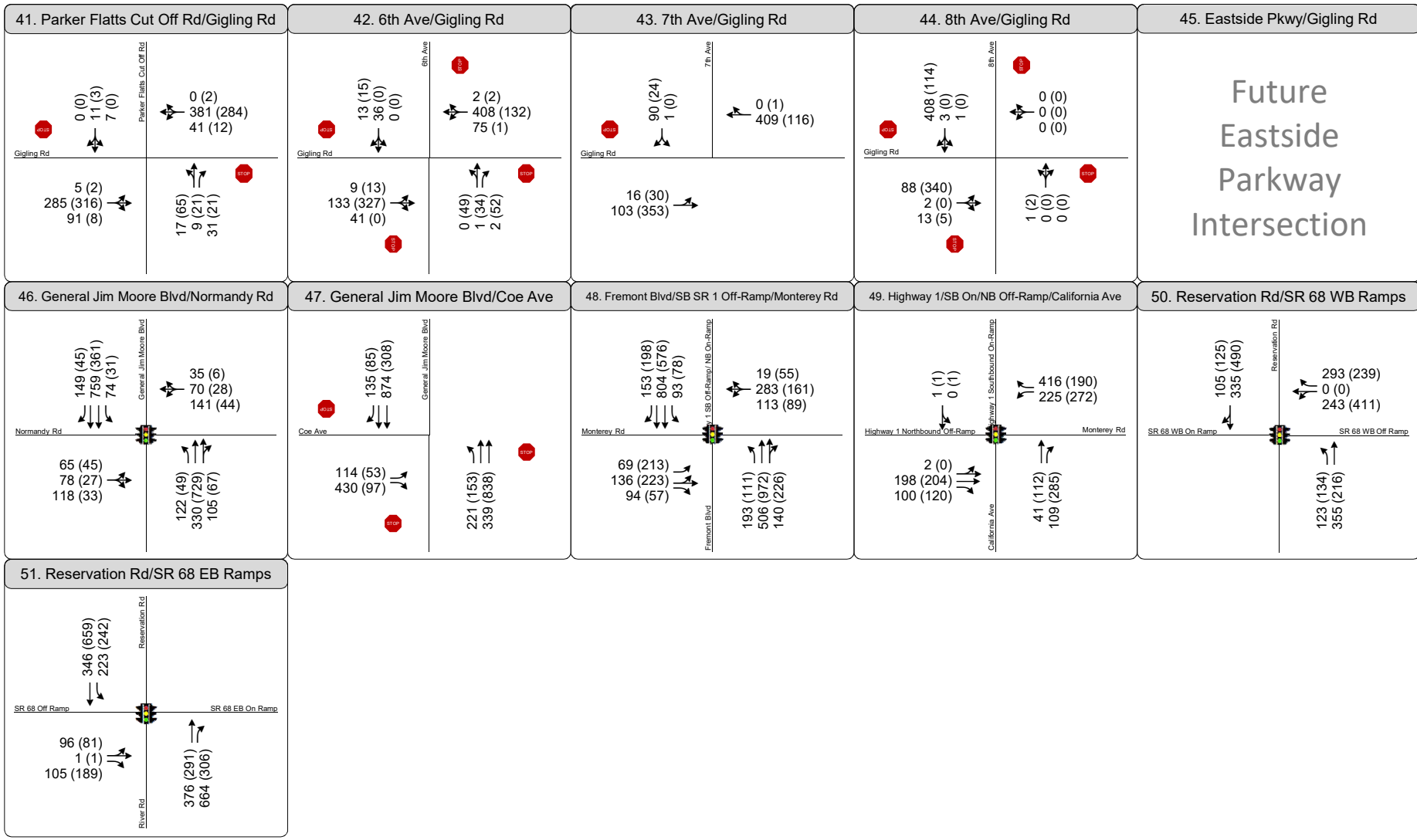
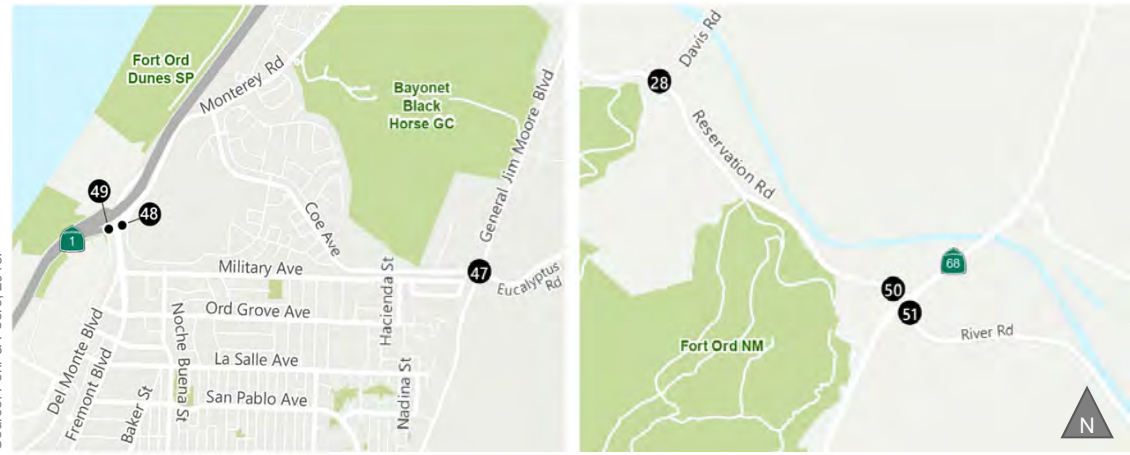
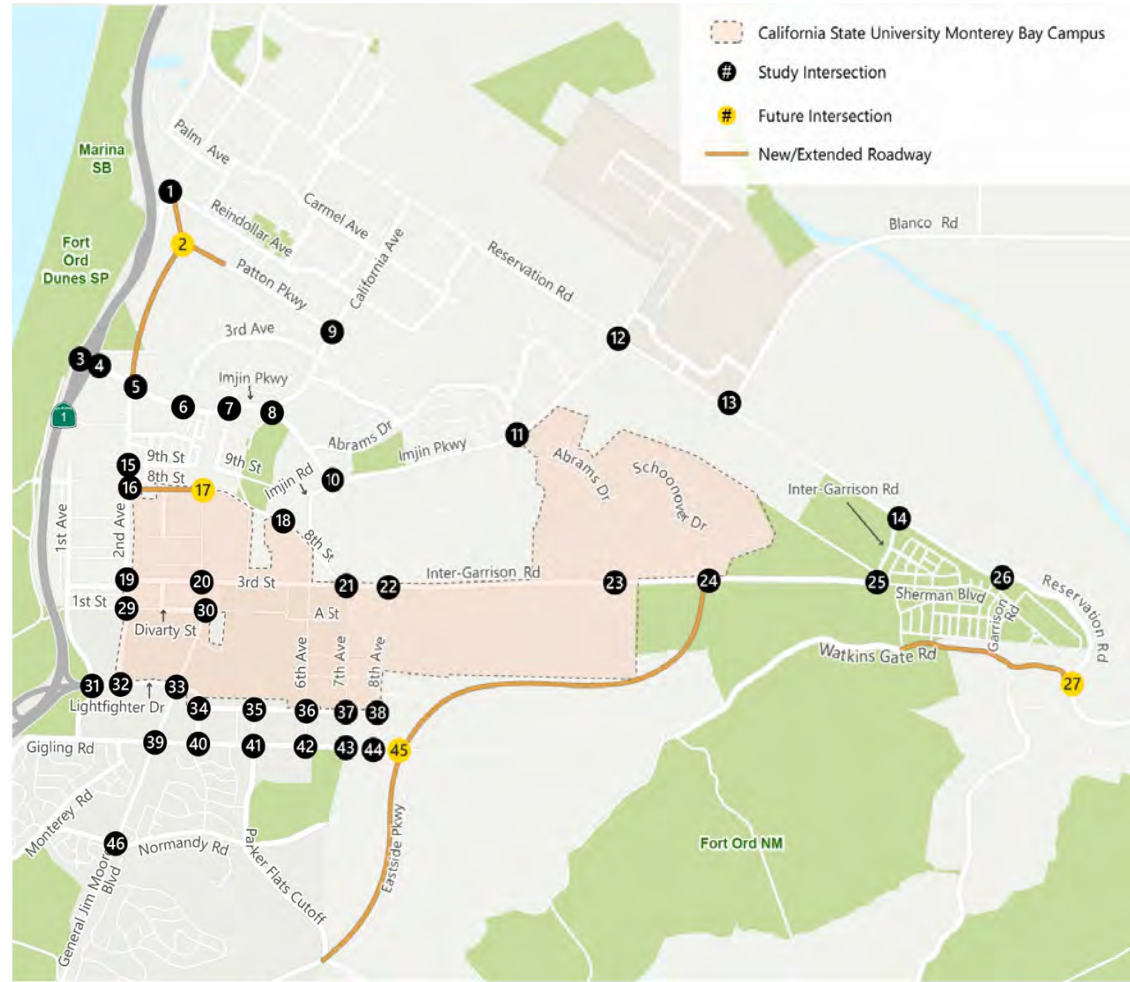

LEGEND

AM (PM) Peak Hour Traffic Volume



Lane Configuration



Stop Sign Controlled



Signalized



Roundabout

Source: Fehr & Peers, 2018.



Figure 12c
Study Intersection Peak Hour Traffic Volumes and Lane Configurations
Existing Conditions

EXISTING FREEWAY SEGMENT OPERATIONS

The existing morning (AM) and evening (PM) peak hour freeway segment levels of service were evaluated using the method described in **Chapter 7**. Traffic volume observations were recorded at five locations along SR 1. **Table 7** shows the existing freeway segment levels of service. The following freeway segments exceed the Caltrans level of service standard (that is, they operate at LOS D or worse under Existing Conditions):

- Southbound SR 1 between Reservation Road and Canyon Del Rey Boulevard during the AM peak hour (all 5 southbound SR 1 segments)
- Northbound SR 1 between Imjin Parkway and Lightfighter Drive during the PM peak hour
- Northbound SR 1 between Fremont Boulevard-Del Monte Boulevard and Canyon Del Rey Boulevard the PM peak hour

TABLE 7: EXISTING FREEWAY SEGMENT LEVELS OF SERVICE

Freeway Segment	Peak Hour ¹	Mixed Lanes	Volume	Density ^{2,3}	Level of Service ⁴
State Route 1 – Southbound					
Reservation Road and Del Monte Boulevard	AM	2	2,705	29.1	D
	PM		1,418	11.3	B
Del Monte Boulevard and Imjin Parkway	AM	3	4,055	26.7	D
	PM		2,088	11.3	B
Imjin Parkway and Lightfighter Drive	AM	3	4,560	30.1	D
	PM		2,859	15.5	B
Lightfighter Drive and Fremont Boulevard-Del Monte Boulevard	AM	3	4,778	30.5	D
	PM		3,177	16.9	B
Fremont Boulevard-Del Monte Boulevard and Canyon Del Rey	AM	2	3,843	34.7	D
	PM		2,629	21.2	C
State Route 1 – Northbound					
Reservation Road and Del Monte Boulevard	AM	2	1,172	9.6	A
	PM		2,671	21.2	C
Del Monte Boulevard and Imjin Parkway	AM	3	1,725	9.9	A
	PM		4,231	22.8	C
Imjin Parkway and Lightfighter Drive	AM	3	2,397	13.6	B
	PM		4,906	26.7	D
Lightfighter Drive and Fremont Boulevard-Del Monte Boulevard	AM	3	2,708	15.2	B
	PM		4,728	25.2	C
Fremont Boulevard-Del Monte Boulevard and Canyon Del Rey Boulevard	AM	2	2,355	20.1	C
	PM		3,745	32.1	D

Notes:

1. AM = AM peak hour, PM = PM peak hour.
2. Measured in passenger cars per mile per lane. Mixed = Mixed-Flow Lanes.
3. If volume/capacity ratio is greater than 1 density is not applicable.
4. Level of service based on density.

Bold text indicates below the applicable level of service standard (LOS D for Caltrans designated facilities).

Source: Fehr & Peers, 2019.



EXISTING FREEWAY RAMP OPERATIONS

The ramp operations were evaluated by comparing the AM and PM peak hour volumes to the ramp capacities. The existing AM and PM peak hour ramp volumes at the SR 1 interchanges at the Imjin Parkway and Lightfighter Drive interchanges are shown and compared in **Table 8** and **Table 9**, respectively. As shown in the tables, all the study ramps operate below capacity during the AM and PM peak periods under Existing Conditions.

TABLE 8: EXISTING RAMP AM PEAK HOUR VOLUMES AND CAPACITIES

Location	Direction	Ramp Type ¹	Lanes	Capacity ¹	Existing Volume (vehicles per hour)
SR 1 and Imjin Parkway	NB	Diagonal On-Ramp	1	1,500	126
	SB	Diagonal On-Ramp	1	1,500	964
	NB	Diagonal Off-Ramp	2	3,000	805
	SB	Diagonal Off-Ramp	1	1,500	414
SR 1 and Lightfighter Drive	NB	Diagonal On-Ramp	1	1,500	197
	SB	Diagonal On-Ramp	2	3,000	739
	NB	Diagonal Off-Ramp	2	3,000	460
	SB	Loop Off-Ramp	1	1,200	431

Notes:

1. Peak hour ramp capacity is 1,500 veh/hr/ln (vehicles per hour per lane) and 1,200 veh/hr/ln for diagonal and loop ramps, respectively.

Bold text indicates volumes above capacity.

Source: Fehr & Peers, 2019.



TABLE 9: EXISTING RAMP PM PEAK-HOUR VOLUMES AND CAPACITIES

Location	Direction	Ramp Type ¹	Lanes	Capacity ¹	Existing Volume (vehicles per hour)
SR 1 and Imjin Parkway	NB	Diagonal On-Ramp	1	1,500	431
	SB	Diagonal On-Ramp	1	1,500	993
	NB	Diagonal Off-Ramp	2	3,000	1,192
	SB	Diagonal Off-Ramp	1	1,500	261
SR 1 and Lightfighter Drive	NB	Diagonal On-Ramp	1	1,500	661
	SB	Diagonal On-Ramp	2	3,000	538
	NB	Diagonal Off-Ramp	2	3,000	384
	SB	Loop Off-Ramp	1	1,200	167

Notes:

1. Peak hour ramp capacity is 1,500 veh/hr/ln (vehicles per hour per lane) and 1,200 veh/hr/ln for diagonal and loop ramps, respectively.

Bold text indicates volumes above capacity.

Source: Fehr & Peers, 2019.

FIELD OBSERVATIONS

Field observations were conducted in May 2017 and May 2018 to observe vehicle operations on the local street and freeway systems, and overall circulation of pedestrians and bicycles around the study intersections. Observations were conducted at each study intersection to confirm lane geometries and operational characteristics, including cycle lengths where possible. Field observations are described for the following key access corridors: Imjin Parkway, Inter-Garrison Road, Lightfighter Drive, and Second Avenue.

Imjin Parkway:

- At SR 1 Interchange: During the AM and PM peak periods, the queue of westbound left-turning vehicles at the SR 1 southbound on-ramp extended to the upstream signalized intersections of SR 1 Northbound Ramps / Imjin Parkway and Second Avenue / Imjin Parkway.
- At Second Avenue: During the AM peak period, queuing on the westbound through approach extended approximately 500 feet upstream from the intersection.
- At Abrams Drive: During the PM peak period, congestion was observed to be heavier in the eastbound direction of Imjin Parkway. Queuing at the Abrams Drive intersection extended west past Third Avenue.
- At Reservation Road: During both peak periods, queues of northbound left-turning vehicles extended past the storage length of the left-turn lanes, approximately 400 feet from the



intersection. Queuing for these left-turn lanes extended farther in the AM period and did not clear after one cycle.

- Along Imjin Parkway: During the AM and PM peak periods, a few people were observed bicycling and walking along Imjin Parkway, and were mostly observed crossing the Second Avenue intersection and Abrams Drive Intersection. Along Imjin Parkway, cyclists were observed using the shared-use path.

Inter-Garrison Road:

- At stop-controlled intersections during both peak periods, little queuing was observed at intersections with no congestion.
- At Eighth Avenue: Two cyclists were observed traveling on the roadway through the roundabout in lieu of using the shared-use path around the intersection. During the AM peak hour, high westbound left-turn volumes resulted in delays to the westbound approach and the overall intersection delay and LOS as shown in **Table 6**. Little to no queuing was observed during off-peak periods as left turn volumes were lower than during the peak period as shown in counts in **Appendix D**.
- Along Inter-Garrison Road: Most pedestrians were observed closer to campus east of Eighth Avenue. During the PM peak period around class dismissal times, westbound traffic experienced longer queues, specifically around intersections at the Main Campus entrance/exit.

Lightfighter Drive:

- At First Avenue: During both AM and PM peak periods, the westbound through vehicles experienced the greatest queuing with queues extending to approximately 150 feet. All queues cleared after one traffic signal cycle.
- At General Jim Moore Boulevard: During the AM and PM peak periods, queues of eastbound through vehicles extended approximately 100 feet and would clear after one cycle. During the PM peak period, northbound left-turning vehicles mainly utilized the outside left-turn lane.

Reservation Road:

- At Blanco Road: During the AM and PM peak periods, observed queues were longest along the westbound left-turn lanes with a maximum of 8 vehicles in each lane in the AM peak period and 18 vehicles in each lane in the PM peak period. The majority of the traffic signal cycle length is utilized by the westbound left and through movement, which allows the westbound left-turn lanes to clear in one cycle. During both peak periods, southbound queuing was limited to a few vehicles, with maximum queue lengths of 75 feet for the left-turn lane. Vehicle queuing for the eastbound approach was substantial in the PM peak hour with a maximum queue of 12 vehicles, translating to nearly a 450-foot queue length.



- At Inter-Garrison Road: Minimal vehicle queuing, approximately 50 feet in length, was observed along Inter-Garrison Road.
- At East Garrison Road: Minimal vehicle queuing, approximately 50 feet in length, was observed along East Garrison Road.
- At Davis Road: Minimal vehicle queuing was observed in the AM and PM peak periods. The longest queues, approximately 125 feet of queued vehicles, were mainly observed along Davis Road on the southbound approach.
- At SR 68 Ramps: A majority of the queuing was observed southbound on Reservation Road at the SR 68 westbound ramps. The queuing in the AM peak period caused a few vehicles to extend past the Portola Drive intersection north of the SR 68 ramps, with a length of approximately 250 feet. During the PM peak period, queues were observed to extend farther back to approximately 375 feet, which blocked the entrance into Portola Drive.
- Along Reservation Road: Minimal to no pedestrian and bicycle activity was observed along Reservation Road.

Second Avenue:

- Most pedestrians were observed crossing and using the shared-use path along Second Avenue. During the PM peak period, pedestrians were mainly observed traveling north on Second Avenue from the campus.

Colonel Durham Street:

- No vehicle queuing or frequent pedestrian activity was observed.

Gigling Road:

- At Parker Flats Cut-Off Road: During the PM peak period, the northbound left-turn vehicles experienced queuing and the length was about 50 feet.
- At Sixth Avenue: During the AM peak period, the westbound through vehicles experienced the most queuing with queues extending over 300 feet from the stop sign. During the PM peak period, queuing occurred in both the eastbound and westbound through directions with queue lengths of about 50 feet.
- At Eighth Avenue: During both the AM and PM peak periods, most pedestrians and cyclists were observed traveling southbound to the trail entrance.
- At General Jim Moore Boulevard: During the AM and PM peak periods, limited queuing was observed at the intersection.
- Along Gigling Road: Minimal pedestrian and bicycle activity was observed along Gigling Road.



SR 1 ramps at Monterey Road/ Fremont Boulevard and Monterey Road/ California Avenue:

- At Fremont Boulevard/ Monterey Road: During the AM and PM peak periods, queues greater than 10 vehicles (250 feet) were mostly observed along the southbound SR 1 off-ramp and northbound Fremont Boulevard on-ramp. Some queues along Monterey Road, both eastbound and westbound, extended between 5 and 10 vehicles (125 feet to 250 feet) and would not clear in one cycle. During the PM peak period, queues from the Monterey Road eastbound approach would queue back to the California Road intersection.
- At California Avenue/ Monterey Road: Queues along Monterey Road were observed to queue back into the northbound right-turn lane along California Avenue for approximately 250 feet. These queues were not served in one cycle.
- At Fremont Boulevard/ Monterey Road and California Avenue/ Monterey Road: More pedestrians were observed along the northbound approach crosswalk, mostly students from the nearby high school traveling between the shopping center and the high school.
- At California Avenue/ Monterey Road: A few pedestrians were observed crossing Monterey Road at the westbound approach, which does not have a crosswalk, to reach the Monterey Peninsula Recreation Trail entrance on the northern end of the intersection. Bicyclists were observed traveling to and from the trail, using either the travel way or crosswalks.

Along the other roadways, light to moderate congestion was observed along the major approaches, and few vehicles were observed using the local streets. Northbound and southbound traffic south of the campus flowed with minimal delay and queuing. During the peak periods, queuing and delay were observed primarily on Imjin Parkway and at intersections closer to State Route 1. At intersections with geometries similar to Eighth Street and Fifth Avenue, vehicles were observed using the intersections as typical stop-controlled T-intersections. In general, the observations indicated that all study intersections, except as noted above, are operating at or near the calculated level of service.



3. SUMMARY OF RELEVANT REGIONAL CIRCULATION AND TRANSPORTATION PLANS

This chapter provides background information regarding circulation and transportation plans employed in the plan consistency evaluation later in this report. While CSUMB is not subject to local and regional plans because CSU is a state agency, this chapter summarizes the key transportation plans, goals, and policies and related plan transportation networks, to support the evaluation of Project conflicts with such plans and policies in **Chapter 5** of this report.

AMBAG REGIONAL TRANSPORTATION PLAN

The Association of Monterey Bay Area Governments (AMBAG) is the Metropolitan Planning Organization (MPO) for the three-county region (Monterey County, San Benito County, and Santa Cruz County). As the MPO, AMBAG is responsible for preparing the regional transportation plan and sustainable community strategy plan titled Monterey Bay 2040 Moving Forward/2040 Metropolitan Transportation Plan and Sustainable Communities Strategy (2040 MTP/SCS), both published in June 2018. The 2040 MTP/SCS is a 20-year planning document, updated every three years with the following goals and policy objectives:

- Access and Mobility – Provide convenient, accessible, and reliable travel options while maximizing productivity for all people and goods in the region.
- Economic Vitality – Raise the region’s standard of living by enhancing the performance of the transportation system.
- Environment – Promote environmental sustainability and protect the natural environment.
- Healthy Communities – Protect the health of our residents; foster efficient development patterns that optimize travel, housing, and employment choices and encourage active transportation.
- Social Equity – Provide an equitable level of transportation services to all segments of the population.
- System Preservation and Safety – Preserve and ensure a sustainable and safe regional transportation system.

Based on these goals and policies, a financially constrained transportation network (i.e., one recognizing current financial limitations) was prepared by AMBAG to establish the planned improvements that best meet the goals and policy objectives and available funding projections.



SEASIDE GENERAL PLAN

SEASIDE GENERAL PLAN (2004)

The 2004 Seaside General Plan includes goals to provide and maintain the City of Seaside's transportation network and ensure that its transportation network is integrated with the regional transportation system (City of Seaside 2004). The general plan also includes multimodal goals to promote additional transit usage and adequate parking. Key transportation goals and policies from the 2004 Seaside General Plan relevant to the analysis presented here include:

Key Goals:

- *Goal C-1:* Provide and maintain a City circulation system that promotes safety and satisfies the demand created by new development and redevelopment in Seaside.
- *Goal C-2:* Provide a local circulation system that is integrated with the larger regional transportation system to ensure the economic well-being of the community.
- *Goal C-3:* Promote the increased use of multimodal transportation.
- *Goal C-4:* Ensure adequate parking is provided throughout Seaside.

Key Policies:

- *Policy C-1.1:* Design roadway capacities and ensure transportation facilities that adequately serve planned land uses.
- *Policy C-1.2:* Improve the Seaside circulation system in concert with public and private land development and redevelopment projects to maintain the City standard of Level of Service "C".
- *Policy C-1.3:* Coordinate improvements to and maintenance of the City circulation system with other major transportation and infrastructure improvement programs.
- *Policy C-1.4:* Provide adequate access to the University, golf courses, and other uses in North Seaside.
- *Policy C-1.5:* Use traffic calming methods within residential and mixed use areas where necessary to create a pedestrian-friendly circulation system.
- *Policy C-1.6:* Apply creative approaches to increase safety and reduce congestion in areas with unique problems, such as: neighborhoods with narrow, one-way streets; areas around schools; neighborhoods with non-essential alleys, businesses with drive-through access; and other special situations.
- *Policy C-1.7:* Reduce impacts on residential neighborhoods from truck traffic and related noise.
- *Policy C-2.1:* Coordinate planning, construction and maintenance of development projects and circulation improvements with adjacent jurisdictions and transportation agencies.
- *Policy C-2.2:* Support programs that help reduce congestion and encourage alternative modes of transportation.



- *Policy C-2.3:* Support development that is compatible with increased operations at the Monterey Peninsula Airport.
- *Policy C-3.1:* Support the provision and expansion of regional transit services and support facilities to serve the City.
- *Policy 3.2:* Work with MST to provide special transit services to meet community needs.
- *Policy C-3.3:* Promote mixed use, higher density residential, and employment-generating development in areas where public transit is convenient and desirable.
- *Policy C-3.4:* Support alternative modes of transportation that encourage physical activity, such as biking and walking.
- *Policy C-4.1:* Require off-street parking in new development and redevelopment projects.
- *Policy C-4.2:* Support the development of well-designed and aesthetically pleasing parking facilities in areas where current parking deficiencies exist or where substantial traffic generating uses are planned.
- *Policy C-4.3:* Ensure well-landscaped parking lots that facilitate pedestrian movement and screen unattractive structures.

SEASIDE DRAFT GENERAL PLAN UPDATE

In addition to the existing general plan approved in 2005, the City of Seaside is currently preparing its next general plan, the 2040 General Plan, *Seaside 2040*, which includes a vision for a multimodal network of complete streets (City of Seaside 2017). The 2040 General Plan is in draft form and has not yet been adopted by the City Council; therefore, the information contained in the draft plan is advisory only. Goal LUD-23 in the *Seaside 2040* Land Use & Community Design section highlights the desire to transform the City's northern area into a "mixed-use, economically-vibrant Campus Town that serves the student population and leverages its geographic adjacency to CSUMB." The area is intended to be high-density with a multimodal focus to improve access and connections for all modes to CSUMB.

Additionally, the 2040 General Plan presents different modal priorities than the currently adopted 2005 General Plan. The 2005 General Plan includes a level of service (LOS) policy that requires the City of Seaside to maintain a LOS C standard during peak hours. Using this LOS C standard requires the construction of larger intersections, which can have a negative effect on pedestrian and bicycle access and comfort. Thus, the draft 2040 General Plan (November 2017) goals include policies that focus on creating accessible, complete streets for all users of the street system and paths. Key transportation goals and policies relevant to the analysis presented here from the 2040 General Plan include:



Key Goals:

- *Goal M-1:* A citywide network of “complete streets” that meets the needs of all users, including bicyclists, children, persons with disabilities, motorists, movers of commercial goods, pedestrians, public transportation, and seniors.
- *Goal M-2:* Mobility options that serve the multi-modal access and travel needs generated by new development in a manner suitable to the local context.
- *Goal M-5:* A citywide bicycle network that connects residential, commercial, educational, and recreational uses, and earns Seaside the reputation of a bicycle-friendly city.
- *Goal M-6:* Transit service that is frequent and convenient, and maximizes ridership potential for residents, employees, and visitors.
- *Goal M-7:* A safe transportation system that eliminates traffic-related fatalities and reduces non-fatal injury collisions.
- *Goal M-9:* Minimize the impact of motor vehicle parking on residential neighborhoods.
- *Goal M-10:* Environmentally sustainable transportation.
- *Goal M-11:* Integrate Seaside’s circulation system with the larger regional transportation system to ensure the economic well-being of the community.

Key Policies:

- *Planning for all modes and transportation/ land use integration.* Design streets holistically, using a complete streets approach, which considers pedestrians, bicyclists, motorists, transit users, and other modes together to adequately serve future land uses.
- *Coordination with new development.* Improve the Seaside circulation system in concert with public and private land development and redevelopment projects.
- *Traffic calming.* Consider the implementation of traffic calming measures to reduce speeding and make streets user-friendly for all modes of transportation, including pedestrians and bicyclists.
- *Multi-modal connectivity.* Promote pedestrian and bicycle improvements that improve connectivity between existing and new development.
- *Pedestrian amenities.* Require new development and redevelopment to increase connectivity through direct and safe pedestrian connections to public amenities, neighborhoods, shopping, and employment destinations throughout the City.
- *Bikeway network completion.* Strive to complete the citywide bicycle network to create a full network of bicycle facilities throughout Seaside.
- *Transit Priority Corridors.* Provide measures to reduce delay to transit vehicles on priority transit corridors, such as queue-jump lanes and/or bus signal prioritization, where feasible, on transit priority street segments.



- *Transit amenities.* Support right-of-way design and amenities consistent with local transit goals to make it easier to get to transit services and improve transit as a viable alternative to driving.
- *Transit stop maintenance is provided.* Work with local and regional transit agencies to ensure that transit stops are maintained in a safe, clean, and attractive condition to encourage transit ridership.
- *Safety Improvements.* Provide safety improvements, and prioritize pedestrian circulation over other travel modes, along high-injury and high-fatality streets and intersections.
- *Safety and traffic calming.* Use traffic calming methods within residential and mixed-use areas, where necessary, to create a pedestrian-friendly circulation system.
- *Safety for all modes.* Ensure that planned non-transportation capital improvement projects, on or near a roadway, consider safety for all modes of travel during construction and upon completion.
- *Transportation demand management (TDM).* Promote TDM measures for new development. Measures may include subsidized transit passes, car share spaces, unbundled parking, and secured bicycle parking. Allow the City to provide incentives to new projects that provide TDM measures.
- *TAMC and countywide planning efforts.* Continue to support the overall vision, goals, objectives, and policies as a partner in TAMC. The City recognizes the regional significance of connecting bicycle and pedestrian facilities, sharing consistent guidelines, needs, and preferences within the City and the greater Monterey County.
- *Regional transit.* Continue to support and encourage development of TAMC's planned regional transit projects and coordinate service and facilities for new development and redeveloped parts of the City.

MARINA GENERAL PLAN

The Marina General Plan was adopted on October 31, 2000 and updated with amendments through August 4, 2010 (City of Marina 2010). The Marina General Plan lays out broad goals and specific policies on land use, community design, circulation, housing, public facilities, open space, recreation, conservation, noise, seismic and safety considerations, and historic preservation. The following are the primary policies of the Marina General Plan from the Transportation Element that are relevant to the analysis presented here:

- *Policy 3.3.2:* Reduce the length and travel time of work trips generated by local residents by maximizing opportunities for residents to work within the community.
- *Policy 3.3.4:* Reduce the number and length of vehicular trips and limit overall traffic congestion by promoting land use patterns which allow for multipurpose trips and trip deferral during peak travel times.



- *Policy 3.3.5:* The City of Marina shall ensure that walking and bicycling routes are integral parts of street design and form a safe and preferred transportation network. Protect existing and future residential areas from through-traffic that creates safety, noise, and pollution problems.
- *Policy 3.3.7:* The City of Marina shall coordinate with surrounding jurisdictions and agencies, such as TAMC, Caltrans, California Department of Parks and Recreation, Monterey Peninsula Regional Park District, CSUMB, AMBAG, FORA, BLM, City of Seaside, and Monterey County to pursue projects that develop new pedestrian and bicycle routes and that improve and maintain existing pedestrian and bicycle routes. New routes shall be linked to existing routes wherever possible.
- *Policy 3.3.8:* Link existing and future areas of the City with an integrated system of roads, transit, footpaths, and bikeways that connect neighborhoods, commercial areas, schools, parks, and other major community-serving destinations.
- *Policy 3.3.9:* Where necessary and feasible, accept some traffic congestion to achieve other community goals, such as encouraging the integrity of neighborhoods and the use of alternative means of travel.
- *Policy 3.3.10:* Make all transportation decisions within a broad policy context that considers visual, environmental, economic, and social objectives rather than being solely responsive to existing or projected traffic problems.

MONTEREY COUNTY GENERAL PLAN

The Monterey County General Plan released on October 26, 2010, presents a long-range vision for the County, looking forward 25 years into the future (County of Monterey, 2010). The transportation goals and polices in the Circulation Element relevant to the analysis presented here are listed below:

- Goal C-1 – Achieve an acceptable level of service by 2030.
 - Policy C-1.1 – The acceptable level of service of County roads and intersection shall be Level of Service D, except as follows:
 - Acceptable level of service for County roads in Community areas may be reduced below LOS D through the Community Plan process.
 - County roads operating at LOS D or below at the time of adopting this General Plan shall not be allowed to be degraded further except in Community areas where the Lower LOS may be approved through the Community Plan process.
 - Area Plans prepared for County Planning Areas may establish an acceptable level of service for County roads other than LOS D. The benefits which justify less than LOS D shall be identified in the Area Plan. Where an Area Plan does not establish a separate LOS, the standard LOS D shall apply.



- Goal C-2 – Optimize the use of the County’s transportation facilities.
 - Policy C-2.4 – A reduction of the number of vehicle miles traveled per person shall be encouraged.
 - Policy C-2.6 – Bicycle and automobile storage facilities shall be encouraged in conjunction with public transportation facilities.
- Goal C-3 – Minimize the negative impacts of transportation in the County.
 - Policy C-3.1 – Transportation modes shall be planned, and strategies developed to protect air quality; reduce noise; reduce the consumption of fossil fuels; and minimize the acquisition of land for roadway construction.
- Goal C-4 – Provide a public road and highway network for the efficient and safe movements of people and commodities.
 - Policy C-4.2 – All new roads and interior circulation systems shall be designed, developed, and maintained according to adopted County standards or allowed through specific agreements and plans.
 - Policy C-4.5 – New public local and collector roads shall be located and designed to minimize disruption of existing development, discourage through auto traffic, and provide for bicycle and pedestrian traffic within the right-of-way.
 - Policy C-4.7 – Where appropriate and sufficient public right-of-way is available, bicycle paths shall be separated from major roads and highways and be provided between adjacent communities.
- Goal C-5 – Maintain and enhance a system of scenic roads and highways through areas of scenic beauty without imposing undue restrictions on private property or constricting the normal flow of traffic.
 - Policy C-5.5 – Agencies involved in officially designating State Scenic Highways and/or County Scenic Roads shall coordinate their efforts for the integrated design and implementation of such designations.
- Goal C-6 – Promote viable transportation options.
 - Policy C-6.3 – The County shall encourage new development to concentrate along major transportation corridors and near cities to make transit services to these areas more feasible.
 - Policy C-6.8 – The County shall encourage coordination between all social service transportation providers.
- Goal C-8 – Encourage a rail system that offers efficient and economical transport of people and commodities.
- Goal C-9 – Promote a safe, convenient bicycle transportation system integrated as part of the public roadway system.



- Policy C-9.2 – Construction of expansion of roadways within major transportation corridors shall consider improved bike routes.
- Policy C-9.5 – Visitor-serving facilities shall provide adequate bicycle access and secure bicycle parking facilities.

TAMC CONGESTION MANAGEMENT PROGRAM

Transportation Agency for Monterey County (TAMC) is the designated Congestion Management Agency for Monterey County. In 1990, the state passed legislation requiring CMAs like TAMC to implement a Congestion Management Program (CMP). The CMP provides level of service and performance standards, trip reduction techniques, development of deficiency programs, transportation system management, and capital improvement programming for the purpose of minimizing regional traffic impacts of development. As a designated CMA, TAMC reviews land use development proposals in order to ensure that traffic impacts of land use development are mitigated. TAMC also undertakes traffic counting regionally, and projects traffic impacts on regional roadways based on adopted general plans and other land use planning documents.

2018 MONTEREY COUNTY ACTIVE TRANSPORTATION PLAN

The 2018 Transportation Agency for Monterey County Active Transportation Plan is an update of the 2011 Bicycle and Pedestrian Master Plan, which identified all existing and planned bicycle and pedestrian facilities in Monterey County. The Plan identifies remaining gaps in the bicycle and pedestrian network and opportunity areas for innovative bicycle facility design, such as a planned separated bikeway (Class IV) improvement along Inter-Garrison Road. These pedestrian and bicycle planned improvements, including the planned Inter-Garrison Road improvement, are shown on **Figure 9** and **Figure 10**. The ATP has added more emphasis on “low-stress networks” that serve people of all ages and abilities, such as separate bike paths, protected bike lanes, bicycle boulevards, and bike protection at intersections. Goals set out in the Plan relevant to the analysis presented here include:

- Increasing the proportion of active transportation trips throughout Monterey County.
- Improve bicycle and pedestrian safety.
- Remove gaps and enhance bicycle and pedestrian network connectivity.
- Provide improved bicycle and pedestrian access to diverse areas and populations in Monterey County.
- Increase awareness of the environmental and public health benefits of bicycling and walking for transportation and recreation.
- Improve the quality of the bike and pedestrian network through innovative design and maintenance of existing facilities.



FORT ORD REUSE AUTHORITY ACT

The Fort Ord Reuse Authority Act was implemented to facilitate the transfer and reuse of the Fort Ord military base, and established Fort Ord Reuse Authority (FORA) as the entity responsible for planning, financing, and carrying out the transfer and reuse of the base in a cooperative, coordinated, balanced, and decisive manner (Cal. Gov. Code § 6765 for a seq.). Founded in 1994, FORA was responsible for oversight of the Monterey Bay area economic recovery following the closure and reuse planning of the former Fort Ord military base. Pursuant to the Act, FORA's legislatively defined mission was complete as of June 30, 2020 and FORA has been dissolved per the FORA resolution No. 18-11.

The FORA Resolution No. 18-11 approved a Transition Plan that was submitted to the Monterey County Local Agency Formation Commission and that assigns assets and liabilities, designates responsible successor agencies, and provides a schedule for the remaining obligations (FORA 2018). The Transition Plan calls for the cities of Marina, Seaside, Monterey and Del Rey Oaks, and the County of Monterey to follow the Reuse Plan policies and programs and states that "...the implementation of the on-site Fort Ord transportation network and transit policies and programs are essential to the long-term success of the economic recovery of the reuse." The Resolution further states that after FORA's ultimate dissolution, any changes to the policies and programs of the Reuse Plan or any part thereof will be made by the respective land use jurisdictions only after full compliance with all applicable laws, including but not limited to CEQA.

After the official closure of Fort Ord in 1994, FORA adopted the Fort Ord Reuse Plan (Reuse Plan) in 1997 (FORA 1997). The Reuse Plan provided a framework for the reuse of more than 45 square miles of the former Fort Ord army base. The Reuse Plan identified transportation improvements to create a balanced transportation system, including pedestrian ways, bikeways, transit, and streets to provide for the safe and efficient movement of people. Responsibility for the remaining capital improvements in the Reuse Plan has been transitioned to the local agencies for implementation. The remaining capital improvements enhance regional access alternatives, provide additional local access routes, and enhance the internal circulation system to reduce through trips on facilities in the higher density or other sensitive areas.

The FORA Regional Urban Design Guidelines (RUDG), adopted on June 10, 2016, established standards for road design, setbacks, building height, landscaping, signage, and other matters of visual importance (FORA 2016). RUDG emphasizes the application and importance of the complete streets and connected street network, as well as providing well-designed transit facilities that improve the rider experience and economic vitality. To realize and support the complete streets concept, the following objectives are identified within the guidelines:

- Encouraging appropriate development scale and pattern to a village environment
- Minimizing street scale to facilitate pedestrian movement while providing adequate circulation and parking opportunities
- Minimizing street width to provide comfortable pedestrian environment



MONTEREY-SALINAS TRANSIT DESIGNING FOR TRANSIT

MST developed the Designing for Transit manual in November 2006 to provide guidance to decision-makers, developers, and community members on planning for safe and efficient transit (MST 2020). This includes guidance on considerations and statements other agencies should consider in their general plans and planning. MST advises these policy statements should be considered in General Plans to achieve a multimodal transportation network:

- Integrate land use and circulation plans to create an urban environment that supports a multimodal transportation system;
- Prioritize future development and redevelopment projects that are accessible using the existing multimodal transportation network;
- Direct development to areas with a confluence of transportation facilities (sidewalks, bike paths, park & rides, and transit centers); and
- Limit development in areas accessible by only a single transportation mode.



4. SIGNIFICANCE CRITERIA AND VMT ANALYSIS METHODS

As previously noted, recent legislation in California, Senate Bill 743, changed the metric by which transportation-related significant impacts are to be assessed from LOS to VMT under CEQA. While lead agencies have until July 2020 to implement this change, they are free to do so prior to that date, as has been the case with multiple jurisdictions throughout the state.

In response to this recent legislation, the CSU Chancellor’s Office recently issued the *2019 California State University Transportation Impact Study Manual (2019 CSU TISM)*. The *2019 CSU TISM* provides guidance for the preparation of CEQA compliant transportation impact analysis pursuant to SB 743 and is the operative TISM for the analysis presented here. The detailed impact criteria for VMT and other transportation-related items are described below followed by the VMT forecasting methods.

An analysis of the Project’s potential impacts is presented in **Chapter 5**.

SIGNIFICANCE CRITERIA

Consistent with the revised CEQA Guidelines, the *2019 CSU TISM* establishes updated significance criteria to be used for environmental impact analysis. The project would result in a significant impact if it meets any of the significance criteria below:

- Plan Conflict: The Project would conflict with a program, plan, ordinance, or policy addressing the circulation system, including transit, roadway, bicycle, and pedestrian facilities.
- VMT Impacts: The Project would result in a VMT-related impact as described below in **Table 10**.
- Hazard Impact: The Project would substantially increase hazards due to a geometric design feature (e.g., sharp curves or dangerous intersections) or incompatible uses (e.g., farm equipment).
- Emergency Access Impact: The Project would result in inadequate emergency vehicle access.

TABLE 10: EXISTING CSU TISM VMT SIGNIFICANCE THRESHOLDS

Impact Categories	CSU Significance Thresholds	Calculated Numeric Thresholds for Project
Project Impacts	The threshold to be applied in assessing Project-specific impacts is 15% below the existing total VMT per service population rate of Monterey County.	The Project would result in a significant project-specific impact if the CSUMB campus total VMT per service population under Existing with Project Conditions is greater than 23.91.
Cumulative Impacts	The threshold to be applied in assessing cumulative impacts is no change in the cumulative conditions (future) boundary VMT per service population for Monterey County.	The Project would result in a significant cumulative impact if it causes the cumulative countywide daily boundary VMT per service population to be greater than 14.07.

Source: CSU 2019.



Each of these impact criteria is discussed further below.

PLAN CONFLICTS

As described in the *2019 CSU TISM*, a Project may cause a significant impact if:

- The Project would conflict with a program, plan, ordinance, or policy addressing the circulation system, including transit, roadway, bicycle, and pedestrian facilities.

To determine the Project's consistency with relevant transportation programs, plans, ordinances or policies, the following significance thresholds were applied to each respective mode of travel – transit, roadways, bicycle facilities and pedestrians as listed below.

Transit

Analysis of transit-related impacts encompasses two components: (1) transit capacity, and (2) the Project's consistency with local transit plans. For transit capacity, a significant impact would occur if the Project creates demand for public transit above the capacity which is provided or planned.

To determine the Project's consistency with local transit plans, significant impacts would occur if the Project or any part of the Project:

- Disrupts existing transit services or facilities;¹⁹ or
- Conflicts with an existing or planned transit facility; or
- Conflicts with transit policies adopted by the City of Seaside, Monterey County, Fort Ord Reuse Authority, Transportation Agency for Monterey County, or Monterey-Salinas Transit for their respective facilities in the study area.

Roadways

To determine the Project's consistency with local roadway plans, significant impacts would occur if the Project or any part of the Project:

- Disrupts existing or planned roadway facilities or conflicts with applicable program, plan, ordinance, or policy.

¹⁹ This includes disruptions caused by the Project relative to transit street operations and transit stops/shelters; or impacts to transit operations from traffic improvements proposed or resulting from the Project.



Bicycle Facilities

To determine the Project's consistency with local bicycle plans, significant impacts would occur if the Project or any part of the Project:

- Disrupts existing or planned bicycle facilities or conflicts with applicable bicycle plans, guidelines, policies, or standards.

Pedestrian Facilities

Analysis of pedestrian impacts encompasses two components: (1) on-campus pedestrian connections, and (2) the Project's consistency with applicable programs, plans, ordinances, or policies. Significant pedestrian impacts would occur if the Project or any part of the Project

- Fails to provide safe pedestrian connections between campus buildings and adjacent streets and transit facilities; or
- Disrupts existing or planned pedestrian facilities or conflicts with applicable programs, plans, ordinances, or policies.

VMT THRESHOLDS AND IMPACT CRITERIA

As discussed in **Chapter 1**, the VMT impact analysis presented in this report considers the Project's direct impacts relative to Project generated VMT using the total VMT per service population metric, as well as a cumulative analysis, which considers the Project's long-term effect on VMT using boundary VMT per service population. Each analysis is addressed separately below.

Project Generated VMT (Project Analysis)

The significance threshold for determining the project's direct impact is a Total VMT per service population rate that is 15 percent below the Existing Conditions total VMT per service population for Monterey County. The OPR *Technical Advisory* suggests a similar threshold for residential and office land uses (i.e., 15 percent below VMT in a geographic area). Per the *2019 CSU TISM*, the CSU has selected the 15 percent reduction relative to Monterey County based on the OPR *Technical Advisory* and the fact that most of the students, faculty, and staff live within Monterey County. As a result, most of the CSUMB campus total VMT would be within Monterey County and, therefore, impacts assessed against the Monterey County baseline is the most appropriate measure of the Project's direct impact. Thus, the threshold applied in this analysis is 15% below the existing VMT of 28.12, which as shown in **Table 10**, is the existing total VMT per service population of Monterey County, or 23.91 (Monterey County total VMT per Service Population of 28.12 x 85% = 23.91).



TABLE 11: PROJECT GENERATED VMT THRESHOLD BASED ON EXISTING CONDITIONS FOR MONTEREY COUNTY

Item	Amount
Monterey County Total Vehicle Miles Traveled (A) ¹	19,158,300
Monterey County Service Population (B) ^{1,2}	681,200
Monterey County Total VMT per Service Population (A/B = C)	28.12
Monterey County Total VMT per Service Population Threshold (C*85% = D)	23.91

Notes:

1. Rounded service population and VMT to nearest 100.
2. Service population is defined as the sum of all employees, residents, and students (Kindergarten through University).

Source: Fehr & Peers, 2019.

Therefore, the Project would cause a significant Project generated VMT impact if

- The Project would result in a significant project-specific impact if the CSUMB campus total VMT per service population under Existing with Project Conditions is greater than 23.91.

Project's Effect on VMT (Cumulative Analysis)

The impact threshold for the Project's effect on VMT, or the Project's cumulative impact, is the Monterey County Boundary VMT per Service Population, or 14.07 (refer to **Table 12** for illustration of how the 14.07 is calculated). Like the Project generated VMT baseline using the total VMT per service population rate of Monterey County, the boundary VMT baseline uses the Monterey County boundary VMT to evaluate the Project's effects on VMT because the Project effects are likely to be localized near the CSUMB campus and within Monterey County.

TABLE 12: PROJECT'S EFFECT ON VMT (BOUNDARY VMT) THRESHOLD BASED ON CUMULATIVE CONDITIONS FOR MONTEREY COUNTY

Item	Amount
Monterey County Boundary Vehicle Miles Traveled (A) ¹	11,268,400
Monterey County Service Population (B) ^{1,2}	800,900
Monterey County Boundary VMT per Service Population (A/B = EC)	14.07
Monterey County Boundary VMT per Service Population Threshold (C)	14.07

Notes:

1. Rounded service population and VMT to nearest 100.
2. Service population is defined as the sum of all employees, residents, and students (Kindergarten to University)

Source: Fehr & Peers, 2019.



Therefore, the Project's effect on VMT would be significant if

- The Project would result in a significant cumulative impact if it causes the cumulative countywide daily boundary VMT per service population to be greater than 14.07.

HAZARD IMPACT

The Project would have a significant impact regarding hazards if

- The Project would substantially increase hazards due to a geometric design feature (e.g., sharp curves or dangerous intersections) or incompatible uses (e.g., farm equipment).

EMERGENCY ACCESS IMPACT

Ease of access and travel time are critical for first responders when traveling in emergency vehicles. Obstructions in the roadway, detours, and excessive delays due to congestion are among the factors that can affect emergency response time. A significant impact would occur if

- The Project would result in inadequate emergency access.

TRAFFIC FORECASTING METHODS

The AMBAG regional travel forecasting model was used to develop daily VMT and traffic forecasts for the CSUMB campus and the Project study area. VMT forecasts were prepared for the SB 743 VMT assessment, as well as for use as inputs for the greenhouse gas (GHG) analysis.

AMBAG MODEL DOCUMENTATION

A description of the base year model validation and future year travel model assumptions is included in **Appendix B**. The future year travel model is used to develop forecasts for Cumulative Conditions and includes traffic from projects presently under construction, approved (but not yet constructed and/or occupied) developments, pending developments, and projected growth to Year 2035. Planned and funded roadway and intersection improvements associated with the approved projects and the Fort Ord Reuse Authority (FORA) Capital Improvement Program, City of Marina, and the *2040 Metropolitan Transportation Plan / Sustainable Communities Strategy (2018)* are included. Refer to **Table 13** for the jurisdictional source and descriptions of roadway improvements within the study area.



Intersection and freeway forecasts were developed using guidelines published in National Cooperative Highway Research Program (NCHRP) Report 765²⁰ for converting raw model results into forecasted volumes. This method, known as the difference forecast method, is based on existing counts and the difference between the model's baseline and future volumes. This method normalizes the model projections based on the accuracy of the model validation and the existing roadway volumes.

²⁰ National Cooperative Highway Research Program (NCHRP). *Report 765: Analytical Travel Forecasting Approaches for Project-Level Planning and Design*, Washington, D.C.: National Academy Press, 2014.



TABLE 13: ROADWAY IMPROVEMENTS FOR CUMULATIVE CONDITIONS

Project Number ¹	Name	Description	Sources ²			Notes
			City ³	FORA ⁴	RTP ⁵	
City of Marina Capital Improvement Program						
R 05	Second Avenue Extension	Extend Second Avenue as a 2-lane arterial between Imjin Parkway and Reindollar Avenue	X	X		
R 34	Eighth Street	Upgrade/construct Eighth Street as a 2-lane arterial from Second Avenue to Inter-Garrison Road	X	X		
R 37	Patton Parkway Extension	Extension of Patton Parkway from Del Monte Boulevard to Crescent Street	X	X		
R 61	Second Avenue Widening	Widen Second Avenue from Tenth street to Inter-Garrison Road. Remove Class II bike lanes and restripe for two lanes each direction	X			Project is planned, funding projected between 2020 and 2035.
Fort Ord Reuse Authority (FORA)						
FO 6	Inter-Garrison Road Widening	Widen Inter-Garrison Road to a 4-lane arterial from Eastside Parkway to Reservation Road		X		Partially completed between Sherman Blvd to Reservation Road
FO 7	Gigling Road	Widen Gigling Road to a 4-lane arterial from General Jim Moore Boulevard to Future Eastside Parkway near Eighth Avenue		X		
AMBAG Regional Transportation Plan (RTP)						
MON-MAR001-MA	Reservation Road Widening	Widen Reservation Road to 4 lanes between East Garrison Gate and Davis Road		X	X	
MON-MAR001-MA	Imjin Parkway Widening	Widen Imjin Parkway to four lanes from Imjin Road to Reservation Road	X		X	

Notes:

1. Project ID Number based on leading agency from source document.
2. Projects appearing in multiple source lists are described and denoted by source.
3. Listed in City of Marina's 5 Year Capital Improvement Project List, Revised March 2016.
4. Listed in Fort Ord Reuse Authority's Capital Improvement Program Fiscal Year 2017/18 through 2027/28, and Fort Ord Reuse Authority Fee Reallocation Study: Deficiency Analysis and Fee Reallocation (2017).
5. Listed in the 2040 Metropolitan Transportation Plan / Sustainable Communities Strategy (2018).

Source: Fehr & Peers, 2019.



VMT ESTIMATION PROCESS FOR THE SB 743 ASSESSMENT

Total VMT per Service Population Estimation Method

The total VMT is the VMT from all vehicle trips for all trip purposes and types caused by the residential population, employment population, and student population in a specific area. It is calculated by summing the "VMT within," "VMT from," and "VMT to" a specified area, as follows:

$$\text{Total VMT} = (II + IX) + (II + XI) = 2 * II + IX + XI$$

- Internal-internal (*II*): The full length of all trips made entirely within the specified geographic area limits.
- Internal-external (*IX*): The full length of all trips with an origin within the specified geographic area and destination outside of the area.
- External-internal (*XI*): The full length of all trips with an origin outside of the specified geographic area and destination within the area.

The intra-zonal VMT and VMT between traffic analysis zones, or TAZs, that are in the specified geographic study area causes some double counting, which is an expected result when summing the trip end based VMT. To ensure a VMT rate is expressed properly (i.e., that the numerator and denominator include the generators of both trip ends of the VMT), the total VMT is divided by the service population (residential population, employment population, plus student population), the generators of both trip ends of the VMT. The VMT estimates are also presented on a per service population basis to account for both the effects of population and/or employment growth and the effects of changes in personal travel behavior. For example, population growth may cause an increase in VMT, while travelers changing their behavior by using different travel modes or decreasing their vehicle trip lengths (such as a higher percentage of students living campus) would cause decreases in VMT.

Project's Effect on VMT Estimation Method (Using Boundary VMT)

As noted earlier, the Project's effect on VMT, or cumulative impact, is evaluated using the boundary VMT, which captures all VMT on the roadway network within a specified geographic area, including local trips plus interregional travel that does not have an origin or destination within the area. The geographical boundary method only considers traffic within the physical limits of the selected study area and does not include the impact of vehicles once they travel outside the area limits. The use of boundary VMT provides a complete evaluation of the potential effects of the Project because it captures the combined effect of new VMT, shifting existing VMT to/from other neighborhoods, and/or shifts in existing traffic to alternate travel routes or modes. The boundary VMT is also divided by the service population (sum of residents, employees, and students) to account for the effects of population and/or employment growth and the effects of changes in personal travel behavior within the specified geographic area.



SERVICE POPULATIONS

Service population is the sum of the number of employees, residents, and students within the designated geographic area. **Table 14** shows the service populations for the CSUMB campus and Monterey County for the analysis scenarios:

- Existing Conditions – Baseline total VMT per service population and boundary VMT per service population based on existing land use and transportation network.
- Existing with Project Conditions – Existing Conditions with the combined effects of the CSUMB Master Plan including increased campus population and modifications to existing campus parking and transportation facilities on total VMT per service population.
- Cumulative Conditions – Year 2035 boundary VMT per service population based on forecasts from the AMBAG regional travel model without Eastside Parkway.
- Cumulative with Project and without Eastside Parkway Conditions– Cumulative Conditions boundary VMT per service population with the combined effects of the CSUMB Master Plan including increased campus population and modifications to existing campus parking and transportation facilities.



TABLE 14: SERVICE POPULATIONS

	Existing Conditions	Existing with Project Conditions	Cumulative Conditions	Cumulative with Project and without Eastside Parkway Conditions
CSUMB Campus				
Employees (A) ^{1,2}	1,030	1,780	1,030	1,780
Residents (B) ^{1,3}	280	70	280	70
Students (C) ^{1,4}	6,640	12,700	6,640	12,700
Service Population (A + B + C = D) ^{1,5}	7,950	14,550	7,950	14,550
Monterey County				
Employees (E) ^{1,2}	183,660	184,410	228,780	229,530
Residents (F) ^{1,3}	384,830	384,620	444,350	444,140
Students (G) ^{1,4}	112,690	124,820	127,680	139,810
Service Population (E + F + G = H) ^{1,5}	681,180	693,850	800,810	813,480

Notes:

1. Rounded service population to nearest 10.
2. Employees are the sum of employees working at the CSUMB Campus or in Monterey County per the AMBAG travel demand model.
3. Residents (defined as the Community Housing Partners living on the East Campus) are the sum of residents living on the CSUMB Campus or in Monterey County per the AMBAG travel demand model. As shown in Table 1, the Community Housing Partner residential population is expected to decrease as CSUMB accommodates more faculty and staff in the East Campus housing.
4. Students are the sum of students (Kindergarten to University) on the CSUMB Campus or Monterey County per the AMBAG travel demand model. Students on the CSUMB Campus are defined as university students.
5. Service population is defined as the sum of all employees, residents, and students (Kindergarten to University).

Source: Fehr & Peers, 2019.



5. CEQA SIGNIFICANT IMPACTS AND MITIGATION

This chapter discusses potential Project impacts per the significance criteria described in **Chapter 4**. The determination of a significant impact related to the transportation network is based on the evaluation of key plans, policies, and goals described in **Chapter 3** of this report. Plan conflict impacts were evaluated by comparing the Project Conditions to applicable programs, plans, ordinances, or policies addressing the circulation system, including transit, roadways, bicycle, and pedestrian facilities. Both direct (Project generated) and cumulative (Project's effect) VMT impacts were evaluated. Direct VMT impacts were evaluated using total VMT per service population rate under Existing with Project Conditions. Cumulative VMT impacts were evaluated using boundary VMT under Cumulative with Project and without Eastside Parkway Conditions, and Cumulative with Project and with Eastside Parkway Conditions. Hazards due to design features and emergency access impacts were evaluated under Project Conditions.

PLAN CONFLICTS ANALYSIS

Conflicts with the relevant transportation plans, as described in **Chapter 3**, were addressed by travel mode as discussed below.

TRANSIT EVALUATION

Existing access for regional MST bus routes is provided primarily via Inter-Garrison Road, Imjin Road, and General Jim Moore Boulevard. Currently, regional routes mainly circulate through Inter-Garrison, Divarty Street, East Campus, and General Jim Moore Boulevard. It is reasonable to expect that as long as there is adequate demand, existing transit circulation would be maintained in the future, including through the future restricted access segments of Inter-Garrison Road and Divarty Street. Since these restricted access segments are primarily designed to preserve bicycle and pedestrian circulation near the core campus, regional transit travel would be limited as much as possible to core routes, and shuttles would primarily travel along the periphery of the Main Campus.

As part of the Project, additional shuttles are proposed to support the regional transit passing through the campus, as well as residents living in Main Campus and East Campus. Existing shuttles run as MST routes and primarily travel along Inter-Garrison Road, Divarty Street, and East Campus. In the future, these additional shuttles are proposed to circulate in a larger loop serving the East Campus, North Main Campus Housing, the multimodal hubs, and parking areas by traveling along the future Fifth Street, Sixth Street, Inter-Garrison Road, Divarty Street, and General Jim Moore.

The Project does not propose changes to the transit system that would impact the *2040 Metropolitan Transportation Plan / Sustainable Communities Strategy (2018)* goals of expanding the role transit plays in meeting the region's mobility needs such as investments in bus rapid transit, expansion of local services,



and planned rail projects. Internal circulation changes would support core regional transit travel within the Campus.

Project transit ridership is estimated using the existing mode splits for each population type by housing location. Assuming the public transit service levels and the destinations accessible by transit (e.g., portion of jobs and other land use destinations) remain similar between Existing Conditions and Existing with Project Conditions, and assuming no parking management strategies are implemented that would encourage transit ridership, for the reasons explained below, it is reasonable to expect that transit travel behavior (e.g., percent transit mode share for each population type and residential location) would generally remain the same as Existing Conditions. Therefore, the existing transit mode share by population type was used in calculating the Project transit ridership.

The reason for this determination is because switching from the disaggregated mode share splits for each population type and residential location to the CSUMB Main Campus transit mode share, the analysis shows there actually would be a decrease in the transit mode share over time as students are moved from East Campus to Main Campus and, therefore, would be less reliant on transit. Based on the CSUMB person trip survey, the transit mode share currently is less than 10 percent of the Campus population travel. As more housing is built on campus and students are moved from East Campus to Main Campus, the share of travel by walking and bicycling is expected to increase and the transit mode share is expected to drop to less than 5 percent (refer to mode share summary in **Chapter 6**).

However, while the transit mode share expressed as a percentage could decrease, the total number of transit riders is likely to increase as CSUMB increases its implementation of effective Parking Management and TDM strategies, which would result in an increase in the transit mode share under future conditions. Relatedly, because the provision of transit service is reactive to increased demand for transit ridership, transit service can be increased via increased bus frequency and additional routes, if justified.

As shown in **Table 15**, Main Campus transit ridership is expected to increase as the Project proposes to house more students on the Main Campus. The student population has higher existing transit ridership rates compared to faculty and staff. Since the same travel behaviors are assumed in the future, increasing the student population on the Main Campus would correspondingly increase Project ridership on the Main Campus.



TABLE 15: MAIN CAMPUS TRANSIT RIDERSHIP SUMMARY

Data Source	Existing Ridership		Project Ridership	
	AM	PM	AM	PM
Mode Share/Trip Gen Data ¹	31	23	67	49
MST Data ²	27	41	N/A	N/A

Notes:

1. Peak hour ridership calculated using mode share data from person trip surveys (inbound - AM, outbound - PM), and campus population type by housing location.
2. Peak hour ridership data from Spring 2017 MST data for all Routes excluding Route 26.

Source: Fehr & Peers, June 2019; MST, August 2017.

In comparison, as shown on **Table 16**, transit ridership would decrease in the East Campus. As summarized in **Appendix A**, the current East Campus faculty and staff transit mode share is 2.9 percent and the East Campus student transit mode share is 32.8 percent. Relocation of student residents to the Main Campus and increasing the number of faculty and staff residents on the East Campus would therefore lower East Campus Project transit ridership overall, because faculty and staff use transit less frequently than students. The transit ridership numbers shown in **Table 16** are based on a condition where there are no additional parking management strategies or limitations in place to discourage use of single occupant vehicles. As previously noted, future parking management strategies could cause transit ridership to increase, thereby potentially exceeding future projected ridership rates. Should this occur, it is expected that future transit service would be implemented to serve the future ridership demand.

TABLE 16: EAST CAMPUS TRANSIT RIDERSHIP SUMMARY

Data Source	Existing Ridership		Project Ridership ³	
	AM	PM	AM	PM
Mode Share/Trip Gen Data ¹	66	51	18	15
MST Data ²	22	29	N/A	N/A

Notes:

1. Peak hour ridership calculated using mode share data from person trip surveys (inbound - AM, outbound - PM), and campus population type by housing location.
2. Peak hour ridership data from Spring 2017 MST data for Route 26, which travels between East Campus and Main Campus.
3. Future ridership conservatively based on current conditions, assuming no increase in on-campus housing, parking policies or additional transit connectivity to encourage ridership.

Source: Fehr & Peers, June 2019; MST, August 2017.

A bus capacity analysis was conducted for the weekday AM and PM peak hours when the Project's estimated public transit ridership is the highest. This analysis assumes that public transit service levels and the destinations accessible by transit (e.g., portion of jobs and other land use destinations) are similar between Existing Conditions and Existing with Project Conditions. Therefore, Project transit riders are estimated to



use each route in similar proportions as Existing Conditions. The estimated Project peak hour boardings per route are presented in **Table 17**. The Existing plus Project peak hour boardings were then divided by the route’s vehicle capacity to determine if the Project would cause the ridership-to-capacity ratio to exceed 1.0 and therefore create demand for public transit above the capacity provided under Existing Conditions.

TABLE 17: WEEKDAY PEAK HOUR BUS ROUTE CAPACITY ANALYSIS

Route ¹	Peak Hour	Peak Hour Capacity [A] ¹	Average Existing Peak Hour Boarding ²	Project Peak Hour Boarding ³	Total Boarding [B]	Over Capacity? (B/A > 1?)
Main Campus						
12	AM	123	8	2	10	No
	PM	74	6	1	7	No
16	AM	118	23	30	53	No
	PM	118	28	19	47	No
18	AM	118	22	17	39	No
	PM	118	33	21	54	No
25	AM	32	8	15	23	No
	PM	32	7	7	14	No
74	AM	56	33	2	35	No
	PM	56	7	1	8	No
East Campus						
26	AM	105	22	18	40	No
	PM	105	29	15	44	No

Notes:

1. Bus capacity is a product of the average number of buses serving the route during the weekday AM and PM peak hours and sitting and standing capacity. Peak hour capacity was calculated by dividing the peak period capacity by two.
2. Calculations based on Spring 2017 Tuesday through Thursday peak period ridership data provided by MST. Peak hour boardings were calculated by dividing the peak period capacity by two.
3. Plan transit ridership per route estimated based on the proportion of ridership for the route.

Source: Fehr & Peers, 2019.

As shown in Table 17, the Project is not anticipated to create demand for public transit above the existing available capacity and, therefore, the impact of the Project on transit ridership and facilities would be less than significant, and no mitigation or additional improvements would be required.

Moreover, the additional shuttles proposed by the Project to circulate within the campus would not affect existing or planned transit facilities and would not reduce existing or planned capacity. These proposed



shuttles would add capacity that could serve estimated Project ridership from the Main Campus and East Campus described above.

Consistent with the *2040 Metropolitan Transportation Plan / Sustainable Communities Strategy (2018)*, the existing transit circulation would be maintained in the future, including through the future restricted access segments of Inter-Garrison Road and Divarty Road. The changes to the vehicle circulation system as part of the Project would not be expected to interfere with existing transit facilities nor conflict with planned transit facilities and services or conflict with adopted transit plans, guidelines, policies, or standards. Additionally, the Project is supportive of the transit use and goals summarized in **Chapter 3**. Therefore, the impact relative to disruption of existing or planned transit facilities or conflicts with transit program, plan, ordinance, or policy would be less than significant.

ROADWAY EVALUATION

The Project includes modifications to existing campus parking and street facilities to create a more pedestrian and bicycle-oriented campus core. These modifications will cause existing and future local and regional traffic to circulate differently on-campus and in some cases divert traffic to adjacent streets. The expected influence on existing and future traffic for each of the key PDFs is to be implemented as part of the Project, as described in the Project Description, Chapter 3 of the Master Plan Draft EIR, are listed below:

- Parking will be consolidated and relocated to select areas on the periphery of the campus core (PDF-MO-1[c]):
 - Traffic Volume Change: Less CSUMB vehicle traffic within the Main Campus core. Increased volumes of CSUMB vehicles along the outer streets of the Main Campus.
- Vehicle access will be limited to CSUMB students, faculty, and staff vehicles on General Jim Moore Boulevard between Eighth Street and Fifth Street (PDF-MO-3):
 - Traffic Volume Change: Shifting of non-CSUMB vehicles to parallel streets of Second Avenue and Eighth Street and direct access to new parking lots for CSUMB vehicles along General Jim Moore Boulevard.
- Vehicle travel through the campus core will be restricted to shuttles, transit vehicles, service vehicles, and emergency vehicles by limiting access at the following locations (PDF-MO-3):
 - Inter-Garrison Road between General Jim Moore Boulevard and Sixth Avenue
 - Divarty Street between General Jim Moore Boulevard and Seventh Avenue
 - Fourth Avenue between Divarty Street and Inter-Garrison Road
 - Fifth Avenue between Divarty Street and Inter-Garrison Road
 - A Street between Divarty Street and Seventh Avenue
 - Sixth Avenue between B Street and north of Divarty Street
 - Butler Street between Sixth Avenue and Seventh Avenue



- Traffic Volume Change: Shifting of existing and future vehicle traffic to nearby roadway facilities including Second Avenue, Eighth Street (future street extension between Third Avenue and Fifth Avenue), Imjin Parkway, Eighth Street, Colonel Durham Street, and Gigling Road.
- Seventh Avenue between Colonel Durham Street and Butler Street will be converted to one-way for vehicles traveling north from Colonel Durham Street to Inter-Garrison Road (PDF-MO-3).
 - Traffic Volume Change: Shifting of outbound traffic to Eighth Avenue. (A complement to limiting vehicle access within the Main Campus core.)

Overall, the Project would not conflict with existing or planned roadway facilities because the proposed roadway changes are limited to on-campus roads. Moreover, while the Project would result in a shift of vehicle traffic from the campus core to nearby roads, the Project also includes a “park once” policy that would limit vehicle circulation on local streets on or near the CSUMB campus. Parallel transportation improvements (such as the Eighth Street extension and Gigling Road to Inter-Garrison Road) would serve the shifts in local and regional traffic that otherwise would travel through the CSUMB campus. The street modifications also would support a more walkable, bikeable and transit oriented Main Campus core. The Project would not be expected to interfere with existing roadway facilities, conflict with planned roadway facilities, or conflict with adopted transportation plans, guidelines, policies, or standards. Therefore, the impact relative to disruption of existing or planned roadways or conflicts with program, plan, ordinance, or policy would be less than significant.

BICYCLE EVALUATION

The Project is expected to generate demand for bicycle lanes, bicycle routes, and off-street shared use paths between the Campus and adjacent land uses, and travel to/from areas within the entire Campus. The Project proposes to improve bicycle access along Inter-Garrison Road and Divarty Street by restricting vehicles along segments of these roadways next to the campus core. Inter-Garrison Road has bicycle lanes (Class II) from the East Campus to Main Campus. The Project proposes to improve bicycle travel throughout the Main Campus through the following steps:

- Replacing the existing Class II facilities (bike lanes) on Inter-Garrison Road between Fourth Avenue and Sixth Avenue with Class I facilities (bike paths).
- Installing a Class I bicycle path facility in place of the existing Class III bicycle route facility along the future restricted access segment of Divarty Street between General Jim Moore Boulevard to Seventh Avenue.
- Installing a Class I bicycle path along the segment of General Jim Moore Boulevard that transverses the Main Campus from Lightfighter Road to Divarty Street that would serve as a main bicycle north-south route.
- Providing a network of Class 1 trails linking the campus together.



The proposed campus bicycle and pedestrian networks are shown on **Figure 4** and **Figure 5**, respectively.

To further facilitate bicycle and pedestrian travel, smaller interior parking lots would be removed, which would allow for increased internal campus facilities, such as campus bicycle and pedestrian paths and trails to aid pedestrian and bicycle circulation. These internal bicycle and pedestrian paths are proposed near housing and other campus buildings that would connect to the proposed bicycle facilities on roadways described above, and existing and planned facilities and trails, including the planned Fort Ord Regional Trail and Greenway (FORTAG) shown on **Figure 10**.

The FORTAG is a planned 30-mile network of regional trails that will connect Seaside, Marina, and CSUMB, and will extend to the existing Monterey Bay Sanctuary Scenic Trail that is parallel to SR 1. The FORTAG trail is planned to go through the Main Campus and along Butler Street, Eighth Street, and Divarty Street within the Campus. The trail would also intersect with Inter-Garrison Road, General Jim Moore Boulevard, and Second Avenue within and around the Main Campus. The Project's consolidation of parking to satellite parking areas would not interfere with the FORTAG trail's alignment and would remove driveways of smaller existing parking lots near the Main Campus, reducing the number of conflict points for the trail. The Project would not interfere with the FORTAG trail's planned route, and proposes bicycle facilities that would provide connections to the trail.

Overall, the Project's bicycle enhancements on the Main Campus core align with the *Monterey County Active Transportation Plan (ATP) 2018*, except for the planned improvement along a portion of Inter-Garrison Road. Under existing conditions, Inter-Garrison Road is a bike route (Class III bikeway) from Second Avenue to Seventh Avenue and has bike lanes (Class II bikeway) from Seventh Avenue to Inter-Garrison Road Connection. Under the *ATP 2018*, Inter-Garrison Road is planned as a cycle track or separated bikeway (Class IV bikeway) from General Jim Moore Boulevard to Eighth Street/Seventh Avenue. As shown on **Figure 4** and **Figure 10**, the Project proposes to restrict vehicle travel and construct a shared-use path (Class I bikeway) along Inter-Garrison Road between General Jim Moore Boulevard and Sixth Avenue. The specifics of this Project improvement differ somewhat from what is proposed in the *ATP 2018*; although, the Project's improvement would provide a path for exclusive use of bicycle and pedestrians. Thus, the path provides bicyclists a similar exclusive travel facility as would a cycle track and, as a result achieves the same purpose and, therefore, is consistent with the *ATP 2018*.

The Project improvements of adding new internal bicycle paths and on-road bicycle facilities connecting to existing and planned bicycle facilities align with the overall goals and policies of the plans described in **Chapter 3**, such as the *Monterey County ATP 2018*, which aims to improve bicycle connectivity by eliminating gaps, improving the quality of the bicycle network, and supporting complete streets for all users, including bicyclists. The Project improvements would not disrupt or conflict with the intent of planned bicycle facilities consistent with relevant plan goals and policies, and would not conflict with applicable programs, plans, ordinances, or policies related to bicycle facilities. Therefore, the bicycle-related impact would be less than significant.



PEDESTRIAN EVALUATION

The Project proposes to increase housing within the Main Campus and relocate parking areas outside of the Main Campus core. These changes are expected to generate demand for sidewalks and off-street shared use paths. As can be presented on **Figure 9**, there are gaps in the existing sidewalks on and around the campus. As shown on **Figure 5**, the Project would expand the pedestrian network on the campus and to adjacent land uses by adding multi-use greenways, pedestrian pathways, and closing existing sidewalk gaps. The Project also proposes to establish additional pedestrian malls such as Divarty Street and Inter-Garrison Road as described in **Chapter 1**.

The Project site plan was evaluated for internal circulation between the residential housing, academic and recreational uses, and transit stops. As part of the Project, Divarty Street would be further developed as a pedestrian mall with restricted vehicle travel. Along with Divarty Street, Inter-Garrison Road would also be limited to only pedestrian, bicycle, and transit travel. These restricted access roadways will allow for improved pedestrian circulation within the central core of the Main Campus. Along with restricting vehicles from traveling along the core of the campus, smaller interior parking lots will be removed, and parking would be located mainly on the periphery of the campus to help minimize pedestrian and vehicle conflicts.

Bus stops are mainly concentrated around the core of the campus along Inter-Garrison Road, Divarty Street, and Sixth Avenue, which would be limited to only pedestrian, bicycle, and transit travel. Pedestrians will continue to have access to the campus core bus stops.

The Project includes expanding the pedestrian network by adding multi-use greenways and pedestrian pathways. These pathways would link the core campus to residential areas in the north end of the Main Campus and the athletics and recreation district in the southern end of the Main Campus.

The pedestrian goals and policies of the plans summarized in **Chapter 3** include increasing trail connections to parks and open space, supporting pedestrian movements, improving pedestrian safety, and removing gaps in the pedestrian network. The Project improvements, such as increased trail connections to existing and planned trails, expanding multi-use greenways and pathways, reducing vehicle circulation through the core of the campus, and closing gaps in the pedestrian network, align with these goals and policies. The Project would not interfere with existing or planned pedestrian facilities nor conflict with applicable non-vehicle transportation plans, guidelines, policies, or standards and, instead, would enhance pedestrian circulation within the Main Campus core and connections to adjacent land uses, which is a beneficial effect on the pedestrian circulation and access. Therefore, the Project would not conflict with pedestrian-related plans and any impact would be less than significant.



SB 743 VMT ANALYSIS

This section presents an analysis of the Project's impacts relative to VMT, including the daily VMT estimates for the SB 743 VMT assessment; data for the greenhouse gas (GHG) analysis can be found in **Appendix G**. **Appendix G** also includes a VMT forecasting outline using the AMBAG regional travel model.

The total VMT and boundary VMT were estimated using the AMBAG travel model. The total VMT per service population rate is used to evaluate the direct effects of the Project under Existing with Project Conditions, while the boundary VMT is used under Cumulative with Project Conditions to evaluate the Project's effect on VMT – an evaluation of cumulative impacts. The results of the Project generated VMT (using total VMT per service population rates) and Project's effect (using boundary VMT per service population ratios) on VMT impact analyses are presented in **Table 18** and **Table 19**, respectively. Each analysis is separately addressed below.

PROJECT GENERATED VMT

As shown in **Table 18**, the CSUMB campus total VMT would increase in absolute terms between Existing Conditions (178,500 total vehicle miles traveled) and Existing with Project Conditions (295,500 total vehicle miles traveled), which is expected due to the planned Campus population increase and the associated increase in related vehicle travel.

However, on a per service population basis, which is the metric relative to assessing impacts under CEQA, VMT would *decrease* by approximately 10 percent between Existing Conditions (22.31) and Existing with Project Conditions (20.24). This decrease would result due to the increase in on-campus housing and modifications to the Campus street system, both attributes of the Project. Other VMT reducing components of the Project include student life buildings, indoor recreation buildings and facilities, outdoor athletics, and recreation support buildings.

As to whether the CSUMB campus total VMT per service population rate under Existing with Project Conditions would result in a significant impact within the meaning of CEQA, **Table 18** presents the CSUMB campus total VMT per service population of 20.24. This is less than the applicable threshold of 23.91. Therefore, the CSUMB campus total VMT rate impact would be less than significant.

Please refer to the sections titled SB 743 VMT Assessment Method Decisions in **Chapter 1** and the Significance Criteria and VMT Analysis Methods in **Chapter 4**, for explanation of the methods utilized to calculate the total VMT and the total VMT per service population rate, and the basis upon which significant impacts are assessed under CEQA.



TABLE 18: PROJECT GENERATED VMT FOR SB 743 VMT ASSESSMENT

	Existing Conditions	Existing with Project Conditions
CSUMB Campus		
Total Vehicle Miles Traveled (A) ¹	178,500	295,500
Service Population (B) ^{1,2}	8,000	14,600
Total VMT per Service Population (A/B = C)	22.31	20.24
Impact Assessment		
	Total VMT per Service Population Threshold (Impact Conclusion)	23.91 (Less Than Significant)

Notes:

1. Rounded service population and VMT to nearest 100.
2. Service population is defined as the sum of all employees, residents, and students (Kindergarten to University).

Source: Fehr & Peers, 2019.

PROJECT'S EFFECT ON VMT

The results of the analysis addressing the Project's effect on VMT under Cumulative with Project and *without* Eastside Parkway Conditions are presented in **Table 19**. Under Cumulative with Project and without Eastside Parkway Conditions the Monterey County boundary VMT per service population²¹ of 13.98 is less than the applicable threshold of 14.07. Therefore, the impact of the Project's effect on VMT under Cumulative without Eastside Parkway Conditions would be less than significant.

The results of the analysis addressing the Project's effect on VMT under Cumulative with Project and *with* Eastside Parkway Conditions are also presented in **Table 19**. Under Cumulative with Project and with Eastside Parkway Conditions the Monterey County boundary VMT per service population of 13.96 is less than the applicable threshold of 14.07. Therefore, the impact of the Project's effect on VMT under Cumulative with Project and with Eastside Parkway Conditions would be less than significant.

Please refer to the sections titled SB 743 VMT Assessment Method Decisions in **Chapter 1** and the Significance Criteria and VMT Analysis Methods in **Chapter 4**, for explanation of the methods utilized to calculate the boundary VMT and the basis upon which significant impacts are assessed under CEQA.

²¹ Service population is defined as the sum of all employees, residents, and students (Kindergarten to University)



TABLE 19: PROJECT’S EFFECT ON VMT (BOUNDARY VMT) FOR SB 743 VMT ASSESSMENT

	Existing Conditions	Cumulative Conditions	Cumulative with Project and without Eastside Parkway Conditions	Cumulative with Project and with Eastside Parkway Conditions
Monterey County				
Vehicle Miles Traveled (D) ¹	9,011,700	11,268,400	11,372,800	11,353,400
Service Population (E) ^{1,2}	681,200	800,900	813,500	813,500
VMT per Service Population (D/E = F)	13.23	14.07	13.98	13.96
Impact Assessment				
		VMT per Service Population Threshold (14.07) (Impact Conclusion)	14.07 (Less Than Significant)	14.07 (Less Than Significant)

Notes:

1. Rounded service population and VMT to nearest 100.
2. Service population is defined as the sum of all employees, residents, and students (Kindergarten to University).

Source: Fehr & Peers, 2019.

HAZARDS EVALUATION ANALYSIS

The Project includes modifications to existing campus parking and transportation facilities to create a more pedestrian and bicycle-oriented campus core. These modifications would change the design of parking lots and local streets and intersections, but they would not create hazards such as sharp curves or include otherwise dangerous transportation-facility design features. Therefore, the Project impact related to hazards would be less than significant.

EMERGENCY ACCESS ANALYSIS

While most vehicle traffic under the Project will have limited access to the Main Campus core, emergency vehicles will have unlimited access to Campus streets restricted to pedestrians, bicyclists, transit vehicles and service vehicles. Additionally, future parking facilities and streets will be designed to accommodate emergency vehicles. As such, emergency and service vehicles will continue to have unlimited access to the campus that will be improved by the design of future parking facilities and streets. Therefore, the Project impact related to emergency access would be less than significant.

CONSTRUCTION IMPACT ANALYSIS

Construction activities include those associated with site preparation, and building and other infrastructure construction.



Site preparation includes all of the activities required to allow construction on the Project site. Major components of site preparation would involve removal of the existing parking lots, excavation and grading of the site, and construction of necessary infrastructure. A variety of equipment would be required for the site preparation stage including bulldozers, grading machines, cranes, and dump trucks, which would be responsible for the removal and deposition of cut and fill material on the site.

Building construction involves the assembly of the buildings. Major elements of building construction could include driving piles to support the building foundation, assembling the concrete reinforcing bars as the building frame, pouring concrete, and completing the building accessories such as elevators. Additional infrastructure construction includes streets and parking lots.

As discussed in **Chapter 7**, at buildout the Project would generate approximately 12,510 average daily trips (ADT), with approximately 1,000 of those trips coming in the morning and evening peak hours. Construction operations would generate substantially fewer trips on a daily basis (less than 1,300 ADT) and, thus, the volume of construction traffic would be less than Project traffic. To address construction traffic, PDF-MO-14 (cited below) requires that the Project contractors implement construction traffic control plans that comply with California Department of Transportation (Caltrans) Standard Specifications and include, among other components, appropriate traffic control devices, such as signage and temporary roadway closures, if necessary. With implementation of the plan, safe access to the pedestrian, bicycle, transit, and street facilities would be maintained while construction activities associated with Project proceed.

PDF-MO-14: Avoid Construction Conflicts – When construction projects require significant work within existing roadways CSUMB will require the design team and/or the project contractor and their qualified registered Civil Engineer to implement a construction traffic control plan. This requirement will be incorporated into construction bid packages. The plans will conform with the current version of the State of California Department of Transportation Standard Specifications, where applicable, and will be reviewed and approved by CSUMB prior to implementation. The traffic control plan will include any detour plans and/or temporary traffic control devices warranted, per the current version of the California Manual on Uniform Traffic Controls Devices to provide for public safety, maintenance of access, temporary roadway closures, if needed, and construction-area signage. CSUMB shall inform emergency services of any roadway or lane closures and alternative travel routes to ensure adequate access for emergency vehicles when construction projects would result in temporary lane or roadway closures.

Therefore, traffic-related impacts associated with Project construction would be less than significant with implementation of PDF-MO-14.



6. PARKING MANAGEMENT AND TDM

This chapter defines the parking supply and mode share assumptions used in the transportation analysis based on observed data (refer to **Appendix A** to **Appendix C**). This chapter provides additional detail about the parking supply and mode share to show the range of parking supply scenarios and potential VMT reductions due to additional parking management and TDM strategies. This parking supply analysis is also used to inform the campus traffic assignment to the new campus parking lots shown in the Operations Analysis section of this report (refer to **Chapter 7** to **11**). Furthermore, this parking and TDM evaluation provides a clear baseline to compare the effectiveness of the Parking Management and TDM Plan strategies to be implemented in the future. This chapter concludes with suggested refinements to the PDFs that could reduce project trips and/or VMT.

MAIN CAMPUS PARKING EVALUATION

PDF-MO-1(c) would manage the parking supply, consolidate and relocate parking lots to the edge of the Main Campus, remove non-essential parking lots from the campus core, and facilitate a “park once” policy.

This parking evaluation builds upon the *CSUMB Draft Parking Supply Scenarios* (Fehr & Peers, August 2015) included in **Appendix H**, which presented three parking supply scenarios with various parking pricing and parking management strategies. The 2015 parking supply scenarios analysis was a high-level analysis focused on parking supply using descriptive parking data provided by campus staff; it did not include existing parking occupancy or peak parking demand data as this analysis does. This parking analysis uses existing parking data to estimate future parking supply and identify potential parking management strategies that could be incorporated into a Parking Management Plan. Three scenarios are discussed:

1. **Future Parking Supply Base Scenario** – This business-as-usual scenario would result in a parking supply of 6,374 parking spaces at the consolidated parking lots. This scenario assumes the future parking supply accommodates future population at the current parking demand rate and implements the existing level of parking policies and parking management program.
2. **Land Area Allocation Parking Supply Scenario** – This scenario is based on the Master Plan land use map (PDF-LU-1) allocation for parking and would result in a parking supply of 5,651 parking spaces at the consolidated parking lots.
3. **Master Plan Vision to Maintain Existing Parking Supply Scenario** – This scenario would maintain the parking supply of 4,721 parking spaces at the consolidated parking lots and would require parking management to reduce the parking demand by implementing parking strategies such as increased parking pricing and permit restrictions for freshmen and sophomores. This scenario was chosen by the campus as part of the public Master Planning process and could be achieved by implementation of a Parking Management Plan and TDM measures per PDF-MO-1. The existing parking supply is described in the CSUMB Master Plan Guidelines as having an over-



supply of parking for the existing campus enrollment. As the campus consolidates parking to satellite parking areas along the edge of the Main Campus, as shown in **Figure 6**, the parking supply is assumed to remain constant. By placing the parking areas along the edge of the Main Campus near the gated entry and campus entries, most vehicle traffic will circulate on Eighth Avenue, Eighth Street, Gigling Road, Second Avenue, and General Jim Moore Boulevard. Parking areas closer to the campus core will include “Multimodal Hubs.”

Below is a description of current academic parking, residential parking, and multimodal hubs used in the parking analysis:

- **Academic parking** areas serve all populations, which includes off-campus students, Main Campus student residents, faculty/staff, visitors, and community housing partners.
- **Residential parking** areas only serve students living on the Main Campus.
- **Multimodal hubs** are located at the academic parking areas at Inter-Garrison Road/Sixth Avenue and Divarty Street/General Jim Moore Boulevard. The multimodal hubs will be designed to serve several transportation modes, including carpool vehicles, pick-up/drop-off activities, transit vehicles, bicyclists, and other populations on campus.

The following is a description of the proposed seven parking areas (refer to **Figure 6**) for the parking area locations):

- Parking Area 1 - Academic and Residential Parking: Located along General Jim Moore Boulevard north of Fifth Street.
- Parking Area 2 - Academic Parking: Located on the southwest corner of the Divarty Street and General Jim Moore Boulevard intersection. This parking area will have a multimodal hub.
- Parking Area 3 - Academic Parking: Located on the northwest corner of the intersection of Inter-Garrison Road and Sixth Avenue. This parking area will have a multimodal hub.
- Parking Area 4 - Academic Parking: Located north and south of A Street between Sixth Avenue and Seventh Avenue.
- Parking Area 5 - Academic Parking: Parking lot for faculty and staff located along the northern side of Inter-Garrison Road west of General Jim Moore Boulevard.
- Parking Area 6 - Academic Parking: Parking lot for faculty and staff located along Sixth Avenue between B Street and Butler Street.
- Parking Area 7 - Residential Parking: Parking lot for student residents located at Promontory Housing, and at the intersection of Eighth Street and Imjin Road.

The Master Plan Guidelines and PDF-MO-1(c) include a requirement to develop a Parking Management Plan that defines measures to manage the parking demand to maintain the existing parking supply for the next phase of campus growth. The following section provides parking supply estimates based on the



parking demand data collected for this report and also the land area allocation from the Master Plan Circulation plan. Therefore, the analysis establishes a base condition using existing travel characteristics (observed travel behavior data), which do not include future enhanced parking management and/or TDM programs, to provide a clear baseline to compare the effectiveness of the Parking Management and TDM Plan strategies to be implemented in the future. The results confirm that the CSUMB campus will have the available space to park vehicles and that the campus can provide a parking supply to accommodate a desired parking demand with the appropriate parking management strategies.

PARKING DEMAND SURVEY AND PARKING SUPPLY ESTIMATES

Existing Parking Demand

The future campus parking supply for the Project was estimated using existing parking inventory and parking occupancy data collected by Mott McDonald in the Fall of 2017. The existing parking inventory and occupancy data is presented in **Chapter 2**. Existing parking demand rates were determined for two types of parking: academic and residential.²² Existing academic parking demand rates were calculated by determining peak parking demand of existing parking lots not restricted to on-campus residents and dividing that demand by the existing student, faculty, and staff population presented in **Table 1**. Existing residential parking demand rates were calculated by determining peak parking demand of existing parking lots restricted to only on-campus residents and dividing that demand by the existing Main Campus residential population presented in **Table 1**. The existing academic and residential parking demand rates are summarized in **Table 3**, and calculations are presented in **Table I-1** and **Table I-2** of **Appendix I**. As presented in **Table 3**, the existing academic parking demand rate is 0.31 spaces per FTE, which is greater than the parking demand rate for residential parking (0.20 spaces per on-campus resident).

Future Parking Demand and Parking Supply Analysis

The parking area locations, estimated size of the parking lots provided by CSUMB, and vehicle occupancy (drive-alone, carpool, or transit) were used in this transportation analysis to develop the on-campus vehicle trip distribution and assignment (refer to **Chapter 7**) and this information was used as a starting point to project the future parking supply. Conservatively, the future academic and residential parking supply base scenario was estimated using the existing parking demand rates as presented in **Chapter 1**, the campus population and a circulation factor²³ of five percent.

²² Academic parking is defined as general parking utilized by students, faculty, and staff that are not restricted to only on-campus residents. Residential parking is parking reserved for on-campus residents.

²³ The existing parking demand rate is the accumulation of vehicles parked on-campus at the peak of the day on a per FTE basis. The parking supply is the total number of available spaces available, regardless of whether they are occupied or not. To ensure there are some available spaces for circulating vehicles a parking circulation factor of 5 percent is applied to the parking demand to estimate the campus parking supply.



The future academic parking supply was determined using the total student, faculty, and staff population of 14,476 FTEs as both off- and on-campus residents are expected to also use parking spaces for academic daily use. The number of future parking spaces needed per parking area was determined by multiplying the percentage of trips traveling to the six academic parking areas. This trip and parking space distribution, and parking supply per parking zone are presented in **Table 20**.

TABLE 20: FUTURE ACADEMIC PARKING SUPPLY BY PARKING ZONE – BASE SCENARIO

Parking Area	Percent of Total Trips	Future Academic Parking Supply (parking spaces)
Parking Area 1	25%	1,190
Parking Area 2	15%	714
Parking Area 3	16%	760
Parking Area 4	29%	1,380
Parking Area 5	7%	333
Parking Area 6	8%	381
Total	100%	4,758

Source: CSUMB, June 2018. Fehr & Peers, 2019.

The future residential parking supply was determined based on the proposed Main Campus residential population of 7,620 students. It is assumed that the Main Campus residential parking supply would be restricted to Main Campus residents and assumes there will be no future parking permit restrictions for on-campus student residents. This establishes a baseline for measuring the effectiveness of parking management and TDM plan strategies. The distribution of residential parking spaces between the two residential parking areas was assumed to be based on proximity to student housing. As the Promontory housing is part of the campus, the Promontory parking area supply was included and assumed to be the same as the existing, 382 spaces. The remaining residential parking spaces are expected to be co-located with the General Parking area along General Jim Moore Boulevard north of Fifth Street (Parking Area 1), which includes both academic and residential parking uses. **Table 21** summarizes the parking supply for the residential uses on campus.

TABLE 21: FUTURE RESIDENTIAL PARKING SUPPLY BY PARKING ZONE – BASE SCENARIO

Parking Area	Percent of Total Trips	Future Residential Parking (parking spaces)
Parking Area 1	76%	1,234
Parking Area 7	24%	382
Total	100%	1,616

Source: CSUMB, June 2018. Fehr & Peers, 2019.



As shown on **Table 22**, the future academic parking supply is estimated to be 4,758 spaces and the projected future residential parking supply would need to be 1,616 spaces assuming existing parking management and TDM measures. Thus, a total future supply of 6,374 spaces would be needed, which is 1,653 more than the existing inventory.

TABLE 22: EXISTING AND FUTURE (BASE SCENARIO) PARKING SUPPLY SUMMARY

Parking Type	Existing (parking spaces)	Future Parking Supply Base Scenario (parking spaces)
Academic	3,730	4,758
Residential	991	1,616
Total	4,721	6,374

Source: CSUMB data received May 2018. Fehr & Peers, 2019.

The future parking supply was estimated based on the Draft EIR Figure 3-7 parking land area allocation (acres). It was then assumed there would be 125 parking spaces per acre. This estimated future parking supply based on land area produces 5,651 parking spaces and is summarized by parking area below in **Table 23**. The future parking supply estimated by campus population growth under the Base Scenario is presented for comparison purposes.

TABLE 23: FUTURE PARKING SUPPLY BY PARKING ZONE (LAND AREA ALLOCATION AND BASE SCENARIOS)

Parking Area	Land Area Allocation Parking Supply Scenario (parking spaces) ¹	Future Parking Supply Base Scenario (parking spaces) ²
Parking Area 1	1,250	2,424
Parking Area 2	1,188	714
Parking Area 3	463	760
Parking Area 4	1,450	1,380
Parking Area 5	500	333
Parking Area 6	375	381
Parking Area 7	425	382
Total	5,651	6,374

Notes:

1. Land Area Allocation Parking Supply Scenario estimated by the CSUMB Master Plan land area allocation provided by CSUMB in June 2018.
2. Future Parking Supply Base Scenario estimated by campus population growth in a business as usual case based on methodology described in **Chapter 7** and tables shown in **Appendix I**.

Source: CSUMB, June 2018. Fehr & Peers, 2019.



The future parking supply base scenario which is estimated based on campus population growth would be 723 spaces greater than the land area allocation parking supply scenario based on the Master Plan land use map (PDF-LU-1).²⁴ Since the existing and proposed student housing would be located close to Parking Area 1 and a quarter of Project off-campus travel is expected to travel to Parking Area 1, the “needed” future parking supply at Parking Area 1 is expected to be higher than the other parking areas and, therefore, potentially more of the nearby land would need to be dedicated to provide parking.

Table 24 shows the summary of the academic and residential parking supply for the three scenarios.

TABLE 24: FUTURE PARKING SUPPLY SUMMARY (FUTURE PARKING SUPPLY BASE SCENARIO, LAND AREA ALLOCATION PARKING SUPPLY SCENARIO, AND MASTER PLAN VISION)

Parking Type	Future Parking Supply Base Scenario	Land Area Allocation Parking Supply Scenario	Master Plan Vision - Maintain Existing Parking Supply Scenario
Academic	4,758	4,451	3,730
Residential	1,616	1,200	991
Total	6,374	5,651	4,721

Source: CSUMB data received May 2018. Fehr & Peers, 2019.

CSUMB would manage the future parking supply by implementing parking and Transportation Demand Management programs and policies that focus on reducing the academic and residential parking demand, per PDF-MO-1. CSUMB campus is developing parking and TDM guidelines, *California State University, Monterey Bay Housing and Parking Management Guidelines, 2021 (Appendix J)*, to inform parking management and TDM programs and policies as part of PDF-MO-1. This guideline introduces the requirement for freshman and sophomores and 90 percent of internal program students to live in on-campus housing, and restricting freshman and sophomores from parking on campus and purchasing parking permits. Several parking pricing and management strategies that could be considered as part of this guideline and incorporated into the development of the parking management plan and TDM programs and policies as part of PDF-MO-1 include the following:

- Adjusting the cost of parking permits – This strategy could include higher cost for on-campus resident parking permits, tiered parking pricing based on the distance to the Main Campus core, and/or a tiered pricing from limited days (1-day, 2-day, etc.). These parking strategies would reduce the residential and academic parking demand.
- Establishing designated parking locations by academic program – This parking management strategy would help manage the academic parking demand.

²⁴ 6,374 parking spaces – 5,651 parking spaces = 723 parking spaces



- Restrict East Campus parking on the Main Campus – This parking management strategy would help manage staff and faculty demand of academic parking on the Main Campus.

MAIN CAMPUS INBOUND AM PEAK HOUR MODE SHARE

As a part of the TA, CSUMB conducted a person travel survey to gather data on existing mode shares. The results were used to estimate the future (with Project) mode shares. The results show that the CSUMB Main Campus would achieve a combined drive alone and shared ride mode share of 46.5 percent by housing more than half of the CSUMB population on-campus, and there is an opportunity for an enhanced TDM plan to reduce the drive alone usage for students, faculty, and staff living off-campus.

The CSUMB Person Travel Survey was conducted in Fall 2017 to better understand the travel choices of CSUMB students, faculty, and staff (refer to **Appendix A** for the sample person travel survey and the trip generation and mode share results). The Existing Conditions and estimated Project Conditions AM peak period inbound person mode shares for CSUMB students, faculty, and staff living on-campus, in East Campus or off-campus are shown in **Table 25**. Under Existing Conditions, the combined drive-alone and shared ride mode share is 62.5 percent while under Project Conditions the combined drive-alone and shared ride mode share is estimated to be less than 47 percent.

TABLE 25: AM PEAK PERIOD INBOUND PERSON MODE SHARE FOR ALL CSUMB STUDENTS, FACULTY AND STAFF

Mode	Existing Conditions ³	Project Conditions ⁴
Drive Alone ¹	53.8%	41.2%
Shared Ride ²	8.7%	5.3%
Sub-Total	62.5%	46.5%
Transit	9.6%	4.6%
Walk	24.2%	40.7%
Bicycle	3.1%	7.3%
Other	0.6%	0.9%

Notes:

1. Drive alone includes motorcycles.
2. Shared ride includes carpooling, vanpooling, drop-off, transportation network companies like Uber and Lyft, and taxis.
3. Existing Conditions mode share summarized from **Tables C-8** and **C-9** of the *CSUMB Master Plan EIR – Trip Generation Evaluation Methods and Estimates* memorandum in **Appendix E** of this TA.
4. Project Conditions mode share accounts for 75 percent reduction in Main Campus student internal vehicle trips due to the change in parking locations. Weighted average AM peak period inbound person mode share of CSUMB students, faculty, and staff using Project Conditions campus populations estimates summarized in **Table 1** and person mode share data from **Table C-7** (of the *CSUMB Master Plan EIR – Trip Generation Evaluation Methods and Estimates* memorandum in **Appendix A** of this TA) except student Main Campus mode share is adjusted as follows: from 12.4% to 3.1% for Drive-Alone; from 6.0% to 1.5% for Shared Ride; 4.6% transit; from 70.3% to 77.3% for walk; from 5.1% to 12% for bicycle; and 1.5 % for other to account for Satellite Campus parking locations.
5. Mode share goal expressed in Figure 7.7 of the *CSUMB Master Plan* (June 2017). This mode share applies to off-campus residents.

Source: Fehr & Peers, 2019.



Under Project Conditions, Main Campus student internal vehicle trip generation rates would be reduced due to two factors, both of which disincentivize vehicle use on campus. The first is that parking will be consolidated and relocated to select areas on the periphery of the campus core, less convenient locations for Main Campus students. Second, new infill student housing will be sited close to the academic core. Both of these changes are expected to shift student travel from vehicles to more convenient on-campus transit, bicycling, walking, and other non-vehicular modes of travel. Correspondingly, the Main Campus student internal vehicle trip generation rates were reduced by 75 percent, which was estimated from existing Main Campus student characteristics from the CSUMB Person Travel Survey. As shown in **Table 25**, the AM peak period inbound drive-alone and shared-ride mode share to Main Campus under Existing Conditions (62.5 percent) would be reduced under Project Conditions (46.5 percent).

The above discussion combines the travel behavior of on-campus and off-campus residents. As shown in the *CSUMB Master Plan EIR – Trip Generation Evaluation Methods and Estimates* memorandum in **Appendix A** of this TA, student, faculty, and staff residents living on-campus drive far less than those living off-campus. Most off-campus student, faculty, and staff residents drive to the CSUMB Main Campus (refer to **Table 26**). The AM inbound drive-alone and shared-ride mode share to Main Campus under Existing Conditions (85.0 percent) would increase under Project Conditions (93.1 percent). This increase is due to faculty and staff who would be housed here driving more to the Main Campus as compared to students who currently live in East Campus housing. As a point of reference, the average combined work trip mode share for Monterey County or Santa Cruz County is 80 percent to 95 percent drive-alone and shared-ride (refer to the *CSUMB Master Plan EIR – Trip Generation Evaluation Methods and Estimates* memorandum in **Appendix A** of this TA). The parking management and TDM programs to be developed as part of PDF-MO-1 could help reduce the vehicle trips generated by students, faculty, and staff living at the East Campus or Off-Campus under Project Conditions by 5 to 10 percentage points.



TABLE 26: AM PEAK PERIOD INBOUND PERSON MODE SHARE FOR CSUMB STUDENTS, FACULTY AND STAFF RESIDENTS OF EAST CAMPUS AND OFF-CAMPUS

Mode	Existing Conditions ³	Project Conditions ⁴
Drive Alone ¹	75.0%	83.6%
Shared Ride ²	10.0%	9.5%
Sub-Total	85.0%	93.1%
Transit	12.2%	4.5%
Walk	0.5%	0.3%
Bicycle	2.1%	2.0%
Other	0.1%	0.1%

Notes:

1. Drive alone includes motorcycles.
2. Shared ride includes carpooling, vanpooling, drop-off, transportation network companies like Uber and Lyft, and taxis.
3. Existing Conditions and Project Conditions mode share summarized from **Tables C-9** and **C-11** of the *CSUMB Master Plan EIR – Trip Generation Evaluation Methods and Estimates* memorandum in **Appendix A** of this TA.
4. Weighted average AM peak period inbound person mode share of CSUMB students, faculty, and staff using Project Conditions campus populations estimates summarized in **Table 1** and person mode share data from **Table C-7** (of the *CSUMB Master Plan EIR – Trip Generation Evaluation Methods and Estimates* memorandum in **Appendix A** of this TA). Person mode share includes East Campus and Off-Campus residents.

Source: Fehr & Peers, 2019.

PROJECT PDFS TO REDUCE PROJECT VEHICLE TRIPS AND VMT

While the Project would not result in significant impacts relative to vehicle travel as determined by the previously presented impact analysis, the CSUMB intends to further develop and implement Parking Management and TDM policies per PDF-MO-1 that would further reduce vehicle trips and VMT. Revisions of the Project PDFs to include the following would assist in achieving these goals (PDF-MO-1 to PDF-MO-6 shown).

PDF-MO-1: TDM Plan – *The campus will continue to implement, enhance, and expand TDM strategies to reduce single-occupant vehicle trips as part of a formal TDM Plan. The TDM Plan will include the following components:*

- TDM Strategies - *Expand upon existing alternative transportation programs (carshare, universal transit pass, late night CSUMB-specific Line 19 downtown Monterey shuttle, Otter Cycle Center, bike rentals, bike repair, guided bike tours, and bike counter bike/scooter share programs) by using strategies taken from the CSU Transportation Demand Management (TDM) Manual (2019/2012) as a guide for project and program development.*
- Commuter Travel An Incentives Program - *Reduce commuter dependency on single-occupancy vehicle travel. Establish and promote an incentives-based commuter program*



to encourage students, faculty and staff commuters to carpool and take ~~alternative~~**active and transit** modes of travel to campus.

- c. Parking Management - ~~Develop parking management~~ Implement strategies and measures to **reduce parking demand**, including the following:
- Consolidate ~~general~~**academic** and/or residential parking on the periphery of the campus **and remove non-essential parking lots from the campus core** per Figure 3-9. (See also PDF-MO-2 for information about multimodal hubs.)
 - **Maintain the existing parking supply of 4,721 parking spaces at the consolidated lots by**
 - **implementing strategies, including, but not limited to, increased parking prices**
 - **and Restrict the number of permits restrictions for allocated to fFreshmen and sSophomores.**
 - Establish residential parking in proximity to new student residential development.
 - Establish parking permit programs/restrictions and lot assignments that discourage movement of vehicles between campus parking **locations (i.e., establish "park once" policy), Main and East Campus housing**, and encourage ~~alternative~~**active and transit** modes of travel.
 - ~~Establish~~ Designated parking stalls **in preferred locations** for the promotion of carpooling, vanpooling, ridesharing and low and zero emission vehicles.
 - Allow limited special parking stalls throughout campus to accommodate accessible and service vehicles, deliveries, loading and unloading activities.
- d. Transit Services - Analyze unmet transit needs and expand transit services in collaboration with MST and other local agencies as needed to provide the level of off-campus connections, inter-campus circulation and para-transportation identified in the TDM plan. (See also PDF-MO-7 through PDF-MO-11 for more information about transit services.)
- e. Bicycle and Pedestrian Improvements – Identify, prioritize, and design bicycle and pedestrian improvements **and create a separated trail network as shown in the Master Plan Guidelines** using connecting landscape features where appropriate. Implement improvements as part of nearby capital projects, where possible. Provide a maintenance plan that creates a system for maintaining pavement quality, signage, bicycle racks and painted markings. (See also PDF-MO-12 and PDF-MO-13 below.)



- f. Monitoring - ~~Maintain an annual~~**Conduct periodic** campus-wide travel surveys to collect data on **Main-Campus CSUMB student and faculty/staff** transportation behavior, experiences, ~~and,~~ mode preferences, and ~~to monitor,~~ mode **sharesplit**.
- g. TDM Program Administration - Expand and manage TDM services and programs. Establish new staff position(s) to coordinate TDM services and programs, and encourage office administration roles to take on advocacy roles for these programs within their offices. Establish an annual budget for non-capital transportation facilities maintenance and upgrades, planning, and TDM programs.

PDF-MO-2: Multimodal Infrastructure - Expand the campus ~~transportation system~~ multimodal **transportation system** infrastructure and programs. Establish two multimodal hubs, consistent with Figure 3-9, to provide centralized arrival points on campus from the four campus entries. The multimodal hubs will prioritize regional transit connections, shuttle service, carsharing, and visitors.

PDF-MO-3: Vehicle Restrictions - Establish restrictions to general vehicle travel through the campus core and locate vehicle circulation and parking on the campus periphery consistent with Figure 3-9. Establish consistent place-making roadway barriers, signs and landscaping to communicate restricted access roadway entrances. Eliminate the use of bollards, k-rails or industrial looking measures to restrict vehicle access. Maintain traffic speeds at safe levels for all road users and implement traffic calming measures where vehicle behavior routinely exceeds safe levels.

PDF-MO-4: Campus Entries - Create four major entries with signs which lead to two key arrival areas, including: Divarty Street and General Jim Moore Boulevard on the west side (Peninsula Gateway) and Inter-Garrison Road and Sixth Avenue on the east side (Valley Gateway) (see Figure 3-9).

PDF-MO-5: Wayfinding - Expand and maintain a comprehensive regional wayfinding sign sequence, in coordination with state and local agencies, from the primary campus entrances, to campus parking locations.

PDF-MO-6: Design Standards - Pursue universally accessible design throughout campus.

PDF-MO-14: Avoid Construction Conflicts - When construction projects require significant work within existing roadways CSUMB will require the design team and/or the project contractor and their qualified registered Civil Engineer to implement a construction traffic control plan. This requirement will be incorporated into construction bid packages. The plans will conform with the current version of the State of California Department of Transportation Standard Specifications, where applicable, and will be reviewed and approved by CSUMB prior to



implementation. The traffic control plan will include any detour plans and/or temporary traffic control devices warranted, per the current version of the California Manual on Uniform Traffic Controls Devices to provide for public safety, maintenance of access, temporary roadway closures, if needed, and construction-area signage. CSUMB shall inform emergency services of any roadway or lane closures and alternative travel routes to ensure adequate access for emergency vehicles when construction projects would result in temporary lane or roadway closures.



7. OPERATIONS ANALYSIS AND PROJECT TRAFFIC FORECASTING METHODS (FOR INFORMATIONAL PURPOSES ONLY)

The following analysis is presented for informational purposes only; that is, for purposes of CEQA analysis, impacts relating to vehicle travel are assessed based on VMT consistent with the requirements of the recently revised CEQA Guidelines (refer to **Chapter 5**). The analyses presented here are used to evaluate the traffic operations of study intersections, freeway segments, and freeway ramps within the context of level of service (LOS), which is no longer the metric used in assessing impacts relative to CEQA.

TRAFFIC ANALYSIS METHODS

The operations of roadway facilities are presented here within the context of LOS, a qualitative description of vehicular traffic flow based on factors such as speed, travel time, delay, and freedom to maneuver. Six levels are defined from LOS A, which reflects free-flow conditions where there is very little interaction between vehicles, to LOS F, where the vehicle demand exceeds the capacity and high levels of vehicle delay result. LOS E represents “at-capacity” operations. When traffic volumes exceed the capacity at an intersection, vehicles may wait through multiple signal cycles before traveling through the intersection; these operations are designated as LOS F. Examples of the various levels of service for a signalized intersection are illustrated in **Figure 13**.

SIGNALIZED INTERSECTIONS

For purposes of this analysis, the LOS method for signalized intersections is based on average control vehicular delay, as described in Chapter 18 of the *2010 Highway Capacity Manual (HCM)* by the Transportation Research Board. Control delay includes initial deceleration delay, queue move-up time, stopped delay, and final acceleration delay. The average control delay for signalized intersections is calculated using the Synchro analysis software and is correlated to a LOS designation as shown in **Table 27**.

When conducting a LOS analysis, CSUMB uses a LOS D standard for local streets, as presented in the *California State University Transportation Impact Study Manual* (2012). Local streets in Marina and Monterey County have a LOS D standard, while Seaside has established a LOS C standard, and Caltrans uses a LOS C/D standard.



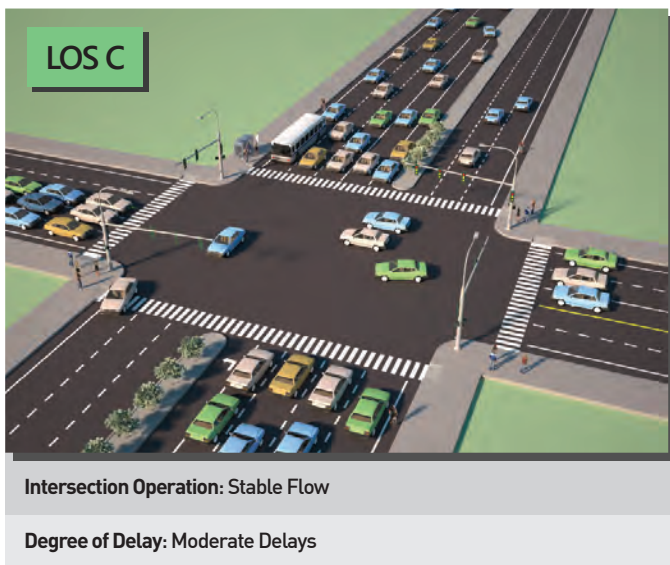
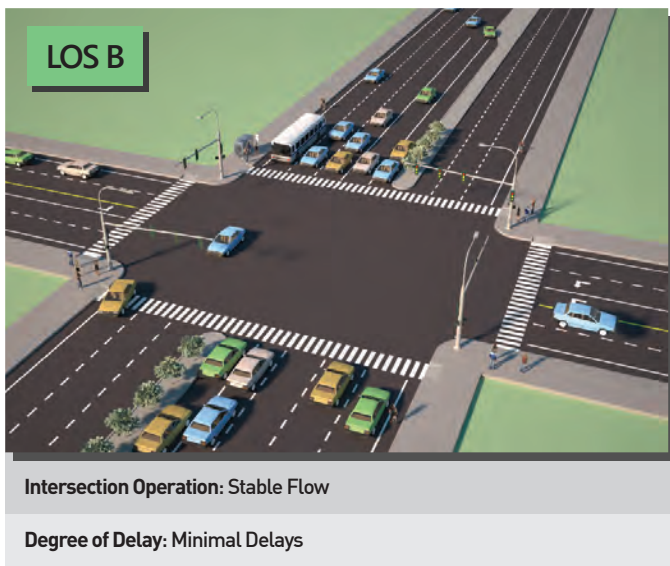

Figure 13
 Signalized Intersection Level of Service Examples

TABLE 27: SIGNALIZED INTERSECTION LEVEL OF SERVICE DEFINITIONS

Level of Service	Description	Average Control Delay Per Vehicle (Seconds)
A	Operations with very low delay occurring with favorable progression and/or short cycle lengths.	≤ 10.0
B	Operations with low delay occurring with good progression and/or short cycle lengths.	> 10.0 to 20.0
C	Operations with average delays resulting from fair progression and/or longer cycle lengths. Individual cycle failures begin to appear.	> 20.0 to 35.0
D	Operations with longer delays due to a combination of unfavorable progression, long cycle lengths, and/or high volume-to-capacity (V/C) ratios. Many vehicles stop and individual cycle failures are noticeable.	> 35.0 to 55.0
E	Operations with long delays indicating poor progression, long cycle lengths, and high V/C ratios. Individual cycle failures are frequent occurrences.	> 55.0 to 80.0
F	Operations with delays unacceptable to most drivers occurring due to over saturation, poor progression, or very long cycle lengths.	> 80.0

Source: *Highway Capacity Manual*, Transportation Research Board, 2010.

UNSIGNALIZED INTERSECTIONS AND ROUNDABOUTS

Operations of the unsignalized study area intersections and roundabouts were evaluated using the methods contained in Chapters 19, 20, and 21 of the *2010 HCM* and calculated using Synchro analysis software. LOS ratings for stop-sign controlled intersections are based on the average control delay expressed in seconds per vehicle. At two-way or side-street-stop controlled intersections, control delay is calculated for each movement, not for the intersection as a whole. For approaches composed of a single lane, control delay is computed as the average of all movements in that lane. For all-way stop-controlled and roundabout locations, a weighted average delay for the entire intersection is presented. **Table 28** summarizes the relationship between delay and LOS for unsignalized intersections and roundabouts.

CSUMB does not have an adopted LOS policy for unsignalized intersections; however, CSUMB strives to maintain LOS D, which is a LOS standard that has been used in other traffic studies on the CSUMB campus. A typical improvement for unsignalized intersections is to install traffic signals. However, unsignalized intersections that operate at LOS E, or have critical movements that operate at LOS E, may not meet warrants established for the consideration of signalization. Therefore, for this analysis, a LOS F operation and fulfilling the peak hour signal warrant is the threshold for an intersection improvement. For two-way stop-controlled intersections, this analysis also determines the need for improvements based on turn movement operations



(such as queues overflowing the storage capacity) as well as peak hour traffic signal warrant analyses described below from the *California Manual on Uniform Traffic Control Devices (CA MUTCD)*.¹

Warrant 3 – Peak hour vehicle volume

This warrant determines if the minor street traffic suffers undue delay when entering or crossing the major street for a minimum of one hour of an average day. This is based on the major street left-turn volume, the higher-volume minor-street approach volume, and calculated delay for vehicles on the higher-volume minor-street approach.

TABLE 28: UNSIGNALIZED INTERSECTION AND ROUNDABOUT LEVEL OF SERVICE DEFINITIONS

Level of Service	Description	Average Control Delay Per Vehicle (Seconds)
A	Little or no delays	≤ 10.0
B	Short traffic delays	> 10.0 to 15.0
C	Average traffic delays	> 15.0 to 25.0
D	Long traffic delays	> 25.0 to 35.0
E	Very long traffic delays	> 35.0 to 50.0
F	Extreme traffic delays with intersection capacity exceeded	> 50.0

Source: *Highway Capacity Manual*, Transportation Research Board, 2010.

FREEWAY SEGMENTS

Freeway mainline segments were analyzed using the methods described in Chapter 11 of *HCM 2010*. This method takes into consideration peak hour traffic volumes, free-flow speeds, percentage of heavy vehicles, and number of travel lanes. These factors are used to determine the vehicle density, measured in passenger cars per mile per lane. The ranges of densities for freeway segment levels of service are shown in **Table 29**. The Caltrans standard for the freeway segments is LOS C/D threshold.

¹ Signal warrant analysis is intended to examine the general correlation between the planned level of future development and the need to install new traffic signals. It estimates future development-generated traffic compared to a sub-set of the standard traffic signal warrants recommended in the 2014 *California Manual on Uniform Traffic Control Devices (CA MUTCD)* guidelines. While satisfying one or more of these warrants could justify the installation of a signal at an intersection, this analysis should not serve as the only basis for deciding whether and when to install a signal. To reach such a decision, the full set of warrants should be investigated by an experienced engineer based on field-measured rather than forecast traffic data and a thorough study of traffic and roadway conditions. Furthermore, the decision to install a signal should not be based solely upon the warrants, since the installation of signals may lead to certain types of collisions.



TABLE 29: FREEWAY SEGMENT LEVEL OF SERVICE DEFINITIONS

Level of Service	Density (passenger cars per mile per lane)
A	≤ 11
B	11.1 to 18.0
C	18.1 to 26.0
D	26.1 to 46.0
E	46.1 to 58.0
F	> 58.0

Source: Highway Capacity Manual, Transportation Research Board, 2010.

FREEWAY ON- AND OFF-RAMPS

To identify the need for an additional freeway on- or off-ramp lane, maximum peak-hour capacity of 1,500 vehicles per hour per lane (veh/hr/ln) and 1,200 veh/hr/ln was used in analyzing direct and loop freeway ramps, respectively. These are planning-level thresholds and are intended to identify potential operational issues.

PROJECT TRAFFIC VOLUMES

For the purpose of this analysis, the amount of traffic associated with the Project was estimated using a three-step process:

1. **Trip Generation** – The *number* of vehicles that would be entering/exiting the Project site with the increased campus population was estimated. (Refer to the *California State University, Monterey Bay Master Plan EIR – Trip Generation Evaluation Methods and Estimates* memorandum in **Appendix A** for a detailed description of the trip generation analysis).
2. **Trip Distribution** – The *directions* that vehicles would use to approach and depart the Project site were projected using the AMBAG travel model.
3. **Trip Assignment** – The number of vehicles that would be generated by the Project was then *assigned* to specific streets and intersection turning movements based on the AMBAG travel model and forecasting methods.

Each of these steps in the process is further described in the following sub-sections.

TRIP GENERATION

The trip generation approach and technical methods were tailored for the Project because of the size of the CSUMB campus, the unique travel behavior of each portion of the CSUMB population, and varied housing



locations of the CSUMB population. In establishing conditions tailored for the Project, the project trip generation is based on observed CSUMB travel characteristics and the assumption that the existing Parking Management and TDM measures would remain in place on the CSUMB campus, and those measures continue to be effective in reducing vehicle trip making and encourage the use of other modes of travel. Rather than calculating the net increase in Project vehicle trips due to the net increase in land uses like most projects, trip generation was prepared for the entire campus under both Existing Conditions and Project Conditions to capture the effects of increasing on-campus housing and shifting of student housing from East Campus to Main Campus. Specifically, the net new Project traffic is the difference in the Project Conditions and Existing Conditions CSUMB campus trip generation. As shown in the analysis, housing an average of 61 percent of the future campus population (students, faculty, and staff) on-campus increases the:

- Likelihood of trips staying within the campus (internal trips); and
- Likelihood of trips shifting to other modes (walking, bicycling, micro-mobility¹, and transit) for both on and off-campus travel.

A detailed discussion of the CSUMB trip generation can be found in the *California State University, Monterey Bay Master Plan EIR – Trip Generation Evaluation Methods and Estimates* memorandum (refer to **Appendix A**). Total vehicle trip generation for the CSUMB campus under Existing Conditions and Project Conditions are presented in **Table 30** and **Table 31**, respectively. As shown, the total trip generation estimates are provided for the Main Campus and East Campus separately, as well as total numbers for the entire campus. Adjustments to account for internal trips are also illustrated.

¹ Micro-mobility is an emerging mode of travel that is characterized by new electric lightweight utility vehicles such as e-scooters and e-bikes.



TABLE 30: EXISTING CONDITIONS VEHICLE TRIP GENERATION FOR CSUMB CAMPUS

Location Type	Trip Type ¹	Daily	AM Peak Hour			PM Peak Hours		
			Total	In	Out	Total	In	Out
Main Campus								
Promontory Housing Internal Trips ²	E	142	12	11	1	8	1	7
Main Campus Internal Trips ³	D	669	272	148	124	140	63	77
Main Campus External Trips	A	10,029	919	633	286	1,005	432	573
Main Campus Trips with East Campus	C	2,171	317	263	54	307	93	214
Main Campus Total [A] A+C+D+E		13,011	1,520	1,055	465	1,460	589	871
East Campus								
East Campus Trips with Main Campus	C	2,171	317	54	263	307	214	93
East Campus External Trips	B	7,846	482	80	402	452	270	182
East Campus Total [B] B+C		10,017	799	134	665	759	484	275
Internal Trip Adjustment								
Promontory Housing Internal Trips	E	-142	-12	-11	-1	-8	-1	-7
Main Campus Internal Trips ³	D	-669	-272	-148	-124	-140	-63	-77
Main Campus Trips with East Campus	C	-2,171	-317	-263	-54	-307	-93	-214
East Campus Trips with Main Campus	C	-2,171	-317	-54	-263	-307	-214	-93
Trip Adjustment [C] C+D+E		-5,153	-918	-476	-442	-762	-371	-391
External Campus Trip Total [A+B+C]⁴	A+B	17,875	1,401	713	688	1,457	702	755

Notes:

1. Trip type shown on Figure 1 in **Appendix A**.
 2. Promontory Housing is an existing residential building for on-campus student residents and is located on Eighth Street in the Main Campus.
 3. Main Campus Internal Trips = Main Campus Students and Campus Supporting Trips.
 4. The campus trip generation is the sum of all Main Campus and East Campus external vehicle trips generated by students, faculty, staff, and visitors.
- Source: Fehr & Peers, 2019.

As shown in **Table 30**, for the purpose of the analysis presented here, existing external vehicle trip generation is calculated as approximately 17,875¹ daily vehicle trips, 1,401 AM peak-hour trips (713 inbound and 688 outbound) and 1,457 PM peak-hour trips (702 inbound and 755 outbound).

As shown in **Table 31**, under Project Conditions the campus external vehicle trip generation would increase to approximately 30,385 daily vehicle trips, 2,290 AM peak-hour trips (1,188 inbound and 1,102 outbound) and 2,495 PM peak-hour trips (1,203 inbound and 1,292 outbound).

¹ This excludes vehicle through trips not associated with the CSUMB campus.



TABLE 31: CSUMB CAMPUS VEHICLE TRIP GENERATION FOR PROJECT CONDITIONS

Trip Type	Trip Type ¹	Daily	AM Peak Hour			PM Peak Hours		
			Total	In	Out	Total	In	Out
Main Campus								
Promontory Housing Internal Trips	E	40	3	3	0	2	0	2
Main Campus Internal Trips ²	D	970	495	261	234	253	120	133
Main Campus External Trips	A	23,953	1,722	1,093	629	2,089	926	1,163
Main Campus Trips with East Campus	C	1,867	434	361	73	488	152	336
Main Campus Total [A]	A+C+D+E	26,830	2,654	1,718	936	2,832	1,198	1,634
East Campus								
East Campus Trips with Main Campus	C	1,867	434	73	361	488	336	152
East Campus External Trips	B	6,432	568	95	473	406	277	129
East Campus Total [B]	B+C	8,299	1,002	168	834	894	613	281
Internal Trip Adjustment								
Promontory Housing Internal Trips	E	-40	-3	-3	-0	-2	-0	-2
Main Campus Internal Trips ²	D	-970	-495	-261	-234	-253	-120	-133
Main Campus Trips with East Campus	C	-1,867	-434	-361	-73	-488	-152	-336
East Campus Trips with Main Campus	C	-1,867	-434	-73	-361	-488	-336	-152
Trip Adjustment [C]	C+D+E	-4,744	-1,366	-698	-668	-1,231	-608	-623
External Campus Trip Total [A+B+C]³	A+B	30,385	2,290	1,188	1,102	2,495	1,203	1,292

Notes:

1. Trip type shown on Figure 1 in **Appendix A**.
2. Main Campus Internal Trips = Main Campus Students and Campus Supporting Trips.
3. The campus trip generation is the sum of all Main Campus and East Campus external vehicle trips generated by students, faculty, staff, and visitors.

Source: Fehr & Peers, 2019.

The amount of Project traffic that would be added to the road network is estimated by subtracting campus-related trip generation under Existing Conditions from campus-related trip generation under Project Conditions. As shown in **Table 32**, based on this calculation, the Project would generate a total of 12,510 additional external daily trips, including 889 additional external AM peak hour trips and 1,038 additional external PM peak hour trips.

By housing a large percentage of students, faculty, and staff on-campus, and consolidating parking to the periphery, the Project would convert a large number of potential off-campus-based trips to on-campus generated trips, thereby reducing the number of external campus trips both to and from campus. Related, because of the increasing in the number of students living on-campus, the number of Project-generated external trips made by on-campus students for purposes such as recreational activities, off-campus dining, visiting family and friends, etc. would increase in absolute terms over existing levels.



TABLE 32: CSUMB CAMPUS VEHICLE TRIP GENERATION RESULTS

Scenario	Daily	AM peak Hour			PM Peak Hours		
		Total	In	Out	Total	In	Out
Existing Conditions [A]	17,875	1,401	713	688	1,457	702	755
Project Conditions [B]	30,385	2,290	1,188	1,102	2,495	1,203	1,292
Additional External Trips [B-A]	12,510	889	475	414	1,038	501	537

Source: Fehr & Peers, 2019.

TRIP DISTRIBUTION

Campus vehicle trips are generated by students, faculty, staff, community housing partners, campus support (trips made by police staff, maintenance, landscapers, custodians staff, etc.), and visitors traveling to/from the CSUMB campus. The AMBAG travel model was used to distribute the vehicle trips from the CSUMB campus to nearby communities for each analysis scenario (Existing Conditions, Existing with Project Conditions, Cumulative Conditions without Project, and Cumulative with Project Conditions). The distribution of Project traffic is described in detail in **Appendix F** and **Chapter 9**, and considered: 1) regional land use destinations outside of the Campus, and 2) ease and convenience of access to nearby freeways and regional streets.

The distribution of vehicle traffic going to/coming from the nearby communities of Castroville (and farther north), Marina, Salinas, Seaside, and Monterey to the CSUMB Campus is presented in **Table 33**. The distribution, as used in determine the study area, is summarized for the inbound direction during the AM peak hour and the outbound direction for the PM peak hour under Existing with Project Conditions and Cumulative with Project Conditions; the distribution of CSUMB campus traffic is similar during the AM and PM peak hours under each scenario.

As shown on **Table 33**, vehicle trips to/from the north account for 25 to 29 percent of all vehicle trips. The communities south of the CSUMB campus account for 36 to 39 percent of vehicle trips. Finally, communities east of the CSUMB campus (Salinas) account for 34 to 37 percent of the vehicle trips.



**TABLE 33: DISTRIBUTION OF CSUMB EXTERNAL VEHICLE TRIPS TO NEARBY COMMUNITIES
(AMBAG MODEL)**

Direction	Existing with Project Conditions		Cumulative with Project Conditions	
	AM Inbound Peak Hour	PM Outbound Peak Hours	AM Inbound Peak Hour	PM Outbound Peak Hours
North				
Castroville and North	18%	17%	20%	17%
Marina	9%	8%	9%	10%
North Total	27%	25%	29%	27%
East				
Salinas	37%	37%	34%	34%
East Total	37%	37%	34%	34%
South				
Seaside	13%	15%	14%	16%
Monterey and West	23%	23%	23%	23%
South Total	36%	38%	37%	39%

Source: Fehr & Peers, 2019.

Distribution to Main Campus Parking Areas

In this analysis it was assumed that once vehicles arrive on the Main Campus, drivers could use any one of the seven parking areas shown in **Figure 6**. The Project trips are distributed to these seven parking areas based on the parking area's proximity to the nearby communities, possible routings, estimated size of the parking areas provided by CSUMB, and vehicle occupancy (drive-alone, carpool or transit). The resulting distribution to each parking area is shown in **Table 34** and additional details and assumptions are provided in **Appendix I**.



TABLE 34: CSUMB MAIN CAMPUS TOTAL DAILY VEHICLE TRIPS

Parking Areas ¹	Number and Percent of Total Trips
1. General Parking (General Jim Moore/Fifth-Eighth)	6,961 (26%)
2. Multimodal Hub/Visitor & Carpool Parking (General Jim Moore/Divarty)	3,994 (15%)
3. Multimodal Hub/Visitor & Carpool Parking (Sixth/Inter-Garrison)	3,698 (14%)
4. General Parking (Seventh/A Street)	7,413 (28%)
5. Inter-Garrison Road between Second & General Jim Moore Boulevard	1,240 (5%)
6. Sixth Street between B and Colonel Durham Street	1,912 (7%)
7. Promontory	1,612 (6%)
Total	26,830 (100%)

Notes:

1. Further details on the Parking Areas are provided in **Chapter 6** section of the report and **Appendix I**.

Source: Fehr & Peers, 2019.

TRIP ASSIGNMENT

The trips generated by the Project were assigned to the roadway system based on the directions of approach and departure and the distribution to the on-campus parking lots. On-campus vehicle trip assignment was based on the vehicle paths shown in **Figure 14** and **Figure 15**. These parking area routes were determined in consideration of existing travel routes to/from the campus and proposed changes to the on-campus vehicle street system described in **Chapter 1**.



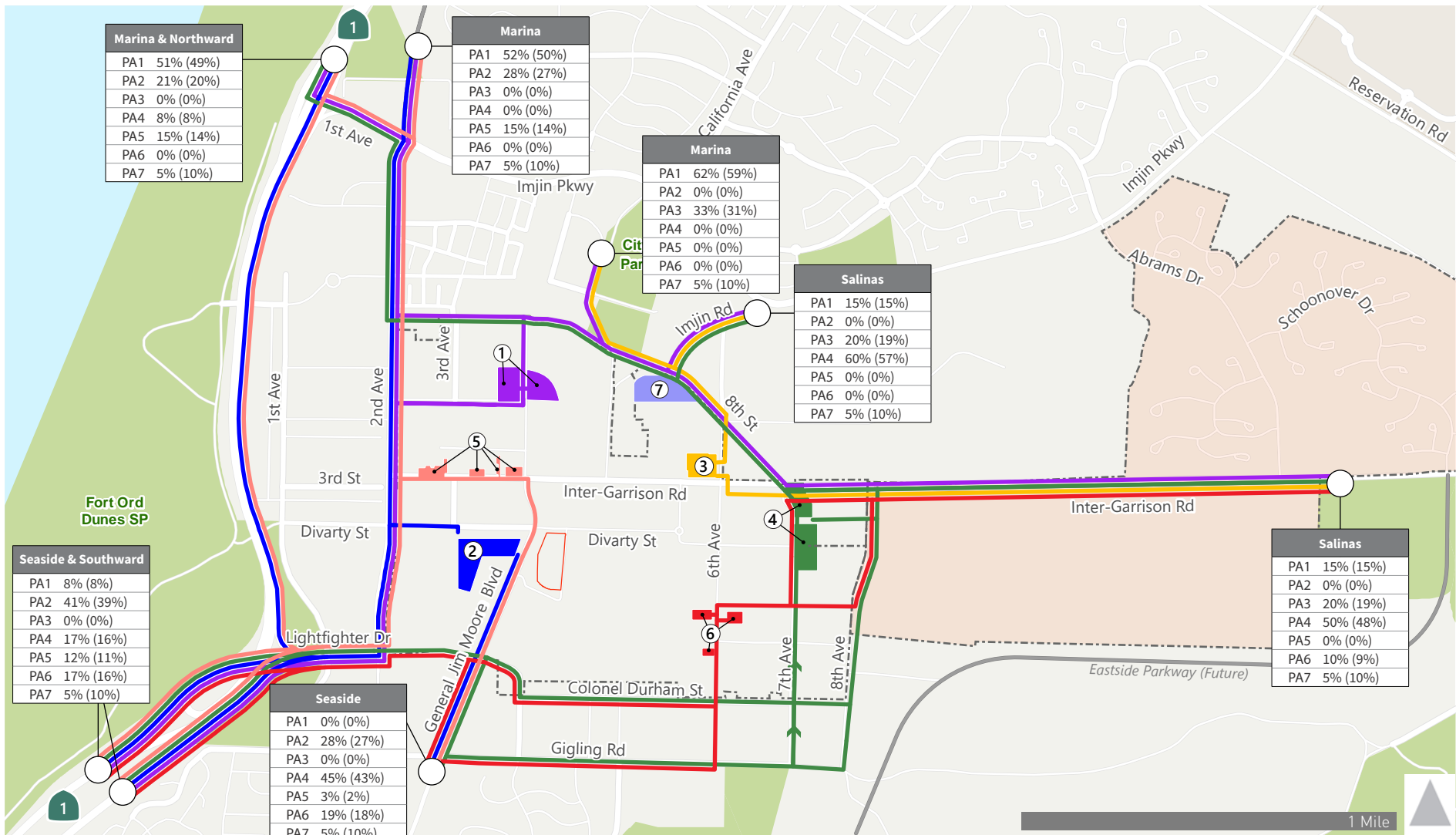

- California State University Monterey Bay Campus
- New/Extended Roadway
- Restricted Access Streets

Parking Area Route

- From/to Parking Area 1
- From/to Parking Area 2
- From/to Parking Area 3
- From/to Parking Area 4
- From/to Parking Area 5
- From/to Parking Area 6

Route Distribution

PA1	AM(PM)
PA2	AM(PM)
PA3	AM(PM)
PA4	AM(PM)
PA5	AM(PM)
PA6	AM(PM)



Figure 14
 Parking Area Ingress/Egress Routes for External Trips

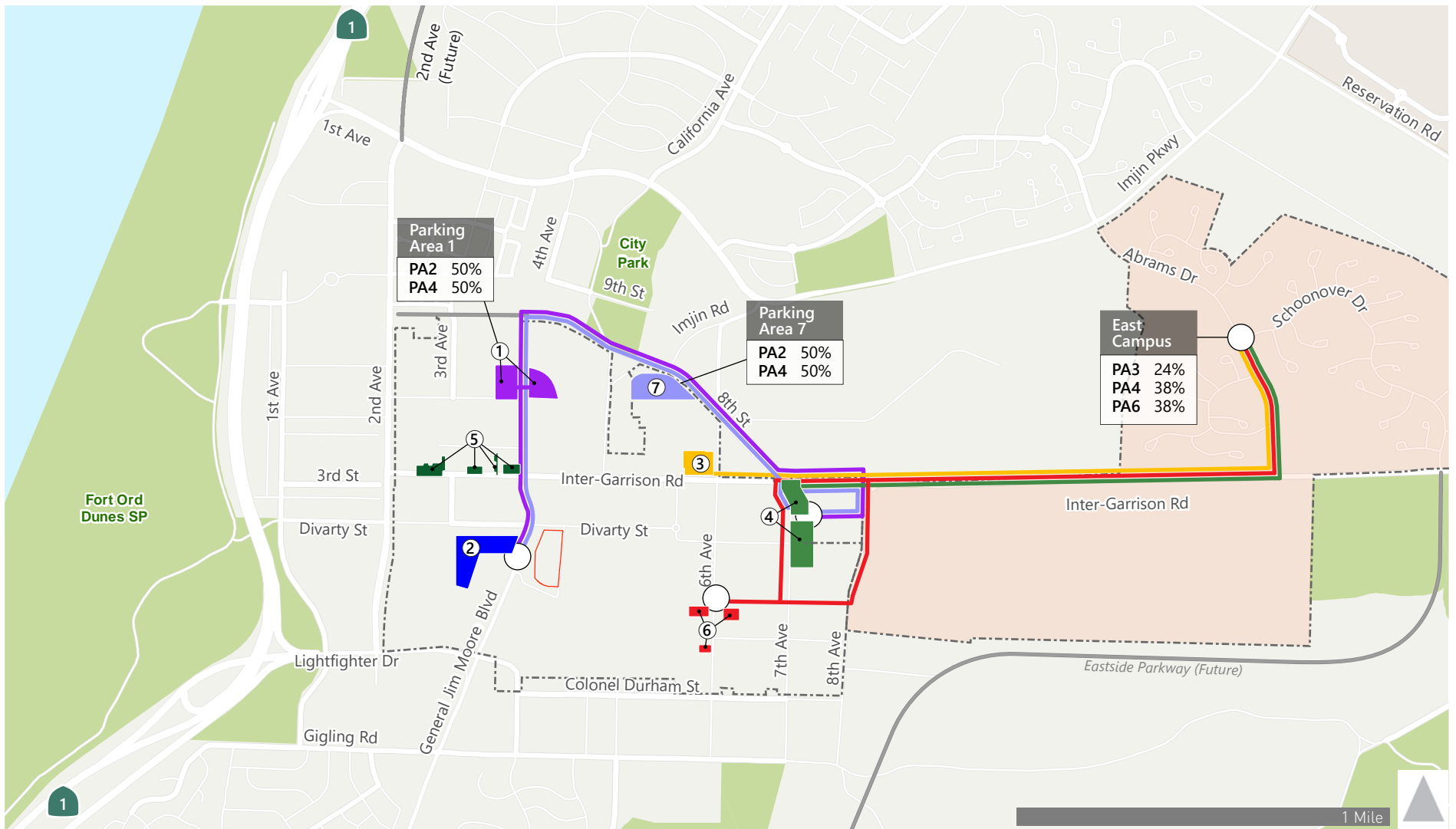

California State University Monterey Bay Campus

New/Extended Roadway

* Multi-modal Hub

** Staff/Faculty Parking

Parking Area Route

From/to Parking Area 1

From/to Parking Area 2

From/to Parking Area 3

From/to Parking Area 4

From/to Parking Area 5

From/to Parking Area 6

From/to Parking Area 7



Figure 15

Parking Area Ingress/Egress Routes for Internal Trips

8. EXISTING WITH PROJECT CONDITIONS (FOR INFORMATION PURPOSES ONLY)

This chapter evaluates the effects of the Project on the surrounding roadway system under Existing with Project Conditions and with the results of the level of service calculations. Existing with Project Conditions are defined as Existing Conditions with the addition of vehicle traffic generated by the Project and modifications to the existing campus parking and transportation facilities. Intersection and freeway segment deficiencies under this scenario are then identified by comparing the level of service results under Existing with Project Conditions to those under Existing Conditions.

EXISTING WITH PROJECT INTERSECTION LEVELS OF SERVICE

Level of service calculations were conducted to evaluate intersection operations under Existing with Project Conditions. The intersection volumes are shown in **Appendix K** and the results of the LOS analysis are summarized in **Table L-2** of **Appendix L**. The results for Existing Conditions are included for comparison purposes. The deficiency criteria in **Chapter 11** are used to identify deficiencies in the roadway system. The corresponding LOS calculation sheets are included in **Appendix E**.

The deficiencies identified in the with Project Condition on the surrounding transportation system, and recommended measures to improve deficiencies, are described in **Chapter 11**.

SIGNAL WARRANT ANALYSIS

For the purpose of this TA, the peak-hour signal warrant was evaluated for unsignalized intersections that operate below their designated LOS threshold under Existing with Project Conditions. The results of the peak-hour warrant analysis presented in **Table N-1** in **Appendix N** indicates the following intersections, which exceed their designated LOS threshold, would meet peak hour warrants:

- Int 16. Second Avenue and Eighth Street (AM and PM peak hour)
- Int 21. Eighth Street/Seventh Avenue and Inter-Garrison Road (PM peak hour)
- Int 22. Eighth Avenue and Inter-Garrison Road (AM and PM peak hour)
- Int 23. Abrams Drive and Inter-Garrison Road (AM and PM peak hour)
- Int 29. Second Avenue and Divarty Street (PM peak hour)
- Int 47. General Jim Moore Boulevard and Coe Avenue (AM and PM peak hour)

Although at the SR 1 Northbound Ramps and Imjin Parkway (Int. 4), the worst movement delay (northbound approach) exceeds the local jurisdiction's designated LOS threshold, the intersection does not meet the peak hour signal warrant as the minor street right turn volumes would be considered negligible. The right



turn volumes from the SR 1 Northbound off-ramp continue onto Imjin Parkway through an added lane without conflict to the eastbound through traffic entering the intersection on a separate receiving lane; therefore, based on guidance from CA MUTCD shown below the northbound approach is evaluated as a one-lane approach with only the northbound through and left turn traffic.

Section 4C.01.10

Similar engineering judgment and rationale should be applied to a street approach with one through/left-turn lane plus a right-turn lane. In this case, the degree of conflict of minor-street right-turn traffic with traffic on the major street should be considered. Thus, right-turn traffic should not be included in the minor-street volume if the movement enters the major street with minimal conflict. The approach should be evaluated as a one-lane approach with only the traffic volume in the through/left-turn lane considered.

EXISTING WITH PROJECT FREEWAY LEVELS OF SERVICE

Freeway segments of SR 1 were analyzed with the added Project traffic (refer to **Appendix M**). Results of the analysis identifying the segments exceeding Caltrans' standard are presented in **Table 35**. Measured against the Caltrans level of service standard, the following freeway segments exceed the level of service standard (that is, they operate at LOS D or worse):

- Southbound SR 1 between Reservation Road and Canyon Del Rey Boulevard during the AM peak hour (all 5 southbound SR 1 segments)
- Northbound SR 1 between Imjin Parkway and Lightfighter Drive during the PM peak hour
- Northbound SR 1 between Fremont Boulevard-Del Monte Boulevard and Canyon Del Rey during the PM peak hour

Freeway segment deficiencies and improvements are addressed in **Chapter 11**.



TABLE 35: EXISTING WITHOUT AND WITH PROJECT CONDITIONS FREEWAY SEGMENT LOS

Freeway Segment	Peak Hour ¹	Capacity	Existing without Project			Existing with Project			Project Percent of Capacity
			Volume	Density ^{2,3}	LOS ⁴	Volume	Density ^{2,3}	LOS ⁴	
State Route 1 – Southbound									
Reservation Road and Del Monte Boulevard	AM	4,700	2,705	29.1	D	2,790	30.4	D	1.6%
	PM		1,418	11.3	B	1,420	11.3	B	1.5%
Del Monte Boulevard and Imjin Parkway	AM	7,050	4,055	26.7	D	4,150	27.5	D	1.4%
	PM		2,088	11.3	B	2,110	11.5	B	1.3%
Imjin Parkway and Lightfighter Drive	AM	7,050	4,560	30.1	D	4,530	29.8	D	0.9%
	PM		2,859	15.5	B	2,820	15.3	B	0.2%
Lightfighter Drive and Fremont Boulevard-Del Monte Boulevard	AM	7,050	4,778	30.5	D	4,850	31.2	D	2.1%
	PM		3,177	16.9	B	3,720	17.4	B	1.9%
Fremont Boulevard-Del Monte Boulevard and Canyon Del Rey	AM	4,700	3,843	34.7	D	3,890	35.4	E	2.2%
	PM		2,629	21.2	C	2,700	21.7	C	2.3%
State Route 1 – Northbound									
Reservation Road and Del Monte Boulevard	AM	4,700	1,172	9.6	A	1,230	10.1	A	1.3%
	PM		2,671	21.2	C	2,790	22.1	C	1.9%
Del Monte Boulevard and Imjin Parkway	AM	7,050	1,725	9.9	A	1,790	10.3	A	1.0%
	PM		4,231	22.8	C	4,360	23.6	C	1.6%
Imjin Parkway and Lightfighter Drive	AM	7,050	2,397	13.6	B	2,410	13.7	B	0.3%
	PM		4,906	26.7	D	4,880	26.5	D	0.9%
Lightfighter Drive and Fremont Boulevard-Del Monte Boulevard	AM	7,050	2,708	15.2	B	2,810	15.7	B	1.7%
	PM		4,728	25.2	C	4,840	26.0	C	2.3%
Fremont Boulevard-Del Monte Boulevard and Canyon Del Rey Boulevard	AM	4,700	2,355	20.1	C	2,440	20.8	C	1.7%
	PM		3,745	32.1	D	3,820	33.1	D	3.5% ⁵

Notes: **Bold** text indicates below the applicable level of service standard (LOS D for Caltrans designated facilities). **Bold and highlighted text** indicates freeway segment deficiency as described in **Chapter 11**.

1. AM = AM peak hour, PM = PM peak hour.
2. Measured in passenger cars per mile per lane. Mixed = Mixed-Flow Lanes.
3. If volume/capacity ratio is greater than 1, density is not applicable.
4. Level of service (LOS) based on density.
5. The vehicle demand for the PM outbound peak hour direction of the next freeway segment (CA-1 between Canyon Del Rey and Casa Verde Way) is less than the project percent capacity. Therefore, the last freeway segment to be studied south of CSUMB campus is between Fremont Boulevard-Del Monte Boulevard and Canyon Del Rey Boulevard.

Source: Fehr & Peers, 2019.



EXISTING WITH PROJECT RAMP ANALYSIS

A freeway ramp analysis was conducted to assess changes in peak hour ramp volumes with the addition of Project traffic and its effects on freeway and local street operations. Ramp capacity is an operational consideration that is managed over time by Caltrans and local jurisdictions.

Freeway ramp segments to/from State Route 1 were analyzed during the AM and PM peak hours with added Project traffic. Results of the analysis identifying the ramps with volumes that exceed the ramp capacity are presented in **Table 36** and **Table 37**. Most of the ramp volumes increase in the Existing with Project Conditions, with the exception of the SR 1 and Imjin Parkway southbound on-ramp during both peak hours, and the SR 1 and Imjin Parkway northbound off-ramp during the PM peak hour. Decreases in volumes under Existing with Project Conditions are due to the displacement and reassignment of existing traffic when the Project volume is added to the roadway network.

As shown in **Table 36** and **Table 37**, under Existing with Project Conditions, all ramp volumes will be less than the ramp capacity during the AM and PM peak hours.

TABLE 36: EXISTING WITHOUT AND WITH PROJECT CONDITIONS RAMP AM PEAK HOUR VOLUMES AND CAPACITIES

Location	Direction	Ramp Type	Lanes	Capacity ¹	Existing without Project (vehicles per hour)	Existing with Project (vehicles per hour)
SR 1 and Imjin Parkway	NB	Diagonal On-Ramp	1	1,500	126	200
	SB	Diagonal On-Ramp	1	1,500	964	950
	NB	Diagonal Off-Ramp	2	3,000	805	830
	SB	Diagonal Off-Ramp	1	1,500	414	530
SR 1 and Lightfighter Drive	NB	Diagonal On-Ramp	1	1,500	197	220
	SB	Diagonal On-Ramp	2	3,000	739	850
	NB	Diagonal Off-Ramp	2	3,000	460	570
	SB	Loop Off-Ramp	1	1,200	431	440

Notes: **Bold** text indicates volumes above capacity.

1. Peak hour ramp capacity is 1,500 veh/hr/ln (vehicles per hour per lane) and 1,200 veh/hr/ln for diagonal and loop ramps, respectively.

Source: Fehr & Peers, 2019.



**TABLE 37: EXISTING WITHOUT AND WITH PROJECT CONDITIONS RAMP PM PEAK HOUR
VOLUMES AND CAPACITIES**

Location	Direction	Ramp Type ¹	Lanes	Capacity ¹	Existing without Project (vehicles per hour)	Existing with Project (vehicles per hour)
SR 1 and Imjin Parkway	NB	Diagonal On-Ramp	1	1,500	431	570
	SB	Diagonal On-Ramp	1	1,500	993	980
	NB	Diagonal Off-Ramp	2	3,000	1,192	1,170
	SB	Diagonal Off-Ramp	1	1,500	261	300
SR 1 and Lightfighter Drive	NB	Diagonal On-Ramp	1	1,500	661	670
	SB	Diagonal On-Ramp	2	3,000	538	680
	NB	Diagonal Off-Ramp	2	3,000	384	540
	SB	Loop Off-Ramp	1	1,200	167	180

Notes: **Bold** text indicates volumes above capacity.

1. Peak hour ramp capacity is 1,500 veh/hr/ln (vehicles per hour per lane) and 1,200 veh/hr/ln for diagonal and loop ramps, respectively.

Source: Fehr & Peers, 2019.



9. CUMULATIVE WITHOUT EASTSIDE PARKWAY CONDITIONS (FOR INFORMATION PURPOSES ONLY)

This chapter evaluates the effects of the Project on the surrounding roadway system under Cumulative without and with the Project Conditions and with the results of the level of service calculations. Cumulative traffic volumes are based on 2035 forecasts from the AMBAG travel model, including the land uses, and transportation network infrastructure described in the AMBAG constrained transportation list and modifications described in the *Association of Monterey Bay Area Governments Travel Model Validation* memorandum included in **Appendix F**. The peak hour vehicle trip estimates into and out of CSUMB are based on the Project vehicle trip estimates discussed in **Chapter 3**.

CUMULATIVE WITHOUT AND WITH PROJECT AND WITHOUT EASTSIDE PARKWAY CONDITIONS TRAFFIC VOLUMES

Cumulative without and with Project off-campus vehicle assignment was determined by the AMBAG travel model. On-campus vehicle trip assignment was refined using the Existing Conditions and Project Conditions trip generation described in **Chapter 3** and vehicle paths shown on **Figure 14** and **Figure 15**. Future model land use changes are described in **Appendix F** and roadway network changes are described below.

CUMULATIVE WITHOUT AND WITH PROJECT AND WITHOUT EASTSIDE PARKWAY CONDITIONS ROADWAY IMPROVEMENTS

The Cumulative without and with Project analysis adds cumulative volumes to the existing transportation network plus funded street improvements planned by the FORA¹, City of Marina, and the *2040 Metropolitan Transportation Plan / Sustainable Communities Strategy (2018)*. Intersection improvements incorporated into the Cumulative Conditions analysis are based on the funded roadways improvements described in **Table 13**: and presented in **Table 38**. The Cumulative with Project analysis also includes Project transportation facility changes to the campus as described in **Chapter 1** and shown on **Figure 6**.

¹ FORA will sunset on June 30, 2020, and transportation facilities in the FORA CIP is being assigned to the local jurisdiction.



TABLE 38: CUMULATIVE WITHOUT AND WITH PROJECT AND WITHOUT EASTSIDE PARKWAY CONDITIONS INTERSECTION IMPROVEMENTS

Project Number ¹	Project Name	Project Description	Sources ²			Intersection	Geometry Changes	Intersection Control Changes
			City ³	FORA ⁴	RTP ⁵			
City of Marina Capital Improvement Program								
R 05	Second Avenue Extension	Extend Second Avenue as a 2-lane arterial between Imjin Parkway and Reindollar Avenue	X	X	2	Patton Parkway and Second Avenue Extension	3-way signalized intersection (NB, SB, and EB legs), one lane in each direction with left turn pockets with 120 feet of vehicle storage	Signalized ⁶
R 34	Eighth Street	Upgrade/construct Eighth Street as a 2-lane arterial from Second Avenue to Inter-Garrison Road	X	X	16	Eighth Street and Second Avenue	Refer to Improvement R 61	Signalized
					18	Eighth Street and Imjin Road	SB: change from a shared through-left and right turn to one lane entering the roundabout EB: change from a shared through-left and right turn to one lane entering the roundabout WB: change from a shared through-left and right turn to one lane entering the roundabout	Roundabout
R 37	Patton Parkway Extension	Extension of Patton Parkway from Del Monte Boulevard to Crescent Street	X	X	2	Patton Parkway and Second Avenue Extension	Refer to Improvement R 05	Refer to Improvement 1



TABLE 38: CUMULATIVE WITHOUT AND WITH PROJECT AND WITHOUT EASTSIDE PARKWAY CONDITIONS INTERSECTION IMPROVEMENTS

Project Number ¹	Project Name	Project Description	Sources ²			Intersection	Geometry Changes	Intersection Control Changes
			City ³	FORA ⁴	RTP ⁵			
R 61 & TI 18	Second Avenue Widening	Widen Second Avenue from Tenth Street to Inter-Garrison Road. Remove Class II bike lanes and restripe for two lanes each direction	X			15 Ninth Street and Second Avenue	SB: change from a shared through-left and 1 right turn to 1 left, 1 through, 1 shared through-right NB: change from 1 left turn and 1 through-right to 1 left, 1 through and 1 a shared through-right	Signalized
						16 Eighth Street and Second Avenue	SB: Change to 2 through lanes and 1 left turn lane NB: Change to 1 through lane and 1 shared through-right	Signalized
						19 Inter-Garrison Road and Second Avenue	SB: from 1 left turn and 1 through to 1 left, 2 through lanes NB: from 1 through and 1 right turn lanes to 1 through and 1 shared through-right lanes	Signalized
TI 06	Traffic Intersection	Intersection Improvement	X			6 Imjin Parkway and Third Avenue	No geometry changes	Signalized
TI 09	Traffic Intersection	Intersection Improvement	X			7 Imjin Parkway and Fourth Avenue	No geometry changes	Signalized
TI 27	Traffic Intersection	Intersection Improvement	X			11 Imjin Parkway and Abrams Drive	Install double left turn lanes on Imjin Pkwy, left and right turn lanes on Abrams Drive	Signalized
TI 44	Traffic Intersection	Intersection Improvement	X			23 Inter-Garrison Road and Abrams Drive	Second SB left-turn.	Signalized



TABLE 38: CUMULATIVE WITHOUT AND WITH PROJECT AND WITHOUT EASTSIDE PARKWAY CONDITIONS INTERSECTION IMPROVEMENTS

Project Number ¹	Project Name	Project Description	Sources ²			Intersection	Geometry Changes	Intersection Control Changes	
			City ³	FORA ⁴	RTP ⁵				
TI 42 & TI 43	Traffic Intersection	Intersection Improvement	X		21	Inter-Garrison Road and Eighth Street/Seventh Avenue	Add EB and WB left-turn pockets <u>NB: 1 left turn lane, 1 through lane and 1 right turn lane</u> <u>SB: 1 left turn lane, and 1 shared through-right lane</u>	Signalized	
TI 45	Traffic Intersection	Intersection Improvement	X		29	Divarty Street and Second Avenue	No geometry changes	Signalized	
Fort Ord Reuse Authority (FORA)									
FO 6	Inter-Garrison Road Widening	Widen Inter-Garrison Road to a 4-lane arterial from Eastside Parkway to Reservation Road		X	25	Inter-Garrison Road and Inter-Garrison Road Connection	WB: 1 shared through-right EB: 1 left turn lane and 1 through lane	AWSC	
FO 7	Gigling Road	Widen Gigling Road to a 4-lane arterial from General Jim Moore Boulevard to Eastside Parkway near Eighth Avenue		X	39-44	Gigling from General Jim Moore Boulevard to Eastside Parkway	Add a through lane both EB/WB on Gigling	Signalized	
AMBAG Regional Transportation Plan (RTP)									
MON-MAR001-MA	Reservation Road Widening	Widen Reservation Road to 4 lanes between East Garrison Gate and Davis Road		X	X	27	Watkins Gate Road and Reservation Road	NB: from one shared left/through/right lane to 1 through, 1 through-right and 1 left turn lane SB: from one shared left/through/right lane to 1 through, 1 through-right and 1 left turn lane EB: 1 left turn and 1 right turn lane	None



TABLE 38: CUMULATIVE WITHOUT AND WITH PROJECT AND WITHOUT EASTSIDE PARKWAY CONDITIONS INTERSECTION IMPROVEMENTS

Project Number ¹	Project Name	Project Description	Sources ²			Intersection	Geometry Changes	Intersection Control Changes
			City ³	FORA ⁴	RTP ⁵			
						28 Reservation Road and Davis Road	SB: from 1 left turn lane and a through lane to 1 left turn lane, 1 through lane, and 1 shared through-right NB: from 1 left turn lane and a through lane to 1 left turn lane, 1 shared through-right EB and WB remain the same	None
MON-MAR001-MA	Imjin Parkway Widening	Widen Imjin Parkway to four lanes from Imjin Road to Reservation Road	X		X	11 Imjin Parkway and Abrams Drive	EB and WB: Install 1 left turn lane, 1 through lane, and 1 shared through-right NB and SB: left and right turn lanes on Abrams Drive	None
						12 Imjin Parkway and Reservation Road	EB: Change to 2 left turn lanes, 1 through lane, and 2 right turn lanes	None

Notes:

1. Project ID Number based on leading agency from source document.
2. Projects appearing in multiple source lists are described and denoted by source.
3. Listed in City of Marina's 5 Year Capital Improvement Project List, Revised March 2016.
4. Listed in Fort Ord Reuse Authority's Capital Improvement Program Fiscal Year 2017/18 through 2027/28, and Fort Ord Reuse Authority Fee Reallocation Study: Deficiency Analysis and Fee Reallocation (2017).
5. Listed in the 2040 Metropolitan Transportation Plan / Sustainable Communities Strategy (2018).
6. Improvement from source does not define control.

Source: Fehr & Peers, 2019.



CUMULATIVE WITHOUT AND WITH PROJECT AND WITHOUT EASTSIDE PARKWAY CONDITIONS INTERSECTION LEVELS OF SERVICE

Level of service calculations were conducted to evaluate intersection operations under Cumulative without Project and without Eastside Parkway Conditions and Cumulative with Project and without Eastside Parkway Conditions. The intersection volumes are shown in **Appendix D** and results of the LOS analysis are summarized in **Table L-3** of **Appendix L**. The deficiency criteria in **Chapter 11** are used to identify deficiencies in the transportation system. The corresponding LOS calculation sheets are included in **Appendix E**.

The deficiencies identified in the with Project Condition on the surrounding transportation system, and potential improvements, are described in **Chapter 11**.

SIGNAL WARRANT ANALYSIS

For the purpose of this TA, the peak-hour signal warrant was also evaluated for unsignalized intersections that operate below their designated LOS threshold under Cumulative with Project and without Eastside Parkway Conditions. The results of the peak-hour warrant analysis presented in **Table N-1** in **Appendix N** indicates the following intersections, which exceed their designated LOS threshold, would meet peak hour warrants:

- Int 22. Eighth Avenue and Inter-Garrison Road (AM and PM peak hour)
- Int 25. Inter-Garrison Road Connection and Inter-Garrison Road (AM and PM peak hour)
- Int 47. General Jim Moore Boulevard and Coe Avenue (AM and PM peak hour)

As described in **Signal Warrant Analysis** section of **Chapter 3**, SR 1 Northbound Ramps and Imjin Parkway (Int. 4) worst movement delay (minor street delay), northbound approach delay, is below the LOS threshold, though the intersection does not meet the peak hour signal warrant as the minor street northbound right traffic would not conflict with the major street eastbound through traffic.

CUMULATIVE WITHOUT AND WITH PROJECT AND WITHOUT EASTSIDE PARKWAY CONDITIONS FREEWAY LEVELS OF SERVICE

Freeway segments of SR 1 were analyzed during the AM and PM peak hours to calculate the amount of Project traffic projected to be added (refer to **Appendix M**). Results of the analysis identifying the segments exceeding Caltrans' standard are presented in **Table 39**. Measured against the Caltrans level of service standard, the following freeway segments would exceed the level of service standard (that is, they operate at LOS D or worse):



- Southbound SR 1 between Reservation Road and Canyon Del Rey Boulevard during the AM peak hour (all 5 southbound SR 1 segments)
- Southbound SR 1 between Fremont Boulevard-Del Monte Boulevard and Canyon Del Rey during the PM peak hour
- Northbound SR 1 between Del Monte Boulevard and Imjin Parkway during the PM peak hour
- Northbound SR 1 between Imjin Parkway and Canyon Del Rey Boulevard the PM peak hour
- Northbound SR 1 between Fremont Boulevard-Del Monte Boulevard and Canyon Del Rey during the AM peak hour

Freeway segment deficiencies and potential improvements are addressed in **Chapter 11**.



TABLE 39: CUMULATIVE WITHOUT AND WITH PROJECT CONDITIONS FREEWAY SEGMENT LEVEL

Freeway Segment	Peak Hour ¹	Capacity	Cumulative without Project			Cumulative with Project			Project Percent of Capacity
			Volume	Density ^{2,3}	LOS ⁴	Volume	Density ^{2,3}	LOS ⁴	
State Route 1 – Southbound									
Reservation Road and Del Monte Boulevard	AM	4,700	3,480	44.7	E	3,560	N/A⁴	F	1.9%
	PM		1,830	14.6	B	1,870	14.9	B	1.7%
Del Monte Boulevard and Imjin Parkway	AM	7,050	5,060	36.9	E	5,150	38.0	E	1.5%
	PM		3,200	17.4	B	2,920	15.9	B	1.4%
Imjin Parkway and Lightfighter Drive	AM	7,050	5,230	37.3	E	5,250	37.6	E	0.9%
	PM		3,490	19.0	C	3,450	18.7	C	0.2%
Lightfighter Drive and Fremont Boulevard-Del Monte Boulevard	AM	7,050	5,450	37.6	E	5,550	38.9	E	2.1%
	PM		3,920	20.8	C	4,010	21.3	C	1.9%
Fremont Boulevard-Del Monte Boulevard and Canyon Del Rey	AM	4,700	4,470	-	F	4,540	N/A⁴	F	2.5%
	PM		3,170	25.9	C	3,240	26.6	D	2.3%
State Route 1 – Northbound									
Reservation Road and Del Monte Boulevard	AM	4,700	1,500	12.3	B	1,520	12.4	B	1.4%
	PM		2,970	23.7	C	3,050	24.4	C	2.2%
Del Monte Boulevard and Imjin Parkway	AM	7,050	2,410	13.8	B	2,440	14.0	B	1.1%
	PM		4,850	26.7	D	4,940	27.3	D	0.9%
Imjin Parkway and Lightfighter Drive	AM	7,050	3,070	17.5	B	3,070	17.5	B	0.3%
	PM		5,530	31.3	D	5,520	31.2	D	1.8%
Lightfighter Drive and Fremont Boulevard-Del Monte Boulevard	AM	7,050	3,480	19.5	C	3,580	20.0	C	1.7%
	PM		5,380	29.7	D	5,470	30.4	D	2.3%
Fremont Boulevard-Del Monte Boulevard and Canyon Del Rey Boulevard	AM	4,700	2,970	25.7	C	3,040	26.4	D	2.0%
	PM		4,290	40.5	E	4,350	41.6	E	2.6%⁵

Notes: **Bold** text indicates below the applicable level of service standard (LOS D for Caltrans designated facilities). **Bold and highlighted text** indicates freeway segment deficiency as described in **Chapter 11**.

1. AM = AM peak hour, PM = PM peak hour.
2. Measured in passenger cars per mile per lane. Mixed = Mixed-Flow Lanes.
3. If volume/capacity ratio is greater than 1, density is not applicable.
4. Level of service (LOS) based on density.
5. The vehicle demand for the PM outbound peak hour direction of the next freeway segment (CA-1 between Canyon Del Rey and Casa Verde Way) is less than the project percent capacity. Therefore, the last freeway segment to be studied south of CSUMB campus is between Fremont Boulevard-Del Monte Boulevard and Canyon Del Rey Boulevard.

Source: Fehr & Peers, 2019.



CUMULATIVE WITHOUT AND WITH PROJECT AND WITHOUT EASTSIDE PARKWAY CONDITIONS RAMP LEVELS OF SERVICE

A freeway ramp analysis was conducted for Cumulative conditions to assess changes in peak hour ramp volumes with the addition of Project traffic and its effects on freeway and local street operations.

Freeway ramp segments to/from State Route 1 were analyzed during the AM and PM peak hours to calculate the amount of Project traffic projected to be added. Results of the analysis identifying the segments that exceed the ramp capacity are presented in **Table 40** and **Table 41**. All of the ramp volumes would increase under Cumulative with Project and without Eastside Parkway Conditions, with the exception of the SR 1 and Imjin Parkway southbound on-ramp in the PM peak hour, and the SR 1 and Imjin Parkway northbound off-ramp during AM peak hour. Decreases in volume under Cumulative with Project and without Eastside Parkway Conditions are due to the displacement and reassignment of cumulative traffic when the Project volume is added to the roadway network.

As shown on **Table 40** and **Table 41**, under Cumulative with Project and without Eastside Parkway Conditions, all ramp volumes would be less than the ramp capacity during the AM and PM peak hours.

TABLE 40: CUMULATIVE WITHOUT AND WITH PROJECT CONDITIONS RAMP AM PEAK HOUR VOLUMES AND CAPACITIES

Location	Direction	Ramp Type	Lanes	Capacity ¹	Cumulative without Project (vehicles per hour)	Cumulative with Project (vehicles per hour)
SR 1 and Imjin Parkway	NB	Diagonal On-Ramp	1	1,500	430	460
	SB	Diagonal On-Ramp	1	1,500	1,180	1,190
	NB	Diagonal Off-Ramp	2	3,000	1,080	1,080
	SB	Diagonal Off-Ramp	1	1,500	920	990
SR 1 and Lightfighter Drive	NB	Diagonal On-Ramp	1	1,500	380	400
	SB	Diagonal On-Ramp	2	3,000	600	700
	NB	Diagonal Off-Ramp	2	3,000	750	860
	SB	Loop Off-Ramp	1	1,200	520	540

Notes: **Bold** text indicates volumes above capacity.

1. Peak hour ramp capacity is 1,500 veh/hr/ln (vehicles per hour per lane) and 1,200 veh/hr/ln for diagonal and loop ramps, respectively.

Source: Fehr & Peers, 2019.



TABLE 41: CUMULATIVE WITHOUT AND WITH PROJECT CONDITIONS RAMP PM PEAK HOUR VOLUMES AND CAPACITIES

Location	Direction	Ramp Type ¹	Lanes	Capacity ¹	Cumulative without Project (vehicles per hour)	Cumulative with Project (vehicles per hour)
SR 1 and Imjin Parkway	NB	Diagonal On-Ramp	1	1,500	860	940
	SB	Diagonal On-Ramp	1	1,500	1,270	1,250
	NB	Diagonal Off-Ramp	2	3,000	1,590	1,580
	SB	Diagonal Off-Ramp	1	1,500	590	670
SR 1 and Lightfighter Drive	NB	Diagonal On-Ramp	1	1,500	770	800
	SB	Diagonal On-Ramp	2	3,000	800	930
	NB	Diagonal Off-Ramp	2	3,000	520	650
	SB	Loop Off-Ramp	1	1,200	320	310

Notes: **Bold** text indicates volumes above capacity.

1. Peak hour ramp capacity is 1,500 veh/hr/ln (vehicles per hour per lane) and 1,200 veh/hr/ln for diagonal and loop ramps, respectively.

Source: Fehr & Peers, 2019.



10. CUMULATIVE WITH EASTSIDE PARKWAY CONDITIONS (FOR INFORMATION PURPOSES ONLY)

This chapter presents the results of the level of service calculations under Cumulative with and without Project, and with the assumption that the Eastside Parkway is constructed. Eastside Parkway is the future two lane arterial connection that would connect General Jim Moore Boulevard and Inter-Garrison Road. At the time of this analysis FORA was responsible for providing the necessary funding for the roadway connection although, as of this writing, when FORA sunsets (June 30, 2020), the local jurisdiction will have the sole responsibility to arrange for the funding of all required road mitigation measures from such Jurisdiction's own resources. TAMC will assume responsibility for collecting Regional Impact Development fees to fund impacts to regional roads resulting from development projects on underlying Jurisdiction's property. Thus, a specific source of funding for future roads has not been identified or when such funding would be available, nor has a final Eastside Parkway project alignment been determined. Currently, FORA is leading the first phase of the environmental review of the roadway project. Cumulative traffic volumes are based on forecasts from the AMBAG travel model, including the land uses and transportation network infrastructure described in **Chapter 9**, plus the Eastside Parkway assumed to be constructed between Inter-Garrison Road and General Jim Moore Boulevard. The peak hour vehicle trip estimates into and out of CSUMB are based on the Project vehicle trip estimates discussed in **Chapter 7**.

CUMULATIVE WITHOUT AND WITH PROJECT AND WITH EASTSIDE PARKWAY CONDITIONS ROADWAY IMPROVEMENTS

The Cumulative without and with Project with Eastside Parkway scenario was evaluated to determine the effects of adding Eastside Parkway and its associated improvements to the results previously presented in **Chapter 9**. As noted above, Eastside Parkway is the planned future two lane arterial connection that would connect General Jim Moore Boulevard and Inter-Garrison Road. The connection would begin at General Jim Moore Boulevard and Coe Avenue (Int. 47) as a continuation of Eucalyptus Road to the east and end at Schoonover Road and Inter-Garrison Road (Int 24). Based on information presently available, the following intersection improvements were assumed part of the Eastside Parkway roadway improvements:

- Int 24. Schoonover Road and Inter-Garrison Road: Signalized intersection. Addition of a northbound approach with a left turn lane, through lane, and right turn lane. Addition of an eastbound shared right/through lane and southbound shared left/through lane.
- Int 45. Eastside Parkway and Gigling Road: Open signalized intersection with Gigling Road. Addition of a northbound approach with a left turn lane and shared right/through lane. Addition of a southbound approach with a left turn lane, through lane, and right turn lane.



- Int 47. General Jim Moore Boulevard and Coe Avenue: Addition of a westbound leg with one left turn lane, one through lane, and one right turn lane. Opening of the southbound left turn lanes, northbound right turn lane, and eastbound through lane. Signalization of the intersection.

The Cumulative with Project and with Eastside Parkway analysis also includes the transportation facility changes to the campus that would be built as part of the Project, as described in **Chapter 1**, and shown on **Figure 2**.

CUMULATIVE WITHOUT AND WITH PROJECT AND WITH EASTSIDE PARKWAY CONDITIONS INTERSECTION LEVELS OF SERVICE

The following intersections that would exceed the applicable LOS threshold under the Cumulative with Project and without Eastside Parkway Conditions (refer to **Chapter 9** and **Appendix L**) would not exceed the applicable level of service threshold in the Cumulative with Project and with Eastside Parkway Conditions (refer to **Table L-4** in **Appendix L**):

- Int 10. Imjin Road and Imjin Parkway (PM peak hour),
- Int 17. Fourth Avenue and Eighth Street (AM peak hour),
- Int 23. Abrams Drive and Inter-Garrison Road (AM and PM peak hour), and
- Int 37. Seventh Avenue and Colonel Durham Street (PM peak hour).

For travel between Seaside and SR 1 from/to Salinas and eastward, the addition of Eastside Parkway is expected to result in a traffic shift from other east-west roadways such as Imjin parkway, Inter-Garrison Road, Eighth Street, and Colonel Durham Street, onto Eastside Parkway. The shift of traffic that would result from this new connector would result in increased travel along Reservation Road to access Eastside Parkway from Inter-Garrison Road. As a result of the redistribution of traffic, the following intersection, which meets the applicable level of service thresholds under the Cumulative with Project and without Eastside Parkway Conditions, would exceed the threshold under Cumulative with Project and with Eastside Parkway Conditions:

- Int 27. Reservation Road and Watkins Gate Road

SIGNAL WARRANT ANALYSIS

The addition of Eastside Parkway as a part of planned improvements would change the intersections that exceed their designated LOS threshold and meet peak hour warrants under Cumulative with Project without Eastside Parkway Conditions. That is, the same intersections operating below their designated LOS threshold and meeting peak hour warrants under the Cumulative with Project without Eastside Parkway Conditions would remain unchanged under the Cumulative with Project and with Eastside Parkway Conditions.



CUMULATIVE WITHOUT AND WITH PROJECT AND WITH EASTSIDE PARKWAY CONDITIONS FREEWAY LEVELS OF SERVICE

Freeway segments of SR 1 were analyzed during the AM and PM peak hours to calculate the effect of Eastside Parkway on the Cumulative without and with Project Conditions. The results of the analysis are presented in **Table 39**. As shown on the table, overall, the same southbound segments would operate below the level of service standard. In the northbound direction, the following segments that exceed the level of service standard in the Cumulative with Project and without Eastside Parkway Condition would not exceed the level of service standard in the Cumulative with Project and with Eastside Parkway Condition:

- Del Monte Boulevard and Imjin Parkway
- Imjin Parkway and Lightfighter Drive

The reason for the improved operations on the above two segments is because, as previously noted, the addition of Eastside Parkway would result in shifts of traffic in the area. This includes a shift of the traffic traveling northward/eastward of the Campus, exiting SR 1 earlier, and using Eastside Parkway to access these destinations. Volume shifts as described would reduce volumes on these segments of SR 1 and, therefore, improve operations in the Cumulative without and with Project and with Eastside Parkway versus the Cumulative without and with Project, and without Eastside Parkway.



**TABLE 42: CUMULATIVE WITHOUT AND WITH PROJECT AND WITH EASTSIDE PARKWAY
CONDITIONS FREEWAY SEGMENT LEVEL OF SERVICE**

Freeway Segment	Peak Hour ¹	Capacity	Cumulative without Project and with Eastside Parkway			Cumulative with Project and with Eastside Parkway			Project Percent of Capacity
			Volume	Density ^{2,3}	LOS ⁴	Volume	Density ^{2,3}	LOS ⁴	
State Route 1 – Southbound									
Reservation Road and Del Monte Boulevard	AM	4,700	3,460	44.2	E	3,497	N/A⁴	F	1.9%
	PM		1,870	14.9	B	1,890	15.1	B	1.7%
Del Monte Boulevard and Imjin Parkway	AM	7,050	5,050	36.7	E	4,633	32.0	D	1.5%
	PM		2,910	15.8	B	2,940	16.0	B	1.4%
Imjin Parkway and Lightfighter Drive	AM	7,050	5,080	35.5	E	4,767	32.1	D	0.9%
	PM		3,380	18.4	C	3,340	18.1	C	0.2%
Lightfighter Drive and Fremont Boulevard-Del Monte Boulevard	AM	7,050	5,490	38.1	E	5,153	34.2	D	1.9%
	PM		3,940	20.9	C	4,030	21.4	C	1.3%
Fremont Boulevard-Del Monte Boulevard and Canyon Del Rey	AM	4,700	4,540	-	F	4,747	N/A⁴	F	2.5%
	PM		3,230	26.5	D	3,300	27.2	D	2.3%
State Route 1 – Northbound									
Reservation Road and Del Monte Boulevard	AM	4,700	1,480	12.1	B	1,520	12.4	B	1.4%
	PM		2,740	21.7	C	3,086	24.7	C	2.2%
Del Monte Boulevard and Imjin Parkway	AM	7,050	2,400	13.8	B	2,450	14.1	B	1.1%
	PM		4,510	24.5	C	4,207	22.7	C	1.8%
Imjin Parkway and Lightfighter Drive	AM	7,050	2,950	16.8	B	2,950	16.8	B	0.3%
	PM		4,570	24.6	C	4,524	24.3	C	0.9%
Lightfighter Drive and Fremont Boulevard-Del Monte Boulevard	AM	7,050	3,440	19.2	C	3,550	19.9	C	1.7%
	PM		4,720	25.2	C	5,167	28.2	D	2.2%
Fremont Boulevard-Del Monte Boulevard and Canyon Del Rey Boulevard	AM	4,700	3,000	26.0	D	3,070	26.7	D	1.9%
	PM		3,570	30.0	D	4,648	N/A⁴	F	2.6%

Notes: **Bold** text indicates below the applicable level of service standard (LOS D for Caltrans designated facilities). **Bold and highlighted text** indicates freeway segment deficiency as described in **Chapter 11**.

1. AM = AM peak hour, PM = PM peak hour.
2. Measured in passenger cars per mile per lane. Mixed = Mixed-Flow Lanes.
3. If volume/capacity ratio is greater than 1, density is not applicable.
4. Level of service (LOS) based on density.
5. The vehicle demand for the PM outbound peak hour direction of the next freeway segment (CA-1 between Canyon Del Rey and Casa Verde Way) is less than the project percent of capacity.

Source: Fehr & Peers, 2019.



CUMULATIVE WITHOUT AND WITH PROJECT AND WITH EASTSIDE PARKWAY CONDITIONS RAMP LEVELS OF SERVICE

Similar to the Cumulative with Project and without Eastside Parkway Conditions, under Cumulative with Project and with Eastside Parkway Conditions, all ramp volumes would be less than the ramp capacity during the AM and PM peak hours. Cumulative without and with Project and with Eastside Parkway Conditions would result in a shift of ramp volumes from the Imjin Parkway southbound on-ramp and northbound on-ramp to the same ramps at Lightfighter. As described above for the **Freeway Level of Service** section, the addition of Eastside Parkway would affect the travel between SR 1 to/from northward/eastward of the Campus.

TABLE 43: CUMULATIVE WITHOUT AND WITH PROJECT, AND WITH EASTSIDE PARKWAY CONDITIONS RAMP AM PEAK HOUR VOLUMES AND CAPACITIES

Location	Direction	Ramp Type	Lanes	Capacity ¹	Cumulative without Project with Eastside Parkway (vehicles per hour)	Cumulative with Project with Eastside Parkway (vehicles per hour)
SR 1 and Imjin Parkway	NB	Diagonal On-Ramp	1	1,500	430	490
	SB	Diagonal On-Ramp	1	1,500	1,050	1,050
	NB	Diagonal Off-Ramp	2	3,000	970	980
	SB	Diagonal Off-Ramp	1	1,500	930	1,010
SR 1 and Lightfighter Drive	NB	Diagonal On-Ramp	1	1,500	380	380
	SB	Diagonal On-Ramp	2	3,000	760	870
	NB	Diagonal Off-Ramp	2	3,000	820	930
	SB	Loop Off-Ramp	1	1,200	510	530

Notes: **Bold** text indicates volumes above capacity.

1. Peak hour ramp capacity is 1,500 veh/hr/ln (vehicles per hour per lane) and 1,200 veh/hr/ln for diagonal and loop ramps, respectively.

Source: Fehr & Peers, 2019.



TABLE 44: CUMULATIVE WITHOUT AND WITH PROJECT, AND WITH EASTSIDE PARKWAY CONDITIONS RAMP PM PEAK HOUR VOLUMES AND CAPACITIES

Location	Direction	Ramp Type ¹	Lanes	Capacity ¹	Cumulative without Project with Eastside Parkway (vehicles per hour)	Cumulative with Project with Eastside Parkway (vehicles per hour)
SR 1 and Imjin Parkway	NB	Diagonal On-Ramp	1	1,500	860	970
	SB	Diagonal On-Ramp	1	1,500	1,210	1,180
	NB	Diagonal Off-Ramp	2	3,000	1,200	1,230
	SB	Diagonal Off-Ramp	1	1,500	690	730
SR 1 and Lightfighter Drive	NB	Diagonal On-Ramp	1	1,500	770	770
	SB	Diagonal On-Ramp	2	3,000	890	1,020
	NB	Diagonal Off-Ramp	2	3,000	960	1,070
	SB	Loop Off-Ramp	1	1,200	290	290

Notes: **Bold** text indicates volumes above capacity.

1. Peak hour ramp capacity is 1,500 veh/hr/ln (vehicles per hour per lane) and 1,200 veh/hr/ln for diagonal and loop ramps, respectively.

Source: Fehr & Peers, 2019.



11. TRANSPORTATION FACILITY DEFICIENCIES AND POTENTIAL IMPROVEMENTS (FOR INFORMATION PURPOSES ONLY)

This chapter discusses the Project's potential effects to the study intersections and study freeway segments. First, the deficiency criteria are described. Next, the deficiencies and potential improvements are presented for each transportation facility type (intersections and freeway segments).

DEFICIENCIES CRITERIA

The deficiency criteria presented in the California State University *Transportation Impact Study Manual* (2012) are used to identify the Project's deficiencies, with a refinement to the freeway deficiency criteria in that criteria based on Caltrans guidance and removal of the construction deficiency criteria.

The deficiencies attributable to the Project were determined by comparing the results of the level of service calculations under Existing with Project Conditions to the results under Existing Conditions without Project to determine Project's effects on existing conditions. In the case of cumulative impacts, the Cumulative with Project and without Eastside Parkway Conditions was compared to the Cumulative without Project and without Eastside Parkway Conditions to determine whether the Project's contribution to that deficiency is cumulatively considerable. Cumulative without and with Project, and with the Eastside Parkway Conditions were similarly evaluated to determine the effects of Eastside Parkway on Cumulative with Project and without Eastside Parkway Conditions.

Below are the deficiency criteria as applied to the Project.

OFF-SITE TRAFFIC OPERATIONS

- A roadway segment or signalized intersection operates at LOS D or better under a no project scenario and the addition of project trips causes overall traffic operations on the facility to operate at LOS E or F. Roadway segment operations criteria are further refined below based on Caltrans guidance from Chapter 11 of the *HCM 2010*.
- A roadway segment or signalized intersection operates at LOS E or F under a no project scenario and the project adds both 10 or more peak hour trips and 5 seconds or more of peak hour delay, during the same peak hour. Roadway segment operations criteria are further refined below based on Caltrans guidance from Chapter 11 of the *HCM 2010*.
- If a signalized intersection operates at a very poor LOS F (control delay of 120 seconds or more), the significance criterion shall be an increase in v/c ratio of 0.02 or more.



- Operational deficiencies on freeway segments in study area within Monterey County were determined to occur when the addition of Project traffic causes:
 - Peak hour freeway segment operations to deteriorate from an acceptable level (LOS C/D threshold or better) under the without Project conditions to an unacceptable level (LOS D or worse) under with Project conditions; or
 - There is an increase in traffic of more than two percent of the capacity on a segment that operates unacceptably under without Project Conditions.
- Deficiencies are said to occur when the with Project scenario results in the average intersection delay for an all-way stop-controlled intersection, or the worst movement/approach for a side-street stop-controlled intersection, to degrade to LOS F and the intersection satisfies the peak hour traffic signal warrant from the *California Manual of Uniform Traffic Control Devices* (MUTCD) (2014).²⁹

DEFICIENCIES ANALYSIS AND POTENTIAL IMPROVEMENTS

The following section summarizes the deficiencies and potential improvements for intersections, freeway segments and freeway ramps. Each section includes a discussion of deficiencies under Existing with Project Conditions, Cumulative with Project and without Eastside Parkway Conditions, and Cumulative with Project and with Eastside Parkway Conditions.

INTERSECTION LEVEL OF SERVICE

The following physical improvements would improve the identified intersection deficiencies by increasing capacity. The improved intersection LOS calculations are presented in **Appendix O**.

Existing with Project Conditions

Under Existing with Project Conditions, implementation of the Project would increase motor vehicle traffic and congestion, resulting in operational deficiencies at the following intersections. The localized improvements identified below would incrementally improve intersection operations and, in some cases, improve street connectivity. The intersections with operation deficiencies and corresponding improvements are further described below.

²⁹ The peak-hour signal warrant analysis should not serve as the only basis for deciding whether and when to install a traffic signal. To reach such a decision, the full set of warrants should be investigated based on a thorough study of traffic and roadway conditions by an experienced engineer. The decision to install a signal should not be based solely upon the warrants, since the installation of signals can lead to certain types of collisions. The responsible state or local agency should undertake regular monitoring of actual traffic conditions and accident data and timely re-evaluation of the full set of warrants in order to prioritize and program intersections for signalization.



Intersection 3: SR 1 Southbound Ramps and Imjin Parkway (Caltrans): Adding a second westbound left turn lane and converting the southbound off-ramp to a loop off-ramp would improve intersection operations and queuing. This would address the deficiency at this intersection.

Intersection 16: Second Avenue and Eighth Street (Marina): Adding a second southbound through lane; converting the northbound left lane to a shared left-through lane; and converting the northbound through lane and northbound right lane to a shared northbound through-right would improve intersection operations and queuing. These southbound changes match the future southbound geometry planned as part of the City of Marina's 5 Year Capital Improvement Project List. This intersection meets peak hour signal warrant in the Existing with Project Conditions; therefore, the improvements evaluated include signalization and optimization of the cycle length and splits. This would address the deficiency at this intersection.

Intersection 21: Eighth Street/Seventh Avenue and Inter-Garrison Road (Monterey County/CSUMB): Adding eastbound and westbound left-turn pockets, converting the shared northbound left, through and right turn lane to a left turn lane, a through lane, and a right turn lane, and converting the shared southbound through-left lane and the right turn lane to a left turn lane, and a shared through-right lane to improve intersection operations and queuing. These geometry and signalized improvements are planned as part of the City of Marina's 5 Year Capital Improvement Project List. This intersection meets peak hour signal warrant in the Existing with Project Conditions; therefore, the improvements evaluated include signalization and optimization of the cycle length and splits. This improvement would address the deficiency at this intersection.

Intersection 22: Eighth Avenue and Inter-Garrison Road (Monterey County/CSUMB): Two improvement options have been identified:

- Option 1 – Signalization of intersection: This intersection meets peak hour signal warrant in the Existing with Project Conditions; therefore, the improvements evaluated for Option 1 include signalization and optimization of the cycle length and splits. This would improve the intersection operations to an acceptable level of service.
- Option 2 – Add second inside turning lane in roundabout and add a westbound left approaching lane: This option enhances intersection operations of the existing roundabout. Adding a second inside turning lane, a dedicated westbound left lane, and a second receiving leg on the south leg would improve the intersection operations and queuing during the AM peak hour. This improvement would address the deficiency at this intersection.

Intersection 23: Abrams Drive and Inter-Garrison Road (CSUMB/Monterey County): Adding a second southbound left lane would improve intersection operations and queuing. This intersection meets peak hour signal warrant in the Existing with Project Conditions; therefore, the improvements evaluated include signalization and optimization of the cycle length and splits. This improvement would address the deficiency at this intersection.



Intersection 29: Second Avenue and Divarty Street (Marina/CSUMB): Adding a through lane to both the northbound and southbound directions, converting the northbound right lane to a shared northbound through-right, and converting the southbound right lane to a shared southbound through-right lane would improve intersection operations and queuing. These changes match the future geometry planned at this intersection. This would address the deficiency at this intersection.

Intersection 47: General Jim Moore Boulevard and Coe Avenue (Seaside): This intersection meets the peak hour signal warrant. Signalizing the intersection and optimizing the cycle length and splits would improve intersection operations and queuing. This would address the deficiency at this intersection.

Table 45 shows the peak hour delays and LOS results for without and with potential improvements for each of the intersections with a level of service deficiency under Existing with Project Conditions. As shown on the table, with implementation of the improvements, operations at each intersection would improve, and the Project’s impacts would be reduced below the local jurisdiction’s thresholds at the six intersections.

TABLE 45: EXISTING WITH PROJECT CONDITIONS INTERSECTION IMPROVEMENTS SUMMARY

Intersection	Improvements ³	Peak Hour ¹	Intersection Operations					
			Without Project Conditions Without Improvements		With Project Conditions Without Improvements		With Project Conditions With Improvements	
			Delay	LOS ²	Delay	LOS ²	Delay	LOS ²
3	SR 1 Southbound Ramps and Imjin Parkway ⁴	AM	36.6	D	61.3	E	- ⁴	A
		PM	17.2	B	19.6	B	- ⁴	A
16	Second Avenue and Eighth Street	AM	56.3	F	>120	F	8.2	A
		PM	12.8	B	23.3	C	6.2	A
21	<u>Eighth Street/Seventh Avenue and Inter-Garrison Road</u>	AM	<u>12.9</u>	<u>B</u>	<u>98.4</u>	<u>F</u>	<u>16.9</u>	<u>B</u>
		PM	<u>8.9</u>	<u>A</u>	<u>51.6</u>	<u>F</u>	<u>16.0</u>	<u>B</u>
22	Eighth Avenue and Inter-Garrison Road	AM	32.1	D	114.3	F	1.4	A
		PM	8.6	A	25.9	E	9.9	A
	Option 2 - Add second circulating lane to the roundabout and Add WBL	AM	32.1	D	114.3	F	14.7	B
		PM	8.6	A	25.9	D	23.0	C
23	Abrams Drive and Inter-Garrison Road	AM	60.3	F	>120	F	21.3	C
		PM	12.8	B	78.8	F	3.9	A
29	Second Avenue and Divarty Street	AM	31.1	D	>120	F	9.2	A
		PM	9.4	A	50.9	F	10.1	B



TABLE 45: EXISTING WITH PROJECT CONDITIONS INTERSECTION IMPROVEMENTS SUMMARY

Intersection	Improvements ³	Peak Hour ¹	Intersection Operations					
			Without Project Conditions Without Improvements		With Project Conditions Without Improvements		With Project Conditions With Improvements	
			Delay	LOS ²	Delay	LOS ²	Delay	LOS ²
47 General Jim Moore Boulevard and Coe Avenue	Signalize intersection and optimize signal timings	AM	92.2	F	103.2	F	12.6	B
		PM	18.4	C	23.0	C	6.0	A

Notes: **Bold text** indicates intersection operates at unacceptable level of service. **Bold and highlighted text** indicates an intersection deficiency.

*Indicates unsignalized intersection.

1. AM = AM peak hour, PM = PM peak hour.
2. LOS = Level of Service. The method described in the *Highway Capacity Manual (HCM)* (Transportation Research Board) was used to prepare the LOS calculations for the signalized study intersections. This method analyzes intersection operations based on average control delay per vehicle. Control delay includes the initial deceleration delay, queue move-up time, stopped delay, and final acceleration delay. The average control delay is calculated using Synchro analysis software and is correlated to a LOS designation
3. EB = Eastbound, WB = Westbound, NB = Northbound, SB = Southbound; T = Through, L = Left-turn, R = Right-turn, LTR = Shared Left-Through-Right Lane, TR = Shared Through-Right Lane, TL = Shared Through-Left Lane.
4. The draft improvement would remove potential conflicting turn movements at this intersection, which removes vehicle control delay at this intersection.

Source: Fehr & Peers, 2019.

Cumulative with Project and without Eastside Parkway Conditions

Under Cumulative with Project and without Eastside Parkway Conditions, implementation of the Project would increase motor vehicle traffic and congestion, resulting in operational deficiencies at the following intersections. The localized improvements identified below would incrementally improve intersection operations and, in some cases, improve street connectivity. The intersections with operation deficiencies and corresponding improvements are further described below.

Intersection 3: SR 1 Southbound Ramps and Imjin Parkway (Caltrans): Adding a second westbound left turn lane and converting the southbound off-ramp into a loop off-ramp would address the deficiency at this intersection.

Intersection 5: Second Avenue and Imjin Parkway (Marina): Reconfigure the intersection to follow improvements identified in *The Dunes at Monterey Bay EIR (2005)*. These improvements include:

- Adding a third northbound left lane and a second northbound right lane.
- Adding a third westbound left lane, two westbound through lanes, and converting a shared westbound through-right lane to a westbound right lane.



- Adding a second southbound left lane, a second southbound through lane, and converting a shared southbound through-right lane to a southbound right lane.
- Adding a second eastbound left lane, a third eastbound through lane, and converting a shared eastbound through-right lane to two eastbound right lanes.
- Converting a shared westbound through-right lane to a westbound right lane, a shared southbound through-right lane to a southbound right lane, and a shared eastbound through-right lane to two eastbound right lanes.

These improvements would address the deficiency at this intersection; however, an important design consideration is the secondary effects to pedestrian and bicyclist operations. The widening would affect the crossing length and time bicyclists and pedestrians spend in front of vehicles. The improvement to widen the northbound approach for additional turning lanes would require widening beyond restriping, which would affect the available right of way for a future parallel separated shared use path.

Intersection 10: Imjin Road and Imjin Parkway (Marina): Adding a second westbound left lane would improve intersection operations and queuing. This would address the deficiency at this intersection.

Intersection 12: Reservation Road and Imjin Parkway (Marina): Adding a third southbound through lane would improve intersection operations and queuing. However, this would not improve the intersection operations to an acceptable level of service. To improve the intersection operations, additional widening, such as adding a northbound through lane, could be considered. Though, this creates a secondary effect on bicyclists and pedestrians as widening an intersection that already has a large footprint would have a detrimental effect on bicyclists and pedestrians because adding lanes increases the distance bicyclists and pedestrians must cross to navigate the intersection, increasing their exposure to vehicles.

Intersection 14: Inter-Garrison Road and Reservation Road (Monterey County): Adding a second northbound left lane would improve intersection operations and queuing. This would address the deficiency at this intersection.

Intersection 22: Eighth Avenue and Inter-Garrison Road (Monterey County/CSUMB): The following potential improvements were evaluated:

- Option 1 – Signalization of intersection: Adding a second northbound left lane, two westbound left lanes, and converting the shared westbound through-left lane to a westbound through lane only would improve intersection operations and queuing. However, this would not improve the intersection operations to an acceptable level of service. Therefore, the deficiency remains under Cumulative with Project and without Eastside Parkway Conditions. Although further widening could be considered as an improvement, an important design consideration is the secondary effects to pedestrian and bicyclist operations; therefore, no other improvements are feasible due to the increased secondary effect to pedestrian and bicyclist operations.



- Option 2 – Add second inside turning lane in roundabout and add a westbound left approaching lane: Adding a second inside turning lane to the roundabout, a dedicated westbound left lane, and a second receiving lane to the south leg would improve intersection operations and queuing. However, this would not improve the intersection operations to an acceptable level of service. Therefore, the deficiency remains under Cumulative with Project and without Eastside Parkway Conditions.

Although further widening could be considered as an improvement, an important design consideration for multi-lane roundabouts is the bicycle and pedestrian crossings across two approach/departure lanes. Refer to further discussion of the impact of multi-land roundabouts to bicyclists and pedestrians in the **Secondary Effects of Intersection Improvements** section.

Intersection 23: Abrams Drive and Inter-Garrison Road (Monterey County): Adding a second eastbound left lane would improve intersection operations and queuing. This would address the deficiency at this intersection.

Intersection 25: Inter-Garrison Road Connection and Inter-Garrison Road (Marina): Signalizing the intersection and optimizing the cycle length and splits would improve intersection operations and queuing. This intersection met peak hour signal warrants. These improvements would address the deficiency at this intersection.

Intersection 28: Davis Road and Reservation Road (Monterey County): Adding a second eastbound left lane would improve intersection operations and queuing. This physical improvement would address the deficiency at this intersection in the AM peak hour; though, the intersection would remain deficient in the PM peak hour.

Intersection 33: General Jim Moore Boulevard and Lightfighter Road (Seaside): The following improvements were evaluated:

- Option 1 – Lane geometry improvements: Reconfiguring the intersection to follow the improvements identified in *The Dunes at Monterey Bay EIR (2005)* would address the deficiency at this intersection. The subject improvements include:
 - Adding a third northbound left lane and a second northbound through lane.
 - Adding a southbound right lane with overlap phase.
 - Adding a second eastbound left lane.
 - Adding a second westbound left lane, and a second westbound through lane.
 - Cycle length and splits are optimized.

As previously noted, increasing vehicle capacity by widening streets generally has a detrimental effect on bicyclists and pedestrians because adding lanes increases the distance bicyclists and pedestrians must cross to navigate the intersection, increasing their exposure to vehicles. With



intersection improvements for approaches on Lightfighter Drive, there would be secondary effect on bicyclist and pedestrian travel along the existing crossings and planned Class IV bicycle facilities for Lightfighter Drive as level of comfort for pedestrians and bicyclists decreases with widening of streets. Please refer to the discussion of potential secondary effects resulting from implementation of the road improvements below.

- Option 2 – Roundabout: A two-lane roundabout is proposed at this intersection under the Campus Town Specific Plan and is in line with the goals of the new *Seaside 2040 General Plan*. A roundabout was also tested to improve the deficiencies at this intersection and was found to address the deficiency. Delays were found to be slightly less than Option 1 (signalized intersection).

As previously noted, an important design consideration for multi-lane roundabouts is the bicycle and pedestrian crossings across two approach/departure lanes. Refer to further discussion of the impact of multi-lane roundabouts to bicyclists and pedestrians in the **Secondary Effects of Intersection Improvements** section.

Intersection 39: General Jim Moore Boulevard and Gigling Road (Seaside): Two improvement options at this intersection are possible.

- Option 1 – Lane geometry improvement: Adding a second westbound left lane would improve intersection operations and queueing. This would address the deficiency at this intersection.

As previously noted, increasing vehicle capacity by widening streets generally has a detrimental effect on bicyclists and pedestrians because adding lanes increases the distance bicyclists and pedestrians must cross to navigate the intersection, increasing their exposure to vehicles. With intersection improvements for approaches on Gigling Road, the secondary effect on planned bicycle facilities for Gigling Road would continue as level of comfort for bicyclists decreases with widening of streets. Please refer to the discussion of potential secondary effects resulting from implementation of the road improvements below.

- Option 2 – Roundabout: A two-lane roundabout is proposed at this intersection under the Campus Town Specific Plan and is in line with the goals of the new *Seaside 2040 General Plan*. A roundabout was tested to improve the deficiencies at this intersection due to the CSUMB expansion and was found to address the deficiency. Delays were found to be slightly less than Option 1 (signalized intersection).

As previously noted, an important design consideration for multi-lane roundabouts is the bicycle and pedestrian crossings across two approach/departure lanes. Specifically, multi-lane roundabouts without controlled pedestrian and bicycling crossings have an inherent “double threat” to pedestrians and bicyclists. For example, a visually impaired pedestrian needs adequate guidance (design features and/or control devices) to know when to enter the street as vehicles and bicyclist yield to the pedestrian. Therefore, each double lane approach/departure should include sufficient design features (staged crossing one lane at a time, bypass lanes) and control devices (signalization,



yield control, etc.) to accommodate all users, especially visually impaired pedestrians and elderly users.

Intersection 47: General Jim Moore Boulevard and Coe Avenue (Seaside): Signalizing the intersection and optimizing the cycle length and splits would improve intersection operations and queuing. This intersection met peak hour signal warrants. These improvements would address the deficiency at this intersection.

Improvements are summarized in **Table 46**. As shown on the table, with implementation of the improvements, operations at each intersection would improve, and deficiencies attributed to the Project would be reduced below the local jurisdiction's thresholds at nine of the 12 intersections; the three exceptions are: Reservation Road and Imjin Parkway (Int. 12); Eighth Avenue and Inter-Garrison Road (Int. 22); and Davis Road and Reservation Road (Int. 28), which would each continue to exceed the applicable LOS threshold, even with implementation of the improvements. **Appendix O** shows the delays, LOS results for without and with improvements for all study intersections with a level of service deficiency under Cumulative with Project and without Eastside Parkway Conditions.



**TABLE 46: CUMULATIVE WITH PROJECT AND WITHOUT EASTSIDE PARKWAY CONDITIONS
INTERSECTION IMPROVEMENTS SUMMARY**

Intersection	Improvements ³	Peak Hour ¹	Intersection Operations					
			Without Project Conditions Without Improvements		With Project Conditions Without Improvements		With Project Conditions With Improvements	
			Delay	LOS ²	Delay	LOS ²	Delay	LOS ²
3 SR 1 Southbound Ramps and Imjin Parkway ⁴	Add WBL. Convert off-ramp to loop ramp equivalent	AM	>120	F	>120	F	- ⁴	A
		PM	>120	F	>120	F	- ⁴	A
5 Second Avenue and Imjin Parkway	Add third NBL, second NBR. Add third WBL, two WBTR, and convert shared WBTR to WBR. Add second SBL, second SBT, convert shared SBTR to SBR. Add second EBL, third EBT, convert shared EBTR to two SBR	AM	51.2	D	59.9	F	20.7	C
		PM	73.6	E	81.2	F	24.7	C
10 Imjin Road and Imjin Parkway	Add second WBL	AM	14.4	B	28.3	C	13.5	B
		PM	24.7	C	62.2	E	30.3	C
12 Reservation Road and Imjin Parkway	Add third SBT	AM	43.8	D	48.4	D	37.2	D
		PM	107.0	F	119.7	F	96.2	F
14 Inter-Garrison Road and Reservation Road	Add second NBL	AM	22.1	C	43.3	D	13.9	B
		PM	41.8	D	80.4	F	43.8	D
22 Eighth Avenue and Inter-Garrison Road	Option 1 - Signalize, optimize signal timings, and add two WBL Option 2 - Add second circulating lane to roundabout and add WBL	AM	107.6	F	>120	F	64.6	E
		PM	28.5	D	114.3	F	97.9	F
23 Abrams Drive and Inter-Garrison Road	Add second EBL	AM	33.4	C	76.9	E	42.7	D
		PM	32.6	C	74.1	E	12.5	B
25 Inter-Garrison Road Connection and Inter-Garrison Road	Signalize intersection optimize cycle length and splits	AM	39.9	E	80.7	F	24.1	C
		PM	17.3	C	34.5	D	16.7	B
28 Davis Road and Reservation Road	Add second EBL	AM	88.8	F	>120	F	52.1	D
		PM	>120	F	>120	F	96.6	F



TABLE 46: CUMULATIVE WITH PROJECT AND WITHOUT EASTSIDE PARKWAY CONDITIONS INTERSECTION IMPROVEMENTS SUMMARY

Intersection	Improvements ³	Peak Hour ¹	Intersection Operations					
			Without Project Conditions Without Improvements		With Project Conditions Without Improvements		With Project Conditions With Improvements	
			Delay	LOS ²	Delay	LOS ²	Delay	LOS ²
33 General Jim Moore Boulevard and Lightfighter	<u>Option 1</u> - Add third NBL, second NBT. Add SBR and overlap phase. Add second EBL. Add second WBL and second WBT. Optimize cycle length and splits	AM	33.7	C	79.6	E	17.8	B
		PM	24.4	C	29.1	C	27.6	C
		AM	33.7	C	79.6	E	13.7	B
		PM	24.4	C	29.1	C	12.2	B
		AM	30.6	C	51.8	D	23.3	C
		PM	22.5	C	56.0	E	36.9	D
39 General Jim Moore Boulevard and Gigling Road	<u>Option 2</u> - Roundabout design	AM	30.6	C	51.8	D	24.8	C
		PM	22.5	C	56.0	E	14.0	B
47 General Jim Moore Boulevard and Coe Avenue	Signalize intersection and optimize signal timings	AM	113.7	F	>120	F	21.7	C
		PM	30.4	D	35.2	E	6.0	A

Notes: **Bold text** indicates intersection operates at unacceptable level of service. **Bold and highlighted text** indicates an intersection deficiency.

*Indicates unsignalized intersection.

1. AM = AM peak hour, PM = PM peak hour.

2. LOS = Level of Service. The method described in the *Highway Capacity Manual* (HCM) (Transportation Research Board) was used to prepare the LOS calculations for the signalized study intersections. This method analyzes intersection operations based on average control delay per vehicle. Control delay includes the initial deceleration delay, queue move-up time, stopped delay, and final acceleration delay. The average control delay is calculated using Synchro analysis software and is correlated to a LOS designation

3. EB = Eastbound, WB = Westbound, NB = Northbound, SB = Southbound; T = Through, L = Left-turn, R = Right-turn, LTR = Shared Left-Through-Right Lane, TR = Shared Through-Right Lane, TL = Shared Through-Left Lane.

4. The draft improvement would remove potential conflicting turn movements at this intersection, which removes vehicle control delay at this intersection.

Source: Fehr & Peers, 2019.

Cumulative with Project and without Eastside Parkway Conditions – Planned Roundabouts Improvements

The *Draft Seaside 2040 General Plan and the Campus Town Specific Plan* proposes roundabouts for General Jim Moore Boulevard and Lightfighter Drive (Int. 33) and General Jim Moore Boulevard and Gigling Road (Int. 39). Along with these proposed roundabouts, there are two roundabouts proposed as part of the



concepts for the Imjin Parkway widening, which is a planned regional transportation plan improvement. The roundabouts associated with the Imjin Parkway widening would be constructed at Imjin Road and Imjin Parkway (Int. 10), and Abrams Drive and Imjin Parkway (Int. 11). The planned roundabout configurations are described below. These planned roundabout improvements were evaluated in the Cumulative without and with Project and without Eastside Parkway Conditions to determine if the desired improvements serve the future traffic, including the Project. **Table 47** summarizes the delays and LOS results with the roundabout improvements for Cumulative with Project and without Eastside Parkway Conditions.

- Int 10. Imjin Parkway widening at Imjin Road and Imjin Parkway:
 - Two-Lane Roundabout
 - Northbound: Two entry lanes (left lane and right turn lane) and one exit lane
 - Eastbound Leg: Two entry lanes (shared through-left and shared through-right lane) and two exit lanes
 - Westbound: Two entry lanes (shared through-left and through lane) and two exit lanes
- Int 11. Abrams Drive and Imjin Parkway:
 - Two-Lane Roundabout
 - Northbound: One entry through-left lane and bypass right turn lane, and one exit lane
 - Eastbound Leg: Two entry lanes (shared through-left and shared through-right lane) and two exit lanes
 - Southbound: One entry through-left lane and bypass right turn lane, and one exit lane
 - Westbound Leg: Two entry lanes (shared through-left and shared through-right lane) and two exit lanes
- Int 33. General Jim Moore Boulevard and Lightfighter Drive:
 - Two-Lane Roundabout
 - Northbound: Two entry lanes (left lane and shared left-through-right lane) and two exit lanes
 - Eastbound Leg: Two entry lanes (shared left-through-right lane and right lane) and two exit lanes
 - Southbound: Two entry lanes (shared through-left and shared through-right lane) and two exit lanes
 - Westbound Leg: Two entry lanes (shared through-left and shared through-right lane) and two exit lanes
- Int 39. General Jim Moore Boulevard and Gigling Road:
 - Two-Lane Roundabout
 - Northbound: Two entry lanes (shared through-left and shared through-right lane) and two exit lanes



- o Eastbound Leg: Two entry lanes (shared through-left and shared through-right lane) and two exit lanes
- o Southbound: Two entry lanes (shared through-left and shared through-right lane) and two exit lanes
- o Westbound Leg: Two entry lanes (shared through-left and shared through-right lane) and two exit lanes

The roundabout improvements would increase the delay of the Imjin Parkway intersections and would result in deficient operations in the PM peak hour at Abrams Drive and Imjin Parkway (Int. 11), which was not previously identified as a deficient intersection in the analysis above. The roundabout improvements for the General Jim Moore Boulevard intersections would result in reduced delay. The roundabout improvements are also presented above for General Jim Moore Boulevard and Lightfighter Drive (Int. 33) and General Jim Moore Boulevard and Gigling Road (Int. 39) to address the intersection deficiencies.

TABLE 47: ROUNDABOUT IMPROVEMENTS INTERSECTION LEVEL OF SERVICE

#	Intersection	Intersection Control	Jurisdiction (LOS Standard) ¹	Peak Hour ²	Cumulative without Project without Roundabout Improvement		Cumulative with Project without Roundabout Improvement		Cumulative with Project with Roundabout Improvement	
					Delay ³	LOS ⁴	Delay ³	LOS ⁴	Delay ³	LOS ⁴
10	Imjin Road and Imjin Parkway	Roundabout	M (D)	AM	14.4	B	28.3	C	28.7	D
				PM	24.7	C	62.2	E	85.2	F
11	Abrams Drive and Imjin Parkway	Roundabout	M (D)	AM	15.3	B	20.9	C	26.5	D
				PM	17.4	B	23.9	C	71.2	F
33	General Jim Moore Boulevard and Lightfighter Drive	Roundabout	S (C)	AM	33.7	C	79.6	E	13.7	B
				PM	24.4	C	29.1	C	12.2	B
39	General Jim Moore Boulevard and Gigling Road	Roundabout	S (C)	AM	30.6	C	51.8	D	24.8	C
				PM	22.5	C	56.0	E	14.0	B

Notes: **Bold text** indicates intersection operates at unacceptable level of service. **Bold and highlighted text** indicates an intersection deficiency.

*Indicates unsignalized intersection.

1. Intersection jurisdiction and associated LOS threshold applied.

i. City of Marina = M



- ii. City of Seaside = S
2. AM = AM peak hour, PM = PM peak hour.
3. LOS = Level of Service. The method described in the *Highway Capacity Manual* (HCM) (Transportation Research Board) was used to prepare the LOS calculations for the signalized study intersections. This method analyzes intersection operations based on average control delay per vehicle. Control delay includes the initial deceleration delay, queue move-up time, stopped delay, and final acceleration delay. The average control delay is calculated using Synchro analysis software and is correlated to a LOS designation
Source: Fehr & Peers, 2019.

Cumulative with Project and with Eastside Parkway Conditions

Under the Cumulative with Project and with Eastside Parkway Conditions, implementation of the Project would increase motor vehicle traffic and congestion, resulting in operational deficiencies at the following intersections. The localized improvements identified below would incrementally improve intersection operations and, in some cases, improve street connectivity. The intersections with operation deficiencies and corresponding improvements are further described below.

However, because all but one of the improvements under this “with Eastside Parkway” scenario were previously described under the “without Eastside Parkway” scenario presented above, no further description of these improvements is necessary and reference to the preceding section is provided; description is provided only as to those improvements not previously described.

Intersection 3: SR 1 Southbound Ramps and Imjin Parkway (Caltrans): Refer to prior discussion under Cumulative with Project and without Eastside Parkway Conditions.

Intersection 5: Second Avenue and Imjin Parkway (Marina): Refer to prior discussion under Cumulative with Project and without Eastside Parkway Conditions.

Intersection 12: Reservation Road and Imjin Parkway (Marina): Refer to prior discussion under Cumulative with Project and without Eastside Parkway Conditions.

Intersection 14: Inter-Garrison Road and Reservation Road (Monterey County): Refer to prior discussion under Cumulative with Project and without Eastside Parkway Conditions.

Intersection 22: Eighth Avenue and Inter-Garrison Road (Monterey County/CSUMB): Two improvement options have been identified:

- Option 1 – Signalization of intersection: This intersection meets peak hour signal warrant in the Cumulative with Project and with Eastside Parkway Conditions; therefore, the improvements evaluated for Option 1 include signalization and optimization of the cycle length and splits. This would address the deficiency at the intersection.
- Option 2 – Add second inside turning lane in roundabout and add a westbound left approaching lane: This option explores improvements that consider enhance the operations of the intersection



assuming the intersection remains as a roundabout. Adding a second inside turning lane, a dedicated westbound left lane, and a second receiving leg on the south leg would make a significant improvement to the intersection operations and queuing during both the AM and PM peak hours. This would address the deficiency at the intersection.

Intersection 25: East Garrison Road and Reservation Road (Monterey County): Refer to prior discussion under Cumulative with Project and without Eastside Parkway Conditions.

Intersection 28: Davis Road and Reservation Road (Monterey County): Refer to prior discussion under Cumulative with Project and without Eastside Parkway Conditions.

Intersection 33: General Jim Moore Boulevard and Lightfighter Road (Seaside): Refer to prior discussion under Cumulative with Project and without Eastside Parkway Conditions.

Intersection 39: General Jim Moore Boulevard and Gigling Road (Seaside): Refer to prior discussion under Cumulative with Project and without Eastside Parkway Conditions.

Intersection 46: General Jim Moore Boulevard and Normandy Road (Seaside): Reconfigure the intersection based on the improvements identified in *The Dunes at Monterey Bay EIR (2005)*. These improvements include:

- Adding a third northbound through lane and third southbound through lane
- Optimizing traffic signal cycle length and splits

Appendix O shows the delays, LOS, and changes in critical volume-to-capacity ratio and delay used to identify deficiencies at the study intersections under the Cumulative with Project and with Eastside Parkway Conditions. Improvements are described below and summarized in **Table 48**. As shown on the table, with implementation of the improvements, operations at each intersection would improve, and deficiencies attributed to the Project would be reduced below the local jurisdiction's thresholds at six of the ten intersections; the three exceptions are: Inter-Garrison Road and Reservation Road (Int. 14); East Garrison Road and Reservation Road (Int. 25); Davis Road and Reservation Road (Int. 28); and General Jim Moore Boulevard and Normandy Road (Int. 46), which would each continue to exceed the applicable LOS threshold, even with implementation of the improvements.



**TABLE 48: CUMULATIVE WITH PROJECT AND WITH EASTSIDE PARKWAY CONDITIONS
INTERSECTION IMPROVEMENTS SUMMARY**

Intersection	Improvements ³	Peak Hour ¹	Intersection Operations					
			Without Project Conditions Without Improvements		With Project Conditions Without Improvements		With Project Conditions With Improvements	
			Delay	LOS ²	Delay	LOS ²	Delay	LOS ²
3 SR 1 Southbound Ramps and Imjin Parkway ⁴	Refer to Cumulative with Project Improvement in Table 46.	AM	>120	F	>120	F	- ⁴	A
		PM	>120	F	>120	F	- ⁴	A
5 Second Avenue and Imjin Parkway	Refer to Cumulative with Project and without Eastside Parkway Conditions Improvement in Table 46.	AM	55.3	E	60.8	E	20.2	C
		PM	54.8	D	65.6	E	21.6	C
12 Reservation road and Imjin Parkway	Refer to Cumulative with Project and without Eastside Parkway Conditions Improvement in Table 46.	AM	25.7	C	26.1	C	23.6	C
		PM	55.6	E	61.5	E	49.9	D
14 Inter-Garrison Road and Reservation Road	Refer to Cumulative with Project and without Eastside Parkway Conditions Improvement in Table 46.	AM	117.8	F	>120	F	16.3	B
		PM	>120	F	>120	F	66.6	E
22 Eighth Avenue and Inter-Garrison Road	<u>Option 1</u> – Refer to Cumulative with Project and without Eastside Parkway Conditions Improvement in Table 46.	AM	50.5	F	>120	F	12.7	B
		PM	14.7	B	33.9	D	11.3	B
		AM	50.5	F	>120	F	12.2	B
		PM	14.7	B	33.9	D	14.1	B
25 East Garrison Road and Reservation Road	Refer to Cumulative with Project and without Eastside Parkway Conditions Improvement in Table 46.	AM	>120	F	>120	F	56.8	E
		PM	>120	F	>120	F	51.3	D
28 Davis Road and Reservation Road	Refer to Cumulative with Project and without Eastside Parkway Conditions Improvement in Table 46.	AM	>120	F	>120	F	77.7	E
		PM	>120	F	>120	F	>120	F



TABLE 48: CUMULATIVE WITH PROJECT AND WITH EASTSIDE PARKWAY CONDITIONS INTERSECTION IMPROVEMENTS SUMMARY

Intersection	Improvements ³	Peak Hour ¹	Intersection Operations					
			Without Project Conditions Without Improvements		With Project Conditions Without Improvements		With Project Conditions With Improvements	
			Delay	LOS ²	Delay	LOS ²	Delay	LOS ²
33 General Jim Moore Boulevard and Lightfighter	Option 1 – Refer to Cumulative with Project and without Eastside Parkway Conditions Improvement in Table 46.	AM	71.6	E	>120	F	19.2	B
		PM	33.0	C	43.6	D	18.4	B
		AM	71.6	E	>120	F	15.1	C
		PM	33.0	C	43.6	D	12.2	B
39 General Jim Moore Boulevard and Gigling Road	Option 1 – Refer to Cumulative with Project and without Eastside Parkway Conditions Improvement in Table 46.	AM	38.5	D	65.3	E	17.9	B
		PM	114.7	F	>120	F	17.2	B
		AM	38.5	D	65.3	E	24.6	C
		PM	114.7	F	>120	F	32.4	D
46 General Jim Moore Boulevard and Normandy Road	Add third NBT, third SBT, optimized cycle length and splits	AM	65.3	E	70.4	E	59.4	E
		PM	18.7	B	20.4	C	13.6	B

Notes: **Bold text** indicates intersection operates at unacceptable level of service. **Bold and highlighted text** indicates an intersection deficiency.

*Indicates unsignalized intersection.

1. AM = AM peak hour, PM = PM peak hour.

2. LOS = Level of Service. The method described in the *Highway Capacity Manual* (HCM) (Transportation Research Board) was used to prepare the LOS calculations for the signalized study intersections. This method analyzes intersection operations based on average control delay per vehicle. Control delay includes the initial deceleration delay, queue move-up time, stopped delay, and final acceleration delay. The average control delay is calculated using Synchro analysis software and is correlated to a LOS designation

3. EB = Eastbound, WB = Westbound, NB = Northbound, SB = Southbound; T = Through, L = Left-turn, R = Right-turn, LTR = Shared Left-Through-Right Lane, TR = Shared Through-Right Lane, TL = Shared Through-Left Lane.

4. The draft improvement would remove potential conflicting turn movements at this intersection, which removes vehicle control delay at this intersection.

Source: Fehr & Peers, 2019.



Although the improvements would not improve operations at the intersection to an acceptable LOS, the improvements would reduce the intersection AM peak hour delay below the Cumulative without Project with Eastside Parkway scenario results and address the deficiency.

While the improvements would reduce the Project's identified deficiency, an important design consideration is the secondary impacts to pedestrian and bicyclist operations. The road widening would affect the crossing length and time bicyclists and pedestrians spend in front of vehicles. The intersection improvement to further widen the northbound and southbound approach for additional turning lanes would require widening beyond restriping, which would affect the available right of way used of existing and proposed Class I shared use path along General Jim Moore Boulevard. Please refer to the discussion of potential secondary effects resulting from implementation of the road improvements below.

FREEWAY SEGMENTS

Deficiencies for freeway segments were determined based on the criteria described in the **Deficiencies Criteria** section of this chapter.

Existing with Project Conditions

For the Existing with Project Conditions, the Project would result in deficiencies at the following segments:

- Southbound SR 1 between Lightfighter Drive and Fremont Boulevard-Del Monte Boulevard during the AM peak hour
- Southbound SR 1 between Fremont Boulevard-Del Monte Boulevard and Canyon Del Rey during the AM Peak hour
- Northbound SR 1 between Fremont Boulevard-Del Monte Boulevard and Canyon Del Rey during the PM Peak hour

Cumulative with Project and without Eastside Parkway Conditions

For the Cumulative with Project and without Eastside Parkway Conditions, the Project's effect on traffic would be cumulatively considerable, thereby resulting in deficiencies at the following segments:

- Southbound SR 1 between Lightfighter Drive and Fremont Boulevard-Del Monte Boulevard during the AM peak hour
- Southbound SR 1 between Fremont Boulevard-Del Monte Boulevard and Canyon Del Rey during the AM Peak hour and PM peak hour
- Northbound SR 1 between Lightfighter Drive and Fremont Boulevard-Del Monte Boulevard during the PM peak hour



- Northbound SR 1 between Fremont Boulevard-Del Monte Boulevard and Canyon Del Rey during the PM Peak hour

Cumulative with Project and with Eastside Parkway Conditions

Similar to the Cumulative with Project and without Eastside Parkway Conditions, the Cumulative with Project and with Eastside Parkway Conditions would have the same freeway deficiencies, except at the southbound segment between Lightfighter Drive and Fremont Boulevard-Del Monte Boulevard in the AM peak hour. The addition of the Eastside Parkway would result in shifts of traffic that could result in a reduced number of Project traffic traveling along this segment of SR 1, thereby eliminating the deficiency at this location.

Freeway Improvements

As part of the *2040 Metropolitan Transportation Plan / Sustainable Communities Strategy* (2018), there is a planned improvement to widen SR 1 to six lanes from Fremont Boulevard-Del Monte Boulevard to Canyon Del Rey Boulevard. This planned improvement would increase capacity and could improve operations along a segment that performs deficiently with the addition of Project traffic and PDFs; thus, addressing the deficiencies on the northbound and southbound SR 1 segments between Fremont Boulevard-Del Monte Boulevard and Canyon Del Rey Boulevard. However, since there is no assurance that the funding will be available, the deficiency would remain as there is no other feasible mitigation.

There are no planned widening improvements for SR 1 north of Fremont Boulevard-Del Monte Boulevard that would address the between Lightfighter Drive and Fremont Boulevard-Del Monte Boulevard. As part of the TAMC 2014 Regional Transportation Plan, the proposed improvements for transit capacity along SR 1 and widening of interchanges of SR 1 would not widen or directly increase vehicle capacity along SR 1. As such, there is no feasible improvement available, and the deficiency would remain.

SECONDARY EFFECTS OF INTERSECTION IMPROVEMENTS

As discussed above, various types of intersection improvements could address the identified deficiencies. These improvements vary in size and type, including reconfiguring intersection approaches, adding lanes, and other types of improvements. Secondary effects associated with widening intersections for vehicle movements include effects relating to pedestrians and bicyclists; that is, the need for additional right of way, removal of trees, relocation of utilities, lengthening of crosswalks, and/or modification of signal phasing could increase the crossing distance/time for pedestrians and bicyclists, thereby resulting in potential safety related impacts.

Where dual right-turn lanes are proposed, they could result in a double threat condition for pedestrians and bicyclists. The double threat for pedestrians and bicyclist may be reduced by implementing a no right-turn on red for movements that have two right-turn lanes. However, despite the implementation of the no



right-turn on red, there continues to be a secondary impact to pedestrians and bicyclists caused by the increased crossing distance on all legs of the intersection.

Widening of a roundabout as discussed for Eighth Avenue and Inter-Garrison Road (Int. 22) would result in the need for additional right of way and widening of approaches and exiting lanes. The widening of approaches and exiting lanes would lengthen crosswalks. Although a separated shared use path is provided for bicyclists through the roundabout, there continues to be a secondary impact to bicyclists caused by increased crossing distances and widening affecting the width and length of the separated shared use path unless a tunnel or bridge are constructed. An important design consideration for multi-lane roundabouts is the bicycle and pedestrian crossings across two approach/departure lanes. Specifically, multi-lane roundabouts without controlled pedestrian and bicycling crossings could have an inherent “double threat” to pedestrians and bicyclists. For example, a visually impaired pedestrian needs adequate guidance (design features and/or control devices) to know when to enter the street as vehicles and bicyclist yield to the pedestrian. Therefore, each double lane approach/departure should include sufficient design features (staged crossing one lane at a time, bypass lanes) and control devices (signalization, yield control, etc.) to accommodate all users, especially visually impaired pedestrians and elderly users.



**APPENDIX A: CSUMB MASTER PLAN EIR – TRIP GENERATION
EVALUATION METHODS AND ESTIMATES**





MEMORANDUM

Date: November 9, 2021

To: Anya Spear and Matt McCluney, California State University Monterey Bay
Steve Lohr and Dawn Theodora, California State University Office of the Chancellor
Ann Sansevero, Dudek

From: Daniel Rubins, Jane Bierstedt, and Matt Haynes, Fehr & Peers

Subject: California State University Monterey Bay Master Plan EIR – Trip Generation Evaluation Methods and Estimates

SJ17-1728

This memorandum describes the trip generation for the proposed California State University Monterey Bay (CSUMB) Master Plan, including Project Design Features (PDFs) drawn from the CSUMB Master Plan Guidelines (the Project).

MEMORANDUM ORGANIZATION

This technically oriented memorandum provides an overview of the Project relative to transportation related matters with four sections: (1) project description, (2) technical methods, (3) trip generation estimates, and 4) summary. The purpose of each section is described below.

- Project Description: This section describes the populations under Existing Conditions and Project Conditions for the CSUMB Main Campus and East Campus that are the basis of this trip generation analysis.
- Technical Methods: The trip generation approach and technical methods are unique because of the size of the CSUMB campus, the unique travel behavior of each portion of the CSUMB population, and varied housing locations of the CSUMB population. Rather than calculating the net increase in project vehicle trips due to the net increase in land use intensity like most projects, the trip generation is prepared for the entire campus (see **Figure 1** for CSUMB campus boundary encompassing Main Campus, East Campus Open Space and East Campus) under Existing Conditions and Project Conditions to capture the



effects of adding student on-campus housing to the Main Campus and shifting of student housing from East Campus to Main Campus, and increasing the portion of faculty and staff living in the East Campus. Specifically, the net new project traffic is the difference between the Project Conditions and Existing Conditions CSUMB campus trip generation. As shown in the analysis, housing a greater percentage of students, faculty and staff on-campus increases the:

- Likelihood of trips staying within the campus (internal trips); and
- Likelihood of trips shifting to other modes (walking, bicycling, micro-mobility, and transit) for both on- and off-campus travel.

This section has three subsections:

- Trip Types and Assumptions: This section describes and illustrates the five trip types studied for the CSUMB Campus and the boundaries used for the trip generation analysis. It also discusses key assumptions and definitions.
- Existing Trip Generation and Travel Characteristics: The Existing Conditions trip generation estimates for the Main Campus and East Campus are based on the *CSUMB Person Trip Travel Survey* conducted by CSUMB staff and analyzed by Fehr & Peers, Main Campus cordon trips from the annual *CSUMB 2016-2017 Traffic Generation* report (Mott MacDonald, November 2017), and the East Campus vehicle cordon counts conducted by Fehr & Peers. This section summarizes the person trip generation, vehicle trip generation and mode share data for those traveling between East Campus and Main Campus, and between Main Campus and off-Campus.
- Trip Generation Rates: This section summarizes the trip generation rates for two vehicle cordons and three sub-cordons. This section also summarizes by reference to an attachment the Existing Conditions and Project Conditions vehicle trip generation rates for the three campus population types (students, faculty and staff) on an FTE basis.
- Trip Generation Estimates: The vehicle trip generation for the CSUMB campus under Existing Conditions and Project Conditions is presented in this section. The total trip generation estimates are provided for the Main Campus and East Campus, as well as total numbers for the entire campus.



- Summary: The memorandum concludes with a summary of the net increase in trip generation between Existing Conditions and Project Conditions. This is the amount of added project traffic that will be evaluated in the transportation analysis (TA).

PROJECT DESCRIPTION

The Project is the CSUMB Master Plan. Project elements that affect the transportation system include the proposed increase in enrollment, the on-campus housing for students, faculty, and staff, and a Main Campus street and parking system that facilitates and prioritizes walking, bicycling, and transit use over vehicle travel. Upon buildout, the Project would accommodate an increase in campus enrollment from the existing 6,634 full time equivalent students (FTES)¹ and 1,024 full time equivalent faculty/staff (FTEF),² to 12,700 FTES and 1,776 FTEF. Under Project Conditions, it is projected that the Project would house at least 60 percent of enrolled students and 65 percent of faculty and staff on campus (PDF-LU-5 and PDF-LU-6, as described in Chapter 3 of the proposed CSUMB Master Plan Draft EIR). As explained in the *California State University, Monterey Bay Proposed Master Plan Housing Memorandum* (see **Attachment A**), the Project Conditions on-campus student housing rate is similar to the existing on-campus student rates, and the Project Conditions on-campus faculty and staff housing rate is expected to increase based on various policies, programs and procedures to be implemented over the coming years.

Table 1 summarizes the number and percentage of students, faculty, and staff presently residing on- and off-campus (Existing Conditions), and the number forecasted to reside on- and off-campus under Project Conditions when FTES enrollment and FTEF employment total reaches 14,476.

¹ Full-time equivalent (FTE) is the unit of measurement used to convert class load to student enrollment. At CSUMB, one FTE is equal to 15 units. Thus, one FTE is equal to one student enrolled in 15 units or three students each enrolled in 5 units. A related unit of measurement is "headcount." In the case of one student taking 15 units, the headcount is 1; in the case of three students collectively taking 15 units, the headcount is 3.

² According to CSUMB Institutional Assessment and Research, 1 FTE = full time faculty or staff headcount + part time faculty or staff headcount divided by 3. The faculty and staff category also includes affiliates, which are companies that have been contracted by the Corporation to provide services that the auxiliary has been asked to provide by the university (e.g., dining, bookstore, etc.), and the affiliate's employee works full-time on campus in that capacity. They are also referred to as contractors. The Auxiliary includes staff of the Corporation, Student Union and Foundation.



TABLE 1: CSUMB POPULATION TYPE BY HOUSING LOCATION

Housing Location	Existing Conditions (FTES or FTEF) ¹	Project Conditions (FTES or FTEF) ¹	Change (Project – Existing) ²
Student Population			
Main Campus	2,600 (39.2%)	7,620 ³ (60.0%)	+5,200
East Campus ⁴	1,380 (20.8%)	0 (0%)	-1,380
Off-Campus	2,654 (40.0%)	5,080 (40.0%)	+2,426
<i>Subtotal [A]</i>	<i>6,634</i> <i>(100%)</i>	<i>12,700</i> <i>(100%)</i>	<i>+6,066</i>
Faculty/Staff Population			
East Campus ⁴	463 (45.2%)	1,154 ³ (65.0%)	+691
Off-Campus	561 (54.8%)	622 (35.0%)	+61
<i>Subtotal [B]</i>	<i>1,024</i> <i>(100%)</i>	<i>1,776</i> <i>(100%)</i>	<i>+752</i>
Student, Faculty, and Staff Population (Campus Population)			
Main Campus and East Campus (Students, Faculty and Staff)	4,443 (58.0%)	8,774 (60.6%)	+4,331
Off-Campus (Students, Faculty and Staff)	3,215 (42.0%)	5,702 (39.4%)	+2,487
Total [A + B = C]	7,658 (100%)	14,476 (100%)	+6,818
Campus Population with Community Housing Partners			
East Campus (Community Housing Partners) [D]	280	66	-214
Total [C+D = E]	7,938	14,542	+6,604

Notes:

1. FTES = Full time equivalent students; FTEF = Full time equivalent faculty/staff.
2. Change (Project - Existing) = Project Conditions column – Existing Conditions column.
3. The transportation trip generation analysis uses a campus population that, meets but does not exceed the 60 percent student housing goal and the 65 faculty and staff housing goal under Project Conditions.
4. Under Existing Conditions 1,380 students, 463 faculty/staff, and 280 community housing partners live in the East Campus housing. Under Project Conditions 1,154 faculty/staff and 66 community housing partners live in the East Campus housing unless housing is needed by for campus employees.

Source: Fehr & Peers, 2019.



The total on-campus housed population (i.e., the number of students, faculty, and staff residing in either Main Campus or East Campus housing) is forecasted to increase from the existing 58 percent (4,443 of 7,658) to 61 percent (8,774 of 14,476). As space permits, community housing partners³ will also reside in the East Campus housing. While community housing partners live on-campus, they are not associated with on-campus housing for students, faculty and staff, and therefore are not included in the student, faculty, and staff population total but are included in the entire campus population total in **Table 1**.

In terms of actual on-campus housing facilities, the Project would provide housing to accommodate an increase in campus population from the existing approximately 6,634 FTES to 12,700 FTES, and an increase in employees (i.e., faculty and staff) from approximately 1,024 FTEF to 1,776 FTEF.⁴

TECHNICAL METHODS

The addition of students, faculty, and staff as part of the Project will increase the overall campus person and vehicle trip generation. The following sections provided a detailed accounting of the trip generation estimates by trip type, CSUMB campus population, and housing location.

TRIP TYPES AND ASSUMPTIONS

Because of the large size of the CSUMB campus, some vehicle trips will start and end within the campus and, as such, are designated internal trips (e.g., vehicle trips between the Main Campus and East Campus or trips within Main Campus). These internal vehicle trips are considered part of the on-campus transportation analysis, and do not affect the operations of off-campus intersections and freeway segments. Only trips that travel off campus (external trips) are used to evaluate the Project's effects on external intersections and freeway segments.

To properly estimate trip generation for the entire campus, five types of vehicle trips were defined based on their origins and destinations: 1) External trips between Main Campus and Off Campus (designated below as "A" trip type), 2) External trips between East Campus and Off Campus ("B" trip type), 3) Internal trips between Main Campus and East Campus ("C" trip type), 4) Internal trips within Main Campus ("D" trip type), and 5) Internal trips between The Promontory and Main Campus ("E" trip type).

³ Community housing partners are made up of affiliates (a subcategory of CSUMB staff), educational partners and military partners, and public sector employees working in the Monterey area.

⁴ Existing student, faculty and staff quantities based on 2016 baseline figures provided by CSUMB staff.



The five trip types are illustrated in **Figure 1** and described below:

- **A – External Trips between Main Campus and Off Campus:**
 - This trip type is made, for example, by students living on-campus and going off-campus, students, faculty/staff living off-campus traveling to campus, as well as campus supporting/visitor trips (by visitors, deliveries, transit, and other supporting activities) that enter or exit the CSUMB Main Campus cordon. These include trips to/from Seaside, Marina, Salinas, and other nearby communities.
- **B – External Trips between East Campus and Off Campus:**
 - This trip type is made, for example, by students and faculty/staff living on East Campus that travel off-campus. This includes trips between East Campus and Seaside, Marina, Salinas, and other nearby communities.
- **C – Internal Trips between Main Campus and East Campus:**
 - This trip type is made, for example, by students and faculty/staff that travel between CSUMB's Main Campus and East Campus. These trips are internal campus trips because both trip ends are located within the entire campus cordon.
- **D – Internal Trips within Main Campus:**
 - This trip type is made, for example, by students, and campus support vehicles that travel within CSUMB's Main Campus. These trip pairs are internal campus trips because both trip ends are located within the Main campus cordon.
- **E – Internal Trips between The Promontory and Main Campus:**
 - This trip type is made, for example, by students and campus support vehicles that travel between The Promontory residential buildings and CSUMB's Main Campus. These trips are internal campus trips because both trip ends are located within the Main Campus cordon.

The Project trip generation estimates are based on existing CSUMB travel data observed at each cordon (or boundary defining a portion of the campus): 1) the Main Campus Cordon, 2) East Campus Cordon, 3) the entire CSUMB campus, 4) East Campus Sub-Cordon for Students, and 5) East Campus Sub-Cordon for faculty, staff and community housing partners (see **Figure 1** for the location of each cordon).



SJ17_1728_Fig01_CSUMB Trip Pairs_v5.ai

- California State University Monterey Bay Campus
- Main Campus Cordon
- East Campus Cordon
- Agency Boundary

- A. External Trips between Main Campus and Off-Campus
- B. External Trips between East Campus and Off-Campus
- C. Internal Trips between Main Campus and East Campus
- D. Internal Trips within Main Campus
- E. Internal Trips between The Promontory and Main Campus

- Promontory Housing Sub-Cordon Location
- East Campus Sub-Cordon for Students
- East Campus Sub-Cordon for Faculty, Staff, and Community Housing Partners



Figure 1
CSUMB Cordons and Trip Types



The Main Campus trip generation is the sum of Main Campus internal vehicle trips and Main Campus Cordon vehicle trips (e.g., vehicle trips to/from Promontory, East Campus, and off-campus locations). East Campus Cordon count/total trip generation is the sum of the East Campus internal vehicle trips with Main Campus and East Campus external trips. This trip generation format is used throughout the memo.

In addition to the trip types, and campus cordon locations described above, the following concepts are intended to assist the reader in understanding the trip generation methods and analysis assumptions presented in the subsequent sections:

- The CSUMB campus population is the sum of full-time equivalent students, faculty, and staff. The entire campus population is the sum of full-time equivalent students, faculty, staff and Community Housing Partners.
- The CSUMB trip generation estimates do not include pass-through traffic (e.g., vehicles that use campus streets to travel through the university to other destinations without stopping).
- The CSUMB External Campus Trip Total is the sum of all Type A and B vehicle trips generated by students, faculty, staff, community housing partners plus campus supporting vehicle trips (e.g., deliveries, maintenance, etc.) and visitor trips.
- The Existing Main Campus Trip Generation is based on the Main Campus daily vehicle cordon count from the annual *CSUMB 2016-2017 Traffic Generation* memorandum, and most of the daily and peak hour vehicle data comes from the *CSUMB Person Trip Travel Survey*, and the inbound/outbound split are from either the annual *CSUMB 2016-2017 Traffic Generation*, the *CSUMB Person Trip Travel Survey*, or a combination of the two data sources.
- The Existing Main Campus Trip Generation for this analysis includes all Main Campus trips (Trip Types A, C, D, and E). In comparison, the Annual Monitoring Cordon Total Trips from the annual *CSUMB 2016-2017 Traffic Generation* memorandum includes only a portion of these trips by excluding a portion of the vehicle trips from the Promontory student housing and internal supporting vehicle trips. Thus, the daily vehicle trip generation reported for this Main Campus Cordon Trips is greater than and defined differently than the Annual Monitoring Cordon Total Trips.
- The Existing East Campus Cordon Total for this analysis includes all East Campus trips (Trip Types B and C) and is based on the East Campus Cordon counts collected in the Fall of 2017 and includes the daily and peak hour data collected from the *CSUMB Person Trip Travel Survey*.



- The Project trip generation estimates presented in this memorandum assume the existing Transportation Demand Management (TDM) and Parking Management measures remain in place on the CSUMB campus, and those measures continue to be as effective in reducing vehicle trip-making and encouraging the use of other modes. It furthermore assumes no growth in TDM and parking measures despite plans to expand these programs.
- On-campus housing vehicle trip rates are less than off-campus vehicle trip rates. Therefore, as the portion of the CSUMB population living on-campus increases, the per person vehicle trip generation rate will decrease.
- Main Campus students, campus supporting vehicle trips (e.g., deliveries, maintenance, etc.) and visitor vehicle trips are included in the trip estimates as one group because of the limited fidelity in the available travel data.

EXISTING TRIP GENERATION AND TRAVEL CHARACTERISTICS

The vehicle trip generation estimates for Existing Conditions are based on the data sources listed below and discussed in greater detail in this section:

1. Person and Vehicle Trip Generation Data: *CSUMB Person Trip Travel Survey* conducted by CSUMB staff and analyzed by Fehr & Peers (Fall 2017);
2. Main Campus Cordon Trips: Main Campus cordon trips from the annual *CSUMB 2016-2017 Traffic Generation* report (Mott MacDonald, November 2017); and
3. East Campus Cordon Trips: East Campus Vehicle Cordon Count collected along the boundary of this portion of the campus (conducted November 2017 by Fehr & Peers).

These studies provide information on the travel behavior of students, faculty and staff living off-campus, living on the Main Campus, and living on the East Campus. Additional detail regarding the person and vehicle trip generation data, Main Campus Cordon Trips, and East Campus Cordon Trips are described in more detail below. The reader may find it useful to refer back to **Figure 1** for specific trip type or campus location definitions.

- Person and Vehicle Trip Generation Travel Data: The *CSUMB Person Trip Travel Survey (Attachment B)* includes questions of the Main Campus population to determine travel choices to/from the Main Campus, primary mode of travel, arrival and departure time on each day of the week, frequency of travel, and the frequency of vehicle use. The 2,410 responses were summarized to determine the person trip generation, vehicle trip generation and primary mode share data for those traveling between East Campus and



Main Campus, and between Main Campus and off-Campus (**Attachment C**). **Tables C-1** through **C-4** summarize the directional personal and vehicle trip rates from the Survey responses. The person and vehicle trips rates in **Tables C-5** and **C-6** were used for the peak commute direction (inbound in the morning peak hour and outbound in the evening peak hour) as described later in the memo.

Most CSUMB students, faculty, and staff residing off-campus travel to/from the campus by passenger vehicle. As shown in **Tables C-7** and **C-8** off-campus residents (see the fourth and last columns from the left in **Table C-7**) have a higher combined drive-alone and shared-ride mode share than the average work trip mode share for Monterey or Santa Cruz counties (see the third through sixth columns from the left in **Table C-8**). In contrast, on-campus residents have a lower drive-alone and shared ride mode share than either County's combined work drive-alone or shared ride mode share.

The drive-alone mode share for the Main Campus, with on- and off-campus students, is approximately 54 percent; the number is approximately 75 percent when excluding on-campus student residents (see **Table C-9**). Thus, including the on-campus student residents has a notable influence on the inbound morning peak hour mode share and illustrates the benefit on-campus housing has on shifting travel behavior from the personal vehicle to walking, bicycling and transit.

Existing Conditions vehicle trip generation rates for the Main Campus and East Campus were derived from the cordon trip counts. The Main Campus cordon trips are a calculated value per the steps described below. East Campus Cordon count comes from the counts collected along the boundary of this portion of the campus. The vehicle trip rates are further divided by campus population using the person trip travel survey trip rates referenced previously and provided in **Attachment C**.

- Main Campus Cordon Vehicle Trips: The Main Campus Cordon Trips is a calculated value that uses several data sources using the following steps.
 - Step 1 – Summary of Daily Trip Generation from Annual Trip Generation report: This step establishes daily trip generation using the Main Campus and Promontory daily trip generation estimate from the annual *CSUMB 2016-2017 Traffic*



Generation report. The Main Campus daily vehicle trip generation⁵ is sourced from the annual *CSUMB 2016-2017 Traffic Generation* report. As shown in **Table 2**, the annual monitor cordon trips of 10,545 daily vehicles (see line 1), Promontory trip count of 1,518 (sum of external (see line 2) and internal (see line 3) trips), and internal campus supporting trips of 948 (line 4) are added together to estimate the Main Campus trip generation of 13,011 daily vehicles (line 5). The internal trips in the annual *CSUMB 2016-2017 Traffic Generation* report were derived from visual CSUMB permit surveys, external delivery travel data provided by CSUMB staff.

TABLE 2: CSUMB MAIN CAMPUS DAILY VEHICLE TRIP GENERATION AND CORDON COUNTS

	Location (Population Type)	Trip Types¹	Daily Vehicle Trips
1	Annual Monitoring Cordon Total Trips ²	A+C	10,545
2	Promontory External Trips ³	A	+661
3	Promontory Internal Trips ⁴	E	+857
4	Main Campus Internal Trips ⁵	D	+948
5	Main Campus Trip Generation	A+C+D+E	13,011

Notes:

FTE = Full time equivalent.

1. Trip pairs shown on Figure 1.

2. From Total CSUMB Int-Ext/Ext-Int Trips line in Exhibit 3 of the annual *CSUMB 2016-2017 Traffic Generation* memorandum.

3. From footnote 7 of Exhibit 3 of the annual *CSUMB 2016-2017 Traffic Generation* memorandum.

4. From Internal Trips line of Exhibit 3 of the annual *CSUMB 2016-2017 Traffic Generation* memorandum.

5. Calculated based on daily vehicle trip generation rate summarized in Attachment C-6 for Main Campus students. This value is calculated as follow: 142 daily vehicle trips = 0.188 daily vehicle trips per student x 756 promontory students.

Source: Fehr & Peers, 2019.

- Step 2 – Daily Trip Generation Using for CSUMB Environmental Analysis: This step allocates the CSUMB Main Campus Trip Generation of 13,011 daily vehicle trips from step 1 based on the daily vehicle trip rates derived from the *CSUMB Person Trip Travel Survey* (see **Attachment C Table C-6**), and the Promontory parking lot driveway data from the annual *CSUMB 2016-2017 Traffic Generation* report (see **Attachment D**). The daily vehicle trips for each location and population type are

⁵ The Main Campus trip generation is the sum of all external vehicle trips generated by students, faculty, staff, visitors, and campus supporting personnel such as security and maintenance staff vehicles such as deliveries.



shown in **Table 3** (see notes for the daily trip rate source). For this trip generation analysis, the Main Campus Supporting Internal Trips (Trip Type D), and the Main Campus Supporting Trips and Visitor Trips (Trip Type A) are the remaining vehicle trips after applying the daily trip rates to the other housing location and population type. By using the person and vehicle trip generation data, the estimate of internal student and supporting trips is less than stated in the annual *CSUMB 2016-2017 Traffic Generation* report.

TABLE 3: CSUMB DAILY MAIN CAMPUS TRIP GENERATION BY LOCATION AND POPULATION TYPE

Location (Population Type)	Trip Types ¹	Population Size (FTE)	Daily Trip Rate (Vehicle Trips per FTE) ²	Daily Vehicle Trips
Main Campus Housing (Students) ³	A	1,844	2.079	3,832
Promontory Housing (Students) ³	A	756	2.079	1,572
Off-Campus Housing (Students) ²	A	2,654	1.285	3,411
Off-Campus Housing (Faculty and Staff) ²	A	561	1.602	899
East Campus Housing (Students) ²	C	1,380	1.030	1,422
East Campus Housing (Faculty and Staff) ²	C	463	1.618	749
Main Campus Housing Internal Trips (Students) ²	D	1,844	0.188	348
Promontory Housing Internal Trips (Students) ²	E	756	0.188	142
Main Campus Supporting Internal Trips (Campus Population) ⁴	D	7,658	0.042	321
Campus Supporting Trips and Visitor Trips (Campus Population) ⁴	A	7,658	0.041	315
Main Campus Trip Generation	A+C +D+E	7,658	1.699	13,011

Notes:

FTE = Full time equivalent.

1. Trip pairs shown on Figure 1.

2. Calculated based on daily vehicle trip rate from **Attachment C Table C-6**.

3. Calculated vehicle trip rate for Main Campus and Promontory Housing vehicle trip rate based on daily Promontory driveway count minus Promontory internal vehicle trips. This value is calculated as (1,714 Promontory vehicle trips – 142 Promontory housing vehicle trips)/756 Promontory Students = 2.079 vehicle trips per FTES.

4. Campus Supporting Internal Trips, and Campus Supporting Trips and Visitor Trips are the remaining daily vehicle trips (split approximately evenly) to sum to the Main Campus Trip Generation.

Source: Fehr & Peers, 2019.

The internal student and campus supporting trips are excluded from the Main Campus Trip Generation to derive the daily Main Campus Cordon Trips. **Table 4**



shows the 142 internal Promontory vehicle trips (see line 2) and 669 daily internal student and campus supporting vehicle trips (see line 3) that are removed. The resulting Main Campus Cordon Trips (12,200) is the number of daily vehicle trips that leave the Main Campus cordon boundary (see line 4).

TABLE 4: CSUMB MAIN CAMPUS CORDON TRIPS

Location (Population Type)	Trip Types ¹	Daily Vehicle Trips
1 Main Campus Trip Generation	A+C+D+E	13,011
2 Promontory Internal Trips ²	E	-142
3 Main Campus Students and Campus Supporting Trips ³	D	-669
4 Main Campus Cordon Trips	A+C	12,200

Notes:

FTE = Full time equivalent.

1. Trip pairs shown on Figure 1.

2. Promontory Internal Trips = 756 Promontory Students * 0.188 vehicle trips per FTES = 142 vehicle trips.

3. Main Campus Supporting Internal Trips (321 daily vehicle trips) and Main Campus Housing Internal Trips (348 daily vehicle trips) = Main Campus Students and Campus Supporting Trips (669 daily vehicle trips).

Source: Fehr & Peers, 2019.

- o Step 3 – Peak Hour Trip Generation: The number of morning and evening peak hour vehicle trips were determined by factoring the daily Main Campus Trip Generation by the ratios of peak hour trips to daily trips. The Main Campus trip generation of 1,520 morning peak hour vehicle trips is approximately 11.7% of the 13,011 daily trips. While the Main Campus trip generation of 1,460 evening peak hour vehicle trips is approximately 11.2% of the 13,011 daily trips.
- o Step 4 – Peak Hour Directional Trip Generation: This step estimates the inbound and outbound splits are based on the vehicle trip rates shown in **Attachment D Table D-2**. These peak hour directional trip rates are derived from sources such as the vehicle trip rates derived from the *CSUMB Person Trip Travel Survey*, the annual *CSUMB 2016-2017 Traffic Generation* report, the Promontory parking lot driveway data from the annual *CSUMB 2016-2017 Traffic Generation* report (see **Attachment D**), and the East Campus Cordon Trips. The result is a 69%/31% in/out split during the morning peak hour and a 40%/60% in/out split during the evening peak hour. The results are similar to the in/out splits from the Institute of Transportation Engineers (ITE) *Trip Generation Manual* 10th Edition for University/College land use code 550 (78%/22% in/out split during the morning peak hour and 32%/66% in/out split during the evening peak hour). The results are summarized in **Table 5**.



The split of inbound, outbound and internal trip estimates are shown in **Table 5** and are the result of using the trip rates described in **Attachment E**. The reader can review the Existing Conditions trip generation estimates by population type in **Attachment F**. The internal trips are summarized on line 3 of **Table F-1**, the Main Campus Cordon Count Trips is on line 10 of **Table F-1**, and the Main Campus Trip Generation is shown on line 14 of **Table F-1**. As shown in **Table 5**, the Main Campus Cordon Count is estimated by subtracting the Main Campus Internal Trips from the Main Campus Trip Generation.

TABLE 5: EXISTING CSUMB MAIN CAMPUS PEAK HOUR VEHICLE TRIP GENERATION AND CORDON COUNTS

Location (Population Type)	Population Size (FTE)	Trip Type ¹	Daily	AM Peak Hour			PM Peak Hour		
				Total	In	Out	Total	In	Out
Vehicle Trip Generation									
Main Campus Trip Generation (Students, Faculty and Staff)	7,658	A+C+ D+E	13,011	1,520	1,055	465	1,460	589	871
Main Campus Internal Student and Campus Supporting Trips	7,658	D+E	-811	-284	-159	-125	-148	-64	-84
Vehicle Cordon									
Main Campus Cordon (Students, Faculty and Staff)	7,658	A+C	12,200	1,236	896	340	1,312	525	787
Vehicle Sub-Cordon									
Promontory Housing	756	A+E	1,714	56	17	39	113	53	60

Notes:

FTE = Full time equivalent.

1. Trip types shown on Figure 1.

Source: Fehr & Peers, 2019.

- East Campus Cordon Trips: The East Campus Cordon Count study collected vehicle counts from collected from the three East Campus neighborhoods (e.g., Frederick Park I, Frederick Park II, and Schoonover Park). Counts were collected Tuesday through Wednesday during the week of November 7th and Tuesday through Thursday during the week of November 14th, 2017. The count results are summarized in **Table 6**.

Unlike the calculated Main Campus Cordon Counts, the East Campus Cordon count data is directly related to the observed vehicle trips from either students or



faculty/staff/community housing partners. Since students live in Frederick Parks I & II neighborhoods and faculty/staff and community housing partners live in Schoonover Park, it is clear which population type is generating trips.

TABLE 6: EXISTING CSUMB EAST CAMPUS CORDON VEHICLE COUNTS

Location (Population Type)	Population Size (FTE)	Trip Type ¹	Daily	AM Peak Hour			PM Peak Hour		
				Total	In	Out	Total	In	Out
Vehicle Cordon									
East Campus Cordon (Students, Faculty, Staff and Community Housing Partners) ²	2,123	B+C	10,017	799	134	665	759	484	275
Vehicle Sub-Cordon									
East Campus Sub- Cordon (Faculty, Staff and Community Housing Partners) ^{2,3}	743	B+C	4,667	519	86	433	444	305	139
East Campus Sub- Cordon (Students) ^{2,4}	1,380	B+C	5,350	280	48	232	315	179	136

Notes:

FTE = Full time equivalent.

1. Trip types shown on Figure 1.
2. Under Existing Conditions, 1,380 students, 463 faculty/staff, and 280 community housing partners (affiliate agency and other government employees) live in the East Campus housing.
3. East Campus Cordon count for faculty, staff, and community housing partners living along Schoonover Road.
4. East Campus Cordon count for students living along Bunker Hill and Manassas Drive.

Source: Fehr & Peers, 2019.

TRIP GENERATION RATES

As previously noted, the existing campus vehicle trip generation rates were calculated based on the *CSUMB Person Trip Travel Survey* data, the annual *CSUMB 2016-2017 Traffic Generation* report data (which includes Main Campus cordon trips and the driveway counts taken at the Promontory student housing and reported in the annual *CSUMB 2016-2017 Traffic Generation* report), and the East Campus vehicle cordon counts conducted by Fehr & Peers.

Table 7 shows the trip rates at two vehicle cordon locations and three sub-cordon locations, which are calculated by dividing the vehicle cordon trip generation summarized in **Tables 5** and **6** by the respective population sizes.



**TABLE 7: EXISTING CONDITIONS CSUMB CAMPUS CORDON
 VEHICLE TRIP GENERATION RATES¹**

Location (Population Type)	Population Size (FTE)	Trip Type ²	Daily	AM Peak Hour			PM Peak Hour		
				Total	In	Out	Total	In	Out
Vehicle Cordon									
Main Campus Cordon (Students, Faculty and Staff)	7,658	A+C	1.59	0.16	0.12	0.04	0.17	0.07	0.10
East Campus Cordon (Students, Faculty, Staff and Community Housing Partners) ²	2,122	B+C	4.72	0.38	0.06	0.32	0.36	0.23	0.13
Vehicle Sub-Cordon									
Promontory Housing	756	A+E	2.27	0.07	0.02	0.05	0.15	0.07	0.08
East Campus Sub- Cordon (Faculty, Staff and Community Housing Partners) ^{2,3}	743	B+C	6.28	0.70	0.12	0.58	0.60	0.41	0.19
East Campus Sub- Cordon (Students) ^{2,4}	1,380	B+C	3.88	0.20	0.03	0.17	0.23	0.13	0.10

Notes:

FTE = Full time equivalent.

1. Vehicle trip generation rates represent vehicles per FTE. For presentation purposes, these rates are rounded to the nearest hundredth.
2. Trip type shown on Figure 1.
3. Under Existing Conditions, 1,380 students, 463 faculty/staff, and 280 community housing partners live in the East Campus housing.
4. East Campus Cordon count for faculty, staff, and community housing partners living along Schoonover Road.
5. East Campus Cordon count for students living along Bunker Hill and Manassas Drive.

Source: Fehr & Peers, 2019.

The Existing Conditions and Project Conditions trip generation rates were calculated separately by location and for the various campus population types and housing location, which show vehicle trips per FTE in **Attachment E**. **Attachment E** also presents a description of each of the CSUMB trip types.

Under Project Conditions, the Main Campus student internal vehicle trip generation rates would be reduced due to two factors, both of which disincentives vehicle use on campus. The first is that parking will be consolidated and relocated to select areas on the periphery of the campus core, a non-convenient location for Main Campus students. Second, new infilled student housing will be close to the academic core. Both of these changes are expected to shift student travel from vehicles



to more convenient on-campus transit, bicycling, walking and other non-vehicle modes of travel. The Main Campus student internal vehicle trip generation rates were reduced by 75 percent.

Attachment F presents the Existing Conditions vehicle trip generation for CSUMB by population type and housing location.

TRIP GENERATION ESTIMATES

Total vehicle trip generation for the CSUMB campus under both Existing Conditions and Project Conditions are presented in **Tables 8** and **9**, respectively. The total trip generation estimates are provided for the Main Campus and East Campus separately, as well as total numbers for the entire campus.

As shown in **Table 8**, under Existing Conditions the Campus external vehicle trip generation is approximately 17,875 daily vehicle trips, 1,401 morning peak-hour trips (713 inbound and 688 outbound) and 1,457 evening peak-hour trips (702 inbound and 755 outbound). A detailed Existing Conditions trip generation table is included as **Attachment E**. The trip estimates are presented by campus population and housing location.



TABLE 8: EXISTING CONDITIONS VEHICLE TRIP GENERATION FOR CSUMB CAMPUS

Location Type	Trip Type ¹	Daily	Morning Peak Hour			Evening Peak Hours		
			Total	In	Out	Total	In	Out
Main Campus								
Promontory Housing Internal Trips	E	142	12	11	1	8	1	7
Main Campus Internal Trips ²	D	669	272	148	124	140	63	77
Main Campus External Trips	A	10,029	919	633	286	1,005	432	573
Main Campus Trips with East Campus	C	2,171	317	263	54	307	93	214
Main Campus Total [A]	A+C+D+E	13,011	1,520	1,055	465	1,460	589	871
East Campus								
East Campus Trips with Main Campus	C	2,171	317	54	263	307	214	93
East Campus External Trips	B	7,846	482	80	402	452	270	182
East Campus Total [B]	B+C	10,017	799	134	665	759	484	275
Internal Trip Adjustment								
Promontory Housing Internal Trips	E	-142	-12	-11	-1	-8	-1	-7
Main Campus Internal Trips ²	D	-669	-272	-148	-124	-140	-63	-77
Main Campus Trips with East Campus	C	-2,171	-317	-263	-54	-307	-93	-214
East Campus Trips with Main Campus	C	-2,171	-317	-54	-263	-307	-214	-93
Trip Adjustment [C]	C+D+E	-5,153	-918	-476	-442	-762	-371	-391
External Campus Trip Total [A+B+C]³	A+B	17,875	1,401	713	688	1,457	702	755

Notes:

1. Trip type shown on Figure 1.
 2. Main Campus Internal Trips = Main Campus Students and Campus Supporting Trips.
 3. The campus trip generation is the sum of all Main Campus and East Campus external vehicle trips generated by students, faculty, staff, and visitors.
- Source: Fehr & Peers, 2019.



As shown in **Table 9**, under Project Conditions the campus external vehicle trip generation would be approximately 30,385 daily vehicle trips, 2,290 morning peak-hour trips (1,188 inbound and 1,102 outbound) and 2,495 evening peak-hour trips (1,203 inbound and 1,292 outbound). A detailed Project Conditions trip generation table is included as **Attachment F**. The trip estimates are presented by person type and housing location.

TABLE 9: CSUMB CAMPUS VEHICLE TRIP GENERATION FOR PROJECT CONDITIONS

Trip Type	Trip Type ¹	Daily	Morning Peak Hour			Evening Peak Hours		
			Total	In	Out	Total	In	Out
Main Campus								
Promontory Housing Internal Trips	E	40	3	3	0	2	0	2
Main Campus Internal Trips ²	D	970	495	261	234	253	120	133
Main Campus External Trips	A	23,953	1,722	1,093	629	2,089	926	1,163
Main Campus Trips with East Campus	C	1,867	434	361	73	488	152	336
Main Campus Total [A]	A+C+D+E	26,830	2,654	1,718	936	2,832	1,198	1,634
East Campus								
East Campus Trips with Main Campus	C	1,867	434	73	361	488	336	152
East Campus External Trips	B	6,432	568	95	473	406	277	129
East Campus Total [B]	B+C	8,299	1,002	168	834	894	613	281
Internal Trip Adjustment								
Promontory Housing Internal Trips	E	-40	-3	-3	-0	-2	-0	-2
Main Campus Internal Trips ²	D	-970	-495	-261	-234	-253	-120	-133
Main Campus Trips with East Campus	C	-1,867	-434	-361	-73	-488	-152	-336
East Campus Trips with Main Campus	C	-1,867	-434	-73	-361	-488	-336	-152
Trip Adjustment [C]	C+D+E	-4,744	-1,366	-698	-668	-1,231	-608	-623
External Campus Trip Total [A+B+C]³	A+B	30,385	2,290	1,188	1,102	2,495	1,203	1,292

Notes:

1. Trip type shown on Figure 1.
2. Main Campus Internal Trips = Main Campus Students and Campus Supporting Trips.
3. The campus trip generation is the sum of all Main Campus and East Campus external vehicle trips generated by students, faculty, staff, and visitors.

Source: Fehr & Peers, 2019.

The amount of added traffic generated by the Project is estimated by subtracting the trip generation for Existing Conditions from the trip generation for Project Conditions. As shown in **Table 10**, the Project would generate 12,510 additional external daily trips, 889 additional external morning peak hour trips and 1,038 additional external evening peak hour trips.



SUMMARY

By housing a large portion of students, faculty, and staff on-campus, and consolidating parking to the periphery, CSUMB would convert many potential off-campus-based trips to on-campus generated trips, thereby reducing both the number of external campus trips to and from campus. Relatedly, by increasing the number of on-campus students, the number of CSUMB external trips made by on-campus students for purposes such as recreational activities, off-campus dining, visiting family and friends, etc. would increase in absolute terms over existing levels.

By comparing **Tables 8** and **9** we can see the net change in vehicle trips due to the Main Campus population growth, the additional on-campus student housing, and faculty and staff moving into residential units currently occupied by students and community housing partners in the East Campus housing. Thus, the net increase in trip generation between Existing Conditions and Project Conditions is the Project increment studied in the transportation analysis. As noted earlier in the document, this trip generation estimate assumes the existing Transportation Demand Management (TDM) and Parking Management measures remain in place on the CSUMB campus, and those measures continue to be as effective in reducing vehicle trip-making and encouraging the use of other modes. **Table 10** presents the net increase in external campus trips between Existing Conditions and Project Conditions.

TABLE 10: CSUMB CAMPUS VEHICLE TRIP GENERATION RESULTS

Scenario	Daily	Morning Peak Hour			Evening Peak Hours		
		Total	In	Out	Total	In	Out
Existing Conditions [A]	17,875	1,401	713	688	1,457	702	755
Project Conditions [B]	30,385	2,290	1,188	1,102	2,495	1,203	1,292
Additional External Trips [B-A]	12,510	889	475	414	1,038	501	537

Source: Fehr & Peers, 2019.

ATTACHMENTS

- Attachment A: California State University, Monterey Bay Proposed Master Plan Housing Memorandum
- Attachment B: CSUMB Person Trip Travel Survey
- Attachment C: CSUMB Person Trip Travel Survey Trip Rates and Primary Mode of Travel Results
- Attachment D: Promontory Driveway Count and Vehicle Trip Rates
- Attachment E: Trip Type Descriptions and Existing and Project Conditions Trip Generation Rates
- Attachment F: Existing and Project Conditions Vehicle Trip Generation for CSUMB by Population Type and Housing Location

Attachment A:
California State University, Monterey Bay
Proposed Master Plan Housing
Memorandum

Refer to Appendix C-1 of the CSUMB Master Plan EIR

Attachment B:
CSUMB Person Trip Travel Survey



California State University MONTEREY BAY

Fall 2017 Travel Survey

Dear Campus Community,

This short survey is intended to support campus planning efforts to improve our transportation systems. The results will also contribute data to the Comprehensive Master Plan.

Individual information collected in this survey will remain confidential. Only aggregated data will be made public.

* 1. What is your primary affiliation with CSUMB?

- Student
- Faculty
- Staff (state or corporation)
- Other (please specify)

* 2. Where do you currently reside?

- Main Campus Housing (Main Quad, North Quad or Promontory)
- East Campus Housing (Frederick's Park or Schoonover Park)
- Other (off-campus)



California State University MONTEREY BAY

Fall 2017 Travel Survey

* 3. Please enter the ZIP code where you currently live?

* 4. What is your primary mode of travel to Main Campus?

- Drive alone
- Motorcycle
- Carpool or Vanpool
- Dropped Off - by family or friends
- Dropped Off - by transportation company (taxi, Uber, Lyft, etc.)
- Bus
- Bicycle
- Walk
- Skateboard
- Other (please specify)



California State University MONTEREY BAY

Fall 2017 Travel Survey

* 5. Do you have a valid CSUMB Main Campus parking permit?

- Yes.
- No.
- No, but I do pay for daily meter rate at least once a week on average.

* 6. How many miles per gallon (mpg) does the vehicle you drive (or ride in) to Main Campus typically achieve?

- I don't know
- Less than 19 mpg
- 19-44 mpg
- Hybrid Vehicle and/or 45 mpg or higher
- All Electric Vehicle. If so, Level I, II or III?

* 7. Where do you typically park on Main Campus?

- In a lot off the Main Quad (lots 1, 12, 16, 18, 205 or 208)
- Across Divarty St., Inter-Garrison Rd., Fourth Ave. or Fifth Ave. from the Main Quad (lots 19, 23, 71, 72, 97, 98, 508)
- Near North Quad or Promontory (lots 300, 301, Promontory)
- Near Campus Police, Otter Sports Center or Athletics area (lots 80, 82, 84, 86, 90, 91, 100, 106, 107, 902, 903)
- Near World Theater, Student Services or University Center (lots 13, 28, 29, 30, 42, 45, 201, 490)
- Off campus on periphery roadways

* 8. How often do you use your vehicle to drive between Main Campus locations during the day?

- 5 to 7 days a week
- 3 to 5 days a week
- 1 to 2 days a week
- 1 to 2 days a month
- Never

* 9. How often do you use your vehicle to leave and return to Main Campus throughout the day? (Not counting your commute)

- Several times a day
- Nearly once a day
- A few days a week
- A few days a month
- Rarely
- Never



California State University MONTEREY BAY

Fall 2017 Travel Survey

* 10. During a typical week, how many days do you travel to Main Campus?

- 0
- 1
- 2
- 3
- 4
- 5
- 6
- 7

* 11. What is your typical travel time to Main Campus using your primary mode from where you currently live?

- 1-10 mins
- 10-15 mins
- 15-30 mins
- 30-60 mins
- More than 60 mins

* 12. Please select what time you typically ARRIVE on Main Campus each day?

	Monday	Tuesday	Wednesday	Thursday	Friday	Saturday
Date	<input type="text"/>	<input type="text"/>	<input type="text"/>	<input type="text"/>	<input type="text"/>	<input type="text"/>
/	<input type="text"/>	<input type="text"/>	<input type="text"/>	<input type="text"/>	<input type="text"/>	<input type="text"/>
Time	<input type="text"/>	<input type="text"/>	<input type="text"/>	<input type="text"/>	<input type="text"/>	<input type="text"/>

* 13. Please select what time you typically DEPART Main Campus each day?

	Monday	Tuesday	Wednesday	Thursday	Friday	Saturday
Date	<input type="text"/>	<input type="text"/>	<input type="text"/>	<input type="text"/>	<input type="text"/>	<input type="text"/>
/	<input type="text"/>	<input type="text"/>	<input type="text"/>	<input type="text"/>	<input type="text"/>	<input type="text"/>
Time	<input type="text"/>	<input type="text"/>	<input type="text"/>	<input type="text"/>	<input type="text"/>	<input type="text"/>



California State University MONTEREY BAY

Fall 2017 Travel Survey

* 14. Do you live within a 5 min walk of a bus stop?

- Yes
- No
- I don't know

* 15. Do you live within a 30 min walk or bike of Main Campus?

- Yes
- No
- I don't know

* 16. How often do you ride the bus to Main Campus?

- Every weekday
- A few days a week
- A few days a month
- On the rare occasion I need to
- I do not ride the bus



California State University MONTEREY BAY

Fall 2017 Travel Survey

* 17. What factors are most important to you in choosing your means of transportation to Main Campus?
(select your top 3)

- Environmental impact
- Amount of things I need to carry
- Cost
- Accessibility
- Stress reduction
- Ability to do other things while commuting
- Travel time or schedule
- Comfort and safety
- Other (please specify)

* 18. If you usually drive alone to Main Campus, what is preventing you from using a commute alternative such as carpooling, riding transit, bicycling or walking? (select your top 3)

- I don't know what other options would work for me
- Transit does not route near my home
- Transit schedules do not work for me
- Need to make stops on my commute
- Can not get home in emergency
- Difficult to find others to carpool
- Use my car on the job
- Prefer to drive my car
- Child or family care responsibilities
- Work/Class at irregular or unpredictable hours
- Inadequate bicycle or pedestrian routes/paths
- I do not have access to a bicycle
- I don't usually drive alone
- Other (please specify)



California State University MONTEREY BAY

Fall 2017 Travel Survey

* 19. If you usually drive alone to Main Campus, which commute alternative would you be willing to try out one or more days per week?

- Carpool/Vanpool
- Drop-off (by family, friend or transport company)
- Bus
- Bicycle or skateboard
- Walk
- Other (please specify)

* 20. If you usually drive alone to Main Campus, which of the following incentives and services would encourage you to use a commute alternative, such as carpool, public transit or bicycle? (select your top 3)

- ANY: A safer, cleaner and better lit route
- ANY: A Commute Club, with incentives for participating members only
- ANY: Employee rebate benefits for not driving to campus
- ANY: More information provided on each commute alternative option
- CARPOOL or LOW EMISSION VEHICLE/EV: Reduced parking permit price and/or designated parking stalls for carpool or low emission vehicle/electric vehicle
- BUS: Altered bus schedule or increased frequency
- BUS: Closer bus stop to residence/campus destination
- BIKE: Access to free or discounted bicycle (rental or bikeshare)
- BIKE: Free or discounted bicycle gear (locks and helmets)
- BIKE: More shower and/or changing room facilities on campus
- BIKE: More covered and secure bicycle parking on campus
- None, I do not wish to carpool, bus, bike or walk to campus
- Other (please specify)

* 21. Which campus transportation programs are unfamiliar to you? Select all that apply.

- MST bus service with your OtterCard
- Electric Vehicle Charging Stations
- Zipcar
- Otter Cycle Center (bike rentals, repair shop, bike bunker indoor parking and community rides)
- Bike locker rentals (Residence Hall Association)
- Emergency Ride Home program (TAMC)
- N/A

* 22. Which campus transportation programs have you used at least once? Select all that apply.

- MST bus service with your OtterCard
- Electric Vehicle Charging Stations
- Zipcar
- Otter Cycle Center (bike rentals, repair shop, bike bunker indoor parking and community rides)
- Bike locker rentals (Residence Hall Association)
- Emergency Ride Home program (TAMC)
- N/A

THANK YOU!

Your feedback is critical for the further development of campus transportation infrastructure and programs.

If you have questions regarding any of the services you read about in this survey, please visit csumb.edu/transportation

Attachment C:
**CSUMB Person Trip Travel Survey Trip Rates
and Primary Mode of Travel Results**

**TABLE C-1: CSUMB PERSON TRAVEL SURVEY – INBOUND DIRECTION FOR PERSON TRIP
OBSERVATIONS FOR MAIN CAMPUS**

Trip Pair	Student				Faculty and Staff				Total [A+B] D+E +C+A
	Main Campus	East Campus	Off- Campus	Sub- total [A] D+E +C+A	Main Campus	East Campus	Off- Campus	Sub- total [B] C+A	
	D+E	C	A		N/A	C	A		
Response Rate Summary									
Survey Responses	711	332	1,122	2,165	N/A	115	136	251	2,416
Current Population	2,600	1,380	2,654	6,634	N/A	463	561	1,024	7,658
Response Rate	27%	24%	42%	33%	N/A	25%	24%	25%	32%
Observations by Time-of-Day									
12:00 am – 5:59 am	29	2	2	33	0	0	0	0	33
6:00 am – 6:59 am	7	7	13	27	0	7	5	12	39
7:00 am – 7:59 am	54	48	157	259	0	40	46	86	345
8:00 am – 8:59 am	81	41	116	238	0	42	46	88	326
9:00 am – 9:59 am	73	74	167	314	0	9	12	21	335
10:00 am – 11:59 am	82	45	122	249	0	5	7	12	261
12:00 pm – 2:59 pm	74	32	111	217	0	1	1	2	219
3:00 pm – 5:59 pm	20	28	99	147	0	1	1	2	149
6:00 pm – 11:59 pm	12	6	31	49	0	1	0	1	50
Observation Summary by Time Period									
Daily Observations	432	283	818	1,533	0	106	118	224	1,757
AM Peak Hour ¹	68	45	137	250	0	41	46	87	337
PM Peak Hour ²	9	13	45	67	0	0	0	0	67
Person Trip Rates by Time Period									
Daily Observations	0.61	0.85	0.73	0.71	NA	0.92	0.87	0.89	0.73
AM Peak Hour	0.09	0.13	0.12	0.12	NA	0.36	0.34	0.35	0.14
PM Peak Hour	0.01	0.04	0.04	0.03	NA	0.00	0.00	0.00	0.03

Notes:

1. AM Peak Hour observations are an average of responses for 7:00 – 7:59 am and 8:00 – 8:59 am.
2. PM Peak Hour observations are factored using a peak period to peak hour factor from the evening outbound observations. Since the survey only has hourly data for the peak direction (outbound), we used the peak hour (5:00 – 6:00 pm) trip value (273) divided by the peak period (3:00 – 6:00 pm) trip value (612) which results in a peak period to peak hour factor of $273/612 = 0.45$. See Table C-2 for values.

Source: Fehr & Peers, 2019.

TABLE C-2: CSUMB PERSON TRAVEL SURVEY – OUTBOUND DIRECTION FOR PERSON TRIP OBSERVATIONS FOR MAIN CAMPUS

Trip Pair	Student				Faculty and Staff				Total [A+B] D+E +C+A
	Main Campus	East Campus	Off-Campus	Sub-total [A]	Main Campus	East Campus	Off-Campus	Sub-total [B]	
	D+E	C	A	D+E +C+A	N/A	C	A	C+A	
Response Rate Summary									
Survey Responses	711	332	1,122	2,165	N/A	115	136	251	2,416
Current Population	2,600	1,380	2,654	6,634	N/A	463	561	1,024	7,658
Response Rate	27%	24%	42%	33%	N/A	25%	24%	25%	32%
Observations by Time-of-Day									
12:00pm - 2:59 pm	71	39	158	268	0	4	1	5	273
3:00 pm - 3:59 pm	28	27	67	122	0	3	3	6	128
4:00 pm - 4:59 pm	37	40	92	169	0	15	27	42	211
5:00 pm - 5:59 pm	44	28	78	150	0	61	62	123	273
6:00 pm - 6:59 pm	51	38	101	190	0	11	15	26	216
7:00 pm - 7:59 pm	41	20	72	133	0	6	3	9	142
8:00 pm - 11:59 pm	97	71	185	353	0	4	6	10	363
12:00 am - 5:59 am	9	4	9	22	0	0	0	0	22
6:00 am - 9:59 am	13	5	15	33	0	0	0	0	33
10:00 am - 11:59 am	19	11	36	66	0	0	1	1	67
Observation Summary by Time Period									
Daily Observations	410	283	813	1,506	0	104	118	222	1,728
AM Peak Hour ¹	4	2	5	11	0	0	0	0	11
PM Peak Hour ²	69	46	129	244	0	5	5	10	254
Person Trip Rates by Time Period									
Daily Observations	0.58	0.85	0.72	0.70	NA	0.90	0.87	0.88	0.72
AM Peak Hour	0.01	0.00	0.00	0.01	NA	0.00	0.00	0.00	0.00
PM Peak Hour	0.07	0.10	0.08	0.08	NA	0.31	0.28	0.30	0.10

Notes:

1. AM Peak Hour represents 7:00 am – 7:59 am. AM Peak Hour observations are factored using a peak period to peak hour factor from the morning observations. Since the survey only has hourly data for the peak direction (inbound), we used the peak hour (7:00 – 7:59 am) trip value (345) divided by the peak period (6:00 – 10:00 am) trip value (1,045) which results in a peak period to peak hour factor of 345/1,045 = 0.33. See Table C-1 for values.
2. PM Peak Hour observations are an average of responses for 5:00 – 5:59 pm and 6:00 – 6:59 pm.

Source: Fehr & Peers, 2019.

TABLE C-3: CSUMB PERSON TRAVEL SURVEY – INBOUND DIRECTION FOR VEHICLE TRIP OBSERVATIONS FOR MAIN CAMPUS

Trip Pair	Student				Faculty and Staff				Total [A+B] D+E+C+A
	Main Campus D+E	East Campus C	Off-Campus A	Sub-total [A] D+E+C+A	Main Campus N/A	East Campus C	Off-Campus A	Sub-total [B] C+A	
Response Rate Summary									
Survey Responses	711	332	1,122	2,165	N/A	115	136	251	2,416
Current Population	2,600	1,380	2,654	6,634	N/A	463	561	1,024	7,658
Response Rate	27%	24%	42%	33%	N/A	25%	24%	25%	32%
Observations by Time-of-Day									
12:00 am – 5:59 am	5	1	2	8	0	0	0	0	8
6:00 am – 6:59 am	2	5	11	18	0	7	5	12	30
7:00 am – 7:59 am	8	32	139	179	0	38	40	78	257
8:00 am – 8:59 am	13	25	99	137	0	34	43	77	214
9:00 am – 9:59 am	13	41	146	200	0	8	12	20	220
10:00 am – 11:59 am	10	24	104	138	0	5	7	12	150
12:00 pm – 2:59 pm	11	19	95	125	0	1	1	2	127
3:00 pm – 5:59 pm	3	17	92	112	0	1	1	2	114
6:00 pm – 11:59 pm	3	5	28	36	0	1	0	1	37
Observation Summary by Time Period									
Daily Observations	68	169	716	953	0	95	109	204	1,157
AM Peak Hour ¹	13	33	123	169	0	21	28	49	219
PM Peak Hour ²	1	8	42	51	0	0	0	0	51
Vehicle Trip Rates by Time Period									
Daily Observations	0.10	0.51	0.64	0.44	NA	0.83	0.80	0.81	0.48
AM Peak Hour	0.01	0.09	0.11	0.07	NA	0.31	0.31	0.31	0.10
PM Peak Hour	0.00	0.02	0.04	0.02	NA	0.00	0.00	0.00	0.02

Notes:

1. AM Peak Hour observations are an average of responses for 7:00 – 7:59 am and 8:00 am – 8:59 am.
2. PM Peak Hour observations are factored using a peak period to peak hour factor from the evening outbound observations. Since the survey only has hourly data for the peak direction (outbound), we used the peak hour (5:00 – 6:00 pm) trip value (194) divided by the peak period (3:00 – 6:00 pm) trip value (424) which results in a peak period to peak hour factor of $194/424 = 0.46$. See Table C-4 for values.

Source: Fehr & Peers, 2019.

**TABLE C-4: CSUMB PERSON TRAVEL SURVEY – OUTBOUND DIRECTION FOR VEHICLE TRIP
OBSERVATIONS FOR MAIN CAMPUS**

Trip Pair					Faculty and Staff			Sub-total [B] C+A	Total [A+B] D+E +C+A
	Main Campus	East Campus	Off-Campus	Sub-total [A] D+E +C+A	Main Campus	East Campus	Off-Campus		
	D+E	C	A		N/A	C	A		
Response Rate Summary									
Survey Responses	711	332	1,122	2,165	N/A	115	136	251	2,416
Current Population	2,600	1,380	2,654	6,634	N/A	463	561	1,024	7,658
Response Rate	27%	24%	42%	33%	N/A	25%	24%	25%	32%
Observations by Time-of-Day									
12:00pm - 2:59 pm	10	26	148	184	0	2	2	4	188
3:00 pm - 3:59 pm	6	16	60	82	0	2	3	5	87
4:00 pm - 4:59 pm	7	24	77	108	0	12	23	35	143
5:00 pm - 5:59 pm	6	16	65	87	0	55	52	107	194
6:00 pm - 6:59 pm	7	22	87	116	0	12	19	31	147
7:00 pm - 7:59 pm	9	14	68	91	0	6	4	10	101
8:00 pm - 11:59 pm	13	36	157	206	0	2	5	7	213
12:00 am - 5:59 am	3	6	17	26	0	0	0	0	26
6:00 am - 9:59 am	1	3	15	19	0	0	0	0	19
10:00 am - 11:59 am	4	10	32	46	0	0	1	1	47
Observation Summary by Time Period									
Daily Observations	66	173	726	965	0	91	109	200	1,165
AM Peak Hour ¹	0	1	5	6	0	0	0	0	6
PM Peak Hour ²	7	19	76	102	0	34	36	70	172
Vehicle Trip Rates by Time Period									
Daily Observations	0.09	0.52	0.65	0.45	NA	0.79	0.80	0.80	0.48
AM Peak Hour	0.00	0.00	0.00	0.00	NA	0.00	0.00	0.00	0.00
PM Peak Hour	0.01	0.06	0.07	0.05	NA	0.29	0.26	0.27	0.07

Notes:

1. AM Peak Hour represents 7:00 am – 7:59 am. AM Peak Hour observations are factored using a peak period to peak hour factor from the morning observations. Since the survey only has hourly data for the peak direction (inbound), we used the peak hour (7:00 – 7:59 am) trip value (257) divided by the peak period (6:00 – 10:00 am) trip value (721) which results in a peak period to peak hour factor of 257/721 = 0.36. See Table C-3 for values.
2. PM Peak Hour observations are an average of responses for 5:00 – 5:59 pm and 6:00 – 6:59 pm.

Source: Fehr & Peers, 2019.

TABLE C-5: CSUMB PERSON TRAVEL SURVEY - PERSON TRIP GENERATION RATES TO/FROM MAIN CAMPUS¹

Housing Location	Trip Pair ²	Daily	AM Peak Hour			PM Peak Hour		
			Total	In	Out	Total	In	Out
Students								
Main Campus ³	D+E	1.19	0.10	0.09	0.01	0.08	0.01	0.07
East Campus	C	1.70	0.13	0.13	0.00	0.14	0.04	0.10
Off-Campus	A	1.45	0.12	0.12	0.00	0.12	0.04	0.08
Faculty and Staff								
Main Campus				N/A ⁴				
East Campus	C	1.82	0.36	0.36	0.00	0.31	0.00	0.31
Off-Campus	A	1.74	0.34	0.34	0.00	0.28	0.00	0.28

Notes:

1. For presentation purposes, person trip generation rates are rounded up to the nearest hundredth.
2. Trip pairs shown on Figure 1.
3. Main campus student trips are internal to the Main Campus Cordon.
4. Faculty and staff are not housed on the Main Campus.

Source: Fehr & Peers, 2019.

TABLE C-6: CSUMB PERSON TRAVEL SURVEY - VEHICLE TRIP GENERATION RATES TO/FROM MAIN CAMPUS¹

Housing Location	Trip Pair ²	Daily	AM Peak Hour			PM Peak Hour		
			Total	In	Out	Total	In	Out
Students								
Main Campus ³	D+E	0.19	0.02	0.02	0.00	0.01	0.00	0.01
East Campus	C	1.03	0.09	0.09	0.00	0.08	0.02	0.06
Off-Campus	A	1.29	0.11	0.11	0.00	0.11	0.04	0.07
Faculty and Staff								
Main Campus				N/A ⁴				
East Campus	C	1.62	0.31	0.31	0.00	0.29	0.00	0.29
Off-Campus	A	1.60	0.31	0.31	0.00	0.26	0.00	0.26

Notes:

1. For presentation purposes the vehicle trip rates are rounded to the nearest hundredth.
2. Trip pairs shown on Figure 1.
3. Main campus student trips are internal to the Main Campus Cordon.
4. Faculty and staff are not housed on the Main Campus.

Source: Fehr & Peers, 2019.

TABLE C-7: CSUMB PERSON TRAVEL SURVEY - PRIMARY MODE OF TRAVEL TO MAIN CAMPUS OBSERVATIONS

Housing Location	Main Campus	Student		Faculty and Staff		
		East Campus	Off-Campus	Main Campus	East Campus	Off-Campus
Survey Responses	711	332	1,122	N/A	115	136
Current Population	2,600	1,380	2,654	N/A	463	561
Drive Alone	12.5%	52.5%	82.9%	N/A	85.3%	85.3%
Shared Ride	6.0%	10.8%	10.6%	N/A	4.3%	10.3%
Transit	4.6%	32.8%	4.8%	N/A	4.3%	2.9%
Walk	70.3%	0.9%	0.4%	N/A	0.0%	0.0%
Bicycle	5.1%	3.0%	1.1%	N/A	6.1%	1.5%
Other	1.5%	0.0%	0.2%	N/A	0.0%	0.0%

Source: Fehr & Peers, 2019.

TABLE C-8: PRIMARY MODE OF TRAVEL COMPARISON

Mode	CSUMB 2017 Existing Mode Share ³	2011-2015 American Community Survey (ACS) ⁴		2012 California Household Travel Survey (CHTS) ⁴	
		Monterey County	Santa Cruz County	Monterey County	Santa Cruz County
Drive Alone ¹	53.8%	70.7%	70.5%	77.4%	75.2%
Shared Ride ²	8.7%	11.9%	9.4%	16.0%	13.5%
Transit	9.6%	2.1%	2.9%	2.2%	2.2%
Walk	24.2%	3.1%	3.9%	1.2%	5.0%
Bicycle	3.1%	0.8%	3.8%	3.2%	4.1%
Other	0.6%	11.4%	9.5%	0.0%	0.0%

Notes:

1. Drive alone includes motorcycles
2. Shared ride includes carpooling, vanpooling, drop-off, Transportation Network Companies like Uber and Lyft, and taxis.
3. Weighted average morning inbound person mode share of CSUMB students, faculty, and staff. Mode share includes Main Campus, East Campus and Off-Campus residents from the *CSUMB Person Trip Travel Survey* data.
4. Home-based work trips only.

Source: Fehr & Peers, 2019.

TABLE C-9: PRIMARY MODE OF TRAVEL TO MAIN CAMPUS FOR CSUMB POPULATION

Housing Location	Student			Faculty and Staff			Main Campus Mode Split	Main Campus Mode Split without Main Campus Residents
	Main Campus	East Campus	Off-Campus	Main Campus	East Campus	Off-Campus		
Campus Population	2,600	1,380	2,654	N/A	463	561	7,658 (100%)	5,058 (100%)
Drive Alone	322	725	2,200	N/A	395	479	4,121 (53.8%)	3,798 (75.1%)
Shared Ride	156	149	281	N/A	20	58	664 (8.7%)	508 (10.0%)
Transit	120	453	127	N/A	20	16	736 (9.6%)	616 (12.2%)
Walk	1,830	12	11	N/A	0	0	1,853 (24.2%)	23 (0.5%)
Bicycle	133	41	29	N/A	28	8	240 (3.1%)	107 (2.1%)
Other	39	0	5	N/A	0	0	44 (0.5%)	6 (0.1%)

Note:

1. Person trips by mode by campus population is calculated by multiplying the mode split shown in Table C-7 by the campus population. The person trips are rounded to the nearest whole number.
2. Main Campus Mode Split is the sum of all student and faculty/staff columns divided by the main campus population.

Source: Fehr & Peers, 2019.

Attachment D:
Promontory Driveway Counts and Vehicle
Trip Rates

TABLE D-1: PROMONTORY DRIVEWAY COUNT AND VEHICLE TRIP RATES

Location (Population Type)	Trip Pair ²	Daily	AM Peak Hour			PM Peak Hour		
			Total	In	Out	Total	In	Out
Vehicle Trips								
Driveway Count ²	A + E	1,714	56	17	39	113	53	60
Promontory Housing Internal Trips (Students) ³	E	142	12	11	1	8	1	7
Promontory Housing Trips (Students) ⁴	A	1,571	24	10	14	54	26	29
Vehicle Trip Rates⁵								
Driveway Count	A + E	2.2672	0.0741	0.0225	0.0516	0.01494	0.0701	0.0793
Promontory Housing Internal Trips (Students)	E	0.1885	0.0153	0.0148	0.0005	0.0110	0.0019	0.0091
Promontory Housing Trips (Students)	A	2.0787	0.0588	0.0077	0.0511	0.1384	0.0682	0.0702

Notes:

1. Trip pairs shown on Figure 1.
2. Promontory housing driveway count from the annual *CSUMB 2016-2017 Traffic Generation* report.
3. Promontory housing internal trips estimated using the vehicle trip rates summarized in Attachment C (of this memo) Table C-6 titled CSUMB Person Travel Survey – Vehicle Trip Generation Rates to/from Main Campus. Rates from Main Campus line under the Students subheading.
4. Promontory Housing Trips are the remaining vehicle trips when the Promontory Housing Internal Trips (Students) are subtracted from the driveway count.
5. For presentation purposes, person trip generation rates are rounded up to the nearest hundred thousandth. Rates derived by dividing the vehicle counts by 756 Full-Time Equivalent Students (FTES).

Source: Fehr & Peers, 2019.

Attachment E:

Trip Type Descriptions and Existing and Project Conditions Trip Generation Rates

ATTACHMENT E-1: CSUMB TRIP TYPE INFORMATION

Row Number	Population Type	Housing Location or Origin	Existing Population	Project Population	Trip Type	Description
Main Campus Internal Trips						
1	Promontory Housing Students	Promontory Housing	756	756	E	These are trips made by students living in The Promontory Housing, driving to Main Campus. These trips may include Promontory housed students driving to class, the gym, or other on-campus uses.
2	Main Campus Students and Campus Supporting Trips	Main Campus (non-Promontory)	7,658	14,476	D	These are trips made by students living on Main Campus, driving to another part of Main Campus (non-Promontory Housing). These trips may include students driving to class, the gym, or other on-campus uses. Plus, trips made by campus support staff including campus security, maintenance, shuttle buses, etc. These trips circulate within the Main Campus.
Main Campus External Trips						
4	Promontory Housing Students	Promontory Housing	756	756	A	These trips are made by students living in Promontory Housing but traveling to off-campus for purposes such as off-campus dining, recreational events, visiting off-campus friends and family, etc.
5	East Campus Students	East Campus	1,380	0	C	These trips are made by students living on East Campus but traveling to/from but traveling to off-campus for purposes such as off-campus dining, recreational events, visiting off-campus friends and family, etc.
6	East Campus Faculty/Staff	East Campus	463	1,154	C	These trips are made by faculty/staff living on East Campus but traveling to/from but traveling to off-campus for purposes such as off-campus dining, recreational events, visiting off-campus friends and family, etc.
7	Off-Campus Students	Off-Campus	2,654	5,080	A	These trips are made by students coming from their off-campus residences to Main Campus for class and other campus related activities.
8	Off-Campus Faculty/Staff	Off-Campus	463	1,154	A	These trips are made by students coming from their off-campus residences to Main Campus for class and other campus related activities.
9	Main Campus Students, Campus Supporting Trips and Visitors	Off-Campus	7,658	14,476	A	These trips are made by students living on Main Campus but traveling to off-campus for purposes such as off-campus dining, recreational events, visiting off-campus friends and family, etc. Plus campus supporting trips coming from off-campus, and visitors.
East Campus Internal Trips						
15	East Campus Students	East Campus	1,380	0	C	These trips are made by students living on East Campus but traveling to/from Main Campus. These trips may include students driving to class, the gym, or other on-campus uses.
16	East Campus Faculty/Staff	East Campus	463	1,154	C	These trips are made by faculty/staff living on East Campus but traveling to/from Main Campus. These trips may include students driving to class, the gym, or other on-campus uses.
East Campus External Trips						
18	East Campus Students	East Campus	1,380	0	B	These trips are made by students living on East Campus but traveling to off-campus for purposes such as off-campus dining, recreational events, visiting off-campus friends and family, etc.
19	East Campus Faculty/Staff	East Campus	463	1,154	B	These trips are made by faculty/staff living on East Campus but traveling to off-campus for purposes such as off-campus dining, recreational events, visiting off-campus friends and family, etc.
20	East Campus Community Housing Partners	East Campus	280	66	B	These trips are made by community partners living on East Campus but traveling to off-campus for purposes such as work, personnel events, visiting friends and family, etc.

Source: Fehr & Peers, 2018.

TABLE E-2: EXISTING CONDITIONS VEHICLE TRIP RATES

Row Number	Population Type	Housing Location	Unit	Size	Trip Type ¹	Daily	AM Peak Hour			PM Peak Hour		
							Total	In	Out	Total	In	Out
Main Campus												
Main Campus Internal Trips												
1	Students	Promontory Housing	FTE	756	E	0.188	0.016	0.015	0.001	0.010	0.001	0.009
2	CSUMB Campus Population	Main Campus Students and Campus Supporting Trips	FTE	7,658	D	0.087	0.035	0.019	0.016	0.018	0.008	0.010
3	<i>Internal Trips [A]</i>		<i>FTE</i>	<i>7,658</i>	<i>D + E</i>	<i>0.106</i>	<i>0.037</i>	<i>0.021</i>	<i>0.016</i>	<i>0.019</i>	<i>0.008</i>	<i>0.011</i>
Main Campus External Trips												
4	Students	Promontory Housing	FTE	756	A	2.079	0.058	0.008	0.050	0.139	0.069	0.070
5	Students	East Campus Housing	FTE	1,380	C	1.030	0.104	0.086	0.018	0.080	0.023	0.057
6	Faculty/Staff	East Campus Housing	FTE	463	C	1.618	0.376	0.313	0.063	0.424	0.132	0.292
7	Students	Off-Campus Housing	FTE	2,654	A	1.285	0.111	0.106	0.005	0.106	0.038	0.068
8	Faculty/Staff	Off-Campus Housing	FTE	561	A	1.602	0.419	0.305	0.114	0.442	0.182	0.260
9	CSUMB Campus Population	Main Campus Students, Campus Supporting Trips, and Visitors	FTE	7,658	A	0.542	0.045	0.023	0.022	0.048	0.023	0.025
10	<i>Main Campus Cordon Trips [B]</i>		<i>FTE</i>	<i>7,658</i>	<i>A + C</i>	<i>1.593</i>	<i>0.161</i>	<i>0.117</i>	<i>0.044</i>	<i>0.172</i>	<i>0.069</i>	<i>0.103</i>
East Campus Housing TDM Reductions												
11	Student East Campus Housing TDM Reduction for Students		FTE	1,380	C	0.000	0.000	0.000	0.000	0.000	0.000	0.000
12	Student East Campus Housing TDM Reduction for Faculty/Staff		FTE	463	C	0.000	0.000	0.000	0.000	0.000	0.000	0.000
13	<i>East Campus Housing TDM Reduction [C]</i>		<i>FTE</i>	<i>1,843</i>	<i>C</i>	<i>0.000</i>	<i>0.000</i>	<i>0.000</i>	<i>0.000</i>	<i>0.000</i>	<i>0.000</i>	<i>0.000</i>
14	Main Campus Trip Generation [A + B - C = D]		FTE	7,658	A+C+D+E	1.699	0.199	0.138	0.061	0.191	0.077	0.114
East Campus												
East Campus Internal Trips												
15	Students	East Campus Housing	FTE	1,380	C	1.030	0.104	0.018	0.086	0.080	0.057	0.023
16	Faculty/Staff	East Campus Housing	FTE	463	C	1.618	0.376	0.063	0.313	0.423	0.292	0.132
17	<i>Internal Trips with Main Campus [F]</i>		<i>FTE</i>	<i>1,843</i>	<i>C</i>	<i>1.178</i>	<i>0.172</i>	<i>0.029</i>	<i>0.143</i>	<i>0.167</i>	<i>0.116</i>	<i>0.051</i>
East Campus External Trips												
18	Students	East Campus Housing	FTE	1,380	B	2.846	0.100	0.017	0.083	0.148	0.073	0.075
19	Faculty/Staff	East Campus Housing	FTE	463	B	5.274	0.465	0.078	0.387	0.335	0.229	0.106
20	Community Housing Partners	East Campus Housing	FTE	280	B	5.275	0.464	0.075	0.389	0.336	0.232	0.104
21	<i>External Trips [E]</i>		<i>FTE</i>	<i>2,123</i>	<i>B</i>	<i>3.696</i>	<i>0.227</i>	<i>0.038</i>	<i>0.189</i>	<i>0.213</i>	<i>0.127</i>	<i>0.086</i>
East Campus Housing TDM Reductions												
22	Student East Campus Housing TDM Reduction for Students		FTE	1,380	C	0.000	0.000	0.000	0.000	0.000	0.000	0.000
23	Student East Campus Housing TDM Reduction for Faculty/Staff		FTE	463	C	0.000	0.000	0.000	0.000	0.000	0.000	0.000
24	East Campus Housing TDM Reduction [G]		FTE	1843	C	0.000	0.000	0.000	0.000	0.000	0.000	0.000
25	East Campus Cordon Trips [F + E - G = H]		FTE	1,843	B+C	4.718	0.376	0.063	0.313	0.358	0.228	0.130
Off Campus												
Off-Campus Housing TDM Reductions												
26	Off-Campus Housing TDM Reduction for Students		FTE	2,654	A	0.000	0.000	0.000	0.000	0.000	0.000	0.000
27	Off-Campus Housing TDM Reduction for Faculty/Staff		FTE	561	A	0.000	0.000	0.000	0.000	0.000	0.000	0.000
28	Off-Campus Housing TDM Reduction [I]		FTE	3,215	A	0.000	0.000	0.000	0.000	0.000	0.000	0.000
CSUMB Campus Internal Trip Adjustment												
Main Campus Internal Trips Adjustment												
29	Students	Promontory Housing	FTE	756	E	0.188	0.016	0.015	0.001	0.010	0.001	0.009
30	CSUMB Campus Population	Main Campus Students and Campus Supporting Trips	FTE	7,658	D	0.087	0.035	0.019	0.016	0.018	0.008	0.010
31	Students	East Campus Housing	FTE	1,380	C	1.030	0.104	0.086	0.018	0.080	0.023	0.057
32	Faculty/Staff	East Campus Housing	FTE	463	C	1.618	0.376	0.313	0.063	0.424	0.132	0.292
33	<i>Internal Trips Adjustment [J]</i>		<i>FTE</i>	<i>7,658</i>	<i>C + D + E</i>	<i>0.389</i>	<i>0.078</i>	<i>0.055</i>	<i>0.023</i>	<i>0.060</i>	<i>0.021</i>	<i>0.039</i>
East Campus Internal Trips Adjustment												
34	Students	East Campus Housing	FTE	1,380	C	1.030	0.104	0.018	0.086	0.080	0.057	0.023
35	Faculty/Staff	East Campus Housing	FTE	463	C	1.618	0.376	0.063	0.313	0.424	0.292	0.132
36	<i>Internal Trips with Main Campus [F]</i>		<i>FTE</i>	<i>1,843</i>	<i>C</i>	<i>1.178</i>	<i>0.172</i>	<i>0.029</i>	<i>0.143</i>	<i>0.166</i>	<i>0.116</i>	<i>0.050</i>
37	Internal Trip Adjustment Total [J + F = L]		FTE	1,843	C	2.796	0.498	0.258	0.240	0.413	0.201	0.212
CSUMB Campus External Trips Total												
38	External Campus Trip Total [D + H - I - L = M]		FTE	7,938	A+B	2.252	0.177	0.090	0.087	0.183	0.088	0.095

Notes:

FTE = Full time equivalent.

1. Vehicle trip generation rates represent vehicles per FTE. For presentation purposes, these rates are rounded to the nearest thousandth.

2. Trip type shown on Figure 1.

Source: Fehr & Peers, 2019.

TABLE E-3: PROJECT CONDITIONS VEHICLE TRIP GENERATION RATES

Row Number	Population Type	Housing Location	Unit	Size	Trip Type ¹	Daily	AM Peak Hour			PM Peak Hour		
							Total	In	Out	Total	In	Out
Main Campus												
Main Campus Internal Trips												
1	Students	Promontory Housing	FTE	756	E	0.053	0.004	0.004	0.000	0.003	0.000	0.003
2	CSUMB Campus Population	Main Campus Students and Campus Supporting Trips	FTE	14,476	D	0.067	0.034	0.018	0.016	0.017	0.008	0.009
3	<i>Internal Trips [A]</i>		<i>FTE</i>	<i>14,476</i>	<i>D + E</i>	0.070	0.034	0.018	0.016	0.018	0.009	0.009
Main Campus External Trips												
4	Students	Promontory Housing	FTE	756	A	2.079	0.058	0.008	0.050	0.139	0.069	0.070
5	Students	East Campus Housing	FTE	0	C							
6	Faculty/Staff	East Campus Housing	FTE	1,154	C	1.618	0.376	0.313	0.063	0.423	0.132	0.291
7	Students	Off-Campus Housing	FTE	5,080	A	1.285	0.111	0.106	0.005	0.106	0.038	0.068
8	Faculty/Staff	Off-Campus Housing	FTE	622	A	1.601	0.420	0.305	0.115	0.442	0.182	0.260
9	CSUMB Campus Population	Main Campus Students, Campus Supporting Trips, and Visitors	FTE	14,476	A	1.026	0.059	0.025	0.034	0.081	0.039	0.042
10	<i>Main Campus Cordon Trips [B]</i>		<i>FTE</i>	<i>14,476</i>	<i>A + C</i>	1.784	0.149	0.100	0.049	0.178	0.074	0.104
East Campus Housing TDM Reductions												
11	Student East Campus Housing TDM Reduction for Students		FTE	0	C							
12	Student East Campus Housing TDM Reduction for Faculty/Staff		FTE	1,154	C	0.000	0.000	0.000	0.000	0.000	0.000	0.000
13	<i>East Campus Housing TDM Reduction [C]</i>		<i>FTE</i>	<i>1,154</i>	<i>C</i>	0.000	0.000	0.000	0.000	0.000	0.000	0.000
14	Main Campus Trip Generation [A + B - C = D]		FTE	14,476	A+C+D+E	1.853	0.183	0.119	0.064	0.196	0.083	0.113
East Campus												
East Campus Internal Trips												
15	Students	East Campus Housing	FTE	0	C							
16	Faculty/Staff	East Campus Housing	FTE	1,154	C	1.618	0.376	0.063	0.313	0.423	0.291	0.132
17	<i>Internal Trips with Main Campus [F]</i>		<i>FTE</i>	<i>1,154</i>	<i>C</i>	1.618	0.376	0.063	0.313	0.423	0.291	0.132
East Campus External Trips												
18	Students	East Campus Housing	FTE	0	B							
19	Faculty/Staff	East Campus Housing	FTE	1,154	B	5.272	0.465	0.078	0.387	0.333	0.227	0.106
20	Community Housing Partners	East Campus Housing	FTE	66	B	5.273	0.470	0.076	0.394	0.333	0.227	0.106
21	<i>External Trips [E]</i>		<i>FTE</i>	<i>1,220</i>	<i>B</i>	5.274	0.466	0.078	0.388	0.334	0.228	0.106
East Campus Housing TDM Reductions												
22	Student East Campus Housing TDM Reduction for Students		FTE	0	C							
23	Student East Campus Housing TDM Reduction for Faculty/Staff		FTE	1,154	C	0	0	0	0	0	0	0
24	<i>East Campus Housing TDM Reduction [G]</i>		<i>FTE</i>	<i>1,154</i>	<i>C</i>	0	0	0	0	0	0	0
25	East Campus Cordon Trips [F + E - G = H]		FTE	1,154	B+C	6.802	0.821	0.138	0.683	0.733	0.503	0.230
Off Campus												
Off-Campus Housing TDM Reductions												
26	Off-Campus Housing TDM Reduction for Students		FTE	5,080	A	0.000	0.000	0.000	0.000	0.000	0.000	0.000
27	Off-Campus Housing TDM Reduction for Faculty/Staff		FTE	622	A	0.000	0.000	0.000	0.000	0.000	0.000	0.000
28	Off-Campus Housing TDM Reduction [I]		FTE	5,702	A	0.000	0.000	0.000	0.000	0.000	0.000	0.000
CSUMB Campus Internal Trip Adjustment												
Main Campus Internal Trips Adjustment												
29	Students	Promontory Housing	FTE	756	E	0.053	0.004	0.004	0.000	0.003	0.000	0.003
30	CSUMB Campus Population	Main Campus Students and Campus Supporting Trips	FTE	14,476	D	0.067	0.034	0.018	0.016	0.017	0.008	0.009
31	Students	East Campus Housing	FTE	0	C							
32	Faculty/Staff	East Campus Housing	FTE	1,154	C	1.618	0.376	0.313	0.063	0.423	0.132	0.291
33	<i>Internal Trips Adjustment [J]</i>		<i>FTE</i>	<i>14,476</i>	<i>C + D + E</i>	0.199	0.064	0.043	0.021	0.051	0.018	0.033
East Campus Internal Trips Adjustment												
34	Students	East Campus Housing	FTE	0	C							
35	Faculty/Staff	East Campus Housing	FTE	1,154	C	1.618	0.376	0.063	0.313	0.423	0.291	0.132
36	<i>Internal Trips with Main Campus [F]</i>		<i>FTE</i>	<i>1,154</i>	<i>C</i>	1.618	0.376	0.063	0.313	0.423	0.291	0.132
37	Internal Trip Adjustment Total [J + F = L]		FTE	15,630	C	0.304	0.087	0.045	0.042	0.079	0.039	0.040
CSUMB Campus External Trips Total												
38	External Campus Trip Total [D + H - I - L = M]		FTE	14,542	A+B	2.089	0.157	0.082	0.075	0.172	0.083	0.089

Notes:

FTE = Full time equivalent.

1. Vehicle trip generation rates represent vehicles per FTE. For presentation purposes, these rates are rounded to the nearest thousandth.

2. Trip type shown on Figure 1.

Source: Fehr & Peers, 2019.

Attachment F:
**Existing and Project Conditions Vehicle Trip
Generation for CSUMB by Population Type
and Housing Location**

ATTACHMENT F-1: EXISTING CONDITIONS VEHICLE TRIP GENERATION FOR CSUMB BY POPULATION TYPE AND HOUSING LOCATION

Row Number	Population Type	Housing Location	Unit	Size	Trip Type ¹	Daily	AM Peak Hour			PM Peak Hour		
							Total	In	Out	Total	In	Out
Main Campus												
Main Campus Internal Trips												
1	Students	Promontory Housing	FTE	756	E	142	12	11	1	8	1	7
2	CSUMB Campus Population	Main Campus Students and Campus Supporting Trips	FTE	7,658	D	669	272	148	124	140	63	77
3	<i>Internal Trips [A]</i>		<i>FTE</i>	<i>7,658</i>	<i>D + E</i>	<i>811</i>	<i>284</i>	<i>159</i>	<i>125</i>	<i>148</i>	<i>64</i>	<i>84</i>
Main Campus External Trips												
4	Students	Promontory Housing	FTE	756	A	1,572	44	6	38	105	52	53
5	Students	East Campus Housing	FTE	1,380	C	1,422	143	118	25	111	32	79
6	Faculty/Staff	East Campus Housing	FTE	463	C	749	174	145	29	196	61	135
7	Students	Off-Campus Housing	FTE	2,654	A	3,411	294	281	13	280	100	180
8	Faculty/Staff	Off-Campus Housing	FTE	561	A	899	235	171	64	248	102	146
9	CSUMB Campus Population	Main Campus Students, Campus Supporting Trips, and Visitor Trips	FTE	7,658	A	4,147	346	175	171	372	178	194
10	<i>Main Campus Cordon Trips [B]</i>		<i>FTE</i>	<i>7,658</i>	<i>A + C</i>	<i>12,200</i>	<i>1,236</i>	<i>896</i>	<i>340</i>	<i>1,312</i>	<i>525</i>	<i>787</i>
East Campus Housing TDM Reductions												
11	Student East Campus Housing TDM Reduction for Students		FTE	1,380	C	0	0	0	0	0	0	0
12	Student East Campus Housing TDM Reduction for Faculty/Staff		FTE	463	C	0	0	0	0	0	0	0
13	<i>East Campus Housing TDM Reduction [C]</i>		<i>FTE</i>	<i>1,843</i>	<i>C</i>	<i>0</i>	<i>0</i>	<i>0</i>	<i>0</i>	<i>0</i>	<i>0</i>	<i>0</i>
14	Main Campus Trip Generation [A + B - C = D]		FTE	7,658	A+C+D+E	13,011	1,520	1,055	465	1,460	589	871
East Campus												
East Campus Internal Trips												
15	Students	East Campus Housing	FTE	1,380	C	1,422	143	25	118	111	79	32
16	Faculty/Staff	East Campus Housing	FTE	463	C	749	174	29	145	196	135	61
17	<i>Internal Trips with Main Campus [F]</i>		<i>FTE</i>	<i>1,843</i>	<i>C</i>	<i>2,171</i>	<i>317</i>	<i>54</i>	<i>263</i>	<i>307</i>	<i>214</i>	<i>93</i>
East Campus External Trips												
18	Students	East Campus Housing	FTE	1,380	B	3,928	137	23	114	204	100	104
19	Faculty/Staff	East Campus Housing	FTE	463	B	2,441	215	36	179	154	105	49
20	Community Housing Partners	East Campus Housing	FTE	280	B	1,477	130	21	109	94	65	29
21	<i>External Trips [E]</i>		<i>FTE</i>	<i>2,123</i>	<i>B</i>	<i>7,846</i>	<i>482</i>	<i>80</i>	<i>402</i>	<i>452</i>	<i>270</i>	<i>182</i>
East Campus Housing TDM Reductions												
22	Student East Campus Housing TDM Reduction for Students		FTE	1,380	C	0	0	0	0	0	0	0
23	Student East Campus Housing TDM Reduction for Faculty/Staff		FTE	463	C	0	0	0	0	0	0	0
24	<i>East Campus Housing TDM Reduction [G]</i>		<i>FTE</i>	<i>1,843</i>	<i>C</i>	<i>0</i>	<i>0</i>	<i>0</i>	<i>0</i>	<i>0</i>	<i>0</i>	<i>0</i>
25	East Campus Cordon Trips [F + E - G = H]		FTE	2,123	B+C	10,017	799	134	665	759	484	275
Off Campus												
Off-Campus Housing TDM Reductions												
26	Off-Campus Housing TDM Reduction for Students		FTE	2,654	A	0	0	0	0	0	0	0
27	Off-Campus Housing TDM Reduction for Faculty/Staff		FTE	561	A	0	0	0	0	0	0	0
28	Off-Campus Housing TDM Reduction [I]		FTE	3,215	A	0	0	0	0	0	0	0
CSUMB Campus Internal Trip Adjustment												
Main Campus Internal Trips Adjustment												
29	Students	Promontory Housing	FTE	756	E	142	12	11	1	8	1	7
30	CSUMB Campus Population	Main Campus Students and Campus Supporting Trips	FTE	7,658	D	669	272	148	124	140	63	77
31	Students	East Campus Housing	FTE	1,380	C	1,422	143	118	25	111	32	79
32	Faculty/Staff	East Campus Housing	FTE	463	C	749	174	145	29	196	61	135
33	<i>Internal Trips Adjustment [J]</i>		<i>FTE</i>	<i>7,658</i>	<i>C + D + E</i>	<i>2,982</i>	<i>601</i>	<i>422</i>	<i>179</i>	<i>455</i>	<i>157</i>	<i>298</i>
East Campus Internal Trips Adjustment												
34	Students	East Campus Housing	FTE	1,380	C	1,422	143	25	118	111	79	32
35	Faculty/Staff	East Campus Housing	FTE	463	C	749	174	29	145	196	135	61
36	<i>Internal Trips with Main Campus [F]</i>		<i>FTE</i>	<i>1,843</i>	<i>C</i>	<i>2,171</i>	<i>317</i>	<i>54</i>	<i>263</i>	<i>307</i>	<i>214</i>	<i>93</i>
37	Internal Trip Adjustment Total [J + F = L]		FTE	1,843	C	5,153	918	476	442	762	371	391
CSUMB Campus External Trips Total												
38	External Campus Trip Total [D + H - I - L = M]		FTE	7,938	A+B	17,875	1,401	713	688	1,457	702	755

Notes:

FTE = Full time equivalent.

1. Trip type shown on Figure 1.

Source: Fehr & Peers, 2019.

ATTACHMENT F-2: PROJECT CONDITIONS VEHICLE TRIP GENERATION FOR CSUMB BY POPULATION TYPE AND HOUSING LOCATION

Row Number	Population Type	Housing Location	Unit	Size	Trip Type ¹	Daily	AM Peak Hour			PM Peak Hour		
							Total	In	Out	Total	In	Out
Main Campus												
Main Campus Internal Trips												
1	Students	Promontory Housing	FTE	756	E	40	3	3	0	2	0	2
2	CSUMB Campus Population	Main Campus Students and Campus Supporting Trips	FTE	14,476	D	970	495	261	234	253	120	133
3	<i>Internal Trips [A]</i>		<i>FTE</i>	<i>14,476</i>	<i>D + E</i>	<i>1,010</i>	<i>498</i>	<i>264</i>	<i>234</i>	<i>255</i>	<i>120</i>	<i>135</i>
Main Campus External Trips												
4	Students	Promontory Housing	FTE	756	A	1,572	44	6	38	105	52	53
5	Students	East Campus Housing	FTE	0	C	0	0	0	0	0	0	0
6	Faculty/Staff	East Campus Housing	FTE	1,154	C	1,867	434	361	73	488	152	336
7	Students	Off-Campus Housing	FTE	5,080	A	6,528	563	538	25	538	193	345
8	Faculty/Staff	Off-Campus Housing	FTE	622	A	996	261	190	71	275	113	162
9	CSUMB Campus Population	Main Campus Students, Campus Supporting Trips, and Visitors	FTE	14,476	A	14,857	854	359	495	1,171	568	603
10	<i>Main Campus Cordon Trips [B]</i>		<i>FTE</i>	<i>14,476</i>	<i>A + C</i>	<i>25,820</i>	<i>2,156</i>	<i>1,454</i>	<i>702</i>	<i>2,577</i>	<i>1,078</i>	<i>1,499</i>
East Campus Housing TDM Reductions												
11	Student East Campus Housing TDM Reduction for Students		FTE	0	C	0	0	0	0	0	0	0
12	Student East Campus Housing TDM Reduction for Faculty/Staff		FTE	1,154	C	0	0	0	0	0	0	0
13	<i>East Campus Housing TDM Reduction [C]</i>		<i>FTE</i>	<i>1,154</i>	<i>C</i>	<i>0</i>	<i>0</i>	<i>0</i>	<i>0</i>	<i>0</i>	<i>0</i>	<i>0</i>
14	Main Campus Trip Generation [A + B - C = D]		FTE	14,476	A+C+D+E	26,830	2,654	1,718	936	2,832	1,198	1,634
East Campus												
East Campus Internal Trips												
15	Students	East Campus Housing	FTE	0	C	0	0	0	0	0	0	0
16	Faculty/Staff	East Campus Housing	FTE	1,154	C	1,867	434	73	361	488	336	152
17	<i>Internal Trips with Main Campus [F]</i>		<i>FTE</i>	<i>1,154</i>	<i>C</i>	<i>1,867</i>	<i>434</i>	<i>73</i>	<i>361</i>	<i>488</i>	<i>336</i>	<i>152</i>
East Campus External Trips												
18	Students	East Campus Housing	FTE	0	B	0	0	0	0	0	0	0
19	Faculty/Staff	East Campus Housing	FTE	1,154	B	6,084	537	90	447	384	262	122
20	Community Housing Partners	East Campus Housing	FTE	66	B	348	31	5	26	22	15	7
21	<i>External Trips [E]</i>		<i>FTE</i>	<i>1,220</i>	<i>B</i>	<i>6,432</i>	<i>568</i>	<i>95</i>	<i>473</i>	<i>406</i>	<i>277</i>	<i>129</i>
East Campus Housing TDM Reductions												
22	Student East Campus Housing TDM Reduction for Students		FTE	0	C	0	0	0	0	0	0	0
23	Student East Campus Housing TDM Reduction for Faculty/Staff		FTE	1,154	C	0	0	0	0	0	0	0
24	<i>East Campus Housing TDM Reduction [G]</i>		<i>FTE</i>	<i>1,154</i>	<i>C</i>	<i>0</i>	<i>0</i>	<i>0</i>	<i>0</i>	<i>0</i>	<i>0</i>	<i>0</i>
25	East Campus Cordon Trips [F + E - G = H]		FTE	1,220	B+C	8,299	1,002	168	834	894	613	281
Off Campus												
Off-Campus Housing TDM Reductions												
26	Off-Campus Housing TDM Reduction for Students		FTE	5,080	A	0	0	0	0	0	0	0
27	Off-Campus Housing TDM Reduction for Faculty/Staff		FTE	622	A	0	0	0	0	0	0	0
28	Off-Campus Housing TDM Reduction [I]		FTE	5,702	A	0	0	0	0	0	0	0
CSUMB Campus Internal Trip Adjustment												
Main Campus Internal Trips Adjustment												
29	Students	Promontory Housing	FTE	756	E	40	3	3	0	2	0	2
30	CSUMB Campus Population	Main Campus Students and Campus Supporting Trips	FTE	14,476	D	970	495	261	234	253	120	133
31	Students	East Campus Housing	FTE	0	C	0	0	0	0	0	0	0
32	Faculty/Staff	East Campus Housing	FTE	1,154	C	1,867	434	361	73	488	152	336
33	<i>Internal Trips Adjustment [J]</i>		<i>FTE</i>	<i>14,476</i>	<i>C + D + E</i>	<i>2,877</i>	<i>932</i>	<i>625</i>	<i>307</i>	<i>743</i>	<i>272</i>	<i>471</i>
East Campus Internal Trips Adjustment												
34	Students	East Campus Housing	FTE	0	C	0	0	0	0	0	0	0
35	Faculty/Staff	East Campus Housing	FTE	1,154	C	1,867	434	73	361	488	336	152
36	<i>Internal Trips with Main Campus [F]</i>		<i>FTE</i>	<i>1,154</i>	<i>C</i>	<i>1,867</i>	<i>434</i>	<i>73</i>	<i>361</i>	<i>488</i>	<i>336</i>	<i>152</i>
37	Internal Trip Adjustment Total [J + F = L]		FTE	15,630	C	4,744	1,366	698	668	1231	608	623
CSUMB Campus External Trips Total												
38	External Campus Trip Total [D + H - I - L = M]		FTE	14,542	A+B	30,385	2,290	1,188	1,102	2,495	1,203	1,292

Notes:

FTE = Full time equivalent.

1. Trip type shown on Figure 1.

Source: Fehr & Peers, 2019.

**APPENDIX B: CALIFORNIA STATE UNIVERSITY, MONTEREY BAY
MASTER PLAN EIR – TRANSPORTATION STUDY AREA LOCATIONS**





MEMORANDUM

Date: June 10, 2019

To: Anya Spear and Matt McCluney, California State University Monterey Bay
Steve Lohr and Dawn Theodora, California State University Office of the Chancellor
Ann Sansevero, Dudek

From: Daniel Rubins and Matt Haynes, Fehr & Peers

**Subject: California State University Monterey Bay 2019 Master Plan EIR –
Transportation Study Area Locations**

SJ17-1728

This memorandum describes how the final study area for the proposed California State University Monterey Bay (CSUMB) Master Plan EIR transportation analysis was determined. Specifically, it describes how the Project traffic volume estimates were used to identify those intersections and freeway segments at which the Project would result in a deficient operation. The memorandum first defines the likely outer edges of the study area. Second, it selects the major intersections along the local access routes to the campus that may be experience deficient operations with the proposed Project based on estimated Project trips and related road distribution and assignment. Local access routes include the on-campus vehicle street system, parking location changes, and the amount of traffic that would be added to the transportation network as a result of implementation of the proposed Project. The memo concludes with a list of the study intersections and freeway segments.

PROJECT DESCRIPTION

The Project is the CSUMB Master Plan. Project elements that affect the transportation system include the proposed increase in enrollment, the on-campus housing for students, faculty, and staff, and a Main Campus street and parking system that facilitates and prioritizes walking, bicycling, and transit use over vehicle travel. Upon buildout, the Project would accommodate an increase in campus enrollment from the existing 6,634 full time equivalent students (FTES)¹ and 1,024 full time

¹ Full-time equivalent (FTE) is the unit of measurement used to convert class load to student enrollment. At CSUMB, one FTE is equal to 15 units. Thus, one FTE is equal to one student enrolled in 15 units or three students each enrolled in 5 units. A related unit of measurement is "headcount." In the case of one student taking 15 units, the headcount is 1; in the case of three students collectively taking 15 units, the headcount is 3.



equivalent faculty/staff (FTEF),² to 12,700 FTES and 1,776 FTEF. Under Project Conditions, it is projected that the Project would house at least 60 percent of enrolled students and 65 percent of faculty and staff on campus (PDF-LU-5 and PDF-LU-6, as described in Chapter 3 of the proposed CSUMB Master Plan Draft EIR). As explained in the *Draft California State University Monterey Bay Proposed Master Plan Housing Memorandum* (see **Attachment A** of the *California State University Monterey Bay Master Plan EIR – Trip Generation Evaluation Methods and Estimates* memorandum), the Project Conditions on-campus student housing rate is similar to the existing on-campus student rates, and the Project Conditions on-campus faculty and staff housing rate is expected to increase based on various policies, programs and procedures to be implemented over the coming years.

Table 1 summarizes the number and percentage of students, faculty, and staff presently residing on- and off-campus (Existing Conditions), and the number forecasted to reside on- and off-campus under Project Conditions when FTES enrollment and FTEF employment total reaches 14,476.

The total on-campus housed population (i.e., the number of students, faculty, and staff residing in either Main Campus or East Campus housing) is forecasted to increase from the existing 58 percent (4,443 of 7,658) to 61 percent (8,774 of 14,476). As space permits, community housing partners³ will also reside in the East Campus housing. While community housing partners live on-campus, they are not associated with on-campus housing for students, faculty and staff, and therefore are not included in the student, faculty, and staff population total but are included in the entire campus population total in **Table 1**.

In terms of actual on-campus housing facilities, the Project would provide housing to accommodate an increase in campus population from the existing approximately 6,634 FTES to 12,700 FTES, and an increase in employees (i.e., faculty and staff) from approximately 1,024 FTEF to 1,776 FTEF.⁴

² According to CSUMB Institutional Assessment and Research, 1 FTE = full time faculty or staff headcount + part time faculty or staff headcount divided by 3. The faculty and staff category also includes affiliates, which are companies that have been contracted by the Corporation to provide services that the auxiliary has been asked to provide by the university (e.g. dining, bookstore, etc.), and the affiliate's employee works full-time on campus in that capacity. They are also referred to as contractors. The Auxiliary includes staff of the Corporation, Student Union and Foundation.

³ Community housing partners are made up of affiliates (a subcategory of CSUMB staff), educational partners and military partners, and public sector employees working in the Monterey area.

⁴ Existing student, faculty and staff quantities based on 2016 baseline figures provided by CSUMB staff.



TABLE 1: CSUMB POPULATION TYPE BY HOUSING LOCATION

Housing Location	Existing Conditions (FTES or FTEF) ¹	Project Conditions (FTES or FTEF) ¹	Change (Project – Existing) ²
Student Population			
Main Campus	2,600 (39.2%)	7,620 (60.0%)	+5,200
East Campus ⁴	1,380 (20.8%)	0 (0%)	-1,380
Off-Campus	2,654 (40.0%)	5,080 (40.0%)	+2,426
<i>Subtotal [A]</i>	<i>6,634</i> <i>(100%)</i>	<i>12,700</i> <i>(100%)</i>	<i>+6,066</i>
Faculty/Staff Population			
East Campus ³	463 (45.2%)	1,154 (65.0%)	+691
Off-Campus	561 (54.8%)	622 (35.0%)	+61
<i>Subtotal [B]</i>	<i>1,024</i> <i>(100%)</i>	<i>1,776</i> <i>(100%)</i>	<i>+752</i>
Student, Faculty, and Staff Population (Campus Population)			
Main Campus and East Campus (Students, Faculty and Staff)	4,443 (58.0%)	8,774 (60.6%)	+4,331
Off-Campus (Students, Faculty and Staff)	3,215 (42.0%)	5,702 (39.4%)	+2,487
Total [A + B = C]	7,658 (100%)	14,476 (100%)	+6,818
Campus Population with Community Housing Partners			
East Campus (Community Housing Partners) [D]	280	66	-214
Total [C+D = E]	7,938	14,542	+6,604

Notes:

1. FTES = Full time equivalent students; FTEF = Full time equivalent faculty/staff.
2. Change (Project - Existing) = Project Conditions column – Existing Conditions column.
3. The transportation trip generation analysis uses a campus population that, meets but does not exceed the 60 percent student housing goal and the 65 faculty and staff housing goal under Project Conditions.
4. Under Existing Conditions 1,380 students, 463 faculty/staff, and 280 community housing partners live in the East Campus housing. Under Project Conditions 1,154 faculty/staff and 66 community housing partners live in the East Campus housing unless housing is needed by for campus employees.

Source: Fehr & Peers, 2019.



PROJECT TRAFFIC VOLUMES

The amount of automobile traffic that would be generated by the proposed Project, and the distribution of that traffic on the area roadways, was estimated using a three-step process:

1. **Trip Generation** – The *number* of vehicles that would enter/exit the Project site with the increased campus population was estimated. (See the *California State University Monterey Bay Master Plan EIR – Trip Generation Evaluation Methods and Estimates* memorandum for a detailed description of the trip generation analysis).
2. **Trip Distribution** – The *direction* that vehicles would use to approach and depart the Project site was projected using the AMBAG travel model.
3. **Trip Assignment** – The number of vehicles that would be generated by the Project was then *assigned* to specific roadway segments using the AMBAG travel model and forecasting methods.

Each of these steps in the process is further described in the following sections.

VEHICLE TRIP GENERATION ESTIMATES

Below is a condensed discussion of the trip generation presented in the *California State University Monterey Bay Master Plan EIR – Trip Generation Evaluation Methods and Estimates* memorandum. The trip generation approach and technical methods are unique because of the size of the CSUMB campus, the unique travel behavior of each portion of the CSUMB population, and varied housing locations of the CSUMB population. Rather than calculating the net increase in project vehicle trips due to the net increase in land use like most projects; the trip generation is prepared for the entire campus under Existing Conditions and Project Conditions to capture the effects of adding on-campus housing and shifting of student housing from East Campus to Main Campus. Specifically, the net new project traffic is the difference in the Project Conditions and Existing Conditions CSUMB campus trip generation. As shown in the analysis, housing an average of 60 percent of the future campus population (students, faculty and staff) on-campus increases the:

- Likelihood of trips staying within the campus (internal trips); and
- Likelihood of trips shifting to other modes (walking, bicycling, micro-mobility⁵, and transit) for both on and off-campus travel.

Total vehicle trip generation for the CSUMB campus under both Existing Conditions and Project Conditions are presented in **Tables 2** and **3**. As shown, the total trip generation estimates are

⁵ Micro-mobility is an emerging mode of travel that is characterized by new electric lightweight utility vehicles such as e-scooters, and e-bikes.



provided for the Main Campus and East Campus separately, as well as total numbers for the entire campus.

TABLE 2: EXISTING CONDITIONS VEHICLE TRIP GENERATION FOR CSUMB CAMPUS

Location Type	Trip Type ¹	Daily	Morning Peak Hour			Evening Peak Hours		
			Total	In	Out	Total	In	Out
Main Campus								
Promontory Housing Internal Trips	E	142	12	11	1	8	1	7
Main Campus Internal Trips ²	D	669	272	148	124	140	63	77
Main Campus External Trips	A	10,029	919	633	286	1,005	432	573
Main Campus Trips with East Campus	C	2,171	317	263	54	307	93	214
Main Campus Total [A]	A+C+D+E	13,011	1,520	1,055	465	1,460	589	871
East Campus								
East Campus Trips with Main Campus	C	2,171	317	54	263	307	214	93
East Campus External Trips	B	7,846	482	80	402	452	270	182
East Campus Total [B]	B+C	10,017	799	134	665	759	484	275
Internal Trip Adjustment								
Promontory Housing Internal Trips	E	-142	-12	-11	-1	-8	-1	-7
Main Campus Internal Trips ²	D	-669	-272	-148	-124	-140	-63	-77
Main Campus Trips with East Campus	C	-2,171	-317	-263	-54	-307	-93	-214
East Campus Trips with Main Campus	C	-2,171	-317	-54	-263	-307	-214	-93
Trip Adjustment [C]	C+D+E	-5,153	-918	-476	-442	-762	-371	-391
External Campus Trip Total [A+B]³	A+B	17,875	1,401	713	688	1,457	702	755

Notes:

1. Trip type shown on Figure 1.
2. Main Campus Internal Trips = Main Campus Students and Campus Supporting Trips.
3. The campus trip generation is the sum of all Main Campus and East Campus external vehicle trips generated by students, faculty, staff, and visitors.

Source: Fehr & Peers, 2019.

As shown in **Table 2**, under Existing Conditions the Campus external vehicle trip generation is approximately 17,875⁶ daily vehicle trips, 1,401 morning peak-hour trips (713 inbound and 688 outbound) and 1,457 evening peak-hour trips (702 inbound and 755 outbound).

As shown in **Table 3**, under Project Conditions the campus external vehicle trip generation would be approximately 30,385 daily vehicle trips, 2,290 morning peak-hour trips (1,188 inbound and 1,102 outbound) and 2,495 evening peak-hour trips (1,203 inbound and 1,292 outbound).

⁶ This excludes vehicle through trips not associated with the CSUMB campus.



TABLE 3: CSUMB CAMPUS VEHICLE TRIP GENERATION FOR PROJECT CONDITIONS

Trip Type	Trip Type ¹	Daily	Morning Peak Hour			Evening Peak Hours		
			Total	In	Out	Total	In	Out
Main Campus								
Promontory Housing Internal Trips	E	40	3	3	0	2	0	2
Main Campus Internal Trips ²	D	970	495	261	234	253	120	133
Main Campus External Trips	A	23,953	1,722	1,093	629	2,089	926	1,163
Main Campus Trips with East Campus	C	1,867	434	361	73	488	152	336
Main Campus Total [A]	A+C+D+E	26,830	2,654	1,718	936	2,832	1,198	1,634
East Campus								
East Campus Trips with Main Campus	C	1,867	434	73	361	488	336	152
East Campus External Trips	B	6,432	568	95	473	406	277	129
East Campus Total [B]	B+C	8,299	1,002	168	834	894	613	281
Internal Trip Adjustment								
Promontory Housing Internal Trips	E	-40	-3	-3	-0	-2	-0	-2
Main Campus Internal Trips ²	D	-970	-495	-261	-234	-253	-120	-133
Main Campus Trips with East Campus	C	-1,867	-434	-361	-73	-488	-152	-336
East Campus Trips with Main Campus	C	-1,867	-434	-73	-361	-488	-336	-152
Trip Adjustment [C]	C+D+E	-4,744	-1,366	-698	-668	-1,231	-608	-623
External Campus Trip Total [A+B]²	A+B	30,385	2,290	1,188	1,102	2,495	1,203	1,292

Notes:

1. Trip type shown on Figure 1.
2. Main Campus Internal Trips = Main Campus Students and Campus Supporting Trips.
3. The campus trip generation is the sum of all Main Campus and East Campus external vehicle trips generated by students, faculty, staff, and visitors.

Source: Fehr & Peers, 2019.

As shown in **Table 4**, the Project (i.e., Project Conditions) would generate 12,510 additional external daily trips, 889 additional external morning peak hour trips and 1,039 additional external evening peak hour trips.

By housing a large portion of students, faculty, and staff on-campus, and consolidating parking to the periphery. CSUMB would convert many potential off-campus-based trips to on-campus generated trips, thereby reducing both the number of external campus trips to and from campus. Relatedly, by increasing the number of on-campus students, the number of CSUMB external trips made by on-campus students for purposes such as recreational activities, off-campus dining, visiting family and friends, etc. would increase in absolute terms over existing levels.

By comparing **Tables 2** and **3** we can see the net change in vehicle trips due to the Main Campus population growth, the additional on-campus student housing, and faculty and staff moving into residential units currently occupied by students and community housing partners in the East Campus housing. Thus, the net increase in trip generation between Existing Conditions and Project



Conditions is the project increment that will be studied in the transportation analysis. **Table 4** presents the net increase in external campus trips between Existing and Project Conditions.

TABLE 4: CSUMB CAMPUS VEHICLE TRIP GENERATION RESULTS

Scenario	Daily	Morning Peak Hour			Evening Peak Hours		
		Total	In	Out	Total	In	Out
Existing Conditions [A]	17,875	1,401	713	688	1,457	702	755
Project Conditions [B]	30,385	2,290	1,188	1,102	2,495	1,205	1,292
Additional Campus Trips [B-A]	12,510	889	475	414	1,039	501	537

Source: Fehr & Peers, 2019.

VEHICLE TRIP DISTRIBUTION ESTIMATES

Campus vehicle trips are generated by students, faculty, staff, community housing partners, campus support (trips made by security staff, maintenance staff, etc.), and visitors traveling to/from the CSUMB campus. The AMBAG travel model was used to distribute the vehicle trips from the CSUMB campus to nearby communities for each analysis scenario (Existing Conditions, Existing with Project Conditions, Cumulative Conditions, and Cumulative with Project Conditions). The distribution of project traffic considered: 1) regional land use destinations outside of the Campus, and 2) ease and convenience of access to nearby freeways and regional streets.

The distribution of vehicle trips going to/coming from nearby communities of Castroville (and north), Marina, Salinas, Seaside, and Monterey to the CSUMB Campus is presented in **Table 5**. The distribution is summarized for the inbound and outbound during the morning peak hour and the evening peak hour under Existing with Project Conditions and Cumulative with Project Conditions. The distribution of CSUMB campus traffic is similar during the morning and evening peak hours under Existing with Project Conditions and Cumulative with Project Conditions. Vehicle trips to/from the north account for 25 to 29 percent of vehicle trips, with the majority traveling to/from Castroville and north. The communities south of the CSUMB campus account for 36% to 39% of vehicle trips. Finally, communities east of the CSUMB campus (Salinas) account for 34 to 37 percent of the vehicle trips.



TABLE 5: DISTRIBUTION OF CSUMB EXTERNAL VEHICLE TRIPS TO NEARBY COMMUNITIES (AMBAG MODEL)

Resident Location	Existing with Project Conditions		Cumulative with Project Conditions	
	Morning Inbound Peak Hour	Evening Outbound Peak Hours	Morning Inbound Peak Hour	Evening Outbound Peak Hours
North				
Castroville and North	18%	17%	20%	17%
Marina	9%	8%	9%	10%
North Total	27%	25%	29%	27%
East				
Salinas	37%	37%	34%	34%
East Total	37%	37%	34%	34%
South				
Seaside	13%	15%	14%	16%
Monterey and West	23%	23%	23%	23%
South Total	36%	38%	37%	39%

Source: Fehr & Peers, 2019.

Comparison of Project Trip Distribution

The following sources were reviewed to determine the accuracy of the Project trip distribution patterns derived from the AMBAG travel model:

- CSUMB Student Resident Zip Code Data (specific to students only) – The CSUMB student zip code data was provided by CSUMB staff and includes on-campus and off-campus student resident location by zip code.
- CSUMB Person Trip Travel Survey Zip Code Data (includes students, as well as faculty and staff) – The *CSUMB Person Trip Travel Survey* was conducted in Fall 2017 and included questions to assist in understanding travel choices to/from the Main Campus, including mode of travel and where (zip code) the respondent currently resides. This data set includes on-campus and off-campus student, faculty, and staff resident location by zip code provided by survey respondents.

Fehr & Peers reviewed the CSUMB Student Resident Zip Code data, which, as noted above, is limited to student resident locations. However, this data set represents only a sample of the student resident locations because some students provide only their parents resident location and not the student's resident location while attending CSUMB; in other words, the survey responses with resident locations listed outside of the proximity of the CSUMB campus were not considered as part of the trip distribution analysis.



As shown in **Table 6**, the distribution of CSUMB student residence locations is similar for both data sets and at least half of the campus population lives on campus. That is, even though the CSUMB student resident zip code data considered as part of the analysis are limited to the student portion of the campus population, both data sets have a similar distribution for resident locations as to students. Furthermore, each data set shows that the majority of the campus population lives on-campus. To compare to the distribution in **Table 5**, the CSUMB zip code and person survey zip code data derived distributions were prepared for off-campus residents only (see **Table 7**).

TABLE 6: DISTRIBUTION OF CSUMB CAMPUS POPULATION TO NEARBY COMMUNITIES

Resident Location	Student Only (from CSUMB Zip Code data)	Student Only (from Person Trip Travel Survey)	CSUMB Faculty/Staff (from Person Trip Travel Survey)	CSUMB Student & Faculty/Staff (from Person Trip Travel Survey)
North				
Castroville and North	13%	10%	10%	10%
Marina	8%	9%	6%	9%
North Total	21%	19%	16%	19%
East				
Salinas	14%	14%	13%	14%
East Total	14%	14%	13%	14%
South				
Seaside	8%	8%	5%	8%
Monterey and West	8%	6%	17%	7%
South Total	16%	14%	22%	15%
On-Campus				
On-Campus (Main or East)	49%	53%	49%	52%
On-Campus Total	49%	53%	49%	52%

Source: Fehr & Peers, 2019.

The trip distribution data from the AMBAG travel model was compared to the data collected from the CSUMB Student Resident Zip Code Data and the *CSUMB Person Trip Travel Survey* data representing student, faculty, and staff resident locations. As a first step, the distribution of on-campus and off-campus students, faculty and staff were reviewed for consistency of distribution pattern between data sets. Based on the *CSUMB Person Trip Travel Survey* data, the distribution of vehicle trips going to/coming from different areas of Monterey, Santa Cruz, and Santa Clara counties to the CSUMB campus is presented in **Table 7**.



TABLE 7: DISTRIBUTION OF CSUMB OFF-CAMPUS POPULATION TO NEARBY COMMUNITIES

Resident Location	Student Only (from CSUMB Zip Code data)	Student Only (from Person Trip Travel Survey)	CSUMB Faculty/Staff (from Person Trip Travel Survey)	CSUMB Student & Faculty/Staff (from Person Trip Travel Survey)
North				
Castroville and North	26%	21%	19%	21%
Marina	16%	19%	13%	18%
North Total	42%	40%	32%	39%
East				
Salinas	28%	30%	25%	30%
East Total	28%	30%	25%	30%
South				
Seaside	15%	17%	9%	16%
Monterey and West	15%	13%	34%	15%
South Total	30%	30%	43%	31%

Source: Fehr & Peers, 2019.

The distribution of CSUMB external vehicle trips to nearby communities in **Table 5** (from the AMBAG travel mode) is similar (within 10 percentage points) to the distributions of CSUMB Students and Faculty/Staff (from the *CSUMB Person Trip Travel Survey* data) shown in **Table 7**. Thus, the project trip distribution percentages derived from the AMBAG travel model are appropriate for use with this analysis.

VEHICLE TRIP ASSIGNMENT ESTIMATES

Once the trip generation and distribution were determined, the AMBAG travel model was used to assign the project trips from the CSUMB campus to the transportation network during the morning and evening peak hour under Existing with Project Conditions and Cumulative with Project Conditions.

SELECTING THE STUDY AREA

The California State University *Transportation Impact Study (TIS) Manual* (November 2012) provides the following guidance for defining the study area (pages 11 and 12):

- *The study area should extend to a sufficient distance from the project site to identify all potentially significant impacts, as supported by substantial evidence.*



- *If the project is of statewide, areawide, or regional significance as defined in Section 21092.5 of the 2017 CEQA Guidelines, then the study area should consider major local arterials and public transit within a maximum of 5 miles of the project site, and freeways, highways and rail transit service within a maximum of 10 miles of the project site.*
- *Additional facilities may be studied based on circumstances unique to the site. CSU should confirm whether TIS preparers may consult with the host City or County early regarding any additional study locations based on local or site-specific issues.*

Using the above guidance, the intersection study area boundary for the proposed Project would extend up to 10 miles from the CSUMB campus and encompass the following locations, with the corresponding geographic location noted in parentheses:

- Highway 1 between Reservation Road and Del Monte Boulevard (County: Castroville and North)
- California Avenue between Third Avenue and Patton Parkway (Marina)
- Del Monte Boulevard between Reindollar Avenue and Cypress Avenue (Marina)
- Blanco Road between Reservation Road and Cooper Road (County: South of Salinas)
- Davis Road between Reservation Road and Foster Road (County: South of Salinas)
- Highway 68 between Reservation Road and Spreckels Avenue (County: South of Salinas)
- Fremont Boulevard south of Highway 1 (Seaside)
- California Avenue south of Highway 1 (Seaside)
- Canyon Del Rey Boulevard south of Highway 1 (Seaside)
- General Jim Moore Boulevard between Coe Avenue and San Pablo Avenue (Seaside)
- Highway 1 between Canyon Del Rey Boulevard and Del Monte Boulevard (County: Monterey and West)

To confirm that the study area boundary is an appropriate distance to diffuse Project traffic such that project traffic would not cause a potential significant impact to the roadway or freeway system beyond the proposed study area, we reviewed the day-to-day variation of roadway and freeway counts within the identified area. This was done by comparing the directional (inbound or outbound) peak hour vehicle trips at the boundary locations listed above to the day-to-day variation of the roadway counts. Using this method, if Project traffic is greater than the day-to-day variation, then the study area boundary may need to be extended beyond the proposed study area boundary described above. Project traffic that is less than the day-to-day variation of a roadway, means that the project traffic is disbursed enough to have little influence on the roadway operation and thus would be unlikely to cause a potentially significant impact. Stated differently, project traffic less than the average day-to-day variation would not be discernable by an observer on the side of the road.



Near the CSUMB campus, the local street system has an average day-to-day variation⁷ of approximately 13 percent during the morning peak hour and 12 percent during the evening peak hour (see **Attachment B** for the day-to-day variation calculated from six roadway segments over two to five days). The freeway system has a day-to-day variation of approximately 2 percent in the morning peak hour and 5 percent in the evening peak hour (see **Attachment B**). Therefore, for this analysis, if the Project traffic would contribute more than 10 percent of the peak hour roadway capacity or more than 2 percent of the peak hour freeway capacity, then the study area would need to be expanded to include those roadways/freeways. Often study intersections are selected based on a 10 trip per lane rule or similar rule of thumb. Expressing the percentage of roadway capacity in vehicle trips per lane units, study intersections are proposed to be analyzed if the Project traffic contributes more than 40 to 50 peak hour project vehicle trips per turn lane to an intersection⁸ and freeway segments are selected with more than 2 percent of the peak hour freeway capacity (for example, 2 percent of capacity of a 2-lane freeway would be 44 peak hour vehicle trips).

Attachment A shows the evaluation of the study boundary for the eleven locations listed above. From left to right the table defines the nearby community, roadways, roadway classification, two-way total roadway capacity, and peak direction roadway assignment distribution from the AMBAG travel model. The evaluation is done by comparing the evening outbound peak hour vehicle trips⁹ (see column A in **Attachment A**) to the evening outbound peak hour direction roadway segment threshold (see column B in **Attachment A**) to determine if the study area needs to be expanded beyond that area identified above (see column C in **Attachment A**). The comparison confirms that the study area does not need to be expanded to ensure that all potentially significant Project impacts are identified.

With the study area boundary defined, the major study area intersections and freeway segments were selected based on the CSUMB Project vehicle trips added to the transportation network at locations that meet one or more of the criteria presented in **Table 8**. Criteria 1 and 2 are based on the evaluation of the day-to-day roadway variation described above, and Criteria 3 and 4 are based on the anticipated changes in the transportation street network.

⁷ Vehicle variation is estimated by comparing day-to-day counts to each other. The difference between the maximum and minimum vehicle volume is defined as the vehicle variation.

⁸ As an example, General Jim Moore Boulevard between Coe Avenue and San Pablo Avenue has a total roadway link vehicle capacity of 3,740 vehicles per peak hour per direction. This street segment has two northbound and two southbound lanes. Major intersections along this street will be selected if the project traffic adds more than 187 vehicles (10 percent * 2 lanes * 935 vehicles per hour per lane) in either the northbound or southbound direction. The approach geometry along General Jim Moore Boulevard is a left turn lane, two through lanes and a right turn lane. Dividing the 187 vehicles by 4 turn lanes would result in approximately 47 vehicles per turn lane.

⁹ The assigned project trips at each boundary location is based on the distribution of project trips summarized in **Table 3** and refined based on the "select zone" assignment analysis using the AMBAG travel model to determine the relative attractiveness of each route. The segment thresholds in terms of vehicle trips were determined by multiplying the roadway/freeway segment capacity by the appropriate day-to-day vehicle volume variation threshold.



TABLE 8: STUDY AREA CRITERIA

Criteria	Intersections along Streets and Corridors that Meet Criteria
<p>Criterion 1: Major intersections (typically arterial to arterial intersections) along local streets and regional corridors segments that provide access to/from the CSUMB Campus within the study area boundary.</p>	<p>The major study intersections along the following local streets and regional corridors within the study area boundary meet Criterion 1:</p> <ul style="list-style-type: none"> • Imjin Parkway between Highway 1 and Reservation Road • Reservation Road between Imjin Parkway and State Route 68 • Inter-Garrison Road between Reservation Road and 8th Avenue • Lightfighter Drive between Highway 1 and General Jim Moore • Second Avenue between Reindollar Avenue (future) and Imjin Parkway • General Jim Moore between Lightfighter Drive and Eucalyptus Road
<p>Criterion 2: Project traffic would contribute more than 2 percent of peak hour capacity on freeway segments that provide access to/from the CSUMB Campus.</p>	<p>Highway 1 segments between State Route 68 and Reservation Road met Criterion 2.</p>
<p>Criterion 3: Local street intersections on or near the Main Campus that may experience changed vehicle patterns due to the closure of Inter-Garrison Road, the one-way re-configuration of 7th Avenue between Colonel Durham Street and Butler Street, or the re-location of Main Campus parking lots to satellite parking lots.¹</p>	<p>The following are nearby and on-campus intersections serving the last mile of access and/or on-campus circulation that meet Criterion 3:</p> <ul style="list-style-type: none"> • Second Avenue between Imjin Parkway and Lightfighter Drive • General Jim More between Eighth Street and Lightfighter Drive • Eighth Avenue between Inter-Garrison Road and Gigling Road • Eight Street between Second Avenue and Inter-Garrison Road • Inter-Garrison Road between Second Avenue and Eighth Avenue • Divarty Street between Second Avenue and Sixth Avenue • Colonel Durham Street between General Jim Moore Boulevard and Eighth Avenue • Gigling Road between General Jim Moore Boulevard and Eighth Avenue
<p>Criterion 4: Local street intersections on or near the Main Campus that may experience changed vehicle patterns due to the Eastside Parkway extension.¹</p>	<p>The following local street intersections along the following streets meet Criterion 4:</p> <ul style="list-style-type: none"> • Inter-Garrison Road between Second Avenue and Schoonover Drive • Lightfighter Drive between Highway 1 and General Jim Moore Boulevard • Colonel Durham Street between General Jim Moore Boulevard and Eight Avenue • Gigling Road between General Jim Moore Boulevard and Eighth Avenue • Second Avenue between Inter-Garrison Road and Lightfighter Drive • General Jim Moore between Inter-Garrison Road and Eucalyptus Road • Eighth Avenue between Inter-Garrison Road and Gigling Road • Eastside Parkway extension from Inter-Garrison Road to Eucalyptus Road

Notes:

1. The re-distribution of existing traffic due to changes to on-campus vehicle street system and parking locations, and Eastside Parkway extension have the potential to shift traffic. Criteria 3 and 4 were used to identify locations where traffic shifts may cause impacts to the transportation system.

Source: Fehr & Peers, 2019.



Study Area Intersections

The resulting list of study area intersections creates a study area generally bounded by Reservation Road to the north, Davis Road to the east, Coe Avenue to the south, and Highway 1 to the west.

The list of study intersections is provided in **Table 9** and illustrated in **Figure 1**.

The intersections requested by reviewing agencies (Caltrans, Monterey County, Fort Ord Reuse Authority, City of Seaside, and City of Marina) and included in the final study area intersection list are highlighted in **Table 9** with an asterisk (*). The only agency requested intersection not included in the final study area intersection list is Normandy Road and Malmedy Road because this route is slower and less direct than traveling via General Jim Moore Boulevard and Gigling Road to/from the CSUMB campus and this intersection does not meet the intersection selection criteria described earlier. In other words, the slower and less direct route is unlikely to experience project traffic.



TABLE 9: STUDY AREA INTERSECTIONS

1	Del Monte Boulevard and Reindollar Avenue	27	Reservation Road and Watkins Gate Road
2	Second Avenue Extension and Patton Parkway	28	Davis Road and Reservation Road
3	SR 1 Southbound Ramps and Imjin Parkway	29	Second Avenue and Divarty Street
4	SR 1 Northbound Ramps and Imjin Parkway	30	General Jim Moore Boulevard and Divarty Street
5	Second Avenue and Imjin Parkway	31	First Avenue and Lightfighter Drive
6	Third Avenue and Imjin Parkway	32	Second Avenue and Lightfighter Drive
7	Fourth Avenue and Imjin Parkway	33	General Jim Moore Boulevard and Lightfighter Drive
8	California Avenue and Imjin Parkway	34	Malmedy Road and Colonel Durham Street
9	California Avenue and Patton Parkway	35	Parker Flatts Cut Off Road and Colonel Durham Street
10	Imjin Road and Imjin Parkway	36	Sixth Avenue and Colonel Durham Street
11	Abrams Drive and Imjin Parkway	37	Seventh Avenue and Colonel Durham Street
12	Reservation Road and Imjin Parkway	38	Eighth Avenue and Colonel Durham Street
13	Blanco Road and Reservation Road	39	General Jim Moore Boulevard and Gigling Road
14	Inter-Garrison Road Connection and Reservation Road	40	Malmedy Road and Gigling Road
15	Second Avenue and Ninth Street	41	Parker Flatts Cut Off Road and Gigling Road
16	Second Avenue and Eighth Street	42	Sixth Avenue and Gigling Road
17	Fourth Avenue and Eighth Street	43	Seventh Avenue and Gigling Road
18	Imjin Road and Eighth Street	44	Eight Avenue and Gigling Road
19	Second Avenue and Inter-Garrison Road	45	Eastside Parkway and Gigling Road
20	General Jim Moore Boulevard and Inter-Garrison Road	46	General Jim Moore Boulevard and Normandy Road
21	Eighth Street/Seventh Avenue and Inter-Garrison Road	47	General Jim Moore Boulevard and Coe Avenue
22	Eighth Avenue and Inter-Garrison Road	48	Fremont Boulevard - Southbound SR 1 Off-Ramp and Monterey Road
23	Abrams Drive and Inter-Garrison Road	49	California Avenue and Monterey Road - Northbound SR 1 Off-Ramp
24	Schoonover Road and Inter-Garrison Road	50	Reservation Road and State Route 68 Westbound Ramps
25	Inter-Garrison Road Connection and Inter-Garrison Road	51	Reservation Road and State Route 68 Eastbound Ramps
26	East Garrison Road and Reservation Road		



STUDY AREA FREEWAY SEGMENTS

A similar approach was used for the determination of study area freeway segments. In reviewing available counts near the CSUMB campus, the freeway system has a day-to-day variation of two percent during the morning peak hour and five percent during the evening peak hour in the peak direction (see **Attachment B**). Freeway segments along Highway 1 to which the Project would add more than two percent traffic would be studied. The final list of study area freeway segments is presented below.

1. Highway 1 between Reservation Road and Del Monte Boulevard (2 segments)
2. Highway 1 between Del Monte Boulevard and Imjin Parkway (2 segments)
3. Highway 1 between Imjin Parkway and Lightfighter Drive (2 segments)
4. Highway 1 between Lightfighter Drive and Fremont Boulevard-Del Monte Boulevard (2 segments)
5. Highway 1 between Fremont Boulevard-Del Monte Boulevard and Canyon Del Rey Boulevard (2 segments)

In addition, the following freeway ramps at the two nearest interchanges closest to the CSUMB campus are studied.

1. Highway 1 and Imjin Parkway Interchange Ramps (4 ramps)
2. Highway 1 and Lightfighter Drive Interchange Ramps (4 ramps)

ATTACHMENTS

- Figure 1: Project Location and Study Area Intersections
Attachment A: Evaluation of Study Area Boundary
Attachment B: Roadway Day-to-Day Variation

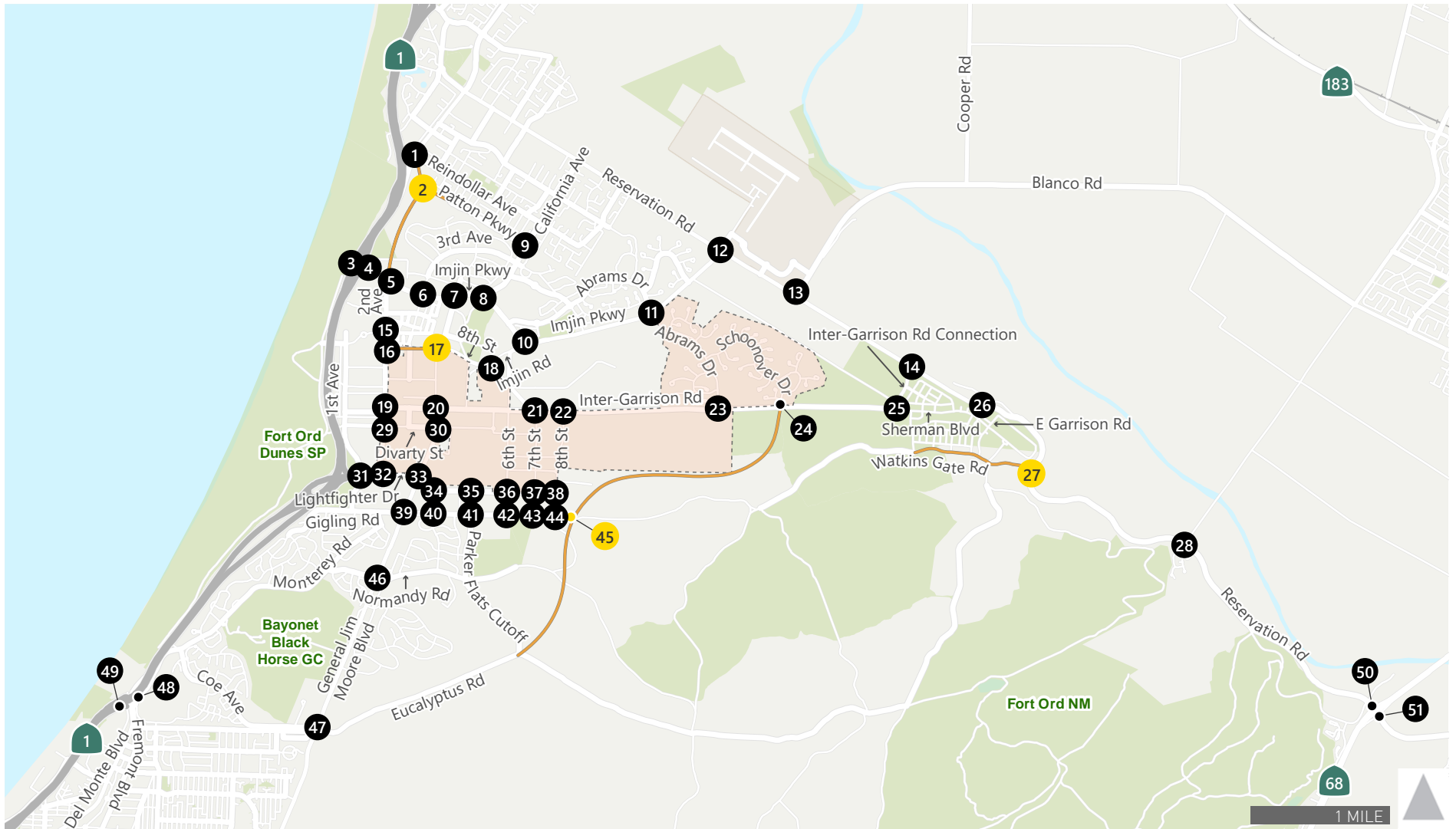

- California State University Monterey Bay Campus
- # Study Intersection
- # Future Intersection
- New/Extended Roadway



Figure 1
Project Location and Study Intersections

ATTACHMENT A: Evaluation of Study Boundary

Nearby Community	Roadways	Roadway Classification	Roadway Capacity (vehicles, both directions) ¹	Peak Direction Roadway Assignment Distribution ²	A: Evening Outbound Peak Hour Vehicle Trips ³	B: Evening Outbound Peak Hour Direction Roadway Segment Threshold ⁴	Distance from CSUMB Campus ⁵	C: Study Further (Yes/No) ⁶
North								
Castroville and Northward	CA-1 between Reservation Road and Del Monte Boulevard	2-Lane Freeway	4,010	17%	81	80	6 miles	No ⁷
Marina	California Avenue between 3rd Avenue and Patton Parkway	2-Lane Arterial	1,870	4%	21	94	2.5 miles	No
	Del Monte Boulevard between Reindollar Avenue and Cypress Avenue	4-Lane Arterial, Divided	3,740	4%	18	188	4 miles	No
East								
Salinas	Blanco Road between Reservation Road and Cooper Road	Minor 2-Lane Highway	1,740	11%	54	87	5 miles	No
	Davis Road between Reservation Road and Foster Road	Minor 2-Lane Highway	3,480	25%	116	174	8 miles	No
	Highway 68 between Reservation Road and Spreckels Avenue	4-Lane, Multilane Highway	1,825	0%	1	182	10 miles	No
South								
Seaside	Fremont Boulevard just south of CA-1	4-Lane Arterial, Divided	3,740	4%	19	188	4 miles	No
	California Avenue just south of CA-1	2-Lane Arterial	1,870	0%	2	94	4 miles	No
	Canyon Del Rey Boulevard just south of CA-1	4-Lane Arterial, Divided	3,740	3%	13	188	5 miles	No
	General Jim Moore Boulevard between Coe Avenue and San Pablo Avenue	4-Lane Arterial, Divided	3,740	8%	37	188	3 miles	No
Monterey and Westward	CA-1 between Canyon Del Rey Boulevard and Del Monte Boulevard	2-Lane Freeway	4,010	23%	108	80	5 miles	No ⁸
Totals				100%	470			

Notes:

- Roadway capacity for CA US-1 and Highway 68 segments represent peak direction capacity only.
- Peak Direction Roadway Assignment Distribution obtained from the AMBAG Travel Model.
- Evening Outbound Peak Hour Direction Project Trips of the project boundary (470 vehicles).
- Non-freeway roadway segment threshold calculated by multiplying the roadways' peak direction capacity by the capacity threshold (ten percent) as described in the memorandum. Freeway segment threshold calculated by multiplying the freeways' peak direction capacity by the capacity threshold (two percent) as described in the memorandum.
- Distance measured along roadway.
- If column A value is less than column B value, then column C equals No. Otherwise, Column C equals Yes unless noted by a footnote.
- The vehicle demand for the evening outbound peak hour direction of the next freeway segment (CA-1 between Del Monte Boulevard and Nashau Road) is 76 vehicles which is less than the Evening Outbound Peak Hour Direction Roadway Segment Threshold. Therefore the last freeway segment to be studied north of the CSUMB campus is between Reservation Road and Del Monte Boulevard.
- The vehicle demand for the evening outbound peak hour direction of the next freeway segment (CA-1 between Del Monte Boulevard and Casa Verde Way) is 67 vehicles which is less than the Evening Outbound Peak Hour Direction Roadway Segment Threshold. Therefore the last freeway segment to be studied south of the CSUMB campus is between Canyon Del Rey Boulevard and Del Monte Boulevard.

Source: Fehr & Peers, 2019.

ATTACHMENT B: ROADWAY DAY-TO-DAY VARIATION

AM Peak Hour: Peak Direction Highway Volumes¹

AM Peak Hour Minimum	AM Peak Hour Maximum	AM Peak Hour Average	Difference in Peak Hour Max and Min	Percent Variation
24,014	24,563	24,289	549	2%

AM Peak Hour: Two-Way Local Roads and Streets Volumes²

AM Peak Hour Minimum	AM Peak Hour Maximum	AM Peak Hour Average	Difference in Peak Hour Max and Min	Percent Variation
27,093	30,756	28,911	3,663	13%

AM Peak Hour: Two-Way Local Roads and Streets Around 5-mile Distance from CSUMB³

AM Peak Hour Minimum	AM Peak Hour Maximum	AM Peak Hour Average	Difference in Peak Hour Max and Min	Percent Variation
4,317	4,768	4,543	451	10%

PM Peak Hour: Peak Direction Highway Volumes¹

PM Peak Hour Minimum	PM Peak Hour Maximum	PM Peak Hour Average	Difference in Peak Hour Max and Min	Percent Variation
26,263	27,579	26,921	1,316	5%

PM Peak Hour: Two-Way Local Roads and Streets Volumes²

PM Peak Hour Minimum	PM Peak Hour Maximum	PM Peak Hour Average	Difference in Peak Hour Max and Min	Percent Variation
25,098	28,334	26,702	3,236	12%

PM Peak Hour: Two-Way Local Roads and Streets Around 5-mile Distance from CSUMB³

PM Peak Hour Minimum	PM Peak Hour Maximum	PM Peak Hour Average	Difference in Peak Hour Max and Min	Percent Variation
4,455	5,274	4,821	819	17%

Notes:

1. Peak direction is towards CSUMB Campus in the morning and away from CSUMB Campus in the evening. The day-to-day variation is based on Highway 1 freeway segments between SR 68 and Reservation Road.

2. Total variation based on 34 roadway segments with the project study area generally bounded by Reservation Road to the north, Davis Road to the east, Coe Avenue to the south, and Highway 1 to the west.

3. Total variation based on 6 roadway segments including Del Monte Boulevard between Beach Road and Reservation Road, General Jim Moore between Coe Avenue and San Pablo Avenue, Reservation Road between Robin Drive and Del Monte Boulevard, Reservation Road between Salinas Avenue and Imjin Parkway, Reservation Road between Inter-Garrison Road and East Garrison Road, and Coe Avenue between Buttercup Boulevard and Malmedy Road.

Source: Fehr & Peers, May 2018.

APPENDIX C: EXISTING PARKING INVENTORY



Table C1: CSUMB Park Inventory

Latitude	Longitude	IDAX ID	Lot Number	Total Spaces
36.65086354	-121.8088451	1	106	106
36.65052353	-121.8076757	2	Otter Soccer Parking	64
36.650091	-121.8063748	3	107	152
36.65139344	-121.8077997	4	100	24
36.6511562	-121.8060918	5	902	16
36.65234941	-121.8041915	6	903	92
36.65383418	-121.8068013	7	91	29
36.65456472	-121.8063399	8	84	12
36.65449156	-121.8087526	9	90	50
36.65533721	-121.807217	10	86	174
36.65508438	-121.8053944	11	82 West	87
36.65541253	-121.8035169	12	82 East	44
36.65513387	-121.8033265	13	80	67
36.6557751	-121.8021972	14	300	224
36.65719633	-121.7996505	15	301	385
36.65829693	-121.7959504	16	Promontory	382
36.65566536	-121.7945194	17	71	707
36.65497572	-121.7957311	18	72	45
36.65515109	-121.7917112	19	490	72
36.65377716	-121.7892864	20	7th Ave - Temp	0
36.65167049	-121.7887312	21	59	862
36.64899728	-121.7878689	22	37	86
36.64824624	-121.7876362	23	35	11
36.64925497	-121.7926633	24	42	96
36.64795734	-121.7942532	25	30	45
36.64944219	-121.7942445	26	29	122
36.65140151	-121.7941439	27	28	168
36.65295946	-121.7939327	28	13	82
36.65429037	-121.7961314	29	12 - Temp	0
36.65439527	-121.7975208	30	16	46
36.65431511	-121.800148	31	18	188
36.65409563	-121.8016487	32	97	72
36.65306221	-121.7995895	33	208	32
36.65192711	-121.7998332	34	23	0
36.65239864	-121.7998114	35	508	96
36.65311816	-121.7986775	36	1	31
36.6530337	-121.7970722	37	205	19
36.65300304	-121.8015448	38	98	3
36.65421721	-121.793181	39	201	6
36.65343627	-121.7955527	40	202	24

Key

- existing parking for future lot 4
- residential parking

Total	4721
--------------	-------------

Source: CSUMB data received May 2018

APPENDIX D: EXISTING TRAFFIC COUNTS



Traffic Data Service

San Jose, CA
 (408) 622-4787
 tdsbay@cs.com

File Name : 1AM FINAL
 Site Code : 00000001
 Start Date : 5/3/2017
 Page No : 1

Groups Printed- Lights - Buses - Trucks

Start Time	CA-1 SB OFF-RAMP Southbound					IMJIN PKWY Westbound					CA-1 SB ON-RAMP Northbound					Eastbound					Int. Total
	Right	Thru	Left	Peds	App. Total	Right	Thru	Left	Peds	App. Total	Right	Thru	Left	Peds	App. Total	Right	Thru	Left	Peds	App. Total	
07:00 AM	0	0	64	0	64	0	0	313	0	313	0	0	0	0	0	0	0	0	0	0	0
07:15 AM	0	2	82	0	84	0	0	268	0	268	0	0	0	0	0	0	0	0	0	0	0
07:30 AM	0	1	95	1	97	0	0	199	0	199	0	0	0	0	0	0	0	0	0	0	0
07:45 AM	0	2	168	2	172	0	0	179	0	179	0	0	0	0	0	0	0	0	0	0	0
Total	0	5	409	3	417	0	0	959	0	959	0	0	0	0	0	0	0	0	0	0	0
08:00 AM	0	2	91	0	93	0	0	175	0	175	0	0	0	0	0	0	0	0	0	0	0
08:15 AM	0	0	68	0	68	0	0	200	0	200	0	0	0	0	0	0	0	0	0	0	0
08:30 AM	0	0	57	0	57	0	0	233	0	233	0	0	0	0	0	0	0	0	0	0	0
08:45 AM	0	1	59	0	60	0	0	231	0	231	0	0	0	0	0	0	0	0	0	0	0
Total	0	3	275	0	278	0	0	839	0	839	0	0	0	0	0	0	0	0	0	0	0
Grand Total	0	8	684	3	695	0	0	1798	0	1798	0	0	0	0	0	0	0	0	0	0	0
Apprch %	0	1.2	98.4	0.4		0	0	100	0		0	0	0	0		0	0	0	0		
Total %	0	0.3	27.4	0.1	27.9	0	0	72.1	0	72.1	0	0	0	0	0	0	0	0	0	0	0
Lights	0	7	662	3	672	0	0	1739	0	1739	0	0	0	0	0	0	0	0	0	0	0
% Lights	0	87.5	96.8	100	96.7	0	0	96.7	0	96.7	0	0	0	0	0	0	0	0	0	0	0
Buses	0	0	5	0	5	0	0	10	0	10	0	0	0	0	0	0	0	0	0	0	0
% Buses	0	0	0.7	0	0.7	0	0	0.6	0	0.6	0	0	0	0	0	0	0	0	0	0	0
Trucks	0	1	17	0	18	0	0	49	0	49	0	0	0	0	0	0	0	0	0	0	0
% Trucks	0	12.5	2.5	0	2.6	0	0	2.7	0	2.7	0	0	0	0	0	0	0	0	0	0	0

Start Time	CA-1 SB OFF-RAMP Southbound				IMJIN PKWY Westbound				CA-1 SB ON-RAMP Northbound				Eastbound				Int. Total
	Right	Thru	Left	App. Total	Right	Thru	Left	App. Total	Right	Thru	Left	App. Total	Right	Thru	Left	App. Total	
Peak Hour Analysis From 07:00 AM to 08:45 AM - Peak 1 of 1																	
Peak Hour for Entire Intersection Begins at 07:00 AM																	
07:00 AM	0	0	64	64	0	0	313	313	0	0	0	0	0	0	0	0	377
07:15 AM	0	2	82	84	0	0	268	268	0	0	0	0	0	0	0	0	352
07:30 AM	0	1	95	96	0	0	199	199	0	0	0	0	0	0	0	0	295
07:45 AM	0	2	168	170	0	0	179	179	0	0	0	0	0	0	0	0	349
Total Volume	0	5	409	414	0	0	959	959	0	0	0	0	0	0	0	0	1373
% App. Total	0	1.2	98.8		0	0	100		0	0	0		0	0	0		
PHF	.000	.625	.609	.609	.000	.000	.766	.766	.000	.000	.000	.000	.000	.000	.000	.000	.910

Traffic Data Service

San Jose, CA
 (408) 622-4787
 tdsbay@cs.com

File Name : 1AM FINAL
 Site Code : 00000001
 Start Date : 5/3/2017
 Page No : 2

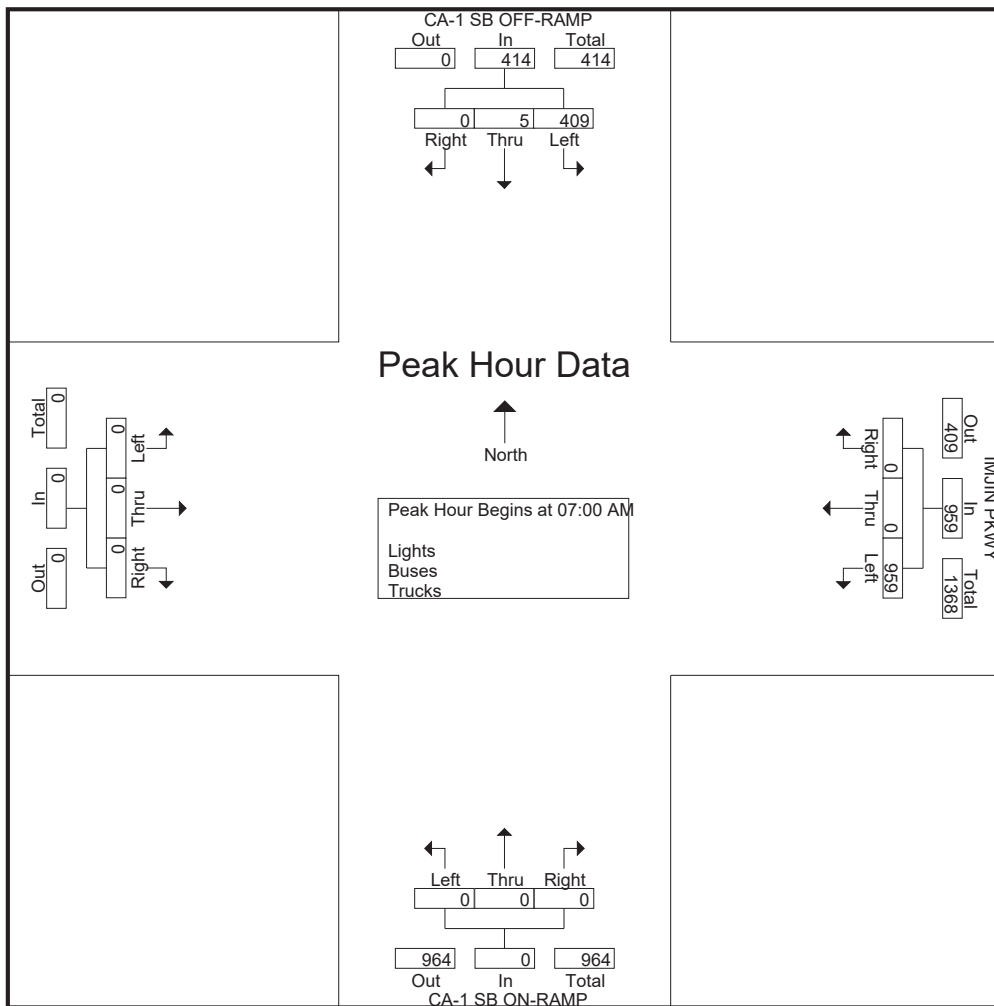

Traffic Data Service

San Jose, CA
 (408) 622-4787
 tdsbay@cs.com

File Name : 1AM FINAL
 Site Code : 00000001
 Start Date : 5/3/2017
 Page No : 1

Groups Printed- Bikes

Start Time	CA-1 SB OFF-RAMP Southbound					IMJIN PKWY Westbound					CA-1 SB ON-RAMP Northbound					Eastbound					Int. Total
	Right	Thru	Left	Peds	App. Total	Right	Thru	Left	Peds	App. Total	Right	Thru	Left	Peds	App. Total	Right	Thru	Left	Peds	App. Total	
07:00 AM	0	0	0	0	0	0	0	0	0	0	0	0	0	0	0	0	0	0	0	0	0
07:15 AM	0	0	0	0	0	0	0	0	0	0	0	0	0	0	0	0	0	0	0	0	0
07:30 AM	0	0	0	0	0	0	0	0	0	0	0	0	0	0	0	0	0	0	0	0	0
07:45 AM	0	0	0	0	0	0	0	0	0	0	0	0	0	0	0	0	0	0	0	0	0
Total	0	0	0	0	0	0	0	0	0	0	0	0	0	0	0	0	0	0	0	0	0
08:00 AM	0	0	0	0	0	0	0	0	0	0	0	0	0	0	0	0	0	0	0	0	0
08:15 AM	0	0	0	0	0	0	0	0	0	0	0	0	0	0	0	0	0	0	0	0	0
08:30 AM	0	0	0	0	0	0	0	0	0	0	0	0	0	0	0	0	0	0	0	0	0
08:45 AM	0	0	0	0	0	0	0	0	0	0	0	0	0	0	0	0	0	0	0	0	0
Total	0	0	0	0	0	0	0	0	0	0	0	0	0	0	0	0	0	0	0	0	0
Grand Total	0	0	0	0	0	0	0	0	0	0	0	0	0	0	0	0	0	0	0	0	0
Apprch %	0	0	0	0		0	0	0	0		0	0	0	0		0	0	0	0		
Total %																					

Start Time	CA-1 SB OFF-RAMP Southbound				IMJIN PKWY Westbound				CA-1 SB ON-RAMP Northbound				Eastbound				Int. Total
	Right	Thru	Left	App. Total	Right	Thru	Left	App. Total	Right	Thru	Left	App. Total	Right	Thru	Left	App. Total	
07:00 AM	0	0	0	0	0	0	0	0	0	0	0	0	0	0	0	0	
07:15 AM	0	0	0	0	0	0	0	0	0	0	0	0	0	0	0	0	
07:30 AM	0	0	0	0	0	0	0	0	0	0	0	0	0	0	0	0	
07:45 AM	0	0	0	0	0	0	0	0	0	0	0	0	0	0	0	0	
Total Volume	0	0	0	0	0	0	0	0	0	0	0	0	0	0	0	0	
% App. Total	0	0	0		0	0	0		0	0	0		0	0	0		
PHF	.000	.000	.000	.000	.000	.000	.000	.000	.000	.000	.000	.000	.000	.000	.000	.000	

Peak Hour Analysis From 07:00 AM to 08:45 AM - Peak 1 of 1
 Peak Hour for Entire Intersection Begins at 07:00 AM

Traffic Data Service

San Jose, CA
(408) 622-4787
tdsbay@cs.com

File Name : 1AM FINAL
Site Code : 00000001
Start Date : 5/3/2017
Page No : 2

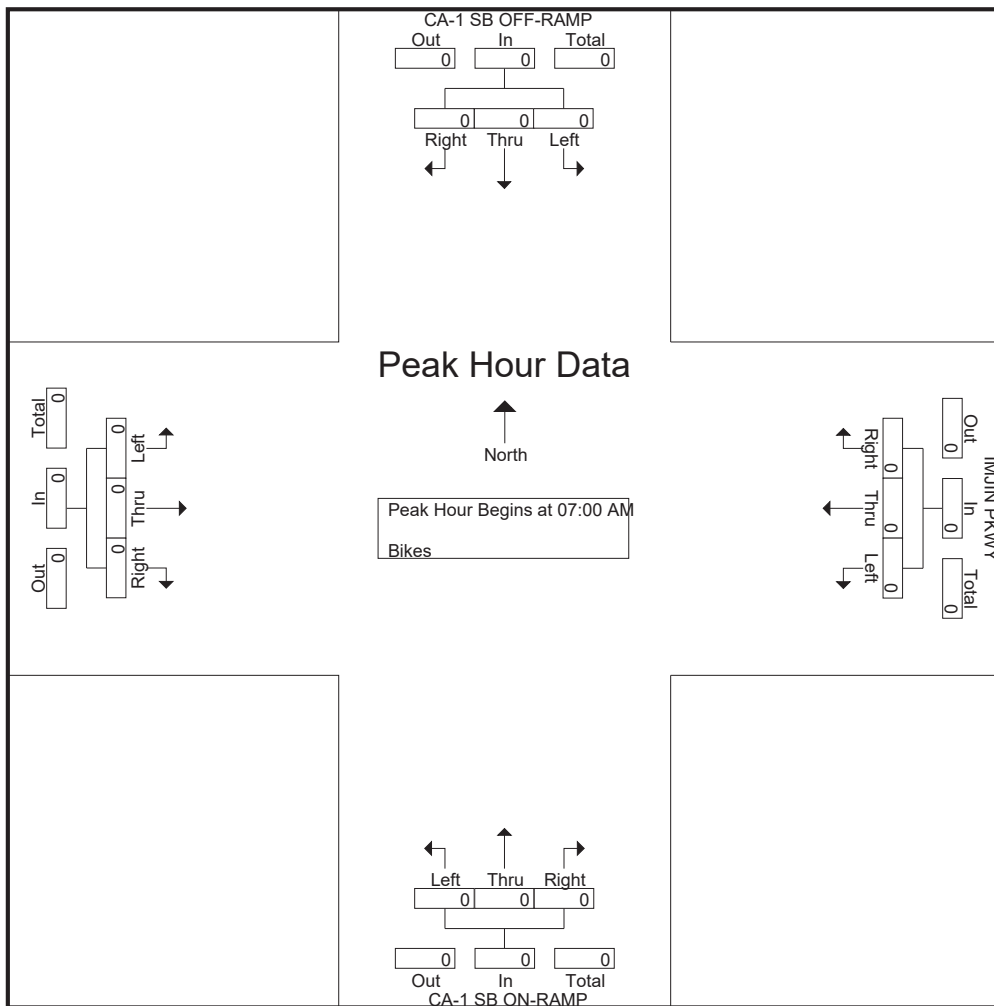

Traffic Data Service

San Jose, CA
 (408) 622-4787
 tdsbay@cs.com

File Name : 1PM FINAL
 Site Code : 00000001
 Start Date : 5/3/2017
 Page No : 2

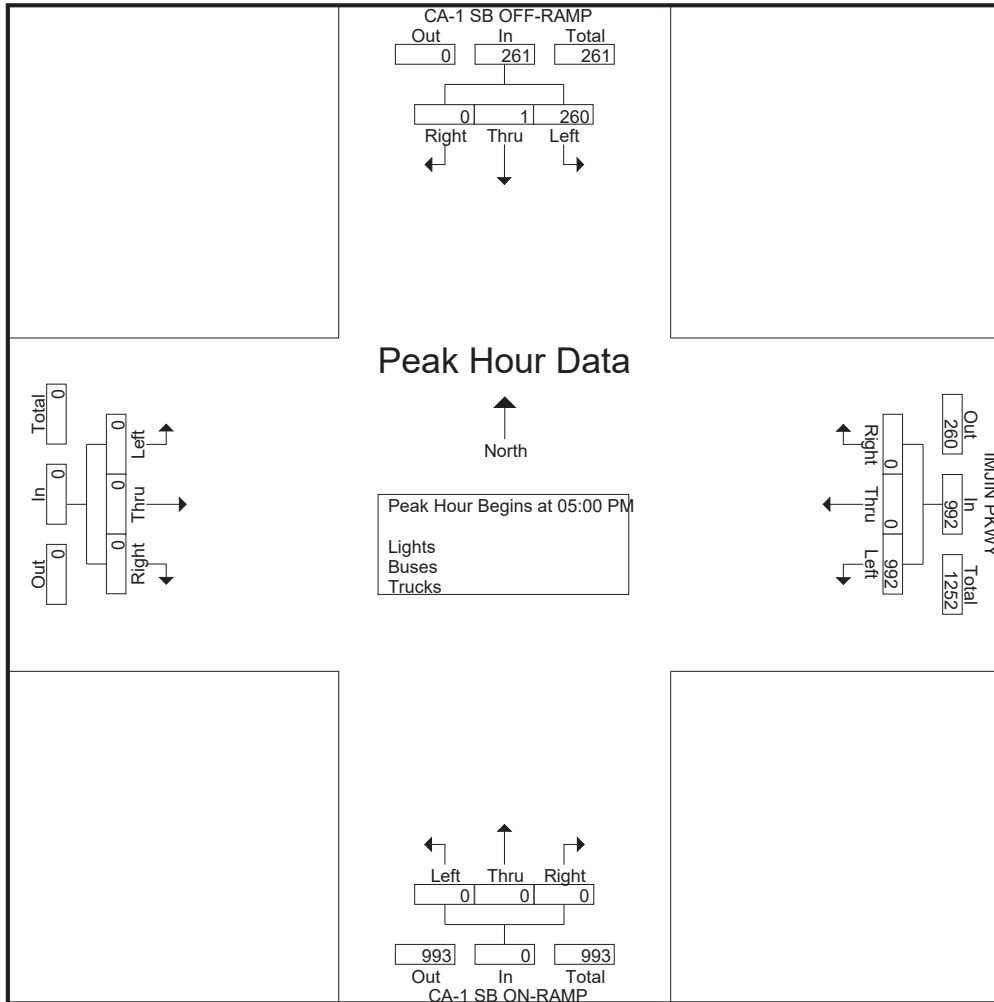

Traffic Data Service

San Jose, CA
 (408) 622-4787
 tdsbay@cs.com

File Name : 1PM FINAL
 Site Code : 00000001
 Start Date : 5/3/2017
 Page No : 1

Groups Printed- Bikes

Start Time	CA-1 SB OFF-RAMP Southbound					IMJIN PKWY Westbound					CA-1 SB ON-RAMP Northbound					Eastbound					Int. Total
	Right	Thru	Left	Peds	App. Total	Right	Thru	Left	Peds	App. Total	Right	Thru	Left	Peds	App. Total	Right	Thru	Left	Peds	App. Total	
04:00 PM	0	0	0	0	0	0	0	0	0	0	0	0	0	0	0	0	0	0	0	0	0
04:15 PM	0	0	0	0	0	0	0	0	0	0	0	0	0	0	0	0	0	0	0	0	0
04:30 PM	0	0	0	0	0	0	0	0	0	0	0	0	0	0	0	0	0	0	0	0	0
04:45 PM	0	0	0	0	0	0	0	0	0	0	0	0	0	0	0	0	0	0	0	0	0
Total	0	0	0	0	0	0	0	0	0	0	0	0	0	0	0	0	0	0	0	0	0
05:00 PM	0	0	0	0	0	0	0	0	0	0	0	0	0	0	0	0	0	0	0	0	0
05:15 PM	0	0	0	0	0	0	0	0	0	0	0	0	0	0	0	0	0	0	0	0	0
05:30 PM	0	0	0	0	0	0	0	0	0	0	0	0	0	0	0	0	0	0	0	0	0
05:45 PM	0	0	0	0	0	0	0	0	0	0	0	0	0	0	0	0	0	0	0	0	0
Total	0	0	0	0	0	0	0	0	0	0	0	0	0	0	0	0	0	0	0	0	0
Grand Total	0	0	0	0	0	0	0	0	0	0	0	0	0	0	0	0	0	0	0	0	0
Apprch %	0	0	0	0		0	0	0	0		0	0	0	0		0	0	0	0		
Total %																					

Start Time	CA-1 SB OFF-RAMP Southbound				IMJIN PKWY Westbound				CA-1 SB ON-RAMP Northbound				Eastbound				Int. Total
	Right	Thru	Left	App. Total	Right	Thru	Left	App. Total	Right	Thru	Left	App. Total	Right	Thru	Left	App. Total	
04:00 PM	0	0	0	0	0	0	0	0	0	0	0	0	0	0	0	0	0
04:15 PM	0	0	0	0	0	0	0	0	0	0	0	0	0	0	0	0	0
04:30 PM	0	0	0	0	0	0	0	0	0	0	0	0	0	0	0	0	0
04:45 PM	0	0	0	0	0	0	0	0	0	0	0	0	0	0	0	0	0
Total Volume	0	0	0	0	0	0	0	0	0	0	0	0	0	0	0	0	0
% App. Total	0	0	0		0	0	0		0	0	0		0	0	0		
PHF	.000	.000	.000	.000	.000	.000	.000	.000	.000	.000	.000	.000	.000	.000	.000	.000	.000

Peak Hour Analysis From 04:00 PM to 05:45 PM - Peak 1 of 1
 Peak Hour for Entire Intersection Begins at 04:00 PM

Traffic Data Service

San Jose, CA
(408) 622-4787
tdsbay@cs.com

File Name : 1PM FINAL
Site Code : 00000001
Start Date : 5/3/2017
Page No : 2

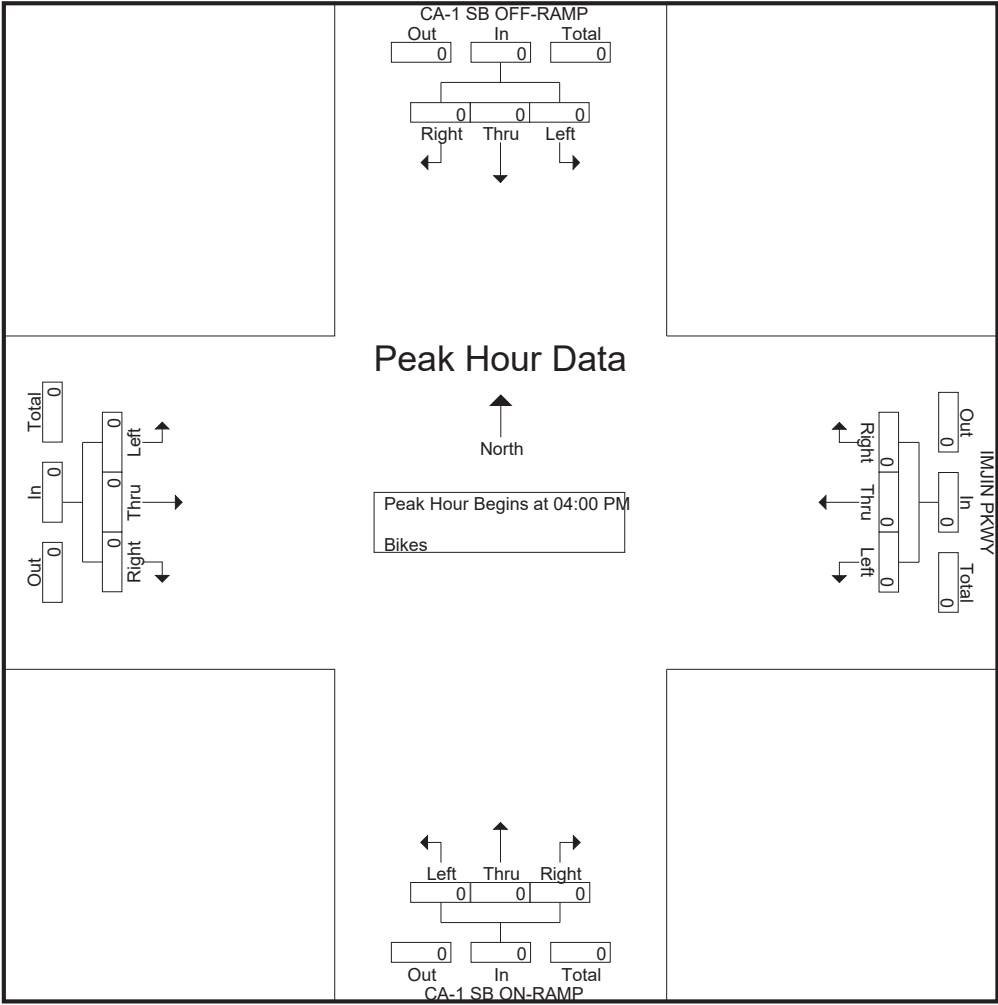

Traffic Data Service

San Jose, CA
(408) 622-4787
tdsbay@cs.com

File Name : 2AM FINAL
Site Code : 00000002
Start Date : 5/3/2017
Page No : 1

Groups Printed- Lights - Buses - Trucks

Start Time	CA-1 NB ON-RAMP Southbound					IMJIN PKWY Westbound					CA-1 NB OFF-RAMP Northbound					IMJIN PKWY Eastbound					Int. Total
	Right	Thru	Left	Peds	App. Total	Right	Thru	Left	Peds	App. Total	Right	Thru	Left	Peds	App. Total	Right	Thru	Left	Peds	App. Total	
07:00 AM	0	0	0	0	0	28	301	0	0	329	149	0	0	0	149	0	67	1	0	68	546
07:15 AM	0	0	0	0	0	27	253	0	0	280	201	0	0	0	201	0	81	1	0	82	563
07:30 AM	0	0	0	1	1	28	191	0	0	219	244	0	0	0	244	0	113	0	0	113	577
07:45 AM	0	0	0	2	2	40	172	0	0	212	211	0	0	0	211	0	160	1	0	161	586
Total	0	0	0	3	3	123	917	0	0	1040	805	0	0	0	805	0	421	3	0	424	2272
08:00 AM	0	0	0	0	0	38	189	0	0	227	225	1	0	0	226	0	80	1	0	81	534
08:15 AM	0	0	0	0	0	40	205	0	0	245	195	0	1	0	196	0	74	0	0	74	515
08:30 AM	0	0	0	0	0	44	239	0	0	283	139	0	0	0	139	0	42	3	0	45	467
08:45 AM	0	0	0	0	0	42	228	0	0	270	146	1	0	0	147	0	58	3	0	61	478
Total	0	0	0	0	0	164	861	0	0	1025	705	2	1	0	708	0	254	7	0	261	1994
Grand Total	0	0	0	3	3	287	1778	0	0	2065	1510	2	1	0	1513	0	675	10	0	685	4266
Apprch %	0	0	0	100		13.9	86.1	0	0		99.8	0.1	0.1	0		0	98.5	1.5	0		
Total %	0	0	0	0.1	0.1	6.7	41.7	0	0	48.4	35.4	0	0	0	35.5	0	15.8	0.2	0	16.1	
Lights	0	0	0	3	3	257	1730	0	0	1987	1475	2	1	0	1478	0	655	10	0	665	4133
% Lights	0	0	0	100	100	89.5	97.3	0	0	96.2	97.7	100	100	0	97.7	0	97	100	0	97.1	96.9
Buses	0	0	0	0	0	5	10	0	0	15	9	0	0	0	9	0	2	0	0	2	26
% Buses	0	0	0	0	0	1.7	0.6	0	0	0.7	0.6	0	0	0	0.6	0	0.3	0	0	0.3	0.6
Trucks	0	0	0	0	0	25	38	0	0	63	26	0	0	0	26	0	18	0	0	18	107
% Trucks	0	0	0	0	0	8.7	2.1	0	0	3.1	1.7	0	0	0	1.7	0	2.7	0	0	2.6	2.5

Start Time	CA-1 NB ON-RAMP Southbound				IMJIN PKWY Westbound				CA-1 NB OFF-RAMP Northbound				IMJIN PKWY Eastbound				Int. Total
	Right	Thru	Left	App. Total	Right	Thru	Left	App. Total	Right	Thru	Left	App. Total	Right	Thru	Left	App. Total	
Peak Hour Analysis From 07:00 AM to 08:45 AM - Peak 1 of 1																	
Peak Hour for Entire Intersection Begins at 07:00 AM																	
07:00 AM	0	0	0	0	28	301	0	329	149	0	0	149	0	67	1	68	546
07:15 AM	0	0	0	0	27	253	0	280	201	0	0	201	0	81	1	82	563
07:30 AM	0	0	0	0	28	191	0	219	244	0	0	244	0	113	0	113	576
07:45 AM	0	0	0	0	40	172	0	212	211	0	0	211	0	160	1	161	584
Total Volume	0	0	0	0	123	917	0	1040	805	0	0	805	0	421	3	424	2269
% App. Total	0	0	0	0	11.8	88.2	0		100	0	0		0	99.3	0.7		
PHF	.000	.000	.000	.000	.769	.762	.000	.790	.825	.000	.000	.825	.000	.658	.750	.658	.971

Traffic Data Service

San Jose, CA
 (408) 622-4787
 tdsbay@cs.com

File Name : 2AM FINAL
 Site Code : 00000002
 Start Date : 5/3/2017
 Page No : 2

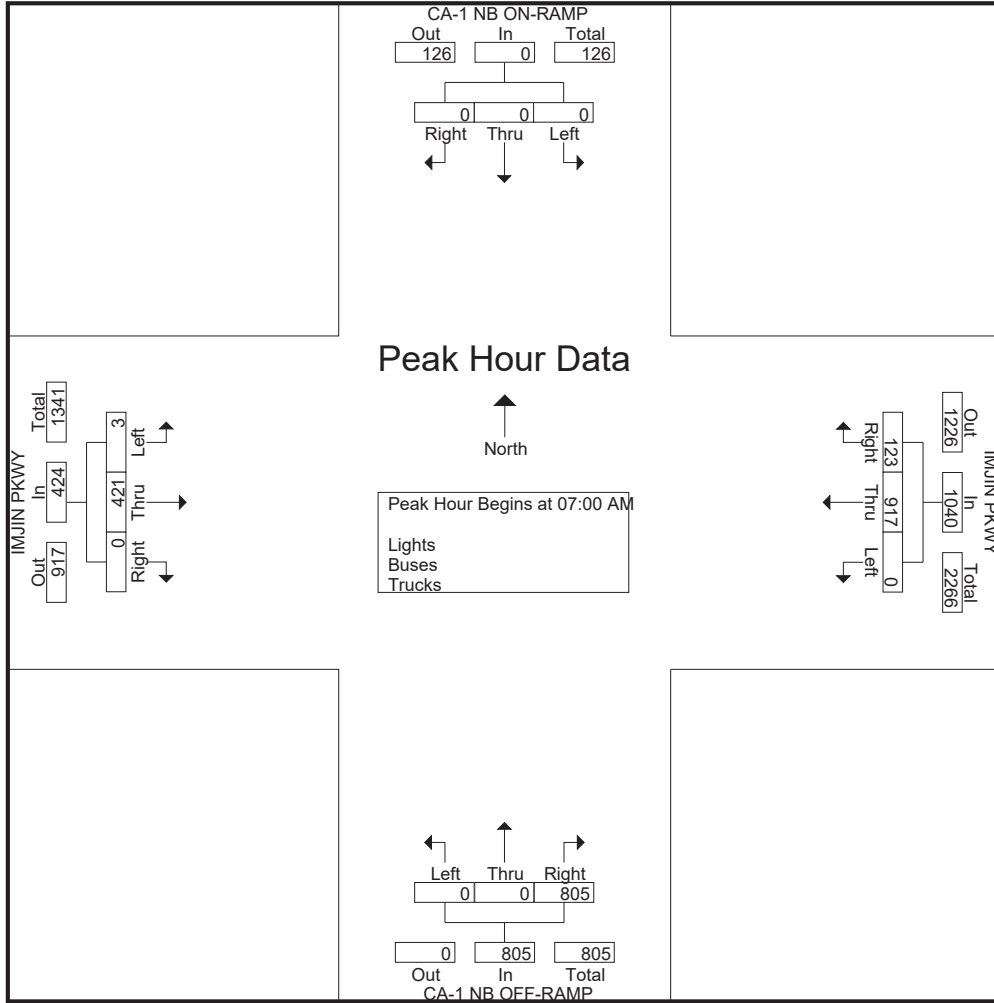

Traffic Data Service

San Jose, CA
 (408) 622-4787
 tdsbay@cs.com

File Name : 2AM FINAL
 Site Code : 00000002
 Start Date : 5/3/2017
 Page No : 1

Groups Printed- Bikes

Start Time	CA-1 NB ON-RAMP Southbound					IMJIN PKWY Westbound					CA-1 NB OFF-RAMP Northbound					IMJIN PKWY Eastbound					Int. Total
	Right	Thru	Left	Peds	App. Total	Right	Thru	Left	Peds	App. Total	Right	Thru	Left	Peds	App. Total	Right	Thru	Left	Peds	App. Total	
07:00 AM	0	0	0	0	0	0	0	0	0	0	0	0	0	0	0	0	0	0	0	0	0
07:15 AM	0	0	0	0	0	0	0	0	0	0	0	0	0	0	0	0	0	0	0	0	0
07:30 AM	0	0	0	0	0	0	1	0	0	1	0	0	0	0	0	0	0	0	0	0	1
07:45 AM	0	0	0	0	0	0	0	0	0	0	0	0	0	0	0	0	0	0	0	0	0
Total	0	0	0	0	0	0	1	0	0	1	0	0	0	0	0	0	0	0	0	0	1
08:00 AM	0	0	0	0	0	0	0	0	0	0	0	0	0	0	0	0	0	0	0	0	0
08:15 AM	0	0	0	0	0	0	0	0	0	0	0	0	0	0	0	0	0	0	0	0	0
08:30 AM	0	0	0	0	0	0	0	0	0	0	0	0	0	0	0	0	0	0	0	0	0
08:45 AM	0	0	0	0	0	0	0	0	0	0	0	0	0	0	0	0	0	0	0	0	0
Total	0	0	0	0	0	0	0	0	0	0	0	0	0	0	0	0	0	0	0	0	0
Grand Total	0	0	0	0	0	0	1	0	0	1	0	0	0	0	0	0	0	0	0	0	1
Apprch %	0	0	0	0	0	0	100	0	0	100	0	0	0	0	0	0	0	0	0	0	0
Total %	0	0	0	0	0	0	100	0	0	100	0	0	0	0	0	0	0	0	0	0	0

Start Time	CA-1 NB ON-RAMP Southbound					IMJIN PKWY Westbound					CA-1 NB OFF-RAMP Northbound					IMJIN PKWY Eastbound					Int. Total
	Right	Thru	Left	Peds	App. Total	Right	Thru	Left	Peds	App. Total	Right	Thru	Left	Peds	App. Total	Right	Thru	Left	Peds	App. Total	
07:00 AM	0	0	0	0	0	0	0	0	0	0	0	0	0	0	0	0	0	0	0	0	0
07:15 AM	0	0	0	0	0	0	0	0	0	0	0	0	0	0	0	0	0	0	0	0	0
07:30 AM	0	0	0	0	0	0	1	0	0	1	0	0	0	0	0	0	0	0	0	0	1
07:45 AM	0	0	0	0	0	0	0	0	0	0	0	0	0	0	0	0	0	0	0	0	0
Total Volume	0	0	0	0	0	0	1	0	0	1	0	0	0	0	0	0	0	0	0	0	1
% App. Total	0	0	0	0	0	0	100	0	0	100	0	0	0	0	0	0	0	0	0	0	0
PHF	.000	.000	.000	.000	.000	.000	.250	.000	.250	.250	.000	.000	.000	.000	.000	.000	.000	.000	.000	.000	.250

Peak Hour Analysis From 07:00 AM to 08:45 AM - Peak 1 of 1

Peak Hour for Entire Intersection Begins at 07:00 AM

Traffic Data Service

San Jose, CA
 (408) 622-4787
 tdsbay@cs.com

File Name : 2AM FINAL
 Site Code : 00000002
 Start Date : 5/3/2017
 Page No : 2

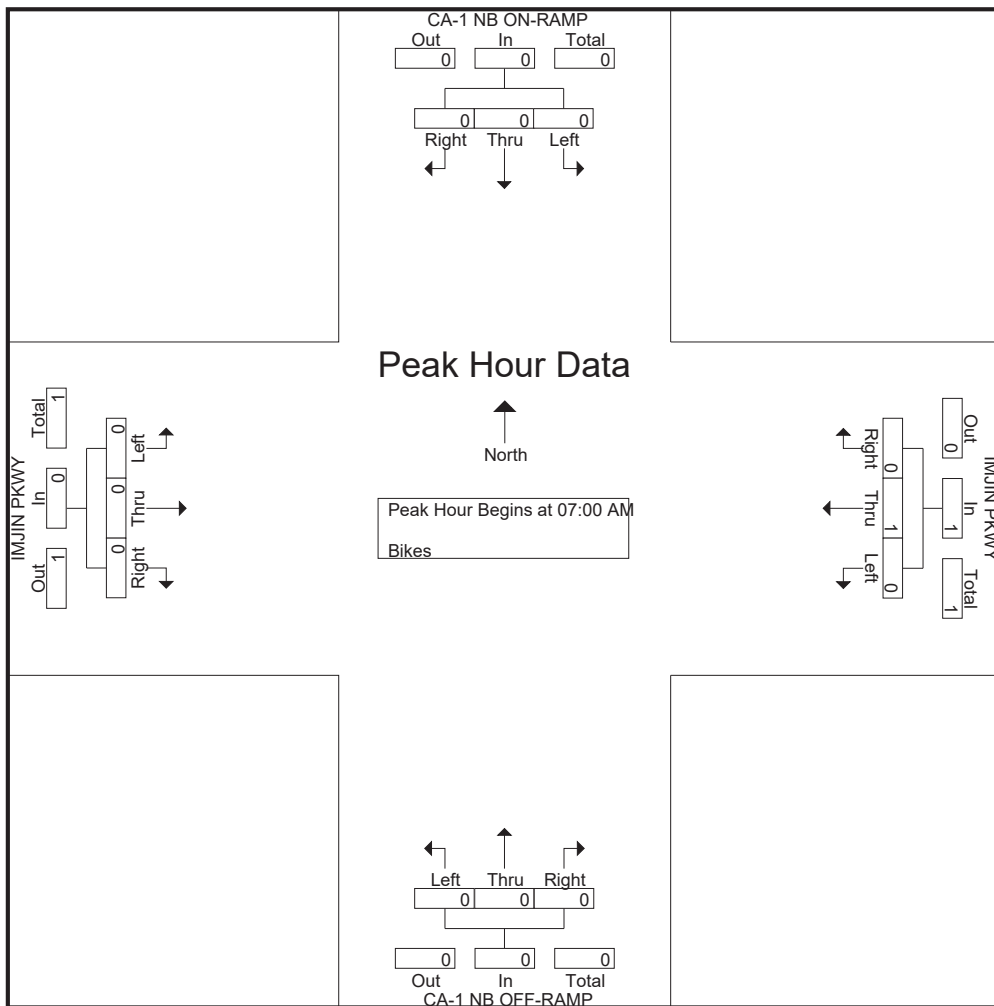

Traffic Data Service

San Jose, CA
 (408) 622-4787
 tdsbay@cs.com

File Name : 2PM FINAL
 Site Code : 00000002
 Start Date : 5/3/2017
 Page No : 1

Groups Printed- Lights - Buses - Trucks

Start Time	CA-1 NB ON-RAMP Southbound					IMJIN PKWY Westbound					CA-1 NB OFF-RAMP Northbound					IMJIN PKWY Eastbound					Int. Total
	Right	Thru	Left	Peds	App. Total	Right	Thru	Left	Peds	App. Total	Right	Thru	Left	Peds	App. Total	Right	Thru	Left	Peds	App. Total	
04:00 PM	0	0	0	2	2	96	218	0	0	314	296	1	3	0	300	0	66	1	0	67	683
04:15 PM	0	0	0	0	0	109	237	0	0	346	297	0	1	0	298	0	56	2	0	58	702
04:30 PM	0	0	0	0	0	96	247	0	0	343	304	0	1	0	305	0	59	2	0	61	709
04:45 PM	0	0	0	0	0	96	243	0	0	339	291	1	2	0	294	0	63	3	0	66	699
Total	0	0	0	2	2	397	945	0	0	1342	1188	2	7	0	1197	0	244	8	0	252	2793
05:00 PM	0	0	0	0	0	114	245	0	0	359	291	0	1	0	292	0	56	2	0	58	709
05:15 PM	0	0	0	0	0	101	237	0	0	338	302	0	1	0	303	0	56	1	0	57	698
05:30 PM	0	0	0	1	1	111	270	0	0	381	302	1	0	0	303	0	72	1	0	73	758
05:45 PM	0	0	0	0	0	90	214	0	0	304	299	0	1	0	300	0	72	1	0	73	677
Total	0	0	0	1	1	416	966	0	0	1382	1194	1	3	0	1198	0	256	5	0	261	2842
Grand Total	0	0	0	3	3	813	1911	0	0	2724	2382	3	10	0	2395	0	500	13	0	513	5635
Apprch %	0	0	0	100		29.8	70.2	0	0		99.5	0.1	0.4	0		0	97.5	2.5	0		
Total %	0	0	0	0.1	0.1	14.4	33.9	0	0	48.3	42.3	0.1	0.2	0	42.5	0	8.9	0.2	0	9.1	
Lights	0	0	0	3	3	805	1887	0	0	2692	2354	3	10	0	2367	0	493	12	0	505	5567
% Lights	0	0	0	100	100	99	98.7	0	0	98.8	98.8	100	100	0	98.8	0	98.6	92.3	0	98.4	98.8
Buses	0	0	0	0	0	2	6	0	0	8	8	0	0	0	8	0	3	0	0	3	19
% Buses	0	0	0	0	0	0.2	0.3	0	0	0.3	0.3	0	0	0	0.3	0	0.6	0	0	0.6	0.3
Trucks	0	0	0	0	0	6	18	0	0	24	20	0	0	0	20	0	4	1	0	5	49
% Trucks	0	0	0	0	0	0.7	0.9	0	0	0.9	0.8	0	0	0	0.8	0	0.8	7.7	0	1	0.9

Start Time	CA-1 NB ON-RAMP Southbound				IMJIN PKWY Westbound				CA-1 NB OFF-RAMP Northbound				IMJIN PKWY Eastbound				Int. Total
	Right	Thru	Left	App. Total	Right	Thru	Left	App. Total	Right	Thru	Left	App. Total	Right	Thru	Left	App. Total	
Peak Hour Analysis From 04:00 PM to 05:45 PM - Peak 1 of 1																	
Peak Hour for Entire Intersection Begins at 04:45 PM																	
04:45 PM	0	0	0	0	96	243	0	339	291	1	2	294	0	63	3	66	699
05:00 PM	0	0	0	0	114	245	0	359	291	0	1	292	0	56	2	58	709
05:15 PM	0	0	0	0	101	237	0	338	302	0	1	303	0	56	1	57	698
05:30 PM	0	0	0	0	111	270	0	381	302	1	0	303	0	72	1	73	757
Total Volume	0	0	0	0	422	995	0	1417	1186	2	4	1192	0	247	7	254	2863
% App. Total	0	0	0	0	29.8	70.2	0		99.5	0.2	0.3		0	97.2	2.8		
PHF	.000	.000	.000	.000	.925	.921	.000	.930	.982	.500	.500	.983	.000	.858	.583	.870	.946

Traffic Data Service

San Jose, CA
 (408) 622-4787
 tdsbay@cs.com

File Name : 2PM FINAL
 Site Code : 00000002
 Start Date : 5/3/2017
 Page No : 2

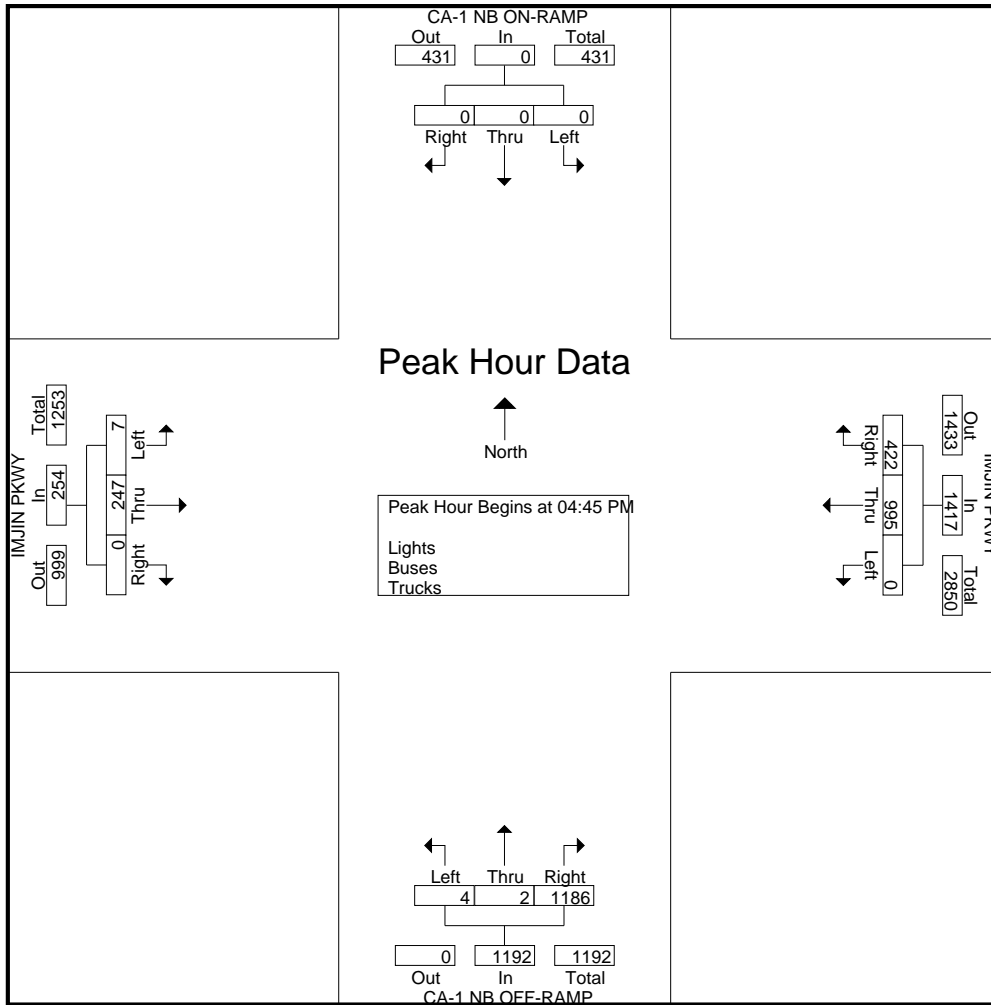

Traffic Data Service

San Jose, CA
 (408) 622-4787
 tdsbay@cs.com

File Name : 2PM FINAL
 Site Code : 00000002
 Start Date : 5/3/2017
 Page No : 1

Groups Printed- Bikes

Start Time	CA-1 NB ON-RAMP Southbound					IMJIN PKWY Westbound					CA-1 NB OFF-RAMP Northbound					IMJIN PKWY Eastbound					Int. Total
	Right	Thru	Left	Peds	App. Total	Right	Thru	Left	Peds	App. Total	Right	Thru	Left	Peds	App. Total	Right	Thru	Left	Peds	App. Total	
04:00 PM	0	0	0	0	0	0	1	0	0	1	0	0	0	0	0	0	0	0	0	0	1
04:15 PM	0	0	0	0	0	0	0	0	0	0	0	0	0	0	0	0	0	0	0	0	0
04:30 PM	0	0	0	0	0	0	0	0	0	0	0	0	0	0	0	0	0	0	0	0	0
04:45 PM	0	0	0	0	0	0	1	0	0	1	0	0	0	0	0	0	0	0	0	0	1
Total	0	0	0	0	0	0	2	0	0	2	0	0	0	0	0	0	0	0	0	0	2
05:00 PM	0	0	0	0	0	0	0	0	0	0	0	0	0	0	0	0	0	0	0	0	0
05:15 PM	0	0	0	0	0	0	0	0	0	0	0	0	0	0	0	0	0	0	0	0	0
05:30 PM	0	0	0	0	0	0	0	0	0	0	0	0	0	0	0	0	0	0	0	0	0
05:45 PM	0	0	0	0	0	0	0	0	0	0	0	0	0	0	0	0	0	0	0	0	0
Total	0	0	0	0	0	0	0	0	0	0	0	0	0	0	0	0	0	0	0	0	0
Grand Total	0	0	0	0	0	0	2	0	0	2	0	0	0	0	0	0	0	0	0	0	2
Apprch %	0	0	0	0	0	0	100	0	0	0	0	0	0	0	0	0	0	0	0	0	0
Total %	0	0	0	0	0	0	100	0	0	100	0	0	0	0	0	0	0	0	0	0	0

Start Time	CA-1 NB ON-RAMP Southbound				IMJIN PKWY Westbound				CA-1 NB OFF-RAMP Northbound				IMJIN PKWY Eastbound				Int. Total
	Right	Thru	Left	App. Total	Right	Thru	Left	App. Total	Right	Thru	Left	App. Total	Right	Thru	Left	App. Total	
Peak Hour Analysis From 04:00 PM to 05:45 PM - Peak 1 of 1																	
Peak Hour for Entire Intersection Begins at 04:00 PM																	
04:00 PM	0	0	0	0	0	1	0	1	0	0	0	0	0	0	0	0	1
04:15 PM	0	0	0	0	0	0	0	0	0	0	0	0	0	0	0	0	0
04:30 PM	0	0	0	0	0	0	0	0	0	0	0	0	0	0	0	0	0
04:45 PM	0	0	0	0	0	1	0	1	0	0	0	0	0	0	0	0	1
Total Volume	0	0	0	0	0	2	0	2	0	0	0	0	0	0	0	0	2
% App. Total	0	0	0	0	0	100	0	0	0	0	0	0	0	0	0	0	0
PHF	.000	.000	.000	.000	.000	.500	.000	.500	.000	.000	.000	.000	.000	.000	.000	.000	.500

Traffic Data Service

San Jose, CA
 (408) 622-4787
 tdsbay@cs.com

File Name : 2PM FINAL
 Site Code : 00000002
 Start Date : 5/3/2017
 Page No : 2

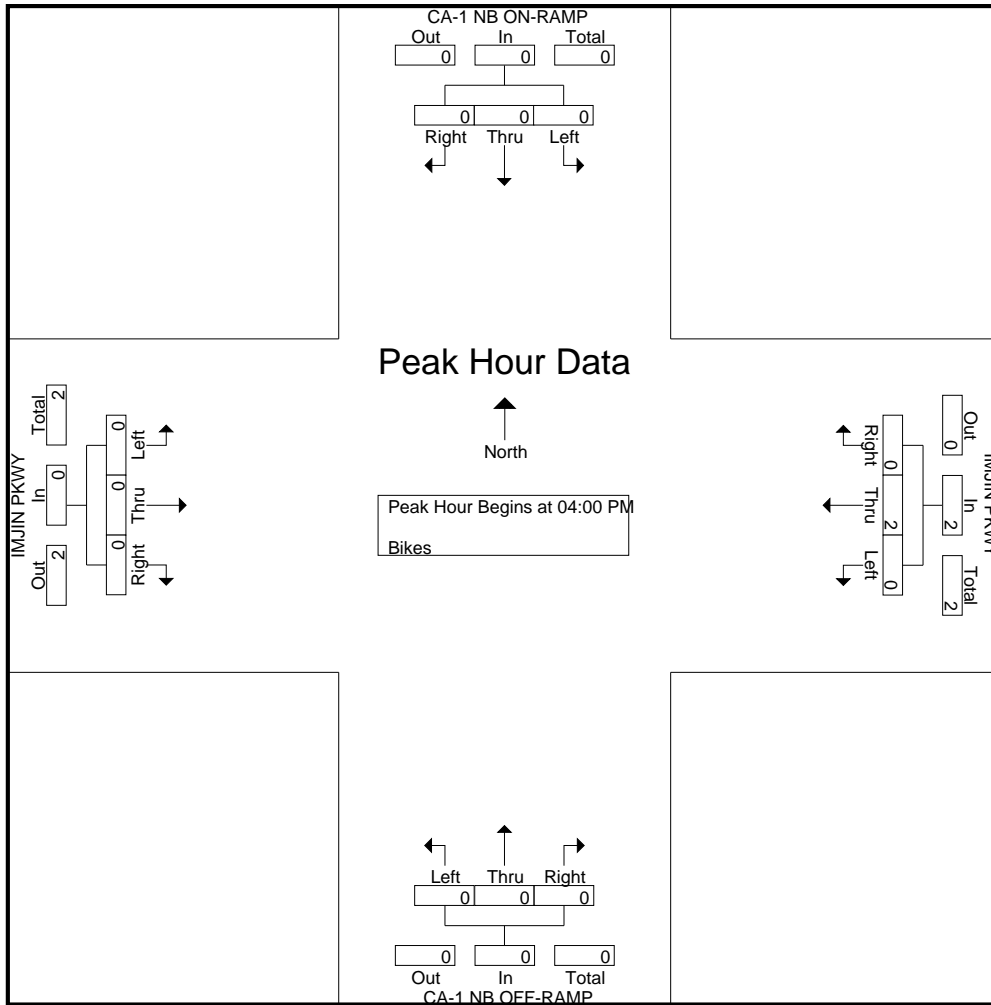

Traffic Data Service

San Jose, CA
(408) 622-4787
tdsbay@cs.com

File Name : 3AM FINAL
Site Code : 00000003
Start Date : 4/27/2017
Page No : 1

Groups Printed- Lights - Buses - Trucks

Start Time	2ND AVE Southbound					IMJIN PKWY Westbound					2ND AVE Northbound					IMJIN PKWY Eastbound					Int. Total
	Right	Thru	Left	Peds	App. Total	Right	Thru	Left	Peds	App. Total	Right	Thru	Left	Peds	App. Total	Right	Thru	Left	Peds	App. Total	
07:00 AM	0	0	0	0	0	1	303	51	0	355	15	1	15	0	31	28	132	5	0	165	551
07:15 AM	2	1	0	0	3	1	251	81	1	334	14	1	18	0	33	74	173	0	1	248	618
07:30 AM	1	3	2	0	6	3	219	91	1	314	31	2	11	0	44	74	210	4	0	288	652
07:45 AM	2	1	2	0	5	2	201	84	0	287	43	2	27	0	72	82	219	2	1	304	668
Total	5	5	4	0	14	7	974	307	2	1290	103	6	71	0	180	258	734	11	2	1005	2489
08:00 AM	1	2	1	0	4	1	184	71	0	256	39	1	30	0	70	117	208	3	0	328	658
08:15 AM	1	1	0	0	2	4	211	64	0	279	25	1	31	0	57	106	204	3	0	313	651
08:30 AM	2	1	3	0	6	1	247	66	0	314	28	3	32	0	63	73	154	2	0	229	612
08:45 AM	2	0	1	2	5	0	231	54	0	285	26	0	36	0	62	56	145	6	2	209	561
Total	6	4	5	2	17	6	873	255	0	1134	118	5	129	0	252	352	711	14	2	1079	2482
Grand Total	11	9	9	2	31	13	1847	562	2	2424	221	11	200	0	432	610	1445	25	4	2084	4971
Apprch %	35.5	29	29	6.5		0.5	76.2	23.2	0.1		51.2	2.5	46.3	0		29.3	69.3	1.2	0.2		
Total %	0.2	0.2	0.2	0	0.6	0.3	37.2	11.3	0	48.8	4.4	0.2	4	0	8.7	12.3	29.1	0.5	0.1	41.9	
Lights	10	9	9	2	30	13	1793	549	2	2357	214	11	186	0	411	594	1418	25	4	2041	4839
% Lights	90.9	100	100	100	96.8	100	97.1	97.7	100	97.2	96.8	100	93	0	95.1	97.4	98.1	100	100	97.9	97.3
Buses	0	0	0	0	0	0	6	8	0	14	4	0	4	0	8	4	9	0	0	13	35
% Buses	0	0	0	0	0	0	0.3	1.4	0	0.6	1.8	0	2	0	1.9	0.7	0.6	0	0	0.6	0.7
Trucks	1	0	0	0	1	0	48	5	0	53	3	0	10	0	13	12	18	0	0	30	97
% Trucks	9.1	0	0	0	3.2	0	2.6	0.9	0	2.2	1.4	0	5	0	3	2	1.2	0	0	1.4	2

Start Time	2ND AVE Southbound				IMJIN PKWY Westbound				2ND AVE Northbound				IMJIN PKWY Eastbound				Int. Total
	Right	Thru	Left	App. Total	Right	Thru	Left	App. Total	Right	Thru	Left	App. Total	Right	Thru	Left	App. Total	
Peak Hour Analysis From 07:00 AM to 08:45 AM - Peak 1 of 1																	
Peak Hour for Entire Intersection Begins at 07:30 AM																	
07:30 AM	1	3	2	6	3	219	91	313	31	2	11	44	74	210	4	288	651
07:45 AM	2	1	2	5	2	201	84	287	43	2	27	72	82	219	2	303	667
08:00 AM	1	2	1	4	1	184	71	256	39	1	30	70	117	208	3	328	658
08:15 AM	1	1	0	2	4	211	64	279	25	1	31	57	106	204	3	313	651
Total Volume	5	7	5	17	10	815	310	1135	138	6	99	243	379	841	12	1232	2627
% App. Total	29.4	41.2	29.4		0.9	71.8	27.3		56.8	2.5	40.7		30.8	68.3	1		
PHF	.625	.583	.625	.708	.625	.930	.852	.907	.802	.750	.798	.844	.810	.960	.750	.939	.985

Traffic Data Service

San Jose, CA
 (408) 622-4787
 tdsbay@cs.com

File Name : 3AM FINAL
 Site Code : 00000003
 Start Date : 4/27/2017
 Page No : 2

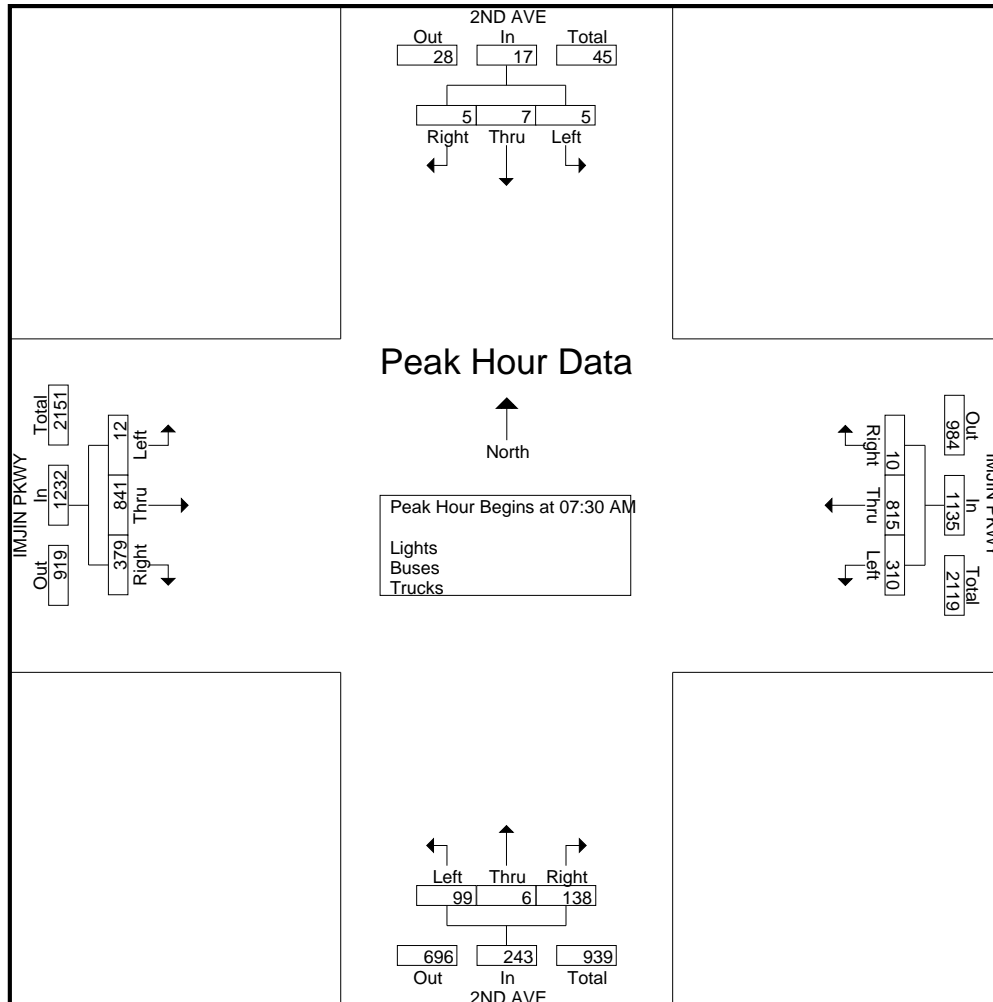

Traffic Data Service

San Jose, CA
 (408) 622-4787
 tdsbay@cs.com

File Name : 3AM FINAL
 Site Code : 00000003
 Start Date : 4/27/2017
 Page No : 1

Groups Printed- Bikes

Start Time	2ND AVE Southbound					IMJIN PKWY Westbound					2ND AVE Northbound					IMJIN PKWY Eastbound					Int. Total	
	Right	Thru	Left	Peds	App. Total	Right	Thru	Left	Peds	App. Total	Right	Thru	Left	Peds	App. Total	Right	Thru	Left	Peds	App. Total		
07:00 AM	0	0	0	0	0	0	0	0	0	0	0	0	0	0	0	0	0	0	0	0	0	0
07:15 AM	0	0	0	0	0	0	0	0	0	0	0	0	0	0	0	0	0	0	0	0	0	0
07:30 AM	0	0	0	0	0	0	0	0	0	0	0	0	0	0	0	0	0	0	0	0	0	0
07:45 AM	0	0	0	0	0	0	0	0	0	0	0	0	0	0	0	0	0	0	0	0	0	0
Total	0	0	0	0	0	0	0	0	0	0	0	0	0	0	0	0	0	0	0	0	0	0
08:00 AM	0	0	0	0	0	0	0	0	0	0	0	0	1	0	1	0	0	0	0	0	0	1
08:15 AM	0	0	0	0	0	0	0	0	0	0	0	0	0	0	0	0	0	0	0	0	0	0
08:30 AM	0	0	0	0	0	0	0	0	0	0	0	0	0	0	0	0	0	0	0	0	0	0
08:45 AM	0	0	0	0	0	0	0	0	0	0	0	0	0	0	0	0	0	0	0	0	0	0
Total	0	0	0	0	0	0	0	0	0	0	0	0	1	0	1	0	0	0	0	0	0	1
Grand Total	0	0	0	0	0	0	0	0	0	0	0	0	1	0	1	0	0	0	0	0	0	1
Apprch %	0	0	0	0	0	0	0	0	0	0	0	0	100	0	100	0	0	0	0	0	0	0
Total %	0	0	0	0	0	0	0	0	0	0	0	0	100	0	100	0	0	0	0	0	0	0

Start Time	2ND AVE Southbound				IMJIN PKWY Westbound				2ND AVE Northbound				IMJIN PKWY Eastbound				Int. Total
	Right	Thru	Left	App. Total	Right	Thru	Left	App. Total	Right	Thru	Left	App. Total	Right	Thru	Left	App. Total	
Peak Hour Analysis From 07:00 AM to 08:45 AM - Peak 1 of 1																	
Peak Hour for Entire Intersection Begins at 07:15 AM																	
07:15 AM	0	0	0	0	0	0	0	0	0	0	0	0	0	0	0	0	
07:30 AM	0	0	0	0	0	0	0	0	0	0	0	0	0	0	0	0	
07:45 AM	0	0	0	0	0	0	0	0	0	0	0	0	0	0	0	0	
08:00 AM	0	0	0	0	0	0	0	0	0	0	1	1	0	0	0	0	
Total Volume	0	0	0	0	0	0	0	0	0	0	1	1	0	0	0	0	
% App. Total	0	0	0	0	0	0	0	0	0	0	100	100	0	0	0	0	
PHF	.000	.000	.000	.000	.000	.000	.000	.000	.000	.000	.250	.250	.000	.000	.000	.000	

Traffic Data Service

San Jose, CA
(408) 622-4787
tdsbay@cs.com

File Name : 3AM FINAL
Site Code : 00000003
Start Date : 4/27/2017
Page No : 2

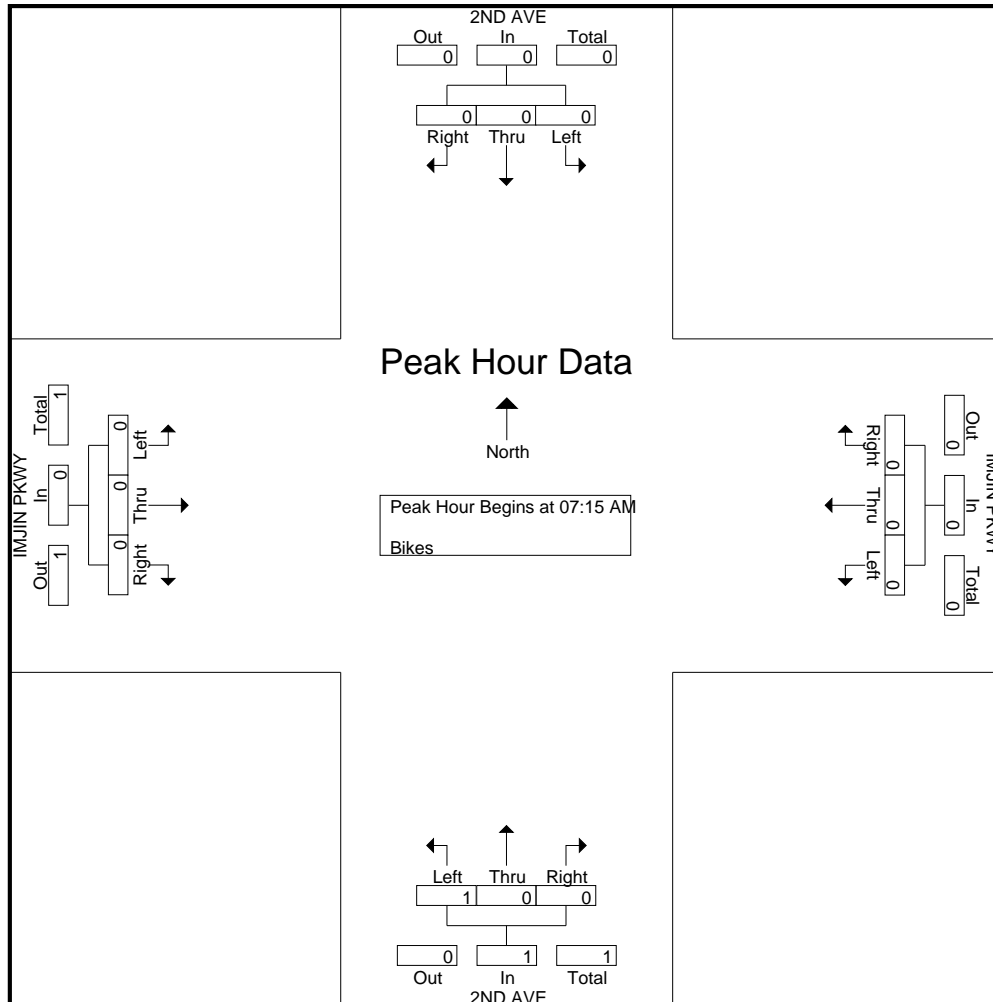

Traffic Data Service

San Jose, CA
 (408) 622-4787
 tdsbay@cs.com

File Name : 3PM FINAL
 Site Code : 00000003
 Start Date : 4/27/2017
 Page No : 1

Groups Printed- Lights - Buses - Trucks

Start Time	2ND AVE Southbound					IMJIN PKWY Westbound					2ND AVE Northbound					IMJIN PKWY Eastbound					Int. Total
	Right	Thru	Left	Peds	App. Total	Right	Thru	Left	Peds	App. Total	Right	Thru	Left	Peds	App. Total	Right	Thru	Left	Peds	App. Total	
04:00 PM	24	5	5	2	36	2	189	57	0	248	71	0	93	0	164	85	223	0	2	310	758
04:15 PM	5	1	2	0	8	0	204	47	1	252	49	1	115	0	165	86	261	2	0	349	774
04:30 PM	7	0	1	0	8	0	209	55	0	264	72	1	124	0	197	95	248	1	1	345	814
04:45 PM	7	0	2	1	10	3	224	67	0	294	81	0	79	0	160	81	252	1	2	336	800
Total	43	6	10	3	62	5	826	226	1	1058	273	2	411	0	686	347	984	4	5	1340	3146
05:00 PM	12	1	5	2	20	0	227	46	0	273	77	0	111	1	189	72	261	0	3	336	818
05:15 PM	10	3	1	2	16	0	236	70	0	306	86	2	104	0	192	85	253	3	1	342	856
05:30 PM	5	5	0	0	10	1	256	67	1	325	63	0	95	0	158	84	247	0	1	332	825
05:45 PM	7	3	3	1	14	2	222	65	0	289	69	0	102	0	171	85	241	3	2	331	805
Total	34	12	9	5	60	3	941	248	1	1193	295	2	412	1	710	326	1002	6	7	1341	3304
Grand Total	77	18	19	8	122	8	1767	474	2	2251	568	4	823	1	1396	673	1986	10	12	2681	6450
Apprch %	63.1	14.8	15.6	6.6		0.4	78.5	21.1	0.1		40.7	0.3	59	0.1		25.1	74.1	0.4	0.4		
Total %	1.2	0.3	0.3	0.1	1.9	0.1	27.4	7.3	0	34.9	8.8	0.1	12.8	0	21.6	10.4	30.8	0.2	0.2	41.6	
Lights	77	18	19	8	122	8	1742	465	2	2217	563	4	820	1	1388	668	1965	10	12	2655	6382
% Lights	100	100	100	100	100	100	98.6	98.1	100	98.5	99.1	100	99.6	100	99.4	99.3	98.9	100	100	99	98.9
Buses	0	0	0	0	0	0	0	12	8	20	3	0	2	0	5	4	1	0	0	5	30
% Buses	0	0	0	0	0	0	0.7	1.7	0	0.9	0.5	0	0.2	0	0.4	0.6	0.1	0	0	0.2	0.5
Trucks	0	0	0	0	0	0	13	1	0	14	2	0	1	0	3	1	20	0	0	21	38
% Trucks	0	0	0	0	0	0	0.7	0.2	0	0.6	0.4	0	0.1	0	0.2	0.1	1	0	0	0.8	0.6

Start Time	2ND AVE Southbound				IMJIN PKWY Westbound				2ND AVE Northbound				IMJIN PKWY Eastbound				Int. Total
	Right	Thru	Left	App. Total	Right	Thru	Left	App. Total	Right	Thru	Left	App. Total	Right	Thru	Left	App. Total	
Peak Hour Analysis From 04:00 PM to 05:45 PM - Peak 1 of 1																	
Peak Hour for Entire Intersection Begins at 05:00 PM																	
05:00 PM	12	1	5	18	0	227	46	273	77	0	111	188	72	261	0	333	812
05:15 PM	10	3	1	14	0	236	70	306	86	2	104	192	85	253	3	341	853
05:30 PM	5	5	0	10	1	256	67	324	63	0	95	158	84	247	0	331	823
05:45 PM	7	3	3	13	2	222	65	289	69	0	102	171	85	241	3	329	802
Total Volume	34	12	9	55	3	941	248	1192	295	2	412	709	326	1002	6	1334	3290
% App. Total	61.8	21.8	16.4		0.3	78.9	20.8		41.6	0.3	58.1		24.4	75.1	0.4		
PHF	.708	.600	.450	.764	.375	.919	.886	.920	.858	.250	.928	.923	.959	.960	.500	.978	.964

Traffic Data Service

San Jose, CA
 (408) 622-4787
 tdsbay@cs.com

File Name : 3PM FINAL
 Site Code : 00000003
 Start Date : 4/27/2017
 Page No : 2

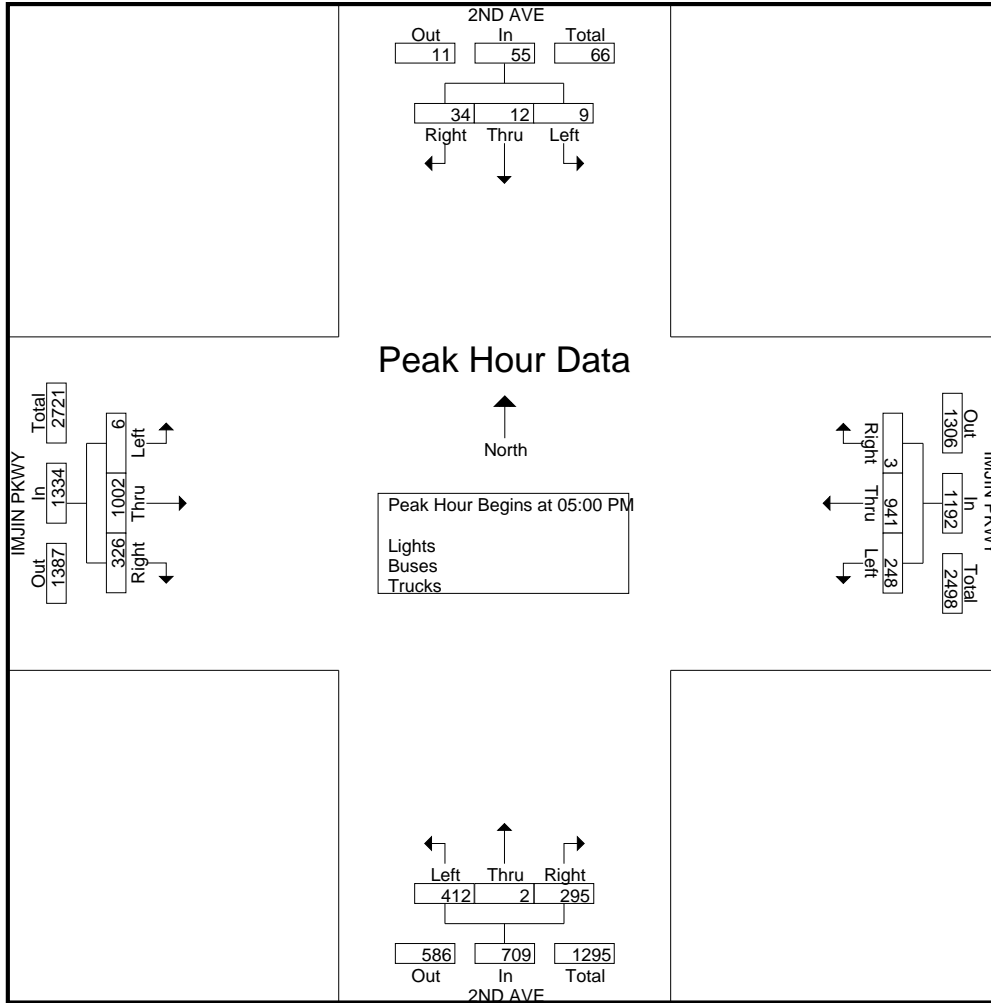

Traffic Data Service

San Jose, CA
 (408) 622-4787
 tdsbay@cs.com

File Name : 3PM FINAL
 Site Code : 00000003
 Start Date : 4/27/2017
 Page No : 1

Groups Printed- Bikes

Start Time	2ND AVE Southbound					IMJIN PKWY Westbound					2ND AVE Northbound					IMJIN PKWY Eastbound					Int. Total
	Right	Thru	Left	Peds	App. Total	Right	Thru	Left	Peds	App. Total	Right	Thru	Left	Peds	App. Total	Right	Thru	Left	Peds	App. Total	
04:00 PM	0	0	0	0	0	0	0	0	0	0	0	0	0	0	0	0	0	0	0	0	0
04:15 PM	0	0	0	0	0	0	0	0	0	0	0	0	0	0	0	0	0	0	0	0	0
04:30 PM	0	0	0	0	0	0	0	0	0	0	0	0	0	0	0	0	0	0	0	0	0
04:45 PM	0	0	0	0	0	0	0	0	0	0	0	0	0	0	0	0	0	0	0	0	0
Total	0	0	0	0	0	0	0	0	0	0	0	0	0	0	0	0	0	0	0	0	0
05:00 PM	0	0	0	0	0	0	0	0	0	0	0	0	0	0	0	0	0	0	0	0	0
05:15 PM	0	0	0	0	0	0	0	0	0	0	0	0	0	0	0	0	0	0	0	0	0
05:30 PM	0	0	0	0	0	0	0	0	0	0	0	0	0	0	0	0	0	0	0	0	0
05:45 PM	0	0	0	0	0	0	0	0	0	0	0	0	0	0	0	0	0	0	0	0	0
Total	0	0	0	0	0	0	0	0	0	0	0	0	0	0	0	0	0	0	0	0	0
Grand Total	0	0	0	0	0	0	0	0	0	0	0	0	0	0	0	0	0	0	0	0	0
Apprch %	0	0	0	0		0	0	0	0		0	0	0	0		0	0	0	0		
Total %																					

Start Time	2ND AVE Southbound				IMJIN PKWY Westbound				2ND AVE Northbound				IMJIN PKWY Eastbound				Int. Total
	Right	Thru	Left	App. Total	Right	Thru	Left	App. Total	Right	Thru	Left	App. Total	Right	Thru	Left	App. Total	
Peak Hour Analysis From 04:00 PM to 05:45 PM - Peak 1 of 1																	
Peak Hour for Entire Intersection Begins at 04:00 PM																	
04:00 PM	0	0	0	0	0	0	0	0	0	0	0	0	0	0	0	0	
04:15 PM	0	0	0	0	0	0	0	0	0	0	0	0	0	0	0	0	
04:30 PM	0	0	0	0	0	0	0	0	0	0	0	0	0	0	0	0	
04:45 PM	0	0	0	0	0	0	0	0	0	0	0	0	0	0	0	0	
Total Volume	0	0	0	0	0	0	0	0	0	0	0	0	0	0	0	0	
% App. Total	0	0	0		0	0	0		0	0	0		0	0	0		
PHF	.000	.000	.000	.000	.000	.000	.000	.000	.000	.000	.000	.000	.000	.000	.000	.000	

Traffic Data Service

San Jose, CA
(408) 622-4787
tdsbay@cs.com

File Name : 3PM FINAL
Site Code : 00000003
Start Date : 4/27/2017
Page No : 2

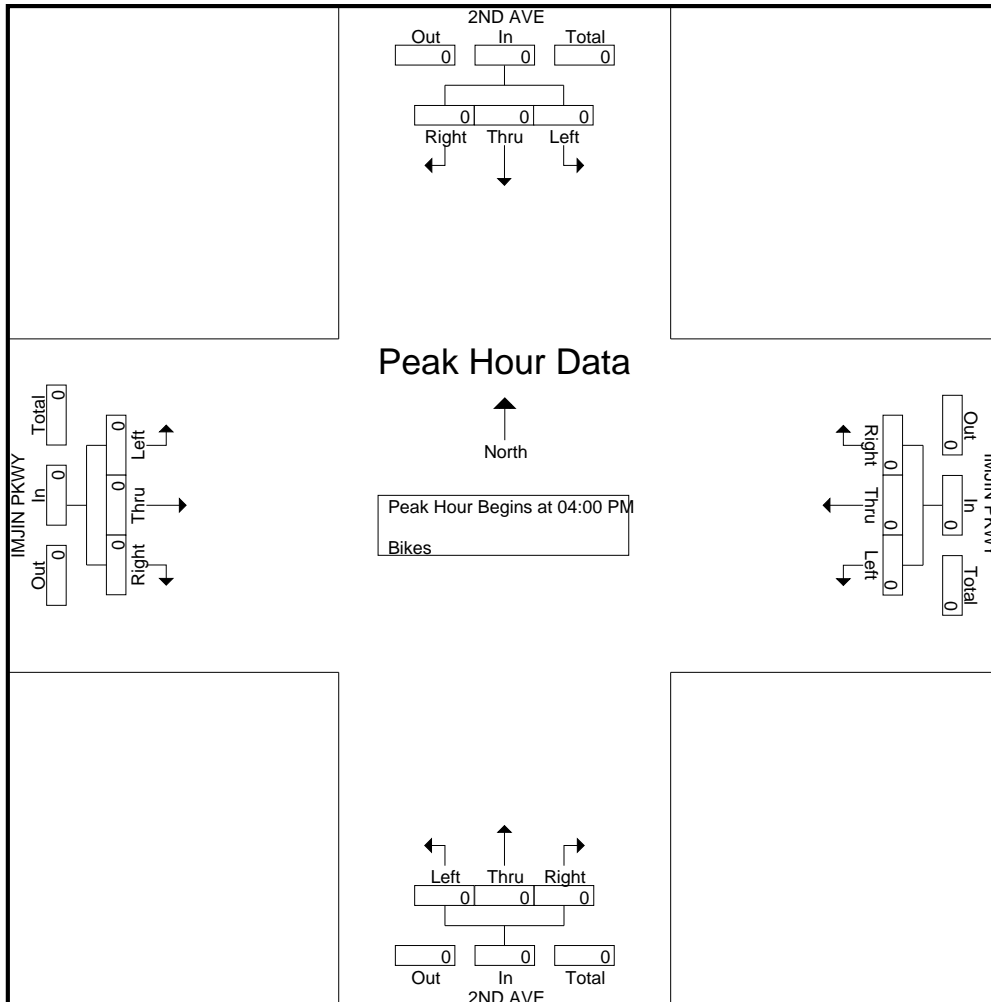

Traffic Data Service

San Jose, CA
 (408) 622-4787
 tdsbay@cs.com

File Name : 4AM FINAL
 Site Code : 00000004
 Start Date : 4/27/2017
 Page No : 1

Groups Printed- Lights - Buses - Trucks

Start Time	3RD AVE Southbound					IMJIN PKWY Westbound					3RD AVE Northbound					IMJIN PKWY Eastbound					Int. Total
	Right	Thru	Left	Peds	App. Total	Right	Thru	Left	Peds	App. Total	Right	Thru	Left	Peds	App. Total	Right	Thru	Left	Peds	App. Total	
07:00 AM	1	0	0	0	1	1	364	24	0	389	2	1	0	0	3	0	151	6	0	157	550
07:15 AM	10	1	1	0	12	4	324	69	0	397	2	0	1	0	3	2	187	7	0	196	608
07:30 AM	8	1	1	1	11	14	255	81	0	350	8	0	0	1	9	6	228	20	2	256	626
07:45 AM	12	1	4	0	17	5	265	60	0	330	4	0	2	0	6	5	234	13	0	252	605
Total	31	3	6	1	41	24	1208	234	0	1466	16	1	3	1	21	13	800	46	2	861	2389
08:00 AM	4	0	1	1	6	3	255	17	0	275	5	0	1	0	6	4	242	12	0	258	545
08:15 AM	2	0	3	0	5	3	294	13	0	310	2	0	1	0	3	0	217	15	0	232	550
08:30 AM	4	0	0	0	4	2	301	7	0	310	3	0	0	0	3	4	179	8	1	192	509
08:45 AM	0	0	0	0	0	5	264	9	0	278	2	2	1	0	5	1	160	5	0	166	449
Total	10	0	4	1	15	13	1114	46	0	1173	12	2	3	0	17	9	798	40	1	848	2053
Grand Total	41	3	10	2	56	37	2322	280	0	2639	28	3	6	1	38	22	1598	86	3	1709	4442
Apprch %	73.2	5.4	17.9	3.6		1.4	88	10.6	0		73.7	7.9	15.8	2.6		1.3	93.5	5	0.2		
Total %	0.9	0.1	0.2	0	1.3	0.8	52.3	6.3	0	59.4	0.6	0.1	0.1	0	0.9	0.5	36	1.9	0.1	38.5	
Lights	39	3	10	2	54	36	2252	279	0	2567	28	3	4	1	36	22	1563	85	3	1673	4330
% Lights	95.1	100	100	100	96.4	97.3	97	99.6	0	97.3	100	100	66.7	100	94.7	100	97.8	98.8	100	97.9	97.5
Buses	2	0	0	0	2	1	12	1	0	14	0	0	0	0	0	0	12	1	0	13	29
% Buses	4.9	0	0	0	3.6	2.7	0.5	0.4	0	0.5	0	0	0	0	0	0	0.8	1.2	0	0.8	0.7
Trucks	0	0	0	0	0	0	58	0	0	58	0	0	2	0	2	0	23	0	0	23	83
% Trucks	0	0	0	0	0	0	2.5	0	0	2.2	0	0	33.3	0	5.3	0	1.4	0	0	1.3	1.9

Start Time	3RD AVE Southbound				IMJIN PKWY Westbound				3RD AVE Northbound				IMJIN PKWY Eastbound				Int. Total
	Right	Thru	Left	App. Total	Right	Thru	Left	App. Total	Right	Thru	Left	App. Total	Right	Thru	Left	App. Total	
Peak Hour Analysis From 07:00 AM to 08:45 AM - Peak 1 of 1																	
Peak Hour for Entire Intersection Begins at 07:00 AM																	
07:00 AM	1	0	0	1	1	364	24	389	2	1	0	3	0	151	6	157	550
07:15 AM	10	1	1	12	4	324	69	397	2	0	1	3	2	187	7	196	608
07:30 AM	8	1	1	10	14	255	81	350	8	0	0	8	6	228	20	254	622
07:45 AM	12	1	4	17	5	265	60	330	4	0	2	6	5	234	13	252	605
Total Volume	31	3	6	40	24	1208	234	1466	16	1	3	20	13	800	46	859	2385
% App. Total	77.5	7.5	15		1.6	82.4	16		80	5	15		1.5	93.1	5.4		
PHF	.646	.750	.375	.588	.429	.830	.722	.923	.500	.250	.375	.625	.542	.855	.575	.845	.959

Traffic Data Service

San Jose, CA
 (408) 622-4787
 tdsbay@cs.com

File Name : 4AM FINAL
 Site Code : 00000004
 Start Date : 4/27/2017
 Page No : 2

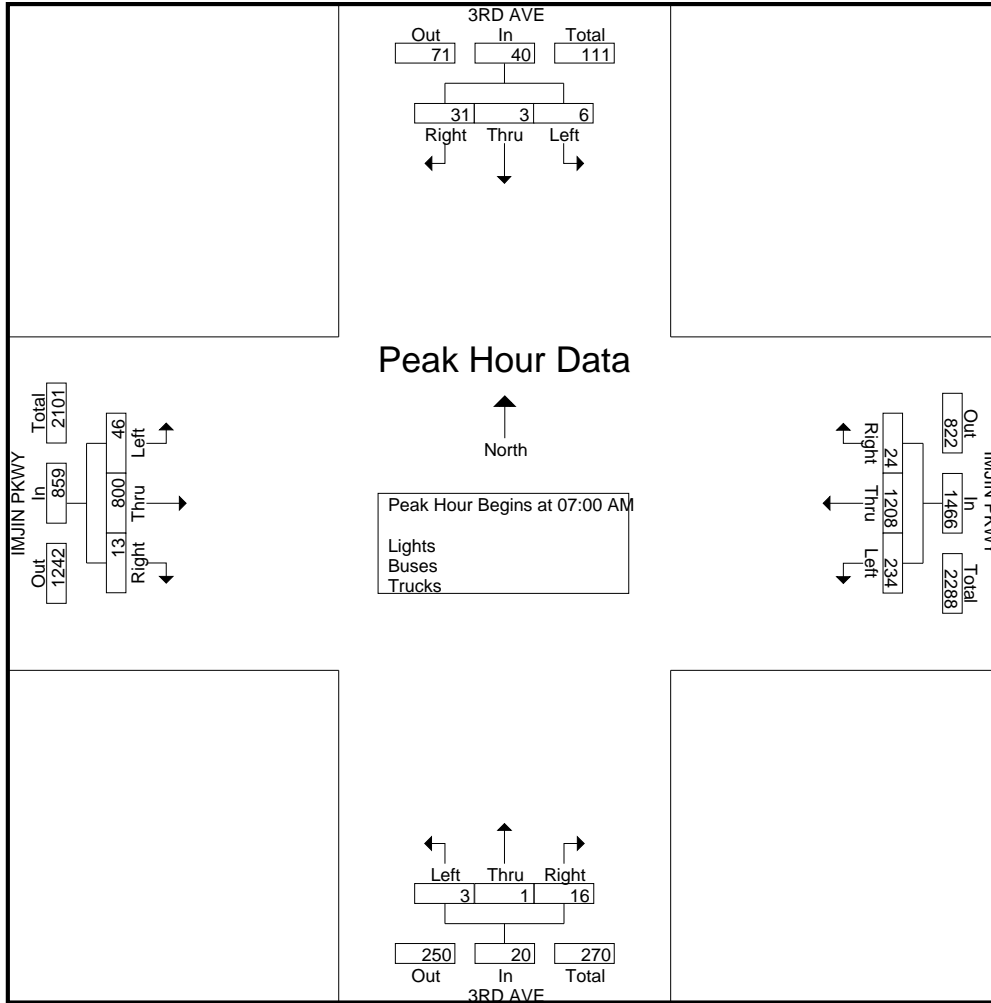

Traffic Data Service

San Jose, CA
 (408) 622-4787
 tdsbay@cs.com

File Name : 4AM FINAL
 Site Code : 00000004
 Start Date : 4/27/2017
 Page No : 1

Groups Printed- Bikes

Start Time	3RD AVE Southbound					IMJIN PKWY Westbound					3RD AVE Northbound					IMJIN PKWY Eastbound					Int. Total	
	Right	Thru	Left	Peds	App. Total	Right	Thru	Left	Peds	App. Total	Right	Thru	Left	Peds	App. Total	Right	Thru	Left	Peds	App. Total		
07:00 AM	0	0	0	0	0	0	0	0	0	0	0	0	0	0	0	0	0	0	0	0	0	0
07:15 AM	0	0	0	0	0	0	0	0	0	0	0	0	0	0	0	0	0	0	0	0	0	0
07:30 AM	0	0	0	0	0	0	0	0	0	0	0	0	0	0	0	0	0	0	0	0	0	0
07:45 AM	0	0	0	0	0	0	0	0	0	0	0	0	0	0	0	0	0	0	0	0	0	0
Total	0	0	0	0	0	0	0	0	0	0	0	0	0	0	0	0	0	0	0	0	0	0
08:00 AM	0	0	0	0	0	0	0	0	0	0	0	0	0	0	0	0	0	0	0	0	0	0
08:15 AM	0	0	0	0	0	0	0	0	0	0	0	0	0	0	0	0	0	0	0	0	0	0
08:30 AM	0	0	0	0	0	0	0	0	0	0	0	0	0	0	0	0	0	0	0	0	0	0
08:45 AM	0	0	0	0	0	0	0	0	0	0	0	0	0	0	0	0	0	0	0	0	0	0
Total	0	0	0	0	0	0	0	0	0	0	0	0	0	0	0	0	0	0	0	0	0	0
Grand Total	0	0	0	0	0	0	0	0	0	0	0	0	0	0	0	0	0	0	0	0	0	0
Apprch %	0	0	0	0		0	0	0	0		0	0	0	0		0	0	0	0			
Total %																						

Start Time	3RD AVE Southbound				IMJIN PKWY Westbound				3RD AVE Northbound				IMJIN PKWY Eastbound				Int. Total
	Right	Thru	Left	App. Total	Right	Thru	Left	App. Total	Right	Thru	Left	App. Total	Right	Thru	Left	App. Total	
Peak Hour Analysis From 07:00 AM to 08:45 AM - Peak 1 of 1																	
Peak Hour for Entire Intersection Begins at 07:00 AM																	
07:00 AM	0	0	0	0	0	0	0	0	0	0	0	0	0	0	0	0	
07:15 AM	0	0	0	0	0	0	0	0	0	0	0	0	0	0	0	0	
07:30 AM	0	0	0	0	0	0	0	0	0	0	0	0	0	0	0	0	
07:45 AM	0	0	0	0	0	0	0	0	0	0	0	0	0	0	0	0	
Total Volume	0	0	0	0	0	0	0	0	0	0	0	0	0	0	0	0	
% App. Total	0	0	0		0	0	0		0	0	0		0	0	0		
PHF	.000	.000	.000	.000	.000	.000	.000	.000	.000	.000	.000	.000	.000	.000	.000	.000	

Traffic Data Service

San Jose, CA
(408) 622-4787
tdsbay@cs.com

File Name : 4AM FINAL
Site Code : 00000004
Start Date : 4/27/2017
Page No : 2

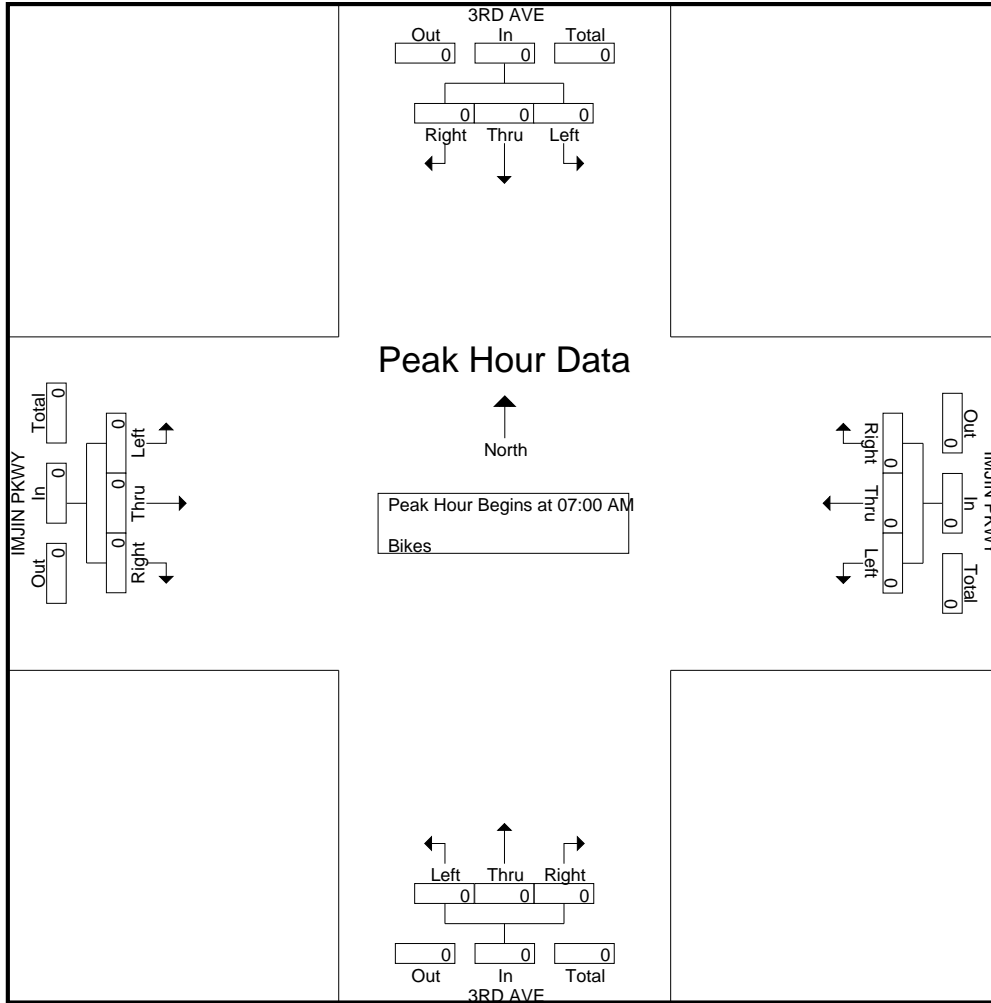

Traffic Data Service

San Jose, CA
 (408) 622-4787
 tdsbay@cs.com

File Name : 4PM FINAL
 Site Code : 00000004
 Start Date : 4/27/2017
 Page No : 1

Groups Printed- Lights - Buses - Trucks

Start Time	3RD AVE Southbound					IMJIN PKWY Westbound					3RD AVE Northbound					IMJIN PKWY Eastbound					Int. Total
	Right	Thru	Left	Peds	App. Total	Right	Thru	Left	Peds	App. Total	Right	Thru	Left	Peds	App. Total	Right	Thru	Left	Peds	App. Total	
04:00 PM	2	0	1	0	3	0	239	4	0	243	7	0	1	3	11	2	305	5	0	312	569
04:15 PM	6	0	1	0	7	0	237	1	0	238	8	0	0	0	8	0	318	7	0	325	578
04:30 PM	8	0	0	2	10	1	271	2	0	274	7	0	2	0	9	3	287	7	0	297	590
04:45 PM	13	0	2	0	15	5	263	6	0	274	5	1	1	1	8	3	319	15	0	337	634
Total	29	0	4	2	35	6	1010	13	0	1029	27	1	4	4	36	8	1229	34	0	1271	2371
05:00 PM	17	0	1	0	18	2	276	5	1	284	5	0	0	1	6	4	323	19	0	346	654
05:15 PM	6	0	0	0	6	4	303	6	0	313	7	0	2	0	9	0	331	4	0	335	663
05:30 PM	6	1	1	1	9	1	302	4	0	307	6	0	1	0	7	1	317	12	0	330	653
05:45 PM	12	1	3	0	16	5	283	3	0	291	7	0	1	0	8	0	300	9	0	309	624
Total	41	2	5	1	49	12	1164	18	1	1195	25	0	4	1	30	5	1271	44	0	1320	2594
Grand Total	70	2	9	3	84	18	2174	31	1	2224	52	1	8	5	66	13	2500	78	0	2591	4965
Apprch %	83.3	2.4	10.7	3.6		0.8	97.8	1.4	0		78.8	1.5	12.1	7.6		0.5	96.5	3	0		
Total %	1.4	0	0.2	0.1	1.7	0.4	43.8	0.6	0	44.8	1	0	0.2	0.1	1.3	0.3	50.4	1.6	0	52.2	
Lights	69	2	9	3	83	18	2137	31	1	2187	52	1	8	5	66	13	2478	78	0	2569	4905
% Lights	98.6	100	100	100	98.8	100	98.3	100	100	98.3	100	100	100	100	100	100	99.1	100	0	99.2	98.8
Buses	1	0	0	0	1	0	17	0	0	17	0	0	0	0	0	0	5	0	0	5	23
% Buses	1.4	0	0	0	1.2	0	0.8	0	0	0.8	0	0	0	0	0	0	0.2	0	0	0.2	0.5
Trucks	0	0	0	0	0	0	20	0	0	20	0	0	0	0	0	0	17	0	0	17	37
% Trucks	0	0	0	0	0	0	0.9	0	0	0.9	0	0	0	0	0	0	0.7	0	0	0.7	0.7

Start Time	3RD AVE Southbound				IMJIN PKWY Westbound				3RD AVE Northbound				IMJIN PKWY Eastbound				Int. Total
	Right	Thru	Left	App. Total	Right	Thru	Left	App. Total	Right	Thru	Left	App. Total	Right	Thru	Left	App. Total	
Peak Hour Analysis From 04:00 PM to 05:45 PM - Peak 1 of 1																	
Peak Hour for Entire Intersection Begins at 04:45 PM																	
04:45 PM	13	0	2	15	5	263	6	274	5	1	1	7	3	319	15	337	633
05:00 PM	17	0	1	18	2	276	5	283	5	0	0	5	4	323	19	346	652
05:15 PM	6	0	0	6	4	303	6	313	7	0	2	9	0	331	4	335	663
05:30 PM	6	1	1	8	1	302	4	307	6	0	1	7	1	317	12	330	652
Total Volume	42	1	4	47	12	1144	21	1177	23	1	4	28	8	1290	50	1348	2600
% App. Total	89.4	2.1	8.5		1	97.2	1.8		82.1	3.6	14.3		0.6	95.7	3.7		
PHF	.618	.250	.500	.653	.600	.944	.875	.940	.821	.250	.500	.778	.500	.974	.658	.974	.980

Traffic Data Service

San Jose, CA
 (408) 622-4787
 tdsbay@cs.com

File Name : 4PM FINAL
 Site Code : 00000004
 Start Date : 4/27/2017
 Page No : 2

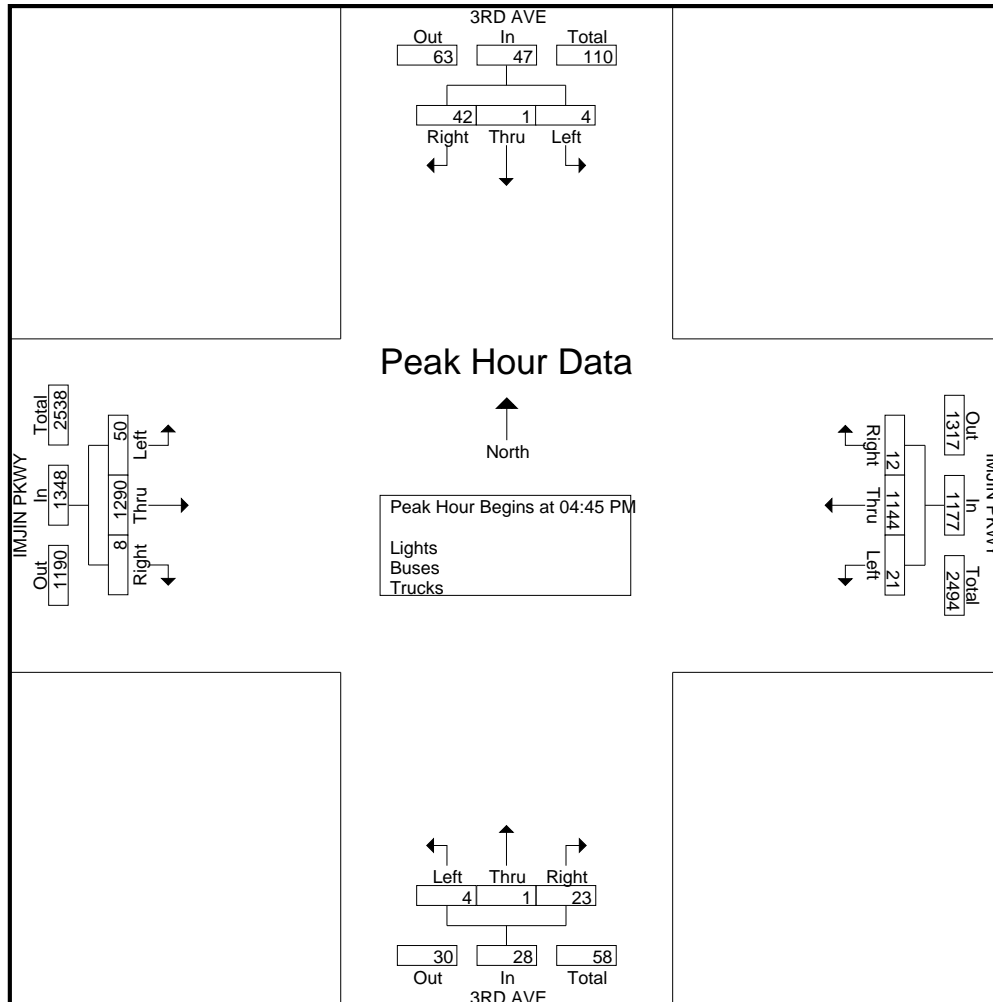

Traffic Data Service

San Jose, CA
 (408) 622-4787
 tdsbay@cs.com

File Name : 4PM FINAL
 Site Code : 00000004
 Start Date : 4/27/2017
 Page No : 1

Groups Printed- Bikes

Start Time	3RD AVE Southbound					IMJIN PKWY Westbound					3RD AVE Northbound					IMJIN PKWY Eastbound					Int. Total	
	Right	Thru	Left	Peds	App. Total	Right	Thru	Left	Peds	App. Total	Right	Thru	Left	Peds	App. Total	Right	Thru	Left	Peds	App. Total		
04:00 PM	0	0	0	0	0	0	0	0	0	0	0	0	0	0	0	0	0	0	0	0	0	0
04:15 PM	0	0	0	0	0	0	0	0	0	0	0	0	0	0	0	0	0	0	0	0	0	0
04:30 PM	0	0	0	0	0	0	0	0	0	0	0	0	0	0	0	0	0	0	0	0	0	0
04:45 PM	0	0	0	0	0	0	0	0	0	0	0	0	0	0	0	0	0	0	0	0	0	0
Total	0	0	0	0	0	0	0	0	0	0	0	0	0	0	0	0	0	0	0	0	0	0
05:00 PM	0	0	0	0	0	0	0	1	0	1	0	0	0	0	0	0	0	0	0	0	0	1
05:15 PM	0	0	0	0	0	0	0	0	0	0	0	0	0	0	0	0	0	0	0	0	0	0
05:30 PM	0	0	0	0	0	0	0	0	0	0	1	0	0	0	1	0	1	0	0	1	1	2
05:45 PM	0	0	0	0	0	0	0	0	0	0	0	0	0	0	0	0	1	0	0	1	1	1
Total	0	0	0	0	0	0	0	1	0	1	1	0	0	0	1	0	2	0	0	2	2	4
Grand Total	0	0	0	0	0	0	0	1	0	1	1	0	0	0	1	0	2	0	0	2	2	4
Apprch %	0	0	0	0	0	0	0	100	0	100	100	0	0	0	100	0	100	0	0	100	0	100
Total %	0	0	0	0	0	0	0	25	0	25	25	0	0	0	25	0	50	0	0	50	0	50

Start Time	3RD AVE Southbound				IMJIN PKWY Westbound				3RD AVE Northbound				IMJIN PKWY Eastbound				Int. Total
	Right	Thru	Left	App. Total	Right	Thru	Left	App. Total	Right	Thru	Left	App. Total	Right	Thru	Left	App. Total	
Peak Hour Analysis From 04:00 PM to 05:45 PM - Peak 1 of 1																	
Peak Hour for Entire Intersection Begins at 05:00 PM																	
05:00 PM	0	0	0	0	0	0	1	1	0	0	0	0	0	0	0	0	1
05:15 PM	0	0	0	0	0	0	0	0	0	0	0	0	0	0	0	0	0
05:30 PM	0	0	0	0	0	0	0	0	1	0	0	1	0	1	0	1	2
05:45 PM	0	0	0	0	0	0	0	0	0	0	0	0	0	1	0	1	1
Total Volume	0	0	0	0	0	0	1	1	1	0	0	1	0	2	0	2	4
% App. Total	0	0	0	0	0	0	100	100	100	0	0	100	0	100	0	100	100
PHF	.000	.000	.000	.000	.000	.000	.250	.250	.250	.000	.000	.250	.000	.500	.000	.500	.500

Traffic Data Service

San Jose, CA
 (408) 622-4787
 tdsbay@cs.com

File Name : 4PM FINAL
 Site Code : 00000004
 Start Date : 4/27/2017
 Page No : 2

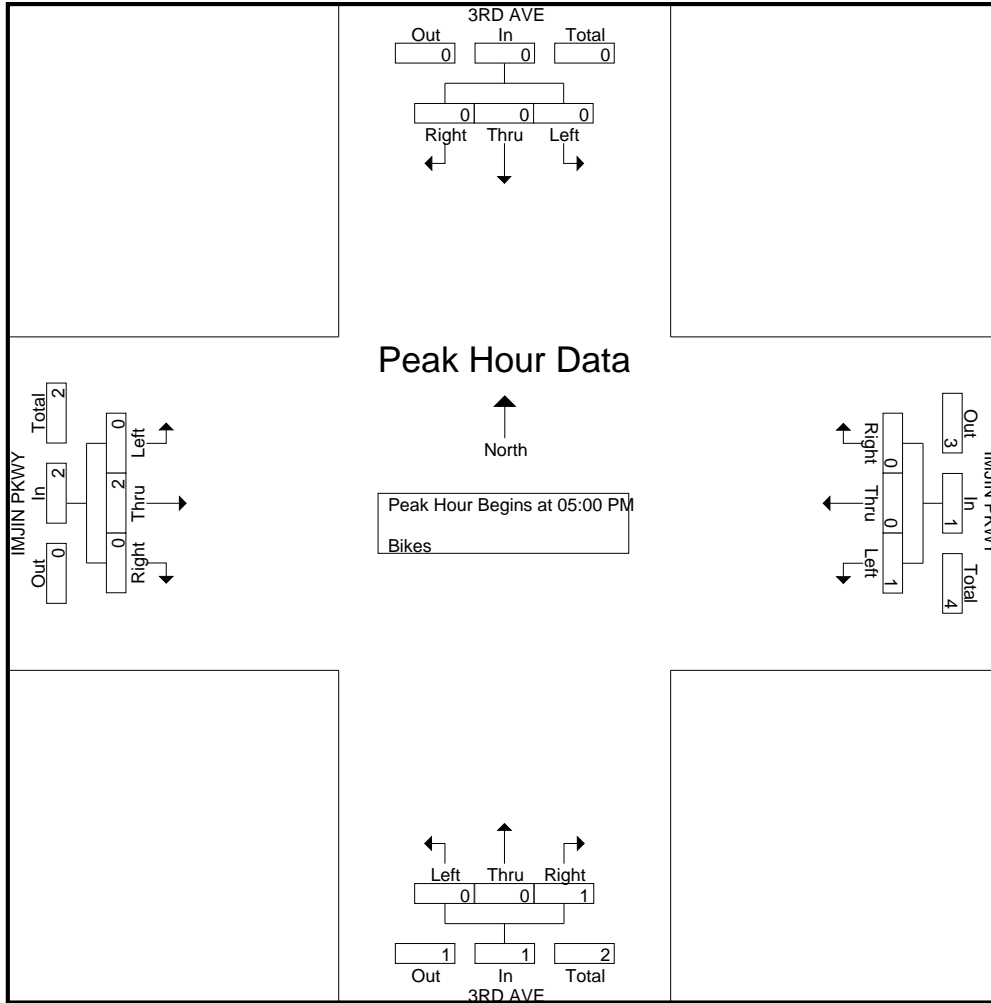

Traffic Data Service

San Jose, CA
 (408) 622-4787
 tdsbay@cs.com

File Name : 5AM FINAL
 Site Code : 00000005
 Start Date : 5/3/2017
 Page No : 1

Groups Printed- Lights - Buses - Trucks

Start Time	GENERAL JIM MOORE BLVD Southbound					IMJIN PKWY Westbound					GENERAL JIM MOORE BLVD Northbound					IMJIN PKWY Eastbound					Int. Total
	Right	Thru	Left	Peds	App. Total	Right	Thru	Left	Peds	App. Total	Right	Thru	Left	Peds	App. Total	Right	Thru	Left	Peds	App. Total	
07:00 AM	0	0	0	0	0	1	394	2	0	397	1	0	1	0	2	5	147	0	0	152	551
07:15 AM	2	0	0	0	2	2	390	0	0	392	0	0	0	1	1	7	194	2	0	203	598
07:30 AM	0	0	3	1	4	2	330	0	0	332	0	0	1	0	1	5	268	0	0	273	610
07:45 AM	0	1	0	0	1	3	293	3	0	299	0	0	1	0	1	2	277	0	0	279	580
Total	2	1	3	1	7	8	1407	5	0	1420	1	0	3	1	5	19	886	2	0	907	2339
08:00 AM	0	0	0	0	0	7	267	0	0	274	1	0	2	0	3	3	213	0	0	216	493
08:15 AM	0	0	0	0	0	4	289	0	0	293	0	0	1	0	1	3	197	1	0	201	495
08:30 AM	0	1	0	0	1	4	295	0	0	299	0	0	0	0	0	3	153	1	0	157	457
08:45 AM	0	0	0	1	1	1	285	0	0	286	0	0	2	1	3	2	152	2	0	156	446
Total	0	1	0	1	2	16	1136	0	0	1152	1	0	5	1	7	11	715	4	0	730	1891
Grand Total	2	2	3	2	9	24	2543	5	0	2572	2	0	8	2	12	30	1601	6	0	1637	4230
Apprch %	22.2	22.2	33.3	22.2		0.9	98.9	0.2	0		16.7	0	66.7	16.7		1.8	97.8	0.4	0		
Total %	0	0	0.1	0	0.2	0.6	60.1	0.1	0	60.8	0	0	0.2	0	0.3	0.7	37.8	0.1	0	38.7	
Lights	2	2	3	2	9	24	2471	5	0	2500	2	0	4	2	8	22	1564	6	0	1592	4109
% Lights	100	100	100	100	100	100	97.2	100	0	97.2	100	0	50	100	66.7	73.3	97.7	100	0	97.3	97.1
Buses	0	0	0	0	0	0	16	0	0	16	0	0	0	0	0	0	12	0	0	12	28
% Buses	0	0	0	0	0	0	0.6	0	0	0.6	0	0	0	0	0	0	0.7	0	0	0.7	0.7
Trucks	0	0	0	0	0	0	56	0	0	56	0	0	4	0	4	8	25	0	0	33	93
% Trucks	0	0	0	0	0	0	2.2	0	0	2.2	0	0	50	0	33.3	26.7	1.6	0	0	2	2.2

Start Time	GENERAL JIM MOORE BLVD Southbound					IMJIN PKWY Westbound					GENERAL JIM MOORE BLVD Northbound					IMJIN PKWY Eastbound					Int. Total
	Right	Thru	Left	Peds	App. Total	Right	Thru	Left	Peds	App. Total	Right	Thru	Left	Peds	App. Total	Right	Thru	Left	Peds	App. Total	
07:00 AM	0	0	0	0	0	1	394	2	397	1	0	1	2	5	147	0	0	152	551		
07:15 AM	2	0	0	0	2	2	390	0	0	392	0	0	0	0	0	7	194	2	0	203	597
07:30 AM	0	0	3	1	4	2	330	0	0	332	0	0	1	1	1	5	268	0	0	273	609
07:45 AM	0	1	0	0	1	3	293	3	0	299	0	0	1	1	1	2	277	0	0	279	580
Total Volume	2	1	3	1	7	8	1407	5	0	1420	1	0	3	2	6	19	886	2	0	907	2337
% App. Total	33.3	16.7	50	25		0.6	99.1	0.4	0		25	0	75	50		2.1	97.7	0.2	0		
PHF	.250	.250	.250	.250	.500	.667	.893	.417	.894	.250	.000	.750	.500	.679	.800	.250	.813	.959			

Peak Hour Analysis From 07:00 AM to 08:45 AM - Peak 1 of 1

Peak Hour for Entire Intersection Begins at 07:00 AM

Traffic Data Service

San Jose, CA
 (408) 622-4787
 tdsbay@cs.com

File Name : 5AM FINAL
 Site Code : 00000005
 Start Date : 5/3/2017
 Page No : 2

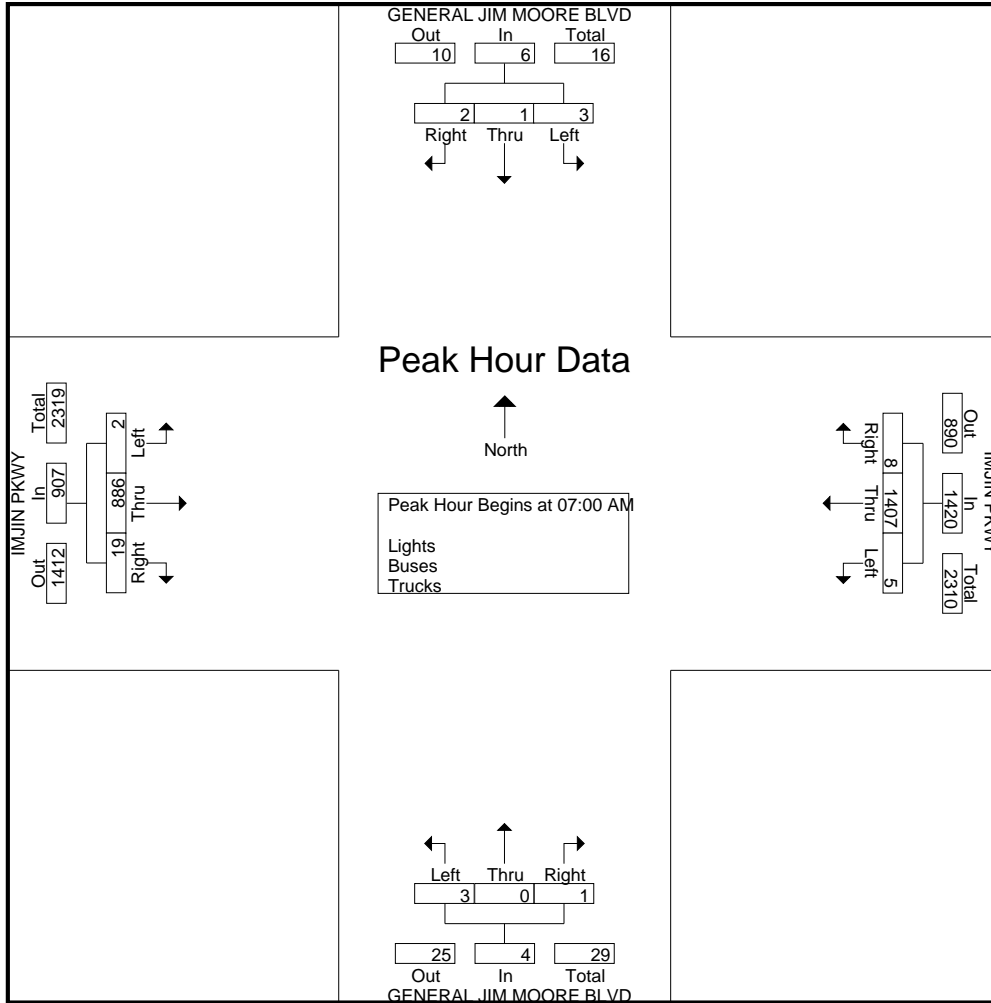

Traffic Data Service

San Jose, CA
(408) 622-4787
tdsbay@cs.com

File Name : 5AM FINAL
Site Code : 00000005
Start Date : 5/3/2017
Page No : 2

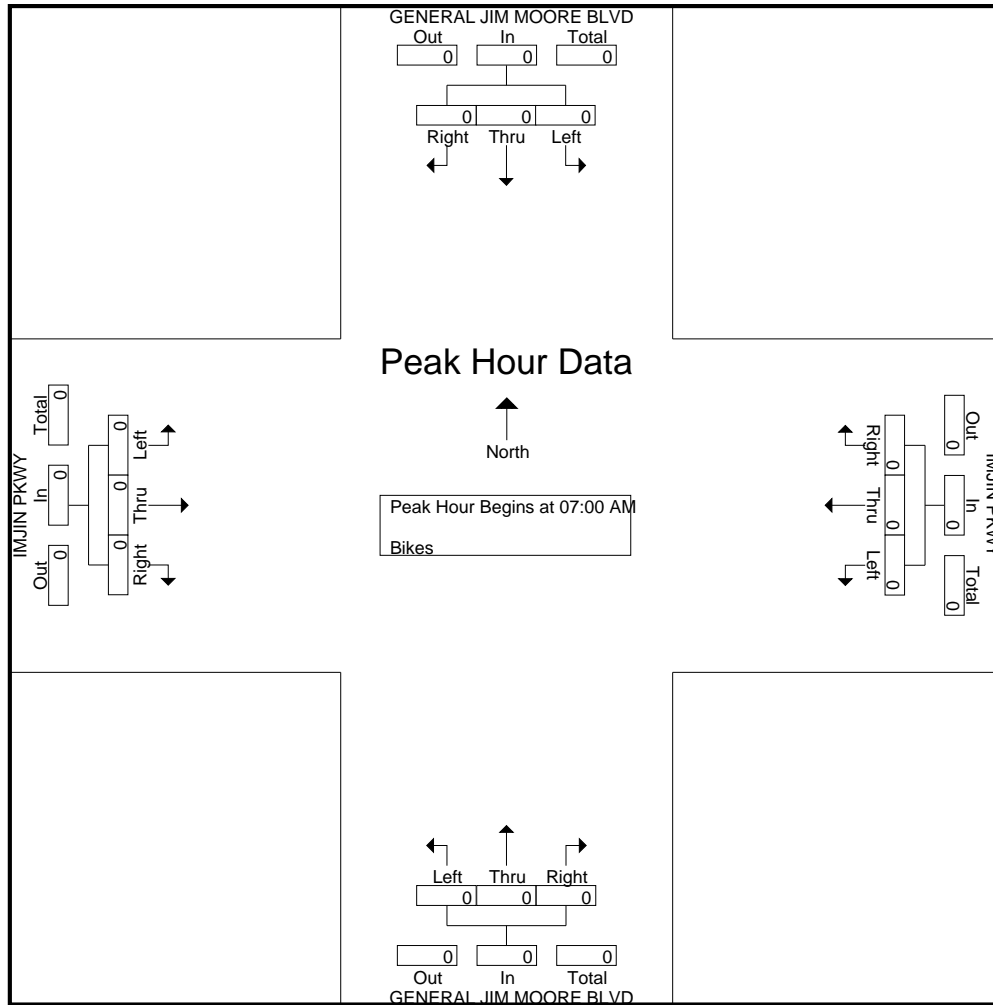

Traffic Data Service

San Jose, CA
 (408) 622-4787
 tdsbay@cs.com

File Name : 5PM FINAL
 Site Code : 00000005
 Start Date : 5/3/2017
 Page No : 1

Groups Printed- Lights - Buses - Trucks

Start Time	GENERAL JIM MOORE BLVD Southbound					IMJIN PKWY Westbound					GENERAL JIM MOORE BLVD Northbound					IMJIN PKWY Eastbound					Int. Total
	Right	Thru	Left	Peds	App. Total	Right	Thru	Left	Peds	App. Total	Right	Thru	Left	Peds	App. Total	Right	Thru	Left	Peds	App. Total	
04:00 PM	1	0	2	0	3	5	242	0	0	247	5	0	12	0	17	1	290	1	0	292	559
04:15 PM	2	0	3	0	5	1	258	2	1	262	1	0	4	2	7	2	359	2	0	363	637
04:30 PM	0	0	0	0	0	1	271	0	0	272	0	0	4	0	4	6	336	0	0	342	618
04:45 PM	4	0	2	1	7	0	271	0	0	271	0	0	2	0	2	0	320	0	0	320	600
Total	7	0	7	1	15	7	1042	2	1	1052	6	0	22	2	30	9	1305	3	0	1317	2414
05:00 PM	0	0	5	0	5	1	299	0	0	300	2	0	6	0	8	2	352	0	0	354	667
05:15 PM	0	0	2	0	2	0	273	0	0	273	0	0	2	0	2	3	371	1	0	375	652
05:30 PM	0	0	0	0	0	0	307	0	0	307	0	0	3	2	5	1	339	0	0	340	652
05:45 PM	0	0	1	0	1	0	277	0	0	277	0	0	3	0	3	1	344	1	0	346	627
Total	0	0	8	0	8	1	1156	0	0	1157	2	0	14	2	18	7	1406	2	0	1415	2598
Grand Total	7	0	15	1	23	8	2198	2	1	2209	8	0	36	4	48	16	2711	5	0	2732	5012
Apprch %	30.4	0	65.2	4.3		0.4	99.5	0.1	0		16.7	0	75	8.3		0.6	99.2	0.2	0		
Total %	0.1	0	0.3	0	0.5	0.2	43.9	0	0	44.1	0.2	0	0.7	0.1	1	0.3	54.1	0.1	0	54.5	
Lights	4	0	15	1	20	8	2170	2	1	2181	8	0	35	4	47	12	2681	5	0	2698	4946
% Lights	57.1	0	100	100	87	100	98.7	100	100	98.7	100	0	97.2	100	97.9	75	98.9	100	0	98.8	98.7
Buses	0	0	0	0	0	0	10	0	0	10	0	0	0	0	0	0	7	0	0	7	17
% Buses	0	0	0	0	0	0	0.5	0	0	0.5	0	0	0	0	0	0	0.3	0	0	0.3	0.3
Trucks	3	0	0	0	3	0	18	0	0	18	0	0	1	0	1	4	23	0	0	27	49
% Trucks	42.9	0	0	0	13	0	0.8	0	0	0.8	0	0	2.8	0	2.1	25	0.8	0	0	1	1

Start Time	GENERAL JIM MOORE BLVD Southbound					IMJIN PKWY Westbound					GENERAL JIM MOORE BLVD Northbound					IMJIN PKWY Eastbound					Int. Total
	Right	Thru	Left	Peds	App. Total	Right	Thru	Left	Peds	App. Total	Right	Thru	Left	Peds	App. Total	Right	Thru	Left	Peds	App. Total	
05:00 PM	0	0	5	0	5	1	299	0	0	300	2	0	6	0	8	2	352	0	0	354	667
05:15 PM	0	0	2	0	2	0	273	0	0	273	0	0	2	0	2	3	371	1	0	375	652
05:30 PM	0	0	0	0	0	0	307	0	0	307	0	0	3	0	3	1	339	0	0	340	650
05:45 PM	0	0	1	0	1	0	277	0	0	277	0	0	3	0	3	1	344	1	0	346	627
Total Volume	0	0	8	0	8	1	1156	0	0	1157	2	0	14	0	16	7	1406	2	0	1415	2596
% App. Total	0	0	100	0		0.1	99.9	0	0		12.5	0	87.5	0		0.5	99.4	0.1	0		
PHF	.000	.000	.400	.000	.400	.250	.941	.000	.000	.942	.250	.000	.583	.000	.500	.583	.947	.500	.000	.943	.973

Peak Hour Analysis From 04:00 PM to 05:45 PM - Peak 1 of 1

Peak Hour for Entire Intersection Begins at 05:00 PM

Traffic Data Service

San Jose, CA
 (408) 622-4787
 tdsbay@cs.com

File Name : 5PM FINAL
 Site Code : 00000005
 Start Date : 5/3/2017
 Page No : 2

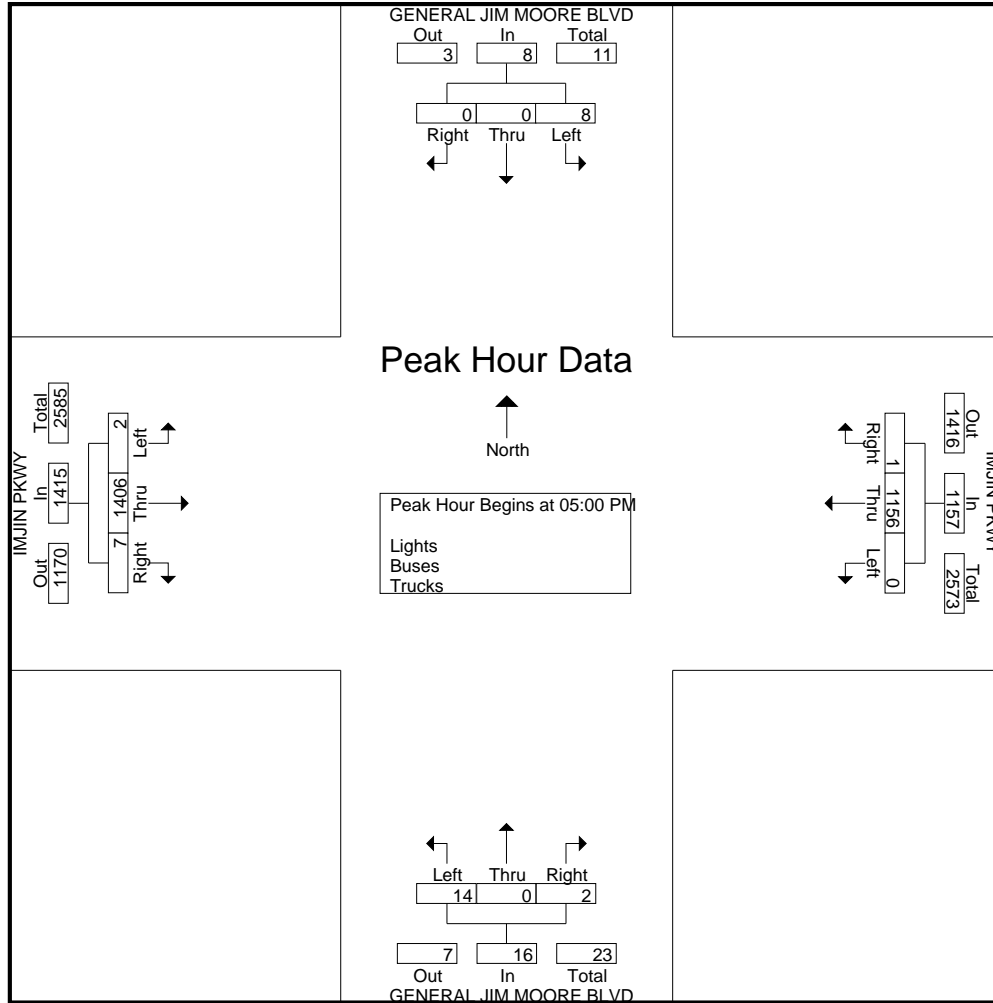

Traffic Data Service

San Jose, CA
 (408) 622-4787
 tdsbay@cs.com

File Name : 5PM FINAL
 Site Code : 00000005
 Start Date : 5/3/2017
 Page No : 1

Groups Printed- Bikes

Start Time	GENERAL JIM MOORE BLVD Southbound					IMJIN PKWY Westbound					GENERAL JIM MOORE BLVD Northbound					IMJIN PKWY Eastbound					Int. Total					
	Right	Thru	Left	Peds	App. Total	Right	Thru	Left	Peds	App. Total	Right	Thru	Left	Peds	App. Total	Right	Thru	Left	Peds	App. Total						
04:00 PM	0	0	0	0	0	0	1	0	0	1	0	0	0	0	0	0	0	0	0	0	0	0	0	0	0	1
04:15 PM	0	0	0	0	0	0	0	0	0	0	0	0	0	0	0	0	0	0	0	0	0	0	0	0	0	0
04:30 PM	0	0	0	0	0	0	0	0	0	0	0	0	0	0	0	0	0	0	0	0	0	0	0	0	0	0
04:45 PM	0	0	0	0	0	0	0	0	0	0	0	0	0	0	0	0	0	0	0	0	0	0	0	0	0	0
Total	0	0	0	0	0	0	1	0	0	1	0	0	0	0	0	0	0	0	0	0	0	0	0	0	0	1
05:00 PM	0	0	0	0	0	0	0	0	0	0	0	0	0	0	0	0	0	0	0	0	0	0	0	0	0	0
05:15 PM	0	0	0	0	0	0	0	0	0	0	0	0	0	0	0	0	0	0	0	0	0	0	0	0	0	0
05:30 PM	0	0	0	0	0	0	0	0	0	0	0	0	0	0	0	0	0	0	0	0	0	0	0	0	0	0
05:45 PM	0	0	0	0	0	0	1	0	0	1	0	0	0	0	0	0	0	0	0	0	0	0	0	0	0	1
Total	0	0	0	0	0	0	1	0	0	1	0	0	0	0	0	0	0	0	0	0	0	0	0	0	0	1
Grand Total	0	0	0	0	0	0	2	0	0	2	0	0	0	0	0	0	0	0	0	0	0	0	0	0	0	2
Apprch %	0	0	0	0	0	0	100	0	0	100	0	0	0	0	0	0	0	0	0	0	0	0	0	0	0	
Total %	0	0	0	0	0	0	100	0	0	100	0	0	0	0	0	0	0	0	0	0	0	0	0	0	0	

Start Time	GENERAL JIM MOORE BLVD Southbound					IMJIN PKWY Westbound					GENERAL JIM MOORE BLVD Northbound					IMJIN PKWY Eastbound					Int. Total					
	Right	Thru	Left	Peds	App. Total	Right	Thru	Left	Peds	App. Total	Right	Thru	Left	Peds	App. Total	Right	Thru	Left	Peds	App. Total						
04:00 PM	0	0	0	0	0	0	1	0	0	1	0	0	0	0	0	0	0	0	0	0	0	0	0	0	0	1
04:15 PM	0	0	0	0	0	0	0	0	0	0	0	0	0	0	0	0	0	0	0	0	0	0	0	0	0	0
04:30 PM	0	0	0	0	0	0	0	0	0	0	0	0	0	0	0	0	0	0	0	0	0	0	0	0	0	0
04:45 PM	0	0	0	0	0	0	0	0	0	0	0	0	0	0	0	0	0	0	0	0	0	0	0	0	0	0
Total Volume	0	0	0	0	0	0	1	0	0	1	0	0	0	0	0	0	0	0	0	0	0	0	0	0	0	1
% App. Total	0	0	0	0	0	0	100	0	0	100	0	0	0	0	0	0	0	0	0	0	0	0	0	0	0	
PHF	.000	.000	.000	.000	.000	.000	.250	.000	.000	.250	.000	.000	.000	.000	.000	.000	.000	.000	.000	.000	.000	.000	.000	.000	.250	

Peak Hour Analysis From 04:00 PM to 05:45 PM - Peak 1 of 1
 Peak Hour for Entire Intersection Begins at 04:00 PM

Traffic Data Service

San Jose, CA
(408) 622-4787
tdsbay@cs.com

File Name : 5PM FINAL
Site Code : 00000005
Start Date : 5/3/2017
Page No : 2

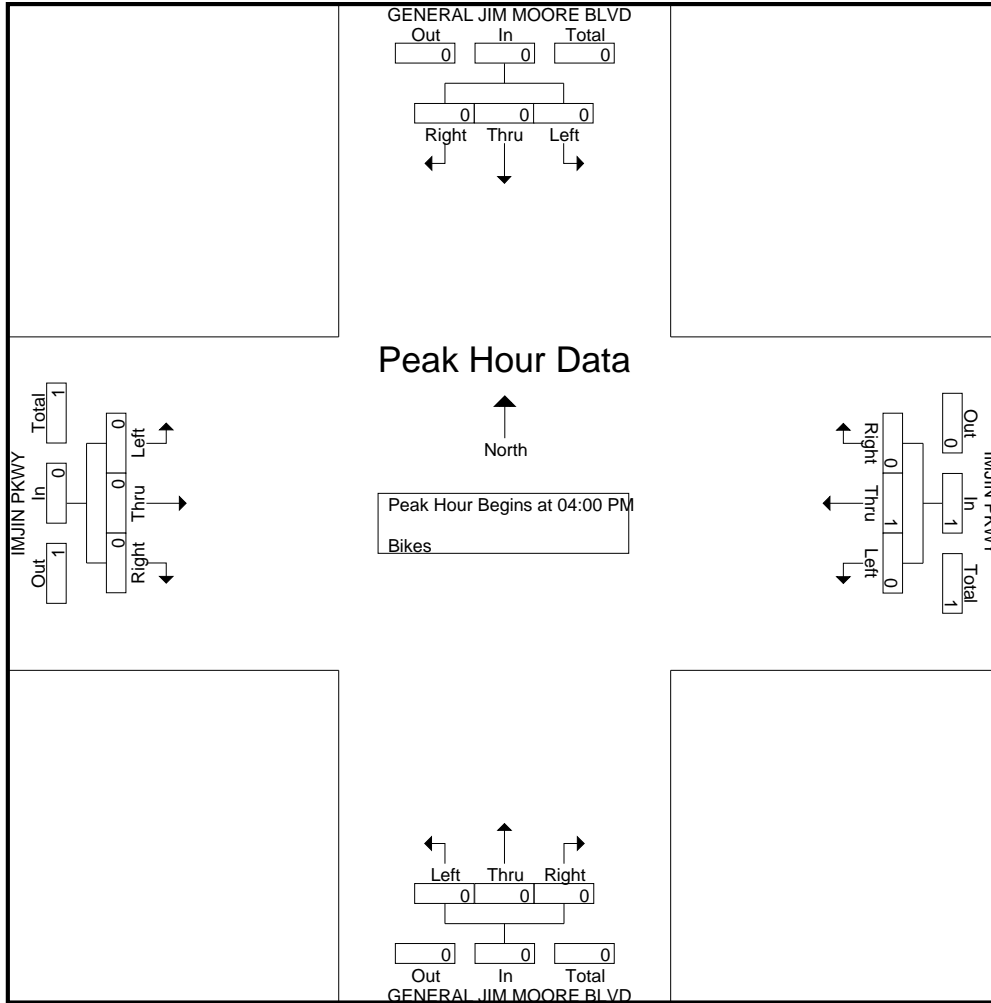

Traffic Data Service

San Jose, CA
 (408) 622-4787
 tdsbay@cs.com

File Name : 6AM FINAL
 Site Code : 00000006
 Start Date : 4/27/2017
 Page No : 1

Groups Printed- Lights - Buses - Trucks

Start Time	CALIFORNIA AVE Southbound					IMJIN PKWY Westbound					CALIFORNIA DR Northbound					IMJIN PKWY Eastbound					Int. Total
	Right	Thru	Left	Peds	App. Total	Right	Thru	Left	Peds	App. Total	Right	Thru	Left	Peds	App. Total	Right	Thru	Left	Peds	App. Total	
07:00 AM	93	8	8	0	109	8	278	0	0	286	0	4	9	0	13	3	131	13	0	147	555
07:15 AM	107	30	10	0	147	9	284	0	0	293	0	1	4	0	5	3	146	25	1	175	620
07:30 AM	102	46	18	0	166	17	236	2	0	255	0	1	2	0	3	3	210	28	1	242	666
07:45 AM	102	42	29	0	173	21	198	1	0	220	1	5	3	0	9	8	192	39	0	239	641
Total	404	126	65	0	595	55	996	3	0	1054	1	11	18	0	30	17	679	105	2	803	2482
08:00 AM	78	28	13	0	119	11	213	1	0	225	0	3	3	0	6	6	213	21	0	240	590
08:15 AM	65	15	9	0	89	7	250	1	0	258	1	2	2	0	5	5	187	21	0	213	565
08:30 AM	62	7	12	0	81	4	252	0	0	256	0	1	5	0	6	1	161	14	1	177	520
08:45 AM	63	4	10	0	77	9	215	1	0	225	0	2	1	0	3	2	138	17	1	158	463
Total	268	54	44	0	366	31	930	3	0	964	1	8	11	0	20	14	699	73	2	788	2138
Grand Total	672	180	109	0	961	86	1926	6	0	2018	2	19	29	0	50	31	1378	178	4	1591	4620
Apprch %	69.9	18.7	11.3	0		4.3	95.4	0.3	0		4	38	58	0		1.9	86.6	11.2	0.3		
Total %	14.5	3.9	2.4	0	20.8	1.9	41.7	0.1	0	43.7	0	0.4	0.6	0	1.1	0.7	29.8	3.9	0.1	34.4	
Lights	665	177	108	0	950	82	1871	6	0	1959	2	19	20	0	41	31	1354	175	4	1564	4514
% Lights	99	98.3	99.1	0	98.9	95.3	97.1	100	0	97.1	100	100	69	0	82	100	98.3	98.3	100	98.3	97.7
Buses	4	2	0	0	6	3	12	0	0	15	0	0	1	0	1	0	10	3	0	13	35
% Buses	0.6	1.1	0	0	0.6	3.5	0.6	0	0	0.7	0	0	3.4	0	2	0	0.7	1.7	0	0.8	0.8
Trucks	3	1	1	0	5	1	43	0	0	44	0	0	8	0	8	0	14	0	0	14	71
% Trucks	0.4	0.6	0.9	0	0.5	1.2	2.2	0	0	2.2	0	0	27.6	0	16	0	1	0	0	0.9	1.5

Start Time	CALIFORNIA AVE Southbound				IMJIN PKWY Westbound				CALIFORNIA DR Northbound				IMJIN PKWY Eastbound				Int. Total
	Right	Thru	Left	App. Total	Right	Thru	Left	App. Total	Right	Thru	Left	App. Total	Right	Thru	Left	App. Total	
Peak Hour Analysis From 07:00 AM to 08:45 AM - Peak 1 of 1																	
Peak Hour for Entire Intersection Begins at 07:15 AM																	
07:15 AM	107	30	10	147	9	284	0	293	0	1	4	5	3	146	25	174	619
07:30 AM	102	46	18	166	17	236	2	255	0	1	2	3	3	210	28	241	665
07:45 AM	102	42	29	173	21	198	1	220	1	5	3	9	8	192	39	239	641
08:00 AM	78	28	13	119	11	213	1	225	0	3	3	6	6	213	21	240	590
Total Volume	389	146	70	605	58	931	4	993	1	10	12	23	20	761	113	894	2515
% App. Total	64.3	24.1	11.6		5.8	93.8	0.4		4.3	43.5	52.2		2.2	85.1	12.6		
PHF	.909	.793	.603	.874	.690	.820	.500	.847	.250	.500	.750	.639	.625	.893	.724	.927	.945

Traffic Data Service

San Jose, CA
 (408) 622-4787
 tdsbay@cs.com

File Name : 6AM FINAL
 Site Code : 00000006
 Start Date : 4/27/2017
 Page No : 2

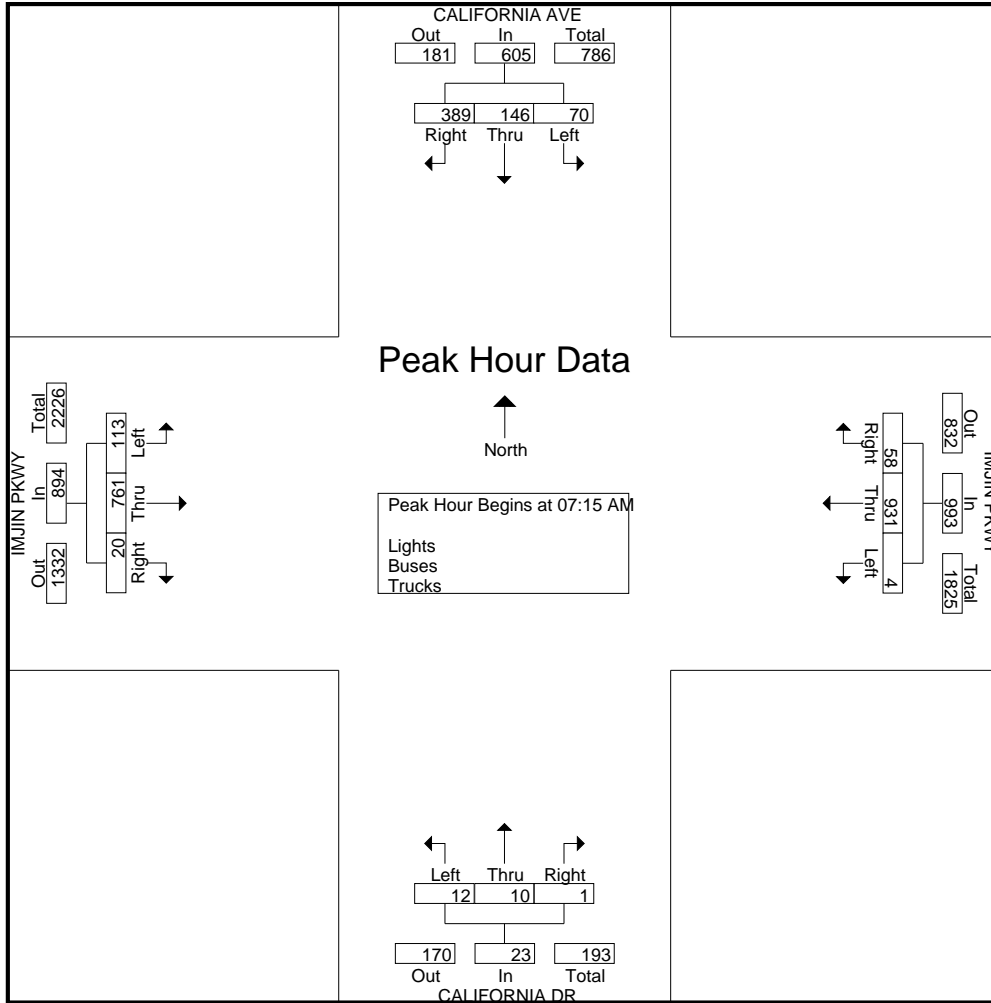

Traffic Data Service

San Jose, CA
 (408) 622-4787
 tdsbay@cs.com

File Name : 6AM FINAL
 Site Code : 00000006
 Start Date : 4/27/2017
 Page No : 1

Groups Printed- Bikes

Start Time	CALIFORNIA AVE Southbound					IMJIN PKWY Westbound					CALIFORNIA DR Northbound					IMJIN PKWY Eastbound					Int. Total
	Right	Thru	Left	Peds	App. Total	Right	Thru	Left	Peds	App. Total	Right	Thru	Left	Peds	App. Total	Right	Thru	Left	Peds	App. Total	
07:00 AM	0	1	0	0	1	0	0	0	0	0	0	0	0	0	0	0	0	0	0	0	0
07:15 AM	1	0	0	0	1	0	0	0	0	0	0	1	0	0	1	0	0	0	0	0	0
07:30 AM	0	0	0	0	0	0	0	0	0	0	0	0	0	0	0	0	1	0	0	1	1
07:45 AM	0	0	0	0	0	0	0	0	0	0	0	0	0	0	0	0	0	0	0	0	0
Total	1	1	0	0	2	0	0	0	0	0	0	1	0	0	1	0	1	0	0	1	4
08:00 AM	0	0	0	0	0	0	0	0	0	0	0	0	0	0	0	0	0	0	0	0	0
08:15 AM	0	0	0	0	0	0	0	0	0	0	0	0	0	0	0	0	0	0	0	0	0
08:30 AM	0	0	0	0	0	0	0	0	0	0	0	0	0	0	0	0	3	0	0	3	3
08:45 AM	0	0	0	0	0	0	0	0	0	0	0	0	0	0	0	0	1	0	0	1	1
Total	0	0	0	0	0	0	0	0	0	0	0	0	0	0	0	0	4	0	0	4	4
Grand Total	1	1	0	0	2	0	0	0	0	0	0	1	0	0	1	0	5	0	0	5	8
Apprch %	50	50	0	0		0	0	0	0		0	100	0	0		0	100	0	0		
Total %	12.5	12.5	0	0	25	0	0	0	0	0	0	12.5	0	0	12.5	0	62.5	0	0	62.5	

Start Time	CALIFORNIA AVE Southbound				IMJIN PKWY Westbound				CALIFORNIA DR Northbound				IMJIN PKWY Eastbound				Int. Total
	Right	Thru	Left	App. Total	Right	Thru	Left	App. Total	Right	Thru	Left	App. Total	Right	Thru	Left	App. Total	
Peak Hour Analysis From 07:00 AM to 08:45 AM - Peak 1 of 1																	
Peak Hour for Entire Intersection Begins at 07:00 AM																	
07:00 AM	0	1	0	1	0	0	0	0	0	0	0	0	0	0	0	0	1
07:15 AM	1	0	0	1	0	0	0	0	0	1	0	1	0	0	0	0	2
07:30 AM	0	0	0	0	0	0	0	0	0	0	0	0	0	1	0	1	1
07:45 AM	0	0	0	0	0	0	0	0	0	0	0	0	0	0	0	0	0
Total Volume	1	1	0	2	0	0	0	0	0	1	0	1	0	1	0	1	4
% App. Total	50	50	0		0	0	0		0	100	0		0	100	0		
PHF	.250	.250	.000	.500	.000	.000	.000	.000	.000	.250	.000	.250	.000	.250	.000	.250	.500

Traffic Data Service

San Jose, CA
 (408) 622-4787
 tdsbay@cs.com

File Name : 6AM FINAL
 Site Code : 00000006
 Start Date : 4/27/2017
 Page No : 2

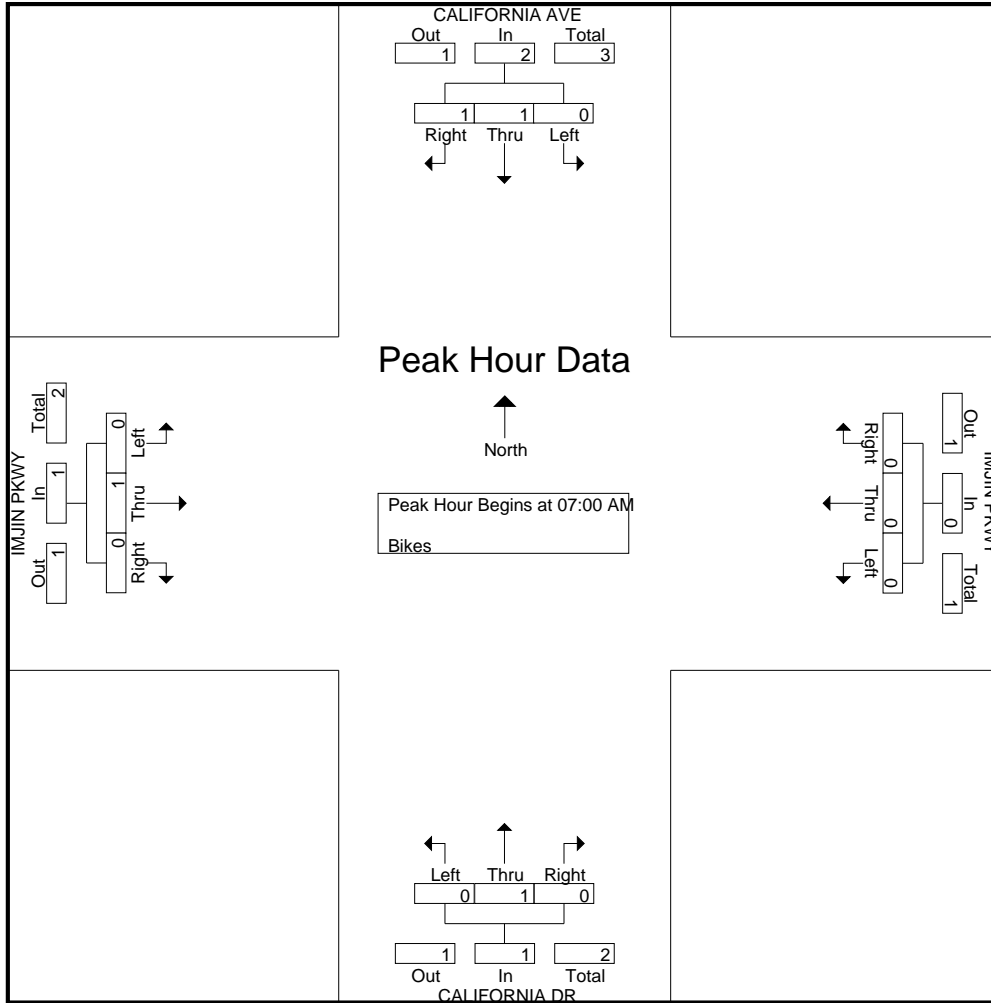

Traffic Data Service

San Jose, CA
 (408) 622-4787
 tdsbay@cs.com

File Name : 6PM FINAL
 Site Code : 00000006
 Start Date : 4/27/2017
 Page No : 1

Groups Printed- Lights - Buses - Trucks

Start Time	CALIFORNIA AVE Southbound					IMJIN PKWY Westbound					CALIFORNIA DR Northbound					IMJIN PKWY Eastbound					Int. Total
	Right	Thru	Left	Peds	App. Total	Right	Thru	Left	Peds	App. Total	Right	Thru	Left	Peds	App. Total	Right	Thru	Left	Peds	App. Total	
04:00 PM	40	9	6	0	55	9	205	1	0	215	1	6	5	1	13	1	256	54	0	311	594
04:15 PM	34	6	9	0	49	11	210	0	0	221	1	8	1	0	10	1	274	58	2	335	615
04:30 PM	42	5	5	0	52	7	224	1	0	232	3	8	3	0	14	2	243	60	0	305	603
04:45 PM	51	3	7	1	62	16	203	1	0	220	0	7	4	0	11	1	253	58	0	312	605
Total	167	23	27	1	218	43	842	3	0	888	5	29	13	1	48	5	1026	230	2	1263	2417
05:00 PM	54	8	11	0	73	19	240	0	0	259	2	9	1	1	13	1	285	65	0	351	696
05:15 PM	42	4	5	0	51	20	268	0	0	288	1	10	5	1	17	0	267	69	1	337	693
05:30 PM	56	5	9	0	70	23	250	2	1	276	1	10	2	1	14	2	253	57	0	312	672
05:45 PM	48	8	12	0	68	6	237	0	0	243	0	9	4	0	13	1	248	64	0	313	637
Total	200	25	37	0	262	68	995	2	1	1066	4	38	12	3	57	4	1053	255	1	1313	2698
Grand Total	367	48	64	1	480	111	1837	5	1	1954	9	67	25	4	105	9	2079	485	3	2576	5115
Apprch %	76.5	10	13.3	0.2		5.7	94	0.3	0.1		8.6	63.8	23.8	3.8		0.3	80.7	18.8	0.1		
Total %	7.2	0.9	1.3	0	9.4	2.2	35.9	0.1	0	38.2	0.2	1.3	0.5	0.1	2.1	0.2	40.6	9.5	0.1	50.4	
Lights	359	47	64	1	471	110	1803	5	1	1919	9	67	25	4	105	9	2049	481	3	2542	5037
% Lights	97.8	97.9	100	100	98.1	99.1	98.1	100	100	98.2	100	100	100	100	100	100	98.6	99.2	100	98.7	98.5
Buses	4	1	0	0	5	0	16	0	0	16	0	0	0	0	0	0	3	0	0	3	24
% Buses	1.1	2.1	0	0	1	0	0.9	0	0	0.8	0	0	0	0	0	0	0.1	0	0	0.1	0.5
Trucks	4	0	0	0	4	1	18	0	0	19	0	0	0	0	0	0	27	4	0	31	54
% Trucks	1.1	0	0	0	0.8	0.9	1	0	0	1	0	0	0	0	0	0	1.3	0.8	0	1.2	1.1

Start Time	CALIFORNIA AVE Southbound					IMJIN PKWY Westbound					CALIFORNIA DR Northbound					IMJIN PKWY Eastbound					Int. Total
	Right	Thru	Left	Peds	App. Total	Right	Thru	Left	Peds	App. Total	Right	Thru	Left	Peds	App. Total	Right	Thru	Left	Peds	App. Total	
Peak Hour Analysis From 04:00 PM to 05:45 PM - Peak 1 of 1																					
Peak Hour for Entire Intersection Begins at 05:00 PM																					
05:00 PM	54	8	11		73	19	240	0	0	259	2	9	1	1	12	1	285	65	351	695	
05:15 PM	42	4	5		51	20	268	0	0	288	1	10	5	16		0	267	69	336	691	
05:30 PM	56	5	9		70	23	250	2	1	275	1	10	2	13		2	253	57	312	670	
05:45 PM	48	8	12		68	6	237	0	0	243	0	9	4	13		1	248	64	313	637	
Total Volume	200	25	37		262	68	995	2	1	1065	4	38	12	54		4	1053	255	1312	2693	
% App. Total	76.3	9.5	14.1			6.4	93.4	0.2			7.4	70.4	22.2			0.3	80.3	19.4			
PHF	.893	.781	.771		.897	.739	.928	.250		.924	.500	.950	.600	.844		.500	.924	.924	.934	.969	

Traffic Data Service

San Jose, CA
 (408) 622-4787
 tdsbay@cs.com

File Name : 6PM FINAL
 Site Code : 00000006
 Start Date : 4/27/2017
 Page No : 2

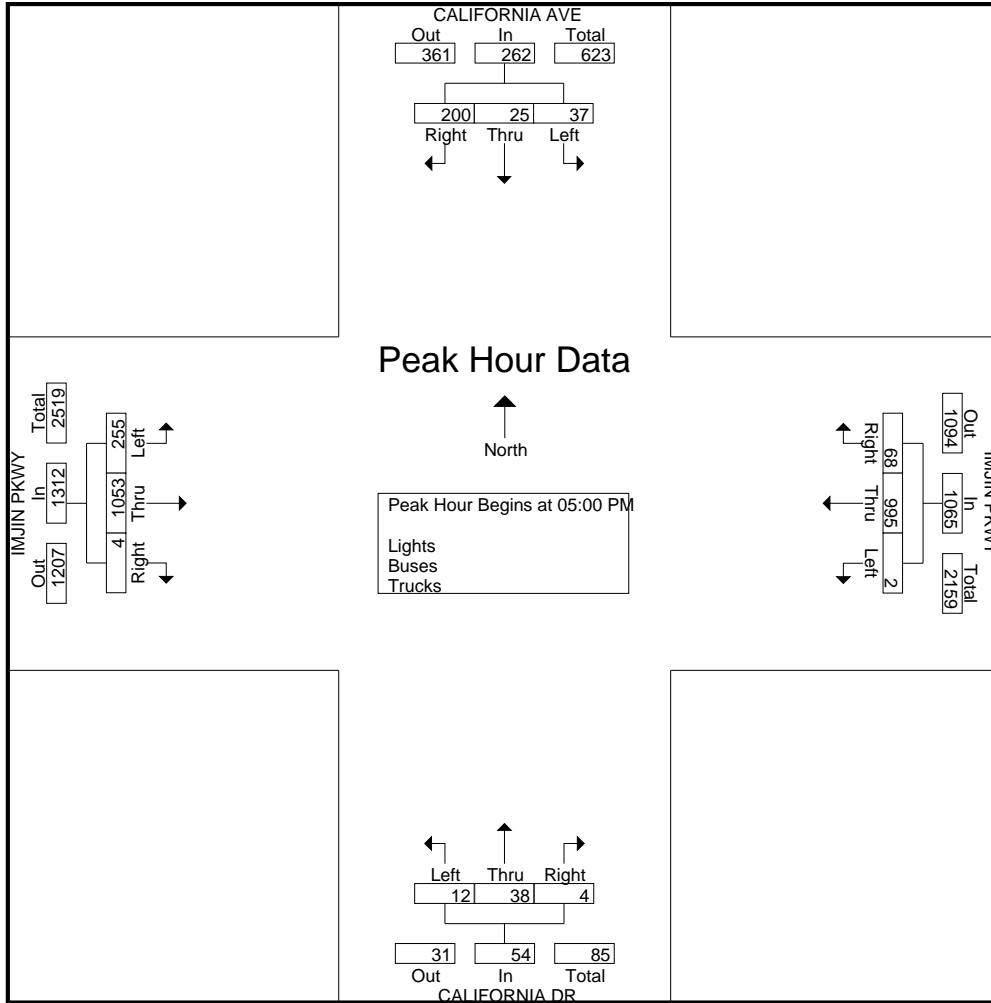

Traffic Data Service

San Jose, CA
 (408) 622-4787
 tdsbay@cs.com

File Name : 6PM FINAL
 Site Code : 00000006
 Start Date : 4/27/2017
 Page No : 1

Groups Printed- Bikes

Start Time	CALIFORNIA AVE Southbound					IMJIN PKWY Westbound					CALIFORNIA DR Northbound					IMJIN PKWY Eastbound					Int. Total
	Right	Thru	Left	Peds	App. Total	Right	Thru	Left	Peds	App. Total	Right	Thru	Left	Peds	App. Total	Right	Thru	Left	Peds	App. Total	
04:00 PM	0	0	0	0	0	0	0	0	0	0	0	0	0	0	0	0	0	0	0	0	0
04:15 PM	0	0	0	0	0	0	1	0	0	1	0	0	0	0	0	0	0	0	0	0	0
04:30 PM	0	0	0	0	0	0	0	0	0	0	0	0	0	0	0	0	0	0	0	0	0
04:45 PM	0	0	0	0	0	0	0	0	0	0	0	0	0	0	0	0	0	0	0	0	0
Total	0	0	0	0	0	0	1	0	0	1	0	0	0	0	0	0	0	0	0	0	1
05:00 PM	0	0	0	0	0	0	0	0	0	0	0	0	0	0	0	0	0	0	0	0	0
05:15 PM	0	0	0	0	0	0	0	0	0	0	0	0	0	0	0	0	0	0	0	0	0
05:30 PM	0	0	0	0	0	0	0	0	0	0	0	0	0	0	0	0	0	0	0	0	0
05:45 PM	0	1	0	0	1	0	0	0	0	0	0	0	0	0	0	0	0	0	0	0	1
Total	0	1	0	0	1	0	0	0	0	0	0	0	0	0	0	0	0	0	0	0	1
Grand Total	0	1	0	0	1	0	1	0	0	1	0	0	0	0	0	0	0	0	0	0	2
Apprch %	0	100	0	0		0	100	0	0		0	0	0	0		0	0	0	0		
Total %	0	50	0	0	50	0	50	0	0	50	0	0	0	0	0	0	0	0	0	0	

Start Time	CALIFORNIA AVE Southbound				IMJIN PKWY Westbound				CALIFORNIA DR Northbound				IMJIN PKWY Eastbound				Int. Total
	Right	Thru	Left	App. Total	Right	Thru	Left	App. Total	Right	Thru	Left	App. Total	Right	Thru	Left	App. Total	
Peak Hour Analysis From 04:00 PM to 05:45 PM - Peak 1 of 1																	
Peak Hour for Entire Intersection Begins at 04:00 PM																	
04:00 PM	0	0	0	0	0	0	0	0	0	0	0	0	0	0	0	0	0
04:15 PM	0	0	0	0	0	1	0	1	0	0	0	0	0	0	0	0	1
04:30 PM	0	0	0	0	0	0	0	0	0	0	0	0	0	0	0	0	0
04:45 PM	0	0	0	0	0	0	0	0	0	0	0	0	0	0	0	0	0
Total Volume	0	0	0	0	0	1	0	1	0	0	0	0	0	0	0	0	1
% App. Total	0	0	0		0	100	0		0	0	0		0	0	0		
PHF	.000	.000	.000	.000	.000	.250	.000	.250	.000	.000	.000	.000	.000	.000	.000	.000	.250

Traffic Data Service

San Jose, CA
(408) 622-4787
tdsbay@cs.com

File Name : 6PM FINAL
Site Code : 00000006
Start Date : 4/27/2017
Page No : 2

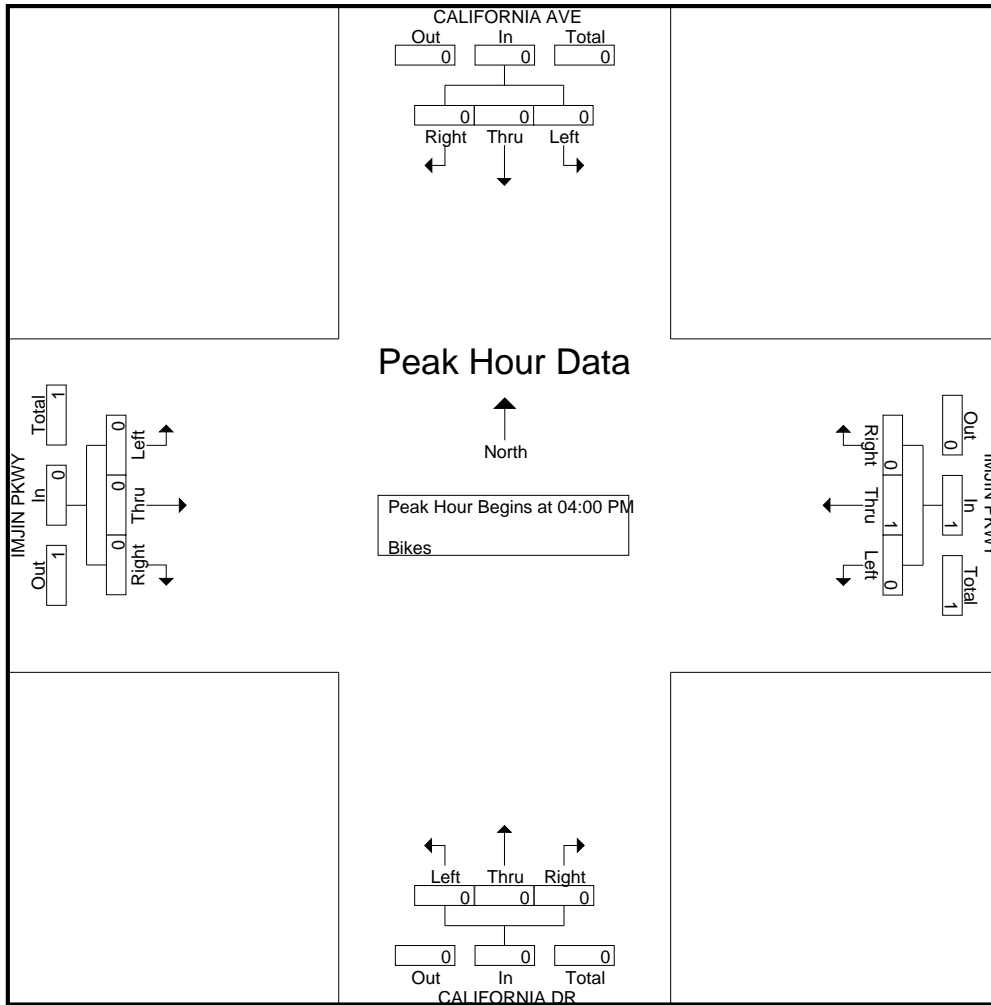

Traffic Data Service

San Jose, CA
 (408) 622-4787
 tdsbay@cs.com

File Name : 7AM FINAL
 Site Code : 00000007
 Start Date : 4/27/2017
 Page No : 1

Groups Printed- Lights - Buses - Trucks

Start Time	Southbound					IMJIN PKWY Westbound					IMJIN RD Northbound					IMJIN PKWY Eastbound					Int. Total
	Right	Thru	Left	Peds	App. Total	Right	Thru	Left	Peds	App. Total	Right	Thru	Left	Peds	App. Total	Right	Thru	Left	Peds	App. Total	
07:00 AM	0	0	0	0	0	0	296	18	0	314	6	0	2	0	8	11	124	0	0	135	457
07:15 AM	0	0	0	0	0	0	299	47	0	346	4	0	3	0	7	16	121	0	0	137	490
07:30 AM	0	0	0	0	0	0	257	72	0	329	11	0	4	2	17	31	179	0	0	210	556
07:45 AM	0	0	0	0	0	0	248	65	0	313	7	0	4	0	11	39	196	0	0	235	559
Total	0	0	0	0	0	0	1100	202	0	1302	28	0	13	2	43	97	620	0	0	717	2062
08:00 AM	0	0	0	0	0	0	209	44	0	253	13	0	5	0	18	28	183	0	0	211	482
08:15 AM	0	0	0	0	0	0	260	35	0	295	10	0	7	0	17	32	179	0	0	211	523
08:30 AM	0	0	0	0	0	0	251	30	0	281	10	0	3	0	13	18	161	0	0	179	473
08:45 AM	0	0	0	0	0	0	208	27	0	235	8	0	13	0	21	17	134	0	0	151	407
Total	0	0	0	0	0	0	928	136	0	1064	41	0	28	0	69	95	657	0	0	752	1885
Grand Total	0	0	0	0	0	0	2028	338	0	2366	69	0	41	2	112	192	1277	0	0	1469	3947
Apprch %	0	0	0	0	0	0	85.7	14.3	0	2366	61.6	0	36.6	1.8	112	13.1	86.9	0	0	1469	3947
Total %	0	0	0	0	0	0	51.4	8.6	0	59.9	1.7	0	1	0.1	2.8	4.9	32.4	0	0	37.2	
Lights	0	0	0	0	0	0	1977	332	0	2309	68	0	32	2	102	188	1250	0	0	1438	3849
% Lights	0	0	0	0	0	0	97.5	98.2	0	97.6	98.6	0	78	100	91.1	97.9	97.9	0	0	97.9	97.5
Buses	0	0	0	0	0	0	9	1	0	10	0	0	5	0	5	1	9	0	0	10	25
% Buses	0	0	0	0	0	0	0.4	0.3	0	0.4	0	0	12.2	0	4.5	0.5	0.7	0	0	0.7	0.6
Trucks	0	0	0	0	0	0	42	5	0	47	1	0	4	0	5	3	18	0	0	21	73
% Trucks	0	0	0	0	0	0	2.1	1.5	0	2	1.4	0	9.8	0	4.5	1.6	1.4	0	0	1.4	1.8

Start Time	Southbound					IMJIN PKWY Westbound					IMJIN RD Northbound					IMJIN PKWY Eastbound					Int. Total
	Right	Thru	Left	Peds	App. Total	Right	Thru	Left	Peds	App. Total	Right	Thru	Left	Peds	App. Total	Right	Thru	Left	Peds	App. Total	
Peak Hour Analysis From 07:00 AM to 08:45 AM - Peak 1 of 1																					
Peak Hour for Entire Intersection Begins at 07:30 AM																					
07:30 AM	0	0	0	0	0	0	257	72	329	11	0	4	15	31	179	0	0	210	554		
07:45 AM	0	0	0	0	0	0	248	65	313	7	0	4	11	39	196	0	0	235	559		
08:00 AM	0	0	0	0	0	0	209	44	253	13	0	5	18	28	183	0	0	211	482		
08:15 AM	0	0	0	0	0	0	260	35	295	10	0	7	17	32	179	0	0	211	523		
Total Volume	0	0	0	0	0	0	974	216	1190	41	0	20	61	130	737	0	0	867	2118		
% App. Total	0	0	0	0	0	0	81.8	18.2		67.2	0	32.8		15	85	0	0				
PHF	.000	.000	.000	.000	.000	.000	.937	.750	.904	.788	.000	.714	.847	.833	.940	.000	.922	.947			

Traffic Data Service

San Jose, CA
 (408) 622-4787
 tdsbay@cs.com

File Name : 7AM FINAL
 Site Code : 00000007
 Start Date : 4/27/2017
 Page No : 2

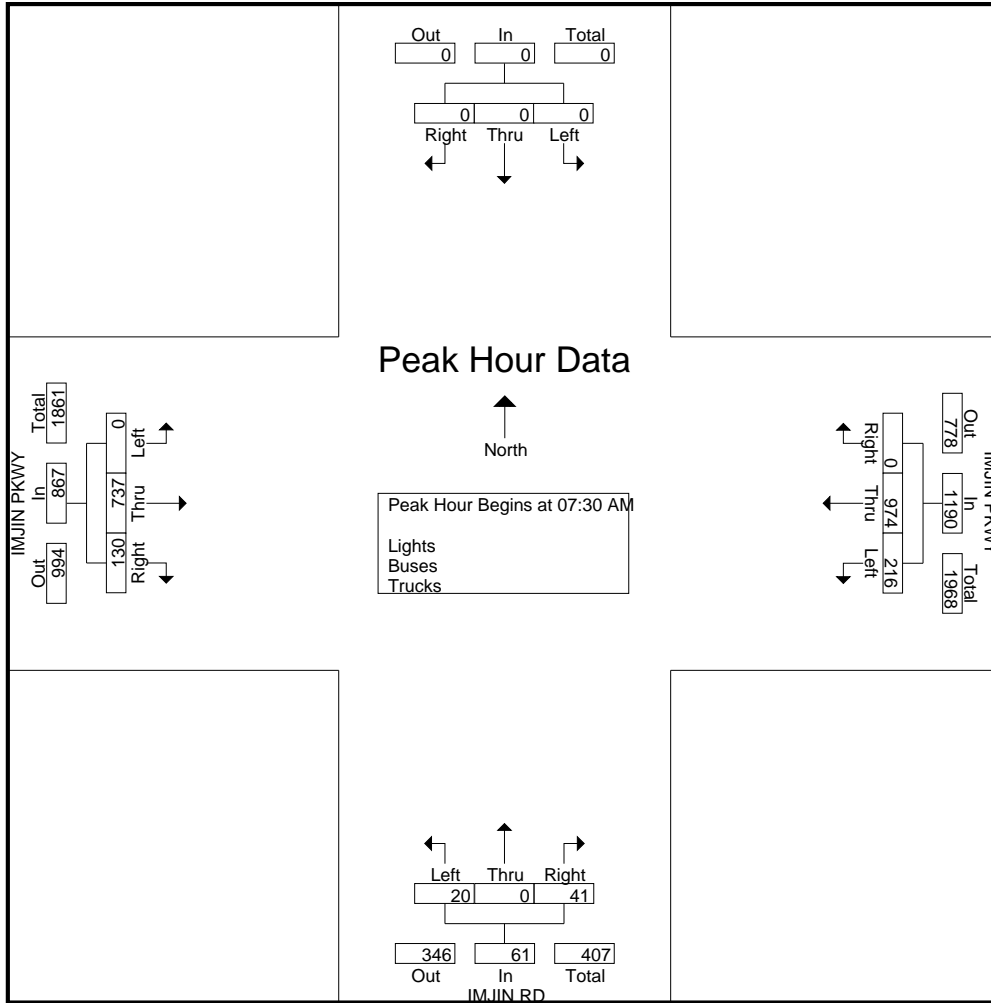

Traffic Data Service

San Jose, CA
 (408) 622-4787
 tdsbay@cs.com

File Name : 7AM FINAL
 Site Code : 00000007
 Start Date : 4/27/2017
 Page No : 1

Groups Printed- Bikes

Start Time	Southbound					IMJIN PKWY Westbound					IMJIN RD Northbound					IMJIN PKWY Eastbound					Int. Total
	Right	Thru	Left	Peds	App. Total	Right	Thru	Left	Peds	App. Total	Right	Thru	Left	Peds	App. Total	Right	Thru	Left	Peds	App. Total	
07:00 AM	0	0	0	0	0	0	0	0	0	0	0	0	0	0	0	0	0	0	0	0	0
07:15 AM	0	0	0	0	0	0	0	0	0	0	0	0	0	0	0	0	0	0	0	0	0
07:30 AM	0	0	0	0	0	0	0	0	0	0	0	0	0	0	0	0	0	0	0	0	0
07:45 AM	0	0	0	0	0	0	0	0	0	0	0	0	0	0	0	0	0	0	0	0	0
Total	0	0	0	0	0	0	0	0	0	0	0	0	0	0	0	0	0	0	0	0	0
08:00 AM	0	0	0	0	0	0	0	0	0	0	0	0	0	0	0	0	0	0	0	0	0
08:15 AM	0	0	0	0	0	0	0	0	0	0	0	0	0	0	0	0	0	0	0	0	0
08:30 AM	0	0	0	0	0	0	0	0	0	0	0	0	0	0	0	0	0	0	0	0	0
08:45 AM	0	0	0	0	0	0	0	0	0	0	0	0	0	0	0	0	0	0	0	0	0
Total	0	0	0	0	0	0	0	0	0	0	0	0	0	0	0	0	0	0	0	0	0
Grand Total	0	0	0	0	0	0	0	0	0	0	0	0	0	0	0	0	0	0	0	0	0
Apprch %	0	0	0	0		0	0	0	0		0	0	0	0		0	0	0	0		
Total %																					

Start Time	Southbound					IMJIN PKWY Westbound					IMJIN RD Northbound					IMJIN PKWY Eastbound					Int. Total
	Right	Thru	Left	Peds	App. Total	Right	Thru	Left	Peds	App. Total	Right	Thru	Left	Peds	App. Total	Right	Thru	Left	Peds	App. Total	
Peak Hour Analysis From 07:00 AM to 08:45 AM - Peak 1 of 1																					
Peak Hour for Entire Intersection Begins at 07:00 AM																					
07:00 AM	0	0	0	0	0	0	0	0	0	0	0	0	0	0	0	0	0	0	0	0	0
07:15 AM	0	0	0	0	0	0	0	0	0	0	0	0	0	0	0	0	0	0	0	0	0
07:30 AM	0	0	0	0	0	0	0	0	0	0	0	0	0	0	0	0	0	0	0	0	0
07:45 AM	0	0	0	0	0	0	0	0	0	0	0	0	0	0	0	0	0	0	0	0	0
Total Volume	0	0	0	0	0	0	0	0	0	0	0	0	0	0	0	0	0	0	0	0	0
% App. Total	0	0	0	0		0	0	0	0		0	0	0	0		0	0	0	0		
PHF	.000	.000	.000	.000	.000	.000	.000	.000	.000	.000	.000	.000	.000	.000	.000	.000	.000	.000	.000	.000	.000

Traffic Data Service

San Jose, CA
(408) 622-4787
tdsbay@cs.com

File Name : 7AM FINAL
Site Code : 00000007
Start Date : 4/27/2017
Page No : 2

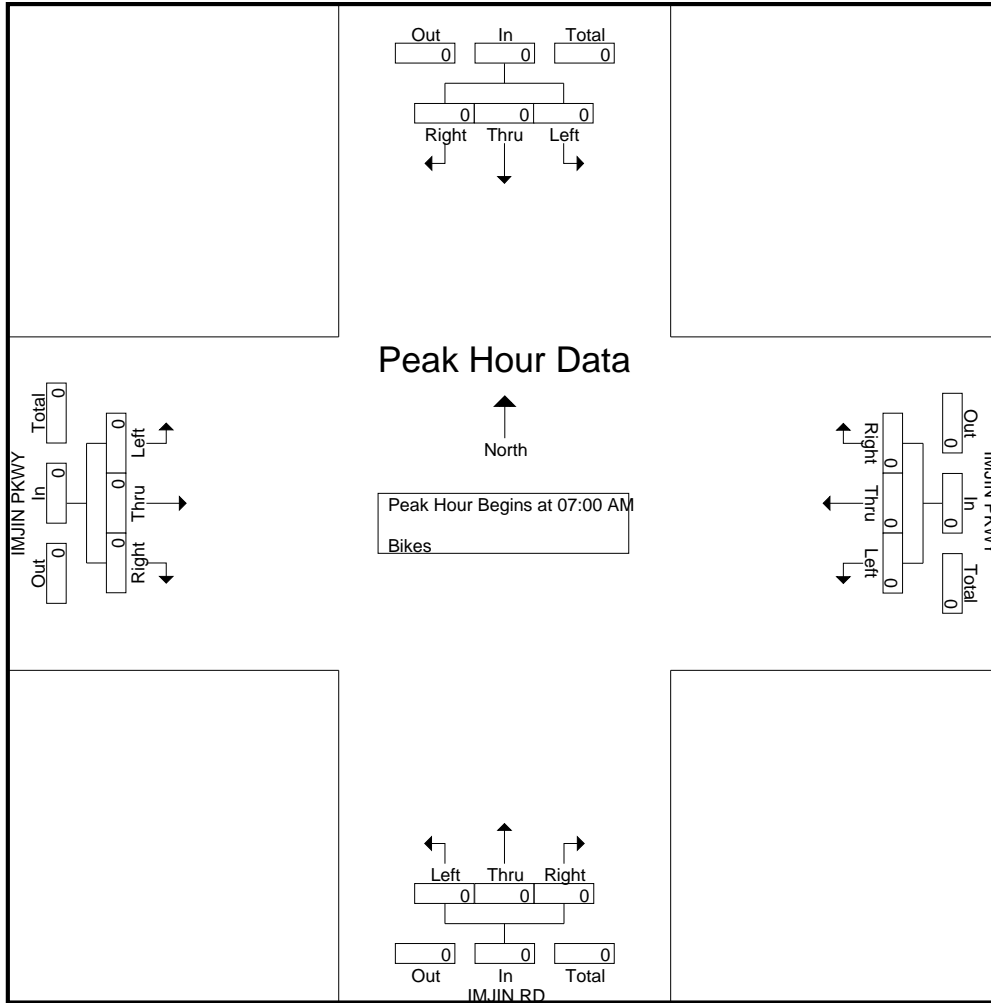

Traffic Data Service

San Jose, CA
 (408) 622-4787
 tdsbay@cs.com

File Name : 7PM FINAL
 Site Code : 00000007
 Start Date : 4/27/2017
 Page No : 1

Groups Printed- Lights - Buses - Trucks

Start Time	Southbound					IMJIN PKWY Westbound					IMJIN RD Northbound					IMJIN PKWY Eastbound					Int. Total
	Right	Thru	Left	Peds	App. Total	Right	Thru	Left	Peds	App. Total	Right	Thru	Left	Peds	App. Total	Right	Thru	Left	Peds	App. Total	
04:00 PM	0	0	0	0	0	0	194	23	0	217	29	0	27	1	57	11	254	0	0	265	539
04:15 PM	0	0	0	0	0	0	197	11	0	208	12	0	19	0	31	5	271	0	0	276	515
04:30 PM	0	0	0	0	0	0	213	15	0	228	23	0	16	0	39	13	242	0	0	255	522
04:45 PM	0	0	0	0	0	0	211	18	0	229	24	0	29	0	53	10	254	0	0	264	546
Total	0	0	0	0	0	0	815	67	0	882	88	0	91	1	180	39	1021	0	0	1060	2122
05:00 PM	0	0	0	0	0	0	219	12	0	231	21	0	34	0	55	14	268	0	0	282	568
05:15 PM	0	0	0	0	0	0	258	20	0	278	28	0	31	0	59	11	257	0	0	268	605
05:30 PM	0	0	0	0	0	0	219	22	0	241	25	0	43	0	68	10	256	0	0	266	575
05:45 PM	0	0	0	0	0	0	205	20	0	225	20	0	28	0	48	19	255	0	0	274	547
Total	0	0	0	0	0	0	901	74	0	975	94	0	136	0	230	54	1036	0	0	1090	2295
Grand Total	0	0	0	0	0	0	1716	141	0	1857	182	0	227	1	410	93	2057	0	0	2150	4417
Apprch %	0	0	0	0	0	0	92.4	7.6	0		44.4	0	55.4	0.2		4.3	95.7	0	0		
Total %	0	0	0	0	0	0	38.8	3.2	0	42	4.1	0	5.1	0	9.3	2.1	46.6	0	0	48.7	
Lights	0	0	0	0	0	0	1691	140	0	1831	181	0	221	1	403	92	2033	0	0	2125	4359
% Lights	0	0	0	0	0	0	98.5	99.3	0	98.6	99.5	0	97.4	100	98.3	98.9	98.8	0	0	98.8	98.7
Buses	0	0	0	0	0	0	8	0	0	8	0	0	5	0	5	0	4	0	0	4	17
% Buses	0	0	0	0	0	0	0.5	0	0	0.4	0	0	2.2	0	1.2	0	0.2	0	0	0.2	0.4
Trucks	0	0	0	0	0	0	17	1	0	18	1	0	1	0	2	1	20	0	0	21	41
% Trucks	0	0	0	0	0	0	1	0.7	0	1	0.5	0	0.4	0	0.5	1.1	1	0	0	1	0.9

Start Time	Southbound				IMJIN PKWY Westbound				IMJIN RD Northbound				IMJIN PKWY Eastbound				Int. Total
	Right	Thru	Left	App. Total	Right	Thru	Left	App. Total	Right	Thru	Left	App. Total	Right	Thru	Left	App. Total	
Peak Hour Analysis From 04:00 PM to 05:45 PM - Peak 1 of 1																	
Peak Hour for Entire Intersection Begins at 05:00 PM																	
05:00 PM	0	0	0	0	0	219	12	231	21	0	34	55	14	268	0	282	568
05:15 PM	0	0	0	0	0	258	20	278	28	0	31	59	11	257	0	268	605
05:30 PM	0	0	0	0	0	219	22	241	25	0	43	68	10	256	0	266	575
05:45 PM	0	0	0	0	0	205	20	225	20	0	28	48	19	255	0	274	547
Total Volume	0	0	0	0	0	901	74	975	94	0	136	230	54	1036	0	1090	2295
% App. Total	0	0	0	0	0	92.4	7.6		40.9	0	59.1		5	95	0		
PHF	.000	.000	.000	.000	.000	.873	.841	.877	.839	.000	.791	.846	.711	.966	.000	.966	.948

Traffic Data Service

San Jose, CA
 (408) 622-4787
 tdsbay@cs.com

File Name : 7PM FINAL
 Site Code : 00000007
 Start Date : 4/27/2017
 Page No : 2

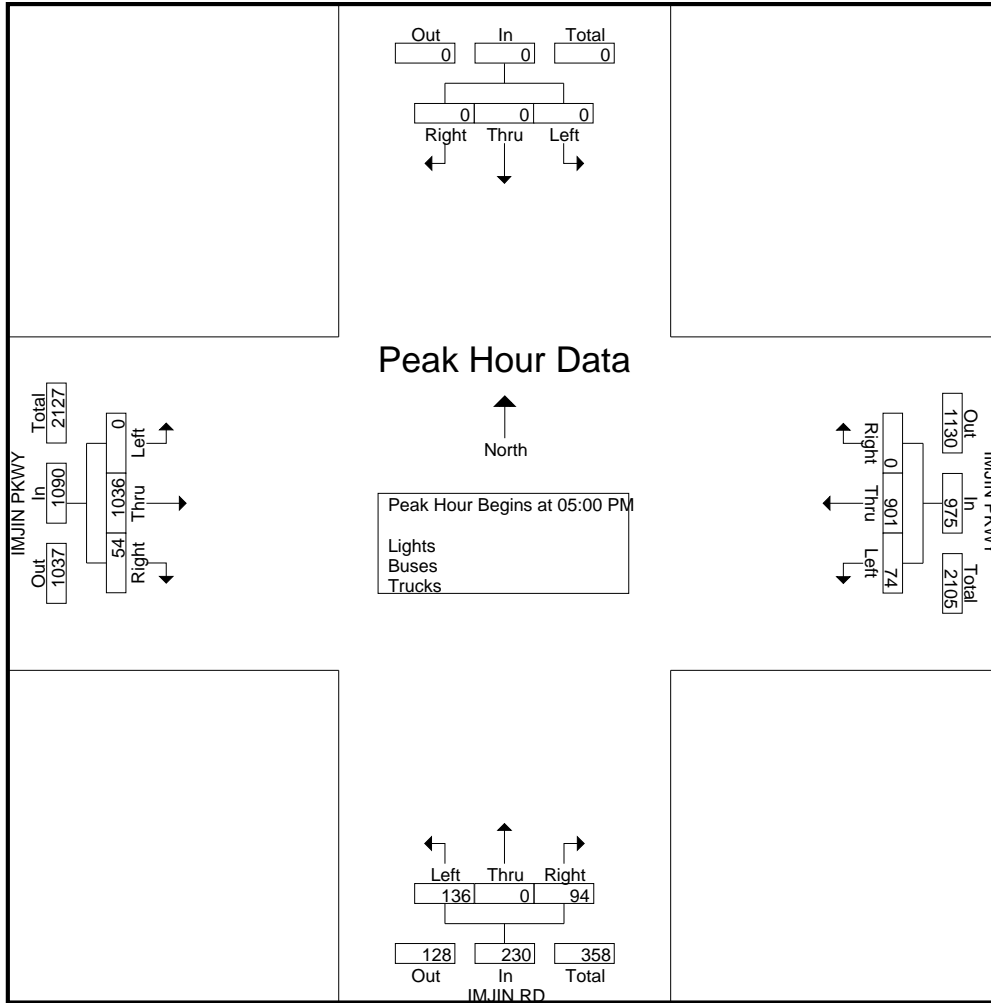

Traffic Data Service

San Jose, CA
 (408) 622-4787
 tdsbay@cs.com

File Name : 7PM FINAL
 Site Code : 00000007
 Start Date : 4/27/2017
 Page No : 1

Groups Printed- Bikes

Start Time	Southbound					IMJIN PKWY Westbound					IMJIN RD Northbound					IMJIN PKWY Eastbound					Int. Total
	Right	Thru	Left	Peds	App. Total	Right	Thru	Left	Peds	App. Total	Right	Thru	Left	Peds	App. Total	Right	Thru	Left	Peds	App. Total	
04:00 PM	0	0	0	0	0	0	0	0	0	0	0	0	0	0	0	0	0	0	0	0	0
04:15 PM	0	0	0	0	0	0	1	0	0	1	1	0	0	0	1	0	0	0	0	0	2
04:30 PM	0	0	0	0	0	0	0	0	0	0	0	0	0	0	0	0	0	0	0	0	0
04:45 PM	0	0	0	0	0	0	0	0	0	0	0	0	0	0	0	0	0	0	0	0	0
Total	0	0	0	0	0	0	1	0	0	1	1	0	0	0	1	0	0	0	0	0	2
05:00 PM	0	0	0	0	0	0	1	0	0	1	0	0	0	0	0	0	0	0	0	0	1
05:15 PM	0	0	0	0	0	0	1	0	0	1	0	0	0	0	0	0	0	0	0	0	1
05:30 PM	0	0	0	0	0	0	0	0	0	0	0	0	0	0	0	0	0	0	0	0	0
05:45 PM	0	0	0	0	0	0	0	0	0	0	0	0	0	0	0	0	0	0	0	0	0
Total	0	0	0	0	0	0	2	0	0	2	0	0	0	0	0	0	0	0	0	0	2
Grand Total	0	0	0	0	0	0	3	0	0	3	1	0	0	0	1	0	0	0	0	0	4
Apprch %	0	0	0	0		0	100	0	0		100	0	0	0		0	0	0	0		
Total %	0	0	0	0		0	75	0	0	75	25	0	0	0	25	0	0	0	0		

Start Time	Southbound					IMJIN PKWY Westbound					IMJIN RD Northbound					IMJIN PKWY Eastbound					Int. Total
	Right	Thru	Left	Peds	App. Total	Right	Thru	Left	Peds	App. Total	Right	Thru	Left	Peds	App. Total	Right	Thru	Left	Peds	App. Total	
Peak Hour Analysis From 04:00 PM to 05:45 PM - Peak 1 of 1																					
Peak Hour for Entire Intersection Begins at 04:15 PM																					
04:15 PM	0	0	0	0	0	0	1	0	0	1	1	0	0	0	1	0	0	0	0	0	2
04:30 PM	0	0	0	0	0	0	0	0	0	0	0	0	0	0	0	0	0	0	0	0	0
04:45 PM	0	0	0	0	0	0	0	0	0	0	0	0	0	0	0	0	0	0	0	0	0
05:00 PM	0	0	0	0	0	0	1	0	0	1	0	0	0	0	0	0	0	0	0	0	1
Total Volume	0	0	0	0	0	0	2	0	0	2	1	0	0	0	1	0	0	0	0	0	3
% App. Total	0	0	0	0		0	100	0	0		100	0	0	0		0	0	0	0		
PHF	.000	.000	.000	.000	.000	.000	.500	.000	.000	.500	.250	.000	.000	.000	.250	.000	.000	.000	.000	.000	.375

Traffic Data Service

San Jose, CA
 (408) 622-4787
 tdsbay@cs.com

File Name : 7PM FINAL
 Site Code : 00000007
 Start Date : 4/27/2017
 Page No : 2

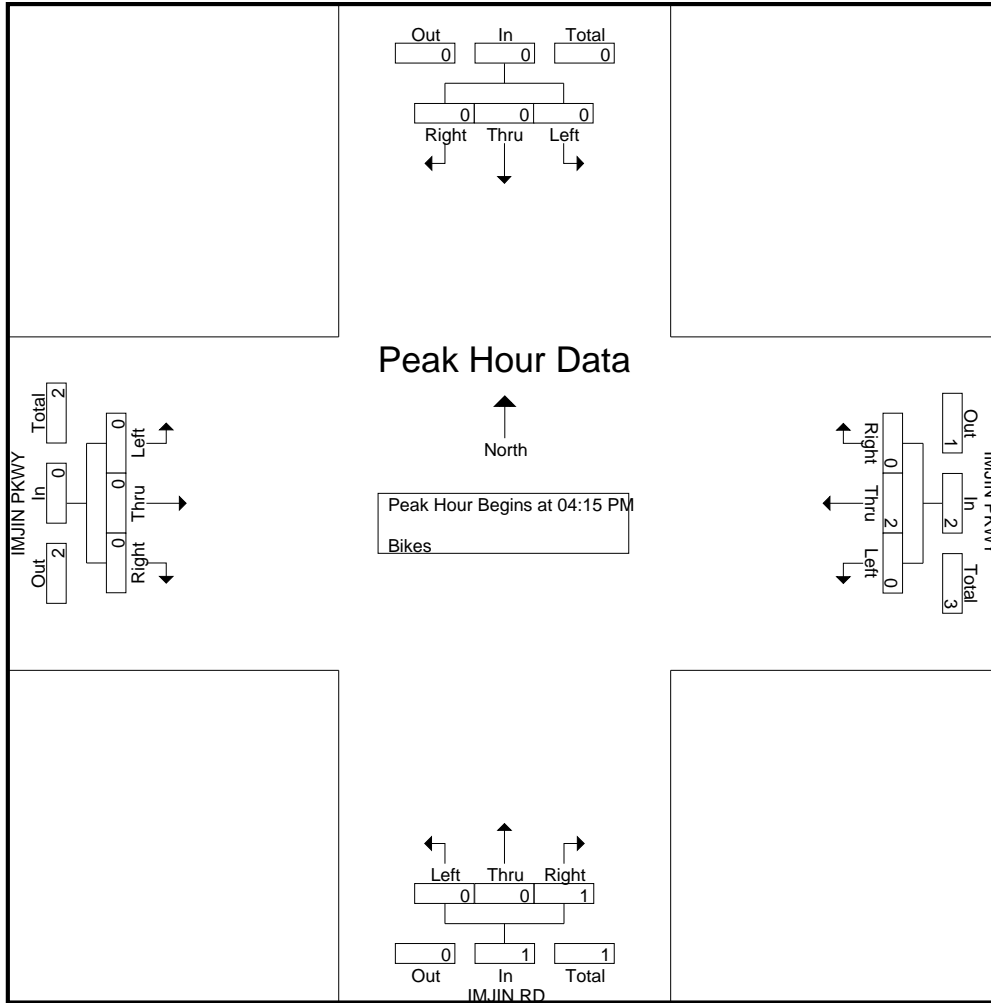

Traffic Data Service

San Jose, CA
 (408) 622-4787
 tdsbay@cs.com

File Name : 8AM FINAL
 Site Code : 00000008
 Start Date : 4/27/2017
 Page No : 1

Groups Printed- Lights - Buses - Trucks

Start Time	ABRAMS DR Southbound					IMJIN PKWY Westbound					ABRAMS DR Northbound					IMJIN PKWY Eastbound					Int. Total
	Right	Thru	Left	Peds	App. Total	Right	Thru	Left	Peds	App. Total	Right	Thru	Left	Peds	App. Total	Right	Thru	Left	Peds	App. Total	
07:00 AM	45	9	6	0	60	4	226	11	0	241	13	4	34	0	51	6	116	2	2	126	478
07:15 AM	64	15	11	0	90	2	249	13	0	264	27	5	36	1	69	6	135	4	1	146	569
07:30 AM	55	18	12	0	85	3	225	21	0	249	36	3	39	0	78	6	175	7	0	188	600
07:45 AM	43	3	8	0	54	5	242	20	0	267	29	4	27	0	60	11	169	14	0	194	575
Total	207	45	37	0	289	14	942	65	0	1021	105	16	136	1	258	29	595	27	3	654	2222
08:00 AM	25	6	2	0	33	7	198	24	0	229	21	6	25	0	52	8	168	10	0	186	500
08:15 AM	23	3	5	0	31	5	245	16	0	266	21	5	23	0	49	4	169	12	0	185	531
08:30 AM	21	5	10	0	36	7	239	15	0	261	16	5	23	0	44	5	155	13	0	173	514
08:45 AM	14	0	4	0	18	7	186	11	0	204	19	3	21	0	43	6	124	6	0	136	401
Total	83	14	21	0	118	26	868	66	0	960	77	19	92	0	188	23	616	41	0	680	1946
Grand Total	290	59	58	0	407	40	1810	131	0	1981	182	35	228	1	446	52	1211	68	3	1334	4168
Apprch %	71.3	14.5	14.3	0		2	91.4	6.6	0		40.8	7.8	51.1	0.2		3.9	90.8	5.1	0.2		
Total %	7	1.4	1.4	0	9.8	1	43.4	3.1	0	47.5	4.4	0.8	5.5	0	10.7	1.2	29.1	1.6	0.1	32	
Lights	285	57	57	0	399	40	1763	123	0	1926	177	27	224	1	429	50	1184	68	3	1305	4059
% Lights	98.3	96.6	98.3	0	98	100	97.4	93.9	0	97.2	97.3	77.1	98.2	100	96.2	96.2	97.8	100	100	97.8	97.4
Buses	5	1	1	0	7	0	6	4	0	10	3	6	1	0	10	2	7	0	0	9	36
% Buses	1.7	1.7	1.7	0	1.7	0	0.3	3.1	0	0.5	1.6	17.1	0.4	0	2.2	3.8	0.6	0	0	0.7	0.9
Trucks	0	1	0	0	1	0	41	4	0	45	2	2	3	0	7	0	20	0	0	20	73
% Trucks	0	1.7	0	0	0.2	0	2.3	3.1	0	2.3	1.1	5.7	1.3	0	1.6	0	1.7	0	0	1.5	1.8

Start Time	ABRAMS DR Southbound					IMJIN PKWY Westbound					ABRAMS DR Northbound					IMJIN PKWY Eastbound					Int. Total
	Right	Thru	Left	Peds	App. Total	Right	Thru	Left	Peds	App. Total	Right	Thru	Left	Peds	App. Total	Right	Thru	Left	Peds	App. Total	
Peak Hour Analysis From 07:00 AM to 08:45 AM - Peak 1 of 1																					
Peak Hour for Entire Intersection Begins at 07:15 AM																					
07:15 AM	64	15	11	0	90	2	249	13	0	264	27	5	36	1	69	6	135	4	1	146	567
07:30 AM	55	18	12	0	85	3	225	21	0	249	36	3	39	0	78	6	175	7	0	188	600
07:45 AM	43	3	8	0	54	5	242	20	0	267	29	4	27	0	60	11	169	14	0	194	575
08:00 AM	25	6	2	0	33	7	198	24	0	229	21	6	25	0	52	8	168	10	0	186	500
Total Volume	187	42	33	0	262	17	914	78	0	1009	113	18	127	1	258	31	647	35	0	713	2242
% App. Total	71.4	16	12.6	0		1.7	90.6	7.7	0		43.8	7	49.2	0		4.3	90.7	4.9	0		
PHF	.730	.583	.688	0	.728	.607	.918	.813	0	.945	.785	.750	.814	0	.827	.705	.924	.625	0	.919	.934

Traffic Data Service

San Jose, CA
 (408) 622-4787
 tdsbay@cs.com

File Name : 8AM FINAL
 Site Code : 00000008
 Start Date : 4/27/2017
 Page No : 2

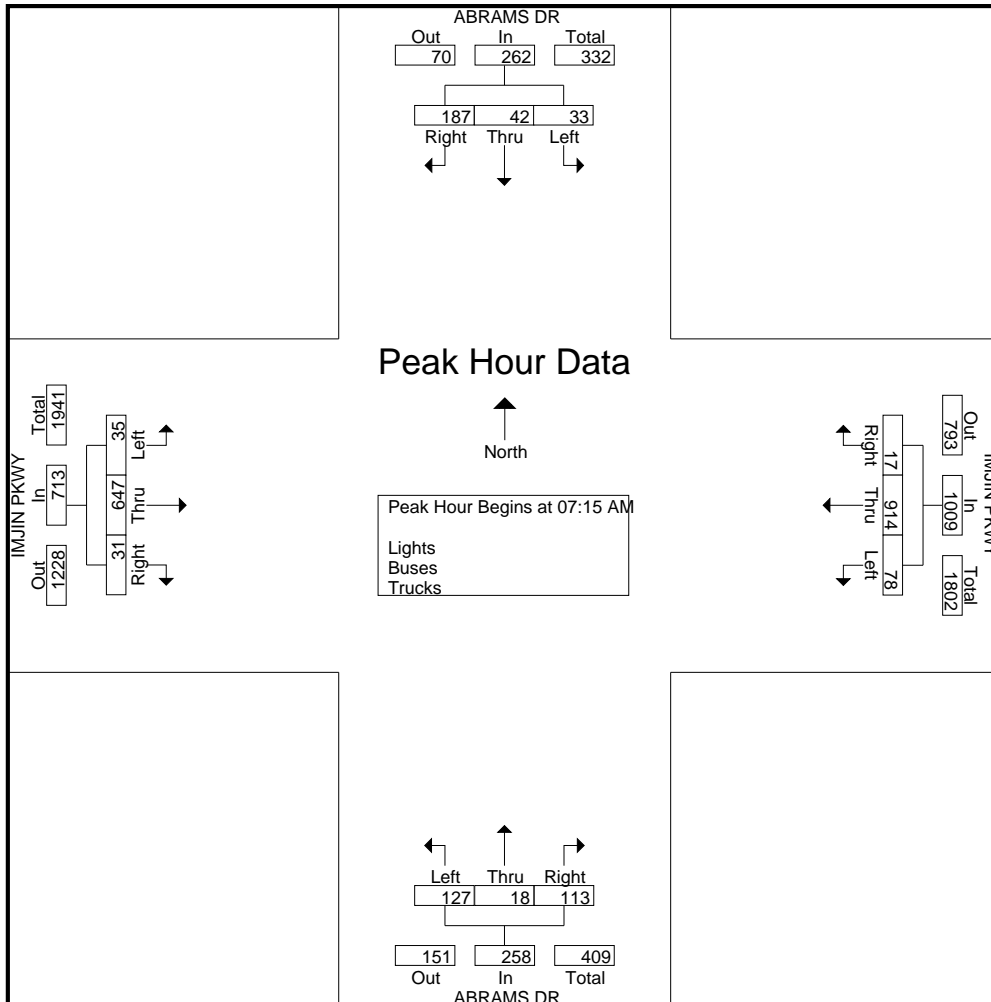

Traffic Data Service

San Jose, CA
 (408) 622-4787
 tdsbay@cs.com

File Name : 8AM FINAL
 Site Code : 00000008
 Start Date : 4/27/2017
 Page No : 1

Groups Printed- Bikes

Start Time	ABRAMS DR Southbound					IMJIN PKWY Westbound					ABRAMS DR Northbound					IMJIN PKWY Eastbound					Int. Total	
	Right	Thru	Left	Peds	App. Total	Right	Thru	Left	Peds	App. Total	Right	Thru	Left	Peds	App. Total	Right	Thru	Left	Peds	App. Total		
07:00 AM	0	0	0	0	0	0	0	0	0	0	0	0	0	0	0	0	0	0	0	0	0	0
07:15 AM	0	0	0	0	0	1	0	0	0	1	0	0	0	0	0	0	0	0	0	0	0	0
07:30 AM	0	0	0	0	0	0	0	0	0	0	0	0	0	0	0	0	0	0	0	0	0	0
07:45 AM	0	0	0	0	0	0	0	0	0	0	0	0	0	0	0	0	0	0	0	0	0	0
Total	0	0	0	0	0	1	0	0	0	1	0	0	0	0	0	0	0	0	0	0	0	1
08:00 AM	0	0	0	0	0	0	0	0	0	0	1	0	0	0	1	0	0	0	0	0	0	1
08:15 AM	0	0	0	0	0	0	0	0	0	0	0	0	0	0	0	0	0	0	0	0	0	0
08:30 AM	0	0	0	0	0	0	0	0	0	0	0	0	0	0	0	0	0	0	0	0	0	0
08:45 AM	0	0	0	0	0	0	0	0	0	0	0	0	0	0	0	0	0	0	0	0	0	0
Total	0	0	0	0	0	0	0	0	0	0	1	0	0	0	1	0	0	0	0	0	0	1
Grand Total	0	0	0	0	0	1	0	0	0	1	1	0	0	0	1	0	0	0	0	0	0	2
Apprch %	0	0	0	0	0	100	0	0	0	100	100	0	0	0	100	0	0	0	0	0	0	
Total %	0	0	0	0	0	50	0	0	0	50	50	0	0	0	50	0	0	0	0	0	0	

Start Time	ABRAMS DR Southbound				IMJIN PKWY Westbound				ABRAMS DR Northbound				IMJIN PKWY Eastbound				Int. Total
	Right	Thru	Left	App. Total	Right	Thru	Left	App. Total	Right	Thru	Left	App. Total	Right	Thru	Left	App. Total	
Peak Hour Analysis From 07:00 AM to 08:45 AM - Peak 1 of 1																	
Peak Hour for Entire Intersection Begins at 07:15 AM																	
07:15 AM	0	0	0	0	1	0	0	1	0	0	0	0	0	0	0	0	1
07:30 AM	0	0	0	0	0	0	0	0	0	0	0	0	0	0	0	0	0
07:45 AM	0	0	0	0	0	0	0	0	0	0	0	0	0	0	0	0	0
08:00 AM	0	0	0	0	0	0	0	0	1	0	0	1	0	0	0	0	1
Total Volume	0	0	0	0	1	0	0	1	1	0	0	1	0	0	0	0	2
% App. Total	0	0	0	0	100	0	0	100	100	0	0	100	0	0	0	0	
PHF	.000	.000	.000	.000	.250	.000	.000	.250	.250	.000	.000	.250	.000	.000	.000	.000	.500

Traffic Data Service

San Jose, CA
 (408) 622-4787
 tdsbay@cs.com

File Name : 8AM FINAL
 Site Code : 00000008
 Start Date : 4/27/2017
 Page No : 2

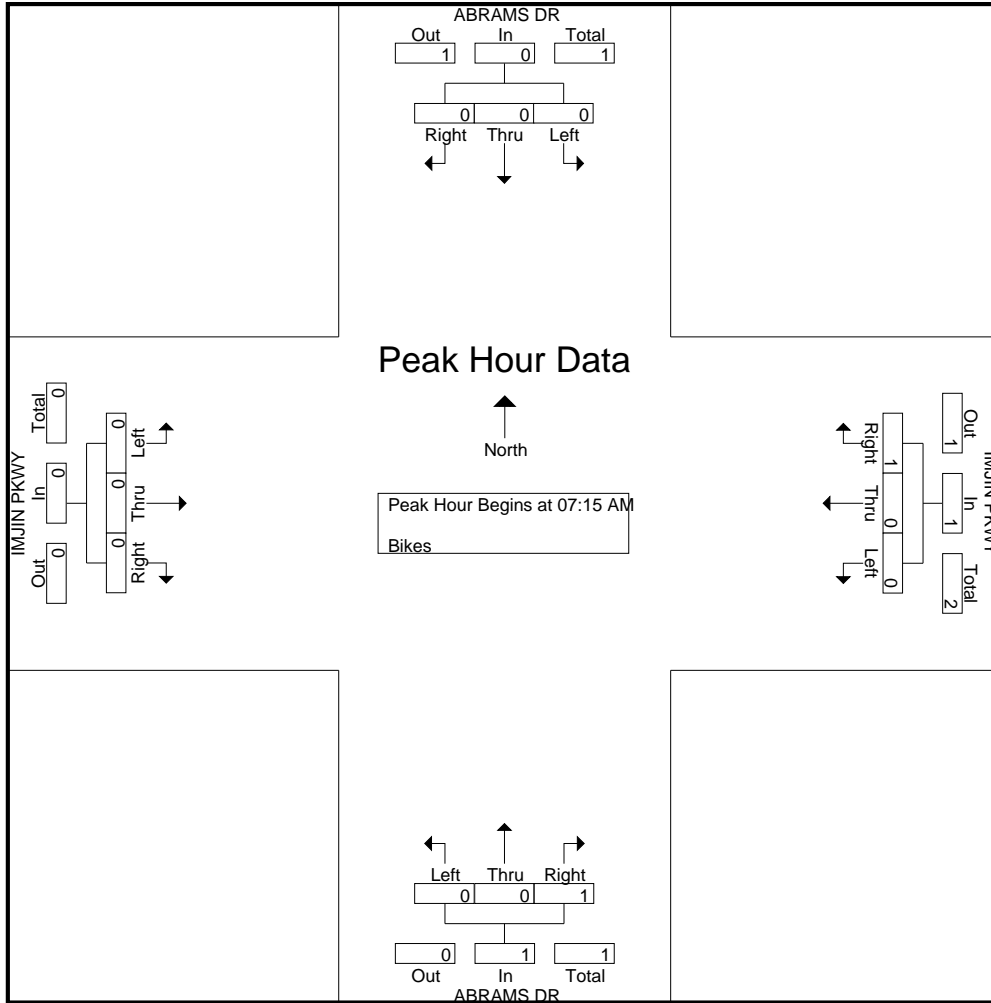

Traffic Data Service

San Jose, CA
(408) 622-4787
tdsbay@cs.com

File Name : 8PM FINAL
Site Code : 00000008
Start Date : 4/27/2017
Page No : 1

Groups Printed- Lights - Buses - Trucks

Start Time	ABRAMS DR Southbound					IMJIN PKWY Westbound					ABRAMS DR Northbound					IMJIN PKWY Eastbound					Int. Total
	Right	Thru	Left	Peds	App. Total	Right	Thru	Left	Peds	App. Total	Right	Thru	Left	Peds	App. Total	Right	Thru	Left	Peds	App. Total	
04:00 PM	19	2	7	1	29	13	163	37	0	213	43	0	30	0	73	25	219	19	0	263	578
04:15 PM	17	2	7	1	27	9	149	23	0	181	23	1	31	0	55	29	253	19	2	303	566
04:30 PM	20	1	9	0	30	9	187	31	0	227	34	10	25	0	69	21	222	15	1	259	585
04:45 PM	23	2	8	0	33	9	179	25	0	213	44	4	22	0	70	19	230	22	0	271	587
Total	79	7	31	2	119	40	678	116	0	834	144	15	108	0	267	94	924	75	3	1096	2316
05:00 PM	16	4	3	0	23	16	193	36	0	245	34	6	30	0	70	30	219	25	1	275	613
05:15 PM	17	2	5	0	24	9	247	28	0	284	43	3	24	0	70	25	244	25	0	294	672
05:30 PM	30	5	6	0	41	14	188	51	0	253	39	7	25	0	71	31	206	23	0	260	625
05:45 PM	21	3	10	0	34	14	168	44	0	226	45	4	30	0	79	28	211	19	0	258	597
Total	84	14	24	0	122	53	796	159	0	1008	161	20	109	0	290	114	880	92	1	1087	2507
Grand Total	163	21	55	2	241	93	1474	275	0	1842	305	35	217	0	557	208	1804	167	4	2183	4823
Apprch %	67.6	8.7	22.8	0.8		5	80	14.9	0		54.8	6.3	39	0		9.5	82.6	7.7	0.2		
Total %	3.4	0.4	1.1	0	5	1.9	30.6	5.7	0	38.2	6.3	0.7	4.5	0	11.5	4.3	37.4	3.5	0.1	45.3	
Lights	162	17	55	2	236	93	1454	272	0	1819	301	33	209	0	543	206	1778	167	4	2155	4753
% Lights	99.4	81	100	100	97.9	100	98.6	98.9	0	98.8	98.7	94.3	96.3	0	97.5	99	98.6	100	100	98.7	98.5
Buses	1	4	0	0	5	0	6	2	0	8	2	2	1	0	5	1	4	0	0	5	23
% Buses	0.6	19	0	0	2.1	0	0.4	0.7	0	0.4	0.7	5.7	0.5	0	0.9	0.5	0.2	0	0	0.2	0.5
Trucks	0	0	0	0	0	0	14	1	0	15	2	0	7	0	9	1	22	0	0	23	47
% Trucks	0	0	0	0	0	0	0.9	0.4	0	0.8	0.7	0	3.2	0	1.6	0.5	1.2	0	0	1.1	1

Start Time	ABRAMS DR Southbound				IMJIN PKWY Westbound				ABRAMS DR Northbound				IMJIN PKWY Eastbound				Int. Total
	Right	Thru	Left	App. Total	Right	Thru	Left	App. Total	Right	Thru	Left	App. Total	Right	Thru	Left	App. Total	
Peak Hour Analysis From 04:00 PM to 05:45 PM - Peak 1 of 1																	
Peak Hour for Entire Intersection Begins at 05:00 PM																	
05:00 PM	16	4	3	23	16	193	36	245	34	6	30	70	30	219	25	274	612
05:15 PM	17	2	5	24	9	247	28	284	43	3	24	70	25	244	25	294	672
05:30 PM	30	5	6	41	14	188	51	253	39	7	25	71	31	206	23	260	625
05:45 PM	21	3	10	34	14	168	44	226	45	4	30	79	28	211	19	258	597
Total Volume	84	14	24	122	53	796	159	1008	161	20	109	290	114	880	92	1086	2506
% App. Total	68.9	11.5	19.7		5.3	79	15.8		55.5	6.9	37.6		10.5	81	8.5		
PHF	.700	.700	.600	.744	.828	.806	.779	.887	.894	.714	.908	.918	.919	.902	.920	.923	.932

Traffic Data Service

San Jose, CA
 (408) 622-4787
 tdsbay@cs.com

File Name : 8PM FINAL
 Site Code : 00000008
 Start Date : 4/27/2017
 Page No : 2

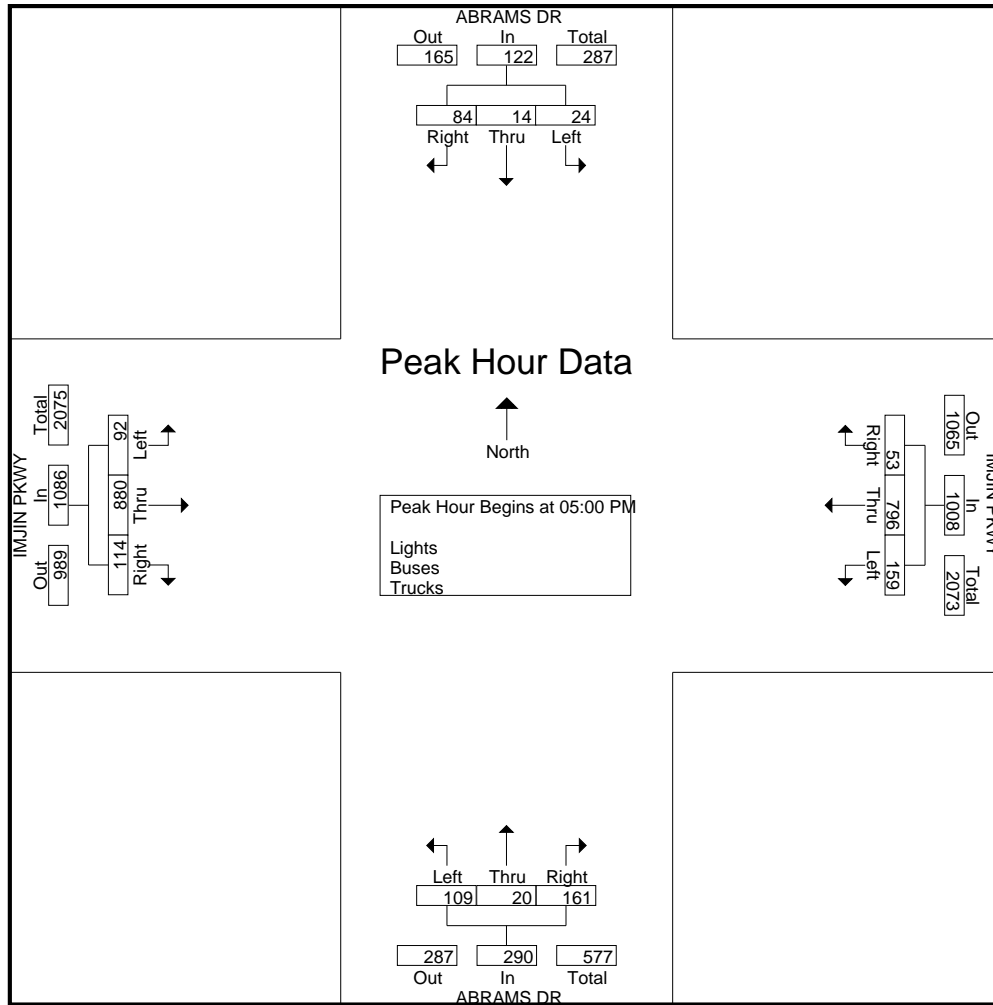

Traffic Data Service

San Jose, CA
 (408) 622-4787
 tdsbay@cs.com

File Name : 8PM FINAL
 Site Code : 00000008
 Start Date : 4/27/2017
 Page No : 1

Groups Printed- Bikes

Start Time	ABRAMS DR Southbound					IMJIN PKWY Westbound					ABRAMS DR Northbound					IMJIN PKWY Eastbound					Int. Total					
	Right	Thru	Left	Peds	App. Total	Right	Thru	Left	Peds	App. Total	Right	Thru	Left	Peds	App. Total	Right	Thru	Left	Peds	App. Total						
04:00 PM	0	0	0	0	0	0	0	0	0	0	0	0	0	0	0	0	0	0	0	0	0	0	0	0	0	0
04:15 PM	0	0	0	0	0	0	0	0	0	0	0	0	0	0	0	0	0	0	0	0	0	0	0	0	0	0
04:30 PM	0	0	0	0	0	0	0	0	0	0	0	0	0	0	0	0	0	0	0	0	0	0	0	0	0	0
04:45 PM	0	0	0	0	0	0	0	0	0	0	0	0	0	0	0	0	0	0	0	0	0	0	0	0	0	0
Total	0	0	0	0	0	0	0	0	0	0	0	0	0	0	0	0	0	0	0	0	0	0	0	0	0	0
05:00 PM	0	0	0	0	0	0	0	0	0	0	0	0	0	0	0	0	0	0	0	0	0	0	0	0	0	0
05:15 PM	0	0	0	0	0	0	0	1	0	1	0	1	0	0	1	0	0	0	0	0	0	0	0	0	0	2
05:30 PM	0	0	0	0	0	0	0	0	0	0	0	0	0	0	0	0	0	0	0	0	0	0	0	0	0	0
05:45 PM	0	0	0	0	0	0	0	1	0	1	0	0	0	0	0	0	0	0	0	0	0	0	0	0	0	1
Total	0	0	0	0	0	0	0	2	0	2	0	1	0	0	1	0	0	0	0	0	0	0	0	0	0	3
Grand Total	0	0	0	0	0	0	0	2	0	2	0	1	0	0	1	0	0	0	0	0	0	0	0	0	0	3
Apprch %	0	0	0	0		0	0	100	0		0	100	0	0		0	0	0	0		0	0	0	0		
Total %	0	0	0	0		0	0	66.7	0	66.7	0	33.3	0	0	33.3	0	0	0	0		0	0	0	0		

Start Time	ABRAMS DR Southbound					IMJIN PKWY Westbound					ABRAMS DR Northbound					IMJIN PKWY Eastbound					Int. Total					
	Right	Thru	Left	Peds	App. Total	Right	Thru	Left	Peds	App. Total	Right	Thru	Left	Peds	App. Total	Right	Thru	Left	Peds	App. Total						
05:00 PM	0	0	0	0	0	0	0	0	0	0	0	0	0	0	0	0	0	0	0	0	0	0	0	0	0	0
05:15 PM	0	0	0	0	0	0	0	1	0	1	0	1	0	0	1	0	0	0	0	0	0	0	0	0	0	2
05:30 PM	0	0	0	0	0	0	0	0	0	0	0	0	0	0	0	0	0	0	0	0	0	0	0	0	0	0
05:45 PM	0	0	0	0	0	0	0	1	0	1	0	0	0	0	0	0	0	0	0	0	0	0	0	0	0	1
Total Volume	0	0	0	0	0	0	0	2	0	2	0	1	0	0	1	0	0	0	0	0	0	0	0	0	0	3
% App. Total	0	0	0	0		0	0	100	0		0	100	0	0		0	0	0	0		0	0	0	0		
PHF	.000	.000	.000	.000		.000	.000	.500	.500		.000	.250	.000	.250		.000	.000	.000	.000		.000	.000	.000	.000		.375

Peak Hour Analysis From 04:00 PM to 05:45 PM - Peak 1 of 1
 Peak Hour for Entire Intersection Begins at 05:00 PM

Traffic Data Service

San Jose, CA
(408) 622-4787
tdsbay@cs.com

File Name : 8PM FINAL
Site Code : 00000008
Start Date : 4/27/2017
Page No : 2

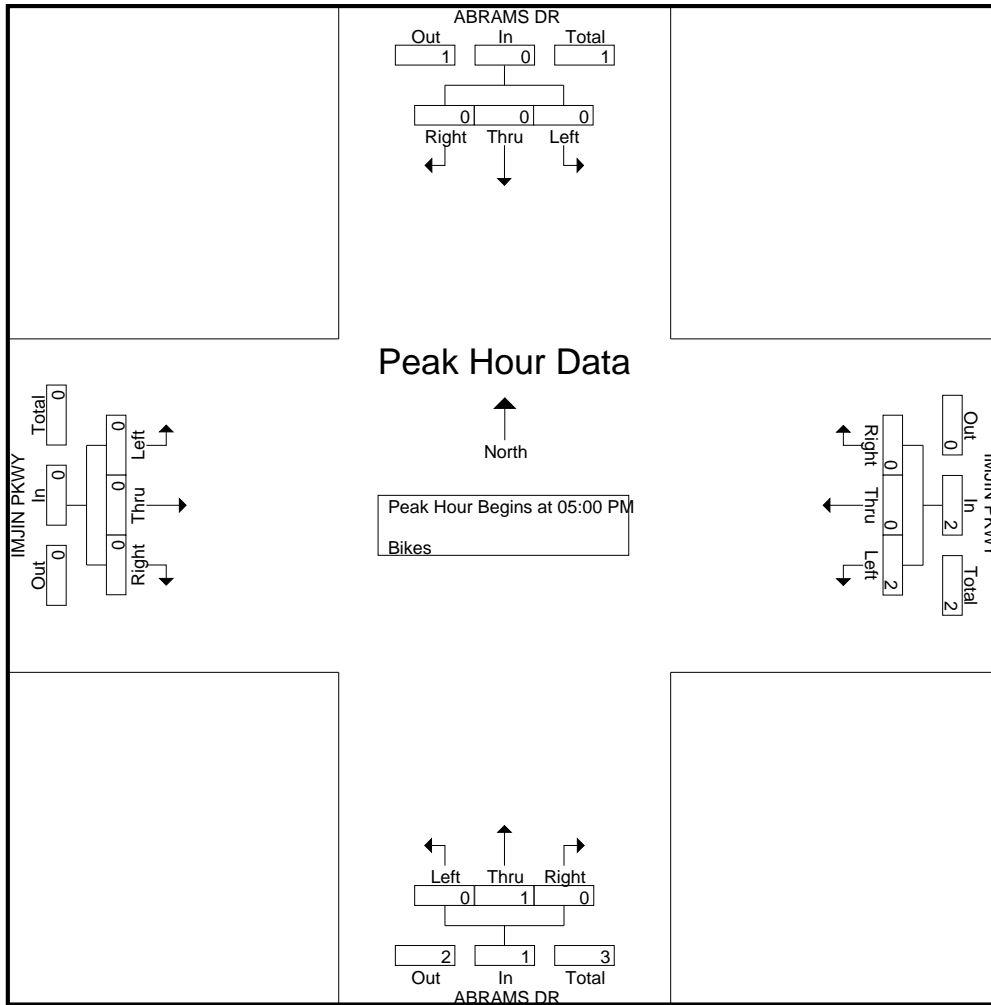

Traffic Data Service

San Jose, CA
 (408) 622-4787
 tdsbay@cs.com

File Name : 9AM FINAL
 Site Code : 00000009
 Start Date : 4/27/2017
 Page No : 1

Groups Printed- Lights - Buses - Trucks

Start Time	IMJIN RD Southbound					RESERVATION RD Westbound					IMJIN PKWY Northbound					RESERVATION RD Eastbound					Int. Total
	Right	Thru	Left	Peds	App. Total	Right	Thru	Left	Peds	App. Total	Right	Thru	Left	Peds	App. Total	Right	Thru	Left	Peds	App. Total	
07:00 AM	1	2	0	0	3	5	175	265	0	445	110	4	10	0	124	12	93	1	0	106	678
07:15 AM	5	1	1	0	7	4	185	260	0	449	171	13	20	0	204	11	107	5	1	124	784
07:30 AM	2	1	1	0	4	3	166	233	0	402	190	3	33	1	227	20	176	9	0	205	838
07:45 AM	4	1	0	0	5	7	150	198	0	355	198	8	48	0	254	22	139	11	0	172	786
Total	12	5	2	0	19	19	676	956	0	1651	669	28	111	1	809	65	515	26	1	607	3086
08:00 AM	4	4	1	0	9	5	122	206	0	333	170	4	14	2	190	31	120	11	0	162	694
08:15 AM	2	5	1	0	8	5	125	250	0	380	174	7	17	0	198	17	95	10	0	122	708
08:30 AM	0	1	0	0	1	5	89	220	0	314	167	10	15	0	192	19	96	13	0	128	635
08:45 AM	2	4	2	0	8	7	96	183	0	286	119	14	10	1	144	11	95	8	0	114	552
Total	8	14	4	0	26	22	432	859	0	1313	630	35	56	3	724	78	406	42	0	526	2589
Grand Total	20	19	6	0	45	41	1108	1815	0	2964	1299	63	167	4	1533	143	921	68	1	1133	5675
Apprch %	44.4	42.2	13.3	0		1.4	37.4	61.2	0		84.7	4.1	10.9	0.3		12.6	81.3	6	0.1		
Total %	0.4	0.3	0.1	0	0.8	0.7	19.5	32	0	52.2	22.9	1.1	2.9	0.1	27	2.5	16.2	1.2	0	20	
Lights	18	16	5	0	39	41	1079	1763	0	2883	1269	61	162	4	1496	136	903	67	1	1107	5525
% Lights	90	84.2	83.3	0	86.7	100	97.4	97.1	0	97.3	97.7	96.8	97	100	97.6	95.1	98	98.5	100	97.7	97.4
Buses	0	0	0	0	0	0	9	7	0	16	8	0	4	0	12	4	6	0	0	10	38
% Buses	0	0	0	0	0	0	0.8	0.4	0	0.5	0.6	0	2.4	0	0.8	2.8	0.7	0	0	0.9	0.7
Trucks	2	3	1	0	6	0	20	45	0	65	22	2	1	0	25	3	12	1	0	16	112
% Trucks	10	15.8	16.7	0	13.3	0	1.8	2.5	0	2.2	1.7	3.2	0.6	0	1.6	2.1	1.3	1.5	0	1.4	2

Start Time	IMJIN RD Southbound				RESERVATION RD Westbound				IMJIN PKWY Northbound				RESERVATION RD Eastbound				Int. Total
	Right	Thru	Left	App. Total	Right	Thru	Left	App. Total	Right	Thru	Left	App. Total	Right	Thru	Left	App. Total	
Peak Hour Analysis From 07:00 AM to 08:45 AM - Peak 1 of 1																	
Peak Hour for Entire Intersection Begins at 07:15 AM																	
07:15 AM	5	1	1	7	4	185	260	449	171	13	20	204	11	107	5	123	783
07:30 AM	2	1	1	4	3	166	233	402	190	3	33	226	20	176	9	205	837
07:45 AM	4	1	0	5	7	150	198	355	198	8	48	254	22	139	11	172	786
08:00 AM	4	4	1	9	5	122	206	333	170	4	14	188	31	120	11	162	692
Total Volume	15	7	3	25	19	623	897	1539	729	28	115	872	84	542	36	662	3098
% App. Total	60	28	12		1.2	40.5	58.3		83.6	3.2	13.2		12.7	81.9	5.4		
PHF	.750	.438	.750	.694	.679	.842	.863	.857	.920	.538	.599	.858	.677	.770	.818	.807	.925

Traffic Data Service

San Jose, CA
 (408) 622-4787
 tdsbay@cs.com

File Name : 9AM FINAL
 Site Code : 00000009
 Start Date : 4/27/2017
 Page No : 2

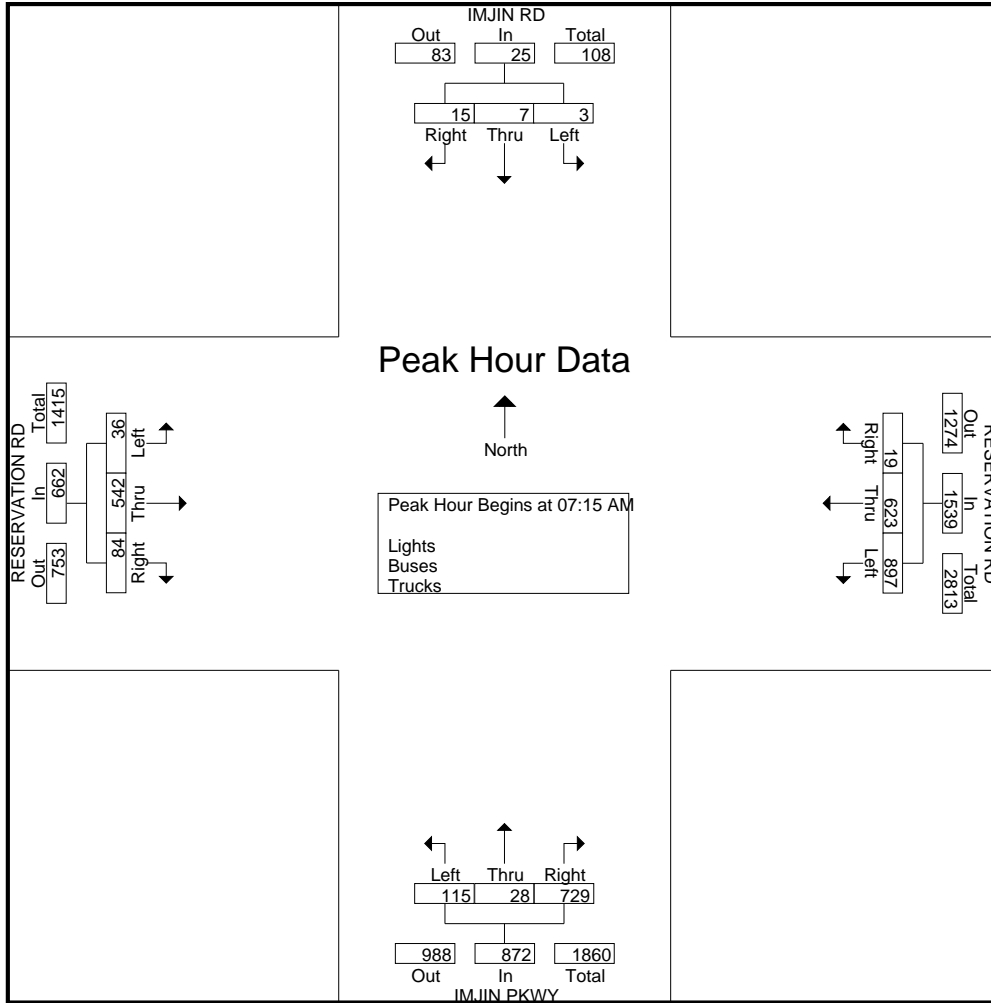

Traffic Data Service

San Jose, CA
 (408) 622-4787
 tdsbay@cs.com

File Name : 9AM FINAL
 Site Code : 00000009
 Start Date : 4/27/2017
 Page No : 1

Groups Printed- Bikes

Start Time	IMJIN RD Southbound					RESERVATION RD Westbound					IMJIN PKWY Northbound					RESERVATION RD Eastbound					Int. Total
	Right	Thru	Left	Peds	App. Total	Right	Thru	Left	Peds	App. Total	Right	Thru	Left	Peds	App. Total	Right	Thru	Left	Peds	App. Total	
07:00 AM	0	0	0	0	0	0	0	0	0	0	0	0	0	0	0	0	0	0	0	0	0
07:15 AM	0	0	0	0	0	0	0	0	0	0	0	0	0	0	0	0	0	0	0	0	0
07:30 AM	0	0	0	0	0	0	0	0	0	0	0	0	0	0	0	0	0	0	0	0	0
07:45 AM	0	0	0	0	0	0	0	0	0	0	0	0	0	0	0	0	0	0	0	0	0
Total	0	0	0	0	0	0	0	0	0	0	0	0	0	0	0	0	0	0	0	0	0
08:00 AM	0	0	0	0	0	0	0	0	0	0	0	0	0	0	0	0	1	0	0	1	1
08:15 AM	0	0	0	0	0	0	0	0	0	0	0	0	0	0	0	0	0	0	0	0	0
08:30 AM	0	0	0	0	0	0	0	0	0	0	0	0	0	0	0	0	0	0	0	0	0
08:45 AM	0	0	0	0	0	0	0	0	0	0	0	0	0	0	0	0	1	0	0	1	1
Total	0	0	0	0	0	0	0	0	0	0	0	0	0	0	0	0	2	0	0	2	2
Grand Total	0	0	0	0	0	0	0	0	0	0	0	0	0	0	0	0	2	0	0	2	2
Apprch %	0	0	0	0		0	0	0	0		0	0	0	0		0	100	0	0		
Total %	0	0	0	0		0	0	0	0		0	0	0	0		0	100	0	0	100	

Start Time	IMJIN RD Southbound				RESERVATION RD Westbound				IMJIN PKWY Northbound				RESERVATION RD Eastbound				Int. Total
	Right	Thru	Left	App. Total	Right	Thru	Left	App. Total	Right	Thru	Left	App. Total	Right	Thru	Left	App. Total	
Peak Hour Analysis From 07:00 AM to 08:45 AM - Peak 1 of 1																	
Peak Hour for Entire Intersection Begins at 08:00 AM																	
08:00 AM	0	0	0	0	0	0	0	0	0	0	0	0	0	1	0	1	1
08:15 AM	0	0	0	0	0	0	0	0	0	0	0	0	0	0	0	0	0
08:30 AM	0	0	0	0	0	0	0	0	0	0	0	0	0	0	0	0	0
08:45 AM	0	0	0	0	0	0	0	0	0	0	0	0	0	1	0	1	1
Total Volume	0	0	0	0	0	0	0	0	0	0	0	0	0	2	0	2	2
% App. Total	0	0	0		0	0	0		0	0	0		0	100	0		
PHF	.000	.000	.000	.000	.000	.000	.000	.000	.000	.000	.000	.000	.000	.500	.000	.500	.500

Traffic Data Service

San Jose, CA
(408) 622-4787
tdsbay@cs.com

File Name : 9AM FINAL
Site Code : 00000009
Start Date : 4/27/2017
Page No : 2

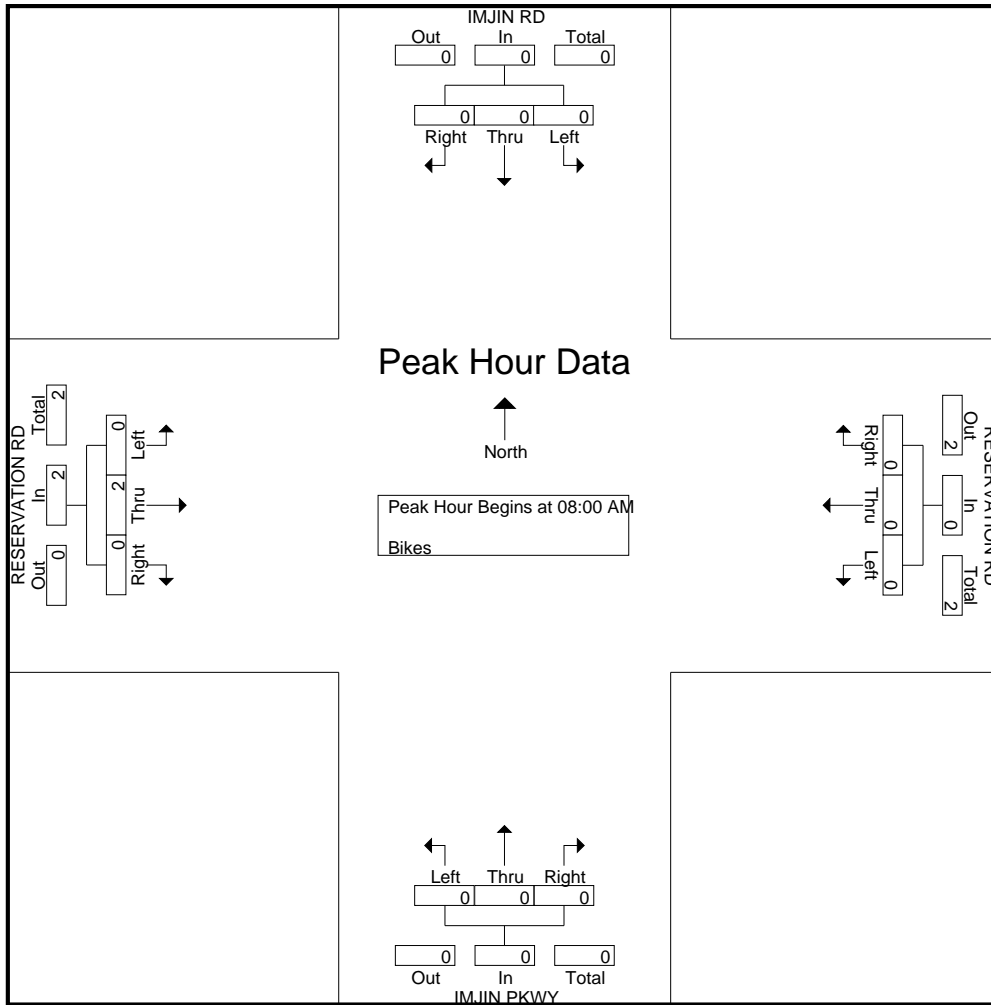

Traffic Data Service

San Jose, CA
 (408) 622-4787
 tdsbay@cs.com

File Name : 9PM FINAL
 Site Code : 00000009
 Start Date : 4/27/2017
 Page No : 1

Groups Printed- Lights - Buses - Trucks

Start Time	IMJIN RD Southbound					RESERVATION RD Westbound					IMJIN PKWY Northbound					RESERVATION RD Eastbound					Int. Total
	Right	Thru	Left	Peds	App. Total	Right	Thru	Left	Peds	App. Total	Right	Thru	Left	Peds	App. Total	Right	Thru	Left	Peds	App. Total	
04:00 PM	9	16	2	0	27	1	133	171	0	305	252	3	17	0	272	39	142	0	0	181	785
04:15 PM	5	6	4	0	15	1	126	171	0	298	251	3	12	0	266	34	185	1	0	220	799
04:30 PM	10	8	7	0	25	0	126	177	0	303	236	3	35	1	275	51	152	5	0	208	811
04:45 PM	9	3	5	0	17	2	122	175	0	299	248	2	18	0	268	39	145	3	1	188	772
Total	33	33	18	0	84	4	507	694	0	1205	987	11	82	1	1081	163	624	9	1	797	3167
05:00 PM	8	9	0	0	17	1	117	210	0	328	241	2	23	0	266	43	164	2	0	209	820
05:15 PM	4	3	1	0	8	1	174	257	0	432	249	1	30	0	280	43	178	1	0	222	942
05:30 PM	1	6	1	0	8	0	129	207	0	336	244	1	29	0	274	50	157	1	1	209	827
05:45 PM	1	3	2	0	6	0	107	163	0	270	244	3	26	0	273	57	152	2	0	211	760
Total	14	21	4	0	39	2	527	837	0	1366	978	7	108	0	1093	193	651	6	1	851	3349
Grand Total	47	54	22	0	123	6	1034	1531	0	2571	1965	18	190	1	2174	356	1275	15	2	1648	6516
Apprch %	38.2	43.9	17.9	0		0.2	40.2	59.5	0		90.4	0.8	8.7	0		21.6	77.4	0.9	0.1		
Total %	0.7	0.8	0.3	0	1.9	0.1	15.9	23.5	0	39.5	30.2	0.3	2.9	0	33.4	5.5	19.6	0.2	0	25.3	
Lights	44	54	19	0	117	5	1013	1510	0	2528	1939	16	185	1	2141	348	1261	11	2	1622	6408
% Lights	93.6	100	86.4	0	95.1	83.3	98	98.6	0	98.3	98.7	88.9	97.4	100	98.5	97.8	98.9	73.3	100	98.4	98.3
Buses	1	0	0	0	1	0	9	6	0	15	6	0	3	0	9	7	10	3	0	20	45
% Buses	2.1	0	0	0	0.8	0	0.9	0.4	0	0.6	0.3	0	1.6	0	0.4	2	0.8	20	0	1.2	0.7
Trucks	2	0	3	0	5	1	12	15	0	28	20	2	2	0	24	1	4	1	0	6	63
% Trucks	4.3	0	13.6	0	4.1	16.7	1.2	1	0	1.1	1	11.1	1.1	0	1.1	0.3	0.3	6.7	0	0.4	1

Start Time	IMJIN RD Southbound				RESERVATION RD Westbound				IMJIN PKWY Northbound				RESERVATION RD Eastbound				Int. Total
	Right	Thru	Left	App. Total	Right	Thru	Left	App. Total	Right	Thru	Left	App. Total	Right	Thru	Left	App. Total	
Peak Hour Analysis From 04:00 PM to 05:45 PM - Peak 1 of 1																	
Peak Hour for Entire Intersection Begins at 04:45 PM																	
04:45 PM	9	3	5	17	2	122	175	299	248	2	18	268	39	145	3	187	771
05:00 PM	8	9	0	17	1	117	210	328	241	2	23	266	43	164	2	209	820
05:15 PM	4	3	1	8	1	174	257	432	249	1	30	280	43	178	1	222	942
05:30 PM	1	6	1	8	0	129	207	336	244	1	29	274	50	157	1	208	826
Total Volume	22	21	7	50	4	542	849	1395	982	6	100	1088	175	644	7	826	3359
% App. Total	44	42	14		0.3	38.9	60.9		90.3	0.6	9.2		21.2	78	0.8		
PHF	.611	.583	.350	.735	.500	.779	.826	.807	.986	.750	.833	.971	.875	.904	.583	.930	.891

Traffic Data Service

San Jose, CA
 (408) 622-4787
 tdsbay@cs.com

File Name : 9PM FINAL
 Site Code : 00000009
 Start Date : 4/27/2017
 Page No : 2

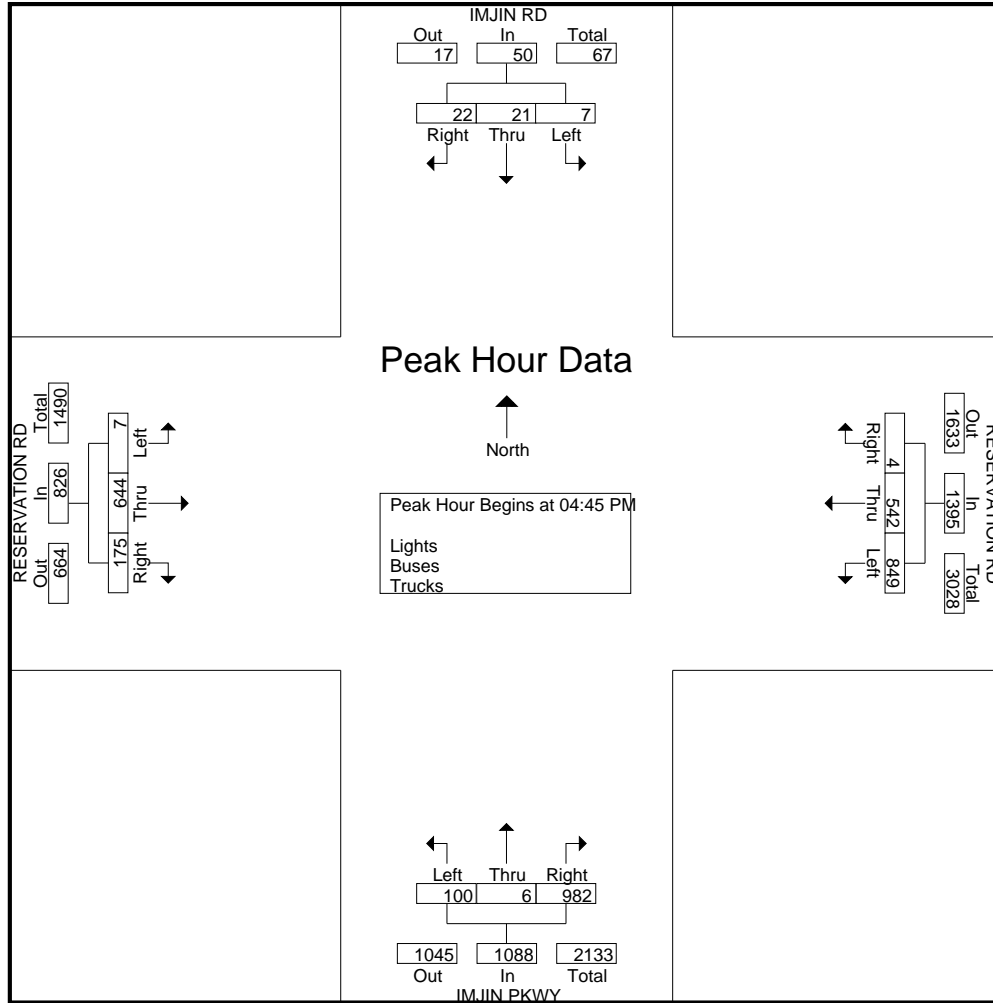

Traffic Data Service

San Jose, CA
 (408) 622-4787
 tdsbay@cs.com

File Name : 9PM FINAL
 Site Code : 00000009
 Start Date : 4/27/2017
 Page No : 1

Groups Printed- Bikes

Start Time	IMJIN RD Southbound					RESERVATION RD Westbound					IMJIN PKWY Northbound					RESERVATION RD Eastbound					Int. Total
	Right	Thru	Left	Peds	App. Total	Right	Thru	Left	Peds	App. Total	Right	Thru	Left	Peds	App. Total	Right	Thru	Left	Peds	App. Total	
04:00 PM	0	0	0	0	0	0	0	0	0	0	0	0	0	0	0	0	0	0	0	0	0
04:15 PM	0	0	0	0	0	0	0	0	0	0	0	0	0	0	0	0	0	0	0	0	0
04:30 PM	0	0	0	0	0	0	0	0	0	0	0	0	0	0	0	0	0	0	0	0	0
04:45 PM	0	0	0	0	0	0	0	0	0	0	0	0	0	0	0	0	0	0	0	0	0
Total	0	0	0	0	0	0	0	0	0	0	0	0	0	0	0	0	0	0	0	0	0
05:00 PM	0	0	0	0	0	0	0	0	0	0	0	0	0	0	0	0	0	0	0	0	0
05:15 PM	0	0	0	0	0	0	0	0	0	0	0	0	0	0	0	0	0	0	0	0	0
05:30 PM	0	0	0	0	0	0	0	0	0	0	0	0	0	0	0	0	0	0	0	0	0
05:45 PM	0	0	0	0	0	0	0	0	0	0	0	0	0	0	0	0	0	0	0	0	0
Total	0	0	0	0	0	0	0	0	0	0	0	0	0	0	0	0	0	0	0	0	0
Grand Total	0	0	0	0	0	0	0	0	0	0	0	0	0	0	0	0	0	0	0	0	0
Apprch %	0	0	0	0		0	0	0	0		0	0	0	0		0	0	0	0		
Total %																					

Start Time	IMJIN RD Southbound					RESERVATION RD Westbound					IMJIN PKWY Northbound					RESERVATION RD Eastbound					Int. Total
	Right	Thru	Left	Peds	App. Total	Right	Thru	Left	Peds	App. Total	Right	Thru	Left	Peds	App. Total	Right	Thru	Left	Peds	App. Total	
Peak Hour Analysis From 04:00 PM to 05:45 PM - Peak 1 of 1																					
Peak Hour for Entire Intersection Begins at 04:00 PM																					
04:00 PM	0	0	0	0	0	0	0	0	0	0	0	0	0	0	0	0	0	0	0	0	0
04:15 PM	0	0	0	0	0	0	0	0	0	0	0	0	0	0	0	0	0	0	0	0	0
04:30 PM	0	0	0	0	0	0	0	0	0	0	0	0	0	0	0	0	0	0	0	0	0
04:45 PM	0	0	0	0	0	0	0	0	0	0	0	0	0	0	0	0	0	0	0	0	0
Total Volume	0	0	0	0	0	0	0	0	0	0	0	0	0	0	0	0	0	0	0	0	0
% App. Total	0	0	0	0		0	0	0	0		0	0	0	0		0	0	0	0		
PHF	.000	.000	.000	.000	.000	.000	.000	.000	.000	.000	.000	.000	.000	.000	.000	.000	.000	.000	.000	.000	.000

Traffic Data Service

San Jose, CA
(408) 622-4787
tdsbay@cs.com

File Name : 9PM FINAL
Site Code : 00000009
Start Date : 4/27/2017
Page No : 2

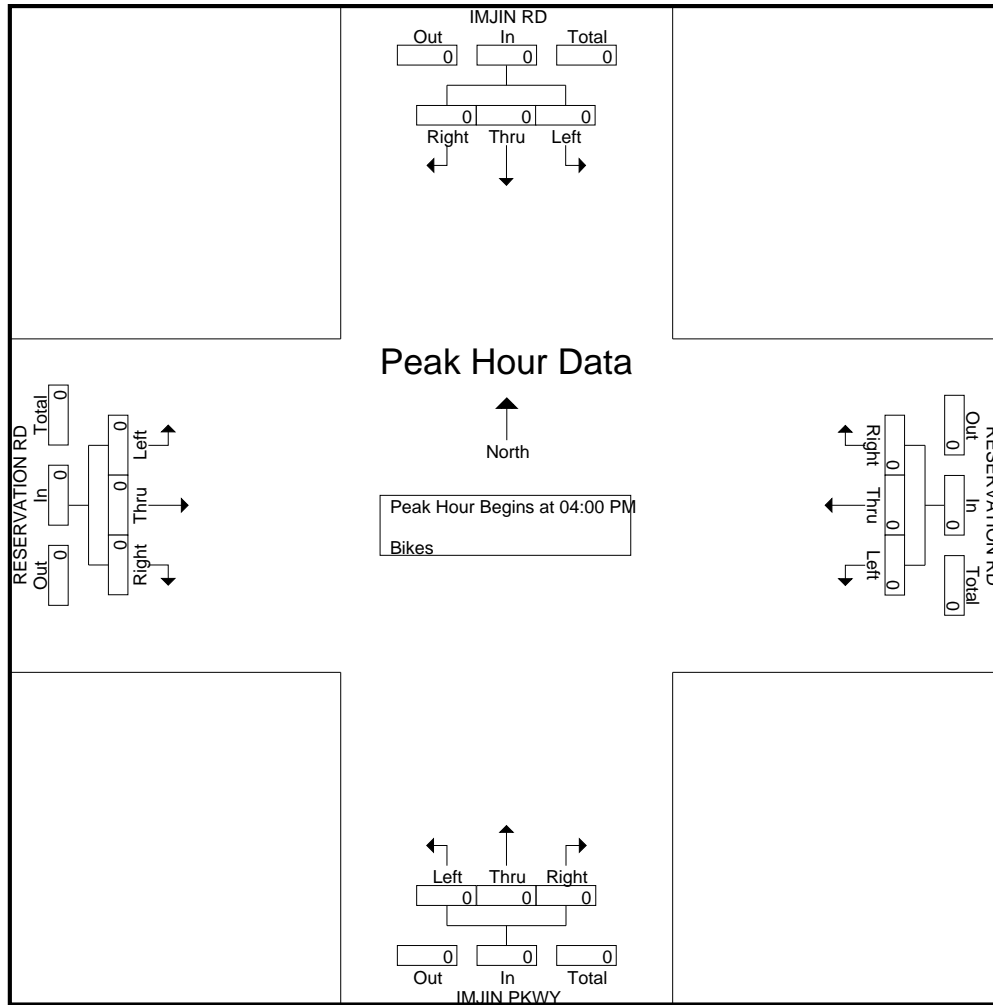

Traffic Data Service

San Jose, CA
(408) 622-4787
tdsbay@cs.com

File Name : 10AM FINAL
 Site Code : 00000010
 Start Date : 4/27/2017
 Page No : 1

Groups Printed- Lights - Buses - Trucks

Start Time	2ND AVE Southbound					9TH ST Westbound					2ND AVE Northbound					9TH ST Eastbound					Int. Total
	Right	Thru	Left	Peds	App. Total	Right	Thru	Left	Peds	App. Total	Right	Thru	Left	Peds	App. Total	Right	Thru	Left	Peds	App. Total	
07:00 AM	2	48	3	0	53	0	1	18	0	19	0	9	3	1	13	3	0	5	0	8	93
07:15 AM	7	116	0	3	126	0	1	61	0	62	1	17	0	0	18	11	1	5	1	18	224
07:30 AM	1	92	0	2	95	2	3	84	0	89	0	27	1	0	28	12	0	10	3	25	237
07:45 AM	3	110	1	0	114	1	4	77	0	82	0	31	3	0	34	10	0	12	0	22	252
Total	13	366	4	5	388	3	9	240	0	252	1	84	7	1	93	36	1	32	4	73	806
08:00 AM	11	141	1	0	153	0	2	20	0	22	3	45	2	0	50	10	0	9	2	21	246
08:15 AM	5	111	0	1	117	1	1	14	1	17	1	20	3	1	25	0	0	9	0	9	168
08:30 AM	11	55	0	1	67	0	0	6	0	6	0	22	6	1	29	3	0	3	0	6	108
08:45 AM	6	62	1	1	70	0	0	6	0	6	1	23	1	0	25	5	0	5	0	10	111
Total	33	369	2	3	407	1	3	46	1	51	5	110	12	2	129	18	0	26	2	46	633
Grand Total	46	735	6	8	795	4	12	286	1	303	6	194	19	3	222	54	1	58	6	119	1439
Apprch %	5.8	92.5	0.8	1		1.3	4	94.4	0.3		2.7	87.4	8.6	1.4		45.4	0.8	48.7	5		
Total %	3.2	51.1	0.4	0.6	55.2	0.3	0.8	19.9	0.1	21.1	0.4	13.5	1.3	0.2	15.4	3.8	0.1	4	0.4	8.3	
Lights	43	722	6	8	779	3	11	286	1	301	6	188	17	3	214	54	1	54	6	115	1409
% Lights	93.5	98.2	100	100	98	75	91.7	100	100	99.3	100	96.9	89.5	100	96.4	100	100	93.1	100	96.6	97.9
Buses	1	9	0	0	10	0	1	0	0	1	0	2	1	0	3	0	0	2	0	2	16
% Buses	2.2	1.2	0	0	1.3	0	8.3	0	0	0.3	0	1	5.3	0	1.4	0	0	3.4	0	1.7	1.1
Trucks	2	4	0	0	6	1	0	0	0	1	0	4	1	0	5	0	0	2	0	2	14
% Trucks	4.3	0.5	0	0	0.8	25	0	0	0	0.3	0	2.1	5.3	0	2.3	0	0	3.4	0	1.7	1

Start Time	2ND AVE Southbound				9TH ST Westbound				2ND AVE Northbound				9TH ST Eastbound				Int. Total
	Right	Thru	Left	App. Total	Right	Thru	Left	App. Total	Right	Thru	Left	App. Total	Right	Thru	Left	App. Total	
Peak Hour Analysis From 07:00 AM to 08:45 AM - Peak 1 of 1																	
Peak Hour for Entire Intersection Begins at 07:15 AM																	
07:15 AM	7	116	0	123	0	1	61	62	1	17	0	18	11	1	5	17	220
07:30 AM	1	92	0	93	2	3	84	89	0	27	1	28	12	0	10	22	232
07:45 AM	3	110	1	114	1	4	77	82	0	31	3	34	10	0	12	22	252
08:00 AM	11	141	1	153	0	2	20	22	3	45	2	50	10	0	9	19	244
Total Volume	22	459	2	483	3	10	242	255	4	120	6	130	43	1	36	80	948
% App. Total	4.6	95	0.4		1.2	3.9	94.9		3.1	92.3	4.6		53.8	1.2	45		
PHF	.500	.814	.500	.789	.375	.625	.720	.716	.333	.667	.500	.650	.896	.250	.750	.909	.940

Traffic Data Service

San Jose, CA
 (408) 622-4787
 tdsbay@cs.com

File Name : 10AM FINAL
 Site Code : 00000010
 Start Date : 4/27/2017
 Page No : 2

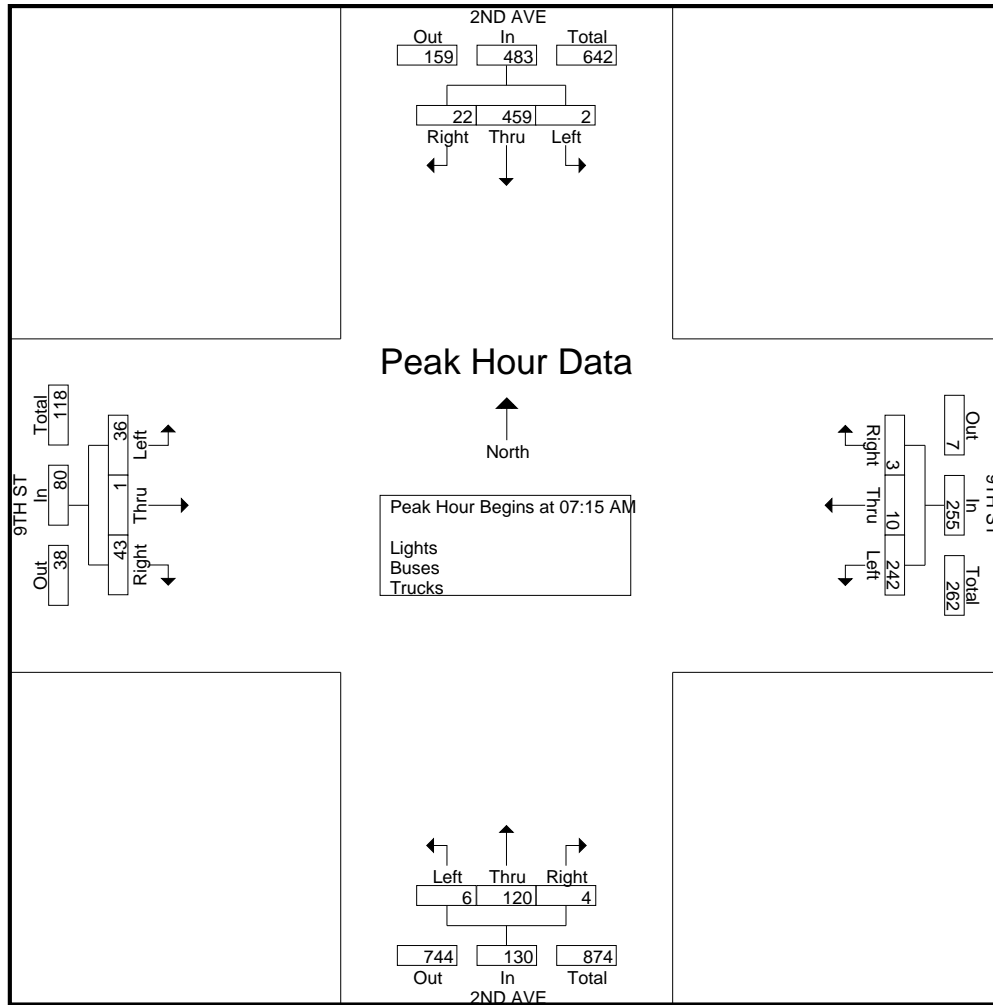

Traffic Data Service

San Jose, CA
 (408) 622-4787
 tdsbay@cs.com

File Name : 10AM FINAL
 Site Code : 00000010
 Start Date : 4/27/2017
 Page No : 1

Groups Printed- Bikes

Start Time	2ND AVE Southbound					9TH ST Westbound					2ND AVE Northbound					9TH ST Eastbound					Int. Total
	Right	Thru	Left	Peds	App. Total	Right	Thru	Left	Peds	App. Total	Right	Thru	Left	Peds	App. Total	Right	Thru	Left	Peds	App. Total	
07:00 AM	0	0	0	0	0	0	0	0	0	0	0	0	0	0	0	0	0	0	0	0	0
07:15 AM	0	0	0	0	0	0	0	0	0	0	0	0	0	0	0	0	0	0	0	0	0
07:30 AM	0	0	0	0	0	0	1	0	0	1	0	0	0	0	0	0	0	0	0	0	1
07:45 AM	0	0	0	0	0	0	0	0	0	0	0	0	0	0	0	0	0	0	0	0	0
Total	0	0	0	0	0	0	1	0	0	1	0	0	0	0	0	0	0	0	0	0	1
08:00 AM	0	0	0	0	0	0	0	0	0	0	0	0	0	0	0	0	0	0	0	0	0
08:15 AM	0	1	0	0	1	0	0	0	0	0	0	0	0	0	0	0	0	0	0	0	1
08:30 AM	0	0	0	0	0	0	0	0	0	0	0	0	0	0	0	0	0	0	0	0	0
08:45 AM	0	0	0	0	0	0	0	0	0	0	0	0	0	0	0	0	0	0	0	0	0
Total	0	1	0	0	1	0	0	0	0	0	0	0	0	0	0	0	0	0	0	0	1
Grand Total	0	1	0	0	1	0	1	0	0	1	0	0	0	0	0	0	0	0	0	0	2
Apprch %	0	100	0	0		0	100	0	0		0	0	0	0		0	0	0	0		
Total %	0	50	0	0	50	0	50	0	0	50	0	0	0	0	0	0	0	0	0	0	

Start Time	2ND AVE Southbound					9TH ST Westbound					2ND AVE Northbound					9TH ST Eastbound					Int. Total
	Right	Thru	Left	Peds	App. Total	Right	Thru	Left	Peds	App. Total	Right	Thru	Left	Peds	App. Total	Right	Thru	Left	Peds	App. Total	
07:30 AM	0	0	0	0	0	0	1	0	0	1	0	0	0	0	0	0	0	0	0	0	1
07:45 AM	0	0	0	0	0	0	0	0	0	0	0	0	0	0	0	0	0	0	0	0	0
08:00 AM	0	0	0	0	0	0	0	0	0	0	0	0	0	0	0	0	0	0	0	0	0
08:15 AM	0	1	0	0	1	0	0	0	0	0	0	0	0	0	0	0	0	0	0	0	1
Total Volume	0	1	0	0	1	0	1	0	0	1	0	0	0	0	0	0	0	0	0	0	2
% App. Total	0	100	0	0		0	100	0	0		0	0	0	0		0	0	0	0		
PHF	.000	.250	.000	.000	.250	.000	.250	.000	.000	.250	.000	.000	.000	.000	.000	.000	.000	.000	.000	.000	.500

Peak Hour Analysis From 07:00 AM to 08:45 AM - Peak 1 of 1
 Peak Hour for Entire Intersection Begins at 07:30 AM

Traffic Data Service

San Jose, CA
(408) 622-4787
tdsbay@cs.com

File Name : 10AM FINAL
Site Code : 00000010
Start Date : 4/27/2017
Page No : 2

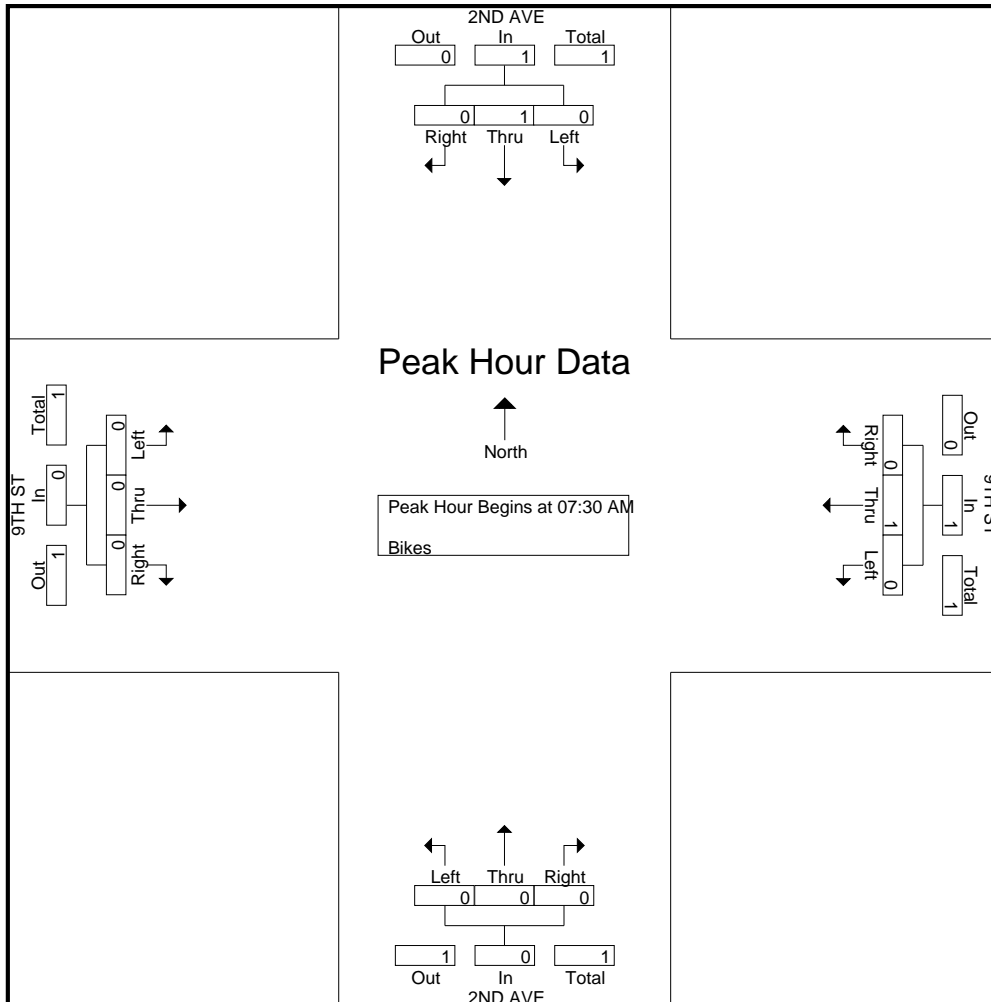

Traffic Data Service

San Jose, CA
 (408) 622-4787
 tdsbay@cs.com

File Name : 10PM FINAL
 Site Code : 00000010
 Start Date : 4/27/2017
 Page No : 1

Groups Printed- Lights - Buses - Trucks

Start Time	2ND AVE Southbound					9TH ST Westbound					2ND AVE Northbound					9TH ST Eastbound					Int. Total
	Right	Thru	Left	Peds	App. Total	Right	Thru	Left	Peds	App. Total	Right	Thru	Left	Peds	App. Total	Right	Thru	Left	Peds	App. Total	
04:00 PM	4	46	2	0	52	0	1	5	0	6	5	55	2	0	62	2	0	7	3	12	132
04:15 PM	3	53	2	0	58	1	0	2	1	4	6	51	6	0	63	4	2	8	0	14	139
04:30 PM	5	63	1	0	69	2	0	0	2	4	7	62	9	0	78	4	0	5	1	10	161
04:45 PM	12	56	1	0	69	0	0	4	1	5	4	76	4	0	84	1	0	11	2	14	172
Total	24	218	6	0	248	3	1	11	4	19	22	244	21	0	287	11	2	31	6	50	604
05:00 PM	2	37	0	1	40	1	1	4	1	7	7	92	3	0	102	2	0	5	1	8	157
05:15 PM	11	53	1	1	66	0	1	2	4	7	7	97	3	0	107	3	0	5	1	9	189
05:30 PM	4	46	0	0	50	1	0	5	0	6	5	67	5	1	78	4	0	6	2	12	146
05:45 PM	9	53	1	0	63	3	0	4	2	9	7	75	2	0	84	3	1	8	3	15	171
Total	26	189	2	2	219	5	2	15	7	29	26	331	13	1	371	12	1	24	7	44	663
Grand Total	50	407	8	2	467	8	3	26	11	48	48	575	34	1	658	23	3	55	13	94	1267
Apprch %	10.7	87.2	1.7	0.4		16.7	6.2	54.2	22.9		7.3	87.4	5.2	0.2		24.5	3.2	58.5	13.8		
Total %	3.9	32.1	0.6	0.2	36.9	0.6	0.2	2.1	0.9	3.8	3.8	45.4	2.7	0.1	51.9	1.8	0.2	4.3	1	7.4	
Lights	50	396	8	2	456	8	2	26	11	47	48	572	33	1	654	23	3	54	13	93	1250
% Lights	100	97.3	100	100	97.6	100	66.7	100	100	97.9	100	99.5	97.1	100	99.4	100	100	98.2	100	98.9	98.7
Buses	0	9	0	0	9	0	0	0	0	0	0	2	0	0	2	0	0	0	0	0	11
% Buses	0	2.2	0	0	1.9	0	0	0	0	0	0	0.3	0	0	0.3	0	0	0	0	0	0.9
Trucks	0	2	0	0	2	0	1	0	0	1	0	1	1	0	2	0	0	1	0	1	6
% Trucks	0	0.5	0	0	0.4	0	33.3	0	0	2.1	0	0.2	2.9	0	0.3	0	0	1.8	0	1.1	0.5

Start Time	2ND AVE Southbound				9TH ST Westbound				2ND AVE Northbound				9TH ST Eastbound				Int. Total
	Right	Thru	Left	App. Total	Right	Thru	Left	App. Total	Right	Thru	Left	App. Total	Right	Thru	Left	App. Total	
Peak Hour Analysis From 04:00 PM to 05:45 PM - Peak 1 of 1																	
Peak Hour for Entire Intersection Begins at 04:30 PM																	
04:30 PM	5	63	1	69	2	0	0	2	7	62	9	78	4	0	5	9	158
04:45 PM	12	56	1	69	0	0	4	4	4	76	4	84	1	0	11	12	169
05:00 PM	2	37	0	39	1	1	4	6	7	92	3	102	2	0	5	7	154
05:15 PM	11	53	1	65	0	1	2	3	7	97	3	107	3	0	5	8	183
Total Volume	30	209	3	242	3	2	10	15	25	327	19	371	10	0	26	36	664
% App. Total	12.4	86.4	1.2		20	13.3	66.7		6.7	88.1	5.1		27.8	0	72.2		
PHF	.625	.829	.750	.877	.375	.500	.625	.625	.893	.843	.528	.867	.625	.000	.591	.750	.907

Traffic Data Service

San Jose, CA
 (408) 622-4787
 tdsbay@cs.com

File Name : 10PM FINAL
 Site Code : 00000010
 Start Date : 4/27/2017
 Page No : 2

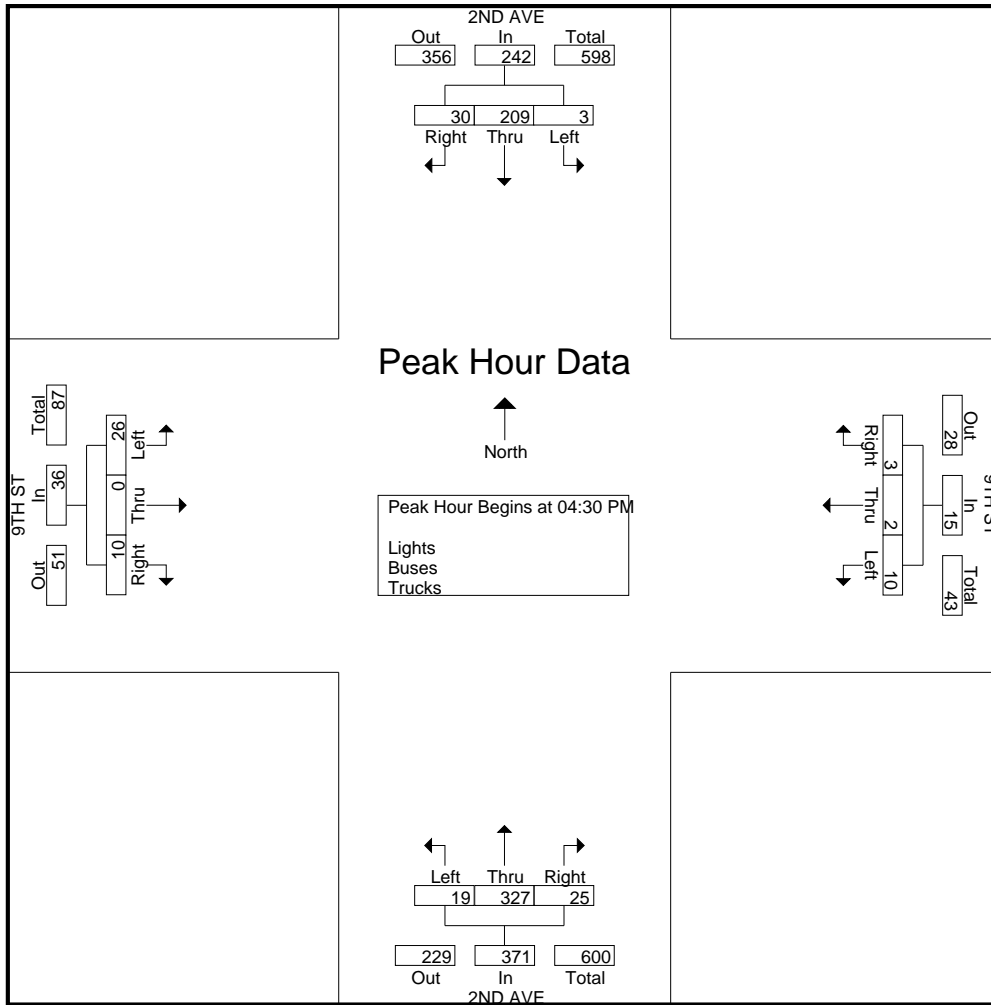

Traffic Data Service

San Jose, CA
 (408) 622-4787
 tdsbay@cs.com

File Name : 10PM FINAL
 Site Code : 00000010
 Start Date : 4/27/2017
 Page No : 1

Groups Printed- Bikes

Start Time	2ND AVE Southbound					9TH ST Westbound					2ND AVE Northbound					9TH ST Eastbound					Int. Total
	Right	Thru	Left	Peds	App. Total	Right	Thru	Left	Peds	App. Total	Right	Thru	Left	Peds	App. Total	Right	Thru	Left	Peds	App. Total	
04:00 PM	0	0	0	0	0	0	0	0	0	0	0	0	0	0	0	0	0	0	0	0	0
04:15 PM	0	0	0	0	0	0	0	0	0	0	0	0	0	0	0	0	0	0	0	0	0
04:30 PM	1	0	0	0	1	0	0	0	0	0	0	2	0	0	2	0	0	0	0	0	3
04:45 PM	0	1	0	0	1	0	0	0	0	0	0	0	0	0	0	0	1	0	0	1	2
Total	1	1	0	0	2	0	0	0	0	0	0	2	0	0	2	0	1	0	0	1	5
05:00 PM	0	0	0	0	0	0	0	0	0	0	0	0	0	0	0	0	0	0	0	0	0
05:15 PM	0	1	0	0	1	0	0	0	0	0	0	0	0	0	0	0	0	0	0	0	1
05:30 PM	0	0	0	0	0	0	0	0	0	0	0	0	0	0	0	0	0	1	0	1	1
05:45 PM	0	0	0	0	0	0	0	0	0	0	0	0	0	0	0	0	0	0	0	0	0
Total	0	1	0	0	1	0	0	0	0	0	0	0	0	0	0	0	0	1	0	1	2
Grand Total	1	2	0	0	3	0	0	0	0	0	0	2	0	0	2	0	1	1	0	2	7
Apprch %	33.3	66.7	0	0		0	0	0	0		0	100	0	0		0	50	50	0		
Total %	14.3	28.6	0	0	42.9	0	0	0	0	0	0	28.6	0	0	28.6	0	14.3	14.3	0	28.6	

Start Time	2ND AVE Southbound				9TH ST Westbound				2ND AVE Northbound				9TH ST Eastbound				Int. Total
	Right	Thru	Left	App. Total	Right	Thru	Left	App. Total	Right	Thru	Left	App. Total	Right	Thru	Left	App. Total	
Peak Hour Analysis From 04:00 PM to 05:45 PM - Peak 1 of 1																	
Peak Hour for Entire Intersection Begins at 04:30 PM																	
04:30 PM	1	0	0	1	0	0	0	0	0	2	0	2	0	0	0	0	3
04:45 PM	0	1	0	1	0	0	0	0	0	0	0	0	0	1	0	1	2
05:00 PM	0	0	0	0	0	0	0	0	0	0	0	0	0	0	0	0	0
05:15 PM	0	1	0	1	0	0	0	0	0	0	0	0	0	0	0	0	1
Total Volume	1	2	0	3	0	0	0	0	0	2	0	2	0	1	0	1	6
% App. Total	33.3	66.7	0		0	0	0		0	100	0		0	100	0		
PHF	.250	.500	.000	.750	.000	.000	.000	.000	.000	.250	.000	.250	.000	.250	.000	.250	.500

Traffic Data Service

San Jose, CA
 (408) 622-4787
 tdsbay@cs.com

File Name : 10PM FINAL
 Site Code : 00000010
 Start Date : 4/27/2017
 Page No : 2

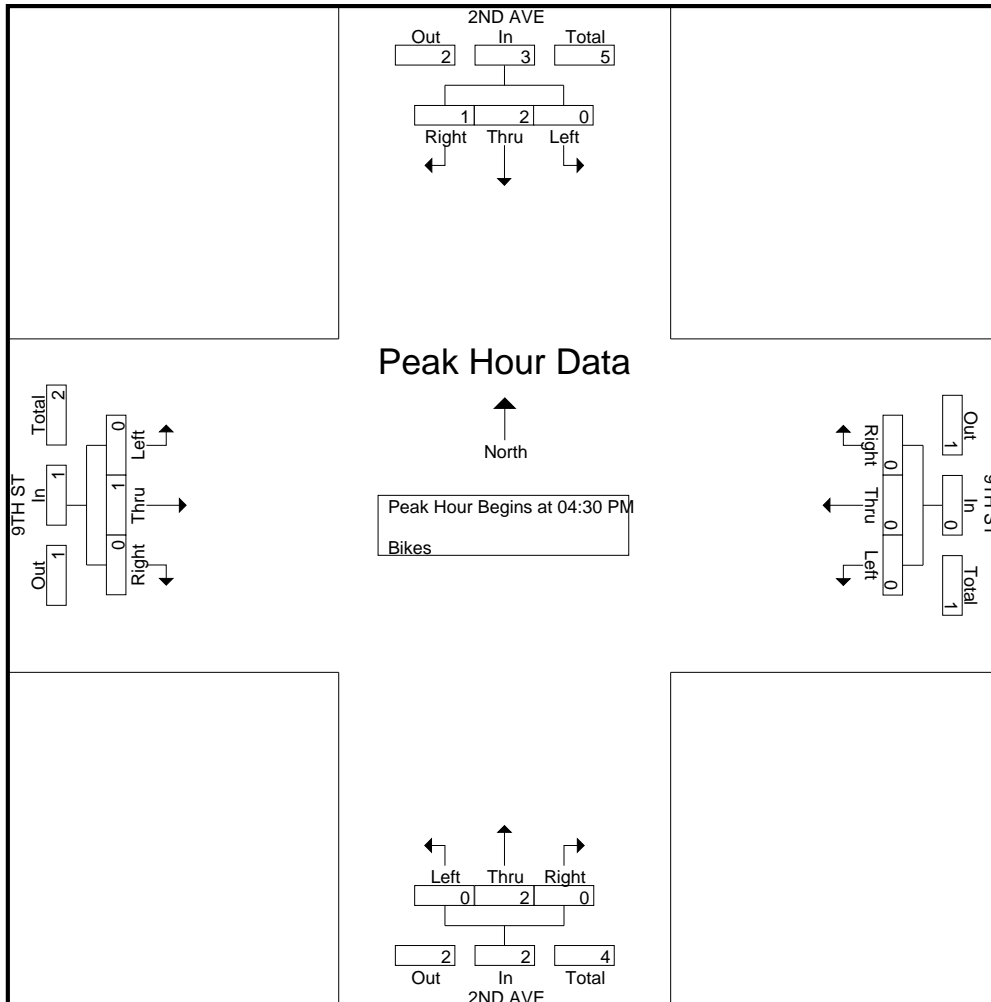

Traffic Data Service

San Jose, CA
(408) 622-4787
tdsbay@cs.com

File Name : 11AM FINAL
 Site Code : 00000011
 Start Date : 4/27/2017
 Page No : 1

Groups Printed- Lights - Buses - Trucks

Start Time	2ND AVE Southbound					8TH ST Westbound					2ND AVE Northbound					8TH ST Eastbound					Int. Total
	Right	Thru	Left	Peds	App. Total	Right	Thru	Left	Peds	App. Total	Right	Thru	Left	Peds	App. Total	Right	Thru	Left	Peds	App. Total	
07:00 AM	0	65	0	0	65	0	0	2	0	2	0	12	0	0	12	0	0	0	0	0	79
07:15 AM	0	182	4	0	186	1	0	0	1	2	0	14	0	0	14	1	0	0	0	0	203
07:30 AM	0	187	2	0	189	0	0	0	0	0	1	30	0	0	31	0	0	0	0	0	220
07:45 AM	0	188	8	0	196	0	0	0	0	0	0	32	1	0	33	0	0	0	0	0	229
Total	0	622	14	0	636	1	0	2	1	4	1	88	1	0	90	1	0	0	0	1	731
08:00 AM	0	177	1	0	178	1	0	3	0	4	1	51	0	0	52	0	0	0	0	0	234
08:15 AM	1	123	0	0	124	1	0	1	2	4	1	24	0	0	25	0	0	0	0	0	153
08:30 AM	2	63	1	0	66	0	0	4	4	8	0	29	0	0	29	3	0	0	0	3	106
08:45 AM	0	73	0	0	73	1	0	0	0	1	0	21	1	1	23	0	0	1	0	1	98
Total	3	436	2	0	441	3	0	8	6	17	2	125	1	1	129	3	0	1	0	4	591
Grand Total	3	1058	16	0	1077	4	0	10	7	21	3	213	2	1	219	4	0	1	0	5	1322
Apprch %	0.3	98.2	1.5	0		19	0	47.6	33.3		1.4	97.3	0.9	0.5		80	0	20	0		
Total %	0.2	80	1.2	0	81.5	0.3	0	0.8	0.5	1.6	0.2	16.1	0.2	0.1	16.6	0.3	0	0.1	0	0.4	
Lights	2	1047	16	0	1065	3	0	7	7	17	3	206	1	1	211	3	0	0	0	3	1296
% Lights	66.7	99	100	0	98.9	75	0	70	100	81	100	96.7	50	100	96.3	75	0	0	0	60	98
Buses	0	9	0	0	9	0	0	0	0	0	0	4	0	0	4	0	0	0	0	0	13
% Buses	0	0.9	0	0	0.8	0	0	0	0	0	0	1.9	0	0	1.8	0	0	0	0	0	1
Trucks	1	2	0	0	3	1	0	3	0	4	0	3	1	0	4	1	0	1	0	2	13
% Trucks	33.3	0.2	0	0	0.3	25	0	30	0	19	0	1.4	50	0	1.8	25	0	100	0	40	1

Start Time	2ND AVE Southbound				8TH ST Westbound				2ND AVE Northbound				8TH ST Eastbound				Int. Total
	Right	Thru	Left	App. Total	Right	Thru	Left	App. Total	Right	Thru	Left	App. Total	Right	Thru	Left	App. Total	
Peak Hour Analysis From 07:00 AM to 08:45 AM - Peak 1 of 1																	
Peak Hour for Entire Intersection Begins at 07:15 AM																	
07:15 AM	0	182	4	186	1	0	0	1	0	14	0	14	1	0	0	1	202
07:30 AM	0	187	2	189	0	0	0	0	1	30	0	31	0	0	0	0	220
07:45 AM	0	188	8	196	0	0	0	0	0	32	1	33	0	0	0	0	229
08:00 AM	0	177	1	178	1	0	3	4	1	51	0	52	0	0	0	0	234
Total Volume	0	734	15	749	2	0	3	5	2	127	1	130	1	0	0	1	885
% App. Total	0	98	2		40	0	60		1.5	97.7	0.8		100	0	0		
PHF	.000	.976	.469	.955	.500	.000	.250	.313	.500	.623	.250	.625	.250	.000	.000	.250	.946

Traffic Data Service

San Jose, CA
 (408) 622-4787
 tdsbay@cs.com

File Name : 11AM FINAL
 Site Code : 00000011
 Start Date : 4/27/2017
 Page No : 2

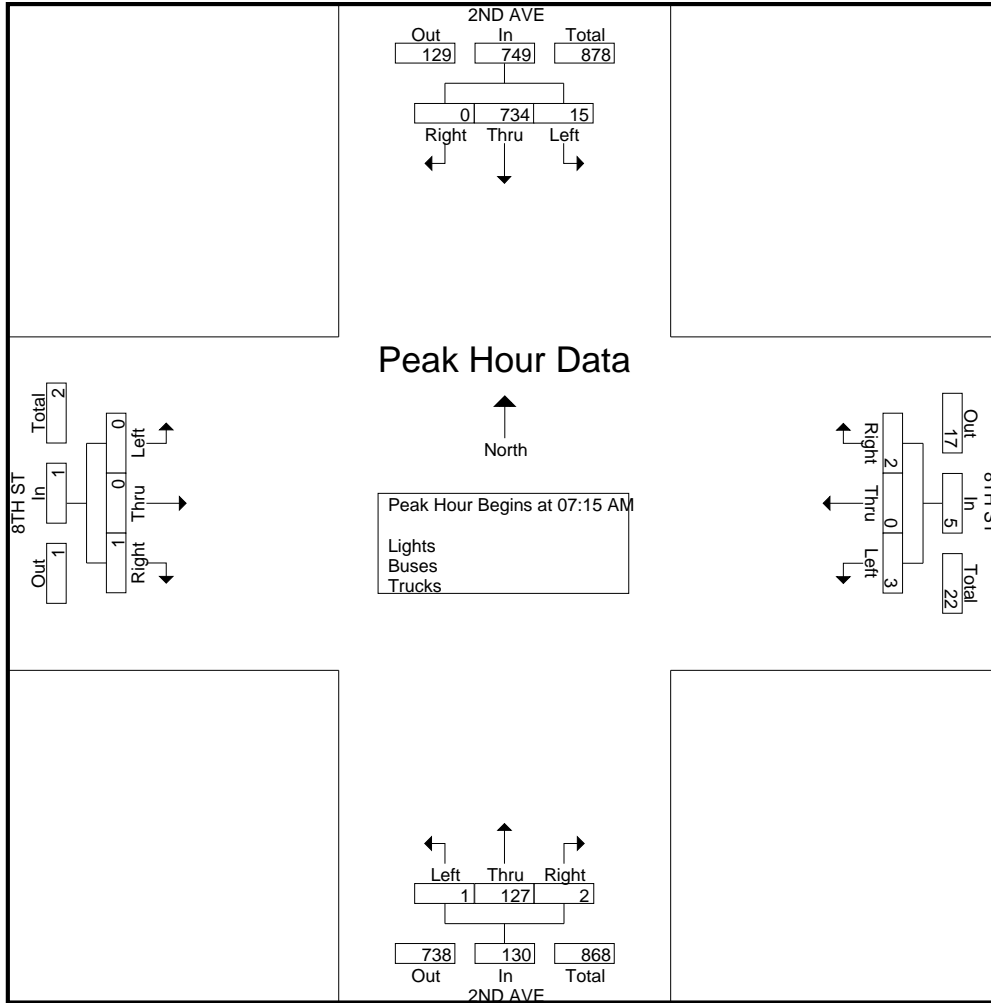

Traffic Data Service

San Jose, CA
 (408) 622-4787
 tdsbay@cs.com

File Name : 11AM FINAL
 Site Code : 00000011
 Start Date : 4/27/2017
 Page No : 1

Groups Printed- Bikes

Start Time	2ND AVE Southbound					8TH ST Westbound					2ND AVE Northbound					8TH ST Eastbound					Int. Total
	Right	Thru	Left	Peds	App. Total	Right	Thru	Left	Peds	App. Total	Right	Thru	Left	Peds	App. Total	Right	Thru	Left	Peds	App. Total	
07:00 AM	0	0	0	0	0	0	0	0	0	0	0	0	0	0	0	0	0	0	0	0	0
07:15 AM	0	0	0	0	0	0	0	0	0	0	0	0	0	0	0	0	0	0	0	0	0
07:30 AM	0	0	0	0	0	0	0	1	0	1	0	0	0	0	0	0	0	0	0	0	1
07:45 AM	0	0	0	0	0	0	0	0	0	0	0	0	0	0	0	0	0	0	0	0	0
Total	0	0	0	0	0	0	0	1	0	1	0	0	0	0	0	0	0	0	0	0	1
08:00 AM	0	0	0	0	0	0	0	0	0	0	0	0	0	0	0	0	0	0	0	0	0
08:15 AM	0	0	0	0	0	0	0	0	0	0	0	0	0	0	0	0	0	0	0	0	0
08:30 AM	0	0	0	0	0	0	0	0	0	0	0	0	0	0	0	0	0	0	0	0	0
08:45 AM	0	0	0	0	0	0	0	0	0	0	0	0	0	0	0	0	0	0	0	0	0
Total	0	0	0	0	0	0	0	0	0	0	0	0	0	0	0	0	0	0	0	0	0
Grand Total	0	0	0	0	0	0	0	1	0	1	0	0	0	0	0	0	0	0	0	0	1
Apprch %	0	0	0	0		0	0	100	0		0	0	0	0		0	0	0	0		
Total %	0	0	0	0		0	0	100	0	100	0	0	0	0		0	0	0	0		

Start Time	2ND AVE Southbound					8TH ST Westbound					2ND AVE Northbound					8TH ST Eastbound					Int. Total
	Right	Thru	Left	Peds	App. Total	Right	Thru	Left	Peds	App. Total	Right	Thru	Left	Peds	App. Total	Right	Thru	Left	Peds	App. Total	
07:00 AM	0	0	0	0	0	0	0	0	0	0	0	0	0	0	0	0	0	0	0	0	0
07:15 AM	0	0	0	0	0	0	0	0	0	0	0	0	0	0	0	0	0	0	0	0	0
07:30 AM	0	0	0	0	0	0	0	1	0	1	0	0	0	0	0	0	0	0	0	0	1
07:45 AM	0	0	0	0	0	0	0	0	0	0	0	0	0	0	0	0	0	0	0	0	0
Total Volume	0	0	0	0	0	0	0	1	0	1	0	0	0	0	0	0	0	0	0	0	1
% App. Total	0	0	0	0		0	0	100	0		0	0	0	0		0	0	0	0		
PHF	.000	.000	.000	.000	.000	.000	.000	.250	.250	.000	.000	.000	.000	.000	.000	.000	.000	.000	.000	.000	.250

Peak Hour Analysis From 07:00 AM to 08:45 AM - Peak 1 of 1
 Peak Hour for Entire Intersection Begins at 07:00 AM

Traffic Data Service

San Jose, CA
(408) 622-4787
tdsbay@cs.com

File Name : 11AM FINAL
Site Code : 00000011
Start Date : 4/27/2017
Page No : 2

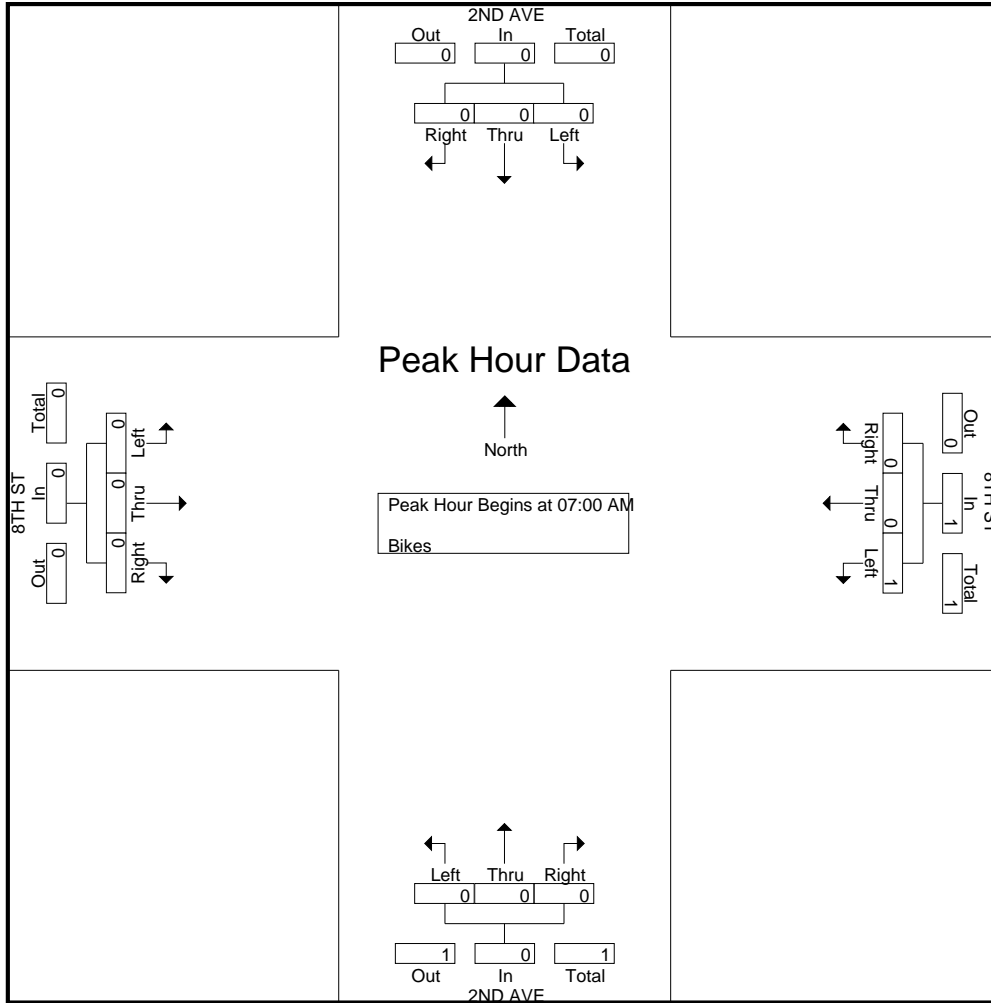

Traffic Data Service

San Jose, CA
 (408) 622-4787
 tdsbay@cs.com

File Name : 11PM FINAL
 Site Code : 00000011
 Start Date : 4/27/2017
 Page No : 1

Groups Printed- Lights - Buses - Trucks

Start Time	2ND AVE Southbound					8TH ST Westbound					2ND AVE Northbound					8TH ST Eastbound					Int. Total
	Right	Thru	Left	Peds	App. Total	Right	Thru	Left	Peds	App. Total	Right	Thru	Left	Peds	App. Total	Right	Thru	Left	Peds	App. Total	
04:00 PM	1	53	0	0	54	6	0	1	0	7	1	55	1	0	57	0	0	0	0	0	118
04:15 PM	1	54	1	0	56	2	0	1	2	5	1	61	0	2	64	2	0	1	2	5	130
04:30 PM	1	67	0	2	70	0	0	0	1	1	2	77	2	0	81	1	0	1	2	4	156
04:45 PM	0	62	1	0	63	2	0	0	2	4	1	82	0	2	85	0	0	1	2	3	155
Total	3	236	2	2	243	10	0	2	5	17	5	275	3	4	287	3	0	3	6	12	559
05:00 PM	0	47	1	0	48	1	0	5	3	9	1	100	0	0	101	0	0	0	0	0	158
05:15 PM	1	55	0	0	56	0	0	0	4	4	1	106	1	0	108	0	0	0	0	0	168
05:30 PM	0	57	0	0	57	0	0	0	1	1	0	76	0	0	76	0	0	0	0	0	134
05:45 PM	0	59	0	0	59	0	0	0	2	2	0	86	4	0	90	2	0	0	0	2	153
Total	1	218	1	0	220	1	0	5	10	16	2	368	5	0	375	2	0	0	0	2	613
Grand Total	4	454	3	2	463	11	0	7	15	33	7	643	8	4	662	5	0	3	6	14	1172
Apprch %	0.9	98.1	0.6	0.4		33.3	0	21.2	45.5		1.1	97.1	1.2	0.6		35.7	0	21.4	42.9		
Total %	0.3	38.7	0.3	0.2	39.5	0.9	0	0.6	1.3	2.8	0.6	54.9	0.7	0.3	56.5	0.4	0	0.3	0.5	1.2	
Lights	4	443	3	2	452	11	0	7	15	33	6	640	8	4	658	5	0	3	6	14	1157
% Lights	100	97.6	100	100	97.6	100	0	100	100	100	85.7	99.5	100	100	99.4	100	0	100	100	100	98.7
Buses	0	9	0	0	9	0	0	0	0	0	0	2	0	0	2	0	0	0	0	0	11
% Buses	0	2	0	0	1.9	0	0	0	0	0	0	0.3	0	0	0.3	0	0	0	0	0	0.9
Trucks	0	2	0	0	2	0	0	0	0	0	1	1	0	0	2	0	0	0	0	0	4
% Trucks	0	0.4	0	0	0.4	0	0	0	0	0	14.3	0.2	0	0	0.3	0	0	0	0	0	0.3

Start Time	2ND AVE Southbound				8TH ST Westbound				2ND AVE Northbound				8TH ST Eastbound				Int. Total
	Right	Thru	Left	App. Total	Right	Thru	Left	App. Total	Right	Thru	Left	App. Total	Right	Thru	Left	App. Total	
Peak Hour Analysis From 04:00 PM to 05:45 PM - Peak 1 of 1																	
Peak Hour for Entire Intersection Begins at 04:30 PM																	
04:30 PM	1	67	0	68	0	0	0	0	2	77	2	81	1	0	1	2	151
04:45 PM	0	62	1	63	2	0	0	2	1	82	0	83	0	0	1	1	149
05:00 PM	0	47	1	48	1	0	5	6	1	100	0	101	0	0	0	0	155
05:15 PM	1	55	0	56	0	0	0	0	1	106	1	108	0	0	0	0	164
Total Volume	2	231	2	235	3	0	5	8	5	365	3	373	1	0	2	3	619
% App. Total	0.9	98.3	0.9		37.5	0	62.5		1.3	97.9	0.8		33.3	0	66.7		
PHF	.500	.862	.500	.864	.375	.000	.250	.333	.625	.861	.375	.863	.250	.000	.500	.375	.944

Traffic Data Service

San Jose, CA
 (408) 622-4787
 tdsbay@cs.com

File Name : 11PM FINAL
 Site Code : 00000011
 Start Date : 4/27/2017
 Page No : 2

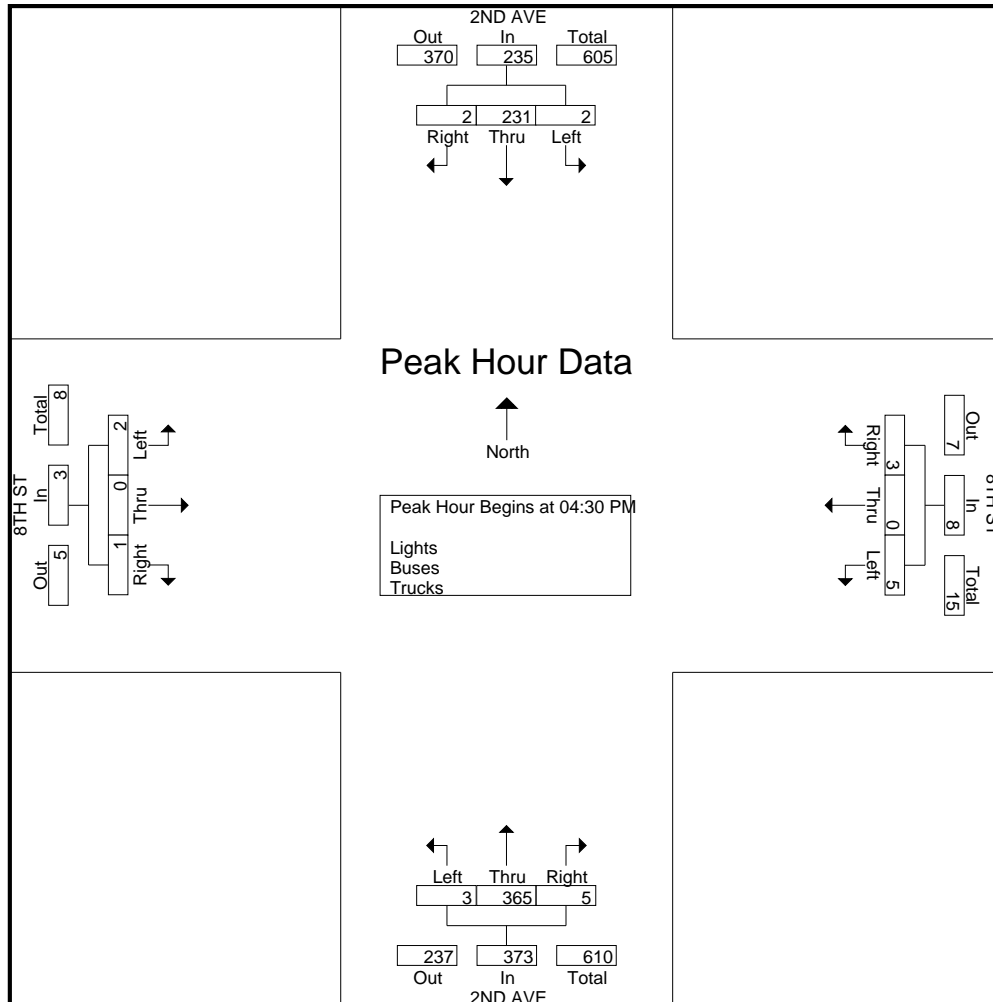

Traffic Data Service

San Jose, CA
 (408) 622-4787
 tdsbay@cs.com

File Name : 11PM FINAL
 Site Code : 00000011
 Start Date : 4/27/2017
 Page No : 1

Groups Printed- Bikes

Start Time	2ND AVE Southbound					8TH ST Westbound					2ND AVE Northbound					8TH ST Eastbound					Int. Total					
	Right	Thru	Left	Peds	App. Total	Right	Thru	Left	Peds	App. Total	Right	Thru	Left	Peds	App. Total	Right	Thru	Left	Peds	App. Total						
04:00 PM	0	0	0	0	0	0	0	0	0	0	0	0	0	0	0	0	0	0	0	0	0	0	0	0	0	0
04:15 PM	0	0	0	0	0	0	0	0	0	0	0	0	0	0	0	0	0	0	0	0	0	0	0	0	0	0
04:30 PM	0	0	0	0	0	0	0	0	0	0	0	1	0	0	1	0	0	0	0	0	0	0	0	0	1	
04:45 PM	0	0	0	0	0	0	0	0	0	0	0	0	0	0	0	0	0	0	0	0	0	0	0	0	0	0
Total	0	0	0	0	0	0	0	0	0	0	0	1	0	0	1	0	0	0	0	0	0	0	0	0	1	
05:00 PM	0	0	0	0	0	0	0	1	0	1	0	0	0	0	0	0	0	0	0	0	0	0	0	0	1	
05:15 PM	0	1	0	0	1	0	0	0	0	0	0	0	0	0	0	0	0	0	0	0	0	0	0	0	1	
05:30 PM	0	0	0	0	0	0	0	0	0	0	0	0	0	0	0	0	0	0	0	0	0	0	0	0	0	
05:45 PM	0	0	0	0	0	0	0	0	0	0	0	0	0	0	0	0	0	0	0	0	0	0	0	0	0	
Total	0	1	0	0	1	0	0	1	0	1	0	0	0	0	0	0	0	0	0	0	0	0	0	0	2	
Grand Total	0	1	0	0	1	0	0	1	0	1	0	1	0	0	1	0	0	0	0	0	0	0	0	0	3	
Apprch %	0	100	0	0		0	0	100	0		0	100	0	0		0	0	0	0		0	0	0	0		
Total %	0	33.3	0	0	33.3	0	0	33.3	0	33.3	0	33.3	0	0	33.3	0	0	0	0	0	0	0	0	0		

Start Time	2ND AVE Southbound				8TH ST Westbound				2ND AVE Northbound				8TH ST Eastbound				Int. Total
	Right	Thru	Left	App. Total	Right	Thru	Left	App. Total	Right	Thru	Left	App. Total	Right	Thru	Left	App. Total	
Peak Hour Analysis From 04:00 PM to 05:45 PM - Peak 1 of 1																	
Peak Hour for Entire Intersection Begins at 04:30 PM																	
04:30 PM	0	0	0	0	0	0	0	0	0	1	0	1	0	0	0	0	1
04:45 PM	0	0	0	0	0	0	0	0	0	0	0	0	0	0	0	0	0
05:00 PM	0	0	0	0	0	0	1	1	0	0	0	0	0	0	0	0	1
05:15 PM	0	1	0	1	0	0	0	0	0	0	0	0	0	0	0	0	1
Total Volume	0	1	0	1	0	0	1	1	0	1	0	1	0	0	0	0	3
% App. Total	0	100	0		0	0	100		0	100	0		0	0	0		
PHF	.000	.250	.000	.250	.000	.000	.250	.250	.000	.250	.000	.250	.000	.000	.000	.000	.750

Traffic Data Service

San Jose, CA
 (408) 622-4787
 tdsbay@cs.com

File Name : 11PM FINAL
 Site Code : 00000011
 Start Date : 4/27/2017
 Page No : 2

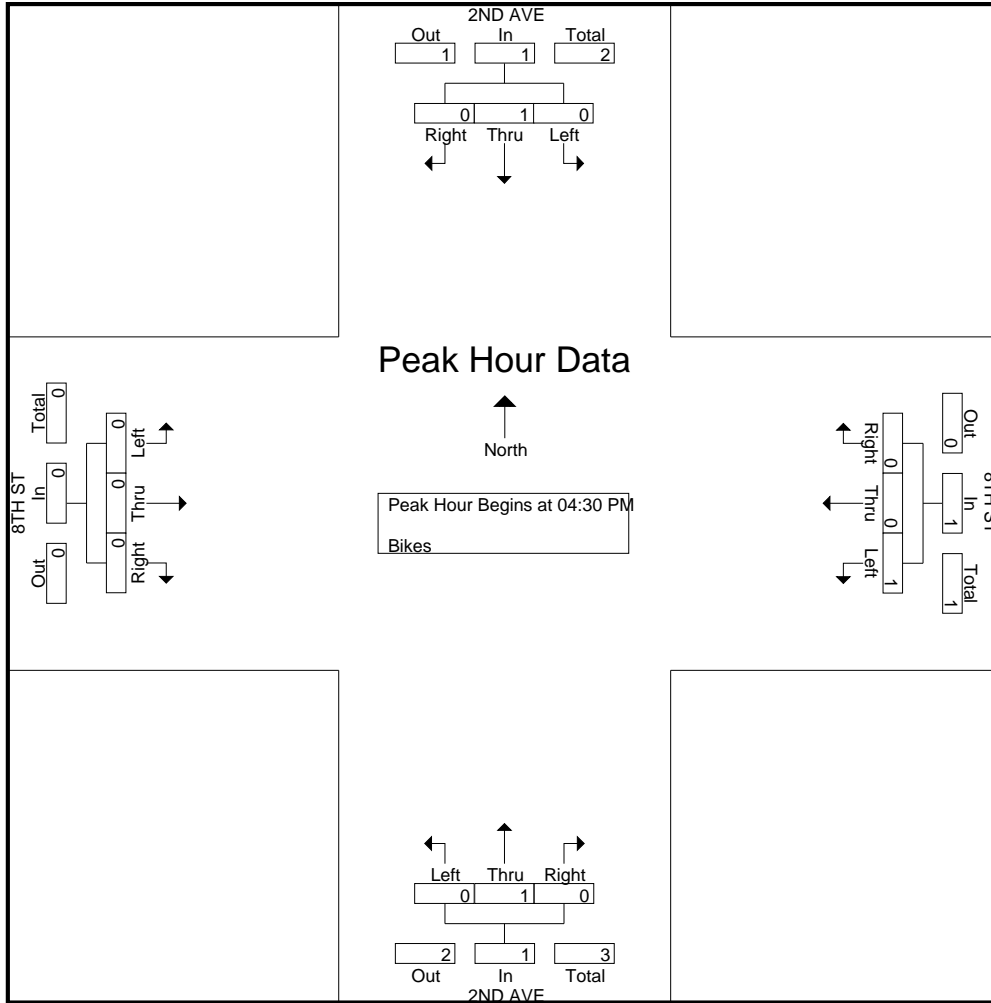

Traffic Data Service

San Jose, CA
(408) 622-4787
tdsbay@cs.com

File Name : 12AM FINAL
Site Code : 00000012
Start Date : 4/27/2017
Page No : 1

Groups Printed- Lights - Buses - Trucks

Start Time	IMJIN RD Southbound					8TH ST Westbound					DRIVEWAY Northbound					8TH ST Eastbound					Int. Total
	Right	Thru	Left	Peds	App. Total	Right	Thru	Left	Peds	App. Total	Right	Thru	Left	Peds	App. Total	Right	Thru	Left	Peds	App. Total	
07:00 AM	3	0	20	0	23	5	2	0	0	7	3	1	0	0	4	0	15	0	0	15	49
07:15 AM	0	2	58	0	60	5	1	0	0	6	1	1	0	0	2	0	30	1	0	31	99
07:30 AM	1	2	95	0	98	13	1	1	0	15	6	2	0	0	8	0	50	0	0	50	171
07:45 AM	2	1	109	0	112	9	4	1	0	14	9	2	0	0	11	1	51	1	0	53	190
Total	6	5	282	0	293	32	8	2	0	42	19	6	0	0	25	1	146	2	0	149	509
08:00 AM	1	3	67	0	71	13	2	3	0	18	8	2	0	0	10	0	41	1	0	42	141
08:15 AM	1	0	66	0	67	13	2	1	0	16	6	1	0	0	7	1	20	5	0	26	116
08:30 AM	0	1	47	0	48	9	3	0	0	12	3	2	0	0	5	0	12	0	0	12	77
08:45 AM	0	1	41	0	42	13	3	2	0	18	3	5	0	0	8	0	9	1	0	10	78
Total	2	5	221	0	228	48	10	6	0	64	20	10	0	0	30	1	82	7	0	90	412
Grand Total	8	10	503	0	521	80	18	8	0	106	39	16	0	0	55	2	228	9	0	239	921
Apprch %	1.5	1.9	96.5	0		75.5	17	7.5	0		70.9	29.1	0	0		0.8	95.4	3.8	0		
Total %	0.9	1.1	54.6	0	56.6	8.7	2	0.9	0	11.5	4.2	1.7	0	0	6	0.2	24.8	1	0	26	
Lights	8	10	496	0	514	71	15	8	0	94	39	16	0	0	55	2	220	9	0	231	894
% Lights	100	100	98.6	0	98.7	88.8	83.3	100	0	88.7	100	100	0	0	100	100	96.5	100	0	96.7	97.1
Buses	0	0	2	0	2	5	0	0	0	5	0	0	0	0	0	0	2	0	0	2	9
% Buses	0	0	0.4	0	0.4	6.2	0	0	0	4.7	0	0	0	0	0	0	0.9	0	0	0.8	1
Trucks	0	0	5	0	5	4	3	0	0	7	0	0	0	0	0	0	6	0	0	6	18
% Trucks	0	0	1	0	1	5	16.7	0	0	6.6	0	0	0	0	0	0	2.6	0	0	2.5	2

Start Time	IMJIN RD Southbound				8TH ST Westbound				DRIVEWAY Northbound				8TH ST Eastbound				Int. Total
	Right	Thru	Left	App. Total	Right	Thru	Left	App. Total	Right	Thru	Left	App. Total	Right	Thru	Left	App. Total	
Peak Hour Analysis From 07:00 AM to 08:45 AM - Peak 1 of 1																	
Peak Hour for Entire Intersection Begins at 07:30 AM																	
07:30 AM	1	2	95	98	13	1	1	15	6	2	0	8	0	50	0	50	171
07:45 AM	2	1	109	112	9	4	1	14	9	2	0	11	1	51	1	53	190
08:00 AM	1	3	67	71	13	2	3	18	8	2	0	10	0	41	1	42	141
08:15 AM	1	0	66	67	13	2	1	16	6	1	0	7	1	20	5	26	116
Total Volume	5	6	337	348	48	9	6	63	29	7	0	36	2	162	7	171	618
% App. Total	1.4	1.7	96.8		76.2	14.3	9.5		80.6	19.4	0		1.2	94.7	4.1		
PHF	.625	.500	.773	.777	.923	.563	.500	.875	.806	.875	.000	.818	.500	.794	.350	.807	.813

Traffic Data Service

San Jose, CA
 (408) 622-4787
 tdsbay@cs.com

File Name : 12AM FINAL
 Site Code : 00000012
 Start Date : 4/27/2017
 Page No : 2

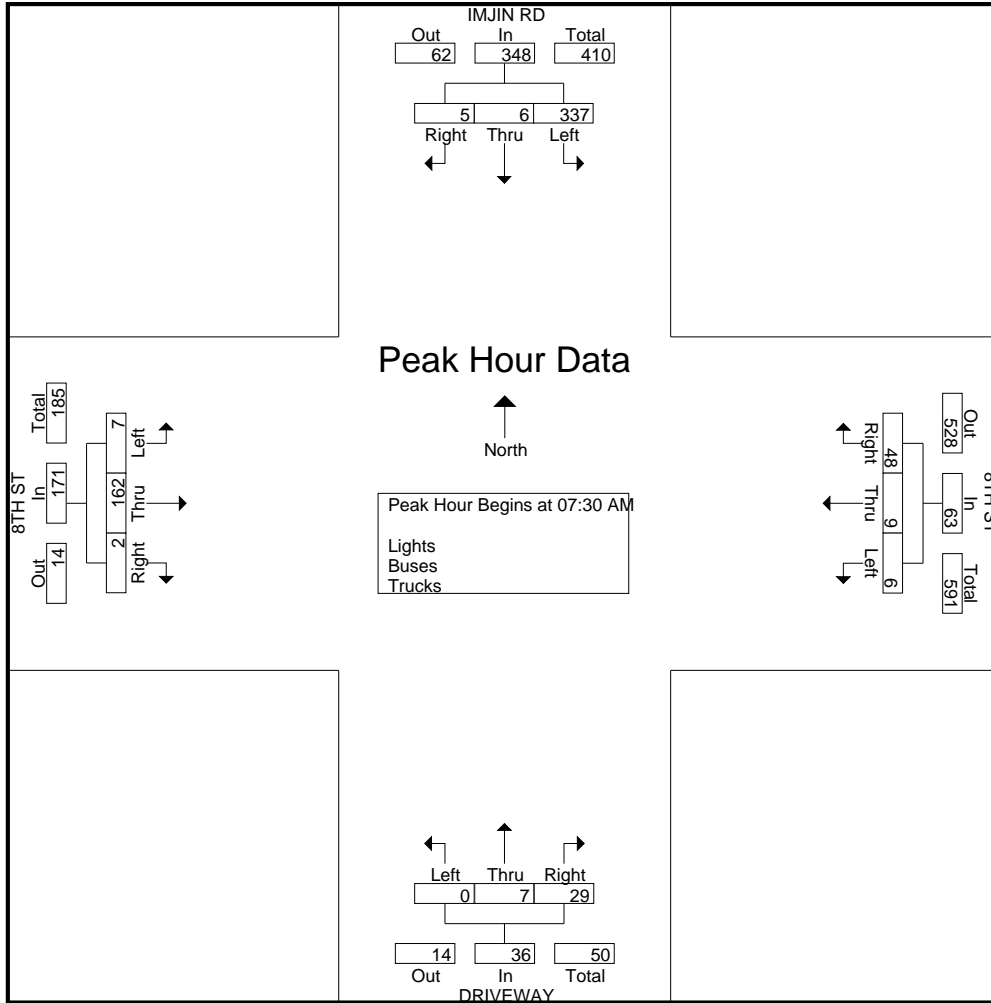

Traffic Data Service

San Jose, CA
 (408) 622-4787
 tdsbay@cs.com

File Name : 12AM FINAL
 Site Code : 00000012
 Start Date : 4/27/2017
 Page No : 1

Groups Printed- Bikes

Start Time	IMJIN RD Southbound					8TH ST Westbound					DRIVEWAY Northbound					8TH ST Eastbound					Int. Total
	Right	Thru	Left	Peds	App. Total	Right	Thru	Left	Peds	App. Total	Right	Thru	Left	Peds	App. Total	Right	Thru	Left	Peds	App. Total	
07:00 AM	0	0	0	0	0	0	0	0	0	0	0	0	0	0	0	0	0	0	0	0	0
07:15 AM	0	0	0	0	0	0	0	0	0	0	0	0	0	0	0	0	0	0	0	0	0
07:30 AM	0	0	0	0	0	0	0	0	0	0	0	0	0	0	0	1	0	0	0	1	1
07:45 AM	0	0	0	0	0	0	0	0	0	0	0	0	0	0	0	0	0	0	0	0	0
Total	0	0	0	0	0	0	0	0	0	0	0	0	0	0	0	1	0	0	0	1	1
08:00 AM	0	0	0	0	0	0	0	0	0	0	0	0	0	0	0	0	0	0	0	0	0
08:15 AM	0	0	0	0	0	0	0	0	0	0	0	0	0	0	0	0	0	0	0	0	0
08:30 AM	0	0	0	0	0	0	0	0	0	0	0	0	0	0	0	0	0	0	0	0	0
08:45 AM	0	0	0	0	0	0	0	0	0	0	0	0	0	0	0	0	0	0	0	0	0
Total	0	0	0	0	0	0	0	0	0	0	0	0	0	0	0	0	0	0	0	0	0
Grand Total	0	0	0	0	0	0	0	0	0	0	0	0	0	0	0	1	0	0	0	1	1
Apprch %	0	0	0	0	0	0	0	0	0	0	0	0	0	0	0	100	0	0	0	0	
Total %	0	0	0	0	0	0	0	0	0	0	0	0	0	0	0	100	0	0	0	100	

Start Time	IMJIN RD Southbound					8TH ST Westbound					DRIVEWAY Northbound					8TH ST Eastbound					Int. Total
	Right	Thru	Left	Peds	App. Total	Right	Thru	Left	Peds	App. Total	Right	Thru	Left	Peds	App. Total	Right	Thru	Left	Peds	App. Total	
07:00 AM	0	0	0	0	0	0	0	0	0	0	0	0	0	0	0	0	0	0	0	0	0
07:15 AM	0	0	0	0	0	0	0	0	0	0	0	0	0	0	0	0	0	0	0	0	0
07:30 AM	0	0	0	0	0	0	0	0	0	0	0	0	0	0	0	1	0	0	0	1	1
07:45 AM	0	0	0	0	0	0	0	0	0	0	0	0	0	0	0	0	0	0	0	0	0
Total Volume	0	0	0	0	0	0	0	0	0	0	0	0	0	0	0	1	0	0	0	1	1
% App. Total	0	0	0	0	0	0	0	0	0	0	0	0	0	0	0	100	0	0	0	0	
PHF	.000	.000	.000	.000	.000	.000	.000	.000	.000	.000	.000	.000	.000	.000	.000	.250	.000	.000	.250	.250	

Peak Hour Analysis From 07:00 AM to 08:45 AM - Peak 1 of 1
 Peak Hour for Entire Intersection Begins at 07:00 AM

Traffic Data Service

San Jose, CA
(408) 622-4787
tdsbay@cs.com

File Name : 12AM FINAL
Site Code : 00000012
Start Date : 4/27/2017
Page No : 2

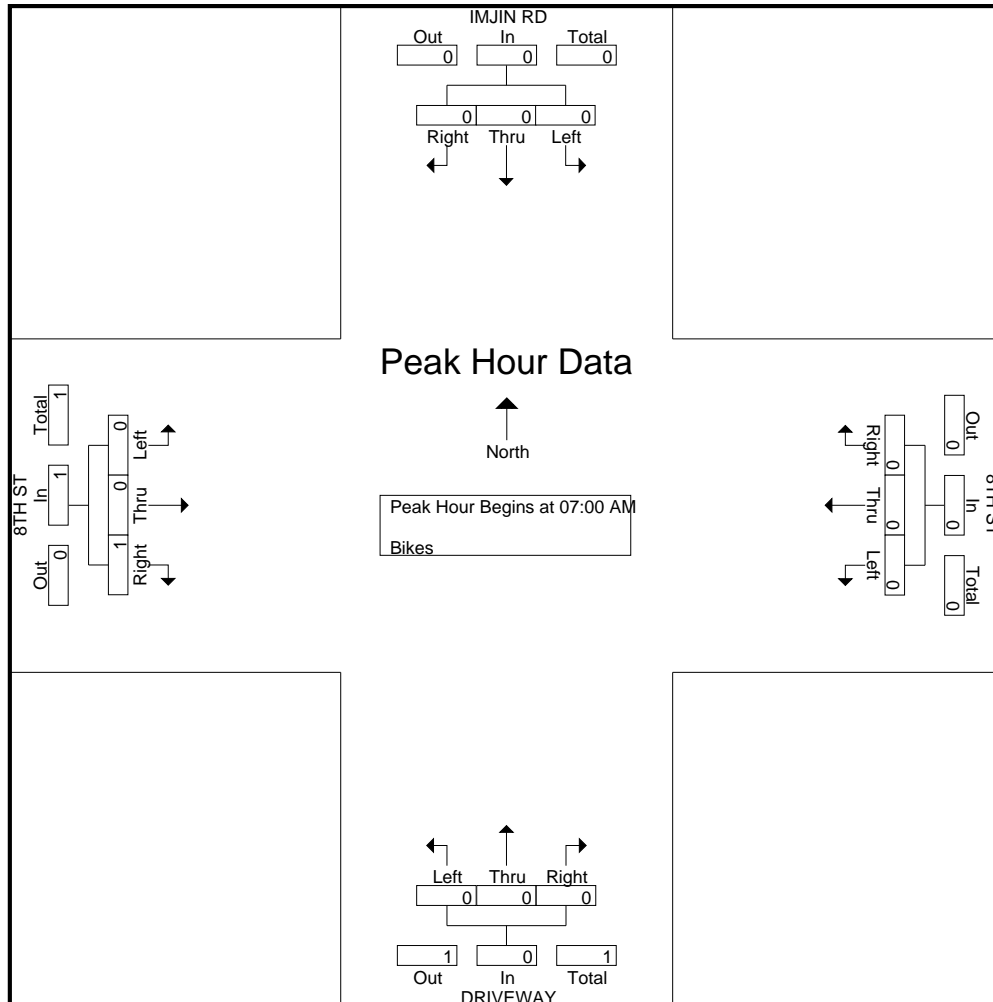

Traffic Data Service

San Jose, CA
 (408) 622-4787
 tdsbay@cs.com

File Name : 12PM FINAL
 Site Code : 00000012
 Start Date : 4/27/2017
 Page No : 1

Groups Printed- Lights - Buses - Trucks

Start Time	IMJIN RD Southbound					8TH ST Westbound					DRIVEWAY Northbound					8TH ST Eastbound					Int. Total
	Right	Thru	Left	Peds	App. Total	Right	Thru	Left	Peds	App. Total	Right	Thru	Left	Peds	App. Total	Right	Thru	Left	Peds	App. Total	
04:00 PM	1	4	30	0	35	46	7	10	0	63	4	9	0	0	13	2	8	1	0	11	122
04:15 PM	0	0	16	0	16	26	7	3	0	36	6	5	1	0	12	0	7	1	0	8	72
04:30 PM	1	8	19	0	28	31	7	4	0	42	4	4	0	0	8	0	8	2	0	10	88
04:45 PM	2	6	19	0	27	46	9	6	0	61	4	10	0	0	14	0	5	0	0	5	107
Total	4	18	84	0	106	149	30	23	0	202	18	28	1	0	47	2	28	4	0	34	389
05:00 PM	0	5	20	0	25	48	12	10	0	70	2	5	0	0	7	2	8	1	0	11	113
05:15 PM	0	3	27	0	30	53	9	13	0	75	7	9	0	0	16	1	4	1	0	6	127
05:30 PM	2	2	29	0	33	58	10	5	0	73	14	6	2	0	22	1	4	0	0	5	133
05:45 PM	1	6	30	0	37	44	11	15	0	70	18	7	0	0	25	2	8	0	0	10	142
Total	3	16	106	0	125	203	42	43	0	288	41	27	2	0	70	6	24	2	0	32	515
Grand Total	7	34	190	0	231	352	72	66	0	490	59	55	3	0	117	8	52	6	0	66	904
Apprch %	3	14.7	82.3	0		71.8	14.7	13.5	0		50.4	47	2.6	0		12.1	78.8	9.1	0		
Total %	0.8	3.8	21	0	25.6	38.9	8	7.3	0	54.2	6.5	6.1	0.3	0	12.9	0.9	5.8	0.7	0	7.3	
Lights	7	34	188	0	229	347	72	65	0	484	58	54	3	0	115	8	50	6	0	64	892
% Lights	100	100	98.9	0	99.1	98.6	100	98.5	0	98.8	98.3	98.2	100	0	98.3	100	96.2	100	0	97	98.7
Buses	0	0	0	0	0	5	0	0	0	5	0	0	0	0	0	0	1	0	0	1	6
% Buses	0	0	0	0	0	1.4	0	0	0	1	0	0	0	0	0	0	1.9	0	0	1.5	0.7
Trucks	0	0	2	0	2	0	0	1	0	1	1	1	0	0	2	0	1	0	0	1	6
% Trucks	0	0	1.1	0	0.9	0	0	1.5	0	0.2	1.7	1.8	0	0	1.7	0	1.9	0	0	1.5	0.7

Start Time	IMJIN RD Southbound				8TH ST Westbound				DRIVEWAY Northbound				8TH ST Eastbound				Int. Total
	Right	Thru	Left	App. Total	Right	Thru	Left	App. Total	Right	Thru	Left	App. Total	Right	Thru	Left	App. Total	
Peak Hour Analysis From 04:00 PM to 05:45 PM - Peak 1 of 1																	
Peak Hour for Entire Intersection Begins at 05:00 PM																	
05:00 PM	0	5	20	25	48	12	10	70	2	5	0	7	2	8	1	11	113
05:15 PM	0	3	27	30	53	9	13	75	7	9	0	16	1	4	1	6	127
05:30 PM	2	2	29	33	58	10	5	73	14	6	2	22	1	4	0	5	133
05:45 PM	1	6	30	37	44	11	15	70	18	7	0	25	2	8	0	10	142
Total Volume	3	16	106	125	203	42	43	288	41	27	2	70	6	24	2	32	515
% App. Total	2.4	12.8	84.8		70.5	14.6	14.9		58.6	38.6	2.9		18.8	75	6.2		
PHF	.375	.667	.883	.845	.875	.875	.717	.960	.569	.750	.250	.700	.750	.750	.500	.727	.907

Traffic Data Service

San Jose, CA
 (408) 622-4787
 tdsbay@cs.com

File Name : 12PM FINAL
 Site Code : 00000012
 Start Date : 4/27/2017
 Page No : 2

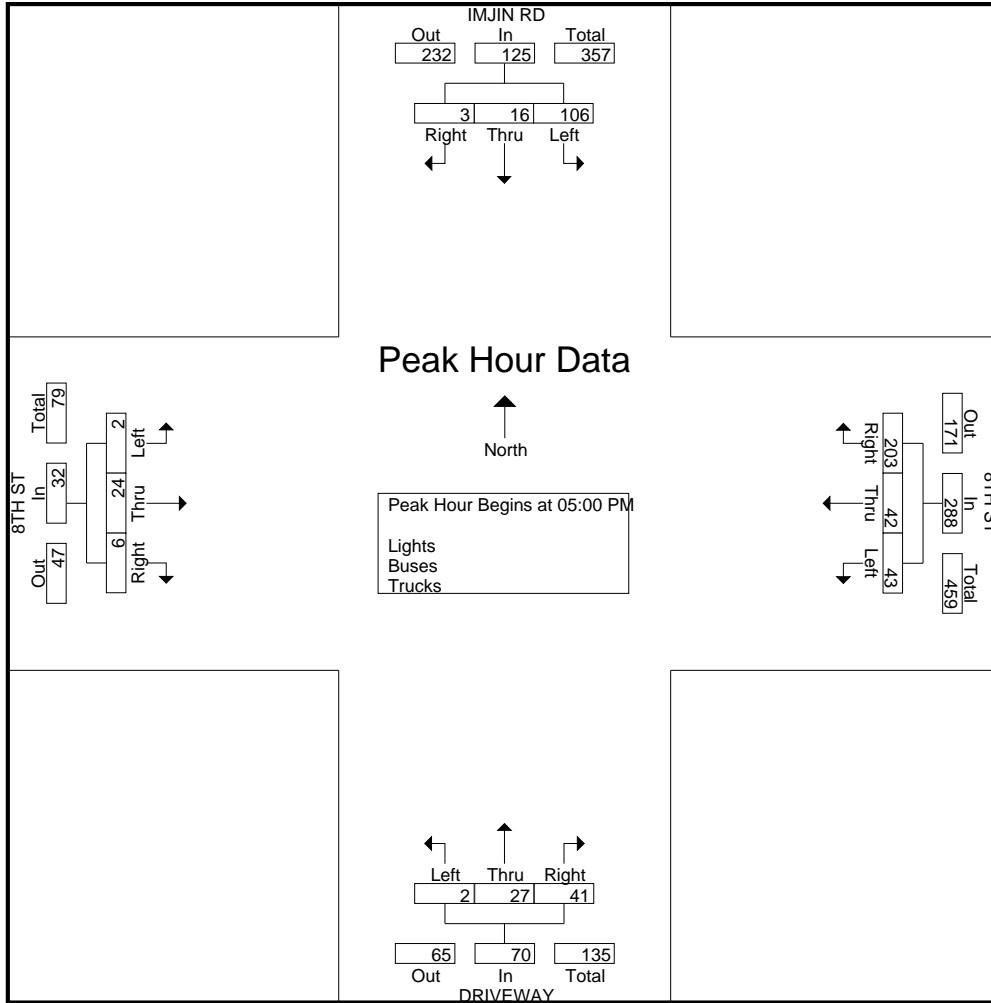

Traffic Data Service

San Jose, CA
 (408) 622-4787
 tdsbay@cs.com

File Name : 12PM FINAL
 Site Code : 00000012
 Start Date : 4/27/2017
 Page No : 1

Groups Printed- Bikes

Start Time	IMJIN RD Southbound					8TH ST Westbound					DRIVEWAY Northbound					8TH ST Eastbound					Int. Total
	Right	Thru	Left	Peds	App. Total	Right	Thru	Left	Peds	App. Total	Right	Thru	Left	Peds	App. Total	Right	Thru	Left	Peds	App. Total	
04:00 PM	0	0	0	0	0	0	0	0	0	0	0	0	0	0	0	0	0	0	0	0	0
04:15 PM	0	0	0	0	0	0	0	0	0	0	0	0	0	0	0	0	0	1	0	1	1
04:30 PM	0	0	0	0	0	0	0	0	0	0	0	0	0	0	0	0	0	0	0	0	0
04:45 PM	0	0	0	0	0	0	0	0	0	0	0	0	0	0	0	0	0	0	0	0	0
Total	0	0	0	0	0	0	0	0	0	0	0	0	0	0	0	0	0	1	0	1	1
05:00 PM	0	0	0	0	0	0	0	0	0	0	0	0	0	0	0	0	0	0	0	0	0
05:15 PM	0	0	0	0	0	0	0	0	0	0	0	0	0	0	0	0	0	0	0	0	0
05:30 PM	0	0	0	0	0	0	0	0	0	0	0	0	0	0	0	0	0	0	0	0	0
05:45 PM	0	0	0	0	0	0	0	0	0	0	0	0	0	0	0	0	0	0	0	0	0
Total	0	0	0	0	0	0	0	0	0	0	0	0	0	0	0	0	0	0	0	0	0
Grand Total	0	0	0	0	0	0	0	0	0	0	0	0	0	0	0	0	0	1	0	1	1
Apprch %	0	0	0	0	0	0	0	0	0	0	0	0	0	0	0	0	0	100	0	0	0
Total %	0	0	0	0	0	0	0	0	0	0	0	0	0	0	0	0	0	100	0	100	0

Start Time	IMJIN RD Southbound					8TH ST Westbound					DRIVEWAY Northbound					8TH ST Eastbound					Int. Total
	Right	Thru	Left	Peds	App. Total	Right	Thru	Left	Peds	App. Total	Right	Thru	Left	Peds	App. Total	Right	Thru	Left	Peds	App. Total	
Peak Hour Analysis From 04:00 PM to 05:45 PM - Peak 1 of 1																					
Peak Hour for Entire Intersection Begins at 04:00 PM																					
04:00 PM	0	0	0	0	0	0	0	0	0	0	0	0	0	0	0	0	0	0	0	0	0
04:15 PM	0	0	0	0	0	0	0	0	0	0	0	0	0	0	0	0	0	1	0	1	1
04:30 PM	0	0	0	0	0	0	0	0	0	0	0	0	0	0	0	0	0	0	0	0	0
04:45 PM	0	0	0	0	0	0	0	0	0	0	0	0	0	0	0	0	0	0	0	0	0
Total Volume	0	0	0	0	0	0	0	0	0	0	0	0	0	0	0	0	0	1	0	1	1
% App. Total	0	0	0	0	0	0	0	0	0	0	0	0	0	0	0	0	0	100	0	0	0
PHF	.000	.000	.000	.000	.000	.000	.000	.000	.000	.000	.000	.000	.000	.000	.000	.000	.000	.250	.250	.250	.250

Traffic Data Service

San Jose, CA
(408) 622-4787
tdsbay@cs.com

File Name : 12PM FINAL
Site Code : 00000012
Start Date : 4/27/2017
Page No : 2

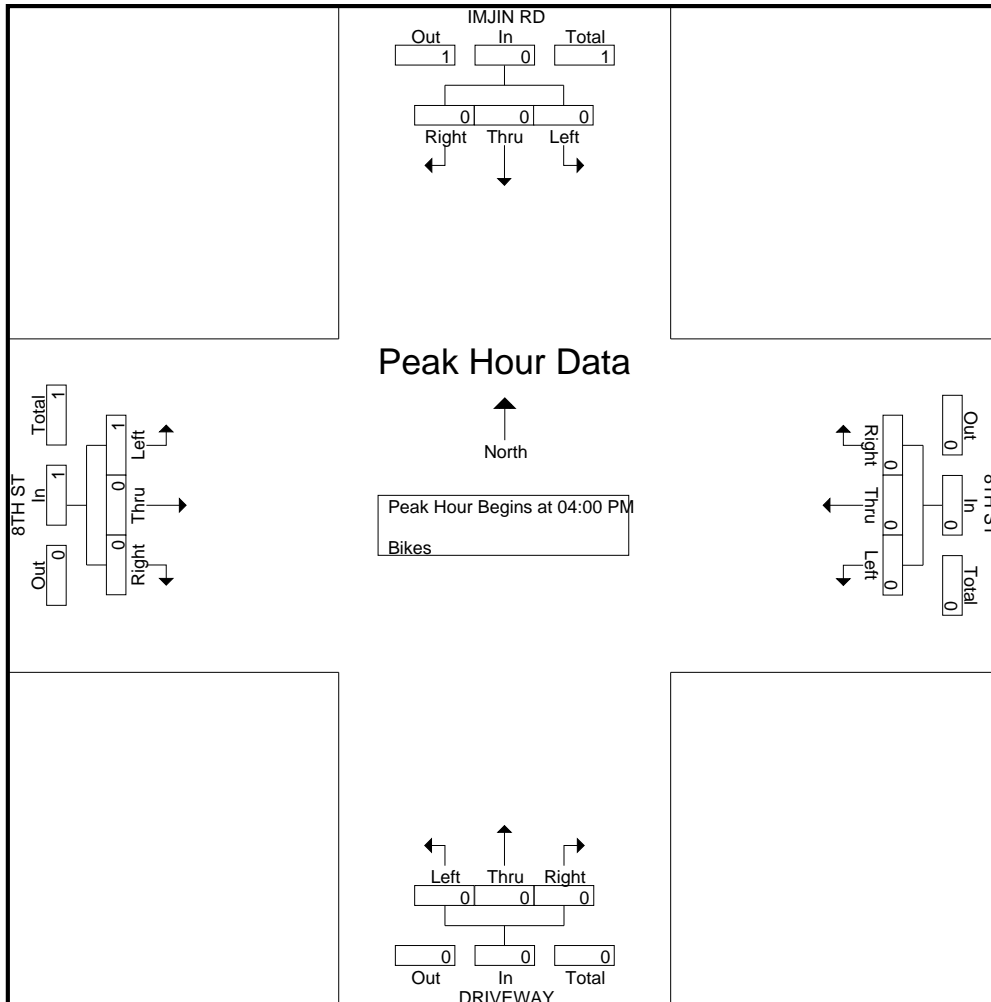

Traffic Data Service

San Jose, CA
 (408) 622-4787
 tdsbay@cs.com

File Name : 13AM FINAL
 Site Code : 00000013
 Start Date : 4/27/2017
 Page No : 1

Groups Printed- Lights - Buses - Trucks

Start Time	2ND AVE Southbound					INTER-GARRISON RD Westbound					2ND AVE Northbound					Eastbound					Int. Total
	Right	Thru	Left	Peds	App. Total	Right	Thru	Left	Peds	App. Total	Right	Thru	Left	Peds	App. Total	Right	Thru	Left	Peds	App. Total	
07:00 AM	0	61	3	0	64	1	0	4	0	5	4	10	0	0	14	0	0	0	0	0	83
07:15 AM	0	154	19	1	174	6	0	1	1	8	1	8	1	0	10	0	0	0	0	0	192
07:30 AM	0	178	9	0	187	3	0	2	0	5	13	21	0	0	34	0	0	0	0	0	226
07:45 AM	0	165	22	0	187	5	0	5	0	10	5	27	0	0	32	0	0	0	0	0	229
Total	0	558	53	1	612	15	0	12	1	28	23	66	1	0	90	0	0	0	0	0	730
08:00 AM	0	147	33	0	180	5	0	1	0	6	10	40	0	0	50	0	0	0	0	0	236
08:15 AM	0	103	24	0	127	2	0	2	0	4	8	20	0	0	28	0	0	0	0	0	159
08:30 AM	0	54	21	0	75	8	0	4	0	12	6	16	0	0	22	0	0	0	0	0	109
08:45 AM	0	52	18	0	70	10	0	1	4	15	15	10	0	0	25	0	0	0	0	0	110
Total	0	356	96	0	452	25	0	8	4	37	39	86	0	0	125	0	0	0	0	0	614
Grand Total	0	914	149	1	1064	40	0	20	5	65	62	152	1	0	215	0	0	0	0	0	1344
Apprch %	0	85.9	14	0.1		61.5	0	30.8	7.7		28.8	70.7	0.5	0		0	0	0	0		
Total %	0	68	11.1	0.1	79.2	3	0	1.5	0.4	4.8	4.6	11.3	0.1	0	16	0	0	0	0		
Lights	0	903	144	1	1048	39	0	19	5	63	62	146	1	0	209	0	0	0	0	0	1320
% Lights	0	98.8	96.6	100	98.5	97.5	0	95	100	96.9	100	96.1	100	0	97.2	0	0	0	0	0	98.2
Buses	0	5	4	0	9	0	0	0	0	0	0	4	0	0	4	0	0	0	0	0	13
% Buses	0	0.5	2.7	0	0.8	0	0	0	0	0	0	2.6	0	0	1.9	0	0	0	0	0	1
Trucks	0	6	1	0	7	1	0	1	0	2	0	2	0	0	2	0	0	0	0	0	11
% Trucks	0	0.7	0.7	0	0.7	2.5	0	5	0	3.1	0	1.3	0	0	0.9	0	0	0	0	0	0.8

Start Time	2ND AVE Southbound				INTER-GARRISON RD Westbound				2ND AVE Northbound				Eastbound				Int. Total
	Right	Thru	Left	App. Total	Right	Thru	Left	App. Total	Right	Thru	Left	App. Total	Right	Thru	Left	App. Total	
Peak Hour Analysis From 07:00 AM to 08:45 AM - Peak 1 of 1																	
Peak Hour for Entire Intersection Begins at 07:15 AM																	
07:15 AM	0	154	19	173	6	0	1	7	1	8	1	10	0	0	0	0	190
07:30 AM	0	178	9	187	3	0	2	5	13	21	0	34	0	0	0	0	226
07:45 AM	0	165	22	187	5	0	5	10	5	27	0	32	0	0	0	0	229
08:00 AM	0	147	33	180	5	0	1	6	10	40	0	50	0	0	0	0	236
Total Volume	0	644	83	727	19	0	9	28	29	96	1	126	0	0	0	0	881
% App. Total	0	88.6	11.4		67.9	0	32.1		23	76.2	0.8		0	0	0		
PHF	.000	.904	.629	.972	.792	.000	.450	.700	.558	.600	.250	.630	.000	.000	.000	.000	.933

Traffic Data Service

San Jose, CA
 (408) 622-4787
 tdsbay@cs.com

File Name : 13AM FINAL
 Site Code : 00000013
 Start Date : 4/27/2017
 Page No : 2

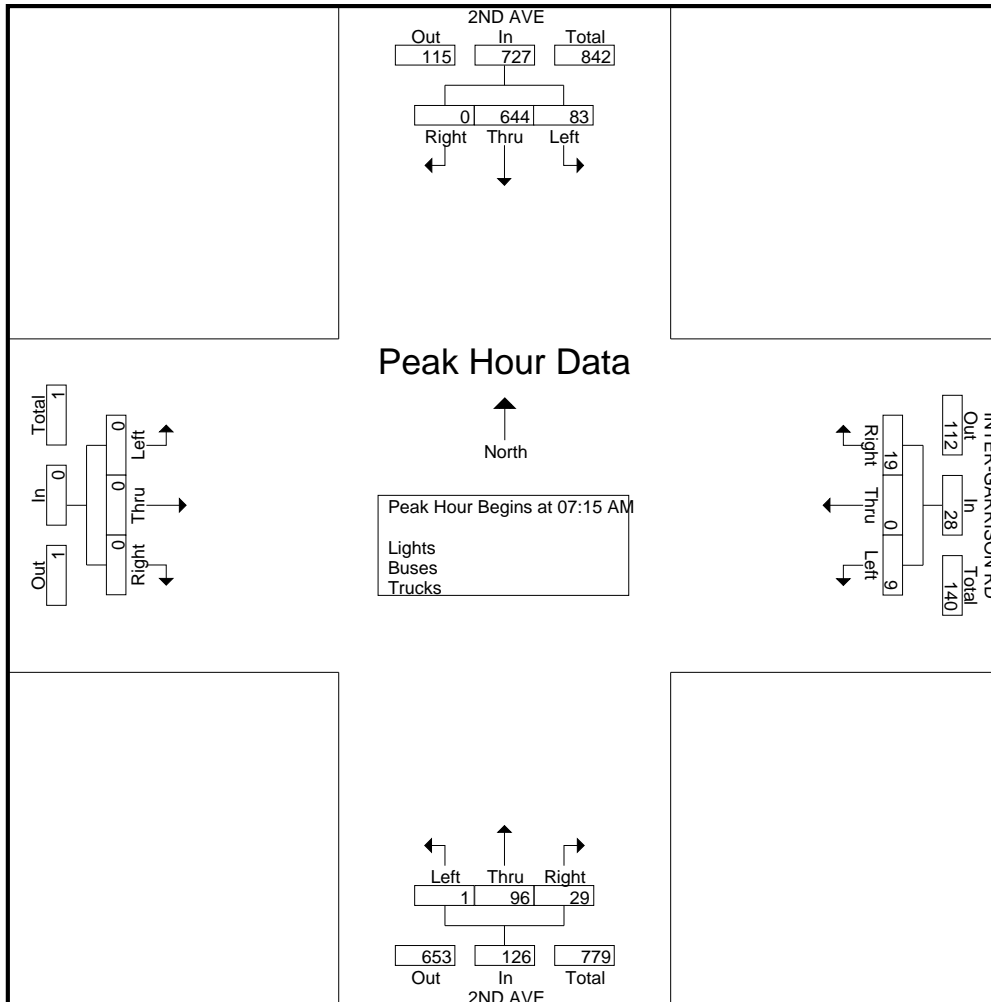

Traffic Data Service

San Jose, CA
 (408) 622-4787
 tdsbay@cs.com

File Name : 13AM FINAL
 Site Code : 00000013
 Start Date : 4/27/2017
 Page No : 1

Groups Printed- Bikes

Start Time	2ND AVE Southbound					INTER-GARRISON RD Westbound					2ND AVE Northbound					Eastbound					Int. Total
	Right	Thru	Left	Peds	App. Total	Right	Thru	Left	Peds	App. Total	Right	Thru	Left	Peds	App. Total	Right	Thru	Left	Peds	App. Total	
07:00 AM	0	0	0	0	0	0	0	0	0	0	0	0	0	0	0	0	0	0	0	0	0
07:15 AM	0	0	0	0	0	0	0	0	0	0	0	0	0	0	0	0	0	0	0	0	0
07:30 AM	0	1	0	0	1	0	0	0	0	0	0	0	0	0	0	0	0	0	0	0	1
07:45 AM	0	0	0	0	0	0	0	0	0	0	0	0	0	0	0	0	0	0	0	0	0
Total	0	1	0	0	1	0	0	0	0	0	0	0	0	0	0	0	0	0	0	0	1
08:00 AM	0	0	0	0	0	0	0	0	0	0	0	0	0	0	0	0	0	0	0	0	0
08:15 AM	0	0	0	0	0	0	0	0	0	0	0	0	0	0	0	0	0	0	0	0	0
08:30 AM	0	0	0	0	0	0	0	0	0	0	0	0	0	0	0	0	0	0	0	0	0
08:45 AM	0	0	0	0	0	0	0	0	0	0	0	0	0	0	0	0	0	0	0	0	0
Total	0	0	0	0	0	0	0	0	0	0	0	0	0	0	0	0	0	0	0	0	0
Grand Total	0	1	0	0	1	0	0	0	0	0	0	0	0	0	0	0	0	0	0	0	1
Apprch %	0	100	0	0		0	0	0	0		0	0	0	0		0	0	0	0		
Total %	0	100	0	0	100	0	0	0	0	0	0	0	0	0	0	0	0	0	0	0	

Start Time	2ND AVE Southbound				INTER-GARRISON RD Westbound				2ND AVE Northbound				Eastbound				Int. Total
	Right	Thru	Left	App. Total	Right	Thru	Left	App. Total	Right	Thru	Left	App. Total	Right	Thru	Left	App. Total	
Peak Hour Analysis From 07:00 AM to 08:45 AM - Peak 1 of 1																	
Peak Hour for Entire Intersection Begins at 07:00 AM																	
07:00 AM	0	0	0	0	0	0	0	0	0	0	0	0	0	0	0	0	0
07:15 AM	0	0	0	0	0	0	0	0	0	0	0	0	0	0	0	0	0
07:30 AM	0	1	0	1	0	0	0	0	0	0	0	0	0	0	0	0	1
07:45 AM	0	0	0	0	0	0	0	0	0	0	0	0	0	0	0	0	0
Total Volume	0	1	0	1	0	0	0	0	0	0	0	0	0	0	0	0	1
% App. Total	0	100	0		0	0	0		0	0	0		0	0	0		
PHF	.000	.250	.000	.250	.000	.000	.000	.000	.000	.000	.000	.000	.000	.000	.000	.000	.250

Traffic Data Service

San Jose, CA
 (408) 622-4787
 tdsbay@cs.com

File Name : 13AM FINAL
 Site Code : 00000013
 Start Date : 4/27/2017
 Page No : 2

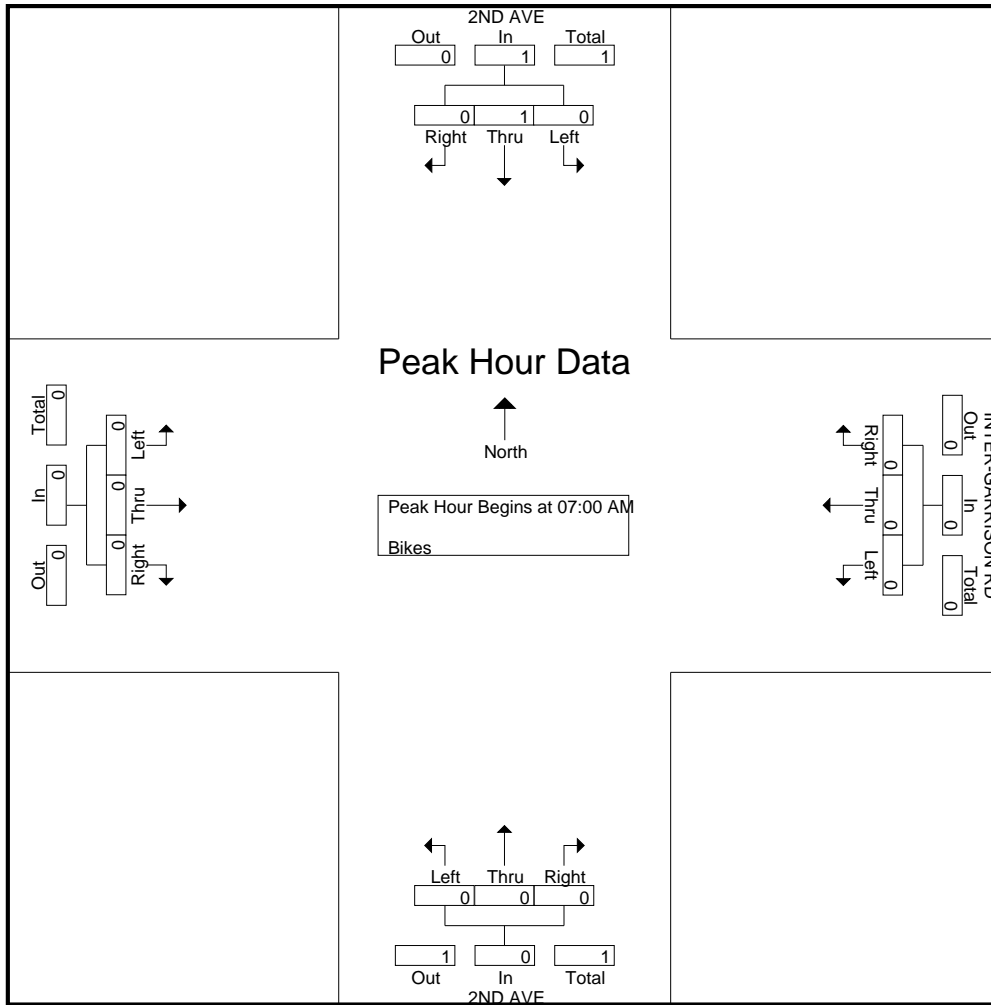

Traffic Data Service

San Jose, CA
 (408) 622-4787
 tdsbay@cs.com

File Name : 13PM FINAL
 Site Code : 00000013
 Start Date : 4/27/2017
 Page No : 1

Groups Printed- Lights - Buses - Trucks

Start Time	2ND AVE Southbound					INTER-GARRISON RD Westbound					2ND AVE Northbound					Eastbound					Int. Total
	Right	Thru	Left	Peds	App. Total	Right	Thru	Left	Peds	App. Total	Right	Thru	Left	Peds	App. Total	Right	Thru	Left	Peds	App. Total	
04:00 PM	0	33	15	0	48	17	0	15	0	32	6	30	0	0	36	0	0	0	0	0	116
04:15 PM	0	44	10	1	55	11	0	4	2	17	4	41	0	1	46	0	0	0	0	0	118
04:30 PM	0	50	13	1	64	18	0	7	0	25	6	45	0	0	51	0	0	0	0	0	140
04:45 PM	0	47	12	2	61	24	0	8	2	34	5	51	0	0	56	0	0	0	0	0	151
Total	0	174	50	4	228	70	0	34	4	108	21	167	0	1	189	0	0	0	0	0	525
05:00 PM	0	28	27	0	55	22	0	16	2	40	6	73	0	0	79	0	0	0	0	0	174
05:15 PM	0	37	15	0	52	35	0	12	0	47	10	57	0	0	67	0	0	0	0	0	166
05:30 PM	0	37	23	1	61	19	0	22	1	42	7	56	1	0	64	0	0	0	0	0	167
05:45 PM	0	41	20	0	61	21	0	16	1	38	8	57	0	0	65	0	0	0	0	0	164
Total	0	143	85	1	229	97	0	66	4	167	31	243	1	0	275	0	0	0	0	0	671
Grand Total	0	317	135	5	457	167	0	100	8	275	52	410	1	1	464	0	0	0	0	0	1196
Apprch %	0	69.4	29.5	1.1		60.7	0	36.4	2.9		11.2	88.4	0.2	0.2		0	0	0	0		
Total %	0	26.5	11.3	0.4	38.2	14	0	8.4	0.7	23	4.3	34.3	0.1	0.1	38.8	0	0	0	0	0	
Lights	0	312	130	5	447	167	0	100	8	275	52	405	1	1	459	0	0	0	0	0	1181
% Lights	0	98.4	96.3	100	97.8	100	0	100	100	100	100	98.8	100	100	98.9	0	0	0	0	0	98.7
Buses	0	4	4	0	8	0	0	0	0	0	0	2	0	0	2	0	0	0	0	0	10
% Buses	0	1.3	3	0	1.8	0	0	0	0	0	0	0.5	0	0	0.4	0	0	0	0	0	0.8
Trucks	0	1	1	0	2	0	0	0	0	0	0	3	0	0	3	0	0	0	0	0	5
% Trucks	0	0.3	0.7	0	0.4	0	0	0	0	0	0	0.7	0	0	0.6	0	0	0	0	0	0.4

Start Time	2ND AVE Southbound				INTER-GARRISON RD Westbound				2ND AVE Northbound				Eastbound				Int. Total
	Right	Thru	Left	App. Total	Right	Thru	Left	App. Total	Right	Thru	Left	App. Total	Right	Thru	Left	App. Total	
Peak Hour Analysis From 04:00 PM to 05:45 PM - Peak 1 of 1																	
Peak Hour for Entire Intersection Begins at 05:00 PM																	
05:00 PM	0	28	27	55	22	0	16	38	6	73	0	79	0	0	0	0	172
05:15 PM	0	37	15	52	35	0	12	47	10	57	0	67	0	0	0	0	166
05:30 PM	0	37	23	60	19	0	22	41	7	56	1	64	0	0	0	0	165
05:45 PM	0	41	20	61	21	0	16	37	8	57	0	65	0	0	0	0	163
Total Volume	0	143	85	228	97	0	66	163	31	243	1	275	0	0	0	0	666
% App. Total	0	62.7	37.3		59.5	0	40.5		11.3	88.4	0.4		0	0	0		
PHF	.000	.872	.787	.934	.693	.000	.750	.867	.775	.832	.250	.870	.000	.000	.000	.000	.968

Traffic Data Service

San Jose, CA
 (408) 622-4787
 tdsbay@cs.com

File Name : 13PM FINAL
 Site Code : 00000013
 Start Date : 4/27/2017
 Page No : 2

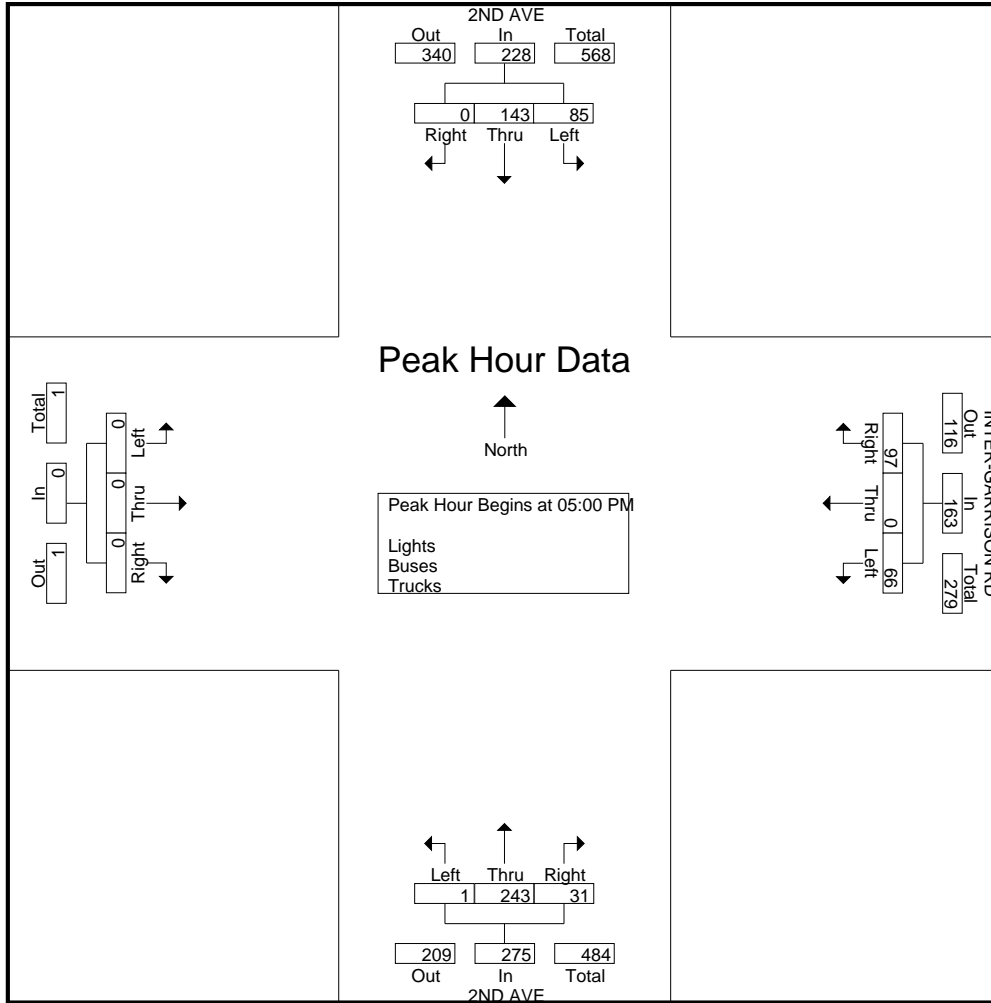

Traffic Data Service

San Jose, CA
 (408) 622-4787
 tdsbay@cs.com

File Name : 13PM FINAL
 Site Code : 00000013
 Start Date : 4/27/2017
 Page No : 1

Groups Printed- Bikes

Start Time	2ND AVE Southbound					INTER-GARRISON RD Westbound					2ND AVE Northbound					Eastbound					Int. Total
	Right	Thru	Left	Peds	App. Total	Right	Thru	Left	Peds	App. Total	Right	Thru	Left	Peds	App. Total	Right	Thru	Left	Peds	App. Total	
04:00 PM	0	0	0	0	0	0	0	0	0	0	0	0	0	0	0	0	0	0	0	0	0
04:15 PM	0	0	0	0	0	0	0	1	0	1	0	0	0	0	0	0	0	0	0	0	0
04:30 PM	0	0	0	0	0	0	0	0	0	0	0	0	0	0	0	0	0	0	0	0	0
04:45 PM	0	0	0	0	0	0	0	0	0	0	0	0	0	0	0	0	0	0	0	0	0
Total	0	0	0	0	0	0	0	1	0	1	0	0	0	0	0	0	0	0	0	0	1
05:00 PM	0	1	0	0	1	0	0	0	0	0	0	0	0	0	0	0	0	0	0	0	1
05:15 PM	0	0	1	0	1	0	0	0	0	0	0	0	0	0	0	0	0	0	0	0	1
05:30 PM	0	0	0	0	0	0	0	0	0	0	1	0	0	0	1	0	0	0	0	0	1
05:45 PM	0	0	0	0	0	0	0	1	0	1	0	0	0	0	0	0	0	0	0	0	1
Total	0	1	1	0	2	0	0	1	0	1	1	0	0	0	1	0	0	0	0	0	4
Grand Total	0	1	1	0	2	0	0	2	0	2	1	0	0	0	1	0	0	0	0	0	5
Apprch %	0	50	50	0		0	0	100	0		100	0	0	0		0	0	0	0		
Total %	0	20	20	0	40	0	0	40	0	40	20	0	0	0	20	0	0	0	0	0	

Start Time	2ND AVE Southbound				INTER-GARRISON RD Westbound				2ND AVE Northbound				Eastbound				Int. Total
	Right	Thru	Left	App. Total	Right	Thru	Left	App. Total	Right	Thru	Left	App. Total	Right	Thru	Left	App. Total	
Peak Hour Analysis From 04:00 PM to 05:45 PM - Peak 1 of 1																	
Peak Hour for Entire Intersection Begins at 05:00 PM																	
05:00 PM	0	1	0	1	0	0	0	0	0	0	0	0	0	0	0	0	1
05:15 PM	0	0	1	1	0	0	0	0	0	0	0	0	0	0	0	0	1
05:30 PM	0	0	0	0	0	0	0	0	1	0	0	1	0	0	0	0	1
05:45 PM	0	0	0	0	0	0	1	1	0	0	0	0	0	0	0	0	1
Total Volume	0	1	1	2	0	0	1	1	1	0	0	1	0	0	0	0	4
% App. Total	0	50	50		0	0	100		100	0	0		0	0	0		
PHF	.000	.250	.250	.500	.000	.000	.250	.250	.250	.000	.000	.250	.000	.000	.000	.000	1.00

Traffic Data Service

San Jose, CA
 (408) 622-4787
 tdsbay@cs.com

File Name : 13PM FINAL
 Site Code : 00000013
 Start Date : 4/27/2017
 Page No : 2

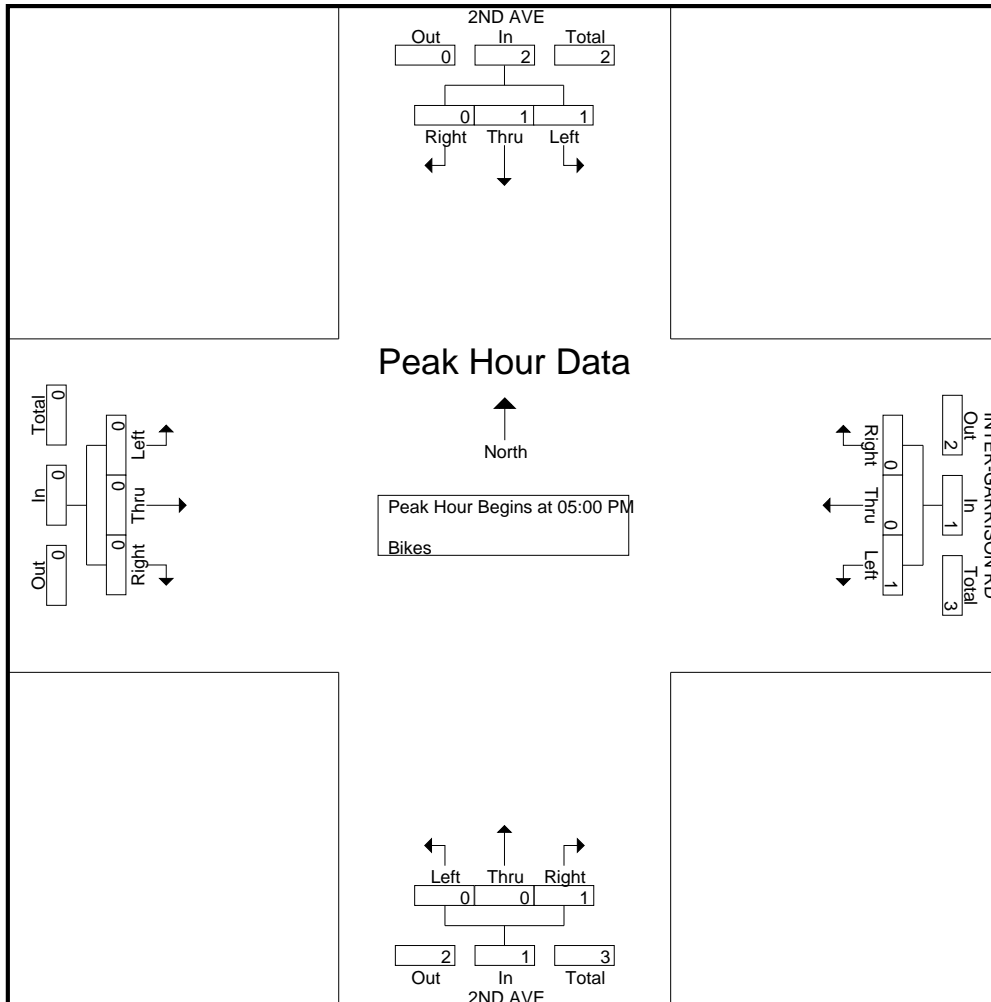

Traffic Data Service

San Jose, CA
 (408) 622-4787
 tdsbay@cs.com

File Name : 16AM FINAL
 Site Code : 00000016
 Start Date : 4/27/2017
 Page No : 1

Groups Printed- Lights - Buses - Trucks

Start Time	ABRAMS DR Southbound					INTER-GARRISON RD Westbound					Northbound					INTER-GARRISON RD Eastbound					Int. Total
	Right	Thru	Left	Peds	App. Total	Right	Thru	Left	Peds	App. Total	Right	Thru	Left	Peds	App. Total	Right	Thru	Left	Peds	App. Total	
07:00 AM	42	0	2	0	44	3	131	0	0	134	0	0	0	0	0	0	7	13	0	20	198
07:15 AM	82	0	4	0	86	2	175	0	0	177	0	0	0	0	0	0	13	9	0	22	285
07:30 AM	81	0	1	1	83	3	165	0	0	168	0	0	0	0	0	0	24	19	0	43	294
07:45 AM	74	0	3	0	77	4	109	0	0	113	0	0	0	0	0	0	20	13	0	33	223
Total	279	0	10	1	290	12	580	0	0	592	0	0	0	0	0	0	64	54	0	118	1000
08:00 AM	54	0	0	0	54	2	85	0	0	87	0	0	0	0	0	0	17	18	0	35	176
08:15 AM	40	0	3	0	43	0	88	0	0	88	0	0	0	0	0	0	8	12	0	20	151
08:30 AM	27	0	2	0	29	3	65	0	0	68	0	0	0	0	0	0	17	12	0	29	126
08:45 AM	45	0	2	0	47	4	58	0	0	62	0	0	0	0	0	0	7	11	0	18	127
Total	166	0	7	0	173	9	296	0	0	305	0	0	0	0	0	0	49	53	0	102	580
Grand Total	445	0	17	1	463	21	876	0	0	897	0	0	0	0	0	0	113	107	0	220	1580
Apprch %	96.1	0	3.7	0.2		2.3	97.7	0	0		0	0	0	0		0	51.4	48.6	0		
Total %	28.2	0	1.1	0.1	29.3	1.3	55.4	0	0	56.8	0	0	0	0	0	0	7.2	6.8	0	13.9	
Lights	439	0	17	1	457	16	867	0	0	883	0	0	0	0	0	0	109	95	0	204	1544
% Lights	98.7	0	100	100	98.7	76.2	99	0	0	98.4	0	0	0	0	0	0	96.5	88.8	0	92.7	97.7
Buses	4	0	0	0	4	5	6	0	0	11	0	0	0	0	0	0	1	11	0	12	27
% Buses	0.9	0	0	0	0.9	23.8	0.7	0	0	1.2	0	0	0	0	0	0	0.9	10.3	0	5.5	1.7
Trucks	2	0	0	0	2	0	3	0	0	3	0	0	0	0	0	0	3	1	0	4	9
% Trucks	0.4	0	0	0	0.4	0	0.3	0	0	0.3	0	0	0	0	0	0	2.7	0.9	0	1.8	0.6

Start Time	ABRAMS DR Southbound				INTER-GARRISON RD Westbound				Northbound				INTER-GARRISON RD Eastbound				Int. Total
	Right	Thru	Left	App. Total	Right	Thru	Left	App. Total	Right	Thru	Left	App. Total	Right	Thru	Left	App. Total	
Peak Hour Analysis From 07:00 AM to 08:45 AM - Peak 1 of 1																	
Peak Hour for Entire Intersection Begins at 07:00 AM																	
07:00 AM	42	0	2	44	3	131	0	134	0	0	0	0	0	7	13	20	198
07:15 AM	82	0	4	86	2	175	0	177	0	0	0	0	0	13	9	22	285
07:30 AM	81	0	1	82	3	165	0	168	0	0	0	0	0	24	19	43	293
07:45 AM	74	0	3	77	4	109	0	113	0	0	0	0	0	20	13	33	223
Total Volume	279	0	10	289	12	580	0	592	0	0	0	0	0	64	54	118	999
% App. Total	96.5	0	3.5		2	98	0		0	0	0		0	54.2	45.8		
PHF	.851	.000	.625	.840	.750	.829	.000	.836	.000	.000	.000	.000	.000	.667	.711	.686	.852

Traffic Data Service

San Jose, CA
 (408) 622-4787
 tdsbay@cs.com

File Name : 16AM FINAL
 Site Code : 00000016
 Start Date : 4/27/2017
 Page No : 2

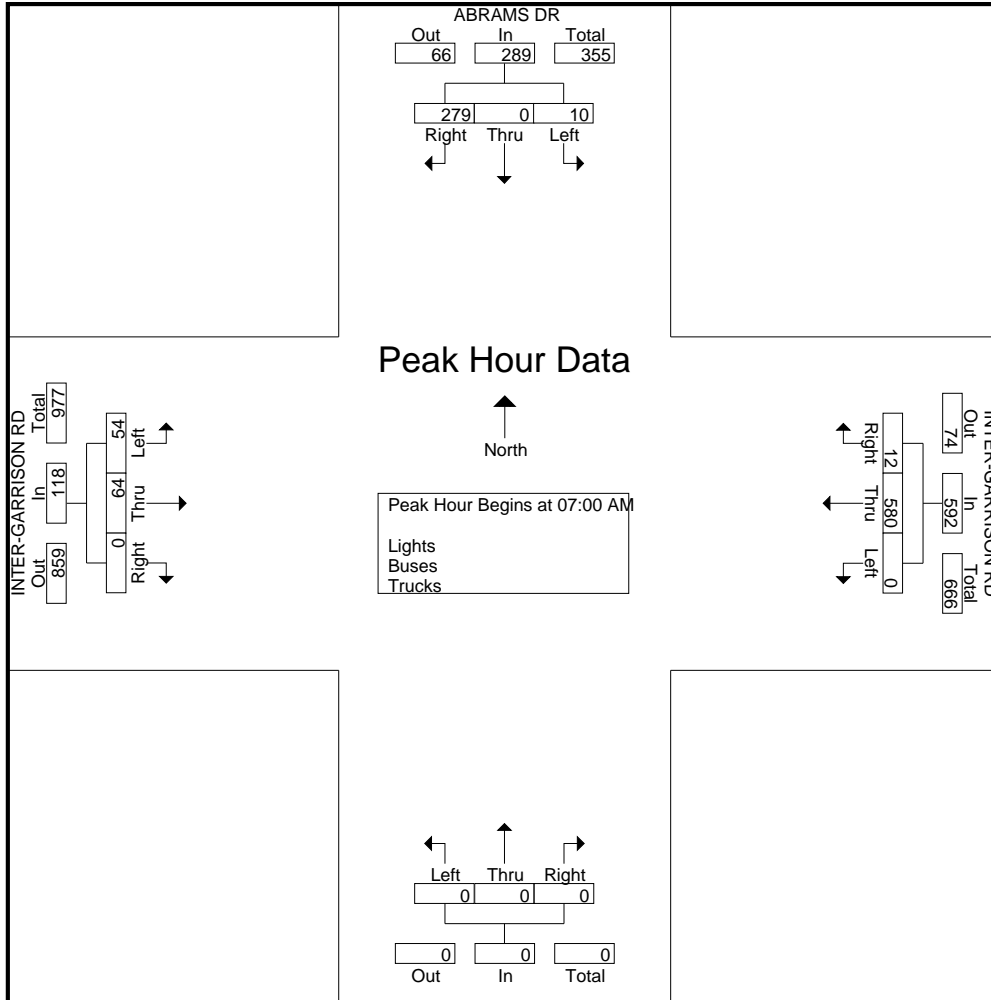

Traffic Data Service

San Jose, CA
 (408) 622-4787
 tdsbay@cs.com

File Name : 16AM FINAL
 Site Code : 00000016
 Start Date : 4/27/2017
 Page No : 1

Groups Printed- Bikes

Start Time	ABRAMS DR Southbound					INTER-GARRISON RD Westbound					Northbound					INTER-GARRISON RD Eastbound					Int. Total
	Right	Thru	Left	Peds	App. Total	Right	Thru	Left	Peds	App. Total	Right	Thru	Left	Peds	App. Total	Right	Thru	Left	Peds	App. Total	
07:00 AM	0	0	0	0	0	0	0	0	0	0	0	0	0	0	0	0	0	0	0	0	0
07:15 AM	0	0	0	0	0	0	0	0	0	0	0	0	0	0	0	0	0	0	0	0	0
07:30 AM	0	0	0	0	0	0	0	0	0	0	0	0	0	0	0	0	0	0	0	0	0
07:45 AM	1	0	0	0	1	0	0	0	0	0	0	0	0	0	0	0	0	0	0	0	1
Total	1	0	0	0	1	0	0	0	0	0	0	0	0	0	0	0	0	0	0	0	1
08:00 AM	1	0	0	0	1	0	0	0	0	0	0	0	0	0	0	0	1	0	0	1	2
08:15 AM	0	0	0	0	0	0	1	0	0	1	0	0	0	0	0	0	0	0	0	0	1
08:30 AM	1	0	0	0	1	0	2	0	0	2	0	0	0	0	0	0	0	0	0	0	3
08:45 AM	1	0	0	0	1	0	0	0	0	0	0	0	0	0	0	0	0	0	0	0	1
Total	3	0	0	0	3	0	3	0	0	3	0	0	0	0	0	0	1	0	0	1	7
Grand Total	4	0	0	0	4	0	3	0	0	3	0	0	0	0	0	0	1	0	0	1	8
Apprch %	100	0	0	0		0	100	0	0		0	0	0	0		0	100	0	0		
Total %	50	0	0	0	50	0	37.5	0	0	37.5	0	0	0	0	0	0	12.5	0	0	12.5	

Start Time	ABRAMS DR Southbound					INTER-GARRISON RD Westbound					Northbound					INTER-GARRISON RD Eastbound					Int. Total
	Right	Thru	Left	Peds	App. Total	Right	Thru	Left	Peds	App. Total	Right	Thru	Left	Peds	App. Total	Right	Thru	Left	Peds	App. Total	
Peak Hour Analysis From 07:00 AM to 08:45 AM - Peak 1 of 1																					
Peak Hour for Entire Intersection Begins at 07:45 AM																					
07:45 AM	1	0	0	0	1	0	0	0	0	0	0	0	0	0	0	0	0	0	0	0	1
08:00 AM	1	0	0	0	1	0	0	0	0	0	0	0	0	0	0	0	1	0	0	1	2
08:15 AM	0	0	0	0	0	0	1	0	0	1	0	0	0	0	0	0	0	0	0	0	1
08:30 AM	1	0	0	0	1	0	2	0	0	2	0	0	0	0	0	0	0	0	0	0	3
Total Volume	3	0	0	0	3	0	3	0	0	3	0	0	0	0	0	0	1	0	0	1	7
% App. Total	100	0	0	0		0	100	0	0		0	0	0	0		0	100	0	0		
PHF	.750	.000	.000	.000	.750	.000	.375	.000	.000	.375	.000	.000	.000	.000	.000	.000	.250	.000	.000	.250	.583

Traffic Data Service

San Jose, CA
 (408) 622-4787
 tdsbay@cs.com

File Name : 16AM FINAL
 Site Code : 00000016
 Start Date : 4/27/2017
 Page No : 2

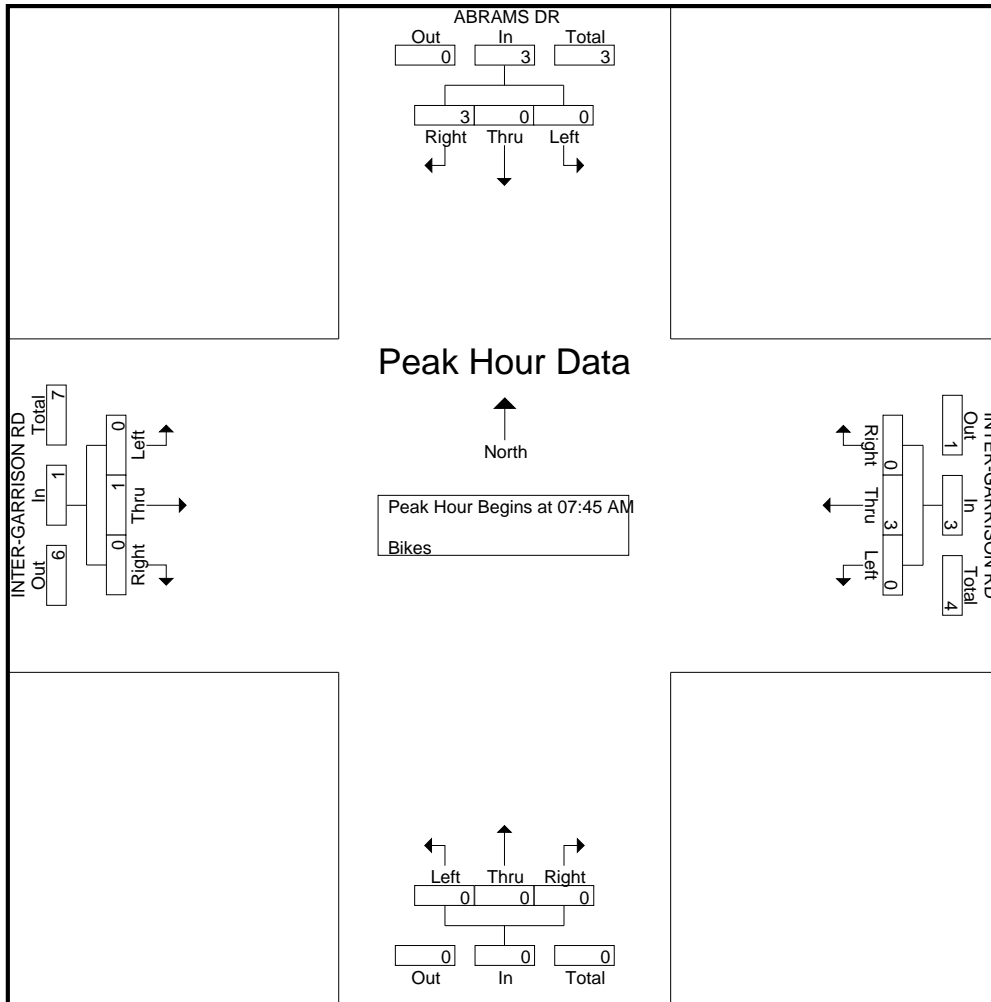

Traffic Data Service

San Jose, CA
 (408) 622-4787
 tdsbay@cs.com

File Name : 16PM FINAL
 Site Code : 00000016
 Start Date : 4/27/2017
 Page No : 1

Groups Printed- Lights - Buses - Trucks

Start Time	ABRAMS DR Southbound					INTER-GARRISON RD Westbound					Northbound					INTER-GARRISON RD Eastbound					Int. Total
	Right	Thru	Left	Peds	App. Total	Right	Thru	Left	Peds	App. Total	Right	Thru	Left	Peds	App. Total	Right	Thru	Left	Peds	App. Total	
04:00 PM	21	0	1	0	22	0	10	0	0	10	0	0	0	0	0	0	74	48	0	122	154
04:15 PM	29	0	0	0	29	4	24	0	0	28	0	0	0	0	0	0	65	43	0	108	165
04:30 PM	24	0	2	0	26	6	27	0	0	33	0	0	0	0	0	0	84	44	0	128	187
04:45 PM	20	0	3	0	23	4	28	0	0	32	0	0	0	0	0	0	91	58	0	149	204
Total	94	0	6	0	100	14	89	0	0	103	0	0	0	0	0	0	314	193	0	507	710
05:00 PM	23	0	0	0	23	5	28	0	0	33	0	0	0	0	0	0	112	67	0	179	235
05:15 PM	13	0	6	0	19	1	24	0	0	25	0	0	0	0	0	0	133	51	0	184	228
05:30 PM	34	0	5	0	39	5	17	0	0	22	0	0	0	0	0	0	94	69	0	163	224
05:45 PM	38	0	4	0	42	6	22	0	0	28	0	0	0	0	0	0	73	64	0	137	207
Total	108	0	15	0	123	17	91	0	0	108	0	0	0	0	0	0	412	251	0	663	894
Grand Total	202	0	21	0	223	31	180	0	0	211	0	0	0	0	0	0	726	444	0	1170	1604
Apprch %	90.6	0	9.4	0		14.7	85.3	0	0		0	0	0	0	0	0	62.1	37.9	0		
Total %	12.6	0	1.3	0	13.9	1.9	11.2	0	0	13.2	0	0	0	0	0	0	45.3	27.7	0	72.9	
Lights	195	0	18	0	213	25	169	0	0	194	0	0	0	0	0	0	721	430	0	1151	1558
% Lights	96.5	0	85.7	0	95.5	80.6	93.9	0	0	91.9	0	0	0	0	0	0	99.3	96.8	0	98.4	97.1
Buses	5	0	1	0	6	6	6	0	0	12	0	0	0	0	0	0	1	11	0	12	30
% Buses	2.5	0	4.8	0	2.7	19.4	3.3	0	0	5.7	0	0	0	0	0	0	0.1	2.5	0	1	1.9
Trucks	2	0	2	0	4	0	5	0	0	5	0	0	0	0	0	0	4	3	0	7	16
% Trucks	1	0	9.5	0	1.8	0	2.8	0	0	2.4	0	0	0	0	0	0	0.6	0.7	0	0.6	1

Start Time	ABRAMS DR Southbound				INTER-GARRISON RD Westbound				Northbound				INTER-GARRISON RD Eastbound				Int. Total	
	Right	Thru	Left	App. Total	Right	Thru	Left	App. Total	Right	Thru	Left	App. Total	Right	Thru	Left	App. Total		
Peak Hour Analysis From 04:00 PM to 05:45 PM - Peak 1 of 1																		
Peak Hour for Entire Intersection Begins at 05:00 PM																		
05:00 PM	23	0	0	23	5	28	0	33	0	0	0	0	0	0	112	67	179	235
05:15 PM	13	0	6	19	1	24	0	25	0	0	0	0	0	0	133	51	184	228
05:30 PM	34	0	5	39	5	17	0	22	0	0	0	0	0	0	94	69	163	224
05:45 PM	38	0	4	42	6	22	0	28	0	0	0	0	0	0	73	64	137	207
Total Volume	108	0	15	123	17	91	0	108	0	0	0	0	0	0	412	251	663	894
% App. Total	87.8	0	12.2		15.7	84.3	0		0	0	0		0	0	62.1	37.9		
PHF	.711	.000	.625	.732	.708	.813	.000	.818	.000	.000	.000	.000	.000	.000	.774	.909	.901	.951

Traffic Data Service

San Jose, CA
 (408) 622-4787
 tdsbay@cs.com

File Name : 16PM FINAL
 Site Code : 00000016
 Start Date : 4/27/2017
 Page No : 2

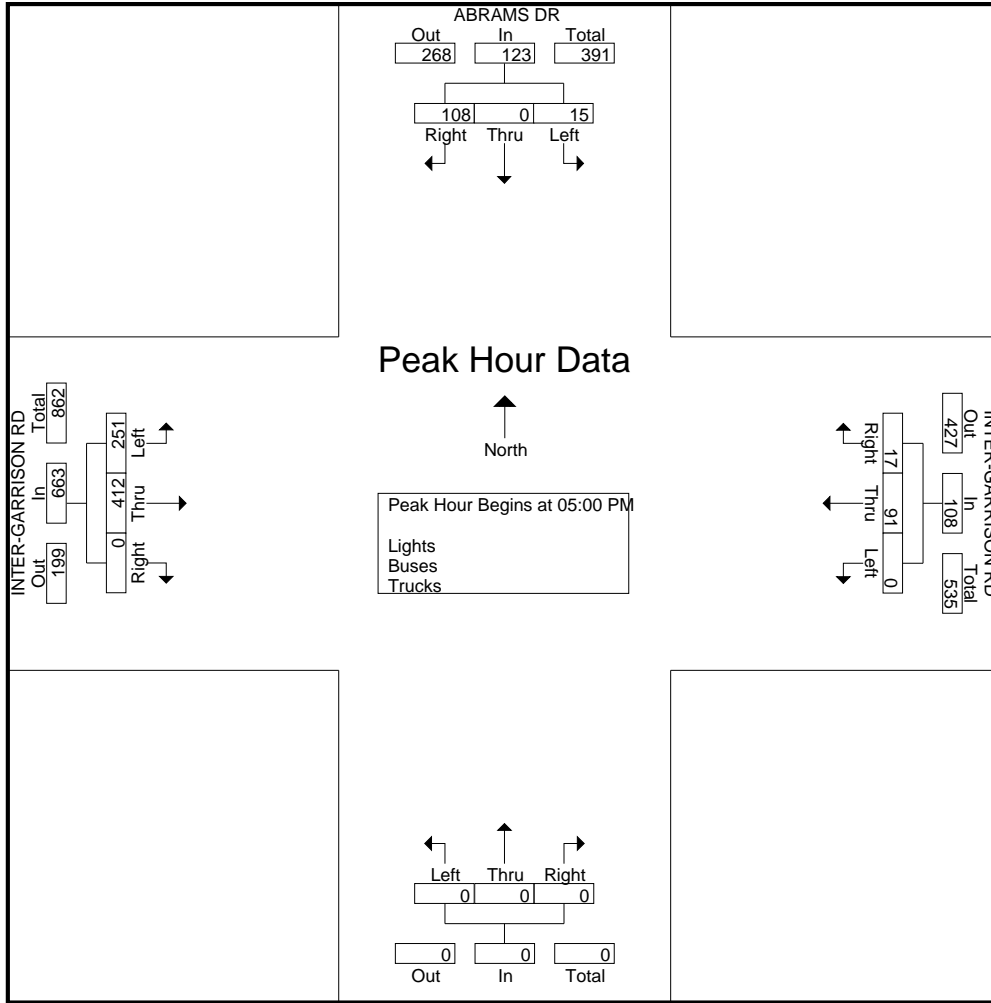

Traffic Data Service

San Jose, CA
 (408) 622-4787
 tdsbay@cs.com

File Name : 16PM FINAL
 Site Code : 00000016
 Start Date : 4/27/2017
 Page No : 1

Groups Printed- Bikes

Start Time	ABRAMS DR Southbound					INTER-GARRISON RD Westbound					Northbound					INTER-GARRISON RD Eastbound					Int. Total
	Right	Thru	Left	Peds	App. Total	Right	Thru	Left	Peds	App. Total	Right	Thru	Left	Peds	App. Total	Right	Thru	Left	Peds	App. Total	
04:00 PM	0	0	0	0	0	0	0	0	0	0	0	0	0	0	0	0	0	0	0	0	0
04:15 PM	0	0	0	0	0	0	0	0	0	0	0	0	0	0	0	0	0	0	0	0	0
04:30 PM	0	0	0	0	0	0	0	0	0	0	0	0	0	0	0	0	1	0	0	1	1
04:45 PM	0	0	0	0	0	0	0	0	0	0	0	0	0	0	0	0	1	0	0	1	1
Total	0	0	0	0	0	0	0	0	0	0	0	0	0	0	0	0	2	0	0	2	2
05:00 PM	0	0	0	0	0	0	0	0	0	0	0	0	0	0	0	0	0	1	0	1	1
05:15 PM	1	0	0	0	1	0	0	0	0	0	0	0	0	0	0	0	0	2	0	2	3
05:30 PM	0	0	0	0	0	0	0	0	0	0	0	0	0	0	0	0	0	1	0	1	1
05:45 PM	0	0	0	0	0	0	1	0	0	1	0	0	0	0	0	0	0	0	0	0	1
Total	1	0	0	0	1	0	1	0	0	1	0	0	0	0	0	0	0	4	0	4	6
Grand Total	1	0	0	0	1	0	1	0	0	1	0	0	0	0	0	0	2	4	0	6	8
Apprch %	100	0	0	0		0	100	0	0		0	0	0	0		0	33.3	66.7	0		
Total %	12.5	0	0	0	12.5	0	12.5	0	0	12.5	0	0	0	0	0	0	25	50	0	75	

Start Time	ABRAMS DR Southbound					INTER-GARRISON RD Westbound					Northbound					INTER-GARRISON RD Eastbound					Int. Total
	Right	Thru	Left	Peds	App. Total	Right	Thru	Left	Peds	App. Total	Right	Thru	Left	Peds	App. Total	Right	Thru	Left	Peds	App. Total	
Peak Hour Analysis From 04:00 PM to 05:45 PM - Peak 1 of 1																					
Peak Hour for Entire Intersection Begins at 04:30 PM																					
04:30 PM	0	0	0	0	0	0	0	0	0	0	0	0	0	0	0	0	1	0	0	1	1
04:45 PM	0	0	0	0	0	0	0	0	0	0	0	0	0	0	0	0	1	0	0	1	1
05:00 PM	0	0	0	0	0	0	0	0	0	0	0	0	0	0	0	0	0	1	0	1	1
05:15 PM	1	0	0	0	1	0	0	0	0	0	0	0	0	0	0	0	0	2	0	2	3
Total Volume	1	0	0	0	1	0	0	0	0	0	0	0	0	0	0	0	2	3	0	5	6
% App. Total	100	0	0	0		0	0	0	0		0	0	0	0		0	40	60	0		
PHF	.250	.000	.000	.000	.250	.000	.000	.000	.000	.000	.000	.000	.000	.000	.000	.000	.500	.375	.625	.500	

Traffic Data Service

San Jose, CA
 (408) 622-4787
 tdsbay@cs.com

File Name : 16PM FINAL
 Site Code : 00000016
 Start Date : 4/27/2017
 Page No : 2

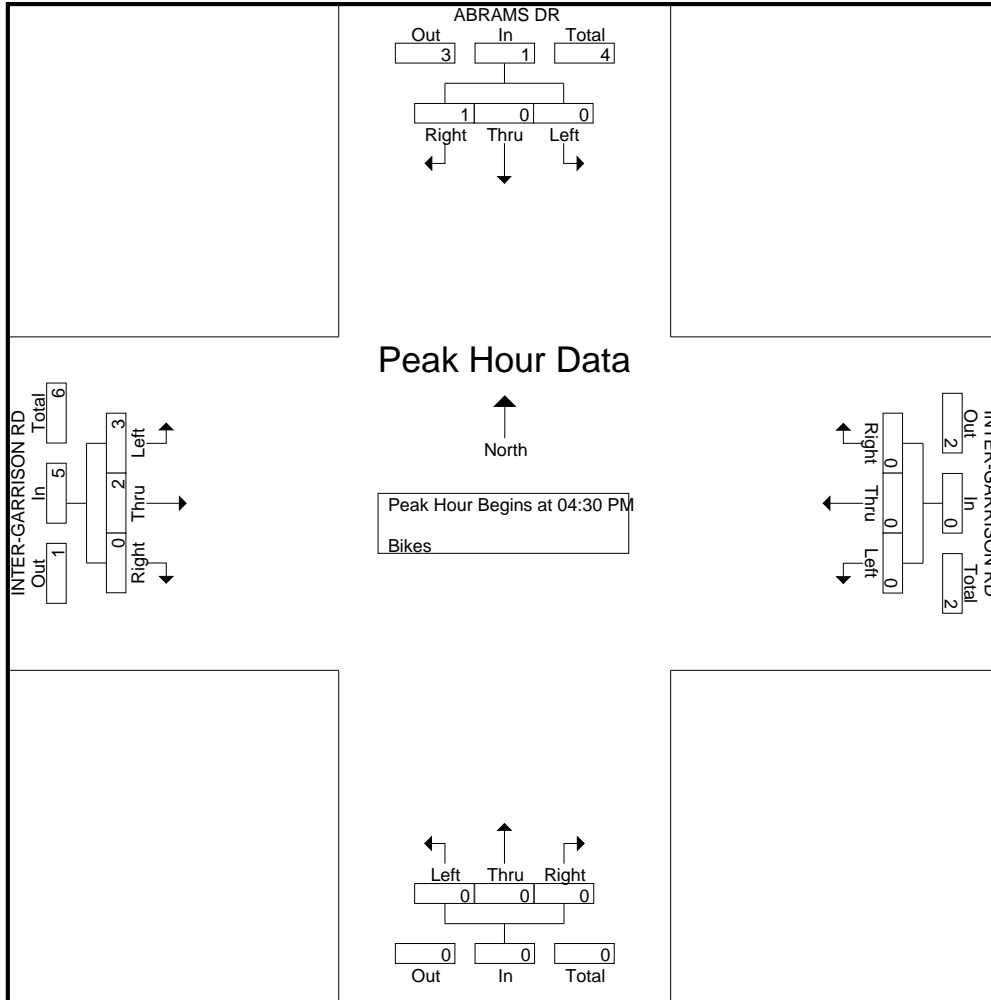

Traffic Data Service

San Jose, CA
 (408) 622-4787
 tdsbay@cs.com

File Name : 17AM FINAL
 Site Code : 00000017
 Start Date : 4/27/2017
 Page No : 1

Groups Printed- Lights - Buses - Trucks

Start Time	SCHOONOVER RD Southbound					INTER-GARRISON RD Westbound					Northbound					INTER-GARRISON RD Eastbound					Int. Total
	Right	Thru	Left	Peds	App. Total	Right	Thru	Left	Peds	App. Total	Right	Thru	Left	Peds	App. Total	Right	Thru	Left	Peds	App. Total	
07:00 AM	28	0	8	0	36	0	108	0	1	109	0	0	0	0	0	0	8	1	0	9	154
07:15 AM	44	0	8	0	52	5	150	0	0	155	0	0	0	0	0	0	14	3	0	17	224
07:30 AM	37	0	12	0	49	4	112	0	0	116	0	0	0	0	0	0	21	3	0	24	189
07:45 AM	37	0	7	0	44	6	72	0	0	78	0	0	0	0	0	0	18	5	0	23	145
Total	146	0	35	0	181	15	442	0	1	458	0	0	0	0	0	0	61	12	0	73	712
08:00 AM	17	0	5	0	22	4	74	0	0	78	0	0	0	0	0	0	13	4	0	17	117
08:15 AM	27	0	3	0	30	1	59	0	0	60	0	0	0	0	0	0	9	2	0	11	101
08:30 AM	14	0	2	0	16	0	52	0	0	52	0	0	0	0	0	0	13	6	0	19	87
08:45 AM	18	0	1	0	19	2	42	0	0	44	0	0	0	0	0	0	8	2	0	10	73
Total	76	0	11	0	87	7	227	0	0	234	0	0	0	0	0	0	43	14	0	57	378
Grand Total	222	0	46	0	268	22	669	0	1	692	0	0	0	0	0	0	104	26	0	130	1090
Apprch %	82.8	0	17.2	0		3.2	96.7	0	0.1		0	0	0	0	0	0	80	20	0		
Total %	20.4	0	4.2	0	24.6	2	61.4	0	0.1	63.5	0	0	0	0	0	0	9.5	2.4	0	11.9	
Lights	212	0	45	0	257	19	664	0	1	684	0	0	0	0	0	0	100	26	0	126	1067
% Lights	95.5	0	97.8	0	95.9	86.4	99.3	0	100	98.8	0	0	0	0	0	0	96.2	100	0	96.9	97.9
Buses	10	0	1	0	11	1	3	0	0	4	0	0	0	0	0	0	1	0	0	1	16
% Buses	4.5	0	2.2	0	4.1	4.5	0.4	0	0	0.6	0	0	0	0	0	0	1	0	0	0.8	1.5
Trucks	0	0	0	0	0	2	2	0	0	4	0	0	0	0	0	0	3	0	0	3	7
% Trucks	0	0	0	0	0	9.1	0.3	0	0	0.6	0	0	0	0	0	0	2.9	0	0	2.3	0.6

Start Time	SCHOONOVER RD Southbound				INTER-GARRISON RD Westbound				Northbound				INTER-GARRISON RD Eastbound				Int. Total	
	Right	Thru	Left	App. Total	Right	Thru	Left	App. Total	Right	Thru	Left	App. Total	Right	Thru	Left	App. Total		
Peak Hour Analysis From 07:00 AM to 08:45 AM - Peak 1 of 1																		
Peak Hour for Entire Intersection Begins at 07:00 AM																		
07:00 AM	28	0	8	36	0	108	0	108	0	0	0	0	0	0	8	1	9	153
07:15 AM	44	0	8	52	5	150	0	155	0	0	0	0	0	0	14	3	17	224
07:30 AM	37	0	12	49	4	112	0	116	0	0	0	0	0	0	21	3	24	189
07:45 AM	37	0	7	44	6	72	0	78	0	0	0	0	0	0	18	5	23	145
Total Volume	146	0	35	181	15	442	0	457	0	0	0	0	0	0	61	12	73	711
% App. Total	80.7	0	19.3		3.3	96.7	0		0	0	0	0	0	0	83.6	16.4		
PHF	.830	.000	.729	.870	.625	.737	.000	.737	.000	.000	.000	.000	.000	.000	.726	.600	.760	.794

Traffic Data Service

San Jose, CA
 (408) 622-4787
 tdsbay@cs.com

File Name : 17AM FINAL
 Site Code : 00000017
 Start Date : 4/27/2017
 Page No : 2

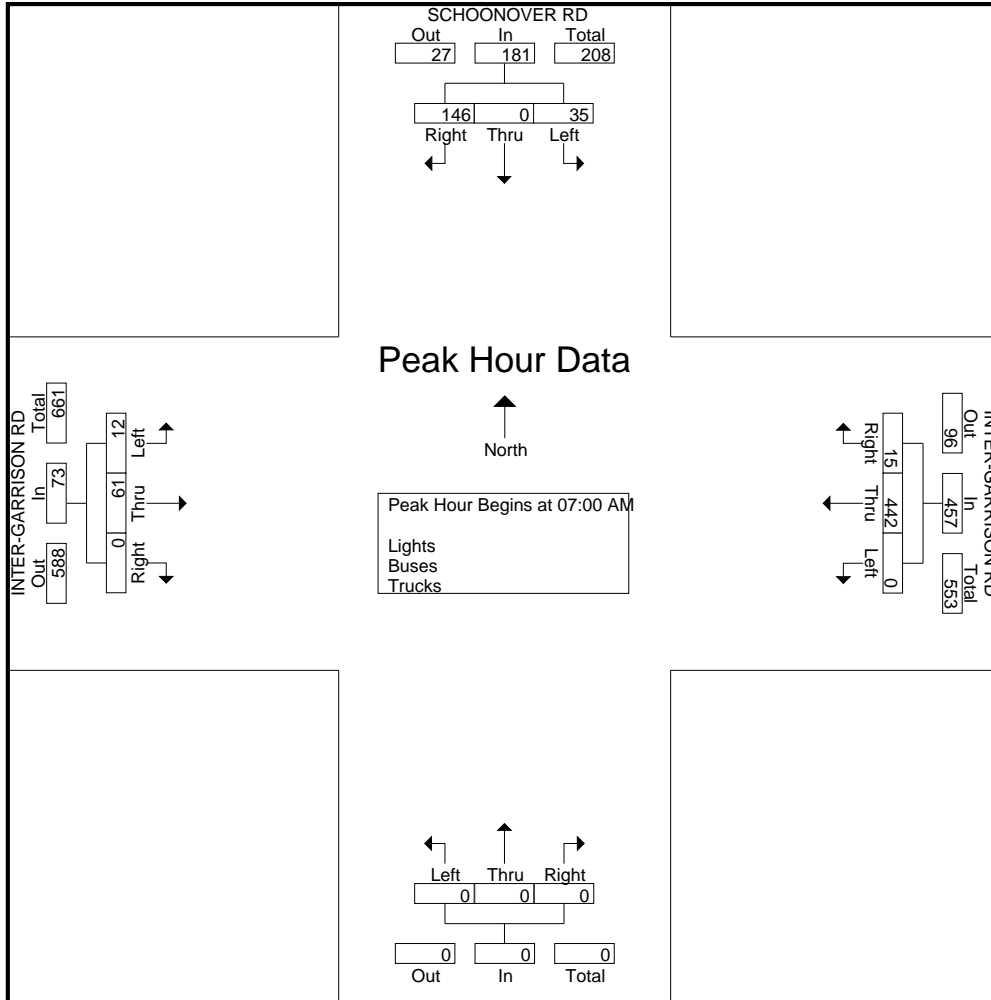

Traffic Data Service

San Jose, CA
 (408) 622-4787
 tdsbay@cs.com

File Name : 17AM FINAL
 Site Code : 00000017
 Start Date : 4/27/2017
 Page No : 1

Groups Printed- Bikes

Start Time	SCHOONOVER RD Southbound					INTER-GARRISON RD Westbound					Northbound					INTER-GARRISON RD Eastbound					Int. Total
	Right	Thru	Left	Peds	App. Total	Right	Thru	Left	Peds	App. Total	Right	Thru	Left	Peds	App. Total	Right	Thru	Left	Peds	App. Total	
07:00 AM	0	0	0	0	0	0	1	0	0	1	0	0	0	0	0	0	0	0	0	0	0
07:15 AM	0	0	1	0	1	0	0	0	0	0	0	0	0	0	0	0	0	0	0	0	0
07:30 AM	0	0	0	0	0	0	0	0	0	0	0	0	0	0	0	0	0	0	0	0	0
07:45 AM	0	0	0	0	0	0	0	0	0	0	0	0	0	0	0	0	0	0	0	0	0
Total	0	0	1	0	1	0	1	0	0	1	0	0	0	0	0	0	0	0	0	0	2
08:00 AM	0	0	0	0	0	0	0	0	0	0	0	0	0	0	0	0	1	0	0	1	1
08:15 AM	1	0	0	0	1	0	0	0	0	0	0	0	0	0	0	0	0	0	0	0	1
08:30 AM	0	0	0	0	0	0	0	0	0	0	0	0	0	0	0	0	0	0	0	0	0
08:45 AM	0	0	0	0	0	0	0	0	0	0	0	0	0	0	0	0	0	0	0	0	0
Total	1	0	0	0	1	0	0	0	0	0	0	0	0	0	0	0	1	0	0	1	2
Grand Total	1	0	1	0	2	0	1	0	0	1	0	0	0	0	0	0	1	0	0	1	4
Apprch %	50	0	50	0		0	100	0	0		0	0	0	0		0	100	0	0		
Total %	25	0	25	0	50	0	25	0	0	25	0	0	0	0	0	0	25	0	0	25	

Start Time	SCHOONOVER RD Southbound					INTER-GARRISON RD Westbound					Northbound					INTER-GARRISON RD Eastbound					Int. Total
	Right	Thru	Left	Peds	App. Total	Right	Thru	Left	Peds	App. Total	Right	Thru	Left	Peds	App. Total	Right	Thru	Left	Peds	App. Total	
07:00 AM	0	0	0	0	0	0	1	0	0	1	0	0	0	0	0	0	0	0	0	0	1
07:15 AM	0	0	1	0	1	0	0	0	0	0	0	0	0	0	0	0	0	0	0	0	1
07:30 AM	0	0	0	0	0	0	0	0	0	0	0	0	0	0	0	0	0	0	0	0	0
07:45 AM	0	0	0	0	0	0	0	0	0	0	0	0	0	0	0	0	0	0	0	0	0
Total Volume	0	0	1	0	1	0	1	0	0	1	0	0	0	0	0	0	0	0	0	0	2
% App. Total	0	0	100	0		0	100	0	0		0	0	0	0		0	0	0	0		
PHF	.000	.000	.250	.000	.250	.000	.250	.000	.000	.250	.000	.000	.000	.000	.000	.000	.000	.000	.000	.000	.500

Peak Hour Analysis From 07:00 AM to 08:45 AM - Peak 1 of 1
 Peak Hour for Entire Intersection Begins at 07:00 AM

Traffic Data Service

San Jose, CA
(408) 622-4787
tdsbay@cs.com

File Name : 17AM FINAL
Site Code : 00000017
Start Date : 4/27/2017
Page No : 2

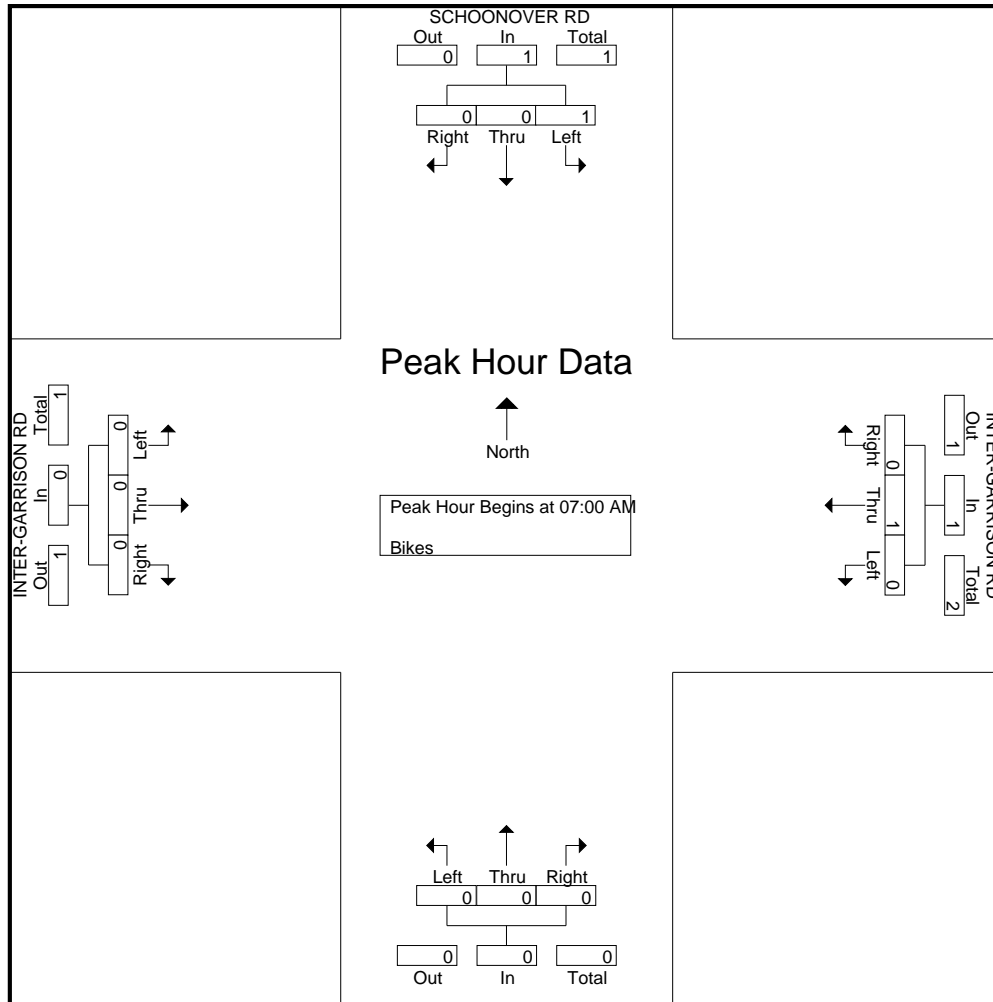

Traffic Data Service

San Jose, CA
 (408) 622-4787
 tdsbay@cs.com

File Name : 17PM FINAL
 Site Code : 00000017
 Start Date : 4/27/2017
 Page No : 1

Groups Printed- Lights - Buses - Trucks

Start Time	SCHOONOVER RD Southbound					INTER-GARRISON RD Westbound					Northbound					INTER-GARRISON RD Eastbound					Int. Total
	Right	Thru	Left	Peds	App. Total	Right	Thru	Left	Peds	App. Total	Right	Thru	Left	Peds	App. Total	Right	Thru	Left	Peds	App. Total	
04:00 PM	4	0	5	0	9	2	6	0	0	8	0	0	0	0	0	0	61	12	0	73	90
04:15 PM	9	0	2	0	11	5	20	0	0	25	0	0	0	0	0	0	56	13	0	69	105
04:30 PM	10	0	4	0	14	5	22	0	0	27	0	0	0	0	0	0	67	15	0	82	123
04:45 PM	7	0	3	3	13	3	24	0	0	27	0	0	0	0	0	0	76	19	0	95	135
Total	30	0	14	3	47	15	72	0	0	87	0	0	0	0	0	0	260	59	0	319	453
05:00 PM	3	0	3	1	7	4	31	0	0	35	0	0	0	0	0	0	86	28	0	114	156
05:15 PM	8	0	3	0	11	4	16	0	0	20	0	0	0	0	0	0	115	23	0	138	169
05:30 PM	6	0	2	2	10	2	18	0	0	20	0	0	0	0	0	0	76	24	0	100	130
05:45 PM	13	0	2	0	15	7	16	0	0	23	0	0	0	0	0	0	64	17	0	81	119
Total	30	0	10	3	43	17	81	0	0	98	0	0	0	0	0	0	341	92	0	433	574
Grand Total	60	0	24	6	90	32	153	0	0	185	0	0	0	0	0	0	601	151	0	752	1027
Apprch %	66.7	0	26.7	6.7		17.3	82.7	0	0		0	0	0	0		0	79.9	20.1	0		
Total %	5.8	0	2.3	0.6	8.8	3.1	14.9	0	0	18	0	0	0	0	0	0	58.5	14.7	0	73.2	
Lights	47	0	23	6	76	31	147	0	0	178	0	0	0	0	0	0	596	151	0	747	1001
% Lights	78.3	0	95.8	100	84.4	96.9	96.1	0	0	96.2	0	0	0	0	0	0	99.2	100	0	99.3	97.5
Buses	13	0	1	0	14	1	0	0	0	1	0	0	0	0	0	0	2	0	0	2	17
% Buses	21.7	0	4.2	0	15.6	3.1	0	0	0	0.5	0	0	0	0	0	0	0.3	0	0	0.3	1.7
Trucks	0	0	0	0	0	0	6	0	0	6	0	0	0	0	0	0	3	0	0	3	9
% Trucks	0	0	0	0	0	0	3.9	0	0	3.2	0	0	0	0	0	0	0.5	0	0	0.4	0.9

Start Time	SCHOONOVER RD Southbound				INTER-GARRISON RD Westbound				Northbound				INTER-GARRISON RD Eastbound				Int. Total
	Right	Thru	Left	App. Total	Right	Thru	Left	App. Total	Right	Thru	Left	App. Total	Right	Thru	Left	App. Total	
Peak Hour Analysis From 04:00 PM to 05:45 PM - Peak 1 of 1																	
Peak Hour for Entire Intersection Begins at 04:45 PM																	
04:45 PM	7	0	3	10	3	24	0	27	0	0	0	0	0	76	19	95	132
05:00 PM	3	0	3	6	4	31	0	35	0	0	0	0	0	86	28	114	155
05:15 PM	8	0	3	11	4	16	0	20	0	0	0	0	0	115	23	138	169
05:30 PM	6	0	2	8	2	18	0	20	0	0	0	0	0	76	24	100	128
Total Volume	24	0	11	35	13	89	0	102	0	0	0	0	0	353	94	447	584
% App. Total	68.6	0	31.4		12.7	87.3	0		0	0	0		0	79	21		
PHF	.750	.000	.917	.795	.813	.718	.000	.729	.000	.000	.000	.000	.000	.767	.839	.810	.864

Traffic Data Service

San Jose, CA
 (408) 622-4787
 tdsbay@cs.com

File Name : 17PM FINAL
 Site Code : 00000017
 Start Date : 4/27/2017
 Page No : 2

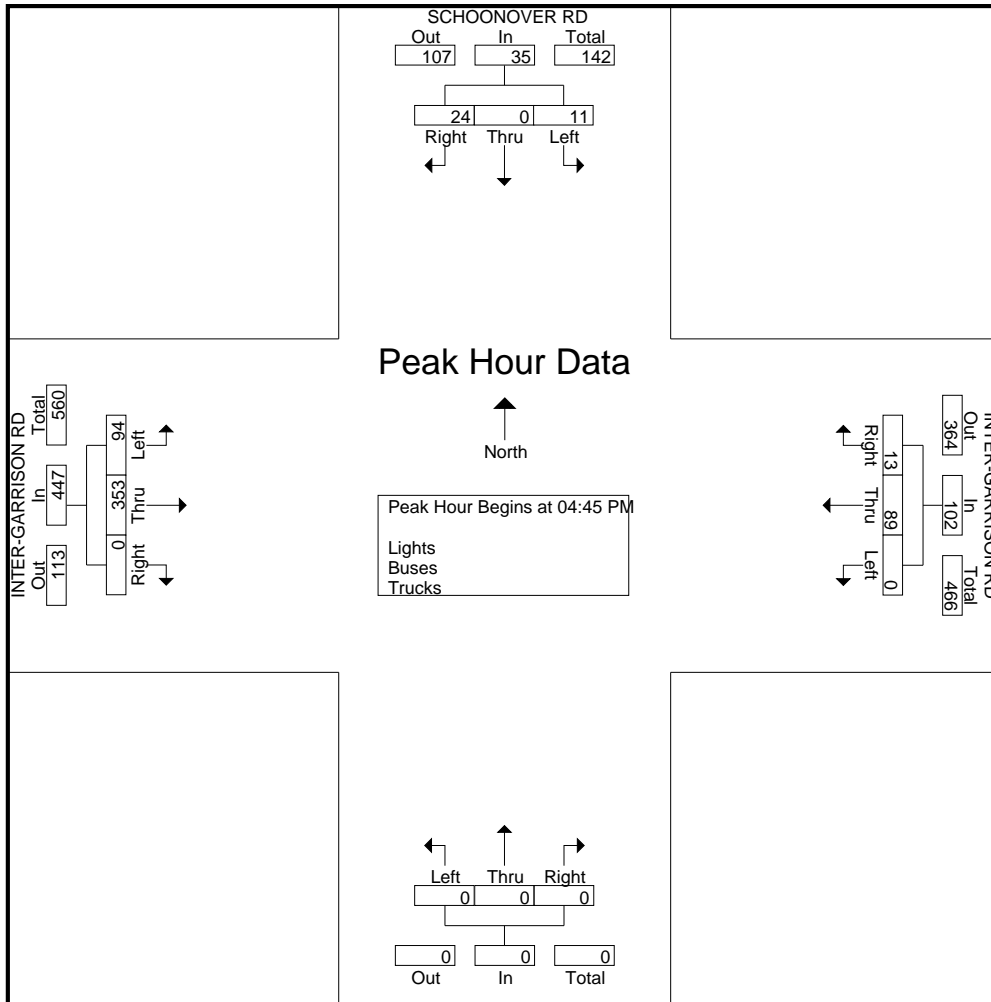

Traffic Data Service

San Jose, CA
 (408) 622-4787
 tdsbay@cs.com

File Name : 17PM FINAL
 Site Code : 00000017
 Start Date : 4/27/2017
 Page No : 1

Groups Printed- Bikes

Start Time	SCHOONOVER RD Southbound					INTER-GARRISON RD Westbound					Northbound					INTER-GARRISON RD Eastbound					Int. Total
	Right	Thru	Left	Peds	App. Total	Right	Thru	Left	Peds	App. Total	Right	Thru	Left	Peds	App. Total	Right	Thru	Left	Peds	App. Total	
04:00 PM	0	0	0	0	0	0	0	0	0	0	0	0	0	0	0	0	0	0	0	0	0
04:15 PM	0	0	0	0	0	0	0	0	0	0	0	0	0	0	0	0	0	0	0	0	0
04:30 PM	0	0	0	0	0	0	0	0	0	0	0	0	0	0	0	0	0	1	0	1	1
04:45 PM	0	0	0	0	0	0	0	0	0	0	0	0	0	0	0	0	0	0	0	0	0
Total	0	0	0	0	0	0	0	0	0	0	0	0	0	0	0	0	0	1	0	1	1
05:00 PM	0	0	0	0	0	0	0	0	0	0	0	0	0	0	0	0	0	1	0	1	1
05:15 PM	0	0	0	0	0	0	0	0	0	0	0	0	0	0	0	0	0	0	0	0	0
05:30 PM	0	0	0	0	0	0	0	0	0	0	0	0	0	0	0	0	0	0	0	0	0
05:45 PM	0	0	0	0	0	0	0	0	0	0	0	0	0	0	0	0	0	0	0	0	0
Total	0	0	0	0	0	0	0	0	0	0	0	0	0	0	0	0	0	1	0	1	1
Grand Total	0	0	0	0	0	0	0	0	0	0	0	0	0	0	0	0	0	2	0	2	2
Apprch %	0	0	0	0	0	0	0	0	0	0	0	0	0	0	0	0	0	100	0	0	0
Total %	0	0	0	0	0	0	0	0	0	0	0	0	0	0	0	0	0	100	0	100	0

Start Time	SCHOONOVER RD Southbound					INTER-GARRISON RD Westbound					Northbound					INTER-GARRISON RD Eastbound					Int. Total
	Right	Thru	Left	Peds	App. Total	Right	Thru	Left	Peds	App. Total	Right	Thru	Left	Peds	App. Total	Right	Thru	Left	Peds	App. Total	
Peak Hour Analysis From 04:00 PM to 05:45 PM - Peak 1 of 1																					
Peak Hour for Entire Intersection Begins at 04:15 PM																					
04:15 PM	0	0	0	0	0	0	0	0	0	0	0	0	0	0	0	0	0	0	0	0	0
04:30 PM	0	0	0	0	0	0	0	0	0	0	0	0	0	0	0	0	0	1	0	1	1
04:45 PM	0	0	0	0	0	0	0	0	0	0	0	0	0	0	0	0	0	0	0	0	0
05:00 PM	0	0	0	0	0	0	0	0	0	0	0	0	0	0	0	0	0	1	0	1	1
Total Volume	0	0	0	0	0	0	0	0	0	0	0	0	0	0	0	0	0	2	0	2	2
% App. Total	0	0	0	0	0	0	0	0	0	0	0	0	0	0	0	0	0	100	0	0	0
PHF	.000	.000	.000	.000	.000	.000	.000	.000	.000	.000	.000	.000	.000	.000	.000	.000	.000	.500	.500	.500	.500

Traffic Data Service

San Jose, CA
(408) 622-4787
tdsbay@cs.com

File Name : 17PM FINAL
Site Code : 00000017
Start Date : 4/27/2017
Page No : 2

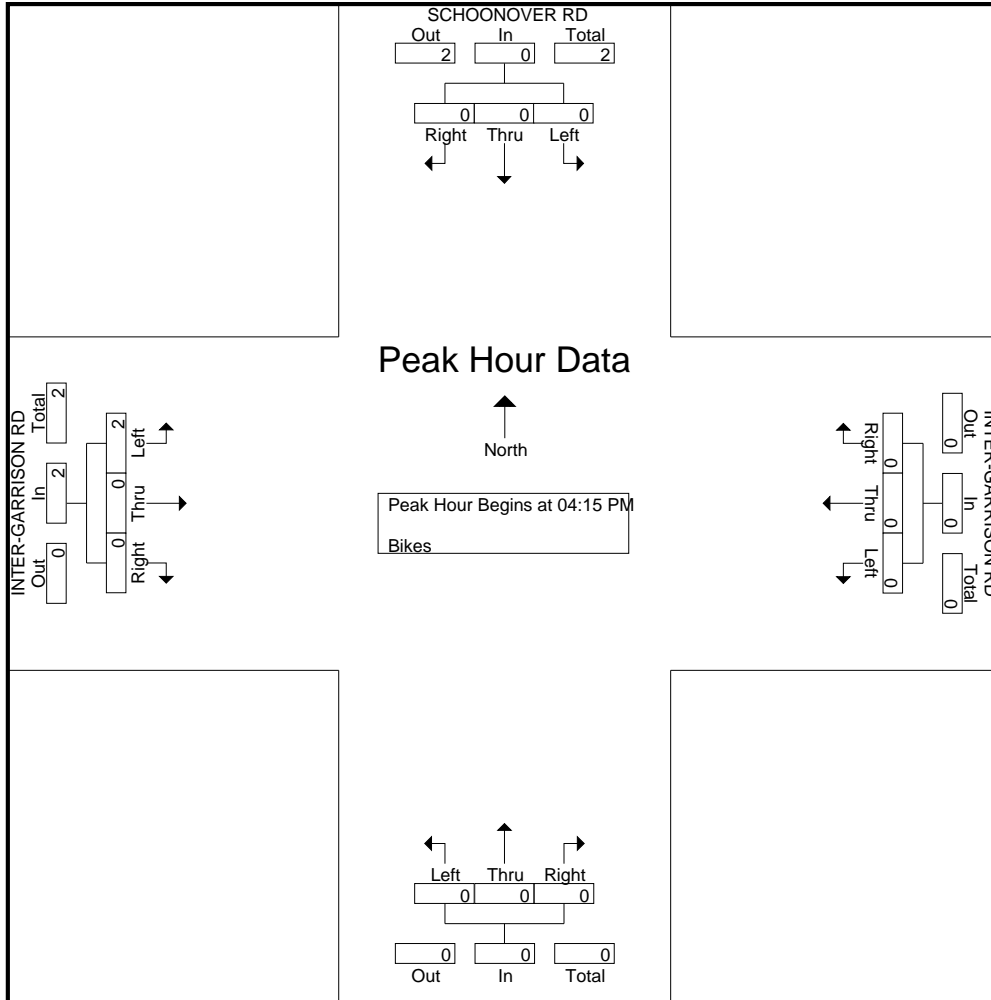

Traffic Data Service

San Jose, CA
(408) 622-4787
tdsbay@cs.com

File Name : 18AM FINAL
 Site Code : 00000018
 Start Date : 4/27/2017
 Page No : 1

Groups Printed- Lights - Buses - Trucks

Start Time	INTER-GARRISON RD Southbound					SHERMAN BLVD Westbound					Northbound					INTER-GARRISON RD Eastbound					Int. Total
	Right	Thru	Left	Peds	App. Total	Right	Thru	Left	Peds	App. Total	Right	Thru	Left	Peds	App. Total	Right	Thru	Left	Peds	App. Total	
07:00 AM	103	0	7	0	110	6	20	0	0	26	0	0	0	0	0	0	1	14	0	15	151
07:15 AM	125	0	3	0	128	2	29	0	0	31	0	0	0	0	0	0	4	18	0	22	181
07:30 AM	97	0	1	0	98	6	18	0	0	24	0	0	0	0	0	0	2	25	0	27	149
07:45 AM	65	0	2	0	67	4	10	0	0	14	0	0	0	0	0	0	3	27	0	30	111
Total	390	0	13	0	403	18	77	0	0	95	0	0	0	0	0	0	10	84	0	94	592
08:00 AM	62	0	4	0	66	4	11	0	0	15	0	0	0	0	0	0	3	14	0	17	98
08:15 AM	53	0	3	0	56	3	7	0	0	10	0	0	0	0	0	0	2	9	0	11	77
08:30 AM	44	0	2	0	46	5	7	0	0	12	0	0	0	0	0	0	6	9	0	15	73
08:45 AM	34	0	3	0	37	4	10	0	0	14	0	0	0	0	0	0	4	6	0	10	61
Total	193	0	12	0	205	16	35	0	0	51	0	0	0	0	0	0	15	38	0	53	309
Grand Total	583	0	25	0	608	34	112	0	0	146	0	0	0	0	0	0	25	122	0	147	901
Apprch %	95.9	0	4.1	0		23.3	76.7	0	0		0	0	0	0	0	0	17	83	0		
Total %	64.7	0	2.8	0	67.5	3.8	12.4	0	0	16.2	0	0	0	0	0	0	2.8	13.5	0	16.3	
Lights	583	0	23	0	606	34	107	0	0	141	0	0	0	0	0	0	23	119	0	142	889
% Lights	100	0	92	0	99.7	100	95.5	0	0	96.6	0	0	0	0	0	0	92	97.5	0	96.6	98.7
Buses	0	0	1	0	1	0	2	0	0	2	0	0	0	0	0	0	1	1	0	2	5
% Buses	0	0	4	0	0.2	0	1.8	0	0	1.4	0	0	0	0	0	0	4	0.8	0	1.4	0.6
Trucks	0	0	1	0	1	0	3	0	0	3	0	0	0	0	0	0	1	2	0	3	7
% Trucks	0	0	4	0	0.2	0	2.7	0	0	2.1	0	0	0	0	0	0	4	1.6	0	2	0.8

Start Time	INTER-GARRISON RD Southbound				SHERMAN BLVD Westbound				Northbound				INTER-GARRISON RD Eastbound				Int. Total
	Right	Thru	Left	App. Total	Right	Thru	Left	App. Total	Right	Thru	Left	App. Total	Right	Thru	Left	App. Total	
Peak Hour Analysis From 07:00 AM to 08:45 AM - Peak 1 of 1																	
Peak Hour for Entire Intersection Begins at 07:00 AM																	
07:00 AM	103	0	7	110	6	20	0	26	0	0	0	0	0	1	14	15	151
07:15 AM	125	0	3	128	2	29	0	31	0	0	0	0	0	4	18	22	181
07:30 AM	97	0	1	98	6	18	0	24	0	0	0	0	0	2	25	27	149
07:45 AM	65	0	2	67	4	10	0	14	0	0	0	0	0	3	27	30	111
Total Volume	390	0	13	403	18	77	0	95	0	0	0	0	0	10	84	94	592
% App. Total	96.8	0	3.2		18.9	81.1	0		0	0	0	0	0	10.6	89.4		
PHF	.780	.000	.464	.787	.750	.664	.000	.766	.000	.000	.000	.000	.000	.625	.778	.783	.818

Traffic Data Service

San Jose, CA
 (408) 622-4787
 tdsbay@cs.com

File Name : 18AM FINAL
 Site Code : 00000018
 Start Date : 4/27/2017
 Page No : 2

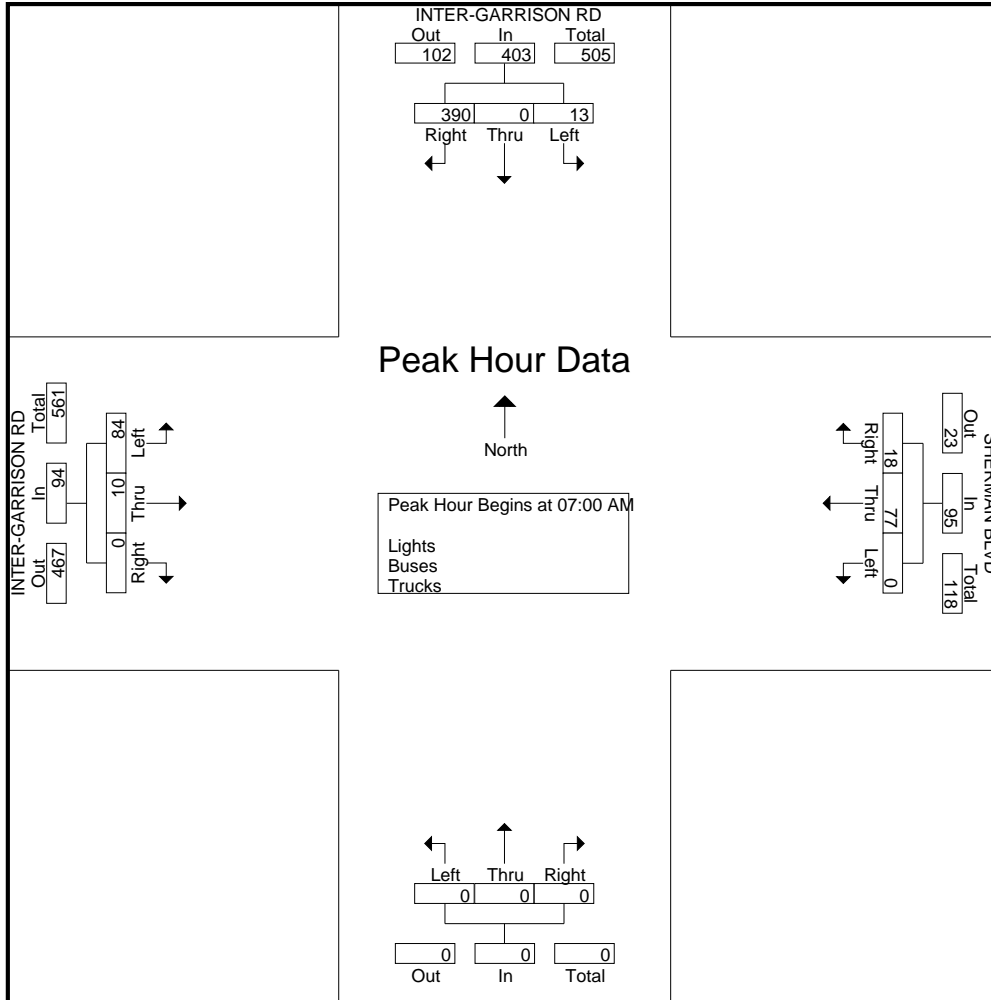

Traffic Data Service

San Jose, CA
 (408) 622-4787
 tdsbay@cs.com

File Name : 18AM FINAL
 Site Code : 00000018
 Start Date : 4/27/2017
 Page No : 1

Groups Printed- Bikes

Start Time	INTER-GARRISON RD Southbound					SHERMAN BLVD Westbound					Northbound					INTER-GARRISON RD Eastbound					Int. Total
	Right	Thru	Left	Peds	App. Total	Right	Thru	Left	Peds	App. Total	Right	Thru	Left	Peds	App. Total	Right	Thru	Left	Peds	App. Total	
07:00 AM	0	0	0	0	0	0	0	0	0	0	0	0	0	0	0	0	0	0	0	0	0
07:15 AM	0	0	0	0	0	0	0	0	0	0	0	0	0	0	0	0	1	0	0	0	1
07:30 AM	0	0	0	0	0	0	0	0	0	0	0	0	0	0	0	0	0	0	0	0	0
07:45 AM	0	0	0	0	0	0	0	0	0	0	0	0	0	0	0	0	0	0	0	0	0
Total	0	0	0	0	0	0	0	0	0	0	0	0	0	0	0	0	1	0	0	0	1
08:00 AM	0	0	0	0	0	0	0	0	0	0	0	0	0	0	0	0	1	0	0	0	1
08:15 AM	0	0	0	0	0	0	0	0	0	0	0	0	0	0	0	0	0	0	0	0	0
08:30 AM	0	0	0	0	0	0	0	0	0	0	0	0	0	0	0	0	0	0	0	0	0
08:45 AM	0	0	0	0	0	0	0	0	0	0	0	0	0	0	0	0	0	0	0	0	0
Total	0	0	0	0	0	0	0	0	0	0	0	0	0	0	0	0	1	0	0	0	1
Grand Total	0	0	0	0	0	0	0	0	0	0	0	0	0	0	0	0	2	0	0	0	2
Apprch %	0	0	0	0	0	0	0	0	0	0	0	0	0	0	0	0	100	0	0	0	
Total %	0	0	0	0	0	0	0	0	0	0	0	0	0	0	0	0	100	0	0	100	

Start Time	INTER-GARRISON RD Southbound					SHERMAN BLVD Westbound					Northbound					INTER-GARRISON RD Eastbound					Int. Total
	Right	Thru	Left	Peds	App. Total	Right	Thru	Left	Peds	App. Total	Right	Thru	Left	Peds	App. Total	Right	Thru	Left	Peds	App. Total	
Peak Hour Analysis From 07:00 AM to 08:45 AM - Peak 1 of 1																					
Peak Hour for Entire Intersection Begins at 07:15 AM																					
07:15 AM	0	0	0	0	0	0	0	0	0	0	0	0	0	0	0	0	1	0	0	0	1
07:30 AM	0	0	0	0	0	0	0	0	0	0	0	0	0	0	0	0	0	0	0	0	0
07:45 AM	0	0	0	0	0	0	0	0	0	0	0	0	0	0	0	0	0	0	0	0	0
08:00 AM	0	0	0	0	0	0	0	0	0	0	0	0	0	0	0	0	1	0	0	0	1
Total Volume	0	0	0	0	0	0	0	0	0	0	0	0	0	0	0	0	2	0	0	0	2
% App. Total	0	0	0	0	0	0	0	0	0	0	0	0	0	0	0	0	100	0	0	0	
PHF	.000	.000	.000	.000	.000	.000	.000	.000	.000	.000	.000	.000	.000	.000	.000	.000	.500	.000	.500	.000	.500

Traffic Data Service

San Jose, CA
(408) 622-4787
tdsbay@cs.com

File Name : 18AM FINAL
Site Code : 00000018
Start Date : 4/27/2017
Page No : 2

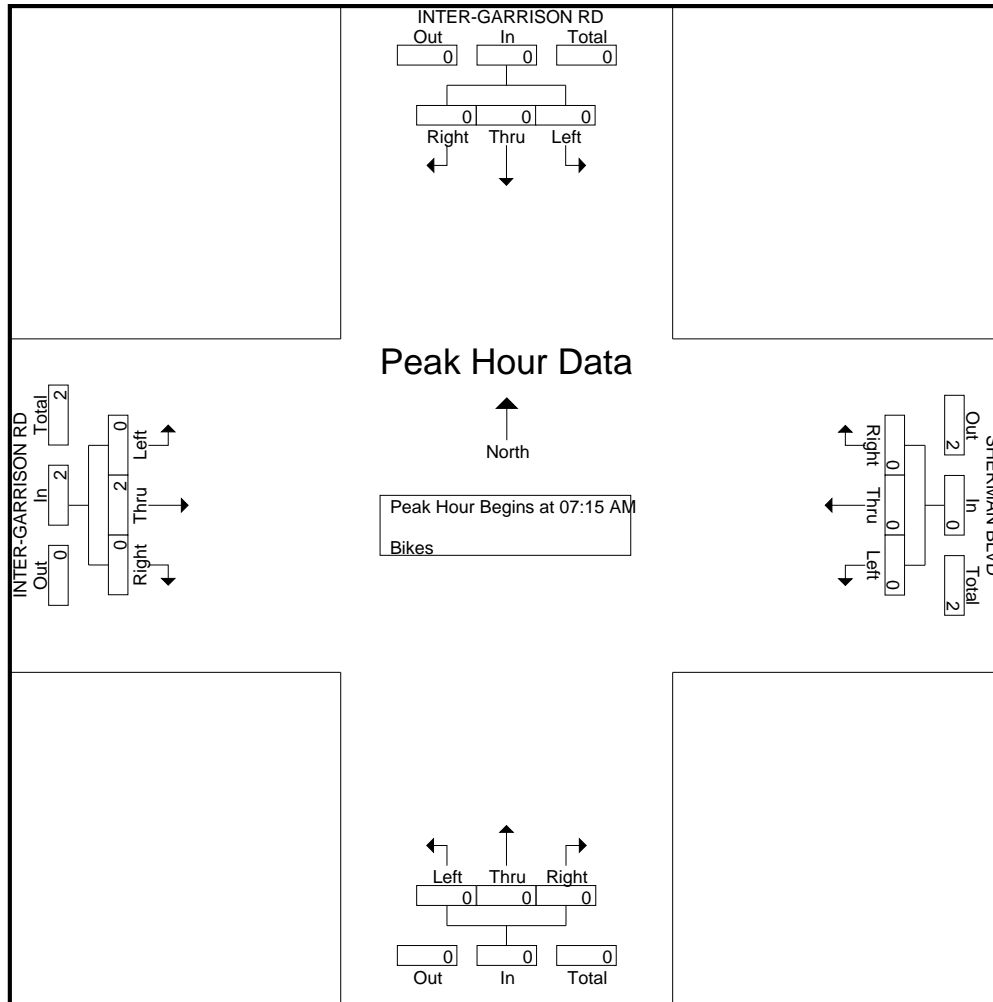

Traffic Data Service

San Jose, CA
 (408) 622-4787
 tdsbay@cs.com

File Name : 18PM FINAL
 Site Code : 00000018
 Start Date : 4/27/2017
 Page No : 1

Groups Printed- Lights - Buses - Trucks

Start Time	INTER-GARRISON RD Southbound					SHERMAN BLVD Westbound					Northbound					INTER-GARRISON RD Eastbound					Int. Total
	Right	Thru	Left	Peds	App. Total	Right	Thru	Left	Peds	App. Total	Right	Thru	Left	Peds	App. Total	Right	Thru	Left	Peds	App. Total	
04:00 PM	9	0	7	0	16	2	4	0	0	6	0	0	0	0	0	0	11	53	0	64	86
04:15 PM	16	0	3	0	19	1	6	0	0	7	0	0	0	0	0	0	8	54	0	62	88
04:30 PM	21	0	3	0	24	3	5	0	0	8	0	0	0	0	0	0	6	60	0	66	98
04:45 PM	22	0	4	0	26	4	5	0	0	9	0	0	0	0	0	0	10	76	0	86	121
Total	68	0	17	0	85	10	20	0	0	30	0	0	0	0	0	0	35	243	0	278	393
05:00 PM	21	0	5	0	26	5	9	0	0	14	0	0	0	0	0	0	8	80	1	89	129
05:15 PM	16	0	2	0	18	2	5	0	0	7	0	0	0	0	0	0	12	105	0	117	142
05:30 PM	16	0	1	0	17	4	2	0	0	6	0	0	0	0	0	0	13	67	0	80	103
05:45 PM	16	0	2	0	18	5	4	0	0	9	0	0	0	0	0	0	13	54	0	67	94
Total	69	0	10	0	79	16	20	0	0	36	0	0	0	0	0	0	46	306	1	353	468
Grand Total	137	0	27	0	164	26	40	0	0	66	0	0	0	0	0	0	81	549	1	631	861
Apprch %	83.5	0	16.5	0		39.4	60.6	0	0		0	0	0	0	0	0	12.8	87	0.2		
Total %	15.9	0	3.1	0	19	3	4.6	0	0	7.7	0	0	0	0	0	0	9.4	63.8	0.1	73.3	
Lights	132	0	26	0	158	25	38	0	0	63	0	0	0	0	0	0	78	544	1	623	844
% Lights	96.4	0	96.3	0	96.3	96.2	95	0	0	95.5	0	0	0	0	0	0	96.3	99.1	100	98.7	98
Buses	1	0	0	0	1	1	0	0	0	1	0	0	0	0	0	0	2	1	0	3	5
% Buses	0.7	0	0	0	0.6	3.8	0	0	0	1.5	0	0	0	0	0	0	2.5	0.2	0	0.5	0.6
Trucks	4	0	1	0	5	0	2	0	0	2	0	0	0	0	0	0	1	4	0	5	12
% Trucks	2.9	0	3.7	0	3	0	5	0	0	3	0	0	0	0	0	0	1.2	0.7	0	0.8	1.4

Start Time	INTER-GARRISON RD Southbound				SHERMAN BLVD Westbound				Northbound				INTER-GARRISON RD Eastbound				Int. Total	
	Right	Thru	Left	App. Total	Right	Thru	Left	App. Total	Right	Thru	Left	App. Total	Right	Thru	Left	App. Total		
Peak Hour Analysis From 04:00 PM to 05:45 PM - Peak 1 of 1																		
Peak Hour for Entire Intersection Begins at 04:45 PM																		
04:45 PM	22	0	4	26	4	5	0	9	0	0	0	0	0	0	10	76	86	121
05:00 PM	21	0	5	26	5	9	0	14	0	0	0	0	0	0	8	80	88	128
05:15 PM	16	0	2	18	2	5	0	7	0	0	0	0	0	12	105	117	142	
05:30 PM	16	0	1	17	4	2	0	6	0	0	0	0	0	13	67	80	103	
Total Volume	75	0	12	87	15	21	0	36	0	0	0	0	0	43	328	371	494	
% App. Total	86.2	0	13.8		41.7	58.3	0		0	0	0		0	11.6	88.4			
PHF	.852	.000	.600	.837	.750	.583	.000	.643	.000	.000	.000	.000	.000	.827	.781	.793	.870	

Traffic Data Service

San Jose, CA
 (408) 622-4787
 tdsbay@cs.com

File Name : 18PM FINAL
 Site Code : 00000018
 Start Date : 4/27/2017
 Page No : 2

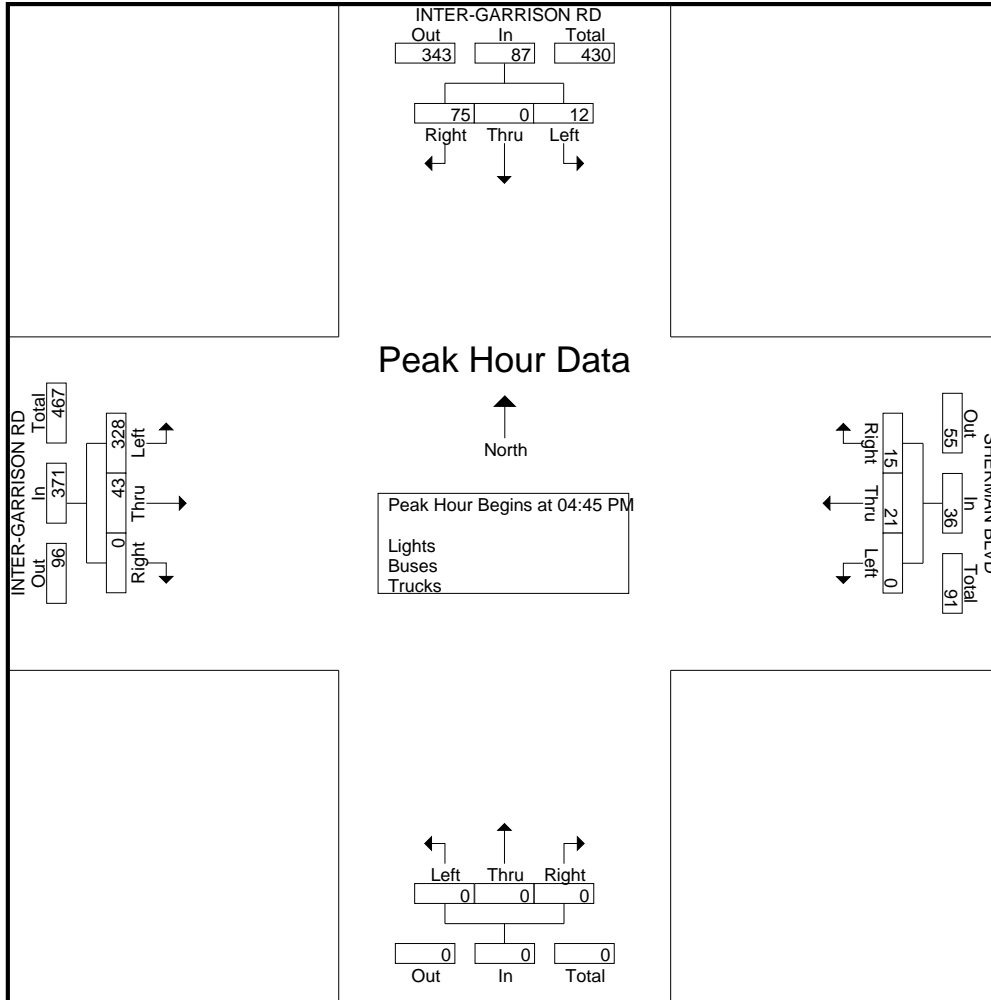

Traffic Data Service

San Jose, CA
 (408) 622-4787
 tdsbay@cs.com

File Name : 18PM FINAL
 Site Code : 00000018
 Start Date : 4/27/2017
 Page No : 1

Groups Printed- Bikes

Start Time	INTER-GARRISON RD Southbound					SHERMAN BLVD Westbound					Northbound					INTER-GARRISON RD Eastbound					Int. Total
	Right	Thru	Left	Peds	App. Total	Right	Thru	Left	Peds	App. Total	Right	Thru	Left	Peds	App. Total	Right	Thru	Left	Peds	App. Total	
04:00 PM	0	0	0	0	0	0	0	0	0	0	0	0	0	0	0	0	0	0	0	0	0
04:15 PM	0	0	0	1	1	0	0	0	0	0	0	0	0	0	0	0	0	1	0	1	2
04:30 PM	0	0	0	0	0	0	0	0	0	0	0	0	0	0	0	0	0	0	0	0	0
04:45 PM	0	0	0	0	0	0	0	0	0	0	0	0	0	0	0	0	0	0	0	0	0
Total	0	0	0	1	1	0	0	0	0	0	0	0	0	0	0	0	0	1	0	1	2
05:00 PM	0	0	0	0	0	0	0	0	0	0	0	0	0	0	0	0	0	0	0	0	0
05:15 PM	0	0	0	0	0	0	0	0	0	0	0	0	0	0	0	0	0	0	0	0	0
05:30 PM	0	0	0	0	0	0	0	0	0	0	0	0	0	0	0	0	0	0	0	0	0
05:45 PM	0	0	0	0	0	0	0	0	0	0	0	0	0	0	0	0	0	0	0	0	0
Total	0	0	0	0	0	0	0	0	0	0	0	0	0	0	0	0	0	0	0	0	0
Grand Total	0	0	0	1	1	0	0	0	0	0	0	0	0	0	0	0	0	1	0	1	2
Apprch %	0	0	0	100		0	0	0	0		0	0	0	0		0	0	100	0		
Total %	0	0	0	50	50	0	0	0	0	0	0	0	0	0	0	0	0	50	0	50	

Start Time	INTER-GARRISON RD Southbound				SHERMAN BLVD Westbound				Northbound				INTER-GARRISON RD Eastbound				Int. Total
	Right	Thru	Left	App. Total	Right	Thru	Left	App. Total	Right	Thru	Left	App. Total	Right	Thru	Left	App. Total	
Peak Hour Analysis From 04:00 PM to 05:45 PM - Peak 1 of 1																	
Peak Hour for Entire Intersection Begins at 04:00 PM																	
04:00 PM	0	0	0	0	0	0	0	0	0	0	0	0	0	0	0	0	0
04:15 PM	0	0	0	0	0	0	0	0	0	0	0	0	0	0	1	1	1
04:30 PM	0	0	0	0	0	0	0	0	0	0	0	0	0	0	0	0	0
04:45 PM	0	0	0	0	0	0	0	0	0	0	0	0	0	0	0	0	0
Total Volume	0	0	0	0	0	0	0	0	0	0	0	0	0	0	1	1	1
% App. Total	0	0	0		0	0	0		0	0	0		0	0	100		
PHF	.000	.000	.000	.000	.000	.000	.000	.000	.000	.000	.000	.000	.000	.000	.250	.250	.250

Traffic Data Service

San Jose, CA
(408) 622-4787
tdsbay@cs.com

File Name : 18PM FINAL
Site Code : 00000018
Start Date : 4/27/2017
Page No : 2

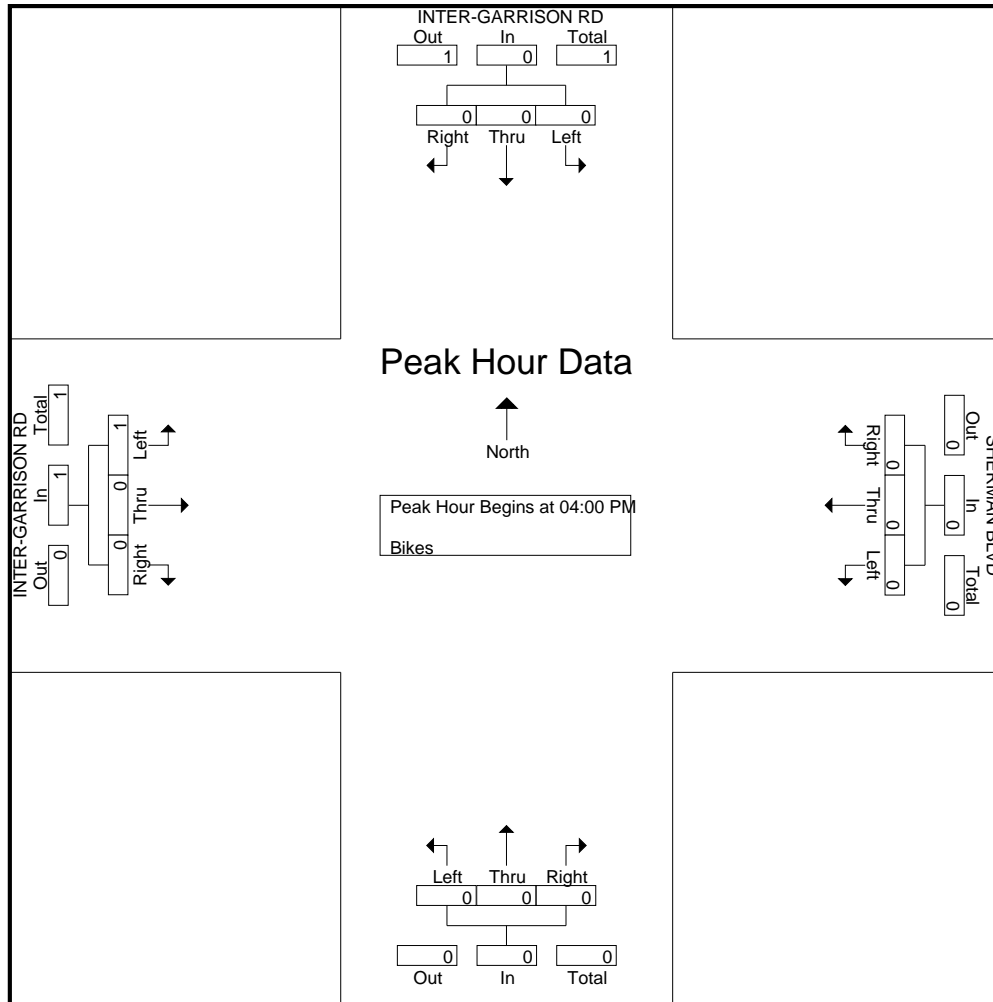

Traffic Data Service

San Jose, CA
(408) 622-4787
tdsbay@cs.com

File Name : 19AM FINAL
Site Code : 00000019
Start Date : 4/27/2017
Page No : 1

Groups Printed- Lights - Buses - Trucks

Start Time	Southbound					RESERVATION RD Westbound					INTER-GARRISON RD Northbound					RESERVATION RD Eastbound					Int. Total
	Right	Thru	Left	Peds	App. Total	Right	Thru	Left	Peds	App. Total	Right	Thru	Left	Peds	App. Total	Right	Thru	Left	Peds	App. Total	
07:00 AM	0	0	0	0	0	0	112	102	0	214	18	0	17	0	35	10	37	0	0	47	296
07:15 AM	0	0	0	0	0	0	105	116	0	221	20	0	8	0	28	12	46	0	0	58	307
07:30 AM	0	0	0	0	0	0	75	89	0	164	24	0	17	0	41	8	69	0	0	77	282
07:45 AM	0	0	0	0	0	0	79	66	0	145	28	0	11	0	39	10	80	0	0	90	274
Total	0	0	0	0	0	0	371	373	0	744	90	0	53	0	143	40	232	0	0	272	1159
08:00 AM	0	0	0	0	0	0	81	57	0	138	13	0	11	0	24	15	51	0	0	66	228
08:15 AM	0	0	0	0	0	0	86	50	0	136	9	0	10	0	19	7	67	0	0	74	229
08:30 AM	0	0	0	0	0	0	66	42	0	108	9	0	5	0	14	4	44	0	0	48	170
08:45 AM	0	0	0	0	0	0	58	33	0	91	7	0	10	0	17	7	47	1	0	55	163
Total	0	0	0	0	0	0	291	182	0	473	38	0	36	0	74	33	209	1	0	243	790
Grand Total	0	0	0	0	0	0	662	555	0	1217	128	0	89	0	217	73	441	1	0	515	1949
Apprch %	0	0	0	0	0	0	54.4	45.6	0		59	0	41	0		14.2	85.6	0.2	0		
Total %	0	0	0	0	0	0	34	28.5	0	62.4	6.6	0	4.6	0	11.1	3.7	22.6	0.1	0	26.4	
Lights	0	0	0	0	0	0	634	554	0	1188	125	0	88	0	213	71	417	1	0	489	1890
% Lights	0	0	0	0	0	0	95.8	99.8	0	97.6	97.7	0	98.9	0	98.2	97.3	94.6	100	0	95	97
Buses	0	0	0	0	0	0	3	1	0	4	1	0	0	0	1	1	4	0	0	5	10
% Buses	0	0	0	0	0	0	0.5	0.2	0	0.3	0.8	0	0	0	0.5	1.4	0.9	0	0	1	0.5
Trucks	0	0	0	0	0	0	25	0	0	25	2	0	1	0	3	1	20	0	0	21	49
% Trucks	0	0	0	0	0	0	3.8	0	0	2.1	1.6	0	1.1	0	1.4	1.4	4.5	0	0	4.1	2.5

Start Time	Southbound				RESERVATION RD Westbound				INTER-GARRISON RD Northbound				RESERVATION RD Eastbound				Int. Total
	Right	Thru	Left	App. Total	Right	Thru	Left	App. Total	Right	Thru	Left	App. Total	Right	Thru	Left	App. Total	
Peak Hour Analysis From 07:00 AM to 08:45 AM - Peak 1 of 1																	
Peak Hour for Entire Intersection Begins at 07:00 AM																	
07:00 AM	0	0	0	0	0	112	102	214	18	0	17	35	10	37	0	47	296
07:15 AM	0	0	0	0	0	105	116	221	20	0	8	28	12	46	0	58	307
07:30 AM	0	0	0	0	0	75	89	164	24	0	17	41	8	69	0	77	282
07:45 AM	0	0	0	0	0	79	66	145	28	0	11	39	10	80	0	90	274
Total Volume	0	0	0	0	0	371	373	744	90	0	53	143	40	232	0	272	1159
% App. Total	0	0	0	0	0	49.9	50.1		62.9	0	37.1		14.7	85.3	0		
PHF	.000	.000	.000	.000	.000	.828	.804	.842	.804	.000	.779	.872	.833	.725	.000	.756	.944

Traffic Data Service

San Jose, CA
 (408) 622-4787
 tdsbay@cs.com

File Name : 19AM FINAL
 Site Code : 00000019
 Start Date : 4/27/2017
 Page No : 2

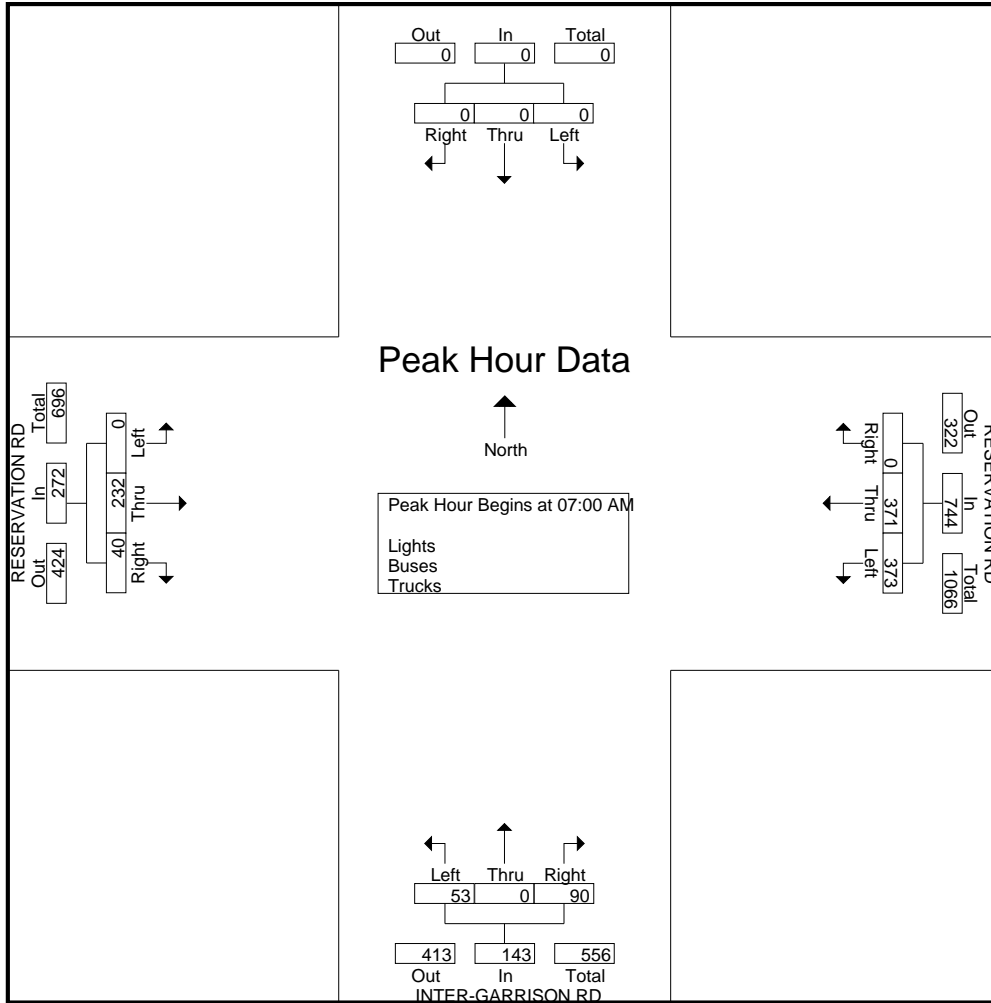

Traffic Data Service

San Jose, CA
 (408) 622-4787
 tdsbay@cs.com

File Name : 19AM FINAL
 Site Code : 00000019
 Start Date : 4/27/2017
 Page No : 1

Groups Printed- Bikes

Start Time	Southbound					RESERVATION RD Westbound					INTER-GARRISON RD Northbound					RESERVATION RD Eastbound					Int. Total
	Right	Thru	Left	Peds	App. Total	Right	Thru	Left	Peds	App. Total	Right	Thru	Left	Peds	App. Total	Right	Thru	Left	Peds	App. Total	
07:00 AM	0	0	0	0	0	0	0	1	0	1	0	0	0	0	0	0	0	0	0	0	0
07:15 AM	0	0	0	0	0	0	0	0	0	0	0	0	0	0	0	0	0	0	0	0	0
07:30 AM	0	0	0	0	0	0	0	0	0	0	0	0	0	0	0	0	0	0	0	0	0
07:45 AM	0	0	0	0	0	0	0	0	0	0	0	0	0	0	0	0	0	0	0	0	0
Total	0	0	0	0	0	0	0	1	0	1	0	0	0	0	0	0	0	0	0	0	1
08:00 AM	0	0	0	0	0	0	0	0	0	0	0	0	0	0	0	0	0	0	0	0	0
08:15 AM	0	0	0	0	0	0	0	0	0	0	0	0	0	0	0	0	0	0	0	0	0
08:30 AM	0	0	0	0	0	0	0	0	0	0	0	0	0	0	0	0	0	0	0	0	0
08:45 AM	0	0	0	0	0	0	0	0	0	0	0	0	0	0	0	0	0	0	0	0	0
Total	0	0	0	0	0	0	0	0	0	0	0	0	0	0	0	0	0	0	0	0	0
Grand Total	0	0	0	0	0	0	0	1	0	1	0	0	0	0	0	0	0	0	0	0	1
Apprch %	0	0	0	0		0	0	100	0		0	0	0	0		0	0	0	0		
Total %	0	0	0	0		0	0	100	0	100	0	0	0	0		0	0	0	0		

Start Time	Southbound					RESERVATION RD Westbound					INTER-GARRISON RD Northbound					RESERVATION RD Eastbound					Int. Total
	Right	Thru	Left	Peds	App. Total	Right	Thru	Left	Peds	App. Total	Right	Thru	Left	Peds	App. Total	Right	Thru	Left	Peds	App. Total	
07:00 AM	0	0	0	0	0	0	0	1	0	1	0	0	0	0	0	0	0	0	0	0	1
07:15 AM	0	0	0	0	0	0	0	0	0	0	0	0	0	0	0	0	0	0	0	0	0
07:30 AM	0	0	0	0	0	0	0	0	0	0	0	0	0	0	0	0	0	0	0	0	0
07:45 AM	0	0	0	0	0	0	0	0	0	0	0	0	0	0	0	0	0	0	0	0	0
Total Volume	0	0	0	0	0	0	0	1	0	1	0	0	0	0	0	0	0	0	0	0	1
% App. Total	0	0	0	0		0	0	100	0		0	0	0	0		0	0	0	0		
PHF	.000	.000	.000	.000	.000	.000	.000	.250	.250	.000	.000	.000	.000	.000	.000	.000	.000	.000	.000	.000	.250

Peak Hour Analysis From 07:00 AM to 08:45 AM - Peak 1 of 1
 Peak Hour for Entire Intersection Begins at 07:00 AM

Traffic Data Service

San Jose, CA
 (408) 622-4787
 tdsbay@cs.com

File Name : 19AM FINAL
 Site Code : 00000019
 Start Date : 4/27/2017
 Page No : 2

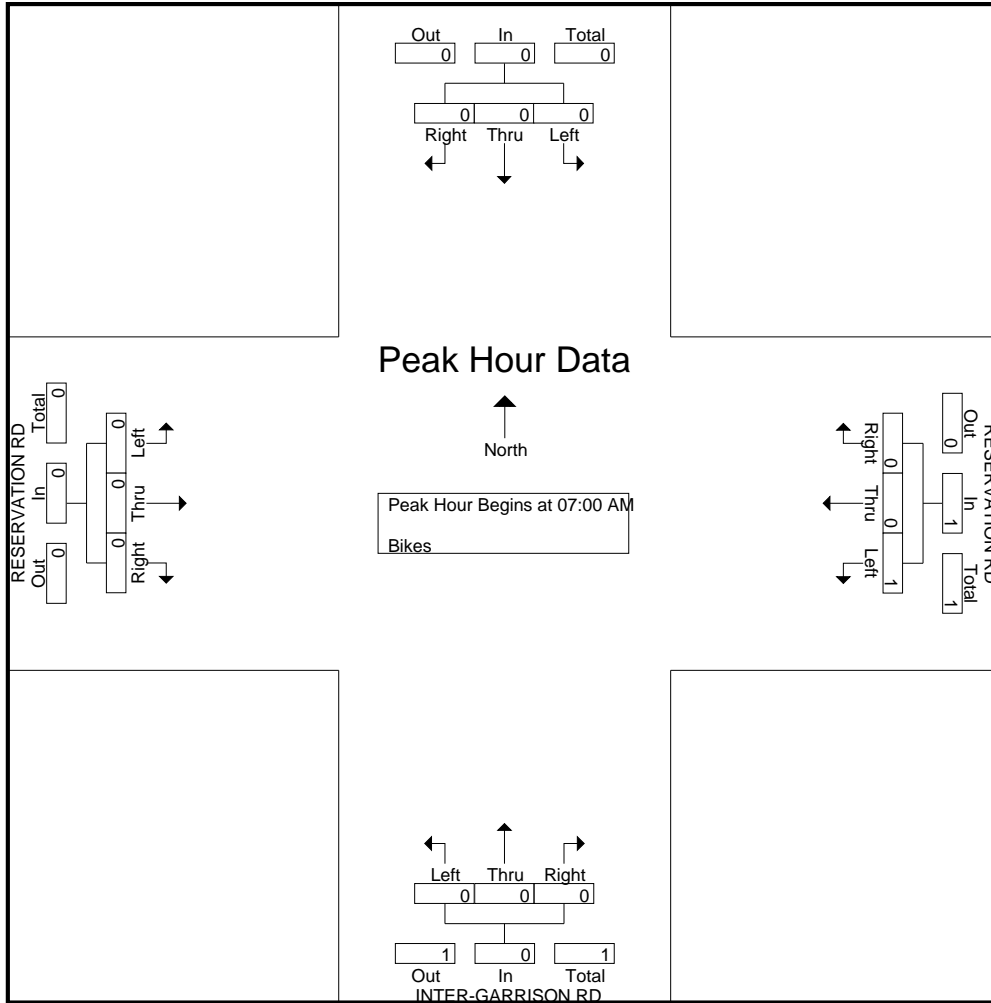

Traffic Data Service

San Jose, CA
(408) 622-4787
tdsbay@cs.com

File Name : 19PM FINAL
Site Code : 00000019
Start Date : 4/27/2017
Page No : 1

Groups Printed- Lights - Buses - Trucks

Start Time	Southbound					RESERVATION RD Westbound					INTER-GARRISON RD Northbound					RESERVATION RD Eastbound					Int. Total
	Right	Thru	Left	Peds	App. Total	Right	Thru	Left	Peds	App. Total	Right	Thru	Left	Peds	App. Total	Right	Thru	Left	Peds	App. Total	
04:00 PM	0	0	0	0	0	0	47	10	0	57	52	0	5	0	57	14	87	0	0	101	215
04:15 PM	0	0	0	0	0	0	63	16	0	79	53	0	8	0	61	13	117	0	0	130	270
04:30 PM	0	0	0	0	0	0	85	18	0	103	58	0	10	0	68	10	105	0	0	115	286
04:45 PM	0	0	0	0	0	0	69	23	0	92	75	0	6	0	81	10	90	0	0	100	273
Total	0	0	0	0	0	0	264	67	0	331	238	0	29	0	267	47	399	0	0	446	1044
05:00 PM	0	0	0	0	0	0	75	20	0	95	70	0	16	0	86	12	104	0	0	116	297
05:15 PM	0	0	0	0	0	0	98	17	0	115	98	0	13	0	111	13	134	0	0	147	373
05:30 PM	0	0	0	0	0	0	62	15	0	77	73	0	12	0	85	13	94	0	0	107	269
05:45 PM	0	0	0	0	0	0	42	14	0	56	55	0	9	0	64	11	114	0	0	125	245
Total	0	0	0	0	0	0	277	66	0	343	296	0	50	0	346	49	446	0	0	495	1184
Grand Total	0	0	0	0	0	0	541	133	0	674	534	0	79	0	613	96	845	0	0	941	2228
Apprch %	0	0	0	0	0	0	80.3	19.7	0		87.1	0	12.9	0		10.2	89.8	0	0		
Total %	0	0	0	0	0	0	24.3	6	0	30.3	24	0	3.5	0	27.5	4.3	37.9	0	0	42.2	
Lights	0	0	0	0	0	0	527	128	0	655	529	0	78	0	607	95	830	0	0	925	2187
% Lights	0	0	0	0	0	0	97.4	96.2	0	97.2	99.1	0	98.7	0	99	99	98.2	0	0	98.3	98.2
Buses	0	0	0	0	0	0	1	1	0	2	1	0	1	0	2	0	3	0	0	3	7
% Buses	0	0	0	0	0	0	0.2	0.8	0	0.3	0.2	0	1.3	0	0.3	0	0.4	0	0	0.3	0.3
Trucks	0	0	0	0	0	0	13	4	0	17	4	0	0	0	4	1	12	0	0	13	34
% Trucks	0	0	0	0	0	0	2.4	3	0	2.5	0.7	0	0	0	0.7	1	1.4	0	0	1.4	1.5

Start Time	Southbound				RESERVATION RD Westbound				INTER-GARRISON RD Northbound				RESERVATION RD Eastbound				Int. Total
	Right	Thru	Left	App. Total	Right	Thru	Left	App. Total	Right	Thru	Left	App. Total	Right	Thru	Left	App. Total	
Peak Hour Analysis From 04:00 PM to 05:45 PM - Peak 1 of 1																	
Peak Hour for Entire Intersection Begins at 04:30 PM																	
04:30 PM	0	0	0	0	0	85	18	103	58	0	10	68	10	105	0	115	286
04:45 PM	0	0	0	0	0	69	23	92	75	0	6	81	10	90	0	100	273
05:00 PM	0	0	0	0	0	75	20	95	70	0	16	86	12	104	0	116	297
05:15 PM	0	0	0	0	0	98	17	115	98	0	13	111	13	134	0	147	373
Total Volume	0	0	0	0	0	327	78	405	301	0	45	346	45	433	0	478	1229
% App. Total	0	0	0	0	0	80.7	19.3		87	0	13		9.4	90.6	0		
PHF	.000	.000	.000	.000	.000	.834	.848	.880	.768	.000	.703	.779	.865	.808	.000	.813	.824

Traffic Data Service

San Jose, CA
 (408) 622-4787
 tdsbay@cs.com

File Name : 19PM FINAL
 Site Code : 00000019
 Start Date : 4/27/2017
 Page No : 2

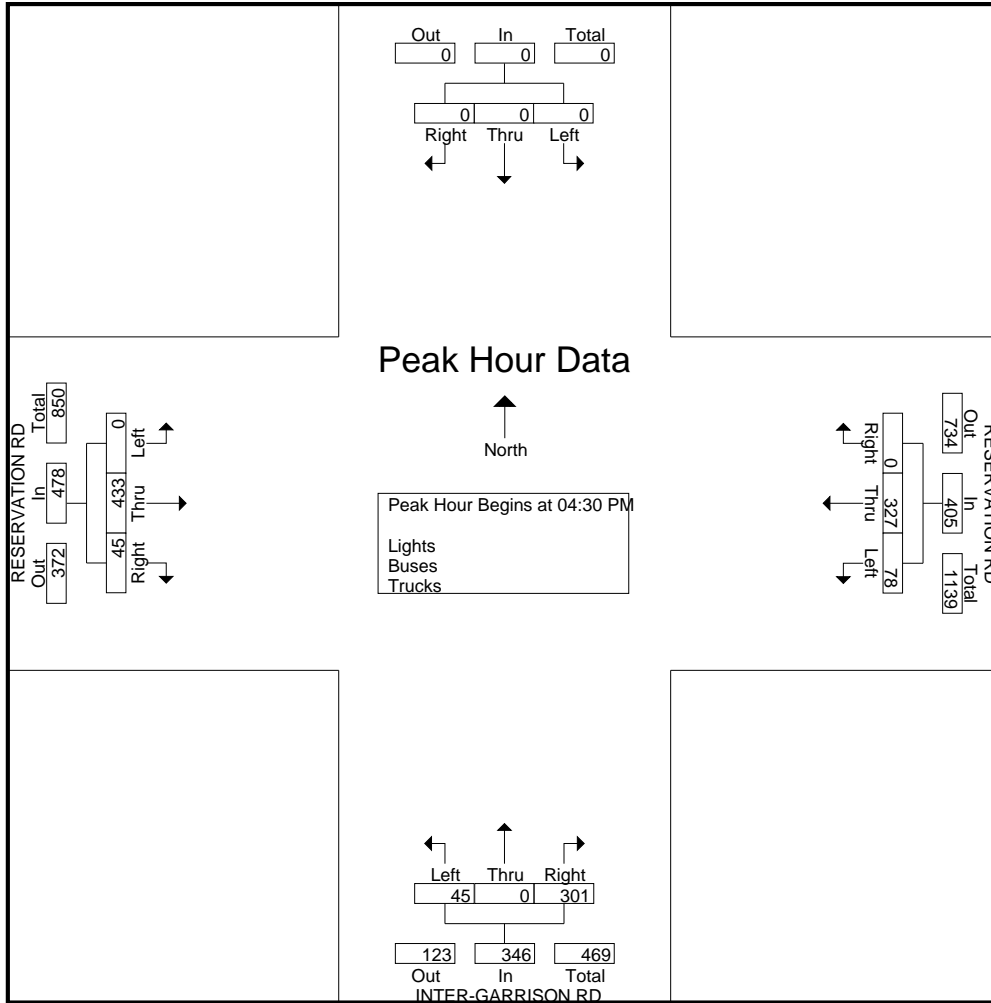

Traffic Data Service

San Jose, CA
 (408) 622-4787
 tdsbay@cs.com

File Name : 19PM FINAL
 Site Code : 00000019
 Start Date : 4/27/2017
 Page No : 1

Groups Printed- Bikes

Start Time	Southbound					RESERVATION RD Westbound					INTER-GARRISON RD Northbound					RESERVATION RD Eastbound					Int. Total
	Right	Thru	Left	Peds	App. Total	Right	Thru	Left	Peds	App. Total	Right	Thru	Left	Peds	App. Total	Right	Thru	Left	Peds	App. Total	
04:00 PM	0	0	0	0	0	0	0	0	0	0	0	0	0	0	0	0	0	0	0	0	0
04:15 PM	0	0	0	0	0	0	0	1	0	1	0	0	0	0	0	0	0	0	0	0	1
04:30 PM	0	0	0	0	0	0	0	0	0	0	0	0	0	0	0	0	0	0	0	0	0
04:45 PM	0	0	0	0	0	0	0	0	0	0	0	0	0	0	0	0	0	0	0	0	0
Total	0	0	0	0	0	0	0	1	0	1	0	0	0	0	0	0	0	0	0	0	1
05:00 PM	0	0	0	0	0	0	0	0	0	0	0	0	0	0	0	0	0	0	0	0	0
05:15 PM	0	0	0	0	0	0	0	0	0	0	0	0	0	0	0	0	0	0	0	0	0
05:30 PM	0	0	0	0	0	0	0	0	0	0	0	0	0	0	0	0	0	0	0	0	0
05:45 PM	0	0	0	0	0	0	0	0	0	0	0	0	0	0	0	0	0	0	0	0	0
Total	0	0	0	0	0	0	0	0	0	0	0	0	0	0	0	0	0	0	0	0	0
Grand Total	0	0	0	0	0	0	0	1	0	1	0	0	0	0	0	0	0	0	0	0	1
Apprch %	0	0	0	0		0	0	100	0		0	0	0	0		0	0	0	0		
Total %	0	0	0	0		0	0	100	0	100	0	0	0	0		0	0	0	0		

Start Time	Southbound					RESERVATION RD Westbound					INTER-GARRISON RD Northbound					RESERVATION RD Eastbound					Int. Total
	Right	Thru	Left	Peds	App. Total	Right	Thru	Left	Peds	App. Total	Right	Thru	Left	Peds	App. Total	Right	Thru	Left	Peds	App. Total	
04:00 PM	0	0	0	0	0	0	0	0	0	0	0	0	0	0	0	0	0	0	0	0	0
04:15 PM	0	0	0	0	0	0	0	1	0	1	0	0	0	0	0	0	0	0	0	0	1
04:30 PM	0	0	0	0	0	0	0	0	0	0	0	0	0	0	0	0	0	0	0	0	0
04:45 PM	0	0	0	0	0	0	0	0	0	0	0	0	0	0	0	0	0	0	0	0	0
Total Volume	0	0	0	0	0	0	0	1	0	1	0	0	0	0	0	0	0	0	0	0	1
% App. Total	0	0	0	0		0	0	100	0		0	0	0	0		0	0	0	0		
PHF	.000	.000	.000	.000		.000	.000	.250	.250		.000	.000	.000	.000		.000	.000	.000	.000		.250

Peak Hour Analysis From 04:00 PM to 05:45 PM - Peak 1 of 1
 Peak Hour for Entire Intersection Begins at 04:00 PM

Traffic Data Service

San Jose, CA
(408) 622-4787
tdsbay@cs.com

File Name : 19PM FINAL
Site Code : 00000019
Start Date : 4/27/2017
Page No : 2

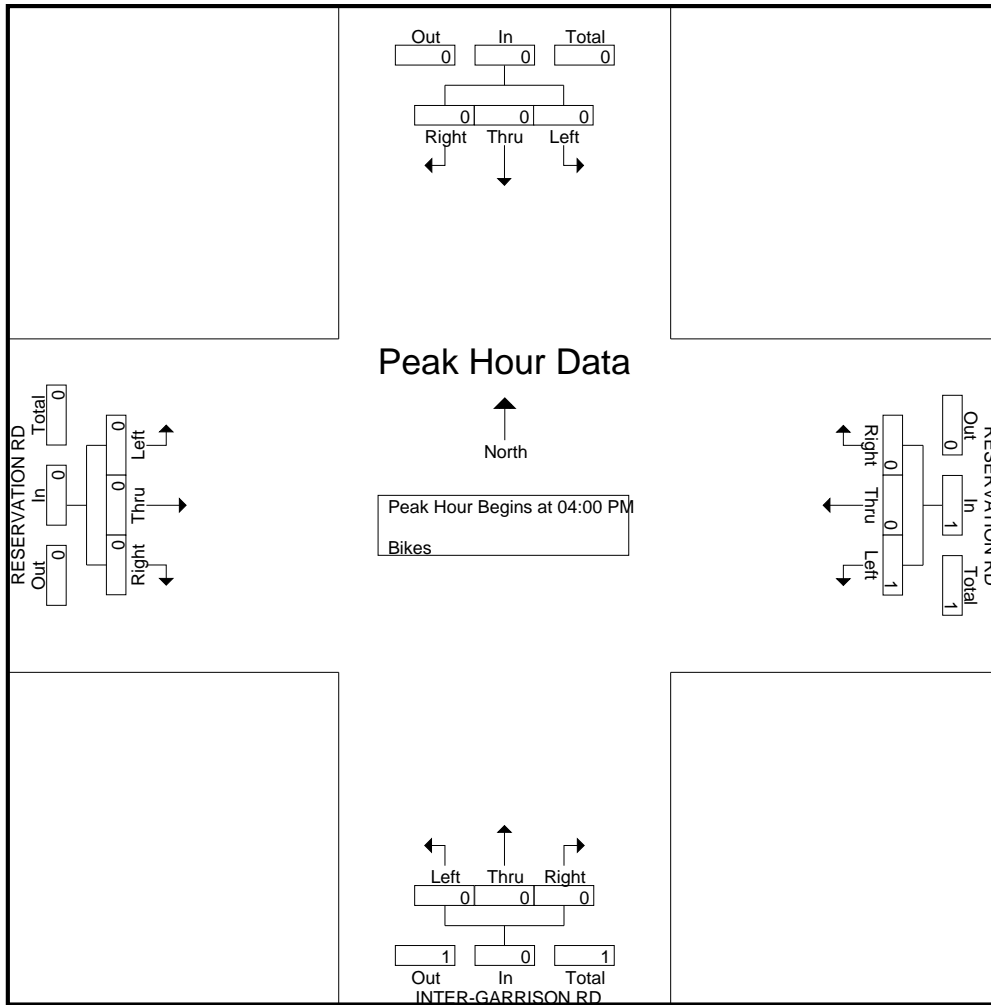

Traffic Data Service

San Jose, CA
 (408) 622-4787
 tdsbay@cs.com

File Name : 20AM FINAL
 Site Code : 00000020
 Start Date : 4/27/2017
 Page No : 1

Groups Printed- Lights - Buses - Trucks

Start Time	2ND AVE Southbound					DIVARTY ST Westbound					2ND AVE Northbound					DIVARTY ST Eastbound					Int. Total
	Right	Thru	Left	Peds	App. Total	Right	Thru	Left	Peds	App. Total	Right	Thru	Left	Peds	App. Total	Right	Thru	Left	Peds	App. Total	
07:00 AM	0	60	1	0	61	0	0	0	0	0	0	13	2	0	15	0	0	0	0	0	76
07:15 AM	1	149	3	1	154	0	1	2	0	3	0	10	2	0	12	1	0	0	1	2	171
07:30 AM	1	176	5	0	182	1	0	2	0	3	5	32	1	0	38	0	3	1	1	5	228
07:45 AM	6	159	6	0	171	1	0	3	0	4	6	33	10	0	49	0	1	0	0	1	225
Total	8	544	15	1	568	2	1	7	0	10	11	88	15	0	114	1	4	1	2	8	700
08:00 AM	5	125	18	0	148	0	0	0	0	0	2	47	5	0	54	0	1	0	0	1	203
08:15 AM	5	95	7	3	110	1	0	2	0	3	4	24	0	0	28	2	0	3	0	5	146
08:30 AM	2	53	4	1	60	2	3	5	0	10	0	19	2	0	21	0	0	3	0	3	94
08:45 AM	1	45	8	0	54	2	1	2	5	10	3	20	7	0	30	0	2	2	0	4	98
Total	13	318	37	4	372	5	4	9	5	23	9	110	14	0	133	2	3	8	0	13	541
Grand Total	21	862	52	5	940	7	5	16	5	33	20	198	29	0	247	3	7	9	2	21	1241
Apprch %	2.2	91.7	5.5	0.5		21.2	15.2	48.5	15.2		8.1	80.2	11.7	0		14.3	33.3	42.9	9.5		
Total %	1.7	69.5	4.2	0.4	75.7	0.6	0.4	1.3	0.4	2.7	1.6	16	2.3	0	19.9	0.2	0.6	0.7	0.2	1.7	
Lights	21	850	51	5	927	6	4	16	5	31	20	194	25	0	239	1	6	9	2	18	1215
% Lights	100	98.6	98.1	100	98.6	85.7	80	100	100	93.9	100	98	86.2	0	96.8	33.3	85.7	100	100	85.7	97.9
Buses	0	4	1	0	5	0	0	0	0	0	0	3	0	0	3	1	0	0	0	1	9
% Buses	0	0.5	1.9	0	0.5	0	0	0	0	0	0	1.5	0	0	1.2	33.3	0	0	0	4.8	0.7
Trucks	0	8	0	0	8	1	1	0	0	2	0	1	4	0	5	1	1	0	0	2	17
% Trucks	0	0.9	0	0	0.9	14.3	20	0	0	6.1	0	0.5	13.8	0	2	33.3	14.3	0	0	9.5	1.4

Start Time	2ND AVE Southbound				DIVARTY ST Westbound				2ND AVE Northbound				DIVARTY ST Eastbound				Int. Total
	Right	Thru	Left	App. Total	Right	Thru	Left	App. Total	Right	Thru	Left	App. Total	Right	Thru	Left	App. Total	
Peak Hour Analysis From 07:00 AM to 08:45 AM - Peak 1 of 1																	
Peak Hour for Entire Intersection Begins at 07:15 AM																	
07:15 AM	1	149	3	153	0	1	2	3	0	10	2	12	1	0	0	1	169
07:30 AM	1	176	5	182	1	0	2	3	5	32	1	38	0	3	1	4	227
07:45 AM	6	159	6	171	1	0	3	4	6	33	10	49	0	1	0	1	225
08:00 AM	5	125	18	148	0	0	0	0	2	47	5	54	0	1	0	1	203
Total Volume	13	609	32	654	2	1	7	10	13	122	18	153	1	5	1	7	824
% App. Total	2	93.1	4.9		20	10	70		8.5	79.7	11.8		14.3	71.4	14.3		
PHF	.542	.865	.444	.898	.500	.250	.583	.625	.542	.649	.450	.708	.250	.417	.250	.438	.907

Traffic Data Service

San Jose, CA
 (408) 622-4787
 tdsbay@cs.com

File Name : 20AM FINAL
 Site Code : 00000020
 Start Date : 4/27/2017
 Page No : 2

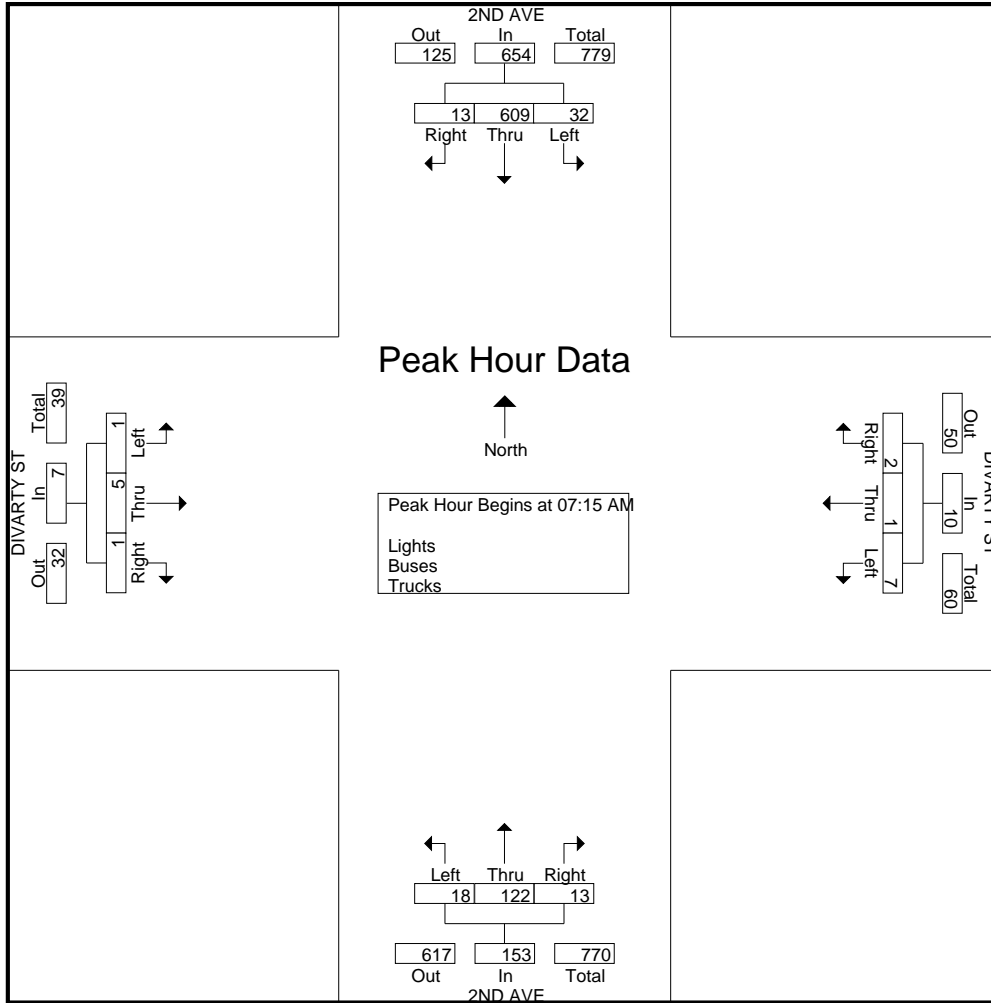

Traffic Data Service

San Jose, CA
 (408) 622-4787
 tdsbay@cs.com

File Name : 20AM FINAL
 Site Code : 00000020
 Start Date : 4/27/2017
 Page No : 1

Groups Printed- Bikes

Start Time	2ND AVE Southbound					DIVARTY ST Westbound					2ND AVE Northbound					DIVARTY ST Eastbound					Int. Total
	Right	Thru	Left	Peds	App. Total	Right	Thru	Left	Peds	App. Total	Right	Thru	Left	Peds	App. Total	Right	Thru	Left	Peds	App. Total	
07:00 AM	0	0	0	0	0	0	0	0	0	0	0	0	0	0	0	0	0	0	0	0	0
07:15 AM	0	0	0	0	0	0	0	0	0	0	0	0	0	0	0	0	0	0	0	0	0
07:30 AM	0	0	0	0	0	0	0	0	0	0	0	0	0	0	0	0	0	0	0	0	0
07:45 AM	0	0	0	0	0	0	0	0	0	0	0	0	0	0	0	0	1	0	0	0	1
Total	0	0	0	0	0	0	0	0	0	0	0	0	0	0	0	0	1	0	0	0	1
08:00 AM	0	0	0	0	0	0	0	0	0	0	0	0	0	0	0	0	1	0	0	0	1
08:15 AM	0	0	0	0	0	0	0	0	0	0	0	0	0	0	0	0	1	0	0	0	1
08:30 AM	0	0	0	0	0	0	0	0	0	0	0	0	0	0	0	0	0	0	0	0	0
08:45 AM	0	0	0	0	0	0	0	0	0	0	0	0	0	0	0	0	0	0	0	0	0
Total	0	0	0	0	0	0	0	0	0	0	0	0	0	0	0	0	2	0	0	0	2
Grand Total	0	0	0	0	0	0	0	0	0	0	0	0	0	0	0	0	3	0	0	0	3
Apprch %	0	0	0	0	0	0	0	0	0	0	0	0	0	0	0	0	100	0	0	0	
Total %	0	0	0	0	0	0	0	0	0	0	0	0	0	0	0	0	100	0	0	100	

Start Time	2ND AVE Southbound					DIVARTY ST Westbound					2ND AVE Northbound					DIVARTY ST Eastbound					Int. Total
	Right	Thru	Left	Peds	App. Total	Right	Thru	Left	Peds	App. Total	Right	Thru	Left	Peds	App. Total	Right	Thru	Left	Peds	App. Total	
Peak Hour Analysis From 07:00 AM to 08:45 AM - Peak 1 of 1																					
Peak Hour for Entire Intersection Begins at 07:30 AM																					
07:30 AM	0	0	0	0	0	0	0	0	0	0	0	0	0	0	0	0	0	0	0	0	0
07:45 AM	0	0	0	0	0	0	0	0	0	0	0	0	0	0	0	0	1	0	0	0	1
08:00 AM	0	0	0	0	0	0	0	0	0	0	0	0	0	0	0	0	1	0	0	0	1
08:15 AM	0	0	0	0	0	0	0	0	0	0	0	0	0	0	0	0	1	0	0	0	1
Total Volume	0	0	0	0	0	0	0	0	0	0	0	0	0	0	0	0	3	0	0	0	3
% App. Total	0	0	0	0	0	0	0	0	0	0	0	0	0	0	0	0	100	0	0	0	
PHF	.000	.000	.000	.000	.000	.000	.000	.000	.000	.000	.000	.000	.000	.000	.000	.000	.750	.000	.750	.750	

Traffic Data Service

San Jose, CA
(408) 622-4787
tdsbay@cs.com

File Name : 20AM FINAL
Site Code : 00000020
Start Date : 4/27/2017
Page No : 2

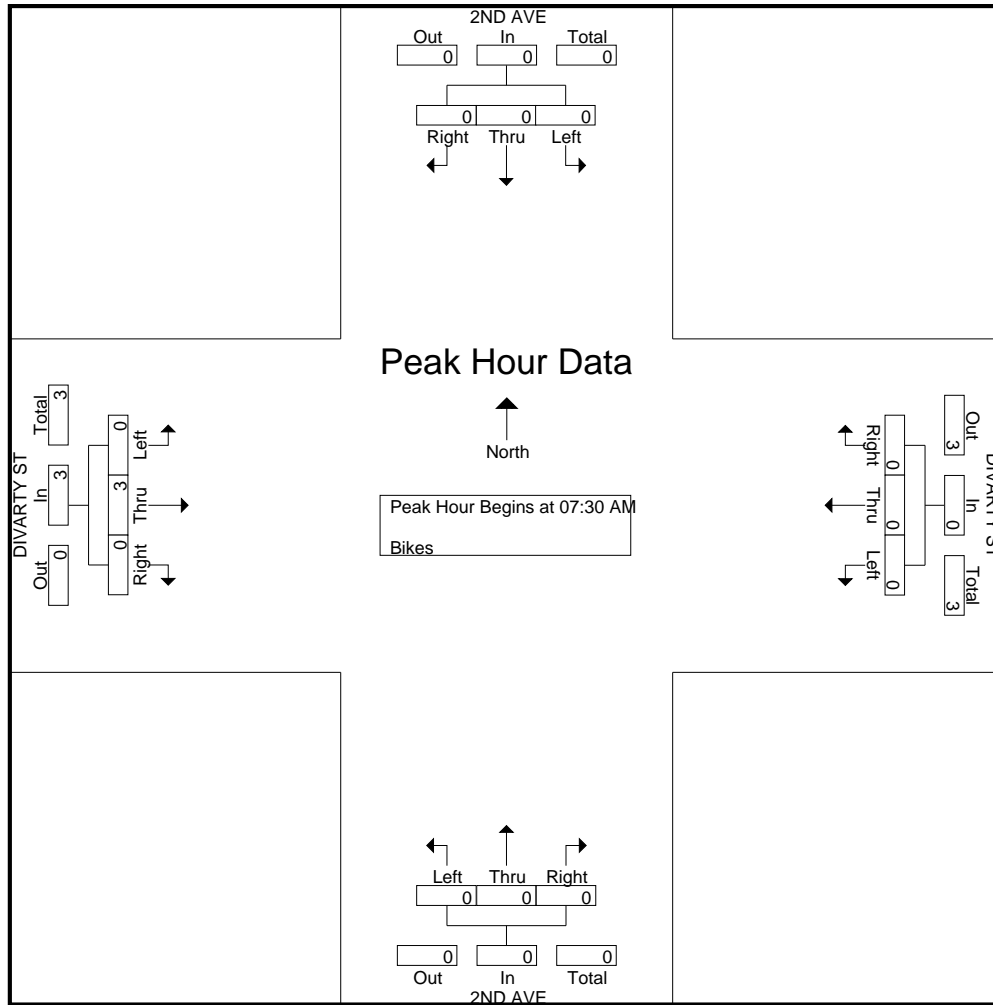

Traffic Data Service

San Jose, CA
 (408) 622-4787
 tdsbay@cs.com

File Name : 20PM FINAL
 Site Code : 00000020
 Start Date : 4/27/2017
 Page No : 1

Groups Printed- Lights - Buses - Trucks

Start Time	2ND AVE Southbound					DIVARTY ST Westbound					2ND AVE Northbound					DIVARTY ST Eastbound					Int. Total
	Right	Thru	Left	Peds	App. Total	Right	Thru	Left	Peds	App. Total	Right	Thru	Left	Peds	App. Total	Right	Thru	Left	Peds	App. Total	
04:00 PM	2	41	7	0	50	7	4	4	0	15	0	28	2	0	30	0	0	1	0	1	96
04:15 PM	5	39	2	0	46	8	1	3	1	13	2	33	4	0	39	0	1	3	2	6	104
04:30 PM	5	52	5	0	62	6	5	5	0	16	1	44	6	0	51	0	2	2	0	4	133
04:45 PM	1	52	2	2	57	8	2	2	1	13	1	44	2	1	48	4	0	3	1	8	126
Total	13	184	16	2	215	29	12	14	2	57	4	149	14	1	168	4	3	9	3	19	459
05:00 PM	2	38	4	1	45	18	1	7	2	28	2	62	1	1	66	0	0	2	0	2	141
05:15 PM	1	45	0	2	48	1	0	2	0	3	0	60	5	1	66	0	0	1	3	4	121
05:30 PM	2	54	4	1	61	8	1	8	0	17	0	55	0	0	55	0	0	1	1	2	135
05:45 PM	3	54	2	1	60	12	2	10	0	24	2	49	2	0	53	2	0	1	0	3	140
Total	8	191	10	5	214	39	4	27	2	72	4	226	8	2	240	2	0	5	4	11	537
Grand Total	21	375	26	7	429	68	16	41	4	129	8	375	22	3	408	6	3	14	7	30	996
Apprch %	4.9	87.4	6.1	1.6		52.7	12.4	31.8	3.1		2	91.9	5.4	0.7		20	10	46.7	23.3		
Total %	2.1	37.7	2.6	0.7	43.1	6.8	1.6	4.1	0.4	13	0.8	37.7	2.2	0.3	41	0.6	0.3	1.4	0.7	3	
Lights	21	369	26	7	423	67	16	41	4	128	8	372	21	3	404	6	3	14	7	30	985
% Lights	100	98.4	100	100	98.6	98.5	100	100	100	99.2	100	99.2	95.5	100	99	100	100	100	100	100	98.9
Buses	0	4	0	0	4	1	0	0	0	1	0	1	0	0	1	0	0	0	0	0	6
% Buses	0	1.1	0	0	0.9	1.5	0	0	0	0.8	0	0.3	0	0	0.2	0	0	0	0	0	0.6
Trucks	0	2	0	0	2	0	0	0	0	0	0	2	1	0	3	0	0	0	0	0	5
% Trucks	0	0.5	0	0	0.5	0	0	0	0	0	0	0.5	4.5	0	0.7	0	0	0	0	0	0.5

Start Time	2ND AVE Southbound				DIVARTY ST Westbound				2ND AVE Northbound				DIVARTY ST Eastbound				Int. Total
	Right	Thru	Left	App. Total	Right	Thru	Left	App. Total	Right	Thru	Left	App. Total	Right	Thru	Left	App. Total	
Peak Hour Analysis From 04:00 PM to 05:45 PM - Peak 1 of 1																	
Peak Hour for Entire Intersection Begins at 05:00 PM																	
05:00 PM	2	38	4	44	18	1	7	26	2	62	1	65	0	0	2	2	137
05:15 PM	1	45	0	46	1	0	2	3	0	60	5	65	0	0	1	1	115
05:30 PM	2	54	4	60	8	1	8	17	0	55	0	55	0	0	1	1	133
05:45 PM	3	54	2	59	12	2	10	24	2	49	2	53	2	0	1	3	139
Total Volume	8	191	10	209	39	4	27	70	4	226	8	238	2	0	5	7	524
% App. Total	3.8	91.4	4.8		55.7	5.7	38.6		1.7	95	3.4		28.6	0	71.4		
PHF	.667	.884	.625	.871	.542	.500	.675	.673	.500	.911	.400	.915	.250	.000	.625	.583	.942

Traffic Data Service

San Jose, CA
 (408) 622-4787
 tdsbay@cs.com

File Name : 20PM FINAL
 Site Code : 00000020
 Start Date : 4/27/2017
 Page No : 2

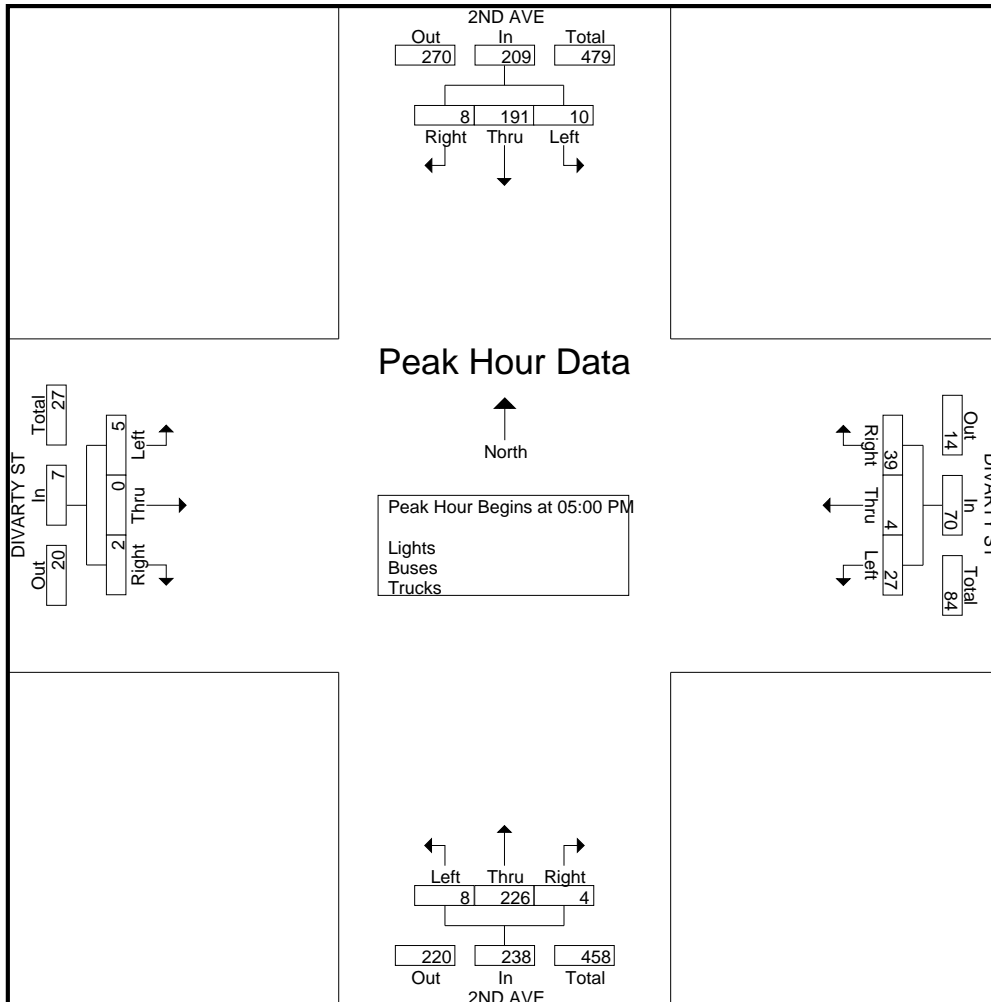

Traffic Data Service

San Jose, CA
 (408) 622-4787
 tdsbay@cs.com

File Name : 20PM FINAL
 Site Code : 00000020
 Start Date : 4/27/2017
 Page No : 1

Groups Printed- Bikes

Start Time	2ND AVE Southbound					DIVARTY ST Westbound					2ND AVE Northbound					DIVARTY ST Eastbound					Int. Total	
	Right	Thru	Left	Peds	App. Total	Right	Thru	Left	Peds	App. Total	Right	Thru	Left	Peds	App. Total	Right	Thru	Left	Peds	App. Total		
04:00 PM	0	0	0	0	0	0	0	0	0	0	0	0	0	0	0	0	0	0	0	0	0	0
04:15 PM	0	0	0	0	0	0	0	0	0	0	0	0	0	0	0	0	0	0	0	0	0	0
04:30 PM	0	0	0	0	0	0	0	0	0	0	0	0	0	0	0	0	0	0	0	0	0	0
04:45 PM	0	0	0	0	0	0	0	0	0	0	0	0	0	0	0	0	0	0	0	0	0	0
Total	0	0	0	0	0	0	0	0	0	0	0	0	0	0	0	0	0	0	0	0	0	0
05:00 PM	0	1	0	0	1	0	0	0	0	0	0	0	0	0	0	0	1	0	0	1		2
05:15 PM	0	0	0	0	0	0	0	0	0	0	0	0	0	0	0	0	0	0	0	0		0
05:30 PM	0	0	0	0	0	0	0	0	0	0	0	0	0	0	0	0	0	0	0	0		0
05:45 PM	0	0	0	0	0	0	2	0	0	2	0	0	0	0	0	0	0	0	0	0		2
Total	0	1	0	0	1	0	2	0	0	2	0	0	0	0	0	0	1	0	0	1		4
Grand Total	0	1	0	0	1	0	2	0	0	2	0	0	0	0	0	0	1	0	0	1		4
Apprch %	0	100	0	0		0	100	0	0		0	0	0	0		0	100	0	0			
Total %	0	25	0	0	25	0	50	0	0	50	0	0	0	0	0	0	25	0	0	25		

Start Time	2ND AVE Southbound					DIVARTY ST Westbound					2ND AVE Northbound					DIVARTY ST Eastbound					Int. Total	
	Right	Thru	Left	Peds	App. Total	Right	Thru	Left	Peds	App. Total	Right	Thru	Left	Peds	App. Total	Right	Thru	Left	Peds	App. Total		
05:00 PM	0	1	0	0	1	0	0	0	0	0	0	0	0	0	0	0	1	0	0	1		2
05:15 PM	0	0	0	0	0	0	0	0	0	0	0	0	0	0	0	0	0	0	0	0		0
05:30 PM	0	0	0	0	0	0	0	0	0	0	0	0	0	0	0	0	0	0	0	0		0
05:45 PM	0	0	0	0	0	0	2	0	0	2	0	0	0	0	0	0	0	0	0	0		2
Total Volume	0	1	0	0	1	0	2	0	0	2	0	0	0	0	0	0	1	0	0	1		4
% App. Total	0	100	0	0		0	100	0	0		0	0	0	0		0	100	0	0			
PHF	.000	.250	.000	.000	.250	.000	.250	.000	.000	.250	.000	.000	.000	.000	.000	.000	.250	.000	.000	.250		.500

Peak Hour Analysis From 04:00 PM to 05:45 PM - Peak 1 of 1
 Peak Hour for Entire Intersection Begins at 05:00 PM

Traffic Data Service

San Jose, CA
 (408) 622-4787
 tdsbay@cs.com

File Name : 20PM FINAL
 Site Code : 00000020
 Start Date : 4/27/2017
 Page No : 2

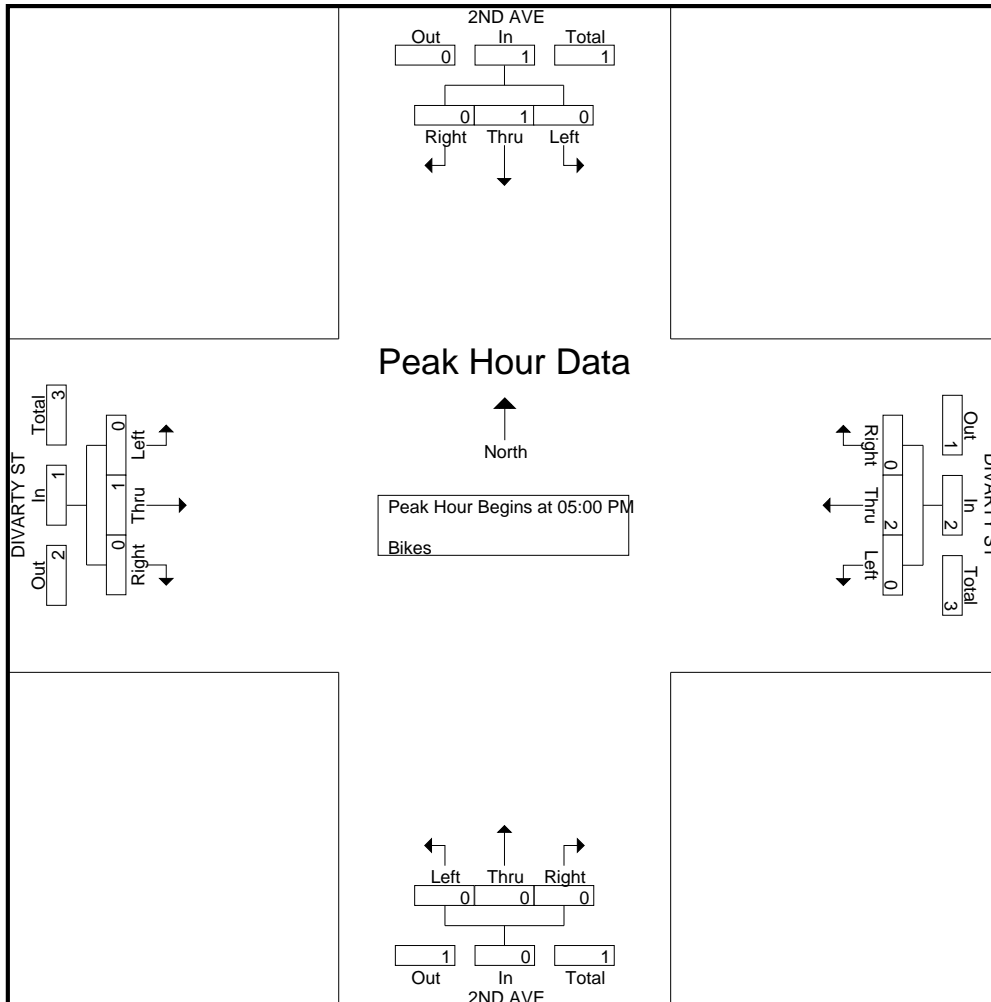

Traffic Data Service

San Jose, CA
 (408) 622-4787
 tdsbay@cs.com

File Name : 21AM FINAL
 Site Code : 00000021
 Start Date : 4/27/2017
 Page No : 1

Groups Printed- Lights - Buses - Trucks

Start Time	GENERAL JIM MOORE BLVD Southbound					DIVARTY ST Westbound					GENERAL JIM MOORE BLVD Northbound					DIVARTY ST Eastbound					Int. Total
	Right	Thru	Left	Peds	App. Total	Right	Thru	Left	Peds	App. Total	Right	Thru	Left	Peds	App. Total	Right	Thru	Left	Peds	App. Total	
07:00 AM	0	10	1	0	11	0	0	9	0	9	3	4	2	0	9	1	0	0	0	1	30
07:15 AM	0	33	0	1	34	1	1	24	0	26	6	11	1	1	19	4	4	0	0	8	87
07:30 AM	1	51	0	0	52	2	0	34	0	36	7	25	1	1	34	1	8	3	0	12	134
07:45 AM	1	37	2	3	43	5	4	12	0	21	27	29	4	1	61	1	9	2	0	12	137
Total	2	131	3	4	140	8	5	79	0	92	43	69	8	3	123	7	21	5	0	33	388
08:00 AM	0	25	7	0	32	7	3	9	0	19	20	31	1	0	52	2	21	1	0	24	127
08:15 AM	0	23	3	3	29	4	1	2	0	7	8	37	3	0	48	1	6	1	0	8	92
08:30 AM	1	20	1	0	22	6	2	3	3	14	11	32	5	1	49	0	4	0	0	4	89
08:45 AM	0	13	2	0	15	11	4	7	0	22	16	30	5	0	51	1	9	1	1	12	100
Total	1	81	13	3	98	28	10	21	3	62	55	130	14	1	200	4	40	3	1	48	408
Grand Total	3	212	16	7	238	36	15	100	3	154	98	199	22	4	323	11	61	8	1	81	796
Apprch %	1.3	89.1	6.7	2.9		23.4	9.7	64.9	1.9		30.3	61.6	6.8	1.2		13.6	75.3	9.9	1.2		
Total %	0.4	26.6	2	0.9	29.9	4.5	1.9	12.6	0.4	19.3	12.3	25	2.8	0.5	40.6	1.4	7.7	1	0.1	10.2	
Lights	3	209	16	7	235	32	14	99	3	148	97	195	20	4	316	10	60	8	1	79	778
% Lights	100	98.6	100	100	98.7	88.9	93.3	99	100	96.1	99	98	90.9	100	97.8	90.9	98.4	100	100	97.5	97.7
Buses	0	1	0	0	1	4	0	1	0	5	0	2	0	0	2	0	1	0	0	1	9
% Buses	0	0.5	0	0	0.4	11.1	0	1	0	3.2	0	1	0	0	0.6	0	1.6	0	0	1.2	1.1
Trucks	0	2	0	0	2	0	1	0	0	1	1	2	2	0	5	1	0	0	0	1	9
% Trucks	0	0.9	0	0	0.8	0	6.7	0	0	0.6	1	1	9.1	0	1.5	9.1	0	0	0	1.2	1.1

Start Time	GENERAL JIM MOORE BLVD Southbound					DIVARTY ST Westbound					GENERAL JIM MOORE BLVD Northbound					DIVARTY ST Eastbound					Int. Total
	Right	Thru	Left	Peds	App. Total	Right	Thru	Left	Peds	App. Total	Right	Thru	Left	Peds	App. Total	Right	Thru	Left	Peds	App. Total	
Peak Hour Analysis From 07:00 AM to 08:45 AM - Peak 1 of 1																					
Peak Hour for Entire Intersection Begins at 07:30 AM																					
07:30 AM	1	51	0	0	52	2	0	34	0	36	7	25	1	0	33	1	8	3	0	12	133
07:45 AM	1	37	2	0	40	5	4	12	0	21	27	29	4	0	60	1	9	2	0	12	133
08:00 AM	0	25	7	0	32	7	3	9	0	19	20	31	1	0	52	2	21	1	0	24	127
08:15 AM	0	23	3	3	26	4	1	2	0	7	8	37	3	0	48	1	6	1	0	8	89
Total Volume	2	136	12	0	150	18	8	57	0	83	62	122	9	0	193	5	44	7	0	56	482
% App. Total	1.3	90.7	8	0		21.7	9.6	68.7	0		32.1	63.2	4.7	0		8.9	78.6	12.5	0		
PHF	.500	.667	.429		.721	.643	.500	.419		.576	.574	.824	.563		.804	.625	.524	.583		.583	.906

Traffic Data Service

San Jose, CA
 (408) 622-4787
 tdsbay@cs.com

File Name : 21AM FINAL
 Site Code : 00000021
 Start Date : 4/27/2017
 Page No : 2

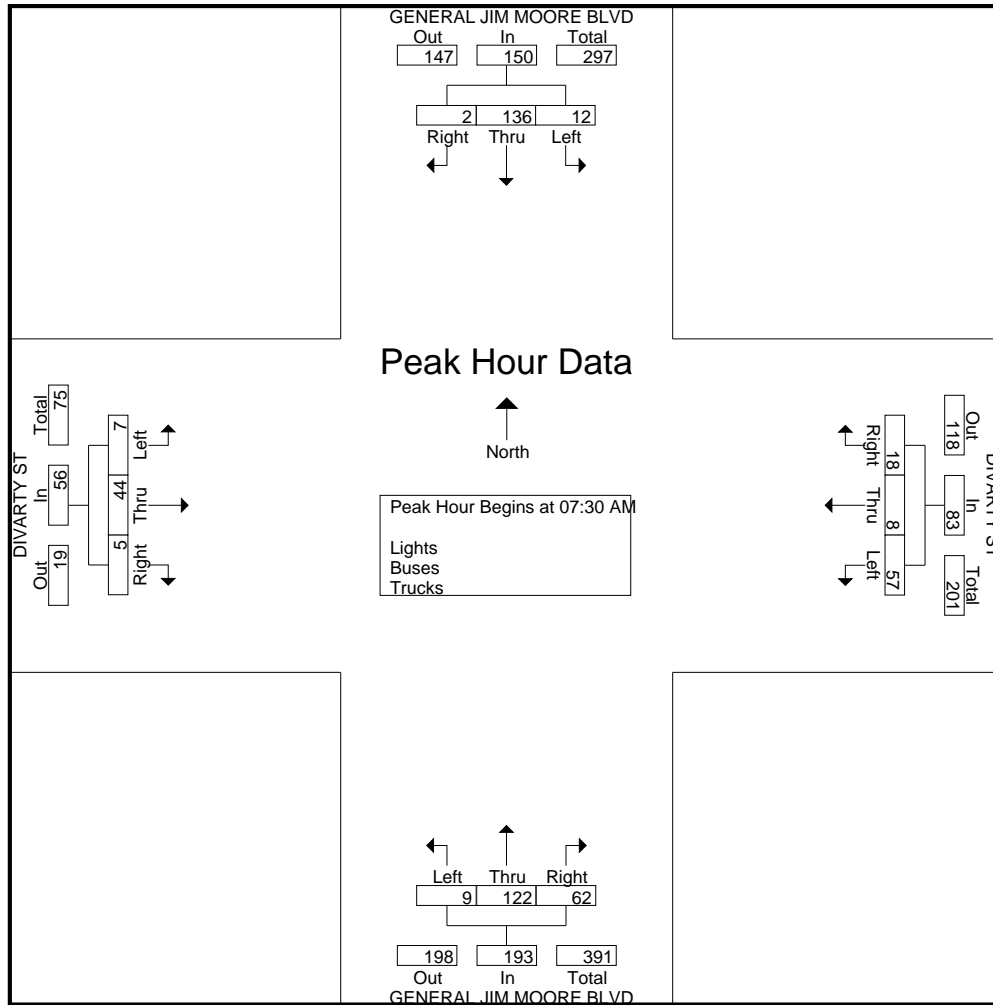

Traffic Data Service

San Jose, CA
 (408) 622-4787
 tdsbay@cs.com

File Name : 21AM FINAL
 Site Code : 00000021
 Start Date : 4/27/2017
 Page No : 1

Groups Printed- Bikes

Start Time	GENERAL JIM MOORE BLVD Southbound					DIVARTY ST Westbound					GENERAL JIM MOORE BLVD Northbound					DIVARTY ST Eastbound					Int. Total					
	Right	Thru	Left	Peds	App. Total	Right	Thru	Left	Peds	App. Total	Right	Thru	Left	Peds	App. Total	Right	Thru	Left	Peds	App. Total						
07:00 AM	0	0	0	0	0	0	0	0	0	0	0	0	0	0	0	0	0	0	0	0	0	0	0	0	0	0
07:15 AM	0	0	0	0	0	0	0	0	0	0	0	0	0	0	0	0	0	0	0	0	0	0	0	0	0	0
07:30 AM	0	1	0	0	1	0	0	0	0	0	0	0	0	0	0	0	0	0	0	0	0	0	0	0	0	1
07:45 AM	0	0	0	0	0	0	0	0	0	0	0	0	0	0	0	0	0	3	0	0	0	3	0	0	3	3
Total	0	1	0	0	1	0	0	0	0	0	0	0	0	0	0	0	0	3	0	0	0	3	0	0	3	4
08:00 AM	0	0	0	0	0	0	0	0	0	0	1	1	0	0	2	0	1	0	0	1	0	1	0	0	1	3
08:15 AM	0	0	0	0	0	0	0	0	0	0	0	0	0	0	0	0	1	0	0	1	0	1	0	0	1	1
08:30 AM	0	0	0	0	0	0	0	0	0	0	0	0	0	0	0	0	0	0	0	0	0	0	0	0	0	0
08:45 AM	0	0	0	0	0	0	0	0	0	0	0	0	0	0	0	0	0	0	0	0	0	0	0	0	0	0
Total	0	0	0	0	0	0	0	0	0	0	1	1	0	0	2	0	2	0	0	2	0	2	0	0	2	4
Grand Total	0	1	0	0	1	0	0	0	0	0	1	1	0	0	2	0	5	0	0	5	0	5	0	0	5	8
Apprch %	0	100	0	0		0	0	0	0		50	50	0	0		0	100	0	0		0	100	0	0		
Total %	0	12.5	0	0	12.5	0	0	0	0	0	12.5	12.5	0	0	25	0	62.5	0	0	62.5	0	62.5	0	0	62.5	

Start Time	GENERAL JIM MOORE BLVD Southbound					DIVARTY ST Westbound					GENERAL JIM MOORE BLVD Northbound					DIVARTY ST Eastbound					Int. Total					
	Right	Thru	Left	Peds	App. Total	Right	Thru	Left	Peds	App. Total	Right	Thru	Left	Peds	App. Total	Right	Thru	Left	Peds	App. Total						
07:30 AM	0	1	0	0	1	0	0	0	0	0	0	0	0	0	0	0	0	0	0	0	0	0	0	0	0	1
07:45 AM	0	0	0	0	0	0	0	0	0	0	0	0	0	0	0	0	3	0	0	3	0	3	0	0	3	3
08:00 AM	0	0	0	0	0	0	0	0	0	0	1	1	0	0	2	0	1	0	0	1	0	1	0	0	1	3
08:15 AM	0	0	0	0	0	0	0	0	0	0	0	0	0	0	0	0	1	0	0	1	0	1	0	0	1	1
Total Volume	0	1	0	0	1	0	0	0	0	0	1	1	0	0	2	0	5	0	0	5	0	5	0	0	5	8
% App. Total	0	100	0	0		0	0	0	0		50	50	0	0		0	100	0	0		0	100	0	0		
PHF	.000	.250	.000	.000	.250	.000	.000	.000	.000	.000	.250	.250	.000	.250	.250	.000	.417	.000	.000	.417	.000	.417	.000	.000	.417	.667

Peak Hour Analysis From 07:00 AM to 08:45 AM - Peak 1 of 1
 Peak Hour for Entire Intersection Begins at 07:30 AM

Traffic Data Service

San Jose, CA
 (408) 622-4787
 tdsbay@cs.com

File Name : 21AM FINAL
 Site Code : 00000021
 Start Date : 4/27/2017
 Page No : 2

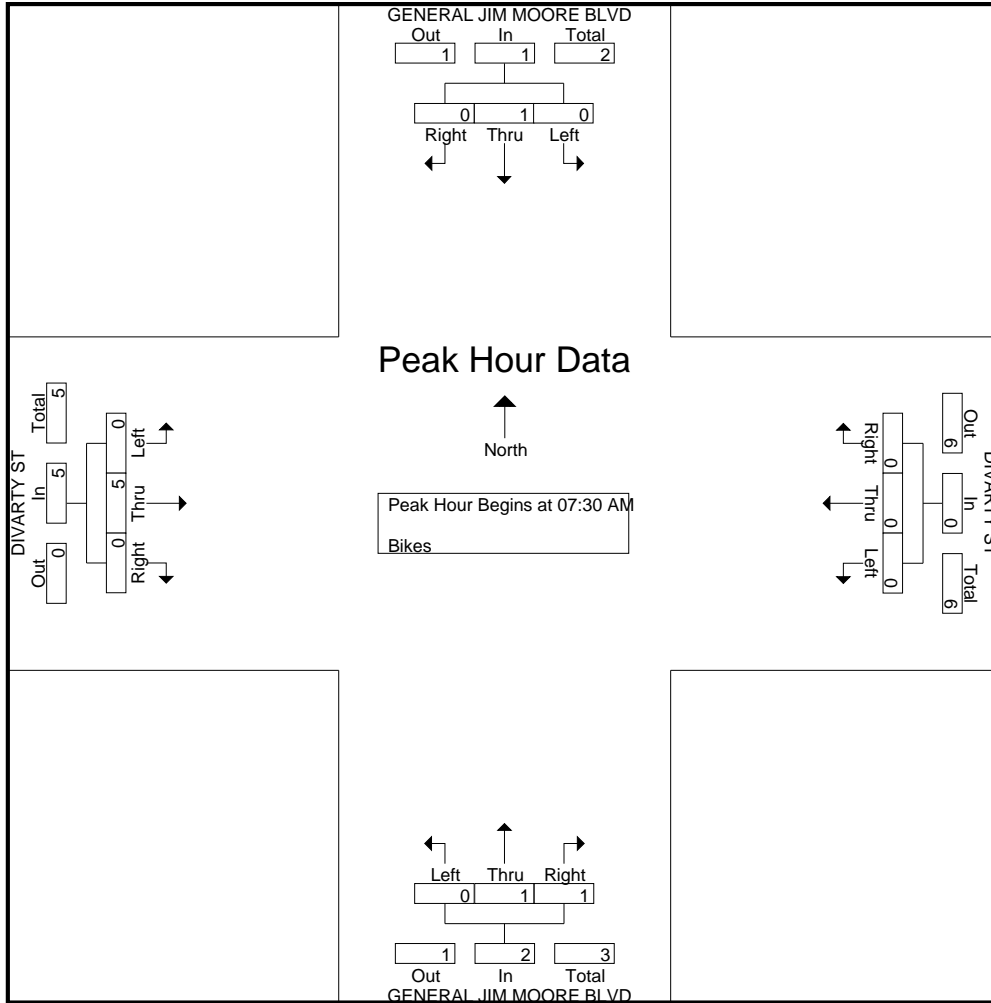

Traffic Data Service

San Jose, CA
 (408) 622-4787
 tdsbay@cs.com

File Name : 21PM FINAL
 Site Code : 00000021
 Start Date : 4/27/2017
 Page No : 1

Groups Printed- Lights - Buses - Trucks

Start Time	GENERAL JIM MOORE BLVD Southbound					DIVARTY ST Westbound					GENERAL JIM MOORE BLVD Northbound					DIVARTY ST Eastbound					Int. Total
	Right	Thru	Left	Peds	App. Total	Right	Thru	Left	Peds	App. Total	Right	Thru	Left	Peds	App. Total	Right	Thru	Left	Peds	App. Total	
04:00 PM	1	25	3	3	32	25	10	16	0	51	5	37	7	0	49	7	7	4	1	19	151
04:15 PM	1	18	1	4	24	14	3	11	0	28	6	23	8	0	37	1	4	1	0	6	95
04:30 PM	3	23	1	2	29	17	7	11	1	36	3	27	9	1	40	2	5	0	1	8	113
04:45 PM	1	27	4	2	34	15	10	8	1	34	5	36	1	1	43	3	1	0	0	4	115
Total	6	93	9	11	119	71	30	46	2	149	19	123	25	2	169	13	17	5	2	37	474
05:00 PM	3	30	1	7	41	32	16	14	2	64	6	37	7	0	50	7	3	1	2	13	168
05:15 PM	0	32	2	0	34	24	2	12	0	38	8	44	1	1	54	0	2	1	0	3	129
05:30 PM	0	27	2	0	29	19	11	14	2	46	5	42	4	1	52	0	6	1	0	7	134
05:45 PM	1	29	6	4	40	43	18	23	2	86	6	37	5	2	50	1	2	1	1	5	181
Total	4	118	11	11	144	118	47	63	6	234	25	160	17	4	206	8	13	4	3	28	612
Grand Total	10	211	20	22	263	189	77	109	8	383	44	283	42	6	375	21	30	9	5	65	1086
Apprch %	3.8	80.2	7.6	8.4		49.3	20.1	28.5	2.1		11.7	75.5	11.2	1.6		32.3	46.2	13.8	7.7		
Total %	0.9	19.4	1.8	2	24.2	17.4	7.1	10	0.7	35.3	4.1	26.1	3.9	0.6	34.5	1.9	2.8	0.8	0.5	6	
Lights	10	210	20	22	262	185	77	106	8	376	44	281	41	6	372	21	30	9	5	65	1075
% Lights	100	99.5	100	100	99.6	97.9	100	97.2	100	98.2	100	99.3	97.6	100	99.2	100	100	100	100	100	99
Buses	0	0	0	0	0	4	0	3	0	7	0	2	1	0	3	0	0	0	0	0	10
% Buses	0	0	0	0	0	2.1	0	2.8	0	1.8	0	0.7	2.4	0	0.8	0	0	0	0	0	0.9
Trucks	0	1	0	0	1	0	0	0	0	0	0	0	0	0	0	0	0	0	0	0	1
% Trucks	0	0.5	0	0	0.4	0	0	0	0	0	0	0	0	0	0	0	0	0	0	0	0.1

Start Time	GENERAL JIM MOORE BLVD Southbound					DIVARTY ST Westbound					GENERAL JIM MOORE BLVD Northbound					DIVARTY ST Eastbound					Int. Total
	Right	Thru	Left	Peds	App. Total	Right	Thru	Left	Peds	App. Total	Right	Thru	Left	Peds	App. Total	Right	Thru	Left	Peds	App. Total	
Peak Hour Analysis From 04:00 PM to 05:45 PM - Peak 1 of 1																					
Peak Hour for Entire Intersection Begins at 05:00 PM																					
05:00 PM	3	30	1		34	32	16	14		62	6	37	7		50	7	3	1		11	157
05:15 PM	0	32	2		34	24	2	12		38	8	44	1		53	0	2	1		3	128
05:30 PM	0	27	2		29	19	11	14		44	5	42	4		51	0	6	1		7	131
05:45 PM	1	29	6		36	43	18	23		84	6	37	5		48	1	2	1		4	172
Total Volume	4	118	11		133	118	47	63		228	25	160	17		202	8	13	4		25	588
% App. Total	3	88.7	8.3			51.8	20.6	27.6			12.4	79.2	8.4			32	52	16			
PHF	.333	.922	.458		.924	.686	.653	.685		.679	.781	.909	.607		.953	.286	.542	1.00		.568	.855

Traffic Data Service

San Jose, CA
 (408) 622-4787
 tdsbay@cs.com

File Name : 21PM FINAL
 Site Code : 00000021
 Start Date : 4/27/2017
 Page No : 2

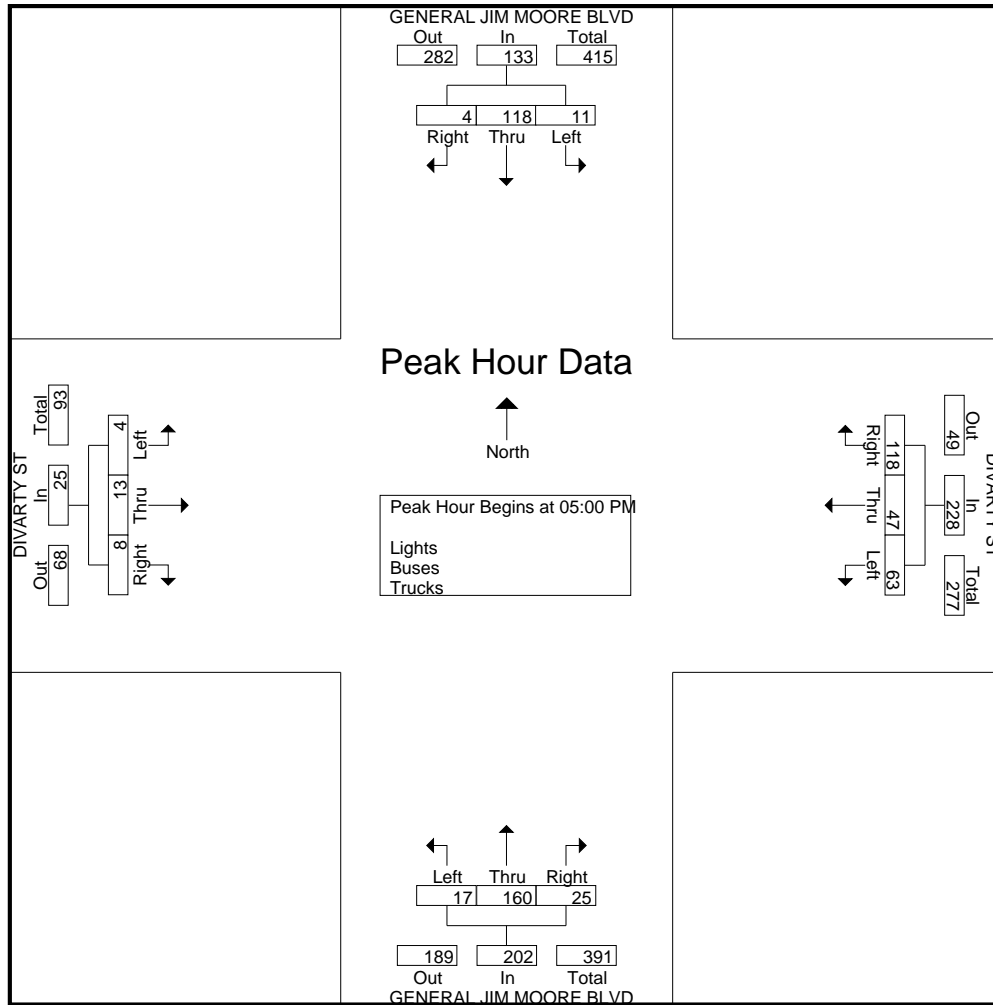

Traffic Data Service

San Jose, CA
 (408) 622-4787
 tdsbay@cs.com

File Name : 21PM FINAL
 Site Code : 00000021
 Start Date : 4/27/2017
 Page No : 1

Groups Printed- Bikes

Start Time	GENERAL JIM MOORE BLVD Southbound					DIVARTY ST Westbound					GENERAL JIM MOORE BLVD Northbound					DIVARTY ST Eastbound					Int. Total					
	Right	Thru	Left	Peds	App. Total	Right	Thru	Left	Peds	App. Total	Right	Thru	Left	Peds	App. Total	Right	Thru	Left	Peds	App. Total						
04:00 PM	0	1	0	0	1	0	0	0	0	0	0	0	0	0	0	0	0	0	0	0	0	0	0	0	0	1
04:15 PM	0	0	0	0	0	0	0	0	0	0	0	1	0	0	1	0	0	0	0	0	0	0	0	0	0	1
04:30 PM	0	0	0	0	0	0	0	0	0	0	0	0	0	0	0	0	0	0	0	0	0	0	0	0	0	0
04:45 PM	0	0	0	0	0	0	0	0	0	0	0	0	0	0	0	0	0	0	0	0	0	0	0	0	0	0
Total	0	1	0	0	1	0	0	0	0	0	0	1	0	0	1	0	0	0	0	0	0	0	0	0	0	2
05:00 PM	0	0	0	0	0	0	0	0	0	0	0	0	0	0	0	0	0	1	0	1	0	0	0	0	1	1
05:15 PM	0	0	0	0	0	0	0	0	0	0	0	0	0	0	0	0	0	0	0	0	0	0	0	0	0	0
05:30 PM	1	0	0	0	1	0	0	0	0	0	0	0	0	0	0	0	0	0	0	0	0	0	0	0	1	1
05:45 PM	0	0	0	0	0	0	2	0	0	2	0	1	0	0	1	0	0	0	0	0	0	0	0	0	3	3
Total	1	0	0	0	1	0	2	0	0	2	0	1	0	0	1	0	0	1	0	1	0	0	0	0	5	5
Grand Total	1	1	0	0	2	0	2	0	0	2	0	2	0	0	2	0	0	1	0	1	0	0	0	0	7	7
Apprch %	50	50	0	0		0	100	0	0		0	100	0	0		0	0	100	0		0	0	0	0		
Total %	14.3	14.3	0	0	28.6	0	28.6	0	0	28.6	0	28.6	0	0	28.6	0	0	14.3	0	14.3	0	0	0	0		

Start Time	GENERAL JIM MOORE BLVD Southbound					DIVARTY ST Westbound					GENERAL JIM MOORE BLVD Northbound					DIVARTY ST Eastbound					Int. Total					
	Right	Thru	Left	Peds	App. Total	Right	Thru	Left	Peds	App. Total	Right	Thru	Left	Peds	App. Total	Right	Thru	Left	Peds	App. Total						
05:00 PM	0	0	0	0	0	0	0	0	0	0	0	0	0	0	0	0	0	1	0	1	0	0	0	0	1	1
05:15 PM	0	0	0	0	0	0	0	0	0	0	0	0	0	0	0	0	0	0	0	0	0	0	0	0	0	0
05:30 PM	1	0	0	0	1	0	0	0	0	0	0	0	0	0	0	0	0	0	0	0	0	0	0	0	1	1
05:45 PM	0	0	0	0	0	0	2	0	0	2	0	1	0	0	1	0	0	0	0	0	0	0	0	0	3	3
Total Volume	1	0	0	0	1	0	2	0	0	2	0	1	0	0	1	0	0	1	0	1	0	0	0	0	5	5
% App. Total	100	0	0	0		0	100	0	0		0	100	0	0		0	0	100	0		0	0	0	0		
PHF	.250	.000	.000	.000	.250	.000	.250	.000	.000	.250	.000	.250	.000	.000	.250	.000	.000	.250	.000	.250	.000	.000	.000	.000	.417	.417

Peak Hour Analysis From 04:00 PM to 05:45 PM - Peak 1 of 1

Peak Hour for Entire Intersection Begins at 05:00 PM

Traffic Data Service

San Jose, CA
 (408) 622-4787
 tdsbay@cs.com

File Name : 21PM FINAL
 Site Code : 00000021
 Start Date : 4/27/2017
 Page No : 2

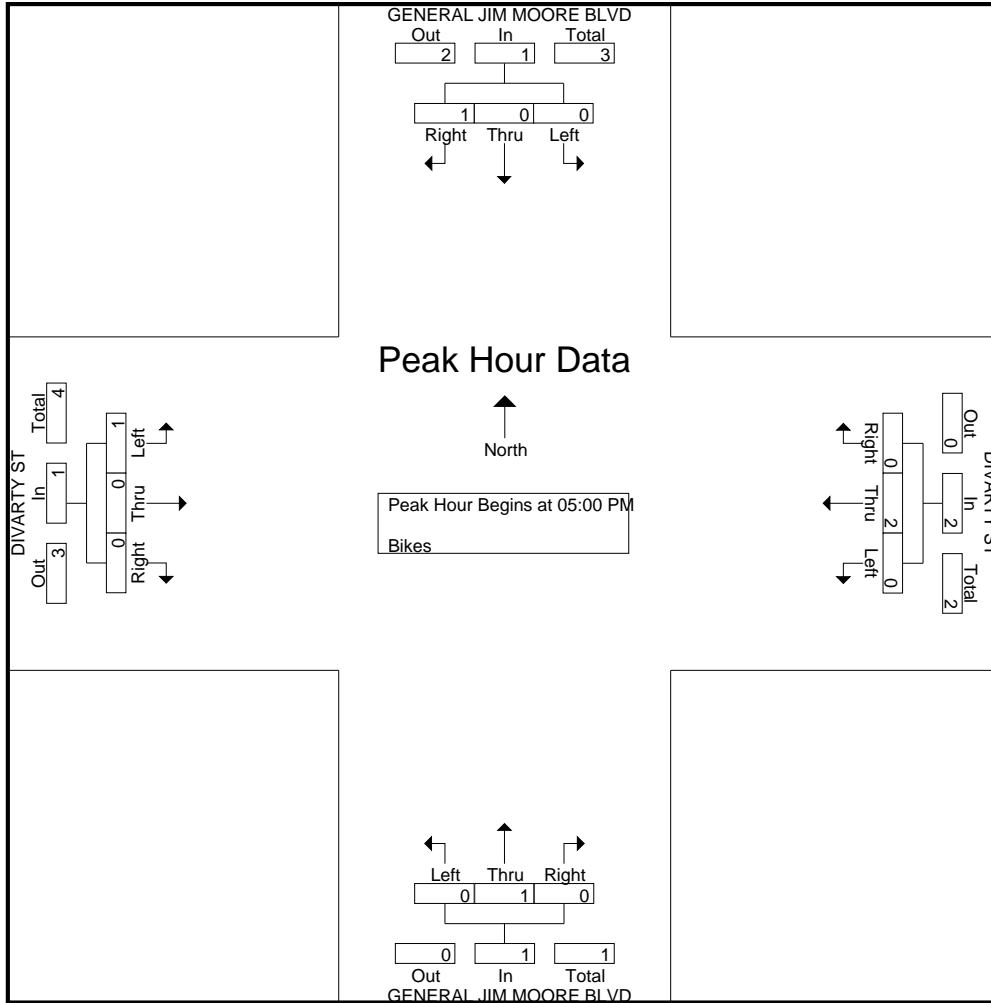

Traffic Data Service

San Jose, CA
 (408) 622-4787
 tdsbay@cs.com

File Name : 22AM FINAL
 Site Code : 00000022
 Start Date : 4/27/2017
 Page No : 1

Groups Printed- Lights - Buses - Trucks

Start Time	1ST AVE Southbound					LIGHTFIGHTER DR Westbound					1ST AVE Northbound					LIGHTFIGHTER DR Eastbound					Int. Total
	Right	Thru	Left	Peds	App. Total	Right	Thru	Left	Peds	App. Total	Right	Thru	Left	Peds	App. Total	Right	Thru	Left	Peds	App. Total	
07:00 AM	2	0	0	0	2	0	126	1	0	127	0	0	53	0	53	12	107	0	0	119	301
07:15 AM	4	1	0	0	5	0	160	7	0	167	0	0	44	0	44	22	160	0	0	182	398
07:30 AM	5	0	1	0	6	0	270	3	0	273	1	0	43	0	44	31	199	0	0	230	553
07:45 AM	5	2	3	0	10	0	182	1	0	183	10	0	35	0	45	44	233	0	0	277	515
Total	16	3	4	0	23	0	738	12	0	750	11	0	175	0	186	109	699	0	0	808	1767
08:00 AM	4	1	10	0	15	0	142	9	0	151	5	0	36	0	41	29	156	0	0	185	392
08:15 AM	4	0	0	0	4	0	99	8	0	107	7	0	28	0	35	40	146	0	0	186	332
08:30 AM	0	0	0	0	0	0	70	2	0	72	0	0	21	0	21	54	137	1	0	192	285
08:45 AM	3	0	0	0	3	0	72	3	0	75	1	0	20	0	21	37	149	1	0	187	286
Total	11	1	10	0	22	0	383	22	0	405	13	0	105	0	118	160	588	2	0	750	1295
Grand Total	27	4	14	0	45	0	1121	34	0	1155	24	0	280	0	304	269	1287	2	0	1558	3062
Apprch %	60	8.9	31.1	0		0	97.1	2.9	0		7.9	0	92.1	0		17.3	82.6	0.1	0		
Total %	0.9	0.1	0.5	0	1.5	0	36.6	1.1	0	37.7	0.8	0	9.1	0	9.9	8.8	42	0.1	0	50.9	
Lights	26	3	14	0	43	0	1093	34	0	1127	23	0	276	0	299	257	1256	2	0	1515	2984
% Lights	96.3	75	100	0	95.6	0	97.5	100	0	97.6	95.8	0	98.6	0	98.4	95.5	97.6	100	0	97.2	97.5
Buses	0	1	0	0	1	0	10	0	0	10	0	0	2	0	2	8	12	0	0	20	33
% Buses	0	25	0	0	2.2	0	0.9	0	0	0.9	0	0	0.7	0	0.7	3	0.9	0	0	1.3	1.1
Trucks	1	0	0	0	1	0	18	0	0	18	1	0	2	0	3	4	19	0	0	23	45
% Trucks	3.7	0	0	0	2.2	0	1.6	0	0	1.6	4.2	0	0.7	0	1	1.5	1.5	0	0	1.5	1.5

Start Time	1ST AVE Southbound				LIGHTFIGHTER DR Westbound				1ST AVE Northbound				LIGHTFIGHTER DR Eastbound				Int. Total
	Right	Thru	Left	App. Total	Right	Thru	Left	App. Total	Right	Thru	Left	App. Total	Right	Thru	Left	App. Total	
Peak Hour Analysis From 07:00 AM to 08:45 AM - Peak 1 of 1																	
Peak Hour for Entire Intersection Begins at 07:15 AM																	
07:15 AM	4	1	0	5	0	160	7	167	0	0	44	44	22	160	0	182	398
07:30 AM	5	0	1	6	0	270	3	273	1	0	43	44	31	199	0	230	553
07:45 AM	5	2	3	10	0	182	1	183	10	0	35	45	44	233	0	277	515
08:00 AM	4	1	10	15	0	142	9	151	5	0	36	41	29	156	0	185	392
Total Volume	18	4	14	36	0	754	20	774	16	0	158	174	126	748	0	874	1858
% App. Total	50	11.1	38.9		0	97.4	2.6		9.2	0	90.8		14.4	85.6	0		
PHF	.900	.500	.350	.600	.000	.698	.556	.709	.400	.000	.898	.967	.716	.803	.000	.789	.840

Traffic Data Service

San Jose, CA
 (408) 622-4787
 tdsbay@cs.com

File Name : 22AM FINAL
 Site Code : 00000022
 Start Date : 4/27/2017
 Page No : 2

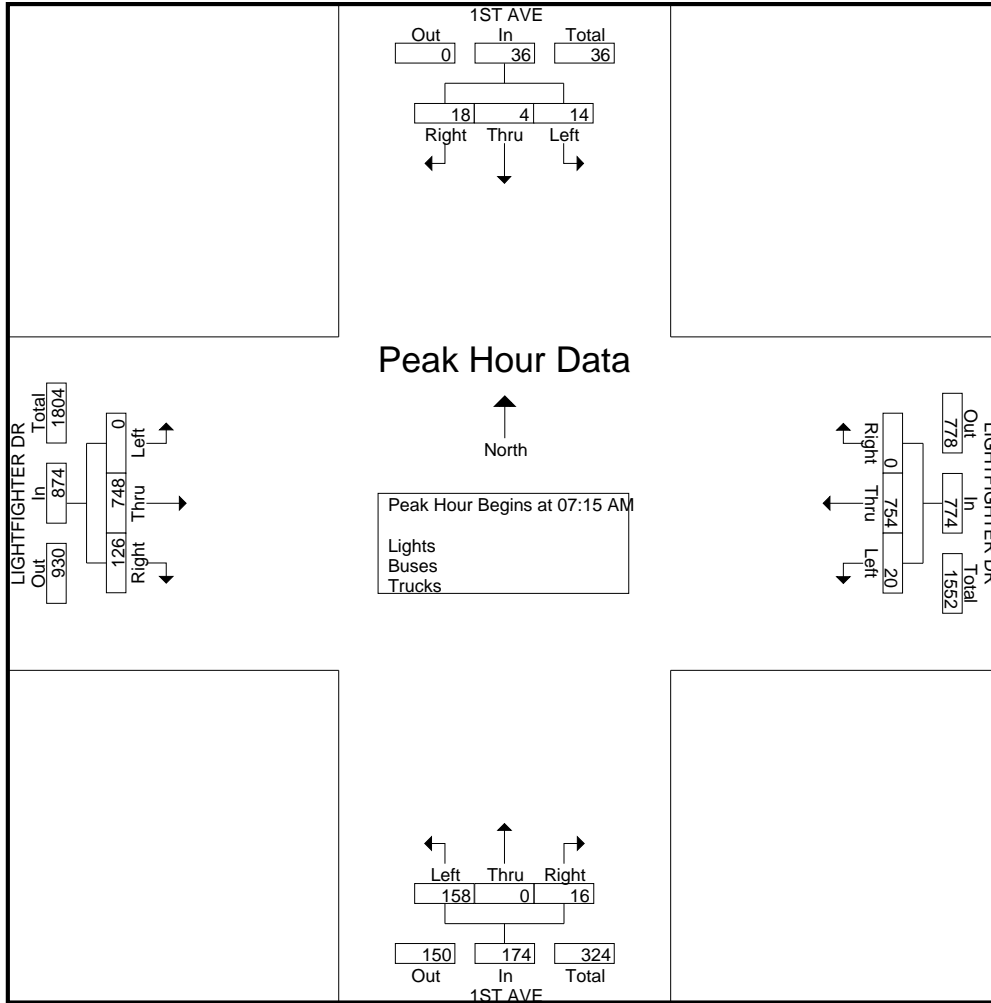

Traffic Data Service

San Jose, CA
 (408) 622-4787
 tdsbay@cs.com

File Name : 22AM FINAL
 Site Code : 00000022
 Start Date : 4/27/2017
 Page No : 1

Groups Printed- Bikes

Start Time	1ST AVE Southbound					LIGHTFIGHTER DR Westbound					1ST AVE Northbound					LIGHTFIGHTER DR Eastbound					Int. Total
	Right	Thru	Left	Peds	App. Total	Right	Thru	Left	Peds	App. Total	Right	Thru	Left	Peds	App. Total	Right	Thru	Left	Peds	App. Total	
07:00 AM	0	0	0	0	0	0	0	0	0	0	0	0	0	0	0	0	0	0	0	0	0
07:15 AM	0	0	0	0	0	0	0	0	0	0	0	0	0	0	0	0	0	0	0	0	0
07:30 AM	0	0	0	0	0	0	1	0	0	1	0	0	0	0	0	0	0	0	0	0	1
07:45 AM	0	0	0	0	0	0	0	0	0	0	0	0	0	0	0	0	0	0	0	0	0
Total	0	0	0	0	0	0	1	0	0	1	0	0	0	0	0	0	0	0	0	0	1
08:00 AM	0	0	0	0	0	0	0	0	0	0	0	0	0	0	0	0	0	0	0	0	0
08:15 AM	0	0	0	0	0	0	0	0	0	0	0	0	0	0	0	0	0	0	0	0	0
08:30 AM	0	0	0	0	0	0	0	0	0	0	0	0	0	0	0	0	0	0	0	0	0
08:45 AM	0	0	0	0	0	0	0	0	0	0	0	0	0	0	0	0	0	0	0	0	0
Total	0	0	0	0	0	0	0	0	0	0	0	0	0	0	0	0	0	0	0	0	0
Grand Total	0	0	0	0	0	0	1	0	0	1	0	0	0	0	0	0	0	0	0	0	1
Apprch %	0	0	0	0	0	0	100	0	0	100	0	0	0	0	0	0	0	0	0	0	0
Total %	0	0	0	0	0	0	100	0	0	100	0	0	0	0	0	0	0	0	0	0	0

Start Time	1ST AVE Southbound					LIGHTFIGHTER DR Westbound					1ST AVE Northbound					LIGHTFIGHTER DR Eastbound					Int. Total
	Right	Thru	Left	Peds	App. Total	Right	Thru	Left	Peds	App. Total	Right	Thru	Left	Peds	App. Total	Right	Thru	Left	Peds	App. Total	
07:00 AM	0	0	0	0	0	0	0	0	0	0	0	0	0	0	0	0	0	0	0	0	0
07:15 AM	0	0	0	0	0	0	0	0	0	0	0	0	0	0	0	0	0	0	0	0	0
07:30 AM	0	0	0	0	0	0	1	0	0	1	0	0	0	0	0	0	0	0	0	0	1
07:45 AM	0	0	0	0	0	0	0	0	0	0	0	0	0	0	0	0	0	0	0	0	0
Total Volume	0	0	0	0	0	0	1	0	0	1	0	0	0	0	0	0	0	0	0	0	1
% App. Total	0	0	0	0	0	0	100	0	0	100	0	0	0	0	0	0	0	0	0	0	0
PHF	.000	.000	.000	.000	.000	.000	.250	.000	.000	.250	.000	.000	.000	.000	.000	.000	.000	.000	.000	.000	.250

Peak Hour Analysis From 07:00 AM to 08:45 AM - Peak 1 of 1
 Peak Hour for Entire Intersection Begins at 07:00 AM

Traffic Data Service

San Jose, CA
 (408) 622-4787
 tdsbay@cs.com

File Name : 22AM FINAL
 Site Code : 00000022
 Start Date : 4/27/2017
 Page No : 2

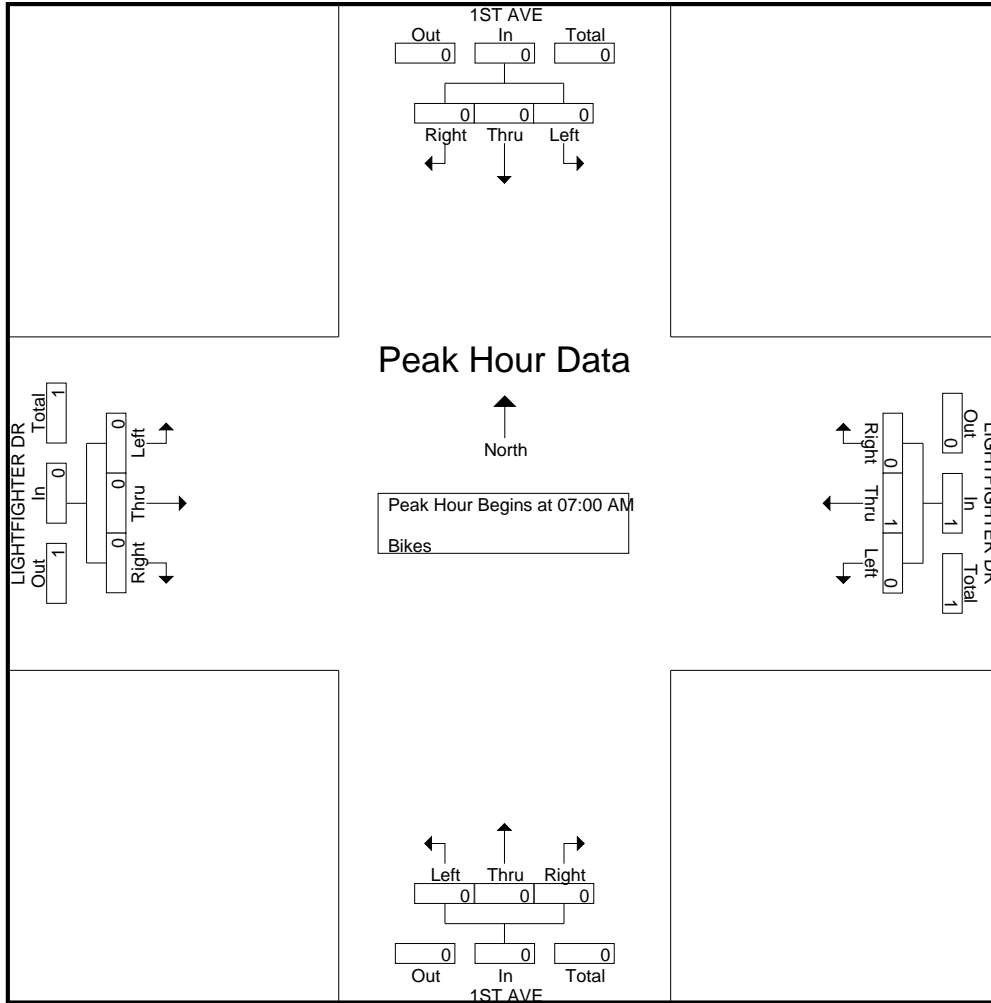

Traffic Data Service

San Jose, CA
(408) 622-4787
tdsbay@cs.com

File Name : 22PM FINAL
Site Code : 00000022
Start Date : 4/27/2017
Page No : 1

Groups Printed- Lights - Buses - Trucks

Start Time	1ST AVE Southbound					LIGHTFIGHTER DR Westbound					1ST AVE Northbound					LIGHTFIGHTER DR Eastbound					Int. Total
	Right	Thru	Left	Peds	App. Total	Right	Thru	Left	Peds	App. Total	Right	Thru	Left	Peds	App. Total	Right	Thru	Left	Peds	App. Total	
04:00 PM	6	0	0	0	6	0	204	5	0	209	6	0	55	0	61	33	86	0	0	119	395
04:15 PM	4	0	0	0	4	0	159	4	0	163	6	0	44	0	50	27	107	0	0	134	351
04:30 PM	4	0	0	0	4	0	222	1	0	223	4	0	53	0	57	32	103	0	0	135	419
04:45 PM	4	0	1	0	5	0	261	8	0	269	4	0	52	0	56	33	107	0	0	140	470
Total	18	0	1	0	19	0	846	18	0	864	20	0	204	0	224	125	403	0	0	528	1635
05:00 PM	12	0	0	0	12	0	241	3	0	244	4	0	55	0	59	16	132	0	0	148	463
05:15 PM	0	0	0	0	0	0	247	2	0	249	10	0	35	0	45	22	111	0	0	133	427
05:30 PM	8	0	0	0	8	0	208	4	0	212	4	0	41	0	45	21	122	0	0	143	408
05:45 PM	4	0	0	0	4	1	189	2	0	192	5	0	29	0	34	25	128	0	0	153	383
Total	24	0	0	0	24	1	885	11	0	897	23	0	160	0	183	84	493	0	0	577	1681
Grand Total	42	0	1	0	43	1	1731	29	0	1761	43	0	364	0	407	209	896	0	0	1105	3316
Apprch %	97.7	0	2.3	0		0.1	98.3	1.6	0		10.6	0	89.4	0		18.9	81.1	0	0		
Total %	1.3	0	0	0	1.3	0	52.2	0.9	0	53.1	1.3	0	11	0	12.3	6.3	27	0	0	33.3	
Lights	41	0	1	0	42	0	1718	27	0	1745	43	0	358	0	401	205	881	0	0	1086	3274
% Lights	97.6	0	100	0	97.7	0	99.2	93.1	0	99.1	100	0	98.4	0	98.5	98.1	98.3	0	0	98.3	98.7
Buses	0	0	0	0	0	0	5	2	0	7	0	0	4	0	4	4	10	0	0	14	25
% Buses	0	0	0	0	0	0	0.3	6.9	0	0.4	0	0	1.1	0	1	1.9	1.1	0	0	1.3	0.8
Trucks	1	0	0	0	1	1	8	0	0	9	0	0	2	0	2	0	5	0	0	5	17
% Trucks	2.4	0	0	0	2.3	100	0.5	0	0	0.5	0	0	0.5	0	0.5	0	0.6	0	0	0.5	0.5

Start Time	1ST AVE Southbound				LIGHTFIGHTER DR Westbound				1ST AVE Northbound				LIGHTFIGHTER DR Eastbound				Int. Total
	Right	Thru	Left	App. Total	Right	Thru	Left	App. Total	Right	Thru	Left	App. Total	Right	Thru	Left	App. Total	
Peak Hour Analysis From 04:00 PM to 05:45 PM - Peak 1 of 1																	
Peak Hour for Entire Intersection Begins at 04:30 PM																	
04:30 PM	4	0	0	4	0	222	1	223	4	0	53	57	32	103	0	135	419
04:45 PM	4	0	1	5	0	261	8	269	4	0	52	56	33	107	0	140	470
05:00 PM	12	0	0	12	0	241	3	244	4	0	55	59	16	132	0	148	463
05:15 PM	0	0	0	0	0	247	2	249	10	0	35	45	22	111	0	133	427
Total Volume	20	0	1	21	0	971	14	985	22	0	195	217	103	453	0	556	1779
% App. Total	95.2	0	4.8		0	98.6	1.4		10.1	0	89.9		18.5	81.5	0		
PHF	.417	.000	.250	.438	.000	.930	.438	.915	.550	.000	.886	.919	.780	.858	.000	.939	.946

Traffic Data Service

San Jose, CA
 (408) 622-4787
 tdsbay@cs.com

File Name : 22PM FINAL
 Site Code : 00000022
 Start Date : 4/27/2017
 Page No : 2

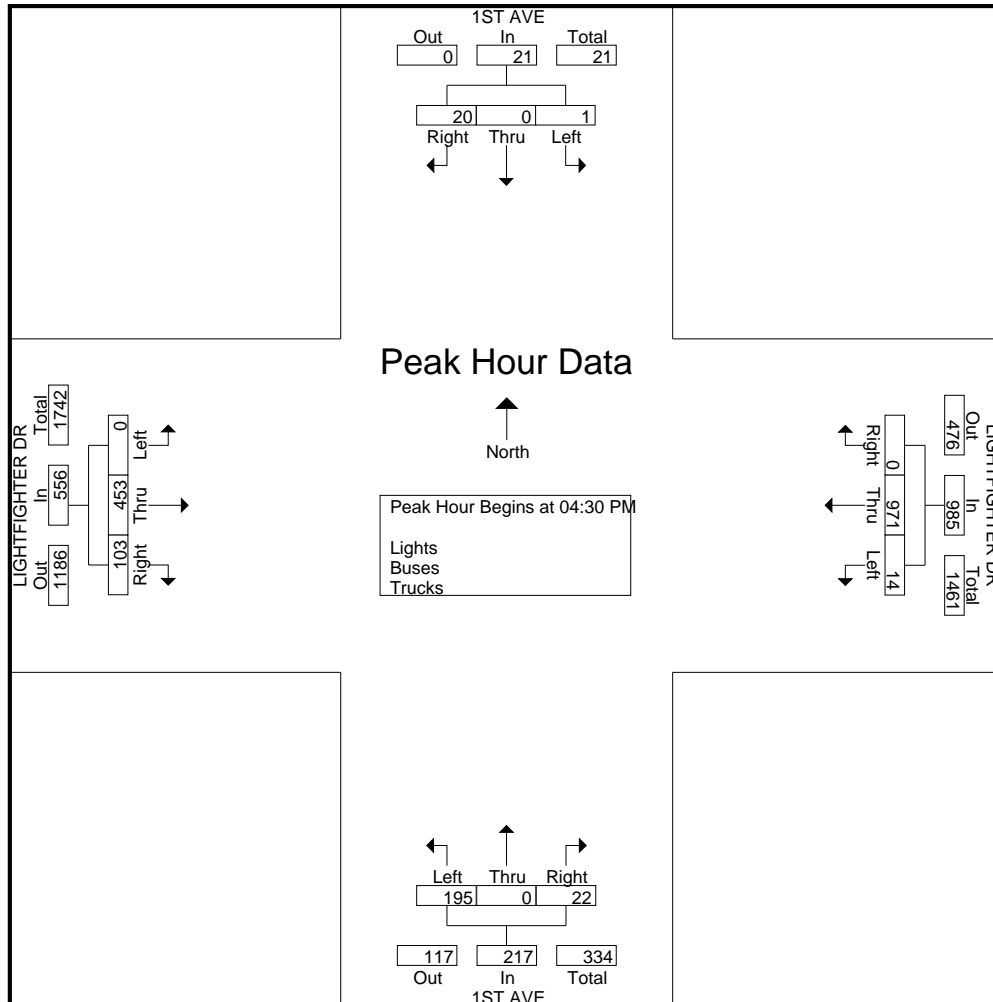

Traffic Data Service

San Jose, CA
 (408) 622-4787
 tdsbay@cs.com

File Name : 22PM FINAL
 Site Code : 00000022
 Start Date : 4/27/2017
 Page No : 1

Groups Printed- Bikes

Start Time	1ST AVE Southbound					LIGHTFIGHTER DR Westbound					1ST AVE Northbound					LIGHTFIGHTER DR Eastbound					Int. Total
	Right	Thru	Left	Peds	App. Total	Right	Thru	Left	Peds	App. Total	Right	Thru	Left	Peds	App. Total	Right	Thru	Left	Peds	App. Total	
04:00 PM	0	0	0	0	0	0	0	0	0	0	0	0	0	0	0	0	0	0	0	0	0
04:15 PM	0	0	0	0	0	0	0	0	0	0	0	0	0	0	0	0	0	0	0	0	0
04:30 PM	0	0	0	0	0	0	0	0	0	0	0	0	0	0	0	0	0	0	0	0	0
04:45 PM	0	0	0	0	0	0	0	0	0	0	0	0	0	0	0	0	0	0	0	0	0
Total	0	0	0	0	0	0	0	0	0	0	0	0	0	0	0	0	0	0	0	0	0
05:00 PM	0	0	0	0	0	0	0	0	0	0	0	0	0	0	0	0	0	0	0	0	0
05:15 PM	0	0	0	0	0	0	0	0	0	0	0	0	0	0	0	0	0	0	0	0	0
05:30 PM	0	0	0	0	0	0	0	0	0	0	0	0	0	0	0	0	0	0	0	0	0
05:45 PM	0	0	0	0	0	0	0	0	0	0	0	0	0	0	0	0	0	0	0	0	0
Total	0	0	0	0	0	0	0	0	0	0	0	0	0	0	0	0	0	0	0	0	0
Grand Total	0	0	0	0	0	0	0	0	0	0	0	0	0	0	0	0	0	0	0	0	0
Apprch %	0	0	0	0		0	0	0	0		0	0	0	0		0	0	0	0		
Total %																					

Start Time	1ST AVE Southbound					LIGHTFIGHTER DR Westbound					1ST AVE Northbound					LIGHTFIGHTER DR Eastbound					Int. Total
	Right	Thru	Left	Peds	App. Total	Right	Thru	Left	Peds	App. Total	Right	Thru	Left	Peds	App. Total	Right	Thru	Left	Peds	App. Total	
04:00 PM	0	0	0	0	0	0	0	0	0	0	0	0	0	0	0	0	0	0	0	0	0
04:15 PM	0	0	0	0	0	0	0	0	0	0	0	0	0	0	0	0	0	0	0	0	0
04:30 PM	0	0	0	0	0	0	0	0	0	0	0	0	0	0	0	0	0	0	0	0	0
04:45 PM	0	0	0	0	0	0	0	0	0	0	0	0	0	0	0	0	0	0	0	0	0
Total Volume	0	0	0	0	0	0	0	0	0	0	0	0	0	0	0	0	0	0	0	0	0
% App. Total	0	0	0	0		0	0	0	0		0	0	0	0		0	0	0	0		
PHF	.000	.000	.000	.000	.000	.000	.000	.000	.000	.000	.000	.000	.000	.000	.000	.000	.000	.000	.000	.000	.000

Peak Hour Analysis From 04:00 PM to 05:45 PM - Peak 1 of 1
 Peak Hour for Entire Intersection Begins at 04:00 PM

Traffic Data Service

San Jose, CA
(408) 622-4787
tdsbay@cs.com

File Name : 22PM FINAL
Site Code : 00000022
Start Date : 4/27/2017
Page No : 2

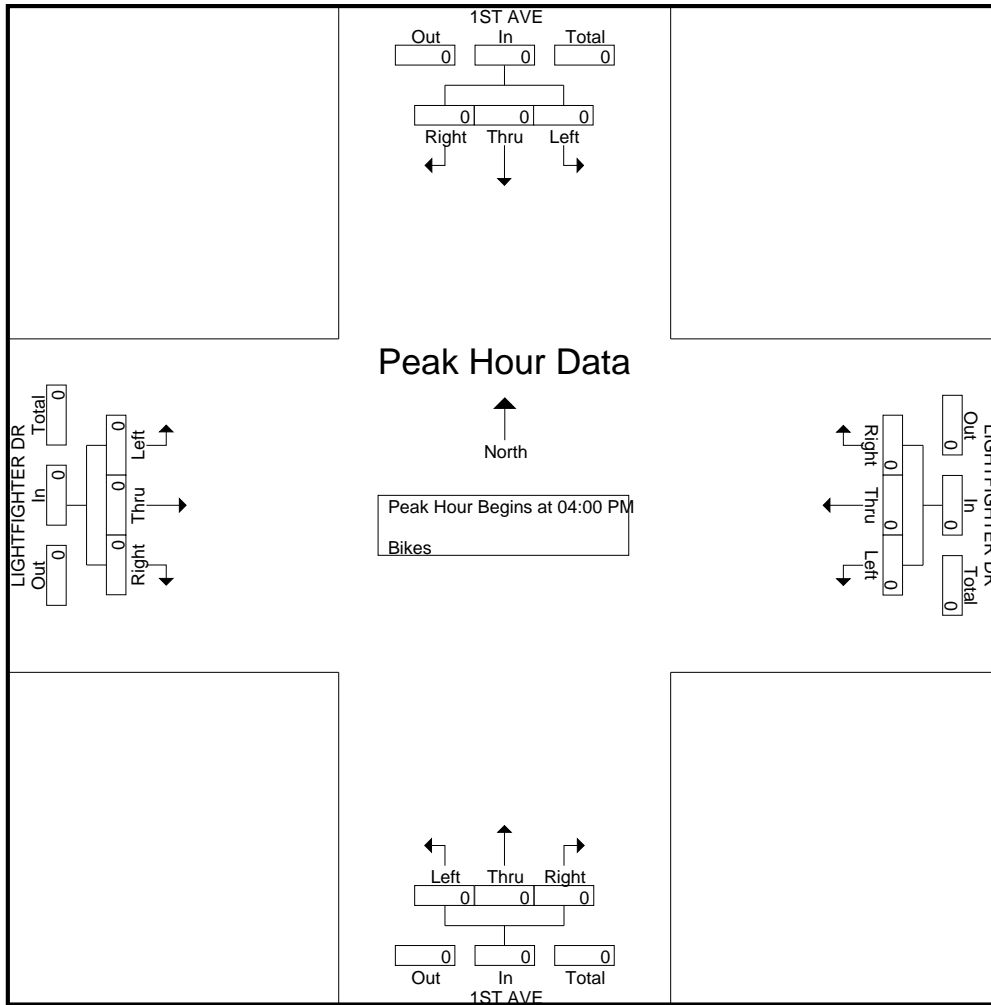

Traffic Data Service

San Jose, CA
 (408) 622-4787
 tdsbay@cs.com

File Name : 23AM FINAL
 Site Code : 00000023
 Start Date : 4/27/2017
 Page No : 1

Groups Printed- Lights - Buses - Trucks

Start Time	2ND AVE Southbound					LIGHTFIGHTER DR Westbound					2ND AVE Northbound					LIGHTFIGHTER DR Eastbound					Int. Total
	Right	Thru	Left	Peds	App. Total	Right	Thru	Left	Peds	App. Total	Right	Thru	Left	Peds	App. Total	Right	Thru	Left	Peds	App. Total	
07:00 AM	32	1	19	0	52	5	103	0	0	108	0	1	0	0	1	0	96	6	0	102	263
07:15 AM	79	1	70	0	150	7	102	0	0	109	1	0	0	0	1	0	155	8	0	163	423
07:30 AM	121	1	64	0	186	14	135	3	0	152	0	0	0	0	0	1	174	14	0	189	527
07:45 AM	87	0	70	0	157	28	94	1	0	123	0	0	0	0	0	1	215	27	0	243	523
Total	319	3	223	0	545	54	434	4	0	492	1	1	0	0	2	2	640	55	0	697	1736
08:00 AM	56	2	68	0	126	19	93	1	0	113	0	1	2	0	3	0	152	29	0	181	423
08:15 AM	38	1	59	3	101	7	61	0	3	71	0	1	0	10	11	0	129	23	8	160	343
08:30 AM	21	0	32	0	53	8	50	0	1	59	2	0	1	0	3	0	121	13	0	134	249
08:45 AM	21	2	29	0	52	5	51	2	1	59	2	0	0	0	2	0	126	23	0	149	262
Total	136	5	188	3	332	39	255	3	5	302	4	2	3	10	19	0	528	88	8	624	1277
Grand Total	455	8	411	3	877	93	689	7	5	794	5	3	3	10	21	2	1168	143	8	1321	3013
Apprch %	51.9	0.9	46.9	0.3		11.7	86.8	0.9	0.6		23.8	14.3	14.3	47.6		0.2	88.4	10.8	0.6		
Total %	15.1	0.3	13.6	0.1	29.1	3.1	22.9	0.2	0.2	26.4	0.2	0.1	0.1	0.3	0.7	0.1	38.8	4.7	0.3	43.8	
Lights	450	8	403	3	864	88	665	7	3	763	4	3	3	10	20	2	1142	139	8	1291	2938
% Lights	98.9	100	98.1	100	98.5	94.6	96.5	100	60	96.1	80	100	100	100	95.2	100	97.8	97.2	100	97.7	97.5
Buses	2	0	4	0	6	2	8	0	0	10	0	0	0	0	0	0	11	1	0	12	28
% Buses	0.4	0	1	0	0.7	2.2	1.2	0	0	1.3	0	0	0	0	0	0	0.9	0.7	0	0.9	0.9
Trucks	3	0	4	0	7	3	16	0	2	21	1	0	0	0	1	0	15	3	0	18	47
% Trucks	0.7	0	1	0	0.8	3.2	2.3	0	40	2.6	20	0	0	0	4.8	0	1.3	2.1	0	1.4	1.6

Start Time	2ND AVE Southbound				LIGHTFIGHTER DR Westbound				2ND AVE Northbound				LIGHTFIGHTER DR Eastbound				Int. Total
	Right	Thru	Left	App. Total	Right	Thru	Left	App. Total	Right	Thru	Left	App. Total	Right	Thru	Left	App. Total	
Peak Hour Analysis From 07:00 AM to 08:45 AM - Peak 1 of 1																	
Peak Hour for Entire Intersection Begins at 07:15 AM																	
07:15 AM	79	1	70	150	7	102	0	109	1	0	0	1	0	155	8	163	423
07:30 AM	121	1	64	186	14	135	3	152	0	0	0	0	1	174	14	189	527
07:45 AM	87	0	70	157	28	94	1	123	0	0	0	0	1	215	27	243	523
08:00 AM	56	2	68	126	19	93	1	113	0	1	2	3	0	152	29	181	423
Total Volume	343	4	272	619	68	424	5	497	1	1	2	4	2	696	78	776	1896
% App. Total	55.4	0.6	43.9		13.7	85.3	1		25	25	50		0.3	89.7	10.1		
PHF	.709	.500	.971	.832	.607	.785	.417	.817	.250	.250	.250	.333	.500	.809	.672	.798	.899

Traffic Data Service

San Jose, CA
 (408) 622-4787
 tdsbay@cs.com

File Name : 23AM FINAL
 Site Code : 00000023
 Start Date : 4/27/2017
 Page No : 2

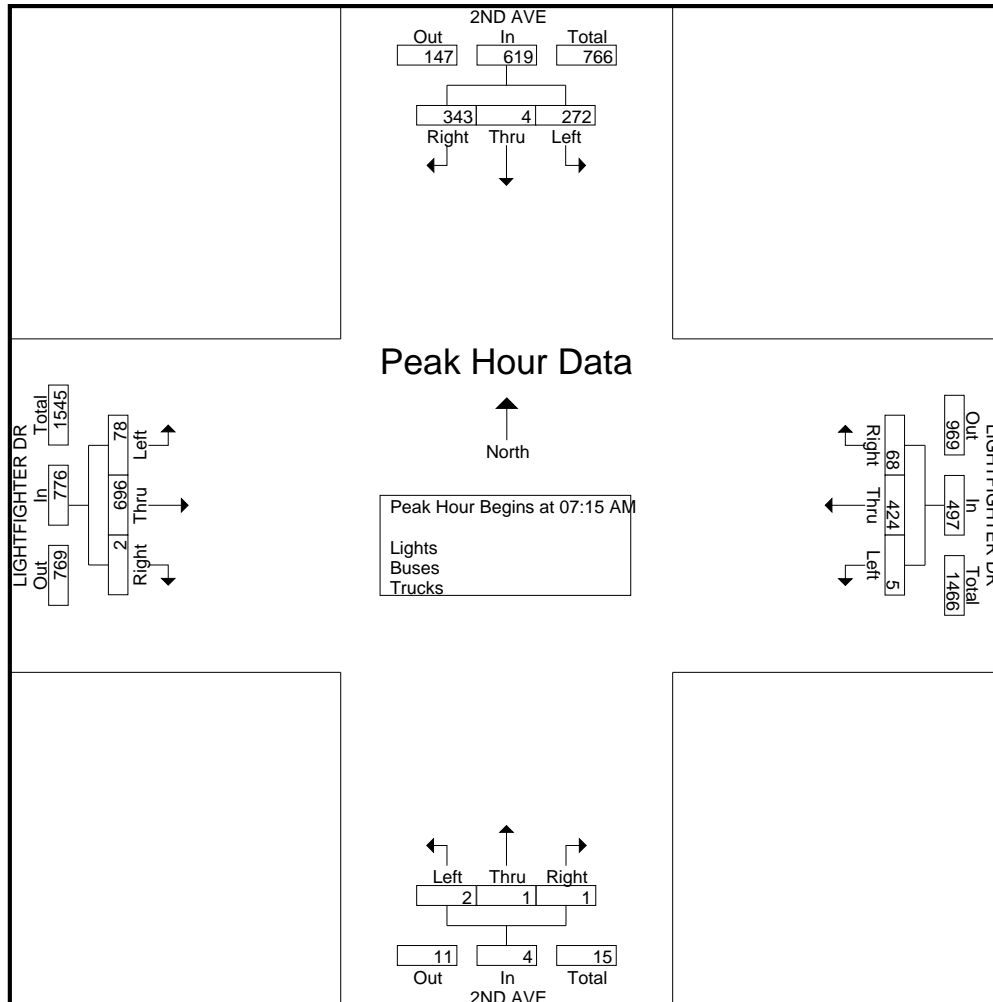

Traffic Data Service

San Jose, CA
 (408) 622-4787
 tdsbay@cs.com

File Name : 23AM FINAL
 Site Code : 00000023
 Start Date : 4/27/2017
 Page No : 1

Groups Printed- Bikes

Start Time	2ND AVE Southbound					LIGHTFIGHTER DR Westbound					2ND AVE Northbound					LIGHTFIGHTER DR Eastbound					Int. Total
	Right	Thru	Left	Peds	App. Total	Right	Thru	Left	Peds	App. Total	Right	Thru	Left	Peds	App. Total	Right	Thru	Left	Peds	App. Total	
07:00 AM	0	0	0	0	0	0	0	0	0	0	0	0	0	0	0	0	0	0	0	0	0
07:15 AM	0	0	0	0	0	0	0	0	0	0	0	0	0	0	0	0	0	0	0	0	0
07:30 AM	0	0	0	0	0	0	0	0	0	0	0	0	0	0	0	0	0	0	0	0	0
07:45 AM	0	0	0	0	0	0	0	0	0	0	0	0	0	0	0	0	0	0	0	0	0
Total	0	0	0	0	0	0	0	0	0	0	0	0	0	0	0	0	0	0	0	0	0
08:00 AM	0	0	0	0	0	0	0	0	0	0	0	0	0	0	0	0	0	0	0	0	0
08:15 AM	0	0	0	0	0	0	0	0	0	0	0	0	0	0	0	0	0	0	0	0	0
08:30 AM	0	0	0	0	0	0	0	0	0	0	0	0	0	0	0	0	0	0	0	0	0
08:45 AM	0	0	0	0	0	0	0	0	0	0	0	0	0	0	0	0	0	0	0	0	0
Total	0	0	0	0	0	0	0	0	0	0	0	0	0	0	0	0	0	0	0	0	0
Grand Total	0	0	0	0	0	0	0	0	0	0	0	0	0	0	0	0	0	0	0	0	0
Apprch %	0	0	0	0		0	0	0	0		0	0	0	0		0	0	0	0		
Total %																					

Start Time	2ND AVE Southbound					LIGHTFIGHTER DR Westbound					2ND AVE Northbound					LIGHTFIGHTER DR Eastbound					Int. Total
	Right	Thru	Left	Peds	App. Total	Right	Thru	Left	Peds	App. Total	Right	Thru	Left	Peds	App. Total	Right	Thru	Left	Peds	App. Total	
Peak Hour Analysis From 07:00 AM to 08:45 AM - Peak 1 of 1																					
Peak Hour for Entire Intersection Begins at 07:00 AM																					
07:00 AM	0	0	0	0	0	0	0	0	0	0	0	0	0	0	0	0	0	0	0	0	0
07:15 AM	0	0	0	0	0	0	0	0	0	0	0	0	0	0	0	0	0	0	0	0	0
07:30 AM	0	0	0	0	0	0	0	0	0	0	0	0	0	0	0	0	0	0	0	0	0
07:45 AM	0	0	0	0	0	0	0	0	0	0	0	0	0	0	0	0	0	0	0	0	0
Total Volume	0	0	0	0	0	0	0	0	0	0	0	0	0	0	0	0	0	0	0	0	0
% App. Total	0	0	0	0		0	0	0	0		0	0	0	0		0	0	0	0		
PHF	.000	.000	.000	.000	.000	.000	.000	.000	.000	.000	.000	.000	.000	.000	.000	.000	.000	.000	.000	.000	.000

Traffic Data Service

San Jose, CA
(408) 622-4787
tdsbay@cs.com

File Name : 23AM FINAL
Site Code : 00000023
Start Date : 4/27/2017
Page No : 2

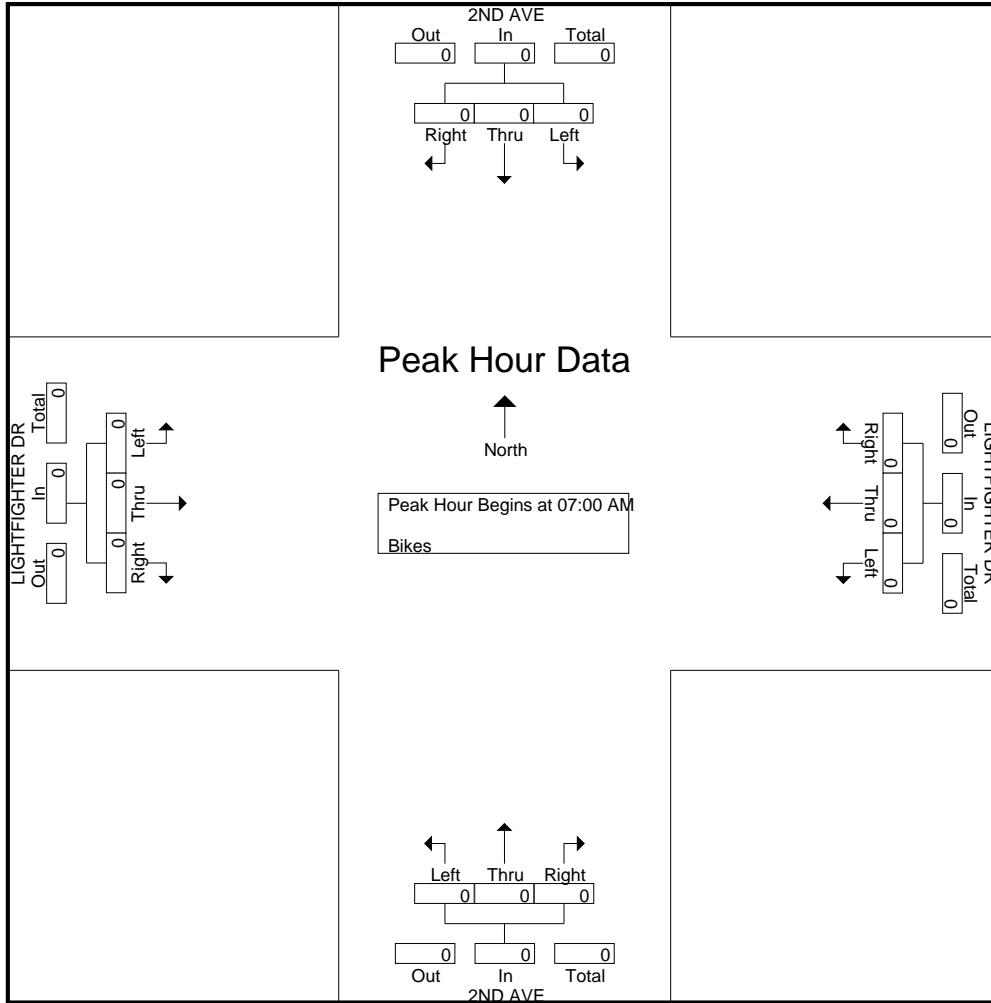

Traffic Data Service

San Jose, CA
 (408) 622-4787
 tdsbay@cs.com

File Name : 23PM FINAL
 Site Code : 00000023
 Start Date : 4/27/2017
 Page No : 1

Groups Printed- Lights - Buses - Trucks

Start Time	2ND AVE Southbound					LIGHTFIGHTER DR Westbound					2ND AVE Northbound					LIGHTFIGHTER DR Eastbound					Int. Total
	Right	Thru	Left	Peds	App. Total	Right	Thru	Left	Peds	App. Total	Right	Thru	Left	Peds	App. Total	Right	Thru	Left	Peds	App. Total	
04:00 PM	21	0	16	0	37	16	188	1	0	205	2	1	0	4	7	0	80	16	2	98	347
04:15 PM	16	0	25	0	41	17	147	0	0	164	2	0	4	0	6	1	79	33	0	113	324
04:30 PM	21	1	20	0	42	24	212	0	0	236	3	1	2	0	6	0	67	40	0	107	391
04:45 PM	21	3	27	0	51	30	238	1	0	269	3	0	1	1	5	1	79	30	2	112	437
Total	79	4	88	0	171	87	785	2	0	874	10	2	7	5	24	2	305	119	4	430	1499
05:00 PM	43	0	11	0	54	33	192	0	0	225	1	0	0	0	1	0	86	42	0	128	408
05:15 PM	28	1	20	0	49	39	226	1	0	266	1	0	2	1	4	0	90	33	2	125	444
05:30 PM	46	0	21	0	67	32	157	0	0	189	0	1	1	0	2	0	101	32	0	133	391
05:45 PM	38	0	27	0	65	31	148	0	1	180	0	1	3	0	4	0	96	34	1	131	380
Total	155	1	79	0	235	135	723	1	1	860	2	2	6	1	11	0	373	141	3	517	1623
Grand Total	234	5	167	0	406	222	1508	3	1	1734	12	4	13	6	35	2	678	260	7	947	3122
Apprch %	57.6	1.2	41.1	0		12.8	87	0.2	0.1		34.3	11.4	37.1	17.1		0.2	71.6	27.5	0.7		
Total %	7.5	0.2	5.3	0	13	7.1	48.3	0.1	0	55.5	0.4	0.1	0.4	0.2	1.1	0.1	21.7	8.3	0.2	30.3	
Lights	231	5	165	0	401	220	1496	3	0	1719	12	4	13	6	35	2	665	256	7	930	3085
% Lights	98.7	100	98.8	0	98.8	99.1	99.2	100	0	99.1	100	100	100	100	100	100	98.1	98.5	100	98.2	98.8
Buses	2	0	2	0	4	1	4	0	0	5	0	0	0	0	0	0	9	1	0	10	19
% Buses	0.9	0	1.2	0	1	0.5	0.3	0	0	0.3	0	0	0	0	0	0	1.3	0.4	0	1.1	0.6
Trucks	1	0	0	0	1	1	8	0	1	10	0	0	0	0	0	0	4	3	0	7	18
% Trucks	0.4	0	0	0	0.2	0.5	0.5	0	100	0.6	0	0	0	0	0	0	0.6	1.2	0	0.7	0.6

Start Time	2ND AVE Southbound				LIGHTFIGHTER DR Westbound				2ND AVE Northbound				LIGHTFIGHTER DR Eastbound				Int. Total
	Right	Thru	Left	App. Total	Right	Thru	Left	App. Total	Right	Thru	Left	App. Total	Right	Thru	Left	App. Total	
Peak Hour Analysis From 04:00 PM to 05:45 PM - Peak 1 of 1																	
Peak Hour for Entire Intersection Begins at 04:30 PM																	
04:30 PM	21	1	20	42	24	212	0	236	3	1	2	6	0	67	40	107	391
04:45 PM	21	3	27	51	30	238	1	269	3	0	1	4	1	79	30	110	434
05:00 PM	43	0	11	54	33	192	0	225	1	0	0	1	0	86	42	128	408
05:15 PM	28	1	20	49	39	226	1	266	1	0	2	3	0	90	33	123	441
Total Volume	113	5	78	196	126	868	2	996	8	1	5	14	1	322	145	468	1674
% App. Total	57.7	2.6	39.8		12.7	87.1	0.2		57.1	7.1	35.7		0.2	68.8	31		
PHF	.657	.417	.722	.907	.808	.912	.500	.926	.667	.250	.625	.583	.250	.894	.863	.914	.949

Traffic Data Service

San Jose, CA
 (408) 622-4787
 tdsbay@cs.com

File Name : 23PM FINAL
 Site Code : 00000023
 Start Date : 4/27/2017
 Page No : 2

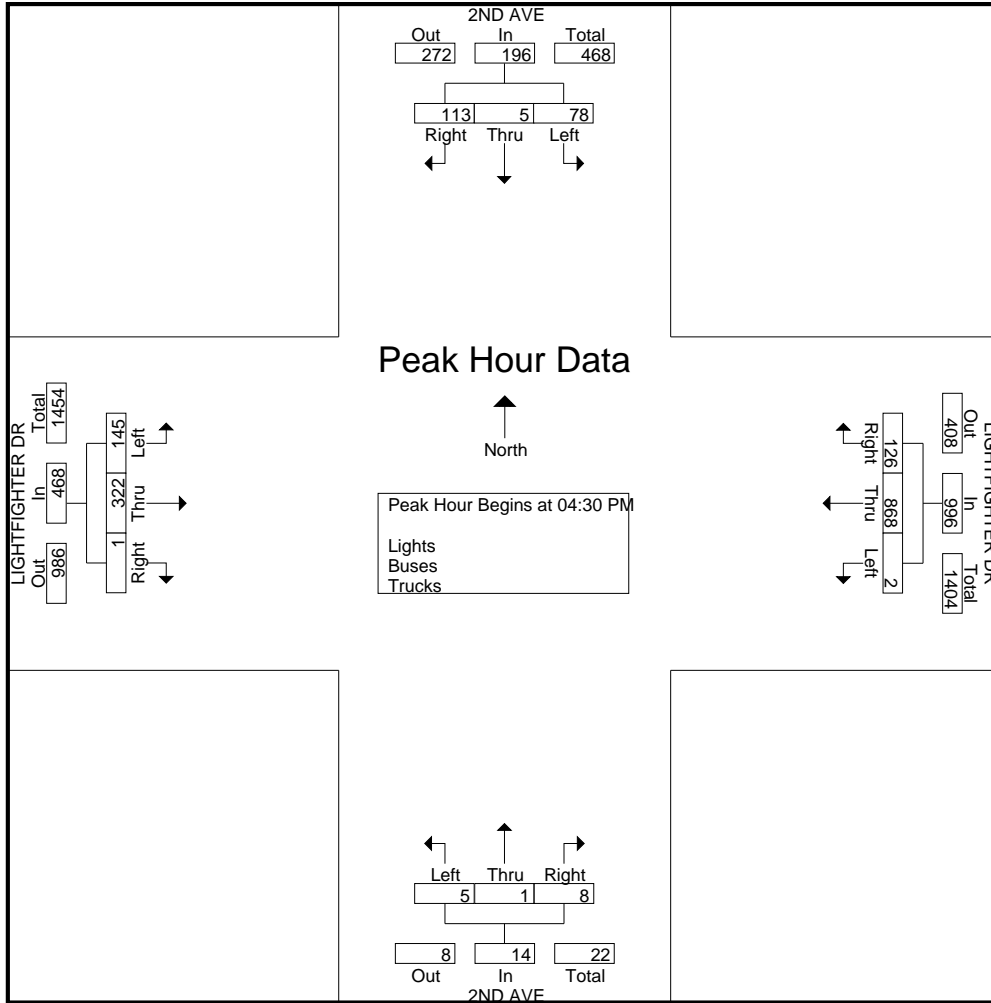

Traffic Data Service

San Jose, CA
 (408) 622-4787
 tdsbay@cs.com

File Name : 23PM FINAL
 Site Code : 00000023
 Start Date : 4/27/2017
 Page No : 1

Groups Printed- Bikes

Start Time	2ND AVE Southbound					LIGHTFIGHTER DR Westbound					2ND AVE Northbound					LIGHTFIGHTER DR Eastbound					Int. Total
	Right	Thru	Left	Peds	App. Total	Right	Thru	Left	Peds	App. Total	Right	Thru	Left	Peds	App. Total	Right	Thru	Left	Peds	App. Total	
04:00 PM	0	0	0	0	0	0	0	0	0	0	0	0	0	0	0	0	0	0	0	0	0
04:15 PM	0	0	0	0	0	0	0	0	0	0	0	0	0	0	0	0	0	0	0	0	0
04:30 PM	0	0	0	0	0	0	0	0	0	0	0	0	0	0	0	0	0	0	0	0	0
04:45 PM	0	0	0	0	0	0	0	0	0	0	0	0	0	0	0	0	0	0	0	0	0
Total	0	0	0	0	0	0	0	0	0	0	0	0	0	0	0	0	0	0	0	0	0
05:00 PM	0	1	0	0	1	0	0	0	0	0	0	0	0	0	0	0	0	0	0	0	1
05:15 PM	0	0	0	0	0	0	0	0	0	0	0	0	0	0	0	0	0	0	0	0	0
05:30 PM	0	0	0	0	0	0	0	0	0	0	0	0	0	0	0	0	0	0	0	0	0
05:45 PM	0	0	0	0	0	0	0	0	0	0	0	0	0	0	0	0	0	0	0	0	0
Total	0	1	0	0	1	0	0	0	0	0	0	0	0	0	0	0	0	0	0	0	1
Grand Total	0	1	0	0	1	0	0	0	0	0	0	0	0	0	0	0	0	0	0	0	1
Apprch %	0	100	0	0		0	0	0	0		0	0	0	0		0	0	0	0		
Total %	0	100	0	0	100	0	0	0	0	0	0	0	0	0	0	0	0	0	0	0	

Start Time	2ND AVE Southbound					LIGHTFIGHTER DR Westbound					2ND AVE Northbound					LIGHTFIGHTER DR Eastbound					Int. Total
	Right	Thru	Left	Peds	App. Total	Right	Thru	Left	Peds	App. Total	Right	Thru	Left	Peds	App. Total	Right	Thru	Left	Peds	App. Total	
Peak Hour Analysis From 04:00 PM to 05:45 PM - Peak 1 of 1																					
Peak Hour for Entire Intersection Begins at 04:15 PM																					
04:15 PM	0	0	0	0	0	0	0	0	0	0	0	0	0	0	0	0	0	0	0	0	0
04:30 PM	0	0	0	0	0	0	0	0	0	0	0	0	0	0	0	0	0	0	0	0	0
04:45 PM	0	0	0	0	0	0	0	0	0	0	0	0	0	0	0	0	0	0	0	0	0
05:00 PM	0	1	0	0	1	0	0	0	0	0	0	0	0	0	0	0	0	0	0	0	1
Total Volume	0	1	0	0	1	0	0	0	0	0	0	0	0	0	0	0	0	0	0	0	1
% App. Total	0	100	0	0		0	0	0	0		0	0	0	0		0	0	0	0		
PHF	.000	.250	.000	.000	.250	.000	.000	.000	.000	.000	.000	.000	.000	.000	.000	.000	.000	.000	.000	.000	.250

Traffic Data Service

San Jose, CA
(408) 622-4787
tdsbay@cs.com

File Name : 23PM FINAL
Site Code : 00000023
Start Date : 4/27/2017
Page No : 2

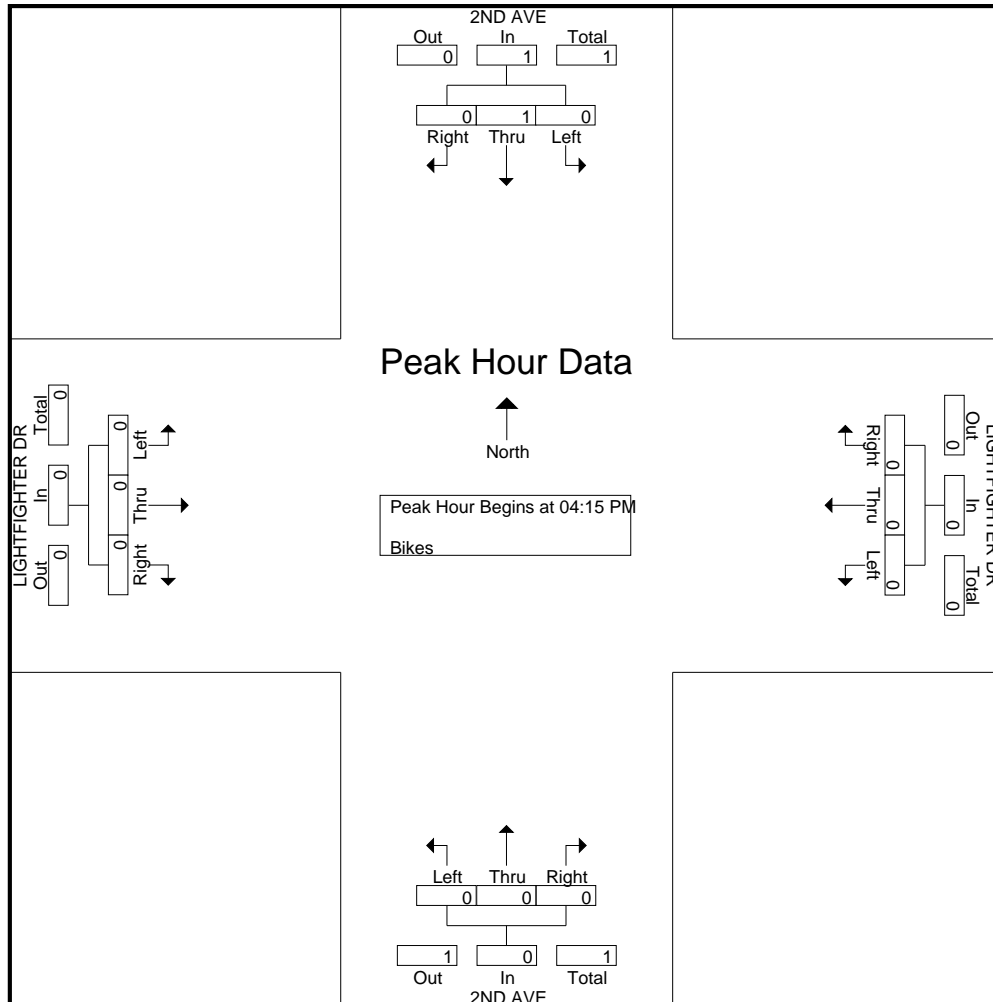

Traffic Data Service

San Jose, CA
(408) 622-4787
tdsbay@cs.com

File Name : 24AM FINAL
Site Code : 00000024
Start Date : 4/27/2017
Page No : 1

Groups Printed- Lights - Buses - Trucks

Start Time	GENERAL JIM MOORE BLVD Southbound					LIGHTFIGHTER DR Westbound					GENERAL JIM MOORE BLVD Northbound					LIGHTFIGHTER DR Eastbound					Int. Total
	Right	Thru	Left	Peds	App. Total	Right	Thru	Left	Peds	App. Total	Right	Thru	Left	Peds	App. Total	Right	Thru	Left	Peds	App. Total	
07:00 AM	6	11	0	0	17	0	71	9	0	80	0	3	32	0	35	92	19	10	0	121	253
07:15 AM	15	43	2	0	60	1	59	5	0	65	0	14	42	0	56	189	27	9	0	225	406
07:30 AM	23	74	0	0	97	2	62	12	0	76	0	21	64	0	85	180	32	24	0	236	494
07:45 AM	11	33	0	2	46	1	39	4	2	46	2	27	67	0	96	188	36	52	1	277	465
Total	55	161	2	2	220	4	231	30	2	267	2	65	205	0	272	649	114	95	1	859	1618
08:00 AM	10	29	8	0	47	6	27	0	0	33	0	28	77	0	105	153	32	38	0	223	408
08:15 AM	5	26	1	0	32	2	21	2	0	25	1	28	42	0	71	128	29	32	0	189	317
08:30 AM	3	19	1	2	25	3	24	1	2	30	0	28	34	0	62	91	18	31	0	140	257
08:45 AM	16	15	2	3	36	5	14	5	1	25	1	26	28	0	55	92	27	39	0	158	274
Total	34	89	12	5	140	16	86	8	3	113	2	110	181	0	293	464	106	140	0	710	1256
Grand Total	89	250	14	7	360	20	317	38	5	380	4	175	386	0	565	1113	220	235	1	1569	2874
Apprch %	24.7	69.4	3.9	1.9		5.3	83.4	10	1.3		0.7	31	68.3	0		70.9	14	15	0.1		
Total %	3.1	8.7	0.5	0.2	12.5	0.7	11	1.3	0.2	13.2	0.1	6.1	13.4	0	19.7	38.7	7.7	8.2	0	54.6	
Lights	87	244	14	7	352	19	300	37	5	361	4	171	377	0	552	1086	213	233	1	1533	2798
% Lights	97.8	97.6	100	100	97.8	95	94.6	97.4	100	95	100	97.7	97.7	0	97.7	97.6	96.8	99.1	100	97.7	97.4
Buses	1	4	0	0	5	0	1	0	0	1	0	2	7	0	9	12	3	0	0	15	30
% Buses	1.1	1.6	0	0	1.4	0	0.3	0	0	0.3	0	1.1	1.8	0	1.6	1.1	1.4	0	0	1	1
Trucks	1	2	0	0	3	1	16	1	0	18	0	2	2	0	4	15	4	2	0	21	46
% Trucks	1.1	0.8	0	0	0.8	5	5	2.6	0	4.7	0	1.1	0.5	0	0.7	1.3	1.8	0.9	0	1.3	1.6

Start Time	GENERAL JIM MOORE BLVD Southbound				LIGHTFIGHTER DR Westbound				GENERAL JIM MOORE BLVD Northbound				LIGHTFIGHTER DR Eastbound				Int. Total
	Right	Thru	Left	App. Total	Right	Thru	Left	App. Total	Right	Thru	Left	App. Total	Right	Thru	Left	App. Total	
Peak Hour Analysis From 07:00 AM to 08:45 AM - Peak 1 of 1																	
Peak Hour for Entire Intersection Begins at 07:15 AM																	
07:15 AM	15	43	2	60	1	59	5	65	0	14	42	56	189	27	9	225	406
07:30 AM	23	74	0	97	2	62	12	76	0	21	64	85	180	32	24	236	494
07:45 AM	11	33	0	44	1	39	4	44	2	27	67	96	188	36	52	276	460
08:00 AM	10	29	8	47	6	27	0	33	0	28	77	105	153	32	38	223	408
Total Volume	59	179	10	248	10	187	21	218	2	90	250	342	710	127	123	960	1768
% App. Total	23.8	72.2	4		4.6	85.8	9.6		0.6	26.3	73.1		74	13.2	12.8		
PHF	.641	.605	.313	.639	.417	.754	.438	.717	.250	.804	.812	.814	.939	.882	.591	.870	.895

Traffic Data Service

San Jose, CA
 (408) 622-4787
 tdsbay@cs.com

File Name : 24AM FINAL
 Site Code : 00000024
 Start Date : 4/27/2017
 Page No : 2

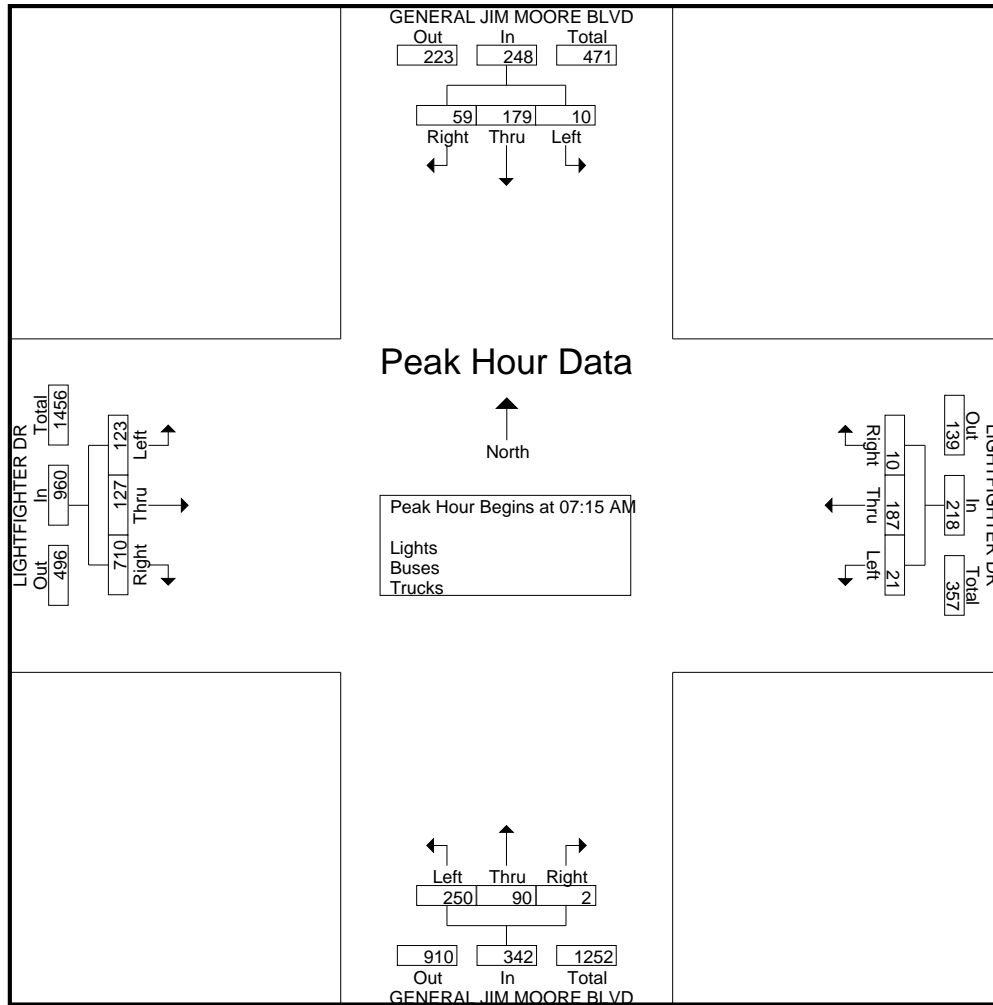

Traffic Data Service

San Jose, CA
 (408) 622-4787
 tdsbay@cs.com

File Name : 24AM FINAL
 Site Code : 00000024
 Start Date : 4/27/2017
 Page No : 1

Groups Printed- Bikes

Start Time	GENERAL JIM MOORE BLVD Southbound					LIGHTFIGHTER DR Westbound					GENERAL JIM MOORE BLVD Northbound					LIGHTFIGHTER DR Eastbound					Int. Total					
	Right	Thru	Left	Peds	App. Total	Right	Thru	Left	Peds	App. Total	Right	Thru	Left	Peds	App. Total	Right	Thru	Left	Peds	App. Total						
07:00 AM	0	0	0	0	0	0	0	0	0	0	0	0	0	0	0	0	0	0	0	0	0	0	0	0	0	0
07:15 AM	0	0	0	0	0	0	0	0	0	0	0	0	0	0	0	0	0	0	0	0	0	0	0	0	0	0
07:30 AM	0	0	0	0	0	0	0	0	0	0	0	0	0	0	0	0	0	0	0	0	0	0	0	0	0	0
07:45 AM	0	0	0	0	0	0	0	0	0	0	0	0	0	0	0	0	0	0	0	0	0	0	0	0	0	0
Total	0	0	0	0	0	0	0	0	0	0	0	0	0	0	0	0	0	0	0	0	0	0	0	0	0	0
08:00 AM	0	0	0	0	0	0	0	0	0	0	0	2	0	0	2	0	0	0	0	0	0	0	0	0	2	2
08:15 AM	0	0	0	0	0	0	0	0	0	0	0	0	0	0	0	0	0	0	0	0	0	0	0	0	0	0
08:30 AM	0	0	0	0	0	0	0	0	0	0	0	0	0	0	0	0	0	0	0	0	0	0	0	0	0	0
08:45 AM	0	0	0	0	0	0	0	0	0	0	0	0	0	0	0	0	0	0	0	0	0	0	0	0	0	0
Total	0	0	0	0	0	0	0	0	0	0	0	2	0	0	2	0	0	0	0	0	0	0	0	0	2	2
Grand Total	0	0	0	0	0	0	0	0	0	0	0	2	0	0	2	0	0	0	0	0	0	0	0	0	2	2
Apprch %	0	0	0	0		0	0	0	0		0	100	0	0		0	0	0	0		0	0	0	0		
Total %	0	0	0	0		0	0	0	0		0	100	0	0	100	0	0	0	0		0	0	0	0		

Start Time	GENERAL JIM MOORE BLVD Southbound					LIGHTFIGHTER DR Westbound					GENERAL JIM MOORE BLVD Northbound					LIGHTFIGHTER DR Eastbound					Int. Total					
	Right	Thru	Left	Peds	App. Total	Right	Thru	Left	Peds	App. Total	Right	Thru	Left	Peds	App. Total	Right	Thru	Left	Peds	App. Total						
Peak Hour Analysis From 07:00 AM to 08:45 AM - Peak 1 of 1																										
Peak Hour for Entire Intersection Begins at 07:15 AM																										
07:15 AM	0	0	0	0	0	0	0	0	0	0	0	0	0	0	0	0	0	0	0	0	0	0	0	0	0	0
07:30 AM	0	0	0	0	0	0	0	0	0	0	0	0	0	0	0	0	0	0	0	0	0	0	0	0	0	0
07:45 AM	0	0	0	0	0	0	0	0	0	0	0	0	0	0	0	0	0	0	0	0	0	0	0	0	0	0
08:00 AM	0	0	0	0	0	0	0	0	0	0	0	2	0	0	2	0	0	0	0	0	0	0	0	0	2	2
Total Volume	0	0	0	0	0	0	0	0	0	0	0	2	0	0	2	0	0	0	0	0	0	0	0	0	2	2
% App. Total	0	0	0	0		0	0	0	0		0	100	0	0		0	0	0	0		0	0	0	0		
PHF	.000	.000	.000	.000		.000	.000	.000	.000		.000	.250	.000	.250		.000	.000	.000	.000		.000	.000	.000	.000		.250

Traffic Data Service

San Jose, CA
 (408) 622-4787
 tdsbay@cs.com

File Name : 24AM FINAL
 Site Code : 00000024
 Start Date : 4/27/2017
 Page No : 2

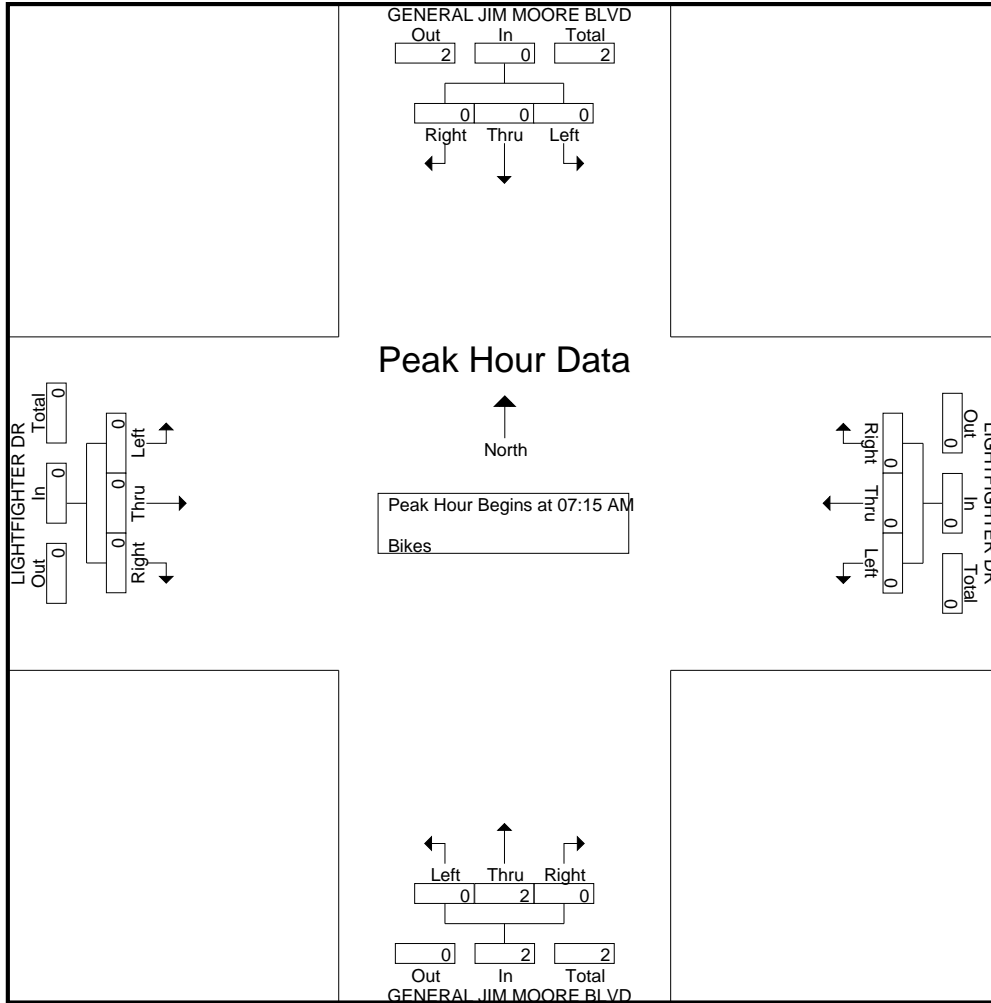

Traffic Data Service

San Jose, CA
(408) 622-4787
tdsbay@cs.com

File Name : 24PM FINAL
Site Code : 00000024
Start Date : 4/27/2017
Page No : 1

Groups Printed- Lights - Buses - Trucks

Start Time	GENERAL JIM MOORE BLVD Southbound					LIGHTFIGHTER DR Westbound					GENERAL JIM MOORE BLVD Northbound					LIGHTFIGHTER DR Eastbound					Int. Total
	Right	Thru	Left	Peds	App. Total	Right	Thru	Left	Peds	App. Total	Right	Thru	Left	Peds	App. Total	Right	Thru	Left	Peds	App. Total	
04:00 PM	44	24	8	0	76	5	36	0	0	41	3	33	106	1	143	60	22	15	0	97	357
04:15 PM	23	16	4	0	43	0	28	0	0	28	2	29	113	0	144	66	33	11	0	110	325
04:30 PM	33	26	2	0	61	3	50	4	0	57	2	21	163	0	186	53	28	13	0	94	398
04:45 PM	30	17	2	0	49	0	61	3	0	64	2	27	175	0	204	55	26	14	0	95	412
Total	130	83	16	0	229	8	175	7	0	190	9	110	557	1	677	234	109	53	0	396	1492
05:00 PM	37	23	1	0	61	4	37	0	0	41	1	36	151	0	188	45	42	17	0	104	394
05:15 PM	37	20	2	0	59	0	65	1	0	66	2	24	160	0	186	47	42	22	0	111	422
05:30 PM	37	13	2	0	52	3	19	0	0	22	1	29	127	0	157	51	45	26	1	123	354
05:45 PM	40	22	3	0	65	3	30	2	0	35	1	27	108	0	136	64	29	23	2	118	354
Total	151	78	8	0	237	10	151	3	0	164	5	116	546	0	667	207	158	88	3	456	1524
Grand Total	281	161	24	0	466	18	326	10	0	354	14	226	1103	1	1344	441	267	141	3	852	3016
Apprch %	60.3	34.5	5.2	0		5.1	92.1	2.8	0		1	16.8	82.1	0.1		51.8	31.3	16.5	0.4		
Total %	9.3	5.3	0.8	0	15.5	0.6	10.8	0.3	0	11.7	0.5	7.5	36.6	0	44.6	14.6	8.9	4.7	0.1	28.2	
Lights	279	159	23	0	461	18	325	10	0	353	14	223	1097	1	1335	429	265	140	0	834	2983
% Lights	99.3	98.8	95.8	0	98.9	100	99.7	100	0	99.7	100	98.7	99.5	100	99.3	97.3	99.3	99.3	0	97.9	98.9
Buses	1	2	0	0	3	0	0	0	0	0	0	3	3	0	6	8	2	1	0	11	20
% Buses	0.4	1.2	0	0	0.6	0	0	0	0	0	0	1.3	0.3	0	0.4	1.8	0.7	0.7	0	1.3	0.7
Trucks	1	0	1	0	2	0	1	0	0	1	0	0	3	0	3	4	0	0	3	7	13
% Trucks	0.4	0	4.2	0	0.4	0	0.3	0	0	0.3	0	0	0.3	0	0.2	0.9	0	0	100	0.8	0.4

Start Time	GENERAL JIM MOORE BLVD Southbound					LIGHTFIGHTER DR Westbound					GENERAL JIM MOORE BLVD Northbound					LIGHTFIGHTER DR Eastbound					Int. Total
	Right	Thru	Left	Peds	App. Total	Right	Thru	Left	Peds	App. Total	Right	Thru	Left	Peds	App. Total	Right	Thru	Left	Peds	App. Total	
Peak Hour Analysis From 04:00 PM to 05:45 PM - Peak 1 of 1																					
Peak Hour for Entire Intersection Begins at 04:30 PM																					
04:30 PM	33	26	2	61		3	50	4	57		2	21	163	186		53	28	13	94	398	
04:45 PM	30	17	2	49		0	61	3	64		2	27	175	204		55	26	14	95	412	
05:00 PM	37	23	1	61		4	37	0	41		1	36	151	188		45	42	17	104	394	
05:15 PM	37	20	2	59		0	65	1	66		2	24	160	186		47	42	22	111	422	
Total Volume	137	86	7	230		7	213	8	228		7	108	649	764		200	138	66	404	1626	
% App. Total	59.6	37.4	3			3.1	93.4	3.5			0.9	14.1	84.9			49.5	34.2	16.3			
PHF	.926	.827	.875	.943		.438	.819	.500	.864		.875	.750	.927	.936		.909	.821	.750	.910	.963	

Traffic Data Service

San Jose, CA
 (408) 622-4787
 tdsbay@cs.com

File Name : 24PM FINAL
 Site Code : 00000024
 Start Date : 4/27/2017
 Page No : 2

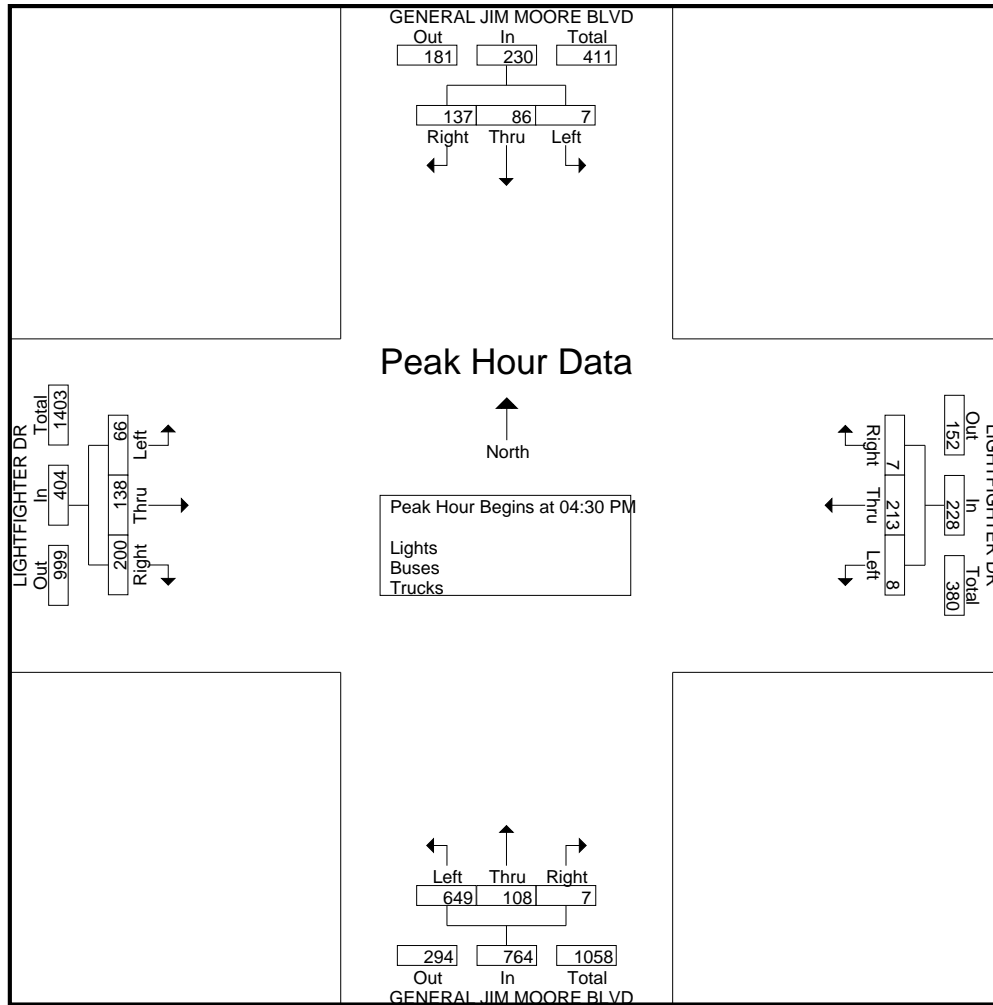

Traffic Data Service

San Jose, CA
 (408) 622-4787
 tdsbay@cs.com

File Name : 24PM FINAL
 Site Code : 00000024
 Start Date : 4/27/2017
 Page No : 1

Groups Printed- Bikes

Start Time	GENERAL JIM MOORE BLVD Southbound					LIGHTFIGHTER DR Westbound					GENERAL JIM MOORE BLVD Northbound					LIGHTFIGHTER DR Eastbound					Int. Total	
	Right	Thru	Left	Peds	App. Total	Right	Thru	Left	Peds	App. Total	Right	Thru	Left	Peds	App. Total	Right	Thru	Left	Peds	App. Total		
04:00 PM	0	1	0	0	1	0	0	0	0	0	0	0	1	0	1	0	0	0	0	0	0	2
04:15 PM	0	0	0	0	0	0	0	0	0	0	0	1	0	0	1	0	0	0	0	0	0	1
04:30 PM	0	0	0	0	0	0	0	0	0	0	0	0	0	0	0	0	0	0	0	0	0	0
04:45 PM	0	0	0	0	0	0	0	0	0	0	0	0	0	0	0	1	0	0	0	0	0	1
Total	0	1	0	0	1	0	0	0	0	0	0	1	1	0	2	1	0	0	0	0	1	4
05:00 PM	0	0	0	0	0	0	0	0	0	0	0	0	0	0	0	0	0	0	0	0	0	0
05:15 PM	0	0	0	0	0	0	0	0	0	0	0	0	0	0	0	0	0	0	0	0	0	0
05:30 PM	0	0	0	0	0	0	0	0	0	0	0	1	0	0	1	0	0	0	0	0	0	1
05:45 PM	0	0	0	0	0	1	0	0	0	1	0	0	0	0	0	0	0	0	0	0	0	1
Total	0	0	0	0	0	1	0	0	0	1	0	1	0	0	1	0	0	0	0	0	0	2
Grand Total	0	1	0	0	1	1	0	0	0	1	0	2	1	0	3	1	0	0	0	0	1	6
Apprch %	0	100	0	0		100	0	0	0		0	66.7	33.3	0		100	0	0	0			
Total %	0	16.7	0	0	16.7	16.7	0	0	0	16.7	0	33.3	16.7	0	50	16.7	0	0	0	16.7		

Start Time	GENERAL JIM MOORE BLVD Southbound					LIGHTFIGHTER DR Westbound					GENERAL JIM MOORE BLVD Northbound					LIGHTFIGHTER DR Eastbound					Int. Total
	Right	Thru	Left	Peds	App. Total	Right	Thru	Left	Peds	App. Total	Right	Thru	Left	Peds	App. Total	Right	Thru	Left	Peds	App. Total	
Peak Hour Analysis From 04:00 PM to 05:45 PM - Peak 1 of 1																					
Peak Hour for Entire Intersection Begins at 04:00 PM																					
04:00 PM	0	1	0	0	1	0	0	0	0	0	0	0	1	1	0	0	0	0	0	0	2
04:15 PM	0	0	0	0	0	0	0	0	0	0	0	1	0	1	0	0	0	0	0	0	1
04:30 PM	0	0	0	0	0	0	0	0	0	0	0	0	0	0	0	0	0	0	0	0	0
04:45 PM	0	0	0	0	0	0	0	0	0	0	0	0	0	0	1	0	0	0	0	1	1
Total Volume	0	1	0	0	1	0	0	0	0	0	0	1	1	2	1	0	0	0	0	1	4
% App. Total	0	100	0	0		0	0	0	0		0	50	50		100	0	0	0			
PHF	.000	.250	.000	.000	.250	.000	.000	.000	.000	.000	.000	.250	.250	.500	.250	.000	.000	.000	.250	.250	.500

Traffic Data Service

San Jose, CA
 (408) 622-4787
 tdsbay@cs.com

File Name : 24PM FINAL
 Site Code : 00000024
 Start Date : 4/27/2017
 Page No : 2

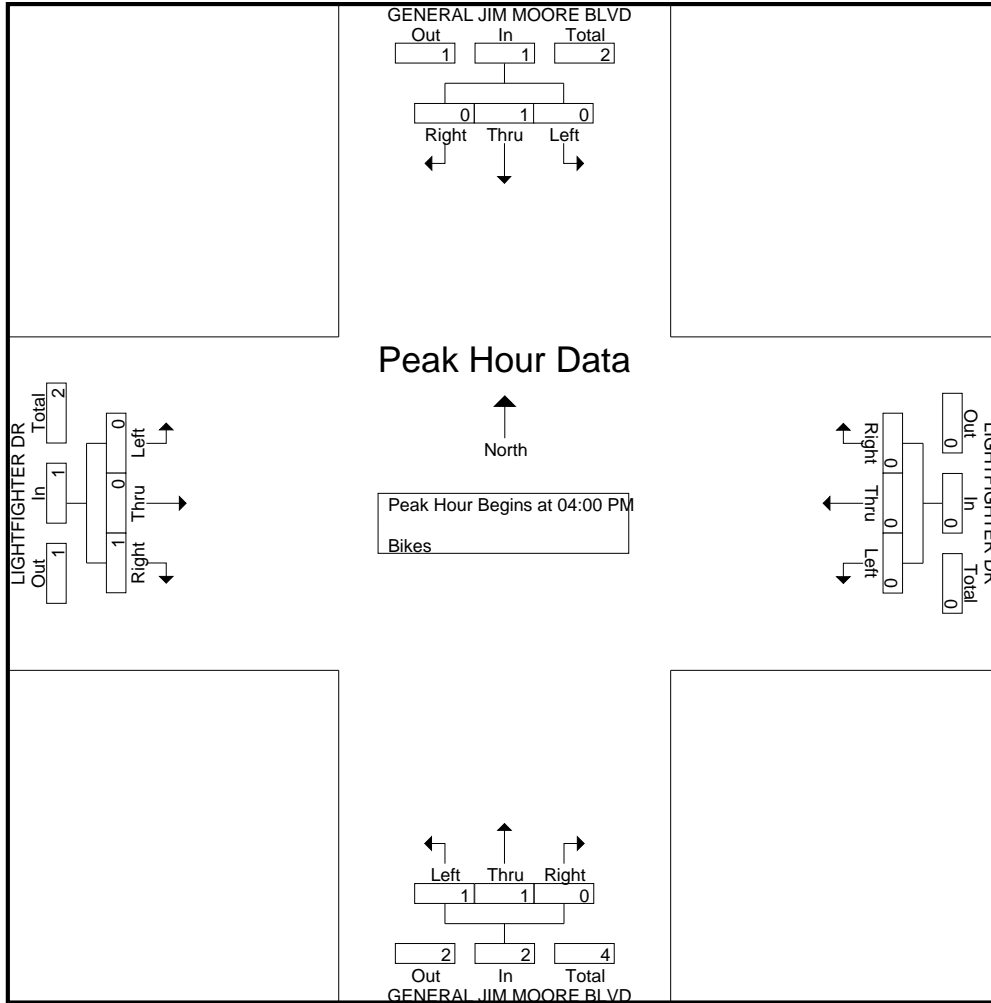

Traffic Data Service

San Jose, CA
 (408) 622-4787
 tdsbay@cs.com

File Name : 25AM FINAL
 Site Code : 00000025
 Start Date : 4/27/2017
 Page No : 1

Groups Printed- Lights - Buses - Trucks

Start Time	GENERAL JIM MOORE BLVD Southbound					GIGLING RD Westbound					GENERAL JIM MOORE BLVD Northbound					GIGLING RD Eastbound					Int. Total
	Right	Thru	Left	Peds	App. Total	Right	Thru	Left	Peds	App. Total	Right	Thru	Left	Peds	App. Total	Right	Thru	Left	Peds	App. Total	
07:00 AM	4	65	28	0	97	8	1	57	0	66	14	21	1	1	37	2	4	5	0	11	211
07:15 AM	7	180	39	0	226	7	5	107	0	119	23	58	3	0	84	10	9	3	0	22	451
07:30 AM	12	217	41	0	270	9	9	107	0	125	45	92	10	0	147	29	29	2	0	60	602
07:45 AM	16	176	42	0	234	16	14	92	0	122	65	78	22	0	165	31	41	9	0	81	602
Total	39	638	150	0	827	40	29	363	0	432	147	249	36	1	433	72	83	19	0	174	1866
08:00 AM	11	144	40	0	195	14	3	55	0	72	45	89	12	1	147	5	15	8	0	28	442
08:15 AM	12	134	26	0	172	9	2	44	0	55	24	65	5	1	95	13	14	4	0	31	353
08:30 AM	6	96	28	0	130	17	4	46	0	67	12	46	8	0	66	23	22	4	0	49	312
08:45 AM	9	69	29	0	107	5	2	37	0	44	27	56	8	1	92	8	21	3	0	32	275
Total	38	443	123	0	604	45	11	182	0	238	108	256	33	3	400	49	72	19	0	140	1382
Grand Total	77	1081	273	0	1431	85	40	545	0	670	255	505	69	4	833	121	155	38	0	314	3248
Apprch %	5.4	75.5	19.1	0		12.7	6	81.3	0		30.6	60.6	8.3	0.5		38.5	49.4	12.1	0		
Total %	2.4	33.3	8.4	0	44.1	2.6	1.2	16.8	0	20.6	7.9	15.5	2.1	0.1	25.6	3.7	4.8	1.2	0	9.7	
Lights	73	1060	265	0	1398	79	39	539	0	657	250	504	67	4	825	117	147	34	0	298	3178
% Lights	94.8	98.1	97.1	0	97.7	92.9	97.5	98.9	0	98.1	98	99.8	97.1	100	99	96.7	94.8	89.5	0	94.9	97.8
Buses	2	6	8	0	16	2	1	3	0	6	2	0	0	0	2	3	7	4	0	14	38
% Buses	2.6	0.6	2.9	0	1.1	2.4	2.5	0.6	0	0.9	0.8	0	0	0	0.2	2.5	4.5	10.5	0	4.5	1.2
Trucks	2	15	0	0	17	4	0	3	0	7	3	1	2	0	6	1	1	0	0	2	32
% Trucks	2.6	1.4	0	0	1.2	4.7	0	0.6	0	1	1.2	0.2	2.9	0	0.7	0.8	0.6	0	0	0.6	1

Start Time	GENERAL JIM MOORE BLVD Southbound					GIGLING RD Westbound					GENERAL JIM MOORE BLVD Northbound					GIGLING RD Eastbound					Int. Total
	Right	Thru	Left	Peds	App. Total	Right	Thru	Left	Peds	App. Total	Right	Thru	Left	Peds	App. Total	Right	Thru	Left	Peds	App. Total	
Peak Hour Analysis From 07:00 AM to 08:45 AM - Peak 1 of 1																					
Peak Hour for Entire Intersection Begins at 07:15 AM																					
07:15 AM	7	180	39		226	7	5	107		119	23	58	3		84	10	9	3		22	451
07:30 AM	12	217	41		270	9	9	107		125	45	92	10		147	29	29	2		60	602
07:45 AM	16	176	42		234	16	14	92		122	65	78	22		165	31	41	9		81	602
08:00 AM	11	144	40		195	14	3	55		72	45	89	12		146	5	15	8		28	441
Total Volume	46	717	162		925	46	31	361		438	178	317	47		542	75	94	22		191	2096
% App. Total	5	77.5	17.5			10.5	7.1	82.4			32.8	58.5	8.7			39.3	49.2	11.5			
PHF	.719	.826	.964		.856	.719	.554	.843		.876	.685	.861	.534		.821	.605	.573	.611		.590	.870

Traffic Data Service

San Jose, CA
 (408) 622-4787
 tdsbay@cs.com

File Name : 25AM FINAL
 Site Code : 00000025
 Start Date : 4/27/2017
 Page No : 2

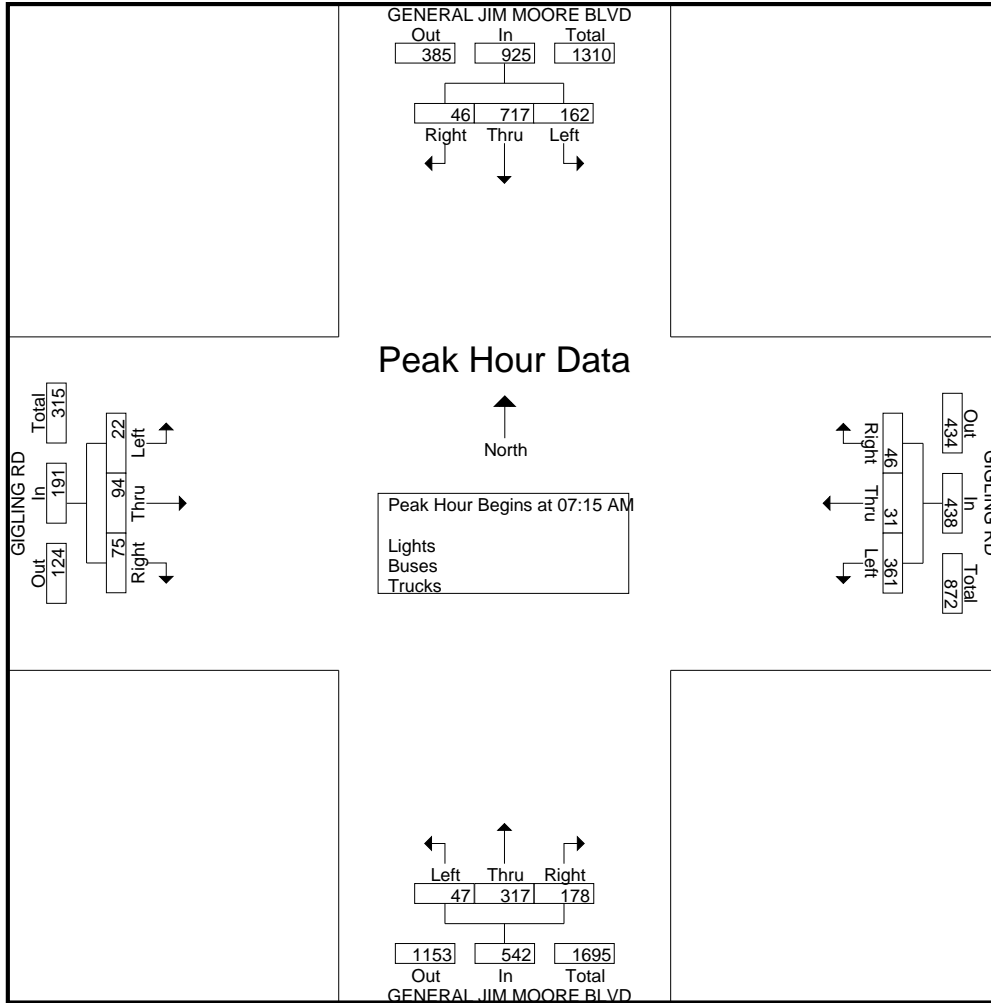

Traffic Data Service

San Jose, CA
 (408) 622-4787
 tdsbay@cs.com

File Name : 25AM FINAL
 Site Code : 00000025
 Start Date : 4/27/2017
 Page No : 1

Groups Printed- Bikes

Start Time	GENERAL JIM MOORE BLVD Southbound					GIGLING RD Westbound					GENERAL JIM MOORE BLVD Northbound					GIGLING RD Eastbound					Int. Total					
	Right	Thru	Left	Peds	App. Total	Right	Thru	Left	Peds	App. Total	Right	Thru	Left	Peds	App. Total	Right	Thru	Left	Peds	App. Total						
07:00 AM	0	0	0	0	0	0	0	0	0	0	0	0	0	0	0	0	0	0	0	0	0	0	0	0	0	0
07:15 AM	0	0	0	0	0	0	0	0	0	0	0	0	0	0	0	0	0	0	0	0	0	0	0	0	0	0
07:30 AM	0	0	0	0	0	0	0	0	0	0	0	0	0	0	0	0	0	0	0	0	0	0	0	0	0	0
07:45 AM	0	0	0	0	0	0	0	0	0	0	0	1	0	0	1	0	0	0	0	0	0	0	0	0	0	1
Total	0	0	0	0	0	0	0	0	0	0	0	1	0	0	1	0	0	0	0	0	0	0	0	0	0	1
08:00 AM	0	0	0	0	0	0	0	0	0	0	0	1	0	0	1	0	0	0	0	0	0	0	0	0	0	1
08:15 AM	0	0	0	0	0	0	0	0	0	0	0	0	0	0	0	0	0	0	0	0	0	0	0	0	0	0
08:30 AM	0	0	0	0	0	0	0	0	0	0	0	0	0	0	0	0	0	0	0	0	0	0	0	0	0	0
08:45 AM	0	0	0	0	0	0	0	0	0	0	0	0	0	0	0	0	1	0	0	1	0	1	0	0	1	1
Total	0	0	0	0	0	0	0	0	0	0	0	1	0	0	1	0	1	0	0	1	0	1	0	0	1	2
Grand Total	0	0	0	0	0	0	0	0	0	0	0	2	0	0	2	0	1	0	0	1	0	1	0	0	1	3
Apprch %	0	0	0	0		0	0	0	0		0	100	0	0		0	100	0	0		0	100	0	0		
Total %	0	0	0	0	0	0	0	0	0	0	0	66.7	0	0	66.7	0	33.3	0	0	33.3	0	33.3	0	0	33.3	

Start Time	GENERAL JIM MOORE BLVD Southbound					GIGLING RD Westbound					GENERAL JIM MOORE BLVD Northbound					GIGLING RD Eastbound					Int. Total					
	Right	Thru	Left	Peds	App. Total	Right	Thru	Left	Peds	App. Total	Right	Thru	Left	Peds	App. Total	Right	Thru	Left	Peds	App. Total						
Peak Hour Analysis From 07:00 AM to 08:45 AM - Peak 1 of 1																										
Peak Hour for Entire Intersection Begins at 07:15 AM																										
07:15 AM	0	0	0	0	0	0	0	0	0	0	0	0	0	0	0	0	0	0	0	0	0	0	0	0	0	0
07:30 AM	0	0	0	0	0	0	0	0	0	0	0	0	0	0	0	0	0	0	0	0	0	0	0	0	0	0
07:45 AM	0	0	0	0	0	0	0	0	0	0	0	1	0	0	1	0	0	0	0	0	0	0	0	0	0	1
08:00 AM	0	0	0	0	0	0	0	0	0	0	0	1	0	0	1	0	0	0	0	0	0	0	0	0	0	1
Total Volume	0	0	0	0	0	0	0	0	0	0	0	2	0	0	2	0	0	0	0	0	0	0	0	0	0	2
% App. Total	0	0	0	0		0	0	0	0		0	100	0	0		0	0	0	0		0	0	0	0		
PHF	.000	.000	.000	.000	.000	.000	.000	.000	.000	.000	.000	.500	.000	.500		.000	.000	.000	.000	.000	.000	.000	.000	.000	.500	

Traffic Data Service

San Jose, CA
(408) 622-4787
tdsbay@cs.com

File Name : 25AM FINAL
Site Code : 00000025
Start Date : 4/27/2017
Page No : 2

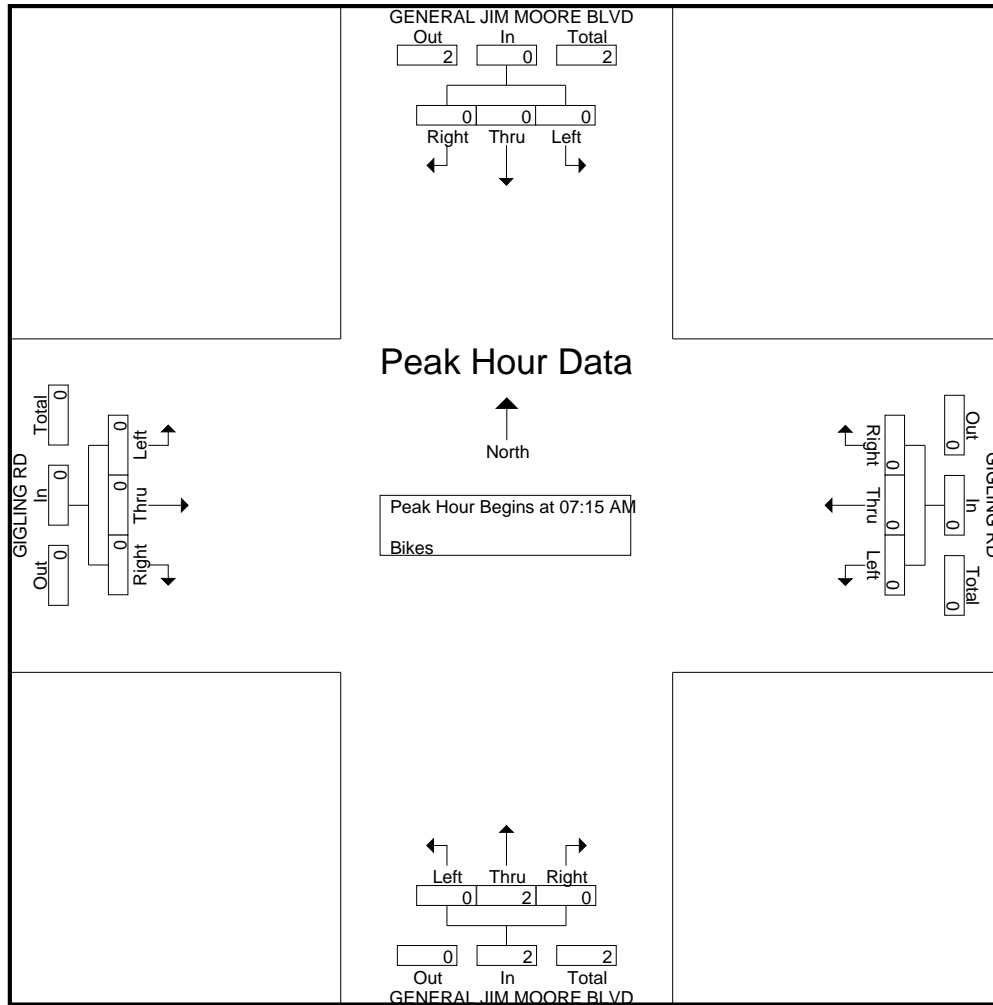

Traffic Data Service

San Jose, CA
 (408) 622-4787
 tdsbay@cs.com

File Name : 25PM FINAL
 Site Code : 00000025
 Start Date : 4/27/2017
 Page No : 1

Groups Printed- Lights - Buses - Trucks

Start Time	GENERAL JIM MOORE BLVD Southbound					GIGLING RD Westbound					GENERAL JIM MOORE BLVD Northbound					GIGLING RD Eastbound					Int. Total
	Right	Thru	Left	Peds	App. Total	Right	Thru	Left	Peds	App. Total	Right	Thru	Left	Peds	App. Total	Right	Thru	Left	Peds	App. Total	
04:00 PM	10	53	18	0	81	43	18	26	0	87	44	88	16	0	148	10	8	5	0	23	339
04:15 PM	16	61	19	2	98	38	14	39	0	91	64	97	12	0	173	10	5	7	1	23	385
04:30 PM	13	61	13	0	87	68	8	41	1	118	56	138	10	0	204	3	3	3	0	9	418
04:45 PM	17	62	21	0	100	67	16	55	0	138	79	133	18	0	230	11	7	6	1	25	493
Total	56	237	71	2	366	216	56	161	1	434	243	456	56	0	755	34	23	21	2	80	1635
05:00 PM	9	53	15	0	77	48	6	37	0	91	84	143	13	2	242	7	2	2	1	12	422
05:15 PM	7	58	18	0	83	35	12	34	0	81	89	140	16	0	245	6	0	7	0	13	422
05:30 PM	10	52	23	0	85	31	3	17	0	51	75	120	7	0	202	7	3	5	0	15	353
05:45 PM	13	58	17	0	88	28	1	19	0	48	57	109	10	0	176	5	1	6	0	12	324
Total	39	221	73	0	333	142	22	107	0	271	305	512	46	2	865	25	6	20	1	52	1521
Grand Total	95	458	144	2	699	358	78	268	1	705	548	968	102	2	1620	59	29	41	3	132	3156
Apprch %	13.6	65.5	20.6	0.3		50.8	11.1	38	0.1		33.8	59.8	6.3	0.1		44.7	22	31.1	2.3		
Total %	3	14.5	4.6	0.1	22.1	11.3	2.5	8.5	0	22.3	17.4	30.7	3.2	0.1	51.3	1.9	0.9	1.3	0.1	4.2	
Lights	93	453	137	2	685	353	76	267	1	697	532	966	102	2	1602	58	27	38	3	126	3110
% Lights	97.9	98.9	95.1	100	98	98.6	97.4	99.6	100	98.9	97.1	99.8	100	100	98.9	98.3	93.1	92.7	100	95.5	98.5
Buses	2	3	5	0	10	4	2	1	0	7	6	0	0	0	6	1	2	2	0	5	28
% Buses	2.1	0.7	3.5	0	1.4	1.1	2.6	0.4	0	1	1.1	0	0	0	0.4	1.7	6.9	4.9	0	3.8	0.9
Trucks	0	2	2	0	4	1	0	0	0	1	10	2	0	0	12	0	0	1	0	1	18
% Trucks	0	0.4	1.4	0	0.6	0.3	0	0	0	0.1	1.8	0.2	0	0	0.7	0	0	2.4	0	0.8	0.6

Start Time	GENERAL JIM MOORE BLVD Southbound					GIGLING RD Westbound					GENERAL JIM MOORE BLVD Northbound					GIGLING RD Eastbound					Int. Total
	Right	Thru	Left	Peds	App. Total	Right	Thru	Left	Peds	App. Total	Right	Thru	Left	Peds	App. Total	Right	Thru	Left	Peds	App. Total	
Peak Hour Analysis From 04:00 PM to 05:45 PM - Peak 1 of 1																					
Peak Hour for Entire Intersection Begins at 04:30 PM																					
04:30 PM	13	61	13		87	68	8	41		117	56	138	10		204	3	3	3		9	417
04:45 PM	17	62	21		100	67	16	55		138	79	133	18		230	11	7	6		24	492
05:00 PM	9	53	15		77	48	6	37		91	84	143	13		240	7	2	2		11	419
05:15 PM	7	58	18		83	35	12	34		81	89	140	16		245	6	0	7		13	422
Total Volume	46	234	67		347	218	42	167		427	308	554	57		919	27	12	18		57	1750
% App. Total	13.3	67.4	19.3			51.1	9.8	39.1			33.5	60.3	6.2			47.4	21.1	31.6			
PHF	.676	.944	.798		.868	.801	.656	.759		.774	.865	.969	.792		.938	.614	.429	.643		.594	.889

Traffic Data Service

San Jose, CA
 (408) 622-4787
 tdsbay@cs.com

File Name : 25PM FINAL
 Site Code : 00000025
 Start Date : 4/27/2017
 Page No : 2

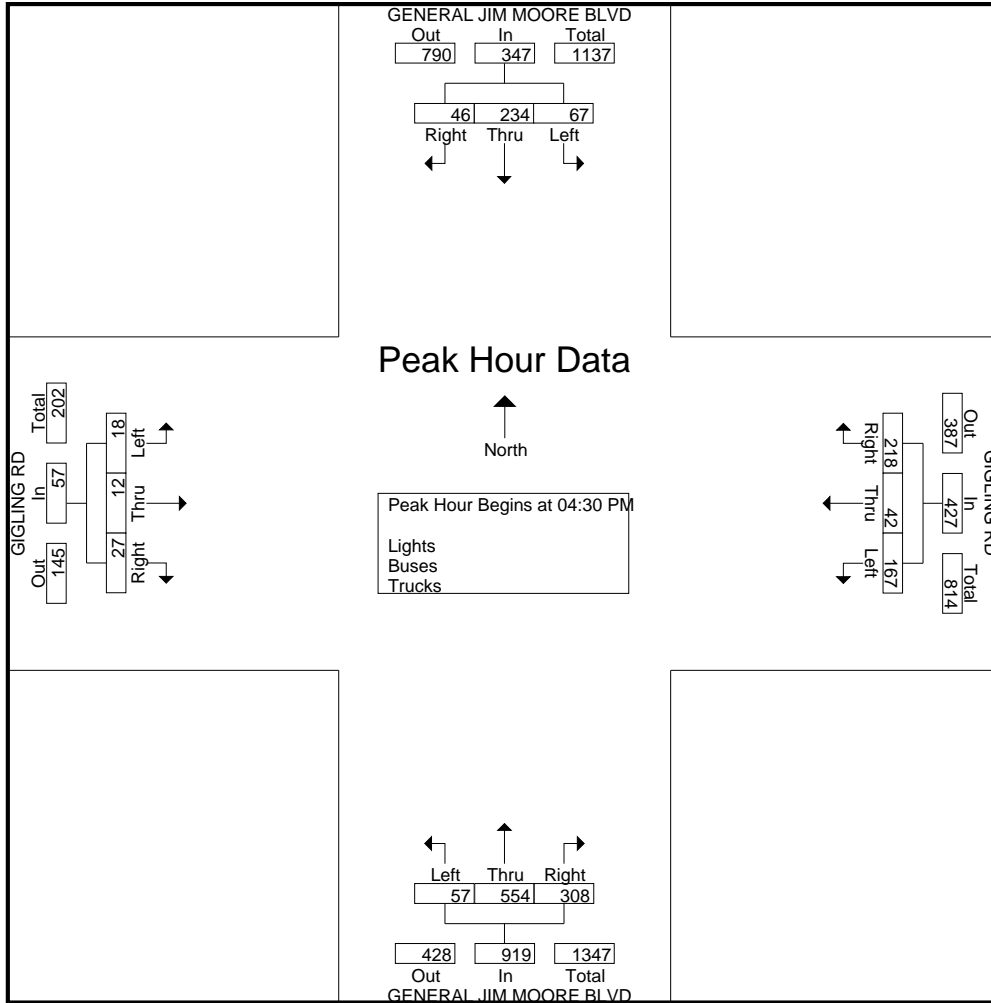

Traffic Data Service

San Jose, CA
 (408) 622-4787
 tdsbay@cs.com

File Name : 25PM FINAL
 Site Code : 00000025
 Start Date : 4/27/2017
 Page No : 1

Groups Printed- Bikes

Start Time	GENERAL JIM MOORE BLVD Southbound					GIGLING RD Westbound					GENERAL JIM MOORE BLVD Northbound					GIGLING RD Eastbound					Int. Total					
	Right	Thru	Left	Peds	App. Total	Right	Thru	Left	Peds	App. Total	Right	Thru	Left	Peds	App. Total	Right	Thru	Left	Peds	App. Total						
04:00 PM	0	0	0	0	0	1	0	0	0	1	0	0	0	0	0	0	0	0	0	0	0	0	0	0	0	1
04:15 PM	0	0	0	0	0	0	0	1	0	1	0	0	0	0	0	0	0	1	0	1	0	0	0	0	0	2
04:30 PM	0	0	0	0	0	0	0	0	0	0	0	0	0	0	0	0	0	0	0	0	0	0	0	0	0	0
04:45 PM	0	0	0	0	0	0	0	0	0	0	0	0	0	0	0	0	0	0	0	0	0	0	0	0	0	0
Total	0	0	0	0	0	1	0	1	0	2	0	0	0	0	0	0	0	1	0	1	0	0	0	0	0	3
05:00 PM	0	0	0	0	0	0	0	0	0	0	0	0	0	0	0	0	0	0	0	0	0	0	0	0	0	0
05:15 PM	0	0	0	0	0	0	0	0	0	0	0	0	0	0	0	0	0	0	0	0	0	0	0	0	0	0
05:30 PM	0	0	0	0	0	0	0	0	0	0	0	0	0	0	0	0	1	0	0	1	0	0	0	0	1	1
05:45 PM	0	0	0	0	0	0	0	0	0	0	0	0	0	0	0	0	0	0	0	0	0	0	0	0	0	0
Total	0	0	0	0	0	0	0	0	0	0	0	0	0	0	0	0	1	0	0	1	0	0	0	0	1	1
Grand Total	0	0	0	0	0	1	0	1	0	2	0	0	0	0	0	0	1	1	0	2	0	0	0	0	4	
Apprch %	0	0	0	0		50	0	50	0		0	0	0	0		0	50	50	0		0	0	0	0		
Total %	0	0	0	0	0	25	0	25	0	50	0	0	0	0	0	0	25	25	0	50	0	0	0	0		

Start Time	GENERAL JIM MOORE BLVD Southbound					GIGLING RD Westbound					GENERAL JIM MOORE BLVD Northbound					GIGLING RD Eastbound					Int. Total				
	Right	Thru	Left	Peds	App. Total	Right	Thru	Left	Peds	App. Total	Right	Thru	Left	Peds	App. Total	Right	Thru	Left	Peds	App. Total					
04:00 PM	0	0	0	0	0	1	0	0	0	1	0	0	0	0	0	0	0	0	0	0	0	0	0	0	1
04:15 PM	0	0	0	0	0	0	0	1	0	1	0	0	0	0	0	0	0	1	0	1	0	0	0	0	2
04:30 PM	0	0	0	0	0	0	0	0	0	0	0	0	0	0	0	0	0	0	0	0	0	0	0	0	0
04:45 PM	0	0	0	0	0	0	0	0	0	0	0	0	0	0	0	0	0	0	0	0	0	0	0	0	0
Total Volume	0	0	0	0	0	1	0	1	0	2	0	0	0	0	0	0	0	1	0	1	0	0	0	0	3
% App. Total	0	0	0	0		50	0	50	0		0	0	0	0		0	0	100	0		0	0	0	0	
PHF	.000	.000	.000	.000	.000	.250	.000	.250	.500	.000	.000	.000	.000	.000	.000	.000	.000	.250	.250	.000	.000	.000	.000	.000	.375

Peak Hour Analysis From 04:00 PM to 05:45 PM - Peak 1 of 1
 Peak Hour for Entire Intersection Begins at 04:00 PM

Traffic Data Service

San Jose, CA
 (408) 622-4787
 tdsbay@cs.com

File Name : 25PM FINAL
 Site Code : 00000025
 Start Date : 4/27/2017
 Page No : 2

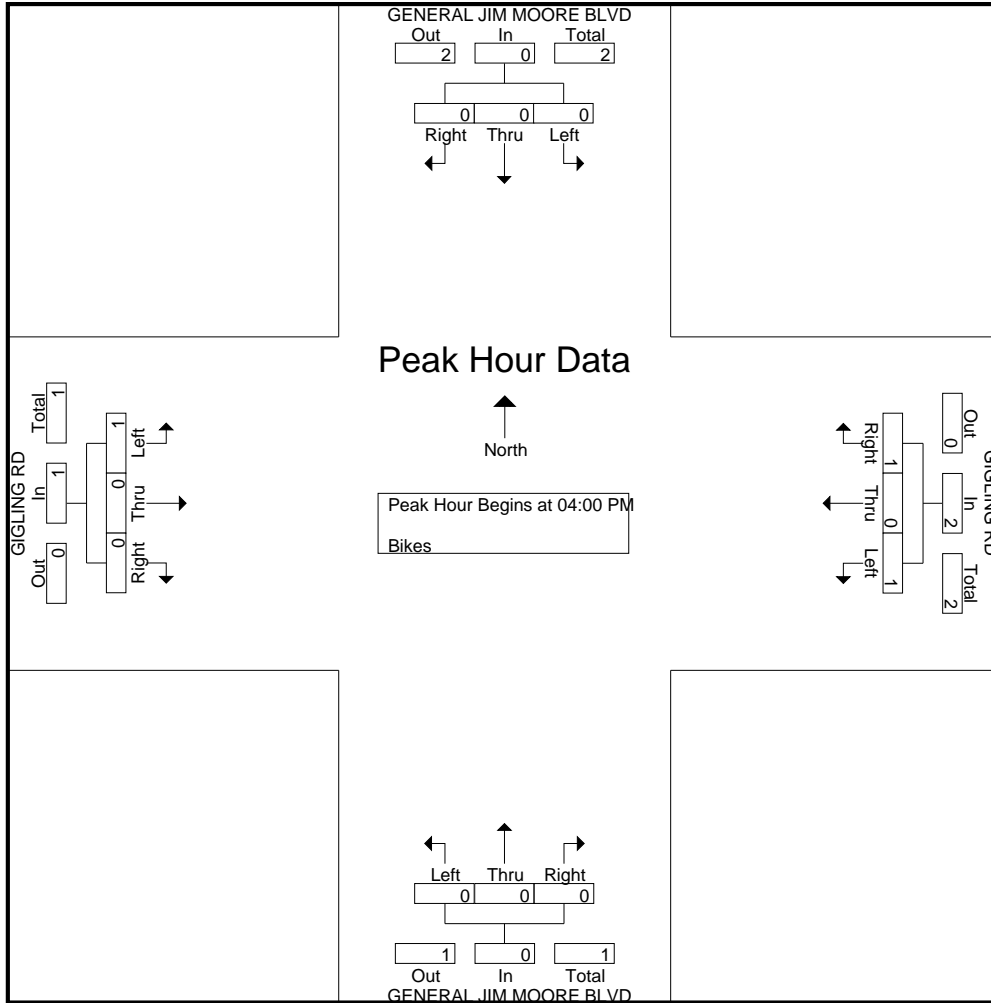

Traffic Data Service

San Jose, CA
 (408) 622-4787
 tdsbay@cs.com

File Name : 26AM FINAL
 Site Code : 00000026
 Start Date : 4/27/2017
 Page No : 1

Groups Printed- Lights - Buses - Trucks

Start Time	CA-1 NB ON-RAMP Southbound					LIGHTFIGHTER DR Westbound					CA-1 NB OFF-RAMP Northbound					CA-1 SB RAMPS Eastbound					Int. Total
	Right	Thru	Left	Peds	App. Total	Right	Thru	Left	Peds	App. Total	Right	Thru	Left	Peds	App. Total	Right	Thru	Left	Peds	App. Total	
07:00 AM	0	0	0	0	0	17	166	0	0	183	40	0	0	0	40	0	83	0	0	83	306
07:15 AM	0	0	0	0	0	32	180	0	0	212	85	0	0	0	85	0	104	0	0	104	401
07:30 AM	0	0	0	0	0	59	261	0	0	320	124	0	0	0	124	0	107	0	0	107	551
07:45 AM	0	0	0	0	0	40	181	0	0	221	150	0	0	0	150	0	119	0	0	119	490
Total	0	0	0	0	0	148	788	0	0	936	399	0	0	0	399	0	413	0	0	413	1748
08:00 AM	0	0	0	0	0	66	117	0	0	183	101	0	0	0	101	0	101	0	0	101	385
08:15 AM	0	0	0	0	0	49	82	0	0	131	109	0	0	0	109	0	70	0	0	70	310
08:30 AM	0	0	0	0	0	24	68	0	0	92	86	0	0	0	86	0	112	0	0	112	290
08:45 AM	0	0	0	0	0	32	62	0	0	94	101	0	0	0	101	0	83	0	0	83	278
Total	0	0	0	0	0	171	329	0	0	500	397	0	0	0	397	0	366	0	0	366	1263
Grand Total	0	0	0	0	0	319	1117	0	0	1436	796	0	0	0	796	0	779	0	0	779	3011
Apprch %	0	0	0	0	0	22.2	77.8	0	0		100	0	0	0		0	100	0	0		
Total %	0	0	0	0	0	10.6	37.1	0	0	47.7	26.4	0	0	0	26.4	0	25.9	0	0	25.9	
Lights	0	0	0	0	0	309	1092	0	0	1401	772	0	0	0	772	0	757	0	0	757	2930
% Lights	0	0	0	0	0	96.9	97.8	0	0	97.6	97	0	0	0	97	0	97.2	0	0	97.2	97.3
Buses	0	0	0	0	0	4	7	0	0	11	15	0	0	0	15	0	6	0	0	6	32
% Buses	0	0	0	0	0	1.3	0.6	0	0	0.8	1.9	0	0	0	1.9	0	0.8	0	0	0.8	1.1
Trucks	0	0	0	0	0	6	18	0	0	24	9	0	0	0	9	0	16	0	0	16	49
% Trucks	0	0	0	0	0	1.9	1.6	0	0	1.7	1.1	0	0	0	1.1	0	2.1	0	0	2.1	1.6

Start Time	CA-1 NB ON-RAMP Southbound				LIGHTFIGHTER DR Westbound				CA-1 NB OFF-RAMP Northbound				CA-1 SB RAMPS Eastbound				Int. Total
	Right	Thru	Left	App. Total	Right	Thru	Left	App. Total	Right	Thru	Left	App. Total	Right	Thru	Left	App. Total	
Peak Hour Analysis From 07:00 AM to 08:45 AM - Peak 1 of 1																	
Peak Hour for Entire Intersection Begins at 07:15 AM																	
07:15 AM	0	0	0	0	32	180	0	212	85	0	0	85	0	104	0	104	401
07:30 AM	0	0	0	0	59	261	0	320	124	0	0	124	0	107	0	107	551
07:45 AM	0	0	0	0	40	181	0	221	150	0	0	150	0	119	0	119	490
08:00 AM	0	0	0	0	66	117	0	183	101	0	0	101	0	101	0	101	385
Total Volume	0	0	0	0	197	739	0	936	460	0	0	460	0	431	0	431	1827
% App. Total	0	0	0	0	21	79	0		100	0	0		0	100	0		
PHF	.000	.000	.000	.000	.746	.708	.000	.731	.767	.000	.000	.767	.000	.905	.000	.905	.829

Traffic Data Service

San Jose, CA
 (408) 622-4787
 tdsbay@cs.com

File Name : 26AM FINAL
 Site Code : 00000026
 Start Date : 4/27/2017
 Page No : 2

sb off-ramp

nb on-ramp

sb-on ramp

nb-off ramp

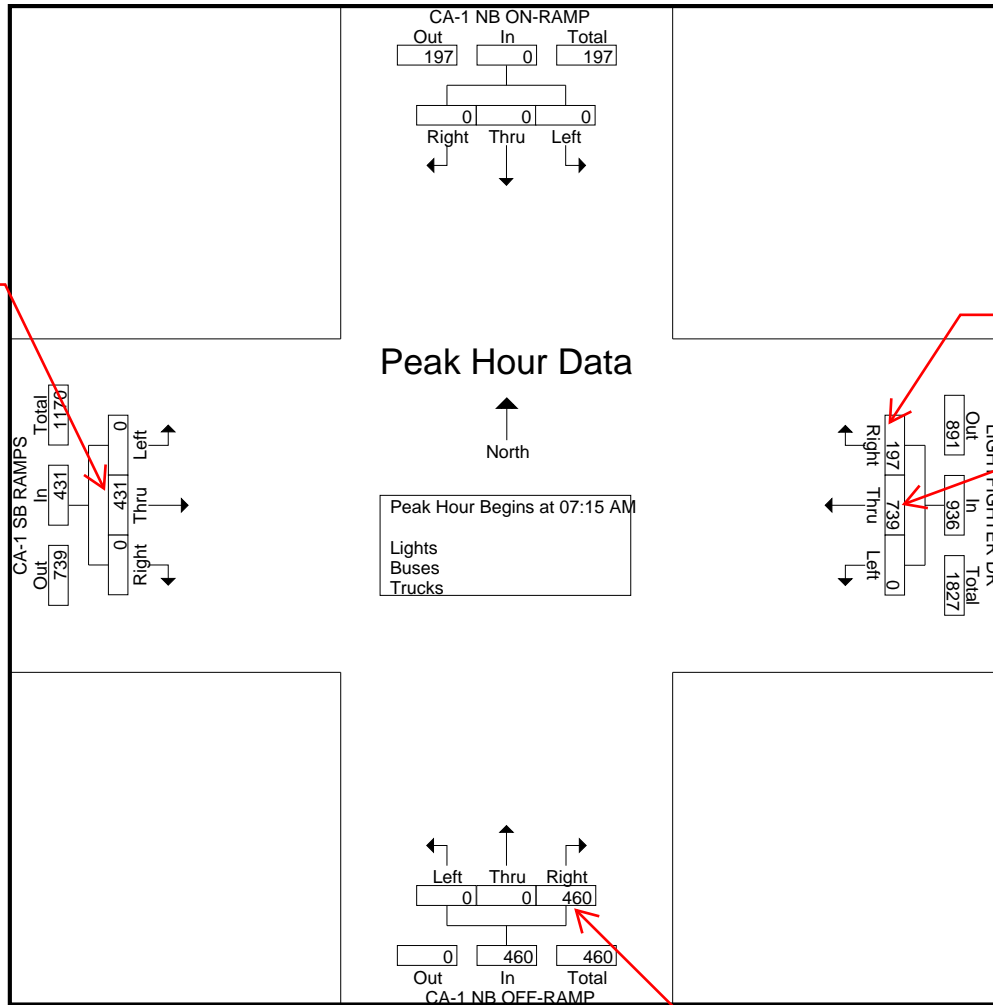

Traffic Data Service

San Jose, CA
 (408) 622-4787
 tdsbay@cs.com

File Name : 26AM FINAL
 Site Code : 00000026
 Start Date : 4/27/2017
 Page No : 1

Groups Printed- Bikes

Start Time	CA-1 NB ON-RAMP Southbound					LIGHTFIGHTER DR Westbound					CA-1 NB OFF-RAMP Northbound					CA-1 SB RAMPS Eastbound					Int. Total
	Right	Thru	Left	Peds	App. Total	Right	Thru	Left	Peds	App. Total	Right	Thru	Left	Peds	App. Total	Right	Thru	Left	Peds	App. Total	
07:00 AM	0	0	0	0	0	0	0	0	0	0	0	0	0	0	0	0	0	0	0	0	0
07:15 AM	0	0	0	0	0	0	0	0	0	0	0	0	0	0	0	0	0	0	0	0	0
07:30 AM	0	0	0	0	0	0	1	0	0	1	0	0	0	0	0	0	0	0	0	0	1
07:45 AM	0	0	0	0	0	0	0	0	0	0	0	0	0	0	0	0	0	0	0	0	0
Total	0	0	0	0	0	0	1	0	0	1	0	0	0	0	0	0	0	0	0	0	1
08:00 AM	0	0	0	0	0	0	0	0	0	0	0	0	0	0	0	0	0	0	0	0	0
08:15 AM	0	0	0	0	0	0	0	0	0	0	0	0	0	0	0	0	0	0	0	0	0
08:30 AM	0	0	0	0	0	0	0	0	0	0	0	0	0	0	0	0	1	0	0	1	1
08:45 AM	0	0	0	0	0	0	0	0	0	0	0	0	0	0	0	0	0	0	0	0	0
Total	0	0	0	0	0	0	0	0	0	0	0	0	0	0	0	0	1	0	0	1	1
Grand Total	0	0	0	0	0	0	1	0	0	1	0	0	0	0	0	0	1	0	0	1	2
Apprch %	0	0	0	0		0	100	0	0		0	0	0	0		0	100	0	0		
Total %	0	0	0	0		0	50	0	0	50	0	0	0	0		0	50	0	0	50	

Start Time	CA-1 NB ON-RAMP Southbound				LIGHTFIGHTER DR Westbound				CA-1 NB OFF-RAMP Northbound				CA-1 SB RAMPS Eastbound				Int. Total
	Right	Thru	Left	App. Total	Right	Thru	Left	App. Total	Right	Thru	Left	App. Total	Right	Thru	Left	App. Total	
Peak Hour Analysis From 07:00 AM to 08:45 AM - Peak 1 of 1																	
Peak Hour for Entire Intersection Begins at 07:00 AM																	
07:00 AM	0	0	0	0	0	0	0	0	0	0	0	0	0	0	0	0	
07:15 AM	0	0	0	0	0	0	0	0	0	0	0	0	0	0	0	0	
07:30 AM	0	0	0	0	0	1	0	1	0	0	0	0	0	0	0	0	
07:45 AM	0	0	0	0	0	0	0	0	0	0	0	0	0	0	0	0	
Total Volume	0	0	0	0	0	1	0	1	0	0	0	0	0	0	0	0	
% App. Total	0	0	0		0	100	0		0	0	0		0	0	0		
PHF	.000	.000	.000	.000	.000	.250	.000	.250	.000	.000	.000	.000	.000	.000	.000	.000	

Traffic Data Service

San Jose, CA
 (408) 622-4787
 tdsbay@cs.com

File Name : 26AM FINAL
 Site Code : 00000026
 Start Date : 4/27/2017
 Page No : 2

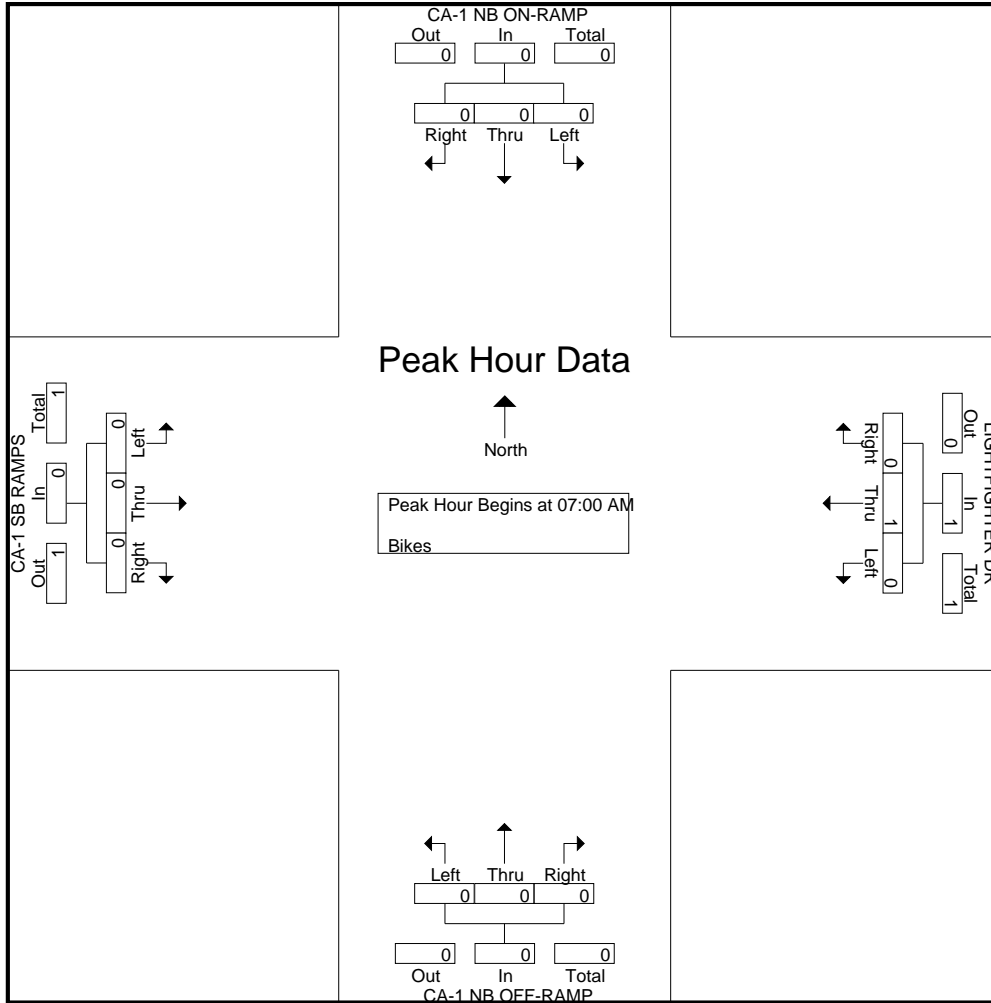

Traffic Data Service

San Jose, CA
(408) 622-4787
tdsbay@cs.com

File Name : 26PM FINAL
 Site Code : 00000026
 Start Date : 4/27/2017
 Page No : 1

Groups Printed- Lights - Buses - Trucks

Start Time	CA-1 NB ON-RAMP Southbound					LIGHTFIGHTER DR Westbound					CA-1 NB OFF-RAMP Northbound					CA-1 SB RAMPS Eastbound					Int. Total
	Right	Thru	Left	Peds	App. Total	Right	Thru	Left	Peds	App. Total	Right	Thru	Left	Peds	App. Total	Right	Thru	Left	Peds	App. Total	
04:00 PM	0	0	0	0	0	137	126	0	0	263	86	0	0	0	86	0	33	0	0	33	382
04:15 PM	0	0	0	0	0	107	99	0	0	206	97	0	0	0	97	0	41	0	0	41	344
04:30 PM	0	0	0	0	0	155	135	0	0	290	87	0	0	0	87	0	48	0	0	48	425
04:45 PM	0	0	0	0	0	166	155	0	0	321	101	0	0	0	101	0	44	0	0	44	466
Total	0	0	0	0	0	565	515	0	0	1080	371	0	0	0	371	0	166	0	0	166	1617
05:00 PM	0	0	0	0	0	172	131	0	0	303	98	0	0	0	98	0	41	0	0	41	442
05:15 PM	0	0	0	0	0	168	117	0	0	285	98	0	0	0	98	0	34	0	0	34	417
05:30 PM	0	0	0	0	0	121	133	0	0	254	113	0	0	0	113	0	36	0	0	36	403
05:45 PM	0	0	0	0	0	112	111	0	0	223	103	0	0	0	103	0	53	0	0	53	379
Total	0	0	0	0	0	573	492	0	0	1065	412	0	0	0	412	0	164	0	0	164	1641
Grand Total	0	0	0	0	0	1138	1007	0	0	2145	783	0	0	0	783	0	330	0	0	330	3258
Apprch %	0	0	0	0	0	53.1	46.9	0	0		100	0	0	0		0	100	0	0		
Total %	0	0	0	0	0	34.9	30.9	0	0	65.8	24	0	0	0	24	0	10.1	0	0	10.1	
Lights	0	0	0	0	0	1126	1001	0	0	2127	771	0	0	0	771	0	323	0	0	323	3221
% Lights	0	0	0	0	0	98.9	99.4	0	0	99.2	98.5	0	0	0	98.5	0	97.9	0	0	97.9	98.9
Buses	0	0	0	0	0	2	4	0	0	6	9	0	0	0	9	0	4	0	0	4	19
% Buses	0	0	0	0	0	0.2	0.4	0	0	0.3	1.1	0	0	0	1.1	0	1.2	0	0	1.2	0.6
Trucks	0	0	0	0	0	10	2	0	0	12	3	0	0	0	3	0	3	0	0	3	18
% Trucks	0	0	0	0	0	0.9	0.2	0	0	0.6	0.4	0	0	0	0.4	0	0.9	0	0	0.9	0.6

Start Time	CA-1 NB ON-RAMP Southbound				LIGHTFIGHTER DR Westbound				CA-1 NB OFF-RAMP Northbound				CA-1 SB RAMPS Eastbound				Int. Total
	Right	Thru	Left	App. Total	Right	Thru	Left	App. Total	Right	Thru	Left	App. Total	Right	Thru	Left	App. Total	
Peak Hour Analysis From 04:00 PM to 05:45 PM - Peak 1 of 1																	
Peak Hour for Entire Intersection Begins at 04:30 PM																	
04:30 PM	0	0	0	0	155	135	0	290	87	0	0	87	0	48	0	48	425
04:45 PM	0	0	0	0	166	155	0	321	101	0	0	101	0	44	0	44	466
05:00 PM	0	0	0	0	172	131	0	303	98	0	0	98	0	41	0	41	442
05:15 PM	0	0	0	0	168	117	0	285	98	0	0	98	0	34	0	34	417
Total Volume	0	0	0	0	661	538	0	1199	384	0	0	384	0	167	0	167	1750
% App. Total	0	0	0	0	55.1	44.9	0		100	0	0		0	100	0		
PHF	.000	.000	.000	.000	.961	.868	.000	.934	.950	.000	.000	.950	.000	.870	.000	.870	.939

Traffic Data Service

San Jose, CA
 (408) 622-4787
 tdsbay@cs.com

File Name : 26PM FINAL
 Site Code : 00000026
 Start Date : 4/27/2017
 Page No : 2

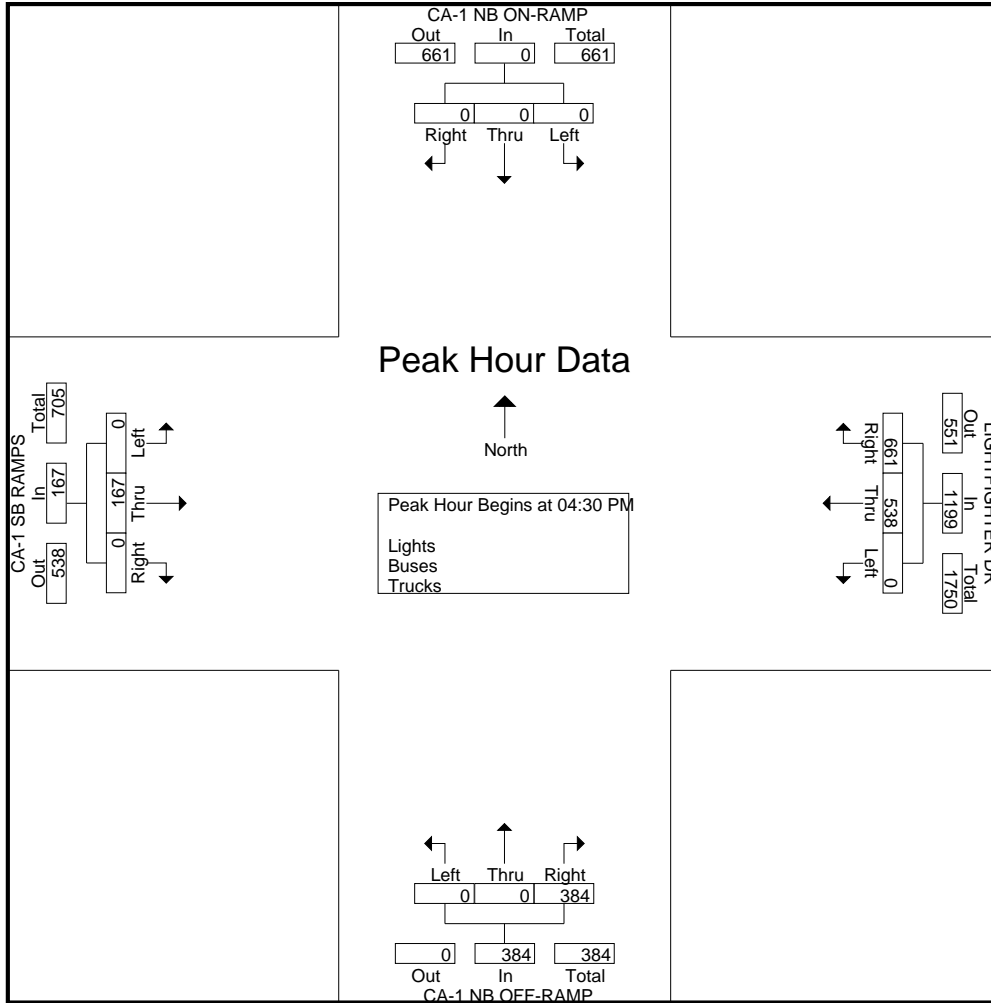

Traffic Data Service

San Jose, CA
 (408) 622-4787
 tdsbay@cs.com

File Name : 26PM FINAL
 Site Code : 00000026
 Start Date : 4/27/2017
 Page No : 1

Groups Printed- Bikes

Start Time	CA-1 NB ON-RAMP Southbound					LIGHTFIGHTER DR Westbound					CA-1 NB OFF-RAMP Northbound					CA-1 SB RAMPS Eastbound					Int. Total
	Right	Thru	Left	Peds	App. Total	Right	Thru	Left	Peds	App. Total	Right	Thru	Left	Peds	App. Total	Right	Thru	Left	Peds	App. Total	
04:00 PM	0	0	0	0	0	0	0	0	0	0	0	0	0	0	0	0	0	0	0	0	0
04:15 PM	0	0	0	0	0	0	0	0	0	0	0	0	0	0	0	0	0	0	0	0	0
04:30 PM	0	0	0	0	0	0	0	0	0	0	0	0	0	0	0	0	0	0	0	0	0
04:45 PM	0	0	0	0	0	0	0	0	0	0	0	0	0	0	0	0	0	0	0	0	0
Total	0	0	0	0	0	0	0	0	0	0	0	0	0	0	0	0	0	0	0	0	0
05:00 PM	0	0	0	0	0	0	0	0	0	0	0	0	0	0	0	0	0	0	0	0	0
05:15 PM	0	0	0	0	0	0	0	0	0	0	0	0	0	0	0	0	0	0	0	0	0
05:30 PM	0	0	0	0	0	0	0	0	0	0	0	0	0	0	0	0	0	0	0	0	0
05:45 PM	0	0	0	0	0	0	0	0	0	0	0	0	0	0	0	0	0	0	0	0	0
Total	0	0	0	0	0	0	0	0	0	0	0	0	0	0	0	0	0	0	0	0	0
Grand Total	0	0	0	0	0	0	0	0	0	0	0	0	0	0	0	0	0	0	0	0	0
Apprch %	0	0	0	0		0	0	0	0		0	0	0	0		0	0	0	0		
Total %																					

Start Time	CA-1 NB ON-RAMP Southbound				LIGHTFIGHTER DR Westbound				CA-1 NB OFF-RAMP Northbound				CA-1 SB RAMPS Eastbound				Int. Total
	Right	Thru	Left	App. Total	Right	Thru	Left	App. Total	Right	Thru	Left	App. Total	Right	Thru	Left	App. Total	
Peak Hour Analysis From 04:00 PM to 05:45 PM - Peak 1 of 1																	
Peak Hour for Entire Intersection Begins at 04:00 PM																	
04:00 PM	0	0	0	0	0	0	0	0	0	0	0	0	0	0	0	0	0
04:15 PM	0	0	0	0	0	0	0	0	0	0	0	0	0	0	0	0	0
04:30 PM	0	0	0	0	0	0	0	0	0	0	0	0	0	0	0	0	0
04:45 PM	0	0	0	0	0	0	0	0	0	0	0	0	0	0	0	0	0
Total Volume	0	0	0	0	0	0	0	0	0	0	0	0	0	0	0	0	0
% App. Total	0	0	0		0	0	0		0	0	0		0	0	0		
PHF	.000	.000	.000	.000	.000	.000	.000	.000	.000	.000	.000	.000	.000	.000	.000	.000	.000

Traffic Data Service

San Jose, CA
(408) 622-4787
tdsbay@cs.com

File Name : 26PM FINAL
Site Code : 00000026
Start Date : 4/27/2017
Page No : 2

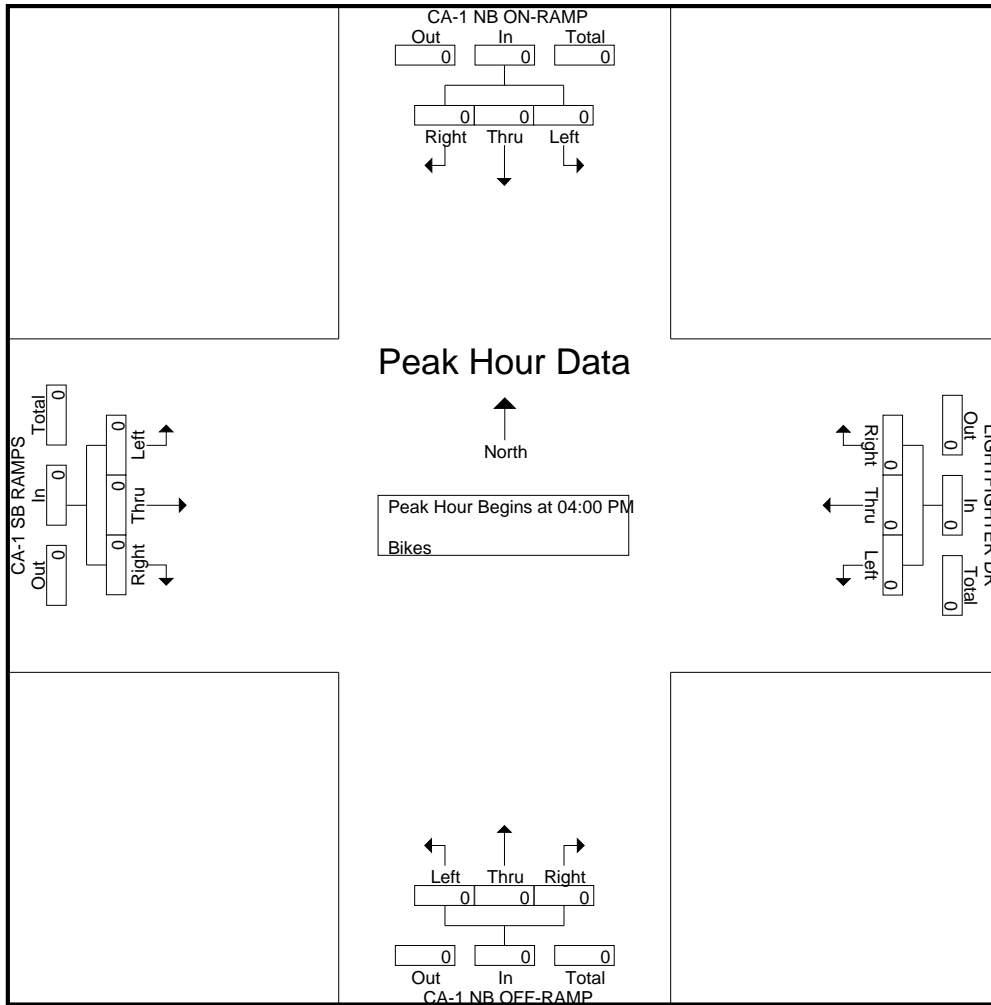

Traffic Data Service

San Jose, CA
 (408) 622-4787
 tdsbay@cs.com

File Name : 1AM FINAL
 Site Code : 00000001
 Start Date : 4/25/2018
 Page No : 1

Groups Printed- Lights - Buses - Trucks

Start Time	DEL MONTE BLVD Southbound					REINDOLLAR AVE Westbound					DEL MONTE BLVD Northbound					Eastbound					Int. Total
	Right	Thru	Left	Peds	App. Total	Right	Thru	Left	Peds	App. Total	Right	Thru	Left	Peds	App. Total	Right	Thru	Left	Peds	App. Total	
07:00 AM	0	260	11	0	271	6	0	135	0	141	12	51	3	0	66	0	0	0	0	0	478
07:15 AM	0	293	16	4	313	9	0	135	2	146	24	55	1	0	80	0	0	0	0	0	539
07:30 AM	0	229	21	1	251	17	0	91	0	108	32	72	1	0	105	0	0	0	0	0	464
07:45 AM	0	157	15	3	175	26	0	69	0	95	37	111	0	0	148	0	0	0	0	0	418
Total	0	939	63	8	1010	58	0	430	2	490	105	289	5	0	399	0	0	0	0	0	1899
08:00 AM	0	161	15	2	178	14	0	76	1	91	50	105	2	0	157	0	0	0	0	0	426
08:15 AM	0	150	10	2	162	14	0	55	1	70	36	93	3	0	132	0	0	0	0	0	364
08:30 AM	0	194	16	1	211	18	0	73	0	91	27	84	2	0	113	0	0	0	0	0	415
08:45 AM	0	166	11	0	177	12	0	57	0	69	23	83	1	0	107	0	0	0	0	0	353
Total	0	671	52	5	728	58	0	261	2	321	136	365	8	0	509	0	0	0	0	0	1558
Grand Total	0	1610	115	13	1738	116	0	691	4	811	241	654	13	0	908	0	0	0	0	0	3457
Apprch %	0	92.6	6.6	0.7		14.3	0	85.2	0.5		26.5	72	1.4	0		0	0	0	0	0	
Total %	0	46.6	3.3	0.4	50.3	3.4	0	20	0.1	23.5	7	18.9	0.4	0	26.3	0	0	0	0	0	0
Lights	0	1557	112	10	1679	112	0	683	4	799	234	633	13	0	880	0	0	0	0	0	3358
% Lights	0	96.7	97.4	76.9	96.6	96.6	0	98.8	100	98.5	97.1	96.8	100	0	96.9	0	0	0	0	0	97.1
Buses	0	18	1	0	19	1	0	3	0	4	5	10	0	0	15	0	0	0	0	0	38
% Buses	0	1.1	0.9	0	1.1	0.9	0	0.4	0	0.5	2.1	1.5	0	0	1.7	0	0	0	0	0	1.1
Trucks	0	35	2	3	40	3	0	5	0	8	2	11	0	0	13	0	0	0	0	0	61
% Trucks	0	2.2	1.7	23.1	2.3	2.6	0	0.7	0	1	0.8	1.7	0	0	1.4	0	0	0	0	0	1.8

Start Time	DEL MONTE BLVD Southbound				REINDOLLAR AVE Westbound				DEL MONTE BLVD Northbound				Eastbound				Int. Total
	Right	Thru	Left	App. Total	Right	Thru	Left	App. Total	Right	Thru	Left	App. Total	Right	Thru	Left	App. Total	
Peak Hour Analysis From 07:00 AM to 08:45 AM - Peak 1 of 1																	
Peak Hour for Entire Intersection Begins at 07:00 AM																	
07:00 AM	0	260	11	271	6	0	135	141	12	51	3	66	0	0	0	0	478
07:15 AM	0	293	16	309	9	0	135	144	24	55	1	80	0	0	0	0	533
07:30 AM	0	229	21	250	17	0	91	108	32	72	1	105	0	0	0	0	463
07:45 AM	0	157	15	172	26	0	69	95	37	111	0	148	0	0	0	0	415
Total Volume	0	939	63	1002	58	0	430	488	105	289	5	399	0	0	0	0	1889
% App. Total	0	93.7	6.3		11.9	0	88.1		26.3	72.4	1.3		0	0	0		
PHF	.000	.801	.750	.811	.558	.000	.796	.847	.709	.651	.417	.674	.000	.000	.000	.000	.886

Traffic Data Service

San Jose, CA
 (408) 622-4787
 tdsbay@cs.com

File Name : 1AM FINAL
 Site Code : 00000001
 Start Date : 4/25/2018
 Page No : 2

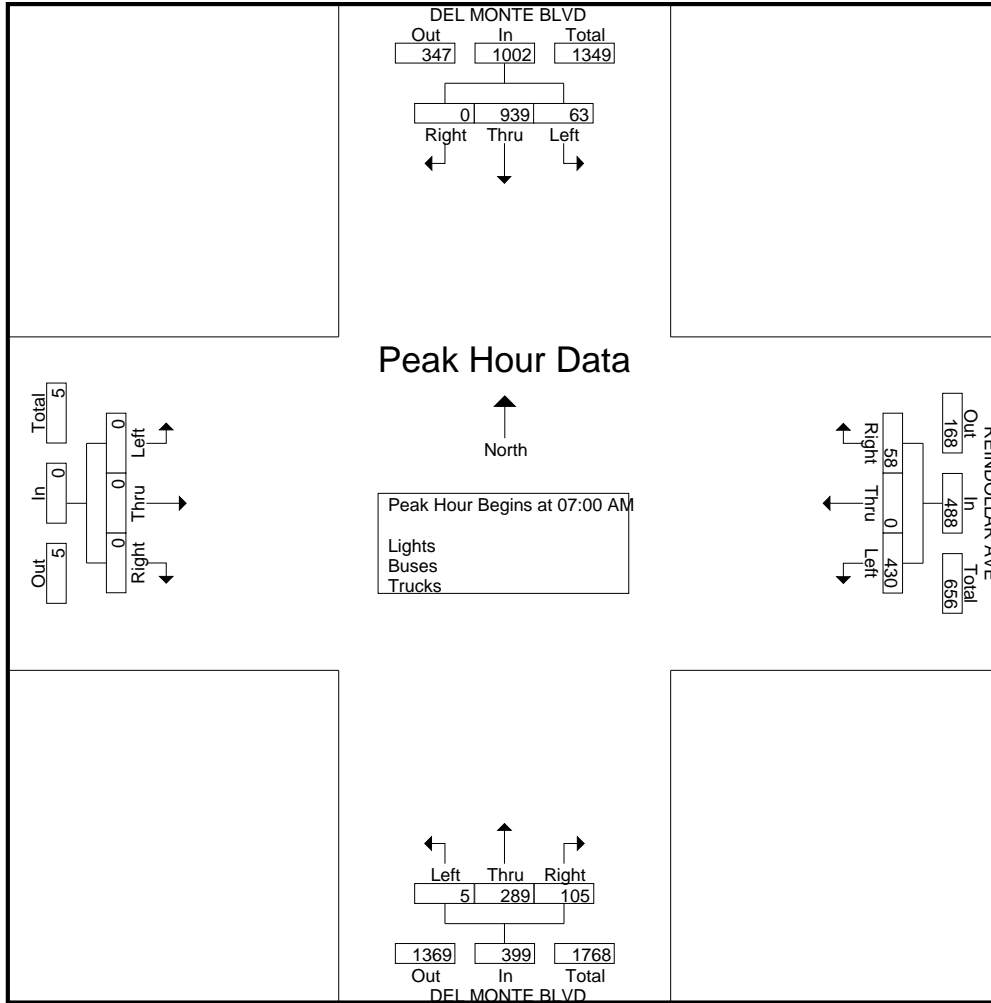

Traffic Data Service

San Jose, CA
 (408) 622-4787
 tdsbay@cs.com

File Name : 1AM FINAL
 Site Code : 00000001
 Start Date : 4/25/2018
 Page No : 1

Groups Printed- Bikes

Start Time	DEL MONTE BLVD Southbound					REINDOLLAR AVE Westbound					DEL MONTE BLVD Northbound					Eastbound					Int. Total
	Right	Thru	Left	Peds	App. Total	Right	Thru	Left	Peds	App. Total	Right	Thru	Left	Peds	App. Total	Right	Thru	Left	Peds	App. Total	
07:00 AM	0	0	0	0	0	0	0	0	0	0	0	0	0	0	0	0	0	0	0	0	0
07:15 AM	0	0	0	0	0	1	0	1	0	2	0	0	0	0	0	0	0	0	0	0	2
07:30 AM	0	0	0	0	0	0	0	0	0	0	0	0	0	0	0	0	0	0	0	0	0
07:45 AM	0	0	0	0	0	0	0	0	0	0	0	0	0	0	0	0	0	0	0	0	0
Total	0	0	0	0	0	1	0	1	0	2	0	0	0	0	0	0	0	0	0	0	2
08:00 AM	0	0	0	0	0	0	0	0	0	0	0	0	0	0	0	0	0	0	0	0	0
08:15 AM	0	0	0	0	0	0	0	0	0	0	0	0	0	0	0	0	0	0	0	0	0
08:30 AM	0	0	0	0	0	0	0	0	0	0	0	0	0	0	0	0	0	0	0	0	0
08:45 AM	0	0	0	0	0	0	0	0	0	0	0	0	0	0	0	0	0	0	0	0	0
Total	0	0	0	0	0	0	0	0	0	0	0	0	0	0	0	0	0	0	0	0	0
Grand Total	0	0	0	0	0	1	0	1	0	2	0	0	0	0	0	0	0	0	0	0	2
Apprch %	0	0	0	0	0	50	0	50	0	100	0	0	0	0	0	0	0	0	0	0	
Total %	0	0	0	0	0	50	0	50	0	100	0	0	0	0	0	0	0	0	0	0	

Start Time	DEL MONTE BLVD Southbound				REINDOLLAR AVE Westbound				DEL MONTE BLVD Northbound				Eastbound				Int. Total
	Right	Thru	Left	App. Total	Right	Thru	Left	App. Total	Right	Thru	Left	App. Total	Right	Thru	Left	App. Total	
Peak Hour Analysis From 07:00 AM to 08:45 AM - Peak 1 of 1																	
Peak Hour for Entire Intersection Begins at 07:00 AM																	
07:00 AM	0	0	0	0	0	0	0	0	0	0	0	0	0	0	0	0	0
07:15 AM	0	0	0	0	1	0	1	2	0	0	0	0	0	0	0	0	2
07:30 AM	0	0	0	0	0	0	0	0	0	0	0	0	0	0	0	0	0
07:45 AM	0	0	0	0	0	0	0	0	0	0	0	0	0	0	0	0	0
Total Volume	0	0	0	0	1	0	1	2	0	0	0	0	0	0	0	0	2
% App. Total	0	0	0	0	50	0	50	100	0	0	0	0	0	0	0	0	
PHF	.000	.000	.000	.000	.250	.000	.250	.250	.000	.000	.000	.000	.000	.000	.000	.000	.250

Traffic Data Service

San Jose, CA
(408) 622-4787
tdsbay@cs.com

File Name : 1AM FINAL
Site Code : 00000001
Start Date : 4/25/2018
Page No : 2

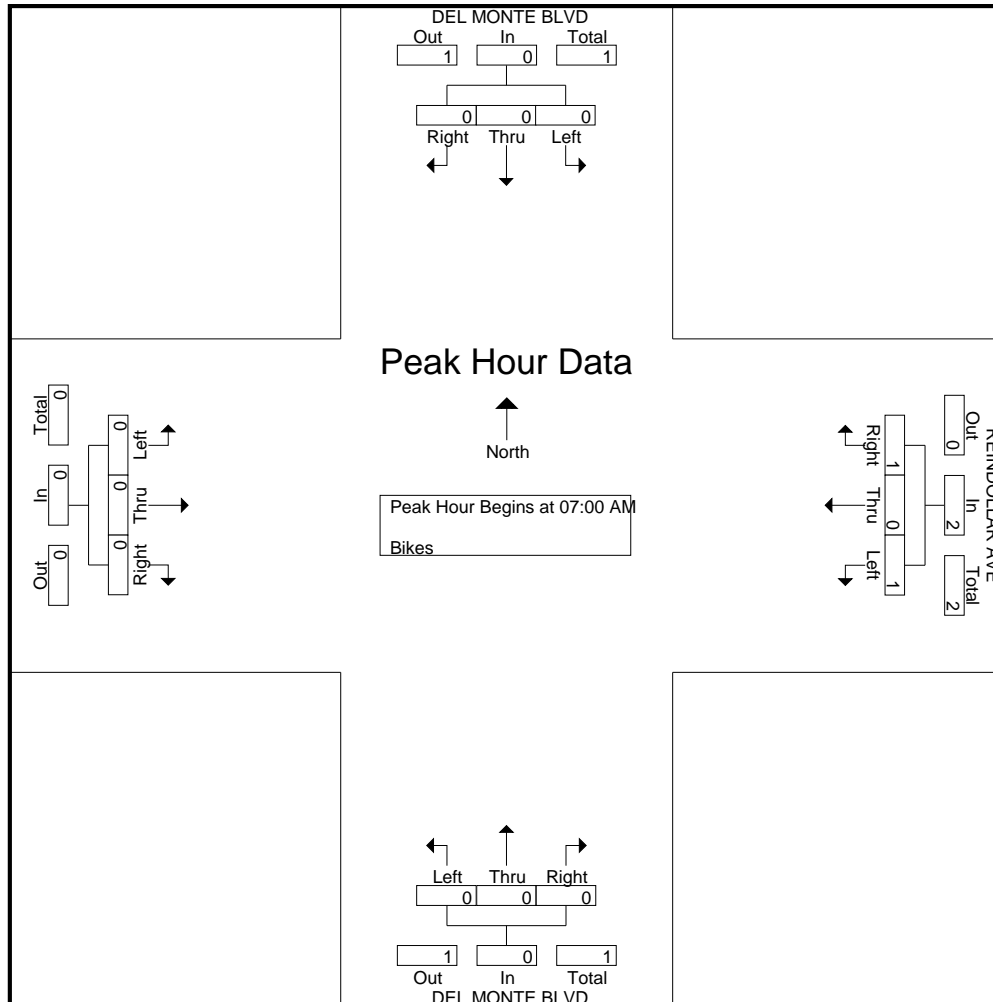

Traffic Data Service

San Jose, CA
 (408) 622-4787
 tdsbay@cs.com

File Name : 1PM FINAL
 Site Code : 00000001
 Start Date : 4/25/2018
 Page No : 1

Groups Printed- Lights - Buses - Trucks

Start Time	DEL MONTE BLVD Southbound					REINDOLLAR AVE Westbound					DEL MONTE BLVD Northbound					Eastbound					Int. Total
	Right	Thru	Left	Peds	App. Total	Right	Thru	Left	Peds	App. Total	Right	Thru	Left	Peds	App. Total	Right	Thru	Left	Peds	App. Total	
04:00 PM	0	123	4	3	130	28	0	41	1	70	74	212	0	0	286	0	0	0	0	0	486
04:15 PM	0	127	12	0	139	18	0	34	0	52	79	236	1	0	316	0	0	0	0	0	507
04:30 PM	0	103	10	2	115	13	0	37	1	51	57	229	1	0	287	0	0	0	0	0	453
04:45 PM	0	121	12	5	138	23	0	46	3	72	78	229	2	0	309	0	0	0	0	0	519
Total	0	474	38	10	522	82	0	158	5	245	288	906	4	0	1198	0	0	0	0	0	1965
05:00 PM	0	131	21	1	153	20	0	35	0	55	94	232	1	0	327	0	0	0	0	0	535
05:15 PM	0	96	11	4	111	25	0	40	0	65	78	240	2	0	320	0	0	0	0	0	496
05:30 PM	0	106	16	0	122	20	0	54	0	74	72	285	0	0	357	0	0	0	0	0	553
05:45 PM	0	142	25	3	170	20	0	42	0	62	74	253	1	0	328	0	0	0	0	0	560
Total	0	475	73	8	556	85	0	171	0	256	318	1010	4	0	1332	0	0	0	0	0	2144
Grand Total	0	949	111	18	1078	167	0	329	5	501	606	1916	8	0	2530	0	0	0	0	0	4109
Apprch %	0	88	10.3	1.7		33.3	0	65.7	1		24	75.7	0.3	0		0	0	0	0		
Total %	0	23.1	2.7	0.4	26.2	4.1	0	8	0.1	12.2	14.7	46.6	0.2	0	61.6	0	0	0	0	0	
Lights	0	938	110	18	1066	167	0	322	5	494	603	1896	8	0	2507	0	0	0	0	0	4067
% Lights	0	98.8	99.1	100	98.9	100	0	97.9	100	98.6	99.5	99	100	0	99.1	0	0	0	0	0	99
Buses	0	5	1	0	6	0	0	1	0	1	2	7	0	0	9	0	0	0	0	0	16
% Buses	0	0.5	0.9	0	0.6	0	0	0.3	0	0.2	0.3	0.4	0	0	0.4	0	0	0	0	0	0.4
Trucks	0	6	0	0	6	0	0	6	0	6	1	13	0	0	14	0	0	0	0	0	26
% Trucks	0	0.6	0	0	0.6	0	0	1.8	0	1.2	0.2	0.7	0	0	0.6	0	0	0	0	0	0.6

Start Time	DEL MONTE BLVD Southbound				REINDOLLAR AVE Westbound				DEL MONTE BLVD Northbound				Eastbound				Int. Total
	Right	Thru	Left	App. Total	Right	Thru	Left	App. Total	Right	Thru	Left	App. Total	Right	Thru	Left	App. Total	
Peak Hour Analysis From 04:00 PM to 05:45 PM - Peak 1 of 1																	
Peak Hour for Entire Intersection Begins at 05:00 PM																	
05:00 PM	0	131	21	152	20	0	35	55	94	232	1	327	0	0	0	0	534
05:15 PM	0	96	11	107	25	0	40	65	78	240	2	320	0	0	0	0	492
05:30 PM	0	106	16	122	20	0	54	74	72	285	0	357	0	0	0	0	553
05:45 PM	0	142	25	167	20	0	42	62	74	253	1	328	0	0	0	0	557
Total Volume	0	475	73	548	85	0	171	256	318	1010	4	1332	0	0	0	0	2136
% App. Total	0	86.7	13.3		33.2	0	66.8		23.9	75.8	0.3		0	0	0		
PHF	.000	.836	.730	.820	.850	.000	.792	.865	.846	.886	.500	.933	.000	.000	.000	.000	.959

Traffic Data Service

San Jose, CA
 (408) 622-4787
 tdsbay@cs.com

File Name : 1PM FINAL
 Site Code : 00000001
 Start Date : 4/25/2018
 Page No : 2

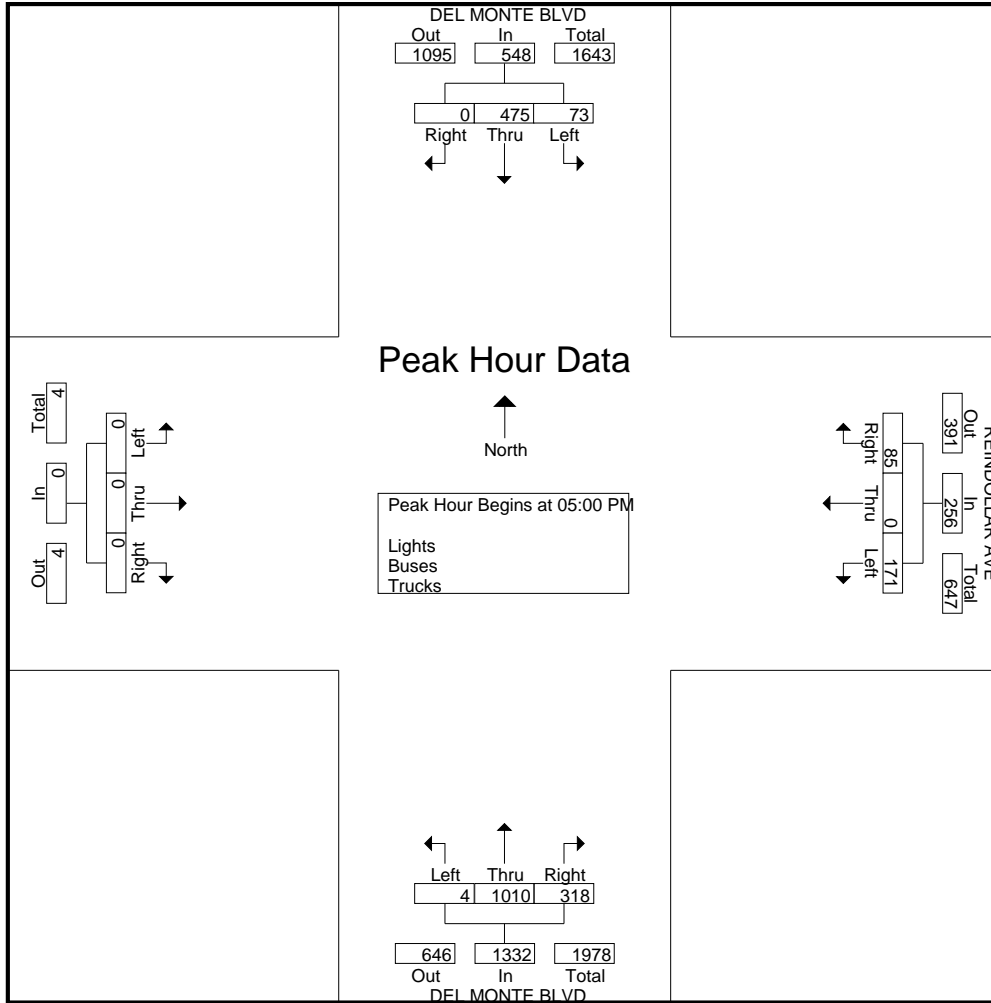

Traffic Data Service

San Jose, CA
 (408) 622-4787
 tdsbay@cs.com

File Name : 1PM FINAL
 Site Code : 00000001
 Start Date : 4/25/2018
 Page No : 1

Groups Printed- Bikes

Start Time	DEL MONTE BLVD Southbound					REINDOLLAR AVE Westbound					DEL MONTE BLVD Northbound					Eastbound					Int. Total
	Right	Thru	Left	Peds	App. Total	Right	Thru	Left	Peds	App. Total	Right	Thru	Left	Peds	App. Total	Right	Thru	Left	Peds	App. Total	
04:00 PM	0	0	0	0	0	0	0	0	0	0	0	0	0	0	0	0	0	0	0	0	0
04:15 PM	0	0	0	0	0	0	0	0	0	0	0	0	0	0	0	0	0	0	0	0	0
04:30 PM	0	0	0	0	0	0	0	0	0	0	0	0	0	0	0	0	0	0	0	0	0
04:45 PM	0	0	0	0	0	0	0	0	0	0	0	0	0	0	0	0	0	0	0	0	0
Total	0	0	0	0	0	0	0	0	0	0	0	0	0	0	0	0	0	0	0	0	0
05:00 PM	0	0	0	0	0	0	0	0	0	0	0	0	0	0	0	0	0	0	0	0	0
05:15 PM	0	0	0	0	0	0	0	0	0	0	0	0	0	0	0	0	0	0	0	0	0
05:30 PM	0	0	0	0	0	0	0	0	0	0	0	0	0	0	0	0	0	0	0	0	0
05:45 PM	0	0	0	0	0	0	0	0	0	0	0	0	0	0	0	0	0	0	0	0	0
Total	0	0	0	0	0	0	0	0	0	0	0	0	0	0	0	0	0	0	0	0	0
Grand Total	0	0	0	0	0	0	0	0	0	0	0	0	0	0	0	0	0	0	0	0	0
Apprch %	0	0	0	0		0	0	0	0		0	0	0	0		0	0	0	0		
Total %																					

Start Time	DEL MONTE BLVD Southbound				REINDOLLAR AVE Westbound				DEL MONTE BLVD Northbound				Eastbound				Int. Total
	Right	Thru	Left	App. Total	Right	Thru	Left	App. Total	Right	Thru	Left	App. Total	Right	Thru	Left	App. Total	
Peak Hour Analysis From 04:00 PM to 05:45 PM - Peak 1 of 1																	
Peak Hour for Entire Intersection Begins at 04:00 PM																	
04:00 PM	0	0	0	0	0	0	0	0	0	0	0	0	0	0	0	0	0
04:15 PM	0	0	0	0	0	0	0	0	0	0	0	0	0	0	0	0	0
04:30 PM	0	0	0	0	0	0	0	0	0	0	0	0	0	0	0	0	0
04:45 PM	0	0	0	0	0	0	0	0	0	0	0	0	0	0	0	0	0
Total Volume	0	0	0	0	0	0	0	0	0	0	0	0	0	0	0	0	0
% App. Total	0	0	0		0	0	0		0	0	0		0	0	0		
PHF	.000	.000	.000	.000	.000	.000	.000	.000	.000	.000	.000	.000	.000	.000	.000	.000	.000

Traffic Data Service

San Jose, CA
(408) 622-4787
tdsbay@cs.com

File Name : 1PM FINAL
Site Code : 00000001
Start Date : 4/25/2018
Page No : 2

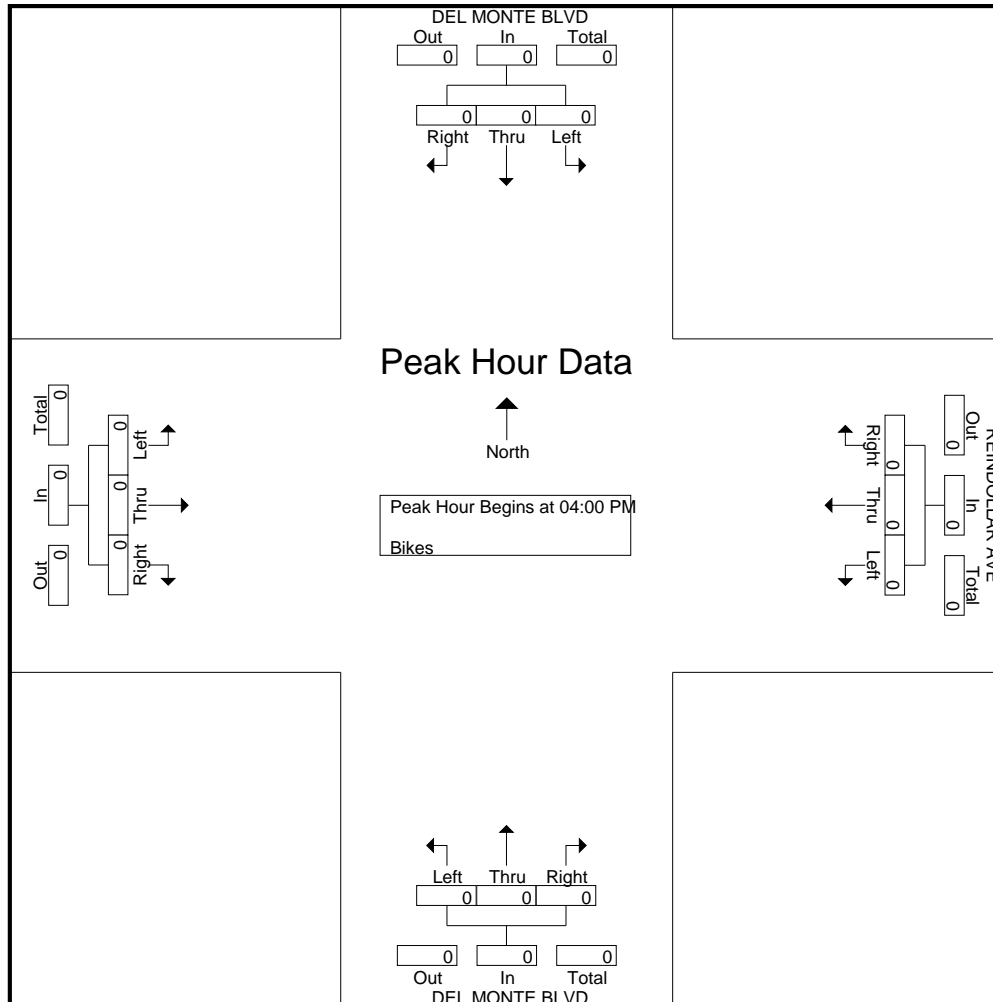

Traffic Data Service

San Jose, CA
 (408) 622-4787
 tdsbay@cs.com

File Name : 2AM FINAL
 Site Code : 00000002
 Start Date : 4/25/2018
 Page No : 1

Groups Printed- Lights - Buses - Trucks

Start Time	CALIFORNIA AVE Southbound					Westbound					CALIFORNIA AVE Northbound					PATTON PKWY Eastbound					Int. Total
	Right	Thru	Left	Peds	App. Total	Right	Thru	Left	Peds	App. Total	Right	Thru	Left	Peds	App. Total	Right	Thru	Left	Peds	App. Total	
07:00 AM	2	107	0	0	109	0	0	0	0	0	0	11	2	0	13	0	0	1	1	2	124
07:15 AM	9	173	0	0	182	0	0	0	0	0	0	25	5	0	30	4	0	1	0	5	217
07:30 AM	48	153	0	0	201	0	0	0	0	0	0	47	12	0	59	10	0	8	2	20	280
07:45 AM	15	115	0	0	130	0	0	0	0	0	0	75	9	0	84	12	0	17	0	29	243
Total	74	548	0	0	622	0	0	0	0	0	0	158	28	0	186	26	0	27	3	56	864
08:00 AM	2	133	0	0	135	0	0	0	0	0	0	41	1	0	42	2	0	3	1	6	183
08:15 AM	0	78	0	0	78	0	0	0	0	0	0	45	1	0	46	2	0	0	3	5	129
08:30 AM	0	90	0	0	90	0	0	0	0	0	0	29	3	0	32	3	0	0	3	6	128
08:45 AM	1	68	0	0	69	0	0	0	0	0	0	24	0	0	24	6	0	0	1	7	100
Total	3	369	0	0	372	0	0	0	0	0	0	139	5	0	144	13	0	3	8	24	540
Grand Total	77	917	0	0	994	0	0	0	0	0	0	297	33	0	330	39	0	30	11	80	1404
Apprch %	7.7	92.3	0	0		0	0	0	0		0	90	10	0		48.8	0	37.5	13.8		
Total %	5.5	65.3	0	0	70.8	0	0	0	0	0	0	21.2	2.4	0	23.5	2.8	0	2.1	0.8	5.7	
Lights	76	897	0	0	973	0	0	0	0	0	0	275	32	0	307	37	0	30	11	78	1358
% Lights	98.7	97.8	0	0	97.9	0	0	0	0	0	0	92.6	97	0	93	94.9	0	100	100	97.5	96.7
Buses	1	3	0	0	4	0	0	0	0	0	0	6	1	0	7	1	0	0	0	1	12
% Buses	1.3	0.3	0	0	0.4	0	0	0	0	0	0	2	3	0	2.1	2.6	0	0	0	1.2	0.9
Trucks	0	17	0	0	17	0	0	0	0	0	0	16	0	0	16	1	0	0	0	1	34
% Trucks	0	1.9	0	0	1.7	0	0	0	0	0	0	5.4	0	0	4.8	2.6	0	0	0	1.2	2.4

Start Time	CALIFORNIA AVE Southbound				Westbound				CALIFORNIA AVE Northbound				PATTON PKWY Eastbound				Int. Total	
	Right	Thru	Left	App. Total	Right	Thru	Left	App. Total	Right	Thru	Left	App. Total	Right	Thru	Left	App. Total		
Peak Hour Analysis From 07:00 AM to 08:45 AM - Peak 1 of 1																		
Peak Hour for Entire Intersection Begins at 07:15 AM																		
07:15 AM	9	173	0	182	0	0	0	0	0	0	25	5	30	4	0	1	5	217
07:30 AM	48	153	0	201	0	0	0	0	0	0	47	12	59	10	0	8	18	278
07:45 AM	15	115	0	130	0	0	0	0	0	0	75	9	84	12	0	17	29	243
08:00 AM	2	133	0	135	0	0	0	0	0	0	41	1	42	2	0	3	5	182
Total Volume	74	574	0	648	0	0	0	0	0	0	188	27	215	28	0	29	57	920
% App. Total	11.4	88.6	0		0	0	0		0	0	87.4	12.6		49.1	0	50.9		
PHF	.385	.829	.000	.806	.000	.000	.000	.000	.000	.000	.627	.563	.640	.583	.000	.426	.491	.827

Traffic Data Service

San Jose, CA
 (408) 622-4787
 tdsbay@cs.com

File Name : 2AM FINAL
 Site Code : 00000002
 Start Date : 4/25/2018
 Page No : 2

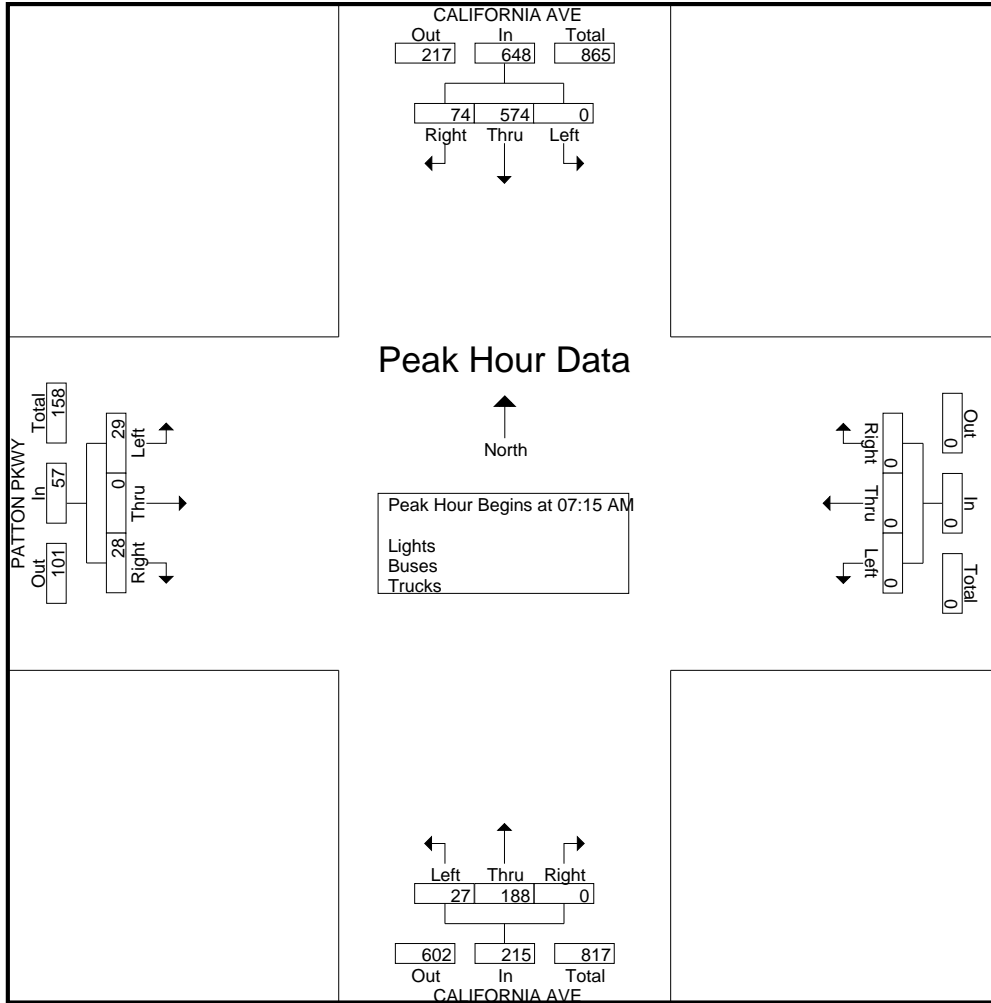

Traffic Data Service

San Jose, CA
 (408) 622-4787
 tdsbay@cs.com

File Name : 2AM FINAL
 Site Code : 00000002
 Start Date : 4/25/2018
 Page No : 1

Groups Printed- Bikes

Start Time	CALIFORNIA AVE Southbound					Westbound					CALIFORNIA AVE Northbound					PATTON PKWY Eastbound					Int. Total
	Right	Thru	Left	Peds	App. Total	Right	Thru	Left	Peds	App. Total	Right	Thru	Left	Peds	App. Total	Right	Thru	Left	Peds	App. Total	
07:00 AM	0	0	0	0	0	0	0	0	0	0	0	0	0	0	0	1	0	0	0	0	1
07:15 AM	0	0	0	0	0	0	0	0	0	0	0	0	0	0	0	0	0	0	0	0	0
07:30 AM	0	0	0	0	0	0	0	0	0	0	0	0	0	0	0	0	0	0	0	0	0
07:45 AM	0	0	0	0	0	0	0	0	0	0	0	0	0	0	0	0	0	0	0	0	0
Total	0	0	0	0	0	0	0	0	0	0	0	0	0	0	0	1	0	0	0	0	1
08:00 AM	0	0	0	0	0	0	0	0	0	0	0	0	0	0	0	0	0	0	0	0	0
08:15 AM	0	0	0	0	0	0	0	0	0	0	0	0	0	0	0	0	0	0	0	0	0
08:30 AM	0	0	0	0	0	0	0	0	0	0	0	0	0	0	0	0	0	0	0	0	0
08:45 AM	0	0	0	0	0	0	0	0	0	0	0	0	0	0	0	0	0	0	0	0	0
Total	0	0	0	0	0	0	0	0	0	0	0	0	0	0	0	0	0	0	0	0	0
Grand Total	0	0	0	0	0	0	0	0	0	0	0	0	0	0	0	1	0	0	0	0	1
Apprch %	0	0	0	0	0	0	0	0	0	0	0	0	0	0	0	100	0	0	0	0	
Total %	0	0	0	0	0	0	0	0	0	0	0	0	0	0	0	100	0	0	0	100	

Start Time	CALIFORNIA AVE Southbound					Westbound					CALIFORNIA AVE Northbound					PATTON PKWY Eastbound					Int. Total
	Right	Thru	Left	Peds	App. Total	Right	Thru	Left	Peds	App. Total	Right	Thru	Left	Peds	App. Total	Right	Thru	Left	Peds	App. Total	
07:00 AM	0	0	0	0	0	0	0	0	0	0	0	0	0	0	0	1	0	0	0	0	1
07:15 AM	0	0	0	0	0	0	0	0	0	0	0	0	0	0	0	0	0	0	0	0	0
07:30 AM	0	0	0	0	0	0	0	0	0	0	0	0	0	0	0	0	0	0	0	0	0
07:45 AM	0	0	0	0	0	0	0	0	0	0	0	0	0	0	0	0	0	0	0	0	0
Total Volume	0	0	0	0	0	0	0	0	0	0	0	0	0	0	0	1	0	0	0	0	1
% App. Total	0	0	0	0	0	0	0	0	0	0	0	0	0	0	0	100	0	0	0	0	
PHF	.000	.000	.000	.000	.000	.000	.000	.000	.000	.000	.000	.000	.000	.000	.000	.250	.000	.000	.000	.250	.250

Peak Hour Analysis From 07:00 AM to 08:45 AM - Peak 1 of 1
 Peak Hour for Entire Intersection Begins at 07:00 AM

Traffic Data Service

San Jose, CA
(408) 622-4787
tdsbay@cs.com

File Name : 2AM FINAL
Site Code : 00000002
Start Date : 4/25/2018
Page No : 2

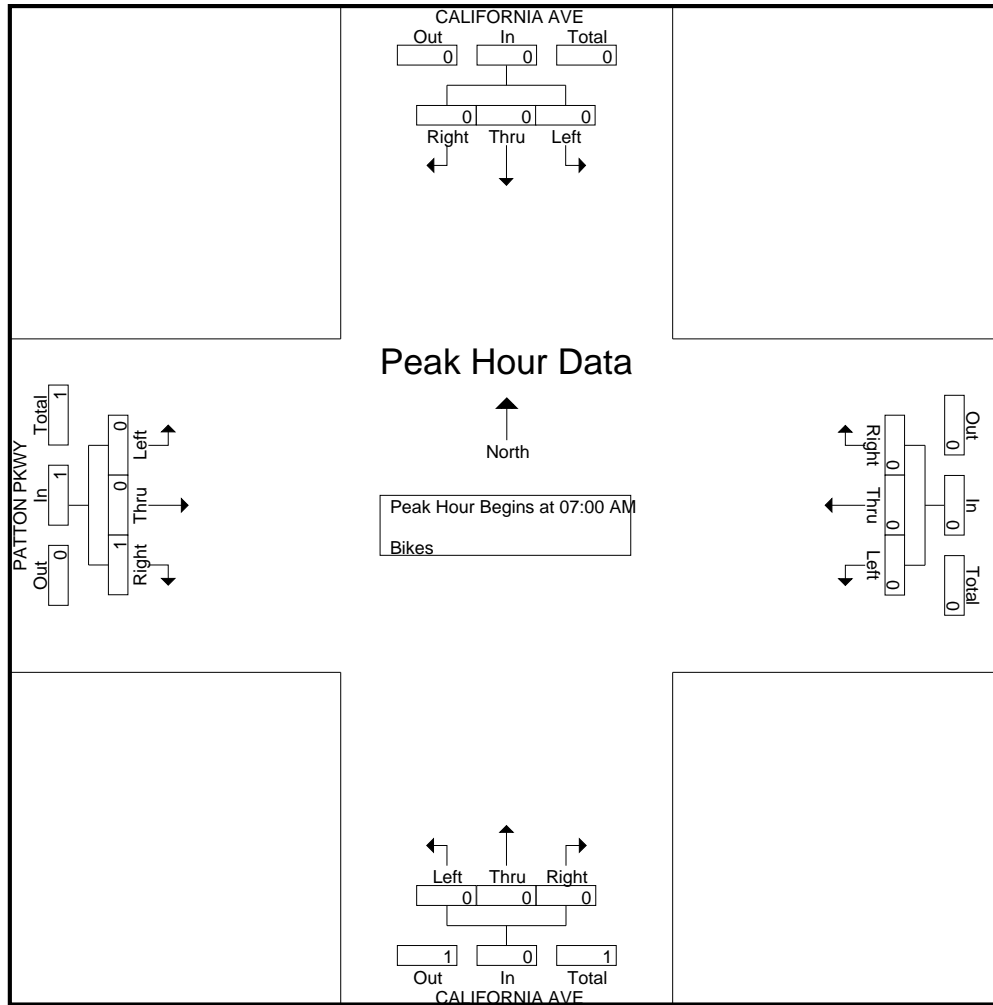

Traffic Data Service

San Jose, CA
 (408) 622-4787
 tdsbay@cs.com

File Name : 2PM FINAL
 Site Code : 00000002
 Start Date : 4/25/2018
 Page No : 1

Groups Printed- Lights - Buses - Trucks

Start Time	CALIFORNIA AVE Southbound					Westbound					CALIFORNIA AVE Northbound					PATTON PKWY Eastbound					Int. Total
	Right	Thru	Left	Peds	App. Total	Right	Thru	Left	Peds	App. Total	Right	Thru	Left	Peds	App. Total	Right	Thru	Left	Peds	App. Total	
04:00 PM	5	35	0	0	40	0	0	0	0	0	0	81	3	0	84	6	0	3	0	9	133
04:15 PM	0	49	0	0	49	0	0	0	0	0	0	90	3	0	93	3	0	0	2	5	147
04:30 PM	0	50	0	0	50	0	0	0	0	0	0	92	2	0	94	1	0	0	0	1	145
04:45 PM	1	47	0	0	48	0	0	0	0	0	0	112	4	0	116	1	0	1	1	3	167
Total	6	181	0	0	187	0	0	0	0	0	0	375	12	0	387	11	0	4	3	18	592
05:00 PM	1	62	0	0	63	0	0	0	0	0	0	84	4	0	88	3	0	0	2	5	156
05:15 PM	0	52	0	0	52	0	0	0	0	0	0	90	5	0	95	3	0	1	0	4	151
05:30 PM	0	64	0	0	64	0	0	0	0	0	0	63	3	0	66	3	0	0	1	4	134
05:45 PM	0	67	0	0	67	0	0	0	0	0	0	79	2	0	81	1	0	0	2	3	151
Total	1	245	0	0	246	0	0	0	0	0	0	316	14	0	330	10	0	1	5	16	592
Grand Total	7	426	0	0	433	0	0	0	0	0	0	691	26	0	717	21	0	5	8	34	1184
Apprch %	1.6	98.4	0	0		0	0	0	0		0	96.4	3.6	0		61.8	0	14.7	23.5		
Total %	0.6	36	0	0	36.6	0	0	0	0	0	0	58.4	2.2	0	60.6	1.8	0	0.4	0.7	2.9	
Lights	7	419	0	0	426	0	0	0	0	0	0	685	26	0	711	21	0	5	8	34	1171
% Lights	100	98.4	0	0	98.4	0	0	0	0	0	0	99.1	100	0	99.2	100	0	100	100	100	98.9
Buses	0	1	0	0	1	0	0	0	0	0	0	1	0	0	1	0	0	0	0	0	2
% Buses	0	0.2	0	0	0.2	0	0	0	0	0	0	0.1	0	0	0.1	0	0	0	0	0	0.2
Trucks	0	6	0	0	6	0	0	0	0	0	0	5	0	0	5	0	0	0	0	0	11
% Trucks	0	1.4	0	0	1.4	0	0	0	0	0	0	0.7	0	0	0.7	0	0	0	0	0	0.9

Start Time	CALIFORNIA AVE Southbound				Westbound				CALIFORNIA AVE Northbound				PATTON PKWY Eastbound				Int. Total	
	Right	Thru	Left	App. Total	Right	Thru	Left	App. Total	Right	Thru	Left	App. Total	Right	Thru	Left	App. Total		
Peak Hour Analysis From 04:00 PM to 05:45 PM - Peak 1 of 1																		
Peak Hour for Entire Intersection Begins at 04:30 PM																		
04:30 PM	0	50	0	50	0	0	0	0	0	0	92	2	94	1	0	0	1	145
04:45 PM	1	47	0	48	0	0	0	0	0	0	112	4	116	1	0	1	2	166
05:00 PM	1	62	0	63	0	0	0	0	0	0	84	4	88	3	0	0	3	154
05:15 PM	0	52	0	52	0	0	0	0	0	0	90	5	95	3	0	1	4	151
Total Volume	2	211	0	213	0	0	0	0	0	0	378	15	393	8	0	2	10	616
% App. Total	0.9	99.1	0		0	0	0		0	0	96.2	3.8		80	0	20		
PHF	.500	.851	.000	.845	.000	.000	.000	.000	.000	.000	.844	.750	.847	.667	.000	.500	.625	.928

Traffic Data Service

San Jose, CA
 (408) 622-4787
 tdsbay@cs.com

File Name : 2PM FINAL
 Site Code : 00000002
 Start Date : 4/25/2018
 Page No : 2

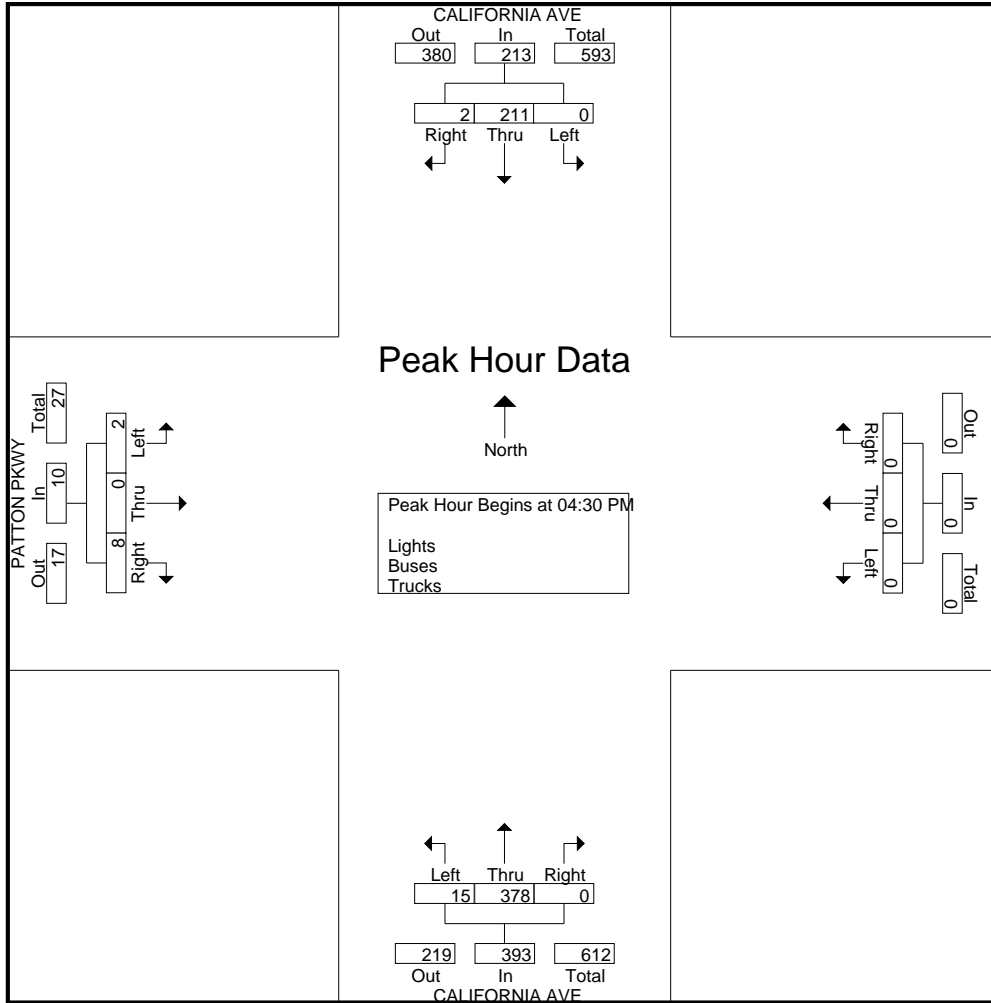

Traffic Data Service

San Jose, CA
 (408) 622-4787
 tdsbay@cs.com

File Name : 2PM FINAL
 Site Code : 00000002
 Start Date : 4/25/2018
 Page No : 1

Groups Printed- Bikes

Start Time	CALIFORNIA AVE Southbound					Westbound					CALIFORNIA AVE Northbound					PATTON PKWY Eastbound					Int. Total
	Right	Thru	Left	Peds	App. Total	Right	Thru	Left	Peds	App. Total	Right	Thru	Left	Peds	App. Total	Right	Thru	Left	Peds	App. Total	
04:00 PM	0	0	0	0	0	0	0	0	0	0	0	0	0	0	0	1	0	1	0	2	2
04:15 PM	0	0	0	0	0	0	0	0	0	0	0	0	0	0	0	0	0	0	0	0	0
04:30 PM	0	1	0	0	1	0	0	0	0	0	0	0	0	0	0	0	0	0	0	0	1
04:45 PM	0	0	0	0	0	0	0	0	0	0	0	0	0	0	0	0	0	0	0	0	0
Total	0	1	0	0	1	0	0	0	0	0	0	0	0	0	0	1	0	1	0	2	3
05:00 PM	0	0	0	0	0	0	0	0	0	0	0	0	0	0	0	0	0	0	0	0	0
05:15 PM	0	0	0	0	0	0	0	0	0	0	0	0	0	0	0	0	0	0	0	0	0
05:30 PM	0	0	0	0	0	0	0	0	0	0	0	0	0	0	0	0	0	0	0	0	0
05:45 PM	0	1	0	0	1	0	0	0	0	0	0	0	0	0	0	0	0	0	0	0	1
Total	0	1	0	0	1	0	0	0	0	0	0	0	0	0	0	0	0	0	0	0	1
Grand Total	0	2	0	0	2	0	0	0	0	0	0	0	0	0	0	1	0	1	0	2	4
Apprch %	0	100	0	0		0	0	0	0		0	0	0	0		50	0	50	0		
Total %	0	50	0	0	50	0	0	0	0	0	0	0	0	0	0	25	0	25	0	50	

Start Time	CALIFORNIA AVE Southbound				Westbound				CALIFORNIA AVE Northbound				PATTON PKWY Eastbound				Int. Total
	Right	Thru	Left	App. Total	Right	Thru	Left	App. Total	Right	Thru	Left	App. Total	Right	Thru	Left	App. Total	
Peak Hour Analysis From 04:00 PM to 05:45 PM - Peak 1 of 1																	
Peak Hour for Entire Intersection Begins at 04:00 PM																	
04:00 PM	0	0	0	0	0	0	0	0	0	0	0	0	1	0	1	2	2
04:15 PM	0	0	0	0	0	0	0	0	0	0	0	0	0	0	0	0	0
04:30 PM	0	1	0	1	0	0	0	0	0	0	0	0	0	0	0	0	1
04:45 PM	0	0	0	0	0	0	0	0	0	0	0	0	0	0	0	0	0
Total Volume	0	1	0	1	0	0	0	0	0	0	0	0	1	0	1	2	3
% App. Total	0	100	0		0	0	0		0	0	0		50	0	50		
PHF	.000	.250	.000	.250	.000	.000	.000	.000	.000	.000	.000	.000	.250	.000	.250	.250	.375

Traffic Data Service

San Jose, CA
 (408) 622-4787
 tdsbay@cs.com

File Name : 2PM FINAL
 Site Code : 00000002
 Start Date : 4/25/2018
 Page No : 2

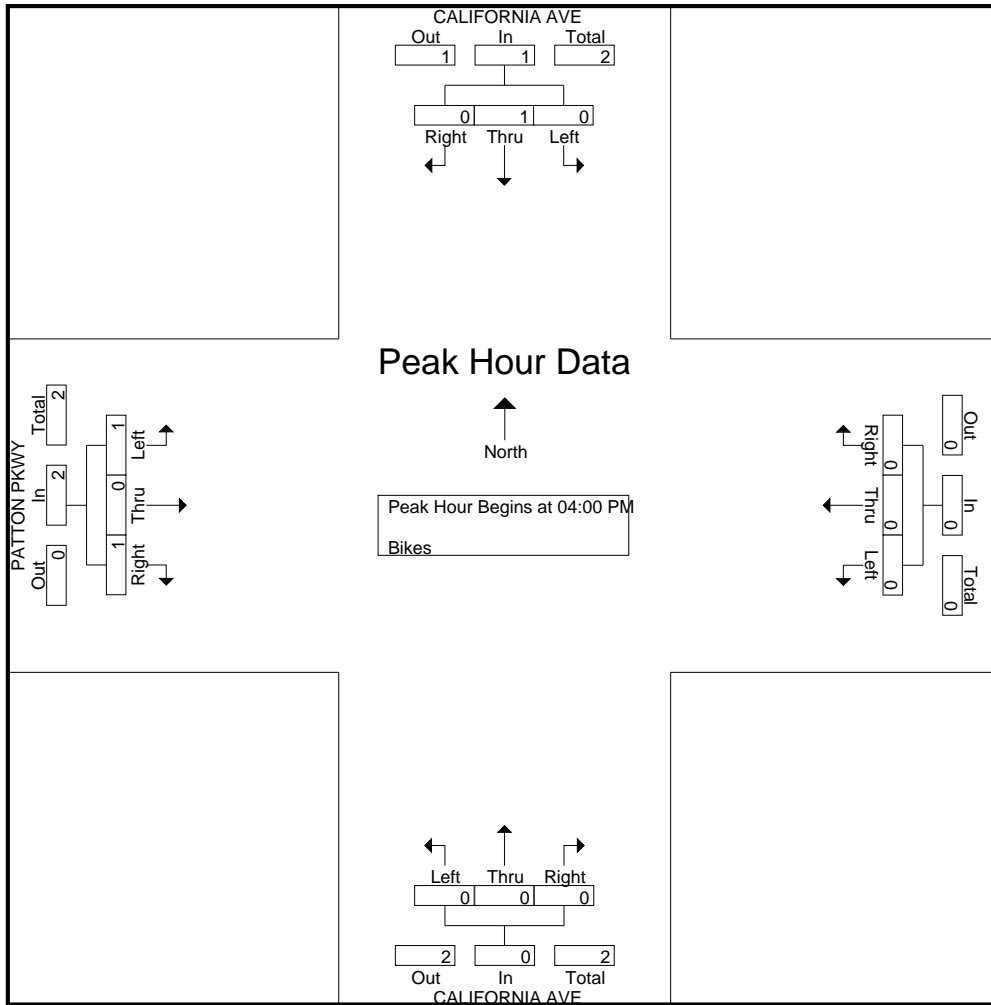

Traffic Data Service

San Jose, CA
 (408) 622-4787
 tdsbay@cs.com

File Name : 3AM FINAL
 Site Code : 00000003
 Start Date : 4/25/2018
 Page No : 1

Groups Printed- Lights - Buses - Trucks

Start Time	BLANCO RD Southbound					RESERVATION RD Westbound					Northbound					RESERVATION RD Eastbound					Int. Total
	Right	Thru	Left	Peds	App. Total	Right	Thru	Left	Peds	App. Total	Right	Thru	Left	Peds	App. Total	Right	Thru	Left	Peds	App. Total	
07:00 AM	312	0	6	0	318	11	89	0	0	100	0	0	0	0	0	0	52	139	0	191	609
07:15 AM	322	0	8	0	330	9	92	0	0	101	0	0	0	0	0	0	49	243	0	292	723
07:30 AM	294	0	6	0	300	8	111	0	0	119	0	0	0	0	0	0	68	293	0	361	780
07:45 AM	282	0	5	0	287	8	80	0	0	88	0	0	0	0	0	0	91	288	0	379	754
Total	1210	0	25	0	1235	36	372	0	0	408	0	0	0	0	0	0	260	963	0	1223	2866
08:00 AM	267	0	9	0	276	1	89	0	0	90	0	0	0	0	0	0	52	224	0	276	642
08:15 AM	274	0	7	0	281	11	90	0	0	101	0	0	0	0	0	0	58	172	0	230	612
08:30 AM	284	0	6	0	290	8	70	0	0	78	0	0	0	0	0	0	34	180	0	214	582
08:45 AM	230	0	3	0	233	5	65	0	0	70	0	0	0	0	0	0	54	154	0	208	511
Total	1055	0	25	0	1080	25	314	0	0	339	0	0	0	0	0	0	198	730	0	928	2347
Grand Total	2265	0	50	0	2315	61	686	0	0	747	0	0	0	0	0	0	458	1693	0	2151	5213
Apprch %	97.8	0	2.2	0		8.2	91.8	0	0		0	0	0	0	0	0	21.3	78.7	0		
Total %	43.4	0	1	0	44.4	1.2	13.2	0	0	14.3	0	0	0	0	0	0	8.8	32.5	0	41.3	
Lights	2202	0	43	0	2245	58	670	0	0	728	0	0	0	0	0	0	439	1658	0	2097	5070
% Lights	97.2	0	86	0	97	95.1	97.7	0	0	97.5	0	0	0	0	0	0	95.9	97.9	0	97.5	97.3
Buses	14	0	1	0	15	0	3	0	0	3	0	0	0	0	0	0	5	14	0	19	37
% Buses	0.6	0	2	0	0.6	0	0.4	0	0	0.4	0	0	0	0	0	0	1.1	0.8	0	0.9	0.7
Trucks	49	0	6	0	55	3	13	0	0	16	0	0	0	0	0	0	14	21	0	35	106
% Trucks	2.2	0	12	0	2.4	4.9	1.9	0	0	2.1	0	0	0	0	0	0	3.1	1.2	0	1.6	2

Start Time	BLANCO RD Southbound				RESERVATION RD Westbound				Northbound				RESERVATION RD Eastbound				Int. Total	
	Right	Thru	Left	App. Total	Right	Thru	Left	App. Total	Right	Thru	Left	App. Total	Right	Thru	Left	App. Total		
Peak Hour Analysis From 07:00 AM to 08:45 AM - Peak 1 of 1																		
Peak Hour for Entire Intersection Begins at 07:15 AM																		
07:15 AM	322	0	8	330	9	92	0	101	0	0	0	0	0	0	49	243	292	723
07:30 AM	294	0	6	300	8	111	0	119	0	0	0	0	0	68	293	361	780	
07:45 AM	282	0	5	287	8	80	0	88	0	0	0	0	0	91	288	379	754	
08:00 AM	267	0	9	276	1	89	0	90	0	0	0	0	0	52	224	276	642	
Total Volume	1165	0	28	1193	26	372	0	398	0	0	0	0	0	260	1048	1308	2899	
% App. Total	97.7	0	2.3		6.5	93.5	0		0	0	0		0	19.9	80.1			
PHF	.905	.000	.778	.904	.722	.838	.000	.836	.000	.000	.000	.000	.000	.714	.894	.863	.929	

Traffic Data Service

San Jose, CA
 (408) 622-4787
 tdsbay@cs.com

File Name : 3AM FINAL
 Site Code : 00000003
 Start Date : 4/25/2018
 Page No : 2

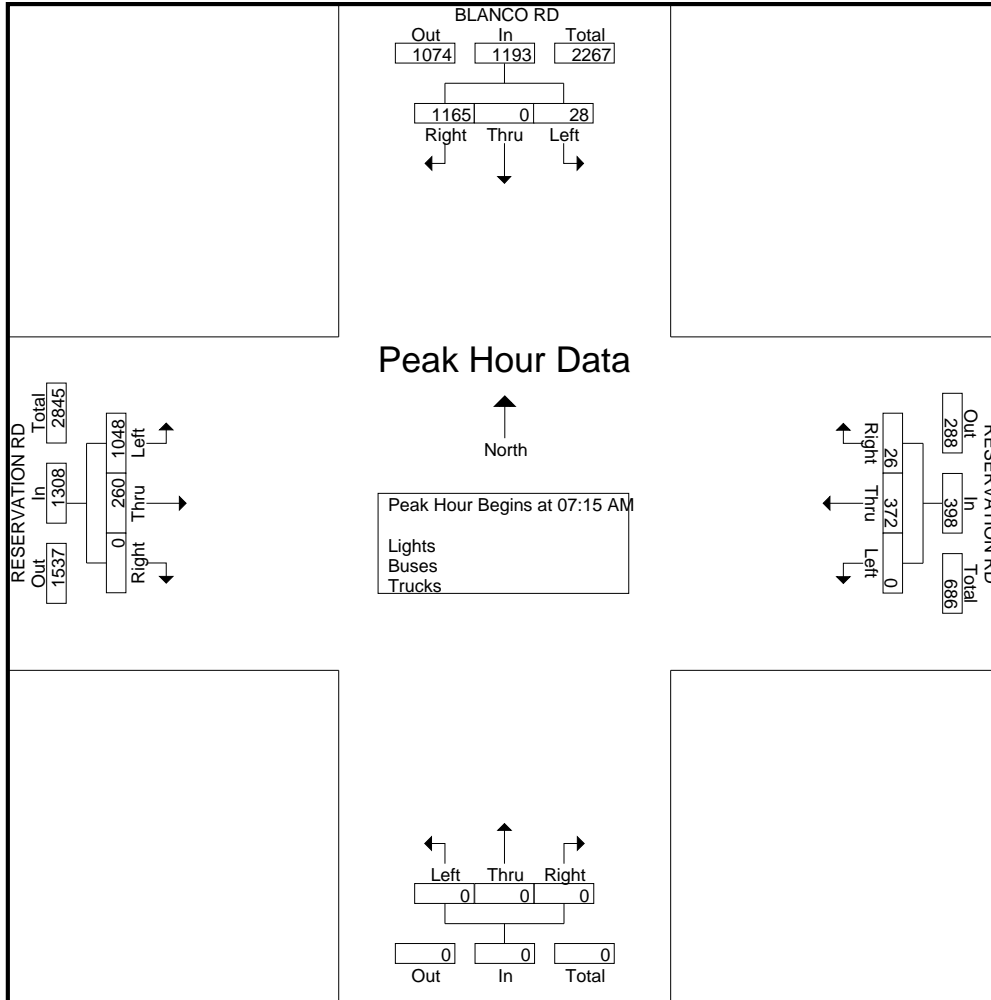

Traffic Data Service

San Jose, CA
 (408) 622-4787
 tdsbay@cs.com

File Name : 3AM FINAL
 Site Code : 00000003
 Start Date : 4/25/2018
 Page No : 1

Groups Printed- Bikes

Start Time	BLANCO RD Southbound					RESERVATION RD Westbound					Northbound					RESERVATION RD Eastbound					Int. Total
	Right	Thru	Left	Peds	App. Total	Right	Thru	Left	Peds	App. Total	Right	Thru	Left	Peds	App. Total	Right	Thru	Left	Peds	App. Total	
07:00 AM	0	0	0	0	0	0	0	0	0	0	0	0	0	0	0	0	0	0	0	0	0
07:15 AM	0	0	0	0	0	0	0	0	0	0	0	0	0	0	0	0	0	0	0	0	0
07:30 AM	0	0	0	0	0	0	0	0	0	0	0	0	0	0	0	0	0	1	0	1	1
07:45 AM	0	0	0	0	0	0	0	0	0	0	0	0	0	0	0	0	0	0	0	0	0
Total	0	0	0	0	0	0	0	0	0	0	0	0	0	0	0	0	0	1	0	1	1
08:00 AM	0	0	0	0	0	0	0	0	0	0	0	0	0	0	0	0	0	0	0	0	0
08:15 AM	0	0	0	0	0	0	0	0	0	0	0	0	0	0	0	0	0	1	0	1	1
08:30 AM	0	0	0	0	0	0	0	0	0	0	0	0	0	0	0	0	0	0	0	0	0
08:45 AM	0	0	0	0	0	0	0	0	0	0	0	0	0	0	0	0	0	0	0	0	0
Total	0	0	0	0	0	0	0	0	0	0	0	0	0	0	0	0	0	1	0	1	1
Grand Total	0	0	0	0	0	0	0	0	0	0	0	0	0	0	0	0	0	2	0	2	2
Apprch %	0	0	0	0	0	0	0	0	0	0	0	0	0	0	0	0	0	100	0	0	
Total %	0	0	0	0	0	0	0	0	0	0	0	0	0	0	0	0	0	100	0	100	

Start Time	BLANCO RD Southbound					RESERVATION RD Westbound					Northbound					RESERVATION RD Eastbound					Int. Total
	Right	Thru	Left	Peds	App. Total	Right	Thru	Left	Peds	App. Total	Right	Thru	Left	Peds	App. Total	Right	Thru	Left	Peds	App. Total	
Peak Hour Analysis From 07:00 AM to 08:45 AM - Peak 1 of 1																					
Peak Hour for Entire Intersection Begins at 07:30 AM																					
07:30 AM	0	0	0	0	0	0	0	0	0	0	0	0	0	0	0	0	0	1	0	1	1
07:45 AM	0	0	0	0	0	0	0	0	0	0	0	0	0	0	0	0	0	0	0	0	0
08:00 AM	0	0	0	0	0	0	0	0	0	0	0	0	0	0	0	0	0	0	0	0	0
08:15 AM	0	0	0	0	0	0	0	0	0	0	0	0	0	0	0	0	0	1	0	1	1
Total Volume	0	0	0	0	0	0	0	0	0	0	0	0	0	0	0	0	0	2	0	2	2
% App. Total	0	0	0	0	0	0	0	0	0	0	0	0	0	0	0	0	0	100	0	0	
PHF	.000	.000	.000	.000	.000	.000	.000	.000	.000	.000	.000	.000	.000	.000	.000	.000	.000	.500	.500	.500	

Traffic Data Service

San Jose, CA
(408) 622-4787
tdsbay@cs.com

File Name : 3AM FINAL
Site Code : 00000003
Start Date : 4/25/2018
Page No : 2

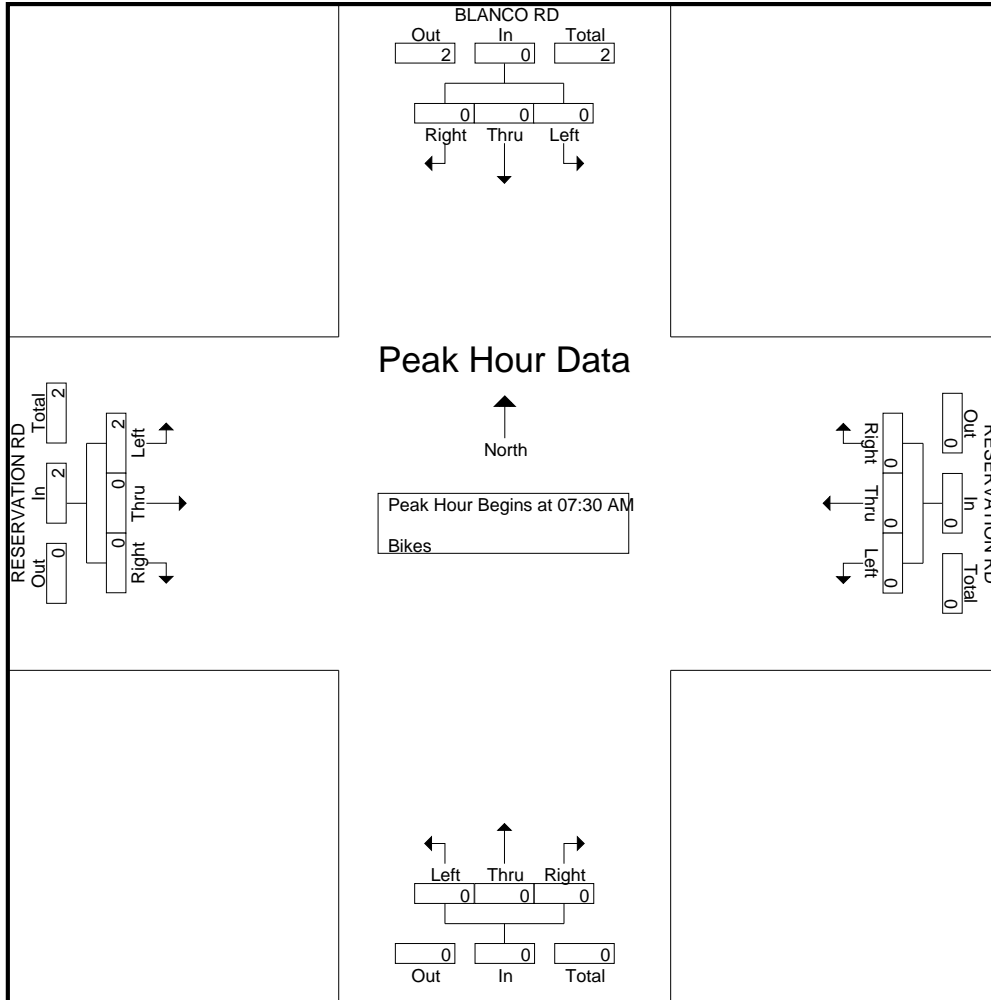

Traffic Data Service

San Jose, CA
 (408) 622-4787
 tdsbay@cs.com

File Name : 3PM FINAL
 Site Code : 00000003
 Start Date : 4/25/2018
 Page No : 1

Groups Printed- Lights - Buses - Trucks

Start Time	BLANCO RD Southbound					RESERVATION RD Westbound					Northbound					RESERVATION RD Eastbound					Int. Total
	Right	Thru	Left	Peds	App. Total	Right	Thru	Left	Peds	App. Total	Right	Thru	Left	Peds	App. Total	Right	Thru	Left	Peds	App. Total	
04:00 PM	224	0	9	0	233	8	57	0	0	65	0	0	0	0	0	0	106	308	0	414	712
04:15 PM	214	0	12	0	226	10	70	0	0	80	0	0	0	0	0	0	107	271	0	378	684
04:30 PM	236	0	3	0	239	7	82	0	0	89	0	0	0	0	0	0	117	282	0	399	727
04:45 PM	231	0	10	0	241	6	72	0	0	78	0	0	0	0	0	0	124	288	0	412	731
Total	905	0	34	0	939	31	281	0	0	312	0	0	0	0	0	0	454	1149	0	1603	2854
05:00 PM	249	0	6	0	255	10	73	0	0	83	0	0	0	0	0	0	124	251	0	375	713
05:15 PM	325	0	0	0	325	11	80	0	0	91	0	0	0	0	0	0	100	287	0	387	803
05:30 PM	280	0	5	0	285	6	100	0	0	106	0	0	0	0	0	0	113	268	0	381	772
05:45 PM	248	0	6	0	254	6	78	0	0	84	0	0	0	0	0	0	121	243	0	364	702
Total	1102	0	17	0	1119	33	331	0	0	364	0	0	0	0	0	0	458	1049	0	1507	2990
Grand Total	2007	0	51	0	2058	64	612	0	0	676	0	0	0	0	0	0	912	2198	0	3110	5844
Apprch %	97.5	0	2.5	0		9.5	90.5	0	0		0	0	0	0	0	0	29.3	70.7	0		
Total %	34.3	0	0.9	0	35.2	1.1	10.5	0	0	11.6	0	0	0	0	0	0	15.6	37.6	0	53.2	
Lights	1972	0	47	0	2019	63	598	0	0	661	0	0	0	0	0	0	897	2160	0	3057	5737
% Lights	98.3	0	92.2	0	98.1	98.4	97.7	0	0	97.8	0	0	0	0	0	0	98.4	98.3	0	98.3	98.2
Buses	13	0	0	0	13	0	0	0	0	0	0	0	0	0	0	0	4	17	0	21	34
% Buses	0.6	0	0	0	0.6	0	0	0	0	0	0	0	0	0	0	0	0.4	0.8	0	0.7	0.6
Trucks	22	0	4	0	26	1	14	0	0	15	0	0	0	0	0	0	11	21	0	32	73
% Trucks	1.1	0	7.8	0	1.3	1.6	2.3	0	0	2.2	0	0	0	0	0	0	1.2	1	0	1	1.2

Start Time	BLANCO RD Southbound				RESERVATION RD Westbound				Northbound				RESERVATION RD Eastbound				Int. Total	
	Right	Thru	Left	App. Total	Right	Thru	Left	App. Total	Right	Thru	Left	App. Total	Right	Thru	Left	App. Total		
Peak Hour Analysis From 04:00 PM to 05:45 PM - Peak 1 of 1																		
Peak Hour for Entire Intersection Begins at 04:45 PM																		
04:45 PM	231	0	10	241	6	72	0	78	0	0	0	0	0	0	124	288	412	731
05:00 PM	249	0	6	255	10	73	0	83	0	0	0	0	0	0	100	287	387	713
05:15 PM	325	0	0	325	11	80	0	91	0	0	0	0	0	0	113	268	381	803
05:30 PM	280	0	5	285	6	100	0	106	0	0	0	0	0	0	113	268	381	772
Total Volume	1085	0	21	1106	33	325	0	358	0	0	0	0	0	0	461	1094	1555	3019
% App. Total	98.1	0	1.9		9.2	90.8	0		0	0	0	0	0	0	29.6	70.4		
PHF	.835	.000	.525	.851	.750	.813	.000	.844	.000	.000	.000	.000	.000	.000	.929	.950	.944	.940

Traffic Data Service

San Jose, CA
 (408) 622-4787
 tdsbay@cs.com

File Name : 3PM FINAL
 Site Code : 00000003
 Start Date : 4/25/2018
 Page No : 2

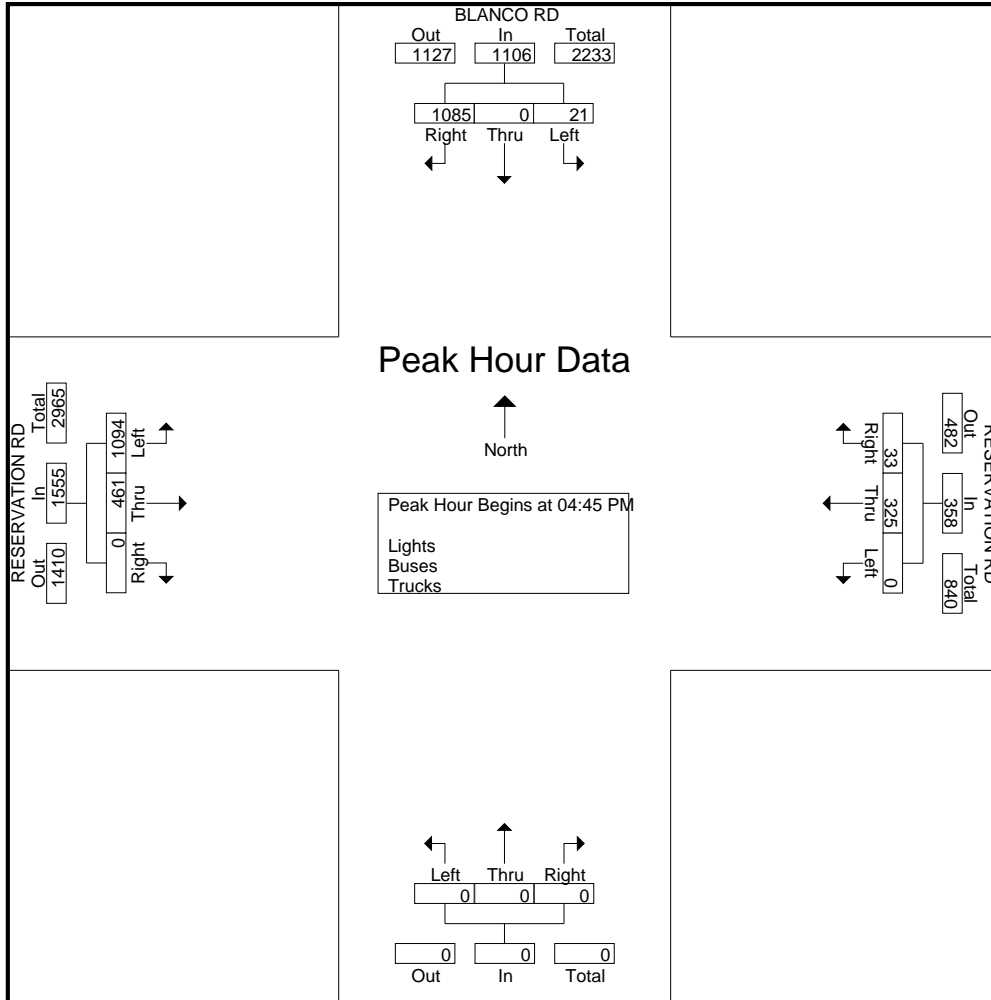

Traffic Data Service

San Jose, CA
 (408) 622-4787
 tdsbay@cs.com

File Name : 3PM FINAL
 Site Code : 00000003
 Start Date : 4/25/2018
 Page No : 1

Groups Printed- Bikes

Start Time	BLANCO RD Southbound					RESERVATION RD Westbound					Northbound					RESERVATION RD Eastbound					Int. Total
	Right	Thru	Left	Peds	App. Total	Right	Thru	Left	Peds	App. Total	Right	Thru	Left	Peds	App. Total	Right	Thru	Left	Peds	App. Total	
04:00 PM	0	0	0	0	0	0	0	0	0	0	0	0	0	0	0	0	0	0	0	0	0
04:15 PM	0	0	0	0	0	0	0	0	0	0	0	0	0	0	0	0	0	0	0	0	0
04:30 PM	0	0	0	0	0	0	0	0	0	0	0	0	0	0	0	0	0	0	0	0	0
04:45 PM	0	0	0	0	0	0	0	0	0	0	0	0	0	0	0	0	0	0	0	0	0
Total	0	0	0	0	0	0	0	0	0	0	0	0	0	0	0	0	0	0	0	0	0
05:00 PM	0	0	0	0	0	0	0	0	0	0	0	0	0	0	0	0	0	0	0	0	0
05:15 PM	0	0	0	0	0	0	0	0	0	0	0	0	0	0	0	0	0	0	0	0	0
05:30 PM	0	0	0	0	0	0	0	0	0	0	0	0	0	0	0	0	0	1	0	1	1
05:45 PM	0	0	0	0	0	0	0	0	0	0	0	0	0	0	0	0	0	0	0	0	0
Total	0	0	0	0	0	0	0	0	0	0	0	0	0	0	0	0	0	1	0	1	1
Grand Total	0	0	0	0	0	0	0	0	0	0	0	0	0	0	0	0	0	1	0	1	1
Apprch %	0	0	0	0		0	0	0	0		0	0	0	0		0	0	100	0		
Total %	0	0	0	0		0	0	0	0		0	0	0	0		0	0	100	0	100	

Start Time	BLANCO RD Southbound					RESERVATION RD Westbound					Northbound					RESERVATION RD Eastbound					Int. Total
	Right	Thru	Left	Peds	App. Total	Right	Thru	Left	Peds	App. Total	Right	Thru	Left	Peds	App. Total	Right	Thru	Left	Peds	App. Total	
Peak Hour Analysis From 04:00 PM to 05:45 PM - Peak 1 of 1																					
Peak Hour for Entire Intersection Begins at 04:45 PM																					
04:45 PM	0	0	0	0	0	0	0	0	0	0	0	0	0	0	0	0	0	0	0	0	0
05:00 PM	0	0	0	0	0	0	0	0	0	0	0	0	0	0	0	0	0	0	0	0	0
05:15 PM	0	0	0	0	0	0	0	0	0	0	0	0	0	0	0	0	0	0	0	0	0
05:30 PM	0	0	0	0	0	0	0	0	0	0	0	0	0	0	0	0	0	1	0	1	1
Total Volume	0	0	0	0	0	0	0	0	0	0	0	0	0	0	0	0	0	1	0	1	1
% App. Total	0	0	0	0		0	0	0	0		0	0	0	0		0	0	100	0		
PHF	.000	.000	.000	.000	.000	.000	.000	.000	.000	.000	.000	.000	.000	.000	.000	.000	.000	.250	.250	.250	.250

Traffic Data Service

San Jose, CA
(408) 622-4787
tdsbay@cs.com

File Name : 3PM FINAL
Site Code : 00000003
Start Date : 4/25/2018
Page No : 2

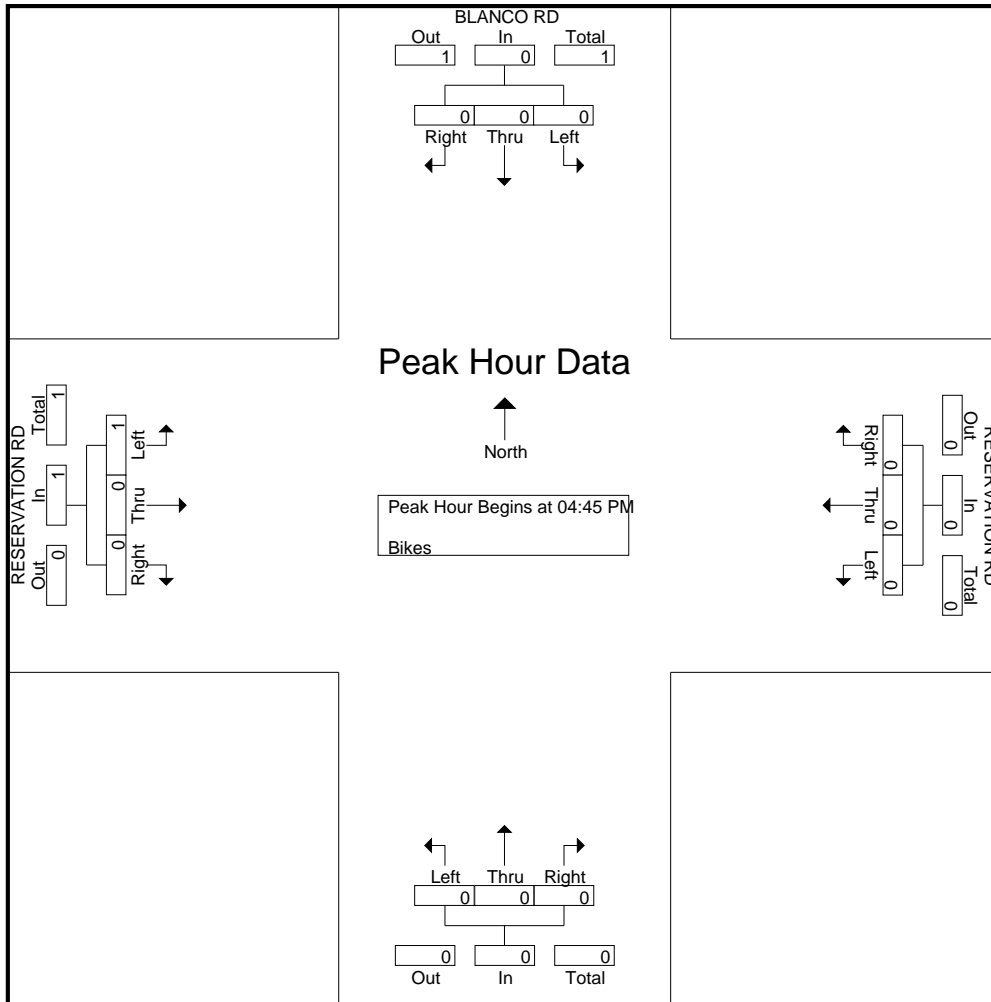

Traffic Data Service

San Jose, CA
(408) 622-4787
tdsbay@cs.com

File Name : 4AM FINAL
Site Code : 00000004
Start Date : 4/25/2018
Page No : 1

Groups Printed- Lights - Buses - Trucks

Start Time	Southbound					RESERVATION RD Westbound					E GARRISON RD Northbound					RESERVATION RD Eastbound					Int. Total
	Right	Thru	Left	Peds	App. Total	Right	Thru	Left	Peds	App. Total	Right	Thru	Left	Peds	App. Total	Right	Thru	Left	Peds	App. Total	
07:00 AM	0	0	0	0	0	0	187	11	0	198	15	0	4	0	19	3	59	0	0	62	279
07:15 AM	0	0	0	0	0	0	198	14	0	212	10	0	10	0	20	1	78	0	0	79	311
07:30 AM	0	0	0	0	0	0	209	6	0	215	24	0	14	0	38	1	92	0	0	93	346
07:45 AM	0	0	0	0	0	0	159	7	0	166	23	0	5	0	28	3	93	0	0	96	290
Total	0	0	0	0	0	0	753	38	0	791	72	0	33	0	105	8	322	0	0	330	1226
08:00 AM	0	0	0	0	0	0	146	4	0	150	17	0	4	2	23	4	66	0	2	72	245
08:15 AM	0	0	0	0	0	0	135	7	0	142	6	0	4	0	10	4	77	0	0	81	233
08:30 AM	0	0	0	0	0	0	116	5	0	121	9	0	3	0	12	2	39	0	0	41	174
08:45 AM	0	0	0	0	0	0	77	5	0	82	9	0	2	0	11	6	47	0	0	53	146
Total	0	0	0	0	0	0	474	21	0	495	41	0	13	2	56	16	229	0	2	247	798
Grand Total	0	0	0	0	0	0	1227	59	0	1286	113	0	46	2	161	24	551	0	2	577	2024
Apprch %	0	0	0	0	0	0	95.4	4.6	0		70.2	0	28.6	1.2		4.2	95.5	0	0.3		
Total %	0	0	0	0	0	0	60.6	2.9	0	63.5	5.6	0	2.3	0.1	8	1.2	27.2	0	0.1	28.5	
Lights	0	0	0	0	0	0	1206	51	0	1257	111	0	44	2	157	18	534	0	2	554	1968
% Lights	0	0	0	0	0	0	98.3	86.4	0	97.7	98.2	0	95.7	100	97.5	75	96.9	0	100	96	97.2
Buses	0	0	0	0	0	0	5	0	0	5	0	0	0	0	0	3	3	0	0	6	11
% Buses	0	0	0	0	0	0	0.4	0	0	0.4	0	0	0	0	0	12.5	0.5	0	0	1	0.5
Trucks	0	0	0	0	0	0	16	8	0	24	2	0	2	0	4	3	14	0	0	17	45
% Trucks	0	0	0	0	0	0	1.3	13.6	0	1.9	1.8	0	4.3	0	2.5	12.5	2.5	0	0	2.9	2.2

Start Time	Southbound				RESERVATION RD Westbound				E GARRISON RD Northbound				RESERVATION RD Eastbound				Int. Total
	Right	Thru	Left	App. Total	Right	Thru	Left	App. Total	Right	Thru	Left	App. Total	Right	Thru	Left	App. Total	
Peak Hour Analysis From 07:00 AM to 08:45 AM - Peak 1 of 1																	
Peak Hour for Entire Intersection Begins at 07:00 AM																	
07:00 AM	0	0	0	0	0	187	11	198	15	0	4	19	3	59	0	62	279
07:15 AM	0	0	0	0	0	198	14	212	10	0	10	20	1	78	0	79	311
07:30 AM	0	0	0	0	0	209	6	215	24	0	14	38	1	92	0	93	346
07:45 AM	0	0	0	0	0	159	7	166	23	0	5	28	3	93	0	96	290
Total Volume	0	0	0	0	0	753	38	791	72	0	33	105	8	322	0	330	1226
% App. Total	0	0	0	0	0	95.2	4.8		68.6	0	31.4		2.4	97.6	0		
PHF	.000	.000	.000	.000	.000	.901	.679	.920	.750	.000	.589	.691	.667	.866	.000	.859	.886

Traffic Data Service

San Jose, CA
 (408) 622-4787
 tdsbay@cs.com

File Name : 4AM FINAL
 Site Code : 00000004
 Start Date : 4/25/2018
 Page No : 2

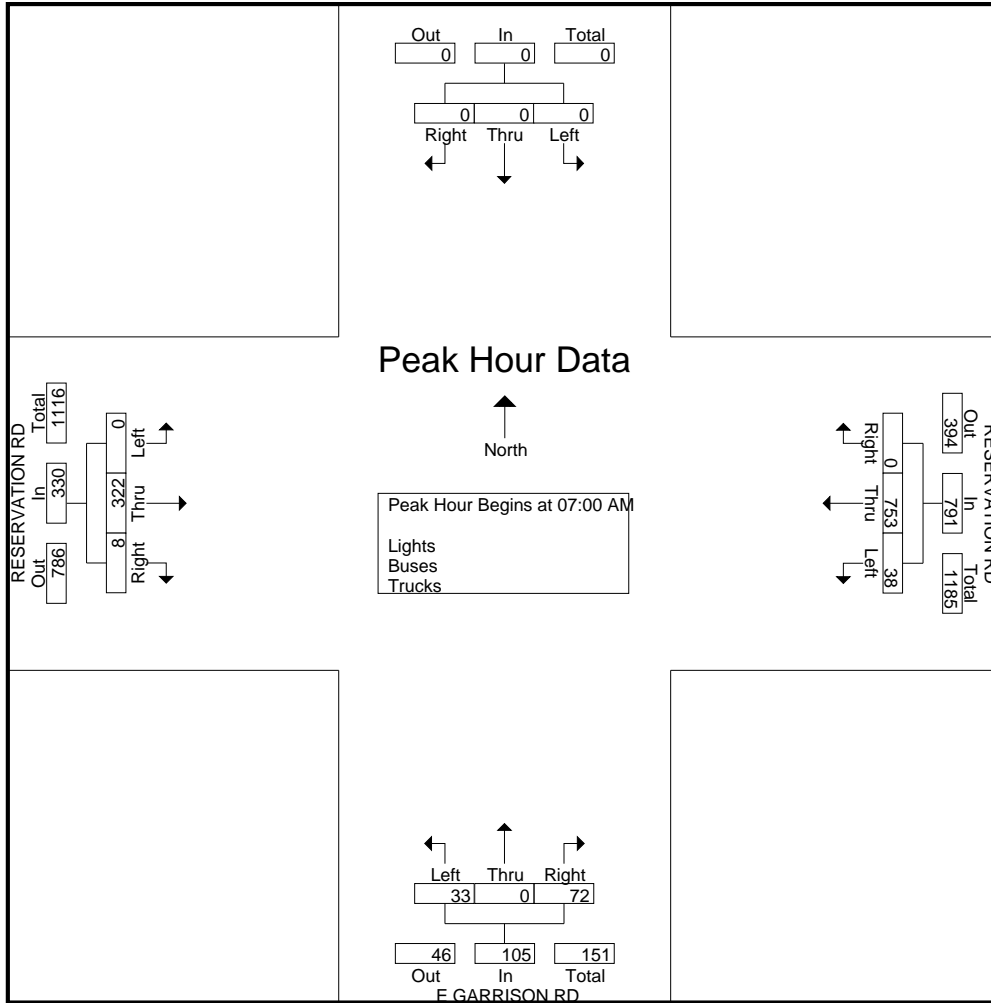

Traffic Data Service

San Jose, CA
 (408) 622-4787
 tdsbay@cs.com

File Name : 4AM FINAL
 Site Code : 00000004
 Start Date : 4/25/2018
 Page No : 1

Groups Printed- Bikes

Start Time	Southbound					RESERVATION RD Westbound					E GARRISON RD Northbound					RESERVATION RD Eastbound					Int. Total
	Right	Thru	Left	Peds	App. Total	Right	Thru	Left	Peds	App. Total	Right	Thru	Left	Peds	App. Total	Right	Thru	Left	Peds	App. Total	
07:00 AM	0	0	0	0	0	0	0	0	0	0	0	0	0	0	0	0	0	0	0	0	0
07:15 AM	0	0	0	0	0	0	0	0	0	0	0	0	0	0	0	0	0	0	0	0	0
07:30 AM	0	0	0	0	0	0	0	0	0	0	0	0	0	0	0	0	0	0	0	0	0
07:45 AM	0	0	0	0	0	0	0	0	0	0	0	0	0	0	0	0	0	0	0	0	0
Total	0	0	0	0	0	0	0	0	0	0	0	0	0	0	0	0	0	0	0	0	0
08:00 AM	0	0	0	0	0	0	0	0	0	0	0	0	0	0	0	0	0	0	0	0	0
08:15 AM	0	0	0	0	0	0	0	0	0	0	0	0	0	0	0	0	0	0	0	0	0
08:30 AM	0	0	0	0	0	0	0	0	0	0	0	0	0	0	0	0	0	0	0	0	0
08:45 AM	0	0	0	0	0	0	0	0	0	0	0	0	0	0	0	0	0	0	0	0	0
Total	0	0	0	0	0	0	0	0	0	0	0	0	0	0	0	0	0	0	0	0	0
Grand Total	0	0	0	0	0	0	0	0	0	0	0	0	0	0	0	0	0	0	0	0	0
Apprch %	0	0	0	0		0	0	0	0		0	0	0	0		0	0	0	0		
Total %																					

Start Time	Southbound				RESERVATION RD Westbound				E GARRISON RD Northbound				RESERVATION RD Eastbound				Int. Total
	Right	Thru	Left	App. Total	Right	Thru	Left	App. Total	Right	Thru	Left	App. Total	Right	Thru	Left	App. Total	
Peak Hour Analysis From 07:00 AM to 08:45 AM - Peak 1 of 1																	
Peak Hour for Entire Intersection Begins at 07:00 AM																	
07:00 AM	0	0	0	0	0	0	0	0	0	0	0	0	0	0	0	0	0
07:15 AM	0	0	0	0	0	0	0	0	0	0	0	0	0	0	0	0	0
07:30 AM	0	0	0	0	0	0	0	0	0	0	0	0	0	0	0	0	0
07:45 AM	0	0	0	0	0	0	0	0	0	0	0	0	0	0	0	0	0
Total Volume	0	0	0	0	0	0	0	0	0	0	0	0	0	0	0	0	0
% App. Total	0	0	0		0	0	0		0	0	0		0	0	0		
PHF	.000	.000	.000	.000	.000	.000	.000	.000	.000	.000	.000	.000	.000	.000	.000	.000	.000

Traffic Data Service

San Jose, CA
(408) 622-4787
tdsbay@cs.com

File Name : 4AM FINAL
Site Code : 00000004
Start Date : 4/25/2018
Page No : 2

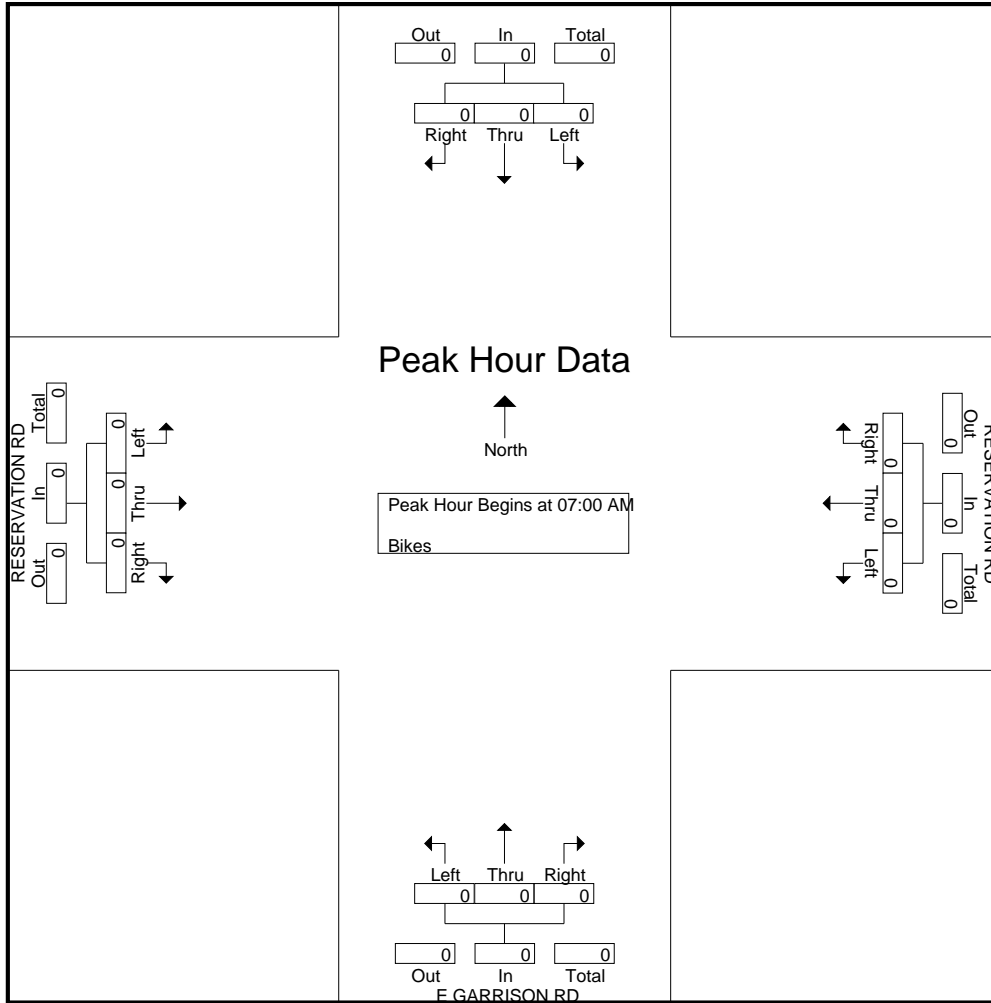

Traffic Data Service

San Jose, CA
 (408) 622-4787
 tdsbay@cs.com

File Name : 4PM FINAL
 Site Code : 00000004
 Start Date : 4/25/2018
 Page No : 1

Groups Printed- Lights - Buses - Trucks

Start Time	Southbound					RESERVATION RD Westbound					E GARRISON RD Northbound					RESERVATION RD Eastbound					Int. Total
	Right	Thru	Left	Peds	App. Total	Right	Thru	Left	Peds	App. Total	Right	Thru	Left	Peds	App. Total	Right	Thru	Left	Peds	App. Total	
04:00 PM	0	0	0	0	0	0	78	14	0	92	14	0	6	0	20	1	160	0	0	161	273
04:15 PM	0	0	0	0	0	0	80	10	0	90	15	0	1	0	16	9	148	1	0	158	264
04:30 PM	0	0	0	0	0	0	90	12	0	102	9	0	2	0	11	7	140	1	0	148	261
04:45 PM	0	0	0	0	0	0	78	10	0	88	6	0	3	0	9	7	181	0	0	188	285
Total	0	0	0	0	0	0	326	46	0	372	44	0	12	0	56	24	629	2	0	655	1083
05:00 PM	0	0	0	0	0	0	99	10	0	109	11	0	3	0	14	6	172	1	0	179	302
05:15 PM	0	0	0	0	0	0	125	16	0	141	9	0	1	0	10	5	159	0	0	164	315
05:30 PM	0	0	0	0	0	0	110	14	0	124	3	0	2	0	5	6	177	0	0	183	312
05:45 PM	0	0	0	0	0	0	96	11	0	107	7	0	3	0	10	7	173	0	0	180	297
Total	0	0	0	0	0	0	430	51	0	481	30	0	9	0	39	24	681	1	0	706	1226
Grand Total	0	0	0	0	0	0	756	97	0	853	74	0	21	0	95	48	1310	3	0	1361	2309
Apprch %	0	0	0	0	0	0	88.6	11.4	0		77.9	0	22.1	0		3.5	96.3	0.2	0		
Total %	0	0	0	0	0	0	32.7	4.2	0	36.9	3.2	0	0.9	0	4.1	2.1	56.7	0.1	0	58.9	
Lights	0	0	0	0	0	0	741	96	0	837	72	0	21	0	93	46	1281	3	0	1330	2260
% Lights	0	0	0	0	0	0	98	99	0	98.1	97.3	0	100	0	97.9	95.8	97.8	100	0	97.7	97.9
Buses	0	0	0	0	0	0	1	0	0	1	0	0	0	0	0	0	7	0	0	7	8
% Buses	0	0	0	0	0	0	0.1	0	0	0.1	0	0	0	0	0	0	0.5	0	0	0.5	0.3
Trucks	0	0	0	0	0	0	14	1	0	15	2	0	0	0	2	2	22	0	0	24	41
% Trucks	0	0	0	0	0	0	1.9	1	0	1.8	2.7	0	0	0	2.1	4.2	1.7	0	0	1.8	1.8

Start Time	Southbound				RESERVATION RD Westbound				E GARRISON RD Northbound				RESERVATION RD Eastbound				Int. Total
	Right	Thru	Left	App. Total	Right	Thru	Left	App. Total	Right	Thru	Left	App. Total	Right	Thru	Left	App. Total	
Peak Hour Analysis From 04:00 PM to 05:45 PM - Peak 1 of 1																	
Peak Hour for Entire Intersection Begins at 05:00 PM																	
05:00 PM	0	0	0	0	0	99	10	109	11	0	3	14	6	172	1	179	302
05:15 PM	0	0	0	0	0	125	16	141	9	0	1	10	5	159	0	164	315
05:30 PM	0	0	0	0	0	110	14	124	3	0	2	5	6	177	0	183	312
05:45 PM	0	0	0	0	0	96	11	107	7	0	3	10	7	173	0	180	297
Total Volume	0	0	0	0	0	430	51	481	30	0	9	39	24	681	1	706	1226
% App. Total	0	0	0	0	0	89.4	10.6		76.9	0	23.1		3.4	96.5	0.1		
PHF	.000	.000	.000	.000	.000	.860	.797	.853	.682	.000	.750	.696	.857	.962	.250	.964	.973

Traffic Data Service

San Jose, CA
 (408) 622-4787
 tdsbay@cs.com

File Name : 4PM FINAL
 Site Code : 00000004
 Start Date : 4/25/2018
 Page No : 2

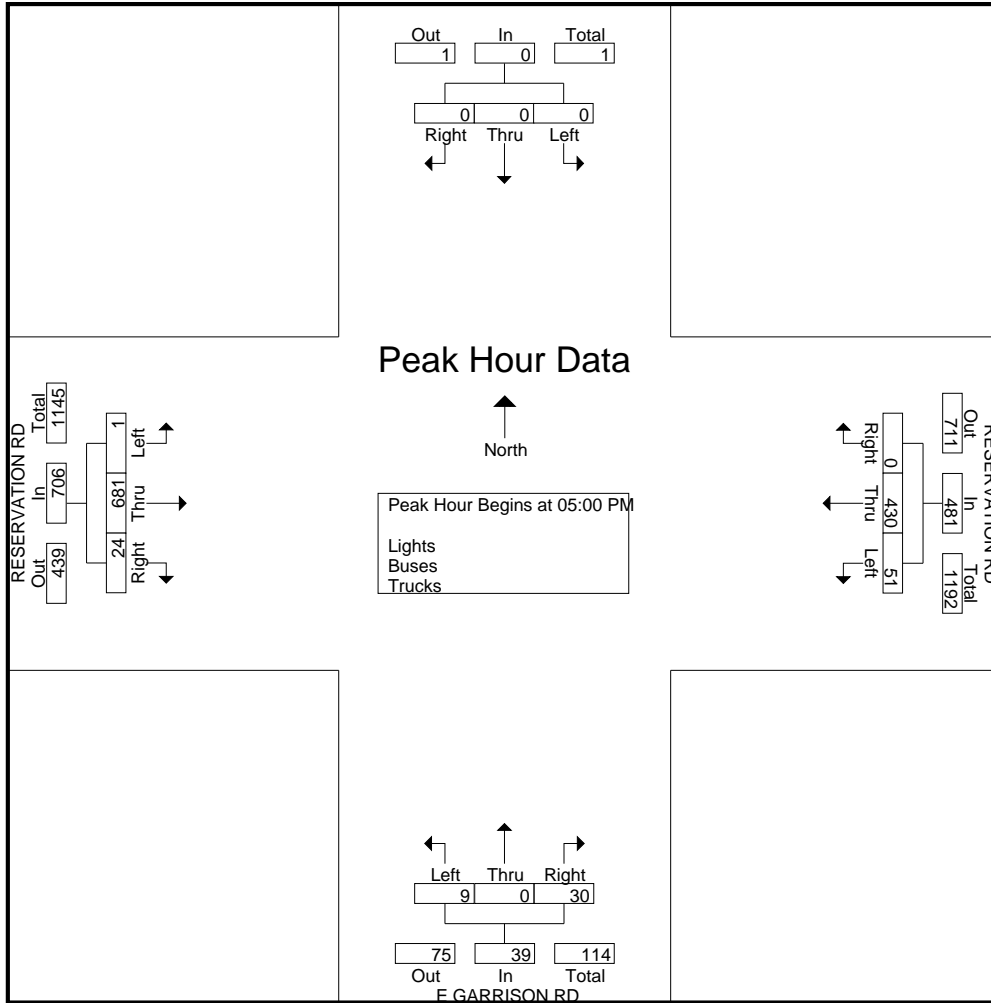

Traffic Data Service

San Jose, CA
 (408) 622-4787
 tdsbay@cs.com

File Name : 4PM FINAL
 Site Code : 00000004
 Start Date : 4/25/2018
 Page No : 1

Groups Printed- Bikes

Start Time	Southbound					RESERVATION RD Westbound					E GARRISON RD Northbound					RESERVATION RD Eastbound					Int. Total
	Right	Thru	Left	Peds	App. Total	Right	Thru	Left	Peds	App. Total	Right	Thru	Left	Peds	App. Total	Right	Thru	Left	Peds	App. Total	
04:00 PM	0	0	0	0	0	0	0	0	0	0	0	0	0	0	0	0	0	0	0	0	0
04:15 PM	0	0	0	0	0	0	0	0	0	0	0	0	0	0	0	0	0	0	0	0	0
04:30 PM	0	0	0	0	0	0	0	0	0	0	0	0	0	0	0	0	0	0	0	0	0
04:45 PM	0	0	0	0	0	0	0	0	0	0	0	0	0	0	0	0	0	0	0	0	0
Total	0	0	0	0	0	0	0	0	0	0	0	0	0	0	0	0	0	0	0	0	0
05:00 PM	0	0	0	0	0	0	0	0	0	0	0	0	0	0	0	0	0	0	0	0	0
05:15 PM	0	0	0	0	0	0	0	0	0	0	0	0	0	0	0	0	0	0	0	0	0
05:30 PM	0	0	0	0	0	0	0	0	0	0	0	0	0	0	0	0	0	0	0	0	0
05:45 PM	0	0	0	0	0	0	0	0	0	0	0	0	0	0	0	0	0	0	0	0	0
Total	0	0	0	0	0	0	0	0	0	0	0	0	0	0	0	0	0	0	0	0	0
Grand Total	0	0	0	0	0	0	0	0	0	0	0	0	0	0	0	0	0	0	0	0	0
Apprch %	0	0	0	0		0	0	0	0		0	0	0	0		0	0	0	0		
Total %																					

Start Time	Southbound					RESERVATION RD Westbound					E GARRISON RD Northbound					RESERVATION RD Eastbound					Int. Total
	Right	Thru	Left	Peds	App. Total	Right	Thru	Left	Peds	App. Total	Right	Thru	Left	Peds	App. Total	Right	Thru	Left	Peds	App. Total	
Peak Hour Analysis From 04:00 PM to 05:45 PM - Peak 1 of 1																					
Peak Hour for Entire Intersection Begins at 04:00 PM																					
04:00 PM	0	0	0	0	0	0	0	0	0	0	0	0	0	0	0	0	0	0	0	0	0
04:15 PM	0	0	0	0	0	0	0	0	0	0	0	0	0	0	0	0	0	0	0	0	0
04:30 PM	0	0	0	0	0	0	0	0	0	0	0	0	0	0	0	0	0	0	0	0	0
04:45 PM	0	0	0	0	0	0	0	0	0	0	0	0	0	0	0	0	0	0	0	0	0
Total Volume	0	0	0	0	0	0	0	0	0	0	0	0	0	0	0	0	0	0	0	0	0
% App. Total	0	0	0	0		0	0	0	0		0	0	0	0		0	0	0	0		
PHF	.000	.000	.000	.000	.000	.000	.000	.000	.000	.000	.000	.000	.000	.000	.000	.000	.000	.000	.000	.000	.000

Traffic Data Service

San Jose, CA
(408) 622-4787
tdsbay@cs.com

File Name : 4PM FINAL
Site Code : 00000004
Start Date : 4/25/2018
Page No : 2

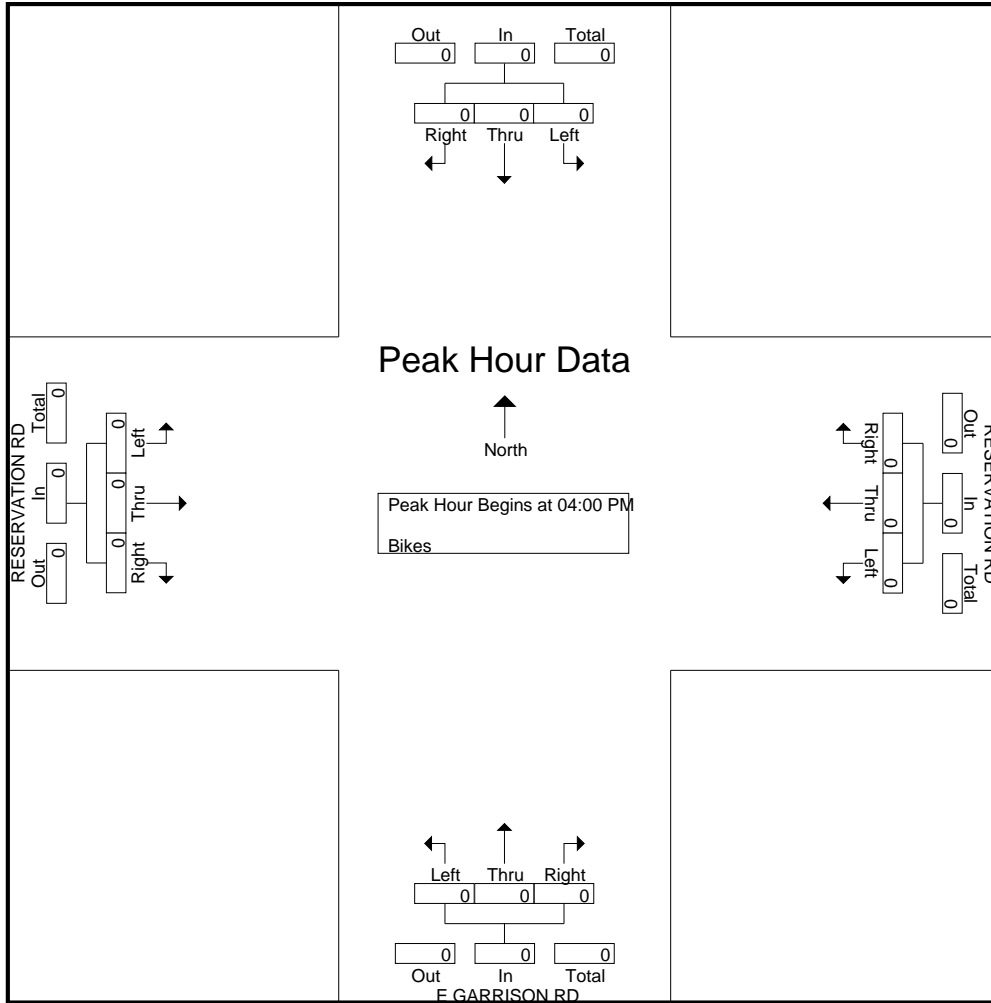

Traffic Data Service

San Jose, CA
 (408) 622-4787
 tdsbay@cs.com

File Name : 5AM FINAL
 Site Code : 00000005
 Start Date : 4/25/2018
 Page No : 1

Groups Printed- Lights - Buses - Trucks

Start Time	4TH AVE Southbound					INTER-GARRISON RD Westbound					4TH AVE Northbound					INTER-GARRISON RD Eastbound					Int. Total
	Right	Thru	Left	Peds	App. Total	Right	Thru	Left	Peds	App. Total	Right	Thru	Left	Peds	App. Total	Right	Thru	Left	Peds	App. Total	
07:00 AM	0	1	0	1	2	0	8	6	0	14	5	0	1	1	7	1	10	0	0	11	34
07:15 AM	0	2	1	0	3	1	13	18	0	32	10	1	0	1	12	0	9	0	0	9	56
07:30 AM	1	1	0	3	5	5	11	29	1	46	16	1	1	6	24	8	8	0	0	16	91
07:45 AM	1	2	1	10	14	10	25	23	6	64	26	3	3	3	35	3	18	0	2	23	136
Total	2	6	2	14	24	16	57	76	7	156	57	5	5	11	78	12	45	0	2	59	317
08:00 AM	1	1	0	5	7	7	29	18	2	56	15	1	2	3	21	3	22	0	2	27	111
08:15 AM	3	2	1	11	17	6	28	15	8	57	7	0	1	6	14	2	30	0	4	36	124
08:30 AM	0	1	0	2	3	4	19	8	3	34	5	0	1	5	11	2	17	1	1	21	69
08:45 AM	2	1	1	2	6	7	17	11	1	36	3	0	3	3	9	2	20	0	1	23	74
Total	6	5	2	20	33	24	93	52	14	183	30	1	7	17	55	9	89	1	8	107	378
Grand Total	8	11	4	34	57	40	150	128	21	339	87	6	12	28	133	21	134	1	10	166	695
Apprch %	14	19.3	7	59.6		11.8	44.2	37.8	6.2		65.4	4.5	9	21.1		12.7	80.7	0.6	6		
Total %	1.2	1.6	0.6	4.9	8.2	5.8	21.6	18.4	3	48.8	12.5	0.9	1.7	4	19.1	3	19.3	0.1	1.4	23.9	
Lights	8	11	4	34	57	40	144	125	21	330	79	6	12	28	125	20	125	1	10	156	668
% Lights	100	100	100	100	100	100	96	97.7	100	97.3	90.8	100	100	100	94	95.2	93.3	100	100	94	96.1
Buses	0	0	0	0	0	0	1	0	0	1	5	0	0	0	5	0	5	0	0	5	11
% Buses	0	0	0	0	0	0	0.7	0	0	0.3	5.7	0	0	0	3.8	0	3.7	0	0	3	1.6
Trucks	0	0	0	0	0	0	5	3	0	8	3	0	0	0	3	1	4	0	0	5	16
% Trucks	0	0	0	0	0	0	3.3	2.3	0	2.4	3.4	0	0	0	2.3	4.8	3	0	0	3	2.3

Start Time	4TH AVE Southbound				INTER-GARRISON RD Westbound				4TH AVE Northbound				INTER-GARRISON RD Eastbound				Int. Total
	Right	Thru	Left	App. Total	Right	Thru	Left	App. Total	Right	Thru	Left	App. Total	Right	Thru	Left	App. Total	
Peak Hour Analysis From 07:00 AM to 08:45 AM - Peak 1 of 1																	
Peak Hour for Entire Intersection Begins at 07:30 AM																	
07:30 AM	1	1	0	2	5	11	29	45	16	1	1	18	8	8	0	16	81
07:45 AM	1	2	1	4	10	25	23	58	26	3	3	32	3	18	0	21	115
08:00 AM	1	1	0	2	7	29	18	54	15	1	2	18	3	22	0	25	99
08:15 AM	3	2	1	6	6	28	15	49	7	0	1	8	2	30	0	32	95
Total Volume	6	6	2	14	28	93	85	206	64	5	7	76	16	78	0	94	390
% App. Total	42.9	42.9	14.3		13.6	45.1	41.3		84.2	6.6	9.2		17	83	0		
PHF	.500	.750	.500	.583	.700	.802	.733	.888	.615	.417	.583	.594	.500	.650	.000	.734	.848

Traffic Data Service

San Jose, CA
 (408) 622-4787
 tdsbay@cs.com

File Name : 5AM FINAL
 Site Code : 00000005
 Start Date : 4/25/2018
 Page No : 2

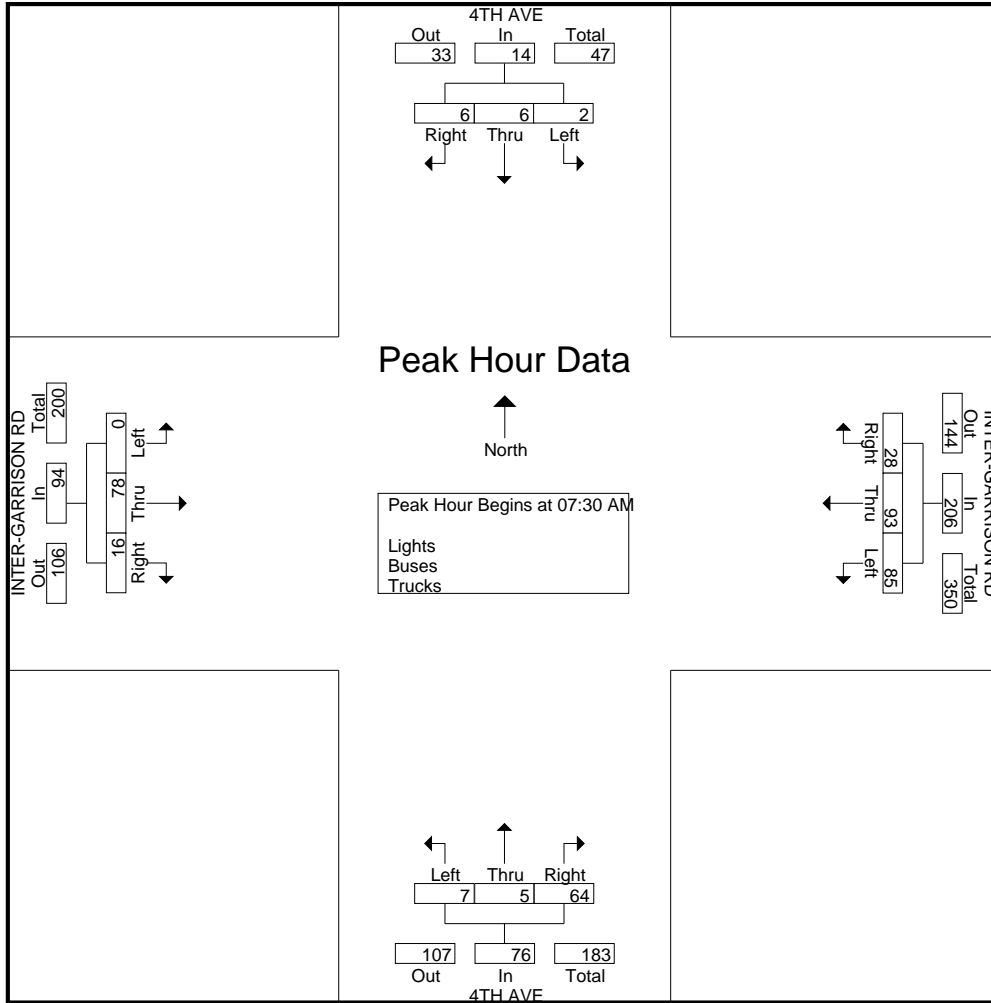

Traffic Data Service

San Jose, CA
 (408) 622-4787
 tdsbay@cs.com

File Name : 5AM FINAL
 Site Code : 00000005
 Start Date : 4/25/2018
 Page No : 1

Groups Printed- Bikes

Start Time	4TH AVE Southbound					INTER-GARRISON RD Westbound					4TH AVE Northbound					INTER-GARRISON RD Eastbound					Int. Total
	Right	Thru	Left	Peds	App. Total	Right	Thru	Left	Peds	App. Total	Right	Thru	Left	Peds	App. Total	Right	Thru	Left	Peds	App. Total	
07:00 AM	1	0	0	0	1	0	1	0	0	1	0	0	0	0	0	0	0	0	0	0	0
07:15 AM	0	0	0	0	0	0	0	0	0	0	0	0	0	0	0	0	0	0	0	0	0
07:30 AM	0	0	0	0	0	0	0	0	0	0	0	0	0	0	0	0	0	0	0	0	0
07:45 AM	0	0	1	0	1	0	0	0	0	0	0	0	2	0	2	0	0	0	0	0	3
Total	1	0	1	0	2	0	1	0	0	1	0	0	2	0	2	0	0	0	0	0	5
08:00 AM	0	0	0	0	0	0	0	0	0	0	0	0	0	0	0	0	0	0	0	0	0
08:15 AM	0	0	0	0	0	0	0	1	0	1	0	0	0	0	0	0	0	0	0	0	1
08:30 AM	0	0	0	0	0	0	0	0	1	1	0	0	0	0	0	0	0	0	0	0	1
08:45 AM	0	0	0	0	0	0	1	0	0	1	0	0	0	0	0	0	0	0	0	0	1
Total	0	0	0	0	0	0	1	1	1	3	0	0	0	0	0	0	0	0	0	0	3
Grand Total	1	0	1	0	2	0	2	1	1	4	0	0	2	0	2	0	0	0	0	0	8
Apprch %	50	0	50	0		0	50	25	25		0	0	100	0		0	0	0	0		
Total %	12.5	0	12.5	0	25	0	25	12.5	12.5	50	0	0	25	0	25	0	0	0	0	0	

Start Time	4TH AVE Southbound					INTER-GARRISON RD Westbound					4TH AVE Northbound					INTER-GARRISON RD Eastbound					Int. Total
	Right	Thru	Left	Peds	App. Total	Right	Thru	Left	Peds	App. Total	Right	Thru	Left	Peds	App. Total	Right	Thru	Left	Peds	App. Total	
07:00 AM	1	0	0	0	1	0	1	0	0	1	0	0	0	0	0	0	0	0	0	0	2
07:15 AM	0	0	0	0	0	0	0	0	0	0	0	0	0	0	0	0	0	0	0	0	0
07:30 AM	0	0	0	0	0	0	0	0	0	0	0	0	0	0	0	0	0	0	0	0	0
07:45 AM	0	0	1	0	1	0	0	0	0	0	0	0	2	0	2	0	0	0	0	0	3
Total Volume	1	0	1	0	2	0	1	0	0	1	0	0	2	0	2	0	0	0	0	0	5
% App. Total	50	0	50	0		0	100	0	0		0	0	100	0		0	0	0	0		
PHF	.250	.000	.250	.000	.500	.000	.250	.000	.000	.250	.000	.000	.250	.000	.250	.000	.000	.000	.000	.000	.417

Peak Hour Analysis From 07:00 AM to 08:45 AM - Peak 1 of 1
 Peak Hour for Entire Intersection Begins at 07:00 AM

Traffic Data Service

San Jose, CA
 (408) 622-4787
 tdsbay@cs.com

File Name : 5AM FINAL
 Site Code : 00000005
 Start Date : 4/25/2018
 Page No : 2

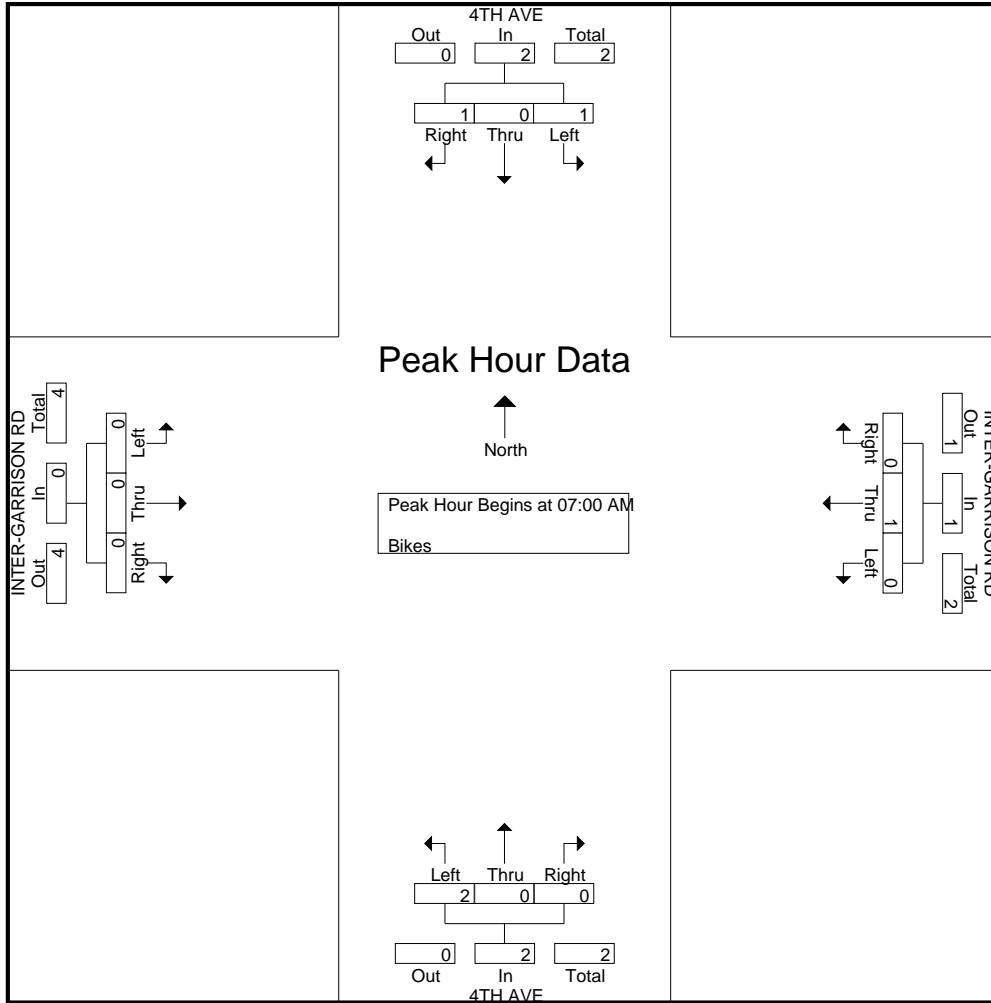

Traffic Data Service

San Jose, CA
 (408) 622-4787
 tdsbay@cs.com

File Name : 5PM FINAL
 Site Code : 00000005
 Start Date : 4/25/2018
 Page No : 1

Groups Printed- Lights - Buses - Trucks

Start Time	4TH AVE Southbound					INTER-GARRISON RD Westbound					4TH AVE Northbound					INTER-GARRISON RD Eastbound					Int. Total
	Right	Thru	Left	Peds	App. Total	Right	Thru	Left	Peds	App. Total	Right	Thru	Left	Peds	App. Total	Right	Thru	Left	Peds	App. Total	
04:00 PM	1	2	3	8	14	7	23	18	2	50	30	6	3	10	49	4	28	2	5	39	152
04:15 PM	0	2	3	2	7	2	19	9	0	30	26	4	4	6	40	0	12	1	3	16	93
04:30 PM	1	4	6	5	16	7	17	10	4	38	23	7	2	5	37	0	23	0	1	24	115
04:45 PM	1	3	7	6	17	4	16	11	1	32	33	9	8	8	58	4	28	2	3	37	144
Total	3	11	19	21	54	20	75	48	7	150	112	26	17	29	184	8	91	5	12	116	504
05:00 PM	2	6	4	7	19	4	10	18	5	37	34	3	7	4	48	1	29	1	1	32	136
05:15 PM	1	4	6	12	23	7	21	26	6	60	34	7	3	9	53	1	36	0	3	40	176
05:30 PM	1	3	6	11	21	5	17	21	5	48	44	6	10	11	71	2	30	3	5	40	180
05:45 PM	1	4	5	8	18	3	37	28	4	72	43	7	17	10	77	4	30	2	7	43	210
Total	5	17	21	38	81	19	85	93	20	217	155	23	37	34	249	8	125	6	16	155	702
Grand Total	8	28	40	59	135	39	160	141	27	367	267	49	54	63	433	16	216	11	28	271	1206
Apprch %	5.9	20.7	29.6	43.7		10.6	43.6	38.4	7.4		61.7	11.3	12.5	14.5		5.9	79.7	4.1	10.3		
Total %	0.7	2.3	3.3	4.9	11.2	3.2	13.3	11.7	2.2	30.4	22.1	4.1	4.5	5.2	35.9	1.3	17.9	0.9	2.3	22.5	
Lights	8	28	40	59	135	39	158	140	27	364	256	49	54	63	422	16	211	11	28	266	1187
% Lights	100	100	100	100	100	100	98.8	99.3	100	99.2	95.9	100	100	100	97.5	100	97.7	100	100	98.2	98.4
Buses	0	0	0	0	0	0	0	0	0	0	7	0	0	0	7	0	4	0	0	4	11
% Buses	0	0	0	0	0	0	0	0	0	0	2.6	0	0	0	1.6	0	1.9	0	0	1.5	0.9
Trucks	0	0	0	0	0	0	2	1	0	3	4	0	0	0	4	0	1	0	0	1	8
% Trucks	0	0	0	0	0	0	1.2	0.7	0	0.8	1.5	0	0	0	0.9	0	0.5	0	0	0.4	0.7

Start Time	4TH AVE Southbound				INTER-GARRISON RD Westbound				4TH AVE Northbound				INTER-GARRISON RD Eastbound				Int. Total
	Right	Thru	Left	App. Total	Right	Thru	Left	App. Total	Right	Thru	Left	App. Total	Right	Thru	Left	App. Total	
Peak Hour Analysis From 04:00 PM to 05:45 PM - Peak 1 of 1																	
Peak Hour for Entire Intersection Begins at 05:00 PM																	
05:00 PM	2	6	4	12	4	10	18	32	34	3	7	44	1	29	1	31	119
05:15 PM	1	4	6	11	7	21	26	54	34	7	3	44	1	36	0	37	146
05:30 PM	1	3	6	10	5	17	21	43	44	6	10	60	2	30	3	35	148
05:45 PM	1	4	5	10	3	37	28	68	43	7	17	67	4	30	2	36	181
Total Volume	5	17	21	43	19	85	93	197	155	23	37	215	8	125	6	139	594
% App. Total	11.6	39.5	48.8		9.6	43.1	47.2		72.1	10.7	17.2		5.8	89.9	4.3		
PHF	.625	.708	.875	.896	.679	.574	.830	.724	.881	.821	.544	.802	.500	.868	.500	.939	.820

Traffic Data Service

San Jose, CA
 (408) 622-4787
 tdsbay@cs.com

File Name : 5PM FINAL
 Site Code : 00000005
 Start Date : 4/25/2018
 Page No : 2

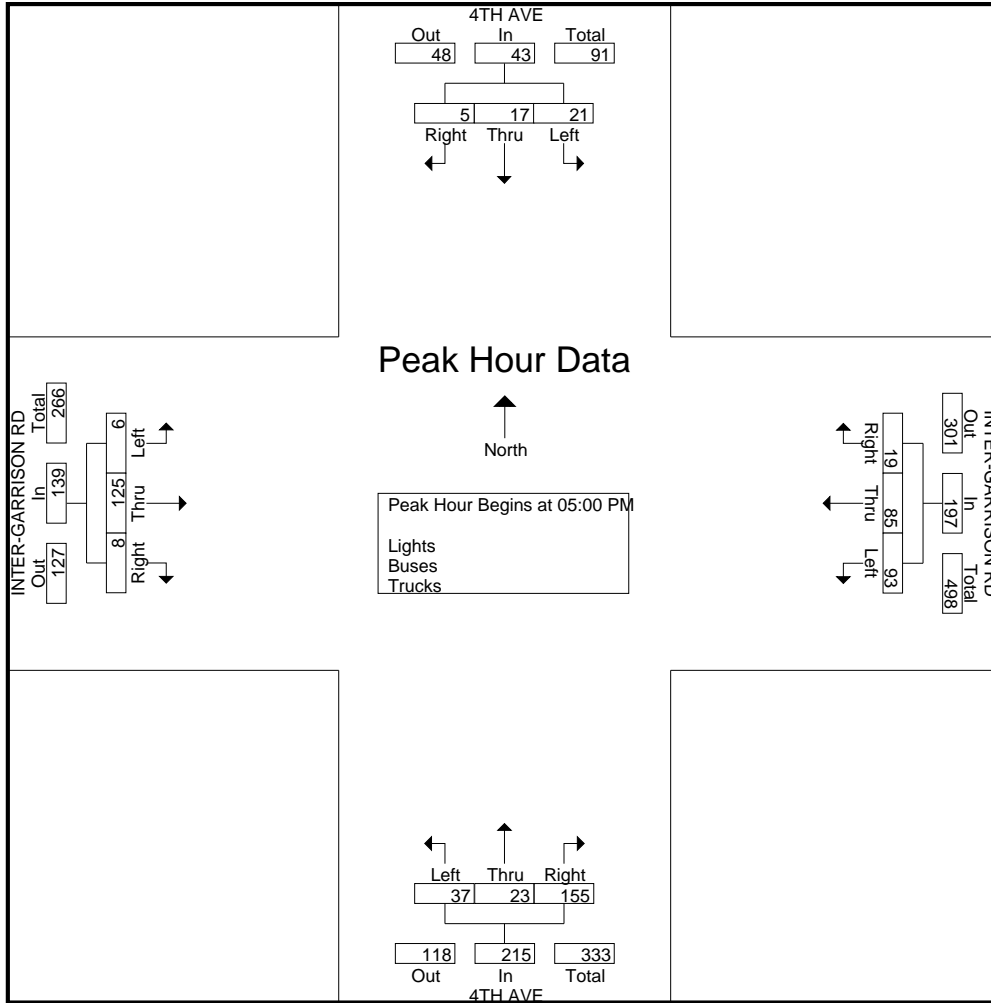

Traffic Data Service

San Jose, CA
 (408) 622-4787
 tdsbay@cs.com

File Name : 5PM FINAL
 Site Code : 00000005
 Start Date : 4/25/2018
 Page No : 1

Groups Printed- Bikes

Start Time	4TH AVE Southbound					INTER-GARRISON RD Westbound					4TH AVE Northbound					INTER-GARRISON RD Eastbound					Int. Total	
	Right	Thru	Left	Peds	App. Total	Right	Thru	Left	Peds	App. Total	Right	Thru	Left	Peds	App. Total	Right	Thru	Left	Peds	App. Total		
04:00 PM	0	0	2	0	2	0	1	0	0	1	0	0	0	0	0	0	1	0	0	0	1	4
04:15 PM	0	0	0	0	0	0	0	0	0	0	0	0	0	0	0	0	1	0	0	0	1	1
04:30 PM	0	0	1	0	1	0	0	0	0	0	0	0	0	0	0	0	0	0	0	0	0	1
04:45 PM	0	0	0	0	0	0	0	0	0	0	0	0	0	0	0	0	0	0	0	0	0	0
Total	0	0	3	0	3	0	1	0	0	1	0	0	0	0	0	0	2	0	0	0	2	6
05:00 PM	0	0	0	0	0	0	0	0	0	0	0	1	0	0	1	0	2	0	0	0	2	3
05:15 PM	0	0	0	0	0	0	0	0	0	0	0	0	0	0	0	1	0	0	0	0	1	1
05:30 PM	0	0	0	0	0	0	0	0	0	0	0	0	0	0	0	0	0	0	0	0	0	0
05:45 PM	0	0	0	0	0	0	0	1	0	1	0	0	0	0	0	0	0	0	0	0	0	1
Total	0	0	0	0	0	0	0	1	0	1	0	1	0	0	1	1	2	0	0	0	3	5
Grand Total	0	0	3	0	3	0	1	1	0	2	0	1	0	0	1	1	4	0	0	0	5	11
Apprch %	0	0	100	0		0	50	50	0		0	100	0	0		20	80	0	0			
Total %	0	0	27.3	0	27.3	0	9.1	9.1	0	18.2	0	9.1	0	0	9.1	9.1	36.4	0	0	45.5		

Start Time	4TH AVE Southbound					INTER-GARRISON RD Westbound					4TH AVE Northbound					INTER-GARRISON RD Eastbound					Int. Total	
	Right	Thru	Left	Peds	App. Total	Right	Thru	Left	Peds	App. Total	Right	Thru	Left	Peds	App. Total	Right	Thru	Left	Peds	App. Total		
Peak Hour Analysis From 04:00 PM to 05:45 PM - Peak 1 of 1																						
Peak Hour for Entire Intersection Begins at 04:00 PM																						
04:00 PM	0	0	2	0	2	0	1	0	0	1	0	0	0	0	0	0	1	0	0	0	1	4
04:15 PM	0	0	0	0	0	0	0	0	0	0	0	0	0	0	0	0	1	0	0	0	1	1
04:30 PM	0	0	1	0	1	0	0	0	0	0	0	0	0	0	0	0	0	0	0	0	0	1
04:45 PM	0	0	0	0	0	0	0	0	0	0	0	0	0	0	0	0	0	0	0	0	0	0
Total Volume	0	0	3	0	3	0	1	0	0	1	0	0	0	0	0	0	2	0	0	0	2	6
% App. Total	0	0	100	0		0	100	0	0		0	0	0	0		0	100	0	0			
PHF	.000	.000	.375		.375	.000	.250	.000		.250	.000	.000	.000		.000	.000	.500	.000		.500		.375

Traffic Data Service

San Jose, CA
(408) 622-4787
tdsbay@cs.com

File Name : 5PM FINAL
Site Code : 00000005
Start Date : 4/25/2018
Page No : 2

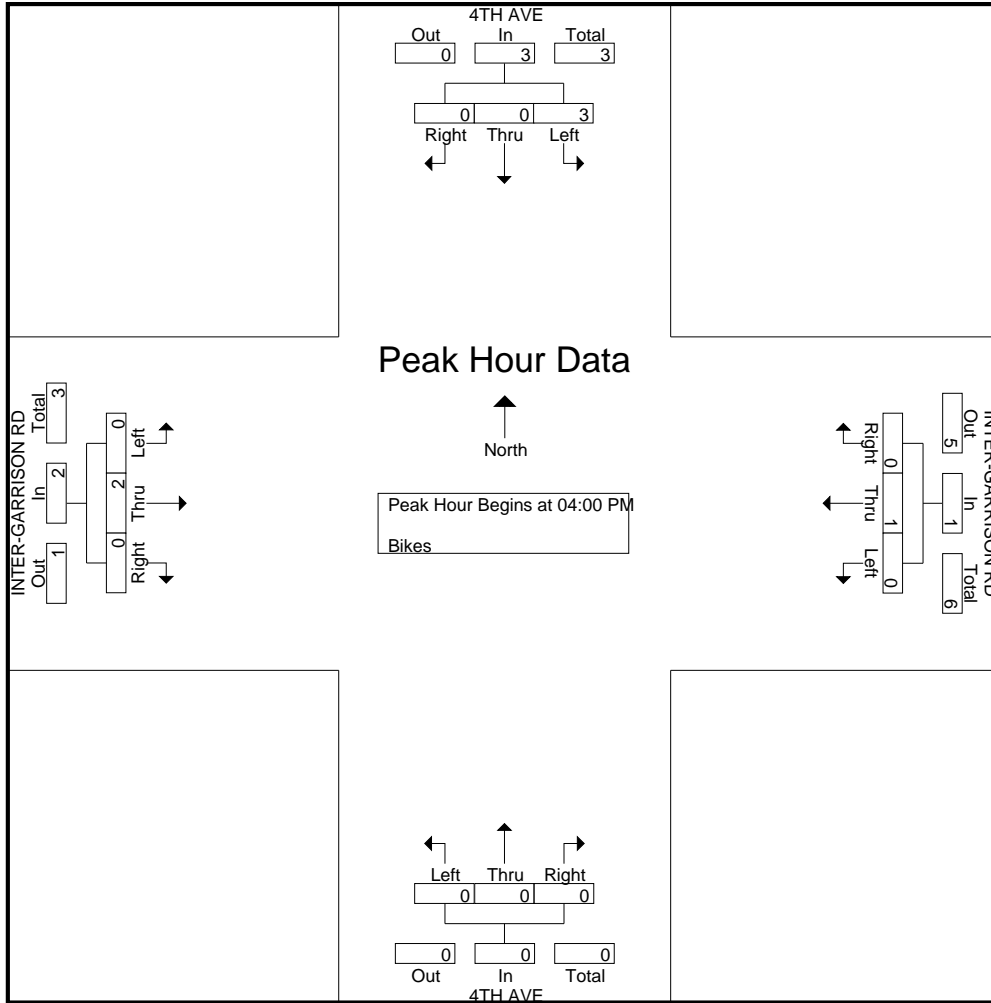

Traffic Data Service

San Jose, CA
 (408) 622-4787
 tdsbay@cs.com

File Name : 6AM FINAL
 Site Code : 00000006
 Start Date : 4/25/2018
 Page No : 1

Groups Printed- Lights - Buses - Trucks

Start Time	RESERVATION RD Southbound					Westbound					RESERVATION RD Northbound					WATKINS GATE RD Eastbound					Int. Total
	Right	Thru	Left	Peds	App. Total	Right	Thru	Left	Peds	App. Total	Right	Thru	Left	Peds	App. Total	Right	Thru	Left	Peds	App. Total	
07:00 AM	0	77	0	0	77	0	0	0	0	0	0	190	0	0	190	0	0	0	0	0	267
07:15 AM	0	91	0	0	91	0	0	0	0	0	0	202	0	0	202	0	0	0	0	0	293
07:30 AM	0	116	0	0	116	0	0	0	0	0	0	218	0	0	218	0	0	0	0	0	334
07:45 AM	0	114	0	0	114	0	0	0	0	0	0	161	0	0	161	0	0	0	0	0	275
Total	0	398	0	0	398	0	0	0	0	0	0	771	0	0	771	0	0	0	0	0	1169
08:00 AM	0	91	0	0	91	0	0	0	0	0	0	149	0	0	149	0	0	0	0	0	240
08:15 AM	0	77	0	0	77	0	0	0	0	0	0	153	0	0	153	0	0	0	0	0	230
08:30 AM	0	51	0	0	51	0	0	0	0	0	0	111	0	0	111	0	0	0	0	0	162
08:45 AM	0	60	0	0	60	0	0	0	0	0	0	88	0	0	88	0	0	0	0	0	148
Total	0	279	0	0	279	0	0	0	0	0	0	501	0	0	501	0	0	0	0	0	780
Grand Total	0	677	0	0	677	0	0	0	0	0	0	1272	0	0	1272	0	0	0	0	0	1949
Apprch %	0	100	0	0		0	0	0	0		0	100	0	0		0	0	0	0		
Total %	0	34.7	0	0	34.7	0	0	0	0	0	0	65.3	0	0	65.3	0	0	0	0	0	
Lights	0	655	0	0	655	0	0	0	0	0	0	1243	0	0	1243	0	0	0	0	0	1898
% Lights	0	96.8	0	0	96.8	0	0	0	0	0	0	97.7	0	0	97.7	0	0	0	0	0	97.4
Buses	0	4	0	0	4	0	0	0	0	0	0	6	0	0	6	0	0	0	0	0	10
% Buses	0	0.6	0	0	0.6	0	0	0	0	0	0	0.5	0	0	0.5	0	0	0	0	0	0.5
Trucks	0	18	0	0	18	0	0	0	0	0	0	23	0	0	23	0	0	0	0	0	41
% Trucks	0	2.7	0	0	2.7	0	0	0	0	0	0	1.8	0	0	1.8	0	0	0	0	0	2.1

Start Time	RESERVATION RD Southbound				Westbound				RESERVATION RD Northbound				WATKINS GATE RD Eastbound				Int. Total	
	Right	Thru	Left	App. Total	Right	Thru	Left	App. Total	Right	Thru	Left	App. Total	Right	Thru	Left	App. Total		
Peak Hour Analysis From 07:00 AM to 08:45 AM - Peak 1 of 1																		
Peak Hour for Entire Intersection Begins at 07:00 AM																		
07:00 AM	0	77	0	77	0	0	0	0	0	0	190	0	190	0	0	0	0	267
07:15 AM	0	91	0	91	0	0	0	0	0	0	202	0	202	0	0	0	0	293
07:30 AM	0	116	0	116	0	0	0	0	0	0	218	0	218	0	0	0	0	334
07:45 AM	0	114	0	114	0	0	0	0	0	0	161	0	161	0	0	0	0	275
Total Volume	0	398	0	398	0	0	0	0	0	0	771	0	771	0	0	0	0	1169
% App. Total	0	100	0		0	0	0		0	0	100	0		0	0	0		
PHF	.000	.858	.000	.858	.000	.000	.000	.000	.000	.000	.884	.000	.884	.000	.000	.000	.000	.875

Traffic Data Service

San Jose, CA
 (408) 622-4787
 tdsbay@cs.com

File Name : 6AM FINAL
 Site Code : 00000006
 Start Date : 4/25/2018
 Page No : 2

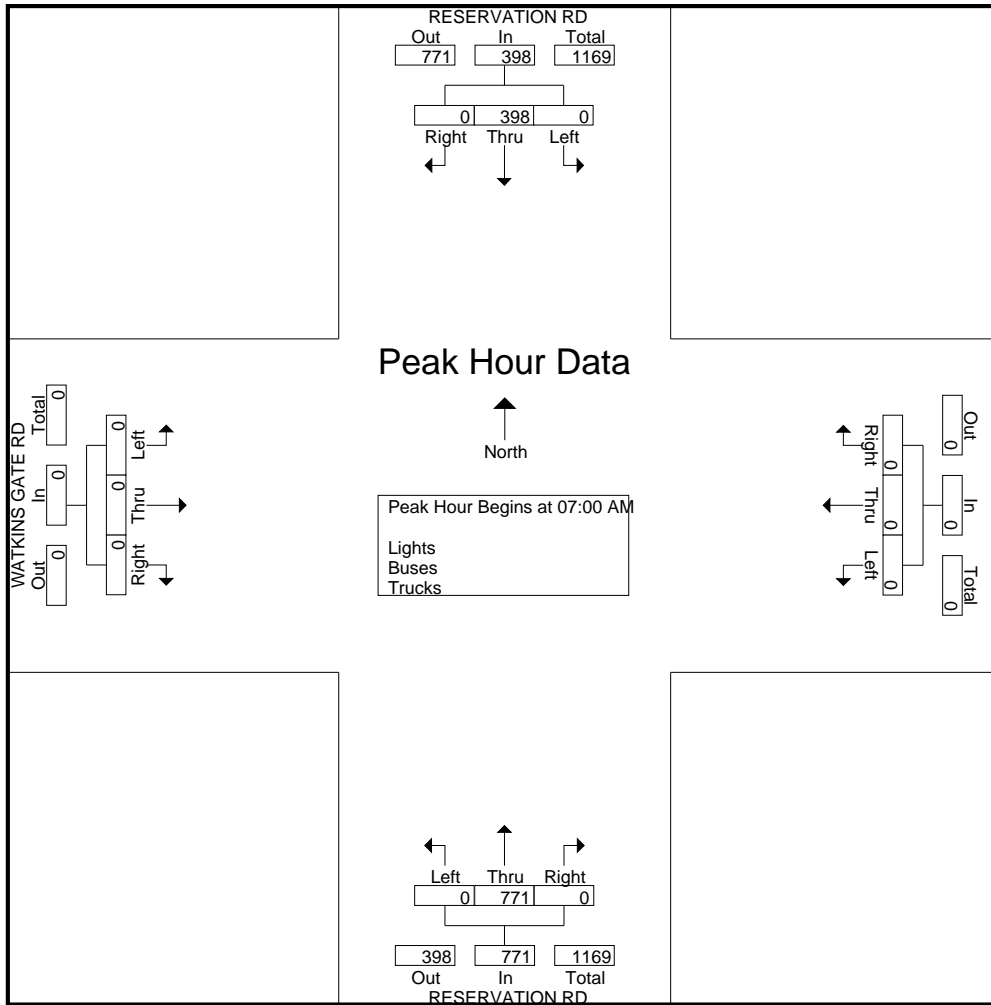

Traffic Data Service

San Jose, CA
 (408) 622-4787
 tdsbay@cs.com

File Name : 6AM FINAL
 Site Code : 00000006
 Start Date : 4/25/2018
 Page No : 1

Groups Printed- Bikes

Start Time	RESERVATION RD Southbound					Westbound					RESERVATION RD Northbound					WATKINS GATE RD Eastbound					Int. Total
	Right	Thru	Left	Peds	App. Total	Right	Thru	Left	Peds	App. Total	Right	Thru	Left	Peds	App. Total	Right	Thru	Left	Peds	App. Total	
07:00 AM	0	0	0	0	0	0	0	0	0	0	0	0	0	0	0	0	0	0	0	0	0
07:15 AM	0	0	0	0	0	0	0	0	0	0	0	0	0	0	0	0	0	0	0	0	0
07:30 AM	0	0	0	0	0	0	0	0	0	0	0	0	0	0	0	0	0	0	0	0	0
07:45 AM	0	0	0	0	0	0	0	0	0	0	0	0	0	0	0	0	0	0	0	0	0
Total	0	0	0	0	0	0	0	0	0	0	0	0	0	0	0	0	0	0	0	0	0
08:00 AM	0	0	0	0	0	0	0	0	0	0	0	0	0	0	0	0	0	0	0	0	0
08:15 AM	0	0	0	0	0	0	0	0	0	0	0	0	0	0	0	0	0	0	0	0	0
08:30 AM	0	0	0	0	0	0	0	0	0	0	0	0	0	0	0	0	0	0	0	0	0
08:45 AM	0	0	0	0	0	0	0	0	0	0	0	0	0	0	0	0	0	0	0	0	0
Total	0	0	0	0	0	0	0	0	0	0	0	0	0	0	0	0	0	0	0	0	0
Grand Total	0	0	0	0	0	0	0	0	0	0	0	0	0	0	0	0	0	0	0	0	0
Apprch %	0	0	0	0		0	0	0	0		0	0	0	0		0	0	0	0		
Total %																					

Start Time	RESERVATION RD Southbound					Westbound					RESERVATION RD Northbound					WATKINS GATE RD Eastbound					Int. Total
	Right	Thru	Left	Peds	App. Total	Right	Thru	Left	Peds	App. Total	Right	Thru	Left	Peds	App. Total	Right	Thru	Left	Peds	App. Total	
07:00 AM	0	0	0	0	0	0	0	0	0	0	0	0	0	0	0	0	0	0	0	0	0
07:15 AM	0	0	0	0	0	0	0	0	0	0	0	0	0	0	0	0	0	0	0	0	0
07:30 AM	0	0	0	0	0	0	0	0	0	0	0	0	0	0	0	0	0	0	0	0	0
07:45 AM	0	0	0	0	0	0	0	0	0	0	0	0	0	0	0	0	0	0	0	0	0
Total Volume	0	0	0	0	0	0	0	0	0	0	0	0	0	0	0	0	0	0	0	0	0
% App. Total	0	0	0	0		0	0	0	0		0	0	0	0		0	0	0	0		
PHF	.000	.000	.000	.000	.000	.000	.000	.000	.000	.000	.000	.000	.000	.000	.000	.000	.000	.000	.000	.000	.000

Peak Hour Analysis From 07:00 AM to 08:45 AM - Peak 1 of 1
 Peak Hour for Entire Intersection Begins at 07:00 AM

Traffic Data Service

San Jose, CA
(408) 622-4787
tdsbay@cs.com

File Name : 6AM FINAL
Site Code : 00000006
Start Date : 4/25/2018
Page No : 2

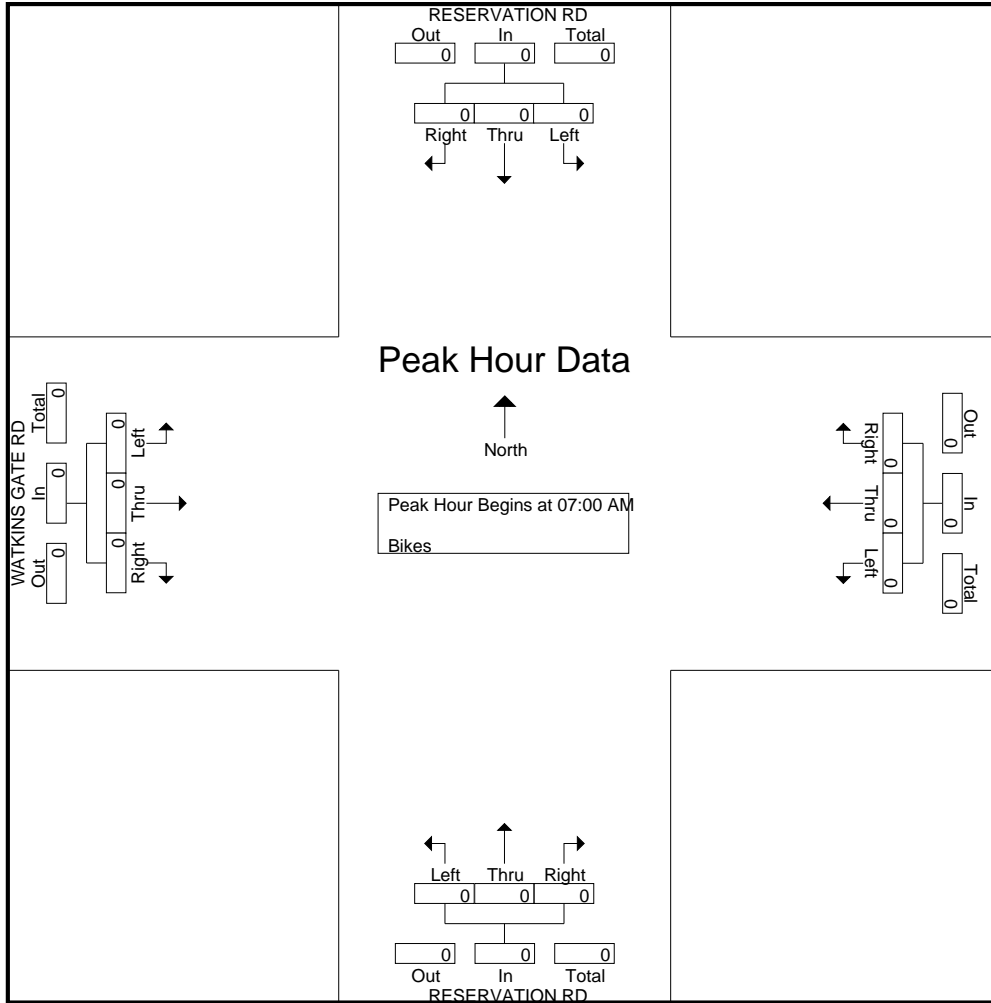

Traffic Data Service

San Jose, CA
 (408) 622-4787
 tdsbay@cs.com

File Name : 6PM FINAL
 Site Code : 00000006
 Start Date : 4/25/2018
 Page No : 2

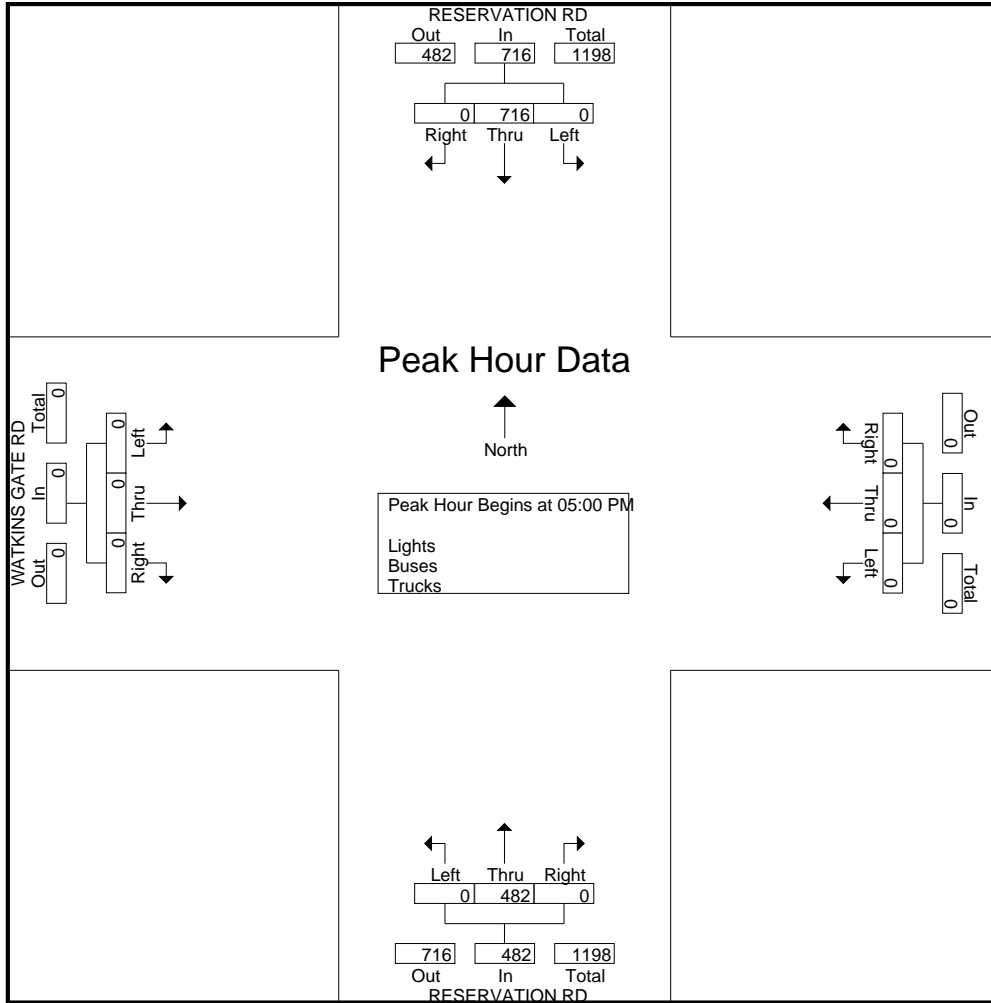

Traffic Data Service

San Jose, CA
 (408) 622-4787
 tdsbay@cs.com

File Name : 6PM FINAL
 Site Code : 00000006
 Start Date : 4/25/2018
 Page No : 1

Groups Printed- Bikes

Start Time	RESERVATION RD Southbound					Westbound					RESERVATION RD Northbound					WATKINS GATE RD Eastbound					Int. Total
	Right	Thru	Left	Peds	App. Total	Right	Thru	Left	Peds	App. Total	Right	Thru	Left	Peds	App. Total	Right	Thru	Left	Peds	App. Total	
04:00 PM	0	0	0	0	0	0	0	0	0	0	0	0	0	0	0	0	0	0	0	0	0
04:15 PM	0	0	0	0	0	0	0	0	0	0	0	0	0	0	0	0	0	0	0	0	0
04:30 PM	0	0	0	0	0	0	0	0	0	0	0	0	0	0	0	0	0	0	0	0	0
04:45 PM	0	0	0	0	0	0	0	0	0	0	0	0	0	0	0	0	0	0	0	0	0
Total	0	0	0	0	0	0	0	0	0	0	0	0	0	0	0	0	0	0	0	0	0
05:00 PM	0	0	0	0	0	0	0	0	0	0	0	0	0	0	0	0	0	0	0	0	0
05:15 PM	0	0	0	0	0	0	0	0	0	0	0	0	0	0	0	0	0	0	0	0	0
05:30 PM	0	0	0	0	0	0	0	0	0	0	0	1	0	0	1	0	0	0	0	0	1
05:45 PM	0	0	0	0	0	0	0	0	0	0	0	1	0	0	1	0	0	0	0	0	1
Total	0	0	0	0	0	0	0	0	0	0	0	2	0	0	2	0	0	0	0	0	2
Grand Total	0	0	0	0	0	0	0	0	0	0	0	2	0	0	2	0	0	0	0	0	2
Apprch %	0	0	0	0	0	0	0	0	0	0	0	100	0	0	0	0	0	0	0	0	
Total %	0	0	0	0	0	0	0	0	0	0	0	100	0	0	100	0	0	0	0	0	

Start Time	RESERVATION RD Southbound					Westbound					RESERVATION RD Northbound					WATKINS GATE RD Eastbound					Int. Total
	Right	Thru	Left	Peds	App. Total	Right	Thru	Left	Peds	App. Total	Right	Thru	Left	Peds	App. Total	Right	Thru	Left	Peds	App. Total	
Peak Hour Analysis From 04:00 PM to 05:45 PM - Peak 1 of 1																					
Peak Hour for Entire Intersection Begins at 05:00 PM																					
05:00 PM	0	0	0	0	0	0	0	0	0	0	0	0	0	0	0	0	0	0	0	0	0
05:15 PM	0	0	0	0	0	0	0	0	0	0	0	0	0	0	0	0	0	0	0	0	0
05:30 PM	0	0	0	0	0	0	0	0	0	0	0	1	0	0	1	0	0	0	0	0	1
05:45 PM	0	0	0	0	0	0	0	0	0	0	0	1	0	0	1	0	0	0	0	0	1
Total Volume	0	0	0	0	0	0	0	0	0	0	0	2	0	0	2	0	0	0	0	0	2
% App. Total	0	0	0	0	0	0	0	0	0	0	0	100	0	0	0	0	0	0	0	0	
PHF	.000	.000	.000	.000	.000	.000	.000	.000	.000	.000	.000	.500	.000	.500	.000	.000	.000	.000	.000	.000	.500

Traffic Data Service

San Jose, CA
 (408) 622-4787
 tdsbay@cs.com

File Name : 6PM FINAL
 Site Code : 00000006
 Start Date : 4/25/2018
 Page No : 2

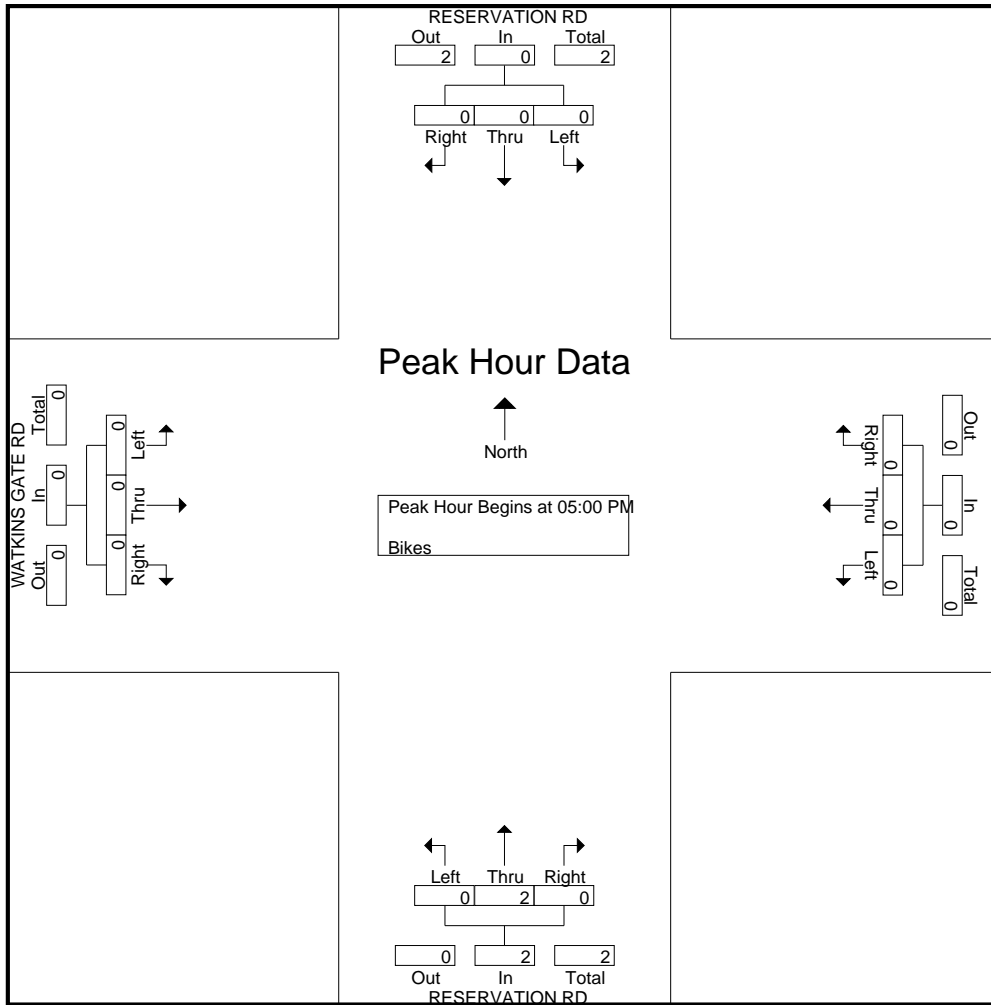

Traffic Data Service

San Jose, CA
 (408) 622-4787
 tdsbay@cs.com

File Name : 7AM FINAL
 Site Code : 00000007
 Start Date : 4/25/2018
 Page No : 1

Groups Printed- Lights - Buses - Trucks

Start Time	S DAVIS RD Southbound					RESERVATION RD Westbound					DRIVEWAY Northbound					RESERVATION RD Eastbound					Int. Total
	Right	Thru	Left	Peds	App. Total	Right	Thru	Left	Peds	App. Total	Right	Thru	Left	Peds	App. Total	Right	Thru	Left	Peds	App. Total	
07:00 AM	96	0	32	0	128	14	102	1	0	117	0	3	0	0	3	0	52	19	0	71	319
07:15 AM	83	1	32	0	116	24	128	0	0	152	1	0	1	0	2	0	49	30	0	79	349
07:30 AM	74	2	38	0	114	38	138	0	0	176	3	1	2	0	6	1	78	48	0	127	423
07:45 AM	48	0	43	0	91	28	121	0	0	149	0	2	0	0	2	0	82	35	0	117	359
Total	301	3	145	0	449	104	489	1	0	594	4	6	3	0	13	1	261	132	0	394	1450
08:00 AM	45	1	39	0	85	33	92	0	0	125	0	1	0	0	1	1	59	40	0	100	311
08:15 AM	43	2	36	0	81	19	106	0	0	125	1	0	0	0	1	0	52	23	0	75	282
08:30 AM	27	2	27	0	56	27	81	1	0	109	1	1	3	0	5	0	42	14	0	56	226
08:45 AM	20	0	37	0	57	33	61	1	0	95	0	0	0	0	0	0	34	23	0	57	209
Total	135	5	139	0	279	112	340	2	0	454	2	2	3	0	7	1	187	100	0	288	1028
Grand Total	436	8	284	0	728	216	829	3	0	1048	6	8	6	0	20	2	448	232	0	682	2478
Apprch %	59.9	1.1	39	0		20.6	79.1	0.3	0		30	40	30	0		0.3	65.7	34	0		
Total %	17.6	0.3	11.5	0	29.4	8.7	33.5	0.1	0	42.3	0.2	0.3	0.2	0	0.8	0.1	18.1	9.4	0	27.5	
Lights	426	8	265	0	699	213	809	3	0	1025	6	8	6	0	20	2	434	223	0	659	2403
% Lights	97.7	100	93.3	0	96	98.6	97.6	100	0	97.8	100	100	100	0	100	100	96.9	96.1	0	96.6	97
Buses	3	0	3	0	6	0	4	0	0	4	0	0	0	0	0	0	2	2	0	4	14
% Buses	0.7	0	1.1	0	0.8	0	0.5	0	0	0.4	0	0	0	0	0	0	0.4	0.9	0	0.6	0.6
Trucks	7	0	16	0	23	3	16	0	0	19	0	0	0	0	0	0	12	7	0	19	61
% Trucks	1.6	0	5.6	0	3.2	1.4	1.9	0	0	1.8	0	0	0	0	0	0	2.7	3	0	2.8	2.5

Start Time	S DAVIS RD Southbound				RESERVATION RD Westbound				DRIVEWAY Northbound				RESERVATION RD Eastbound				Int. Total
	Right	Thru	Left	App. Total	Right	Thru	Left	App. Total	Right	Thru	Left	App. Total	Right	Thru	Left	App. Total	
Peak Hour Analysis From 07:00 AM to 08:45 AM - Peak 1 of 1																	
Peak Hour for Entire Intersection Begins at 07:00 AM																	
07:00 AM	96	0	32	128	14	102	1	117	0	3	0	3	0	52	19	71	319
07:15 AM	83	1	32	116	24	128	0	152	1	0	1	2	0	49	30	79	349
07:30 AM	74	2	38	114	38	138	0	176	3	1	2	6	1	78	48	127	423
07:45 AM	48	0	43	91	28	121	0	149	0	2	0	2	0	82	35	117	359
Total Volume	301	3	145	449	104	489	1	594	4	6	3	13	1	261	132	394	1450
% App. Total	67	0.7	32.3		17.5	82.3	0.2		30.8	46.2	23.1		0.3	66.2	33.5		
PHF	.784	.375	.843	.877	.684	.886	.250	.844	.333	.500	.375	.542	.250	.796	.688	.776	.857

Traffic Data Service

San Jose, CA
 (408) 622-4787
 tdsbay@cs.com

File Name : 7AM FINAL
 Site Code : 00000007
 Start Date : 4/25/2018
 Page No : 2

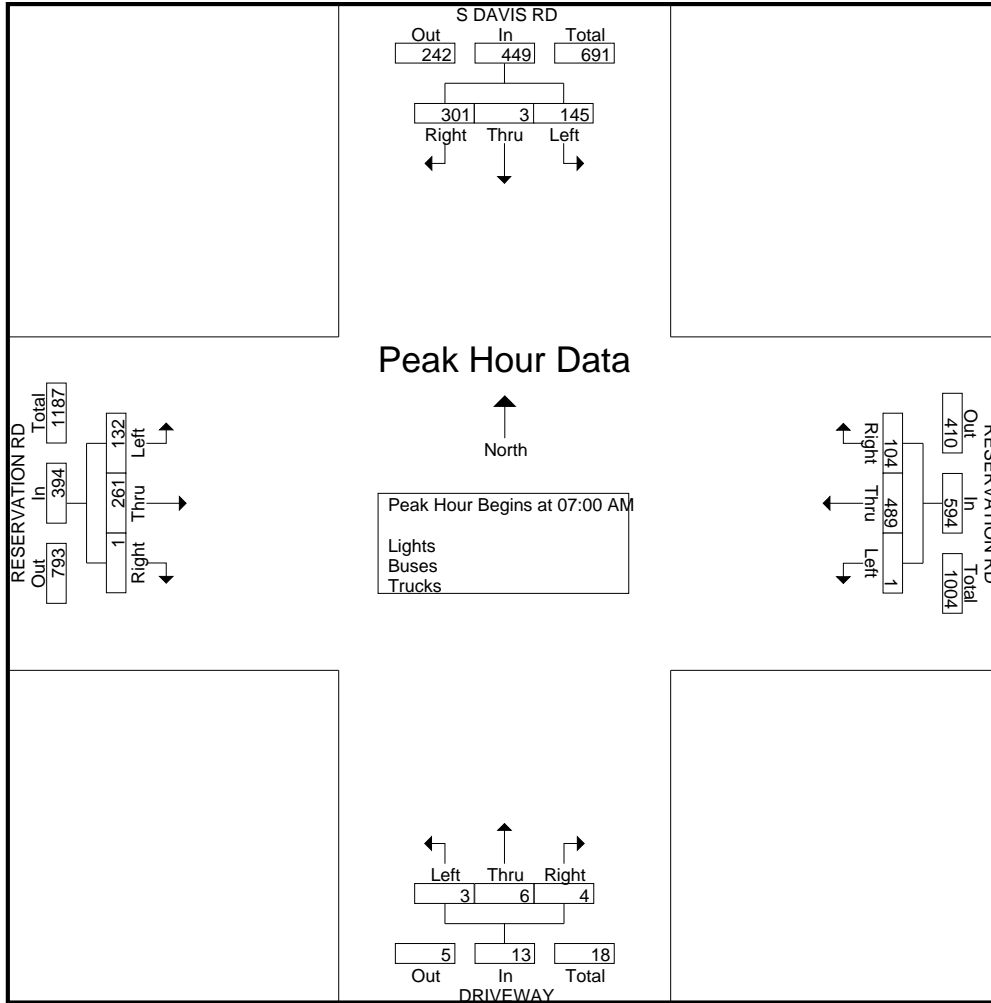

Traffic Data Service

San Jose, CA
 (408) 622-4787
 tdsbay@cs.com

File Name : 7AM FINAL
 Site Code : 00000007
 Start Date : 4/25/2018
 Page No : 1

Groups Printed- Bikes

Start Time	S DAVIS RD Southbound					RESERVATION RD Westbound					DRIVEWAY Northbound					RESERVATION RD Eastbound					Int. Total
	Right	Thru	Left	Peds	App. Total	Right	Thru	Left	Peds	App. Total	Right	Thru	Left	Peds	App. Total	Right	Thru	Left	Peds	App. Total	
07:00 AM	0	0	0	0	0	0	0	0	0	0	1	0	0	0	1	1	0	0	0	1	2
07:15 AM	0	0	0	0	0	0	0	0	0	0	0	0	0	0	0	0	0	0	0	0	0
07:30 AM	0	0	0	0	0	0	0	0	0	0	0	0	0	0	0	0	0	0	0	0	0
07:45 AM	0	0	0	0	0	0	0	0	0	0	0	0	0	0	0	0	0	0	0	0	0
Total	0	0	0	0	0	0	0	0	0	0	1	0	0	0	1	1	0	0	0	1	2
08:00 AM	0	0	0	0	0	0	0	0	0	0	0	0	0	0	0	0	0	0	0	0	0
08:15 AM	0	0	0	0	0	0	0	0	0	0	0	0	0	0	0	0	0	0	0	0	0
08:30 AM	0	0	0	0	0	0	0	0	0	0	0	0	0	0	0	0	0	0	0	0	0
08:45 AM	0	0	0	0	0	1	0	0	0	1	0	0	0	0	0	0	0	0	0	0	1
Total	0	0	0	0	0	1	0	0	0	1	0	0	0	0	0	0	0	0	0	0	1
Grand Total	0	0	0	0	0	1	0	0	0	1	1	0	0	0	1	1	0	0	0	1	3
Apprch %	0	0	0	0	0	100	0	0	0	100	100	0	0	0	100	100	0	0	0	100	
Total %	0	0	0	0	0	33.3	0	0	0	33.3	33.3	0	0	0	33.3	33.3	0	0	0	33.3	

Start Time	S DAVIS RD Southbound					RESERVATION RD Westbound					DRIVEWAY Northbound					RESERVATION RD Eastbound					Int. Total
	Right	Thru	Left	Peds	App. Total	Right	Thru	Left	Peds	App. Total	Right	Thru	Left	Peds	App. Total	Right	Thru	Left	Peds	App. Total	
Peak Hour Analysis From 07:00 AM to 08:45 AM - Peak 1 of 1																					
Peak Hour for Entire Intersection Begins at 07:00 AM																					
07:00 AM	0	0	0	0	0	0	0	0	0	0	1	0	0	0	1	1	0	0	0	1	2
07:15 AM	0	0	0	0	0	0	0	0	0	0	0	0	0	0	0	0	0	0	0	0	0
07:30 AM	0	0	0	0	0	0	0	0	0	0	0	0	0	0	0	0	0	0	0	0	0
07:45 AM	0	0	0	0	0	0	0	0	0	0	0	0	0	0	0	0	0	0	0	0	0
Total Volume	0	0	0	0	0	0	0	0	0	0	1	0	0	0	1	1	0	0	0	1	2
% App. Total	0	0	0	0	0	0	0	0	0	0	100	0	0	0	100	100	0	0	0	100	
PHF	.000	.000	.000	.000	.000	.000	.000	.000	.000	.000	.250	.000	.000	.250	.250	.000	.000	.250	.250	.250	

Traffic Data Service

San Jose, CA
(408) 622-4787
tdsbay@cs.com

File Name : 7AM FINAL
Site Code : 00000007
Start Date : 4/25/2018
Page No : 2

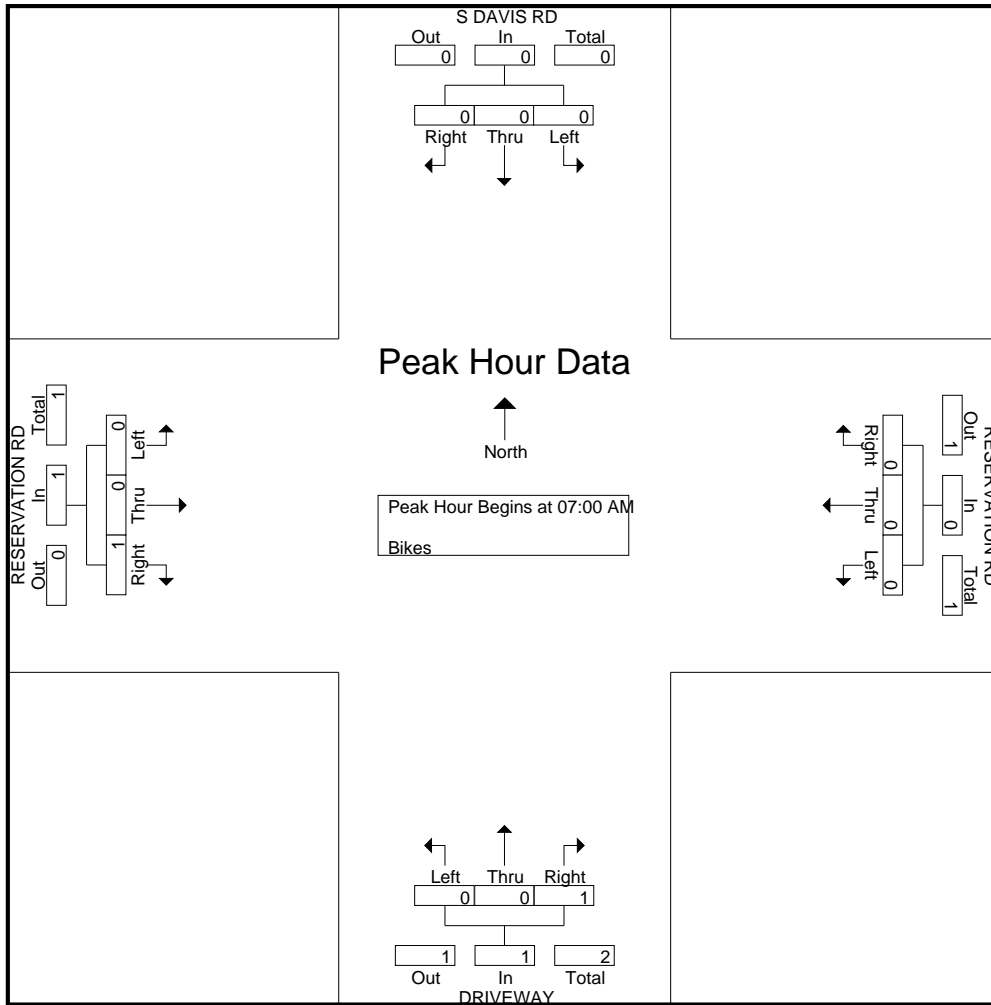

Traffic Data Service

San Jose, CA
(408) 622-4787
tdsbay@cs.com

File Name : 7PM FINAL
Site Code : 00000007
Start Date : 4/25/2018
Page No : 1

Groups Printed- Lights - Buses - Trucks

Start Time	S DAVIS RD Southbound					RESERVATION RD Westbound					DRIVEWAY Northbound					RESERVATION RD Eastbound					Int. Total
	Right	Thru	Left	Peds	App. Total	Right	Thru	Left	Peds	App. Total	Right	Thru	Left	Peds	App. Total	Right	Thru	Left	Peds	App. Total	
04:00 PM	33	1	23	0	57	27	65	1	0	93	1	0	0	0	1	1	96	59	0	156	307
04:15 PM	27	0	37	0	64	24	78	0	0	102	0	0	0	0	0	0	101	79	0	180	346
04:30 PM	32	2	33	0	67	27	59	1	0	87	1	0	0	0	1	0	86	52	0	138	293
04:45 PM	19	1	31	0	51	17	75	0	0	92	1	0	1	0	2	0	106	74	0	180	325
Total	111	4	124	0	239	95	277	2	0	374	3	0	1	0	4	1	389	264	0	654	1271
05:00 PM	39	1	23	0	63	47	71	0	0	118	0	1	0	0	1	0	119	71	0	190	372
05:15 PM	67	0	34	0	101	26	80	0	0	106	1	0	2	0	3	1	98	77	0	176	386
05:30 PM	36	2	26	0	64	20	82	2	0	104	0	0	0	0	0	0	111	75	0	186	354
05:45 PM	40	0	30	0	70	16	65	3	0	84	2	0	0	0	2	1	103	78	0	182	338
Total	182	3	113	0	298	109	298	5	0	412	3	1	2	0	6	2	431	301	0	734	1450
Grand Total	293	7	237	0	537	204	575	7	0	786	6	1	3	0	10	3	820	565	0	1388	2721
Apprch %	54.6	1.3	44.1	0		26	73.2	0.9	0		60	10	30	0		0.2	59.1	40.7	0		
Total %	10.8	0.3	8.7	0	19.7	7.5	21.1	0.3	0	28.9	0.2	0	0.1	0	0.4	0.1	30.1	20.8	0	51	
Lights	290	7	228	0	525	193	556	7	0	756	6	1	3	0	10	3	798	559	0	1360	2651
% Lights	99	100	96.2	0	97.8	94.6	96.7	100	0	96.2	100	100	100	0	100	100	97.3	98.9	0	98	97.4
Buses	0	0	0	0	0	0	0	0	0	0	0	0	0	0	0	0	5	0	0	5	5
% Buses	0	0	0	0	0	0	0	0	0	0	0	0	0	0	0	0	0.6	0	0	0.4	0.2
Trucks	3	0	9	0	12	11	19	0	0	30	0	0	0	0	0	0	17	6	0	23	65
% Trucks	1	0	3.8	0	2.2	5.4	3.3	0	0	3.8	0	0	0	0	0	0	2.1	1.1	0	1.7	2.4

Start Time	S DAVIS RD Southbound					RESERVATION RD Westbound					DRIVEWAY Northbound					RESERVATION RD Eastbound					Int. Total
	Right	Thru	Left	Peds	App. Total	Right	Thru	Left	Peds	App. Total	Right	Thru	Left	Peds	App. Total	Right	Thru	Left	Peds	App. Total	
Peak Hour Analysis From 04:00 PM to 05:45 PM - Peak 1 of 1																					
Peak Hour for Entire Intersection Begins at 05:00 PM																					
05:00 PM	39	1	23	0	63	47	71	0	0	118	0	1	0	0	1	0	119	71	0	190	372
05:15 PM	67	0	34	0	101	26	80	0	0	106	1	0	2	0	3	1	98	77	0	176	386
05:30 PM	36	2	26	0	64	20	82	2	0	104	0	0	0	0	0	0	111	75	0	186	354
05:45 PM	40	0	30	0	70	16	65	3	0	84	2	0	0	0	2	1	103	78	0	182	338
Total Volume	182	3	113	0	298	109	298	5	0	412	3	1	2	0	6	2	431	301	0	734	1450
% App. Total	61.1	1	37.9	0		26.5	72.3	1.2	0		50	16.7	33.3	0		0.3	58.7	41	0		
PHF	.679	.375	.831	0	.738	.580	.909	.417	0	.873	.375	.250	.250	0	.500	.500	.905	.965	0	.966	.939

Traffic Data Service

San Jose, CA
 (408) 622-4787
 tdsbay@cs.com

File Name : 7PM FINAL
 Site Code : 00000007
 Start Date : 4/25/2018
 Page No : 2

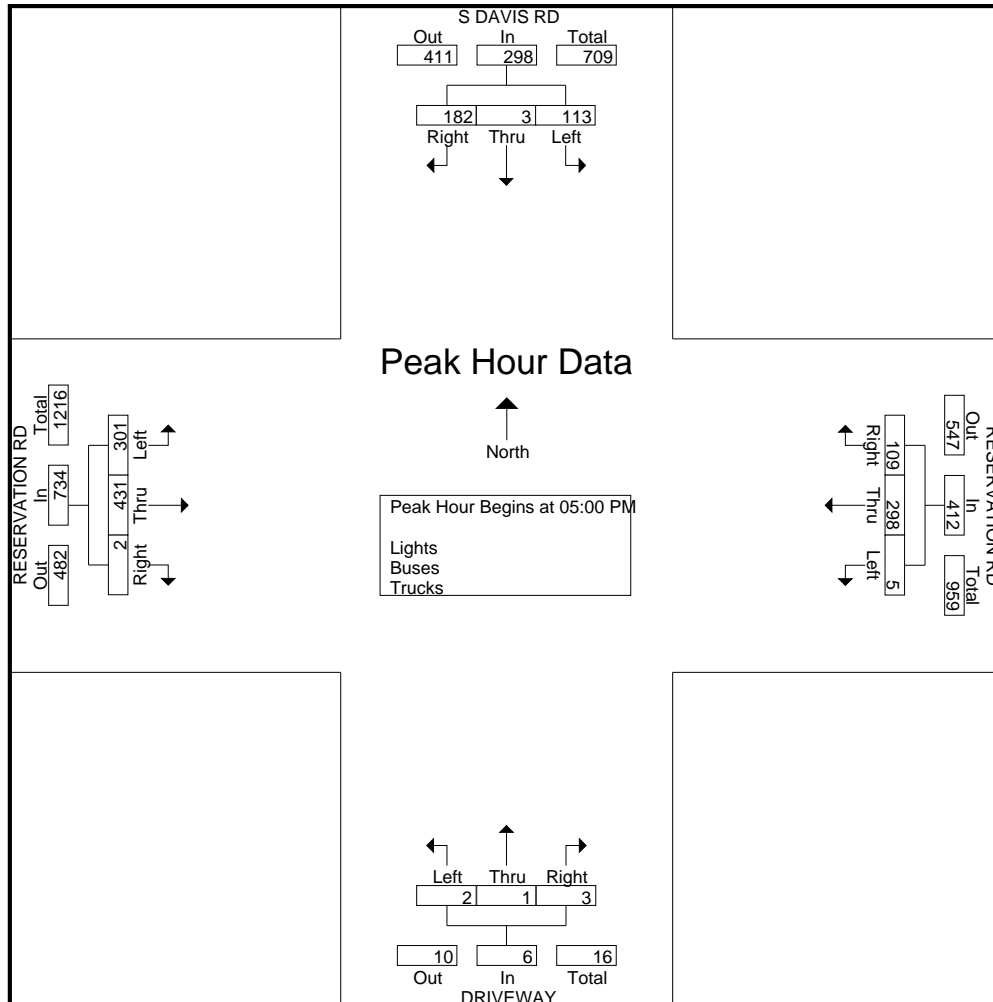

Traffic Data Service

San Jose, CA
 (408) 622-4787
 tdsbay@cs.com

File Name : 7PM FINAL
 Site Code : 00000007
 Start Date : 4/25/2018
 Page No : 1

Groups Printed- Bikes

Start Time	S DAVIS RD Southbound					RESERVATION RD Westbound					DRIVEWAY Northbound					RESERVATION RD Eastbound					Int. Total
	Right	Thru	Left	Peds	App. Total	Right	Thru	Left	Peds	App. Total	Right	Thru	Left	Peds	App. Total	Right	Thru	Left	Peds	App. Total	
04:00 PM	0	0	0	0	0	0	0	0	0	0	0	0	0	0	0	0	0	0	0	0	0
04:15 PM	0	0	1	0	1	0	0	0	0	0	0	0	0	0	0	0	0	0	0	0	0
04:30 PM	0	0	0	0	0	0	0	0	0	0	0	0	0	0	0	0	0	0	0	0	0
04:45 PM	0	0	0	0	0	0	0	0	0	0	0	0	0	0	0	0	0	0	0	0	0
Total	0	0	1	0	1	0	0	0	0	0	0	0	0	0	0	0	0	0	0	0	1
05:00 PM	0	0	0	0	0	0	0	0	0	0	0	0	0	0	0	0	0	0	0	0	0
05:15 PM	0	0	0	0	0	0	0	0	0	0	0	0	0	0	0	0	0	0	0	0	0
05:30 PM	0	0	0	0	0	0	0	0	0	0	0	0	0	0	0	0	0	0	0	0	0
05:45 PM	1	0	0	0	1	0	0	0	0	0	0	0	0	0	0	0	0	0	0	0	1
Total	1	0	0	0	1	0	0	0	0	0	0	0	0	0	0	0	0	0	0	0	1
Grand Total	1	0	1	0	2	0	0	0	0	0	0	0	0	0	0	0	0	0	0	0	2
Apprch %	50	0	50	0		0	0	0	0		0	0	0	0		0	0	0	0		
Total %	50	0	50	0	100	0	0	0	0	0	0	0	0	0	0	0	0	0	0	0	

Start Time	S DAVIS RD Southbound					RESERVATION RD Westbound					DRIVEWAY Northbound					RESERVATION RD Eastbound					Int. Total
	Right	Thru	Left	Peds	App. Total	Right	Thru	Left	Peds	App. Total	Right	Thru	Left	Peds	App. Total	Right	Thru	Left	Peds	App. Total	
Peak Hour Analysis From 04:00 PM to 05:45 PM - Peak 1 of 1																					
Peak Hour for Entire Intersection Begins at 04:00 PM																					
04:00 PM	0	0	0	0	0	0	0	0	0	0	0	0	0	0	0	0	0	0	0	0	0
04:15 PM	0	0	1	0	1	0	0	0	0	0	0	0	0	0	0	0	0	0	0	0	1
04:30 PM	0	0	0	0	0	0	0	0	0	0	0	0	0	0	0	0	0	0	0	0	0
04:45 PM	0	0	0	0	0	0	0	0	0	0	0	0	0	0	0	0	0	0	0	0	0
Total Volume	0	0	1	0	1	0	0	0	0	0	0	0	0	0	0	0	0	0	0	0	1
% App. Total	0	0	100	0		0	0	0	0		0	0	0	0		0	0	0	0		
PHF	.000	.000	.250		.250	.000	.000	.000		.000	.000	.000	.000		.000	.000	.000	.000		.000	.250

Traffic Data Service

San Jose, CA
(408) 622-4787
tdsbay@cs.com

File Name : 7PM FINAL
Site Code : 00000007
Start Date : 4/25/2018
Page No : 2

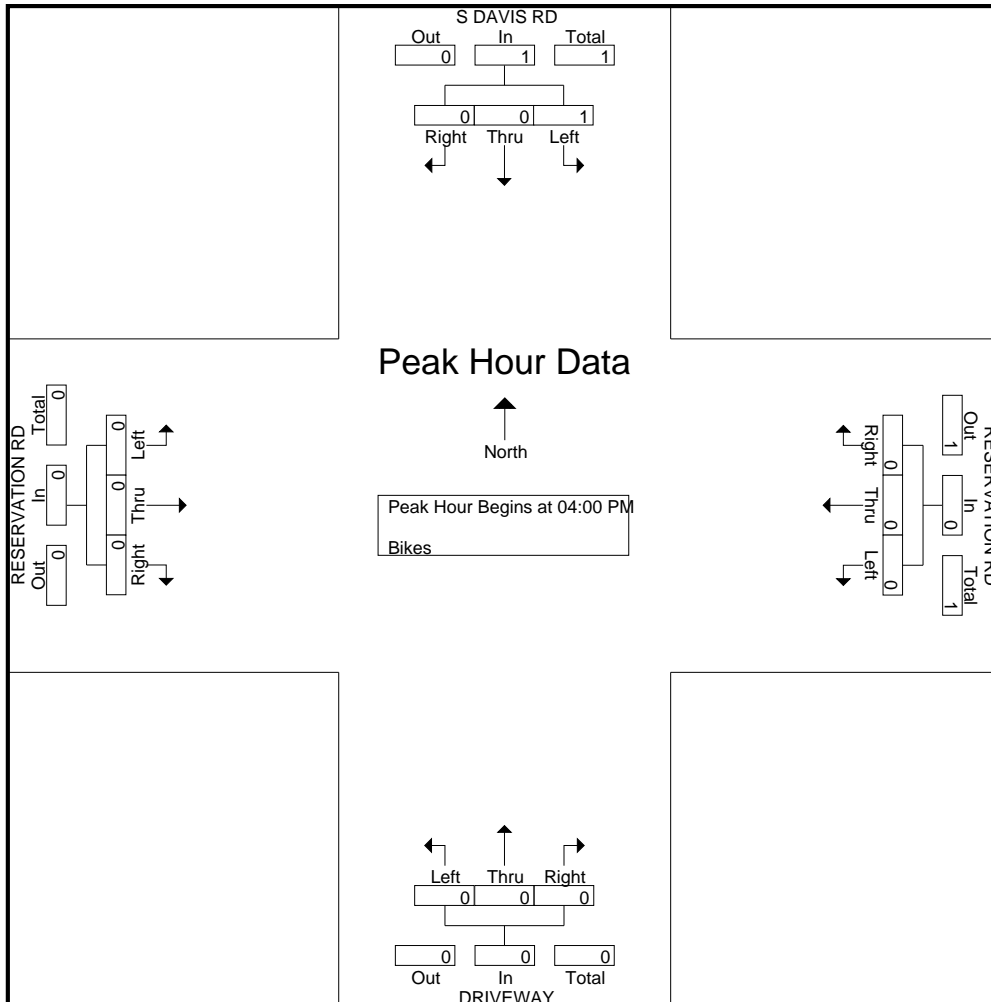

Traffic Data Service

San Jose, CA
 (408) 622-4787
 tdsbay@cs.com

File Name : 8AM FINAL
 Site Code : 00000008
 Start Date : 4/25/2018
 Page No : 2

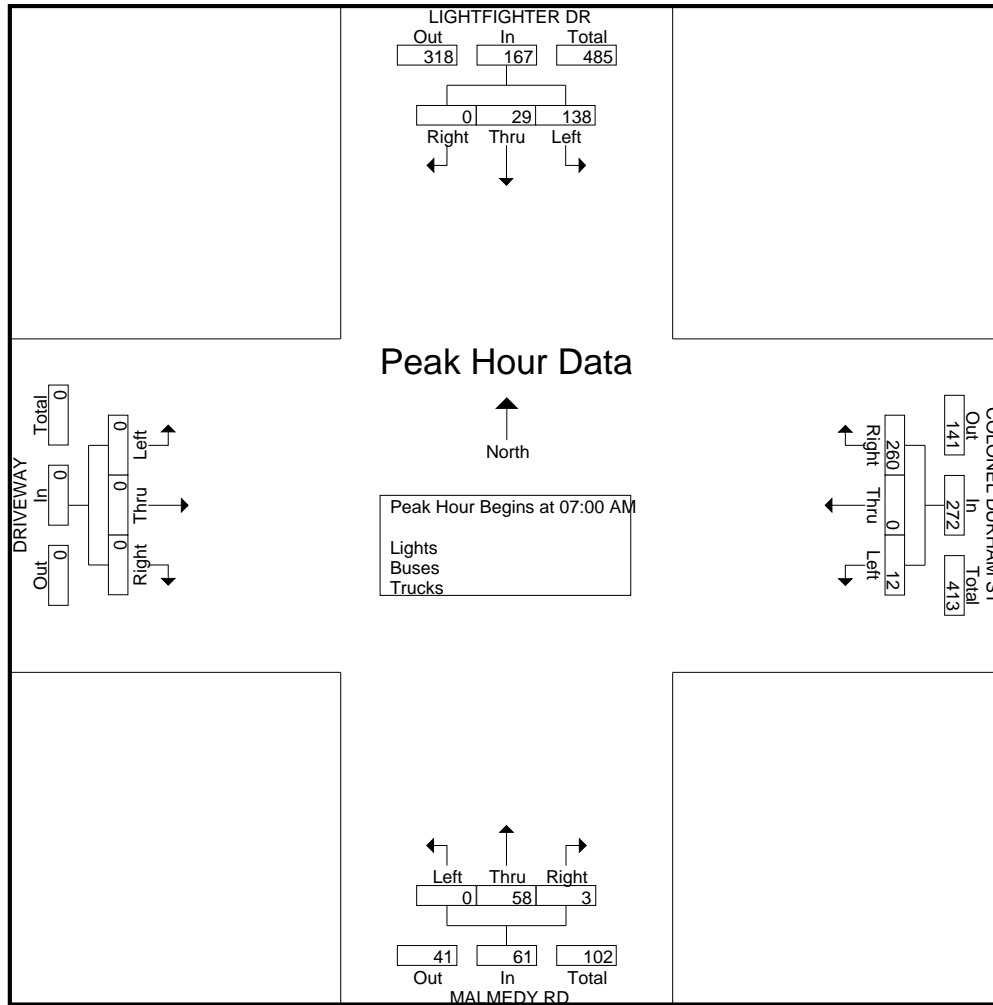

Traffic Data Service

San Jose, CA
 (408) 622-4787
 tdsbay@cs.com

File Name : 8AM FINAL
 Site Code : 00000008
 Start Date : 4/25/2018
 Page No : 1

Groups Printed- Bikes

Start Time	LIGHTFIGHTER DR Southbound					COLONEL DURHAM ST Westbound					MALMEDY RD Northbound					DRIVEWAY Eastbound					Int. Total
	Right	Thru	Left	Peds	App. Total	Right	Thru	Left	Peds	App. Total	Right	Thru	Left	Peds	App. Total	Right	Thru	Left	Peds	App. Total	
07:00 AM	0	0	0	0	0	0	0	0	0	0	1	0	0	0	1	0	0	0	0	0	0
07:15 AM	0	0	1	0	1	0	0	0	0	0	0	0	0	0	0	0	0	0	0	0	0
07:30 AM	0	0	0	0	0	0	0	0	0	0	0	0	0	0	0	0	0	0	0	0	0
07:45 AM	0	0	0	0	0	0	0	0	0	0	0	0	0	0	0	0	0	0	0	0	0
Total	0	0	1	0	1	0	0	0	0	0	1	0	0	0	1	0	0	0	0	0	2
08:00 AM	0	0	0	0	0	0	0	0	0	0	0	0	0	0	0	0	0	0	0	0	0
08:15 AM	0	0	0	0	0	0	0	0	0	0	0	0	0	0	0	0	0	0	0	0	0
08:30 AM	0	0	1	0	1	0	0	0	0	0	0	0	0	0	0	0	0	0	0	0	1
08:45 AM	0	0	0	0	0	0	0	0	0	0	0	0	0	0	0	0	0	0	0	0	0
Total	0	0	1	0	1	0	0	0	0	0	0	0	0	0	0	0	0	0	0	0	1
Grand Total	0	0	2	0	2	0	0	0	0	0	1	0	0	0	1	0	0	0	0	0	3
Apprch %	0	0	100	0		0	0	0	0		100	0	0	0		0	0	0	0		
Total %	0	0	66.7	0	66.7	0	0	0	0	0	33.3	0	0	0	33.3	0	0	0	0	0	

Start Time	LIGHTFIGHTER DR Southbound					COLONEL DURHAM ST Westbound					MALMEDY RD Northbound					DRIVEWAY Eastbound					Int. Total
	Right	Thru	Left	Peds	App. Total	Right	Thru	Left	Peds	App. Total	Right	Thru	Left	Peds	App. Total	Right	Thru	Left	Peds	App. Total	
Peak Hour Analysis From 07:00 AM to 08:45 AM - Peak 1 of 1																					
Peak Hour for Entire Intersection Begins at 07:00 AM																					
07:00 AM	0	0	0	0	0	0	0	0	0	0	1	0	0	0	1	0	0	0	0	0	1
07:15 AM	0	0	1	0	1	0	0	0	0	0	0	0	0	0	0	0	0	0	0	0	1
07:30 AM	0	0	0	0	0	0	0	0	0	0	0	0	0	0	0	0	0	0	0	0	0
07:45 AM	0	0	0	0	0	0	0	0	0	0	0	0	0	0	0	0	0	0	0	0	0
Total Volume	0	0	1	0	1	0	0	0	0	0	1	0	0	0	1	0	0	0	0	0	2
% App. Total	0	0	100	0		0	0	0	0		100	0	0	0		0	0	0	0		
PHF	.000	.000	.250	.000	.250	.000	.000	.000	.000	.000	.250	.000	.000	.000	.250	.000	.000	.000	.000	.000	.500

Traffic Data Service

San Jose, CA
(408) 622-4787
tdsbay@cs.com

File Name : 8AM FINAL
Site Code : 00000008
Start Date : 4/25/2018
Page No : 2

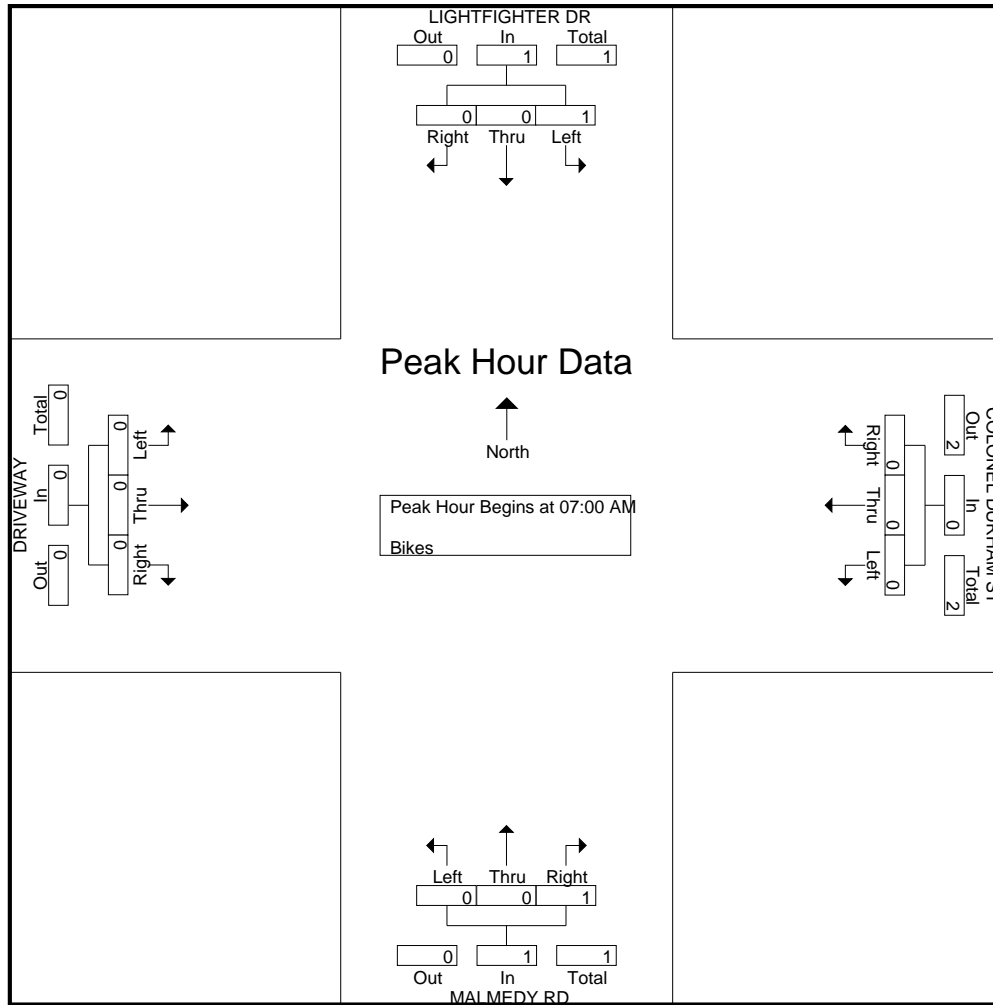

Traffic Data Service

San Jose, CA
 (408) 622-4787
 tdsbay@cs.com

File Name : 8PM FINAL
 Site Code : 00000008
 Start Date : 4/25/2018
 Page No : 1

Groups Printed- Lights - Buses - Trucks

Start Time	LIGHTFIGHTER DR Southbound					COLONEL DURHAM ST Westbound					MALMEDY RD Northbound					DRIVEWAY Eastbound					Int. Total
	Right	Thru	Left	Peds	App. Total	Right	Thru	Left	Peds	App. Total	Right	Thru	Left	Peds	App. Total	Right	Thru	Left	Peds	App. Total	
04:00 PM	0	12	32	0	44	46	0	0	0	46	0	10	0	0	10	0	0	0	0	0	100
04:15 PM	0	9	17	0	26	29	0	1	0	30	2	13	0	0	15	0	0	0	0	0	71
04:30 PM	0	8	29	0	37	35	0	0	0	35	1	13	0	0	14	0	0	0	0	0	86
04:45 PM	0	12	32	0	44	41	0	3	0	44	3	10	0	0	13	0	0	0	0	0	101
Total	0	41	110	0	151	151	0	4	0	155	6	46	0	0	52	0	0	0	0	0	358
05:00 PM	0	10	34	0	44	49	0	2	0	51	1	10	0	0	11	0	0	0	0	0	106
05:15 PM	0	7	20	0	27	42	0	1	0	43	0	12	0	0	12	0	0	0	0	0	82
05:30 PM	0	9	34	0	43	25	1	3	0	29	2	9	0	0	11	0	1	0	0	1	84
05:45 PM	0	5	32	0	37	26	0	2	0	28	0	9	0	0	9	0	0	0	0	0	74
Total	0	31	120	0	151	142	1	8	0	151	3	40	0	0	43	0	1	0	0	1	346
Grand Total	0	72	230	0	302	293	1	12	0	306	9	86	0	0	95	0	1	0	0	1	704
Apprch %	0	23.8	76.2	0		95.8	0.3	3.9	0		9.5	90.5	0	0		0	100	0	0		
Total %	0	10.2	32.7	0	42.9	41.6	0.1	1.7	0	43.5	1.3	12.2	0	0	13.5	0	0.1	0	0	0.1	
Lights	0	70	224	0	294	290	1	12	0	303	9	85	0	0	94	0	1	0	0	1	692
% Lights	0	97.2	97.4	0	97.4	99	100	100	0	99	100	98.8	0	0	98.9	0	100	0	0	100	98.3
Buses	0	1	1	0	2	2	0	0	0	2	0	0	0	0	0	0	0	0	0	0	4
% Buses	0	1.4	0.4	0	0.7	0.7	0	0	0	0.7	0	0	0	0	0	0	0	0	0	0	0.6
Trucks	0	1	5	0	6	1	0	0	0	1	0	1	0	0	1	0	0	0	0	0	8
% Trucks	0	1.4	2.2	0	2	0.3	0	0	0	0.3	0	1.2	0	0	1.1	0	0	0	0	0	1.1

Start Time	LIGHTFIGHTER DR Southbound				COLONEL DURHAM ST Westbound				MALMEDY RD Northbound				DRIVEWAY Eastbound				Int. Total
	Right	Thru	Left	App. Total	Right	Thru	Left	App. Total	Right	Thru	Left	App. Total	Right	Thru	Left	App. Total	
Peak Hour Analysis From 04:00 PM to 05:45 PM - Peak 1 of 1																	
Peak Hour for Entire Intersection Begins at 04:30 PM																	
04:30 PM	0	8	29	37	35	0	0	35	1	13	0	14	0	0	0	0	86
04:45 PM	0	12	32	44	41	0	3	44	3	10	0	13	0	0	0	0	101
05:00 PM	0	10	34	44	49	0	2	51	1	10	0	11	0	0	0	0	106
05:15 PM	0	7	20	27	42	0	1	43	0	12	0	12	0	0	0	0	82
Total Volume	0	37	115	152	167	0	6	173	5	45	0	50	0	0	0	0	375
% App. Total	0	24.3	75.7		96.5	0	3.5		10	90	0		0	0	0		
PHF	.000	.771	.846	.864	.852	.000	.500	.848	.417	.865	.000	.893	.000	.000	.000	.000	.884

Traffic Data Service

San Jose, CA
 (408) 622-4787
 tdsbay@cs.com

File Name : 8PM FINAL
 Site Code : 00000008
 Start Date : 4/25/2018
 Page No : 2

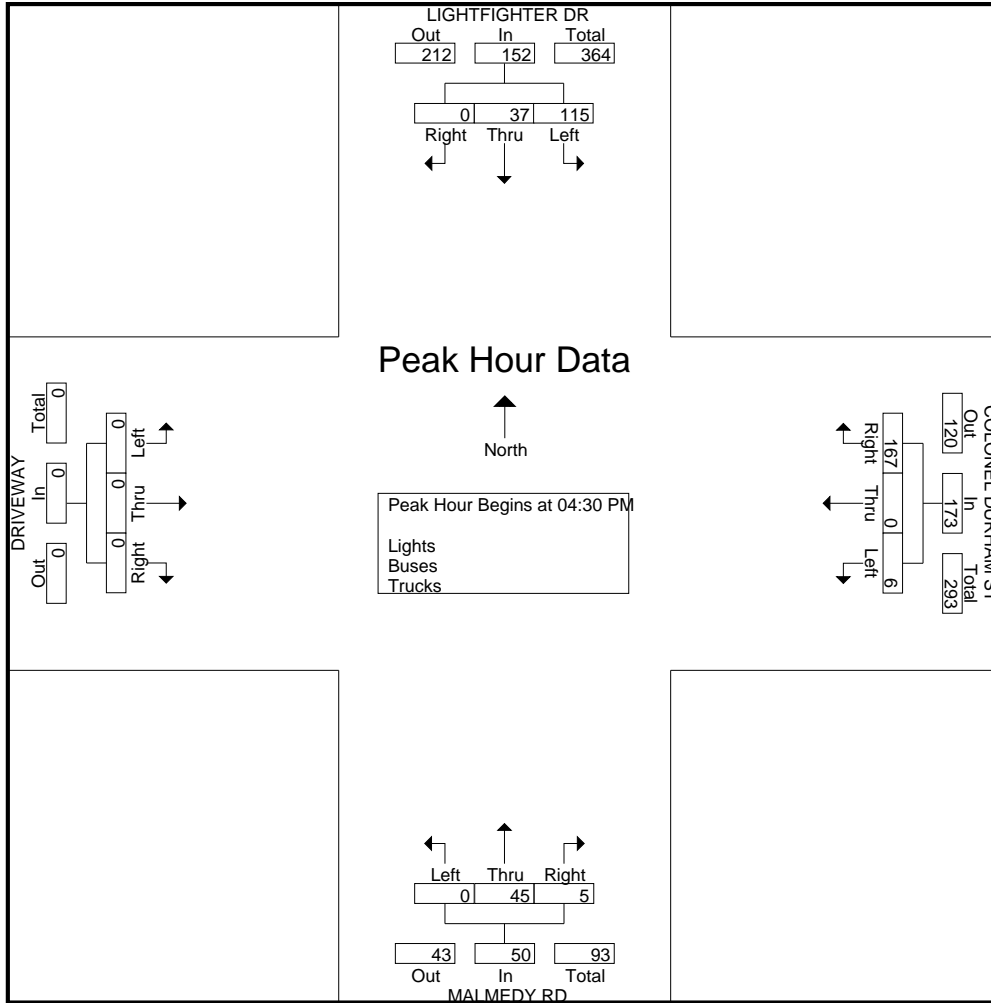

Traffic Data Service

San Jose, CA
 (408) 622-4787
 tdsbay@cs.com

File Name : 8PM FINAL
 Site Code : 00000008
 Start Date : 4/25/2018
 Page No : 1

Groups Printed- Bikes

Start Time	LIGHTFIGHTER DR Southbound					COLONEL DURHAM ST Westbound					MALMEDY RD Northbound					DRIVEWAY Eastbound					Int. Total
	Right	Thru	Left	Peds	App. Total	Right	Thru	Left	Peds	App. Total	Right	Thru	Left	Peds	App. Total	Right	Thru	Left	Peds	App. Total	
04:00 PM	0	0	0	0	0	0	0	0	0	0	0	0	0	0	0	0	0	0	0	0	0
04:15 PM	0	0	0	0	0	0	0	0	0	0	0	1	0	0	1	0	0	0	0	0	0
04:30 PM	0	0	0	0	0	0	0	0	0	0	0	0	0	0	0	0	0	0	0	0	0
04:45 PM	0	0	0	0	0	0	0	0	0	0	1	0	0	0	1	0	0	0	0	0	0
Total	0	0	0	0	0	0	0	0	0	0	1	1	0	0	2	0	0	0	0	0	0
05:00 PM	0	0	0	0	0	0	0	0	0	0	0	0	0	0	0	0	0	0	0	0	0
05:15 PM	0	1	0	0	1	0	0	0	0	0	0	0	0	0	0	0	0	0	0	0	0
05:30 PM	0	0	0	0	0	0	0	0	0	0	0	0	0	0	0	0	0	0	0	0	0
05:45 PM	0	0	0	0	0	0	0	0	0	0	0	0	0	0	0	0	0	0	0	0	0
Total	0	1	0	0	1	0	0	0	0	0	0	0	0	0	0	0	0	0	0	0	0
Grand Total	0	1	0	0	1	0	0	0	0	0	1	1	0	0	2	0	0	0	0	0	3
Apprch %	0	100	0	0		0	0	0	0		50	50	0	0		0	0	0	0		
Total %	0	33.3	0	0	33.3	0	0	0	0	0	33.3	33.3	0	0	66.7	0	0	0	0	0	

Start Time	LIGHTFIGHTER DR Southbound					COLONEL DURHAM ST Westbound					MALMEDY RD Northbound					DRIVEWAY Eastbound					Int. Total
	Right	Thru	Left	Peds	App. Total	Right	Thru	Left	Peds	App. Total	Right	Thru	Left	Peds	App. Total	Right	Thru	Left	Peds	App. Total	
04:00 PM	0	0	0	0	0	0	0	0	0	0	0	0	0	0	0	0	0	0	0	0	0
04:15 PM	0	0	0	0	0	0	0	0	0	0	0	1	0	0	1	0	0	0	0	0	0
04:30 PM	0	0	0	0	0	0	0	0	0	0	0	0	0	0	0	0	0	0	0	0	0
04:45 PM	0	0	0	0	0	0	0	0	0	0	1	0	0	0	1	0	0	0	0	0	0
Total Volume	0	0	0	0	0	0	0	0	0	0	1	1	0	0	2	0	0	0	0	0	2
% App. Total	0	0	0	0		0	0	0	0		50	50	0	0		0	0	0	0		
PHF	.000	.000	.000	.000	.000	.000	.000	.000	.000	.000	.250	.250	.000	.500	.500	.000	.000	.000	.000	.000	.500

Peak Hour Analysis From 04:00 PM to 05:45 PM - Peak 1 of 1
 Peak Hour for Entire Intersection Begins at 04:00 PM

Traffic Data Service

San Jose, CA
 (408) 622-4787
 tdsbay@cs.com

File Name : 8PM FINAL
 Site Code : 00000008
 Start Date : 4/25/2018
 Page No : 2

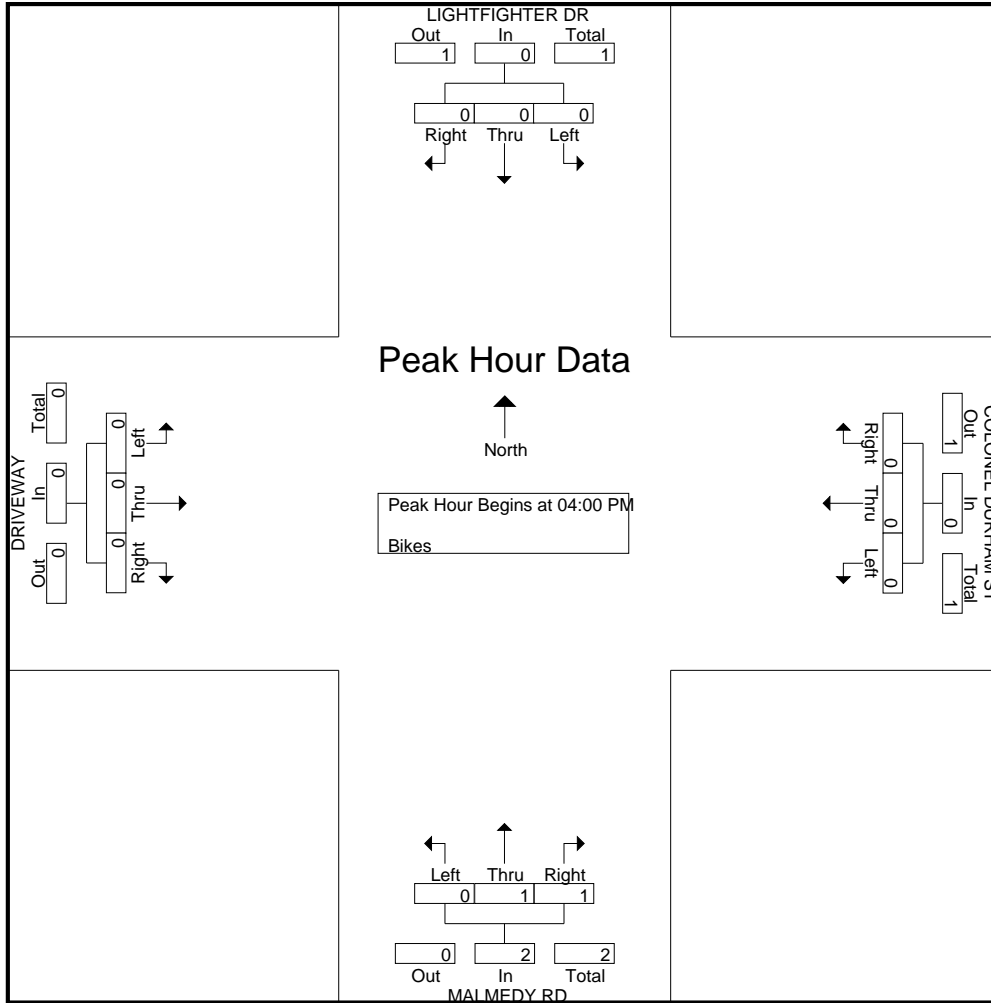

Traffic Data Service

San Jose, CA
 (408) 622-4787
 tdsbay@cs.com

File Name : 9AM FINAL
 Site Code : 00000009
 Start Date : 4/25/2018
 Page No : 1

Groups Printed- Lights - Buses - Trucks

Start Time	Southbound					COLONEL DURHAM ST Westbound					PARKER FLATS CUT OFF RD Northbound					COLONEL DURHAM ST Eastbound					Int. Total
	Right	Thru	Left	Peds	App. Total	Right	Thru	Left	Peds	App. Total	Right	Thru	Left	Peds	App. Total	Right	Thru	Left	Peds	App. Total	
07:00 AM	0	0	0	0	0	0	61	1	0	62	1	0	1	0	2	1	9	0	0	10	74
07:15 AM	0	0	0	0	0	0	82	3	0	85	1	0	2	0	3	4	10	0	0	14	102
07:30 AM	0	0	0	0	0	0	92	1	0	93	0	0	2	0	2	6	23	0	0	29	124
07:45 AM	0	0	0	0	0	0	42	3	0	45	1	0	2	0	3	6	34	0	0	40	88
Total	0	0	0	0	0	0	277	8	0	285	3	0	7	0	10	17	76	0	0	93	388
08:00 AM	0	0	0	0	0	0	37	1	0	38	2	0	1	0	3	6	27	0	0	33	74
08:15 AM	0	0	0	0	0	0	24	2	0	26	1	0	2	0	3	4	36	0	0	40	69
08:30 AM	0	0	0	0	0	0	28	0	0	28	1	0	0	0	1	4	28	0	0	32	61
08:45 AM	0	0	0	0	0	0	21	1	0	22	0	0	3	0	3	8	27	0	0	35	60
Total	0	0	0	0	0	0	110	4	0	114	4	0	6	0	10	22	118	0	0	140	264
Grand Total	0	0	0	0	0	0	387	12	0	399	7	0	13	0	20	39	194	0	0	233	652
Apprch %	0	0	0	0	0	0	97	3	0	100	35	0	65	0	100	16.7	83.3	0	0	100	
Total %	0	0	0	0	0	0	59.4	1.8	0	61.2	1.1	0	2	0	3.1	6	29.8	0	0	35.7	
Lights	0	0	0	0	0	0	376	12	0	388	7	0	13	0	20	39	185	0	0	224	632
% Lights	0	0	0	0	0	0	97.2	100	0	97.2	100	0	100	0	100	100	95.4	0	0	96.1	96.9
Buses	0	0	0	0	0	0	0	0	0	0	0	0	0	0	0	0	7	0	0	7	7
% Buses	0	0	0	0	0	0	0	0	0	0	0	0	0	0	0	0	3.6	0	0	3	1.1
Trucks	0	0	0	0	0	0	11	0	0	11	0	0	0	0	0	0	2	0	0	2	13
% Trucks	0	0	0	0	0	0	2.8	0	0	2.8	0	0	0	0	0	0	1	0	0	0.9	2

Start Time	Southbound					COLONEL DURHAM ST Westbound					PARKER FLATS CUT OFF RD Northbound					COLONEL DURHAM ST Eastbound					Int. Total
	Right	Thru	Left	Peds	App. Total	Right	Thru	Left	Peds	App. Total	Right	Thru	Left	Peds	App. Total	Right	Thru	Left	Peds	App. Total	
07:00 AM	0	0	0	0	0	0	61	1	0	62	1	0	1	0	2	1	9	0	0	10	74
07:15 AM	0	0	0	0	0	0	82	3	0	85	1	0	2	0	3	4	10	0	0	14	102
07:30 AM	0	0	0	0	0	0	92	1	0	93	0	0	2	0	2	6	23	0	0	29	124
07:45 AM	0	0	0	0	0	0	42	3	0	45	1	0	2	0	3	6	34	0	0	40	88
Total Volume	0	0	0	0	0	0	277	8	0	285	3	0	7	0	10	17	76	0	0	93	388
% App. Total	0	0	0	0	0	0	97.2	2.8	0	97.2	30	0	70	0	100	18.3	81.7	0	0	96.1	96.9
PHF	.000	.000	.000	.000	.000	.000	.753	.667	.766	.766	.750	.000	.875	.833	.833	.708	.559	.000	.581	.581	.782

Peak Hour Analysis From 07:00 AM to 08:45 AM - Peak 1 of 1

Peak Hour for Entire Intersection Begins at 07:00 AM

Traffic Data Service

San Jose, CA
 (408) 622-4787
 tdsbay@cs.com

File Name : 9AM FINAL
 Site Code : 00000009
 Start Date : 4/25/2018
 Page No : 2

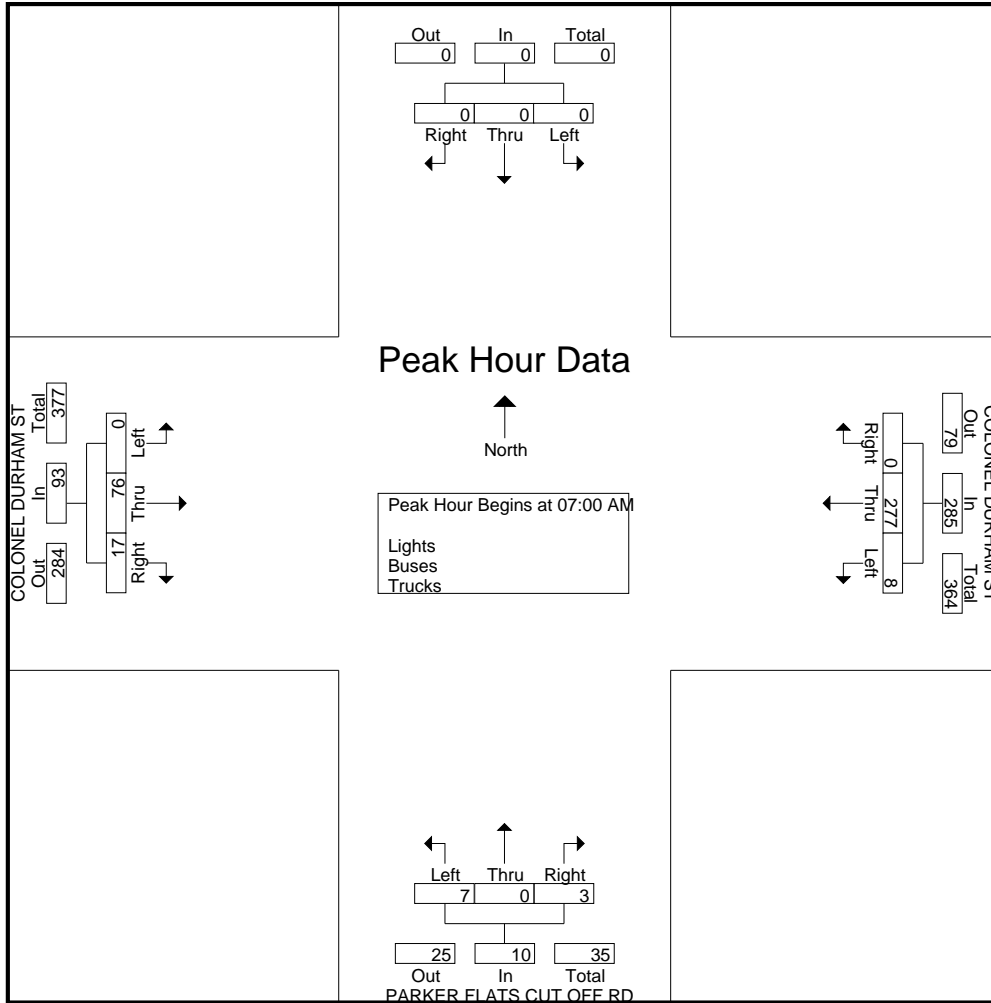

Traffic Data Service

San Jose, CA
 (408) 622-4787
 tdsbay@cs.com

File Name : 9AM FINAL
 Site Code : 00000009
 Start Date : 4/25/2018
 Page No : 1

Groups Printed- Bikes

Start Time	Southbound					COLONEL DURHAM ST Westbound					PARKER FLATS CUT OFF RD Northbound					COLONEL DURHAM ST Eastbound					Int. Total
	Right	Thru	Left	Peds	App. Total	Right	Thru	Left	Peds	App. Total	Right	Thru	Left	Peds	App. Total	Right	Thru	Left	Peds	App. Total	
07:00 AM	0	0	0	0	0	0	0	0	0	0	0	0	0	0	0	0	1	0	0	1	1
07:15 AM	0	0	0	0	0	0	0	0	0	0	0	0	0	0	0	1	0	0	0	1	1
07:30 AM	0	0	0	0	0	0	0	1	0	1	0	0	0	0	0	0	0	0	0	0	1
07:45 AM	0	0	0	0	0	0	0	1	0	1	1	0	0	0	1	0	0	0	0	0	2
Total	0	0	0	0	0	0	0	2	0	2	1	0	0	0	1	1	1	0	0	2	5
08:00 AM	0	0	0	0	0	0	0	0	0	0	0	0	0	0	0	0	0	0	0	0	0
08:15 AM	0	0	0	0	0	0	0	0	0	0	0	0	0	0	0	0	0	0	0	0	0
08:30 AM	0	0	0	0	0	0	0	0	0	0	0	0	0	0	0	0	1	0	0	1	1
08:45 AM	0	0	0	0	0	0	0	0	0	0	0	0	0	0	0	0	0	0	0	0	0
Total	0	0	0	0	0	0	0	0	0	0	0	0	0	0	0	0	1	0	0	1	1
Grand Total	0	0	0	0	0	0	0	2	0	2	1	0	0	0	1	1	2	0	0	3	6
Apprch %	0	0	0	0		0	0	100	0		100	0	0	0		33.3	66.7	0	0		
Total %	0	0	0	0	0	0	0	33.3	0	33.3	16.7	0	0	0	16.7	16.7	33.3	0	0	50	

Start Time	Southbound					COLONEL DURHAM ST Westbound					PARKER FLATS CUT OFF RD Northbound					COLONEL DURHAM ST Eastbound					Int. Total
	Right	Thru	Left	Peds	App. Total	Right	Thru	Left	Peds	App. Total	Right	Thru	Left	Peds	App. Total	Right	Thru	Left	Peds	App. Total	
Peak Hour Analysis From 07:00 AM to 08:45 AM - Peak 1 of 1																					
Peak Hour for Entire Intersection Begins at 07:00 AM																					
07:00 AM	0	0	0	0	0	0	0	0	0	0	0	0	0	0	0	0	1	0	0	1	1
07:15 AM	0	0	0	0	0	0	0	0	0	0	0	0	0	0	0	1	0	0	0	1	1
07:30 AM	0	0	0	0	0	0	0	1	0	1	0	0	0	0	0	0	0	0	0	0	1
07:45 AM	0	0	0	0	0	0	0	1	0	1	1	0	0	0	1	0	0	0	0	0	2
Total Volume	0	0	0	0	0	0	0	2	0	2	1	0	0	0	1	1	1	0	0	2	5
% App. Total	0	0	0	0		0	0	100	0		100	0	0	0		50	50	0	0		
PHF	.000	.000	.000	.000	.000	.000	.000	.500	.500	.500	.250	.000	.000	.250	.250	.250	.250	.000	.500	.500	.625

Traffic Data Service

San Jose, CA
 (408) 622-4787
 tdsbay@cs.com

File Name : 9AM FINAL
 Site Code : 00000009
 Start Date : 4/25/2018
 Page No : 2

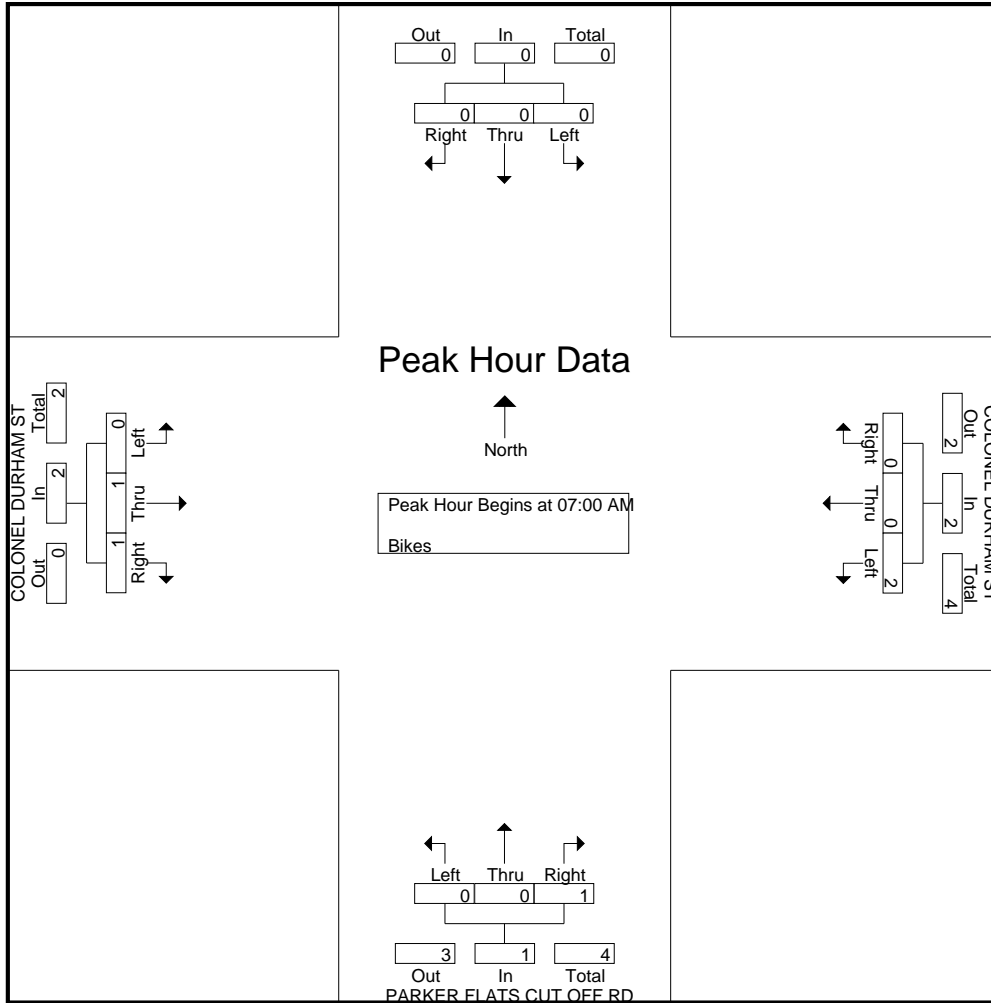

Traffic Data Service

San Jose, CA
 (408) 622-4787
 tdsbay@cs.com

File Name : 9PM FINAL
 Site Code : 00000009
 Start Date : 4/25/2018
 Page No : 1

Groups Printed- Lights - Buses - Trucks

Start Time	Southbound					COLONEL DURHAM ST Westbound					PARKER FLATS CUT OFF RD Northbound					COLONEL DURHAM ST Eastbound					Int. Total
	Right	Thru	Left	Peds	App. Total	Right	Thru	Left	Peds	App. Total	Right	Thru	Left	Peds	App. Total	Right	Thru	Left	Peds	App. Total	
04:00 PM	0	0	0	0	0	0	32	3	0	35	2	0	8	0	10	1	33	0	0	34	79
04:15 PM	0	0	0	0	0	0	17	0	0	17	3	0	7	0	10	1	16	0	0	17	44
04:30 PM	0	0	0	0	0	0	26	2	0	28	0	0	6	0	6	0	23	0	0	23	57
04:45 PM	0	0	0	0	0	0	38	0	0	38	3	0	5	0	8	0	31	0	0	31	77
Total	0	0	0	0	0	0	113	5	0	118	8	0	26	0	34	2	103	0	0	105	257
05:00 PM	0	0	0	0	0	0	37	0	0	37	0	0	9	0	9	2	32	0	0	34	80
05:15 PM	0	0	0	0	0	0	35	0	0	35	1	0	4	2	7	2	15	0	0	17	59
05:30 PM	0	0	0	0	0	0	19	1	0	20	1	0	8	0	9	1	24	0	0	25	54
05:45 PM	0	0	0	0	0	0	21	0	0	21	0	0	4	2	6	0	21	0	0	21	48
Total	0	0	0	0	0	0	112	1	0	113	2	0	25	4	31	5	92	0	0	97	241
Grand Total	0	0	0	0	0	0	225	6	0	231	10	0	51	4	65	7	195	0	0	202	498
Apprch %	0	0	0	0	0	0	97.4	2.6	0	231	15.4	0	78.5	6.2	65	3.5	96.5	0	0	202	498
Total %	0	0	0	0	0	0	45.2	1.2	0	46.4	2	0	10.2	0.8	13.1	1.4	39.2	0	0	40.6	498
Lights	0	0	0	0	0	0	223	6	0	229	10	0	51	4	65	7	188	0	0	195	489
% Lights	0	0	0	0	0	0	99.1	100	0	99.1	100	0	100	100	100	100	96.4	0	0	96.5	98.2
Buses	0	0	0	0	0	0	2	0	0	2	0	0	0	0	0	0	1	0	0	1	3
% Buses	0	0	0	0	0	0	0.9	0	0	0.9	0	0	0	0	0	0	0.5	0	0	0.5	0.6
Trucks	0	0	0	0	0	0	0	0	0	0	0	0	0	0	0	0	6	0	0	6	6
% Trucks	0	0	0	0	0	0	0	0	0	0	0	0	0	0	0	0	3.1	0	0	3	1.2

Start Time	Southbound				COLONEL DURHAM ST Westbound				PARKER FLATS CUT OFF RD Northbound				COLONEL DURHAM ST Eastbound				Int. Total
	Right	Thru	Left	App. Total	Right	Thru	Left	App. Total	Right	Thru	Left	App. Total	Right	Thru	Left	App. Total	
Peak Hour Analysis From 04:00 PM to 05:45 PM - Peak 1 of 1																	
Peak Hour for Entire Intersection Begins at 04:30 PM																	
04:30 PM	0	0	0	0	0	26	2	28	0	0	6	6	0	23	0	23	57
04:45 PM	0	0	0	0	0	38	0	38	3	0	5	8	0	31	0	31	77
05:00 PM	0	0	0	0	0	37	0	37	0	0	9	9	2	32	0	34	80
05:15 PM	0	0	0	0	0	35	0	35	1	0	4	5	2	15	0	17	57
Total Volume	0	0	0	0	0	136	2	138	4	0	24	28	4	101	0	105	271
% App. Total	0	0	0	0	0	98.6	1.4	138	14.3	0	85.7	28	3.8	96.2	0	105	271
PHF	.000	.000	.000	.000	.000	.895	.250	.908	.333	.000	.667	.778	.500	.789	.000	.772	.847

Traffic Data Service

San Jose, CA
 (408) 622-4787
 tdsbay@cs.com

File Name : 9PM FINAL
 Site Code : 00000009
 Start Date : 4/25/2018
 Page No : 2

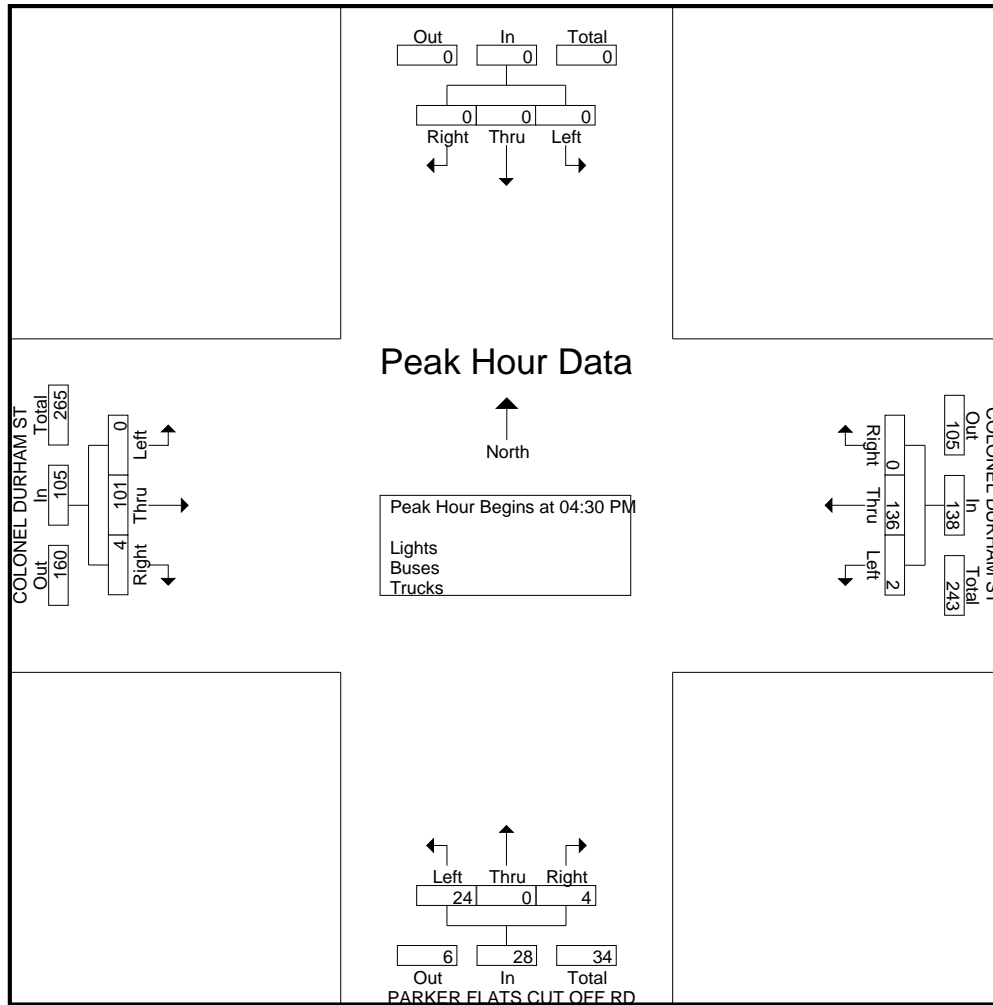

Traffic Data Service

San Jose, CA
 (408) 622-4787
 tdsbay@cs.com

File Name : 9PM FINAL
 Site Code : 00000009
 Start Date : 4/25/2018
 Page No : 1

Groups Printed- Bikes

Start Time	Southbound					COLONEL DURHAM ST Westbound					PARKER FLATS CUT OFF RD Northbound					COLONEL DURHAM ST Eastbound					Int. Total
	Right	Thru	Left	Peds	App. Total	Right	Thru	Left	Peds	App. Total	Right	Thru	Left	Peds	App. Total	Right	Thru	Left	Peds	App. Total	
04:00 PM	0	0	0	0	0	0	0	0	0	0	0	0	0	0	0	0	0	0	0	0	0
04:15 PM	0	0	0	0	0	0	0	0	0	0	0	0	0	0	0	0	0	0	0	0	0
04:30 PM	0	0	0	0	0	0	0	1	0	1	0	0	0	0	0	0	0	0	0	0	1
04:45 PM	0	0	0	0	0	0	0	0	0	0	0	0	0	0	0	0	0	0	0	0	0
Total	0	0	0	0	0	0	0	1	0	1	0	0	0	0	0	0	0	0	0	0	1
05:00 PM	0	0	0	0	0	0	0	0	0	0	0	0	0	0	0	0	1	0	0	1	1
05:15 PM	0	0	0	0	0	0	0	0	0	0	0	0	0	0	0	0	0	0	0	0	0
05:30 PM	0	0	0	0	0	0	0	0	0	0	0	0	0	0	0	0	0	0	0	0	0
05:45 PM	0	0	0	0	0	0	0	0	0	0	0	0	0	0	0	0	0	0	0	0	0
Total	0	0	0	0	0	0	0	0	0	0	0	0	0	0	0	0	1	0	0	1	1
Grand Total	0	0	0	0	0	0	0	1	0	1	0	0	0	0	0	0	1	0	0	1	2
Apprch %	0	0	0	0		0	0	100	0		0	0	0	0		0	100	0	0		
Total %	0	0	0	0	0	0	0	50	0	50	0	0	0	0	0	0	50	0	0	50	

Start Time	Southbound					COLONEL DURHAM ST Westbound					PARKER FLATS CUT OFF RD Northbound					COLONEL DURHAM ST Eastbound					Int. Total
	Right	Thru	Left	Peds	App. Total	Right	Thru	Left	Peds	App. Total	Right	Thru	Left	Peds	App. Total	Right	Thru	Left	Peds	App. Total	
Peak Hour Analysis From 04:00 PM to 05:45 PM - Peak 1 of 1																					
Peak Hour for Entire Intersection Begins at 04:15 PM																					
04:15 PM	0	0	0	0	0	0	0	0	0	0	0	0	0	0	0	0	0	0	0	0	0
04:30 PM	0	0	0	0	0	0	0	1	0	1	0	0	0	0	0	0	0	0	0	0	1
04:45 PM	0	0	0	0	0	0	0	0	0	0	0	0	0	0	0	0	0	0	0	0	0
05:00 PM	0	0	0	0	0	0	0	0	0	0	0	0	0	0	0	0	1	0	0	1	1
Total Volume	0	0	0	0	0	0	0	1	0	1	0	0	0	0	0	0	1	0	0	1	2
% App. Total	0	0	0	0		0	0	100	0		0	0	0	0		0	100	0	0		
PHF	.000	.000	.000	.000	.000	.000	.000	.250	.250	.000	.000	.000	.000	.000	.000	.000	.250	.000	.250	.500	

Traffic Data Service

San Jose, CA
 (408) 622-4787
 tdsbay@cs.com

File Name : 9PM FINAL
 Site Code : 00000009
 Start Date : 4/25/2018
 Page No : 2

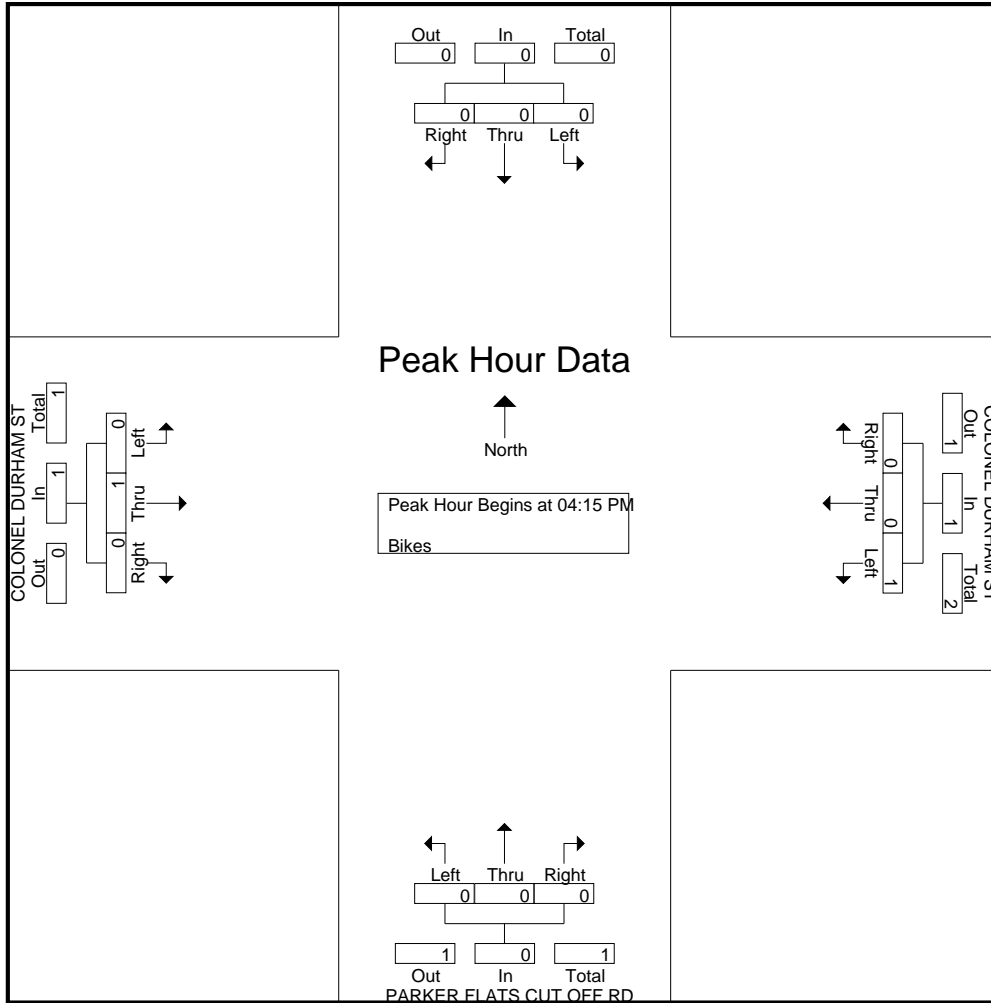

Traffic Data Service

San Jose, CA
 (408) 622-4787
 tdsbay@cs.com

File Name : 10AM FINAL
 Site Code : 00000010
 Start Date : 4/25/2018
 Page No : 1

Groups Printed- Lights - Buses - Trucks

Start Time	6TH AVE Southbound					COLONEL DURHAM ST Westbound					6TH AVE Northbound					COLONEL DURHAM ST Eastbound					Int. Total
	Right	Thru	Left	Peds	App. Total	Right	Thru	Left	Peds	App. Total	Right	Thru	Left	Peds	App. Total	Right	Thru	Left	Peds	App. Total	
07:00 AM	11	0	0	0	11	0	55	0	0	55	0	0	0	0	0	1	7	1	0	9	75
07:15 AM	21	1	0	0	22	0	58	2	0	60	0	1	0	0	1	5	6	2	0	13	96
07:30 AM	13	3	0	0	16	0	78	4	0	82	1	2	1	0	4	7	9	5	0	21	123
07:45 AM	8	1	0	0	9	0	39	4	0	43	1	4	0	0	5	10	23	6	0	39	96
Total	53	5	0	0	58	0	230	10	0	240	2	7	1	0	10	23	45	14	0	82	390
08:00 AM	7	5	0	0	12	0	31	2	0	33	0	1	0	0	1	5	17	4	1	27	73
08:15 AM	6	1	1	0	8	0	20	1	0	21	0	2	0	0	2	3	16	14	0	33	64
08:30 AM	3	0	0	0	3	0	22	1	0	23	0	3	3	0	6	4	14	14	0	32	64
08:45 AM	4	0	0	0	4	0	17	1	0	18	0	3	0	0	3	2	9	15	0	26	51
Total	20	6	1	0	27	0	90	5	0	95	0	9	3	0	12	14	56	47	1	118	252
Grand Total	73	11	1	0	85	0	320	15	0	335	2	16	4	0	22	37	101	61	1	200	642
Apprch %	85.9	12.9	1.2	0		0	95.5	4.5	0		9.1	72.7	18.2	0		18.5	50.5	30.5	0.5		
Total %	11.4	1.7	0.2	0	13.2	0	49.8	2.3	0	52.2	0.3	2.5	0.6	0	3.4	5.8	15.7	9.5	0.2	31.2	
Lights	72	10	1	0	83	0	310	15	0	325	1	15	4	0	20	37	93	60	1	191	619
% Lights	98.6	90.9	100	0	97.6	0	96.9	100	0	97	50	93.8	100	0	90.9	100	92.1	98.4	100	95.5	96.4
Buses	0	1	0	0	1	0	0	0	0	0	1	1	0	0	2	0	6	1	0	7	10
% Buses	0	9.1	0	0	1.2	0	0	0	0	0	50	6.2	0	0	9.1	0	5.9	1.6	0	3.5	1.6
Trucks	1	0	0	0	1	0	10	0	0	10	0	0	0	0	0	0	2	0	0	2	13
% Trucks	1.4	0	0	0	1.2	0	3.1	0	0	3	0	0	0	0	0	0	2	0	0	1	2

Start Time	6TH AVE Southbound				COLONEL DURHAM ST Westbound				6TH AVE Northbound				COLONEL DURHAM ST Eastbound				Int. Total	
	Right	Thru	Left	App. Total	Right	Thru	Left	App. Total	Right	Thru	Left	App. Total	Right	Thru	Left	App. Total		
Peak Hour Analysis From 07:00 AM to 08:45 AM - Peak 1 of 1																		
Peak Hour for Entire Intersection Begins at 07:00 AM																		
07:00 AM	11	0	0	11	0	55	0	55	0	0	0	0	0	1	7	1	9	75
07:15 AM	21	1	0	22	0	58	2	60	0	1	0	1	5	6	2	13	96	
07:30 AM	13	3	0	16	0	78	4	82	1	2	1	4	7	9	5	21	123	
07:45 AM	8	1	0	9	0	39	4	43	1	4	0	5	10	23	6	39	96	
Total Volume	53	5	0	58	0	230	10	240	2	7	1	10	23	45	14	82	390	
% App. Total	91.4	8.6	0		0	95.8	4.2		20	70	10		28	54.9	17.1			
PHF	.631	.417	.000	.659	.000	.737	.625	.732	.500	.438	.250	.500	.575	.489	.583	.526	.793	

Traffic Data Service

San Jose, CA
 (408) 622-4787
 tdsbay@cs.com

File Name : 10AM FINAL
 Site Code : 00000010
 Start Date : 4/25/2018
 Page No : 2

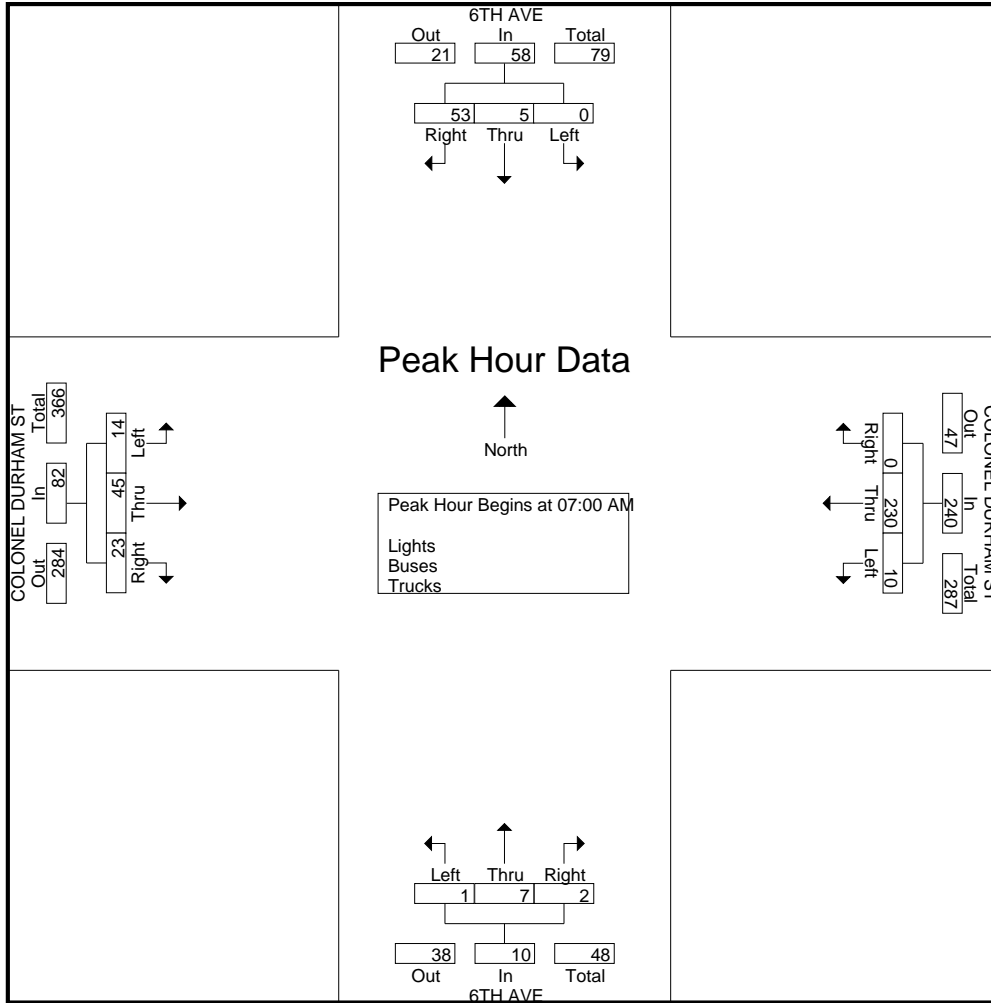

Traffic Data Service

San Jose, CA
 (408) 622-4787
 tdsbay@cs.com

File Name : 10AM FINAL
 Site Code : 00000010
 Start Date : 4/25/2018
 Page No : 1

Groups Printed- Bikes

Start Time	6TH AVE Southbound					COLONEL DURHAM ST Westbound					6TH AVE Northbound					COLONEL DURHAM ST Eastbound					Int. Total
	Right	Thru	Left	Peds	App. Total	Right	Thru	Left	Peds	App. Total	Right	Thru	Left	Peds	App. Total	Right	Thru	Left	Peds	App. Total	
07:00 AM	0	0	0	0	0	0	0	0	0	0	0	0	0	0	0	0	0	0	0	0	0
07:15 AM	0	0	0	0	0	0	0	0	0	0	0	0	0	0	0	0	0	0	0	0	0
07:30 AM	1	0	0	0	1	0	0	0	0	0	0	0	0	0	0	0	0	0	0	0	1
07:45 AM	1	0	0	0	1	0	0	0	0	0	0	0	0	0	0	0	0	0	0	0	1
Total	2	0	0	0	2	0	0	0	0	0	0	0	0	0	0	0	0	0	0	0	2
08:00 AM	0	1	0	0	1	0	0	0	0	0	0	0	0	0	0	0	0	0	0	0	1
08:15 AM	0	0	0	0	0	0	0	0	0	0	0	0	0	0	0	0	0	0	0	0	0
08:30 AM	0	1	0	0	1	0	0	0	0	0	0	0	0	0	0	0	0	1	0	1	2
08:45 AM	0	1	0	0	1	0	0	0	0	0	0	0	0	0	0	0	0	0	0	0	1
Total	0	3	0	0	3	0	0	0	0	0	0	0	0	0	0	0	0	1	0	1	4
Grand Total	2	3	0	0	5	0	0	0	0	0	0	0	0	0	0	0	0	1	0	1	6
Apprch %	40	60	0	0		0	0	0	0		0	0	0	0		0	0	100	0		
Total %	33.3	50	0	0	83.3	0	0	0	0	0	0	0	0	0	0	0	0	16.7	0	16.7	

Start Time	6TH AVE Southbound					COLONEL DURHAM ST Westbound					6TH AVE Northbound					COLONEL DURHAM ST Eastbound					Int. Total
	Right	Thru	Left	Peds	App. Total	Right	Thru	Left	Peds	App. Total	Right	Thru	Left	Peds	App. Total	Right	Thru	Left	Peds	App. Total	
Peak Hour Analysis From 07:00 AM to 08:45 AM - Peak 1 of 1																					
Peak Hour for Entire Intersection Begins at 07:45 AM																					
07:45 AM	1	0	0	0	1	0	0	0	0	0	0	0	0	0	0	0	0	0	0	0	1
08:00 AM	0	1	0	0	1	0	0	0	0	0	0	0	0	0	0	0	0	0	0	0	1
08:15 AM	0	0	0	0	0	0	0	0	0	0	0	0	0	0	0	0	0	0	0	0	0
08:30 AM	0	1	0	0	1	0	0	0	0	0	0	0	0	0	0	0	0	1	0	1	2
Total Volume	1	2	0	0	3	0	0	0	0	0	0	0	0	0	0	0	0	1	0	1	4
% App. Total	33.3	66.7	0	0		0	0	0	0		0	0	0	0		0	0	100	0		
PHF	.250	.500	.000	.000	.750	.000	.000	.000	.000	.000	.000	.000	.000	.000	.000	.000	.000	.250	.250	.500	

Traffic Data Service

San Jose, CA
(408) 622-4787
tdsbay@cs.com

File Name : 10AM FINAL
Site Code : 00000010
Start Date : 4/25/2018
Page No : 2

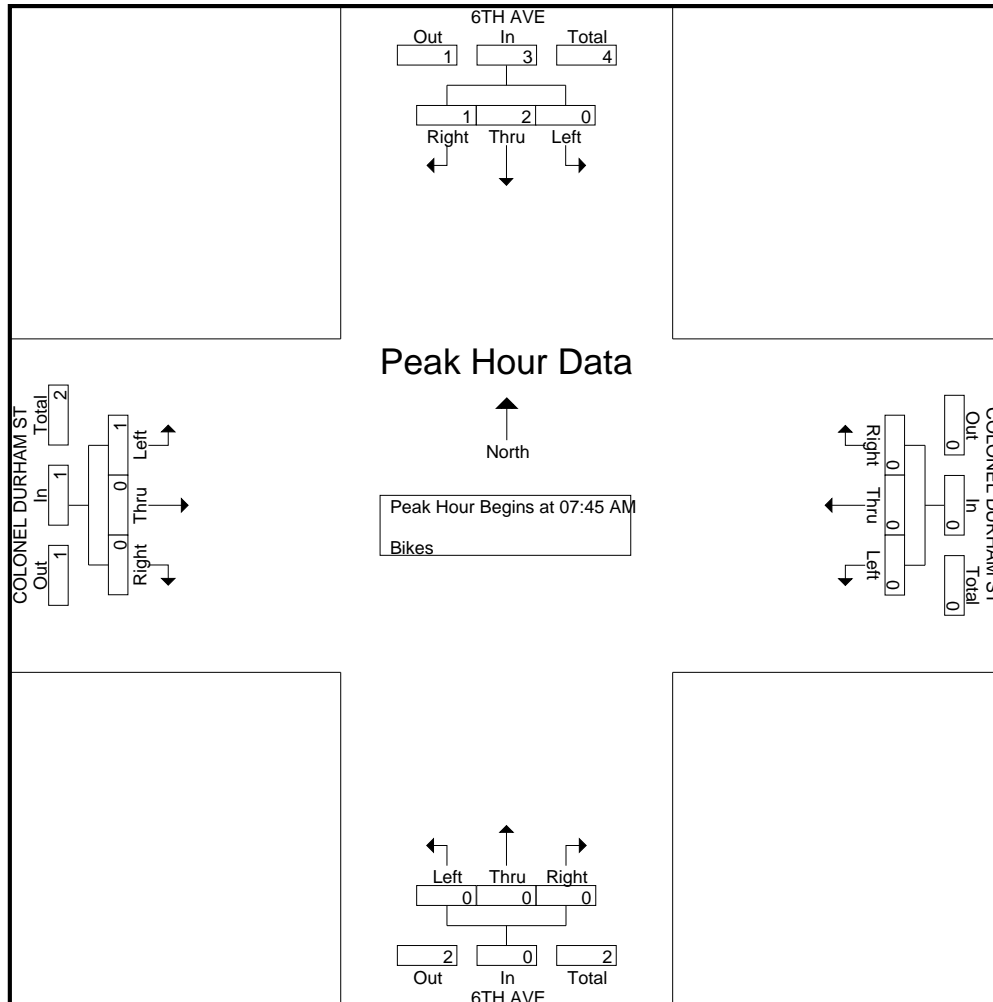

Traffic Data Service

San Jose, CA
 (408) 622-4787
 tdsbay@cs.com

File Name : 10PM FINAL
 Site Code : 00000010
 Start Date : 4/25/2018
 Page No : 1

Groups Printed- Lights - Buses - Trucks

Start Time	6TH AVE Southbound					COLONEL DURHAM ST Westbound					6TH AVE Northbound					COLONEL DURHAM ST Eastbound					Int. Total
	Right	Thru	Left	Peds	App. Total	Right	Thru	Left	Peds	App. Total	Right	Thru	Left	Peds	App. Total	Right	Thru	Left	Peds	App. Total	
04:00 PM	15	1	0	0	16	0	11	0	0	11	1	2	7	0	10	0	26	7	0	33	70
04:15 PM	4	1	0	0	5	0	11	0	0	11	0	4	2	0	6	0	20	1	0	21	43
04:30 PM	6	1	0	0	7	0	14	0	0	14	2	1	8	0	11	0	22	1	1	24	56
04:45 PM	9	2	0	0	11	0	25	0	0	25	1	4	5	0	10	0	30	2	0	32	78
Total	34	5	0	0	39	0	61	0	0	61	4	11	22	0	37	0	98	11	1	110	247
05:00 PM	12	7	1	0	20	0	13	0	0	13	2	5	13	0	20	0	24	8	2	34	87
05:15 PM	11	4	0	0	15	0	19	0	0	19	0	5	4	0	9	0	15	2	0	17	60
05:30 PM	6	3	1	0	10	0	11	1	0	12	0	2	3	0	5	0	19	3	4	26	53
05:45 PM	12	0	0	0	12	0	10	0	0	10	0	2	1	0	3	0	21	3	0	24	49
Total	41	14	2	0	57	0	53	1	0	54	2	14	21	0	37	0	79	16	6	101	249
Grand Total	75	19	2	0	96	0	114	1	0	115	6	25	43	0	74	0	177	27	7	211	496
Apprch %	78.1	19.8	2.1	0		0	99.1	0.9	0		8.1	33.8	58.1	0		0	83.9	12.8	3.3		
Total %	15.1	3.8	0.4	0	19.4	0	23	0.2	0	23.2	1.2	5	8.7	0	14.9	0	35.7	5.4	1.4	42.5	
Lights	74	19	2	0	95	0	113	1	0	114	5	25	43	0	73	0	172	27	7	206	488
% Lights	98.7	100	100	0	99	0	99.1	100	0	99.1	83.3	100	100	0	98.6	0	97.2	100	100	97.6	98.4
Buses	1	0	0	0	1	0	1	0	0	1	1	0	0	0	1	0	1	0	0	1	4
% Buses	1.3	0	0	0	1	0	0.9	0	0	0.9	16.7	0	0	0	1.4	0	0.6	0	0	0.5	0.8
Trucks	0	0	0	0	0	0	0	0	0	0	0	0	0	0	0	0	4	0	0	4	4
% Trucks	0	0	0	0	0	0	0	0	0	0	0	0	0	0	0	0	2.3	0	0	1.9	0.8

Start Time	6TH AVE Southbound				COLONEL DURHAM ST Westbound				6TH AVE Northbound				COLONEL DURHAM ST Eastbound				Int. Total
	Right	Thru	Left	App. Total	Right	Thru	Left	App. Total	Right	Thru	Left	App. Total	Right	Thru	Left	App. Total	
Peak Hour Analysis From 04:00 PM to 05:45 PM - Peak 1 of 1																	
Peak Hour for Entire Intersection Begins at 04:30 PM																	
04:30 PM	6	1	0	7	0	14	0	14	2	1	8	11	0	22	1	23	55
04:45 PM	9	2	0	11	0	25	0	25	1	4	5	10	0	30	2	32	78
05:00 PM	12	7	1	20	0	13	0	13	2	5	13	20	0	24	8	32	85
05:15 PM	11	4	0	15	0	19	0	19	0	5	4	9	0	15	2	17	60
Total Volume	38	14	1	53	0	71	0	71	5	15	30	50	0	91	13	104	278
% App. Total	71.7	26.4	1.9		0	100	0		10	30	60		0	87.5	12.5		
PHF	.792	.500	.250	.663	.000	.710	.000	.710	.625	.750	.577	.625	.000	.758	.406	.813	.818

Traffic Data Service

San Jose, CA
 (408) 622-4787
 tdsbay@cs.com

File Name : 10PM FINAL
 Site Code : 00000010
 Start Date : 4/25/2018
 Page No : 2

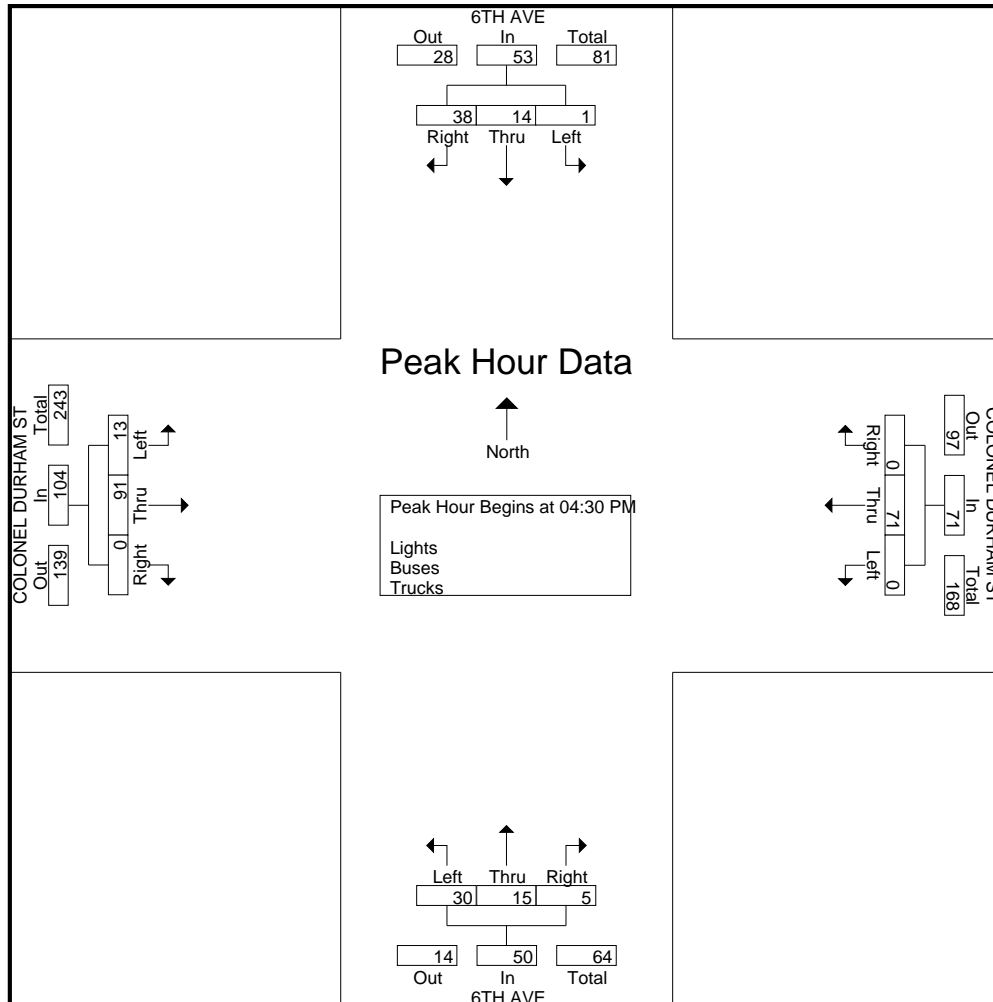

Traffic Data Service

San Jose, CA
(408) 622-4787
tdsbay@cs.com

File Name : 10PM FINAL
Site Code : 00000010
Start Date : 4/25/2018
Page No : 1

Groups Printed- Bikes

Start Time	6TH AVE Southbound					COLONEL DURHAM ST Westbound					6TH AVE Northbound					COLONEL DURHAM ST Eastbound					Int. Total
	Right	Thru	Left	Peds	App. Total	Right	Thru	Left	Peds	App. Total	Right	Thru	Left	Peds	App. Total	Right	Thru	Left	Peds	App. Total	
04:00 PM	0	0	0	0	0	0	0	0	0	0	0	0	0	0	0	0	0	0	0	0	0
04:15 PM	0	0	0	0	0	1	0	0	0	1	0	0	0	0	0	0	0	0	0	0	0
04:30 PM	1	0	1	0	2	0	0	0	0	0	0	0	0	0	0	0	0	0	0	0	0
04:45 PM	0	0	0	0	0	1	0	0	0	1	0	0	0	0	0	0	0	0	0	0	0
Total	1	0	1	0	2	2	0	0	0	2	0	0	0	0	0	0	0	0	0	0	4
05:00 PM	0	0	0	0	0	0	0	0	0	0	0	1	0	0	1	0	0	1	0	1	2
05:15 PM	0	0	0	0	0	0	0	0	0	0	0	0	0	0	0	0	0	0	0	0	0
05:30 PM	0	0	0	0	0	0	0	0	0	0	0	0	0	0	0	0	0	0	0	0	0
05:45 PM	0	0	0	0	0	0	0	0	0	0	0	0	0	0	0	0	0	0	0	0	0
Total	0	0	0	0	0	0	0	0	0	0	0	1	0	0	1	0	0	1	0	1	2
Grand Total	1	0	1	0	2	2	0	0	0	2	0	1	0	0	1	0	0	1	0	1	6
Apprch %	50	0	50	0		100	0	0	0		0	100	0	0		0	0	100	0		
Total %	16.7	0	16.7	0	33.3	33.3	0	0	0	33.3	0	16.7	0	0	16.7	0	0	16.7	0	16.7	

Start Time	6TH AVE Southbound				COLONEL DURHAM ST Westbound				6TH AVE Northbound				COLONEL DURHAM ST Eastbound				Int. Total
	Right	Thru	Left	App. Total	Right	Thru	Left	App. Total	Right	Thru	Left	App. Total	Right	Thru	Left	App. Total	
Peak Hour Analysis From 04:00 PM to 05:45 PM - Peak 1 of 1																	
Peak Hour for Entire Intersection Begins at 04:15 PM																	
04:15 PM	0	0	0	0	1	0	0	1	0	0	0	0	0	0	0	0	1
04:30 PM	1	0	1	2	0	0	0	0	0	0	0	0	0	0	0	0	2
04:45 PM	0	0	0	0	1	0	0	1	0	0	0	0	0	0	0	0	1
05:00 PM	0	0	0	0	0	0	0	0	0	1	0	1	0	0	1	1	2
Total Volume	1	0	1	2	2	0	0	2	0	1	0	1	0	0	1	1	6
% App. Total	50	0	50		100	0	0		0	100	0		0	0	100		
PHF	.250	.000	.250	.250	.500	.000	.000	.500	.000	.250	.000	.250	.000	.000	.250	.250	.750

Traffic Data Service

San Jose, CA
 (408) 622-4787
 tdsbay@cs.com

File Name : 10PM FINAL
 Site Code : 00000010
 Start Date : 4/25/2018
 Page No : 2

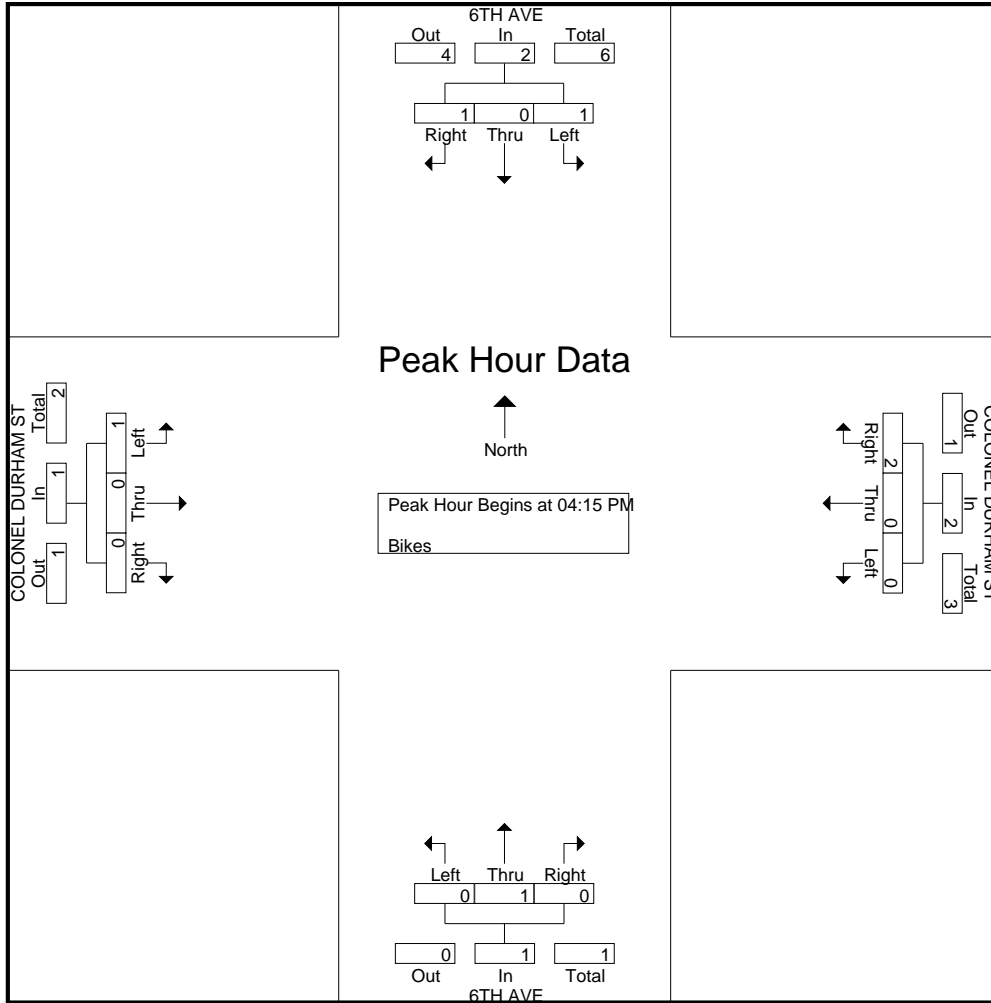

Traffic Data Service

San Jose, CA
 (408) 622-4787
 tdsbay@cs.com

File Name : 11AM FINAL
 Site Code : 00000011
 Start Date : 4/25/2018
 Page No : 1

Groups Printed- Lights - Buses - Trucks

Start Time	7TH AVE Southbound					COLONEL DURHAM ST Westbound					7TH AVE Northbound					COLONEL DURHAM ST Eastbound					Int. Total
	Right	Thru	Left	Peds	App. Total	Right	Thru	Left	Peds	App. Total	Right	Thru	Left	Peds	App. Total	Right	Thru	Left	Peds	App. Total	
07:00 AM	9	7	0	0	16	0	44	0	0	44	0	2	0	0	2	0	3	4	0	7	69
07:15 AM	20	25	0	0	45	0	43	0	0	43	0	0	0	0	0	0	4	2	0	6	94
07:30 AM	22	24	0	0	46	0	56	2	0	58	0	6	0	0	6	0	7	3	0	10	120
07:45 AM	11	32	0	0	43	0	31	0	0	31	0	7	0	0	7	1	18	3	0	22	103
Total	62	88	0	0	150	0	174	2	0	176	0	15	0	0	15	1	32	12	0	45	386
08:00 AM	7	16	0	0	23	0	27	0	0	27	0	7	0	0	7	0	8	11	1	20	77
08:15 AM	1	17	0	0	18	0	19	0	0	19	0	1	0	0	1	0	7	9	0	16	54
08:30 AM	4	17	0	0	21	0	19	0	0	19	0	3	0	0	3	2	9	4	0	15	58
08:45 AM	3	6	0	0	9	0	15	0	0	15	0	1	0	0	1	0	5	4	0	9	34
Total	15	56	0	0	71	0	80	0	0	80	0	12	0	0	12	2	29	28	1	60	223
Grand Total	77	144	0	0	221	0	254	2	0	256	0	27	0	0	27	3	61	40	1	105	609
Apprch %	34.8	65.2	0	0		0	99.2	0.8	0		0	100	0	0		2.9	58.1	38.1	1		
Total %	12.6	23.6	0	0	36.3	0	41.7	0.3	0	42	0	4.4	0	0	4.4	0.5	10	6.6	0.2	17.2	
Lights	68	135	0	0	203	0	254	2	0	256	0	25	0	0	25	1	55	39	1	96	580
% Lights	88.3	93.8	0	0	91.9	0	100	100	0	100	0	92.6	0	0	92.6	33.3	90.2	97.5	100	91.4	95.2
Buses	0	1	0	0	1	0	0	0	0	0	0	1	0	0	1	2	5	0	0	7	9
% Buses	0	0.7	0	0	0.5	0	0	0	0	0	0	3.7	0	0	3.7	66.7	8.2	0	0	6.7	1.5
Trucks	9	8	0	0	17	0	0	0	0	0	0	1	0	0	1	0	1	1	0	2	20
% Trucks	11.7	5.6	0	0	7.7	0	0	0	0	0	0	3.7	0	0	3.7	0	1.6	2.5	0	1.9	3.3

Start Time	7TH AVE Southbound				COLONEL DURHAM ST Westbound				7TH AVE Northbound				COLONEL DURHAM ST Eastbound				Int. Total	
	Right	Thru	Left	App. Total	Right	Thru	Left	App. Total	Right	Thru	Left	App. Total	Right	Thru	Left	App. Total		
Peak Hour Analysis From 07:00 AM to 08:45 AM - Peak 1 of 1																		
Peak Hour for Entire Intersection Begins at 07:15 AM																		
07:15 AM	20	25	0	45	0	43	0	43	0	0	0	0	0	0	4	2	6	94
07:30 AM	22	24	0	46	0	56	2	58	0	6	0	6	0	7	3	10	120	
07:45 AM	11	32	0	43	0	31	0	31	0	7	0	7	1	18	3	22	103	
08:00 AM	7	16	0	23	0	27	0	27	0	7	0	7	0	8	11	19	76	
Total Volume	60	97	0	157	0	157	2	159	0	20	0	20	1	37	19	57	393	
% App. Total	38.2	61.8	0		0	98.7	1.3		0	100	0		1.8	64.9	33.3			
PHF	.682	.758	.000	.853	.000	.701	.250	.685	.000	.714	.000	.714	.250	.514	.432	.648	.819	

Traffic Data Service

San Jose, CA
 (408) 622-4787
 tdsbay@cs.com

File Name : 11AM FINAL
 Site Code : 00000011
 Start Date : 4/25/2018
 Page No : 2

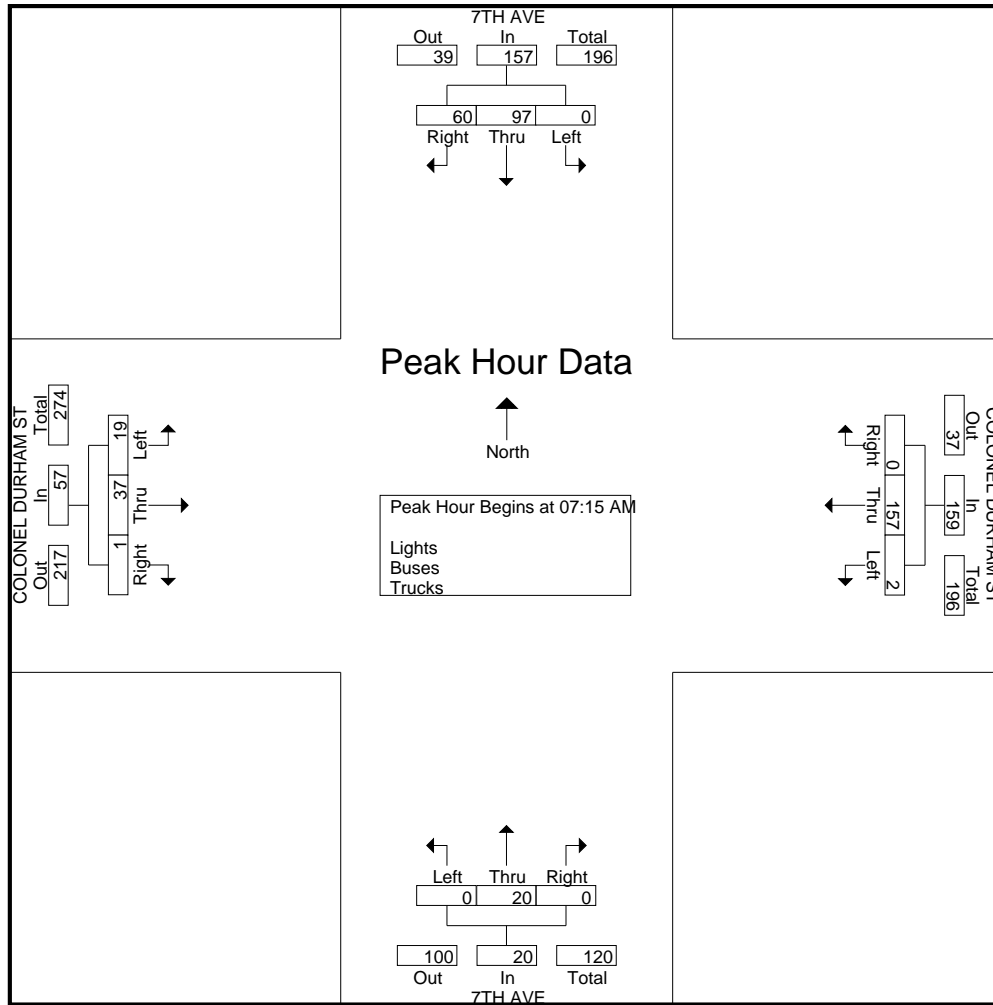

Traffic Data Service

San Jose, CA
 (408) 622-4787
 tdsbay@cs.com

File Name : 11AM FINAL
 Site Code : 00000011
 Start Date : 4/25/2018
 Page No : 1

Groups Printed- Bikes

Start Time	7TH AVE Southbound					COLONEL DURHAM ST Westbound					7TH AVE Northbound					COLONEL DURHAM ST Eastbound					Int. Total	
	Right	Thru	Left	Peds	App. Total	Right	Thru	Left	Peds	App. Total	Right	Thru	Left	Peds	App. Total	Right	Thru	Left	Peds	App. Total		
07:00 AM	0	0	0	0	0	0	0	0	0	0	0	0	0	0	0	0	0	0	0	0	0	0
07:15 AM	0	0	0	0	0	0	0	0	0	0	0	0	0	0	0	0	0	0	0	0	0	0
07:30 AM	0	0	0	0	0	0	0	0	0	0	0	0	0	0	0	0	0	0	0	0	0	0
07:45 AM	0	0	0	0	0	0	0	0	0	0	0	0	0	0	0	0	0	0	0	0	0	0
Total	0	0	0	0	0	0	0	0	0	0	0	0	0	0	0	0	0	0	0	0	0	0
08:00 AM	0	0	0	0	0	0	0	0	0	0	0	0	0	0	0	0	0	0	0	0	0	0
08:15 AM	0	0	0	0	0	0	0	0	0	0	0	0	0	0	0	0	0	0	0	0	0	0
08:30 AM	0	0	0	0	0	0	0	0	0	0	0	0	0	0	0	0	0	0	0	0	0	0
08:45 AM	0	0	0	0	0	0	0	0	0	0	0	0	0	0	0	0	0	0	0	0	0	0
Total	0	0	0	0	0	0	0	0	0	0	0	0	0	0	0	0	0	0	0	0	0	0
Grand Total	0	0	0	0	0	0	0	0	0	0	0	0	0	0	0	0	0	0	0	0	0	0
Apprch %	0	0	0	0		0	0	0	0		0	0	0	0		0	0	0	0			
Total %																						

Start Time	7TH AVE Southbound					COLONEL DURHAM ST Westbound					7TH AVE Northbound					COLONEL DURHAM ST Eastbound					Int. Total	
	Right	Thru	Left	Peds	App. Total	Right	Thru	Left	Peds	App. Total	Right	Thru	Left	Peds	App. Total	Right	Thru	Left	Peds	App. Total		
Peak Hour Analysis From 07:00 AM to 08:45 AM - Peak 1 of 1																						
Peak Hour for Entire Intersection Begins at 07:00 AM																						
07:00 AM	0	0	0	0	0	0	0	0	0	0	0	0	0	0	0	0	0	0	0	0	0	0
07:15 AM	0	0	0	0	0	0	0	0	0	0	0	0	0	0	0	0	0	0	0	0	0	0
07:30 AM	0	0	0	0	0	0	0	0	0	0	0	0	0	0	0	0	0	0	0	0	0	0
07:45 AM	0	0	0	0	0	0	0	0	0	0	0	0	0	0	0	0	0	0	0	0	0	0
Total Volume	0	0	0	0	0	0	0	0	0	0	0	0	0	0	0	0	0	0	0	0	0	0
% App. Total	0	0	0	0		0	0	0	0		0	0	0	0		0	0	0	0			
PHF	.000	.000	.000	.000	.000	.000	.000	.000	.000	.000	.000	.000	.000	.000	.000	.000	.000	.000	.000	.000	.000	.000

Traffic Data Service

San Jose, CA
(408) 622-4787
tdsbay@cs.com

File Name : 11AM FINAL
Site Code : 00000011
Start Date : 4/25/2018
Page No : 2

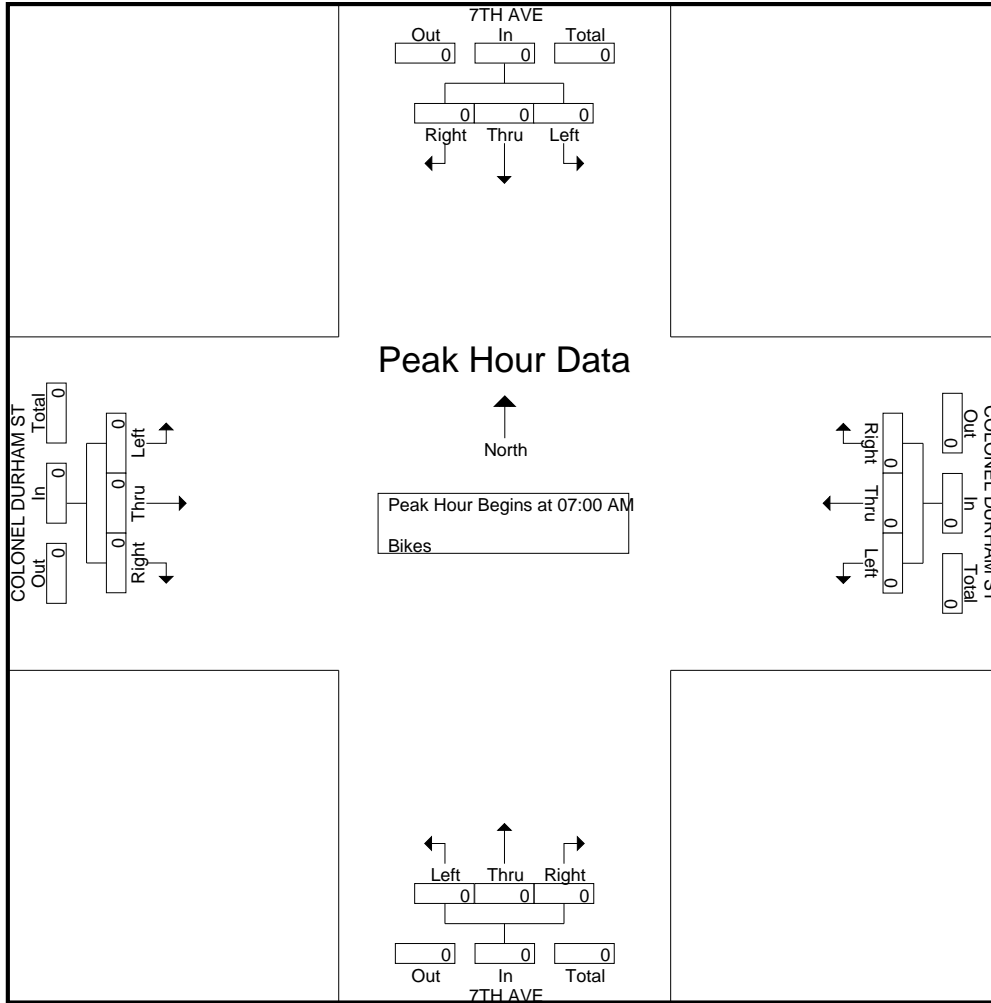

Traffic Data Service

San Jose, CA
(408) 622-4787
tdsbay@cs.com

File Name : 11PM FINAL
Site Code : 00000011
Start Date : 4/25/2018
Page No : 1

Groups Printed- Lights - Buses - Trucks

Start Time	7TH AVE Southbound					COLONEL DURHAM ST Westbound					7TH AVE Northbound					COLONEL DURHAM ST Eastbound					Int. Total
	Right	Thru	Left	Peds	App. Total	Right	Thru	Left	Peds	App. Total	Right	Thru	Left	Peds	App. Total	Right	Thru	Left	Peds	App. Total	
04:00 PM	4	4	0	0	8	0	7	0	0	7	0	6	0	0	6	0	18	9	0	27	48
04:15 PM	2	6	0	0	8	0	9	0	0	9	0	8	0	0	8	0	15	6	0	21	46
04:30 PM	4	4	0	0	8	0	10	0	0	10	0	7	0	0	7	0	15	5	0	20	45
04:45 PM	1	6	0	0	7	0	25	0	0	25	0	12	0	0	12	1	28	3	0	32	76
Total	11	20	0	0	31	0	51	0	0	51	0	33	0	0	33	1	76	23	0	100	215
05:00 PM	7	7	0	0	14	0	6	0	0	6	0	9	0	0	9	0	27	3	0	30	59
05:15 PM	5	6	0	0	11	0	12	0	0	12	0	2	0	0	2	0	14	1	0	15	40
05:30 PM	3	5	0	0	8	0	10	0	0	10	0	8	0	0	8	0	17	2	0	19	45
05:45 PM	6	11	0	0	17	0	5	0	0	5	0	5	1	0	6	0	19	2	0	21	49
Total	21	29	0	0	50	0	33	0	0	33	0	24	1	0	25	0	77	8	0	85	193
Grand Total	32	49	0	0	81	0	84	0	0	84	0	57	1	0	58	1	153	31	0	185	408
Apprch %	39.5	60.5	0	0		0	100	0	0		0	98.3	1.7	0		0.5	82.7	16.8	0		
Total %	7.8	12	0	0	19.9	0	20.6	0	0	20.6	0	14	0.2	0	14.2	0.2	37.5	7.6	0	45.3	
Lights	32	46	0	0	78	0	82	0	0	82	0	53	1	0	54	0	151	25	0	176	390
% Lights	100	93.9	0	0	96.3	0	97.6	0	0	97.6	0	93	100	0	93.1	0	98.7	80.6	0	95.1	95.6
Buses	0	0	0	0	0	0	1	0	0	1	0	1	0	0	1	1	1	0	0	2	4
% Buses	0	0	0	0	0	0	1.2	0	0	1.2	0	1.8	0	0	1.7	100	0.7	0	0	1.1	1
Trucks	0	3	0	0	3	0	1	0	0	1	0	3	0	0	3	0	1	6	0	7	14
% Trucks	0	6.1	0	0	3.7	0	1.2	0	0	1.2	0	5.3	0	0	5.2	0	0.7	19.4	0	3.8	3.4

Start Time	7TH AVE Southbound				COLONEL DURHAM ST Westbound				7TH AVE Northbound				COLONEL DURHAM ST Eastbound				Int. Total
	Right	Thru	Left	App. Total	Right	Thru	Left	App. Total	Right	Thru	Left	App. Total	Right	Thru	Left	App. Total	
Peak Hour Analysis From 04:00 PM to 05:45 PM - Peak 1 of 1																	
Peak Hour for Entire Intersection Begins at 04:15 PM																	
04:15 PM	2	6	0	8	0	9	0	9	0	8	0	8	0	15	6	21	46
04:30 PM	4	4	0	8	0	10	0	10	0	7	0	7	0	15	5	20	45
04:45 PM	1	6	0	7	0	25	0	25	0	12	0	12	1	28	3	32	76
05:00 PM	7	7	0	14	0	6	0	6	0	9	0	9	0	27	3	30	59
Total Volume	14	23	0	37	0	50	0	50	0	36	0	36	1	85	17	103	226
% App. Total	37.8	62.2	0		0	100	0		0	100	0		1	82.5	16.5		
PHF	.500	.821	.000	.661	.000	.500	.000	.500	.000	.750	.000	.750	.250	.759	.708	.805	.743

Traffic Data Service

San Jose, CA
 (408) 622-4787
 tdsbay@cs.com

File Name : 11PM FINAL
 Site Code : 00000011
 Start Date : 4/25/2018
 Page No : 2

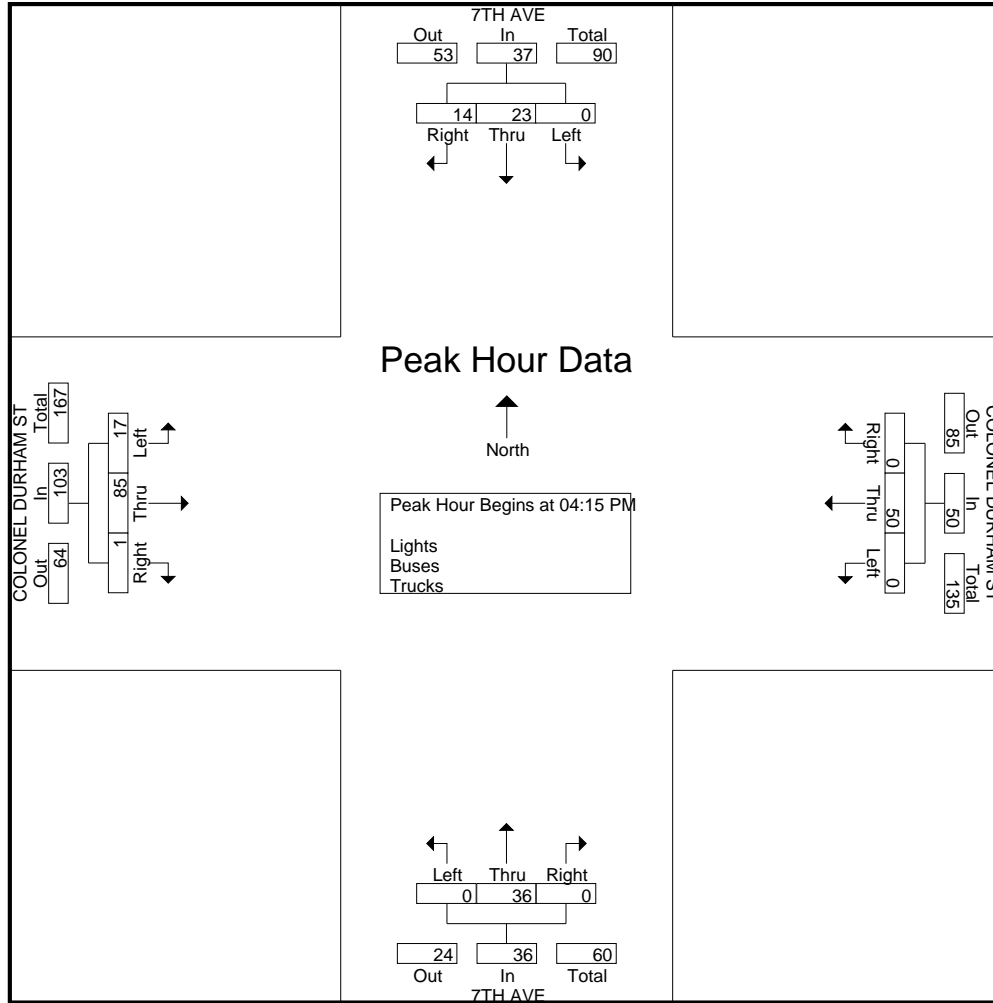

Traffic Data Service

San Jose, CA
 (408) 622-4787
 tdsbay@cs.com

File Name : 11PM FINAL
 Site Code : 00000011
 Start Date : 4/25/2018
 Page No : 1

Groups Printed- Bikes

Start Time	7TH AVE Southbound					COLONEL DURHAM ST Westbound					7TH AVE Northbound					COLONEL DURHAM ST Eastbound					Int. Total	
	Right	Thru	Left	Peds	App. Total	Right	Thru	Left	Peds	App. Total	Right	Thru	Left	Peds	App. Total	Right	Thru	Left	Peds	App. Total		
04:00 PM	0	0	0	0	0	0	0	0	0	0	0	0	0	0	0	0	0	0	0	0	0	0
04:15 PM	0	0	0	0	0	0	0	0	0	0	0	0	1	0	1	0	0	0	0	0	0	0
04:30 PM	0	0	0	0	0	0	0	0	0	0	0	0	0	0	0	1	0	0	0	1	1	1
04:45 PM	0	0	0	0	0	0	0	0	0	0	0	0	1	0	1	0	0	0	0	0	0	1
Total	0	0	0	0	0	0	0	0	0	0	0	0	2	0	2	1	0	0	0	1	1	3
05:00 PM	0	0	0	0	0	0	0	0	0	0	0	0	0	0	0	0	0	0	0	0	0	0
05:15 PM	0	0	0	0	0	0	0	0	0	0	0	1	0	0	1	0	0	0	0	0	0	1
05:30 PM	0	0	0	0	0	0	0	0	0	0	0	0	0	0	0	0	0	0	0	0	0	0
05:45 PM	0	0	0	0	0	0	0	0	0	0	0	0	0	0	0	0	0	0	0	0	0	0
Total	0	0	0	0	0	0	0	0	0	0	0	1	0	0	1	0	0	0	0	0	0	1
Grand Total	0	0	0	0	0	0	0	0	0	0	0	1	2	0	3	1	0	0	0	1	1	4
Apprch %	0	0	0	0	0	0	0	0	0	0	0	33.3	66.7	0	0	100	0	0	0	0	0	0
Total %	0	0	0	0	0	0	0	0	0	0	0	25	50	0	75	25	0	0	0	25	0	0

Start Time	7TH AVE Southbound					COLONEL DURHAM ST Westbound					7TH AVE Northbound					COLONEL DURHAM ST Eastbound					Int. Total	
	Right	Thru	Left	Peds	App. Total	Right	Thru	Left	Peds	App. Total	Right	Thru	Left	Peds	App. Total	Right	Thru	Left	Peds	App. Total		
04:00 PM	0	0	0	0	0	0	0	0	0	0	0	0	0	0	0	0	0	0	0	0	0	0
04:15 PM	0	0	0	0	0	0	0	0	0	0	0	0	1	0	1	0	0	0	0	0	0	1
04:30 PM	0	0	0	0	0	0	0	0	0	0	0	0	0	0	0	1	0	0	0	1	1	1
04:45 PM	0	0	0	0	0	0	0	0	0	0	0	0	1	0	1	0	0	0	0	0	0	1
Total Volume	0	0	0	0	0	0	0	0	0	0	0	0	2	0	2	1	0	0	0	1	1	3
% App. Total	0	0	0	0	0	0	0	0	0	0	0	0	100	0	0	100	0	0	0	0	0	0
PHF	.000	.000	.000	.000	.000	.000	.000	.000	.000	.000	.000	.000	.500	.500	.250	.000	.000	.250	.250	.250	.750	

Peak Hour Analysis From 04:00 PM to 05:45 PM - Peak 1 of 1
 Peak Hour for Entire Intersection Begins at 04:00 PM

Traffic Data Service

San Jose, CA
 (408) 622-4787
 tdsbay@cs.com

File Name : 11PM FINAL
 Site Code : 00000011
 Start Date : 4/25/2018
 Page No : 2

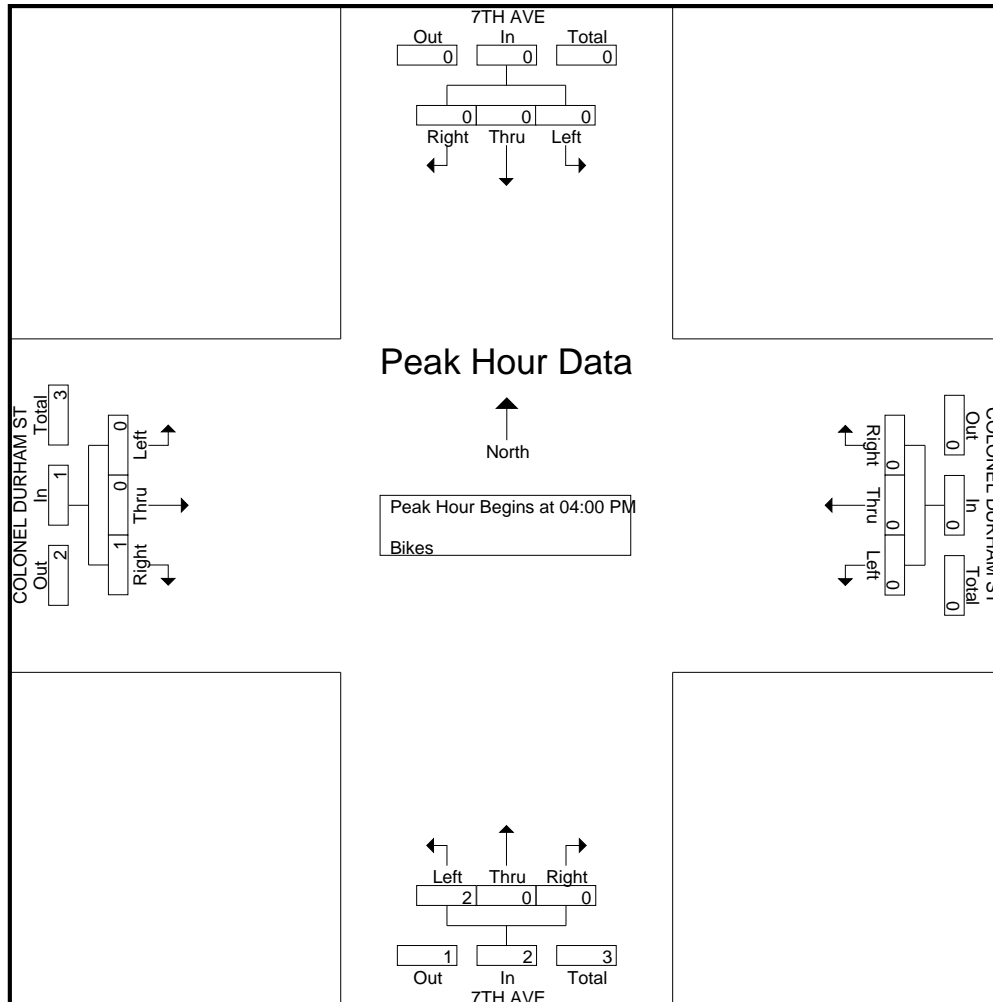

Traffic Data Service

San Jose, CA
 (408) 622-4787
 tdsbay@cs.com

File Name : 12AM FINAL
 Site Code : 00000012
 Start Date : 4/25/2018
 Page No : 1

Groups Printed- Lights - Buses - Trucks

Start Time	8TH AVE Southbound					Westbound					8TH AVE Northbound					COLONEL DURHAM ST Eastbound					Int. Total
	Right	Thru	Left	Peds	App. Total	Right	Thru	Left	Peds	App. Total	Right	Thru	Left	Peds	App. Total	Right	Thru	Left	Peds	App. Total	
07:00 AM	44	78	0	0	122	0	0	0	0	0	0	15	0	0	15	0	0	3	0	3	140
07:15 AM	46	126	0	0	172	0	0	0	0	0	0	18	0	0	18	0	0	2	0	2	192
07:30 AM	56	107	0	0	163	0	0	0	0	0	0	27	0	0	27	0	0	7	0	7	197
07:45 AM	30	98	0	0	128	0	0	0	0	0	0	28	0	0	28	0	0	19	0	19	175
Total	176	409	0	0	585	0	0	0	0	0	0	88	0	0	88	0	0	31	0	31	704
08:00 AM	27	50	0	0	77	0	0	0	0	0	0	25	0	0	25	0	0	9	0	9	111
08:15 AM	22	55	0	0	77	0	0	0	0	0	0	27	0	0	27	0	0	6	0	6	110
08:30 AM	18	40	0	0	58	0	0	0	0	0	0	21	0	0	21	0	0	9	0	9	88
08:45 AM	13	31	0	0	44	0	0	0	0	0	0	13	0	0	13	0	0	5	0	5	62
Total	80	176	0	0	256	0	0	0	0	0	0	86	0	0	86	0	0	29	0	29	371
Grand Total	256	585	0	0	841	0	0	0	0	0	0	174	0	0	174	0	0	60	0	60	1075
Apprch %	30.4	69.6	0	0		0	0	0	0		0	100	0	0		0	0	100	0		
Total %	23.8	54.4	0	0	78.2	0	0	0	0	0	0	16.2	0	0	16.2	0	0	5.6	0	5.6	
Lights	256	582	0	0	838	0	0	0	0	0	0	166	0	0	166	0	0	54	0	54	1058
% Lights	100	99.5	0	0	99.6	0	0	0	0	0	0	95.4	0	0	95.4	0	0	90	0	90	98.4
Buses	0	3	0	0	3	0	0	0	0	0	0	6	0	0	6	0	0	5	0	5	14
% Buses	0	0.5	0	0	0.4	0	0	0	0	0	0	3.4	0	0	3.4	0	0	8.3	0	8.3	1.3
Trucks	0	0	0	0	0	0	0	0	0	0	0	2	0	0	2	0	0	1	0	1	3
% Trucks	0	0	0	0	0	0	0	0	0	0	0	1.1	0	0	1.1	0	0	1.7	0	1.7	0.3

Start Time	8TH AVE Southbound				Westbound				8TH AVE Northbound				COLONEL DURHAM ST Eastbound				Int. Total
	Right	Thru	Left	App. Total	Right	Thru	Left	App. Total	Right	Thru	Left	App. Total	Right	Thru	Left	App. Total	
Peak Hour Analysis From 07:00 AM to 08:45 AM - Peak 1 of 1																	
Peak Hour for Entire Intersection Begins at 07:00 AM																	
07:00 AM	44	78	0	122	0	0	0	0	0	15	0	15	0	0	3	3	140
07:15 AM	46	126	0	172	0	0	0	0	0	18	0	18	0	0	2	2	192
07:30 AM	56	107	0	163	0	0	0	0	0	27	0	27	0	0	7	7	197
07:45 AM	30	98	0	128	0	0	0	0	0	28	0	28	0	0	19	19	175
Total Volume	176	409	0	585	0	0	0	0	0	88	0	88	0	0	31	31	704
% App. Total	30.1	69.9	0		0	0	0		0	100	0		0	0	100		
PHF	.786	.812	.000	.850	.000	.000	.000	.000	.000	.786	.000	.786	.000	.000	.408	.408	.893

Traffic Data Service

San Jose, CA
 (408) 622-4787
 tdsbay@cs.com

File Name : 12AM FINAL
 Site Code : 00000012
 Start Date : 4/25/2018
 Page No : 2

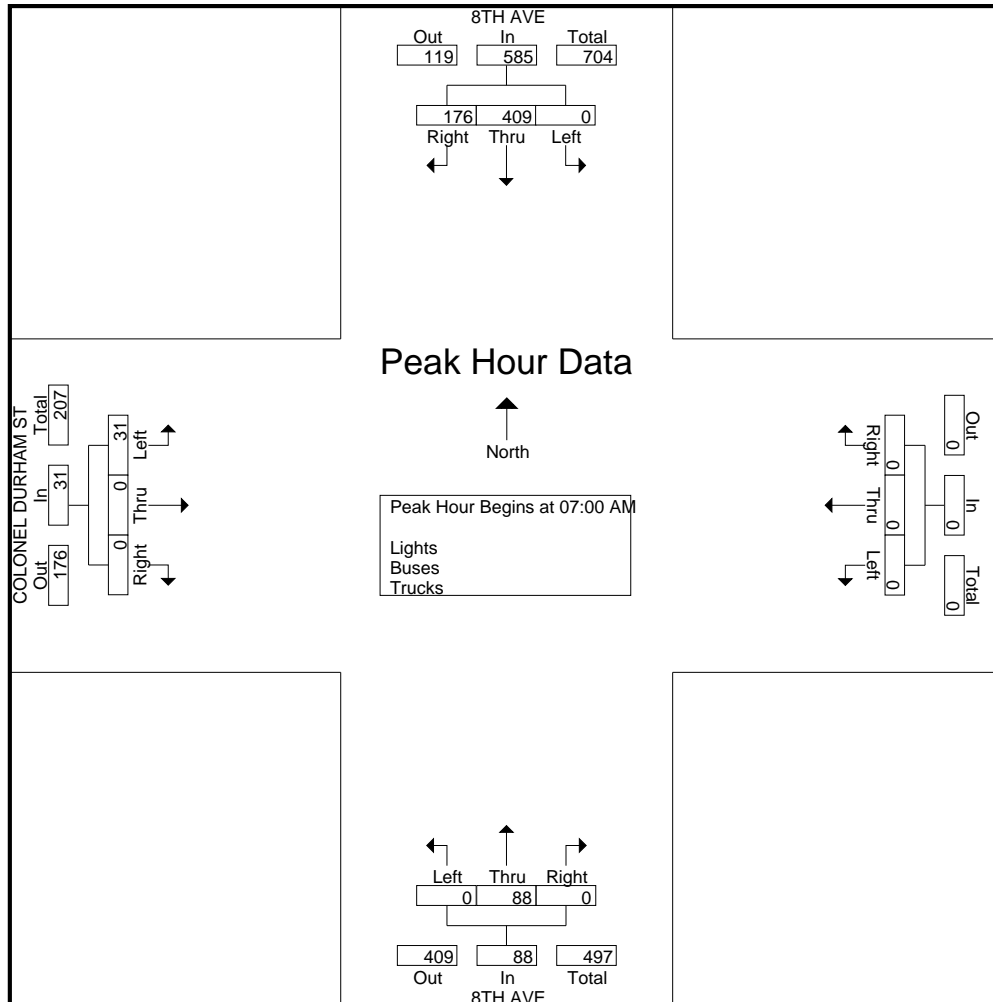

Traffic Data Service

San Jose, CA
 (408) 622-4787
 tdsbay@cs.com

File Name : 12AM FINAL
 Site Code : 00000012
 Start Date : 4/25/2018
 Page No : 1

Groups Printed- Bikes

Start Time	8TH AVE Southbound					Westbound					8TH AVE Northbound					COLONEL DURHAM ST Eastbound					Int. Total
	Right	Thru	Left	Peds	App. Total	Right	Thru	Left	Peds	App. Total	Right	Thru	Left	Peds	App. Total	Right	Thru	Left	Peds	App. Total	
07:00 AM	0	0	0	0	0	0	0	0	0	0	0	0	0	0	0	0	0	0	0	0	0
07:15 AM	0	0	0	0	0	0	0	0	0	0	0	0	0	0	0	0	0	0	0	0	0
07:30 AM	0	0	0	0	0	0	0	0	0	0	0	0	0	0	0	0	0	0	0	0	0
07:45 AM	0	0	0	0	0	0	0	0	0	0	0	0	0	0	0	0	0	0	0	0	0
Total	0	0	0	0	0	0	0	0	0	0	0	0	0	0	0	0	0	0	0	0	0
08:00 AM	0	0	0	0	0	0	0	0	0	0	0	0	0	0	0	0	0	0	0	0	0
08:15 AM	0	0	0	0	0	0	0	0	0	0	0	0	0	0	0	0	0	0	0	0	0
08:30 AM	0	0	0	0	0	0	0	0	0	0	0	0	0	0	0	0	0	0	0	0	0
08:45 AM	0	0	0	0	0	0	0	0	0	0	0	0	0	0	0	0	0	0	0	0	0
Total	0	0	0	0	0	0	0	0	0	0	0	0	0	0	0	0	0	0	0	0	0
Grand Total	0	0	0	0	0	0	0	0	0	0	0	0	0	0	0	0	0	0	0	0	0
Apprch %	0	0	0	0		0	0	0	0		0	0	0	0		0	0	0	0		
Total %																					

Start Time	8TH AVE Southbound					Westbound					8TH AVE Northbound					COLONEL DURHAM ST Eastbound					Int. Total
	Right	Thru	Left	Peds	App. Total	Right	Thru	Left	Peds	App. Total	Right	Thru	Left	Peds	App. Total	Right	Thru	Left	Peds	App. Total	
07:00 AM	0	0	0	0	0	0	0	0	0	0	0	0	0	0	0	0	0	0	0	0	0
07:15 AM	0	0	0	0	0	0	0	0	0	0	0	0	0	0	0	0	0	0	0	0	0
07:30 AM	0	0	0	0	0	0	0	0	0	0	0	0	0	0	0	0	0	0	0	0	0
07:45 AM	0	0	0	0	0	0	0	0	0	0	0	0	0	0	0	0	0	0	0	0	0
Total Volume	0	0	0	0	0	0	0	0	0	0	0	0	0	0	0	0	0	0	0	0	0
% App. Total	0	0	0	0		0	0	0	0		0	0	0	0		0	0	0	0		
PHF	.000	.000	.000	.000	.000	.000	.000	.000	.000	.000	.000	.000	.000	.000	.000	.000	.000	.000	.000	.000	.000

Peak Hour Analysis From 07:00 AM to 08:45 AM - Peak 1 of 1
 Peak Hour for Entire Intersection Begins at 07:00 AM

Traffic Data Service

San Jose, CA
(408) 622-4787
tdsbay@cs.com

File Name : 12AM FINAL
Site Code : 00000012
Start Date : 4/25/2018
Page No : 2

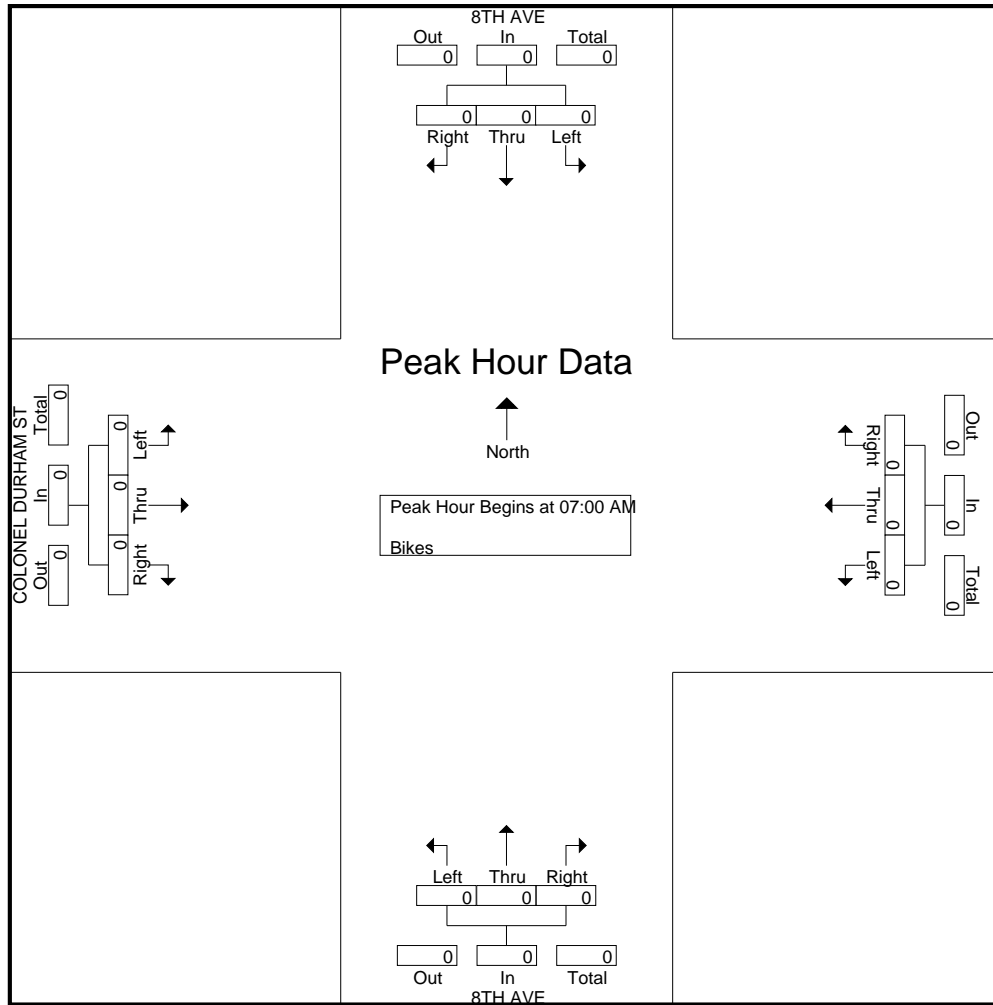

Traffic Data Service

San Jose, CA
 (408) 622-4787
 tdsbay@cs.com

File Name : 12PM FINAL
 Site Code : 00000012
 Start Date : 4/25/2018
 Page No : 1

Groups Printed- Lights - Buses - Trucks

Start Time	8TH AVE Southbound					Westbound					8TH AVE Northbound					COLONEL DURHAM ST Eastbound					Int. Total
	Right	Thru	Left	Peds	App. Total	Right	Thru	Left	Peds	App. Total	Right	Thru	Left	Peds	App. Total	Right	Thru	Left	Peds	App. Total	
04:00 PM	9	28	0	0	37	0	0	0	0	0	0	62	0	0	62	1	0	17	0	18	117
04:15 PM	7	16	0	0	23	0	0	0	0	0	0	76	0	0	76	0	0	14	0	14	113
04:30 PM	10	21	0	0	31	0	0	0	0	0	0	72	0	0	72	0	0	16	0	16	119
04:45 PM	25	29	0	0	54	0	0	0	0	0	0	88	0	0	88	1	0	27	0	28	170
Total	51	94	0	0	145	0	0	0	0	0	0	298	0	0	298	2	0	74	0	76	519
05:00 PM	6	26	0	0	32	0	0	0	0	0	0	77	0	0	77	0	0	27	0	27	136
05:15 PM	13	29	0	0	42	0	0	0	0	0	0	97	0	0	97	0	0	13	0	13	152
05:30 PM	10	33	0	0	43	0	0	0	0	0	0	78	0	0	78	0	0	19	0	19	140
05:45 PM	5	21	0	0	26	0	0	0	0	0	0	55	0	0	55	0	0	15	0	15	96
Total	34	109	0	0	143	0	0	0	0	0	0	307	0	0	307	0	0	74	0	74	524
Grand Total	85	203	0	0	288	0	0	0	0	0	0	605	0	0	605	2	0	148	0	150	1043
Apprch %	29.5	70.5	0	0		0	0	0	0		0	100	0	0		1.3	0	98.7	0		
Total %	8.1	19.5	0	0	27.6	0	0	0	0	0	0	58	0	0	58	0.2	0	14.2	0	14.4	
Lights	84	200	0	0	284	0	0	0	0	0	0	591	0	0	591	1	0	147	0	148	1023
% Lights	98.8	98.5	0	0	98.6	0	0	0	0	0	0	97.7	0	0	97.7	50	0	99.3	0	98.7	98.1
Buses	1	2	0	0	3	0	0	0	0	0	0	7	0	0	7	0	0	1	0	1	11
% Buses	1.2	1	0	0	1	0	0	0	0	0	0	1.2	0	0	1.2	0	0	0.7	0	0.7	1.1
Trucks	0	1	0	0	1	0	0	0	0	0	0	7	0	0	7	1	0	0	0	1	9
% Trucks	0	0.5	0	0	0.3	0	0	0	0	0	0	1.2	0	0	1.2	50	0	0	0	0.7	0.9

Start Time	8TH AVE Southbound				Westbound				8TH AVE Northbound				COLONEL DURHAM ST Eastbound				Int. Total	
	Right	Thru	Left	App. Total	Right	Thru	Left	App. Total	Right	Thru	Left	App. Total	Right	Thru	Left	App. Total		
Peak Hour Analysis From 04:00 PM to 05:45 PM - Peak 1 of 1																		
Peak Hour for Entire Intersection Begins at 04:45 PM																		
04:45 PM	25	29	0	54	0	0	0	0	0	0	88	0	88	1	0	27	28	170
05:00 PM	6	26	0	32	0	0	0	0	0	0	77	0	77	0	0	27	27	136
05:15 PM	13	29	0	42	0	0	0	0	0	0	97	0	97	0	0	13	13	152
05:30 PM	10	33	0	43	0	0	0	0	0	0	78	0	78	0	0	19	19	140
Total Volume	54	117	0	171	0	0	0	0	0	0	340	0	340	1	0	86	87	598
% App. Total	31.6	68.4	0		0	0	0		0	0	100	0		1.1	0	98.9		
PHF	.540	.886	.000	.792	.000	.000	.000	.000	.000	.000	.876	.000	.876	.250	.000	.796	.777	.879

Traffic Data Service

San Jose, CA
 (408) 622-4787
 tdsbay@cs.com

File Name : 12PM FINAL
 Site Code : 00000012
 Start Date : 4/25/2018
 Page No : 2

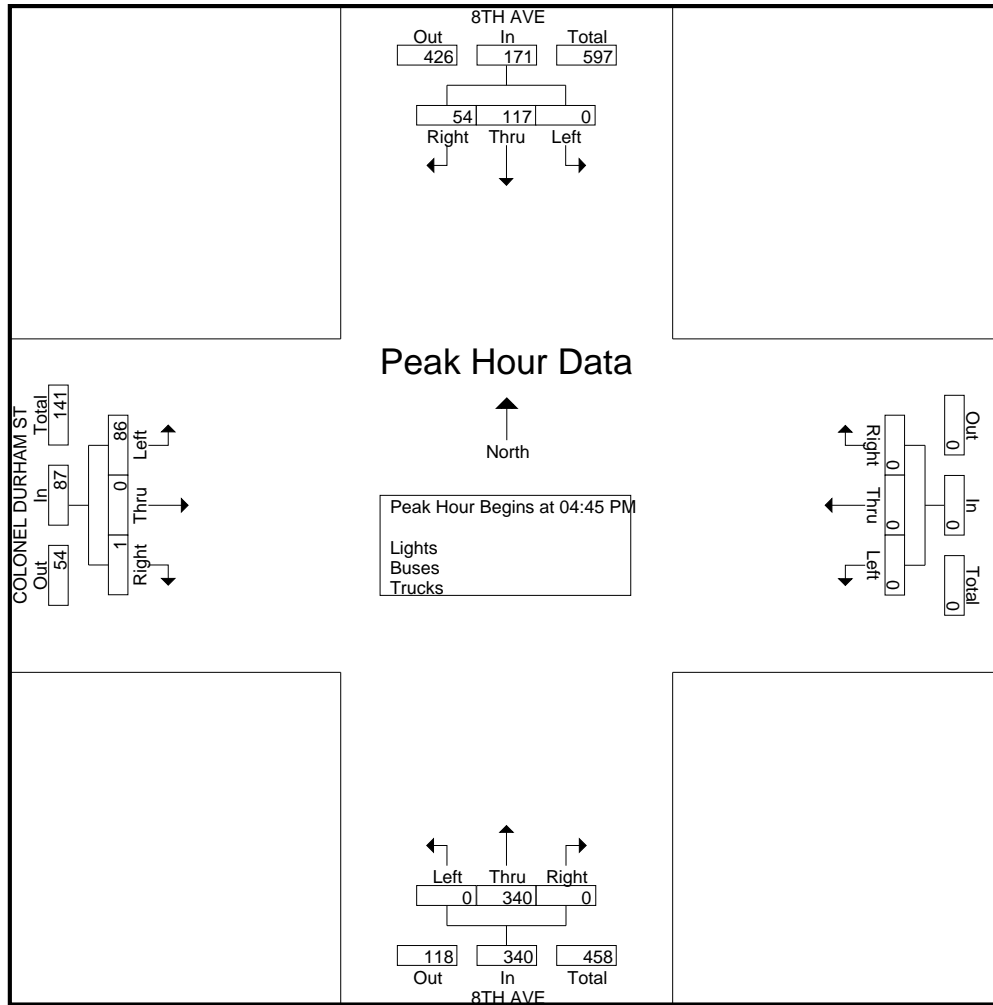

Traffic Data Service

San Jose, CA
(408) 622-4787
tdsbay@cs.com

File Name : 12PM FINAL
Site Code : 00000012
Start Date : 4/25/2018
Page No : 1

Groups Printed- Bikes

Start Time	8TH AVE Southbound					Westbound					8TH AVE Northbound					COLONEL DURHAM ST Eastbound					Int. Total
	Right	Thru	Left	Peds	App. Total	Right	Thru	Left	Peds	App. Total	Right	Thru	Left	Peds	App. Total	Right	Thru	Left	Peds	App. Total	
04:00 PM	0	0	0	0	0	0	0	0	0	0	0	0	0	0	0	0	0	0	0	0	0
04:15 PM	0	0	0	0	0	0	0	0	0	0	0	0	0	0	0	0	0	0	0	0	0
04:30 PM	0	0	0	0	0	0	0	0	0	0	0	0	0	0	0	0	0	0	0	0	0
04:45 PM	0	0	0	0	0	0	0	0	0	0	0	0	0	0	0	0	0	0	0	0	0
Total	0	0	0	0	0	0	0	0	0	0	0	0	0	0	0	0	0	0	0	0	0
05:00 PM	0	0	0	0	0	0	0	0	0	0	0	0	0	0	0	0	0	0	0	0	0
05:15 PM	0	1	0	0	1	0	0	0	0	0	0	0	0	0	0	0	0	0	0	0	1
05:30 PM	0	0	0	0	0	0	0	0	0	0	0	0	0	0	0	0	0	0	0	0	0
05:45 PM	0	0	0	0	0	0	0	0	0	0	0	0	0	0	0	0	0	0	0	0	0
Total	0	1	0	0	1	0	0	0	0	0	0	0	0	0	0	0	0	0	0	0	1
Grand Total	0	1	0	0	1	0	0	0	0	0	0	0	0	0	0	0	0	0	0	0	1
Apprch %	0	100	0	0		0	0	0	0		0	0	0	0		0	0	0	0		
Total %	0	100	0	0	100	0	0	0	0	0	0	0	0	0	0	0	0	0	0	0	

Start Time	8TH AVE Southbound					Westbound					8TH AVE Northbound					COLONEL DURHAM ST Eastbound					Int. Total
	Right	Thru	Left	Peds	App. Total	Right	Thru	Left	Peds	App. Total	Right	Thru	Left	Peds	App. Total	Right	Thru	Left	Peds	App. Total	
Peak Hour Analysis From 04:00 PM to 05:45 PM - Peak 1 of 1																					
Peak Hour for Entire Intersection Begins at 04:30 PM																					
04:30 PM	0	0	0	0	0	0	0	0	0	0	0	0	0	0	0	0	0	0	0	0	0
04:45 PM	0	0	0	0	0	0	0	0	0	0	0	0	0	0	0	0	0	0	0	0	0
05:00 PM	0	0	0	0	0	0	0	0	0	0	0	0	0	0	0	0	0	0	0	0	0
05:15 PM	0	1	0	0	1	0	0	0	0	0	0	0	0	0	0	0	0	0	0	0	1
Total Volume	0	1	0	0	1	0	0	0	0	0	0	0	0	0	0	0	0	0	0	0	1
% App. Total	0	100	0	0		0	0	0	0		0	0	0	0		0	0	0	0		
PHF	.000	.250	.000	.250		.000	.000	.000	.000		.000	.000	.000	.000		.000	.000	.000	.000		.250

Traffic Data Service

San Jose, CA
(408) 622-4787
tdsbay@cs.com

File Name : 12PM FINAL
Site Code : 00000012
Start Date : 4/25/2018
Page No : 2

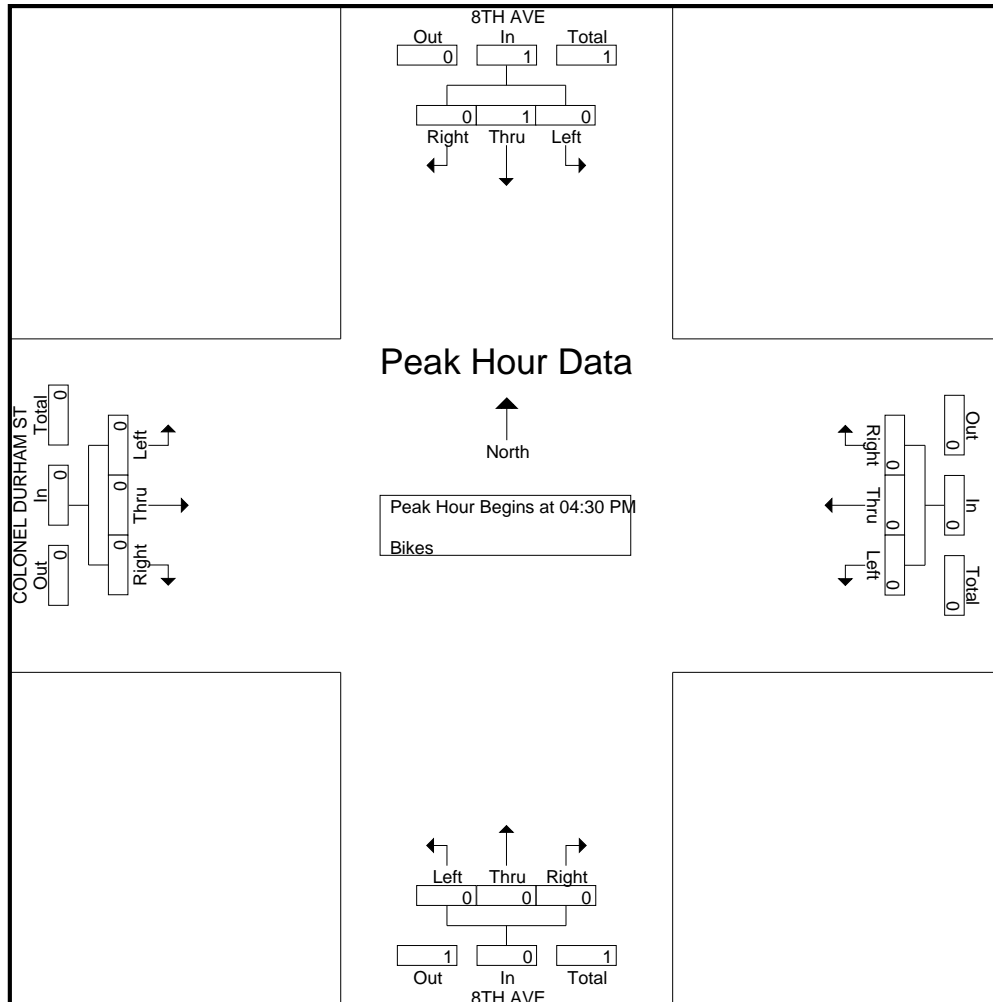

Traffic Data Service

San Jose, CA
 (408) 622-4787
 tdsbay@cs.com

File Name : 13AM FINAL
 Site Code : 00000013
 Start Date : 4/25/2018
 Page No : 1

Groups Printed- Lights - Buses - Trucks

Start Time	MALMEDY RD Southbound					GIGLING RD Westbound					MALMEDY RD Northbound					GIGLING RD Eastbound					Int. Total
	Right	Thru	Left	Peds	App. Total	Right	Thru	Left	Peds	App. Total	Right	Thru	Left	Peds	App. Total	Right	Thru	Left	Peds	App. Total	
07:00 AM	1	1	1	0	3	0	69	0	0	69	2	10	1	0	13	1	43	0	0	44	129
07:15 AM	3	1	2	0	6	4	111	1	0	116	0	15	6	0	21	2	54	0	0	56	199
07:30 AM	3	0	5	0	8	6	125	1	0	132	2	11	5	0	18	6	92	2	0	100	258
07:45 AM	3	2	13	1	19	4	87	10	0	101	3	10	8	0	21	5	114	0	0	119	260
Total	10	4	21	1	36	14	392	12	0	418	7	46	20	0	73	14	303	2	0	319	846
08:00 AM	4	6	10	0	20	1	59	1	0	61	2	9	11	0	22	3	93	1	0	97	200
08:15 AM	2	5	7	0	14	4	78	4	0	86	1	9	2	0	12	1	73	1	0	75	187
08:30 AM	2	3	9	0	14	0	61	1	0	62	1	1	1	0	3	2	59	0	0	61	140
08:45 AM	2	3	6	0	11	2	30	0	0	32	3	4	4	0	11	2	45	2	0	49	103
Total	10	17	32	0	59	7	228	6	0	241	7	23	18	0	48	8	270	4	0	282	630
Grand Total	20	21	53	1	95	21	620	18	0	659	14	69	38	0	121	22	573	6	0	601	1476
Apprch %	21.1	22.1	55.8	1.1		3.2	94.1	2.7	0		11.6	57	31.4	0		3.7	95.3	1	0		
Total %	1.4	1.4	3.6	0.1	6.4	1.4	42	1.2	0	44.6	0.9	4.7	2.6	0	8.2	1.5	38.8	0.4	0	40.7	
Lights	20	21	50	1	92	18	600	18	0	636	13	69	37	0	119	20	555	5	0	580	1427
% Lights	100	100	94.3	100	96.8	85.7	96.8	100	0	96.5	92.9	100	97.4	0	98.3	90.9	96.9	83.3	0	96.5	96.7
Buses	0	0	0	0	0	0	10	0	0	10	0	0	1	0	1	2	11	0	0	13	24
% Buses	0	0	0	0	0	0	1.6	0	0	1.5	0	0	2.6	0	0.8	9.1	1.9	0	0	2.2	1.6
Trucks	0	0	3	0	3	3	10	0	0	13	1	0	0	0	1	0	7	1	0	8	25
% Trucks	0	0	5.7	0	3.2	14.3	1.6	0	0	2	7.1	0	0	0	0.8	0	1.2	16.7	0	1.3	1.7

Start Time	MALMEDY RD Southbound				GIGLING RD Westbound				MALMEDY RD Northbound				GIGLING RD Eastbound				Int. Total
	Right	Thru	Left	App. Total	Right	Thru	Left	App. Total	Right	Thru	Left	App. Total	Right	Thru	Left	App. Total	
Peak Hour Analysis From 07:00 AM to 08:45 AM - Peak 1 of 1																	
Peak Hour for Entire Intersection Begins at 07:15 AM																	
07:15 AM	3	1	2	6	4	111	1	116	0	15	6	21	2	54	0	56	199
07:30 AM	3	0	5	8	6	125	1	132	2	11	5	18	6	92	2	100	258
07:45 AM	3	2	13	18	4	87	10	101	3	10	8	21	5	114	0	119	259
08:00 AM	4	6	10	20	1	59	1	61	2	9	11	22	3	93	1	97	200
Total Volume	13	9	30	52	15	382	13	410	7	45	30	82	16	353	3	372	916
% App. Total	25	17.3	57.7		3.7	93.2	3.2		8.5	54.9	36.6		4.3	94.9	0.8		
PHF	.813	.375	.577	.650	.625	.764	.325	.777	.583	.750	.682	.932	.667	.774	.375	.782	.884

Traffic Data Service

San Jose, CA
 (408) 622-4787
 tdsbay@cs.com

File Name : 13AM FINAL
 Site Code : 00000013
 Start Date : 4/25/2018
 Page No : 2

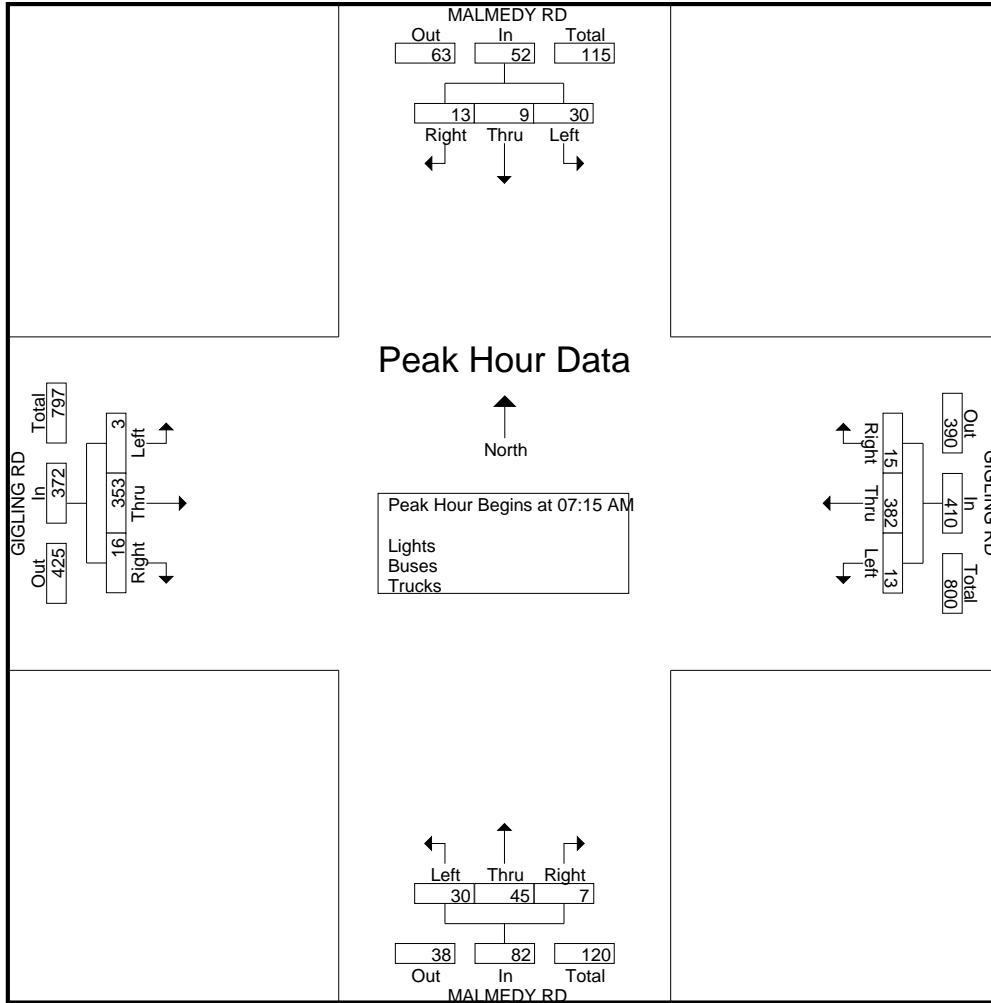

Traffic Data Service

San Jose, CA
 (408) 622-4787
 tdsbay@cs.com

File Name : 13AM FINAL
 Site Code : 00000013
 Start Date : 4/25/2018
 Page No : 1

Groups Printed- Bikes

Start Time	MALMEDY RD Southbound					GIGLING RD Westbound					MALMEDY RD Northbound					GIGLING RD Eastbound					Int. Total
	Right	Thru	Left	Peds	App. Total	Right	Thru	Left	Peds	App. Total	Right	Thru	Left	Peds	App. Total	Right	Thru	Left	Peds	App. Total	
07:00 AM	0	0	0	0	0	0	0	0	0	0	0	0	0	0	0	0	0	1	0	0	1
07:15 AM	0	0	0	0	0	0	0	0	0	0	0	0	0	0	0	0	0	0	0	0	0
07:30 AM	0	0	0	0	0	0	0	0	0	0	0	0	0	0	0	0	0	0	0	0	0
07:45 AM	0	0	0	0	0	0	0	0	0	0	0	0	0	0	0	0	0	0	0	0	0
Total	0	0	0	0	0	0	0	0	0	0	0	0	0	0	0	0	0	1	0	1	1
08:00 AM	0	0	0	0	0	0	0	0	0	0	0	0	0	0	0	0	0	0	0	0	0
08:15 AM	0	0	0	0	0	0	0	0	0	0	0	0	0	0	0	0	0	0	0	0	0
08:30 AM	0	0	0	0	0	0	0	0	0	0	0	0	0	0	0	0	0	0	0	0	0
08:45 AM	0	0	0	0	0	0	0	0	0	0	0	0	0	0	0	0	0	0	0	0	0
Total	0	0	0	0	0	0	0	0	0	0	0	0	0	0	0	0	0	0	0	0	0
Grand Total	0	0	0	0	0	0	0	0	0	0	0	0	0	0	0	0	0	1	0	1	1
Apprch %	0	0	0	0	0	0	0	0	0	0	0	0	0	0	0	0	0	100	0	0	0
Total %	0	0	0	0	0	0	0	0	0	0	0	0	0	0	0	0	0	100	0	100	0

Start Time	MALMEDY RD Southbound					GIGLING RD Westbound					MALMEDY RD Northbound					GIGLING RD Eastbound					Int. Total
	Right	Thru	Left	Peds	App. Total	Right	Thru	Left	Peds	App. Total	Right	Thru	Left	Peds	App. Total	Right	Thru	Left	Peds	App. Total	
Peak Hour Analysis From 07:00 AM to 08:45 AM - Peak 1 of 1																					
Peak Hour for Entire Intersection Begins at 07:00 AM																					
07:00 AM	0	0	0	0	0	0	0	0	0	0	0	0	0	0	0	0	0	1	0	1	1
07:15 AM	0	0	0	0	0	0	0	0	0	0	0	0	0	0	0	0	0	0	0	0	0
07:30 AM	0	0	0	0	0	0	0	0	0	0	0	0	0	0	0	0	0	0	0	0	0
07:45 AM	0	0	0	0	0	0	0	0	0	0	0	0	0	0	0	0	0	0	0	0	0
Total Volume	0	0	0	0	0	0	0	0	0	0	0	0	0	0	0	0	0	1	0	1	1
% App. Total	0	0	0	0	0	0	0	0	0	0	0	0	0	0	0	0	0	100	0	0	0
PHF	.000	.000	.000	.000	.000	.000	.000	.000	.000	.000	.000	.000	.000	.000	.000	.000	.000	.250	.250	.250	.250

Traffic Data Service

San Jose, CA
(408) 622-4787
tdsbay@cs.com

File Name : 13AM FINAL
Site Code : 00000013
Start Date : 4/25/2018
Page No : 2

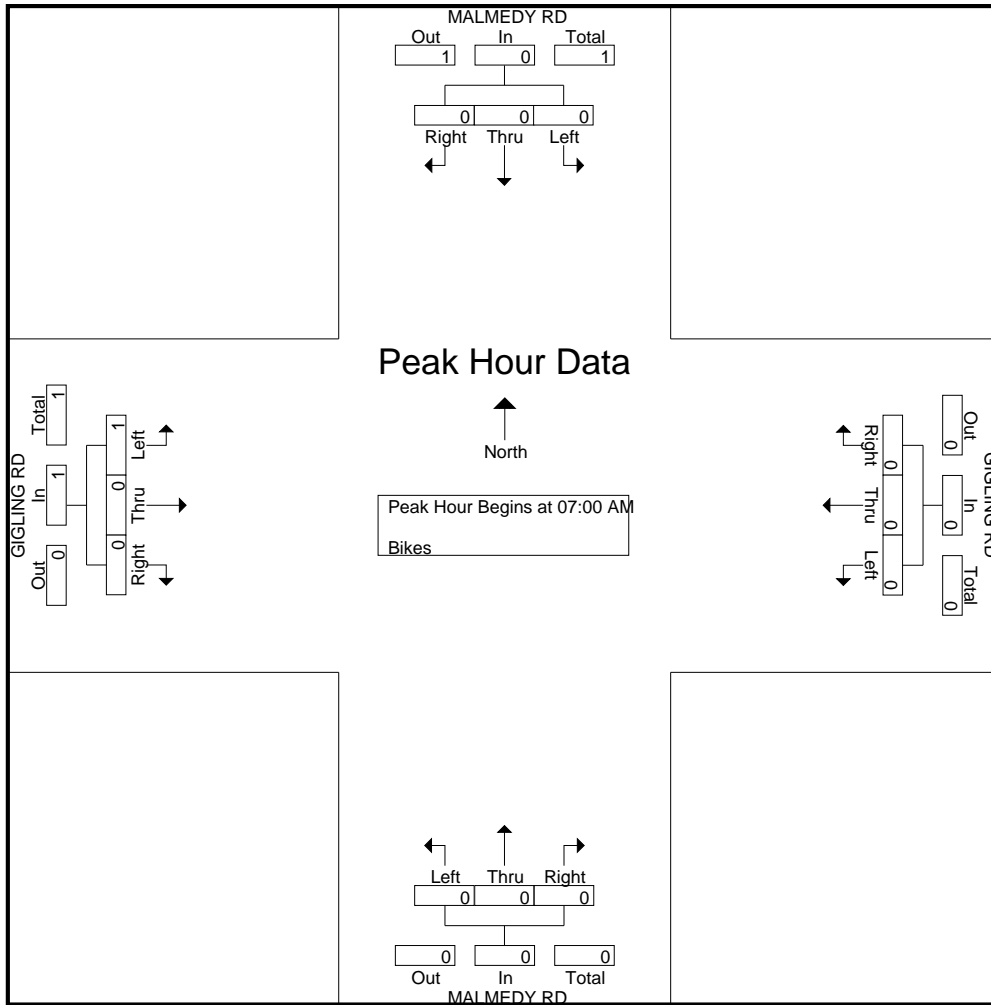

Traffic Data Service

San Jose, CA
(408) 622-4787
tdsbay@cs.com

File Name : 13PM FINAL
Site Code : 00000013
Start Date : 4/25/2018
Page No : 1

Groups Printed- Lights - Buses - Trucks

Start Time	MALMEDY RD Southbound					GIGLING RD Westbound					MALMEDY RD Northbound					GIGLING RD Eastbound					Int. Total
	Right	Thru	Left	Peds	App. Total	Right	Thru	Left	Peds	App. Total	Right	Thru	Left	Peds	App. Total	Right	Thru	Left	Peds	App. Total	
04:00 PM	1	6	5	0	12	4	89	2	0	95	0	5	2	0	7	6	52	0	0	58	172
04:15 PM	1	5	4	0	10	5	70	1	0	76	0	9	1	0	10	4	59	1	0	64	160
04:30 PM	0	4	3	0	7	6	81	0	0	87	3	8	3	1	15	3	57	0	0	60	169
04:45 PM	1	11	3	0	15	4	99	1	0	104	2	5	4	0	11	11	79	0	0	90	220
Total	3	26	15	0	44	19	339	4	0	362	5	27	10	1	43	24	247	1	0	272	721
05:00 PM	0	5	3	0	8	3	83	5	0	91	1	5	6	0	12	11	83	1	0	95	206
05:15 PM	2	7	1	1	11	3	74	4	0	81	0	9	0	0	9	6	99	0	0	105	206
05:30 PM	2	4	2	1	9	3	56	2	0	61	3	6	2	1	12	11	79	2	0	92	174
05:45 PM	0	4	2	0	6	2	49	2	0	53	1	7	1	0	9	8	62	0	0	70	138
Total	4	20	8	2	34	11	262	13	0	286	5	27	9	1	42	36	323	3	0	362	724
Grand Total	7	46	23	2	78	30	601	17	0	648	10	54	19	2	85	60	570	4	0	634	1445
Apprch %	9	59	29.5	2.6		4.6	92.7	2.6	0		11.8	63.5	22.4	2.4		9.5	89.9	0.6	0		
Total %	0.5	3.2	1.6	0.1	5.4	2.1	41.6	1.2	0	44.8	0.7	3.7	1.3	0.1	5.9	4.2	39.4	0.3	0	43.9	
Lights	7	45	22	2	76	30	591	17	0	638	10	53	19	2	84	59	552	4	0	615	1413
% Lights	100	97.8	95.7	100	97.4	100	98.3	100	0	98.5	100	98.1	100	100	98.8	98.3	96.8	100	0	97	97.8
Buses	0	0	1	0	1	0	6	0	0	6	0	0	0	0	0	1	11	0	0	12	19
% Buses	0	0	4.3	0	1.3	0	1	0	0	0.9	0	0	0	0	0	1.7	1.9	0	0	1.9	1.3
Trucks	0	1	0	0	1	0	4	0	0	4	0	1	0	0	1	0	7	0	0	7	13
% Trucks	0	2.2	0	0	1.3	0	0.7	0	0	0.6	0	1.9	0	0	1.2	0	1.2	0	0	1.1	0.9

Start Time	MALMEDY RD Southbound				GIGLING RD Westbound				MALMEDY RD Northbound				GIGLING RD Eastbound				Int. Total
	Right	Thru	Left	App. Total	Right	Thru	Left	App. Total	Right	Thru	Left	App. Total	Right	Thru	Left	App. Total	
Peak Hour Analysis From 04:00 PM to 05:45 PM - Peak 1 of 1																	
Peak Hour for Entire Intersection Begins at 04:45 PM																	
04:45 PM	1	11	3	15	4	99	1	104	2	5	4	11	11	79	0	90	220
05:00 PM	0	5	3	8	3	83	5	91	1	5	6	12	11	83	1	95	206
05:15 PM	2	7	1	10	3	74	4	81	0	9	0	9	6	99	0	105	205
05:30 PM	2	4	2	8	3	56	2	61	3	6	2	11	11	79	2	92	172
Total Volume	5	27	9	41	13	312	12	337	6	25	12	43	39	340	3	382	803
% App. Total	12.2	65.9	22		3.9	92.6	3.6		14	58.1	27.9		10.2	89	0.8		
PHF	.625	.614	.750	.683	.813	.788	.600	.810	.500	.694	.500	.896	.886	.859	.375	.910	.913

Traffic Data Service

San Jose, CA
 (408) 622-4787
 tdsbay@cs.com

File Name : 13PM FINAL
 Site Code : 00000013
 Start Date : 4/25/2018
 Page No : 2

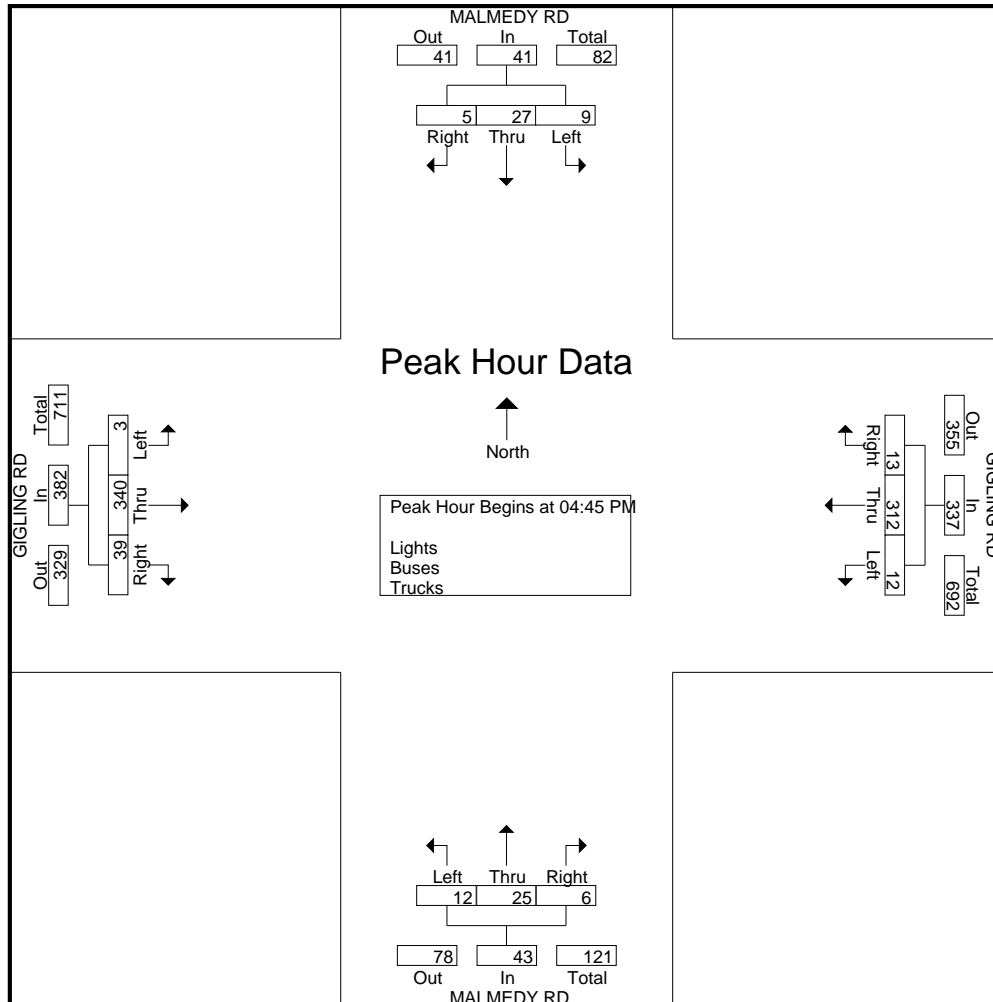

Traffic Data Service

San Jose, CA
 (408) 622-4787
 tdsbay@cs.com

File Name : 13PM FINAL
 Site Code : 00000013
 Start Date : 4/25/2018
 Page No : 1

Groups Printed- Bikes

Start Time	MALMEDY RD Southbound					GIGLING RD Westbound					MALMEDY RD Northbound					GIGLING RD Eastbound					Int. Total	
	Right	Thru	Left	Peds	App. Total	Right	Thru	Left	Peds	App. Total	Right	Thru	Left	Peds	App. Total	Right	Thru	Left	Peds	App. Total		
04:00 PM	0	0	0	0	0	0	0	0	0	0	0	0	0	0	0	0	0	0	0	0	0	0
04:15 PM	0	0	0	0	0	0	0	0	0	0	0	1	0	0	1	0	0	0	0	0	0	0
04:30 PM	0	0	0	0	0	0	0	0	0	0	0	0	0	0	0	0	0	0	0	0	0	0
04:45 PM	0	0	0	0	0	0	0	0	0	0	0	0	0	0	0	0	0	0	0	0	0	0
Total	0	0	0	0	0	0	0	0	0	0	0	1	0	0	1	0	0	0	0	0	0	0
05:00 PM	0	0	0	0	0	0	0	0	0	0	0	0	0	0	0	0	0	0	0	0	0	0
05:15 PM	0	1	0	0	1	0	0	0	0	0	0	0	0	0	0	0	0	0	0	0	0	1
05:30 PM	0	0	0	0	0	0	0	0	0	0	0	0	0	0	0	0	0	0	0	0	0	0
05:45 PM	0	0	0	0	0	0	0	0	0	0	0	0	0	0	0	0	0	0	0	0	0	0
Total	0	1	0	0	1	0	0	0	0	0	0	0	0	0	0	0	0	0	0	0	0	1
Grand Total	0	1	0	0	1	0	0	0	0	0	0	1	0	0	1	0	0	0	0	0	0	2
Apprch %	0	100	0	0		0	0	0	0		0	100	0	0		0	0	0	0			
Total %	0	50	0	0	50	0	0	0	0	0	0	50	0	0	50	0	0	0	0	0		

Start Time	MALMEDY RD Southbound					GIGLING RD Westbound					MALMEDY RD Northbound					GIGLING RD Eastbound					Int. Total	
	Right	Thru	Left	Peds	App. Total	Right	Thru	Left	Peds	App. Total	Right	Thru	Left	Peds	App. Total	Right	Thru	Left	Peds	App. Total		
Peak Hour Analysis From 04:00 PM to 05:45 PM - Peak 1 of 1																						
Peak Hour for Entire Intersection Begins at 04:00 PM																						
04:00 PM	0	0	0	0	0	0	0	0	0	0	0	0	0	0	0	0	0	0	0	0	0	0
04:15 PM	0	0	0	0	0	0	0	0	0	0	0	1	0	0	1	0	0	0	0	0	0	1
04:30 PM	0	0	0	0	0	0	0	0	0	0	0	0	0	0	0	0	0	0	0	0	0	0
04:45 PM	0	0	0	0	0	0	0	0	0	0	0	0	0	0	0	0	0	0	0	0	0	0
Total Volume	0	0	0	0	0	0	0	0	0	0	0	1	0	0	1	0	0	0	0	0	0	1
% App. Total	0	0	0	0		0	0	0	0		0	100	0	0		0	0	0	0			
PHF	.000	.000	.000	.000	.000	.000	.000	.000	.000	.000	.000	.250	.000	.250	.000	.000	.000	.000	.000	.000	.000	.250

Traffic Data Service

San Jose, CA
 (408) 622-4787
 tdsbay@cs.com

File Name : 13PM FINAL
 Site Code : 00000013
 Start Date : 4/25/2018
 Page No : 2

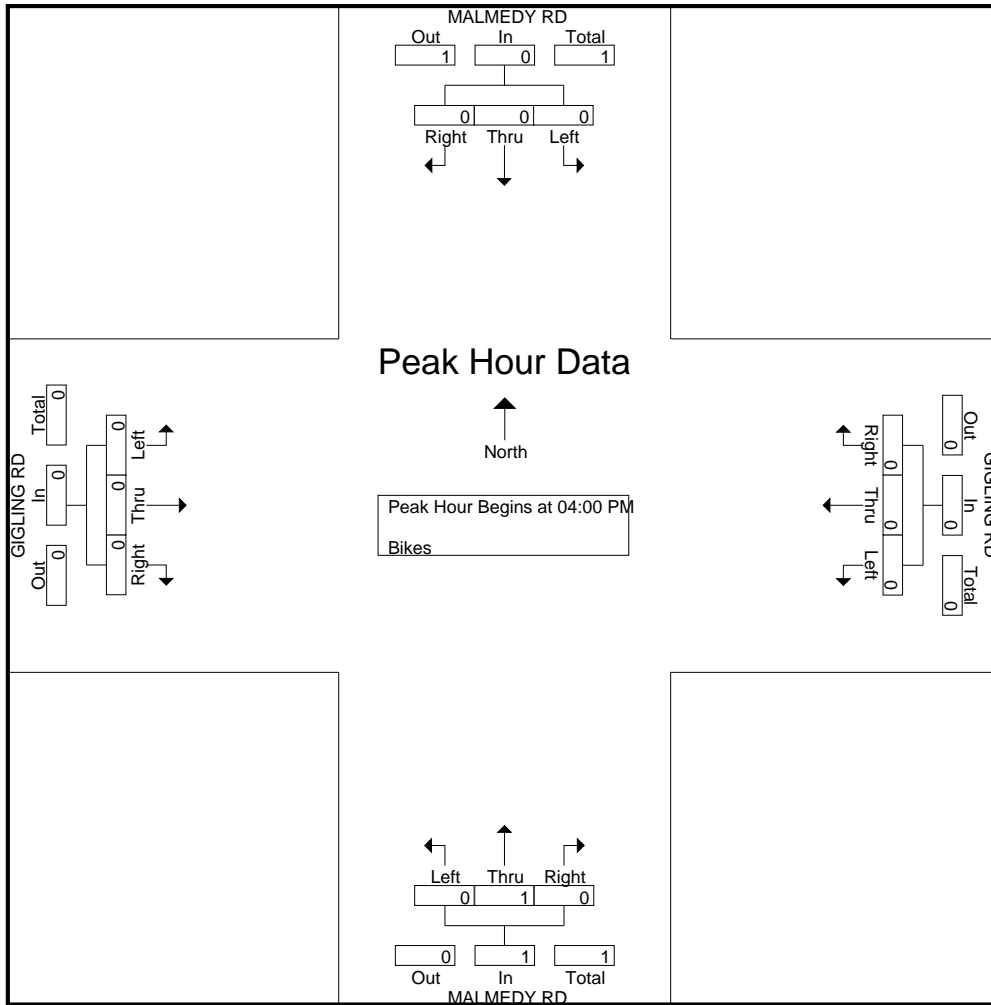

Traffic Data Service

San Jose, CA
 (408) 622-4787
 tdsbay@cs.com

File Name : 14AM FINAL
 Site Code : 00000014
 Start Date : 4/25/2018
 Page No : 1

Groups Printed- Lights - Buses - Trucks

Start Time	PARKER FLATS CUT OFF RD Southbound					GIGLING RD Westbound					PARKER FLATS CUT OFF RD Northbound					GIGLING RD Eastbound					Int. Total
	Right	Thru	Left	Peds	App. Total	Right	Thru	Left	Peds	App. Total	Right	Thru	Left	Peds	App. Total	Right	Thru	Left	Peds	App. Total	
07:00 AM	0	1	0	0	1	0	62	3	0	65	2	1	2	0	5	8	41	0	0	49	120
07:15 AM	0	2	1	0	3	0	112	9	0	121	6	2	4	0	12	10	45	0	0	55	191
07:30 AM	0	2	4	0	6	0	124	10	0	134	9	3	1	0	13	17	80	2	0	99	252
07:45 AM	0	5	1	0	6	0	84	17	0	101	9	3	6	0	18	40	97	0	0	137	262
Total	0	10	6	0	16	0	382	39	0	421	26	9	13	0	48	75	263	2	0	340	825
08:00 AM	0	2	1	0	3	0	61	5	0	66	7	1	6	0	14	24	63	3	0	90	173
08:15 AM	0	4	0	0	4	1	55	4	0	60	3	3	12	0	18	25	56	0	0	81	163
08:30 AM	0	4	0	0	4	0	45	4	0	49	2	0	6	1	9	17	47	1	0	65	127
08:45 AM	0	8	1	0	9	0	25	4	0	29	3	2	4	0	9	9	43	1	0	53	100
Total	0	18	2	0	20	1	186	17	0	204	15	6	28	1	50	75	209	5	0	289	563
Grand Total	0	28	8	0	36	1	568	56	0	625	41	15	41	1	98	150	472	7	0	629	1388
Apprch %	0	77.8	22.2	0		0.2	90.9	9	0		41.8	15.3	41.8	1		23.8	75	1.1	0		
Total %	0	2	0.6	0	2.6	0.1	40.9	4	0	45	3	1.1	3	0.1	7.1	10.8	34	0.5	0	45.3	
Lights	0	28	8	0	36	1	554	56	0	611	41	15	34	1	91	142	460	7	0	609	1347
% Lights	0	100	100	0	100	100	97.5	100	0	97.8	100	100	82.9	100	92.9	94.7	97.5	100	0	96.8	97
Buses	0	0	0	0	0	0	6	0	0	6	0	0	7	0	7	2	8	0	0	10	23
% Buses	0	0	0	0	0	0	1.1	0	0	1	0	0	17.1	0	7.1	1.3	1.7	0	0	1.6	1.7
Trucks	0	0	0	0	0	0	8	0	0	8	0	0	0	0	0	6	4	0	0	10	18
% Trucks	0	0	0	0	0	0	1.4	0	0	1.3	0	0	0	0	0	4	0.8	0	0	1.6	1.3

Start Time	PARKER FLATS CUT OFF RD Southbound					GIGLING RD Westbound					PARKER FLATS CUT OFF RD Northbound					GIGLING RD Eastbound					Int. Total
	Right	Thru	Left	Peds	App. Total	Right	Thru	Left	Peds	App. Total	Right	Thru	Left	Peds	App. Total	Right	Thru	Left	Peds	App. Total	
Peak Hour Analysis From 07:00 AM to 08:45 AM - Peak 1 of 1																					
Peak Hour for Entire Intersection Begins at 07:15 AM																					
07:15 AM	0	2	1	0	3	0	112	9	0	121	6	2	4	0	12	10	45	0	0	55	191
07:30 AM	0	2	4	0	6	0	124	10	0	134	9	3	1	0	13	17	80	2	0	99	252
07:45 AM	0	5	1	0	6	0	84	17	0	101	9	3	6	0	18	40	97	0	0	137	262
08:00 AM	0	2	1	0	3	0	61	5	0	66	7	1	6	0	14	24	63	3	0	90	173
Total Volume	0	11	7	0	18	0	381	41	0	422	31	9	17	0	57	91	285	5	0	381	878
% App. Total	0	61.1	38.9	0		0	90.3	9.7	0		54.4	15.8	29.8	0		23.9	74.8	1.3	0		
PHF	.000	.550	.438	.750		.000	.768	.603	.787		.861	.750	.708	.792		.569	.735	.417	.695		.838

Traffic Data Service

San Jose, CA
 (408) 622-4787
 tdsbay@cs.com

File Name : 14AM FINAL
 Site Code : 00000014
 Start Date : 4/25/2018
 Page No : 2

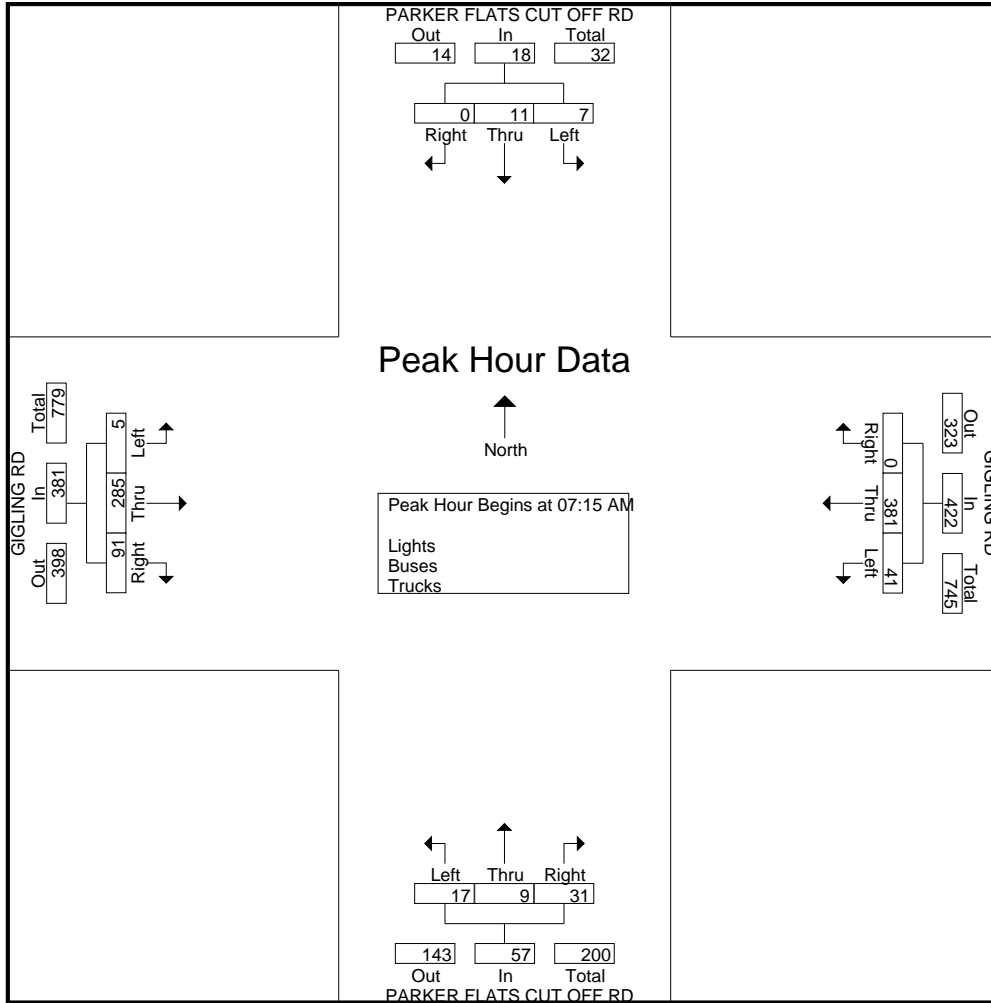

Traffic Data Service

San Jose, CA
 (408) 622-4787
 tdsbay@cs.com

File Name : 14AM FINAL
 Site Code : 00000014
 Start Date : 4/25/2018
 Page No : 1

Groups Printed- Bikes

Start Time	PARKER FLATS CUT OFF RD Southbound					GIGLING RD Westbound					PARKER FLATS CUT OFF RD Northbound					GIGLING RD Eastbound					Int. Total					
	Right	Thru	Left	Peds	App. Total	Right	Thru	Left	Peds	App. Total	Right	Thru	Left	Peds	App. Total	Right	Thru	Left	Peds	App. Total						
07:00 AM	0	0	0	0	0	0	0	0	0	0	0	0	0	0	0	0	0	0	0	0	0	0	0	0	0	0
07:15 AM	0	0	1	0	1	0	0	0	0	0	0	0	0	0	0	0	0	0	0	0	0	0	0	0	0	1
07:30 AM	0	1	0	0	1	0	0	0	0	0	0	0	0	0	0	0	0	0	0	0	0	0	0	0	0	1
07:45 AM	0	1	0	0	1	0	0	0	0	0	0	1	0	0	1	0	0	0	0	0	0	0	0	0	0	2
Total	0	2	1	0	3	0	0	0	0	0	0	1	0	0	1	0	0	0	0	0	0	0	0	0	0	4
08:00 AM	0	0	0	0	0	0	0	0	0	0	0	0	0	0	0	0	0	0	0	0	0	0	0	0	0	0
08:15 AM	0	0	0	0	0	0	0	0	0	0	0	0	0	0	0	0	0	0	0	0	0	0	0	0	0	0
08:30 AM	0	0	0	0	0	0	0	0	0	0	0	0	0	0	0	0	0	0	0	0	0	0	0	0	0	0
08:45 AM	0	0	0	0	0	0	0	0	0	0	0	0	0	0	0	0	0	0	0	0	0	0	0	0	0	0
Total	0	0	0	0	0	0	0	0	0	0	0	0	0	0	0	0	0	0	0	0	0	0	0	0	0	0
Grand Total	0	2	1	0	3	0	0	0	0	0	0	1	0	0	1	0	0	0	0	0	0	0	0	0	0	4
Apprch %	0	66.7	33.3	0		0	0	0	0		0	100	0	0		0	0	0	0		0	0	0	0		
Total %	0	50	25	0	75	0	0	0	0	0	0	25	0	0	25	0	0	0	0	0	0	0	0	0	0	

Start Time	PARKER FLATS CUT OFF RD Southbound					GIGLING RD Westbound					PARKER FLATS CUT OFF RD Northbound					GIGLING RD Eastbound					Int. Total					
	Right	Thru	Left	Peds	App. Total	Right	Thru	Left	Peds	App. Total	Right	Thru	Left	Peds	App. Total	Right	Thru	Left	Peds	App. Total						
Peak Hour Analysis From 07:00 AM to 08:45 AM - Peak 1 of 1																										
Peak Hour for Entire Intersection Begins at 07:00 AM																										
07:00 AM	0	0	0	0	0	0	0	0	0	0	0	0	0	0	0	0	0	0	0	0	0	0	0	0	0	0
07:15 AM	0	0	1	0	1	0	0	0	0	0	0	0	0	0	0	0	0	0	0	0	0	0	0	0	0	1
07:30 AM	0	1	0	0	1	0	0	0	0	0	0	0	0	0	0	0	0	0	0	0	0	0	0	0	0	1
07:45 AM	0	1	0	0	1	0	0	0	0	0	0	1	0	0	1	0	0	0	0	0	0	0	0	0	0	2
Total Volume	0	2	1	0	3	0	0	0	0	0	0	1	0	0	1	0	0	0	0	0	0	0	0	0	0	4
% App. Total	0	66.7	33.3	0		0	0	0	0		0	100	0	0		0	0	0	0		0	0	0	0		
PHF	.000	.500	.250		.750	.000	.000	.000		.000	.000	.250	.000		.250	.000	.000	.000		.000	.000	.000	.000		.500	

Traffic Data Service

San Jose, CA
 (408) 622-4787
 tdsbay@cs.com

File Name : 14AM FINAL
 Site Code : 00000014
 Start Date : 4/25/2018
 Page No : 2

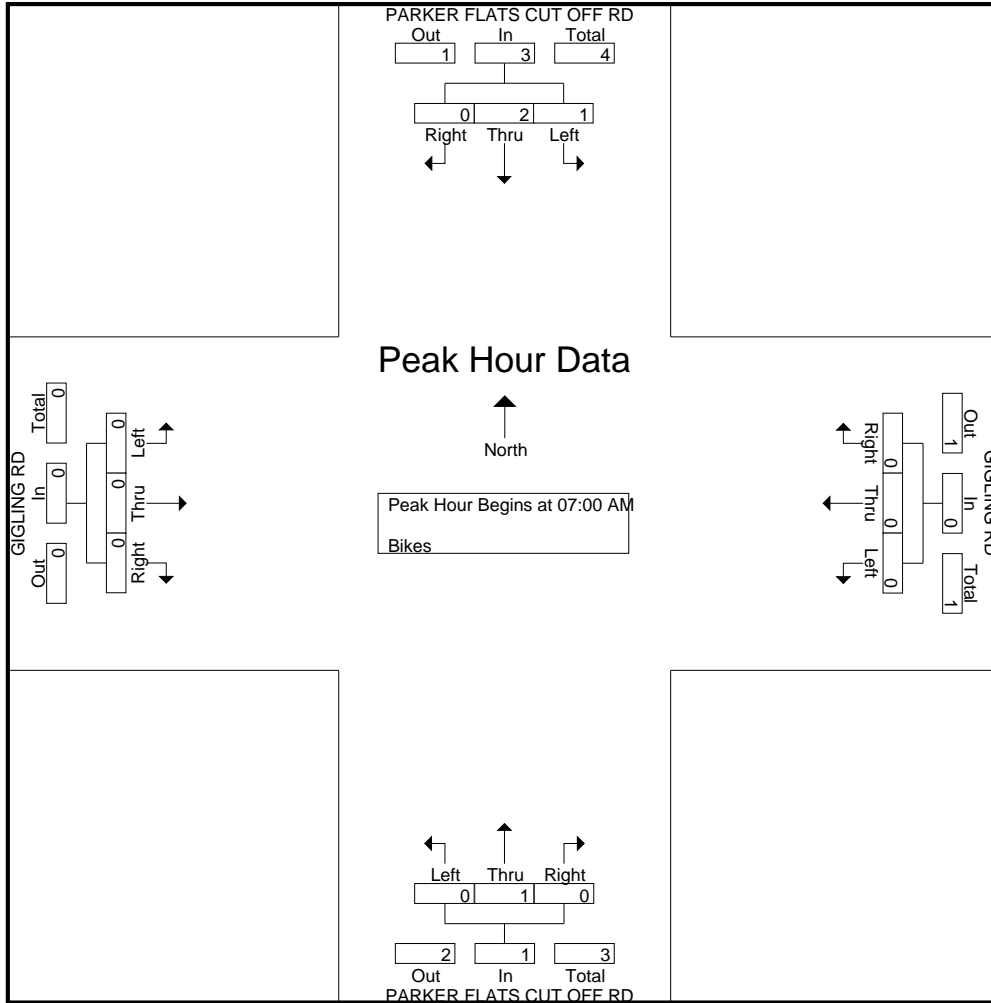

Traffic Data Service

San Jose, CA
 (408) 622-4787
 tdsbay@cs.com

File Name : 14PM FINAL
 Site Code : 00000014
 Start Date : 4/25/2018
 Page No : 1

Groups Printed- Lights - Buses - Trucks

Start Time	PARKER FLATS CUT OFF RD Southbound					GIGLING RD Westbound					PARKER FLATS CUT OFF RD Northbound					GIGLING RD Eastbound					Int. Total
	Right	Thru	Left	Peds	App. Total	Right	Thru	Left	Peds	App. Total	Right	Thru	Left	Peds	App. Total	Right	Thru	Left	Peds	App. Total	
04:00 PM	2	1	0	0	3	0	64	2	1	67	7	6	18	1	32	2	55	0	0	57	159
04:15 PM	0	1	0	0	1	0	48	3	0	51	6	9	18	0	33	3	53	1	0	57	142
04:30 PM	0	1	0	0	1	0	65	4	0	69	7	6	20	1	34	2	62	0	0	64	168
04:45 PM	0	0	0	0	0	1	81	5	0	87	6	5	25	0	36	2	81	1	0	84	207
Total	2	3	0	0	5	1	258	14	1	274	26	26	81	2	135	9	251	2	0	262	676
05:00 PM	0	0	0	0	0	1	80	2	2	85	5	7	6	0	18	2	77	0	0	79	182
05:15 PM	0	2	0	0	2	0	58	1	0	59	3	3	14	2	22	2	96	1	0	99	182
05:30 PM	1	2	0	0	3	0	50	3	0	53	3	7	7	0	17	2	82	1	0	85	158
05:45 PM	1	0	0	0	1	0	45	1	0	46	3	2	8	0	13	2	55	0	0	57	117
Total	2	4	0	0	6	1	233	7	2	243	14	19	35	2	70	8	310	2	0	320	639
Grand Total	4	7	0	0	11	2	491	21	3	517	40	45	116	4	205	17	561	4	0	582	1315
Apprch %	36.4	63.6	0	0		0.4	95	4.1	0.6		19.5	22	56.6	2		2.9	96.4	0.7	0		
Total %	0.3	0.5	0	0	0.8	0.2	37.3	1.6	0.2	39.3	3	3.4	8.8	0.3	15.6	1.3	42.7	0.3	0	44.3	
Lights	4	7	0	0	11	2	482	21	3	508	39	45	114	4	202	17	543	4	0	564	1285
% Lights	100	100	0	0	100	100	98.2	100	100	98.3	97.5	100	98.3	100	98.5	100	96.8	100	0	96.9	97.7
Buses	0	0	0	0	0	0	6	0	0	6	0	0	0	0	0	0	12	0	0	12	18
% Buses	0	0	0	0	0	0	1.2	0	0	1.2	0	0	0	0	0	0	2.1	0	0	2.1	1.4
Trucks	0	0	0	0	0	0	3	0	0	3	1	0	2	0	3	0	6	0	0	6	12
% Trucks	0	0	0	0	0	0	0.6	0	0	0.6	2.5	0	1.7	0	1.5	0	1.1	0	0	1	0.9

Start Time	PARKER FLATS CUT OFF RD Southbound					GIGLING RD Westbound					PARKER FLATS CUT OFF RD Northbound					GIGLING RD Eastbound					Int. Total
	Right	Thru	Left	Peds	App. Total	Right	Thru	Left	Peds	App. Total	Right	Thru	Left	Peds	App. Total	Right	Thru	Left	Peds	App. Total	
Peak Hour Analysis From 04:00 PM to 05:45 PM - Peak 1 of 1																					
Peak Hour for Entire Intersection Begins at 04:30 PM																					
04:30 PM	0	1	0	0	1	0	65	4	0	69	7	6	20	33	2	62	0	0	64	167	
04:45 PM	0	0	0	0	0	1	81	5	0	87	6	5	25	36	2	81	1	0	84	207	
05:00 PM	0	0	0	0	0	1	80	2	0	83	5	7	6	18	2	77	0	0	79	180	
05:15 PM	0	2	0	0	2	0	58	1	0	59	3	3	14	20	2	96	1	0	99	180	
Total Volume	0	3	0	0	3	2	284	12	0	298	21	21	65	107	8	316	2	0	326	734	
% App. Total	0	100	0	0		0.7	95.3	4	0		19.6	19.6	60.7		2.5	96.9	0.6	0			
PHF	.000	.375	.000	.000	.375	.500	.877	.600	.000	.856	.750	.750	.650	.743	1.00	.823	.500	.000	.823	.886	

Traffic Data Service

San Jose, CA
 (408) 622-4787
 tdsbay@cs.com

File Name : 14PM FINAL
 Site Code : 00000014
 Start Date : 4/25/2018
 Page No : 2

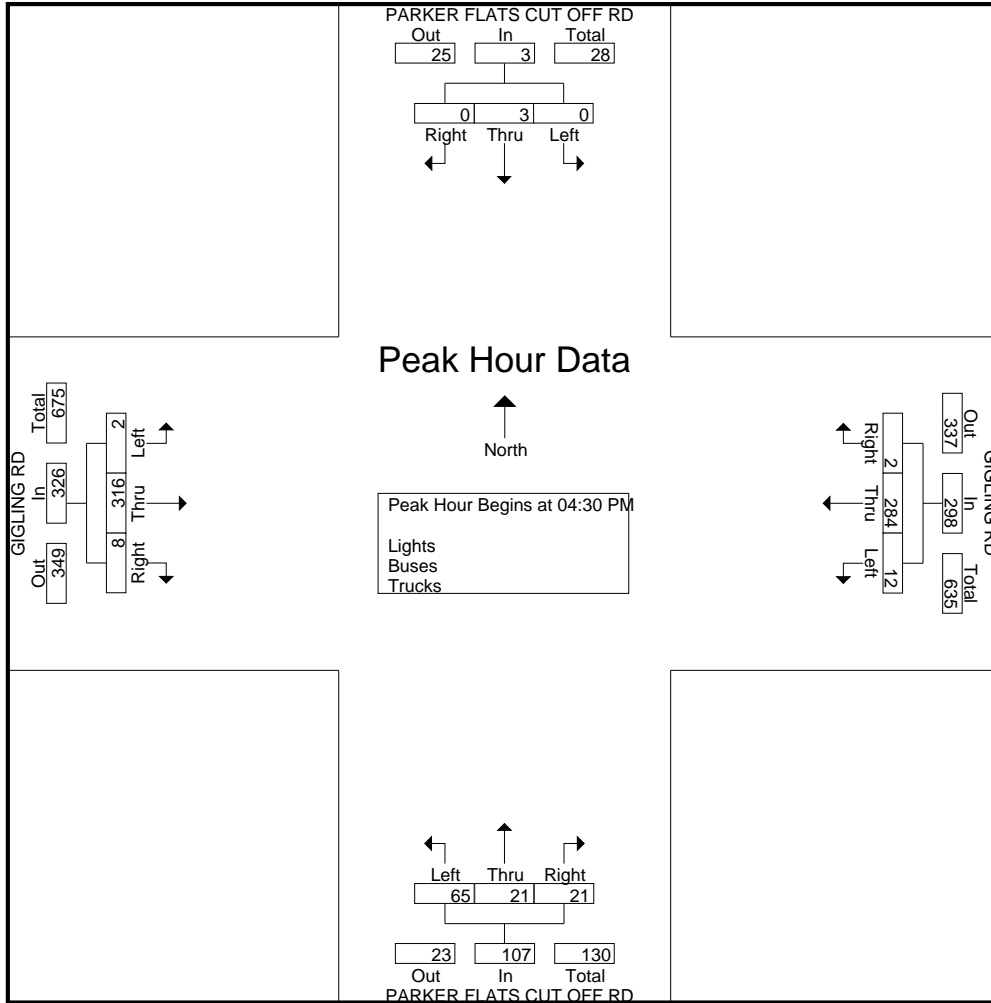

Traffic Data Service

San Jose, CA
 (408) 622-4787
 tdsbay@cs.com

File Name : 14PM FINAL
 Site Code : 00000014
 Start Date : 4/25/2018
 Page No : 1

Groups Printed- Bikes

Start Time	PARKER FLATS CUT OFF RD Southbound					GIGLING RD Westbound					PARKER FLATS CUT OFF RD Northbound					GIGLING RD Eastbound					Int. Total					
	Right	Thru	Left	Peds	App. Total	Right	Thru	Left	Peds	App. Total	Right	Thru	Left	Peds	App. Total	Right	Thru	Left	Peds	App. Total						
04:00 PM	0	0	0	0	0	0	0	0	0	0	0	0	0	0	0	0	0	0	0	0	0	0	0	0	0	0
04:15 PM	0	0	0	0	0	0	0	0	0	0	0	0	0	0	0	0	0	0	0	0	0	0	0	0	0	0
04:30 PM	0	0	0	0	0	0	0	0	0	0	0	0	0	0	0	0	0	0	0	0	0	0	0	0	0	0
04:45 PM	0	1	0	0	1	0	0	0	0	0	0	0	0	0	0	0	0	0	0	0	0	0	0	0	0	1
Total	0	1	0	0	1	0	0	0	0	0	0	0	0	0	0	0	0	0	0	0	0	0	0	0	0	1
05:00 PM	0	0	0	0	0	0	0	0	0	0	0	0	0	0	0	0	0	0	0	0	0	0	0	0	0	0
05:15 PM	0	0	0	0	0	0	0	0	0	0	0	0	0	0	0	0	0	0	0	0	0	0	0	0	0	0
05:30 PM	0	0	0	0	0	0	0	0	0	0	0	0	0	0	0	0	0	0	0	0	0	0	0	0	0	0
05:45 PM	0	0	0	0	0	0	0	0	0	0	0	0	0	0	0	0	0	0	0	0	0	0	0	0	0	0
Total	0	0	0	0	0	0	0	0	0	0	0	0	0	0	0	0	0	0	0	0	0	0	0	0	0	0
Grand Total	0	1	0	0	1	0	0	0	0	0	0	0	0	0	0	0	0	0	0	0	0	0	0	0	0	1
Apprch %	0	100	0	0		0	0	0	0		0	0	0	0		0	0	0	0		0	0	0	0		
Total %	0	100	0	0	100	0	0	0	0	0	0	0	0	0	0	0	0	0	0	0	0	0	0	0	0	

Start Time	PARKER FLATS CUT OFF RD Southbound					GIGLING RD Westbound					PARKER FLATS CUT OFF RD Northbound					GIGLING RD Eastbound					Int. Total					
	Right	Thru	Left	Peds	App. Total	Right	Thru	Left	Peds	App. Total	Right	Thru	Left	Peds	App. Total	Right	Thru	Left	Peds	App. Total						
04:00 PM	0	0	0	0	0	0	0	0	0	0	0	0	0	0	0	0	0	0	0	0	0	0	0	0	0	0
04:15 PM	0	0	0	0	0	0	0	0	0	0	0	0	0	0	0	0	0	0	0	0	0	0	0	0	0	0
04:30 PM	0	0	0	0	0	0	0	0	0	0	0	0	0	0	0	0	0	0	0	0	0	0	0	0	0	0
04:45 PM	0	1	0	0	1	0	0	0	0	0	0	0	0	0	0	0	0	0	0	0	0	0	0	0	0	1
Total Volume	0	1	0	0	1	0	0	0	0	0	0	0	0	0	0	0	0	0	0	0	0	0	0	0	0	1
% App. Total	0	100	0	0		0	0	0	0		0	0	0	0		0	0	0	0		0	0	0	0		
PHF	.000	.250	.000	.000	.250	.000	.000	.000	.000	.000	.000	.000	.000	.000	.000	.000	.000	.000	.000	.000	.000	.000	.000	.000	.250	

Peak Hour Analysis From 04:00 PM to 05:45 PM - Peak 1 of 1
 Peak Hour for Entire Intersection Begins at 04:00 PM

Traffic Data Service

San Jose, CA
 (408) 622-4787
 tdsbay@cs.com

File Name : 14PM FINAL
 Site Code : 00000014
 Start Date : 4/25/2018
 Page No : 2

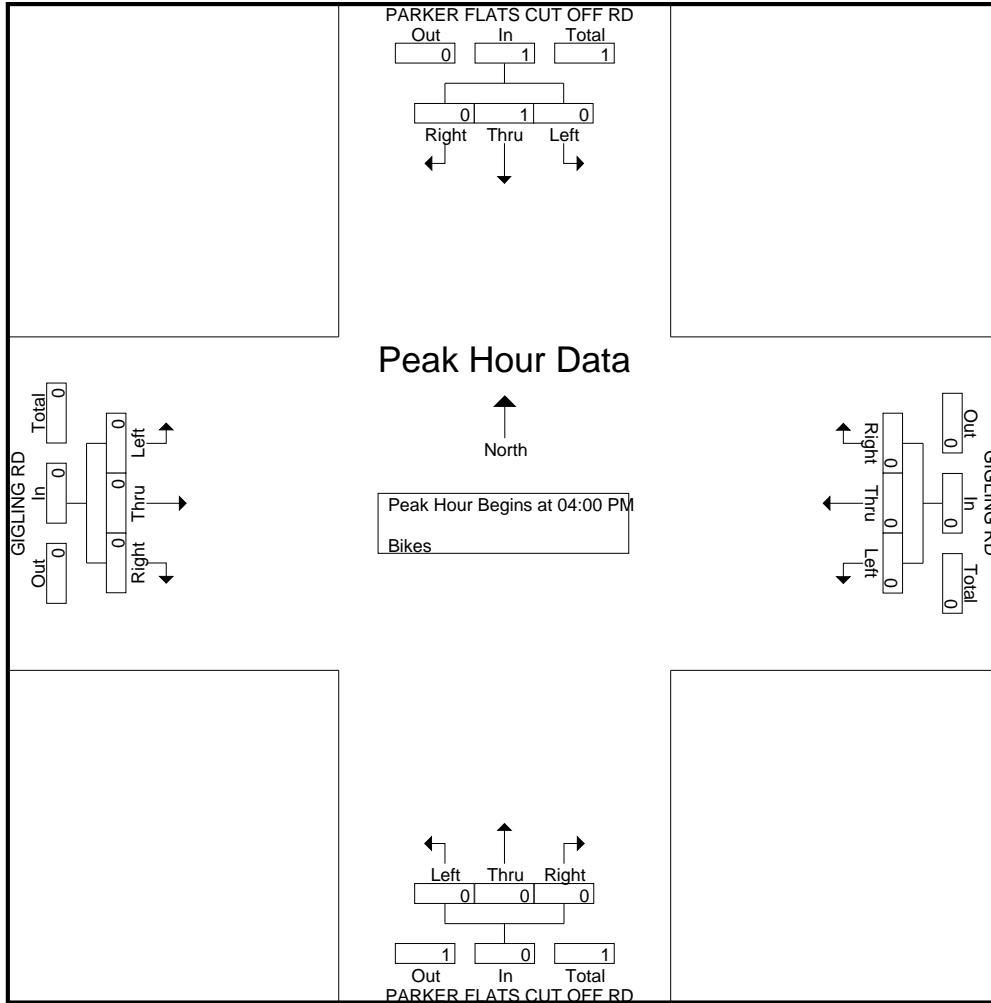

Traffic Data Service

San Jose, CA
 (408) 622-4787
 tdsbay@cs.com

File Name : 15AM FINAL
 Site Code : 00000015
 Start Date : 4/25/2018
 Page No : 1

Groups Printed- Lights - Buses - Trucks

Start Time	6TH AVE Southbound					GIGLING RD Westbound					6TH AVE Northbound					GIGLING RD Eastbound					Int. Total
	Right	Thru	Left	Peds	App. Total	Right	Thru	Left	Peds	App. Total	Right	Thru	Left	Peds	App. Total	Right	Thru	Left	Peds	App. Total	
07:00 AM	0	1	0	0	1	0	71	13	0	84	0	0	0	0	0	1	23	0	0	24	109
07:15 AM	2	6	0	0	8	1	126	17	0	144	1	1	0	0	2	4	28	1	0	33	187
07:30 AM	6	8	0	0	14	1	121	17	0	139	0	0	0	0	0	13	33	3	1	50	203
07:45 AM	2	13	0	0	15	0	100	26	0	126	0	0	0	0	0	14	37	5	0	56	197
Total	10	28	0	0	38	2	418	73	0	493	1	1	0	0	2	32	121	9	1	163	696
08:00 AM	3	9	0	0	12	0	61	15	0	76	1	0	0	0	1	10	35	0	1	46	135
08:15 AM	0	5	0	0	5	0	61	8	0	69	1	0	1	0	2	6	26	2	0	34	110
08:30 AM	0	5	0	0	5	0	50	10	0	60	0	3	0	0	3	8	20	3	0	31	99
08:45 AM	0	3	0	0	3	0	26	10	0	36	0	0	0	0	0	6	15	3	0	24	63
Total	3	22	0	0	25	0	198	43	0	241	2	3	1	0	6	30	96	8	1	135	407
Grand Total	13	50	0	0	63	2	616	116	0	734	3	4	1	0	8	62	217	17	2	298	1103
Apprch %	20.6	79.4	0	0		0.3	83.9	15.8	0		37.5	50	12.5	0		20.8	72.8	5.7	0.7		
Total %	1.2	4.5	0	0	5.7	0.2	55.8	10.5	0	66.5	0.3	0.4	0.1	0	0.7	5.6	19.7	1.5	0.2	27	
Lights	13	49	0	0	62	2	605	115	0	722	2	4	1	0	7	62	210	15	2	289	1080
% Lights	100	98	0	0	98.4	100	98.2	99.1	0	98.4	66.7	100	100	0	87.5	100	96.8	88.2	100	97	97.9
Buses	0	1	0	0	1	0	4	1	0	5	1	0	0	0	1	0	5	2	0	7	14
% Buses	0	2	0	0	1.6	0	0.6	0.9	0	0.7	33.3	0	0	0	12.5	0	2.3	11.8	0	2.3	1.3
Trucks	0	0	0	0	0	0	7	0	0	7	0	0	0	0	0	0	2	0	0	2	9
% Trucks	0	0	0	0	0	0	1.1	0	0	1	0	0	0	0	0	0	0.9	0	0	0.7	0.8

Start Time	6TH AVE Southbound				GIGLING RD Westbound				6TH AVE Northbound				GIGLING RD Eastbound				Int. Total
	Right	Thru	Left	App. Total	Right	Thru	Left	App. Total	Right	Thru	Left	App. Total	Right	Thru	Left	App. Total	
Peak Hour Analysis From 07:00 AM to 08:45 AM - Peak 1 of 1																	
Peak Hour for Entire Intersection Begins at 07:15 AM																	
07:15 AM	2	6	0	8	1	126	17	144	1	1	0	2	4	28	1	33	187
07:30 AM	6	8	0	14	1	121	17	139	0	0	0	0	13	33	3	49	202
07:45 AM	2	13	0	15	0	100	26	126	0	0	0	0	14	37	5	56	197
08:00 AM	3	9	0	12	0	61	15	76	1	0	0	1	10	35	0	45	134
Total Volume	13	36	0	49	2	408	75	485	2	1	0	3	41	133	9	183	720
% App. Total	26.5	73.5	0		0.4	84.1	15.5		66.7	33.3	0		22.4	72.7	4.9		
PHF	.542	.692	.000	.817	.500	.810	.721	.842	.500	.250	.000	.375	.732	.899	.450	.817	.891

Traffic Data Service

San Jose, CA
 (408) 622-4787
 tdsbay@cs.com

File Name : 15AM FINAL
 Site Code : 00000015
 Start Date : 4/25/2018
 Page No : 2

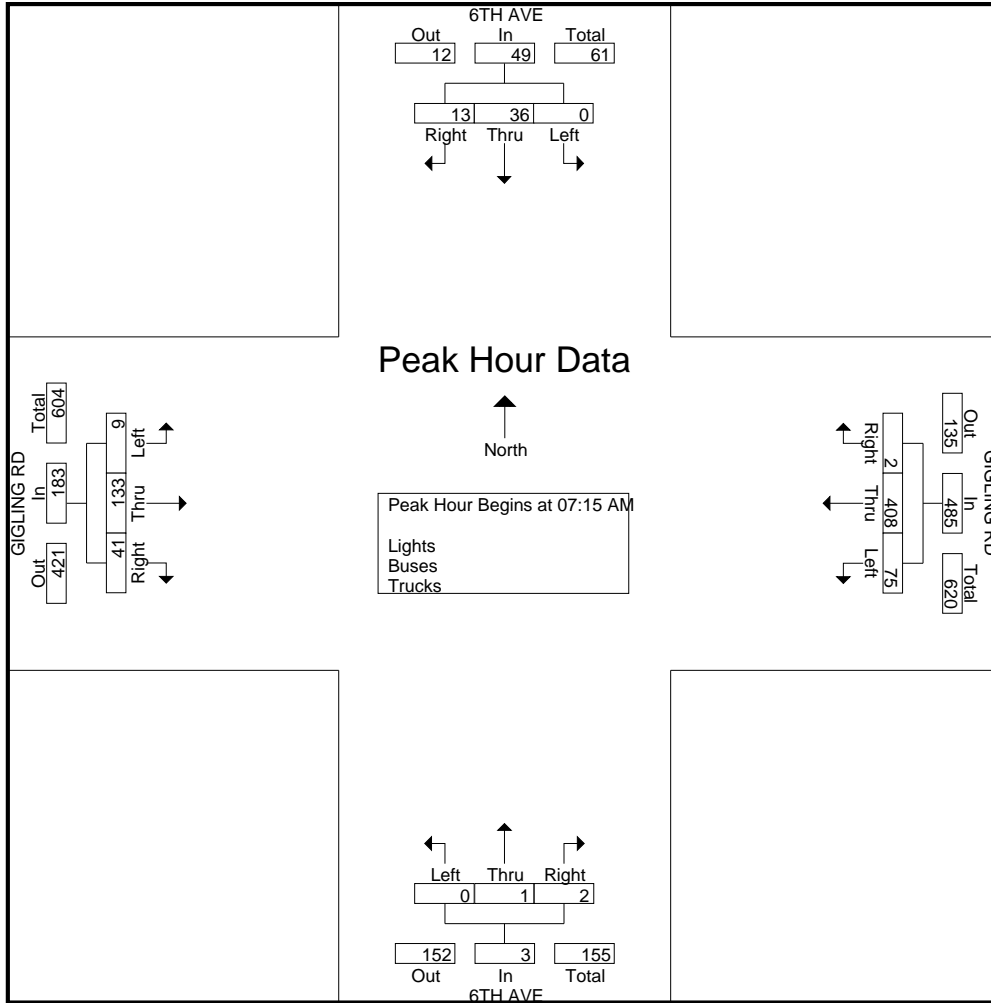

Traffic Data Service

San Jose, CA
 (408) 622-4787
 tdsbay@cs.com

File Name : 15AM FINAL
 Site Code : 00000015
 Start Date : 4/25/2018
 Page No : 1

Groups Printed- Bikes

Start Time	6TH AVE Southbound					GIGLING RD Westbound					6TH AVE Northbound					GIGLING RD Eastbound					Int. Total
	Right	Thru	Left	Peds	App. Total	Right	Thru	Left	Peds	App. Total	Right	Thru	Left	Peds	App. Total	Right	Thru	Left	Peds	App. Total	
07:00 AM	0	0	0	0	0	0	0	0	0	0	0	0	0	0	0	0	0	0	0	0	0
07:15 AM	0	0	0	0	0	0	0	0	0	0	0	0	0	0	0	0	0	0	0	0	0
07:30 AM	0	0	0	0	0	0	0	0	0	0	0	0	0	0	0	0	0	0	0	0	0
07:45 AM	0	0	0	0	0	0	0	0	0	0	0	0	0	0	0	0	0	0	0	0	0
Total	0	0	0	0	0	0	0	0	0	0	0	0	0	0	0	0	0	0	0	0	0
08:00 AM	0	0	0	0	0	0	0	0	0	0	0	0	0	0	0	0	0	0	0	0	0
08:15 AM	0	0	0	0	0	0	0	0	0	0	0	0	0	0	0	0	0	0	0	0	0
08:30 AM	1	0	0	0	1	0	0	0	0	0	0	0	0	0	0	0	0	0	0	0	1
08:45 AM	0	0	0	0	0	0	0	0	0	0	0	0	0	0	0	0	0	0	0	0	0
Total	1	0	0	0	1	0	0	0	0	0	0	0	0	0	0	0	0	0	0	0	1
Grand Total	1	0	0	0	1	0	0	0	0	0	0	0	0	0	0	0	0	0	0	0	1
Apprch %	100	0	0	0		0	0	0	0		0	0	0	0		0	0	0	0		
Total %	100	0	0	0	100	0	0	0	0	0	0	0	0	0	0	0	0	0	0	0	

Start Time	6TH AVE Southbound				GIGLING RD Westbound				6TH AVE Northbound				GIGLING RD Eastbound				Int. Total
	Right	Thru	Left	App. Total	Right	Thru	Left	App. Total	Right	Thru	Left	App. Total	Right	Thru	Left	App. Total	
Peak Hour Analysis From 07:00 AM to 08:45 AM - Peak 1 of 1																	
Peak Hour for Entire Intersection Begins at 07:45 AM																	
07:45 AM	0	0	0	0	0	0	0	0	0	0	0	0	0	0	0	0	0
08:00 AM	0	0	0	0	0	0	0	0	0	0	0	0	0	0	0	0	0
08:15 AM	0	0	0	0	0	0	0	0	0	0	0	0	0	0	0	0	0
08:30 AM	1	0	0	1	0	0	0	0	0	0	0	0	0	0	0	0	1
Total Volume	1	0	0	1	0	0	0	0	0	0	0	0	0	0	0	0	1
% App. Total	100	0	0		0	0	0		0	0	0		0	0	0		
PHF	.250	.000	.000	.250	.000	.000	.000	.000	.000	.000	.000	.000	.000	.000	.000	.000	.250

Traffic Data Service

San Jose, CA
(408) 622-4787
tdsbay@cs.com

File Name : 15AM FINAL
Site Code : 00000015
Start Date : 4/25/2018
Page No : 2

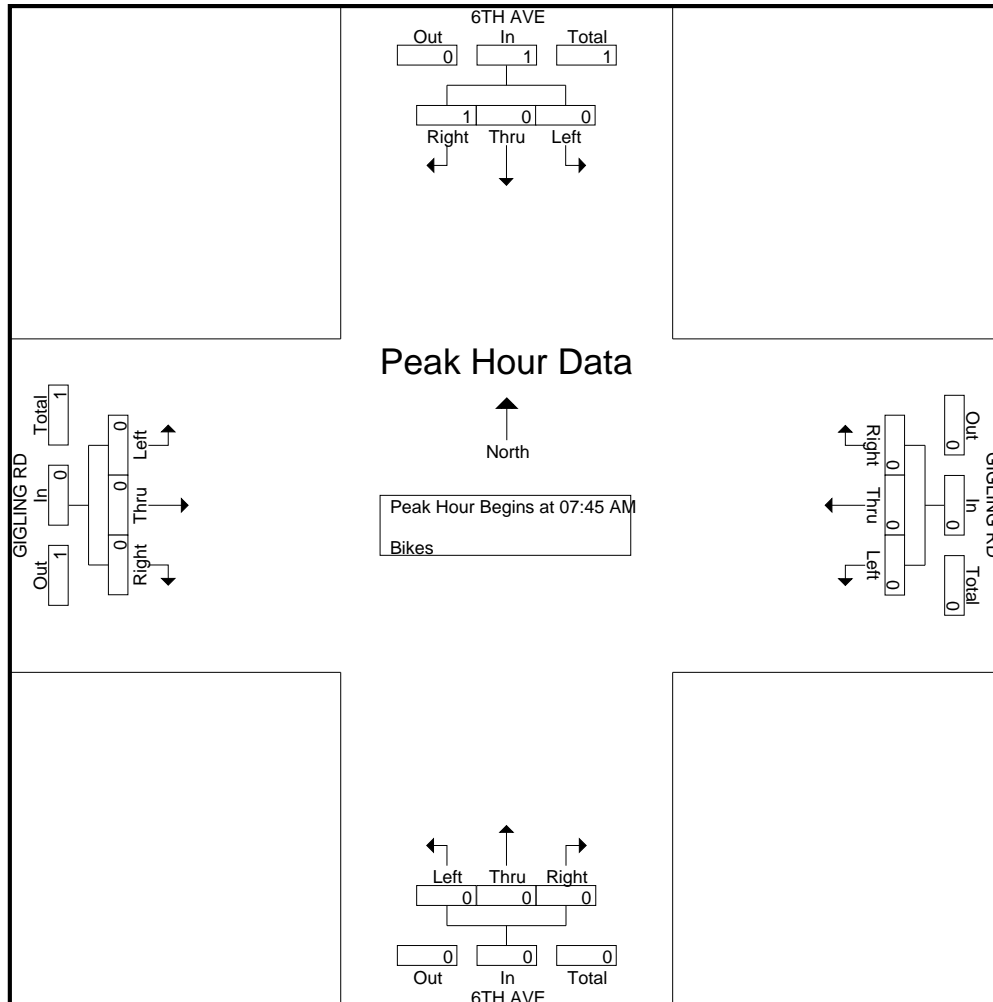

Traffic Data Service

San Jose, CA
 (408) 622-4787
 tdsbay@cs.com

File Name : 15PM FINAL
 Site Code : 00000015
 Start Date : 4/25/2018
 Page No : 1

Groups Printed- Lights - Buses - Trucks

Start Time	6TH AVE Southbound					GIGLING RD Westbound					6TH AVE Northbound					GIGLING RD Eastbound					Int. Total
	Right	Thru	Left	Peds	App. Total	Right	Thru	Left	Peds	App. Total	Right	Thru	Left	Peds	App. Total	Right	Thru	Left	Peds	App. Total	
04:00 PM	1	0	0	0	1	0	30	0	0	30	11	8	9	0	28	1	61	3	1	66	125
04:15 PM	1	0	0	0	1	0	22	0	0	22	8	2	13	0	23	0	57	3	0	60	106
04:30 PM	1	0	0	0	1	0	28	1	0	29	20	10	12	0	42	0	66	1	0	67	139
04:45 PM	3	0	0	0	3	1	36	0	0	37	12	5	14	0	31	0	85	5	1	91	162
Total	6	0	0	0	6	1	116	1	0	118	51	25	48	0	124	1	269	12	2	284	532
05:00 PM	7	0	0	0	7	0	35	0	0	35	15	13	12	0	40	0	78	5	0	83	165
05:15 PM	4	0	0	0	4	1	33	0	0	34	5	6	11	0	22	0	98	2	0	100	160
05:30 PM	3	0	0	0	3	1	33	0	0	34	5	2	10	0	17	0	82	1	0	83	137
05:45 PM	0	0	0	0	0	0	31	0	0	31	2	1	4	0	7	0	57	2	0	59	97
Total	14	0	0	0	14	2	132	0	0	134	27	22	37	0	86	0	315	10	0	325	559
Grand Total	20	0	0	0	20	3	248	1	0	252	78	47	85	0	210	1	584	22	2	609	1091
Apprch %	100	0	0	0		1.2	98.4	0.4	0		37.1	22.4	40.5	0		0.2	95.9	3.6	0.3		
Total %	1.8	0	0	0	1.8	0.3	22.7	0.1	0	23.1	7.1	4.3	7.8	0	19.2	0.1	53.5	2	0.2	55.8	
Lights	20	0	0	0	20	3	241	1	0	245	78	47	85	0	210	1	568	21	2	592	1067
% Lights	100	0	0	0	100	100	97.2	100	0	97.2	100	100	100	0	100	100	97.3	95.5	100	97.2	97.8
Buses	0	0	0	0	0	0	4	0	0	4	0	0	0	0	0	0	10	1	0	11	15
% Buses	0	0	0	0	0	0	1.6	0	0	1.6	0	0	0	0	0	0	1.7	4.5	0	1.8	1.4
Trucks	0	0	0	0	0	0	3	0	0	3	0	0	0	0	0	0	6	0	0	6	9
% Trucks	0	0	0	0	0	0	1.2	0	0	1.2	0	0	0	0	0	0	1	0	0	1	0.8

Start Time	6TH AVE Southbound				GIGLING RD Westbound				6TH AVE Northbound				GIGLING RD Eastbound				Int. Total
	Right	Thru	Left	App. Total	Right	Thru	Left	App. Total	Right	Thru	Left	App. Total	Right	Thru	Left	App. Total	
Peak Hour Analysis From 04:00 PM to 05:45 PM - Peak 1 of 1																	
Peak Hour for Entire Intersection Begins at 04:30 PM																	
04:30 PM	1	0	0	1	0	28	1	29	20	10	12	42	0	66	1	67	139
04:45 PM	3	0	0	3	1	36	0	37	12	5	14	31	0	85	5	90	161
05:00 PM	7	0	0	7	0	35	0	35	15	13	12	40	0	78	5	83	165
05:15 PM	4	0	0	4	1	33	0	34	5	6	11	22	0	98	2	100	160
Total Volume	15	0	0	15	2	132	1	135	52	34	49	135	0	327	13	340	625
% App. Total	100	0	0		1.5	97.8	0.7		38.5	25.2	36.3		0	96.2	3.8		
PHF	.536	.000	.000	.536	.500	.917	.250	.912	.650	.654	.875	.804	.000	.834	.650	.850	.947

Traffic Data Service

San Jose, CA
 (408) 622-4787
 tdsbay@cs.com

File Name : 15PM FINAL
 Site Code : 00000015
 Start Date : 4/25/2018
 Page No : 2

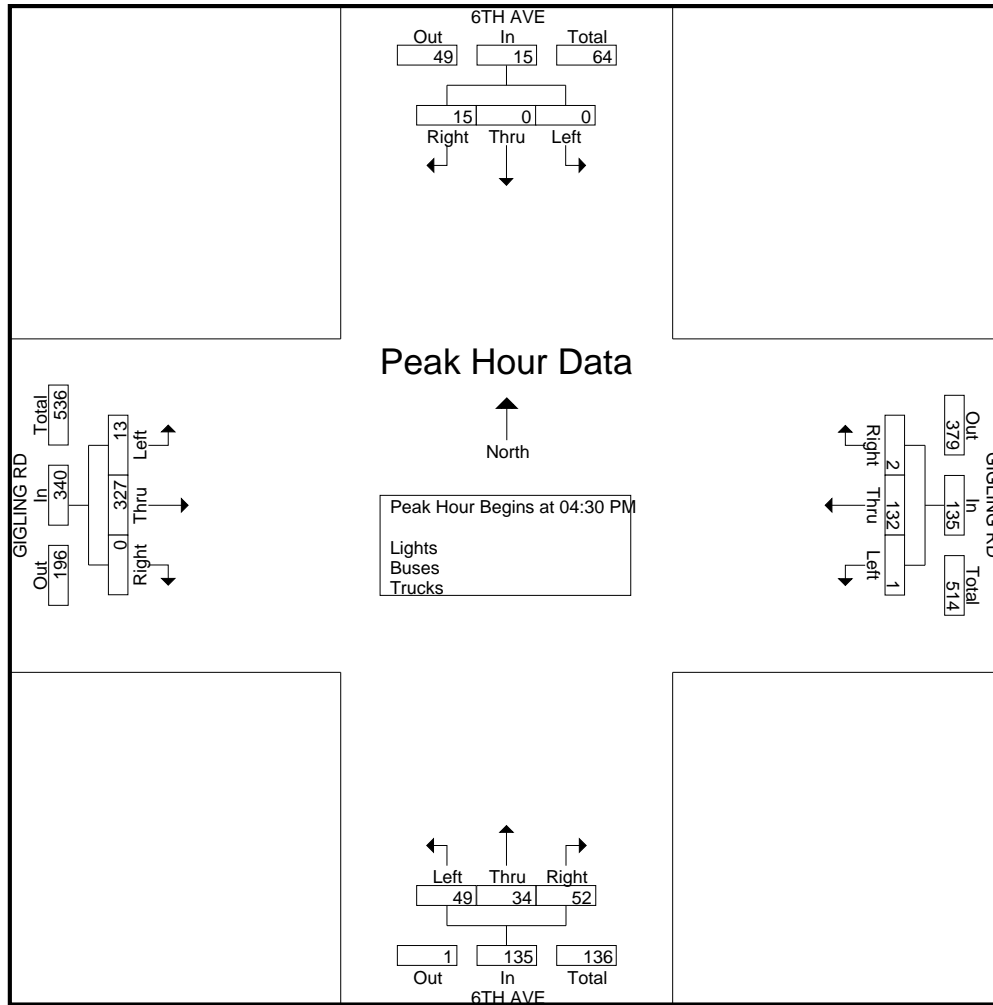

Traffic Data Service

San Jose, CA
 (408) 622-4787
 tdsbay@cs.com

File Name : 15PM FINAL
 Site Code : 00000015
 Start Date : 4/25/2018
 Page No : 1

Groups Printed- Bikes

Start Time	6TH AVE Southbound					GIGLING RD Westbound					6TH AVE Northbound					GIGLING RD Eastbound					Int. Total	
	Right	Thru	Left	Peds	App. Total	Right	Thru	Left	Peds	App. Total	Right	Thru	Left	Peds	App. Total	Right	Thru	Left	Peds	App. Total		
04:00 PM	0	0	0	0	0	0	0	0	0	0	0	0	0	0	0	0	0	0	0	0	0	0
04:15 PM	0	0	0	0	0	0	0	0	0	0	0	0	0	0	0	0	0	0	0	0	0	0
04:30 PM	0	0	0	0	0	0	0	0	0	0	0	0	0	0	0	0	0	0	0	0	0	0
04:45 PM	0	0	0	0	0	0	0	0	0	0	0	0	0	0	0	0	0	0	0	0	0	0
Total	0	0	0	0	0	0	0	0	0	0	0	0	0	0	0	0	0	0	0	0	0	0
05:00 PM	0	0	0	0	0	0	0	0	0	0	0	2	0	0	2	0	0	0	0	0	0	2
05:15 PM	0	0	0	0	0	0	0	0	0	0	0	0	0	0	0	0	1	0	0	0	0	1
05:30 PM	0	0	0	0	0	0	0	0	0	0	0	0	0	0	0	0	0	0	0	0	0	0
05:45 PM	0	0	0	0	0	0	0	0	0	0	0	0	0	0	0	0	0	0	0	0	0	0
Total	0	0	0	0	0	0	0	0	0	0	0	2	0	0	2	0	1	0	0	0	0	3
Grand Total	0	0	0	0	0	0	0	0	0	0	0	2	0	0	2	0	1	0	0	0	0	3
Apprch %	0	0	0	0	0	0	0	0	0	0	0	100	0	0	0	0	100	0	0	0	0	0
Total %	0	0	0	0	0	0	0	0	0	0	0	66.7	0	0	66.7	0	33.3	0	0	33.3	0	0

Start Time	6TH AVE Southbound					GIGLING RD Westbound					6TH AVE Northbound					GIGLING RD Eastbound					Int. Total	
	Right	Thru	Left	Peds	App. Total	Right	Thru	Left	Peds	App. Total	Right	Thru	Left	Peds	App. Total	Right	Thru	Left	Peds	App. Total		
Peak Hour Analysis From 04:00 PM to 05:45 PM - Peak 1 of 1																						
Peak Hour for Entire Intersection Begins at 04:30 PM																						
04:30 PM	0	0	0	0	0	0	0	0	0	0	0	0	0	0	0	0	0	0	0	0	0	0
04:45 PM	0	0	0	0	0	0	0	0	0	0	0	0	0	0	0	0	0	0	0	0	0	0
05:00 PM	0	0	0	0	0	0	0	0	0	0	0	2	0	0	2	0	0	0	0	0	0	2
05:15 PM	0	0	0	0	0	0	0	0	0	0	0	0	0	0	0	0	1	0	0	0	0	1
Total Volume	0	0	0	0	0	0	0	0	0	0	0	2	0	0	2	0	1	0	0	0	0	3
% App. Total	0	0	0	0	0	0	0	0	0	0	0	100	0	0	0	0	100	0	0	0	0	0
PHF	.000	.000	.000	.000	.000	.000	.000	.000	.000	.000	.000	.250	.000	.250	.000	.000	.250	.000	.250	.000	.000	.375

Traffic Data Service

San Jose, CA
 (408) 622-4787
 tdsbay@cs.com

File Name : 15PM FINAL
 Site Code : 00000015
 Start Date : 4/25/2018
 Page No : 2

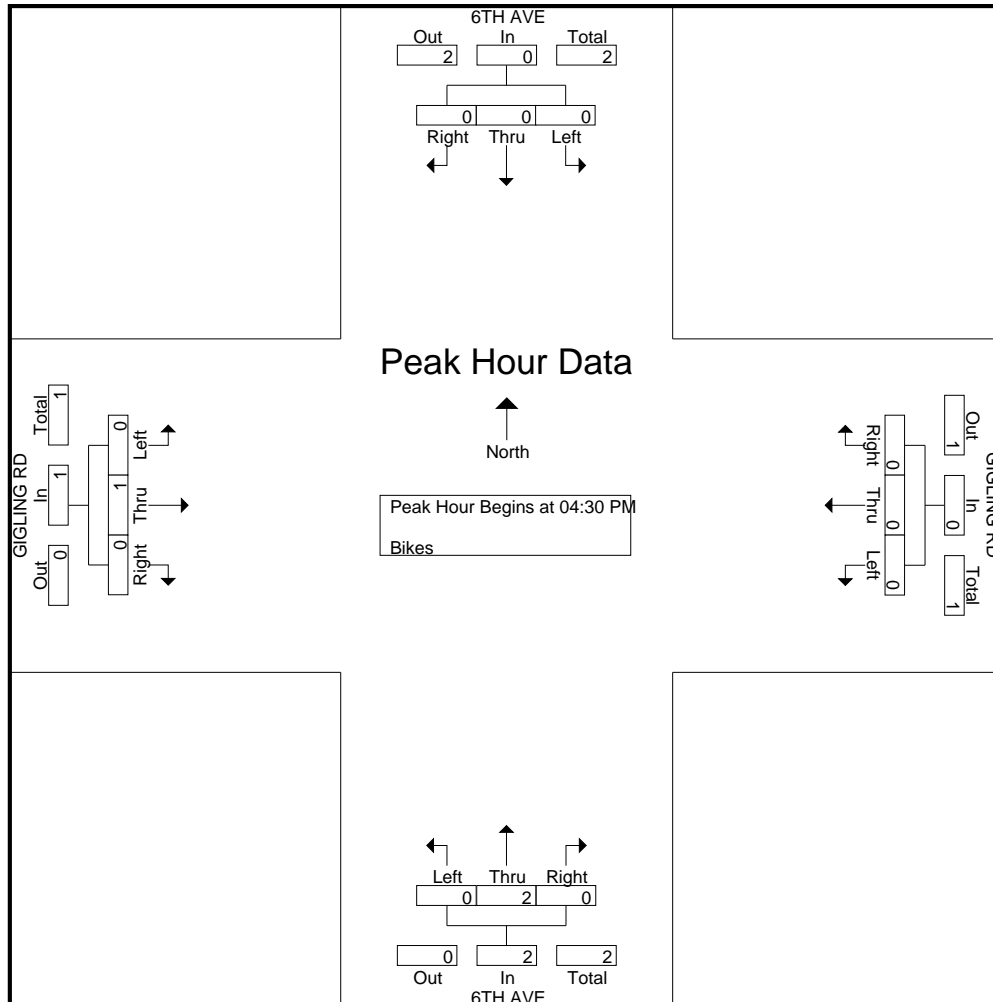

Traffic Data Service

San Jose, CA
(408) 622-4787
tdsbay@cs.com

File Name : 16AM FINAL
Site Code : 00000016
Start Date : 4/25/2018
Page No : 1

Groups Printed- Lights - Buses - Trucks

Start Time	7TH AVE Southbound					GIGLING RD Westbound					DRIVEWAY Northbound					GIGLING RD Eastbound					Int. Total
	Right	Thru	Left	Peds	App. Total	Right	Thru	Left	Peds	App. Total	Right	Thru	Left	Peds	App. Total	Right	Thru	Left	Peds	App. Total	
07:00 AM	6	0	0	0	6	0	76	0	0	76	0	0	0	0	0	0	21	2	0	23	105
07:15 AM	26	0	0	0	26	0	125	0	0	125	0	0	0	0	0	0	27	1	0	28	179
07:30 AM	27	0	0	0	27	0	108	0	0	108	0	0	0	0	0	0	27	5	0	32	167
07:45 AM	31	0	1	0	32	0	100	0	0	100	0	0	0	0	0	0	28	8	0	36	168
Total	90	0	1	0	91	0	409	0	0	409	0	0	0	0	0	0	103	16	0	119	619
08:00 AM	16	0	0	1	17	0	52	0	0	52	0	0	0	0	0	0	29	8	0	37	106
08:15 AM	16	0	1	0	17	0	54	0	0	54	0	0	0	0	0	0	27	1	0	28	99
08:30 AM	16	0	3	0	19	0	42	0	0	42	0	0	0	0	0	0	18	2	0	20	81
08:45 AM	6	0	0	0	6	0	30	0	0	30	0	0	0	0	0	0	14	1	0	15	51
Total	54	0	4	1	59	0	178	0	0	178	0	0	0	0	0	0	88	12	0	100	337
Grand Total	144	0	5	1	150	0	587	0	0	587	0	0	0	0	0	0	191	28	0	219	956
Apprch %	96	0	3.3	0.7		0	100	0	0		0	0	0	0		0	87.2	12.8	0		
Total %	15.1	0	0.5	0.1	15.7	0	61.4	0	0	61.4	0	0	0	0	0	0	20	2.9	0	22.9	
Lights	136	0	2	1	139	0	584	0	0	584	0	0	0	0	0	0	185	26	0	211	934
% Lights	94.4	0	40	100	92.7	0	99.5	0	0	99.5	0	0	0	0	0	0	96.9	92.9	0	96.3	97.7
Buses	2	0	1	0	3	0	2	0	0	2	0	0	0	0	0	0	5	1	0	6	11
% Buses	1.4	0	20	0	2	0	0.3	0	0	0.3	0	0	0	0	0	0	2.6	3.6	0	2.7	1.2
Trucks	6	0	2	0	8	0	1	0	0	1	0	0	0	0	0	0	1	1	0	2	11
% Trucks	4.2	0	40	0	5.3	0	0.2	0	0	0.2	0	0	0	0	0	0	0.5	3.6	0	0.9	1.2

Start Time	7TH AVE Southbound				GIGLING RD Westbound				DRIVEWAY Northbound				GIGLING RD Eastbound				Int. Total
	Right	Thru	Left	App. Total	Right	Thru	Left	App. Total	Right	Thru	Left	App. Total	Right	Thru	Left	App. Total	
Peak Hour Analysis From 07:00 AM to 08:45 AM - Peak 1 of 1																	
Peak Hour for Entire Intersection Begins at 07:00 AM																	
07:00 AM	6	0	0	6	0	76	0	76	0	0	0	0	0	21	2	23	105
07:15 AM	26	0	0	26	0	125	0	125	0	0	0	0	0	27	1	28	179
07:30 AM	27	0	0	27	0	108	0	108	0	0	0	0	0	27	5	32	167
07:45 AM	31	0	1	32	0	100	0	100	0	0	0	0	0	28	8	36	168
Total Volume	90	0	1	91	0	409	0	409	0	0	0	0	0	103	16	119	619
% App. Total	98.9	0	1.1		0	100	0		0	0	0		0	86.6	13.4		
PHF	.726	.000	.250	.711	.000	.818	.000	.818	.000	.000	.000	.000	.000	.920	.500	.826	.865

Traffic Data Service

San Jose, CA
 (408) 622-4787
 tdsbay@cs.com

File Name : 16AM FINAL
 Site Code : 00000016
 Start Date : 4/25/2018
 Page No : 2

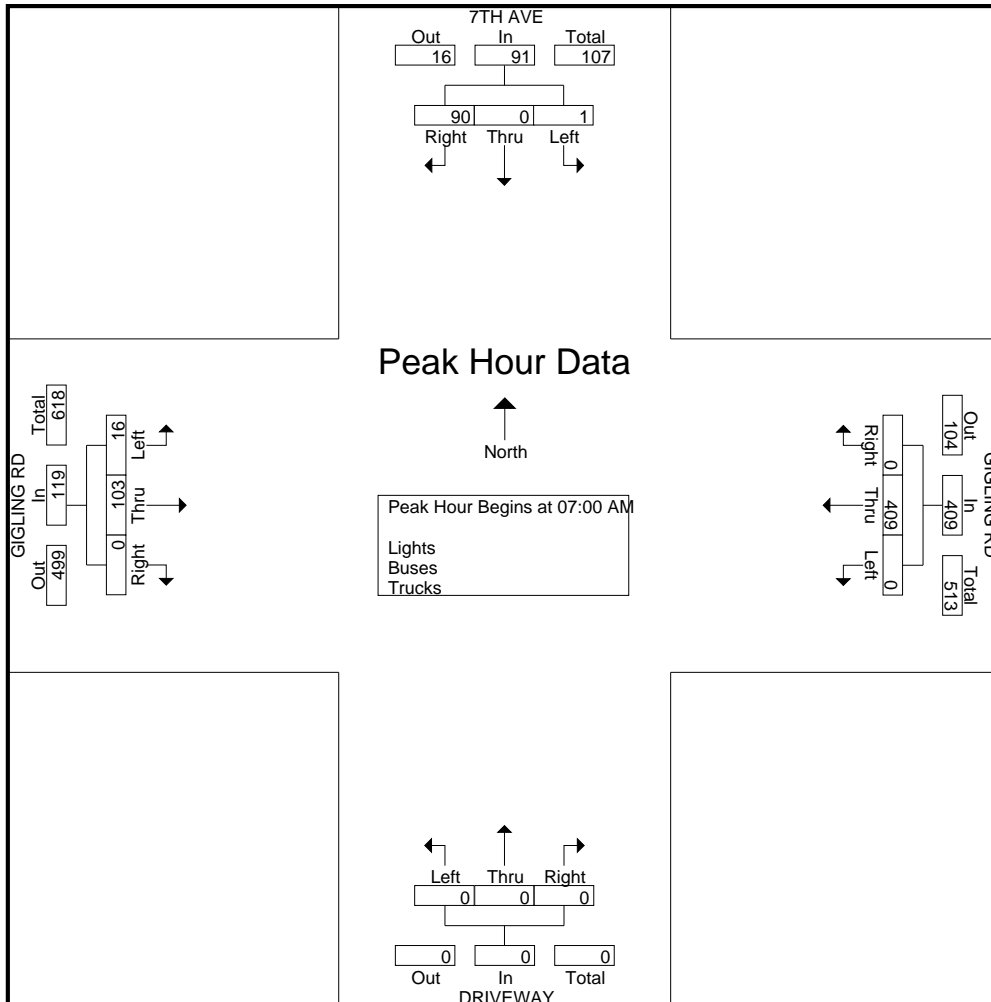

Traffic Data Service

San Jose, CA
 (408) 622-4787
 tdsbay@cs.com

File Name : 16AM FINAL
 Site Code : 00000016
 Start Date : 4/25/2018
 Page No : 1

Groups Printed- Bikes

Start Time	7TH AVE Southbound					GIGLING RD Westbound					DRIVEWAY Northbound					GIGLING RD Eastbound					Int. Total
	Right	Thru	Left	Peds	App. Total	Right	Thru	Left	Peds	App. Total	Right	Thru	Left	Peds	App. Total	Right	Thru	Left	Peds	App. Total	
07:00 AM	0	0	0	0	0	0	0	0	0	0	0	0	0	0	0	0	0	0	0	0	0
07:15 AM	0	0	0	0	0	0	0	0	0	0	0	0	0	0	0	0	0	0	0	0	0
07:30 AM	0	0	0	0	0	0	0	0	0	0	0	0	0	0	0	0	0	0	0	0	0
07:45 AM	0	0	0	0	0	0	0	0	0	0	0	0	0	0	0	0	0	0	0	0	0
Total	0	0	0	0	0	0	0	0	0	0	0	0	0	0	0	0	0	0	0	0	0
08:00 AM	0	0	0	0	0	0	0	0	0	0	0	0	0	0	0	0	0	0	0	0	0
08:15 AM	0	0	0	0	0	0	0	0	0	0	0	0	0	0	0	0	0	0	0	0	0
08:30 AM	0	0	0	0	0	0	0	0	0	0	0	0	0	0	0	0	0	0	0	0	0
08:45 AM	0	0	0	0	0	0	0	0	0	0	0	0	0	0	0	0	0	0	0	0	0
Total	0	0	0	0	0	0	0	0	0	0	0	0	0	0	0	0	0	0	0	0	0
Grand Total	0	0	0	0	0	0	0	0	0	0	0	0	0	0	0	0	0	0	0	0	0
Apprch %	0	0	0	0		0	0	0	0		0	0	0	0		0	0	0	0		
Total %																					

Start Time	7TH AVE Southbound					GIGLING RD Westbound					DRIVEWAY Northbound					GIGLING RD Eastbound					Int. Total
	Right	Thru	Left	Peds	App. Total	Right	Thru	Left	Peds	App. Total	Right	Thru	Left	Peds	App. Total	Right	Thru	Left	Peds	App. Total	
Peak Hour Analysis From 07:00 AM to 08:45 AM - Peak 1 of 1																					
Peak Hour for Entire Intersection Begins at 07:00 AM																					
07:00 AM	0	0	0	0	0	0	0	0	0	0	0	0	0	0	0	0	0	0	0	0	0
07:15 AM	0	0	0	0	0	0	0	0	0	0	0	0	0	0	0	0	0	0	0	0	0
07:30 AM	0	0	0	0	0	0	0	0	0	0	0	0	0	0	0	0	0	0	0	0	0
07:45 AM	0	0	0	0	0	0	0	0	0	0	0	0	0	0	0	0	0	0	0	0	0
Total Volume	0	0	0	0	0	0	0	0	0	0	0	0	0	0	0	0	0	0	0	0	0
% App. Total	0	0	0	0		0	0	0	0		0	0	0	0		0	0	0	0		
PHF	.000	.000	.000	.000	.000	.000	.000	.000	.000	.000	.000	.000	.000	.000	.000	.000	.000	.000	.000	.000	.000

Traffic Data Service

San Jose, CA
(408) 622-4787
tdsbay@cs.com

File Name : 16AM FINAL
Site Code : 00000016
Start Date : 4/25/2018
Page No : 2

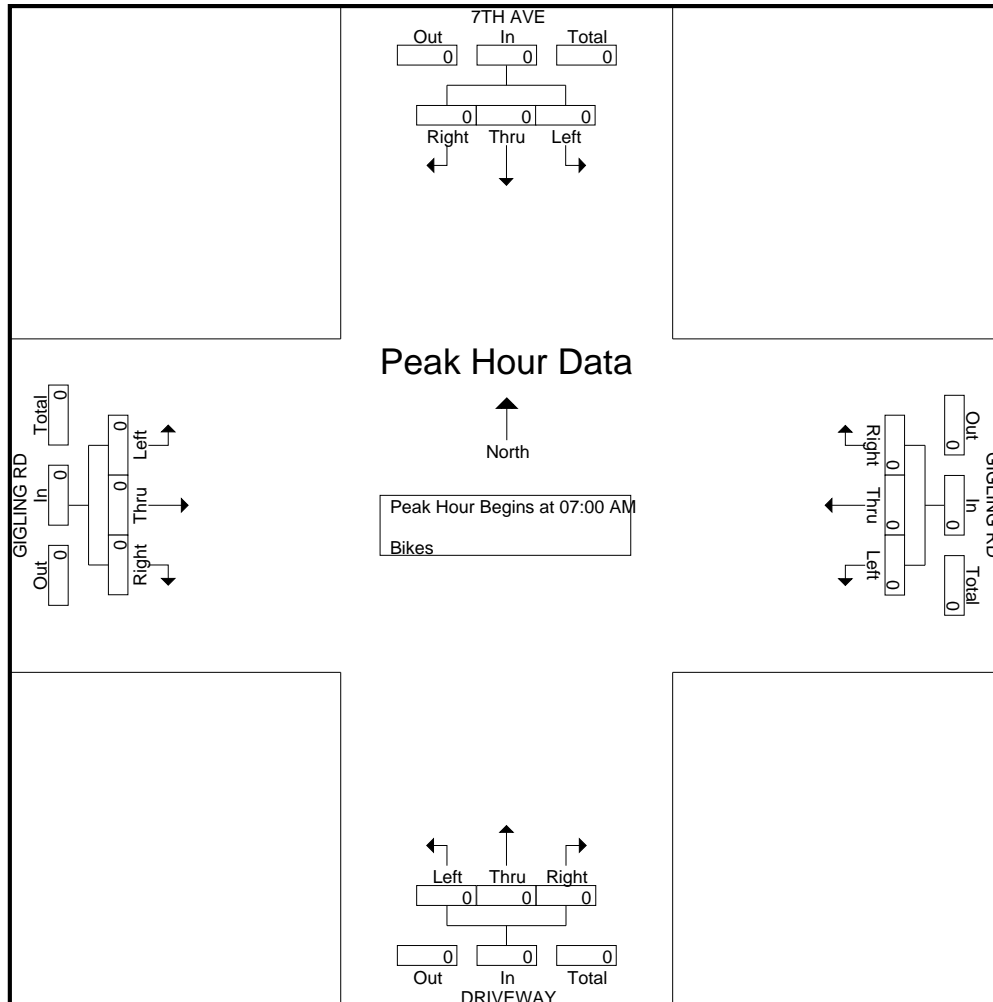

Traffic Data Service

San Jose, CA
 (408) 622-4787
 tdsbay@cs.com

File Name : 16PM FINAL
 Site Code : 00000016
 Start Date : 4/25/2018
 Page No : 1

Groups Printed- Lights - Buses - Trucks

Start Time	7TH AVE Southbound					GIGLING RD Westbound					DRIVEWAY Northbound					GIGLING RD Eastbound					Int. Total
	Right	Thru	Left	Peds	App. Total	Right	Thru	Left	Peds	App. Total	Right	Thru	Left	Peds	App. Total	Right	Thru	Left	Peds	App. Total	
04:00 PM	3	0	1	0	4	1	28	0	0	29	0	0	0	0	0	0	59	9	0	68	101
04:15 PM	6	0	0	0	6	0	15	0	0	15	0	0	0	0	0	0	61	7	0	68	89
04:30 PM	4	0	0	0	4	0	25	1	0	26	0	0	0	0	0	0	75	8	0	83	113
04:45 PM	7	0	0	0	7	1	30	0	0	31	0	0	0	0	0	0	86	11	0	97	135
Total	20	0	1	0	21	2	98	1	0	101	0	0	0	0	0	0	281	35	0	316	438
05:00 PM	7	0	0	0	7	0	27	0	0	27	0	0	0	0	0	0	86	8	0	94	128
05:15 PM	6	0	0	0	6	0	29	0	1	30	0	0	0	0	0	0	100	2	0	102	138
05:30 PM	4	0	0	0	4	0	30	0	0	30	0	0	0	0	0	0	81	9	0	90	124
05:45 PM	7	0	3	0	10	0	23	0	0	23	0	0	0	0	0	0	53	4	0	57	90
Total	24	0	3	0	27	0	109	0	1	110	0	0	0	0	0	0	320	23	0	343	480
Grand Total	44	0	4	0	48	2	207	1	1	211	0	0	0	0	0	0	601	58	0	659	918
Apprch %	91.7	0	8.3	0		0.9	98.1	0.5	0.5		0	0	0	0	0	0	91.2	8.8	0		
Total %	4.8	0	0.4	0	5.2	0.2	22.5	0.1	0.1	23	0	0	0	0	0	0	65.5	6.3	0	71.8	
Lights	41	0	4	0	45	1	204	1	1	207	0	0	0	0	0	0	589	53	0	642	894
% Lights	93.2	0	100	0	93.8	50	98.6	100	100	98.1	0	0	0	0	0	0	98	91.4	0	97.4	97.4
Buses	2	0	0	0	2	0	2	0	0	2	0	0	0	0	0	0	7	2	0	9	13
% Buses	4.5	0	0	0	4.2	0	1	0	0	0.9	0	0	0	0	0	0	1.2	3.4	0	1.4	1.4
Trucks	1	0	0	0	1	1	1	0	0	2	0	0	0	0	0	0	5	3	0	8	11
% Trucks	2.3	0	0	0	2.1	50	0.5	0	0	0.9	0	0	0	0	0	0	0.8	5.2	0	1.2	1.2

Start Time	7TH AVE Southbound				GIGLING RD Westbound				DRIVEWAY Northbound				GIGLING RD Eastbound				Int. Total	
	Right	Thru	Left	App. Total	Right	Thru	Left	App. Total	Right	Thru	Left	App. Total	Right	Thru	Left	App. Total		
Peak Hour Analysis From 04:00 PM to 05:45 PM - Peak 1 of 1																		
Peak Hour for Entire Intersection Begins at 04:45 PM																		
04:45 PM	7	0	0	7	1	30	0	31	0	0	0	0	0	0	86	11	97	135
05:00 PM	7	0	0	7	0	27	0	27	0	0	0	0	0	0	86	8	94	128
05:15 PM	6	0	0	6	0	29	0	29	0	0	0	0	0	100	2	102	137	
05:30 PM	4	0	0	4	0	30	0	30	0	0	0	0	0	81	9	90	124	
Total Volume	24	0	0	24	1	116	0	117	0	0	0	0	0	353	30	383	524	
% App. Total	100	0	0		0.9	99.1	0		0	0	0		0	92.2	7.8			
PHF	.857	.000	.000	.857	.250	.967	.000	.944	.000	.000	.000	.000	.000	.883	.682	.939	.956	

Traffic Data Service

San Jose, CA
 (408) 622-4787
 tdsbay@cs.com

File Name : 16PM FINAL
 Site Code : 00000016
 Start Date : 4/25/2018
 Page No : 2

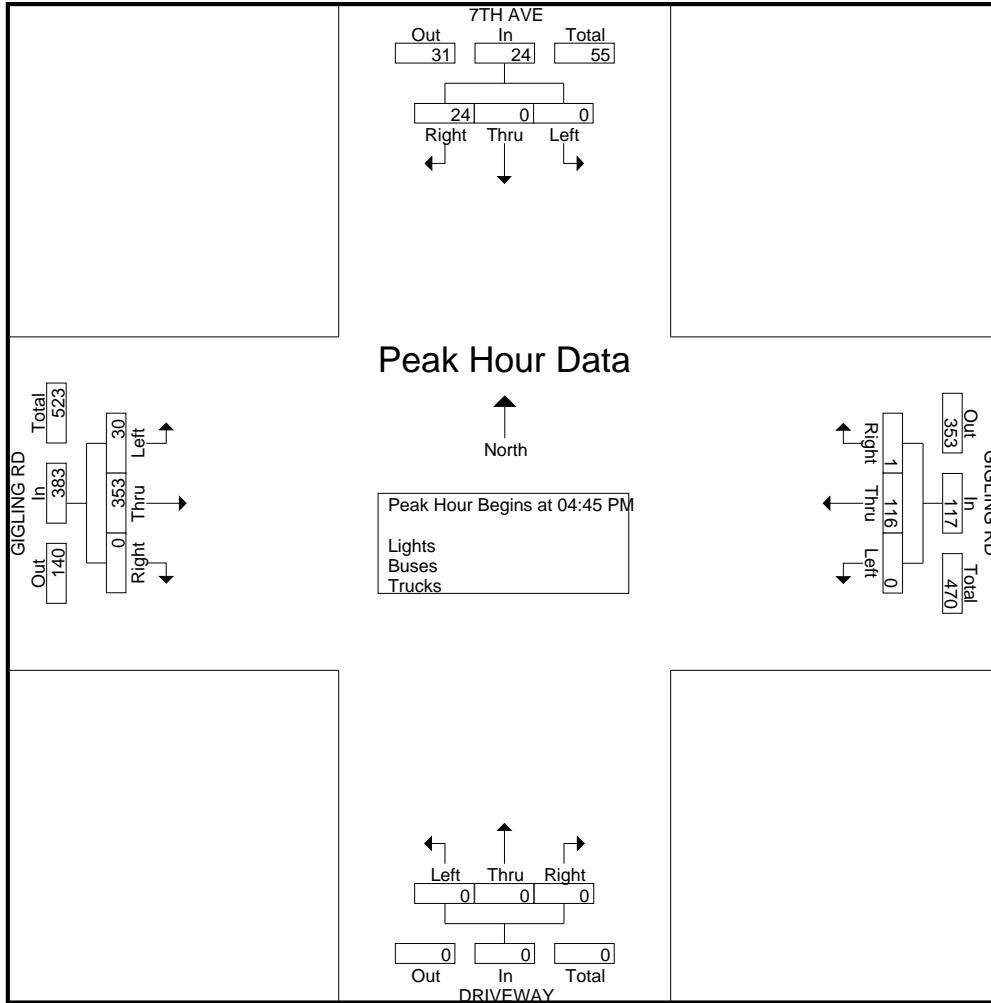

Traffic Data Service

San Jose, CA
 (408) 622-4787
 tdsbay@cs.com

File Name : 16PM FINAL
 Site Code : 00000016
 Start Date : 4/25/2018
 Page No : 1

Groups Printed- Bikes

Start Time	7TH AVE Southbound					GIGLING RD Westbound					DRIVEWAY Northbound					GIGLING RD Eastbound					Int. Total
	Right	Thru	Left	Peds	App. Total	Right	Thru	Left	Peds	App. Total	Right	Thru	Left	Peds	App. Total	Right	Thru	Left	Peds	App. Total	
04:00 PM	0	0	0	0	0	0	0	0	0	0	0	0	0	0	0	0	0	0	0	0	0
04:15 PM	0	0	0	0	0	1	0	0	0	1	0	0	0	0	0	0	0	0	0	0	0
04:30 PM	0	0	1	0	1	0	0	0	0	0	0	0	0	0	0	0	0	0	0	0	0
04:45 PM	0	0	0	0	0	1	0	0	0	1	0	0	0	0	0	0	0	0	0	0	0
Total	0	0	1	0	1	2	0	0	0	2	0	0	0	0	0	0	0	0	0	0	3
05:00 PM	0	0	0	0	0	0	0	0	0	0	0	0	0	0	0	0	0	0	0	0	0
05:15 PM	0	0	0	0	0	0	0	0	0	0	0	0	0	0	0	0	0	1	0	1	1
05:30 PM	0	0	0	0	0	0	0	0	0	0	0	0	0	0	0	0	0	0	0	0	0
05:45 PM	0	0	0	0	0	0	0	0	0	0	0	0	0	0	0	0	0	0	0	0	0
Total	0	0	0	0	0	0	0	0	0	0	0	0	0	0	0	0	0	1	0	1	1
Grand Total	0	0	1	0	1	2	0	0	0	2	0	0	0	0	0	0	0	1	0	1	4
Apprch %	0	0	100	0		100	0	0	0		0	0	0	0		0	0	100	0		
Total %	0	0	25	0	25	50	0	0	0	50	0	0	0	0	0	0	0	25	0	25	

Start Time	7TH AVE Southbound					GIGLING RD Westbound					DRIVEWAY Northbound					GIGLING RD Eastbound					Int. Total
	Right	Thru	Left	Peds	App. Total	Right	Thru	Left	Peds	App. Total	Right	Thru	Left	Peds	App. Total	Right	Thru	Left	Peds	App. Total	
Peak Hour Analysis From 04:00 PM to 05:45 PM - Peak 1 of 1																					
Peak Hour for Entire Intersection Begins at 04:00 PM																					
04:00 PM	0	0	0	0	0	0	0	0	0	0	0	0	0	0	0	0	0	0	0	0	0
04:15 PM	0	0	0	0	0	1	0	0	0	1	0	0	0	0	0	0	0	0	0	0	1
04:30 PM	0	0	1	0	1	0	0	0	0	0	0	0	0	0	0	0	0	0	0	0	1
04:45 PM	0	0	0	0	0	1	0	0	0	1	0	0	0	0	0	0	0	0	0	0	1
Total Volume	0	0	1	0	1	2	0	0	0	2	0	0	0	0	0	0	0	0	0	0	3
% App. Total	0	0	100	0		100	0	0	0		0	0	0	0		0	0	0	0		
PHF	.000	.000	.250		.250	.500	.000	.000		.500	.000	.000	.000		.000	.000	.000	.000		.000	.750

Traffic Data Service

San Jose, CA
 (408) 622-4787
 tdsbay@cs.com

File Name : 16PM FINAL
 Site Code : 00000016
 Start Date : 4/25/2018
 Page No : 2

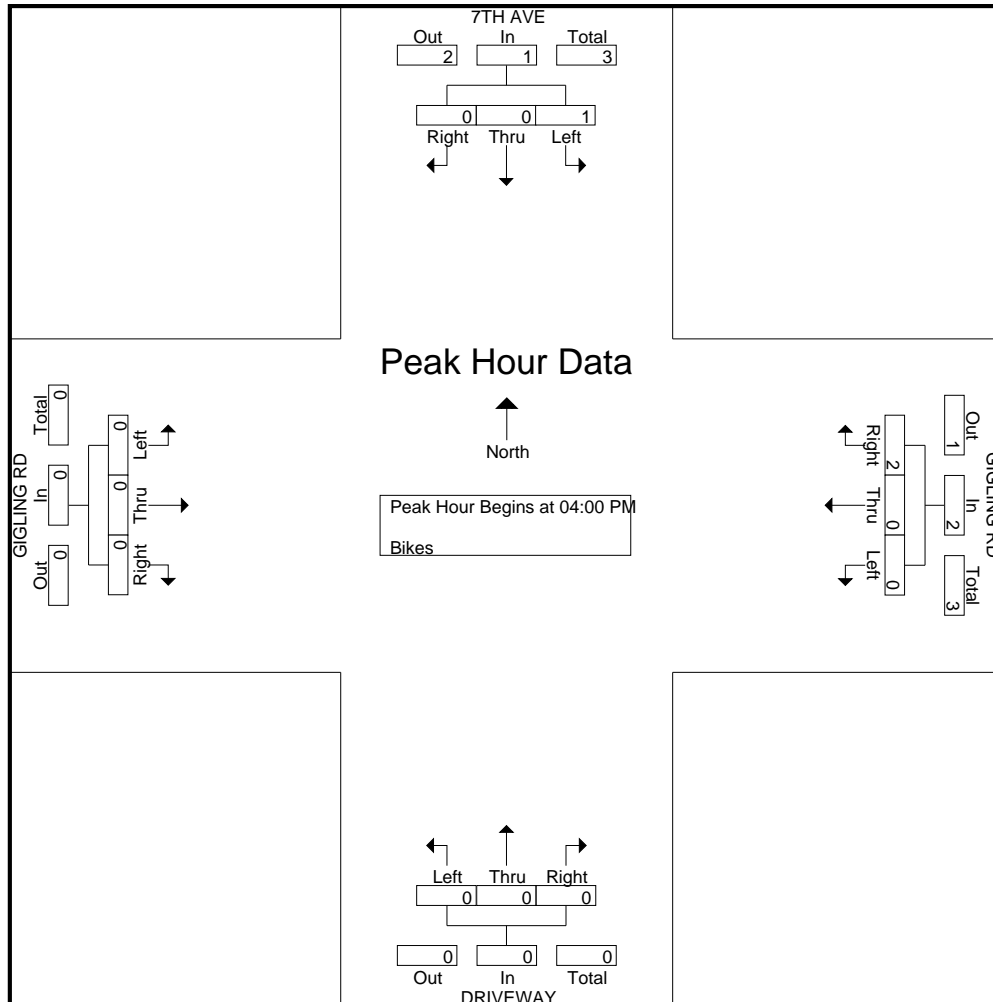

Traffic Data Service

San Jose, CA
 (408) 622-4787
 tdsbay@cs.com

File Name : 17AM FINAL
 Site Code : 00000017
 Start Date : 4/25/2018
 Page No : 1

Groups Printed- Lights - Buses - Trucks

Start Time	8TH AVE Southbound					GIGLING RD Westbound					8TH AVE Northbound					GIGLING RD Eastbound					Int. Total
	Right	Thru	Left	Peds	App. Total	Right	Thru	Left	Peds	App. Total	Right	Thru	Left	Peds	App. Total	Right	Thru	Left	Peds	App. Total	
07:00 AM	78	0	1	0	79	0	0	0	0	0	0	0	0	0	0	4	1	15	0	20	99
07:15 AM	125	0	0	0	125	0	0	0	0	0	0	0	0	0	0	6	1	19	0	26	151
07:30 AM	107	1	0	0	108	0	0	0	0	0	0	0	1	0	1	2	0	26	0	28	137
07:45 AM	98	2	0	0	100	0	0	0	0	0	0	0	0	0	0	1	0	28	0	29	129
Total	408	3	1	0	412	0	0	0	0	0	0	0	1	0	1	13	2	88	0	103	516
08:00 AM	51	0	0	1	52	0	0	0	0	0	0	0	0	0	0	0	0	27	0	27	79
08:15 AM	55	0	0	0	55	0	0	0	0	0	0	0	0	0	0	0	1	26	0	27	82
08:30 AM	42	1	1	0	44	0	0	0	0	0	0	0	0	0	0	1	0	19	0	20	64
08:45 AM	28	1	0	0	29	0	0	0	0	0	0	0	1	0	1	0	0	13	0	13	43
Total	176	2	1	1	180	0	0	0	0	0	0	0	1	0	1	1	1	85	0	87	268
Grand Total	584	5	2	1	592	0	0	0	0	0	0	0	2	0	2	14	3	173	0	190	784
Apprch %	98.6	0.8	0.3	0.2		0	0	0	0	0	0	0	100	0		7.4	1.6	91.1	0		
Total %	74.5	0.6	0.3	0.1	75.5	0	0	0	0	0	0	0	0.3	0	0.3	1.8	0.4	22.1	0	24.2	
Lights	581	5	2	1	589	0	0	0	0	0	0	0	2	0	2	14	2	165	0	181	772
% Lights	99.5	100	100	100	99.5	0	0	0	0	0	0	0	100	0	100	100	66.7	95.4	0	95.3	98.5
Buses	2	0	0	0	2	0	0	0	0	0	0	0	0	0	0	0	0	6	0	6	8
% Buses	0.3	0	0	0	0.3	0	0	0	0	0	0	0	0	0	0	0	0	3.5	0	3.2	1
Trucks	1	0	0	0	1	0	0	0	0	0	0	0	0	0	0	0	1	2	0	3	4
% Trucks	0.2	0	0	0	0.2	0	0	0	0	0	0	0	0	0	0	0	33.3	1.2	0	1.6	0.5

Start Time	8TH AVE Southbound				GIGLING RD Westbound				8TH AVE Northbound				GIGLING RD Eastbound				Int. Total	
	Right	Thru	Left	App. Total	Right	Thru	Left	App. Total	Right	Thru	Left	App. Total	Right	Thru	Left	App. Total		
Peak Hour Analysis From 07:00 AM to 08:45 AM - Peak 1 of 1																		
Peak Hour for Entire Intersection Begins at 07:00 AM																		
07:00 AM	78	0	1	79	0	0	0	0	0	0	0	0	0	4	1	15	20	99
07:15 AM	125	0	0	125	0	0	0	0	0	0	0	0	0	6	1	19	26	151
07:30 AM	107	1	0	108	0	0	0	0	0	0	0	1	1	2	0	26	28	137
07:45 AM	98	2	0	100	0	0	0	0	0	0	0	0	0	1	0	28	29	129
Total Volume	408	3	1	412	0	0	0	0	0	0	0	1	1	13	2	88	103	516
% App. Total	99	0.7	0.2		0	0	0			0	0	100		12.6	1.9	85.4		
PHF	.816	.375	.250	.824	.000	.000	.000	.000	.000	.000	.000	.250	.250	.542	.500	.786	.888	.854

Traffic Data Service

San Jose, CA
 (408) 622-4787
 tdsbay@cs.com

File Name : 17AM FINAL
 Site Code : 00000017
 Start Date : 4/25/2018
 Page No : 2

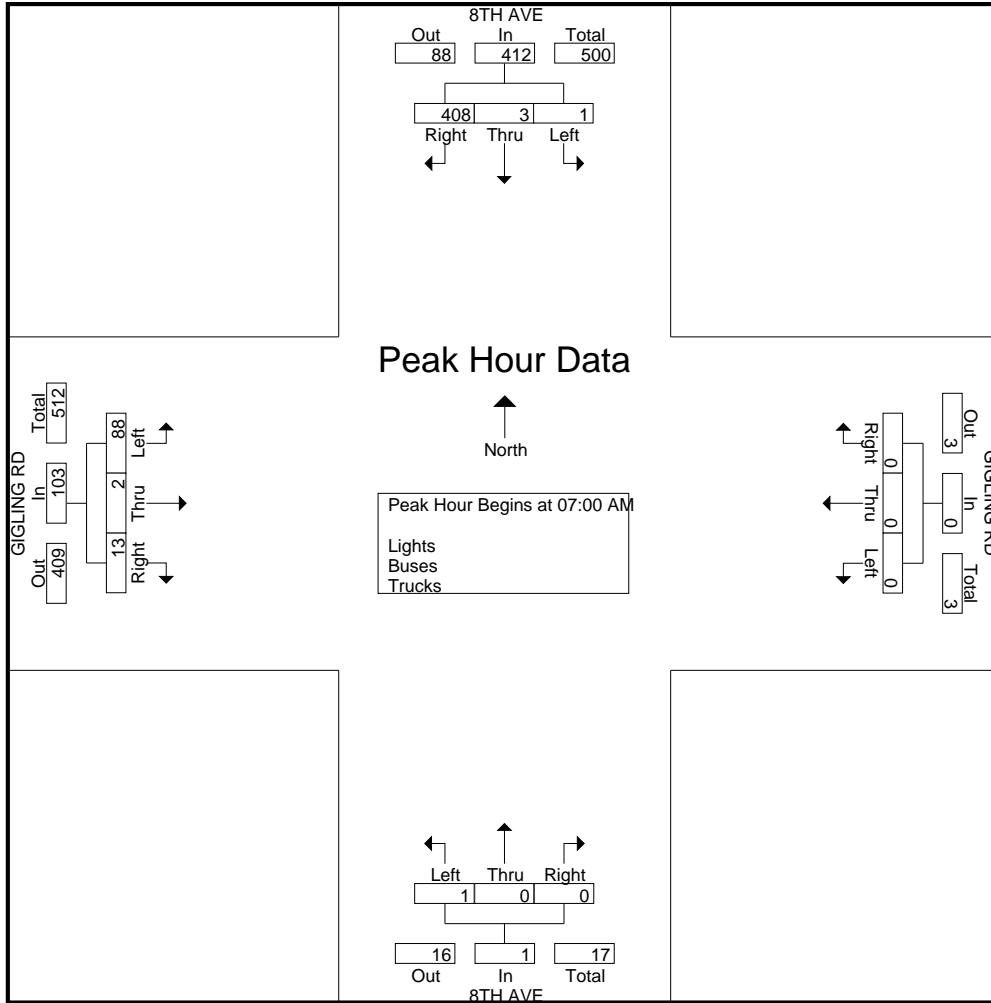

Traffic Data Service

San Jose, CA
 (408) 622-4787
 tdsbay@cs.com

File Name : 17AM FINAL
 Site Code : 00000017
 Start Date : 4/25/2018
 Page No : 1

Groups Printed- Bikes

Start Time	8TH AVE Southbound					GIGLING RD Westbound					8TH AVE Northbound					GIGLING RD Eastbound					Int. Total
	Right	Thru	Left	Peds	App. Total	Right	Thru	Left	Peds	App. Total	Right	Thru	Left	Peds	App. Total	Right	Thru	Left	Peds	App. Total	
07:00 AM	0	0	0	0	0	0	0	0	0	0	0	0	0	0	0	0	2	0	0	0	2
07:15 AM	0	0	0	0	0	0	0	0	0	0	0	0	0	0	0	0	0	0	0	0	0
07:30 AM	1	0	0	0	1	0	0	0	0	0	0	0	0	0	0	0	0	0	0	0	0
07:45 AM	0	0	0	0	0	0	0	0	0	0	0	0	0	0	0	0	0	0	0	0	0
Total	1	0	0	0	1	0	0	0	0	0	0	0	0	0	0	0	2	0	0	2	3
08:00 AM	0	0	0	0	0	0	0	0	0	0	0	0	1	0	1	0	0	0	0	0	0
08:15 AM	0	0	0	0	0	0	0	0	0	0	0	0	0	0	0	2	0	0	0	0	2
08:30 AM	0	0	0	0	0	0	0	0	0	0	0	0	0	0	0	0	0	0	0	0	0
08:45 AM	0	0	0	0	0	0	0	0	0	0	0	0	0	0	0	0	0	0	0	0	0
Total	0	0	0	0	0	0	0	0	0	0	0	0	1	0	1	2	0	0	0	2	3
Grand Total	1	0	0	0	1	0	0	0	0	0	0	0	1	0	1	2	2	0	0	4	6
Apprch %	100	0	0	0		0	0	0	0		0	0	100	0		50	50	0	0		
Total %	16.7	0	0	0	16.7	0	0	0	0	0	0	0	16.7	0	16.7	33.3	33.3	0	0	66.7	

Start Time	8TH AVE Southbound					GIGLING RD Westbound					8TH AVE Northbound					GIGLING RD Eastbound					Int. Total
	Right	Thru	Left	Peds	App. Total	Right	Thru	Left	Peds	App. Total	Right	Thru	Left	Peds	App. Total	Right	Thru	Left	Peds	App. Total	
Peak Hour Analysis From 07:00 AM to 08:45 AM - Peak 1 of 1																					
Peak Hour for Entire Intersection Begins at 07:30 AM																					
07:30 AM	1	0	0	0	1	0	0	0	0	0	0	0	0	0	0	0	0	0	0	0	0
07:45 AM	0	0	0	0	0	0	0	0	0	0	0	0	0	0	0	0	0	0	0	0	0
08:00 AM	0	0	0	0	0	0	0	0	0	0	0	0	0	1	1	0	0	0	0	0	0
08:15 AM	0	0	0	0	0	0	0	0	0	0	0	0	0	0	0	2	0	0	0	2	2
Total Volume	1	0	0	0	1	0	0	0	0	0	0	0	1	1	1	2	0	0	0	2	4
% App. Total	100	0	0	0		0	0	0	0		0	0	100	0		100	0	0	0		
PHF	.250	.000	.000	.000	.250	.000	.000	.000	.000	.000	.000	.000	.250	.250	.250	.250	.000	.000	.000	.250	.500

Traffic Data Service

San Jose, CA
 (408) 622-4787
 tdsbay@cs.com

File Name : 17AM FINAL
 Site Code : 00000017
 Start Date : 4/25/2018
 Page No : 2

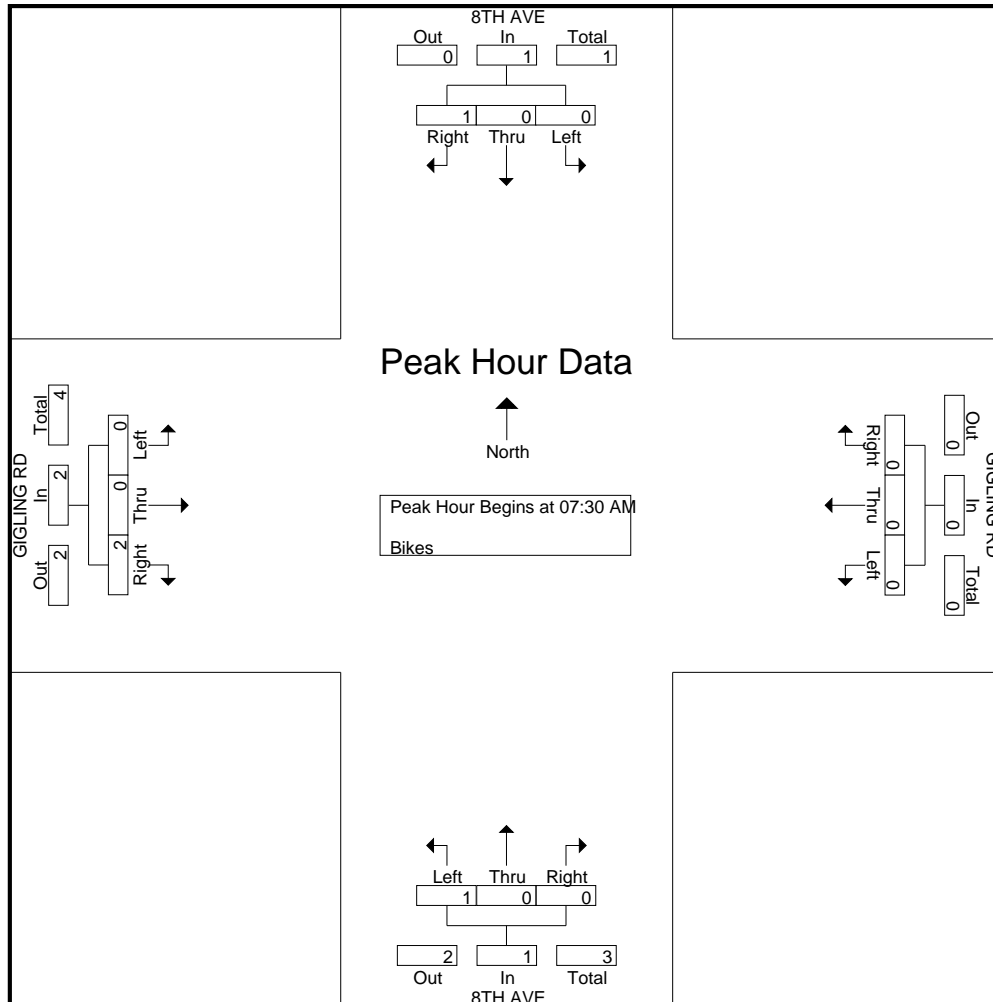

Traffic Data Service

San Jose, CA
 (408) 622-4787
 tdsbay@cs.com

File Name : 17PM FINAL
 Site Code : 00000017
 Start Date : 4/25/2018
 Page No : 1

Groups Printed- Lights - Buses - Trucks

Start Time	8TH AVE Southbound					GIGLING RD Westbound					8TH AVE Northbound					GIGLING RD Eastbound					Int. Total
	Right	Thru	Left	Peds	App. Total	Right	Thru	Left	Peds	App. Total	Right	Thru	Left	Peds	App. Total	Right	Thru	Left	Peds	App. Total	
04:00 PM	28	1	0	0	29	0	0	0	0	0	1	5	1	0	7	0	0	60	0	60	96
04:15 PM	14	0	0	0	14	0	0	0	0	0	0	17	1	0	18	0	0	59	0	59	91
04:30 PM	24	0	0	0	24	0	0	0	0	0	0	1	0	0	1	0	0	74	0	74	99
04:45 PM	30	0	0	0	30	0	0	0	0	0	0	0	1	0	1	0	0	83	0	83	114
Total	96	1	0	0	97	0	0	0	0	0	1	23	3	0	27	0	0	276	0	276	400
05:00 PM	26	0	0	0	26	0	0	0	0	0	0	0	1	0	1	1	0	81	0	82	109
05:15 PM	27	0	0	0	27	0	0	0	1	1	0	0	0	0	0	2	0	98	0	100	128
05:30 PM	31	0	0	0	31	0	0	0	0	0	0	0	0	0	0	2	0	78	0	80	111
05:45 PM	23	0	0	0	23	0	0	0	0	0	0	0	2	0	2	1	0	54	0	55	80
Total	107	0	0	0	107	0	0	0	1	1	0	0	3	0	3	6	0	311	0	317	428
Grand Total	203	1	0	0	204	0	0	0	1	1	1	23	6	0	30	6	0	587	0	593	828
Apprch %	99.5	0.5	0	0		0	0	0	100		3.3	76.7	20	0		1	0	99	0		
Total %	24.5	0.1	0	0	24.6	0	0	0	0.1	0.1	0.1	2.8	0.7	0	3.6	0.7	0	70.9	0	71.6	
Lights	200	1	0	0	201	0	0	0	1	1	1	23	6	0	30	6	0	575	0	581	813
% Lights	98.5	100	0	0	98.5	0	0	0	100	100	100	100	100	0	100	100	0	98	0	98	98.2
Buses	2	0	0	0	2	0	0	0	0	0	0	0	0	0	0	0	0	7	0	7	9
% Buses	1	0	0	0	1	0	0	0	0	0	0	0	0	0	0	0	0	1.2	0	1.2	1.1
Trucks	1	0	0	0	1	0	0	0	0	0	0	0	0	0	0	0	0	5	0	5	6
% Trucks	0.5	0	0	0	0.5	0	0	0	0	0	0	0	0	0	0	0	0	0.9	0	0.8	0.7

Start Time	8TH AVE Southbound				GIGLING RD Westbound				8TH AVE Northbound				GIGLING RD Eastbound				Int. Total	
	Right	Thru	Left	App. Total	Right	Thru	Left	App. Total	Right	Thru	Left	App. Total	Right	Thru	Left	App. Total		
Peak Hour Analysis From 04:00 PM to 05:45 PM - Peak 1 of 1																		
Peak Hour for Entire Intersection Begins at 04:45 PM																		
04:45 PM	30	0	0	30	0	0	0	0	0	0	0	1	1	0	0	83	83	114
05:00 PM	26	0	0	26	0	0	0	0	0	0	0	1	1	1	0	81	82	109
05:15 PM	27	0	0	27	0	0	0	0	0	0	0	0	0	2	0	98	100	127
05:30 PM	31	0	0	31	0	0	0	0	0	0	0	0	0	2	0	78	80	111
Total Volume	114	0	0	114	0	0	0	0	0	0	0	2	2	5	0	340	345	461
% App. Total	100	0	0		0	0	0				0	100		1.4	0	98.6		
PHF	.919	.000	.000	.919	.000	.000	.000	.000	.000	.000	.000	.500	.500	.625	.000	.867	.863	.907

Traffic Data Service

San Jose, CA
 (408) 622-4787
 tdsbay@cs.com

File Name : 17PM FINAL
 Site Code : 00000017
 Start Date : 4/25/2018
 Page No : 2

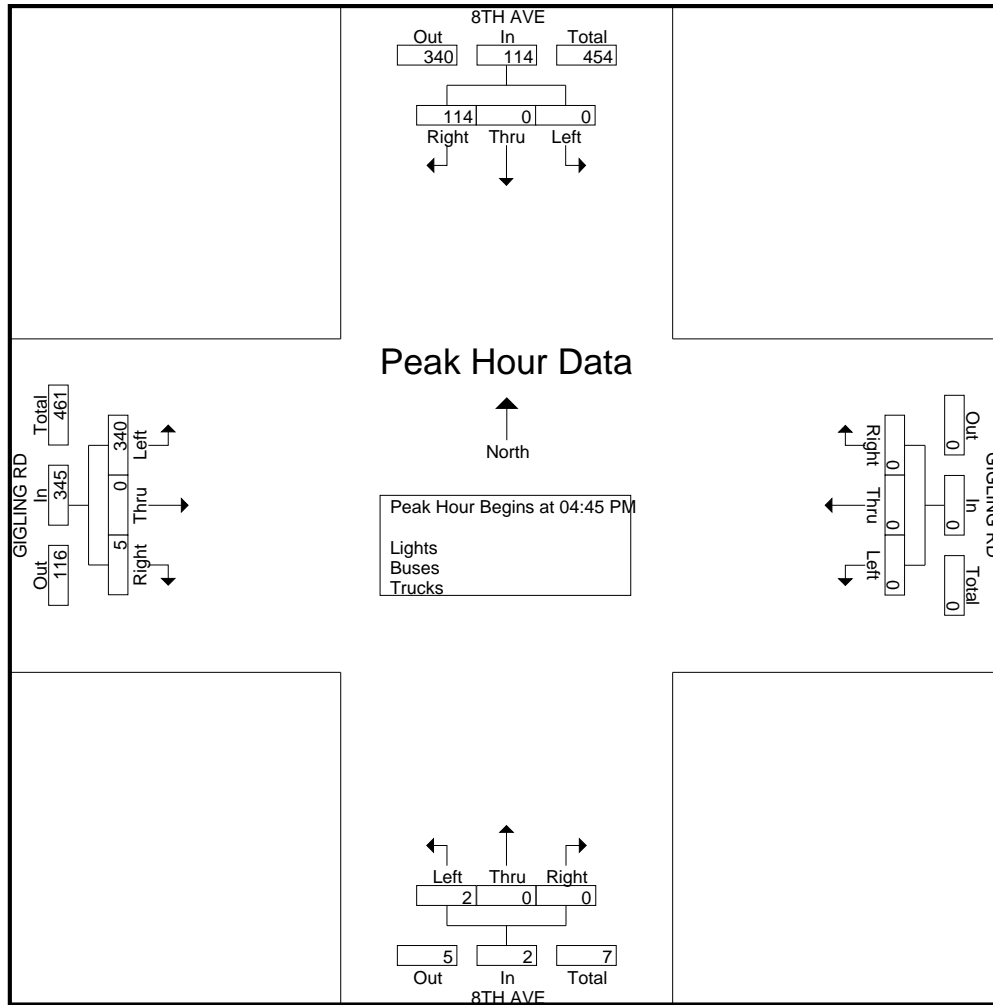

Traffic Data Service

San Jose, CA
 (408) 622-4787
 tdsbay@cs.com

File Name : 17PM FINAL
 Site Code : 00000017
 Start Date : 4/25/2018
 Page No : 1

Groups Printed- Bikes

Start Time	8TH AVE Southbound					GIGLING RD Westbound					8TH AVE Northbound					GIGLING RD Eastbound					Int. Total
	Right	Thru	Left	Peds	App. Total	Right	Thru	Left	Peds	App. Total	Right	Thru	Left	Peds	App. Total	Right	Thru	Left	Peds	App. Total	
04:00 PM	0	0	0	0	0	0	0	0	0	0	0	0	0	0	0	0	0	0	0	0	0
04:15 PM	0	0	0	0	0	0	0	0	0	0	1	0	1	0	2	0	0	0	0	0	0
04:30 PM	0	0	0	0	0	0	0	0	0	0	1	0	0	0	1	0	0	0	0	0	0
04:45 PM	0	0	0	0	0	0	0	0	0	0	1	0	0	0	1	0	0	0	0	0	0
Total	0	0	0	0	0	0	0	0	0	0	3	0	1	0	4	0	0	0	0	0	0
05:00 PM	0	0	0	0	0	0	0	1	0	1	1	0	0	0	1	0	0	0	0	0	0
05:15 PM	0	1	1	0	2	0	0	0	0	0	0	0	0	0	0	0	0	0	0	0	0
05:30 PM	0	0	0	0	0	0	0	1	0	1	0	0	0	1	1	0	0	0	0	0	0
05:45 PM	0	0	0	0	0	0	0	3	0	3	2	1	0	0	3	0	0	0	0	0	0
Total	0	1	1	0	2	0	0	5	0	5	3	1	0	1	5	0	0	0	0	0	0
Grand Total	0	1	1	0	2	0	0	5	0	5	6	1	1	1	9	0	0	0	0	0	0
Apprch %	0	50	50	0		0	0	100	0		66.7	11.1	11.1	11.1		0	0	0	0		
Total %	0	6.2	6.2	0	12.5	0	0	31.2	0	31.2	37.5	6.2	6.2	6.2	56.2	0	0	0	0	0	

Start Time	8TH AVE Southbound					GIGLING RD Westbound					8TH AVE Northbound					GIGLING RD Eastbound					Int. Total
	Right	Thru	Left	Peds	App. Total	Right	Thru	Left	Peds	App. Total	Right	Thru	Left	Peds	App. Total	Right	Thru	Left	Peds	App. Total	
05:00 PM	0	0	0	0	0	0	0	1	0	1	1	0	0	0	1	0	0	0	0	0	0
05:15 PM	0	1	1	0	2	0	0	0	0	0	0	0	0	0	0	0	0	0	0	0	0
05:30 PM	0	0	0	0	0	0	0	1	0	1	0	0	0	0	0	0	0	0	0	0	0
05:45 PM	0	0	0	0	0	0	0	3	0	3	2	1	0	0	3	0	0	0	0	0	0
Total Volume	0	1	1	0	2	0	0	5	0	5	3	1	0	0	4	0	0	0	0	0	0
% App. Total	0	50	50	0		0	0	100	0		75	25	0	0		0	0	0	0		
PHF	.000	.250	.250	0	.250	.000	.000	.417	0	.417	.375	.250	.000	0	.333	.000	.000	.000	0	.000	.458

Peak Hour Analysis From 04:00 PM to 05:45 PM - Peak 1 of 1
 Peak Hour for Entire Intersection Begins at 05:00 PM

Traffic Data Service

San Jose, CA
 (408) 622-4787
 tdsbay@cs.com

File Name : 17PM FINAL
 Site Code : 00000017
 Start Date : 4/25/2018
 Page No : 2

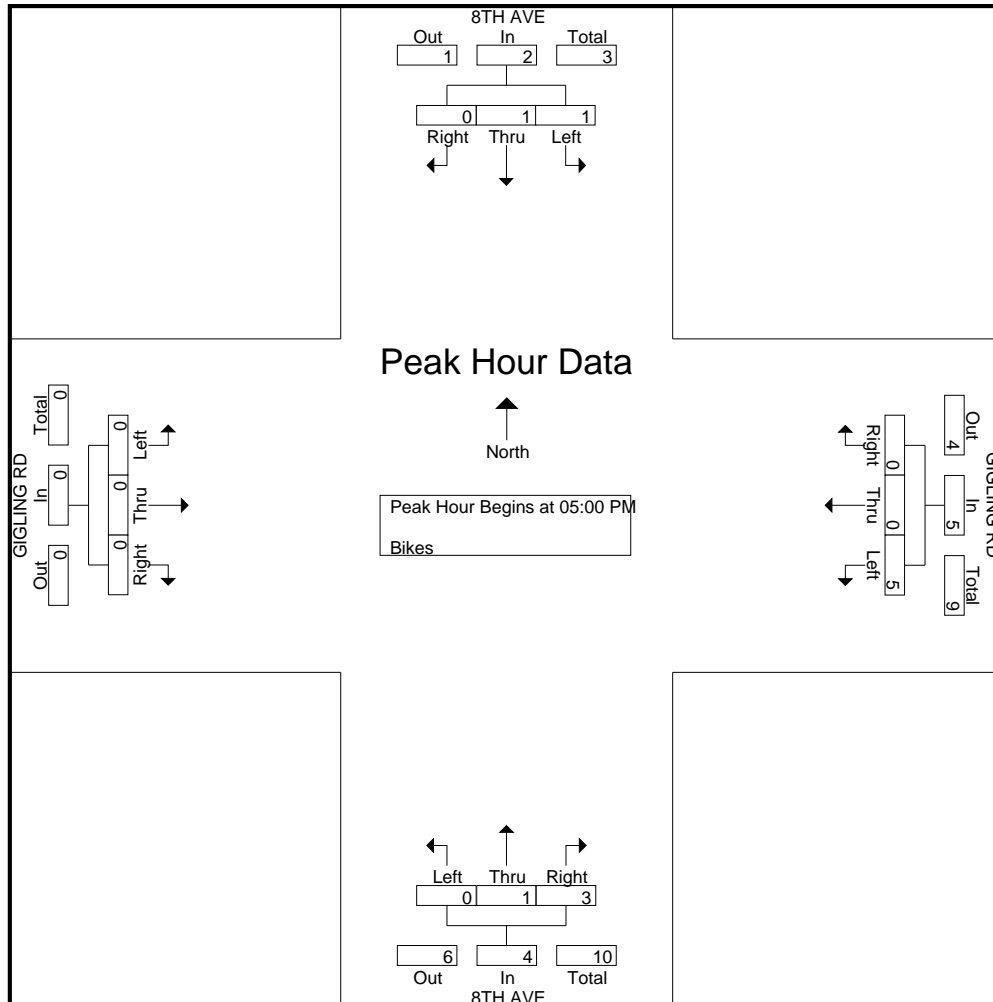

Traffic Data Service

San Jose, CA
(408) 622-4787
tdsbay@cs.com

File Name : 18AM FINAL
Site Code : 00000018
Start Date : 4/25/2018
Page No : 1

Groups Printed- Lights - Buses - Trucks

Start Time	GENERAL JIM MOORE BLVD Southbound					NORMANDY RD Westbound					GENERAL JIM MOORE BLVD Northbound					NORMANDY RD Eastbound					Int. Total
	Right	Thru	Left	Peds	App. Total	Right	Thru	Left	Peds	App. Total	Right	Thru	Left	Peds	App. Total	Right	Thru	Left	Peds	App. Total	
07:00 AM	8	97	6	0	111	0	4	7	0	11	3	46	6	0	55	7	3	10	3	23	200
07:15 AM	23	191	10	3	227	2	7	20	1	30	17	50	13	0	80	20	8	14	2	44	381
07:30 AM	37	238	22	14	311	8	19	43	0	70	32	85	36	0	153	29	28	14	0	71	605
07:45 AM	66	186	35	13	300	11	28	42	1	82	49	103	61	0	213	30	35	13	5	83	678
Total	134	712	73	30	949	21	58	112	2	193	101	284	116	0	501	86	74	51	10	221	1864
08:00 AM	23	144	7	0	174	14	16	36	0	66	7	92	12	0	111	39	7	24	0	70	421
08:15 AM	9	172	8	1	190	2	3	10	0	15	9	53	9	0	71	7	4	6	2	19	295
08:30 AM	7	113	1	3	124	3	2	11	1	17	3	52	3	0	58	7	5	7	1	20	219
08:45 AM	11	82	3	2	98	5	3	8	2	18	2	51	7	2	62	6	1	7	2	16	194
Total	50	511	19	6	586	24	24	65	3	116	21	248	31	2	302	59	17	44	5	125	1129
Grand Total	184	1223	92	36	1535	45	82	177	5	309	122	532	147	2	803	145	91	95	15	346	2993
Apprch %	12	79.7	6	2.3		14.6	26.5	57.3	1.6		15.2	66.3	18.3	0.2		41.9	26.3	27.5	4.3		
Total %	6.1	40.9	3.1	1.2	51.3	1.5	2.7	5.9	0.2	10.3	4.1	17.8	4.9	0.1	26.8	4.8	3	3.2	0.5	11.6	
Lights	183	1191	92	36	1502	41	80	176	5	302	120	528	142	2	792	141	91	95	15	342	2938
% Lights	99.5	97.4	100	100	97.9	91.1	97.6	99.4	100	97.7	98.4	99.2	96.6	100	98.6	97.2	100	100	100	98.8	98.2
Buses	0	16	0	0	16	2	2	1	0	5	1	2	3	0	6	3	0	0	0	3	30
% Buses	0	1.3	0	0	1	4.4	2.4	0.6	0	1.6	0.8	0.4	2	0	0.7	2.1	0	0	0	0.9	1
Trucks	1	16	0	0	17	2	0	0	0	2	1	2	2	0	5	1	0	0	0	1	25
% Trucks	0.5	1.3	0	0	1.1	4.4	0	0	0	0.6	0.8	0.4	1.4	0	0.6	0.7	0	0	0	0.3	0.8

Start Time	GENERAL JIM MOORE BLVD Southbound					NORMANDY RD Westbound					GENERAL JIM MOORE BLVD Northbound					NORMANDY RD Eastbound					Int. Total
	Right	Thru	Left	Peds	App. Total	Right	Thru	Left	Peds	App. Total	Right	Thru	Left	Peds	App. Total	Right	Thru	Left	Peds	App. Total	
Peak Hour Analysis From 07:00 AM to 08:45 AM - Peak 1 of 1																					
Peak Hour for Entire Intersection Begins at 07:15 AM																					
07:15 AM	23	191	10		224	2	7	20		29	17	50	13		80	20	8	14		42	375
07:30 AM	37	238	22		297	8	19	43		70	32	85	36		153	29	28	14		71	591
07:45 AM	66	186	35		287	11	28	42		81	49	103	61		213	30	35	13		78	659
08:00 AM	23	144	7		174	14	16	36		66	7	92	12		111	39	7	24		70	421
Total Volume	149	759	74		982	35	70	141		246	105	330	122		557	118	78	65		261	2046
% App. Total	15.2	77.3	7.5			14.2	28.5	57.3			18.9	59.2	21.9			45.2	29.9	24.9			
PHF	.564	.797	.529		.827	.625	.625	.820		.759	.536	.801	.500		.654	.756	.557	.677		.837	.776

Traffic Data Service

San Jose, CA
 (408) 622-4787
 tdsbay@cs.com

File Name : 18AM FINAL
 Site Code : 00000018
 Start Date : 4/25/2018
 Page No : 2

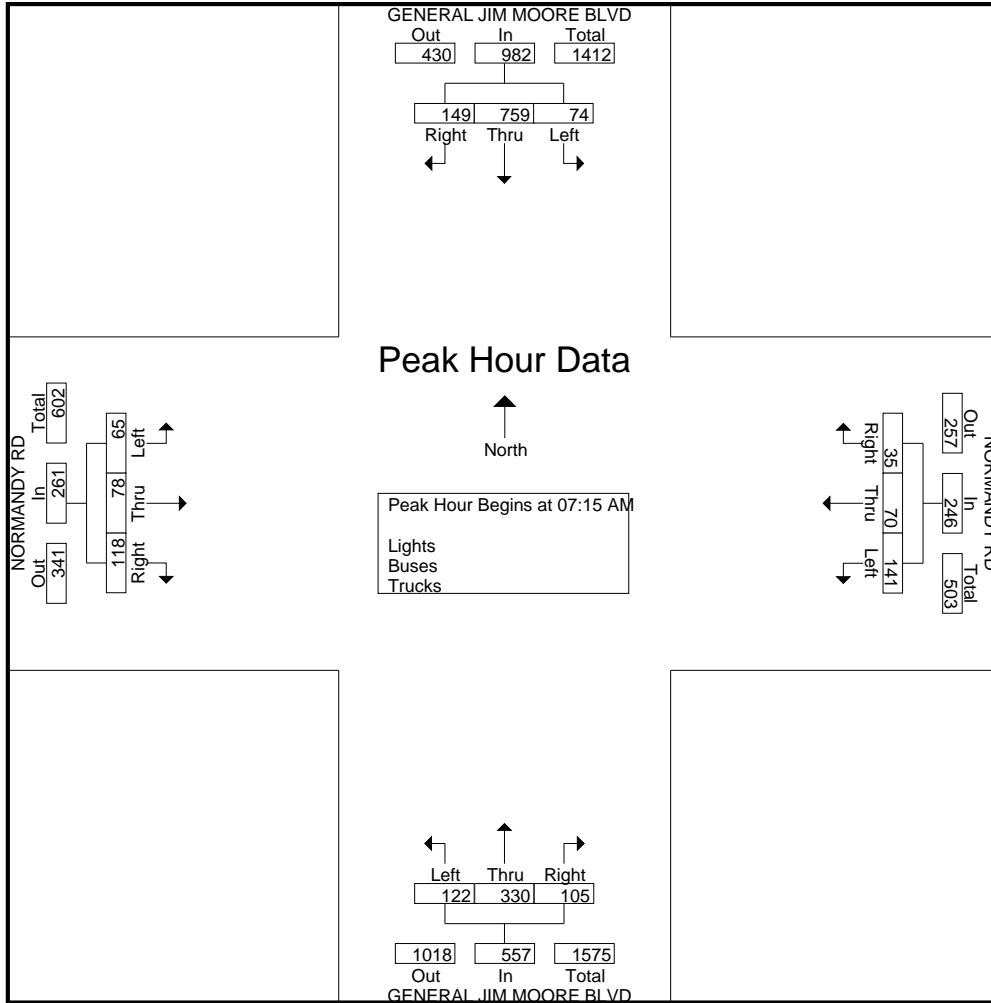

Traffic Data Service

San Jose, CA
 (408) 622-4787
 tdsbay@cs.com

File Name : 18AM FINAL
 Site Code : 00000018
 Start Date : 4/25/2018
 Page No : 1

Groups Printed- Bikes

Start Time	GENERAL JIM MOORE BLVD Southbound					NORMANDY RD Westbound					GENERAL JIM MOORE BLVD Northbound					NORMANDY RD Eastbound					Int. Total
	Right	Thru	Left	Peds	App. Total	Right	Thru	Left	Peds	App. Total	Right	Thru	Left	Peds	App. Total	Right	Thru	Left	Peds	App. Total	
07:00 AM	0	0	0	0	0	0	0	0	0	0	0	1	0	0	1	0	0	0	0	0	0
07:15 AM	0	0	0	0	0	0	0	0	0	0	0	0	0	0	0	0	0	0	0	0	0
07:30 AM	0	0	0	0	0	0	0	0	0	0	0	0	0	0	0	0	0	0	0	0	0
07:45 AM	0	0	0	0	0	0	0	0	0	0	0	0	0	0	0	0	0	0	0	0	0
Total	0	0	0	0	0	0	0	0	0	0	0	1	0	0	1	0	0	0	0	0	0
08:00 AM	0	0	0	0	0	0	0	0	0	0	0	0	0	0	0	0	0	0	0	0	0
08:15 AM	0	0	0	0	0	0	0	0	0	0	0	0	0	0	0	0	0	0	0	0	0
08:30 AM	0	0	0	0	0	0	0	0	0	0	1	0	0	0	1	0	1	0	0	1	2
08:45 AM	0	0	0	0	0	0	0	0	0	0	0	0	0	0	0	0	0	0	0	0	0
Total	0	0	0	0	0	0	0	0	0	0	1	0	0	0	1	0	1	0	0	1	2
Grand Total	0	0	0	0	0	0	0	0	0	0	1	1	0	0	2	0	1	0	0	1	3
Apprch %	0	0	0	0	0	0	0	0	0	0	50	50	0	0		0	100	0	0		
Total %	0	0	0	0	0	0	0	0	0	0	33.3	33.3	0	0	66.7	0	33.3	0	0	33.3	

Start Time	GENERAL JIM MOORE BLVD Southbound					NORMANDY RD Westbound					GENERAL JIM MOORE BLVD Northbound					NORMANDY RD Eastbound					Int. Total
	Right	Thru	Left	Peds	App. Total	Right	Thru	Left	Peds	App. Total	Right	Thru	Left	Peds	App. Total	Right	Thru	Left	Peds	App. Total	
07:45 AM	0	0	0	0	0	0	0	0	0	0	0	0	0	0	0	0	0	0	0	0	0
08:00 AM	0	0	0	0	0	0	0	0	0	0	0	0	0	0	0	0	0	0	0	0	0
08:15 AM	0	0	0	0	0	0	0	0	0	0	0	0	0	0	0	0	0	0	0	0	0
08:30 AM	0	0	0	0	0	0	0	0	0	0	1	0	0	0	1	0	1	0	0	1	2
Total Volume	0	0	0	0	0	0	0	0	0	0	1	0	0	0	1	0	1	0	0	1	2
% App. Total	0	0	0	0	0	0	0	0	0	0	100	0	0	0		0	100	0	0		
PHF	.000	.000	.000	.000	.000	.000	.000	.000	.000	.000	.250	.000	.000	.250		.000	.250	.000	.250	.250	

Peak Hour Analysis From 07:00 AM to 08:45 AM - Peak 1 of 1
 Peak Hour for Entire Intersection Begins at 07:45 AM

Traffic Data Service

San Jose, CA
 (408) 622-4787
 tdsbay@cs.com

File Name : 18AM FINAL
 Site Code : 00000018
 Start Date : 4/25/2018
 Page No : 2

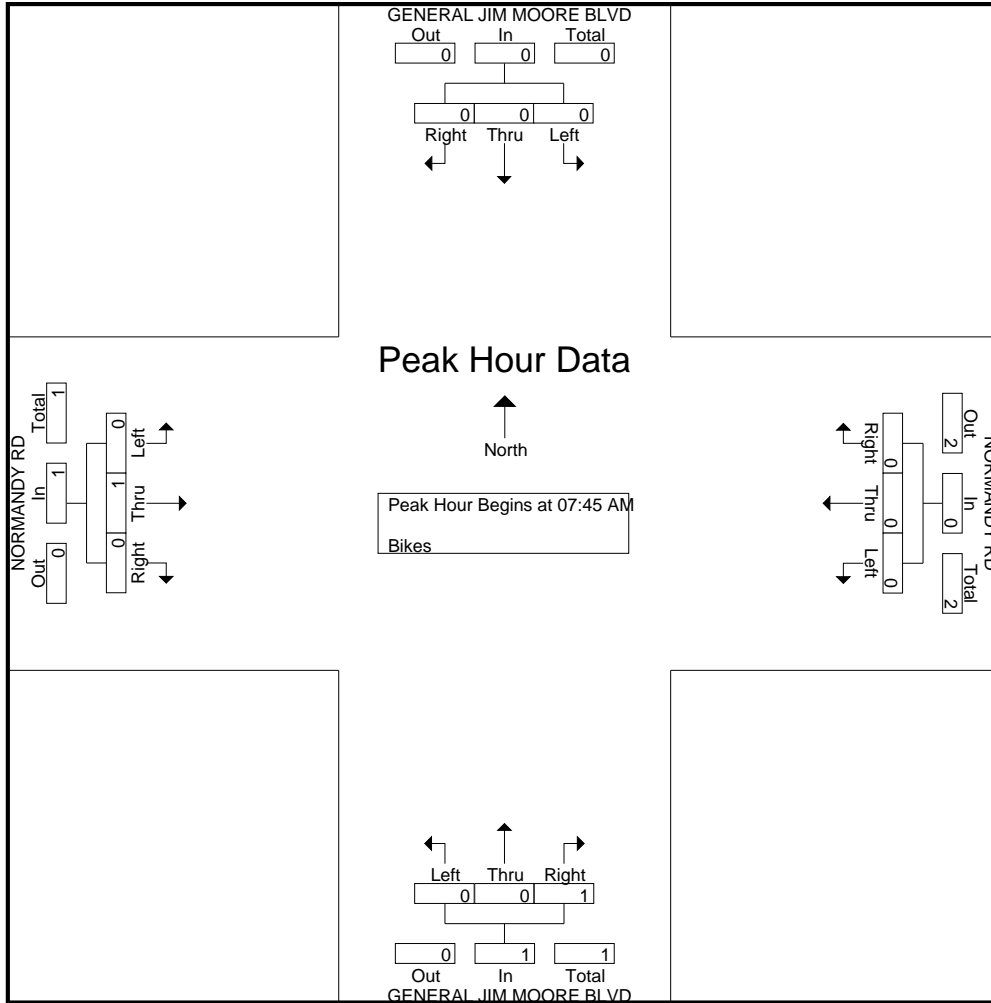

Traffic Data Service

San Jose, CA
 (408) 622-4787
 tdsbay@cs.com

File Name : 18PM FINAL
 Site Code : 00000018
 Start Date : 4/25/2018
 Page No : 1

Groups Printed- Lights - Buses - Trucks

Start Time	GENERAL JIM MOORE BLVD Southbound					NORMANDY RD Westbound					GENERAL JIM MOORE BLVD Northbound					NORMANDY RD Eastbound					Int. Total
	Right	Thru	Left	Peds	App. Total	Right	Thru	Left	Peds	App. Total	Right	Thru	Left	Peds	App. Total	Right	Thru	Left	Peds	App. Total	
04:00 PM	9	79	8	0	96	5	4	8	0	17	6	114	5	0	125	8	3	10	0	21	259
04:15 PM	9	63	5	2	79	3	9	12	0	24	9	118	12	0	139	7	9	7	0	23	265
04:30 PM	13	83	4	0	100	2	5	4	0	11	14	149	12	1	176	8	3	10	1	22	309
04:45 PM	8	102	9	0	119	2	1	13	0	16	14	171	13	0	198	8	7	5	1	21	354
Total	39	327	26	2	394	12	19	37	0	68	43	552	42	1	638	31	22	32	2	87	1187
05:00 PM	13	92	5	0	110	2	11	8	0	21	18	180	17	0	215	8	8	12	0	28	374
05:15 PM	11	87	8	0	106	1	5	15	0	21	19	206	11	0	236	11	7	15	0	33	396
05:30 PM	13	80	9	3	105	1	11	8	0	20	16	172	8	0	196	6	5	13	0	24	345
05:45 PM	12	65	11	4	92	1	8	6	0	15	16	145	12	0	173	12	8	10	0	30	310
Total	49	324	33	7	413	5	35	37	0	77	69	703	48	0	820	37	28	50	0	115	1425
Grand Total	88	651	59	9	807	17	54	74	0	145	112	1255	90	1	1458	68	50	82	2	202	2612
Apprch %	10.9	80.7	7.3	1.1		11.7	37.2	51	0		7.7	86.1	6.2	0.1		33.7	24.8	40.6	1		
Total %	3.4	24.9	2.3	0.3	30.9	0.7	2.1	2.8	0	5.6	4.3	48	3.4	0	55.8	2.6	1.9	3.1	0.1	7.7	
Lights	87	646	59	9	801	17	54	72	0	143	112	1242	88	1	1443	67	50	81	2	200	2587
% Lights	98.9	99.2	100	100	99.3	100	100	97.3	0	98.6	100	99	97.8	100	99	98.5	100	98.8	100	99	99
Buses	0	0	0	0	0	0	0	1	0	1	0	4	2	0	6	0	0	0	0	0	7
% Buses	0	0	0	0	0	0	0	1.4	0	0.7	0	0.3	2.2	0	0.4	0	0	0	0	0	0.3
Trucks	1	5	0	0	6	0	0	1	0	1	0	9	0	0	9	1	0	1	0	2	18
% Trucks	1.1	0.8	0	0	0.7	0	0	1.4	0	0.7	0	0.7	0	0	0.6	1.5	0	1.2	0	1	0.7

Start Time	GENERAL JIM MOORE BLVD Southbound					NORMANDY RD Westbound					GENERAL JIM MOORE BLVD Northbound					NORMANDY RD Eastbound					Int. Total
	Right	Thru	Left	Peds	App. Total	Right	Thru	Left	Peds	App. Total	Right	Thru	Left	Peds	App. Total	Right	Thru	Left	Peds	App. Total	
Peak Hour Analysis From 04:00 PM to 05:45 PM - Peak 1 of 1																					
Peak Hour for Entire Intersection Begins at 04:45 PM																					
04:45 PM	8	102	9		119	2	1	13		16	14	171	13		198	8	7	5		20	353
05:00 PM	13	92	5		110	2	11	8		21	18	180	17		215	8	8	12		28	374
05:15 PM	11	87	8		106	1	5	15		21	19	206	11		236	11	7	15		33	396
05:30 PM	13	80	9		102	1	11	8		20	16	172	8		196	6	5	13		24	342
Total Volume	45	361	31		437	6	28	44		78	67	729	49		845	33	27	45		105	1465
% App. Total	10.3	82.6	7.1			7.7	35.9	56.4			7.9	86.3	5.8			31.4	25.7	42.9			
PHF	.865	.885	.861		.918	.750	.636	.733		.929	.882	.885	.721		.895	.750	.844	.750		.795	.925

Traffic Data Service

San Jose, CA
 (408) 622-4787
 tdsbay@cs.com

File Name : 18PM FINAL
 Site Code : 00000018
 Start Date : 4/25/2018
 Page No : 2

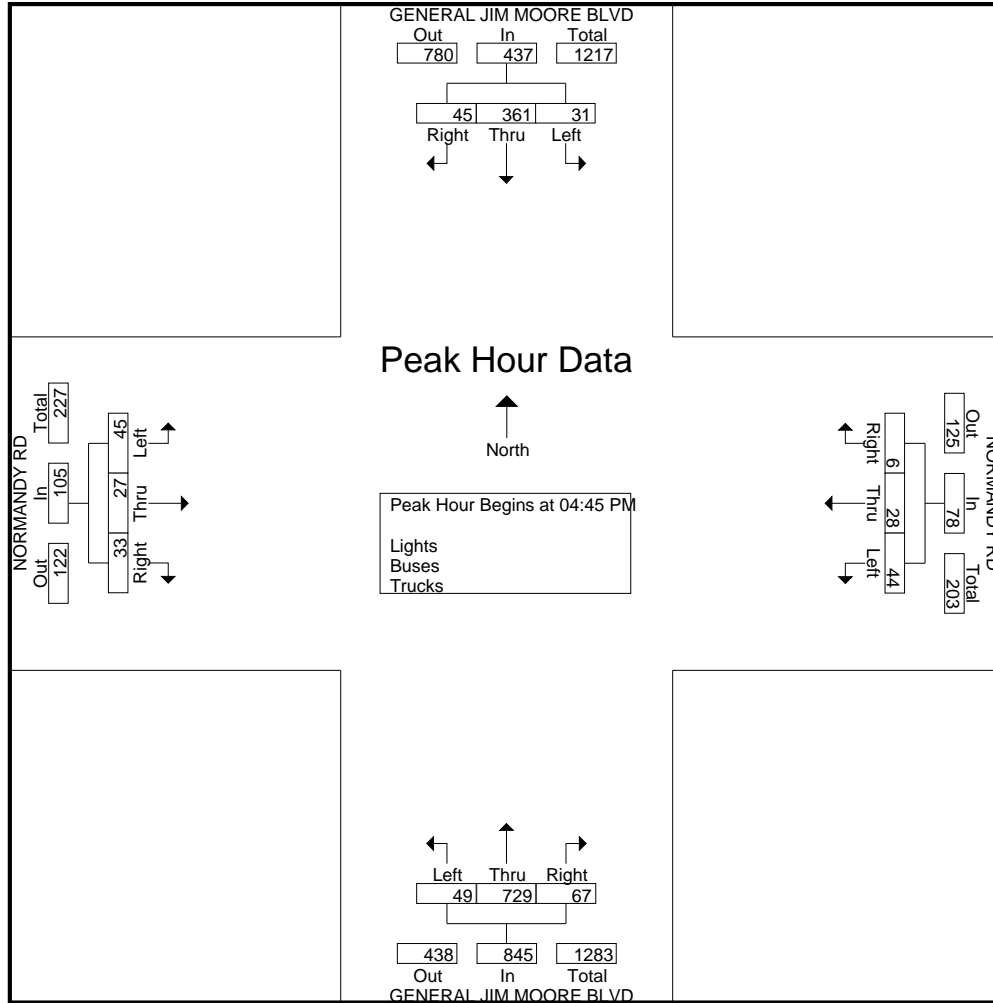

Traffic Data Service

San Jose, CA
 (408) 622-4787
 tdsbay@cs.com

File Name : 18PM FINAL
 Site Code : 00000018
 Start Date : 4/25/2018
 Page No : 1

Groups Printed- Bikes

Start Time	GENERAL JIM MOORE BLVD Southbound					NORMANDY RD Westbound					GENERAL JIM MOORE BLVD Northbound					NORMANDY RD Eastbound					Int. Total					
	Right	Thru	Left	Peds	App. Total	Right	Thru	Left	Peds	App. Total	Right	Thru	Left	Peds	App. Total	Right	Thru	Left	Peds	App. Total						
04:00 PM	0	0	0	0	0	0	0	0	0	0	0	0	0	0	0	0	0	0	0	0	0	0	0	0	0	0
04:15 PM	0	0	0	0	0	0	0	0	0	0	0	0	0	0	0	0	0	0	0	0	0	0	0	0	0	0
04:30 PM	0	0	1	0	1	0	0	0	0	0	0	0	0	0	0	0	0	0	0	0	0	0	0	0	0	1
04:45 PM	0	0	0	0	0	1	0	0	0	1	0	0	0	0	0	0	0	0	0	0	0	0	0	0	0	1
Total	0	0	1	0	1	1	0	0	0	1	0	0	0	0	0	0	0	0	0	0	0	0	0	0	0	2
05:00 PM	0	0	0	0	0	0	0	1	0	1	0	0	0	0	0	0	0	0	0	0	0	0	0	0	0	1
05:15 PM	0	0	0	0	0	0	0	2	0	2	0	0	0	0	0	0	0	0	0	0	0	0	0	0	0	2
05:30 PM	0	0	0	0	0	0	0	0	0	0	0	0	0	0	0	0	0	0	0	0	0	0	0	0	0	0
05:45 PM	0	0	0	0	0	0	0	0	0	0	0	0	0	0	0	0	0	0	0	0	0	0	0	0	0	0
Total	0	0	0	0	0	0	0	3	0	3	0	0	0	0	0	0	0	0	0	0	0	0	0	0	0	3
Grand Total	0	0	1	0	1	1	0	3	0	4	0	0	0	0	0	0	0	0	0	0	0	0	0	0	0	5
Apprch %	0	0	100	0		25	0	75	0		0	0	0	0		0	0	0	0		0	0	0	0		
Total %	0	0	20	0	20	20	0	60	0	80	0	0	0	0	0	0	0	0	0	0	0	0	0	0	0	

Start Time	GENERAL JIM MOORE BLVD Southbound					NORMANDY RD Westbound					GENERAL JIM MOORE BLVD Northbound					NORMANDY RD Eastbound					Int. Total					
	Right	Thru	Left	Peds	App. Total	Right	Thru	Left	Peds	App. Total	Right	Thru	Left	Peds	App. Total	Right	Thru	Left	Peds	App. Total						
Peak Hour Analysis From 04:00 PM to 05:45 PM - Peak 1 of 1																										
Peak Hour for Entire Intersection Begins at 04:30 PM																										
04:30 PM	0	0	1	0	1	0	0	0	0	0	0	0	0	0	0	0	0	0	0	0	0	0	0	0	0	1
04:45 PM	0	0	0	0	0	1	0	0	0	1	0	0	0	0	0	0	0	0	0	0	0	0	0	0	0	1
05:00 PM	0	0	0	0	0	0	0	1	0	1	0	0	0	0	0	0	0	0	0	0	0	0	0	0	0	1
05:15 PM	0	0	0	0	0	0	0	2	0	2	0	0	0	0	0	0	0	0	0	0	0	0	0	0	0	2
Total Volume	0	0	1	0	1	1	0	3	0	4	0	0	0	0	0	0	0	0	0	0	0	0	0	0	0	5
% App. Total	0	0	100	0		25	0	75	0		0	0	0	0		0	0	0	0		0	0	0	0		
PHF	.000	.000	.250	0	.250	.250	.000	.375	0	.500	.000	.000	.000	0	.000	.000	.000	.000	0	.000	.000	.000	.000	0	.625	

Traffic Data Service

San Jose, CA
 (408) 622-4787
 tdsbay@cs.com

File Name : 18PM FINAL
 Site Code : 00000018
 Start Date : 4/25/2018
 Page No : 2

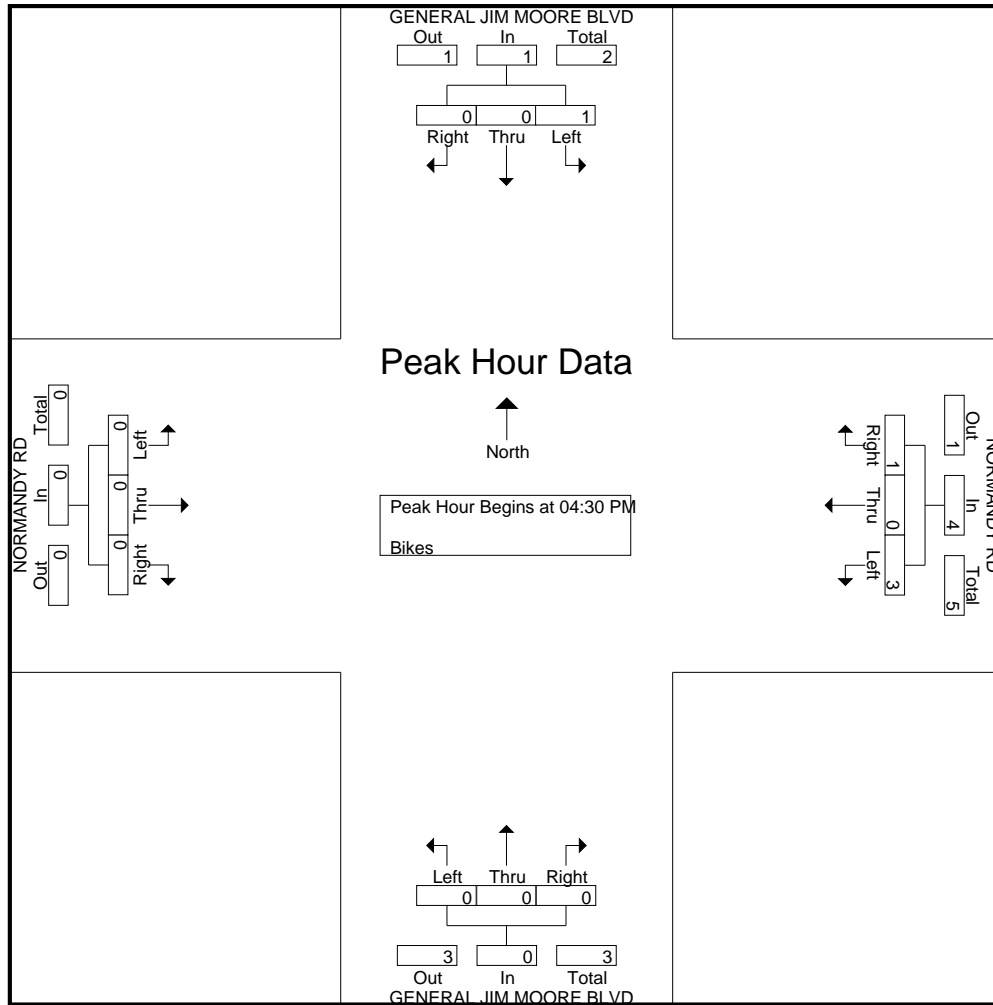

Traffic Data Service

San Jose, CA
 (408) 622-4787
 tdsbay@cs.com

File Name : 19AM FINAL
 Site Code : 00000019
 Start Date : 4/25/2018
 Page No : 1

Groups Printed- Lights - Buses - Trucks

Start Time	GENERAL JIM MOORE BLVD Southbound					EUCALYPTUS RD Westbound					GENERAL JIM MOORE BLVD Northbound					COE AVE Eastbound					Int. Total
	Right	Thru	Left	Peds	App. Total	Right	Thru	Left	Peds	App. Total	Right	Thru	Left	Peds	App. Total	Right	Thru	Left	Peds	App. Total	
07:00 AM	5	121	0	0	126	0	0	0	1	1	0	29	15	0	44	21	0	7	0	28	199
07:15 AM	19	239	0	0	258	0	0	0	0	0	0	57	17	0	74	60	0	14	2	76	408
07:30 AM	19	258	0	0	277	0	0	0	0	0	0	103	26	0	129	99	0	31	0	130	536
07:45 AM	42	230	0	1	273	0	0	0	0	0	1	122	48	0	171	111	0	34	0	145	589
Total	85	848	0	1	934	0	0	0	1	1	1	311	106	0	418	291	0	86	2	379	1732
08:00 AM	37	198	0	0	235	0	0	0	0	0	0	68	93	0	161	104	0	29	2	135	531
08:15 AM	37	188	0	0	225	0	0	0	0	0	0	46	54	0	100	116	0	20	0	136	461
08:30 AM	8	125	0	0	133	0	0	0	0	0	0	38	14	0	52	49	0	10	2	61	246
08:45 AM	9	102	0	0	111	0	0	0	0	0	0	49	11	0	60	21	0	6	1	28	199
Total	91	613	0	0	704	0	0	0	0	0	0	201	172	0	373	290	0	65	5	360	1437
Grand Total	176	1461	0	1	1638	0	0	0	1	1	1	512	278	0	791	581	0	151	7	739	3169
Apprch %	10.7	89.2	0	0.1		0	0	0	100		0.1	64.7	35.1	0		78.6	0	20.4	0.9		
Total %	5.6	46.1	0	0	51.7	0	0	0	0	0	0	16.2	8.8	0	25	18.3	0	4.8	0.2	23.3	
Lights	170	1431	0	1	1602	0	0	0	1	1	1	506	272	0	779	568	0	149	7	724	3106
% Lights	96.6	97.9	0	100	97.8	0	0	0	100	100	100	98.8	97.8	0	98.5	97.8	0	98.7	100	98	98
Buses	5	15	0	0	20	0	0	0	0	0	0	4	5	0	9	9	0	2	0	11	40
% Buses	2.8	1	0	0	1.2	0	0	0	0	0	0	0.8	1.8	0	1.1	1.5	0	1.3	0	1.5	1.3
Trucks	1	15	0	0	16	0	0	0	0	0	0	2	1	0	3	4	0	0	0	4	23
% Trucks	0.6	1	0	0	1	0	0	0	0	0	0	0.4	0.4	0	0.4	0.7	0	0	0	0.5	0.7

Start Time	GENERAL JIM MOORE BLVD Southbound					EUCALYPTUS RD Westbound					GENERAL JIM MOORE BLVD Northbound					COE AVE Eastbound					Int. Total
	Right	Thru	Left	Peds	App. Total	Right	Thru	Left	Peds	App. Total	Right	Thru	Left	Peds	App. Total	Right	Thru	Left	Peds	App. Total	
Peak Hour Analysis From 07:00 AM to 08:45 AM - Peak 1 of 1																					
Peak Hour for Entire Intersection Begins at 07:30 AM																					
07:30 AM	19	258	0	0	277	0	0	0	0	0	0	103	26	129	99	0	31	130	536		
07:45 AM	42	230	0	0	272	0	0	0	0	0	1	122	48	171	111	0	34	145	588		
08:00 AM	37	198	0	0	235	0	0	0	0	0	0	68	93	161	104	0	29	133	529		
08:15 AM	37	188	0	0	225	0	0	0	0	0	0	46	54	100	116	0	20	136	461		
Total Volume	135	874	0	0	1009	0	0	0	0	0	1	339	221	561	430	0	114	544	2114		
% App. Total	13.4	86.6	0	0		0	0	0	0	0	0.2	60.4	39.4		79	0	21				
PHF	.804	.847	.000	.911		.000	.000	.000	.000	.000	.250	.695	.594	.820	.927	.000	.838	.938	.899		

Traffic Data Service

San Jose, CA
 (408) 622-4787
 tdsbay@cs.com

File Name : 19AM FINAL
 Site Code : 00000019
 Start Date : 4/25/2018
 Page No : 2

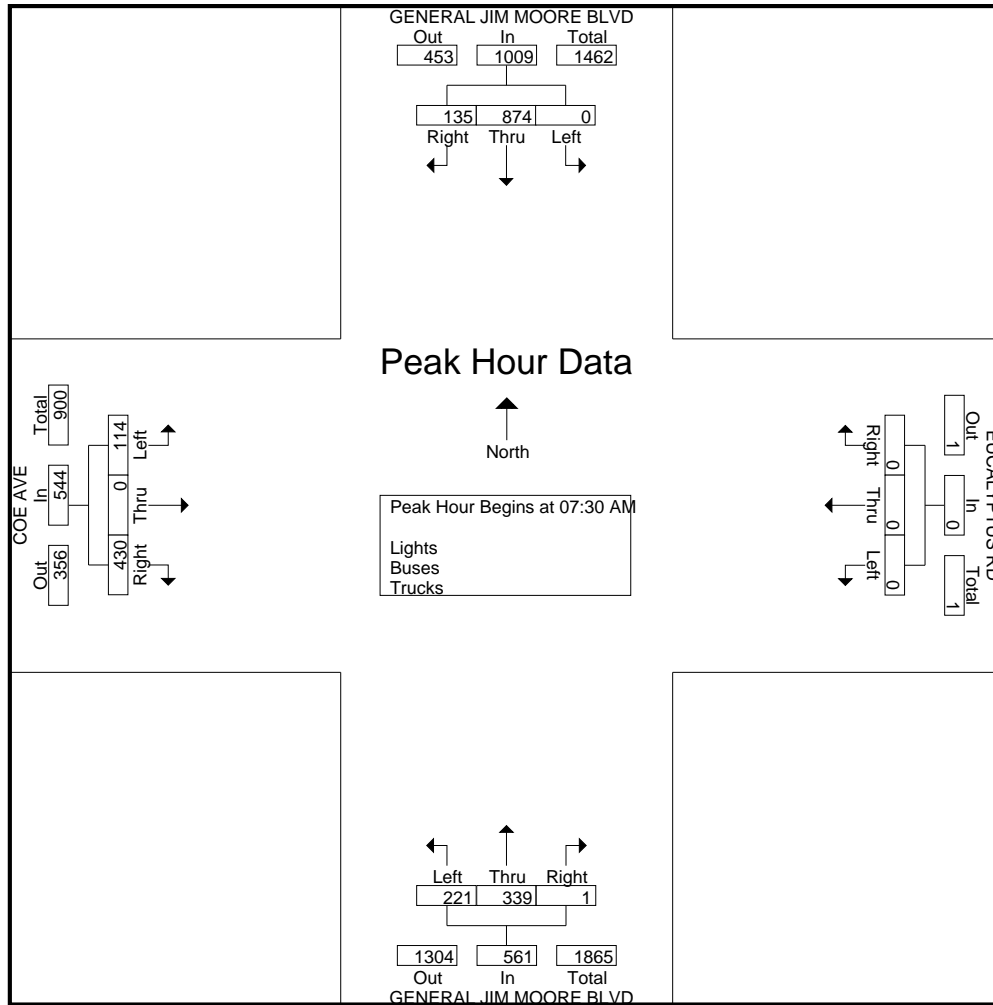

Traffic Data Service

San Jose, CA
 (408) 622-4787
 tdsbay@cs.com

File Name : 19AM FINAL
 Site Code : 00000019
 Start Date : 4/25/2018
 Page No : 1

Groups Printed- Bikes

Start Time	GENERAL JIM MOORE BLVD Southbound					EUCALYPTUS RD Westbound					GENERAL JIM MOORE BLVD Northbound					COE AVE Eastbound					Int. Total
	Right	Thru	Left	Peds	App. Total	Right	Thru	Left	Peds	App. Total	Right	Thru	Left	Peds	App. Total	Right	Thru	Left	Peds	App. Total	
07:00 AM	0	0	0	0	0	0	0	0	0	0	0	1	0	0	1	0	0	0	0	0	0
07:15 AM	0	0	0	0	0	0	0	0	0	0	0	0	0	0	0	0	0	0	0	0	0
07:30 AM	0	0	0	0	0	0	0	0	0	0	0	0	0	0	0	0	0	0	0	0	0
07:45 AM	0	0	0	0	0	0	0	0	0	0	0	0	0	0	0	0	0	0	0	0	0
Total	0	0	0	0	0	0	0	0	0	0	0	1	0	0	1	0	0	0	0	0	0
08:00 AM	0	0	0	0	0	0	0	0	0	0	0	0	0	0	0	0	0	0	0	0	0
08:15 AM	0	1	0	0	1	0	0	0	0	0	0	1	0	0	1	0	0	0	0	0	2
08:30 AM	0	0	0	0	0	0	0	0	0	0	0	0	0	0	0	0	0	0	0	0	0
08:45 AM	0	0	0	0	0	0	0	0	0	0	1	1	0	0	2	0	0	0	0	0	2
Total	0	1	0	0	1	0	0	0	0	0	1	2	0	0	3	0	0	0	0	0	4
Grand Total	0	1	0	0	1	0	0	0	0	0	1	3	0	0	4	0	0	0	0	0	5
Apprch %	0	100	0	0		0	0	0	0		25	75	0	0		0	0	0	0		
Total %	0	20	0	0	20	0	0	0	0	0	20	60	0	0	80	0	0	0	0	0	

Start Time	GENERAL JIM MOORE BLVD Southbound					EUCALYPTUS RD Westbound					GENERAL JIM MOORE BLVD Northbound					COE AVE Eastbound					Int. Total
	Right	Thru	Left	Peds	App. Total	Right	Thru	Left	Peds	App. Total	Right	Thru	Left	Peds	App. Total	Right	Thru	Left	Peds	App. Total	
Peak Hour Analysis From 07:00 AM to 08:45 AM - Peak 1 of 1																					
Peak Hour for Entire Intersection Begins at 08:00 AM																					
08:00 AM	0	0	0	0	0	0	0	0	0	0	0	0	0	0	0	0	0	0	0	0	0
08:15 AM	0	1	0	0	1	0	0	0	0	0	0	1	0	0	1	0	0	0	0	0	2
08:30 AM	0	0	0	0	0	0	0	0	0	0	0	0	0	0	0	0	0	0	0	0	0
08:45 AM	0	0	0	0	0	0	0	0	0	0	1	1	0	0	2	0	0	0	0	0	2
Total Volume	0	1	0	0	1	0	0	0	0	0	1	2	0	0	3	0	0	0	0	0	4
% App. Total	0	100	0	0		0	0	0	0		33.3	66.7	0	0		0	0	0	0		
PHF	.000	.250	.000	.000	.250	.000	.000	.000	.000	.000	.250	.500	.000	.375	.375	.000	.000	.000	.000	.000	.500

Traffic Data Service

San Jose, CA
 (408) 622-4787
 tdsbay@cs.com

File Name : 19AM FINAL
 Site Code : 00000019
 Start Date : 4/25/2018
 Page No : 2

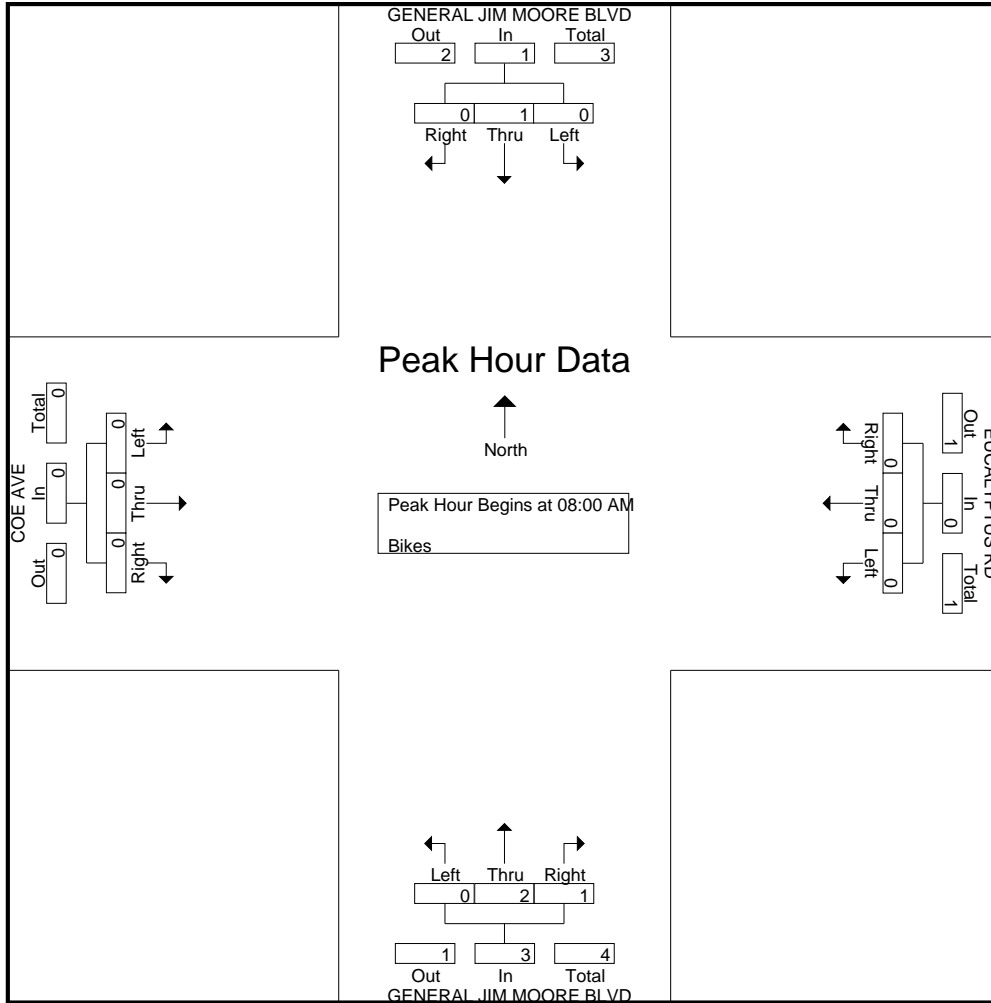

Traffic Data Service

San Jose, CA
(408) 622-4787
tdsbay@cs.com

File Name : 19PM FINAL
Site Code : 00000019
Start Date : 4/25/2018
Page No : 1

Groups Printed- Lights - Buses - Trucks

Start Time	GENERAL JIM MOORE BLVD Southbound					EUCALYPTUS RD Westbound					GENERAL JIM MOORE BLVD Northbound					COE AVE Eastbound					Int. Total
	Right	Thru	Left	Peds	App. Total	Right	Thru	Left	Peds	App. Total	Right	Thru	Left	Peds	App. Total	Right	Thru	Left	Peds	App. Total	
04:00 PM	16	77	0	0	93	0	0	1	0	1	3	139	26	0	168	14	0	9	1	24	286
04:15 PM	12	54	0	0	66	0	1	0	0	1	1	130	40	3	174	13	0	2	0	15	256
04:30 PM	13	60	0	0	73	1	0	1	1	3	2	170	28	0	200	14	1	19	0	34	310
04:45 PM	20	89	0	3	112	2	1	0	2	5	0	197	35	3	235	17	0	12	0	29	381
Total	61	280	0	3	344	3	2	2	3	10	6	636	129	6	777	58	1	42	1	102	1233
05:00 PM	20	83	1	2	106	0	0	0	3	3	1	203	42	1	247	22	0	10	0	32	388
05:15 PM	22	80	1	1	104	0	0	3	0	3	1	227	39	0	267	38	1	20	1	60	434
05:30 PM	23	56	0	2	81	0	0	0	0	0	1	211	37	2	251	20	0	10	0	30	362
05:45 PM	21	62	1	1	85	0	0	1	2	3	1	139	26	3	169	17	0	18	0	35	292
Total	86	281	3	6	376	0	0	4	5	9	4	780	144	6	934	97	1	58	1	157	1476
Grand Total	147	561	3	9	720	3	2	6	8	19	10	1416	273	12	1711	155	2	100	2	259	2709
Apprch %	20.4	77.9	0.4	1.2		15.8	10.5	31.6	42.1		0.6	82.8	16	0.7		59.8	0.8	38.6	0.8		
Total %	5.4	20.7	0.1	0.3	26.6	0.1	0.1	0.2	0.3	0.7	0.4	52.3	10.1	0.4	63.2	5.7	0.1	3.7	0.1	9.6	
Lights	144	555	3	9	711	3	2	6	8	19	10	1404	272	12	1698	154	2	99	2	257	2685
% Lights	98	98.9	100	100	98.8	100	100	100	100	100	100	99.2	99.6	100	99.2	99.4	100	99	100	99.2	99.1
Buses	1	0	0	0	1	0	0	0	0	0	0	2	0	0	2	1	0	1	0	2	5
% Buses	0.7	0	0	0	0.1	0	0	0	0	0	0	0.1	0	0	0.1	0.6	0	1	0	0.8	0.2
Trucks	2	6	0	0	8	0	0	0	0	0	0	10	1	0	11	0	0	0	0	0	19
% Trucks	1.4	1.1	0	0	1.1	0	0	0	0	0	0	0.7	0.4	0	0.6	0	0	0	0	0	0.7

Start Time	GENERAL JIM MOORE BLVD Southbound					EUCALYPTUS RD Westbound					GENERAL JIM MOORE BLVD Northbound					COE AVE Eastbound					Int. Total
	Right	Thru	Left	Peds	App. Total	Right	Thru	Left	Peds	App. Total	Right	Thru	Left	Peds	App. Total	Right	Thru	Left	Peds	App. Total	
Peak Hour Analysis From 04:00 PM to 05:45 PM - Peak 1 of 1																					
Peak Hour for Entire Intersection Begins at 04:45 PM																					
04:45 PM	20	89	0		109	2	1	0		3	0	197	35		232	17	0	12		29	373
05:00 PM	20	83	1		104	0	0	0		0	1	203	42		246	22	0	10		32	382
05:15 PM	22	80	1		103	0	0	3		3	1	227	39		267	38	1	20		59	432
05:30 PM	23	56	0		79	0	0	0		0	1	211	37		249	20	0	10		30	358
Total Volume	85	308	2		395	2	1	3		6	3	838	153		994	97	1	52		150	1545
% App. Total	21.5	78	0.5			33.3	16.7	50			0.3	84.3	15.4			64.7	0.7	34.7			
PHF	.924	.865	.500		.906	.250	.250	.250		.500	.750	.923	.911		.931	.638	.250	.650		.636	.894

Traffic Data Service

San Jose, CA
 (408) 622-4787
 tdsbay@cs.com

File Name : 19PM FINAL
 Site Code : 00000019
 Start Date : 4/25/2018
 Page No : 2

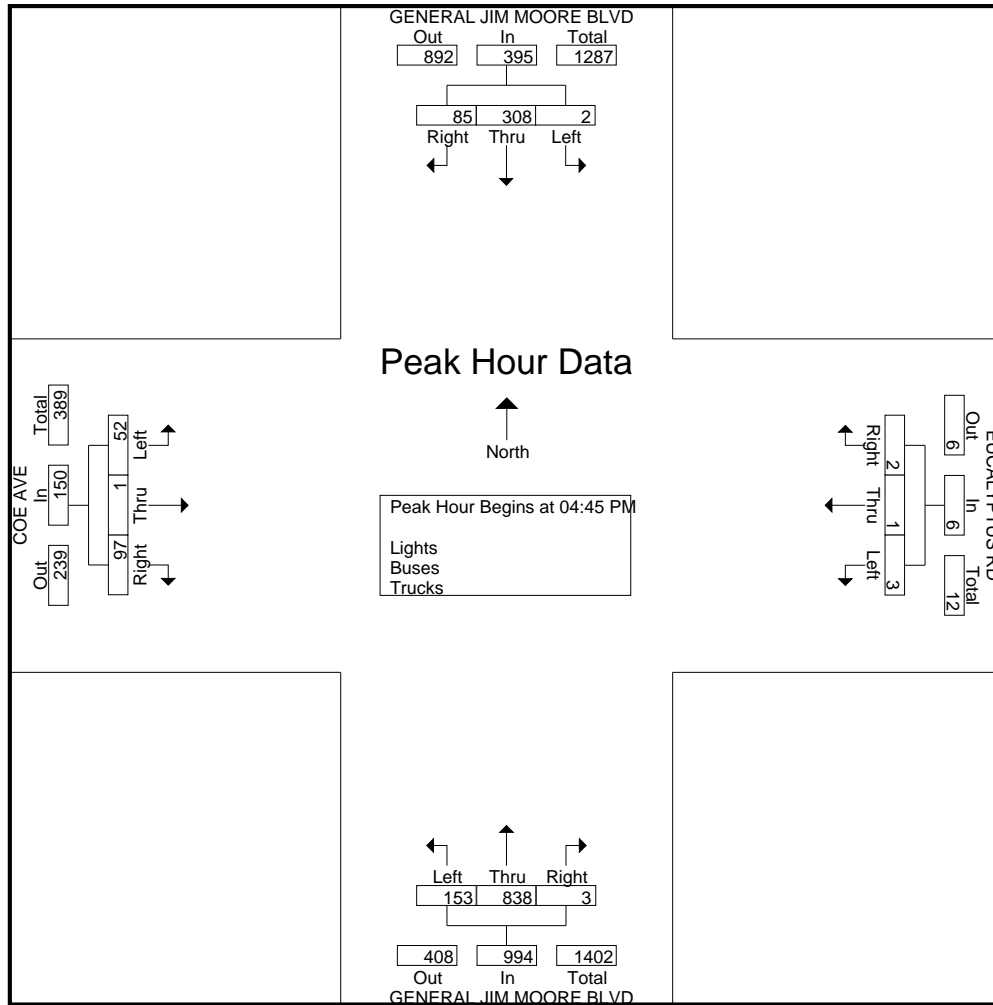

Traffic Data Service

San Jose, CA
 (408) 622-4787
 tdsbay@cs.com

File Name : 19PM FINAL
 Site Code : 00000019
 Start Date : 4/25/2018
 Page No : 1

Groups Printed- Bikes

Start Time	GENERAL JIM MOORE BLVD Southbound					EUCALYPTUS RD Westbound					GENERAL JIM MOORE BLVD Northbound					COE AVE Eastbound					Int. Total					
	Right	Thru	Left	Peds	App. Total	Right	Thru	Left	Peds	App. Total	Right	Thru	Left	Peds	App. Total	Right	Thru	Left	Peds	App. Total						
04:00 PM	0	0	0	0	0	0	0	0	0	0	0	0	0	0	0	0	0	0	0	0	0	0	0	0	0	0
04:15 PM	0	1	0	0	1	0	0	1	0	1	0	0	0	0	0	0	0	0	0	0	0	0	0	0	0	2
04:30 PM	0	0	0	0	0	0	0	0	0	0	0	0	0	0	0	0	0	0	0	0	0	0	0	0	0	0
04:45 PM	0	0	0	0	0	0	0	0	0	0	0	1	0	0	1	0	0	0	0	0	0	0	0	0	0	1
Total	0	1	0	0	1	0	0	1	0	1	0	1	0	0	1	0	0	0	0	0	0	0	0	0	0	3
05:00 PM	0	0	0	0	0	0	0	0	0	0	0	0	0	0	0	0	0	0	0	0	0	0	0	0	0	0
05:15 PM	0	1	0	0	1	0	0	0	0	0	0	0	0	0	0	0	0	0	0	0	0	0	0	0	0	1
05:30 PM	0	1	0	0	1	0	0	0	0	0	0	0	1	0	1	0	0	0	0	0	0	0	0	0	0	2
05:45 PM	0	0	0	0	0	0	0	0	0	0	0	0	0	0	0	0	0	0	0	0	0	0	0	0	0	0
Total	0	2	0	0	2	0	0	0	0	0	0	0	1	0	1	0	0	0	0	0	0	0	0	0	0	3
Grand Total	0	3	0	0	3	0	0	1	0	1	0	1	1	0	2	0	0	0	0	0	0	0	0	0	0	6
Apprch %	0	100	0	0		0	0	100	0		0	50	50	0		0	0	0	0							
Total %	0	50	0	0	50	0	0	16.7	0	16.7	0	16.7	16.7	0	33.3	0	0	0	0	0						

Start Time	GENERAL JIM MOORE BLVD Southbound					EUCALYPTUS RD Westbound					GENERAL JIM MOORE BLVD Northbound					COE AVE Eastbound					Int. Total					
	Right	Thru	Left	Peds	App. Total	Right	Thru	Left	Peds	App. Total	Right	Thru	Left	Peds	App. Total	Right	Thru	Left	Peds	App. Total						
Peak Hour Analysis From 04:00 PM to 05:45 PM - Peak 1 of 1																										
Peak Hour for Entire Intersection Begins at 04:45 PM																										
04:45 PM	0	0	0	0	0	0	0	0	0	0	0	1	0	0	1	0	0	0	0	0	0	0	0	0	0	1
05:00 PM	0	0	0	0	0	0	0	0	0	0	0	0	0	0	0	0	0	0	0	0	0	0	0	0	0	0
05:15 PM	0	1	0	0	1	0	0	0	0	0	0	0	0	0	0	0	0	0	0	0	0	0	0	0	0	1
05:30 PM	0	1	0	0	1	0	0	0	0	0	0	0	1	0	1	0	0	0	0	0	0	0	0	0	0	2
Total Volume	0	2	0	0	2	0	0	0	0	0	0	1	1	0	2	0	0	0	0	0	0	0	0	0	0	4
% App. Total	0	100	0	0		0	0	0	0		0	50	50	0		0	0	0	0							
PHF	.000	.500	.000	.000	.500	.000	.000	.000	.000	.000	.000	.250	.250	.000	.500	.000	.000	.000	.000	.000	.000	.000	.000	.000	.500	

Traffic Data Service

San Jose, CA
 (408) 622-4787
 tdsbay@cs.com

File Name : 19PM FINAL
 Site Code : 00000019
 Start Date : 4/25/2018
 Page No : 2

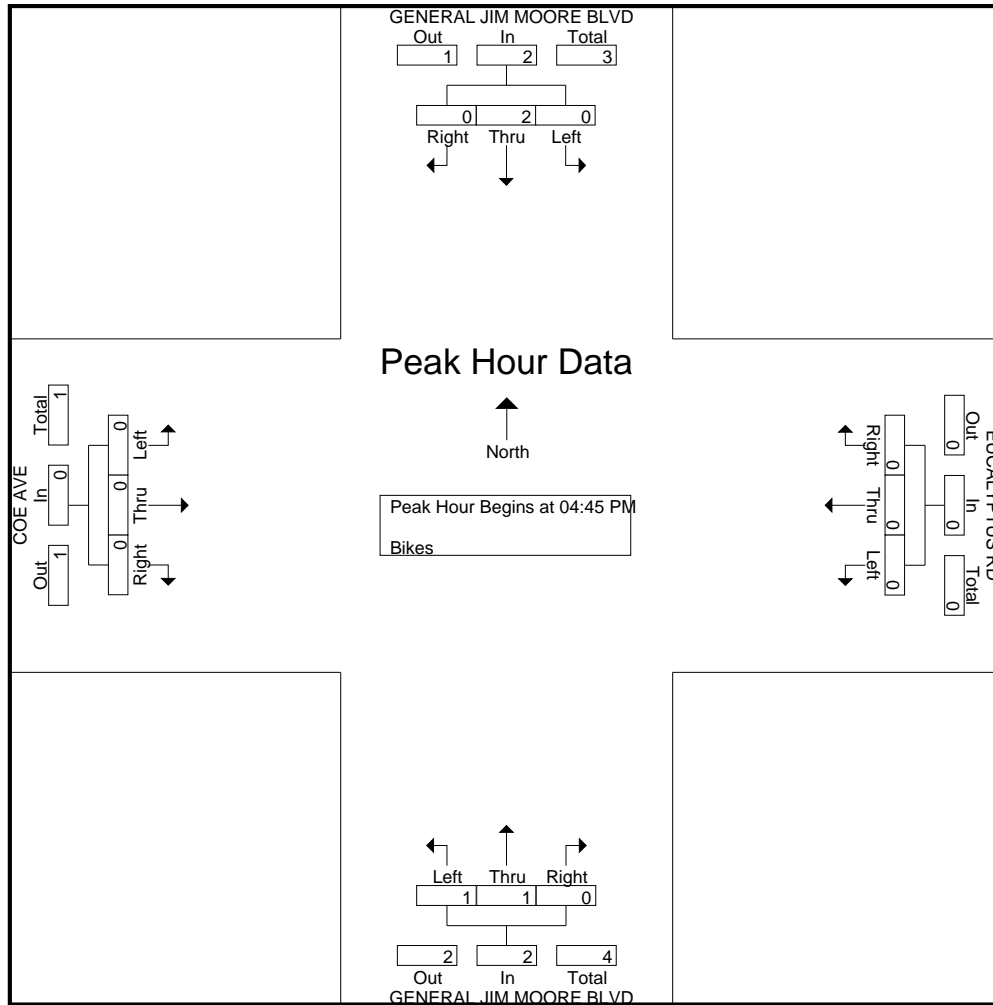

Traffic Data Service

San Jose, CA
 (408) 622-4787
 tdsbay@cs.com

File Name : 20AM FINAL
 Site Code : 00000020
 Start Date : 4/25/2018
 Page No : 1

Groups Printed- Lights - Buses - Trucks

Start Time	HWY 1 RAMPS Southbound					MONTEREY RD Westbound					FREMONT BLVD Northbound					MONTEREY RD Eastbound					Int. Total
	Right	Thru	Left	Peds	App. Total	Right	Thru	Left	Peds	App. Total	Right	Thru	Left	Peds	App. Total	Right	Thru	Left	Peds	App. Total	
07:00 AM	49	179	15	0	243	15	78	17	0	110	11	94	29	3	137	7	8	14	0	29	519
07:15 AM	51	187	19	0	257	7	66	20	0	93	11	109	49	6	175	8	25	16	1	50	575
07:30 AM	41	174	30	0	245	4	78	22	0	104	30	130	49	3	212	22	39	19	3	83	644
07:45 AM	40	197	36	0	273	7	70	29	0	106	59	142	53	1	255	21	46	18	5	90	724
Total	181	737	100	0	1018	33	292	88	0	413	111	475	180	13	779	58	118	67	9	252	2462
08:00 AM	35	216	19	0	270	2	64	29	0	95	28	127	39	5	199	18	30	16	4	68	632
08:15 AM	37	217	8	1	263	6	71	33	0	110	23	107	52	4	186	33	21	16	1	71	630
08:30 AM	34	191	6	1	232	7	57	32	0	96	12	124	50	8	194	21	25	27	0	73	595
08:45 AM	37	207	6	1	251	5	59	35	0	99	18	103	45	1	167	21	25	19	1	66	583
Total	143	831	39	3	1016	20	251	129	0	400	81	461	186	18	746	93	101	78	6	278	2440
Grand Total	324	1568	139	3	2034	53	543	217	0	813	192	936	366	31	1525	151	219	145	15	530	4902
Apprch %	15.9	77.1	6.8	0.1		6.5	66.8	26.7	0		12.6	61.4	24	2		28.5	41.3	27.4	2.8		
Total %	6.6	32	2.8	0.1	41.5	1.1	11.1	4.4	0	16.6	3.9	19.1	7.5	0.6	31.1	3.1	4.5	3	0.3	10.8	
Lights	312	1515	138	3	1968	52	538	211	0	801	184	887	359	31	1461	147	216	136	15	514	4744
% Lights	96.3	96.6	99.3	100	96.8	98.1	99.1	97.2	0	98.5	95.8	94.8	98.1	100	95.8	97.4	98.6	93.8	100	97	96.8
Buses	6	7	0	0	13	0	2	2	0	4	5	9	2	0	16	1	1	4	0	6	39
% Buses	1.9	0.4	0	0	0.6	0	0.4	0.9	0	0.5	2.6	1	0.5	0	1	0.7	0.5	2.8	0	1.1	0.8
Trucks	6	46	1	0	53	1	3	4	0	8	3	40	5	0	48	3	2	5	0	10	119
% Trucks	1.9	2.9	0.7	0	2.6	1.9	0.6	1.8	0	1	1.6	4.3	1.4	0	3.1	2	0.9	3.4	0	1.9	2.4

Start Time	HWY 1 RAMPS Southbound				MONTEREY RD Westbound				FREMONT BLVD Northbound				MONTEREY RD Eastbound				Int. Total
	Right	Thru	Left	App. Total	Right	Thru	Left	App. Total	Right	Thru	Left	App. Total	Right	Thru	Left	App. Total	
Peak Hour Analysis From 07:00 AM to 08:45 AM - Peak 1 of 1																	
Peak Hour for Entire Intersection Begins at 07:30 AM																	
07:30 AM	41	174	30	245	4	78	22	104	30	130	49	209	22	39	19	80	638
07:45 AM	40	197	36	273	7	70	29	106	59	142	53	254	21	46	18	85	718
08:00 AM	35	216	19	270	2	64	29	95	28	127	39	194	18	30	16	64	623
08:15 AM	37	217	8	262	6	71	33	110	23	107	52	182	33	21	16	70	624
Total Volume	153	804	93	1050	19	283	113	415	140	506	193	839	94	136	69	299	2603
% App. Total	14.6	76.6	8.9		4.6	68.2	27.2		16.7	60.3	23		31.4	45.5	23.1		
PHF	.933	.926	.646	.962	.679	.907	.856	.943	.593	.891	.910	.826	.712	.739	.908	.879	.906

Traffic Data Service

San Jose, CA
 (408) 622-4787
 tdsbay@cs.com

File Name : 20AM FINAL
 Site Code : 00000020
 Start Date : 4/25/2018
 Page No : 2

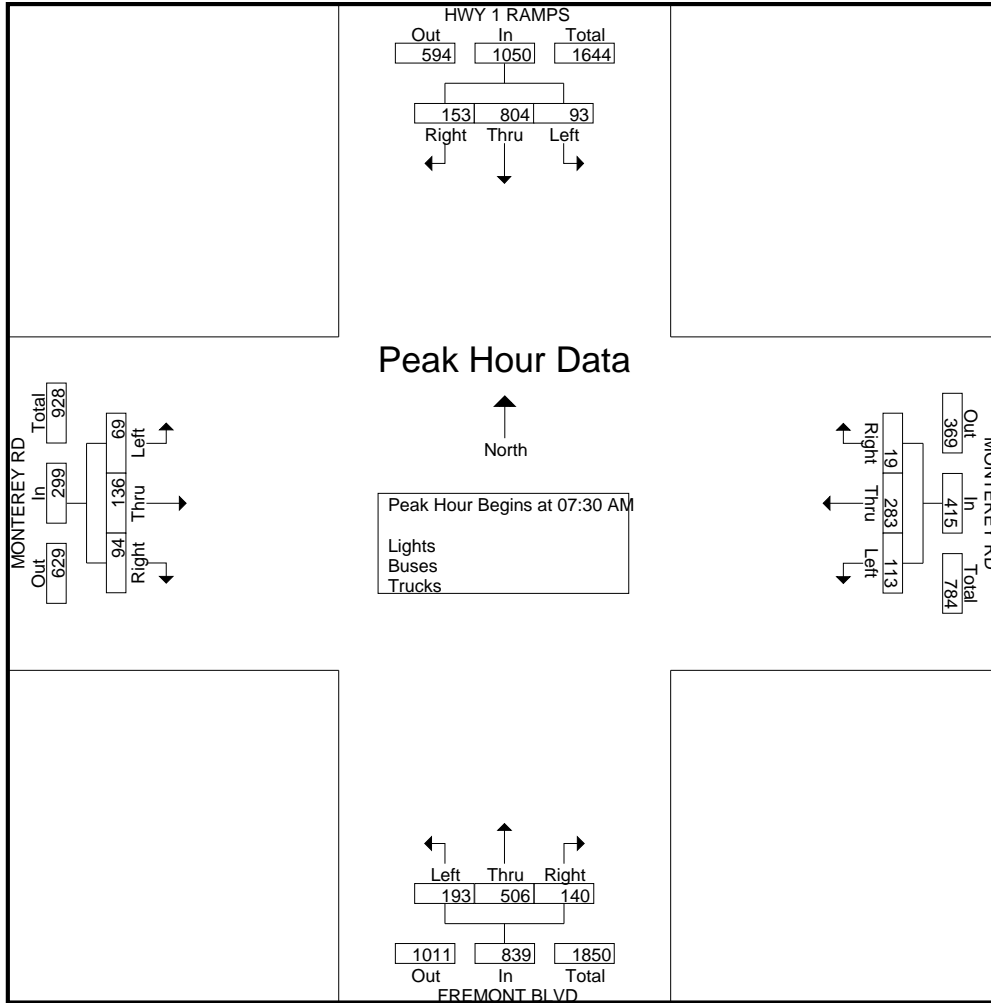

Traffic Data Service

San Jose, CA
 (408) 622-4787
 tdsbay@cs.com

File Name : 20AM FINAL
 Site Code : 00000020
 Start Date : 4/25/2018
 Page No : 1

Groups Printed- Bikes

Start Time	HWY 1 RAMPS Southbound					MONTEREY RD Westbound					FREMONT BLVD Northbound					MONTEREY RD Eastbound					Int. Total
	Right	Thru	Left	Peds	App. Total	Right	Thru	Left	Peds	App. Total	Right	Thru	Left	Peds	App. Total	Right	Thru	Left	Peds	App. Total	
07:00 AM	0	0	0	0	0	0	0	0	0	0	0	0	0	0	0	0	0	0	0	0	0
07:15 AM	0	0	0	0	0	0	0	0	0	0	0	0	0	0	0	0	0	0	0	0	0
07:30 AM	0	0	0	0	0	0	1	0	0	1	0	0	0	0	0	0	1	0	0	1	2
07:45 AM	0	0	0	0	0	0	0	0	0	0	0	0	0	0	0	0	0	0	0	0	0
Total	0	0	0	0	0	0	1	0	0	1	0	0	0	0	0	0	1	0	0	1	2
08:00 AM	0	0	0	0	0	0	1	0	0	1	0	0	0	0	0	0	0	0	0	0	1
08:15 AM	0	0	0	0	0	0	0	0	0	0	0	0	0	0	0	0	0	0	0	0	0
08:30 AM	0	0	0	0	0	0	0	0	0	0	0	0	0	0	0	0	0	0	0	0	0
08:45 AM	0	0	0	0	0	0	0	0	0	0	0	0	0	0	0	1	0	0	0	1	1
Total	0	0	0	0	0	0	1	0	0	1	0	0	0	0	0	1	0	0	0	1	2
Grand Total	0	0	0	0	0	0	2	0	0	2	0	0	0	0	0	1	1	0	0	2	4
Apprch %	0	0	0	0	0	0	100	0	0	0	0	0	0	0	0	50	50	0	0	0	
Total %	0	0	0	0	0	0	50	0	0	50	0	0	0	0	0	25	25	0	0	50	

Start Time	HWY 1 RAMPS Southbound					MONTEREY RD Westbound					FREMONT BLVD Northbound					MONTEREY RD Eastbound					Int. Total
	Right	Thru	Left	Peds	App. Total	Right	Thru	Left	Peds	App. Total	Right	Thru	Left	Peds	App. Total	Right	Thru	Left	Peds	App. Total	
07:15 AM	0	0	0	0	0	0	0	0	0	0	0	0	0	0	0	0	0	0	0	0	0
07:30 AM	0	0	0	0	0	0	1	0	0	1	0	0	0	0	0	0	1	0	0	1	2
07:45 AM	0	0	0	0	0	0	0	0	0	0	0	0	0	0	0	0	0	0	0	0	0
08:00 AM	0	0	0	0	0	0	1	0	0	1	0	0	0	0	0	0	0	0	0	0	1
Total Volume	0	0	0	0	0	0	2	0	0	2	0	0	0	0	0	0	1	0	0	1	3
% App. Total	0	0	0	0	0	0	100	0	0	0	0	0	0	0	0	0	100	0	0	0	
PHF	.000	.000	.000	.000	.000	.000	.500	.000	.000	.500	.000	.000	.000	.000	.000	.000	.250	.000	.250	.375	

Peak Hour Analysis From 07:00 AM to 08:45 AM - Peak 1 of 1
 Peak Hour for Entire Intersection Begins at 07:15 AM

Traffic Data Service

San Jose, CA
(408) 622-4787
tdsbay@cs.com

File Name : 20AM FINAL
Site Code : 00000020
Start Date : 4/25/2018
Page No : 2

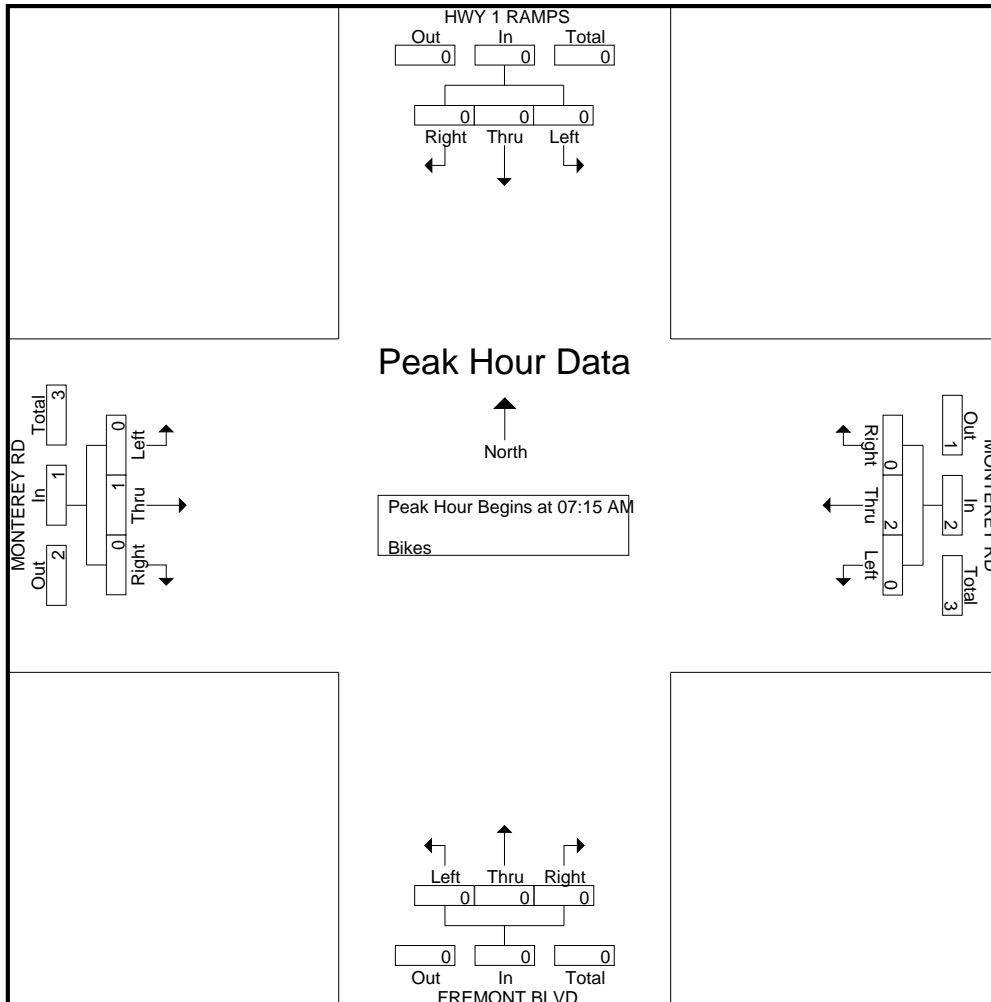

Traffic Data Service

San Jose, CA
 (408) 622-4787
 tdsbay@cs.com

File Name : 20PM FINAL
 Site Code : 00000020
 Start Date : 4/25/2018
 Page No : 1

Groups Printed- Lights - Buses - Trucks

Start Time	HWY 1 RAMPS Southbound					MONTEREY RD Westbound					FREMONT BLVD Northbound					MONTEREY RD Eastbound					Int. Total
	Right	Thru	Left	Peds	App. Total	Right	Thru	Left	Peds	App. Total	Right	Thru	Left	Peds	App. Total	Right	Thru	Left	Peds	App. Total	
04:00 PM	63	164	13	0	240	15	24	15	0	54	43	250	36	2	331	19	41	52	0	112	737
04:15 PM	46	147	20	0	213	14	38	20	0	72	38	211	34	0	283	20	51	62	1	134	702
04:30 PM	42	141	15	0	198	19	39	18	0	76	38	222	46	6	312	13	42	55	1	111	697
04:45 PM	49	148	14	0	211	14	32	16	0	62	50	238	35	2	325	19	37	36	5	97	695
Total	200	600	62	0	862	62	133	69	0	264	169	921	151	10	1251	71	171	205	7	454	2831
05:00 PM	39	183	12	0	234	12	45	17	0	74	46	269	31	0	346	9	50	50	0	109	763
05:15 PM	51	128	26	0	205	12	41	23	0	76	60	248	22	3	333	14	43	49	2	108	722
05:30 PM	52	129	18	0	199	15	32	18	0	65	61	230	24	1	316	13	71	66	1	151	731
05:45 PM	56	136	22	1	215	16	43	31	0	90	59	225	34	0	318	21	59	48	3	131	754
Total	198	576	78	1	853	55	161	89	0	305	226	972	111	4	1313	57	223	213	6	499	2970
Grand Total	398	1176	140	1	1715	117	294	158	0	569	395	1893	262	14	2564	128	394	418	13	953	5801
Apprch %	23.2	68.6	8.2	0.1		20.6	51.7	27.8	0		15.4	73.8	10.2	0.5		13.4	41.3	43.9	1.4		
Total %	6.9	20.3	2.4	0	29.6	2	5.1	2.7	0	9.8	6.8	32.6	4.5	0.2	44.2	2.2	6.8	7.2	0.2	16.4	
Lights	391	1159	140	1	1691	116	292	158	0	566	391	1869	260	14	2534	127	390	414	13	944	5735
% Lights	98.2	98.6	100	100	98.6	99.1	99.3	100	0	99.5	99	98.7	99.2	100	98.8	99.2	99	99	100	99.1	98.9
Buses	6	4	0	0	10	0	2	0	0	2	0	4	1	0	5	0	4	4	0	8	25
% Buses	1.5	0.3	0	0	0.6	0	0.7	0	0	0.4	0	0.2	0.4	0	0.2	0	1	1	0	0.8	0.4
Trucks	1	13	0	0	14	1	0	0	0	1	4	20	1	0	25	1	0	0	0	1	41
% Trucks	0.3	1.1	0	0	0.8	0.9	0	0	0	0.2	1	1.1	0.4	0	1	0.8	0	0	0	0.1	0.7

Start Time	HWY 1 RAMPS Southbound					MONTEREY RD Westbound					FREMONT BLVD Northbound					MONTEREY RD Eastbound					Int. Total
	Right	Thru	Left	Peds	App. Total	Right	Thru	Left	Peds	App. Total	Right	Thru	Left	Peds	App. Total	Right	Thru	Left	Peds	App. Total	
Peak Hour Analysis From 04:00 PM to 05:45 PM - Peak 1 of 1																					
Peak Hour for Entire Intersection Begins at 05:00 PM																					
05:00 PM	39	183	12		234	12	45	17		74	46	269	31		346	9	50	50		109	763
05:15 PM	51	128	26		205	12	41	23		76	60	248	22		330	14	43	49		106	717
05:30 PM	52	129	18		199	15	32	18		65	61	230	24		315	13	71	66		150	729
05:45 PM	56	136	22		214	16	43	31		90	59	225	34		318	21	59	48		128	750
Total Volume	198	576	78		852	55	161	89		305	226	972	111		1309	57	223	213		493	2959
% App. Total	23.2	67.6	9.2			18	52.8	29.2			17.3	74.3	8.5			11.6	45.2	43.2			
PHF	.884	.787	.750		.910	.859	.894	.718		.847	.926	.903	.816		.946	.679	.785	.807		.822	.970

Traffic Data Service

San Jose, CA
 (408) 622-4787
 tdsbay@cs.com

File Name : 20PM FINAL
 Site Code : 00000020
 Start Date : 4/25/2018
 Page No : 2

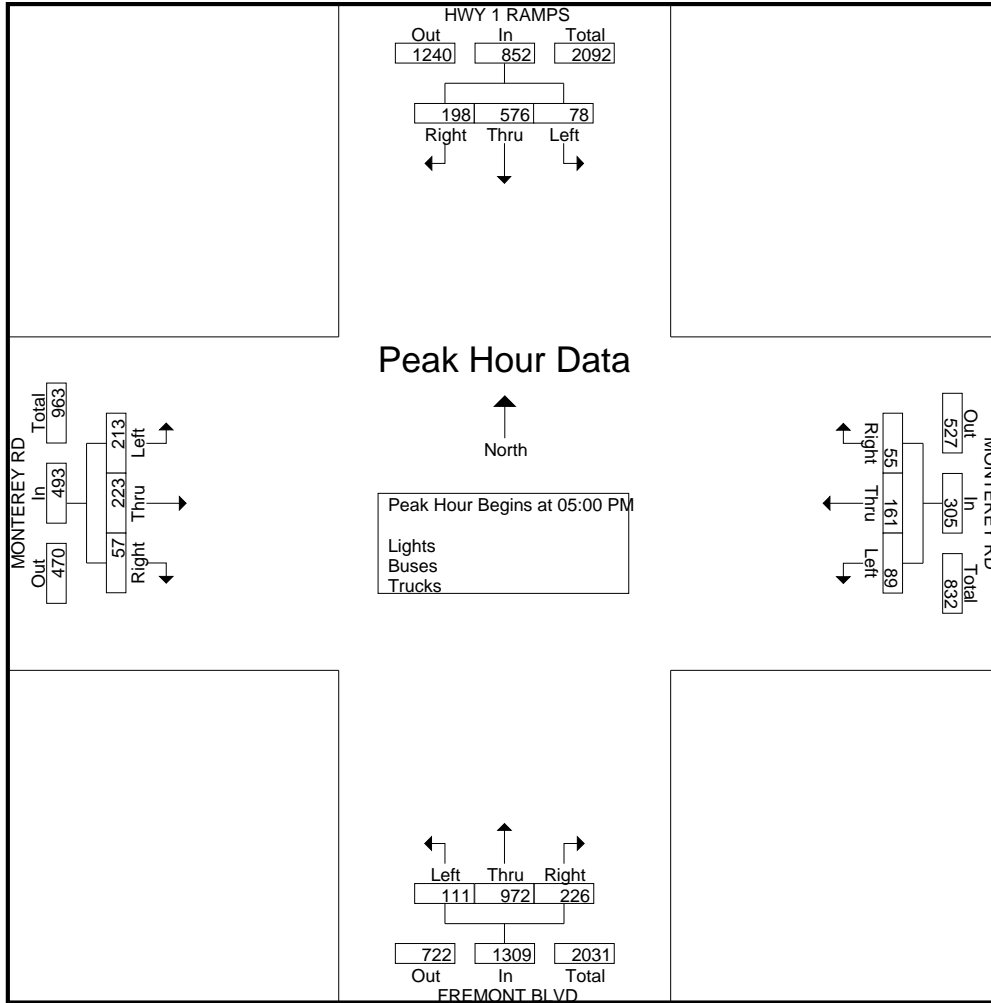

Traffic Data Service

San Jose, CA
(408) 622-4787
tdsbay@cs.com

File Name : 20PM FINAL
Site Code : 00000020
Start Date : 4/25/2018
Page No : 1

Groups Printed- Bikes

Start Time	HWY 1 RAMPS Southbound					MONTEREY RD Westbound					FREMONT BLVD Northbound					MONTEREY RD Eastbound					Int. Total
	Right	Thru	Left	Peds	App. Total	Right	Thru	Left	Peds	App. Total	Right	Thru	Left	Peds	App. Total	Right	Thru	Left	Peds	App. Total	
04:00 PM	1	0	0	0	1	0	0	0	0	0	0	0	0	0	0	0	0	0	0	0	0
04:15 PM	1	0	0	0	1	0	0	0	0	0	0	0	0	0	0	0	0	0	0	0	0
04:30 PM	0	0	0	0	0	0	0	0	0	0	0	0	0	0	0	0	0	0	0	0	0
04:45 PM	0	1	0	0	1	0	0	0	0	0	0	0	0	0	0	0	1	0	0	1	2
Total	2	1	0	0	3	0	0	0	0	0	0	0	0	0	0	0	1	0	0	1	4
05:00 PM	0	0	0	0	0	0	0	0	0	0	0	0	0	0	0	0	0	0	0	0	0
05:15 PM	0	0	0	0	0	0	0	0	0	0	0	0	0	0	0	0	1	0	0	1	1
05:30 PM	0	0	0	0	0	0	0	0	0	0	0	0	0	0	0	0	0	0	0	0	0
05:45 PM	0	0	0	0	0	0	0	0	0	0	0	0	0	0	0	0	0	0	0	0	0
Total	0	0	0	0	0	0	0	0	0	0	0	0	0	0	0	0	1	0	0	1	1
Grand Total	2	1	0	0	3	0	0	0	0	0	0	0	0	0	0	0	2	0	0	2	5
Apprch %	66.7	33.3	0	0		0	0	0	0		0	0	0	0		0	100	0	0		
Total %	40	20	0	0	60	0	0	0	0	0	0	0	0	0	0	0	40	0	0	40	

Start Time	HWY 1 RAMPS Southbound					MONTEREY RD Westbound					FREMONT BLVD Northbound					MONTEREY RD Eastbound					Int. Total
	Right	Thru	Left	Peds	App. Total	Right	Thru	Left	Peds	App. Total	Right	Thru	Left	Peds	App. Total	Right	Thru	Left	Peds	App. Total	
Peak Hour Analysis From 04:00 PM to 05:45 PM - Peak 1 of 1																					
Peak Hour for Entire Intersection Begins at 04:00 PM																					
04:00 PM	1	0	0	0	1	0	0	0	0	0	0	0	0	0	0	0	0	0	0	0	1
04:15 PM	1	0	0	0	1	0	0	0	0	0	0	0	0	0	0	0	0	0	0	0	1
04:30 PM	0	0	0	0	0	0	0	0	0	0	0	0	0	0	0	0	0	0	0	0	0
04:45 PM	0	1	0	0	1	0	0	0	0	0	0	0	0	0	0	0	1	0	0	1	2
Total Volume	2	1	0	0	3	0	0	0	0	0	0	0	0	0	0	0	1	0	0	1	4
% App. Total	66.7	33.3	0	0		0	0	0	0		0	0	0	0		0	100	0	0		
PHF	.500	.250	.000	.000	.750	.000	.000	.000	.000	.000	.000	.000	.000	.000	.000	.000	.250	.000	.000	.250	.500

Traffic Data Service

San Jose, CA
 (408) 622-4787
 tdsbay@cs.com

File Name : 20PM FINAL
 Site Code : 00000020
 Start Date : 4/25/2018
 Page No : 2

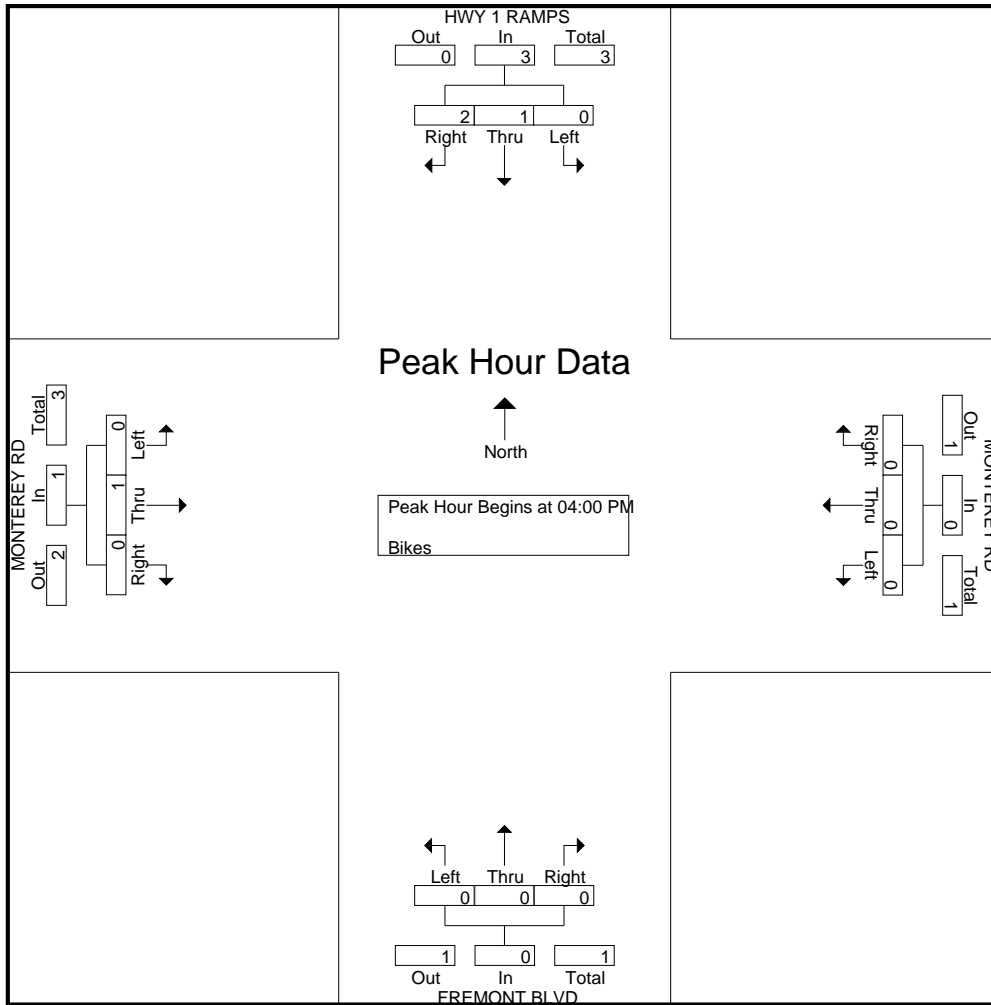

Traffic Data Service

San Jose, CA
 (408) 622-4787
 tdsbay@cs.com

File Name : 21AM FINAL
 Site Code : 00000021
 Start Date : 4/25/2018
 Page No : 1

Groups Printed- Lights - Buses - Trucks

Start Time	HWY 1 SB ON-RAMP Southbound					MONTEREY RD Westbound					CALIFORNIA AVE Northbound					HWY 1 NB OFF-RAMP Eastbound					Int. Total
	Right	Thru	Left	Peds	App. Total	Right	Thru	Left	Peds	App. Total	Right	Thru	Left	Peds	App. Total	Right	Thru	Left	Peds	App. Total	
07:00 AM	0	0	0	0	0	102	0	53	0	155	19	17	0	0	36	16	13	1	0	30	221
07:15 AM	0	0	0	0	0	107	0	55	0	162	23	17	0	0	40	14	27	0	0	41	243
07:30 AM	0	0	0	0	0	118	0	52	0	170	28	6	0	0	34	13	48	0	0	61	265
07:45 AM	0	0	0	0	0	111	0	54	0	165	33	8	0	1	42	22	53	0	0	75	282
Total	0	0	0	0	0	438	0	214	0	652	103	48	0	1	152	65	141	1	0	207	1011
08:00 AM	0	1	0	0	1	90	0	62	3	155	23	12	0	0	35	31	50	0	0	81	272
08:15 AM	0	0	0	0	0	97	0	57	0	154	25	15	0	1	41	34	47	2	0	83	278
08:30 AM	0	0	1	0	1	90	0	57	0	147	36	13	0	0	49	29	35	2	0	66	263
08:45 AM	0	0	1	0	1	97	0	47	0	144	33	18	0	1	52	23	34	0	0	57	254
Total	0	1	2	0	3	374	0	223	3	600	117	58	0	2	177	117	166	4	0	287	1067
Grand Total	0	1	2	0	3	812	0	437	3	1252	220	106	0	3	329	182	307	5	0	494	2078
Apprch %	0	33.3	66.7	0		64.9	0	34.9	0.2		66.9	32.2	0	0.9		36.8	62.1	1	0		
Total %	0	0	0.1	0	0.1	39.1	0	21	0.1	60.3	10.6	5.1	0	0.1	15.8	8.8	14.8	0.2	0	23.8	
Lights	0	1	2	0	3	801	0	421	3	1225	209	103	0	3	315	174	300	5	0	479	2022
% Lights	0	100	100	0	100	98.6	0	96.3	100	97.8	95	97.2	0	100	95.7	95.6	97.7	100	0	97	97.3
Buses	0	0	0	0	0	2	0	7	0	9	4	0	0	0	4	5	1	0	0	6	19
% Buses	0	0	0	0	0	0.2	0	1.6	0	0.7	1.8	0	0	0	1.2	2.7	0.3	0	0	1.2	0.9
Trucks	0	0	0	0	0	9	0	9	0	18	7	3	0	0	10	3	6	0	0	9	37
% Trucks	0	0	0	0	0	1.1	0	2.1	0	1.4	3.2	2.8	0	0	3	1.6	2	0	0	1.8	1.8

Start Time	HWY 1 SB ON-RAMP Southbound				MONTEREY RD Westbound				CALIFORNIA AVE Northbound				HWY 1 NB OFF-RAMP Eastbound				Int. Total
	Right	Thru	Left	App. Total	Right	Thru	Left	App. Total	Right	Thru	Left	App. Total	Right	Thru	Left	App. Total	
Peak Hour Analysis From 07:00 AM to 08:45 AM - Peak 1 of 1																	
Peak Hour for Entire Intersection Begins at 07:30 AM																	
07:30 AM	0	0	0	0	118	0	52	170	28	6	0	34	13	48	0	61	265
07:45 AM	0	0	0	0	111	0	54	165	33	8	0	41	22	53	0	75	281
08:00 AM	0	1	0	1	90	0	62	152	23	12	0	35	31	50	0	81	269
08:15 AM	0	0	0	0	97	0	57	154	25	15	0	40	34	47	2	83	277
Total Volume	0	1	0	1	416	0	225	641	109	41	0	150	100	198	2	300	1092
% App. Total	0	100	0		64.9	0	35.1		72.7	27.3	0		33.3	66	0.7		
PHF	.000	.250	.000	.250	.881	.000	.907	.943	.826	.683	.000	.915	.735	.934	.250	.904	.972

Traffic Data Service

San Jose, CA
 (408) 622-4787
 tdsbay@cs.com

File Name : 21AM FINAL
 Site Code : 00000021
 Start Date : 4/25/2018
 Page No : 2

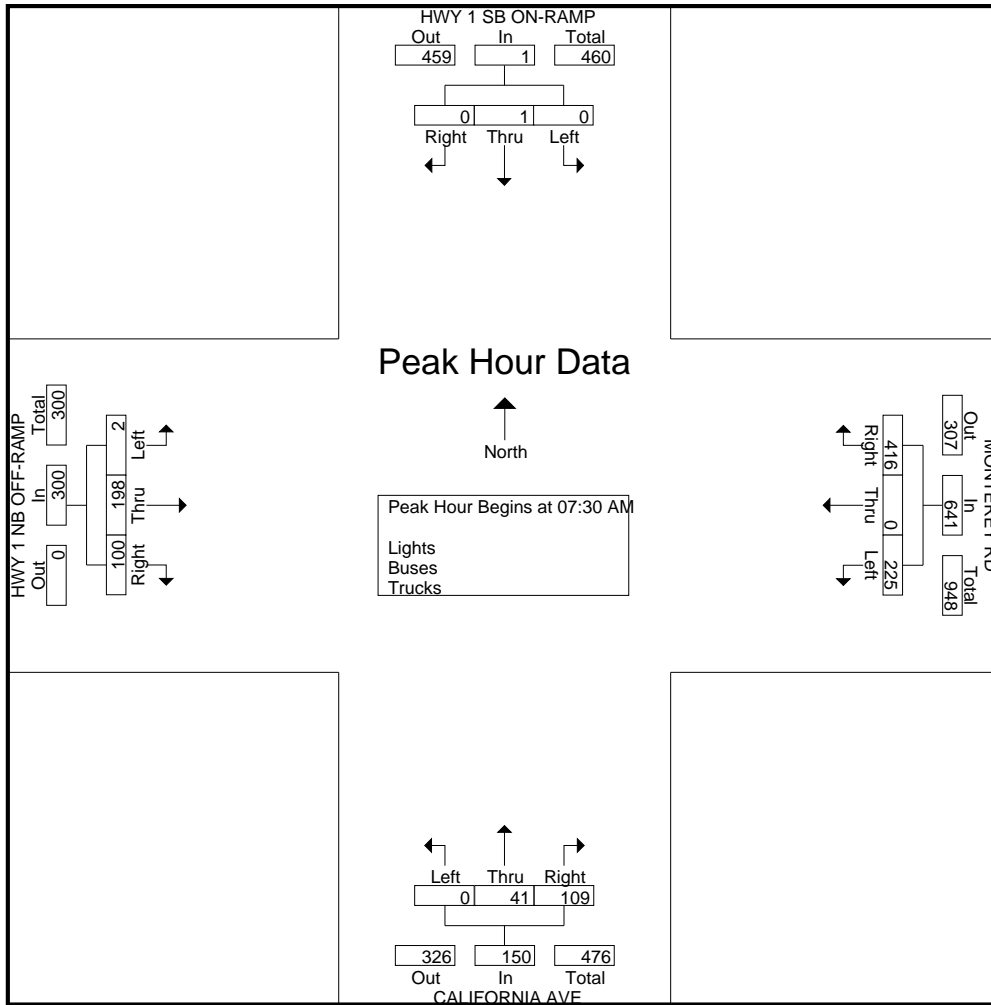

Traffic Data Service

San Jose, CA
 (408) 622-4787
 tdsbay@cs.com

File Name : 21AM FINAL
 Site Code : 00000021
 Start Date : 4/25/2018
 Page No : 1

Groups Printed- Bikes

Start Time	HWY 1 SB ON-RAMP Southbound					MONTEREY RD Westbound					CALIFORNIA AVE Northbound					HWY 1 NB OFF-RAMP Eastbound					Int. Total
	Right	Thru	Left	Peds	App. Total	Right	Thru	Left	Peds	App. Total	Right	Thru	Left	Peds	App. Total	Right	Thru	Left	Peds	App. Total	
07:00 AM	0	0	0	0	0	0	0	0	0	0	0	0	0	0	0	0	0	0	0	0	0
07:15 AM	0	0	0	0	0	0	0	1	0	1	0	0	0	0	0	0	0	0	0	0	1
07:30 AM	0	0	0	0	0	0	0	1	0	1	0	0	0	0	0	0	0	0	0	0	1
07:45 AM	0	0	0	0	0	0	0	0	0	0	1	0	0	0	1	0	0	0	0	0	1
Total	0	0	0	0	0	0	0	2	0	2	1	0	0	0	1	0	0	0	0	0	3
08:00 AM	0	0	0	0	0	0	0	1	0	1	0	0	0	0	0	0	0	0	0	0	1
08:15 AM	0	0	0	0	0	0	0	0	0	0	1	0	0	0	1	0	0	0	0	0	1
08:30 AM	0	0	0	0	0	0	0	0	0	0	0	0	0	0	0	0	0	0	0	0	0
08:45 AM	0	0	0	0	0	0	0	0	0	0	1	0	0	0	1	0	0	0	0	0	1
Total	0	0	0	0	0	0	0	1	0	1	2	0	0	0	2	0	0	0	0	0	3
Grand Total	0	0	0	0	0	0	0	3	0	3	3	0	0	0	3	0	0	0	0	0	6
Apprch %	0	0	0	0	0	0	0	100	0	100	100	0	0	0	100	0	0	0	0	0	
Total %	0	0	0	0	0	0	0	50	0	50	50	0	0	0	50	0	0	0	0	0	

Start Time	HWY 1 SB ON-RAMP Southbound					MONTEREY RD Westbound					CALIFORNIA AVE Northbound					HWY 1 NB OFF-RAMP Eastbound					Int. Total
	Right	Thru	Left	Peds	App. Total	Right	Thru	Left	Peds	App. Total	Right	Thru	Left	Peds	App. Total	Right	Thru	Left	Peds	App. Total	
07:15 AM	0	0	0	0	0	0	0	1	0	1	0	0	0	0	0	0	0	0	0	0	1
07:30 AM	0	0	0	0	0	0	0	1	0	1	0	0	0	0	0	0	0	0	0	0	1
07:45 AM	0	0	0	0	0	0	0	0	0	0	1	0	0	0	1	0	0	0	0	0	1
08:00 AM	0	0	0	0	0	0	0	1	0	1	0	0	0	0	0	0	0	0	0	0	1
Total Volume	0	0	0	0	0	0	0	3	0	3	1	0	0	0	1	0	0	0	0	0	4
% App. Total	0	0	0	0	0	0	0	100	0	100	100	0	0	0	100	0	0	0	0	0	
PHF	.000	.000	.000	.000	.000	.000	.000	.750	.750	.250	.000	.000	.250	.000	.000	.000	.000	.000	1.00		

Peak Hour Analysis From 07:00 AM to 08:45 AM - Peak 1 of 1
 Peak Hour for Entire Intersection Begins at 07:15 AM

Traffic Data Service

San Jose, CA
 (408) 622-4787
 tdsbay@cs.com

File Name : 21AM FINAL
 Site Code : 00000021
 Start Date : 4/25/2018
 Page No : 2

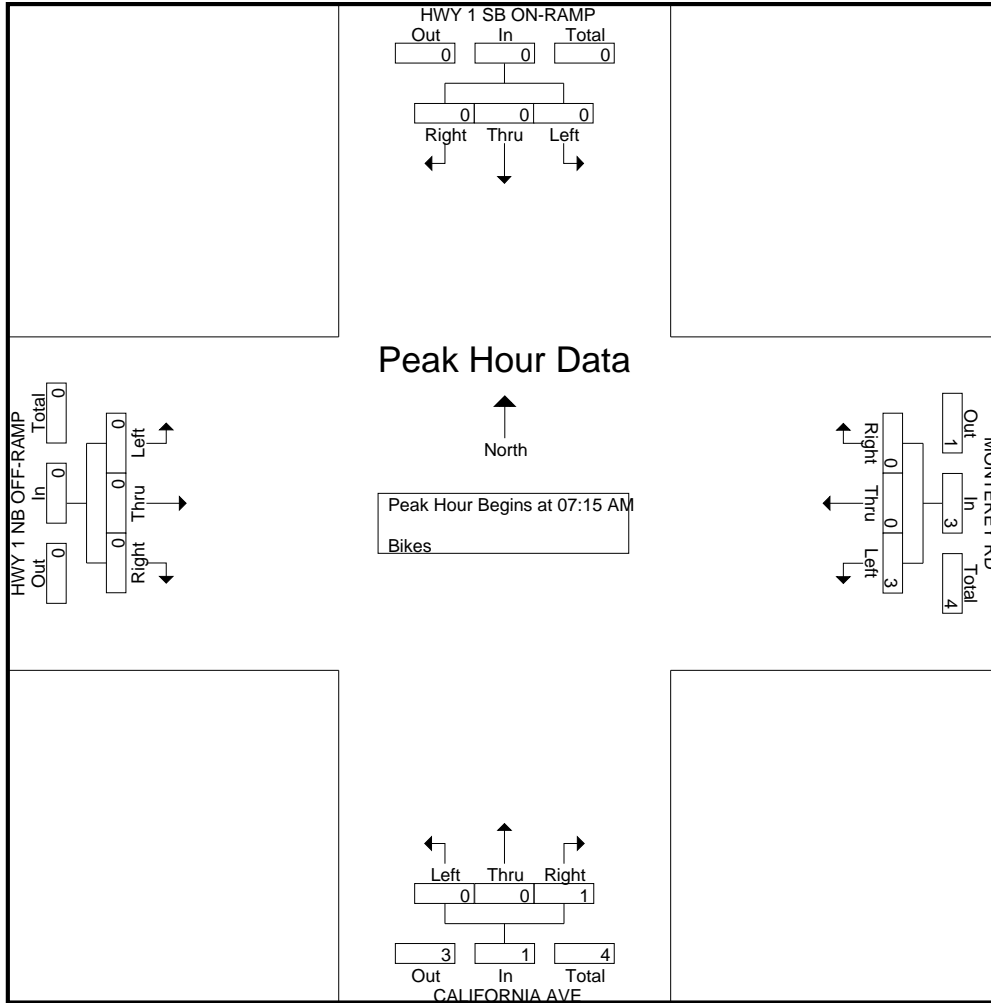

Traffic Data Service

San Jose, CA
 (408) 622-4787
 tdsbay@cs.com

File Name : 21PM FINAL
 Site Code : 00000021
 Start Date : 4/25/2018
 Page No : 1

Groups Printed- Lights - Buses - Trucks

Start Time	HWY 1 SB ON-RAMP Southbound					MONTEREY RD Westbound					CALIFORNIA AVE Northbound					HWY 1 NB OFF-RAMP Eastbound					Int. Total
	Right	Thru	Left	Peds	App. Total	Right	Thru	Left	Peds	App. Total	Right	Thru	Left	Peds	App. Total	Right	Thru	Left	Peds	App. Total	
04:00 PM	0	0	0	0	0	44	0	74	0	118	67	23	0	1	91	31	45	0	0	76	285
04:15 PM	0	0	0	0	0	60	0	57	0	117	85	32	0	0	117	35	51	0	0	86	320
04:30 PM	0	0	0	0	0	65	0	52	1	118	75	32	0	1	108	17	35	0	0	52	278
04:45 PM	0	0	1	0	1	47	0	69	0	116	55	30	0	2	87	28	35	0	0	63	267
Total	0	0	1	0	1	216	0	252	1	469	282	117	0	4	403	111	166	0	0	277	1150
05:00 PM	0	1	0	0	1	53	0	60	0	113	65	34	0	0	99	22	49	0	0	71	284
05:15 PM	0	0	0	0	0	45	0	71	0	116	69	23	0	3	95	24	39	0	0	63	274
05:30 PM	0	0	1	0	1	43	0	61	0	104	80	28	0	0	108	29	62	0	0	91	304
05:45 PM	0	0	0	0	0	49	0	80	0	129	71	27	0	0	98	45	54	0	0	99	326
Total	0	1	1	0	2	190	0	272	0	462	285	112	0	3	400	120	204	0	0	324	1188
Grand Total	0	1	2	0	3	406	0	524	1	931	567	229	0	7	803	231	370	0	0	601	2338
Apprch %	0	33.3	66.7	0		43.6	0	56.3	0.1		70.6	28.5	0	0.9		38.4	61.6	0	0		
Total %	0	0	0.1	0	0.1	17.4	0	22.4	0	39.8	24.3	9.8	0	0.3	34.3	9.9	15.8	0	0	25.7	
Lights	0	1	2	0	3	403	0	516	1	920	562	224	0	7	793	229	366	0	0	595	2311
% Lights	0	100	100	0	100	99.3	0	98.5	100	98.8	99.1	97.8	0	100	98.8	99.1	98.9	0	0	99	98.8
Buses	0	0	0	0	0	2	0	7	0	9	5	4	0	0	9	1	3	0	0	4	22
% Buses	0	0	0	0	0	0.5	0	1.3	0	1	0.9	1.7	0	0	1.1	0.4	0.8	0	0	0.7	0.9
Trucks	0	0	0	0	0	1	0	1	0	2	0	1	0	0	1	1	1	0	0	2	5
% Trucks	0	0	0	0	0	0.2	0	0.2	0	0.2	0	0.4	0	0	0.1	0.4	0.3	0	0	0.3	0.2

Start Time	HWY 1 SB ON-RAMP Southbound				MONTEREY RD Westbound				CALIFORNIA AVE Northbound				HWY 1 NB OFF-RAMP Eastbound				Int. Total
	Right	Thru	Left	App. Total	Right	Thru	Left	App. Total	Right	Thru	Left	App. Total	Right	Thru	Left	App. Total	
Peak Hour Analysis From 04:00 PM to 05:45 PM - Peak 1 of 1																	
Peak Hour for Entire Intersection Begins at 05:00 PM																	
05:00 PM	0	1	0	1	53	0	60	113	65	34	0	99	22	49	0	71	284
05:15 PM	0	0	0	0	45	0	71	116	69	23	0	92	24	39	0	63	271
05:30 PM	0	0	1	1	43	0	61	104	80	28	0	108	29	62	0	91	304
05:45 PM	0	0	0	0	49	0	80	129	71	27	0	98	45	54	0	99	326
Total Volume	0	1	1	2	190	0	272	462	285	112	0	397	120	204	0	324	1185
% App. Total	0	50	50		41.1	0	58.9		71.8	28.2	0		37	63	0		
PHF	.000	.250	.250	.500	.896	.000	.850	.895	.891	.824	.000	.919	.667	.823	.000	.818	.909

Traffic Data Service

San Jose, CA
 (408) 622-4787
 tdsbay@cs.com

File Name : 21PM FINAL
 Site Code : 00000021
 Start Date : 4/25/2018
 Page No : 2

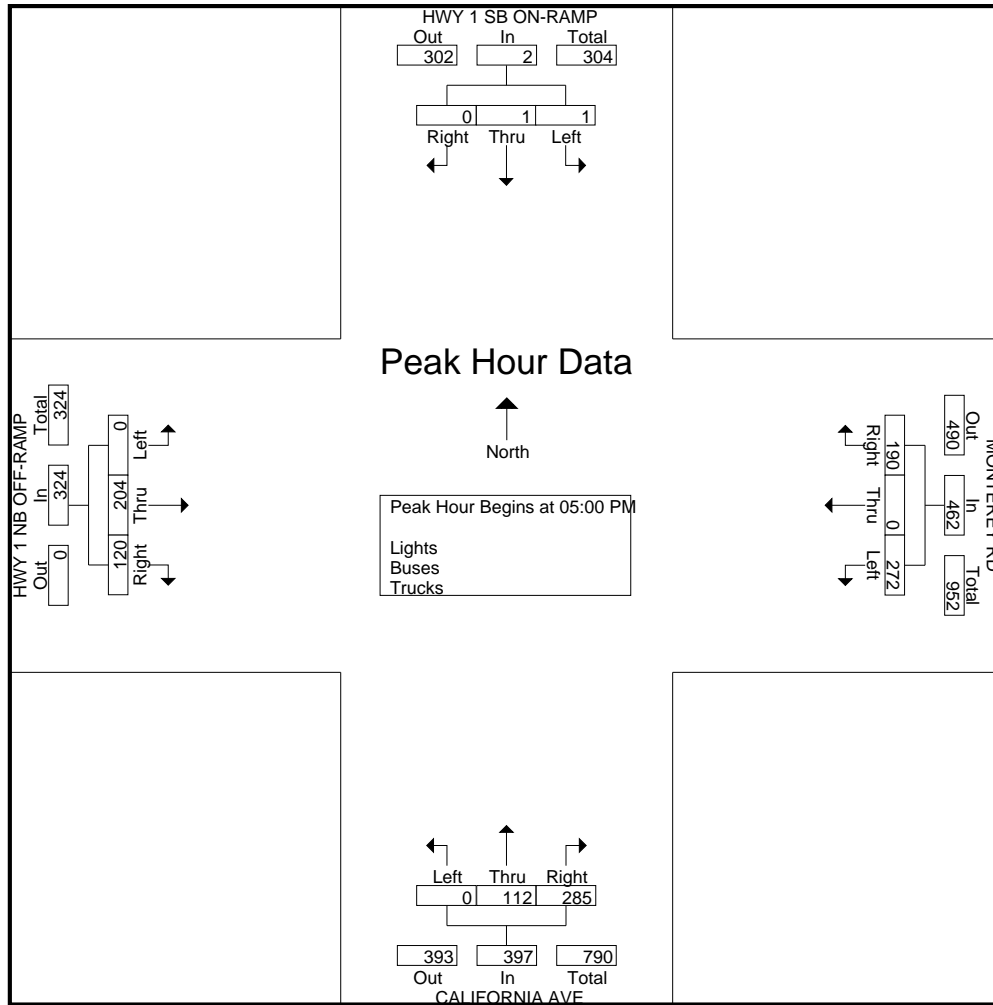

Traffic Data Service

San Jose, CA
 (408) 622-4787
 tdsbay@cs.com

File Name : 21PM FINAL
 Site Code : 00000021
 Start Date : 4/25/2018
 Page No : 1

Groups Printed- Bikes

Start Time	HWY 1 SB ON-RAMP Southbound					MONTEREY RD Westbound					CALIFORNIA AVE Northbound					HWY 1 NB OFF-RAMP Eastbound					Int. Total
	Right	Thru	Left	Peds	App. Total	Right	Thru	Left	Peds	App. Total	Right	Thru	Left	Peds	App. Total	Right	Thru	Left	Peds	App. Total	
04:00 PM	0	0	0	0	0	0	0	1	0	1	0	0	0	0	0	0	0	0	0	0	0
04:15 PM	0	0	0	0	0	0	0	1	0	1	0	0	0	0	0	0	0	0	0	0	0
04:30 PM	0	0	0	0	0	0	0	0	0	0	0	0	0	0	0	0	0	0	0	0	0
04:45 PM	0	0	0	0	0	0	0	1	0	1	0	0	0	0	0	0	0	0	0	0	0
Total	0	0	0	0	0	0	0	3	0	3	0	0	0	0	0	0	0	0	0	0	3
05:00 PM	0	0	0	0	0	0	0	0	0	0	0	0	0	0	0	0	0	0	0	0	0
05:15 PM	0	0	0	0	0	0	0	0	0	0	0	0	0	0	0	0	0	0	0	0	0
05:30 PM	0	0	0	0	0	0	0	0	0	0	0	0	0	0	0	0	0	0	0	0	0
05:45 PM	0	0	0	0	0	0	0	0	0	0	0	0	0	0	0	0	0	0	0	0	0
Total	0	0	0	0	0	0	0	0	0	0	0	0	0	0	0	0	0	0	0	0	0
Grand Total	0	0	0	0	0	0	0	3	0	3	0	0	0	0	0	0	0	0	0	0	3
Apprch %	0	0	0	0	0	0	0	100	0	0	0	0	0	0	0	0	0	0	0	0	0
Total %	0	0	0	0	0	0	0	100	0	100	0	0	0	0	0	0	0	0	0	0	0

Start Time	HWY 1 SB ON-RAMP Southbound				MONTEREY RD Westbound				CALIFORNIA AVE Northbound				HWY 1 NB OFF-RAMP Eastbound				Int. Total
	Right	Thru	Left	App. Total	Right	Thru	Left	App. Total	Right	Thru	Left	App. Total	Right	Thru	Left	App. Total	
04:00 PM	0	0	0	0	0	0	1	1	0	0	0	0	0	0	0	0	1
04:15 PM	0	0	0	0	0	0	1	1	0	0	0	0	0	0	0	0	1
04:30 PM	0	0	0	0	0	0	0	0	0	0	0	0	0	0	0	0	0
04:45 PM	0	0	0	0	0	0	1	1	0	0	0	0	0	0	0	0	1
Total Volume	0	0	0	0	0	0	3	3	0	0	0	0	0	0	0	0	3
% App. Total	0	0	0	0	0	0	100	0	0	0	0	0	0	0	0	0	0
PHF	.000	.000	.000	.000	.000	.000	.750	.750	.000	.000	.000	.000	.000	.000	.000	.000	.750

Peak Hour Analysis From 04:00 PM to 05:45 PM - Peak 1 of 1
 Peak Hour for Entire Intersection Begins at 04:00 PM

Traffic Data Service

San Jose, CA
 (408) 622-4787
 tdsbay@cs.com

File Name : 21PM FINAL
 Site Code : 00000021
 Start Date : 4/25/2018
 Page No : 2

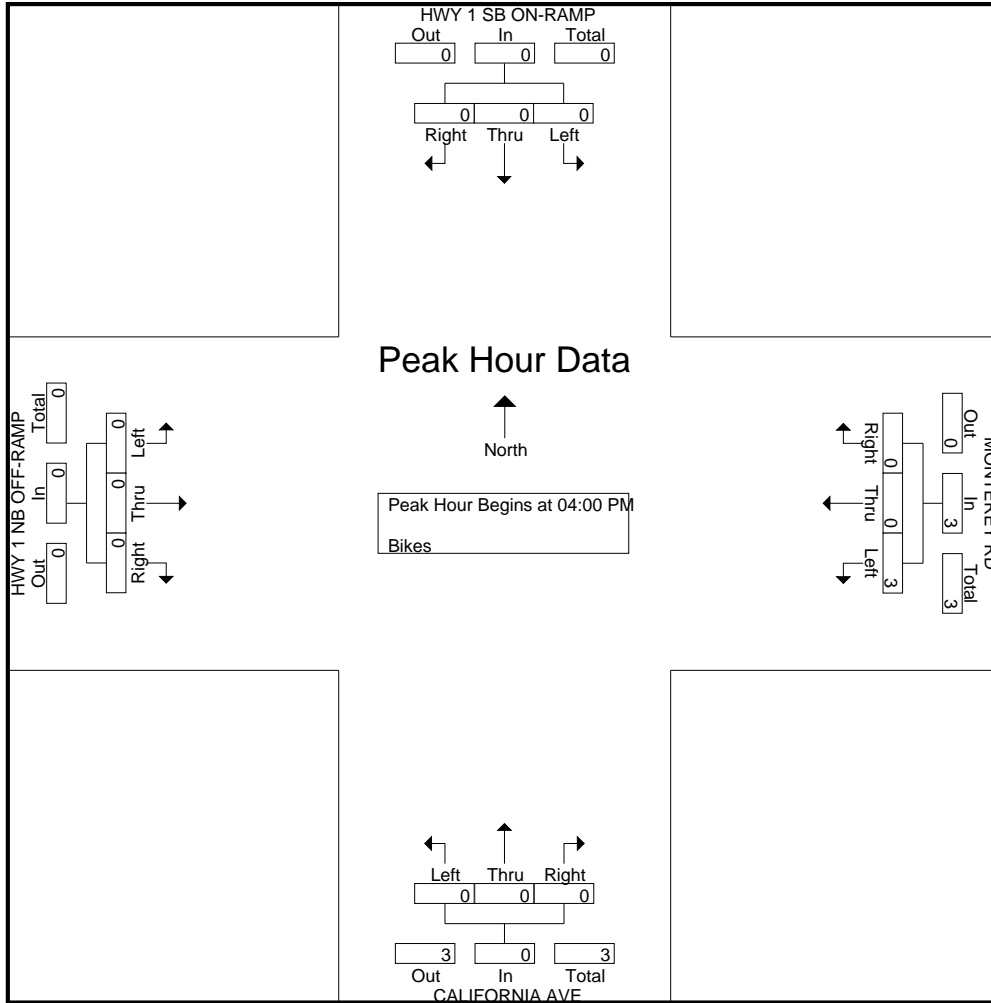

Traffic Data Service

San Jose, CA
 (408) 622-4787
 tdsbay@cs.com

File Name : 22AM FINAL
 Site Code : 00000022
 Start Date : 4/25/2018
 Page No : 1

Groups Printed- Lights - Buses - Trucks

Start Time	Southbound					INTER-GARRISON RD Westbound					8TH AVE Northbound					INTER-GARRISON RD Eastbound					Int. Total
	Right	Thru	Left	Peds	App. Total	Right	Thru	Left	Peds	App. Total	Right	Thru	Left	Peds	App. Total	Right	Thru	Left	Peds	App. Total	
07:00 AM	0	0	0	0	0	0	25	145	0	170	13	0	0	0	13	2	5	0	0	7	190
07:15 AM	0	0	0	0	0	0	40	194	0	234	18	0	0	0	18	1	10	0	0	11	263
07:30 AM	0	0	0	0	0	0	73	181	0	254	28	0	0	0	28	2	5	0	0	7	289
07:45 AM	0	0	0	0	0	0	114	148	0	262	39	0	0	0	39	7	4	0	0	11	312
Total	0	0	0	0	0	0	252	668	0	920	98	0	0	0	98	12	24	0	0	36	1054
08:00 AM	0	0	0	0	0	0	84	95	0	179	29	0	2	0	31	1	14	0	0	15	225
08:15 AM	0	0	0	0	0	0	65	85	0	150	21	0	2	1	24	4	8	0	0	12	186
08:30 AM	0	0	0	0	0	0	40	60	0	100	18	0	3	0	21	4	11	0	0	15	136
08:45 AM	0	0	0	0	0	0	42	46	0	88	14	0	0	1	15	3	5	0	0	8	111
Total	0	0	0	0	0	0	231	286	0	517	82	0	7	2	91	12	38	0	0	50	658
Grand Total	0	0	0	0	0	0	483	954	0	1437	180	0	7	2	189	24	62	0	0	86	1712
Apprch %	0	0	0	0	0	0	33.6	66.4	0	100	95.2	0	3.7	1.1	100	27.9	72.1	0	0	100	
Total %	0	0	0	0	0	0	28.2	55.7	0	83.9	10.5	0	0.4	0.1	11	1.4	3.6	0	0	5	
Lights	0	0	0	0	0	0	467	948	0	1415	178	0	4	2	184	21	48	0	0	69	1668
% Lights	0	0	0	0	0	0	96.7	99.4	0	98.5	98.9	0	57.1	100	97.4	87.5	77.4	0	0	80.2	97.4
Buses	0	0	0	0	0	0	11	3	0	14	1	0	1	0	2	3	10	0	0	13	29
% Buses	0	0	0	0	0	0	2.3	0.3	0	1	0.6	0	14.3	0	1.1	12.5	16.1	0	0	15.1	1.7
Trucks	0	0	0	0	0	0	5	3	0	8	1	0	2	0	3	0	4	0	0	4	15
% Trucks	0	0	0	0	0	0	1	0.3	0	0.6	0.6	0	28.6	0	1.6	0	6.5	0	0	4.7	0.9

Start Time	Southbound				INTER-GARRISON RD Westbound				8TH AVE Northbound				INTER-GARRISON RD Eastbound				Int. Total
	Right	Thru	Left	App. Total	Right	Thru	Left	App. Total	Right	Thru	Left	App. Total	Right	Thru	Left	App. Total	
Peak Hour Analysis From 07:00 AM to 08:45 AM - Peak 1 of 1																	
Peak Hour for Entire Intersection Begins at 07:15 AM																	
07:15 AM	0	0	0	0	0	40	194	234	18	0	0	18	1	10	0	11	263
07:30 AM	0	0	0	0	0	73	181	254	28	0	0	28	2	5	0	7	289
07:45 AM	0	0	0	0	0	114	148	262	39	0	0	39	7	4	0	11	312
08:00 AM	0	0	0	0	0	84	95	179	29	0	2	31	1	14	0	15	225
Total Volume	0	0	0	0	0	311	618	929	114	0	2	116	11	33	0	44	1089
% App. Total	0	0	0	0	0	33.5	66.5	100	98.3	0	1.7	100	25	75	0	100	
PHF	.000	.000	.000	.000	.000	.682	.796	.886	.731	.000	.250	.744	.393	.589	.000	.733	.873

Traffic Data Service

San Jose, CA
 (408) 622-4787
 tdsbay@cs.com

File Name : 22AM FINAL
 Site Code : 00000022
 Start Date : 4/25/2018
 Page No : 2

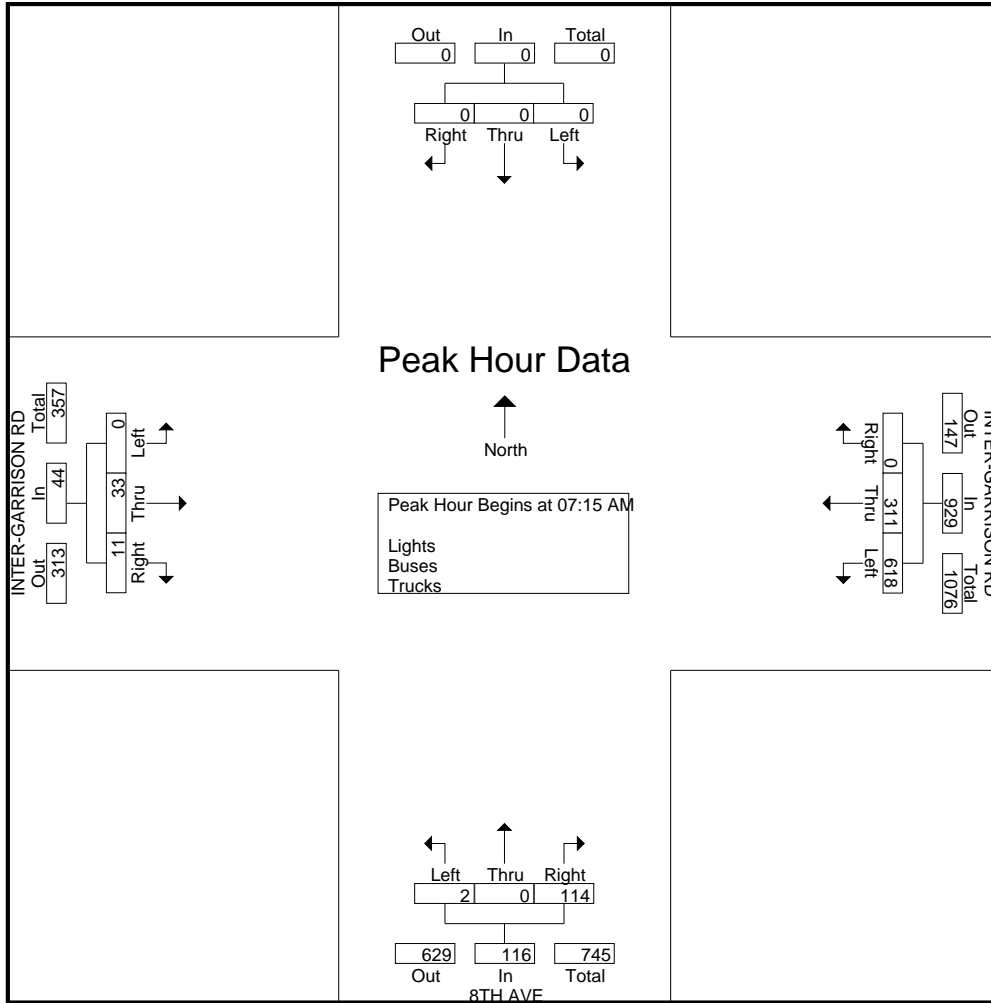

Traffic Data Service

San Jose, CA
 (408) 622-4787
 tdsbay@cs.com

File Name : 22AM FINAL
 Site Code : 00000022
 Start Date : 4/25/2018
 Page No : 1

Groups Printed- Bikes

Start Time	Southbound					INTER-GARRISON RD Westbound					8TH AVE Northbound					INTER-GARRISON RD Eastbound					Int. Total
	Right	Thru	Left	Peds	App. Total	Right	Thru	Left	Peds	App. Total	Right	Thru	Left	Peds	App. Total	Right	Thru	Left	Peds	App. Total	
07:00 AM	0	0	0	0	0	0	0	0	0	0	0	0	0	0	0	1	0	0	0	0	1
07:15 AM	0	0	0	0	0	0	0	0	0	0	0	0	0	0	0	0	0	0	0	0	0
07:30 AM	0	0	0	0	0	0	0	0	0	0	0	0	0	0	0	0	0	0	0	0	0
07:45 AM	0	0	0	0	0	0	0	0	0	0	0	0	0	0	0	0	0	0	0	0	0
Total	0	0	0	0	0	0	0	0	0	0	0	0	0	0	0	1	0	0	0	0	1
08:00 AM	0	0	0	0	0	0	0	0	0	0	0	0	0	0	0	0	0	0	0	0	0
08:15 AM	0	0	0	0	0	0	0	0	0	0	0	0	0	0	0	0	0	0	0	0	0
08:30 AM	0	0	0	0	0	0	0	0	0	0	0	0	0	0	0	0	0	0	0	0	0
08:45 AM	0	0	0	0	0	0	1	0	0	1	0	0	0	0	0	0	0	0	0	0	1
Total	0	0	0	0	0	0	1	0	0	1	0	0	0	0	0	0	0	0	0	0	1
Grand Total	0	0	0	0	0	0	1	0	0	1	0	0	0	0	0	1	0	0	0	0	2
Apprch %	0	0	0	0	0	0	100	0	0	100	0	0	0	0	0	100	0	0	0	0	
Total %	0	0	0	0	0	0	50	0	0	50	0	0	0	0	0	50	0	0	0	50	

Start Time	Southbound					INTER-GARRISON RD Westbound					8TH AVE Northbound					INTER-GARRISON RD Eastbound					Int. Total
	Right	Thru	Left	Peds	App. Total	Right	Thru	Left	Peds	App. Total	Right	Thru	Left	Peds	App. Total	Right	Thru	Left	Peds	App. Total	
Peak Hour Analysis From 07:00 AM to 08:45 AM - Peak 1 of 1																					
Peak Hour for Entire Intersection Begins at 07:00 AM																					
07:00 AM	0	0	0	0	0	0	0	0	0	0	0	0	0	0	0	1	0	0	0	0	1
07:15 AM	0	0	0	0	0	0	0	0	0	0	0	0	0	0	0	0	0	0	0	0	0
07:30 AM	0	0	0	0	0	0	0	0	0	0	0	0	0	0	0	0	0	0	0	0	0
07:45 AM	0	0	0	0	0	0	0	0	0	0	0	0	0	0	0	0	0	0	0	0	0
Total Volume	0	0	0	0	0	0	0	0	0	0	0	0	0	0	0	1	0	0	0	0	1
% App. Total	0	0	0	0	0	0	0	0	0	0	0	0	0	0	0	100	0	0	0	0	
PHF	.000	.000	.000	.000	.000	.000	.000	.000	.000	.000	.000	.000	.000	.000	.000	.250	.000	.000	.000	.250	.250

Traffic Data Service

San Jose, CA
(408) 622-4787
tdsbay@cs.com

File Name : 22AM FINAL
Site Code : 00000022
Start Date : 4/25/2018
Page No : 2

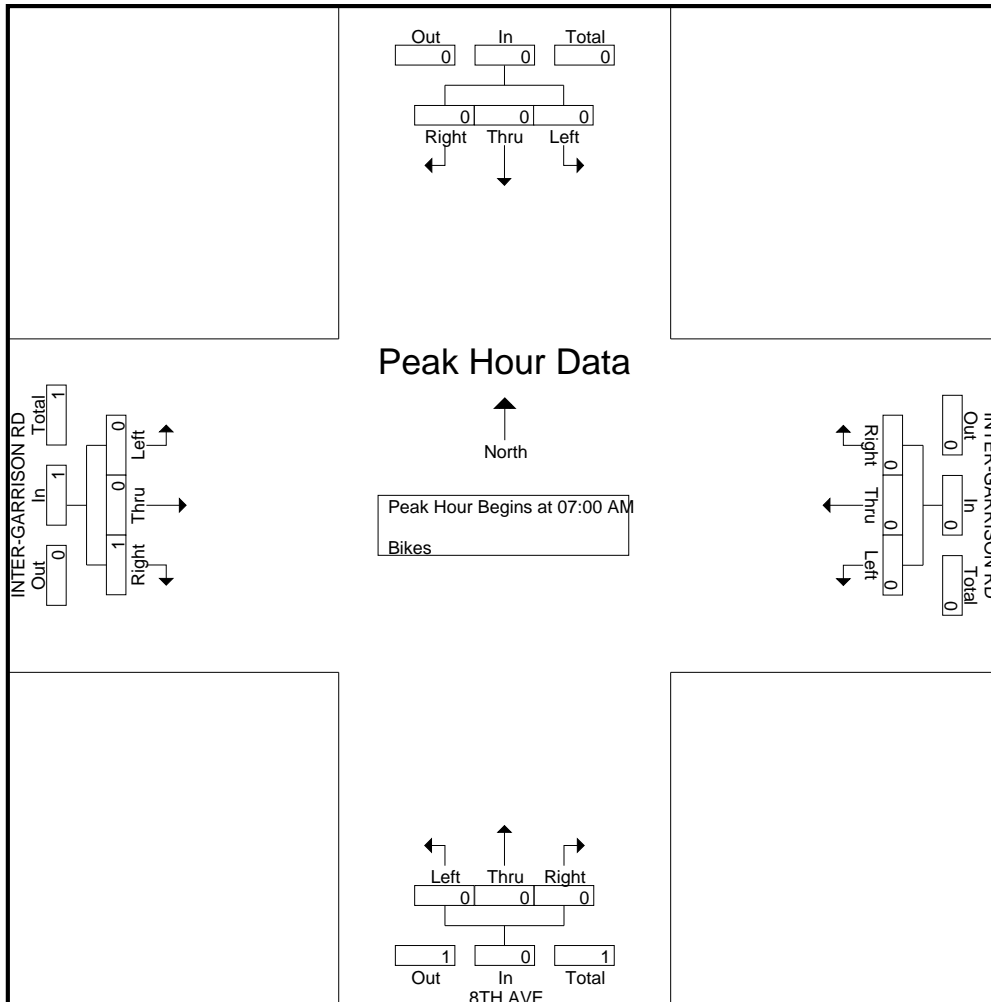

Traffic Data Service

San Jose, CA
 (408) 622-4787
 tdsbay@cs.com

File Name : 22PM FINAL
 Site Code : 00000022
 Start Date : 4/25/2018
 Page No : 1

Groups Printed- Lights - Buses - Trucks

Start Time	Southbound					INTER-GARRISON RD Westbound					8TH AVE Northbound					INTER-GARRISON RD Eastbound					Int. Total
	Right	Thru	Left	Peds	App. Total	Right	Thru	Left	Peds	App. Total	Right	Thru	Left	Peds	App. Total	Right	Thru	Left	Peds	App. Total	
04:00 PM	0	0	0	0	0	0	24	24	0	48	83	0	3	2	88	1	43	0	0	44	180
04:15 PM	0	0	0	0	0	0	12	24	1	37	68	0	2	2	72	1	35	0	0	36	145
04:30 PM	0	0	0	0	0	0	14	28	0	42	104	0	3	0	107	2	27	0	0	29	178
04:45 PM	0	0	0	0	0	0	21	19	0	40	122	0	3	0	125	0	29	0	0	29	194
Total	0	0	0	0	0	0	71	95	1	167	377	0	11	4	392	4	134	0	0	138	697
05:00 PM	0	0	0	0	0	0	16	24	0	40	135	0	1	1	137	1	75	0	0	76	253
05:15 PM	0	0	0	0	0	0	26	39	0	65	116	0	3	1	120	2	64	0	0	66	251
05:30 PM	0	0	0	0	0	0	51	39	0	90	110	0	2	1	113	0	54	0	0	54	257
05:45 PM	0	0	0	0	0	0	61	28	0	89	87	0	1	2	90	3	57	0	0	60	239
Total	0	0	0	0	0	0	154	130	0	284	448	0	7	5	460	6	250	0	0	256	1000
Grand Total	0	0	0	0	0	0	225	225	1	451	825	0	18	9	852	10	384	0	0	394	1697
Apprch %	0	0	0	0	0	0	49.9	49.9	0.2		96.8	0	2.1	1.1		2.5	97.5	0	0		
Total %	0	0	0	0	0	0	13.3	13.3	0.1	26.6	48.6	0	1.1	0.5	50.2	0.6	22.6	0	0	23.2	
Lights	0	0	0	0	0	0	215	222	1	438	822	0	18	9	849	10	371	0	0	381	1668
% Lights	0	0	0	0	0	0	95.6	98.7	100	97.1	99.6	0	100	100	99.6	100	96.6	0	0	96.7	98.3
Buses	0	0	0	0	0	0	10	0	0	10	2	0	0	0	2	0	12	0	0	12	24
% Buses	0	0	0	0	0	0	4.4	0	0	2.2	0.2	0	0	0	0.2	0	3.1	0	0	3	1.4
Trucks	0	0	0	0	0	0	0	3	0	3	1	0	0	0	1	0	1	0	0	1	5
% Trucks	0	0	0	0	0	0	0	1.3	0	0.7	0.1	0	0	0	0.1	0	0.3	0	0	0.3	0.3

Start Time	Southbound				INTER-GARRISON RD Westbound				8TH AVE Northbound				INTER-GARRISON RD Eastbound				Int. Total
	Right	Thru	Left	App. Total	Right	Thru	Left	App. Total	Right	Thru	Left	App. Total	Right	Thru	Left	App. Total	
Peak Hour Analysis From 04:00 PM to 05:45 PM - Peak 1 of 1																	
Peak Hour for Entire Intersection Begins at 05:00 PM																	
05:00 PM	0	0	0	0	0	16	24	40	135	0	1	136	1	75	0	76	252
05:15 PM	0	0	0	0	0	26	39	65	116	0	3	119	2	64	0	66	250
05:30 PM	0	0	0	0	0	51	39	90	110	0	2	112	0	54	0	54	256
05:45 PM	0	0	0	0	0	61	28	89	87	0	1	88	3	57	0	60	237
Total Volume	0	0	0	0	0	154	130	284	448	0	7	455	6	250	0	256	995
% App. Total	0	0	0	0	0	54.2	45.8		98.5	0	1.5		2.3	97.7	0		
PHF	.000	.000	.000	.000	.000	.631	.833	.789	.830	.000	.583	.836	.500	.833	.000	.842	.972

Traffic Data Service

San Jose, CA
 (408) 622-4787
 tdsbay@cs.com

File Name : 22PM FINAL
 Site Code : 00000022
 Start Date : 4/25/2018
 Page No : 2

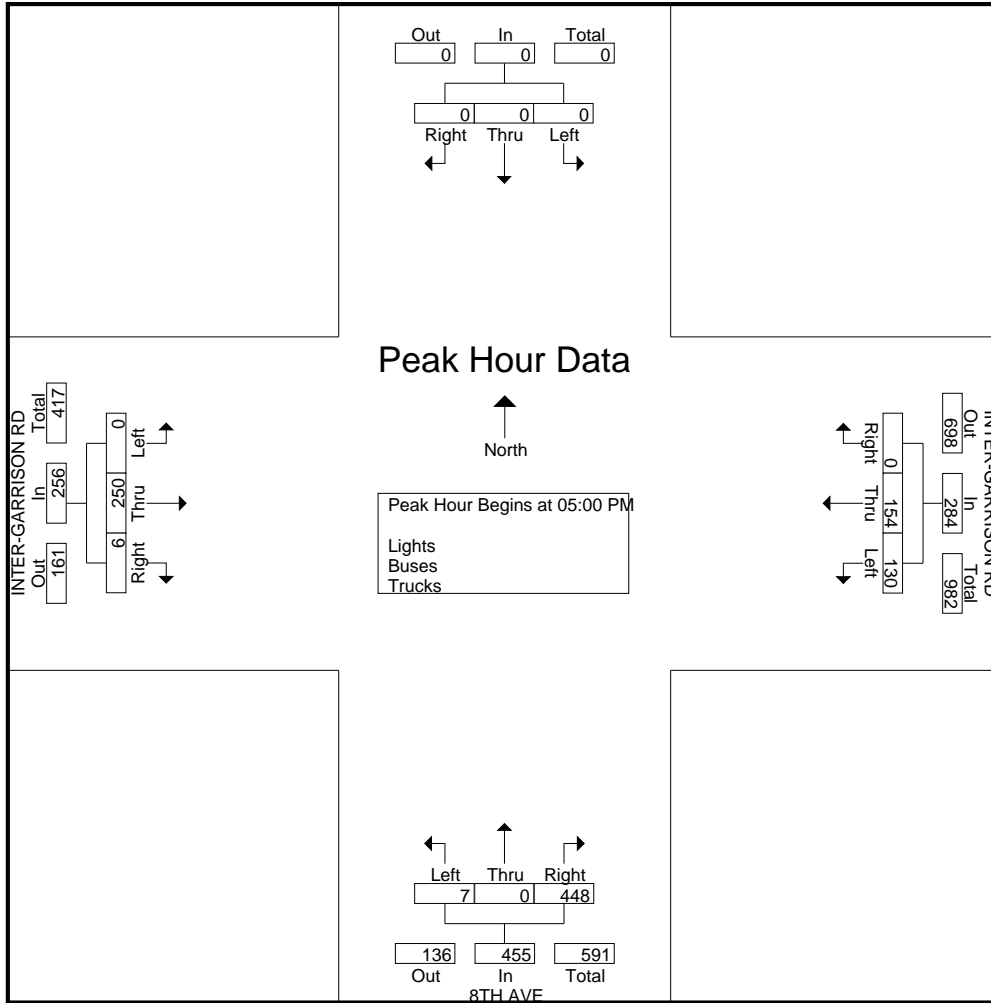

Traffic Data Service

San Jose, CA
 (408) 622-4787
 tdsbay@cs.com

File Name : 22PM FINAL
 Site Code : 00000022
 Start Date : 4/25/2018
 Page No : 1

Groups Printed- Bikes

Start Time	Southbound					INTER-GARRISON RD Westbound					8TH AVE Northbound					INTER-GARRISON RD Eastbound					Int. Total
	Right	Thru	Left	Peds	App. Total	Right	Thru	Left	Peds	App. Total	Right	Thru	Left	Peds	App. Total	Right	Thru	Left	Peds	App. Total	
04:00 PM	0	0	0	0	0	0	0	0	0	0	0	0	0	0	0	0	2	0	0	0	2
04:15 PM	0	0	0	0	0	0	0	0	0	0	0	0	0	0	0	0	0	0	0	0	0
04:30 PM	0	0	0	0	0	0	0	0	0	0	0	0	0	0	0	0	0	0	0	0	0
04:45 PM	0	0	0	0	0	0	0	0	0	0	0	0	0	0	0	0	0	0	0	0	0
Total	0	0	0	0	0	0	0	0	0	0	0	0	0	0	0	0	2	0	0	0	2
05:00 PM	0	0	0	0	0	0	0	0	0	0	0	0	0	0	0	0	0	0	0	0	0
05:15 PM	0	0	0	0	0	0	0	0	0	0	0	0	0	0	0	0	0	0	0	0	0
05:30 PM	0	0	0	0	0	0	0	0	0	0	1	0	0	0	1	0	0	0	0	0	1
05:45 PM	0	0	0	0	0	0	0	0	0	0	0	0	0	0	0	0	1	0	0	0	1
Total	0	0	0	0	0	0	0	0	0	0	1	0	0	0	1	0	1	0	0	0	1
Grand Total	0	0	0	0	0	0	0	0	0	0	1	0	0	0	1	0	3	0	0	0	3
Apprch %	0	0	0	0	0	0	0	0	0	0	100	0	0	0	0	0	100	0	0	0	0
Total %	0	0	0	0	0	0	0	0	0	0	25	0	0	0	25	0	75	0	0	0	75

Start Time	Southbound					INTER-GARRISON RD Westbound					8TH AVE Northbound					INTER-GARRISON RD Eastbound					Int. Total
	Right	Thru	Left	Peds	App. Total	Right	Thru	Left	Peds	App. Total	Right	Thru	Left	Peds	App. Total	Right	Thru	Left	Peds	App. Total	
Peak Hour Analysis From 04:00 PM to 05:45 PM - Peak 1 of 1																					
Peak Hour for Entire Intersection Begins at 04:00 PM																					
04:00 PM	0	0	0	0	0	0	0	0	0	0	0	0	0	0	0	0	2	0	0	0	2
04:15 PM	0	0	0	0	0	0	0	0	0	0	0	0	0	0	0	0	0	0	0	0	0
04:30 PM	0	0	0	0	0	0	0	0	0	0	0	0	0	0	0	0	0	0	0	0	0
04:45 PM	0	0	0	0	0	0	0	0	0	0	0	0	0	0	0	0	0	0	0	0	0
Total Volume	0	0	0	0	0	0	0	0	0	0	0	0	0	0	0	0	2	0	0	0	2
% App. Total	0	0	0	0	0	0	0	0	0	0	0	0	0	0	0	0	100	0	0	0	0
PHF	.000	.000	.000	.000	.000	.000	.000	.000	.000	.000	.000	.000	.000	.000	.000	.000	.250	.000	.000	.250	.250

Traffic Data Service

San Jose, CA
(408) 622-4787
tdsbay@cs.com

File Name : 22PM FINAL
Site Code : 00000022
Start Date : 4/25/2018
Page No : 2

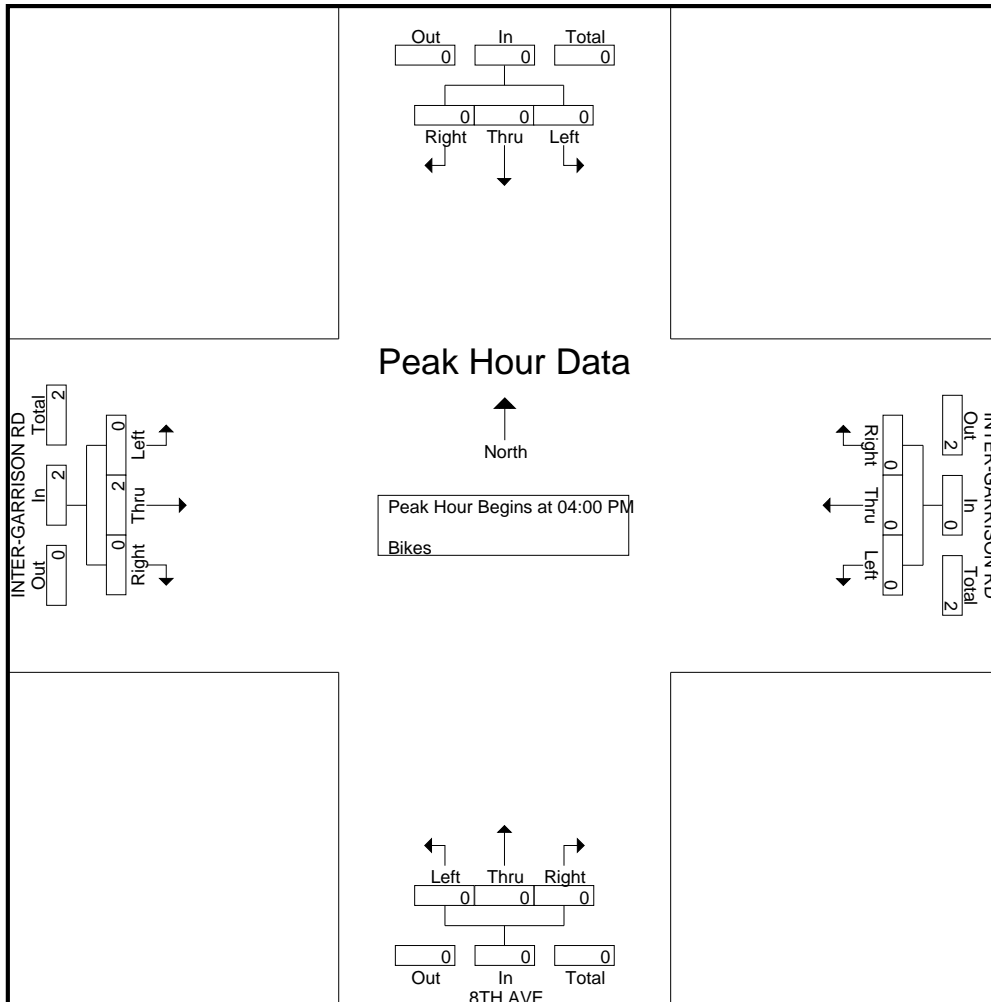

Traffic Data Service

San Jose, CA
(408) 622-4787
tdsbay@cs.com

File Name : 23AM FINAL
Site Code : 00000023
Start Date : 4/25/2018
Page No : 1

Groups Printed- Lights - Buses - Trucks

Start Time	8TH ST Southbound					INTER-GARRISON RD Westbound					7TH AVE Northbound					INTER-GARRISON RD Eastbound					Int. Total
	Right	Thru	Left	Peds	App. Total	Right	Thru	Left	Peds	App. Total	Right	Thru	Left	Peds	App. Total	Right	Thru	Left	Peds	App. Total	
07:00 AM	0	17	1	0	18	0	17	5	0	22	0	3	2	0	5	2	6	0	0	8	53
07:15 AM	0	11	3	0	14	2	20	5	0	27	1	3	3	0	7	1	5	0	0	6	54
07:30 AM	0	31	4	0	35	3	31	7	0	41	1	3	4	0	8	3	6	0	0	9	93
07:45 AM	1	42	2	0	45	3	78	7	0	88	1	10	6	1	18	1	3	0	0	4	155
Total	1	101	10	0	112	8	146	24	0	178	3	19	15	1	38	7	20	0	0	27	355
08:00 AM	2	38	6	0	46	11	104	5	0	120	0	9	9	1	19	4	6	1	0	11	196
08:15 AM	0	30	2	0	32	8	68	3	0	79	2	8	10	1	21	4	12	2	0	18	150
08:30 AM	3	20	5	0	28	8	58	5	0	71	2	1	15	0	18	6	8	1	0	15	132
08:45 AM	1	16	3	0	20	7	26	4	0	37	1	3	9	0	13	3	9	0	0	12	82
Total	6	104	16	0	126	34	256	17	0	307	5	21	43	2	71	17	35	4	0	56	560
Grand Total	7	205	26	0	238	42	402	41	0	485	8	40	58	3	109	24	55	4	0	83	915
Apprch %	2.9	86.1	10.9	0		8.7	82.9	8.5	0		7.3	36.7	53.2	2.8		28.9	66.3	4.8	0		
Total %	0.8	22.4	2.8	0	26	4.6	43.9	4.5	0	53	0.9	4.4	6.3	0.3	11.9	2.6	6	0.4	0	9.1	
Lights	6	194	22	0	222	37	396	33	0	466	2	31	52	3	88	23	47	4	0	74	850
% Lights	85.7	94.6	84.6	0	93.3	88.1	98.5	80.5	0	96.1	25	77.5	89.7	100	80.7	95.8	85.5	100	0	89.2	92.9
Buses	0	1	0	0	1	1	4	7	0	12	6	1	2	0	9	0	7	0	0	7	29
% Buses	0	0.5	0	0	0.4	2.4	1	17.1	0	2.5	75	2.5	3.4	0	8.3	0	12.7	0	0	8.4	3.2
Trucks	1	10	4	0	15	4	2	1	0	7	0	8	4	0	12	1	1	0	0	2	36
% Trucks	14.3	4.9	15.4	0	6.3	9.5	0.5	2.4	0	1.4	0	20	6.9	0	11	4.2	1.8	0	0	2.4	3.9

Start Time	8TH ST Southbound				INTER-GARRISON RD Westbound				7TH AVE Northbound				INTER-GARRISON RD Eastbound				Int. Total
	Right	Thru	Left	App. Total	Right	Thru	Left	App. Total	Right	Thru	Left	App. Total	Right	Thru	Left	App. Total	
Peak Hour Analysis From 07:00 AM to 08:45 AM - Peak 1 of 1																	
Peak Hour for Entire Intersection Begins at 07:45 AM																	
07:45 AM	1	42	2	45	3	78	7	88	1	10	6	17	1	3	0	4	154
08:00 AM	2	38	6	46	11	104	5	120	0	9	9	18	4	6	1	11	195
08:15 AM	0	30	2	32	8	68	3	79	2	8	10	20	4	12	2	18	149
08:30 AM	3	20	5	28	8	58	5	71	2	1	15	18	6	8	1	15	132
Total Volume	6	130	15	151	30	308	20	358	5	28	40	73	15	29	4	48	630
% App. Total	4	86.1	9.9		8.4	86	5.6		6.8	38.4	54.8		31.2	60.4	8.3		
PHF	.500	.774	.625	.821	.682	.740	.714	.746	.625	.700	.667	.913	.625	.604	.500	.667	.808

Traffic Data Service

San Jose, CA
 (408) 622-4787
 tdsbay@cs.com

File Name : 23AM FINAL
 Site Code : 00000023
 Start Date : 4/25/2018
 Page No : 2

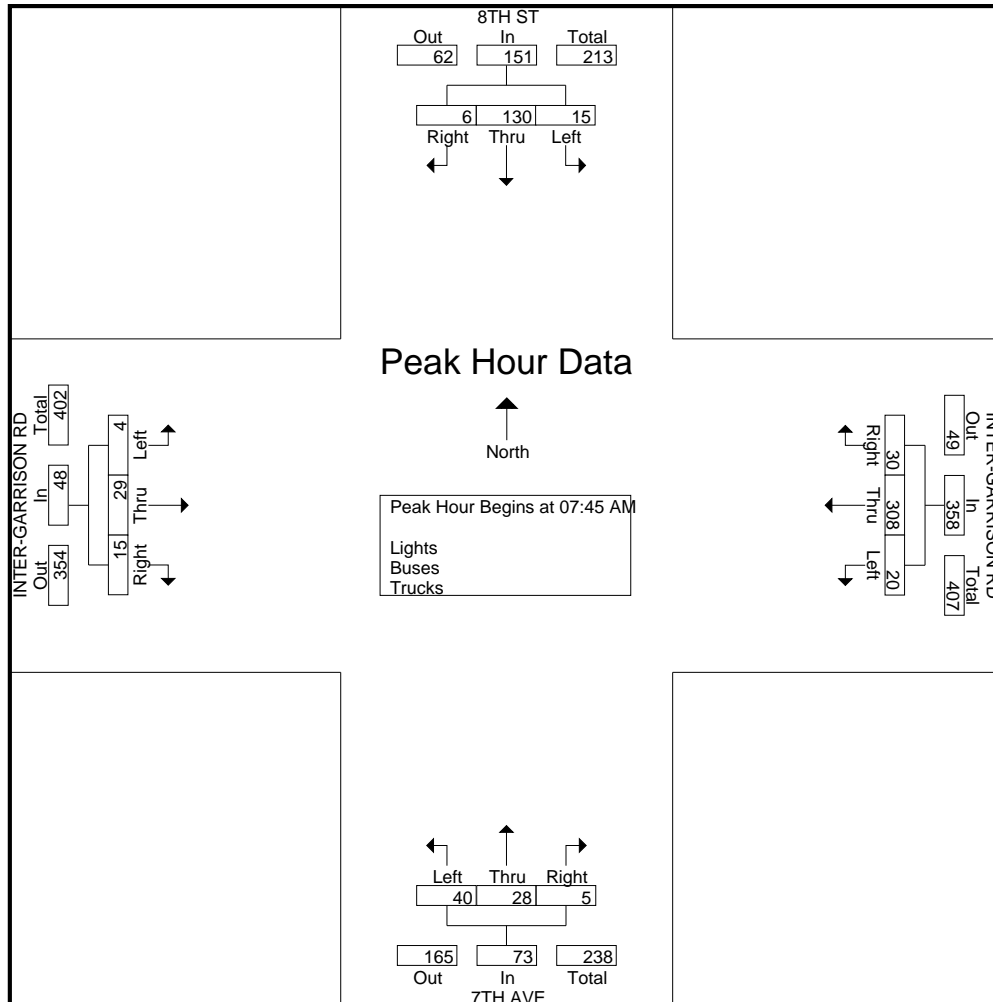

Traffic Data Service

San Jose, CA
 (408) 622-4787
 tdsbay@cs.com

File Name : 23AM FINAL
 Site Code : 00000023
 Start Date : 4/25/2018
 Page No : 1

Groups Printed- Bikes

Start Time	8TH ST Southbound					INTER-GARRISON RD Westbound					7TH AVE Northbound					INTER-GARRISON RD Eastbound					Int. Total
	Right	Thru	Left	Peds	App. Total	Right	Thru	Left	Peds	App. Total	Right	Thru	Left	Peds	App. Total	Right	Thru	Left	Peds	App. Total	
07:00 AM	0	0	0	0	0	0	0	0	0	0	0	0	0	0	0	0	0	0	0	0	0
07:15 AM	0	0	0	0	0	0	1	0	0	1	0	0	0	0	0	0	0	0	0	0	0
07:30 AM	0	0	0	0	0	0	0	0	0	0	0	0	0	0	0	0	0	0	0	0	0
07:45 AM	0	0	0	0	0	0	1	0	0	1	0	0	0	0	0	0	0	0	0	0	0
Total	0	0	0	0	0	0	2	0	0	2	0	0	0	0	0	0	0	0	0	0	2
08:00 AM	0	0	0	0	0	0	0	0	0	0	0	0	0	0	0	0	0	0	0	0	0
08:15 AM	0	0	0	0	0	0	0	0	0	0	0	0	0	0	0	0	0	0	0	0	0
08:30 AM	0	0	0	0	0	0	0	1	0	1	0	0	0	0	0	0	0	0	0	0	1
08:45 AM	0	0	0	0	0	0	0	0	0	0	0	0	0	0	0	1	1	0	0	2	2
Total	0	0	0	0	0	0	0	1	0	1	0	0	0	0	0	1	1	0	0	2	3
Grand Total	0	0	0	0	0	0	2	1	0	3	0	0	0	0	0	1	1	0	0	2	5
Apprch %	0	0	0	0		0	66.7	33.3	0		0	0	0	0		50	50	0	0		
Total %	0	0	0	0		0	40	20	0	60	0	0	0	0		20	20	0	0	40	

Start Time	8TH ST Southbound					INTER-GARRISON RD Westbound					7TH AVE Northbound					INTER-GARRISON RD Eastbound					Int. Total
	Right	Thru	Left	Peds	App. Total	Right	Thru	Left	Peds	App. Total	Right	Thru	Left	Peds	App. Total	Right	Thru	Left	Peds	App. Total	
Peak Hour Analysis From 07:00 AM to 08:45 AM - Peak 1 of 1																					
Peak Hour for Entire Intersection Begins at 08:00 AM																					
08:00 AM	0	0	0	0	0	0	0	0	0	0	0	0	0	0	0	0	0	0	0	0	0
08:15 AM	0	0	0	0	0	0	0	0	0	0	0	0	0	0	0	0	0	0	0	0	0
08:30 AM	0	0	0	0	0	0	0	1	0	1	0	0	0	0	0	0	0	0	0	0	1
08:45 AM	0	0	0	0	0	0	0	0	0	0	0	0	0	0	0	1	1	0	0	2	2
Total Volume	0	0	0	0	0	0	0	1	0	1	0	0	0	0	0	1	1	0	0	2	3
% App. Total	0	0	0	0		0	0	100	0		0	0	0	0		50	50	0	0		
PHF	.000	.000	.000	.000		.000	.000	.250	.250		.000	.000	.000	.000		.250	.250	.000	.250		.375

Traffic Data Service

San Jose, CA
 (408) 622-4787
 tdsbay@cs.com

File Name : 23AM FINAL
 Site Code : 00000023
 Start Date : 4/25/2018
 Page No : 2

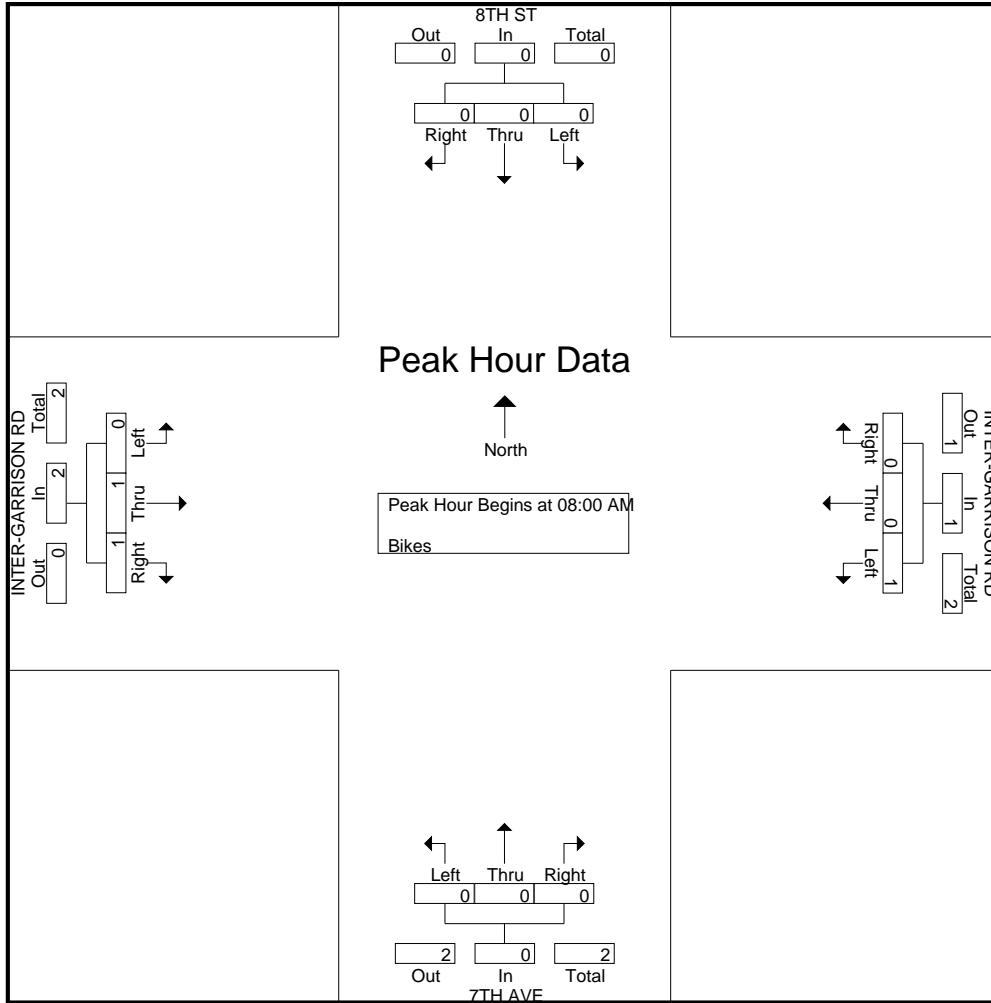

Traffic Data Service

San Jose, CA
 (408) 622-4787
 tdsbay@cs.com

File Name : 23PM FINAL
 Site Code : 00000023
 Start Date : 4/25/2018
 Page No : 1

Groups Printed- Lights - Buses - Trucks

Start Time	8TH ST Southbound					INTER-GARRISON RD Westbound					7TH AVE Northbound					INTER-GARRISON RD Eastbound					Int. Total
	Right	Thru	Left	Peds	App. Total	Right	Thru	Left	Peds	App. Total	Right	Thru	Left	Peds	App. Total	Right	Thru	Left	Peds	App. Total	
04:00 PM	0	18	5	0	23	2	30	10	0	42	2	21	21	0	44	13	41	6	0	60	169
04:15 PM	1	14	4	0	19	7	18	0	0	25	8	15	6	2	31	8	30	1	0	39	114
04:30 PM	1	6	6	1	14	1	9	2	0	12	2	16	9	0	27	2	23	1	0	26	79
04:45 PM	0	5	2	1	8	3	13	2	0	18	1	21	3	0	25	3	30	0	0	33	84
Total	2	43	17	2	64	13	70	14	0	97	13	73	39	2	127	26	124	8	0	158	446
05:00 PM	0	7	2	0	9	4	18	1	0	23	3	17	5	0	25	4	28	6	0	38	95
05:15 PM	2	7	4	0	13	3	11	3	0	17	5	15	4	3	27	3	69	0	1	73	130
05:30 PM	0	5	4	0	9	0	28	5	0	33	7	16	6	1	30	6	49	2	0	57	129
05:45 PM	0	2	3	0	5	2	50	1	0	53	4	9	8	0	21	5	45	0	0	50	129
Total	2	21	13	0	36	9	107	10	0	126	19	57	23	4	103	18	191	8	1	218	483
Grand Total	4	64	30	2	100	22	177	24	0	223	32	130	62	6	230	44	315	16	1	376	929
Apprch %	4	64	30	2		9.9	79.4	10.8	0		13.9	56.5	27	2.6		11.7	83.8	4.3	0.3		
Total %	0.4	6.9	3.2	0.2	10.8	2.4	19.1	2.6	0	24	3.4	14	6.7	0.6	24.8	4.7	33.9	1.7	0.1	40.5	
Lights	4	63	30	2	99	22	174	18	0	214	24	129	61	6	220	44	310	16	1	371	904
% Lights	100	98.4	100	100	99	100	98.3	75	0	96	75	99.2	98.4	100	95.7	100	98.4	100	100	98.7	97.3
Buses	0	1	0	0	1	0	3	6	0	9	8	1	0	0	9	0	4	0	0	4	23
% Buses	0	1.6	0	0	1	0	1.7	25	0	4	25	0.8	0	0	3.9	0	1.3	0	0	1.1	2.5
Trucks	0	0	0	0	0	0	0	0	0	0	0	0	1	0	1	0	1	0	0	1	2
% Trucks	0	0	0	0	0	0	0	0	0	0	0	0	1.6	0	0.4	0	0.3	0	0	0.3	0.2

Start Time	8TH ST Southbound				INTER-GARRISON RD Westbound				7TH AVE Northbound				INTER-GARRISON RD Eastbound				Int. Total
	Right	Thru	Left	App. Total	Right	Thru	Left	App. Total	Right	Thru	Left	App. Total	Right	Thru	Left	App. Total	
Peak Hour Analysis From 04:00 PM to 05:45 PM - Peak 1 of 1																	
Peak Hour for Entire Intersection Begins at 05:00 PM																	
05:00 PM	0	7	2	9	4	18	1	23	3	17	5	25	4	28	6	38	95
05:15 PM	2	7	4	13	3	11	3	17	5	15	4	24	3	69	0	72	126
05:30 PM	0	5	4	9	0	28	5	33	7	16	6	29	6	49	2	57	128
05:45 PM	0	2	3	5	2	50	1	53	4	9	8	21	5	45	0	50	129
Total Volume	2	21	13	36	9	107	10	126	19	57	23	99	18	191	8	217	478
% App. Total	5.6	58.3	36.1		7.1	84.9	7.9		19.2	57.6	23.2		8.3	88	3.7		
PHF	.250	.750	.813	.692	.563	.535	.500	.594	.679	.838	.719	.853	.750	.692	.333	.753	.926

Traffic Data Service

San Jose, CA
 (408) 622-4787
 tdsbay@cs.com

File Name : 23PM FINAL
 Site Code : 00000023
 Start Date : 4/25/2018
 Page No : 2

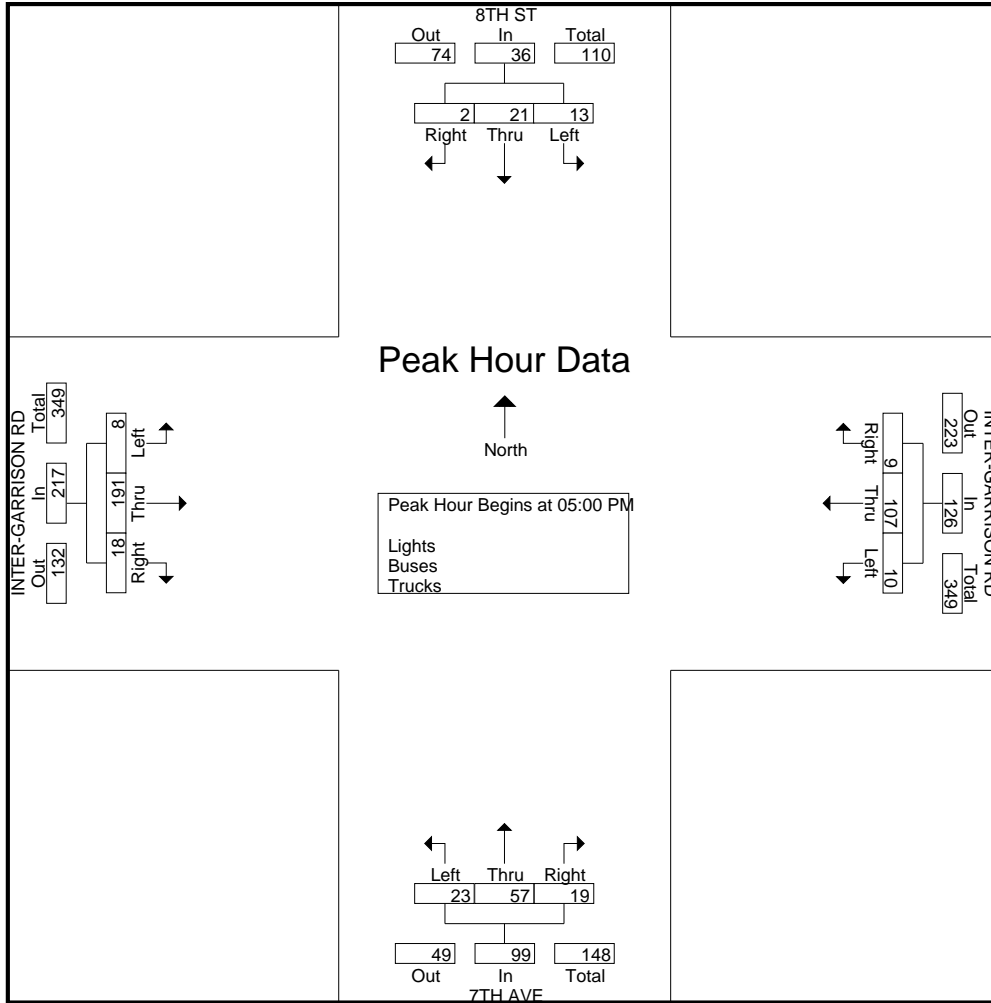

Traffic Data Service

San Jose, CA
 (408) 622-4787
 tdsbay@cs.com

File Name : 23PM FINAL
 Site Code : 00000023
 Start Date : 4/25/2018
 Page No : 1

Groups Printed- Bikes

Start Time	8TH ST Southbound					INTER-GARRISON RD Westbound					7TH AVE Northbound					INTER-GARRISON RD Eastbound					Int. Total
	Right	Thru	Left	Peds	App. Total	Right	Thru	Left	Peds	App. Total	Right	Thru	Left	Peds	App. Total	Right	Thru	Left	Peds	App. Total	
04:00 PM	0	0	0	0	0	0	1	0	0	1	0	0	0	0	0	0	0	0	0	0	0
04:15 PM	0	0	0	0	0	0	0	0	0	0	0	0	0	0	0	0	0	1	0	1	1
04:30 PM	0	0	0	0	0	0	0	0	0	0	0	0	0	0	0	0	1	0	0	1	1
04:45 PM	0	0	0	0	0	0	0	0	0	0	0	0	0	0	0	0	1	0	0	1	1
Total	0	0	0	0	0	0	1	0	0	1	0	0	0	0	0	0	2	1	0	3	4
05:00 PM	0	0	0	0	0	0	0	0	0	0	0	0	0	0	0	0	0	0	0	0	0
05:15 PM	0	0	0	0	0	0	0	0	0	0	0	0	0	0	0	0	0	0	0	0	0
05:30 PM	0	0	0	0	0	0	0	0	0	0	0	1	0	0	1	0	0	0	0	0	1
05:45 PM	0	0	0	0	0	0	0	0	0	0	0	0	0	0	0	0	0	0	0	0	0
Total	0	0	0	0	0	0	0	0	0	0	0	1	0	0	1	0	0	0	0	0	1
Grand Total	0	0	0	0	0	0	1	0	0	1	0	1	0	0	1	0	2	1	0	3	5
Apprch %	0	0	0	0		0	100	0	0		0	100	0	0		0	66.7	33.3	0		
Total %	0	0	0	0		0	20	0	0	20	0	20	0	0	20	0	40	20	0	60	

Start Time	8TH ST Southbound					INTER-GARRISON RD Westbound					7TH AVE Northbound					INTER-GARRISON RD Eastbound					Int. Total
	Right	Thru	Left	Peds	App. Total	Right	Thru	Left	Peds	App. Total	Right	Thru	Left	Peds	App. Total	Right	Thru	Left	Peds	App. Total	
Peak Hour Analysis From 04:00 PM to 05:45 PM - Peak 1 of 1																					
Peak Hour for Entire Intersection Begins at 04:00 PM																					
04:00 PM	0	0	0	0	0	0	1	0	0	1	0	0	0	0	0	0	0	0	0	0	1
04:15 PM	0	0	0	0	0	0	0	0	0	0	0	0	0	0	0	0	0	1	0	1	1
04:30 PM	0	0	0	0	0	0	0	0	0	0	0	0	0	0	0	0	1	0	0	1	1
04:45 PM	0	0	0	0	0	0	0	0	0	0	0	0	0	0	0	0	1	0	0	1	1
Total Volume	0	0	0	0	0	0	1	0	0	1	0	0	0	0	0	0	2	1	0	3	4
% App. Total	0	0	0	0		0	100	0	0		0	0	0	0		0	66.7	33.3	0		
PHF	.000	.000	.000	.000		.000	.250	.000	.250		.000	.000	.000	.000		.000	.500	.250	.750		1.00

Traffic Data Service

San Jose, CA
(408) 622-4787
tdsbay@cs.com

File Name : 23PM FINAL
Site Code : 00000023
Start Date : 4/25/2018
Page No : 2

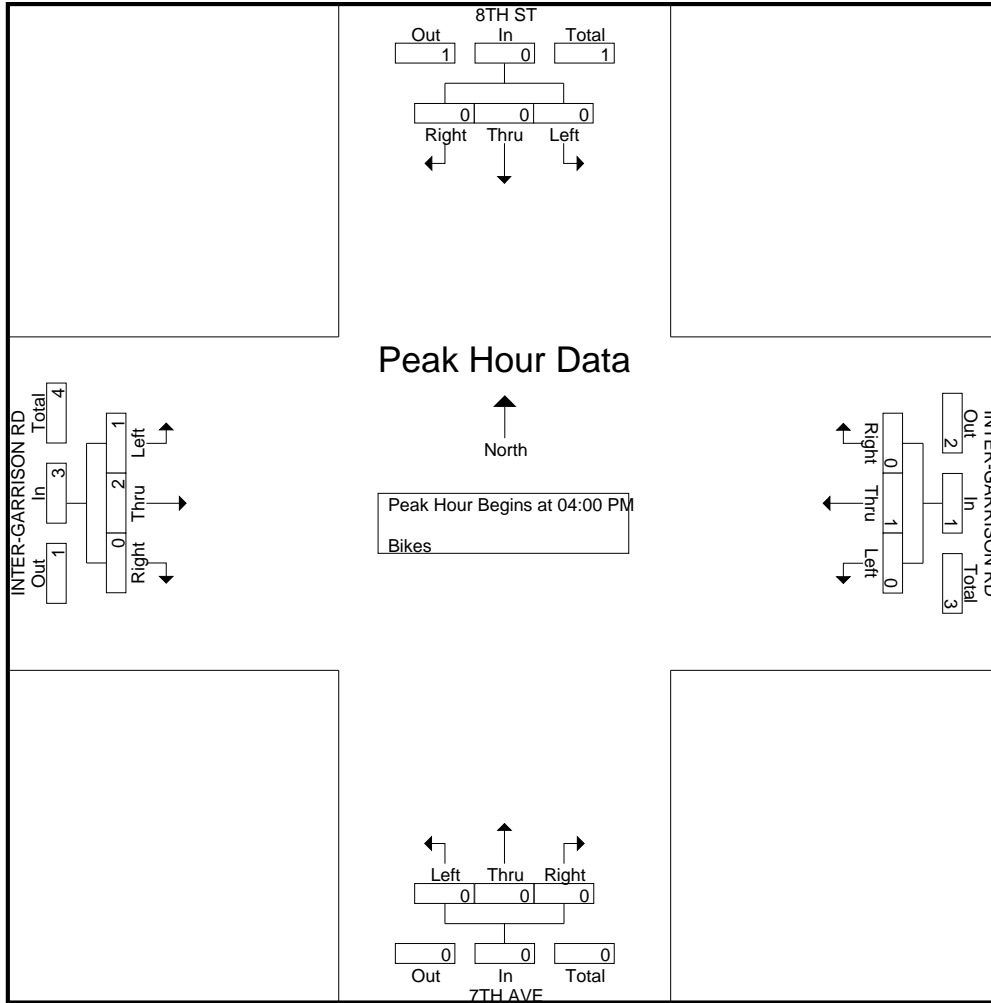

Traffic Data Service

San Jose, CA
 (408) 622-4787
 tdsbay@cs.com

File Name : 24AM FINAL
 Site Code : 00000024
 Start Date : 4/25/2018
 Page No : 1

Groups Printed- Lights - Buses - Trucks

Start Time	RESERVATION RD Southbound					HWY 68 WB OFF-RAMP Westbound					RIVER RD Northbound					HWY 68 WB ON-RAMP Eastbound					Int. Total	
	Right	Thru	Left	Peds	App. Total	Right	Thru	Left	Peds	App. Total	Right	Thru	Left	Peds	App. Total	Right	Thru	Left	Peds	App. Total		
07:00 AM	28	57	0	0	85	72	0	23	0	95	0	90	47	0	137	0	0	0	0	0	0	317
07:15 AM	15	60	0	0	75	80	0	32	0	112	0	89	38	0	127	0	0	0	0	0	0	314
07:30 AM	28	91	0	0	119	75	0	42	0	117	0	104	37	0	141	0	0	0	0	0	0	377
07:45 AM	29	89	0	0	118	79	0	63	0	142	0	93	29	0	122	0	0	0	0	0	0	382
Total	100	297	0	0	397	306	0	160	0	466	0	376	151	0	527	0	0	0	0	0	0	1390
08:00 AM	24	92	0	0	116	63	0	80	0	143	0	77	29	0	106	0	0	0	0	0	0	365
08:15 AM	24	63	0	0	87	76	0	58	0	134	0	81	28	0	109	0	0	0	0	0	0	330
08:30 AM	26	52	0	0	78	55	0	46	0	101	0	58	25	0	83	0	0	0	0	0	0	262
08:45 AM	38	48	0	0	86	36	0	39	0	75	0	63	28	0	91	0	0	0	0	0	0	252
Total	112	255	0	0	367	230	0	223	0	453	0	279	110	0	389	0	0	0	0	0	0	1209
Grand Total	212	552	0	0	764	536	0	383	0	919	0	655	261	0	916	0	0	0	0	0	0	2599
Apprch %	27.7	72.3	0	0		58.3	0	41.7	0		0	71.5	28.5	0		0	0	0	0	0	0	
Total %	8.2	21.2	0	0	29.4	20.6	0	14.7	0	35.4	0	25.2	10	0	35.2	0	0	0	0	0	0	
Lights	205	523	0	0	728	516	0	366	0	882	0	647	257	0	904	0	0	0	0	0	0	2514
% Lights	96.7	94.7	0	0	95.3	96.3	0	95.6	0	96	0	98.8	98.5	0	98.7	0	0	0	0	0	0	96.7
Buses	2	4	0	0	6	5	0	3	0	8	0	0	3	0	3	0	0	0	0	0	0	17
% Buses	0.9	0.7	0	0	0.8	0.9	0	0.8	0	0.9	0	0	1.1	0	0.3	0	0	0	0	0	0	0.7
Trucks	5	25	0	0	30	15	0	14	0	29	0	8	1	0	9	0	0	0	0	0	0	68
% Trucks	2.4	4.5	0	0	3.9	2.8	0	3.7	0	3.2	0	1.2	0.4	0	1	0	0	0	0	0	0	2.6

Start Time	RESERVATION RD Southbound				HWY 68 WB OFF-RAMP Westbound				RIVER RD Northbound				HWY 68 WB ON-RAMP Eastbound				Int. Total
	Right	Thru	Left	App. Total	Right	Thru	Left	App. Total	Right	Thru	Left	App. Total	Right	Thru	Left	App. Total	
Peak Hour Analysis From 07:00 AM to 08:45 AM - Peak 1 of 1																	
Peak Hour for Entire Intersection Begins at 07:30 AM																	
07:30 AM	28	91	0	119	75	0	42	117	0	104	37	141	0	0	0	0	377
07:45 AM	29	89	0	118	79	0	63	142	0	93	29	122	0	0	0	0	382
08:00 AM	24	92	0	116	63	0	80	143	0	77	29	106	0	0	0	0	365
08:15 AM	24	63	0	87	76	0	58	134	0	81	28	109	0	0	0	0	330
Total Volume	105	335	0	440	293	0	243	536	0	355	123	478	0	0	0	0	1454
% App. Total	23.9	76.1	0		54.7	0	45.3		0	74.3	25.7		0	0	0		
PHF	.905	.910	.000	.924	.927	.000	.759	.937	.000	.853	.831	.848	.000	.000	.000	.000	.952

Traffic Data Service

San Jose, CA
 (408) 622-4787
 tdsbay@cs.com

File Name : 24AM FINAL
 Site Code : 00000024
 Start Date : 4/25/2018
 Page No : 2

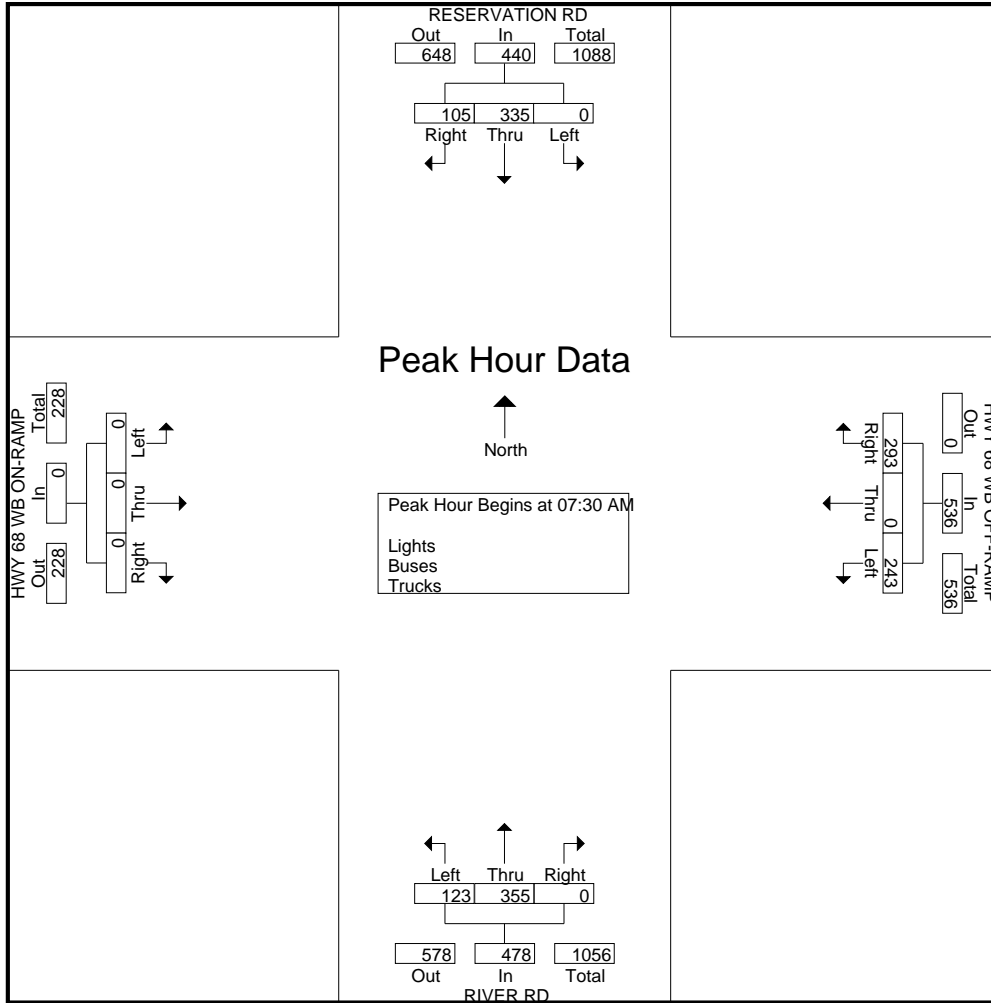

Traffic Data Service

San Jose, CA
 (408) 622-4787
 tdsbay@cs.com

File Name : 24AM FINAL
 Site Code : 00000024
 Start Date : 4/25/2018
 Page No : 1

Groups Printed- Bikes

Start Time	RESERVATION RD Southbound					HWY 68 WB OFF-RAMP Westbound					RIVER RD Northbound					HWY 68 WB ON-RAMP Eastbound					Int. Total	
	Right	Thru	Left	Peds	App. Total	Right	Thru	Left	Peds	App. Total	Right	Thru	Left	Peds	App. Total	Right	Thru	Left	Peds	App. Total		
07:00 AM	0	1	0	0	1	0	0	0	0	0	0	0	0	0	0	0	0	0	0	0	0	1
07:15 AM	0	0	0	0	0	0	0	0	0	0	0	0	0	0	0	0	0	0	0	0	0	0
07:30 AM	0	0	0	0	0	0	0	0	0	0	0	0	0	0	0	0	0	0	0	0	0	0
07:45 AM	0	0	0	0	0	0	0	0	0	0	0	0	0	0	0	0	0	0	0	0	0	0
Total	0	1	0	0	1	0	0	0	0	0	0	0	0	0	0	0	0	0	0	0	0	1
08:00 AM	0	0	0	0	0	0	0	0	0	0	0	0	0	0	0	0	0	0	0	0	0	0
08:15 AM	0	0	0	0	0	0	0	0	0	0	0	0	0	0	0	0	0	0	0	0	0	0
08:30 AM	0	1	0	0	1	0	0	0	0	0	0	1	0	0	1	0	0	0	0	0	0	2
08:45 AM	0	0	0	0	0	0	0	0	0	0	0	0	0	0	0	0	0	0	0	0	0	0
Total	0	1	0	0	1	0	0	0	0	0	0	1	0	0	1	0	0	0	0	0	0	2
Grand Total	0	2	0	0	2	0	0	0	0	0	0	1	0	0	1	0	0	0	0	0	0	3
Apprch %	0	100	0	0		0	0	0	0		0	100	0	0		0	0	0	0			
Total %	0	66.7	0	0	66.7	0	0	0	0		0	33.3	0	0	33.3	0	0	0	0			

Start Time	RESERVATION RD Southbound				HWY 68 WB OFF-RAMP Westbound				RIVER RD Northbound				HWY 68 WB ON-RAMP Eastbound				Int. Total
	Right	Thru	Left	App. Total	Right	Thru	Left	App. Total	Right	Thru	Left	App. Total	Right	Thru	Left	App. Total	
Peak Hour Analysis From 07:00 AM to 08:45 AM - Peak 1 of 1																	
Peak Hour for Entire Intersection Begins at 07:45 AM																	
07:45 AM	0	0	0	0	0	0	0	0	0	0	0	0	0	0	0	0	0
08:00 AM	0	0	0	0	0	0	0	0	0	0	0	0	0	0	0	0	0
08:15 AM	0	0	0	0	0	0	0	0	0	0	0	0	0	0	0	0	0
08:30 AM	0	1	0	1	0	0	0	0	0	0	1	0	1	0	0	0	0
Total Volume	0	1	0	1	0	0	0	0	0	0	1	0	1	0	0	0	0
% App. Total	0	100	0		0	0	0		0	100	0		0	0	0		
PHF	.000	.250	.000	.250	.000	.000	.000	.000	.000	.000	.250	.000	.250	.000	.000	.000	.250

Traffic Data Service

San Jose, CA
(408) 622-4787
tdsbay@cs.com

File Name : 24AM FINAL
Site Code : 00000024
Start Date : 4/25/2018
Page No : 2

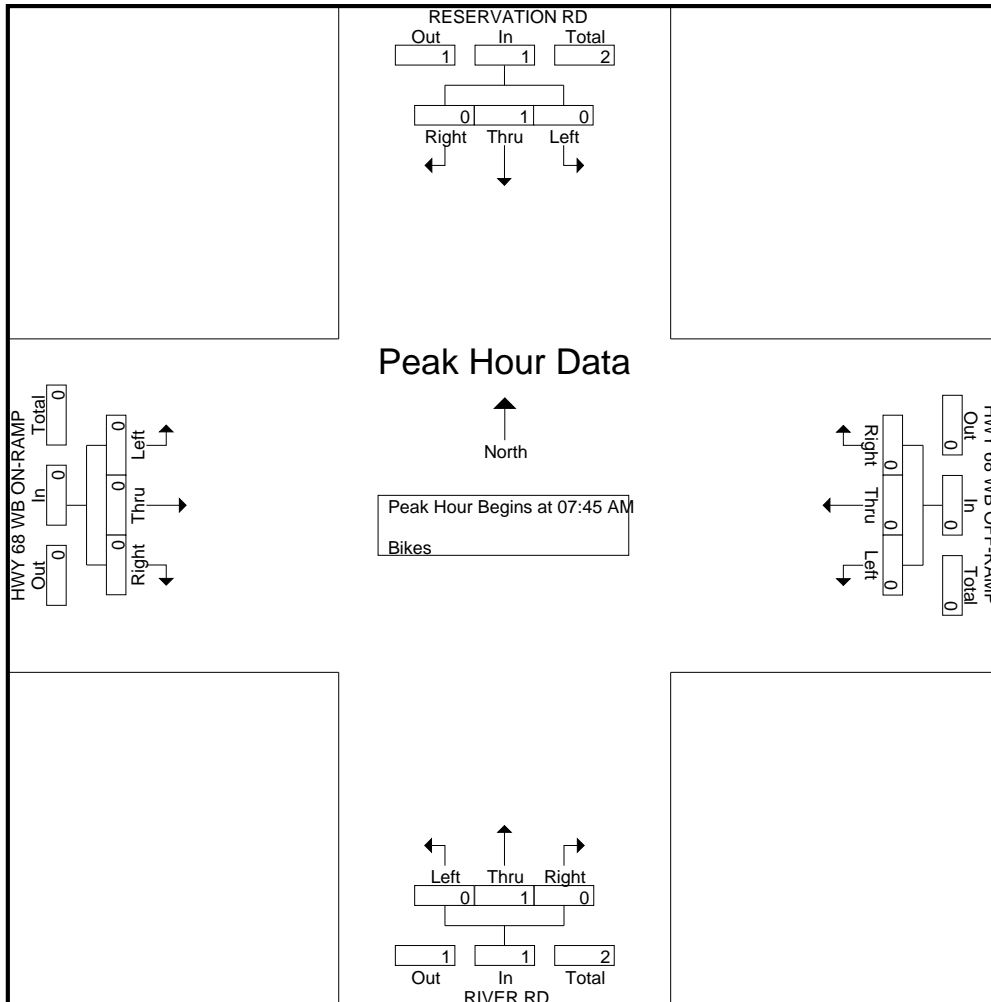

Traffic Data Service

San Jose, CA
 (408) 622-4787
 tdsbay@cs.com

File Name : 24PM FINAL
 Site Code : 00000024
 Start Date : 4/25/2018
 Page No : 1

Groups Printed- Lights - Buses - Trucks

Start Time	RESERVATION RD Southbound					HWY 68 WB OFF-RAMP Westbound					RIVER RD Northbound					HWY 68 WB ON-RAMP Eastbound					Int. Total	
	Right	Thru	Left	Peds	App. Total	Right	Thru	Left	Peds	App. Total	Right	Thru	Left	Peds	App. Total	Right	Thru	Left	Peds	App. Total		
04:00 PM	39	113	0	0	152	52	0	88	0	140	0	51	30	0	81	0	0	0	0	0	0	373
04:15 PM	35	111	0	0	146	60	0	101	0	161	0	54	36	0	90	0	0	0	0	0	0	397
04:30 PM	31	120	0	0	151	53	0	86	0	139	0	49	38	0	87	0	0	0	0	0	0	377
04:45 PM	37	133	0	0	170	43	0	74	0	117	0	52	50	0	102	0	0	0	0	0	0	389
Total	142	477	0	0	619	208	0	349	0	557	0	206	154	0	360	0	0	0	0	0	0	1536
05:00 PM	27	129	0	1	157	53	0	118	0	171	0	61	28	0	89	0	0	0	1	1	1	418
05:15 PM	36	118	0	0	154	75	0	110	0	185	0	58	34	0	92	0	0	0	0	0	0	431
05:30 PM	25	110	0	0	135	68	0	109	0	177	0	45	22	0	67	0	0	0	0	0	0	379
05:45 PM	27	111	0	0	138	49	0	88	0	137	0	37	23	0	60	0	0	0	0	0	0	335
Total	115	468	0	1	584	245	0	425	0	670	0	201	107	0	308	0	0	0	1	1	1	1563
Grand Total	257	945	0	1	1203	453	0	774	0	1227	0	407	261	0	668	0	0	0	1	1	1	3099
Apprch %	21.4	78.6	0	0.1		36.9	0	63.1	0		0	60.9	39.1	0		0	0	0	100			
Total %	8.3	30.5	0	0	38.8	14.6	0	25	0	39.6	0	13.1	8.4	0	21.6	0	0	0	0	0	0	
Lights	254	905	0	1	1160	440	0	754	0	1194	0	392	260	0	652	0	0	0	1	1	1	3007
% Lights	98.8	95.8	0	100	96.4	97.1	0	97.4	0	97.3	0	96.3	99.6	0	97.6	0	0	0	100	100	100	97
Buses	1	6	0	0	7	0	0	0	0	0	0	0	0	0	0	0	0	0	0	0	0	7
% Buses	0.4	0.6	0	0	0.6	0	0	0	0	0	0	0	0	0	0	0	0	0	0	0	0	0.2
Trucks	2	34	0	0	36	13	0	20	0	33	0	15	1	0	16	0	0	0	0	0	0	85
% Trucks	0.8	3.6	0	0	3	2.9	0	2.6	0	2.7	0	3.7	0.4	0	2.4	0	0	0	0	0	0	2.7

Start Time	RESERVATION RD Southbound				HWY 68 WB OFF-RAMP Westbound				RIVER RD Northbound				HWY 68 WB ON-RAMP Eastbound				Int. Total
	Right	Thru	Left	App. Total	Right	Thru	Left	App. Total	Right	Thru	Left	App. Total	Right	Thru	Left	App. Total	
Peak Hour Analysis From 04:00 PM to 05:45 PM - Peak 1 of 1																	
Peak Hour for Entire Intersection Begins at 04:45 PM																	
04:45 PM	37	133	0	170	43	0	74	117	0	52	50	102	0	0	0	0	389
05:00 PM	27	129	0	156	53	0	118	171	0	61	28	89	0	0	0	0	416
05:15 PM	36	118	0	154	75	0	110	185	0	58	34	92	0	0	0	0	431
05:30 PM	25	110	0	135	68	0	109	177	0	45	22	67	0	0	0	0	379
Total Volume	125	490	0	615	239	0	411	650	0	216	134	350	0	0	0	0	1615
% App. Total	20.3	79.7	0		36.8	0	63.2		0	61.7	38.3		0	0	0		
PHF	.845	.921	.000	.904	.797	.000	.871	.878	.000	.885	.670	.858	.000	.000	.000	.000	.937

Traffic Data Service

San Jose, CA
 (408) 622-4787
 tdsbay@cs.com

File Name : 24PM FINAL
 Site Code : 00000024
 Start Date : 4/25/2018
 Page No : 2

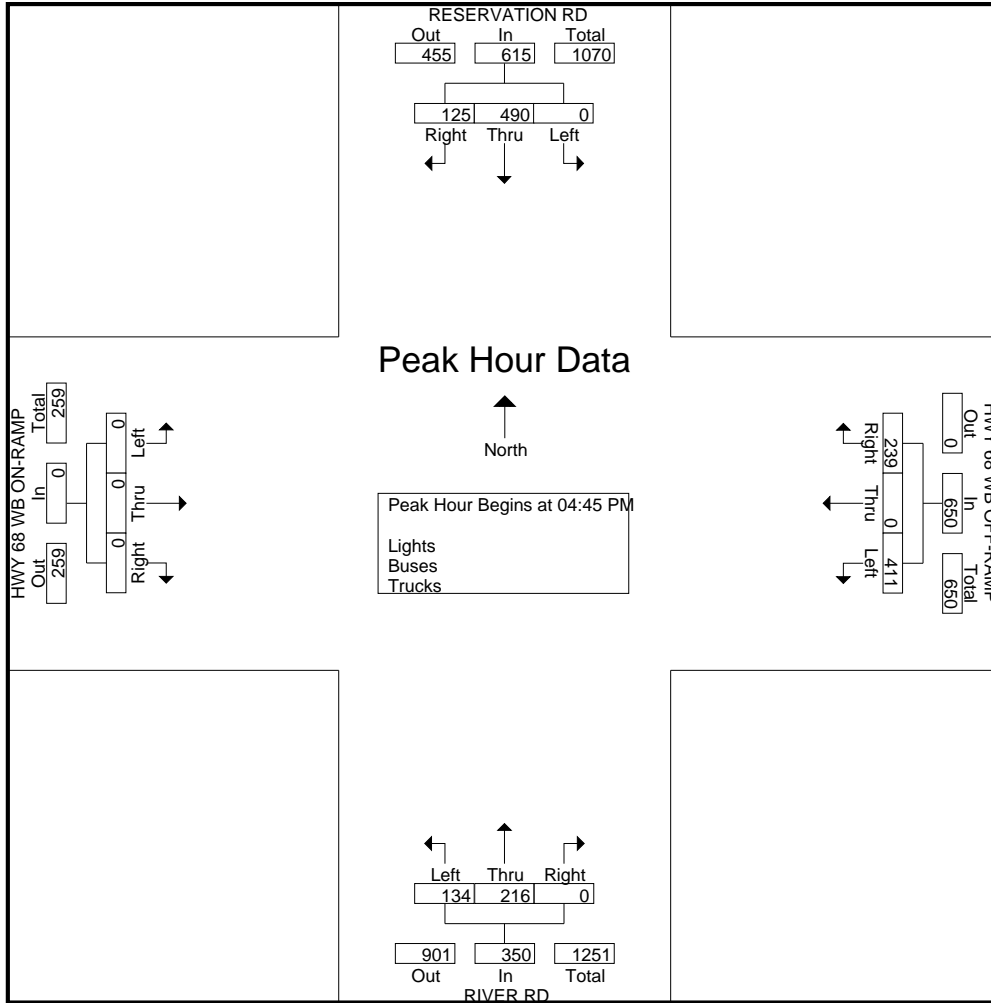

Traffic Data Service

San Jose, CA
 (408) 622-4787
 tdsbay@cs.com

File Name : 24PM FINAL
 Site Code : 00000024
 Start Date : 4/25/2018
 Page No : 1

Groups Printed- Bikes

Start Time	RESERVATION RD Southbound					HWY 68 WB OFF-RAMP Westbound					RIVER RD Northbound					HWY 68 WB ON-RAMP Eastbound					Int. Total
	Right	Thru	Left	Peds	App. Total	Right	Thru	Left	Peds	App. Total	Right	Thru	Left	Peds	App. Total	Right	Thru	Left	Peds	App. Total	
04:00 PM	0	0	0	0	0	0	0	0	0	0	0	0	0	0	0	0	0	0	0	0	0
04:15 PM	0	1	0	0	1	0	0	0	0	0	0	0	0	0	0	0	0	0	0	0	0
04:30 PM	0	0	0	0	0	0	0	0	0	0	0	0	0	0	0	0	0	0	0	0	0
04:45 PM	0	0	0	0	0	0	0	0	0	0	0	0	0	0	0	0	0	0	0	0	0
Total	0	1	0	0	1	0	0	0	0	0	0	0	0	0	0	0	0	0	0	0	1
05:00 PM	0	0	0	0	0	0	0	0	0	0	0	0	0	0	0	0	0	0	0	0	0
05:15 PM	0	0	0	0	0	0	0	0	0	0	0	0	0	0	0	0	0	0	0	0	0
05:30 PM	0	0	0	0	0	0	0	0	0	0	0	0	0	0	0	0	0	0	0	0	0
05:45 PM	0	0	0	0	0	0	0	0	0	0	0	0	0	0	0	0	0	0	0	0	0
Total	0	0	0	0	0	0	0	0	0	0	0	0	0	0	0	0	0	0	0	0	0
Grand Total	0	1	0	0	1	0	0	0	0	0	0	0	0	0	0	0	0	0	0	0	1
Apprch %	0	100	0	0		0	0	0	0		0	0	0	0		0	0	0	0		
Total %	0	100	0	0	100	0	0	0	0	0	0	0	0	0	0	0	0	0	0	0	

Start Time	RESERVATION RD Southbound				HWY 68 WB OFF-RAMP Westbound				RIVER RD Northbound				HWY 68 WB ON-RAMP Eastbound				Int. Total
	Right	Thru	Left	App. Total	Right	Thru	Left	App. Total	Right	Thru	Left	App. Total	Right	Thru	Left	App. Total	
Peak Hour Analysis From 04:00 PM to 05:45 PM - Peak 1 of 1																	
Peak Hour for Entire Intersection Begins at 04:00 PM																	
04:00 PM	0	0	0	0	0	0	0	0	0	0	0	0	0	0	0	0	0
04:15 PM	0	1	0	1	0	0	0	0	0	0	0	0	0	0	0	0	1
04:30 PM	0	0	0	0	0	0	0	0	0	0	0	0	0	0	0	0	0
04:45 PM	0	0	0	0	0	0	0	0	0	0	0	0	0	0	0	0	0
Total Volume	0	1	0	1	0	0	0	0	0	0	0	0	0	0	0	0	1
% App. Total	0	100	0		0	0	0		0	0	0		0	0	0		
PHF	.000	.250	.000	.250	.000	.000	.000	.000	.000	.000	.000	.000	.000	.000	.000	.000	.250

Traffic Data Service

San Jose, CA
(408) 622-4787
tdsbay@cs.com

File Name : 24PM FINAL
Site Code : 00000024
Start Date : 4/25/2018
Page No : 2

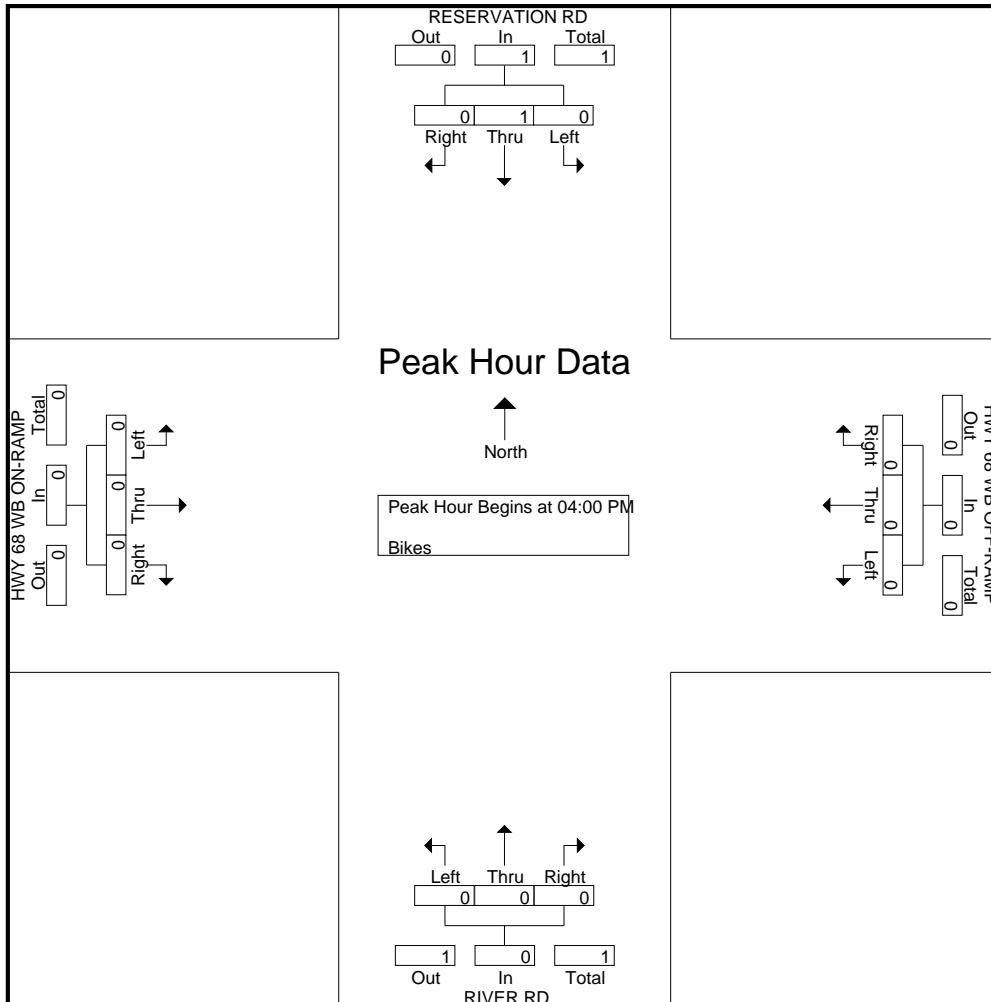

Traffic Data Service

San Jose, CA
 (408) 622-4787
 tdsbay@cs.com

File Name : 25AM FINAL
 Site Code : 00000025
 Start Date : 4/25/2018
 Page No : 1

Groups Printed- Lights - Buses - Trucks

Start Time	RIVER RD Southbound					HWY 68 EB ON-RAMP Westbound					RIVER RD Northbound					HWY 68 EB OFF-RAMP Eastbound					Int. Total
	Right	Thru	Left	Peds	App. Total	Right	Thru	Left	Peds	App. Total	Right	Thru	Left	Peds	App. Total	Right	Thru	Left	Peds	App. Total	
07:00 AM	0	53	27	0	80	0	0	0	0	0	64	117	0	0	181	30	0	19	0	49	310
07:15 AM	0	54	40	0	94	0	0	0	0	0	115	108	0	0	223	28	0	26	0	54	371
07:30 AM	0	65	59	0	124	0	0	0	0	0	201	109	0	0	310	30	0	26	0	56	490
07:45 AM	0	87	57	0	144	0	0	0	0	0	158	108	0	0	266	23	0	17	0	40	450
Total	0	259	183	0	442	0	0	0	0	0	538	442	0	0	980	111	0	88	0	199	1621
08:00 AM	0	118	65	0	183	0	0	0	0	0	160	85	0	0	245	24	1	19	0	44	472
08:15 AM	0	76	42	0	118	0	0	0	0	0	145	74	0	0	219	28	0	34	0	62	399
08:30 AM	0	62	35	0	97	0	0	0	0	0	62	62	0	1	125	29	0	24	1	54	276
08:45 AM	0	48	26	0	74	0	0	0	0	0	61	62	0	0	123	18	0	25	0	43	240
Total	0	304	168	0	472	0	0	0	0	0	428	283	0	1	712	99	1	102	1	203	1387
Grand Total	0	563	351	0	914	0	0	0	0	0	966	725	0	1	1692	210	1	190	1	402	3008
Apprch %	0	61.6	38.4	0		0	0	0	0		57.1	42.8	0	0.1		52.2	0.2	47.3	0.2		
Total %	0	18.7	11.7	0	30.4	0	0	0	0	0	32.1	24.1	0	0	56.2	7	0	6.3	0	13.4	
Lights	0	532	339	0	871	0	0	0	0	0	948	717	0	1	1666	205	1	190	1	397	2934
% Lights	0	94.5	96.6	0	95.3	0	0	0	0	0	98.1	98.9	0	100	98.5	97.6	100	100	100	98.8	97.5
Buses	0	5	2	0	7	0	0	0	0	0	7	3	0	0	10	2	0	0	0	2	19
% Buses	0	0.9	0.6	0	0.8	0	0	0	0	0	0.7	0.4	0	0	0.6	1	0	0	0	0.5	0.6
Trucks	0	26	10	0	36	0	0	0	0	0	11	5	0	0	16	3	0	0	0	3	55
% Trucks	0	4.6	2.8	0	3.9	0	0	0	0	0	1.1	0.7	0	0	0.9	1.4	0	0	0	0.7	1.8

Start Time	RIVER RD Southbound				HWY 68 EB ON-RAMP Westbound				RIVER RD Northbound				HWY 68 EB OFF-RAMP Eastbound				Int. Total
	Right	Thru	Left	App. Total	Right	Thru	Left	App. Total	Right	Thru	Left	App. Total	Right	Thru	Left	App. Total	
Peak Hour Analysis From 07:00 AM to 08:45 AM - Peak 1 of 1																	
Peak Hour for Entire Intersection Begins at 07:30 AM																	
07:30 AM	0	65	59	124	0	0	0	0	201	109	0	310	30	0	26	56	490
07:45 AM	0	87	57	144	0	0	0	0	158	108	0	266	23	0	17	40	450
08:00 AM	0	118	65	183	0	0	0	0	160	85	0	245	24	1	19	44	472
08:15 AM	0	76	42	118	0	0	0	0	145	74	0	219	28	0	34	62	399
Total Volume	0	346	223	569	0	0	0	0	664	376	0	1040	105	1	96	202	1811
% App. Total	0	60.8	39.2		0	0	0		63.8	36.2	0		52	0.5	47.5		
PHF	.000	.733	.858	.777	.000	.000	.000	.000	.826	.862	.000	.839	.875	.250	.706	.815	.924

Traffic Data Service

San Jose, CA
 (408) 622-4787
 tdsbay@cs.com

File Name : 25AM FINAL
 Site Code : 00000025
 Start Date : 4/25/2018
 Page No : 2

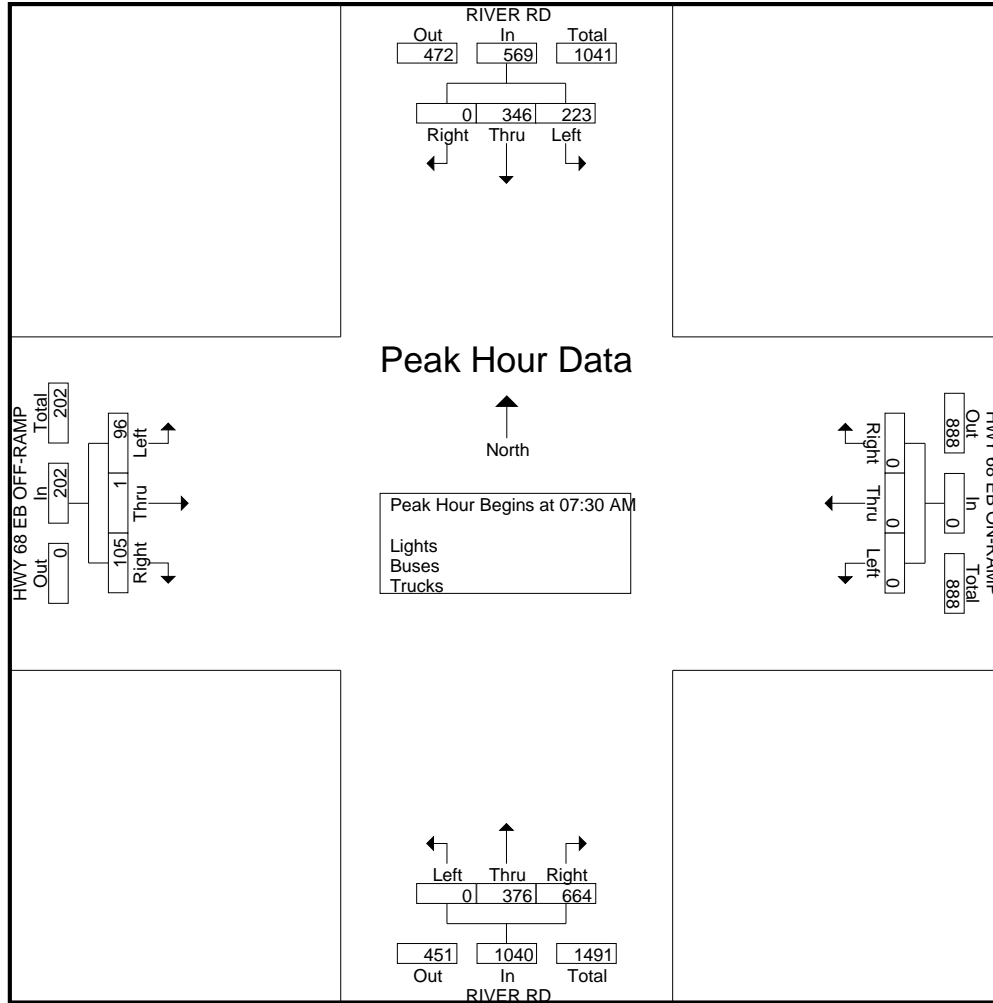

Traffic Data Service

San Jose, CA
 (408) 622-4787
 tdsbay@cs.com

File Name : 25AM FINAL
 Site Code : 00000025
 Start Date : 4/25/2018
 Page No : 1

Groups Printed- Bikes

Start Time	RIVER RD Southbound					HWY 68 EB ON-RAMP Westbound					RIVER RD Northbound					HWY 68 EB OFF-RAMP Eastbound					Int. Total
	Right	Thru	Left	Peds	App. Total	Right	Thru	Left	Peds	App. Total	Right	Thru	Left	Peds	App. Total	Right	Thru	Left	Peds	App. Total	
07:00 AM	0	1	0	0	1	0	0	0	0	0	0	0	0	0	0	0	0	0	0	0	0
07:15 AM	0	0	0	0	0	0	0	0	0	0	0	0	0	0	0	0	0	0	0	0	0
07:30 AM	0	0	0	0	0	0	0	0	0	0	0	0	0	0	0	0	0	0	0	0	0
07:45 AM	0	0	0	0	0	0	0	0	0	0	0	0	0	0	0	0	0	0	0	0	0
Total	0	1	0	0	1	0	0	0	0	0	0	0	0	0	0	0	0	0	0	0	1
08:00 AM	0	0	0	0	0	0	0	0	0	0	0	0	0	0	0	0	0	0	0	0	0
08:15 AM	0	0	0	0	0	0	0	0	0	0	0	0	0	0	0	0	0	0	0	0	0
08:30 AM	0	0	0	0	0	0	0	0	0	0	0	0	0	0	0	0	0	0	0	0	0
08:45 AM	0	0	0	0	0	0	0	0	0	0	0	0	0	0	0	1	0	0	0	1	1
Total	0	0	0	0	0	0	0	0	0	0	0	0	0	0	0	1	0	0	0	1	1
Grand Total	0	1	0	0	1	0	0	0	0	0	0	0	0	0	0	1	0	0	0	1	2
Apprch %	0	100	0	0		0	0	0	0		0	0	0	0		100	0	0	0		
Total %	0	50	0	0	50	0	0	0	0	0	0	0	0	0	0	50	0	0	0	50	

Start Time	RIVER RD Southbound					HWY 68 EB ON-RAMP Westbound					RIVER RD Northbound					HWY 68 EB OFF-RAMP Eastbound					Int. Total
	Right	Thru	Left	Peds	App. Total	Right	Thru	Left	Peds	App. Total	Right	Thru	Left	Peds	App. Total	Right	Thru	Left	Peds	App. Total	
Peak Hour Analysis From 07:00 AM to 08:45 AM - Peak 1 of 1																					
Peak Hour for Entire Intersection Begins at 07:00 AM																					
07:00 AM	0	1	0	0	1	0	0	0	0	0	0	0	0	0	0	0	0	0	0	0	1
07:15 AM	0	0	0	0	0	0	0	0	0	0	0	0	0	0	0	0	0	0	0	0	0
07:30 AM	0	0	0	0	0	0	0	0	0	0	0	0	0	0	0	0	0	0	0	0	0
07:45 AM	0	0	0	0	0	0	0	0	0	0	0	0	0	0	0	0	0	0	0	0	0
Total Volume	0	1	0	0	1	0	0	0	0	0	0	0	0	0	0	0	0	0	0	0	1
% App. Total	0	100	0	0		0	0	0	0		0	0	0	0		0	0	0	0		
PHF	.000	.250	.000	.000	.250	.000	.000	.000	.000	.000	.000	.000	.000	.000	.000	.000	.000	.000	.000	.000	.250

Traffic Data Service

San Jose, CA
 (408) 622-4787
 tdsbay@cs.com

File Name : 25AM FINAL
 Site Code : 00000025
 Start Date : 4/25/2018
 Page No : 2

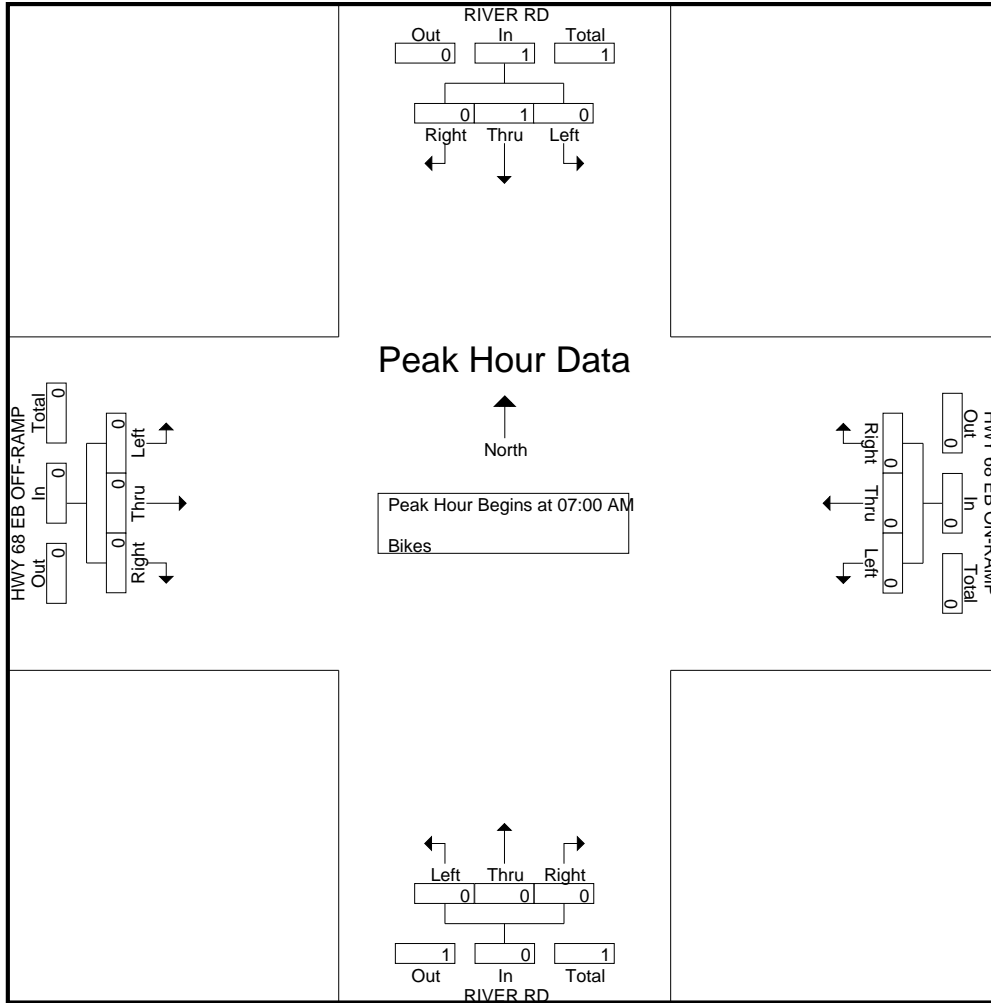

Traffic Data Service

San Jose, CA
 (408) 622-4787
 tdsbay@cs.com

File Name : 25PM FINAL
 Site Code : 00000025
 Start Date : 4/25/2018
 Page No : 1

Groups Printed- Lights - Buses - Trucks

Start Time	RIVER RD Southbound					HWY 68 EB ON-RAMP Westbound					RIVER RD Northbound					HWY 68 EB OFF-RAMP Eastbound					Int. Total
	Right	Thru	Left	Peds	App. Total	Right	Thru	Left	Peds	App. Total	Right	Thru	Left	Peds	App. Total	Right	Thru	Left	Peds	App. Total	
04:00 PM	0	135	63	0	198	0	0	0	0	0	54	57	0	0	111	47	0	26	0	73	382
04:15 PM	0	159	44	0	203	0	0	0	0	0	48	73	0	0	121	57	0	21	0	78	402
04:30 PM	0	153	65	0	218	0	0	0	0	0	73	77	0	0	150	48	0	15	0	63	431
04:45 PM	0	145	66	0	211	0	0	0	0	0	57	73	0	0	130	44	0	23	0	67	408
Total	0	592	238	0	830	0	0	0	0	0	232	280	0	0	512	196	0	85	0	281	1623
05:00 PM	0	188	55	0	243	0	0	0	0	0	89	68	0	0	157	48	1	21	0	70	470
05:15 PM	0	173	56	0	229	0	0	0	0	0	87	73	0	0	160	49	0	22	0	71	460
05:30 PM	0	172	47	0	219	0	0	0	0	0	83	46	0	0	129	47	0	17	0	64	412
05:45 PM	0	152	52	0	204	0	0	0	0	0	65	52	0	0	117	47	0	12	0	59	380
Total	0	685	210	0	895	0	0	0	0	0	324	239	0	0	563	191	1	72	0	264	1722
Grand Total	0	1277	448	0	1725	0	0	0	0	0	556	519	0	0	1075	387	1	157	0	545	3345
Apprch %	0	74	26	0		0	0	0	0		51.7	48.3	0	0		71	0.2	28.8	0		
Total %	0	38.2	13.4	0	51.6	0	0	0	0	0	16.6	15.5	0	0	32.1	11.6	0	4.7	0	16.3	
Lights	0	1243	420	0	1663	0	0	0	0	0	535	504	0	0	1039	384	1	153	0	538	3240
% Lights	0	97.3	93.8	0	96.4	0	0	0	0	0	96.2	97.1	0	0	96.7	99.2	100	97.5	0	98.7	96.9
Buses	0	2	5	0	7	0	0	0	0	0	3	0	0	0	3	0	0	0	0	0	10
% Buses	0	0.2	1.1	0	0.4	0	0	0	0	0	0.5	0	0	0	0.3	0	0	0	0	0	0.3
Trucks	0	32	23	0	55	0	0	0	0	0	18	15	0	0	33	3	0	4	0	7	95
% Trucks	0	2.5	5.1	0	3.2	0	0	0	0	0	3.2	2.9	0	0	3.1	0.8	0	2.5	0	1.3	2.8

Start Time	RIVER RD Southbound				HWY 68 EB ON-RAMP Westbound				RIVER RD Northbound				HWY 68 EB OFF-RAMP Eastbound				Int. Total
	Right	Thru	Left	App. Total	Right	Thru	Left	App. Total	Right	Thru	Left	App. Total	Right	Thru	Left	App. Total	
Peak Hour Analysis From 04:00 PM to 05:45 PM - Peak 1 of 1																	
Peak Hour for Entire Intersection Begins at 04:30 PM																	
04:30 PM	0	153	65	218	0	0	0	0	73	77	0	150	48	0	15	63	431
04:45 PM	0	145	66	211	0	0	0	0	57	73	0	130	44	0	23	67	408
05:00 PM	0	188	55	243	0	0	0	0	89	68	0	157	48	1	21	70	470
05:15 PM	0	173	56	229	0	0	0	0	87	73	0	160	49	0	22	71	460
Total Volume	0	659	242	901	0	0	0	0	306	291	0	597	189	1	81	271	1769
% App. Total	0	73.1	26.9		0	0	0		51.3	48.7	0		69.7	0.4	29.9		
PHF	.000	.876	.917	.927	.000	.000	.000	.000	.860	.945	.000	.933	.964	.250	.880	.954	.941

Traffic Data Service

San Jose, CA
 (408) 622-4787
 tdsbay@cs.com

File Name : 25PM FINAL
 Site Code : 00000025
 Start Date : 4/25/2018
 Page No : 2

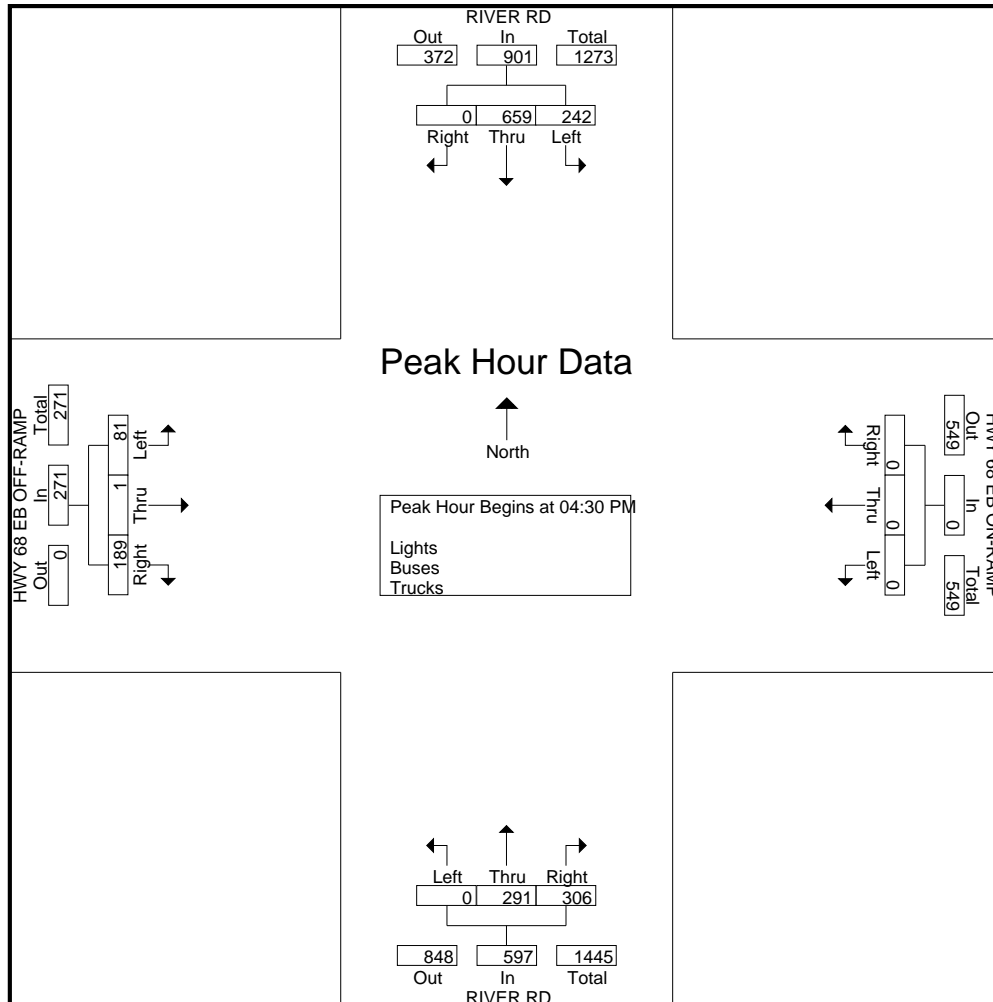

Traffic Data Service

San Jose, CA
 (408) 622-4787
 tdsbay@cs.com

File Name : 25PM FINAL
 Site Code : 00000025
 Start Date : 4/25/2018
 Page No : 1

Groups Printed- Bikes

Start Time	RIVER RD Southbound					HWY 68 EB ON-RAMP Westbound					RIVER RD Northbound					HWY 68 EB OFF-RAMP Eastbound					Int. Total
	Right	Thru	Left	Peds	App. Total	Right	Thru	Left	Peds	App. Total	Right	Thru	Left	Peds	App. Total	Right	Thru	Left	Peds	App. Total	
04:00 PM	0	0	0	0	0	0	0	0	0	0	0	0	0	0	0	0	0	0	0	0	0
04:15 PM	0	1	0	0	1	0	0	0	0	0	0	0	0	0	0	0	0	0	0	0	0
04:30 PM	0	0	0	0	0	0	0	0	0	0	0	0	0	0	0	0	0	0	0	0	0
04:45 PM	0	0	0	0	0	0	0	0	0	0	0	0	0	0	0	0	0	0	0	0	0
Total	0	1	0	0	1	0	0	0	0	0	0	0	0	0	0	0	0	0	0	0	1
05:00 PM	0	0	0	0	0	0	0	0	0	0	0	0	0	0	0	0	0	0	0	0	0
05:15 PM	0	0	1	0	1	0	0	0	0	0	0	0	0	0	0	0	0	0	0	0	1
05:30 PM	0	0	0	0	0	0	0	0	0	0	0	0	0	0	0	0	0	0	0	0	0
05:45 PM	0	0	0	0	0	0	0	0	0	0	0	0	0	0	0	0	0	0	0	0	0
Total	0	0	1	0	1	0	0	0	0	0	0	0	0	0	0	0	0	0	0	0	1
Grand Total	0	1	1	0	2	0	0	0	0	0	0	0	0	0	0	0	0	0	0	0	2
Apprch %	0	50	50	0		0	0	0	0		0	0	0	0		0	0	0	0		
Total %	0	50	50	0	100	0	0	0	0	0	0	0	0	0	0	0	0	0	0	0	

Start Time	RIVER RD Southbound				HWY 68 EB ON-RAMP Westbound				RIVER RD Northbound				HWY 68 EB OFF-RAMP Eastbound				Int. Total
	Right	Thru	Left	App. Total	Right	Thru	Left	App. Total	Right	Thru	Left	App. Total	Right	Thru	Left	App. Total	
Peak Hour Analysis From 04:00 PM to 05:45 PM - Peak 1 of 1																	
Peak Hour for Entire Intersection Begins at 04:00 PM																	
04:00 PM	0	0	0	0	0	0	0	0	0	0	0	0	0	0	0	0	
04:15 PM	0	1	0	1	0	0	0	0	0	0	0	0	0	0	0	0	
04:30 PM	0	0	0	0	0	0	0	0	0	0	0	0	0	0	0	0	
04:45 PM	0	0	0	0	0	0	0	0	0	0	0	0	0	0	0	0	
Total Volume	0	1	0	1	0	0	0	0	0	0	0	0	0	0	0	0	
% App. Total	0	100	0		0	0	0		0	0	0		0	0	0		
PHF	.000	.250	.000	.250	.000	.000	.000	.000	.000	.000	.000	.000	.000	.000	.000	.000	

Traffic Data Service

San Jose, CA
 (408) 622-4787
 tdsbay@cs.com

File Name : 25PM FINAL
 Site Code : 00000025
 Start Date : 4/25/2018
 Page No : 2

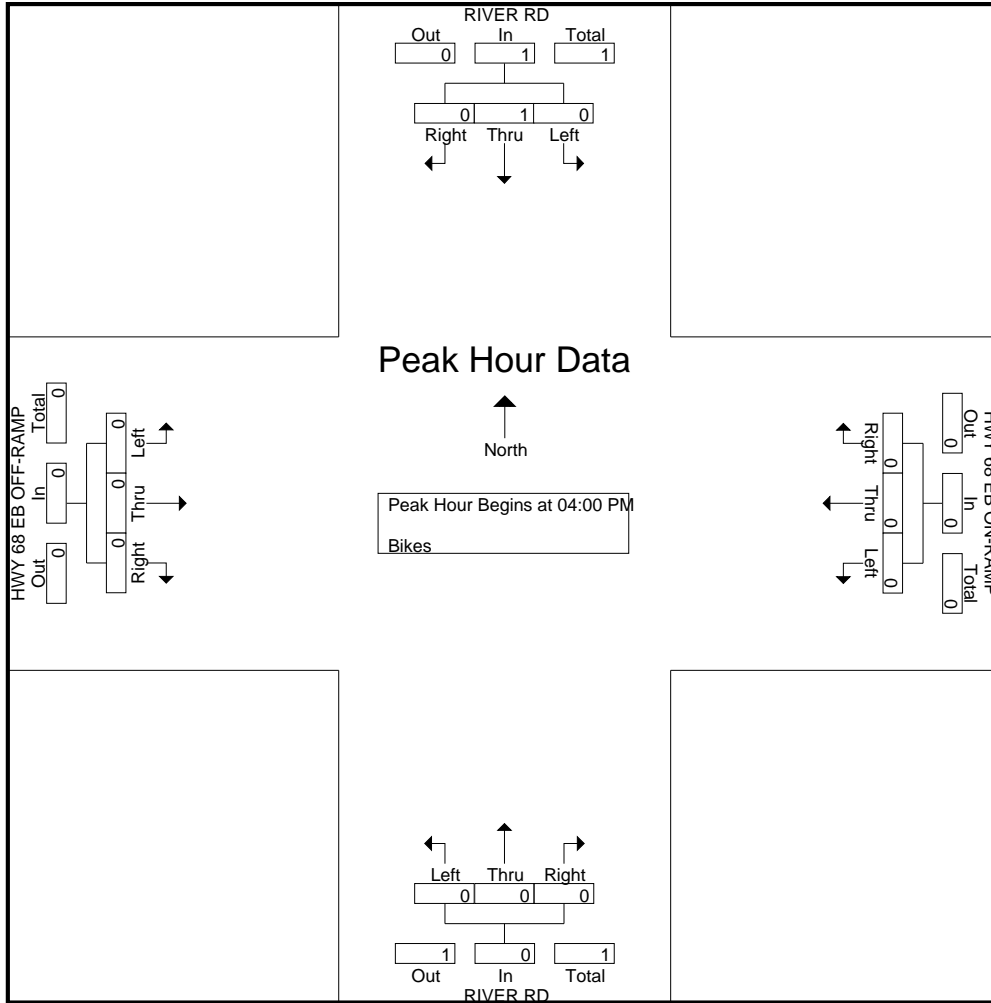

Study Name 101 - SB Cabrillo Hwy

Start Date 05/03/2017

Start Time 12:00 AM

Site Code 27

Channel Direction	Lights	Buses	Trucks	Total	
	Direction				
	Southbound				
12:00 AM		35	0	0	35
12:15 AM		26	0	0	26
12:30 AM		27	0	1	28
12:45 AM		25	0	0	25
1:00 AM		20	0	1	21
1:15 AM		12	0	2	14
1:30 AM		10	0	1	11
1:45 AM		14	0	0	14
2:00 AM		10	0	0	10
2:15 AM		10	0	0	10
2:30 AM		14	0	2	16
2:45 AM		19	0	0	19
3:00 AM		8	0	0	8
3:15 AM		12	0	1	13
3:30 AM		12	0	3	15
3:45 AM		21	0	2	23
4:00 AM		18	0	5	23
4:15 AM		39	0	4	43
4:30 AM		49	0	9	58
4:45 AM		51	0	8	59
5:00 AM		45	0	10	55
5:15 AM		89	0	12	101
5:30 AM		134	0	16	150
5:45 AM		180	0	32	212
6:00 AM		215	1	24	240
6:15 AM		309	1	20	330
6:30 AM		502	2	29	533
6:45 AM		584	1	22	607
7:00 AM		886	1	26	913
7:15 AM		687	1	33	721
7:30 AM		514	0	26	540
7:45 AM		517	0	21	538
8:00 AM		420	1	20	441

8:15 AM	435	0	29	464
8:30 AM	469	3	30	502
8:45 AM	436	1	32	469
9:00 AM	375	1	27	403
9:15 AM	398	0	30	428
9:30 AM	448	3	24	475
9:45 AM	386	4	13	403
10:00 AM	346	5	21	372
10:15 AM	364	4	16	384
10:30 AM	401	6	28	435
10:45 AM	385	5	26	416
11:00 AM	370	2	13	385
11:15 AM	373	3	17	393
11:30 AM	515	1	20	536
11:45 AM	438	0	25	463
12:00 PM	420	2	12	434
12:15 PM	434	6	14	454
12:30 PM	388	2	23	413
12:45 PM	385	0	23	408
1:00 PM	399	1	20	420
1:15 PM	436	0	14	450
1:30 PM	412	1	10	423
1:45 PM	362	1	15	378
2:00 PM	403	2	11	416
2:15 PM	400	1	13	414
2:30 PM	384	2	5	391
2:45 PM	398	3	13	414
3:00 PM	350	2	10	362
3:15 PM	382	2	11	395
3:30 PM	378	2	20	400
3:45 PM	386	0	12	398
4:00 PM	364	1	6	371
4:15 PM	368	3	8	379
4:30 PM	335	1	9	345
4:45 PM	308	2	6	316
5:00 PM	345	0	1	346
5:15 PM	328	1	4	333
5:30 PM	372	0	2	374
5:45 PM	350	2	2	354
6:00 PM	339	0	4	343
6:15 PM	283	0	5	288
6:30 PM	342	0	3	345
6:45 PM	260	0	4	264
7:00 PM	247	0	1	248
7:15 PM	227	1	3	231
7:30 PM	202	0	0	202

7:45 PM	211	0	0	211
8:00 PM	192	0	1	193
8:15 PM	175	0	2	177
8:30 PM	148	0	3	151
8:45 PM	129	0	1	130
9:00 PM	151	0	3	154
9:15 PM	163	0	0	163
9:30 PM	117	0	1	118
9:45 PM	140	0	1	141
10:00 PM	94	0	0	94
10:15 PM	93	0	2	95
10:30 PM	88	1	0	89
10:45 PM	94	0	0	94
11:00 PM	79	0	2	81
11:15 PM	68	0	0	68
11:30 PM	57	0	1	58
11:45 PM	45	0	0	45
12:00 AM	34	0	0	34
12:15 AM	29	0	0	29
12:30 AM	13	0	1	14
12:45 AM	29	0	1	30
1:00 AM	15	0	0	15
1:15 AM	13	0	3	16
1:30 AM	16	0	1	17
1:45 AM	10	0	1	11
2:00 AM	14	0	0	14
2:15 AM	16	0	0	16
2:30 AM	3	0	0	3
2:45 AM	8	0	1	9
3:00 AM	15	0	4	19
3:15 AM	13	0	4	17
3:30 AM	17	0	5	22
3:45 AM	21	0	3	24
4:00 AM	11	0	0	11
4:15 AM	36	0	7	43
4:30 AM	46	0	10	56
4:45 AM	43	0	6	49
5:00 AM	47	2	15	64
5:15 AM	83	2	7	92
5:30 AM	136	0	13	149
5:45 AM	183	0	19	202
6:00 AM	213	1	17	231
6:15 AM	308	0	23	331
6:30 AM	517	2	27	546
6:45 AM	616	1	37	654
7:00 AM	819	3	41	863

7:15 AM	702	0	33	735
7:30 AM	546	0	31	577
7:45 AM	488	1	32	521
8:00 AM	479	0	24	503
8:15 AM	454	4	29	487
8:30 AM	473	0	28	501
8:45 AM	430	3	32	465
9:00 AM	437	3	21	461
9:15 AM	366	2	28	396
9:30 AM	472	2	33	507
9:45 AM	373	3	23	399
10:00 AM	352	4	29	385
10:15 AM	405	1	19	425
10:30 AM	407	6	25	438
10:45 AM	405	1	17	423
11:00 AM	372	3	21	396
11:15 AM	366	1	20	387
11:30 AM	425	7	31	463
11:45 AM	409	3	31	443
12:00 PM	422	1	27	450
12:15 PM	398	3	18	419
12:30 PM	415	1	22	438
12:45 PM	399	2	21	422
1:00 PM	372	1	15	388
1:15 PM	432	0	15	447
1:30 PM	456	0	13	469
1:45 PM	369	0	7	376
2:00 PM	386	1	17	404
2:15 PM	366	1	11	378
2:30 PM	436	2	13	451
2:45 PM	393	1	16	410
3:00 PM	367	1	10	378
3:15 PM	396	1	6	403
3:30 PM	396	0	11	407
3:45 PM	365	1	6	372
4:00 PM	283	2	6	291
4:15 PM	357	0	4	361
4:30 PM	336	2	4	342
4:45 PM	345	2	5	352
5:00 PM	371	0	4	375
5:15 PM	357	0	2	359
5:30 PM	350	0	6	356
5:45 PM	335	0	2	337
6:00 PM	346	0	5	351
6:15 PM	339	0	1	340
6:30 PM	315	2	2	319

6:45 PM	295	0	5	300
7:00 PM	287	0	4	291
7:15 PM	246	2	2	250
7:30 PM	258	0	4	262
7:45 PM	215	1	2	218
8:00 PM	216	1	4	221
8:15 PM	194	0	1	195
8:30 PM	172	0	3	175
8:45 PM	161	0	4	165
9:00 PM	151	0	0	151
9:15 PM	137	0	0	137
9:30 PM	148	0	3	151
9:45 PM	131	1	0	132
10:00 PM	105	0	1	106
10:15 PM	88	0	3	91
10:30 PM	94	0	1	95
10:45 PM	73	0	1	74
11:00 PM	56	1	1	58
11:15 PM	56	1	1	58
11:30 PM	48	0	1	49
11:45 PM	47	0	0	47

Study Name 102 - SB 3006 CA-1

Start Date 05/03/2017

Start Time 12:00 AM

Site Code 28

Channel Direction	Lights	Buses	Trucks	Total	
	Direction				
	Southbound				
12:00 AM		46	1	0	47
12:15 AM		34	0	1	35
12:30 AM		36	0	2	38
12:45 AM		38	0	0	38
1:00 AM		32	0	1	33
1:15 AM		17	0	2	19
1:30 AM		13	0	1	14
1:45 AM		20	0	2	22
2:00 AM		14	0	0	14
2:15 AM		15	0	0	15
2:30 AM		17	0	2	19
2:45 AM		23	0	3	26
3:00 AM		15	0	0	15
3:15 AM		15	0	2	17
3:30 AM		23	0	3	26
3:45 AM		34	0	1	35
4:00 AM		29	0	5	34
4:15 AM		48	0	7	55
4:30 AM		78	0	8	86
4:45 AM		78	0	12	90
5:00 AM		81	0	10	91
5:15 AM		137	0	14	151
5:30 AM		219	0	18	237
5:45 AM		257	0	29	286
6:00 AM		310	2	26	338
6:15 AM		443	2	26	471
6:30 AM		700	3	34	737
6:45 AM		822	3	39	864
7:00 AM		1211	4	29	1244
7:15 AM		1053	4	34	1091
7:30 AM		933	1	30	964
7:45 AM		775	2	29	806
8:00 AM		664	4	22	690

8:15 AM	670	4	36	710
8:30 AM	694	12	35	741
8:45 AM	659	4	45	708
9:00 AM	554	2	26	582
9:15 AM	587	2	42	631
9:30 AM	658	3	29	690
9:45 AM	556	3	19	578
10:00 AM	479	7	23	509
10:15 AM	510	5	24	539
10:30 AM	565	6	29	600
10:45 AM	546	3	30	579
11:00 AM	497	5	18	520
11:15 AM	527	3	22	552
11:30 AM	682	5	20	707
11:45 AM	590	4	26	620
12:00 PM	582	4	10	596
12:15 PM	615	7	15	637
12:30 PM	580	5	27	612
12:45 PM	531	1	22	554
1:00 PM	590	3	24	617
1:15 PM	617	2	14	633
1:30 PM	616	3	11	630
1:45 PM	548	3	17	568
2:00 PM	547	3	18	568
2:15 PM	569	2	15	586
2:30 PM	558	7	10	575
2:45 PM	555	1	17	573
3:00 PM	525	3	14	542
3:15 PM	533	5	11	549
3:30 PM	549	2	19	570
3:45 PM	527	5	9	541
4:00 PM	552	5	12	569
4:15 PM	508	5	14	527
4:30 PM	515	2	10	527
4:45 PM	483	5	11	499
5:00 PM	501	4	0	505
5:15 PM	480	3	4	487
5:30 PM	557	1	4	562
5:45 PM	529	3	2	534
6:00 PM	476	0	4	480
6:15 PM	446	3	9	458
6:30 PM	469	2	5	476
6:45 PM	376	2	6	384
7:00 PM	376	0	1	377
7:15 PM	328	1	3	332
7:30 PM	314	0	1	315

7:45 PM	311	1	0	312
8:00 PM	302	1	1	304
8:15 PM	256	0	4	260
8:30 PM	230	0	4	234
8:45 PM	221	0	6	227
9:00 PM	212	0	4	216
9:15 PM	211	0	1	212
9:30 PM	179	0	2	181
9:45 PM	194	0	3	197
10:00 PM	145	0	0	145
10:15 PM	146	0	2	148
10:30 PM	128	0	0	128
10:45 PM	178	0	0	178
11:00 PM	118	0	3	121
11:15 PM	89	0	3	92
11:30 PM	70	0	1	71
11:45 PM	62	0	1	63
12:00 AM	55	0	0	55
12:15 AM	38	0	0	38
12:30 AM	22	0	1	23
12:45 AM	42	0	1	43
1:00 AM	23	0	1	24
1:15 AM	19	0	3	22
1:30 AM	23	0	1	24
1:45 AM	16	0	1	17
2:00 AM	20	0	0	20
2:15 AM	21	0	0	21
2:30 AM	11	0	1	12
2:45 AM	11	0	1	12
3:00 AM	20	0	5	25
3:15 AM	21	0	5	26
3:30 AM	29	0	5	34
3:45 AM	37	0	4	41
4:00 AM	25	0	0	25
4:15 AM	57	0	8	65
4:30 AM	64	0	10	74
4:45 AM	64	0	6	70
5:00 AM	73	0	17	90
5:15 AM	134	0	9	143
5:30 AM	197	0	26	223
5:45 AM	271	0	34	305
6:00 AM	303	1	20	324
6:15 AM	432	3	22	457
6:30 AM	741	4	29	774
6:45 AM	912	5	40	957
7:00 AM	1219	8	44	1271

7:15 AM	1054	1	37	1092
7:30 AM	744	2	34	780
7:45 AM	805	2	53	860
8:00 AM	679	2	31	712
8:15 AM	706	6	39	751
8:30 AM	721	7	37	765
8:45 AM	644	7	45	696
9:00 AM	598	3	27	628
9:15 AM	543	3	27	573
9:30 AM	606	7	33	646
9:45 AM	553	5	26	584
10:00 AM	497	4	35	536
10:15 AM	550	1	32	583
10:30 AM	553	4	31	588
10:45 AM	528	2	18	548
11:00 AM	527	6	23	556
11:15 AM	482	1	27	510
11:30 AM	620	10	29	659
11:45 AM	579	5	31	615
12:00 PM	581	2	33	616
12:15 PM	557	4	19	580
12:30 PM	596	4	20	620
12:45 PM	577	3	23	603
1:00 PM	523	1	19	543
1:15 PM	614	1	21	636
1:30 PM	616	1	15	632
1:45 PM	539	1	13	553
2:00 PM	581	2	18	601
2:15 PM	543	2	13	558
2:30 PM	619	5	17	641
2:45 PM	563	3	16	582
3:00 PM	529	3	9	541
3:15 PM	578	2	10	590
3:30 PM	587	3	9	599
3:45 PM	556	7	6	569
4:00 PM	450	6	8	464
4:15 PM	513	2	3	518
4:30 PM	522	3	4	529
4:45 PM	533	2	6	541
5:00 PM	515	3	5	523
5:15 PM	518	1	2	521
5:30 PM	530	0	7	537
5:45 PM	499	3	3	505
6:00 PM	502	0	4	506
6:15 PM	466	0	2	468
6:30 PM	458	2	2	462

6:45 PM	436	1	6	443
7:00 PM	401	0	4	405
7:15 PM	346	4	2	352
7:30 PM	373	0	3	376
7:45 PM	340	3	4	347
8:00 PM	310	1	5	316
8:15 PM	304	0	2	306
8:30 PM	249	0	4	253
8:45 PM	234	0	6	240
9:00 PM	234	0	1	235
9:15 PM	194	0	0	194
9:30 PM	217	0	3	220
9:45 PM	173	1	1	175
10:00 PM	158	0	3	161
10:15 PM	144	0	2	146
10:30 PM	174	0	2	176
10:45 PM	120	0	1	121
11:00 PM	80	1	1	82
11:15 PM	91	0	1	92
11:30 PM	69	0	2	71
11:45 PM	63	0	1	64

Study Name 103 - SB Cabrillo Hwy
 Start Date 05/03/2017
 Start Time 12:00 AM
 Site Code 29

Channel Direction	Lights	Buses	Trucks	Total	
	Direction				
	Southbound				
12:00 AM		58	0	3	61
12:15 AM		39	0	1	40
12:30 AM		43	0	1	44
12:45 AM		37	0	1	38
1:00 AM		28	0	1	29
1:15 AM		25	0	1	26
1:30 AM		16	0	2	18
1:45 AM		20	0	2	22
2:00 AM		21	0	1	22
2:15 AM		16	0	1	17
2:30 AM		23	0	2	25
2:45 AM		24	0	1	25
3:00 AM		20	0	0	20
3:15 AM		22	0	1	23
3:30 AM		43	0	3	46
3:45 AM		49	0	0	49
4:00 AM		36	0	7	43
4:15 AM		67	0	6	73
4:30 AM		112	0	11	123
4:45 AM		143	0	12	155
5:00 AM		101	0	13	114
5:15 AM		142	0	12	154
5:30 AM		267	1	18	286
5:45 AM		360	0	24	384
6:00 AM		366	3	29	398
6:15 AM		569	3	27	599
6:30 AM		886	4	26	916
6:45 AM		1082	3	22	1107
7:00 AM		1308	4	36	1348
7:15 AM		1026	5	30	1061
7:30 AM		1013	3	46	1062
7:45 AM		893	3	35	931
8:00 AM		934	5	40	979

8:15 AM	812	4	36	852
8:30 AM	883	12	40	935
8:45 AM	836	5	45	886
9:00 AM	713	2	39	754
9:15 AM	749	4	41	794
9:30 AM	755	4	32	791
9:45 AM	690	3	18	711
10:00 AM	598	8	24	630
10:15 AM	640	6	31	677
10:30 AM	680	6	34	720
10:45 AM	706	2	28	736
11:00 AM	622	6	23	651
11:15 AM	666	4	26	696
11:30 AM	789	4	17	810
11:45 AM	700	4	28	732
12:00 PM	718	5	16	739
12:15 PM	778	8	21	807
12:30 PM	735	6	29	770
12:45 PM	660	3	20	683
1:00 PM	724	3	32	759
1:15 PM	735	4	16	755
1:30 PM	742	3	10	755
1:45 PM	707	2	17	726
2:00 PM	687	2	15	704
2:15 PM	679	2	13	694
2:30 PM	717	8	11	736
2:45 PM	701	7	15	723
3:00 PM	648	1	15	664
3:15 PM	680	6	16	702
3:30 PM	704	2	21	727
3:45 PM	685	5	11	701
4:00 PM	702	3	16	721
4:15 PM	696	5	16	717
4:30 PM	690	2	5	697
4:45 PM	686	4	13	703
5:00 PM	658	1	10	669
5:15 PM	674	2	4	680
5:30 PM	771	1	8	780
5:45 PM	671	6	5	682
6:00 PM	612	0	4	616
6:15 PM	581	1	8	590
6:30 PM	572	1	9	582
6:45 PM	489	1	6	496
7:00 PM	450	0	1	451
7:15 PM	419	0	4	423
7:30 PM	409	1	1	411

7:45 PM	377	1	1	379
8:00 PM	375	3	3	381
8:15 PM	324	0	3	327
8:30 PM	287	0	4	291
8:45 PM	237	0	5	242
9:00 PM	246	0	4	250
9:15 PM	206	0	2	208
9:30 PM	209	0	1	210
9:45 PM	202	0	3	205
10:00 PM	169	0	1	170
10:15 PM	167	0	2	169
10:30 PM	150	0	0	150
10:45 PM	174	0	1	175
11:00 PM	116	0	3	119
11:15 PM	92	0	2	94
11:30 PM	76	0	1	77
11:45 PM	53	0	0	53
12:00 AM	56	0	0	56
12:15 AM	44	0	0	44
12:30 AM	27	1	0	28
12:45 AM	47	1	0	48
1:00 AM	26	0	1	27
1:15 AM	23	0	2	25
1:30 AM	24	0	1	25
1:45 AM	21	0	1	22
2:00 AM	17	0	0	17
2:15 AM	25	0	0	25
2:30 AM	17	0	1	18
2:45 AM	12	0	1	13
3:00 AM	26	0	4	30
3:15 AM	24	0	6	30
3:30 AM	40	0	4	44
3:45 AM	51	0	2	53
4:00 AM	27	1	1	29
4:15 AM	63	1	7	71
4:30 AM	108	0	12	120
4:45 AM	118	0	7	125
5:00 AM	88	0	17	105
5:15 AM	142	0	9	151
5:30 AM	258	0	29	287
5:45 AM	343	0	28	371
6:00 AM	370	3	20	393
6:15 AM	562	4	25	591
6:30 AM	877	3	31	911
6:45 AM	1058	4	37	1099
7:00 AM	1350	10	35	1395

7:15 AM	1116	4	27	1147
7:30 AM	1002	4	24	1030
7:45 AM	1090	2	52	1144
8:00 AM	836	3	31	870
8:15 AM	792	7	80	879
8:30 AM	871	8	35	914
8:45 AM	866	7	50	923
9:00 AM	772	4	33	809
9:15 AM	730	2	25	757
9:30 AM	732	9	40	781
9:45 AM	735	5	25	765
10:00 AM	603	3	28	634
10:15 AM	668	4	23	695
10:30 AM	685	4	37	726
10:45 AM	708	4	21	733
11:00 AM	661	4	30	695
11:15 AM	584	4	23	611
11:30 AM	713	7	27	747
11:45 AM	672	7	32	711
12:00 PM	709	1	37	747
12:15 PM	685	4	27	716
12:30 PM	732	4	20	756
12:45 PM	690	4	25	719
1:00 PM	609	2	20	631
1:15 PM	701	2	17	720
1:30 PM	750	0	16	766
1:45 PM	630	3	20	653
2:00 PM	688	2	17	707
2:15 PM	715	3	15	733
2:30 PM	783	5	17	805
2:45 PM	699	6	16	721
3:00 PM	679	2	13	694
3:15 PM	691	4	9	704
3:30 PM	732	2	18	752
3:45 PM	714	9	8	731
4:00 PM	611	4	9	624
4:15 PM	655	5	4	664
4:30 PM	657	5	6	668
4:45 PM	709	2	5	716
5:00 PM	705	0	8	713
5:15 PM	732	1	4	737
5:30 PM	710	1	6	717
5:45 PM	652	4	4	660
6:00 PM	650	0	7	657
6:15 PM	609	0	3	612
6:30 PM	583	3	3	589

6:45 PM	531	2	8	541
7:00 PM	470	0	3	473
7:15 PM	460	2	3	465
7:30 PM	423	0	3	426
7:45 PM	370	3	4	377
8:00 PM	365	1	3	369
8:15 PM	373	0	3	376
8:30 PM	296	0	2	298
8:45 PM	291	0	4	295
9:00 PM	295	0	0	295
9:15 PM	235	0	3	238
9:30 PM	240	0	3	243
9:45 PM	213	0	2	215
10:00 PM	171	0	1	172
10:15 PM	169	0	2	171
10:30 PM	185	0	3	188
10:45 PM	127	0	3	130
11:00 PM	105	0	4	109
11:15 PM	110	0	3	113
11:30 PM	80	0	2	82
11:45 PM	73	0	1	74

Study Name 104 SB Cabrillo Hwy
 Start Date 05/03/2017
 Start Time 12:00 AM
 Site Code 30

Channel Direction	Lights	Buses	Trucks	Total	
	Direction Southbound				
12:00 AM		58	0	1	59
12:15 AM		40	0	0	40
12:30 AM		47	0	3	50
12:45 AM		39	0	1	40
1:00 AM		30	0	1	31
1:15 AM		24	0	2	26
1:30 AM		26	0	2	28
1:45 AM		18	0	2	20
2:00 AM		24	0	1	25
2:15 AM		14	0	1	15
2:30 AM		20	0	2	22
2:45 AM		24	0	2	26
3:00 AM		20	0	0	20
3:15 AM		20	0	0	20
3:30 AM		46	0	0	46
3:45 AM		49	0	0	49
4:00 AM		37	0	7	44
4:15 AM		66	0	7	73
4:30 AM		113	0	13	126
4:45 AM		138	0	13	151
5:00 AM		102	5	0	107
5:15 AM		136	7	5	148
5:30 AM		216	7	15	238
5:45 AM		358	6	24	388
6:00 AM		344	5	27	376
6:15 AM		548	6	27	581
6:30 AM		846	6	25	877
6:45 AM		1108	5	23	1136
7:00 AM		1386	6	33	1425
7:15 AM		1150	5	20	1175
7:30 AM		1003	5	37	1045
7:45 AM		1043	2	43	1088
8:00 AM		976	6	50	1032

8:15 AM	998	3	56	1057
8:30 AM	877	11	49	937
8:45 AM	827	6	39	872
9:00 AM	745	3	36	784
9:15 AM	766	6	31	803
9:30 AM	719	4	33	756
9:45 AM	732	8	15	755
10:00 AM	605	8	25	638
10:15 AM	667	11	29	707
10:30 AM	690	5	35	730
10:45 AM	749	4	30	783
11:00 AM	659	5	21	685
11:15 AM	646	7	20	673
11:30 AM	774	2	21	797
11:45 AM	763	4	27	794
12:00 PM	763	4	16	783
12:15 PM	826	10	21	857
12:30 PM	791	4	21	816
12:45 PM	686	2	23	711
1:00 PM	752	3	27	782
1:15 PM	751	3	25	779
1:30 PM	792	2	12	806
1:45 PM	730	4	15	749
2:00 PM	734	3	17	754
2:15 PM	729	8	14	751
2:30 PM	721	9	13	743
2:45 PM	725	8	15	748
3:00 PM	693	2	17	712
3:15 PM	750	6	19	775
3:30 PM	740	4	17	761
3:45 PM	744	4	17	765
4:00 PM	798	2	13	813
4:15 PM	750	3	10	763
4:30 PM	773	1	3	777
4:45 PM	818	1	8	827
5:00 PM	749	1	9	759
5:15 PM	731	3	8	742
5:30 PM	801	0	7	808
5:45 PM	756	4	4	764
6:00 PM	658	1	4	663
6:15 PM	621	2	5	628
6:30 PM	594	1	8	603
6:45 PM	549	1	5	555
7:00 PM	505	0	2	507
7:15 PM	461	2	4	467
7:30 PM	425	1	1	427

7:45 PM	440	0	0	440
8:00 PM	392	4	2	398
8:15 PM	357	0	2	359
8:30 PM	325	0	4	329
8:45 PM	245	0	5	250
9:00 PM	259	0	3	262
9:15 PM	213	0	3	216
9:30 PM	246	0	3	249
9:45 PM	213	0	2	215
10:00 PM	198	0	1	199
10:15 PM	166	1	1	168
10:30 PM	182	1	2	185
10:45 PM	172	1	1	174
11:00 PM	110	1	1	112
11:15 PM	95	1	2	98
11:30 PM	87	0	1	88
11:45 PM	66	0	0	66
12:00 AM	49	0	0	49
12:15 AM	52	0	0	52
12:30 AM	25	0	1	26
12:45 AM	44	0	1	45
1:00 AM	33	0	1	34
1:15 AM	22	0	2	24
1:30 AM	27	0	1	28
1:45 AM	19	0	2	21
2:00 AM	21	0	0	21
2:15 AM	21	0	1	22
2:30 AM	16	0	1	17
2:45 AM	10	0	0	10
3:00 AM	25	0	3	28
3:15 AM	23	0	7	30
3:30 AM	38	0	5	43
3:45 AM	54	0	3	57
4:00 AM	27	0	2	29
4:15 AM	48	0	8	56
4:30 AM	109	0	13	122
4:45 AM	114	0	8	122
5:00 AM	93	1	12	106
5:15 AM	154	1	8	163
5:30 AM	248	6	22	276
5:45 AM	331	3	27	361
6:00 AM	375	7	24	406
6:15 AM	531	4	20	555
6:30 AM	850	5	34	889
6:45 AM	1042	8	31	1081
7:00 AM	1304	5	39	1348

7:15 AM	1083	6	30	1119
7:30 AM	1197	4	27	1228
7:45 AM	1086	2	38	1126
8:00 AM	963	2	51	1016
8:15 AM	982	8	51	1041
8:30 AM	866	6	33	905
8:45 AM	880	5	37	922
9:00 AM	761	6	40	807
9:15 AM	714	1	29	744
9:30 AM	673	8	44	725
9:45 AM	761	7	32	800
10:00 AM	597	4	26	627
10:15 AM	674	10	20	704
10:30 AM	703	5	31	739
10:45 AM	777	5	25	807
11:00 AM	675	3	27	705
11:15 AM	613	4	26	643
11:30 AM	739	3	23	765
11:45 AM	770	10	33	813
12:00 PM	815	0	28	843
12:15 PM	784	4	22	810
12:30 PM	745	4	18	767
12:45 PM	702	3	18	723
1:00 PM	634	1	24	659
1:15 PM	724	4	22	750
1:30 PM	785	0	22	807
1:45 PM	700	1	25	726
2:00 PM	716	2	20	738
2:15 PM	731	7	15	753
2:30 PM	792	7	14	813
2:45 PM	731	8	17	756
3:00 PM	765	3	17	785
3:15 PM	758	4	8	770
3:30 PM	780	4	15	799
3:45 PM	782	10	10	802
4:00 PM	684	7	7	698
4:15 PM	701	6	2	709
4:30 PM	729	4	3	736
4:45 PM	811	1	5	817
5:00 PM	813	3	9	825
5:15 PM	790	4	3	797
5:30 PM	769	1	7	777
5:45 PM	704	3	2	709
6:00 PM	710	0	4	714
6:15 PM	617	1	7	625
6:30 PM	614	1	2	617

6:45 PM	536	0	6	542
7:00 PM	539	1	4	544
7:15 PM	457	3	5	465
7:30 PM	460	0	3	463
7:45 PM	396	1	3	400
8:00 PM	385	2	6	393
8:15 PM	384	0	3	387
8:30 PM	355	0	2	357
8:45 PM	385	0	4	389
9:00 PM	259	0	3	262
9:15 PM	269	0	0	269
9:30 PM	239	0	2	241
9:45 PM	223	0	3	226
10:00 PM	192	0	2	194
10:15 PM	192	1	3	196
10:30 PM	188	1	2	191
10:45 PM	123	0	3	126
11:00 PM	102	0	8	110
11:15 PM	95	1	3	99
11:30 PM	80	0	5	85
11:45 PM	69	0	2	71

Study Name 105 SB Cabrillo Hwy
 Start Date 05/03/2017
 Start Time 12:00 AM
 Site Code 31

Channel Direction	lights	buses	trucks	Total	
	Direction				
	Southbound				
12:00 AM		51	0	0	51
12:15 AM		35	0	0	35
12:30 AM		33	0	0	33
12:45 AM		36	0	0	36
1:00 AM		24	0	0	24
1:15 AM		21	0	1	22
1:30 AM		22	0	2	24
1:45 AM		14	0	2	16
2:00 AM		15	0	1	16
2:15 AM		10	0	1	11
2:30 AM		16	0	1	17
2:45 AM		19	0	1	20
3:00 AM		20	0	1	21
3:15 AM		14	0	1	15
3:30 AM		32	0	4	36
3:45 AM		32	0	1	33
4:00 AM		29	0	3	32
4:15 AM		56	2	6	64
4:30 AM		118	0	10	128
4:45 AM		128	0	10	138
5:00 AM		106	0	4	110
5:15 AM		144	0	9	153
5:30 AM		233	4	16	253
5:45 AM		332	3	19	354
6:00 AM		316	2	21	339
6:15 AM		492	4	23	519
6:30 AM		764	3	22	789
6:45 AM		990	3	19	1012
7:00 AM		990	4	18	1012
7:15 AM		972	2	18	992
7:30 AM		916	2	28	946
7:45 AM		871	1	21	893
8:00 AM		799	3	47	849

8:15 AM	875	1	43	919
8:30 AM	802	8	43	853
8:45 AM	784	4	33	821
9:00 AM	676	4	32	712
9:15 AM	666	3	30	699
9:30 AM	668	3	39	710
9:45 AM	644	6	11	661
10:00 AM	528	7	21	556
10:15 AM	582	10	25	617
10:30 AM	628	5	22	655
10:45 AM	678	1	18	697
11:00 AM	567	5	16	588
11:15 AM	573	4	19	596
11:30 AM	703	3	16	722
11:45 AM	676	6	25	707
12:00 PM	618	2	16	636
12:15 PM	720	6	14	740
12:30 PM	669	4	16	689
12:45 PM	604	2	23	629
1:00 PM	617	0	20	637
1:15 PM	647	5	26	678
1:30 PM	660	2	14	676
1:45 PM	678	2	11	691
2:00 PM	661	2	8	671
2:15 PM	636	5	13	654
2:30 PM	652	5	10	667
2:45 PM	624	9	14	647
3:00 PM	604	4	10	618
3:15 PM	649	4	13	666
3:30 PM	613	5	8	626
3:45 PM	623	4	14	641
4:00 PM	612	4	10	626
4:15 PM	652	3	10	665
4:30 PM	646	3	4	653
4:45 PM	669	3	13	685
5:00 PM	588	3	3	594
5:15 PM	582	1	5	588
5:30 PM	639	1	4	644
5:45 PM	621	1	2	624
6:00 PM	550	4	3	557
6:15 PM	529	0	4	533
6:30 PM	495	0	2	497
6:45 PM	448	1	6	455
7:00 PM	413	1	0	414
7:15 PM	404	0	3	407
7:30 PM	346	1	0	347

7:45 PM	336	0	0	336
8:00 PM	313	4	1	318
8:15 PM	281	0	1	282
8:30 PM	268	0	3	271
8:45 PM	231	0	3	234
9:00 PM	224	0	2	226
9:15 PM	208	0	3	211
9:30 PM	196	0	2	198
9:45 PM	191	0	1	192
10:00 PM	177	0	1	178
10:15 PM	143	0	1	144
10:30 PM	141	0	1	142
10:45 PM	126	0	0	126
11:00 PM	106	0	1	107
11:15 PM	72	0	0	72
11:30 PM	76	0	0	76
11:45 PM	47	0	0	47
12:00 AM	42	0	0	42
12:15 AM	46	0	0	46
12:30 AM	25	0	1	26
12:45 AM	37	0	0	37
1:00 AM	24	0	1	25
1:15 AM	20	0	1	21
1:30 AM	24	0	1	25
1:45 AM	10	0	1	11
2:00 AM	13	0	0	13
2:15 AM	17	0	0	17
2:30 AM	15	0	1	16
2:45 AM	11	0	0	11
3:00 AM	17	0	3	20
3:15 AM	16	0	6	22
3:30 AM	28	0	2	30
3:45 AM	31	0	4	35
4:00 AM	27	0	2	29
4:15 AM	50	3	3	56
4:30 AM	114	0	11	125
4:45 AM	116	0	6	122
5:00 AM	92	0	7	99
5:15 AM	142	0	5	147
5:30 AM	229	3	17	249
5:45 AM	309	4	15	328
6:00 AM	343	3	21	367
6:15 AM	476	4	13	493
6:30 AM	829	2	30	861
6:45 AM	900	4	29	933
7:00 AM	1009	5	29	1043

7:15 AM	981	4	24	1009
7:30 AM	1053	1	22	1076
7:45 AM	852	1	41	894
8:00 AM	859	1	41	901
8:15 AM	872	5	38	915
8:30 AM	790	3	39	832
8:45 AM	827	4	27	858
9:00 AM	677	4	25	706
9:15 AM	647	1	26	674
9:30 AM	641	6	31	678
9:45 AM	665	8	22	695
10:00 AM	515	4	26	545
10:15 AM	612	9	23	644
10:30 AM	600	4	25	629
10:45 AM	665	3	21	689
11:00 AM	609	4	20	633
11:15 AM	526	2	17	545
11:30 AM	628	2	24	654
11:45 AM	672	7	26	705
12:00 PM	692	0	25	717
12:15 PM	610	0	16	626
12:30 PM	688	5	16	709
12:45 PM	614	1	19	634
1:00 PM	552	1	19	572
1:15 PM	648	2	18	668
1:30 PM	725	0	16	741
1:45 PM	602	0	16	618
2:00 PM	612	2	20	634
2:15 PM	630	3	10	643
2:30 PM	703	5	10	718
2:45 PM	657	6	17	680
3:00 PM	624	3	14	641
3:15 PM	643	2	8	653
3:30 PM	690	3	8	701
3:45 PM	652	9	10	671
4:00 PM	569	7	8	584
4:15 PM	596	6	2	604
4:30 PM	620	4	3	627
4:45 PM	300	3	0	303

Study Name 101 NB Cabrillo Hwy
 Start Date 05/03/2017
 Start Time 12:00 AM
 Site Code 36

Channel	lights	buses	trucks	Total	
Direction	Direction				
	Northbound				
12:00 AM		37	0	2	39
12:15 AM		26	0	0	26
12:30 AM		18	0	1	19
12:45 AM		23	0	1	24
1:00 AM		16	0	1	17
1:15 AM		16	0	1	17
1:30 AM		15	0	4	19
1:45 AM		16	0	4	20
2:00 AM		9	0	0	9
2:15 AM		15	0	1	16
2:30 AM		7	0	1	8
2:45 AM		16	0	1	17
3:00 AM		11	0	1	12
3:15 AM		18	0	0	18
3:30 AM		19	1	0	20
3:45 AM		42	0	0	42
4:00 AM		26	0	2	28
4:15 AM		33	0	2	35
4:30 AM		36	0	2	38
4:45 AM		54	0	4	58
5:00 AM		59	0	7	66
5:15 AM		85	0	6	91
5:30 AM		99	0	6	105
5:45 AM		121	0	10	131
6:00 AM		139	2	6	147
6:15 AM		165	0	8	173
6:30 AM		174	0	6	180
6:45 AM		194	3	7	204
7:00 AM		205	4	11	220
7:15 AM		255	0	11	266
7:30 AM		262	1	11	274
7:45 AM		302	0	13	315
8:00 AM		271	0	17	288

8:15 AM	250	2	21	273
8:30 AM	203	0	20	223
8:45 AM	241	2	19	262
9:00 AM	233	2	26	261
9:15 AM	288	0	26	314
9:30 AM	245	1	18	264
9:45 AM	294	0	31	325
10:00 AM	278	1	36	315
10:15 AM	290	1	25	316
10:30 AM	282	1	23	306
10:45 AM	301	0	21	322
11:00 AM	294	0	27	321
11:15 AM	301	1	27	329
11:30 AM	355	1	28	384
11:45 AM	263	0	23	286
12:00 PM	303	1	20	324
12:15 PM	328	0	21	349
12:30 PM	335	0	25	360
12:45 PM	494	2	37	533
1:00 PM	434	3	26	463
1:15 PM	388	6	24	418
1:30 PM	388	2	26	416
1:45 PM	384	1	21	406
2:00 PM	417	5	35	457
2:15 PM	453	3	33	489
2:30 PM	419	1	29	449
2:45 PM	483	2	25	510
3:00 PM	506	5	26	537
3:15 PM	549	1	29	579
3:30 PM	643	3	25	671
3:45 PM	593	1	17	611
4:00 PM	620	3	22	645
4:15 PM	654	0	16	670
4:30 PM	611	1	15	627
4:45 PM	637	2	13	652
5:00 PM	689	1	11	701
5:15 PM	659	1	13	673
5:30 PM	628	1	16	645
5:45 PM	621	2	10	633
6:00 PM	516	2	12	530
6:15 PM	489	7	8	504
6:30 PM	408	0	11	419
6:45 PM	395	0	7	402
7:00 PM	332	1	4	337
7:15 PM	319	0	1	320
7:30 PM	314	1	5	320

7:45 PM	297	0	7	304
8:00 PM	273	0	5	278
8:15 PM	285	0	1	286
8:30 PM	253	0	0	253
8:45 PM	239	0	5	244
9:00 PM	237	0	4	241
9:15 PM	188	0	4	192
9:30 PM	149	1	4	154
9:45 PM	144	0	1	145
10:00 PM	141	0	0	141
10:15 PM	112	1	0	113
10:30 PM	84	0	0	84
10:45 PM	66	0	1	67
11:00 PM	68	0	2	70
11:15 PM	56	0	2	58
11:30 PM	30	0	1	31
11:45 PM	34	0	2	36
12:00 AM	39	0	1	40
12:15 AM	30	0	1	31
12:30 AM	18	0	2	20
12:45 AM	34	0	0	34
1:00 AM	16	0	1	17
1:15 AM	14	0	4	18
1:30 AM	12	0	0	12
1:45 AM	16	0	2	18
2:00 AM	9	0	0	9
2:15 AM	17	0	2	19
2:30 AM	18	0	0	18
2:45 AM	17	0	1	18
3:00 AM	20	0	1	21
3:15 AM	19	0	0	19
3:30 AM	9	0	3	12
3:45 AM	22	0	2	24
4:00 AM	31	0	5	36
4:15 AM	42	0	3	45
4:30 AM	48	0	0	48
4:45 AM	52	0	3	55
5:00 AM	48	0	4	52
5:15 AM	68	0	4	72
5:30 AM	87	0	3	90
5:45 AM	113	0	4	117
6:00 AM	130	0	7	137
6:15 AM	171	1	10	182
6:30 AM	175	0	11	186
6:45 AM	152	0	10	162
7:00 AM	216	3	11	230

7:15 AM	230	2	19	251
7:30 AM	272	1	18	291
7:45 AM	273	0	15	288
8:00 AM	265	1	22	288
8:15 AM	298	2	25	325
8:30 AM	261	0	18	279
8:45 AM	267	1	23	291
9:00 AM	267	1	36	304
9:15 AM	284	0	24	308
9:30 AM	291	1	29	321
9:45 AM	296	0	29	325
10:00 AM	290	2	24	316
10:15 AM	287	0	27	314
10:30 AM	310	1	28	339
10:45 AM	328	0	20	348
11:00 AM	341	1	24	366
11:15 AM	307	1	21	329
11:30 AM	327	2	23	352
11:45 AM	324	1	18	343
12:00 PM	327	1	34	362
12:15 PM	340	2	33	375
12:30 PM	378	1	30	409
12:45 PM	332	0	29	361
1:00 PM	274	1	26	301
1:15 PM	374	5	37	416
1:30 PM	399	0	31	430
1:45 PM	365	1	26	392
2:00 PM	393	1	25	419
2:15 PM	439	2	35	476
2:30 PM	443	3	35	481
2:45 PM	471	0	24	495
3:00 PM	504	7	24	535
3:15 PM	554	5	23	582
3:30 PM	657	3	22	682
3:45 PM	613	2	23	638
4:00 PM	593	2	22	617
4:15 PM	577	1	25	603
4:30 PM	620	1	15	636
4:45 PM	628	1	21	650
5:00 PM	639	0	12	651
5:15 PM	677	4	8	689
5:30 PM	670	2	9	681
5:45 PM	578	3	8	589
6:00 PM	606	0	7	613
6:15 PM	457	0	9	466
6:30 PM	374	1	7	382

6:45 PM	351	0	4	355
7:00 PM	289	1	5	295
7:15 PM	291	0	6	297
7:30 PM	282	1	2	285
7:45 PM	280	0	2	282
8:00 PM	233	0	1	234
8:15 PM	245	0	4	249
8:30 PM	206	0	1	207
8:45 PM	210	0	0	210
9:00 PM	184	0	1	185
9:15 PM	204	0	4	208
9:30 PM	169	0	3	172
9:45 PM	151	0	2	153
10:00 PM	142	0	1	143
10:15 PM	142	0	0	142
10:30 PM	76	0	0	76
10:45 PM	87	0	0	87
11:00 PM	70	0	1	71
11:15 PM	70	0	1	71
11:30 PM	47	0	0	47
11:45 PM	55	0	1	56

Study Name 102 NB 3006 CA-1
 Start Date 05/03/2017
 Start Time 12:00 AM
 Site Code 37

Channel Direction	lights	buses	trucks	Total	
	Direction				
	Northbound				
12:00 AM		70	0	0	70
12:15 AM		51	1	0	52
12:30 AM		37	0	2	39
12:45 AM		39	0	1	40
1:00 AM		21	0	3	24
1:15 AM		29	0	0	29
1:30 AM		31	0	1	32
1:45 AM		31	0	3	34
2:00 AM		19	0	1	20
2:15 AM		20	0	1	21
2:30 AM		11	0	2	13
2:45 AM		17	0	1	18
3:00 AM		15	0	2	17
3:15 AM		23	0	1	24
3:30 AM		28	0	2	30
3:45 AM		39	1	0	40
4:00 AM		37	0	2	39
4:15 AM		39	0	0	39
4:30 AM		50	0	1	51
4:45 AM		55	0	2	57
5:00 AM		72	0	7	79
5:15 AM		91	2	5	98
5:30 AM		112	0	8	120
5:45 AM		144	1	9	154
6:00 AM		170	2	6	178
6:15 AM		209	3	8	220
6:30 AM		210	5	7	222
6:45 AM		245	2	9	256
7:00 AM		269	5	12	286
7:15 AM		326	1	10	337
7:30 AM		381	4	13	398
7:45 AM		425	0	10	435
8:00 AM		432	5	23	460

8:15 AM	349	7	23	379
8:30 AM	322	2	20	344
8:45 AM	328	5	21	354
9:00 AM	355	2	26	383
9:15 AM	388	1	32	421
9:30 AM	347	1	24	372
9:45 AM	387	1	34	422
10:00 AM	407	1	40	448
10:15 AM	407	1	19	427
10:30 AM	420	0	30	450
10:45 AM	431	1	21	453
11:00 AM	457	2	28	487
11:15 AM	478	6	29	513
11:30 AM	515	1	31	547
11:45 AM	459	2	23	484
12:00 PM	493	3	27	523
12:15 PM	512	3	24	539
12:30 PM	529	2	31	562
12:45 PM	721	7	38	766
1:00 PM	634	3	34	671
1:15 PM	618	6	24	648
1:30 PM	577	5	29	611
1:45 PM	575	3	24	602
2:00 PM	636	6	41	683
2:15 PM	687	7	36	730
2:30 PM	627	4	32	663
2:45 PM	698	1	28	727
3:00 PM	749	9	31	789
3:15 PM	821	3	31	855
3:30 PM	942	5	25	972
3:45 PM	904	1	20	925
4:00 PM	939	5	29	973
4:15 PM	968	1	20	989
4:30 PM	969	3	17	989
4:45 PM	984	3	19	1006
5:00 PM	1073	4	13	1090
5:15 PM	1072	6	17	1095
5:30 PM	1041	3	16	1060
5:45 PM	984	3	14	1001
6:00 PM	846	7	11	864
6:15 PM	811	4	15	830
6:30 PM	639	0	13	652
6:45 PM	599	1	7	607
7:00 PM	537	0	3	540
7:15 PM	532	1	1	534
7:30 PM	478	1	6	485

7:45 PM	477	0	8	485
8:00 PM	466	0	4	470
8:15 PM	491	0	2	493
8:30 PM	407	0	1	408
8:45 PM	399	3	4	406
9:00 PM	366	0	3	369
9:15 PM	318	1	5	324
9:30 PM	248	1	5	254
9:45 PM	253	0	1	254
10:00 PM	256	0	0	256
10:15 PM	212	1	1	214
10:30 PM	141	0	0	141
10:45 PM	131	0	2	133
11:00 PM	133	0	2	135
11:15 PM	108	1	2	111
11:30 PM	94	0	2	96
11:45 PM	63	0	1	64
12:00 AM	71	2	0	73
12:15 AM	55	0	2	57
12:30 AM	38	0	2	40
12:45 AM	53	0	0	53
1:00 AM	27	0	1	28
1:15 AM	28	0	4	32
1:30 AM	33	0	1	34
1:45 AM	25	0	2	27
2:00 AM	19	0	0	19
2:15 AM	28	0	3	31
2:30 AM	24	0	0	24
2:45 AM	19	0	2	21
3:00 AM	23	0	1	24
3:15 AM	20	0	0	20
3:30 AM	13	0	2	15
3:45 AM	30	0	3	33
4:00 AM	38	0	4	42
4:15 AM	49	0	4	53
4:30 AM	56	0	2	58
4:45 AM	51	0	4	55
5:00 AM	57	0	6	63
5:15 AM	69	1	5	75
5:30 AM	106	0	3	109
5:45 AM	121	0	4	125
6:00 AM	166	1	10	177
6:15 AM	206	3	12	221
6:30 AM	221	6	16	243
6:45 AM	215	1	8	224
7:00 AM	277	4	12	293

7:15 AM	300	3	20	323
7:30 AM	385	3	23	411
7:45 AM	427	1	16	444
8:00 AM	445	3	29	477
8:15 AM	409	8	25	442
8:30 AM	361	3	14	378
8:45 AM	351	2	31	384
9:00 AM	374	2	37	413
9:15 AM	399	2	24	425
9:30 AM	374	1	33	408
9:45 AM	410	1	34	445
10:00 AM	404	1	25	430
10:15 AM	430	1	28	459
10:30 AM	427	0	37	464
10:45 AM	510	2	23	535
11:00 AM	504	3	30	537
11:15 AM	467	4	22	493
11:30 AM	529	4	23	556
11:45 AM	528	2	26	556
12:00 PM	527	2	34	563
12:15 PM	532	3	42	577
12:30 PM	555	3	34	592
12:45 PM	511	2	33	546
1:00 PM	540	2	32	574
1:15 PM	568	7	36	611
1:30 PM	605	3	33	641
1:45 PM	616	3	31	650
2:00 PM	602	4	35	641
2:15 PM	686	8	41	735
2:30 PM	632	4	43	679
2:45 PM	714	2	30	746
3:00 PM	716	8	22	746
3:15 PM	850	6	21	877
3:30 PM	957	9	23	989
3:45 PM	938	7	22	967
4:00 PM	977	1	30	1008
4:15 PM	946	3	21	970
4:30 PM	936	3	13	952
4:45 PM	975	2	26	1003
5:00 PM	1049	2	12	1063
5:15 PM	1096	6	12	1114
5:30 PM	1012	4	12	1028
5:45 PM	933	3	9	945
6:00 PM	951	2	11	964
6:15 PM	683	1	8	692
6:30 PM	635	1	5	641

6:45 PM	546	1	4	551
7:00 PM	481	1	7	489
7:15 PM	511	1	8	520
7:30 PM	463	1	1	465
7:45 PM	449	0	3	452
8:00 PM	394	1	3	398
8:15 PM	431	0	5	436
8:30 PM	369	1	1	371
8:45 PM	347	0	1	348
9:00 PM	360	0	2	362
9:15 PM	346	0	4	350
9:30 PM	299	1	3	303
9:45 PM	285	0	5	290
10:00 PM	252	0	4	256
10:15 PM	243	0	1	244
10:30 PM	144	0	2	146
10:45 PM	141	0	4	145
11:00 PM	131	1	1	133
11:15 PM	149	1	1	151
11:30 PM	84	0	1	85
11:45 PM	98	1	1	100

Study Name 103 - NB Cabrillo Hwy
 Start Date 05/03/2017
 Start Time 12:00 AM
 Site Code 38

Channel	lights	buses	trucks	Total	
Direction	Direction				
	Northbound				
12:00 AM		80	1	4	85
12:15 AM		62	0	0	62
12:30 AM		69	0	2	71
12:45 AM		51	0	2	53
1:00 AM		34	0	3	37
1:15 AM		30	0	0	30
1:30 AM		42	0	1	43
1:45 AM		33	0	3	36
2:00 AM		27	0	1	28
2:15 AM		22	0	2	24
2:30 AM		21	0	0	21
2:45 AM		21	0	1	22
3:00 AM		18	0	1	19
3:15 AM		31	0	3	34
3:30 AM		27	0	0	27
3:45 AM		39	0	0	39
4:00 AM		36	0	1	37
4:15 AM		39	0	0	39
4:30 AM		65	0	1	66
4:45 AM		49	0	1	50
5:00 AM		81	0	6	87
5:15 AM		116	0	6	122
5:30 AM		127	1	7	135
5:45 AM		168	1	6	175
6:00 AM		210	3	5	218
6:15 AM		258	4	9	271
6:30 AM		287	7	7	301
6:45 AM		321	3	11	335
7:00 AM		410	8	13	431
7:15 AM		498	2	14	514
7:30 AM		601	5	15	621
7:45 AM		595	3	10	608
8:00 AM		615	7	19	641

8:15 AM	479	6	21	506
8:30 AM	407	4	18	429
8:45 AM	446	2	24	472
9:00 AM	446	5	29	480
9:15 AM	465	1	33	499
9:30 AM	454	2	32	488
9:45 AM	447	2	38	487
10:00 AM	477	2	35	514
10:15 AM	489	3	22	514
10:30 AM	505	2	23	530
10:45 AM	505	3	23	531
11:00 AM	501	3	33	537
11:15 AM	529	3	35	567
11:30 AM	564	3	44	611
11:45 AM	533	2	28	563
12:00 PM	563	5	23	591
12:15 PM	586	6	16	608
12:30 PM	635	1	31	667
12:45 PM	909	9	39	957
1:00 PM	785	6	29	820
1:15 PM	743	7	30	780
1:30 PM	718	5	33	756
1:45 PM	722	4	26	752
2:00 PM	781	4	32	817
2:15 PM	810	6	31	847
2:30 PM	757	3	35	795
2:45 PM	860	3	27	890
3:00 PM	932	6	35	973
3:15 PM	1020	4	24	1048
3:30 PM	1110	6	27	1143
3:45 PM	1058	2	23	1083
4:00 PM	1163	6	23	1192
4:15 PM	1135	2	21	1158
4:30 PM	1176	4	15	1195
4:45 PM	1170	3	16	1189
5:00 PM	1235	5	12	1252
5:15 PM	1211	6	17	1234
5:30 PM	1202	3	21	1226
5:45 PM	1171	3	11	1185
6:00 PM	1009	8	13	1030
6:15 PM	988	2	14	1004
6:30 PM	781	0	12	793
6:45 PM	715	2	8	725
7:00 PM	709	1	4	714
7:15 PM	665	2	6	673
7:30 PM	602	2	8	612

7:45 PM	596	0	7	603
8:00 PM	562	0	2	564
8:15 PM	555	0	4	559
8:30 PM	508	0	0	508
8:45 PM	471	1	5	477
9:00 PM	466	0	3	469
9:15 PM	385	0	4	389
9:30 PM	317	0	5	322
9:45 PM	312	0	2	314
10:00 PM	322	1	1	324
10:15 PM	247	1	0	248
10:30 PM	192	0	0	192
10:45 PM	175	1	3	179
11:00 PM	171	1	1	173
11:15 PM	150	0	3	153
11:30 PM	117	0	3	120
11:45 PM	99	0	1	100
12:00 AM	94	0	2	96
12:15 AM	71	0	2	73
12:30 AM	57	0	3	60
12:45 AM	67	0	0	67
1:00 AM	42	0	1	43
1:15 AM	36	0	4	40
1:30 AM	43	0	1	44
1:45 AM	24	0	2	26
2:00 AM	22	0	2	24
2:15 AM	35	0	1	36
2:30 AM	26	0	0	26
2:45 AM	23	0	0	23
3:00 AM	25	0	4	29
3:15 AM	14	0	6	20
3:30 AM	17	0	5	22
3:45 AM	31	0	10	41
4:00 AM	38	1	2	41
4:15 AM	47	1	3	51
4:30 AM	64	1	1	66
4:45 AM	60	0	4	64
5:00 AM	57	0	4	61
5:15 AM	86	0	6	92
5:30 AM	127	1	2	130
5:45 AM	154	0	5	159
6:00 AM	202	2	6	210
6:15 AM	247	4	13	264
6:30 AM	308	8	11	327
6:45 AM	266	1	9	276
7:00 AM	380	6	16	402

7:15 AM	472	4	17	493
7:30 AM	594	3	16	613
7:45 AM	565	5	14	584
8:00 AM	631	8	25	664
8:15 AM	534	7	14	555
8:30 AM	500	3	19	522
8:45 AM	443	2	25	470
9:00 AM	458	2	36	496
9:15 AM	487	3	33	523
9:30 AM	465	3	36	504
9:45 AM	483	1	43	527
10:00 AM	483	2	29	514
10:15 AM	535	2	22	559
10:30 AM	540	2	27	569
10:45 AM	608	3	26	637
11:00 AM	602	2	32	636
11:15 AM	571	1	25	597
11:30 AM	600	1	32	633
11:45 AM	603	3	33	639
12:00 PM	631	1	32	664
12:15 PM	631	5	50	686
12:30 PM	663	2	30	695
12:45 PM	650	3	34	687
1:00 PM	633	0	34	667
1:15 PM	680	11	32	723
1:30 PM	736	3	30	769
1:45 PM	733	3	32	768
2:00 PM	738	5	31	774
2:15 PM	848	10	35	893
2:30 PM	799	8	38	845
2:45 PM	855	3	30	888
3:00 PM	878	10	23	911
3:15 PM	1069	6	23	1098
3:30 PM	1093	7	26	1126
3:45 PM	1037	5	29	1071
4:00 PM	1095	1	36	1132
4:15 PM	1082	4	21	1107
4:30 PM	1153	2	23	1178
4:45 PM	1125	2	20	1147
5:00 PM	1243	4	20	1267
5:15 PM	1274	8	13	1295
5:30 PM	1182	5	12	1199
5:45 PM	1080	5	13	1098
6:00 PM	1113	0	9	1122
6:15 PM	868	1	10	879
6:30 PM	782	1	3	786

6:45 PM	685	2	4	691
7:00 PM	602	1	9	612
7:15 PM	669	0	5	674
7:30 PM	581	2	2	585
7:45 PM	520	0	4	524
8:00 PM	495	1	3	499
8:15 PM	532	1	4	537
8:30 PM	435	0	4	439
8:45 PM	416	0	5	421
9:00 PM	425	0	2	427
9:15 PM	417	0	3	420
9:30 PM	332	1	1	334
9:45 PM	325	0	3	328
10:00 PM	291	0	2	293
10:15 PM	312	0	2	314
10:30 PM	208	0	4	212
10:45 PM	181	0	3	184
11:00 PM	178	0	1	179
11:15 PM	162	1	1	164
11:30 PM	130	0	1	131
11:45 PM	137	0	2	139

Study Name 104 NB Cabrillo Hwy
 Start Date 05/03/2017
 Start Time 12:00 AM
 Site Code 39

Channel Direction	lights	buses	trucks	Total
	Direction			
	Northbound			
12:00 AM	85	1	1	87
12:15 AM	63	0	0	63
12:30 AM	67	0	2	69
12:45 AM	51	0	2	53
1:00 AM	33	0	3	36
1:15 AM	27	0	1	28
1:30 AM	37	0	3	40
1:45 AM	33	0	2	35
2:00 AM	26	0	2	28
2:15 AM	27	0	1	28
2:30 AM	21	0	0	21
2:45 AM	26	0	0	26
3:00 AM	19	0	1	20
3:15 AM	32	0	2	34
3:30 AM	28	0	1	29
3:45 AM	33	0	1	34
4:00 AM	33	0	0	33
4:15 AM	38	0	0	38
4:30 AM	69	0	3	72
4:45 AM	49	1	0	50
5:00 AM	90	0	7	97
5:15 AM	120	0	5	125
5:30 AM	132	0	7	139
5:45 AM	170	1	7	178
6:00 AM	247	4	5	256
6:15 AM	280	2	13	295
6:30 AM	301	7	7	315
6:45 AM	345	3	14	362
7:00 AM	441	6	10	457
7:15 AM	570	2	16	588
7:30 AM	712	6	18	736
7:45 AM	694	7	11	712
8:00 AM	639	11	20	670

8:15 AM	540	3	24	567
8:30 AM	447	2	17	466
8:45 AM	474	4	28	506
9:00 AM	461	3	27	491
9:15 AM	479	4	31	514
9:30 AM	501	3	30	534
9:45 AM	504	2	37	543
10:00 AM	507	3	28	538
10:15 AM	499	3	27	529
10:30 AM	513	2	23	538
10:45 AM	513	4	25	542
11:00 AM	492	3	33	528
11:15 AM	539	2	35	576
11:30 AM	560	2	38	600
11:45 AM	547	1	23	571
12:00 PM	567	4	30	601
12:15 PM	606	5	27	638
12:30 PM	664	2	36	702
12:45 PM	962	6	40	1008
1:00 PM	808	8	25	841
1:15 PM	765	10	24	799
1:30 PM	766	5	37	808
1:45 PM	752	4	28	784
2:00 PM	805	4	30	839
2:15 PM	812	6	38	856
2:30 PM	749	2	36	787
2:45 PM	842	3	26	871
3:00 PM	963	8	31	1002
3:15 PM	1030	4	27	1061
3:30 PM	1136	7	20	1163
3:45 PM	1057	2	30	1089
4:00 PM	1129	6	16	1151
4:15 PM	1114	3	18	1135
4:30 PM	1146	2	12	1160
4:45 PM	1138	1	19	1158
5:00 PM	1160	6	17	1183
5:15 PM	1148	4	19	1171
5:30 PM	1210	6	24	1240
5:45 PM	1154	8	10	1172
6:00 PM	1052	6	15	1073
6:15 PM	962	3	9	974
6:30 PM	783	0	11	794
6:45 PM	736	4	5	745
7:00 PM	699	3	7	709
7:15 PM	671	3	4	678
7:30 PM	624	4	5	633

7:45 PM	609	1	7	617
8:00 PM	576	1	2	579
8:15 PM	526	0	2	528
8:30 PM	542	0	0	542
8:45 PM	448	5	4	457
9:00 PM	497	0	7	504
9:15 PM	373	0	5	378
9:30 PM	327	0	4	331
9:45 PM	312	0	3	315
10:00 PM	318	0	0	318
10:15 PM	240	1	0	241
10:30 PM	204	1	1	206
10:45 PM	159	1	2	162
11:00 PM	185	0	4	189
11:15 PM	146	0	4	150
11:30 PM	133	1	0	134
11:45 PM	106	1	0	107
12:00 AM	101	1	0	102
12:15 AM	71	1	1	73
12:30 AM	59	0	3	62
12:45 AM	61	2	0	63
1:00 AM	48	0	1	49
1:15 AM	33	0	3	36
1:30 AM	38	0	1	39
1:45 AM	26	0	3	29
2:00 AM	22	0	1	23
2:15 AM	33	0	1	34
2:30 AM	28	0	0	28
2:45 AM	26	0	2	28
3:00 AM	29	0	0	29
3:15 AM	23	0	0	23
3:30 AM	26	0	2	28
3:45 AM	28	0	3	31
4:00 AM	42	0	2	44
4:15 AM	42	0	3	45
4:30 AM	67	1	1	69
4:45 AM	55	0	3	58
5:00 AM	66	0	5	71
5:15 AM	90	1	6	97
5:30 AM	137	0	2	139
5:45 AM	158	0	5	163
6:00 AM	231	2	7	240
6:15 AM	262	4	12	278
6:30 AM	321	11	11	343
6:45 AM	288	4	13	305
7:00 AM	418	3	15	436

7:15 AM	543	4	15	562
7:30 AM	689	7	17	713
7:45 AM	663	7	17	687
8:00 AM	652	10	25	687
8:15 AM	621	5	15	641
8:30 AM	535	5	18	558
8:45 AM	498	2	31	531
9:00 AM	503	2	35	540
9:15 AM	515	3	31	549
9:30 AM	533	1	41	575
9:45 AM	537	3	35	575
10:00 AM	506	3	29	538
10:15 AM	538	3	27	568
10:30 AM	582	2	26	610
10:45 AM	668	4	29	701
11:00 AM	636	5	26	667
11:15 AM	592	2	23	617
11:30 AM	632	2	29	663
11:45 AM	621	2	40	663
12:00 PM	617	2	30	649
12:15 PM	672	5	44	721
12:30 PM	665	1	33	699
12:45 PM	713	3	33	749
1:00 PM	695	2	40	737
1:15 PM	719	12	28	759
1:30 PM	795	4	38	837
1:45 PM	754	1	32	787
2:00 PM	765	6	29	800
2:15 PM	869	8	40	917
2:30 PM	793	7	45	845
2:45 PM	848	6	35	889
3:00 PM	896	10	23	929
3:15 PM	1129	9	23	1161
3:30 PM	1093	4	23	1120
3:45 PM	1012	7	26	1045
4:00 PM	1083	1	35	1119
4:15 PM	1075	5	18	1098
4:30 PM	1141	3	28	1172
4:45 PM	1081	3	24	1108
5:00 PM	1158	2	15	1175
5:15 PM	1193	7	21	1221
5:30 PM	1151	8	10	1169
5:45 PM	1103	7	13	1123
6:00 PM	1058	1	14	1073
6:15 PM	872	3	8	883
6:30 PM	806	1	3	810

6:45 PM	677	4	4	685
7:00 PM	627	4	8	639
7:15 PM	685	1	4	690
7:30 PM	597	3	2	602
7:45 PM	536	1	5	542
8:00 PM	515	2	1	518
8:15 PM	496	1	1	498
8:30 PM	432	0	2	434
8:45 PM	430	0	2	432
9:00 PM	435	0	3	438
9:15 PM	418	1	2	421
9:30 PM	347	0	3	350
9:45 PM	343	0	3	346
10:00 PM	277	0	3	280
10:15 PM	303	0	1	304
10:30 PM	225	0	4	229
10:45 PM	190	0	1	191
11:00 PM	186	0	6	192
11:15 PM	160	1	2	163
11:30 PM	146	0	2	148
11:45 PM	142	0	1	143

Study Name 105 NB Cabrillo Hwy
 Start Date 05/03/2017
 Start Time 12:00 AM
 Site Code 40

Channel Direction	lights	buses	trucks	Total	
	Direction				
	Northbound				
12:00 AM		72	1	1	74
12:15 AM		61	0	0	61
12:30 AM		57	0	2	59
12:45 AM		44	0	2	46
1:00 AM		22	0	0	22
1:15 AM		22	0	0	22
1:30 AM		35	0	2	37
1:45 AM		24	0	1	25
2:00 AM		16	0	1	17
2:15 AM		18	0	1	19
2:30 AM		17	0	1	18
2:45 AM		16	0	2	18
3:00 AM		17	0	2	19
3:15 AM		20	0	2	22
3:30 AM		22	0	3	25
3:45 AM		16	0	9	25
4:00 AM		23	0	1	24
4:15 AM		26	0	0	26
4:30 AM		55	0	1	56
4:45 AM		36	0	4	40
5:00 AM		65	0	10	75
5:15 AM		74	0	8	82
5:30 AM		97	0	7	104
5:45 AM		139	1	5	145
6:00 AM		190	4	1	195
6:15 AM		202	4	5	211
6:30 AM		229	7	4	240
6:45 AM		286	2	10	298
7:00 AM		356	4	6	366
7:15 AM		490	3	4	497
7:30 AM		631	7	5	643
7:45 AM		602	6	6	614
8:00 AM		554	9	12	575

8:15 AM	501	1	21	523
8:30 AM	358	1	13	372
8:45 AM	353	2	8	363
9:00 AM	319	3	15	337
9:15 AM	331	4	18	353
9:30 AM	339	5	10	354
9:45 AM	328	2	26	356
10:00 AM	348	3	16	367
10:15 AM	341	1	19	361
10:30 AM	325	1	16	342
10:45 AM	315	4	16	335
11:00 AM	305	2	18	325
11:15 AM	308	0	22	330
11:30 AM	329	0	20	349
11:45 AM	334	0	11	345
12:00 PM	346	2	19	367
12:15 PM	357	1	16	374
12:30 PM	373	0	21	394
12:45 PM	739	6	27	772
1:00 PM	648	5	15	668
1:15 PM	667	5	15	687
1:30 PM	655	5	22	682
1:45 PM	659	2	17	678
2:00 PM	707	3	17	727
2:15 PM	680	4	30	714
2:30 PM	654	5	21	680
2:45 PM	720	7	26	753
3:00 PM	883	6	17	906
3:15 PM	915	2	17	934
3:30 PM	939	4	16	959
3:45 PM	848	2	14	864
4:00 PM	905	4	18	927
4:15 PM	879	1	23	903
4:30 PM	914	3	9	926
4:45 PM	891	1	15	907
5:00 PM	912	4	15	931
5:15 PM	887	5	16	908
5:30 PM	942	5	14	961
5:45 PM	928	7	10	945
6:00 PM	868	10	5	883
6:15 PM	736	3	13	752
6:30 PM	606	0	5	611
6:45 PM	575	3	6	584
7:00 PM	597	2	4	603
7:15 PM	533	0	6	539
7:30 PM	498	2	2	502

7:45 PM	524	2	8	534
8:00 PM	421	1	3	425
8:15 PM	457	0	2	459
8:30 PM	389	0	1	390
8:45 PM	346	3	4	353
9:00 PM	429	2	2	433
9:15 PM	312	2	4	318
9:30 PM	264	0	4	268
9:45 PM	246	0	5	251
10:00 PM	251	0	2	253
10:15 PM	197	0	1	198
10:30 PM	164	0	3	167
10:45 PM	164	0	5	169
11:00 PM	139	3	1	143
11:15 PM	120	3	1	124
11:30 PM	112	0	0	112
11:45 PM	95	1	0	96
12:00 AM	77	0	1	78
12:15 AM	55	0	1	56
12:30 AM	52	0	1	53
12:45 AM	59	0	1	60
1:00 AM	40	0	1	41
1:15 AM	26	0	3	29
1:30 AM	38	0	1	39
1:45 AM	28	0	1	29
2:00 AM	13	0	0	13
2:15 AM	25	0	3	28
2:30 AM	23	0	2	25
2:45 AM	18	0	2	20
3:00 AM	21	0	2	23
3:15 AM	18	0	1	19
3:30 AM	22	0	2	24
3:45 AM	24	0	2	26
4:00 AM	28	1	1	30
4:15 AM	28	3	0	31
4:30 AM	44	1	1	46
4:45 AM	37	0	2	39
5:00 AM	48	0	5	53
5:15 AM	65	0	6	71
5:30 AM	100	0	4	104
5:45 AM	115	0	3	118
6:00 AM	183	3	5	191
6:15 AM	189	3	9	201
6:30 AM	268	6	4	278
6:45 AM	245	5	9	259
7:00 AM	337	3	9	349





















7:15 AM	460	3	13	476
7:30 AM	603	8	12	623
7:45 AM	602	9	14	625
8:00 AM	555	8	19	582
8:15 AM	527	4	9	540
8:30 AM	472	4	14	490
8:45 AM	432	1	23	456
9:00 AM	443	1	18	462
9:15 AM	465	4	17	486
9:30 AM	474	3	20	497
9:45 AM	464	1	28	493
10:00 AM	477	1	24	502
10:15 AM	442	2	16	460
10:30 AM	475	1	26	502
10:45 AM	587	6	22	615
11:00 AM	541	4	16	561
11:15 AM	504	1	18	523
11:30 AM	574	2	21	597
11:45 AM	576	1	23	600
12:00 PM	557	1	27	585
12:15 PM	589	3	23	615
12:30 PM	595	1	28	624
12:45 PM	612	2	23	637
1:00 PM	635	2	33	670
1:15 PM	636	9	26	671
1:30 PM	688	3	30	721
1:45 PM	644	1	26	671
2:00 PM	693	5	18	716
2:15 PM	764	9	35	808
2:30 PM	708	5	35	748
2:45 PM	753	4	29	786
3:00 PM	836	8	17	861
3:15 PM	1050	3	17	1070
3:30 PM	916	4	12	932
3:45 PM	872	5	24	901
4:00 PM	887	0	23	910
4:15 PM	843	2	11	856
4:30 PM	879	1	21	901
4:45 PM	368	0	11	379

APPENDIX E: INTERSECTION LEVEL OF SERVICE CALCULATIONS



HCM 2010 Signalized Intersection Summary
 1: Del Monte Boulevard & Reindollar Avenue

Existing, AM
 06/11/2019

													
Movement	EBL	EBT	EBR	WBL	WBT	WBR	NBL	NBT	NBR	SBL	SBT	SBR	
Lane Configurations													
Traffic Volume (veh/h)	0	0	0	430	0	58	5	289	105	65	939	0	
Future Volume (veh/h)	0	0	0	430	0	58	5	289	105	65	939	0	
Number				3	8	18	1	6	16	5	2	12	
Initial Q (Qb), veh				0	0	0	0	0	0	0	0	0	
Ped-Bike Adj(A_pbT)				1.00		1.00	1.00		1.00	1.00		1.00	
Parking Bus, Adj				1.00	1.00	1.00	1.00	1.00	1.00	1.00	1.00	1.00	
Adj Sat Flow, veh/h/ln				1900	1900	1900	1863	1863	1863	1845	1845	0	
Adj Flow Rate, veh/h				504	0	0	6	325	51	73	1055	0	
Adj No. of Lanes				2	1	0	1	2	1	1	2	0	
Peak Hour Factor				0.89	0.89	0.89	0.89	0.89	0.89	0.89	0.89	0.89	
Percent Heavy Veh, %				0	0	0	2	2	2	3	3	0	
Cap, veh/h				811	426	0	14	1394	622	119	1590	0	
Arrive On Green				0.22	0.00	0.00	0.01	0.39	0.39	0.07	0.45	0.00	
Sat Flow, veh/h				3619	1900	0	1774	3539	1579	1757	3597	0	
Grp Volume(v), veh/h				504	0	0	6	325	51	73	1055	0	
Grp Sat Flow(s),veh/h/ln				1810	1900	0	1774	1770	1579	1757	1752	0	
Q Serve(g_s), s				5.4	0.0	0.0	0.1	2.6	0.9	1.7	10.1	0.0	
Cycle Q Clear(g_c), s				5.4	0.0	0.0	0.1	2.6	0.9	1.7	10.1	0.0	
Prop In Lane				1.00		0.00	1.00		1.00	1.00		0.00	
Lane Grp Cap(c), veh/h				811	426	0	14	1394	622	119	1590	0	
V/C Ratio(X)				0.62	0.00	0.00	0.42	0.23	0.08	0.61	0.66	0.00	
Avail Cap(c_a), veh/h				2527	1327	0	1239	2472	1103	1227	2448	0	
HCM Platoon Ratio				1.00	1.00	1.00	1.00	1.00	1.00	1.00	1.00	1.00	
Upstream Filter(I)				1.00	0.00	0.00	1.00	1.00	1.00	1.00	1.00	0.00	
Uniform Delay (d), s/veh				15.0	0.0	0.0	21.2	8.7	8.2	19.5	9.2	0.0	
Incr Delay (d2), s/veh				0.8	0.0	0.0	18.5	0.1	0.1	5.1	0.5	0.0	
Initial Q Delay(d3),s/veh				0.0	0.0	0.0	0.0	0.0	0.0	0.0	0.0	0.0	
%ile BackOfQ(50%),veh/ln				2.7	0.0	0.0	0.1	1.3	0.4	1.0	4.9	0.0	
LnGrp Delay(d),s/veh				15.8	0.0	0.0	39.7	8.8	8.2	24.5	9.7	0.0	
LnGrp LOS				B			D	A	A	C	A		
Approach Vol, veh/h					504			382			1128		
Approach Delay, s/veh					15.8			9.2			10.6		
Approach LOS					B			A			B		
Timer	1	2	3	4	5	6	7	8					
Assigned Phs	1	2			5	6		8					
Phs Duration (G+Y+Rc), s	3.8	24.5			6.4	21.9		14.6					
Change Period (Y+Rc), s	3.5	5.0			3.5	5.0		5.0					
Max Green Setting (Gmax), s	30.0	30.0			30.0	30.0		30.0					
Max Q Clear Time (g_c+I1), s	2.1	12.1			3.7	4.6		7.4					
Green Ext Time (p_c), s	0.0	7.4			0.2	2.2		1.9					
Intersection Summary													
HCM 2010 Ctrl Delay				11.6									
HCM 2010 LOS				B									
Notes													

HCM 2010 Signalized Intersection Summary
 3: SR 1 SB On-Ramp/SR 1 SB Off-Ramp & Imjin Parkway

Existing, AM
 06/11/2019



Movement	EBL	EBT	EBR	WBL	WBT	WBR	NBL	NBT	NBR	SBL	SBT	SBR
Lane Configurations					↕						↕	
Traffic Volume (veh/h)	0	0	0	959	0	0	0	0	0	409	5	0
Future Volume (veh/h)	0	0	0	959	0	0	0	0	0	409	5	0
Number				1	6	16				7	4	14
Initial Q (Qb), veh				0	0	0				0	0	0
Ped-Bike Adj(A_pbT)				1.00		1.00				1.00		1.00
Parking Bus, Adj				1.00	1.00	1.00				1.00	1.00	1.00
Adj Sat Flow, veh/h/ln				1900	1845	0				1900	1845	0
Adj Flow Rate, veh/h				1054	0	0				449	5	0
Adj No. of Lanes				0	1	0				0	1	0
Peak Hour Factor				0.91	0.91	0.91				0.91	0.91	0.91
Percent Heavy Veh, %				3	3	0				3	3	0
Cap, veh/h				1123	0	0				502	6	0
Arrive On Green				0.64	0.00	0.00				0.29	0.29	0.00
Sat Flow, veh/h				1757	0	0				1738	19	0
Grp Volume(v), veh/h				1054	0	0				454	0	0
Grp Sat Flow(s),veh/h/ln				1757	0	0				1758	0	0
Q Serve(g_s), s				65.8	0.0	0.0				30.1	0.0	0.0
Cycle Q Clear(g_c), s				65.8	0.0	0.0				30.1	0.0	0.0
Prop In Lane				1.00		0.00				0.99		0.00
Lane Grp Cap(c), veh/h				1123	0	0				508	0	0
V/C Ratio(X)				0.94	0.00	0.00				0.89	0.00	0.00
Avail Cap(c_a), veh/h				1298	0	0				866	0	0
HCM Platoon Ratio				1.00	1.00	1.00				1.00	1.00	1.00
Upstream Filter(I)				1.00	0.00	0.00				1.00	0.00	0.00
Uniform Delay (d), s/veh				19.6	0.0	0.0				41.3	0.0	0.0
Incr Delay (d2), s/veh				12.1	0.0	0.0				6.7	0.0	0.0
Initial Q Delay(d3),s/veh				0.0	0.0	0.0				0.0	0.0	0.0
%ile BackOfQ(50%),veh/ln				35.4	0.0	0.0				15.6	0.0	0.0
LnGrp Delay(d),s/veh				31.7	0.0	0.0				48.0	0.0	0.0
LnGrp LOS				C						D		
Approach Vol, veh/h					1054						454	
Approach Delay, s/veh					31.7						48.0	
Approach LOS					C						D	
Timer	1	2	3	4	5	6	7	8				
Assigned Phs				4		6						
Phs Duration (G+Y+Rc), s				39.6		82.2						
Change Period (Y+Rc), s				4.4		4.4						
Max Green Setting (Gmax), s				60.0		90.0						
Max Q Clear Time (g_c+I1), s				32.1		67.8						
Green Ext Time (p_c), s				3.0		10.0						
Intersection Summary												
HCM 2010 Ctrl Delay				36.6								
HCM 2010 LOS				D								

Intersection												
Int Delay, s/veh	0											
Movement	EBL	EBT	EBR	WBL	WBT	WBR	NBL	NBT	NBR	SBL	SBT	SBR
Lane Configurations		↖			↑	↗		↖	↗			
Traffic Vol, veh/h	3	421	0	0	917	123	0	0	805	0	0	0
Future Vol, veh/h	3	421	0	0	917	123	0	0	805	0	0	0
Conflicting Peds, #/hr	0	0	3	3	0	0	0	0	0	0	0	0
Sign Control	Free	Free	Free	Free	Free	Free	Stop	Stop	Stop	Stop	Stop	Stop
RT Channelized	-	-	None	-	-	Free	-	-	Free	-	-	None
Storage Length	-	-	-	-	-	0	-	-	800	-	-	-
Veh in Median Storage, #	-	0	-	-	0	-	-	0	-	-	16965	-
Grade, %	-	0	-	-	0	-	-	0	-	-	0	-
Peak Hour Factor	97	97	97	97	97	97	97	97	97	97	97	97
Heavy Vehicles, %	3	3	3	3	3	3	2	2	2	2	2	2
Mvmt Flow	3	434	0	0	945	127	0	0	830	0	0	0























Major/Minor	Major1	Major2	Minor1
Conflicting Flow All	945	0	0
Stage 1	-	-	440
Stage 2	-	-	945
Critical Hdwy	4.13	-	6.42
Critical Hdwy Stg 1	-	-	5.42
Critical Hdwy Stg 2	-	-	5.42
Follow-up Hdwy	2.227	-	3.518
Pot Cap-1 Maneuver	722	0	0
Stage 1	-	0	649
Stage 2	-	0	378
Platoon blocked, %	-	-	-
Mov Cap-1 Maneuver	722	-	157
Mov Cap-2 Maneuver	-	-	157
Stage 1	-	-	646
Stage 2	-	-	378

Approach	EB	WB	NB
HCM Control Delay, s	0.1	0	0
HCM LOS			A

Minor Lane/Major Mvmt	NBLn1	NBLn2	EBL	EBT	WBT
Capacity (veh/h)	-	-	722	-	-
HCM Lane V/C Ratio	-	-	0.004	-	-
HCM Control Delay (s)	0	0	10	0	-
HCM Lane LOS	A	A	B	A	-
HCM 95th %tile Q(veh)	-	-	0	-	-

HCM 2010 Signalized Intersection Summary
5: 2nd Avenue & Imjin Parkway

Existing, AM
06/11/2019

												
Movement	EBL	EBT	EBR	WBL	WBT	WBR	NBL	NBT	NBR	SBL	SBT	SBR
Lane Configurations												
Traffic Volume (veh/h)	12	841	379	310	815	10	99	6	138	5	7	5
Future Volume (veh/h)	12	841	379	310	815	10	99	6	138	5	7	5
Number	5	2	12	1	6	16	3	8	18	7	4	14
Initial Q (Qb), veh	0	0	0	0	0	0	0	0	0	0	0	0
Ped-Bike Adj(A_pbT)	1.00		1.00	1.00		1.00	1.00		1.00	1.00		1.00
Parking Bus, Adj	1.00	1.00	1.00	1.00	1.00	1.00	1.00	1.00	1.00	1.00	1.00	1.00
Adj Sat Flow, veh/h/ln	1863	1863	1863	1863	1863	1900	1810	1810	1810	1900	1900	1900
Adj Flow Rate, veh/h	12	858	168	316	832	10	101	6	19	5	7	0
Adj No. of Lanes	1	2	1	2	2	0	2	1	1	1	2	0
Peak Hour Factor	0.98	0.98	0.98	0.98	0.98	0.98	0.98	0.98	0.98	0.98	0.98	0.98
Percent Heavy Veh, %	2	2	2	2	2	2	5	5	5	0	0	0
Cap, veh/h	139	1083	484	483	1318	16	205	60	51	99	96	0
Arrive On Green	0.08	0.31	0.31	0.14	0.37	0.37	0.06	0.03	0.03	0.05	0.03	0.00
Sat Flow, veh/h	1774	3539	1583	3442	3582	43	3343	1810	1535	1810	3705	0
Grp Volume(v), veh/h	12	858	168	316	411	431	101	6	19	5	7	0
Grp Sat Flow(s),veh/h/ln	1774	1770	1583	1721	1770	1855	1672	1810	1535	1810	1805	0
Q Serve(g_s), s	0.2	8.5	3.2	3.3	7.3	7.3	1.1	0.1	0.5	0.1	0.1	0.0
Cycle Q Clear(g_c), s	0.2	8.5	3.2	3.3	7.3	7.3	1.1	0.1	0.5	0.1	0.1	0.0
Prop In Lane	1.00		1.00	1.00		0.02	1.00		1.00	1.00		0.00
Lane Grp Cap(c), veh/h	139	1083	484	483	651	683	205	60	51	99	96	0
V/C Ratio(X)	0.09	0.79	0.35	0.65	0.63	0.63	0.49	0.10	0.37	0.05	0.07	0.00
Avail Cap(c_a), veh/h	693	2764	1236	1344	1382	1449	1740	989	839	471	1973	0
HCM Platoon Ratio	1.00	1.00	1.00	1.00	1.00	1.00	1.00	1.00	1.00	1.00	1.00	1.00
Upstream Filter(I)	1.00	1.00	1.00	1.00	1.00	1.00	1.00	1.00	1.00	1.00	1.00	0.00
Uniform Delay (d), s/veh	16.4	12.2	10.4	15.6	10.0	10.0	17.4	18.0	18.2	17.2	18.2	0.0
Incr Delay (d2), s/veh	0.1	0.5	0.2	0.6	0.4	0.4	0.7	0.3	1.7	0.1	0.1	0.0
Initial Q Delay(d3),s/veh	0.0	0.0	0.0	0.0	0.0	0.0	0.0	0.0	0.0	0.0	0.0	0.0
%ile BackOfQ(50%),veh/ln	0.1	4.1	1.4	1.6	3.6	3.8	0.5	0.1	0.2	0.1	0.0	0.0
LnGrp Delay(d),s/veh	16.5	12.7	10.5	16.2	10.4	10.4	18.1	18.3	19.8	17.3	18.4	0.0
LnGrp LOS	B	B	B	B	B	B	B	B	B	B	B	
Approach Vol, veh/h		1038			1158			126				12
Approach Delay, s/veh		12.4			12.0			18.4				17.9
Approach LOS		B			B			B				B
Timer	1	2	3	4	5	6	7	8				
Assigned Phs	1	2	3	4	5	6	7	8				
Phs Duration (G+Y+Rc), s	9.9	17.1	5.9	5.6	7.5	19.4	5.6	5.9				
Change Period (Y+Rc), s	4.5	5.3	3.5	4.6	4.5	5.3	3.5	4.6				
Max Green Setting (Gmax), s	15.0	30.0	20.0	21.0	15.0	30.0	10.0	21.0				
Max Q Clear Time (g_c+I1), s	5.3	10.5	3.1	2.1	2.2	9.3	2.1	2.5				
Green Ext Time (p_c), s	0.0	1.2	0.0	0.0	0.0	0.9	0.0	0.0				
Intersection Summary												
HCM 2010 Ctrl Delay			12.5									
HCM 2010 LOS			B									

Intersection												
Int Delay, s/veh	3.7											
Movement	EBL	EBT	EBR	WBL	WBT	WBR	NBL	NBT	NBR	SBL	SBT	SBR
Lane Configurations	↖	↖↗		↖	↖↗		↖	↗		↖	↗	
Traffic Vol, veh/h	46	800	13	234	1208	24	3	1	16	6	3	31
Future Vol, veh/h	46	800	13	234	1208	24	3	1	16	6	3	31
Conflicting Peds, #/hr	1	0	1	1	0	1	0	0	2	2	0	0
Sign Control	Free	Free	Free	Free	Free	Free	Stop	Stop	Stop	Stop	Stop	Stop
RT Channelized	-	-	None	-	-	None	-	-	None	-	-	None
Storage Length	300	-	-	300	-	-	85	-	-	25	-	-
Veh in Median Storage, #	-	0	-	-	0	-	-	0	-	-	0	-
Grade, %	-	0	-	-	0	-	-	0	-	-	0	-
Peak Hour Factor	96	96	96	96	96	96	96	96	96	96	96	96
Heavy Vehicles, %	2	2	2	2	2	2	5	5	5	2	2	2
Mvmt Flow	48	833	14	244	1258	25	3	1	17	6	3	32

Major/Minor	Major1			Major2			Minor1			Minor2		
Conflicting Flow All	1284	0	0	848	0	0	2056	2709	427	2275	2704	643
Stage 1	-	-	-	-	-	-	937	937	-	1760	1760	-
Stage 2	-	-	-	-	-	-	1119	1772	-	515	944	-
Critical Hdwy	4.14	-	-	4.14	-	-	7.6	6.6	7	7.54	6.54	6.94
Critical Hdwy Stg 1	-	-	-	-	-	-	6.6	5.6	-	6.54	5.54	-
Critical Hdwy Stg 2	-	-	-	-	-	-	6.6	5.6	-	6.54	5.54	-
Follow-up Hdwy	2.22	-	-	2.22	-	-	3.55	4.05	3.35	3.52	4.02	3.32
Pot Cap-1 Maneuver	536	-	-	785	-	-	31	20	568	22	21	416
Stage 1	-	-	-	-	-	-	279	335	-	88	136	-
Stage 2	-	-	-	-	-	-	215	130	-	511	339	-
Platoon blocked, %	-	-	-	-	-	-	-	-	-	-	-	-
Mov Cap-1 Maneuver	535	-	-	784	-	-	17	13	566	14	13	416
Mov Cap-2 Maneuver	-	-	-	-	-	-	17	13	-	14	13	-
Stage 1	-	-	-	-	-	-	254	305	-	80	94	-
Stage 2	-	-	-	-	-	-	132	89	-	449	308	-

Approach	EB			WB			NB			SB		
HCM Control Delay, s	0.7			1.9			64.3			103.6		
HCM LOS							F			F		

Minor Lane/Major Mvmt	NBLn1	NBLn2	EBL	EBT	EBR	WBL	WBT	WBR	SBLn1	SBLn2
Capacity (veh/h)	17	162	535	-	-	784	-	-	14	111
HCM Lane V/C Ratio	0.184	0.109	0.09	-	-	0.311	-	-	0.446	0.319
HCM Control Delay (s)	259.5	29.9	12.4	-	-	11.7	-	-	396.8	51.9
HCM Lane LOS	F	D	B	-	-	B	-	-	F	F
HCM 95th %tile Q(veh)	0.5	0.4	0.3	-	-	1.3	-	-	1.1	1.2

Intersection												
Int Delay, s/veh	0.4											
Movement	EBL	EBT	EBR	WBL	WBT	WBR	NBL	NBT	NBR	SBL	SBT	SBR
Lane Configurations	↖	↗		↖	↗			↕			↕	
Traffic Vol, veh/h	2	886	19	5	1407	8	3	0	1	3	1	2
Future Vol, veh/h	2	886	19	5	1407	8	3	0	1	3	1	2
Conflicting Peds, #/hr	1	0	1	1	0	1	0	0	0	0	0	0
Sign Control	Free	Free	Free	Free	Free	Free	Stop	Stop	Stop	Stop	Stop	Stop
RT Channelized	-	-	None	-	-	None	-	-	None	-	-	Stop
Storage Length	330	-	-	330	-	-	-	-	-	-	-	-
Veh in Median Storage, #	-	0	-	-	0	-	-	0	-	-	0	-
Grade, %	-	0	-	-	0	-	-	0	-	-	0	-
Peak Hour Factor	96	96	96	96	96	96	96	96	96	96	96	96
Heavy Vehicles, %	2	2	2	2	2	2	50	50	50	0	0	0
Mvmt Flow	2	923	20	5	1466	8	3	0	1	3	1	2



















Major/Minor	Major1			Major2			Minor1			Minor2		
Conflicting Flow All	1475	0	0	944	0	0	1682	2423	473	1947	2429	738
Stage 1	-	-	-	-	-	-	938	938	-	1481	1481	-
Stage 2	-	-	-	-	-	-	744	1485	-	466	948	-
Critical Hdwy	4.14	-	-	4.14	-	-	8.5	7.5	7.9	7.5	6.5	6.9
Critical Hdwy Stg 1	-	-	-	-	-	-	7.5	6.5	-	6.5	5.5	-
Critical Hdwy Stg 2	-	-	-	-	-	-	7.5	6.5	-	6.5	5.5	-
Follow-up Hdwy	2.22	-	-	2.22	-	-	4	4.5	3.8	3.5	4	3.3
Pot Cap-1 Maneuver	453	-	-	722	-	-	37	16	426	40	32	365
Stage 1	-	-	-	-	-	-	205	250	-	134	191	-
Stage 2	-	-	-	-	-	-	281	121	-	551	342	-
Platoon blocked, %	-	-	-	-	-	-	-	-	-	-	-	-
Mov Cap-1 Maneuver	453	-	-	721	-	-	36	16	426	40	32	365
Mov Cap-2 Maneuver	-	-	-	-	-	-	36	16	-	40	32	-
Stage 1	-	-	-	-	-	-	204	249	-	133	189	-
Stage 2	-	-	-	-	-	-	276	120	-	547	340	-

Approach	EB			WB			NB			SB		
HCM Control Delay, s	0			0			88.9			77.2		
HCM LOS							F			F		

Minor Lane/Major Mvmt	NBLn1	EBL	EBT	EBR	WBL	WBT	WBR	SBLn1
Capacity (veh/h)	47	453	-	-	721	-	-	56
HCM Lane V/C Ratio	0.089	0.005	-	-	0.007	-	-	0.112
HCM Control Delay (s)	88.9	13	-	-	10	-	-	77.2
HCM Lane LOS	F	B	-	-	B	-	-	F
HCM 95th %tile Q(veh)	0.3	0	-	-	0	-	-	0.4

HCM 2010 Signalized Intersection Summary
 8: 5th Avenue/California Avenue & Imjin Parkway

Existing, AM
 06/11/2019

												
Movement	EBL	EBT	EBR	WBL	WBT	WBR	NBL	NBT	NBR	SBL	SBT	SBR
Lane Configurations												
Traffic Volume (veh/h)	113	761	20	4	931	58	12	10	1	70	146	389
Future Volume (veh/h)	113	761	20	4	931	58	12	10	1	70	146	389
Number	5	2	12	1	6	16	3	8	18	7	4	14
Initial Q (Qb), veh	0	0	0	0	0	0	0	0	0	0	0	0
Ped-Bike Adj(A_pbT)	1.00		0.98	1.00		1.00	1.00		1.00	1.00		1.00
Parking Bus, Adj	1.00	1.00	1.00	1.00	1.00	1.00	1.00	1.00	1.00	1.00	1.00	1.00
Adj Sat Flow, veh/h/ln	1881	1881	1900	1863	1863	1900	1900	1624	1900	1900	1881	1900
Adj Flow Rate, veh/h	119	801	19	4	980	55	13	11	0	74	154	335
Adj No. of Lanes	1	2	0	1	2	0	0	1	0	0	1	0
Peak Hour Factor	0.95	0.95	0.95	0.95	0.95	0.95	0.95	0.95	0.95	0.95	0.95	0.95
Percent Heavy Veh, %	1	1	1	2	2	2	17	17	17	1	1	1
Cap, veh/h	153	1441	34	6	1097	62	223	153	0	127	183	349
Arrive On Green	0.09	0.40	0.40	0.00	0.32	0.32	0.37	0.35	0.00	0.37	0.35	0.35
Sat Flow, veh/h	1792	3567	85	1774	3407	191	352	431	0	155	515	984
Grp Volume(v), veh/h	119	401	419	4	509	526	24	0	0	563	0	0
Grp Sat Flow(s),veh/h/ln	1792	1787	1864	1774	1770	1829	782	0	0	1654	0	0
Q Serve(g_s), s	3.7	9.7	9.7	0.1	15.4	15.4	0.0	0.0	0.0	12.7	0.0	0.0
Cycle Q Clear(g_c), s	3.7	9.7	9.7	0.1	15.4	15.4	0.5	0.0	0.0	18.4	0.0	0.0
Prop In Lane	1.00		0.05	1.00		0.10	0.54		0.00	0.13		0.60
Lane Grp Cap(c), veh/h	153	722	753	6	570	589	385	0	0	677	0	0
V/C Ratio(X)	0.78	0.56	0.56	0.70	0.89	0.89	0.06	0.00	0.00	0.83	0.00	0.00
Avail Cap(c_a), veh/h	477	951	992	472	942	974	385	0	0	677	0	0
HCM Platoon Ratio	1.00	1.00	1.00	1.00	1.00	1.00	1.00	1.00	1.00	1.00	1.00	1.00
Upstream Filter(I)	1.00	1.00	1.00	1.00	1.00	1.00	1.00	0.00	0.00	1.00	0.00	0.00
Uniform Delay (d), s/veh	25.3	12.9	12.9	28.1	18.2	18.2	11.8	0.0	0.0	17.6	0.0	0.0
Incr Delay (d2), s/veh	3.2	0.2	0.2	43.9	3.8	3.7	0.0	0.0	0.0	8.2	0.0	0.0
Initial Q Delay(d3),s/veh	0.0	0.0	0.0	0.0	0.0	0.0	0.0	0.0	0.0	0.0	0.0	0.0
%ile BackOfQ(50%),veh/ln	2.0	4.8	5.1	0.1	8.1	8.3	0.2	0.0	0.0	9.7	0.0	0.0
LnGrp Delay(d),s/veh	28.5	13.2	13.1	71.9	21.9	21.8	11.8	0.0	0.0	25.8	0.0	0.0
LnGrp LOS	C	B	B	E	C	C	B			C		
Approach Vol, veh/h		939			1039			24			563	
Approach Delay, s/veh		15.1			22.1			11.8			25.8	
Approach LOS		B			C			B			C	
Timer	1	2	3	4	5	6	7	8				
Assigned Phs	1	2		4	5	6		8				
Phs Duration (G+Y+Rc), s	3.7	28.1		24.6	8.3	23.4		24.6				
Change Period (Y+Rc), s	3.5	5.3		4.6	3.5	5.3		4.6				
Max Green Setting (Gmax), s	15.0	30.0		20.0	15.0	30.0		20.0				
Max Q Clear Time (g_c+I1), s	2.1	11.7		20.4	5.7	17.4		2.5				
Green Ext Time (p_c), s	0.0	0.6		0.0	0.0	0.7		0.0				
Intersection Summary												
HCM 2010 Ctrl Delay				20.2								
HCM 2010 LOS				C								

Intersection						
Int Delay, s/veh	1.4					
Movement	EBL	EBR	NBL	NBT	SBT	SBR
Lane Configurations	Y		Y	↑	↑	
Traffic Vol, veh/h	29	28	27	188	574	74
Future Vol, veh/h	29	28	27	188	574	74
Conflicting Peds, #/hr	0	0	0	0	0	0
Sign Control	Stop	Stop	Free	Free	Free	Free
RT Channelized	-	None	-	None	-	None
Storage Length	0	-	155	-	-	-
Veh in Median Storage, #	0	-	-	0	0	-
Grade, %	0	-	-	0	0	-
Peak Hour Factor	92	92	92	92	92	92
Heavy Vehicles, %	2	2	2	2	2	2
Mvmt Flow	32	30	29	204	624	80











Major/Minor	Minor2	Major1	Major2			
Conflicting Flow All	926	664	704	0	-	0
Stage 1	664	-	-	-	-	-
Stage 2	262	-	-	-	-	-
Critical Hdwy	6.42	6.22	4.12	-	-	-
Critical Hdwy Stg 1	5.42	-	-	-	-	-
Critical Hdwy Stg 2	5.42	-	-	-	-	-
Follow-up Hdwy	3.518	3.318	2.218	-	-	-
Pot Cap-1 Maneuver	298	461	894	-	-	-
Stage 1	512	-	-	-	-	-
Stage 2	782	-	-	-	-	-
Platoon blocked, %				-	-	-
Mov Cap-1 Maneuver	288	461	894	-	-	-
Mov Cap-2 Maneuver	288	-	-	-	-	-
Stage 1	496	-	-	-	-	-
Stage 2	782	-	-	-	-	-

Approach	EB	NB	SB
HCM Control Delay, s	17.4	1.2	0
HCM LOS	C		

Minor Lane/Major Mvmt	NBL	NBT	EBLn1	SBT	SBR
Capacity (veh/h)	894	-	353	-	-
HCM Lane V/C Ratio	0.033	-	0.176	-	-
HCM Control Delay (s)	9.2	-	17.4	-	-
HCM Lane LOS	A	-	C	-	-
HCM 95th %tile Q(veh)	0.1	-	0.6	-	-

HCM 2010 Signalized Intersection Summary
 10: Imjin Road & Imjin Parkway

Existing, AM
 06/11/2019

								
Movement	EBT	EBR	WBL	WBT	NBL	NBR		
Lane Configurations								
Traffic Volume (veh/h)	737	130	216	974	20	41		
Future Volume (veh/h)	737	130	216	974	20	41		
Number	2	12	1	6	3	18		
Initial Q (Qb), veh	0	0	0	0	0	0		
Ped-Bike Adj(A_pbT)		1.00	1.00		1.00	1.00		
Parking Bus, Adj	1.00	1.00	1.00	1.00	1.00	1.00		
Adj Sat Flow, veh/h/ln	1863	1900	1845	1845	1810	1810		
Adj Flow Rate, veh/h	776	124	227	1025	21	43		
Adj No. of Lanes	2	0	1	2	1	2		
Peak Hour Factor	0.95	0.95	0.95	0.95	0.95	0.95		
Percent Heavy Veh, %	2	2	3	3	5	5		
Cap, veh/h	974	156	287	2296	71	127		
Arrive On Green	0.32	0.32	0.16	0.66	0.04	0.04		
Sat Flow, veh/h	3151	489	1757	3597	1723	3076		
Grp Volume(v), veh/h	449	451	227	1025	21	43		
Grp Sat Flow(s),veh/h/ln	1770	1777	1757	1752	1723	1538		
Q Serve(g_s), s	7.1	7.1	3.8	4.4	0.4	0.4		
Cycle Q Clear(g_c), s	7.1	7.1	3.8	4.4	0.4	0.4		
Prop In Lane		0.27	1.00		1.00	1.00		
Lane Grp Cap(c), veh/h	564	566	287	2296	71	127		
V/C Ratio(X)	0.80	0.80	0.79	0.45	0.30	0.34		
Avail Cap(c_a), veh/h	1734	1741	1148	3435	1239	2211		
HCM Platoon Ratio	1.00	1.00	1.00	1.00	1.00	1.00		
Upstream Filter(I)	1.00	1.00	1.00	1.00	1.00	1.00		
Uniform Delay (d), s/veh	9.5	9.5	12.3	2.6	14.2	14.3		
Incr Delay (d2), s/veh	1.0	1.0	1.9	0.1	0.9	0.6		
Initial Q Delay(d3),s/veh	0.0	0.0	0.0	0.0	0.0	0.0		
%ile BackOfQ(50%),veh/ln	3.5	3.5	2.0	2.0	0.2	0.2		
LnGrp Delay(d),s/veh	10.5	10.5	14.2	2.6	15.1	14.9		
LnGrp LOS	B	B	B	A	B	B		
Approach Vol, veh/h	900			1252	64			
Approach Delay, s/veh	10.5			4.7	14.9			
Approach LOS	B			A	B			
Timer	1	2	3	4	5	6	7	8
Assigned Phs	1	2				6		8
Phs Duration (G+Y+Rc), s	10.3	15.1				25.4		5.3
Change Period (Y+Rc), s	5.3	* 5.3				5.3		4.0
Max Green Setting (Gmax), s	20.0	* 30				30.0		22.0
Max Q Clear Time (g_c+I1), s	5.8	9.1				6.4		2.4
Green Ext Time (p_c), s	0.0	0.7				1.2		0.0
Intersection Summary								
HCM 2010 Ctrl Delay			7.4					
HCM 2010 LOS			A					
Notes								

HCM 2010 Signalized Intersection Summary
 11: Abrams Drive & Imjin Parkway

Existing, AM
 06/11/2019



Movement	EBL	EBT	EBR	WBL	WBT	WBR	NBL	NBT	NBR	SBL	SBT	SBR
Lane Configurations												
Traffic Volume (veh/h)	35	647	31	78	914	17	127	18	113	33	42	187
Future Volume (veh/h)	35	647	31	78	914	17	127	18	113	33	42	187
Number	5	2	12	1	6	16	3	8	18	7	4	14
Initial Q (Qb), veh	0	0	0	0	0	0	0	0	0	0	0	0
Ped-Bike Adj(A_pbT)	1.00		1.00	1.00		1.00	1.00		1.00	1.00		1.00
Parking Bus, Adj	1.00	1.00	1.00	1.00	1.00	1.00	1.00	1.00	1.00	1.00	1.00	1.00
Adj Sat Flow, veh/h/ln	1881	1881	1881	1863	1863	1863	1900	1845	1845	1900	1863	1863
Adj Flow Rate, veh/h	38	696	0	84	983	0	137	19	0	35	45	0
Adj No. of Lanes	1	1	1	1	1	1	0	1	1	0	1	1
Peak Hour Factor	0.93	0.93	0.93	0.93	0.93	0.93	0.93	0.93	0.93	0.93	0.93	0.93
Percent Heavy Veh, %	1	1	1	2	2	2	3	3	3	2	2	2
Cap, veh/h	82	1151	978	108	1153	980	277	24	207	153	161	209
Arrive On Green	0.05	0.61	0.00	0.06	0.62	0.00	0.13	0.13	0.00	0.13	0.13	0.00
Sat Flow, veh/h	1792	1881	1599	1774	1863	1583	1316	182	1568	557	1224	1583
Grp Volume(v), veh/h	38	696	0	84	983	0	156	0	0	80	0	0
Grp Sat Flow(s),veh/h/ln	1792	1881	1599	1774	1863	1583	1498	0	1568	1781	0	1583
Q Serve(g_s), s	1.4	14.9	0.0	3.1	27.8	0.0	3.9	0.0	0.0	0.0	0.0	0.0
Cycle Q Clear(g_c), s	1.4	14.9	0.0	3.1	27.8	0.0	6.4	0.0	0.0	2.6	0.0	0.0
Prop In Lane	1.00		1.00	1.00		1.00	0.88		1.00	0.44		1.00
Lane Grp Cap(c), veh/h	82	1151	978	108	1153	980	301	0	207	314	0	209
V/C Ratio(X)	0.46	0.60	0.00	0.78	0.85	0.00	0.52	0.00	0.00	0.25	0.00	0.00
Avail Cap(c_a), veh/h	548	1438	1223	543	1424	1211	754	0	719	843	0	726
HCM Platoon Ratio	1.00	1.00	1.00	1.00	1.00	1.00	1.00	1.00	1.00	1.00	1.00	1.00
Upstream Filter(I)	1.00	1.00	0.00	1.00	1.00	0.00	1.00	0.00	0.00	1.00	0.00	0.00
Uniform Delay (d), s/veh	30.4	7.8	0.0	30.3	10.1	0.0	27.2	0.0	0.0	25.7	0.0	0.0
Incr Delay (d2), s/veh	1.5	0.2	0.0	4.6	3.7	0.0	0.5	0.0	0.0	0.2	0.0	0.0
Initial Q Delay(d3),s/veh	0.0	0.0	0.0	0.0	0.0	0.0	0.0	0.0	0.0	0.0	0.0	0.0
%ile BackOfQ(50%),veh/ln	0.7	7.6	0.0	1.6	15.1	0.0	2.8	0.0	0.0	1.3	0.0	0.0
LnGrp Delay(d),s/veh	31.9	8.0	0.0	34.8	13.7	0.0	27.8	0.0	0.0	25.9	0.0	0.0
LnGrp LOS	C	A		C	B		C			C		
Approach Vol, veh/h		734			1067			156			80	
Approach Delay, s/veh		9.3			15.4			27.8			25.9	
Approach LOS		A			B			C			C	
Timer	1	2	3	4	5	6	7	8				
Assigned Phs	1	2		4	5	6		8				
Phs Duration (G+Y+Rc), s	7.5	45.3		12.6	7.0	45.8		12.6				
Change Period (Y+Rc), s	3.5	5.3		4.0	4.0	5.3		4.0				
Max Green Setting (Gmax), s	20.0	50.0		30.0	20.0	50.0		30.0				
Max Q Clear Time (g_c+15), s	15.0	16.9		4.6	3.4	29.8		8.4				
Green Ext Time (p_c), s	0.0	0.5		0.1	0.0	0.8		0.1				
Intersection Summary												
HCM 2010 Ctrl Delay				14.5								
HCM 2010 LOS				B								

HCM 2010 Signalized Intersection Summary
 12: Reservation Road & Imjin Parkway

Existing, AM
 06/11/2019



Movement	EBL	EBT	EBR	WBL	WBT	WBR	NBL	NBT	NBR	SBL	SBT	SBR
Lane Configurations												
Traffic Volume (veh/h)	115	28	729	3	7	15	897	623	19	36	542	84
Future Volume (veh/h)	115	28	729	3	7	15	897	623	19	36	542	84
Number	3	8	18	7	4	14	1	6	16	5	2	12
Initial Q (Qb), veh	0	0	0	0	0	0	0	0	0	0	0	0
Ped-Bike Adj(A_pbT)	1.00		1.00	1.00		0.99	1.00		1.00	1.00		0.97
Parking Bus, Adj	1.00	1.00	1.00	1.00	1.00	1.00	1.00	1.00	1.00	1.00	1.00	1.00
Adj Sat Flow, veh/h/ln	1863	1863	1863	1638	1638	1638	1863	1863	1863	1863	1863	1863
Adj Flow Rate, veh/h	77	96	370	3	8	3	965	670	14	39	583	27
Adj No. of Lanes	1	1	2	1	1	1	2	2	1	2	2	1
Peak Hour Factor	0.93	0.93	0.93	0.93	0.93	0.93	0.93	0.93	0.93	0.93	0.93	0.93
Percent Heavy Veh, %	2	2	2	16	16	16	2	2	2	2	2	2
Cap, veh/h	213	223	1356	27	29	24	1062	2012	898	100	1022	445
Arrive On Green	0.12	0.12	0.12	0.02	0.02	0.02	0.31	0.57	0.57	0.03	0.29	0.29
Sat Flow, veh/h	1774	1863	3153	1560	1638	1384	3442	3539	1581	3442	3539	1542
Grp Volume(v), veh/h	77	96	370	3	8	3	965	670	14	39	583	27
Grp Sat Flow(s),veh/h/ln	1774	1863	1577	1560	1638	1384	1721	1770	1581	1721	1770	1542
Q Serve(g_s), s	3.1	3.8	6.0	0.1	0.4	0.2	21.1	7.9	0.3	0.9	11.0	1.0
Cycle Q Clear(g_c), s	3.1	3.8	6.0	0.1	0.4	0.2	21.1	7.9	0.3	0.9	11.0	1.0
Prop In Lane	1.00		1.00	1.00		1.00	1.00		1.00	1.00		1.00
Lane Grp Cap(c), veh/h	213	223	1356	27	29	24	1062	2012	898	100	1022	445
V/C Ratio(X)	0.36	0.43	0.27	0.11	0.28	0.12	0.91	0.33	0.02	0.39	0.57	0.06
Avail Cap(c_a), veh/h	791	830	2383	616	647	546	1534	2254	1007	877	2705	1178
HCM Platoon Ratio	1.00	1.00	1.00	1.00	1.00	1.00	1.00	1.00	1.00	1.00	1.00	1.00
Upstream Filter(I)	1.00	1.00	1.00	1.00	1.00	1.00	1.00	1.00	1.00	1.00	1.00	1.00
Uniform Delay (d), s/veh	31.8	32.1	14.5	38.0	38.1	38.0	26.1	9.0	7.4	37.4	23.8	20.2
Incr Delay (d2), s/veh	0.4	0.5	0.0	0.6	1.9	0.8	4.8	0.3	0.0	0.9	1.4	0.2
Initial Q Delay(d3),s/veh	0.0	0.0	0.0	0.0	0.0	0.0	0.0	0.0	0.0	0.0	0.0	0.0
%ile BackOfQ(50%),veh/ln	1.6	2.0	2.6	0.1	0.2	0.1	10.8	3.9	0.1	0.4	5.5	0.4
LnGrp Delay(d),s/veh	32.2	32.5	14.6	38.6	40.0	38.8	30.9	9.3	7.4	38.3	25.2	20.4
LnGrp LOS	C	C	B	D	D	D	C	A	A	D	C	C
Approach Vol, veh/h		543			14			1649			649	
Approach Delay, s/veh		20.2			39.4			21.9			25.7	
Approach LOS		C			D			C			C	
Timer	1	2	3	4	5	6	7	8				
Assigned Phs	1	2		4	5	6		8				
Phs Duration (G+Y+Rc), s	28.3			6.4	6.4	50.8		14.9				
Change Period (Y+Rc), s	4.1	* 6.2		5.0	4.1	* 6.2		5.5				
Max Green Setting (Gmax), s	35.0	* 60		31.0	20.0	* 50		35.0				
Max Q Clear Time (g_c+Y), s	23.1	13.0		2.4	2.9	9.9		8.0				
Green Ext Time (p_c), s	1.1	9.6		0.0	0.0	10.8		1.2				
Intersection Summary												
HCM 2010 Ctrl Delay			22.5									
HCM 2010 LOS			C									
Notes												

HCM 2010 Signalized Intersection Summary
 13: Reservation Road & Blanco Road

Existing, AM
 06/11/2019

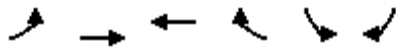

Movement	EBL	EBT	WBT	WBR	SBL	SBR		
Lane Configurations	↶↷	↶↷	↶	↶	↶↷	↶↷		
Traffic Volume (veh/h)	1048	260	372	26	28	1165		
Future Volume (veh/h)	1048	260	372	26	28	1165		
Number	5	2	6	16	7	14		
Initial Q (Qb), veh	0	0	0	0	0	0		
Ped-Bike Adj(A_pbT)	1.00			1.00	1.00	1.00		
Parking Bus, Adj	1.00	1.00	1.00	1.00	1.00	1.00		
Adj Sat Flow, veh/h/ln	1863	1863	1845	1845	1845	1845		
Adj Flow Rate, veh/h	1127	280	400	9	30	0		
Adj No. of Lanes	2	2	1	1	2	2		
Peak Hour Factor	0.93	0.93	0.93	0.93	0.93	0.93		
Percent Heavy Veh, %	2	2	3	3	3	3		
Cap, veh/h	1265	2720	517	439	95	77		
Arrive On Green	0.37	0.77	0.28	0.28	0.03	0.00		
Sat Flow, veh/h	3442	3632	1845	1568	3408	2760		
Grp Volume(v), veh/h	1127	280	400	9	30	0		
Grp Sat Flow(s),veh/h/ln	1721	1770	1845	1568	1704	1380		
Q Serve(g_s), s	14.0	0.9	9.1	0.2	0.4	0.0		
Cycle Q Clear(g_c), s	14.0	0.9	9.1	0.2	0.4	0.0		
Prop In Lane	1.00			1.00	1.00	1.00		
Lane Grp Cap(c), veh/h	1265	2720	517	439	95	77		
V/C Ratio(X)	0.89	0.10	0.77	0.02	0.32	0.00		
Avail Cap(c_a), veh/h	3017	4654	2426	2062	2017	1633		
HCM Platoon Ratio	1.00	1.00	1.00	1.00	1.00	1.00		
Upstream Filter(I)	1.00	1.00	1.00	1.00	1.00	0.00		
Uniform Delay (d), s/veh	13.6	1.3	15.1	11.9	21.8	0.0		
Incr Delay (d2), s/veh	0.9	0.0	1.9	0.0	0.7	0.0		
Initial Q Delay(d3),s/veh	0.0	0.0	0.0	0.0	0.0	0.0		
%ile BackOfQ(50%),veh/ln	6.7	0.4	4.8	0.1	0.2	0.0		
LnGrp Delay(d),s/veh	14.5	1.3	17.0	11.9	22.5	0.0		
LnGrp LOS	B	A	B	B	C			
Approach Vol, veh/h		1407	409		30			
Approach Delay, s/veh		11.9	16.8		22.5			
Approach LOS		B	B		C			
Timer	1	2	3	4	5	6	7	8
Assigned Phs		2		4	5	6		
Phs Duration (G+Y+Rc), s		40.9		4.8	22.3	18.6		
Change Period (Y+Rc), s		5.8		3.5	5.5	5.8		
Max Green Setting (Gmax), s		60.0		27.0	40.0	60.0		
Max Q Clear Time (g_c+I1), s		2.9		2.4	16.0	11.1		
Green Ext Time (p_c), s		1.3		0.0	0.7	1.7		
Intersection Summary								
HCM 2010 Ctrl Delay			13.1					
HCM 2010 LOS			B					

HCM 2010 Signalized Intersection Summary
 14: Reservation Road & Inter-Garrison Road

Existing, AM
 06/11/2019



Movement	EBL	EBR	NBL	NBT	SBT	SBR		
Lane Configurations								
Traffic Volume (veh/h)	53	90	373	371	232	40		
Future Volume (veh/h)	53	90	373	371	232	40		
Number	3	18	1	6	2	12		
Initial Q (Qb), veh	0	0	0	0	0	0		
Ped-Bike Adj(A_pbT)	1.00	1.00	1.00			1.00		
Parking Bus, Adj	1.00	1.00	1.00	1.00	1.00	1.00		
Adj Sat Flow, veh/h/ln	1845	1845	1863	1863	1845	1900		
Adj Flow Rate, veh/h	56	57	397	395	247	27		
Adj No. of Lanes	1	1	1	2	2	0		
Peak Hour Factor	0.94	0.94	0.94	0.94	0.94	0.94		
Percent Heavy Veh, %	3	3	2	2	3	3		
Cap, veh/h	196	599	481	2103	626	68		
Arrive On Green	0.11	0.11	0.27	0.59	0.20	0.20		
Sat Flow, veh/h	1757	1568	1774	3632	3283	346		
Grp Volume(v), veh/h	56	57	397	395	135	139		
Grp Sat Flow(s),veh/h/ln	1757	1568	1774	1770	1752	1784		
Q Serve(g_s), s	1.1	0.9	7.8	1.9	2.5	2.5		
Cycle Q Clear(g_c), s	1.1	0.9	7.8	1.9	2.5	2.5		
Prop In Lane	1.00	1.00	1.00			0.19		
Lane Grp Cap(c), veh/h	196	599	481	2103	344	350		
V/C Ratio(X)	0.29	0.10	0.83	0.19	0.39	0.40		
Avail Cap(c_a), veh/h	1282	1569	959	5738	2841	2892		
HCM Platoon Ratio	1.00	1.00	1.00	1.00	1.00	1.00		
Upstream Filter(I)	1.00	1.00	1.00	1.00	1.00	1.00		
Uniform Delay (d), s/veh	15.1	7.3	12.7	3.4	13.0	13.0		
Incr Delay (d2), s/veh	0.8	0.1	1.4	0.1	1.4	1.4		
Initial Q Delay(d3),s/veh	0.0	0.0	0.0	0.0	0.0	0.0		
%ile BackOfQ(50%),veh/ln	0.6	0.4	3.9	0.9	1.3	1.4		
LnGrp Delay(d),s/veh	15.9	7.4	14.1	3.5	14.3	14.3		
LnGrp LOS	B	A	B	A	B	B		
Approach Vol, veh/h	113			792	274			
Approach Delay, s/veh	11.6			8.8	14.3			
Approach LOS	B			A	B			
Timer	1	2	3	4	5	6	7	8
Assigned Phs	1	2				6		8
Phs Duration (G+Y+Rc), s	4.7	13.7				28.4		8.6
Change Period (Y+Rc), s	4.7	6.4				6.4		4.5
Max Green Setting (Gmax), s	20	60.0				60.0		27.0
Max Q Clear Time (g_c+19), s	4.5					3.9		3.1
Green Ext Time (p_c), s	0.4	2.7				4.5		0.3
Intersection Summary								
HCM 2010 Ctrl Delay			10.4					
HCM 2010 LOS			B					
Notes								

Intersection												
Intersection Delay, s/veh	21.9											
Intersection LOS	C											

Movement	EBL	EBT	EBR	WBL	WBT	WBR	NBL	NBT	NBR	SBL	SBT	SBR
Lane Configurations		↖	↗		↕		↖	↗			↖	↗
Traffic Vol, veh/h	36	1	43	242	10	3	6	120	4	2	459	22
Future Vol, veh/h	36	1	43	242	10	3	6	120	4	2	459	22
Peak Hour Factor	0.94	0.94	0.94	0.94	0.94	0.94	0.94	0.94	0.94	0.94	0.94	0.94
Heavy Vehicles, %	1	1	1	0	0	0	1	1	1	2	2	2
Mvmt Flow	38	1	46	257	11	3	6	128	4	2	488	23
Number of Lanes	0	1	1	0	1	0	1	1	0	0	1	1

Approach	EB	WB	NB	SB
Opposing Approach	WB	EB	SB	NB
Opposing Lanes	1	2	2	2
Conflicting Approach Left	SB	NB	EB	WB
Conflicting Lanes Left	2	2	2	1
Conflicting Approach Right	NB	SB	WB	EB
Conflicting Lanes Right	2	2	1	2
HCM Control Delay	10.3	16.9	11.3	29.3
HCM LOS	B	C	B	D

Lane	NBLn1	NBLn2	EBLn1	EBLn2	WBLn1	SBLn1	SBLn2
Vol Left, %	100%	0%	97%	0%	95%	0%	0%
Vol Thru, %	0%	97%	3%	0%	4%	100%	0%
Vol Right, %	0%	3%	0%	100%	1%	0%	100%
Sign Control	Stop	Stop	Stop	Stop	Stop	Stop	Stop
Traffic Vol by Lane	6	124	37	43	255	461	22
LT Vol	6	0	36	0	242	2	0
Through Vol	0	120	1	0	10	459	0
RT Vol	0	4	0	43	3	0	22
Lane Flow Rate	6	132	39	46	271	490	23
Geometry Grp	7	7	7	7	6	7	7
Degree of Util (X)	0.013	0.24	0.083	0.081	0.512	0.818	0.034
Departure Headway (Hd)	7.086	6.552	7.577	6.365	6.795	6.002	5.29
Convergence, Y/N	Yes	Yes	Yes	Yes	Yes	Yes	Yes
Cap	502	545	470	558	529	603	674
Service Time	4.87	4.335	5.374	4.161	4.868	3.76	3.048
HCM Lane V/C Ratio	0.012	0.242	0.083	0.082	0.512	0.813	0.034
HCM Control Delay	10	11.4	11.1	9.7	16.9	30.3	8.2
HCM Lane LOS	A	B	B	A	C	D	A
HCM 95th-tile Q	0	0.9	0.3	0.3	2.9	8.3	0.1

Intersection

Intersection Delay, s/veh 56.3

Intersection LOS F

Movement	EBL	EBT	EBR	WBL	WBT	WBR	NBL	NBT	NBR	SBL	SBT	SBR
Lane Configurations	↙	↑	↗		↖	↗	↙	↑	↗	↙	↗	
Traffic Vol, veh/h	0	0	1	3	0	2	1	127	2	15	734	0
Future Vol, veh/h	0	0	1	3	0	2	1	127	2	15	734	0
Peak Hour Factor	0.95	0.95	0.95	0.95	0.95	0.95	0.95	0.95	0.95	0.95	0.95	0.95
Heavy Vehicles, %	0	0	0	20	20	20	2	2	2	1	1	1
Mvmt Flow	0	0	1	3	0	2	1	134	2	16	773	0
Number of Lanes	1	1	1	0	1	1	1	1	1	1	1	0

Approach	EB	WB	NB	SB
Opposing Approach	WB	EB	SB	NB
Opposing Lanes	2	3	2	3
Conflicting Approach Left	SB	NB	EB	WB
Conflicting Lanes Left	2	3	3	2
Conflicting Approach Right	NB	SB	WB	EB
Conflicting Lanes Right	3	2	2	3
HCM Control Delay	9.1	10.1	10.6	64.6
HCM LOS	A	B	B	F

Lane	NBLn1	NBLn2	NBLn3	EBLn1	EBLn2	EBLn3	WBLn1	WBLn2	SBLn1	SBLn2
Vol Left, %	100%	0%	0%	0%	0%	0%	100%	0%	100%	0%
Vol Thru, %	0%	100%	0%	100%	100%	0%	0%	0%	0%	100%
Vol Right, %	0%	0%	100%	0%	0%	100%	0%	100%	0%	0%
Sign Control	Stop	Stop	Stop	Stop	Stop	Stop	Stop	Stop	Stop	Stop
Traffic Vol by Lane	1	127	2	0	0	1	3	2	15	734
LT Vol	1	0	0	0	0	0	3	0	15	0
Through Vol	0	127	0	0	0	0	0	0	0	734
RT Vol	0	0	2	0	0	1	0	2	0	0
Lane Flow Rate	1	134	2	0	0	1	3	2	16	773
Geometry Grp	8	8	8	8	8	8	8	8	8	8
Degree of Util (X)	0.002	0.225	0.003	0	0	0.002	0.007	0.004	0.023	1.042
Departure Headway (Hd)	6.666	6.163	5.359	7.046	7.046	6.34	7.871	6.663	5.356	4.856
Convergence, Y/N	Yes	Yes	Yes	Yes	Yes	Yes	Yes	Yes	Yes	Yes
Cap	540	586	660	0	0	568	457	540	669	749
Service Time	4.366	3.863	3.158	4.746	4.746	4.04	5.571	4.363	3.086	2.585
HCM Lane V/C Ratio	0.002	0.229	0.003	0	0	0.002	0.007	0.004	0.024	1.032
HCM Control Delay	9.4	10.6	8.2	9.7	9.7	9.1	10.6	9.4	8.2	65.8
HCM Lane LOS	A	B	A	N	N	A	B	A	A	F
HCM 95th-tile Q	0	0.9	0	0	0	0	0	0	0.1	19

Intersection												
Intersection Delay, s/veh	17.9											
Intersection LOS	C											

Movement	EBL	EBT	EBR	WBL	WBT	WBR	NBL	NBT	NBR	SBL	SBT	SBR
Lane Configurations												
Traffic Vol, veh/h	7	162	2	6	9	48	0	7	29	337	6	5
Future Vol, veh/h	7	162	2	6	9	48	0	7	29	337	6	5
Peak Hour Factor	0.81	0.81	0.81	0.81	0.81	0.81	0.81	0.81	0.81	0.81	0.81	0.81
Heavy Vehicles, %	3	3	3	5	5	5	0	0	0	1	1	1
Mvmt Flow	9	200	2	7	11	59	0	9	36	416	7	6
Number of Lanes	1	1	0	1	1	1	0	1	0	0	1	1

Approach	EB	WB	NB	SB
Opposing Approach	WB	EB	SB	NB
Opposing Lanes	3	2	2	1
Conflicting Approach Left	SB	NB	EB	WB
Conflicting Lanes Left	2	1	2	3
Conflicting Approach Right	NB	SB	WB	EB
Conflicting Lanes Right	1	2	3	2
HCM Control Delay	12.7	9.7	9.3	22.9
HCM LOS	B	A	A	C

Lane	NBLn1	EBLn1	EBLn2	WBLn1	WBLn2	WBLn3	SBLn1	SBLn2
Vol Left, %	0%	100%	0%	100%	0%	0%	98%	0%
Vol Thru, %	19%	0%	99%	0%	100%	0%	2%	0%
Vol Right, %	81%	0%	1%	0%	0%	100%	0%	100%
Sign Control	Stop	Stop	Stop	Stop	Stop	Stop	Stop	Stop
Traffic Vol by Lane	36	7	164	6	9	48	343	5
LT Vol	0	7	0	6	0	0	337	0
Through Vol	7	0	162	0	9	0	6	0
RT Vol	29	0	2	0	0	48	0	5
Lane Flow Rate	44	9	202	7	11	59	423	6
Geometry Grp	8	8	8	8	8	8	8	8
Degree of Util (X)	0.075	0.017	0.362	0.015	0.021	0.101	0.72	0.008
Departure Headway (Hd)	6.049	6.952	6.434	7.337	6.828	6.115	6.125	4.931
Convergence, Y/N	Yes	Yes	Yes	Yes	Yes	Yes	Yes	Yes
Cap	591	515	559	487	523	584	593	726
Service Time	3.798	4.696	4.178	5.091	4.582	3.869	3.853	2.659
HCM Lane V/C Ratio	0.074	0.017	0.361	0.014	0.021	0.101	0.713	0.008
HCM Control Delay	9.3	9.8	12.8	10.2	9.7	9.6	23.1	7.7
HCM Lane LOS	A	A	B	B	A	A	C	A
HCM 95th-tile Q	0.2	0.1	1.6	0	0.1	0.3	6	0

Intersection

Intersection Delay, s/veh	26.5
Intersection LOS	D

Movement	WBL	WBR	NBT	NBR	SBL	SBT
Lane Configurations	↘	↗	↑	↗	↘	↑
Traffic Vol, veh/h	9	19	96	29	83	644
Future Vol, veh/h	9	19	96	29	83	644
Peak Hour Factor	0.93	0.93	0.93	0.93	0.93	0.93
Heavy Vehicles, %	0	0	1	1	1	1
Mvmt Flow	10	20	103	31	89	692
Number of Lanes	1	1	1	1	1	1

Approach	WB	NB	SB
Opposing Approach		SB	NB
Opposing Lanes	0	2	2
Conflicting Approach Left	NB		WB
Conflicting Lanes Left	2	0	2
Conflicting Approach Right	SB	WB	
Conflicting Lanes Right	2	2	0
HCM Control Delay	9.2	8.6	30.2
HCM LOS	A	A	D

Lane	NBLn1	NBLn2	WBLn1	WBLn2	SBLn1	SBLn2
Vol Left, %	0%	0%	100%	0%	100%	0%
Vol Thru, %	100%	0%	0%	0%	0%	100%
Vol Right, %	0%	100%	0%	100%	0%	0%
Sign Control	Stop	Stop	Stop	Stop	Stop	Stop
Traffic Vol by Lane	96	29	9	19	83	644
LT Vol	0	0	9	0	83	0
Through Vol	96	0	0	0	0	644
RT Vol	0	29	0	19	0	0
Lane Flow Rate	103	31	10	20	89	692
Geometry Grp	7	7	7	7	7	7
Degree of Util (X)	0.15	0.039	0.019	0.033	0.127	0.892
Departure Headway (Hd)	5.245	4.54	7.052	5.84	5.137	4.637
Convergence, Y/N	Yes	Yes	Yes	Yes	Yes	Yes
Cap	686	791	510	616	690	769
Service Time	2.957	2.253	4.764	3.551	2.929	2.428
HCM Lane V/C Ratio	0.15	0.039	0.02	0.032	0.129	0.9
HCM Control Delay	8.9	7.4	9.9	8.8	8.7	33
HCM Lane LOS	A	A	A	A	A	D
HCM 95th-tile Q	0.5	0.1	0.1	0.1	0.4	11.6

Intersection	
Intersection Delay, s/veh	8.5
Intersection LOS	A

Movement	EBL	EBT	EBR	WBL	WBT	WBR	NBL	NBT	NBR	SBL	SBT	SBR
Lane Configurations		↕			↕			↕			↕	
Traffic Vol, veh/h	0	78	16	85	93	28	7	5	64	2	6	6
Future Vol, veh/h	0	78	16	85	93	28	7	5	64	2	6	6
Peak Hour Factor	0.85	0.85	0.85	0.85	0.85	0.85	0.85	0.85	0.85	0.85	0.85	0.85
Heavy Vehicles, %	6	6	6	2	2	2	4	4	4	0	0	0
Mvmt Flow	0	92	19	100	109	33	8	6	75	2	7	7
Number of Lanes	0	1	0	0	1	0	0	1	0	0	1	0

Approach	EB	WB	NB	SB
Opposing Approach	WB	EB	SB	NB
Opposing Lanes	1	1	1	1
Conflicting Approach Left	SB	NB	EB	WB
Conflicting Lanes Left	1	1	1	1
Conflicting Approach Right	NB	SB	WB	EB
Conflicting Lanes Right	1	1	1	1
HCM Control Delay	8.1	9	7.8	7.7
HCM LOS	A	A	A	A

Lane	NBLn1	EBLn1	WBLn1	SBLn1
Vol Left, %	9%	0%	41%	14%
Vol Thru, %	7%	83%	45%	43%
Vol Right, %	84%	17%	14%	43%
Sign Control	Stop	Stop	Stop	Stop
Traffic Vol by Lane	76	94	206	14
LT Vol	7	0	85	2
Through Vol	5	78	93	6
RT Vol	64	16	28	6
Lane Flow Rate	89	111	242	16
Geometry Grp	1	1	1	1
Degree of Util (X)	0.106	0.135	0.283	0.021
Departure Headway (Hd)	4.285	4.389	4.204	4.562
Convergence, Y/N	Yes	Yes	Yes	Yes
Cap	840	821	841	787
Service Time	2.293	2.399	2.303	2.574
HCM Lane V/C Ratio	0.106	0.135	0.288	0.02
HCM Control Delay	7.8	8.1	9	7.7
HCM Lane LOS	A	A	A	A
HCM 95th-tile Q	0.4	0.5	1.2	0.1

Intersection												
Intersection Delay, s/veh	12.9											
Intersection LOS	B											

Movement	EBL	EBT	EBR	WBL	WBT	WBR	NBL	NBT	NBR	SBL	SBT	SBR
Lane Configurations		↕			↕			↕			↕	↕
Traffic Vol, veh/h	4	29	15	20	308	30	40	28	5	15	130	6
Future Vol, veh/h	4	29	15	20	308	30	40	28	5	15	130	6
Peak Hour Factor	0.81	0.81	0.81	0.81	0.81	0.81	0.81	0.81	0.81	0.81	0.81	0.81
Heavy Vehicles, %	8	8	8	3	3	3	19	19	19	7	7	7
Mvmt Flow	5	36	19	25	380	37	49	35	6	19	160	7
Number of Lanes	0	1	0	0	1	0	0	1	0	0	1	1

Approach	EB	WB	NB	SB
Opposing Approach	WB	EB	SB	NB
Opposing Lanes	1	1	2	1
Conflicting Approach Left	SB	NB	EB	WB
Conflicting Lanes Left	2	1	1	1
Conflicting Approach Right	NB	SB	WB	EB
Conflicting Lanes Right	1	2	1	1
HCM Control Delay	8.9	14.6	10.1	11.4
HCM LOS	A	B	B	B

Lane	NBLn1	EBLn1	WBLn1	SBLn1	SBLn2
Vol Left, %	55%	8%	6%	10%	0%
Vol Thru, %	38%	60%	86%	90%	0%
Vol Right, %	7%	31%	8%	0%	100%
Sign Control	Stop	Stop	Stop	Stop	Stop
Traffic Vol by Lane	73	48	358	145	6
LT Vol	40	4	20	15	0
Through Vol	28	29	308	130	0
RT Vol	5	15	30	0	6
Lane Flow Rate	90	59	442	179	7
Geometry Grp	5	2	2	7	7
Degree of Util (X)	0.152	0.088	0.588	0.304	0.011
Departure Headway (Hd)	6.054	5.352	4.786	6.12	5.359
Convergence, Y/N	Yes	Yes	Yes	Yes	Yes
Cap	595	671	747	591	671
Service Time	4.064	3.372	2.875	3.828	3.066
HCM Lane V/C Ratio	0.151	0.088	0.592	0.303	0.01
HCM Control Delay	10.1	8.9	14.6	11.5	8.1
HCM Lane LOS	B	A	B	B	A
HCM 95th-tile Q	0.5	0.3	3.9	1.3	0

Intersection			
Intersection Delay, s/veh	32.1		
Intersection LOS	D		
Approach	EB	WB	NB
Entry Lanes	1	1	1
Conflicting Circle Lanes	1	1	1
Adj Approach Flow, veh/h	51	1067	133
Demand Flow Rate, veh/h	64	1078	137
Vehicles Circulating, veh/h	717	2	47
Vehicles Exiting, veh/h	363	182	733
Follow-Up Headway, s	3.186	3.186	3.186
Ped Vol Crossing Leg, #/h	0	0	0
Ped Cap Adj	1.000	1.000	1.000
Approach Delay, s/veh	9.8	36.6	4.6
Approach LOS	A	E	A
Lane	Left	Left	Left
Designated Moves	TR	LT	LR
Assumed Moves	TR	LT	LR
RT Channelized			
Lane Util	1.000	1.000	1.000
Critical Headway, s	5.193	5.193	5.193
Entry Flow, veh/h	64	1078	137
Cap Entry Lane, veh/h	552	1128	1078
Entry HV Adj Factor	0.803	0.990	0.971
Flow Entry, veh/h	51	1067	133
Cap Entry, veh/h	443	1117	1047
V/C Ratio	0.116	0.956	0.127
Control Delay, s/veh	9.8	36.6	4.6
LOS	A	E	A
95th %tile Queue, veh	0	17	0

Intersection	
Intersection Delay, s/veh	60.3
Intersection LOS	F

Movement	EBL	EBT	WBT	WBR	SBL	SBR
Lane Configurations	↘	↑	↑	↗	↘	↗
Traffic Vol, veh/h	54	64	580	12	10	279
Future Vol, veh/h	54	64	580	12	10	279
Peak Hour Factor	0.85	0.85	0.85	0.85	0.85	0.85
Heavy Vehicles, %	8	8	1	1	1	1
Mvmt Flow	64	75	682	14	12	328
Number of Lanes	1	1	1	1	1	1

Approach	EB	WB	SB
Opposing Approach	WB	EB	
Opposing Lanes	2	2	0
Conflicting Approach Left	SB		WB
Conflicting Lanes Left	2	0	2
Conflicting Approach Right		SB	EB
Conflicting Lanes Right	0	2	2
HCM Control Delay	10.8	91.8	16
HCM LOS	B	F	C

Lane	EBLn1	EBLn2	WBLn1	WBLn2	SBLn1	SBLn2
Vol Left, %	100%	0%	0%	0%	100%	0%
Vol Thru, %	0%	100%	100%	0%	0%	0%
Vol Right, %	0%	0%	0%	100%	0%	100%
Sign Control	Stop	Stop	Stop	Stop	Stop	Stop
Traffic Vol by Lane	54	64	580	12	10	279
LT Vol	54	0	0	0	10	0
Through Vol	0	64	580	0	0	0
RT Vol	0	0	0	12	0	279
Lane Flow Rate	64	75	682	14	12	328
Geometry Grp	7	7	7	7	7	7
Degree of Util (X)	0.125	0.138	1.112	0.02	0.024	0.546
Departure Headway (Hd)	7.323	6.811	5.865	5.156	7.466	6.249
Convergence, Y/N	Yes	Yes	Yes	Yes	Yes	Yes
Cap	492	529	621	698	482	581
Service Time	5.023	4.511	3.569	2.859	5.166	3.949
HCM Lane V/C Ratio	0.13	0.142	1.098	0.02	0.025	0.565
HCM Control Delay	11.1	10.6	93.5	8	10.3	16.2
HCM Lane LOS	B	B	F	A	B	C
HCM 95th-tile Q	0.4	0.5	20.9	0.1	0.1	3.3

Intersection	
Intersection Delay, s/veh	20.8
Intersection LOS	C

Movement	EBL	EBT	WBT	WBR	SBL	SBR
Lane Configurations	↘	↑	↑	↗	↘	↗
Traffic Vol, veh/h	12	61	442	15	35	146
Future Vol, veh/h	12	61	442	15	35	146
Peak Hour Factor	0.79	0.79	0.79	0.79	0.79	0.79
Heavy Vehicles, %	5	5	1	1	3	3
Mvmt Flow	15	77	559	19	44	185
Number of Lanes	1	1	1	1	1	1

Approach	EB	WB	SB
Opposing Approach	WB	EB	
Opposing Lanes	2	2	0
Conflicting Approach Left	SB		WB
Conflicting Lanes Left	2	0	2
Conflicting Approach Right		SB	EB
Conflicting Lanes Right	0	2	2
HCM Control Delay	9.5	26.7	10.5
HCM LOS	A	D	B

Lane	EBLn1	EBLn2	WBLn1	WBLn2	SBLn1	SBLn2
Vol Left, %	100%	0%	0%	0%	100%	0%
Vol Thru, %	0%	100%	100%	0%	0%	0%
Vol Right, %	0%	0%	0%	100%	0%	100%
Sign Control	Stop	Stop	Stop	Stop	Stop	Stop
Traffic Vol by Lane	12	61	442	15	35	146
LT Vol	12	0	0	0	35	0
Through Vol	0	61	442	0	0	0
RT Vol	0	0	0	15	0	146
Lane Flow Rate	15	77	559	19	44	185
Geometry Grp	7	7	7	7	7	7
Degree of Util (X)	0.027	0.127	0.816	0.024	0.084	0.289
Departure Headway (Hd)	6.441	5.934	5.25	4.545	6.849	5.638
Convergence, Y/N	Yes	Yes	Yes	Yes	Yes	Yes
Cap	558	606	683	776	526	641
Service Time	4.155	3.648	3.044	2.338	4.549	3.338
HCM Lane V/C Ratio	0.027	0.127	0.818	0.024	0.084	0.289
HCM Control Delay	9.3	9.5	27.3	7.5	10.2	10.6
HCM Lane LOS	A	A	D	A	B	B
HCM 95th-tile Q	0.1	0.4	8.6	0.1	0.3	1.2

Intersection	
Intersection Delay, s/veh	11.8
Intersection LOS	B

Movement	EBL	EBT	WBT	WBR	SBL	SBR
Lane Configurations		↶	↷		↶	↷
Traffic Vol, veh/h	84	10	77	18	13	390
Future Vol, veh/h	84	10	77	18	13	390
Peak Hour Factor	0.82	0.82	0.82	0.82	0.82	0.82
Heavy Vehicles, %	5	5	1	1	0	0
Mvmt Flow	102	12	94	22	16	476
Number of Lanes	0	1	1	0	1	1

Approach	EB	WB	SB
Opposing Approach	WB	EB	
Opposing Lanes	1	1	0
Conflicting Approach Left	SB		WB
Conflicting Lanes Left	2	0	1
Conflicting Approach Right		SB	EB
Conflicting Lanes Right	0	2	1
HCM Control Delay	9.6	9.1	13
HCM LOS	A	A	B

Lane	EBLn1	WBLn1	SBLn1	SBLn2
Vol Left, %	89%	0%	100%	0%
Vol Thru, %	11%	81%	0%	0%
Vol Right, %	0%	19%	0%	100%
Sign Control	Stop	Stop	Stop	Stop
Traffic Vol by Lane	94	95	13	390
LT Vol	84	0	13	0
Through Vol	10	77	0	0
RT Vol	0	18	0	390
Lane Flow Rate	115	116	16	476
Geometry Grp	2	2	7	7
Degree of Util (X)	0.173	0.163	0.025	0.581
Departure Headway (Hd)	5.433	5.079	5.606	4.4
Convergence, Y/N	Yes	Yes	Yes	Yes
Cap	657	701	638	818
Service Time	3.498	3.145	3.343	2.136
HCM Lane V/C Ratio	0.175	0.165	0.025	0.582
HCM Control Delay	9.6	9.1	8.5	13.1
HCM Lane LOS	A	A	A	B
HCM 95th-tile Q	0.6	0.6	0.1	3.8

HCM 2010 Signalized Intersection Summary
 26: East Garrison Road & Reservation Road



















Existing, AM
 06/11/2019



Movement	EBL	EBT	EBR	WBL	WBT	WBR	NBL	NBT	NBR	SBL	SBT	SBR
Lane Configurations	↖	↗		↖	↗		↖		↗			
Traffic Volume (veh/h)	0	322	8	38	753	0	33	0	72	0	0	0
Future Volume (veh/h)	0	322	8	38	753	0	33	0	72	0	0	0
Number	5	2	12	1	6	16	3	8	18			
Initial Q (Qb), veh	0	0	0	0	0	0	0	0	0			
Ped-Bike Adj(A_pbT)	1.00		1.00	1.00		1.00	1.00		1.00			
Parking Bus, Adj	1.00	1.00	1.00	1.00	1.00	1.00	1.00	1.00	1.00			
Adj Sat Flow, veh/h/ln	1827	1827	1900	1863	1863	0	1881	0	1881			
Adj Flow Rate, veh/h	0	362	7	43	846	0	37	0	9			
Adj No. of Lanes	1	2	0	1	2	0	1	0	1			
Peak Hour Factor	0.89	0.89	0.89	0.89	0.89	0.89	0.89	0.89	0.89			
Percent Heavy Veh, %	4	4	4	2	2	0	1	0	1			
Cap, veh/h	7	1195	23	92	1920	0	79	0	70			
Arrive On Green	0.00	0.34	0.34	0.05	0.54	0.00	0.04	0.00	0.04			
Sat Flow, veh/h	1740	3483	67	1774	3632	0	1792	0	1599			
Grp Volume(v), veh/h	0	180	189	43	846	0	37	0	9			
Grp Sat Flow(s),veh/h/ln	1740	1736	1815	1774	1770	0	1792	0	1599			
Q Serve(g_s), s	0.0	1.9	1.9	0.6	3.5	0.0	0.5	0.0	0.1			
Cycle Q Clear(g_c), s	0.0	1.9	1.9	0.6	3.5	0.0	0.5	0.0	0.1			
Prop In Lane	1.00		0.04	1.00		0.00	1.00		1.00			
Lane Grp Cap(c), veh/h	7	596	623	92	1920	0	79	0	70			
V/C Ratio(X)	0.00	0.30	0.30	0.47	0.44	0.00	0.47	0.00	0.13			
Avail Cap(c_a), veh/h	1425	4265	4460	1453	8697	0	1981	0	1768			
HCM Platoon Ratio	1.00	1.00	1.00	1.00	1.00	1.00	1.00	1.00	1.00			
Upstream Filter(I)	0.00	1.00	1.00	1.00	1.00	0.00	1.00	0.00	1.00			
Uniform Delay (d), s/veh	0.0	5.9	5.9	11.2	3.4	0.0	11.4	0.0	11.2			
Incr Delay (d2), s/veh	0.0	0.5	0.5	1.4	0.2	0.0	1.6	0.0	0.3			
Initial Q Delay(d3),s/veh	0.0	0.0	0.0	0.0	0.0	0.0	0.0	0.0	0.0			
%ile BackOfQ(50%),veh/ln	0.0	0.9	1.0	0.3	1.7	0.0	0.3	0.0	0.1			
LnGrp Delay(d),s/veh	0.0	6.4	6.4	12.6	3.6	0.0	13.0	0.0	11.5			
LnGrp LOS		A	A	B	A		B		B			
Approach Vol, veh/h		369			889			46				
Approach Delay, s/veh		6.4			4.0			12.7				
Approach LOS		A			A			B				
Timer	1	2	3	4	5	6	7	8				
Assigned Phs	1	2			5	6		8				
Phs Duration (G+Y+Rc), s	4.9	13.8			0.0	18.6		5.8				
Change Period (Y+Rc), s	3.6	5.4			3.5	5.4		4.7				
Max Green Setting (Gmax)	20	60.0			20.0	60.0		27.0				
Max Q Clear Time (g_c+1)	12.6	3.9			0.0	5.5		2.5				
Green Ext Time (p_c), s	0.0	3.8			0.0	7.7		0.0				
Intersection Summary												
HCM 2010 Ctrl Delay				5.0								
HCM 2010 LOS				A								
Notes												

HCM 2010 Signalized Intersection Summary
28: Davis Road & Reservation Road

Existing, AM
06/11/2019

												
Movement	EBL	EBT	EBR	WBL	WBT	WBR	NBL	NBT	NBR	SBL	SBT	SBR
Lane Configurations												
Traffic Volume (veh/h)	132	261	1	1	489	104	3	6	4	145	3	301
Future Volume (veh/h)	132	261	1	1	489	104	3	6	4	145	3	301
Number	5	2	12	1	6	16	3	8	18	7	4	14
Initial Q (Qb), veh	0	0	0	0	0	0	0	0	0	0	0	0
Ped-Bike Adj(A_pbT)	1.00		1.00	1.00		1.00	1.00		1.00	1.00		1.00
Parking Bus, Adj	1.00	1.00	1.00	1.00	1.00	1.00	1.00	1.00	1.00	1.00	1.00	1.00
Adj Sat Flow, veh/h/ln	1863	1863	1900	1863	1863	1900	1900	1900	1900	1900	1845	1845
Adj Flow Rate, veh/h	143	284	1	1	569	113	3	7	2	169	3	108
Adj No. of Lanes	1	1	0	1	1	0	0	1	0	0	1	1
Peak Hour Factor	0.92	0.92	0.92	0.86	0.86	0.92	0.86	0.86	0.86	0.86	0.86	0.86
Percent Heavy Veh, %	2	2	2	2	2	2	0	0	0	3	3	3
Cap, veh/h	181	1062	4	3	714	142	7	16	5	225	4	364
Arrive On Green	0.10	0.57	0.57	0.00	0.47	0.47	0.02	0.02	0.02	0.13	0.13	0.13
Sat Flow, veh/h	1774	1855	7	1774	1510	300	456	1064	304	1728	31	1568
Grp Volume(v), veh/h	143	0	285	1	0	682	12	0	0	172	0	108
Grp Sat Flow(s),veh/h/ln	1774	0	1862	1774	0	1810	1824	0	0	1758	0	1568
Q Serve(g_s), s	5.0	0.0	4.9	0.0	0.0	20.3	0.4	0.0	0.0	6.0	0.0	3.6
Cycle Q Clear(g_c), s	5.0	0.0	4.9	0.0	0.0	20.3	0.4	0.0	0.0	6.0	0.0	3.6
Prop In Lane	1.00		0.00	1.00		0.17	0.25		0.17	0.98		1.00
Lane Grp Cap(c), veh/h	181	0	1065	3	0	856	27	0	0	229	0	364
V/C Ratio(X)	0.79	0.00	0.27	0.36	0.00	0.80	0.44	0.00	0.00	0.75	0.00	0.30
Avail Cap(c_a), veh/h	837	0	1757	837	0	1708	860	0	0	830	0	900
HCM Platoon Ratio	1.00	1.00	1.00	1.00	1.00	1.00	1.00	1.00	1.00	1.00	1.00	1.00
Upstream Filter(I)	1.00	0.00	1.00	1.00	0.00	1.00	1.00	0.00	0.00	1.00	0.00	1.00
Uniform Delay (d), s/veh	27.9	0.0	6.9	31.7	0.0	14.2	31.1	0.0	0.0	26.7	0.0	20.1
Incr Delay (d2), s/veh	2.9	0.0	0.2	26.4	0.0	2.7	4.0	0.0	0.0	1.9	0.0	0.2
Initial Q Delay(d3),s/veh	0.0	0.0	0.0	0.0	0.0	0.0	0.0	0.0	0.0	0.0	0.0	0.0
%ile BackOfQ(50%),veh/ln	2.6	0.0	2.5	0.0	0.0	10.7	0.2	0.0	0.0	3.0	0.0	1.6
LnGrp Delay(d),s/veh	30.8	0.0	7.1	58.1	0.0	16.9	35.1	0.0	0.0	28.6	0.0	20.3
LnGrp LOS	C		A	E		B	D			C		C
Approach Vol, veh/h		428			683			12			280	
Approach Delay, s/veh		15.0			17.0			35.1			25.4	
Approach LOS		B			B			D			C	
Timer	1	2	3	4	5	6	7	8				
Assigned Phs	1	2		4	5	6		8				
Phs Duration (G+Y+Rc), s	4.0	41.4		13.3	10.3	35.1		5.0				
Change Period (Y+Rc), s	* 3.9	5.0		5.0	* 3.8	5.0		4.0				
Max Green Setting (Gmax), s	* 30	60.0		30.0	* 30	60.0		30.0				
Max Q Clear Time (g_c+I1), s	2.0	6.9		8.0	7.0	22.3		2.4				
Green Ext Time (p_c), s	0.0	2.6		0.3	0.0	7.8		0.0				
Intersection Summary												
HCM 2010 Ctrl Delay			18.2									
HCM 2010 LOS			B									
Notes												

Intersection												
Intersection Delay, s/veh	31.1											
Intersection LOS	D											

Movement	EBL	EBT	EBR	WBL	WBT	WBR	NBL	NBT	NBR	SBL	SBT	SBR
Lane Configurations		↔			↔	↔	↔	↔		↔	↔	↔
Traffic Vol, veh/h	1	5	1	7	1	2	18	122	13	32	609	13
Future Vol, veh/h	1	5	1	7	1	2	18	122	13	32	609	13
Peak Hour Factor	0.91	0.91	0.91	0.91	0.91	0.91	0.91	0.91	0.91	0.91	0.91	0.91
Heavy Vehicles, %	14	14	14	0	0	0	2	2	2	1	1	1
Mvmt Flow	1	5	1	8	1	2	20	134	14	35	669	14
Number of Lanes	0	1	0	0	1	1	1	2	0	1	1	1

Approach	EB	WB	NB	SB
Opposing Approach	WB	EB	SB	NB
Opposing Lanes	2	1	3	3
Conflicting Approach Left	SB	NB	EB	WB
Conflicting Lanes Left	3	3	1	2
Conflicting Approach Right	NB	SB	WB	EB
Conflicting Lanes Right	3	3	2	1
HCM Control Delay	9.9	9.9	9.6	36.7
HCM LOS	A	A	A	E

Lane	NBLn1	NBLn2	NBLn3	EBLn1	WBLn1	WBLn2	SBLn1	SBLn2	SBLn3
Vol Left, %	100%	0%	0%	14%	88%	0%	100%	0%	0%
Vol Thru, %	0%	100%	76%	71%	12%	0%	0%	100%	0%
Vol Right, %	0%	0%	24%	14%	0%	100%	0%	0%	100%
Sign Control	Stop	Stop	Stop	Stop	Stop	Stop	Stop	Stop	Stop
Traffic Vol by Lane	18	81	54	7	8	2	32	609	13
LT Vol	18	0	0	1	7	0	32	0	0
Through Vol	0	81	41	5	1	0	0	609	0
RT Vol	0	0	13	1	0	2	0	0	13
Lane Flow Rate	20	89	59	8	9	2	35	669	14
Geometry Grp	8	8	8	8	8	8	8	8	8
Degree of Util (X)	0.036	0.148	0.095	0.015	0.018	0.004	0.053	0.921	0.017
Departure Headway (Hd)	6.478	5.978	5.808	6.958	7.179	6.043	5.455	4.955	4.254
Convergence, Y/N	Yes	Yes	Yes	Yes	Yes	Yes	Yes	Yes	Yes
Cap	551	597	614	510	495	586	655	729	838
Service Time	4.241	3.74	3.57	4.758	4.979	3.843	3.197	2.696	1.996
HCM Lane V/C Ratio	0.036	0.149	0.096	0.016	0.018	0.003	0.053	0.918	0.017
HCM Control Delay	9.5	9.8	9.2	9.9	10.1	8.9	8.5	38.8	7.1
HCM Lane LOS	A	A	A	A	B	A	A	E	A
HCM 95th-tile Q	0.1	0.5	0.3	0	0.1	0	0.2	12.6	0.1

Intersection												
Intersection Delay, s/veh	9.1											
Intersection LOS	A											

Movement	EBL	EBT	EBR	WBL	WBT	WBR	NBL	NBT	NBR	SBL	SBT	SBR
Lane Configurations		↕			↕		↕	↕		↕	↕	
Traffic Vol, veh/h	7	44	5	57	8	18	9	122	62	12	136	2
Future Vol, veh/h	7	44	5	57	8	18	9	122	62	12	136	2
Peak Hour Factor	0.91	0.91	0.91	0.91	0.91	0.91	0.91	0.91	0.91	0.91	0.91	0.91
Heavy Vehicles, %	0	0	0	1	1	1	2	2	2	1	1	1
Mvmt Flow	8	48	5	63	9	20	10	134	68	13	149	2
Number of Lanes	0	1	0	0	1	0	1	1	0	1	1	0

Approach	EB	WB	NB	SB
Opposing Approach	WB	EB	SB	NB
Opposing Lanes	1	1	2	2
Conflicting Approach Left	SB	NB	EB	WB
Conflicting Lanes Left	2	2	1	1
Conflicting Approach Right	NB	SB	WB	EB
Conflicting Lanes Right	2	2	1	1
HCM Control Delay	8.4	8.7	9.4	9.1
HCM LOS	A	A	A	A

Lane	NBLn1	NBLn2	EBLn1	WBLn1	SBLn1	SBLn2
Vol Left, %	100%	0%	12%	69%	100%	0%
Vol Thru, %	0%	66%	79%	10%	0%	99%
Vol Right, %	0%	34%	9%	22%	0%	1%
Sign Control	Stop	Stop	Stop	Stop	Stop	Stop
Traffic Vol by Lane	9	184	56	83	12	138
LT Vol	9	0	7	57	12	0
Through Vol	0	122	44	8	0	136
RT Vol	0	62	5	18	0	2
Lane Flow Rate	10	202	62	91	13	152
Geometry Grp	7	7	2	2	7	7
Degree of Util (X)	0.015	0.271	0.084	0.125	0.02	0.214
Departure Headway (Hd)	5.571	4.831	4.911	4.92	5.588	5.075
Convergence, Y/N	Yes	Yes	Yes	Yes	Yes	Yes
Cap	642	742	728	728	640	707
Service Time	3.306	2.566	2.951	2.957	3.324	2.811
HCM Lane V/C Ratio	0.016	0.272	0.085	0.125	0.02	0.215
HCM Control Delay	8.4	9.4	8.4	8.7	8.4	9.2
HCM Lane LOS	A	A	A	A	A	A
HCM 95th-tile Q	0	1.1	0.3	0.4	0.1	0.8

HCM 2010 Signalized Intersection Summary
 31: 1st Avenue & Lightfighter Drive

Existing, AM
 06/11/2019



Movement	EBL	EBT	EBR	WBL	WBT	WBR	NBL	NBT	NBR	SBL	SBT	SBR
Lane Configurations		↑↑	↑	↑	↑↑		↑		↑	↑	↑	↑
Traffic Volume (veh/h)	0	748	126	20	754	0	158	0	16	14	4	18
Future Volume (veh/h)	0	748	126	20	754	0	158	0	16	14	4	18
Number	7	4	14	3	8	18	5	2	12	1	6	16
Initial Q (Qb), veh	0	0	0	0	0	0	0	0	0	0	0	0
Ped-Bike Adj(A_pbT)	1.00		1.00	1.00		1.00	1.00		1.00	1.00		1.00
Parking Bus, Adj	1.00	1.00	1.00	1.00	1.00	1.00	1.00	1.00	1.00	1.00	1.00	1.00
Adj Sat Flow, veh/h/ln	0	1863	1863	1863	1863	0	1863	0	1863	1792	1792	1792
Adj Flow Rate, veh/h	0	890	0	24	898	0	188	0	5	17	5	2
Adj No. of Lanes	0	2	1	1	2	0	1	0	1	1	1	1
Peak Hour Factor	0.84	0.84	0.84	0.84	0.84	0.84	0.84	0.84	0.84	0.84	0.84	0.84
Percent Heavy Veh, %	0	2	2	2	2	0	2	0	2	6	6	6
Cap, veh/h	0	1998	894	26	2446	0	0	0	0	24	25	21
Arrive On Green	0.00	0.56	0.00	0.01	0.69	0.00	0.00	0.00	0.00	0.01	0.01	0.01
Sat Flow, veh/h	0	3632	1583	1774	3632	0	0	0	1707	1792	1524	
Grp Volume(v), veh/h	0	890	0	24	898	0	0.0	0.0	17	5	2	
Grp Sat Flow(s),veh/h/ln	0	1770	1583	1774	1770	0	0.0	0.0	1707	1792	1524	
Q Serve(g_s), s	0.0	4.6	0.0	0.4	3.3	0.0	0.0	0.0	0.3	0.1	0.0	
Cycle Q Clear(g_c), s	0.0	4.6	0.0	0.4	3.3	0.0	0.0	0.0	0.3	0.1	0.0	
Prop In Lane	0.00		1.00	1.00		0.00			1.00		1.00	
Lane Grp Cap(c), veh/h	0	1998	894	26	2446	0	0	0	24	25	21	
V/C Ratio(X)	0.00	0.45	0.00	0.92	0.37	0.00	0.00	0.00	0.71	0.20	0.09	
Avail Cap(c_a), veh/h	0	5102	2283	1137	5102	0	0	0	1367	1436	1220	
HCM Platoon Ratio	1.00	1.00	1.00	1.00	1.00	1.00	1.00	1.00	1.00	1.00	1.00	
Upstream Filter(I)	0.00	1.00	0.00	1.00	1.00	0.00	0.00	0.00	1.00	1.00	1.00	
Uniform Delay (d), s/veh	0.0	4.0	0.0	15.4	2.0	0.0	0.0	0.0	15.3	15.2	15.2	
Incr Delay (d2), s/veh	0.0	0.2	0.0	33.8	0.1	0.0	0.0	0.0	13.4	1.4	0.7	
Initial Q Delay(d3),s/veh	0.0	0.0	0.0	0.0	0.0	0.0	0.0	0.0	0.0	0.0	0.0	
%ile BackOfQ(50%),veh/ln	0.0	2.2	0.0	0.4	1.5	0.0	0.0	0.0	0.2	0.1	0.0	
LnGrp Delay(d),s/veh	0.0	4.2	0.0	49.2	2.1	0.0	0.0	0.0	28.8	16.6	15.9	
LnGrp LOS		A		D	A				C	B	B	
Approach Vol, veh/h		890			922						24	
Approach Delay, s/veh		4.2			3.4						25.2	
Approach LOS		A			A						C	
Timer	1	2	3	4	5	6	7	8				
Assigned Phs			3	4		6		8				
Phs Duration (G+Y+Rc), s			4.0	22.2		5.0		26.2				
Change Period (Y+Rc), s			3.5	4.6		4.6		4.6				
Max Green Setting (Gmax), s			20.0	45.0		25.0		45.0				
Max Q Clear Time (g_c+I1), s			2.4	6.6		2.3		5.3				
Green Ext Time (p_c), s			0.0	11.1		0.0		10.4				
Intersection Summary												
HCM 2010 Ctrl Delay			4.0									
HCM 2010 LOS			A									

HCM 2010 Signalized Intersection Summary
 32: 2nd Avenue & Lightfighter Drive

Existing, AM
 06/11/2019



Movement	EBL	EBT	EBR	WBL	WBT	WBR	NBL	NBT	NBR	SBL	SBT	SBR
Lane Configurations												
Traffic Volume (veh/h)	78	696	2	5	424	68	2	1	1	272	4	343
Future Volume (veh/h)	78	696	2	5	424	68	2	1	1	272	4	343
Number	5	2	12	1	6	16	3	8	18	7	4	14
Initial Q (Qb), veh	0	0	0	0	0	0	0	0	0	0	0	0
Ped-Bike Adj(A_pbT)	1.00		1.00	1.00		1.00	1.00		1.00	1.00		1.00
Parking Bus, Adj	1.00	1.00	1.00	1.00	1.00	1.00	1.00	1.00	1.00	1.00	1.00	1.00
Adj Sat Flow, veh/h/ln	1863	1863	1900	1827	1827	1900	1900	1900	1900	1881	1881	1881
Adj Flow Rate, veh/h	87	773	2	6	471	67	2	1	0	302	4	105
Adj No. of Lanes	1	2	0	1	2	0	0	1	0	1	1	1
Peak Hour Factor	0.90	0.90	0.90	0.90	0.90	0.90	0.90	0.90	0.90	0.90	0.90	0.90
Percent Heavy Veh, %	2	2	2	4	4	4	0	0	0	1	1	1
Cap, veh/h	111	2281	6	11	1752	248	276	126	0	403	436	371
Arrive On Green	0.06	0.63	0.63	0.01	0.57	0.57	0.24	0.23	0.00	0.23	0.23	0.23
Sat Flow, veh/h	1774	3621	9	1740	3054	432	930	545	0	1424	1881	1599
Grp Volume(v), veh/h	87	378	397	6	267	271	3	0	0	302	4	105
Grp Sat Flow(s),veh/h/ln	1774	1770	1861	1740	1736	1751	1476	0	0	1424	1881	1599
Q Serve(g_s), s	4.8	10.0	10.0	0.3	7.7	7.8	0.0	0.0	0.0	20.5	0.2	5.4
Cycle Q Clear(g_c), s	4.8	10.0	10.0	0.3	7.7	7.8	0.1	0.0	0.0	20.6	0.2	5.4
Prop In Lane	1.00		0.01	1.00		0.25	0.67		0.00	1.00		1.00
Lane Grp Cap(c), veh/h	111	1115	1172	11	995	1004	411	0	0	403	436	371
V/C Ratio(X)	0.79	0.34	0.34	0.56	0.27	0.27	0.01	0.00	0.00	0.75	0.01	0.28
Avail Cap(c_a), veh/h	220	1115	1172	216	995	1004	662	0	0	648	760	646
HCM Platoon Ratio	1.00	1.00	1.00	1.00	1.00	1.00	1.00	1.00	1.00	1.00	1.00	1.00
Upstream Filter(I)	0.87	0.87	0.87	0.82	0.82	0.82	1.00	0.00	0.00	1.00	1.00	1.00
Uniform Delay (d), s/veh	46.2	8.7	8.7	49.6	10.7	10.8	29.4	0.0	0.0	37.4	29.6	31.6
Incr Delay (d2), s/veh	4.0	0.7	0.7	13.3	0.5	0.5	0.0	0.0	0.0	1.1	0.0	0.2
Initial Q Delay(d3),s/veh	0.0	0.0	0.0	0.0	0.0	0.0	0.0	0.0	0.0	0.0	0.0	0.0
%ile BackOfQ(50%),veh/ln	2.5	5.0	5.3	0.2	3.9	3.9	0.1	0.0	0.0	8.3	0.1	2.4
LnGrp Delay(d),s/veh	50.2	9.4	9.4	62.9	11.3	11.3	29.4	0.0	0.0	38.5	29.6	31.7
LnGrp LOS	D	A	A	E	B	B	C			D	C	C
Approach Vol, veh/h		862			544			3			411	
Approach Delay, s/veh		13.5			11.9			29.4			36.7	
Approach LOS		B			B			C			D	
Timer	1	2	3	4	5	6	7	8				
Assigned Phs	1	2		4	5	6		8				
Phs Duration (G+Y+Rc), s	4.6	67.6		27.8	10.2	62.0		27.8				
Change Period (Y+Rc), s	4.0	4.6		4.6	4.0	4.6		4.6				
Max Green Setting (Gmax), s	2.4	34.0		40.4	12.4	24.4		40.4				
Max Q Clear Time (g_c+1/3), s	12.3	12.0		22.6	6.8	9.8		2.1				
Green Ext Time (p_c), s	0.0	2.8		0.6	0.0	1.7		0.0				
Intersection Summary												
HCM 2010 Ctrl Delay			18.3									
HCM 2010 LOS			B									

HCM 2010 Signalized Intersection Summary
 33: General Jim Moore Boulevard & Lightfighter Drive

Existing, AM
 06/11/2019



Movement	EBL	EBT	EBR	WBL	WBT	WBR	NBL	NBT	NBR	SBL	SBT	SBR
Lane Configurations												
Traffic Volume (veh/h)	123	127	710	21	187	10	250	90	2	10	179	59
Future Volume (veh/h)	123	127	710	21	187	10	250	90	2	10	179	59
Number	3	8	18	7	4	14	1	6	16	5	2	12
Initial Q (Qb), veh	0	0	0	0	0	0	0	0	0	0	0	0
Ped-Bike Adj(A_pbT)	1.00		1.00	1.00		0.99	1.00		1.00	1.00		1.00
Parking Bus, Adj	1.00	1.00	1.00	1.00	1.00	1.00	1.00	1.00	1.00	1.00	1.00	1.00
Adj Sat Flow, veh/h/ln	1863	1863	1863	1792	1792	1900	1881	1881	1900	1863	1863	1900
Adj Flow Rate, veh/h	138	143	0	24	210	9	281	101	1	11	201	66
Adj No. of Lanes	1	1	1	1	1	0	2	1	0	1	2	0
Peak Hour Factor	0.89	0.89	0.89	0.89	0.89	0.89	0.89	0.89	0.89	0.89	0.89	0.89
Percent Heavy Veh, %	2	2	2	6	6	6	1	1	1	2	2	2
Cap, veh/h	183	493	419	39	314	13	682	633	6	20	411	131
Arrive On Green	0.10	0.26	0.00	0.02	0.18	0.18	0.20	0.34	0.34	0.01	0.16	0.16
Sat Flow, veh/h	1774	1863	1583	1707	1706	73	3476	1859	18	1774	2639	841
Grp Volume(v), veh/h	138	143	0	24	0	219	281	0	102	11	133	134
Grp Sat Flow(s),veh/h/ln	1774	1863	1583	1707	0	1779	1738	0	1878	1774	1770	1710
Q Serve(g_s), s	3.8	3.1	0.0	0.7	0.0	5.7	3.5	0.0	1.9	0.3	3.4	3.6
Cycle Q Clear(g_c), s	3.8	3.1	0.0	0.7	0.0	5.7	3.5	0.0	1.9	0.3	3.4	3.6
Prop In Lane	1.00		1.00	1.00		0.04	1.00		0.01	1.00		0.49
Lane Grp Cap(c), veh/h	183	493	419	39	0	328	682	0	640	20	275	266
V/C Ratio(X)	0.75	0.29	0.00	0.62	0.00	0.67	0.41	0.00	0.16	0.55	0.48	0.50
Avail Cap(c_a), veh/h	711	1120	952	684	0	1069	696	0	1129	533	1064	1028
HCM Platoon Ratio	1.00	1.00	1.00	1.00	1.00	1.00	1.00	1.00	1.00	1.00	1.00	1.00
Upstream Filter(I)	1.00	1.00	0.00	1.00	0.00	1.00	1.00	0.00	1.00	1.00	1.00	1.00
Uniform Delay (d), s/veh	21.8	14.6	0.0	24.2	0.0	18.9	17.5	0.0	11.5	24.5	19.2	19.3
Incr Delay (d2), s/veh	6.1	0.4	0.0	5.9	0.0	2.8	0.3	0.0	0.2	8.3	1.6	1.8
Initial Q Delay(d3),s/veh	0.0	0.0	0.0	0.0	0.0	0.0	0.0	0.0	0.0	0.0	0.0	0.0
%ile BackOfQ(50%),veh/ln	2.2	1.6	0.0	0.4	0.0	3.1	1.7	0.0	1.0	0.2	1.8	1.8
LnGrp Delay(d),s/veh	27.9	15.0	0.0	30.0	0.0	21.8	17.8	0.0	11.7	32.9	20.8	21.1
LnGrp LOS	C	B		C		C	B		B	C	C	C
Approach Vol, veh/h		281			243			383			278	
Approach Delay, s/veh		21.3			22.6			16.2			21.4	
Approach LOS		C			C			B			C	
Timer	1	2	3	4	5	6	7	8				
Assigned Phs	1	2	3	4	5	6	7	8				
Phs Duration (G+Y+Rc), s	4.3	12.3	9.7	13.7	5.1	21.5	5.6	17.7				
Change Period (Y+Rc), s	4.5	4.5	4.5	4.5	4.5	4.5	4.5	4.5				
Max Green Setting (Gmax), s	30.0	30.0	20.0	30.0	15.0	30.0	20.0	30.0				
Max Q Clear Time (g_c+15), s	5.6	5.6	5.8	7.7	2.3	3.9	2.7	5.1				
Green Ext Time (p_c), s	0.3	1.8	0.3	1.5	0.0	0.9	0.0	0.8				
Intersection Summary												
HCM 2010 Ctrl Delay			20.0									
HCM 2010 LOS			B									

Intersection	
Intersection Delay, s/veh	9.9
Intersection LOS	A

Movement	WBL	WBR	NBT	NBR	SBL	SBT
Lane Configurations						
Traffic Vol, veh/h	12	260	58	3	138	29
Future Vol, veh/h	12	260	58	3	138	29
Peak Hour Factor	0.77	0.77	0.77	0.77	0.77	0.77
Heavy Vehicles, %	4	4	3	3	2	2
Mvmt Flow	16	338	75	4	179	38
Number of Lanes	1	0	1	0	0	1

Approach	WB	NB	SB
Opposing Approach		SB	NB
Opposing Lanes	0	1	1
Conflicting Approach Left	NB		WB
Conflicting Lanes Left	1	0	1
Conflicting Approach Right	SB	WB	
Conflicting Lanes Right	1	1	0
HCM Control Delay	10	8.6	10.1
HCM LOS	A	A	B

Lane	NBLn1	WBLn1	SBLn1
Vol Left, %	0%	4%	83%
Vol Thru, %	95%	0%	17%
Vol Right, %	5%	96%	0%
Sign Control	Stop	Stop	Stop
Traffic Vol by Lane	61	272	167
LT Vol	0	12	138
Through Vol	58	0	29
RT Vol	3	260	0
Lane Flow Rate	79	353	217
Geometry Grp	1	1	1
Degree of Util (X)	0.109	0.407	0.299
Departure Headway (Hd)	4.964	4.145	4.96
Convergence, Y/N	Yes	Yes	Yes
Cap	718	869	722
Service Time	3.025	2.175	3.013
HCM Lane V/C Ratio	0.11	0.406	0.301
HCM Control Delay	8.6	10	10.1
HCM Lane LOS	A	A	B
HCM 95th-tile Q	0.4	2	1.3

Intersection						
Int Delay, s/veh	0.4					
Movement	EBT	EBR	WBL	WBT	NBL	NBR
Lane Configurations						
Traffic Vol, veh/h	76	17	8	277	7	3
Future Vol, veh/h	76	17	8	277	7	3
Conflicting Peds, #/hr	0	0	0	0	0	0
Sign Control	Free	Free	Free	Free	Stop	Stop
RT Channelized	-	None	-	None	-	None
Storage Length	-	-	-	-	0	-
Veh in Median Storage, #	0	-	-	0	0	-
Grade, %	0	-	-	0	0	-
Peak Hour Factor	78	78	78	78	78	78
Heavy Vehicles, %	5	5	4	4	0	0
Mvmt Flow	97	22	10	355	9	4

Major/Minor	Major1	Major2	Minor1		
Conflicting Flow All	0	0	119	0	483
Stage 1	-	-	-	-	108
Stage 2	-	-	-	-	375
Critical Hdwy	-	-	4.14	-	6.4
Critical Hdwy Stg 1	-	-	-	-	5.4
Critical Hdwy Stg 2	-	-	-	-	5.4
Follow-up Hdwy	-	-	2.236	-	3.5
Pot Cap-1 Maneuver	-	-	1457	-	546
Stage 1	-	-	-	-	921
Stage 2	-	-	-	-	699
Platoon blocked, %	-	-	-	-	-
Mov Cap-1 Maneuver	-	-	1457	-	541
Mov Cap-2 Maneuver	-	-	-	-	541
Stage 1	-	-	-	-	913
Stage 2	-	-	-	-	699

Approach	EB	WB	NB
HCM Control Delay, s	0	0.2	10.9
HCM LOS			B

Minor Lane/Major Mvmt	NBLn1	EBT	EBR	WBL	WBT
Capacity (veh/h)	621	-	-	1457	-
HCM Lane V/C Ratio	0.021	-	-	0.007	-
HCM Control Delay (s)	10.9	-	-	7.5	0
HCM Lane LOS	B	-	-	A	A
HCM 95th %tile Q(veh)	0.1	-	-	0	-

Intersection	
Intersection Delay, s/veh	8.9
Intersection LOS	A

Movement	EBL	EBT	EBR	WBL	WBT	WBR	NBL	NBT	NBR	SBL	SBT	SBR
Lane Configurations		↕			↕			↕			↕	
Traffic Vol, veh/h	14	45	23	10	230	0	1	7	2	0	5	53
Future Vol, veh/h	14	45	23	10	230	0	1	7	2	0	5	53
Peak Hour Factor	0.79	0.79	0.79	0.79	0.79	0.79	0.79	0.79	0.79	0.79	0.79	0.79
Heavy Vehicles, %	6	6	6	4	4	4	20	20	20	2	2	2
Mvmt Flow	18	57	29	13	291	0	1	9	3	0	6	67
Number of Lanes	0	1	0	0	1	0	0	1	0	0	1	0

Approach	EB	WB	NB	SB
Opposing Approach	WB	EB	SB	NB
Opposing Lanes	1	1	1	1
Conflicting Approach Left	SB	NB	EB	WB
Conflicting Lanes Left	1	1	1	1
Conflicting Approach Right	NB	SB	WB	EB
Conflicting Lanes Right	1	1	1	1
HCM Control Delay	8	9.6	8.2	7.7
HCM LOS	A	A	A	A

Lane	NBLn1	EBLn1	WBLn1	SBLn1
Vol Left, %	10%	17%	4%	0%
Vol Thru, %	70%	55%	96%	9%
Vol Right, %	20%	28%	0%	91%
Sign Control	Stop	Stop	Stop	Stop
Traffic Vol by Lane	10	82	240	58
LT Vol	1	14	10	0
Through Vol	7	45	230	5
RT Vol	2	23	0	53
Lane Flow Rate	13	104	304	73
Geometry Grp	1	1	1	1
Degree of Util (X)	0.018	0.126	0.355	0.088
Departure Headway (Hd)	5.139	4.374	4.205	4.307
Convergence, Y/N	Yes	Yes	Yes	Yes
Cap	699	822	842	835
Service Time	3.15	2.387	2.294	2.313
HCM Lane V/C Ratio	0.019	0.127	0.361	0.087
HCM Control Delay	8.2	8	9.6	7.7
HCM Lane LOS	A	A	A	A
HCM 95th-tile Q	0.1	0.4	1.6	0.3

Intersection												
Int Delay, s/veh	6.6											
Movement	EBL	EBT	EBR	WBL	WBT	WBR	NBL	NBT	NBR	SBL	SBT	SBR
Lane Configurations		↕			↕			↕			↕	
Traffic Vol, veh/h	19	37	1	2	157	0	0	20	0	0	97	60
Future Vol, veh/h	19	37	1	2	157	0	0	20	0	0	97	60
Conflicting Peds, #/hr	0	0	0	0	0	0	0	0	1	1	0	0
Sign Control	Stop	Stop	Stop	Stop	Stop	Stop	Free	Free	Free	Free	Free	Free
RT Channelized	-	-	None	-	-	None	-	-	None	-	-	None
Storage Length	-	-	-	-	-	-	-	-	-	-	-	-
Veh in Median Storage, #	-	0	-	-	0	-	-	0	-	-	0	-
Grade, %	-	0	-	-	0	-	-	0	-	-	0	-
Peak Hour Factor	82	82	82	82	82	82	82	82	82	82	82	82
Heavy Vehicles, %	12	12	12	0	0	0	10	10	10	10	10	10
Mvmt Flow	23	45	1	2	191	0	0	24	0	0	118	73

Major/Minor	Minor2		Minor1		Major1			Major2				
Conflicting Flow All	275	180	155	203	216	25	191	0	0	25	0	0
Stage 1	155	155	-	25	25	-	-	-	-	-	-	-
Stage 2	120	25	-	178	191	-	-	-	-	-	-	-
Critical Hdwy	7.22	6.62	6.32	7.1	6.5	6.2	4.2	-	-	4.2	-	-
Critical Hdwy Stg 1	6.22	5.62	-	6.1	5.5	-	-	-	-	-	-	-
Critical Hdwy Stg 2	6.22	5.62	-	6.1	5.5	-	-	-	-	-	-	-
Follow-up Hdwy	3.608	4.108	3.408	3.5	4	3.3	2.29	-	-	2.29	-	-
Pot Cap-1 Maneuver	658	696	865	759	685	1057	1336	-	-	1539	-	-
Stage 1	824	751	-	998	878	-	-	-	-	-	-	-
Stage 2	861	855	-	828	746	-	-	-	-	-	-	-
Platoon blocked, %								-	-	-	-	-
Mov Cap-1 Maneuver	516	695	865	720	684	1056	1336	-	-	1538	-	-
Mov Cap-2 Maneuver	516	695	-	720	684	-	-	-	-	-	-	-
Stage 1	824	751	-	997	877	-	-	-	-	-	-	-
Stage 2	673	854	-	777	746	-	-	-	-	-	-	-

Approach	EB		WB		NB		SB	
HCM Control Delay, s	11.5		12.3		0		0	
HCM LOS	B		B					

Minor Lane/Major Mvmt	NBL	NBT	NBR	EBLn1WBLn1	SBL	SBT	SBR
Capacity (veh/h)	1336	-	-	625	684	1538	-
HCM Lane V/C Ratio	-	-	-	0.111	0.283	-	-
HCM Control Delay (s)	0	-	-	11.5	12.3	0	-
HCM Lane LOS	A	-	-	B	B	A	-
HCM 95th %tile Q(veh)	0	-	-	0.4	1.2	0	-

Intersection						
Int Delay, s/veh	0.6					
Movement	EBL	EBR	NBL	NBT	SBT	SBR
Lane Configurations	T			T		T
Traffic Vol, veh/h	31	0	0	88	409	176
Future Vol, veh/h	31	0	0	88	409	176
Conflicting Peds, #/hr	0	0	0	0	0	0
Sign Control	Stop	Stop	Free	Free	Free	Free
RT Channelized	-	None	-	None	-	None
Storage Length	0	-	-	-	-	-
Veh in Median Storage, #	0	-	-	0	0	-
Grade, %	0	-	-	0	0	-
Peak Hour Factor	89	89	89	89	89	89
Heavy Vehicles, %	13	13	2	2	0	0
Mvmt Flow	35	0	0	99	460	198























Major/Minor	Minor2	Major1	Major2			
Conflicting Flow All	658	559	658	0	-	0
Stage 1	559	-	-	-	-	-
Stage 2	99	-	-	-	-	-
Critical Hdwy	6.53	6.33	4.12	-	-	-
Critical Hdwy Stg 1	5.53	-	-	-	-	-
Critical Hdwy Stg 2	5.53	-	-	-	-	-
Follow-up Hdwy	3.617	3.417	2.218	-	-	-
Pot Cap-1 Maneuver	412	508	930	-	-	-
Stage 1	551	-	-	-	-	-
Stage 2	898	-	-	-	-	-
Platoon blocked, %				-	-	-
Mov Cap-1 Maneuver	412	508	930	-	-	-
Mov Cap-2 Maneuver	412	-	-	-	-	-
Stage 1	551	-	-	-	-	-
Stage 2	898	-	-	-	-	-

Approach	EB	NB	SB
HCM Control Delay, s	14.5	0	0
HCM LOS	B		

Minor Lane/Major Mvmt	NBL	NBT	EBLn1	SBT	SBR
Capacity (veh/h)	930	-	412	-	-
HCM Lane V/C Ratio	-	-	0.085	-	-
HCM Control Delay (s)	0	-	14.5	-	-
HCM Lane LOS	A	-	B	-	-
HCM 95th %tile Q(veh)	0	-	0.3	-	-

HCM 2010 Signalized Intersection Summary
 39: General Jim Moore Boulevard & Gigling Road

Existing, AM
 06/11/2019

												
Movement	EBL	EBT	EBR	WBL	WBT	WBR	NBL	NBT	NBR	SBL	SBT	SBR
Lane Configurations												
Traffic Volume (veh/h)	22	94	75	361	31	46	47	317	178	162	717	46
Future Volume (veh/h)	22	94	75	361	31	46	47	317	178	162	717	46
Number	3	8	18	7	4	14	1	6	16	5	2	12
Initial Q (Qb), veh	0	0	0	0	0	0	0	0	0	0	0	0
Ped-Bike Adj(A_pbT)	1.00		1.00	1.00		1.00	1.00		1.00	1.00		1.00
Parking Bus, Adj	1.00	1.00	1.00	1.00	1.00	1.00	1.00	1.00	1.00	1.00	1.00	1.00
Adj Sat Flow, veh/h/ln	1810	1810	1900	1863	1863	1863	1881	1881	1881	1863	1863	1863
Adj Flow Rate, veh/h	25	108	54	415	36	0	54	364	0	186	824	0
Adj No. of Lanes	1	1	0	1	1	1	1	2	1	1	2	1
Peak Hour Factor	0.87	0.87	0.87	0.87	0.87	0.87	0.87	0.87	0.87	0.87	0.87	0.87
Percent Heavy Veh, %	5	5	5	2	2	2	1	1	1	2	2	2
Cap, veh/h	49	144	72	460	667	567	88	683	306	229	961	430
Arrive On Green	0.03	0.13	0.13	0.26	0.36	0.00	0.05	0.19	0.00	0.13	0.27	0.00
Sat Flow, veh/h	1723	1138	569	1774	1863	1583	1792	3574	1599	1774	3539	1583
Grp Volume(v), veh/h	25	0	162	415	36	0	54	364	0	186	824	0
Grp Sat Flow(s),veh/h/ln	1723	0	1707	1774	1863	1583	1792	1787	1599	1774	1770	1583
Q Serve(g_s), s	0.9	0.0	5.6	13.9	0.8	0.0	1.8	5.6	0.0	6.3	13.6	0.0
Cycle Q Clear(g_c), s	0.9	0.0	5.6	13.9	0.8	0.0	1.8	5.6	0.0	6.3	13.6	0.0
Prop In Lane	1.00		0.33	1.00		1.00	1.00		1.00	1.00		1.00
Lane Grp Cap(c), veh/h	49	0	217	460	667	567	88	683	306	229	961	430
V/C Ratio(X)	0.51	0.00	0.75	0.90	0.05	0.00	0.62	0.53	0.00	0.81	0.86	0.00
Avail Cap(c_a), veh/h	295	0	862	592	1243	1057	160	1455	651	448	2017	902
HCM Platoon Ratio	1.00	1.00	1.00	1.00	1.00	1.00	1.00	1.00	1.00	1.00	1.00	1.00
Upstream Filter(I)	1.00	0.00	1.00	1.00	1.00	0.00	1.00	1.00	0.00	1.00	1.00	0.00
Uniform Delay (d), s/veh	29.4	0.0	25.9	22.0	12.9	0.0	28.6	22.4	0.0	26.0	21.2	0.0
Incr Delay (d2), s/veh	3.1	0.0	1.9	12.5	0.0	0.0	2.6	0.2	0.0	2.6	0.9	0.0
Initial Q Delay(d3),s/veh	0.0	0.0	0.0	0.0	0.0	0.0	0.0	0.0	0.0	0.0	0.0	0.0
%ile BackOfQ(50%),veh/ln	0.5	0.0	2.8	8.4	0.4	0.0	1.0	2.8	0.0	3.2	6.8	0.0
LnGrp Delay(d),s/veh	32.5	0.0	27.8	34.5	12.9	0.0	31.2	22.6	0.0	28.6	22.1	0.0
LnGrp LOS	C		C	C	B		C	C		C	C	
Approach Vol, veh/h		187			451			418			1010	
Approach Delay, s/veh		28.4			32.8			23.7			23.3	
Approach LOS		C			C			C			C	
Timer	1	2	3	4	5	6	7	8				
Assigned Phs	1	2	3	4	5	6	7	8				
Phs Duration (G+Y+Rc), s	7.5	21.2	6.2	26.5	12.4	16.2	20.4	12.3				
Change Period (Y+Rc), s	4.5	4.5	4.5	4.5	4.5	4.5	4.5	4.5				
Max Green Setting (Gmax), s	5.5	35.0	10.5	41.0	15.5	25.0	20.5	31.0				
Max Q Clear Time (g_c+I1), s	3.8	15.6	2.9	2.8	8.3	7.6	15.9	7.6				
Green Ext Time (p_c), s	0.0	1.1	0.0	0.0	0.0	0.4	0.1	0.1				
Intersection Summary												
HCM 2010 Ctrl Delay			25.9									
HCM 2010 LOS			C									
Notes												

Intersection												
Int Delay, s/veh	3.7											
Movement	EBL	EBT	EBR	WBL	WBT	WBR	NBL	NBT	NBR	SBL	SBT	SBR
Lane Configurations		↕			↕			↕			↕	
Traffic Vol, veh/h	3	353	16	13	382	15	30	45	7	30	9	13
Future Vol, veh/h	3	353	16	13	382	15	30	45	7	30	9	13
Conflicting Peds, #/hr	0	0	1	1	0	0	0	0	0	0	0	0
Sign Control	Free	Free	Free	Free	Free	Free	Stop	Stop	Stop	Stop	Stop	Stop
RT Channelized	-	-	None	-	-	None	-	-	None	-	-	None
Storage Length	-	-	-	-	-	-	-	-	-	-	-	-
Veh in Median Storage, #	-	0	-	-	0	-	-	0	-	-	0	-
Grade, %	-	0	-	-	0	-	-	0	-	-	0	-
Peak Hour Factor	88	88	88	88	88	88	88	88	88	88	88	88
Heavy Vehicles, %	3	3	3	3	3	3	2	2	2	4	4	4
Mvmt Flow	3	401	18	15	434	17	34	51	8	34	10	15

Major/Minor	Major1		Major2		Minor1		Minor2					
Conflicting Flow All	451	0	0	420	0	0	902	898	411	919	899	443
Stage 1	-	-	-	-	-	-	417	417	-	473	473	-
Stage 2	-	-	-	-	-	-	485	481	-	446	426	-
Critical Hdwy	4.13	-	-	4.13	-	-	7.12	6.52	6.22	7.14	6.54	6.24
Critical Hdwy Stg 1	-	-	-	-	-	-	6.12	5.52	-	6.14	5.54	-
Critical Hdwy Stg 2	-	-	-	-	-	-	6.12	5.52	-	6.14	5.54	-
Follow-up Hdwy	2.227	-	-	2.227	-	-	3.518	4.018	3.318	3.536	4.036	3.336
Pot Cap-1 Maneuver	1104	-	-	1134	-	-	259	279	641	250	277	611
Stage 1	-	-	-	-	-	-	613	591	-	568	555	-
Stage 2	-	-	-	-	-	-	563	554	-	588	582	-
Platoon blocked, %		-	-		-	-						
Mov Cap-1 Maneuver	1104	-	-	1133	-	-	241	273	640	208	271	611
Mov Cap-2 Maneuver	-	-	-	-	-	-	241	273	-	208	271	-
Stage 1	-	-	-	-	-	-	610	588	-	566	545	-
Stage 2	-	-	-	-	-	-	529	544	-	528	579	-

Approach	EB		WB		NB		SB	
HCM Control Delay, s	0.1		0.3		24.9		22.7	
HCM LOS					C		C	

Minor Lane/Major Mvmt	NBLn1	EBL	EBT	EBR	WBL	WBT	WBR	SBLn1
Capacity (veh/h)	273	1104	-	-	1133	-	-	262
HCM Lane V/C Ratio	0.341	0.003	-	-	0.013	-	-	0.226
HCM Control Delay (s)	24.9	8.3	0	-	8.2	0	-	22.7
HCM Lane LOS	C	A	A	-	A	A	-	C
HCM 95th %tile Q(veh)	1.5	0	-	-	0	-	-	0.8

Intersection												
Int Delay, s/veh	2											
Movement	EBL	EBT	EBR	WBL	WBT	WBR	NBL	NBT	NBR	SBL	SBT	SBR
Lane Configurations		↕			↕			↕	↕		↕	
Traffic Vol, veh/h	5	285	91	41	381	0	17	9	31	7	11	0
Future Vol, veh/h	5	285	91	41	381	0	17	9	31	7	11	0
Conflicting Peds, #/hr	0	0	0	0	0	0	0	0	0	0	0	0
Sign Control	Free	Free	Free	Free	Free	Free	Stop	Stop	Stop	Stop	Stop	Stop
RT Channelized	-	-	None	-	-	None	-	-	None	-	-	None
Storage Length	-	-	-	-	-	-	-	-	135	-	-	-
Veh in Median Storage, #	-	0	-	-	0	-	-	0	-	-	0	-
Grade, %	-	0	-	-	0	-	-	0	-	-	0	-
Peak Hour Factor	84	84	84	84	84	84	84	84	84	84	84	84
Heavy Vehicles, %	3	3	3	2	2	2	2	2	2	0	0	0
Mvmt Flow	6	339	108	49	454	0	20	11	37	8	13	0

Major/Minor	Major1			Major2			Minor1			Minor2		
Conflicting Flow All	454	0	0	447	0	0	964	957	393	981	1011	454
Stage 1	-	-	-	-	-	-	405	405	-	552	552	-
Stage 2	-	-	-	-	-	-	559	552	-	429	459	-
Critical Hdwy	4.13	-	-	4.12	-	-	7.12	6.52	6.22	7.1	6.5	6.2
Critical Hdwy Stg 1	-	-	-	-	-	-	6.12	5.52	-	6.1	5.5	-
Critical Hdwy Stg 2	-	-	-	-	-	-	6.12	5.52	-	6.1	5.5	-
Follow-up Hdwy	2.227	-	-	2.218	-	-	3.518	4.018	3.318	3.5	4	3.3
Pot Cap-1 Maneuver	1101	-	-	1113	-	-	235	258	656	231	241	610
Stage 1	-	-	-	-	-	-	622	598	-	522	518	-
Stage 2	-	-	-	-	-	-	513	515	-	608	570	-
Platoon blocked, %		-	-		-	-						
Mov Cap-1 Maneuver	1101	-	-	1113	-	-	213	241	656	200	225	610
Mov Cap-2 Maneuver	-	-	-	-	-	-	213	241	-	200	225	-
Stage 1	-	-	-	-	-	-	618	594	-	518	487	-
Stage 2	-	-	-	-	-	-	470	485	-	560	566	-

Approach	EB			WB			NB			SB		
HCM Control Delay, s	0.1			0.8			16.7			23.6		
HCM LOS							C			C		

Minor Lane/Major Mvmt	NBLn1	NBLn2	EBL	EBT	EBR	WBL	WBT	WBR	SBLn1
Capacity (veh/h)	222	656	1101	-	-	1113	-	-	215
HCM Lane V/C Ratio	0.139	0.056	0.005	-	-	0.044	-	-	0.1
HCM Control Delay (s)	23.8	10.8	8.3	0	-	8.4	0	-	23.6
HCM Lane LOS	C	B	A	A	-	A	A	-	C
HCM 95th %tile Q(veh)	0.5	0.2	0	-	-	0.1	-	-	0.3

Intersection	
Intersection Delay, s/veh	13.3
Intersection LOS	B

Movement	EBL	EBT	EBR	WBL	WBT	WBR	NBL	NBT	NBR	SBL	SBT	SBR
Lane Configurations		↕			↕			↕	↕		↕	
Traffic Vol, veh/h	9	133	41	75	408	2	0	1	2	0	36	13
Future Vol, veh/h	9	133	41	75	408	2	0	1	2	0	36	13
Peak Hour Factor	0.89	0.89	0.89	0.89	0.89	0.89	0.89	0.89	0.89	0.89	0.89	0.89
Heavy Vehicles, %	3	3	3	2	2	2	33	33	33	2	2	2
Mvmt Flow	10	149	46	84	458	2	0	1	2	0	40	15
Number of Lanes	0	1	0	0	1	0	0	1	1	0	1	0

Approach	EB	WB	NB	SB
Opposing Approach	WB	EB	SB	NB
Opposing Lanes	1	1	1	2
Conflicting Approach Left	SB	NB	EB	WB
Conflicting Lanes Left	1	2	1	1
Conflicting Approach Right	NB	SB	WB	EB
Conflicting Lanes Right	2	1	1	1
HCM Control Delay	9.2	15.3	9.1	9.1
HCM LOS	A	C	A	A

Lane	NBLn1	NBLn2	EBLn1	WBLn1	SBLn1
Vol Left, %	0%	0%	5%	15%	0%
Vol Thru, %	100%	0%	73%	84%	73%
Vol Right, %	0%	100%	22%	0%	27%
Sign Control	Stop	Stop	Stop	Stop	Stop
Traffic Vol by Lane	1	2	183	485	49
LT Vol	0	0	9	75	0
Through Vol	1	0	133	408	36
RT Vol	0	2	41	2	13
Lane Flow Rate	1	2	206	545	55
Geometry Grp	7	7	2	2	5
Degree of Util (X)	0.002	0.004	0.26	0.657	0.084
Departure Headway (Hd)	6.803	6.092	4.545	4.341	5.522
Convergence, Y/N	Yes	Yes	Yes	Yes	Yes
Cap	525	585	790	834	647
Service Time	4.563	3.851	2.574	2.364	3.572
HCM Lane V/C Ratio	0.002	0.003	0.261	0.653	0.085
HCM Control Delay	9.6	8.9	9.2	15.3	9.1
HCM Lane LOS	A	A	A	C	A
HCM 95th-tile Q	0	0	1	5	0.3

Intersection						
Int Delay, s/veh	2.1					
Movement	EBL	EBT	WBT	WBR	SBL	SBR
Lane Configurations		↕	↕		↕	
Traffic Vol, veh/h	16	103	409	0	1	90
Future Vol, veh/h	16	103	409	0	1	90
Conflicting Peds, #/hr	0	0	0	0	0	0
Sign Control	Free	Free	Free	Free	Stop	Stop
RT Channelized	-	None	-	None	-	None
Storage Length	-	-	-	-	0	-
Veh in Median Storage, #	-	0	0	-	0	-
Grade, %	-	0	0	-	0	-
Peak Hour Factor	86	86	86	86	86	86
Heavy Vehicles, %	3	3	0	0	8	8
Mvmt Flow	19	120	476	0	1	105

Major/Minor	Major1	Major2	Minor2		
Conflicting Flow All	476	0	-	0	634 476
Stage 1	-	-	-	-	476 -
Stage 2	-	-	-	-	158 -
Critical Hdwy	4.13	-	-	-	6.48 6.28
Critical Hdwy Stg 1	-	-	-	-	5.48 -
Critical Hdwy Stg 2	-	-	-	-	5.48 -
Follow-up Hdwy	2.227	-	-	-	3.572 3.372
Pot Cap-1 Maneuver	1081	-	-	-	434 577
Stage 1	-	-	-	-	613 -
Stage 2	-	-	-	-	856 -
Platoon blocked, %		-	-	-	
Mov Cap-1 Maneuver	1081	-	-	-	426 577
Mov Cap-2 Maneuver	-	-	-	-	426 -
Stage 1	-	-	-	-	601 -
Stage 2	-	-	-	-	856 -

Approach	EB	WB	SB
HCM Control Delay, s	1.1	0	12.7
HCM LOS			B

Minor Lane/Major Mvmt	EBL	EBT	WBT	WBR	SBLn1
Capacity (veh/h)	1081	-	-	-	575
HCM Lane V/C Ratio	0.017	-	-	-	0.184
HCM Control Delay (s)	8.4	0	-	-	12.7
HCM Lane LOS	A	A	-	-	B
HCM 95th %tile Q(veh)	0.1	-	-	-	0.7

Intersection	
Intersection Delay, s/veh	9.9
Intersection LOS	A

Movement	EBL	EBT	EBR	WBL	WBT	WBR	NBL	NBT	NBR	SBL	SBT	SBR
Lane Configurations		↕			↕			↕			↕	
Traffic Vol, veh/h	88	2	13	0	0	0	1	0	0	1	3	408
Future Vol, veh/h	88	2	13	0	0	0	1	0	0	1	3	408
Peak Hour Factor	0.85	0.85	0.85	0.85	0.85	0.85	0.85	0.85	0.85	0.85	0.85	0.85
Heavy Vehicles, %	2	2	2	2	2	2	0	0	0	0	0	0
Mvmt Flow	104	2	15	0	0	0	1	0	0	1	4	480
Number of Lanes	0	1	0	0	1	0	0	1	0	0	1	0

Approach	EB	WB	NB	SB
Opposing Approach	WB	EB	SB	NB
Opposing Lanes	1	1	1	1
Conflicting Approach Left	SB	NB	EB	WB
Conflicting Lanes Left	1	1	1	1
Conflicting Approach Right	NB	SB	WB	EB
Conflicting Lanes Right	1	1	1	1
HCM Control Delay	9	0	7.9	10.1
HCM LOS	A	-	A	B

Lane	NBLn1	EBLn1	WBLn1	SBLn1
Vol Left, %	100%	85%	0%	0%
Vol Thru, %	0%	2%	100%	1%
Vol Right, %	0%	13%	0%	99%
Sign Control	Stop	Stop	Stop	Stop
Traffic Vol by Lane	1	103	0	412
LT Vol	1	88	0	1
Through Vol	0	2	0	3
RT Vol	0	13	0	408
Lane Flow Rate	1	121	0	485
Geometry Grp	1	1	1	1
Degree of Util (X)	0.002	0.168	0	0.489
Departure Headway (Hd)	4.853	4.988	5.037	3.63
Convergence, Y/N	Yes	Yes	Yes	Yes
Cap	738	723	0	998
Service Time	2.875	2.988	3.072	1.638
HCM Lane V/C Ratio	0.001	0.167	0	0.486
HCM Control Delay	7.9	9	8.1	10.1
HCM Lane LOS	A	A	N	B
HCM 95th-tile Q	0	0.6	0	2.8

HCM 2010 Signalized Intersection Summary
 46: General Jim Moore Boulevard & Normandy Road

Existing, AM
 06/11/2019



Movement	EBL	EBT	EBR	WBL	WBT	WBR	NBL	NBT	NBR	SBL	SBT	SBR
Lane Configurations		↕			↕		↕	↕↕		↕	↕↕	↕
Traffic Volume (veh/h)	65	78	118	141	70	35	122	330	105	74	759	149
Future Volume (veh/h)	65	78	118	141	70	35	122	330	105	74	759	149
Number	3	8	18	7	4	14	1	6	16	5	2	12
Initial Q (Qb), veh	0	0	0	0	0	0	0	0	0	0	0	0
Ped-Bike Adj(A_pbT)	0.98		0.97	0.99		0.97	1.00		0.98	1.00		0.99
Parking Bus, Adj	1.00	1.00	1.00	1.00	1.00	1.00	1.00	1.00	1.00	1.00	1.00	1.00
Adj Sat Flow, veh/h/ln	1900	1881	1900	1900	1863	1900	1881	1881	1900	1863	1863	1863
Adj Flow Rate, veh/h	83	100	122	181	90	41	156	423	108	95	973	122
Adj No. of Lanes	0	1	0	0	1	0	1	2	0	1	2	1
Peak Hour Factor	0.78	0.78	0.78	0.78	0.78	0.78	0.78	0.78	0.78	0.78	0.78	0.78
Percent Heavy Veh, %	1	1	1	2	2	2	1	1	1	2	2	2
Cap, veh/h	194	230	232	350	164	64	196	579	146	383	1105	489
Arrive On Green	0.36	0.35	0.35	0.36	0.35	0.35	0.11	0.21	0.21	0.22	0.31	0.31
Sat Flow, veh/h	334	649	655	722	463	179	1792	2816	712	1774	3539	1566
Grp Volume(v), veh/h	305	0	0	312	0	0	156	267	264	95	973	122
Grp Sat Flow(s),veh/h/ln	1637	0	0	1365	0	0	1792	1787	1741	1774	1770	1566
Q Serve(g_s), s	0.0	0.0	0.0	2.8	0.0	0.0	5.1	8.4	8.6	2.7	15.7	3.5
Cycle Q Clear(g_c), s	8.3	0.0	0.0	11.1	0.0	0.0	5.1	8.4	8.6	2.7	15.7	3.5
Prop In Lane	0.27		0.40	0.58		0.13	1.00		0.41	1.00		1.00
Lane Grp Cap(c), veh/h	670	0	0	590	0	0	196	367	358	383	1105	489
V/C Ratio(X)	0.46	0.00	0.00	0.53	0.00	0.00	0.80	0.73	0.74	0.25	0.88	0.25
Avail Cap(c_a), veh/h	967	0	0	847	0	0	238	756	736	383	1497	662
HCM Platoon Ratio	1.00	1.00	1.00	1.00	1.00	1.00	1.00	1.00	1.00	1.00	1.00	1.00
Upstream Filter(I)	1.00	0.00	0.00	1.00	0.00	0.00	1.00	1.00	1.00	1.00	1.00	1.00
Uniform Delay (d), s/veh	15.2	0.0	0.0	15.8	0.0	0.0	26.2	22.4	22.4	19.6	19.7	15.5
Incr Delay (d2), s/veh	0.2	0.0	0.0	0.3	0.0	0.0	11.6	1.0	1.1	0.1	4.0	0.1
Initial Q Delay(d3),s/veh	0.0	0.0	0.0	0.0	0.0	0.0	0.0	0.0	0.0	0.0	0.0	0.0
%ile BackOfQ(50%),veh/ln	3.9	0.0	0.0	4.3	0.0	0.0	3.1	4.3	4.2	1.3	8.2	1.5
LnGrp Delay(d),s/veh	15.3	0.0	0.0	16.1	0.0	0.0	37.8	23.4	23.6	19.7	23.7	15.6
LnGrp LOS	B			B			D	C	C	B	C	B
Approach Vol, veh/h		305			312			687			1190	
Approach Delay, s/veh		15.3			16.1			26.7			22.5	
Approach LOS		B			B			C			C	
Timer	1	2	3	4	5	6	7	8				
Assigned Phs	1	2		4	5	6		8				
Phs Duration (G+Y+Rc), s	11.1	23.3		25.9	17.5	16.9		25.9				
Change Period (Y+Rc), s	4.5	4.5		4.5	4.5	4.5		4.5				
Max Green Setting (Gmax), s	25.5	25.5		33.0	8.0	25.5		33.0				
Max Q Clear Time (g_c+11), s	17.7	17.7		13.1	4.7	10.6		10.3				
Green Ext Time (p_c), s	0.0	1.1		0.5	0.0	0.5		0.4				
Intersection Summary												
HCM 2010 Ctrl Delay			22.0									
HCM 2010 LOS			C									

Intersection	
Intersection Delay, s/veh	92.2
Intersection LOS	F

Movement	EBL	EBR	NBL	NBT	SBT	SBR
Lane Configurations						
Traffic Vol, veh/h	114	430	221	339	874	135
Future Vol, veh/h	114	430	221	339	874	135
Peak Hour Factor	0.90	0.90	0.90	0.90	0.90	0.90
Heavy Vehicles, %	1	1	1	1	2	2
Mvmt Flow	127	478	246	377	971	150
Number of Lanes	1	1	1	2	2	1

Approach	EB	NB	SB
Opposing Approach		SB	NB
Opposing Lanes	0	3	3
Conflicting Approach Left	SB		
Conflicting Lanes Left	3	2	0
Conflicting Approach Right	NB		EB
Conflicting Lanes Right	3	0	2
HCM Control Delay	115.7	25	116.8
HCM LOS	F	C	F

Lane	NBLn1	NBLn2	NBLn3	EBLn1	EBLn2	SBLn1	SBLn2	SBLn3
Vol Left, %	100%	0%	0%	100%	0%	0%	0%	0%
Vol Thru, %	0%	100%	100%	0%	0%	100%	100%	0%
Vol Right, %	0%	0%	0%	0%	100%	0%	0%	100%
Sign Control	Stop	Stop	Stop	Stop	Stop	Stop	Stop	Stop
Traffic Vol by Lane	221	170	170	114	430	437	437	135
LT Vol	221	0	0	114	0	0	0	0
Through Vol	0	170	170	0	0	437	437	0
RT Vol	0	0	0	0	430	0	0	135
Lane Flow Rate	246	188	188	127	478	486	486	150
Geometry Grp	8	8	8	8	8	8	8	8
Degree of Util (X)	0.671	0.489	0.399	0.36	1.199	1.178	1.178	0.263
Departure Headway (Hd)	10.89	10.366	8.565	10.689	9.47	9.334	9.334	6.786
Convergence, Y/N	Yes	Yes	Yes	Yes	Yes	Yes	Yes	Yes
Cap	334	350	424	338	387	393	393	533
Service Time	8.59	8.066	6.265	8.389	7.17	7.034	7.034	4.486
HCM Lane V/C Ratio	0.737	0.537	0.443	0.376	1.235	1.237	1.237	0.281
HCM Control Delay	33.2	22.6	16.8	19.3	141.3	133	133	11.9
HCM Lane LOS	D	C	C	C	F	F	F	B
HCM 95th-tile Q	4.6	2.6	1.9	1.6	18.6	18	18	1

HCM 2010 Signalized Intersection Summary
 48: Fremont Boulevard/Hwy 1 SB Off-Ramp/ NB On-Ramp & Monterey Road

Existing, AM
 06/11/2019



Movement	EBL	EBT	EBR	WBL	WBT	WBR	NBL	NBT	NBR	SBL	SBT	SBR
Lane Configurations	↖	↗	↘		↔		↖	↗		↖	↗	↘
Traffic Volume (veh/h)	69	136	94	113	283	19	193	506	140	93	804	153
Future Volume (veh/h)	69	136	94	113	283	19	193	506	140	93	804	153
Number	7	4	14	3	8	18	5	2	12	1	6	16
Initial Q (Qb), veh	0	0	0	0	0	0	0	0	0	0	0	0
Ped-Bike Adj(A_pbT)	1.00		0.96	1.00		0.97	1.00		0.98	1.00		0.98
Parking Bus, Adj	1.00	1.00	1.00	1.00	1.00	1.00	1.00	1.00	1.00	1.00	1.00	1.00
Adj Sat Flow, veh/h/ln	1845	1845	1845	1900	1881	1900	1827	1827	1900	1827	1827	1827
Adj Flow Rate, veh/h	76	149	14	124	311	19	212	556	139	102	884	101
Adj No. of Lanes	1	1	1	0	1	0	1	2	0	1	2	1
Peak Hour Factor	0.91	0.91	0.91	0.91	0.91	0.91	0.91	0.91	0.91	0.91	0.91	0.91
Percent Heavy Veh, %	3	3	3	1	1	1	4	4	4	4	4	4
Cap, veh/h	230	241	196	113	282	17	398	1150	286	125	880	388
Arrive On Green	0.13	0.13	0.13	0.22	0.22	0.22	0.23	0.42	0.42	0.07	0.25	0.25
Sat Flow, veh/h	1757	1845	1501	502	1260	77	1740	2745	684	1740	3471	1529
Grp Volume(v), veh/h	76	149	14	454	0	0	212	351	344	102	884	101
Grp Sat Flow(s),veh/h/ln	1757	1845	1501	1840	0	0	1740	1736	1694	1740	1736	1529
Q Serve(g_s), s	4.9	9.5	1.0	28.0	0.0	0.0	13.4	18.4	18.5	7.2	31.7	6.6
Cycle Q Clear(g_c), s	4.9	9.5	1.0	28.0	0.0	0.0	13.4	18.4	18.5	7.2	31.7	6.6
Prop In Lane	1.00		1.00	0.27		0.04	1.00		0.40	1.00		1.00
Lane Grp Cap(c), veh/h	230	241	196	412	0	0	398	727	709	125	880	388
V/C Ratio(X)	0.33	0.62	0.07	1.10	0.00	0.00	0.53	0.48	0.49	0.81	1.00	0.26
Avail Cap(c_a), veh/h	436	457	372	412	0	0	398	727	709	209	880	388
HCM Platoon Ratio	1.00	1.00	1.00	1.00	1.00	1.00	1.00	1.00	1.00	1.00	1.00	1.00
Upstream Filter(I)	0.78	0.78	0.78	1.00	0.00	0.00	1.00	1.00	1.00	1.00	1.00	1.00
Uniform Delay (d), s/veh	49.4	51.4	47.7	48.5	0.0	0.0	42.4	26.4	26.5	57.2	46.7	37.3
Incr Delay (d2), s/veh	0.7	2.0	0.1	74.8	0.0	0.0	0.7	2.3	2.4	4.8	31.4	1.6
Initial Q Delay(d3),s/veh	0.0	0.0	0.0	0.0	0.0	0.0	0.0	0.0	0.0	0.0	0.0	0.0
%ile BackOfQ(50%),veh/ln	2.4	5.0	0.4	22.8	0.0	0.0	6.5	9.2	9.1	3.7	19.0	3.0
LnGrp Delay(d),s/veh	50.0	53.4	47.8	123.3	0.0	0.0	43.1	28.7	28.9	61.9	78.0	38.9
LnGrp LOS	D	D	D	F			D	C	C	E	F	D
Approach Vol, veh/h		239			454			907			1087	
Approach Delay, s/veh		52.0			123.3			32.1			72.9	
Approach LOS		D			F			C			E	
Timer	1	2	3	4	5	6	7	8				
Assigned Phs	1	2		4	5	6		8				
Phs Duration (G+Y+Rc), s	3.2	57.7		21.0	33.9	37.0		33.1				
Change Period (Y+Rc), s	4.2	5.3		* 4.7	5.3	* 5.3		5.1				
Max Green Setting (Gmax), s	15	31.7		* 31	15.0	* 32		28.0				
Max Q Clear Time (g_c+1/2), s	19.2	20.5		11.5	15.4	33.7		30.0				
Green Ext Time (p_c), s	0.1	2.7		1.0	0.0	0.0		0.0				

Intersection Summary

HCM 2010 Ctrl Delay	65.8
HCM 2010 LOS	E

Notes

HCM 2010 Signalized Intersection Summary
 49: Highway 1 SB On-Ramp & Highway 1 NB Off-Ramp/Monterey Road

Existing, AM
 06/11/2019



Movement	EBL	EBT	EBR	WBL	WBT	WBR	NBL	NBT	NBR	SBL	SBT	SBR
Lane Configurations		↕↕	↗	↖		↗		↕	↗		↕	
Traffic Volume (veh/h)	2	198	100	225	0	416	0	41	109	0	1	0
Future Volume (veh/h)	2	198	100	225	0	416	0	41	109	0	1	0
Number	1	6	16	5	2	12	7	4	14	3	8	18
Initial Q (Qb), veh	0	0	0	0	0	0	0	0	0	0	0	0
Ped-Bike Adj(A_pbT)	1.00		1.00	1.00		1.00	1.00		1.00	1.00		1.00
Parking Bus, Adj	1.00	1.00	1.00	1.00	1.00	1.00	1.00	1.00	1.00	1.00	1.00	1.00
Adj Sat Flow, veh/h/ln	1900	1845	1845	1863	0	1863	0	1845	1845	1900	1900	0
Adj Flow Rate, veh/h	2	204	9	232	0	290	0	42	9	0	1	0
Adj No. of Lanes	0	2	1	1	0	1	0	1	1	0	1	0
Peak Hour Factor	0.97	0.97	0.97	0.97	0.97	0.97	0.97	0.97	0.97	0.97	0.97	0.97
Percent Heavy Veh, %	3	3	3	2	0	2	0	3	3	0	0	0
Cap, veh/h	29	3079	1354	0	0	0	0	110	94	0	114	0
Arrive On Green	0.86	0.86	0.86	0.00	0.00	0.00	0.00	0.06	0.06	0.00	0.06	0.00
Sat Flow, veh/h	33	3562	1566			0	0	1845	1568	0	1900	0
Grp Volume(v), veh/h	110	96	9		0.0		0	42	9	0	1	0
Grp Sat Flow(s),veh/h/ln	1843	1752	1566				0	1845	1568	0	1900	0
Q Serve(g_s), s	1.1	1.0	0.1				0.0	2.7	0.7	0.0	0.1	0.0
Cycle Q Clear(g_c), s	1.1	1.0	0.1				0.0	2.7	0.7	0.0	0.1	0.0
Prop In Lane	0.02		1.00				0.00		1.00	0.00		0.00
Lane Grp Cap(c), veh/h	1593	1515	1354				0	110	94	0	114	0
V/C Ratio(X)	0.07	0.06	0.01				0.00	0.38	0.10	0.00	0.01	0.00
Avail Cap(c_a), veh/h	1593	1515	1354				0	148	125	0	152	0
HCM Platoon Ratio	1.00	1.00	1.00				1.00	1.00	1.00	1.00	1.00	1.00
Upstream Filter(I)	1.00	1.00	1.00				0.00	1.00	1.00	0.00	1.00	0.00
Uniform Delay (d), s/veh	1.2	1.2	1.2				0.0	56.5	55.6	0.0	55.3	0.0
Incr Delay (d2), s/veh	0.0	0.0	0.0				0.0	0.8	0.2	0.0	0.0	0.0
Initial Q Delay(d3),s/veh	0.0	0.0	0.0				0.0	0.0	0.0	0.0	0.0	0.0
%ile BackOfQ(50%),veh/ln	0.6	0.5	0.0				0.0	1.4	0.3	0.0	0.0	0.0
LnGrp Delay(d),s/veh	1.2	1.2	1.2				0.0	57.3	55.7	0.0	55.3	0.0
LnGrp LOS	A	A	A					E	E		E	
Approach Vol, veh/h		215						51			1	
Approach Delay, s/veh		1.2						57.1			55.3	
Approach LOS		A						E			E	
Timer	1	2	3	4	5	6	7	8				
Assigned Phs				4		6		8				
Phs Duration (G+Y+Rc), s				11.7		113.3		11.7				
Change Period (Y+Rc), s				* 4.2		5.3		* 4.2				
Max Green Setting (Gmax), s				* 10		21.0		* 10				
Max Q Clear Time (g_c+I1), s				4.7		3.1		2.1				
Green Ext Time (p_c), s				0.0		0.7		0.0				
Intersection Summary												
HCM 2010 Ctrl Delay				12.1								
HCM 2010 LOS				B								
Notes												

HCM 2010 Signalized Intersection Summary
 50: Reservation Road & SR 68 WB On Ramp/SR 68 WB Off Ramp

Existing, AM
 06/11/2019



Movement	EBL	EBT	EBR	WBL	WBT	WBR	NBL	NBT	NBR	SBL	SBT	SBR
Lane Configurations					↕	↕	↕	↕			↕	
Traffic Volume (veh/h)	0	0	0	243	0	293	123	355	0	0	335	105
Future Volume (veh/h)	0	0	0	243	0	293	123	355	0	0	335	105
Number				7	4	14	1	6	16	5	2	12
Initial Q (Qb), veh				0	0	0	0	0	0	0	0	0
Ped-Bike Adj(A_pbT)				1.00		1.00	1.00		1.00	1.00		1.00
Parking Bus, Adj				1.00	1.00	1.00	1.00	1.00	1.00	1.00	1.00	1.00
Adj Sat Flow, veh/h/ln				1900	1827	1827	1863	1863	0	0	1827	1900
Adj Flow Rate, veh/h				256	0	56	129	374	0	0	353	102
Adj No. of Lanes				0	1	1	1	1	0	0	1	0
Peak Hour Factor				0.95	0.95	0.95	0.95	0.95	0.95	0.95	0.95	0.95
Percent Heavy Veh, %				4	4	4	2	2	0	0	4	4
Cap, veh/h				374	0	334	223	1004	0	0	456	132
Arrive On Green				0.22	0.00	0.22	0.13	0.54	0.00	0.00	0.33	0.33
Sat Flow, veh/h				1740	0	1553	1774	1863	0	0	1363	394
Grp Volume(v), veh/h				256	0	56	129	374	0	0	0	455
Grp Sat Flow(s),veh/h/ln				1740	0	1553	1774	1863	0	0	0	1757
Q Serve(g_s), s				6.0	0.0	1.3	3.0	5.1	0.0	0.0	0.0	10.3
Cycle Q Clear(g_c), s				6.0	0.0	1.3	3.0	5.1	0.0	0.0	0.0	10.3
Prop In Lane				1.00		1.00	1.00		0.00	0.00		0.22
Lane Grp Cap(c), veh/h				374	0	334	223	1004	0	0	0	587
V/C Ratio(X)				0.68	0.00	0.17	0.58	0.37	0.00	0.00	0.00	0.77
Avail Cap(c_a), veh/h				1571	0	1402	1041	1598	0	0	0	1507
HCM Platoon Ratio				1.00	1.00	1.00	1.00	1.00	1.00	1.00	1.00	1.00
Upstream Filter(I)				1.00	0.00	1.00	1.00	1.00	0.00	0.00	0.00	1.00
Uniform Delay (d), s/veh				16.0	0.0	14.2	18.3	5.9	0.0	0.0	0.0	13.3
Incr Delay (d2), s/veh				2.2	0.0	0.2	0.9	0.2	0.0	0.0	0.0	2.2
Initial Q Delay(d3),s/veh				0.0	0.0	0.0	0.0	0.0	0.0	0.0	0.0	0.0
%ile BackOfQ(50%),veh/ln				3.1	0.0	0.6	1.5	2.7	0.0	0.0	0.0	5.3
LnGrp Delay(d),s/veh				18.2	0.0	14.4	19.1	6.1	0.0	0.0	0.0	15.5
LnGrp LOS				B		B	B	A				B
Approach Vol, veh/h					312			503			455	
Approach Delay, s/veh					17.5			9.5			15.5	
Approach LOS					B			A			B	
Timer	1	2	3	4	5	6	7	8				
Assigned Phs	1	2		4		6						
Phs Duration (G+Y+Rc), s	9.1	20.8		14.4		29.9						
Change Period (Y+Rc), s	3.5	6.0		4.9		6.0						
Max Green Setting (Gmax), s	26.0	38.0		40.0		38.0						
Max Q Clear Time (g_c+15), s	15.0	12.3		8.0		7.1						
Green Ext Time (p_c), s	0.1	2.5		1.7		2.0						
Intersection Summary												
HCM 2010 Ctrl Delay				13.6								
HCM 2010 LOS				B								

HCM 2010 Signalized Intersection Summary
 51: River Road/Reservation Road & SR 68 Off Ramp/SR 68 EB On Ramp





















Existing, AM
 06/11/2019



Movement	EBL	EBT	EBR	WBL	WBT	WBR	NBL	NBT	NBR	SBL	SBT	SBR
Lane Configurations		↕	↗					↑	↗	↘	↑	
Traffic Volume (veh/h)	96	1	105	0	0	0	0	376	664	223	346	0
Future Volume (veh/h)	96	1	105	0	0	0	0	376	664	223	346	0
Number	3	8	18				1	6	16	5	2	12
Initial Q (Qb), veh	0	0	0				0	0	0	0	0	0
Ped-Bike Adj(A_pbT)	1.00		1.00				1.00		1.00	1.00		1.00
Parking Bus, Adj	1.00	1.00	1.00				1.00	1.00	1.00	1.00	1.00	1.00
Adj Sat Flow, veh/h/ln	1900	1881	1881				0	1881	1881	1827	1827	0
Adj Flow Rate, veh/h	104	1	13				0	409	393	242	376	0
Adj No. of Lanes	0	1	1				0	1	1	1	1	0
Peak Hour Factor	0.92	0.92	0.92				0.92	0.92	0.92	0.92	0.92	0.92
Percent Heavy Veh, %	1	1	1				0	1	1	4	4	0
Cap, veh/h	151	1	136				0	664	564	330	1163	0
Arrive On Green	0.09	0.09	0.09				0.00	0.35	0.35	0.19	0.64	0.00
Sat Flow, veh/h	1775	17	1599				0	1881	1599	1740	1827	0
Grp Volume(v), veh/h	105	0	13				0	409	393	242	376	0
Grp Sat Flow(s),veh/h/ln	1792	0	1599				0	1881	1599	1740	1827	0
Q Serve(g_s), s	2.2	0.0	0.3				0.0	7.0	8.3	5.1	3.7	0.0
Cycle Q Clear(g_c), s	2.2	0.0	0.3				0.0	7.0	8.3	5.1	3.7	0.0
Prop In Lane	0.99		1.00				0.00		1.00	1.00		0.00
Lane Grp Cap(c), veh/h	152	0	136				0	664	564	330	1163	0
V/C Ratio(X)	0.69	0.00	0.10				0.00	0.62	0.70	0.73	0.32	0.00
Avail Cap(c_a), veh/h	1830	0	1632				0	1776	1510	1066	1725	0
HCM Platoon Ratio	1.00	1.00	1.00				1.00	1.00	1.00	1.00	1.00	1.00
Upstream Filter(I)	1.00	0.00	1.00				0.00	1.00	1.00	1.00	1.00	0.00
Uniform Delay (d), s/veh	17.4	0.0	16.5				0.0	10.5	10.9	14.9	3.3	0.0
Incr Delay (d2), s/veh	2.1	0.0	0.1				0.0	0.9	1.6	3.2	0.2	0.0
Initial Q Delay(d3),s/veh	0.0	0.0	0.0				0.0	0.0	0.0	0.0	0.0	0.0
%ile BackOfQ(50%),veh/ln	1.2	0.0	0.1				0.0	3.8	3.8	2.7	1.8	0.0
LnGrp Delay(d),s/veh	19.5	0.0	16.6				0.0	11.4	12.4	18.1	3.4	0.0
LnGrp LOS	B		B					B	B	B	A	
Approach Vol, veh/h		118						802			618	
Approach Delay, s/veh		19.2						11.9			9.2	
Approach LOS		B						B			A	
Timer	1	2	3	4	5	6	7	8				
Assigned Phs		2			5	6		8				
Phs Duration (G+Y+Rc), s		31.0			11.1	19.8		8.2				
Change Period (Y+Rc), s		6.0			3.7	6.0		4.9				
Max Green Setting (Gmax), s		37.0			24.0	37.0		40.0				
Max Q Clear Time (g_c+I1), s		5.7			7.1	10.3		4.2				
Green Ext Time (p_c), s		2.1			0.6	3.6		0.4				
Intersection Summary												
HCM 2010 Ctrl Delay			11.4									
HCM 2010 LOS			B									

HCM 2010 Signalized Intersection Summary
 1: Del Monte Boulevard & Reindollar Avenue

Existing, PM
 06/11/2019

												
Movement	EBL	EBT	EBR	WBL	WBT	WBR	NBL	NBT	NBR	SBL	SBT	SBR
Lane Configurations												
Traffic Volume (veh/h)	0	0	0	171	0	85	4	1010	318	73	475	0
Future Volume (veh/h)	0	0	0	171	0	85	4	1010	318	73	475	0
Number				3	8	18	1	6	16	5	2	12
Initial Q (Qb), veh				0	0	0	0	0	0	0	0	0
Ped-Bike Adj(A_pbT)				1.00		1.00	1.00		1.00	1.00		1.00
Parking Bus, Adj				1.00	1.00	1.00	1.00	1.00	1.00	1.00	1.00	1.00
Adj Sat Flow, veh/h/ln				1881	1881	1900	1881	1881	1881	1881	1881	0
Adj Flow Rate, veh/h				194	0	0	4	1052	248	76	495	0
Adj No. of Lanes				2	1	0	1	2	1	1	2	0
Peak Hour Factor				0.96	0.96	0.96	0.96	0.96	0.96	0.96	0.96	0.96
Percent Heavy Veh, %				1	1	1	1	1	1	1	1	0
Cap, veh/h				453	238	0	10	1683	753	127	1917	0
Arrive On Green				0.13	0.00	0.00	0.01	0.47	0.47	0.07	0.54	0.00
Sat Flow, veh/h				3583	1881	0	1792	3574	1599	1792	3668	0
Grp Volume(v), veh/h				194	0	0	4	1052	248	76	495	0
Grp Sat Flow(s),veh/h/ln				1792	1881	0	1792	1787	1599	1792	1787	0
Q Serve(g_s), s				2.0	0.0	0.0	0.1	9.0	4.0	1.7	3.0	0.0
Cycle Q Clear(g_c), s				2.0	0.0	0.0	0.1	9.0	4.0	1.7	3.0	0.0
Prop In Lane				1.00		0.00	1.00		1.00	1.00		0.00
Lane Grp Cap(c), veh/h				453	238	0	10	1683	753	127	1917	0
V/C Ratio(X)				0.43	0.00	0.00	0.41	0.63	0.33	0.60	0.26	0.00
Avail Cap(c_a), veh/h				2642	1387	0	1321	2636	1179	1321	2636	0
HCM Platoon Ratio				1.00	1.00	1.00	1.00	1.00	1.00	1.00	1.00	1.00
Upstream Filter(I)				1.00	0.00	0.00	1.00	1.00	1.00	1.00	1.00	0.00
Uniform Delay (d), s/veh				16.4	0.0	0.0	20.2	8.1	6.7	18.3	5.1	0.0
Incr Delay (d2), s/veh				0.6	0.0	0.0	25.4	0.4	0.3	4.5	0.1	0.0
Initial Q Delay(d3),s/veh				0.0	0.0	0.0	0.0	0.0	0.0	0.0	0.0	0.0
%ile BackOfQ(50%),veh/ln				1.0	0.0	0.0	0.1	4.5	1.8	1.0	1.5	0.0
LnGrp Delay(d),s/veh				17.1	0.0	0.0	45.6	8.5	7.0	22.8	5.1	0.0
LnGrp LOS				B			D	A	A	C	A	
Approach Vol, veh/h					194			1304			571	
Approach Delay, s/veh					17.1			8.3			7.5	
Approach LOS					B			A			A	
Timer	1	2	3	4	5	6	7	8				
Assigned Phs	1	2			5	6		8				
Phs Duration (G+Y+Rc), s	3.7	26.8			6.4	24.2		10.1				
Change Period (Y+Rc), s	3.5	5.0			3.5	5.0		5.0				
Max Green Setting (Gmax), s	30.0	30.0			30.0	30.0		30.0				
Max Q Clear Time (g_c+I1), s	2.1	5.0			3.7	11.0		4.0				
Green Ext Time (p_c), s	0.0	3.4			0.2	8.2		0.7				
Intersection Summary												
HCM 2010 Ctrl Delay				8.9								
HCM 2010 LOS				A								
Notes												

HCM 2010 Signalized Intersection Summary
 3: SR 1 SB On-Ramp/SR 1 SB Off-Ramp & Imjin Parkway

Existing, PM
 06/11/2019



Movement	EBL	EBT	EBR	WBL	WBT	WBR	NBL	NBT	NBR	SBL	SBT	SBR
Lane Configurations					↕						↕	
Traffic Volume (veh/h)	0	0	0	992	0	0	0	0	0	260	1	0
Future Volume (veh/h)	0	0	0	992	0	0	0	0	0	260	1	0
Number				1	6	16				7	4	14
Initial Q (Qb), veh				0	0	0				0	0	0
Ped-Bike Adj(A_pbT)				1.00		1.00				1.00		1.00
Parking Bus, Adj				1.00	1.00	1.00				1.00	1.00	1.00
Adj Sat Flow, veh/h/ln				1900	1881	0				1900	1863	0
Adj Flow Rate, veh/h				1090	0	0				286	1	0
Adj No. of Lanes				0	1	0				0	1	0
Peak Hour Factor				0.91	0.91	0.91				0.91	0.91	0.91
Percent Heavy Veh, %				1	1	0				2	2	0
Cap, veh/h				1233	0	0				357	1	0
Arrive On Green				0.69	0.00	0.00				0.21	0.20	0.00
Sat Flow, veh/h				1792	0	0				1768	6	0
Grp Volume(v), veh/h				1090	0	0				287	0	0
Grp Sat Flow(s),veh/h/ln				1792	0	0				1774	0	0
Q Serve(g_s), s				38.5	0.0	0.0				12.3	0.0	0.0
Cycle Q Clear(g_c), s				38.5	0.0	0.0				12.3	0.0	0.0
Prop In Lane				1.00		0.00				1.00		0.00
Lane Grp Cap(c), veh/h				1233	0	0				358	0	0
V/C Ratio(X)				0.88	0.00	0.00				0.80	0.00	0.00
Avail Cap(c_a), veh/h				2020	0	0				1334	0	0
HCM Platoon Ratio				1.00	1.00	1.00				1.00	1.00	1.00
Upstream Filter(I)				1.00	0.00	0.00				1.00	0.00	0.00
Uniform Delay (d), s/veh				9.7	0.0	0.0				30.1	0.0	0.0
Incr Delay (d2), s/veh				2.9	0.0	0.0				4.2	0.0	0.0
Initial Q Delay(d3),s/veh				0.0	0.0	0.0				0.0	0.0	0.0
%ile BackOfQ(50%),veh/ln				19.4	0.0	0.0				6.4	0.0	0.0
LnGrp Delay(d),s/veh				12.7	0.0	0.0				34.3	0.0	0.0
LnGrp LOS				B						C		
Approach Vol, veh/h					1090						287	
Approach Delay, s/veh					12.7						34.3	
Approach LOS					B						C	
Timer	1	2	3	4	5	6	7	8				
Assigned Phs				4		6						
Phs Duration (G+Y+Rc), s				20.5		59.3						
Change Period (Y+Rc), s				4.4		4.4						
Max Green Setting (Gmax), s				60.0		90.0						
Max Q Clear Time (g_c+I1), s				14.3		40.5						
Green Ext Time (p_c), s				1.8		14.4						
Intersection Summary												
HCM 2010 Ctrl Delay				17.2								
HCM 2010 LOS				B								

Intersection												
Int Delay, s/veh	0.2											
Movement	EBL	EBT	EBR	WBL	WBT	WBR	NBL	NBT	NBR	SBL	SBT	SBR
Lane Configurations		↔			↑	↗		↖	↗			
Traffic Vol, veh/h	7	247	0	0	995	422	4	2	1186	0	0	0
Future Vol, veh/h	7	247	0	0	995	422	4	2	1186	0	0	0
Conflicting Peds, #/hr	0	0	1	1	0	0	0	0	0	0	0	0
Sign Control	Free	Free	Free	Free	Free	Free	Stop	Stop	Stop	Stop	Stop	Stop
RT Channelized	-	-	None	-	-	Free	-	-	Free	-	-	None
Storage Length	-	-	-	-	-	0	-	-	800	-	-	-
Veh in Median Storage, #	-	0	-	-	0	-	-	0	-	-	16965	-
Grade, %	-	0	-	-	0	-	-	0	-	-	0	-
Peak Hour Factor	95	95	95	95	95	95	95	95	95	95	95	95
Heavy Vehicles, %	2	2	2	1	1	1	1	1	1	2	2	2
Mvmt Flow	7	260	0	0	1047	444	4	2	1248	0	0	0























Major/Minor	Major1	Major2	Minor1
Conflicting Flow All	1047	0	-
Stage 1	-	-	-
Stage 2	-	-	-
Critical Hdwy	4.12	-	-
Critical Hdwy Stg 1	-	-	-
Critical Hdwy Stg 2	-	-	-
Follow-up Hdwy	2.218	-	-
Pot Cap-1 Maneuver	665	0	0
Stage 1	-	0	0
Stage 2	-	0	0
Platoon blocked, %	-	-	-
Mov Cap-1 Maneuver	665	-	-
Mov Cap-2 Maneuver	-	-	-
Stage 1	-	-	-
Stage 2	-	-	-

Approach	EB	WB	NB
HCM Control Delay, s	0.3	0	26.7
HCM LOS			D

Minor Lane/Major Mvmt	NBLn1	NBLn2	EBL	EBT	WBT
Capacity (veh/h)	172	-	665	-	-
HCM Lane V/C Ratio	0.037	-	0.011	-	-
HCM Control Delay (s)	26.7	0	10.5	0	-
HCM Lane LOS	D	A	B	A	-
HCM 95th %tile Q(veh)	0.1	-	0	-	-

HCM 2010 Signalized Intersection Summary
5: 2nd Avenue & Imjin Parkway

Existing, PM
06/11/2019

												
Movement	EBL	EBT	EBR	WBL	WBT	WBR	NBL	NBT	NBR	SBL	SBT	SBR
Lane Configurations												
Traffic Volume (veh/h)	6	1002	326	248	941	3	412	2	295	9	12	34
Future Volume (veh/h)	6	1002	326	248	941	3	412	2	295	9	12	34
Number	5	2	12	1	6	16	3	8	18	7	4	14
Initial Q (Qb), veh	0	0	0	0	0	0	0	0	0	0	0	0
Ped-Bike Adj(A_pbT)	1.00		1.00	1.00		0.99	1.00		0.98	1.00		0.96
Parking Bus, Adj	1.00	1.00	1.00	1.00	1.00	1.00	1.00	1.00	1.00	1.00	1.00	1.00
Adj Sat Flow, veh/h/ln	1881	1881	1881	1881	1881	1900	1900	1900	1900	1900	1900	1900
Adj Flow Rate, veh/h	6	1044	140	258	980	3	429	2	73	9	12	4
Adj No. of Lanes	1	2	1	2	2	0	2	1	1	1	2	0
Peak Hour Factor	0.96	0.96	0.96	0.96	0.96	0.96	0.96	0.96	0.96	0.96	0.96	0.96
Percent Heavy Veh, %	1	1	1	1	1	1	0	0	0	0	0	0
Cap, veh/h	107	1225	545	388	1443	4	555	247	207	108	85	27
Arrive On Green	0.06	0.34	0.34	0.11	0.39	0.39	0.16	0.13	0.13	0.06	0.03	0.03
Sat Flow, veh/h	1792	3574	1592	3476	3655	11	3510	1900	1589	1810	2683	838
Grp Volume(v), veh/h	6	1044	140	258	479	504	429	2	73	9	8	8
Grp Sat Flow(s),veh/h/ln	1792	1787	1592	1738	1787	1879	1755	1900	1589	1810	1805	1716
Q Serve(g_s), s	0.2	13.6	3.2	3.6	11.2	11.2	5.9	0.0	2.1	0.2	0.2	0.2
Cycle Q Clear(g_c), s	0.2	13.6	3.2	3.6	11.2	11.2	5.9	0.0	2.1	0.2	0.2	0.2
Prop In Lane	1.00		1.00	1.00		0.01	1.00		1.00	1.00		0.49
Lane Grp Cap(c), veh/h	107	1225	545	388	705	742	555	247	207	108	57	54
V/C Ratio(X)	0.06	0.85	0.26	0.66	0.68	0.68	0.77	0.01	0.35	0.08	0.14	0.15
Avail Cap(c_a), veh/h	534	2132	950	1037	1066	1121	1396	793	663	360	754	717
HCM Platoon Ratio	1.00	1.00	1.00	1.00	1.00	1.00	1.00	1.00	1.00	1.00	1.00	1.00
Upstream Filter(I)	1.00	1.00	1.00	1.00	1.00	1.00	1.00	1.00	1.00	1.00	1.00	1.00
Uniform Delay (d), s/veh	22.3	15.4	11.9	21.4	12.6	12.6	20.3	19.0	19.9	22.4	23.7	23.7
Incr Delay (d2), s/veh	0.1	0.7	0.1	0.7	0.4	0.4	0.9	0.0	0.4	0.1	0.4	0.5
Initial Q Delay(d3),s/veh	0.0	0.0	0.0	0.0	0.0	0.0	0.0	0.0	0.0	0.0	0.0	0.0
%ile BackOfQ(50%),veh/ln	0.1	6.8	1.4	1.8	5.5	5.8	2.9	0.0	0.9	0.1	0.1	0.1
LnGrp Delay(d),s/veh	22.4	16.0	12.0	22.2	13.0	13.0	21.2	19.0	20.3	22.5	24.1	24.2
LnGrp LOS	C	B	B	C	B	B	C	B	C	C	C	C
Approach Vol, veh/h		1190			1241			504			25	
Approach Delay, s/veh		15.6			14.9			21.1			23.5	
Approach LOS		B			B			C			C	
Timer	1	2	3	4	5	6	7	8				
Assigned Phs	1	2	3	4	5	6	7	8				
Phs Duration (G+Y+Rc), s	10.1	22.5	11.5	6.2	7.5	25.2	6.5	11.1				
Change Period (Y+Rc), s	4.5	5.3	3.5	4.6	4.5	5.3	3.5	4.6				
Max Green Setting (Gmax), s	15.0	30.0	20.0	21.0	15.0	30.0	10.0	21.0				
Max Q Clear Time (g_c+I1), s	5.6	15.6	7.9	2.2	2.2	13.2	2.2	4.1				
Green Ext Time (p_c), s	0.0	1.5	0.1	0.0	0.0	1.0	0.0	0.0				
Intersection Summary												
HCM 2010 Ctrl Delay				16.3								
HCM 2010 LOS				B								

Intersection												
Int Delay, s/veh	1.3											
Movement	EBL	EBT	EBR	WBL	WBT	WBR	NBL	NBT	NBR	SBL	SBT	SBR
Lane Configurations	↖	↖↗		↖	↖↗		↖	↗		↖	↗	
Traffic Vol, veh/h	50	1290	8	21	1144	12	4	1	23	4	1	42
Future Vol, veh/h	50	1290	8	21	1144	12	4	1	23	4	1	42
Conflicting Peds, #/hr	2	0	1	1	0	2	1	0	0	0	0	1
Sign Control	Free	Free	Free	Free	Free	Free	Stop	Stop	Stop	Stop	Stop	Stop
RT Channelized	-	-	None	-	-	None	-	-	None	-	-	None
Storage Length	300	-	-	300	-	-	85	-	-	25	-	-
Veh in Median Storage, #	-	0	-	-	0	-	-	0	-	-	0	-
Grade, %	-	0	-	-	0	-	-	0	-	-	0	-
Peak Hour Factor	98	98	98	98	98	98	98	98	98	98	98	98
Heavy Vehicles, %	1	1	1	1	1	1	0	0	0	0	0	0
Mvmt Flow	51	1316	8	21	1167	12	4	1	23	4	1	43

Major/Minor	Major1			Major2			Minor1			Minor2		
Conflicting Flow All	1181	0	0	1325	0	0	2050	2646	663	1978	2644	593
Stage 1	-	-	-	-	-	-	1423	1423	-	1217	1217	-
Stage 2	-	-	-	-	-	-	627	1223	-	761	1427	-
Critical Hdwy	4.12	-	-	4.12	-	-	7.5	6.5	6.9	7.5	6.5	6.9
Critical Hdwy Stg 1	-	-	-	-	-	-	6.5	5.5	-	6.5	5.5	-
Critical Hdwy Stg 2	-	-	-	-	-	-	6.5	5.5	-	6.5	5.5	-
Follow-up Hdwy	2.21	-	-	2.21	-	-	3.5	4	3.3	3.5	4	3.3
Pot Cap-1 Maneuver	593	-	-	522	-	-	33	24	409	38	24	454
Stage 1	-	-	-	-	-	-	145	204	-	195	256	-
Stage 2	-	-	-	-	-	-	443	254	-	368	203	-
Platoon blocked, %	-	-	-	-	-	-	-	-	-	-	-	-
Mov Cap-1 Maneuver	592	-	-	522	-	-	26	21	409	31	21	453
Mov Cap-2 Maneuver	-	-	-	-	-	-	26	21	-	31	21	-
Stage 1	-	-	-	-	-	-	132	186	-	178	245	-
Stage 2	-	-	-	-	-	-	383	243	-	315	185	-

Approach	EB			WB			NB			SB		
HCM Control Delay, s	0.4			0.2			43.2			28.9		
HCM LOS							E			D		

Minor Lane/Major Mvmt	NBLn1	NBLn2	EBL	EBT	EBR	WBL	WBT	WBR	SBLn1	SBLn2
Capacity (veh/h)	26	231	592	-	-	522	-	-	31	306
HCM Lane V/C Ratio	0.157	0.106	0.086	-	-	0.041	-	-	0.132	0.143
HCM Control Delay (s)	167.7	22.4	11.7	-	-	12.2	-	-	138	18.7
HCM Lane LOS	F	C	B	-	-	B	-	-	F	C
HCM 95th %tile Q(veh)	0.5	0.4	0.3	-	-	0.1	-	-	0.4	0.5

Intersection												
Int Delay, s/veh	1.4											
Movement	EBL	EBT	EBR	WBL	WBT	WBR	NBL	NBT	NBR	SBL	SBT	SBR
Lane Configurations	↵	↕		↵	↕			↕			↕	
Traffic Vol, veh/h	2	1406	7	0	1156	1	14	0	2	8	0	0
Future Vol, veh/h	2	1406	7	0	1156	1	14	0	2	8	0	0
Conflicting Peds, #/hr	2	0	0	0	0	2	0	0	0	0	0	0
Sign Control	Free	Free	Free	Free	Free	Free	Stop	Stop	Stop	Stop	Stop	Stop
RT Channelized	-	-	None	-	-	None	-	-	None	-	-	Stop
Storage Length	330	-	-	330	-	-	-	-	-	-	-	-
Veh in Median Storage, #	-	0	-	-	0	-	-	0	-	-	0	-
Grade, %	-	0	-	-	0	-	-	0	-	-	0	-
Peak Hour Factor	97	97	97	97	97	97	97	97	97	97	97	97
Heavy Vehicles, %	1	1	1	1	1	1	0	0	0	0	0	0
Mvmt Flow	2	1449	7	0	1192	1	14	0	2	8	0	0



















Major/Minor	Major1			Major2			Minor1			Minor2		
Conflicting Flow All	1195	0	0	1456	0	0	2053	2652	728	1924	2655	599
Stage 1	-	-	-	-	-	-	1457	1457	-	1195	1195	-
Stage 2	-	-	-	-	-	-	596	1195	-	729	1460	-
Critical Hdwy	4.12	-	-	4.12	-	-	7.5	6.5	6.9	7.5	6.5	6.9
Critical Hdwy Stg 1	-	-	-	-	-	-	6.5	5.5	-	6.5	5.5	-
Critical Hdwy Stg 2	-	-	-	-	-	-	6.5	5.5	-	6.5	5.5	-
Follow-up Hdwy	2.21	-	-	2.21	-	-	3.5	4	3.3	3.5	4	3.3
Pot Cap-1 Maneuver	586	-	-	466	-	-	33	23	370	41	23	450
Stage 1	-	-	-	-	-	-	139	196	-	201	262	-
Stage 2	-	-	-	-	-	-	462	262	-	385	196	-
Platoon blocked, %	-	-	-	-	-	-	-	-	-	-	-	-
Mov Cap-1 Maneuver	585	-	-	466	-	-	33	23	370	41	23	449
Mov Cap-2 Maneuver	-	-	-	-	-	-	33	23	-	41	23	-
Stage 1	-	-	-	-	-	-	139	195	-	200	261	-
Stage 2	-	-	-	-	-	-	462	261	-	382	195	-

Approach	EB			WB			NB			SB		
HCM Control Delay, s	0			0			164.9			113.7		
HCM LOS							F			F		

Minor Lane/Major Mvmt	NBLn1	EBL	EBT	EBR	WBL	WBT	WBR	SBLn1
Capacity (veh/h)	37	585	-	-	466	-	-	41
HCM Lane V/C Ratio	0.446	0.004	-	-	-	-	-	0.201
HCM Control Delay (s)	164.9	11.2	-	-	0	-	-	113.7
HCM Lane LOS	F	B	-	-	A	-	-	F
HCM 95th %tile Q(veh)	1.5	0	-	-	0	-	-	0.7

HCM 2010 Signalized Intersection Summary
 8: 5th Avenue/California Avenue & Imjin Parkway

Existing, PM
 06/11/2019

												
Movement	EBL	EBT	EBR	WBL	WBT	WBR	NBL	NBT	NBR	SBL	SBT	SBR
Lane Configurations												
Traffic Volume (veh/h)	255	1053	4	2	995	68	12	38	4	37	25	200
Future Volume (veh/h)	255	1053	4	2	995	68	12	38	4	37	25	200
Number	5	2	12	1	6	16	3	8	18	7	4	14
Initial Q (Qb), veh	0	0	0	0	0	0	0	0	0	0	0	0
Ped-Bike Adj(A_pbT)	1.00		1.00	1.00		1.00	1.00		1.00	1.00		0.98
Parking Bus, Adj	1.00	1.00	1.00	1.00	1.00	1.00	1.00	1.00	1.00	1.00	1.00	1.00
Adj Sat Flow, veh/h/ln	1881	1881	1900	1881	1881	1900	1900	1900	1900	1900	1881	1900
Adj Flow Rate, veh/h	263	1086	4	2	1026	64	12	39	1	38	26	37
Adj No. of Lanes	1	2	0	1	2	0	0	1	0	0	1	0
Peak Hour Factor	0.97	0.97	0.97	0.97	0.97	0.97	0.97	0.97	0.97	0.97	0.97	0.97
Percent Heavy Veh, %	1	1	1	1	1	1	0	0	0	1	1	1
Cap, veh/h	328	1963	7	5	1217	76	153	135	3	191	41	56
Arrive On Green	0.18	0.54	0.54	0.00	0.36	0.36	0.11	0.09	0.09	0.11	0.09	0.09
Sat Flow, veh/h	1792	3652	13	1792	3417	213	338	1438	35	585	440	592
Grp Volume(v), veh/h	263	531	559	2	537	553	52	0	0	101	0	0
Grp Sat Flow(s),veh/h/ln	1792	1787	1879	1792	1787	1843	1811	0	0	1617	0	0
Q Serve(g_s), s	5.1	7.2	7.2	0.0	10.1	10.1	0.0	0.0	0.0	1.2	0.0	0.0
Cycle Q Clear(g_c), s	5.1	7.2	7.2	0.0	10.1	10.1	0.9	0.0	0.0	2.1	0.0	0.0
Prop In Lane	1.00		0.01	1.00		0.12	0.23		0.02	0.38		0.37
Lane Grp Cap(c), veh/h	328	960	1010	5	636	656	322	0	0	314	0	0
V/C Ratio(X)	0.80	0.55	0.55	0.41	0.84	0.84	0.16	0.00	0.00	0.32	0.00	0.00
Avail Cap(c_a), veh/h	736	1468	1543	736	1468	1513	1108	0	0	1018	0	0
HCM Platoon Ratio	1.00	1.00	1.00	1.00	1.00	1.00	1.00	1.00	1.00	1.00	1.00	1.00
Upstream Filter(I)	1.00	1.00	1.00	1.00	1.00	1.00	1.00	0.00	0.00	1.00	0.00	0.00
Uniform Delay (d), s/veh	14.3	5.6	5.6	18.2	10.8	10.8	15.3	0.0	0.0	15.8	0.0	0.0
Incr Delay (d2), s/veh	1.7	0.2	0.2	18.9	1.2	1.2	0.1	0.0	0.0	0.2	0.0	0.0
Initial Q Delay(d3),s/veh	0.0	0.0	0.0	0.0	0.0	0.0	0.0	0.0	0.0	0.0	0.0	0.0
%ile BackOfQ(50%),veh/ln	2.6	3.4	3.6	0.0	5.1	5.3	0.5	0.0	0.0	1.0	0.0	0.0
LnGrp Delay(d),s/veh	16.0	5.7	5.7	37.1	12.0	12.0	15.4	0.0	0.0	16.0	0.0	0.0
LnGrp LOS	B	A	A	D	B	B	B			B		
Approach Vol, veh/h		1353			1092			52			101	
Approach Delay, s/veh		7.7			12.0			15.4			16.0	
Approach LOS		A			B			B			B	
Timer	1	2	3	4	5	6	7	8				
Assigned Phs	1	2		4	5	6		8				
Phs Duration (G+Y+Rc), s	3.6	24.9		8.0	10.2	18.3		8.0				
Change Period (Y+Rc), s	3.5	5.3		4.6	3.5	5.3		4.6				
Max Green Setting (Gmax), s	15.0	30.0		20.0	15.0	30.0		20.0				
Max Q Clear Time (g_c+I1), s	2.0	9.2		4.1	7.1	12.1		2.9				
Green Ext Time (p_c), s	0.0	0.8		0.1	0.0	0.8		0.0				
Intersection Summary												
HCM 2010 Ctrl Delay			10.0									
HCM 2010 LOS			B									

Intersection						
Int Delay, s/veh	0.4					
Movement	EBL	EBR	NBL	NBT	SBT	SBR
Lane Configurations	↔		↔	↑	↑	
Traffic Vol, veh/h	2	8	15	378	211	2
Future Vol, veh/h	2	8	15	378	211	2
Conflicting Peds, #/hr	0	0	0	0	0	0
Sign Control	Stop	Stop	Free	Free	Free	Free
RT Channelized	-	None	-	None	-	None
Storage Length	0	-	155	-	-	-
Veh in Median Storage, #	0	-	-	0	0	-
Grade, %	0	-	-	0	0	-
Peak Hour Factor	92	92	92	92	92	92
Heavy Vehicles, %	2	2	2	2	2	2
Mvmt Flow	2	9	16	411	229	2

Major/Minor	Minor2	Major1	Major2			
Conflicting Flow All	673	230	231	0	-	0
Stage 1	230	-	-	-	-	-
Stage 2	443	-	-	-	-	-
Critical Hdwy	6.42	6.22	4.12	-	-	-
Critical Hdwy Stg 1	5.42	-	-	-	-	-
Critical Hdwy Stg 2	5.42	-	-	-	-	-
Follow-up Hdwy	3.518	3.318	2.218	-	-	-
Pot Cap-1 Maneuver	421	809	1337	-	-	-
Stage 1	808	-	-	-	-	-
Stage 2	647	-	-	-	-	-
Platoon blocked, %				-	-	-
Mov Cap-1 Maneuver	416	809	1337	-	-	-
Mov Cap-2 Maneuver	416	-	-	-	-	-
Stage 1	798	-	-	-	-	-
Stage 2	647	-	-	-	-	-

Approach	EB	NB	SB
HCM Control Delay, s	10.4	0.3	0
HCM LOS	B		

Minor Lane/Major Mvmt	NBL	NBT	EBLn1	SBT	SBR
Capacity (veh/h)	1337	-	680	-	-
HCM Lane V/C Ratio	0.012	-	0.016	-	-
HCM Control Delay (s)	7.7	-	10.4	-	-
HCM Lane LOS	A	-	B	-	-
HCM 95th %tile Q(veh)	0	-	0	-	-

HCM 2010 Signalized Intersection Summary
 10: Imjin Road & Imjin Parkway

Existing, PM
 06/11/2019

	→	↘	↙	←	↖	↗		
Movement	EBT	EBR	WBL	WBT	NBL	NBR		
Lane Configurations	↑↑		↖	↑↑	↖↗	↗		
Traffic Volume (veh/h)	1036	54	74	901	136	94		
Future Volume (veh/h)	1036	54	74	901	136	94		
Number	2	12	1	6	3	18		
Initial Q (Qb), veh	0	0	0	0	0	0		
Ped-Bike Adj(A_pbT)		1.00	1.00		1.00	1.00		
Parking Bus, Adj	1.00	1.00	1.00	1.00	1.00	1.00		
Adj Sat Flow, veh/h/ln	1881	1900	1881	1881	1881	1881		
Adj Flow Rate, veh/h	1091	54	78	948	143	33		
Adj No. of Lanes	2	0	1	2	2	1		
Peak Hour Factor	0.95	0.95	0.95	0.95	0.95	0.95		
Percent Heavy Veh, %	1	1	1	1	1	1		
Cap, veh/h	1315	65	94	2176	291	130		
Arrive On Green	0.38	0.38	0.05	0.61	0.08	0.08		
Sat Flow, veh/h	3561	172	1792	3668	3583	1599		
Grp Volume(v), veh/h	562	583	78	948	143	33		
Grp Sat Flow(s),veh/h/ln	1787	1851	1792	1787	1792	1599		
Q Serve(g_s), s	8.5	8.6	1.3	4.2	1.1	0.6		
Cycle Q Clear(g_c), s	8.5	8.6	1.3	4.2	1.1	0.6		
Prop In Lane		0.09	1.00		1.00	1.00		
Lane Grp Cap(c), veh/h	678	702	94	2176	291	130		
V/C Ratio(X)	0.83	0.83	0.83	0.44	0.49	0.25		
Avail Cap(c_a), veh/h	1787	1851	1194	3574	2628	1173		
HCM Platoon Ratio	1.00	1.00	1.00	1.00	1.00	1.00		
Upstream Filter(I)	1.00	1.00	1.00	1.00	1.00	1.00		
Uniform Delay (d), s/veh	8.4	8.4	14.1	3.1	13.2	12.9		
Incr Delay (d2), s/veh	1.0	1.0	6.7	0.1	0.5	0.4		
Initial Q Delay(d3),s/veh	0.0	0.0	0.0	0.0	0.0	0.0		
%ile BackOfQ(50%),veh/ln	4.3	4.4	0.8	2.0	0.6	0.3		
LnGrp Delay(d),s/veh	9.4	9.4	20.8	3.2	13.7	13.3		
LnGrp LOS	A	A	C	A	B	B		
Approach Vol, veh/h	1145			1026	176			
Approach Delay, s/veh	9.4			4.5	13.6			
Approach LOS	A			A	B			
Timer	1	2	3	4	5	6	7	8
Assigned Phs	1	2				6		8
Phs Duration (G+Y+Rc), s	6.9	16.7				23.6		6.4
Change Period (Y+Rc), s	5.3	* 5.3				5.3		4.0
Max Green Setting (Gmax), s	20.0	* 30				30.0		22.0
Max Q Clear Time (g_c+I1), s	3.3	10.6				6.2		3.1
Green Ext Time (p_c), s	0.0	0.8				1.0		0.0
Intersection Summary								
HCM 2010 Ctrl Delay			7.6					
HCM 2010 LOS			A					
Notes								

HCM 2010 Signalized Intersection Summary
 11: Abrams Drive & Imjin Parkway

Existing, PM
 06/11/2019



Movement	EBL	EBT	EBR	WBL	WBT	WBR	NBL	NBT	NBR	SBL	SBT	SBR
Lane Configurations												
Traffic Volume (veh/h)	92	880	114	159	796	53	109	20	161	24	14	84
Future Volume (veh/h)	92	880	114	159	796	53	109	20	161	24	14	84
Number	5	2	12	1	6	16	3	8	18	7	4	14
Initial Q (Qb), veh	0	0	0	0	0	0	0	0	0	0	0	0
Ped-Bike Adj(A_pbT)	1.00		1.00	1.00		1.00	1.00		1.00	1.00		1.00
Parking Bus, Adj	1.00	1.00	1.00	1.00	1.00	1.00	1.00	1.00	1.00	1.00	1.00	1.00
Adj Sat Flow, veh/h/ln	1881	1881	1881	1881	1881	1881	1900	1881	1881	1900	1863	1863
Adj Flow Rate, veh/h	99	946	0	171	856	0	117	22	0	26	15	0
Adj No. of Lanes	1	1	1	1	1	1	0	1	1	0	1	1
Peak Hour Factor	0.93	0.93	0.93	0.93	0.93	0.93	0.93	0.93	0.93	0.93	0.93	0.93
Percent Heavy Veh, %	1	1	1	1	1	1	1	1	1	2	2	2
Cap, veh/h	132	1090	926	211	1159	985	246	28	188	193	93	186
Arrive On Green	0.07	0.58	0.00	0.12	0.62	0.00	0.12	0.12	0.00	0.12	0.12	0.00
Sat Flow, veh/h	1792	1881	1599	1792	1881	1599	1280	241	1599	922	792	1583
Grp Volume(v), veh/h	99	946	0	171	856	0	139	0	0	41	0	0
Grp Sat Flow(s),veh/h/ln	1792	1881	1599	1792	1881	1599	1520	0	1599	1714	0	1583
Q Serve(g_s), s	3.7	29.4	0.0	6.4	22.1	0.0	4.7	0.0	0.0	0.0	0.0	0.0
Cycle Q Clear(g_c), s	3.7	29.4	0.0	6.4	22.1	0.0	6.0	0.0	0.0	1.4	0.0	0.0
Prop In Lane	1.00		1.00	1.00		1.00	0.84		1.00	0.63		1.00
Lane Grp Cap(c), veh/h	132	1090	926	211	1159	985	275	0	188	287	0	186
V/C Ratio(X)	0.75	0.87	0.00	0.81	0.74	0.00	0.51	0.00	0.00	0.14	0.00	0.00
Avail Cap(c_a), veh/h	519	1362	1158	519	1362	1158	738	0	695	770	0	688
HCM Platoon Ratio	1.00	1.00	1.00	1.00	1.00	1.00	1.00	1.00	1.00	1.00	1.00	1.00
Upstream Filter(I)	1.00	1.00	0.00	1.00	1.00	0.00	1.00	0.00	0.00	1.00	0.00	0.00
Uniform Delay (d), s/veh	31.3	12.3	0.0	29.7	9.3	0.0	29.4	0.0	0.0	27.5	0.0	0.0
Incr Delay (d2), s/veh	3.1	4.4	0.0	2.8	1.4	0.0	0.5	0.0	0.0	0.1	0.0	0.0
Initial Q Delay(d3),s/veh	0.0	0.0	0.0	0.0	0.0	0.0	0.0	0.0	0.0	0.0	0.0	0.0
%ile BackOfQ(50%),veh/ln	2.0	16.3	0.0	3.3	11.6	0.0	2.6	0.0	0.0	0.7	0.0	0.0
LnGrp Delay(d),s/veh	34.5	16.7	0.0	32.5	10.7	0.0	30.0	0.0	0.0	27.6	0.0	0.0
LnGrp LOS	C	B		C	B		C			C		
Approach Vol, veh/h		1045			1027			139			41	
Approach Delay, s/veh		18.4			14.3			30.0			27.6	
Approach LOS		B			B			C			C	
Timer	1	2	3	4	5	6	7	8				
Assigned Phs	1	2		4	5	6		8				
Phs Duration (G+Y+Rc), s	1.6	45.3		12.1	9.1	47.8		12.1				
Change Period (Y+Rc), s	3.5	5.3		4.0	4.0	5.3		4.0				
Max Green Setting (Gmax), s	20.0	50.0		30.0	20.0	50.0		30.0				
Max Q Clear Time (g_c+1/3), s	13.4	31.4		3.4	5.7	24.1		8.0				
Green Ext Time (p_c), s	0.0	0.7		0.0	0.0	0.7		0.1				
Intersection Summary												
HCM 2010 Ctrl Delay				17.4								
HCM 2010 LOS				B								

HCM 2010 Signalized Intersection Summary
 12: Reservation Road & Imjin Parkway

Existing, PM
 06/11/2019



Movement	EBL	EBT	EBR	WBL	WBT	WBR	NBL	NBT	NBR	SBL	SBT	SBR
Lane Configurations												
Traffic Volume (veh/h)	100	6	982	7	21	22	849	542	4	7	644	175
Future Volume (veh/h)	100	6	982	7	21	22	849	542	4	7	644	175
Number	3	8	18	7	4	14	1	6	16	5	2	12
Initial Q (Qb), veh	0	0	0	0	0	0	0	0	0	0	0	0
Ped-Bike Adj(A_pbT)	1.00		0.99	1.00		0.98	1.00		1.00	1.00		1.00
Parking Bus, Adj	1.00	1.00	1.00	1.00	1.00	1.00	1.00	1.00	1.00	1.00	1.00	1.00
Adj Sat Flow, veh/h/ln	1881	1881	1881	1827	1827	1827	1881	1881	1881	1881	1881	1881
Adj Flow Rate, veh/h	117	0	702	8	24	3	954	609	3	8	724	63
Adj No. of Lanes	2	0	2	1	1	1	2	2	1	2	2	1
Peak Hour Factor	0.89	0.89	0.89	0.89	0.89	0.89	0.89	0.89	0.89	0.89	0.89	0.89
Percent Heavy Veh, %	1	1	1	4	4	4	1	1	1	1	1	1
Cap, veh/h	665	0	1522	55	58	48	1013	2102	940	27	1089	487
Arrive On Green	0.19	0.00	0.19	0.03	0.03	0.03	0.29	0.59	0.59	0.01	0.30	0.30
Sat Flow, veh/h	3583	0	3181	1740	1827	1527	3476	3574	1599	3476	3574	1599
Grp Volume(v), veh/h	117	0	702	8	24	3	954	609	3	8	724	63
Grp Sat Flow(s),veh/h/ln	1792	0	1590	1740	1827	1527	1738	1787	1599	1738	1787	1599
Q Serve(g_s), s	3.1	0.0	16.5	0.5	1.4	0.2	29.9	9.4	0.1	0.3	19.7	3.2
Cycle Q Clear(g_c), s	3.1	0.0	16.5	0.5	1.4	0.2	29.9	9.4	0.1	0.3	19.7	3.2
Prop In Lane	1.00		1.00	1.00		1.00	1.00		1.00	1.00		1.00
Lane Grp Cap(c), veh/h	665	0	1522	55	58	48	1013	2102	940	27	1089	487
V/C Ratio(X)	0.18	0.00	0.46	0.15	0.41	0.06	0.94	0.29	0.00	0.29	0.66	0.13
Avail Cap(c_a), veh/h	1126	0	1931	484	508	425	1092	2102	940	624	1925	861
HCM Platoon Ratio	1.00	1.00	1.00	1.00	1.00	1.00	1.00	1.00	1.00	1.00	1.00	1.00
Upstream Filter(I)	1.00	0.00	1.00	1.00	1.00	1.00	1.00	1.00	1.00	1.00	1.00	1.00
Uniform Delay (d), s/veh	38.2	0.0	19.6	52.5	52.9	52.3	38.5	11.4	9.5	54.9	33.8	28.0
Incr Delay (d2), s/veh	0.0	0.0	0.1	0.4	1.8	0.2	14.3	0.2	0.0	2.2	1.9	0.3
Initial Q Delay(d3),s/veh	0.0	0.0	0.0	0.0	0.0	0.0	0.0	0.0	0.0	0.0	0.0	0.0
%ile BackOfQ(50%),veh/ln	1.5	0.0	7.3	0.2	0.8	0.1	16.3	4.7	0.0	0.1	9.9	1.4
LnGrp Delay(d),s/veh	38.2	0.0	19.6	52.9	54.7	52.5	52.9	11.6	9.5	57.1	35.7	28.4
LnGrp LOS	D		B	D	D	D	D	B	A	E	D	C
Approach Vol, veh/h		819			35			1566			795	
Approach Delay, s/veh		22.3			54.1			36.7			35.3	
Approach LOS		C			D			D			D	
Timer	1	2	3	4	5	6	7	8				
Assigned Phs	1	2		4	5	6		8				
Phs Duration (G+Y+Rc), s	36.5	40.1		8.5	5.0	71.7		26.2				
Change Period (Y+Rc), s	4.1	* 6.2		5.0	4.1	* 6.2		5.5				
Max Green Setting (Gmax), s	35.0	* 60		31.0	20.0	* 50		35.0				
Max Q Clear Time (g_c+Q1), s	31.5	21.7		3.4	2.3	11.4		18.5				
Green Ext Time (p_c), s	0.6	12.3		0.1	0.0	9.4		1.7				
Intersection Summary												
HCM 2010 Ctrl Delay			32.9									
HCM 2010 LOS			C									
Notes												

HCM 2010 Signalized Intersection Summary
 13: Reservation Road & Blanco Road

Existing, PM
 06/11/2019

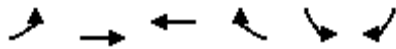

Movement	EBL	EBT	WBT	WBR	SBL	SBR		
Lane Configurations	↶↷	↶↷	↶	↶↷	↶↷	↶↷		
Traffic Volume (veh/h)	1094	461	325	33	21	1085		
Future Volume (veh/h)	1094	461	325	33	21	1085		
Number	5	2	6	16	7	14		
Initial Q (Qb), veh	0	0	0	0	0	0		
Ped-Bike Adj(A_pbT)	1.00			1.00	1.00	1.00		
Parking Bus, Adj	1.00	1.00	1.00	1.00	1.00	1.00		
Adj Sat Flow, veh/h/ln	1881	1881	1863	1863	1863	1863		
Adj Flow Rate, veh/h	1164	490	346	11	22	0		
Adj No. of Lanes	2	2	1	1	2	2		
Peak Hour Factor	0.94	0.94	0.94	0.94	0.94	0.94		
Percent Heavy Veh, %	1	1	2	2	2	2		
Cap, veh/h	1314	2714	469	399	74	60		
Arrive On Green	0.38	0.76	0.25	0.25	0.02	0.00		
Sat Flow, veh/h	3476	3668	1863	1583	3442	2787		
Grp Volume(v), veh/h	1164	490	346	11	22	0		
Grp Sat Flow(s),veh/h/ln	1738	1787	1863	1583	1721	1393		
Q Serve(g_s), s	13.3	1.6	7.2	0.2	0.3	0.0		
Cycle Q Clear(g_c), s	13.3	1.6	7.2	0.2	0.3	0.0		
Prop In Lane	1.00			1.00	1.00	1.00		
Lane Grp Cap(c), veh/h	1314	2714	469	399	74	60		
V/C Ratio(X)	0.89	0.18	0.74	0.03	0.30	0.00		
Avail Cap(c_a), veh/h	3276	5054	2634	2239	2190	1773		
HCM Platoon Ratio	1.00	1.00	1.00	1.00	1.00	1.00		
Upstream Filter(I)	1.00	1.00	1.00	1.00	1.00	0.00		
Uniform Delay (d), s/veh	12.3	1.4	14.6	12.0	20.4	0.0		
Incr Delay (d2), s/veh	0.8	0.0	1.7	0.0	0.8	0.0		
Initial Q Delay(d3),s/veh	0.0	0.0	0.0	0.0	0.0	0.0		
%ile BackOfQ(50%),veh/ln	6.5	0.8	3.9	0.1	0.1	0.0		
LnGrp Delay(d),s/veh	13.2	1.4	16.3	12.0	21.3	0.0		
LnGrp LOS	B	A	B	B	C			
Approach Vol, veh/h		1654	357		22			
Approach Delay, s/veh		9.7	16.2		21.3			
Approach LOS		A	B		C			
Timer	1	2	3	4	5	6	7	8
Assigned Phs		2		4	5	6		
Phs Duration (G+Y+Rc), s		38.0		4.4	21.5	16.5		
Change Period (Y+Rc), s		5.8		3.5	5.5	5.8		
Max Green Setting (Gmax), s		60.0		27.0	40.0	60.0		
Max Q Clear Time (g_c+I1), s		3.6		2.3	15.3	9.2		
Green Ext Time (p_c), s		2.4		0.0	0.7	1.4		
Intersection Summary								
HCM 2010 Ctrl Delay			11.0					
HCM 2010 LOS			B					

HCM 2010 Signalized Intersection Summary
 14: Reservation Road & Inter-Garrison Road

Existing, PM
 06/11/2019



Movement	EBL	EBR	NBL	NBT	SBT	SBR		
Lane Configurations								
Traffic Volume (veh/h)	45	301	78	327	433	45		
Future Volume (veh/h)	45	301	78	327	433	45		
Number	3	18	1	6	2	12		
Initial Q (Qb), veh	0	0	0	0	0	0		
Ped-Bike Adj(A_pbT)	1.00	1.00	1.00			1.00		
Parking Bus, Adj	1.00	1.00	1.00	1.00	1.00	1.00		
Adj Sat Flow, veh/h/ln	1881	1881	1845	1845	1881	1900		
Adj Flow Rate, veh/h	55	212	95	399	528	46		
Adj No. of Lanes	1	1	1	2	2	0		
Peak Hour Factor	0.82	0.82	0.82	0.82	0.82	0.82		
Percent Heavy Veh, %	1	1	3	3	1	1		
Cap, veh/h	310	433	172	1937	1119	97		
Arrive On Green	0.17	0.17	0.10	0.55	0.34	0.34		
Sat Flow, veh/h	1792	1599	1757	3597	3422	289		
Grp Volume(v), veh/h	55	212	95	399	283	291		
Grp Sat Flow(s),veh/h/ln	1792	1599	1757	1752	1787	1830		
Q Serve(g_s), s	1.0	4.4	2.0	2.3	5.0	5.0		
Cycle Q Clear(g_c), s	1.0	4.4	2.0	2.3	5.0	5.0		
Prop In Lane	1.00	1.00	1.00			0.16		
Lane Grp Cap(c), veh/h	310	433	172	1937	601	616		
V/C Ratio(X)	0.18	0.49	0.55	0.21	0.47	0.47		
Avail Cap(c_a), veh/h	1217	1243	884	5292	2698	2763		
HCM Platoon Ratio	1.00	1.00	1.00	1.00	1.00	1.00		
Upstream Filter(I)	1.00	1.00	1.00	1.00	1.00	1.00		
Uniform Delay (d), s/veh	14.0	12.2	17.1	4.5	10.4	10.4		
Incr Delay (d2), s/veh	0.3	0.9	1.0	0.1	1.1	1.1		
Initial Q Delay(d3),s/veh	0.0	0.0	0.0	0.0	0.0	0.0		
%ile BackOfQ(50%),veh/ln	0.5	2.0	1.0	1.1	2.6	2.7		
LnGrp Delay(d),s/veh	14.3	13.0	18.1	4.6	11.5	11.5		
LnGrp LOS	B	B	B	A	B	B		
Approach Vol, veh/h	267			494	574			
Approach Delay, s/veh	13.3			7.2	11.5			
Approach LOS	B			A	B			
Timer	1	2	3	4	5	6	7	8
Assigned Phs	1	2				6		8
Phs Duration (G+Y+Rc), s	8.6	19.8				28.4		11.4
Change Period (Y+Rc), s	4.7	6.4				6.4		4.5
Max Green Setting (Gmax)	20	60.0				60.0		27.0
Max Q Clear Time (g_c+14)	14.5	7.0				4.3		6.4
Green Ext Time (p_c), s	0.1	6.4				4.6		0.8
Intersection Summary								
HCM 2010 Ctrl Delay			10.2					
HCM 2010 LOS			B					
Notes								

Intersection												
Intersection Delay, s/veh	11.4											
Intersection LOS	B											

Movement	EBL	EBT	EBR	WBL	WBT	WBR	NBL	NBT	NBR	SBL	SBT	SBR
Lane Configurations		↕	↕		↕	↕	↕	↕			↕	↕
Traffic Vol, veh/h	26	0	10	10	2	3	19	327	25	3	209	30
Future Vol, veh/h	26	0	10	10	2	3	19	327	25	3	209	30
Peak Hour Factor	0.91	0.91	0.91	0.91	0.91	0.91	0.91	0.91	0.91	0.91	0.91	0.91
Heavy Vehicles, %	0	0	0	0	0	0	1	1	1	4	4	4
Mvmt Flow	29	0	11	11	2	3	21	359	27	3	230	33
Number of Lanes	0	1	1	0	1	0	1	1	0	0	1	1

Approach	EB	WB	NB	SB
Opposing Approach	WB	EB	SB	NB
Opposing Lanes	1	2	2	2
Conflicting Approach Left	SB	NB	EB	WB
Conflicting Lanes Left	2	2	2	1
Conflicting Approach Right	NB	SB	WB	EB
Conflicting Lanes Right	2	2	1	2
HCM Control Delay	9.3	9.4	12.6	9.9
HCM LOS	A	A	B	A

Lane	NBLn1	NBLn2	EBLn1	EBLn2	WBLn1	SBLn1	SBLn2
Vol Left, %	100%	0%	100%	0%	67%	1%	0%
Vol Thru, %	0%	93%	0%	0%	13%	99%	0%
Vol Right, %	0%	7%	0%	100%	20%	0%	100%
Sign Control	Stop	Stop	Stop	Stop	Stop	Stop	Stop
Traffic Vol by Lane	19	352	26	10	15	212	30
LT Vol	19	0	26	0	10	3	0
Through Vol	0	327	0	0	2	209	0
RT Vol	0	25	0	10	3	0	30
Lane Flow Rate	21	387	29	11	16	233	33
Geometry Grp	7	7	7	7	6	7	7
Degree of Util (X)	0.031	0.522	0.052	0.016	0.028	0.328	0.04
Departure Headway (Hd)	5.406	4.855	6.594	5.382	6.151	5.071	4.361
Convergence, Y/N	Yes	Yes	Yes	Yes	Yes	Yes	Yes
Cap	663	743	542	663	580	711	821
Service Time	3.13	2.579	4.348	3.135	4.209	2.799	2.088
HCM Lane V/C Ratio	0.032	0.521	0.054	0.017	0.028	0.328	0.04
HCM Control Delay	8.3	12.8	9.7	8.2	9.4	10.3	7.3
HCM Lane LOS	A	B	A	A	A	B	A
HCM 95th-tile Q	0.1	3.1	0.2	0	0.1	1.4	0.1

Intersection

Intersection Delay, s/veh 12.8

Intersection LOS B

Movement	EBL	EBT	EBR	WBL	WBT	WBR	NBL	NBT	NBR	SBL	SBT	SBR
Lane Configurations	↙	↑	↗		↖	↗	↙	↑	↗	↙	↗	
Traffic Vol, veh/h	2	0	1	5	0	3	3	365	5	2	231	2
Future Vol, veh/h	2	0	1	5	0	3	3	365	5	2	231	2
Peak Hour Factor	0.94	0.94	0.94	0.94	0.94	0.94	0.94	0.94	0.94	0.94	0.94	0.94
Heavy Vehicles, %	0	0	0	0	0	0	1	1	1	4	4	4
Mvmt Flow	2	0	1	5	0	3	3	388	5	2	246	2
Number of Lanes	1	1	1	0	1	1	1	1	1	1	1	0

Approach	EB	WB	NB	SB
Opposing Approach	WB	EB	SB	NB
Opposing Lanes	2	3	2	3
Conflicting Approach Left	SB	NB	EB	WB
Conflicting Lanes Left	2	3	3	2
Conflicting Approach Right	NB	SB	WB	EB
Conflicting Lanes Right	3	2	2	3
HCM Control Delay	9.2	9.2	13.8	11.3
HCM LOS	A	A	B	B

Lane	NBLn1	NBLn2	NBLn3	EBLn1	EBLn2	EBLn3	WBLn1	WBLn2	SBLn1	SBLn2
Vol Left, %	100%	0%	0%	100%	0%	0%	100%	0%	100%	0%
Vol Thru, %	0%	100%	0%	0%	100%	0%	0%	0%	0%	99%
Vol Right, %	0%	0%	100%	0%	0%	100%	0%	100%	0%	1%
Sign Control	Stop	Stop	Stop	Stop	Stop	Stop	Stop	Stop	Stop	Stop
Traffic Vol by Lane	3	365	5	2	0	1	5	3	2	233
LT Vol	3	0	0	2	0	0	5	0	2	0
Through Vol	0	365	0	0	0	0	0	0	0	231
RT Vol	0	0	5	0	0	1	0	3	0	2
Lane Flow Rate	3	388	5	2	0	1	5	3	2	248
Geometry Grp	8	8	8	8	8	8	8	8	8	8
Degree of Util (X)	0.005	0.549	0.006	0.004	0	0.002	0.01	0.005	0.003	0.371
Departure Headway (Hd)	5.595	5.094	4.392	6.769	6.265	5.561	6.755	5.548	5.898	5.392
Convergence, Y/N	Yes	Yes	Yes	Yes	Yes	Yes	Yes	Yes	Yes	Yes
Cap	639	707	813	526	0	638	527	640	606	667
Service Time	3.33	2.829	2.127	4.55	4.046	3.341	4.535	3.327	3.639	3.133
HCM Lane V/C Ratio	0.005	0.549	0.006	0.004	0	0.002	0.009	0.005	0.003	0.372
HCM Control Delay	8.4	13.9	7.2	9.6	9	8.4	9.6	8.4	8.7	11.3
HCM Lane LOS	A	B	A	A	N	A	A	A	A	B
HCM 95th-tile Q	0	3.4	0	0	0	0	0	0	0	1.7

Intersection	
Intersection Delay, s/veh	9.3
Intersection LOS	A

Movement	EBL	EBT	EBR	WBL	WBT	WBR	NBL	NBT	NBR	SBL	SBT	SBR
Lane Configurations												
Traffic Vol, veh/h	2	24	6	43	42	203	2	27	41	106	16	3
Future Vol, veh/h	2	24	6	43	42	203	2	27	41	106	16	3
Peak Hour Factor	0.91	0.91	0.91	0.91	0.91	0.91	0.91	0.91	0.91	0.91	0.91	0.91
Heavy Vehicles, %	3	3	3	1	1	1	0	0	0	2	2	2
Mvmt Flow	2	26	7	47	46	223	2	30	45	116	18	3
Number of Lanes	1	1	0	1	1	1	0	1	0	0	1	1

Approach	EB	WB	NB	SB
Opposing Approach	WB	EB	SB	NB
Opposing Lanes	3	2	2	1
Conflicting Approach Left	SB	NB	EB	WB
Conflicting Lanes Left	2	1	2	3
Conflicting Approach Right	NB	SB	WB	EB
Conflicting Lanes Right	1	2	3	2
HCM Control Delay	8.8	9	8.8	10.4
HCM LOS	A	A	A	B

Lane	NBLn1	EBLn1	EBLn2	WBLn1	WBLn2	WBLn3	SBLn1	SBLn2
Vol Left, %	3%	100%	0%	100%	0%	0%	87%	0%
Vol Thru, %	39%	0%	80%	0%	100%	0%	13%	0%
Vol Right, %	59%	0%	20%	0%	0%	100%	0%	100%
Sign Control	Stop	Stop	Stop	Stop	Stop	Stop	Stop	Stop
Traffic Vol by Lane	70	2	30	43	42	203	122	3
LT Vol	2	2	0	43	0	0	106	0
Through Vol	27	0	24	0	42	0	16	0
RT Vol	41	0	6	0	0	203	0	3
Lane Flow Rate	77	2	33	47	46	223	134	3
Geometry Grp	8	8	8	8	8	8	8	8
Degree of Util (X)	0.113	0.004	0.052	0.076	0.068	0.283	0.223	0.004
Departure Headway (Hd)	5.308	6.324	5.678	5.779	5.277	4.573	6	4.864
Convergence, Y/N	Yes	Yes	Yes	Yes	Yes	Yes	Yes	Yes
Cap	670	562	626	619	677	783	595	730
Service Time	3.081	4.102	3.456	3.525	3.022	2.318	3.769	2.632
HCM Lane V/C Ratio	0.115	0.004	0.053	0.076	0.068	0.285	0.225	0.004
HCM Control Delay	8.8	9.1	8.8	9	8.4	9.1	10.5	7.7
HCM Lane LOS	A	A	A	A	A	A	B	A
HCM 95th-tile Q	0.4	0	0.2	0.2	0.2	1.2	0.8	0

Intersection	
Intersection Delay, s/veh	9.8
Intersection LOS	A

Movement	WBL	WBR	NBT	NBR	SBL	SBT
Lane Configurations						
Traffic Vol, veh/h	66	97	243	31	85	143
Future Vol, veh/h	66	97	243	31	85	143
Peak Hour Factor	0.97	0.97	0.97	0.97	0.97	0.97
Heavy Vehicles, %	0	0	1	1	2	2
Mvmt Flow	68	100	251	32	88	147
Number of Lanes	1	1	1	1	1	1

Approach	WB	NB	SB
Opposing Approach		SB	NB
Opposing Lanes	0	2	2
Conflicting Approach Left	NB		WB
Conflicting Lanes Left	2	0	2
Conflicting Approach Right	SB	WB	
Conflicting Lanes Right	2	2	0
HCM Control Delay	9.1	10.5	9.5
HCM LOS	A	B	A

Lane	NBLn1	NBLn2	WBLn1	WBLn2	SBLn1	SBLn2
Vol Left, %	0%	0%	100%	0%	100%	0%
Vol Thru, %	100%	0%	0%	0%	0%	100%
Vol Right, %	0%	100%	0%	100%	0%	0%
Sign Control	Stop	Stop	Stop	Stop	Stop	Stop
Traffic Vol by Lane	243	31	66	97	85	143
LT Vol	0	0	66	0	85	0
Through Vol	243	0	0	0	0	143
RT Vol	0	31	0	97	0	0
Lane Flow Rate	251	32	68	100	88	147
Geometry Grp	7	7	7	7	7	7
Degree of Util (X)	0.363	0.04	0.118	0.14	0.14	0.215
Departure Headway (Hd)	5.21	4.505	6.256	5.048	5.757	5.253
Convergence, Y/N	Yes	Yes	Yes	Yes	Yes	Yes
Cap	689	790	571	706	620	680
Service Time	2.963	2.258	4.016	2.807	3.513	3.009
HCM Lane V/C Ratio	0.364	0.041	0.119	0.142	0.142	0.216
HCM Control Delay	10.9	7.4	9.9	8.6	9.5	9.5
HCM Lane LOS	B	A	A	A	A	A
HCM 95th-tile Q	1.7	0.1	0.4	0.5	0.5	0.8

Intersection												
Intersection Delay, s/veh	9.9											
Intersection LOS	A											

Movement	EBL	EBT	EBR	WBL	WBT	WBR	NBL	NBT	NBR	SBL	SBT	SBR
Lane Configurations		↕			↕			↕			↕	
Traffic Vol, veh/h	6	125	8	93	85	19	37	23	155	21	17	5
Future Vol, veh/h	6	125	8	93	85	19	37	23	155	21	17	5
Peak Hour Factor	0.82	0.82	0.82	0.82	0.82	0.82	0.82	0.82	0.82	0.82	0.82	0.82
Heavy Vehicles, %	1	1	1	1	1	1	3	3	3	0	0	0
Mvmt Flow	7	152	10	113	104	23	45	28	189	26	21	6
Number of Lanes	0	1	0	0	1	0	0	1	0	0	1	0

Approach	EB	WB	NB	SB
Opposing Approach	WB	EB	SB	NB
Opposing Lanes	1	1	1	1
Conflicting Approach Left	SB	NB	EB	WB
Conflicting Lanes Left	1	1	1	1
Conflicting Approach Right	NB	SB	WB	EB
Conflicting Lanes Right	1	1	1	1
HCM Control Delay	9.5	10.4	10	8.8
HCM LOS	A	B	A	A

Lane	NBLn1	EBLn1	WBLn1	SBLn1
Vol Left, %	17%	4%	47%	49%
Vol Thru, %	11%	90%	43%	40%
Vol Right, %	72%	6%	10%	12%
Sign Control	Stop	Stop	Stop	Stop
Traffic Vol by Lane	215	139	197	43
LT Vol	37	6	93	21
Through Vol	23	125	85	17
RT Vol	155	8	19	5
Lane Flow Rate	262	170	240	52
Geometry Grp	1	1	1	1
Degree of Util (X)	0.336	0.233	0.328	0.077
Departure Headway (Hd)	4.618	4.945	4.914	5.27
Convergence, Y/N	Yes	Yes	Yes	Yes
Cap	773	719	726	672
Service Time	2.685	3.023	2.987	3.362
HCM Lane V/C Ratio	0.339	0.236	0.331	0.077
HCM Control Delay	10	9.5	10.4	8.8
HCM Lane LOS	A	A	B	A
HCM 95th-tile Q	1.5	0.9	1.4	0.2

Intersection	
Intersection Delay, s/veh	8.9
Intersection LOS	A

Movement	EBL	EBT	EBR	WBL	WBT	WBR	NBL	NBT	NBR	SBL	SBT	SBR
Lane Configurations		↕			↕			↕			↕	↕
Traffic Vol, veh/h	8	191	18	10	107	9	23	57	19	13	21	2
Future Vol, veh/h	8	191	18	10	107	9	23	57	19	13	21	2
Peak Hour Factor	0.93	0.93	0.93	0.93	0.93	0.93	0.93	0.93	0.93	0.93	0.93	0.93
Heavy Vehicles, %	1	1	1	4	4	4	5	5	5	0	0	0
Mvmt Flow	9	205	19	11	115	10	25	61	20	14	23	2
Number of Lanes	0	1	0	0	1	0	0	1	0	0	1	1

Approach	EB	WB	NB	SB
Opposing Approach	WB	EB	SB	NB
Opposing Lanes	1	1	2	1
Conflicting Approach Left	SB	NB	EB	WB
Conflicting Lanes Left	2	1	1	1
Conflicting Approach Right	NB	SB	WB	EB
Conflicting Lanes Right	1	2	1	1
HCM Control Delay	9.2	8.6	8.8	8.6
HCM LOS	A	A	A	A

Lane	NBLn1	EBLn1	WBLn1	SBLn1	SBLn2
Vol Left, %	23%	4%	8%	38%	0%
Vol Thru, %	58%	88%	85%	62%	0%
Vol Right, %	19%	8%	7%	0%	100%
Sign Control	Stop	Stop	Stop	Stop	Stop
Traffic Vol by Lane	99	217	126	34	2
LT Vol	23	8	10	13	0
Through Vol	57	191	107	21	0
RT Vol	19	18	9	0	2
Lane Flow Rate	106	233	135	37	2
Geometry Grp	5	2	2	7	7
Degree of Util (X)	0.145	0.285	0.172	0.057	0.003
Departure Headway (Hd)	4.913	4.402	4.57	5.646	4.747
Convergence, Y/N	Yes	Yes	Yes	Yes	Yes
Cap	729	817	784	634	752
Service Time	2.949	2.426	2.598	3.387	2.488
HCM Lane V/C Ratio	0.145	0.285	0.172	0.058	0.003
HCM Control Delay	8.8	9.2	8.6	8.7	7.5
HCM Lane LOS	A	A	A	A	A
HCM 95th-tile Q	0.5	1.2	0.6	0.2	0

Intersection			
Intersection Delay, s/veh	8.6		
Intersection LOS	A		
Approach	EB	WB	NB
Entry Lanes	1	1	1
Conflicting Circle Lanes	1	1	1
Adj Approach Flow, veh/h	264	293	469
Demand Flow Rate, veh/h	269	299	469
Vehicles Circulating, veh/h	137	7	263
Vehicles Exiting, veh/h	169	725	143
Follow-Up Headway, s	3.186	3.186	3.186
Ped Vol Crossing Leg, #/h	0	0	0
Ped Cap Adj	1.000	1.000	1.000
Approach Delay, s/veh	6.5	5.8	11.6
Approach LOS	A	A	B
Lane	Left	Left	Left
Designated Moves	TR	LT	LR
Assumed Moves	TR	LT	LR
RT Channelized			
Lane Util	1.000	1.000	1.000
Critical Headway, s	5.193	5.193	5.193
Entry Flow, veh/h	269	299	469
Cap Entry Lane, veh/h	985	1122	869
Entry HV Adj Factor	0.981	0.979	1.000
Flow Entry, veh/h	264	293	469
Cap Entry, veh/h	966	1099	869
V/C Ratio	0.273	0.266	0.540
Control Delay, s/veh	6.5	5.8	11.6
LOS	A	A	B
95th %tile Queue, veh	1	1	3

Intersection	
Intersection Delay, s/veh	12.8
Intersection LOS	B

Movement	EBL	EBT	WBT	WBR	SBL	SBR
Lane Configurations						
Traffic Vol, veh/h	251	412	91	17	15	108
Future Vol, veh/h	251	412	91	17	15	108
Peak Hour Factor	0.95	0.95	0.95	0.95	0.95	0.95
Heavy Vehicles, %	2	2	6	6	4	4
Mvmt Flow	264	434	96	18	16	114
Number of Lanes	1	1	1	1	1	1

Approach	EB	WB	SB
Opposing Approach	WB	EB	
Opposing Lanes	2	2	0
Conflicting Approach Left	SB		WB
Conflicting Lanes Left	2	0	2
Conflicting Approach Right		SB	EB
Conflicting Lanes Right	0	2	2
HCM Control Delay	14	9.2	9.7
HCM LOS	B	A	A

Lane	EBLn1	EBLn2	WBLn1	WBLn2	SBLn1	SBLn2
Vol Left, %	100%	0%	0%	0%	100%	0%
Vol Thru, %	0%	100%	100%	0%	0%	0%
Vol Right, %	0%	0%	0%	100%	0%	100%
Sign Control	Stop	Stop	Stop	Stop	Stop	Stop
Traffic Vol by Lane	251	412	91	17	15	108
LT Vol	251	0	0	0	15	0
Through Vol	0	412	91	0	0	0
RT Vol	0	0	0	17	0	108
Lane Flow Rate	264	434	96	18	16	114
Geometry Grp	7	7	7	7	7	7
Degree of Util (X)	0.405	0.604	0.152	0.025	0.03	0.179
Departure Headway (Hd)	5.513	5.01	5.695	4.988	6.889	5.679
Convergence, Y/N	Yes	Yes	Yes	Yes	Yes	Yes
Cap	650	720	626	711	518	629
Service Time	3.263	2.761	3.471	2.764	4.655	3.444
HCM Lane V/C Ratio	0.406	0.603	0.153	0.025	0.031	0.181
HCM Control Delay	12	15.2	9.5	7.9	9.9	9.7
HCM Lane LOS	B	C	A	A	A	A
HCM 95th-tile Q	2	4.1	0.5	0.1	0.1	0.6

Intersection

Intersection Delay, s/veh 11.1

Intersection LOS B

Movement	EBL	EBT	WBT	WBR	SBL	SBR
Lane Configurations						
Traffic Vol, veh/h	94	353	89	13	11	24
Future Vol, veh/h	94	353	89	13	11	24
Peak Hour Factor	0.86	0.86	0.86	0.86	0.86	0.86
Heavy Vehicles, %	1	1	5	5	17	17
Mvmt Flow	109	410	103	15	13	28
Number of Lanes	1	1	1	1	1	1

Approach	EB	WB	SB
Opposing Approach	WB	EB	
Opposing Lanes	2	2	0
Conflicting Approach Left	SB		WB
Conflicting Lanes Left	2	0	2
Conflicting Approach Right		SB	EB
Conflicting Lanes Right	0	2	2
HCM Control Delay	11.9	8.5	8.8
HCM LOS	B	A	A

Lane	EBLn1	EBLn2	WBLn1	WBLn2	SBLn1	SBLn2
Vol Left, %	100%	0%	0%	0%	100%	0%
Vol Thru, %	0%	100%	100%	0%	0%	0%
Vol Right, %	0%	0%	0%	100%	0%	100%
Sign Control	Stop	Stop	Stop	Stop	Stop	Stop
Traffic Vol by Lane	94	353	89	13	11	24
LT Vol	94	0	0	0	11	0
Through Vol	0	353	89	0	0	0
RT Vol	0	0	0	13	0	24
Lane Flow Rate	109	410	103	15	13	28
Geometry Grp	7	7	7	7	7	7
Degree of Util (X)	0.156	0.53	0.148	0.019	0.024	0.043
Departure Headway (Hd)	5.147	4.646	5.144	4.44	6.748	5.54
Convergence, Y/N	Yes	Yes	Yes	Yes	Yes	Yes
Cap	688	763	700	809	533	649
Service Time	2.946	2.445	2.855	2.152	4.459	3.25
HCM Lane V/C Ratio	0.158	0.537	0.147	0.019	0.024	0.043
HCM Control Delay	8.9	12.7	8.7	7.2	9.6	8.5
HCM Lane LOS	A	B	A	A	A	A
HCM 95th-tile Q	0.6	3.2	0.5	0.1	0.1	0.1

Intersection						
Intersection Delay, s/veh	11.1					
Intersection LOS	B					

Movement	EBL	EBT	WBT	WBR	SBL	SBR
Lane Configurations		↶	↷		↶	↷
Traffic Vol, veh/h	328	43	21	15	12	75
Future Vol, veh/h	328	43	21	15	12	75
Peak Hour Factor	0.87	0.87	0.87	0.87	0.87	0.87
Heavy Vehicles, %	1	1	6	6	3	3
Mvmt Flow	377	49	24	17	14	86
Number of Lanes	0	1	1	0	1	1

Approach	EB	WB	SB
Opposing Approach	WB	EB	
Opposing Lanes	1	1	0
Conflicting Approach Left	SB		WB
Conflicting Lanes Left	2	0	1
Conflicting Approach Right		SB	EB
Conflicting Lanes Right	0	2	1
HCM Control Delay	12.1	7.7	8.4
HCM LOS	B	A	A

Lane	EBLn1	WBLn1	SBLn1	SBLn2
Vol Left, %	88%	0%	100%	0%
Vol Thru, %	12%	58%	0%	0%
Vol Right, %	0%	42%	0%	100%
Sign Control	Stop	Stop	Stop	Stop
Traffic Vol by Lane	371	36	12	75
LT Vol	328	0	12	0
Through Vol	43	21	0	0
RT Vol	0	15	0	75
Lane Flow Rate	426	41	14	86
Geometry Grp	2	2	7	7
Degree of Util (X)	0.523	0.051	0.024	0.118
Departure Headway (Hd)	4.411	4.459	6.134	4.923
Convergence, Y/N	Yes	Yes	Yes	Yes
Cap	823	802	584	728
Service Time	2.411	2.49	3.864	2.653
HCM Lane V/C Ratio	0.518	0.051	0.024	0.118
HCM Control Delay	12.1	7.7	9	8.3
HCM Lane LOS	B	A	A	A
HCM 95th-tile Q	3.1	0.2	0.1	0.4

HCM 2010 Signalized Intersection Summary
 26: East Garrison Road & Reservation Road



















Existing, PM
 06/11/2019



Movement	EBL	EBT	EBR	WBL	WBT	WBR	NBL	NBT	NBR	SBL	SBT	SBR
Lane Configurations												
Traffic Volume (veh/h)	1	681	24	51	430	0	9	0	30	0	0	0
Future Volume (veh/h)	1	681	24	51	430	0	9	0	30	0	0	0
Number	5	2	12	1	6	16	3	8	18			
Initial Q (Qb), veh	0	0	0	0	0	0	0	0	0			
Ped-Bike Adj(A_pbT)	1.00		1.00	1.00		1.00	1.00		1.00			
Parking Bus, Adj	1.00	1.00	1.00	1.00	1.00	1.00	1.00	1.00	1.00			
Adj Sat Flow, veh/h/ln	1863	1863	1900	1881	1881	0	1845	0	1845			
Adj Flow Rate, veh/h	1	702	23	53	443	0	9	0	2			
Adj No. of Lanes	1	2	0	1	2	0	1	0	1			
Peak Hour Factor	0.97	0.97	0.97	0.97	0.97	0.97	0.97	0.97	0.97			
Percent Heavy Veh, %	2	2	2	1	1	0	3	0	3			
Cap, veh/h	6	1677	55	106	1933	0	21	0	18			
Arrive On Green	0.00	0.48	0.48	0.06	0.54	0.00	0.01	0.00	0.01			
Sat Flow, veh/h	1774	3498	115	1792	3668	0	1757	0	1568			
Grp Volume(v), veh/h	1	355	370	53	443	0	9	0	2			
Grp Sat Flow(s),veh/h/ln	1774	1770	1843	1792	1787	0	1757	0	1568			
Q Serve(g_s), s	0.0	4.0	4.0	0.9	2.0	0.0	0.2	0.0	0.0			
Cycle Q Clear(g_c), s	0.0	4.0	4.0	0.9	2.0	0.0	0.2	0.0	0.0			
Prop In Lane	1.00		0.06	1.00		0.00	1.00		1.00			
Lane Grp Cap(c), veh/h	6	848	883	106	1933	0	21	0	18			
V/C Ratio(X)	0.17	0.42	0.42	0.50	0.23	0.00	0.44	0.00	0.11			
Avail Cap(c_a), veh/h	1165	3485	3629	1176	7039	0	1557	0	1390			
HCM Platoon Ratio	1.00	1.00	1.00	1.00	1.00	1.00	1.00	1.00	1.00			
Upstream Filter(I)	1.00	1.00	1.00	1.00	1.00	0.00	1.00	0.00	1.00			
Uniform Delay (d), s/veh	15.2	5.2	5.2	13.9	3.7	0.0	15.0	0.0	14.9			
Incr Delay (d2), s/veh	5.1	0.6	0.6	1.3	0.1	0.0	5.4	0.0	1.0			
Initial Q Delay(d3),s/veh	0.0	0.0	0.0	0.0	0.0	0.0	0.0	0.0	0.0			
%ile BackOfQ(50%),veh/ln	0.0	2.0	2.1	0.5	0.9	0.0	0.1	0.0	0.0			
LnGrp Delay(d),s/veh	20.2	5.8	5.8	15.2	3.7	0.0	20.3	0.0	15.9			
LnGrp LOS	C	A	A	B	A		C		B			
Approach Vol, veh/h		726			496			11				
Approach Delay, s/veh		5.8			5.0			19.5				
Approach LOS		A			A			B				
Timer	1	2	3	4	5	6	7	8				
Assigned Phs	1	2			5	6		8				
Phs Duration (G+Y+Rc), s	5.4	20.0			3.5	21.9		5.1				
Change Period (Y+Rc), s	3.6	5.4			3.5	5.4		4.7				
Max Green Setting (Gmax), s	20	60.0			20.0	60.0		27.0				
Max Q Clear Time (g_c+11), s	12	6.0			2.0	4.0		2.2				
Green Ext Time (p_c), s	0.0	8.6			0.0	3.5		0.0				
Intersection Summary												
HCM 2010 Ctrl Delay				5.6								
HCM 2010 LOS				A								
Notes												

HCM 2010 Signalized Intersection Summary
28: Davis Road & Reservation Road

Existing, PM
06/11/2019

												
Movement	EBL	EBT	EBR	WBL	WBT	WBR	NBL	NBT	NBR	SBL	SBT	SBR
Lane Configurations												
Traffic Volume (veh/h)	301	431	2	5	298	109	2	1	3	113	3	182
Future Volume (veh/h)	301	431	2	5	298	109	2	1	3	113	3	182
Number	5	2	12	1	6	16	3	8	18	7	4	14
Initial Q (Qb), veh	0	0	0	0	0	0	0	0	0	0	0	0
Ped-Bike Adj(A_pbT)	1.00		1.00	1.00		1.00	1.00		1.00	1.00		1.00
Parking Bus, Adj	1.00	1.00	1.00	1.00	1.00	1.00	1.00	1.00	1.00	1.00	1.00	1.00
Adj Sat Flow, veh/h/ln	1863	1863	1900	1827	1837	1900	1900	1900	1900	1900	1881	1881
Adj Flow Rate, veh/h	327	468	2	5	317	118	2	1	1	120	3	59
Adj No. of Lanes	1	1	0	1	1	0	0	1	0	0	1	1
Peak Hour Factor	0.92	0.92	0.92	0.94	0.94	0.92	0.94	0.94	0.94	0.94	0.94	0.94
Percent Heavy Veh, %	2	2	2	4	4	4	0	0	0	1	1	1
Cap, veh/h	382	1015	4	9	434	161	5	2	2	176	4	505
Arrive On Green	0.22	0.55	0.55	0.01	0.34	0.34	0.02	0.01	0.01	0.12	0.10	0.10
Sat Flow, veh/h	1774	1853	8	1740	1277	475	889	444	444	1750	44	1599
Grp Volume(v), veh/h	327	0	470	5	0	435	4	0	0	123	0	59
Grp Sat Flow(s),veh/h/ln	1774	0	1861	1740	0	1753	1777	0	0	1794	0	1599
Q Serve(g_s), s	9.3	0.0	8.0	0.2	0.0	11.4	0.1	0.0	0.0	3.5	0.0	1.4
Cycle Q Clear(g_c), s	9.3	0.0	8.0	0.2	0.0	11.4	0.1	0.0	0.0	3.5	0.0	1.4
Prop In Lane	1.00		0.00	1.00		0.27	0.50		0.25	0.98		1.00
Lane Grp Cap(c), veh/h	382	0	1020	9	0	595	10	0	0	180	0	505
V/C Ratio(X)	0.86	0.00	0.46	0.54	0.00	0.73	0.42	0.00	0.00	0.68	0.00	0.12
Avail Cap(c_a), veh/h	1014	0	2127	994	0	2003	1016	0	0	1025	0	1258
HCM Platoon Ratio	1.00	1.00	1.00	1.00	1.00	1.00	1.00	1.00	1.00	1.00	1.00	1.00
Upstream Filter(I)	1.00	0.00	1.00	1.00	0.00	1.00	1.00	0.00	0.00	1.00	0.00	1.00
Uniform Delay (d), s/veh	19.8	0.0	7.2	26.0	0.0	15.2	25.8	0.0	0.0	22.3	0.0	12.8
Incr Delay (d2), s/veh	2.2	0.0	0.5	16.6	0.0	2.8	10.3	0.0	0.0	1.7	0.0	0.0
Initial Q Delay(d3),s/veh	0.0	0.0	0.0	0.0	0.0	0.0	0.0	0.0	0.0	0.0	0.0	0.0
%ile BackOfQ(50%),veh/ln	4.8	0.0	4.2	0.1	0.0	5.9	0.1	0.0	0.0	1.8	0.0	0.6
LnGrp Delay(d),s/veh	22.0	0.0	7.7	42.6	0.0	18.0	36.1	0.0	0.0	24.0	0.0	12.8
LnGrp LOS	C		A	D		B	D			C		B
Approach Vol, veh/h		797			440			4				182
Approach Delay, s/veh		13.6			18.3			36.1				20.4
Approach LOS		B			B			D				C
Timer	1	2	3	4	5	6	7	8				
Assigned Phs	1	2		4	5	6		8				
Phs Duration (G+Y+Rc), s	4.2	33.8		10.3	15.1	22.8		4.3				
Change Period (Y+Rc), s	* 3.9	5.0		5.0	* 3.8	5.0		4.0				
Max Green Setting (Gmax), s	* 30	60.0		30.0	* 30	60.0		30.0				
Max Q Clear Time (g_c+I1), s	2.2	10.0		5.5	11.3	13.4		2.1				
Green Ext Time (p_c), s	0.0	4.7		0.2	0.1	4.4		0.0				
Intersection Summary												
HCM 2010 Ctrl Delay			15.9									
HCM 2010 LOS			B									
Notes												

Intersection	
Intersection Delay, s/veh	9.4
Intersection LOS	A

Movement	EBL	EBT	EBR	WBL	WBT	WBR	NBL	NBT	NBR	SBL	SBT	SBR
Lane Configurations		↔			↔	↔	↔	↔		↔	↔	↔
Traffic Vol, veh/h	5	0	2	27	4	39	8	226	4	10	191	8
Future Vol, veh/h	5	0	2	27	4	39	8	226	4	10	191	8
Peak Hour Factor	0.94	0.94	0.94	0.94	0.94	0.94	0.94	0.94	0.94	0.94	0.94	0.94
Heavy Vehicles, %	0	0	0	0	0	0	0	0	0	1	1	1
Mvmt Flow	5	0	2	29	4	41	9	240	4	11	203	9
Number of Lanes	0	1	0	0	1	1	1	2	0	1	1	1

Approach	EB	WB	NB	SB
Opposing Approach	WB	EB	SB	NB
Opposing Lanes	2	1	3	3
Conflicting Approach Left	SB	NB	EB	WB
Conflicting Lanes Left	3	3	1	2
Conflicting Approach Right	NB	SB	WB	EB
Conflicting Lanes Right	3	3	2	1
HCM Control Delay	8.9	8.6	9.2	10
HCM LOS	A	A	A	A

Lane	NBLn1	NBLn2	NBLn3	EBLn1	WBLn1	WBLn2	SBLn1	SBLn2	SBLn3
Vol Left, %	100%	0%	0%	71%	87%	0%	100%	0%	0%
Vol Thru, %	0%	100%	95%	0%	13%	0%	0%	100%	0%
Vol Right, %	0%	0%	5%	29%	0%	100%	0%	0%	100%
Sign Control	Stop	Stop	Stop	Stop	Stop	Stop	Stop	Stop	Stop
Traffic Vol by Lane	8	151	79	7	31	39	10	191	8
LT Vol	8	0	0	5	27	0	10	0	0
Through Vol	0	151	75	0	4	0	0	191	0
RT Vol	0	0	4	2	0	39	0	0	8
Lane Flow Rate	9	160	84	7	33	41	11	203	9
Geometry Grp	8	8	8	8	8	8	8	8	8
Degree of Util (X)	0.013	0.232	0.121	0.012	0.057	0.058	0.017	0.297	0.011
Departure Headway (Hd)	5.71	5.208	5.173	6.039	6.172	5.038	5.771	5.269	4.567
Convergence, Y/N	Yes	Yes	Yes	Yes	Yes	Yes	Yes	Yes	Yes
Cap	626	688	691	589	578	707	619	681	781
Service Time	3.454	2.952	2.917	3.813	3.932	2.799	3.515	3.013	2.311
HCM Lane V/C Ratio	0.014	0.233	0.122	0.012	0.057	0.058	0.018	0.298	0.012
HCM Control Delay	8.5	9.5	8.6	8.9	9.3	8.1	8.6	10.2	7.4
HCM Lane LOS	A	A	A	A	A	A	A	B	A
HCM 95th-tile Q	0	0.9	0.4	0	0.2	0.2	0.1	1.2	0

Intersection												
Intersection Delay, s/veh	10.2											
Intersection LOS	B											

Movement	EBL	EBT	EBR	WBL	WBT	WBR	NBL	NBT	NBR	SBL	SBT	SBR
Lane Configurations		↕			↕		↕	↕		↕	↕	
Traffic Vol, veh/h	4	13	8	63	47	118	17	160	25	11	118	4
Future Vol, veh/h	4	13	8	63	47	118	17	160	25	11	118	4
Peak Hour Factor	0.85	0.85	0.85	0.85	0.85	0.85	0.85	0.85	0.85	0.85	0.85	0.85
Heavy Vehicles, %	0	0	0	1	1	1	0	0	0	1	1	1
Mvmt Flow	5	15	9	74	55	139	20	188	29	13	139	5
Number of Lanes	0	1	0	0	1	0	1	1	0	1	1	0

Approach	EB	WB	NB	SB
Opposing Approach	WB	EB	SB	NB
Opposing Lanes	1	1	2	2
Conflicting Approach Left	SB	NB	EB	WB
Conflicting Lanes Left	2	2	1	1
Conflicting Approach Right	NB	SB	WB	EB
Conflicting Lanes Right	2	2	1	1
HCM Control Delay	8.4	10.3	10.5	9.7
HCM LOS	A	B	B	A

Lane	NBLn1	NBLn2	EBLn1	WBLn1	SBLn1	SBLn2
Vol Left, %	100%	0%	16%	28%	100%	0%
Vol Thru, %	0%	86%	52%	21%	0%	97%
Vol Right, %	0%	14%	32%	52%	0%	3%
Sign Control	Stop	Stop	Stop	Stop	Stop	Stop
Traffic Vol by Lane	17	185	25	228	11	122
LT Vol	17	0	4	63	11	0
Through Vol	0	160	13	47	0	118
RT Vol	0	25	8	118	0	4
Lane Flow Rate	20	218	29	268	13	144
Geometry Grp	7	7	2	2	7	7
Degree of Util (X)	0.033	0.32	0.042	0.351	0.022	0.218
Departure Headway (Hd)	5.894	5.293	5.114	4.706	5.999	5.47
Convergence, Y/N	Yes	Yes	Yes	Yes	Yes	Yes
Cap	603	673	692	759	592	650
Service Time	3.673	3.072	3.206	2.764	3.783	3.255
HCM Lane V/C Ratio	0.033	0.324	0.042	0.353	0.022	0.222
HCM Control Delay	8.9	10.6	8.4	10.3	8.9	9.8
HCM Lane LOS	A	B	A	B	A	A
HCM 95th-tile Q	0.1	1.4	0.1	1.6	0.1	0.8

HCM 2010 Signalized Intersection Summary
31: 1st Avenue & Lightfighter Drive

Existing, PM
06/11/2019



Movement	EBL	EBT	EBR	WBL	WBT	WBR	NBL	NBT	NBR	SBL	SBT	SBR
Lane Configurations		↑↑	↑	↑	↑↑		↑		↑	↑	↑	↑
Traffic Volume (veh/h)	0	453	103	14	971	0	195	0	22	1	0	20
Future Volume (veh/h)	0	453	103	14	971	0	195	0	22	1	0	20
Number	7	4	14	3	8	18	5	2	12	1	6	16
Initial Q (Qb), veh	0	0	0	0	0	0	0	0	0	0	0	0
Ped-Bike Adj(A_pbT)	1.00		1.00	1.00		1.00	1.00		1.00	1.00		1.00
Parking Bus, Adj	1.00	1.00	1.00	1.00	1.00	1.00	1.00	1.00	1.00	1.00	1.00	1.00
Adj Sat Flow, veh/h/ln	0	1881	1881	1881	1881	0	1881	0	1881	1810	1810	1810
Adj Flow Rate, veh/h	0	477	0	15	1022	0	205	0	5	1	0	1
Adj No. of Lanes	0	2	1	1	2	0	1	0	1	1	1	1
Peak Hour Factor	0.95	0.95	0.95	0.95	0.95	0.95	0.95	0.95	0.95	0.95	0.95	0.95
Percent Heavy Veh, %	0	1	1	1	1	0	1	0	1	5	5	5
Cap, veh/h	0	1878	840	16	2367	0	0	0	0	6	7	6
Arrive On Green	0.00	0.53	0.00	0.01	0.66	0.00	0.00	0.00	0.00	0.00	0.00	0.00
Sat Flow, veh/h	0	3668	1599	1792	3668	0	0	0	1723	1810	1538	
Grp Volume(v), veh/h	0	477	0	15	1022	0	0.0	0.0	0.0	1	0	1
Grp Sat Flow(s),veh/h/ln	0	1787	1599	1792	1787	0	0.0	0.0	0.0	1723	1810	1538
Q Serve(g_s), s	0.0	2.0	0.0	0.2	3.7	0.0	0.0	0.0	0.0	0.0	0.0	0.0
Cycle Q Clear(g_c), s	0.0	2.0	0.0	0.2	3.7	0.0	0.0	0.0	0.0	0.0	0.0	0.0
Prop In Lane	0.00		1.00	1.00		0.00				1.00		1.00
Lane Grp Cap(c), veh/h	0	1878	840	16	2367	0	0	0	0	6	7	6
V/C Ratio(X)	0.00	0.25	0.00	0.95	0.43	0.00	0.00	0.00	0.00	0.16	0.00	0.18
Avail Cap(c_a), veh/h	0	5884	2632	1311	5884	0	0	0	0	1576	1655	1407
HCM Platoon Ratio	1.00	1.00	1.00	1.00	1.00	1.00	1.00	1.00	1.00	1.00	1.00	1.00
Upstream Filter(I)	0.00	1.00	0.00	1.00	1.00	0.00	0.00	0.00	0.00	1.00	0.00	1.00
Uniform Delay (d), s/veh	0.0	3.6	0.0	13.5	2.2	0.0	0.0	0.0	0.0	13.6	0.0	13.6
Incr Delay (d2), s/veh	0.0	0.1	0.0	52.7	0.2	0.0	0.0	0.0	0.0	4.3	0.0	5.5
Initial Q Delay(d3),s/veh	0.0	0.0	0.0	0.0	0.0	0.0	0.0	0.0	0.0	0.0	0.0	0.0
%ile BackOfQ(50%),veh/lr	0.0	1.0	0.0	0.3	1.8	0.0	0.0	0.0	0.0	0.0	0.0	0.0
LnGrp Delay(d),s/veh	0.0	3.7	0.0	66.2	2.4	0.0	0.0	0.0	0.0	17.9	0.0	19.1
LnGrp LOS		A		E	A					B		B
Approach Vol, veh/h		477			1037						2	
Approach Delay, s/veh		3.7			3.3						18.5	
Approach LOS		A			A						B	
Timer	1	2	3	4	5	6	7	8				
Assigned Phs			3	4		6		8				
Phs Duration (G+Y+Rc), s			3.7	19.0		4.6		22.7				
Change Period (Y+Rc), s			3.5	4.6		4.6		4.6				
Max Green Setting (Gmax), s			20.0	45.0		25.0		45.0				
Max Q Clear Time (g_c+I1), s			2.2	4.0		2.0		5.7				
Green Ext Time (p_c), s			0.0	5.1		0.0		12.4				
Intersection Summary												
HCM 2010 Ctrl Delay			3.4									
HCM 2010 LOS			A									

HCM 2010 Signalized Intersection Summary
 32: 2nd Avenue & Lightfighter Drive

Existing, PM
 06/11/2019



Movement	EBL	EBT	EBR	WBL	WBT	WBR	NBL	NBT	NBR	SBL	SBT	SBR
Lane Configurations												
Traffic Volume (veh/h)	145	322	1	2	868	126	5	1	8	78	5	113
Future Volume (veh/h)	145	322	1	2	868	126	5	1	8	78	5	113
Number	5	2	12	1	6	16	3	8	18	7	4	14
Initial Q (Qb), veh	0	0	0	0	0	0	0	0	0	0	0	0
Ped-Bike Adj(A_pbT)	1.00		1.00	1.00		1.00	0.99		0.99	0.99		0.99
Parking Bus, Adj	1.00	1.00	1.00	1.00	1.00	1.00	1.00	1.00	1.00	1.00	1.00	1.00
Adj Sat Flow, veh/h/ln	1881	1881	1900	1881	1881	1900	1900	1900	1900	1845	1845	1845
Adj Flow Rate, veh/h	153	339	1	2	914	128	5	1	2	82	5	16
Adj No. of Lanes	1	2	0	1	2	0	0	1	0	1	1	1
Peak Hour Factor	0.95	0.95	0.95	0.95	0.95	0.95	0.95	0.95	0.95	0.95	0.95	0.95
Percent Heavy Veh, %	1	1	1	1	1	1	0	0	0	3	3	3
Cap, veh/h	184	2832	8	4	2124	297	133	30	35	199	168	141
Arrive On Green	0.10	0.77	0.77	0.00	0.67	0.67	0.10	0.09	0.09	0.09	0.09	0.09
Sat Flow, veh/h	1792	3656	11	1792	3149	441	818	330	383	1376	1845	1547
Grp Volume(v), veh/h	153	166	174	2	519	523	8	0	0	82	5	16
Grp Sat Flow(s),veh/h/ln	1792	1787	1879	1792	1787	1803	1531	0	0	1376	1845	1547
Q Serve(g_s), s	8.4	2.3	2.3	0.1	13.3	13.3	0.0	0.0	0.0	5.2	0.2	0.9
Cycle Q Clear(g_c), s	8.4	2.3	2.3	0.1	13.3	13.3	0.4	0.0	0.0	5.6	0.2	0.9
Prop In Lane	1.00		0.01	1.00		0.24	0.62		0.25	1.00		1.00
Lane Grp Cap(c), veh/h	184	1385	1456	4	1205	1216	207	0	0	199	168	141
V/C Ratio(X)	0.83	0.12	0.12	0.52	0.43	0.43	0.04	0.00	0.00	0.41	0.03	0.11
Avail Cap(c_a), veh/h	222	1385	1456	222	1205	1216	674	0	0	629	745	625
HCM Platoon Ratio	1.00	1.00	1.00	1.00	1.00	1.00	1.00	1.00	1.00	1.00	1.00	1.00
Upstream Filter(I)	0.98	0.98	0.98	0.37	0.37	0.37	1.00	0.00	0.00	1.00	1.00	1.00
Uniform Delay (d), s/veh	44.0	2.8	2.8	49.8	7.5	7.5	41.3	0.0	0.0	43.8	41.4	41.7
Incr Delay (d2), s/veh	16.7	0.2	0.2	13.7	0.4	0.4	0.0	0.0	0.0	0.5	0.0	0.1
Initial Q Delay(d3),s/veh	0.0	0.0	0.0	0.0	0.0	0.0	0.0	0.0	0.0	0.0	0.0	0.0
%ile BackOfQ(50%),veh/ln	6.0	1.2	1.2	0.1	6.6	6.7	0.2	0.0	0.0	2.2	0.1	0.4
LnGrp Delay(d),s/veh	60.7	3.0	3.0	63.5	7.9	7.9	41.3	0.0	0.0	44.3	41.4	41.9
LnGrp LOS	E	A	A	E	A	A	D			D	D	D
Approach Vol, veh/h		493			1044			8			103	
Approach Delay, s/veh		20.9			8.0			41.3			43.8	
Approach LOS		C			A			D			D	
Timer	1	2	3	4	5	6	7	8				
Assigned Phs	1	2		4	5	6		8				
Phs Duration (G+Y+Rc), s	4.2	82.1		13.7	14.3	72.0		13.7				
Change Period (Y+Rc), s	4.0	4.6		4.6	4.0	4.6		4.6				
Max Green Setting (Gmax), s	4.4	34.0		40.4	12.4	24.4		40.4				
Max Q Clear Time (g_c+1/2), s	4.4	4.3		7.6	10.4	15.3		2.4				
Green Ext Time (p_c), s	0.0	1.1		0.1	0.0	3.0		0.0				
Intersection Summary												
HCM 2010 Ctrl Delay			14.2									
HCM 2010 LOS			B									

HCM 2010 Signalized Intersection Summary
 33: General Jim Moore Boulevard & Lightfighter Drive

Existing, PM
 06/11/2019



Movement	EBL	EBT	EBR	WBL	WBT	WBR	NBL	NBT	NBR	SBL	SBT	SBR
Lane Configurations	↖	↑	↗	↖	↗		↖	↗		↖	↗	
Traffic Volume (veh/h)	66	138	200	8	213	7	649	108	7	7	86	137
Future Volume (veh/h)	66	138	200	8	213	7	649	108	7	7	86	137
Number	3	8	18	7	4	14	1	6	16	5	2	12
Initial Q (Qb), veh	0	0	0	0	0	0	0	0	0	0	0	0
Ped-Bike Adj(A_pbT)	1.00		1.00	1.00		1.00	1.00		1.00	1.00		1.00
Parking Bus, Adj	1.00	1.00	1.00	1.00	1.00	1.00	1.00	1.00	1.00	1.00	1.00	1.00
Adj Sat Flow, veh/h/ln	1881	1881	1881	1900	1900	1900	1881	1881	1900	1900	1900	1900
Adj Flow Rate, veh/h	69	144	0	8	222	6	676	112	5	7	90	31
Adj No. of Lanes	1	1	1	1	1	0	2	1	0	1	2	0
Peak Hour Factor	0.96	0.96	0.96	0.96	0.96	0.96	0.96	0.96	0.96	0.96	0.96	0.96
Percent Heavy Veh, %	1	1	1	0	0	0	1	1	1	0	0	0
Cap, veh/h	92	438	372	15	349	9	776	625	28	13	357	118
Arrive On Green	0.05	0.23	0.00	0.01	0.19	0.19	0.22	0.35	0.35	0.01	0.13	0.13
Sat Flow, veh/h	1792	1881	1599	1810	1841	50	3476	1787	80	1810	2669	880
Grp Volume(v), veh/h	69	144	0	8	0	228	676	0	117	7	60	61
Grp Sat Flow(s),veh/h/ln	1792	1881	1599	1810	0	1891	1738	0	1867	1810	1805	1745
Q Serve(g_s), s	1.7	2.8	0.0	0.2	0.0	5.0	8.4	0.0	1.9	0.2	1.3	1.4
Cycle Q Clear(g_c), s	1.7	2.8	0.0	0.2	0.0	5.0	8.4	0.0	1.9	0.2	1.3	1.4
Prop In Lane	1.00		1.00	1.00		0.03	1.00		0.04	1.00		0.50
Lane Grp Cap(c), veh/h	92	438	372	15	0	359	776	0	653	13	242	234
V/C Ratio(X)	0.75	0.33	0.00	0.52	0.00	0.64	0.87	0.00	0.18	0.52	0.25	0.26
Avail Cap(c_a), veh/h	800	1260	1071	808	0	1266	776	0	1250	606	1209	1168
HCM Platoon Ratio	1.00	1.00	1.00	1.00	1.00	1.00	1.00	1.00	1.00	1.00	1.00	1.00
Upstream Filter(I)	1.00	1.00	0.00	1.00	0.00	1.00	1.00	0.00	1.00	1.00	1.00	1.00
Uniform Delay (d), s/veh	21.0	14.3	0.0	22.1	0.0	16.7	16.8	0.0	10.1	22.2	17.4	17.4
Incr Delay (d2), s/veh	11.4	0.5	0.0	9.8	0.0	2.3	10.4	0.0	0.3	11.0	0.6	0.7
Initial Q Delay(d3),s/veh	0.0	0.0	0.0	0.0	0.0	0.0	0.0	0.0	0.0	0.0	0.0	0.0
%ile BackOfQ(50%),veh/ln	1.1	1.5	0.0	0.1	0.0	2.8	5.2	0.0	1.1	0.1	0.7	0.7
LnGrp Delay(d),s/veh	32.4	14.8	0.0	32.0	0.0	19.0	27.2	0.0	10.4	33.1	18.0	18.1
LnGrp LOS	C	B		C		B	C		B	C	B	B
Approach Vol, veh/h		213			236			793			128	
Approach Delay, s/veh		20.5			19.4			24.7			18.9	
Approach LOS		C			B			C			B	
Timer	1	2	3	4	5	6	7	8				
Assigned Phs	1	2	3	4	5	6	7	8				
Phs Duration (G+Y+Rc), s	4.5	10.5	6.8	13.0	4.8	20.2	4.9	14.9				
Change Period (Y+Rc), s	4.5	4.5	4.5	4.5	4.5	4.5	4.5	4.5				
Max Green Setting (Gmax), s	30.0	30.0	20.0	30.0	15.0	30.0	20.0	30.0				
Max Q Clear Time (g_c+1), s	3.4	3.7	7.0	2.2	3.9	2.2	4.8					
Green Ext Time (p_c), s	0.0	0.7	0.1	1.6	0.0	1.1	0.0	0.8				
Intersection Summary												
HCM 2010 Ctrl Delay			22.6									
HCM 2010 LOS			C									

Intersection	
Intersection Delay, s/veh	8.3
Intersection LOS	A

Movement	WBL	WBR	NBT	NBR	SBL	SBT
Lane Configurations						
Traffic Vol, veh/h	6	167	45	5	115	37
Future Vol, veh/h	6	167	45	5	115	37
Peak Hour Factor	0.88	0.88	0.88	0.88	0.88	0.88
Heavy Vehicles, %	0	0	2	2	1	1
Mvmt Flow	7	190	51	6	131	42
Number of Lanes	1	0	1	0	0	1

Approach	WB	NB	SB
Opposing Approach		SB	NB
Opposing Lanes	0	1	1
Conflicting Approach Left	NB		WB
Conflicting Lanes Left	1	0	1
Conflicting Approach Right	SB	WB	
Conflicting Lanes Right	1	1	0
HCM Control Delay	7.9	7.8	8.8
HCM LOS	A	A	A

Lane	NBLn1	WBLn1	SBLn1
Vol Left, %	0%	3%	76%
Vol Thru, %	90%	0%	24%
Vol Right, %	10%	97%	0%
Sign Control	Stop	Stop	Stop
Traffic Vol by Lane	50	173	152
LT Vol	0	6	115
Through Vol	45	0	37
RT Vol	5	167	0
Lane Flow Rate	57	197	173
Geometry Grp	1	1	1
Degree of Util (X)	0.071	0.211	0.214
Departure Headway (Hd)	4.471	3.868	4.46
Convergence, Y/N	Yes	Yes	Yes
Cap	803	934	793
Service Time	2.487	1.871	2.551
HCM Lane V/C Ratio	0.071	0.211	0.218
HCM Control Delay	7.8	7.9	8.8
HCM Lane LOS	A	A	A
HCM 95th-tile Q	0.2	0.8	0.8

Intersection						
Int Delay, s/veh	1.1					
Movement	EBT	EBR	WBL	WBT	NBL	NBR
Lane Configurations						
Traffic Vol, veh/h	101	4	2	136	24	4
Future Vol, veh/h	101	4	2	136	24	4
Conflicting Peds, #/hr	0	0	0	0	0	0
Sign Control	Free	Free	Free	Free	Stop	Stop
RT Channelized	-	None	-	None	-	None
Storage Length	-	-	-	-	0	-
Veh in Median Storage, #	0	-	-	0	0	-
Grade, %	0	-	-	0	0	-
Peak Hour Factor	85	85	85	85	85	85
Heavy Vehicles, %	0	0	0	0	0	0
Mvmt Flow	119	5	2	160	28	5

Major/Minor	Major1	Major2	Minor1	Minor2	Minor3
Conflicting Flow All	0	0	124	0	286
Stage 1	-	-	-	-	122
Stage 2	-	-	-	-	164
Critical Hdwy	-	-	4.1	-	6.4
Critical Hdwy Stg 1	-	-	-	-	5.4
Critical Hdwy Stg 2	-	-	-	-	5.4
Follow-up Hdwy	-	-	2.2	-	3.5
Pot Cap-1 Maneuver	-	-	1475	-	709
Stage 1	-	-	-	-	908
Stage 2	-	-	-	-	870
Platoon blocked, %	-	-	-	-	-
Mov Cap-1 Maneuver	-	-	1475	-	708
Mov Cap-2 Maneuver	-	-	-	-	708
Stage 1	-	-	-	-	907
Stage 2	-	-	-	-	870

Approach	EB	WB	NB
HCM Control Delay, s	0	0.1	10.1
HCM LOS			B

Minor Lane/Major Mvmt	NBLn1	EBT	EBR	WBL	WBT
Capacity (veh/h)	733	-	-	1475	-
HCM Lane V/C Ratio	0.045	-	-	0.002	-
HCM Control Delay (s)	10.1	-	-	7.4	0
HCM Lane LOS	B	-	-	A	A
HCM 95th %tile Q(veh)	0.1	-	-	0	-

Intersection	
Intersection Delay, s/veh	7.8
Intersection LOS	A

Movement	EBL	EBT	EBR	WBL	WBT	WBR	NBL	NBT	NBR	SBL	SBT	SBR
Lane Configurations		↕			↕			↕			↕	
Traffic Vol, veh/h	13	91	0	0	71	0	30	15	5	1	14	38
Future Vol, veh/h	13	91	0	0	71	0	30	15	5	1	14	38
Peak Hour Factor	0.82	0.82	0.82	0.82	0.82	0.82	0.82	0.82	0.82	0.82	0.82	0.82
Heavy Vehicles, %	0	0	0	0	0	0	2	2	2	0	0	0
Mvmt Flow	16	111	0	0	87	0	37	18	6	1	17	46
Number of Lanes	0	1	0	0	1	0	0	1	0	0	1	0

Approach	EB	WB	NB	SB
Opposing Approach	WB	EB	SB	NB
Opposing Lanes	1	1	1	1
Conflicting Approach Left	SB	NB	EB	WB
Conflicting Lanes Left	1	1	1	1
Conflicting Approach Right	NB	SB	WB	EB
Conflicting Lanes Right	1	1	1	1
HCM Control Delay	8.1	7.8	7.9	7.3
HCM LOS	A	A	A	A

Lane	NBLn1	EBLn1	WBLn1	SBLn1
Vol Left, %	60%	12%	0%	2%
Vol Thru, %	30%	88%	100%	26%
Vol Right, %	10%	0%	0%	72%
Sign Control	Stop	Stop	Stop	Stop
Traffic Vol by Lane	50	104	71	53
LT Vol	30	13	0	1
Through Vol	15	91	71	14
RT Vol	5	0	0	38
Lane Flow Rate	61	127	87	65
Geometry Grp	1	1	1	1
Degree of Util (X)	0.077	0.148	0.104	0.072
Departure Headway (Hd)	4.539	4.209	4.322	4.021
Convergence, Y/N	Yes	Yes	Yes	Yes
Cap	793	838	834	895
Service Time	2.547	2.307	2.322	2.028
HCM Lane V/C Ratio	0.077	0.152	0.104	0.073
HCM Control Delay	7.9	8.1	7.8	7.3
HCM Lane LOS	A	A	A	A
HCM 95th-tile Q	0.2	0.5	0.3	0.2

Intersection												
Int Delay, s/veh	7											
Movement	EBL	EBT	EBR	WBL	WBT	WBR	NBL	NBT	NBR	SBL	SBT	SBR
Lane Configurations		↕			↕			↕			↕	
Traffic Vol, veh/h	17	85	1	0	50	0	0	36	0	0	23	14
Future Vol, veh/h	17	85	1	0	50	0	0	36	0	0	23	14
Conflicting Peds, #/hr	0	0	0	0	0	0	0	0	0	0	0	0
Sign Control	Stop	Stop	Stop	Stop	Stop	Stop	Free	Free	Free	Free	Free	Free
RT Channelized	-	-	None	-	-	None	-	-	None	-	-	None
Storage Length	-	-	-	-	-	-	-	-	-	-	-	-
Veh in Median Storage, #	-	0	-	-	0	-	-	0	-	-	0	-
Grade, %	-	0	-	-	0	-	-	0	-	-	0	-
Peak Hour Factor	74	74	74	74	74	74	74	74	74	74	74	74
Heavy Vehicles, %	3	3	3	2	2	2	3	3	3	8	8	8
Mvmt Flow	23	115	1	0	68	0	0	49	0	0	31	19

Major/Minor	Minor2		Minor1		Major1			Major2				
Conflicting Flow All	124	90	41	148	99	49	50	0	0	49	0	0
Stage 1	41	41	-	49	49	-	-	-	-	-	-	-
Stage 2	83	49	-	99	50	-	-	-	-	-	-	-
Critical Hdwy	7.13	6.53	6.23	7.12	6.52	6.22	4.13	-	-	4.18	-	-
Critical Hdwy Stg 1	6.13	5.53	-	6.12	5.52	-	-	-	-	-	-	-
Critical Hdwy Stg 2	6.13	5.53	-	6.12	5.52	-	-	-	-	-	-	-
Follow-up Hdwy	3.527	4.027	3.327	3.518	4.018	3.318	2.227	-	-	2.272	-	-
Pot Cap-1 Maneuver	848	798	1027	820	791	1020	1550	-	-	1520	-	-
Stage 1	971	859	-	964	854	-	-	-	-	-	-	-
Stage 2	923	852	-	907	853	-	-	-	-	-	-	-
Platoon blocked, %								-	-	-	-	-
Mov Cap-1 Maneuver	793	798	1027	728	791	1020	1550	-	-	1520	-	-
Mov Cap-2 Maneuver	793	798	-	728	791	-	-	-	-	-	-	-
Stage 1	971	859	-	964	854	-	-	-	-	-	-	-
Stage 2	850	852	-	785	853	-	-	-	-	-	-	-

Approach	EB		WB		NB		SB	
HCM Control Delay, s	10.5		10		0		0	
HCM LOS	B		B					

Minor Lane/Major Mvmt	NBL	NBT	NBR	EBLn1	WBLn1	SBL	SBT	SBR
Capacity (veh/h)	1550	-	-	799	791	1520	-	-
HCM Lane V/C Ratio	-	-	-	0.174	0.085	-	-	-
HCM Control Delay (s)	0	-	-	10.5	10	0	-	-
HCM Lane LOS	A	-	-	B	B	A	-	-
HCM 95th %tile Q(veh)	0	-	-	0.6	0.3	0	-	-

Intersection						
Int Delay, s/veh	2					
Movement	EBL	EBR	NBL	NBT	SBT	SBR
Lane Configurations	T			T		T
Traffic Vol, veh/h	86	1	0	340	117	54
Future Vol, veh/h	86	1	0	340	117	54
Conflicting Peds, #/hr	0	0	0	0	0	0
Sign Control	Stop	Stop	Free	Free	Free	Free
RT Channelized	-	None	-	None	-	None
Storage Length	0	-	-	-	-	-
Veh in Median Storage, #	0	-	-	0	0	-
Grade, %	0	-	-	0	0	-
Peak Hour Factor	88	88	88	88	88	88
Heavy Vehicles, %	0	0	2	2	1	1
Mvmt Flow	98	1	0	386	133	61























Major/Minor	Minor2	Major1		Major2	
Conflicting Flow All	550	164	194	0	0
Stage 1	164	-	-	-	-
Stage 2	386	-	-	-	-
Critical Hdwy	6.4	6.2	4.12	-	-
Critical Hdwy Stg 1	5.4	-	-	-	-
Critical Hdwy Stg 2	5.4	-	-	-	-
Follow-up Hdwy	3.5	3.3	2.218	-	-
Pot Cap-1 Maneuver	500	886	1379	-	-
Stage 1	870	-	-	-	-
Stage 2	691	-	-	-	-
Platoon blocked, %				-	-
Mov Cap-1 Maneuver	500	886	1379	-	-
Mov Cap-2 Maneuver	500	-	-	-	-
Stage 1	870	-	-	-	-
Stage 2	691	-	-	-	-

Approach	EB	NB	SB
HCM Control Delay, s	13.9	0	0
HCM LOS	B		

Minor Lane/Major Mvmt	NBL	NBT	EBLn1	SBT	SBR
Capacity (veh/h)	1379	-	503	-	-
HCM Lane V/C Ratio	-	-	0.197	-	-
HCM Control Delay (s)	0	-	13.9	-	-
HCM Lane LOS	A	-	B	-	-
HCM 95th %tile Q(veh)	0	-	0.7	-	-

HCM 2010 Signalized Intersection Summary
 39: General Jim Moore Boulevard & Gigling Road

Existing, PM
 06/11/2019

												
Movement	EBL	EBT	EBR	WBL	WBT	WBR	NBL	NBT	NBR	SBL	SBT	SBR
Lane Configurations												
Traffic Volume (veh/h)	18	12	27	167	42	218	57	554	308	67	234	46
Future Volume (veh/h)	18	12	27	167	42	218	57	554	308	67	234	46
Number	3	8	18	7	4	14	1	6	16	5	2	12
Initial Q (Qb), veh	0	0	0	0	0	0	0	0	0	0	0	0
Ped-Bike Adj(A_pbT)	1.00		1.00	1.00		1.00	1.00		1.00	1.00		1.00
Parking Bus, Adj	1.00	1.00	1.00	1.00	1.00	1.00	1.00	1.00	1.00	1.00	1.00	1.00
Adj Sat Flow, veh/h/ln	1776	1776	1900	1881	1881	1881	1863	1863	1863	1863	1863	1863
Adj Flow Rate, veh/h	20	13	-1	188	47	0	64	622	0	75	263	0
Adj No. of Lanes	1	1	0	1	1	1	1	2	1	1	2	1
Peak Hour Factor	0.89	0.89	0.89	0.89	0.89	0.89	0.89	0.89	0.89	0.89	0.89	0.89
Percent Heavy Veh, %	7	7	7	1	1	1	2	2	2	2	2	2
Cap, veh/h	42	153	0	240	366	311	114	856	383	127	881	394
Arrive On Green	0.03	0.09	0.00	0.13	0.19	0.00	0.06	0.24	0.00	0.07	0.25	0.00
Sat Flow, veh/h	1691	1776	0	1792	1881	1599	1774	3539	1583	1774	3539	1583
Grp Volume(v), veh/h	20	12	0	188	47	0	64	622	0	75	263	0
Grp Sat Flow(s),veh/h/ln	1691	1776	0	1792	1881	1599	1774	1770	1583	1774	1770	1583
Q Serve(g_s), s	0.4	0.2	0.0	3.9	0.8	0.0	1.3	6.2	0.0	1.6	2.3	0.0
Cycle Q Clear(g_c), s	0.4	0.2	0.0	3.9	0.8	0.0	1.3	6.2	0.0	1.6	2.3	0.0
Prop In Lane	1.00		0.00	1.00		1.00	1.00		1.00	1.00		1.00
Lane Grp Cap(c), veh/h	42	153	0	240	366	311	114	856	383	127	881	394
V/C Ratio(X)	0.47	0.08	0.00	0.78	0.13	0.00	0.56	0.73	0.00	0.59	0.30	0.00
Avail Cap(c_a), veh/h	899	1405	0	953	1488	1265	483	2341	1047	483	2341	1047
HCM Platoon Ratio	1.00	1.00	1.00	1.00	1.00	1.00	1.00	1.00	1.00	1.00	1.00	1.00
Upstream Filter(I)	1.00	1.00	0.00	1.00	1.00	0.00	1.00	1.00	0.00	1.00	1.00	0.00
Uniform Delay (d), s/veh	18.5	16.2	0.0	16.2	12.8	0.0	17.5	13.4	0.0	17.3	11.7	0.0
Incr Delay (d2), s/veh	3.0	0.1	0.0	2.1	0.1	0.0	1.6	0.4	0.0	1.6	0.1	0.0
Initial Q Delay(d3),s/veh	0.0	0.0	0.0	0.0	0.0	0.0	0.0	0.0	0.0	0.0	0.0	0.0
%ile BackOfQ(50%),veh/ln	0.2	0.1	0.0	2.1	0.4	0.0	0.7	3.1	0.0	0.8	1.1	0.0
LnGrp Delay(d),s/veh	21.6	16.3	0.0	18.3	12.9	0.0	19.1	13.9	0.0	19.0	11.8	0.0
LnGrp LOS	C	B		B	B		B	B		B	B	
Approach Vol, veh/h		32			235			686			338	
Approach Delay, s/veh		19.6			17.2			14.4			13.4	
Approach LOS		B			B			B			B	
Timer	1	2	3	4	5	6	7	8				
Assigned Phs	1	2	3	4	5	6	7	8				
Phs Duration (G+Y+Rc), s	7.0	14.1	5.5	12.0	7.3	13.8	9.7	7.8				
Change Period (Y+Rc), s	4.5	4.5	4.5	4.5	4.5	4.5	4.5	4.5				
Max Green Setting (Gmax), s	10.5	25.5	20.5	30.5	10.5	25.5	20.5	30.5				
Max Q Clear Time (g_c+I1), s	3.3	4.3	2.4	2.8	3.6	8.2	5.9	2.2				
Green Ext Time (p_c), s	0.0	0.3	0.0	0.0	0.0	0.8	0.0	0.0				
Intersection Summary												
HCM 2010 Ctrl Delay			14.8									
HCM 2010 LOS			B									
Notes												

Intersection												
Int Delay, s/veh	2											
Movement	EBL	EBT	EBR	WBL	WBT	WBR	NBL	NBT	NBR	SBL	SBT	SBR
Lane Configurations		↕			↕			↕			↕	
Traffic Vol, veh/h	3	340	39	12	312	13	12	25	6	9	27	5
Future Vol, veh/h	3	340	39	12	312	13	12	25	6	9	27	5
Conflicting Peds, #/hr	1	0	2	2	0	1	0	0	0	0	0	0
Sign Control	Free	Free	Free	Free	Free	Free	Stop	Stop	Stop	Stop	Stop	Stop
RT Channelized	-	-	None	-	-	None	-	-	None	-	-	None
Storage Length	-	-	-	-	-	-	-	-	-	-	-	-
Veh in Median Storage, #	-	0	-	-	0	-	-	0	-	-	0	-
Grade, %	-	0	-	-	0	-	-	0	-	-	0	-
Peak Hour Factor	91	91	91	91	91	91	91	91	91	91	91	91
Heavy Vehicles, %	2	2	2	1	1	1	0	0	0	5	5	5
Mvmt Flow	3	374	43	13	343	14	13	27	7	10	30	5

Major/Minor	Major1			Major2			Minor1			Minor2		
Conflicting Flow All	358	0	0	419	0	0	798	788	398	796	802	351
Stage 1	-	-	-	-	-	-	404	404	-	377	377	-
Stage 2	-	-	-	-	-	-	394	384	-	419	425	-
Critical Hdwy	4.12	-	-	4.11	-	-	7.1	6.5	6.2	7.15	6.55	6.25
Critical Hdwy Stg 1	-	-	-	-	-	-	6.1	5.5	-	6.15	5.55	-
Critical Hdwy Stg 2	-	-	-	-	-	-	6.1	5.5	-	6.15	5.55	-
Follow-up Hdwy	2.218	-	-	2.209	-	-	3.5	4	3.3	3.545	4.045	3.345
Pot Cap-1 Maneuver	1201	-	-	1145	-	-	306	326	656	301	314	686
Stage 1	-	-	-	-	-	-	627	603	-	638	611	-
Stage 2	-	-	-	-	-	-	635	615	-	606	581	-
Platoon blocked, %		-	-		-	-						
Mov Cap-1 Maneuver	1200	-	-	1143	-	-	277	319	655	275	308	685
Mov Cap-2 Maneuver	-	-	-	-	-	-	277	319	-	275	308	-
Stage 1	-	-	-	-	-	-	624	600	-	635	602	-
Stage 2	-	-	-	-	-	-	590	606	-	571	578	-

Approach	EB		WB		NB		SB	
HCM Control Delay, s	0.1		0.3		17.8		18	
HCM LOS					C		C	

Minor Lane/Major Mvmt	NBLn1	EBL	EBT	EBR	WBL	WBT	WBR	SBLn1
Capacity (veh/h)	329	1200	-	-	1143	-	-	321
HCM Lane V/C Ratio	0.144	0.003	-	-	0.012	-	-	0.14
HCM Control Delay (s)	17.8	8	0	-	8.2	0	-	18
HCM Lane LOS	C	A	A	-	A	A	-	C
HCM 95th %tile Q(veh)	0.5	0	-	-	0	-	-	0.5

Intersection												
Int Delay, s/veh	2.8											
Movement	EBL	EBT	EBR	WBL	WBT	WBR	NBL	NBT	NBR	SBL	SBT	SBR
Lane Configurations		↕			↕			↕	↕		↕	
Traffic Vol, veh/h	2	316	8	12	284	2	65	21	21	0	3	0
Future Vol, veh/h	2	316	8	12	284	2	65	21	21	0	3	0
Conflicting Peds, #/hr	3	0	0	0	0	3	2	0	0	0	0	2
Sign Control	Free	Free	Free	Free	Free	Free	Stop	Stop	Stop	Stop	Stop	Stop
RT Channelized	-	-	None	-	-	None	-	-	None	-	-	None
Storage Length	-	-	-	-	-	-	-	-	135	-	-	-
Veh in Median Storage, #	-	0	-	-	0	-	-	0	-	-	0	-
Grade, %	-	0	-	-	0	-	-	0	-	-	0	-
Peak Hour Factor	89	89	89	89	89	89	89	89	89	89	89	89
Heavy Vehicles, %	2	2	2	1	1	1	0	0	0	0	0	0
Mvmt Flow	2	355	9	13	319	2	73	24	24	0	3	0

Major/Minor	Major1			Major2			Minor1			Minor2		
Conflicting Flow All	324	0	0	364	0	0	714	714	360	737	717	325
Stage 1	-	-	-	-	-	-	364	364	-	349	349	-
Stage 2	-	-	-	-	-	-	350	350	-	388	368	-
Critical Hdwy	4.12	-	-	4.11	-	-	7.1	6.5	6.2	7.1	6.5	6.2
Critical Hdwy Stg 1	-	-	-	-	-	-	6.1	5.5	-	6.1	5.5	-
Critical Hdwy Stg 2	-	-	-	-	-	-	6.1	5.5	-	6.1	5.5	-
Follow-up Hdwy	2.218	-	-	2.209	-	-	3.5	4	3.3	3.5	4	3.3
Pot Cap-1 Maneuver	1236	-	-	1200	-	-	349	359	689	337	358	721
Stage 1	-	-	-	-	-	-	659	627	-	671	637	-
Stage 2	-	-	-	-	-	-	671	636	-	640	625	-
Platoon blocked, %		-	-		-	-						
Mov Cap-1 Maneuver	1232	-	-	1200	-	-	342	353	689	304	352	718
Mov Cap-2 Maneuver	-	-	-	-	-	-	342	353	-	304	352	-
Stage 1	-	-	-	-	-	-	658	626	-	668	627	-
Stage 2	-	-	-	-	-	-	657	626	-	594	624	-

Approach	EB			WB			NB			SB		
HCM Control Delay, s	0			0.3			17.6			15.3		
HCM LOS							C			C		

Minor Lane/Major Mvmt	NBLn1	NBLn2	EBL	EBT	EBR	WBL	WBT	WBR	SBLn1
Capacity (veh/h)	345	689	1232	-	-	1200	-	-	352
HCM Lane V/C Ratio	0.28	0.034	0.002	-	-	0.011	-	-	0.01
HCM Control Delay (s)	19.4	10.4	7.9	0	-	8	0	-	15.3
HCM Lane LOS	C	B	A	A	-	A	A	-	C
HCM 95th %tile Q(veh)	1.1	0.1	0	-	-	0	-	-	0

Intersection	
Intersection Delay, s/veh	10.2
Intersection LOS	B

Movement	EBL	EBT	EBR	WBL	WBT	WBR	NBL	NBT	NBR	SBL	SBT	SBR
Lane Configurations		↔			↔			↔	↔		↔	
Traffic Vol, veh/h	13	327	0	1	132	2	49	34	52	0	0	15
Future Vol, veh/h	13	327	0	1	132	2	49	34	52	0	0	15
Peak Hour Factor	0.95	0.95	0.95	0.95	0.95	0.95	0.95	0.95	0.95	0.95	0.95	0.95
Heavy Vehicles, %	1	1	1	2	2	2	0	0	0	0	0	0
Mvmt Flow	14	344	0	1	139	2	52	36	55	0	0	16
Number of Lanes	0	1	0	0	1	0	0	1	1	0	1	0

Approach	EB	WB	NB	SB
Opposing Approach	WB	EB	SB	NB
Opposing Lanes	1	1	1	2
Conflicting Approach Left	SB	NB	EB	WB
Conflicting Lanes Left	1	2	1	1
Conflicting Approach Right	NB	SB	WB	EB
Conflicting Lanes Right	2	1	1	1
HCM Control Delay	11.2	8.9	9.1	7.9
HCM LOS	B	A	A	A

Lane	NBLn1	NBLn2	EBLn1	WBLn1	SBLn1
Vol Left, %	59%	0%	4%	1%	0%
Vol Thru, %	41%	0%	96%	98%	0%
Vol Right, %	0%	100%	0%	1%	100%
Sign Control	Stop	Stop	Stop	Stop	Stop
Traffic Vol by Lane	83	52	340	135	15
LT Vol	49	0	13	1	0
Through Vol	34	0	327	132	0
RT Vol	0	52	0	2	15
Lane Flow Rate	87	55	358	142	16
Geometry Grp	7	7	2	2	5
Degree of Util (X)	0.145	0.075	0.448	0.187	0.021
Departure Headway (Hd)	5.957	4.951	4.508	4.745	4.765
Convergence, Y/N	Yes	Yes	Yes	Yes	Yes
Cap	600	720	798	753	745
Service Time	3.713	2.707	2.543	2.791	2.835
HCM Lane V/C Ratio	0.145	0.076	0.449	0.189	0.021
HCM Control Delay	9.7	8.1	11.2	8.9	7.9
HCM Lane LOS	A	A	B	A	A
HCM 95th-tile Q	0.5	0.2	2.3	0.7	0.1

Intersection						
Int Delay, s/veh	0.9					
Movement	EBL	EBT	WBT	WBR	SBL	SBR
Lane Configurations		↕	↕		↕	
Traffic Vol, veh/h	30	353	116	1	0	24
Future Vol, veh/h	30	353	116	1	0	24
Conflicting Peds, #/hr	0	0	0	0	0	1
Sign Control	Free	Free	Free	Free	Stop	Stop
RT Channelized	-	None	-	None	-	None
Storage Length	-	-	-	-	0	-
Veh in Median Storage, #	-	0	0	-	0	-
Grade, %	-	0	0	-	0	-
Peak Hour Factor	96	96	96	96	96	96
Heavy Vehicles, %	2	2	1	1	4	4
Mvmt Flow	31	368	121	1	0	25

Major/Minor	Major1	Major2	Minor2		
Conflicting Flow All	122	0	-	0	552 123
Stage 1	-	-	-	-	122 -
Stage 2	-	-	-	-	430 -
Critical Hdwy	4.12	-	-	-	6.44 6.24
Critical Hdwy Stg 1	-	-	-	-	5.44 -
Critical Hdwy Stg 2	-	-	-	-	5.44 -
Follow-up Hdwy	2.218	-	-	-	3.536 3.336
Pot Cap-1 Maneuver	1465	-	-	-	491 923
Stage 1	-	-	-	-	898 -
Stage 2	-	-	-	-	652 -
Platoon blocked, %		-	-	-	
Mov Cap-1 Maneuver	1465	-	-	-	478 922
Mov Cap-2 Maneuver	-	-	-	-	478 -
Stage 1	-	-	-	-	874 -
Stage 2	-	-	-	-	652 -

Approach	EB	WB	SB
HCM Control Delay, s	0.6	0	9
HCM LOS			A

Minor Lane/Major Mvmt	EBL	EBT	WBT	WBR	SBLn1
Capacity (veh/h)	1465	-	-	-	922
HCM Lane V/C Ratio	0.021	-	-	-	0.027
HCM Control Delay (s)	7.5	0	-	-	9
HCM Lane LOS	A	A	-	-	A
HCM 95th %tile Q(veh)	0.1	-	-	-	0.1

Intersection	
Intersection Delay, s/veh	10.3
Intersection LOS	B

Movement	EBL	EBT	EBR	WBL	WBT	WBR	NBL	NBT	NBR	SBL	SBT	SBR
Lane Configurations		↕			↕			↕			↕	
Traffic Vol, veh/h	340	0	5	0	0	0	2	0	0	0	0	114
Future Vol, veh/h	340	0	5	0	0	0	2	0	0	0	0	114
Peak Hour Factor	0.91	0.91	0.91	0.91	0.91	0.91	0.91	0.91	0.91	0.91	0.91	0.91
Heavy Vehicles, %	2	2	2	2	2	2	0	0	0	1	1	1
Mvmt Flow	374	0	5	0	0	0	2	0	0	0	0	125
Number of Lanes	0	1	0	0	1	0	0	1	0	0	1	0

Approach	EB	WB	NB	SB
Opposing Approach	WB	EB	SB	NB
Opposing Lanes	1	1	1	1
Conflicting Approach Left	SB	NB	EB	WB
Conflicting Lanes Left	1	1	1	1
Conflicting Approach Right	NB	SB	WB	EB
Conflicting Lanes Right	1	1	1	1
HCM Control Delay	11.1	0	8.2	7.9
HCM LOS	B	-	A	A

Lane	NBLn1	EBLn1	WBLn1	SBLn1
Vol Left, %	100%	99%	0%	0%
Vol Thru, %	0%	0%	100%	0%
Vol Right, %	0%	1%	0%	100%
Sign Control	Stop	Stop	Stop	Stop
Traffic Vol by Lane	2	345	0	114
LT Vol	2	340	0	0
Through Vol	0	0	0	0
RT Vol	0	5	0	114
Lane Flow Rate	2	379	0	125
Geometry Grp	1	1	1	1
Degree of Util (X)	0.003	0.457	0	0.147
Departure Headway (Hd)	5.145	4.343	4.619	4.216
Convergence, Y/N	Yes	Yes	Yes	Yes
Cap	699	823	0	856
Service Time	3.154	2.416	2.638	2.216
HCM Lane V/C Ratio	0.003	0.461	0	0.146
HCM Control Delay	8.2	11.1	7.6	7.9
HCM Lane LOS	A	B	N	A
HCM 95th-tile Q	0	2.4	0	0.5

HCM 2010 Signalized Intersection Summary
 46: General Jim Moore Boulevard & Normandy Road

Existing, PM
 06/11/2019



Movement	EBL	EBT	EBR	WBL	WBT	WBR	NBL	NBT	NBR	SBL	SBT	SBR
Lane Configurations		↕			↕		↕	↕↕		↕	↕↕	↕
Traffic Volume (veh/h)	45	27	33	44	28	6	49	729	67	31	361	45
Future Volume (veh/h)	45	27	33	44	28	6	49	729	67	31	361	45
Number	3	8	18	7	4	14	1	6	16	5	2	12
Initial Q (Qb), veh	0	0	0	0	0	0	0	0	0	0	0	0
Ped-Bike Adj(A_pbT)	1.00		1.00	1.00		1.00	1.00		1.00	1.00		1.00
Parking Bus, Adj	1.00	1.00	1.00	1.00	1.00	1.00	1.00	1.00	1.00	1.00	1.00	1.00
Adj Sat Flow, veh/h/ln	1900	1863	1900	1900	1881	1900	1881	1881	1900	1900	1900	1900
Adj Flow Rate, veh/h	49	29	11	48	30	4	53	792	50	34	392	-10
Adj No. of Lanes	0	1	0	0	1	0	1	2	0	1	2	1
Peak Hour Factor	0.92	0.92	0.92	0.92	0.92	0.92	0.92	0.92	0.92	0.92	0.92	0.92
Percent Heavy Veh, %	2	2	2	1	1	1	1	1	1	0	0	0
Cap, veh/h	316	105	31	329	119	12	290	1065	67	75	692	310
Arrive On Green	0.18	0.16	0.16	0.18	0.16	0.16	0.16	0.31	0.31	0.04	0.19	0.00
Sat Flow, veh/h	723	667	196	776	756	79	1792	3414	216	1810	3610	1615
Grp Volume(v), veh/h	89	0	0	82	0	0	53	414	428	34	392	-10
Grp Sat Flow(s),veh/h/ln	1586	0	0	1611	0	0	1792	1787	1843	1810	1805	1615
Q Serve(g_s), s	0.1	0.0	0.0	0.0	0.0	0.0	0.7	5.7	5.7	0.5	2.7	0.0
Cycle Q Clear(g_c), s	1.2	0.0	0.0	1.1	0.0	0.0	0.7	5.7	5.7	0.5	2.7	0.0
Prop In Lane	0.55		0.12	0.59		0.05	1.00		0.12	1.00		1.00
Lane Grp Cap(c), veh/h	480	0	0	489	0	0	290	558	575	75	692	310
V/C Ratio(X)	0.19	0.00	0.00	0.17	0.00	0.00	0.18	0.74	0.74	0.45	0.57	-0.03
Avail Cap(c_a), veh/h	2062	0	0	2082	0	0	520	1652	1704	525	3337	1493
HCM Platoon Ratio	1.00	1.00	1.00	1.00	1.00	1.00	1.00	1.00	1.00	1.00	1.00	1.00
Upstream Filter(l)	1.00	0.00	0.00	1.00	0.00	0.00	1.00	1.00	1.00	1.00	1.00	0.00
Uniform Delay (d), s/veh	10.2	0.0	0.0	10.1	0.0	0.0	10.0	8.5	8.5	12.9	10.1	0.0
Incr Delay (d2), s/veh	0.1	0.0	0.0	0.1	0.0	0.0	0.1	0.7	0.7	1.6	0.3	0.0
Initial Q Delay(d3),s/veh	0.0	0.0	0.0	0.0	0.0	0.0	0.0	0.0	0.0	0.0	0.0	0.0
%ile BackOfQ(50%),veh/ln	0.6	0.0	0.0	0.5	0.0	0.0	0.3	2.9	3.0	0.3	1.3	0.0
LnGrp Delay(d),s/veh	10.2	0.0	0.0	10.2	0.0	0.0	10.1	9.2	9.2	14.5	10.4	0.0
LnGrp LOS	B			B			B	A	A	B	B	
Approach Vol, veh/h		89			82			895			416	
Approach Delay, s/veh		10.2			10.2			9.3			11.0	
Approach LOS		B			B			A			B	
Timer	1	2	3	4	5	6	7	8				
Assigned Phs	1	2		4	5	6		8				
Phs Duration (G+Y+Rc), s	9.0	9.8		8.8	5.6	13.1		8.8				
Change Period (Y+Rc), s	4.5	4.5		4.5	4.5	4.5		4.5				
Max Green Setting (Gmax), s	30.0	25.5		33.0	8.0	25.5		33.0				
Max Q Clear Time (g_c+1/2), s	12.5	4.7		3.1	2.5	7.7		3.2				
Green Ext Time (p_c), s	0.0	0.5		0.1	0.0	0.8		0.1				
Intersection Summary												
HCM 2010 Ctrl Delay				9.9								
HCM 2010 LOS				A								

Intersection

Intersection Delay, s/veh 18.4
Intersection LOS C

Movement	EBL	EBR	NBL	NBT	SBT	SBR
Lane Configurations						
Traffic Vol, veh/h	53	97	153	838	308	85
Future Vol, veh/h	53	97	153	838	308	85
Peak Hour Factor	0.89	0.89	0.89	0.89	0.89	0.89
Heavy Vehicles, %	1	1	1	1	1	1
Mvmt Flow	60	109	172	942	346	96
Number of Lanes	1	1	1	2	2	1

Approach	EB	NB	SB
Opposing Approach		SB	NB
Opposing Lanes	0	3	3
Conflicting Approach Left	SB	EB	
Conflicting Lanes Left	3	2	0
Conflicting Approach Right	NB	EB	
Conflicting Lanes Right	3	0	2
HCM Control Delay	12.6	21.5	12.7
HCM LOS	B	C	B

Lane	NBLn1	NBLn2	NBLn3	EBLn1	EBLn2	SBLn1	SBLn2	SBLn3
Vol Left, %	100%	0%	0%	100%	0%	0%	0%	0%
Vol Thru, %	0%	100%	100%	0%	0%	100%	100%	0%
Vol Right, %	0%	0%	0%	0%	100%	0%	0%	100%
Sign Control	Stop	Stop	Stop	Stop	Stop	Stop	Stop	Stop
Traffic Vol by Lane	153	419	419	53	97	154	154	85
LT Vol	153	0	0	53	0	0	0	0
Through Vol	0	419	419	0	0	154	154	0
RT Vol	0	0	0	0	97	0	0	85
Lane Flow Rate	172	471	471	60	109	173	173	96
Geometry Grp	8	8	8	8	8	8	8	8
Degree of Util (X)	0.325	0.823	0.596	0.144	0.226	0.352	0.352	0.126
Departure Headway (Hd)	6.801	6.295	4.558	8.682	7.472	7.319	7.319	4.767
Convergence, Y/N	Yes	Yes	Yes	Yes	Yes	Yes	Yes	Yes
Cap	524	570	782	415	483	495	495	741
Service Time	4.598	4.091	2.353	6.396	5.186	5.019	5.019	2.567
HCM Lane V/C Ratio	0.328	0.826	0.602	0.145	0.226	0.349	0.349	0.13
HCM Control Delay	12.9	32.1	14	12.9	12.4	13.9	13.9	8.3
HCM Lane LOS	B	D	B	B	B	B	B	A
HCM 95th-tile Q	1.4	8.4	4	0.5	0.9	1.6	1.6	0.4

HCM 2010 Signalized Intersection Summary
 48: Fremont Boulevard/Hwy 1 SB Off-Ramp/ NB On-Ramp & Monterey Road

Existing, PM
 06/11/2019



Movement	EBL	EBT	EBR	WBL	WBT	WBR	NBL	NBT	NBR	SBL	SBT	SBR
Lane Configurations												
Traffic Volume (veh/h)	213	223	57	89	161	55	111	972	226	78	576	198
Future Volume (veh/h)	213	223	57	89	161	55	111	972	226	78	576	198
Number	7	4	14	3	8	18	5	2	12	1	6	16
Initial Q (Qb), veh	0	0	0	0	0	0	0	0	0	0	0	0
Ped-Bike Adj(A_pbT)	1.00		0.98	1.00		0.99	1.00		0.99	1.00		0.99
Parking Bus, Adj	1.00	1.00	1.00	1.00	1.00	1.00	1.00	1.00	1.00	1.00	1.00	1.00
Adj Sat Flow, veh/h/ln	1881	1881	1881	1900	1900	1900	1881	1881	1900	1863	1863	1863
Adj Flow Rate, veh/h	220	230	12	92	166	51	114	1002	221	80	594	132
Adj No. of Lanes	1	1	1	0	1	0	1	2	0	1	2	1
Peak Hour Factor	0.97	0.97	0.97	0.97	0.97	0.97	0.97	0.97	0.97	0.97	0.97	0.97
Percent Heavy Veh, %	1	1	1	0	0	0	1	1	1	2	2	2
Cap, veh/h	284	298	248	101	182	56	542	1291	284	101	671	297
Arrive On Green	0.16	0.16	0.16	0.19	0.19	0.19	0.30	0.44	0.44	0.06	0.19	0.19
Sat Flow, veh/h	1792	1881	1566	541	977	300	1792	2910	640	1774	3539	1568
Grp Volume(v), veh/h	220	230	12	309	0	0	114	614	609	80	594	132
Grp Sat Flow(s),veh/h/ln	1792	1881	1566	1818	0	0	1792	1787	1763	1774	1770	1568
Q Serve(g_s), s	14.7	14.7	0.8	20.8	0.0	0.0	5.9	36.4	36.7	5.6	20.4	9.3
Cycle Q Clear(g_c), s	14.7	14.7	0.8	20.8	0.0	0.0	5.9	36.4	36.7	5.6	20.4	9.3
Prop In Lane	1.00		1.00	0.30		0.17	1.00		0.36	1.00		1.00
Lane Grp Cap(c), veh/h	284	298	248	339	0	0	542	793	782	101	671	297
V/C Ratio(X)	0.78	0.77	0.05	0.91	0.00	0.00	0.21	0.77	0.78	0.79	0.89	0.44
Avail Cap(c_a), veh/h	573	602	501	364	0	0	542	793	782	241	671	297
HCM Platoon Ratio	1.00	1.00	1.00	1.00	1.00	1.00	1.00	1.00	1.00	1.00	1.00	1.00
Upstream Filter(I)	0.68	0.68	0.68	1.00	0.00	0.00	1.00	1.00	1.00	1.00	1.00	1.00
Uniform Delay (d), s/veh	50.5	50.5	44.6	49.8	0.0	0.0	32.5	29.5	29.5	58.2	49.3	44.8
Incr Delay (d2), s/veh	3.1	2.9	0.1	26.1	0.0	0.0	0.1	7.3	7.5	5.1	15.8	4.7
Initial Q Delay(d3),s/veh	0.0	0.0	0.0	0.0	0.0	0.0	0.0	0.0	0.0	0.0	0.0	0.0
%ile BackOfQ(50%),veh/ln	7.5	7.8	0.4	12.9	0.0	0.0	3.0	19.5	19.4	2.9	11.5	4.4
LnGrp Delay(d),s/veh	53.6	53.4	44.7	75.9	0.0	0.0	32.6	36.8	37.1	63.2	65.2	49.6
LnGrp LOS	D	D	D	E			C	D	D	E	E	D
Approach Vol, veh/h		462			309			1337			806	
Approach Delay, s/veh		53.3			75.9			36.5			62.4	
Approach LOS		D			E			D			E	
Timer	1	2	3	4	5	6	7	8				
Assigned Phs	1	2		4	5	6		8				
Phs Duration (G+Y+Rc), s	1.3	60.8		24.5	43.1	29.0		28.4				
Change Period (Y+Rc), s	4.2	5.3		* 4.7	5.3	* 5.3		5.1				
Max Green Setting (Gmax), s	13	23.7		* 40	17.0	* 24		25.0				
Max Q Clear Time (g_c+11), s	13	38.7		16.7	7.9	22.4		22.8				
Green Ext Time (p_c), s	0.1	0.0		2.0	0.1	0.5		0.5				
Intersection Summary												
HCM 2010 Ctrl Delay				50.5								
HCM 2010 LOS				D								
Notes												

HCM 2010 Signalized Intersection Summary
 49: Highway 1 SB On-Ramp & Highway 1 NB Off-Ramp/Monterey Road

Existing, PM
 06/11/2019



Movement	EBL	EBT	EBR	WBL	WBT	WBR	NBL	NBT	NBR	SBL	SBT	SBR
Lane Configurations		↕↕	↗	↖		↗		↕	↗		↕	
Traffic Volume (veh/h)	0	204	120	272	0	190	0	112	285	1	1	0
Future Volume (veh/h)	0	204	120	272	0	190	0	112	285	1	1	0
Number	1	6	16	5	2	12	7	4	14	3	8	18
Initial Q (Qb), veh	0	0	0	0	0	0	0	0	0	0	0	0
Ped-Bike Adj(A_pbT)	1.00		1.00	1.00		1.00	1.00		1.00	1.00		1.00
Parking Bus, Adj	1.00	1.00	1.00	1.00	1.00	1.00	1.00	1.00	1.00	1.00	1.00	1.00
Adj Sat Flow, veh/h/ln	1900	1863	1863	1900	0	1900	0	1881	1881	1900	1900	0
Adj Flow Rate, veh/h	0	224	14	299	0	135	0	123	34	1	1	0
Adj No. of Lanes	0	2	1	1	0	1	0	1	1	0	1	0
Peak Hour Factor	0.91	0.91	0.91	0.91	0.91	0.91	0.91	0.91	0.91	0.91	0.91	0.91
Percent Heavy Veh, %	2	2	2	0	0	0	0	1	1	0	0	0
Cap, veh/h	0	2980	1331	0	0	0	0	154	131	59	44	0
Arrive On Green	0.00	0.84	0.84	0.00	0.00	0.00	0.00	0.08	0.08	0.09	0.08	0.00
Sat Flow, veh/h	0	3632	1581		0		0	1881	1599	190	536	0
Grp Volume(v), veh/h	0	224	14		0.0		0	123	34	2	0	0
Grp Sat Flow(s),veh/h/ln	0	1770	1581				0	1881	1599	726	0	0
Q Serve(g_s), s	0.0	1.3	0.2				0.0	8.0	2.5	0.0	0.0	0.0
Cycle Q Clear(g_c), s	0.0	1.3	0.2				0.0	8.0	2.5	8.0	0.0	0.0
Prop In Lane	0.00		1.00				0.00		1.00	0.50		0.00
Lane Grp Cap(c), veh/h	0	2980	1331				0	154	131	106	0	0
V/C Ratio(X)	0.00	0.08	0.01				0.00	0.80	0.26	0.02	0.00	0.00
Avail Cap(c_a), veh/h	0	2980	1331				0	271	230	139	0	0
HCM Platoon Ratio	1.00	1.00	1.00				1.00	1.00	1.00	1.00	1.00	1.00
Upstream Filter(I)	0.00	1.00	1.00				0.00	1.00	1.00	1.00	0.00	0.00
Uniform Delay (d), s/veh	0.0	1.7	1.6				0.0	56.4	53.8	52.8	0.0	0.0
Incr Delay (d2), s/veh	0.0	0.0	0.0				0.0	3.6	0.4	0.0	0.0	0.0
Initial Q Delay(d3),s/veh	0.0	0.0	0.0				0.0	0.0	0.0	0.0	0.0	0.0
%ile BackOfQ(50%),veh/ln	0.0	0.7	0.1				0.0	4.3	1.1	0.1	0.0	0.0
LnGrp Delay(d),s/veh	0.0	1.7	1.6				0.0	59.9	54.2	52.8	0.0	0.0
LnGrp LOS		A	A					E	D	D		
Approach Vol, veh/h		238						157			2	
Approach Delay, s/veh		1.7						58.7			52.8	
Approach LOS		A						E			D	
Timer	1	2	3	4	5	6	7	8				
Assigned Phs				4		6		8				
Phs Duration (G+Y+Rc), s				14.4		110.6		14.4				
Change Period (Y+Rc), s				* 4.2		5.3		* 4.2				
Max Green Setting (Gmax), s				* 18		21.0		* 13				
Max Q Clear Time (g_c+I1), s				10.0		3.3		10.0				
Green Ext Time (p_c), s				0.3		0.9		0.0				
Intersection Summary												
HCM 2010 Ctrl Delay				24.5								
HCM 2010 LOS				C								
Notes												

HCM 2010 Signalized Intersection Summary
 50: Reservation Road & SR 68 WB On Ramp/SR 68 WB Off Ramp

Existing, PM
 06/11/2019



Movement	EBL	EBT	EBR	WBL	WBT	WBR	NBL	NBT	NBR	SBL	SBT	SBR
Lane Configurations					↕	↕	↕	↑			↕	
Traffic Volume (veh/h)	0	0	0	411	0	239	134	216	0	0	490	125
Future Volume (veh/h)	0	0	0	411	0	239	134	216	0	0	490	125
Number				7	4	14	1	6	16	5	2	12
Initial Q (Qb), veh				0	0	0	0	0	0	0	0	0
Ped-Bike Adj(A_pbT)				1.00		1.00	1.00		1.00	1.00		1.00
Parking Bus, Adj				1.00	1.00	1.00	1.00	1.00	1.00	1.00	1.00	1.00
Adj Sat Flow, veh/h/ln				1900	1863	1863	1845	1845	0	0	1827	1900
Adj Flow Rate, veh/h				437	0	72	143	230	0	0	521	123
Adj No. of Lanes				0	1	1	1	1	0	0	1	0
Peak Hour Factor				0.94	0.94	0.94	0.94	0.94	0.94	0.94	0.94	0.94
Percent Heavy Veh, %				2	2	2	3	3	0	0	4	4
Cap, veh/h				488	0	435	178	1100	0	0	649	153
Arrive On Green				0.29	0.00	0.28	0.03	0.20	0.00	0.00	0.45	0.45
Sat Flow, veh/h				1774	0	1580	1757	1845	0	0	1430	338
Grp Volume(v), veh/h				437	0	72	143	230	0	0	0	644
Grp Sat Flow(s),veh/h/ln				1774	0	1580	1757	1845	0	0	0	1767
Q Serve(g_s), s				20.1	0.0	2.9	6.9	8.9	0.0	0.0	0.0	26.6
Cycle Q Clear(g_c), s				20.1	0.0	2.9	6.9	8.9	0.0	0.0	0.0	26.6
Prop In Lane				1.00		1.00	1.00		0.00	0.00		0.19
Lane Grp Cap(c), veh/h				488	0	435	178	1100	0	0	0	803
V/C Ratio(X)				0.90	0.00	0.17	0.80	0.21	0.00	0.00	0.00	0.80
Avail Cap(c_a), veh/h				564	0	502	248	1100	0	0	0	803
HCM Platoon Ratio				1.00	1.00	1.00	0.33	0.33	1.00	1.00	1.00	1.00
Upstream Filter(I)				1.00	0.00	1.00	0.96	0.96	0.00	0.00	0.00	1.00
Uniform Delay (d), s/veh				29.2	0.0	23.4	40.2	17.3	0.0	0.0	0.0	19.9
Incr Delay (d2), s/veh				15.4	0.0	0.2	8.0	0.4	0.0	0.0	0.0	8.3
Initial Q Delay(d3),s/veh				0.0	0.0	0.0	0.0	0.0	0.0	0.0	0.0	0.0
%ile BackOfQ(50%),veh/ln				11.9	0.0	1.3	3.7	4.7	0.0	0.0	0.0	14.7
LnGrp Delay(d),s/veh				44.6	0.0	23.6	48.3	17.7	0.0	0.0	0.0	28.3
LnGrp LOS				D		C	D	B				C
Approach Vol, veh/h					509			373			644	
Approach Delay, s/veh					41.6			29.4			28.3	
Approach LOS					D			C			C	
Timer	1	2	3	4	5	6	7	8				
Assigned Phs	1	2		4		6						
Phs Duration (G+Y+Rc), s	2.1	44.6		28.3		56.7						
Change Period (Y+Rc), s	3.5	6.0		4.9		6.0						
Max Green Setting (Gmax), s	2.0	31.6		27.0		47.1						
Max Q Clear Time (g_c+1.0), s	2.0	28.6		22.1		10.9						
Green Ext Time (p_c), s	0.0	1.1		1.3		1.1						
Intersection Summary												
HCM 2010 Ctrl Delay				33.0								
HCM 2010 LOS				C								

HCM 2010 Signalized Intersection Summary
 51: River Road/Reservation Road & SR 68 Off Ramp/SR 68 EB On Ramp



















Existing, PM
 06/11/2019



Movement	EBL	EBT	EBR	WBL	WBT	WBR	NBL	NBT	NBR	SBL	SBT	SBR
Lane Configurations		↕	↗					↑	↗	↖	↑	
Traffic Volume (veh/h)	81	1	189	0	0	0	0	291	306	242	659	0
Future Volume (veh/h)	81	1	189	0	0	0	0	291	306	242	659	0
Number	3	8	18				1	6	16	5	2	12
Initial Q (Qb), veh	0	0	0				0	0	0	0	0	0
Ped-Bike Adj(A_pbT)	1.00		1.00				1.00		1.00	1.00		1.00
Parking Bus, Adj	1.00	1.00	1.00				1.00	1.00	1.00	1.00	1.00	1.00
Adj Sat Flow, veh/h/ln	1900	1863	1863				0	1845	1845	1827	1827	0
Adj Flow Rate, veh/h	86	1	22				0	310	187	257	701	0
Adj No. of Lanes	0	1	1				0	1	1	1	1	0
Peak Hour Factor	0.94	0.94	0.94				0.94	0.94	0.94	0.94	0.94	0.94
Percent Heavy Veh, %	2	2	2				0	3	3	4	4	0
Cap, veh/h	123	1	111				0	1092	928	288	1464	0
Arrive On Green	0.08	0.07	0.07				0.00	0.59	0.59	0.33	1.00	0.00
Sat Flow, veh/h	1755	20	1583				0	1845	1568	1740	1827	0
Grp Volume(v), veh/h	87	0	22				0	310	187	257	701	0
Grp Sat Flow(s),veh/h/ln	1755	0	1583				0	1845	1568	1740	1827	0
Q Serve(g_s), s	4.1	0.0	1.1				0.0	7.0	4.7	11.9	0.0	0.0
Cycle Q Clear(g_c), s	4.1	0.0	1.1				0.0	7.0	4.7	11.9	0.0	0.0
Prop In Lane	0.99		1.00				0.00		1.00	1.00		0.00
Lane Grp Cap(c), veh/h	125	0	111				0	1092	928	288	1464	0
V/C Ratio(X)	0.70	0.00	0.20				0.00	0.28	0.20	0.89	0.48	0.00
Avail Cap(c_a), veh/h	522	0	466				0	1092	928	348	1464	0
HCM Platoon Ratio	1.00	1.00	1.00				1.00	1.00	1.00	2.00	2.00	1.00
Upstream Filter(I)	1.00	0.00	1.00				0.00	1.00	1.00	0.39	0.39	0.00
Uniform Delay (d), s/veh	38.2	0.0	37.3				0.0	8.5	8.0	27.7	0.0	0.0
Incr Delay (d2), s/veh	6.8	0.0	0.9				0.0	0.7	0.5	9.8	0.4	0.0
Initial Q Delay(d3),s/veh	0.0	0.0	0.0				0.0	0.0	0.0	0.0	0.0	0.0
%ile BackOfQ(50%),veh/ln	2.2	0.0	0.5				0.0	3.7	2.2	6.4	0.2	0.0
LnGrp Delay(d),s/veh	45.0	0.0	38.1				0.0	9.2	8.5	37.4	0.4	0.0
LnGrp LOS	D		D					A	A	D	A	
Approach Vol, veh/h		109						497			958	
Approach Delay, s/veh		43.6						8.9			10.4	
Approach LOS		D						A			B	
Timer	1	2	3	4	5	6	7	8				
Assigned Phs		2			5	6		8				
Phs Duration (G+Y+Rc), s		74.1			17.8	56.3		10.9				
Change Period (Y+Rc), s		6.0			3.7	6.0		4.9				
Max Green Setting (Gmax), s		43.1			17.0	28.4		25.0				
Max Q Clear Time (g_c+I1), s		2.0			13.9	9.0		6.1				
Green Ext Time (p_c), s		4.8			0.2	2.0		0.4				
Intersection Summary												
HCM 2010 Ctrl Delay			12.2									
HCM 2010 LOS			B									

HCM 2010 Signalized Intersection Summary
1: Del Monte Boulevard & Reindollar Avenue

Existing with Project, AM
06/11/2019

													
Movement	EBL	EBT	EBR	WBL	WBT	WBR	NBL	NBT	NBR	SBL	SBT	SBR	
Lane Configurations													
Traffic Volume (veh/h)	0	0	0	430	0	60	10	300	110	70	950	0	
Future Volume (veh/h)	0	0	0	430	0	60	10	300	110	70	950	0	
Number				3	8	18	1	6	16	5	2	12	
Initial Q (Qb), veh				0	0	0	0	0	0	0	0	0	
Ped-Bike Adj(A_pbT)				1.00		1.00	1.00		1.00	1.00		1.00	
Parking Bus, Adj				1.00	1.00	1.00	1.00	1.00	1.00	1.00	1.00	1.00	
Adj Sat Flow, veh/h/ln				1900	1900	1900	1863	1863	1863	1845	1845	0	
Adj Flow Rate, veh/h				506	0	0	11	337	57	79	1067	0	
Adj No. of Lanes				2	1	0	1	2	1	1	2	0	
Peak Hour Factor				0.89	0.89	0.89	0.89	0.89	0.89	0.89	0.89	0.89	
Percent Heavy Veh, %				0	0	0	2	2	2	3	3	0	
Cap, veh/h				808	424	0	25	1407	628	124	1591	0	
Arrive On Green				0.22	0.00	0.00	0.01	0.40	0.40	0.07	0.45	0.00	
Sat Flow, veh/h				3619	1900	0	1774	3539	1579	1757	3597	0	
Grp Volume(v), veh/h				506	0	0	11	337	57	79	1067	0	
Grp Sat Flow(s),veh/h/ln				1810	1900	0	1774	1770	1579	1757	1752	0	
Q Serve(g_s), s				5.5	0.0	0.0	0.3	2.8	1.0	1.9	10.5	0.0	
Cycle Q Clear(g_c), s				5.5	0.0	0.0	0.3	2.8	1.0	1.9	10.5	0.0	
Prop In Lane				1.00		0.00	1.00		1.00	1.00		0.00	
Lane Grp Cap(c), veh/h				808	424	0	25	1407	628	124	1591	0	
V/C Ratio(X)				0.63	0.00	0.00	0.43	0.24	0.09	0.64	0.67	0.00	
Avail Cap(c_a), veh/h				2482	1303	0	1217	2427	1083	1205	2404	0	
HCM Platoon Ratio				1.00	1.00	1.00	1.00	1.00	1.00	1.00	1.00	1.00	
Upstream Filter(I)				1.00	0.00	0.00	1.00	1.00	1.00	1.00	1.00	0.00	
Uniform Delay (d), s/veh				15.3	0.0	0.0	21.4	8.8	8.2	19.8	9.4	0.0	
Incr Delay (d2), s/veh				0.8	0.0	0.0	11.2	0.1	0.1	5.3	0.5	0.0	
Initial Q Delay(d3),s/veh				0.0	0.0	0.0	0.0	0.0	0.0	0.0	0.0	0.0	
%ile BackOfQ(50%),veh/ln				2.8	0.0	0.0	0.2	1.4	0.4	1.1	5.0	0.0	
LnGrp Delay(d),s/veh				16.1	0.0	0.0	32.6	8.9	8.3	25.1	9.9	0.0	
LnGrp LOS				B			C	A	A	C	A		
Approach Vol, veh/h					506			405			1146		
Approach Delay, s/veh					16.1			9.4			10.9		
Approach LOS					B			A			B		
Timer	1	2	3	4	5	6	7	8					
Assigned Phs	1	2			5	6		8					
Phs Duration (G+Y+Rc), s	4.1	24.9			6.6	22.4		14.8					
Change Period (Y+Rc), s	3.5	5.0			3.5	5.0		5.0					
Max Green Setting (Gmax), s	30.0	30.0			30.0	30.0		30.0					
Max Q Clear Time (g_c+I1), s	2.3	12.5			3.9	4.8		7.5					
Green Ext Time (p_c), s	0.0	7.4			0.2	2.3		1.9					
Intersection Summary													
HCM 2010 Ctrl Delay				11.9									
HCM 2010 LOS				B									
Notes													

HCM 2010 Signalized Intersection Summary
 3: SR 1 SB On-Ramp/SR 1 SB Off-Ramp & Imjin Parkway

Existing with Project, AM
 06/11/2019



Movement	EBL	EBT	EBR	WBL	WBT	WBR	NBL	NBT	NBR	SBL	SBT	SBR
Lane Configurations					↕						↕	
Traffic Volume (veh/h)	0	0	0	940	0	0	0	0	0	520	10	0
Future Volume (veh/h)	0	0	0	940	0	0	0	0	0	520	10	0
Number				1	6	16				7	4	14
Initial Q (Qb), veh				0	0	0				0	0	0
Ped-Bike Adj(A_pbT)				1.00		1.00				1.00		1.00
Parking Bus, Adj				1.00	1.00	1.00				1.00	1.00	1.00
Adj Sat Flow, veh/h/ln				1900	1845	0				1900	1845	0
Adj Flow Rate, veh/h				1033	0	0				571	11	0
Adj No. of Lanes				0	1	0				0	1	0
Peak Hour Factor				0.91	0.91	0.91				0.91	0.91	0.91
Percent Heavy Veh, %				3	3	0				3	3	0
Cap, veh/h				1038	0	0				606	12	0
Arrive On Green				0.59	0.00	0.00				0.35	0.35	0.00
Sat Flow, veh/h				1757	0	0				1725	33	0
Grp Volume(v), veh/h				1033	0	0				582	0	0
Grp Sat Flow(s),veh/h/ln				1757	0	0				1758	0	0
Q Serve(g_s), s				88.8	0.0	0.0				48.9	0.0	0.0
Cycle Q Clear(g_c), s				88.8	0.0	0.0				48.9	0.0	0.0
Prop In Lane				1.00		0.00				0.98		0.00
Lane Grp Cap(c), veh/h				1038	0	0				617	0	0
V/C Ratio(X)				0.99	0.00	0.00				0.94	0.00	0.00
Avail Cap(c_a), veh/h				1038	0	0				693	0	0
HCM Platoon Ratio				1.00	1.00	1.00				1.00	1.00	1.00
Upstream Filter(I)				1.00	0.00	0.00				1.00	0.00	0.00
Uniform Delay (d), s/veh				30.9	0.0	0.0				47.9	0.0	0.0
Incr Delay (d2), s/veh				26.6	0.0	0.0				20.2	0.0	0.0
Initial Q Delay(d3),s/veh				0.0	0.0	0.0				0.0	0.0	0.0
%ile BackOfQ(50%),veh/ln				50.4	0.0	0.0				27.2	0.0	0.0
LnGrp Delay(d),s/veh				57.5	0.0	0.0				68.1	0.0	0.0
LnGrp LOS				E						E		
Approach Vol, veh/h					1033						582	
Approach Delay, s/veh					57.5						68.1	
Approach LOS					E						E	
Timer	1	2	3	4	5	6	7	8				
Assigned Phs				4		6						
Phs Duration (G+Y+Rc), s				57.9		94.4						
Change Period (Y+Rc), s				4.4		4.4						
Max Green Setting (Gmax), s				60.0		90.0						
Max Q Clear Time (g_c+I1), s				50.9		90.8						
Green Ext Time (p_c), s				2.6		0.0						
Intersection Summary												
HCM 2010 Ctrl Delay				61.3								
HCM 2010 LOS				E								

Intersection												
Int Delay, s/veh	0.6											
Movement	EBL	EBT	EBR	WBL	WBT	WBR	NBL	NBT	NBR	SBL	SBT	SBR
Lane Configurations		↖			↑	↗		↖	↗			
Traffic Vol, veh/h	10	530	0	0	900	180	10	10	810	0	0	0
Future Vol, veh/h	10	530	0	0	900	180	10	10	810	0	0	0
Conflicting Peds, #/hr	0	0	3	3	0	0	0	0	0	0	0	0
Sign Control	Free	Free	Free	Free	Free	Free	Stop	Stop	Stop	Stop	Stop	Stop
RT Channelized	-	-	None	-	-	Free	-	-	Free	-	-	None
Storage Length	-	-	-	-	-	0	-	-	800	-	-	-
Veh in Median Storage, #	-	0	-	-	0	-	-	0	-	-	16965	-
Grade, %	-	0	-	-	0	-	-	0	-	-	0	-
Peak Hour Factor	97	97	97	97	97	97	97	97	97	97	97	97
Heavy Vehicles, %	3	3	3	3	3	3	2	2	2	2	2	2
Mvmt Flow	10	546	0	0	928	186	10	10	835	0	0	0























Major/Minor	Major1	Major2	Minor1
Conflicting Flow All	928	0	-
Stage 1	-	-	-
Stage 2	-	-	-
Critical Hdwy	4.13	-	-
Critical Hdwy Stg 1	-	-	-
Critical Hdwy Stg 2	-	-	-
Follow-up Hdwy	2.227	-	-
Pot Cap-1 Maneuver	733	-	0
Stage 1	-	-	0
Stage 2	-	-	0
Platoon blocked, %	-	-	-
Mov Cap-1 Maneuver	733	-	-
Mov Cap-2 Maneuver	-	-	-
Stage 1	-	-	-
Stage 2	-	-	-

Approach	EB	WB	NB
HCM Control Delay, s	0.2	0	37
HCM LOS			E

Minor Lane/Major Mvmt	NBLn1	NBLn2	EBL	EBT	WBT
Capacity (veh/h)	133	-	733	-	-
HCM Lane V/C Ratio	0.155	-	0.014	-	-
HCM Control Delay (s)	37	0	10	0	-
HCM Lane LOS	E	A	A	A	-
HCM 95th %tile Q(veh)	0.5	-	0	-	-

HCM 2010 Signalized Intersection Summary
5: 2nd Avenue & Imjin Parkway

Existing with Project, AM
06/11/2019

												
Movement	EBL	EBT	EBR	WBL	WBT	WBR	NBL	NBT	NBR	SBL	SBT	SBR
Lane Configurations												
Traffic Volume (veh/h)	20	910	430	330	840	20	110	10	140	10	10	10
Future Volume (veh/h)	20	910	430	330	840	20	110	10	140	10	10	10
Number	5	2	12	1	6	16	3	8	18	7	4	14
Initial Q (Qb), veh	0	0	0	0	0	0	0	0	0	0	0	0
Ped-Bike Adj(A_pbT)	1.00		1.00	1.00		1.00	1.00		1.00	1.00		1.00
Parking Bus, Adj	1.00	1.00	1.00	1.00	1.00	1.00	1.00	1.00	1.00	1.00	1.00	1.00
Adj Sat Flow, veh/h/ln	1863	1863	1863	1863	1863	1900	1810	1810	1810	1900	1900	1900
Adj Flow Rate, veh/h	20	929	220	337	857	20	112	10	21	10	10	5
Adj No. of Lanes	1	2	1	2	2	0	2	1	1	1	2	0
Peak Hour Factor	0.98	0.98	0.98	0.98	0.98	0.98	0.98	0.98	0.98	0.98	0.98	0.98
Percent Heavy Veh, %	2	2	2	2	2	2	5	5	5	0	0	0
Cap, veh/h	130	1141	510	493	1386	32	225	71	60	105	71	33
Arrive On Green	0.07	0.32	0.32	0.14	0.39	0.39	0.07	0.04	0.04	0.06	0.03	0.03
Sat Flow, veh/h	1774	3539	1583	3442	3535	83	3343	1810	1534	1810	2398	1107
Grp Volume(v), veh/h	20	929	220	337	429	448	112	10	21	10	7	8
Grp Sat Flow(s),veh/h/ln	1774	1770	1583	1721	1770	1848	1672	1810	1534	1810	1805	1699
Q Serve(g_s), s	0.4	9.9	4.5	3.8	8.0	8.0	1.3	0.2	0.5	0.2	0.2	0.2
Cycle Q Clear(g_c), s	0.4	9.9	4.5	3.8	8.0	8.0	1.3	0.2	0.5	0.2	0.2	0.2
Prop In Lane	1.00		1.00	1.00		0.04	1.00		1.00	1.00		0.65
Lane Grp Cap(c), veh/h	130	1141	510	493	694	725	225	71	60	105	54	50
V/C Ratio(X)	0.15	0.81	0.43	0.68	0.62	0.62	0.50	0.14	0.35	0.10	0.14	0.15
Avail Cap(c_a), veh/h	651	2596	1161	1262	1298	1355	1635	929	788	442	927	872
HCM Platoon Ratio	1.00	1.00	1.00	1.00	1.00	1.00	1.00	1.00	1.00	1.00	1.00	1.00
Upstream Filter(I)	1.00	1.00	1.00	1.00	1.00	1.00	1.00	1.00	1.00	1.00	1.00	1.00
Uniform Delay (d), s/veh	17.8	12.7	10.9	16.6	10.0	10.0	18.4	19.0	19.1	18.3	19.3	19.3
Incr Delay (d2), s/veh	0.2	0.5	0.2	0.6	0.3	0.3	0.6	0.3	1.3	0.1	0.4	0.5
Initial Q Delay(d3),s/veh	0.0	0.0	0.0	0.0	0.0	0.0	0.0	0.0	0.0	0.0	0.0	0.0
%ile BackOfQ(50%),veh/ln	0.2	4.9	2.0	1.8	3.9	4.0	0.6	0.1	0.3	0.1	0.1	0.1
LnGrp Delay(d),s/veh	18.0	13.3	11.1	17.3	10.3	10.3	19.0	19.3	20.4	18.4	19.8	19.9
LnGrp LOS	B	B	B	B	B	B	B	B	C	B	B	B
Approach Vol, veh/h		1169			1214			143			25	
Approach Delay, s/veh		13.0			12.2			19.3			19.2	
Approach LOS		B			B			B			B	
Timer	1	2	3	4	5	6	7	8				
Assigned Phs	1	2	3	4	5	6	7	8				
Phs Duration (G+Y+Rc), s	10.4	18.5	6.3	5.8	7.5	21.3	5.9	6.2				
Change Period (Y+Rc), s	4.5	5.3	3.5	4.6	4.5	5.3	3.5	4.6				
Max Green Setting (Gmax), s	15.0	30.0	20.0	21.0	15.0	30.0	10.0	21.0				
Max Q Clear Time (g_c+I1), s	5.8	11.9	3.3	2.2	2.4	10.0	2.2	2.5				
Green Ext Time (p_c), s	0.1	1.3	0.0	0.0	0.0	0.9	0.0	0.0				
Intersection Summary												
HCM 2010 Ctrl Delay			13.0									
HCM 2010 LOS			B									

Intersection												
Int Delay, s/veh	1.4											
Movement	EBL	EBT	EBR	WBL	WBT	WBR	NBL	NBT	NBR	SBL	SBT	SBR
Lane Configurations	↖	↕		↖	↕		↖	↕		↖	↕	
Traffic Vol, veh/h	50	870	20	240	1250	30	10	10	20	10	10	40
Future Vol, veh/h	50	870	20	240	1250	30	10	10	20	10	10	40
Conflicting Peds, #/hr	1	0	1	1	0	1	0	0	2	2	0	0
Sign Control	Free	Free	Free	Free	Free	Free	Stop	Stop	Stop	Stop	Stop	Stop
RT Channelized	-	-	None	-	-	None	-	-	None	-	-	None
Storage Length	300	-	-	300	-	-	85	-	-	25	-	-
Veh in Median Storage, #	-	0	-	-	0	-	-	0	-	-	0	-
Grade, %	-	0	-	-	0	-	-	0	-	-	0	-
Peak Hour Factor	96	96	96	96	96	96	96	96	96	96	96	96
Heavy Vehicles, %	2	2	2	2	2	2	5	5	5	2	2	2
Mvmt Flow	52	906	21	250	1302	31	10	10	21	10	10	42

Major/Minor	Major1			Major2			Minor1			Minor2		
Conflicting Flow All	1334	0	0	928	0	0	2178	2856	467	2383	2851	668
Stage 1	-	-	-	-	-	-	1022	1022	-	1819	1819	-
Stage 2	-	-	-	-	-	-	1156	1834	-	564	1032	-
Critical Hdwy	4.14	-	-	4.14	-	-	7.6	6.6	7	7.54	6.54	6.94
Critical Hdwy Stg 1	-	-	-	-	-	-	6.6	5.6	-	6.54	5.54	-
Critical Hdwy Stg 2	-	-	-	-	-	-	6.6	5.6	-	6.54	5.54	-
Follow-up Hdwy	2.22	-	-	2.22	-	-	3.55	4.05	3.35	3.52	4.02	3.32
Pot Cap-1 Maneuver	513	-	-	733	-	-	25	16	534	18	17	401
Stage 1	-	-	-	-	-	-	247	305	-	80	127	-
Stage 2	-	-	-	-	-	-	204	121	-	478	308	-
Platoon blocked, %	-	-	-	-	-	-	-	-	-	-	-	-
Mov Cap-1 Maneuver	513	-	-	732	-	-	~9	532	-	~10	401	-
Mov Cap-2 Maneuver	-	-	-	-	-	-	~9	-	-	~10	-	-
Stage 1	-	-	-	-	-	-	222	274	-	72	83	-
Stage 2	-	-	-	-	-	-	105	79	-	396	277	-

Approach	EB	WB	NB	SB
HCM Control Delay, s	0.7	2		
HCM LOS			-	-

Minor Lane/Major Mvmt	NBLn1	NBLn2	EBL	EBT	EBR	WBL	WBT	WBR	SBLn1	SBLn2
Capacity (veh/h)	-	26	513	-	-	732	-	-	-	45
HCM Lane V/C Ratio	-	1.202	0.102	-	-	0.342	-	-	-	1.157
HCM Control Delay (s)	-	\$ 466.3	12.8	-	-	12.4	-	-	-	\$ 327.6
HCM Lane LOS	-	F	B	-	-	B	-	-	-	F
HCM 95th %tile Q(veh)	-	3.8	0.3	-	-	1.5	-	-	-	4.9

Notes
 ~: Volume exceeds capacity \$: Delay exceeds 300s +: Computation Not Defined *: All major volume in platoon

Intersection												
Int Delay, s/veh	17.3											
Movement	EBL	EBT	EBR	WBL	WBT	WBR	NBL	NBT	NBR	SBL	SBT	SBR
Lane Configurations	↖	↗		↖	↗			↕			↕	
Traffic Vol, veh/h	10	960	20	10	1440	10	10	10	10	10	10	10
Future Vol, veh/h	10	960	20	10	1440	10	10	10	10	10	10	10
Conflicting Peds, #/hr	1	0	1	1	0	1	0	0	0	0	0	0
Sign Control	Free	Free	Free	Free	Free	Free	Stop	Stop	Stop	Stop	Stop	Stop
RT Channelized	-	-	None	-	-	None	-	-	None	-	-	Stop
Storage Length	330	-	-	330	-	-	-	-	-	-	-	-
Veh in Median Storage, #	-	0	-	-	0	-	-	0	-	-	0	-
Grade, %	-	0	-	-	0	-	-	0	-	-	0	-
Peak Hour Factor	96	96	96	96	96	96	96	96	96	96	96	96
Heavy Vehicles, %	2	2	2	2	2	2	50	50	50	0	0	0
Mvmt Flow	10	1000	21	10	1500	10	10	10	10	10	10	10

Major/Minor	Major1			Major2			Minor1			Minor2		
Conflicting Flow All	1511	0	0	1022	0	0	1807	2563	512	2051	2568	756
Stage 1	-	-	-	-	-	-	1032	1032	-	1526	1526	-
Stage 2	-	-	-	-	-	-	775	1531	-	525	1042	-
Critical Hdwy	4.14	-	-	4.14	-	-	8.5	7.5	7.9	7.5	6.5	6.9
Critical Hdwy Stg 1	-	-	-	-	-	-	7.5	6.5	-	6.5	5.5	-
Critical Hdwy Stg 2	-	-	-	-	-	-	7.5	6.5	-	6.5	5.5	-
Follow-up Hdwy	2.22	-	-	2.22	-	-	4	4.5	3.8	3.5	4	3.3
Pot Cap-1 Maneuver	439	-	-	675	-	-	29	13	399	33	26	355
Stage 1	-	-	-	-	-	-	176	221	-	126	182	-
Stage 2	-	-	-	-	-	-	267	113	-	509	309	-
Platoon blocked, %	-	-	-	-	-	-	-	-	-	-	-	-
Mov Cap-1 Maneuver	439	-	-	674	-	-	18	12	399	~ 8	25	355
Mov Cap-2 Maneuver	-	-	-	-	-	-	18	12	-	~ 8	25	-
Stage 1	-	-	-	-	-	-	172	216	-	123	179	-
Stage 2	-	-	-	-	-	-	240	111	-	461	302	-



















Approach	EB			WB			NB			SB		
HCM Control Delay, s	0.1			0.1			\$ 642.4			\$ 799.2		
HCM LOS							F			F		

Minor Lane/Major Mvmt	NBLn1	EBL	EBT	EBR	WBL	WBT	WBR	SBLn1
Capacity (veh/h)	21	439	-	-	674	-	-	18
HCM Lane V/C Ratio	1.488	0.024	-	-	0.015	-	-	1.736
HCM Control Delay (s)	\$ 642.4	13.4	-	-	10.4	-	-	\$ 799.2
HCM Lane LOS	F	B	-	-	B	-	-	F
HCM 95th %tile Q(veh)	4.1	0.1	-	-	0	-	-	4.4

Notes
 ~: Volume exceeds capacity \$: Delay exceeds 300s +: Computation Not Defined *: All major volume in platoon

HCM 2010 Signalized Intersection Summary
 8: 5th Avenue/California Avenue & Imjin Parkway

Existing with Project, AM
 06/11/2019

												
Movement	EBL	EBT	EBR	WBL	WBT	WBR	NBL	NBT	NBR	SBL	SBT	SBR
Lane Configurations												
Traffic Volume (veh/h)	120	830	20	10	970	80	20	20	10	100	150	400
Future Volume (veh/h)	120	830	20	10	970	80	20	20	10	100	150	400
Number	5	2	12	1	6	16	3	8	18	7	4	14
Initial Q (Qb), veh	0	0	0	0	0	0	0	0	0	0	0	0
Ped-Bike Adj(A_pbT)	1.00		0.98	1.00		1.00	1.00		0.99	1.00		1.00
Parking Bus, Adj	1.00	1.00	1.00	1.00	1.00	1.00	1.00	1.00	1.00	1.00	1.00	1.00
Adj Sat Flow, veh/h/ln	1881	1881	1900	1863	1863	1900	1900	1624	1900	1900	1881	1900
Adj Flow Rate, veh/h	126	874	19	11	1021	78	21	21	10	105	158	347
Adj No. of Lanes	1	2	0	1	2	0	0	1	0	0	1	0
Peak Hour Factor	0.95	0.95	0.95	0.95	0.95	0.95	0.95	0.95	0.95	0.95	0.95	0.95
Percent Heavy Veh, %	1	1	1	2	2	2	17	17	17	1	1	1
Cap, veh/h	161	1505	33	15	1131	86	183	160	61	148	165	318
Arrive On Green	0.09	0.42	0.42	0.01	0.34	0.34	0.34	0.34	0.34	0.34	0.34	0.34
Sat Flow, veh/h	1792	3575	78	1774	3333	255	282	468	178	223	482	930
Grp Volume(v), veh/h	126	437	456	11	542	557	52	0	0	610	0	0
Grp Sat Flow(s),veh/h/ln	1792	1787	1866	1774	1770	1818	928	0	0	1635	0	0
Q Serve(g_s), s	4.0	11.0	11.0	0.4	17.1	17.1	0.0	0.0	0.0	16.0	0.0	0.0
Cycle Q Clear(g_c), s	4.0	11.0	11.0	0.4	17.1	17.1	1.3	0.0	0.0	20.0	0.0	0.0
Prop In Lane	1.00		0.04	1.00		0.14	0.40		0.19	0.17		0.57
Lane Grp Cap(c), veh/h	161	752	785	15	600	617	404	0	0	631	0	0
V/C Ratio(X)	0.78	0.58	0.58	0.74	0.90	0.90	0.13	0.00	0.00	0.97	0.00	0.00
Avail Cap(c_a), veh/h	459	916	956	455	907	932	404	0	0	631	0	0
HCM Platoon Ratio	1.00	1.00	1.00	1.00	1.00	1.00	1.00	1.00	1.00	1.00	1.00	1.00
Upstream Filter(I)	1.00	1.00	1.00	1.00	1.00	1.00	1.00	0.00	0.00	1.00	0.00	0.00
Uniform Delay (d), s/veh	26.1	13.0	13.0	29.0	18.4	18.4	13.1	0.0	0.0	20.0	0.0	0.0
Incr Delay (d2), s/veh	3.1	0.3	0.3	22.9	6.3	6.2	0.1	0.0	0.0	27.5	0.0	0.0
Initial Q Delay(d3),s/veh	0.0	0.0	0.0	0.0	0.0	0.0	0.0	0.0	0.0	0.0	0.0	0.0
%ile BackOfQ(50%),veh/ln	2.1	5.4	5.6	0.3	9.3	9.6	0.6	0.0	0.0	14.5	0.0	0.0
LnGrp Delay(d),s/veh	29.2	13.3	13.2	51.8	24.7	24.6	13.2	0.0	0.0	47.5	0.0	0.0
LnGrp LOS	C	B	B	D	C	C	B			D		
Approach Vol, veh/h		1019			1110			52			610	
Approach Delay, s/veh		15.2			24.9			13.2			47.5	
Approach LOS		B			C			B			D	
Timer	1	2	3	4	5	6	7	8				
Assigned Phs	1	2		4	5	6		8				
Phs Duration (G+Y+Rc), s	4.0	29.9		24.6	8.8	25.2		24.6				
Change Period (Y+Rc), s	3.5	5.3		4.6	3.5	5.3		4.6				
Max Green Setting (Gmax), s	15.0	30.0		20.0	15.0	30.0		20.0				
Max Q Clear Time (g_c+I1), s	2.4	13.0		22.0	6.0	19.1		3.3				
Green Ext Time (p_c), s	0.0	0.6		0.0	0.0	0.8		0.0				
Intersection Summary												
HCM 2010 Ctrl Delay				26.1								
HCM 2010 LOS				C								

Intersection						
Int Delay, s/veh	1.4					
Movement	EBL	EBR	NBL	NBT	SBT	SBR
Lane Configurations						
Traffic Vol, veh/h	30	30	30	210	600	80
Future Vol, veh/h	30	30	30	210	600	80
Conflicting Peds, #/hr	0	0	0	0	0	0
Sign Control	Stop	Stop	Free	Free	Free	Free
RT Channelized	-	None	-	None	-	None
Storage Length	0	-	155	-	-	-
Veh in Median Storage, #	0	-	-	0	0	-
Grade, %	0	-	-	0	0	-
Peak Hour Factor	92	92	92	92	92	92
Heavy Vehicles, %	2	2	2	2	2	2
Mvmt Flow	33	33	33	228	652	87











Major/Minor	Minor2	Major1	Major2			
Conflicting Flow All	990	696	739	0	-	0
Stage 1	696	-	-	-	-	-
Stage 2	294	-	-	-	-	-
Critical Hdwy	6.42	6.22	4.12	-	-	-
Critical Hdwy Stg 1	5.42	-	-	-	-	-
Critical Hdwy Stg 2	5.42	-	-	-	-	-
Follow-up Hdwy	3.518	3.318	2.218	-	-	-
Pot Cap-1 Maneuver	273	442	867	-	-	-
Stage 1	495	-	-	-	-	-
Stage 2	756	-	-	-	-	-
Platoon blocked, %				-	-	-
Mov Cap-1 Maneuver	263	442	867	-	-	-
Mov Cap-2 Maneuver	263	-	-	-	-	-
Stage 1	476	-	-	-	-	-
Stage 2	756	-	-	-	-	-

Approach	EB	NB	SB
HCM Control Delay, s	18.6	1.2	0
HCM LOS	C		

Minor Lane/Major Mvmt	NBL	NBT	EBLn1	SBT	SBR
Capacity (veh/h)	867	-	330	-	-
HCM Lane V/C Ratio	0.038	-	0.198	-	-
HCM Control Delay (s)	9.3	-	18.6	-	-
HCM Lane LOS	A	-	C	-	-
HCM 95th %tile Q(veh)	0.1	-	0.7	-	-

HCM 2010 Signalized Intersection Summary
 10: Imjin Road & Imjin Parkway

Existing with Project, AM
 06/11/2019

								
Movement	EBT	EBR	WBL	WBT	NBL	NBR		
Lane Configurations								
Traffic Volume (veh/h)	750	210	410	960	80	100		
Future Volume (veh/h)	750	210	410	960	80	100		
Number	2	12	1	6	3	18		
Initial Q (Qb), veh	0	0	0	0	0	0		
Ped-Bike Adj(A_pbT)		1.00	1.00		1.00	1.00		
Parking Bus, Adj	1.00	1.00	1.00	1.00	1.00	1.00		
Adj Sat Flow, veh/h/ln	1863	1900	1845	1845	1810	1810		
Adj Flow Rate, veh/h	789	208	432	1011	63	127		
Adj No. of Lanes	2	0	1	2	1	2		
Peak Hour Factor	0.95	0.95	0.95	0.95	0.95	0.95		
Percent Heavy Veh, %	2	2	3	3	5	5		
Cap, veh/h	908	239	490	2529	132	235		
Arrive On Green	0.33	0.33	0.28	0.72	0.08	0.08		
Sat Flow, veh/h	2866	731	1757	3597	1723	3076		
Grp Volume(v), veh/h	504	493	432	1011	63	127		
Grp Sat Flow(s),veh/h/ln	1770	1734	1757	1752	1723	1538		
Q Serve(g_s), s	12.3	12.3	10.8	5.2	1.6	1.8		
Cycle Q Clear(g_c), s	12.3	12.3	10.8	5.2	1.6	1.8		
Prop In Lane		0.42	1.00		1.00	1.00		
Lane Grp Cap(c), veh/h	579	568	490	2529	132	235		
V/C Ratio(X)	0.87	0.87	0.88	0.40	0.48	0.54		
Avail Cap(c_a), veh/h	1152	1129	763	2529	823	1469		
HCM Platoon Ratio	1.00	1.00	1.00	1.00	1.00	1.00		
Upstream Filter(I)	1.00	1.00	1.00	1.00	1.00	1.00		
Uniform Delay (d), s/veh	14.6	14.6	15.9	2.5	20.4	20.5		
Incr Delay (d2), s/veh	1.6	1.6	5.0	0.0	1.0	0.7		
Initial Q Delay(d3),s/veh	0.0	0.0	0.0	0.0	0.0	0.0		
%ile BackOfQ(50%),veh/ln	6.1	6.0	5.8	2.4	0.8	0.8		
LnGrp Delay(d),s/veh	16.2	16.2	20.9	2.5	21.4	21.2		
LnGrp LOS	B	B	C	A	C	C		
Approach Vol, veh/h	997			1443	190			
Approach Delay, s/veh	16.2			8.0	21.3			
Approach LOS	B			A	C			
Timer	1	2	3	4	5	6	7	8
Assigned Phs	1	2				6		8
Phs Duration (G+Y+Rc), s	18.2	20.4				38.5		7.5
Change Period (Y+Rc), s	5.3	* 5.3				5.3		4.0
Max Green Setting (Gmax), s	20.0	* 30				30.0		22.0
Max Q Clear Time (g_c+I1), s	12.8	14.3				7.2		3.8
Green Ext Time (p_c), s	0.1	0.8				1.1		0.0
Intersection Summary								
HCM 2010 Ctrl Delay			12.1					
HCM 2010 LOS			B					
Notes								

HCM 2010 Signalized Intersection Summary
 11: Abrams Drive & Imjin Parkway

Existing with Project, AM
 06/11/2019



Movement	EBL	EBT	EBR	WBL	WBT	WBR	NBL	NBT	NBR	SBL	SBT	SBR
Lane Configurations												
Traffic Volume (veh/h)	40	680	70	80	900	20	320	20	60	40	50	190
Future Volume (veh/h)	40	680	70	80	900	20	320	20	60	40	50	190
Number	5	2	12	1	6	16	3	8	18	7	4	14
Initial Q (Qb), veh	0	0	0	0	0	0	0	0	0	0	0	0
Ped-Bike Adj(A_pbT)	1.00		1.00	1.00		1.00	1.00		1.00	1.00		1.00
Parking Bus, Adj	1.00	1.00	1.00	1.00	1.00	1.00	1.00	1.00	1.00	1.00	1.00	1.00
Adj Sat Flow, veh/h/ln	1881	1881	1881	1863	1863	1863	1900	1845	1845	1900	1863	1863
Adj Flow Rate, veh/h	43	731	0	86	968	0	344	22	0	43	54	0
Adj No. of Lanes	1	1	1	1	1	1	0	1	1	0	1	1
Peak Hour Factor	0.93	0.93	0.93	0.93	0.93	0.93	0.93	0.93	0.93	0.93	0.93	0.93
Percent Heavy Veh, %	1	1	1	2	2	2	3	3	3	2	2	2
Cap, veh/h	79	978	831	110	992	843	444	23	433	255	300	438
Arrive On Green	0.04	0.52	0.00	0.06	0.53	0.00	0.28	0.28	0.00	0.28	0.28	0.00
Sat Flow, veh/h	1792	1881	1599	1774	1863	1583	1327	85	1568	714	1085	1583
Grp Volume(v), veh/h	43	731	0	86	968	0	366	0	0	97	0	0
Grp Sat Flow(s),veh/h/ln	1792	1881	1599	1774	1863	1583	1412	0	1568	1799	0	1583
Q Serve(g_s), s	2.1	27.5	0.0	4.3	45.7	0.0	19.1	0.0	0.0	0.0	0.0	0.0
Cycle Q Clear(g_c), s	2.1	27.5	0.0	4.3	45.7	0.0	22.7	0.0	0.0	3.6	0.0	0.0
Prop In Lane	1.00		1.00	1.00		1.00	0.94		1.00	0.44		1.00
Lane Grp Cap(c), veh/h	79	978	831	110	992	843	468	0	433	555	0	438
V/C Ratio(X)	0.55	0.75	0.00	0.78	0.98	0.00	0.78	0.00	0.00	0.17	0.00	0.00
Avail Cap(c_a), veh/h	397	1042	886	393	1032	877	544	0	521	645	0	526
HCM Platoon Ratio	1.00	1.00	1.00	1.00	1.00	1.00	1.00	1.00	1.00	1.00	1.00	1.00
Upstream Filter(I)	1.00	1.00	0.00	1.00	1.00	0.00	1.00	0.00	0.00	1.00	0.00	0.00
Uniform Delay (d), s/veh	42.3	17.0	0.0	41.7	20.5	0.0	31.4	0.0	0.0	24.9	0.0	0.0
Incr Delay (d2), s/veh	2.2	2.4	0.0	4.5	21.8	0.0	5.2	0.0	0.0	0.1	0.0	0.0
Initial Q Delay(d3),s/veh	0.0	0.0	0.0	0.0	0.0	0.0	0.0	0.0	0.0	0.0	0.0	0.0
%ile BackOfQ(50%),veh/ln	1.1	14.9	0.0	2.2	29.1	0.0	9.5	0.0	0.0	1.8	0.0	0.0
LnGrp Delay(d),s/veh	44.5	19.4	0.0	46.2	42.3	0.0	36.7	0.0	0.0	25.0	0.0	0.0
LnGrp LOS	D	B		D	D		D			C		
Approach Vol, veh/h		774			1054			366			97	
Approach Delay, s/veh		20.8			42.6			36.7			25.0	
Approach LOS		C			D			D			C	
Timer	1	2	3	4	5	6	7	8				
Assigned Phs	1	2		4	5	6		8				
Phs Duration (G+Y+Rc), s	9.1	52.2		28.9	8.0	53.3		28.9				
Change Period (Y+Rc), s	3.5	5.3		4.0	4.0	5.3		4.0				
Max Green Setting (Gmax), s	20.0	50.0		30.0	20.0	50.0		30.0				
Max Q Clear Time (g_c+10), s	10.3	29.5		5.6	4.1	47.7		24.7				
Green Ext Time (p_c), s	0.0	0.5		0.1	0.0	0.4		0.2				
Intersection Summary												
HCM 2010 Ctrl Delay				33.6								
HCM 2010 LOS				C								

HCM 2010 Signalized Intersection Summary
 12: Reservation Road & Imjin Parkway

Existing with Project, AM
 06/11/2019



Movement	EBL	EBT	EBR	WBL	WBT	WBR	NBL	NBT	NBR	SBL	SBT	SBR
Lane Configurations												
Traffic Volume (veh/h)	130	30	690	10	10	20	880	620	20	40	540	90
Future Volume (veh/h)	130	30	690	10	10	20	880	620	20	40	540	90
Number	3	8	18	7	4	14	1	6	16	5	2	12
Initial Q (Qb), veh	0	0	0	0	0	0	0	0	0	0	0	0
Ped-Bike Adj(A_pbT)	1.00		1.00	1.00		0.99	1.00		1.00	1.00		0.97
Parking Bus, Adj	1.00	1.00	1.00	1.00	1.00	1.00	1.00	1.00	1.00	1.00	1.00	1.00
Adj Sat Flow, veh/h/ln	1863	1863	1863	1638	1638	1638	1863	1863	1863	1863	1863	1863
Adj Flow Rate, veh/h	163	0	328	11	11	9	946	667	16	43	581	34
Adj No. of Lanes	2	0	2	1	1	1	2	2	1	2	2	1
Peak Hour Factor	0.93	0.93	0.93	0.93	0.93	0.93	0.93	0.93	0.93	0.93	0.93	0.93
Percent Heavy Veh, %	2	2	2	16	16	16	2	2	2	2	2	2
Cap, veh/h	390	0	1308	46	48	40	1044	1991	889	107	1027	447
Arrive On Green	0.11	0.00	0.11	0.03	0.03	0.03	0.30	0.56	0.56	0.03	0.29	0.29
Sat Flow, veh/h	3548	0	3152	1560	1638	1384	3442	3539	1581	3442	3539	1542
Grp Volume(v), veh/h	163	0	328	11	11	9	946	667	16	43	581	34
Grp Sat Flow(s),veh/h/ln	1774	0	1576	1560	1638	1384	1721	1770	1581	1721	1770	1542
Q Serve(g_s), s	3.3	0.0	5.3	0.5	0.5	0.5	20.6	7.9	0.3	1.0	10.9	1.2
Cycle Q Clear(g_c), s	3.3	0.0	5.3	0.5	0.5	0.5	20.6	7.9	0.3	1.0	10.9	1.2
Prop In Lane	1.00		1.00	1.00		1.00	1.00		1.00	1.00		1.00
Lane Grp Cap(c), veh/h	390	0	1308	46	48	40	1044	1991	889	107	1027	447
V/C Ratio(X)	0.42	0.00	0.25	0.24	0.23	0.22	0.91	0.34	0.02	0.40	0.57	0.08
Avail Cap(c_a), veh/h	1595	0	2378	621	652	551	1548	2273	1015	884	2728	1188
HCM Platoon Ratio	1.00	1.00	1.00	1.00	1.00	1.00	1.00	1.00	1.00	1.00	1.00	1.00
Upstream Filter(I)	1.00	0.00	1.00	1.00	1.00	1.00	1.00	1.00	1.00	1.00	1.00	1.00
Uniform Delay (d), s/veh	32.3	0.0	14.9	36.9	36.9	36.9	26.0	9.2	7.5	37.0	23.5	20.1
Incr Delay (d2), s/veh	0.3	0.0	0.0	1.0	0.9	1.0	4.3	0.3	0.0	0.9	1.4	0.2
Initial Q Delay(d3),s/veh	0.0	0.0	0.0	0.0	0.0	0.0	0.0	0.0	0.0	0.0	0.0	0.0
%ile BackOfQ(50%),veh/ln	1.6	0.0	2.3	0.2	0.2	0.2	10.3	3.9	0.2	0.5	5.4	0.6
LnGrp Delay(d),s/veh	32.6	0.0	15.0	37.9	37.8	37.9	30.3	9.5	7.5	37.9	24.8	20.3
LnGrp LOS	C		B	D	D	D	C	A	A	D	C	C
Approach Vol, veh/h		491			31			1629			658	
Approach Delay, s/veh		20.8			37.9			21.6			25.4	
Approach LOS		C			D			C			C	
Timer	1	2	3	4	5	6	7	8				
Assigned Phs	1	2		4	5	6		8				
Phs Duration (G+Y+Rc), s	27.7			7.3	6.5	50.0		14.1				
Change Period (Y+Rc), s	4.1	* 6.2		5.0	4.1	* 6.2		5.5				
Max Green Setting (Gmax), s	35.0	* 60		31.0	20.0	* 50		35.0				
Max Q Clear Time (g_c+T), s	22.6	12.9		2.5	3.0	9.9		7.3				
Green Ext Time (p_c), s	1.1	9.6		0.0	0.0	10.7		1.0				
Intersection Summary												
HCM 2010 Ctrl Delay			22.5									
HCM 2010 LOS			C									
Notes												

HCM 2010 Signalized Intersection Summary
 13: Reservation Road & Blanco Road

Existing with Project, AM
 06/11/2019

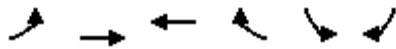

Movement	EBL	EBT	WBT	WBR	SBL	SBR		
Lane Configurations	↶↷	↶↶	↶	↷	↶↷	↶↷		
Traffic Volume (veh/h)	1000	270	390	30	30	1140		
Future Volume (veh/h)	1000	270	390	30	30	1140		
Number	5	2	6	16	7	14		
Initial Q (Qb), veh	0	0	0	0	0	0		
Ped-Bike Adj(A_pbT)	1.00			1.00	1.00	1.00		
Parking Bus, Adj	1.00	1.00	1.00	1.00	1.00	1.00		
Adj Sat Flow, veh/h/ln	1863	1863	1845	1845	1845	1845		
Adj Flow Rate, veh/h	1075	290	419	13	32	0		
Adj No. of Lanes	2	2	1	1	2	2		
Peak Hour Factor	0.93	0.93	0.93	0.93	0.93	0.93		
Percent Heavy Veh, %	2	2	3	3	3	3		
Cap, veh/h	1215	2711	538	458	100	81		
Arrive On Green	0.35	0.77	0.29	0.29	0.03	0.00		
Sat Flow, veh/h	3442	3632	1845	1568	3408	2760		
Grp Volume(v), veh/h	1075	290	419	13	32	0		
Grp Sat Flow(s),veh/h/ln	1721	1770	1845	1568	1704	1380		
Q Serve(g_s), s	13.3	0.9	9.5	0.3	0.4	0.0		
Cycle Q Clear(g_c), s	13.3	0.9	9.5	0.3	0.4	0.0		
Prop In Lane	1.00			1.00	1.00	1.00		
Lane Grp Cap(c), veh/h	1215	2711	538	458	100	81		
V/C Ratio(X)	0.88	0.11	0.78	0.03	0.32	0.00		
Avail Cap(c_a), veh/h	3032	4676	2437	2072	2027	1641		
HCM Platoon Ratio	1.00	1.00	1.00	1.00	1.00	1.00		
Upstream Filter(I)	1.00	1.00	1.00	1.00	1.00	0.00		
Uniform Delay (d), s/veh	13.8	1.4	14.7	11.5	21.6	0.0		
Incr Delay (d2), s/veh	0.9	0.0	1.8	0.0	0.7	0.0		
Initial Q Delay(d3),s/veh	0.0	0.0	0.0	0.0	0.0	0.0		
%ile BackOfQ(50%),veh/ln	6.4	0.4	5.0	0.1	0.2	0.0		
LnGrp Delay(d),s/veh	14.7	1.4	16.6	11.5	22.3	0.0		
LnGrp LOS	B	A	B	B	C			
Approach Vol, veh/h		1365	432		32			
Approach Delay, s/veh		11.9	16.4		22.3			
Approach LOS		B	B		C			
Timer	1	2	3	4	5	6	7	8
Assigned Phs		2		4	5	6		
Phs Duration (G+Y+Rc), s		40.6		4.8	21.5	19.1		
Change Period (Y+Rc), s		5.8		3.5	5.5	5.8		
Max Green Setting (Gmax), s		60.0		27.0	40.0	60.0		
Max Q Clear Time (g_c+I1), s		2.9		2.4	15.3	11.5		
Green Ext Time (p_c), s		1.3		0.0	0.7	1.8		
Intersection Summary								
HCM 2010 Ctrl Delay			13.1					
HCM 2010 LOS			B					

HCM 2010 Signalized Intersection Summary
 14: Reservation Road & Inter-Garrison Road

Existing with Project, AM
 06/11/2019



Movement	EBL	EBR	NBL	NBT	SBT	SBR		
Lane Configurations								
Traffic Volume (veh/h)	60	240	500	390	240	50		
Future Volume (veh/h)	60	240	500	390	240	50		
Number	3	18	1	6	2	12		
Initial Q (Qb), veh	0	0	0	0	0	0		
Ped-Bike Adj(A_pbT)	1.00	1.00	1.00			1.00		
Parking Bus, Adj	1.00	1.00	1.00	1.00	1.00	1.00		
Adj Sat Flow, veh/h/ln	1845	1845	1863	1863	1845	1900		
Adj Flow Rate, veh/h	64	216	532	415	255	37		
Adj No. of Lanes	1	1	1	2	2	0		
Peak Hour Factor	0.94	0.94	0.94	0.94	0.94	0.94		
Percent Heavy Veh, %	3	3	2	2	3	3		
Cap, veh/h	249	750	597	2198	561	80		
Arrive On Green	0.14	0.14	0.34	0.62	0.18	0.18		
Sat Flow, veh/h	1757	1568	1774	3632	3170	441		
Grp Volume(v), veh/h	64	216	532	415	144	148		
Grp Sat Flow(s),veh/h/ln	1757	1568	1774	1770	1752	1767		
Q Serve(g_s), s	1.5	3.8	13.1	2.3	3.4	3.4		
Cycle Q Clear(g_c), s	1.5	3.8	13.1	2.3	3.4	3.4		
Prop In Lane	1.00	1.00	1.00			0.25		
Lane Grp Cap(c), veh/h	249	750	597	2198	319	322		
V/C Ratio(X)	0.26	0.29	0.89	0.19	0.45	0.46		
Avail Cap(c_a), veh/h	1031	1448	771	4617	2286	2305		
HCM Platoon Ratio	1.00	1.00	1.00	1.00	1.00	1.00		
Upstream Filter(I)	1.00	1.00	1.00	1.00	1.00	1.00		
Uniform Delay (d), s/veh	17.6	7.3	14.5	3.7	16.8	16.8		
Incr Delay (d2), s/veh	0.5	0.2	8.9	0.1	1.8	1.9		
Initial Q Delay(d3),s/veh	0.0	0.0	0.0	0.0	0.0	0.0		
%ile BackOfQ(50%),veh/ln	0.7	1.7	7.8	1.1	1.8	1.9		
LnGrp Delay(d),s/veh	18.1	7.5	23.4	3.8	18.6	18.7		
LnGrp LOS	B	A	C	A	B	B		
Approach Vol, veh/h	280			947	292			
Approach Delay, s/veh	9.9			14.8	18.6			
Approach LOS	A			B	B			
Timer	1	2	3	4	5	6	7	8
Assigned Phs	1	2				6		8
Phs Duration (G+Y+Rc), s	20.2	14.8				35.0		11.0
Change Period (Y+Rc), s	4.7	6.4				6.4		4.5
Max Green Setting (Gmax), s	20	60.0				60.0		27.0
Max Q Clear Time (g_c+11.5, s)	11.5	5.4				4.3		5.8
Green Ext Time (p_c), s	0.4	2.9				4.8		0.9
Intersection Summary								
HCM 2010 Ctrl Delay			14.6					
HCM 2010 LOS			B					
Notes								

Intersection

Intersection Delay, s/veh 39.4

Intersection LOS E

Movement	EBL	EBT	EBR	WBL	WBT	WBR	NBL	NBT	NBR	SBL	SBT	SBR
Lane Configurations		↔	↔		↔		↔	↔			↔	↔
Traffic Vol, veh/h	40	10	50	250	10	10	10	140	10	10	520	30
Future Vol, veh/h	40	10	50	250	10	10	10	140	10	10	520	30
Peak Hour Factor	0.94	0.94	0.94	0.94	0.94	0.94	0.94	0.94	0.94	0.94	0.94	0.94
Heavy Vehicles, %	1	1	1	0	0	0	1	1	1	2	2	2
Mvmt Flow	43	11	53	266	11	11	11	149	11	11	553	32
Number of Lanes	0	1	1	0	1	0	1	1	0	0	1	1

Approach	EB	WB	NB	SB
Opposing Approach	WB	EB	SB	NB
Opposing Lanes	1	2	2	2
Conflicting Approach Left	SB	NB	EB	WB
Conflicting Lanes Left	2	2	2	1
Conflicting Approach Right	NB	SB	WB	EB
Conflicting Lanes Right	2	2	1	2
HCM Control Delay	11.4	20.4	12.9	61.1
HCM LOS	B	C	B	F

Lane	NBLn1	NBLn2	EBLn1	EBLn2	WBLn1	SBLn1	SBLn2
Vol Left, %	100%	0%	80%	0%	93%	2%	0%
Vol Thru, %	0%	93%	20%	0%	4%	98%	0%
Vol Right, %	0%	7%	0%	100%	4%	0%	100%
Sign Control	Stop	Stop	Stop	Stop	Stop	Stop	Stop
Traffic Vol by Lane	10	150	50	50	270	530	30
LT Vol	10	0	40	0	250	10	0
Through Vol	0	140	10	0	10	520	0
RT Vol	0	10	0	50	10	0	30
Lane Flow Rate	11	160	53	53	287	564	32
Geometry Grp	7	7	7	7	6	7	7
Degree of Util (X)	0.023	0.314	0.121	0.104	0.587	1.005	0.05
Departure Headway (Hd)	7.644	7.082	8.177	7.046	7.351	6.416	5.694
Convergence, Y/N	Yes	Yes	Yes	Yes	Yes	Yes	Yes
Cap	467	506	437	506	491	569	633
Service Time	5.405	4.842	5.95	4.818	5.407	4.116	3.394
HCM Lane V/C Ratio	0.024	0.316	0.121	0.105	0.585	0.991	0.051
HCM Control Delay	10.6	13.1	12.1	10.6	20.4	64.1	8.7
HCM Lane LOS	B	B	B	B	C	F	A
HCM 95th-tile Q	0.1	1.3	0.4	0.3	3.7	14.7	0.2

Intersection												
Intersection Delay, s/veh	69.8											
Intersection LOS	F											

Movement	EBL	EBT	EBR	WBL	WBT	WBR	NBL	NBT	NBR	SBL	SBT	SBR
Lane Configurations	↖	↑	↗		↖	↗	↖	↑	↗	↖	↗	
Traffic Vol, veh/h	10	10	10	270	10	30	10	210	130	60	770	10
Future Vol, veh/h	10	10	10	270	10	30	10	210	130	60	770	10
Peak Hour Factor	0.95	0.95	0.95	0.95	0.95	0.95	0.95	0.95	0.95	0.95	0.95	0.95
Heavy Vehicles, %	0	0	0	20	20	20	2	2	2	1	1	1
Mvmt Flow	11	11	11	284	11	32	11	221	137	63	811	11
Number of Lanes	1	1	1	0	1	1	1	1	1	1	1	0

Approach	EB	WB	NB	SB
Opposing Approach	WB	EB	SB	NB
Opposing Lanes	2	3	2	3
Conflicting Approach Left	SB	NB	EB	WB
Conflicting Lanes Left	2	3	3	2
Conflicting Approach Right	NB	SB	WB	EB
Conflicting Lanes Right	3	2	2	3
HCM Control Delay	13.3	30.2	17	290.5
HCM LOS	B	D	C	F

Lane	NBLn1	NBLn2	NBLn3	EBLn1	EBLn2	EBLn3	WBLn1	WBLn2	SBLn1	SBLn2
Vol Left, %	100%	0%	0%	100%	0%	0%	96%	0%	100%	0%
Vol Thru, %	0%	100%	0%	0%	100%	0%	4%	0%	0%	99%
Vol Right, %	0%	0%	100%	0%	0%	100%	0%	100%	0%	1%
Sign Control	Stop	Stop	Stop	Stop	Stop	Stop	Stop	Stop	Stop	Stop
Traffic Vol by Lane	10	210	130	10	10	10	280	30	60	780
LT Vol	10	0	0	10	0	0	270	0	60	0
Through Vol	0	210	0	0	10	0	10	0	0	770
RT Vol	0	0	130	0	0	10	0	30	0	10
Lane Flow Rate	11	221	137	11	11	11	295	32	63	821
Geometry Grp	8	8	8	8	8	8	8	8	8	8
Degree of Util (X)	0.024	0.476	0.268	0.028	0.026	0.024	0.701	0.065	0.135	1.632
Departure Headway (Hd)	9.317	8.802	8.08	10.88	10.357	9.624	9.69	8.48	7.672	7.157
Convergence, Y/N	Yes	Yes	Yes	Yes	Yes	Yes	Yes	Yes	Yes	Yes
Cap	387	413	447	331	348	374	377	425	467	509
Service Time	7.017	6.502	5.78	8.58	8.057	7.324	7.39	6.18	5.434	4.918
HCM Lane V/C Ratio	0.028	0.535	0.306	0.033	0.032	0.029	0.782	0.075	0.135	1.613
HCM Control Delay	12.2	19.2	13.7	13.9	13.3	12.6	32.2	11.8	11.6	311.9
HCM Lane LOS	B	C	B	B	B	B	D	B	B	F
HCM 95th-tile Q	0.1	2.5	1.1	0.1	0.1	0.1	5.1	0.2	0.5	46

Intersection

Intersection Delay, s/veh 12.5

Intersection LOS B

Movement	EBT	EBR	WBL	WBT	NBL	NBR
Lane Configurations	↑	↗	↖	↑	↖	↗
Traffic Vol, veh/h	130	60	290	270	30	180
Future Vol, veh/h	130	60	290	270	30	180
Peak Hour Factor	0.92	0.92	0.92	0.92	0.92	0.92
Heavy Vehicles, %	2	2	2	2	2	2
Mvmt Flow	141	65	315	293	33	196
Number of Lanes	1	1	1	1	1	1

Approach	EB	WB	NB
Opposing Approach	WB	EB	
Opposing Lanes	2	2	0
Conflicting Approach Left		NB	EB
Conflicting Lanes Left	0	2	2
Conflicting Approach Right	NB		WB
Conflicting Lanes Right	2	0	2
HCM Control Delay	10	13.9	11.1
HCM LOS	A	B	B

Lane	NBLn1	NBLn2	EBLn1	EBLn2	WBLn1	WBLn2
Vol Left, %	100%	0%	0%	0%	100%	0%
Vol Thru, %	0%	0%	100%	0%	0%	100%
Vol Right, %	0%	100%	0%	100%	0%	0%
Sign Control	Stop	Stop	Stop	Stop	Stop	Stop
Traffic Vol by Lane	30	180	130	60	290	270
LT Vol	30	0	0	0	290	0
Through Vol	0	0	130	0	0	270
RT Vol	0	180	0	60	0	0
Lane Flow Rate	33	196	141	65	315	293
Geometry Grp	7	7	7	7	7	7
Degree of Util (X)	0.064	0.316	0.236	0.096	0.526	0.449
Departure Headway (Hd)	7.033	5.82	6.015	5.306	6.008	5.503
Convergence, Y/N	Yes	Yes	Yes	Yes	Yes	Yes
Cap	510	618	598	676	602	657
Service Time	4.763	3.55	3.745	3.035	3.728	3.223
HCM Lane V/C Ratio	0.065	0.317	0.236	0.096	0.523	0.446
HCM Control Delay	10.2	11.2	10.6	8.6	15.2	12.6
HCM Lane LOS	B	B	B	A	C	B
HCM 95th-tile Q	0.2	1.4	0.9	0.3	3.1	2.3

Intersection												
Intersection Delay, s/veh	37.3											
Intersection LOS	E											

Movement	EBL	EBT	EBR	WBL	WBT	WBR	NBL	NBT	NBR	SBL	SBT	SBR
Lane Configurations												
Traffic Vol, veh/h	50	70	10	10	90	170	10	20	10	420	10	190
Future Vol, veh/h	50	70	10	10	90	170	10	20	10	420	10	190
Peak Hour Factor	0.81	0.81	0.81	0.81	0.81	0.81	0.81	0.81	0.81	0.81	0.81	0.81
Heavy Vehicles, %	3	3	3	5	5	5	0	0	0	1	1	1
Mvmt Flow	62	86	12	12	111	210	12	25	12	519	12	235
Number of Lanes	1	1	0	1	1	1	0	1	0	0	1	1

Approach	EB	WB	NB	SB
Opposing Approach	WB	EB	SB	NB
Opposing Lanes	3	2	2	1
Conflicting Approach Left	SB	NB	EB	WB
Conflicting Lanes Left	2	1	2	3
Conflicting Approach Right	NB	SB	WB	EB
Conflicting Lanes Right	1	2	3	2
HCM Control Delay	13	13.8	12	54.2
HCM LOS	B	B	B	F

Lane	NBLn1	EBLn1	EBLn2	WBLn1	WBLn2	WBLn3	SBLn1	SBLn2
Vol Left, %	25%	100%	0%	100%	0%	0%	98%	0%
Vol Thru, %	50%	0%	88%	0%	100%	0%	2%	0%
Vol Right, %	25%	0%	12%	0%	0%	100%	0%	100%
Sign Control	Stop	Stop	Stop	Stop	Stop	Stop	Stop	Stop
Traffic Vol by Lane	40	50	80	10	90	170	430	190
LT Vol	10	50	0	10	0	0	420	0
Through Vol	20	0	70	0	90	0	10	0
RT Vol	10	0	10	0	0	170	0	190
Lane Flow Rate	49	62	99	12	111	210	531	235
Geometry Grp	8	8	8	8	8	8	8	8
Degree of Util (X)	0.111	0.145	0.219	0.028	0.237	0.406	1.026	0.376
Departure Headway (Hd)	8.278	8.734	8.126	8.301	7.789	7.071	6.961	5.764
Convergence, Y/N	Yes	Yes	Yes	Yes	Yes	Yes	Yes	Yes
Cap	436	413	444	434	463	512	520	619
Service Time	5.978	6.434	5.826	6.001	5.489	4.771	4.746	3.548
HCM Lane V/C Ratio	0.112	0.15	0.223	0.028	0.24	0.41	1.021	0.38
HCM Control Delay	12	12.9	13.1	11.2	12.9	14.5	72.9	12
HCM Lane LOS	B	B	B	B	B	B	F	B
HCM 95th-tile Q	0.4	0.5	0.8	0.1	0.9	1.9	14.9	1.7

Intersection

Intersection Delay, s/veh 192.8

Intersection LOS F

Movement	WBL	WBR	NBT	NBR	SBL	SBT
Lane Configurations	↘	↗	↑	↗	↘	↑
Traffic Vol, veh/h	30	10	340	40	10	1030
Future Vol, veh/h	30	10	340	40	10	1030
Peak Hour Factor	0.93	0.93	0.93	0.93	0.93	0.93
Heavy Vehicles, %	0	0	1	1	1	1
Mvmt Flow	32	11	366	43	11	1108
Number of Lanes	1	1	1	1	1	1

Approach	WB	NB	SB
Opposing Approach		SB	NB
Opposing Lanes	0	2	2
Conflicting Approach Left NB			WB
Conflicting Lanes Left	2	0	2
Conflicting Approach Right SB		WB	
Conflicting Lanes Right	2	2	0
HCM Control Delay	11.4	13.6	265.3
HCM LOS	B	B	F

Lane	NBLn1	NBLn2	WBLn1	WBLn2	SBLn1	SBLn2
Vol Left, %	0%	0%	100%	0%	100%	0%
Vol Thru, %	100%	0%	0%	0%	0%	100%
Vol Right, %	0%	100%	0%	100%	0%	0%
Sign Control	Stop	Stop	Stop	Stop	Stop	Stop
Traffic Vol by Lane	340	40	30	10	10	1030
LT Vol	0	0	30	0	10	0
Through Vol	340	0	0	0	0	1030
RT Vol	0	40	0	10	0	0
Lane Flow Rate	366	43	32	11	11	1108
Geometry Grp	7	7	7	7	7	7
Degree of Util (X)	0.523	0.054	0.068	0.019	0.017	1.548
Departure Headway (Hd)	5.62	4.912	8.515	7.28	5.536	5.033
Convergence, Y/N	Yes	Yes	Yes	Yes	Yes	Yes
Cap	647	733	423	495	649	731
Service Time	3.32	2.612	6.215	4.98	3.244	2.741
HCM Lane V/C Ratio	0.566	0.059	0.076	0.022	0.017	1.516
HCM Control Delay	14.3	7.9	11.8	10.1	8.3	267.8
HCM Lane LOS	B	A	B	B	A	F
HCM 95th-tile Q	3	0.2	0.2	0.1	0.1	56.3

Intersection	
Intersection Delay, s/veh	8.9
Intersection LOS	A

Movement	EBL	EBT	EBR	WBL	WBT	WBR	NBL	NBT	NBR	SBL	SBT	SBR
Lane Configurations		↕			↕			↕			↕	
Traffic Vol, veh/h	10	10	10	10	10	30	10	170	10	30	150	10
Future Vol, veh/h	10	10	10	10	10	30	10	170	10	30	150	10
Peak Hour Factor	0.85	0.85	0.85	0.85	0.85	0.85	0.85	0.85	0.85	0.85	0.85	0.85
Heavy Vehicles, %	6	6	6	2	2	2	4	4	4	0	0	0
Mvmt Flow	12	12	12	12	12	35	12	200	12	35	176	12
Number of Lanes	0	1	0	0	1	0	0	1	0	0	1	0

Approach	EB	WB	NB	SB
Opposing Approach	WB	EB	SB	NB
Opposing Lanes	1	1	1	1
Conflicting Approach Left	SB	NB	EB	WB
Conflicting Lanes Left	1	1	1	1
Conflicting Approach Right	NB	SB	WB	EB
Conflicting Lanes Right	1	1	1	1
HCM Control Delay	8.2	8.1	9.1	9
HCM LOS	A	A	A	A

Lane	NBLn1	EBLn1	WBLn1	SBLn1
Vol Left, %	5%	33%	20%	16%
Vol Thru, %	89%	33%	20%	79%
Vol Right, %	5%	33%	60%	5%
Sign Control	Stop	Stop	Stop	Stop
Traffic Vol by Lane	190	30	50	190
LT Vol	10	10	10	30
Through Vol	170	10	10	150
RT Vol	10	10	30	10
Lane Flow Rate	224	35	59	224
Geometry Grp	1	1	1	1
Degree of Util (X)	0.274	0.048	0.076	0.271
Departure Headway (Hd)	4.409	4.938	4.652	4.365
Convergence, Y/N	Yes	Yes	Yes	Yes
Cap	816	725	769	825
Service Time	2.429	2.972	2.683	2.384
HCM Lane V/C Ratio	0.275	0.048	0.077	0.272
HCM Control Delay	9.1	8.2	8.1	9
HCM Lane LOS	A	A	A	A
HCM 95th-tile Q	1.1	0.2	0.2	1.1

Intersection	
Intersection Delay, s/veh	98.4
Intersection LOS	F

Movement	EBL	EBT	EBR	WBL	WBT	WBR	NBL	NBT	NBR	SBL	SBT	SBR
Lane Configurations		↕			↕			↕			↕	↕
Traffic Vol, veh/h	10	50	20	310	150	30	30	170	110	170	200	10
Future Vol, veh/h	10	50	20	310	150	30	30	170	110	170	200	10
Peak Hour Factor	0.81	0.81	0.81	0.81	0.81	0.81	0.81	0.81	0.81	0.81	0.81	0.81
Heavy Vehicles, %	8	8	8	3	3	3	19	19	19	7	7	7
Mvmt Flow	12	62	25	383	185	37	37	210	136	210	247	12
Number of Lanes	0	1	0	0	1	0	0	1	0	0	1	1

Approach	EB	WB	NB	SB
Opposing Approach	WB	EB	SB	NB
Opposing Lanes	1	1	2	1
Conflicting Approach Left	SB	NB	EB	WB
Conflicting Lanes Left	2	1	1	1
Conflicting Approach Right	NB	SB	WB	EB
Conflicting Lanes Right	1	2	1	1
HCM Control Delay	16.5	157.6	42	85.2
HCM LOS	C	F	E	F

Lane	NBLn1	EBLn1	WBLn1	SBLn1	SBLn2
Vol Left, %	10%	12%	63%	46%	0%
Vol Thru, %	55%	62%	31%	54%	0%
Vol Right, %	35%	25%	6%	0%	100%
Sign Control	Stop	Stop	Stop	Stop	Stop
Traffic Vol by Lane	310	80	490	370	10
LT Vol	30	10	310	170	0
Through Vol	170	50	150	200	0
RT Vol	110	20	30	0	10
Lane Flow Rate	383	99	605	457	12
Geometry Grp	5	2	2	7	7
Degree of Util (X)	0.827	0.251	1.26	1.043	0.025
Departure Headway (Hd)	8.783	10.11	7.733	9.031	8.064
Convergence, Y/N	Yes	Yes	Yes	Yes	Yes
Cap	417	358	472	407	447
Service Time	6.783	8.11	5.733	6.731	5.764
HCM Lane V/C Ratio	0.918	0.277	1.282	1.123	0.027
HCM Control Delay	42	16.5	157.6	87.2	11
HCM Lane LOS	E	C	F	F	B
HCM 95th-tile Q	7.7	1	24.2	13.6	0.1

Intersection			
Intersection Delay, s/veh	114.3		
Intersection LOS	F		
Approach	EB	WB	NB
Entry Lanes	1	1	1
Conflicting Circle Lanes	1	1	1
Adj Approach Flow, veh/h	379	1414	287
Demand Flow Rate, veh/h	474	1428	295
Vehicles Circulating, veh/h	847	11	259
Vehicles Exiting, veh/h	592	543	1062
Follow-Up Headway, s	3.186	3.186	3.186
Ped Vol Crossing Leg, #/h	0	0	0
Ped Cap Adj	1.000	1.000	1.000
Approach Delay, s/veh	73.5	146.7	8.1
Approach LOS	F	F	A
Lane	Left	Left	Left
Designated Moves	TR	LT	LR
Assumed Moves	TR	LT	LR
RT Channelized			
Lane Util	1.000	1.000	1.000
Critical Headway, s	5.193	5.193	5.193
Entry Flow, veh/h	474	1428	295
Cap Entry Lane, veh/h	484	1118	872
Entry HV Adj Factor	0.800	0.990	0.973
Flow Entry, veh/h	379	1414	287
Cap Entry, veh/h	388	1107	848
V/C Ratio	0.979	1.278	0.338
Control Delay, s/veh	73.5	146.7	8.1
LOS	F	F	A
95th %tile Queue, veh	11	49	2

Intersection	
Intersection Delay, s/veh	202.6
Intersection LOS	F

Movement	EBL	EBT	WBT	WBR	SBL	SBR
Lane Configurations						
Traffic Vol, veh/h	210	200	740	10	30	490
Future Vol, veh/h	210	200	740	10	30	490
Peak Hour Factor	0.85	0.85	0.85	0.85	0.85	0.85
Heavy Vehicles, %	8	8	1	1	1	1
Mvmt Flow	247	235	871	12	35	576
Number of Lanes	1	1	1	1	1	1

Approach	EB	WB	SB
Opposing Approach	WB	EB	
Opposing Lanes	2	2	0
Conflicting Approach Left	SB		WB
Conflicting Lanes Left	2	0	2
Conflicting Approach Right		SB	EB
Conflicting Lanes Right	0	2	2
HCM Control Delay	22.5	381.7	86.4
HCM LOS	C	F	F

Lane	EBLn1	EBLn2	WBLn1	WBLn2	SBLn1	SBLn2
Vol Left, %	100%	0%	0%	0%	100%	0%
Vol Thru, %	0%	100%	100%	0%	0%	0%
Vol Right, %	0%	0%	0%	100%	0%	100%
Sign Control	Stop	Stop	Stop	Stop	Stop	Stop
Traffic Vol by Lane	210	200	740	10	30	490
LT Vol	210	0	0	0	30	0
Through Vol	0	200	740	0	0	0
RT Vol	0	0	0	10	0	490
Lane Flow Rate	247	235	871	12	35	576
Geometry Grp	7	7	7	7	7	7
Degree of Util (X)	0.566	0.506	1.799	0.022	0.077	1.074
Departure Headway (Hd)	9.666	9.138	7.771	7.047	9.071	7.822
Convergence, Y/N	Yes	Yes	Yes	Yes	Yes	Yes
Cap	376	398	479	511	397	467
Service Time	7.366	6.838	5.471	4.747	6.771	5.522
HCM Lane V/C Ratio	0.657	0.59	1.818	0.023	0.088	1.233
HCM Control Delay	24.2	20.8	386.7	9.9	12.5	90.9
HCM Lane LOS	C	C	F	A	B	F
HCM 95th-tile Q	3.4	2.8	52.2	0.1	0.2	15.9

Intersection						
Intersection Delay, s/veh	79.1					
Intersection LOS	F					

Movement	EBL	EBT	WBT	WBR	SBL	SBR
Lane Configurations	↘	↑	↑	↗	↘	↗
Traffic Vol, veh/h	30	200	590	10	50	160
Future Vol, veh/h	30	200	590	10	50	160
Peak Hour Factor	0.79	0.79	0.79	0.79	0.79	0.79
Heavy Vehicles, %	5	5	1	1	3	3
Mvmt Flow	38	253	747	13	63	203
Number of Lanes	1	1	1	1	1	1

Approach	EB	WB	SB
Opposing Approach	WB	EB	
Opposing Lanes	2	2	0
Conflicting Approach Left	SB		WB
Conflicting Lanes Left	2	0	2
Conflicting Approach Right		SB	EB
Conflicting Lanes Right	0	2	2
HCM Control Delay	13.7	127.4	12.7
HCM LOS	B	F	B

Lane	EBLn1	EBLn2	WBLn1	WBLn2	SBLn1	SBLn2
Vol Left, %	100%	0%	0%	0%	100%	0%
Vol Thru, %	0%	100%	100%	0%	0%	0%
Vol Right, %	0%	0%	0%	100%	0%	100%
Sign Control	Stop	Stop	Stop	Stop	Stop	Stop
Traffic Vol by Lane	30	200	590	10	50	160
LT Vol	30	0	0	0	50	0
Through Vol	0	200	590	0	0	0
RT Vol	0	0	0	10	0	160
Lane Flow Rate	38	253	747	13	63	203
Geometry Grp	7	7	7	7	7	7
Degree of Util (X)	0.071	0.439	1.21	0.018	0.131	0.352
Departure Headway (Hd)	7.017	6.506	5.831	5.121	7.954	6.729
Convergence, Y/N	Yes	Yes	Yes	Yes	Yes	Yes
Cap	514	557	627	702	454	539
Service Time	4.717	4.206	3.539	2.829	5.654	4.429
HCM Lane V/C Ratio	0.074	0.454	1.191	0.019	0.139	0.377
HCM Control Delay	10.3	14.2	129.4	7.9	11.8	13
HCM Lane LOS	B	B	F	A	B	B
HCM 95th-tile Q	0.2	2.2	26.7	0.1	0.4	1.6

Intersection	
Intersection Delay, s/veh	27
Intersection LOS	D

Movement	EBL	EBT	WBT	WBR	SBL	SBR
Lane Configurations		↶	↷		↶	↷
Traffic Vol, veh/h	240	10	80	20	20	520
Future Vol, veh/h	240	10	80	20	20	520
Peak Hour Factor	0.82	0.82	0.82	0.82	0.82	0.82
Heavy Vehicles, %	5	5	1	1	0	0
Mvmt Flow	293	12	98	24	24	634
Number of Lanes	0	1	1	0	1	1

Approach	EB	WB	SB
Opposing Approach	WB	EB	
Opposing Lanes	1	1	0
Conflicting Approach Left	SB		WB
Conflicting Lanes Left	2	0	1
Conflicting Approach Right		SB	EB
Conflicting Lanes Right	0	2	1
HCM Control Delay	15.7	10.8	35.3
HCM LOS	C	B	E

Lane	EBLn1	WBLn1	SBLn1	SBLn2
Vol Left, %	96%	0%	100%	0%
Vol Thru, %	4%	80%	0%	0%
Vol Right, %	0%	20%	0%	100%
Sign Control	Stop	Stop	Stop	Stop
Traffic Vol by Lane	250	100	20	520
LT Vol	240	0	20	0
Through Vol	10	80	0	0
RT Vol	0	20	0	520
Lane Flow Rate	305	122	24	634
Geometry Grp	2	2	7	7
Degree of Util (X)	0.521	0.208	0.043	0.9
Departure Headway (Hd)	6.148	6.138	6.32	5.107
Convergence, Y/N	Yes	Yes	Yes	Yes
Cap	585	582	566	710
Service Time	4.201	4.203	4.062	2.849
HCM Lane V/C Ratio	0.521	0.21	0.042	0.893
HCM Control Delay	15.7	10.8	9.3	36.3
HCM Lane LOS	C	B	A	E
HCM 95th-tile Q	3	0.8	0.1	11.6

HCM 2010 Signalized Intersection Summary
 26: East Garrison Road & Reservation Road



















Existing with Project, AM
 06/11/2019



Movement	EBL	EBT	EBR	WBL	WBT	WBR	NBL	NBT	NBR	SBL	SBT	SBR
Lane Configurations												
Traffic Volume (veh/h)	0	480	10	40	890	0	40	0	80	0	0	0
Future Volume (veh/h)	0	480	10	40	890	0	40	0	80	0	0	0
Number	5	2	12	1	6	16	3	8	18			
Initial Q (Qb), veh	0	0	0	0	0	0	0	0	0			
Ped-Bike Adj(A_pbT)	1.00		1.00	1.00		1.00	1.00		1.00			
Parking Bus, Adj	1.00	1.00	1.00	1.00	1.00	1.00	1.00	1.00	1.00			
Adj Sat Flow, veh/h/ln	1827	1827	1900	1863	1863	0	1881	0	1881			
Adj Flow Rate, veh/h	0	539	9	45	1000	0	45	0	18			
Adj No. of Lanes	1	2	0	1	2	0	1	0	1			
Peak Hour Factor	0.89	0.89	0.89	0.89	0.89	0.89	0.89	0.89	0.89			
Percent Heavy Veh, %	4	4	4	2	2	0	1	0	1			
Cap, veh/h	6	1411	24	94	2070	0	99	0	88			
Arrive On Green	0.00	0.40	0.40	0.05	0.58	0.00	0.06	0.00	0.06			
Sat Flow, veh/h	1740	3494	58	1774	3632	0	1792	0	1599			
Grp Volume(v), veh/h	0	268	280	45	1000	0	45	0	18			
Grp Sat Flow(s),veh/h/ln	1740	1736	1817	1774	1770	0	1792	0	1599			
Q Serve(g_s), s	0.0	3.1	3.1	0.7	4.6	0.0	0.7	0.0	0.3			
Cycle Q Clear(g_c), s	0.0	3.1	3.1	0.7	4.6	0.0	0.7	0.0	0.3			
Prop In Lane	1.00		0.03	1.00		0.00	1.00		1.00			
Lane Grp Cap(c), veh/h	6	701	734	94	2070	0	99	0	88			
V/C Ratio(X)	0.00	0.38	0.38	0.48	0.48	0.00	0.45	0.00	0.20			
Avail Cap(c_a), veh/h	1240	3710	3883	1264	7566	0	1723	0	1538			
HCM Platoon Ratio	1.00	1.00	1.00	1.00	1.00	1.00	1.00	1.00	1.00			
Upstream Filter(I)	0.00	1.00	1.00	1.00	1.00	0.00	1.00	0.00	1.00			
Uniform Delay (d), s/veh	0.0	5.9	5.9	12.9	3.4	0.0	12.8	0.0	12.7			
Incr Delay (d2), s/veh	0.0	0.6	0.6	1.4	0.2	0.0	1.2	0.0	0.4			
Initial Q Delay(d3),s/veh	0.0	0.0	0.0	0.0	0.0	0.0	0.0	0.0	0.0			
%ile BackOfQ(50%),veh/ln	0.0	1.5	1.6	0.4	2.1	0.0	0.4	0.0	0.1			
LnGrp Delay(d),s/veh	0.0	6.5	6.5	14.3	3.6	0.0	14.0	0.0	13.1			
LnGrp LOS		A	A	B	A		B		B			
Approach Vol, veh/h		548			1045			63				
Approach Delay, s/veh		6.5			4.1			13.8				
Approach LOS		A			A			B				
Timer	1	2	3	4	5	6	7	8				
Assigned Phs	1	2			5	6		8				
Phs Duration (G+Y+Rc), s	5.1	16.7			0.0	21.8		6.3				
Change Period (Y+Rc), s	3.6	5.4			3.5	5.4		4.7				
Max Green Setting (Gmax), s	20	60.0			20.0	60.0		27.0				
Max Q Clear Time (g_c+12), s	12	5.1			0.0	6.6		2.7				
Green Ext Time (p_c), s	0.0	6.0			0.0	9.8		0.0				
Intersection Summary												
HCM 2010 Ctrl Delay				5.2								
HCM 2010 LOS				A								
Notes												

HCM 2010 Signalized Intersection Summary
28: Davis Road & Reservation Road

Existing with Project, AM
06/11/2019

												
Movement	EBL	EBT	EBR	WBL	WBT	WBR	NBL	NBT	NBR	SBL	SBT	SBR
Lane Configurations												
Traffic Volume (veh/h)	280	280	10	10	500	110	10	10	10	150	10	430
Future Volume (veh/h)	280	280	10	10	500	110	10	10	10	150	10	430
Number	5	2	12	1	6	16	3	8	18	7	4	14
Initial Q (Qb), veh	0	0	0	0	0	0	0	0	0	0	0	0
Ped-Bike Adj(A_pbT)	1.00		1.00	1.00		1.00	1.00		1.00	1.00		1.00
Parking Bus, Adj	1.00	1.00	1.00	1.00	1.00	1.00	1.00	1.00	1.00	1.00	1.00	1.00
Adj Sat Flow, veh/h/ln	1863	1863	1900	1863	1863	1900	1900	1900	1900	1900	1845	1845
Adj Flow Rate, veh/h	304	304	11	12	581	120	12	12	9	174	12	258
Adj No. of Lanes	1	1	0	1	1	0	0	1	0	0	1	1
Peak Hour Factor	0.92	0.92	0.92	0.86	0.86	0.92	0.86	0.86	0.86	0.86	0.86	0.86
Percent Heavy Veh, %	2	2	2	2	2	2	0	0	0	3	3	3
Cap, veh/h	335	1110	40	20	666	138	20	20	15	254	18	538
Arrive On Green	0.19	0.62	0.62	0.01	0.44	0.44	0.03	0.03	0.03	0.15	0.15	0.15
Sat Flow, veh/h	1774	1787	65	1774	1499	310	648	648	486	1649	114	1568
Grp Volume(v), veh/h	304	0	315	12	0	701	33	0	0	186	0	258
Grp Sat Flow(s),veh/h/ln	1774	0	1851	1774	0	1808	1782	0	0	1762	0	1568
Q Serve(g_s), s	16.4	0.0	7.6	0.7	0.0	34.4	1.8	0.0	0.0	9.8	0.0	12.6
Cycle Q Clear(g_c), s	16.4	0.0	7.6	0.7	0.0	34.4	1.8	0.0	0.0	9.8	0.0	12.6
Prop In Lane	1.00		0.03	1.00		0.17	0.36		0.27	0.94		1.00
Lane Grp Cap(c), veh/h	335	0	1150	20	0	804	54	0	0	272	0	538
V/C Ratio(X)	0.91	0.00	0.27	0.59	0.00	0.87	0.61	0.00	0.00	0.68	0.00	0.48
Avail Cap(c_a), veh/h	545	0	1150	545	0	1110	547	0	0	541	0	778
HCM Platoon Ratio	1.00	1.00	1.00	1.00	1.00	1.00	1.00	1.00	1.00	1.00	1.00	1.00
Upstream Filter(I)	1.00	0.00	1.00	1.00	0.00	1.00	1.00	0.00	0.00	1.00	0.00	1.00
Uniform Delay (d), s/veh	38.8	0.0	8.5	48.1	0.0	24.6	46.8	0.0	0.0	39.1	0.0	25.2
Incr Delay (d2), s/veh	8.2	0.0	0.2	9.9	0.0	7.0	4.1	0.0	0.0	1.1	0.0	0.2
Initial Q Delay(d3),s/veh	0.0	0.0	0.0	0.0	0.0	0.0	0.0	0.0	0.0	0.0	0.0	0.0
%ile BackOfQ(50%),veh/ln	8.8	0.0	3.9	0.4	0.0	18.7	0.9	0.0	0.0	4.8	0.0	5.5
LnGrp Delay(d),s/veh	46.9	0.0	8.7	58.0	0.0	31.7	50.9	0.0	0.0	40.2	0.0	25.5
LnGrp LOS	D		A	E		C	D			D		C
Approach Vol, veh/h		619			713			33				444
Approach Delay, s/veh		27.4			32.1			50.9				31.7
Approach LOS		C			C			D				C
Timer	1	2	3	4	5	6	7	8				
Assigned Phs	1	2		4	5	6		8				
Phs Duration (G+Y+Rc), s	5.0	65.7		20.1	22.3	48.4		7.0				
Change Period (Y+Rc), s	* 3.9	5.0		5.0	* 3.8	5.0		4.0				
Max Green Setting (Gmax), s	* 30	60.0		30.0	* 30	60.0		30.0				
Max Q Clear Time (g_c+I1), s	2.7	9.6		14.6	18.4	36.4		3.8				
Green Ext Time (p_c), s	0.0	2.9		0.4	0.1	7.0		0.0				
Intersection Summary												
HCM 2010 Ctrl Delay			30.7									
HCM 2010 LOS			C									
Notes												

Intersection												
Intersection Delay, s/veh	12.9											
Intersection LOS	F											

Movement	EBL	EBT	EBR	WBL	WBT	WBR	NBL	NBT	NBR	SBL	SBT	SBR
Lane Configurations		↕			↕	↕	↕	↕		↕	↕	↕
Traffic Vol, veh/h	10	10	10	70	10	10	10	370	120	10	1040	10
Future Vol, veh/h	10	10	10	70	10	10	10	370	120	10	1040	10
Peak Hour Factor	0.91	0.91	0.91	0.91	0.91	0.91	0.91	0.91	0.91	0.91	0.91	0.91
Heavy Vehicles, %	14	14	14	0	0	0	2	2	2	1	1	1
Mvmt Flow	11	11	11	77	11	11	11	407	132	11	1143	11
Number of Lanes	0	1	0	0	1	1	1	2	0	1	1	1

Approach	EB	WB	NB	SB
Opposing Approach	WB	EB	SB	NB
Opposing Lanes	2	1	3	3
Conflicting Approach Left	SB	NB	EB	WB
Conflicting Lanes Left	3	3	1	2
Conflicting Approach Right	NB	SB	WB	EB
Conflicting Lanes Right	3	3	2	1
HCM Control Delay	13.7	15.1	18	485.7
HCM LOS	B	C	C	F

Lane	NBLn1	NBLn2	NBLn3	EBLn1	WBLn1	WBLn2	SBLn1	SBLn2	SBLn3
Vol Left, %	100%	0%	0%	33%	88%	0%	100%	0%	0%
Vol Thru, %	0%	100%	51%	33%	12%	0%	0%	100%	0%
Vol Right, %	0%	0%	49%	33%	0%	100%	0%	0%	100%
Sign Control	Stop	Stop	Stop	Stop	Stop	Stop	Stop	Stop	Stop
Traffic Vol by Lane	10	247	243	30	80	10	10	1040	10
LT Vol	10	0	0	10	70	0	10	0	0
Through Vol	0	247	123	10	10	0	0	1040	0
RT Vol	0	0	120	10	0	10	0	0	10
Lane Flow Rate	11	271	267	33	88	11	11	1143	11
Geometry Grp	8	8	8	8	8	8	8	8	8
Degree of Util (X)	0.022	0.498	0.465	0.076	0.203	0.022	0.021	2.052	0.018
Departure Headway (Hd)	8.795	8.286	7.935	10.179	10.226	9.053	6.97	6.465	5.758
Convergence, Y/N	Yes	Yes	Yes	Yes	Yes	Yes	Yes	Yes	Yes
Cap	409	439	457	354	353	398	517	571	625
Service Time	6.495	5.986	5.635	7.879	7.926	6.753	4.67	4.165	3.458
HCM Lane V/C Ratio	0.027	0.617	0.584	0.093	0.249	0.028	0.021	2.002	0.018
HCM Control Delay	11.7	18.9	17.3	13.7	15.5	12	9.8	494.9	8.6
HCM Lane LOS	B	C	C	B	C	B	A	F	A
HCM 95th-tile Q	0.1	2.7	2.4	0.2	0.7	0.1	0.1	78.7	0.1

Intersection	
Intersection Delay, s/veh	8.8
Intersection LOS	A

Movement	EBL	EBT	EBR	WBL	WBT	WBR	NBL	NBT	NBR	SBL	SBT	SBR
Lane Configurations		↕			↕		↕	↕		↕	↕	
Traffic Vol, veh/h	10	10	10	10	10	20	10	160	10	20	140	10
Future Vol, veh/h	10	10	10	10	10	20	10	160	10	20	140	10
Peak Hour Factor	0.91	0.91	0.91	0.91	0.91	0.91	0.91	0.91	0.91	0.91	0.91	0.91
Heavy Vehicles, %	0	0	0	1	1	1	2	2	2	1	1	1
Mvmt Flow	11	11	11	11	11	22	11	176	11	22	154	11
Number of Lanes	0	1	0	0	1	0	1	1	0	1	1	0

Approach	EB	WB	NB	SB
Opposing Approach	WB	EB	SB	NB
Opposing Lanes	1	1	2	2
Conflicting Approach Left	SB	NB	EB	WB
Conflicting Lanes Left	2	2	1	1
Conflicting Approach Right	NB	SB	WB	EB
Conflicting Lanes Right	2	2	1	1
HCM Control Delay	8	7.9	9.1	8.8
HCM LOS	A	A	A	A

Lane	NBLn1	NBLn2	EBLn1	WBLn1	SBLn1	SBLn2
Vol Left, %	100%	0%	33%	25%	100%	0%
Vol Thru, %	0%	94%	33%	25%	0%	93%
Vol Right, %	0%	6%	33%	50%	0%	7%
Sign Control	Stop	Stop	Stop	Stop	Stop	Stop
Traffic Vol by Lane	10	170	30	40	20	150
LT Vol	10	0	10	10	20	0
Through Vol	0	160	10	10	0	140
RT Vol	0	10	10	20	0	10
Lane Flow Rate	11	187	33	44	22	165
Geometry Grp	7	7	2	2	7	7
Degree of Util (X)	0.016	0.251	0.043	0.056	0.033	0.22
Departure Headway (Hd)	5.371	4.828	4.738	4.624	5.361	4.812
Convergence, Y/N	Yes	Yes	Yes	Yes	Yes	Yes
Cap	669	745	757	775	670	748
Service Time	3.086	2.543	2.762	2.647	3.075	2.527
HCM Lane V/C Ratio	0.016	0.251	0.044	0.057	0.033	0.221
HCM Control Delay	8.2	9.2	8	7.9	8.3	8.9
HCM Lane LOS	A	A	A	A	A	A
HCM 95th-tile Q	0	1	0.1	0.2	0.1	0.8

HCM 2010 Signalized Intersection Summary
 31: 1st Avenue & Lightfighter Drive

Existing with Project, AM
 06/11/2019



Movement	EBL	EBT	EBR	WBL	WBT	WBR	NBL	NBT	NBR	SBL	SBT	SBR
Lane Configurations		↑↑	↑	↑	↑↑		↑		↑	↑	↑	↑
Traffic Volume (veh/h)	0	860	130	30	890	0	160	0	20	20	10	20
Future Volume (veh/h)	0	860	130	30	890	0	160	0	20	20	10	20
Number	7	4	14	3	8	18	5	2	12	1	6	16
Initial Q (Qb), veh	0	0	0	0	0	0	0	0	0	0	0	0
Ped-Bike Adj(A_pbT)	1.00		1.00	1.00		1.00	1.00		1.00	1.00		1.00
Parking Bus, Adj	1.00	1.00	1.00	1.00	1.00	1.00	1.00	1.00	1.00	1.00	1.00	1.00
Adj Sat Flow, veh/h/ln	0	1863	1863	1863	1863	0	1863	0	1863	1792	1792	1792
Adj Flow Rate, veh/h	0	1024	0	36	1060	0	190	0	10	24	12	5
Adj No. of Lanes	0	2	1	1	2	0	1	0	1	1	1	1
Peak Hour Factor	0.84	0.84	0.84	0.84	0.84	0.84	0.84	0.84	0.84	0.84	0.84	0.84
Percent Heavy Veh, %	0	2	2	2	2	0	2	0	2	6	6	6
Cap, veh/h	0	2104	941	41	2535	0	0	0	0	41	43	36
Arrive On Green	0.00	0.59	0.00	0.02	0.72	0.00	0.00	0.00	0.00	0.02	0.02	0.02
Sat Flow, veh/h	0	3632	1583	1774	3632	0		0		1707	1792	1524
Grp Volume(v), veh/h	0	1024	0	36	1060	0		0.0		24	12	5
Grp Sat Flow(s),veh/h/ln	0	1770	1583	1774	1770	0				1707	1792	1524
Q Serve(g_s), s	0.0	5.8	0.0	0.7	4.3	0.0				0.5	0.2	0.1
Cycle Q Clear(g_c), s	0.0	5.8	0.0	0.7	4.3	0.0				0.5	0.2	0.1
Prop In Lane	0.00		1.00	1.00		0.00				1.00		1.00
Lane Grp Cap(c), veh/h	0	2104	941	41	2535	0				41	43	36
V/C Ratio(X)	0.00	0.49	0.00	0.88	0.42	0.00				0.59	0.28	0.14
Avail Cap(c_a), veh/h	0	4499	2013	1002	4499	0				1206	1266	1076
HCM Platoon Ratio	1.00	1.00	1.00	1.00	1.00	1.00				1.00	1.00	1.00
Upstream Filter(I)	0.00	1.00	0.00	1.00	1.00	0.00				1.00	1.00	1.00
Uniform Delay (d), s/veh	0.0	4.1	0.0	17.2	2.0	0.0				17.1	17.0	16.9
Incr Delay (d2), s/veh	0.0	0.2	0.0	19.1	0.2	0.0				5.0	1.3	0.6
Initial Q Delay(d3),s/veh	0.0	0.0	0.0	0.0	0.0	0.0				0.0	0.0	0.0
%ile BackOfQ(50%),veh/lr	0.0	2.8	0.0	0.6	2.0	0.0				0.3	0.1	0.1
LnGrp Delay(d),s/veh	0.0	4.3	0.0	36.3	2.2	0.0				22.1	18.3	17.6
LnGrp LOS		A		D	A					C	B	B
Approach Vol, veh/h		1024			1096						41	
Approach Delay, s/veh		4.3			3.3						20.4	
Approach LOS		A			A						C	
Timer	1	2	3	4	5	6	7	8				
Assigned Phs			3	4		6		8				
Phs Duration (G+Y+Rc), s			4.3	25.6		5.4		30.0				
Change Period (Y+Rc), s			3.5	4.6		4.6		4.6				
Max Green Setting (Gmax), s			20.0	45.0		25.0		45.0				
Max Q Clear Time (g_c+I1), s			2.7	7.8		2.5		6.3				
Green Ext Time (p_c), s			0.0	13.2		0.0		13.0				
Intersection Summary												
HCM 2010 Ctrl Delay			4.1									
HCM 2010 LOS			A									

HCM 2010 Signalized Intersection Summary
 32: 2nd Avenue & Lightfighter Drive

Existing with Project, AM
 06/11/2019



Movement	EBL	EBT	EBR	WBL	WBT	WBR	NBL	NBT	NBR	SBL	SBT	SBR
Lane Configurations												
Traffic Volume (veh/h)	80	810	10	10	560	70	10	10	10	280	10	350
Future Volume (veh/h)	80	810	10	10	560	70	10	10	10	280	10	350
Number	5	2	12	1	6	16	3	8	18	7	4	14
Initial Q (Qb), veh	0	0	0	0	0	0	0	0	0	0	0	0
Ped-Bike Adj(A_pbT)	1.00		1.00	1.00		1.00	1.00		1.00	1.00		1.00
Parking Bus, Adj	1.00	1.00	1.00	1.00	1.00	1.00	1.00	1.00	1.00	1.00	1.00	1.00
Adj Sat Flow, veh/h/ln	1863	1863	1900	1827	1827	1900	1900	1900	1900	1881	1881	1881
Adj Flow Rate, veh/h	89	900	11	11	622	69	11	11	10	311	11	113
Adj No. of Lanes	1	2	0	1	2	0	0	1	0	1	1	1
Peak Hour Factor	0.90	0.90	0.90	0.90	0.90	0.90	0.90	0.90	0.90	0.90	0.90	0.90
Percent Heavy Veh, %	2	2	2	4	4	4	0	0	0	1	1	1
Cap, veh/h	113	2215	27	18	1782	197	156	155	119	412	450	382
Arrive On Green	0.06	0.62	0.62	0.01	0.57	0.57	0.24	0.24	0.24	0.24	0.24	0.24
Sat Flow, veh/h	1774	3581	44	1740	3152	349	451	647	499	1399	1881	1599
Grp Volume(v), veh/h	89	445	466	11	342	349	32	0	0	311	11	113
Grp Sat Flow(s),veh/h/ln	1774	1770	1855	1740	1736	1765	1597	0	0	1399	1881	1599
Q Serve(g_s), s	4.9	12.8	12.8	0.6	10.7	10.7	0.0	0.0	0.0	19.9	0.4	5.8
Cycle Q Clear(g_c), s	4.9	12.8	12.8	0.6	10.7	10.7	1.4	0.0	0.0	21.3	0.4	5.8
Prop In Lane	1.00		0.02	1.00		0.20	0.34		0.31	1.00		1.00
Lane Grp Cap(c), veh/h	113	1095	1147	18	981	998	430	0	0	412	450	382
V/C Ratio(X)	0.79	0.41	0.41	0.60	0.35	0.35	0.07	0.00	0.00	0.76	0.02	0.30
Avail Cap(c_a), veh/h	220	1095	1147	216	981	998	687	0	0	643	760	646
HCM Platoon Ratio	1.00	1.00	1.00	1.00	1.00	1.00	1.00	1.00	1.00	1.00	1.00	1.00
Upstream Filter(I)	0.83	0.83	0.83	0.68	0.68	0.68	1.00	0.00	0.00	1.00	1.00	1.00
Uniform Delay (d), s/veh	46.1	9.7	9.7	49.3	11.8	11.8	29.5	0.0	0.0	36.9	29.1	31.2
Incr Delay (d2), s/veh	3.8	0.9	0.9	7.7	0.7	0.7	0.0	0.0	0.0	1.1	0.0	0.2
Initial Q Delay(d3),s/veh	0.0	0.0	0.0	0.0	0.0	0.0	0.0	0.0	0.0	0.0	0.0	0.0
%ile BackOfQ(50%),veh/ln	2.5	6.5	6.8	0.3	5.2	5.3	0.7	0.0	0.0	8.5	0.2	2.6
LnGrp Delay(d),s/veh	49.9	10.7	10.6	57.0	12.4	12.4	29.5	0.0	0.0	37.9	29.1	31.3
LnGrp LOS	D	B	B	E	B	B	C			D	C	C
Approach Vol, veh/h		1000			702			32			435	
Approach Delay, s/veh		14.1			13.1			29.5			36.0	
Approach LOS		B			B			C			D	
Timer	1	2	3	4	5	6	7	8				
Assigned Phs	1	2		4	5	6		8				
Phs Duration (G+Y+Rc), s	5.1	66.5		28.5	10.4	61.1		28.5				
Change Period (Y+Rc), s	4.0	4.6		4.6	4.0	4.6		4.6				
Max Green Setting (Gmax), s	2.4	34.0		40.4	12.4	24.4		40.4				
Max Q Clear Time (g_c+1/2), s	12.6	14.8		23.3	6.9	12.7		3.4				
Green Ext Time (p_c), s	0.0	3.3		0.6	0.0	2.1		0.1				
Intersection Summary												
HCM 2010 Ctrl Delay			18.4									
HCM 2010 LOS			B									

HCM 2010 Signalized Intersection Summary
 33: General Jim Moore Boulevard & Lightfighter Drive

Existing with Project, AM
 06/11/2019



Movement	EBL	EBT	EBR	WBL	WBT	WBR	NBL	NBT	NBR	SBL	SBT	SBR
Lane Configurations												
Traffic Volume (veh/h)	10	170	750	10	70	20	540	30	10	20	20	10
Future Volume (veh/h)	10	170	750	10	70	20	540	30	10	20	20	10
Number	3	8	18	7	4	14	1	6	16	5	2	12
Initial Q (Qb), veh	0	0	0	0	0	0	0	0	0	0	0	0
Ped-Bike Adj(A_pbT)	1.00		1.00	1.00		0.99	1.00		1.00	1.00		1.00
Parking Bus, Adj	1.00	1.00	1.00	1.00	1.00	1.00	1.00	1.00	1.00	1.00	1.00	1.00
Adj Sat Flow, veh/h/ln	1863	1863	1863	1792	1792	1900	1881	1881	1900	1863	1863	1900
Adj Flow Rate, veh/h	11	191	0	11	79	20	607	34	10	22	22	11
Adj No. of Lanes	1	1	1	1	1	0	2	1	0	1	2	0
Peak Hour Factor	0.89	0.89	0.89	0.89	0.89	0.89	0.89	0.89	0.89	0.89	0.89	0.89
Percent Heavy Veh, %	2	2	2	6	6	6	1	1	1	2	2	2
Cap, veh/h	20	308	262	20	228	58	832	517	152	38	359	166
Arrive On Green	0.01	0.17	0.00	0.01	0.17	0.17	0.24	0.37	0.37	0.02	0.15	0.15
Sat Flow, veh/h	1774	1863	1583	1707	1379	349	3476	1397	411	1774	2349	1087
Grp Volume(v), veh/h	11	191	0	11	0	99	607	0	44	22	16	17
Grp Sat Flow(s),veh/h/ln	1774	1863	1583	1707	0	1728	1738	0	1808	1774	1770	1666
Q Serve(g_s), s	0.3	4.0	0.0	0.3	0.0	2.1	6.7	0.0	0.7	0.5	0.3	0.4
Cycle Q Clear(g_c), s	0.3	4.0	0.0	0.3	0.0	2.1	6.7	0.0	0.7	0.5	0.3	0.4
Prop In Lane	1.00		1.00	1.00		0.20	1.00		0.23	1.00		0.65
Lane Grp Cap(c), veh/h	20	308	262	20	0	286	832	0	670	38	270	254
V/C Ratio(X)	0.54	0.62	0.00	0.56	0.00	0.35	0.73	0.00	0.07	0.57	0.06	0.07
Avail Cap(c_a), veh/h	850	1338	1138	818	0	1242	832	0	1299	637	1271	1197
HCM Platoon Ratio	1.00	1.00	1.00	1.00	1.00	1.00	1.00	1.00	1.00	1.00	1.00	1.00
Upstream Filter(I)	1.00	1.00	0.00	1.00	0.00	1.00	1.00	0.00	1.00	1.00	1.00	1.00
Uniform Delay (d), s/veh	20.5	16.2	0.0	20.5	0.0	15.4	14.6	0.0	8.5	20.2	15.1	15.1
Incr Delay (d2), s/veh	20.4	2.4	0.0	9.0	0.0	0.9	3.1	0.0	0.1	5.0	0.1	0.1
Initial Q Delay(d3),s/veh	0.0	0.0	0.0	0.0	0.0	0.0	0.0	0.0	0.0	0.0	0.0	0.0
%ile BackOfQ(50%),veh/ln	0.2	2.2	0.0	0.2	0.0	1.1	3.6	0.0	0.3	0.3	0.2	0.2
LnGrp Delay(d),s/veh	41.0	18.6	0.0	29.5	0.0	16.3	17.7	0.0	8.6	25.2	15.2	15.3
LnGrp LOS	D	B		C		B	B		A	C	B	B
Approach Vol, veh/h		202			110			651			55	
Approach Delay, s/veh		19.9			17.6			17.1			19.2	
Approach LOS		B			B			B			B	
Timer	1	2	3	4	5	6	7	8				
Assigned Phs	1	2	3	4	5	6	7	8				
Phs Duration (G+Y+Rc), s	4.5	10.9	5.0	11.4	5.4	20.0	5.0	11.4				
Change Period (Y+Rc), s	4.5	4.5	4.5	4.5	4.5	4.5	4.5	4.5				
Max Green Setting (Gmax), s	30.0	30.0	20.0	30.0	15.0	30.0	20.0	30.0				
Max Q Clear Time (g_c+1/3), s	2.4	2.3	4.1	2.5	2.7	2.3	6.0					
Green Ext Time (p_c), s	0.3	0.1	0.0	0.6	0.0	0.3	0.0	1.1				
Intersection Summary												
HCM 2010 Ctrl Delay				17.8								
HCM 2010 LOS				B								

Intersection	
Intersection Delay, s/veh	8.7
Intersection LOS	A

Movement	WBL	WBR	NBT	NBR	SBL	SBT
Lane Configurations						
Traffic Vol, veh/h	20	70	20	10	150	40
Future Vol, veh/h	20	70	20	10	150	40
Peak Hour Factor	0.77	0.77	0.77	0.77	0.77	0.77
Heavy Vehicles, %	4	4	3	3	2	2
Mvmt Flow	26	91	26	13	195	52
Number of Lanes	1	0	1	0	0	1

Approach	WB	NB	SB
Opposing Approach		SB	NB
Opposing Lanes	0	1	1
Conflicting Approach Left	NB		WB
Conflicting Lanes Left	1	0	1
Conflicting Approach Right	SB	WB	
Conflicting Lanes Right	1	1	0
HCM Control Delay	7.9	7.5	9.3
HCM LOS	A	A	A

Lane	NBLn1	WBLn1	SBLn1
Vol Left, %	0%	22%	79%
Vol Thru, %	67%	0%	21%
Vol Right, %	33%	78%	0%
Sign Control	Stop	Stop	Stop
Traffic Vol by Lane	30	90	190
LT Vol	0	20	150
Through Vol	20	0	40
RT Vol	10	70	0
Lane Flow Rate	39	117	247
Geometry Grp	1	1	1
Degree of Util (X)	0.046	0.136	0.297
Departure Headway (Hd)	4.272	4.203	4.328
Convergence, Y/N	Yes	Yes	Yes
Cap	841	858	822
Service Time	2.283	2.204	2.402
HCM Lane V/C Ratio	0.046	0.136	0.3
HCM Control Delay	7.5	7.9	9.3
HCM Lane LOS	A	A	A
HCM 95th-tile Q	0.1	0.5	1.2

Intersection						
Int Delay, s/veh	1.1					
Movement	EBT	EBR	WBL	WBT	NBL	NBR
Lane Configurations						
Traffic Vol, veh/h	130	20	10	80	10	10
Future Vol, veh/h	130	20	10	80	10	10
Conflicting Peds, #/hr	0	0	0	0	0	0
Sign Control	Free	Free	Free	Free	Stop	Stop
RT Channelized	-	None	-	None	-	None
Storage Length	-	-	-	-	0	-
Veh in Median Storage, #	0	-	-	0	0	-
Grade, %	0	-	-	0	0	-
Peak Hour Factor	78	78	78	78	78	78
Heavy Vehicles, %	5	5	4	4	0	0
Mvmt Flow	167	26	13	103	13	13

Major/Minor	Major1	Major2	Minor1	Minor2	Minor3
Conflicting Flow All	0	0	193	0	309
Stage 1	-	-	-	-	180
Stage 2	-	-	-	-	129
Critical Hdwy	-	-	4.14	-	6.4
Critical Hdwy Stg 1	-	-	-	-	5.4
Critical Hdwy Stg 2	-	-	-	-	5.4
Follow-up Hdwy	-	-	2.236	-	3.5
Pot Cap-1 Maneuver	-	-	1368	-	687
Stage 1	-	-	-	-	856
Stage 2	-	-	-	-	902
Platoon blocked, %	-	-	-	-	-
Mov Cap-1 Maneuver	-	-	1368	-	680
Mov Cap-2 Maneuver	-	-	-	-	680
Stage 1	-	-	-	-	847
Stage 2	-	-	-	-	902

Approach	EB	WB	NB
HCM Control Delay, s	0	0.9	9.9
HCM LOS			A

Minor Lane/Major Mvmt	NBLn1	EBT	EBR	WBL	WBT
Capacity (veh/h)	763	-	-	1368	-
HCM Lane V/C Ratio	0.034	-	-	0.009	-
HCM Control Delay (s)	9.9	-	-	7.7	0
HCM Lane LOS	A	-	-	A	A
HCM 95th %tile Q(veh)	0.1	-	-	0	-

Intersection	
Intersection Delay, s/veh	9.9
Intersection LOS	A

Movement	EBL	EBT	EBR	WBL	WBT	WBR	NBL	NBT	NBR	SBL	SBT	SBR
Lane Configurations		↕			↕			↕			↕	
Traffic Vol, veh/h	10	120	10	10	80	10	10	140	10	10	120	10
Future Vol, veh/h	10	120	10	10	80	10	10	140	10	10	120	10
Peak Hour Factor	0.79	0.79	0.79	0.79	0.79	0.79	0.79	0.79	0.79	0.79	0.79	0.79
Heavy Vehicles, %	6	6	6	4	4	4	20	20	20	2	2	2
Mvmt Flow	13	152	13	13	101	13	13	177	13	13	152	13
Number of Lanes	0	1	0	0	1	0	0	1	0	0	1	0

Approach	EB	WB	NB	SB
Opposing Approach	WB	EB	SB	NB
Opposing Lanes	1	1	1	1
Conflicting Approach Left	SB	NB	EB	WB
Conflicting Lanes Left	1	1	1	1
Conflicting Approach Right	NB	SB	WB	EB
Conflicting Lanes Right	1	1	1	1
HCM Control Delay	9.9	9.4	10.5	9.6
HCM LOS	A	A	B	A

Lane	NBLn1	EBLn1	WBLn1	SBLn1
Vol Left, %	6%	7%	10%	7%
Vol Thru, %	88%	86%	80%	86%
Vol Right, %	6%	7%	10%	7%
Sign Control	Stop	Stop	Stop	Stop
Traffic Vol by Lane	160	140	100	140
LT Vol	10	10	10	10
Through Vol	140	120	80	120
RT Vol	10	10	10	10
Lane Flow Rate	203	177	127	177
Geometry Grp	1	1	1	1
Degree of Util (X)	0.293	0.251	0.18	0.244
Departure Headway (Hd)	5.209	5.098	5.126	4.948
Convergence, Y/N	Yes	Yes	Yes	Yes
Cap	683	698	692	718
Service Time	3.291	3.182	3.217	3.031
HCM Lane V/C Ratio	0.297	0.254	0.184	0.247
HCM Control Delay	10.5	9.9	9.4	9.6
HCM Lane LOS	B	A	A	A
HCM 95th-tile Q	1.2	1	0.7	1

Intersection												
Int Delay, s/veh	6.9											
Movement	EBL	EBT	EBR	WBL	WBT	WBR	NBL	NBT	NBR	SBL	SBT	SBR
Lane Configurations		↕			↕			↕			↕	
Traffic Vol, veh/h	20	40	70	10	50	10	30	100	10	0	0	0
Future Vol, veh/h	20	40	70	10	50	10	30	100	10	0	0	0
Conflicting Peds, #/hr	0	0	0	0	0	0	0	0	1	1	0	0
Sign Control	Stop	Stop	Stop	Stop	Stop	Stop	Free	Free	Free	Free	Free	Free
RT Channelized	-	-	None	-	-	None	-	-	None	-	-	None
Storage Length	-	-	-	-	-	-	-	-	-	-	-	-
Veh in Median Storage, #	-	0	-	-	0	-	-	0	-	-	0	-
Grade, %	-	0	-	-	0	-	-	0	-	-	0	-
Peak Hour Factor	82	82	82	82	82	82	82	82	82	82	82	82
Heavy Vehicles, %	12	12	12	0	0	0	10	10	10	10	10	10
Mvmt Flow	24	49	85	12	61	12	37	122	12	0	0	0

Major/Minor	Minor2		Minor1		Major1			Major2				
Conflicting Flow All	240	210	1	271	204	129	1	0	0	135	0	0
Stage 1	1	1	-	203	203	-	-	-	-	-	-	-
Stage 2	239	209	-	68	1	-	-	-	-	-	-	-
Critical Hdwy	7.22	6.62	6.32	7.1	6.5	6.2	4.2	-	-	4.2	-	-
Critical Hdwy Stg 1	6.22	5.62	-	6.1	5.5	-	-	-	-	-	-	-
Critical Hdwy Stg 2	6.22	5.62	-	6.1	5.5	-	-	-	-	-	-	-
Follow-up Hdwy	3.608	4.108	3.408	3.5	4	3.3	2.29	-	-	2.29	-	-
Pot Cap-1 Maneuver	694	670	1055	686	696	926	1571	-	-	1401	-	-
Stage 1	997	875	-	804	737	-	-	-	-	-	-	-
Stage 2	742	711	-	947	899	-	-	-	-	-	-	-
Platoon blocked, %								-	-	-	-	-
Mov Cap-1 Maneuver	626	653	1055	582	678	925	1571	-	-	1400	-	-
Mov Cap-2 Maneuver	626	653	-	582	678	-	-	-	-	-	-	-
Stage 1	972	875	-	783	718	-	-	-	-	-	-	-
Stage 2	653	693	-	822	899	-	-	-	-	-	-	-

Approach	EB		WB		NB		SB	
HCM Control Delay, s	10.5		11		1.6		0	
HCM LOS	B		B					

Minor Lane/Major Mvmt	NBL	NBT	NBR	EBLn1WBLn1	SBL	SBT	SBR
Capacity (veh/h)	1571	-	-	815	688	1400	-
HCM Lane V/C Ratio	0.023	-	-	0.195	0.124	-	-
HCM Control Delay (s)	7.3	0	-	10.5	11	0	-
HCM Lane LOS	A	A	-	B	B	A	-
HCM 95th %tile Q(veh)	0.1	-	-	0.7	0.4	0	-

Intersection						
Int Delay, s/veh	1.3					
Movement	EBL	EBR	NBL	NBT	SBT	SBR
Lane Configurations	T			T		T
Traffic Vol, veh/h	40	10	10	110	720	50
Future Vol, veh/h	40	10	10	110	720	50
Conflicting Peds, #/hr	0	0	0	0	0	0
Sign Control	Stop	Stop	Free	Free	Free	Free
RT Channelized	-	None	-	None	-	None
Storage Length	0	-	-	-	-	-
Veh in Median Storage, #	0	-	-	0	0	-
Grade, %	0	-	-	0	0	-
Peak Hour Factor	89	89	89	89	89	89
Heavy Vehicles, %	13	13	2	2	0	0
Mvmt Flow	45	11	11	124	809	56























Major/Minor	Minor2	Major1	Major2			
Conflicting Flow All	983	837	865	0	-	0
Stage 1	837	-	-	-	-	-
Stage 2	146	-	-	-	-	-
Critical Hdwy	6.53	6.33	4.12	-	-	-
Critical Hdwy Stg 1	5.53	-	-	-	-	-
Critical Hdwy Stg 2	5.53	-	-	-	-	-
Follow-up Hdwy	3.617	3.417	2.218	-	-	-
Pot Cap-1 Maneuver	263	350	778	-	-	-
Stage 1	407	-	-	-	-	-
Stage 2	855	-	-	-	-	-
Platoon blocked, %				-	-	-
Mov Cap-1 Maneuver	259	350	778	-	-	-
Mov Cap-2 Maneuver	259	-	-	-	-	-
Stage 1	401	-	-	-	-	-
Stage 2	855	-	-	-	-	-

Approach	EB	NB	SB
HCM Control Delay, s	21.6	0.8	0
HCM LOS	C		

Minor Lane/Major Mvmt	NBL	NBT	EBLn1	SBT	SBR
Capacity (veh/h)	778	-	273	-	-
HCM Lane V/C Ratio	0.014	-	0.206	-	-
HCM Control Delay (s)	9.7	0	21.6	-	-
HCM Lane LOS	A	A	C	-	-
HCM 95th %tile Q(veh)	0	-	0.8	-	-

HCM 2010 Signalized Intersection Summary
 39: General Jim Moore Boulevard & Gigling Road

Existing with Project, AM
 06/11/2019

												
Movement	EBL	EBT	EBR	WBL	WBT	WBR	NBL	NBT	NBR	SBL	SBT	SBR
Lane Configurations												
Traffic Volume (veh/h)	30	100	80	440	40	60	50	330	220	170	690	50
Future Volume (veh/h)	30	100	80	440	40	60	50	330	220	170	690	50
Number	3	8	18	7	4	14	1	6	16	5	2	12
Initial Q (Qb), veh	0	0	0	0	0	0	0	0	0	0	0	0
Ped-Bike Adj(A_pbT)	1.00		1.00	1.00		1.00	1.00		1.00	1.00		1.00
Parking Bus, Adj	1.00	1.00	1.00	1.00	1.00	1.00	1.00	1.00	1.00	1.00	1.00	1.00
Adj Sat Flow, veh/h/ln	1810	1810	1900	1863	1863	1863	1881	1881	1881	1863	1863	1863
Adj Flow Rate, veh/h	34	115	60	506	46	0	57	379	0	195	793	0
Adj No. of Lanes	1	1	0	1	1	1	1	2	1	1	2	1
Peak Hour Factor	0.87	0.87	0.87	0.87	0.87	0.87	0.87	0.87	0.87	0.87	0.87	0.87
Percent Heavy Veh, %	5	5	5	2	2	2	1	1	1	2	2	2
Cap, veh/h	60	148	77	530	738	628	86	620	277	236	915	409
Arrive On Green	0.03	0.13	0.13	0.30	0.40	0.00	0.05	0.17	0.00	0.13	0.26	0.00
Sat Flow, veh/h	1723	1120	585	1774	1863	1583	1792	3574	1599	1774	3539	1583
Grp Volume(v), veh/h	34	0	175	506	46	0	57	379	0	195	793	0
Grp Sat Flow(s),veh/h/ln	1723	0	1705	1774	1863	1583	1792	1787	1599	1774	1770	1583
Q Serve(g_s), s	1.3	0.0	6.8	19.2	1.0	0.0	2.1	6.7	0.0	7.3	14.7	0.0
Cycle Q Clear(g_c), s	1.3	0.0	6.8	19.2	1.0	0.0	2.1	6.7	0.0	7.3	14.7	0.0
Prop In Lane	1.00		0.34	1.00		1.00	1.00		1.00	1.00		1.00
Lane Grp Cap(c), veh/h	60	0	226	530	738	628	86	620	277	236	915	409
V/C Ratio(X)	0.57	0.00	0.77	0.96	0.06	0.00	0.66	0.61	0.00	0.82	0.87	0.00
Avail Cap(c_a), veh/h	264	0	770	530	1112	946	144	1301	582	401	1804	807
HCM Platoon Ratio	1.00	1.00	1.00	1.00	1.00	1.00	1.00	1.00	1.00	1.00	1.00	1.00
Upstream Filter(I)	1.00	0.00	1.00	1.00	1.00	0.00	1.00	1.00	0.00	1.00	1.00	0.00
Uniform Delay (d), s/veh	32.6	0.0	28.8	23.6	12.8	0.0	32.1	26.2	0.0	29.0	24.3	0.0
Incr Delay (d2), s/veh	3.1	0.0	2.1	27.9	0.0	0.0	3.2	0.4	0.0	2.8	1.0	0.0
Initial Q Delay(d3),s/veh	0.0	0.0	0.0	0.0	0.0	0.0	0.0	0.0	0.0	0.0	0.0	0.0
%ile BackOfQ(50%),veh/ln	0.7	0.0	3.3	13.5	0.5	0.0	1.1	3.3	0.0	3.8	7.3	0.0
LnGrp Delay(d),s/veh	35.7	0.0	30.9	51.5	12.8	0.0	35.3	26.6	0.0	31.7	25.3	0.0
LnGrp LOS	D		C	D	B		D	C		C	C	
Approach Vol, veh/h		209			552			436			988	
Approach Delay, s/veh		31.7			48.3			27.7			26.6	
Approach LOS		C			D			C			C	
Timer	1	2	3	4	5	6	7	8				
Assigned Phs	1	2	3	4	5	6	7	8				
Phs Duration (G+Y+Rc), s	7.8	22.2	6.9	31.7	13.6	16.4	25.0	13.6				
Change Period (Y+Rc), s	4.5	4.5	4.5	4.5	4.5	4.5	4.5	4.5				
Max Green Setting (Gmax), s	5.5	35.0	10.5	41.0	15.5	25.0	20.5	31.0				
Max Q Clear Time (g_c+I1), s	4.1	16.7	3.3	3.0	9.3	8.7	21.2	8.8				
Green Ext Time (p_c), s	0.0	1.0	0.0	0.0	0.0	0.4	0.0	0.2				
Intersection Summary												
HCM 2010 Ctrl Delay			32.8									
HCM 2010 LOS			C									
Notes												

Intersection												
Int Delay, s/veh	5.4											
Movement	EBL	EBT	EBR	WBL	WBT	WBR	NBL	NBT	NBR	SBL	SBT	SBR
Lane Configurations		↕			↕			↕			↕	
Traffic Vol, veh/h	10	460	50	10	860	10	20	10	10	10	30	20
Future Vol, veh/h	10	460	50	10	860	10	20	10	10	10	30	20
Conflicting Peds, #/hr	0	0	1	1	0	0	0	0	0	0	0	0
Sign Control	Free	Free	Free	Free	Free	Free	Stop	Stop	Stop	Stop	Stop	Stop
RT Channelized	-	-	None	-	-	None	-	-	None	-	-	None
Storage Length	-	-	-	-	-	-	-	-	-	-	-	-
Veh in Median Storage, #	-	0	-	-	0	-	-	0	-	-	0	-
Grade, %	-	0	-	-	0	-	-	0	-	-	0	-
Peak Hour Factor	88	88	88	88	88	88	88	88	88	88	88	88
Heavy Vehicles, %	3	3	3	3	3	3	2	2	2	4	4	4
Mvmt Flow	11	523	57	11	977	11	23	11	11	11	34	23

Major/Minor	Major1			Major2			Minor1			Minor2		
Conflicting Flow All	988	0	0	581	0	0	1608	1585	553	1590	1608	983
Stage 1	-	-	-	-	-	-	575	575	-	1005	1005	-
Stage 2	-	-	-	-	-	-	1033	1010	-	585	603	-
Critical Hdwy	4.13	-	-	4.13	-	-	7.12	6.52	6.22	7.14	6.54	6.24
Critical Hdwy Stg 1	-	-	-	-	-	-	6.12	5.52	-	6.14	5.54	-
Critical Hdwy Stg 2	-	-	-	-	-	-	6.12	5.52	-	6.14	5.54	-
Follow-up Hdwy	2.227	-	-	2.227	-	-	3.518	4.018	3.318	3.536	4.036	3.336
Pot Cap-1 Maneuver	696	-	-	988	-	-	84	108	533	86	104	299
Stage 1	-	-	-	-	-	-	503	503	-	289	317	-
Stage 2	-	-	-	-	-	-	281	317	-	494	485	-
Platoon blocked, %	-	-	-	-	-	-	-	-	-	-	-	-
Mov Cap-1 Maneuver	696	-	-	987	-	-	55	103	532	74	99	299
Mov Cap-2 Maneuver	-	-	-	-	-	-	55	103	-	74	99	-
Stage 1	-	-	-	-	-	-	490	490	-	282	309	-
Stage 2	-	-	-	-	-	-	225	309	-	461	473	-

Approach	EB			WB			NB			SB		
HCM Control Delay, s	0.2			0.1			91.7			69.7		
HCM LOS							F			F		

Minor Lane/Major Mvmt	NBLn1	EBL	EBT	EBR	WBL	WBT	WBR	SBLn1
Capacity (veh/h)	83	696	-	-	987	-	-	119
HCM Lane V/C Ratio	0.548	0.016	-	-	0.012	-	-	0.573
HCM Control Delay (s)	91.7	10.3	0	-	8.7	0	-	69.7
HCM Lane LOS	F	B	A	-	A	A	-	F
HCM 95th %tile Q(veh)	2.4	0.1	-	-	0	-	-	2.8

Intersection												
Int Delay, s/veh	8.9											
Movement	EBL	EBT	EBR	WBL	WBT	WBR	NBL	NBT	NBR	SBL	SBT	SBR
Lane Configurations		↕			↕			↕	↕		↕	
Traffic Vol, veh/h	10	370	110	20	830	10	50	10	10	10	10	10
Future Vol, veh/h	10	370	110	20	830	10	50	10	10	10	10	10
Conflicting Peds, #/hr	0	0	0	0	0	0	0	0	0	0	0	0
Sign Control	Free	Free	Free	Free	Free	Free	Stop	Stop	Stop	Stop	Stop	Stop
RT Channelized	-	-	None	-	-	None	-	-	None	-	-	None
Storage Length	-	-	-	-	-	-	-	-	135	-	-	-
Veh in Median Storage, #	-	0	-	-	0	-	-	0	-	-	0	-
Grade, %	-	0	-	-	0	-	-	0	-	-	0	-
Peak Hour Factor	84	84	84	84	84	84	84	84	84	84	84	84
Heavy Vehicles, %	3	3	3	2	2	2	2	2	2	0	0	0
Mvmt Flow	12	440	131	24	988	12	60	12	12	12	12	12

Major/Minor	Major1			Major2			Minor1			Minor2		
Conflicting Flow All	1000	0	0	571	0	0	1584	1578	506	1584	1637	994
Stage 1	-	-	-	-	-	-	530	530	-	1042	1042	-
Stage 2	-	-	-	-	-	-	1054	1048	-	542	595	-
Critical Hdwy	4.13	-	-	4.12	-	-	7.12	6.52	6.22	7.1	6.5	6.2
Critical Hdwy Stg 1	-	-	-	-	-	-	6.12	5.52	-	6.1	5.5	-
Critical Hdwy Stg 2	-	-	-	-	-	-	6.12	5.52	-	6.1	5.5	-
Follow-up Hdwy	2.227	-	-	2.218	-	-	3.518	4.018	3.318	3.5	4	3.3
Pot Cap-1 Maneuver	688	-	-	1002	-	-	88	109	566	89	102	300
Stage 1	-	-	-	-	-	-	533	527	-	280	309	-
Stage 2	-	-	-	-	-	-	273	305	-	528	496	-
Platoon blocked, %		-	-		-	-						
Mov Cap-1 Maneuver	688	-	-	1002	-	-	72	100	566	74	94	300
Mov Cap-2 Maneuver	-	-	-	-	-	-	72	100	-	74	94	-
Stage 1	-	-	-	-	-	-	519	513	-	273	292	-
Stage 2	-	-	-	-	-	-	238	289	-	492	483	-

Approach	EB			WB			NB			SB		
HCM Control Delay, s	0.2			0.2			156.8			53.3		
HCM LOS							F			F		

Minor Lane/Major Mvmt	NBLn1	NBLn2	EBL	EBT	EBR	WBL	WBT	WBR	SBLn1
Capacity (veh/h)	76	566	688	-	-	1002	-	-	109
HCM Lane V/C Ratio	0.94	0.021	0.017	-	-	0.024	-	-	0.328
HCM Control Delay (s)	181	11.5	10.3	0	-	8.7	0	-	53.3
HCM Lane LOS	F	B	B	A	-	A	A	-	F
HCM 95th %tile Q(veh)	4.9	0.1	0.1	-	-	0.1	-	-	1.3

Intersection	
Intersection Delay, s/veh	86.8
Intersection LOS	F

Movement	EBL	EBT	EBR	WBL	WBT	WBR	NBL	NBT	NBR	SBL	SBT	SBR
Lane Configurations		↕			↕			↕	↕		↕	
Traffic Vol, veh/h	140	250	10	10	730	10	10	10	10	10	10	120
Future Vol, veh/h	140	250	10	10	730	10	10	10	10	10	10	120
Peak Hour Factor	0.89	0.89	0.89	0.89	0.89	0.89	0.89	0.89	0.89	0.89	0.89	0.89
Heavy Vehicles, %	3	3	3	2	2	2	33	33	33	2	2	2
Mvmt Flow	157	281	11	11	820	11	11	11	11	11	11	135
Number of Lanes	0	1	0	0	1	0	0	1	1	0	1	0

Approach	EB	WB	NB	SB
Opposing Approach	WB	EB	SB	NB
Opposing Lanes	1	1	1	2
Conflicting Approach Left	SB	NB	EB	WB
Conflicting Lanes Left	1	2	1	1
Conflicting Approach Right	NB	SB	WB	EB
Conflicting Lanes Right	2	1	1	1
HCM Control Delay	21.1	138.6	11.9	12.6
HCM LOS	C	F	B	B

Lane	NBLn1	NBLn2	EBLn1	WBLn1	SBLn1
Vol Left, %	50%	0%	35%	1%	7%
Vol Thru, %	50%	0%	62%	97%	7%
Vol Right, %	0%	100%	3%	1%	86%
Sign Control	Stop	Stop	Stop	Stop	Stop
Traffic Vol by Lane	20	10	400	750	140
LT Vol	10	0	140	10	10
Through Vol	10	0	250	730	10
RT Vol	0	10	10	10	120
Lane Flow Rate	22	11	449	843	157
Geometry Grp	7	7	2	2	5
Degree of Util (X)	0.053	0.024	0.69	1.239	0.28
Departure Headway (Hd)	9.136	8.152	5.941	5.291	6.918
Convergence, Y/N	Yes	Yes	Yes	Yes	Yes
Cap	394	442	611	691	522
Service Time	6.836	5.852	3.941	3.304	4.918
HCM Lane V/C Ratio	0.056	0.025	0.735	1.22	0.301
HCM Control Delay	12.3	11.1	21.1	138.6	12.6
HCM Lane LOS	B	B	C	F	B
HCM 95th-tile Q	0.2	0.1	5.4	30.6	1.1

Intersection						
Int Delay, s/veh	1.5					
Movement	EBL	EBT	WBT	WBR	SBL	SBR
Lane Configurations		↕	↕		↕	
Traffic Vol, veh/h	100	110	720	10	10	10
Future Vol, veh/h	100	110	720	10	10	10
Conflicting Peds, #/hr	0	0	0	0	0	0
Sign Control	Free	Free	Free	Free	Stop	Stop
RT Channelized	-	None	-	None	-	None
Storage Length	-	-	-	-	0	-
Veh in Median Storage, #	-	0	0	-	0	-
Grade, %	-	0	0	-	0	-
Peak Hour Factor	86	86	86	86	86	86
Heavy Vehicles, %	3	3	0	0	8	8
Mvmt Flow	116	128	837	12	12	12

Major/Minor	Major1	Major2	Minor2		
Conflicting Flow All	849	0	-	0	1203 843
Stage 1	-	-	-	-	843 -
Stage 2	-	-	-	-	360 -
Critical Hdwy	4.13	-	-	-	6.48 6.28
Critical Hdwy Stg 1	-	-	-	-	5.48 -
Critical Hdwy Stg 2	-	-	-	-	5.48 -
Follow-up Hdwy	2.227	-	-	-	3.572 3.372
Pot Cap-1 Maneuver	785	-	-	-	198 355
Stage 1	-	-	-	-	412 -
Stage 2	-	-	-	-	693 -
Platoon blocked, %		-	-	-	
Mov Cap-1 Maneuver	785	-	-	-	167 355
Mov Cap-2 Maneuver	-	-	-	-	167 -
Stage 1	-	-	-	-	346 -
Stage 2	-	-	-	-	693 -

Approach	EB	WB	SB
HCM Control Delay, s	4.9	0	22.7
HCM LOS			C

Minor Lane/Major Mvmt	EBL	EBT	WBT	WBR	SBLn1
Capacity (veh/h)	785	-	-	-	227
HCM Lane V/C Ratio	0.148	-	-	-	0.102
HCM Control Delay (s)	10.4	0	-	-	22.7
HCM Lane LOS	B	A	-	-	C
HCM 95th %tile Q(veh)	0.5	-	-	-	0.3

Intersection	
Intersection Delay, s/veh	32.8
Intersection LOS	D

Movement	EBL	EBT	EBR	WBL	WBT	WBR	NBL	NBT	NBR	SBL	SBT	SBR
Lane Configurations		↕			↕			↕			↕	
Traffic Vol, veh/h	110	10	10	10	10	10	10	10	10	10	10	720
Future Vol, veh/h	110	10	10	10	10	10	10	10	10	10	10	720
Peak Hour Factor	0.85	0.85	0.85	0.85	0.85	0.85	0.85	0.85	0.85	0.85	0.85	0.85
Heavy Vehicles, %	2	2	2	2	2	2	0	0	0	0	0	0
Mvmt Flow	129	12	12	12	12	12	12	12	12	12	12	847
Number of Lanes	0	1	0	0	1	0	0	1	0	0	1	0

Approach	EB	WB	NB	SB
Opposing Approach	WB	EB	SB	NB
Opposing Lanes	1	1	1	1
Conflicting Approach Left	SB	NB	EB	WB
Conflicting Lanes Left	1	1	1	1
Conflicting Approach Right	NB	SB	WB	EB
Conflicting Lanes Right	1	1	1	1
HCM Control Delay	11.2	9.4	8.6	38.5
HCM LOS	B	A	A	E

Lane	NBLn1	EBLn1	WBLn1	SBLn1
Vol Left, %	33%	85%	33%	1%
Vol Thru, %	33%	8%	33%	1%
Vol Right, %	33%	8%	33%	97%
Sign Control	Stop	Stop	Stop	Stop
Traffic Vol by Lane	30	130	30	740
LT Vol	10	110	10	10
Through Vol	10	10	10	10
RT Vol	10	10	10	720
Lane Flow Rate	35	153	35	871
Geometry Grp	1	1	1	1
Degree of Util (X)	0.052	0.258	0.059	0.95
Departure Headway (Hd)	5.312	6.065	6.059	3.929
Convergence, Y/N	Yes	Yes	Yes	Yes
Cap	678	595	594	914
Service Time	3.312	4.067	4.068	1.977
HCM Lane V/C Ratio	0.052	0.257	0.059	0.953
HCM Control Delay	8.6	11.2	9.4	38.5
HCM Lane LOS	A	B	A	E
HCM 95th-tile Q	0.2	1	0.2	15.4

HCM 2010 Signalized Intersection Summary
 46: General Jim Moore Boulevard & Normandy Road

Existing with Project, AM
 06/11/2019



Movement	EBL	EBT	EBR	WBL	WBT	WBR	NBL	NBT	NBR	SBL	SBT	SBR
Lane Configurations		↕			↕		↕	↕↕		↕	↕↕	↕
Traffic Volume (veh/h)	70	80	120	150	70	40	130	370	110	80	790	150
Future Volume (veh/h)	70	80	120	150	70	40	130	370	110	80	790	150
Number	3	8	18	7	4	14	1	6	16	5	2	12
Initial Q (Qb), veh	0	0	0	0	0	0	0	0	0	0	0	0
Ped-Bike Adj(A_pbT)	0.99		0.98	0.99		0.98	1.00		0.98	1.00		0.99
Parking Bus, Adj	1.00	1.00	1.00	1.00	1.00	1.00	1.00	1.00	1.00	1.00	1.00	1.00
Adj Sat Flow, veh/h/ln	1900	1881	1900	1900	1863	1900	1881	1881	1900	1863	1863	1863
Adj Flow Rate, veh/h	90	103	125	192	90	47	167	474	114	103	1013	123
Adj No. of Lanes	0	1	0	0	1	0	1	2	0	1	2	1
Peak Hour Factor	0.78	0.78	0.78	0.78	0.78	0.78	0.78	0.78	0.78	0.78	0.78	0.78
Percent Heavy Veh, %	1	1	1	2	2	2	1	1	1	2	2	2
Cap, veh/h	197	225	228	340	152	68	207	613	146	389	1128	499
Arrive On Green	0.36	0.36	0.36	0.36	0.36	0.36	0.12	0.21	0.21	0.22	0.32	0.32
Sat Flow, veh/h	353	626	634	702	423	187	1792	2853	681	1774	3539	1566
Grp Volume(v), veh/h	318	0	0	329	0	0	167	296	292	103	1013	123
Grp Sat Flow(s),veh/h/ln	1613	0	0	1312	0	0	1792	1787	1748	1774	1770	1566
Q Serve(g_s), s	0.0	0.0	0.0	4.4	0.0	0.0	6.0	10.2	10.4	3.2	18.0	3.8
Cycle Q Clear(g_c), s	9.8	0.0	0.0	14.2	0.0	0.0	6.0	10.2	10.4	3.2	18.0	3.8
Prop In Lane	0.28		0.39	0.58		0.14	1.00		0.39	1.00		1.00
Lane Grp Cap(c), veh/h	651	0	0	559	0	0	207	384	376	389	1128	499
V/C Ratio(X)	0.49	0.00	0.00	0.59	0.00	0.00	0.81	0.77	0.78	0.26	0.90	0.25
Avail Cap(c_a), veh/h	869	0	0	747	0	0	218	693	678	389	1373	607
HCM Platoon Ratio	1.00	1.00	1.00	1.00	1.00	1.00	1.00	1.00	1.00	1.00	1.00	1.00
Upstream Filter(I)	1.00	0.00	0.00	1.00	0.00	0.00	1.00	1.00	1.00	1.00	1.00	1.00
Uniform Delay (d), s/veh	16.5	0.0	0.0	17.9	0.0	0.0	28.4	24.3	24.3	21.3	21.4	16.6
Incr Delay (d2), s/veh	0.2	0.0	0.0	0.4	0.0	0.0	17.2	1.2	1.3	0.1	6.4	0.1
Initial Q Delay(d3),s/veh	0.0	0.0	0.0	0.0	0.0	0.0	0.0	0.0	0.0	0.0	0.0	0.0
%ile BackOfQ(50%),veh/ln	4.5	0.0	0.0	5.1	0.0	0.0	4.0	5.1	5.1	1.6	9.7	1.7
LnGrp Delay(d),s/veh	16.7	0.0	0.0	18.2	0.0	0.0	45.6	25.5	25.7	21.4	27.8	16.6
LnGrp LOS	B			B			D	C	C	C	C	B
Approach Vol, veh/h		318			329			755			1239	
Approach Delay, s/veh		16.7			18.2			30.0			26.1	
Approach LOS		B			B			C			C	
Timer	1	2	3	4	5	6	7	8				
Assigned Phs	1	2		4	5	6		8				
Phs Duration (G+Y+Rc), s	2.1	25.5		28.2	18.9	18.6		28.2				
Change Period (Y+Rc), s	4.5	4.5		4.5	4.5	4.5		4.5				
Max Green Setting (Gmax), s	30.0	25.5		33.0	8.0	25.5		33.0				
Max Q Clear Time (g_c+1/3), s	10.0	20.0		16.2	5.2	12.4		11.8				
Green Ext Time (p_c), s	0.0	1.0		0.5	0.0	0.5		0.5				
Intersection Summary												
HCM 2010 Ctrl Delay				25.1								
HCM 2010 LOS				C								

Intersection	
Intersection Delay, s/veh	103.2
Intersection LOS	F

Movement	EBL	EBR	NBL	NBT	SBT	SBR
Lane Configurations						
Traffic Vol, veh/h	120	430	230	370	900	140
Future Vol, veh/h	120	430	230	370	900	140
Peak Hour Factor	0.90	0.90	0.90	0.90	0.90	0.90
Heavy Vehicles, %	1	1	1	1	2	2
Mvmt Flow	133	478	256	411	1000	156
Number of Lanes	1	1	1	2	2	1

Approach	EB	NB	SB
Opposing Approach		SB	NB
Opposing Lanes	0	3	3
Conflicting Approach Left	SB		
Conflicting Lanes Left	3	2	0
Conflicting Approach Right		NB	EB
Conflicting Lanes Right	3	0	2
HCM Control Delay	124.3	27.2	135.9
HCM LOS	F	D	F

Lane	NBLn1	NBLn2	NBLn3	EBLn1	EBLn2	SBLn1	SBLn2	SBLn3
Vol Left, %	100%	0%	0%	100%	0%	0%	0%	0%
Vol Thru, %	0%	100%	100%	0%	0%	100%	100%	0%
Vol Right, %	0%	0%	0%	0%	100%	0%	0%	100%
Sign Control	Stop	Stop	Stop	Stop	Stop	Stop	Stop	Stop
Traffic Vol by Lane	230	185	185	120	430	450	450	140
LT Vol	230	0	0	120	0	0	0	0
Through Vol	0	185	185	0	0	450	450	0
RT Vol	0	0	0	0	430	0	0	140
Lane Flow Rate	256	206	206	133	478	500	500	156
Geometry Grp	8	8	8	8	8	8	8	8
Degree of Util (X)	0.702	0.537	0.439	0.387	1.227	1.235	1.235	0.279
Departure Headway (Hd)	11.131	10.607	8.806	11.06	9.84	9.546	9.546	6.996
Convergence, Y/N	Yes	Yes	Yes	Yes	Yes	Yes	Yes	Yes
Cap	327	343	411	328	373	385	385	516
Service Time	8.831	8.307	6.506	8.76	7.54	7.246	7.246	4.696
HCM Lane V/C Ratio	0.783	0.601	0.501	0.405	1.282	1.299	1.299	0.302
HCM Control Delay	36.3	25	18.2	20.6	153.3	155.1	155.1	12.4
HCM Lane LOS	E	C	C	C	F	F	F	B
HCM 95th-tile Q	5	3	2.2	1.8	19.2	19.9	19.9	1.1



Movement	EBL	EBT	EBR	WBL	WBT	WBR	NBL	NBT	NBR	SBL	SBT	SBR
Lane Configurations												
Traffic Volume (veh/h)	70	140	100	120	280	20	200	520	140	100	820	160
Future Volume (veh/h)	70	140	100	120	280	20	200	520	140	100	820	160
Number	7	4	14	3	8	18	5	2	12	1	6	16
Initial Q (Qb), veh	0	0	0	0	0	0	0	0	0	0	0	0
Ped-Bike Adj(A_pbT)	1.00		0.96	1.00		0.97	1.00		0.98	1.00		0.98
Parking Bus, Adj	1.00	1.00	1.00	1.00	1.00	1.00	1.00	1.00	1.00	1.00	1.00	1.00
Adj Sat Flow, veh/h/ln	1845	1845	1845	1900	1881	1900	1827	1827	1900	1827	1827	1827
Adj Flow Rate, veh/h	77	154	21	132	308	20	220	571	139	110	901	109
Adj No. of Lanes	1	1	1	0	1	0	1	2	0	1	2	1
Peak Hour Factor	0.91	0.91	0.91	0.91	0.91	0.91	0.91	0.91	0.91	0.91	0.91	0.91
Percent Heavy Veh, %	3	3	3	1	1	1	4	4	4	4	4	4
Cap, veh/h	234	245	200	118	276	18	394	1137	276	134	880	388
Arrive On Green	0.13	0.13	0.13	0.22	0.22	0.22	0.23	0.41	0.41	0.08	0.25	0.25
Sat Flow, veh/h	1757	1845	1502	527	1230	80	1740	2762	670	1740	3471	1529
Grp Volume(v), veh/h	77	154	21	460	0	0	220	358	352	110	901	109
Grp Sat Flow(s),veh/h/ln	1757	1845	1502	1838	0	0	1740	1736	1696	1740	1736	1529
Q Serve(g_s), s	5.0	9.9	1.5	28.0	0.0	0.0	14.0	19.1	19.3	7.8	31.7	7.2
Cycle Q Clear(g_c), s	5.0	9.9	1.5	28.0	0.0	0.0	14.0	19.1	19.3	7.8	31.7	7.2
Prop In Lane	1.00		1.00	0.29		0.04	1.00		0.40	1.00		1.00
Lane Grp Cap(c), veh/h	234	245	200	412	0	0	394	714	698	134	880	388
V/C Ratio(X)	0.33	0.63	0.11	1.12	0.00	0.00	0.56	0.50	0.50	0.82	1.02	0.28
Avail Cap(c_a), veh/h	436	457	372	412	0	0	394	714	698	209	880	388
HCM Platoon Ratio	1.00	1.00	1.00	1.00	1.00	1.00	1.00	1.00	1.00	1.00	1.00	1.00
Upstream Filter(I)	0.77	0.77	0.77	1.00	0.00	0.00	1.00	1.00	1.00	1.00	1.00	1.00
Uniform Delay (d), s/veh	49.1	51.3	47.6	48.5	0.0	0.0	42.8	27.3	27.3	56.8	46.7	37.5
Incr Delay (d2), s/veh	0.6	2.0	0.2	80.3	0.0	0.0	1.1	2.5	2.6	7.3	36.4	1.8
Initial Q Delay(d3),s/veh	0.0	0.0	0.0	0.0	0.0	0.0	0.0	0.0	0.0	0.0	0.0	0.0
%ile BackOfQ(50%),veh/ln	2.5	5.2	0.6	23.4	0.0	0.0	6.8	9.7	9.5	4.0	19.6	3.2
LnGrp Delay(d),s/veh	49.8	53.3	47.8	128.8	0.0	0.0	43.9	29.8	29.9	64.2	83.1	39.3
LnGrp LOS	D	D	D	F			D	C	C	E	F	D
Approach Vol, veh/h		252			460			930			1120	
Approach Delay, s/veh		51.8			128.8			33.2			77.0	
Approach LOS		D			F			C			E	
Timer	1	2	3	4	5	6	7	8				
Assigned Phs	1	2		4	5	6		8				
Phs Duration (G+Y+Rc), s	3.8	56.7		21.3	33.6	37.0		33.1				
Change Period (Y+Rc), s	4.2	5.3		* 4.7	5.3	* 5.3		5.1				
Max Green Setting (Gmax), s	15	31.7		* 31	15.0	* 32		28.0				
Max Q Clear Time (g_c+1/9), s	19.8	21.3		11.9	16.0	33.7		30.0				
Green Ext Time (p_c), s	0.1	2.7		1.0	0.0	0.0		0.0				

Intersection Summary

HCM 2010 Ctrl Delay	68.5
HCM 2010 LOS	E

Notes

HCM 2010 Signalized Intersection Summary
 49: Highway 1 SB On-Ramp & Highway 1 NB Off-Ramp/Monterey Road

Existing with Project, AM
 06/11/2019



Movement	EBL	EBT	EBR	WBL	WBT	WBR	NBL	NBT	NBR	SBL	SBT	SBR
Lane Configurations		↕↕	↗	↖		↗		↕	↗		↕	
Traffic Volume (veh/h)	10	200	110	230	0	420	0	50	110	10	10	0
Future Volume (veh/h)	10	200	110	230	0	420	0	50	110	10	10	0
Number	1	6	16	5	2	12	7	4	14	3	8	18
Initial Q (Qb), veh	0	0	0	0	0	0	0	0	0	0	0	0
Ped-Bike Adj(A_pbT)	1.00		1.00	1.00		1.00	1.00		1.00	1.00		1.00
Parking Bus, Adj	1.00	1.00	1.00	1.00	1.00	1.00	1.00	1.00	1.00	1.00	1.00	1.00
Adj Sat Flow, veh/h/ln	1900	1845	1845	1863	0	1863	0	1845	1845	1900	1900	0
Adj Flow Rate, veh/h	10	206	19	237	0	294	0	52	10	10	10	0
Adj No. of Lanes	0	2	1	1	0	1	0	1	1	0	1	0
Peak Hour Factor	0.97	0.97	0.97	0.97	0.97	0.97	0.97	0.97	0.97	0.97	0.97	0.97
Percent Heavy Veh, %	3	3	3	2	0	2	0	3	3	0	0	0
Cap, veh/h	137	2951	1347	0	0	0	0	117	100	72	57	0
Arrive On Green	0.86	0.86	0.86	0.00	0.00	0.00	0.00	0.06	0.06	0.06	0.06	0.00
Sat Flow, veh/h	159	3430	1566		0		0	1845	1568	455	902	0
Grp Volume(v), veh/h	116	100	19		0.0		0	52	10	20	0	0
Grp Sat Flow(s),veh/h/ln	1837	1752	1566				0	1845	1568	1357	0	0
Q Serve(g_s), s	1.2	1.1	0.2				0.0	3.4	0.8	0.0	0.0	0.0
Cycle Q Clear(g_c), s	1.2	1.1	0.2				0.0	3.4	0.8	3.4	0.0	0.0
Prop In Lane	0.09		1.00				0.00		1.00	0.50		0.00
Lane Grp Cap(c), veh/h	1580	1508	1347				0	117	100	130	0	0
V/C Ratio(X)	0.07	0.07	0.01				0.00	0.44	0.10	0.15	0.00	0.00
Avail Cap(c_a), veh/h	1580	1508	1347				0	148	125	155	0	0
HCM Platoon Ratio	1.00	1.00	1.00				1.00	1.00	1.00	1.00	1.00	1.00
Upstream Filter(I)	1.00	1.00	1.00				0.00	1.00	1.00	1.00	0.00	0.00
Uniform Delay (d), s/veh	1.3	1.3	1.2				0.0	56.4	55.2	55.4	0.0	0.0
Incr Delay (d2), s/veh	0.0	0.0	0.0				0.0	1.0	0.2	0.2	0.0	0.0
Initial Q Delay(d3),s/veh	0.0	0.0	0.0				0.0	0.0	0.0	0.0	0.0	0.0
%ile BackOfQ(50%),veh/ln	0.6	0.5	0.1				0.0	1.8	0.3	0.7	0.0	0.0
LnGrp Delay(d),s/veh	1.3	1.3	1.2				0.0	57.4	55.3	55.6	0.0	0.0
LnGrp LOS	A	A	A					E	E	E		
Approach Vol, veh/h		235						62			20	
Approach Delay, s/veh		1.3						57.0			55.6	
Approach LOS		A						E			E	
Timer	1	2	3	4	5	6	7	8				
Assigned Phs				4		6		8				
Phs Duration (G+Y+Rc), s				12.2		112.8		12.2				
Change Period (Y+Rc), s				* 4.2		5.3		* 4.2				
Max Green Setting (Gmax), s				* 10		21.0		* 10				
Max Q Clear Time (g_c+I1), s				5.4		3.2		5.4				
Green Ext Time (p_c), s				0.0		0.7		0.0				
Intersection Summary												
HCM 2010 Ctrl Delay			15.6									
HCM 2010 LOS			B									
Notes												

HCM 2010 Signalized Intersection Summary
 50: Reservation Road & SR 68 WB On Ramp/SR 68 WB Off Ramp

Existing with Project, AM
 06/11/2019





















Movement	EBL	EBT	EBR	WBL	WBT	WBR	NBL	NBT	NBR	SBL	SBT	SBR
Lane Configurations					↕	↕	↕	↕			↕	
Traffic Volume (veh/h)	0	0	0	250	10	300	130	370	0	0	340	110
Future Volume (veh/h)	0	0	0	250	10	300	130	370	0	0	340	110
Number				7	4	14	1	6	16	5	2	12
Initial Q (Qb), veh				0	0	0	0	0	0	0	0	0
Ped-Bike Adj(A_pbT)				1.00		1.00	1.00		1.00	1.00		1.00
Parking Bus, Adj				1.00	1.00	1.00	1.00	1.00	1.00	1.00	1.00	1.00
Adj Sat Flow, veh/h/ln				1900	1827	1827	1863	1863	0	0	1827	1900
Adj Flow Rate, veh/h				263	11	64	137	389	0	0	358	107
Adj No. of Lanes				0	1	1	1	1	0	0	1	0
Peak Hour Factor				0.95	0.95	0.95	0.95	0.95	0.95	0.95	0.95	0.95
Percent Heavy Veh, %				4	4	4	2	2	0	0	4	4
Cap, veh/h				377	16	350	222	1003	0	0	456	136
Arrive On Green				0.23	0.23	0.23	0.13	0.54	0.00	0.00	0.34	0.34
Sat Flow, veh/h				1673	70	1553	1774	1863	0	0	1352	404
Grp Volume(v), veh/h				274	0	64	137	389	0	0	0	465
Grp Sat Flow(s),veh/h/ln				1743	0	1553	1774	1863	0	0	0	1756
Q Serve(g_s), s				6.7	0.0	1.5	3.4	5.6	0.0	0.0	0.0	11.0
Cycle Q Clear(g_c), s				6.7	0.0	1.5	3.4	5.6	0.0	0.0	0.0	11.0
Prop In Lane				0.96		1.00	1.00		0.00	0.00		0.23
Lane Grp Cap(c), veh/h				393	0	350	222	1003	0	0	0	592
V/C Ratio(X)				0.70	0.00	0.18	0.62	0.39	0.00	0.00	0.00	0.79
Avail Cap(c_a), veh/h				1509	0	1344	998	1532	0	0	0	1444
HCM Platoon Ratio				1.00	1.00	1.00	1.00	1.00	1.00	1.00	1.00	1.00
Upstream Filter(I)				1.00	0.00	1.00	1.00	1.00	0.00	0.00	0.00	1.00
Uniform Delay (d), s/veh				16.4	0.0	14.5	19.2	6.2	0.0	0.0	0.0	13.8
Incr Delay (d2), s/veh				2.2	0.0	0.2	1.0	0.2	0.0	0.0	0.0	2.3
Initial Q Delay(d3),s/veh				0.0	0.0	0.0	0.0	0.0	0.0	0.0	0.0	0.0
%ile BackOfQ(50%),veh/ln				3.4	0.0	0.7	1.7	2.9	0.0	0.0	0.0	5.7
LnGrp Delay(d),s/veh				18.7	0.0	14.7	20.2	6.5	0.0	0.0	0.0	16.1
LnGrp LOS				B		B	C	A				B
Approach Vol, veh/h					338			526			465	
Approach Delay, s/veh					17.9			10.0			16.1	
Approach LOS					B			B			B	
Timer	1	2	3	4	5	6	7	8				
Assigned Phs	1	2		4		6						
Phs Duration (G+Y+Rc), s	9.3	21.6		15.3		30.9						
Change Period (Y+Rc), s	3.5	6.0		4.9		6.0						
Max Green Setting (Gmax), s	26.0	38.0		40.0		38.0						
Max Q Clear Time (g_c+1), s	15.4	13.0		8.7		7.6						
Green Ext Time (p_c), s	0.1	2.6		1.9		2.0						
Intersection Summary												
HCM 2010 Ctrl Delay				14.2								
HCM 2010 LOS				B								



Movement	EBL	EBT	EBR	WBL	WBT	WBR	NBL	NBT	NBR	SBL	SBT	SBR
Lane Configurations		↔	↗					↑	↗	↖	↑	
Traffic Volume (veh/h)	100	10	110	0	0	0	0	380	670	230	350	0
Future Volume (veh/h)	100	10	110	0	0	0	0	380	670	230	350	0
Number	3	8	18				1	6	16	5	2	12
Initial Q (Qb), veh	0	0	0				0	0	0	0	0	0
Ped-Bike Adj(A_pbT)	1.00		1.00				1.00		1.00	1.00		1.00
Parking Bus, Adj	1.00	1.00	1.00				1.00	1.00	1.00	1.00	1.00	1.00
Adj Sat Flow, veh/h/ln	1900	1881	1881				0	1881	1881	1827	1827	0
Adj Flow Rate, veh/h	109	11	19				0	413	399	250	380	0
Adj No. of Lanes	0	1	1				0	1	1	1	1	0
Peak Hour Factor	0.92	0.92	0.92				0.92	0.92	0.92	0.92	0.92	0.92
Percent Heavy Veh, %	1	1	1				0	1	1	4	4	0
Cap, veh/h	161	16	158				0	665	565	328	1156	0
Arrive On Green	0.10	0.10	0.10				0.00	0.35	0.35	0.19	0.63	0.00
Sat Flow, veh/h	1635	165	1599				0	1881	1599	1740	1827	0
Grp Volume(v), veh/h	120	0	19				0	413	399	250	380	0
Grp Sat Flow(s),veh/h/ln	1799	0	1599				0	1881	1599	1740	1827	0
Q Serve(g_s), s	2.6	0.0	0.4				0.0	7.4	8.7	5.5	3.9	0.0
Cycle Q Clear(g_c), s	2.6	0.0	0.4				0.0	7.4	8.7	5.5	3.9	0.0
Prop In Lane	0.91		1.00				0.00		1.00	1.00		0.00
Lane Grp Cap(c), veh/h	177	0	158				0	665	565	328	1156	0
V/C Ratio(X)	0.68	0.00	0.12				0.00	0.62	0.71	0.76	0.33	0.00
Avail Cap(c_a), veh/h	1774	0	1577				0	1716	1458	1029	1666	0
HCM Platoon Ratio	1.00	1.00	1.00				1.00	1.00	1.00	1.00	1.00	1.00
Upstream Filter(I)	1.00	0.00	1.00				0.00	1.00	1.00	1.00	1.00	0.00
Uniform Delay (d), s/veh	17.7	0.0	16.7				0.0	10.9	11.3	15.6	3.5	0.0
Incr Delay (d2), s/veh	1.7	0.0	0.1				0.0	1.0	1.6	3.7	0.2	0.0
Initial Q Delay(d3),s/veh	0.0	0.0	0.0				0.0	0.0	0.0	0.0	0.0	0.0
%ile BackOfQ(50%),veh/ln	1.4	0.0	0.2				0.0	4.0	4.0	3.0	2.0	0.0
LnGrp Delay(d),s/veh	19.3	0.0	16.8				0.0	11.8	12.9	19.3	3.6	0.0
LnGrp LOS	B		B					B	B	B	A	
Approach Vol, veh/h		139						812			630	
Approach Delay, s/veh		19.0						12.4			9.8	
Approach LOS		B						B			A	
Timer	1	2	3	4	5	6	7	8				
Assigned Phs		2			5	6		8				
Phs Duration (G+Y+Rc), s		31.7			11.3	20.3		8.9				
Change Period (Y+Rc), s		6.0			3.7	6.0		4.9				
Max Green Setting (Gmax), s		37.0			24.0	37.0		40.0				
Max Q Clear Time (g_c+I1), s		5.9			7.5	10.7		4.6				
Green Ext Time (p_c), s		2.1			0.6	3.6		0.4				
Intersection Summary												
HCM 2010 Ctrl Delay			11.9									
HCM 2010 LOS			B									

HCM 2010 Signalized Intersection Summary
 1: Del Monte Boulevard & Reindollar Avenue

Existing with Project, PM
 06/11/2019

												
Movement	EBL	EBT	EBR	WBL	WBT	WBR	NBL	NBT	NBR	SBL	SBT	SBR
Lane Configurations												
Traffic Volume (veh/h)	0	0	0	180	0	90	10	1020	320	70	490	0
Future Volume (veh/h)	0	0	0	180	0	90	10	1020	320	70	490	0
Number				3	8	18	1	6	16	5	2	12
Initial Q (Qb), veh				0	0	0	0	0	0	0	0	0
Ped-Bike Adj(A_pbT)				1.00		1.00	1.00		1.00	1.00		1.00
Parking Bus, Adj				1.00	1.00	1.00	1.00	1.00	1.00	1.00	1.00	1.00
Adj Sat Flow, veh/h/ln				1881	1881	1900	1881	1881	1881	1881	1881	0
Adj Flow Rate, veh/h				209	0	0	10	1062	250	73	510	0
Adj No. of Lanes				2	1	0	1	2	1	1	2	0
Peak Hour Factor				0.96	0.96	0.96	0.96	0.96	0.96	0.96	0.96	0.96
Percent Heavy Veh, %				1	1	1	1	1	1	1	1	0
Cap, veh/h				459	241	0	24	1691	756	123	1890	0
Arrive On Green				0.13	0.00	0.00	0.01	0.47	0.47	0.07	0.53	0.00
Sat Flow, veh/h				3583	1881	0	1792	3574	1599	1792	3668	0
Grp Volume(v), veh/h				209	0	0	10	1062	250	73	510	0
Grp Sat Flow(s),veh/h/ln				1792	1881	0	1792	1787	1599	1792	1787	0
Q Serve(g_s), s				2.2	0.0	0.0	0.2	9.1	4.0	1.6	3.2	0.0
Cycle Q Clear(g_c), s				2.2	0.0	0.0	0.2	9.1	4.0	1.6	3.2	0.0
Prop In Lane				1.00		0.00	1.00		1.00	1.00		0.00
Lane Grp Cap(c), veh/h				459	241	0	24	1691	756	123	1890	0
V/C Ratio(X)				0.46	0.00	0.00	0.43	0.63	0.33	0.59	0.27	0.00
Avail Cap(c_a), veh/h				2628	1380	0	1314	2622	1173	1314	2622	0
HCM Platoon Ratio				1.00	1.00	1.00	1.00	1.00	1.00	1.00	1.00	1.00
Upstream Filter(l)				1.00	0.00	0.00	1.00	1.00	1.00	1.00	1.00	0.00
Uniform Delay (d), s/veh				16.5	0.0	0.0	20.0	8.1	6.7	18.5	5.3	0.0
Incr Delay (d2), s/veh				0.7	0.0	0.0	11.7	0.4	0.3	4.5	0.1	0.0
Initial Q Delay(d3),s/veh				0.0	0.0	0.0	0.0	0.0	0.0	0.0	0.0	0.0
%ile BackOfQ(50%),veh/ln				1.1	0.0	0.0	0.2	4.5	1.8	0.9	1.6	0.0
LnGrp Delay(d),s/veh				17.2	0.0	0.0	31.7	8.5	7.0	22.9	5.4	0.0
LnGrp LOS				B			C	A	A	C	A	
Approach Vol, veh/h					209			1322			583	
Approach Delay, s/veh					17.2			8.4			7.6	
Approach LOS					B			A			A	
Timer	1	2	3	4	5	6	7	8				
Assigned Phs	1	2			5	6		8				
Phs Duration (G+Y+Rc), s	4.0	26.6			6.3	24.3		10.2				
Change Period (Y+Rc), s	3.5	5.0			3.5	5.0		5.0				
Max Green Setting (Gmax), s	30.0	30.0			30.0	30.0		30.0				
Max Q Clear Time (g_c+I1), s	2.2	5.2			3.6	11.1		4.2				
Green Ext Time (p_c), s	0.0	3.6			0.2	8.2		0.7				
Intersection Summary												
HCM 2010 Ctrl Delay				9.0								
HCM 2010 LOS				A								
Notes												

HCM 2010 Signalized Intersection Summary
 3: SR 1 SB On-Ramp/SR 1 SB Off-Ramp & Imjin Parkway

Existing with Project, PM
 06/11/2019



Movement	EBL	EBT	EBR	WBL	WBT	WBR	NBL	NBT	NBR	SBL	SBT	SBR
Lane Configurations					↕						↕	
Traffic Volume (veh/h)	0	0	0	970	0	0	0	0	0	290	10	0
Future Volume (veh/h)	0	0	0	970	0	0	0	0	0	290	10	0
Number				1	6	16				7	4	14
Initial Q (Qb), veh				0	0	0				0	0	0
Ped-Bike Adj(A_pbT)				1.00		1.00				1.00		1.00
Parking Bus, Adj				1.00	1.00	1.00				1.00	1.00	1.00
Adj Sat Flow, veh/h/ln				1900	1881	0				1900	1863	0
Adj Flow Rate, veh/h				1066	0	0				319	11	0
Adj No. of Lanes				0	1	0				0	1	0
Peak Hour Factor				0.91	0.91	0.91				0.91	0.91	0.91
Percent Heavy Veh, %				1	1	0				2	2	0
Cap, veh/h				1200	0	0				388	13	0
Arrive On Green				0.67	0.00	0.00				0.23	0.23	0.00
Sat Flow, veh/h				1792	0	0				1718	59	0
Grp Volume(v), veh/h				1066	0	0				330	0	0
Grp Sat Flow(s),veh/h/ln				1792	0	0				1777	0	0
Q Serve(g_s), s				40.9	0.0	0.0				14.9	0.0	0.0
Cycle Q Clear(g_c), s				40.9	0.0	0.0				14.9	0.0	0.0
Prop In Lane				1.00		0.00				0.97		0.00
Lane Grp Cap(c), veh/h				1200	0	0				401	0	0
V/C Ratio(X)				0.89	0.00	0.00				0.82	0.00	0.00
Avail Cap(c_a), veh/h				1913	0	0				1265	0	0
HCM Platoon Ratio				1.00	1.00	1.00				1.00	1.00	1.00
Upstream Filter(I)				1.00	0.00	0.00				1.00	0.00	0.00
Uniform Delay (d), s/veh				11.3	0.0	0.0				31.0	0.0	0.0
Incr Delay (d2), s/veh				3.4	0.0	0.0				4.3	0.0	0.0
Initial Q Delay(d3),s/veh				0.0	0.0	0.0				0.0	0.0	0.0
%ile BackOfQ(50%),veh/ln				21.0	0.0	0.0				7.7	0.0	0.0
LnGrp Delay(d),s/veh				14.8	0.0	0.0				35.3	0.0	0.0
LnGrp LOS				B						D		
Approach Vol, veh/h					1066						330	
Approach Delay, s/veh					14.8						35.3	
Approach LOS					B						D	
Timer	1	2	3	4	5	6	7	8				
Assigned Phs				4		6						
Phs Duration (G+Y+Rc), s				23.4		60.8						
Change Period (Y+Rc), s				4.4		4.4						
Max Green Setting (Gmax), s				60.0		90.0						
Max Q Clear Time (g_c+I1), s				16.9		42.9						
Green Ext Time (p_c), s				2.2		13.5						
Intersection Summary												
HCM 2010 Ctrl Delay				19.6								
HCM 2010 LOS				B								

Intersection												
Int Delay, s/veh	0.5											
Movement	EBL	EBT	EBR	WBL	WBT	WBR	NBL	NBT	NBR	SBL	SBT	SBR
Lane Configurations		↔			↑	↗		↖	↗			
Traffic Vol, veh/h	10	270	0	0	970	550	10	10	1150	0	0	0
Future Vol, veh/h	10	270	0	0	970	550	10	10	1150	0	0	0
Conflicting Peds, #/hr	0	0	1	1	0	0	0	0	0	0	0	0
Sign Control	Free	Free	Free	Free	Free	Free	Stop	Stop	Stop	Stop	Stop	Stop
RT Channelized	-	-	None	-	-	Free	-	-	Free	-	-	None
Storage Length	-	-	-	-	-	0	-	-	800	-	-	-
Veh in Median Storage, #	-	0	-	-	0	-	-	0	-	-	16965	-
Grade, %	-	0	-	-	0	-	-	0	-	-	0	-
Peak Hour Factor	95	95	95	95	95	95	95	95	95	95	95	95
Heavy Vehicles, %	2	2	2	1	1	1	1	1	1	2	2	2
Mvmt Flow	11	284	0	0	1021	579	11	11	1211	0	0	0























Major/Minor	Major1	Major2	Minor1
Conflicting Flow All	1021	0	-
Stage 1	-	-	-
Stage 2	-	-	-
Critical Hdwy	4.12	-	-
Critical Hdwy Stg 1	-	-	-
Critical Hdwy Stg 2	-	-	-
Follow-up Hdwy	2.218	-	-
Pot Cap-1 Maneuver	680	0	0
Stage 1	-	0	0
Stage 2	-	0	0
Platoon blocked, %	-	-	-
Mov Cap-1 Maneuver	680	-	-
Mov Cap-2 Maneuver	-	-	-
Stage 1	-	-	-
Stage 2	-	-	-

Approach	EB	WB	NB
HCM Control Delay, s	0.4	0	29.3
HCM LOS			D

Minor Lane/Major Mvmt	NBLn1	NBLn2	EBL	EBT	WBT
Capacity (veh/h)	169	-	680	-	-
HCM Lane V/C Ratio	0.125	-	0.015	-	-
HCM Control Delay (s)	29.3	0	10.4	0	-
HCM Lane LOS	D	A	B	A	-
HCM 95th %tile Q(veh)	0.4	-	0	-	-

HCM 2010 Signalized Intersection Summary
5: 2nd Avenue & Imjin Parkway

Existing with Project, PM
06/11/2019

												
Movement	EBL	EBT	EBR	WBL	WBT	WBR	NBL	NBT	NBR	SBL	SBT	SBR
Lane Configurations												
Traffic Volume (veh/h)	10	960	360	250	980	10	470	10	300	20	20	40
Future Volume (veh/h)	10	960	360	250	980	10	470	10	300	20	20	40
Number	5	2	12	1	6	16	3	8	18	7	4	14
Initial Q (Qb), veh	0	0	0	0	0	0	0	0	0	0	0	0
Ped-Bike Adj(A_pbT)	1.00		1.00	1.00		0.99	1.00		0.99	1.00		0.96
Parking Bus, Adj	1.00	1.00	1.00	1.00	1.00	1.00	1.00	1.00	1.00	1.00	1.00	1.00
Adj Sat Flow, veh/h/ln	1881	1881	1881	1881	1881	1900	1900	1900	1900	1900	1900	1900
Adj Flow Rate, veh/h	10	1000	175	260	1021	10	490	10	78	21	21	11
Adj No. of Lanes	1	2	1	2	2	0	2	1	1	1	2	0
Peak Hour Factor	0.96	0.96	0.96	0.96	0.96	0.96	0.96	0.96	0.96	0.96	0.96	0.96
Percent Heavy Veh, %	1	1	1	1	1	1	0	0	0	0	0	0
Cap, veh/h	104	1174	523	386	1385	14	611	298	250	105	95	45
Arrive On Green	0.06	0.33	0.33	0.11	0.38	0.38	0.17	0.16	0.16	0.06	0.04	0.04
Sat Flow, veh/h	1792	3574	1592	3476	3626	36	3510	1900	1593	1810	2345	1114
Grp Volume(v), veh/h	10	1000	175	260	503	528	490	10	78	21	16	16
Grp Sat Flow(s),veh/h/ln	1792	1787	1592	1738	1787	1875	1755	1900	1593	1810	1805	1654
Q Serve(g_s), s	0.3	13.5	4.3	3.7	12.5	12.5	6.9	0.2	2.2	0.6	0.4	0.5
Cycle Q Clear(g_c), s	0.3	13.5	4.3	3.7	12.5	12.5	6.9	0.2	2.2	0.6	0.4	0.5
Prop In Lane	1.00		1.00	1.00		0.02	1.00		1.00	1.00		0.67
Lane Grp Cap(c), veh/h	104	1174	523	386	682	716	611	298	250	105	73	67
V/C Ratio(X)	0.10	0.85	0.33	0.67	0.74	0.74	0.80	0.03	0.31	0.20	0.21	0.24
Avail Cap(c_a), veh/h	519	2071	922	1007	1035	1086	1356	771	646	349	732	671
HCM Platoon Ratio	1.00	1.00	1.00	1.00	1.00	1.00	1.00	1.00	1.00	1.00	1.00	1.00
Upstream Filter(I)	1.00	1.00	1.00	1.00	1.00	1.00	1.00	1.00	1.00	1.00	1.00	1.00
Uniform Delay (d), s/veh	23.1	16.2	13.1	22.1	13.8	13.8	20.5	18.5	19.4	23.2	24.0	24.1
Incr Delay (d2), s/veh	0.1	0.7	0.1	0.8	0.6	0.6	0.9	0.0	0.3	0.3	0.5	0.7
Initial Q Delay(d3),s/veh	0.0	0.0	0.0	0.0	0.0	0.0	0.0	0.0	0.0	0.0	0.0	0.0
%ile BackOfQ(50%),veh/ln	0.1	6.6	1.9	1.8	6.3	6.6	3.4	0.1	1.0	0.3	0.2	0.2
LnGrp Delay(d),s/veh	23.3	16.9	13.3	22.9	14.4	14.3	21.5	18.5	19.6	23.6	24.6	24.8
LnGrp LOS	C	B	B	C	B	B	C	B	B	C	C	C
Approach Vol, veh/h		1185			1291			578			53	
Approach Delay, s/veh		16.4			16.1			21.2			24.2	
Approach LOS		B			B			C			C	
Timer	1	2	3	4	5	6	7	8				
Assigned Phs	1	2	3	4	5	6	7	8				
Phs Duration (G+Y+Rc), s	10.3	22.3	12.5	6.7	7.5	25.1	6.5	12.7				
Change Period (Y+Rc), s	4.5	5.3	3.5	4.6	4.5	5.3	3.5	4.6				
Max Green Setting (Gmax), s	15.0	30.0	20.0	21.0	15.0	30.0	10.0	21.0				
Max Q Clear Time (g_c+I1), s	5.7	15.5	8.9	2.5	2.3	14.5	2.6	4.2				
Green Ext Time (p_c), s	0.0	1.4	0.1	0.0	0.0	1.1	0.0	0.0				
Intersection Summary												
HCM 2010 Ctrl Delay			17.3									
HCM 2010 LOS			B									

Intersection												
Int Delay, s/veh	7.1											
Movement	EBL	EBT	EBR	WBL	WBT	WBR	NBL	NBT	NBR	SBL	SBT	SBR
Lane Configurations	↖	↕		↖	↕		↖	↕		↖	↕	
Traffic Vol, veh/h	50	1250	10	30	1180	20	10	10	30	10	10	50
Future Vol, veh/h	50	1250	10	30	1180	20	10	10	30	10	10	50
Conflicting Peds, #/hr	2	0	1	1	0	2	1	0	0	0	0	1
Sign Control	Free	Free	Free	Free	Free	Free	Stop	Stop	Stop	Stop	Stop	Stop
RT Channelized	-	-	None	-	-	None	-	-	None	-	-	None
Storage Length	300	-	-	300	-	-	85	-	-	25	-	-
Veh in Median Storage, #	-	0	-	-	0	-	-	0	-	-	0	-
Grade, %	-	0	-	-	0	-	-	0	-	-	0	-
Peak Hour Factor	98	98	98	98	98	98	98	98	98	98	98	98
Heavy Vehicles, %	1	1	1	1	1	1	0	0	0	0	0	0
Mvmt Flow	51	1276	10	31	1204	20	10	10	31	10	10	51

Major/Minor	Major1			Major2			Minor1			Minor2		
Conflicting Flow All	1226	0	0	1287	0	0	2054	2672	644	2023	2667	615
Stage 1	-	-	-	-	-	-	1384	1384	-	1278	1278	-
Stage 2	-	-	-	-	-	-	670	1288	-	745	1389	-
Critical Hdwy	4.12	-	-	4.12	-	-	7.5	6.5	6.9	7.5	6.5	6.9
Critical Hdwy Stg 1	-	-	-	-	-	-	6.5	5.5	-	6.5	5.5	-
Critical Hdwy Stg 2	-	-	-	-	-	-	6.5	5.5	-	6.5	5.5	-
Follow-up Hdwy	2.21	-	-	2.21	-	-	3.5	4	3.3	3.5	4	3.3
Pot Cap-1 Maneuver	570	-	-	540	-	-	33	23	420	35	23	439
Stage 1	-	-	-	-	-	-	154	213	-	179	239	-
Stage 2	-	-	-	-	-	-	417	237	-	377	212	-
Platoon blocked, %	-	-	-	-	-	-	-	-	-	-	-	-
Mov Cap-1 Maneuver	569	-	-	539	-	-	16	20	420	17	20	438
Mov Cap-2 Maneuver	-	-	-	-	-	-	16	20	-	17	20	-
Stage 1	-	-	-	-	-	-	140	194	-	163	225	-
Stage 2	-	-	-	-	-	-	331	223	-	301	193	-

Approach	EB			WB			NB			SB		
HCM Control Delay, s	0.5			0.3			172.6			131.2		
HCM LOS							F			F		

Minor Lane/Major Mvmt	NBLn1	NBLn2	EBL	EBT	EBR	WBL	WBT	WBR	SBLn1	SBLn2
Capacity (veh/h)	16	70	569	-	-	539	-	-	17	98
HCM Lane V/C Ratio	0.638	0.583	0.09	-	-	0.057	-	-	0.6	0.625
HCM Control Delay (s)	\$ 415.4	111.9	11.9	-	-	12.1	-	-	\$ 382.3	89.4
HCM Lane LOS	F	F	B	-	-	B	-	-	F	F
HCM 95th %tile Q(veh)	1.6	2.5	0.3	-	-	0.2	-	-	1.6	3

Intersection												
Int Delay, s/veh	13.1											
Movement	EBL	EBT	EBR	WBL	WBT	WBR	NBL	NBT	NBR	SBL	SBT	SBR
Lane Configurations	↖	↕		↖	↕			↕			↕	↕
Traffic Vol, veh/h	10	1370	10	10	1190	10	20	10	10	10	10	10
Future Vol, veh/h	10	1370	10	10	1190	10	20	10	10	10	10	10
Conflicting Peds, #/hr	2	0	0	0	0	2	0	0	0	0	0	0
Sign Control	Free	Free	Free	Free	Free	Free	Stop	Stop	Stop	Stop	Stop	Stop
RT Channelized	-	-	None	-	-	None	-	-	None	-	-	Stop
Storage Length	330	-	-	330	-	-	-	-	-	-	-	-
Veh in Median Storage, #	-	0	-	-	0	-	-	0	-	-	0	-
Grade, %	-	0	-	-	0	-	-	0	-	-	0	-
Peak Hour Factor	97	97	97	97	97	97	97	97	97	97	97	97
Heavy Vehicles, %	1	1	1	1	1	1	0	0	0	0	0	0
Mvmt Flow	10	1412	10	10	1227	10	21	10	10	10	10	10

Major/Minor	Major1			Major2			Minor1			Minor2		
Conflicting Flow All	1239	0	0	1422	0	0	2076	2696	711	1985	2696	621
Stage 1	-	-	-	-	-	-	1437	1437	-	1254	1254	-
Stage 2	-	-	-	-	-	-	639	1259	-	731	1442	-
Critical Hdwy	4.12	-	-	4.12	-	-	7.5	6.5	6.9	7.5	6.5	6.9
Critical Hdwy Stg 1	-	-	-	-	-	-	6.5	5.5	-	6.5	5.5	-
Critical Hdwy Stg 2	-	-	-	-	-	-	6.5	5.5	-	6.5	5.5	-
Follow-up Hdwy	2.21	-	-	2.21	-	-	3.5	4	3.3	3.5	4	3.3
Pot Cap-1 Maneuver	563	-	-	480	-	-	32	22	380	37	22	435
Stage 1	-	-	-	-	-	-	143	201	-	185	246	-
Stage 2	-	-	-	-	-	-	436	244	-	384	199	-
Platoon blocked, %	-	-	-	-	-	-	-	-	-	-	-	-
Mov Cap-1 Maneuver	562	-	-	480	-	-	~ 19	21	380	21	21	434
Mov Cap-2 Maneuver	-	-	-	-	-	-	~ 19	21	-	21	21	-
Stage 1	-	-	-	-	-	-	140	197	-	181	240	-
Stage 2	-	-	-	-	-	-	399	238	-	348	195	-



















Approach	EB			WB			NB			SB		
HCM Control Delay, s	0.1			0.1			\$ 616.2			\$ 331.3		
HCM LOS							F			F		

Minor Lane/Major Mvmt	NBLn1	EBL	EBT	EBR	WBL	WBT	WBR	SBLn1
Capacity (veh/h)	26	562	-	-	480	-	-	32
HCM Lane V/C Ratio	1.586	0.018	-	-	0.021	-	-	0.966
HCM Control Delay (s)	\$ 616.2	11.5	-	-	12.7	-	-	\$ 331.3
HCM Lane LOS	F	B	-	-	B	-	-	F
HCM 95th %tile Q(veh)	5	0.1	-	-	0.1	-	-	3.3

Notes
 ~: Volume exceeds capacity \$: Delay exceeds 300s +: Computation Not Defined *: All major volume in platoon

HCM 2010 Signalized Intersection Summary
 8: 5th Avenue/California Avenue & Imjin Parkway

Existing with Project, PM
 06/11/2019

												
Movement	EBL	EBT	EBR	WBL	WBT	WBR	NBL	NBT	NBR	SBL	SBT	SBR
Lane Configurations												
Traffic Volume (veh/h)	260	1020	10	10	1030	100	20	40	10	70	30	200
Future Volume (veh/h)	260	1020	10	10	1030	100	20	40	10	70	30	200
Number	5	2	12	1	6	16	3	8	18	7	4	14
Initial Q (Qb), veh	0	0	0	0	0	0	0	0	0	0	0	0
Ped-Bike Adj(A_pbT)	1.00		1.00	1.00		1.00	1.00		1.00	1.00		0.98
Parking Bus, Adj	1.00	1.00	1.00	1.00	1.00	1.00	1.00	1.00	1.00	1.00	1.00	1.00
Adj Sat Flow, veh/h/ln	1881	1881	1900	1881	1881	1900	1900	1900	1900	1900	1881	1900
Adj Flow Rate, veh/h	268	1052	10	10	1062	97	21	41	7	72	31	37
Adj No. of Lanes	1	2	0	1	2	0	0	1	0	0	1	0
Peak Hour Factor	0.97	0.97	0.97	0.97	0.97	0.97	0.97	0.97	0.97	0.97	0.97	0.97
Percent Heavy Veh, %	1	1	1	1	1	1	0	0	0	1	1	1
Cap, veh/h	330	1976	19	14	1220	111	159	155	23	224	53	52
Arrive On Green	0.18	0.54	0.54	0.01	0.37	0.37	0.12	0.12	0.12	0.12	0.12	0.12
Sat Flow, veh/h	1792	3628	34	1792	3311	302	368	1248	182	747	425	421
Grp Volume(v), veh/h	268	518	544	10	573	586	69	0	0	140	0	0
Grp Sat Flow(s),veh/h/ln	1792	1787	1875	1792	1787	1826	1799	0	0	1592	0	0
Q Serve(g_s), s	6.0	7.7	7.7	0.2	12.4	12.4	0.0	0.0	0.0	2.0	0.0	0.0
Cycle Q Clear(g_c), s	6.0	7.7	7.7	0.2	12.4	12.4	1.4	0.0	0.0	3.4	0.0	0.0
Prop In Lane	1.00		0.02	1.00		0.17	0.30		0.10	0.51		0.26
Lane Grp Cap(c), veh/h	330	974	1021	14	659	673	337	0	0	330	0	0
V/C Ratio(X)	0.81	0.53	0.53	0.71	0.87	0.87	0.20	0.00	0.00	0.42	0.00	0.00
Avail Cap(c_a), veh/h	648	1292	1355	648	1292	1320	932	0	0	869	0	0
HCM Platoon Ratio	1.00	1.00	1.00	1.00	1.00	1.00	1.00	1.00	1.00	1.00	1.00	1.00
Upstream Filter(I)	1.00	1.00	1.00	1.00	1.00	1.00	1.00	0.00	0.00	1.00	0.00	0.00
Uniform Delay (d), s/veh	16.2	6.1	6.1	20.5	12.2	12.2	16.5	0.0	0.0	17.3	0.0	0.0
Incr Delay (d2), s/veh	1.9	0.2	0.2	21.4	1.4	1.4	0.1	0.0	0.0	0.3	0.0	0.0
Initial Q Delay(d3),s/veh	0.0	0.0	0.0	0.0	0.0	0.0	0.0	0.0	0.0	0.0	0.0	0.0
%ile BackOfQ(50%),veh/ln	3.1	3.8	4.0	0.2	6.3	6.4	0.7	0.0	0.0	1.5	0.0	0.0
LnGrp Delay(d),s/veh	18.1	6.2	6.2	41.9	13.6	13.6	16.6	0.0	0.0	17.6	0.0	0.0
LnGrp LOS	B	A	A	D	B	B	B			B		
Approach Vol, veh/h		1330			1169			69				140
Approach Delay, s/veh		8.6			13.8			16.6				17.6
Approach LOS		A			B			B				B
Timer	1	2	3	4	5	6	7	8				
Assigned Phs	1	2		4	5	6		8				
Phs Duration (G+Y+Rc), s	3.8	27.9		9.8	11.1	20.6		9.8				
Change Period (Y+Rc), s	3.5	5.3		4.6	3.5	5.3		4.6				
Max Green Setting (Gmax), s	15.0	30.0		20.0	15.0	30.0		20.0				
Max Q Clear Time (g_c+I1), s	2.2	9.7		5.4	8.0	14.4		3.4				
Green Ext Time (p_c), s	0.0	0.7		0.1	0.0	0.9		0.0				
Intersection Summary												
HCM 2010 Ctrl Delay				11.5								
HCM 2010 LOS				B								

Intersection						
Int Delay, s/veh	0.6					
Movement	EBL	EBR	NBL	NBT	SBT	SBR
Lane Configurations	↔		↔	↑	↑	
Traffic Vol, veh/h	10	10	20	410	240	10
Future Vol, veh/h	10	10	20	410	240	10
Conflicting Peds, #/hr	0	0	0	0	0	0
Sign Control	Stop	Stop	Free	Free	Free	Free
RT Channelized	-	None	-	None	-	None
Storage Length	0	-	155	-	-	-
Veh in Median Storage, #	0	-	-	0	0	-
Grade, %	0	-	-	0	0	-
Peak Hour Factor	92	92	92	92	92	92
Heavy Vehicles, %	2	2	2	2	2	2
Mvmt Flow	11	11	22	446	261	11















Major/Minor	Minor2	Major1	Major2			
Conflicting Flow All	757	267	272	0	-	0
Stage 1	267	-	-	-	-	-
Stage 2	490	-	-	-	-	-
Critical Hdwy	6.42	6.22	4.12	-	-	-
Critical Hdwy Stg 1	5.42	-	-	-	-	-
Critical Hdwy Stg 2	5.42	-	-	-	-	-
Follow-up Hdwy	3.518	3.318	2.218	-	-	-
Pot Cap-1 Maneuver	375	772	1291	-	-	-
Stage 1	778	-	-	-	-	-
Stage 2	616	-	-	-	-	-
Platoon blocked, %				-	-	-
Mov Cap-1 Maneuver	369	772	1291	-	-	-
Mov Cap-2 Maneuver	369	-	-	-	-	-
Stage 1	765	-	-	-	-	-
Stage 2	616	-	-	-	-	-

Approach	EB	NB	SB
HCM Control Delay, s	12.5	0.4	0
HCM LOS	B		

Minor Lane/Major Mvmt	NBL	NBT	EBLn1	SBT	SBR
Capacity (veh/h)	1291	-	499	-	-
HCM Lane V/C Ratio	0.017	-	0.044	-	-
HCM Control Delay (s)	7.8	-	12.5	-	-
HCM Lane LOS	A	-	B	-	-
HCM 95th %tile Q(veh)	0.1	-	0.1	-	-

HCM 2010 Signalized Intersection Summary
 10: Imjin Road & Imjin Parkway

Existing with Project, PM
 06/11/2019

								
Movement	EBT	EBR	WBL	WBT	NBL	NBR		
Lane Configurations	 			 	  			
Traffic Volume (veh/h)	970	110	200	870	240	390		
Future Volume (veh/h)	970	110	200	870	240	390		
Number	2	12	1	6	3	18		
Initial Q (Qb), veh	0	0	0	0	0	0		
Ped-Bike Adj(A_pbT)		1.00	1.00		1.00	1.00		
Parking Bus, Adj	1.00	1.00	1.00	1.00	1.00	1.00		
Adj Sat Flow, veh/h/ln	1881	1900	1881	1881	1881	1881		
Adj Flow Rate, veh/h	1021	113	211	916	199	402		
Adj No. of Lanes	2	0	1	2	1	2		
Peak Hour Factor	0.95	0.95	0.95	0.95	0.95	0.95		
Percent Heavy Veh, %	1	1	1	1	1	1		
Cap, veh/h	1163	129	265	2233	299	533		
Arrive On Green	0.36	0.36	0.15	0.62	0.17	0.17		
Sat Flow, veh/h	3340	359	1792	3668	1792	3198		
Grp Volume(v), veh/h	562	572	211	916	199	402		
Grp Sat Flow(s),veh/h/ln	1787	1818	1792	1787	1792	1599		
Q Serve(g_s), s	13.1	13.2	5.1	5.8	4.6	5.3		
Cycle Q Clear(g_c), s	13.1	13.2	5.1	5.8	4.6	5.3		
Prop In Lane		0.20	1.00		1.00	1.00		
Lane Grp Cap(c), veh/h	640	651	265	2233	299	533		
V/C Ratio(X)	0.88	0.88	0.80	0.41	0.67	0.75		
Avail Cap(c_a), veh/h	1202	1222	803	2403	883	1577		
HCM Platoon Ratio	1.00	1.00	1.00	1.00	1.00	1.00		
Upstream Filter(I)	1.00	1.00	1.00	1.00	1.00	1.00		
Uniform Delay (d), s/veh	13.4	13.4	18.4	4.2	17.4	17.7		
Incr Delay (d2), s/veh	1.6	1.6	2.1	0.0	1.0	0.8		
Initial Q Delay(d3),s/veh	0.0	0.0	0.0	0.0	0.0	0.0		
%ile BackOfQ(50%),veh/ln	6.7	6.8	2.7	2.8	2.3	2.4		
LnGrp Delay(d),s/veh	15.0	15.0	20.4	4.3	18.4	18.5		
LnGrp LOS	B	B	C	A	B	B		
Approach Vol, veh/h	1134			1127	601			
Approach Delay, s/veh	15.0			7.3	18.5			
Approach LOS	B			A	B			
Timer	1	2	3	4	5	6	7	8
Assigned Phs	1	2				6		8
Phs Duration (G+Y+Rc), s	11.9	21.3				33.2		11.4
Change Period (Y+Rc), s	5.3	* 5.3				5.3		4.0
Max Green Setting (Gmax), s	20.0	* 30				30.0		22.0
Max Q Clear Time (g_c+I1), s	7.1	15.2				7.8		7.3
Green Ext Time (p_c), s	0.0	0.8				1.0		0.1
Intersection Summary								
HCM 2010 Ctrl Delay			12.7					
HCM 2010 LOS			B					
Notes								

HCM 2010 Signalized Intersection Summary
 11: Abrams Drive & Imjin Parkway

Existing with Project, PM
 06/11/2019



Movement	EBL	EBT	EBR	WBL	WBT	WBR	NBL	NBT	NBR	SBL	SBT	SBR
Lane Configurations												
Traffic Volume (veh/h)	100	960	250	170	830	60	160	20	160	30	20	90
Future Volume (veh/h)	100	960	250	170	830	60	160	20	160	30	20	90
Number	5	2	12	1	6	16	3	8	18	7	4	14
Initial Q (Qb), veh	0	0	0	0	0	0	0	0	0	0	0	0
Ped-Bike Adj(A_pbT)	1.00		1.00	1.00		1.00	1.00		1.00	1.00		1.00
Parking Bus, Adj	1.00	1.00	1.00	1.00	1.00	1.00	1.00	1.00	1.00	1.00	1.00	1.00
Adj Sat Flow, veh/h/ln	1881	1881	1881	1881	1881	1881	1900	1881	1881	1900	1863	1863
Adj Flow Rate, veh/h	108	1032	0	183	892	0	172	22	0	32	22	0
Adj No. of Lanes	1	1	1	1	1	1	0	1	1	0	1	1
Peak Hour Factor	0.93	0.93	0.93	0.93	0.93	0.93	0.93	0.93	0.93	0.93	0.93	0.93
Percent Heavy Veh, %	1	1	1	1	1	1	1	1	1	2	2	2
Cap, veh/h	138	1060	901	220	1136	965	288	26	245	208	126	242
Arrive On Green	0.08	0.56	0.00	0.12	0.60	0.00	0.15	0.15	0.00	0.15	0.15	0.00
Sat Flow, veh/h	1792	1881	1599	1792	1881	1599	1329	170	1599	893	822	1583
Grp Volume(v), veh/h	108	1032	0	183	892	0	194	0	0	54	0	0
Grp Sat Flow(s),veh/h/ln	1792	1881	1599	1792	1881	1599	1498	0	1599	1715	0	1583
Q Serve(g_s), s	4.7	42.4	0.0	8.0	28.5	0.0	7.9	0.0	0.0	0.0	0.0	0.0
Cycle Q Clear(g_c), s	4.7	42.4	0.0	8.0	28.5	0.0	10.0	0.0	0.0	2.1	0.0	0.0
Prop In Lane	1.00		1.00	1.00		1.00	0.89		1.00	0.59		1.00
Lane Grp Cap(c), veh/h	138	1060	901	220	1136	965	314	0	245	334	0	242
V/C Ratio(X)	0.78	0.97	0.00	0.83	0.79	0.00	0.62	0.00	0.00	0.16	0.00	0.00
Avail Cap(c_a), veh/h	448	1177	1001	448	1177	1001	634	0	600	678	0	595
HCM Platoon Ratio	1.00	1.00	1.00	1.00	1.00	1.00	1.00	1.00	1.00	1.00	1.00	1.00
Upstream Filter(I)	1.00	1.00	0.00	1.00	1.00	0.00	1.00	0.00	0.00	1.00	0.00	0.00
Uniform Delay (d), s/veh	36.2	16.8	0.0	34.2	11.9	0.0	32.7	0.0	0.0	29.5	0.0	0.0
Incr Delay (d2), s/veh	3.7	18.7	0.0	3.1	3.1	0.0	0.7	0.0	0.0	0.1	0.0	0.0
Initial Q Delay(d3),s/veh	0.0	0.0	0.0	0.0	0.0	0.0	0.0	0.0	0.0	0.0	0.0	0.0
%ile BackOfQ(50%),veh/ln	2.5	27.3	0.0	4.1	15.6	0.0	4.2	0.0	0.0	1.0	0.0	0.0
LnGrp Delay(d),s/veh	39.9	35.5	0.0	37.3	15.0	0.0	33.4	0.0	0.0	29.6	0.0	0.0
LnGrp LOS	D	D		D	B		C			C		
Approach Vol, veh/h		1140			1075			194			54	
Approach Delay, s/veh		35.9			18.8			33.4			29.6	
Approach LOS		D			B			C			C	
Timer	1	2	3	4	5	6	7	8				
Assigned Phs	1	2		4	5	6		8				
Phs Duration (G+Y+Rc), s	3.3	50.3		16.2	10.1	53.5		16.2				
Change Period (Y+Rc), s	3.5	5.3		4.0	4.0	5.3		4.0				
Max Green Setting (Gmax), s	20.0	50.0		30.0	20.0	50.0		30.0				
Max Q Clear Time (g_c+110), s	11.0	44.4		4.1	6.7	30.5		12.0				
Green Ext Time (p_c), s	0.0	0.7		0.0	0.0	0.7		0.2				
Intersection Summary												
HCM 2010 Ctrl Delay				28.1								
HCM 2010 LOS				C								

HCM 2010 Signalized Intersection Summary
 12: Reservation Road & Imjin Parkway

Existing with Project, PM
 06/11/2019



Movement	EBL	EBT	EBR	WBL	WBT	WBR	NBL	NBT	NBR	SBL	SBT	SBR
Lane Configurations												
Traffic Volume (veh/h)	100	10	1070	10	30	30	890	540	10	10	650	190
Future Volume (veh/h)	100	10	1070	10	30	30	890	540	10	10	650	190
Number	3	8	18	7	4	14	1	6	16	5	2	12
Initial Q (Qb), veh	0	0	0	0	0	0	0	0	0	0	0	0
Ped-Bike Adj(A_pbT)	1.00		1.00	1.00		0.98	1.00		1.00	1.00		1.00
Parking Bus, Adj	1.00	1.00	1.00	1.00	1.00	1.00	1.00	1.00	1.00	1.00	1.00	1.00
Adj Sat Flow, veh/h/ln	1881	1881	1881	1827	1827	1827	1881	1881	1881	1881	1881	1881
Adj Flow Rate, veh/h	120	0	801	11	34	12	1000	607	10	11	730	79
Adj No. of Lanes	2	0	2	1	1	1	2	2	1	2	2	1
Peak Hour Factor	0.89	0.89	0.89	0.89	0.89	0.89	0.89	0.89	0.89	0.89	0.89	0.89
Percent Heavy Veh, %	1	1	1	4	4	4	1	1	1	1	1	1
Cap, veh/h	735	0	1573	66	70	58	1001	2057	920	35	1065	476
Arrive On Green	0.21	0.00	0.21	0.04	0.04	0.04	0.29	0.58	0.58	0.01	0.30	0.30
Sat Flow, veh/h	3583	0	3182	1740	1827	1528	3476	3574	1599	3476	3574	1599
Grp Volume(v), veh/h	120	0	801	11	34	12	1000	607	10	11	730	79
Grp Sat Flow(s),veh/h/ln	1792	0	1591	1740	1827	1528	1738	1787	1599	1738	1787	1599
Q Serve(g_s), s	3.3	0.0	20.7	0.7	2.2	0.9	35.0	10.6	0.3	0.4	21.9	4.4
Cycle Q Clear(g_c), s	3.3	0.0	20.7	0.7	2.2	0.9	35.0	10.6	0.3	0.4	21.9	4.4
Prop In Lane	1.00		1.00	1.00		1.00	1.00		1.00	1.00		1.00
Lane Grp Cap(c), veh/h	735	0	1573	66	70	58	1001	2057	920	35	1065	476
V/C Ratio(X)	0.16	0.00	0.51	0.17	0.49	0.21	1.00	0.30	0.01	0.31	0.69	0.17
Avail Cap(c_a), veh/h	1032	0	1837	444	466	390	1001	2057	920	572	1764	789
HCM Platoon Ratio	1.00	1.00	1.00	1.00	1.00	1.00	1.00	1.00	1.00	1.00	1.00	1.00
Upstream Filter(I)	1.00	0.00	1.00	1.00	1.00	1.00	1.00	1.00	1.00	1.00	1.00	1.00
Uniform Delay (d), s/veh	39.7	0.0	20.9	56.6	57.3	56.7	43.3	13.2	11.0	59.7	37.7	31.5
Incr Delay (d2), s/veh	0.0	0.0	0.1	0.4	2.0	0.6	28.3	0.2	0.0	1.8	2.2	0.4
Initial Q Delay(d3),s/veh	0.0	0.0	0.0	0.0	0.0	0.0	0.0	0.0	0.0	0.0	0.0	0.0
%ile BackOfQ(50%),veh/ln	1.7	0.0	9.1	0.4	1.2	0.4	20.6	5.3	0.1	0.2	11.2	2.0
LnGrp Delay(d),s/veh	39.8	0.0	21.0	57.0	59.3	57.3	71.6	13.4	11.0	61.6	39.8	32.0
LnGrp LOS	D		C	E	E	E	E	B	B	E	D	C
Approach Vol, veh/h		921			57			1617			820	
Approach Delay, s/veh		23.4			58.4			49.4			39.4	
Approach LOS		C			E			D			D	
Timer	1	2	3	4	5	6	7	8				
Assigned Phs	1	2		4	5	6		8				
Phs Duration (G+Y+Rc), s	39.1	42.4		9.6	5.3	76.2		30.4				
Change Period (Y+Rc), s	4.1	* 6.2		5.0	4.1	* 6.2		5.5				
Max Green Setting (Gmax), s	35.0	* 60		31.0	20.0	* 50		35.0				
Max Q Clear Time (g_c+Q), s	37.0	23.9		4.2	2.4	12.6		22.7				
Green Ext Time (p_c), s	0.0	12.3		0.1	0.0	9.3		1.8				
Intersection Summary												
HCM 2010 Ctrl Delay			40.1									
HCM 2010 LOS			D									
Notes												

HCM 2010 Signalized Intersection Summary
 13: Reservation Road & Blanco Road

Existing with Project, PM
 06/11/2019

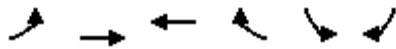

Movement	EBL	EBT	WBT	WBR	SBL	SBR		
Lane Configurations	↶↷	↶↷	↶	↶	↶↷	↶↷		
Traffic Volume (veh/h)	1080	560	340	40	30	1110		
Future Volume (veh/h)	1080	560	340	40	30	1110		
Number	5	2	6	16	7	14		
Initial Q (Qb), veh	0	0	0	0	0	0		
Ped-Bike Adj(A_pbT)	1.00			1.00	1.00	1.00		
Parking Bus, Adj	1.00	1.00	1.00	1.00	1.00	1.00		
Adj Sat Flow, veh/h/ln	1881	1881	1863	1863	1863	1863		
Adj Flow Rate, veh/h	1149	596	362	19	32	0		
Adj No. of Lanes	2	2	1	1	2	2		
Peak Hour Factor	0.94	0.94	0.94	0.94	0.94	0.94		
Percent Heavy Veh, %	1	1	2	2	2	2		
Cap, veh/h	1295	2708	483	411	101	82		
Arrive On Green	0.37	0.76	0.26	0.26	0.03	0.00		
Sat Flow, veh/h	3476	3668	1863	1583	3442	2787		
Grp Volume(v), veh/h	1149	596	362	19	32	0		
Grp Sat Flow(s),veh/h/ln	1738	1787	1863	1583	1721	1393		
Q Serve(g_s), s	13.5	2.1	7.8	0.4	0.4	0.0		
Cycle Q Clear(g_c), s	13.5	2.1	7.8	0.4	0.4	0.0		
Prop In Lane	1.00			1.00	1.00	1.00		
Lane Grp Cap(c), veh/h	1295	2708	483	411	101	82		
V/C Ratio(X)	0.89	0.22	0.75	0.05	0.32	0.00		
Avail Cap(c_a), veh/h	3181	4907	2557	2174	2126	1721		
HCM Platoon Ratio	1.00	1.00	1.00	1.00	1.00	1.00		
Upstream Filter(I)	1.00	1.00	1.00	1.00	1.00	0.00		
Uniform Delay (d), s/veh	12.9	1.5	14.9	12.1	20.8	0.0		
Incr Delay (d2), s/veh	0.9	0.0	1.8	0.0	0.7	0.0		
Initial Q Delay(d3),s/veh	0.0	0.0	0.0	0.0	0.0	0.0		
%ile BackOfQ(50%),veh/ln	6.5	1.0	4.2	0.2	0.2	0.0		
LnGrp Delay(d),s/veh	13.7	1.6	16.6	12.2	21.4	0.0		
LnGrp LOS	B	A	B	B	C			
Approach Vol, veh/h		1745	381		32			
Approach Delay, s/veh		9.6	16.4		21.4			
Approach LOS		A	B		C			
Timer	1	2	3	4	5	6	7	8
Assigned Phs		2		4	5	6		
Phs Duration (G+Y+Rc), s		38.9		4.8	21.8	17.1		
Change Period (Y+Rc), s		5.8		3.5	5.5	5.8		
Max Green Setting (Gmax), s		60.0		27.0	40.0	60.0		
Max Q Clear Time (g_c+I1), s		4.1		2.4	15.5	9.8		
Green Ext Time (p_c), s		3.0		0.0	0.7	1.5		
Intersection Summary								
HCM 2010 Ctrl Delay			11.0					
HCM 2010 LOS			B					

HCM 2010 Signalized Intersection Summary
 14: Reservation Road & Inter-Garrison Road

Existing with Project, PM
 06/11/2019



Movement	EBL	EBR	NBL	NBT	SBT	SBR		
Lane Configurations								
Traffic Volume (veh/h)	50	350	200	340	530	50		
Future Volume (veh/h)	50	350	200	340	530	50		
Number	3	18	1	6	2	12		
Initial Q (Qb), veh	0	0	0	0	0	0		
Ped-Bike Adj(A_pbT)	1.00	1.00	1.00			1.00		
Parking Bus, Adj	1.00	1.00	1.00	1.00	1.00	1.00		
Adj Sat Flow, veh/h/ln	1881	1881	1845	1845	1881	1900		
Adj Flow Rate, veh/h	61	272	244	415	646	52		
Adj No. of Lanes	1	1	1	2	2	0		
Peak Hour Factor	0.82	0.82	0.82	0.82	0.82	0.82		
Percent Heavy Veh, %	1	1	3	3	1	1		
Cap, veh/h	336	573	300	2128	1164	94		
Arrive On Green	0.19	0.19	0.17	0.61	0.35	0.35		
Sat Flow, veh/h	1792	1599	1757	3597	3445	269		
Grp Volume(v), veh/h	61	272	244	415	344	354		
Grp Sat Flow(s),veh/h/ln	1792	1599	1757	1752	1787	1834		
Q Serve(g_s), s	1.5	7.0	7.1	2.8	8.3	8.3		
Cycle Q Clear(g_c), s	1.5	7.0	7.1	2.8	8.3	8.3		
Prop In Lane	1.00	1.00	1.00			0.15		
Lane Grp Cap(c), veh/h	336	573	300	2128	621	637		
V/C Ratio(X)	0.18	0.47	0.81	0.20	0.55	0.56		
Avail Cap(c_a), veh/h	912	1087	662	3965	2022	2074		
HCM Platoon Ratio	1.00	1.00	1.00	1.00	1.00	1.00		
Upstream Filter(I)	1.00	1.00	1.00	1.00	1.00	1.00		
Uniform Delay (d), s/veh	18.1	13.2	21.2	4.6	14.0	14.0		
Incr Delay (d2), s/veh	0.3	0.6	2.0	0.1	1.4	1.4		
Initial Q Delay(d3),s/veh	0.0	0.0	0.0	0.0	0.0	0.0		
%ile BackOfQ(50%),veh/ln	0.8	3.1	3.6	1.4	4.3	4.4		
LnGrp Delay(d),s/veh	18.4	13.8	23.2	4.7	15.4	15.4		
LnGrp LOS	B	B	C	A	B	B		
Approach Vol, veh/h	333			659	698			
Approach Delay, s/veh	14.6			11.6	15.4			
Approach LOS	B			B	B			
Timer	1	2	3	4	5	6	7	8
Assigned Phs	1	2				6		8
Phs Duration (G+Y+Rc), s	3.8	24.8				38.6		14.4
Change Period (Y+Rc), s	4.7	6.4				6.4		4.5
Max Green Setting (Gmax), s	20	60.0				60.0		27.0
Max Q Clear Time (g_c+19), s	10.3					4.8		9.0
Green Ext Time (p_c), s	0.2	8.2				4.8		1.0
Intersection Summary								
HCM 2010 Ctrl Delay			13.8					
HCM 2010 LOS			B					
Notes								

Intersection												
Intersection Delay, s/veh	14.3											
Intersection LOS	B											

Movement	EBL	EBT	EBR	WBL	WBT	WBR	NBL	NBT	NBR	SBL	SBT	SBR
Lane Configurations		↕	↗		↕		↕	↗			↕	↗
Traffic Vol, veh/h	30	10	10	10	10	10	20	400	30	10	260	30
Future Vol, veh/h	30	10	10	10	10	10	20	400	30	10	260	30
Peak Hour Factor	0.91	0.91	0.91	0.91	0.91	0.91	0.91	0.91	0.91	0.91	0.91	0.91
Heavy Vehicles, %	0	0	0	0	0	0	1	1	1	4	4	4
Mvmt Flow	33	11	11	11	11	11	22	440	33	11	286	33
Number of Lanes	0	1	1	0	1	0	1	1	0	0	1	1

Approach	EB	WB	NB	SB
Opposing Approach	WB	EB	SB	NB
Opposing Lanes	1	2	2	2
Conflicting Approach Left	SB	NB	EB	WB
Conflicting Lanes Left	2	2	2	1
Conflicting Approach Right	NB	SB	WB	EB
Conflicting Lanes Right	2	2	1	2
HCM Control Delay	10	9.9	16.8	11.6
HCM LOS	A	A	C	B

Lane	NBLn1	NBLn2	EBLn1	EBLn2	WBLn1	SBLn1	SBLn2
Vol Left, %	100%	0%	75%	0%	33%	4%	0%
Vol Thru, %	0%	93%	25%	0%	33%	96%	0%
Vol Right, %	0%	7%	0%	100%	33%	0%	100%
Sign Control	Stop	Stop	Stop	Stop	Stop	Stop	Stop
Traffic Vol by Lane	20	430	40	10	30	270	30
LT Vol	20	0	30	0	10	10	0
Through Vol	0	400	10	0	10	260	0
RT Vol	0	30	0	10	10	0	30
Lane Flow Rate	22	473	44	11	33	297	33
Geometry Grp	7	7	7	7	6	7	7
Degree of Util (X)	0.034	0.661	0.085	0.018	0.06	0.436	0.042
Departure Headway (Hd)	5.591	5.039	6.966	5.875	6.519	5.294	4.571
Convergence, Y/N	Yes	Yes	Yes	Yes	Yes	Yes	Yes
Cap	638	714	517	613	553	676	777
Service Time	3.35	2.798	4.668	3.576	4.52	3.059	2.335
HCM Lane V/C Ratio	0.034	0.662	0.085	0.018	0.06	0.439	0.042
HCM Control Delay	8.5	17.2	10.3	8.7	9.9	12.1	7.5
HCM Lane LOS	A	C	B	A	A	B	A
HCM 95th-tile Q	0.1	5	0.3	0.1	0.2	2.2	0.1

Intersection												
Intersection Delay, s/veh	23.3											
Intersection LOS	C											

Movement	EBL	EBT	EBR	WBL	WBT	WBR	NBL	NBT	NBR	SBL	SBT	SBR
Lane Configurations												
Traffic Vol, veh/h	10	10	10	180	10	50	10	400	160	50	310	10
Future Vol, veh/h	10	10	10	180	10	50	10	400	160	50	310	10
Peak Hour Factor	0.94	0.94	0.94	0.94	0.94	0.94	0.94	0.94	0.94	0.94	0.94	0.94
Heavy Vehicles, %	0	0	0	0	0	0	1	1	1	4	4	4
Mvmt Flow	11	11	11	191	11	53	11	426	170	53	330	11
Number of Lanes	1	1	1	0	1	1	1	1	1	1	1	0

Approach	EB	WB	NB	SB
Opposing Approach	WB	EB	SB	NB
Opposing Lanes	2	3	2	3
Conflicting Approach Left	SB	NB	EB	WB
Conflicting Lanes Left	2	3	3	2
Conflicting Approach Right	NB	SB	WB	EB
Conflicting Lanes Right	3	2	2	3
HCM Control Delay	11.6	16.5	27.1	22.7
HCM LOS	B	C	D	C

Lane	NBLn1	NBLn2	NBLn3	EBLn1	EBLn2	EBLn3	WBLn1	WBLn2	SBLn1	SBLn2
Vol Left, %	100%	0%	0%	100%	0%	0%	95%	0%	100%	0%
Vol Thru, %	0%	100%	0%	0%	100%	0%	5%	0%	0%	97%
Vol Right, %	0%	0%	100%	0%	0%	100%	0%	100%	0%	3%
Sign Control	Stop	Stop	Stop	Stop	Stop	Stop	Stop	Stop	Stop	Stop
Traffic Vol by Lane	10	400	160	10	10	10	190	50	50	320
LT Vol	10	0	0	10	0	0	180	0	50	0
Through Vol	0	400	0	0	10	0	10	0	0	310
RT Vol	0	0	160	0	0	10	0	50	0	10
Lane Flow Rate	11	426	170	11	11	11	202	53	53	340
Geometry Grp	8	8	8	8	8	8	8	8	8	8
Degree of Util (X)	0.022	0.817	0.293	0.027	0.026	0.024	0.464	0.104	0.115	0.686
Departure Headway (Hd)	7.42	6.914	6.205	9.22	8.706	7.985	8.257	7.063	7.783	7.255
Convergence, Y/N	Yes	Yes	Yes	Yes	Yes	Yes	Yes	Yes	Yes	Yes
Cap	483	523	579	388	411	447	437	507	461	497
Service Time	5.161	4.654	3.945	6.985	6.47	5.75	6.001	4.807	5.525	4.998
HCM Lane V/C Ratio	0.023	0.815	0.294	0.028	0.027	0.025	0.462	0.105	0.115	0.684
HCM Control Delay	10.3	33.7	11.5	12.2	11.7	10.9	18	10.6	11.5	24.5
HCM Lane LOS	B	D	B	B	B	B	C	B	B	C
HCM 95th-tile Q	0.1	8	1.2	0.1	0.1	0.1	2.4	0.3	0.4	5.2

Intersection	
Intersection Delay, s/veh	12.3
Intersection LOS	B

Movement	EBT	EBR	WBL	WBT	NBL	NBR
Lane Configurations	↑	↗	↖	↑	↖	↗
Traffic Vol, veh/h	170	50	220	180	50	270
Future Vol, veh/h	170	50	220	180	50	270
Peak Hour Factor	0.92	0.92	0.92	0.92	0.92	0.92
Heavy Vehicles, %	2	2	2	2	2	2
Mvmt Flow	185	54	239	196	54	293
Number of Lanes	1	1	1	1	1	1

Approach	EB	WB	NB
Opposing Approach	WB	EB	
Opposing Lanes	2	2	0
Conflicting Approach Left		NB	EB
Conflicting Lanes Left	0	2	2
Conflicting Approach Right	NB		WB
Conflicting Lanes Right	2	0	2
HCM Control Delay	11.1	12.7	12.7
HCM LOS	B	B	B

Lane	NBLn1	NBLn2	EBLn1	EBLn2	WBLn1	WBLn2
Vol Left, %	100%	0%	0%	0%	100%	0%
Vol Thru, %	0%	0%	100%	0%	0%	100%
Vol Right, %	0%	100%	0%	100%	0%	0%
Sign Control	Stop	Stop	Stop	Stop	Stop	Stop
Traffic Vol by Lane	50	270	170	50	220	180
LT Vol	50	0	0	0	220	0
Through Vol	0	0	170	0	0	180
RT Vol	0	270	0	50	0	0
Lane Flow Rate	54	293	185	54	239	196
Geometry Grp	7	7	7	7	7	7
Degree of Util (X)	0.103	0.459	0.318	0.083	0.426	0.321
Departure Headway (Hd)	6.838	5.626	6.19	5.478	6.411	5.904
Convergence, Y/N	Yes	Yes	Yes	Yes	Yes	Yes
Cap	524	640	580	653	562	608
Service Time	4.578	3.365	3.931	3.219	4.147	3.64
HCM Lane V/C Ratio	0.103	0.458	0.319	0.083	0.425	0.322
HCM Control Delay	10.4	13.1	11.8	8.7	13.8	11.4
HCM Lane LOS	B	B	B	A	B	B
HCM 95th-tile Q	0.3	2.4	1.4	0.3	2.1	1.4

Intersection												
Intersection Delay, s/veh	21.7											
Intersection LOS	C											

Movement	EBL	EBT	EBR	WBL	WBT	WBR	NBL	NBT	NBR	SBL	SBT	SBR
Lane Configurations	↖	↗		↖	↗	↖		↔			↖	↗
Traffic Vol, veh/h	190	60	20	10	50	370	20	20	20	260	20	90
Future Vol, veh/h	190	60	20	10	50	370	20	20	20	260	20	90
Peak Hour Factor	0.91	0.91	0.91	0.91	0.91	0.91	0.91	0.91	0.91	0.91	0.91	0.91
Heavy Vehicles, %	3	3	3	1	1	1	0	0	0	2	2	2
Mvmt Flow	209	66	22	11	55	407	22	22	22	286	22	99
Number of Lanes	1	1	0	1	1	1	0	1	0	0	1	1

Approach	EB	WB	NB	SB
Opposing Approach	WB	EB	SB	NB
Opposing Lanes	3	2	2	1
Conflicting Approach Left	SB	NB	EB	WB
Conflicting Lanes Left	2	1	2	3
Conflicting Approach Right	NB	SB	WB	EB
Conflicting Lanes Right	1	2	3	2
HCM Control Delay	16.8	25.3	12.9	22.6
HCM LOS	C	D	B	C

Lane	NBLn1	EBLn1	EBLn2	WBLn1	WBLn2	WBLn3	SBLn1	SBLn2
Vol Left, %	33%	100%	0%	100%	0%	0%	93%	0%
Vol Thru, %	33%	0%	75%	0%	100%	0%	7%	0%
Vol Right, %	33%	0%	25%	0%	0%	100%	0%	100%
Sign Control	Stop	Stop	Stop	Stop	Stop	Stop	Stop	Stop
Traffic Vol by Lane	60	190	80	10	50	370	280	90
LT Vol	20	190	0	10	0	0	260	0
Through Vol	20	0	60	0	50	0	20	0
RT Vol	20	0	20	0	0	370	0	90
Lane Flow Rate	66	209	88	11	55	407	308	99
Geometry Grp	8	8	8	8	8	8	8	8
Degree of Util (X)	0.156	0.484	0.187	0.024	0.113	0.758	0.682	0.187
Departure Headway (Hd)	8.543	8.34	7.644	7.941	7.429	6.712	7.984	6.801
Convergence, Y/N	Yes	Yes	Yes	Yes	Yes	Yes	Yes	Yes
Cap	418	432	469	450	481	537	452	526
Service Time	6.331	6.108	5.411	5.7	5.188	4.471	5.748	4.564
HCM Lane V/C Ratio	0.158	0.484	0.188	0.024	0.114	0.758	0.681	0.188
HCM Control Delay	12.9	18.7	12.2	10.9	11.1	27.6	26.3	11.1
HCM Lane LOS	B	C	B	B	B	D	D	B
HCM 95th-tile Q	0.5	2.6	0.7	0.1	0.4	6.6	5	0.7

Intersection	
Intersection Delay, s/veh	22.3
Intersection LOS	C

Movement	WBL	WBR	NBT	NBR	SBL	SBT
Lane Configurations						
Traffic Vol, veh/h	40	10	550	30	10	490
Future Vol, veh/h	40	10	550	30	10	490
Peak Hour Factor	0.97	0.97	0.97	0.97	0.97	0.97
Heavy Vehicles, %	0	0	1	1	2	2
Mvmt Flow	41	10	567	31	10	505
Number of Lanes	1	1	1	1	1	1

Approach	WB	NB	SB
Opposing Approach		SB	NB
Opposing Lanes	0	2	2
Conflicting Approach Left	NB		WB
Conflicting Lanes Left	2	0	2
Conflicting Approach Right	SB	WB	
Conflicting Lanes Right	2	2	0
HCM Control Delay	10.7	24.8	20.6
HCM LOS	B	C	C

Lane	NBLn1	NBLn2	WBLn1	WBLn2	SBLn1	SBLn2
Vol Left, %	0%	0%	100%	0%	100%	0%
Vol Thru, %	100%	0%	0%	0%	0%	100%
Vol Right, %	0%	100%	0%	100%	0%	0%
Sign Control	Stop	Stop	Stop	Stop	Stop	Stop
Traffic Vol by Lane	550	30	40	10	10	490
LT Vol	0	0	40	0	10	0
Through Vol	550	0	0	0	0	490
RT Vol	0	30	0	10	0	0
Lane Flow Rate	567	31	41	10	10	505
Geometry Grp	7	7	7	7	7	7
Degree of Util (X)	0.807	0.038	0.087	0.018	0.016	0.73
Departure Headway (Hd)	5.124	4.419	7.631	6.406	5.709	5.205
Convergence, Y/N	Yes	Yes	Yes	Yes	Yes	Yes
Cap	703	806	473	562	625	692
Service Time	2.876	2.171	5.331	4.106	3.466	2.962
HCM Lane V/C Ratio	0.807	0.038	0.087	0.018	0.016	0.73
HCM Control Delay	25.8	7.3	11.1	9.2	8.6	20.8
HCM Lane LOS	D	A	B	A	A	C
HCM 95th-tile Q	8.4	0.1	0.3	0.1	0	6.4

Intersection												
Intersection Delay, s/veh	7.9											
Intersection LOS	A											

Movement	EBL	EBT	EBR	WBL	WBT	WBR	NBL	NBT	NBR	SBL	SBT	SBR
Lane Configurations		↕			↕			↕			↕	
Traffic Vol, veh/h	10	10	10	10	10	20	10	80	10	20	90	10
Future Vol, veh/h	10	10	10	10	10	20	10	80	10	20	90	10
Peak Hour Factor	0.82	0.82	0.82	0.82	0.82	0.82	0.82	0.82	0.82	0.82	0.82	0.82
Heavy Vehicles, %	1	1	1	1	1	1	3	3	3	0	0	0
Mvmt Flow	12	12	12	12	12	24	12	98	12	24	110	12
Number of Lanes	0	1	0	0	1	0	0	1	0	0	1	0

Approach	EB	WB	NB	SB
Opposing Approach	WB	EB	SB	NB
Opposing Lanes	1	1	1	1
Conflicting Approach Left	SB	NB	EB	WB
Conflicting Lanes Left	1	1	1	1
Conflicting Approach Right	NB	SB	WB	EB
Conflicting Lanes Right	1	1	1	1
HCM Control Delay	7.6	7.6	8	8.1
HCM LOS	A	A	A	A

Lane	NBLn1	EBLn1	WBLn1	SBLn1
Vol Left, %	10%	33%	25%	17%
Vol Thru, %	80%	33%	25%	75%
Vol Right, %	10%	33%	50%	8%
Sign Control	Stop	Stop	Stop	Stop
Traffic Vol by Lane	100	30	40	120
LT Vol	10	10	10	20
Through Vol	80	10	10	90
RT Vol	10	10	20	10
Lane Flow Rate	122	37	49	146
Geometry Grp	1	1	1	1
Degree of Util (X)	0.141	0.045	0.058	0.168
Departure Headway (Hd)	4.172	4.428	4.298	4.125
Convergence, Y/N	Yes	Yes	Yes	Yes
Cap	848	813	838	858
Service Time	2.259	2.43	2.299	2.207
HCM Lane V/C Ratio	0.144	0.046	0.058	0.17
HCM Control Delay	8	7.6	7.6	8.1
HCM Lane LOS	A	A	A	A
HCM 95th-tile Q	0.5	0.1	0.2	0.6

Intersection	
Intersection Delay, s/veh	51.6
Intersection LOS	F

Movement	EBL	EBT	EBR	WBL	WBT	WBR	NBL	NBT	NBR	SBL	SBT	SBR
Lane Configurations		↕			↕			↕			↕	↕
Traffic Vol, veh/h	10	140	10	180	80	30	10	270	300	80	140	10
Future Vol, veh/h	10	140	10	180	80	30	10	270	300	80	140	10
Peak Hour Factor	0.93	0.93	0.93	0.93	0.93	0.93	0.93	0.93	0.93	0.93	0.93	0.93
Heavy Vehicles, %	1	1	1	4	4	4	5	5	5	0	0	0
Mvmt Flow	11	151	11	194	86	32	11	290	323	86	151	11
Number of Lanes	0	1	0	0	1	0	0	1	0	0	1	1

Approach	EB	WB	NB	SB
Opposing Approach	WB	EB	SB	NB
Opposing Lanes	1	1	2	1
Conflicting Approach Left	SB	NB	EB	WB
Conflicting Lanes Left	2	1	1	1
Conflicting Approach Right	NB	SB	WB	EB
Conflicting Lanes Right	1	2	1	1
HCM Control Delay	15.3	22.2	89.7	17.7
HCM LOS	C	C	F	C

Lane	NBLn1	EBLn1	WBLn1	SBLn1	SBLn2
Vol Left, %	2%	6%	62%	36%	0%
Vol Thru, %	47%	88%	28%	64%	0%
Vol Right, %	52%	6%	10%	0%	100%
Sign Control	Stop	Stop	Stop	Stop	Stop
Traffic Vol by Lane	580	160	290	220	10
LT Vol	10	10	180	80	0
Through Vol	270	140	80	140	0
RT Vol	300	10	30	0	10
Lane Flow Rate	624	172	312	237	11
Geometry Grp	5	2	2	7	7
Degree of Util (X)	1.093	0.36	0.623	0.497	0.02
Departure Headway (Hd)	6.307	7.928	7.523	7.89	6.98
Convergence, Y/N	Yes	Yes	Yes	Yes	Yes
Cap	580	456	483	459	516
Service Time	4.307	5.928	5.523	5.59	4.68
HCM Lane V/C Ratio	1.076	0.377	0.646	0.516	0.021
HCM Control Delay	89.7	15.3	22.2	18.1	9.8
HCM Lane LOS	F	C	C	C	A
HCM 95th-tile Q	19	1.6	4.2	2.7	0.1

Intersection			
Intersection Delay, s/veh	25.9		
Intersection LOS	D		
Approach	EB	WB	NB
Entry Lanes	1	1	1
Conflicting Circle Lanes	1	1	1
Adj Approach Flow, veh/h	547	691	639
Demand Flow Rate, veh/h	558	705	639
Vehicles Circulating, veh/h	410	10	505
Vehicles Exiting, veh/h	305	1134	463
Follow-Up Headway, s	3.186	3.186	3.186
Ped Vol Crossing Leg, #/h	0	0	0
Ped Cap Adj	1.000	1.000	1.000
Approach Delay, s/veh	21.4	11.9	45.1
Approach LOS	C	B	E
Lane	Left	Left	Left
Designated Moves	TR	LT	LR
Assumed Moves	TR	LT	LR
RT Channelized			
Lane Util	1.000	1.000	1.000
Critical Headway, s	5.193	5.193	5.193
Entry Flow, veh/h	558	705	639
Cap Entry Lane, veh/h	750	1119	682
Entry HV Adj Factor	0.980	0.980	1.000
Flow Entry, veh/h	547	691	639
Cap Entry, veh/h	735	1097	682
V/C Ratio	0.744	0.630	0.937
Control Delay, s/veh	21.4	11.9	45.1
LOS	C	B	E
95th %tile Queue, veh	7	5	13

Intersection						
Intersection Delay, s/veh	78.8					
Intersection LOS	F					

Movement	EBL	EBT	WBT	WBR	SBL	SBR
Lane Configurations						
Traffic Vol, veh/h	540	550	260	20	10	420
Future Vol, veh/h	540	550	260	20	10	420
Peak Hour Factor	0.95	0.95	0.95	0.95	0.95	0.95
Heavy Vehicles, %	2	2	6	6	4	4
Mvmt Flow	568	579	274	21	11	442
Number of Lanes	1	1	1	1	1	1

Approach	EB	WB	SB
Opposing Approach	WB	EB	
Opposing Lanes	2	2	0
Conflicting Approach Left	SB		WB
Conflicting Lanes Left	2	0	2
Conflicting Approach Right		SB	EB
Conflicting Lanes Right	0	2	2
HCM Control Delay	110.4	20.3	36.6
HCM LOS	F	C	E

Lane	EBLn1	EBLn2	WBLn1	WBLn2	SBLn1	SBLn2
Vol Left, %	100%	0%	0%	0%	100%	0%
Vol Thru, %	0%	100%	100%	0%	0%	0%
Vol Right, %	0%	0%	0%	100%	0%	100%
Sign Control	Stop	Stop	Stop	Stop	Stop	Stop
Traffic Vol by Lane	540	550	260	20	10	420
LT Vol	540	0	0	0	10	0
Through Vol	0	550	260	0	0	0
RT Vol	0	0	0	20	0	420
Lane Flow Rate	568	579	274	21	11	442
Geometry Grp	7	7	7	7	7	7
Degree of Util (X)	1.172	1.111	0.584	0.041	0.024	0.841
Departure Headway (Hd)	7.424	6.911	7.917	7.194	8.362	7.137
Convergence, Y/N	Yes	Yes	Yes	Yes	Yes	Yes
Cap	495	527	460	501	431	513
Service Time	5.137	4.624	5.617	4.894	6.062	4.837
HCM Lane V/C Ratio	1.147	1.099	0.596	0.042	0.026	0.862
HCM Control Delay	122.5	98.5	21.1	10.2	11.3	37.2
HCM Lane LOS	F	F	C	B	B	E
HCM 95th-tile Q	20.7	18.8	3.6	0.1	0.1	8.6

Intersection	
Intersection Delay, s/veh	13.9
Intersection LOS	B

Movement	EBL	EBT	WBT	WBR	SBL	SBR
Lane Configurations						
Traffic Vol, veh/h	150	410	210	30	10	70
Future Vol, veh/h	150	410	210	30	10	70
Peak Hour Factor	0.86	0.86	0.86	0.86	0.86	0.86
Heavy Vehicles, %	1	1	5	5	17	17
Mvmt Flow	174	477	244	35	12	81
Number of Lanes	1	1	1	1	1	1

Approach	EB	WB	SB
Opposing Approach	WB	EB	
Opposing Lanes	2	2	0
Conflicting Approach Left	SB		WB
Conflicting Lanes Left	2	0	2
Conflicting Approach Right		SB	EB
Conflicting Lanes Right	0	2	2
HCM Control Delay	15.6	11.1	10
HCM LOS	C	B	A

Lane	EBLn1	EBLn2	WBLn1	WBLn2	SBLn1	SBLn2
Vol Left, %	100%	0%	0%	0%	100%	0%
Vol Thru, %	0%	100%	100%	0%	0%	0%
Vol Right, %	0%	0%	0%	100%	0%	100%
Sign Control	Stop	Stop	Stop	Stop	Stop	Stop
Traffic Vol by Lane	150	410	210	30	10	70
LT Vol	150	0	0	0	10	0
Through Vol	0	410	210	0	0	0
RT Vol	0	0	0	30	0	70
Lane Flow Rate	174	477	244	35	12	81
Geometry Grp	7	7	7	7	7	7
Degree of Util (X)	0.269	0.669	0.374	0.047	0.024	0.139
Departure Headway (Hd)	5.557	5.054	5.507	4.801	7.352	6.137
Convergence, Y/N	Yes	Yes	Yes	Yes	Yes	Yes
Cap	644	710	650	740	484	580
Service Time	3.315	2.812	3.279	2.572	5.145	3.929
HCM Lane V/C Ratio	0.27	0.672	0.375	0.047	0.025	0.14
HCM Control Delay	10.4	17.5	11.6	7.8	10.3	9.9
HCM Lane LOS	B	C	B	A	B	A
HCM 95th-tile Q	1.1	5.2	1.7	0.1	0.1	0.5

Intersection

Intersection Delay, s/veh 13.7

Intersection LOS B

Movement	EBL	EBT	WBT	WBR	SBL	SBR
Lane Configurations		↔	↔		↔	↔
Traffic Vol, veh/h	370	50	30	20	20	190
Future Vol, veh/h	370	50	30	20	20	190
Peak Hour Factor	0.87	0.87	0.87	0.87	0.87	0.87
Heavy Vehicles, %	1	1	6	6	3	3
Mvmt Flow	425	57	34	23	23	218
Number of Lanes	0	1	1	0	1	1

Approach	EB	WB	SB
Opposing Approach	WB	EB	
Opposing Lanes	1	1	0
Conflicting Approach Left	SB		WB
Conflicting Lanes Left	2	0	1
Conflicting Approach Right		SB	EB
Conflicting Lanes Right	0	2	1
HCM Control Delay	16.1	8.5	10.2
HCM LOS	C	A	B

Lane	EBLn1	WBLn1	SBLn1	SBLn2
Vol Left, %	88%	0%	100%	0%
Vol Thru, %	12%	60%	0%	0%
Vol Right, %	0%	40%	0%	100%
Sign Control	Stop	Stop	Stop	Stop
Traffic Vol by Lane	420	50	20	190
LT Vol	370	0	20	0
Through Vol	50	30	0	0
RT Vol	0	20	0	190
Lane Flow Rate	483	57	23	218
Geometry Grp	2	2	7	7
Degree of Util (X)	0.641	0.079	0.041	0.313
Departure Headway (Hd)	4.783	4.973	6.367	5.154
Convergence, Y/N	Yes	Yes	Yes	Yes
Cap	753	713	560	692
Service Time	2.837	3.058	4.136	2.922
HCM Lane V/C Ratio	0.641	0.08	0.041	0.315
HCM Control Delay	16.1	8.5	9.4	10.3
HCM Lane LOS	C	A	A	B
HCM 95th-tile Q	4.7	0.3	0.1	1.3

HCM 2010 Signalized Intersection Summary
 26: East Garrison Road & Reservation Road



















Existing with Project, PM
 06/11/2019



Movement	EBL	EBT	EBR	WBL	WBT	WBR	NBL	NBT	NBR	SBL	SBT	SBR
Lane Configurations												
Traffic Volume (veh/h)	0	820	30	60	550	0	10	0	30	0	0	0
Future Volume (veh/h)	0	820	30	60	550	0	10	0	30	0	0	0
Number	5	2	12	1	6	16	3	8	18			
Initial Q (Qb), veh	0	0	0	0	0	0	0	0	0			
Ped-Bike Adj(A_pbT)	1.00		1.00	1.00		1.00	1.00		1.00			
Parking Bus, Adj	1.00	1.00	1.00	1.00	1.00	1.00	1.00	1.00	1.00			
Adj Sat Flow, veh/h/ln	1863	1863	1900	1881	1881	0	1845	0	1845			
Adj Flow Rate, veh/h	0	845	29	62	567	0	10	0	2			
Adj No. of Lanes	1	2	0	1	2	0	1	0	1			
Peak Hour Factor	0.97	0.97	0.97	0.97	0.97	0.97	0.97	0.97	0.97			
Percent Heavy Veh, %	2	2	2	1	1	0	3	0	3			
Cap, veh/h	5	1849	63	116	2493	0	22	0	20			
Arrive On Green	0.00	0.53	0.53	0.06	0.70	0.00	0.01	0.00	0.01			
Sat Flow, veh/h	1774	3491	120	1792	3668	0	1757	0	1568			
Grp Volume(v), veh/h	0	428	446	62	567	0	10	0	2			
Grp Sat Flow(s),veh/h/ln	1774	1770	1842	1792	1787	0	1757	0	1568			
Q Serve(g_s), s	0.0	5.2	5.2	1.2	2.0	0.0	0.2	0.0	0.0			
Cycle Q Clear(g_c), s	0.0	5.2	5.2	1.2	2.0	0.0	0.2	0.0	0.0			
Prop In Lane	1.00		0.07	1.00		0.00	1.00		1.00			
Lane Grp Cap(c), veh/h	5	937	975	116	2493	0	22	0	20			
V/C Ratio(X)	0.00	0.46	0.46	0.53	0.23	0.00	0.45	0.00	0.10			
Avail Cap(c_a), veh/h	1018	3047	3171	1028	6155	0	1361	0	1215			
HCM Platoon Ratio	1.00	1.00	1.00	1.00	1.00	1.00	1.00	1.00	1.00			
Upstream Filter(I)	0.00	1.00	1.00	1.00	1.00	0.00	1.00	0.00	1.00			
Uniform Delay (d), s/veh	0.0	5.1	5.1	15.8	1.9	0.0	17.1	0.0	17.0			
Incr Delay (d2), s/veh	0.0	0.7	0.6	1.4	0.1	0.0	5.3	0.0	0.8			
Initial Q Delay(d3),s/veh	0.0	0.0	0.0	0.0	0.0	0.0	0.0	0.0	0.0			
%ile BackOfQ(50%),veh/ln	0.0	2.7	2.8	0.6	1.0	0.0	0.1	0.0	0.0			
LnGrp Delay(d),s/veh	0.0	5.7	5.7	17.2	2.0	0.0	22.3	0.0	17.8			
LnGrp LOS		A	A	B	A		C		B			
Approach Vol, veh/h		874			629			12				
Approach Delay, s/veh		5.7			3.5			21.6				
Approach LOS		A			A			C				
Timer	1	2	3	4	5	6	7	8				
Assigned Phs	1	2			5	6		8				
Phs Duration (G+Y+Rc), s	5.9	23.8			0.0	29.7		5.1				
Change Period (Y+Rc), s	3.6	5.4			3.5	5.4		4.7				
Max Green Setting (Gmax), s	20	60.0			20.0	60.0		27.0				
Max Q Clear Time (g_c+13), s	2	7.2			0.0	4.0		2.2				
Green Ext Time (p_c), s	0.0	11.2			0.0	4.6		0.0				
Intersection Summary												
HCM 2010 Ctrl Delay				4.9								
HCM 2010 LOS				A								
Notes												

HCM 2010 Signalized Intersection Summary
28: Davis Road & Reservation Road

Existing with Project, PM
06/11/2019

												
Movement	EBL	EBT	EBR	WBL	WBT	WBR	NBL	NBT	NBR	SBL	SBT	SBR
Lane Configurations												
Traffic Volume (veh/h)	430	440	10	10	320	110	10	10	10	120	10	290
Future Volume (veh/h)	430	440	10	10	320	110	10	10	10	120	10	290
Number	5	2	12	1	6	16	3	8	18	7	4	14
Initial Q (Qb), veh	0	0	0	0	0	0	0	0	0	0	0	0
Ped-Bike Adj(A_pbT)	1.00		1.00	1.00		1.00	1.00		1.00	1.00		1.00
Parking Bus, Adj	1.00	1.00	1.00	1.00	1.00	1.00	1.00	1.00	1.00	1.00	1.00	1.00
Adj Sat Flow, veh/h/ln	1863	1863	1900	1827	1836	1900	1900	1900	1900	1900	1881	1881
Adj Flow Rate, veh/h	467	478	11	11	340	120	11	11	9	128	11	174
Adj No. of Lanes	1	1	0	1	1	0	0	1	0	0	1	1
Peak Hour Factor	0.92	0.92	0.92	0.94	0.94	0.92	0.94	0.94	0.94	0.94	0.94	0.94
Percent Heavy Veh, %	2	2	2	4	4	4	0	0	0	1	1	1
Cap, veh/h	506	1093	25	19	428	151	20	20	17	176	15	626
Arrive On Green	0.29	0.60	0.60	0.01	0.33	0.33	0.03	0.03	0.03	0.11	0.11	0.11
Sat Flow, veh/h	1774	1814	42	1740	1297	458	631	631	516	1656	142	1599
Grp Volume(v), veh/h	467	0	489	11	0	460	31	0	0	139	0	174
Grp Sat Flow(s),veh/h/ln	1774	0	1855	1740	0	1755	1777	0	0	1798	0	1599
Q Serve(g_s), s	18.4	0.0	10.3	0.5	0.0	17.2	1.2	0.0	0.0	5.4	0.0	5.4
Cycle Q Clear(g_c), s	18.4	0.0	10.3	0.5	0.0	17.2	1.2	0.0	0.0	5.4	0.0	5.4
Prop In Lane	1.00		0.02	1.00		0.26	0.35		0.29	0.92		1.00
Lane Grp Cap(c), veh/h	506	0	1118	19	0	579	57	0	0	192	0	626
V/C Ratio(X)	0.92	0.00	0.44	0.58	0.00	0.79	0.54	0.00	0.00	0.73	0.00	0.28
Avail Cap(c_a), veh/h	737	0	1541	723	0	1458	738	0	0	747	0	1120
HCM Platoon Ratio	1.00	1.00	1.00	1.00	1.00	1.00	1.00	1.00	1.00	1.00	1.00	1.00
Upstream Filter(I)	1.00	0.00	1.00	1.00	0.00	1.00	1.00	0.00	0.00	1.00	0.00	1.00
Uniform Delay (d), s/veh	25.1	0.0	7.7	35.5	0.0	22.0	34.4	0.0	0.0	31.2	0.0	15.0
Incr Delay (d2), s/veh	10.7	0.0	0.4	9.8	0.0	3.9	3.0	0.0	0.0	2.0	0.0	0.1
Initial Q Delay(d3),s/veh	0.0	0.0	0.0	0.0	0.0	0.0	0.0	0.0	0.0	0.0	0.0	0.0
%ile BackOfQ(50%),veh/ln	10.5	0.0	5.3	0.3	0.0	8.9	0.7	0.0	0.0	2.8	0.0	2.4
LnGrp Delay(d),s/veh	35.8	0.0	8.2	45.3	0.0	25.9	37.4	0.0	0.0	33.2	0.0	15.1
LnGrp LOS	D		A	D		C	D			C		B
Approach Vol, veh/h		956			471			31				313
Approach Delay, s/veh		21.6			26.4			37.4				23.1
Approach LOS		C			C			D				C
Timer	1	2	3	4	5	6	7	8				
Assigned Phs	1	2		4	5	6		8				
Phs Duration (G+Y+Rc), s	4.7	48.5		12.7	24.4	28.8		6.3				
Change Period (Y+Rc), s	* 3.9	5.0		5.0	* 3.8	5.0		4.0				
Max Green Setting (Gmax), s	* 30	60.0		30.0	* 30	60.0		30.0				
Max Q Clear Time (g_c+I1), s	2.5	12.3		7.4	20.4	19.2		3.2				
Green Ext Time (p_c), s	0.0	5.0		0.3	0.1	4.6		0.0				
Intersection Summary												
HCM 2010 Ctrl Delay			23.4									
HCM 2010 LOS			C									
Notes												

Intersection												
Intersection Delay, s/veh	50.9											
Intersection LOS	F											

Movement	EBL	EBT	EBR	WBL	WBT	WBR	NBL	NBT	NBR	SBL	SBT	SBR
Lane Configurations		↕			↕	↕	↕	↕		↕	↕	↕
Traffic Vol, veh/h	10	10	10	130	10	10	10	580	110	10	520	10
Future Vol, veh/h	10	10	10	130	10	10	10	580	110	10	520	10
Peak Hour Factor	0.94	0.94	0.94	0.94	0.94	0.94	0.94	0.94	0.94	0.94	0.94	0.94
Heavy Vehicles, %	0	0	0	0	0	0	0	0	0	1	1	1
Mvmt Flow	11	11	11	138	11	11	11	617	117	11	553	11
Number of Lanes	0	1	0	0	1	1	1	2	0	1	1	1

Approach	EB	WB	NB	SB
Opposing Approach	WB	EB	SB	NB
Opposing Lanes	2	1	3	3
Conflicting Approach Left	SB	NB	EB	WB
Conflicting Lanes Left	3	3	1	2
Conflicting Approach Right	NB	SB	WB	EB
Conflicting Lanes Right	3	3	2	1
HCM Control Delay	12.6	16.5	26.3	94.6
HCM LOS	B	C	D	F

Lane	NBLn1	NBLn2	NBLn3	EBLn1	WBLn1	WBLn2	SBLn1	SBLn2	SBLn3
Vol Left, %	100%	0%	0%	33%	93%	0%	100%	0%	0%
Vol Thru, %	0%	100%	64%	33%	7%	0%	0%	100%	0%
Vol Right, %	0%	0%	36%	33%	0%	100%	0%	0%	100%
Sign Control	Stop	Stop	Stop	Stop	Stop	Stop	Stop	Stop	Stop
Traffic Vol by Lane	10	387	303	30	140	10	10	520	10
LT Vol	10	0	0	10	130	0	10	0	0
Through Vol	0	387	193	10	10	0	0	520	0
RT Vol	0	0	110	10	0	10	0	0	10
Lane Flow Rate	11	411	323	32	149	11	11	553	11
Geometry Grp	8	8	8	8	8	8	8	8	8
Degree of Util (X)	0.022	0.792	0.599	0.078	0.363	0.023	0.023	1.104	0.019
Departure Headway (Hd)	7.721	7.211	6.953	9.153	9.111	7.923	7.691	7.182	6.471
Convergence, Y/N	Yes	Yes	Yes	Yes	Yes	Yes	Yes	Yes	Yes
Cap	466	506	523	394	398	455	462	503	548
Service Time	5.421	4.911	4.653	6.853	6.811	5.623	5.487	4.978	4.266
HCM Lane V/C Ratio	0.024	0.812	0.618	0.081	0.374	0.024	0.024	1.099	0.02
HCM Control Delay	10.6	32.1	19.5	12.6	16.9	10.8	10.7	97.9	9.4
HCM Lane LOS	B	D	C	B	C	B	B	F	A
HCM 95th-tile Q	0.1	7.3	3.9	0.3	1.6	0.1	0.1	17.9	0.1

Intersection	
Intersection Delay, s/veh	8
Intersection LOS	A

Movement	EBL	EBT	EBR	WBL	WBT	WBR	NBL	NBT	NBR	SBL	SBT	SBR
Lane Configurations		↕			↕		↕	↕		↕	↕	
Traffic Vol, veh/h	10	10	10	10	10	10	10	80	10	10	80	10
Future Vol, veh/h	10	10	10	10	10	10	10	80	10	10	80	10
Peak Hour Factor	0.85	0.85	0.85	0.85	0.85	0.85	0.85	0.85	0.85	0.85	0.85	0.85
Heavy Vehicles, %	0	0	0	1	1	1	0	0	0	1	1	1
Mvmt Flow	12	12	12	12	12	12	12	94	12	12	94	12
Number of Lanes	0	1	0	0	1	0	1	1	0	1	1	0

Approach	EB	WB	NB	SB
Opposing Approach	WB	EB	SB	NB
Opposing Lanes	1	1	2	2
Conflicting Approach Left	SB	NB	EB	WB
Conflicting Lanes Left	2	2	1	1
Conflicting Approach Right	NB	SB	WB	EB
Conflicting Lanes Right	2	2	1	1
HCM Control Delay	7.6	7.6	8.1	8.1
HCM LOS	A	A	A	A

Lane	NBLn1	NBLn2	EBLn1	WBLn1	SBLn1	SBLn2
Vol Left, %	100%	0%	33%	33%	100%	0%
Vol Thru, %	0%	89%	33%	33%	0%	89%
Vol Right, %	0%	11%	33%	33%	0%	11%
Sign Control	Stop	Stop	Stop	Stop	Stop	Stop
Traffic Vol by Lane	10	90	30	30	10	90
LT Vol	10	0	10	10	10	0
Through Vol	0	80	10	10	0	80
RT Vol	0	10	10	10	0	10
Lane Flow Rate	12	106	35	35	12	106
Geometry Grp	7	7	2	2	7	7
Degree of Util (X)	0.017	0.135	0.043	0.043	0.017	0.136
Departure Headway (Hd)	5.183	4.604	4.367	4.384	5.2	4.621
Convergence, Y/N	Yes	Yes	Yes	Yes	Yes	Yes
Cap	684	771	824	821	682	768
Service Time	2.962	2.383	2.369	2.386	2.978	2.399
HCM Lane V/C Ratio	0.018	0.137	0.042	0.043	0.018	0.138
HCM Control Delay	8.1	8.1	7.6	7.6	8.1	8.1
HCM Lane LOS	A	A	A	A	A	A
HCM 95th-tile Q	0.1	0.5	0.1	0.1	0.1	0.5

HCM 2010 Signalized Intersection Summary
 31: 1st Avenue & Lightfighter Drive

Existing with Project, PM
 06/11/2019



Movement	EBL	EBT	EBR	WBL	WBT	WBR	NBL	NBT	NBR	SBL	SBT	SBR
Lane Configurations		↑↑	↑	↑	↑↑		↑		↑	↑	↑	↑
Traffic Volume (veh/h)	0	620	110	20	1120	0	200	0	30	10	10	30
Future Volume (veh/h)	0	620	110	20	1120	0	200	0	30	10	10	30
Number	7	4	14	3	8	18	5	2	12	1	6	16
Initial Q (Qb), veh	0	0	0	0	0	0	0	0	0	0	0	0
Ped-Bike Adj(A_pbT)	1.00		1.00	1.00		1.00	1.00		1.00	1.00		1.00
Parking Bus, Adj	1.00	1.00	1.00	1.00	1.00	1.00	1.00	1.00	1.00	1.00	1.00	1.00
Adj Sat Flow, veh/h/ln	0	1881	1881	1881	1881	0	1881	0	1881	1810	1810	1810
Adj Flow Rate, veh/h	0	653	0	21	1179	0	211	0	14	11	11	12
Adj No. of Lanes	0	2	1	1	2	0	1	0	1	1	1	1
Peak Hour Factor	0.95	0.95	0.95	0.95	0.95	0.95	0.95	0.95	0.95	0.95	0.95	0.95
Percent Heavy Veh, %	0	1	1	1	1	0	1	0	1	5	5	5
Cap, veh/h	0	2027	907	23	2468	0	0	0	0	32	34	29
Arrive On Green	0.00	0.57	0.00	0.01	0.69	0.00	0.00	0.00	0.00	0.02	0.02	0.02
Sat Flow, veh/h	0	3668	1599	1792	3668	0		0		1723	1810	1538
Grp Volume(v), veh/h	0	653	0	21	1179	0		0.0		11	11	12
Grp Sat Flow(s),veh/h/ln	0	1787	1599	1792	1787	0				1723	1810	1538
Q Serve(g_s), s	0.0	3.1	0.0	0.4	4.8	0.0				0.2	0.2	0.2
Cycle Q Clear(g_c), s	0.0	3.1	0.0	0.4	4.8	0.0				0.2	0.2	0.2
Prop In Lane	0.00		1.00	1.00		0.00				1.00		1.00
Lane Grp Cap(c), veh/h	0	2027	907	23	2468	0				32	34	29
V/C Ratio(X)	0.00	0.32	0.00	0.92	0.48	0.00				0.34	0.33	0.42
Avail Cap(c_a), veh/h	0	5087	2276	1133	5087	0				1363	1431	1216
HCM Platoon Ratio	1.00	1.00	1.00	1.00	1.00	1.00				1.00	1.00	1.00
Upstream Filter(I)	0.00	1.00	0.00	1.00	1.00	0.00				1.00	1.00	1.00
Uniform Delay (d), s/veh	0.0	3.6	0.0	15.6	2.3	0.0				15.3	15.3	15.3
Incr Delay (d2), s/veh	0.0	0.1	0.0	37.2	0.2	0.0				2.3	2.1	3.6
Initial Q Delay(d3),s/veh	0.0	0.0	0.0	0.0	0.0	0.0				0.0	0.0	0.0
%ile BackOfQ(50%),veh/ln	0.0	1.5	0.0	0.4	2.4	0.0				0.1	0.1	0.1
LnGrp Delay(d),s/veh	0.0	3.8	0.0	52.8	2.5	0.0				17.6	17.4	18.9
LnGrp LOS		A		D	A					B	B	B
Approach Vol, veh/h		653			1200						34	
Approach Delay, s/veh		3.8			3.3						18.0	
Approach LOS		A			A						B	
Timer	1	2	3	4	5	6	7	8				
Assigned Phs			3	4		6		8				
Phs Duration (G+Y+Rc), s			3.9	22.5		5.2		26.4				
Change Period (Y+Rc), s			3.5	4.6		4.6		4.6				
Max Green Setting (Gmax), s			20.0	45.0		25.0		45.0				
Max Q Clear Time (g_c+I1), s			2.4	5.1		2.2		6.8				
Green Ext Time (p_c), s			0.0	7.5		0.0		15.0				
Intersection Summary												
HCM 2010 Ctrl Delay			3.8									
HCM 2010 LOS			A									

HCM 2010 Signalized Intersection Summary
 32: 2nd Avenue & Lightfighter Drive

Existing with Project, PM
 06/11/2019



Movement	EBL	EBT	EBR	WBL	WBT	WBR	NBL	NBT	NBR	SBL	SBT	SBR
Lane Configurations												
Traffic Volume (veh/h)	150	480	10	10	1020	130	10	10	10	80	10	120
Future Volume (veh/h)	150	480	10	10	1020	130	10	10	10	80	10	120
Number	5	2	12	1	6	16	3	8	18	7	4	14
Initial Q (Qb), veh	0	0	0	0	0	0	0	0	0	0	0	0
Ped-Bike Adj(A_pbT)	1.00		1.00	1.00		1.00	0.99		0.99	0.99		0.99
Parking Bus, Adj	1.00	1.00	1.00	1.00	1.00	1.00	1.00	1.00	1.00	1.00	1.00	1.00
Adj Sat Flow, veh/h/ln	1881	1881	1900	1881	1881	1900	1900	1900	1900	1845	1845	1845
Adj Flow Rate, veh/h	158	505	11	11	1074	132	11	11	5	84	11	23
Adj No. of Lanes	1	2	0	1	2	0	0	1	0	1	1	1
Peak Hour Factor	0.95	0.95	0.95	0.95	0.95	0.95	0.95	0.95	0.95	0.95	0.95	0.95
Percent Heavy Veh, %	1	1	1	1	1	1	0	0	0	3	3	3
Cap, veh/h	189	2736	60	19	2147	264	94	83	29	203	171	143
Arrive On Green	0.11	0.76	0.76	0.01	0.67	0.67	0.09	0.09	0.09	0.09	0.09	0.09
Sat Flow, veh/h	1792	3577	78	1792	3205	393	465	893	308	1362	1845	1548
Grp Volume(v), veh/h	158	252	264	11	598	608	27	0	0	84	11	23
Grp Sat Flow(s),veh/h/ln	1792	1787	1867	1792	1787	1811	1666	0	0	1362	1845	1548
Q Serve(g_s), s	8.7	3.9	3.9	0.6	16.6	16.7	0.0	0.0	0.0	4.2	0.5	1.4
Cycle Q Clear(g_c), s	8.7	3.9	3.9	0.6	16.6	16.7	1.4	0.0	0.0	5.6	0.5	1.4
Prop In Lane	1.00		0.04	1.00		0.22	0.41		0.19	1.00		1.00
Lane Grp Cap(c), veh/h	189	1367	1428	19	1197	1214	205	0	0	203	171	143
V/C Ratio(X)	0.84	0.18	0.18	0.58	0.50	0.50	0.13	0.00	0.00	0.41	0.06	0.16
Avail Cap(c_a), veh/h	222	1367	1428	222	1197	1214	702	0	0	627	745	625
HCM Platoon Ratio	1.00	1.00	1.00	1.00	1.00	1.00	1.00	1.00	1.00	1.00	1.00	1.00
Upstream Filter(I)	0.95	0.95	0.95	0.77	0.77	0.77	1.00	0.00	0.00	1.00	1.00	1.00
Uniform Delay (d), s/veh	43.9	3.2	3.2	49.3	8.2	8.2	41.8	0.0	0.0	43.6	41.4	41.8
Incr Delay (d2), s/veh	17.6	0.3	0.3	7.9	1.2	1.1	0.1	0.0	0.0	0.5	0.1	0.2
Initial Q Delay(d3),s/veh	0.0	0.0	0.0	0.0	0.0	0.0	0.0	0.0	0.0	0.0	0.0	0.0
%ile BackOfQ(50%),veh/ln	5.2	2.0	2.1	0.3	8.5	8.7	0.7	0.0	0.0	2.3	0.3	0.6
LnGrp Delay(d),s/veh	61.4	3.5	3.5	57.2	9.3	9.3	41.9	0.0	0.0	44.1	41.5	42.0
LnGrp LOS	E	A	A	E	A	A	D			D	D	D
Approach Vol, veh/h		674			1217			27			118	
Approach Delay, s/veh		17.1			9.8			41.9			43.4	
Approach LOS		B			A			D			D	
Timer	1	2	3	4	5	6	7	8				
Assigned Phs	1	2		4	5	6		8				
Phs Duration (G+Y+Rc), s	5.1	81.1		13.9	14.5	71.6		13.9				
Change Period (Y+Rc), s	4.0	4.6		4.6	4.0	4.6		4.6				
Max Green Setting (Gmax), s	2.4	34.0		40.4	12.4	24.4		40.4				
Max Q Clear Time (g_c+1), s	12.6	5.9		7.6	10.7	18.7		3.4				
Green Ext Time (p_c), s	0.0	1.8		0.2	0.0	2.6		0.1				
Intersection Summary												
HCM 2010 Ctrl Delay			14.6									
HCM 2010 LOS			B									

HCM 2010 Signalized Intersection Summary
 33: General Jim Moore Boulevard & Lightfighter Drive

Existing with Project, PM
 06/11/2019



Movement	EBL	EBT	EBR	WBL	WBT	WBR	NBL	NBT	NBR	SBL	SBT	SBR
Lane Configurations	↖	↑	↗	↖	↗		↖	↗		↖	↗	
Traffic Volume (veh/h)	10	140	460	10	170	10	510	30	10	10	30	10
Future Volume (veh/h)	10	140	460	10	170	10	510	30	10	10	30	10
Number	3	8	18	7	4	14	1	6	16	5	2	12
Initial Q (Qb), veh	0	0	0	0	0	0	0	0	0	0	0	0
Ped-Bike Adj(A_pbT)	1.00		1.00	1.00		1.00	1.00		1.00	1.00		1.00
Parking Bus, Adj	1.00	1.00	1.00	1.00	1.00	1.00	1.00	1.00	1.00	1.00	1.00	1.00
Adj Sat Flow, veh/h/ln	1881	1881	1881	1900	1900	1900	1881	1881	1900	1900	1900	1900
Adj Flow Rate, veh/h	10	146	0	10	177	9	531	31	8	10	31	-102
Adj No. of Lanes	1	1	1	1	1	0	2	1	0	1	2	0
Peak Hour Factor	0.96	0.96	0.96	0.96	0.96	0.96	0.96	0.96	0.96	0.96	0.96	0.96
Percent Heavy Veh, %	1	1	1	0	0	0	1	1	1	0	0	0
Cap, veh/h	19	334	284	19	318	16	989	413	107	19	22	429
Arrive On Green	0.01	0.18	0.00	0.01	0.18	0.18	0.28	0.29	0.29	0.01	0.01	0.00
Sat Flow, veh/h	1792	1881	1599	1810	1793	91	3476	1443	372	1810	3705	0
Grp Volume(v), veh/h	10	146	0	10	0	186	531	0	39	10	-71	-102
Grp Sat Flow(s),veh/h/ln	1792	1881	1599	1810	0	1884	1738	0	1815	1810	1805	1615
Q Serve(g_s), s	0.2	2.4	0.0	0.2	0.0	3.1	4.5	0.0	0.5	0.2	0.0	0.0
Cycle Q Clear(g_c), s	0.2	2.4	0.0	0.2	0.0	3.1	4.5	0.0	0.5	0.2	0.0	0.0
Prop In Lane	1.00		1.00	1.00		0.05	1.00		0.21	1.00		0.00
Lane Grp Cap(c), veh/h	19	334	284	19	0	334	989	0	520	19	22	0
V/C Ratio(X)	0.53	0.44	0.00	0.52	0.00	0.56	0.54	0.00	0.08	0.52	-3.21	0.00
Avail Cap(c_a), veh/h	1025	1615	1373	1036	0	1617	995	0	1559	777	1550	0
HCM Platoon Ratio	1.00	1.00	1.00	1.00	1.00	1.00	1.00	1.00	1.00	1.00	1.00	1.00
Upstream Filter(I)	1.00	1.00	0.00	1.00	0.00	1.00	1.00	0.00	1.00	1.00	0.00	0.00
Uniform Delay (d), s/veh	17.2	12.8	0.0	17.2	0.0	13.1	10.6	0.0	9.1	17.2	0.0	0.0
Incr Delay (d2), s/veh	20.8	1.1	0.0	7.9	0.0	1.7	0.5	0.0	0.1	7.9	0.0	0.0
Initial Q Delay(d3),s/veh	0.0	0.0	0.0	0.0	0.0	0.0	0.0	0.0	0.0	0.0	0.0	0.0
%ile BackOfQ(50%),veh/ln	0.2	1.4	0.0	0.1	0.0	1.8	2.2	0.0	0.3	0.1	0.0	0.0
LnGrp Delay(d),s/veh	38.0	13.9	0.0	25.1	0.0	14.9	11.0	0.0	9.2	25.1	0.0	0.0
LnGrp LOS	D	B		C		B	B		A	C		
Approach Vol, veh/h		156			196			570			-163	
Approach Delay, s/veh		15.4			15.4			10.9			-1.5	
Approach LOS		B			B			B			A	
Timer	1	2	3	4	5	6	7	8				
Assigned Phs	1	2	3	4	5	6	7	8				
Phs Duration (G+Y+Rc), s	4.4	4.9	4.9	10.7	4.9	14.5	4.9	10.7				
Change Period (Y+Rc), s	4.5	4.5	4.5	4.5	4.5	4.5	4.5	4.5				
Max Green Setting (Gmax), s	30.0	30.0	20.0	30.0	15.0	30.0	20.0	30.0				
Max Q Clear Time (g_c+1), s	10.5	0.0	2.2	5.1	2.2	2.5	2.2	4.4				
Green Ext Time (p_c), s	0.6	0.0	0.0	1.3	0.0	0.3	0.0	0.8				
Intersection Summary												
HCM 2010 Ctrl Delay				15.7								
HCM 2010 LOS				B								

Intersection	
Intersection Delay, s/veh	8.2
Intersection LOS	A

Movement	WBL	WBR	NBT	NBR	SBL	SBT
Lane Configurations						
Traffic Vol, veh/h	10	120	60	10	120	40
Future Vol, veh/h	10	120	60	10	120	40
Peak Hour Factor	0.88	0.88	0.88	0.88	0.88	0.88
Heavy Vehicles, %	0	0	2	2	1	1
Mvmt Flow	11	136	68	11	136	45
Number of Lanes	1	0	1	0	0	1

Approach	WB	NB	SB
Opposing Approach		SB	NB
Opposing Lanes	0	1	1
Conflicting Approach Left	NB		WB
Conflicting Lanes Left	1	0	1
Conflicting Approach Right	SB	WB	
Conflicting Lanes Right	1	1	0
HCM Control Delay	7.7	7.8	8.7
HCM LOS	A	A	A

Lane	NBLn1	WBLn1	SBLn1
Vol Left, %	0%	8%	75%
Vol Thru, %	86%	0%	25%
Vol Right, %	14%	92%	0%
Sign Control	Stop	Stop	Stop
Traffic Vol by Lane	70	130	160
LT Vol	0	10	120
Through Vol	60	0	40
RT Vol	10	120	0
Lane Flow Rate	80	148	182
Geometry Grp	1	1	1
Degree of Util (X)	0.096	0.163	0.222
Departure Headway (Hd)	4.355	3.962	4.389
Convergence, Y/N	Yes	Yes	Yes
Cap	825	910	807
Service Time	2.37	1.965	2.476
HCM Lane V/C Ratio	0.097	0.163	0.226
HCM Control Delay	7.8	7.7	8.7
HCM Lane LOS	A	A	A
HCM 95th-tile Q	0.3	0.6	0.8

Intersection						
Int Delay, s/veh	1.3					
Movement	EBT	EBR	WBL	WBT	NBL	NBR
Lane Configurations						
Traffic Vol, veh/h	110	20	10	110	20	10
Future Vol, veh/h	110	20	10	110	20	10
Conflicting Peds, #/hr	0	0	0	0	0	0
Sign Control	Free	Free	Free	Free	Stop	Stop
RT Channelized	-	None	-	None	-	None
Storage Length	-	-	-	-	0	-
Veh in Median Storage, #	0	-	-	0	0	-
Grade, %	0	-	-	0	0	-
Peak Hour Factor	85	85	85	85	85	85
Heavy Vehicles, %	0	0	0	0	0	0
Mvmt Flow	129	24	12	129	24	12

Major/Minor	Major1	Major2	Minor1	Minor2	Minor3
Conflicting Flow All	0	0	153	0	294
Stage 1	-	-	-	-	141
Stage 2	-	-	-	-	153
Critical Hdwy	-	-	4.1	-	6.4
Critical Hdwy Stg 1	-	-	-	-	5.4
Critical Hdwy Stg 2	-	-	-	-	5.4
Follow-up Hdwy	-	-	2.2	-	3.5
Pot Cap-1 Maneuver	-	-	1440	-	701
Stage 1	-	-	-	-	891
Stage 2	-	-	-	-	880
Platoon blocked, %	-	-	-	-	-
Mov Cap-1 Maneuver	-	-	1440	-	695
Mov Cap-2 Maneuver	-	-	-	-	695
Stage 1	-	-	-	-	883
Stage 2	-	-	-	-	880

Approach	EB	WB	NB
HCM Control Delay, s	0	0.6	10
HCM LOS			B

Minor Lane/Major Mvmt	NBLn1	EBT	EBR	WBL	WBT
Capacity (veh/h)	755	-	-	1440	-
HCM Lane V/C Ratio	0.047	-	-	0.008	-
HCM Control Delay (s)	10	-	-	7.5	0
HCM Lane LOS	B	-	-	A	A
HCM 95th %tile Q(veh)	0.1	-	-	0	-

Intersection	
Intersection Delay, s/veh	10.6
Intersection LOS	B

Movement	EBL	EBT	EBR	WBL	WBT	WBR	NBL	NBT	NBR	SBL	SBT	SBR
Lane Configurations		↕			↕			↕			↕	
Traffic Vol, veh/h	10	100	10	10	100	10	10	180	10	10	200	10
Future Vol, veh/h	10	100	10	10	100	10	10	180	10	10	200	10
Peak Hour Factor	0.82	0.82	0.82	0.82	0.82	0.82	0.82	0.82	0.82	0.82	0.82	0.82
Heavy Vehicles, %	0	0	0	0	0	0	2	2	2	0	0	0
Mvmt Flow	12	122	12	12	122	12	12	220	12	12	244	12
Number of Lanes	0	1	0	0	1	0	0	1	0	0	1	0

Approach	EB	WB	NB	SB
Opposing Approach	WB	EB	SB	NB
Opposing Lanes	1	1	1	1
Conflicting Approach Left	SB	NB	EB	WB
Conflicting Lanes Left	1	1	1	1
Conflicting Approach Right	NB	SB	WB	EB
Conflicting Lanes Right	1	1	1	1
HCM Control Delay	10	10	10.9	11.1
HCM LOS	A	A	B	B

Lane	NBLn1	EBLn1	WBLn1	SBLn1
Vol Left, %	5%	8%	8%	5%
Vol Thru, %	90%	83%	83%	91%
Vol Right, %	5%	8%	8%	5%
Sign Control	Stop	Stop	Stop	Stop
Traffic Vol by Lane	200	120	120	220
LT Vol	10	10	10	10
Through Vol	180	100	100	200
RT Vol	10	10	10	10
Lane Flow Rate	244	146	146	268
Geometry Grp	1	1	1	1
Degree of Util (X)	0.347	0.221	0.221	0.377
Departure Headway (Hd)	5.122	5.442	5.442	5.059
Convergence, Y/N	Yes	Yes	Yes	Yes
Cap	702	660	660	711
Service Time	3.151	3.476	3.476	3.086
HCM Lane V/C Ratio	0.348	0.221	0.221	0.377
HCM Control Delay	10.9	10	10	11.1
HCM Lane LOS	B	A	A	B
HCM 95th-tile Q	1.6	0.8	0.8	1.8

Intersection												
Int Delay, s/veh	6.5											
Movement	EBL	EBT	EBR	WBL	WBT	WBR	NBL	NBT	NBR	SBL	SBT	SBR
Lane Configurations		↕			↕			↕			↕	
Traffic Vol, veh/h	20	60	20	10	30	10	70	160	10	0	0	0
Future Vol, veh/h	20	60	20	10	30	10	70	160	10	0	0	0
Conflicting Peds, #/hr	0	0	0	0	0	0	0	0	0	0	0	0
Sign Control	Stop	Stop	Stop	Stop	Stop	Stop	Free	Free	Free	Free	Free	Free
RT Channelized	-	-	None	-	-	None	-	-	None	-	-	None
Storage Length	-	-	-	-	-	-	-	-	-	-	-	-
Veh in Median Storage, #	-	0	-	-	0	-	-	0	-	-	0	-
Grade, %	-	0	-	-	0	-	-	0	-	-	0	-
Peak Hour Factor	74	74	74	74	74	74	74	74	74	74	74	74
Heavy Vehicles, %	3	3	3	2	2	2	3	3	3	8	8	8
Mvmt Flow	27	81	27	14	41	14	95	216	14	0	0	0

Major/Minor	Minor2		Minor1		Major1			Major2				
Conflicting Flow All	442	421	1	468	414	223	1	0	0	230	0	0
Stage 1	1	1	-	413	413	-	-	-	-	-	-	-
Stage 2	441	420	-	55	1	-	-	-	-	-	-	-
Critical Hdwy	7.13	6.53	6.23	7.12	6.52	6.22	4.13	-	-	4.18	-	-
Critical Hdwy Stg 1	6.13	5.53	-	6.12	5.52	-	-	-	-	-	-	-
Critical Hdwy Stg 2	6.13	5.53	-	6.12	5.52	-	-	-	-	-	-	-
Follow-up Hdwy	3.527	4.027	3.327	3.518	4.018	3.318	2.227	-	-	2.272	-	-
Pot Cap-1 Maneuver	524	522	1081	505	529	817	1615	-	-	1303	-	-
Stage 1	1019	893	-	616	594	-	-	-	-	-	-	-
Stage 2	593	588	-	957	895	-	-	-	-	-	-	-
Platoon blocked, %								-	-	-	-	-
Mov Cap-1 Maneuver	458	487	1081	408	493	817	1615	-	-	1303	-	-
Mov Cap-2 Maneuver	458	487	-	408	493	-	-	-	-	-	-	-
Stage 1	950	893	-	574	554	-	-	-	-	-	-	-
Stage 2	504	548	-	848	895	-	-	-	-	-	-	-

Approach	EB		WB		NB		SB	
HCM Control Delay, s	13.9		13.1		2.1		0	
HCM LOS	B		B					

Minor Lane/Major Mvmt	NBL	NBT	NBR	EBLn1	WBLn1	SBL	SBT	SBR
Capacity (veh/h)	1615	-	-	539	512	1303	-	-
HCM Lane V/C Ratio	0.059	-	-	0.251	0.132	-	-	-
HCM Control Delay (s)	7.4	0	-	13.9	13.1	0	-	-
HCM Lane LOS	A	A	-	B	B	A	-	-
HCM 95th %tile Q(veh)	0.2	-	-	1	0.5	0	-	-

Intersection						
Int Delay, s/veh	1.6					
Movement	EBL	EBR	NBL	NBT	SBT	SBR
Lane Configurations	T			T		T
Traffic Vol, veh/h	60	10	10	360	330	30
Future Vol, veh/h	60	10	10	360	330	30
Conflicting Peds, #/hr	0	0	0	0	0	0
Sign Control	Stop	Stop	Free	Free	Free	Free
RT Channelized	-	None	-	None	-	None
Storage Length	0	-	-	-	-	-
Veh in Median Storage, #	0	-	-	0	0	-
Grade, %	0	-	-	0	0	-
Peak Hour Factor	88	88	88	88	88	88
Heavy Vehicles, %	0	0	2	2	1	1
Mvmt Flow	68	11	11	409	375	34























Major/Minor	Minor2	Major1		Major2	
Conflicting Flow All	823	392	409	0	0
Stage 1	392	-	-	-	-
Stage 2	431	-	-	-	-
Critical Hdwy	6.4	6.2	4.12	-	-
Critical Hdwy Stg 1	5.4	-	-	-	-
Critical Hdwy Stg 2	5.4	-	-	-	-
Follow-up Hdwy	3.5	3.3	2.218	-	-
Pot Cap-1 Maneuver	346	661	1150	-	-
Stage 1	687	-	-	-	-
Stage 2	660	-	-	-	-
Platoon blocked, %				-	-
Mov Cap-1 Maneuver	342	661	1150	-	-
Mov Cap-2 Maneuver	342	-	-	-	-
Stage 1	679	-	-	-	-
Stage 2	660	-	-	-	-

Approach	EB	NB	SB
HCM Control Delay, s	17.5	0.2	0
HCM LOS	C		

Minor Lane/Major Mvmt	NBL	NBT	EBLn1	SBT	SBR
Capacity (veh/h)	1150	-	367	-	-
HCM Lane V/C Ratio	0.01	-	0.217	-	-
HCM Control Delay (s)	8.2	0	17.5	-	-
HCM Lane LOS	A	A	C	-	-
HCM 95th %tile Q(veh)	0	-	0.8	-	-

HCM 2010 Signalized Intersection Summary
 39: General Jim Moore Boulevard & Gigling Road

Existing with Project, PM
 06/11/2019

												
Movement	EBL	EBT	EBR	WBL	WBT	WBR	NBL	NBT	NBR	SBL	SBT	SBR
Lane Configurations												
Traffic Volume (veh/h)	20	20	30	220	50	220	60	490	150	100	240	50
Future Volume (veh/h)	20	20	30	220	50	220	60	490	150	100	240	50
Number	3	8	18	7	4	14	1	6	16	5	2	12
Initial Q (Qb), veh	0	0	0	0	0	0	0	0	0	0	0	0
Ped-Bike Adj(A_pbT)	1.00		0.99	1.00		1.00	1.00		1.00	1.00		1.00
Parking Bus, Adj	1.00	1.00	1.00	1.00	1.00	1.00	1.00	1.00	1.00	1.00	1.00	1.00
Adj Sat Flow, veh/h/ln	1776	1776	1900	1881	1881	1881	1863	1863	1863	1863	1863	1863
Adj Flow Rate, veh/h	22	22	3	247	56	0	67	551	0	112	270	0
Adj No. of Lanes	1	1	0	1	1	1	1	2	1	1	2	1
Peak Hour Factor	0.89	0.89	0.89	0.89	0.89	0.89	0.89	0.89	0.89	0.89	0.89	0.89
Percent Heavy Veh, %	7	7	7	1	1	1	2	2	2	2	2	2
Cap, veh/h	46	145	20	307	450	382	115	767	343	154	846	378
Arrive On Green	0.03	0.09	0.09	0.17	0.24	0.00	0.06	0.22	0.00	0.09	0.24	0.00
Sat Flow, veh/h	1691	1529	209	1792	1881	1599	1774	3539	1583	1774	3539	1583
Grp Volume(v), veh/h	22	0	25	247	56	0	67	551	0	112	270	0
Grp Sat Flow(s),veh/h/ln	1691	0	1738	1792	1881	1599	1774	1770	1583	1774	1770	1583
Q Serve(g_s), s	0.5	0.0	0.6	5.5	1.0	0.0	1.5	6.0	0.0	2.6	2.6	0.0
Cycle Q Clear(g_c), s	0.5	0.0	0.6	5.5	1.0	0.0	1.5	6.0	0.0	2.6	2.6	0.0
Prop In Lane	1.00		0.12	1.00		1.00	1.00		1.00	1.00		1.00
Lane Grp Cap(c), veh/h	46	0	165	307	450	382	115	767	343	154	846	378
V/C Ratio(X)	0.48	0.00	0.15	0.80	0.12	0.00	0.58	0.72	0.00	0.73	0.32	0.00
Avail Cap(c_a), veh/h	829	0	1267	878	1371	1166	445	2157	965	445	2157	965
HCM Platoon Ratio	1.00	1.00	1.00	1.00	1.00	1.00	1.00	1.00	1.00	1.00	1.00	1.00
Upstream Filter(I)	1.00	0.00	1.00	1.00	1.00	0.00	1.00	1.00	0.00	1.00	1.00	0.00
Uniform Delay (d), s/veh	20.1	0.0	17.4	16.7	12.5	0.0	19.0	15.2	0.0	18.6	13.1	0.0
Incr Delay (d2), s/veh	2.9	0.0	0.2	1.9	0.0	0.0	1.7	0.5	0.0	2.4	0.1	0.0
Initial Q Delay(d3),s/veh	0.0	0.0	0.0	0.0	0.0	0.0	0.0	0.0	0.0	0.0	0.0	0.0
%ile BackOfQ(50%),veh/ln	0.3	0.0	0.3	2.9	0.5	0.0	0.8	3.0	0.0	1.3	1.3	0.0
LnGrp Delay(d),s/veh	23.0	0.0	17.5	18.6	12.5	0.0	20.8	15.7	0.0	21.0	13.2	0.0
LnGrp LOS	C		B	B	B		C	B		C	B	
Approach Vol, veh/h		47			303			618			382	
Approach Delay, s/veh		20.1			17.4			16.2			15.5	
Approach LOS		C			B			B			B	
Timer	1	2	3	4	5	6	7	8				
Assigned Phs	1	2	3	4	5	6	7	8				
Phs Duration (G+Y+Rc), s	7.2	14.5	5.6	14.5	8.1	13.6	11.7	8.5				
Change Period (Y+Rc), s	4.5	4.5	4.5	4.5	4.5	4.5	4.5	4.5				
Max Green Setting (Gmax), s	10.5	25.5	20.5	30.5	10.5	25.5	20.5	30.5				
Max Q Clear Time (g_c+I1), s	3.5	4.6	2.5	3.0	4.6	8.0	7.5	2.6				
Green Ext Time (p_c), s	0.0	0.3	0.0	0.0	0.0	0.7	0.1	0.0				
Intersection Summary												
HCM 2010 Ctrl Delay			16.4									
HCM 2010 LOS			B									
Notes												

Intersection												
Int Delay, s/veh	5.1											
Movement	EBL	EBT	EBR	WBL	WBT	WBR	NBL	NBT	NBR	SBL	SBT	SBR
Lane Configurations		↕			↕			↕			↕	
Traffic Vol, veh/h	10	590	10	10	530	30	30	30	20	30	10	10
Future Vol, veh/h	10	590	10	10	530	30	30	30	20	30	10	10
Conflicting Peds, #/hr	1	0	2	2	0	1	0	0	0	0	0	0
Sign Control	Free	Free	Free	Free	Free	Free	Stop	Stop	Stop	Stop	Stop	Stop
RT Channelized	-	-	None	-	-	None	-	-	None	-	-	None
Storage Length	-	-	-	-	-	-	-	-	-	-	-	-
Veh in Median Storage, #	-	0	-	-	0	-	-	0	-	-	0	-
Grade, %	-	0	-	-	0	-	-	0	-	-	0	-
Peak Hour Factor	91	91	91	91	91	91	91	91	91	91	91	91
Heavy Vehicles, %	2	2	2	1	1	1	0	0	0	5	5	5
Mvmt Flow	11	648	11	11	582	33	33	33	22	33	11	11

Major/Minor	Major1			Major2			Minor1			Minor2		
Conflicting Flow All	616	0	0	661	0	0	1310	1316	656	1325	1305	600
Stage 1	-	-	-	-	-	-	678	678	-	622	622	-
Stage 2	-	-	-	-	-	-	632	638	-	703	683	-
Critical Hdwy	4.12	-	-	4.11	-	-	7.1	6.5	6.2	7.15	6.55	6.25
Critical Hdwy Stg 1	-	-	-	-	-	-	6.1	5.5	-	6.15	5.55	-
Critical Hdwy Stg 2	-	-	-	-	-	-	6.1	5.5	-	6.15	5.55	-
Follow-up Hdwy	2.218	-	-	2.209	-	-	3.5	4	3.3	3.545	4.045	3.345
Pot Cap-1 Maneuver	964	-	-	932	-	-	137	159	469	131	158	495
Stage 1	-	-	-	-	-	-	445	455	-	469	474	-
Stage 2	-	-	-	-	-	-	472	474	-	423	445	-
Platoon blocked, %		-	-		-	-						
Mov Cap-1 Maneuver	963	-	-	930	-	-	123	153	468	101	152	495
Mov Cap-2 Maneuver	-	-	-	-	-	-	123	153	-	101	152	-
Stage 1	-	-	-	-	-	-	436	446	-	460	465	-
Stage 2	-	-	-	-	-	-	443	465	-	367	436	-

Approach	EB			WB			NB			SB		
HCM Control Delay, s	0.1			0.2			48.8			51		
HCM LOS							E			F		

Minor Lane/Major Mvmt	NBLn1	EBL	EBT	EBR	WBL	WBT	WBR	SBLn1
Capacity (veh/h)	166	963	-	-	930	-	-	131
HCM Lane V/C Ratio	0.53	0.011	-	-	0.012	-	-	0.419
HCM Control Delay (s)	48.8	8.8	0	-	8.9	0	-	51
HCM Lane LOS	E	A	A	-	A	A	-	F
HCM 95th %tile Q(veh)	2.7	0	-	-	0	-	-	1.8

Intersection												
Int Delay, s/veh	9.1											
Movement	EBL	EBT	EBR	WBL	WBT	WBR	NBL	NBT	NBR	SBL	SBT	SBR
Lane Configurations		↕			↕			↕	↕		↕	
Traffic Vol, veh/h	10	610	20	20	490	20	80	10	50	10	10	10
Future Vol, veh/h	10	610	20	20	490	20	80	10	50	10	10	10
Conflicting Peds, #/hr	3	0	0	0	0	3	2	0	0	0	0	2
Sign Control	Free	Free	Free	Free	Free	Free	Stop	Stop	Stop	Stop	Stop	Stop
RT Channelized	-	-	None	-	-	None	-	-	None	-	-	None
Storage Length	-	-	-	-	-	-	-	-	135	-	-	-
Veh in Median Storage, #	-	0	-	-	0	-	-	0	-	-	0	-
Grade, %	-	0	-	-	0	-	-	0	-	-	0	-
Peak Hour Factor	89	89	89	89	89	89	89	89	89	89	89	89
Heavy Vehicles, %	2	2	2	1	1	1	0	0	0	0	0	0
Mvmt Flow	11	685	22	22	551	22	90	11	56	11	11	11

Major/Minor	Major1			Major2			Minor1			Minor2		
Conflicting Flow All	576	0	0	707	0	0	1337	1338	696	1361	1338	567
Stage 1	-	-	-	-	-	-	718	718	-	609	609	-
Stage 2	-	-	-	-	-	-	619	620	-	752	729	-
Critical Hdwy	4.12	-	-	4.11	-	-	7.1	6.5	6.2	7.1	6.5	6.2
Critical Hdwy Stg 1	-	-	-	-	-	-	6.1	5.5	-	6.1	5.5	-
Critical Hdwy Stg 2	-	-	-	-	-	-	6.1	5.5	-	6.1	5.5	-
Follow-up Hdwy	2.218	-	-	2.209	-	-	3.5	4	3.3	3.5	4	3.3
Pot Cap-1 Maneuver	997	-	-	896	-	-	132	154	445	127	154	527
Stage 1	-	-	-	-	-	-	423	436	-	486	488	-
Stage 2	-	-	-	-	-	-	480	483	-	405	431	-
Platoon blocked, %		-	-	-	-	-						
Mov Cap-1 Maneuver	994	-	-	896	-	-	116	145	445	100	145	524
Mov Cap-2 Maneuver	-	-	-	-	-	-	116	145	-	100	145	-
Stage 1	-	-	-	-	-	-	415	428	-	476	469	-
Stage 2	-	-	-	-	-	-	441	464	-	338	423	-

Approach	EB			WB			NB			SB		
HCM Control Delay, s	0.1			0.3			78.5			33.4		
HCM LOS							F			D		

Minor Lane/Major Mvmt	NBLn1	NBLn2	EBL	EBT	EBR	WBL	WBT	WBR	SBLn1
Capacity (veh/h)	119	445	994	-	-	896	-	-	160
HCM Lane V/C Ratio	0.85	0.126	0.011	-	-	0.025	-	-	0.211
HCM Control Delay (s)	114.2	14.3	8.7	0	-	9.1	0	-	33.4
HCM Lane LOS	F	B	A	A	-	A	A	-	D
HCM 95th %tile Q(veh)	5.1	0.4	0	-	-	0.1	-	-	0.8

Intersection	
Intersection Delay, s/veh	55.1
Intersection LOS	F

Movement	EBL	EBT	EBR	WBL	WBT	WBR	NBL	NBT	NBR	SBL	SBT	SBR
Lane Configurations		↕			↕			↕	↕		↕	
Traffic Vol, veh/h	180	500	10	10	320	10	10	10	20	10	10	200
Future Vol, veh/h	180	500	10	10	320	10	10	10	20	10	10	200
Peak Hour Factor	0.95	0.95	0.95	0.95	0.95	0.95	0.95	0.95	0.95	0.95	0.95	0.95
Heavy Vehicles, %	1	1	1	2	2	2	0	0	0	0	0	0
Mvmt Flow	189	526	11	11	337	11	11	11	21	11	11	211
Number of Lanes	0	1	0	0	1	0	0	1	1	0	1	0

Approach	EB	WB	NB	SB
Opposing Approach	WB	EB	SB	NB
Opposing Lanes	1	1	1	2
Conflicting Approach Left	SB	NB	EB	WB
Conflicting Lanes Left	1	2	1	1
Conflicting Approach Right	NB	SB	WB	EB
Conflicting Lanes Right	2	1	1	1
HCM Control Delay	89.6	17	11	13.8
HCM LOS	F	C	B	B

Lane	NBLn1	NBLn2	EBLn1	WBLn1	SBLn1
Vol Left, %	50%	0%	26%	3%	5%
Vol Thru, %	50%	0%	72%	94%	5%
Vol Right, %	0%	100%	1%	3%	91%
Sign Control	Stop	Stop	Stop	Stop	Stop
Traffic Vol by Lane	20	20	690	340	220
LT Vol	10	0	180	10	10
Through Vol	10	0	500	320	10
RT Vol	0	20	10	10	200
Lane Flow Rate	21	21	726	358	232
Geometry Grp	7	7	2	2	5
Degree of Util (X)	0.047	0.041	1.105	0.579	0.4
Departure Headway (Hd)	8.386	7.404	5.479	6.043	6.512
Convergence, Y/N	Yes	Yes	Yes	Yes	Yes
Cap	430	487	661	601	556
Service Time	6.086	5.104	3.509	4.043	4.512
HCM Lane V/C Ratio	0.049	0.043	1.098	0.596	0.417
HCM Control Delay	11.5	10.4	89.6	17	13.8
HCM Lane LOS	B	B	F	C	B
HCM 95th-tile Q	0.1	0.1	21.3	3.7	1.9

Intersection						
Int Delay, s/veh	1.9					
Movement	EBL	EBT	WBT	WBR	SBL	SBR
Lane Configurations		↶	↷		↶	
Traffic Vol, veh/h	160	360	330	10	10	10
Future Vol, veh/h	160	360	330	10	10	10
Conflicting Peds, #/hr	0	0	0	0	0	1
Sign Control	Free	Free	Free	Free	Stop	Stop
RT Channelized	-	None	-	None	-	None
Storage Length	-	-	-	-	0	-
Veh in Median Storage, #	-	0	0	-	0	-
Grade, %	-	0	0	-	0	-
Peak Hour Factor	96	96	96	96	96	96
Heavy Vehicles, %	2	2	1	1	4	4
Mvmt Flow	167	375	344	10	10	10

Major/Minor	Major1	Major2	Minor2		
Conflicting Flow All	354	0	-	0	1058 350
Stage 1	-	-	-	-	349 -
Stage 2	-	-	-	-	709 -
Critical Hdwy	4.12	-	-	-	6.44 6.24
Critical Hdwy Stg 1	-	-	-	-	5.44 -
Critical Hdwy Stg 2	-	-	-	-	5.44 -
Follow-up Hdwy	2.218	-	-	-	3.536 3.336
Pot Cap-1 Maneuver	1205	-	-	-	247 689
Stage 1	-	-	-	-	710 -
Stage 2	-	-	-	-	484 -
Platoon blocked, %		-	-	-	
Mov Cap-1 Maneuver	1205	-	-	-	204 688
Mov Cap-2 Maneuver	-	-	-	-	204 -
Stage 1	-	-	-	-	586 -
Stage 2	-	-	-	-	484 -

Approach	EB	WB	SB
HCM Control Delay, s	2.6	0	17.2
HCM LOS			C

Minor Lane/Major Mvmt	EBL	EBT	WBT	WBR	SBLn1
Capacity (veh/h)	1205	-	-	-	315
HCM Lane V/C Ratio	0.138	-	-	-	0.066
HCM Control Delay (s)	8.5	0	-	-	17.2
HCM Lane LOS	A	A	-	-	C
HCM 95th %tile Q(veh)	0.5	-	-	-	0.2

Intersection	
Intersection Delay, s/veh	13.6
Intersection LOS	B

Movement	EBL	EBT	EBR	WBL	WBT	WBR	NBL	NBT	NBR	SBL	SBT	SBR
Lane Configurations		↕			↕			↕			↕	
Traffic Vol, veh/h	360	10	10	10	10	10	10	10	10	10	10	330
Future Vol, veh/h	360	10	10	10	10	10	10	10	10	10	10	330
Peak Hour Factor	0.91	0.91	0.91	0.91	0.91	0.91	0.91	0.91	0.91	0.91	0.91	0.91
Heavy Vehicles, %	2	2	2	2	2	2	0	0	0	1	1	1
Mvmt Flow	396	11	11	11	11	11	11	11	11	11	11	363
Number of Lanes	0	1	0	0	1	0	0	1	0	0	1	0

Approach	EB	WB	NB	SB
Opposing Approach	WB	EB	SB	NB
Opposing Lanes	1	1	1	1
Conflicting Approach Left	SB	NB	EB	WB
Conflicting Lanes Left	1	1	1	1
Conflicting Approach Right	NB	SB	WB	EB
Conflicting Lanes Right	1	1	1	1
HCM Control Delay	15.8	8.8	8.9	12.1
HCM LOS	C	A	A	B

Lane	NBLn1	EBLn1	WBLn1	SBLn1
Vol Left, %	33%	95%	33%	3%
Vol Thru, %	33%	3%	33%	3%
Vol Right, %	33%	3%	33%	94%
Sign Control	Stop	Stop	Stop	Stop
Traffic Vol by Lane	30	380	30	350
LT Vol	10	360	10	10
Through Vol	10	10	10	10
RT Vol	10	10	10	330
Lane Flow Rate	33	418	33	385
Geometry Grp	1	1	1	1
Degree of Util (X)	0.051	0.604	0.05	0.489
Departure Headway (Hd)	5.558	5.203	5.485	4.578
Convergence, Y/N	Yes	Yes	Yes	Yes
Cap	645	697	655	777
Service Time	3.586	3.205	3.5	2.67
HCM Lane V/C Ratio	0.051	0.6	0.05	0.495
HCM Control Delay	8.9	15.8	8.8	12.1
HCM Lane LOS	A	C	A	B
HCM 95th-tile Q	0.2	4.1	0.2	2.7

HCM 2010 Signalized Intersection Summary
 46: General Jim Moore Boulevard & Normandy Road

Existing with Project, PM
 06/11/2019



Movement	EBL	EBT	EBR	WBL	WBT	WBR	NBL	NBT	NBR	SBL	SBT	SBR
Lane Configurations		↕			↕		↕	↕↕		↕	↕↕	↕
Traffic Volume (veh/h)	50	30	40	50	30	10	50	780	70	30	410	50
Future Volume (veh/h)	50	30	40	50	30	10	50	780	70	30	410	50
Number	3	8	18	7	4	14	1	6	16	5	2	12
Initial Q (Qb), veh	0	0	0	0	0	0	0	0	0	0	0	0
Ped-Bike Adj(A_pbT)	1.00		0.99	1.00		0.99	1.00		1.00	1.00		1.00
Parking Bus, Adj	1.00	1.00	1.00	1.00	1.00	1.00	1.00	1.00	1.00	1.00	1.00	1.00
Adj Sat Flow, veh/h/ln	1900	1863	1900	1900	1881	1900	1881	1881	1900	1900	1900	1900
Adj Flow Rate, veh/h	54	33	18	54	33	8	54	848	53	33	446	-5
Adj No. of Lanes	0	1	0	0	1	0	1	2	0	1	2	1
Peak Hour Factor	0.92	0.92	0.92	0.92	0.92	0.92	0.92	0.92	0.92	0.92	0.92	0.92
Percent Heavy Veh, %	2	2	2	1	1	1	1	1	1	0	0	0
Cap, veh/h	298	109	45	318	122	22	288	1111	69	73	738	330
Arrive On Green	0.16	0.16	0.16	0.16	0.16	0.16	0.16	0.33	0.33	0.04	0.20	0.00
Sat Flow, veh/h	660	667	275	739	750	137	1792	3417	214	1810	3610	1615
Grp Volume(v), veh/h	105	0	0	95	0	0	54	444	457	33	446	-5
Grp Sat Flow(s),veh/h/ln	1601	0	0	1625	0	0	1792	1787	1843	1810	1805	1615
Q Serve(g_s), s	0.2	0.0	0.0	0.0	0.0	0.0	0.7	6.4	6.4	0.5	3.2	0.0
Cycle Q Clear(g_c), s	1.5	0.0	0.0	1.3	0.0	0.0	0.7	6.4	6.4	0.5	3.2	0.0
Prop In Lane	0.51		0.17	0.57		0.08	1.00		0.12	1.00		1.00
Lane Grp Cap(c), veh/h	452	0	0	463	0	0	288	581	599	73	738	330
V/C Ratio(X)	0.23	0.00	0.00	0.21	0.00	0.00	0.19	0.76	0.76	0.45	0.60	-0.02
Avail Cap(c_a), veh/h	1956	0	0	1967	0	0	500	1591	1641	505	3213	1437
HCM Platoon Ratio	1.00	1.00	1.00	1.00	1.00	1.00	1.00	1.00	1.00	1.00	1.00	1.00
Upstream Filter(l)	1.00	0.00	0.00	1.00	0.00	0.00	1.00	1.00	1.00	1.00	1.00	0.00
Uniform Delay (d), s/veh	10.6	0.0	0.0	10.6	0.0	0.0	10.4	8.7	8.7	13.4	10.3	0.0
Incr Delay (d2), s/veh	0.1	0.0	0.0	0.1	0.0	0.0	0.1	0.8	0.8	1.6	0.3	0.0
Initial Q Delay(d3),s/veh	0.0	0.0	0.0	0.0	0.0	0.0	0.0	0.0	0.0	0.0	0.0	0.0
%ile BackOfQ(50%),veh/ln	0.7	0.0	0.0	0.7	0.0	0.0	0.4	3.2	3.3	0.3	1.6	0.0
LnGrp Delay(d),s/veh	10.7	0.0	0.0	10.7	0.0	0.0	10.5	9.5	9.4	15.1	10.6	0.0
LnGrp LOS	B			B			B	A	A	B	B	
Approach Vol, veh/h		105			95			955			474	
Approach Delay, s/veh		10.7			10.7			9.5			11.1	
Approach LOS		B			B			A			B	
Timer	1	2	3	4	5	6	7	8				
Assigned Phs	1	2		4	5	6		8				
Phs Duration (G+Y+Rc), s	9.1	10.4		9.2	5.7	13.8		9.2				
Change Period (Y+Rc), s	4.5	4.5		4.5	4.5	4.5		4.5				
Max Green Setting (Gmax), s	25.5	25.5		33.0	8.0	25.5		33.0				
Max Q Clear Time (g_c+1/2), s	5.2	5.2		3.3	2.5	8.4		3.5				
Green Ext Time (p_c), s	0.0	0.5		0.1	0.0	0.8		0.1				
Intersection Summary												
HCM 2010 Ctrl Delay				10.1								
HCM 2010 LOS				B								

Intersection	
Intersection Delay, s/veh	23
Intersection LOS	C

Movement	EBL	EBR	NBL	NBT	SBT	SBR
Lane Configurations						
Traffic Vol, veh/h	60	100	160	880	350	90
Future Vol, veh/h	60	100	160	880	350	90
Peak Hour Factor	0.89	0.89	0.89	0.89	0.89	0.89
Heavy Vehicles, %	1	1	1	1	1	1
Mvmt Flow	67	112	180	989	393	101
Number of Lanes	1	1	1	2	2	1

Approach	EB	NB	SB
Opposing Approach		SB	NB
Opposing Lanes	0	3	3
Conflicting Approach Left	SB	EB	
Conflicting Lanes Left	3	2	0
Conflicting Approach Right	NB		EB
Conflicting Lanes Right	3	0	2
HCM Control Delay	13.3	28.3	14.1
HCM LOS	B	D	B

Lane	NBLn1	NBLn2	NBLn3	EBLn1	EBLn2	SBLn1	SBLn2	SBLn3
Vol Left, %	100%	0%	0%	100%	0%	0%	0%	0%
Vol Thru, %	0%	100%	100%	0%	0%	100%	100%	0%
Vol Right, %	0%	0%	0%	0%	100%	0%	0%	100%
Sign Control	Stop	Stop	Stop	Stop	Stop	Stop	Stop	Stop
Traffic Vol by Lane	160	440	440	60	100	175	175	90
LT Vol	160	0	0	60	0	0	0	0
Through Vol	0	440	440	0	0	175	175	0
RT Vol	0	0	0	0	100	0	0	90
Lane Flow Rate	180	494	494	67	112	197	197	101
Geometry Grp	8	8	8	8	8	8	8	8
Degree of Util (X)	0.356	0.91	0.671	0.169	0.244	0.411	0.411	0.142
Departure Headway (Hd)	7.135	6.628	4.887	9.02	7.808	7.522	7.522	5.067
Convergence, Y/N	Yes	Yes	Yes	Yes	Yes	Yes	Yes	Yes
Cap	507	549	747	397	460	478	478	705
Service Time	4.835	4.328	2.587	6.782	5.569	5.273	5.273	2.817
HCM Lane V/C Ratio	0.355	0.9	0.661	0.169	0.243	0.412	0.412	0.143
HCM Control Delay	13.7	45	17	13.6	13.1	15.5	15.5	8.7
HCM Lane LOS	B	E	C	B	B	C	C	A
HCM 95th-tile Q	1.6	10.9	5.2	0.6	0.9	2	2	0.5



Movement	EBL	EBT	EBR	WBL	WBT	WBR	NBL	NBT	NBR	SBL	SBT	SBR
Lane Configurations												
Traffic Volume (veh/h)	220	230	60	90	170	60	110	1000	230	100	570	220
Future Volume (veh/h)	220	230	60	90	170	60	110	1000	230	100	570	220
Number	7	4	14	3	8	18	5	2	12	1	6	16
Initial Q (Qb), veh	0	0	0	0	0	0	0	0	0	0	0	0
Ped-Bike Adj(A_pbT)	1.00		0.98	1.00		0.99	1.00		0.99	1.00		0.99
Parking Bus, Adj	1.00	1.00	1.00	1.00	1.00	1.00	1.00	1.00	1.00	1.00	1.00	1.00
Adj Sat Flow, veh/h/ln	1881	1881	1881	1900	1900	1900	1881	1881	1900	1863	1863	1863
Adj Flow Rate, veh/h	227	237	15	93	175	56	113	1031	225	103	588	155
Adj No. of Lanes	1	1	1	0	1	0	1	2	0	1	2	1
Peak Hour Factor	0.97	0.97	0.97	0.97	0.97	0.97	0.97	0.97	0.97	0.97	0.97	0.97
Percent Heavy Veh, %	1	1	1	0	0	0	1	1	1	2	2	2
Cap, veh/h	291	305	254	101	190	61	522	1220	265	127	671	297
Arrive On Green	0.16	0.16	0.16	0.19	0.19	0.19	0.29	0.42	0.42	0.07	0.19	0.19
Sat Flow, veh/h	1792	1881	1566	521	981	314	1792	2917	634	1774	3539	1568
Grp Volume(v), veh/h	227	237	15	324	0	0	113	630	626	103	588	155
Grp Sat Flow(s),veh/h/ln	1792	1881	1566	1816	0	0	1792	1787	1764	1774	1770	1568
Q Serve(g_s), s	15.2	15.1	1.0	21.9	0.0	0.0	6.0	39.6	40.0	7.2	20.2	11.1
Cycle Q Clear(g_c), s	15.2	15.1	1.0	21.9	0.0	0.0	6.0	39.6	40.0	7.2	20.2	11.1
Prop In Lane	1.00		1.00	0.29		0.17	1.00		0.36	1.00		1.00
Lane Grp Cap(c), veh/h	291	305	254	351	0	0	522	748	738	127	671	297
V/C Ratio(X)	0.78	0.78	0.06	0.92	0.00	0.00	0.22	0.84	0.85	0.81	0.88	0.52
Avail Cap(c_a), veh/h	573	602	501	363	0	0	522	748	738	241	671	297
HCM Platoon Ratio	1.00	1.00	1.00	1.00	1.00	1.00	1.00	1.00	1.00	1.00	1.00	1.00
Upstream Filter(I)	0.67	0.67	0.67	1.00	0.00	0.00	1.00	1.00	1.00	1.00	1.00	1.00
Uniform Delay (d), s/veh	50.2	50.2	44.3	49.5	0.0	0.0	33.5	32.7	32.8	57.2	49.2	45.5
Incr Delay (d2), s/veh	3.1	2.9	0.1	28.5	0.0	0.0	0.1	11.2	11.6	4.6	15.0	6.4
Initial Q Delay(d3),s/veh	0.0	0.0	0.0	0.0	0.0	0.0	0.0	0.0	0.0	0.0	0.0	0.0
%ile BackOfQ(50%),veh/ln	7.8	8.1	0.4	13.8	0.0	0.0	3.0	21.8	21.8	3.7	11.3	5.4
LnGrp Delay(d),s/veh	53.3	53.1	44.4	78.0	0.0	0.0	33.6	43.9	44.4	61.8	64.2	51.9
LnGrp LOS	D	D	D	E			C	D	D	E	E	D
Approach Vol, veh/h		479			324			1369			846	
Approach Delay, s/veh		52.9			78.0			43.3			61.7	
Approach LOS		D			E			D			E	
Timer	1	2	3	4	5	6	7	8				
Assigned Phs	1	2		4	5	6		8				
Phs Duration (G+Y+Rc), s	3.2	57.6		25.0	41.7	29.0		29.3				
Change Period (Y+Rc), s	4.2	5.3		* 4.7	5.3	* 5.3		5.1				
Max Green Setting (Gmax), s	13	23.7		* 40	17.0	* 24		25.0				
Max Q Clear Time (g_c+19.2), s	19.2	42.0		17.2	8.0	22.2		23.9				
Green Ext Time (p_c), s	0.1	0.0		2.1	0.1	0.6		0.3				
Intersection Summary												
HCM 2010 Ctrl Delay			53.7									
HCM 2010 LOS			D									
Notes												



Movement	EBL	EBT	EBR	WBL	WBT	WBR	NBL	NBT	NBR	SBL	SBT	SBR
Lane Configurations		↕↕	↗	↖		↗		↕	↗		↕	
Traffic Volume (veh/h)	10	200	120	280	0	190	0	120	290	10	10	0
Future Volume (veh/h)	10	200	120	280	0	190	0	120	290	10	10	0
Number	1	6	16	5	2	12	7	4	14	3	8	18
Initial Q (Qb), veh	0	0	0	0	0	0	0	0	0	0	0	0
Ped-Bike Adj(A_pbT)	1.00		1.00	1.00		1.00	1.00		1.00	1.00		1.00
Parking Bus, Adj	1.00	1.00	1.00	1.00	1.00	1.00	1.00	1.00	1.00	1.00	1.00	1.00
Adj Sat Flow, veh/h/ln	1900	1863	1863	1900	0	1900	0	1881	1881	1900	1900	0
Adj Flow Rate, veh/h	11	220	14	308	0	135	0	132	40	11	11	0
Adj No. of Lanes	0	2	1	1	0	1	0	1	1	0	1	0
Peak Hour Factor	0.91	0.91	0.91	0.91	0.91	0.91	0.91	0.91	0.91	0.91	0.91	0.91
Percent Heavy Veh, %	2	2	2	0	0	0	0	1	1	0	0	0
Cap, veh/h	138	2896	1323	0	0	0	0	163	139	57	43	0
Arrive On Green	0.84	0.84	0.84	0.00	0.00	0.00	0.00	0.09	0.09	0.09	0.09	0.00
Sat Flow, veh/h	165	3459	1580				0	1881	1599	154	496	0
Grp Volume(v), veh/h	124	107	14		0.0		0	132	40	22	0	0
Grp Sat Flow(s),veh/h/ln	1855	1770	1580				0	1881	1599	651	0	0
Q Serve(g_s), s	1.5	1.3	0.2				0.0	8.6	2.9	0.1	0.0	0.0
Cycle Q Clear(g_c), s	1.5	1.3	0.2				0.0	8.6	2.9	8.7	0.0	0.0
Prop In Lane	0.09		1.00				0.00		1.00	0.50		0.00
Lane Grp Cap(c), veh/h	1552	1481	1323				0	163	139	100	0	0
V/C Ratio(X)	0.08	0.07	0.01				0.00	0.81	0.29	0.22	0.00	0.00
Avail Cap(c_a), veh/h	1552	1481	1323				0	271	230	125	0	0
HCM Platoon Ratio	1.00	1.00	1.00				1.00	1.00	1.00	1.00	1.00	1.00
Upstream Filter(I)	1.00	1.00	1.00				0.00	1.00	1.00	1.00	0.00	0.00
Uniform Delay (d), s/veh	1.8	1.8	1.7				0.0	56.0	53.5	52.9	0.0	0.0
Incr Delay (d2), s/veh	0.0	0.0	0.0				0.0	3.6	0.4	0.4	0.0	0.0
Initial Q Delay(d3),s/veh	0.0	0.0	0.0				0.0	0.0	0.0	0.0	0.0	0.0
%ile BackOfQ(50%),veh/ln	0.7	0.6	0.1				0.0	4.6	1.3	0.7	0.0	0.0
LnGrp Delay(d),s/veh	1.8	1.8	1.7				0.0	59.6	53.9	53.3	0.0	0.0
LnGrp LOS	A	A	A					E	D	D		
Approach Vol, veh/h		245						172			22	
Approach Delay, s/veh		1.8						58.3			53.3	
Approach LOS		A						E			D	
Timer	1	2	3	4	5	6	7	8				
Assigned Phs				4		6		8				
Phs Duration (G+Y+Rc), s				15.1		109.9		15.1				
Change Period (Y+Rc), s				* 4.2		5.3		* 4.2				
Max Green Setting (Gmax), s				* 18		21.0		* 13				
Max Q Clear Time (g_c+I1), s				10.6		3.5		10.7				
Green Ext Time (p_c), s				0.3		0.8		0.0				
Intersection Summary												
HCM 2010 Ctrl Delay			26.5									
HCM 2010 LOS			C									
Notes												

HCM 2010 Signalized Intersection Summary
 50: Reservation Road & SR 68 WB On Ramp/SR 68 WB Off Ramp





















Existing with Project, PM
 06/11/2019



Movement	EBL	EBT	EBR	WBL	WBT	WBR	NBL	NBT	NBR	SBL	SBT	SBR
Lane Configurations					↕	↕	↕	↑			↕	
Traffic Volume (veh/h)	0	0	0	420	10	250	140	230	0	0	500	130
Future Volume (veh/h)	0	0	0	420	10	250	140	230	0	0	500	130
Number				7	4	14	1	6	16	5	2	12
Initial Q (Qb), veh				0	0	0	0	0	0	0	0	0
Ped-Bike Adj(A_pbT)				1.00		1.00	1.00		1.00	1.00		1.00
Parking Bus, Adj				1.00	1.00	1.00	1.00	1.00	1.00	1.00	1.00	1.00
Adj Sat Flow, veh/h/ln				1900	1863	1863	1845	1845	0	0	1827	1900
Adj Flow Rate, veh/h				447	11	84	149	245	0	0	532	128
Adj No. of Lanes				0	1	1	1	1	0	0	1	0
Peak Hour Factor				0.94	0.94	0.94	0.94	0.94	0.94	0.94	0.94	0.94
Percent Heavy Veh, %				2	2	2	3	3	0	0	4	4
Cap, veh/h				495	12	451	185	1082	0	0	627	151
Arrive On Green				0.29	0.29	0.29	0.03	0.19	0.00	0.00	0.44	0.44
Sat Flow, veh/h				1733	43	1581	1757	1845	0	0	1424	343
Grp Volume(v), veh/h				458	0	84	149	245	0	0	0	660
Grp Sat Flow(s),veh/h/ln				1776	0	1581	1757	1845	0	0	0	1766
Q Serve(g_s), s				21.1	0.0	3.4	7.2	9.5	0.0	0.0	0.0	28.4
Cycle Q Clear(g_c), s				21.1	0.0	3.4	7.2	9.5	0.0	0.0	0.0	28.4
Prop In Lane				0.98		1.00	1.00		0.00	0.00		0.19
Lane Grp Cap(c), veh/h				507	0	451	185	1082	0	0	0	777
V/C Ratio(X)				0.90	0.00	0.19	0.81	0.23	0.00	0.00	0.00	0.85
Avail Cap(c_a), veh/h				564	0	502	248	1082	0	0	0	777
HCM Platoon Ratio				1.00	1.00	1.00	0.33	0.33	1.00	1.00	1.00	1.00
Upstream Filter(I)				1.00	0.00	1.00	0.95	0.95	0.00	0.00	0.00	1.00
Uniform Delay (d), s/veh				29.2	0.0	22.9	40.2	18.0	0.0	0.0	0.0	21.3
Incr Delay (d2), s/veh				16.9	0.0	0.2	9.3	0.5	0.0	0.0	0.0	11.2
Initial Q Delay(d3),s/veh				0.0	0.0	0.0	0.0	0.0	0.0	0.0	0.0	0.0
%ile BackOfQ(50%),veh/ln				12.7	0.0	1.5	4.0	5.0	0.0	0.0	0.0	16.2
LnGrp Delay(d),s/veh				46.1	0.0	23.1	49.5	18.5	0.0	0.0	0.0	32.4
LnGrp LOS				D		C	D	B				C
Approach Vol, veh/h					542			394			660	
Approach Delay, s/veh					42.6			30.2			32.4	
Approach LOS					D			C			C	
Timer	1	2	3	4	5	6	7	8				
Assigned Phs	1	2		4		6						
Phs Duration (G+Y+Rc), s	2.4	43.4		29.2		55.8						
Change Period (Y+Rc), s	3.5	6.0		4.9		6.0						
Max Green Setting (Gmax), s	2.0	31.6		27.0		47.1						
Max Q Clear Time (g_c+1.2), s	19.2	30.4		23.1		11.5						
Green Ext Time (p_c), s	0.0	0.5		1.2		1.2						
Intersection Summary												
HCM 2010 Ctrl Delay				35.3								
HCM 2010 LOS				D								

HCM 2010 Signalized Intersection Summary
1: Del Monte Boulevard & Reindollar Avenue

Cumulative, AM
06/11/2019

												
Movement	EBL	EBT	EBR	WBL	WBT	WBR	NBL	NBT	NBR	SBL	SBT	SBR
Lane Configurations												
Traffic Volume (veh/h)	0	0	0	450	0	420	10	640	120	410	1160	0
Future Volume (veh/h)	0	0	0	450	0	420	10	640	120	410	1160	0
Number				3	8	18	1	6	16	5	2	12
Initial Q (Qb), veh				0	0	0	0	0	0	0	0	0
Ped-Bike Adj(A_pbT)				1.00		0.99	1.00		1.00	1.00		1.00
Parking Bus, Adj				1.00	1.00	1.00	1.00	1.00	1.00	1.00	1.00	1.00
Adj Sat Flow, veh/h/ln				1900	1900	1900	1863	1863	1863	1845	1845	0
Adj Flow Rate, veh/h				468	54	429	11	719	68	461	1303	0
Adj No. of Lanes				1	1	0	1	2	1	1	2	0
Peak Hour Factor				0.89	0.89	0.89	0.89	0.89	0.89	0.89	0.89	0.89
Percent Heavy Veh, %				0	0	0	2	2	2	3	3	0
Cap, veh/h				575	58	461	24	892	397	499	1832	0
Arrive On Green				0.32	0.32	0.32	0.01	0.25	0.25	0.28	0.52	0.00
Sat Flow, veh/h				1810	183	1451	1774	3539	1577	1757	3597	0
Grp Volume(v), veh/h				468	0	483	11	719	68	461	1303	0
Grp Sat Flow(s),veh/h/ln				1810	0	1634	1774	1770	1577	1757	1752	0
Q Serve(g_s), s				21.9	0.0	26.4	0.6	17.6	3.1	23.5	26.0	0.0
Cycle Q Clear(g_c), s				21.9	0.0	26.4	0.6	17.6	3.1	23.5	26.0	0.0
Prop In Lane				1.00		0.89	1.00		1.00	1.00		0.00
Lane Grp Cap(c), veh/h				575	0	519	24	892	397	499	1832	0
V/C Ratio(X)				0.81	0.00	0.93	0.47	0.81	0.17	0.92	0.71	0.00
Avail Cap(c_a), veh/h				589	0	532	578	1153	514	572	1832	0
HCM Platoon Ratio				1.00	1.00	1.00	1.00	1.00	1.00	1.00	1.00	1.00
Upstream Filter(I)				1.00	0.00	1.00	1.00	1.00	1.00	1.00	1.00	0.00
Uniform Delay (d), s/veh				28.9	0.0	30.5	45.1	32.3	26.9	32.0	16.7	0.0
Incr Delay (d2), s/veh				8.5	0.0	23.0	13.6	3.3	0.2	19.4	1.3	0.0
Initial Q Delay(d3),s/veh				0.0	0.0	0.0	0.0	0.0	0.0	0.0	0.0	0.0
%ile BackOfQ(50%),veh/ln				12.3	0.0	15.1	0.4	9.0	1.4	14.1	12.8	0.0
LnGrp Delay(d),s/veh				37.4	0.0	53.4	58.7	35.7	27.1	51.5	18.0	0.0
LnGrp LOS				D		D	E	D	C	D	B	
Approach Vol, veh/h					951			798			1764	
Approach Delay, s/veh					45.5			35.3			26.8	
Approach LOS					D			D			C	
Timer	1	2	3	4	5	6	7	8				
Assigned Phs	1	2			5	6		8				
Phs Duration (G+Y+Rc), s	4.7	53.1			29.7	28.2		34.2				
Change Period (Y+Rc), s	3.5	5.0			3.5	5.0		5.0				
Max Green Setting (Gmax), s	30.0	30.0			30.0	30.0		30.0				
Max Q Clear Time (g_c+I1), s	2.6	28.0			25.5	19.6		28.4				
Green Ext Time (p_c), s	0.0	1.5			0.7	3.6		0.9				
Intersection Summary												
HCM 2010 Ctrl Delay				33.8								
HCM 2010 LOS				C								
Notes												

HCM 2010 Signalized Intersection Summary
2: 2nd Avenue & Patton Parkway

Cumulative, AM
06/11/2019



Movement	EBL	EBT	EBR	WBL	WBT	WBR	NBL	NBT	NBR	SBL	SBT	SBR
Lane Configurations	↖	↗		↖	↗		↖	↗		↖	↗	
Traffic Volume (veh/h)	50	90	60	30	90	100	70	220	100	90	200	50
Future Volume (veh/h)	50	90	60	30	90	100	70	220	100	90	200	50
Number	7	4	14	3	8	18	5	2	12	1	6	16
Initial Q (Qb), veh	0	0	0	0	0	0	0	0	0	0	0	0
Ped-Bike Adj(A_pbT)	1.00		1.00	1.00		1.00	1.00		1.00	1.00		1.00
Parking Bus, Adj	1.00	1.00	1.00	1.00	1.00	1.00	1.00	1.00	1.00	1.00	1.00	1.00
Adj Sat Flow, veh/h/ln	1863	1863	1900	1863	1863	1900	1863	1863	1900	1863	1863	1900
Adj Flow Rate, veh/h	54	98	65	33	98	109	76	239	109	98	217	54
Adj No. of Lanes	1	1	0	1	1	0	1	1	0	1	1	0
Peak Hour Factor	0.92	0.92	0.92	0.92	0.92	0.92	0.92	0.92	0.92	0.92	0.92	0.92
Percent Heavy Veh, %	2	2	2	2	2	2	2	2	2	2	2	2
Cap, veh/h	97	247	164	67	177	197	121	330	151	139	407	101
Arrive On Green	0.05	0.24	0.24	0.04	0.22	0.22	0.07	0.27	0.27	0.08	0.28	0.28
Sat Flow, veh/h	1774	1046	694	1774	807	897	1774	1212	553	1774	1441	359
Grp Volume(v), veh/h	54	0	163	33	0	207	76	0	348	98	0	271
Grp Sat Flow(s),veh/h/ln	1774	0	1740	1774	0	1704	1774	0	1765	1774	0	1799
Q Serve(g_s), s	1.3	0.0	3.6	0.8	0.0	4.9	1.9	0.0	8.1	2.4	0.0	5.8
Cycle Q Clear(g_c), s	1.3	0.0	3.6	0.8	0.0	4.9	1.9	0.0	8.1	2.4	0.0	5.8
Prop In Lane	1.00		0.40	1.00		0.53	1.00		0.31	1.00		0.20
Lane Grp Cap(c), veh/h	97	0	411	67	0	374	121	0	481	139	0	509
V/C Ratio(X)	0.56	0.00	0.40	0.50	0.00	0.55	0.63	0.00	0.72	0.71	0.00	0.53
Avail Cap(c_a), veh/h	235	0	1364	235	0	1336	235	0	1384	235	0	1411
HCM Platoon Ratio	1.00	1.00	1.00	1.00	1.00	1.00	1.00	1.00	1.00	1.00	1.00	1.00
Upstream Filter(I)	1.00	0.00	1.00	1.00	0.00	1.00	1.00	0.00	1.00	1.00	0.00	1.00
Uniform Delay (d), s/veh	20.9	0.0	14.6	21.4	0.0	15.7	20.5	0.0	14.9	20.4	0.0	13.7
Incr Delay (d2), s/veh	5.0	0.0	0.6	5.6	0.0	1.3	5.3	0.0	2.1	6.4	0.0	0.9
Initial Q Delay(d3),s/veh	0.0	0.0	0.0	0.0	0.0	0.0	0.0	0.0	0.0	0.0	0.0	0.0
%ile BackOfQ(50%),veh/ln	0.8	0.0	1.8	0.5	0.0	2.4	1.1	0.0	4.1	1.4	0.0	3.0
LnGrp Delay(d),s/veh	25.9	0.0	15.2	27.0	0.0	17.0	25.9	0.0	17.0	26.8	0.0	14.6
LnGrp LOS	C		B	C		B	C		B	C		B
Approach Vol, veh/h		217			240			424			369	
Approach Delay, s/veh		17.8			18.4			18.6			17.8	
Approach LOS		B			B			B			B	
Timer	1	2	3	4	5	6	7	8				
Assigned Phs	1	2	3	4	5	6	7	8				
Phs Duration (G+Y+Rc), s	7.5	16.8	5.7	15.2	7.1	17.3	6.5	14.4				
Change Period (Y+Rc), s	4.0	4.5	4.0	4.5	4.0	4.5	4.0	4.5				
Max Green Setting (Gmax), s	6.0	35.5	6.0	35.5	6.0	35.5	6.0	35.5				
Max Q Clear Time (g_c+14), s	14.4	10.1	2.8	5.6	3.9	7.8	3.3	6.9				
Green Ext Time (p_c), s	0.0	2.2	0.0	1.0	0.0	1.7	0.0	1.3				
Intersection Summary												
HCM 2010 Ctrl Delay			18.2									
HCM 2010 LOS			B									

HCM 2010 Signalized Intersection Summary
 3: SR 1 SB On-Ramp/SR 1 SB Off-Ramp & Imjin Parkway

Cumulative, AM
 06/11/2019



Movement	EBL	EBT	EBR	WBL	WBT	WBR	NBL	NBT	NBR	SBL	SBT	SBR
Lane Configurations					↕						↕	
Traffic Volume (veh/h)	0	0	0	1170	0	0	0	0	0	910	10	0
Future Volume (veh/h)	0	0	0	1170	0	0	0	0	0	910	10	0
Number				1	6	16				7	4	14
Initial Q (Qb), veh				0	0	0				0	0	0
Ped-Bike Adj(A_pbT)				1.00		1.00				1.00		1.00
Parking Bus, Adj				1.00	1.00	1.00				1.00	1.00	1.00
Adj Sat Flow, veh/h/ln				1900	1845	0				1900	1845	0
Adj Flow Rate, veh/h				1286	0	0				1000	11	0
Adj No. of Lanes				0	1	0				0	1	0
Peak Hour Factor				0.91	0.91	0.91				0.91	0.91	0.91
Percent Heavy Veh, %				3	3	0				3	3	0
Cap, veh/h				996	0	0				657	7	0
Arrive On Green				0.57	0.00	0.00				0.38	0.38	0.00
Sat Flow, veh/h				1757	0	0				1739	19	0
Grp Volume(v), veh/h				1286	0	0				1011	0	0
Grp Sat Flow(s),veh/h/ln				1757	0	0				1758	0	0
Q Serve(g_s), s				90.0	0.0	0.0				60.0	0.0	0.0
Cycle Q Clear(g_c), s				90.0	0.0	0.0				60.0	0.0	0.0
Prop In Lane				1.00		0.00				0.99		0.00
Lane Grp Cap(c), veh/h				996	0	0				664	0	0
V/C Ratio(X)				1.29	0.00	0.00				1.52	0.00	0.00
Avail Cap(c_a), veh/h				996	0	0				664	0	0
HCM Platoon Ratio				1.00	1.00	1.00				1.00	1.00	1.00
Upstream Filter(I)				1.00	0.00	0.00				1.00	0.00	0.00
Uniform Delay (d), s/veh				34.2	0.0	0.0				49.2	0.0	0.0
Incr Delay (d2), s/veh				138.8	0.0	0.0				242.7	0.0	0.0
Initial Q Delay(d3),s/veh				0.0	0.0	0.0				0.0	0.0	0.0
%ile BackOfQ(50%),veh/ln				81.8	0.0	0.0				73.7	0.0	0.0
LnGrp Delay(d),s/veh				173.0	0.0	0.0				291.9	0.0	0.0
LnGrp LOS				F						F		
Approach Vol, veh/h					1286						1011	
Approach Delay, s/veh					173.0						291.9	
Approach LOS					F						F	
Timer	1	2	3	4	5	6	7	8				
Assigned Phs				4		6						
Phs Duration (G+Y+Rc), s				64.4		94.4						
Change Period (Y+Rc), s				4.4		4.4						
Max Green Setting (Gmax), s				60.0		90.0						
Max Q Clear Time (g_c+I1), s				62.0		92.0						
Green Ext Time (p_c), s				0.0		0.0						
Intersection Summary												
HCM 2010 Ctrl Delay				225.3								
HCM 2010 LOS				F								

Intersection												
Int Delay, s/veh	1.1											
Movement	EBL	EBT	EBR	WBL	WBT	WBR	NBL	NBT	NBR	SBL	SBT	SBR
Lane Configurations		↕			↑	↗		↕	↗			
Traffic Vol, veh/h	10	920	0	0	1120	410	10	10	1060	0	0	0
Future Vol, veh/h	10	920	0	0	1120	410	10	10	1060	0	0	0
Conflicting Peds, #/hr	0	0	3	3	0	0	0	0	0	0	0	0
Sign Control	Free	Free	Free	Free	Free	Free	Stop	Stop	Stop	Stop	Stop	Stop
RT Channelized	-	-	None	-	-	Free	-	-	Free	-	-	None
Storage Length	-	-	-	-	-	0	-	-	800	-	-	-
Veh in Median Storage, #	-	0	-	-	0	-	-	0	-	-	16965	-
Grade, %	-	0	-	-	0	-	-	0	-	-	0	-
Peak Hour Factor	97	97	97	97	97	97	97	97	97	97	97	97
Heavy Vehicles, %	3	3	3	3	3	3	2	2	2	2	2	2
Mvmt Flow	10	948	0	0	1155	423	10	10	1093	0	0	0























Major/Minor	Major1	Major2	Minor1
Conflicting Flow All	1155	0	-
Stage 1	-	-	-
Stage 2	-	-	-
Critical Hdwy	4.13	-	-
Critical Hdwy Stg 1	-	-	-
Critical Hdwy Stg 2	-	-	-
Follow-up Hdwy	2.227	-	-
Pot Cap-1 Maneuver	601	-	0
Stage 1	-	-	0
Stage 2	-	-	0
Platoon blocked, %	-	-	-
Mov Cap-1 Maneuver	601	-	-
Mov Cap-2 Maneuver	-	-	-
Stage 1	-	-	-
Stage 2	-	-	-

Approach	EB	WB	NB
HCM Control Delay, s	0.1	0	110.9
HCM LOS			F

Minor Lane/Major Mvmt	NBLn1	NBLn2	EBL	EBT	WBT
Capacity (veh/h)	53	-	601	-	-
HCM Lane V/C Ratio	0.389	-	0.017	-	-
HCM Control Delay (s)	110.9	0	11.1	0	-
HCM Lane LOS	F	A	B	A	-
HCM 95th %tile Q(veh)	1.4	-	0.1	-	-

HCM 2010 Signalized Intersection Summary
5: 2nd Avenue & Imjin Parkway

Cumulative, AM
06/11/2019

												
Movement	EBL	EBT	EBR	WBL	WBT	WBR	NBL	NBT	NBR	SBL	SBT	SBR
Lane Configurations												
Traffic Volume (veh/h)	180	1110	850	480	970	120	370	90	200	50	100	210
Future Volume (veh/h)	180	1110	850	480	970	120	370	90	200	50	100	210
Number	5	2	12	1	6	16	3	8	18	7	4	14
Initial Q (Qb), veh	0	0	0	0	0	0	0	0	0	0	0	0
Ped-Bike Adj(A_pbT)	1.00		1.00	1.00		1.00	1.00		1.00	1.00		1.00
Parking Bus, Adj	1.00	1.00	1.00	1.00	1.00	1.00	1.00	1.00	1.00	1.00	1.00	1.00
Adj Sat Flow, veh/h/ln	1863	1863	1863	1863	1863	1900	1810	1810	1810	1900	1900	1900
Adj Flow Rate, veh/h	184	1133	648	490	990	122	378	92	82	51	102	209
Adj No. of Lanes	1	2	1	2	2	0	2	1	1	1	2	0
Peak Hour Factor	0.98	0.98	0.98	0.98	0.98	0.98	0.98	0.98	0.98	0.98	0.98	0.98
Percent Heavy Veh, %	2	2	2	2	2	2	5	5	5	0	0	0
Cap, veh/h	221	1220	546	559	1214	149	448	428	364	91	277	247
Arrive On Green	0.12	0.34	0.34	0.16	0.38	0.38	0.13	0.24	0.24	0.05	0.15	0.15
Sat Flow, veh/h	1774	3539	1583	3442	3173	391	3343	1810	1536	1810	1805	1612
Grp Volume(v), veh/h	184	1133	648	490	552	560	378	92	82	51	102	209
Grp Sat Flow(s),veh/h/ln	1774	1770	1583	1721	1770	1794	1672	1810	1536	1810	1805	1612
Q Serve(g_s), s	8.8	26.8	30.0	12.1	24.4	24.4	9.6	3.6	3.7	2.4	4.4	11.0
Cycle Q Clear(g_c), s	8.8	26.8	30.0	12.1	24.4	24.4	9.6	3.6	3.7	2.4	4.4	11.0
Prop In Lane	1.00		1.00	1.00		0.22	1.00		1.00	1.00		1.00
Lane Grp Cap(c), veh/h	221	1220	546	559	677	686	448	428	364	91	277	247
V/C Ratio(X)	0.83	0.93	1.19	0.88	0.82	0.82	0.84	0.21	0.23	0.56	0.37	0.85
Avail Cap(c_a), veh/h	306	1220	546	593	677	686	768	437	371	208	436	389
HCM Platoon Ratio	1.00	1.00	1.00	1.00	1.00	1.00	1.00	1.00	1.00	1.00	1.00	1.00
Upstream Filter(I)	1.00	1.00	1.00	1.00	1.00	1.00	1.00	1.00	1.00	1.00	1.00	1.00
Uniform Delay (d), s/veh	37.2	27.5	28.5	35.6	24.1	24.1	36.8	26.7	26.8	40.4	33.1	35.8
Incr Delay (d2), s/veh	9.6	12.1	101.5	12.7	7.1	7.1	1.7	0.1	0.1	2.0	0.3	5.5
Initial Q Delay(d3),s/veh	0.0	0.0	0.0	0.0	0.0	0.0	0.0	0.0	0.0	0.0	0.0	0.0
%ile BackOfQ(50%),veh/ln	4.9	15.1	28.4	6.7	13.2	13.3	4.5	1.8	1.6	1.3	2.2	5.3
LnGrp Delay(d),s/veh	46.8	39.6	130.0	48.3	31.3	31.2	38.5	26.8	26.9	42.3	33.4	41.4
LnGrp LOS	D	D	F	D	C	C	D	C	C	D	C	D
Approach Vol, veh/h		1965			1602			552			362	
Approach Delay, s/veh		70.1			36.5			34.8			39.2	
Approach LOS		E			D			C			D	
Timer	1	2	3	4	5	6	7	8				
Assigned Phs	1	2	3	4	5	6	7	8				
Phs Duration (G+Y+Rc), s	18.6	35.3	15.2	17.9	15.3	38.6	7.9	25.2				
Change Period (Y+Rc), s	4.5	5.3	3.5	4.6	4.5	5.3	3.5	4.6				
Max Green Setting (Gmax), s	15.0	30.0	20.0	21.0	15.0	30.0	10.0	21.0				
Max Q Clear Time (g_c+I1), s	14.1	32.0	11.6	13.0	10.8	26.4	4.4	5.7				
Green Ext Time (p_c), s	0.0	0.0	0.1	0.3	0.0	0.7	0.0	0.1				
Intersection Summary												
HCM 2010 Ctrl Delay			51.2									
HCM 2010 LOS			D									

HCM 2010 Signalized Intersection Summary
6: 3rd Avenue & Imjin Parkway

Cumulative, AM
06/11/2019



Movement	EBL	EBT	EBR	WBL	WBT	WBR	NBL	NBT	NBR	SBL	SBT	SBR
Lane Configurations	↖	↗		↖	↗		↖	↗		↖	↗	
Traffic Volume (veh/h)	50	960	230	350	1420	30	130	10	70	10	10	40
Future Volume (veh/h)	50	960	230	350	1420	30	130	10	70	10	10	40
Number	5	2	12	1	6	16	3	8	18	7	4	14
Initial Q (Qb), veh	0	0	0	0	0	0	0	0	0	0	0	0
Ped-Bike Adj(A_pbT)	1.00		1.00	1.00		1.00	1.00		1.00	1.00		1.00
Parking Bus, Adj	1.00	1.00	1.00	1.00	1.00	1.00	1.00	1.00	1.00	1.00	1.00	1.00
Adj Sat Flow, veh/h/ln	1863	1863	1900	1863	1863	1900	1810	1810	1900	1863	1863	1900
Adj Flow Rate, veh/h	52	1000	211	365	1479	30	135	10	19	10	10	7
Adj No. of Lanes	1	2	0	1	2	0	1	1	0	1	1	0
Peak Hour Factor	0.96	0.96	0.96	0.96	0.96	0.96	0.96	0.96	0.96	0.96	0.96	0.96
Percent Heavy Veh, %	2	2	2	2	2	2	5	5	5	2	2	2
Cap, veh/h	64	1124	237	382	2007	41	319	81	154	313	148	104
Arrive On Green	0.04	0.39	0.39	0.22	0.57	0.57	0.15	0.15	0.15	0.15	0.15	0.15
Sat Flow, veh/h	1774	2910	613	1774	3548	72	1345	558	1060	1370	1020	714
Grp Volume(v), veh/h	52	607	604	365	737	772	135	0	29	10	0	17
Grp Sat Flow(s),veh/h/ln	1774	1770	1754	1774	1770	1850	1345	0	1617	1370	0	1733
Q Serve(g_s), s	1.6	17.1	17.2	10.8	16.5	16.6	5.1	0.0	0.8	0.3	0.0	0.5
Cycle Q Clear(g_c), s	1.6	17.1	17.2	10.8	16.5	16.6	5.6	0.0	0.8	1.2	0.0	0.5
Prop In Lane	1.00		0.35	1.00		0.04	1.00		0.66	1.00		0.41
Lane Grp Cap(c), veh/h	64	683	677	382	1001	1047	319	0	235	313	0	252
V/C Ratio(X)	0.82	0.89	0.89	0.95	0.74	0.74	0.42	0.00	0.12	0.03	0.00	0.07
Avail Cap(c_a), veh/h	382	1077	1068	382	1077	1126	817	0	833	819	0	893
HCM Platoon Ratio	1.00	1.00	1.00	1.00	1.00	1.00	1.00	1.00	1.00	1.00	1.00	1.00
Upstream Filter(I)	1.00	1.00	1.00	1.00	1.00	1.00	1.00	0.00	1.00	1.00	0.00	1.00
Uniform Delay (d), s/veh	25.6	15.3	15.3	20.7	8.6	8.6	22.1	0.0	19.8	20.4	0.0	19.7
Incr Delay (d2), s/veh	9.2	3.8	4.1	34.1	2.1	2.0	0.3	0.0	0.1	0.0	0.0	0.0
Initial Q Delay(d3),s/veh	0.0	0.0	0.0	0.0	0.0	0.0	0.0	0.0	0.0	0.0	0.0	0.0
%ile BackOfQ(50%),veh/ln	0.9	9.0	9.0	8.9	8.6	8.9	1.9	0.0	0.4	0.1	0.0	0.2
LnGrp Delay(d),s/veh	34.7	19.2	19.4	54.8	10.7	10.6	22.4	0.0	19.9	20.4	0.0	19.7
LnGrp LOS	C	B	B	D	B	B	C		B	C		B
Approach Vol, veh/h		1263			1874			164			27	
Approach Delay, s/veh		19.9			19.3			22.0			20.0	
Approach LOS		B			B			C			B	
Timer	1	2	3	4	5	6	7	8				
Assigned Phs	1	2		4	5	6		8				
Phs Duration (G+Y+Rc), s	5.0	26.1		12.3	5.4	35.7		12.3				
Change Period (Y+Rc), s	3.5	5.5		4.5	3.5	5.5		4.5				
Max Green Setting (Gmax), s	1.5	32.5		27.5	11.5	32.5		27.5				
Max Q Clear Time (g_c+1), s	12.8	19.2		3.2	3.6	18.6		7.6				
Green Ext Time (p_c), s	0.0	1.4		0.0	0.0	1.1		0.0				
Intersection Summary												
HCM 2010 Ctrl Delay				19.6								
HCM 2010 LOS				B								

HCM 2010 Signalized Intersection Summary
7: 4th Avenue & Imjin Parkway

Cumulative, AM
06/11/2019



Movement	EBL	EBT	EBR	WBL	WBT	WBR	NBL	NBT	NBR	SBL	SBT	SBR
Lane Configurations												
Traffic Volume (veh/h)	10	1060	20	10	1730	10	10	10	10	10	10	10
Future Volume (veh/h)	10	1060	20	10	1730	10	10	10	10	10	10	10
Number	5	2	12	1	6	16	3	8	18	7	4	14
Initial Q (Qb), veh	0	0	0	0	0	0	0	0	0	0	0	0
Ped-Bike Adj(A_pbT)	1.00		1.00	1.00		1.00	1.00		1.00	1.00		1.00
Parking Bus, Adj	1.00	1.00	1.00	1.00	1.00	1.00	1.00	1.00	1.00	1.00	1.00	1.00
Adj Sat Flow, veh/h/ln	1863	1863	1900	1863	1863	1900	1900	1267	1900	1900	1900	1900
Adj Flow Rate, veh/h	10	1104	20	10	1802	9	10	10	9	10	10	10
Adj No. of Lanes	1	2	0	1	2	0	0	1	0	0	1	0
Peak Hour Factor	0.96	0.96	0.96	0.96	0.96	0.96	0.96	0.96	0.96	0.96	0.96	0.96
Percent Heavy Veh, %	2	2	2	2	2	2	50	50	50	0	0	0
Cap, veh/h	14	1956	35	14	1986	10	160	19	17	168	29	29
Arrive On Green	0.01	0.55	0.55	0.01	0.55	0.55	0.06	0.05	0.05	0.06	0.05	0.05
Sat Flow, veh/h	1774	3556	64	1774	3611	18	386	386	347	570	570	570
Grp Volume(v), veh/h	10	549	575	10	882	929	29	0	0	30	0	0
Grp Sat Flow(s),veh/h/ln	1774	1770	1851	1774	1770	1860	1119	0	0	1711	0	0
Q Serve(g_s), s	0.2	7.0	7.0	0.2	15.4	15.5	0.3	0.0	0.0	0.0	0.0	0.0
Cycle Q Clear(g_c), s	0.2	7.0	7.0	0.2	15.4	15.5	0.8	0.0	0.0	0.5	0.0	0.0
Prop In Lane	1.00		0.03	1.00		0.01	0.34		0.31	0.33		0.33
Lane Grp Cap(c), veh/h	14	973	1018	14	973	1022	213	0	0	250	0	0
V/C Ratio(X)	0.71	0.56	0.56	0.71	0.91	0.91	0.14	0.00	0.00	0.12	0.00	0.00
Avail Cap(c_a), veh/h	593	1670	1748	593	1670	1755	1021	0	0	1463	0	0
HCM Platoon Ratio	1.00	1.00	1.00	1.00	1.00	1.00	1.00	1.00	1.00	1.00	1.00	1.00
Upstream Filter(I)	1.00	1.00	1.00	1.00	1.00	1.00	1.00	0.00	0.00	1.00	0.00	0.00
Uniform Delay (d), s/veh	17.0	5.1	5.1	17.0	7.0	7.0	15.8	0.0	0.0	15.7	0.0	0.0
Incr Delay (d2), s/veh	21.4	0.2	0.2	21.4	2.3	2.2	0.1	0.0	0.0	0.1	0.0	0.0
Initial Q Delay(d3),s/veh	0.0	0.0	0.0	0.0	0.0	0.0	0.0	0.0	0.0	0.0	0.0	0.0
%ile BackOfQ(50%),veh/ln	0.2	3.4	3.6	0.2	7.7	8.1	0.3	0.0	0.0	0.3	0.0	0.0
LnGrp Delay(d),s/veh	38.5	5.3	5.2	38.5	9.2	9.2	15.9	0.0	0.0	15.8	0.0	0.0
LnGrp LOS	D	A	A	D	A	A	B			B		
Approach Vol, veh/h		1134			1821			29			30	
Approach Delay, s/veh		5.5			9.4			15.9			15.8	
Approach LOS		A			A			B			B	
Timer	1	2	3	4	5	6	7	8				
Assigned Phs	1	2		4	5	6		8				
Phs Duration (G+Y+Rc), s	3.8	24.4		6.2	3.8	24.4		6.2				
Change Period (Y+Rc), s	3.5	5.5		4.5	3.5	5.5		4.5				
Max Green Setting (Gmax), s	1.5	32.5		27.5	11.5	32.5		27.5				
Max Q Clear Time (g_c+1), s	12.2	9.0		2.5	2.2	17.5		2.8				
Green Ext Time (p_c), s	0.0	0.8		0.0	0.0	1.5		0.0				
Intersection Summary												
HCM 2010 Ctrl Delay				8.0								
HCM 2010 LOS				A								

HCM 2010 Signalized Intersection Summary
 8: 5th Avenue/California Avenue & Imjin Parkway

Cumulative, AM
 06/11/2019



Movement	EBL	EBT	EBR	WBL	WBT	WBR	NBL	NBT	NBR	SBL	SBT	SBR
Lane Configurations												
Traffic Volume (veh/h)	140	970	20	10	1130	70	20	10	10	90	150	460
Future Volume (veh/h)	140	970	20	10	1130	70	20	10	10	90	150	460
Number	5	2	12	1	6	16	3	8	18	7	4	14
Initial Q (Qb), veh	0	0	0	0	0	0	0	0	0	0	0	0
Ped-Bike Adj(A_pbT)	1.00		0.98	1.00		1.00	1.00		0.99	1.00		1.00
Parking Bus, Adj	1.00	1.00	1.00	1.00	1.00	1.00	1.00	1.00	1.00	1.00	1.00	1.00
Adj Sat Flow, veh/h/ln	1881	1881	1900	1863	1863	1900	1900	1624	1900	1900	1881	1900
Adj Flow Rate, veh/h	147	1021	19	11	1189	68	21	11	10	95	158	410
Adj No. of Lanes	1	2	0	1	2	0	0	1	0	0	1	0
Peak Hour Factor	0.95	0.95	0.95	0.95	0.95	0.95	0.95	0.95	0.95	0.95	0.95	0.95
Percent Heavy Veh, %	1	1	1	2	2	2	17	17	17	1	1	1
Cap, veh/h	185	1697	32	15	1286	73	178	85	56	122	136	314
Arrive On Green	0.10	0.47	0.47	0.01	0.38	0.38	0.32	0.31	0.31	0.32	0.31	0.31
Sat Flow, veh/h	1792	3588	67	1774	3404	194	303	273	180	187	437	1011
Grp Volume(v), veh/h	147	509	531	11	618	639	42	0	0	663	0	0
Grp Sat Flow(s),veh/h/ln	1792	1787	1868	1774	1770	1828	756	0	0	1636	0	0
Q Serve(g_s), s	5.2	13.5	13.5	0.4	21.5	21.5	0.0	0.0	0.0	16.6	0.0	0.0
Cycle Q Clear(g_c), s	5.2	13.5	13.5	0.4	21.5	21.5	1.2	0.0	0.0	20.6	0.0	0.0
Prop In Lane	1.00		0.04	1.00		0.11	0.50		0.24	0.14		0.62
Lane Grp Cap(c), veh/h	185	845	884	15	669	691	326	0	0	587	0	0
V/C Ratio(X)	0.79	0.60	0.60	0.75	0.92	0.93	0.13	0.00	0.00	1.13	0.00	0.00
Avail Cap(c_a), veh/h	417	845	884	413	824	852	326	0	0	587	0	0
HCM Platoon Ratio	1.00	1.00	1.00	1.00	1.00	1.00	1.00	1.00	1.00	1.00	1.00	1.00
Upstream Filter(I)	1.00	1.00	1.00	1.00	1.00	1.00	1.00	0.00	0.00	1.00	0.00	0.00
Uniform Delay (d), s/veh	28.2	12.5	12.5	31.9	19.1	19.2	15.6	0.0	0.0	23.4	0.0	0.0
Incr Delay (d2), s/veh	2.9	0.9	0.8	23.6	12.8	12.7	0.1	0.0	0.0	78.1	0.0	0.0
Initial Q Delay(d3),s/veh	0.0	0.0	0.0	0.0	0.0	0.0	0.0	0.0	0.0	0.0	0.0	0.0
%ile BackOfQ(50%),veh/ln	2.7	6.8	7.1	0.3	12.8	13.3	0.5	0.0	0.0	22.9	0.0	0.0
LnGrp Delay(d),s/veh	31.1	13.4	13.3	55.5	31.9	31.8	15.7	0.0	0.0	101.6	0.0	0.0
LnGrp LOS	C	B	B	E	C	C	B			F		
Approach Vol, veh/h		1187			1268			42			663	
Approach Delay, s/veh		15.5			32.1			15.7			101.6	
Approach LOS		B			C			B			F	
Timer	1	2	3	4	5	6	7	8				
Assigned Phs	1	2		4	5	6		8				
Phs Duration (G+Y+Rc), s	4.0	35.8		24.6	10.2	29.6		24.6				
Change Period (Y+Rc), s	3.5	5.3		4.6	3.5	5.3		4.6				
Max Green Setting (Gmax), s	15.0	30.0		20.0	15.0	30.0		20.0				
Max Q Clear Time (g_c+1), s	12.4	15.5		22.6	7.2	23.5		3.2				
Green Ext Time (p_c), s	0.0	0.7		0.0	0.0	0.8		0.0				
Intersection Summary												
HCM 2010 Ctrl Delay			40.2									
HCM 2010 LOS			D									

Intersection						
Int Delay, s/veh	1.4					
Movement	EBL	EBR	NBL	NBT	SBT	SBR
Lane Configurations	↔		↔	↑	↑	
Traffic Vol, veh/h	30	30	30	210	610	80
Future Vol, veh/h	30	30	30	210	610	80
Conflicting Peds, #/hr	0	0	0	0	0	0
Sign Control	Stop	Stop	Free	Free	Free	Free
RT Channelized	-	None	-	None	-	None
Storage Length	0	-	155	-	-	-
Veh in Median Storage, #	0	-	-	0	0	-
Grade, %	0	-	-	0	0	-
Peak Hour Factor	92	92	92	92	92	92
Heavy Vehicles, %	2	2	2	2	2	2
Mvmt Flow	33	33	33	228	663	87











Major/Minor	Minor2	Major1	Major2			
Conflicting Flow All	1001	707	750	0	-	0
Stage 1	707	-	-	-	-	-
Stage 2	294	-	-	-	-	-
Critical Hdwy	6.42	6.22	4.12	-	-	-
Critical Hdwy Stg 1	5.42	-	-	-	-	-
Critical Hdwy Stg 2	5.42	-	-	-	-	-
Follow-up Hdwy	3.518	3.318	2.218	-	-	-
Pot Cap-1 Maneuver	269	435	859	-	-	-
Stage 1	489	-	-	-	-	-
Stage 2	756	-	-	-	-	-
Platoon blocked, %				-	-	-
Mov Cap-1 Maneuver	259	435	859	-	-	-
Mov Cap-2 Maneuver	259	-	-	-	-	-
Stage 1	470	-	-	-	-	-
Stage 2	756	-	-	-	-	-

Approach	EB	NB	SB
HCM Control Delay, s	18.8	1.2	0
HCM LOS	C		

Minor Lane/Major Mvmt	NBL	NBT	EBLn1	SBT	SBR
Capacity (veh/h)	859	-	325	-	-
HCM Lane V/C Ratio	0.038	-	0.201	-	-
HCM Control Delay (s)	9.4	-	18.8	-	-
HCM Lane LOS	A	-	C	-	-
HCM 95th %tile Q(veh)	0.1	-	0.7	-	-

HCM 2010 Signalized Intersection Summary
 10: Imjin Road & Imjin Parkway

Cumulative, AM
 06/11/2019

								
Movement	EBT	EBR	WBL	WBT	NBL	NBR		
Lane Configurations								
Traffic Volume (veh/h)	900	190	430	1140	60	120		
Future Volume (veh/h)	900	190	430	1140	60	120		
Number	2	12	1	6	3	18		
Initial Q (Qb), veh	0	0	0	0	0	0		
Ped-Bike Adj(A_pbT)		1.00	1.00		1.00	1.00		
Parking Bus, Adj	1.00	1.00	1.00	1.00	1.00	1.00		
Adj Sat Flow, veh/h/ln	1863	1900	1845	1845	1810	1810		
Adj Flow Rate, veh/h	947	187	453	1200	63	126		
Adj No. of Lanes	2	0	1	2	1	2		
Peak Hour Factor	0.95	0.95	0.95	0.95	0.95	0.95		
Percent Heavy Veh, %	2	2	3	3	5	5		
Cap, veh/h	1057	209	505	2621	127	226		
Arrive On Green	0.36	0.36	0.29	0.75	0.07	0.07		
Sat Flow, veh/h	3041	582	1757	3597	1723	3076		
Grp Volume(v), veh/h	568	566	453	1200	63	126		
Grp Sat Flow(s),veh/h/ln	1770	1760	1757	1752	1723	1538		
Q Serve(g_s), s	15.8	15.8	12.9	6.8	1.8	2.1		
Cycle Q Clear(g_c), s	15.8	15.8	12.9	6.8	1.8	2.1		
Prop In Lane		0.33	1.00		1.00	1.00		
Lane Grp Cap(c), veh/h	635	631	505	2621	127	226		
V/C Ratio(X)	0.90	0.90	0.90	0.46	0.50	0.56		
Avail Cap(c_a), veh/h	1021	1015	675	2621	729	1301		
HCM Platoon Ratio	1.00	1.00	1.00	1.00	1.00	1.00		
Upstream Filter(I)	1.00	1.00	1.00	1.00	1.00	1.00		
Uniform Delay (d), s/veh	15.8	15.8	17.8	2.5	23.2	23.3		
Incr Delay (d2), s/veh	4.1	4.2	10.1	0.0	1.1	0.8		
Initial Q Delay(d3),s/veh	0.0	0.0	0.0	0.0	0.0	0.0		
%ile BackOfQ(50%),veh/ln	8.3	8.3	7.6	3.2	0.9	0.9		
LnGrp Delay(d),s/veh	19.9	20.0	27.9	2.6	24.3	24.1		
LnGrp LOS	B	B	C	A	C	C		
Approach Vol, veh/h	1134			1653	189			
Approach Delay, s/veh	19.9			9.5	24.2			
Approach LOS	B			A	C			
Timer	1	2	3	4	5	6	7	8
Assigned Phs	1	2				6		8
Phs Duration (G+Y+Rc), s	20.2	24.0				44.2		7.8
Change Period (Y+Rc), s	5.3	* 5.3				5.3		4.0
Max Green Setting (Gmax), s	20.0	* 30				30.0		22.0
Max Q Clear Time (g_c+I1), s	14.9	17.8				8.8		4.1
Green Ext Time (p_c), s	0.1	0.8				1.4		0.0
Intersection Summary								
HCM 2010 Ctrl Delay			14.4					
HCM 2010 LOS			B					
Notes								

HCM 2010 Signalized Intersection Summary
 11: Abrams Drive & Imjin Parkway

Cumulative, AM
 06/11/2019



Movement	EBL	EBT	EBR	WBL	WBT	WBR	NBL	NBT	NBR	SBL	SBT	SBR
Lane Configurations	↖↗	↕		↖↗	↕		↖	↕	↗	↖	↕	↗
Traffic Volume (veh/h)	50	810	60	80	1200	70	220	30	110	90	50	250
Future Volume (veh/h)	50	810	60	80	1200	70	220	30	110	90	50	250
Number	5	2	12	1	6	16	3	8	18	7	4	14
Initial Q (Qb), veh	0	0	0	0	0	0	0	0	0	0	0	0
Ped-Bike Adj(A_pbT)	1.00		1.00	1.00		1.00	1.00		1.00	1.00		1.00
Parking Bus, Adj	1.00	1.00	1.00	1.00	1.00	1.00	1.00	1.00	1.00	1.00	1.00	1.00
Adj Sat Flow, veh/h/ln	1881	1881	1900	1863	1863	1900	1845	1845	1845	1863	1863	1863
Adj Flow Rate, veh/h	54	871	53	86	1290	70	237	32	0	97	54	0
Adj No. of Lanes	2	2	0	2	2	0	1	1	1	1	1	1
Peak Hour Factor	0.93	0.93	0.93	0.93	0.93	0.93	0.93	0.93	0.93	0.93	0.93	0.93
Percent Heavy Veh, %	1	1	1	2	2	2	3	3	3	2	2	2
Cap, veh/h	189	1915	116	147	1847	100	365	415	352	386	419	356
Arrive On Green	0.05	0.56	0.54	0.04	0.54	0.52	0.22	0.22	0.00	0.22	0.22	0.00
Sat Flow, veh/h	3476	3423	208	3442	3415	185	1330	1845	1568	1370	1863	1583
Grp Volume(v), veh/h	54	455	469	86	668	692	237	32	0	97	54	0
Grp Sat Flow(s),veh/h/ln	1738	1787	1844	1721	1770	1830	1330	1845	1568	1370	1863	1583
Q Serve(g_s), s	1.1	11.1	11.2	1.8	20.6	20.7	12.8	1.0	0.0	4.4	1.7	0.0
Cycle Q Clear(g_c), s	1.1	11.1	11.2	1.8	20.6	20.7	14.5	1.0	0.0	5.5	1.7	0.0
Prop In Lane	1.00		0.11	1.00		0.10	1.00		1.00	1.00		1.00
Lane Grp Cap(c), veh/h	189	1000	1031	147	957	990	365	415	352	386	419	356
V/C Ratio(X)	0.29	0.45	0.45	0.58	0.70	0.70	0.65	0.08	0.00	0.25	0.13	0.00
Avail Cap(c_a), veh/h	940	1209	1247	931	1197	1238	606	748	636	634	756	642
HCM Platoon Ratio	1.00	1.00	1.00	1.00	1.00	1.00	1.00	1.00	1.00	1.00	1.00	1.00
Upstream Filter(I)	1.00	1.00	1.00	1.00	1.00	1.00	1.00	1.00	0.00	1.00	1.00	0.00
Uniform Delay (d), s/veh	33.6	9.6	9.7	34.7	12.5	12.6	28.7	22.6	0.0	24.8	22.9	0.0
Incr Delay (d2), s/veh	0.3	0.1	0.1	1.4	0.8	0.8	0.7	0.0	0.0	0.1	0.1	0.0
Initial Q Delay(d3),s/veh	0.0	0.0	0.0	0.0	0.0	0.0	0.0	0.0	0.0	0.0	0.0	0.0
%ile BackOfQ(50%),veh/ln	0.5	5.5	5.7	0.9	10.0	10.6	4.7	0.5	0.0	1.7	0.9	0.0
LnGrp Delay(d),s/veh	33.9	9.8	9.8	36.1	13.3	13.4	29.4	22.6	0.0	24.9	22.9	0.0
LnGrp LOS	C	A	A	D	B	B	C	C		C	C	
Approach Vol, veh/h		978			1446			269			151	
Approach Delay, s/veh		11.1			14.7			28.6			24.2	
Approach LOS		B			B			C			C	
Timer	1	2	3	4	5	6	7	8				
Assigned Phs	1	2		4	5	6		8				
Phs Duration (G+Y+Rc), s	6.7	46.7		20.6	8.0	45.3		20.6				
Change Period (Y+Rc), s	3.5	5.3		4.0	4.0	5.3		4.0				
Max Green Setting (Gmax)	20.0	50.0		30.0	20.0	50.0		30.0				
Max Q Clear Time (g_c+1)	13.8	13.2		7.5	3.1	22.7		16.5				
Green Ext Time (p_c), s	0.0	0.7		0.0	0.0	1.0		0.1				
Intersection Summary												
HCM 2010 Ctrl Delay				15.3								
HCM 2010 LOS				B								

HCM 2010 Signalized Intersection Summary
 12: Reservation Road & Imjin Parkway

Cumulative, AM
 06/11/2019



Movement	EBL	EBT	EBR	WBL	WBT	WBR	NBL	NBT	NBR	SBL	SBT	SBR
Lane Configurations	↖↗	↑	↖↗	↖	↑	↖	↖↗	↑↑	↖	↖↗	↑↑	↖
Traffic Volume (veh/h)	170	50	820	10	20	30	1180	890	20	60	590	90
Future Volume (veh/h)	170	50	820	10	20	30	1180	890	20	60	590	90
Number	3	8	18	7	4	14	1	6	16	5	2	12
Initial Q (Qb), veh	0	0	0	0	0	0	0	0	0	0	0	0
Ped-Bike Adj(A_pbT)	1.00		1.00	1.00		0.99	1.00		1.00	1.00		0.98
Parking Bus, Adj	1.00	1.00	1.00	1.00	1.00	1.00	1.00	1.00	1.00	1.00	1.00	1.00
Adj Sat Flow, veh/h/ln	1863	1863	1863	1638	1638	1638	1863	1863	1863	1863	1863	1863
Adj Flow Rate, veh/h	183	54	468	11	22	19	1269	957	16	65	634	34
Adj No. of Lanes	2	1	2	1	1	1	2	2	1	2	2	1
Peak Hour Factor	0.93	0.93	0.93	0.93	0.93	0.93	0.93	0.93	0.93	0.93	0.93	0.93
Percent Heavy Veh, %	2	2	2	16	16	16	2	2	2	2	2	2
Cap, veh/h	487	264	1347	53	56	47	1178	2081	930	113	987	434
Arrive On Green	0.14	0.14	0.14	0.03	0.03	0.03	0.34	0.59	0.59	0.03	0.28	0.28
Sat Flow, veh/h	3442	1863	2777	1560	1638	1382	3442	3539	1581	3442	3539	1558
Grp Volume(v), veh/h	183	54	468	11	22	19	1269	957	16	65	634	34
Grp Sat Flow(s),veh/h/ln	1721	1863	1388	1560	1638	1382	1721	1770	1581	1721	1770	1558
Q Serve(g_s), s	4.9	2.6	10.7	0.7	1.3	1.4	35.0	15.6	0.4	1.9	16.1	1.6
Cycle Q Clear(g_c), s	4.9	2.6	10.7	0.7	1.3	1.4	35.0	15.6	0.4	1.9	16.1	1.6
Prop In Lane	1.00		1.00	1.00		1.00	1.00		1.00	1.00		1.00
Lane Grp Cap(c), veh/h	487	264	1347	53	56	47	1178	2081	930	113	987	434
V/C Ratio(X)	0.38	0.20	0.35	0.21	0.39	0.40	1.08	0.46	0.02	0.57	0.64	0.08
Avail Cap(c_a), veh/h	1178	637	1904	473	496	419	1178	2081	930	673	2076	914
HCM Platoon Ratio	1.00	1.00	1.00	1.00	1.00	1.00	1.00	1.00	1.00	1.00	1.00	1.00
Upstream Filter(I)	1.00	1.00	1.00	1.00	1.00	1.00	1.00	1.00	1.00	1.00	1.00	1.00
Uniform Delay (d), s/veh	39.8	38.8	16.4	48.1	48.4	48.4	33.6	11.9	8.8	48.8	32.4	27.2
Incr Delay (d2), s/veh	0.2	0.1	0.1	0.7	1.7	2.1	49.8	0.4	0.0	1.7	1.9	0.2
Initial Q Delay(d3),s/veh	0.0	0.0	0.0	0.0	0.0	0.0	0.0	0.0	0.0	0.0	0.0	0.0
%ile BackOfQ(50%),veh/ln	2.4	1.4	4.1	0.3	0.6	0.6	24.7	7.7	0.2	0.9	8.1	0.7
LnGrp Delay(d),s/veh	40.0	39.0	16.5	48.8	50.0	50.4	83.5	12.3	8.8	50.4	34.3	27.4
LnGrp LOS	D	D	B	D	D	D	F	B	A	D	C	C
Approach Vol, veh/h		705			52			2242			733	
Approach Delay, s/veh		24.3			49.9			52.6			35.4	
Approach LOS		C			D			D			D	
Timer	1	2	3	4	5	6	7	8				
Assigned Phs	1	2		4	5	6		8				
Phs Duration (G+Y+Rc), s	39.1	34.7		8.5	7.5	66.4		20.0				
Change Period (Y+Rc), s	4.1	* 6.2		5.0	4.1	* 6.2		5.5				
Max Green Setting (Gmax), s	35.0	* 60		31.0	20.0	* 50		35.0				
Max Q Clear Time (g_c+Q), s	37.0	18.1		3.4	3.9	17.6		12.7				
Green Ext Time (p_c), s	0.0	10.4		0.1	0.0	15.2		1.5				
Intersection Summary												
HCM 2010 Ctrl Delay			43.8									
HCM 2010 LOS			D									
Notes												

HCM 2010 Signalized Intersection Summary
 13: Reservation Road & Blanco Road

Cumulative, AM
 06/11/2019

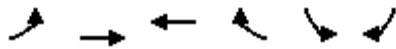

Movement	EBL	EBT	WBT	WBR	SBL	SBR		
Lane Configurations								
Traffic Volume (veh/h)	1070	370	680	40	40	1410		
Future Volume (veh/h)	1070	370	680	40	40	1410		
Number	5	2	6	16	7	14		
Initial Q (Qb), veh	0	0	0	0	0	0		
Ped-Bike Adj(A_pbT)	1.00			1.00	1.00	1.00		
Parking Bus, Adj	1.00	1.00	1.00	1.00	1.00	1.00		
Adj Sat Flow, veh/h/ln	1863	1863	1845	1845	1845	1845		
Adj Flow Rate, veh/h	1151	398	731	24	43	0		
Adj No. of Lanes	2	2	1	1	2	2		
Peak Hour Factor	0.93	0.93	0.93	0.93	0.93	0.93		
Percent Heavy Veh, %	2	2	3	3	3	3		
Cap, veh/h	1225	3039	806	685	103	83		
Arrive On Green	0.36	0.86	0.44	0.44	0.03	0.00		
Sat Flow, veh/h	3442	3632	1845	1568	3408	2760		
Grp Volume(v), veh/h	1151	398	731	24	43	0		
Grp Sat Flow(s),veh/h/ln	1721	1770	1845	1568	1704	1380		
Q Serve(g_s), s	27.1	1.5	30.9	0.7	1.0	0.0		
Cycle Q Clear(g_c), s	27.1	1.5	30.9	0.7	1.0	0.0		
Prop In Lane	1.00			1.00	1.00	1.00		
Lane Grp Cap(c), veh/h	1225	3039	806	685	103	83		
V/C Ratio(X)	0.94	0.13	0.91	0.04	0.42	0.00		
Avail Cap(c_a), veh/h	1645	3039	1322	1124	1099	890		
HCM Platoon Ratio	1.00	1.00	1.00	1.00	1.00	1.00		
Upstream Filter(I)	1.00	1.00	1.00	1.00	1.00	0.00		
Uniform Delay (d), s/veh	26.1	0.9	22.0	13.5	39.9	0.0		
Incr Delay (d2), s/veh	7.9	0.0	4.9	0.0	1.0	0.0		
Initial Q Delay(d3),s/veh	0.0	0.0	0.0	0.0	0.0	0.0		
%ile BackOfQ(50%),veh/ln	4.1	0.7	16.7	0.3	0.5	0.0		
LnGrp Delay(d),s/veh	34.0	1.0	26.8	13.5	40.9	0.0		
LnGrp LOS	C	A	C	B	D			
Approach Vol, veh/h		1549	755		43			
Approach Delay, s/veh		25.5	26.4		40.9			
Approach LOS		C	C		D			
Timer	1	2	3	4	5	6	7	8
Assigned Phs		2		4	5	6		
Phs Duration (G+Y+Rc), s		77.7		6.0	35.3	42.4		
Change Period (Y+Rc), s		5.8		3.5	5.5	5.8		
Max Green Setting (Gmax), s		60.0		27.0	40.0	60.0		
Max Q Clear Time (g_c+I1), s		3.5		3.0	29.1	32.9		
Green Ext Time (p_c), s		1.9		0.0	0.7	3.6		
Intersection Summary								
HCM 2010 Ctrl Delay			26.1					
HCM 2010 LOS			C					

HCM 2010 Signalized Intersection Summary
 14: Reservation Road & Inter-Garrison Road

Cumulative, AM
 06/11/2019



Movement	EBL	EBR	NBL	NBT	SBT	SBR		
Lane Configurations								
Traffic Volume (veh/h)	190	280	510	560	310	190		
Future Volume (veh/h)	190	280	510	560	310	190		
Number	3	18	1	6	2	12		
Initial Q (Qb), veh	0	0	0	0	0	0		
Ped-Bike Adj(A_pbT)	1.00	1.00	1.00			1.00		
Parking Bus, Adj	1.00	1.00	1.00	1.00	1.00	1.00		
Adj Sat Flow, veh/h/ln	1845	1845	1863	1863	1845	1900		
Adj Flow Rate, veh/h	202	259	543	596	330	186		
Adj No. of Lanes	1	1	1	2	2	0		
Peak Hour Factor	0.94	0.94	0.94	0.94	0.94	0.94		
Percent Heavy Veh, %	3	3	2	2	3	3		
Cap, veh/h	289	764	573	2334	568	314		
Arrive On Green	0.16	0.16	0.32	0.66	0.26	0.26		
Sat Flow, veh/h	1757	1568	1774	3632	2273	1204		
Grp Volume(v), veh/h	202	259	543	596	264	252		
Grp Sat Flow(s),veh/h/ln	1757	1568	1774	1770	1752	1632		
Q Serve(g_s), s	6.7	6.3	18.5	4.3	8.1	8.4		
Cycle Q Clear(g_c), s	6.7	6.3	18.5	4.3	8.1	8.4		
Prop In Lane	1.00	1.00	1.00			0.74		
Lane Grp Cap(c), veh/h	289	764	573	2334	456	425		
V/C Ratio(X)	0.70	0.34	0.95	0.26	0.58	0.59		
Avail Cap(c_a), veh/h	766	1191	573	3431	1699	1582		
HCM Platoon Ratio	1.00	1.00	1.00	1.00	1.00	1.00		
Upstream Filter(I)	1.00	1.00	1.00	1.00	1.00	1.00		
Uniform Delay (d), s/veh	24.4	9.7	20.4	4.3	19.9	20.0		
Incr Delay (d2), s/veh	3.1	0.3	24.8	0.1	2.2	2.5		
Initial Q Delay(d3),s/veh	0.0	0.0	0.0	0.0	0.0	0.0		
%ile BackOfQ(50%),veh/ln	3.5	2.8	12.9	2.1	4.2	4.0		
LnGrp Delay(d),s/veh	27.5	10.0	45.3	4.4	22.1	22.5		
LnGrp LOS	C	A	D	A	C	C		
Approach Vol, veh/h	461			1139	516			
Approach Delay, s/veh	17.7			23.9	22.3			
Approach LOS	B			C	C			
Timer	1	2	3	4	5	6	7	8
Assigned Phs	1	2				6		8
Phs Duration (G+Y+Rc), s	24.7	22.5				47.2		14.7
Change Period (Y+Rc), s	4.7	6.4				6.4		4.5
Max Green Setting (Gmax), s	26	60.0				60.0		27.0
Max Q Clear Time (g_c+20), s	20.5	10.4				6.3		8.7
Green Ext Time (p_c), s	0.0	5.8				7.4		1.5
Intersection Summary								
HCM 2010 Ctrl Delay			22.1					
HCM 2010 LOS			C					
Notes								

HCM 2010 Signalized Intersection Summary
 15: 2nd Avenue & 9th Street

Cumulative, AM
 06/11/2019



Movement	EBL	EBT	EBR	WBL	WBT	WBR	NBL	NBT	NBR	SBL	SBT	SBR
Lane Configurations		↖	↗		↔		↖	↗		↖	↗	
Traffic Volume (veh/h)	10	10	10	260	10	20	20	360	30	40	830	10
Future Volume (veh/h)	10	10	10	260	10	20	20	360	30	40	830	10
Number	5	2	12	1	6	16	3	8	18	7	4	14
Initial Q (Qb), veh	0	0	0	0	0	0	0	0	0	0	0	0
Ped-Bike Adj(A_pbT)	0.99		1.00	1.00		0.99	1.00		0.99	1.00		0.99
Parking Bus, Adj	1.00	1.00	1.00	1.00	1.00	1.00	1.00	1.00	1.00	1.00	1.00	1.00
Adj Sat Flow, veh/h/ln	1900	1881	1881	1900	1900	1900	1881	1881	1900	1863	1863	1900
Adj Flow Rate, veh/h	11	11	-24	277	11	20	21	383	27	43	883	4
Adj No. of Lanes	0	1	1	0	1	0	1	2	0	1	2	0
Peak Hour Factor	0.94	0.94	0.94	0.94	0.94	0.94	0.94	0.94	0.94	0.94	0.94	0.94
Percent Heavy Veh, %	1	1	1	0	0	0	1	1	1	2	2	2
Cap, veh/h	325	282	450	524	15	27	46	1252	88	82	1410	6
Arrive On Green	0.30	0.28	0.00	0.30	0.28	0.28	0.03	0.37	0.37	0.05	0.39	0.39
Sat Flow, veh/h	726	1001	1599	1318	52	95	1792	3386	238	1774	3613	16
Grp Volume(v), veh/h	22	0	-24	308	0	0	21	201	209	43	432	455
Grp Sat Flow(s),veh/h/ln	1727	0	1599	1465	0	0	1792	1787	1837	1774	1770	1860
Q Serve(g_s), s	0.0	0.0	0.0	7.9	0.0	0.0	0.5	3.6	3.6	1.1	8.8	8.8
Cycle Q Clear(g_c), s	0.4	0.0	0.0	8.2	0.0	0.0	0.5	3.6	3.6	1.1	8.8	8.8
Prop In Lane	0.50		1.00	0.90		0.06	1.00		0.13	1.00		0.01
Lane Grp Cap(c), veh/h	646	0	450	599	0	0	46	661	679	82	691	726
V/C Ratio(X)	0.03	0.00	-0.05	0.51	0.00	0.00	0.46	0.30	0.31	0.52	0.63	0.63
Avail Cap(c_a), veh/h	1267	0	1074	1167	0	0	462	1801	1852	457	1784	1875
HCM Platoon Ratio	1.00	1.00	1.00	1.00	1.00	1.00	1.00	1.00	1.00	1.00	1.00	1.00
Upstream Filter(I)	1.00	0.00	0.00	1.00	0.00	0.00	1.00	1.00	1.00	1.00	1.00	1.00
Uniform Delay (d), s/veh	11.5	0.0	0.0	14.0	0.0	0.0	21.4	10.0	10.0	20.8	11.0	11.0
Incr Delay (d2), s/veh	0.0	0.0	0.0	0.7	0.0	0.0	6.9	0.3	0.3	5.1	0.9	0.9
Initial Q Delay(d3),s/veh	0.0	0.0	0.0	0.0	0.0	0.0	0.0	0.0	0.0	0.0	0.0	0.0
%ile BackOfQ(50%),veh/ln	0.2	0.0	0.0	3.3	0.0	0.0	0.3	1.8	1.8	0.6	4.4	4.6
LnGrp Delay(d),s/veh	11.5	0.0	0.0	14.7	0.0	0.0	28.3	10.3	10.3	25.9	11.9	11.9
LnGrp LOS	B			B			C	B	B	C	B	B
Approach Vol, veh/h		-2			308			431			930	
Approach Delay, s/veh		-126.4			14.7			11.1			12.5	
Approach LOS		A			B			B			B	
Timer	1	2	3	4	5	6	7	8				
Assigned Phs		2	3	4		6	7	8				
Phs Duration (G+Y+Rc), s		17.6	4.6	22.4		17.6	5.6	21.5				
Change Period (Y+Rc), s		5.0	3.5	5.0		5.0	3.5	5.0				
Max Green Setting (Gmax), s		30.0	11.5	45.0		30.0	11.5	45.0				
Max Q Clear Time (g_c+I1), s		2.4	2.5	10.8		10.2	3.1	5.6				
Green Ext Time (p_c), s		0.1	0.0	6.3		1.7	0.0	2.5				
Intersection Summary												
HCM 2010 Ctrl Delay				12.7								
HCM 2010 LOS				B								

HCM 2010 Signalized Intersection Summary
 16: 2nd Avenue & 8th Street

Cumulative, AM
 06/11/2019



Movement	WBL	WBR	NBT	NBR	SBL	SBT		
Lane Configurations								
Traffic Volume (veh/h)	340	20	510	130	50	1060		
Future Volume (veh/h)	340	20	510	130	50	1060		
Number	1	16	8	18	7	4		
Initial Q (Qb), veh	0	0	0	0	0	0		
Ped-Bike Adj(A_pbT)	1.00	1.00		1.00	1.00			
Parking Bus, Adj	1.00	1.00	1.00	1.00	1.00	1.00		
Adj Sat Flow, veh/h/ln	1583	1583	1863	1900	1881	1881		
Adj Flow Rate, veh/h	358	5	537	121	53	1116		
Adj No. of Lanes	1	1	2	0	1	2		
Peak Hour Factor	0.95	0.95	0.95	0.95	0.95	0.95		
Percent Heavy Veh, %	20	20	2	2	1	1		
Cap, veh/h	431	385	1057	237	96	1777		
Arrive On Green	0.29	0.29	0.37	0.37	0.05	0.50		
Sat Flow, veh/h	1508	1346	2967	645	1792	3668		
Grp Volume(v), veh/h	358	5	330	328	53	1116		
Grp Sat Flow(s),veh/h/ln	1508	1346	1770	1749	1792	1787		
Q Serve(g_s), s	10.2	0.1	6.7	6.7	1.3	10.5		
Cycle Q Clear(g_c), s	10.2	0.1	6.7	6.7	1.3	10.5		
Prop In Lane	1.00	1.00		0.37	1.00			
Lane Grp Cap(c), veh/h	431	385	651	643	96	1777		
V/C Ratio(X)	0.83	0.01	0.51	0.51	0.55	0.63		
Avail Cap(c_a), veh/h	982	876	1728	1708	447	4653		
HCM Platoon Ratio	1.00	1.00	1.00	1.00	1.00	1.00		
Upstream Filter(I)	1.00	1.00	1.00	1.00	1.00	1.00		
Uniform Delay (d), s/veh	15.4	11.8	11.3	11.3	21.3	8.5		
Incr Delay (d2), s/veh	4.2	0.0	0.6	0.6	4.9	0.4		
Initial Q Delay(d3),s/veh	0.0	0.0	0.0	0.0	0.0	0.0		
%ile BackOfQ(50%),veh/ln	4.7	0.1	3.3	3.3	0.8	5.2		
LnGrp Delay(d),s/veh	19.6	11.8	11.9	12.0	26.2	8.8		
LnGrp LOS	B	B	B	B	C	A		
Approach Vol, veh/h	363		658			1169		
Approach Delay, s/veh	19.5		11.9			9.6		
Approach LOS	B		B			A		
Timer	1	2	3	4	5	6	7	8
Assigned Phs				4		6	7	8
Phs Duration (G+Y+Rc), s				27.9		18.2	6.0	22.0
Change Period (Y+Rc), s				5.0		5.0	3.5	5.0
Max Green Setting (Gmax), s				60.0		30.0	11.5	45.0
Max Q Clear Time (g_c+I1), s				12.5		12.2	3.3	8.7
Green Ext Time (p_c), s				10.4		1.1	0.0	4.4
Intersection Summary								
HCM 2010 Ctrl Delay			12.0					
HCM 2010 LOS			B					

Intersection	
Intersection Delay, s/veh	11.7
Intersection LOS	B

Movement	EBT	EBR	WBL	WBT	NBL	NBR
Lane Configurations	↑	↑	↑	↑	↑	↑
Traffic Vol, veh/h	130	50	190	350	20	110
Future Vol, veh/h	130	50	190	350	20	110
Peak Hour Factor	0.92	0.92	0.92	0.92	0.92	0.92
Heavy Vehicles, %	2	2	2	2	2	2
Mvmt Flow	141	54	207	380	22	120
Number of Lanes	1	1	1	1	1	1

Approach	EB	WB	NB
Opposing Approach	WB	EB	
Opposing Lanes	2	2	0
Conflicting Approach Left		NB	EB
Conflicting Lanes Left	0	2	2
Conflicting Approach Right	NB		WB
Conflicting Lanes Right	2	0	2
HCM Control Delay	9.4	12.9	9.7
HCM LOS	A	B	A

Lane	NBLn1	NBLn2	EBLn1	EBLn2	WBLn1	WBLn2
Vol Left, %	100%	0%	0%	0%	100%	0%
Vol Thru, %	0%	0%	100%	0%	0%	100%
Vol Right, %	0%	100%	0%	100%	0%	0%
Sign Control	Stop	Stop	Stop	Stop	Stop	Stop
Traffic Vol by Lane	20	110	130	50	190	350
LT Vol	20	0	0	0	190	0
Through Vol	0	0	130	0	0	350
RT Vol	0	110	0	50	0	0
Lane Flow Rate	22	120	141	54	207	380
Geometry Grp	7	7	7	7	7	7
Degree of Util (X)	0.041	0.186	0.217	0.073	0.322	0.541
Departure Headway (Hd)	6.806	5.595	5.539	4.833	5.618	5.115
Convergence, Y/N	Yes	Yes	Yes	Yes	Yes	Yes
Cap	523	636	643	734	636	700
Service Time	4.584	3.372	3.318	2.611	3.38	2.877
HCM Lane V/C Ratio	0.042	0.189	0.219	0.074	0.325	0.543
HCM Control Delay	9.9	9.7	9.9	8	11.1	13.8
HCM Lane LOS	A	A	A	A	B	B
HCM 95th-tile Q	0.1	0.7	0.8	0.2	1.4	3.3

Intersection				
Intersection Delay, s/veh	13.9			
Intersection LOS	B			
Approach	EB	WB	NB	SB
Entry Lanes	1	1	1	1
Conflicting Circle Lanes	1	1	1	1
Adj Approach Flow, veh/h	147	197	36	777
Demand Flow Rate, veh/h	151	207	36	785
Vehicles Circulating, veh/h	424	113	538	90
Vehicles Exiting, veh/h	451	461	37	230
Follow-Up Headway, s	3.186	3.186	3.186	3.186
Ped Vol Crossing Leg, #/h	0	0	0	0
Ped Cap Adj	1.000	1.000	1.000	1.000
Approach Delay, s/veh	7.3	5.7	6.0	17.5
Approach LOS	A	A	A	C
Lane	Left	Left	Left	Left
Designated Moves	LTR	LTR	LTR	LTR
Assumed Moves	LTR	LTR	LTR	LTR
RT Channelized				
Lane Util	1.000	1.000	1.000	1.000
Critical Headway, s	5.193	5.193	5.193	5.193
Entry Flow, veh/h	151	207	36	785
Cap Entry Lane, veh/h	739	1009	660	1033
Entry HV Adj Factor	0.970	0.951	1.000	0.990
Flow Entry, veh/h	147	197	36	777
Cap Entry, veh/h	718	960	660	1022
V/C Ratio	0.204	0.205	0.055	0.760
Control Delay, s/veh	7.3	5.7	6.0	17.5
LOS	A	A	A	C
95th %tile Queue, veh	1	1	0	8

HCM 2010 Signalized Intersection Summary
 19: 2nd Avenue & Inter-Garrison Road

Cumulative, AM
 06/11/2019



Movement	WBL	WBR	NBT	NBR	SBL	SBT		
Lane Configurations								
Traffic Volume (veh/h)	60	30	640	60	20	1390		
Future Volume (veh/h)	60	30	640	60	20	1390		
Number	1	16	8	18	7	4		
Initial Q (Qb), veh	0	0	0	0	0	0		
Ped-Bike Adj(A_pbT)	1.00	1.00		1.00	1.00			
Parking Bus, Adj	1.00	1.00	1.00	1.00	1.00	1.00		
Adj Sat Flow, veh/h/ln	1900	1900	1881	1900	1881	1881		
Adj Flow Rate, veh/h	65	8	688	57	22	1495		
Adj No. of Lanes	1	1	2	0	1	2		
Peak Hour Factor	0.93	0.93	0.93	0.93	0.93	0.93		
Percent Heavy Veh, %	0	0	1	1	1	1		
Cap, veh/h	239	214	1822	151	48	2318		
Arrive On Green	0.13	0.13	0.55	0.55	0.03	0.65		
Sat Flow, veh/h	1810	1615	3437	277	1792	3668		
Grp Volume(v), veh/h	65	8	368	377	22	1495		
Grp Sat Flow(s),veh/h/ln	1810	1615	1787	1832	1792	1787		
Q Serve(g_s), s	1.5	0.2	5.4	5.4	0.6	11.5		
Cycle Q Clear(g_c), s	1.5	0.2	5.4	5.4	0.6	11.5		
Prop In Lane	1.00	1.00		0.15	1.00			
Lane Grp Cap(c), veh/h	239	214	974	999	48	2318		
V/C Ratio(X)	0.27	0.04	0.38	0.38	0.46	0.65		
Avail Cap(c_a), veh/h	1389	1239	1567	1607	452	4310		
HCM Platoon Ratio	1.00	1.00	1.00	1.00	1.00	1.00		
Upstream Filter(I)	1.00	1.00	1.00	1.00	1.00	1.00		
Uniform Delay (d), s/veh	17.8	17.3	5.9	5.9	21.9	4.8		
Incr Delay (d2), s/veh	0.6	0.1	0.2	0.2	6.8	0.3		
Initial Q Delay(d3),s/veh	0.0	0.0	0.0	0.0	0.0	0.0		
%ile BackOfQ(50%),veh/ln	0.8	0.2	2.6	2.7	0.4	5.5		
LnGrp Delay(d),s/veh	18.4	17.3	6.2	6.2	28.6	5.1		
LnGrp LOS	B	B	A	A	C	A		
Approach Vol, veh/h	73		745			1517		
Approach Delay, s/veh	18.3		6.2			5.5		
Approach LOS	B		A			A		
Timer	1	2	3	4	5	6	7	8
Assigned Phs				4		6	7	8
Phs Duration (G+Y+Rc), s				34.6		11.0	4.7	29.9
Change Period (Y+Rc), s				5.0		5.0	3.5	5.0
Max Green Setting (Gmax), s				55.0		35.0	11.5	40.0
Max Q Clear Time (g_c+I1), s				13.5		3.5	2.6	7.4
Green Ext Time (p_c), s				16.0		0.2	0.0	5.0
Intersection Summary								
HCM 2010 Ctrl Delay			6.1					
HCM 2010 LOS			A					

Intersection												
Intersection Delay, s/veh 11.3												
Intersection LOS B												























Movement	EBL	EBT	EBR	WBL	WBT	WBR	NBL	NBT	NBR	SBL	SBT	SBR
Lane Configurations		↕			↕			↕			↕	
Traffic Vol, veh/h	10	30	10	120	50	20	20	140	140	20	140	10
Future Vol, veh/h	10	30	10	120	50	20	20	140	140	20	140	10
Peak Hour Factor	0.85	0.85	0.85	0.85	0.85	0.85	0.85	0.85	0.85	0.85	0.85	0.85
Heavy Vehicles, %	6	6	6	2	2	2	4	4	4	0	0	0
Mvmt Flow	12	35	12	141	59	24	24	165	165	24	165	12
Number of Lanes	0	1	0	0	1	0	0	1	0	0	1	0

Approach	EB	WB	NB	SB
Opposing Approach	WB	EB	SB	NB
Opposing Lanes	1	1	1	1
Conflicting Approach Left	SB	NB	EB	WB
Conflicting Lanes Left	1	1	1	1
Conflicting Approach Right	NB	SB	WB	EB
Conflicting Lanes Right	1	1	1	1
HCM Control Delay	9.3	11.3	12.1	10.3
HCM LOS	A	B	B	B

Lane	NBLn1	EBLn1	WBLn1	SBLn1
Vol Left, %	7%	20%	63%	12%
Vol Thru, %	47%	60%	26%	82%
Vol Right, %	47%	20%	11%	6%
Sign Control	Stop	Stop	Stop	Stop
Traffic Vol by Lane	300	50	190	170
LT Vol	20	10	120	20
Through Vol	140	30	50	140
RT Vol	140	10	20	10
Lane Flow Rate	353	59	224	200
Geometry Grp	1	1	1	1
Degree of Util (X)	0.473	0.093	0.34	0.288
Departure Headway (Hd)	4.829	5.718	5.483	5.182
Convergence, Y/N	Yes	Yes	Yes	Yes
Cap	752	626	655	694
Service Time	2.829	3.76	3.517	3.213
HCM Lane V/C Ratio	0.469	0.094	0.342	0.288
HCM Control Delay	12.1	9.3	11.3	10.3
HCM Lane LOS	B	A	B	B
HCM 95th-tile Q	2.6	0.3	1.5	1.2

HCM 2010 Signalized Intersection Summary
 21: 7th Avenue/8th Street & Inter-Garrison Road

Cumulative, AM
 07/12/2019

												
Movement	EBL	EBT	EBR	WBL	WBT	WBR	NBL	NBT	NBR	SBL	SBT	SBR
Lane Configurations												
Traffic Volume (veh/h)	10	130	30	140	270	30	50	100	130	110	200	10
Future Volume (veh/h)	10	130	30	140	270	30	50	100	130	110	200	10
Number	5	2	12	1	6	16	3	8	18	7	4	14
Initial Q (Qb), veh	0	0	0	0	0	0	0	0	0	0	0	0
Ped-Bike Adj(A_pbT)	1.00		0.99	1.00		1.00	1.00		1.00	1.00		1.00
Parking Bus, Adj	1.00	1.00	1.00	1.00	1.00	1.00	1.00	1.00	1.00	1.00	1.00	1.00
Adj Sat Flow, veh/h/ln	1759	1759	1900	1845	1845	1900	1597	1597	1597	1776	1776	1900
Adj Flow Rate, veh/h	12	160	28	173	333	0	62	123	127	136	247	5
Adj No. of Lanes	1	1	0	1	1	0	1	1	1	1	1	0
Peak Hour Factor	0.81	0.81	0.81	0.81	0.81	0.81	0.81	0.81	0.81	0.81	0.81	0.81
Percent Heavy Veh, %	8	8	8	3	3	3	19	19	19	7	7	7
Cap, veh/h	21	357	62	230	671	0	108	252	214	213	369	7
Arrive On Green	0.01	0.24	0.24	0.13	0.36	0.00	0.07	0.16	0.16	0.13	0.21	0.21
Sat Flow, veh/h	1675	1457	255	1757	1845	0	1521	1597	1357	1691	1734	35
Grp Volume(v), veh/h	12	0	188	173	333	0	62	123	127	136	0	252
Grp Sat Flow(s),veh/h/ln	1675	0	1712	1757	1845	0	1521	1597	1357	1691	0	1770
Q Serve(g_s), s	0.3	0.0	4.1	4.2	6.2	0.0	1.7	3.1	3.8	3.4	0.0	5.8
Cycle Q Clear(g_c), s	0.3	0.0	4.1	4.2	6.2	0.0	1.7	3.1	3.8	3.4	0.0	5.8
Prop In Lane	1.00		0.15	1.00		0.00	1.00		1.00	1.00		0.02
Lane Grp Cap(c), veh/h	21	0	419	230	671	0	108	252	214	213	0	376
V/C Ratio(X)	0.58	0.00	0.45	0.75	0.50	0.00	0.57	0.49	0.59	0.64	0.00	0.67
Avail Cap(c_a), veh/h	156	0	1309	829	2110	0	811	1159	985	710	0	1084
HCM Platoon Ratio	1.00	1.00	1.00	1.00	1.00	1.00	1.00	1.00	1.00	1.00	1.00	1.00
Upstream Filter(I)	1.00	0.00	1.00	1.00	1.00	0.00	1.00	1.00	1.00	1.00	0.00	1.00
Uniform Delay (d), s/veh	21.6	0.0	14.1	18.5	10.9	0.0	19.8	16.9	17.3	18.3	0.0	15.9
Incr Delay (d2), s/veh	22.8	0.0	0.8	4.9	0.6	0.0	4.7	1.5	2.6	3.2	0.0	2.1
Initial Q Delay(d3),s/veh	0.0	0.0	0.0	0.0	0.0	0.0	0.0	0.0	0.0	0.0	0.0	0.0
%ile BackOfQ(50%),veh/ln	0.3	0.0	2.0	2.3	3.3	0.0	0.9	1.5	1.6	1.7	0.0	3.0
LnGrp Delay(d),s/veh	44.5	0.0	14.9	23.3	11.5	0.0	24.6	18.4	19.9	21.5	0.0	18.0
LnGrp LOS	D		B	C	B		C	B	B	C		B
Approach Vol, veh/h		200			506			312			388	
Approach Delay, s/veh		16.6			15.5			20.2			19.2	
Approach LOS		B			B			C			B	
Timer	1	2	3	4	5	6	7	8				
Assigned Phs	1	2	3	4	5	6	7	8				
Phs Duration (G+Y+Rc), s	9.3	15.8	5.6	13.4	4.0	21.0	8.1	10.9				
Change Period (Y+Rc), s	3.5	5.0	3.5	4.0	3.5	5.0	3.5	4.0				
Max Green Setting (Gmax), s	20.8	33.7	22.5	27.0	4.1	50.4	17.5	32.0				
Max Q Clear Time (g_c+I1), s	6.2	6.1	3.7	7.8	2.3	8.2	5.4	5.8				
Green Ext Time (p_c), s	0.4	1.0	0.1	1.3	0.0	2.2	0.2	1.1				
Intersection Summary												
HCM 2010 Ctrl Delay			17.7									
HCM 2010 LOS			B									

Intersection			
Intersection Delay, s/veh 107.6			
Intersection LOS F			
Approach	EB	WB	NB
Entry Lanes	1	1	1
Conflicting Circle Lanes	1	1	1
Adj Approach Flow, veh/h	425	1276	437
Demand Flow Rate, veh/h	531	1289	450
Vehicles Circulating, veh/h	860	95	345
Vehicles Exiting, veh/h	524	700	1046
Follow-Up Headway, s	3.186	3.186	3.186
Ped Vol Crossing Leg, #/h	0	0	0
Ped Cap Adj	1.000	1.000	1.000
Approach Delay, s/veh	112.2	138.4	13.2
Approach LOS	F	F	B
Lane	Left	Left	Left
Designated Moves	TR	LT	LR
Assumed Moves	TR	LT	LR
RT Channelized			
Lane Util	1.000	1.000	1.000
Critical Headway, s	5.193	5.193	5.193
Entry Flow, veh/h	531	1289	450
Cap Entry Lane, veh/h	478	1028	800
Entry HV Adj Factor	0.800	0.990	0.971
Flow Entry, veh/h	425	1276	437
Cap Entry, veh/h	383	1017	777
V/C Ratio	1.111	1.254	0.562
Control Delay, s/veh	112.2	138.4	13.2
LOS	F	F	B
95th %tile Queue, veh	16	43	4

HCM 2010 Signalized Intersection Summary
 23: Inter-Garrison Road & Abrams Drive

Cumulative, AM
 06/11/2019

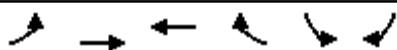

Movement	EBL	EBT	WBT	WBR	SBL	SBR		
Lane Configurations								
Traffic Volume (veh/h)	250	300	680	10	40	430		
Future Volume (veh/h)	250	300	680	10	40	430		
Number	5	2	6	16	7	14		
Initial Q (Qb), veh	0	0	0	0	0	0		
Ped-Bike Adj(A_pbT)	1.00			1.00	1.00	1.00		
Parking Bus, Adj	1.00	1.00	1.00	1.00	1.00	1.00		
Adj Sat Flow, veh/h/ln	1759	1759	1881	1881	1881	1881		
Adj Flow Rate, veh/h	294	353	800	6	47	288		
Adj No. of Lanes	1	1	1	1	2	1		
Peak Hour Factor	0.85	0.85	0.85	0.85	0.85	0.85		
Percent Heavy Veh, %	8	8	1	1	1	1		
Cap, veh/h	284	1179	844	718	711	327		
Arrive On Green	0.17	0.67	0.45	0.45	0.20	0.20		
Sat Flow, veh/h	1675	1759	1881	1599	3476	1599		
Grp Volume(v), veh/h	294	353	800	6	47	288		
Grp Sat Flow(s),veh/h/ln	1675	1759	1881	1599	1738	1599		
Q Serve(g_s), s	11.5	5.6	27.7	0.1	0.7	11.9		
Cycle Q Clear(g_c), s	11.5	5.6	27.7	0.1	0.7	11.9		
Prop In Lane	1.00			1.00	1.00	1.00		
Lane Grp Cap(c), veh/h	284	1179	844	718	711	327		
V/C Ratio(X)	1.04	0.30	0.95	0.01	0.07	0.88		
Avail Cap(c_a), veh/h	284	1556	1248	1061	1614	742		
HCM Platoon Ratio	1.00	1.00	1.00	1.00	1.00	1.00		
Upstream Filter(I)	1.00	1.00	1.00	1.00	1.00	1.00		
Uniform Delay (d), s/veh	28.2	4.6	17.9	10.3	21.7	26.2		
Incr Delay (d2), s/veh	62.8	0.1	9.3	0.0	0.0	3.0		
Initial Q Delay(d3),s/veh	0.0	0.0	0.0	0.0	0.0	0.0		
%ile BackOfQ(50%),veh/lt	0.2	2.7	16.4	0.1	0.4	10.0		
LnGrp Delay(d),s/veh	91.0	4.7	27.3	10.3	21.8	29.2		
LnGrp LOS	F	A	C	B	C	C		
Approach Vol, veh/h		647	806		335			
Approach Delay, s/veh		43.9	27.1		28.2			
Approach LOS		D	C		C			
Timer	1	2	3	4	5	6	7	8
Assigned Phs		2		4	5	6		
Phs Duration (G+Y+Rc), s		50.5		17.4	15.0	35.5		
Change Period (Y+Rc), s		5.0		3.5	3.5	5.0		
Max Green Setting (Gmax), s		60.0		31.5	11.5	45.0		
Max Q Clear Time (g_c+I1), s		7.6		13.9	13.5	29.7		
Green Ext Time (p_c), s		0.3		0.1	0.0	0.8		
Intersection Summary								
HCM 2010 Ctrl Delay			33.4					
HCM 2010 LOS			C					

Intersection	
Intersection Delay, s/veh	21.1
Intersection LOS	C

Movement	EBL	EBT	WBT	WBR	SBL	SBR
Lane Configurations						
Traffic Vol, veh/h	60	290	550	10	60	120
Future Vol, veh/h	60	290	550	10	60	120
Peak Hour Factor	0.79	0.79	0.79	0.79	0.79	0.79
Heavy Vehicles, %	5	5	1	1	3	3
Mvmt Flow	76	367	696	13	76	152
Number of Lanes	1	1	2	1	1	1

Approach	EB	WB	SB
Opposing Approach	WB	EB	
Opposing Lanes	3	2	0
Conflicting Approach Left	SB		WB
Conflicting Lanes Left	2	0	3
Conflicting Approach Right		SB	EB
Conflicting Lanes Right	0	2	2
HCM Control Delay	24.9	21.2	13.2
HCM LOS	C	C	B

Lane	EBLn1	EBLn2	WBLn1	WBLn2	WBLn3	SBLn1	SBLn2
Vol Left, %	100%	0%	0%	0%	0%	100%	0%
Vol Thru, %	0%	100%	100%	100%	0%	0%	0%
Vol Right, %	0%	0%	0%	0%	100%	0%	100%
Sign Control	Stop	Stop	Stop	Stop	Stop	Stop	Stop
Traffic Vol by Lane	60	290	275	275	10	60	120
LT Vol	60	0	0	0	0	60	0
Through Vol	0	290	275	275	0	0	0
RT Vol	0	0	0	0	10	0	120
Lane Flow Rate	76	367	348	348	13	76	152
Geometry Grp	8	8	8	8	8	8	8
Degree of Util (X)	0.163	0.736	0.656	0.656	0.015	0.18	0.308
Departure Headway (Hd)	7.737	7.213	6.787	6.787	4.33	8.521	7.299
Convergence, Y/N	Yes	Yes	Yes	Yes	Yes	Yes	Yes
Cap	465	503	536	536	831	422	492
Service Time	5.461	4.952	4.489	4.489	2.032	6.265	5.042
HCM Lane V/C Ratio	0.163	0.73	0.649	0.649	0.016	0.18	0.309
HCM Control Delay	12	27.6	21.5	21.5	7.1	13.1	13.3
HCM Lane LOS	B	D	C	C	A	B	B
HCM 95th-tile Q	0.6	6.1	4.7	4.7	0	0.6	1.3

Intersection						
Intersection Delay, s/veh	39.9					
Intersection LOS	E					

Movement	EBL	EBT	WBT	WBR	SBL	SBR
Lane Configurations						
Traffic Vol, veh/h	270	80	170	210	110	430
Future Vol, veh/h	270	80	170	210	110	430
Peak Hour Factor	0.82	0.82	0.82	0.82	0.82	0.82
Heavy Vehicles, %	5	5	1	1	0	0
Mvmt Flow	329	98	207	256	134	524
Number of Lanes	1	1	1	0	1	1

Approach	EB	WB	SB
Opposing Approach	WB	EB	
Opposing Lanes	1	2	0
Conflicting Approach Left	SB		WB
Conflicting Lanes Left	2	0	1
Conflicting Approach Right		SB	EB
Conflicting Lanes Right	0	2	2
HCM Control Delay	27.1	42.4	46.5
HCM LOS	D	E	E

Lane	EBLn1	EBLn2	WBLn1	SBLn1	SBLn2
Vol Left, %	100%	0%	0%	100%	0%
Vol Thru, %	0%	100%	45%	0%	0%
Vol Right, %	0%	0%	55%	0%	100%
Sign Control	Stop	Stop	Stop	Stop	Stop
Traffic Vol by Lane	270	80	380	110	430
LT Vol	270	0	0	110	0
Through Vol	0	80	170	0	0
RT Vol	0	0	210	0	430
Lane Flow Rate	329	98	463	134	524
Geometry Grp	7	7	4	7	7
Degree of Util (X)	0.746	0.207	0.884	0.292	0.961
Departure Headway (Hd)	8.157	7.641	6.866	7.829	6.599
Convergence, Y/N	Yes	Yes	Yes	Yes	Yes
Cap	445	469	528	460	551
Service Time	5.91	5.394	4.909	5.568	4.338
HCM Lane V/C Ratio	0.739	0.209	0.877	0.291	0.951
HCM Control Delay	31.4	12.4	42.4	13.8	54.9
HCM Lane LOS	D	B	E	B	F
HCM 95th-tile Q	6.1	0.8	9.9	1.2	12.7

HCM 2010 Signalized Intersection Summary
 26: East Garrison Road & Reservation Road

Cumulative, AM
 06/11/2019



Movement	EBL	EBT	EBR	WBL	WBT	WBR	NBL	NBT	NBR	SBL	SBT	SBR
Lane Configurations												
Traffic Volume (veh/h)	0	420	120	160	850	0	200	0	270	0	0	0
Future Volume (veh/h)	0	420	120	160	850	0	200	0	270	0	0	0
Number	5	2	12	1	6	16	3	8	18			
Initial Q (Qb), veh	0	0	0	0	0	0	0	0	0			
Ped-Bike Adj(A_pbT)	1.00		1.00	1.00		1.00	1.00		1.00			
Parking Bus, Adj	1.00	1.00	1.00	1.00	1.00	1.00	1.00	1.00	1.00			
Adj Sat Flow, veh/h/ln	1827	1827	1900	1863	1863	0	1881	0	1881			
Adj Flow Rate, veh/h	0	472	133	180	955	0	225	0	231			
Adj No. of Lanes	1	2	0	1	2	0	1	0	1			
Peak Hour Factor	0.89	0.89	0.89	0.89	0.89	0.89	0.89	0.89	0.89			
Percent Heavy Veh, %	4	4	4	2	2	0	1	0	1			
Cap, veh/h	4	947	265	229	2013	0	339	0	303			
Arrive On Green	0.00	0.35	0.35	0.13	0.57	0.00	0.19	0.00	0.19			
Sat Flow, veh/h	1740	2680	750	1774	3632	0	1792	0	1599			
Grp Volume(v), veh/h	0	305	300	180	955	0	225	0	231			
Grp Sat Flow(s),veh/h/ln	1740	1736	1695	1774	1770	0	1792	0	1599			
Q Serve(g_s), s	0.0	5.7	5.8	4.1	6.7	0.0	4.9	0.0	5.7			
Cycle Q Clear(g_c), s	0.0	5.7	5.8	4.1	6.7	0.0	4.9	0.0	5.7			
Prop In Lane	1.00		0.44	1.00		0.00	1.00		1.00			
Lane Grp Cap(c), veh/h	4	613	599	229	2013	0	339	0	303			
V/C Ratio(X)	0.00	0.50	0.50	0.79	0.47	0.00	0.66	0.00	0.76			
Avail Cap(c_a), veh/h	833	2494	2435	850	5086	0	1159	0	1034			
HCM Platoon Ratio	1.00	1.00	1.00	1.00	1.00	1.00	1.00	1.00	1.00			
Upstream Filter(I)	0.00	1.00	1.00	1.00	1.00	0.00	1.00	0.00	1.00			
Uniform Delay (d), s/veh	0.0	10.6	10.6	17.6	5.3	0.0	15.7	0.0	16.0			
Incr Delay (d2), s/veh	0.0	1.2	1.2	2.3	0.2	0.0	0.8	0.0	1.5			
Initial Q Delay(d3),s/veh	0.0	0.0	0.0	0.0	0.0	0.0	0.0	0.0	0.0			
%ile BackOfQ(50%),veh/ln	0.0	2.9	2.9	2.1	3.2	0.0	2.5	0.0	2.6			
LnGrp Delay(d),s/veh	0.0	11.7	11.8	19.9	5.5	0.0	16.5	0.0	17.6			
LnGrp LOS		B	B	B	A		B		B			
Approach Vol, veh/h		605			1135			456				
Approach Delay, s/veh		11.8			7.8			17.0				
Approach LOS		B			A			B				
Timer	1	2	3	4	5	6	7	8				
Assigned Phs	1	2			5	6		8				
Phs Duration (G+Y+Rc), s	9.0	20.2			0.0	29.1		12.6				
Change Period (Y+Rc), s	3.6	5.4			3.5	5.4		4.7				
Max Green Setting (Gmax), s	20	60.0			20.0	60.0		27.0				
Max Q Clear Time (g_c+10), s	10	7.8			0.0	8.7		7.7				
Green Ext Time (p_c), s	0.0	6.9			0.0	9.1		0.2				
Intersection Summary												
HCM 2010 Ctrl Delay				10.8								
HCM 2010 LOS				B								
Notes												

HCM 2010 Signalized Intersection Summary
 27: Reservation Road & Watkins Gate Road

Cumulative, AM
 06/11/2019



Movement	EBL	EBR	NBL	NBT	SBT	SBR		
Lane Configurations								
Traffic Volume (veh/h)	10	260	170	1240	800	60		
Future Volume (veh/h)	10	260	170	1240	800	60		
Number	5	12	3	8	4	14		
Initial Q (Qb), veh	0	0	0	0	0	0		
Ped-Bike Adj(A_pbT)	1.00	1.00	1.00			1.00		
Parking Bus, Adj	1.00	1.00	1.00	1.00	1.00	1.00		
Adj Sat Flow, veh/h/ln	1863	1863	1863	1863	1863	1900		
Adj Flow Rate, veh/h	11	55	185	1348	870	58		
Adj No. of Lanes	1	1	1	2	2	0		
Peak Hour Factor	0.92	0.92	0.92	0.92	0.92	0.92		
Percent Heavy Veh, %	2	2	2	2	2	2		
Cap, veh/h	107	96	233	2389	1557	104		
Arrive On Green	0.06	0.06	0.13	0.68	0.46	0.46		
Sat Flow, veh/h	1774	1583	1774	3632	3461	225		
Grp Volume(v), veh/h	11	55	185	1348	457	471		
Grp Sat Flow(s),veh/h/ln	1774	1583	1774	1770	1770	1823		
Q Serve(g_s), s	0.3	1.7	5.0	9.8	9.2	9.2		
Cycle Q Clear(g_c), s	0.3	1.7	5.0	9.8	9.2	9.2		
Prop In Lane	1.00	1.00	1.00			0.12		
Lane Grp Cap(c), veh/h	107	96	233	2389	818	843		
V/C Ratio(X)	0.10	0.57	0.79	0.56	0.56	0.56		
Avail Cap(c_a), veh/h	668	596	650	4934	1675	1725		
HCM Platoon Ratio	1.00	1.00	1.00	1.00	1.00	1.00		
Upstream Filter(I)	1.00	1.00	1.00	1.00	1.00	1.00		
Uniform Delay (d), s/veh	21.8	22.5	20.7	4.2	9.6	9.6		
Incr Delay (d2), s/veh	0.2	2.0	2.3	0.3	1.0	0.9		
Initial Q Delay(d3),s/veh	0.0	0.0	0.0	0.0	0.0	0.0		
%ile BackOfQ(50%),veh/ln	0.1	0.8	2.6	4.8	4.7	4.8		
LnGrp Delay(d),s/veh	22.0	24.5	23.0	4.5	10.5	10.5		
LnGrp LOS	C	C	C	A	B	B		
Approach Vol, veh/h	66			1533	928			
Approach Delay, s/veh	24.1			6.8	10.5			
Approach LOS	C			A	B			
Timer	1	2	3	4	5	6	7	8
Assigned Phs		2	3	4				8
Phs Duration (G+Y+Rc), s		9.5	10.5	29.2				39.7
Change Period (Y+Rc), s		6.5	4.0	6.5				6.5
Max Green Setting (Gmax), s		18.5	18.0	46.5				68.5
Max Q Clear Time (g_c+11), s		3.7	7.0	11.2				11.8
Green Ext Time (p_c), s		0.0	0.0	9.8				21.3
Intersection Summary								
HCM 2010 Ctrl Delay			8.6					
HCM 2010 LOS			A					

HCM 2010 Signalized Intersection Summary
28: Davis Road & Reservation Road

Cumulative, AM
06/11/2019



Movement	EBL	EBT	EBR	WBL	WBT	WBR	NBL	NBT	NBR	SBL	SBT	SBR
Lane Configurations												
Traffic Volume (veh/h)	460	300	10	10	560	90	10	10	10	160	10	520
Future Volume (veh/h)	460	300	10	10	560	90	10	10	10	160	10	520
Number	5	2	12	1	6	16	3	8	18	7	4	14
Initial Q (Qb), veh	0	0	0	0	0	0	0	0	0	0	0	0
Ped-Bike Adj(A_pbT)	1.00		1.00	1.00		1.00	1.00		1.00	1.00		1.00
Parking Bus, Adj	1.00	1.00	1.00	1.00	1.00	1.00	1.00	1.00	1.00	1.00	1.00	1.00
Adj Sat Flow, veh/h/ln	1863	1863	1900	1863	1863	1900	1900	1900	1900	1900	1845	1845
Adj Flow Rate, veh/h	535	349	12	12	651	105	12	12	9	186	12	363
Adj No. of Lanes	1	2	0	1	1	0	0	1	0	0	1	1
Peak Hour Factor	0.86	0.86	0.86	0.86	0.86	0.86	0.86	0.86	0.86	0.86	0.86	0.86
Percent Heavy Veh, %	2	2	2	2	2	2	0	0	0	3	3	3
Cap, veh/h	387	2252	77	18	684	110	17	17	13	334	22	645
Arrive On Green	0.22	0.65	0.64	0.01	0.44	0.43	0.03	0.03	0.03	0.20	0.20	0.19
Sat Flow, veh/h	1774	3491	120	1774	1566	253	648	648	486	1655	107	1568
Grp Volume(v), veh/h	535	176	185	12	0	756	33	0	0	198	0	363
Grp Sat Flow(s),veh/h/ln	1774	1770	1842	1774	0	1818	1782	0	0	1762	0	1568
Q Serve(g_s), s	29.8	5.4	5.4	0.9	0.0	54.7	2.5	0.0	0.0	13.8	0.0	24.2
Cycle Q Clear(g_c), s	29.8	5.4	5.4	0.9	0.0	54.7	2.5	0.0	0.0	13.8	0.0	24.2
Prop In Lane	1.00		0.07	1.00		0.14	0.36		0.27	0.94		1.00
Lane Grp Cap(c), veh/h	387	1142	1188	18	0	794	47	0	0	355	0	645
V/C Ratio(X)	1.38	0.15	0.16	0.68	0.00	0.95	0.71	0.00	0.00	0.56	0.00	0.56
Avail Cap(c_a), veh/h	387	1142	1188	389	0	813	392	0	0	400	0	685
HCM Platoon Ratio	1.00	1.00	1.00	1.00	1.00	1.00	1.00	1.00	1.00	1.00	1.00	1.00
Upstream Filter(I)	1.00	1.00	1.00	1.00	0.00	1.00	1.00	0.00	0.00	1.00	0.00	1.00
Uniform Delay (d), s/veh	53.3	9.5	9.6	67.3	0.0	37.1	65.9	0.0	0.0	49.0	0.0	30.8
Incr Delay (d2), s/veh	186.9	0.1	0.1	15.5	0.0	20.8	7.1	0.0	0.0	0.5	0.0	0.5
Initial Q Delay(d3),s/veh	0.0	0.0	0.0	0.0	0.0	0.0	0.0	0.0	0.0	0.0	0.0	0.0
%ile BackOfQ(50%),veh/ln	4.6	2.6	2.8	0.5	0.0	31.9	1.3	0.0	0.0	6.8	0.0	10.5
LnGrp Delay(d),s/veh	240.3	9.6	9.7	82.8	0.0	57.9	73.1	0.0	0.0	49.5	0.0	31.3
LnGrp LOS	F	A	A	F		E	E			D		C
Approach Vol, veh/h		896			768			33			561	
Approach Delay, s/veh		147.4			58.3			73.1			37.7	
Approach LOS		F			E			E			D	
Timer	1	2	3	4	5	6	7	8				
Assigned Phs	1	2		4	5	6		8				
Phs Duration (G+Y+Rc), s	5.4	92.0		31.5	33.8	63.6		7.6				
Change Period (Y+Rc), s	3.9	5.0		5.0	* 3.8	5.0		4.0				
Max Green Setting (Gmax), s	30	60.0		30.0	* 30	60.0		30.0				
Max Q Clear Time (g_c+1/2g), s	11.5	7.4		26.2	31.8	56.7		4.5				
Green Ext Time (p_c), s	0.0	3.2		0.3	0.0	1.9		0.0				
Intersection Summary												
HCM 2010 Ctrl Delay				88.8								
HCM 2010 LOS				F								
Notes												

HCM 2010 Signalized Intersection Summary
 29: 2nd Avenue & Divarty Street

Cumulative, AM
 06/11/2019



Movement	EBL	EBT	EBR	WBL	WBT	WBR	NBL	NBT	NBR	SBL	SBT	SBR
Lane Configurations		↕			↕	↕	↕	↕↔		↕	↕↔	
Traffic Volume (veh/h)	80	10	40	40	20	20	130	610	80	20	1180	250
Future Volume (veh/h)	80	10	40	40	20	20	130	610	80	20	1180	250
Number	5	2	12	1	6	16	3	8	18	7	4	14
Initial Q (Qb), veh	0	0	0	0	0	0	0	0	0	0	0	0
Ped-Bike Adj(A_pbT)	1.00		1.00	1.00		1.00	1.00		1.00	1.00		1.00
Parking Bus, Adj	1.00	1.00	1.00	1.00	1.00	1.00	1.00	1.00	1.00	1.00	1.00	1.00
Adj Sat Flow, veh/h/ln	1900	1667	1900	1900	1900	1900	1863	1863	1900	1881	1881	1900
Adj Flow Rate, veh/h	88	11	44	44	22	22	143	670	88	22	1297	275
Adj No. of Lanes	0	1	0	0	1	1	1	2	0	1	2	0
Peak Hour Factor	0.91	0.91	0.91	0.91	0.91	0.91	0.91	0.91	0.91	0.91	0.91	0.91
Percent Heavy Veh, %	14	14	14	0	0	0	2	2	2	1	1	1
Cap, veh/h	190	32	59	239	100	256	182	1927	253	45	1574	329
Arrive On Green	0.17	0.16	0.16	0.17	0.16	0.16	0.10	0.61	0.61	0.03	0.53	0.53
Sat Flow, veh/h	644	199	375	933	631	1612	1774	3146	413	1792	2943	616
Grp Volume(v), veh/h	143	0	0	66	0	22	143	377	381	22	781	791
Grp Sat Flow(s),veh/h/ln	1218	0	0	1564	0	1612	1774	1770	1789	1792	1787	1771
Q Serve(g_s), s	5.4	0.0	0.0	0.0	0.0	0.8	5.2	6.9	7.0	0.8	23.9	24.9
Cycle Q Clear(g_c), s	7.6	0.0	0.0	2.2	0.0	0.8	5.2	6.9	7.0	0.8	23.9	24.9
Prop In Lane	0.62		0.31	0.67		1.00	1.00		0.23	1.00		0.35
Lane Grp Cap(c), veh/h	299	0	0	362	0	256	182	1084	1096	45	956	947
V/C Ratio(X)	0.48	0.00	0.00	0.18	0.00	0.09	0.78	0.35	0.35	0.49	0.82	0.84
Avail Cap(c_a), veh/h	777	0	0	919	0	850	308	1084	1096	311	1078	1068
HCM Platoon Ratio	1.00	1.00	1.00	1.00	1.00	1.00	1.00	1.00	1.00	1.00	1.00	1.00
Upstream Filter(I)	1.00	0.00	0.00	1.00	0.00	1.00	1.00	1.00	1.00	1.00	1.00	1.00
Uniform Delay (d), s/veh	26.5	0.0	0.0	24.1	0.0	23.8	29.0	6.3	6.3	31.9	12.7	13.0
Incr Delay (d2), s/veh	1.2	0.0	0.0	0.2	0.0	0.1	7.2	0.2	0.2	8.0	4.5	5.3
Initial Q Delay(d3),s/veh	0.0	0.0	0.0	0.0	0.0	0.0	0.0	0.0	0.0	0.0	0.0	0.0
%ile BackOfQ(50%),veh/ln	2.5	0.0	0.0	1.1	0.0	0.4	2.9	3.4	3.4	0.5	12.9	13.5
LnGrp Delay(d),s/veh	27.7	0.0	0.0	24.3	0.0	23.9	36.3	6.5	6.5	39.9	17.3	18.3
LnGrp LOS	C			C		C	D	A	A	D	B	B
Approach Vol, veh/h		143			88			901			1594	
Approach Delay, s/veh		27.7			24.2			11.2			18.1	
Approach LOS		C			C			B			B	
Timer	1	2	3	4	5	6	7	8				
Assigned Phs		2	3	4		6	7	8				
Phs Duration (G+Y+Rc), s		15.5	10.3	40.5		15.5	5.2	45.6				
Change Period (Y+Rc), s		5.0	3.5	5.0		5.0	3.5	5.0				
Max Green Setting (Gmax), s		35.0	11.5	40.0		35.0	11.5	40.0				
Max Q Clear Time (g_c+I1), s		9.6	7.2	26.9		4.2	2.8	9.0				
Green Ext Time (p_c), s		0.8	0.1	8.6		0.4	0.0	5.1				
Intersection Summary												
HCM 2010 Ctrl Delay				16.5								
HCM 2010 LOS				B								

Intersection												
Intersection Delay, s/veh	11.6											
Intersection LOS	B											

Movement	EBL	EBT	EBR	WBL	WBT	WBR	NBL	NBT	NBR	SBL	SBT	SBR
Lane Configurations		↕			↕		↕	↕		↕	↕	
Traffic Vol, veh/h	10	10	20	60	10	10	20	280	40	10	240	20
Future Vol, veh/h	10	10	20	60	10	10	20	280	40	10	240	20
Peak Hour Factor	0.91	0.91	0.91	0.91	0.91	0.91	0.91	0.91	0.91	0.91	0.91	0.91
Heavy Vehicles, %	0	0	0	1	1	1	2	2	2	1	1	1
Mvmt Flow	11	11	22	66	11	11	22	308	44	11	264	22
Number of Lanes	0	1	0	0	1	0	1	1	0	1	1	0

Approach	EB	WB	NB	SB
Opposing Approach	WB	EB	SB	NB
Opposing Lanes	1	1	2	2
Conflicting Approach Left	SB	NB	EB	WB
Conflicting Lanes Left	2	2	1	1
Conflicting Approach Right	NB	SB	WB	EB
Conflicting Lanes Right	2	2	1	1
HCM Control Delay	8.9	9.7	12.6	11.4
HCM LOS	A	A	B	B

Lane	NBLn1	NBLn2	EBLn1	WBLn1	SBLn1	SBLn2
Vol Left, %	100%	0%	25%	75%	100%	0%
Vol Thru, %	0%	88%	25%	12%	0%	92%
Vol Right, %	0%	12%	50%	12%	0%	8%
Sign Control	Stop	Stop	Stop	Stop	Stop	Stop
Traffic Vol by Lane	20	320	40	80	10	260
LT Vol	20	0	10	60	10	0
Through Vol	0	280	10	10	0	240
RT Vol	0	40	20	10	0	20
Lane Flow Rate	22	352	44	88	11	286
Geometry Grp	7	7	2	2	7	7
Degree of Util (X)	0.035	0.496	0.066	0.138	0.017	0.41
Departure Headway (Hd)	5.669	5.078	5.406	5.658	5.722	5.164
Convergence, Y/N	Yes	Yes	Yes	Yes	Yes	Yes
Cap	629	707	655	629	622	694
Service Time	3.429	2.837	3.502	3.742	3.486	2.927
HCM Lane V/C Ratio	0.035	0.498	0.067	0.14	0.018	0.412
HCM Control Delay	8.6	12.8	8.9	9.7	8.6	11.5
HCM Lane LOS	A	B	A	A	A	B
HCM 95th-tile Q	0.1	2.8	0.2	0.5	0.1	2

HCM 2010 Signalized Intersection Summary
31: 1st Avenue & Lightfighter Drive

Cumulative, AM
06/11/2019



Movement	EBL	EBT	EBR	WBL	WBT	WBR	NBL	NBT	NBR	SBL	SBT	SBR
Lane Configurations		↑↑	↑	↑	↑↑		↑		↑	↑	↑	↑
Traffic Volume (veh/h)	0	1120	130	20	1030	0	160	0	20	120	30	100
Future Volume (veh/h)	0	1120	130	20	1030	0	160	0	20	120	30	100
Number	7	4	14	3	8	18	5	2	12	1	6	16
Initial Q (Qb), veh	0	0	0	0	0	0	0	0	0	0	0	0
Ped-Bike Adj(A_pbT)	1.00		1.00	1.00		1.00	1.00		1.00	1.00		1.00
Parking Bus, Adj	1.00	1.00	1.00	1.00	1.00	1.00	1.00	1.00	1.00	1.00	1.00	1.00
Adj Sat Flow, veh/h/ln	0	1863	1863	1863	1863	0	1863	0	1863	1792	1792	1792
Adj Flow Rate, veh/h	0	1333	0	24	1226	0	190	0	10	143	36	100
Adj No. of Lanes	0	2	1	1	2	0	1	0	1	1	1	1
Peak Hour Factor	0.84	0.84	0.84	0.84	0.84	0.84	0.84	0.84	0.84	0.84	0.84	0.84
Percent Heavy Veh, %	0	2	2	2	2	0	2	0	2	6	6	6
Cap, veh/h	0	2159	966	27	2456	0	0	0	0	214	225	191
Arrive On Green	0.00	0.61	0.00	0.02	0.69	0.00	0.00	0.00	0.00	0.13	0.13	0.13
Sat Flow, veh/h	0	3632	1583	1774	3632	0		0		1707	1792	1524
Grp Volume(v), veh/h	0	1333	0	24	1226	0		0.0		143	36	100
Grp Sat Flow(s),veh/h/ln	0	1770	1583	1774	1770	0				1707	1792	1524
Q Serve(g_s), s	0.0	12.0	0.0	0.7	8.3	0.0				4.1	0.9	3.1
Cycle Q Clear(g_c), s	0.0	12.0	0.0	0.7	8.3	0.0				4.1	0.9	3.1
Prop In Lane	0.00		1.00	1.00		0.00				1.00		1.00
Lane Grp Cap(c), veh/h	0	2159	966	27	2456	0				214	225	191
V/C Ratio(X)	0.00	0.62	0.00	0.89	0.50	0.00				0.67	0.16	0.52
Avail Cap(c_a), veh/h	0	3128	1399	697	3128	0				838	880	748
HCM Platoon Ratio	1.00	1.00	1.00	1.00	1.00	1.00				1.00	1.00	1.00
Upstream Filter(I)	0.00	1.00	0.00	1.00	1.00	0.00				1.00	1.00	1.00
Uniform Delay (d), s/veh	0.0	6.2	0.0	25.0	3.6	0.0				21.3	19.9	20.8
Incr Delay (d2), s/veh	0.0	0.4	0.0	27.2	0.2	0.0				1.3	0.1	0.8
Initial Q Delay(d3),s/veh	0.0	0.0	0.0	0.0	0.0	0.0				0.0	0.0	0.0
%ile BackOfQ(50%),veh/lr0.0	0.0	5.9	0.0	0.5	4.0	0.0				2.0	0.5	1.3
LnGrp Delay(d),s/veh	0.0	6.6	0.0	52.2	3.9	0.0				22.6	20.0	21.7
LnGrp LOS		A		D	A					C	B	C
Approach Vol, veh/h		1333			1250						279	
Approach Delay, s/veh		6.6			4.8						21.9	
Approach LOS		A			A						C	
Timer	1	2	3	4	5	6	7	8				
Assigned Phs			3	4		6		8				
Phs Duration (G+Y+Rc), s			4.3	35.7		11.0		39.9				
Change Period (Y+Rc), s			3.5	4.6		4.6		4.6				
Max Green Setting (Gmax), s			20.0	45.0		25.0		45.0				
Max Q Clear Time (g_c+I1), s			2.7	14.0		6.1		10.3				
Green Ext Time (p_c), s			0.0	17.1		0.4		15.2				
Intersection Summary												
HCM 2010 Ctrl Delay			7.3									
HCM 2010 LOS			A									

HCM 2010 Signalized Intersection Summary
 32: 2nd Avenue & Lightfighter Drive

Cumulative, AM
 06/11/2019



Movement	EBL	EBT	EBR	WBL	WBT	WBR	NBL	NBT	NBR	SBL	SBT	SBR
Lane Configurations												
Traffic Volume (veh/h)	340	910	10	40	600	180	20	20	50	350	10	490
Future Volume (veh/h)	340	910	10	40	600	180	20	20	50	350	10	490
Number	5	2	12	1	6	16	3	8	18	7	4	14
Initial Q (Qb), veh	0	0	0	0	0	0	0	0	0	0	0	0
Ped-Bike Adj(A_pbT)	1.00		1.00	1.00		1.00	1.00		1.00	1.00		1.00
Parking Bus, Adj	1.00	1.00	1.00	1.00	1.00	1.00	1.00	1.00	1.00	1.00	1.00	1.00
Adj Sat Flow, veh/h/ln	1863	1863	1900	1827	1827	1900	1900	1900	1900	1881	1881	1881
Adj Flow Rate, veh/h	378	1011	11	44	667	191	22	22	55	389	11	268
Adj No. of Lanes	1	2	0	1	2	0	0	1	0	1	1	1
Peak Hour Factor	0.90	0.90	0.90	0.90	0.90	0.90	0.90	0.90	0.90	0.90	0.90	0.90
Percent Heavy Veh, %	2	2	2	4	4	4	0	0	0	1	1	1
Cap, veh/h	220	1908	21	56	1173	336	124	131	264	489	572	486
Arrive On Green	0.12	0.53	0.53	0.03	0.44	0.44	0.31	0.30	0.30	0.30	0.30	0.30
Sat Flow, veh/h	1774	3586	39	1740	2665	763	262	432	868	1330	1881	1599
Grp Volume(v), veh/h	378	499	523	44	434	424	99	0	0	389	11	268
Grp Sat Flow(s),veh/h/ln	1774	1770	1856	1740	1736	1692	1563	0	0	1330	1881	1599
Q Serve(g_s), s	12.4	18.4	18.4	2.5	18.7	18.7	0.0	0.0	0.0	23.2	0.4	14.0
Cycle Q Clear(g_c), s	12.4	18.4	18.4	2.5	18.7	18.7	4.2	0.0	0.0	27.4	0.4	14.0
Prop In Lane	1.00		0.02	1.00		0.45	0.22		0.56	1.00		1.00
Lane Grp Cap(c), veh/h	220	942	987	56	764	745	529	0	0	489	572	486
V/C Ratio(X)	1.72	0.53	0.53	0.79	0.57	0.57	0.19	0.00	0.00	0.79	0.02	0.55
Avail Cap(c_a), veh/h	220	942	987	216	764	745	680	0	0	622	760	646
HCM Platoon Ratio	1.00	1.00	1.00	1.00	1.00	1.00	1.00	1.00	1.00	1.00	1.00	1.00
Upstream Filter(I)	0.62	0.62	0.62	0.09	0.09	0.09	1.00	0.00	0.00	0.39	0.39	0.39
Uniform Delay (d), s/veh	43.8	15.2	15.2	48.1	20.9	20.9	25.6	0.0	0.0	33.4	24.4	29.1
Incr Delay (d2), s/veh	335.0	1.3	1.3	0.9	0.3	0.3	0.1	0.0	0.0	1.7	0.0	0.1
Initial Q Delay(d3),s/veh	0.0	0.0	0.0	0.0	0.0	0.0	0.0	0.0	0.0	0.0	0.0	0.0
%ile BackOfQ(50%),veh/ln	26.5	9.2	9.6	1.2	9.0	8.8	2.0	0.0	0.0	10.6	0.2	6.2
LnGrp Delay(d),s/veh	378.8	16.6	16.5	49.0	21.2	21.2	25.7	0.0	0.0	35.1	24.4	29.2
LnGrp LOS	F	B	B	D	C	C	C			D	C	C
Approach Vol, veh/h		1400			902			99			668	
Approach Delay, s/veh		114.4			22.6			25.7			32.5	
Approach LOS		F			C			C			C	
Timer	1	2	3	4	5	6	7	8				
Assigned Phs	1	2		4	5	6		8				
Phs Duration (G+Y+Rc), s	7.2	57.8		35.0	16.4	48.6		35.0				
Change Period (Y+Rc), s	4.0	4.6		4.6	4.0	4.6		4.6				
Max Green Setting (Gmax), s	2.4	34.0		40.4	12.4	24.4		40.4				
Max Q Clear Time (g_c+1), s	14.5	20.4		29.4	14.4	20.7		6.2				
Green Ext Time (p_c), s	0.0	3.5		1.0	0.0	1.3		0.4				
Intersection Summary												
HCM 2010 Ctrl Delay			66.7									
HCM 2010 LOS			E									

HCM 2010 Signalized Intersection Summary
 33: General Jim Moore Boulevard & Lightfighter Drive

Cumulative, AM
 06/11/2019



Movement	EBL	EBT	EBR	WBL	WBT	WBR	NBL	NBT	NBR	SBL	SBT	SBR
Lane Configurations												
Traffic Volume (veh/h)	70	280	760	20	200	60	620	150	10	30	150	70
Future Volume (veh/h)	70	280	760	20	200	60	620	150	10	30	150	70
Number	3	8	18	7	4	14	1	6	16	5	2	12
Initial Q (Qb), veh	0	0	0	0	0	0	0	0	0	0	0	0
Ped-Bike Adj(A_pbT)	1.00		1.00	1.00		1.00	1.00		1.00	1.00		1.00
Parking Bus, Adj	1.00	1.00	1.00	1.00	1.00	1.00	1.00	1.00	1.00	1.00	1.00	1.00
Adj Sat Flow, veh/h/ln	1863	1863	1863	1792	1792	1900	1881	1881	1900	1863	1863	1900
Adj Flow Rate, veh/h	79	315	0	22	225	65	697	169	10	34	169	79
Adj No. of Lanes	1	1	1	1	1	0	2	1	0	1	2	0
Peak Hour Factor	0.89	0.89	0.89	0.89	0.89	0.89	0.89	0.89	0.89	0.89	0.89	0.89
Percent Heavy Veh, %	2	2	2	6	6	6	1	1	1	2	2	2
Cap, veh/h	102	508	432	36	316	91	691	559	33	53	354	159
Arrive On Green	0.06	0.27	0.00	0.02	0.24	0.24	0.20	0.32	0.32	0.03	0.15	0.15
Sat Flow, veh/h	1774	1863	1583	1707	1336	386	3476	1759	104	1774	2376	1063
Grp Volume(v), veh/h	79	315	0	22	0	290	697	0	179	34	124	124
Grp Sat Flow(s),veh/h/ln	1774	1863	1583	1707	0	1722	1738	0	1863	1774	1770	1670
Q Serve(g_s), s	2.2	7.4	0.0	0.6	0.0	7.8	10.0	0.0	3.6	1.0	3.2	3.4
Cycle Q Clear(g_c), s	2.2	7.4	0.0	0.6	0.0	7.8	10.0	0.0	3.6	1.0	3.2	3.4
Prop In Lane	1.00		1.00	1.00		0.22	1.00		0.06	1.00		0.64
Lane Grp Cap(c), veh/h	102	508	432	36	0	407	691	0	592	53	264	249
V/C Ratio(X)	0.77	0.62	0.00	0.61	0.00	0.71	1.01	0.00	0.30	0.64	0.47	0.50
Avail Cap(c_a), veh/h	706	1112	945	679	0	1028	691	0	1112	529	1056	997
HCM Platoon Ratio	1.00	1.00	1.00	1.00	1.00	1.00	1.00	1.00	1.00	1.00	1.00	1.00
Upstream Filter(I)	1.00	1.00	0.00	1.00	0.00	1.00	1.00	0.00	1.00	1.00	1.00	1.00
Uniform Delay (d), s/veh	23.4	16.0	0.0	24.4	0.0	17.6	20.1	0.0	12.9	24.1	19.6	19.7
Incr Delay (d2), s/veh	11.5	1.5	0.0	6.1	0.0	2.8	36.2	0.0	0.6	4.6	1.6	1.9
Initial Q Delay(d3),s/veh	0.0	0.0	0.0	0.0	0.0	0.0	0.0	0.0	0.0	0.0	0.0	0.0
%ile BackOfQ(50%),veh/ln	1.4	4.0	0.0	0.4	0.0	3.9	8.2	0.0	1.9	0.5	1.7	1.7
LnGrp Delay(d),s/veh	34.9	17.5	0.0	30.5	0.0	20.4	56.4	0.0	13.5	28.7	21.1	21.5
LnGrp LOS	C	B		C		C	F		B	C	C	C
Approach Vol, veh/h		394			312			876			282	
Approach Delay, s/veh		21.0			21.2			47.6			22.2	
Approach LOS		C			C			D			C	
Timer	1	2	3	4	5	6	7	8				
Assigned Phs	1	2	3	4	5	6	7	8				
Phs Duration (G+Y+Rc), s	4.5	12.0	7.4	16.4	6.0	20.5	5.6	18.2				
Change Period (Y+Rc), s	4.5	4.5	4.5	4.5	4.5	4.5	4.5	4.5				
Max Green Setting (Gmax), s	30.0	30.0	20.0	30.0	15.0	30.0	20.0	30.0				
Max Q Clear Time (g_c+1), s	5.4	4.2	9.8	3.0	5.6	2.6	9.4					
Green Ext Time (p_c), s	0.0	1.6	0.1	2.1	0.0	1.8	0.0	2.0				
Intersection Summary												
HCM 2010 Ctrl Delay			33.7									
HCM 2010 LOS			C									

Intersection

Intersection Delay, s/veh 14.6

Intersection LOS B

Movement	WBL	WBR	NBT	NBR	SBL	SBT
Lane Configurations						
Traffic Vol, veh/h	70	240	50	20	270	50
Future Vol, veh/h	70	240	50	20	270	50
Peak Hour Factor	0.77	0.77	0.77	0.77	0.77	0.77
Heavy Vehicles, %	4	4	3	3	2	2
Mvmt Flow	91	312	65	26	351	65
Number of Lanes	1	0	1	0	0	1

Approach	WB	NB	SB
Opposing Approach		SB	NB
Opposing Lanes	0	1	1
Conflicting Approach Left NB			WB
Conflicting Lanes Left	1	0	1
Conflicting Approach Right SB		WB	
Conflicting Lanes Right	1	1	0
HCM Control Delay	13.9	9.4	16.5
HCM LOS	B	A	C

Lane	NBLn1	WBLn1	SBLn1
Vol Left, %	0%	23%	84%
Vol Thru, %	71%	0%	16%
Vol Right, %	29%	77%	0%
Sign Control	Stop	Stop	Stop
Traffic Vol by Lane	70	310	320
LT Vol	0	70	270
Through Vol	50	0	50
RT Vol	20	240	0
Lane Flow Rate	91	403	416
Geometry Grp	1	1	1
Degree of Util (X)	0.138	0.554	0.614
Departure Headway (Hd)	5.484	4.955	5.316
Convergence, Y/N	Yes	Yes	Yes
Cap	653	733	682
Service Time	3.526	2.955	3.345
HCM Lane V/C Ratio	0.139	0.55	0.61
HCM Control Delay	9.4	13.9	16.5
HCM Lane LOS	A	B	C
HCM 95th-tile Q	0.5	3.4	4.2

Intersection						
Int Delay, s/veh	1.5					
Movement	EBT	EBR	WBL	WBT	NBL	NBR
Lane Configurations						
Traffic Vol, veh/h	260	30	20	280	30	30
Future Vol, veh/h	260	30	20	280	30	30
Conflicting Peds, #/hr	0	0	0	0	0	0
Sign Control	Free	Free	Free	Free	Stop	Stop
RT Channelized	-	None	-	None	-	None
Storage Length	-	-	-	-	0	-
Veh in Median Storage, #	0	-	-	0	0	-
Grade, %	0	-	-	0	0	-
Peak Hour Factor	78	78	78	78	78	78
Heavy Vehicles, %	5	5	4	4	0	0
Mvmt Flow	333	38	26	359	38	38

Major/Minor	Major1	Major2	Minor1	Minor2
Conflicting Flow All	0	0	371	0
Stage 1	-	-	-	352
Stage 2	-	-	-	411
Critical Hdwy	-	-	4.14	-
Critical Hdwy Stg 1	-	-	-	5.4
Critical Hdwy Stg 2	-	-	-	5.4
Follow-up Hdwy	-	-	2.236	-
Pot Cap-1 Maneuver	-	-	1177	-
Stage 1	-	-	-	716
Stage 2	-	-	-	674
Platoon blocked, %	-	-	-	-
Mov Cap-1 Maneuver	-	-	1177	-
Mov Cap-2 Maneuver	-	-	-	365
Stage 1	-	-	-	696
Stage 2	-	-	-	674

Approach	EB	WB	NB
HCM Control Delay, s	0	0.5	13.9
HCM LOS			B

Minor Lane/Major Mvmt	NBLn1	EBT	EBR	WBL	WBT
Capacity (veh/h)	479	-	-	1177	-
HCM Lane V/C Ratio	0.161	-	-	0.022	-
HCM Control Delay (s)	13.9	-	-	8.1	0
HCM Lane LOS	B	-	-	A	A
HCM 95th %tile Q(veh)	0.6	-	-	0.1	-

Intersection	
Intersection Delay, s/veh	13.1
Intersection LOS	B

Movement	EBL	EBT	EBR	WBL	WBT	WBR	NBL	NBT	NBR	SBL	SBT	SBR
Lane Configurations		↕			↕			↕			↕	
Traffic Vol, veh/h	10	250	30	10	220	10	50	70	20	10	50	30
Future Vol, veh/h	10	250	30	10	220	10	50	70	20	10	50	30
Peak Hour Factor	0.79	0.79	0.79	0.79	0.79	0.79	0.79	0.79	0.79	0.79	0.79	0.79
Heavy Vehicles, %	6	6	6	4	4	4	20	20	20	2	2	2
Mvmt Flow	13	316	38	13	278	13	63	89	25	13	63	38
Number of Lanes	0	1	0	0	1	0	0	1	0	0	1	0

Approach	EB	WB	NB	SB
Opposing Approach	WB	EB	SB	NB
Opposing Lanes	1	1	1	1
Conflicting Approach Left	SB	NB	EB	WB
Conflicting Lanes Left	1	1	1	1
Conflicting Approach Right	NB	SB	WB	EB
Conflicting Lanes Right	1	1	1	1
HCM Control Delay	14.6	13	12.1	10.4
HCM LOS	B	B	B	B

Lane	NBLn1	EBLn1	WBLn1	SBLn1
Vol Left, %	36%	3%	4%	11%
Vol Thru, %	50%	86%	92%	56%
Vol Right, %	14%	10%	4%	33%
Sign Control	Stop	Stop	Stop	Stop
Traffic Vol by Lane	140	290	240	90
LT Vol	50	10	10	10
Through Vol	70	250	220	50
RT Vol	20	30	10	30
Lane Flow Rate	177	367	304	114
Geometry Grp	1	1	1	1
Degree of Util (X)	0.308	0.544	0.458	0.188
Departure Headway (Hd)	6.247	5.336	5.432	5.942
Convergence, Y/N	Yes	Yes	Yes	Yes
Cap	574	675	662	600
Service Time	4.308	3.386	3.485	4.01
HCM Lane V/C Ratio	0.308	0.544	0.459	0.19
HCM Control Delay	12.1	14.6	13	10.4
HCM Lane LOS	B	B	B	B
HCM 95th-tile Q	1.3	3.3	2.4	0.7

Intersection												
Int Delay, s/veh	18.3											
Movement	EBL	EBT	EBR	WBL	WBT	WBR	NBL	NBT	NBR	SBL	SBT	SBR
Lane Configurations		↕			↕			↕			↕	
Traffic Vol, veh/h	80	110	90	10	100	20	50	100	20	10	170	80
Future Vol, veh/h	80	110	90	10	100	20	50	100	20	10	170	80
Conflicting Peds, #/hr	0	0	0	0	0	0	0	0	1	1	0	0
Sign Control	Stop	Stop	Stop	Stop	Stop	Stop	Free	Free	Free	Free	Free	Free
RT Channelized	-	-	None	-	-	None	-	-	None	-	-	None
Storage Length	-	-	-	-	-	-	-	-	-	-	-	-
Veh in Median Storage, #	-	0	-	-	0	-	-	0	-	-	0	-
Grade, %	-	0	-	-	0	-	-	0	-	-	0	-
Peak Hour Factor	82	82	82	82	82	82	82	82	82	82	82	82
Heavy Vehicles, %	12	12	12	0	0	0	10	10	10	10	10	10
Mvmt Flow	98	134	110	12	122	24	61	122	24	12	207	98

Major/Minor	Minor2		Minor1		Major1		Major2					
Conflicting Flow All	609	549	256	659	586	135	305	0	0	147	0	0
Stage 1	280	280	-	257	257	-	-	-	-	-	-	-
Stage 2	329	269	-	402	329	-	-	-	-	-	-	-
Critical Hdwy	7.22	6.62	6.32	7.1	6.5	6.2	4.2	-	-	4.2	-	-
Critical Hdwy Stg 1	6.22	5.62	-	6.1	5.5	-	-	-	-	-	-	-
Critical Hdwy Stg 2	6.22	5.62	-	6.1	5.5	-	-	-	-	-	-	-
Follow-up Hdwy	3.608	4.108	3.408	3.5	4	3.3	2.29	-	-	2.29	-	-
Pot Cap-1 Maneuver	393	430	759	380	425	919	1212	-	-	1387	-	-
Stage 1	705	661	-	752	699	-	-	-	-	-	-	-
Stage 2	663	669	-	629	650	-	-	-	-	-	-	-
Platoon blocked, %								-	-	-	-	-
Mov Cap-1 Maneuver	278	402	759	230	397	918	1212	-	-	1386	-	-
Mov Cap-2 Maneuver	278	402	-	230	397	-	-	-	-	-	-	-
Stage 1	666	654	-	710	660	-	-	-	-	-	-	-
Stage 2	497	632	-	423	643	-	-	-	-	-	-	-

Approach	EB		WB		NB		SB	
HCM Control Delay, s	44.1		19.2		2.4		0.3	
HCM LOS	E		C					

Minor Lane/Major Mvmt	NBL	NBT	NBR	EBLn1WBLn1	SBL	SBT	SBR
Capacity (veh/h)	1212	-	-	412	410	1386	-
HCM Lane V/C Ratio	0.05	-	-	0.829	0.387	0.009	-
HCM Control Delay (s)	8.1	0	-	44.1	19.2	7.6	0
HCM Lane LOS	A	A	-	E	C	A	A
HCM 95th %tile Q(veh)	0.2	-	-	7.7	1.8	0	-

Intersection						
Int Delay, s/veh	3.9					
Movement	EBL	EBR	NBL	NBT	SBT	SBR
Lane Configurations	T		T		T	
Traffic Vol, veh/h	130	10	10	230	420	130
Future Vol, veh/h	130	10	10	230	420	130
Conflicting Peds, #/hr	0	0	0	0	0	0
Sign Control	Stop	Stop	Free	Free	Free	Free
RT Channelized	-	None	-	None	-	None
Storage Length	0	-	-	-	-	-
Veh in Median Storage, #	0	-	-	0	0	-
Grade, %	0	-	-	0	0	-
Peak Hour Factor	89	89	89	89	89	89
Heavy Vehicles, %	13	13	2	2	0	0
Mvmt Flow	146	11	11	258	472	146























Major/Minor	Minor2	Major1		Major2	
Conflicting Flow All	825	545	618	0	0
Stage 1	545	-	-	-	-
Stage 2	280	-	-	-	-
Critical Hdwy	6.53	6.33	4.12	-	-
Critical Hdwy Stg 1	5.53	-	-	-	-
Critical Hdwy Stg 2	5.53	-	-	-	-
Follow-up Hdwy	3.617	3.417	2.218	-	-
Pot Cap-1 Maneuver	328	518	962	-	-
Stage 1	560	-	-	-	-
Stage 2	743	-	-	-	-
Platoon blocked, %				-	-
Mov Cap-1 Maneuver	324	518	962	-	-
Mov Cap-2 Maneuver	324	-	-	-	-
Stage 1	553	-	-	-	-
Stage 2	743	-	-	-	-

Approach	EB	NB	SB
HCM Control Delay, s	25.1	0.4	0
HCM LOS	D		

Minor Lane/Major Mvmt	NBL	NBT	EBLn1	SBT	SBR
Capacity (veh/h)	962	-	333	-	-
HCM Lane V/C Ratio	0.012	-	0.472	-	-
HCM Control Delay (s)	8.8	0	25.1	-	-
HCM Lane LOS	A	A	D	-	-
HCM 95th %tile Q(veh)	0	-	2.4	-	-

HCM 2010 Signalized Intersection Summary
 39: General Jim Moore Boulevard & Gigling Road

Cumulative, AM
 06/11/2019

												
Movement	EBL	EBT	EBR	WBL	WBT	WBR	NBL	NBT	NBR	SBL	SBT	SBR
Lane Configurations												
Traffic Volume (veh/h)	30	100	80	420	40	260	50	460	200	230	710	50
Future Volume (veh/h)	30	100	80	420	40	260	50	460	200	230	710	50
Number	3	8	18	7	4	14	1	6	16	5	2	12
Initial Q (Qb), veh	0	0	0	0	0	0	0	0	0	0	0	0
Ped-Bike Adj(A_pbT)	1.00		1.00	1.00		1.00	1.00		1.00	1.00		1.00
Parking Bus, Adj	1.00	1.00	1.00	1.00	1.00	1.00	1.00	1.00	1.00	1.00	1.00	1.00
Adj Sat Flow, veh/h/ln	1810	1810	1900	1863	1863	1863	1881	1881	1881	1863	1863	1863
Adj Flow Rate, veh/h	34	115	60	483	46	0	57	529	0	264	816	0
Adj No. of Lanes	1	2	0	1	2	1	1	2	1	1	2	1
Peak Hour Factor	0.87	0.87	0.87	0.87	0.87	0.87	0.87	0.87	0.87	0.87	0.87	0.87
Percent Heavy Veh, %	5	5	5	2	2	2	1	1	1	2	2	2
Cap, veh/h	60	195	96	521	1226	549	87	646	289	307	1082	484
Arrive On Green	0.03	0.09	0.09	0.29	0.35	0.00	0.05	0.18	0.00	0.17	0.31	0.00
Sat Flow, veh/h	1723	2232	1098	1774	3539	1583	1792	3574	1599	1774	3539	1583
Grp Volume(v), veh/h	34	87	88	483	46	0	57	529	0	264	816	0
Grp Sat Flow(s),veh/h/ln	1723	1719	1611	1774	1770	1583	1792	1787	1599	1774	1770	1583
Q Serve(g_s), s	1.3	3.3	3.6	18.0	0.6	0.0	2.1	9.7	0.0	9.8	14.2	0.0
Cycle Q Clear(g_c), s	1.3	3.3	3.6	18.0	0.6	0.0	2.1	9.7	0.0	9.8	14.2	0.0
Prop In Lane	1.00		0.68	1.00		1.00	1.00		1.00	1.00		1.00
Lane Grp Cap(c), veh/h	60	150	141	521	1226	549	87	646	289	307	1082	484
V/C Ratio(X)	0.57	0.58	0.62	0.93	0.04	0.00	0.66	0.82	0.00	0.86	0.75	0.00
Avail Cap(c_a), veh/h	266	783	734	535	2133	954	145	1314	588	404	1821	815
HCM Platoon Ratio	1.00	1.00	1.00	1.00	1.00	1.00	1.00	1.00	1.00	1.00	1.00	1.00
Upstream Filter(I)	1.00	1.00	1.00	1.00	1.00	0.00	1.00	1.00	0.00	1.00	1.00	0.00
Uniform Delay (d), s/veh	32.3	29.8	30.0	23.3	14.7	0.0	31.8	26.8	0.0	27.3	21.3	0.0
Incr Delay (d2), s/veh	3.1	1.3	1.7	21.7	0.0	0.0	3.1	1.0	0.0	11.0	0.4	0.0
Initial Q Delay(d3),s/veh	0.0	0.0	0.0	0.0	0.0	0.0	0.0	0.0	0.0	0.0	0.0	0.0
%ile BackOfQ(50%),veh/ln	0.7	1.6	1.7	11.9	0.3	0.0	1.1	4.9	0.0	5.7	7.0	0.0
LnGrp Delay(d),s/veh	35.4	31.1	31.6	45.0	14.7	0.0	34.9	27.8	0.0	38.3	21.7	0.0
LnGrp LOS	D	C	C	D	B		C	C		D	C	
Approach Vol, veh/h		209			529			586			1080	
Approach Delay, s/veh		32.0			42.3			28.5			25.8	
Approach LOS		C			D			C			C	
Timer	1	2	3	4	5	6	7	8				
Assigned Phs	1	2	3	4	5	6	7	8				
Phs Duration (G+Y+Rc), s	7.8	25.3	6.9	28.1	16.3	16.8	24.5	10.5				
Change Period (Y+Rc), s	4.5	4.5	4.5	4.5	4.5	4.5	4.5	4.5				
Max Green Setting (Gmax), s	5.5	35.0	10.5	41.0	15.5	25.0	20.5	31.0				
Max Q Clear Time (g_c+I1), s	4.1	16.2	3.3	2.6	11.8	11.7	20.0	5.6				
Green Ext Time (p_c), s	0.0	1.1	0.0	0.1	0.0	0.6	0.0	0.2				
Intersection Summary												
HCM 2010 Ctrl Delay			30.6									
HCM 2010 LOS			C									
Notes												

HCM 2010 Signalized Intersection Summary
40: Malmedy Road & Gigling Road

Cumulative, AM
06/11/2019



Movement	EBL	EBT	EBR	WBL	WBT	WBR	NBL	NBT	NBR	SBL	SBT	SBR
Lane Configurations		↕↕			↕↕			↕↕			↕↕	
Traffic Volume (veh/h)	20	420	30	50	610	10	20	30	30	10	60	70
Future Volume (veh/h)	20	420	30	50	610	10	20	30	30	10	60	70
Number	7	4	14	3	8	18	5	2	12	1	6	16
Initial Q (Qb), veh	0	0	0	0	0	0	0	0	0	0	0	0
Ped-Bike Adj(A_pbT)	1.00		1.00	1.00		1.00	1.00		1.00	1.00		1.00
Parking Bus, Adj	1.00	1.00	1.00	1.00	1.00	1.00	1.00	1.00	1.00	1.00	1.00	1.00
Adj Sat Flow, veh/h/ln	1900	1845	1900	1900	1845	1900	1900	1863	1900	1900	1827	1900
Adj Flow Rate, veh/h	23	477	34	57	693	11	23	34	34	11	68	80
Adj No. of Lanes	0	2	0	0	2	0	0	1	0	0	1	0
Peak Hour Factor	0.88	0.88	0.88	0.88	0.88	0.88	0.88	0.88	0.88	0.88	0.88	0.88
Percent Heavy Veh, %	3	3	3	3	3	3	2	2	2	4	4	4
Cap, veh/h	224	1029	74	264	1070	17	295	140	119	216	143	159
Arrive On Green	0.34	0.34	0.34	0.34	0.34	0.34	0.19	0.19	0.19	0.19	0.19	0.19
Sat Flow, veh/h	61	3042	218	143	3163	50	309	731	620	77	743	830
Grp Volume(v), veh/h	279	0	255	393	0	368	91	0	0	159	0	0
Grp Sat Flow(s),veh/h/ln	1681	0	1640	1686	0	1670	1661	0	0	1650	0	0
Q Serve(g_s), s	0.1	0.0	2.3	1.2	0.0	3.6	0.0	0.0	0.0	0.4	0.0	0.0
Cycle Q Clear(g_c), s	3.6	0.0	2.3	3.6	0.0	3.6	0.9	0.0	0.0	1.6	0.0	0.0
Prop In Lane	0.08		0.13	0.14		0.03	0.25		0.37	0.07		0.50
Lane Grp Cap(c), veh/h	772	0	555	786	0	565	554	0	0	518	0	0
V/C Ratio(X)	0.36	0.00	0.46	0.50	0.00	0.65	0.16	0.00	0.00	0.31	0.00	0.00
Avail Cap(c_a), veh/h	4539	0	4322	4438	0	4401	2737	0	0	2808	0	0
HCM Platoon Ratio	1.00	1.00	1.00	1.00	1.00	1.00	1.00	1.00	1.00	1.00	1.00	1.00
Upstream Filter(I)	1.00	0.00	1.00	1.00	0.00	1.00	1.00	0.00	0.00	1.00	0.00	0.00
Uniform Delay (d), s/veh	4.9	0.0	5.0	5.4	0.0	5.4	6.6	0.0	0.0	6.9	0.0	0.0
Incr Delay (d2), s/veh	0.1	0.0	0.2	0.2	0.0	0.5	0.1	0.0	0.0	0.1	0.0	0.0
Initial Q Delay(d3),s/veh	0.0	0.0	0.0	0.0	0.0	0.0	0.0	0.0	0.0	0.0	0.0	0.0
%ile BackOfQ(50%),veh/ln	1.1	0.0	1.0	1.8	0.0	1.7	0.4	0.0	0.0	0.8	0.0	0.0
LnGrp Delay(d),s/veh	5.0	0.0	5.2	5.5	0.0	5.9	6.6	0.0	0.0	7.0	0.0	0.0
LnGrp LOS	A		A	A		A	A			A		
Approach Vol, veh/h		534			761			91			159	
Approach Delay, s/veh		5.1			5.7			6.6			7.0	
Approach LOS		A			A			A			A	
Timer	1	2	3	4	5	6	7	8				
Assigned Phs		2		4		6		8				
Phs Duration (G+Y+Rc), s		8.2		11.0		8.2		11.0				
Change Period (Y+Rc), s		4.5		4.5		4.5		4.5				
Max Green Setting (Gmax), s		30.5		50.5		30.5		50.5				
Max Q Clear Time (g_c+I1), s		2.9		5.6		3.6		5.6				
Green Ext Time (p_c), s		0.1		0.5		0.2		0.8				
Intersection Summary												
HCM 2010 Ctrl Delay				5.7								
HCM 2010 LOS				A								

HCM 2010 Signalized Intersection Summary
 41: Parker Flatts Cut Off Road & Gigling Road

Cumulative, AM
 06/11/2019



Movement	EBL	EBT	EBR	WBL	WBT	WBR	NBL	NBT	NBR	SBL	SBT	SBR
Lane Configurations		↔↑			↔↑			↔	↔		↔	
Traffic Volume (veh/h)	10	370	80	110	610	10	40	10	50	10	30	10
Future Volume (veh/h)	10	370	80	110	610	10	40	10	50	10	30	10
Number	7	4	14	3	8	18	5	2	12	1	6	16
Initial Q (Qb), veh	0	0	0	0	0	0	0	0	0	0	0	0
Ped-Bike Adj(A_pbT)	1.00		1.00	1.00		1.00	1.00		1.00	1.00		1.00
Parking Bus, Adj	1.00	1.00	1.00	1.00	1.00	1.00	1.00	1.00	1.00	1.00	1.00	1.00
Adj Sat Flow, veh/h/ln	1900	1845	1900	1900	1863	1900	1900	1863	1863	1900	1900	1900
Adj Flow Rate, veh/h	12	440	95	131	726	12	48	12	60	12	36	12
Adj No. of Lanes	0	2	0	0	2	0	0	1	1	0	1	0
Peak Hour Factor	0.84	0.84	0.84	0.84	0.84	0.84	0.84	0.84	0.84	0.84	0.84	0.84
Percent Heavy Veh, %	3	3	3	2	2	2	2	2	2	0	0	0
Cap, veh/h	195	1105	235	350	1112	19	489	66	249	254	176	54
Arrive On Green	0.40	0.40	0.40	0.40	0.40	0.40	0.16	0.16	0.16	0.16	0.16	0.16
Sat Flow, veh/h	26	2764	588	297	2782	46	1081	420	1583	263	1122	346
Grp Volume(v), veh/h	292	0	255	433	0	436	60	0	60	60	0	0
Grp Sat Flow(s),veh/h/ln	1803	0	1575	1439	0	1687	1502	0	1583	1731	0	0
Q Serve(g_s), s	0.0	0.0	2.4	2.7	0.0	4.2	0.0	0.0	0.7	0.0	0.0	0.0
Cycle Q Clear(g_c), s	2.3	0.0	2.4	5.1	0.0	4.2	0.6	0.0	0.7	0.6	0.0	0.0
Prop In Lane	0.04		0.37	0.30		0.03	0.80		1.00	0.20		0.20
Lane Grp Cap(c), veh/h	905	0	630	806	0	674	555	0	249	485	0	0
V/C Ratio(X)	0.32	0.00	0.40	0.54	0.00	0.65	0.11	0.00	0.24	0.12	0.00	0.00
Avail Cap(c_a), veh/h	4944	0	4304	4030	0	4610	2126	0	1988	2353	0	0
HCM Platoon Ratio	1.00	1.00	1.00	1.00	1.00	1.00	1.00	1.00	1.00	1.00	1.00	1.00
Upstream Filter(I)	1.00	0.00	1.00	1.00	0.00	1.00	1.00	0.00	1.00	1.00	0.00	0.00
Uniform Delay (d), s/veh	4.3	0.0	4.4	5.0	0.0	4.9	7.5	0.0	7.5	7.5	0.0	0.0
Incr Delay (d2), s/veh	0.1	0.0	0.2	0.2	0.0	0.4	0.0	0.0	0.2	0.0	0.0	0.0
Initial Q Delay(d3),s/veh	0.0	0.0	0.0	0.0	0.0	0.0	0.0	0.0	0.0	0.0	0.0	0.0
%ile BackOfQ(50%),veh/ln	1.2	0.0	1.0	2.0	0.0	2.0	0.3	0.0	0.3	0.3	0.0	0.0
LnGrp Delay(d),s/veh	4.4	0.0	4.5	5.2	0.0	5.3	7.5	0.0	7.7	7.5	0.0	0.0
LnGrp LOS	A		A	A		A	A		A	A		
Approach Vol, veh/h		547			869			120			60	
Approach Delay, s/veh		4.5			5.3			7.6			7.5	
Approach LOS		A			A			A			A	
Timer	1	2	3	4	5	6	7	8				
Assigned Phs		2		4		6		8				
Phs Duration (G+Y+Rc), s		7.7		12.6		7.7		12.6				
Change Period (Y+Rc), s		4.5		4.5		4.5		4.5				
Max Green Setting (Gmax), s		25.5		55.5		25.5		55.5				
Max Q Clear Time (g_c+I1), s		2.7		4.4		2.6		7.1				
Green Ext Time (p_c), s		0.0		0.5		0.0		1.0				
Intersection Summary												
HCM 2010 Ctrl Delay				5.3								
HCM 2010 LOS				A								

HCM 2010 Signalized Intersection Summary
42: 6th Avenue & Gigling Road

Cumulative, AM
06/11/2019



Movement	EBL	EBT	EBR	WBL	WBT	WBR	NBL	NBT	NBR	SBL	SBT	SBR
Lane Configurations		↔			↔			↕	↕		↕	
Traffic Volume (veh/h)	90	340	10	30	610	10	10	10	10	10	10	120
Future Volume (veh/h)	90	340	10	30	610	10	10	10	10	10	10	120
Number	7	4	14	3	8	18	5	2	12	1	6	16
Initial Q (Qb), veh	0	0	0	0	0	0	0	0	0	0	0	0
Ped-Bike Adj(A_pbT)	1.00		1.00	1.00		1.00	1.00		1.00	1.00		1.00
Parking Bus, Adj	1.00	1.00	1.00	1.00	1.00	1.00	1.00	1.00	1.00	1.00	1.00	1.00
Adj Sat Flow, veh/h/ln	1900	1845	1900	1900	1863	1900	1900	1429	1429	1900	1863	1900
Adj Flow Rate, veh/h	101	382	11	34	685	11	11	11	0	11	11	135
Adj No. of Lanes	0	2	0	0	2	0	0	1	1	0	1	0
Peak Hour Factor	0.89	0.89	0.89	0.89	0.89	0.89	0.89	0.89	0.89	0.89	0.89	0.89
Percent Heavy Veh, %	3	3	3	2	2	2	33	33	33	2	2	2
Cap, veh/h	354	846	26	237	1163	19	364	144	209	220	24	236
Arrive On Green	0.35	0.35	0.35	0.35	0.35	0.35	0.17	0.17	0.00	0.17	0.17	0.17
Sat Flow, veh/h	240	2430	74	82	3341	53	445	837	1214	83	140	1367
Grp Volume(v), veh/h	247	0	247	382	0	348	22	0	0	157	0	0
Grp Sat Flow(s),veh/h/ln1078	0	1666	1790	0	1686	1281	0	1214	1590	0	0	0
Q Serve(g_s), s	0.7	0.0	2.1	0.1	0.0	3.2	0.0	0.0	0.0	0.9	0.0	0.0
Cycle Q Clear(g_c), s	3.8	0.0	2.1	3.2	0.0	3.2	0.2	0.0	0.0	1.7	0.0	0.0
Prop In Lane	0.41		0.04	0.09		0.03	0.50		1.00	0.07		0.86
Lane Grp Cap(c), veh/h	646	0	580	832	0	587	509	0	209	479	0	0
V/C Ratio(X)	0.38	0.00	0.43	0.46	0.00	0.59	0.04	0.00	0.00	0.33	0.00	0.00
Avail Cap(c_a), veh/h	3326	0	4482	4877	0	4537	2163	0	1974	2778	0	0
HCM Platoon Ratio	1.00	1.00	1.00	1.00	1.00	1.00	1.00	1.00	1.00	1.00	1.00	1.00
Upstream Filter(I)	1.00	0.00	1.00	1.00	0.00	1.00	1.00	0.00	0.00	1.00	0.00	0.00
Uniform Delay (d), s/veh	4.8	0.0	4.7	5.0	0.0	5.0	6.5	0.0	0.0	7.1	0.0	0.0
Incr Delay (d2), s/veh	0.1	0.0	0.2	0.1	0.0	0.4	0.0	0.0	0.0	0.1	0.0	0.0
Initial Q Delay(d3),s/veh	0.0	0.0	0.0	0.0	0.0	0.0	0.0	0.0	0.0	0.0	0.0	0.0
%ile BackOfQ(50%),veh/ln1.1	0.0	1.0	1.6	0.0	1.5	0.1	0.0	0.0	0.0	0.8	0.0	0.0
LnGrp Delay(d),s/veh	4.9	0.0	4.9	5.2	0.0	5.4	6.5	0.0	0.0	7.3	0.0	0.0
LnGrp LOS	A		A	A		A	A			A		
Approach Vol, veh/h		494			730			22			157	
Approach Delay, s/veh		4.9			5.3			6.5			7.3	
Approach LOS		A			A			A			A	
Timer	1	2	3	4	5	6	7	8				
Assigned Phs		2		4		6		8				
Phs Duration (G+Y+Rc), s		7.7		11.0		7.7		11.0				
Change Period (Y+Rc), s		4.5		4.5		4.5		4.5				
Max Green Setting (Gmax), s		30.5		50.5		30.5		50.5				
Max Q Clear Time (g_c+I1), s		2.2		5.8		3.7		5.2				
Green Ext Time (p_c), s		0.0		0.7		0.2		0.7				
Intersection Summary												
HCM 2010 Ctrl Delay				5.4								
HCM 2010 LOS				A								

HCM 2010 Signalized Intersection Summary
43: Gigling Road & 7th Avenue

Cumulative, AM
06/11/2019

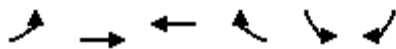

Movement	EBL	EBT	WBT	WBR	SBL	SBR		
Lane Configurations		↑↑	↑↑		↑↑			
Traffic Volume (veh/h)	130	230	420	10	10	230		
Future Volume (veh/h)	130	230	420	10	10	230		
Number	7	4	8	18	1	16		
Initial Q (Qb), veh	0	0	0	0	0	0		
Ped-Bike Adj(A_pbT)	1.00			1.00	1.00	1.00		
Parking Bus, Adj	1.00	1.00	1.00	1.00	1.00	1.00		
Adj Sat Flow, veh/h/ln	1900	1845	1900	1900	1759	1900		
Adj Flow Rate, veh/h	151	267	488	12	12	267		
Adj No. of Lanes	0	2	2	0	0	0		
Peak Hour Factor	0.86	0.86	0.86	0.86	0.86	0.86		
Percent Heavy Veh, %	3	3	0	0	0	0		
Cap, veh/h	462	700	1203	30	14	318		
Arrive On Green	0.33	0.33	0.33	0.33	0.22	0.22		
Sat Flow, veh/h	493	2178	3696	88	64	1433		
Grp Volume(v), veh/h	225	193	244	256	280	0		
Grp Sat Flow(s),veh/h/ln	993	1595	1805	1884	1503	0		
Q Serve(g_s), s	2.1	1.9	2.1	2.1	3.6	0.0		
Cycle Q Clear(g_c), s	4.2	1.9	2.1	2.1	3.6	0.0		
Prop In Lane	0.67			0.05	0.04	0.95		
Lane Grp Cap(c), veh/h	629	533	603	630	334	0		
V/C Ratio(X)	0.36	0.36	0.41	0.41	0.84	0.00		
Avail Cap(c_a), veh/h	3194	4365	4941	5158	1890	0		
HCM Platoon Ratio	1.00	1.00	1.00	1.00	1.00	1.00		
Upstream Filter(I)	1.00	1.00	1.00	1.00	1.00	0.00		
Uniform Delay (d), s/veh	5.8	5.1	5.2	5.2	7.5	0.0		
Incr Delay (d2), s/veh	0.1	0.2	0.2	0.2	2.2	0.0		
Initial Q Delay(d3),s/veh	0.0	0.0	0.0	0.0	0.0	0.0		
%ile BackOfQ(50%),veh/ln	1.1	0.8	1.0	1.1	1.7	0.0		
LnGrp Delay(d),s/veh	5.9	5.3	5.4	5.4	9.7	0.0		
LnGrp LOS	A	A	A	A	A			
Approach Vol, veh/h		418	500		280			
Approach Delay, s/veh		5.6	5.4		9.7			
Approach LOS		A	A		A			
Timer	1	2	3	4	5	6	7	8
Assigned Phs				4		6		8
Phs Duration (G+Y+Rc), s				11.3		9.0		11.3
Change Period (Y+Rc), s				4.5		4.5		4.5
Max Green Setting (Gmax), s				55.5		25.5		55.5
Max Q Clear Time (g_c+I1), s				6.2		5.6		4.1
Green Ext Time (p_c), s				0.6		0.1		0.4
Intersection Summary								
HCM 2010 Ctrl Delay				6.5				
HCM 2010 LOS				A				
Notes								

HCM 2010 Signalized Intersection Summary
44: 8th Avenue & Gigling Road

Cumulative, AM
06/11/2019



Movement	EBL	EBT	EBR	WBL	WBT	WBR	NBL	NBT	NBR	SBL	SBT	SBR
Lane Configurations		↕↕			↕↕			↕			↕	
Traffic Volume (veh/h)	230	10	10	10	10	10	10	10	10	10	10	420
Future Volume (veh/h)	230	10	10	10	10	10	10	10	10	10	10	420
Number	7	4	14	3	8	18	5	2	12	1	6	16
Initial Q (Qb), veh	0	0	0	0	0	0	0	0	0	0	0	0
Ped-Bike Adj(A_pbT)	1.00		1.00	1.00		1.00	1.00		1.00	1.00		1.00
Parking Bus, Adj	1.00	1.00	1.00	1.00	1.00	1.00	1.00	1.00	1.00	1.00	1.00	1.00
Adj Sat Flow, veh/h/ln	1900	1863	1900	1900	1863	1900	1900	1900	1900	1900	1900	1900
Adj Flow Rate, veh/h	271	12	12	12	12	12	12	12	12	12	12	494
Adj No. of Lanes	0	2	0	0	2	0	0	1	0	0	1	0
Peak Hour Factor	0.85	0.85	0.85	0.85	0.85	0.85	0.85	0.85	0.85	0.85	0.85	0.85
Percent Heavy Veh, %	2	2	2	2	2	2	0	0	0	0	0	0
Cap, veh/h	627	198	198	401	311	302	329	302	220	152	24	601
Arrive On Green	0.25	0.25	0.25	0.25	0.25	0.25	0.39	0.39	0.39	0.39	0.39	0.39
Sat Flow, veh/h	1340	779	779	693	1225	1188	356	779	567	14	61	1547
Grp Volume(v), veh/h	271	0	24	21	0	15	36	0	0	518	0	0
Grp Sat Flow(s),veh/h/ln	1340	0	1558	1621	0	1485	1702	0	0	1622	0	0
Q Serve(g_s), s	4.6	0.0	0.3	0.0	0.0	0.2	0.0	0.0	0.0	1.1	0.0	0.0
Cycle Q Clear(g_c), s	4.8	0.0	0.3	0.2	0.0	0.2	0.3	0.0	0.0	7.2	0.0	0.0
Prop In Lane	1.00		0.50	0.57		0.80	0.33		0.33	0.02		0.95
Lane Grp Cap(c), veh/h	627	0	395	637	0	377	852	0	0	776	0	0
V/C Ratio(X)	0.43	0.00	0.06	0.03	0.00	0.04	0.04	0.00	0.00	0.67	0.00	0.00
Avail Cap(c_a), veh/h	2226	0	2199	2435	0	2097	2749	0	0	3072	0	0
HCM Platoon Ratio	1.00	1.00	1.00	1.00	1.00	1.00	1.00	1.00	1.00	1.00	1.00	1.00
Upstream Filter(I)	1.00	0.00	1.00	1.00	0.00	1.00	1.00	0.00	0.00	1.00	0.00	0.00
Uniform Delay (d), s/veh	8.9	0.0	7.1	7.1	0.0	7.1	4.8	0.0	0.0	6.9	0.0	0.0
Incr Delay (d2), s/veh	0.2	0.0	0.0	0.0	0.0	0.0	0.0	0.0	0.0	0.4	0.0	0.0
Initial Q Delay(d3),s/veh	0.0	0.0	0.0	0.0	0.0	0.0	0.0	0.0	0.0	0.0	0.0	0.0
%ile BackOfQ(50%),veh/ln	1.8	0.0	0.1	0.1	0.0	0.1	0.2	0.0	0.0	3.2	0.0	0.0
LnGrp Delay(d),s/veh	9.1	0.0	7.1	7.1	0.0	7.1	4.8	0.0	0.0	7.3	0.0	0.0
LnGrp LOS	A		A	A		A	A			A		
Approach Vol, veh/h		295			36			36			518	
Approach Delay, s/veh		8.9			7.1			4.8			7.3	
Approach LOS		A			A			A			A	
Timer	1	2	3	4	5	6	7	8				
Assigned Phs		2		4		6		8				
Phs Duration (G+Y+Rc), s		14.3		10.9		14.3		10.9				
Change Period (Y+Rc), s		4.5		4.5		4.5		4.5				
Max Green Setting (Gmax), s		45.5		35.5		45.5		35.5				
Max Q Clear Time (g_c+I1), s		2.3		6.8		9.2		2.2				
Green Ext Time (p_c), s		0.0		0.3		0.8		0.0				
Intersection Summary												
HCM 2010 Ctrl Delay				7.7								
HCM 2010 LOS				A								

HCM 2010 Signalized Intersection Summary
 46: General Jim Moore Boulevard & Normandy Road

Cumulative, AM
 06/11/2019



Movement	EBL	EBT	EBR	WBL	WBT	WBR	NBL	NBT	NBR	SBL	SBT	SBR
Lane Configurations		↕			↕		↕	↕↕		↕	↕↕	↕
Traffic Volume (veh/h)	90	80	150	150	70	40	200	460	110	80	810	250
Future Volume (veh/h)	90	80	150	150	70	40	200	460	110	80	810	250
Number	3	8	18	7	4	14	1	6	16	5	2	12
Initial Q (Qb), veh	0	0	0	0	0	0	0	0	0	0	0	0
Ped-Bike Adj(A_pbT)	0.99		0.98	0.99		0.98	1.00		0.99	1.00		0.99
Parking Bus, Adj	1.00	1.00	1.00	1.00	1.00	1.00	1.00	1.00	1.00	1.00	1.00	1.00
Adj Sat Flow, veh/h/ln	1900	1881	1900	1900	1863	1900	1881	1881	1900	1863	1863	1863
Adj Flow Rate, veh/h	115	103	163	192	90	47	256	590	114	103	1038	252
Adj No. of Lanes	0	1	0	0	1	0	1	2	0	1	2	1
Peak Hour Factor	0.78	0.78	0.78	0.78	0.78	0.78	0.78	0.78	0.78	0.78	0.78	0.78
Percent Heavy Veh, %	1	1	1	2	2	2	1	1	1	2	2	2
Cap, veh/h	212	188	248	321	143	64	206	714	138	351	1141	505
Arrive On Green	0.38	0.37	0.37	0.38	0.37	0.37	0.12	0.24	0.24	0.20	0.32	0.32
Sat Flow, veh/h	392	509	674	647	388	173	1792	2982	575	1774	3539	1566
Grp Volume(v), veh/h	381	0	0	329	0	0	256	353	351	103	1038	252
Grp Sat Flow(s),veh/h/ln	1575	0	0	1208	0	0	1792	1787	1770	1774	1770	1566
Q Serve(g_s), s	0.0	0.0	0.0	3.7	0.0	0.0	8.0	13.0	13.1	3.4	19.6	9.0
Cycle Q Clear(g_c), s	13.4	0.0	0.0	17.2	0.0	0.0	8.0	13.0	13.1	3.4	19.6	9.0
Prop In Lane	0.30		0.43	0.58		0.14	1.00		0.32	1.00		1.00
Lane Grp Cap(c), veh/h	659	0	0	536	0	0	206	428	423	351	1141	505
V/C Ratio(X)	0.58	0.00	0.00	0.61	0.00	0.00	1.24	0.83	0.83	0.29	0.91	0.50
Avail Cap(c_a), veh/h	820	0	0	673	0	0	206	655	649	351	1298	574
HCM Platoon Ratio	1.00	1.00	1.00	1.00	1.00	1.00	1.00	1.00	1.00	1.00	1.00	1.00
Upstream Filter(l)	1.00	0.00	0.00	1.00	0.00	0.00	1.00	1.00	1.00	1.00	1.00	1.00
Uniform Delay (d), s/veh	17.9	0.0	0.0	19.1	0.0	0.0	30.8	25.1	25.1	23.7	22.6	19.0
Incr Delay (d2), s/veh	0.3	0.0	0.0	0.4	0.0	0.0	143.0	2.9	3.1	0.2	8.3	0.3
Initial Q Delay(d3),s/veh	0.0	0.0	0.0	0.0	0.0	0.0	0.0	0.0	0.0	0.0	0.0	0.0
%ile BackOfQ(50%),veh/ln	5.9	0.0	0.0	5.5	0.0	0.0	12.1	6.7	6.7	1.7	10.8	4.0
LnGrp Delay(d),s/veh	18.2	0.0	0.0	19.5	0.0	0.0	173.8	28.0	28.2	23.9	30.9	19.3
LnGrp LOS	B			B			F	C	C	C	C	B
Approach Vol, veh/h		381			329			960			1393	
Approach Delay, s/veh		18.2			19.5			66.9			28.3	
Approach LOS		B			B			E			C	
Timer	1	2	3	4	5	6	7	8				
Assigned Phs	1	2		4	5	6		8				
Phs Duration (G+Y+Rc), s	26.9	26.9		30.1	18.3	21.1		30.1				
Change Period (Y+Rc), s	4.5	4.5		4.5	4.5	4.5		4.5				
Max Green Setting (Gmax), s	25.5	25.5		33.0	8.0	25.5		33.0				
Max Q Clear Time (g_c+110), s	21.6	21.6		19.2	5.4	15.1		15.4				
Green Ext Time (p_c), s	0.0	0.9		0.5	0.0	0.6		0.6				
Intersection Summary												
HCM 2010 Ctrl Delay				38.2								
HCM 2010 LOS				D								

Intersection	
Intersection Delay, s/veh	13.7
Intersection LOS	F

Movement	EBL	EBR	NBL	NBT	SBT	SBR
Lane Configurations						
Traffic Vol, veh/h	90	430	230	390	960	80
Future Vol, veh/h	90	430	230	390	960	80
Peak Hour Factor	0.90	0.90	0.90	0.90	0.90	0.90
Heavy Vehicles, %	1	1	1	1	2	2
Mvmt Flow	100	478	256	433	1067	89
Number of Lanes	1	1	1	2	2	1

Approach	EB	NB	SB
Opposing Approach		SB	NB
Opposing Lanes	0	3	3
Conflicting Approach Left	SB		
Conflicting Lanes Left	3	2	0
Conflicting Approach Right	NB		EB
Conflicting Lanes Right	3	0	2
HCM Control Delay	118.8	25.8	163.6
HCM LOS	F	D	F

Lane	NBLn1	NBLn2	NBLn3	EBLn1	EBLn2	SBLn1	SBLn2	SBLn3
Vol Left, %	100%	0%	0%	100%	0%	0%	0%	0%
Vol Thru, %	0%	100%	100%	0%	0%	100%	100%	0%
Vol Right, %	0%	0%	0%	0%	100%	0%	0%	100%
Sign Control	Stop	Stop	Stop	Stop	Stop	Stop	Stop	Stop
Traffic Vol by Lane	230	195	195	90	430	480	480	80
LT Vol	230	0	0	90	0	0	0	0
Through Vol	0	195	195	0	0	480	480	0
RT Vol	0	0	0	0	430	0	0	80
Lane Flow Rate	256	217	217	100	478	533	533	89
Geometry Grp	8	8	8	8	8	8	8	8
Degree of Util (X)	0.684	0.55	0.447	0.283	1.192	1.291	1.291	0.155
Departure Headway (Hd)	10.7	10.176	8.377	10.969	9.751	9.397	9.397	6.847
Convergence, Y/N	Yes	Yes	Yes	Yes	Yes	Yes	Yes	Yes
Cap	340	358	433	330	377	389	389	527
Service Time	8.4	7.876	6.077	8.669	7.451	7.097	7.097	4.547
HCM Lane V/C Ratio	0.753	0.606	0.501	0.303	1.268	1.37	1.37	0.169
HCM Control Delay	33.7	24.6	17.7	17.9	139.9	176.3	176.3	10.8
HCM Lane LOS	D	C	C	C	F	F	F	B
HCM 95th-tile Q	4.8	3.2	2.3	1.1	18	22.3	22.3	0.5

HCM 2010 Signalized Intersection Summary
 48: Fremont Boulevard/Hwy 1 SB Off-Ramp/ NB On-Ramp & Monterey Road

Cumulative, AM
 06/11/2019



Movement	EBL	EBT	EBR	WBL	WBT	WBR	NBL	NBT	NBR	SBL	SBT	SBR
Lane Configurations												
Traffic Volume (veh/h)	80	100	150	120	220	30	230	670	140	60	990	120
Future Volume (veh/h)	80	100	150	120	220	30	230	670	140	60	990	120
Number	7	4	14	3	8	18	5	2	12	1	6	16
Initial Q (Qb), veh	0	0	0	0	0	0	0	0	0	0	0	0
Ped-Bike Adj(A_pbT)	1.00		0.95	1.00		0.97	1.00		0.99	1.00		0.98
Parking Bus, Adj	1.00	1.00	1.00	1.00	1.00	1.00	1.00	1.00	1.00	1.00	1.00	1.00
Adj Sat Flow, veh/h/ln	1845	1845	1845	1900	1881	1900	1827	1827	1900	1827	1827	1827
Adj Flow Rate, veh/h	88	110	76	132	242	31	253	736	139	66	1088	65
Adj No. of Lanes	1	1	1	0	1	0	1	2	0	1	2	1
Peak Hour Factor	0.91	0.91	0.91	0.91	0.91	0.91	0.91	0.91	0.91	0.91	0.91	0.91
Percent Heavy Veh, %	3	3	3	1	1	1	4	4	4	4	4	4
Cap, veh/h	202	212	172	133	244	31	425	1332	252	84	880	388
Arrive On Green	0.12	0.12	0.12	0.23	0.22	0.22	0.24	0.46	0.46	0.05	0.25	0.25
Sat Flow, veh/h	1757	1845	1494	594	1088	139	1740	2907	549	1740	3471	1529
Grp Volume(v), veh/h	88	110	76	405	0	0	253	439	436	66	1088	65
Grp Sat Flow(s),veh/h/ln	1757	1845	1494	1822	0	0	1740	1736	1721	1740	1736	1529
Q Serve(g_s), s	5.8	7.0	5.9	27.7	0.0	0.0	16.1	22.9	23.0	4.7	31.7	4.1
Cycle Q Clear(g_c), s	5.8	7.0	5.9	27.7	0.0	0.0	16.1	22.9	23.0	4.7	31.7	4.1
Prop In Lane	1.00		1.00	0.33		0.08	1.00		0.32	1.00		1.00
Lane Grp Cap(c), veh/h	202	212	172	408	0	0	425	795	788	84	880	388
V/C Ratio(X)	0.44	0.52	0.44	0.99	0.00	0.00	0.60	0.55	0.55	0.78	1.24	0.17
Avail Cap(c_a), veh/h	436	457	371	408	0	0	425	795	788	209	880	388
HCM Platoon Ratio	1.00	1.00	1.00	1.00	1.00	1.00	1.00	1.00	1.00	1.00	1.00	1.00
Upstream Filter(I)	0.76	0.76	0.76	1.00	0.00	0.00	1.00	1.00	1.00	1.00	1.00	1.00
Uniform Delay (d), s/veh	51.5	52.1	51.6	48.2	0.0	0.0	41.8	24.6	24.6	58.8	46.7	36.4
Incr Delay (d2), s/veh	1.1	1.5	1.4	42.5	0.0	0.0	1.6	2.8	2.8	5.9	116.0	0.9
Initial Q Delay(d3),s/veh	0.0	0.0	0.0	0.0	0.0	0.0	0.0	0.0	0.0	0.0	0.0	0.0
%ile BackOfQ(50%),veh/ln	2.9	3.7	2.5	18.8	0.0	0.0	7.9	11.6	11.5	2.4	29.3	1.9
LnGrp Delay(d),s/veh	52.7	53.5	52.9	90.7	0.0	0.0	43.4	27.3	27.4	64.7	162.6	37.3
LnGrp LOS	D	D	D	F			D	C	C	E	F	D
Approach Vol, veh/h		274			405			1128			1219	
Approach Delay, s/veh		53.1			90.7			30.9			150.7	
Approach LOS		D			F			C			F	
Timer	1	2	3	4	5	6	7	8				
Assigned Phs	1	2		4	5	6		8				
Phs Duration (G+Y+Rc), s	40.2	62.6		19.1	35.8	37.0		33.1				
Change Period (Y+Rc), s	4.2	5.3		* 4.7	5.3	* 5.3		5.1				
Max Green Setting (Gmax), s	15	31.7		* 31	15.0	* 32		28.0				
Max Q Clear Time (g_c+10), s	15	25.0		9.0	18.1	33.7		29.7				
Green Ext Time (p_c), s	0.0	2.6		1.1	0.0	0.0		0.0				
Intersection Summary												
HCM 2010 Ctrl Delay				89.2								
HCM 2010 LOS				F								
Notes												

HCM 2010 Signalized Intersection Summary
 49: Highway 1 SB On-Ramp & Highway 1 NB Off-Ramp/Monterey Road

Cumulative, AM
 06/11/2019



Movement	EBL	EBT	EBR	WBL	WBT	WBR	NBL	NBT	NBR	SBL	SBT	SBR
Lane Configurations		↔↔	↗	↖		↗		↕	↗		↖	
Traffic Volume (veh/h)	10	200	100	240	0	380	0	50	120	10	10	0
Future Volume (veh/h)	10	200	100	240	0	380	0	50	120	10	10	0
Number	1	6	16	5	2	12	7	4	14	3	8	18
Initial Q (Qb), veh	0	0	0	0	0	0	0	0	0	0	0	0
Ped-Bike Adj(A_pbT)	1.00		1.00	1.00		1.00	1.00		1.00	1.00		1.00
Parking Bus, Adj	1.00	1.00	1.00	1.00	1.00	1.00	1.00	1.00	1.00	1.00	1.00	1.00
Adj Sat Flow, veh/h/ln	1900	1845	1845	1863	0	1863	0	1845	1845	1900	1900	0
Adj Flow Rate, veh/h	10	206	9	247	0	253	0	52	21	10	10	0
Adj No. of Lanes	0	2	1	1	0	1	0	1	1	0	1	0
Peak Hour Factor	0.97	0.97	0.97	0.97	0.97	0.97	0.97	0.97	0.97	0.97	0.97	0.97
Percent Heavy Veh, %	3	3	3	2	0	2	0	3	3	0	0	0
Cap, veh/h	136	2942	1343	0	0	0	0	122	104	75	60	0
Arrive On Green	0.87	0.86	0.86	0.00	0.00	0.00	0.00	0.07	0.07	0.07	0.07	0.00
Sat Flow, veh/h	159	3430	1566		0		0	1845	1568	474	898	0
Grp Volume(v), veh/h	116	100	9		0.0		0	52	21	20	0	0
Grp Sat Flow(s),veh/h/ln	1837	1752	1566				0	1845	1568	1372	0	0
Q Serve(g_s), s	1.2	1.1	0.1				0.0	3.4	1.6	0.0	0.0	0.0
Cycle Q Clear(g_c), s	1.2	1.1	0.1				0.0	3.4	1.6	3.4	0.0	0.0
Prop In Lane	0.09		1.00				0.00		1.00	0.50		0.00
Lane Grp Cap(c), veh/h	1575	1503	1343				0	122	104	136	0	0
V/C Ratio(X)	0.07	0.07	0.01				0.00	0.43	0.20	0.15	0.00	0.00
Avail Cap(c_a), veh/h	1575	1503	1343				0	148	125	158	0	0
HCM Platoon Ratio	1.00	1.00	1.00				1.00	1.00	1.00	1.00	1.00	1.00
Upstream Filter(I)	1.00	1.00	1.00				0.00	1.00	1.00	1.00	0.00	0.00
Uniform Delay (d), s/veh	1.3	1.3	1.3				0.0	56.1	55.2	55.0	0.0	0.0
Incr Delay (d2), s/veh	0.0	0.0	0.0				0.0	0.9	0.4	0.2	0.0	0.0
Initial Q Delay(d3),s/veh	0.0	0.0	0.0				0.0	0.0	0.0	0.0	0.0	0.0
%ile BackOfQ(50%),veh/ln	0.6	0.5	0.0				0.0	1.8	0.7	0.7	0.0	0.0
LnGrp Delay(d),s/veh	1.3	1.3	1.3				0.0	56.9	55.6	55.2	0.0	0.0
LnGrp LOS	A	A	A					E	E	E		
Approach Vol, veh/h		225						73			20	
Approach Delay, s/veh		1.3						56.5			55.2	
Approach LOS		A						E			E	
Timer	1	2	3	4	5	6	7	8				
Assigned Phs				4		6		8				
Phs Duration (G+Y+Rc), s				12.5		112.5		12.5				
Change Period (Y+Rc), s				* 4.2		5.3		* 4.2				
Max Green Setting (Gmax), s				* 10		21.0		* 10				
Max Q Clear Time (g_c+I1), s				5.4		3.2		5.4				
Green Ext Time (p_c), s				0.1		0.7		0.0				
Intersection Summary												
HCM 2010 Ctrl Delay			17.4									
HCM 2010 LOS			B									
Notes												

HCM 2010 Signalized Intersection Summary
 50: Reservation Road & SR 68 WB On Ramp/SR 68 WB Off Ramp

Cumulative, AM
 06/11/2019



Movement	EBL	EBT	EBR	WBL	WBT	WBR	NBL	NBT	NBR	SBL	SBT	SBR
Lane Configurations					↕	↕	↕	↕			↕	
Traffic Volume (veh/h)	0	0	0	260	10	310	120	390	0	0	350	140
Future Volume (veh/h)	0	0	0	260	10	310	120	390	0	0	350	140
Number				7	4	14	1	6	16	5	2	12
Initial Q (Qb), veh				0	0	0	0	0	0	0	0	0
Ped-Bike Adj(A_pbT)				1.00		1.00	1.00		1.00	1.00		1.00
Parking Bus, Adj				1.00	1.00	1.00	1.00	1.00	1.00	1.00	1.00	1.00
Adj Sat Flow, veh/h/ln				1900	1827	1827	1863	1863	0	0	1827	1900
Adj Flow Rate, veh/h				274	11	74	126	411	0	0	368	138
Adj No. of Lanes				0	1	1	1	1	0	0	1	0
Peak Hour Factor				0.95	0.95	0.95	0.95	0.95	0.95	0.95	0.95	0.95
Percent Heavy Veh, %				4	4	4	2	2	0	0	4	4
Cap, veh/h				384	15	356	208	1022	0	0	456	171
Arrive On Green				0.25	0.23	0.23	0.12	0.55	0.00	0.00	0.36	0.36
Sat Flow, veh/h				1676	67	1553	1774	1863	0	0	1268	475
Grp Volume(v), veh/h				285	0	74	126	411	0	0	0	506
Grp Sat Flow(s),veh/h/ln				1743	0	1553	1774	1863	0	0	0	1743
Q Serve(g_s), s				7.3	0.0	1.9	3.3	6.3	0.0	0.0	0.0	12.8
Cycle Q Clear(g_c), s				7.3	0.0	1.9	3.3	6.3	0.0	0.0	0.0	12.8
Prop In Lane				0.96		1.00	1.00		0.00	0.00		0.27
Lane Grp Cap(c), veh/h				400	0	356	208	1022	0	0	0	628
V/C Ratio(X)				0.71	0.00	0.21	0.61	0.40	0.00	0.00	0.00	0.81
Avail Cap(c_a), veh/h				1422	0	1267	941	1443	0	0	0	1351
HCM Platoon Ratio				1.00	1.00	1.00	1.00	1.00	1.00	1.00	1.00	1.00
Upstream Filter(I)				1.00	0.00	1.00	1.00	1.00	0.00	0.00	0.00	1.00
Uniform Delay (d), s/veh				17.0	0.0	15.3	20.6	6.4	0.0	0.0	0.0	14.1
Incr Delay (d2), s/veh				2.4	0.0	0.3	1.1	0.3	0.0	0.0	0.0	2.5
Initial Q Delay(d3),s/veh				0.0	0.0	0.0	0.0	0.0	0.0	0.0	0.0	0.0
%ile BackOfQ(50%),veh/ln				3.7	0.0	0.8	1.7	3.3	0.0	0.0	0.0	6.5
LnGrp Delay(d),s/veh				19.4	0.0	15.6	21.6	6.7	0.0	0.0	0.0	16.7
LnGrp LOS				B		B	C	A				B
Approach Vol, veh/h					359			537			506	
Approach Delay, s/veh					18.6			10.2			16.7	
Approach LOS					B			B			B	
Timer	1	2	3	4	5	6	7	8				
Assigned Phs	1	2		4		6						
Phs Duration (G+Y+Rc), s	9.2	23.7		16.1		32.9						
Change Period (Y+Rc), s	3.5	6.0		4.9		6.0						
Max Green Setting (Gmax)	26.0	38.0		40.0		38.0						
Max Q Clear Time (g_c+15)	15.3	14.8		9.3		8.3						
Green Ext Time (p_c), s	0.1	2.8		2.0		2.2						
Intersection Summary												
HCM 2010 Ctrl Delay				14.7								
HCM 2010 LOS				B								

HCM 2010 Signalized Intersection Summary
 51: River Road/Reservation Road & SR 68 Off Ramp/SR 68 EB On Ramp





















Cumulative, AM
 06/11/2019



Movement	EBL	EBT	EBR	WBL	WBT	WBR	NBL	NBT	NBR	SBL	SBT	SBR
Lane Configurations		↔	↗					↑	↗	↘	↑	
Traffic Volume (veh/h)	120	10	110	0	0	0	0	380	660	230	370	0
Future Volume (veh/h)	120	10	110	0	0	0	0	380	660	230	370	0
Number	3	8	18				1	6	16	5	2	12
Initial Q (Qb), veh	0	0	0				0	0	0	0	0	0
Ped-Bike Adj(A_pbT)	1.00		1.00				1.00		1.00	1.00		1.00
Parking Bus, Adj	1.00	1.00	1.00				1.00	1.00	1.00	1.00	1.00	1.00
Adj Sat Flow, veh/h/ln	1900	1881	1881				0	1881	1881	1827	1827	0
Adj Flow Rate, veh/h	130	11	19				0	413	388	250	402	0
Adj No. of Lanes	0	1	1				0	1	1	1	1	0
Peak Hour Factor	0.92	0.92	0.92				0.92	0.92	0.92	0.92	0.92	0.92
Percent Heavy Veh, %	1	1	1				0	1	1	4	4	0
Cap, veh/h	189	16	183				0	648	551	327	1136	0
Arrive On Green	0.14	0.11	0.11				0.00	0.34	0.34	0.19	0.62	0.00
Sat Flow, veh/h	1658	140	1599				0	1881	1599	1740	1827	0
Grp Volume(v), veh/h	141	0	19				0	413	388	250	402	0
Grp Sat Flow(s),veh/h/ln	1798	0	1599				0	1881	1599	1740	1827	0
Q Serve(g_s), s	3.1	0.0	0.4				0.0	7.6	8.7	5.6	4.4	0.0
Cycle Q Clear(g_c), s	3.1	0.0	0.4				0.0	7.6	8.7	5.6	4.4	0.0
Prop In Lane	0.92		1.00				0.00		1.00	1.00		0.00
Lane Grp Cap(c), veh/h	205	0	183				0	648	551	327	1136	0
V/C Ratio(X)	0.69	0.00	0.10				0.00	0.64	0.70	0.77	0.35	0.00
Avail Cap(c_a), veh/h	1741	0	1548				0	1685	1432	1011	1636	0
HCM Platoon Ratio	1.00	1.00	1.00				1.00	1.00	1.00	1.00	1.00	1.00
Upstream Filter(I)	1.00	0.00	1.00				0.00	1.00	1.00	1.00	1.00	0.00
Uniform Delay (d), s/veh	17.2	0.0	16.4				0.0	11.4	11.7	15.9	3.8	0.0
Incr Delay (d2), s/veh	1.5	0.0	0.1				0.0	1.0	1.7	3.7	0.2	0.0
Initial Q Delay(d3),s/veh	0.0	0.0	0.0				0.0	0.0	0.0	0.0	0.0	0.0
%ile BackOfQ(50%),veh/ln	1.6	0.0	0.2				0.0	4.1	4.0	3.0	2.2	0.0
LnGrp Delay(d),s/veh	18.7	0.0	16.5				0.0	12.4	13.4	19.7	4.0	0.0
LnGrp LOS	B		B					B	B	B	A	
Approach Vol, veh/h		160						801			652	
Approach Delay, s/veh		18.4						12.9			10.0	
Approach LOS		B						B			A	
Timer	1	2	3	4	5	6	7	8				
Assigned Phs		2			5	6		8				
Phs Duration (G+Y+Rc), s		31.7			11.5	20.2		9.6				
Change Period (Y+Rc), s		6.0			3.7	6.0		4.9				
Max Green Setting (Gmax), s		37.0			24.0	37.0		40.0				
Max Q Clear Time (g_c+I1), s		6.4			7.6	10.7		5.1				
Green Ext Time (p_c), s		2.2			0.6	3.6		0.5				
Intersection Summary												
HCM 2010 Ctrl Delay			12.3									
HCM 2010 LOS			B									

HCM 2010 Signalized Intersection Summary
1: Del Monte Boulevard & Reindollar Avenue

Cumulative, PM
06/11/2019

												
Movement	EBL	EBT	EBR	WBL	WBT	WBR	NBL	NBT	NBR	SBL	SBT	SBR
Lane Configurations												
Traffic Volume (veh/h)	0	0	0	190	0	450	10	1320	340	400	830	0
Future Volume (veh/h)	0	0	0	190	0	450	10	1320	340	400	830	0
Number				3	8	18	1	6	16	5	2	12
Initial Q (Qb), veh				0	0	0	0	0	0	0	0	0
Ped-Bike Adj(A_pbT)				1.00		0.99	1.00		1.00	1.00		1.00
Parking Bus, Adj				1.00	1.00	1.00	1.00	1.00	1.00	1.00	1.00	1.00
Adj Sat Flow, veh/h/ln				1881	1881	1900	1881	1881	1881	1881	1881	0
Adj Flow Rate, veh/h				198	0	397	10	1375	271	417	865	0
Adj No. of Lanes				1	1	0	1	2	1	1	2	0
Peak Hour Factor				0.96	0.96	0.96	0.96	0.96	0.96	0.96	0.96	0.96
Percent Heavy Veh, %				1	1	1	1	1	1	1	1	0
Cap, veh/h				501	0	444	22	1145	512	458	2015	0
Arrive On Green				0.28	0.00	0.28	0.01	0.32	0.32	0.26	0.56	0.00
Sat Flow, veh/h				1792	0	1585	1792	3574	1599	1792	3668	0
Grp Volume(v), veh/h				198	0	397	10	1375	271	417	865	0
Grp Sat Flow(s),veh/h/ln				1792	0	1585	1792	1787	1599	1792	1787	0
Q Serve(g_s), s				8.4	0.0	22.5	0.5	30.0	13.0	21.1	13.0	0.0
Cycle Q Clear(g_c), s				8.4	0.0	22.5	0.5	30.0	13.0	21.1	13.0	0.0
Prop In Lane				1.00		1.00	1.00		1.00	1.00		0.00
Lane Grp Cap(c), veh/h				501	0	444	22	1145	512	458	2015	0
V/C Ratio(X)				0.39	0.00	0.89	0.46	1.20	0.53	0.91	0.43	0.00
Avail Cap(c_a), veh/h				574	0	508	574	1145	512	574	2015	0
HCM Platoon Ratio				1.00	1.00	1.00	1.00	1.00	1.00	1.00	1.00	1.00
Upstream Filter(I)				1.00	0.00	1.00	1.00	1.00	1.00	1.00	1.00	0.00
Uniform Delay (d), s/veh				27.3	0.0	32.4	45.9	31.8	26.0	33.8	11.8	0.0
Incr Delay (d2), s/veh				0.5	0.0	16.8	14.1	99.0	1.0	16.2	0.1	0.0
Initial Q Delay(d3),s/veh				0.0	0.0	0.0	0.0	0.0	0.0	0.0	0.0	0.0
%ile BackOfQ(50%),veh/ln				4.2	0.0	11.9	0.3	30.4	5.9	12.5	6.4	0.0
LnGrp Delay(d),s/veh				27.8	0.0	49.2	60.0	130.8	27.1	50.0	11.9	0.0
LnGrp LOS				C		D	E	F	C	D	B	
Approach Vol, veh/h					595			1656			1282	
Approach Delay, s/veh					42.1			113.4			24.3	
Approach LOS					D			F			C	
Timer	1	2	3	4	5	6	7	8				
Assigned Phs	1	2			5	6		8				
Phs Duration (G+Y+Rc), s	4.6	57.8			27.5	35.0		31.2				
Change Period (Y+Rc), s	3.5	5.0			3.5	5.0		5.0				
Max Green Setting (Gmax), s	30.0	30.0			30.0	30.0		30.0				
Max Q Clear Time (g_c+I1), s	2.5	15.0			23.1	32.0		24.5				
Green Ext Time (p_c), s	0.0	5.4			0.8	0.0		1.7				
Intersection Summary												
HCM 2010 Ctrl Delay				69.1								
HCM 2010 LOS				E								
Notes												

HCM 2010 Signalized Intersection Summary
2: 2nd Avenue & Patton Parkway

Cumulative, PM
06/11/2019



Movement	EBL	EBT	EBR	WBL	WBT	WBR	NBL	NBT	NBR	SBL	SBT	SBR
Lane Configurations												
Traffic Volume (veh/h)	50	50	60	90	80	80	70	240	90	80	200	50
Future Volume (veh/h)	50	50	60	90	80	80	70	240	90	80	200	50
Number	7	4	14	3	8	18	5	2	12	1	6	16
Initial Q (Qb), veh	0	0	0	0	0	0	0	0	0	0	0	0
Ped-Bike Adj(A_pbT)	1.00		1.00	1.00		1.00	1.00		1.00	1.00		1.00
Parking Bus, Adj	1.00	1.00	1.00	1.00	1.00	1.00	1.00	1.00	1.00	1.00	1.00	1.00
Adj Sat Flow, veh/h/ln	1863	1863	1900	1863	1863	1900	1863	1863	1900	1863	1863	1900
Adj Flow Rate, veh/h	54	54	65	98	87	87	76	261	98	87	217	54
Adj No. of Lanes	1	1	0	1	1	0	1	1	0	1	1	0
Peak Hour Factor	0.92	0.92	0.92	0.92	0.92	0.92	0.92	0.92	0.92	0.92	0.92	0.92
Percent Heavy Veh, %	2	2	2	2	2	2	2	2	2	2	2	2
Cap, veh/h	96	163	196	137	201	201	119	356	134	128	405	101
Arrive On Green	0.05	0.21	0.21	0.08	0.23	0.23	0.07	0.28	0.28	0.07	0.28	0.28
Sat Flow, veh/h	1774	771	928	1774	856	856	1774	1292	485	1774	1441	359
Grp Volume(v), veh/h	54	0	119	98	0	174	76	0	359	87	0	271
Grp Sat Flow(s),veh/h/ln	1774	0	1699	1774	0	1712	1774	0	1777	1774	0	1799
Q Serve(g_s), s	1.4	0.0	2.8	2.5	0.0	4.0	2.0	0.0	8.6	2.2	0.0	6.0
Cycle Q Clear(g_c), s	1.4	0.0	2.8	2.5	0.0	4.0	2.0	0.0	8.6	2.2	0.0	6.0
Prop In Lane	1.00		0.55	1.00		0.50	1.00		0.27	1.00		0.20
Lane Grp Cap(c), veh/h	96	0	359	137	0	402	119	0	490	128	0	505
V/C Ratio(X)	0.56	0.00	0.33	0.72	0.00	0.43	0.64	0.00	0.73	0.68	0.00	0.54
Avail Cap(c_a), veh/h	228	0	1290	228	0	1300	228	0	1349	228	0	1366
HCM Platoon Ratio	1.00	1.00	1.00	1.00	1.00	1.00	1.00	1.00	1.00	1.00	1.00	1.00
Upstream Filter(I)	1.00	0.00	1.00	1.00	0.00	1.00	1.00	0.00	1.00	1.00	0.00	1.00
Uniform Delay (d), s/veh	21.6	0.0	15.6	21.1	0.0	15.2	21.3	0.0	15.4	21.2	0.0	14.2
Incr Delay (d2), s/veh	5.1	0.0	0.5	6.9	0.0	0.7	5.6	0.0	2.1	6.1	0.0	0.9
Initial Q Delay(d3),s/veh	0.0	0.0	0.0	0.0	0.0	0.0	0.0	0.0	0.0	0.0	0.0	0.0
%ile BackOfQ(50%),veh/ln	0.8	0.0	1.3	1.5	0.0	2.0	1.1	0.0	4.5	1.3	0.0	3.1
LnGrp Delay(d),s/veh	26.7	0.0	16.2	27.9	0.0	16.0	26.8	0.0	17.5	27.3	0.0	15.1
LnGrp LOS	C		B	C		B	C		B	C		B
Approach Vol, veh/h		173			272			435			358	
Approach Delay, s/veh		19.5			20.3			19.1			18.1	
Approach LOS		B			C			B			B	
Timer	1	2	3	4	5	6	7	8				
Assigned Phs	1	2	3	4	5	6	7	8				
Phs Duration (G+Y+Rc), s	7.4	17.4	7.6	14.4	7.1	17.6	6.5	15.5				
Change Period (Y+Rc), s	4.0	4.5	4.0	4.5	4.0	4.5	4.0	4.5				
Max Green Setting (Gmax), s	35.5	35.5	6.0	35.5	6.0	35.5	6.0	35.5				
Max Q Clear Time (g_c+14), s	10.6	10.6	4.5	4.8	4.0	8.0	3.4	6.0				
Green Ext Time (p_c), s	0.0	2.3	0.0	0.7	0.0	1.7	0.0	1.1				
Intersection Summary												
HCM 2010 Ctrl Delay				19.1								
HCM 2010 LOS				B								

HCM 2010 Signalized Intersection Summary
 3: SR 1 SB On-Ramp/SR 1 SB Off-Ramp & Imjin Parkway

Cumulative, PM
 06/11/2019



Movement	EBL	EBT	EBR	WBL	WBT	WBR	NBL	NBT	NBR	SBL	SBT	SBR
Lane Configurations					↕						↕	
Traffic Volume (veh/h)	0	0	0	1260	0	0	0	0	0	580	10	0
Future Volume (veh/h)	0	0	0	1260	0	0	0	0	0	580	10	0
Number				1	6	16				7	4	14
Initial Q (Qb), veh				0	0	0				0	0	0
Ped-Bike Adj(A_pbT)				1.00		1.00				1.00		1.00
Parking Bus, Adj				1.00	1.00	1.00				1.00	1.00	1.00
Adj Sat Flow, veh/h/ln				1900	1881	0				1900	1863	0
Adj Flow Rate, veh/h				1385	0	0				637	11	0
Adj No. of Lanes				0	1	0				0	1	0
Peak Hour Factor				0.91	0.91	0.91				0.91	0.91	0.91
Percent Heavy Veh, %				1	1	0				2	2	0
Cap, veh/h				1020	0	0				655	11	0
Arrive On Green				0.57	0.00	0.00				0.38	0.38	0.00
Sat Flow, veh/h				1792	0	0				1745	30	0
Grp Volume(v), veh/h				1385	0	0				648	0	0
Grp Sat Flow(s),veh/h/ln				1792	0	0				1775	0	0
Q Serve(g_s), s				90.0	0.0	0.0				56.8	0.0	0.0
Cycle Q Clear(g_c), s				90.0	0.0	0.0				56.8	0.0	0.0
Prop In Lane				1.00		0.00				0.98		0.00
Lane Grp Cap(c), veh/h				1020	0	0				666	0	0
V/C Ratio(X)				1.36	0.00	0.00				0.97	0.00	0.00
Avail Cap(c_a), veh/h				1020	0	0				674	0	0
HCM Platoon Ratio				1.00	1.00	1.00				1.00	1.00	1.00
Upstream Filter(I)				1.00	0.00	0.00				1.00	0.00	0.00
Uniform Delay (d), s/veh				33.9	0.0	0.0				48.4	0.0	0.0
Incr Delay (d2), s/veh				167.6	0.0	0.0				27.8	0.0	0.0
Initial Q Delay(d3),s/veh				0.0	0.0	0.0				0.0	0.0	0.0
%ile BackOfQ(50%),veh/ln				91.7	0.0	0.0				33.0	0.0	0.0
LnGrp Delay(d),s/veh				201.5	0.0	0.0				76.2	0.0	0.0
LnGrp LOS				F						E		
Approach Vol, veh/h					1385						648	
Approach Delay, s/veh					201.5						76.2	
Approach LOS					F						E	
Timer	1	2	3	4	5	6	7	8				
Assigned Phs				4		6						
Phs Duration (G+Y+Rc), s				63.7		94.4						
Change Period (Y+Rc), s				4.4		4.4						
Max Green Setting (Gmax), s				60.0		90.0						
Max Q Clear Time (g_c+I1), s				58.8		92.0						
Green Ext Time (p_c), s				0.5		0.0						
Intersection Summary												
HCM 2010 Ctrl Delay				161.5								
HCM 2010 LOS				F								

Intersection												
Int Delay, s/veh	0.9											
Movement	EBL	EBT	EBR	WBL	WBT	WBR	NBL	NBT	NBR	SBL	SBT	SBR
Lane Configurations		↖			↑	↗		↖	↗			
Traffic Vol, veh/h	10	570	0	0	1250	840	10	10	1570	0	0	0
Future Vol, veh/h	10	570	0	0	1250	840	10	10	1570	0	0	0
Conflicting Peds, #/hr	0	0	1	1	0	0	0	0	0	0	0	0
Sign Control	Free	Free	Free	Free	Free	Free	Stop	Stop	Stop	Stop	Stop	Stop
RT Channelized	-	-	None	-	-	Free	-	-	Free	-	-	None
Storage Length	-	-	-	-	-	0	-	-	800	-	-	-
Veh in Median Storage, #	-	0	-	-	0	-	-	0	-	-	16965	-
Grade, %	-	0	-	-	0	-	-	0	-	-	0	-
Peak Hour Factor	95	95	95	95	95	95	95	95	95	95	95	95
Heavy Vehicles, %	2	2	2	1	1	1	1	1	1	2	2	2
Mvmt Flow	11	600	0	0	1316	884	11	11	1653	0	0	0























Major/Minor	Major1	Major2	Minor1
Conflicting Flow All	1316	0	-
Stage 1	-	-	-
Stage 2	-	-	-
Critical Hdwy	4.12	-	-
Critical Hdwy Stg 1	-	-	-
Critical Hdwy Stg 2	-	-	-
Follow-up Hdwy	2.218	-	-
Pot Cap-1 Maneuver	525	-	0
Stage 1	-	-	0
Stage 2	-	-	0
Platoon blocked, %	-	-	-
Mov Cap-1 Maneuver	525	-	-
Mov Cap-2 Maneuver	-	-	-
Stage 1	-	-	-
Stage 2	-	-	-

Approach	EB	WB	NB
HCM Control Delay, s	0.2	0	77.2
HCM LOS			F

Minor Lane/Major Mvmt	NBLn1	NBLn2	EBL	EBT	WBT
Capacity (veh/h)	70	-	525	-	-
HCM Lane V/C Ratio	0.301	-	0.02	-	-
HCM Control Delay (s)	77.2	0	12	0	-
HCM Lane LOS	F	A	B	A	-
HCM 95th %tile Q(veh)	1.1	-	0.1	-	-

HCM 2010 Signalized Intersection Summary
5: 2nd Avenue & Imjin Parkway

Cumulative, PM
06/11/2019

												
Movement	EBL	EBT	EBR	WBL	WBT	WBR	NBL	NBT	NBR	SBL	SBT	SBR
Lane Configurations												
Traffic Volume (veh/h)	140	1340	670	340	1140	140	800	110	490	90	90	150
Future Volume (veh/h)	140	1340	670	340	1140	140	800	110	490	90	90	150
Number	5	2	12	1	6	16	3	8	18	7	4	14
Initial Q (Qb), veh	0	0	0	0	0	0	0	0	0	0	0	0
Ped-Bike Adj(A_pbT)	1.00		1.00	1.00		0.99	1.00		0.99	1.00		0.98
Parking Bus, Adj	1.00	1.00	1.00	1.00	1.00	1.00	1.00	1.00	1.00	1.00	1.00	1.00
Adj Sat Flow, veh/h/ln	1881	1881	1881	1881	1881	1900	1900	1900	1900	1900	1900	1900
Adj Flow Rate, veh/h	146	1396	498	354	1188	146	833	115	276	94	94	125
Adj No. of Lanes	1	2	1	2	2	0	2	1	1	1	2	0
Peak Hour Factor	0.96	0.96	0.96	0.96	0.96	0.96	0.96	0.96	0.96	0.96	0.96	0.96
Percent Heavy Veh, %	1	1	1	1	1	1	0	0	0	0	0	0
Cap, veh/h	183	1209	538	426	1148	141	792	502	423	133	202	177
Arrive On Green	0.10	0.34	0.34	0.12	0.36	0.36	0.23	0.26	0.26	0.07	0.11	0.11
Sat Flow, veh/h	1792	3574	1592	3476	3203	393	3510	1900	1602	1810	1805	1585
Grp Volume(v), veh/h	146	1396	498	354	661	673	833	115	276	94	94	125
Grp Sat Flow(s),veh/h/ln	1792	1787	1592	1738	1787	1809	1755	1900	1602	1810	1805	1585
Q Serve(g_s), s	7.1	30.0	26.7	8.8	31.8	31.8	20.0	4.2	13.6	4.5	4.3	6.7
Cycle Q Clear(g_c), s	7.1	30.0	26.7	8.8	31.8	31.8	20.0	4.2	13.6	4.5	4.3	6.7
Prop In Lane	1.00		1.00	1.00		0.22	1.00		1.00	1.00		1.00
Lane Grp Cap(c), veh/h	183	1209	538	426	640	648	792	502	423	133	202	177
V/C Ratio(X)	0.80	1.15	0.92	0.83	1.03	1.04	1.05	0.23	0.65	0.71	0.47	0.70
Avail Cap(c_a), veh/h	303	1209	538	588	640	648	792	502	423	204	427	375
HCM Platoon Ratio	1.00	1.00	1.00	1.00	1.00	1.00	1.00	1.00	1.00	1.00	1.00	1.00
Upstream Filter(I)	1.00	1.00	1.00	1.00	1.00	1.00	1.00	1.00	1.00	1.00	1.00	1.00
Uniform Delay (d), s/veh	38.9	29.3	28.3	38.0	28.5	28.5	34.3	25.6	29.0	40.2	36.9	38.0
Incr Delay (d2), s/veh	3.0	79.4	21.6	5.2	44.2	45.6	46.6	0.1	2.8	2.6	0.6	1.9
Initial Q Delay(d3),s/veh	0.0	0.0	0.0	0.0	0.0	0.0	0.0	0.0	0.0	0.0	0.0	0.0
%ile BackOfQ(50%),veh/ln	3.6	27.9	15.0	4.5	23.3	23.9	14.7	2.2	6.3	2.3	2.2	3.0
LnGrp Delay(d),s/veh	41.9	108.7	49.9	43.3	72.6	74.0	81.0	25.7	31.8	42.7	37.5	39.9
LnGrp LOS	D	F	D	D	F	F	F	C	C	D	D	D
Approach Vol, veh/h		2040			1688			1224			313	
Approach Delay, s/veh		89.6			67.0			64.7			40.0	
Approach LOS		F			E			E			D	
Timer	1	2	3	4	5	6	7	8				
Assigned Phs	1	2	3	4	5	6	7	8				
Phs Duration (G+Y+Rc), s	15.4	35.3	23.5	14.5	13.6	37.1	10.0	28.0				
Change Period (Y+Rc), s	4.5	5.3	3.5	4.6	4.5	5.3	3.5	4.6				
Max Green Setting (Gmax), s	15.0	30.0	20.0	21.0	15.0	30.0	10.0	21.0				
Max Q Clear Time (g_c+I1), s	10.8	32.0	22.0	8.7	9.1	33.8	6.5	15.6				
Green Ext Time (p_c), s	0.0	0.0	0.0	0.2	0.0	0.0	0.0	0.1				
Intersection Summary												
HCM 2010 Ctrl Delay			73.6									
HCM 2010 LOS			E									

HCM 2010 Signalized Intersection Summary
6: 3rd Avenue & Imjin Parkway

Cumulative, PM
06/11/2019



Movement	EBL	EBT	EBR	WBL	WBT	WBR	NBL	NBT	NBR	SBL	SBT	SBR
Lane Configurations												
Traffic Volume (veh/h)	50	1740	170	90	1240	20	220	10	150	10	10	50
Future Volume (veh/h)	50	1740	170	90	1240	20	220	10	150	10	10	50
Number	5	2	12	1	6	16	3	8	18	7	4	14
Initial Q (Qb), veh	0	0	0	0	0	0	0	0	0	0	0	0
Ped-Bike Adj(A_pbT)	1.00		0.98	1.00		1.00	1.00		1.00	1.00		1.00
Parking Bus, Adj	1.00	1.00	1.00	1.00	1.00	1.00	1.00	1.00	1.00	1.00	1.00	1.00
Adj Sat Flow, veh/h/ln	1881	1881	1900	1881	1881	1900	1900	1900	1900	1900	1900	1900
Adj Flow Rate, veh/h	51	1776	165	92	1265	19	224	10	41	10	10	10
Adj No. of Lanes	1	2	0	1	2	0	1	1	0	1	1	0
Peak Hour Factor	0.98	0.98	0.98	0.98	0.98	0.98	0.98	0.98	0.98	0.98	0.98	0.98
Percent Heavy Veh, %	1	1	1	1	1	1	0	0	0	0	0	0
Cap, veh/h	107	1718	157	118	1897	28	382	65	265	353	173	173
Arrive On Green	0.06	0.52	0.52	0.07	0.53	0.53	0.20	0.20	0.20	0.20	0.20	0.20
Sat Flow, veh/h	1792	3305	302	1792	3605	54	1412	326	1336	1373	872	872
Grp Volume(v), veh/h	51	946	995	92	627	657	224	0	51	10	0	20
Grp Sat Flow(s),veh/h/ln	1792	1787	1820	1792	1787	1872	1412	0	1662	1373	0	1745
Q Serve(g_s), s	1.7	32.5	32.5	3.2	16.0	16.0	9.6	0.0	1.6	0.4	0.0	0.6
Cycle Q Clear(g_c), s	1.7	32.5	32.5	3.2	16.0	16.0	10.1	0.0	1.6	2.0	0.0	0.6
Prop In Lane	1.00		0.17	1.00		0.03	1.00		0.80	1.00		0.50
Lane Grp Cap(c), veh/h	107	929	946	118	940	985	382	0	330	353	0	346
V/C Ratio(X)	0.48	1.02	1.05	0.78	0.67	0.67	0.59	0.00	0.15	0.03	0.00	0.06
Avail Cap(c_a), veh/h	330	929	946	330	940	985	723	0	731	684	0	767
HCM Platoon Ratio	1.00	1.00	1.00	1.00	1.00	1.00	1.00	1.00	1.00	1.00	1.00	1.00
Upstream Filter(I)	1.00	1.00	1.00	1.00	1.00	1.00	1.00	0.00	1.00	1.00	0.00	1.00
Uniform Delay (d), s/veh	28.5	15.0	15.0	28.7	10.8	10.8	24.4	0.0	20.7	21.5	0.0	20.3
Incr Delay (d2), s/veh	1.2	34.1	44.0	4.1	1.5	1.4	0.5	0.0	0.1	0.0	0.0	0.0
Initial Q Delay(d3),s/veh	0.0	0.0	0.0	0.0	0.0	0.0	0.0	0.0	0.0	0.0	0.0	0.0
%ile BackOfQ(50%),veh/ln	0.9	24.6	27.6	1.7	8.2	8.6	3.8	0.0	0.7	0.1	0.0	0.3
LnGrp Delay(d),s/veh	29.7	49.2	59.0	32.9	12.3	12.2	25.0	0.0	20.8	21.6	0.0	20.4
LnGrp LOS	C	F	F	C	B	B	C		C	C		C
Approach Vol, veh/h		1992			1376			275			30	
Approach Delay, s/veh		53.6			13.6			24.2			20.8	
Approach LOS		D			B			C			C	
Timer	1	2	3	4	5	6	7	8				
Assigned Phs	1	2		4	5	6		8				
Phs Duration (G+Y+Rc), s	7.6	38.0		16.9	7.2	38.4		16.9				
Change Period (Y+Rc), s	3.5	5.5		4.5	3.5	5.5		4.5				
Max Green Setting (Gmax), s	11.5	32.5		27.5	11.5	32.5		27.5				
Max Q Clear Time (g_c+1), s	11.5	34.5		4.0	3.7	18.0		12.1				
Green Ext Time (p_c), s	0.0	0.0		0.0	0.0	0.9		0.1				
Intersection Summary												
HCM 2010 Ctrl Delay				36.1								
HCM 2010 LOS				D								

HCM 2010 Signalized Intersection Summary
 7: 4th Avenue & Imjin Parkway

Cumulative, PM
 06/11/2019



Movement	EBL	EBT	EBR	WBL	WBT	WBR	NBL	NBT	NBR	SBL	SBT	SBR
Lane Configurations												
Traffic Volume (veh/h)	10	1900	10	10	1320	10	20	10	10	10	10	10
Future Volume (veh/h)	10	1900	10	10	1320	10	20	10	10	10	10	10
Number	5	2	12	1	6	16	3	8	18	7	4	14
Initial Q (Qb), veh	0	0	0	0	0	0	0	0	0	0	0	0
Ped-Bike Adj(A_pbT)	1.00		1.00	1.00		0.98	1.00		1.00	1.00		1.00
Parking Bus, Adj	1.00	1.00	1.00	1.00	1.00	1.00	1.00	1.00	1.00	1.00	1.00	1.00
Adj Sat Flow, veh/h/ln	1881	1881	1900	1881	1881	1900	1900	1900	1900	1900	1900	1900
Adj Flow Rate, veh/h	10	1959	10	10	1361	10	21	10	8	10	10	10
Adj No. of Lanes	1	2	0	1	2	0	0	1	0	0	1	0
Peak Hour Factor	0.97	0.97	0.97	0.97	0.97	0.97	0.97	0.97	0.97	0.97	0.97	0.97
Percent Heavy Veh, %	1	1	1	1	1	1	0	0	0	0	0	0
Cap, veh/h	14	2122	11	14	2116	16	194	23	18	157	31	31
Arrive On Green	0.01	0.58	0.58	0.01	0.58	0.58	0.07	0.05	0.05	0.07	0.05	0.05
Sat Flow, veh/h	1792	3646	19	1792	3636	27	874	416	333	566	566	566
Grp Volume(v), veh/h	10	959	1010	10	669	702	39	0	0	30	0	0
Grp Sat Flow(s),veh/h/ln	1792	1787	1878	1792	1787	1876	1623	0	0	1698	0	0
Q Serve(g_s), s	0.2	18.4	18.5	0.2	9.5	9.5	0.2	0.0	0.0	0.0	0.0	0.0
Cycle Q Clear(g_c), s	0.2	18.4	18.5	0.2	9.5	9.5	0.8	0.0	0.0	0.6	0.0	0.0
Prop In Lane	1.00		0.01	1.00		0.01	0.54		0.21	0.33		0.33
Lane Grp Cap(c), veh/h	14	1040	1093	14	1040	1092	256	0	0	241	0	0
V/C Ratio(X)	0.71	0.92	0.92	0.71	0.64	0.64	0.15	0.00	0.00	0.12	0.00	0.00
Avail Cap(c_a), veh/h	543	1530	1608	543	1530	1606	1298	0	0	1327	0	0
HCM Platoon Ratio	1.00	1.00	1.00	1.00	1.00	1.00	1.00	1.00	1.00	1.00	1.00	1.00
Upstream Filter(I)	1.00	1.00	1.00	1.00	1.00	1.00	1.00	0.00	0.00	1.00	0.00	0.00
Uniform Delay (d), s/veh	18.8	7.2	7.2	18.8	5.3	5.3	17.2	0.0	0.0	17.2	0.0	0.0
Incr Delay (d2), s/veh	21.0	5.6	5.4	21.0	0.2	0.2	0.1	0.0	0.0	0.1	0.0	0.0
Initial Q Delay(d3),s/veh	0.0	0.0	0.0	0.0	0.0	0.0	0.0	0.0	0.0	0.0	0.0	0.0
%ile BackOfQ(50%),veh/ln	0.2	10.4	10.9	0.2	4.5	4.8	0.4	0.0	0.0	0.3	0.0	0.0
LnGrp Delay(d),s/veh	39.8	12.7	12.6	39.8	5.5	5.5	17.3	0.0	0.0	17.2	0.0	0.0
LnGrp LOS	D	B	B	D	A	A	B			B		
Approach Vol, veh/h		1979			1381			39			30	
Approach Delay, s/veh		12.8			5.8			17.3			17.2	
Approach LOS		B			A			B			B	
Timer	1	2	3	4	5	6	7	8				
Assigned Phs	1	2		4	5	6		8				
Phs Duration (G+Y+Rc), s	3.8	27.6		6.6	3.8	27.6		6.6				
Change Period (Y+Rc), s	3.5	5.5		4.5	3.5	5.5		4.5				
Max Green Setting (Gmax), s	1.5	32.5		27.5	11.5	32.5		27.5				
Max Q Clear Time (g_c+1), s	12.2	20.5		2.6	2.2	11.5		2.8				
Green Ext Time (p_c), s	0.0	1.6		0.0	0.0	1.0		0.0				
Intersection Summary												
HCM 2010 Ctrl Delay				10.1								
HCM 2010 LOS				B								

HCM 2010 Signalized Intersection Summary
 8: 5th Avenue/California Avenue & Imjin Parkway

Cumulative, PM
 06/11/2019



Movement	EBL	EBT	EBR	WBL	WBT	WBR	NBL	NBT	NBR	SBL	SBT	SBR
Lane Configurations												
Traffic Volume (veh/h)	280	1570	10	10	1080	90	20	40	10	50	30	230
Future Volume (veh/h)	280	1570	10	10	1080	90	20	40	10	50	30	230
Number	5	2	12	1	6	16	3	8	18	7	4	14
Initial Q (Qb), veh	0	0	0	0	0	0	0	0	0	0	0	0
Ped-Bike Adj(A_pbT)	1.00		1.00	1.00		1.00	1.00		1.00	1.00		0.98
Parking Bus, Adj	1.00	1.00	1.00	1.00	1.00	1.00	1.00	1.00	1.00	1.00	1.00	1.00
Adj Sat Flow, veh/h/ln	1881	1881	1900	1881	1881	1900	1900	1900	1900	1900	1881	1900
Adj Flow Rate, veh/h	289	1619	10	10	1113	87	21	41	7	52	31	68
Adj No. of Lanes	1	2	0	1	2	0	0	1	0	0	1	0
Peak Hour Factor	0.97	0.97	0.97	0.97	0.97	0.97	0.97	0.97	0.97	0.97	0.97	0.97
Percent Heavy Veh, %	1	1	1	1	1	1	0	0	0	1	1	1
Cap, veh/h	350	2047	13	14	1259	98	152	161	24	167	55	93
Arrive On Green	0.20	0.56	0.56	0.01	0.37	0.37	0.14	0.13	0.13	0.14	0.13	0.13
Sat Flow, veh/h	1792	3642	22	1792	3358	262	364	1238	181	454	423	718
Grp Volume(v), veh/h	289	794	835	10	592	608	69	0	0	151	0	0
Grp Sat Flow(s),veh/h/ln	1792	1787	1877	1792	1787	1834	1783	0	0	1595	0	0
Q Serve(g_s), s	6.9	15.6	15.7	0.2	13.8	13.9	0.0	0.0	0.0	2.4	0.0	0.0
Cycle Q Clear(g_c), s	6.9	15.6	15.7	0.2	13.8	13.9	1.5	0.0	0.0	3.9	0.0	0.0
Prop In Lane	1.00		0.01	1.00		0.14	0.30		0.10	0.34		0.45
Lane Grp Cap(c), veh/h	350	1005	1055	14	670	687	361	0	0	337	0	0
V/C Ratio(X)	0.83	0.79	0.79	0.71	0.88	0.88	0.19	0.00	0.00	0.45	0.00	0.00
Avail Cap(c_a), veh/h	601	1200	1260	601	1200	1231	884	0	0	827	0	0
HCM Platoon Ratio	1.00	1.00	1.00	1.00	1.00	1.00	1.00	1.00	1.00	1.00	1.00	1.00
Upstream Filter(I)	1.00	1.00	1.00	1.00	1.00	1.00	1.00	0.00	0.00	1.00	0.00	0.00
Uniform Delay (d), s/veh	17.3	7.7	7.7	22.1	13.1	13.1	17.5	0.0	0.0	18.5	0.0	0.0
Incr Delay (d2), s/veh	1.9	2.5	2.4	21.7	1.6	1.6	0.1	0.0	0.0	0.3	0.0	0.0
Initial Q Delay(d3),s/veh	0.0	0.0	0.0	0.0	0.0	0.0	0.0	0.0	0.0	0.0	0.0	0.0
%ile BackOfQ(50%),veh/ln	3.6	8.2	8.6	0.2	7.0	7.2	0.8	0.0	0.0	1.8	0.0	0.0
LnGrp Delay(d),s/veh	19.2	10.2	10.1	43.8	14.6	14.6	17.6	0.0	0.0	18.8	0.0	0.0
LnGrp LOS	B	B	B	D	B	B	B			B		
Approach Vol, veh/h		1918			1210			69			151	
Approach Delay, s/veh		11.5			14.9			17.6			18.8	
Approach LOS		B			B			B			B	
Timer	1	2	3	4	5	6	7	8				
Assigned Phs	1	2		4	5	6		8				
Phs Duration (G+Y+Rc), s	3.9	30.4		10.4	12.2	22.0		10.4				
Change Period (Y+Rc), s	3.5	5.3		4.6	3.5	5.3		4.6				
Max Green Setting (Gmax), s	15.0	30.0		20.0	15.0	30.0		20.0				
Max Q Clear Time (g_c+1), s	12.2	17.7		5.9	8.9	15.9		3.5				
Green Ext Time (p_c), s	0.0	1.2		0.1	0.0	0.9		0.0				
Intersection Summary												
HCM 2010 Ctrl Delay				13.2								
HCM 2010 LOS				B								

Intersection						
Int Delay, s/veh	0.6					
Movement	EBL	EBR	NBL	NBT	SBT	SBR
Lane Configurations	↔		↔	↑	↑	
Traffic Vol, veh/h	10	10	20	380	240	10
Future Vol, veh/h	10	10	20	380	240	10
Conflicting Peds, #/hr	0	0	0	0	0	0
Sign Control	Stop	Stop	Free	Free	Free	Free
RT Channelized	-	None	-	None	-	None
Storage Length	0	-	155	-	-	-
Veh in Median Storage, #	0	-	-	0	0	-
Grade, %	0	-	-	0	0	-
Peak Hour Factor	92	92	92	92	92	92
Heavy Vehicles, %	2	2	2	2	2	2
Mvmt Flow	11	11	22	413	261	11















Major/Minor	Minor2	Major1	Major2			
Conflicting Flow All	724	267	272	0	-	0
Stage 1	267	-	-	-	-	-
Stage 2	457	-	-	-	-	-
Critical Hdwy	6.42	6.22	4.12	-	-	-
Critical Hdwy Stg 1	5.42	-	-	-	-	-
Critical Hdwy Stg 2	5.42	-	-	-	-	-
Follow-up Hdwy	3.518	3.318	2.218	-	-	-
Pot Cap-1 Maneuver	393	772	1291	-	-	-
Stage 1	778	-	-	-	-	-
Stage 2	638	-	-	-	-	-
Platoon blocked, %				-	-	-
Mov Cap-1 Maneuver	386	772	1291	-	-	-
Mov Cap-2 Maneuver	386	-	-	-	-	-
Stage 1	765	-	-	-	-	-
Stage 2	638	-	-	-	-	-

Approach	EB	NB	SB
HCM Control Delay, s	12.3	0.4	0
HCM LOS	B		

Minor Lane/Major Mvmt	NBL	NBT	EBLn1	SBT	SBR
Capacity (veh/h)	1291	-	515	-	-
HCM Lane V/C Ratio	0.017	-	0.042	-	-
HCM Control Delay (s)	7.8	-	12.3	-	-
HCM Lane LOS	A	-	B	-	-
HCM 95th %tile Q(veh)	0.1	-	0.1	-	-

HCM 2010 Signalized Intersection Summary
 10: Imjin Road & Imjin Parkway

Cumulative, PM
 06/11/2019

								
Movement	EBT	EBR	WBL	WBT	NBL	NBR		
Lane Configurations	 			 	  			
Traffic Volume (veh/h)	1540	80	170	960	180	430		
Future Volume (veh/h)	1540	80	170	960	180	430		
Number	2	12	1	6	3	18		
Initial Q (Qb), veh	0	0	0	0	0	0		
Ped-Bike Adj(A_pbT)		1.00	1.00		1.00	1.00		
Parking Bus, Adj	1.00	1.00	1.00	1.00	1.00	1.00		
Adj Sat Flow, veh/h/ln	1881	1900	1881	1881	1881	1881		
Adj Flow Rate, veh/h	1621	81	179	1011	189	387		
Adj No. of Lanes	2	0	1	2	1	2		
Peak Hour Factor	0.95	0.95	0.95	0.95	0.95	0.95		
Percent Heavy Veh, %	1	1	1	1	1	1		
Cap, veh/h	1689	84	222	2494	270	483		
Arrive On Green	0.49	0.49	0.12	0.70	0.15	0.15		
Sat Flow, veh/h	3560	172	1792	3668	1792	3198		
Grp Volume(v), veh/h	832	870	179	1011	189	387		
Grp Sat Flow(s),veh/h/ln	1787	1851	1792	1787	1792	1599		
Q Serve(g_s), s	27.5	27.9	6.0	7.3	6.2	7.2		
Cycle Q Clear(g_c), s	27.5	27.9	6.0	7.3	6.2	7.2		
Prop In Lane		0.09	1.00		1.00	1.00		
Lane Grp Cap(c), veh/h	871	902	222	2494	270	483		
V/C Ratio(X)	0.96	0.96	0.80	0.41	0.70	0.80		
Avail Cap(c_a), veh/h	872	903	583	2494	641	1144		
HCM Platoon Ratio	1.00	1.00	1.00	1.00	1.00	1.00		
Upstream Filter(I)	1.00	1.00	1.00	1.00	1.00	1.00		
Uniform Delay (d), s/veh	15.1	15.2	26.2	3.9	24.8	25.2		
Incr Delay (d2), s/veh	20.2	21.5	2.6	0.0	1.2	1.2		
Initial Q Delay(d3),s/veh	0.0	0.0	0.0	0.0	0.0	0.0		
%ile BackOfQ(50%),veh/ln	18.3	19.4	3.1	3.5	3.1	3.3		
LnGrp Delay(d),s/veh	35.3	36.7	28.8	4.0	26.0	26.4		
LnGrp LOS	D	D	C	A	C	C		
Approach Vol, veh/h	1702			1190	576			
Approach Delay, s/veh	36.0			7.7	26.3			
Approach LOS	D			A	C			
Timer	1	2	3	4	5	6	7	8
Assigned Phs	1	2				6		8
Phs Duration (G+Y+Rc), s	12.9	35.3				48.2		13.3
Change Period (Y+Rc), s	5.3	* 5.3				5.3		4.0
Max Green Setting (Gmax), s	20.0	* 30				30.0		22.0
Max Q Clear Time (g_c+I1), s	8.0	29.9				9.3		9.2
Green Ext Time (p_c), s	0.0	0.0				1.1		0.1
Intersection Summary								
HCM 2010 Ctrl Delay			24.7					
HCM 2010 LOS			C					
Notes								

HCM 2010 Signalized Intersection Summary
 11: Abrams Drive & Imjin Parkway

Cumulative, PM
 06/11/2019



Movement	EBL	EBT	EBR	WBL	WBT	WBR	NBL	NBT	NBR	SBL	SBT	SBR
Lane Configurations	↖ ↗	↖ ↗		↖ ↗	↖ ↗		↖	↖	↖	↖	↖	↖
Traffic Volume (veh/h)	130	1570	180	170	920	120	160	30	210	60	20	120
Future Volume (veh/h)	130	1570	180	170	920	120	160	30	210	60	20	120
Number	5	2	12	1	6	16	3	8	18	7	4	14
Initial Q (Qb), veh	0	0	0	0	0	0	0	0	0	0	0	0
Ped-Bike Adj(A_pbT)	1.00		1.00	1.00		1.00	1.00		1.00	1.00		1.00
Parking Bus, Adj	1.00	1.00	1.00	1.00	1.00	1.00	1.00	1.00	1.00	1.00	1.00	1.00
Adj Sat Flow, veh/h/ln	1881	1881	1900	1881	1881	1900	1881	1881	1881	1863	1863	1863
Adj Flow Rate, veh/h	140	1688	145	183	989	109	172	32	0	65	22	0
Adj No. of Lanes	2	2	0	2	2	0	1	1	1	1	1	1
Peak Hour Factor	0.93	0.93	0.93	0.93	0.93	0.93	0.93	0.93	0.93	0.93	0.93	0.93
Percent Heavy Veh, %	1	1	1	1	1	1	1	1	1	2	2	2
Cap, veh/h	278	1932	164	270	1852	204	312	302	256	302	299	254
Arrive On Green	0.08	0.58	0.56	0.08	0.57	0.55	0.16	0.16	0.00	0.16	0.16	0.00
Sat Flow, veh/h	3476	3335	283	3476	3247	358	1395	1881	1599	1369	1863	1583
Grp Volume(v), veh/h	140	896	937	183	544	554	172	32	0	65	22	0
Grp Sat Flow(s),veh/h/ln	1738	1787	1831	1738	1787	1818	1395	1881	1599	1369	1863	1583
Q Serve(g_s), s	2.7	29.6	31.0	3.6	13.2	13.3	8.4	1.0	0.0	3.0	0.7	0.0
Cycle Q Clear(g_c), s	2.7	29.6	31.0	3.6	13.2	13.3	9.1	1.0	0.0	4.0	0.7	0.0
Prop In Lane	1.00		0.15	1.00		0.20	1.00		1.00	1.00		1.00
Lane Grp Cap(c), veh/h	278	1036	1061	270	1019	1037	312	302	256	302	299	254
V/C Ratio(X)	0.50	0.86	0.88	0.68	0.53	0.53	0.55	0.11	0.00	0.22	0.07	0.00
Avail Cap(c_a), veh/h	991	1274	1305	991	1274	1296	685	804	684	668	797	677
HCM Platoon Ratio	1.00	1.00	1.00	1.00	1.00	1.00	1.00	1.00	1.00	1.00	1.00	1.00
Upstream Filter(I)	1.00	1.00	1.00	1.00	1.00	1.00	1.00	1.00	0.00	1.00	1.00	0.00
Uniform Delay (d), s/veh	30.9	12.4	12.8	31.5	9.3	9.4	28.9	25.2	0.0	26.9	25.0	0.0
Incr Delay (d2), s/veh	0.5	4.7	5.6	1.1	0.2	0.2	0.6	0.1	0.0	0.1	0.0	0.0
Initial Q Delay(d3),s/veh	0.0	0.0	0.0	0.0	0.0	0.0	0.0	0.0	0.0	0.0	0.0	0.0
%ile BackOfQ(50%),veh/ln	1.3	15.8	17.0	1.8	6.4	6.7	3.2	0.5	0.0	1.1	0.4	0.0
LnGrp Delay(d),s/veh	31.5	17.1	18.4	32.6	9.5	9.6	29.5	25.2	0.0	27.0	25.1	0.0
LnGrp LOS	C	B	B	C	A	A	C	C		C	C	
Approach Vol, veh/h		1973			1281			204			87	
Approach Delay, s/veh		18.7			12.8			28.8			26.5	
Approach LOS		B			B			C			C	
Timer	1	2	3	4	5	6	7	8				
Assigned Phs	1	2		4	5	6		8				
Phs Duration (G+Y+Rc), s	9.0	46.0		15.2	9.6	45.3		15.2				
Change Period (Y+Rc), s	3.5	5.3		4.0	4.0	5.3		4.0				
Max Green Setting (Gmax), s	20.0	50.0		30.0	20.0	50.0		30.0				
Max Q Clear Time (g_c+15), s	15.6	33.0		6.0	4.7	15.3		11.1				
Green Ext Time (p_c), s	0.0	1.6		0.0	0.0	0.8		0.0				
Intersection Summary												
HCM 2010 Ctrl Delay				17.4								
HCM 2010 LOS				B								

HCM 2010 Signalized Intersection Summary
 12: Reservation Road & Imjin Parkway













Cumulative, PM
 06/11/2019



Movement	EBL	EBT	EBR	WBL	WBT	WBR	NBL	NBT	NBR	SBL	SBT	SBR
Lane Configurations	↔↔	↑	↔↔	↔	↑	↔	↔↔	↑↑	↔	↔↔	↑↑	↔
Traffic Volume (veh/h)	120	20	1670	10	40	30	970	640	10	20	950	200
Future Volume (veh/h)	120	20	1670	10	40	30	970	640	10	20	950	200
Number	3	8	18	7	4	14	1	6	16	5	2	12
Initial Q (Qb), veh	0	0	0	0	0	0	0	0	0	0	0	0
Ped-Bike Adj(A_pbT)	1.00		1.00	1.00		0.99	1.00		1.00	1.00		1.00
Parking Bus, Adj	1.00	1.00	1.00	1.00	1.00	1.00	1.00	1.00	1.00	1.00	1.00	1.00
Adj Sat Flow, veh/h/ln	1881	1881	1881	1827	1827	1827	1881	1881	1881	1881	1881	1881
Adj Flow Rate, veh/h	135	22	1475	11	45	12	1090	719	10	22	1067	91
Adj No. of Lanes	2	1	2	1	1	1	2	2	1	2	2	1
Peak Hour Factor	0.89	0.89	0.89	0.89	0.89	0.89	0.89	0.89	0.89	0.89	0.89	0.89
Percent Heavy Veh, %	1	1	1	4	4	4	1	1	1	1	1	1
Cap, veh/h	799	433	1292	75	79	66	799	2052	918	55	1287	576
Arrive On Green	0.23	0.23	0.23	0.04	0.04	0.04	0.23	0.57	0.57	0.02	0.36	0.36
Sat Flow, veh/h	3476	1881	2802	1740	1827	1531	3476	3574	1599	3476	3574	1599
Grp Volume(v), veh/h	135	22	1475	11	45	12	1090	719	10	22	1067	91
Grp Sat Flow(s),veh/h/ln	1738	1881	1401	1740	1827	1531	1738	1787	1599	1738	1787	1599
Q Serve(g_s), s	4.7	1.4	35.0	0.9	3.7	1.1	35.0	16.3	0.4	1.0	41.4	5.9
Cycle Q Clear(g_c), s	4.7	1.4	35.0	0.9	3.7	1.1	35.0	16.3	0.4	1.0	41.4	5.9
Prop In Lane	1.00		1.00	1.00		1.00	1.00		1.00	1.00		1.00
Lane Grp Cap(c), veh/h	799	433	1292	75	79	66	799	2052	918	55	1287	576
V/C Ratio(X)	0.17	0.05	1.14	0.15	0.57	0.18	1.36	0.35	0.01	0.40	0.83	0.16
Avail Cap(c_a), veh/h	799	433	1292	354	372	312	799	2052	918	457	1409	630
HCM Platoon Ratio	1.00	1.00	1.00	1.00	1.00	1.00	1.00	1.00	1.00	1.00	1.00	1.00
Upstream Filter(I)	1.00	1.00	1.00	1.00	1.00	1.00	1.00	1.00	1.00	1.00	1.00	1.00
Uniform Delay (d), s/veh	46.9	45.6	41.1	70.1	71.4	70.2	58.6	17.3	13.9	74.2	44.4	33.0
Incr Delay (d2), s/veh	0.0	0.0	73.6	0.3	2.4	0.5	171.6	0.3	0.0	1.7	5.1	0.3
Initial Q Delay(d3),s/veh	0.0	0.0	0.0	0.0	0.0	0.0	0.0	0.0	0.0	0.0	0.0	0.0
%ile BackOfQ(50%),veh/ln	2.3	0.7	40.3	0.5	1.9	0.5	35.8	8.1	0.2	0.5	21.4	2.7
LnGrp Delay(d),s/veh	47.0	45.7	114.7	70.4	73.8	70.7	230.2	17.6	13.9	75.9	49.5	33.4
LnGrp LOS	D	D	F	E	E	E	F	B	B	E	D	C
Approach Vol, veh/h		1632			68			1819			1180	
Approach Delay, s/veh		108.2			72.7			145.0			48.8	
Approach LOS		F			E			F			D	
Timer	1	2	3	4	5	6	7	8				
Assigned Phs	1	2		4	5	6		8				
Phs Duration (G+Y+Rc), s	39.1	61.0		11.6	6.5	93.6		40.5				
Change Period (Y+Rc), s	4.1	* 6.2		5.0	4.1	* 6.2		5.5				
Max Green Setting (Gmax), s	35.0	* 60		31.0	20.0	* 50		35.0				
Max Q Clear Time (g_c+Q), s	37.0	43.4		5.7	3.0	18.3		37.0				
Green Ext Time (p_c), s	0.0	11.4		0.2	0.0	10.8		0.0				
Intersection Summary												
HCM 2010 Ctrl Delay			107.0									
HCM 2010 LOS			F									
Notes												

HCM 2010 Signalized Intersection Summary
 13: Reservation Road & Blanco Road

Cumulative, PM
 04/20/2022

								
Movement	EBL	EBT	WBT	WBR	SBL	SBR		
Lane Configurations								
Traffic Volume (veh/h)	1110	1440	490	50	40	1140		
Future Volume (veh/h)	1110	1440	490	50	40	1140		
Number	5	2	6	16	7	14		
Initial Q (Qb), veh	0	0	0	0	0	0		
Ped-Bike Adj(A_pbT)	1.00			1.00	1.00	1.00		
Parking Bus, Adj	1.00	1.00	1.00	1.00	1.00	1.00		
Adj Sat Flow, veh/h/ln	1881	1881	1863	1863	1863	1863		
Adj Flow Rate, veh/h	1181	1532	521	29	43	0		
Adj No. of Lanes	2	2	1	1	2	2		
Peak Hour Factor	0.94	0.94	0.94	0.94	0.94	0.94		
Percent Heavy Veh, %	1	1	2	2	2	2		
Cap, veh/h	1292	2869	624	530	119	96		
Arrive On Green	0.37	0.80	0.33	0.33	0.03	0.00		
Sat Flow, veh/h	3476	3668	1863	1583	3442	2787		
Grp Volume(v), veh/h	1181	1532	521	29	43	0		
Grp Sat Flow(s),veh/h/ln	1738	1787	1863	1583	1721	1393		
Q Serve(g_s), s	18.5	8.5	14.8	0.7	0.7	0.0		
Cycle Q Clear(g_c), s	18.5	8.5	14.8	0.7	0.7	0.0		
Prop In Lane	1.00			1.00	1.00	1.00		
Lane Grp Cap(c), veh/h	1292	2869	624	530	119	96		
V/C Ratio(X)	0.91	0.53	0.84	0.05	0.36	0.00		
Avail Cap(c_a), veh/h	2431	3751	1955	1661	1625	1316		
HCM Platoon Ratio	1.00	1.00	1.00	1.00	1.00	1.00		
Upstream Filter(I)	1.00	1.00	1.00	1.00	1.00	0.00		
Uniform Delay (d), s/veh	17.1	1.9	17.6	12.9	27.0	0.0		
Incr Delay (d2), s/veh	1.2	0.1	2.3	0.0	0.7	0.0		
Initial Q Delay(d3),s/veh	0.0	0.0	0.0	0.0	0.0	0.0		
%ile BackOfQ(50%),veh/ln	9.1	4.1	7.9	0.3	0.3	0.0		
LnGrp Delay(d),s/veh	18.2	2.1	19.8	12.9	27.7	0.0		
LnGrp LOS	B	A	B	B	C			
Approach Vol, veh/h		2713	550		43			
Approach Delay, s/veh		9.1	19.5		27.7			
Approach LOS		A	B		C			
Timer	1	2	3	4	5	6	7	8
Assigned Phs		2		4	5	6		
Phs Duration (G+Y+Rc), s		51.7		5.5	26.8	24.9		
Change Period (Y+Rc), s		5.8		3.5	5.5	5.8		
Max Green Setting (Gmax), s		60.0		27.0	40.0	60.0		
Max Q Clear Time (g_c+I1), s		10.5		2.7	20.5	16.8		
Green Ext Time (p_c), s		11.2		0.0	0.8	2.4		
Intersection Summary								
HCM 2010 Ctrl Delay			11.1					
HCM 2010 LOS			B					

HCM 2010 Signalized Intersection Summary
 14: Reservation Road & Inter-Garrison Road

Cumulative, PM
 06/11/2019



Movement	EBL	EBR	NBL	NBT	SBT	SBR		
Lane Configurations								
Traffic Volume (veh/h)	110	320	220	440	1300	270		
Future Volume (veh/h)	110	320	220	440	1300	270		
Number	3	18	1	6	2	12		
Initial Q (Qb), veh	0	0	0	0	0	0		
Ped-Bike Adj(A_pbT)	1.00	1.00	1.00			1.00		
Parking Bus, Adj	1.00	1.00	1.00	1.00	1.00	1.00		
Adj Sat Flow, veh/h/ln	1881	1881	1845	1845	1881	1900		
Adj Flow Rate, veh/h	134	235	268	537	1585	320		
Adj No. of Lanes	1	1	1	2	2	0		
Peak Hour Factor	0.82	0.82	0.82	0.82	0.82	0.82		
Percent Heavy Veh, %	1	1	3	3	1	1		
Cap, veh/h	260	502	296	2649	1624	318		
Arrive On Green	0.15	0.15	0.17	0.76	0.54	0.54		
Sat Flow, veh/h	1792	1599	1757	3597	3076	584		
Grp Volume(v), veh/h	134	235	268	537	930	975		
Grp Sat Flow(s),veh/h/ln	1792	1599	1757	1752	1787	1778		
Q Serve(g_s), s	7.6	13.0	16.5	4.9	54.5	60.0		
Cycle Q Clear(g_c), s	7.6	13.0	16.5	4.9	54.5	60.0		
Prop In Lane	1.00	1.00	1.00			0.33		
Lane Grp Cap(c), veh/h	260	502	296	2649	973	969		
V/C Ratio(X)	0.51	0.47	0.91	0.20	0.96	1.01		
Avail Cap(c_a), veh/h	439	661	319	2649	973	969		
HCM Platoon Ratio	1.00	1.00	1.00	1.00	1.00	1.00		
Upstream Filter(I)	1.00	1.00	1.00	1.00	1.00	1.00		
Uniform Delay (d), s/veh	43.5	30.4	44.9	3.9	23.8	25.1		
Incr Delay (d2), s/veh	1.6	0.7	25.7	0.1	19.2	30.5		
Initial Q Delay(d3),s/veh	0.0	0.0	0.0	0.0	0.0	0.0		
%ile BackOfQ(50%),veh/ln	3.9	5.8	10.2	2.3	31.8	37.5		
LnGrp Delay(d),s/veh	45.1	31.1	70.7	3.9	43.0	55.5		
LnGrp LOS	D	C	E	A	D	F		
Approach Vol, veh/h	369			805	1905			
Approach Delay, s/veh	36.2			26.2	49.4			
Approach LOS	D			C	D			
Timer	1	2	3	4	5	6	7	8
Assigned Phs	1	2				6		8
Phs Duration (G+Y+Rc), s	33.2	66.4				89.6		20.5
Change Period (Y+Rc), s	4.7	6.4				6.4		4.5
Max Green Setting (Gmax), s	26	60.0				60.0		27.0
Max Q Clear Time (g_c+11), s	11.5	62.0				6.9		15.0
Green Ext Time (p_c), s	0.1	0.0				6.5		1.0
Intersection Summary								
HCM 2010 Ctrl Delay			41.8					
HCM 2010 LOS			D					
Notes								

HCM 2010 Signalized Intersection Summary
 15: 2nd Avenue & 9th Street

Cumulative, PM
 06/11/2019



Movement	EBL	EBT	EBR	WBL	WBT	WBR	NBL	NBT	NBR	SBL	SBT	SBR
Lane Configurations		↔	↔		↔		↔	↕		↔	↕	
Traffic Volume (veh/h)	10	10	30	40	10	20	20	640	50	40	540	10
Future Volume (veh/h)	10	10	30	40	10	20	20	640	50	40	540	10
Number	5	2	12	1	6	16	3	8	18	7	4	14
Initial Q (Qb), veh	0	0	0	0	0	0	0	0	0	0	0	0
Ped-Bike Adj(A_pbT)	1.00		0.99	1.00		1.00	1.00		0.97	1.00		1.00
Parking Bus, Adj	1.00	1.00	1.00	1.00	1.00	1.00	1.00	1.00	1.00	1.00	1.00	1.00
Adj Sat Flow, veh/h/ln	1900	1900	1900	1900	1900	1900	1881	1881	1900	1827	1827	1900
Adj Flow Rate, veh/h	11	11	23	44	11	3	22	703	51	44	593	-1
Adj No. of Lanes	0	1	1	0	1	0	1	2	0	1	2	0
Peak Hour Factor	0.91	0.91	0.91	0.91	0.91	0.91	0.91	0.91	0.91	0.91	0.91	0.91
Percent Heavy Veh, %	0	0	0	0	0	0	1	1	1	4	4	4
Cap, veh/h	273	207	306	379	78	15	49	1254	91	87	1369	0
Arrive On Green	0.22	0.19	0.19	0.22	0.19	0.19	0.03	0.37	0.37	0.05	0.39	0.00
Sat Flow, veh/h	616	1074	1591	1029	404	78	1792	3371	244	1740	3563	0
Grp Volume(v), veh/h	22	0	23	58	0	0	22	372	382	44	592	0
Grp Sat Flow(s),veh/h/ln	1689	0	1591	1511	0	0	1792	1787	1828	1740	1736	0
Q Serve(g_s), s	0.0	0.0	0.4	0.3	0.0	0.0	0.4	5.8	5.8	0.9	4.4	0.0
Cycle Q Clear(g_c), s	0.3	0.0	0.4	0.9	0.0	0.0	0.4	5.8	5.8	0.9	4.4	0.0
Prop In Lane	0.50		1.00	0.76		0.05	1.00		0.13	1.00		0.00
Lane Grp Cap(c), veh/h	528	0	306	515	0	0	49	665	680	87	1369	0
V/C Ratio(X)	0.04	0.00	0.08	0.11	0.00	0.00	0.45	0.56	0.56	0.51	0.43	0.00
Avail Cap(c_a), veh/h	1838	0	1591	1709	0	0	589	2043	2090	572	3968	0
HCM Platoon Ratio	1.00	1.00	1.00	1.00	1.00	1.00	1.00	1.00	1.00	1.00	1.00	1.00
Upstream Filter(l)	1.00	0.00	1.00	1.00	0.00	0.00	1.00	1.00	1.00	1.00	1.00	0.00
Uniform Delay (d), s/veh	11.3	0.0	11.6	11.5	0.0	0.0	16.8	8.7	8.7	16.2	7.7	0.0
Incr Delay (d2), s/veh	0.0	0.0	0.1	0.1	0.0	0.0	6.2	0.7	0.7	4.6	0.2	0.0
Initial Q Delay(d3),s/veh	0.0	0.0	0.0	0.0	0.0	0.0	0.0	0.0	0.0	0.0	0.0	0.0
%ile BackOfQ(50%),veh/ln	0.2	0.0	0.2	0.5	0.0	0.0	0.3	2.9	3.0	0.5	2.1	0.0
LnGrp Delay(d),s/veh	11.4	0.0	11.7	11.6	0.0	0.0	23.0	9.5	9.4	20.8	8.0	0.0
LnGrp LOS	B		B	B			C	A	A	C	A	
Approach Vol, veh/h		45			58			776			636	
Approach Delay, s/veh		11.5			11.6			9.8			8.8	
Approach LOS		B			B			A			A	
Timer	1	2	3	4	5	6	7	8				
Assigned Phs		2	3	4		6	7	8				
Phs Duration (G+Y+Rc), s		11.7	4.5	18.8		11.7	5.2	18.0				
Change Period (Y+Rc), s		5.0	3.5	5.0		5.0	3.5	5.0				
Max Green Setting (Gmax), s		35.0	11.5	40.0		35.0	11.5	40.0				
Max Q Clear Time (g_c+I1), s		2.4	2.4	6.4		2.9	2.9	7.8				
Green Ext Time (p_c), s		0.1	0.0	4.3		0.3	0.0	5.1				
Intersection Summary												
HCM 2010 Ctrl Delay			9.5									
HCM 2010 LOS			A									

HCM 2010 Signalized Intersection Summary
 16: 2nd Avenue & 8th Street

Cumulative, PM
 06/11/2019



Movement	WBL	WBR	NBT	NBR	SBL	SBT		
Lane Configurations								
Traffic Volume (veh/h)	130	40	580	260	30	560		
Future Volume (veh/h)	130	40	580	260	30	560		
Number	1	16	8	18	7	4		
Initial Q (Qb), veh	0	0	0	0	0	0		
Ped-Bike Adj(A_pbT)	1.00	1.00		0.97	1.00			
Parking Bus, Adj	1.00	1.00	1.00	1.00	1.00	1.00		
Adj Sat Flow, veh/h/ln	1900	1900	1881	1900	1827	1827		
Adj Flow Rate, veh/h	138	9	617	246	32	596		
Adj No. of Lanes	1	1	2	0	1	2		
Peak Hour Factor	0.94	0.94	0.94	0.94	0.94	0.94		
Percent Heavy Veh, %	0	0	1	1	4	4		
Cap, veh/h	202	180	1102	439	67	2042		
Arrive On Green	0.11	0.11	0.44	0.44	0.04	0.59		
Sat Flow, veh/h	1810	1615	2571	987	1740	3563		
Grp Volume(v), veh/h	138	9	445	418	32	596		
Grp Sat Flow(s),veh/h/ln	1810	1615	1787	1677	1740	1736		
Q Serve(g_s), s	2.4	0.2	6.1	6.1	0.6	2.8		
Cycle Q Clear(g_c), s	2.4	0.2	6.1	6.1	0.6	2.8		
Prop In Lane	1.00	1.00		0.59	1.00			
Lane Grp Cap(c), veh/h	202	180	795	746	67	2042		
V/C Ratio(X)	0.68	0.05	0.56	0.56	0.48	0.29		
Avail Cap(c_a), veh/h	1629	1454	2414	2265	601	6251		
HCM Platoon Ratio	1.00	1.00	1.00	1.00	1.00	1.00		
Upstream Filter(I)	1.00	1.00	1.00	1.00	1.00	1.00		
Uniform Delay (d), s/veh	14.2	13.2	6.8	6.8	15.7	3.4		
Incr Delay (d2), s/veh	4.0	0.1	0.6	0.7	5.2	0.1		
Initial Q Delay(d3),s/veh	0.0	0.0	0.0	0.0	0.0	0.0		
%ile BackOfQ(50%),veh/ln	1.4	0.2	3.1	2.9	0.4	1.3		
LnGrp Delay(d),s/veh	18.3	13.3	7.5	7.5	20.9	3.5		
LnGrp LOS	B	B	A	A	C	A		
Approach Vol, veh/h	147		863			628		
Approach Delay, s/veh	18.0		7.5			4.4		
Approach LOS	B		A			A		
Timer	1	2	3	4	5	6	7	8
Assigned Phs				4		6	7	8
Phs Duration (G+Y+Rc), s				24.6		8.7	4.8	19.8
Change Period (Y+Rc), s				5.0		5.0	3.5	5.0
Max Green Setting (Gmax), s				60.0		30.0	11.5	45.0
Max Q Clear Time (g_c+I1), s				4.8		4.4	2.6	8.1
Green Ext Time (p_c), s				4.5		0.4	0.0	6.4
Intersection Summary								
HCM 2010 Ctrl Delay			7.2					
HCM 2010 LOS			A					

Intersection	
Intersection Delay, s/veh	10.2
Intersection LOS	B

Movement	EBT	EBR	WBL	WBT	NBL	NBR
Lane Configurations	↑	↑	↑	↑	↑	↑
Traffic Vol, veh/h	270	30	80	130	30	110
Future Vol, veh/h	270	30	80	130	30	110
Peak Hour Factor	0.92	0.92	0.92	0.92	0.92	0.92
Heavy Vehicles, %	2	2	2	2	2	2
Mvmt Flow	293	33	87	141	33	120
Number of Lanes	1	1	1	1	1	1

Approach	EB	WB	NB
Opposing Approach	WB	EB	
Opposing Lanes	2	2	0
Conflicting Approach Left		NB	EB
Conflicting Lanes Left	0	2	2
Conflicting Approach Right	NB		WB
Conflicting Lanes Right	2	0	2
HCM Control Delay	11.3	9.4	9.1
HCM LOS	B	A	A

Lane	NBLn1	NBLn2	EBLn1	EBLn2	WBLn1	WBLn2
Vol Left, %	100%	0%	0%	0%	100%	0%
Vol Thru, %	0%	0%	100%	0%	0%	100%
Vol Right, %	0%	100%	0%	100%	0%	0%
Sign Control	Stop	Stop	Stop	Stop	Stop	Stop
Traffic Vol by Lane	30	110	270	30	80	130
LT Vol	30	0	0	0	80	0
Through Vol	0	0	270	0	0	130
RT Vol	0	110	0	30	0	0
Lane Flow Rate	33	120	293	33	87	141
Geometry Grp	7	7	7	7	7	7
Degree of Util (X)	0.058	0.171	0.421	0.04	0.139	0.206
Departure Headway (Hd)	6.371	5.162	5.169	4.465	5.745	5.242
Convergence, Y/N	Yes	Yes	Yes	Yes	Yes	Yes
Cap	560	691	696	798	622	682
Service Time	4.132	2.923	2.919	2.214	3.499	2.995
HCM Lane V/C Ratio	0.059	0.174	0.421	0.041	0.14	0.207
HCM Control Delay	9.5	9	11.7	7.4	9.4	9.4
HCM Lane LOS	A	A	B	A	A	A
HCM 95th-tile Q	0.2	0.6	2.1	0.1	0.5	0.8

Intersection				
Intersection Delay, s/veh	7.7			
Intersection LOS	A			
Approach	EB	WB	NB	SB
Entry Lanes	1	1	1	1
Conflicting Circle Lanes	1	1	1	1
Adj Approach Flow, veh/h	361	283	66	284
Demand Flow Rate, veh/h	372	285	66	289
Vehicles Circulating, veh/h	162	350	474	74
Vehicles Exiting, veh/h	201	190	60	561
Follow-Up Headway, s	3.186	3.186	3.186	3.186
Ped Vol Crossing Leg, #/h	0	0	0	0
Ped Cap Adj	1.000	1.000	1.000	1.000
Approach Delay, s/veh	8.2	8.9	6.1	6.2
Approach LOS	A	A	A	A
Lane	Left	Left	Left	Left
Designated Moves	LTR	LTR	LTR	LTR
Assumed Moves	LTR	LTR	LTR	LTR
RT Channelized				
Lane Util	1.000	1.000	1.000	1.000
Critical Headway, s	5.193	5.193	5.193	5.193
Entry Flow, veh/h	372	285	66	289
Cap Entry Lane, veh/h	961	796	703	1049
Entry HV Adj Factor	0.970	0.992	1.000	0.981
Flow Entry, veh/h	361	283	66	284
Cap Entry, veh/h	932	790	703	1030
V/C Ratio	0.387	0.358	0.094	0.275
Control Delay, s/veh	8.2	8.9	6.1	6.2
LOS	A	A	A	A
95th %tile Queue, veh	2	2	0	1

HCM 2010 Signalized Intersection Summary
 19: 2nd Avenue & Inter-Garrison Road

Cumulative, PM
 06/11/2019



Movement	WBL	WBR	NBT	NBR	SBL	SBT		
Lane Configurations								
Traffic Volume (veh/h)	60	30	820	60	30	670		
Future Volume (veh/h)	60	30	820	60	30	670		
Number	1	16	8	18	7	4		
Initial Q (Qb), veh	0	0	0	0	0	0		
Ped-Bike Adj(A_pbT)	1.00	1.00		1.00	1.00			
Parking Bus, Adj	1.00	1.00	1.00	1.00	1.00	1.00		
Adj Sat Flow, veh/h/ln	1900	1900	1881	1900	1863	1863		
Adj Flow Rate, veh/h	62	7	845	54	31	691		
Adj No. of Lanes	1	1	2	0	1	2		
Peak Hour Factor	0.97	0.97	0.97	0.97	0.97	0.97		
Percent Heavy Veh, %	0	0	1	1	2	2		
Cap, veh/h	254	227	1467	94	66	2013		
Arrive On Green	0.14	0.14	0.43	0.43	0.04	0.57		
Sat Flow, veh/h	1810	1615	3506	218	1774	3632		
Grp Volume(v), veh/h	62	7	443	456	31	691		
Grp Sat Flow(s),veh/h/ln	1810	1615	1787	1843	1774	1770		
Q Serve(g_s), s	1.0	0.1	6.5	6.5	0.6	3.6		
Cycle Q Clear(g_c), s	1.0	0.1	6.5	6.5	0.6	3.6		
Prop In Lane	1.00	1.00		0.12	1.00			
Lane Grp Cap(c), veh/h	254	227	768	792	66	2013		
V/C Ratio(X)	0.24	0.03	0.58	0.58	0.47	0.34		
Avail Cap(c_a), veh/h	1841	1643	2078	2143	593	5659		
HCM Platoon Ratio	1.00	1.00	1.00	1.00	1.00	1.00		
Upstream Filter(I)	1.00	1.00	1.00	1.00	1.00	1.00		
Uniform Delay (d), s/veh	13.2	12.8	7.4	7.4	16.2	4.0		
Incr Delay (d2), s/veh	0.5	0.1	0.7	0.7	5.1	0.1		
Initial Q Delay(d3),s/veh	0.0	0.0	0.0	0.0	0.0	0.0		
%ile BackOfQ(50%),veh/ln	0.6	0.1	3.2	3.3	0.4	1.8		
LnGrp Delay(d),s/veh	13.7	12.8	8.1	8.1	21.3	4.1		
LnGrp LOS	B	B	A	A	C	A		
Approach Vol, veh/h	69		899			722		
Approach Delay, s/veh	13.6		8.1			4.8		
Approach LOS	B		A			A		
Timer	1	2	3	4	5	6	7	8
Assigned Phs				4		6	7	8
Phs Duration (G+Y+Rc), s				24.6		9.8	4.8	19.8
Change Period (Y+Rc), s				5.0		5.0	3.5	5.0
Max Green Setting (Gmax), s				55.0		35.0	11.5	40.0
Max Q Clear Time (g_c+I1), s				5.6		3.0	2.6	8.5
Green Ext Time (p_c), s				5.4		0.2	0.0	6.3
Intersection Summary								
HCM 2010 Ctrl Delay			6.9					
HCM 2010 LOS			A					

Intersection												
Intersection Delay, s/veh	10.5											
Intersection LOS	B											























Movement	EBL	EBT	EBR	WBL	WBT	WBR	NBL	NBT	NBR	SBL	SBT	SBR
Lane Configurations		↕			↕			↕			↕	
Traffic Vol, veh/h	10	40	30	170	30	10	20	60	170	20	70	10
Future Vol, veh/h	10	40	30	170	30	10	20	60	170	20	70	10
Peak Hour Factor	0.82	0.82	0.82	0.82	0.82	0.82	0.82	0.82	0.82	0.82	0.82	0.82
Heavy Vehicles, %	1	1	1	1	1	1	3	3	3	0	0	0
Mvmt Flow	12	49	37	207	37	12	24	73	207	24	85	12
Number of Lanes	0	1	0	0	1	0	0	1	0	0	1	0

Approach	EB	WB	NB	SB
Opposing Approach	WB	EB	SB	NB
Opposing Lanes	1	1	1	1
Conflicting Approach Left	SB	NB	EB	WB
Conflicting Lanes Left	1	1	1	1
Conflicting Approach Right	NB	SB	WB	EB
Conflicting Lanes Right	1	1	1	1
HCM Control Delay	9.1	11.4	10.7	9.4
HCM LOS	A	B	B	A

Lane	NBLn1	EBLn1	WBLn1	SBLn1
Vol Left, %	8%	12%	81%	20%
Vol Thru, %	24%	50%	14%	70%
Vol Right, %	68%	38%	5%	10%
Sign Control	Stop	Stop	Stop	Stop
Traffic Vol by Lane	250	80	210	100
LT Vol	20	10	170	20
Through Vol	60	40	30	70
RT Vol	170	30	10	10
Lane Flow Rate	305	98	256	122
Geometry Grp	1	1	1	1
Degree of Util (X)	0.392	0.141	0.376	0.178
Departure Headway (Hd)	4.729	5.2	5.283	5.269
Convergence, Y/N	Yes	Yes	Yes	Yes
Cap	765	692	686	682
Service Time	2.729	3.215	3.283	3.291
HCM Lane V/C Ratio	0.399	0.142	0.373	0.179
HCM Control Delay	10.7	9.1	11.4	9.4
HCM Lane LOS	B	A	B	A
HCM 95th-tile Q	1.9	0.5	1.8	0.6

HCM 2010 Signalized Intersection Summary
 21: 7th Avenue/8th Street & Inter-Garrison Road

Cumulative, PM
 07/12/2019

												
Movement	EBL	EBT	EBR	WBL	WBT	WBR	NBL	NBT	NBR	SBL	SBT	SBR
Lane Configurations												
Traffic Volume (veh/h)	10	260	70	130	170	30	50	180	240	80	60	10
Future Volume (veh/h)	10	260	70	130	170	30	50	180	240	80	60	10
Number	5	2	12	1	6	16	3	8	18	7	4	14
Initial Q (Qb), veh	0	0	0	0	0	0	0	0	0	0	0	0
Ped-Bike Adj(A_pbT)	1.00		0.99	1.00		0.99	1.00		0.98	1.00		1.00
Parking Bus, Adj	1.00	1.00	1.00	1.00	1.00	1.00	1.00	1.00	1.00	1.00	1.00	1.00
Adj Sat Flow, veh/h/ln	1881	1881	1900	1827	1827	1827	1810	1810	1810	1900	1900	1900
Adj Flow Rate, veh/h	11	280	69	140	183	17	54	194	186	86	65	2
Adj No. of Lanes	1	1	0	1	1	1	1	1	1	1	1	0
Peak Hour Factor	0.93	0.93	0.93	0.93	0.93	0.93	0.93	0.93	0.93	0.93	0.93	0.93
Percent Heavy Veh, %	1	1	1	4	4	4	5	5	5	0	0	0
Cap, veh/h	20	412	102	179	684	578	114	354	294	152	392	12
Arrive On Green	0.01	0.28	0.28	0.10	0.37	0.37	0.07	0.20	0.20	0.08	0.21	0.21
Sat Flow, veh/h	1792	1456	359	1740	1827	1545	1723	1810	1501	1810	1833	56
Grp Volume(v), veh/h	11	0	349	140	183	17	54	194	186	86	0	67
Grp Sat Flow(s),veh/h/ln	1792	0	1815	1740	1827	1545	1723	1810	1501	1810	0	1890
Q Serve(g_s), s	0.3	0.0	7.7	3.5	3.1	0.3	1.4	4.3	5.1	2.0	0.0	1.3
Cycle Q Clear(g_c), s	0.3	0.0	7.7	3.5	3.1	0.3	1.4	4.3	5.1	2.0	0.0	1.3
Prop In Lane	1.00		0.20	1.00		1.00	1.00		1.00	1.00		0.03
Lane Grp Cap(c), veh/h	20	0	514	179	684	578	114	354	294	152	0	404
V/C Ratio(X)	0.54	0.00	0.68	0.78	0.27	0.03	0.48	0.55	0.63	0.57	0.00	0.17
Avail Cap(c_a), veh/h	160	0	1295	291	1446	1222	903	887	736	948	0	927
HCM Platoon Ratio	1.00	1.00	1.00	1.00	1.00	1.00	1.00	1.00	1.00	1.00	1.00	1.00
Upstream Filter(I)	1.00	0.00	1.00	1.00	1.00	1.00	1.00	1.00	1.00	1.00	0.00	1.00
Uniform Delay (d), s/veh	22.1	0.0	14.3	19.6	9.8	8.9	20.2	16.3	16.6	19.8	0.0	14.4
Incr Delay (d2), s/veh	20.1	0.0	1.6	7.3	0.2	0.0	3.1	1.3	2.3	3.3	0.0	0.2
Initial Q Delay(d3),s/veh	0.0	0.0	0.0	0.0	0.0	0.0	0.0	0.0	0.0	0.0	0.0	0.0
%ile BackOfQ(50%),veh/ln	0.2	0.0	4.0	2.0	1.6	0.1	0.7	2.3	2.3	1.2	0.0	0.7
LnGrp Delay(d),s/veh	42.2	0.0	15.9	26.9	10.0	8.9	23.3	17.6	18.8	23.0	0.0	14.6
LnGrp LOS	D		B	C	A	A	C	B	B	C		B
Approach Vol, veh/h		360			340			434			153	
Approach Delay, s/veh		16.7			16.9			18.8			19.3	
Approach LOS		B			B			B			B	
Timer	1	2	3	4	5	6	7	8				
Assigned Phs	1	2	3	4	5	6	7	8				
Phs Duration (G+Y+Rc), s	8.1	17.7	5.5	13.6	4.0	21.8	6.3	12.8				
Change Period (Y+Rc), s	3.5	5.0	3.5	4.0	3.5	5.0	3.5	4.0				
Max Green Setting (Gmax), s	7.5	32.0	22.5	22.0	4.0	35.5	22.5	22.0				
Max Q Clear Time (g_c+I1), s	5.5	9.7	3.4	3.3	2.3	5.1	4.0	7.1				
Green Ext Time (p_c), s	0.1	2.0	0.1	0.2	0.0	1.1	0.2	1.5				
Intersection Summary												
HCM 2010 Ctrl Delay			17.8									
HCM 2010 LOS			B									

Intersection			
Intersection Delay, s/veh 28.5			
Intersection LOS D			
Approach	EB	WB	NB
Entry Lanes	1	1	1
Conflicting Circle Lanes	1	1	1
Adj Approach Flow, veh/h	598	680	660
Demand Flow Rate, veh/h	609	694	660
Vehicles Circulating, veh/h	410	62	483
Vehicles Exiting, veh/h	346	1081	536
Follow-Up Headway, s	3.186	3.186	3.186
Ped Vol Crossing Leg, #/h	0	0	0
Ped Cap Adj	1.000	1.000	1.000
Approach Delay, s/veh	26.5	13.0	46.3
Approach LOS	D	B	E
Lane	Left	Left	Left
Designated Moves	TR	LT	LR
Assumed Moves	TR	LT	LR
RT Channelized			
Lane Util	1.000	1.000	1.000
Critical Headway, s	5.193	5.193	5.193
Entry Flow, veh/h	609	694	660
Cap Entry Lane, veh/h	750	1062	697
Entry HV Adj Factor	0.981	0.980	1.000
Flow Entry, veh/h	598	680	660
Cap Entry, veh/h	736	1041	697
V/C Ratio	0.812	0.653	0.947
Control Delay, s/veh	26.5	13.0	46.3
LOS	D	B	E
95th %tile Queue, veh	9	5	14

HCM 2010 Signalized Intersection Summary
 23: Inter-Garrison Road & Abrams Drive

Cumulative, PM
 06/11/2019

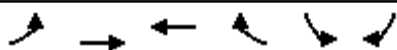

Movement	EBL	EBT	WBT	WBR	SBL	SBR		
Lane Configurations								
Traffic Volume (veh/h)	520	520	260	30	20	410		
Future Volume (veh/h)	520	520	260	30	20	410		
Number	5	2	6	16	7	14		
Initial Q (Qb), veh	0	0	0	0	0	0		
Ped-Bike Adj(A_pbT)	1.00			0.98	1.00	1.00		
Parking Bus, Adj	1.00	1.00	1.00	1.00	1.00	1.00		
Adj Sat Flow, veh/h/ln	1863	1863	1792	1792	1827	1827		
Adj Flow Rate, veh/h	547	547	274	6	21	209		
Adj No. of Lanes	1	1	1	1	2	1		
Peak Hour Factor	0.95	0.95	0.95	0.95	0.95	0.95		
Percent Heavy Veh, %	2	2	6	6	4	4		
Cap, veh/h	508	1158	446	371	562	259		
Arrive On Green	0.29	0.62	0.25	0.25	0.17	0.17		
Sat Flow, veh/h	1774	1863	1792	1491	3375	1553		
Grp Volume(v), veh/h	547	547	274	6	21	209		
Grp Sat Flow(s),veh/h/ln	1774	1863	1792	1491	1688	1553		
Q Serve(g_s), s	11.5	6.3	5.4	0.1	0.2	5.2		
Cycle Q Clear(g_c), s	11.5	6.3	5.4	0.1	0.2	5.2		
Prop In Lane	1.00			1.00	1.00	1.00		
Lane Grp Cap(c), veh/h	508	1158	446	371	562	259		
V/C Ratio(X)	1.08	0.47	0.61	0.02	0.04	0.81		
Avail Cap(c_a), veh/h	508	2780	2007	1669	2645	1217		
HCM Platoon Ratio	1.00	1.00	1.00	1.00	1.00	1.00		
Upstream Filter(I)	1.00	1.00	1.00	1.00	1.00	1.00		
Uniform Delay (d), s/veh	14.3	4.1	13.4	11.4	14.0	16.1		
Incr Delay (d2), s/veh	62.5	0.1	0.5	0.0	0.0	2.3		
Initial Q Delay(d3),s/veh	0.0	0.0	0.0	0.0	0.0	0.0		
%ile BackOfQ(50%),veh/ln	4.3	3.2	2.7	0.1	0.1	4.4		
LnGrp Delay(d),s/veh	76.9	4.2	13.9	11.4	14.1	18.4		
LnGrp LOS	F	A	B	B	B	B		
Approach Vol, veh/h		1094	280		230			
Approach Delay, s/veh		40.5	13.8		18.0			
Approach LOS		D	B		B			
Timer	1	2	3	4	5	6	7	8
Assigned Phs		2		4	5	6		
Phs Duration (G+Y+Rc), s		30.0		10.2	15.0	15.0		
Change Period (Y+Rc), s		5.0		3.5	3.5	5.0		
Max Green Setting (Gmax), s		60.0		31.5	11.5	45.0		
Max Q Clear Time (g_c+I1), s		8.3		7.2	13.5	7.4		
Green Ext Time (p_c), s		0.5		0.0	0.0	0.2		
Intersection Summary								
HCM 2010 Ctrl Delay			32.6					
HCM 2010 LOS			C					
Notes								

Intersection	
Intersection Delay, s/veh	19.8
Intersection LOS	C

Movement	EBL	EBT	WBT	WBR	SBL	SBR
Lane Configurations						
Traffic Vol, veh/h	110	460	220	50	30	40
Future Vol, veh/h	110	460	220	50	30	40
Peak Hour Factor	0.86	0.86	0.86	0.86	0.86	0.86
Heavy Vehicles, %	1	1	5	5	17	17
Mvmt Flow	128	535	256	58	35	47
Number of Lanes	1	1	2	1	1	1

Approach	EB	WB	SB
Opposing Approach	WB	EB	
Opposing Lanes	3	2	0
Conflicting Approach Left	SB		WB
Conflicting Lanes Left	2	0	3
Conflicting Approach Right		SB	EB
Conflicting Lanes Right	0	2	2
HCM Control Delay	25.6	10.1	10.6
HCM LOS	D	B	B

Lane	EBLn1	EBLn2	WBLn1	WBLn2	WBLn3	SBLn1	SBLn2
Vol Left, %	100%	0%	0%	0%	0%	100%	0%
Vol Thru, %	0%	100%	100%	100%	0%	0%	0%
Vol Right, %	0%	0%	0%	0%	100%	0%	100%
Sign Control	Stop	Stop	Stop	Stop	Stop	Stop	Stop
Traffic Vol by Lane	110	460	110	110	50	30	40
LT Vol	110	0	0	0	0	30	0
Through Vol	0	460	110	110	0	0	0
RT Vol	0	0	0	0	50	0	40
Lane Flow Rate	128	535	128	128	58	35	47
Geometry Grp	8	8	8	8	8	8	8
Degree of Util (X)	0.215	0.826	0.226	0.226	0.062	0.077	0.087
Departure Headway (Hd)	6.062	5.56	6.357	6.357	3.849	7.934	6.723
Convergence, Y/N	Yes	Yes	Yes	Yes	Yes	Yes	Yes
Cap	593	653	565	565	928	452	533
Service Time	3.786	3.283	4.09	4.09	1.582	5.68	4.468
HCM Lane V/C Ratio	0.216	0.819	0.227	0.227	0.063	0.077	0.088
HCM Control Delay	10.4	29.2	10.9	10.9	6.8	11.3	10.1
HCM Lane LOS	B	D	B	B	A	B	B
HCM 95th-tile Q	0.8	8.8	0.9	0.9	0.2	0.2	0.3

Intersection						
Intersection Delay, s/veh	17.3					
Intersection LOS	C					

Movement	EBL	EBT	WBT	WBR	SBL	SBR
Lane Configurations						
Traffic Vol, veh/h	350	140	100	130	190	110
Future Vol, veh/h	350	140	100	130	190	110
Peak Hour Factor	0.87	0.87	0.87	0.87	0.87	0.87
Heavy Vehicles, %	1	1	6	6	3	3
Mvmt Flow	402	161	115	149	218	126
Number of Lanes	1	1	1	0	1	1

Approach	EB	WB	SB
Opposing Approach	WB	EB	
Opposing Lanes	1	2	0
Conflicting Approach Left	SB		WB
Conflicting Lanes Left	2	0	1
Conflicting Approach Right		SB	EB
Conflicting Lanes Right	0	2	2
HCM Control Delay	21.1	13.7	13.9
HCM LOS	C	B	B

Lane	EBLn1	EBLn2	WBLn1	SBLn1	SBLn2
Vol Left, %	100%	0%	0%	100%	0%
Vol Thru, %	0%	100%	43%	0%	0%
Vol Right, %	0%	0%	57%	0%	100%
Sign Control	Stop	Stop	Stop	Stop	Stop
Traffic Vol by Lane	350	140	230	190	110
LT Vol	350	0	0	190	0
Through Vol	0	140	100	0	0
RT Vol	0	0	130	0	110
Lane Flow Rate	402	161	264	218	126
Geometry Grp	7	7	4	7	7
Degree of Util (X)	0.732	0.27	0.44	0.443	0.214
Departure Headway (Hd)	6.553	6.046	5.988	7.299	6.079
Convergence, Y/N	Yes	Yes	Yes	Yes	Yes
Cap	551	594	600	494	589
Service Time	4.299	3.792	4.037	5.052	3.831
HCM Lane V/C Ratio	0.73	0.271	0.44	0.441	0.214
HCM Control Delay	25.2	11	13.7	15.8	10.5
HCM Lane LOS	D	B	B	C	B
HCM 95th-tile Q	6.1	1.1	2.2	2.2	0.8

HCM 2010 Signalized Intersection Summary
 26: East Garrison Road & Reservation Road

Cumulative, PM
 06/11/2019



Movement	EBL	EBT	EBR	WBL	WBT	WBR	NBL	NBT	NBR	SBL	SBT	SBR
Lane Configurations	↖	↗		↖	↗		↖		↗			
Traffic Volume (veh/h)	0	1350	190	240	500	0	150	0	150	0	0	0
Future Volume (veh/h)	0	1350	190	240	500	0	150	0	150	0	0	0
Number	5	2	12	1	6	16	3	8	18			
Initial Q (Qb), veh	0	0	0	0	0	0	0	0	0			
Ped-Bike Adj(A_pbT)	1.00		1.00	1.00		1.00	1.00		1.00			
Parking Bus, Adj	1.00	1.00	1.00	1.00	1.00	1.00	1.00	1.00	1.00			
Adj Sat Flow, veh/h/ln	1863	1863	1900	1881	1881	0	1845	0	1845			
Adj Flow Rate, veh/h	0	1392	194	247	515	0	155	0	126			
Adj No. of Lanes	1	2	0	1	2	0	1	0	1			
Peak Hour Factor	0.97	0.97	0.97	0.97	0.97	0.97	0.97	0.97	0.97			
Percent Heavy Veh, %	2	2	2	1	1	0	3	0	3			
Cap, veh/h	2	1814	250	282	2780	0	193	0	172			
Arrive On Green	0.00	0.58	0.58	0.16	0.78	0.00	0.11	0.00	0.11			
Sat Flow, veh/h	1774	3125	431	1792	3668	0	1757	0	1568			
Grp Volume(v), veh/h	0	783	803	247	515	0	155	0	126			
Grp Sat Flow(s),veh/h/ln	1774	1770	1787	1792	1787	0	1757	0	1568			
Q Serve(g_s), s	0.0	29.9	30.8	12.1	3.4	0.0	7.7	0.0	7.0			
Cycle Q Clear(g_c), s	0.0	29.9	30.8	12.1	3.4	0.0	7.7	0.0	7.0			
Prop In Lane	1.00		0.24	1.00		0.00	1.00		1.00			
Lane Grp Cap(c), veh/h	2	1027	1037	282	2780	0	193	0	172			
V/C Ratio(X)	0.00	0.76	0.77	0.88	0.19	0.00	0.80	0.00	0.73			
Avail Cap(c_a), veh/h	395	1182	1193	399	2780	0	528	0	471			
HCM Platoon Ratio	1.00	1.00	1.00	1.00	1.00	1.00	1.00	1.00	1.00			
Upstream Filter(I)	0.00	1.00	1.00	1.00	1.00	0.00	1.00	0.00	1.00			
Uniform Delay (d), s/veh	0.0	14.2	14.4	37.0	2.6	0.0	39.0	0.0	38.7			
Incr Delay (d2), s/veh	0.0	3.2	3.5	11.3	0.0	0.0	3.0	0.0	2.2			
Initial Q Delay(d3),s/veh	0.0	0.0	0.0	0.0	0.0	0.0	0.0	0.0	0.0			
%ile BackOfQ(50%),veh/ln	0.0	15.3	16.0	6.9	1.7	0.0	3.9	0.0	3.1			
LnGrp Delay(d),s/veh	0.0	17.4	17.9	48.3	2.6	0.0	42.0	0.0	41.0			
LnGrp LOS		B	B	D	A		D		D			
Approach Vol, veh/h		1586			762			281				
Approach Delay, s/veh		17.7			17.4			41.5				
Approach LOS		B			B			D				
Timer	1	2	3	4	5	6	7	8				
Assigned Phs	1	2			5	6		8				
Phs Duration (G+Y+Rc), s	7.7	57.6			0.0	75.3		14.6				
Change Period (Y+Rc), s	3.6	5.4			3.5	5.4		4.7				
Max Green Setting (Gmax), s	20	60.0			20.0	60.0		27.0				
Max Q Clear Time (g_c+1/4), s	11.4	32.8			0.0	5.4		9.7				
Green Ext Time (p_c), s	0.0	19.4			0.0	4.1		0.1				
Intersection Summary												
HCM 2010 Ctrl Delay				20.1								
HCM 2010 LOS				C								
Notes												

HCM 2010 Signalized Intersection Summary
 27: Reservation Road & Watkins Gate Road

Cumulative, PM
 06/11/2019



Movement	EBL	EBR	NBL	NBT	SBT	SBR		
Lane Configurations								
Traffic Volume (veh/h)	10	230	220	930	1960	60		
Future Volume (veh/h)	10	230	220	930	1960	60		
Number	5	12	3	8	4	14		
Initial Q (Qb), veh	0	0	0	0	0	0		
Ped-Bike Adj(A_pbT)	1.00	1.00	1.00			1.00		
Parking Bus, Adj	1.00	1.00	1.00	1.00	1.00	1.00		
Adj Sat Flow, veh/h/ln	1863	1863	1881	1881	1863	1900		
Adj Flow Rate, veh/h	11	43	239	1011	2130	62		
Adj No. of Lanes	1	1	1	2	2	0		
Peak Hour Factor	0.92	0.92	0.92	0.92	0.92	0.92		
Percent Heavy Veh, %	2	2	1	1	2	2		
Cap, veh/h	65	58	247	3088	2443	71		
Arrive On Green	0.04	0.04	0.14	0.86	0.70	0.70		
Sat Flow, veh/h	1774	1583	1792	3668	3606	102		
Grp Volume(v), veh/h	11	43	239	1011	1068	1124		
Grp Sat Flow(s),veh/h/ln	1774	1583	1792	1787	1770	1845		
Q Serve(g_s), s	0.8	3.5	17.3	7.0	60.5	62.0		
Cycle Q Clear(g_c), s	0.8	3.5	17.3	7.0	60.5	62.0		
Prop In Lane	1.00	1.00	1.00			0.06		
Lane Grp Cap(c), veh/h	65	58	247	3088	1231	1283		
V/C Ratio(X)	0.17	0.75	0.97	0.33	0.87	0.88		
Avail Cap(c_a), veh/h	279	249	247	3189	1281	1335		
HCM Platoon Ratio	1.00	1.00	1.00	1.00	1.00	1.00		
Upstream Filter(I)	1.00	1.00	1.00	1.00	1.00	1.00		
Uniform Delay (d), s/veh	61.0	62.3	56.0	1.7	15.3	15.5		
Incr Delay (d2), s/veh	0.5	6.9	47.8	0.1	6.7	7.0		
Initial Q Delay(d3),s/veh	0.0	0.0	0.0	0.0	0.0	0.0		
%ile BackOfQ(50%),veh/ln	0.4	1.6	11.8	3.4	31.4	33.7		
LnGrp Delay(d),s/veh	61.5	69.2	103.8	1.8	22.0	22.5		
LnGrp LOS	E	E	F	A	C	C		
Approach Vol, veh/h	54			1250	2192			
Approach Delay, s/veh	67.7			21.3	22.2			
Approach LOS	E			C	C			
Timer	1	2	3	4	5	6	7	8
Assigned Phs		2	3	4				8
Phs Duration (G+Y+Rc), s		11.3	22.0	97.3				119.3
Change Period (Y+Rc), s		6.5	4.0	6.5				6.5
Max Green Setting (Gmax), s		20.5	18.0	94.5				116.5
Max Q Clear Time (g_c+11), s		5.5	19.3	64.0				9.0
Green Ext Time (p_c), s		0.0	0.0	26.8				14.0
Intersection Summary								
HCM 2010 Ctrl Delay			22.6					
HCM 2010 LOS			C					

HCM 2010 Signalized Intersection Summary
28: Davis Road & Reservation Road

Cumulative, PM
06/11/2019



Movement	EBL	EBT	EBR	WBL	WBT	WBR	NBL	NBT	NBR	SBL	SBT	SBR
Lane Configurations												
Traffic Volume (veh/h)	1120	500	10	10	350	110	10	10	10	130	10	480
Future Volume (veh/h)	1120	500	10	10	350	110	10	10	10	130	10	480
Number	5	2	12	1	6	16	3	8	18	7	4	14
Initial Q (Qb), veh	0	0	0	0	0	0	0	0	0	0	0	0
Ped-Bike Adj(A_pbT)	1.00		1.00	1.00		1.00	1.00		1.00	1.00		1.00
Parking Bus, Adj	1.00	1.00	1.00	1.00	1.00	1.00	1.00	1.00	1.00	1.00	1.00	1.00
Adj Sat Flow, veh/h/ln	1863	1863	1900	1827	1835	1900	1900	1900	1900	1900	1881	1881
Adj Flow Rate, veh/h	1191	532	11	11	372	117	11	11	9	138	11	376
Adj No. of Lanes	1	2	0	1	1	0	0	1	0	0	1	1
Peak Hour Factor	0.94	0.94	0.94	0.94	0.94	0.94	0.94	0.94	0.94	0.94	0.94	0.94
Percent Heavy Veh, %	2	2	2	4	4	4	0	0	0	1	1	1
Cap, veh/h	511	2123	44	17	444	140	18	18	15	317	25	728
Arrive On Green	0.29	0.60	0.60	0.01	0.33	0.32	0.03	0.03	0.03	0.20	0.19	0.18
Sat Flow, veh/h	1774	3546	73	1740	1340	421	631	631	516	1665	133	1599
Grp Volume(v), veh/h	1191	265	278	11	0	489	31	0	0	149	0	376
Grp Sat Flow(s),veh/h/ln	1774	1770	1850	1740	0	1761	1777	0	0	1798	0	1599
Q Serve(g_s), s	30.0	7.4	7.4	0.7	0.0	26.8	1.8	0.0	0.0	7.6	0.0	17.4
Cycle Q Clear(g_c), s	30.0	7.4	7.4	0.7	0.0	26.8	1.8	0.0	0.0	7.6	0.0	17.4
Prop In Lane	1.00		0.04	1.00		0.24	0.35		0.29	0.93		1.00
Lane Grp Cap(c), veh/h	511	1060	1108	17	0	584	51	0	0	342	0	728
V/C Ratio(X)	2.33	0.25	0.25	0.66	0.00	0.84	0.61	0.00	0.00	0.44	0.00	0.52
Avail Cap(c_a), veh/h	511	1060	1108	500	0	1032	512	0	0	518	0	884
HCM Platoon Ratio	1.00	1.00	1.00	1.00	1.00	1.00	1.00	1.00	1.00	1.00	1.00	1.00
Upstream Filter(I)	1.00	1.00	1.00	1.00	0.00	1.00	1.00	0.00	0.00	1.00	0.00	1.00
Uniform Delay (d), s/veh	37.1	9.9	9.9	51.4	0.0	32.3	50.0	0.0	0.0	36.8	0.0	20.2
Incr Delay (d2), s/veh	604.8	0.2	0.2	15.6	0.0	5.1	4.4	0.0	0.0	0.3	0.0	0.2
Initial Q Delay(d3),s/veh	0.0	0.0	0.0	0.0	0.0	0.0	0.0	0.0	0.0	0.0	0.0	0.0
%ile BackOfQ(50%),veh/ln	100.5	3.6	3.8	0.4	0.0	13.7	0.9	0.0	0.0	3.8	0.0	7.7
LnGrp Delay(d),s/veh	641.9	10.1	10.0	67.1	0.0	37.4	54.4	0.0	0.0	37.1	0.0	20.4
LnGrp LOS	F	B	B	E		D	D			D		C
Approach Vol, veh/h		1734			500			31			525	
Approach Delay, s/veh		444.0			38.0			54.4			25.1	
Approach LOS		F			D			D			C	
Timer	1	2	3	4	5	6	7	8				
Assigned Phs	1	2		4	5	6		8				
Phs Duration (G+Y+Rc), s	5.0	67.4		24.8	33.8	38.5		7.0				
Change Period (Y+Rc), s	3.9	5.0		5.0	* 3.8	5.0		4.0				
Max Green Setting (Gmax), s	30	60.0		30.0	* 30	60.0		30.0				
Max Q Clear Time (g_c+1/2), s	12.5	9.4		19.4	32.0	28.8		3.8				
Green Ext Time (p_c), s	0.0	5.1		0.4	0.0	4.8		0.0				
Intersection Summary												
HCM 2010 Ctrl Delay				288.1								
HCM 2010 LOS				F								
Notes												

HCM 2010 Signalized Intersection Summary
 29: 2nd Avenue & Divarty Street

Cumulative, PM
 06/11/2019



Movement	EBL	EBT	EBR	WBL	WBT	WBR	NBL	NBT	NBR	SBL	SBT	SBR
Lane Configurations		↕			↕	↕	↕	↕↔		↕	↕↔	
Traffic Volume (veh/h)	200	10	80	80	10	20	40	670	60	20	620	100
Future Volume (veh/h)	200	10	80	80	10	20	40	670	60	20	620	100
Number	5	2	12	1	6	16	3	8	18	7	4	14
Initial Q (Qb), veh	0	0	0	0	0	0	0	0	0	0	0	0
Ped-Bike Adj(A_pbT)	1.00		1.00	1.00		1.00	1.00		0.99	1.00		0.99
Parking Bus, Adj	1.00	1.00	1.00	1.00	1.00	1.00	1.00	1.00	1.00	1.00	1.00	1.00
Adj Sat Flow, veh/h/ln	1900	1900	1900	1900	1900	1900	1900	1900	1900	1881	1881	1900
Adj Flow Rate, veh/h	213	11	85	85	11	21	43	713	64	21	660	106
Adj No. of Lanes	0	1	0	0	1	1	1	2	0	1	2	0
Peak Hour Factor	0.94	0.94	0.94	0.94	0.94	0.94	0.94	0.94	0.94	0.94	0.94	0.94
Percent Heavy Veh, %	0	0	0	0	0	0	0	0	0	1	1	1
Cap, veh/h	405	37	117	531	59	501	84	1214	109	46	1054	169
Arrive On Green	0.33	0.31	0.31	0.33	0.31	0.31	0.05	0.36	0.36	0.03	0.34	0.34
Sat Flow, veh/h	867	119	374	1219	190	1607	1810	3350	300	1792	3083	495
Grp Volume(v), veh/h	309	0	0	96	0	21	43	384	393	21	382	384
Grp Sat Flow(s),veh/h/ln	1361	0	0	1409	0	1607	1810	1805	1845	1792	1787	1790
Q Serve(g_s), s	7.3	0.0	0.0	0.0	0.0	0.4	1.0	7.7	7.8	0.5	8.0	8.1
Cycle Q Clear(g_c), s	9.4	0.0	0.0	2.1	0.0	0.4	1.0	7.7	7.8	0.5	8.0	8.1
Prop In Lane	0.69		0.28	0.89		1.00	1.00		0.16	1.00		0.28
Lane Grp Cap(c), veh/h	590	0	0	621	0	501	84	654	669	46	611	612
V/C Ratio(X)	0.52	0.00	0.00	0.15	0.00	0.04	0.51	0.59	0.59	0.46	0.63	0.63
Avail Cap(c_a), veh/h	1272	0	0	1259	0	1252	463	1606	1642	458	1392	1394
HCM Platoon Ratio	1.00	1.00	1.00	1.00	1.00	1.00	1.00	1.00	1.00	1.00	1.00	1.00
Upstream Filter(I)	1.00	0.00	0.00	1.00	0.00	1.00	1.00	1.00	1.00	1.00	1.00	1.00
Uniform Delay (d), s/veh	13.9	0.0	0.0	11.0	0.0	10.8	20.9	11.6	11.6	21.6	12.4	12.4
Incr Delay (d2), s/veh	0.7	0.0	0.0	0.1	0.0	0.0	4.8	0.8	0.8	6.9	1.1	1.1
Initial Q Delay(d3),s/veh	0.0	0.0	0.0	0.0	0.0	0.0	0.0	0.0	0.0	0.0	0.0	0.0
%ile BackOfQ(50%),veh/ln	3.3	0.0	0.0	0.8	0.0	0.2	0.6	4.0	4.1	0.3	4.1	4.1
LnGrp Delay(d),s/veh	14.6	0.0	0.0	11.1	0.0	10.8	25.8	12.4	12.4	28.5	13.4	13.5
LnGrp LOS	B			B		B	C	B	B	C	B	B
Approach Vol, veh/h		309			117			820			787	
Approach Delay, s/veh		14.6			11.1			13.1			13.8	
Approach LOS		B			B			B			B	
Timer	1	2	3	4	5	6	7	8				
Assigned Phs		2	3	4		6	7	8				
Phs Duration (G+Y+Rc), s		19.0	5.6	20.4		19.0	4.7	21.3				
Change Period (Y+Rc), s		5.0	3.5	5.0		5.0	3.5	5.0				
Max Green Setting (Gmax), s		35.0	11.5	35.0		35.0	11.5	40.0				
Max Q Clear Time (g_c+I1), s		11.4	3.0	10.1		4.1	2.5	9.8				
Green Ext Time (p_c), s		1.8	0.0	5.0		0.6	0.0	5.2				
Intersection Summary												
HCM 2010 Ctrl Delay				13.5								
HCM 2010 LOS				B								

Intersection												
Intersection Delay, s/veh	11.9											
Intersection LOS	B											

Movement	EBL	EBT	EBR	WBL	WBT	WBR	NBL	NBT	NBR	SBL	SBT	SBR
Lane Configurations		↕			↕		↕	↕		↕	↕	
Traffic Vol, veh/h	20	10	30	40	10	10	20	240	70	10	240	20
Future Vol, veh/h	20	10	30	40	10	10	20	240	70	10	240	20
Peak Hour Factor	0.85	0.85	0.85	0.85	0.85	0.85	0.85	0.85	0.85	0.85	0.85	0.85
Heavy Vehicles, %	0	0	0	1	1	1	0	0	0	1	1	1
Mvmt Flow	24	12	35	47	12	12	24	282	82	12	282	24
Number of Lanes	0	1	0	0	1	0	1	1	0	1	1	0

Approach	EB	WB	NB	SB
Opposing Approach	WB	EB	SB	NB
Opposing Lanes	1	1	2	2
Conflicting Approach Left	SB	NB	EB	WB
Conflicting Lanes Left	2	2	1	1
Conflicting Approach Right	NB	SB	WB	EB
Conflicting Lanes Right	2	2	1	1
HCM Control Delay	9.2	9.6	12.7	12
HCM LOS	A	A	B	B

Lane	NBLn1	NBLn2	EBLn1	WBLn1	SBLn1	SBLn2
Vol Left, %	100%	0%	33%	67%	100%	0%
Vol Thru, %	0%	77%	17%	17%	0%	92%
Vol Right, %	0%	23%	50%	17%	0%	8%
Sign Control	Stop	Stop	Stop	Stop	Stop	Stop
Traffic Vol by Lane	20	310	60	60	10	260
LT Vol	20	0	20	40	10	0
Through Vol	0	240	10	10	0	240
RT Vol	0	70	30	10	0	20
Lane Flow Rate	24	365	71	71	12	306
Geometry Grp	7	7	2	2	7	7
Degree of Util (X)	0.037	0.509	0.109	0.114	0.019	0.442
Departure Headway (Hd)	5.683	5.02	5.562	5.839	5.758	5.199
Convergence, Y/N	Yes	Yes	Yes	Yes	Yes	Yes
Cap	625	711	648	617	617	685
Service Time	3.46	2.797	3.562	3.842	3.54	2.981
HCM Lane V/C Ratio	0.038	0.513	0.11	0.115	0.019	0.447
HCM Control Delay	8.7	13	9.2	9.6	8.7	12.1
HCM Lane LOS	A	B	A	A	A	B
HCM 95th-tile Q	0.1	2.9	0.4	0.4	0.1	2.3

HCM 2010 Signalized Intersection Summary
 31: 1st Avenue & Lightfighter Drive

Cumulative, PM
 06/11/2019



Movement	EBL	EBT	EBR	WBL	WBT	WBR	NBL	NBT	NBR	SBL	SBT	SBR
Lane Configurations		↑↑	↑	↑	↑↑		↑		↑	↑	↑	↑
Traffic Volume (veh/h)	0	730	110	20	1340	0	200	0	30	60	50	80
Future Volume (veh/h)	0	730	110	20	1340	0	200	0	30	60	50	80
Number	7	4	14	3	8	18	5	2	12	1	6	16
Initial Q (Qb), veh	0	0	0	0	0	0	0	0	0	0	0	0
Ped-Bike Adj(A_pbT)	1.00		1.00	1.00		1.00	1.00		1.00	1.00		1.00
Parking Bus, Adj	1.00	1.00	1.00	1.00	1.00	1.00	1.00	1.00	1.00	1.00	1.00	1.00
Adj Sat Flow, veh/h/ln	0	1881	1881	1881	1881	0	1881	0	1881	1810	1810	1810
Adj Flow Rate, veh/h	0	768	0	21	1411	0	211	0	14	63	53	64
Adj No. of Lanes	0	2	1	1	2	0	1	0	1	1	1	1
Peak Hour Factor	0.95	0.95	0.95	0.95	0.95	0.95	0.95	0.95	0.95	0.95	0.95	0.95
Percent Heavy Veh, %	0	1	1	1	1	0	1	0	1	5	5	5
Cap, veh/h	0	2129	952	23	2478	0	0	0	0	144	152	129
Arrive On Green	0.00	0.60	0.00	0.01	0.69	0.00	0.00	0.00	0.00	0.08	0.08	0.08
Sat Flow, veh/h	0	3668	1599	1792	3668	0		0		1723	1810	1538
Grp Volume(v), veh/h	0	768	0	21	1411	0		0.0		63	53	64
Grp Sat Flow(s),veh/h/ln	0	1787	1599	1792	1787	0				1723	1810	1538
Q Serve(g_s), s	0.0	4.6	0.0	0.5	8.3	0.0				1.4	1.1	1.6
Cycle Q Clear(g_c), s	0.0	4.6	0.0	0.5	8.3	0.0				1.4	1.1	1.6
Prop In Lane	0.00		1.00	1.00		0.00				1.00		1.00
Lane Grp Cap(c), veh/h	0	2129	952	23	2478	0				144	152	129
V/C Ratio(X)	0.00	0.36	0.00	0.91	0.57	0.00				0.44	0.35	0.50
Avail Cap(c_a), veh/h	0	3897	1744	868	3897	0				1044	1096	932
HCM Platoon Ratio	1.00	1.00	1.00	1.00	1.00	1.00				1.00	1.00	1.00
Upstream Filter(I)	0.00	1.00	0.00	1.00	1.00	0.00				1.00	1.00	1.00
Uniform Delay (d), s/veh	0.0	4.3	0.0	20.3	3.2	0.0				18.0	17.8	18.1
Incr Delay (d2), s/veh	0.0	0.1	0.0	33.7	0.3	0.0				0.8	0.5	1.1
Initial Q Delay(d3),s/veh	0.0	0.0	0.0	0.0	0.0	0.0				0.0	0.0	0.0
%ile BackOfQ(50%),veh/ln	0.0	2.2	0.0	0.5	4.0	0.0				0.7	0.6	0.7
LnGrp Delay(d),s/veh	0.0	4.4	0.0	54.0	3.5	0.0				18.7	18.4	19.2
LnGrp LOS		A		D	A					B	B	B
Approach Vol, veh/h		768			1432						180	
Approach Delay, s/veh		4.4			4.2						18.8	
Approach LOS		A			A						B	
Timer	1	2	3	4	5	6	7	8				
Assigned Phs			3	4		6		8				
Phs Duration (G+Y+Rc), s			4.0	29.2		8.1		33.2				
Change Period (Y+Rc), s			3.5	4.6		4.6		4.6				
Max Green Setting (Gmax), s			20.0	45.0		25.0		45.0				
Max Q Clear Time (g_c+I1), s			2.5	6.6		3.6		10.3				
Green Ext Time (p_c), s			0.0	9.1		0.3		18.4				
Intersection Summary												
HCM 2010 Ctrl Delay			5.4									
HCM 2010 LOS			A									

HCM 2010 Signalized Intersection Summary
32: 2nd Avenue & Lightfighter Drive

Cumulative, PM
06/11/2019



Movement	EBL	EBT	EBR	WBL	WBT	WBR	NBL	NBT	NBR	SBL	SBT	SBR
Lane Configurations												
Traffic Volume (veh/h)	290	530	10	80	1070	220	20	20	50	230	30	330
Future Volume (veh/h)	290	530	10	80	1070	220	20	20	50	230	30	330
Number	5	2	12	1	6	16	3	8	18	7	4	14
Initial Q (Qb), veh	0	0	0	0	0	0	0	0	0	0	0	0
Ped-Bike Adj(A_pbT)	1.00		1.00	1.00		1.00	1.00		0.99	1.00		0.99
Parking Bus, Adj	1.00	1.00	1.00	1.00	1.00	1.00	1.00	1.00	1.00	1.00	1.00	1.00
Adj Sat Flow, veh/h/ln	1881	1881	1900	1881	1881	1900	1900	1900	1900	1845	1845	1845
Adj Flow Rate, veh/h	305	558	11	84	1126	227	21	21	47	242	32	244
Adj No. of Lanes	1	2	0	1	2	0	0	1	0	1	1	1
Peak Hour Factor	0.95	0.95	0.95	0.95	0.95	0.95	0.95	0.95	0.95	0.95	0.95	0.95
Percent Heavy Veh, %	1	1	1	1	1	1	0	0	0	3	3	3
Cap, veh/h	222	2170	43	108	1606	322	96	99	168	349	374	316
Arrive On Green	0.12	0.61	0.61	0.06	0.54	0.54	0.21	0.20	0.20	0.20	0.20	0.20
Sat Flow, veh/h	1792	3585	71	1792	2967	595	252	490	830	1308	1845	1559
Grp Volume(v), veh/h	305	278	291	84	676	677	89	0	0	242	32	244
Grp Sat Flow(s),veh/h/ln	1792	1787	1869	1792	1787	1775	1571	0	0	1308	1845	1559
Q Serve(g_s), s	12.4	7.3	7.3	4.6	27.9	28.3	0.0	0.0	0.0	12.7	1.4	14.8
Cycle Q Clear(g_c), s	12.4	7.3	7.3	4.6	27.9	28.3	4.3	0.0	0.0	17.0	1.4	14.8
Prop In Lane	1.00		0.04	1.00		0.34	0.24		0.53	1.00		1.00
Lane Grp Cap(c), veh/h	222	1082	1131	108	967	961	372	0	0	349	374	316
V/C Ratio(X)	1.37	0.26	0.26	0.78	0.70	0.70	0.24	0.00	0.00	0.69	0.09	0.77
Avail Cap(c_a), veh/h	222	1082	1131	222	967	961	675	0	0	612	745	630
HCM Platoon Ratio	1.00	1.00	1.00	1.00	1.00	1.00	1.00	1.00	1.00	1.00	1.00	1.00
Upstream Filter(I)	0.91	0.91	0.91	0.20	0.20	0.20	1.00	0.00	0.00	0.77	0.77	0.77
Uniform Delay (d), s/veh	43.8	9.2	9.2	46.4	16.9	17.0	33.4	0.0	0.0	38.3	32.3	37.7
Incr Delay (d2), s/veh	191.6	0.5	0.5	1.0	0.9	0.9	0.1	0.0	0.0	0.7	0.0	1.2
Initial Q Delay(d3),s/veh	0.0	0.0	0.0	0.0	0.0	0.0	0.0	0.0	0.0	0.0	0.0	0.0
%ile BackOfQ(50%),veh/ln	7.9	3.7	3.9	2.3	13.9	14.0	2.1	0.0	0.0	6.5	0.7	6.5
LnGrp Delay(d),s/veh	235.4	9.8	9.7	47.3	17.8	17.9	33.6	0.0	0.0	39.0	32.4	38.9
LnGrp LOS	F	A	A	D	B	B	C			D	C	D
Approach Vol, veh/h		874			1437			89			518	
Approach Delay, s/veh		88.5			19.6			33.6			38.5	
Approach LOS		F			B			C			D	
Timer	1	2	3	4	5	6	7	8				
Assigned Phs	1	2		4	5	6		8				
Phs Duration (G+Y+Rc), s	40.0	65.1		24.9	16.4	58.7		24.9				
Change Period (Y+Rc), s	4.0	4.6		4.6	4.0	4.6		4.6				
Max Green Setting (Gmax), s	40.0	34.0		40.4	12.4	24.4		40.4				
Max Q Clear Time (g_c+10), s	10.0	9.3		19.0	14.4	30.3		6.3				
Green Ext Time (p_c), s	0.0	2.0		0.9	0.0	0.0		0.3				
Intersection Summary												
HCM 2010 Ctrl Delay				44.0								
HCM 2010 LOS				D								

HCM 2010 Signalized Intersection Summary
 33: General Jim Moore Boulevard & Lightfighter Drive

Cumulative, PM
 06/11/2019



Movement	EBL	EBT	EBR	WBL	WBT	WBR	NBL	NBT	NBR	SBL	SBT	SBR
Lane Configurations												
Traffic Volume (veh/h)	80	270	600	40	270	50	600	170	20	60	180	40
Future Volume (veh/h)	80	270	600	40	270	50	600	170	20	60	180	40
Number	3	8	18	7	4	14	1	6	16	5	2	12
Initial Q (Qb), veh	0	0	0	0	0	0	0	0	0	0	0	0
Ped-Bike Adj(A_pbT)	1.00		1.00	1.00		1.00	1.00		1.00	1.00		1.00
Parking Bus, Adj	1.00	1.00	1.00	1.00	1.00	1.00	1.00	1.00	1.00	1.00	1.00	1.00
Adj Sat Flow, veh/h/ln	1881	1881	1881	1900	1900	1900	1881	1881	1900	1900	1900	1900
Adj Flow Rate, veh/h	83	281	0	42	281	51	625	177	19	62	188	-70
Adj No. of Lanes	1	1	1	1	1	0	2	1	0	1	2	0
Peak Hour Factor	0.96	0.96	0.96	0.96	0.96	0.96	0.96	0.96	0.96	0.96	0.96	0.96
Percent Heavy Veh, %	1	1	1	0	0	0	1	1	1	0	0	0
Cap, veh/h	108	522	444	64	396	72	702	462	50	84	438	0
Arrive On Green	0.06	0.28	0.00	0.04	0.25	0.25	0.20	0.28	0.28	0.05	0.12	0.00
Sat Flow, veh/h	1792	1881	1599	1810	1566	284	3476	1670	179	1810	3705	0
Grp Volume(v), veh/h	83	281	0	42	0	332	625	0	196	62	118	0
Grp Sat Flow(s),veh/h/ln	1792	1881	1599	1810	0	1850	1738	0	1850	1810	1805	0
Q Serve(g_s), s	2.3	6.3	0.0	1.1	0.0	8.1	8.7	0.0	4.2	1.7	1.5	0.0
Cycle Q Clear(g_c), s	2.3	6.3	0.0	1.1	0.0	8.1	8.7	0.0	4.2	1.7	1.5	0.0
Prop In Lane	1.00		1.00	1.00		0.15	1.00		0.10	1.00		0.00
Lane Grp Cap(c), veh/h	108	522	444	64	0	467	702	0	512	84	438	0
V/C Ratio(X)	0.77	0.54	0.00	0.65	0.00	0.71	0.89	0.00	0.38	0.74	0.27	0.00
Avail Cap(c_a), veh/h	724	1140	969	731	0	1121	702	0	1121	548	2188	0
HCM Platoon Ratio	1.00	1.00	1.00	1.00	1.00	1.00	1.00	1.00	1.00	1.00	1.00	1.00
Upstream Filter(I)	1.00	1.00	0.00	1.00	0.00	1.00	1.00	0.00	1.00	1.00	1.00	0.00
Uniform Delay (d), s/veh	22.9	15.2	0.0	23.6	0.0	16.8	19.2	0.0	14.5	23.3	19.8	0.0
Incr Delay (d2), s/veh	10.6	1.0	0.0	4.1	0.0	2.4	13.3	0.0	1.0	4.7	0.4	0.0
Initial Q Delay(d3),s/veh	0.0	0.0	0.0	0.0	0.0	0.0	0.0	0.0	0.0	0.0	0.0	0.0
%ile BackOfQ(50%),veh/ln	1.4	3.4	0.0	0.6	0.0	4.4	5.5	0.0	2.3	0.9	0.8	0.0
LnGrp Delay(d),s/veh	33.5	16.2	0.0	27.7	0.0	19.3	32.6	0.0	15.5	28.0	20.2	0.0
LnGrp LOS	C	B		C		B	C		B	C	C	
Approach Vol, veh/h		364			374			821			180	
Approach Delay, s/veh		20.2			20.2			28.5			22.9	
Approach LOS		C			C			C			C	
Timer	1	2	3	4	5	6	7	8				
Assigned Phs	1	2	3	4	5	6	7	8				
Phs Duration (G+Y+Rc), s	4.5	10.5	7.5	17.0	6.8	18.2	6.3	18.2				
Change Period (Y+Rc), s	4.5	4.5	4.5	4.5	4.5	4.5	4.5	4.5				
Max Green Setting (Gmax), s	30.0	30.0	20.0	30.0	15.0	30.0	20.0	30.0				
Max Q Clear Time (g_c+110), s	3.5	4.3	10.1	3.7	6.2	3.1	8.3					
Green Ext Time (p_c), s	0.0	0.8	0.1	2.4	0.0	2.0	0.0	1.8				
Intersection Summary												
HCM 2010 Ctrl Delay			24.4									
HCM 2010 LOS			C									

Intersection	
Intersection Delay, s/veh	13
Intersection LOS	B

Movement	WBL	WBR	NBT	NBR	SBL	SBT
Lane Configurations						
Traffic Vol, veh/h	30	290	60	50	300	50
Future Vol, veh/h	30	290	60	50	300	50
Peak Hour Factor	0.88	0.88	0.88	0.88	0.88	0.88
Heavy Vehicles, %	0	0	2	2	1	1
Mvmt Flow	34	330	68	57	341	57
Number of Lanes	1	0	1	0	0	1

Approach	WB	NB	SB
Opposing Approach		SB	NB
Opposing Lanes	0	1	1
Conflicting Approach Left	NB		WB
Conflicting Lanes Left	1	0	1
Conflicting Approach Right	SB	WB	
Conflicting Lanes Right	1	1	0
HCM Control Delay	12	9.3	15
HCM LOS	B	A	B

Lane	NBLn1	WBLn1	SBLn1
Vol Left, %	0%	9%	86%
Vol Thru, %	55%	0%	14%
Vol Right, %	45%	91%	0%
Sign Control	Stop	Stop	Stop
Traffic Vol by Lane	110	320	350
LT Vol	0	30	300
Through Vol	60	0	50
RT Vol	50	290	0
Lane Flow Rate	125	364	398
Geometry Grp	1	1	1
Degree of Util (X)	0.18	0.472	0.575
Departure Headway (Hd)	5.172	4.773	5.208
Convergence, Y/N	Yes	Yes	Yes
Cap	696	760	696
Service Time	3.183	2.773	3.208
HCM Lane V/C Ratio	0.18	0.479	0.572
HCM Control Delay	9.3	12	15
HCM Lane LOS	A	B	B
HCM 95th-tile Q	0.7	2.6	3.7

Intersection						
Int Delay, s/veh	1.8					
Movement	EBT	EBR	WBL	WBT	NBL	NBR
Lane Configurations						
Traffic Vol, veh/h	300	50	30	280	40	30
Future Vol, veh/h	300	50	30	280	40	30
Conflicting Peds, #/hr	0	0	0	0	0	0
Sign Control	Free	Free	Free	Free	Stop	Stop
RT Channelized	-	None	-	None	-	None
Storage Length	-	-	-	-	0	-
Veh in Median Storage, #	0	-	-	0	0	-
Grade, %	0	-	-	0	0	-
Peak Hour Factor	85	85	85	85	85	85
Heavy Vehicles, %	0	0	0	0	0	0
Mvmt Flow	353	59	35	329	47	35

Major/Minor	Major1	Major2	Minor1	Minor2	Minor3
Conflicting Flow All	0	0	412	0	782
Stage 1	-	-	-	-	383
Stage 2	-	-	-	-	399
Critical Hdwy	-	-	4.1	-	6.4
Critical Hdwy Stg 1	-	-	-	-	5.4
Critical Hdwy Stg 2	-	-	-	-	5.4
Follow-up Hdwy	-	-	2.2	-	3.5
Pot Cap-1 Maneuver	-	-	1158	-	366
Stage 1	-	-	-	-	694
Stage 2	-	-	-	-	682
Platoon blocked, %	-	-	-	-	-
Mov Cap-1 Maneuver	-	-	1158	-	352
Mov Cap-2 Maneuver	-	-	-	-	352
Stage 1	-	-	-	-	668
Stage 2	-	-	-	-	682

Approach	EB	WB	NB
HCM Control Delay, s	0	0.8	15
HCM LOS			C

Minor Lane/Major Mvmt	NBLn1	EBT	EBR	WBL	WBT
Capacity (veh/h)	442	-	-	1158	-
HCM Lane V/C Ratio	0.186	-	-	0.03	-
HCM Control Delay (s)	15	-	-	8.2	0
HCM Lane LOS	C	-	-	A	A
HCM 95th %tile Q(veh)	0.7	-	-	0.1	-

Intersection	
Intersection Delay, s/veh	14.2
Intersection LOS	B

Movement	EBL	EBT	EBR	WBL	WBT	WBR	NBL	NBT	NBR	SBL	SBT	SBR
Lane Configurations		↕			↕			↕			↕	
Traffic Vol, veh/h	10	270	60	30	240	10	50	60	20	10	80	20
Future Vol, veh/h	10	270	60	30	240	10	50	60	20	10	80	20
Peak Hour Factor	0.82	0.82	0.82	0.82	0.82	0.82	0.82	0.82	0.82	0.82	0.82	0.82
Heavy Vehicles, %	0	0	0	0	0	0	2	2	2	0	0	0
Mvmt Flow	12	329	73	37	293	12	61	73	24	12	98	24
Number of Lanes	0	1	0	0	1	0	0	1	0	0	1	0

Approach	EB	WB	NB	SB
Opposing Approach	WB	EB	SB	NB
Opposing Lanes	1	1	1	1
Conflicting Approach Left	SB	NB	EB	WB
Conflicting Lanes Left	1	1	1	1
Conflicting Approach Right	NB	SB	WB	EB
Conflicting Lanes Right	1	1	1	1
HCM Control Delay	16.1	14.3	11.6	11.1
HCM LOS	C	B	B	B

Lane	NBLn1	EBLn1	WBLn1	SBLn1
Vol Left, %	38%	3%	11%	9%
Vol Thru, %	46%	79%	86%	73%
Vol Right, %	15%	18%	4%	18%
Sign Control	Stop	Stop	Stop	Stop
Traffic Vol by Lane	130	340	280	110
LT Vol	50	10	30	10
Through Vol	60	270	240	80
RT Vol	20	60	10	20
Lane Flow Rate	159	415	341	134
Geometry Grp	1	1	1	1
Degree of Util (X)	0.273	0.605	0.517	0.229
Departure Headway (Hd)	6.195	5.255	5.451	6.151
Convergence, Y/N	Yes	Yes	Yes	Yes
Cap	575	684	659	580
Service Time	4.274	3.314	3.513	4.233
HCM Lane V/C Ratio	0.277	0.607	0.517	0.231
HCM Control Delay	11.6	16.1	14.3	11.1
HCM Lane LOS	B	C	B	B
HCM 95th-tile Q	1.1	4.1	3	0.9

Intersection												
Int Delay, s/veh	97.6											
Movement	EBL	EBT	EBR	WBL	WBT	WBR	NBL	NBT	NBR	SBL	SBT	SBR
Lane Configurations		↕			↕			↕			↕	
Traffic Vol, veh/h	90	150	50	30	130	10	90	160	20	10	100	50
Future Vol, veh/h	90	150	50	30	130	10	90	160	20	10	100	50
Conflicting Peds, #/hr	0	0	0	0	0	0	0	0	0	0	0	0
Sign Control	Stop	Stop	Stop	Stop	Stop	Stop	Free	Free	Free	Free	Free	Free
RT Channelized	-	-	None	-	-	None	-	-	None	-	-	None
Storage Length	-	-	-	-	-	-	-	-	-	-	-	-
Veh in Median Storage, #	-	0	-	-	0	-	-	0	-	-	0	-
Grade, %	-	0	-	-	0	-	-	0	-	-	0	-
Peak Hour Factor	74	74	74	74	74	74	74	74	74	74	74	74
Heavy Vehicles, %	3	3	3	2	2	2	3	3	3	8	8	8
Mvmt Flow	122	203	68	41	176	14	122	216	27	14	135	68

Major/Minor	Minor2		Minor1		Major1		Major2					
Conflicting Flow All	766	684	169	807	705	230	203	0	0	243	0	0
Stage 1	197	197	-	474	474	-	-	-	-	-	-	-
Stage 2	569	487	-	333	231	-	-	-	-	-	-	-
Critical Hdwy	7.13	6.53	6.23	7.12	6.52	6.22	4.13	-	-	4.18	-	-
Critical Hdwy Stg 1	6.13	5.53	-	6.12	5.52	-	-	-	-	-	-	-
Critical Hdwy Stg 2	6.13	5.53	-	6.12	5.52	-	-	-	-	-	-	-
Follow-up Hdwy	3.527	4.027	3.327	3.518	4.018	3.318	2.227	-	-	2.272	-	-
Pot Cap-1 Maneuver	318	370	872	300	361	809	1363	-	-	1289	-	-
Stage 1	803	736	-	571	558	-	-	-	-	-	-	-
Stage 2	505	549	-	681	713	-	-	-	-	-	-	-
Platoon blocked, %								-	-	-	-	-
Mov Cap-1 Maneuver	162	327	872	129	319	809	1363	-	-	1289	-	-
Mov Cap-2 Maneuver	162	327	-	129	319	-	-	-	-	-	-	-
Stage 1	719	727	-	512	500	-	-	-	-	-	-	-
Stage 2	289	492	-	448	704	-	-	-	-	-	-	-

Approach	EB		WB		NB		SB	
HCM Control Delay, s	255.5		70.5		2.6		0.5	
HCM LOS	F		F					

Minor Lane/Major Mvmt	NBL	NBT	NBR	EBLn1WBLn1	SBL	SBT	SBR
Capacity (veh/h)	1363	-	-	271	261	1289	-
HCM Lane V/C Ratio	0.089	-	-	1.446	0.88	0.01	-
HCM Control Delay (s)	7.9	0	-	255.5	70.5	7.8	0
HCM Lane LOS	A	A	-	F	F	A	A
HCM 95th %tile Q(veh)	0.3	-	-	21.8	7.5	0	-

Intersection						
Int Delay, s/veh	5.1					
Movement	EBL	EBR	NBL	NBT	SBT	SBR
Lane Configurations	T		T		T	
Traffic Vol, veh/h	170	10	10	370	220	160
Future Vol, veh/h	170	10	10	370	220	160
Conflicting Peds, #/hr	0	0	0	0	0	0
Sign Control	Stop	Stop	Free	Free	Free	Free
RT Channelized	-	None	-	None	-	None
Storage Length	0	-	-	-	-	-
Veh in Median Storage, #	0	-	-	0	0	-
Grade, %	0	-	-	0	0	-
Peak Hour Factor	88	88	88	88	88	88
Heavy Vehicles, %	0	0	2	2	1	1
Mvmt Flow	193	11	11	420	250	182























Major/Minor	Minor2	Major1		Major2	
Conflicting Flow All	783	341	432	0	0
Stage 1	341	-	-	-	-
Stage 2	442	-	-	-	-
Critical Hdwy	6.4	6.2	4.12	-	-
Critical Hdwy Stg 1	5.4	-	-	-	-
Critical Hdwy Stg 2	5.4	-	-	-	-
Follow-up Hdwy	3.5	3.3	2.218	-	-
Pot Cap-1 Maneuver	365	706	1128	-	-
Stage 1	725	-	-	-	-
Stage 2	652	-	-	-	-
Platoon blocked, %				-	-
Mov Cap-1 Maneuver	360	706	1128	-	-
Mov Cap-2 Maneuver	360	-	-	-	-
Stage 1	716	-	-	-	-
Stage 2	652	-	-	-	-

Approach	EB	NB	SB
HCM Control Delay, s	26.1	0.2	0
HCM LOS	D		

Minor Lane/Major Mvmt	NBL	NBT	EBLn1	SBT	SBR
Capacity (veh/h)	1128	-	370	-	-
HCM Lane V/C Ratio	0.01	-	0.553	-	-
HCM Control Delay (s)	8.2	0	26.1	-	-
HCM Lane LOS	A	A	D	-	-
HCM 95th %tile Q(veh)	0	-	3.2	-	-

HCM 2010 Signalized Intersection Summary
 39: General Jim Moore Boulevard & Gigling Road

Cumulative, PM
 06/11/2019

												
Movement	EBL	EBT	EBR	WBL	WBT	WBR	NBL	NBT	NBR	SBL	SBT	SBR
Lane Configurations												
Traffic Volume (veh/h)	20	20	30	170	50	320	60	430	320	310	430	50
Future Volume (veh/h)	20	20	30	170	50	320	60	430	320	310	430	50
Number	3	8	18	7	4	14	1	6	16	5	2	12
Initial Q (Qb), veh	0	0	0	0	0	0	0	0	0	0	0	0
Ped-Bike Adj(A_pbT)	1.00		0.99	1.00		1.00	1.00		1.00	1.00		1.00
Parking Bus, Adj	1.00	1.00	1.00	1.00	1.00	1.00	1.00	1.00	1.00	1.00	1.00	1.00
Adj Sat Flow, veh/h/ln	1776	1776	1900	1881	1881	1881	1863	1863	1863	1863	1863	1863
Adj Flow Rate, veh/h	22	22	3	191	56	0	67	483	0	348	483	0
Adj No. of Lanes	1	2	0	1	2	1	1	2	1	1	2	1
Peak Hour Factor	0.89	0.89	0.89	0.89	0.89	0.89	0.89	0.89	0.89	0.89	0.89	0.89
Percent Heavy Veh, %	7	7	7	1	1	1	2	2	2	2	2	2
Cap, veh/h	45	265	35	241	702	314	109	670	300	384	1220	546
Arrive On Green	0.03	0.09	0.09	0.13	0.20	0.00	0.06	0.19	0.00	0.22	0.34	0.00
Sat Flow, veh/h	1691	2991	399	1792	3574	1599	1774	3539	1583	1774	3539	1583
Grp Volume(v), veh/h	22	12	13	191	56	0	67	483	0	348	483	0
Grp Sat Flow(s),veh/h/ln	1691	1687	1703	1792	1787	1599	1774	1770	1583	1774	1770	1583
Q Serve(g_s), s	0.6	0.3	0.3	5.0	0.6	0.0	1.8	6.2	0.0	9.3	5.0	0.0
Cycle Q Clear(g_c), s	0.6	0.3	0.3	5.0	0.6	0.0	1.8	6.2	0.0	9.3	5.0	0.0
Prop In Lane	1.00		0.23	1.00		1.00	1.00		1.00	1.00		1.00
Lane Grp Cap(c), veh/h	45	150	151	241	702	314	109	670	300	384	1220	546
V/C Ratio(X)	0.49	0.08	0.08	0.79	0.08	0.00	0.62	0.72	0.00	0.91	0.40	0.00
Avail Cap(c_a), veh/h	715	1061	1071	757	2248	1006	384	1861	833	384	1861	833
HCM Platoon Ratio	1.00	1.00	1.00	1.00	1.00	1.00	1.00	1.00	1.00	1.00	1.00	1.00
Upstream Filter(I)	1.00	1.00	1.00	1.00	1.00	0.00	1.00	1.00	0.00	1.00	1.00	0.00
Uniform Delay (d), s/veh	23.3	20.3	20.3	20.3	15.9	0.0	22.2	18.5	0.0	18.5	12.1	0.0
Incr Delay (d2), s/veh	3.1	0.1	0.1	2.3	0.0	0.0	2.1	0.6	0.0	23.9	0.1	0.0
Initial Q Delay(d3),s/veh	0.0	0.0	0.0	0.0	0.0	0.0	0.0	0.0	0.0	0.0	0.0	0.0
%ile BackOfQ(50%),veh/ln	0.3	0.2	0.2	2.6	0.3	0.0	0.9	3.1	0.0	7.1	2.4	0.0
LnGrp Delay(d),s/veh	26.4	20.4	20.4	22.6	15.9	0.0	24.3	19.0	0.0	42.4	12.1	0.0
LnGrp LOS	C	C	C	C	B		C	B		D	B	
Approach Vol, veh/h		47			247			550			831	
Approach Delay, s/veh		23.2			21.1			19.6			24.8	
Approach LOS		C			C			B			C	
Timer	1	2	3	4	5	6	7	8				
Assigned Phs	1	2	3	4	5	6	7	8				
Phs Duration (G+Y+Rc), s	7.5	21.2	5.8	14.0	15.0	13.7	11.0	8.8				
Change Period (Y+Rc), s	4.5	4.5	4.5	4.5	4.5	4.5	4.5	4.5				
Max Green Setting (Gmax), s	10.5	25.5	20.5	30.5	10.5	25.5	20.5	30.5				
Max Q Clear Time (g_c+I1), s	3.8	7.0	2.6	2.6	11.3	8.2	7.0	2.3				
Green Ext Time (p_c), s	0.0	0.6	0.0	0.1	0.0	0.6	0.0	0.0				
Intersection Summary												
HCM 2010 Ctrl Delay				22.5								
HCM 2010 LOS				C								
Notes												

HCM 2010 Signalized Intersection Summary
40: Malmedy Road & Gigling Road

Cumulative, PM
06/11/2019



Movement	EBL	EBT	EBR	WBL	WBT	WBR	NBL	NBT	NBR	SBL	SBT	SBR
Lane Configurations		↔			↔			↔			↔	
Traffic Volume (veh/h)	50	600	10	30	490	10	30	60	50	10	40	20
Future Volume (veh/h)	50	600	10	30	490	10	30	60	50	10	40	20
Number	7	4	14	3	8	18	5	2	12	1	6	16
Initial Q (Qb), veh	0	0	0	0	0	0	0	0	0	0	0	0
Ped-Bike Adj(A_pbT)	1.00		1.00	1.00		1.00	1.00		1.00	1.00		1.00
Parking Bus, Adj	1.00	1.00	1.00	1.00	1.00	1.00	1.00	1.00	1.00	1.00	1.00	1.00
Adj Sat Flow, veh/h/ln	1900	1863	1900	1900	1881	1900	1900	1900	1900	1900	1810	1900
Adj Flow Rate, veh/h	55	659	11	33	538	11	33	66	55	11	44	22
Adj No. of Lanes	0	2	0	0	2	0	0	1	0	0	1	0
Peak Hour Factor	0.91	0.91	0.91	0.91	0.91	0.91	0.91	0.91	0.91	0.91	0.91	0.91
Percent Heavy Veh, %	2	2	2	1	1	1	0	0	0	5	5	5
Cap, veh/h	267	1058	18	241	1069	22	287	147	112	250	192	89
Arrive On Green	0.33	0.33	0.33	0.33	0.33	0.33	0.19	0.19	0.19	0.19	0.19	0.19
Sat Flow, veh/h	141	3160	53	85	3192	66	291	791	601	166	1029	478
Grp Volume(v), veh/h	374	0	351	300	0	282	154	0	0	77	0	0
Grp Sat Flow(s),veh/h/ln	1669	0	1686	1644	0	1700	1683	0	0	1673	0	0
Q Serve(g_s), s	0.9	0.0	3.3	0.1	0.0	2.5	0.8	0.0	0.0	0.0	0.0	0.0
Cycle Q Clear(g_c), s	3.4	0.0	3.3	3.4	0.0	2.5	1.5	0.0	0.0	0.7	0.0	0.0
Prop In Lane	0.15		0.03	0.11		0.04	0.21		0.36	0.14		0.29
Lane Grp Cap(c), veh/h	779	0	565	763	0	569	546	0	0	531	0	0
V/C Ratio(X)	0.48	0.00	0.62	0.39	0.00	0.49	0.28	0.00	0.00	0.15	0.00	0.00
Avail Cap(c_a), veh/h	4510	0	4527	4582	0	4566	2921	0	0	2855	0	0
HCM Platoon Ratio	1.00	1.00	1.00	1.00	1.00	1.00	1.00	1.00	1.00	1.00	1.00	1.00
Upstream Filter(I)	1.00	0.00	1.00	1.00	0.00	1.00	1.00	0.00	0.00	1.00	0.00	0.00
Uniform Delay (d), s/veh	5.2	0.0	5.3	5.0	0.0	5.0	6.8	0.0	0.0	6.5	0.0	0.0
Incr Delay (d2), s/veh	0.2	0.0	0.4	0.1	0.0	0.2	0.1	0.0	0.0	0.0	0.0	0.0
Initial Q Delay(d3),s/veh	0.0	0.0	0.0	0.0	0.0	0.0	0.0	0.0	0.0	0.0	0.0	0.0
%ile BackOfQ(50%),veh/ln	1.6	0.0	1.5	1.2	0.0	1.1	0.7	0.0	0.0	0.3	0.0	0.0
LnGrp Delay(d),s/veh	5.4	0.0	5.7	5.1	0.0	5.2	6.9	0.0	0.0	6.6	0.0	0.0
LnGrp LOS	A		A	A		A	A			A		
Approach Vol, veh/h		725			582			154			77	
Approach Delay, s/veh		5.5			5.2			6.9			6.6	
Approach LOS		A			A			A			A	
Timer	1	2	3	4	5	6	7	8				
Assigned Phs		2		4		6		8				
Phs Duration (G+Y+Rc), s		8.0		10.8		8.0		10.8				
Change Period (Y+Rc), s		4.5		4.5		4.5		4.5				
Max Green Setting (Gmax), s		30.5		50.5		30.5		50.5				
Max Q Clear Time (g_c+I1), s		3.5		5.4		2.7		5.4				
Green Ext Time (p_c), s		0.2		0.7		0.1		0.6				
Intersection Summary												
HCM 2010 Ctrl Delay				5.6								
HCM 2010 LOS				A								

HCM 2010 Signalized Intersection Summary
 41: Parker Flatts Cut Off Road & Gigling Road

Cumulative, PM
 06/11/2019



Movement	EBL	EBT	EBR	WBL	WBT	WBR	NBL	NBT	NBR	SBL	SBT	SBR
Lane Configurations		↔			↔			↔	↔		↔	
Traffic Volume (veh/h)	10	620	30	50	440	20	90	20	100	20	20	10
Future Volume (veh/h)	10	620	30	50	440	20	90	20	100	20	20	10
Number	7	4	14	3	8	18	5	2	12	1	6	16
Initial Q (Qb), veh	0	0	0	0	0	0	0	0	0	0	0	0
Ped-Bike Adj(A_pbT)	1.00		1.00	1.00		1.00	1.00		1.00	1.00		1.00
Parking Bus, Adj	1.00	1.00	1.00	1.00	1.00	1.00	1.00	1.00	1.00	1.00	1.00	1.00
Adj Sat Flow, veh/h/ln	1900	1863	1900	1900	1881	1900	1900	1900	1900	1900	1900	1900
Adj Flow Rate, veh/h	11	697	34	56	494	22	101	22	112	22	22	11
Adj No. of Lanes	0	2	0	0	2	0	0	1	1	0	1	0
Peak Hour Factor	0.89	0.89	0.89	0.89	0.89	0.89	0.89	0.89	0.89	0.89	0.89	0.89
Percent Heavy Veh, %	2	2	2	1	1	1	0	0	0	0	0	0
Cap, veh/h	194	1110	54	261	941	44	566	85	341	343	188	69
Arrive On Green	0.33	0.33	0.33	0.33	0.33	0.33	0.21	0.21	0.21	0.21	0.21	0.21
Sat Flow, veh/h	21	3323	161	130	2818	131	1112	400	1611	420	888	327
Grp Volume(v), veh/h	391	0	351	289	0	283	123	0	112	55	0	0
Grp Sat Flow(s),veh/h/ln	1839	0	1666	1392	0	1688	1512	0	1611	1634	0	0
Q Serve(g_s), s	0.0	0.0	3.5	0.3	0.0	2.7	0.8	0.0	1.2	0.0	0.0	0.0
Cycle Q Clear(g_c), s	3.5	0.0	3.5	3.8	0.0	2.7	1.3	0.0	1.2	0.5	0.0	0.0
Prop In Lane	0.03		0.10	0.19		0.08	0.82		1.00	0.40		0.20
Lane Grp Cap(c), veh/h	801	0	556	682	0	564	651	0	341	600	0	0
V/C Ratio(X)	0.49	0.00	0.63	0.42	0.00	0.50	0.19	0.00	0.33	0.09	0.00	0.00
Avail Cap(c_a), veh/h	4804	0	4248	3874	0	4305	2596	0	2482	2648	0	0
HCM Platoon Ratio	1.00	1.00	1.00	1.00	1.00	1.00	1.00	1.00	1.00	1.00	1.00	1.00
Upstream Filter(I)	1.00	0.00	1.00	1.00	0.00	1.00	1.00	0.00	1.00	1.00	0.00	0.00
Uniform Delay (d), s/veh	5.6	0.0	5.6	5.2	0.0	5.3	6.6	0.0	6.6	6.3	0.0	0.0
Incr Delay (d2), s/veh	0.2	0.0	0.4	0.2	0.0	0.3	0.1	0.0	0.2	0.0	0.0	0.0
Initial Q Delay(d3),s/veh	0.0	0.0	0.0	0.0	0.0	0.0	0.0	0.0	0.0	0.0	0.0	0.0
%ile BackOfQ(50%),veh/ln	1.8	0.0	1.6	1.2	0.0	1.2	0.6	0.0	0.5	0.2	0.0	0.0
LnGrp Delay(d),s/veh	5.7	0.0	6.0	5.4	0.0	5.5	6.7	0.0	6.8	6.4	0.0	0.0
LnGrp LOS	A		A	A		A	A		A	A		
Approach Vol, veh/h		742			572			235			55	
Approach Delay, s/veh		5.9			5.5			6.7			6.4	
Approach LOS		A			A			A			A	
Timer	1	2	3	4	5	6	7	8				
Assigned Phs		2		4		6		8				
Phs Duration (G+Y+Rc), s		8.7		11.1		8.7		11.1				
Change Period (Y+Rc), s		4.5		4.5		4.5		4.5				
Max Green Setting (Gmax), s		30.5		50.5		30.5		50.5				
Max Q Clear Time (g_c+I1), s		3.3		5.5		2.5		5.8				
Green Ext Time (p_c), s		0.1		0.7		0.0		0.7				
Intersection Summary												
HCM 2010 Ctrl Delay				5.9								
HCM 2010 LOS				A								

HCM 2010 Signalized Intersection Summary
42: 6th Avenue & Gigling Road

Cumulative, PM
06/11/2019



Movement	EBL	EBT	EBR	WBL	WBT	WBR	NBL	NBT	NBR	SBL	SBT	SBR
Lane Configurations		↔			↔			↔	↔		↔	
Traffic Volume (veh/h)	140	590	10	10	370	10	10	10	20	10	10	140
Future Volume (veh/h)	140	590	10	10	370	10	10	10	20	10	10	140
Number	7	4	14	3	8	18	5	2	12	1	6	16
Initial Q (Qb), veh	0	0	0	0	0	0	0	0	0	0	0	0
Ped-Bike Adj(A_pbT)	1.00		1.00	1.00		1.00	1.00		1.00	1.00		1.00
Parking Bus, Adj	1.00	1.00	1.00	1.00	1.00	1.00	1.00	1.00	1.00	1.00	1.00	1.00
Adj Sat Flow, veh/h/ln	1900	1881	1900	1900	1863	1900	1900	1900	1900	1900	1900	1900
Adj Flow Rate, veh/h	147	621	11	11	389	11	11	11	0	11	11	147
Adj No. of Lanes	0	2	0	0	2	0	0	1	1	0	1	0
Peak Hour Factor	0.95	0.95	0.95	0.95	0.95	0.95	0.95	0.95	0.95	0.95	0.95	0.95
Percent Heavy Veh, %	1	1	1	2	2	2	0	0	0	0	0	0
Cap, veh/h	402	1008	18	205	1251	35	374	193	275	208	23	240
Arrive On Green	0.37	0.37	0.37	0.37	0.37	0.37	0.17	0.17	0.00	0.17	0.17	0.17
Sat Flow, veh/h	407	2714	49	34	3366	94	582	1134	1615	77	134	1412
Grp Volume(v), veh/h	396	0	383	216	0	195	22	0	0	169	0	0
Grp Sat Flow(s),veh/h/ln	1467	0	1703	1816	0	1678	1715	0	1615	1623	0	0
Q Serve(g_s), s	2.8	0.0	3.6	0.0	0.0	1.6	0.0	0.0	0.0	1.0	0.0	0.0
Cycle Q Clear(g_c), s	4.4	0.0	3.6	1.6	0.0	1.6	0.2	0.0	0.0	1.9	0.0	0.0
Prop In Lane	0.37		0.03	0.05		0.06	0.50		1.00	0.07		0.87
Lane Grp Cap(c), veh/h	796	0	633	868	0	624	567	0	275	471	0	0
V/C Ratio(X)	0.50	0.00	0.60	0.25	0.00	0.31	0.04	0.00	0.00	0.36	0.00	0.00
Avail Cap(c_a), veh/h	3900	0	4381	4702	0	4317	2649	0	2509	2705	0	0
HCM Platoon Ratio	1.00	1.00	1.00	1.00	1.00	1.00	1.00	1.00	1.00	1.00	1.00	1.00
Upstream Filter(I)	1.00	0.00	1.00	1.00	0.00	1.00	1.00	0.00	0.00	1.00	0.00	0.00
Uniform Delay (d), s/veh	5.2	0.0	5.0	4.4	0.0	4.4	6.8	0.0	0.0	7.5	0.0	0.0
Incr Delay (d2), s/veh	0.2	0.0	0.3	0.1	0.0	0.1	0.0	0.0	0.0	0.2	0.0	0.0
Initial Q Delay(d3),s/veh	0.0	0.0	0.0	0.0	0.0	0.0	0.0	0.0	0.0	0.0	0.0	0.0
%ile BackOfQ(50%),veh/ln	1.8	0.0	1.7	0.8	0.0	0.7	0.1	0.0	0.0	0.9	0.0	0.0
LnGrp Delay(d),s/veh	5.3	0.0	5.3	4.4	0.0	4.5	6.9	0.0	0.0	7.7	0.0	0.0
LnGrp LOS	A		A	A		A	A			A		
Approach Vol, veh/h		779			411			22			169	
Approach Delay, s/veh		5.3			4.5			6.9			7.7	
Approach LOS		A			A			A			A	
Timer	1	2	3	4	5	6	7	8				
Assigned Phs		2		4		6		8				
Phs Duration (G+Y+Rc), s		7.8		11.8		7.8		11.8				
Change Period (Y+Rc), s		4.5		4.5		4.5		4.5				
Max Green Setting (Gmax), s		30.5		50.5		30.5		50.5				
Max Q Clear Time (g_c+I1), s		2.2		6.4		3.9		3.6				
Green Ext Time (p_c), s		0.0		0.9		0.2		0.4				
Intersection Summary												
HCM 2010 Ctrl Delay				5.4								
HCM 2010 LOS				A								

HCM 2010 Signalized Intersection Summary
43: Gigling Road & 7th Avenue

Cumulative, PM
06/11/2019

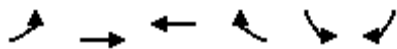

Movement	EBL	EBT	WBT	WBR	SBL	SBR		
Lane Configurations		↑↑	↑↑		↑↑			
Traffic Volume (veh/h)	250	370	230	10	10	160		
Future Volume (veh/h)	250	370	230	10	10	160		
Number	7	4	8	18	1	16		
Initial Q (Qb), veh	0	0	0	0	0	0		
Ped-Bike Adj(A_pbT)	1.00			1.00	1.00	1.00		
Parking Bus, Adj	1.00	1.00	1.00	1.00	1.00	1.00		
Adj Sat Flow, veh/h/ln	1900	1863	1881	1900	1827	1900		
Adj Flow Rate, veh/h	260	385	240	10	10	167		
Adj No. of Lanes	0	2	2	0	0	0		
Peak Hour Factor	0.96	0.96	0.96	0.96	0.96	0.96		
Percent Heavy Veh, %	2	2	1	1	0	0		
Cap, veh/h	633	781	1359	56	14	234		
Arrive On Green	0.39	0.39	0.39	0.39	0.16	0.16		
Sat Flow, veh/h	820	2095	3592	145	88	1465		
Grp Volume(v), veh/h	351	294	122	128	178	0		
Grp Sat Flow(s),veh/h/ln	1220	1610	1787	1856	1562	0		
Q Serve(g_s), s	4.1	2.7	0.9	0.9	2.2	0.0		
Cycle Q Clear(g_c), s	5.0	2.7	0.9	0.9	2.2	0.0		
Prop In Lane	0.74			0.08	0.06	0.94		
Lane Grp Cap(c), veh/h	788	626	694	721	250	0		
V/C Ratio(X)	0.45	0.47	0.18	0.18	0.71	0.00		
Avail Cap(c_a), veh/h	3794	4485	4977	5168	1999	0		
HCM Platoon Ratio	1.00	1.00	1.00	1.00	1.00	1.00		
Upstream Filter(I)	1.00	1.00	1.00	1.00	1.00	0.00		
Uniform Delay (d), s/veh	5.3	4.6	4.0	4.0	7.9	0.0		
Incr Delay (d2), s/veh	0.1	0.2	0.0	0.0	1.4	0.0		
Initial Q Delay(d3),s/veh	0.0	0.0	0.0	0.0	0.0	0.0		
%ile BackOfQ(50%),veh/ln	1.6	1.2	0.4	0.5	1.0	0.0		
LnGrp Delay(d),s/veh	5.5	4.8	4.0	4.0	9.4	0.0		
LnGrp LOS	A	A	A	A	A			
Approach Vol, veh/h		645	250		178			
Approach Delay, s/veh		5.1	4.0		9.4			
Approach LOS		A	A		A			
Timer	1	2	3	4	5	6	7	8
Assigned Phs				4		6		8
Phs Duration (G+Y+Rc), s				12.2		7.7		12.2
Change Period (Y+Rc), s				4.5		4.5		4.5
Max Green Setting (Gmax), s				55.5		25.5		55.5
Max Q Clear Time (g_c+I1), s				7.0		4.2		2.9
Green Ext Time (p_c), s				0.8		0.0		0.2
Intersection Summary								
HCM 2010 Ctrl Delay				5.6				
HCM 2010 LOS				A				
Notes								

HCM 2010 Signalized Intersection Summary
44: 8th Avenue & Gigling Road

Cumulative, PM
06/11/2019



Movement	EBL	EBT	EBR	WBL	WBT	WBR	NBL	NBT	NBR	SBL	SBT	SBR
Lane Configurations		↔			↔			↔			↔	
Traffic Volume (veh/h)	370	10	10	10	10	10	10	10	10	10	10	220
Future Volume (veh/h)	370	10	10	10	10	10	10	10	10	10	10	220
Number	7	4	14	3	8	18	5	2	12	1	6	16
Initial Q (Qb), veh	0	0	0	0	0	0	0	0	0	0	0	0
Ped-Bike Adj(A_pbT)	1.00		1.00	1.00		1.00	1.00		1.00	1.00		1.00
Parking Bus, Adj	1.00	1.00	1.00	1.00	1.00	1.00	1.00	1.00	1.00	1.00	1.00	1.00
Adj Sat Flow, veh/h/ln	1900	1863	1900	1900	1863	1900	1900	1900	1900	1900	1881	1900
Adj Flow Rate, veh/h	407	11	11	11	11	11	11	11	11	11	11	242
Adj No. of Lanes	0	2	0	0	2	0	0	1	0	0	1	0
Peak Hour Factor	0.91	0.91	0.91	0.91	0.91	0.91	0.91	0.91	0.91	0.91	0.91	0.91
Percent Heavy Veh, %	2	2	2	2	2	2	0	0	0	1	1	1
Cap, veh/h	831	287	287	536	437	428	289	182	125	180	21	321
Arrive On Green	0.37	0.37	0.37	0.37	0.37	0.37	0.22	0.22	0.22	0.22	0.22	0.22
Sat Flow, veh/h	1356	777	777	743	1184	1159	315	834	574	38	96	1474
Grp Volume(v), veh/h	407	0	22	19	0	14	33	0	0	264	0	0
Grp Sat Flow(s),veh/h/ln	1356	0	1554	1602	0	1485	1723	0	0	1608	0	0
Q Serve(g_s), s	5.8	0.0	0.2	0.0	0.0	0.1	0.0	0.0	0.0	1.3	0.0	0.0
Cycle Q Clear(g_c), s	5.9	0.0	0.2	0.1	0.0	0.1	0.3	0.0	0.0	3.3	0.0	0.0
Prop In Lane	1.00		0.50	0.58		0.78	0.33		0.33	0.04		0.92
Lane Grp Cap(c), veh/h	831	0	573	852	0	548	596	0	0	523	0	0
V/C Ratio(X)	0.49	0.00	0.04	0.02	0.00	0.03	0.06	0.00	0.00	0.51	0.00	0.00
Avail Cap(c_a), veh/h	3203	0	3247	3513	0	3102	2694	0	0	2781	0	0
HCM Platoon Ratio	1.00	1.00	1.00	1.00	1.00	1.00	1.00	1.00	1.00	1.00	1.00	1.00
Upstream Filter(I)	1.00	0.00	1.00	1.00	0.00	1.00	1.00	0.00	0.00	1.00	0.00	0.00
Uniform Delay (d), s/veh	6.3	0.0	4.4	4.4	0.0	4.4	6.8	0.0	0.0	8.0	0.0	0.0
Incr Delay (d2), s/veh	0.2	0.0	0.0	0.0	0.0	0.0	0.0	0.0	0.0	0.3	0.0	0.0
Initial Q Delay(d3),s/veh	0.0	0.0	0.0	0.0	0.0	0.0	0.0	0.0	0.0	0.0	0.0	0.0
%ile BackOfQ(50%),veh/ln	2.2	0.0	0.1	0.1	0.0	0.1	0.2	0.0	0.0	1.5	0.0	0.0
LnGrp Delay(d),s/veh	6.4	0.0	4.4	4.4	0.0	4.4	6.8	0.0	0.0	8.2	0.0	0.0
LnGrp LOS	A		A	A		A	A			A		
Approach Vol, veh/h		429			33			33			264	
Approach Delay, s/veh		6.3			4.4			6.8			8.2	
Approach LOS		A			A			A			A	
Timer	1	2	3	4	5	6	7	8				
Assigned Phs		2		4		6		8				
Phs Duration (G+Y+Rc), s		9.2		12.5		9.2		12.5				
Change Period (Y+Rc), s		4.5		4.5		4.5		4.5				
Max Green Setting (Gmax), s		35.5		45.5		35.5		45.5				
Max Q Clear Time (g_c+I1), s		2.3		7.9		5.3		2.1				
Green Ext Time (p_c), s		0.0		0.4		0.4		0.0				
Intersection Summary												
HCM 2010 Ctrl Delay				6.9								
HCM 2010 LOS				A								

HCM 2010 Signalized Intersection Summary
 46: General Jim Moore Boulevard & Normandy Road

Cumulative, PM
 06/11/2019



Movement	EBL	EBT	EBR	WBL	WBT	WBR	NBL	NBT	NBR	SBL	SBT	SBR
Lane Configurations		↕			↕		↕	↕↕		↕	↕↕	↕
Traffic Volume (veh/h)	150	30	100	50	30	10	90	830	70	30	530	80
Future Volume (veh/h)	150	30	100	50	30	10	90	830	70	30	530	80
Number	3	8	18	7	4	14	1	6	16	5	2	12
Initial Q (Qb), veh	0	0	0	0	0	0	0	0	0	0	0	0
Ped-Bike Adj(A_pbT)	1.00		1.00	1.00		1.00	1.00		1.00	1.00		1.00
Parking Bus, Adj	1.00	1.00	1.00	1.00	1.00	1.00	1.00	1.00	1.00	1.00	1.00	1.00
Adj Sat Flow, veh/h/ln	1900	1863	1900	1900	1881	1900	1881	1881	1900	1900	1900	1900
Adj Flow Rate, veh/h	163	33	84	54	33	8	98	902	53	33	576	28
Adj No. of Lanes	0	1	0	0	1	0	1	2	0	1	2	1
Peak Hour Factor	0.92	0.92	0.92	0.92	0.92	0.92	0.92	0.92	0.92	0.92	0.92	0.92
Percent Heavy Veh, %	2	2	2	1	1	1	1	1	1	0	0	0
Cap, veh/h	358	57	105	347	179	33	247	1126	66	71	829	370
Arrive On Green	0.25	0.23	0.23	0.25	0.23	0.23	0.14	0.33	0.33	0.04	0.23	0.23
Sat Flow, veh/h	818	245	456	777	777	143	1792	3431	202	1810	3610	1611
Grp Volume(v), veh/h	280	0	0	95	0	0	98	470	485	33	576	28
Grp Sat Flow(s),veh/h/ln	1519	0	0	1697	0	0	1792	1787	1845	1810	1805	1611
Q Serve(g_s), s	4.3	0.0	0.0	0.0	0.0	0.0	1.7	8.1	8.1	0.6	4.9	0.5
Cycle Q Clear(g_c), s	5.6	0.0	0.0	1.4	0.0	0.0	1.7	8.1	8.1	0.6	4.9	0.5
Prop In Lane	0.58		0.30	0.57		0.08	1.00		0.11	1.00		1.00
Lane Grp Cap(c), veh/h	543	0	0	585	0	0	247	587	606	71	829	370
V/C Ratio(X)	0.52	0.00	0.00	0.16	0.00	0.00	0.40	0.80	0.80	0.46	0.69	0.08
Avail Cap(c_a), veh/h	1642	0	0	1686	0	0	426	1355	1399	430	2737	1222
HCM Platoon Ratio	1.00	1.00	1.00	1.00	1.00	1.00	1.00	1.00	1.00	1.00	1.00	1.00
Upstream Filter(I)	1.00	0.00	0.00	1.00	0.00	0.00	1.00	1.00	1.00	1.00	1.00	1.00
Uniform Delay (d), s/veh	11.9	0.0	0.0	10.4	0.0	0.0	13.2	10.3	10.3	15.8	11.9	10.2
Incr Delay (d2), s/veh	0.3	0.0	0.0	0.0	0.0	0.0	0.4	1.0	0.9	1.7	0.4	0.0
Initial Q Delay(d3),s/veh	0.0	0.0	0.0	0.0	0.0	0.0	0.0	0.0	0.0	0.0	0.0	0.0
%ile BackOfQ(50%),veh/ln	2.3	0.0	0.0	0.7	0.0	0.0	0.8	4.1	4.2	0.3	2.4	0.2
LnGrp Delay(d),s/veh	12.2	0.0	0.0	10.4	0.0	0.0	13.6	11.3	11.2	17.5	12.3	10.2
LnGrp LOS	B			B			B	B	B	B	B	B
Approach Vol, veh/h		280			95			1053			637	
Approach Delay, s/veh		12.2			10.4			11.5			12.4	
Approach LOS		B			B			B			B	
Timer	1	2	3	4	5	6	7	8				
Assigned Phs	1	2		4	5	6		8				
Phs Duration (G+Y+Rc), s	9.1	12.2		12.3	5.8	15.5		12.3				
Change Period (Y+Rc), s	4.5	4.5		4.5	4.5	4.5		4.5				
Max Green Setting (Gmax), s	25.5	25.5		33.0	8.0	25.5		33.0				
Max Q Clear Time (g_c+1), s	6.9	6.9		3.4	2.6	10.1		7.6				
Green Ext Time (p_c), s	0.0	0.7		0.1	0.0	0.9		0.4				
Intersection Summary												
HCM 2010 Ctrl Delay				11.8								
HCM 2010 LOS				B								

Intersection	
Intersection Delay, s/veh	30.4
Intersection LOS	D

Movement	EBL	EBR	NBL	NBT	SBT	SBR
Lane Configurations						
Traffic Vol, veh/h	60	100	150	950	410	50
Future Vol, veh/h	60	100	150	950	410	50
Peak Hour Factor	0.89	0.89	0.89	0.89	0.89	0.89
Heavy Vehicles, %	1	1	1	1	1	1
Mvmt Flow	67	112	169	1067	461	56
Number of Lanes	1	1	1	2	2	1

Approach	EB	NB	SB
Opposing Approach		SB	NB
Opposing Lanes	0	3	3
Conflicting Approach Left	SB		
Conflicting Lanes Left	3	2	0
Conflicting Approach Right	NB		EB
Conflicting Lanes Right	3	0	2
HCM Control Delay	13.8	38.6	16.6
HCM LOS	B	E	C

Lane	NBLn1	NBLn2	NBLn3	EBLn1	EBLn2	SBLn1	SBLn2	SBLn3
Vol Left, %	100%	0%	0%	100%	0%	0%	0%	0%
Vol Thru, %	0%	100%	100%	0%	0%	100%	100%	0%
Vol Right, %	0%	0%	0%	0%	100%	0%	0%	100%
Sign Control	Stop	Stop	Stop	Stop	Stop	Stop	Stop	Stop
Traffic Vol by Lane	150	475	475	60	100	205	205	50
LT Vol	150	0	0	60	0	0	0	0
Through Vol	0	475	475	0	0	205	205	0
RT Vol	0	0	0	0	100	0	0	50
Lane Flow Rate	169	534	534	67	112	230	230	56
Geometry Grp	8	8	8	8	8	8	8	8
Degree of Util (X)	0.339	0.999	0.741	0.174	0.253	0.491	0.491	0.081
Departure Headway (Hd)	7.246	6.739	4.997	9.307	8.092	7.674	7.674	5.217
Convergence, Y/N	Yes	Yes	Yes	Yes	Yes	Yes	Yes	Yes
Cap	497	539	726	385	443	470	470	685
Service Time	4.982	4.475	2.732	7.069	5.854	5.423	5.423	2.965
HCM Lane V/C Ratio	0.34	0.991	0.736	0.174	0.253	0.489	0.489	0.082
HCM Control Delay	13.7	64.4	20.7	14	13.6	17.6	17.6	8.4
HCM Lane LOS	B	F	C	B	B	C	C	A
HCM 95th-tile Q	1.5	14.1	6.7	0.6	1	2.7	2.7	0.3



Movement	EBL	EBT	EBR	WBL	WBT	WBR	NBL	NBT	NBR	SBL	SBT	SBR
Lane Configurations												
Traffic Volume (veh/h)	220	170	80	90	100	70	110	1180	230	100	680	220
Future Volume (veh/h)	220	170	80	90	100	70	110	1180	230	100	680	220
Number	7	4	14	3	8	18	5	2	12	1	6	16
Initial Q (Qb), veh	0	0	0	0	0	0	0	0	0	0	0	0
Ped-Bike Adj(A_pbT)	1.00		0.98	1.00		0.99	1.00		0.99	1.00		0.99
Parking Bus, Adj	1.00	1.00	1.00	1.00	1.00	1.00	1.00	1.00	1.00	1.00	1.00	1.00
Adj Sat Flow, veh/h/ln	1881	1881	1881	1900	1900	1900	1881	1881	1900	1863	1863	1863
Adj Flow Rate, veh/h	201	211	35	93	103	66	113	1216	225	103	701	155
Adj No. of Lanes	1	1	1	0	1	0	1	2	0	1	2	1
Peak Hour Factor	0.97	0.97	0.97	0.97	0.97	0.97	0.97	0.97	0.97	0.97	0.97	0.97
Percent Heavy Veh, %	1	1	1	0	0	0	1	1	1	2	2	2
Cap, veh/h	265	279	232	105	117	75	596	1385	254	127	671	297
Arrive On Green	0.15	0.15	0.15	0.17	0.17	0.17	0.33	0.46	0.46	0.07	0.19	0.19
Sat Flow, veh/h	1792	1881	1565	634	702	450	1792	3013	553	1774	3539	1568
Grp Volume(v), veh/h	201	211	35	262	0	0	113	718	723	103	701	155
Grp Sat Flow(s),veh/h/ln	1792	1881	1565	1785	0	0	1792	1787	1779	1774	1770	1568
Q Serve(g_s), s	13.5	13.5	2.4	17.9	0.0	0.0	5.6	45.3	46.3	7.2	23.7	11.1
Cycle Q Clear(g_c), s	13.5	13.5	2.4	17.9	0.0	0.0	5.6	45.3	46.3	7.2	23.7	11.1
Prop In Lane	1.00		1.00	0.35		0.25	1.00		0.31	1.00		1.00
Lane Grp Cap(c), veh/h	265	279	232	297	0	0	596	821	818	127	671	297
V/C Ratio(X)	0.76	0.76	0.15	0.88	0.00	0.00	0.19	0.87	0.88	0.81	1.04	0.52
Avail Cap(c_a), veh/h	573	602	501	357	0	0	596	821	818	241	671	297
HCM Platoon Ratio	1.00	1.00	1.00	1.00	1.00	1.00	1.00	1.00	1.00	1.00	1.00	1.00
Upstream Filter(I)	0.69	0.69	0.69	1.00	0.00	0.00	1.00	1.00	1.00	1.00	1.00	1.00
Uniform Delay (d), s/veh	51.1	51.1	46.4	50.7	0.0	0.0	29.7	30.5	30.8	57.2	50.7	45.5
Incr Delay (d2), s/veh	3.1	2.9	0.2	20.8	0.0	0.0	0.1	12.4	13.4	4.6	47.0	6.4
Initial Q Delay(d3),s/veh	0.0	0.0	0.0	0.0	0.0	0.0	0.0	0.0	0.0	0.0	0.0	0.0
%ile BackOfQ(50%),veh/ln	6.9	7.2	1.1	10.6	0.0	0.0	2.8	25.2	25.8	3.7	15.9	5.4
LnGrp Delay(d),s/veh	54.1	54.0	46.6	71.5	0.0	0.0	29.7	42.9	44.2	61.8	97.6	51.9
LnGrp LOS	D	D	D	E			C	D	D	E	F	D
Approach Vol, veh/h		447			262			1554			959	
Approach Delay, s/veh		53.5			71.5			42.5			86.4	
Approach LOS		D			E			D			F	
Timer	1	2	3	4	5	6	7	8				
Assigned Phs	1	2		4	5	6		8				
Phs Duration (G+Y+Rc), s	3.2	62.8		23.2	46.9	29.0		25.9				
Change Period (Y+Rc), s	4.2	5.3		* 4.7	5.3	* 5.3		5.1				
Max Green Setting (Gmax), s	13	23.7		* 40	17.0	* 24		25.0				
Max Q Clear Time (g_c+119), s	19.2	48.3		15.5	7.6	25.7		19.9				
Green Ext Time (p_c), s	0.1	0.0		1.9	0.1	0.0		0.8				

Intersection Summary

HCM 2010 Ctrl Delay	59.5
HCM 2010 LOS	E

Notes

HCM 2010 Signalized Intersection Summary
 49: Highway 1 SB On-Ramp & Highway 1 NB Off-Ramp/Monterey Road

Cumulative, PM
 06/11/2019



Movement	EBL	EBT	EBR	WBL	WBT	WBR	NBL	NBT	NBR	SBL	SBT	SBR
Lane Configurations		↕↕	↗	↖		↗		↕	↗		↕	
Traffic Volume (veh/h)	10	160	120	280	0	130	0	120	300	10	10	0
Future Volume (veh/h)	10	160	120	280	0	130	0	120	300	10	10	0
Number	1	6	16	5	2	12	7	4	14	3	8	18
Initial Q (Qb), veh	0	0	0	0	0	0	0	0	0	0	0	0
Ped-Bike Adj(A_pbT)	1.00		1.00	1.00		1.00	1.00		1.00	1.00		1.00
Parking Bus, Adj	1.00	1.00	1.00	1.00	1.00	1.00	1.00	1.00	1.00	1.00	1.00	1.00
Adj Sat Flow, veh/h/ln	1900	1863	1863	1900	0	1900	0	1881	1881	1900	1900	0
Adj Flow Rate, veh/h	11	176	14	308	0	69	0	132	51	11	11	0
Adj No. of Lanes	0	2	1	1	0	1	0	1	1	0	1	0
Peak Hour Factor	0.91	0.91	0.91	0.91	0.91	0.91	0.91	0.91	0.91	0.91	0.91	0.91
Percent Heavy Veh, %	2	2	2	0	0	0	0	1	1	0	0	0
Cap, veh/h	170	2861	1323	0	0	0	0	164	139	58	44	0
Arrive On Green	0.85	0.84	0.84	0.00	0.00	0.00	0.00	0.09	0.09	0.09	0.09	0.00
Sat Flow, veh/h	203	3419	1580				0	1881	1599	166	501	0
Grp Volume(v), veh/h	100	87	14		0.0		0	132	51	22	0	0
Grp Sat Flow(s),veh/h/ln	1853	1770	1580				0	1881	1599	667	0	0
Q Serve(g_s), s	1.2	1.1	0.2				0.0	8.6	3.8	0.1	0.0	0.0
Cycle Q Clear(g_c), s	1.2	1.1	0.2				0.0	8.6	3.8	8.7	0.0	0.0
Prop In Lane	0.11		1.00				0.00		1.00	0.50		0.00
Lane Grp Cap(c), veh/h	1551	1481	1323				0	164	139	102	0	0
V/C Ratio(X)	0.06	0.06	0.01				0.00	0.81	0.37	0.22	0.00	0.00
Avail Cap(c_a), veh/h	1551	1481	1323				0	271	230	127	0	0
HCM Platoon Ratio	1.00	1.00	1.00				1.00	1.00	1.00	1.00	1.00	1.00
Upstream Filter(I)	1.00	1.00	1.00				0.00	1.00	1.00	1.00	0.00	0.00
Uniform Delay (d), s/veh	1.7	1.7	1.7				0.0	56.0	53.8	52.8	0.0	0.0
Incr Delay (d2), s/veh	0.0	0.0	0.0				0.0	3.5	0.6	0.4	0.0	0.0
Initial Q Delay(d3),s/veh	0.0	0.0	0.0				0.0	0.0	0.0	0.0	0.0	0.0
%ile BackOfQ(50%),veh/ln	0.6	0.5	0.1				0.0	4.6	1.7	0.7	0.0	0.0
LnGrp Delay(d),s/veh	1.8	1.8	1.7				0.0	59.5	54.4	53.2	0.0	0.0
LnGrp LOS	A	A	A					E	D	D		
Approach Vol, veh/h		201						183			22	
Approach Delay, s/veh		1.7						58.1			53.2	
Approach LOS		A						E			D	
Timer	1	2	3	4	5	6	7	8				
Assigned Phs				4		6		8				
Phs Duration (G+Y+Rc), s				15.1		109.9		15.1				
Change Period (Y+Rc), s				* 4.2		5.3		* 4.2				
Max Green Setting (Gmax), s				* 18		21.0		* 13				
Max Q Clear Time (g_c+I1), s				10.6		3.2		10.7				
Green Ext Time (p_c), s				0.3		0.6		0.0				
Intersection Summary												
HCM 2010 Ctrl Delay			29.9									
HCM 2010 LOS			C									
Notes												

HCM 2010 Signalized Intersection Summary
 50: Reservation Road & SR 68 WB On Ramp/SR 68 WB Off Ramp

Cumulative, PM
 06/11/2019



Movement	EBL	EBT	EBR	WBL	WBT	WBR	NBL	NBT	NBR	SBL	SBT	SBR
Lane Configurations					↕	↕	↕	↑			↕	
Traffic Volume (veh/h)	0	0	0	410	10	250	140	250	0	0	510	180
Future Volume (veh/h)	0	0	0	410	10	250	140	250	0	0	510	180
Number				7	4	14	1	6	16	5	2	12
Initial Q (Qb), veh				0	0	0	0	0	0	0	0	0
Ped-Bike Adj(A_pbT)				1.00		1.00	1.00		1.00	1.00		1.00
Parking Bus, Adj				1.00	1.00	1.00	1.00	1.00	1.00	1.00	1.00	1.00
Adj Sat Flow, veh/h/ln				1900	1863	1863	1845	1845	0	0	1827	1900
Adj Flow Rate, veh/h				436	11	84	149	266	0	0	543	181
Adj No. of Lanes				0	1	1	1	1	0	0	1	0
Peak Hour Factor				0.94	0.94	0.94	0.94	0.94	0.94	0.94	0.94	0.94
Percent Heavy Veh, %				2	2	2	3	3	0	0	4	4
Cap, veh/h				485	12	442	185	1092	0	0	585	195
Arrive On Green				0.29	0.28	0.28	0.03	0.20	0.00	0.00	0.45	0.45
Sat Flow, veh/h				1732	44	1581	1757	1845	0	0	1312	437
Grp Volume(v), veh/h				447	0	84	149	266	0	0	0	724
Grp Sat Flow(s),veh/h/ln				1776	0	1581	1757	1845	0	0	0	1750
Q Serve(g_s), s				20.5	0.0	3.4	7.2	10.4	0.0	0.0	0.0	33.3
Cycle Q Clear(g_c), s				20.5	0.0	3.4	7.2	10.4	0.0	0.0	0.0	33.3
Prop In Lane				0.98		1.00	1.00		0.00	0.00		0.25
Lane Grp Cap(c), veh/h				497	0	442	185	1092	0	0	0	780
V/C Ratio(X)				0.90	0.00	0.19	0.81	0.24	0.00	0.00	0.00	0.93
Avail Cap(c_a), veh/h				564	0	502	248	1092	0	0	0	780
HCM Platoon Ratio				1.00	1.00	1.00	0.33	0.33	1.00	1.00	1.00	1.00
Upstream Filter(I)				1.00	0.00	1.00	0.95	0.95	0.00	0.00	0.00	1.00
Uniform Delay (d), s/veh				29.0	0.0	23.3	40.2	18.1	0.0	0.0	0.0	22.3
Incr Delay (d2), s/veh				16.1	0.0	0.2	9.3	0.5	0.0	0.0	0.0	18.9
Initial Q Delay(d3),s/veh				0.0	0.0	0.0	0.0	0.0	0.0	0.0	0.0	0.0
%ile BackOfQ(50%),veh/ln				12.3	0.0	1.5	4.0	5.5	0.0	0.0	0.0	20.0
LnGrp Delay(d),s/veh				45.1	0.0	23.5	49.5	18.6	0.0	0.0	0.0	41.2
LnGrp LOS				D		C	D	B				D
Approach Vol, veh/h					531			415			724	
Approach Delay, s/veh					41.7			29.7			41.2	
Approach LOS					D			C			D	
Timer	1	2	3	4	5	6	7	8				
Assigned Phs	1	2		4		6						
Phs Duration (G+Y+Rc), s	2.4	43.9		28.7		56.3						
Change Period (Y+Rc), s	3.5	6.0		4.9		6.0						
Max Green Setting (Gmax), s	2.0	31.6		27.0		47.1						
Max Q Clear Time (g_c+19.2), s	19.2	35.3		22.5		12.4						
Green Ext Time (p_c), s	0.0	0.0		1.3		1.3						
Intersection Summary												
HCM 2010 Ctrl Delay				38.5								
HCM 2010 LOS				D								

HCM 2010 Signalized Intersection Summary
 51: River Road/Reservation Road & SR 68 Off Ramp/SR 68 EB On Ramp





















Cumulative, PM
 06/11/2019



Movement	EBL	EBT	EBR	WBL	WBT	WBR	NBL	NBT	NBR	SBL	SBT	SBR
Lane Configurations		↔	↗					↑	↗	↘	↑	
Traffic Volume (veh/h)	110	10	190	0	0	0	0	300	320	250	670	0
Future Volume (veh/h)	110	10	190	0	0	0	0	300	320	250	670	0
Number	3	8	18				1	6	16	5	2	12
Initial Q (Qb), veh	0	0	0				0	0	0	0	0	0
Ped-Bike Adj(A_pbT)	1.00		1.00				1.00		1.00	1.00		1.00
Parking Bus, Adj	1.00	1.00	1.00				1.00	1.00	1.00	1.00	1.00	1.00
Adj Sat Flow, veh/h/ln	1900	1863	1863				0	1845	1845	1827	1827	0
Adj Flow Rate, veh/h	117	11	23				0	319	201	266	713	0
Adj No. of Lanes	0	1	1				0	1	1	1	1	0
Peak Hour Factor	0.94	0.94	0.94				0.94	0.94	0.94	0.94	0.94	0.94
Percent Heavy Veh, %	2	2	2				0	3	3	4	4	0
Cap, veh/h	159	15	154				0	1033	878	297	1415	0
Arrive On Green	0.11	0.10	0.10				0.00	0.56	0.56	0.34	1.00	0.00
Sat Flow, veh/h	1628	153	1583				0	1845	1568	1740	1827	0
Grp Volume(v), veh/h	128	0	23				0	319	201	266	713	0
Grp Sat Flow(s),veh/h/ln	1781	0	1583				0	1845	1568	1740	1827	0
Q Serve(g_s), s	5.9	0.0	1.1				0.0	7.8	5.5	12.3	0.0	0.0
Cycle Q Clear(g_c), s	5.9	0.0	1.1				0.0	7.8	5.5	12.3	0.0	0.0
Prop In Lane	0.91		1.00				0.00		1.00	1.00		0.00
Lane Grp Cap(c), veh/h	174	0	154				0	1033	878	297	1415	0
V/C Ratio(X)	0.74	0.00	0.15				0.00	0.31	0.23	0.90	0.50	0.00
Avail Cap(c_a), veh/h	524	0	466				0	1033	878	348	1415	0
HCM Platoon Ratio	1.00	1.00	1.00				1.00	1.00	1.00	2.00	2.00	1.00
Upstream Filter(I)	1.00	0.00	1.00				0.00	1.00	1.00	0.13	0.13	0.00
Uniform Delay (d), s/veh	36.9	0.0	35.1				0.0	9.9	9.4	27.3	0.0	0.0
Incr Delay (d2), s/veh	6.0	0.0	0.4				0.0	0.8	0.6	4.1	0.2	0.0
Initial Q Delay(d3),s/veh	0.0	0.0	0.0				0.0	0.0	0.0	0.0	0.0	0.0
%ile BackOfQ(50%),veh/ln	3.2	0.0	0.5				0.0	4.2	2.5	6.2	0.1	0.0
LnGrp Delay(d),s/veh	42.9	0.0	35.6				0.0	10.7	10.0	31.4	0.2	0.0
LnGrp LOS	D		D					B	B	C	A	
Approach Vol, veh/h		151						520			979	
Approach Delay, s/veh		41.7						10.5			8.6	
Approach LOS		D						B			A	
Timer	1	2	3	4	5	6	7	8				
Assigned Phs		2			5	6		8				
Phs Duration (G+Y+Rc), s		71.8			18.2	53.6		13.2				
Change Period (Y+Rc), s		6.0			3.7	6.0		4.9				
Max Green Setting (Gmax), s		43.1			17.0	28.4		25.0				
Max Q Clear Time (g_c+I1), s		2.0			14.3	9.8		7.9				
Green Ext Time (p_c), s		4.9			0.2	2.1		0.6				
Intersection Summary												
HCM 2010 Ctrl Delay			12.2									
HCM 2010 LOS			B									

HCM 2010 Signalized Intersection Summary
1: Del Monte Boulevard & Reindollar Avenue

Cumulative with Project, AM
06/11/2019

												
Movement	EBL	EBT	EBR	WBL	WBT	WBR	NBL	NBT	NBR	SBL	SBT	SBR
Lane Configurations												
Traffic Volume (veh/h)	0	0	0	450	0	420	10	650	120	410	1170	0
Future Volume (veh/h)	0	0	0	450	0	420	10	650	120	410	1170	0
Number				3	8	18	1	6	16	5	2	12
Initial Q (Qb), veh				0	0	0	0	0	0	0	0	0
Ped-Bike Adj(A_pbT)				1.00		0.99	1.00		1.00	1.00		1.00
Parking Bus, Adj				1.00	1.00	1.00	1.00	1.00	1.00	1.00	1.00	1.00
Adj Sat Flow, veh/h/ln				1900	1900	1900	1863	1863	1863	1845	1845	0
Adj Flow Rate, veh/h				468	54	429	11	730	68	461	1315	0
Adj No. of Lanes				1	1	0	1	2	1	1	2	0
Peak Hour Factor				0.89	0.89	0.89	0.89	0.89	0.89	0.89	0.89	0.89
Percent Heavy Veh, %				0	0	0	2	2	2	3	3	0
Cap, veh/h				573	58	459	24	900	401	498	1839	0
Arrive On Green				0.32	0.32	0.32	0.01	0.25	0.25	0.28	0.52	0.00
Sat Flow, veh/h				1810	183	1451	1774	3539	1577	1757	3597	0
Grp Volume(v), veh/h				468	0	483	11	730	68	461	1315	0
Grp Sat Flow(s),veh/h/ln				1810	0	1634	1774	1770	1577	1757	1752	0
Q Serve(g_s), s				22.1	0.0	26.6	0.6	18.0	3.1	23.6	26.5	0.0
Cycle Q Clear(g_c), s				22.1	0.0	26.6	0.6	18.0	3.1	23.6	26.5	0.0
Prop In Lane				1.00		0.89	1.00		1.00	1.00		0.00
Lane Grp Cap(c), veh/h				573	0	517	24	900	401	498	1839	0
V/C Ratio(X)				0.82	0.00	0.93	0.47	0.81	0.17	0.92	0.72	0.00
Avail Cap(c_a), veh/h				585	0	529	574	1145	510	568	1839	0
HCM Platoon Ratio				1.00	1.00	1.00	1.00	1.00	1.00	1.00	1.00	1.00
Upstream Filter(I)				1.00	0.00	1.00	1.00	1.00	1.00	1.00	1.00	0.00
Uniform Delay (d), s/veh				29.2	0.0	30.8	45.4	32.5	27.0	32.3	16.8	0.0
Incr Delay (d2), s/veh				8.7	0.0	23.7	13.6	3.6	0.2	19.8	1.3	0.0
Initial Q Delay(d3),s/veh				0.0	0.0	0.0	0.0	0.0	0.0	0.0	0.0	0.0
%ile BackOfQ(50%),veh/ln				12.4	0.0	15.3	0.4	9.2	1.4	14.1	12.9	0.0
LnGrp Delay(d),s/veh				37.9	0.0	54.4	59.0	36.1	27.2	52.0	18.1	0.0
LnGrp LOS				D		D	E	D	C	D	B	
Approach Vol, veh/h					951			809			1776	
Approach Delay, s/veh					46.3			35.6			26.9	
Approach LOS					D			D			C	
Timer	1	2	3	4	5	6	7	8				
Assigned Phs	1	2			5	6		8				
Phs Duration (G+Y+Rc), s	4.7	53.7			29.8	28.6		34.4				
Change Period (Y+Rc), s	3.5	5.0			3.5	5.0		5.0				
Max Green Setting (Gmax), s	30.0	30.0			30.0	30.0		30.0				
Max Q Clear Time (g_c+I1), s	2.6	28.5			25.6	20.0		28.6				
Green Ext Time (p_c), s	0.0	1.2			0.7	3.6		0.8				
Intersection Summary												
HCM 2010 Ctrl Delay				34.1								
HCM 2010 LOS				C								
Notes												

HCM 2010 Signalized Intersection Summary
2: 2nd Avenue & Patton Parkway

Cumulative with Project, AM
06/11/2019



Movement	EBL	EBT	EBR	WBL	WBT	WBR	NBL	NBT	NBR	SBL	SBT	SBR
Lane Configurations	↖	↗		↖	↗		↖	↗		↖	↗	
Traffic Volume (veh/h)	50	90	60	30	90	100	70	220	100	90	200	50
Future Volume (veh/h)	50	90	60	30	90	100	70	220	100	90	200	50
Number	7	4	14	3	8	18	5	2	12	1	6	16
Initial Q (Qb), veh	0	0	0	0	0	0	0	0	0	0	0	0
Ped-Bike Adj(A_pbT)	1.00		1.00	1.00		1.00	1.00		1.00	1.00		1.00
Parking Bus, Adj	1.00	1.00	1.00	1.00	1.00	1.00	1.00	1.00	1.00	1.00	1.00	1.00
Adj Sat Flow, veh/h/ln	1863	1863	1900	1863	1863	1900	1863	1863	1900	1863	1863	1900
Adj Flow Rate, veh/h	54	98	65	33	98	109	76	239	109	98	217	54
Adj No. of Lanes	1	1	0	1	1	0	1	1	0	1	1	0
Peak Hour Factor	0.92	0.92	0.92	0.92	0.92	0.92	0.92	0.92	0.92	0.92	0.92	0.92
Percent Heavy Veh, %	2	2	2	2	2	2	2	2	2	2	2	2
Cap, veh/h	97	247	164	67	177	197	121	330	151	139	407	101
Arrive On Green	0.05	0.24	0.24	0.04	0.22	0.22	0.07	0.27	0.27	0.08	0.28	0.28
Sat Flow, veh/h	1774	1046	694	1774	807	897	1774	1212	553	1774	1441	359
Grp Volume(v), veh/h	54	0	163	33	0	207	76	0	348	98	0	271
Grp Sat Flow(s),veh/h/ln	1774	0	1740	1774	0	1704	1774	0	1765	1774	0	1799
Q Serve(g_s), s	1.3	0.0	3.6	0.8	0.0	4.9	1.9	0.0	8.1	2.4	0.0	5.8
Cycle Q Clear(g_c), s	1.3	0.0	3.6	0.8	0.0	4.9	1.9	0.0	8.1	2.4	0.0	5.8
Prop In Lane	1.00		0.40	1.00		0.53	1.00		0.31	1.00		0.20
Lane Grp Cap(c), veh/h	97	0	411	67	0	374	121	0	481	139	0	509
V/C Ratio(X)	0.56	0.00	0.40	0.50	0.00	0.55	0.63	0.00	0.72	0.71	0.00	0.53
Avail Cap(c_a), veh/h	235	0	1364	235	0	1336	235	0	1384	235	0	1411
HCM Platoon Ratio	1.00	1.00	1.00	1.00	1.00	1.00	1.00	1.00	1.00	1.00	1.00	1.00
Upstream Filter(I)	1.00	0.00	1.00	1.00	0.00	1.00	1.00	0.00	1.00	1.00	0.00	1.00
Uniform Delay (d), s/veh	20.9	0.0	14.6	21.4	0.0	15.7	20.5	0.0	14.9	20.4	0.0	13.7
Incr Delay (d2), s/veh	5.0	0.0	0.6	5.6	0.0	1.3	5.3	0.0	2.1	6.4	0.0	0.9
Initial Q Delay(d3),s/veh	0.0	0.0	0.0	0.0	0.0	0.0	0.0	0.0	0.0	0.0	0.0	0.0
%ile BackOfQ(50%),veh/ln	0.8	0.0	1.8	0.5	0.0	2.4	1.1	0.0	4.1	1.4	0.0	3.0
LnGrp Delay(d),s/veh	25.9	0.0	15.2	27.0	0.0	17.0	25.9	0.0	17.0	26.8	0.0	14.6
LnGrp LOS	C		B	C		B	C		B	C		B
Approach Vol, veh/h		217			240			424			369	
Approach Delay, s/veh		17.8			18.4			18.6			17.8	
Approach LOS		B			B			B			B	
Timer	1	2	3	4	5	6	7	8				
Assigned Phs	1	2	3	4	5	6	7	8				
Phs Duration (G+Y+Rc), s	7.5	16.8	5.7	15.2	7.1	17.3	6.5	14.4				
Change Period (Y+Rc), s	4.0	4.5	4.0	4.5	4.0	4.5	4.0	4.5				
Max Green Setting (Gmax), s	6.0	35.5	6.0	35.5	6.0	35.5	6.0	35.5				
Max Q Clear Time (g_c+14), s	14.4	10.1	2.8	5.6	3.9	7.8	3.3	6.9				
Green Ext Time (p_c), s	0.0	2.2	0.0	1.0	0.0	1.7	0.0	1.3				
Intersection Summary												
HCM 2010 Ctrl Delay			18.2									
HCM 2010 LOS			B									

HCM 2010 Signalized Intersection Summary
 3: SR 1 SB On-Ramp/SR 1 SB Off-Ramp & Imjin Parkway

Cumulative with Project, AM
 06/11/2019



Movement	EBL	EBT	EBR	WBL	WBT	WBR	NBL	NBT	NBR	SBL	SBT	SBR
Lane Configurations					↕						↕	
Traffic Volume (veh/h)	0	0	0	1180	0	0	0	0	0	980	10	0
Future Volume (veh/h)	0	0	0	1180	0	0	0	0	0	980	10	0
Number				1	6	16				7	4	14
Initial Q (Qb), veh				0	0	0				0	0	0
Ped-Bike Adj(A_pbT)				1.00		1.00				1.00		1.00
Parking Bus, Adj				1.00	1.00	1.00				1.00	1.00	1.00
Adj Sat Flow, veh/h/ln				1900	1845	0				1900	1845	0
Adj Flow Rate, veh/h				1297	0	0				1077	11	0
Adj No. of Lanes				0	1	0				0	1	0
Peak Hour Factor				0.91	0.91	0.91				0.91	0.91	0.91
Percent Heavy Veh, %				3	3	0				3	3	0
Cap, veh/h				996	0	0				657	7	0
Arrive On Green				0.57	0.00	0.00				0.38	0.38	0.00
Sat Flow, veh/h				1757	0	0				1740	18	0
Grp Volume(v), veh/h				1297	0	0				1088	0	0
Grp Sat Flow(s),veh/h/ln				1757	0	0				1758	0	0
Q Serve(g_s), s				90.0	0.0	0.0				60.0	0.0	0.0
Cycle Q Clear(g_c), s				90.0	0.0	0.0				60.0	0.0	0.0
Prop In Lane				1.00		0.00				0.99		0.00
Lane Grp Cap(c), veh/h				996	0	0				664	0	0
V/C Ratio(X)				1.30	0.00	0.00				1.64	0.00	0.00
Avail Cap(c_a), veh/h				996	0	0				664	0	0
HCM Platoon Ratio				1.00	1.00	1.00				1.00	1.00	1.00
Upstream Filter(I)				1.00	0.00	0.00				1.00	0.00	0.00
Uniform Delay (d), s/veh				34.4	0.0	0.0				49.4	0.0	0.0
Incr Delay (d2), s/veh				143.6	0.0	0.0				294.0	0.0	0.0
Initial Q Delay(d3),s/veh				0.0	0.0	0.0				0.0	0.0	0.0
%ile BackOfQ(50%),veh/ln				83.1	0.0	0.0				83.2	0.0	0.0
LnGrp Delay(d),s/veh				178.0	0.0	0.0				343.4	0.0	0.0
LnGrp LOS				F						F		
Approach Vol, veh/h					1297						1088	
Approach Delay, s/veh					178.0						343.4	
Approach LOS					F						F	
Timer	1	2	3	4	5	6	7	8				
Assigned Phs				4		6						
Phs Duration (G+Y+Rc), s				64.4		94.4						
Change Period (Y+Rc), s				4.4		4.4						
Max Green Setting (Gmax), s				60.0		90.0						
Max Q Clear Time (g_c+I1), s				62.0		92.0						
Green Ext Time (p_c), s				0.0		0.0						
Intersection Summary												
HCM 2010 Ctrl Delay				253.4								
HCM 2010 LOS				F								

Intersection												
Int Delay, s/veh	1.3											
Movement	EBL	EBT	EBR	WBL	WBT	WBR	NBL	NBT	NBR	SBL	SBT	SBR
Lane Configurations		↖			↑	↗		↖	↗			
Traffic Vol, veh/h	10	990	0	0	1140	440	10	10	1060	0	0	0
Future Vol, veh/h	10	990	0	0	1140	440	10	10	1060	0	0	0
Conflicting Peds, #/hr	0	0	3	3	0	0	0	0	0	0	0	0
Sign Control	Free	Free	Free	Free	Free	Free	Stop	Stop	Stop	Stop	Stop	Stop
RT Channelized	-	-	None	-	-	Free	-	-	Free	-	-	None
Storage Length	-	-	-	-	-	0	-	-	800	-	-	-
Veh in Median Storage, #	-	0	-	-	0	-	-	0	-	-	16965	-
Grade, %	-	0	-	-	0	-	-	0	-	-	0	-
Peak Hour Factor	97	97	97	97	97	97	97	97	97	97	97	97
Heavy Vehicles, %	3	3	3	3	3	3	2	2	2	2	2	2
Mvmt Flow	10	1021	0	0	1175	454	10	10	1093	0	0	0























Major/Minor	Major1	Major2	Minor1
Conflicting Flow All	1175	0	-
Stage 1	-	-	-
Stage 2	-	-	-
Critical Hdwy	4.13	-	-
Critical Hdwy Stg 1	-	-	-
Critical Hdwy Stg 2	-	-	-
Follow-up Hdwy	2.227	-	-
Pot Cap-1 Maneuver	591	0	0
Stage 1	-	0	0
Stage 2	-	0	0
Platoon blocked, %	-	-	-
Mov Cap-1 Maneuver	591	-	-
Mov Cap-2 Maneuver	-	-	-
Stage 1	-	-	-
Stage 2	-	-	-

Approach	EB	WB	NB
HCM Control Delay, s	0.1	0	135.7
HCM LOS			F

Minor Lane/Major Mvmt	NBLn1	NBLn2	EBL	EBT	WBT
Capacity (veh/h)	46	-	591	-	-
HCM Lane V/C Ratio	0.448	-	0.017	-	-
HCM Control Delay (s)	135.7	0	11.2	0	-
HCM Lane LOS	F	A	B	A	-
HCM 95th %tile Q(veh)	1.6	-	0.1	-	-

HCM 2010 Signalized Intersection Summary
5: 2nd Avenue & Imjin Parkway

Cumulative with Project, AM
06/11/2019

												
Movement	EBL	EBT	EBR	WBL	WBT	WBR	NBL	NBT	NBR	SBL	SBT	SBR
Lane Configurations												
Traffic Volume (veh/h)	180	1160	880	520	1010	120	370	90	200	50	100	210
Future Volume (veh/h)	180	1160	880	520	1010	120	370	90	200	50	100	210
Number	5	2	12	1	6	16	3	8	18	7	4	14
Initial Q (Qb), veh	0	0	0	0	0	0	0	0	0	0	0	0
Ped-Bike Adj(A_pbT)	1.00		1.00	1.00		1.00	1.00		1.00	1.00		1.00
Parking Bus, Adj	1.00	1.00	1.00	1.00	1.00	1.00	1.00	1.00	1.00	1.00	1.00	1.00
Adj Sat Flow, veh/h/ln	1863	1863	1863	1863	1863	1900	1810	1810	1810	1900	1900	1900
Adj Flow Rate, veh/h	184	1184	679	531	1031	122	378	92	82	51	102	209
Adj No. of Lanes	1	2	1	2	2	0	2	1	1	1	2	0
Peak Hour Factor	0.98	0.98	0.98	0.98	0.98	0.98	0.98	0.98	0.98	0.98	0.98	0.98
Percent Heavy Veh, %	2	2	2	2	2	2	5	5	5	0	0	0
Cap, veh/h	220	1204	539	585	1231	146	447	428	363	91	276	247
Arrive On Green	0.12	0.34	0.34	0.17	0.39	0.39	0.13	0.24	0.24	0.05	0.15	0.15
Sat Flow, veh/h	1774	3539	1583	3442	3189	377	3343	1810	1536	1810	1805	1612
Grp Volume(v), veh/h	184	1184	679	531	572	581	378	92	82	51	102	209
Grp Sat Flow(s),veh/h/ln	1774	1770	1583	1721	1770	1796	1672	1810	1536	1810	1805	1612
Q Serve(g_s), s	8.9	29.2	30.0	13.3	25.8	25.9	9.7	3.6	3.8	2.4	4.5	11.1
Cycle Q Clear(g_c), s	8.9	29.2	30.0	13.3	25.8	25.9	9.7	3.6	3.8	2.4	4.5	11.1
Prop In Lane	1.00		1.00	1.00		0.21	1.00		1.00	1.00		1.00
Lane Grp Cap(c), veh/h	220	1204	539	585	683	694	447	428	363	91	276	247
V/C Ratio(X)	0.83	0.98	1.26	0.91	0.84	0.84	0.85	0.22	0.23	0.56	0.37	0.85
Avail Cap(c_a), veh/h	302	1204	539	585	683	694	758	431	366	205	430	384
HCM Platoon Ratio	1.00	1.00	1.00	1.00	1.00	1.00	1.00	1.00	1.00	1.00	1.00	1.00
Upstream Filter(I)	1.00	1.00	1.00	1.00	1.00	1.00	1.00	1.00	1.00	1.00	1.00	1.00
Uniform Delay (d), s/veh	37.7	28.8	29.1	35.9	24.5	24.6	37.3	27.1	27.2	40.9	33.5	36.3
Incr Delay (d2), s/veh	10.2	21.8	131.6	17.5	8.5	8.4	1.7	0.1	0.1	2.0	0.3	6.0
Initial Q Delay(d3),s/veh	0.0	0.0	0.0	0.0	0.0	0.0	0.0	0.0	0.0	0.0	0.0	0.0
%ile BackOfQ(50%),veh/ln	5.0	17.8	32.7	7.8	14.2	14.4	4.6	1.8	1.6	1.3	2.3	5.3
LnGrp Delay(d),s/veh	47.9	50.7	160.7	53.4	33.0	33.0	39.0	27.2	27.3	42.9	33.8	42.4
LnGrp LOS	D	D	F	D	C	C	D	C	C	D	C	D
Approach Vol, veh/h		2047			1684			552			362	
Approach Delay, s/veh		86.9			39.4			35.3			40.1	
Approach LOS		F			D			D			D	
Timer	1	2	3	4	5	6	7	8				
Assigned Phs	1	2	3	4	5	6	7	8				
Phs Duration (G+Y+Rc), s	19.5	35.3	15.3	18.1	15.5	39.3	7.9	25.4				
Change Period (Y+Rc), s	4.5	5.3	3.5	4.6	4.5	5.3	3.5	4.6				
Max Green Setting (Gmax), s	15.0	30.0	20.0	21.0	15.0	30.0	10.0	21.0				
Max Q Clear Time (g_c+I1), s	15.3	32.0	11.7	13.1	10.9	27.9	4.4	5.8				
Green Ext Time (p_c), s	0.0	0.0	0.1	0.3	0.0	0.5	0.0	0.1				
Intersection Summary												
HCM 2010 Ctrl Delay			59.9									
HCM 2010 LOS			E									

HCM 2010 Signalized Intersection Summary
6: 3rd Avenue & Imjin Parkway

Cumulative with Project, AM
06/11/2019



Movement	EBL	EBT	EBR	WBL	WBT	WBR	NBL	NBT	NBR	SBL	SBT	SBR
Lane Configurations	↖	↗		↖	↗		↖	↗		↖	↗	
Traffic Volume (veh/h)	50	1010	220	350	1510	30	130	10	70	10	10	30
Future Volume (veh/h)	50	1010	220	350	1510	30	130	10	70	10	10	30
Number	5	2	12	1	6	16	3	8	18	7	4	14
Initial Q (Qb), veh	0	0	0	0	0	0	0	0	0	0	0	0
Ped-Bike Adj(A_pbT)	1.00		1.00	1.00		1.00	1.00		1.00	1.00		1.00
Parking Bus, Adj	1.00	1.00	1.00	1.00	1.00	1.00	1.00	1.00	1.00	1.00	1.00	1.00
Adj Sat Flow, veh/h/ln	1863	1863	1900	1863	1863	1900	1810	1810	1900	1863	1863	1900
Adj Flow Rate, veh/h	52	1052	200	365	1573	30	135	10	19	10	10	-4
Adj No. of Lanes	1	2	0	1	2	0	1	1	0	1	1	0
Peak Hour Factor	0.96	0.96	0.96	0.96	0.96	0.96	0.96	0.96	0.96	0.96	0.96	0.96
Percent Heavy Veh, %	2	2	2	2	2	2	5	5	5	2	2	2
Cap, veh/h	64	1178	223	380	2042	39	318	77	146	302	257	0
Arrive On Green	0.04	0.40	0.40	0.21	0.57	0.57	0.14	0.14	0.14	0.14	0.14	0.00
Sat Flow, veh/h	1774	2969	563	1774	3553	68	1358	558	1059	1370	1863	0
Grp Volume(v), veh/h	52	626	626	365	782	821	135	0	29	10	6	0
Grp Sat Flow(s),veh/h/ln	1774	1770	1763	1774	1770	1851	1358	0	1617	1370	1863	0
Q Serve(g_s), s	1.6	17.7	17.9	10.9	18.1	18.2	5.1	0.0	0.8	0.3	0.1	0.0
Cycle Q Clear(g_c), s	1.6	17.7	17.9	10.9	18.1	18.2	5.3	0.0	0.8	1.2	0.1	0.0
Prop In Lane	1.00		0.32	1.00		0.04	1.00		0.66	1.00		0.00
Lane Grp Cap(c), veh/h	64	702	699	380	1017	1064	318	0	223	302	257	0
V/C Ratio(X)	0.82	0.89	0.90	0.96	0.77	0.77	0.42	0.00	0.13	0.03	0.02	0.00
Avail Cap(c_a), veh/h	380	1070	1066	380	1070	1120	825	0	828	814	953	0
HCM Platoon Ratio	1.00	1.00	1.00	1.00	1.00	1.00	1.00	1.00	1.00	1.00	1.00	1.00
Upstream Filter(I)	1.00	1.00	1.00	1.00	1.00	1.00	1.00	0.00	1.00	1.00	1.00	0.00
Uniform Delay (d), s/veh	25.7	15.1	15.2	20.9	8.7	8.7	22.3	0.0	20.3	20.8	20.0	0.0
Incr Delay (d2), s/veh	9.1	4.6	4.8	35.8	2.9	2.8	0.3	0.0	0.1	0.0	0.0	0.0
Initial Q Delay(d3),s/veh	0.0	0.0	0.0	0.0	0.0	0.0	0.0	0.0	0.0	0.0	0.0	0.0
%ile BackOfQ(50%),veh/ln	0.9	9.4	9.5	9.0	9.5	10.0	1.9	0.0	0.4	0.1	0.1	0.0
LnGrp Delay(d),s/veh	34.9	19.7	20.0	56.7	11.6	11.6	22.6	0.0	20.4	20.9	20.0	0.0
LnGrp LOS	C	B	B	E	B	B	C		C	C	C	
Approach Vol, veh/h		1304			1968			164			16	
Approach Delay, s/veh		20.4			19.9			22.2			20.6	
Approach LOS		C			B			C			C	
Timer	1	2	3	4	5	6	7	8				
Assigned Phs	1	2		4	5	6		8				
Phs Duration (G+Y+Rc), s	5.0	26.8		11.9	5.4	36.4		11.9				
Change Period (Y+Rc), s	3.5	5.5		4.5	3.5	5.5		4.5				
Max Green Setting (Gmax), s	1.5	32.5		27.5	11.5	32.5		27.5				
Max Q Clear Time (g_c+1), s	1.5	19.9		3.2	3.6	20.2		7.3				
Green Ext Time (p_c), s	0.0	1.4		0.0	0.0	1.2		0.0				
Intersection Summary												
HCM 2010 Ctrl Delay				20.2								
HCM 2010 LOS				C								

HCM 2010 Signalized Intersection Summary
7: 4th Avenue & Imjin Parkway

Cumulative with Project, AM
06/11/2019



Movement	EBL	EBT	EBR	WBL	WBT	WBR	NBL	NBT	NBR	SBL	SBT	SBR
Lane Configurations												
Traffic Volume (veh/h)	10	1110	20	10	1820	10	10	10	10	10	10	10
Future Volume (veh/h)	10	1110	20	10	1820	10	10	10	10	10	10	10
Number	5	2	12	1	6	16	3	8	18	7	4	14
Initial Q (Qb), veh	0	0	0	0	0	0	0	0	0	0	0	0
Ped-Bike Adj(A_pbT)	1.00		1.00	1.00		1.00	1.00		1.00	1.00		1.00
Parking Bus, Adj	1.00	1.00	1.00	1.00	1.00	1.00	1.00	1.00	1.00	1.00	1.00	1.00
Adj Sat Flow, veh/h/ln	1863	1863	1900	1863	1863	1900	1900	1267	1900	1900	1900	1900
Adj Flow Rate, veh/h	10	1156	20	10	1896	9	10	10	9	10	10	10
Adj No. of Lanes	1	2	0	1	2	0	0	1	0	0	1	0
Peak Hour Factor	0.96	0.96	0.96	0.96	0.96	0.96	0.96	0.96	0.96	0.96	0.96	0.96
Percent Heavy Veh, %	2	2	2	2	2	2	50	50	50	0	0	0
Cap, veh/h	14	2036	35	14	2066	10	152	19	17	160	29	29
Arrive On Green	0.01	0.57	0.57	0.01	0.57	0.57	0.05	0.05	0.05	0.05	0.05	0.05
Sat Flow, veh/h	1774	3560	62	1774	3612	17	390	390	351	580	580	580
Grp Volume(v), veh/h	10	575	601	10	928	977	29	0	0	30	0	0
Grp Sat Flow(s),veh/h/ln	1774	1770	1852	1774	1770	1860	1132	0	0	1740	0	0
Q Serve(g_s), s	0.2	7.5	7.5	0.2	17.2	17.2	0.3	0.0	0.0	0.0	0.0	0.0
Cycle Q Clear(g_c), s	0.2	7.5	7.5	0.2	17.2	17.2	0.9	0.0	0.0	0.6	0.0	0.0
Prop In Lane	1.00		0.03	1.00		0.01	0.34		0.31	0.33		0.33
Lane Grp Cap(c), veh/h	14	1012	1059	14	1012	1064	189	0	0	218	0	0
V/C Ratio(X)	0.71	0.57	0.57	0.71	0.92	0.92	0.15	0.00	0.00	0.14	0.00	0.00
Avail Cap(c_a), veh/h	560	1580	1653	560	1580	1660	951	0	0	1361	0	0
HCM Platoon Ratio	1.00	1.00	1.00	1.00	1.00	1.00	1.00	1.00	1.00	1.00	1.00	1.00
Upstream Filter(I)	1.00	1.00	1.00	1.00	1.00	1.00	1.00	0.00	0.00	1.00	0.00	0.00
Uniform Delay (d), s/veh	18.0	4.9	4.9	18.0	7.0	7.0	16.8	0.0	0.0	16.7	0.0	0.0
Incr Delay (d2), s/veh	21.6	0.2	0.2	21.6	4.3	4.2	0.1	0.0	0.0	0.1	0.0	0.0
Initial Q Delay(d3),s/veh	0.0	0.0	0.0	0.0	0.0	0.0	0.0	0.0	0.0	0.0	0.0	0.0
%ile BackOfQ(50%),veh/ln	0.2	3.6	3.7	0.2	9.2	9.6	0.3	0.0	0.0	0.3	0.0	0.0
LnGrp Delay(d),s/veh	39.6	5.1	5.1	39.6	11.3	11.2	17.0	0.0	0.0	16.8	0.0	0.0
LnGrp LOS	D	A	A	D	B	B	B			B		
Approach Vol, veh/h		1186			1915			29			30	
Approach Delay, s/veh		5.4			11.4			17.0			16.8	
Approach LOS		A			B			B			B	
Timer	1	2	3	4	5	6	7	8				
Assigned Phs	1	2		4	5	6		8				
Phs Duration (G+Y+Rc), s	3.8	26.3		6.3	3.8	26.3		6.3				
Change Period (Y+Rc), s	3.5	5.5		4.5	3.5	5.5		4.5				
Max Green Setting (Gmax), s	1.5	32.5		27.5	11.5	32.5		27.5				
Max Q Clear Time (g_c+1/2), s	12.2	9.5		2.6	2.2	19.2		2.9				
Green Ext Time (p_c), s	0.0	0.8		0.0	0.0	1.6		0.0				
Intersection Summary												
HCM 2010 Ctrl Delay				9.2								
HCM 2010 LOS				A								

HCM 2010 Signalized Intersection Summary
 8: 5th Avenue/California Avenue & Imjin Parkway

Cumulative with Project, AM
 06/11/2019



Movement	EBL	EBT	EBR	WBL	WBT	WBR	NBL	NBT	NBR	SBL	SBT	SBR
Lane Configurations												
Traffic Volume (veh/h)	140	1020	20	10	1200	80	20	20	10	100	130	490
Future Volume (veh/h)	140	1020	20	10	1200	80	20	20	10	100	130	490
Number	5	2	12	1	6	16	3	8	18	7	4	14
Initial Q (Qb), veh	0	0	0	0	0	0	0	0	0	0	0	0
Ped-Bike Adj(A_pbT)	1.00		0.98	1.00		1.00	1.00		0.99	1.00		1.00
Parking Bus, Adj	1.00	1.00	1.00	1.00	1.00	1.00	1.00	1.00	1.00	1.00	1.00	1.00
Adj Sat Flow, veh/h/ln	1881	1881	1900	1863	1863	1900	1900	1624	1900	1900	1881	1900
Adj Flow Rate, veh/h	147	1074	19	11	1263	78	21	21	10	105	137	442
Adj No. of Lanes	1	2	0	1	2	0	0	1	0	0	1	0
Peak Hour Factor	0.95	0.95	0.95	0.95	0.95	0.95	0.95	0.95	0.95	0.95	0.95	0.95
Percent Heavy Veh, %	1	1	1	2	2	2	17	17	17	1	1	1
Cap, veh/h	185	1773	31	15	1350	83	157	137	52	123	110	312
Arrive On Green	0.10	0.49	0.49	0.01	0.40	0.40	0.30	0.30	0.30	0.30	0.30	0.30
Sat Flow, veh/h	1792	3592	64	1774	3387	209	275	461	175	205	368	1047
Grp Volume(v), veh/h	147	534	559	11	659	682	52	0	0	684	0	0
Grp Sat Flow(s),veh/h/ln	1792	1787	1868	1774	1770	1826	911	0	0	1620	0	0
Q Serve(g_s), s	5.4	14.5	14.5	0.4	23.9	24.0	0.0	0.0	0.0	16.6	0.0	0.0
Cycle Q Clear(g_c), s	5.4	14.5	14.5	0.4	23.9	24.0	1.6	0.0	0.0	20.0	0.0	0.0
Prop In Lane	1.00		0.03	1.00		0.11	0.40		0.19	0.15		0.65
Lane Grp Cap(c), veh/h	185	882	922	15	706	728	347	0	0	545	0	0
V/C Ratio(X)	0.80	0.61	0.61	0.75	0.93	0.94	0.15	0.00	0.00	1.25	0.00	0.00
Avail Cap(c_a), veh/h	401	882	922	397	792	817	347	0	0	545	0	0
HCM Platoon Ratio	1.00	1.00	1.00	1.00	1.00	1.00	1.00	1.00	1.00	1.00	1.00	1.00
Upstream Filter(I)	1.00	1.00	1.00	1.00	1.00	1.00	1.00	0.00	0.00	1.00	0.00	0.00
Uniform Delay (d), s/veh	29.4	12.3	12.3	33.2	19.3	19.3	17.1	0.0	0.0	24.6	0.0	0.0
Incr Delay (d2), s/veh	2.9	0.9	0.8	24.0	16.2	16.2	0.1	0.0	0.0	129.0	0.0	0.0
Initial Q Delay(d3),s/veh	0.0	0.0	0.0	0.0	0.0	0.0	0.0	0.0	0.0	0.0	0.0	0.0
%ile BackOfQ(50%),veh/ln	2.8	7.3	7.7	0.3	14.7	15.2	0.7	0.0	0.0	29.5	0.0	0.0
LnGrp Delay(d),s/veh	32.3	13.1	13.1	57.2	35.5	35.6	17.2	0.0	0.0	153.6	0.0	0.0
LnGrp LOS	C	B	B	E	D	D	B			F		
Approach Vol, veh/h		1240			1352			52			684	
Approach Delay, s/veh		15.4			35.7			17.2			153.6	
Approach LOS		B			D			B			F	
Timer	1	2	3	4	5	6	7	8				
Assigned Phs	1	2		4	5	6		8				
Phs Duration (G+Y+Rc), s	4.1	38.4		24.6	10.4	32.0		24.6				
Change Period (Y+Rc), s	3.5	5.3		4.6	3.5	5.3		4.6				
Max Green Setting (Gmax), s	5.0	30.0		20.0	15.0	30.0		20.0				
Max Q Clear Time (g_c+1), s	12.4	16.5		22.0	7.4	26.0		3.6				
Green Ext Time (p_c), s	0.0	0.8		0.0	0.0	0.7		0.1				
Intersection Summary												
HCM 2010 Ctrl Delay				52.1								
HCM 2010 LOS				D								

Intersection						
Int Delay, s/veh	1.4					
Movement	EBL	EBR	NBL	NBT	SBT	SBR
Lane Configurations						
Traffic Vol, veh/h	30	30	30	220	620	80
Future Vol, veh/h	30	30	30	220	620	80
Conflicting Peds, #/hr	0	0	0	0	0	0
Sign Control	Stop	Stop	Free	Free	Free	Free
RT Channelized	-	None	-	None	-	None
Storage Length	0	-	155	-	-	-
Veh in Median Storage, #	0	-	-	0	0	-
Grade, %	0	-	-	0	0	-
Peak Hour Factor	92	92	92	92	92	92
Heavy Vehicles, %	2	2	2	2	2	2
Mvmt Flow	33	33	33	239	674	87

Major/Minor	Minor2	Major1		Major2	
Conflicting Flow All	1023	718	761	0	0
Stage 1	718	-	-	-	-
Stage 2	305	-	-	-	-
Critical Hdwy	6.42	6.22	4.12	-	-
Critical Hdwy Stg 1	5.42	-	-	-	-
Critical Hdwy Stg 2	5.42	-	-	-	-
Follow-up Hdwy	3.518	3.318	2.218	-	-
Pot Cap-1 Maneuver	261	429	851	-	-
Stage 1	483	-	-	-	-
Stage 2	748	-	-	-	-
Platoon blocked, %				-	-
Mov Cap-1 Maneuver	251	429	851	-	-
Mov Cap-2 Maneuver	251	-	-	-	-
Stage 1	464	-	-	-	-
Stage 2	748	-	-	-	-

Approach	EB	NB	SB
HCM Control Delay, s	19.3	1.1	0
HCM LOS	C		

Minor Lane/Major Mvmt	NBL	NBT	EBLn1	SBT	SBR
Capacity (veh/h)	851	-	317	-	-
HCM Lane V/C Ratio	0.038	-	0.206	-	-
HCM Control Delay (s)	9.4	-	19.3	-	-
HCM Lane LOS	A	-	C	-	-
HCM 95th %tile Q(veh)	0.1	-	0.8	-	-

HCM 2010 Signalized Intersection Summary
 10: Imjin Road & Imjin Parkway

Cumulative with Project, AM
 06/11/2019

Movement	EBT	EBR	WBL	WBT	NBL	NBR		
Lane Configurations								
Traffic Volume (veh/h)	900	250	550	1170	100	160		
Future Volume (veh/h)	900	250	550	1170	100	160		
Number	2	12	1	6	3	18		
Initial Q (Qb), veh	0	0	0	0	0	0		
Ped-Bike Adj(A_pbT)		1.00	1.00		1.00	1.00		
Parking Bus, Adj	1.00	1.00	1.00	1.00	1.00	1.00		
Adj Sat Flow, veh/h/ln	1863	1900	1845	1845	1810	1810		
Adj Flow Rate, veh/h	947	250	579	1232	91	183		
Adj No. of Lanes	2	0	1	2	1	2		
Peak Hour Factor	0.95	0.95	0.95	0.95	0.95	0.95		
Percent Heavy Veh, %	2	2	3	3	5	5		
Cap, veh/h	1030	271	548	2685	153	273		
Arrive On Green	0.37	0.37	0.31	0.77	0.09	0.09		
Sat Flow, veh/h	2866	730	1757	3597	1723	3076		
Grp Volume(v), veh/h	604	593	579	1232	91	183		
Grp Sat Flow(s),veh/h/ln	1770	1734	1757	1752	1723	1538		
Q Serve(g_s), s	20.9	21.0	20.0	8.1	3.3	3.7		
Cycle Q Clear(g_c), s	20.9	21.0	20.0	8.1	3.3	3.7		
Prop In Lane		0.42	1.00		1.00	1.00		
Lane Grp Cap(c), veh/h	657	644	548	2685	153	273		
V/C Ratio(X)	0.92	0.92	1.06	0.46	0.59	0.67		
Avail Cap(c_a), veh/h	828	812	548	2685	592	1056		
HCM Platoon Ratio	1.00	1.00	1.00	1.00	1.00	1.00		
Upstream Filter(I)	1.00	1.00	1.00	1.00	1.00	1.00		
Uniform Delay (d), s/veh	19.2	19.3	22.0	2.7	28.1	28.3		
Incr Delay (d2), s/veh	11.7	12.4	54.1	0.0	1.4	1.1		
Initial Q Delay(d3),s/veh	0.0	0.0	0.0	0.0	0.0	0.0		
%ile BackOfQ(50%),veh/ln	12.2	12.1	17.8	3.8	1.6	1.6		
LnGrp Delay(d),s/veh	30.9	31.6	76.1	2.8	29.5	29.3		
LnGrp LOS	C	C	F	A	C	C		
Approach Vol, veh/h	1197			1811	274			
Approach Delay, s/veh	31.3			26.2	29.4			
Approach LOS	C			C	C			
Timer	1	2	3	4	5	6	7	8
Assigned Phs	1	2				6		8
Phs Duration (G+Y+Rc), s	25.3	29.1				54.4		9.7
Change Period (Y+Rc), s	5.3	* 5.3				5.3		4.0
Max Green Setting (Gmax), s	20.0	* 30				30.0		22.0
Max Q Clear Time (g_c+I1), s	22.0	23.0				10.1		5.7
Green Ext Time (p_c), s	0.0	0.8				1.5		0.0
Intersection Summary								
HCM 2010 Ctrl Delay			28.3					
HCM 2010 LOS			C					
Notes								

HCM 2010 Signalized Intersection Summary
 11: Abrams Drive & Imjin Parkway

Cumulative with Project, AM
 06/11/2019



Movement	EBL	EBT	EBR	WBL	WBT	WBR	NBL	NBT	NBR	SBL	SBT	SBR
Lane Configurations	↔	↑		↔	↑		↔	↑	↔	↔	↑	↔
Traffic Volume (veh/h)	50	840	80	90	1250	70	320	30	90	90	50	250
Future Volume (veh/h)	50	840	80	90	1250	70	320	30	90	90	50	250
Number	5	2	12	1	6	16	3	8	18	7	4	14
Initial Q (Qb), veh	0	0	0	0	0	0	0	0	0	0	0	0
Ped-Bike Adj(A_pbT)	1.00		1.00	1.00		1.00	1.00		1.00	1.00		1.00
Parking Bus, Adj	1.00	1.00	1.00	1.00	1.00	1.00	1.00	1.00	1.00	1.00	1.00	1.00
Adj Sat Flow, veh/h/ln	1881	1881	1900	1863	1863	1900	1845	1845	1845	1863	1863	1863
Adj Flow Rate, veh/h	54	903	74	97	1344	70	344	32	0	97	54	0
Adj No. of Lanes	2	2	0	2	2	0	1	1	1	1	1	1
Peak Hour Factor	0.93	0.93	0.93	0.93	0.93	0.93	0.93	0.93	0.93	0.93	0.93	0.93
Percent Heavy Veh, %	1	1	1	2	2	2	3	3	3	2	2	2
Cap, veh/h	180	1670	137	160	1670	87	457	550	468	479	555	472
Arrive On Green	0.05	0.50	0.50	0.05	0.49	0.49	0.30	0.30	0.00	0.30	0.30	0.00
Sat Flow, veh/h	3476	3346	274	3442	3423	178	1330	1845	1568	1370	1863	1583
Grp Volume(v), veh/h	54	482	495	97	694	720	344	32	0	97	54	0
Grp Sat Flow(s),veh/h/ln	1738	1787	1833	1721	1770	1831	1330	1845	1568	1370	1863	1583
Q Serve(g_s), s	1.2	15.2	15.2	2.3	27.1	27.2	20.7	1.0	0.0	4.5	1.7	0.0
Cycle Q Clear(g_c), s	1.2	15.2	15.2	2.3	27.1	27.2	22.4	1.0	0.0	5.5	1.7	0.0
Prop In Lane	1.00		0.15	1.00		0.10	1.00		1.00	1.00		1.00
Lane Grp Cap(c), veh/h	180	892	915	160	863	893	457	550	468	479	555	472
V/C Ratio(X)	0.30	0.54	0.54	0.61	0.80	0.81	0.75	0.06	0.00	0.20	0.10	0.00
Avail Cap(c_a), veh/h	848	1090	1117	839	1079	1117	547	675	574	572	682	579
HCM Platoon Ratio	1.00	1.00	1.00	1.00	1.00	1.00	1.00	1.00	1.00	1.00	1.00	1.00
Upstream Filter(I)	1.00	1.00	1.00	1.00	1.00	1.00	1.00	1.00	0.00	1.00	1.00	0.00
Uniform Delay (d), s/veh	37.4	14.1	14.1	38.4	17.7	17.7	28.9	20.5	0.0	22.5	20.8	0.0
Incr Delay (d2), s/veh	0.3	0.2	0.2	1.4	2.8	2.8	3.7	0.0	0.0	0.1	0.0	0.0
Initial Q Delay(d3),s/veh	0.0	0.0	0.0	0.0	0.0	0.0	0.0	0.0	0.0	0.0	0.0	0.0
%ile BackOfQ(50%),veh/ln	0.6	7.4	7.6	1.1	13.8	14.3	8.0	0.5	0.0	1.7	0.9	0.0
LnGrp Delay(d),s/veh	37.8	14.3	14.3	39.7	20.5	20.5	32.6	20.6	0.0	22.6	20.8	0.0
LnGrp LOS	D	B	B	D	C	C	C	C		C	C	
Approach Vol, veh/h		1031			1511			376			151	
Approach Delay, s/veh		15.5			21.8			31.6			22.0	
Approach LOS		B			C			C			C	
Timer	1	2	3	4	5	6	7	8				
Assigned Phs	1	2		4	5	6		8				
Phs Duration (G+Y+Rc), s	7.3	46.2		28.5	8.2	45.3		28.5				
Change Period (Y+Rc), s	3.5	5.3		4.0	4.0	5.3		4.0				
Max Green Setting (Gmax), s	20.0	50.0		30.0	20.0	50.0		30.0				
Max Q Clear Time (g_c+14), s	14.3	17.2		7.5	3.2	29.2		24.4				
Green Ext Time (p_c), s	0.0	0.7		0.0	0.0	1.1		0.1				
Intersection Summary												
HCM 2010 Ctrl Delay				20.9								
HCM 2010 LOS				C								

HCM 2010 Signalized Intersection Summary
 12: Reservation Road & Imjin Parkway

Cumulative with Project, AM
 06/11/2019



Movement	EBL	EBT	EBR	WBL	WBT	WBR	NBL	NBT	NBR	SBL	SBT	SBR
Lane Configurations	↖↗	↑	↖↗	↖	↑	↖	↖↗	↑↑	↖	↖↗	↑↑	↖
Traffic Volume (veh/h)	180	50	810	10	20	30	1220	890	20	60	590	90
Future Volume (veh/h)	180	50	810	10	20	30	1220	890	20	60	590	90
Number	3	8	18	7	4	14	1	6	16	5	2	12
Initial Q (Qb), veh	0	0	0	0	0	0	0	0	0	0	0	0
Ped-Bike Adj(A_pbT)	1.00		1.00	1.00		0.99	1.00		1.00	1.00		0.98
Parking Bus, Adj	1.00	1.00	1.00	1.00	1.00	1.00	1.00	1.00	1.00	1.00	1.00	1.00
Adj Sat Flow, veh/h/ln	1863	1863	1863	1638	1638	1638	1863	1863	1863	1863	1863	1863
Adj Flow Rate, veh/h	194	54	457	11	22	19	1312	957	16	65	634	34
Adj No. of Lanes	2	1	2	1	1	1	2	2	1	2	2	1
Peak Hour Factor	0.93	0.93	0.93	0.93	0.93	0.93	0.93	0.93	0.93	0.93	0.93	0.93
Percent Heavy Veh, %	2	2	2	16	16	16	2	2	2	2	2	2
Cap, veh/h	479	259	1343	53	56	47	1182	2087	932	114	988	435
Arrive On Green	0.14	0.14	0.14	0.03	0.03	0.03	0.34	0.59	0.59	0.03	0.28	0.28
Sat Flow, veh/h	3442	1863	2777	1560	1638	1382	3442	3539	1581	3442	3539	1558
Grp Volume(v), veh/h	194	54	457	11	22	19	1312	957	16	65	634	34
Grp Sat Flow(s),veh/h/ln	1721	1863	1388	1560	1638	1382	1721	1770	1581	1721	1770	1558
Q Serve(g_s), s	5.2	2.6	10.4	0.7	1.3	1.4	35.0	15.5	0.4	1.9	16.0	1.6
Cycle Q Clear(g_c), s	5.2	2.6	10.4	0.7	1.3	1.4	35.0	15.5	0.4	1.9	16.0	1.6
Prop In Lane	1.00		1.00	1.00		1.00	1.00		1.00	1.00		1.00
Lane Grp Cap(c), veh/h	479	259	1343	53	56	47	1182	2087	932	114	988	435
V/C Ratio(X)	0.41	0.21	0.34	0.21	0.39	0.40	1.11	0.46	0.02	0.57	0.64	0.08
Avail Cap(c_a), veh/h	1182	640	1911	475	498	420	1182	2087	932	675	2084	917
HCM Platoon Ratio	1.00	1.00	1.00	1.00	1.00	1.00	1.00	1.00	1.00	1.00	1.00	1.00
Upstream Filter(l)	1.00	1.00	1.00	1.00	1.00	1.00	1.00	1.00	1.00	1.00	1.00	1.00
Uniform Delay (d), s/veh	40.0	38.9	16.3	47.9	48.2	48.2	33.5	11.8	8.7	48.6	32.2	27.1
Incr Delay (d2), s/veh	0.2	0.1	0.1	0.7	1.7	2.0	61.8	0.4	0.0	1.7	1.9	0.2
Initial Q Delay(d3),s/veh	0.0	0.0	0.0	0.0	0.0	0.0	0.0	0.0	0.0	0.0	0.0	0.0
%ile BackOfQ(50%),veh/ln	2.5	1.4	4.0	0.3	0.6	0.6	26.7	7.7	0.2	0.9	8.1	0.7
LnGrp Delay(d),s/veh	40.2	39.0	16.4	48.6	49.8	50.2	95.2	12.2	8.7	50.2	34.2	27.3
LnGrp LOS	D	D	B	D	D	D	F	B	A	D	C	C
Approach Vol, veh/h		705			52			2285			733	
Approach Delay, s/veh		24.7			49.7			59.9			35.3	
Approach LOS		C			D			E			D	
Timer	1	2	3	4	5	6	7	8				
Assigned Phs	1	2		4	5	6		8				
Phs Duration (G+Y+Rc), s	39.1	34.7		8.5	7.5	66.3		19.7				
Change Period (Y+Rc), s	4.1	* 6.2		5.0	4.1	* 6.2		5.5				
Max Green Setting (Gmax), s	35.0	* 60		31.0	20.0	* 50		35.0				
Max Q Clear Time (g_c+Q), s	37.0	18.0		3.4	3.9	17.5		12.4				
Green Ext Time (p_c), s	0.0	10.4		0.1	0.0	15.3		1.5				
Intersection Summary												
HCM 2010 Ctrl Delay			48.4									
HCM 2010 LOS			D									
Notes												

HCM 2010 Signalized Intersection Summary
 13: Reservation Road & Blanco Road

Cumulative with Project, AM
 06/11/2019

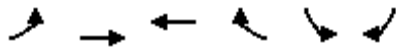

Movement	EBL	EBT	WBT	WBR	SBL	SBR		
Lane Configurations								
Traffic Volume (veh/h)	1060	380	720	40	40	1410		
Future Volume (veh/h)	1060	380	720	40	40	1410		
Number	5	2	6	16	7	14		
Initial Q (Qb), veh	0	0	0	0	0	0		
Ped-Bike Adj(A_pbT)	1.00			1.00	1.00	1.00		
Parking Bus, Adj	1.00	1.00	1.00	1.00	1.00	1.00		
Adj Sat Flow, veh/h/ln	1863	1863	1845	1845	1845	1845		
Adj Flow Rate, veh/h	1140	409	774	24	43	0		
Adj No. of Lanes	2	2	1	1	2	2		
Peak Hour Factor	0.93	0.93	0.93	0.93	0.93	0.93		
Percent Heavy Veh, %	2	2	3	3	3	3		
Cap, veh/h	1208	3074	843	716	99	80		
Arrive On Green	0.35	0.87	0.46	0.46	0.03	0.00		
Sat Flow, veh/h	3442	3632	1845	1568	3408	2760		
Grp Volume(v), veh/h	1140	409	774	24	43	0		
Grp Sat Flow(s),veh/h/ln	1721	1770	1845	1568	1704	1380		
Q Serve(g_s), s	29.2	1.6	35.7	0.8	1.1	0.0		
Cycle Q Clear(g_c), s	29.2	1.6	35.7	0.8	1.1	0.0		
Prop In Lane	1.00			1.00	1.00	1.00		
Lane Grp Cap(c), veh/h	1208	3074	843	716	99	80		
V/C Ratio(X)	0.94	0.13	0.92	0.03	0.43	0.00		
Avail Cap(c_a), veh/h	1516	3074	1219	1036	1013	821		
HCM Platoon Ratio	1.00	1.00	1.00	1.00	1.00	1.00		
Upstream Filter(I)	1.00	1.00	1.00	1.00	1.00	0.00		
Uniform Delay (d), s/veh	28.6	0.9	23.1	13.6	43.3	0.0		
Incr Delay (d2), s/veh	9.8	0.0	7.7	0.0	1.1	0.0		
Initial Q Delay(d3),s/veh	0.0	0.0	0.0	0.0	0.0	0.0		
%ile BackOfQ(50%),veh/ft	5.4	0.7	19.9	0.3	0.5	0.0		
LnGrp Delay(d),s/veh	38.4	0.9	30.8	13.6	44.4	0.0		
LnGrp LOS	D	A	C	B	D			
Approach Vol, veh/h		1549	798		43			
Approach Delay, s/veh		28.5	30.3		44.4			
Approach LOS		C	C		D			
Timer	1	2	3	4	5	6	7	8
Assigned Phs		2		4	5	6		
Phs Duration (G+Y+Rc), s		84.6		6.1	37.4	47.3		
Change Period (Y+Rc), s		5.8		3.5	5.5	5.8		
Max Green Setting (Gmax), s		60.0		27.0	40.0	60.0		
Max Q Clear Time (g_c+I1), s		3.6		3.1	31.2	37.7		
Green Ext Time (p_c), s		1.9		0.0	0.7	3.8		
Intersection Summary								
HCM 2010 Ctrl Delay			29.4					
HCM 2010 LOS			C					

HCM 2010 Signalized Intersection Summary
 14: Reservation Road & Inter-Garrison Road

Cumulative with Project, AM
 06/11/2019



Movement	EBL	EBR	NBL	NBT	SBT	SBR		
Lane Configurations								
Traffic Volume (veh/h)	190	370	600	600	310	190		
Future Volume (veh/h)	190	370	600	600	310	190		
Number	3	18	1	6	2	12		
Initial Q (Qb), veh	0	0	0	0	0	0		
Ped-Bike Adj(A_pbT)	1.00	1.00	1.00			1.00		
Parking Bus, Adj	1.00	1.00	1.00	1.00	1.00	1.00		
Adj Sat Flow, veh/h/ln	1845	1845	1863	1863	1845	1900		
Adj Flow Rate, veh/h	202	355	638	638	330	186		
Adj No. of Lanes	1	1	1	2	2	0		
Peak Hour Factor	0.94	0.94	0.94	0.94	0.94	0.94		
Percent Heavy Veh, %	3	3	2	2	3	3		
Cap, veh/h	354	795	542	2236	555	307		
Arrive On Green	0.20	0.20	0.31	0.63	0.25	0.25		
Sat Flow, veh/h	1757	1568	1774	3632	2273	1204		
Grp Volume(v), veh/h	202	355	638	638	264	252		
Grp Sat Flow(s),veh/h/ln	1757	1568	1774	1770	1752	1632		
Q Serve(g_s), s	6.8	9.4	20.0	5.3	8.7	8.9		
Cycle Q Clear(g_c), s	6.8	9.4	20.0	5.3	8.7	8.9		
Prop In Lane	1.00	1.00	1.00			0.74		
Lane Grp Cap(c), veh/h	354	795	542	2236	446	416		
V/C Ratio(X)	0.57	0.45	1.18	0.29	0.59	0.61		
Avail Cap(c_a), veh/h	724	1126	542	3243	1606	1496		
HCM Platoon Ratio	1.00	1.00	1.00	1.00	1.00	1.00		
Upstream Filter(I)	1.00	1.00	1.00	1.00	1.00	1.00		
Uniform Delay (d), s/veh	23.6	10.3	22.7	5.4	21.4	21.5		
Incr Delay (d2), s/veh	1.4	0.4	97.8	0.1	2.3	2.7		
Initial Q Delay(d3),s/veh	0.0	0.0	0.0	0.0	0.0	0.0		
%ile BackOfQ(50%),veh/ln	3.4	4.2	24.4	2.6	4.5	4.3		
LnGrp Delay(d),s/veh	25.0	10.7	120.5	5.5	23.7	24.2		
LnGrp LOS	C	B	F	A	C	C		
Approach Vol, veh/h	557			1276	516			
Approach Delay, s/veh	15.9			63.0	23.9			
Approach LOS	B			E	C			
Timer	1	2	3	4	5	6	7	8
Assigned Phs	1	2				6		8
Phs Duration (G+Y+Rc), s	24.7	23.1				47.8		17.7
Change Period (Y+Rc), s	4.7	6.4				6.4		4.5
Max Green Setting (Gmax), s	26	60.0				60.0		27.0
Max Q Clear Time (g_c+Yc), s	22.6	10.9				7.3		11.4
Green Ext Time (p_c), s	0.0	5.8				8.0		1.8
Intersection Summary								
HCM 2010 Ctrl Delay			43.3					
HCM 2010 LOS			D					
Notes								

HCM 2010 Signalized Intersection Summary
 15: 2nd Avenue & 9th Street

Cumulative with Project, AM
 06/11/2019



Movement	EBL	EBT	EBR	WBL	WBT	WBR	NBL	NBT	NBR	SBL	SBT	SBR
Lane Configurations		↕	↗		↕		↖	↕		↖	↕	
Traffic Volume (veh/h)	10	10	10	260	10	20	20	390	30	40	920	10
Future Volume (veh/h)	10	10	10	260	10	20	20	390	30	40	920	10
Number	5	2	12	1	6	16	3	8	18	7	4	14
Initial Q (Qb), veh	0	0	0	0	0	0	0	0	0	0	0	0
Ped-Bike Adj(A_pbT)	0.99		1.00	0.99		0.99	1.00		0.99	1.00		0.99
Parking Bus, Adj	1.00	1.00	1.00	1.00	1.00	1.00	1.00	1.00	1.00	1.00	1.00	1.00
Adj Sat Flow, veh/h/ln	1900	1881	1881	1900	1900	1900	1881	1881	1900	1863	1863	1900
Adj Flow Rate, veh/h	11	11	-24	277	11	20	21	415	27	43	979	4
Adj No. of Lanes	0	1	1	0	1	0	1	2	0	1	2	0
Peak Hour Factor	0.94	0.94	0.94	0.94	0.94	0.94	0.94	0.94	0.94	0.94	0.94	0.94
Percent Heavy Veh, %	1	1	1	0	0	0	1	1	1	2	2	2
Cap, veh/h	318	283	450	513	15	27	46	1337	87	81	1491	6
Arrive On Green	0.28	0.28	0.00	0.28	0.28	0.28	0.03	0.39	0.39	0.05	0.41	0.41
Sat Flow, veh/h	731	1006	1599	1318	52	95	1792	3406	221	1774	3615	15
Grp Volume(v), veh/h	22	0	-24	308	0	0	21	217	225	43	479	504
Grp Sat Flow(s),veh/h/ln1737	0	1599	1466	0	0	1792	1787	1840	1774	1770	1860	
Q Serve(g_s), s	0.0	0.0	0.0	8.7	0.0	0.0	0.6	4.0	4.1	1.1	10.5	10.5
Cycle Q Clear(g_c), s	0.4	0.0	0.0	9.2	0.0	0.0	0.6	4.0	4.1	1.1	10.5	10.5
Prop In Lane	0.50		1.00	0.90		0.06	1.00		0.12	1.00		0.01
Lane Grp Cap(c), veh/h	601	0	450	555	0	0	46	701	722	81	730	767
V/C Ratio(X)	0.04	0.00	-0.05	0.56	0.00	0.00	0.46	0.31	0.31	0.53	0.66	0.66
Avail Cap(c_a), veh/h	1146	0	998	1053	0	0	429	1673	1723	424	1657	1741
HCM Platoon Ratio	1.00	1.00	1.00	1.00	1.00	1.00	1.00	1.00	1.00	1.00	1.00	1.00
Upstream Filter(I)	1.00	0.00	0.00	1.00	0.00	0.00	1.00	1.00	1.00	1.00	1.00	1.00
Uniform Delay (d), s/veh	12.6	0.0	0.0	15.7	0.0	0.0	23.1	10.1	10.1	22.4	11.4	11.4
Incr Delay (d2), s/veh	0.0	0.0	0.0	0.9	0.0	0.0	7.1	0.2	0.2	5.4	1.0	1.0
Initial Q Delay(d3),s/veh	0.0	0.0	0.0	0.0	0.0	0.0	0.0	0.0	0.0	0.0	0.0	0.0
%ile BackOfQ(50%),veh/ln0.2	0.0	0.0	0.0	3.8	0.0	0.0	0.4	2.0	2.1	0.7	5.3	5.5
LnGrp Delay(d),s/veh	12.6	0.0	0.0	16.5	0.0	0.0	30.2	10.3	10.4	27.8	12.4	12.3
LnGrp LOS	B			B			C	B	B	C	B	B
Approach Vol, veh/h		-2			308			463			1026	
Approach Delay, s/veh		-138.5			16.5			11.2			13.0	
Approach LOS		A			B			B			B	
Timer	1	2	3	4	5	6	7	8				
Assigned Phs		2	3	4		6	7	8				
Phs Duration (G+Y+Rc), s		18.5	4.7	24.8		18.5	5.7	23.9				
Change Period (Y+Rc), s		5.0	3.5	5.0		5.0	3.5	5.0				
Max Green Setting (Gmax), s		30.0	11.5	45.0		30.0	11.5	45.0				
Max Q Clear Time (g_c+I1), s		2.4	2.6	12.5		11.2	3.1	6.1				
Green Ext Time (p_c), s		0.1	0.0	7.1		1.6	0.0	2.7				
Intersection Summary												
HCM 2010 Ctrl Delay				13.3								
HCM 2010 LOS				B								

HCM 2010 Signalized Intersection Summary
 16: 2nd Avenue & 8th Street

Cumulative with Project, AM
 06/11/2019



Movement	WBL	WBR	NBT	NBR	SBL	SBT		
Lane Configurations								
Traffic Volume (veh/h)	380	40	510	160	80	1070		
Future Volume (veh/h)	380	40	510	160	80	1070		
Number	1	16	8	18	7	4		
Initial Q (Qb), veh	0	0	0	0	0	0		
Ped-Bike Adj(A_pbT)	1.00	1.00		1.00	1.00			
Parking Bus, Adj	1.00	1.00	1.00	1.00	1.00	1.00		
Adj Sat Flow, veh/h/ln	1583	1583	1863	1900	1881	1881		
Adj Flow Rate, veh/h	400	26	537	152	84	1126		
Adj No. of Lanes	1	1	2	0	1	2		
Peak Hour Factor	0.95	0.95	0.95	0.95	0.95	0.95		
Percent Heavy Veh, %	20	20	2	2	1	1		
Cap, veh/h	471	420	948	267	124	1740		
Arrive On Green	0.31	0.31	0.35	0.35	0.07	0.49		
Sat Flow, veh/h	1508	1346	2821	769	1792	3668		
Grp Volume(v), veh/h	400	26	348	341	84	1126		
Grp Sat Flow(s),veh/h/ln	1508	1346	1770	1727	1792	1787		
Q Serve(g_s), s	12.4	0.7	7.9	8.0	2.3	11.8		
Cycle Q Clear(g_c), s	12.4	0.7	7.9	8.0	2.3	11.8		
Prop In Lane	1.00	1.00		0.45	1.00			
Lane Grp Cap(c), veh/h	471	420	615	600	124	1740		
V/C Ratio(X)	0.85	0.06	0.57	0.57	0.68	0.65		
Avail Cap(c_a), veh/h	908	811	1599	1560	414	4306		
HCM Platoon Ratio	1.00	1.00	1.00	1.00	1.00	1.00		
Upstream Filter(I)	1.00	1.00	1.00	1.00	1.00	1.00		
Uniform Delay (d), s/veh	16.0	12.0	13.2	13.2	22.6	9.6		
Incr Delay (d2), s/veh	4.4	0.1	0.8	0.8	6.4	0.4		
Initial Q Delay(d3),s/veh	0.0	0.0	0.0	0.0	0.0	0.0		
%ile BackOfQ(50%),veh/ln	6.7	0.6	4.0	3.9	1.3	5.7		
LnGrp Delay(d),s/veh	20.4	12.1	14.0	14.1	29.0	10.0		
LnGrp LOS	C	B	B	B	C	A		
Approach Vol, veh/h	426		689			1210		
Approach Delay, s/veh	19.9		14.0			11.3		
Approach LOS	B		B			B		
Timer	1	2	3	4	5	6	7	8
Assigned Phs				4		6	7	8
Phs Duration (G+Y+Rc), s				29.2		20.6	6.9	22.3
Change Period (Y+Rc), s				5.0		5.0	3.5	5.0
Max Green Setting (Gmax), s				60.0		30.0	11.5	45.0
Max Q Clear Time (g_c+I1), s				13.8		14.4	4.3	10.0
Green Ext Time (p_c), s				10.5		1.2	0.1	4.7
Intersection Summary								
HCM 2010 Ctrl Delay			13.7					
HCM 2010 LOS			B					

Intersection	
Intersection Delay, s/veh	14.9
Intersection LOS	B

Movement	EBT	EBR	WBL	WBT	NBL	NBR
Lane Configurations	↑	↑	↑	↑	↑	↑
Traffic Vol, veh/h	160	80	270	390	40	180
Future Vol, veh/h	160	80	270	390	40	180
Peak Hour Factor	0.92	0.92	0.92	0.92	0.92	0.92
Heavy Vehicles, %	2	2	2	2	2	2
Mvmt Flow	174	87	293	424	43	196
Number of Lanes	1	1	1	1	1	1

Approach	EB	WB	NB
Opposing Approach	WB	EB	
Opposing Lanes	2	2	0
Conflicting Approach Left		NB	EB
Conflicting Lanes Left	0	2	2
Conflicting Approach Right	NB		WB
Conflicting Lanes Right	2	0	2
HCM Control Delay	10.8	17.4	11.8
HCM LOS	B	C	B

Lane	NBLn1	NBLn2	EBLn1	EBLn2	WBLn1	WBLn2
Vol Left, %	100%	0%	0%	0%	100%	0%
Vol Thru, %	0%	0%	100%	0%	0%	100%
Vol Right, %	0%	100%	0%	100%	0%	0%
Sign Control	Stop	Stop	Stop	Stop	Stop	Stop
Traffic Vol by Lane	40	180	160	80	270	390
LT Vol	40	0	0	0	270	0
Through Vol	0	0	160	0	0	390
RT Vol	0	180	0	80	0	0
Lane Flow Rate	43	196	174	87	293	424
Geometry Grp	7	7	7	7	7	7
Degree of Util (X)	0.089	0.334	0.302	0.134	0.502	0.666
Departure Headway (Hd)	7.363	6.147	6.244	5.533	6.162	5.656
Convergence, Y/N	Yes	Yes	Yes	Yes	Yes	Yes
Cap	487	585	576	647	587	640
Service Time	5.107	3.89	3.987	3.276	3.892	3.387
HCM Lane V/C Ratio	0.088	0.335	0.302	0.134	0.499	0.662
HCM Control Delay	10.8	12	11.7	9.1	15	19
HCM Lane LOS	B	B	B	A	B	C
HCM 95th-tile Q	0.3	1.5	1.3	0.5	2.8	5

Intersection				
Intersection Delay, s/veh 25.7				
Intersection LOS D				
Approach	EB	WB	NB	SB
Entry Lanes	1	1	1	1
Conflicting Circle Lanes	1	1	1	1
Adj Approach Flow, veh/h	197	333	49	901
Demand Flow Rate, veh/h	203	350	49	910
Vehicles Circulating, veh/h	549	126	715	154
Vehicles Exiting, veh/h	515	638	37	322
Follow-Up Headway, s	3.186	3.186	3.186	3.186
Ped Vol Crossing Leg, #/h	0	0	0	0
Ped Cap Adj	1.000	1.000	1.000	1.000
Approach Delay, s/veh	9.8	7.6	7.6	36.9
Approach LOS	A	A	A	E
Lane	Left	Left	Left	Left
Designated Moves	LTR	LTR	LTR	LTR
Assumed Moves	LTR	LTR	LTR	LTR
RT Channelized				
Lane Util	1.000	1.000	1.000	1.000
Critical Headway, s	5.193	5.193	5.193	5.193
Entry Flow, veh/h	203	350	49	910
Cap Entry Lane, veh/h	653	996	553	969
Entry HV Adj Factor	0.971	0.951	1.000	0.990
Flow Entry, veh/h	197	333	49	901
Cap Entry, veh/h	633	947	553	959
V/C Ratio	0.311	0.351	0.089	0.939
Control Delay, s/veh	9.8	7.6	7.6	36.9
LOS	A	A	A	E
95th %tile Queue, veh	1	2	0	15

HCM 2010 Signalized Intersection Summary
 19: 2nd Avenue & Inter-Garrison Road

Cumulative with Project, AM
 06/11/2019



Movement	WBL	WBR	NBT	NBR	SBL	SBT		
Lane Configurations								
Traffic Volume (veh/h)	40	30	680	60	30	1440		
Future Volume (veh/h)	40	30	680	60	30	1440		
Number	1	16	8	18	7	4		
Initial Q (Qb), veh	0	0	0	0	0	0		
Ped-Bike Adj(A_pbT)	1.00	1.00		1.00	1.00			
Parking Bus, Adj	1.00	1.00	1.00	1.00	1.00	1.00		
Adj Sat Flow, veh/h/ln	1900	1900	1881	1900	1881	1881		
Adj Flow Rate, veh/h	43	8	731	57	32	1548		
Adj No. of Lanes	1	1	2	0	1	2		
Peak Hour Factor	0.93	0.93	0.93	0.93	0.93	0.93		
Percent Heavy Veh, %	0	0	1	1	1	1		
Cap, veh/h	190	169	1876	146	66	2405		
Arrive On Green	0.10	0.10	0.56	0.56	0.04	0.67		
Sat Flow, veh/h	1810	1615	3454	262	1792	3668		
Grp Volume(v), veh/h	43	8	389	399	32	1548		
Grp Sat Flow(s),veh/h/ln	1810	1615	1787	1835	1792	1787		
Q Serve(g_s), s	1.0	0.2	5.5	5.5	0.8	11.2		
Cycle Q Clear(g_c), s	1.0	0.2	5.5	5.5	0.8	11.2		
Prop In Lane	1.00	1.00		0.14	1.00			
Lane Grp Cap(c), veh/h	190	169	998	1025	66	2405		
V/C Ratio(X)	0.23	0.05	0.39	0.39	0.49	0.64		
Avail Cap(c_a), veh/h	1408	1257	1590	1632	458	4371		
HCM Platoon Ratio	1.00	1.00	1.00	1.00	1.00	1.00		
Upstream Filter(I)	1.00	1.00	1.00	1.00	1.00	1.00		
Uniform Delay (d), s/veh	18.5	18.1	5.6	5.6	21.2	4.2		
Incr Delay (d2), s/veh	0.6	0.1	0.2	0.2	5.5	0.3		
Initial Q Delay(d3),s/veh	0.0	0.0	0.0	0.0	0.0	0.0		
%ile BackOfQ(50%),veh/ln	0.5	0.2	2.8	2.8	0.5	5.5		
LnGrp Delay(d),s/veh	19.1	18.2	5.9	5.8	26.8	4.5		
LnGrp LOS	B	B	A	A	C	A		
Approach Vol, veh/h	51		788			1580		
Approach Delay, s/veh	18.9		5.8			5.0		
Approach LOS	B		A			A		
Timer	1	2	3	4	5	6	7	8
Assigned Phs				4		6	7	8
Phs Duration (G+Y+Rc), s				35.3		9.7	5.1	30.1
Change Period (Y+Rc), s				5.0		5.0	3.5	5.0
Max Green Setting (Gmax), s				55.0		35.0	11.5	40.0
Max Q Clear Time (g_c+I1), s				13.2		3.0	2.8	7.5
Green Ext Time (p_c), s				17.0		0.1	0.0	5.4
Intersection Summary								
HCM 2010 Ctrl Delay			5.6					
HCM 2010 LOS			A					

Intersection												
Intersection Delay, s/veh 10.5												
Intersection LOS B												























Movement	EBL	EBT	EBR	WBL	WBT	WBR	NBL	NBT	NBR	SBL	SBT	SBR
Lane Configurations		↕			↕			↕			↕	
Traffic Vol, veh/h	10	20	10	70	20	30	20	180	100	30	160	10
Future Vol, veh/h	10	20	10	70	20	30	20	180	100	30	160	10
Peak Hour Factor	0.85	0.85	0.85	0.85	0.85	0.85	0.85	0.85	0.85	0.85	0.85	0.85
Heavy Vehicles, %	6	6	6	2	2	2	4	4	4	0	0	0
Mvmt Flow	12	24	12	82	24	35	24	212	118	35	188	12
Number of Lanes	0	1	0	0	1	0	0	1	0	0	1	0

Approach	EB	WB	NB	SB
Opposing Approach	WB	EB	SB	NB
Opposing Lanes	1	1	1	1
Conflicting Approach Left	SB	NB	EB	WB
Conflicting Lanes Left	1	1	1	1
Conflicting Approach Right	NB	SB	WB	EB
Conflicting Lanes Right	1	1	1	1
HCM Control Delay	9	9.8	11.3	10.1
HCM LOS	A	A	B	B

Lane	NBLn1	EBLn1	WBLn1	SBLn1
Vol Left, %	7%	25%	58%	15%
Vol Thru, %	60%	50%	17%	80%
Vol Right, %	33%	25%	25%	5%
Sign Control	Stop	Stop	Stop	Stop
Traffic Vol by Lane	300	40	120	200
LT Vol	20	10	70	30
Through Vol	180	20	20	160
RT Vol	100	10	30	10
Lane Flow Rate	353	47	141	235
Geometry Grp	1	1	1	1
Degree of Util (X)	0.447	0.073	0.208	0.314
Departure Headway (Hd)	4.562	5.567	5.302	4.802
Convergence, Y/N	Yes	Yes	Yes	Yes
Cap	784	648	671	741
Service Time	2.625	3.567	3.39	2.874
HCM Lane V/C Ratio	0.45	0.073	0.21	0.317
HCM Control Delay	11.3	9	9.8	10.1
HCM Lane LOS	B	A	A	B
HCM 95th-tile Q	2.3	0.2	0.8	1.3

HCM 2010 Signalized Intersection Summary
 21: 7th Avenue/8th Street & Inter-Garrison Road

Cumulative with Project, AM
 07/12/2019

												
Movement	EBL	EBT	EBR	WBL	WBT	WBR	NBL	NBT	NBR	SBL	SBT	SBR
Lane Configurations												
Traffic Volume (veh/h)	10	90	50	350	230	40	80	170	150	240	150	10
Future Volume (veh/h)	10	90	50	350	230	40	80	170	150	240	150	10
Number	5	2	12	1	6	16	3	8	18	7	4	14
Initial Q (Qb), veh	0	0	0	0	0	0	0	0	0	0	0	0
Ped-Bike Adj(A_pbT)	1.00		0.99	1.00		1.00	1.00		1.00	1.00		1.00
Parking Bus, Adj	1.00	1.00	1.00	1.00	1.00	1.00	1.00	1.00	1.00	1.00	1.00	1.00
Adj Sat Flow, veh/h/ln	1759	1759	1900	1845	1845	1900	1597	1597	1597	1776	1776	1900
Adj Flow Rate, veh/h	12	111	53	432	284	0	99	210	152	296	185	5
Adj No. of Lanes	1	1	0	1	1	0	1	1	1	1	1	0
Peak Hour Factor	0.81	0.81	0.81	0.81	0.81	0.81	0.81	0.81	0.81	0.81	0.81	0.81
Percent Heavy Veh, %	8	8	8	3	3	3	19	19	19	7	7	7
Cap, veh/h	20	167	80	483	759	0	123	269	228	340	497	13
Arrive On Green	0.01	0.15	0.15	0.28	0.41	0.00	0.08	0.17	0.17	0.20	0.29	0.29
Sat Flow, veh/h	1675	1122	536	1757	1845	0	1521	1597	1357	1691	1721	47
Grp Volume(v), veh/h	12	0	164	432	284	0	99	210	152	296	0	190
Grp Sat Flow(s),veh/h/ln	1675	0	1658	1757	1845	0	1521	1597	1357	1691	0	1767
Q Serve(g_s), s	0.6	0.0	7.2	18.2	8.3	0.0	4.9	9.7	8.1	13.1	0.0	6.6
Cycle Q Clear(g_c), s	0.6	0.0	7.2	18.2	8.3	0.0	4.9	9.7	8.1	13.1	0.0	6.6
Prop In Lane	1.00		0.32	1.00		0.00	1.00		1.00	1.00		0.03
Lane Grp Cap(c), veh/h	20	0	246	483	759	0	123	269	228	340	0	510
V/C Ratio(X)	0.61	0.00	0.67	0.89	0.37	0.00	0.81	0.78	0.67	0.87	0.00	0.37
Avail Cap(c_a), veh/h	87	0	688	663	1365	0	302	455	387	458	0	632
HCM Platoon Ratio	1.00	1.00	1.00	1.00	1.00	1.00	1.00	1.00	1.00	1.00	1.00	1.00
Upstream Filter(I)	1.00	0.00	1.00	1.00	1.00	0.00	1.00	1.00	1.00	1.00	0.00	1.00
Uniform Delay (d), s/veh	38.0	0.0	31.0	26.9	15.8	0.0	34.9	30.7	30.1	29.9	0.0	21.9
Incr Delay (d2), s/veh	26.7	0.0	3.1	11.5	0.3	0.0	11.7	4.9	3.3	13.0	0.0	0.5
Initial Q Delay(d3),s/veh	0.0	0.0	0.0	0.0	0.0	0.0	0.0	0.0	0.0	0.0	0.0	0.0
%ile BackOfQ(50%),veh/ln	0.4	0.0	3.5	10.3	4.2	0.0	2.5	4.6	3.2	7.3	0.0	3.3
LnGrp Delay(d),s/veh	64.7	0.0	34.1	38.4	16.1	0.0	46.6	35.7	33.4	42.9	0.0	22.3
LnGrp LOS	E		C	D	B		D	D	C	D		C
Approach Vol, veh/h		176			716			461			486	
Approach Delay, s/veh		36.2			29.6			37.3			34.8	
Approach LOS		D			C			D			C	
Timer	1	2	3	4	5	6	7	8				
Assigned Phs	1	2	3	4	5	6	7	8				
Phs Duration (G+Y+Rc), s	24.7	16.5	9.7	26.3	4.4	36.8	19.0	17.0				
Change Period (Y+Rc), s	3.5	5.0	3.5	4.0	3.5	5.0	3.5	4.0				
Max Green Setting (Gmax), s	29.1	32.0	15.3	27.6	4.0	57.1	20.9	22.0				
Max Q Clear Time (g_c+I1), s	20.2	9.2	6.9	8.6	2.6	10.3	15.1	11.7				
Green Ext Time (p_c), s	1.0	0.8	0.1	0.9	0.0	1.9	0.5	1.3				
Intersection Summary												
HCM 2010 Ctrl Delay			33.5									
HCM 2010 LOS			C									

Intersection			
Intersection Delay, s/veh	185.7		
Intersection LOS	F		
Approach	EB	WB	NB
Entry Lanes	1	1	1
Conflicting Circle Lanes	1	1	1
Adj Approach Flow, veh/h	563	1517	528
Demand Flow Rate, veh/h	704	1533	544
Vehicles Circulating, veh/h	871	59	345
Vehicles Exiting, veh/h	721	830	1230
Follow-Up Headway, s	3.186	3.186	3.186
Ped Vol Crossing Leg, #/h	0	0	0
Ped Cap Adj	1.000	1.000	1.000
Approach Delay, s/veh	260.3	216.7	17.3
Approach LOS	F	F	C
Lane	Left	Left	Left
Designated Moves	TR	LT	LR
Assumed Moves	TR	LT	LR
RT Channelized			
Lane Util	1.000	1.000	1.000
Critical Headway, s	5.193	5.193	5.193
Entry Flow, veh/h	704	1533	544
Cap Entry Lane, veh/h	473	1065	800
Entry HV Adj Factor	0.800	0.990	0.971
Flow Entry, veh/h	563	1517	528
Cap Entry, veh/h	378	1054	777
V/C Ratio	1.489	1.439	0.680
Control Delay, s/veh	260.3	216.7	17.3
LOS	F	F	C
95th %tile Queue, veh	30	66	5

HCM 2010 Signalized Intersection Summary
 23: Inter-Garrison Road & Abrams Drive

Cumulative with Project, AM
 06/11/2019

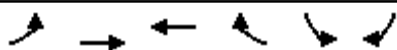

Movement	EBL	EBT	WBT	WBR	SBL	SBR		
Lane Configurations								
Traffic Volume (veh/h)	260	390	820	10	40	500		
Future Volume (veh/h)	260	390	820	10	40	500		
Number	5	2	6	16	7	14		
Initial Q (Qb), veh	0	0	0	0	0	0		
Ped-Bike Adj(A_pbT)	1.00			1.00	1.00	1.00		
Parking Bus, Adj	1.00	1.00	1.00	1.00	1.00	1.00		
Adj Sat Flow, veh/h/ln	1759	1759	1881	1881	1881	1881		
Adj Flow Rate, veh/h	306	459	965	6	47	370		
Adj No. of Lanes	1	1	1	1	2	1		
Peak Hour Factor	0.85	0.85	0.85	0.85	0.85	0.85		
Percent Heavy Veh, %	8	8	1	1	1	1		
Cap, veh/h	211	1157	928	789	865	398		
Arrive On Green	0.13	0.66	0.49	0.49	0.25	0.25		
Sat Flow, veh/h	1675	1759	1881	1599	3476	1599		
Grp Volume(v), veh/h	306	459	965	6	47	370		
Grp Sat Flow(s),veh/h/ln	1675	1759	1881	1599	1738	1599		
Q Serve(g_s), s	11.5	11.0	45.0	0.2	0.9	20.6		
Cycle Q Clear(g_c), s	11.5	11.0	45.0	0.2	0.9	20.6		
Prop In Lane	1.00			1.00	1.00	1.00		
Lane Grp Cap(c), veh/h	211	1157	928	789	865	398		
V/C Ratio(X)	1.45	0.40	1.04	0.01	0.05	0.93		
Avail Cap(c_a), veh/h	211	1157	928	789	1201	552		
HCM Platoon Ratio	1.00	1.00	1.00	1.00	1.00	1.00		
Upstream Filter(I)	1.00	1.00	1.00	1.00	1.00	1.00		
Uniform Delay (d), s/veh	39.8	7.2	23.1	11.7	26.1	33.5		
Incr Delay (d2), s/veh	226.3	0.1	40.3	0.0	0.0	15.7		
Initial Q Delay(d3),s/veh	0.0	0.0	0.0	0.0	0.0	0.0		
%ile BackOfQ(50%),veh/ln	8.6	5.3	33.6	0.1	0.5	18.1		
LnGrp Delay(d),s/veh	266.1	7.3	63.4	11.7	26.1	49.2		
LnGrp LOS	F	A	F	B	C	D		
Approach Vol, veh/h		765	971		417			
Approach Delay, s/veh		110.8	63.1		46.6			
Approach LOS		F	E		D			
Timer	1	2	3	4	5	6	7	8
Assigned Phs		2		4	5	6		
Phs Duration (G+Y+Rc), s		65.0		26.2	15.0	50.0		
Change Period (Y+Rc), s		5.0		3.5	3.5	5.0		
Max Green Setting (Gmax), s		60.0		31.5	11.5	45.0		
Max Q Clear Time (g_c+I1), s		13.0		22.6	13.5	47.0		
Green Ext Time (p_c), s		0.4		0.1	0.0	0.0		
Intersection Summary								
HCM 2010 Ctrl Delay			76.9					
HCM 2010 LOS			E					

Intersection	
Intersection Delay, s/veh	49.4
Intersection LOS	E

Movement	EBL	EBT	WBT	WBR	SBL	SBR
Lane Configurations						
Traffic Vol, veh/h	70	380	660	10	70	160
Future Vol, veh/h	70	380	660	10	70	160
Peak Hour Factor	0.79	0.79	0.79	0.79	0.79	0.79
Heavy Vehicles, %	5	5	1	1	3	3
Mvmt Flow	89	481	835	13	89	203
Number of Lanes	1	1	2	1	1	1

Approach	EB	WB	SB
Opposing Approach	WB	EB	
Opposing Lanes	3	2	0
Conflicting Approach Left	SB		WB
Conflicting Lanes Left	2	0	3
Conflicting Approach Right		SB	EB
Conflicting Lanes Right	0	2	2
HCM Control Delay	77.7	41.6	16.7
HCM LOS	F	E	C

Lane	EBLn1	EBLn2	WBLn1	WBLn2	WBLn3	SBLn1	SBLn2
Vol Left, %	100%	0%	0%	0%	0%	100%	0%
Vol Thru, %	0%	100%	100%	100%	0%	0%	0%
Vol Right, %	0%	0%	0%	0%	100%	0%	100%
Sign Control	Stop	Stop	Stop	Stop	Stop	Stop	Stop
Traffic Vol by Lane	70	380	330	330	10	70	160
LT Vol	70	0	0	0	0	70	0
Through Vol	0	380	330	330	0	0	0
RT Vol	0	0	0	0	10	0	160
Lane Flow Rate	89	481	418	418	13	89	203
Geometry Grp	8	8	8	8	8	8	8
Degree of Util (X)	0.209	1.067	0.863	0.863	0.017	0.228	0.451
Departure Headway (Hd)	8.5	7.987	7.638	7.638	5.162	9.48	8.245
Convergence, Y/N	Yes	Yes	Yes	Yes	Yes	Yes	Yes
Cap	424	457	476	476	698	381	439
Service Time	6.2	5.687	5.338	5.338	2.862	7.18	5.945
HCM Lane V/C Ratio	0.21	1.053	0.878	0.878	0.019	0.234	0.462
HCM Control Delay	13.4	89.5	42.1	42.1	8	15	17.5
HCM Lane LOS	B	F	E	E	A	B	C
HCM 95th-tile Q	0.8	15.4	9	9	0.1	0.9	2.3

Intersection	
Intersection Delay, s/veh	80.7
Intersection LOS	F

Movement	EBL	EBT	WBT	WBR	SBL	SBR
Lane Configurations						
Traffic Vol, veh/h	370	80	170	210	110	510
Future Vol, veh/h	370	80	170	210	110	510
Peak Hour Factor	0.82	0.82	0.82	0.82	0.82	0.82
Heavy Vehicles, %	5	5	1	1	0	0
Mvmt Flow	451	98	207	256	134	622
Number of Lanes	1	1	1	0	1	1

Approach	EB	WB	SB
Opposing Approach	WB	EB	
Opposing Lanes	1	2	0
Conflicting Approach Left	SB		WB
Conflicting Lanes Left	2	0	1
Conflicting Approach Right		SB	EB
Conflicting Lanes Right	0	2	2
HCM Control Delay	67.3	49.6	109.5
HCM LOS	F	E	F

Lane	EBLn1	EBLn2	WBLn1	SBLn1	SBLn2
Vol Left, %	100%	0%	0%	100%	0%
Vol Thru, %	0%	100%	45%	0%	0%
Vol Right, %	0%	0%	55%	0%	100%
Sign Control	Stop	Stop	Stop	Stop	Stop
Traffic Vol by Lane	370	80	380	110	510
LT Vol	370	0	0	110	0
Through Vol	0	80	170	0	0
RT Vol	0	0	210	0	510
Lane Flow Rate	451	98	463	134	622
Geometry Grp	7	7	4	7	7
Degree of Util (X)	1.019	0.207	0.91	0.3	1.198
Departure Headway (Hd)	8.701	8.183	7.589	8.216	6.932
Convergence, Y/N	Yes	Yes	Yes	Yes	Yes
Cap	420	441	482	440	522
Service Time	6.401	5.883	5.589	5.916	4.68
HCM Lane V/C Ratio	1.074	0.222	0.961	0.305	1.192
HCM Control Delay	79	13	49.6	14.4	130
HCM Lane LOS	F	B	E	B	F
HCM 95th-tile Q	13.1	0.8	10.3	1.2	22.9

HCM 2010 Signalized Intersection Summary
 26: East Garrison Road & Reservation Road

Cumulative with Project, AM
 06/11/2019



Movement	EBL	EBT	EBR	WBL	WBT	WBR	NBL	NBT	NBR	SBL	SBT	SBR
Lane Configurations												
Traffic Volume (veh/h)	0	520	120	160	970	0	200	0	270	0	0	0
Future Volume (veh/h)	0	520	120	160	970	0	200	0	270	0	0	0
Number	5	2	12	1	6	16	3	8	18			
Initial Q (Qb), veh	0	0	0	0	0	0	0	0	0			
Ped-Bike Adj(A_pbT)	1.00		1.00	1.00		1.00	1.00		1.00			
Parking Bus, Adj	1.00	1.00	1.00	1.00	1.00	1.00	1.00	1.00	1.00			
Adj Sat Flow, veh/h/ln	1827	1827	1900	1863	1863	0	1881	0	1881			
Adj Flow Rate, veh/h	0	584	133	180	1090	0	225	0	231			
Adj No. of Lanes	1	2	0	1	2	0	1	0	1			
Peak Hour Factor	0.89	0.89	0.89	0.89	0.89	0.89	0.89	0.89	0.89			
Percent Heavy Veh, %	4	4	4	2	2	0	1	0	1			
Cap, veh/h	4	1096	249	228	2111	0	332	0	296			
Arrive On Green	0.00	0.39	0.39	0.13	0.60	0.00	0.19	0.00	0.19			
Sat Flow, veh/h	1740	2811	639	1774	3632	0	1792	0	1599			
Grp Volume(v), veh/h	0	360	357	180	1090	0	225	0	231			
Grp Sat Flow(s),veh/h/ln	1740	1736	1714	1774	1770	0	1792	0	1599			
Q Serve(g_s), s	0.0	7.4	7.4	4.5	8.3	0.0	5.4	0.0	6.4			
Cycle Q Clear(g_c), s	0.0	7.4	7.4	4.5	8.3	0.0	5.4	0.0	6.4			
Prop In Lane	1.00		0.37	1.00		0.00	1.00		1.00			
Lane Grp Cap(c), veh/h	4	677	668	228	2111	0	332	0	296			
V/C Ratio(X)	0.00	0.53	0.53	0.79	0.52	0.00	0.68	0.00	0.78			
Avail Cap(c_a), veh/h	753	2252	2225	767	4593	0	1046	0	934			
HCM Platoon Ratio	1.00	1.00	1.00	1.00	1.00	1.00	1.00	1.00	1.00			
Upstream Filter(I)	0.00	1.00	1.00	1.00	1.00	0.00	1.00	0.00	1.00			
Uniform Delay (d), s/veh	0.0	10.9	10.9	19.5	5.4	0.0	17.6	0.0	17.9			
Incr Delay (d2), s/veh	0.0	1.2	1.2	2.3	0.2	0.0	0.9	0.0	1.7			
Initial Q Delay(d3),s/veh	0.0	0.0	0.0	0.0	0.0	0.0	0.0	0.0	0.0			
%ile BackOfQ(50%),veh/ln	0.0	3.7	3.7	2.3	4.0	0.0	2.7	0.0	2.9			
LnGrp Delay(d),s/veh	0.0	12.1	12.1	21.8	5.7	0.0	18.5	0.0	19.6			
LnGrp LOS		B	B	C	A		B		B			
Approach Vol, veh/h		717			1270			456				
Approach Delay, s/veh		12.1			8.0			19.1				
Approach LOS		B			A			B				
Timer	1	2	3	4	5	6	7	8				
Assigned Phs	1	2			5	6		8				
Phs Duration (G+Y+Rc), s	9.5	23.4			0.0	33.0		13.3				
Change Period (Y+Rc), s	3.6	5.4			3.5	5.4		4.7				
Max Green Setting (Gmax)	20	60.0			20.0	60.0		27.0				
Max Q Clear Time (g_c+10)	5	9.4			0.0	10.3		8.4				
Green Ext Time (p_c), s	0.0	8.6			0.0	11.1		0.2				
Intersection Summary												
HCM 2010 Ctrl Delay				11.3								
HCM 2010 LOS				B								
Notes												

HCM 2010 Signalized Intersection Summary
 27: Reservation Road & Watkins Gate Road

Cumulative with Project, AM
 06/11/2019



Movement	EBL	EBR	NBL	NBT	SBT	SBR		
Lane Configurations								
Traffic Volume (veh/h)	10	260	170	1370	890	60		
Future Volume (veh/h)	10	260	170	1370	890	60		
Number	5	12	3	8	4	14		
Initial Q (Qb), veh	0	0	0	0	0	0		
Ped-Bike Adj(A_pbT)	1.00	1.00	1.00			1.00		
Parking Bus, Adj	1.00	1.00	1.00	1.00	1.00	1.00		
Adj Sat Flow, veh/h/ln	1863	1863	1863	1863	1863	1900		
Adj Flow Rate, veh/h	11	55	185	1489	967	58		
Adj No. of Lanes	1	1	1	2	2	0		
Peak Hour Factor	0.92	0.92	0.92	0.92	0.92	0.92		
Percent Heavy Veh, %	2	2	2	2	2	2		
Cap, veh/h	103	92	231	2495	1702	102		
Arrive On Green	0.06	0.06	0.13	0.70	0.50	0.50		
Sat Flow, veh/h	1774	1583	1774	3632	3486	204		
Grp Volume(v), veh/h	11	55	185	1489	504	521		
Grp Sat Flow(s),veh/h/ln	1774	1583	1774	1770	1770	1827		
Q Serve(g_s), s	0.3	1.9	5.5	11.7	10.9	10.9		
Cycle Q Clear(g_c), s	0.3	1.9	5.5	11.7	10.9	10.9		
Prop In Lane	1.00	1.00	1.00			0.11		
Lane Grp Cap(c), veh/h	103	92	231	2495	888	916		
V/C Ratio(X)	0.11	0.60	0.80	0.60	0.57	0.57		
Avail Cap(c_a), veh/h	599	535	583	4425	1502	1550		
HCM Platoon Ratio	1.00	1.00	1.00	1.00	1.00	1.00		
Upstream Filter(I)	1.00	1.00	1.00	1.00	1.00	1.00		
Uniform Delay (d), s/veh	24.5	25.2	23.1	4.1	9.5	9.5		
Incr Delay (d2), s/veh	0.2	2.3	2.4	0.4	0.9	0.9		
Initial Q Delay(d3),s/veh	0.0	0.0	0.0	0.0	0.0	0.0		
%ile BackOfQ(50%),veh/ln	0.2	0.9	2.9	5.7	5.4	5.6		
LnGrp Delay(d),s/veh	24.6	27.5	25.6	4.5	10.4	10.4		
LnGrp LOS	C	C	C	A	B	B		
Approach Vol, veh/h	66			1674	1025			
Approach Delay, s/veh	27.0			6.8	10.4			
Approach LOS	C			A	B			
Timer	1	2	3	4	5	6	7	8
Assigned Phs		2	3	4				8
Phs Duration (G+Y+Rc), s		9.7	11.1	34.0				45.1
Change Period (Y+Rc), s		6.5	4.0	6.5				6.5
Max Green Setting (Gmax), s		18.5	18.0	46.5				68.5
Max Q Clear Time (g_c+I1), s		3.9	7.5	12.9				13.7
Green Ext Time (p_c), s		0.0	0.0	11.0				24.9
Intersection Summary								
HCM 2010 Ctrl Delay			8.6					
HCM 2010 LOS			A					

HCM 2010 Signalized Intersection Summary
28: Davis Road & Reservation Road

Cumulative with Project, AM
06/11/2019



Movement	EBL	EBT	EBR	WBL	WBT	WBR	NBL	NBT	NBR	SBL	SBT	SBR
Lane Configurations												
Traffic Volume (veh/h)	550	310	10	10	560	90	10	10	10	150	10	640
Future Volume (veh/h)	550	310	10	10	560	90	10	10	10	150	10	640
Number	5	2	12	1	6	16	3	8	18	7	4	14
Initial Q (Qb), veh	0	0	0	0	0	0	0	0	0	0	0	0
Ped-Bike Adj(A_pbT)	1.00		1.00	1.00		1.00	1.00		1.00	1.00		1.00
Parking Bus, Adj	1.00	1.00	1.00	1.00	1.00	1.00	1.00	1.00	1.00	1.00	1.00	1.00
Adj Sat Flow, veh/h/ln	1863	1863	1900	1863	1863	1900	1900	1900	1900	1900	1845	1845
Adj Flow Rate, veh/h	640	360	12	12	651	105	12	12	9	174	12	502
Adj No. of Lanes	1	2	0	1	1	0	0	1	0	0	1	1
Peak Hour Factor	0.86	0.86	0.86	0.86	0.86	0.86	0.86	0.86	0.86	0.86	0.86	0.86
Percent Heavy Veh, %	2	2	2	2	2	2	0	0	0	3	3	3
Cap, veh/h	376	2185	73	19	664	107	17	17	12	350	24	665
Arrive On Green	0.21	0.62	0.62	0.01	0.42	0.42	0.03	0.03	0.03	0.21	0.21	0.21
Sat Flow, veh/h	1774	3496	116	1774	1566	253	648	648	486	1649	114	1568
Grp Volume(v), veh/h	640	182	190	12	0	756	33	0	0	186	0	502
Grp Sat Flow(s),veh/h/ln	1774	1770	1842	1774	0	1818	1782	0	0	1762	0	1568
Q Serve(g_s), s	30.0	6.1	6.1	1.0	0.0	58.0	2.6	0.0	0.0	13.1	0.0	30.0
Cycle Q Clear(g_c), s	30.0	6.1	6.1	1.0	0.0	58.0	2.6	0.0	0.0	13.1	0.0	30.0
Prop In Lane	1.00		0.06	1.00		0.14	0.36		0.27	0.94		1.00
Lane Grp Cap(c), veh/h	376	1106	1151	19	0	771	46	0	0	374	0	665
V/C Ratio(X)	1.70	0.16	0.17	0.64	0.00	0.98	0.72	0.00	0.00	0.50	0.00	0.75
Avail Cap(c_a), veh/h	376	1106	1151	376	0	771	378	0	0	374	0	665
HCM Platoon Ratio	1.00	1.00	1.00	1.00	1.00	1.00	1.00	1.00	1.00	1.00	1.00	1.00
Upstream Filter(I)	1.00	1.00	1.00	1.00	0.00	1.00	1.00	0.00	0.00	1.00	0.00	1.00
Uniform Delay (d), s/veh	55.7	11.1	11.1	69.7	0.0	40.1	68.4	0.0	0.0	49.1	0.0	34.5
Incr Delay (d2), s/veh	326.5	0.1	0.1	12.4	0.0	27.5	7.7	0.0	0.0	0.4	0.0	4.4
Initial Q Delay(d3),s/veh	0.0	0.0	0.0	0.0	0.0	0.0	0.0	0.0	0.0	0.0	0.0	0.0
%ile BackOfQ(50%),veh/ln	8.8	3.0	3.1	0.5	0.0	34.9	1.4	0.0	0.0	6.4	0.0	17.3
LnGrp Delay(d),s/veh	382.2	11.2	11.2	82.1	0.0	67.7	76.1	0.0	0.0	49.5	0.0	38.9
LnGrp LOS	F	B	B	F		E	E			D		D
Approach Vol, veh/h		1012			768			33			688	
Approach Delay, s/veh		245.8			67.9			76.1			41.7	
Approach LOS		F			E			E			D	
Timer	1	2	3	4	5	6	7	8				
Assigned Phs	1	2		4	5	6		8				
Phs Duration (G+Y+Rc), s	5.4	93.4		35.0	33.8	65.0		7.6				
Change Period (Y+Rc), s	3.9	5.0		5.0	* 3.8	5.0		4.0				
Max Green Setting (Gmax), s	30	60.0		30.0	* 30	60.0		30.0				
Max Q Clear Time (g_c+13), s	3.0	8.1		32.0	32.0	60.0		4.6				
Green Ext Time (p_c), s	0.0	3.3		0.0	0.0	0.0		0.0				
Intersection Summary												
HCM 2010 Ctrl Delay				132.8								
HCM 2010 LOS				F								
Notes												

HCM 2010 Signalized Intersection Summary
 29: 2nd Avenue & Divarty Street

Cumulative with Project, AM
 06/11/2019



Movement	EBL	EBT	EBR	WBL	WBT	WBR	NBL	NBT	NBR	SBL	SBT	SBR
Lane Configurations		↕			↕	↕	↕	↕↔		↕	↕↔	
Traffic Volume (veh/h)	80	10	40	70	20	20	130	640	130	20	1200	250
Future Volume (veh/h)	80	10	40	70	20	20	130	640	130	20	1200	250
Number	5	2	12	1	6	16	3	8	18	7	4	14
Initial Q (Qb), veh	0	0	0	0	0	0	0	0	0	0	0	0
Ped-Bike Adj(A_pbT)	1.00		1.00	1.00		1.00	1.00		1.00	1.00		1.00
Parking Bus, Adj	1.00	1.00	1.00	1.00	1.00	1.00	1.00	1.00	1.00	1.00	1.00	1.00
Adj Sat Flow, veh/h/ln	1900	1667	1900	1900	1900	1900	1863	1863	1900	1881	1881	1900
Adj Flow Rate, veh/h	88	11	44	77	22	22	143	703	143	22	1319	275
Adj No. of Lanes	0	1	0	0	1	1	1	2	0	1	2	0
Peak Hour Factor	0.91	0.91	0.91	0.91	0.91	0.91	0.91	0.91	0.91	0.91	0.91	0.91
Percent Heavy Veh, %	14	14	14	0	0	0	2	2	2	1	1	1
Cap, veh/h	182	32	59	282	70	300	181	1756	357	44	1542	317
Arrive On Green	0.19	0.19	0.19	0.19	0.19	0.19	0.10	0.60	0.60	0.02	0.52	0.52
Sat Flow, veh/h	540	171	316	1033	377	1612	1774	2930	596	1792	2953	607
Grp Volume(v), veh/h	143	0	0	99	0	22	143	424	422	22	791	803
Grp Sat Flow(s),veh/h/ln	1026	0	0	1410	0	1612	1774	1770	1756	1792	1787	1773
Q Serve(g_s), s	6.0	0.0	0.0	0.0	0.0	0.8	5.6	9.0	9.0	0.9	27.0	28.2
Cycle Q Clear(g_c), s	10.3	0.0	0.0	4.3	0.0	0.8	5.6	9.0	9.0	0.9	27.0	28.2
Prop In Lane	0.62		0.31	0.78		1.00	1.00		0.34	1.00		0.34
Lane Grp Cap(c), veh/h	273	0	0	352	0	300	181	1061	1053	44	933	926
V/C Ratio(X)	0.52	0.00	0.00	0.28	0.00	0.07	0.79	0.40	0.40	0.50	0.85	0.87
Avail Cap(c_a), veh/h	670	0	0	799	0	794	287	1061	1053	290	1005	997
HCM Platoon Ratio	1.00	1.00	1.00	1.00	1.00	1.00	1.00	1.00	1.00	1.00	1.00	1.00
Upstream Filter(l)	1.00	0.00	0.00	1.00	0.00	1.00	1.00	1.00	1.00	1.00	1.00	1.00
Uniform Delay (d), s/veh	28.5	0.0	0.0	25.2	0.0	23.9	31.2	7.5	7.5	34.2	14.6	14.8
Incr Delay (d2), s/veh	1.6	0.0	0.0	0.4	0.0	0.1	7.5	0.2	0.2	8.3	6.5	7.8
Initial Q Delay(d3),s/veh	0.0	0.0	0.0	0.0	0.0	0.0	0.0	0.0	0.0	0.0	0.0	0.0
%ile BackOfQ(50%),veh/ln	2.8	0.0	0.0	1.7	0.0	0.4	3.1	4.4	4.4	0.5	14.9	15.6
LnGrp Delay(d),s/veh	30.1	0.0	0.0	25.6	0.0	24.0	38.7	7.8	7.8	42.5	21.1	22.7
LnGrp LOS	C			C		C	D	A	A	D	C	C
Approach Vol, veh/h		143			121			989			1616	
Approach Delay, s/veh		30.1			25.3			12.2			22.2	
Approach LOS		C			C			B			C	
Timer	1	2	3	4	5	6	7	8				
Assigned Phs		2	3	4		6	7	8				
Phs Duration (G+Y+Rc), s		18.2	10.8	42.1		18.2	5.3	47.6				
Change Period (Y+Rc), s		5.0	3.5	5.0		5.0	3.5	5.0				
Max Green Setting (Gmax), s		35.0	11.5	40.0		35.0	11.5	40.0				
Max Q Clear Time (g_c+I1), s		12.3	7.6	30.2		6.3	2.9	11.0				
Green Ext Time (p_c), s		0.7	0.1	7.0		0.6	0.0	5.8				
Intersection Summary												
HCM 2010 Ctrl Delay				19.3								
HCM 2010 LOS				B								

Intersection												
Intersection Delay, s/veh	10.2											
Intersection LOS	B											

Movement	EBL	EBT	EBR	WBL	WBT	WBR	NBL	NBT	NBR	SBL	SBT	SBR
Lane Configurations		↕			↕		↗	↘		↗	↘	
Traffic Vol, veh/h	10	10	20	10	10	20	30	260	10	20	200	20
Future Vol, veh/h	10	10	20	10	10	20	30	260	10	20	200	20
Peak Hour Factor	0.91	0.91	0.91	0.91	0.91	0.91	0.91	0.91	0.91	0.91	0.91	0.91
Heavy Vehicles, %	0	0	0	1	1	1	2	2	2	1	1	1
Mvmt Flow	11	11	22	11	11	22	33	286	11	22	220	22
Number of Lanes	0	1	0	0	1	0	1	1	0	1	1	0

Approach	EB	WB	NB	SB
Opposing Approach	WB	EB	SB	NB
Opposing Lanes	1	1	2	2
Conflicting Approach Left	SB	NB	EB	WB
Conflicting Lanes Left	2	2	1	1
Conflicting Approach Right	NB	SB	WB	EB
Conflicting Lanes Right	2	2	1	1
HCM Control Delay	8.5	8.5	10.8	10.1
HCM LOS	A	A	B	B

Lane	NBLn1	NBLn2	EBLn1	WBLn1	SBLn1	SBLn2
Vol Left, %	100%	0%	25%	25%	100%	0%
Vol Thru, %	0%	96%	25%	25%	0%	91%
Vol Right, %	0%	4%	50%	50%	0%	9%
Sign Control	Stop	Stop	Stop	Stop	Stop	Stop
Traffic Vol by Lane	30	270	40	40	20	220
LT Vol	30	0	10	10	20	0
Through Vol	0	260	10	10	0	200
RT Vol	0	10	20	20	0	20
Lane Flow Rate	33	297	44	44	22	242
Geometry Grp	7	7	2	2	7	7
Degree of Util (X)	0.05	0.408	0.062	0.063	0.034	0.333
Departure Headway (Hd)	5.481	4.953	5.103	5.121	5.524	4.958
Convergence, Y/N	Yes	Yes	Yes	Yes	Yes	Yes
Cap	653	727	699	697	648	725
Service Time	3.214	2.685	3.153	3.169	3.258	2.691
HCM Lane V/C Ratio	0.051	0.409	0.063	0.063	0.034	0.334
HCM Control Delay	8.5	11.1	8.5	8.5	8.5	10.2
HCM Lane LOS	A	B	A	A	A	B
HCM 95th-tile Q	0.2	2	0.2	0.2	0.1	1.5

HCM 2010 Signalized Intersection Summary
 31: 1st Avenue & Lightfighter Drive

Cumulative with Project, AM
 06/11/2019



Movement	EBL	EBT	EBR	WBL	WBT	WBR	NBL	NBT	NBR	SBL	SBT	SBR
Lane Configurations		↑↑	↑	↑	↑↑		↑		↑	↑	↑	↑
Traffic Volume (veh/h)	0	1250	130	20	1150	0	160	0	20	120	30	100
Future Volume (veh/h)	0	1250	130	20	1150	0	160	0	20	120	30	100
Number	7	4	14	3	8	18	5	2	12	1	6	16
Initial Q (Qb), veh	0	0	0	0	0	0	0	0	0	0	0	0
Ped-Bike Adj(A_pbT)	1.00		1.00	1.00		1.00	1.00		1.00	1.00		1.00
Parking Bus, Adj	1.00	1.00	1.00	1.00	1.00	1.00	1.00	1.00	1.00	1.00	1.00	1.00
Adj Sat Flow, veh/h/ln	0	1863	1863	1863	1863	0	1863	0	1863	1792	1792	1792
Adj Flow Rate, veh/h	0	1488	0	24	1369	0	190	0	10	143	36	100
Adj No. of Lanes	0	2	1	1	2	0	1	0	1	1	1	1
Peak Hour Factor	0.84	0.84	0.84	0.84	0.84	0.84	0.84	0.84	0.84	0.84	0.84	0.84
Percent Heavy Veh, %	0	2	2	2	2	0	2	0	2	6	6	6
Cap, veh/h	0	2238	1001	27	2517	0	0	0	0	209	220	187
Arrive On Green	0.00	0.63	0.00	0.02	0.71	0.00	0.00	0.00	0.00	0.12	0.12	0.12
Sat Flow, veh/h	0	3632	1583	1774	3632	0	0	0	0	1707	1792	1524
Grp Volume(v), veh/h	0	1488	0	24	1369	0	0	0	0	143	36	100
Grp Sat Flow(s),veh/h/ln	0	1770	1583	1774	1770	0	0	0	0	1707	1792	1524
Q Serve(g_s), s	0.0	14.7	0.0	0.7	10.1	0.0	0.0	0.0	0.0	4.4	1.0	3.4
Cycle Q Clear(g_c), s	0.0	14.7	0.0	0.7	10.1	0.0	0.0	0.0	0.0	4.4	1.0	3.4
Prop In Lane	0.00		1.00	1.00		0.00				1.00		1.00
Lane Grp Cap(c), veh/h	0	2238	1001	27	2517	0	0	0	0	209	220	187
V/C Ratio(X)	0.00	0.66	0.00	0.88	0.54	0.00	0.00	0.00	0.00	0.68	0.16	0.54
Avail Cap(c_a), veh/h	0	2880	1288	642	2880	0	0	0	0	772	810	689
HCM Platoon Ratio	1.00	1.00	1.00	1.00	1.00	1.00	1.00	1.00	1.00	1.00	1.00	1.00
Upstream Filter(I)	0.00	1.00	0.00	1.00	1.00	0.00	0.00	0.00	0.00	1.00	1.00	1.00
Uniform Delay (d), s/veh	0.0	6.4	0.0	27.2	3.8	0.0	0.0	0.0	0.0	23.2	21.7	22.8
Incr Delay (d2), s/veh	0.0	0.5	0.0	26.1	0.3	0.0	0.0	0.0	0.0	1.5	0.1	0.9
Initial Q Delay(d3),s/veh	0.0	0.0	0.0	0.0	0.0	0.0	0.0	0.0	0.0	0.0	0.0	0.0
%ile BackOfQ(50%),veh/ln	0.0	7.2	0.0	0.6	4.8	0.0	0.0	0.0	0.0	2.2	0.5	1.5
LnGrp Delay(d),s/veh	0.0	7.0	0.0	53.3	4.0	0.0	0.0	0.0	0.0	24.7	21.9	23.7
LnGrp LOS		A		D	A					C	C	C
Approach Vol, veh/h		1488			1393						279	
Approach Delay, s/veh		7.0			4.9						24.0	
Approach LOS		A			A						C	
Timer	1	2	3	4	5	6	7	8				
Assigned Phs			3	4		6		8				
Phs Duration (G+Y+Rc), s			4.4	39.6		11.4		43.9				
Change Period (Y+Rc), s			3.5	4.6		4.6		4.6				
Max Green Setting (Gmax), s			20.0	45.0		25.0		45.0				
Max Q Clear Time (g_c+I1), s			2.7	16.7		6.4		12.1				
Green Ext Time (p_c), s			0.0	18.2		0.4		17.2				
Intersection Summary												
HCM 2010 Ctrl Delay			7.5									
HCM 2010 LOS			A									

HCM 2010 Signalized Intersection Summary
 32: 2nd Avenue & Lightfighter Drive

Cumulative with Project, AM
 06/11/2019



Movement	EBL	EBT	EBR	WBL	WBT	WBR	NBL	NBT	NBR	SBL	SBT	SBR
Lane Configurations												
Traffic Volume (veh/h)	340	1040	10	40	710	180	20	20	50	370	10	490
Future Volume (veh/h)	340	1040	10	40	710	180	20	20	50	370	10	490
Number	5	2	12	1	6	16	3	8	18	7	4	14
Initial Q (Qb), veh	0	0	0	0	0	0	0	0	0	0	0	0
Ped-Bike Adj(A_pbT)	1.00		1.00	1.00		1.00	1.00		1.00	1.00		1.00
Parking Bus, Adj	1.00	1.00	1.00	1.00	1.00	1.00	1.00	1.00	1.00	1.00	1.00	1.00
Adj Sat Flow, veh/h/ln	1863	1863	1900	1827	1827	1900	1900	1900	1900	1881	1881	1881
Adj Flow Rate, veh/h	378	1156	11	44	789	191	22	22	55	411	11	268
Adj No. of Lanes	1	2	0	1	2	0	0	1	0	1	1	1
Peak Hour Factor	0.90	0.90	0.90	0.90	0.90	0.90	0.90	0.90	0.90	0.90	0.90	0.90
Percent Heavy Veh, %	2	2	2	4	4	4	0	0	0	1	1	1
Cap, veh/h	220	1856	18	56	1178	285	128	137	277	511	601	511
Arrive On Green	0.12	0.52	0.52	0.03	0.42	0.42	0.32	0.32	0.32	0.32	0.32	0.32
Sat Flow, veh/h	1774	3592	34	1740	2773	671	264	430	868	1330	1881	1599
Grp Volume(v), veh/h	378	569	598	44	494	486	99	0	0	411	11	268
Grp Sat Flow(s),veh/h/ln	1774	1770	1857	1740	1736	1708	1562	0	0	1330	1881	1599
Q Serve(g_s), s	12.4	22.9	22.9	2.5	22.9	22.9	0.0	0.0	0.0	24.8	0.4	13.7
Cycle Q Clear(g_c), s	12.4	22.9	22.9	2.5	22.9	22.9	4.1	0.0	0.0	28.9	0.4	13.7
Prop In Lane	1.00		0.02	1.00		0.39	0.22		0.56	1.00		1.00
Lane Grp Cap(c), veh/h	220	915	960	56	737	726	543	0	0	511	601	511
V/C Ratio(X)	1.72	0.62	0.62	0.79	0.67	0.67	0.18	0.00	0.00	0.80	0.02	0.52
Avail Cap(c_a), veh/h	220	915	960	216	737	726	671	0	0	623	760	646
HCM Platoon Ratio	1.00	1.00	1.00	1.00	1.00	1.00	1.00	1.00	1.00	1.00	1.00	1.00
Upstream Filter(I)	0.50	0.50	0.50	0.09	0.09	0.09	1.00	0.00	0.00	0.36	0.36	0.36
Uniform Delay (d), s/veh	43.8	17.2	17.2	48.1	23.1	23.1	24.6	0.0	0.0	32.6	23.3	27.8
Incr Delay (d2), s/veh	332.8	1.6	1.5	0.9	0.4	0.5	0.1	0.0	0.0	1.9	0.0	0.1
Initial Q Delay(d3),s/veh	0.0	0.0	0.0	0.0	0.0	0.0	0.0	0.0	0.0	0.0	0.0	0.0
%ile BackOfQ(50%),veh/ln	26.4	11.5	12.0	1.2	11.1	10.9	2.0	0.0	0.0	11.2	0.2	6.1
LnGrp Delay(d),s/veh	376.6	18.8	18.7	49.0	23.6	23.6	24.6	0.0	0.0	34.5	23.3	27.9
LnGrp LOS	F	B	B	D	C	C	C			C	C	C
Approach Vol, veh/h		1545			1024			99			690	
Approach Delay, s/veh		106.3			24.7			24.6			31.8	
Approach LOS		F			C			C			C	
Timer	1	2	3	4	5	6	7	8				
Assigned Phs	1	2		4	5	6		8				
Phs Duration (G+Y+Rc), s	7.2	56.3		36.5	16.4	47.1		36.5				
Change Period (Y+Rc), s	4.0	4.6		4.6	4.0	4.6		4.6				
Max Green Setting (Gmax), s	2.4	34.0		40.4	12.4	24.4		40.4				
Max Q Clear Time (g_c+1), s	14.5	24.9		30.9	14.4	24.9		6.1				
Green Ext Time (p_c), s	0.0	3.3		1.0	0.0	0.0		0.4				
Intersection Summary												
HCM 2010 Ctrl Delay			63.7									
HCM 2010 LOS			E									

HCM 2010 Signalized Intersection Summary
 33: General Jim Moore Boulevard & Lightfighter Drive

Cumulative with Project, AM
 06/11/2019



Movement	EBL	EBT	EBR	WBL	WBT	WBR	NBL	NBT	NBR	SBL	SBT	SBR
Lane Configurations												
Traffic Volume (veh/h)	50	280	880	20	170	70	810	70	10	40	50	20
Future Volume (veh/h)	50	280	880	20	170	70	810	70	10	40	50	20
Number	3	8	18	7	4	14	1	6	16	5	2	12
Initial Q (Qb), veh	0	0	0	0	0	0	0	0	0	0	0	0
Ped-Bike Adj(A_pbT)	1.00		1.00	1.00		1.00	1.00		1.00	1.00		1.00
Parking Bus, Adj	1.00	1.00	1.00	1.00	1.00	1.00	1.00	1.00	1.00	1.00	1.00	1.00
Adj Sat Flow, veh/h/ln	1863	1863	1863	1792	1792	1900	1881	1881	1900	1863	1863	1900
Adj Flow Rate, veh/h	56	315	0	22	191	77	910	79	10	45	56	22
Adj No. of Lanes	1	1	1	1	1	0	2	1	0	1	2	0
Peak Hour Factor	0.89	0.89	0.89	0.89	0.89	0.89	0.89	0.89	0.89	0.89	0.89	0.89
Percent Heavy Veh, %	2	2	2	6	6	6	1	1	1	2	2	2
Cap, veh/h	78	467	397	36	277	111	735	507	64	67	343	127
Arrive On Green	0.04	0.25	0.00	0.02	0.23	0.23	0.21	0.31	0.31	0.04	0.14	0.14
Sat Flow, veh/h	1774	1863	1583	1707	1214	489	3476	1637	207	1774	2524	938
Grp Volume(v), veh/h	56	315	0	22	0	268	910	0	89	45	38	40
Grp Sat Flow(s),veh/h/ln	1774	1863	1583	1707	0	1704	1738	0	1844	1774	1770	1692
Q Serve(g_s), s	1.5	7.2	0.0	0.6	0.0	6.8	10.0	0.0	1.7	1.2	0.9	1.0
Cycle Q Clear(g_c), s	1.5	7.2	0.0	0.6	0.0	6.8	10.0	0.0	1.7	1.2	0.9	1.0
Prop In Lane	1.00		1.00	1.00		0.29	1.00		0.11	1.00		0.55
Lane Grp Cap(c), veh/h	78	467	397	36	0	388	735	0	571	67	240	230
V/C Ratio(X)	0.72	0.67	0.00	0.61	0.00	0.69	1.24	0.00	0.16	0.67	0.16	0.17
Avail Cap(c_a), veh/h	751	1182	1005	722	0	1081	735	0	1170	563	1123	1074
HCM Platoon Ratio	1.00	1.00	1.00	1.00	1.00	1.00	1.00	1.00	1.00	1.00	1.00	1.00
Upstream Filter(I)	1.00	1.00	0.00	1.00	0.00	1.00	1.00	0.00	1.00	1.00	1.00	1.00
Uniform Delay (d), s/veh	22.3	16.0	0.0	22.9	0.0	16.7	18.6	0.0	11.8	22.5	18.0	18.1
Incr Delay (d2), s/veh	11.5	2.1	0.0	5.9	0.0	2.7	118.5	0.0	0.3	4.3	0.4	0.4
Initial Q Delay(d3),s/veh	0.0	0.0	0.0	0.0	0.0	0.0	0.0	0.0	0.0	0.0	0.0	0.0
%ile BackOfQ(50%),veh/ln	1.0	3.9	0.0	0.3	0.0	3.5	16.8	0.0	0.9	0.7	0.5	0.5
LnGrp Delay(d),s/veh	33.8	18.0	0.0	28.9	0.0	19.4	137.1	0.0	12.1	26.7	18.4	18.5
LnGrp LOS	C	B		C		B	F		B	C	B	B
Approach Vol, veh/h		371			290			999			123	
Approach Delay, s/veh		20.4			20.1			126.0			21.5	
Approach LOS		C			C			F			C	
Timer	1	2	3	4	5	6	7	8				
Assigned Phs	1	2	3	4	5	6	7	8				
Phs Duration (G+Y+Rc), s	4.5	10.9	6.6	15.3	6.3	19.1	5.5	16.3				
Change Period (Y+Rc), s	4.5	4.5	4.5	4.5	4.5	4.5	4.5	4.5				
Max Green Setting (Gmax), s	30.0	30.0	20.0	30.0	15.0	30.0	20.0	30.0				
Max Q Clear Time (g_c+1), s	3.0	3.5	8.8	3.2	3.7	2.6	9.2					
Green Ext Time (p_c), s	0.0	0.4	0.1	2.0	0.0	0.8	0.0	2.0				
Intersection Summary												
HCM 2010 Ctrl Delay				79.6								
HCM 2010 LOS				E								

Intersection

Intersection Delay, s/veh 13.1
 Intersection LOS B

Movement	WBL	WBR	NBT	NBR	SBL	SBT
Lane Configurations						
Traffic Vol, veh/h	30	200	60	10	270	70
Future Vol, veh/h	30	200	60	10	270	70
Peak Hour Factor	0.77	0.77	0.77	0.77	0.77	0.77
Heavy Vehicles, %	4	4	3	3	2	2
Mvmt Flow	39	260	78	13	351	91
Number of Lanes	1	0	1	0	0	1

Approach	WB	NB	SB
Opposing Approach		SB	NB
Opposing Lanes	0	1	1
Conflicting Approach Left NB			WB
Conflicting Lanes Left	1	0	1
Conflicting Approach Right SB		WB	
Conflicting Lanes Right	1	1	0
HCM Control Delay	11	9.1	15.4
HCM LOS	B	A	C

Lane	NBLn1	WBLn1	SBLn1
Vol Left, %	0%	13%	79%
Vol Thru, %	86%	0%	21%
Vol Right, %	14%	87%	0%
Sign Control	Stop	Stop	Stop
Traffic Vol by Lane	70	230	340
LT Vol	0	30	270
Through Vol	60	0	70
RT Vol	10	200	0
Lane Flow Rate	91	299	442
Geometry Grp	1	1	1
Degree of Util (X)	0.133	0.397	0.605
Departure Headway (Hd)	5.254	4.78	4.929
Convergence, Y/N	Yes	Yes	Yes
Cap	686	747	724
Service Time	3.254	2.854	3.011
HCM Lane V/C Ratio	0.133	0.4	0.61
HCM Control Delay	9.1	11	15.4
HCM Lane LOS	A	B	C
HCM 95th-tile Q	0.5	1.9	4.1

Intersection						
Int Delay, s/veh	1.7					
Movement	EBT	EBR	WBL	WBT	NBL	NBR
Lane Configurations						
Traffic Vol, veh/h	250	30	20	200	30	30
Future Vol, veh/h	250	30	20	200	30	30
Conflicting Peds, #/hr	0	0	0	0	0	0
Sign Control	Free	Free	Free	Free	Stop	Stop
RT Channelized	-	None	-	None	-	None
Storage Length	-	-	-	-	0	-
Veh in Median Storage, #	0	-	-	0	0	-
Grade, %	0	-	-	0	0	-
Peak Hour Factor	78	78	78	78	78	78
Heavy Vehicles, %	5	5	4	4	0	0
Mvmt Flow	321	38	26	256	38	38

Major/Minor	Major1	Major2	Minor1	Minor2
Conflicting Flow All	0	0	359	648
Stage 1	-	-	-	340
Stage 2	-	-	-	308
Critical Hdwy	-	-	4.14	6.4
Critical Hdwy Stg 1	-	-	-	5.4
Critical Hdwy Stg 2	-	-	-	5.4
Follow-up Hdwy	-	-	2.236	3.5
Pot Cap-1 Maneuver	-	-	1189	438
Stage 1	-	-	-	725
Stage 2	-	-	-	750
Platoon blocked, %	-	-	-	-
Mov Cap-1 Maneuver	-	-	1189	427
Mov Cap-2 Maneuver	-	-	-	427
Stage 1	-	-	-	707
Stage 2	-	-	-	750

Approach	EB	WB	NB
HCM Control Delay, s	0	0.7	12.9
HCM LOS			B

Minor Lane/Major Mvmt	NBLn1	EBT	EBR	WBL	WBT
Capacity (veh/h)	532	-	-	1189	-
HCM Lane V/C Ratio	0.145	-	-	0.022	-
HCM Control Delay (s)	12.9	-	-	8.1	0
HCM Lane LOS	B	-	-	A	A
HCM 95th %tile Q(veh)	0.5	-	-	0.1	-

Intersection	
Intersection Delay, s/veh	15.9
Intersection LOS	C

Movement	EBL	EBT	EBR	WBL	WBT	WBR	NBL	NBT	NBR	SBL	SBT	SBR
Lane Configurations		↕			↕			↕			↕	
Traffic Vol, veh/h	10	230	30	10	140	10	50	170	20	10	140	40
Future Vol, veh/h	10	230	30	10	140	10	50	170	20	10	140	40
Peak Hour Factor	0.79	0.79	0.79	0.79	0.79	0.79	0.79	0.79	0.79	0.79	0.79	0.79
Heavy Vehicles, %	6	6	6	4	4	4	20	20	20	2	2	2
Mvmt Flow	13	291	38	13	177	13	63	215	25	13	177	51
Number of Lanes	0	1	0	0	1	0	0	1	0	0	1	0

Approach	EB	WB	NB	SB
Opposing Approach	WB	EB	SB	NB
Opposing Lanes	1	1	1	1
Conflicting Approach Left	SB	NB	EB	WB
Conflicting Lanes Left	1	1	1	1
Conflicting Approach Right	NB	SB	WB	EB
Conflicting Lanes Right	1	1	1	1
HCM Control Delay	17.7	13.3	17.3	13.8
HCM LOS	C	B	C	B

Lane	NBLn1	EBLn1	WBLn1	SBLn1
Vol Left, %	21%	4%	6%	5%
Vol Thru, %	71%	85%	88%	74%
Vol Right, %	8%	11%	6%	21%
Sign Control	Stop	Stop	Stop	Stop
Traffic Vol by Lane	240	270	160	190
LT Vol	50	10	10	10
Through Vol	170	230	140	140
RT Vol	20	30	10	40
Lane Flow Rate	304	342	203	241
Geometry Grp	1	1	1	1
Degree of Util (X)	0.55	0.586	0.365	0.419
Departure Headway (Hd)	6.514	6.174	6.492	6.275
Convergence, Y/N	Yes	Yes	Yes	Yes
Cap	553	584	553	572
Service Time	4.564	4.223	4.549	4.332
HCM Lane V/C Ratio	0.55	0.586	0.367	0.421
HCM Control Delay	17.3	17.7	13.3	13.8
HCM Lane LOS	C	C	B	B
HCM 95th-tile Q	3.3	3.8	1.7	2.1

Intersection												
Int Delay, s/veh	10.4											
Movement	EBL	EBT	EBR	WBL	WBT	WBR	NBL	NBT	NBR	SBL	SBT	SBR
Lane Configurations		↕			↕			↕			↕	
Traffic Vol, veh/h	80	80	90	10	90	20	50	140	20	0	0	0
Future Vol, veh/h	80	80	90	10	90	20	50	140	20	0	0	0
Conflicting Peds, #/hr	0	0	0	0	0	0	0	0	1	1	0	0
Sign Control	Stop	Stop	Stop	Stop	Stop	Stop	Free	Free	Free	Free	Free	Free
RT Channelized	-	-	None	-	-	None	-	-	None	-	-	None
Storage Length	-	-	-	-	-	-	-	-	-	-	-	-
Veh in Median Storage, #	-	0	-	-	0	-	-	0	-	-	0	-
Grade, %	-	0	-	-	0	-	-	0	-	-	0	-
Peak Hour Factor	82	82	82	82	82	82	82	82	82	82	82	82
Heavy Vehicles, %	12	12	12	0	0	0	10	10	10	10	10	10
Mvmt Flow	98	98	110	12	110	24	61	171	24	0	0	0

Major/Minor	Minor2		Minor1		Major1			Major2				
Conflicting Flow All	373	319	1	411	307	184	1	0	0	196	0	0
Stage 1	1	1	-	306	306	-	-	-	-	-	-	-
Stage 2	372	318	-	105	1	-	-	-	-	-	-	-
Critical Hdwy	7.22	6.62	6.32	7.1	6.5	6.2	4.2	-	-	4.2	-	-
Critical Hdwy Stg 1	6.22	5.62	-	6.1	5.5	-	-	-	-	-	-	-
Critical Hdwy Stg 2	6.22	5.62	-	6.1	5.5	-	-	-	-	-	-	-
Follow-up Hdwy	3.608	4.108	3.408	3.5	4	3.3	2.29	-	-	2.29	-	-
Pot Cap-1 Maneuver	566	582	1055	555	610	864	1571	-	-	1330	-	-
Stage 1	997	875	-	708	665	-	-	-	-	-	-	-
Stage 2	629	636	-	906	899	-	-	-	-	-	-	-
Platoon blocked, %								-	-	-	-	-
Mov Cap-1 Maneuver	455	556	1055	416	583	863	1571	-	-	1329	-	-
Mov Cap-2 Maneuver	455	556	-	416	583	-	-	-	-	-	-	-
Stage 1	953	875	-	676	635	-	-	-	-	-	-	-
Stage 2	483	607	-	721	899	-	-	-	-	-	-	-

Approach	EB	WB	NB	SB
HCM Control Delay, s	16.4	13	1.8	0
HCM LOS	C	B		

Minor Lane/Major Mvmt	NBL	NBT	NBR	EBLn1WBLn1	SBL	SBT	SBR
Capacity (veh/h)	1571	-	-	617	595	1329	-
HCM Lane V/C Ratio	0.039	-	-	0.494	0.246	-	-
HCM Control Delay (s)	7.4	0	-	16.4	13	0	-
HCM Lane LOS	A	A	-	C	B	A	-
HCM 95th %tile Q(veh)	0.1	-	-	2.7	1	0	-

Intersection						
Int Delay, s/veh	6.3					
Movement	EBL	EBR	NBL	NBT	SBT	SBR
Lane Configurations	T			T		T
Traffic Vol, veh/h	110	10	10	260	780	120
Future Vol, veh/h	110	10	10	260	780	120
Conflicting Peds, #/hr	0	0	0	0	0	0
Sign Control	Stop	Stop	Free	Free	Free	Free
RT Channelized	-	None	-	None	-	None
Storage Length	0	-	-	-	-	-
Veh in Median Storage, #	0	-	-	0	0	-
Grade, %	0	-	-	0	0	-
Peak Hour Factor	89	89	89	89	89	89
Heavy Vehicles, %	13	13	2	2	0	0
Mvmt Flow	124	11	11	292	876	135























Major/Minor	Minor2	Major1		Major2	
Conflicting Flow All	1258	944	1011	0	0
Stage 1	944	-	-	-	-
Stage 2	314	-	-	-	-
Critical Hdwy	6.53	6.33	4.12	-	-
Critical Hdwy Stg 1	5.53	-	-	-	-
Critical Hdwy Stg 2	5.53	-	-	-	-
Follow-up Hdwy	3.617	3.417	2.218	-	-
Pot Cap-1 Maneuver	179	303	686	-	-
Stage 1	361	-	-	-	-
Stage 2	716	-	-	-	-
Platoon blocked, %				-	-
Mov Cap-1 Maneuver	176	303	686	-	-
Mov Cap-2 Maneuver	176	-	-	-	-
Stage 1	354	-	-	-	-
Stage 2	716	-	-	-	-

Approach	EB	NB	SB
HCM Control Delay, s	66.4	0.4	0
HCM LOS	F		

Minor Lane/Major Mvmt	NBL	NBT	EBLn1	SBT	SBR
Capacity (veh/h)	686	-	182	-	-
HCM Lane V/C Ratio	0.016	-	0.741	-	-
HCM Control Delay (s)	10.3	0	66.4	-	-
HCM Lane LOS	B	A	F	-	-
HCM 95th %tile Q(veh)	0.1	-	4.8	-	-

HCM 2010 Signalized Intersection Summary
 39: General Jim Moore Boulevard & Gigling Road

Cumulative with Project, AM
 06/11/2019

												
Movement	EBL	EBT	EBR	WBL	WBT	WBR	NBL	NBT	NBR	SBL	SBT	SBR
Lane Configurations												
Traffic Volume (veh/h)	30	100	80	510	40	410	50	410	280	310	650	50
Future Volume (veh/h)	30	100	80	510	40	410	50	410	280	310	650	50
Number	3	8	18	7	4	14	1	6	16	5	2	12
Initial Q (Qb), veh	0	0	0	0	0	0	0	0	0	0	0	0
Ped-Bike Adj(A_pbT)	1.00		1.00	1.00		1.00	1.00		1.00	1.00		1.00
Parking Bus, Adj	1.00	1.00	1.00	1.00	1.00	1.00	1.00	1.00	1.00	1.00	1.00	1.00
Adj Sat Flow, veh/h/ln	1810	1810	1900	1863	1863	1863	1881	1881	1881	1863	1863	1863
Adj Flow Rate, veh/h	34	115	60	586	46	0	57	471	0	356	747	0
Adj No. of Lanes	1	2	0	1	2	1	1	2	1	1	2	1
Peak Hour Factor	0.87	0.87	0.87	0.87	0.87	0.87	0.87	0.87	0.87	0.87	0.87	0.87
Percent Heavy Veh, %	5	5	5	2	2	2	1	1	1	2	2	2
Cap, veh/h	59	192	94	506	1193	534	85	581	260	383	1171	524
Arrive On Green	0.03	0.09	0.09	0.29	0.34	0.00	0.05	0.16	0.00	0.22	0.33	0.00
Sat Flow, veh/h	1723	2232	1098	1774	3539	1583	1792	3574	1599	1774	3539	1583
Grp Volume(v), veh/h	34	87	88	586	46	0	57	471	0	356	747	0
Grp Sat Flow(s),veh/h/ln	1723	1719	1611	1774	1770	1583	1792	1787	1599	1774	1770	1583
Q Serve(g_s), s	1.4	3.5	3.8	20.5	0.6	0.0	2.2	9.1	0.0	14.2	12.9	0.0
Cycle Q Clear(g_c), s	1.4	3.5	3.8	20.5	0.6	0.0	2.2	9.1	0.0	14.2	12.9	0.0
Prop In Lane	1.00		0.68	1.00		1.00	1.00		1.00	1.00		1.00
Lane Grp Cap(c), veh/h	59	148	139	506	1193	534	85	581	260	383	1171	524
V/C Ratio(X)	0.58	0.59	0.64	1.16	0.04	0.00	0.67	0.81	0.00	0.93	0.64	0.00
Avail Cap(c_a), veh/h	252	742	695	506	2019	903	137	1243	556	383	1724	771
HCM Platoon Ratio	1.00	1.00	1.00	1.00	1.00	1.00	1.00	1.00	1.00	1.00	1.00	1.00
Upstream Filter(I)	1.00	1.00	1.00	1.00	1.00	0.00	1.00	1.00	0.00	1.00	1.00	0.00
Uniform Delay (d), s/veh	34.2	31.6	31.8	25.7	16.0	0.0	33.7	29.0	0.0	27.7	20.4	0.0
Incr Delay (d2), s/veh	3.2	1.4	1.8	91.4	0.0	0.0	3.4	1.0	0.0	28.6	0.2	0.0
Initial Q Delay(d3),s/veh	0.0	0.0	0.0	0.0	0.0	0.0	0.0	0.0	0.0	0.0	0.0	0.0
%ile BackOfQ(50%),veh/ln	0.7	1.7	1.8	22.7	0.3	0.0	1.2	4.6	0.0	10.0	6.3	0.0
LnGrp Delay(d),s/veh	37.4	33.0	33.5	117.1	16.0	0.0	37.1	30.1	0.0	56.3	20.6	0.0
LnGrp LOS	D	C	C	F	B		D	C		E	C	
Approach Vol, veh/h		209			632			528			1103	
Approach Delay, s/veh		33.9			109.7			30.8			32.1	
Approach LOS		C			F			C			C	
Timer	1	2	3	4	5	6	7	8				
Assigned Phs	1	2	3	4	5	6	7	8				
Phs Duration (G+Y+Rc), s	7.9	28.3	7.0	28.7	20.0	16.2	25.0	10.7				
Change Period (Y+Rc), s	4.5	4.5	4.5	4.5	4.5	4.5	4.5	4.5				
Max Green Setting (Gmax), s	5.5	35.0	10.5	41.0	15.5	25.0	20.5	31.0				
Max Q Clear Time (g_c+I1), s	4.2	14.9	3.4	2.6	16.2	11.1	22.5	5.8				
Green Ext Time (p_c), s	0.0	1.0	0.0	0.1	0.0	0.5	0.0	0.2				
Intersection Summary												
HCM 2010 Ctrl Delay			51.8									
HCM 2010 LOS			D									
Notes												

HCM 2010 Signalized Intersection Summary
40: Malmedy Road & Gigling Road

Cumulative with Project, AM
06/11/2019



Movement	EBL	EBT	EBR	WBL	WBT	WBR	NBL	NBT	NBR	SBL	SBT	SBR
Lane Configurations		↕↕			↕↕			↕			↕	
Traffic Volume (veh/h)	10	590	30	50	900	20	20	30	30	20	60	30
Future Volume (veh/h)	10	590	30	50	900	20	20	30	30	20	60	30
Number	7	4	14	3	8	18	5	2	12	1	6	16
Initial Q (Qb), veh	0	0	0	0	0	0	0	0	0	0	0	0
Ped-Bike Adj(A_pbT)	1.00		1.00	1.00		1.00	1.00		1.00	1.00		1.00
Parking Bus, Adj	1.00	1.00	1.00	1.00	1.00	1.00	1.00	1.00	1.00	1.00	1.00	1.00
Adj Sat Flow, veh/h/ln	1900	1845	1900	1900	1845	1900	1900	1863	1900	1900	1827	1900
Adj Flow Rate, veh/h	11	670	34	57	1023	23	23	34	34	23	68	34
Adj No. of Lanes	0	2	0	0	2	0	0	1	0	0	1	0
Peak Hour Factor	0.88	0.88	0.88	0.88	0.88	0.88	0.88	0.88	0.88	0.88	0.88	0.88
Percent Heavy Veh, %	3	3	3	3	3	3	2	2	2	4	4	4
Cap, veh/h	176	1385	70	218	1362	30	258	121	103	233	163	75
Arrive On Green	0.42	0.42	0.42	0.42	0.42	0.42	0.17	0.17	0.17	0.17	0.17	0.17
Sat Flow, veh/h	17	3271	165	89	3215	71	317	723	620	231	979	452
Grp Volume(v), veh/h	375	0	340	566	0	537	91	0	0	125	0	0
Grp Sat Flow(s),veh/h/ln	1803	0	1649	1709	0	1666	1661	0	0	1662	0	0
Q Serve(g_s), s	0.0	0.0	3.3	1.8	0.0	6.0	0.0	0.0	0.0	0.4	0.0	0.0
Cycle Q Clear(g_c), s	3.2	0.0	3.3	5.9	0.0	6.0	1.0	0.0	0.0	1.4	0.0	0.0
Prop In Lane	0.03		0.10	0.10		0.04	0.25		0.37	0.18		0.27
Lane Grp Cap(c), veh/h	932	0	699	904	0	706	482	0	0	471	0	0
V/C Ratio(X)	0.40	0.00	0.49	0.63	0.00	0.76	0.19	0.00	0.00	0.27	0.00	0.00
Avail Cap(c_a), veh/h	4158	0	3792	3905	0	3830	2413	0	0	2460	0	0
HCM Platoon Ratio	1.00	1.00	1.00	1.00	1.00	1.00	1.00	1.00	1.00	1.00	1.00	1.00
Upstream Filter(l)	1.00	0.00	1.00	1.00	0.00	1.00	1.00	0.00	0.00	1.00	0.00	0.00
Uniform Delay (d), s/veh	4.6	0.0	4.6	5.3	0.0	5.4	8.0	0.0	0.0	8.2	0.0	0.0
Incr Delay (d2), s/veh	0.1	0.0	0.2	0.3	0.0	0.6	0.1	0.0	0.0	0.1	0.0	0.0
Initial Q Delay(d3),s/veh	0.0	0.0	0.0	0.0	0.0	0.0	0.0	0.0	0.0	0.0	0.0	0.0
%ile BackOfQ(50%),veh/ln	1.6	0.0	1.5	2.9	0.0	2.8	0.5	0.0	0.0	0.7	0.0	0.0
LnGrp Delay(d),s/veh	4.7	0.0	4.8	5.6	0.0	6.0	8.1	0.0	0.0	8.3	0.0	0.0
LnGrp LOS	A		A	A		A	A			A		
Approach Vol, veh/h		715			1103			91			125	
Approach Delay, s/veh		4.7			5.8			8.1			8.3	
Approach LOS		A			A			A			A	
Timer	1	2	3	4	5	6	7	8				
Assigned Phs		2		4		6		8				
Phs Duration (G+Y+Rc), s		8.2		13.8		8.2		13.8				
Change Period (Y+Rc), s		4.5		4.5		4.5		4.5				
Max Green Setting (Gmax), s		30.5		50.5		30.5		50.5				
Max Q Clear Time (g_c+I1), s		3.0		5.3		3.4		8.0				
Green Ext Time (p_c), s		0.1		0.7		0.1		1.2				
Intersection Summary												
HCM 2010 Ctrl Delay				5.7								
HCM 2010 LOS				A								

HCM 2010 Signalized Intersection Summary
 41: Parker Flatts Cut Off Road & Gigling Road

Cumulative with Project, AM
 06/11/2019



Movement	EBL	EBT	EBR	WBL	WBT	WBR	NBL	NBT	NBR	SBL	SBT	SBR
Lane Configurations		↔↕			↔↕			↕	↔		↔↕	
Traffic Volume (veh/h)	10	560	80	110	910	10	40	10	50	10	30	10
Future Volume (veh/h)	10	560	80	110	910	10	40	10	50	10	30	10
Number	7	4	14	3	8	18	5	2	12	1	6	16
Initial Q (Qb), veh	0	0	0	0	0	0	0	0	0	0	0	0
Ped-Bike Adj(A_pbT)	1.00		1.00	1.00		1.00	1.00		1.00	1.00		1.00
Parking Bus, Adj	1.00	1.00	1.00	1.00	1.00	1.00	1.00	1.00	1.00	1.00	1.00	1.00
Adj Sat Flow, veh/h/ln	1900	1845	1900	1900	1863	1900	1900	1863	1863	1900	1900	1900
Adj Flow Rate, veh/h	12	667	95	131	1083	12	48	12	60	12	36	12
Adj No. of Lanes	0	2	0	0	2	0	0	1	1	0	1	0
Peak Hour Factor	0.84	0.84	0.84	0.84	0.84	0.84	0.84	0.84	0.84	0.84	0.84	0.84
Percent Heavy Veh, %	3	3	3	2	2	2	2	2	2	0	0	0
Cap, veh/h	159	1449	204	281	1417	16	417	67	229	213	165	50
Arrive On Green	0.49	0.49	0.49	0.49	0.49	0.49	0.14	0.14	0.14	0.14	0.14	0.14
Sat Flow, veh/h	15	2975	419	208	2909	32	1049	461	1583	248	1142	347
Grp Volume(v), veh/h	410	0	364	596	0	630	60	0	60	60	0	0
Grp Sat Flow(s),veh/h/ln	1805	0	1605	1460	0	1689	1510	0	1583	1737	0	0
Q Serve(g_s), s	0.0	0.0	3.7	4.6	0.0	7.4	0.0	0.0	0.8	0.0	0.0	0.0
Cycle Q Clear(g_c), s	3.6	0.0	3.7	8.2	0.0	7.4	0.7	0.0	0.8	0.7	0.0	0.0
Prop In Lane	0.03		0.26	0.22		0.02	0.80		1.00	0.20		0.20
Lane Grp Cap(c), veh/h	1031	0	782	891	0	823	483	0	229	428	0	0
V/C Ratio(X)	0.40	0.00	0.47	0.67	0.00	0.77	0.12	0.00	0.26	0.14	0.00	0.00
Avail Cap(c_a), veh/h	4088	0	3646	3329	0	3839	1770	0	1653	1958	0	0
HCM Platoon Ratio	1.00	1.00	1.00	1.00	1.00	1.00	1.00	1.00	1.00	1.00	1.00	1.00
Upstream Filter(I)	1.00	0.00	1.00	1.00	0.00	1.00	1.00	0.00	1.00	1.00	0.00	0.00
Uniform Delay (d), s/veh	4.1	0.0	4.2	5.1	0.0	5.1	9.2	0.0	9.3	9.2	0.0	0.0
Incr Delay (d2), s/veh	0.1	0.0	0.2	0.3	0.0	0.6	0.0	0.0	0.2	0.1	0.0	0.0
Initial Q Delay(d3),s/veh	0.0	0.0	0.0	0.0	0.0	0.0	0.0	0.0	0.0	0.0	0.0	0.0
%ile BackOfQ(50%),veh/ln	1.7	0.0	1.5	3.2	0.0	3.5	0.4	0.0	0.4	0.4	0.0	0.0
LnGrp Delay(d),s/veh	4.2	0.0	4.3	5.4	0.0	5.7	9.3	0.0	9.5	9.3	0.0	0.0
LnGrp LOS	A		A	A		A	A		A	A		
Approach Vol, veh/h		774			1226			120			60	
Approach Delay, s/veh		4.3			5.5			9.4			9.3	
Approach LOS		A			A			A			A	
Timer	1	2	3	4	5	6	7	8				
Assigned Phs		2		4		6		8				
Phs Duration (G+Y+Rc), s		8.0		16.4		8.0		16.4				
Change Period (Y+Rc), s		4.5		4.5		4.5		4.5				
Max Green Setting (Gmax), s		25.5		55.5		25.5		55.5				
Max Q Clear Time (g_c+I1), s		2.8		5.7		2.7		10.2				
Green Ext Time (p_c), s		0.0		0.8		0.0		1.7				
Intersection Summary												
HCM 2010 Ctrl Delay				5.4								
HCM 2010 LOS				A								

HCM 2010 Signalized Intersection Summary
42: 6th Avenue & Gigling Road

Cumulative with Project, AM
06/11/2019



Movement	EBL	EBT	EBR	WBL	WBT	WBR	NBL	NBT	NBR	SBL	SBT	SBR
Lane Configurations		↔			↔			↔	↔		↔	
Traffic Volume (veh/h)	200	420	10	30	820	10	10	10	10	10	10	210
Future Volume (veh/h)	200	420	10	30	820	10	10	10	10	10	10	210
Number	7	4	14	3	8	18	5	2	12	1	6	16
Initial Q (Qb), veh	0	0	0	0	0	0	0	0	0	0	0	0
Ped-Bike Adj(A_pbT)	1.00		1.00	1.00		1.00	1.00		1.00	1.00		1.00
Parking Bus, Adj	1.00	1.00	1.00	1.00	1.00	1.00	1.00	1.00	1.00	1.00	1.00	1.00
Adj Sat Flow, veh/h/ln	1900	1845	1900	1900	1863	1900	1900	1429	1429	1900	1863	1900
Adj Flow Rate, veh/h	225	472	11	34	921	11	11	11	0	11	11	236
Adj No. of Lanes	0	2	0	0	2	0	0	1	1	0	1	0
Peak Hour Factor	0.89	0.89	0.89	0.89	0.89	0.89	0.89	0.89	0.89	0.89	0.89	0.89
Percent Heavy Veh, %	3	3	3	2	2	2	33	33	33	2	2	2
Cap, veh/h	403	992	23	119	1997	23	220	159	252	92	22	302
Arrive On Green	0.59	0.59	0.59	0.59	0.59	0.59	0.21	0.21	0.00	0.21	0.21	0.21
Sat Flow, veh/h	420	1690	40	53	3401	40	465	766	1214	29	106	1455
Grp Volume(v), veh/h	248	0	460	501	0	465	22	0	0	258	0	0
Grp Sat Flow(s),veh/h/ln	478	0	1672	1807	0	1688	1231	0	1214	1591	0	0
Q Serve(g_s), s	15.2	0.0	6.9	0.0	0.0	6.9	0.0	0.0	0.0	1.6	0.0	0.0
Cycle Q Clear(g_c), s	22.0	0.0	6.9	6.7	0.0	6.9	0.5	0.0	0.0	6.7	0.0	0.0
Prop In Lane	0.91		0.02	0.07		0.02	0.50		1.00	0.04		0.91
Lane Grp Cap(c), veh/h	437	0	981	1148	0	991	379	0	252	416	0	0
V/C Ratio(X)	0.57	0.00	0.47	0.44	0.00	0.47	0.06	0.00	0.00	0.62	0.00	0.00
Avail Cap(c_a), veh/h	794	0	1924	2129	0	1943	904	0	844	1186	0	0
HCM Platoon Ratio	1.00	1.00	1.00	1.00	1.00	1.00	1.00	1.00	1.00	1.00	1.00	1.00
Upstream Filter(I)	1.00	0.00	1.00	1.00	0.00	1.00	1.00	0.00	0.00	1.00	0.00	0.00
Uniform Delay (d), s/veh	10.9	0.0	5.2	5.1	0.0	5.2	14.0	0.0	0.0	16.4	0.0	0.0
Incr Delay (d2), s/veh	0.4	0.0	0.1	0.1	0.0	0.1	0.0	0.0	0.0	0.6	0.0	0.0
Initial Q Delay(d3),s/veh	0.0	0.0	0.0	0.0	0.0	0.0	0.0	0.0	0.0	0.0	0.0	0.0
%ile BackOfQ(50%),veh/ln	2.7	0.0	3.1	3.4	0.0	3.1	0.2	0.0	0.0	3.0	0.0	0.0
LnGrp Delay(d),s/veh	11.4	0.0	5.3	5.2	0.0	5.3	14.0	0.0	0.0	17.0	0.0	0.0
LnGrp LOS	B		A	A		A	B			B		
Approach Vol, veh/h		708			966			22			258	
Approach Delay, s/veh		7.4			5.2			14.0			17.0	
Approach LOS		A			A			B			B	
Timer	1	2	3	4	5	6	7	8				
Assigned Phs		2		4		6		8				
Phs Duration (G+Y+Rc), s		13.6		30.3		13.6		30.3				
Change Period (Y+Rc), s		4.5		4.5		4.5		4.5				
Max Green Setting (Gmax), s		30.5		50.5		30.5		50.5				
Max Q Clear Time (g_c+I1), s		2.5		24.0		8.7		8.9				
Green Ext Time (p_c), s		0.0		1.7		0.4		1.0				
Intersection Summary												
HCM 2010 Ctrl Delay				7.7								
HCM 2010 LOS				A								

HCM 2010 Signalized Intersection Summary
43: Gigling Road & 7th Avenue

Cumulative with Project, AM
06/11/2019

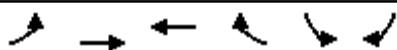

Movement	EBL	EBT	WBT	WBR	SBL	SBR		
Lane Configurations		↑↑	↑↑		↑↑			
Traffic Volume (veh/h)	180	260	780	10	10	70		
Future Volume (veh/h)	180	260	780	10	10	70		
Number	7	4	8	18	1	16		
Initial Q (Qb), veh	0	0	0	0	0	0		
Ped-Bike Adj(A_pbT)	1.00			1.00	1.00	1.00		
Parking Bus, Adj	1.00	1.00	1.00	1.00	1.00	1.00		
Adj Sat Flow, veh/h/ln	1900	1845	1900	1900	1759	1900		
Adj Flow Rate, veh/h	209	302	907	12	12	81		
Adj No. of Lanes	0	2	2	0	0	0		
Peak Hour Factor	0.86	0.86	0.86	0.86	0.86	0.86		
Percent Heavy Veh, %	3	3	0	0	0	0		
Cap, veh/h	522	918	2086	28	18	123		
Arrive On Green	0.57	0.57	0.57	0.57	0.09	0.09		
Sat Flow, veh/h	449	1690	3743	48	194	1309		
Grp Volume(v), veh/h	212	299	449	470	94	0		
Grp Sat Flow(s),veh/h/ln	460	1595	1805	1891	1519	0		
Q Serve(g_s), s	8.1	2.7	3.8	3.8	1.6	0.0		
Cycle Q Clear(g_c), s	11.9	2.7	3.8	3.8	1.6	0.0		
Prop In Lane	0.98			0.03	0.13	0.86		
Lane Grp Cap(c), veh/h	528	912	1032	1081	142	0		
V/C Ratio(X)	0.40	0.33	0.43	0.43	0.66	0.00		
Avail Cap(c_a), veh/h	1432	3289	3723	3901	1439	0		
HCM Platoon Ratio	1.00	1.00	1.00	1.00	1.00	1.00		
Upstream Filter(I)	1.00	1.00	1.00	1.00	1.00	0.00		
Uniform Delay (d), s/veh	6.6	3.0	3.3	3.3	11.8	0.0		
Incr Delay (d2), s/veh	0.2	0.1	0.1	0.1	1.9	0.0		
Initial Q Delay(d3),s/veh	0.0	0.0	0.0	0.0	0.0	0.0		
%ile BackOfQ(50%),veh/ln	1.4	1.2	1.9	2.0	0.7	0.0		
LnGrp Delay(d),s/veh	6.8	3.1	3.4	3.4	13.7	0.0		
LnGrp LOS	A	A	A	A	B			
Approach Vol, veh/h		511	919		94			
Approach Delay, s/veh		4.6	3.4		13.7			
Approach LOS		A	A		B			
Timer	1	2	3	4	5	6	7	8
Assigned Phs				4		6		8
Phs Duration (G+Y+Rc), s				19.9		7.0		19.9
Change Period (Y+Rc), s				4.5		4.5		4.5
Max Green Setting (Gmax), s				55.5		25.5		55.5
Max Q Clear Time (g_c+I1), s				13.9		3.6		5.8
Green Ext Time (p_c), s				1.5		0.0		0.8
Intersection Summary								
HCM 2010 Ctrl Delay			4.4					
HCM 2010 LOS			A					
Notes								

HCM 2010 Signalized Intersection Summary
44: 8th Avenue & Gigling Road

Cumulative with Project, AM
06/11/2019



Movement	EBL	EBT	EBR	WBL	WBT	WBR	NBL	NBT	NBR	SBL	SBT	SBR
Lane Configurations		↔↔			↔↔			↔			↔	
Traffic Volume (veh/h)	260	10	10	10	10	10	10	10	10	10	10	780
Future Volume (veh/h)	260	10	10	10	10	10	10	10	10	10	10	780
Number	7	4	14	3	8	18	5	2	12	1	6	16
Initial Q (Qb), veh	0	0	0	0	0	0	0	0	0	0	0	0
Ped-Bike Adj(A_pbT)	1.00		1.00	1.00		1.00	1.00		1.00	1.00		1.00
Parking Bus, Adj	1.00	1.00	1.00	1.00	1.00	1.00	1.00	1.00	1.00	1.00	1.00	1.00
Adj Sat Flow, veh/h/ln	1900	1863	1900	1900	1863	1900	1900	1900	1900	1900	1900	1900
Adj Flow Rate, veh/h	306	12	12	12	12	12	12	12	12	12	12	918
Adj No. of Lanes	0	2	0	0	2	0	0	1	0	0	1	0
Peak Hour Factor	0.85	0.85	0.85	0.85	0.85	0.85	0.85	0.85	0.85	0.85	0.85	0.85
Percent Heavy Veh, %	2	2	2	2	2	2	0	0	0	0	0	0
Cap, veh/h	456	200	200	311	281	285	183	183	146	61	21	952
Arrive On Green	0.26	0.26	0.26	0.26	0.26	0.26	0.60	0.60	0.60	0.60	0.60	0.60
Sat Flow, veh/h	1338	779	779	860	1093	1109	180	303	241	7	34	1578
Grp Volume(v), veh/h	306	0	24	20	0	16	36	0	0	942	0	0
Grp Sat Flow(s),veh/h/ln	1338	0	1558	1563	0	1499	724	0	0	1619	0	0
Q Serve(g_s), s	13.8	0.0	0.7	0.0	0.0	0.5	0.0	0.0	0.0	9.5	0.0	0.0
Cycle Q Clear(g_c), s	14.3	0.0	0.7	0.5	0.0	0.5	0.5	0.0	0.0	35.6	0.0	0.0
Prop In Lane	1.00		0.50	0.61		0.74	0.33		0.33	0.01		0.97
Lane Grp Cap(c), veh/h	456	0	400	491	0	385	511	0	0	1034	0	0
V/C Ratio(X)	0.67	0.00	0.06	0.04	0.00	0.04	0.07	0.00	0.00	0.91	0.00	0.00
Avail Cap(c_a), veh/h	861	0	857	943	0	825	621	0	0	1198	0	0
HCM Platoon Ratio	1.00	1.00	1.00	1.00	1.00	1.00	1.00	1.00	1.00	1.00	1.00	1.00
Upstream Filter(I)	1.00	0.00	1.00	1.00	0.00	1.00	1.00	0.00	0.00	1.00	0.00	0.00
Uniform Delay (d), s/veh	23.4	0.0	18.1	18.0	0.0	18.0	5.2	0.0	0.0	12.1	0.0	0.0
Incr Delay (d2), s/veh	0.6	0.0	0.0	0.0	0.0	0.0	0.0	0.0	0.0	8.9	0.0	0.0
Initial Q Delay(d3),s/veh	0.0	0.0	0.0	0.0	0.0	0.0	0.0	0.0	0.0	0.0	0.0	0.0
%ile BackOfQ(50%),veh/ln	5.4	0.0	0.3	0.3	0.0	0.2	0.3	0.0	0.0	18.0	0.0	0.0
LnGrp Delay(d),s/veh	24.0	0.0	18.1	18.0	0.0	18.0	5.2	0.0	0.0	21.0	0.0	0.0
LnGrp LOS	C		B	B		B	A			C		
Approach Vol, veh/h		330			36			36			942	
Approach Delay, s/veh		23.6			18.0			5.2			21.0	
Approach LOS		C			B			A			C	
Timer	1	2	3	4	5	6	7	8				
Assigned Phs		2		4		6		8				
Phs Duration (G+Y+Rc), s		43.4		21.1		43.4		21.1				
Change Period (Y+Rc), s		4.5		4.5		4.5		4.5				
Max Green Setting (Gmax), s		45.5		35.5		45.5		35.5				
Max Q Clear Time (g_c+I1), s		2.5		16.3		37.6		2.5				
Green Ext Time (p_c), s		0.1		0.3		1.4		0.0				
Intersection Summary												
HCM 2010 Ctrl Delay				21.1								
HCM 2010 LOS				C								

HCM 2010 Signalized Intersection Summary
 46: General Jim Moore Boulevard & Normandy Road

Cumulative with Project, AM
 06/11/2019



Movement	EBL	EBT	EBR	WBL	WBT	WBR	NBL	NBT	NBR	SBL	SBT	SBR
Lane Configurations		↕			↕		↕	↕↕		↕	↕↕	↕
Traffic Volume (veh/h)	90	80	150	150	70	40	200	490	110	80	840	250
Future Volume (veh/h)	90	80	150	150	70	40	200	490	110	80	840	250
Number	3	8	18	7	4	14	1	6	16	5	2	12
Initial Q (Qb), veh	0	0	0	0	0	0	0	0	0	0	0	0
Ped-Bike Adj(A_pbT)	0.99		0.98	0.99		0.98	1.00		0.99	1.00		0.99
Parking Bus, Adj	1.00	1.00	1.00	1.00	1.00	1.00	1.00	1.00	1.00	1.00	1.00	1.00
Adj Sat Flow, veh/h/ln	1900	1881	1900	1900	1863	1900	1881	1881	1900	1863	1863	1863
Adj Flow Rate, veh/h	115	103	163	192	90	47	256	628	114	103	1077	252
Adj No. of Lanes	0	1	0	0	1	0	1	2	0	1	2	1
Peak Hour Factor	0.78	0.78	0.78	0.78	0.78	0.78	0.78	0.78	0.78	0.78	0.78	0.78
Percent Heavy Veh, %	1	1	1	2	2	2	1	1	1	2	2	2
Cap, veh/h	210	187	248	315	141	63	201	745	135	348	1170	518
Arrive On Green	0.37	0.37	0.37	0.37	0.37	0.37	0.11	0.25	0.25	0.20	0.33	0.33
Sat Flow, veh/h	391	509	673	640	384	171	1792	3016	546	1774	3539	1567
Grp Volume(v), veh/h	381	0	0	329	0	0	256	372	370	103	1077	252
Grp Sat Flow(s),veh/h/ln	1573	0	0	1195	0	0	1792	1787	1776	1774	1770	1567
Q Serve(g_s), s	0.0	0.0	0.0	4.1	0.0	0.0	8.0	14.1	14.1	3.5	20.9	9.1
Cycle Q Clear(g_c), s	13.9	0.0	0.0	18.1	0.0	0.0	8.0	14.1	14.1	3.5	20.9	9.1
Prop In Lane	0.30		0.43	0.58		0.14	1.00		0.31	1.00		1.00
Lane Grp Cap(c), veh/h	644	0	0	520	0	0	201	441	438	348	1170	518
V/C Ratio(X)	0.59	0.00	0.00	0.63	0.00	0.00	1.27	0.84	0.84	0.30	0.92	0.49
Avail Cap(c_a), veh/h	789	0	0	643	0	0	201	639	635	348	1266	561
HCM Platoon Ratio	1.00	1.00	1.00	1.00	1.00	1.00	1.00	1.00	1.00	1.00	1.00	1.00
Upstream Filter(I)	1.00	0.00	0.00	1.00	0.00	0.00	1.00	1.00	1.00	1.00	1.00	1.00
Uniform Delay (d), s/veh	18.5	0.0	0.0	19.9	0.0	0.0	31.6	25.5	25.5	24.5	23.0	19.0
Incr Delay (d2), s/veh	0.3	0.0	0.0	0.6	0.0	0.0	155.7	4.7	4.9	0.2	10.1	0.3
Initial Q Delay(d3),s/veh	0.0	0.0	0.0	0.0	0.0	0.0	0.0	0.0	0.0	0.0	0.0	0.0
%ile BackOfQ(50%),veh/ln	6.2	0.0	0.0	5.8	0.0	0.0	12.6	7.5	7.5	1.7	11.8	4.0
LnGrp Delay(d),s/veh	18.8	0.0	0.0	20.5	0.0	0.0	187.4	30.2	30.4	24.6	33.0	19.3
LnGrp LOS	B			C			F	C	C	C	C	B
Approach Vol, veh/h		381			329			998			1432	
Approach Delay, s/veh		18.8			20.5			70.6			30.0	
Approach LOS		B			C			E			C	
Timer	1	2	3	4	5	6	7	8				
Assigned Phs	1	2		4	5	6		8				
Phs Duration (G+Y+Rc), s	2.5	28.1		30.7	18.5	22.1		30.7				
Change Period (Y+Rc), s	4.5	4.5		4.5	4.5	4.5		4.5				
Max Green Setting (Gmax), s	30.0	25.5		33.0	8.0	25.5		33.0				
Max Q Clear Time (g_c+110), s	11.0	22.9		20.1	5.5	16.1		15.9				
Green Ext Time (p_c), s	0.0	0.7		0.5	0.0	0.6		0.6				
Intersection Summary												
HCM 2010 Ctrl Delay	40.6											
HCM 2010 LOS	D											

Intersection	
Intersection Delay, s/veh	22.3
Intersection LOS	F

Movement	EBL	EBR	NBL	NBT	SBT	SBR
Lane Configurations						
Traffic Vol, veh/h	90	430	230	420	980	80
Future Vol, veh/h	90	430	230	420	980	80
Peak Hour Factor	0.90	0.90	0.90	0.90	0.90	0.90
Heavy Vehicles, %	1	1	1	1	2	2
Mvmt Flow	100	478	256	467	1089	89
Number of Lanes	1	1	1	2	2	1

Approach	EB	NB	SB
Opposing Approach		SB	NB
Opposing Lanes	0	3	3
Conflicting Approach Left	SB		
Conflicting Lanes Left	3	2	0
Conflicting Approach Right	NB		EB
Conflicting Lanes Right	3	0	2
HCM Control Delay	125.2	26.7	179.4
HCM LOS	F	D	F

Lane	NBLn1	NBLn2	NBLn3	EBLn1	EBLn2	SBLn1	SBLn2	SBLn3
Vol Left, %	100%	0%	0%	100%	0%	0%	0%	0%
Vol Thru, %	0%	100%	100%	0%	0%	100%	100%	0%
Vol Right, %	0%	0%	0%	0%	100%	0%	0%	100%
Sign Control	Stop	Stop	Stop	Stop	Stop	Stop	Stop	Stop
Traffic Vol by Lane	230	210	210	90	430	490	490	80
LT Vol	230	0	0	90	0	0	0	0
Through Vol	0	210	210	0	0	490	490	0
RT Vol	0	0	0	0	430	0	0	80
Lane Flow Rate	256	233	233	100	478	544	544	89
Geometry Grp	8	8	8	8	8	8	8	8
Degree of Util (X)	0.684	0.592	0.481	0.286	1.21	1.332	1.332	0.158
Departure Headway (Hd)	10.797	10.273	8.473	11.218	10	9.52	9.52	6.968
Convergence, Y/N	Yes	Yes	Yes	Yes	Yes	Yes	Yes	Yes
Cap	337	355	429	322	368	387	387	518
Service Time	8.497	7.973	6.173	8.918	7.7	7.22	7.22	4.668
HCM Lane V/C Ratio	0.76	0.656	0.543	0.311	1.299	1.406	1.406	0.172
HCM Control Delay	33.9	26.8	18.8	18.4	147.6	193.2	193.2	11
HCM Lane LOS	D	D	C	C	F	F	F	B
HCM 95th-tile Q	4.8	3.6	2.5	1.2	18.4	23.7	23.7	0.6



Movement	EBL	EBT	EBR	WBL	WBT	WBR	NBL	NBT	NBR	SBL	SBT	SBR
Lane Configurations												
Traffic Volume (veh/h)	80	100	140	120	210	30	230	680	140	60	1010	120
Future Volume (veh/h)	80	100	140	120	210	30	230	680	140	60	1010	120
Number	7	4	14	3	8	18	5	2	12	1	6	16
Initial Q (Qb), veh	0	0	0	0	0	0	0	0	0	0	0	0
Ped-Bike Adj(A_pbT)	1.00		0.95	1.00		0.97	1.00		0.99	1.00		0.98
Parking Bus, Adj	1.00	1.00	1.00	1.00	1.00	1.00	1.00	1.00	1.00	1.00	1.00	1.00
Adj Sat Flow, veh/h/ln	1845	1845	1845	1900	1881	1900	1827	1827	1900	1827	1827	1827
Adj Flow Rate, veh/h	88	110	65	132	231	31	253	747	139	66	1110	65
Adj No. of Lanes	1	1	1	0	1	0	1	2	0	1	2	1
Peak Hour Factor	0.91	0.91	0.91	0.91	0.91	0.91	0.91	0.91	0.91	0.91	0.91	0.91
Percent Heavy Veh, %	3	3	3	1	1	1	4	4	4	4	4	4
Cap, veh/h	202	212	172	137	239	32	425	1337	249	84	880	388
Arrive On Green	0.11	0.11	0.11	0.22	0.22	0.22	0.24	0.46	0.46	0.05	0.25	0.25
Sat Flow, veh/h	1757	1845	1494	610	1067	143	1740	2915	542	1740	3471	1529
Grp Volume(v), veh/h	88	110	65	394	0	0	253	445	441	66	1110	65
Grp Sat Flow(s),veh/h/ln	1757	1845	1494	1820	0	0	1740	1736	1722	1740	1736	1529
Q Serve(g_s), s	5.8	7.0	5.0	26.8	0.0	0.0	16.1	23.3	23.3	4.7	31.7	4.1
Cycle Q Clear(g_c), s	5.8	7.0	5.0	26.8	0.0	0.0	16.1	23.3	23.3	4.7	31.7	4.1
Prop In Lane	1.00		1.00	0.34		0.08	1.00		0.31	1.00		1.00
Lane Grp Cap(c), veh/h	202	212	172	408	0	0	425	796	789	84	880	388
V/C Ratio(X)	0.44	0.52	0.38	0.97	0.00	0.00	0.59	0.56	0.56	0.78	1.26	0.17
Avail Cap(c_a), veh/h	436	457	371	408	0	0	425	796	789	209	880	388
HCM Platoon Ratio	1.00	1.00	1.00	1.00	1.00	1.00	1.00	1.00	1.00	1.00	1.00	1.00
Upstream Filter(I)	0.76	0.76	0.76	1.00	0.00	0.00	1.00	1.00	1.00	1.00	1.00	1.00
Uniform Delay (d), s/veh	51.6	52.1	51.2	48.0	0.0	0.0	41.8	24.6	24.6	58.8	46.7	36.4
Incr Delay (d2), s/veh	1.1	1.5	1.1	35.9	0.0	0.0	1.6	2.8	2.8	5.9	126.6	0.9
Initial Q Delay(d3),s/veh	0.0	0.0	0.0	0.0	0.0	0.0	0.0	0.0	0.0	0.0	0.0	0.0
%ile BackOfQ(50%),veh/ln	2.9	3.7	2.1	17.5	0.0	0.0	7.9	11.7	11.7	2.4	30.6	1.9
LnGrp Delay(d),s/veh	52.7	53.6	52.3	83.9	0.0	0.0	43.3	27.5	27.5	64.7	173.2	37.3
LnGrp LOS	D	D	D	F			D	C	C	E	F	D
Approach Vol, veh/h		263			394			1139			1241	
Approach Delay, s/veh		53.0			83.9			31.0			160.4	
Approach LOS		D			F			C			F	
Timer	1	2	3	4	5	6	7	8				
Assigned Phs	1	2		4	5	6		8				
Phs Duration (G+Y+Rc), s	0.2	62.6		19.0	35.9	37.0		33.1				
Change Period (Y+Rc), s	4.2	5.3		* 4.7	5.3	* 5.3		5.1				
Max Green Setting (Gmax), s	15	31.7		* 31	15.0	* 32		28.0				
Max Q Clear Time (g_c+10), s	15	25.3		9.0	18.1	33.7		28.8				
Green Ext Time (p_c), s	0.0	2.5		1.0	0.0	0.0		0.0				

Intersection Summary

HCM 2010 Ctrl Delay	92.6
HCM 2010 LOS	F

Notes

HCM 2010 Signalized Intersection Summary
 49: Highway 1 SB On-Ramp & Highway 1 NB Off-Ramp/Monterey Road

Cumulative with Project, AM
 06/11/2019



Movement	EBL	EBT	EBR	WBL	WBT	WBR	NBL	NBT	NBR	SBL	SBT	SBR
Lane Configurations		↕↕	↗	↖		↗		↕	↗		↕	
Traffic Volume (veh/h)	10	200	100	240	0	380	0	50	120	10	10	0
Future Volume (veh/h)	10	200	100	240	0	380	0	50	120	10	10	0
Number	1	6	16	5	2	12	7	4	14	3	8	18
Initial Q (Qb), veh	0	0	0	0	0	0	0	0	0	0	0	0
Ped-Bike Adj(A_pbT)	1.00		1.00	1.00		1.00	1.00		1.00	1.00		1.00
Parking Bus, Adj	1.00	1.00	1.00	1.00	1.00	1.00	1.00	1.00	1.00	1.00	1.00	1.00
Adj Sat Flow, veh/h/ln	1900	1845	1845	1863	0	1863	0	1845	1845	1900	1900	0
Adj Flow Rate, veh/h	10	206	9	247	0	253	0	52	21	10	10	0
Adj No. of Lanes	0	2	1	1	0	1	0	1	1	0	1	0
Peak Hour Factor	0.97	0.97	0.97	0.97	0.97	0.97	0.97	0.97	0.97	0.97	0.97	0.97
Percent Heavy Veh, %	3	3	3	2	0	2	0	3	3	0	0	0
Cap, veh/h	136	2942	1343	0	0	0	0	122	104	74	60	0
Arrive On Green	0.86	0.86	0.86	0.00	0.00	0.00	0.00	0.07	0.07	0.07	0.07	0.00
Sat Flow, veh/h	159	3430	1566				0	1845	1568	466	899	0
Grp Volume(v), veh/h	116	100	9		0.0		0	52	21	20	0	0
Grp Sat Flow(s),veh/h/ln	1837	1752	1566				0	1845	1568	1365	0	0
Q Serve(g_s), s	1.2	1.1	0.1				0.0	3.4	1.6	0.0	0.0	0.0
Cycle Q Clear(g_c), s	1.2	1.1	0.1				0.0	3.4	1.6	3.4	0.0	0.0
Prop In Lane	0.09		1.00				0.00		1.00	0.50		0.00
Lane Grp Cap(c), veh/h	1575	1503	1343				0	122	104	134	0	0
V/C Ratio(X)	0.07	0.07	0.01				0.00	0.43	0.20	0.15	0.00	0.00
Avail Cap(c_a), veh/h	1575	1503	1343				0	148	125	155	0	0
HCM Platoon Ratio	1.00	1.00	1.00				1.00	1.00	1.00	1.00	1.00	1.00
Upstream Filter(I)	1.00	1.00	1.00				0.00	1.00	1.00	1.00	0.00	0.00
Uniform Delay (d), s/veh	1.4	1.3	1.3				0.0	56.1	55.2	55.1	0.0	0.0
Incr Delay (d2), s/veh	0.0	0.0	0.0				0.0	0.9	0.4	0.2	0.0	0.0
Initial Q Delay(d3),s/veh	0.0	0.0	0.0				0.0	0.0	0.0	0.0	0.0	0.0
%ile BackOfQ(50%),veh/ln	0.6	0.5	0.0				0.0	1.8	0.7	0.7	0.0	0.0
LnGrp Delay(d),s/veh	1.4	1.3	1.3				0.0	56.9	55.6	55.3	0.0	0.0
LnGrp LOS	A	A	A					E	E	E		
Approach Vol, veh/h		225						73			20	
Approach Delay, s/veh		1.4						56.5			55.3	
Approach LOS		A						E			E	
Timer	1	2	3	4	5	6	7	8				
Assigned Phs				4		6		8				
Phs Duration (G+Y+Rc), s				12.5		112.5		12.5				
Change Period (Y+Rc), s				* 4.2		5.3		* 4.2				
Max Green Setting (Gmax), s				* 10		21.0		* 10				
Max Q Clear Time (g_c+I1), s				5.4		3.2		5.4				
Green Ext Time (p_c), s				0.1		0.7		0.0				
Intersection Summary												
HCM 2010 Ctrl Delay				17.4								
HCM 2010 LOS				B								
Notes												

HCM 2010 Signalized Intersection Summary
 50: Reservation Road & SR 68 WB On Ramp/SR 68 WB Off Ramp

Cumulative with Project, AM
 06/11/2019























Movement	EBL	EBT	EBR	WBL	WBT	WBR	NBL	NBT	NBR	SBL	SBT	SBR
Lane Configurations					↕	↕	↕	↕			↕	
Traffic Volume (veh/h)	0	0	0	260	10	310	120	400	0	0	350	130
Future Volume (veh/h)	0	0	0	260	10	310	120	400	0	0	350	130
Number				7	4	14	1	6	16	5	2	12
Initial Q (Qb), veh				0	0	0	0	0	0	0	0	0
Ped-Bike Adj(A_pbT)				1.00		1.00	1.00		1.00	1.00		1.00
Parking Bus, Adj				1.00	1.00	1.00	1.00	1.00	1.00	1.00	1.00	1.00
Adj Sat Flow, veh/h/ln				1900	1827	1827	1863	1863	0	0	1827	1900
Adj Flow Rate, veh/h				274	11	74	126	421	0	0	368	128
Adj No. of Lanes				0	1	1	1	1	0	0	1	0
Peak Hour Factor				0.95	0.95	0.95	0.95	0.95	0.95	0.95	0.95	0.95
Percent Heavy Veh, %				4	4	4	2	2	0	0	4	4
Cap, veh/h				387	16	359	209	1014	0	0	459	160
Arrive On Green				0.23	0.23	0.23	0.12	0.54	0.00	0.00	0.35	0.35
Sat Flow, veh/h				1676	67	1553	1774	1863	0	0	1296	451
Grp Volume(v), veh/h				285	0	74	126	421	0	0	0	496
Grp Sat Flow(s),veh/h/ln				1743	0	1553	1774	1863	0	0	0	1747
Q Serve(g_s), s				7.3	0.0	1.9	3.3	6.5	0.0	0.0	0.0	12.4
Cycle Q Clear(g_c), s				7.3	0.0	1.9	3.3	6.5	0.0	0.0	0.0	12.4
Prop In Lane				0.96		1.00	1.00		0.00	0.00		0.26
Lane Grp Cap(c), veh/h				403	0	359	209	1014	0	0	0	619
V/C Ratio(X)				0.71	0.00	0.21	0.60	0.42	0.00	0.00	0.00	0.80
Avail Cap(c_a), veh/h				1438	0	1281	952	1460	0	0	0	1370
HCM Platoon Ratio				1.00	1.00	1.00	1.00	1.00	1.00	1.00	1.00	1.00
Upstream Filter(I)				1.00	0.00	1.00	1.00	1.00	0.00	0.00	0.00	1.00
Uniform Delay (d), s/veh				17.1	0.0	15.1	20.3	6.5	0.0	0.0	0.0	14.1
Incr Delay (d2), s/veh				2.3	0.0	0.3	1.0	0.3	0.0	0.0	0.0	2.5
Initial Q Delay(d3),s/veh				0.0	0.0	0.0	0.0	0.0	0.0	0.0	0.0	0.0
%ile BackOfQ(50%),veh/ln				3.7	0.0	0.8	1.6	3.4	0.0	0.0	0.0	6.3
LnGrp Delay(d),s/veh				19.4	0.0	15.3	21.3	6.8	0.0	0.0	0.0	16.6
LnGrp LOS				B		B	C	A				B
Approach Vol, veh/h					359			547			496	
Approach Delay, s/veh					18.6			10.1			16.6	
Approach LOS					B			B			B	
Timer	1	2	3	4	5	6	7	8				
Assigned Phs	1	2		4		6						
Phs Duration (G+Y+Rc), s	9.2	23.2		16.1		32.4						
Change Period (Y+Rc), s	3.5	6.0		4.9		6.0						
Max Green Setting (Gmax), s	26.0	38.0		40.0		38.0						
Max Q Clear Time (g_c+15), s	15.3	14.4		9.3		8.5						
Green Ext Time (p_c), s	0.1	2.8		2.0		2.2						
Intersection Summary												
HCM 2010 Ctrl Delay				14.6								
HCM 2010 LOS				B								



Movement	EBL	EBT	EBR	WBL	WBT	WBR	NBL	NBT	NBR	SBL	SBT	SBR
Lane Configurations		↔	↗					↑	↗	↘	↑	
Traffic Volume (veh/h)	130	10	110	0	0	0	0	390	660	230	370	0
Future Volume (veh/h)	130	10	110	0	0	0	0	390	660	230	370	0
Number	3	8	18				1	6	16	5	2	12
Initial Q (Qb), veh	0	0	0				0	0	0	0	0	0
Ped-Bike Adj(A_pbT)	1.00		1.00				1.00		1.00	1.00		1.00
Parking Bus, Adj	1.00	1.00	1.00				1.00	1.00	1.00	1.00	1.00	1.00
Adj Sat Flow, veh/h/ln	1900	1881	1881				0	1881	1881	1827	1827	0
Adj Flow Rate, veh/h	141	11	19				0	424	388	250	402	0
Adj No. of Lanes	0	1	1				0	1	1	1	1	0
Peak Hour Factor	0.92	0.92	0.92				0.92	0.92	0.92	0.92	0.92	0.92
Percent Heavy Veh, %	1	1	1				0	1	1	4	4	0
Cap, veh/h	205	16	196				0	647	550	326	1130	0
Arrive On Green	0.12	0.12	0.12				0.00	0.34	0.34	0.19	0.62	0.00
Sat Flow, veh/h	1668	130	1599				0	1881	1599	1740	1827	0
Grp Volume(v), veh/h	152	0	19				0	424	388	250	402	0
Grp Sat Flow(s),veh/h/ln	1798	0	1599				0	1881	1599	1740	1827	0
Q Serve(g_s), s	3.4	0.0	0.4				0.0	8.1	8.9	5.8	4.5	0.0
Cycle Q Clear(g_c), s	3.4	0.0	0.4				0.0	8.1	8.9	5.8	4.5	0.0
Prop In Lane	0.93		1.00				0.00		1.00	1.00		0.00
Lane Grp Cap(c), veh/h	221	0	196				0	647	550	326	1130	0
V/C Ratio(X)	0.69	0.00	0.10				0.00	0.66	0.71	0.77	0.36	0.00
Avail Cap(c_a), veh/h	1705	0	1517				0	1650	1403	990	1603	0
HCM Platoon Ratio	1.00	1.00	1.00				1.00	1.00	1.00	1.00	1.00	1.00
Upstream Filter(I)	1.00	0.00	1.00				0.00	1.00	1.00	1.00	1.00	0.00
Uniform Delay (d), s/veh	17.7	0.0	16.4				0.0	11.7	12.0	16.3	3.9	0.0
Incr Delay (d2), s/veh	1.4	0.0	0.1				0.0	1.1	1.7	3.8	0.2	0.0
Initial Q Delay(d3),s/veh	0.0	0.0	0.0				0.0	0.0	0.0	0.0	0.0	0.0
%ile BackOfQ(50%),veh/ln	1.8	0.0	0.2				0.0	4.3	4.1	3.1	2.3	0.0
LnGrp Delay(d),s/veh	19.2	0.0	16.5				0.0	12.9	13.7	20.1	4.1	0.0
LnGrp LOS	B		B					B	B	C	A	
Approach Vol, veh/h		171						812			652	
Approach Delay, s/veh		18.9						13.2			10.2	
Approach LOS		B						B			B	
Timer	1	2	3	4	5	6	7	8				
Assigned Phs		2			5	6		8				
Phs Duration (G+Y+Rc), s		32.1			11.6	20.5		10.1				
Change Period (Y+Rc), s		6.0			3.7	6.0		4.9				
Max Green Setting (Gmax), s		37.0			24.0	37.0		40.0				
Max Q Clear Time (g_c+I1), s		6.5			7.8	10.9		5.4				
Green Ext Time (p_c), s		2.2			0.6	3.6		0.6				
Intersection Summary												
HCM 2010 Ctrl Delay			12.6									
HCM 2010 LOS			B									

HCM 2010 Signalized Intersection Summary
1: Del Monte Boulevard & Reindollar Avenue

Cumulative with Project, PM
06/11/2019

												
Movement	EBL	EBT	EBR	WBL	WBT	WBR	NBL	NBT	NBR	SBL	SBT	SBR
Lane Configurations												
Traffic Volume (veh/h)	0	0	0	190	0	450	10	1330	340	400	850	0
Future Volume (veh/h)	0	0	0	190	0	450	10	1330	340	400	850	0
Number				3	8	18	1	6	16	5	2	12
Initial Q (Qb), veh				0	0	0	0	0	0	0	0	0
Ped-Bike Adj(A_pbT)				1.00		0.99	1.00		1.00	1.00		1.00
Parking Bus, Adj				1.00	1.00	1.00	1.00	1.00	1.00	1.00	1.00	1.00
Adj Sat Flow, veh/h/ln				1881	1881	1900	1881	1881	1881	1881	1881	0
Adj Flow Rate, veh/h				198	0	397	10	1385	271	417	885	0
Adj No. of Lanes				1	1	0	1	2	1	1	2	0
Peak Hour Factor				0.96	0.96	0.96	0.96	0.96	0.96	0.96	0.96	0.96
Percent Heavy Veh, %				1	1	1	1	1	1	1	1	0
Cap, veh/h				501	0	444	22	1145	512	458	2015	0
Arrive On Green				0.28	0.00	0.28	0.01	0.32	0.32	0.26	0.56	0.00
Sat Flow, veh/h				1792	0	1585	1792	3574	1599	1792	3668	0
Grp Volume(v), veh/h				198	0	397	10	1385	271	417	885	0
Grp Sat Flow(s),veh/h/ln				1792	0	1585	1792	1787	1599	1792	1787	0
Q Serve(g_s), s				8.4	0.0	22.5	0.5	30.0	13.0	21.1	13.4	0.0
Cycle Q Clear(g_c), s				8.4	0.0	22.5	0.5	30.0	13.0	21.1	13.4	0.0
Prop In Lane				1.00		1.00	1.00		1.00	1.00		0.00
Lane Grp Cap(c), veh/h				501	0	444	22	1145	512	458	2015	0
V/C Ratio(X)				0.39	0.00	0.89	0.46	1.21	0.53	0.91	0.44	0.00
Avail Cap(c_a), veh/h				574	0	508	574	1145	512	574	2015	0
HCM Platoon Ratio				1.00	1.00	1.00	1.00	1.00	1.00	1.00	1.00	1.00
Upstream Filter(I)				1.00	0.00	1.00	1.00	1.00	1.00	1.00	1.00	0.00
Uniform Delay (d), s/veh				27.3	0.0	32.4	45.9	31.8	26.0	33.8	11.8	0.0
Incr Delay (d2), s/veh				0.5	0.0	16.8	14.1	102.7	1.0	16.2	0.2	0.0
Initial Q Delay(d3),s/veh				0.0	0.0	0.0	0.0	0.0	0.0	0.0	0.0	0.0
%ile BackOfQ(50%),veh/ln				4.2	0.0	11.9	0.3	31.0	5.9	12.5	6.7	0.0
LnGrp Delay(d),s/veh				27.8	0.0	49.2	60.0	134.5	27.1	50.0	12.0	0.0
LnGrp LOS				C		D	E	F	C	D	B	
Approach Vol, veh/h					595			1666			1302	
Approach Delay, s/veh					42.1			116.6			24.2	
Approach LOS					D			F			C	
Timer	1	2	3	4	5	6	7	8				
Assigned Phs	1	2			5	6		8				
Phs Duration (G+Y+Rc), s	4.6	57.8			27.5	35.0		31.2				
Change Period (Y+Rc), s	3.5	5.0			3.5	5.0		5.0				
Max Green Setting (Gmax), s	30.0	30.0			30.0	30.0		30.0				
Max Q Clear Time (g_c+I1), s	2.5	15.4			23.1	32.0		24.5				
Green Ext Time (p_c), s	0.0	5.4			0.8	0.0		1.7				
Intersection Summary												
HCM 2010 Ctrl Delay				70.4								
HCM 2010 LOS				E								
Notes												

HCM 2010 Signalized Intersection Summary
2: 2nd Avenue & Patton Parkway

Cumulative with Project, PM
06/11/2019



Movement	EBL	EBT	EBR	WBL	WBT	WBR	NBL	NBT	NBR	SBL	SBT	SBR
Lane Configurations												
Traffic Volume (veh/h)	50	50	60	90	80	80	70	240	90	80	200	50
Future Volume (veh/h)	50	50	60	90	80	80	70	240	90	80	200	50
Number	7	4	14	3	8	18	5	2	12	1	6	16
Initial Q (Qb), veh	0	0	0	0	0	0	0	0	0	0	0	0
Ped-Bike Adj(A_pbT)	1.00		1.00	1.00		1.00	1.00		1.00	1.00		1.00
Parking Bus, Adj	1.00	1.00	1.00	1.00	1.00	1.00	1.00	1.00	1.00	1.00	1.00	1.00
Adj Sat Flow, veh/h/ln	1863	1863	1900	1863	1863	1900	1863	1863	1900	1863	1863	1900
Adj Flow Rate, veh/h	54	54	65	98	87	87	76	261	98	87	217	54
Adj No. of Lanes	1	1	0	1	1	0	1	1	0	1	1	0
Peak Hour Factor	0.92	0.92	0.92	0.92	0.92	0.92	0.92	0.92	0.92	0.92	0.92	0.92
Percent Heavy Veh, %	2	2	2	2	2	2	2	2	2	2	2	2
Cap, veh/h	96	163	196	137	201	201	119	356	134	128	405	101
Arrive On Green	0.05	0.21	0.21	0.08	0.23	0.23	0.07	0.28	0.28	0.07	0.28	0.28
Sat Flow, veh/h	1774	771	928	1774	856	856	1774	1292	485	1774	1441	359
Grp Volume(v), veh/h	54	0	119	98	0	174	76	0	359	87	0	271
Grp Sat Flow(s),veh/h/ln	1774	0	1699	1774	0	1712	1774	0	1777	1774	0	1799
Q Serve(g_s), s	1.4	0.0	2.8	2.5	0.0	4.0	2.0	0.0	8.6	2.2	0.0	6.0
Cycle Q Clear(g_c), s	1.4	0.0	2.8	2.5	0.0	4.0	2.0	0.0	8.6	2.2	0.0	6.0
Prop In Lane	1.00		0.55	1.00		0.50	1.00		0.27	1.00		0.20
Lane Grp Cap(c), veh/h	96	0	359	137	0	402	119	0	490	128	0	505
V/C Ratio(X)	0.56	0.00	0.33	0.72	0.00	0.43	0.64	0.00	0.73	0.68	0.00	0.54
Avail Cap(c_a), veh/h	228	0	1290	228	0	1300	228	0	1349	228	0	1366
HCM Platoon Ratio	1.00	1.00	1.00	1.00	1.00	1.00	1.00	1.00	1.00	1.00	1.00	1.00
Upstream Filter(I)	1.00	0.00	1.00	1.00	0.00	1.00	1.00	0.00	1.00	1.00	0.00	1.00
Uniform Delay (d), s/veh	21.6	0.0	15.6	21.1	0.0	15.2	21.3	0.0	15.4	21.2	0.0	14.2
Incr Delay (d2), s/veh	5.1	0.0	0.5	6.9	0.0	0.7	5.6	0.0	2.1	6.1	0.0	0.9
Initial Q Delay(d3),s/veh	0.0	0.0	0.0	0.0	0.0	0.0	0.0	0.0	0.0	0.0	0.0	0.0
%ile BackOfQ(50%),veh/ln	0.8	0.0	1.3	1.5	0.0	2.0	1.1	0.0	4.5	1.3	0.0	3.1
LnGrp Delay(d),s/veh	26.7	0.0	16.2	27.9	0.0	16.0	26.8	0.0	17.5	27.3	0.0	15.1
LnGrp LOS	C		B	C		B	C		B	C		B
Approach Vol, veh/h		173			272			435			358	
Approach Delay, s/veh		19.5			20.3			19.1			18.1	
Approach LOS		B			C			B			B	
Timer	1	2	3	4	5	6	7	8				
Assigned Phs	1	2	3	4	5	6	7	8				
Phs Duration (G+Y+Rc), s	7.4	17.4	7.6	14.4	7.1	17.6	6.5	15.5				
Change Period (Y+Rc), s	4.0	4.5	4.0	4.5	4.0	4.5	4.0	4.5				
Max Green Setting (Gmax), s	35.5	35.5	6.0	35.5	6.0	35.5	6.0	35.5				
Max Q Clear Time (g_c+14), s	10.6	10.6	4.5	4.8	4.0	8.0	3.4	6.0				
Green Ext Time (p_c), s	0.0	2.3	0.0	0.7	0.0	1.7	0.0	1.1				
Intersection Summary												
HCM 2010 Ctrl Delay				19.1								
HCM 2010 LOS				B								

HCM 2010 Signalized Intersection Summary
 3: SR 1 SB On-Ramp/SR 1 SB Off-Ramp & Imjin Parkway

Cumulative with Project, PM
 06/11/2019



Movement	EBL	EBT	EBR	WBL	WBT	WBR	NBL	NBT	NBR	SBL	SBT	SBR
Lane Configurations					↕						↕	
Traffic Volume (veh/h)	0	0	0	1240	0	0	0	0	0	660	10	0
Future Volume (veh/h)	0	0	0	1240	0	0	0	0	0	660	10	0
Number				1	6	16				7	4	14
Initial Q (Qb), veh				0	0	0				0	0	0
Ped-Bike Adj(A_pbT)				1.00		1.00				1.00		1.00
Parking Bus, Adj				1.00	1.00	1.00				1.00	1.00	1.00
Adj Sat Flow, veh/h/ln				1900	1881	0				1900	1863	0
Adj Flow Rate, veh/h				1363	0	0				725	11	0
Adj No. of Lanes				0	1	0				0	1	0
Peak Hour Factor				0.91	0.91	0.91				0.91	0.91	0.91
Percent Heavy Veh, %				1	1	0				2	2	0
Cap, veh/h				1015	0	0				661	10	0
Arrive On Green				0.57	0.00	0.00				0.38	0.38	0.00
Sat Flow, veh/h				1792	0	0				1749	27	0
Grp Volume(v), veh/h				1363	0	0				736	0	0
Grp Sat Flow(s),veh/h/ln				1792	0	0				1775	0	0
Q Serve(g_s), s				90.0	0.0	0.0				60.0	0.0	0.0
Cycle Q Clear(g_c), s				90.0	0.0	0.0				60.0	0.0	0.0
Prop In Lane				1.00		0.00				0.99		0.00
Lane Grp Cap(c), veh/h				1015	0	0				671	0	0
V/C Ratio(X)				1.34	0.00	0.00				1.10	0.00	0.00
Avail Cap(c_a), veh/h				1015	0	0				671	0	0
HCM Platoon Ratio				1.00	1.00	1.00				1.00	1.00	1.00
Upstream Filter(I)				1.00	0.00	0.00				1.00	0.00	0.00
Uniform Delay (d), s/veh				34.4	0.0	0.0				49.4	0.0	0.0
Incr Delay (d2), s/veh				160.7	0.0	0.0				64.4	0.0	0.0
Initial Q Delay(d3),s/veh				0.0	0.0	0.0				0.0	0.0	0.0
%ile BackOfQ(50%),veh/ln				89.6	0.0	0.0				41.2	0.0	0.0
LnGrp Delay(d),s/veh				195.1	0.0	0.0				113.8	0.0	0.0
LnGrp LOS				F						F		
Approach Vol, veh/h					1363						736	
Approach Delay, s/veh					195.1						113.8	
Approach LOS					F						F	
Timer	1	2	3	4	5	6	7	8				
Assigned Phs				4		6						
Phs Duration (G+Y+Rc), s				64.4		94.4						
Change Period (Y+Rc), s				4.4		4.4						
Max Green Setting (Gmax), s				60.0		90.0						
Max Q Clear Time (g_c+I1), s				62.0		92.0						
Green Ext Time (p_c), s				0.0		0.0						
Intersection Summary												
HCM 2010 Ctrl Delay				166.6								
HCM 2010 LOS				F								

Intersection												
Int Delay, s/veh	1											
Movement	EBL	EBT	EBR	WBL	WBT	WBR	NBL	NBT	NBR	SBL	SBT	SBR
Lane Configurations		↕			↑	↗		↕	↗			
Traffic Vol, veh/h	10	650	0	0	1220	920	10	10	1560	0	0	0
Future Vol, veh/h	10	650	0	0	1220	920	10	10	1560	0	0	0
Conflicting Peds, #/hr	0	0	1	1	0	0	0	0	0	0	0	0
Sign Control	Free	Free	Free	Free	Free	Free	Stop	Stop	Stop	Stop	Stop	Stop
RT Channelized	-	-	None	-	-	Free	-	-	Free	-	-	None
Storage Length	-	-	-	-	-	0	-	-	800	-	-	-
Veh in Median Storage, #	-	0	-	-	0	-	-	0	-	-	16965	-
Grade, %	-	0	-	-	0	-	-	0	-	-	0	-
Peak Hour Factor	95	95	95	95	95	95	95	95	95	95	95	95
Heavy Vehicles, %	2	2	2	1	1	1	1	1	1	2	2	2
Mvmt Flow	11	684	0	0	1284	968	11	11	1642	0	0	0























Major/Minor	Major1	Major2	Minor1
Conflicting Flow All	1284	0	-
Stage 1	-	-	-
Stage 2	-	-	-
Critical Hdwy	4.12	-	-
Critical Hdwy Stg 1	-	-	-
Critical Hdwy Stg 2	-	-	-
Follow-up Hdwy	2.218	-	-
Pot Cap-1 Maneuver	540	0	0
Stage 1	-	0	0
Stage 2	-	0	0
Platoon blocked, %	-	-	-
Mov Cap-1 Maneuver	540	-	-
Mov Cap-2 Maneuver	-	-	-
Stage 1	-	-	-
Stage 2	-	-	-

Approach	EB	WB	NB
HCM Control Delay, s	0.2	0	84.9
HCM LOS			F

Minor Lane/Major Mvmt	NBLn1	NBLn2	EBL	EBT	WBT
Capacity (veh/h)	65	-	540	-	-
HCM Lane V/C Ratio	0.324	-	0.019	-	-
HCM Control Delay (s)	84.9	0	11.8	0	-
HCM Lane LOS	F	A	B	A	-
HCM 95th %tile Q(veh)	1.2	-	0.1	-	-

HCM 2010 Signalized Intersection Summary
5: 2nd Avenue & Imjin Parkway

Cumulative with Project, PM
06/11/2019

												
Movement	EBL	EBT	EBR	WBL	WBT	WBR	NBL	NBT	NBR	SBL	SBT	SBR
Lane Configurations												
Traffic Volume (veh/h)	140	1370	710	330	1160	140	830	110	540	90	100	150
Future Volume (veh/h)	140	1370	710	330	1160	140	830	110	540	90	100	150
Number	5	2	12	1	6	16	3	8	18	7	4	14
Initial Q (Qb), veh	0	0	0	0	0	0	0	0	0	0	0	0
Ped-Bike Adj(A_pbT)	1.00		1.00	1.00		0.99	1.00		0.99	1.00		0.98
Parking Bus, Adj	1.00	1.00	1.00	1.00	1.00	1.00	1.00	1.00	1.00	1.00	1.00	1.00
Adj Sat Flow, veh/h/ln	1881	1881	1881	1881	1881	1900	1900	1900	1900	1900	1900	1900
Adj Flow Rate, veh/h	146	1427	540	344	1208	146	865	115	328	94	104	125
Adj No. of Lanes	1	2	1	2	2	0	2	1	1	1	2	0
Peak Hour Factor	0.96	0.96	0.96	0.96	0.96	0.96	0.96	0.96	0.96	0.96	0.96	0.96
Percent Heavy Veh, %	1	1	1	1	1	1	0	0	0	0	0	0
Cap, veh/h	184	1213	540	416	1145	138	794	503	425	133	203	178
Arrive On Green	0.10	0.34	0.34	0.12	0.36	0.36	0.23	0.26	0.26	0.07	0.11	0.11
Sat Flow, veh/h	1792	3574	1592	3476	3210	387	3510	1900	1602	1810	1805	1585
Grp Volume(v), veh/h	146	1427	540	344	671	683	865	115	328	94	104	125
Grp Sat Flow(s),veh/h/ln	1792	1787	1592	1738	1787	1810	1755	1900	1602	1810	1805	1585
Q Serve(g_s), s	7.0	30.0	30.0	8.5	31.5	31.5	20.0	4.2	16.7	4.5	4.8	6.7
Cycle Q Clear(g_c), s	7.0	30.0	30.0	8.5	31.5	31.5	20.0	4.2	16.7	4.5	4.8	6.7
Prop In Lane	1.00		1.00	1.00		0.21	1.00		1.00	1.00		1.00
Lane Grp Cap(c), veh/h	184	1213	540	416	637	645	794	503	425	133	203	178
V/C Ratio(X)	0.80	1.18	1.00	0.83	1.05	1.06	1.09	0.23	0.77	0.71	0.51	0.70
Avail Cap(c_a), veh/h	304	1213	540	590	637	645	794	503	425	205	429	376
HCM Platoon Ratio	1.00	1.00	1.00	1.00	1.00	1.00	1.00	1.00	1.00	1.00	1.00	1.00
Upstream Filter(I)	1.00	1.00	1.00	1.00	1.00	1.00	1.00	1.00	1.00	1.00	1.00	1.00
Uniform Delay (d), s/veh	38.8	29.2	29.2	38.0	28.4	28.4	34.2	25.4	30.0	40.0	37.0	37.8
Incr Delay (d2), s/veh	3.0	88.3	38.6	4.5	50.2	52.0	59.0	0.1	7.8	2.6	0.7	1.9
Initial Q Delay(d3),s/veh	0.0	0.0	0.0	0.0	0.0	0.0	0.0	0.0	0.0	0.0	0.0	0.0
%ile BackOfQ(50%),veh/ln	3.6	29.5	18.9	4.4	24.3	24.9	16.1	2.2	8.3	2.3	2.4	3.0
LnGrp Delay(d),s/veh	41.7	117.5	67.8	42.6	78.7	80.4	93.2	25.5	37.8	42.6	37.7	39.7
LnGrp LOS	D	F	E	D	F	F	F	C	D	D	D	D
Approach Vol, veh/h		2113			1698			1308			323	
Approach Delay, s/veh		99.6			72.1			73.3			39.9	
Approach LOS		F			E			E			D	
Timer	1	2	3	4	5	6	7	8				
Assigned Phs	1	2	3	4	5	6	7	8				
Phs Duration (G+Y+Rc), s	15.1	35.3	23.5	14.5	13.6	36.8	10.0	28.0				
Change Period (Y+Rc), s	4.5	5.3	3.5	4.6	4.5	5.3	3.5	4.6				
Max Green Setting (Gmax), s	15.0	30.0	20.0	21.0	15.0	30.0	10.0	21.0				
Max Q Clear Time (g_c+I1), s	10.5	32.0	22.0	8.7	9.0	33.5	6.5	18.7				
Green Ext Time (p_c), s	0.0	0.0	0.0	0.2	0.0	0.0	0.0	0.0				
Intersection Summary												
HCM 2010 Ctrl Delay			81.2									
HCM 2010 LOS			F									

HCM 2010 Signalized Intersection Summary
6: 3rd Avenue & Imjin Parkway

Cumulative with Project, PM
06/11/2019



Movement	EBL	EBT	EBR	WBL	WBT	WBR	NBL	NBT	NBR	SBL	SBT	SBR
Lane Configurations												
Traffic Volume (veh/h)	50	1830	160	100	1260	20	220	10	150	10	10	50
Future Volume (veh/h)	50	1830	160	100	1260	20	220	10	150	10	10	50
Number	5	2	12	1	6	16	3	8	18	7	4	14
Initial Q (Qb), veh	0	0	0	0	0	0	0	0	0	0	0	0
Ped-Bike Adj(A_pbT)	1.00		0.98	1.00		1.00	1.00		1.00	1.00		1.00
Parking Bus, Adj	1.00	1.00	1.00	1.00	1.00	1.00	1.00	1.00	1.00	1.00	1.00	1.00
Adj Sat Flow, veh/h/ln	1881	1881	1900	1881	1881	1900	1900	1900	1900	1900	1900	1900
Adj Flow Rate, veh/h	51	1867	155	102	1286	19	224	10	41	10	10	10
Adj No. of Lanes	1	2	0	1	2	0	1	1	0	1	1	0
Peak Hour Factor	0.98	0.98	0.98	0.98	0.98	0.98	0.98	0.98	0.98	0.98	0.98	0.98
Percent Heavy Veh, %	1	1	1	1	1	1	0	0	0	0	0	0
Cap, veh/h	106	1720	141	131	1906	28	381	65	265	351	173	173
Arrive On Green	0.06	0.51	0.51	0.07	0.53	0.53	0.20	0.20	0.20	0.20	0.20	0.20
Sat Flow, veh/h	1792	3340	273	1792	3606	53	1412	326	1336	1373	872	872
Grp Volume(v), veh/h	51	985	1037	102	637	668	224	0	51	10	0	20
Grp Sat Flow(s),veh/h/ln	1792	1787	1826	1792	1787	1872	1412	0	1662	1373	0	1745
Q Serve(g_s), s	1.7	32.5	32.5	3.5	16.5	16.5	9.7	0.0	1.6	0.4	0.0	0.6
Cycle Q Clear(g_c), s	1.7	32.5	32.5	3.5	16.5	16.5	10.2	0.0	1.6	2.0	0.0	0.6
Prop In Lane	1.00		0.15	1.00		0.03	1.00		0.80	1.00		0.50
Lane Grp Cap(c), veh/h	106	920	940	131	945	990	381	0	329	351	0	346
V/C Ratio(X)	0.48	1.07	1.10	0.78	0.67	0.67	0.59	0.00	0.15	0.03	0.00	0.06
Avail Cap(c_a), veh/h	326	920	940	326	945	990	716	0	724	678	0	760
HCM Platoon Ratio	1.00	1.00	1.00	1.00	1.00	1.00	1.00	1.00	1.00	1.00	1.00	1.00
Upstream Filter(I)	1.00	1.00	1.00	1.00	1.00	1.00	1.00	0.00	1.00	1.00	0.00	1.00
Uniform Delay (d), s/veh	28.7	15.3	15.3	28.7	10.9	10.9	24.7	0.0	20.9	21.8	0.0	20.5
Incr Delay (d2), s/veh	1.2	50.4	61.8	3.7	1.6	1.5	0.5	0.0	0.1	0.0	0.0	0.0
Initial Q Delay(d3),s/veh	0.0	0.0	0.0	0.0	0.0	0.0	0.0	0.0	0.0	0.0	0.0	0.0
%ile BackOfQ(50%),veh/ln	0.9	28.7	32.3	1.9	8.4	8.8	3.8	0.0	0.7	0.1	0.0	0.3
LnGrp Delay(d),s/veh	30.0	65.7	77.1	32.5	12.5	12.4	25.2	0.0	21.0	21.8	0.0	20.6
LnGrp LOS	C	F	F	C	B	B	C		C	C		C
Approach Vol, veh/h		2073			1407			275			30	
Approach Delay, s/veh		70.5			13.9			24.4			21.0	
Approach LOS		E			B			C			C	
Timer	1	2	3	4	5	6	7	8				
Assigned Phs	1	2		4	5	6		8				
Phs Duration (G+Y+Rc), s	8.1	38.0		17.0	7.2	38.9		17.0				
Change Period (Y+Rc), s	3.5	5.5		4.5	3.5	5.5		4.5				
Max Green Setting (Gmax), s	1.5	32.5		27.5	11.5	32.5		27.5				
Max Q Clear Time (g_c+1), s	1.5	34.5		4.0	3.7	18.5		12.2				
Green Ext Time (p_c), s	0.0	0.0		0.0	0.0	0.9		0.1				
Intersection Summary												
HCM 2010 Ctrl Delay				45.7								
HCM 2010 LOS				D								

HCM 2010 Signalized Intersection Summary
7: 4th Avenue & Imjin Parkway

Cumulative with Project, PM
06/11/2019



Movement	EBL	EBT	EBR	WBL	WBT	WBR	NBL	NBT	NBR	SBL	SBT	SBR
Lane Configurations												
Traffic Volume (veh/h)	10	2000	10	10	1340	10	20	10	10	10	10	10
Future Volume (veh/h)	10	2000	10	10	1340	10	20	10	10	10	10	10
Number	5	2	12	1	6	16	3	8	18	7	4	14
Initial Q (Qb), veh	0	0	0	0	0	0	0	0	0	0	0	0
Ped-Bike Adj(A_pbT)	1.00		1.00	1.00		0.98	1.00		1.00	1.00		1.00
Parking Bus, Adj	1.00	1.00	1.00	1.00	1.00	1.00	1.00	1.00	1.00	1.00	1.00	1.00
Adj Sat Flow, veh/h/ln	1881	1881	1900	1881	1881	1900	1900	1900	1900	1900	1900	1900
Adj Flow Rate, veh/h	10	2062	10	10	1381	10	21	10	8	10	10	10
Adj No. of Lanes	1	2	0	1	2	0	0	1	0	0	1	0
Peak Hour Factor	0.97	0.97	0.97	0.97	0.97	0.97	0.97	0.97	0.97	0.97	0.97	0.97
Percent Heavy Veh, %	1	1	1	1	1	1	0	0	0	0	0	0
Cap, veh/h	14	2208	11	14	2202	16	184	22	18	149	31	31
Arrive On Green	0.01	0.61	0.61	0.01	0.61	0.61	0.05	0.05	0.05	0.05	0.05	0.05
Sat Flow, veh/h	1792	3647	18	1792	3637	26	884	421	337	573	573	573
Grp Volume(v), veh/h	10	1009	1063	10	678	713	39	0	0	30	0	0
Grp Sat Flow(s),veh/h/ln	1792	1787	1878	1792	1787	1876	1641	0	0	1720	0	0
Q Serve(g_s), s	0.2	20.7	20.8	0.2	9.8	9.8	0.2	0.0	0.0	0.0	0.0	0.0
Cycle Q Clear(g_c), s	0.2	20.7	20.8	0.2	9.8	9.8	0.9	0.0	0.0	0.6	0.0	0.0
Prop In Lane	1.00		0.01	1.00		0.01	0.54		0.21	0.33		0.33
Lane Grp Cap(c), veh/h	14	1082	1137	14	1082	1136	224	0	0	210	0	0
V/C Ratio(X)	0.71	0.93	0.93	0.71	0.63	0.63	0.17	0.00	0.00	0.14	0.00	0.00
Avail Cap(c_a), veh/h	509	1434	1507	509	1434	1505	1198	0	0	1224	0	0
HCM Platoon Ratio	1.00	1.00	1.00	1.00	1.00	1.00	1.00	1.00	1.00	1.00	1.00	1.00
Upstream Filter(I)	1.00	1.00	1.00	1.00	1.00	1.00	1.00	0.00	0.00	1.00	0.00	0.00
Uniform Delay (d), s/veh	20.0	7.2	7.3	20.0	5.1	5.1	18.5	0.0	0.0	18.4	0.0	0.0
Incr Delay (d2), s/veh	21.3	8.3	8.1	21.3	0.2	0.2	0.1	0.0	0.0	0.1	0.0	0.0
Initial Q Delay(d3),s/veh	0.0	0.0	0.0	0.0	0.0	0.0	0.0	0.0	0.0	0.0	0.0	0.0
%ile BackOfQ(50%),veh/ln	0.2	12.3	12.9	0.2	4.8	5.0	0.4	0.0	0.0	0.3	0.0	0.0
LnGrp Delay(d),s/veh	41.3	15.5	15.4	41.3	5.3	5.3	18.7	0.0	0.0	18.6	0.0	0.0
LnGrp LOS	D	B	B	D	A	A	B			B		
Approach Vol, veh/h		2082			1401			39			30	
Approach Delay, s/veh		15.6			5.6			18.7			18.6	
Approach LOS		B			A			B			B	
Timer	1	2	3	4	5	6	7	8				
Assigned Phs	1	2		4	5	6		8				
Phs Duration (G+Y+Rc), s	3.8	30.0		6.7	3.8	30.0		6.7				
Change Period (Y+Rc), s	3.5	5.5		4.5	3.5	5.5		4.5				
Max Green Setting (Gmax), s	1.5	32.5		27.5	11.5	32.5		27.5				
Max Q Clear Time (g_c+12.2), s	1.5	22.8		2.6	2.2	11.8		2.9				
Green Ext Time (p_c), s	0.0	1.7		0.0	0.0	1.0		0.0				
Intersection Summary												
HCM 2010 Ctrl Delay				11.7								
HCM 2010 LOS				B								

HCM 2010 Signalized Intersection Summary
 8: 5th Avenue/California Avenue & Imjin Parkway

Cumulative with Project, PM
 06/11/2019



Movement	EBL	EBT	EBR	WBL	WBT	WBR	NBL	NBT	NBR	SBL	SBT	SBR
Lane Configurations												
Traffic Volume (veh/h)	280	1670	10	10	1100	110	20	50	10	70	30	230
Future Volume (veh/h)	280	1670	10	10	1100	110	20	50	10	70	30	230
Number	5	2	12	1	6	16	3	8	18	7	4	14
Initial Q (Qb), veh	0	0	0	0	0	0	0	0	0	0	0	0
Ped-Bike Adj(A_pbT)	1.00		1.00	1.00		1.00	1.00		1.00	1.00		0.98
Parking Bus, Adj	1.00	1.00	1.00	1.00	1.00	1.00	1.00	1.00	1.00	1.00	1.00	1.00
Adj Sat Flow, veh/h/ln	1881	1881	1900	1881	1881	1900	1900	1900	1900	1900	1881	1900
Adj Flow Rate, veh/h	289	1722	10	10	1134	107	21	52	7	72	31	68
Adj No. of Lanes	1	2	0	1	2	0	0	1	0	0	1	0
Peak Hour Factor	0.97	0.97	0.97	0.97	0.97	0.97	0.97	0.97	0.97	0.97	0.97	0.97
Percent Heavy Veh, %	1	1	1	1	1	1	0	0	0	1	1	1
Cap, veh/h	347	2075	12	14	1267	119	136	197	23	187	56	91
Arrive On Green	0.19	0.57	0.57	0.01	0.38	0.38	0.14	0.14	0.14	0.14	0.14	0.14
Sat Flow, veh/h	1792	3643	21	1792	3301	311	285	1371	159	563	393	631
Grp Volume(v), veh/h	289	844	888	10	613	628	80	0	0	171	0	0
Grp Sat Flow(s),veh/h/ln	1792	1787	1877	1792	1787	1825	1815	0	0	1586	0	0
Q Serve(g_s), s	7.5	18.5	18.6	0.3	15.5	15.5	0.0	0.0	0.0	3.0	0.0	0.0
Cycle Q Clear(g_c), s	7.5	18.5	18.6	0.3	15.5	15.5	1.8	0.0	0.0	4.9	0.0	0.0
Prop In Lane	1.00		0.01	1.00		0.17	0.26		0.09	0.42		0.40
Lane Grp Cap(c), veh/h	347	1018	1069	14	686	700	356	0	0	335	0	0
V/C Ratio(X)	0.83	0.83	0.83	0.72	0.89	0.90	0.22	0.00	0.00	0.51	0.00	0.00
Avail Cap(c_a), veh/h	559	1116	1172	559	1116	1140	813	0	0	747	0	0
HCM Platoon Ratio	1.00	1.00	1.00	1.00	1.00	1.00	1.00	1.00	1.00	1.00	1.00	1.00
Upstream Filter(I)	1.00	1.00	1.00	1.00	1.00	1.00	1.00	0.00	0.00	1.00	0.00	0.00
Uniform Delay (d), s/veh	18.6	8.4	8.4	23.8	13.9	13.9	18.4	0.0	0.0	19.6	0.0	0.0
Incr Delay (d2), s/veh	2.8	4.5	4.3	22.1	3.5	3.6	0.1	0.0	0.0	0.4	0.0	0.0
Initial Q Delay(d3),s/veh	0.0	0.0	0.0	0.0	0.0	0.0	0.0	0.0	0.0	0.0	0.0	0.0
%ile BackOfQ(50%),veh/ln	4.0	10.2	10.7	0.2	8.2	8.4	0.9	0.0	0.0	2.2	0.0	0.0
LnGrp Delay(d),s/veh	21.4	12.9	12.8	45.9	17.4	17.5	18.5	0.0	0.0	20.0	0.0	0.0
LnGrp LOS	C	B	B	D	B	B	B			C		
Approach Vol, veh/h		2021			1251			80			171	
Approach Delay, s/veh		14.1			17.7			18.5			20.0	
Approach LOS		B			B			B			C	
Timer	1	2	3	4	5	6	7	8				
Assigned Phs	1	2		4	5	6		8				
Phs Duration (G+Y+Rc), s	3.9	32.7		11.5	12.8	23.7		11.5				
Change Period (Y+Rc), s	3.5	5.3		4.6	3.5	5.3		4.6				
Max Green Setting (Gmax), s	30.0	30.0		20.0	15.0	30.0		20.0				
Max Q Clear Time (g_c+1/3), s	20.6	20.6		6.9	9.5	17.5		3.8				
Green Ext Time (p_c), s	0.0	1.3		0.1	0.0	0.9		0.1				
Intersection Summary												
HCM 2010 Ctrl Delay				15.7								
HCM 2010 LOS				B								

Intersection						
Int Delay, s/veh	0.6					
Movement	EBL	EBR	NBL	NBT	SBT	SBR
Lane Configurations	↔		↔	↑	↑	
Traffic Vol, veh/h	10	10	20	400	260	10
Future Vol, veh/h	10	10	20	400	260	10
Conflicting Peds, #/hr	0	0	0	0	0	0
Sign Control	Stop	Stop	Free	Free	Free	Free
RT Channelized	-	None	-	None	-	None
Storage Length	0	-	155	-	-	-
Veh in Median Storage, #	0	-	-	0	0	-
Grade, %	0	-	-	0	0	-
Peak Hour Factor	92	92	92	92	92	92
Heavy Vehicles, %	2	2	2	2	2	2
Mvmt Flow	11	11	22	435	283	11















Major/Minor	Minor2	Major1		Major2	
Conflicting Flow All	768	289	294	0	0
Stage 1	289	-	-	-	-
Stage 2	479	-	-	-	-
Critical Hdwy	6.42	6.22	4.12	-	-
Critical Hdwy Stg 1	5.42	-	-	-	-
Critical Hdwy Stg 2	5.42	-	-	-	-
Follow-up Hdwy	3.518	3.318	2.218	-	-
Pot Cap-1 Maneuver	370	750	1268	-	-
Stage 1	760	-	-	-	-
Stage 2	623	-	-	-	-
Platoon blocked, %				-	-
Mov Cap-1 Maneuver	364	750	1268	-	-
Mov Cap-2 Maneuver	364	-	-	-	-
Stage 1	747	-	-	-	-
Stage 2	623	-	-	-	-

Approach	EB	NB	SB
HCM Control Delay, s	12.7	0.4	0
HCM LOS	B		

Minor Lane/Major Mvmt	NBL	NBT	EBLn1	SBT	SBR
Capacity (veh/h)	1268	-	490	-	-
HCM Lane V/C Ratio	0.017	-	0.044	-	-
HCM Control Delay (s)	7.9	-	12.7	-	-
HCM Lane LOS	A	-	B	-	-
HCM 95th %tile Q(veh)	0.1	-	0.1	-	-

HCM 2010 Signalized Intersection Summary
 10: Imjin Road & Imjin Parkway

Cumulative with Project, PM
 06/11/2019

								
Movement	EBT	EBR	WBL	WBT	NBL	NBR		
Lane Configurations	 			 	  			
Traffic Volume (veh/h)	1590	150	260	920	250	520		
Future Volume (veh/h)	1590	150	260	920	250	520		
Number	2	12	1	6	3	18		
Initial Q (Qb), veh	0	0	0	0	0	0		
Ped-Bike Adj(A_pbT)		1.00	1.00		1.00	1.00		
Parking Bus, Adj	1.00	1.00	1.00	1.00	1.00	1.00		
Adj Sat Flow, veh/h/ln	1881	1900	1881	1881	1881	1881		
Adj Flow Rate, veh/h	1674	155	274	968	248	497		
Adj No. of Lanes	2	0	1	2	1	2		
Peak Hour Factor	0.95	0.95	0.95	0.95	0.95	0.95		
Percent Heavy Veh, %	1	1	1	1	1	1		
Cap, veh/h	1429	131	317	2448	325	579		
Arrive On Green	0.43	0.43	0.18	0.69	0.18	0.18		
Sat Flow, veh/h	3406	303	1792	3668	1792	3198		
Grp Volume(v), veh/h	894	935	274	968	248	497		
Grp Sat Flow(s),veh/h/ln	1787	1828	1792	1787	1792	1599		
Q Serve(g_s), s	30.0	30.0	10.3	8.1	9.1	10.5		
Cycle Q Clear(g_c), s	30.0	30.0	10.3	8.1	9.1	10.5		
Prop In Lane		0.17	1.00		1.00	1.00		
Lane Grp Cap(c), veh/h	771	789	317	2448	325	579		
V/C Ratio(X)	1.16	1.19	0.86	0.40	0.76	0.86		
Avail Cap(c_a), veh/h	771	789	516	2448	567	1012		
HCM Platoon Ratio	1.00	1.00	1.00	1.00	1.00	1.00		
Upstream Filter(I)	1.00	1.00	1.00	1.00	1.00	1.00		
Uniform Delay (d), s/veh	19.8	19.8	27.8	4.7	27.0	27.6		
Incr Delay (d2), s/veh	85.8	96.0	4.6	0.0	1.4	1.5		
Initial Q Delay(d3),s/veh	0.0	0.0	0.0	0.0	0.0	0.0		
%ile BackOfQ(50%),veh/ln	32.9	35.9	5.5	3.9	4.6	4.7		
LnGrp Delay(d),s/veh	105.5	115.7	32.4	4.8	28.5	29.1		
LnGrp LOS	F	F	C	A	C	C		
Approach Vol, veh/h	1829			1242	745			
Approach Delay, s/veh	110.7			10.9	28.9			
Approach LOS	F			B	C			
Timer	1	2	3	4	5	6	7	8
Assigned Phs	1	2				6		8
Phs Duration (G+Y+Rc), s	17.6	35.3				52.9		16.6
Change Period (Y+Rc), s	5.3	* 5.3				5.3		4.0
Max Green Setting (Gmax), s	20.0	* 30				30.0		22.0
Max Q Clear Time (g_c+I1), s	12.3	32.0				10.1		12.5
Green Ext Time (p_c), s	0.0	0.0				1.1		0.1
Intersection Summary								
HCM 2010 Ctrl Delay			62.2					
HCM 2010 LOS			E					
Notes								

HCM 2010 Signalized Intersection Summary
 11: Abrams Drive & Imjin Parkway

Cumulative with Project, PM
 06/11/2019



Movement	EBL	EBT	EBR	WBL	WBT	WBR	NBL	NBT	NBR	SBL	SBT	SBR
Lane Configurations	↔	↗		↔	↗		↔	↑	↗	↔	↑	↗
Traffic Volume (veh/h)	130	1630	250	180	950	120	180	30	190	60	20	130
Future Volume (veh/h)	130	1630	250	180	950	120	180	30	190	60	20	130
Number	5	2	12	1	6	16	3	8	18	7	4	14
Initial Q (Qb), veh	0	0	0	0	0	0	0	0	0	0	0	0
Ped-Bike Adj(A_pbT)	1.00		1.00	1.00		1.00	1.00		1.00	1.00		1.00
Parking Bus, Adj	1.00	1.00	1.00	1.00	1.00	1.00	1.00	1.00	1.00	1.00	1.00	1.00
Adj Sat Flow, veh/h/ln	1881	1881	1900	1881	1881	1900	1881	1881	1881	1863	1863	1863
Adj Flow Rate, veh/h	140	1753	220	194	1022	109	194	32	0	65	22	0
Adj No. of Lanes	2	2	0	2	2	0	1	1	1	1	1	1
Peak Hour Factor	0.93	0.93	0.93	0.93	0.93	0.93	0.93	0.93	0.93	0.93	0.93	0.93
Percent Heavy Veh, %	1	1	1	1	1	1	1	1	1	2	2	2
Cap, veh/h	260	1856	228	277	1882	201	323	326	277	312	323	274
Arrive On Green	0.07	0.58	0.58	0.08	0.58	0.58	0.17	0.17	0.00	0.17	0.17	0.00
Sat Flow, veh/h	3476	3205	394	3476	3260	347	1395	1881	1599	1369	1863	1583
Grp Volume(v), veh/h	140	961	1012	194	560	571	194	32	0	65	22	0
Grp Sat Flow(s),veh/h/ln	1738	1787	1812	1738	1787	1820	1395	1881	1599	1369	1863	1583
Q Serve(g_s), s	3.0	37.3	40.6	4.1	14.7	14.7	10.3	1.1	0.0	3.2	0.8	0.0
Cycle Q Clear(g_c), s	3.0	37.3	40.6	4.1	14.7	14.7	11.0	1.1	0.0	4.3	0.8	0.0
Prop In Lane	1.00		0.22	1.00		0.19	1.00		1.00	1.00		1.00
Lane Grp Cap(c), veh/h	260	1035	1049	277	1032	1051	323	326	277	312	323	274
V/C Ratio(X)	0.54	0.93	0.96	0.70	0.54	0.54	0.60	0.10	0.00	0.21	0.07	0.00
Avail Cap(c_a), veh/h	913	1173	1189	913	1173	1194	630	741	630	614	734	624
HCM Platoon Ratio	1.00	1.00	1.00	1.00	1.00	1.00	1.00	1.00	1.00	1.00	1.00	1.00
Upstream Filter(I)	1.00	1.00	1.00	1.00	1.00	1.00	1.00	1.00	0.00	1.00	1.00	0.00
Uniform Delay (d), s/veh	34.0	14.6	15.3	34.2	9.9	9.9	31.0	26.5	0.0	28.3	26.3	0.0
Incr Delay (d2), s/veh	0.6	11.2	16.6	1.2	0.2	0.2	0.7	0.0	0.0	0.1	0.0	0.0
Initial Q Delay(d3),s/veh	0.0	0.0	0.0	0.0	0.0	0.0	0.0	0.0	0.0	0.0	0.0	0.0
%ile BackOfQ(50%),veh/ln	1.4	21.4	24.8	2.0	7.2	7.3	4.0	0.6	0.0	1.2	0.4	0.0
LnGrp Delay(d),s/veh	34.6	25.8	31.9	35.4	10.1	10.1	31.6	26.5	0.0	28.4	26.4	0.0
LnGrp LOS	C	C	C	D	B	B	C	C		C	C	
Approach Vol, veh/h		2113			1325			226			87	
Approach Delay, s/veh		29.3			13.8			30.9			27.9	
Approach LOS		C			B			C			C	
Timer	1	2	3	4	5	6	7	8				
Assigned Phs	1	2		4	5	6		8				
Phs Duration (G+Y+Rc), s	9.6	49.4		17.2	9.7	49.3		17.2				
Change Period (Y+Rc), s	3.5	5.3		4.0	4.0	5.3		4.0				
Max Green Setting (Gmax), s	20.0	50.0		30.0	20.0	50.0		30.0				
Max Q Clear Time (g_c+10), s	10.0	42.6		6.3	5.0	16.7		13.0				
Green Ext Time (p_c), s	0.0	1.6		0.0	0.0	0.8		0.0				
Intersection Summary												
HCM 2010 Ctrl Delay				23.9								
HCM 2010 LOS				C								













HCM 2010 Signalized Intersection Summary
 12: Reservation Road & Imjin Parkway

Cumulative with Project, PM
 06/11/2019



Movement	EBL	EBT	EBR	WBL	WBT	WBR	NBL	NBT	NBR	SBL	SBT	SBR
Lane Configurations												
Traffic Volume (veh/h)	110	20	1730	10	40	30	1000	630	10	20	950	200
Future Volume (veh/h)	110	20	1730	10	40	30	1000	630	10	20	950	200
Number	3	8	18	7	4	14	1	6	16	5	2	12
Initial Q (Qb), veh	0	0	0	0	0	0	0	0	0	0	0	0
Ped-Bike Adj(A_pbT)	1.00		1.00	1.00		0.99	1.00		1.00	1.00		1.00
Parking Bus, Adj	1.00	1.00	1.00	1.00	1.00	1.00	1.00	1.00	1.00	1.00	1.00	1.00
Adj Sat Flow, veh/h/ln	1881	1881	1881	1827	1827	1827	1881	1881	1881	1881	1881	1881
Adj Flow Rate, veh/h	124	22	1543	11	45	12	1124	708	10	22	1067	91
Adj No. of Lanes	2	1	2	1	1	1	2	2	1	2	2	1
Peak Hour Factor	0.89	0.89	0.89	0.89	0.89	0.89	0.89	0.89	0.89	0.89	0.89	0.89
Percent Heavy Veh, %	1	1	1	4	4	4	1	1	1	1	1	1
Cap, veh/h	799	433	1292	75	79	66	799	2052	918	55	1287	576
Arrive On Green	0.23	0.23	0.23	0.04	0.04	0.04	0.23	0.57	0.57	0.02	0.36	0.36
Sat Flow, veh/h	3476	1881	2802	1740	1827	1531	3476	3574	1599	3476	3574	1599
Grp Volume(v), veh/h	124	22	1543	11	45	12	1124	708	10	22	1067	91
Grp Sat Flow(s),veh/h/ln	1738	1881	1401	1740	1827	1531	1738	1787	1599	1738	1787	1599
Q Serve(g_s), s	4.3	1.4	35.0	0.9	3.7	1.1	35.0	16.0	0.4	1.0	41.4	5.9
Cycle Q Clear(g_c), s	4.3	1.4	35.0	0.9	3.7	1.1	35.0	16.0	0.4	1.0	41.4	5.9
Prop In Lane	1.00		1.00	1.00		1.00	1.00		1.00	1.00		1.00
Lane Grp Cap(c), veh/h	799	433	1292	75	79	66	799	2052	918	55	1287	576
V/C Ratio(X)	0.16	0.05	1.19	0.15	0.57	0.18	1.41	0.34	0.01	0.40	0.83	0.16
Avail Cap(c_a), veh/h	799	433	1292	354	372	312	799	2052	918	457	1409	630
HCM Platoon Ratio	1.00	1.00	1.00	1.00	1.00	1.00	1.00	1.00	1.00	1.00	1.00	1.00
Upstream Filter(I)	1.00	1.00	1.00	1.00	1.00	1.00	1.00	1.00	1.00	1.00	1.00	1.00
Uniform Delay (d), s/veh	46.8	45.6	41.1	70.1	71.4	70.2	58.6	17.2	13.9	74.2	44.4	33.0
Incr Delay (d2), s/veh	0.0	0.0	95.4	0.3	2.4	0.5	190.2	0.3	0.0	1.7	5.1	0.3
Initial Q Delay(d3),s/veh	0.0	0.0	0.0	0.0	0.0	0.0	0.0	0.0	0.0	0.0	0.0	0.0
%ile BackOfQ(50%),veh/ln	2.1	0.7	44.2	0.5	1.9	0.5	37.9	7.9	0.2	0.5	21.4	2.7
LnGrp Delay(d),s/veh	46.8	45.7	136.5	70.4	73.8	70.7	248.8	17.5	13.9	75.9	49.5	33.4
LnGrp LOS	D	D	F	E	E	E	F	B	B	E	D	C
Approach Vol, veh/h		1689			68			1842			1180	
Approach Delay, s/veh		128.8			72.7			158.6			48.8	
Approach LOS		F			E			F			D	
Timer	1	2	3	4	5	6	7	8				
Assigned Phs	1	2		4	5	6		8				
Phs Duration (G+Y+Rc), s	39.1	61.0		11.6	6.5	93.6		40.5				
Change Period (Y+Rc), s	4.1	* 6.2		5.0	4.1	* 6.2		5.5				
Max Green Setting (Gmax), s	35.0	* 60		31.0	20.0	* 50		35.0				
Max Q Clear Time (g_c+Q), s	37.0	43.4		5.7	3.0	18.0		37.0				
Green Ext Time (p_c), s	0.0	11.4		0.2	0.0	10.6		0.0				
Intersection Summary												
HCM 2010 Ctrl Delay			119.7									
HCM 2010 LOS			F									
Notes												

HCM 2010 Signalized Intersection Summary
13: Reservation Road & Blanco Road

								
Movement	EBL	EBT	WBT	WBR	SBL	SBR		
Lane Configurations								
Traffic Volume (veh/h)	1130	1490	490	50	40	1160		
Future Volume (veh/h)	1130	1490	490	50	40	1160		
Number	5	2	6	16	7	14		
Initial Q (Qb), veh	0	0	0	0	0	0		
Ped-Bike Adj(A_pbT)	1.00			1.00	1.00	1.00		
Parking Bus, Adj	1.00	1.00	1.00	1.00	1.00	1.00		
Adj Sat Flow, veh/h/ln	1881	1881	1863	1863	1863	1863		
Adj Flow Rate, veh/h	1202	1585	521	29	43	0		
Adj No. of Lanes	2	2	1	1	2	2		
Peak Hour Factor	0.94	0.94	0.94	0.94	0.94	0.94		
Percent Heavy Veh, %	1	1	2	2	2	2		
Cap, veh/h	1311	2879	622	529	119	96		
Arrive On Green	0.38	0.81	0.33	0.33	0.03	0.00		
Sat Flow, veh/h	3476	3668	1863	1583	3442	2787		
Grp Volume(v), veh/h	1202	1585	521	29	43	0		
Grp Sat Flow(s),veh/h/ln	1738	1787	1863	1583	1721	1393		
Q Serve(g_s), s	19.1	9.0	15.0	0.7	0.7	0.0		
Cycle Q Clear(g_c), s	19.1	9.0	15.0	0.7	0.7	0.0		
Prop In Lane	1.00			1.00	1.00	1.00		
Lane Grp Cap(c), veh/h	1311	2879	622	529	119	96		
V/C Ratio(X)	0.92	0.55	0.84	0.05	0.36	0.00		
Avail Cap(c_a), veh/h	2391	3688	1922	1634	1598	1294		
HCM Platoon Ratio	1.00	1.00	1.00	1.00	1.00	1.00		
Upstream Filter(I)	1.00	1.00	1.00	1.00	1.00	0.00		
Uniform Delay (d), s/veh	17.2	2.0	17.9	13.1	27.4	0.0		
Incr Delay (d2), s/veh	1.2	0.1	2.3	0.0	0.7	0.0		
Initial Q Delay(d3),s/veh	0.0	0.0	0.0	0.0	0.0	0.0		
%ile BackOfQ(50%),veh/ln	9.2	4.2	8.1	0.3	0.3	0.0		
LnGrp Delay(d),s/veh	18.5	2.1	20.2	13.2	28.1	0.0		
LnGrp LOS	B	A	C	B	C			
Approach Vol, veh/h		2787	550		43			
Approach Delay, s/veh		9.2	19.9		28.1			
Approach LOS		A	B		C			
Timer	1	2	3	4	5	6	7	8
Assigned Phs		2		4	5	6		
Phs Duration (G+Y+Rc), s		52.6		5.5	27.4	25.2		
Change Period (Y+Rc), s		5.8		3.5	5.5	5.8		
Max Green Setting (Gmax), s		60.0		27.0	40.0	60.0		
Max Q Clear Time (g_c+I1), s		11.0		2.7	21.1	17.0		
Green Ext Time (p_c), s		11.9		0.0	0.8	2.4		
Intersection Summary								
HCM 2010 Ctrl Delay			11.1					
HCM 2010 LOS			B					

HCM 2010 Signalized Intersection Summary
 14: Reservation Road & Inter-Garrison Road

Cumulative with Project, PM
 06/11/2019



Movement	EBL	EBR	NBL	NBT	SBT	SBR		
Lane Configurations								
Traffic Volume (veh/h)	110	430	290	450	1350	270		
Future Volume (veh/h)	110	430	290	450	1350	270		
Number	3	18	1	6	2	12		
Initial Q (Qb), veh	0	0	0	0	0	0		
Ped-Bike Adj(A_pbT)	1.00	1.00	1.00			1.00		
Parking Bus, Adj	1.00	1.00	1.00	1.00	1.00	1.00		
Adj Sat Flow, veh/h/ln	1881	1881	1845	1845	1881	1900		
Adj Flow Rate, veh/h	134	369	354	549	1646	320		
Adj No. of Lanes	1	1	1	2	2	0		
Peak Hour Factor	0.82	0.82	0.82	0.82	0.82	0.82		
Percent Heavy Veh, %	1	1	3	3	1	1		
Cap, veh/h	373	598	291	2458	1492	281		
Arrive On Green	0.21	0.21	0.17	0.70	0.50	0.50		
Sat Flow, veh/h	1792	1599	1757	3597	3097	565		
Grp Volume(v), veh/h	134	369	354	549	958	1008		
Grp Sat Flow(s),veh/h/ln	1792	1599	1757	1752	1787	1781		
Q Serve(g_s), s	7.7	22.7	20.0	6.7	60.0	60.0		
Cycle Q Clear(g_c), s	7.7	22.7	20.0	6.7	60.0	60.0		
Prop In Lane	1.00	1.00	1.00			0.32		
Lane Grp Cap(c), veh/h	373	598	291	2458	888	885		
V/C Ratio(X)	0.36	0.62	1.22	0.22	1.08	1.14		
Avail Cap(c_a), veh/h	401	622	291	2458	888	885		
HCM Platoon Ratio	1.00	1.00	1.00	1.00	1.00	1.00		
Upstream Filter(I)	1.00	1.00	1.00	1.00	1.00	1.00		
Uniform Delay (d), s/veh	40.9	30.8	50.4	6.4	30.4	30.4		
Incr Delay (d2), s/veh	0.6	1.7	124.7	0.1	53.7	76.3		
Initial Q Delay(d3),s/veh	0.0	0.0	0.0	0.0	0.0	0.0		
%ile BackOfQ(50%),veh/ln	3.9	10.3	19.7	3.2	42.6	48.0		
LnGrp Delay(d),s/veh	41.5	32.5	175.0	6.5	84.1	106.6		
LnGrp LOS	D	C	F	A	F	F		
Approach Vol, veh/h	503			903	1966			
Approach Delay, s/veh	34.9			72.6	95.7			
Approach LOS	C			E	F			
Timer	1	2	3	4	5	6	7	8
Assigned Phs	1	2				6		8
Phs Duration (G+Y+Rc), s	24.7	66.4				91.1		29.7
Change Period (Y+Rc), s	4.7	6.4				6.4		4.5
Max Green Setting (Gmax), s	26	60.0				60.0		27.0
Max Q Clear Time (g_c+Yc), s	22.6	62.0				8.7		24.7
Green Ext Time (p_c), s	0.0	0.0				6.7		0.5
Intersection Summary								
HCM 2010 Ctrl Delay			80.4					
HCM 2010 LOS			F					
Notes								

HCM 2010 Signalized Intersection Summary
 15: 2nd Avenue & 9th Street

Cumulative with Project, PM
 06/11/2019



Movement	EBL	EBT	EBR	WBL	WBT	WBR	NBL	NBT	NBR	SBL	SBT	SBR
Lane Configurations		↖	↗		↖		↖	↕		↖	↕	
Traffic Volume (veh/h)	10	10	30	40	10	20	20	760	50	40	620	10
Future Volume (veh/h)	10	10	30	40	10	20	20	760	50	40	620	10
Number	5	2	12	1	6	16	3	8	18	7	4	14
Initial Q (Qb), veh	0	0	0	0	0	0	0	0	0	0	0	0
Ped-Bike Adj(A_pbT)	1.00		0.98	1.00		1.00	1.00		0.97	1.00		1.00
Parking Bus, Adj	1.00	1.00	1.00	1.00	1.00	1.00	1.00	1.00	1.00	1.00	1.00	1.00
Adj Sat Flow, veh/h/ln	1900	1900	1900	1900	1900	1900	1881	1881	1900	1827	1827	1900
Adj Flow Rate, veh/h	11	11	23	44	11	3	22	835	51	44	681	-1
Adj No. of Lanes	0	1	1	0	1	0	1	2	0	1	2	0
Peak Hour Factor	0.91	0.91	0.91	0.91	0.91	0.91	0.91	0.91	0.91	0.91	0.91	0.91
Percent Heavy Veh, %	0	0	0	0	0	0	1	1	1	4	4	4
Cap, veh/h	255	204	296	357	77	15	49	1393	85	85	1491	0
Arrive On Green	0.19	0.19	0.19	0.19	0.19	0.19	0.03	0.41	0.41	0.05	0.43	0.00
Sat Flow, veh/h	601	1093	1591	1020	415	78	1792	3415	209	1740	3563	0
Grp Volume(v), veh/h	22	0	23	58	0	0	22	437	449	44	680	0
Grp Sat Flow(s),veh/h/ln	1694	0	1591	1514	0	0	1792	1787	1836	1740	1736	0
Q Serve(g_s), s	0.0	0.0	0.5	0.4	0.0	0.0	0.5	7.2	7.2	0.9	5.3	0.0
Cycle Q Clear(g_c), s	0.4	0.0	0.5	1.1	0.0	0.0	0.5	7.2	7.2	0.9	5.3	0.0
Prop In Lane	0.50		1.00	0.76		0.05	1.00		0.11	1.00		0.00
Lane Grp Cap(c), veh/h	458	0	296	449	0	0	49	729	749	85	1491	0
V/C Ratio(X)	0.05	0.00	0.08	0.13	0.00	0.00	0.45	0.60	0.60	0.52	0.46	0.00
Avail Cap(c_a), veh/h	1657	0	1472	1541	0	0	545	1890	1942	529	3670	0
HCM Platoon Ratio	1.00	1.00	1.00	1.00	1.00	1.00	1.00	1.00	1.00	1.00	1.00	1.00
Upstream Filter(I)	1.00	0.00	1.00	1.00	0.00	0.00	1.00	1.00	1.00	1.00	1.00	0.00
Uniform Delay (d), s/veh	12.7	0.0	12.7	12.9	0.0	0.0	18.1	8.8	8.8	17.6	7.7	0.0
Incr Delay (d2), s/veh	0.0	0.0	0.1	0.1	0.0	0.0	6.4	0.8	0.8	4.8	0.2	0.0
Initial Q Delay(d3),s/veh	0.0	0.0	0.0	0.0	0.0	0.0	0.0	0.0	0.0	0.0	0.0	0.0
%ile BackOfQ(50%),veh/ln	0.2	0.0	0.2	0.5	0.0	0.0	0.3	3.7	3.8	0.6	2.5	0.0
LnGrp Delay(d),s/veh	12.7	0.0	12.8	13.1	0.0	0.0	24.5	9.6	9.5	22.3	7.9	0.0
LnGrp LOS	B		B	B			C	A	A	C	A	
Approach Vol, veh/h		45			58			908			724	
Approach Delay, s/veh		12.8			13.1			9.9			8.7	
Approach LOS		B			B			A			A	
Timer	1	2	3	4	5	6	7	8				
Assigned Phs		2	3	4		6	7	8				
Phs Duration (G+Y+Rc), s		12.0	4.5	21.3		12.0	5.4	20.4				
Change Period (Y+Rc), s		5.0	3.5	5.0		5.0	3.5	5.0				
Max Green Setting (Gmax), s		35.0	11.5	40.0		35.0	11.5	40.0				
Max Q Clear Time (g_c+I1), s		2.5	2.5	7.3		3.1	2.9	9.2				
Green Ext Time (p_c), s		0.1	0.0	5.1		0.3	0.0	6.2				
Intersection Summary												
HCM 2010 Ctrl Delay			9.6									
HCM 2010 LOS			A									

HCM 2010 Signalized Intersection Summary
 16: 2nd Avenue & 8th Street

Cumulative with Project, PM
 06/11/2019



Movement	WBL	WBR	NBT	NBR	SBL	SBT		
Lane Configurations								
Traffic Volume (veh/h)	130	80	600	270	70	570		
Future Volume (veh/h)	130	80	600	270	70	570		
Number	1	16	8	18	7	4		
Initial Q (Qb), veh	0	0	0	0	0	0		
Ped-Bike Adj(A_pbT)	1.00	1.00		0.97	1.00			
Parking Bus, Adj	1.00	1.00	1.00	1.00	1.00	1.00		
Adj Sat Flow, veh/h/ln	1900	1900	1881	1900	1827	1827		
Adj Flow Rate, veh/h	138	51	638	256	74	606		
Adj No. of Lanes	1	1	2	0	1	2		
Peak Hour Factor	0.94	0.94	0.94	0.94	0.94	0.94		
Percent Heavy Veh, %	0	0	1	1	4	4		
Cap, veh/h	218	195	1085	435	126	2106		
Arrive On Green	0.12	0.12	0.44	0.44	0.07	0.61		
Sat Flow, veh/h	1810	1615	2566	991	1740	3563		
Grp Volume(v), veh/h	138	51	461	433	74	606		
Grp Sat Flow(s),veh/h/ln	1810	1615	1787	1676	1740	1736		
Q Serve(g_s), s	2.7	1.1	7.2	7.2	1.5	3.1		
Cycle Q Clear(g_c), s	2.7	1.1	7.2	7.2	1.5	3.1		
Prop In Lane	1.00	1.00		0.59	1.00			
Lane Grp Cap(c), veh/h	218	195	785	736	126	2106		
V/C Ratio(X)	0.63	0.26	0.59	0.59	0.59	0.29		
Avail Cap(c_a), veh/h	1480	1321	2193	2057	546	5680		
HCM Platoon Ratio	1.00	1.00	1.00	1.00	1.00	1.00		
Upstream Filter(I)	1.00	1.00	1.00	1.00	1.00	1.00		
Uniform Delay (d), s/veh	15.3	14.6	7.8	7.8	16.5	3.4		
Incr Delay (d2), s/veh	3.0	0.7	0.7	0.8	4.3	0.1		
Initial Q Delay(d3),s/veh	0.0	0.0	0.0	0.0	0.0	0.0		
%ile BackOfQ(50%),veh/ln	1.5	1.0	3.6	3.4	0.9	1.5		
LnGrp Delay(d),s/veh	18.4	15.3	8.5	8.5	20.8	3.5		
LnGrp LOS	B	B	A	A	C	A		
Approach Vol, veh/h	189		894			680		
Approach Delay, s/veh	17.5		8.5			5.4		
Approach LOS	B		A			A		
Timer	1	2	3	4	5	6	7	8
Assigned Phs				4		6	7	8
Phs Duration (G+Y+Rc), s				27.2		9.4	6.1	21.1
Change Period (Y+Rc), s				5.0		5.0	3.5	5.0
Max Green Setting (Gmax), s				60.0		30.0	11.5	45.0
Max Q Clear Time (g_c+I1), s				5.1		4.7	3.5	9.2
Green Ext Time (p_c), s				4.6		0.5	0.1	6.7
Intersection Summary								
HCM 2010 Ctrl Delay			8.3					
HCM 2010 LOS			A					

Intersection	
Intersection Delay, s/veh	12.3
Intersection LOS	B

Movement	EBT	EBR	WBL	WBT	NBL	NBR
Lane Configurations	↑	↑	↑	↑	↑	↑
Traffic Vol, veh/h	270	70	180	130	80	220
Future Vol, veh/h	270	70	180	130	80	220
Peak Hour Factor	0.92	0.92	0.92	0.92	0.92	0.92
Heavy Vehicles, %	2	2	2	2	2	2
Mvmt Flow	293	76	196	141	87	239
Number of Lanes	1	1	1	1	1	1

Approach	EB	WB	NB
Opposing Approach	WB	EB	
Opposing Lanes	2	2	0
Conflicting Approach Left		NB	EB
Conflicting Lanes Left	0	2	2
Conflicting Approach Right	NB		WB
Conflicting Lanes Right	2	0	2
HCM Control Delay	13.2	11.9	11.7
HCM LOS	B	B	B

Lane	NBLn1	NBLn2	EBLn1	EBLn2	WBLn1	WBLn2
Vol Left, %	100%	0%	0%	0%	100%	0%
Vol Thru, %	0%	0%	100%	0%	0%	100%
Vol Right, %	0%	100%	0%	100%	0%	0%
Sign Control	Stop	Stop	Stop	Stop	Stop	Stop
Traffic Vol by Lane	80	220	270	70	180	130
LT Vol	80	0	0	0	180	0
Through Vol	0	0	270	0	0	130
RT Vol	0	220	0	70	0	0
Lane Flow Rate	87	239	293	76	196	141
Geometry Grp	7	7	7	7	7	7
Degree of Util (X)	0.167	0.379	0.489	0.112	0.354	0.236
Departure Headway (Hd)	6.917	5.703	5.998	5.288	6.517	6.01
Convergence, Y/N	Yes	Yes	Yes	Yes	Yes	Yes
Cap	518	631	602	677	552	598
Service Time	4.658	3.443	3.736	3.025	4.255	3.748
HCM Lane V/C Ratio	0.168	0.379	0.487	0.112	0.355	0.236
HCM Control Delay	11	11.9	14.4	8.7	12.8	10.6
HCM Lane LOS	B	B	B	A	B	B
HCM 95th-tile Q	0.6	1.8	2.7	0.4	1.6	0.9

Intersection				
Intersection Delay, s/veh	10.4			
Intersection LOS	B			
Approach	EB	WB	NB	SB
Entry Lanes	1	1	1	1
Conflicting Circle Lanes	1	1	1	1
Adj Approach Flow, veh/h	418	429	66	374
Demand Flow Rate, veh/h	431	433	66	381
Vehicles Circulating, veh/h	257	361	621	111
Vehicles Exiting, veh/h	235	326	67	683
Follow-Up Headway, s	3.186	3.186	3.186	3.186
Ped Vol Crossing Leg, #/h	0	0	0	0
Ped Cap Adj	1.000	1.000	1.000	1.000
Approach Delay, s/veh	10.8	12.8	7.2	7.7
Approach LOS	B	B	A	A
Lane	Left	Left	Left	Left
Designated Moves	LTR	LTR	LTR	LTR
Assumed Moves	LTR	LTR	LTR	LTR
RT Channelized				
Lane Util	1.000	1.000	1.000	1.000
Critical Headway, s	5.193	5.193	5.193	5.193
Entry Flow, veh/h	431	433	66	381
Cap Entry Lane, veh/h	874	788	607	1011
Entry HV Adj Factor	0.971	0.992	1.000	0.980
Flow Entry, veh/h	418	429	66	374
Cap Entry, veh/h	848	781	607	992
V/C Ratio	0.493	0.550	0.109	0.377
Control Delay, s/veh	10.8	12.8	7.2	7.7
LOS	B	B	A	A
95th %tile Queue, veh	3	3	0	2



Movement	WBL	WBR	NBT	NBR	SBL	SBT		
Lane Configurations								
Traffic Volume (veh/h)	70	30	840	60	40	690		
Future Volume (veh/h)	70	30	840	60	40	690		
Number	1	16	8	18	7	4		
Initial Q (Qb), veh	0	0	0	0	0	0		
Ped-Bike Adj(A_pbT)	1.00	1.00		1.00	1.00			
Parking Bus, Adj	1.00	1.00	1.00	1.00	1.00	1.00		
Adj Sat Flow, veh/h/ln	1900	1900	1881	1900	1863	1863		
Adj Flow Rate, veh/h	72	7	866	54	41	711		
Adj No. of Lanes	1	1	2	0	1	2		
Peak Hour Factor	0.97	0.97	0.97	0.97	0.97	0.97		
Percent Heavy Veh, %	0	0	1	1	2	2		
Cap, veh/h	274	245	1466	91	83	2025		
Arrive On Green	0.15	0.15	0.43	0.43	0.05	0.57		
Sat Flow, veh/h	1810	1615	3512	213	1774	3632		
Grp Volume(v), veh/h	72	7	453	467	41	711		
Grp Sat Flow(s),veh/h/ln	1810	1615	1787	1844	1774	1770		
Q Serve(g_s), s	1.3	0.1	7.0	7.0	0.8	3.9		
Cycle Q Clear(g_c), s	1.3	0.1	7.0	7.0	0.8	3.9		
Prop In Lane	1.00	1.00		0.12	1.00			
Lane Grp Cap(c), veh/h	274	245	766	791	83	2025		
V/C Ratio(X)	0.26	0.03	0.59	0.59	0.50	0.35		
Avail Cap(c_a), veh/h	1750	1562	1975	2038	564	5379		
HCM Platoon Ratio	1.00	1.00	1.00	1.00	1.00	1.00		
Upstream Filter(I)	1.00	1.00	1.00	1.00	1.00	1.00		
Uniform Delay (d), s/veh	13.6	13.1	7.9	7.9	16.8	4.1		
Incr Delay (d2), s/veh	0.5	0.0	0.7	0.7	4.5	0.1		
Initial Q Delay(d3),s/veh	0.0	0.0	0.0	0.0	0.0	0.0		
%ile BackOfQ(50%),veh/ln	0.7	0.1	3.6	3.7	0.5	1.9		
LnGrp Delay(d),s/veh	14.1	13.1	8.6	8.6	21.4	4.2		
LnGrp LOS	B	B	A	A	C	A		
Approach Vol, veh/h	79		920			752		
Approach Delay, s/veh	14.0		8.6			5.2		
Approach LOS	B		A			A		
Timer	1	2	3	4	5	6	7	8
Assigned Phs				4		6	7	8
Phs Duration (G+Y+Rc), s				25.7		10.5	5.2	20.5
Change Period (Y+Rc), s				5.0		5.0	3.5	5.0
Max Green Setting (Gmax), s				55.0		35.0	11.5	40.0
Max Q Clear Time (g_c+I1), s				5.9		3.3	2.8	9.0
Green Ext Time (p_c), s				5.6		0.2	0.0	6.5
Intersection Summary								
HCM 2010 Ctrl Delay			7.4					
HCM 2010 LOS			A					

Intersection												
Intersection Delay, s/veh	9.5											
Intersection LOS	A											























Movement	EBL	EBT	EBR	WBL	WBT	WBR	NBL	NBT	NBR	SBL	SBT	SBR
Lane Configurations		↕			↕			↕			↕	
Traffic Vol, veh/h	10	20	30	120	30	20	20	80	100	20	90	10
Future Vol, veh/h	10	20	30	120	30	20	20	80	100	20	90	10
Peak Hour Factor	0.82	0.82	0.82	0.82	0.82	0.82	0.82	0.82	0.82	0.82	0.82	0.82
Heavy Vehicles, %	1	1	1	1	1	1	3	3	3	0	0	0
Mvmt Flow	12	24	37	146	37	24	24	98	122	24	110	12
Number of Lanes	0	1	0	0	1	0	0	1	0	0	1	0

Approach	EB	WB	NB	SB
Opposing Approach	WB	EB	SB	NB
Opposing Lanes	1	1	1	1
Conflicting Approach Left	SB	NB	EB	WB
Conflicting Lanes Left	1	1	1	1
Conflicting Approach Right	NB	SB	WB	EB
Conflicting Lanes Right	1	1	1	1
HCM Control Delay	8.4	10.1	9.6	9.1
HCM LOS	A	B	A	A

Lane	NBLn1	EBLn1	WBLn1	SBLn1
Vol Left, %	10%	17%	71%	17%
Vol Thru, %	40%	33%	18%	75%
Vol Right, %	50%	50%	12%	8%
Sign Control	Stop	Stop	Stop	Stop
Traffic Vol by Lane	200	60	170	120
LT Vol	20	10	120	20
Through Vol	80	20	30	90
RT Vol	100	30	20	10
Lane Flow Rate	244	73	207	146
Geometry Grp	1	1	1	1
Degree of Util (X)	0.308	0.098	0.287	0.198
Departure Headway (Hd)	4.552	4.838	4.982	4.871
Convergence, Y/N	Yes	Yes	Yes	Yes
Cap	785	733	717	732
Service Time	2.608	2.916	3.047	2.935
HCM Lane V/C Ratio	0.311	0.1	0.289	0.199
HCM Control Delay	9.6	8.4	10.1	9.1
HCM Lane LOS	A	A	B	A
HCM 95th-tile Q	1.3	0.3	1.2	0.7

HCM 2010 Signalized Intersection Summary
 21: 7th Avenue/8th Street & Inter-Garrison Road

Cumulative with Project, PM
 07/12/2019

												
Movement	EBL	EBT	EBR	WBL	WBT	WBR	NBL	NBT	NBR	SBL	SBT	SBR
Lane Configurations												
Traffic Volume (veh/h)	10	250	80	250	170	50	60	250	400	130	90	10
Future Volume (veh/h)	10	250	80	250	170	50	60	250	400	130	90	10
Number	5	2	12	1	6	16	3	8	18	7	4	14
Initial Q (Qb), veh	0	0	0	0	0	0	0	0	0	0	0	0
Ped-Bike Adj(A_pbT)	1.00		0.99	1.00		1.00	1.00		0.98	1.00		1.00
Parking Bus, Adj	1.00	1.00	1.00	1.00	1.00	1.00	1.00	1.00	1.00	1.00	1.00	1.00
Adj Sat Flow, veh/h/ln	1881	1881	1900	1827	1827	1900	1810	1810	1810	1900	1900	1900
Adj Flow Rate, veh/h	11	269	80	269	183	39	65	269	358	140	97	2
Adj No. of Lanes	1	1	0	1	1	0	1	1	1	1	1	0
Peak Hour Factor	0.93	0.93	0.93	0.93	0.93	0.93	0.93	0.93	0.93	0.93	0.93	0.93
Percent Heavy Veh, %	1	1	1	4	4	4	5	5	5	0	0	0
Cap, veh/h	20	335	100	314	599	128	83	488	405	176	592	12
Arrive On Green	0.01	0.24	0.24	0.18	0.41	0.41	0.05	0.27	0.27	0.10	0.32	0.32
Sat Flow, veh/h	1792	1391	414	1740	1459	311	1723	1810	1502	1810	1855	38
Grp Volume(v), veh/h	11	0	349	269	0	222	65	269	358	140	0	99
Grp Sat Flow(s),veh/h/ln	1792	0	1804	1740	0	1770	1723	1810	1502	1810	0	1893
Q Serve(g_s), s	0.5	0.0	13.8	11.3	0.0	6.4	2.8	9.7	17.3	5.7	0.0	2.8
Cycle Q Clear(g_c), s	0.5	0.0	13.8	11.3	0.0	6.4	2.8	9.7	17.3	5.7	0.0	2.8
Prop In Lane	1.00		0.23	1.00		0.18	1.00		1.00	1.00		0.02
Lane Grp Cap(c), veh/h	20	0	435	314	0	727	83	488	405	176	0	604
V/C Ratio(X)	0.56	0.00	0.80	0.86	0.00	0.31	0.79	0.55	0.88	0.79	0.00	0.16
Avail Cap(c_a), veh/h	95	0	786	425	0	1110	216	550	456	227	0	604
HCM Platoon Ratio	1.00	1.00	1.00	1.00	1.00	1.00	1.00	1.00	1.00	1.00	1.00	1.00
Upstream Filter(I)	1.00	0.00	1.00	1.00	0.00	1.00	1.00	1.00	1.00	1.00	0.00	1.00
Uniform Delay (d), s/veh	37.3	0.0	27.0	30.1	0.0	15.0	35.7	23.7	26.5	33.4	0.0	18.5
Incr Delay (d2), s/veh	22.9	0.0	3.5	12.2	0.0	0.2	15.1	1.0	16.9	13.7	0.0	0.1
Initial Q Delay(d3),s/veh	0.0	0.0	0.0	0.0	0.0	0.0	0.0	0.0	0.0	0.0	0.0	0.0
%ile BackOfQ(50%),veh/ln	0.4	0.0	7.3	6.5	0.0	3.1	1.7	4.9	9.0	3.5	0.0	1.5
LnGrp Delay(d),s/veh	60.2	0.0	30.5	42.3	0.0	15.3	50.7	24.7	43.4	47.1	0.0	18.6
LnGrp LOS	E		C	D		B	D	C	D	D		B
Approach Vol, veh/h		360			491			692			239	
Approach Delay, s/veh		31.4			30.1			36.8			35.3	
Approach LOS		C			C			D			D	
Timer	1	2	3	4	5	6	7	8				
Assigned Phs	1	2	3	4	5	6	7	8				
Phs Duration (G+Y+Rc), s	17.2	23.3	7.1	28.2	4.3	36.1	10.9	24.4				
Change Period (Y+Rc), s	3.5	5.0	3.5	4.0	3.5	5.0	3.5	4.0				
Max Green Setting (Gmax), s	18.5	33.0	9.5	23.0	4.0	47.5	9.5	23.0				
Max Q Clear Time (g_c+I1), s	13.3	15.8	4.8	4.8	2.5	8.4	7.7	19.3				
Green Ext Time (p_c), s	0.4	1.9	0.0	0.4	0.0	1.4	0.1	1.1				
Intersection Summary												
HCM 2010 Ctrl Delay			33.7									
HCM 2010 LOS			C									

Intersection			
Intersection Delay, s/veh	114.3		
Intersection LOS	F		
Approach	EB	WB	NB
Entry Lanes	1	1	1
Conflicting Circle Lanes	1	1	1
Adj Approach Flow, veh/h	804	866	825
Demand Flow Rate, veh/h	820	883	825
Vehicles Circulating, veh/h	452	52	673
Vehicles Exiting, veh/h	483	1446	599
Follow-Up Headway, s	3.186	3.186	3.186
Ped Vol Crossing Leg, #/h	0	0	0
Ped Cap Adj	1.000	1.000	1.000
Approach Delay, s/veh	101.9	21.1	224.1
Approach LOS	F	C	F
Lane	Left	Left	Left
Designated Moves	TR	LT	LR
Assumed Moves	TR	LT	LR
RT Channelized			
Lane Util	1.000	1.000	1.000
Critical Headway, s	5.193	5.193	5.193
Entry Flow, veh/h	820	883	825
Cap Entry Lane, veh/h	719	1073	576
Entry HV Adj Factor	0.980	0.980	1.000
Flow Entry, veh/h	804	866	825
Cap Entry, veh/h	705	1051	576
V/C Ratio	1.140	0.823	1.431
Control Delay, s/veh	101.9	21.1	224.1
LOS	F	C	F
95th %tile Queue, veh	25	10	39

HCM 2010 Signalized Intersection Summary
 23: Inter-Garrison Road & Abrams Drive

Cumulative with Project, PM
 06/11/2019

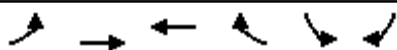

Movement	EBL	EBT	WBT	WBR	SBL	SBR		
Lane Configurations								
Traffic Volume (veh/h)	630	760	420	30	20	420		
Future Volume (veh/h)	630	760	420	30	20	420		
Number	5	2	6	16	7	14		
Initial Q (Qb), veh	0	0	0	0	0	0		
Ped-Bike Adj(A_pbT)	1.00			0.98	1.00	1.00		
Parking Bus, Adj	1.00	1.00	1.00	1.00	1.00	1.00		
Adj Sat Flow, veh/h/ln	1863	1863	1792	1792	1827	1827		
Adj Flow Rate, veh/h	663	800	442	6	21	219		
Adj No. of Lanes	1	1	1	1	2	1		
Peak Hour Factor	0.95	0.95	0.95	0.95	0.95	0.95		
Percent Heavy Veh, %	2	2	6	6	4	4		
Cap, veh/h	468	1178	516	430	583	268		
Arrive On Green	0.26	0.63	0.29	0.29	0.17	0.17		
Sat Flow, veh/h	1774	1863	1792	1491	3375	1553		
Grp Volume(v), veh/h	663	800	442	6	21	219		
Grp Sat Flow(s),veh/h/ln	1774	1863	1792	1491	1688	1553		
Q Serve(g_s), s	11.5	12.1	10.2	0.1	0.2	5.9		
Cycle Q Clear(g_c), s	11.5	12.1	10.2	0.1	0.2	5.9		
Prop In Lane	1.00			1.00	1.00	1.00		
Lane Grp Cap(c), veh/h	468	1178	516	430	583	268		
V/C Ratio(X)	1.42	0.68	0.86	0.01	0.04	0.82		
Avail Cap(c_a), veh/h	468	2564	1850	1539	2439	1122		
HCM Platoon Ratio	1.00	1.00	1.00	1.00	1.00	1.00		
Upstream Filter(I)	1.00	1.00	1.00	1.00	1.00	1.00		
Uniform Delay (d), s/veh	16.0	5.2	14.7	11.1	15.0	17.4		
Incr Delay (d2), s/veh	199.7	0.3	1.6	0.0	0.0	2.3		
Initial Q Delay(d3),s/veh	0.0	0.0	0.0	0.0	0.0	0.0		
%ile BackOfQ(50%),veh/ln	1.4	6.1	5.1	0.1	0.1	5.0		
LnGrp Delay(d),s/veh	215.8	5.4	16.3	11.1	15.0	19.7		
LnGrp LOS	F	A	B	B	B	B		
Approach Vol, veh/h		1463	448		240			
Approach Delay, s/veh		100.8	16.2		19.3			
Approach LOS		F	B		B			
Timer	1	2	3	4	5	6	7	8
Assigned Phs		2		4	5	6		
Phs Duration (G+Y+Rc), s		32.6		11.0	15.0	17.6		
Change Period (Y+Rc), s		5.0		3.5	3.5	5.0		
Max Green Setting (Gmax), s		60.0		31.5	11.5	45.0		
Max Q Clear Time (g_c+I1), s		14.1		7.9	13.5	12.2		
Green Ext Time (p_c), s		0.8		0.0	0.0	0.4		
Intersection Summary								
HCM 2010 Ctrl Delay			74.1					
HCM 2010 LOS			E					
Notes								

Intersection	
Intersection Delay, s/veh	67.1
Intersection LOS	F

Movement	EBL	EBT	WBT	WBR	SBL	SBR
Lane Configurations						
Traffic Vol, veh/h	200	610	350	50	20	70
Future Vol, veh/h	200	610	350	50	20	70
Peak Hour Factor	0.86	0.86	0.86	0.86	0.86	0.86
Heavy Vehicles, %	1	1	5	5	17	17
Mvmt Flow	233	709	407	58	23	81
Number of Lanes	1	1	2	1	1	1

Approach	EB	WB	SB
Opposing Approach	WB	EB	
Opposing Lanes	3	2	0
Conflicting Approach Left	SB		WB
Conflicting Lanes Left	2	0	3
Conflicting Approach Right		SB	EB
Conflicting Lanes Right	0	2	2
HCM Control Delay	99.6	13.5	12.2
HCM LOS	F	B	B

Lane	EBLn1	EBLn2	WBLn1	WBLn2	WBLn3	SBLn1	SBLn2
Vol Left, %	100%	0%	0%	0%	0%	100%	0%
Vol Thru, %	0%	100%	100%	100%	0%	0%	0%
Vol Right, %	0%	0%	0%	0%	100%	0%	100%
Sign Control	Stop	Stop	Stop	Stop	Stop	Stop	Stop
Traffic Vol by Lane	200	610	175	175	50	20	70
LT Vol	200	0	0	0	0	20	0
Through Vol	0	610	175	175	0	0	0
RT Vol	0	0	0	0	50	0	70
Lane Flow Rate	233	709	203	203	58	23	81
Geometry Grp	8	8	8	8	8	8	8
Degree of Util (X)	0.427	1.202	0.388	0.388	0.071	0.056	0.17
Departure Headway (Hd)	6.607	6.103	7.165	7.165	4.647	9.124	7.899
Convergence, Y/N	Yes	Yes	Yes	Yes	Yes	Yes	Yes
Cap	547	596	505	505	776	395	457
Service Time	4.334	3.83	4.865	4.865	2.347	6.824	5.599
HCM Lane V/C Ratio	0.426	1.19	0.402	0.402	0.075	0.058	0.177
HCM Control Delay	14.2	127.6	14.3	14.3	7.7	12.4	12.2
HCM Lane LOS	B	F	B	B	A	B	B
HCM 95th-tile Q	2.1	25.3	1.8	1.8	0.2	0.2	0.6

Intersection	
Intersection Delay, s/veh	34.5
Intersection LOS	D

Movement	EBL	EBT	WBT	WBR	SBL	SBR
Lane Configurations						
Traffic Vol, veh/h	460	150	100	130	190	180
Future Vol, veh/h	460	150	100	130	190	180
Peak Hour Factor	0.87	0.87	0.87	0.87	0.87	0.87
Heavy Vehicles, %	1	1	6	6	3	3
Mvmt Flow	529	172	115	149	218	207
Number of Lanes	1	1	1	0	1	1

Approach	EB	WB	SB
Opposing Approach	WB	EB	
Opposing Lanes	1	2	0
Conflicting Approach Left	SB		WB
Conflicting Lanes Left	2	0	1
Conflicting Approach Right		SB	EB
Conflicting Lanes Right	0	2	2
HCM Control Delay	53.4	15.2	15.2
HCM LOS	F	C	C

Lane	EBLn1	EBLn2	WBLn1	SBLn1	SBLn2
Vol Left, %	100%	0%	0%	100%	0%
Vol Thru, %	0%	100%	43%	0%	0%
Vol Right, %	0%	0%	57%	0%	100%
Sign Control	Stop	Stop	Stop	Stop	Stop
Traffic Vol by Lane	460	150	230	190	180
LT Vol	460	0	0	190	0
Through Vol	0	150	100	0	0
RT Vol	0	0	130	0	180
Lane Flow Rate	529	172	264	218	207
Geometry Grp	7	7	4	7	7
Degree of Util (X)	1.006	0.304	0.473	0.468	0.373
Departure Headway (Hd)	6.849	6.341	6.438	7.707	6.482
Convergence, Y/N	Yes	Yes	Yes	Yes	Yes
Cap	529	566	558	465	552
Service Time	4.613	4.104	4.507	5.481	4.256
HCM Lane V/C Ratio	1	0.304	0.473	0.469	0.375
HCM Control Delay	66.9	11.9	15.2	17.1	13.1
HCM Lane LOS	F	B	C	C	B
HCM 95th-tile Q	14.2	1.3	2.5	2.4	1.7

HCM 2010 Signalized Intersection Summary
 26: East Garrison Road & Reservation Road

Cumulative with Project, PM
 06/11/2019



Movement	EBL	EBT	EBR	WBL	WBT	WBR	NBL	NBT	NBR	SBL	SBT	SBR
Lane Configurations												
Traffic Volume (veh/h)	0	1500	190	240	570	0	150	0	150	0	0	0
Future Volume (veh/h)	0	1500	190	240	570	0	150	0	150	0	0	0
Number	5	2	12	1	6	16	3	8	18			
Initial Q (Qb), veh	0	0	0	0	0	0	0	0	0			
Ped-Bike Adj(A_pbT)	1.00		1.00	1.00		1.00	1.00		1.00			
Parking Bus, Adj	1.00	1.00	1.00	1.00	1.00	1.00	1.00	1.00	1.00			
Adj Sat Flow, veh/h/ln	1863	1863	1900	1881	1881	0	1845	0	1845			
Adj Flow Rate, veh/h	0	1546	194	247	588	0	155	0	126			
Adj No. of Lanes	1	2	0	1	2	0	1	0	1			
Peak Hour Factor	0.97	0.97	0.97	0.97	0.97	0.97	0.97	0.97	0.97			
Percent Heavy Veh, %	2	2	2	1	1	0	3	0	3			
Cap, veh/h	2	1876	232	280	2808	0	191	0	170			
Arrive On Green	0.00	0.59	0.59	0.16	0.79	0.00	0.11	0.00	0.11			
Sat Flow, veh/h	1774	3170	393	1792	3668	0	1757	0	1568			
Grp Volume(v), veh/h	0	854	886	247	588	0	155	0	126			
Grp Sat Flow(s),veh/h/ln	1774	1770	1793	1792	1787	0	1757	0	1568			
Q Serve(g_s), s	0.0	36.3	38.0	12.9	4.0	0.0	8.2	0.0	7.4			
Cycle Q Clear(g_c), s	0.0	36.3	38.0	12.9	4.0	0.0	8.2	0.0	7.4			
Prop In Lane	1.00		0.22	1.00		0.00	1.00		1.00			
Lane Grp Cap(c), veh/h	2	1047	1061	280	2808	0	191	0	170			
V/C Ratio(X)	0.00	0.82	0.84	0.88	0.21	0.00	0.81	0.00	0.74			
Avail Cap(c_a), veh/h	372	1113	1128	376	2808	0	497	0	444			
HCM Platoon Ratio	1.00	1.00	1.00	1.00	1.00	1.00	1.00	1.00	1.00			
Upstream Filter(I)	0.00	1.00	1.00	1.00	1.00	0.00	1.00	0.00	1.00			
Uniform Delay (d), s/veh	0.0	15.4	15.7	39.4	2.6	0.0	41.6	0.0	41.2			
Incr Delay (d2), s/veh	0.0	5.2	5.9	14.1	0.0	0.0	3.2	0.0	2.4			
Initial Q Delay(d3),s/veh	0.0	0.0	0.0	0.0	0.0	0.0	0.0	0.0	0.0			
%ile BackOfQ(50%),veh/ln	0.0	19.1	20.4	7.5	2.0	0.0	4.2	0.0	3.3			
LnGrp Delay(d),s/veh	0.0	20.5	21.6	53.5	2.7	0.0	44.7	0.0	43.6			
LnGrp LOS		C	C	D	A		D		D			
Approach Vol, veh/h		1740			835			281				
Approach Delay, s/veh		21.1			17.7			44.2				
Approach LOS		C			B			D				
Timer	1	2	3	4	5	6	7	8				
Assigned Phs	1	2			5	6		8				
Phs Duration (G+Y+Rc), s	8.5	61.8			0.0	80.3		15.1				
Change Period (Y+Rc), s	3.6	5.4			3.5	5.4		4.7				
Max Green Setting (Gmax), s	20	60.0			20.0	60.0		27.0				
Max Q Clear Time (g_c+1/4), s	14.5	40.0			0.0	6.0		10.2				
Green Ext Time (p_c), s	0.0	16.4			0.0	4.8		0.1				
Intersection Summary												
HCM 2010 Ctrl Delay				22.4								
HCM 2010 LOS				C								
Notes												

HCM 2010 Signalized Intersection Summary
27: Reservation Road & Watkins Gate Road

Cumulative with Project, PM
06/11/2019



Movement	EBL	EBR	NBL	NBT	SBT	SBR		
Lane Configurations								
Traffic Volume (veh/h)	10	230	210	1000	2110	60		
Future Volume (veh/h)	10	230	210	1000	2110	60		
Number	5	12	3	8	4	14		
Initial Q (Qb), veh	0	0	0	0	0	0		
Ped-Bike Adj(A_pbT)	1.00	1.00	1.00			1.00		
Parking Bus, Adj	1.00	1.00	1.00	1.00	1.00	1.00		
Adj Sat Flow, veh/h/ln	1863	1863	1881	1881	1863	1900		
Adj Flow Rate, veh/h	11	43	228	1087	2293	62		
Adj No. of Lanes	1	1	1	2	2	0		
Peak Hour Factor	0.92	0.92	0.92	0.92	0.92	0.92		
Percent Heavy Veh, %	2	2	1	1	2	2		
Cap, veh/h	64	58	242	3096	2470	66		
Arrive On Green	0.04	0.04	0.13	0.87	0.70	0.70		
Sat Flow, veh/h	1774	1583	1792	3668	3614	95		
Grp Volume(v), veh/h	11	43	228	1087	1147	1208		
Grp Sat Flow(s),veh/h/ln	1774	1583	1792	1787	1770	1846		
Q Serve(g_s), s	0.8	3.6	16.8	7.8	73.5	75.4		
Cycle Q Clear(g_c), s	0.8	3.6	16.8	7.8	73.5	75.4		
Prop In Lane	1.00	1.00	1.00			0.05		
Lane Grp Cap(c), veh/h	64	58	242	3096	1241	1295		
V/C Ratio(X)	0.17	0.75	0.94	0.35	0.92	0.93		
Avail Cap(c_a), veh/h	272	243	242	3119	1253	1307		
HCM Platoon Ratio	1.00	1.00	1.00	1.00	1.00	1.00		
Upstream Filter(I)	1.00	1.00	1.00	1.00	1.00	1.00		
Uniform Delay (d), s/veh	62.4	63.7	57.3	1.7	16.9	17.2		
Incr Delay (d2), s/veh	0.5	7.0	42.1	0.1	11.7	12.3		
Initial Q Delay(d3),s/veh	0.0	0.0	0.0	0.0	0.0	0.0		
%ile BackOfQ(50%),veh/ln	0.4	1.7	11.2	3.8	39.4	42.3		
LnGrp Delay(d),s/veh	62.8	70.7	99.4	1.8	28.6	29.5		
LnGrp LOS	E	E	F	A	C	C		
Approach Vol, veh/h	54			1315	2355			
Approach Delay, s/veh	69.1			18.7	29.1			
Approach LOS	E			B	C			
Timer	1	2	3	4	5	6	7	8
Assigned Phs		2	3	4				8
Phs Duration (G+Y+Rc), s		11.4	22.0	100.2				122.2
Change Period (Y+Rc), s		6.5	4.0	6.5				6.5
Max Green Setting (Gmax), s		20.5	18.0	94.5				116.5
Max Q Clear Time (g_c+I1), s		5.6	18.8	77.4				9.8
Green Ext Time (p_c), s		0.0	0.0	16.3				15.9
Intersection Summary								
HCM 2010 Ctrl Delay			26.0					
HCM 2010 LOS			C					

HCM 2010 Signalized Intersection Summary
28: Davis Road & Reservation Road

Cumulative with Project, PM
06/11/2019



Movement	EBL	EBT	EBR	WBL	WBT	WBR	NBL	NBT	NBR	SBL	SBT	SBR
Lane Configurations												
Traffic Volume (veh/h)	1260	500	10	10	360	100	10	10	10	120	10	540
Future Volume (veh/h)	1260	500	10	10	360	100	10	10	10	120	10	540
Number	5	2	12	1	6	16	3	8	18	7	4	14
Initial Q (Qb), veh	0	0	0	0	0	0	0	0	0	0	0	0
Ped-Bike Adj(A_pbT)	1.00		1.00	1.00		1.00	1.00		1.00	1.00		1.00
Parking Bus, Adj	1.00	1.00	1.00	1.00	1.00	1.00	1.00	1.00	1.00	1.00	1.00	1.00
Adj Sat Flow, veh/h/ln	1863	1863	1900	1827	1835	1900	1900	1900	1900	1900	1881	1881
Adj Flow Rate, veh/h	1340	532	11	11	383	106	11	11	9	128	11	439
Adj No. of Lanes	1	2	0	1	1	0	0	1	0	0	1	1
Peak Hour Factor	0.94	0.94	0.94	0.94	0.94	0.94	0.94	0.94	0.94	0.94	0.94	0.94
Percent Heavy Veh, %	2	2	2	4	4	4	0	0	0	1	1	1
Cap, veh/h	486	2069	43	18	444	123	18	18	14	356	31	782
Arrive On Green	0.27	0.58	0.58	0.01	0.32	0.32	0.03	0.03	0.03	0.22	0.22	0.22
Sat Flow, veh/h	1774	3546	73	1740	1384	383	631	631	516	1656	142	1599
Grp Volume(v), veh/h	1340	265	278	11	0	489	31	0	0	139	0	439
Grp Sat Flow(s),veh/h/ln	1774	1770	1850	1740	0	1767	1777	0	0	1798	0	1599
Q Serve(g_s), s	30.0	8.1	8.1	0.7	0.0	28.5	1.9	0.0	0.0	7.2	0.0	21.2
Cycle Q Clear(g_c), s	30.0	8.1	8.1	0.7	0.0	28.5	1.9	0.0	0.0	7.2	0.0	21.2
Prop In Lane	1.00		0.04	1.00		0.22	0.35		0.29	0.92		1.00
Lane Grp Cap(c), veh/h	486	1032	1079	18	0	567	50	0	0	387	0	782
V/C Ratio(X)	2.76	0.26	0.26	0.61	0.00	0.86	0.63	0.00	0.00	0.36	0.00	0.56
Avail Cap(c_a), veh/h	486	1032	1079	476	0	967	487	0	0	492	0	875
HCM Platoon Ratio	1.00	1.00	1.00	1.00	1.00	1.00	1.00	1.00	1.00	1.00	1.00	1.00
Upstream Filter(I)	1.00	1.00	1.00	1.00	0.00	1.00	1.00	0.00	0.00	1.00	0.00	1.00
Uniform Delay (d), s/veh	39.8	11.2	11.2	54.0	0.0	34.9	52.7	0.0	0.0	36.6	0.0	19.7
Incr Delay (d2), s/veh	797.5	0.2	0.2	11.6	0.0	6.3	4.7	0.0	0.0	0.2	0.0	0.2
Initial Q Delay(d3),s/veh	0.0	0.0	0.0	0.0	0.0	0.0	0.0	0.0	0.0	0.0	0.0	0.0
%ile BackOfQ(50%),veh/ln	22.1	4.0	4.1	0.4	0.0	14.8	1.0	0.0	0.0	3.6	0.0	9.3
LnGrp Delay(d),s/veh	837.3	11.4	11.4	65.6	0.0	41.2	57.4	0.0	0.0	36.8	0.0	20.0
LnGrp LOS	F	B	B	E		D	E			D		B
Approach Vol, veh/h		1883			500			31			578	
Approach Delay, s/veh		599.1			41.8			57.4			24.0	
Approach LOS		F			D			E			C	
Timer	1	2	3	4	5	6	7	8				
Assigned Phs	1	2		4	5	6		8				
Phs Duration (G+Y+Rc), s	5.0	68.9		28.6	33.8	40.2		7.1				
Change Period (Y+Rc), s	3.9	5.0		5.0	* 3.8	5.0		4.0				
Max Green Setting (Gmax), s	30	60.0		30.0	* 30	60.0		30.0				
Max Q Clear Time (g_c+1/2), s	11.2	10.1		23.2	32.0	30.5		3.9				
Green Ext Time (p_c), s	0.0	5.1		0.4	0.0	4.7		0.0				
Intersection Summary												
HCM 2010 Ctrl Delay				389.3								
HCM 2010 LOS				F								
Notes												

HCM 2010 Signalized Intersection Summary
 29: 2nd Avenue & Divarty Street

Cumulative with Project, PM
 06/11/2019



Movement	EBL	EBT	EBR	WBL	WBT	WBR	NBL	NBT	NBR	SBL	SBT	SBR
Lane Configurations		↕			↕	↕	↕	↕↔		↕	↕↔	
Traffic Volume (veh/h)	200	10	80	140	10	30	40	660	110	30	630	100
Future Volume (veh/h)	200	10	80	140	10	30	40	660	110	30	630	100
Number	5	2	12	1	6	16	3	8	18	7	4	14
Initial Q (Qb), veh	0	0	0	0	0	0	0	0	0	0	0	0
Ped-Bike Adj(A_pbT)	1.00		1.00	1.00		1.00	1.00		0.99	1.00		0.99
Parking Bus, Adj	1.00	1.00	1.00	1.00	1.00	1.00	1.00	1.00	1.00	1.00	1.00	1.00
Adj Sat Flow, veh/h/ln	1900	1900	1900	1900	1900	1900	1900	1900	1900	1881	1881	1900
Adj Flow Rate, veh/h	213	11	85	149	11	32	43	702	117	32	670	106
Adj No. of Lanes	0	1	0	0	1	1	1	2	0	1	2	0
Peak Hour Factor	0.94	0.94	0.94	0.94	0.94	0.94	0.94	0.94	0.94	0.94	0.94	0.94
Percent Heavy Veh, %	0	0	0	0	0	0	0	0	0	1	1	1
Cap, veh/h	382	37	113	572	38	558	81	1076	179	64	1046	165
Arrive On Green	0.35	0.35	0.35	0.35	0.35	0.35	0.04	0.35	0.35	0.04	0.34	0.34
Sat Flow, veh/h	752	107	326	1249	108	1608	1810	3095	515	1792	3090	488
Grp Volume(v), veh/h	309	0	0	160	0	32	43	409	410	32	387	389
Grp Sat Flow(s),veh/h/ln	1185	0	0	1358	0	1608	1810	1805	1806	1792	1787	1792
Q Serve(g_s), s	8.6	0.0	0.0	0.0	0.0	0.7	1.2	9.6	9.6	0.9	9.2	9.2
Cycle Q Clear(g_c), s	12.9	0.0	0.0	4.3	0.0	0.7	1.2	9.6	9.6	0.9	9.2	9.2
Prop In Lane	0.69		0.28	0.93		1.00	1.00		0.29	1.00		0.27
Lane Grp Cap(c), veh/h	532	0	0	610	0	558	81	628	628	64	605	607
V/C Ratio(X)	0.58	0.00	0.00	0.26	0.00	0.06	0.53	0.65	0.65	0.50	0.64	0.64
Avail Cap(c_a), veh/h	1044	0	0	1084	0	1124	416	1442	1443	412	1250	1253
HCM Platoon Ratio	1.00	1.00	1.00	1.00	1.00	1.00	1.00	1.00	1.00	1.00	1.00	1.00
Upstream Filter(I)	1.00	0.00	0.00	1.00	0.00	1.00	1.00	1.00	1.00	1.00	1.00	1.00
Uniform Delay (d), s/veh	16.0	0.0	0.0	12.1	0.0	10.9	23.4	13.8	13.8	23.7	14.0	14.0
Incr Delay (d2), s/veh	1.0	0.0	0.0	0.2	0.0	0.0	5.2	1.2	1.2	5.8	1.1	1.1
Initial Q Delay(d3),s/veh	0.0	0.0	0.0	0.0	0.0	0.0	0.0	0.0	0.0	0.0	0.0	0.0
%ile BackOfQ(50%),veh/ln	4.0	0.0	0.0	1.6	0.0	0.3	0.7	4.9	5.0	0.5	4.7	4.7
LnGrp Delay(d),s/veh	17.0	0.0	0.0	12.3	0.0	10.9	28.6	14.9	14.9	29.5	15.1	15.1
LnGrp LOS	B			B		B	C	B	B	C	B	B
Approach Vol, veh/h		309			192			862			808	
Approach Delay, s/veh		17.0			12.1			15.6			15.7	
Approach LOS		B			B			B			B	
Timer	1	2	3	4	5	6	7	8				
Assigned Phs		2	3	4		6	7	8				
Phs Duration (G+Y+Rc), s		22.4	5.8	21.9		22.4	5.3	22.4				
Change Period (Y+Rc), s		5.0	3.5	5.0		5.0	3.5	5.0				
Max Green Setting (Gmax), s		35.0	11.5	35.0		35.0	11.5	40.0				
Max Q Clear Time (g_c+I1), s		14.9	3.2	11.2		6.3	2.9	11.6				
Green Ext Time (p_c), s		1.8	0.0	5.0		1.0	0.0	5.5				
Intersection Summary												
HCM 2010 Ctrl Delay				15.5								
HCM 2010 LOS				B								

Intersection	
Intersection Delay, s/veh	10
Intersection LOS	A

Movement	EBL	EBT	EBR	WBL	WBT	WBR	NBL	NBT	NBR	SBL	SBT	SBR
Lane Configurations		↕			↕		↕	↕		↕	↕	
Traffic Vol, veh/h	20	10	40	10	10	10	30	180	10	10	220	20
Future Vol, veh/h	20	10	40	10	10	10	30	180	10	10	220	20
Peak Hour Factor	0.85	0.85	0.85	0.85	0.85	0.85	0.85	0.85	0.85	0.85	0.85	0.85
Heavy Vehicles, %	0	0	0	1	1	1	0	0	0	1	1	1
Mvmt Flow	24	12	47	12	12	12	35	212	12	12	259	24
Number of Lanes	0	1	0	0	1	0	1	1	0	1	1	0

Approach	EB	WB	NB	SB
Opposing Approach	WB	EB	SB	NB
Opposing Lanes	1	1	2	2
Conflicting Approach Left	SB	NB	EB	WB
Conflicting Lanes Left	2	2	1	1
Conflicting Approach Right	NB	SB	WB	EB
Conflicting Lanes Right	2	2	1	1
HCM Control Delay	8.7	8.6	9.8	10.8
HCM LOS	A	A	A	B

Lane	NBLn1	NBLn2	EBLn1	WBLn1	SBLn1	SBLn2
Vol Left, %	100%	0%	29%	33%	100%	0%
Vol Thru, %	0%	95%	14%	33%	0%	92%
Vol Right, %	0%	5%	57%	33%	0%	8%
Sign Control	Stop	Stop	Stop	Stop	Stop	Stop
Traffic Vol by Lane	30	190	70	30	10	240
LT Vol	30	0	20	10	10	0
Through Vol	0	180	10	10	0	220
RT Vol	0	10	40	10	0	20
Lane Flow Rate	35	224	82	35	12	282
Geometry Grp	7	7	2	2	7	7
Degree of Util (X)	0.054	0.311	0.114	0.051	0.018	0.391
Departure Headway (Hd)	5.554	5.014	4.978	5.223	5.548	4.986
Convergence, Y/N	Yes	Yes	Yes	Yes	Yes	Yes
Cap	644	715	717	682	645	720
Service Time	3.295	2.754	3.027	3.28	3.287	2.725
HCM Lane V/C Ratio	0.054	0.313	0.114	0.051	0.019	0.392
HCM Control Delay	8.6	10	8.7	8.6	8.4	10.9
HCM Lane LOS	A	A	A	A	A	B
HCM 95th-tile Q	0.2	1.3	0.4	0.2	0.1	1.9

HCM 2010 Signalized Intersection Summary
31: 1st Avenue & Lightfighter Drive

Cumulative with Project, PM
06/11/2019



Movement	EBL	EBT	EBR	WBL	WBT	WBR	NBL	NBT	NBR	SBL	SBT	SBR
Lane Configurations		↑↑	↑	↑	↑↑		↑		↑	↑	↑	↑
Traffic Volume (veh/h)	0	860	110	20	1500	0	200	0	30	60	50	80
Future Volume (veh/h)	0	860	110	20	1500	0	200	0	30	60	50	80
Number	7	4	14	3	8	18	5	2	12	1	6	16
Initial Q (Qb), veh	0	0	0	0	0	0	0	0	0	0	0	0
Ped-Bike Adj(A_pbT)	1.00		1.00	1.00		1.00	1.00		1.00	1.00		1.00
Parking Bus, Adj	1.00	1.00	1.00	1.00	1.00	1.00	1.00	1.00	1.00	1.00	1.00	1.00
Adj Sat Flow, veh/h/ln	0	1881	1881	1881	1881	0	1881	0	1881	1810	1810	1810
Adj Flow Rate, veh/h	0	905	0	21	1579	0	211	0	14	63	53	64
Adj No. of Lanes	0	2	1	1	2	0	1	0	1	1	1	1
Peak Hour Factor	0.95	0.95	0.95	0.95	0.95	0.95	0.95	0.95	0.95	0.95	0.95	0.95
Percent Heavy Veh, %	0	1	1	1	1	0	1	0	1	5	5	5
Cap, veh/h	0	2239	1002	23	2561	0	0	0	0	140	147	125
Arrive On Green	0.00	0.63	0.00	0.01	0.72	0.00	0.00	0.00	0.00	0.08	0.08	0.08
Sat Flow, veh/h	0	3668	1599	1792	3668	0		0		1723	1810	1538
Grp Volume(v), veh/h	0	905	0	21	1579	0		0.0		63	53	64
Grp Sat Flow(s),veh/h/ln	0	1787	1599	1792	1787	0				1723	1810	1538
Q Serve(g_s), s	0.0	5.8	0.0	0.5	10.2	0.0				1.6	1.3	1.8
Cycle Q Clear(g_c), s	0.0	5.8	0.0	0.5	10.2	0.0				1.6	1.3	1.8
Prop In Lane	0.00		1.00	1.00		0.00				1.00		1.00
Lane Grp Cap(c), veh/h	0	2239	1002	23	2561	0				140	147	125
V/C Ratio(X)	0.00	0.40	0.00	0.90	0.62	0.00				0.45	0.36	0.51
Avail Cap(c_a), veh/h	0	3533	1580	787	3533	0				946	994	845
HCM Platoon Ratio	1.00	1.00	1.00	1.00	1.00	1.00				1.00	1.00	1.00
Upstream Filter(I)	0.00	1.00	0.00	1.00	1.00	0.00				1.00	1.00	1.00
Uniform Delay (d), s/veh	0.0	4.3	0.0	22.4	3.3	0.0				19.9	19.8	20.0
Incr Delay (d2), s/veh	0.0	0.2	0.0	32.4	0.3	0.0				0.8	0.5	1.2
Initial Q Delay(d3),s/veh	0.0	0.0	0.0	0.0	0.0	0.0				0.0	0.0	0.0
%ile BackOfQ(50%),veh/ln	0.0	2.8	0.0	0.5	4.9	0.0				0.8	0.7	0.8
LnGrp Delay(d),s/veh	0.0	4.4	0.0	54.8	3.6	0.0				20.8	20.3	21.2
LnGrp LOS		A		D	A					C	C	C
Approach Vol, veh/h		905			1600						180	
Approach Delay, s/veh		4.4			4.3						20.8	
Approach LOS		A			A						C	
Timer	1	2	3	4	5	6	7	8				
Assigned Phs			3	4		6		8				
Phs Duration (G+Y+Rc), s			4.1	33.1		8.3		37.2				
Change Period (Y+Rc), s			3.5	4.6		4.6		4.6				
Max Green Setting (Gmax), s			20.0	45.0		25.0		45.0				
Max Q Clear Time (g_c+I1), s			2.5	7.8		3.8		12.2				
Green Ext Time (p_c), s			0.0	11.2		0.3		20.4				
Intersection Summary												
HCM 2010 Ctrl Delay			5.4									
HCM 2010 LOS			A									

HCM 2010 Signalized Intersection Summary
 32: 2nd Avenue & Lightfighter Drive

Cumulative with Project, PM
 06/11/2019



Movement	EBL	EBT	EBR	WBL	WBT	WBR	NBL	NBT	NBR	SBL	SBT	SBR
Lane Configurations												
Traffic Volume (veh/h)	290	660	10	80	1230	220	20	20	50	230	30	330
Future Volume (veh/h)	290	660	10	80	1230	220	20	20	50	230	30	330
Number	5	2	12	1	6	16	3	8	18	7	4	14
Initial Q (Qb), veh	0	0	0	0	0	0	0	0	0	0	0	0
Ped-Bike Adj(A_pbT)	1.00		1.00	1.00		1.00	1.00		0.99	1.00		0.99
Parking Bus, Adj	1.00	1.00	1.00	1.00	1.00	1.00	1.00	1.00	1.00	1.00	1.00	1.00
Adj Sat Flow, veh/h/ln	1881	1881	1900	1881	1881	1900	1900	1900	1900	1845	1845	1845
Adj Flow Rate, veh/h	305	695	11	84	1295	227	21	21	47	242	32	244
Adj No. of Lanes	1	2	0	1	2	0	0	1	0	1	1	1
Peak Hour Factor	0.95	0.95	0.95	0.95	0.95	0.95	0.95	0.95	0.95	0.95	0.95	0.95
Percent Heavy Veh, %	1	1	1	1	1	1	0	0	0	3	3	3
Cap, veh/h	222	2179	34	108	1648	286	95	100	168	349	374	316
Arrive On Green	0.12	0.61	0.61	0.06	0.54	0.54	0.20	0.20	0.20	0.20	0.20	0.20
Sat Flow, veh/h	1792	3601	57	1792	3045	529	249	493	831	1308	1845	1559
Grp Volume(v), veh/h	305	345	361	84	755	767	89	0	0	242	32	244
Grp Sat Flow(s),veh/h/ln	1792	1787	1871	1792	1787	1787	1573	0	0	1308	1845	1559
Q Serve(g_s), s	12.4	9.4	9.4	4.6	33.6	34.5	0.0	0.0	0.0	12.7	1.4	14.8
Cycle Q Clear(g_c), s	12.4	9.4	9.4	4.6	33.6	34.5	4.3	0.0	0.0	17.0	1.4	14.8
Prop In Lane	1.00		0.03	1.00		0.30	0.24		0.53	1.00		1.00
Lane Grp Cap(c), veh/h	222	1081	1132	108	967	967	364	0	0	349	374	316
V/C Ratio(X)	1.37	0.32	0.32	0.78	0.78	0.79	0.24	0.00	0.00	0.69	0.09	0.77
Avail Cap(c_a), veh/h	222	1081	1132	222	967	967	666	0	0	612	745	630
HCM Platoon Ratio	1.00	1.00	1.00	1.00	1.00	1.00	1.00	1.00	1.00	1.00	1.00	1.00
Upstream Filter(I)	0.88	0.88	0.88	0.24	0.24	0.24	1.00	0.00	0.00	0.77	0.77	0.77
Uniform Delay (d), s/veh	43.8	9.7	9.7	46.4	18.2	18.4	33.5	0.0	0.0	38.3	32.3	37.7
Incr Delay (d2), s/veh	190.8	0.7	0.7	1.1	1.6	1.7	0.1	0.0	0.0	0.7	0.0	1.2
Initial Q Delay(d3),s/veh	0.0	0.0	0.0	0.0	0.0	0.0	0.0	0.0	0.0	0.0	0.0	0.0
%ile BackOfQ(50%),veh/ln	7.9	4.8	5.0	2.3	16.8	17.3	2.1	0.0	0.0	6.5	0.7	6.5
LnGrp Delay(d),s/veh	234.6	10.3	10.3	47.5	19.8	20.1	33.6	0.0	0.0	39.0	32.4	38.8
LnGrp LOS	F	B	B	D	B	C	C			D	C	D
Approach Vol, veh/h		1011			1606			89			518	
Approach Delay, s/veh		78.0			21.4			33.6			38.5	
Approach LOS		E			C			C			D	
Timer	1	2	3	4	5	6	7	8				
Assigned Phs	1	2		4	5	6		8				
Phs Duration (G+Y+Rc), s	40.0	65.1		24.9	16.4	58.7		24.9				
Change Period (Y+Rc), s	4.0	4.6		4.6	4.0	4.6		4.6				
Max Green Setting (Gmax), s	40.0	34.0		40.4	12.4	24.4		40.4				
Max Q Clear Time (g_c+10), s	10.0	11.4		19.0	14.4	36.5		6.3				
Green Ext Time (p_c), s	0.0	2.5		0.9	0.0	0.0		0.3				
Intersection Summary												
HCM 2010 Ctrl Delay				42.2								
HCM 2010 LOS				D								

HCM 2010 Signalized Intersection Summary
 33: General Jim Moore Boulevard & Lightfighter Drive

Cumulative with Project, PM
 06/11/2019



Movement	EBL	EBT	EBR	WBL	WBT	WBR	NBL	NBT	NBR	SBL	SBT	SBR
Lane Configurations												
Traffic Volume (veh/h)	50	280	690	40	250	50	670	70	20	60	100	40
Future Volume (veh/h)	50	280	690	40	250	50	670	70	20	60	100	40
Number	3	8	18	7	4	14	1	6	16	5	2	12
Initial Q (Qb), veh	0	0	0	0	0	0	0	0	0	0	0	0
Ped-Bike Adj(A_pbT)	1.00		1.00	1.00		1.00	1.00		1.00	1.00		1.00
Parking Bus, Adj	1.00	1.00	1.00	1.00	1.00	1.00	1.00	1.00	1.00	1.00	1.00	1.00
Adj Sat Flow, veh/h/ln	1881	1881	1881	1900	1900	1900	1881	1881	1900	1900	1900	1900
Adj Flow Rate, veh/h	52	292	0	42	260	51	698	73	19	62	104	-70
Adj No. of Lanes	1	1	1	1	1	0	2	1	0	1	2	0
Peak Hour Factor	0.96	0.96	0.96	0.96	0.96	0.96	0.96	0.96	0.96	0.96	0.96	0.96
Percent Heavy Veh, %	1	1	1	0	0	0	1	1	1	0	0	0
Cap, veh/h	75	468	398	65	375	74	731	417	109	85	456	0
Arrive On Green	0.04	0.25	0.00	0.04	0.24	0.24	0.21	0.29	0.29	0.05	0.13	0.00
Sat Flow, veh/h	1792	1881	1599	1810	1544	303	3476	1440	375	1810	3705	0
Grp Volume(v), veh/h	52	292	0	42	0	311	698	0	92	62	34	0
Grp Sat Flow(s),veh/h/ln	1792	1881	1599	1810	0	1847	1738	0	1815	1810	1805	0
Q Serve(g_s), s	1.4	6.6	0.0	1.1	0.0	7.3	9.4	0.0	1.8	1.6	0.4	0.0
Cycle Q Clear(g_c), s	1.4	6.6	0.0	1.1	0.0	7.3	9.4	0.0	1.8	1.6	0.4	0.0
Prop In Lane	1.00		1.00	1.00		0.16	1.00		0.21	1.00		0.00
Lane Grp Cap(c), veh/h	75	468	398	65	0	449	731	0	525	85	456	0
V/C Ratio(X)	0.69	0.62	0.00	0.65	0.00	0.69	0.95	0.00	0.18	0.73	0.07	0.00
Avail Cap(c_a), veh/h	754	1187	1009	761	0	1165	731	0	1145	571	2278	0
HCM Platoon Ratio	1.00	1.00	1.00	1.00	1.00	1.00	1.00	1.00	1.00	1.00	1.00	1.00
Upstream Filter(I)	1.00	1.00	0.00	1.00	0.00	1.00	1.00	0.00	1.00	1.00	1.00	0.00
Uniform Delay (d), s/veh	22.5	15.9	0.0	22.6	0.0	16.4	18.5	0.0	12.6	22.4	18.3	0.0
Incr Delay (d2), s/veh	10.9	1.6	0.0	4.0	0.0	2.3	22.7	0.0	0.3	4.4	0.1	0.0
Initial Q Delay(d3),s/veh	0.0	0.0	0.0	0.0	0.0	0.0	0.0	0.0	0.0	0.0	0.0	0.0
%ile BackOfQ(50%),veh/ln	0.9	3.6	0.0	0.6	0.0	4.0	6.8	0.0	0.9	0.9	0.2	0.0
LnGrp Delay(d),s/veh	33.4	17.5	0.0	26.6	0.0	18.7	41.3	0.0	13.0	26.7	18.4	0.0
LnGrp LOS	C	B		C		B	D		B	C	B	
Approach Vol, veh/h		344			353			790			96	
Approach Delay, s/veh		19.9			19.6			38.0			23.8	
Approach LOS		B			B			D			C	
Timer	1	2	3	4	5	6	7	8				
Assigned Phs	1	2	3	4	5	6	7	8				
Phs Duration (G+Y+Rc), s	4.5	10.5	6.5	16.1	6.7	18.3	6.2	16.3				
Change Period (Y+Rc), s	4.5	4.5	4.5	4.5	4.5	4.5	4.5	4.5				
Max Green Setting (Gmax), s	30.0	30.0	20.0	30.0	15.0	30.0	20.0	30.0				
Max Q Clear Time (g_c+I1), s	4.5	2.4	3.4	9.3	3.6	3.8	3.1	8.6				
Green Ext Time (p_c), s	0.0	0.1	0.1	2.3	0.0	0.8	0.0	1.8				
Intersection Summary												
HCM 2010 Ctrl Delay				29.1								
HCM 2010 LOS				C								

Intersection

Intersection Delay, s/veh 12.1

Intersection LOS B

Movement	WBL	WBR	NBT	NBR	SBL	SBT
Lane Configurations						
Traffic Vol, veh/h	10	250	90	20	270	90
Future Vol, veh/h	10	250	90	20	270	90
Peak Hour Factor	0.88	0.88	0.88	0.88	0.88	0.88
Heavy Vehicles, %	0	0	2	2	1	1
Mvmt Flow	11	284	102	23	307	102
Number of Lanes	1	0	1	0	0	1

Approach	WB	NB	SB
Opposing Approach		SB	NB
Opposing Lanes	0	1	1
Conflicting Approach Left NB			WB
Conflicting Lanes Left	1	0	1
Conflicting Approach Right SB		WB	
Conflicting Lanes Right	1	1	0
HCM Control Delay	10.5	9.2	14.1
HCM LOS	B	A	B

Lane	NBLn1	WBLn1	SBLn1
Vol Left, %	0%	4%	75%
Vol Thru, %	82%	0%	25%
Vol Right, %	18%	96%	0%
Sign Control	Stop	Stop	Stop
Traffic Vol by Lane	110	260	360
LT Vol	0	10	270
Through Vol	90	0	90
RT Vol	20	250	0
Lane Flow Rate	125	295	409
Geometry Grp	1	1	1
Degree of Util (X)	0.175	0.38	0.558
Departure Headway (Hd)	5.031	4.625	4.913
Convergence, Y/N	Yes	Yes	Yes
Cap	704	771	728
Service Time	3.128	2.689	2.992
HCM Lane V/C Ratio	0.178	0.383	0.562
HCM Control Delay	9.2	10.5	14.1
HCM Lane LOS	A	B	B
HCM 95th-tile Q	0.6	1.8	3.5

Intersection						
Int Delay, s/veh	1.9					
Movement	EBT	EBR	WBL	WBT	NBL	NBR
Lane Configurations						
Traffic Vol, veh/h	250	50	30	220	40	30
Future Vol, veh/h	250	50	30	220	40	30
Conflicting Peds, #/hr	0	0	0	0	0	0
Sign Control	Free	Free	Free	Free	Stop	Stop
RT Channelized	-	None	-	None	-	None
Storage Length	-	-	-	-	0	-
Veh in Median Storage, #	0	-	-	0	0	-
Grade, %	0	-	-	0	0	-
Peak Hour Factor	85	85	85	85	85	85
Heavy Vehicles, %	0	0	0	0	0	0
Mvmt Flow	294	59	35	259	47	35

Major/Minor	Major1	Major2	Minor1	Minor2	Minor3
Conflicting Flow All	0	0	353	0	653
Stage 1	-	-	-	-	324
Stage 2	-	-	-	-	329
Critical Hdwy	-	-	4.1	-	6.4
Critical Hdwy Stg 1	-	-	-	-	5.4
Critical Hdwy Stg 2	-	-	-	-	5.4
Follow-up Hdwy	-	-	2.2	-	3.5
Pot Cap-1 Maneuver	-	-	1217	-	435
Stage 1	-	-	-	-	738
Stage 2	-	-	-	-	734
Platoon blocked, %	-	-	-	-	-
Mov Cap-1 Maneuver	-	-	1217	-	420
Mov Cap-2 Maneuver	-	-	-	-	420
Stage 1	-	-	-	-	713
Stage 2	-	-	-	-	734

Approach	EB	WB	NB
HCM Control Delay, s	0	1	13.4
HCM LOS			B

Minor Lane/Major Mvmt	NBLn1	EBT	EBR	WBL	WBT
Capacity (veh/h)	512	-	-	1217	-
HCM Lane V/C Ratio	0.161	-	-	0.029	-
HCM Control Delay (s)	13.4	-	-	8	0
HCM Lane LOS	B	-	-	A	A
HCM 95th %tile Q(veh)	0.6	-	-	0.1	-

Intersection	
Intersection Delay, s/veh	22
Intersection LOS	C

Movement	EBL	EBT	EBR	WBL	WBT	WBR	NBL	NBT	NBR	SBL	SBT	SBR
Lane Configurations		↕			↕			↕			↕	
Traffic Vol, veh/h	10	200	60	30	180	10	50	230	20	10	220	30
Future Vol, veh/h	10	200	60	30	180	10	50	230	20	10	220	30
Peak Hour Factor	0.82	0.82	0.82	0.82	0.82	0.82	0.82	0.82	0.82	0.82	0.82	0.82
Heavy Vehicles, %	0	0	0	0	0	0	2	2	2	0	0	0
Mvmt Flow	12	244	73	37	220	12	61	280	24	12	268	37
Number of Lanes	0	1	0	0	1	0	0	1	0	0	1	0

Approach	EB	WB	NB	SB
Opposing Approach	WB	EB	SB	NB
Opposing Lanes	1	1	1	1
Conflicting Approach Left	SB	NB	EB	WB
Conflicting Lanes Left	1	1	1	1
Conflicting Approach Right	NB	SB	WB	EB
Conflicting Lanes Right	1	1	1	1
HCM Control Delay	21.8	18.8	25.5	21
HCM LOS	C	C	D	C

Lane	NBLn1	EBLn1	WBLn1	SBLn1
Vol Left, %	17%	4%	14%	4%
Vol Thru, %	77%	74%	82%	85%
Vol Right, %	7%	22%	5%	12%
Sign Control	Stop	Stop	Stop	Stop
Traffic Vol by Lane	300	270	220	260
LT Vol	50	10	30	10
Through Vol	230	200	180	220
RT Vol	20	60	10	30
Lane Flow Rate	366	329	268	317
Geometry Grp	1	1	1	1
Degree of Util (X)	0.71	0.64	0.544	0.62
Departure Headway (Hd)	6.982	6.999	7.301	7.038
Convergence, Y/N	Yes	Yes	Yes	Yes
Cap	516	514	491	510
Service Time	5.052	5.071	5.377	5.112
HCM Lane V/C Ratio	0.709	0.64	0.546	0.622
HCM Control Delay	25.5	21.8	18.8	21
HCM Lane LOS	D	C	C	C
HCM 95th-tile Q	5.6	4.5	3.2	4.2

Intersection												
Int Delay, s/veh	18.5											
Movement	EBL	EBT	EBR	WBL	WBT	WBR	NBL	NBT	NBR	SBL	SBT	SBR
Lane Configurations		↕			↕			↕			↕	
Traffic Vol, veh/h	70	110	50	30	90	10	90	210	20	0	0	0
Future Vol, veh/h	70	110	50	30	90	10	90	210	20	0	0	0
Conflicting Peds, #/hr	0	0	0	0	0	0	0	0	0	0	0	0
Sign Control	Stop	Stop	Stop	Stop	Stop	Stop	Free	Free	Free	Free	Free	Free
RT Channelized	-	-	None	-	-	None	-	-	None	-	-	None
Storage Length	-	-	-	-	-	-	-	-	-	-	-	-
Veh in Median Storage, #	-	0	-	-	0	-	-	0	-	-	0	-
Grade, %	-	0	-	-	0	-	-	0	-	-	0	-
Peak Hour Factor	74	74	74	74	74	74	74	74	74	74	74	74
Heavy Vehicles, %	3	3	3	2	2	2	3	3	3	8	8	8
Mvmt Flow	95	149	68	41	122	14	122	284	27	0	0	0

Major/Minor	Minor2		Minor1		Major1			Major2				
Conflicting Flow All	611	556	1	652	543	298	1	0	0	311	0	0
Stage 1	1	1	-	542	542	-	-	-	-	-	-	-
Stage 2	610	555	-	110	1	-	-	-	-	-	-	-
Critical Hdwy	7.13	6.53	6.23	7.12	6.52	6.22	4.13	-	-	4.18	-	-
Critical Hdwy Stg 1	6.13	5.53	-	6.12	5.52	-	-	-	-	-	-	-
Critical Hdwy Stg 2	6.13	5.53	-	6.12	5.52	-	-	-	-	-	-	-
Follow-up Hdwy	3.527	4.027	3.327	3.518	4.018	3.318	2.227	-	-	2.272	-	-
Pot Cap-1 Maneuver	404	438	1081	381	447	741	1615	-	-	1216	-	-
Stage 1	1019	893	-	525	520	-	-	-	-	-	-	-
Stage 2	480	512	-	895	895	-	-	-	-	-	-	-
Platoon blocked, %								-	-	-	-	-
Mov Cap-1 Maneuver	284	398	1081	237	406	741	1615	-	-	1216	-	-
Mov Cap-2 Maneuver	284	398	-	237	406	-	-	-	-	-	-	-
Stage 1	925	893	-	477	472	-	-	-	-	-	-	-
Stage 2	318	465	-	699	895	-	-	-	-	-	-	-

Approach	EB		WB		NB		SB	
HCM Control Delay, s	38		24.3		2.1		0	
HCM LOS	E		C					

Minor Lane/Major Mvmt	NBL	NBT	NBR	EBLn1	WBLn1	SBL	SBT	SBR
Capacity (veh/h)	1615	-	-	404	359	1216	-	-
HCM Lane V/C Ratio	0.075	-	-	0.769	0.489	-	-	-
HCM Control Delay (s)	7.4	0	-	38	24.3	0	-	-
HCM Lane LOS	A	A	-	E	C	A	-	-
HCM 95th %tile Q(veh)	0.2	-	-	6.4	2.6	0	-	-

Intersection						
Int Delay, s/veh	4.7					
Movement	EBL	EBR	NBL	NBT	SBT	SBR
Lane Configurations	T		T		T	
Traffic Vol, veh/h	130	10	10	450	380	120
Future Vol, veh/h	130	10	10	450	380	120
Conflicting Peds, #/hr	0	0	0	0	0	0
Sign Control	Stop	Stop	Free	Free	Free	Free
RT Channelized	-	None	-	None	-	None
Storage Length	0	-	-	-	-	-
Veh in Median Storage, #	0	-	-	0	0	-
Grade, %	0	-	-	0	0	-
Peak Hour Factor	88	88	88	88	88	88
Heavy Vehicles, %	0	0	2	2	1	1
Mvmt Flow	148	11	11	511	432	136























Major/Minor	Minor2	Major1		Major2	
Conflicting Flow All	1033	500	568	0	0
Stage 1	500	-	-	-	-
Stage 2	533	-	-	-	-
Critical Hdwy	6.4	6.2	4.12	-	-
Critical Hdwy Stg 1	5.4	-	-	-	-
Critical Hdwy Stg 2	5.4	-	-	-	-
Follow-up Hdwy	3.5	3.3	2.218	-	-
Pot Cap-1 Maneuver	260	575	1004	-	-
Stage 1	613	-	-	-	-
Stage 2	593	-	-	-	-
Platoon blocked, %				-	-
Mov Cap-1 Maneuver	256	575	1004	-	-
Mov Cap-2 Maneuver	256	-	-	-	-
Stage 1	604	-	-	-	-
Stage 2	593	-	-	-	-

Approach	EB	NB	SB
HCM Control Delay, s	36.6	0.2	0
HCM LOS	E		

Minor Lane/Major Mvmt	NBL	NBT	EBLn1	SBT	SBR
Capacity (veh/h)	1004	-	267	-	-
HCM Lane V/C Ratio	0.011	-	0.596	-	-
HCM Control Delay (s)	8.6	0	36.6	-	-
HCM Lane LOS	A	A	E	-	-
HCM 95th %tile Q(veh)	0	-	3.5	-	-

HCM 2010 Signalized Intersection Summary
 39: General Jim Moore Boulevard & Gigling Road

Cumulative with Project, PM
 06/11/2019

												
Movement	EBL	EBT	EBR	WBL	WBT	WBR	NBL	NBT	NBR	SBL	SBT	SBR
Lane Configurations												
Traffic Volume (veh/h)	20	20	30	290	50	380	60	340	460	400	350	50
Future Volume (veh/h)	20	20	30	290	50	380	60	340	460	400	350	50
Number	3	8	18	7	4	14	1	6	16	5	2	12
Initial Q (Qb), veh	0	0	0	0	0	0	0	0	0	0	0	0
Ped-Bike Adj(A_pbT)	1.00		0.99	1.00		1.00	1.00		1.00	1.00		1.00
Parking Bus, Adj	1.00	1.00	1.00	1.00	1.00	1.00	1.00	1.00	1.00	1.00	1.00	1.00
Adj Sat Flow, veh/h/ln	1776	1776	1900	1881	1881	1881	1863	1863	1863	1863	1863	1863
Adj Flow Rate, veh/h	22	22	3	326	56	0	67	382	0	449	393	0
Adj No. of Lanes	1	2	0	1	2	1	1	2	1	1	2	1
Peak Hour Factor	0.89	0.89	0.89	0.89	0.89	0.89	0.89	0.89	0.89	0.89	0.89	0.89
Percent Heavy Veh, %	7	7	7	1	1	1	2	2	2	2	2	2
Cap, veh/h	44	255	34	381	972	435	105	557	249	356	1057	473
Arrive On Green	0.03	0.09	0.09	0.21	0.27	0.00	0.06	0.16	0.00	0.20	0.30	0.00
Sat Flow, veh/h	1691	2991	399	1792	3574	1599	1774	3539	1583	1774	3539	1583
Grp Volume(v), veh/h	22	12	13	326	56	0	67	382	0	449	393	0
Grp Sat Flow(s),veh/h/ln	1691	1687	1702	1792	1787	1599	1774	1770	1583	1774	1770	1583
Q Serve(g_s), s	0.7	0.3	0.4	9.2	0.6	0.0	1.9	5.3	0.0	10.5	4.6	0.0
Cycle Q Clear(g_c), s	0.7	0.3	0.4	9.2	0.6	0.0	1.9	5.3	0.0	10.5	4.6	0.0
Prop In Lane	1.00		0.23	1.00		1.00	1.00		1.00	1.00		1.00
Lane Grp Cap(c), veh/h	44	144	145	381	972	435	105	557	249	356	1057	473
V/C Ratio(X)	0.50	0.08	0.09	0.86	0.06	0.00	0.64	0.69	0.00	1.26	0.37	0.00
Avail Cap(c_a), veh/h	662	983	992	702	2083	932	356	1724	771	356	1724	771
HCM Platoon Ratio	1.00	1.00	1.00	1.00	1.00	1.00	1.00	1.00	1.00	1.00	1.00	1.00
Upstream Filter(I)	1.00	1.00	1.00	1.00	1.00	0.00	1.00	1.00	0.00	1.00	1.00	0.00
Uniform Delay (d), s/veh	25.1	22.0	22.1	19.8	14.1	0.0	24.1	20.8	0.0	20.9	14.5	0.0
Incr Delay (d2), s/veh	3.2	0.1	0.1	2.2	0.0	0.0	2.3	0.6	0.0	138.4	0.1	0.0
Initial Q Delay(d3),s/veh	0.0	0.0	0.0	0.0	0.0	0.0	0.0	0.0	0.0	0.0	0.0	0.0
%ile BackOfQ(50%),veh/ln	0.4	0.2	0.2	4.8	0.3	0.0	1.0	2.6	0.0	18.7	2.2	0.0
LnGrp Delay(d),s/veh	28.3	22.1	22.2	22.0	14.1	0.0	26.4	21.4	0.0	159.4	14.6	0.0
LnGrp LOS	C	C	C	C	B		C	C		F	B	
Approach Vol, veh/h		47			382			449			842	
Approach Delay, s/veh		25.0			20.8			22.1			91.8	
Approach LOS		C			C			C			F	
Timer	1	2	3	4	5	6	7	8				
Assigned Phs	1	2	3	4	5	6	7	8				
Phs Duration (G+Y+Rc), s	7.6	20.1	5.9	18.7	15.0	12.7	15.6	9.0				
Change Period (Y+Rc), s	4.5	4.5	4.5	4.5	4.5	4.5	4.5	4.5				
Max Green Setting (Gmax), s	10.5	25.5	20.5	30.5	10.5	25.5	20.5	30.5				
Max Q Clear Time (g_c+I1), s	3.9	6.6	2.7	2.6	12.5	7.3	11.2	2.4				
Green Ext Time (p_c), s	0.0	0.5	0.0	0.1	0.0	0.5	0.1	0.0				
Intersection Summary												
HCM 2010 Ctrl Delay			56.0									
HCM 2010 LOS			E									
Notes												

HCM 2010 Signalized Intersection Summary
40: Malmedy Road & Gigling Road

Cumulative with Project, PM
06/11/2019



Movement	EBL	EBT	EBR	WBL	WBT	WBR	NBL	NBT	NBR	SBL	SBT	SBR
Lane Configurations		↔			↔			↔			↔	
Traffic Volume (veh/h)	20	850	10	30	680	40	30	60	50	40	40	10
Future Volume (veh/h)	20	850	10	30	680	40	30	60	50	40	40	10
Number	7	4	14	3	8	18	5	2	12	1	6	16
Initial Q (Qb), veh	0	0	0	0	0	0	0	0	0	0	0	0
Ped-Bike Adj(A_pbT)	1.00		1.00	1.00		1.00	1.00		1.00	1.00		1.00
Parking Bus, Adj	1.00	1.00	1.00	1.00	1.00	1.00	1.00	1.00	1.00	1.00	1.00	1.00
Adj Sat Flow, veh/h/ln	1900	1863	1900	1900	1881	1900	1900	1900	1900	1900	1810	1900
Adj Flow Rate, veh/h	22	934	11	33	747	44	33	66	55	44	44	11
Adj No. of Lanes	0	2	0	0	2	0	0	1	0	0	1	0
Peak Hour Factor	0.91	0.91	0.91	0.91	0.91	0.91	0.91	0.91	0.91	0.91	0.91	0.91
Percent Heavy Veh, %	2	2	2	1	1	1	0	0	0	5	5	5
Cap, veh/h	192	1326	15	204	1186	72	260	149	111	353	156	33
Arrive On Green	0.39	0.39	0.39	0.39	0.39	0.39	0.18	0.18	0.18	0.18	0.18	0.18
Sat Flow, veh/h	33	3422	40	50	3060	185	280	811	606	573	850	178
Grp Volume(v), veh/h	503	0	464	425	0	399	154	0	0	99	0	0
Grp Sat Flow(s),veh/h/ln	1806	0	1688	1617	0	1679	1696	0	0	1601	0	0
Q Serve(g_s), s	0.1	0.0	4.9	0.2	0.0	4.0	0.6	0.0	0.0	0.0	0.0	0.0
Cycle Q Clear(g_c), s	4.8	0.0	4.9	5.1	0.0	4.0	1.7	0.0	0.0	1.0	0.0	0.0
Prop In Lane	0.04		0.02	0.08		0.11	0.21		0.36	0.44		0.11
Lane Grp Cap(c), veh/h	879	0	654	811	0	650	520	0	0	542	0	0
V/C Ratio(X)	0.57	0.00	0.71	0.52	0.00	0.61	0.30	0.00	0.00	0.18	0.00	0.00
Avail Cap(c_a), veh/h	4375	0	4062	4065	0	4040	2625	0	0	2411	0	0
HCM Platoon Ratio	1.00	1.00	1.00	1.00	1.00	1.00	1.00	1.00	1.00	1.00	1.00	1.00
Upstream Filter(I)	1.00	0.00	1.00	1.00	0.00	1.00	1.00	0.00	0.00	1.00	0.00	0.00
Uniform Delay (d), s/veh	5.4	0.0	5.4	5.1	0.0	5.2	7.7	0.0	0.0	7.4	0.0	0.0
Incr Delay (d2), s/veh	0.2	0.0	0.5	0.2	0.0	0.4	0.1	0.0	0.0	0.1	0.0	0.0
Initial Q Delay(d3),s/veh	0.0	0.0	0.0	0.0	0.0	0.0	0.0	0.0	0.0	0.0	0.0	0.0
%ile BackOfQ(50%),veh/ln	2.4	0.0	2.3	1.9	0.0	1.8	0.8	0.0	0.0	0.5	0.0	0.0
LnGrp Delay(d),s/veh	5.6	0.0	6.0	5.3	0.0	5.5	7.8	0.0	0.0	7.5	0.0	0.0
LnGrp LOS	A		A	A		A	A			A		
Approach Vol, veh/h		967			824			154			99	
Approach Delay, s/veh		5.8			5.4			7.8			7.5	
Approach LOS		A			A			A			A	
Timer	1	2	3	4	5	6	7	8				
Assigned Phs		2		4		6		8				
Phs Duration (G+Y+Rc), s		8.4		12.6		8.4		12.6				
Change Period (Y+Rc), s		4.5		4.5		4.5		4.5				
Max Green Setting (Gmax), s		30.5		50.5		30.5		50.5				
Max Q Clear Time (g_c+I1), s		3.7		6.9		3.0		7.1				
Green Ext Time (p_c), s		0.2		1.0		0.1		0.9				
Intersection Summary												
HCM 2010 Ctrl Delay				5.9								
HCM 2010 LOS				A								

HCM 2010 Signalized Intersection Summary
41: Parker Flatts Cut Off Road & Gigling Road

Cumulative with Project, PM
06/11/2019



Movement	EBL	EBT	EBR	WBL	WBT	WBR	NBL	NBT	NBR	SBL	SBT	SBR
Lane Configurations		↔			↔			↔	↔		↔	
Traffic Volume (veh/h)	10	910	30	50	650	20	90	20	100	20	20	10
Future Volume (veh/h)	10	910	30	50	650	20	90	20	100	20	20	10
Number	7	4	14	3	8	18	5	2	12	1	6	16
Initial Q (Qb), veh	0	0	0	0	0	0	0	0	0	0	0	0
Ped-Bike Adj(A_pbT)	1.00		1.00	1.00		1.00	1.00		1.00	1.00		1.00
Parking Bus, Adj	1.00	1.00	1.00	1.00	1.00	1.00	1.00	1.00	1.00	1.00	1.00	1.00
Adj Sat Flow, veh/h/ln	1900	1863	1900	1900	1881	1900	1900	1900	1900	1900	1900	1900
Adj Flow Rate, veh/h	11	1022	34	56	730	22	101	22	112	22	22	11
Adj No. of Lanes	0	2	0	0	2	0	0	1	1	0	1	0
Peak Hour Factor	0.89	0.89	0.89	0.89	0.89	0.89	0.89	0.89	0.89	0.89	0.89	0.89
Percent Heavy Veh, %	2	2	2	1	1	1	0	0	0	0	0	0
Cap, veh/h	164	1416	47	210	1217	38	506	76	311	298	173	63
Arrive On Green	0.42	0.42	0.42	0.42	0.42	0.42	0.19	0.19	0.19	0.19	0.19	0.19
Sat Flow, veh/h	12	3394	112	77	2918	92	1151	393	1611	414	896	327
Grp Volume(v), veh/h	560	0	507	401	0	407	123	0	112	55	0	0
Grp Sat Flow(s),veh/h/ln	1844	0	1675	1391	0	1695	1544	0	1611	1637	0	0
Q Serve(g_s), s	0.0	0.0	5.8	0.6	0.0	4.2	0.5	0.0	1.4	0.0	0.0	0.0
Cycle Q Clear(g_c), s	5.8	0.0	5.8	6.5	0.0	4.2	1.4	0.0	1.4	0.6	0.0	0.0
Prop In Lane	0.02		0.07	0.14		0.05	0.82		1.00	0.40		0.20
Lane Grp Cap(c), veh/h	928	0	699	758	0	707	582	0	311	534	0	0
V/C Ratio(X)	0.60	0.00	0.73	0.53	0.00	0.58	0.21	0.00	0.36	0.10	0.00	0.00
Avail Cap(c_a), veh/h	4123	0	3664	3226	0	3709	2234	0	2128	2273	0	0
HCM Platoon Ratio	1.00	1.00	1.00	1.00	1.00	1.00	1.00	1.00	1.00	1.00	1.00	1.00
Upstream Filter(I)	1.00	0.00	1.00	1.00	0.00	1.00	1.00	0.00	1.00	1.00	0.00	0.00
Uniform Delay (d), s/veh	5.6	0.0	5.6	5.1	0.0	5.2	8.1	0.0	8.1	7.8	0.0	0.0
Incr Delay (d2), s/veh	0.2	0.0	0.5	0.2	0.0	0.3	0.1	0.0	0.3	0.0	0.0	0.0
Initial Q Delay(d3),s/veh	0.0	0.0	0.0	0.0	0.0	0.0	0.0	0.0	0.0	0.0	0.0	0.0
%ile BackOfQ(50%),veh/ln	2.9	0.0	2.6	1.8	0.0	2.0	0.7	0.0	0.6	0.3	0.0	0.0
LnGrp Delay(d),s/veh	5.8	0.0	6.2	5.3	0.0	5.4	8.1	0.0	8.3	7.8	0.0	0.0
LnGrp LOS	A		A	A		A	A		A	A		
Approach Vol, veh/h		1067			808			235			55	
Approach Delay, s/veh		6.0			5.4			8.2			7.8	
Approach LOS		A			A			A			A	
Timer	1	2	3	4	5	6	7	8				
Assigned Phs		2		4		6		8				
Phs Duration (G+Y+Rc), s		9.0		14.1		9.0		14.1				
Change Period (Y+Rc), s		4.5		4.5		4.5		4.5				
Max Green Setting (Gmax), s		30.5		50.5		30.5		50.5				
Max Q Clear Time (g_c+I1), s		3.4		7.8		2.6		8.5				
Green Ext Time (p_c), s		0.1		1.1		0.0		1.0				
Intersection Summary												
HCM 2010 Ctrl Delay				6.0								
HCM 2010 LOS				A								

HCM 2010 Signalized Intersection Summary
42: 6th Avenue & Gigling Road

Cumulative with Project, PM
06/11/2019



Movement	EBL	EBT	EBR	WBL	WBT	WBR	NBL	NBT	NBR	SBL	SBT	SBR
Lane Configurations		↔			↔			↕	↗		↕	
Traffic Volume (veh/h)	310	710	10	10	440	10	10	10	20	10	10	280
Future Volume (veh/h)	310	710	10	10	440	10	10	10	20	10	10	280
Number	7	4	14	3	8	18	5	2	12	1	6	16
Initial Q (Qb), veh	0	0	0	0	0	0	0	0	0	0	0	0
Ped-Bike Adj(A_pbT)	1.00		1.00	1.00		1.00	1.00		1.00	1.00		1.00
Parking Bus, Adj	1.00	1.00	1.00	1.00	1.00	1.00	1.00	1.00	1.00	1.00	1.00	1.00
Adj Sat Flow, veh/h/ln	1900	1881	1900	1900	1863	1900	1900	1900	1900	1900	1900	1900
Adj Flow Rate, veh/h	326	747	11	11	463	11	11	11	0	11	11	295
Adj No. of Lanes	0	2	0	0	2	0	0	1	1	0	1	0
Peak Hour Factor	0.95	0.95	0.95	0.95	0.95	0.95	0.95	0.95	0.95	0.95	0.95	0.95
Percent Heavy Veh, %	1	1	1	2	2	2	0	0	0	0	0	0
Cap, veh/h	503	1073	16	102	1839	43	274	232	391	96	22	366
Arrive On Green	0.54	0.54	0.54	0.54	0.54	0.54	0.24	0.24	0.00	0.24	0.24	0.24
Sat Flow, veh/h	657	1990	31	20	3410	80	588	958	1615	23	90	1511
Grp Volume(v), veh/h	469	0	615	253	0	232	22	0	0	317	0	0
Grp Sat Flow(s),veh/h/ln	971	0	1706	1829	0	1681	1546	0	1615	1624	0	0
Q Serve(g_s), s	15.6	0.0	10.7	0.0	0.0	3.0	0.0	0.0	0.0	1.7	0.0	0.0
Cycle Q Clear(g_c), s	18.6	0.0	10.7	3.0	0.0	3.0	0.4	0.0	0.0	7.6	0.0	0.0
Prop In Lane	0.70		0.02	0.04		0.05	0.50		1.00	0.03		0.93
Lane Grp Cap(c), veh/h	672	0	920	1078	0	907	505	0	391	483	0	0
V/C Ratio(X)	0.70	0.00	0.67	0.24	0.00	0.26	0.04	0.00	0.00	0.66	0.00	0.00
Avail Cap(c_a), veh/h	1424	0	2093	2273	0	2062	1196	0	1196	1289	0	0
HCM Platoon Ratio	1.00	1.00	1.00	1.00	1.00	1.00	1.00	1.00	1.00	1.00	1.00	1.00
Upstream Filter(I)	1.00	0.00	1.00	1.00	0.00	1.00	1.00	0.00	0.00	1.00	0.00	0.00
Uniform Delay (d), s/veh	9.7	0.0	6.8	5.1	0.0	5.1	12.0	0.0	0.0	14.7	0.0	0.0
Incr Delay (d2), s/veh	0.5	0.0	0.3	0.0	0.0	0.1	0.0	0.0	0.0	0.6	0.0	0.0
Initial Q Delay(d3),s/veh	0.0	0.0	0.0	0.0	0.0	0.0	0.0	0.0	0.0	0.0	0.0	0.0
%ile BackOfQ(50%),veh/ln#	4.8	0.0	5.0	1.5	0.0	1.4	0.2	0.0	0.0	3.4	0.0	0.0
LnGrp Delay(d),s/veh	10.2	0.0	7.1	5.1	0.0	5.1	12.0	0.0	0.0	15.2	0.0	0.0
LnGrp LOS	B		A	A		A	B			B		
Approach Vol, veh/h		1084			485			22			317	
Approach Delay, s/veh		8.5			5.1			12.0			15.2	
Approach LOS		A			A			B			B	
Timer	1	2	3	4	5	6	7	8				
Assigned Phs		2		4		6		8				
Phs Duration (G+Y+Rc), s		14.5		26.7		14.5		26.7				
Change Period (Y+Rc), s		4.5		4.5		4.5		4.5				
Max Green Setting (Gmax), s		30.5		50.5		30.5		50.5				
Max Q Clear Time (g_c+I1), s		2.4		20.6		9.6		5.0				
Green Ext Time (p_c), s		0.0		1.6		0.5		0.4				
Intersection Summary												
HCM 2010 Ctrl Delay				8.8								
HCM 2010 LOS				A								

HCM 2010 Signalized Intersection Summary
43: Gigling Road & 7th Avenue

Cumulative with Project, PM
06/11/2019

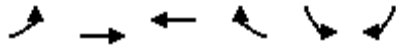

Movement	EBL	EBT	WBT	WBR	SBL	SBR		
Lane Configurations		↑↑	↑↑		↘			
Traffic Volume (veh/h)	290	450	390	10	10	70		
Future Volume (veh/h)	290	450	390	10	10	70		
Number	7	4	8	18	1	16		
Initial Q (Qb), veh	0	0	0	0	0	0		
Ped-Bike Adj(A_pbT)	1.00			1.00	1.00	1.00		
Parking Bus, Adj	1.00	1.00	1.00	1.00	1.00	1.00		
Adj Sat Flow, veh/h/ln	1900	1863	1881	1900	1827	1900		
Adj Flow Rate, veh/h	302	469	406	10	10	73		
Adj No. of Lanes	0	2	2	0	0	0		
Peak Hour Factor	0.96	0.96	0.96	0.96	0.96	0.96		
Percent Heavy Veh, %	2	2	1	1	0	0		
Cap, veh/h	648	915	1693	42	18	130		
Arrive On Green	0.47	0.47	0.47	0.47	0.10	0.10		
Sat Flow, veh/h	721	2012	3659	88	187	1368		
Grp Volume(v), veh/h	389	382	203	213	84	0		
Grp Sat Flow(s),veh/h/ln	1037	1610	1787	1866	1574	0		
Q Serve(g_s), s	5.4	3.4	1.4	1.4	1.1	0.0		
Cycle Q Clear(g_c), s	6.8	3.4	1.4	1.4	1.1	0.0		
Prop In Lane	0.78			0.05	0.12	0.87		
Lane Grp Cap(c), veh/h	798	765	849	886	150	0		
V/C Ratio(X)	0.49	0.50	0.24	0.24	0.56	0.00		
Avail Cap(c_a), veh/h	3156	4270	4739	4947	1918	0		
HCM Platoon Ratio	1.00	1.00	1.00	1.00	1.00	1.00		
Upstream Filter(I)	1.00	1.00	1.00	1.00	1.00	0.00		
Uniform Delay (d), s/veh	4.8	3.8	3.3	3.3	9.1	0.0		
Incr Delay (d2), s/veh	0.2	0.2	0.1	0.1	1.2	0.0		
Initial Q Delay(d3),s/veh	0.0	0.0	0.0	0.0	0.0	0.0		
%ile BackOfQ(50%),veh/ln	1.9	1.5	0.7	0.7	0.5	0.0		
LnGrp Delay(d),s/veh	4.9	4.0	3.3	3.3	10.3	0.0		
LnGrp LOS	A	A	A	A	B			
Approach Vol, veh/h		771	416		84			
Approach Delay, s/veh		4.5	3.3		10.3			
Approach LOS		A	A		B			
Timer	1	2	3	4	5	6	7	8
Assigned Phs				4		6		8
Phs Duration (G+Y+Rc), s				14.4		6.5		14.4
Change Period (Y+Rc), s				4.5		4.5		4.5
Max Green Setting (Gmax), s				55.5		25.5		55.5
Max Q Clear Time (g_c+I1), s				8.8		3.1		3.4
Green Ext Time (p_c), s				1.1		0.0		0.4
Intersection Summary								
HCM 2010 Ctrl Delay				4.5				
HCM 2010 LOS				A				
Notes								

HCM 2010 Signalized Intersection Summary
44: 8th Avenue & Gigling Road

Cumulative with Project, PM
06/11/2019



Movement	EBL	EBT	EBR	WBL	WBT	WBR	NBL	NBT	NBR	SBL	SBT	SBR
Lane Configurations		↔			↔			↔			↔	
Traffic Volume (veh/h)	450	10	10	10	10	10	10	10	10	10	10	380
Future Volume (veh/h)	450	10	10	10	10	10	10	10	10	10	10	380
Number	7	4	14	3	8	18	5	2	12	1	6	16
Initial Q (Qb), veh	0	0	0	0	0	0	0	0	0	0	0	0
Ped-Bike Adj(A_pbT)	1.00		1.00	1.00		1.00	1.00		1.00	1.00		1.00
Parking Bus, Adj	1.00	1.00	1.00	1.00	1.00	1.00	1.00	1.00	1.00	1.00	1.00	1.00
Adj Sat Flow, veh/h/ln	1900	1863	1900	1900	1863	1900	1900	1900	1900	1900	1881	1900
Adj Flow Rate, veh/h	495	11	11	11	11	11	11	11	11	11	11	418
Adj No. of Lanes	0	2	0	0	2	0	0	1	0	0	1	0
Peak Hour Factor	0.91	0.91	0.91	0.91	0.91	0.91	0.91	0.91	0.91	0.91	0.91	0.91
Percent Heavy Veh, %	2	2	2	2	2	2	0	0	0	1	1	1
Cap, veh/h	770	320	320	514	456	460	256	241	179	112	21	498
Arrive On Green	0.41	0.41	0.41	0.41	0.41	0.41	0.33	0.33	0.33	0.33	0.33	0.33
Sat Flow, veh/h	1360	777	777	840	1107	1115	357	739	548	15	66	1526
Grp Volume(v), veh/h	495	0	22	18	0	15	33	0	0	440	0	0
Grp Sat Flow(s),veh/h/ln	1360	0	1555	1568	0	1493	1644	0	0	1607	0	0
Q Serve(g_s), s	11.4	0.0	0.3	0.0	0.0	0.2	0.0	0.0	0.0	1.6	0.0	0.0
Cycle Q Clear(g_c), s	11.6	0.0	0.3	0.2	0.0	0.2	0.4	0.0	0.0	8.7	0.0	0.0
Prop In Lane	1.00		0.50	0.60		0.75	0.33		0.33	0.02		0.95
Lane Grp Cap(c), veh/h	770	0	641	814	0	616	676	0	0	632	0	0
V/C Ratio(X)	0.64	0.00	0.03	0.02	0.00	0.02	0.05	0.00	0.00	0.70	0.00	0.00
Avail Cap(c_a), veh/h	2024	0	2055	2213	0	1974	1650	0	0	1759	0	0
HCM Platoon Ratio	1.00	1.00	1.00	1.00	1.00	1.00	1.00	1.00	1.00	1.00	1.00	1.00
Upstream Filter(I)	1.00	0.00	1.00	1.00	0.00	1.00	1.00	0.00	0.00	1.00	0.00	0.00
Uniform Delay (d), s/veh	9.5	0.0	6.0	6.0	0.0	6.0	8.0	0.0	0.0	10.7	0.0	0.0
Incr Delay (d2), s/veh	0.3	0.0	0.0	0.0	0.0	0.0	0.0	0.0	0.0	0.5	0.0	0.0
Initial Q Delay(d3),s/veh	0.0	0.0	0.0	0.0	0.0	0.0	0.0	0.0	0.0	0.0	0.0	0.0
%ile BackOfQ(50%),veh/ln	4.3	0.0	0.1	0.1	0.0	0.1	0.2	0.0	0.0	3.9	0.0	0.0
LnGrp Delay(d),s/veh	9.8	0.0	6.0	6.0	0.0	6.0	8.0	0.0	0.0	11.3	0.0	0.0
LnGrp LOS	A		A	A		A	A			B		
Approach Vol, veh/h		517			33			33			440	
Approach Delay, s/veh		9.6			6.0			8.0			11.3	
Approach LOS		A			A			A			B	
Timer	1	2	3	4	5	6	7	8				
Assigned Phs		2		4		6		8				
Phs Duration (G+Y+Rc), s		15.7		18.7		15.7		18.7				
Change Period (Y+Rc), s		4.5		4.5		4.5		4.5				
Max Green Setting (Gmax), s		35.5		45.5		35.5		45.5				
Max Q Clear Time (g_c+I1), s		2.4		13.6		10.7		2.2				
Green Ext Time (p_c), s		0.0		0.5		0.6		0.0				
Intersection Summary												
HCM 2010 Ctrl Delay				10.2								
HCM 2010 LOS				B								

HCM 2010 Signalized Intersection Summary
 46: General Jim Moore Boulevard & Normandy Road

Cumulative with Project, PM
 06/11/2019



Movement	EBL	EBT	EBR	WBL	WBT	WBR	NBL	NBT	NBR	SBL	SBT	SBR
Lane Configurations		↕			↕		↕	↕↕		↕	↕↕	↕
Traffic Volume (veh/h)	150	30	100	50	30	10	90	860	70	30	570	80
Future Volume (veh/h)	150	30	100	50	30	10	90	860	70	30	570	80
Number	3	8	18	7	4	14	1	6	16	5	2	12
Initial Q (Qb), veh	0	0	0	0	0	0	0	0	0	0	0	0
Ped-Bike Adj(A_pbT)	1.00		1.00	1.00		1.00	1.00		1.00	1.00		1.00
Parking Bus, Adj	1.00	1.00	1.00	1.00	1.00	1.00	1.00	1.00	1.00	1.00	1.00	1.00
Adj Sat Flow, veh/h/ln	1900	1863	1900	1900	1881	1900	1881	1881	1900	1900	1900	1900
Adj Flow Rate, veh/h	163	33	84	54	33	8	98	935	53	33	620	28
Adj No. of Lanes	0	1	0	0	1	0	1	2	0	1	2	1
Peak Hour Factor	0.92	0.92	0.92	0.92	0.92	0.92	0.92	0.92	0.92	0.92	0.92	0.92
Percent Heavy Veh, %	2	2	2	1	1	1	1	1	1	0	0	0
Cap, veh/h	355	59	106	343	182	33	241	1154	65	71	869	388
Arrive On Green	0.23	0.23	0.23	0.23	0.23	0.23	0.13	0.34	0.34	0.04	0.24	0.24
Sat Flow, veh/h	814	252	457	771	782	143	1792	3439	195	1810	3610	1612
Grp Volume(v), veh/h	280	0	0	95	0	0	98	486	502	33	620	28
Grp Sat Flow(s),veh/h/ln	1523	0	0	1696	0	0	1792	1787	1846	1810	1805	1612
Q Serve(g_s), s	4.4	0.0	0.0	0.0	0.0	0.0	1.7	8.5	8.5	0.6	5.4	0.5
Cycle Q Clear(g_c), s	5.8	0.0	0.0	1.4	0.0	0.0	1.7	8.5	8.5	0.6	5.4	0.5
Prop In Lane	0.58		0.30	0.57		0.08	1.00		0.11	1.00		1.00
Lane Grp Cap(c), veh/h	519	0	0	558	0	0	241	600	620	71	869	388
V/C Ratio(X)	0.54	0.00	0.00	0.17	0.00	0.00	0.41	0.81	0.81	0.46	0.71	0.07
Avail Cap(c_a), veh/h	1585	0	0	1625	0	0	417	1325	1369	421	2677	1195
HCM Platoon Ratio	1.00	1.00	1.00	1.00	1.00	1.00	1.00	1.00	1.00	1.00	1.00	1.00
Upstream Filter(I)	1.00	0.00	0.00	1.00	0.00	0.00	1.00	1.00	1.00	1.00	1.00	1.00
Uniform Delay (d), s/veh	12.3	0.0	0.0	10.7	0.0	0.0	13.6	10.4	10.4	16.2	12.0	10.1
Incr Delay (d2), s/veh	0.3	0.0	0.0	0.1	0.0	0.0	0.4	1.0	1.0	1.7	0.4	0.0
Initial Q Delay(d3),s/veh	0.0	0.0	0.0	0.0	0.0	0.0	0.0	0.0	0.0	0.0	0.0	0.0
%ile BackOfQ(50%),veh/ln	2.5	0.0	0.0	0.7	0.0	0.0	0.9	4.4	4.5	0.3	2.7	0.2
LnGrp Delay(d),s/veh	12.6	0.0	0.0	10.7	0.0	0.0	14.0	11.4	11.4	17.9	12.4	10.1
LnGrp LOS	B			B			B	B	B	B	B	B
Approach Vol, veh/h		280			95			1086			681	
Approach Delay, s/veh		12.6			10.7			11.7			12.6	
Approach LOS		B			B			B			B	
Timer	1	2	3	4	5	6	7	8				
Assigned Phs	1	2		4	5	6		8				
Phs Duration (G+Y+Rc), s	9.1	12.8		12.5	5.9	16.0		12.5				
Change Period (Y+Rc), s	4.5	4.5		4.5	4.5	4.5		4.5				
Max Green Setting (Gmax), s	25.5	25.5		33.0	8.0	25.5		33.0				
Max Q Clear Time (g_c+1), s	7.4	7.4		3.4	2.6	10.5		7.8				
Green Ext Time (p_c), s	0.0	0.8		0.1	0.0	0.9		0.4				
Intersection Summary												
HCM 2010 Ctrl Delay				12.0								
HCM 2010 LOS				B								

Intersection	
Intersection Delay, s/veh	35.2
Intersection LOS	E

Movement	EBL	EBR	NBL	NBT	SBT	SBR
Lane Configurations						
Traffic Vol, veh/h	60	100	150	980	440	50
Future Vol, veh/h	60	100	150	980	440	50
Peak Hour Factor	0.89	0.89	0.89	0.89	0.89	0.89
Heavy Vehicles, %	1	1	1	1	1	1
Mvmt Flow	67	112	169	1101	494	56
Number of Lanes	1	1	1	2	2	1

Approach	EB	NB	SB
Opposing Approach		SB	NB
Opposing Lanes	0	3	3
Conflicting Approach Left	SB		
Conflicting Lanes Left	3	2	0
Conflicting Approach Right	NB		EB
Conflicting Lanes Right	3	0	2
HCM Control Delay	14.1	45.8	17.7
HCM LOS	B	E	C

Lane	NBLn1	NBLn2	NBLn3	EBLn1	EBLn2	SBLn1	SBLn2	SBLn3
Vol Left, %	100%	0%	0%	100%	0%	0%	0%	0%
Vol Thru, %	0%	100%	100%	0%	0%	100%	100%	0%
Vol Right, %	0%	0%	0%	0%	100%	0%	0%	100%
Sign Control	Stop	Stop	Stop	Stop	Stop	Stop	Stop	Stop
Traffic Vol by Lane	150	490	490	60	100	220	220	50
LT Vol	150	0	0	60	0	0	0	0
Through Vol	0	490	490	0	0	220	220	0
RT Vol	0	0	0	0	100	0	0	50
Lane Flow Rate	169	551	551	67	112	247	247	56
Geometry Grp	8	8	8	8	8	8	8	8
Degree of Util (X)	0.344	1.047	0.781	0.175	0.257	0.524	0.524	0.081
Departure Headway (Hd)	7.356	6.849	5.106	9.561	8.345	7.809	7.809	5.351
Convergence, Y/N	Yes	Yes	Yes	Yes	Yes	Yes	Yes	Yes
Cap	492	534	710	378	433	465	465	674
Service Time	5.064	4.557	2.814	7.261	6.045	5.509	5.509	3.051
HCM Lane V/C Ratio	0.343	1.032	0.776	0.177	0.259	0.531	0.531	0.083
HCM Control Delay	13.9	77.9	23.5	14.3	13.9	18.8	18.8	8.5
HCM Lane LOS	B	F	C	B	B	C	C	A
HCM 95th-tile Q	1.5	16	7.7	0.6	1	3	3	0.3



Movement	EBL	EBT	EBR	WBL	WBT	WBR	NBL	NBT	NBR	SBL	SBT	SBR
Lane Configurations												
Traffic Volume (veh/h)	230	170	70	90	100	70	110	1200	230	100	690	220
Future Volume (veh/h)	230	170	70	90	100	70	110	1200	230	100	690	220
Number	7	4	14	3	8	18	5	2	12	1	6	16
Initial Q (Qb), veh	0	0	0	0	0	0	0	0	0	0	0	0
Ped-Bike Adj(A_pbT)	1.00		0.98	1.00		0.99	1.00		0.99	1.00		0.99
Parking Bus, Adj	1.00	1.00	1.00	1.00	1.00	1.00	1.00	1.00	1.00	1.00	1.00	1.00
Adj Sat Flow, veh/h/ln	1881	1881	1881	1900	1900	1900	1881	1881	1900	1863	1863	1863
Adj Flow Rate, veh/h	206	218	25	93	103	66	113	1237	225	103	711	155
Adj No. of Lanes	1	1	1	0	1	0	1	2	0	1	2	1
Peak Hour Factor	0.97	0.97	0.97	0.97	0.97	0.97	0.97	0.97	0.97	0.97	0.97	0.97
Percent Heavy Veh, %	1	1	1	0	0	0	1	1	1	2	2	2
Cap, veh/h	272	285	237	105	117	75	590	1379	249	127	671	297
Arrive On Green	0.15	0.15	0.15	0.17	0.17	0.17	0.33	0.46	0.46	0.07	0.19	0.19
Sat Flow, veh/h	1792	1881	1565	634	702	450	1792	3022	545	1774	3539	1568
Grp Volume(v), veh/h	206	218	25	262	0	0	113	727	735	103	711	155
Grp Sat Flow(s),veh/h/ln	1792	1881	1565	1785	0	0	1792	1787	1781	1774	1770	1568
Q Serve(g_s), s	13.8	13.9	1.7	17.9	0.0	0.0	5.6	46.7	47.7	7.2	23.7	11.1
Cycle Q Clear(g_c), s	13.8	13.9	1.7	17.9	0.0	0.0	5.6	46.7	47.7	7.2	23.7	11.1
Prop In Lane	1.00		1.00	0.35		0.25	1.00		0.31	1.00		1.00
Lane Grp Cap(c), veh/h	272	285	237	297	0	0	590	815	812	127	671	297
V/C Ratio(X)	0.76	0.76	0.11	0.88	0.00	0.00	0.19	0.89	0.90	0.81	1.06	0.52
Avail Cap(c_a), veh/h	573	602	501	357	0	0	590	815	812	241	671	297
HCM Platoon Ratio	1.00	1.00	1.00	1.00	1.00	1.00	1.00	1.00	1.00	1.00	1.00	1.00
Upstream Filter(I)	0.69	0.69	0.69	1.00	0.00	0.00	1.00	1.00	1.00	1.00	1.00	1.00
Uniform Delay (d), s/veh	50.8	50.9	45.7	50.9	0.0	0.0	30.0	31.2	31.5	57.2	50.7	45.5
Incr Delay (d2), s/veh	3.0	3.0	0.1	20.8	0.0	0.0	0.1	14.2	15.4	4.6	51.6	6.4
Initial Q Delay(d3),s/veh	0.0	0.0	0.0	0.0	0.0	0.0	0.0	0.0	0.0	0.0	0.0	0.0
%ile BackOfQ(50%),veh/ln	7.0	7.4	0.8	10.6	0.0	0.0	2.8	26.0	27.0	3.7	16.4	5.4
LnGrp Delay(d),s/veh	53.9	53.9	45.9	71.7	0.0	0.0	30.1	45.3	46.9	61.8	102.2	51.9
LnGrp LOS	D	D	D	E			C	D	D	E	F	D
Approach Vol, veh/h		449			262			1575			969	
Approach Delay, s/veh		53.4			71.7			45.0			89.9	
Approach LOS		D			E			D			F	
Timer	1	2	3	4	5	6	7	8				
Assigned Phs	1	2		4	5	6		8				
Phs Duration (G+Y+Rc), s	3.2	62.3		23.6	46.5	29.0		25.9				
Change Period (Y+Rc), s	4.2	5.3		* 4.7	5.3	* 5.3		5.1				
Max Green Setting (Gmax), s	13	23.7		* 40	17.0	* 24		25.0				
Max Q Clear Time (g_c+19), s	19.2	49.7		15.9	7.6	25.7		19.9				
Green Ext Time (p_c), s	0.1	0.0		1.9	0.1	0.0		0.8				
Intersection Summary												
HCM 2010 Ctrl Delay				61.7								
HCM 2010 LOS				E								
Notes												

HCM 2010 Signalized Intersection Summary
 49: Highway 1 SB On-Ramp & Highway 1 NB Off-Ramp/Monterey Road

Cumulative with Project, PM
 06/11/2019



Movement	EBL	EBT	EBR	WBL	WBT	WBR	NBL	NBT	NBR	SBL	SBT	SBR
Lane Configurations		↕↕	↗	↖		↗		↕	↗		↕	
Traffic Volume (veh/h)	10	150	120	280	0	130	0	120	300	10	10	0
Future Volume (veh/h)	10	150	120	280	0	130	0	120	300	10	10	0
Number	1	6	16	5	2	12	7	4	14	3	8	18
Initial Q (Qb), veh	0	0	0	0	0	0	0	0	0	0	0	0
Ped-Bike Adj(A_pbT)	1.00		1.00	1.00		1.00	1.00		1.00	1.00		1.00
Parking Bus, Adj	1.00	1.00	1.00	1.00	1.00	1.00	1.00	1.00	1.00	1.00	1.00	1.00
Adj Sat Flow, veh/h/ln	1900	1863	1863	1900	0	1900	0	1881	1881	1900	1900	0
Adj Flow Rate, veh/h	11	165	14	308	0	69	0	132	51	11	11	0
Adj No. of Lanes	0	2	1	1	0	1	0	1	1	0	1	0
Peak Hour Factor	0.91	0.91	0.91	0.91	0.91	0.91	0.91	0.91	0.91	0.91	0.91	0.91
Percent Heavy Veh, %	2	2	2	0	0	0	0	1	1	0	0	0
Cap, veh/h	181	2850	1323	0	0	0	0	164	139	57	43	0
Arrive On Green	0.84	0.84	0.84	0.00	0.00	0.00	0.00	0.09	0.09	0.09	0.09	0.00
Sat Flow, veh/h	216	3406	1580				0	1881	1599	155	496	0
Grp Volume(v), veh/h	94	82	14		0.0		0	132	51	22	0	0
Grp Sat Flow(s),veh/h/ln	182	1770	1580				0	1881	1599	651	0	0
Q Serve(g_s), s	1.1	1.0	0.2				0.0	8.6	3.8	0.1	0.0	0.0
Cycle Q Clear(g_c), s	1.1	1.0	0.2				0.0	8.6	3.8	8.7	0.0	0.0
Prop In Lane	0.12		1.00				0.00		1.00	0.50		0.00
Lane Grp Cap(c), veh/h	1550	1481	1323				0	164	139	100	0	0
V/C Ratio(X)	0.06	0.06	0.01				0.00	0.81	0.37	0.22	0.00	0.00
Avail Cap(c_a), veh/h	1550	1481	1323				0	271	230	125	0	0
HCM Platoon Ratio	1.00	1.00	1.00				1.00	1.00	1.00	1.00	1.00	1.00
Upstream Filter(I)	1.00	1.00	1.00				0.00	1.00	1.00	1.00	0.00	0.00
Uniform Delay (d), s/veh	1.8	1.7	1.7				0.0	56.0	53.8	52.9	0.0	0.0
Incr Delay (d2), s/veh	0.0	0.0	0.0				0.0	3.5	0.6	0.4	0.0	0.0
Initial Q Delay(d3),s/veh	0.0	0.0	0.0				0.0	0.0	0.0	0.0	0.0	0.0
%ile BackOfQ(50%),veh/ln	0.6	0.5	0.1				0.0	4.6	1.7	0.7	0.0	0.0
LnGrp Delay(d),s/veh	1.8	1.7	1.7				0.0	59.5	54.4	53.3	0.0	0.0
LnGrp LOS	A	A	A					E	D	D		
Approach Vol, veh/h		190						183			22	
Approach Delay, s/veh		1.7						58.1			53.3	
Approach LOS		A						E			D	
Timer	1	2	3	4	5	6	7	8				
Assigned Phs				4		6		8				
Phs Duration (G+Y+Rc), s				15.1		109.9		15.1				
Change Period (Y+Rc), s				* 4.2		5.3		* 4.2				
Max Green Setting (Gmax), s				* 18		21.0		* 13				
Max Q Clear Time (g_c+I1), s				10.6		3.1		10.7				
Green Ext Time (p_c), s				0.3		0.6		0.0				
Intersection Summary												
HCM 2010 Ctrl Delay			30.7									
HCM 2010 LOS			C									
Notes												

HCM 2010 Signalized Intersection Summary
 50: Reservation Road & SR 68 WB On Ramp/SR 68 WB Off Ramp

Cumulative with Project, PM
 06/11/2019























Movement	EBL	EBT	EBR	WBL	WBT	WBR	NBL	NBT	NBR	SBL	SBT	SBR
Lane Configurations					↕	↕	↕	↑			↕	
Traffic Volume (veh/h)	0	0	0	410	10	250	140	250	0	0	520	180
Future Volume (veh/h)	0	0	0	410	10	250	140	250	0	0	520	180
Number				7	4	14	1	6	16	5	2	12
Initial Q (Qb), veh				0	0	0	0	0	0	0	0	0
Ped-Bike Adj(A_pbT)				1.00		1.00	1.00		1.00	1.00		1.00
Parking Bus, Adj				1.00	1.00	1.00	1.00	1.00	1.00	1.00	1.00	1.00
Adj Sat Flow, veh/h/ln				1900	1863	1863	1845	1845	0	0	1827	1900
Adj Flow Rate, veh/h				436	11	84	149	266	0	0	553	181
Adj No. of Lanes				0	1	1	1	1	0	0	1	0
Peak Hour Factor				0.94	0.94	0.94	0.94	0.94	0.94	0.94	0.94	0.94
Percent Heavy Veh, %				2	2	2	3	3	0	0	4	4
Cap, veh/h				485	12	443	185	1091	0	0	587	192
Arrive On Green				0.28	0.28	0.28	0.03	0.20	0.00	0.00	0.45	0.45
Sat Flow, veh/h				1732	44	1581	1757	1845	0	0	1319	432
Grp Volume(v), veh/h				447	0	84	149	266	0	0	0	734
Grp Sat Flow(s),veh/h/ln				1776	0	1581	1757	1845	0	0	0	1751
Q Serve(g_s), s				20.6	0.0	3.4	7.2	10.4	0.0	0.0	0.0	34.0
Cycle Q Clear(g_c), s				20.6	0.0	3.4	7.2	10.4	0.0	0.0	0.0	34.0
Prop In Lane				0.98		1.00	1.00		0.00	0.00		0.25
Lane Grp Cap(c), veh/h				498	0	443	185	1091	0	0	0	780
V/C Ratio(X)				0.90	0.00	0.19	0.81	0.24	0.00	0.00	0.00	0.94
Avail Cap(c_a), veh/h				564	0	502	248	1091	0	0	0	780
HCM Platoon Ratio				1.00	1.00	1.00	0.33	0.33	1.00	1.00	1.00	1.00
Upstream Filter(I)				1.00	0.00	1.00	0.95	0.95	0.00	0.00	0.00	1.00
Uniform Delay (d), s/veh				29.4	0.0	23.3	40.2	18.1	0.0	0.0	0.0	22.5
Incr Delay (d2), s/veh				15.9	0.0	0.2	9.3	0.5	0.0	0.0	0.0	20.8
Initial Q Delay(d3),s/veh				0.0	0.0	0.0	0.0	0.0	0.0	0.0	0.0	0.0
%ile BackOfQ(50%),veh/ln				12.3	0.0	1.5	4.0	5.5	0.0	0.0	0.0	20.8
LnGrp Delay(d),s/veh				45.4	0.0	23.5	49.5	18.6	0.0	0.0	0.0	43.3
LnGrp LOS				D		C	D	B				D
Approach Vol, veh/h					531			415			734	
Approach Delay, s/veh					41.9			29.7			43.3	
Approach LOS					D			C			D	
Timer	1	2	3	4	5	6	7	8				
Assigned Phs	1	2		4		6						
Phs Duration (G+Y+Rc), s	2.4	43.8		28.7		56.3						
Change Period (Y+Rc), s	3.5	6.0		4.9		6.0						
Max Green Setting (Gmax), s	2.0	31.6		27.0		47.1						
Max Q Clear Time (g_c+19.2), s	19.2	36.0		22.6		12.4						
Green Ext Time (p_c), s	0.0	0.0		1.2		1.3						
Intersection Summary												
HCM 2010 Ctrl Delay				39.5								
HCM 2010 LOS				D								



Movement	EBL	EBT	EBR	WBL	WBT	WBR	NBL	NBT	NBR	SBL	SBT	SBR
Lane Configurations		↕	↗					↑	↗	↖	↑	
Traffic Volume (veh/h)	110	10	190	0	0	0	0	300	320	260	670	0
Future Volume (veh/h)	110	10	190	0	0	0	0	300	320	260	670	0
Number	3	8	18				1	6	16	5	2	12
Initial Q (Qb), veh	0	0	0				0	0	0	0	0	0
Ped-Bike Adj(A_pbT)	1.00		1.00				1.00		1.00	1.00		1.00
Parking Bus, Adj	1.00	1.00	1.00				1.00	1.00	1.00	1.00	1.00	1.00
Adj Sat Flow, veh/h/ln	1900	1863	1863				0	1845	1845	1827	1827	0
Adj Flow Rate, veh/h	117	11	23				0	319	201	277	713	0
Adj No. of Lanes	0	1	1				0	1	1	1	1	0
Peak Hour Factor	0.94	0.94	0.94				0.94	0.94	0.94	0.94	0.94	0.94
Percent Heavy Veh, %	2	2	2				0	3	3	4	4	0
Cap, veh/h	159	15	155				0	1022	869	307	1414	0
Arrive On Green	0.10	0.10	0.10				0.00	0.55	0.55	0.35	1.00	0.00
Sat Flow, veh/h	1628	153	1583				0	1845	1568	1740	1827	0
Grp Volume(v), veh/h	128	0	23				0	319	201	277	713	0
Grp Sat Flow(s),veh/h/ln	1781	0	1583				0	1845	1568	1740	1827	0
Q Serve(g_s), s	5.9	0.0	1.1				0.0	7.9	5.6	12.8	0.0	0.0
Cycle Q Clear(g_c), s	5.9	0.0	1.1				0.0	7.9	5.6	12.8	0.0	0.0
Prop In Lane	0.91		1.00				0.00		1.00	1.00		0.00
Lane Grp Cap(c), veh/h	174	0	155				0	1022	869	307	1414	0
V/C Ratio(X)	0.74	0.00	0.15				0.00	0.31	0.23	0.90	0.50	0.00
Avail Cap(c_a), veh/h	524	0	466				0	1022	869	348	1414	0
HCM Platoon Ratio	1.00	1.00	1.00				1.00	1.00	1.00	2.00	2.00	1.00
Upstream Filter(I)	1.00	0.00	1.00				0.00	1.00	1.00	0.10	0.10	0.00
Uniform Delay (d), s/veh	37.3	0.0	35.1				0.0	10.2	9.7	26.8	0.0	0.0
Incr Delay (d2), s/veh	5.9	0.0	0.4				0.0	0.8	0.6	3.4	0.1	0.0
Initial Q Delay(d3),s/veh	0.0	0.0	0.0				0.0	0.0	0.0	0.0	0.0	0.0
%ile BackOfQ(50%),veh/ln	3.2	0.0	0.5				0.0	4.2	2.6	6.4	0.1	0.0
LnGrp Delay(d),s/veh	43.2	0.0	35.5				0.0	11.0	10.3	30.2	0.1	0.0
LnGrp LOS	D		D					B	B	C	A	
Approach Vol, veh/h		151						520			990	
Approach Delay, s/veh		42.0						10.7			8.5	
Approach LOS		D						B			A	
Timer	1	2	3	4	5	6	7	8				
Assigned Phs		2			5	6		8				
Phs Duration (G+Y+Rc), s		71.8			18.7	53.1		13.2				
Change Period (Y+Rc), s		6.0			3.7	6.0		4.9				
Max Green Setting (Gmax), s		43.1			17.0	28.4		25.0				
Max Q Clear Time (g_c+I1), s		2.0			14.8	9.9		7.9				
Green Ext Time (p_c), s		4.9			0.2	2.1		0.6				
Intersection Summary												
HCM 2010 Ctrl Delay			12.3									
HCM 2010 LOS			B									

HCM 2010 Signalized Intersection Summary
1: Del Monte Boulevard & Reindollar Avenue

Cumulative with Eastside Parkway, AM
06/11/2019

												
Movement	EBL	EBT	EBR	WBL	WBT	WBR	NBL	NBT	NBR	SBL	SBT	SBR
Lane Configurations												
Traffic Volume (veh/h)	0	0	0	450	0	420	10	640	120	410	1170	0
Future Volume (veh/h)	0	0	0	450	0	420	10	640	120	410	1170	0
Number				3	8	18	1	6	16	5	2	12
Initial Q (Qb), veh				0	0	0	0	0	0	0	0	0
Ped-Bike Adj(A_pbT)				1.00		0.99	1.00		1.00	1.00		1.00
Parking Bus, Adj				1.00	1.00	1.00	1.00	1.00	1.00	1.00	1.00	1.00
Adj Sat Flow, veh/h/ln				1900	1900	1900	1863	1863	1863	1845	1845	0
Adj Flow Rate, veh/h				468	54	429	11	719	68	461	1315	0
Adj No. of Lanes				1	1	0	1	2	1	1	2	0
Peak Hour Factor				0.89	0.89	0.89	0.89	0.89	0.89	0.89	0.89	0.89
Percent Heavy Veh, %				0	0	0	2	2	2	3	3	0
Cap, veh/h				575	58	461	24	892	397	499	1832	0
Arrive On Green				0.32	0.32	0.32	0.01	0.25	0.25	0.28	0.52	0.00
Sat Flow, veh/h				1810	183	1451	1774	3539	1577	1757	3597	0
Grp Volume(v), veh/h				468	0	483	11	719	68	461	1315	0
Grp Sat Flow(s),veh/h/ln				1810	0	1634	1774	1770	1577	1757	1752	0
Q Serve(g_s), s				21.9	0.0	26.4	0.6	17.6	3.1	23.5	26.4	0.0
Cycle Q Clear(g_c), s				21.9	0.0	26.4	0.6	17.6	3.1	23.5	26.4	0.0
Prop In Lane				1.00		0.89	1.00		1.00	1.00		0.00
Lane Grp Cap(c), veh/h				575	0	519	24	892	397	499	1832	0
V/C Ratio(X)				0.81	0.00	0.93	0.47	0.81	0.17	0.92	0.72	0.00
Avail Cap(c_a), veh/h				589	0	532	578	1153	514	572	1832	0
HCM Platoon Ratio				1.00	1.00	1.00	1.00	1.00	1.00	1.00	1.00	1.00
Upstream Filter(I)				1.00	0.00	1.00	1.00	1.00	1.00	1.00	1.00	0.00
Uniform Delay (d), s/veh				28.9	0.0	30.5	45.1	32.3	26.9	32.0	16.8	0.0
Incr Delay (d2), s/veh				8.5	0.0	23.0	13.6	3.3	0.2	19.4	1.4	0.0
Initial Q Delay(d3),s/veh				0.0	0.0	0.0	0.0	0.0	0.0	0.0	0.0	0.0
%ile BackOfQ(50%),veh/ln				12.3	0.0	15.1	0.4	9.0	1.4	14.1	13.0	0.0
LnGrp Delay(d),s/veh				37.4	0.0	53.4	58.7	35.7	27.1	51.5	18.2	0.0
LnGrp LOS				D		D	E	D	C	D	B	
Approach Vol, veh/h					951			798			1776	
Approach Delay, s/veh					45.5			35.3			26.8	
Approach LOS					D			D			C	
Timer	1	2	3	4	5	6	7	8				
Assigned Phs	1	2			5	6		8				
Phs Duration (G+Y+Rc), s	4.7	53.1			29.7	28.2		34.2				
Change Period (Y+Rc), s	3.5	5.0			3.5	5.0		5.0				
Max Green Setting (Gmax), s	30.0	30.0			30.0	30.0		30.0				
Max Q Clear Time (g_c+I1), s	2.6	28.4			25.5	19.6		28.4				
Green Ext Time (p_c), s	0.0	1.2			0.7	3.6		0.9				
Intersection Summary												
HCM 2010 Ctrl Delay				33.8								
HCM 2010 LOS				C								
Notes												

HCM 2010 Signalized Intersection Summary
2: 2nd Avenue & Patton Parkway

Cumulative with Eastside Parkway, AM
06/11/2019



Movement	EBL	EBT	EBR	WBL	WBT	WBR	NBL	NBT	NBR	SBL	SBT	SBR
Lane Configurations	↖	↗		↖	↗		↖	↗		↖	↗	
Traffic Volume (veh/h)	50	90	60	30	90	100	70	220	100	90	200	50
Future Volume (veh/h)	50	90	60	30	90	100	70	220	100	90	200	50
Number	7	4	14	3	8	18	5	2	12	1	6	16
Initial Q (Qb), veh	0	0	0	0	0	0	0	0	0	0	0	0
Ped-Bike Adj(A_pbT)	1.00		1.00	1.00		1.00	1.00		1.00	1.00		1.00
Parking Bus, Adj	1.00	1.00	1.00	1.00	1.00	1.00	1.00	1.00	1.00	1.00	1.00	1.00
Adj Sat Flow, veh/h/ln	1863	1863	1900	1863	1863	1900	1863	1863	1900	1863	1863	1900
Adj Flow Rate, veh/h	54	98	65	33	98	109	76	239	109	98	217	54
Adj No. of Lanes	1	1	0	1	1	0	1	1	0	1	1	0
Peak Hour Factor	0.92	0.92	0.92	0.92	0.92	0.92	0.92	0.92	0.92	0.92	0.92	0.92
Percent Heavy Veh, %	2	2	2	2	2	2	2	2	2	2	2	2
Cap, veh/h	97	247	164	67	177	197	121	330	151	139	407	101
Arrive On Green	0.05	0.24	0.24	0.04	0.22	0.22	0.07	0.27	0.27	0.08	0.28	0.28
Sat Flow, veh/h	1774	1046	694	1774	807	897	1774	1212	553	1774	1441	359
Grp Volume(v), veh/h	54	0	163	33	0	207	76	0	348	98	0	271
Grp Sat Flow(s),veh/h/ln	1774	0	1740	1774	0	1704	1774	0	1765	1774	0	1799
Q Serve(g_s), s	1.3	0.0	3.6	0.8	0.0	4.9	1.9	0.0	8.1	2.4	0.0	5.8
Cycle Q Clear(g_c), s	1.3	0.0	3.6	0.8	0.0	4.9	1.9	0.0	8.1	2.4	0.0	5.8
Prop In Lane	1.00		0.40	1.00		0.53	1.00		0.31	1.00		0.20
Lane Grp Cap(c), veh/h	97	0	411	67	0	374	121	0	481	139	0	509
V/C Ratio(X)	0.56	0.00	0.40	0.50	0.00	0.55	0.63	0.00	0.72	0.71	0.00	0.53
Avail Cap(c_a), veh/h	235	0	1364	235	0	1336	235	0	1384	235	0	1411
HCM Platoon Ratio	1.00	1.00	1.00	1.00	1.00	1.00	1.00	1.00	1.00	1.00	1.00	1.00
Upstream Filter(I)	1.00	0.00	1.00	1.00	0.00	1.00	1.00	0.00	1.00	1.00	0.00	1.00
Uniform Delay (d), s/veh	20.9	0.0	14.6	21.4	0.0	15.7	20.5	0.0	14.9	20.4	0.0	13.7
Incr Delay (d2), s/veh	5.0	0.0	0.6	5.6	0.0	1.3	5.3	0.0	2.1	6.4	0.0	0.9
Initial Q Delay(d3),s/veh	0.0	0.0	0.0	0.0	0.0	0.0	0.0	0.0	0.0	0.0	0.0	0.0
%ile BackOfQ(50%),veh/ln	0.8	0.0	1.8	0.5	0.0	2.4	1.1	0.0	4.1	1.4	0.0	3.0
LnGrp Delay(d),s/veh	25.9	0.0	15.2	27.0	0.0	17.0	25.9	0.0	17.0	26.8	0.0	14.6
LnGrp LOS	C		B	C		B	C		B	C		B
Approach Vol, veh/h		217			240			424			369	
Approach Delay, s/veh		17.8			18.4			18.6			17.8	
Approach LOS		B			B			B			B	
Timer	1	2	3	4	5	6	7	8				
Assigned Phs	1	2	3	4	5	6	7	8				
Phs Duration (G+Y+Rc), s	7.5	16.8	5.7	15.2	7.1	17.3	6.5	14.4				
Change Period (Y+Rc), s	4.0	4.5	4.0	4.5	4.0	4.5	4.0	4.5				
Max Green Setting (Gmax), s	35.5	35.5	6.0	35.5	6.0	35.5	6.0	35.5				
Max Q Clear Time (g_c+14), s	14.4	10.1	2.8	5.6	3.9	7.8	3.3	6.9				
Green Ext Time (p_c), s	0.0	2.2	0.0	1.0	0.0	1.7	0.0	1.3				
Intersection Summary												
HCM 2010 Ctrl Delay			18.2									
HCM 2010 LOS			B									

HCM 2010 Signalized Intersection Summary
 3: SR 1 SB On-Ramp/SR 1 SB Off-Ramp & Imjin Parkway

Cumulative with Eastside Parkway, AM
 06/11/2019



Movement	EBL	EBT	EBR	WBL	WBT	WBR	NBL	NBT	NBR	SBL	SBT	SBR
Lane Configurations					↕						↕	
Traffic Volume (veh/h)	0	0	0	1040	0	0	0	0	0	920	10	0
Future Volume (veh/h)	0	0	0	1040	0	0	0	0	0	920	10	0
Number				1	6	16				7	4	14
Initial Q (Qb), veh				0	0	0				0	0	0
Ped-Bike Adj(A_pbT)				1.00		1.00				1.00		1.00
Parking Bus, Adj				1.00	1.00	1.00				1.00	1.00	1.00
Adj Sat Flow, veh/h/ln				1900	1845	0				1900	1845	0
Adj Flow Rate, veh/h				1143	0	0				1011	11	0
Adj No. of Lanes				0	1	0				0	1	0
Peak Hour Factor				0.91	0.91	0.91				0.91	0.91	0.91
Percent Heavy Veh, %				3	3	0				3	3	0
Cap, veh/h				996	0	0				657	7	0
Arrive On Green				0.57	0.00	0.00				0.38	0.38	0.00
Sat Flow, veh/h				1757	0	0				1739	19	0
Grp Volume(v), veh/h				1143	0	0				1022	0	0
Grp Sat Flow(s),veh/h/ln				1757	0	0				1758	0	0
Q Serve(g_s), s				90.0	0.0	0.0				60.0	0.0	0.0
Cycle Q Clear(g_c), s				90.0	0.0	0.0				60.0	0.0	0.0
Prop In Lane				1.00		0.00				0.99		0.00
Lane Grp Cap(c), veh/h				996	0	0				664	0	0
V/C Ratio(X)				1.15	0.00	0.00				1.54	0.00	0.00
Avail Cap(c_a), veh/h				996	0	0				664	0	0
HCM Platoon Ratio				1.00	1.00	1.00				1.00	1.00	1.00
Upstream Filter(I)				1.00	0.00	0.00				1.00	0.00	0.00
Uniform Delay (d), s/veh				34.4	0.0	0.0				49.4	0.0	0.0
Incr Delay (d2), s/veh				78.5	0.0	0.0				250.0	0.0	0.0
Initial Q Delay(d3),s/veh				0.0	0.0	0.0				0.0	0.0	0.0
%ile BackOfQ(50%),veh/ln				65.1	0.0	0.0				75.1	0.0	0.0
LnGrp Delay(d),s/veh				112.9	0.0	0.0				299.4	0.0	0.0
LnGrp LOS				F						F		
Approach Vol, veh/h					1143						1022	
Approach Delay, s/veh					112.9						299.4	
Approach LOS					F						F	
Timer	1	2	3	4	5	6	7	8				
Assigned Phs				4		6						
Phs Duration (G+Y+Rc), s				64.4		94.4						
Change Period (Y+Rc), s				4.4		4.4						
Max Green Setting (Gmax), s				60.0		90.0						
Max Q Clear Time (g_c+I1), s				62.0		92.0						
Green Ext Time (p_c), s				0.0		0.0						
Intersection Summary												
HCM 2010 Ctrl Delay				200.9								
HCM 2010 LOS				F								

Intersection												
Int Delay, s/veh	0.9											
Movement	EBL	EBT	EBR	WBL	WBT	WBR	NBL	NBT	NBR	SBL	SBT	SBR
Lane Configurations		↕			↑	↗		↕	↗			
Traffic Vol, veh/h	10	930	0	0	1000	410	10	10	950	0	0	0
Future Vol, veh/h	10	930	0	0	1000	410	10	10	950	0	0	0
Conflicting Peds, #/hr	0	0	3	3	0	0	0	0	0	0	0	0
Sign Control	Free	Free	Free	Free	Free	Free	Stop	Stop	Stop	Stop	Stop	Stop
RT Channelized	-	-	None	-	-	Free	-	-	Free	-	-	None
Storage Length	-	-	-	-	-	0	-	-	800	-	-	-
Veh in Median Storage, #	-	0	-	-	0	-	-	0	-	-	16965	-
Grade, %	-	0	-	-	0	-	-	0	-	-	0	-
Peak Hour Factor	97	97	97	97	97	97	97	97	97	97	97	97
Heavy Vehicles, %	3	3	3	3	3	3	2	2	2	2	2	2
Mvmt Flow	10	959	0	0	1031	423	10	10	979	0	0	0























Major/Minor	Major1	Major2	Minor1
Conflicting Flow All	1031	0	-
Stage 1	-	-	-
Stage 2	-	-	-
Critical Hdwy	4.13	-	-
Critical Hdwy Stg 1	-	-	-
Critical Hdwy Stg 2	-	-	-
Follow-up Hdwy	2.227	-	-
Pot Cap-1 Maneuver	670	-	0
Stage 1	-	-	0
Stage 2	-	-	0
Platoon blocked, %	-	-	-
Mov Cap-1 Maneuver	670	-	-
Mov Cap-2 Maneuver	-	-	-
Stage 1	-	-	-
Stage 2	-	-	-

Approach	EB	WB	NB
HCM Control Delay, s	0.1	0	87.8
HCM LOS			F

Minor Lane/Major Mvmt	NBLn1	NBLn2	EBL	EBT	WBT
Capacity (veh/h)	63	-	670	-	-
HCM Lane V/C Ratio	0.327	-	0.015	-	-
HCM Control Delay (s)	87.8	0	10.5	0	-
HCM Lane LOS	F	A	B	A	-
HCM 95th %tile Q(veh)	1.2	-	0	-	-

HCM 2010 Signalized Intersection Summary
5: 2nd Avenue & Imjin Parkway

Cumulative with Eastside Parkway, AM
06/11/2019

												
Movement	EBL	EBT	EBR	WBL	WBT	WBR	NBL	NBT	NBR	SBL	SBT	SBR
Lane Configurations												
Traffic Volume (veh/h)	180	970	890	470	830	120	390	90	200	50	100	210
Future Volume (veh/h)	180	970	890	470	830	120	390	90	200	50	100	210
Number	5	2	12	1	6	16	3	8	18	7	4	14
Initial Q (Qb), veh	0	0	0	0	0	0	0	0	0	0	0	0
Ped-Bike Adj(A_pbT)	1.00		1.00	1.00		1.00	1.00		1.00	1.00		1.00
Parking Bus, Adj	1.00	1.00	1.00	1.00	1.00	1.00	1.00	1.00	1.00	1.00	1.00	1.00
Adj Sat Flow, veh/h/ln	1863	1863	1863	1863	1863	1900	1810	1810	1810	1900	1900	1900
Adj Flow Rate, veh/h	184	990	689	480	847	122	398	92	82	51	102	209
Adj No. of Lanes	1	2	1	2	2	0	2	1	1	1	2	0
Peak Hour Factor	0.98	0.98	0.98	0.98	0.98	0.98	0.98	0.98	0.98	0.98	0.98	0.98
Percent Heavy Veh, %	2	2	2	2	2	2	5	5	5	0	0	0
Cap, veh/h	221	1214	543	549	1174	169	467	439	372	91	276	247
Arrive On Green	0.12	0.34	0.34	0.16	0.38	0.38	0.14	0.24	0.24	0.05	0.15	0.15
Sat Flow, veh/h	1774	3539	1583	3442	3106	447	3343	1810	1536	1810	1805	1612
Grp Volume(v), veh/h	184	990	689	480	483	486	398	92	82	51	102	209
Grp Sat Flow(s),veh/h/ln	1774	1770	1583	1721	1770	1784	1672	1810	1536	1810	1805	1612
Q Serve(g_s), s	8.9	22.3	30.0	11.9	20.4	20.4	10.2	3.5	3.7	2.4	4.4	11.0
Cycle Q Clear(g_c), s	8.9	22.3	30.0	11.9	20.4	20.4	10.2	3.5	3.7	2.4	4.4	11.0
Prop In Lane	1.00		1.00	1.00		0.25	1.00		1.00	1.00		1.00
Lane Grp Cap(c), veh/h	221	1214	543	549	669	674	467	439	372	91	276	247
V/C Ratio(X)	0.83	0.82	1.27	0.88	0.72	0.72	0.85	0.21	0.22	0.56	0.37	0.85
Avail Cap(c_a), veh/h	304	1214	543	590	669	674	765	439	372	207	433	387
HCM Platoon Ratio	1.00	1.00	1.00	1.00	1.00	1.00	1.00	1.00	1.00	1.00	1.00	1.00
Upstream Filter(I)	1.00	1.00	1.00	1.00	1.00	1.00	1.00	1.00	1.00	1.00	1.00	1.00
Uniform Delay (d), s/veh	37.4	26.2	28.7	35.9	23.3	23.3	36.7	26.4	26.5	40.6	33.2	36.0
Incr Delay (d2), s/veh	9.8	4.1	134.8	12.4	3.3	3.3	2.5	0.1	0.1	2.0	0.3	5.7
Initial Q Delay(d3),s/veh	0.0	0.0	0.0	0.0	0.0	0.0	0.0	0.0	0.0	0.0	0.0	0.0
%ile BackOfQ(50%),veh/ln	4.9	11.6	33.4	6.6	10.5	10.6	4.9	1.8	1.6	1.3	2.2	5.3
LnGrp Delay(d),s/veh	47.2	30.3	163.6	48.3	26.6	26.5	39.2	26.5	26.6	42.5	33.5	41.7
LnGrp LOS	D	C	F	D	C	C	D	C	C	D	C	D
Approach Vol, veh/h		1863			1449			572			362	
Approach Delay, s/veh		81.3			33.7			35.4			39.5	
Approach LOS		F			C			D			D	
Timer	1	2	3	4	5	6	7	8				
Assigned Phs	1	2	3	4	5	6	7	8				
Phs Duration (G+Y+Rc), s	18.4	35.3	15.7	18.0	15.4	38.4	7.9	25.8				
Change Period (Y+Rc), s	4.5	5.3	3.5	4.6	4.5	5.3	3.5	4.6				
Max Green Setting (Gmax), s	15.0	30.0	20.0	21.0	15.0	30.0	10.0	21.0				
Max Q Clear Time (g_c+I1), s	13.9	32.0	12.2	13.0	10.9	22.4	4.4	5.7				
Green Ext Time (p_c), s	0.0	0.0	0.1	0.3	0.0	0.9	0.0	0.1				
Intersection Summary												
HCM 2010 Ctrl Delay			55.3									
HCM 2010 LOS			E									

HCM 2010 Signalized Intersection Summary
6: 3rd Avenue & Imjin Parkway

Cumulative with Eastside Parkway, AM
06/11/2019



Movement	EBL	EBT	EBR	WBL	WBT	WBR	NBL	NBT	NBR	SBL	SBT	SBR
Lane Configurations												
Traffic Volume (veh/h)	50	820	230	340	1240	30	130	10	60	10	10	40
Future Volume (veh/h)	50	820	230	340	1240	30	130	10	60	10	10	40
Number	5	2	12	1	6	16	3	8	18	7	4	14
Initial Q (Qb), veh	0	0	0	0	0	0	0	0	0	0	0	0
Ped-Bike Adj(A_pbT)	1.00		1.00	1.00		1.00	1.00		1.00	1.00		1.00
Parking Bus, Adj	1.00	1.00	1.00	1.00	1.00	1.00	1.00	1.00	1.00	1.00	1.00	1.00
Adj Sat Flow, veh/h/ln	1863	1863	1900	1863	1863	1900	1810	1810	1900	1863	1863	1900
Adj Flow Rate, veh/h	52	854	211	354	1292	30	135	10	8	10	10	7
Adj No. of Lanes	1	2	0	1	2	0	1	1	0	1	1	0
Peak Hour Factor	0.96	0.96	0.96	0.96	0.96	0.96	0.96	0.96	0.96	0.96	0.96	0.96
Percent Heavy Veh, %	2	2	2	2	2	2	5	5	5	2	2	2
Cap, veh/h	63	983	243	409	1926	45	330	135	108	334	148	104
Arrive On Green	0.04	0.35	0.35	0.23	0.54	0.54	0.15	0.15	0.15	0.15	0.15	0.15
Sat Flow, veh/h	1774	2814	695	1774	3536	82	1345	930	744	1384	1020	714
Grp Volume(v), veh/h	52	537	528	354	646	676	135	0	18	10	0	17
Grp Sat Flow(s),veh/h/ln	1774	1770	1739	1774	1770	1848	1345	0	1675	1384	0	1733
Q Serve(g_s), s	1.4	13.9	13.9	9.4	12.9	12.9	4.7	0.0	0.5	0.3	0.0	0.4
Cycle Q Clear(g_c), s	1.4	13.9	13.9	9.4	12.9	12.9	5.1	0.0	0.5	0.8	0.0	0.4
Prop In Lane	1.00		0.40	1.00		0.04	1.00		0.44	1.00		0.41
Lane Grp Cap(c), veh/h	63	618	608	409	964	1007	330	0	243	334	0	251
V/C Ratio(X)	0.82	0.87	0.87	0.87	0.67	0.67	0.41	0.00	0.07	0.03	0.00	0.07
Avail Cap(c_a), veh/h	415	1171	1150	415	1171	1223	888	0	937	908	0	970
HCM Platoon Ratio	1.00	1.00	1.00	1.00	1.00	1.00	1.00	1.00	1.00	1.00	1.00	1.00
Upstream Filter(I)	1.00	1.00	1.00	1.00	1.00	1.00	1.00	0.00	1.00	1.00	0.00	1.00
Uniform Delay (d), s/veh	23.5	14.9	14.9	18.2	8.0	8.0	20.4	0.0	18.1	18.5	0.0	18.1
Incr Delay (d2), s/veh	9.6	1.5	1.5	16.2	0.7	0.6	0.3	0.0	0.0	0.0	0.0	0.0
Initial Q Delay(d3),s/veh	0.0	0.0	0.0	0.0	0.0	0.0	0.0	0.0	0.0	0.0	0.0	0.0
%ile BackOfQ(50%),veh/ln	0.9	7.0	6.9	6.4	6.3	6.6	1.8	0.0	0.2	0.1	0.0	0.2
LnGrp Delay(d),s/veh	33.1	16.4	16.5	34.4	8.7	8.7	20.7	0.0	18.2	18.5	0.0	18.2
LnGrp LOS	C	B	B	C	A	A	C		B	B		B
Approach Vol, veh/h		1117			1676			153			27	
Approach Delay, s/veh		17.2			14.1			20.4			18.3	
Approach LOS		B			B			C			B	
Timer	1	2	3	4	5	6	7	8				
Assigned Phs	1	2		4	5	6		8				
Phs Duration (G+Y+Rc), s	4.8	22.7		11.6	5.2	32.3		11.6				
Change Period (Y+Rc), s	3.5	5.5		4.5	3.5	5.5		4.5				
Max Green Setting (Gmax), s	1.5	32.5		27.5	11.5	32.5		27.5				
Max Q Clear Time (g_c+I1), s	1.4	15.9		2.8	3.4	14.9		7.1				
Green Ext Time (p_c), s	0.0	1.2		0.0	0.0	1.0		0.0				
Intersection Summary												
HCM 2010 Ctrl Delay				15.6								
HCM 2010 LOS				B								

HCM 2010 Signalized Intersection Summary
7: 4th Avenue & Imjin Parkway

Cumulative with Eastside Parkway, AM
06/11/2019



Movement	EBL	EBT	EBR	WBL	WBT	WBR	NBL	NBT	NBR	SBL	SBT	SBR
Lane Configurations												
Traffic Volume (veh/h)	10	910	20	10	1530	10	10	10	10	10	10	10
Future Volume (veh/h)	10	910	20	10	1530	10	10	10	10	10	10	10
Number	5	2	12	1	6	16	3	8	18	7	4	14
Initial Q (Qb), veh	0	0	0	0	0	0	0	0	0	0	0	0
Ped-Bike Adj(A_pbT)	1.00		1.00	1.00		1.00	1.00		1.00	1.00		1.00
Parking Bus, Adj	1.00	1.00	1.00	1.00	1.00	1.00	1.00	1.00	1.00	1.00	1.00	1.00
Adj Sat Flow, veh/h/ln	1863	1863	1900	1863	1863	1900	1900	1267	1900	1900	1900	1900
Adj Flow Rate, veh/h	10	948	20	10	1594	9	10	10	9	10	10	10
Adj No. of Lanes	1	2	0	1	2	0	0	1	0	0	1	0
Peak Hour Factor	0.96	0.96	0.96	0.96	0.96	0.96	0.96	0.96	0.96	0.96	0.96	0.96
Percent Heavy Veh, %	2	2	2	2	2	2	50	50	50	0	0	0
Cap, veh/h	14	1776	37	14	1809	10	178	20	18	186	30	30
Arrive On Green	0.01	0.50	0.50	0.01	0.50	0.50	0.05	0.05	0.05	0.05	0.05	0.05
Sat Flow, veh/h	1774	3544	75	1774	3608	20	389	389	351	578	578	578
Grp Volume(v), veh/h	10	473	495	10	781	822	29	0	0	30	0	0
Grp Sat Flow(s),veh/h/ln	1774	1770	1849	1774	1770	1859	1129	0	0	1735	0	0
Q Serve(g_s), s	0.2	5.6	5.6	0.2	12.1	12.1	0.3	0.0	0.0	0.0	0.0	0.0
Cycle Q Clear(g_c), s	0.2	5.6	5.6	0.2	12.1	12.1	0.7	0.0	0.0	0.5	0.0	0.0
Prop In Lane	1.00		0.04	1.00		0.01	0.34		0.31	0.33		0.33
Lane Grp Cap(c), veh/h	14	887	927	14	887	932	216	0	0	246	0	0
V/C Ratio(X)	0.71	0.53	0.53	0.71	0.88	0.88	0.13	0.00	0.00	0.12	0.00	0.00
Avail Cap(c_a), veh/h	664	1871	1956	664	1871	1966	1126	0	0	1612	0	0
HCM Platoon Ratio	1.00	1.00	1.00	1.00	1.00	1.00	1.00	1.00	1.00	1.00	1.00	1.00
Upstream Filter(I)	1.00	1.00	1.00	1.00	1.00	1.00	1.00	0.00	0.00	1.00	0.00	0.00
Uniform Delay (d), s/veh	15.2	5.2	5.2	15.2	6.8	6.8	14.2	0.0	0.0	14.0	0.0	0.0
Incr Delay (d2), s/veh	21.0	0.2	0.2	21.0	1.2	1.1	0.1	0.0	0.0	0.1	0.0	0.0
Initial Q Delay(d3),s/veh	0.0	0.0	0.0	0.0	0.0	0.0	0.0	0.0	0.0	0.0	0.0	0.0
%ile BackOfQ(50%),veh/ln	0.2	2.7	2.8	0.2	5.9	6.2	0.2	0.0	0.0	0.2	0.0	0.0
LnGrp Delay(d),s/veh	36.2	5.4	5.4	36.2	8.0	8.0	14.3	0.0	0.0	14.1	0.0	0.0
LnGrp LOS	D	A	A	D	A	A	B			B		
Approach Vol, veh/h		978			1613			29			30	
Approach Delay, s/veh		5.7			8.2			14.3			14.1	
Approach LOS		A			A			B			B	
Timer	1	2	3	4	5	6	7	8				
Assigned Phs	1	2		4	5	6		8				
Phs Duration (G+Y+Rc), s	3.7	20.9		6.1	3.7	20.9		6.1				
Change Period (Y+Rc), s	3.5	5.5		4.5	3.5	5.5		4.5				
Max Green Setting (Gmax), s	1.5	32.5		27.5	11.5	32.5		27.5				
Max Q Clear Time (g_c+1), s	12.2	7.6		2.5	2.2	14.1		2.7				
Green Ext Time (p_c), s	0.0	0.7		0.0	0.0	1.3		0.0				
Intersection Summary												
HCM 2010 Ctrl Delay				7.4								
HCM 2010 LOS				A								

HCM 2010 Signalized Intersection Summary
 8: 5th Avenue/California Avenue & Imjin Parkway

Cumulative with Eastside Parkway, AM
 06/11/2019



Movement	EBL	EBT	EBR	WBL	WBT	WBR	NBL	NBT	NBR	SBL	SBT	SBR
Lane Configurations												
Traffic Volume (veh/h)	140	790	20	10	960	70	20	20	10	80	150	460
Future Volume (veh/h)	140	790	20	10	960	70	20	20	10	80	150	460
Number	5	2	12	1	6	16	3	8	18	7	4	14
Initial Q (Qb), veh	0	0	0	0	0	0	0	0	0	0	0	0
Ped-Bike Adj(A_pbT)	1.00		0.98	1.00		1.00	1.00		0.99	1.00		1.00
Parking Bus, Adj	1.00	1.00	1.00	1.00	1.00	1.00	1.00	1.00	1.00	1.00	1.00	1.00
Adj Sat Flow, veh/h/ln	1881	1881	1900	1863	1863	1900	1900	1624	1900	1900	1881	1900
Adj Flow Rate, veh/h	147	832	19	11	1011	68	21	21	10	84	158	410
Adj No. of Lanes	1	2	0	1	2	0	0	1	0	0	1	0
Peak Hour Factor	0.95	0.95	0.95	0.95	0.95	0.95	0.95	0.95	0.95	0.95	0.95	0.95
Percent Heavy Veh, %	1	1	1	2	2	2	17	17	17	1	1	1
Cap, veh/h	186	1530	35	15	1120	75	175	152	58	122	152	348
Arrive On Green	0.10	0.43	0.43	0.01	0.33	0.33	0.34	0.34	0.34	0.34	0.34	0.34
Sat Flow, veh/h	1792	3570	82	1774	3366	226	266	452	171	157	452	1032
Grp Volume(v), veh/h	147	416	435	11	531	548	52	0	0	652	0	0
Grp Sat Flow(s),veh/h/ln	1792	1787	1865	1774	1770	1823	889	0	0	1640	0	0
Q Serve(g_s), s	4.8	10.3	10.3	0.4	17.0	17.0	0.0	0.0	0.0	15.0	0.0	0.0
Cycle Q Clear(g_c), s	4.8	10.3	10.3	0.4	17.0	17.0	1.4	0.0	0.0	20.0	0.0	0.0
Prop In Lane	1.00		0.04	1.00		0.12	0.40		0.19	0.13		0.63
Lane Grp Cap(c), veh/h	186	766	799	15	589	607	385	0	0	622	0	0
V/C Ratio(X)	0.79	0.54	0.54	0.74	0.90	0.90	0.14	0.00	0.00	1.05	0.00	0.00
Avail Cap(c_a), veh/h	453	904	943	449	895	922	385	0	0	622	0	0
HCM Platoon Ratio	1.00	1.00	1.00	1.00	1.00	1.00	1.00	1.00	1.00	1.00	1.00	1.00
Upstream Filter(I)	1.00	1.00	1.00	1.00	1.00	1.00	1.00	0.00	0.00	1.00	0.00	0.00
Uniform Delay (d), s/veh	25.9	12.6	12.6	29.3	18.9	18.9	13.5	0.0	0.0	20.7	0.0	0.0
Incr Delay (d2), s/veh	2.8	0.2	0.2	23.0	6.2	6.1	0.1	0.0	0.0	49.5	0.0	0.0
Initial Q Delay(d3),s/veh	0.0	0.0	0.0	0.0	0.0	0.0	0.0	0.0	0.0	0.0	0.0	0.0
%ile BackOfQ(50%),veh/ln	2.5	5.0	5.2	0.3	9.3	9.5	0.6	0.0	0.0	18.6	0.0	0.0
LnGrp Delay(d),s/veh	28.7	12.9	12.8	52.3	25.1	25.0	13.5	0.0	0.0	70.2	0.0	0.0
LnGrp LOS	C	B	B	D	C	C	B			F		
Approach Vol, veh/h		998			1090			52			652	
Approach Delay, s/veh		15.2			25.3			13.5			70.2	
Approach LOS		B			C			B			E	
Timer	1	2	3	4	5	6	7	8				
Assigned Phs	1	2		4	5	6		8				
Phs Duration (G+Y+Rc), s	4.0	30.7		24.6	9.7	25.0		24.6				
Change Period (Y+Rc), s	3.5	5.3		4.6	3.5	5.3		4.6				
Max Green Setting (Gmax), s	30.0	30.0		20.0	15.0	30.0		20.0				
Max Q Clear Time (g_c+1), s	12.4	12.3		22.0	6.8	19.0		3.4				
Green Ext Time (p_c), s	0.0	0.6		0.0	0.0	0.8		0.1				
Intersection Summary												
HCM 2010 Ctrl Delay				32.0								
HCM 2010 LOS				C								

Intersection						
Int Delay, s/veh	1.4					
Movement	EBL	EBR	NBL	NBT	SBT	SBR
Lane Configurations						
Traffic Vol, veh/h	30	30	30	210	610	80
Future Vol, veh/h	30	30	30	210	610	80
Conflicting Peds, #/hr	0	0	0	0	0	0
Sign Control	Stop	Stop	Free	Free	Free	Free
RT Channelized	-	None	-	None	-	None
Storage Length	0	-	155	-	-	-
Veh in Median Storage, #	0	-	-	0	0	-
Grade, %	0	-	-	0	0	-
Peak Hour Factor	92	92	92	92	92	92
Heavy Vehicles, %	2	2	2	2	2	2
Mvmt Flow	33	33	33	228	663	87











Major/Minor	Minor2	Major1	Major2			
Conflicting Flow All	1001	707	750	0	-	0
Stage 1	707	-	-	-	-	-
Stage 2	294	-	-	-	-	-
Critical Hdwy	6.42	6.22	4.12	-	-	-
Critical Hdwy Stg 1	5.42	-	-	-	-	-
Critical Hdwy Stg 2	5.42	-	-	-	-	-
Follow-up Hdwy	3.518	3.318	2.218	-	-	-
Pot Cap-1 Maneuver	269	435	859	-	-	-
Stage 1	489	-	-	-	-	-
Stage 2	756	-	-	-	-	-
Platoon blocked, %				-	-	-
Mov Cap-1 Maneuver	259	435	859	-	-	-
Mov Cap-2 Maneuver	259	-	-	-	-	-
Stage 1	470	-	-	-	-	-
Stage 2	756	-	-	-	-	-

Approach	EB	NB	SB
HCM Control Delay, s	18.8	1.2	0
HCM LOS	C		

Minor Lane/Major Mvmt	NBL	NBT	EBLn1	SBT	SBR
Capacity (veh/h)	859	-	325	-	-
HCM Lane V/C Ratio	0.038	-	0.201	-	-
HCM Control Delay (s)	9.4	-	18.8	-	-
HCM Lane LOS	A	-	C	-	-
HCM 95th %tile Q(veh)	0.1	-	0.7	-	-

HCM 2010 Signalized Intersection Summary
 10: Imjin Road & Imjin Parkway

Cumulative with Eastside Parkway, AM
 06/11/2019

								
Movement	EBT	EBR	WBL	WBT	NBL	NBR		
Lane Configurations								
Traffic Volume (veh/h)	750	150	310	1000	30	20		
Future Volume (veh/h)	750	150	310	1000	30	20		
Number	2	12	1	6	3	18		
Initial Q (Qb), veh	0	0	0	0	0	0		
Ped-Bike Adj(A_pbT)		1.00	1.00		1.00	1.00		
Parking Bus, Adj	1.00	1.00	1.00	1.00	1.00	1.00		
Adj Sat Flow, veh/h/ln	1863	1900	1845	1845	1810	1810		
Adj Flow Rate, veh/h	789	145	326	1053	35	18		
Adj No. of Lanes	2	0	1	2	2	1		
Peak Hour Factor	0.95	0.95	0.95	0.95	0.95	0.95		
Percent Heavy Veh, %	2	2	3	3	5	5		
Cap, veh/h	959	176	397	2449	119	53		
Arrive On Green	0.32	0.32	0.23	0.70	0.03	0.03		
Sat Flow, veh/h	3080	549	1757	3597	3447	1538		
Grp Volume(v), veh/h	467	467	326	1053	35	18		
Grp Sat Flow(s),veh/h/ln	1770	1766	1757	1752	1723	1538		
Q Serve(g_s), s	8.5	8.5	6.2	4.5	0.3	0.4		
Cycle Q Clear(g_c), s	8.5	8.5	6.2	4.5	0.3	0.4		
Prop In Lane		0.31	1.00		1.00	1.00		
Lane Grp Cap(c), veh/h	568	567	397	2449	119	53		
V/C Ratio(X)	0.82	0.82	0.82	0.43	0.29	0.34		
Avail Cap(c_a), veh/h	1523	1520	1008	3016	2175	971		
HCM Platoon Ratio	1.00	1.00	1.00	1.00	1.00	1.00		
Upstream Filter(I)	1.00	1.00	1.00	1.00	1.00	1.00		
Uniform Delay (d), s/veh	10.9	10.9	12.8	2.3	16.4	16.4		
Incr Delay (d2), s/veh	1.2	1.2	1.6	0.0	0.5	1.4		
Initial Q Delay(d3),s/veh	0.0	0.0	0.0	0.0	0.0	0.0		
%ile BackOfQ(50%),veh/ln	4.2	4.2	3.1	2.1	0.2	0.2		
LnGrp Delay(d),s/veh	12.1	12.1	14.5	2.3	16.9	17.8		
LnGrp LOS	B	B	B	A	B	B		
Approach Vol, veh/h	934			1379	53			
Approach Delay, s/veh	12.1			5.2	17.2			
Approach LOS	B			A	B			
Timer	1	2	3	4	5	6	7	8
Assigned Phs	1	2				6		8
Phs Duration (G+Y+Rc), s	13.2	16.5				29.7		5.2
Change Period (Y+Rc), s	5.3	* 5.3				5.3		4.0
Max Green Setting (Gmax), s	20.0	* 30				30.0		22.0
Max Q Clear Time (g_c+I1), s	8.2	10.5				6.5		2.4
Green Ext Time (p_c), s	0.1	0.7				1.2		0.0
Intersection Summary								
HCM 2010 Ctrl Delay			8.2					
HCM 2010 LOS			A					
Notes								

HCM 2010 Signalized Intersection Summary
 11: Abrams Drive & Imjin Parkway

Cumulative with Eastside Parkway, AM
 06/11/2019



Movement	EBL	EBT	EBR	WBL	WBT	WBR	NBL	NBT	NBR	SBL	SBT	SBR
Lane Configurations	↖↗	↖↗		↖↗	↖↗		↖	↖	↖	↖	↖	↖
Traffic Volume (veh/h)	50	590	50	80	960	70	170	30	160	90	50	250
Future Volume (veh/h)	50	590	50	80	960	70	170	30	160	90	50	250
Number	5	2	12	1	6	16	3	8	18	7	4	14
Initial Q (Qb), veh	0	0	0	0	0	0	0	0	0	0	0	0
Ped-Bike Adj(A_pbT)	1.00		1.00	1.00		1.00	1.00		1.00	1.00		1.00
Parking Bus, Adj	1.00	1.00	1.00	1.00	1.00	1.00	1.00	1.00	1.00	1.00	1.00	1.00
Adj Sat Flow, veh/h/ln	1881	1881	1900	1863	1863	1900	1845	1845	1845	1863	1863	1863
Adj Flow Rate, veh/h	54	634	42	86	1032	70	183	32	0	97	54	0
Adj No. of Lanes	2	2	0	2	2	0	1	1	1	1	1	1
Peak Hour Factor	0.93	0.93	0.93	0.93	0.93	0.93	0.93	0.93	0.93	0.93	0.93	0.93
Percent Heavy Veh, %	1	1	1	2	2	2	3	3	3	2	2	2
Cap, veh/h	193	1998	132	149	1909	129	320	347	295	340	351	298
Arrive On Green	0.06	0.59	0.59	0.04	0.57	0.57	0.19	0.19	0.00	0.19	0.19	0.00
Sat Flow, veh/h	3476	3403	225	3442	3364	228	1330	1845	1568	1370	1863	1583
Grp Volume(v), veh/h	54	333	343	86	543	559	183	32	0	97	54	0
Grp Sat Flow(s),veh/h/ln	1738	1787	1841	1721	1770	1822	1330	1845	1568	1370	1863	1583
Q Serve(g_s), s	1.1	6.7	6.7	1.7	13.5	13.5	9.4	1.0	0.0	4.4	1.7	0.0
Cycle Q Clear(g_c), s	1.1	6.7	6.7	1.7	13.5	13.5	11.1	1.0	0.0	5.4	1.7	0.0
Prop In Lane	1.00		0.12	1.00		0.13	1.00		1.00	1.00		1.00
Lane Grp Cap(c), veh/h	193	1049	1081	149	1004	1034	320	347	295	340	351	298
V/C Ratio(X)	0.28	0.32	0.32	0.58	0.54	0.54	0.57	0.09	0.00	0.29	0.15	0.00
Avail Cap(c_a), veh/h	986	1268	1306	977	1255	1293	636	785	667	665	793	674
HCM Platoon Ratio	1.00	1.00	1.00	1.00	1.00	1.00	1.00	1.00	1.00	1.00	1.00	1.00
Upstream Filter(I)	1.00	1.00	1.00	1.00	1.00	1.00	1.00	1.00	0.00	1.00	1.00	0.00
Uniform Delay (d), s/veh	31.9	7.4	7.4	33.1	9.5	9.5	28.6	23.6	0.0	25.9	23.9	0.0
Incr Delay (d2), s/veh	0.3	0.1	0.1	1.3	0.2	0.2	0.6	0.0	0.0	0.2	0.1	0.0
Initial Q Delay(d3),s/veh	0.0	0.0	0.0	0.0	0.0	0.0	0.0	0.0	0.0	0.0	0.0	0.0
%ile BackOfQ(50%),veh/ln	0.5	3.3	3.4	0.9	6.5	6.7	3.5	0.5	0.0	1.7	0.9	0.0
LnGrp Delay(d),s/veh	32.2	7.4	7.4	34.4	9.7	9.7	29.2	23.7	0.0	26.1	24.0	0.0
LnGrp LOS	C	A	A	C	A	A	C	C		C	C	
Approach Vol, veh/h		730			1188			215			151	
Approach Delay, s/veh		9.3			11.5			28.3			25.3	
Approach LOS		A			B			C			C	
Timer	1	2	3	4	5	6	7	8				
Assigned Phs	1	2		4	5	6		8				
Phs Duration (G+Y+Rc), s	6.5	46.7		17.3	7.9	45.3		17.3				
Change Period (Y+Rc), s	3.5	5.3		4.0	4.0	5.3		4.0				
Max Green Setting (Gmax), s	20.0	50.0		30.0	20.0	50.0		30.0				
Max Q Clear Time (g_c+13), s	13.5	8.7		7.4	3.1	15.5		13.1				
Green Ext Time (p_c), s	0.0	0.5		0.0	0.0	0.8		0.0				
Intersection Summary												
HCM 2010 Ctrl Delay			13.3									
HCM 2010 LOS			B									

HCM 2010 Signalized Intersection Summary
 12: Reservation Road & Imjin Parkway

Cumulative with Eastside Parkway, AM
 06/11/2019



Movement	EBL	EBT	EBR	WBL	WBT	WBR	NBL	NBT	NBR	SBL	SBT	SBR
Lane Configurations												
Traffic Volume (veh/h)	170	50	670	10	20	30	940	880	20	60	590	90
Future Volume (veh/h)	170	50	670	10	20	30	940	880	20	60	590	90
Number	3	8	18	7	4	14	1	6	16	5	2	12
Initial Q (Qb), veh	0	0	0	0	0	0	0	0	0	0	0	0
Ped-Bike Adj(A_pbT)	1.00		1.00	1.00		0.99	1.00		1.00	1.00		0.98
Parking Bus, Adj	1.00	1.00	1.00	1.00	1.00	1.00	1.00	1.00	1.00	1.00	1.00	1.00
Adj Sat Flow, veh/h/ln	1863	1863	1863	1638	1638	1638	1863	1863	1863	1863	1863	1863
Adj Flow Rate, veh/h	183	54	306	11	22	19	1011	946	16	65	634	34
Adj No. of Lanes	2	1	2	1	1	1	2	2	1	2	2	1
Peak Hour Factor	0.93	0.93	0.93	0.93	0.93	0.93	0.93	0.93	0.93	0.93	0.93	0.93
Percent Heavy Veh, %	2	2	2	16	16	16	2	2	2	2	2	2
Cap, veh/h	379	205	1192	57	60	51	1096	2050	916	125	1052	463
Arrive On Green	0.11	0.11	0.11	0.04	0.04	0.04	0.32	0.58	0.58	0.04	0.30	0.30
Sat Flow, veh/h	3442	1863	2774	1560	1638	1383	3442	3539	1581	3442	3539	1558
Grp Volume(v), veh/h	183	54	306	11	22	19	1011	946	16	65	634	34
Grp Sat Flow(s),veh/h/ln	1721	1863	1387	1560	1638	1383	1721	1770	1581	1721	1770	1558
Q Serve(g_s), s	4.4	2.3	6.2	0.6	1.1	1.2	24.8	13.4	0.4	1.6	13.4	1.4
Cycle Q Clear(g_c), s	4.4	2.3	6.2	0.6	1.1	1.2	24.8	13.4	0.4	1.6	13.4	1.4
Prop In Lane	1.00		1.00	1.00		1.00	1.00		1.00	1.00		1.00
Lane Grp Cap(c), veh/h	379	205	1192	57	60	51	1096	2050	916	125	1052	463
V/C Ratio(X)	0.48	0.26	0.26	0.19	0.37	0.37	0.92	0.46	0.02	0.52	0.60	0.07
Avail Cap(c_a), veh/h	1377	745	1997	553	580	490	1377	2050	916	787	2427	1069
HCM Platoon Ratio	1.00	1.00	1.00	1.00	1.00	1.00	1.00	1.00	1.00	1.00	1.00	1.00
Upstream Filter(I)	1.00	1.00	1.00	1.00	1.00	1.00	1.00	1.00	1.00	1.00	1.00	1.00
Uniform Delay (d), s/veh	36.6	35.7	16.1	40.9	41.1	41.2	28.8	10.6	7.8	41.4	26.3	22.1
Incr Delay (d2), s/veh	0.4	0.3	0.0	0.6	1.4	1.7	8.1	0.4	0.0	1.2	1.5	0.2
Initial Q Delay(d3),s/veh	0.0	0.0	0.0	0.0	0.0	0.0	0.0	0.0	0.0	0.0	0.0	0.0
%ile BackOfQ(50%),veh/ln	2.1	1.2	2.4	0.3	0.5	0.5	13.0	6.6	0.2	0.8	6.7	0.6
LnGrp Delay(d),s/veh	37.0	35.9	16.1	41.5	42.5	42.8	36.9	11.0	7.8	42.7	27.9	22.3
LnGrp LOS	D	D	B	D	D	D	D	B	A	D	C	C
Approach Vol, veh/h		543			52			1973			733	
Approach Delay, s/veh		25.1			42.4			24.3			28.9	
Approach LOS		C			D			C			C	
Timer	1	2	3	4	5	6	7	8				
Assigned Phs	1	2		4	5	6		8				
Phs Duration (G+Y+Rc), s	32.0			8.2	7.3	56.9		15.1				
Change Period (Y+Rc), s	4.1	* 6.2		5.0	4.1	* 6.2		5.5				
Max Green Setting (Gmax), s	35.0	* 60		31.0	20.0	* 50		35.0				
Max Q Clear Time (g_c+Tb), s	26.8	15.4		3.2	3.6	15.4		8.2				
Green Ext Time (p_c), s	1.0	10.6		0.1	0.0	15.5		1.1				
Intersection Summary												
HCM 2010 Ctrl Delay			25.7									
HCM 2010 LOS			C									
Notes												

HCM 2010 Signalized Intersection Summary
 13: Reservation Road & Blanco Road

Cumulative with Eastside Parkway, AM
 06/11/2019

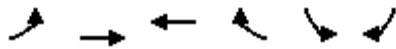

Movement	EBL	EBT	WBT	WBR	SBL	SBR		
Lane Configurations	↶↷	↶↷	↶	↶	↶↷	↶↷		
Traffic Volume (veh/h)	1000	300	500	40	40	1340		
Future Volume (veh/h)	1000	300	500	40	40	1340		
Number	5	2	6	16	7	14		
Initial Q (Qb), veh	0	0	0	0	0	0		
Ped-Bike Adj(A_pbT)	1.00			1.00	1.00	1.00		
Parking Bus, Adj	1.00	1.00	1.00	1.00	1.00	1.00		
Adj Sat Flow, veh/h/ln	1863	1863	1845	1845	1845	1845		
Adj Flow Rate, veh/h	1075	323	538	24	43	0		
Adj No. of Lanes	2	2	1	1	2	2		
Peak Hour Factor	0.93	0.93	0.93	0.93	0.93	0.93		
Percent Heavy Veh, %	2	2	3	3	3	3		
Cap, veh/h	1191	2816	644	548	119	97		
Arrive On Green	0.35	0.80	0.35	0.35	0.04	0.00		
Sat Flow, veh/h	3442	3632	1845	1568	3408	2760		
Grp Volume(v), veh/h	1075	323	538	24	43	0		
Grp Sat Flow(s),veh/h/ln	1721	1770	1845	1568	1704	1380		
Q Serve(g_s), s	16.3	1.1	14.7	0.6	0.7	0.0		
Cycle Q Clear(g_c), s	16.3	1.1	14.7	0.6	0.7	0.0		
Prop In Lane	1.00			1.00	1.00	1.00		
Lane Grp Cap(c), veh/h	1191	2816	644	548	119	97		
V/C Ratio(X)	0.90	0.11	0.83	0.04	0.36	0.00		
Avail Cap(c_a), veh/h	2508	3869	2016	1714	1676	1357		
HCM Platoon Ratio	1.00	1.00	1.00	1.00	1.00	1.00		
Upstream Filter(I)	1.00	1.00	1.00	1.00	1.00	0.00		
Uniform Delay (d), s/veh	17.1	1.3	16.4	11.8	25.9	0.0		
Incr Delay (d2), s/veh	1.1	0.0	2.2	0.0	0.7	0.0		
Initial Q Delay(d3),s/veh	0.0	0.0	0.0	0.0	0.0	0.0		
%ile BackOfQ(50%),veh/ln	7.8	0.5	7.9	0.2	0.3	0.0		
LnGrp Delay(d),s/veh	18.2	1.3	18.6	11.8	26.6	0.0		
LnGrp LOS	B	A	B	B	C			
Approach Vol, veh/h		1398	562		43			
Approach Delay, s/veh		14.3	18.3		26.6			
Approach LOS		B	B		C			
Timer	1	2	3	4	5	6	7	8
Assigned Phs		2		4	5	6		
Phs Duration (G+Y+Rc), s		49.5		5.4	24.5	25.0		
Change Period (Y+Rc), s		5.8		3.5	5.5	5.8		
Max Green Setting (Gmax), s		60.0		27.0	40.0	60.0		
Max Q Clear Time (g_c+I1), s		3.1		2.7	18.3	16.7		
Green Ext Time (p_c), s		1.5		0.0	0.7	2.5		
Intersection Summary								
HCM 2010 Ctrl Delay			15.7					
HCM 2010 LOS			B					

HCM 2010 Signalized Intersection Summary
 14: Reservation Road & Inter-Garrison Road

Cumulative with Eastside Parkway, AM
 06/11/2019



Movement	EBL	EBR	NBL	NBT	SBT	SBR		
Lane Configurations								
Traffic Volume (veh/h)	110	500	790	460	260	160		
Future Volume (veh/h)	110	500	790	460	260	160		
Number	3	18	1	6	2	12		
Initial Q (Qb), veh	0	0	0	0	0	0		
Ped-Bike Adj(A_pbT)	1.00	1.00	1.00			1.00		
Parking Bus, Adj	1.00	1.00	1.00	1.00	1.00	1.00		
Adj Sat Flow, veh/h/ln	1845	1845	1863	1863	1845	1900		
Adj Flow Rate, veh/h	117	493	840	489	277	154		
Adj No. of Lanes	1	1	1	2	2	0		
Peak Hour Factor	0.94	0.94	0.94	0.94	0.94	0.94		
Percent Heavy Veh, %	3	3	2	2	3	3		
Cap, veh/h	458	870	523	2049	473	255		
Arrive On Green	0.26	0.26	0.29	0.58	0.21	0.21		
Sat Flow, veh/h	1757	1568	1774	3632	2291	1188		
Grp Volume(v), veh/h	117	493	840	489	219	212		
Grp Sat Flow(s),veh/h/ln	1757	1568	1774	1770	1752	1635		
Q Serve(g_s), s	3.6	13.8	20.0	4.6	7.6	7.9		
Cycle Q Clear(g_c), s	3.6	13.8	20.0	4.6	7.6	7.9		
Prop In Lane	1.00	1.00	1.00			0.73		
Lane Grp Cap(c), veh/h	458	870	523	2049	377	351		
V/C Ratio(X)	0.26	0.57	1.61	0.24	0.58	0.60		
Avail Cap(c_a), veh/h	699	1086	523	3129	1549	1446		
HCM Platoon Ratio	1.00	1.00	1.00	1.00	1.00	1.00		
Upstream Filter(I)	1.00	1.00	1.00	1.00	1.00	1.00		
Uniform Delay (d), s/veh	19.9	9.8	23.9	7.0	23.9	24.0		
Incr Delay (d2), s/veh	0.3	0.6	281.8	0.1	2.6	3.1		
Initial Q Delay(d3),s/veh	0.0	0.0	0.0	0.0	0.0	0.0		
%ile BackOfQ(50%),veh/ln	1.8	6.1	50.7	2.3	3.9	3.9		
LnGrp Delay(d),s/veh	20.2	10.4	305.7	7.1	26.5	27.1		
LnGrp LOS	C	B	F	A	C	C		
Approach Vol, veh/h	610			1329	431			
Approach Delay, s/veh	12.3			195.8	26.8			
Approach LOS	B			F	C			
Timer	1	2	3	4	5	6	7	8
Assigned Phs	1	2				6		8
Phs Duration (G+Y+Rc), s	24.7	21.0				45.7		22.2
Change Period (Y+Rc), s	4.7	6.4				6.4		4.5
Max Green Setting (Gmax), s	26	60.0				60.0		27.0
Max Q Clear Time (g_c+Yc), s	22.5	9.9				6.6		15.8
Green Ext Time (p_c), s	0.0	4.7				5.8		1.8
Intersection Summary								
HCM 2010 Ctrl Delay			117.8					
HCM 2010 LOS			F					
Notes								

HCM 2010 Signalized Intersection Summary
15: 2nd Avenue & 9th Street

Cumulative with Eastside Parkway, AM
06/11/2019



Movement	EBL	EBT	EBR	WBL	WBT	WBR	NBL	NBT	NBR	SBL	SBT	SBR
Lane Configurations		↕	↗		↕		↖	↕		↖	↕	
Traffic Volume (veh/h)	10	10	10	260	10	20	20	360	30	40	850	10
Future Volume (veh/h)	10	10	10	260	10	20	20	360	30	40	850	10
Number	5	2	12	1	6	16	3	8	18	7	4	14
Initial Q (Qb), veh	0	0	0	0	0	0	0	0	0	0	0	0
Ped-Bike Adj(A_pbT)	0.99		1.00	0.99		0.99	1.00		0.99	1.00		0.99
Parking Bus, Adj	1.00	1.00	1.00	1.00	1.00	1.00	1.00	1.00	1.00	1.00	1.00	1.00
Adj Sat Flow, veh/h/ln	1900	1881	1881	1900	1900	1900	1881	1881	1900	1863	1863	1900
Adj Flow Rate, veh/h	11	11	-24	277	11	20	21	383	27	43	904	4
Adj No. of Lanes	0	1	1	0	1	0	1	2	0	1	2	0
Peak Hour Factor	0.94	0.94	0.94	0.94	0.94	0.94	0.94	0.94	0.94	0.94	0.94	0.94
Percent Heavy Veh, %	1	1	1	0	0	0	1	1	1	2	2	2
Cap, veh/h	325	288	455	525	15	27	46	1266	89	82	1425	6
Arrive On Green	0.28	0.28	0.00	0.28	0.28	0.28	0.03	0.37	0.37	0.05	0.39	0.39
Sat Flow, veh/h	725	1012	1599	1318	52	95	1792	3386	238	1774	3613	16
Grp Volume(v), veh/h	22	0	-24	308	0	0	21	201	209	43	443	465
Grp Sat Flow(s),veh/h/ln1737	0	1599	1466	0	0	1792	1787	1837	1774	1770	1860	
Q Serve(g_s), s	0.0	0.0	0.0	8.3	0.0	0.0	0.5	3.6	3.7	1.1	9.2	9.2
Cycle Q Clear(g_c), s	0.4	0.0	0.0	8.7	0.0	0.0	0.5	3.6	3.7	1.1	9.2	9.2
Prop In Lane	0.50		1.00	0.90		0.06	1.00		0.13	1.00		0.01
Lane Grp Cap(c), veh/h	612	0	455	567	0	0	46	668	687	82	698	733
V/C Ratio(X)	0.04	0.00	-0.05	0.54	0.00	0.00	0.46	0.30	0.30	0.53	0.63	0.63
Avail Cap(c_a), veh/h	1205	0	1051	1109	0	0	451	1761	1811	447	1744	1833
HCM Platoon Ratio	1.00	1.00	1.00	1.00	1.00	1.00	1.00	1.00	1.00	1.00	1.00	1.00
Upstream Filter(I)	1.00	0.00	0.00	1.00	0.00	0.00	1.00	1.00	1.00	1.00	1.00	1.00
Uniform Delay (d), s/veh	11.8	0.0	0.0	14.7	0.0	0.0	21.9	10.1	10.1	21.3	11.2	11.2
Incr Delay (d2), s/veh	0.0	0.0	0.0	0.8	0.0	0.0	7.0	0.3	0.2	5.2	1.0	0.9
Initial Q Delay(d3),s/veh	0.0	0.0	0.0	0.0	0.0	0.0	0.0	0.0	0.0	0.0	0.0	0.0
%ile BackOfQ(50%),veh/ln0.2	0.0	0.0	0.0	3.6	0.0	0.0	0.3	1.8	1.9	0.6	4.6	4.8
LnGrp Delay(d),s/veh	11.9	0.0	0.0	15.6	0.0	0.0	28.9	10.3	10.3	26.5	12.1	12.1
LnGrp LOS	B			B			C	B	B	C	B	B
Approach Vol, veh/h		-2			308			431			951	
Approach Delay, s/veh		-130.4			15.6			11.2			12.8	
Approach LOS		A			B			B			B	
Timer	1	2	3	4	5	6	7	8				
Assigned Phs		2	3	4		6	7	8				
Phs Duration (G+Y+Rc), s		18.0	4.7	23.0		18.0	5.6	22.1				
Change Period (Y+Rc), s		5.0	3.5	5.0		5.0	3.5	5.0				
Max Green Setting (Gmax), s		30.0	11.5	45.0		30.0	11.5	45.0				
Max Q Clear Time (g_c+I1), s		2.4	2.5	11.2		10.7	3.1	5.7				
Green Ext Time (p_c), s		0.1	0.0	6.5		1.7	0.0	2.5				
Intersection Summary												
HCM 2010 Ctrl Delay				13.1								
HCM 2010 LOS				B								

HCM 2010 Signalized Intersection Summary
 16: 2nd Avenue & 8th Street

Cumulative with Eastside Parkway, AM
 06/11/2019



Movement	WBL	WBR	NBT	NBR	SBL	SBT		
Lane Configurations								
Traffic Volume (veh/h)	210	20	480	110	50	910		
Future Volume (veh/h)	210	20	480	110	50	910		
Number	1	16	8	18	7	4		
Initial Q (Qb), veh	0	0	0	0	0	0		
Ped-Bike Adj(A_pbT)	1.00	1.00		1.00	1.00			
Parking Bus, Adj	1.00	1.00	1.00	1.00	1.00	1.00		
Adj Sat Flow, veh/h/ln	1583	1583	1863	1900	1881	1881		
Adj Flow Rate, veh/h	221	5	505	100	53	958		
Adj No. of Lanes	1	1	2	0	1	2		
Peak Hour Factor	0.95	0.95	0.95	0.95	0.95	0.95		
Percent Heavy Veh, %	20	20	2	2	1	1		
Cap, veh/h	289	258	988	195	105	1791		
Arrive On Green	0.19	0.19	0.34	0.34	0.06	0.50		
Sat Flow, veh/h	1508	1346	3042	581	1792	3668		
Grp Volume(v), veh/h	221	5	302	303	53	958		
Grp Sat Flow(s),veh/h/ln	1508	1346	1770	1760	1792	1787		
Q Serve(g_s), s	4.5	0.1	4.5	4.5	0.9	5.9		
Cycle Q Clear(g_c), s	4.5	0.1	4.5	4.5	0.9	5.9		
Prop In Lane	1.00	1.00		0.33	1.00			
Lane Grp Cap(c), veh/h	289	258	593	590	105	1791		
V/C Ratio(X)	0.77	0.02	0.51	0.51	0.51	0.53		
Avail Cap(c_a), veh/h	1391	1241	2448	2435	633	6593		
HCM Platoon Ratio	1.00	1.00	1.00	1.00	1.00	1.00		
Upstream Filter(I)	1.00	1.00	1.00	1.00	1.00	1.00		
Uniform Delay (d), s/veh	12.5	10.7	8.7	8.7	14.9	5.5		
Incr Delay (d2), s/veh	4.2	0.0	0.7	0.7	3.7	0.2		
Initial Q Delay(d3),s/veh	0.0	0.0	0.0	0.0	0.0	0.0		
%ile BackOfQ(50%),veh/ln	2.2	0.1	2.2	2.3	0.6	2.9		
LnGrp Delay(d),s/veh	16.7	10.7	9.4	9.4	18.6	5.8		
LnGrp LOS	B	B	A	A	B	A		
Approach Vol, veh/h	226		605			1011		
Approach Delay, s/veh	16.6		9.4			6.5		
Approach LOS	B		A			A		
Timer	1	2	3	4	5	6	7	8
Assigned Phs				4		6	7	8
Phs Duration (G+Y+Rc), s				21.3		11.2	5.4	15.9
Change Period (Y+Rc), s				5.0		5.0	3.5	5.0
Max Green Setting (Gmax), s				60.0		30.0	11.5	45.0
Max Q Clear Time (g_c+I1), s				7.9		6.5	2.9	6.5
Green Ext Time (p_c), s				8.4		0.6	0.0	4.0
Intersection Summary								
HCM 2010 Ctrl Delay			8.6					
HCM 2010 LOS			A					

Intersection	
Intersection Delay, s/veh	9.7
Intersection LOS	A

Movement	EBT	EBR	WBL	WBT	NBL	NBR
Lane Configurations	↑	↑	↑	↑	↑	↑
Traffic Vol, veh/h	110	50	170	210	20	100
Future Vol, veh/h	110	50	170	210	20	100
Peak Hour Factor	0.92	0.92	0.92	0.92	0.92	0.92
Heavy Vehicles, %	2	2	2	2	2	2
Mvmt Flow	120	54	185	228	22	109
Number of Lanes	1	1	1	1	1	1

Approach	EB	WB	NB
Opposing Approach	WB	EB	
Opposing Lanes	2	2	0
Conflicting Approach Left		NB	EB
Conflicting Lanes Left	0	2	2
Conflicting Approach Right	NB		WB
Conflicting Lanes Right	2	0	2
HCM Control Delay	8.7	10.3	9
HCM LOS	A	B	A

Lane	NBLn1	NBLn2	EBLn1	EBLn2	WBLn1	WBLn2
Vol Left, %	100%	0%	0%	0%	100%	0%
Vol Thru, %	0%	0%	100%	0%	0%	100%
Vol Right, %	0%	100%	0%	100%	0%	0%
Sign Control	Stop	Stop	Stop	Stop	Stop	Stop
Traffic Vol by Lane	20	100	110	50	170	210
LT Vol	20	0	0	0	170	0
Through Vol	0	0	110	0	0	210
RT Vol	0	100	0	50	0	0
Lane Flow Rate	22	109	120	54	185	228
Geometry Grp	7	7	7	7	7	7
Degree of Util (X)	0.039	0.157	0.176	0.069	0.284	0.319
Departure Headway (Hd)	6.406	5.198	5.294	4.589	5.538	5.036
Convergence, Y/N	Yes	Yes	Yes	Yes	Yes	Yes
Cap	558	688	676	777	647	712
Service Time	4.156	2.947	3.046	2.341	3.283	2.78
HCM Lane V/C Ratio	0.039	0.158	0.178	0.069	0.286	0.32
HCM Control Delay	9.4	8.9	9.2	7.7	10.5	10.1
HCM Lane LOS	A	A	A	A	B	B
HCM 95th-tile Q	0.1	0.6	0.6	0.2	1.2	1.4

Intersection				
Intersection Delay, s/veh	8.0			
Intersection LOS	A			
Approach	EB	WB	NB	SB
Entry Lanes	1	1	1	1
Conflicting Circle Lanes	1	1	1	1
Adj Approach Flow, veh/h	135	197	49	518
Demand Flow Rate, veh/h	138	207	49	523
Vehicles Circulating, veh/h	324	113	425	90
Vehicles Exiting, veh/h	289	361	37	230
Follow-Up Headway, s	3.186	3.186	3.186	3.186
Ped Vol Crossing Leg, #/h	0	0	0	0
Ped Cap Adj	1.000	1.000	1.000	1.000
Approach Delay, s/veh	6.3	5.7	5.6	9.6
Approach LOS	A	A	A	A
Lane	Left	Left	Left	Left
Designated Moves	LTR	LTR	LTR	LTR
Assumed Moves	LTR	LTR	LTR	LTR
RT Channelized				
Lane Util	1.000	1.000	1.000	1.000
Critical Headway, s	5.193	5.193	5.193	5.193
Entry Flow, veh/h	138	207	49	523
Cap Entry Lane, veh/h	817	1009	739	1033
Entry HV Adj Factor	0.975	0.951	1.000	0.990
Flow Entry, veh/h	135	197	49	518
Cap Entry, veh/h	797	960	739	1023
V/C Ratio	0.169	0.205	0.066	0.506
Control Delay, s/veh	6.3	5.7	5.6	9.6
LOS	A	A	A	A
95th %tile Queue, veh	1	1	0	3

HCM 2010 Signalized Intersection Summary
 19: 2nd Avenue & Inter-Garrison Road

Cumulative with Eastside Parkway, AM
 06/11/2019



Movement	WBL	WBR	NBT	NBR	SBL	SBT		
Lane Configurations								
Traffic Volume (veh/h)	50	30	590	70	20	1110		
Future Volume (veh/h)	50	30	590	70	20	1110		
Number	1	16	8	18	7	4		
Initial Q (Qb), veh	0	0	0	0	0	0		
Ped-Bike Adj(A_pbT)	1.00	1.00		1.00	1.00			
Parking Bus, Adj	1.00	1.00	1.00	1.00	1.00	1.00		
Adj Sat Flow, veh/h/ln	1900	1900	1881	1900	1881	1881		
Adj Flow Rate, veh/h	54	8	634	67	22	1194		
Adj No. of Lanes	1	1	2	0	1	2		
Peak Hour Factor	0.93	0.93	0.93	0.93	0.93	0.93		
Percent Heavy Veh, %	0	0	1	1	1	1		
Cap, veh/h	233	208	1506	159	49	2102		
Arrive On Green	0.13	0.13	0.46	0.46	0.03	0.59		
Sat Flow, veh/h	1810	1615	3357	344	1792	3668		
Grp Volume(v), veh/h	54	8	347	354	22	1194		
Grp Sat Flow(s),veh/h/ln	1810	1615	1787	1820	1792	1787		
Q Serve(g_s), s	0.9	0.2	4.6	4.6	0.4	7.3		
Cycle Q Clear(g_c), s	0.9	0.2	4.6	4.6	0.4	7.3		
Prop In Lane	1.00	1.00		0.19	1.00			
Lane Grp Cap(c), veh/h	233	208	825	840	49	2102		
V/C Ratio(X)	0.23	0.04	0.42	0.42	0.45	0.57		
Avail Cap(c_a), veh/h	1792	1600	2023	2061	583	5563		
HCM Platoon Ratio	1.00	1.00	1.00	1.00	1.00	1.00		
Upstream Filter(I)	1.00	1.00	1.00	1.00	1.00	1.00		
Uniform Delay (d), s/veh	13.8	13.5	6.4	6.4	16.9	4.5		
Incr Delay (d2), s/veh	0.5	0.1	0.3	0.3	6.2	0.2		
Initial Q Delay(d3),s/veh	0.0	0.0	0.0	0.0	0.0	0.0		
%ile BackOfQ(50%),veh/ln	0.5	0.2	2.3	2.3	0.3	3.6		
LnGrp Delay(d),s/veh	14.3	13.5	6.7	6.7	23.1	4.7		
LnGrp LOS	B	B	A	A	C	A		
Approach Vol, veh/h	62		701			1216		
Approach Delay, s/veh	14.2		6.7			5.1		
Approach LOS	B		A			A		
Timer	1	2	3	4	5	6	7	8
Assigned Phs				4		6	7	8
Phs Duration (G+Y+Rc), s				25.8		9.6	4.5	21.3
Change Period (Y+Rc), s				5.0		5.0	3.5	5.0
Max Green Setting (Gmax), s				55.0		35.0	11.5	40.0
Max Q Clear Time (g_c+I1), s				9.3		2.9	2.4	6.6
Green Ext Time (p_c), s				11.5		0.1	0.0	4.7
Intersection Summary								
HCM 2010 Ctrl Delay			5.9					
HCM 2010 LOS			A					

Intersection												
Intersection Delay, s/veh 10.1												
Intersection LOS B												























Movement	EBL	EBT	EBR	WBL	WBT	WBR	NBL	NBT	NBR	SBL	SBT	SBR
Lane Configurations		↕			↕			↕			↕	
Traffic Vol, veh/h	10	40	10	90	40	20	20	130	120	20	110	10
Future Vol, veh/h	10	40	10	90	40	20	20	130	120	20	110	10
Peak Hour Factor	0.85	0.85	0.85	0.85	0.85	0.85	0.85	0.85	0.85	0.85	0.85	0.85
Heavy Vehicles, %	6	6	6	2	2	2	4	4	4	0	0	0
Mvmt Flow	12	47	12	106	47	24	24	153	141	24	129	12
Number of Lanes	0	1	0	0	1	0	0	1	0	0	1	0

Approach	EB	WB	NB	SB
Opposing Approach	WB	EB	SB	NB
Opposing Lanes	1	1	1	1
Conflicting Approach Left	SB	NB	EB	WB
Conflicting Lanes Left	1	1	1	1
Conflicting Approach Right	NB	SB	WB	EB
Conflicting Lanes Right	1	1	1	1
HCM Control Delay	9	10	10.7	9.4
HCM LOS	A	A	B	A

Lane	NBLn1	EBLn1	WBLn1	SBLn1
Vol Left, %	7%	17%	60%	14%
Vol Thru, %	48%	67%	27%	79%
Vol Right, %	44%	17%	13%	7%
Sign Control	Stop	Stop	Stop	Stop
Traffic Vol by Lane	270	60	150	140
LT Vol	20	10	90	20
Through Vol	130	40	40	110
RT Vol	120	10	20	10
Lane Flow Rate	318	71	176	165
Geometry Grp	1	1	1	1
Degree of Util (X)	0.403	0.104	0.254	0.224
Departure Headway (Hd)	4.563	5.307	5.181	4.902
Convergence, Y/N	Yes	Yes	Yes	Yes
Cap	785	667	686	726
Service Time	2.625	3.405	3.266	2.978
HCM Lane V/C Ratio	0.405	0.106	0.257	0.227
HCM Control Delay	10.7	9	10	9.4
HCM Lane LOS	B	A	A	A
HCM 95th-tile Q	2	0.3	1	0.9

HCM 2010 Signalized Intersection Summary
 21: 7th Avenue/8th Street & Inter-Garrison Road

Cumulative with Eastside Parkway, AM
 07/12/2019

												
Movement	EBL	EBT	EBR	WBL	WBT	WBR	NBL	NBT	NBR	SBL	SBT	SBR
Lane Configurations												
Traffic Volume (veh/h)	10	110	30	80	240	20	50	100	80	130	80	10
Future Volume (veh/h)	10	110	30	80	240	20	50	100	80	130	80	10
Number	5	2	12	1	6	16	3	8	18	7	4	14
Initial Q (Qb), veh	0	0	0	0	0	0	0	0	0	0	0	0
Ped-Bike Adj(A_pbT)	1.00		0.99	1.00		1.00	1.00		1.00	1.00		1.00
Parking Bus, Adj	1.00	1.00	1.00	1.00	1.00	1.00	1.00	1.00	1.00	1.00	1.00	1.00
Adj Sat Flow, veh/h/ln	1759	1759	1900	1845	1845	1900	1597	1597	1597	1776	1776	1900
Adj Flow Rate, veh/h	12	136	28	99	296	0	62	123	66	160	99	5
Adj No. of Lanes	1	1	0	1	1	0	1	1	1	1	1	0
Peak Hour Factor	0.81	0.81	0.81	0.81	0.81	0.81	0.81	0.81	0.81	0.81	0.81	0.81
Percent Heavy Veh, %	8	8	8	3	3	3	19	19	19	7	7	7
Cap, veh/h	21	377	78	127	602	0	76	220	187	210	356	18
Arrive On Green	0.01	0.27	0.27	0.07	0.33	0.00	0.05	0.14	0.14	0.12	0.21	0.21
Sat Flow, veh/h	1675	1415	291	1757	1845	0	1521	1597	1357	1691	1676	85
Grp Volume(v), veh/h	12	0	164	99	296	0	62	123	66	160	0	104
Grp Sat Flow(s),veh/h/ln	1675	0	1706	1757	1845	0	1521	1597	1357	1691	0	1761
Q Serve(g_s), s	0.3	0.0	3.1	2.2	5.2	0.0	1.6	2.9	1.8	3.7	0.0	2.0
Cycle Q Clear(g_c), s	0.3	0.0	3.1	2.2	5.2	0.0	1.6	2.9	1.8	3.7	0.0	2.0
Prop In Lane	1.00		0.17	1.00		0.00	1.00		1.00	1.00		0.05
Lane Grp Cap(c), veh/h	21	0	455	127	602	0	76	220	187	210	0	374
V/C Ratio(X)	0.57	0.00	0.36	0.78	0.49	0.00	0.82	0.56	0.35	0.76	0.00	0.28
Avail Cap(c_a), veh/h	167	0	1383	535	1873	0	398	876	745	730	0	1265
HCM Platoon Ratio	1.00	1.00	1.00	1.00	1.00	1.00	1.00	1.00	1.00	1.00	1.00	1.00
Upstream Filter(I)	1.00	0.00	1.00	1.00	1.00	0.00	1.00	1.00	1.00	1.00	0.00	1.00
Uniform Delay (d), s/veh	19.7	0.0	11.9	18.3	10.8	0.0	18.9	16.1	15.7	17.0	0.0	13.2
Incr Delay (d2), s/veh	22.4	0.0	0.5	9.8	0.6	0.0	18.9	2.2	1.1	5.7	0.0	0.4
Initial Q Delay(d3),s/veh	0.0	0.0	0.0	0.0	0.0	0.0	0.0	0.0	0.0	0.0	0.0	0.0
%ile BackOfQ(50%),veh/ln	0.3	0.0	1.5	1.4	2.7	0.0	1.1	1.4	0.7	2.0	0.0	1.0
LnGrp Delay(d),s/veh	42.1	0.0	12.4	28.1	11.5	0.0	37.8	18.3	16.8	22.7	0.0	13.6
LnGrp LOS	D		B	C	B		D	B	B	C		B
Approach Vol, veh/h		176			395			251				264
Approach Delay, s/veh		14.4			15.6			22.7				19.1
Approach LOS		B			B			C				B
Timer	1	2	3	4	5	6	7	8				
Assigned Phs	1	2	3	4	5	6	7	8				
Phs Duration (G+Y+Rc), s	6.4	15.7	5.5	12.5	4.0	18.1	8.5	9.5				
Change Period (Y+Rc), s	3.5	5.0	3.5	4.0	3.5	5.0	3.5	4.0				
Max Green Setting (Gmax), s	12.2	32.5	10.5	28.8	4.0	40.7	17.3	22.0				
Max Q Clear Time (g_c+I1), s	4.2	5.1	3.6	4.0	2.3	7.2	5.7	4.9				
Green Ext Time (p_c), s	0.1	0.9	0.1	0.5	0.0	1.9	0.3	0.8				
Intersection Summary												
HCM 2010 Ctrl Delay			17.9									
HCM 2010 LOS			B									

Intersection			
Intersection Delay, s/veh 50.5			
Intersection LOS F			
Approach	EB	WB	NB
Entry Lanes	1	1	1
Conflicting Circle Lanes	1	1	1
Adj Approach Flow, veh/h	368	1080	425
Demand Flow Rate, veh/h	460	1091	438
Vehicles Circulating, veh/h	778	95	230
Vehicles Exiting, veh/h	408	573	1008
Follow-Up Headway, s	3.186	3.186	3.186
Ped Vol Crossing Leg, #/h	0	0	0
Ped Cap Adj	1.000	1.000	1.000
Approach Delay, s/veh	51.6	65.8	10.4
Approach LOS	F	F	B
Lane	Left	Left	Left
Designated Moves	TR	LT	LR
Assumed Moves	TR	LT	LR
RT Channelized			
Lane Util	1.000	1.000	1.000
Critical Headway, s	5.193	5.193	5.193
Entry Flow, veh/h	460	1091	438
Cap Entry Lane, veh/h	519	1028	898
Entry HV Adj Factor	0.800	0.990	0.970
Flow Entry, veh/h	368	1080	425
Cap Entry, veh/h	415	1017	871
V/C Ratio	0.886	1.062	0.488
Control Delay, s/veh	51.6	65.8	10.4
LOS	F	F	B
95th %tile Queue, veh	9	24	3

HCM 2010 Signalized Intersection Summary
 23: Inter-Garrison Road & Abrams Drive

Cumulative with Eastside Parkway, AM
 06/11/2019

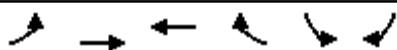

Movement	EBL	EBT	WBT	WBR	SBL	SBR		
Lane Configurations								
Traffic Volume (veh/h)	160	290	620	70	80	320		
Future Volume (veh/h)	160	290	620	70	80	320		
Number	5	2	6	16	7	14		
Initial Q (Qb), veh	0	0	0	0	0	0		
Ped-Bike Adj(A_pbT)	1.00			1.00	1.00	1.00		
Parking Bus, Adj	1.00	1.00	1.00	1.00	1.00	1.00		
Adj Sat Flow, veh/h/ln	1759	1759	1881	1881	1881	1881		
Adj Flow Rate, veh/h	188	341	729	76	94	158		
Adj No. of Lanes	1	1	1	1	2	1		
Peak Hour Factor	0.85	0.85	0.85	0.85	0.85	0.85		
Percent Heavy Veh, %	8	8	1	1	1	1		
Cap, veh/h	234	1151	806	685	474	218		
Arrive On Green	0.14	0.65	0.43	0.43	0.14	0.14		
Sat Flow, veh/h	1675	1759	1881	1599	3476	1599		
Grp Volume(v), veh/h	188	341	729	76	94	158		
Grp Sat Flow(s),veh/h/ln	1675	1759	1881	1599	1738	1599		
Q Serve(g_s), s	4.4	3.4	14.7	1.2	1.0	3.8		
Cycle Q Clear(g_c), s	4.4	3.4	14.7	1.2	1.0	3.8		
Prop In Lane	1.00			1.00	1.00	1.00		
Lane Grp Cap(c), veh/h	234	1151	806	685	474	218		
V/C Ratio(X)	0.80	0.30	0.90	0.11	0.20	0.72		
Avail Cap(c_a), veh/h	475	2602	2087	1774	2699	1242		
HCM Platoon Ratio	1.00	1.00	1.00	1.00	1.00	1.00		
Upstream Filter(I)	1.00	1.00	1.00	1.00	1.00	1.00		
Uniform Delay (d), s/veh	16.9	3.0	10.8	7.0	15.5	16.8		
Incr Delay (d2), s/veh	2.5	0.1	1.6	0.0	0.1	1.7		
Initial Q Delay(d3),s/veh	0.0	0.0	0.0	0.0	0.0	0.0		
%ile BackOfQ(50%),veh/ln	2.2	1.6	7.9	0.5	0.5	3.4		
LnGrp Delay(d),s/veh	19.4	3.1	12.5	7.0	15.6	18.5		
LnGrp LOS	B	A	B	A	B	B		
Approach Vol, veh/h		529	805		252			
Approach Delay, s/veh		8.9	11.9		17.4			
Approach LOS		A	B		B			
Timer	1	2	3	4	5	6	7	8
Assigned Phs		2		4	5	6		
Phs Duration (G+Y+Rc), s		31.5		9.0	9.2	22.4		
Change Period (Y+Rc), s		5.0		3.5	3.5	5.0		
Max Green Setting (Gmax), s		60.0		31.5	11.5	45.0		
Max Q Clear Time (g_c+I1), s		5.4		5.8	6.4	16.7		
Green Ext Time (p_c), s		0.3		0.0	0.0	0.7		
Intersection Summary								
HCM 2010 Ctrl Delay			11.8					
HCM 2010 LOS			B					

HCM 2010 Signalized Intersection Summary
 24: Inter-Garrison Road & Schoonover Road

Cumulative with Eastside Parkway, AM
 06/11/2019



Movement	EBL	EBT	EBR	WBL	WBT	WBR	NBL	NBT	NBR	SBL	SBT	SBR
Lane Configurations												
Traffic Volume (veh/h)	60	270	60	560	490	10	60	10	340	40	40	120
Future Volume (veh/h)	60	270	60	560	490	10	60	10	340	40	40	120
Number	5	2	12	1	6	16	3	8	18	7	4	14
Initial Q (Qb), veh	0	0	0	0	0	0	0	0	0	0	0	0
Ped-Bike Adj(A_pbT)	1.00		1.00	1.00		1.00	1.00		1.00	1.00		1.00
Parking Bus, Adj	1.00	1.00	1.00	1.00	1.00	1.00	1.00	1.00	1.00	1.00	1.00	1.00
Adj Sat Flow, veh/h/ln	1810	1819	1900	1863	1881	1881	1863	1863	1863	1900	1854	1845
Adj Flow Rate, veh/h	76	342	51	709	620	9	76	13	0	51	51	101
Adj No. of Lanes	1	2	0	1	2	1	1	1	1	0	1	1
Peak Hour Factor	0.79	0.79	0.79	0.79	0.79	0.79	0.79	0.79	0.79	0.79	0.79	0.79
Percent Heavy Veh, %	5	5	5	2	1	1	2	2	2	2	2	3
Cap, veh/h	102	420	62	736	1768	791	185	194	165	109	109	189
Arrive On Green	0.06	0.14	0.14	0.42	0.49	0.49	0.10	0.10	0.00	0.12	0.12	0.12
Sat Flow, veh/h	1723	3022	447	1774	3574	1599	1774	1863	1583	904	904	1564
Grp Volume(v), veh/h	76	194	199	709	620	9	76	13	0	102	0	101
Grp Sat Flow(s),veh/h/ln	1723	1728	1740	1774	1787	1599	1774	1863	1583	1808	0	1564
Q Serve(g_s), s	3.6	9.1	9.3	32.6	8.9	0.2	3.4	0.5	0.0	4.4	0.0	5.1
Cycle Q Clear(g_c), s	3.6	9.1	9.3	32.6	8.9	0.2	3.4	0.5	0.0	4.4	0.0	5.1
Prop In Lane	1.00		0.26	1.00		1.00	1.00		1.00	0.50		1.00
Lane Grp Cap(c), veh/h	102	240	242	736	1768	791	185	194	165	218	0	189
V/C Ratio(X)	0.74	0.81	0.82	0.96	0.35	0.01	0.41	0.07	0.00	0.47	0.00	0.53
Avail Cap(c_a), veh/h	319	619	623	1006	2645	1183	572	600	510	583	0	504
HCM Platoon Ratio	1.00	1.00	1.00	1.00	1.00	1.00	1.00	1.00	1.00	1.00	1.00	1.00
Upstream Filter(I)	1.00	1.00	1.00	1.00	1.00	1.00	1.00	1.00	0.00	1.00	0.00	1.00
Uniform Delay (d), s/veh	38.8	35.0	35.1	23.9	12.9	10.8	35.1	33.8	0.0	34.3	0.0	34.6
Incr Delay (d2), s/veh	3.9	2.5	2.7	15.2	0.0	0.0	0.5	0.1	0.0	0.6	0.0	0.9
Initial Q Delay(d3),s/veh	0.0	0.0	0.0	0.0	0.0	0.0	0.0	0.0	0.0	0.0	0.0	0.0
%ile BackOfQ(50%),veh/ln	1.8	4.5	4.6	18.9	4.4	0.1	1.7	0.3	0.0	2.2	0.0	2.3
LnGrp Delay(d),s/veh	42.7	37.5	37.7	39.0	13.0	10.8	35.6	33.9	0.0	34.9	0.0	35.5
LnGrp LOS	D	D	D	D	B	B	D	C		C		D
Approach Vol, veh/h		469			1338			89			203	
Approach Delay, s/veh		38.4			26.8			35.4			35.2	
Approach LOS		D			C			D			D	
Timer	1	2	3	4	5	6	7	8				
Assigned Phs	1	2		4	5	6		8				
Phs Duration (G+Y+Rc), s	38.3	16.6		15.1	8.5	46.4		13.7				
Change Period (Y+Rc), s	3.5	5.0		5.0	3.5	5.0		5.0				
Max Green Setting (Gmax), s	47.5	30.0		27.0	15.5	62.0		27.0				
Max Q Clear Time (g_c+3.6), s	34.6	11.3		7.1	5.6	10.9		5.4				
Green Ext Time (p_c), s	0.2	0.3		0.1	0.0	0.8		0.0				
Intersection Summary												
HCM 2010 Ctrl Delay				30.5								
HCM 2010 LOS				C								

Intersection	
Intersection Delay, s/veh	198.7
Intersection LOS	F

Movement	EBL	EBT	WBT	WBR	SBL	SBR
Lane Configurations						
Traffic Vol, veh/h	490	130	310	130	90	700
Future Vol, veh/h	490	130	310	130	90	700
Peak Hour Factor	0.82	0.82	0.82	0.82	0.82	0.82
Heavy Vehicles, %	5	5	1	1	0	0
Mvmt Flow	598	159	378	159	110	854
Number of Lanes	1	1	1	0	1	1

Approach	EB	WB	SB
Opposing Approach	WB	EB	
Opposing Lanes	1	2	0
Conflicting Approach Left	SB		WB
Conflicting Lanes Left	2	0	1
Conflicting Approach Right		SB	EB
Conflicting Lanes Right	0	2	2
HCM Control Delay	165.2	97.2	281.5
HCM LOS	F	F	F

Lane	EBLn1	EBLn2	WBLn1	SBLn1	SBLn2
Vol Left, %	100%	0%	0%	100%	0%
Vol Thru, %	0%	100%	70%	0%	0%
Vol Right, %	0%	0%	30%	0%	100%
Sign Control	Stop	Stop	Stop	Stop	Stop
Traffic Vol by Lane	490	130	440	90	700
LT Vol	490	0	0	90	0
Through Vol	0	130	310	0	0
RT Vol	0	0	130	0	700
Lane Flow Rate	598	159	537	110	854
Geometry Grp	7	7	4	7	7
Degree of Util (X)	1.357	0.338	1.077	0.247	1.639
Departure Headway (Hd)	9.865	9.341	8.921	8.734	7.488
Convergence, Y/N	Yes	Yes	Yes	Yes	Yes
Cap	376	388	413	414	495
Service Time	7.565	7.041	6.921	6.434	5.188
HCM Lane V/C Ratio	1.59	0.41	1.3	0.266	1.725
HCM Control Delay	204.6	16.7	97.2	14.3	315.8
HCM Lane LOS	F	C	F	B	F
HCM 95th-tile Q	24	1.5	14.9	1	45

HCM 2010 Signalized Intersection Summary
 26: East Garrison Road & Reservation Road

Cumulative with Eastside Parkway, AM
 06/11/2019



Movement	EBL	EBT	EBR	WBL	WBT	WBR	NBL	NBT	NBR	SBL	SBT	SBR
Lane Configurations	↖	↗		↖	↗		↖		↗			
Traffic Volume (veh/h)	0	620	80	150	1090	0	130	0	260	0	0	0
Future Volume (veh/h)	0	620	80	150	1090	0	130	0	260	0	0	0
Number	5	2	12	1	6	16	3	8	18			
Initial Q (Qb), veh	0	0	0	0	0	0	0	0	0			
Ped-Bike Adj(A_pbT)	1.00		1.00	1.00		1.00	1.00		1.00			
Parking Bus, Adj	1.00	1.00	1.00	1.00	1.00	1.00	1.00	1.00	1.00			
Adj Sat Flow, veh/h/ln	1827	1827	1900	1863	1863	0	1881	0	1881			
Adj Flow Rate, veh/h	0	697	88	169	1225	0	146	0	220			
Adj No. of Lanes	1	2	0	1	2	0	1	0	1			
Peak Hour Factor	0.89	0.89	0.89	0.89	0.89	0.89	0.89	0.89	0.89			
Percent Heavy Veh, %	4	4	4	2	2	0	1	0	1			
Cap, veh/h	4	1287	162	215	2164	0	315	0	281			
Arrive On Green	0.00	0.41	0.41	0.12	0.61	0.00	0.18	0.00	0.18			
Sat Flow, veh/h	1740	3102	391	1774	3632	0	1792	0	1599			
Grp Volume(v), veh/h	0	390	395	169	1225	0	146	0	220			
Grp Sat Flow(s),veh/h/ln	1740	1736	1758	1774	1770	0	1792	0	1599			
Q Serve(g_s), s	0.0	8.1	8.1	4.4	9.8	0.0	3.5	0.0	6.2			
Cycle Q Clear(g_c), s	0.0	8.1	8.1	4.4	9.8	0.0	3.5	0.0	6.2			
Prop In Lane	1.00		0.22	1.00		0.00	1.00		1.00			
Lane Grp Cap(c), veh/h	4	720	729	215	2164	0	315	0	281			
V/C Ratio(X)	0.00	0.54	0.54	0.79	0.57	0.00	0.46	0.00	0.78			
Avail Cap(c_a), veh/h	732	2191	2219	746	4467	0	1018	0	908			
HCM Platoon Ratio	1.00	1.00	1.00	1.00	1.00	1.00	1.00	1.00	1.00			
Upstream Filter(I)	0.00	1.00	1.00	1.00	1.00	0.00	1.00	0.00	1.00			
Uniform Delay (d), s/veh	0.0	10.5	10.5	20.3	5.5	0.0	17.6	0.0	18.7			
Incr Delay (d2), s/veh	0.0	1.2	1.2	2.4	0.3	0.0	0.4	0.0	1.8			
Initial Q Delay(d3),s/veh	0.0	0.0	0.0	0.0	0.0	0.0	0.0	0.0	0.0			
%ile BackOfQ(50%),veh/ln	0.0	4.0	4.1	2.3	4.7	0.0	1.7	0.0	2.9			
LnGrp Delay(d),s/veh	0.0	11.7	11.7	22.7	5.8	0.0	18.0	0.0	20.5			
LnGrp LOS		B	B	C	A		B		C			
Approach Vol, veh/h		785			1394			366				
Approach Delay, s/veh		11.7			7.8			19.5				
Approach LOS		B			A			B				
Timer	1	2	3	4	5	6	7	8				
Assigned Phs	1	2			5	6		8				
Phs Duration (G+Y+Rc), s	9.4	25.1			0.0	34.5		13.1				
Change Period (Y+Rc), s	3.6	5.4			3.5	5.4		4.7				
Max Green Setting (Gmax)	20	60.0			20.0	60.0		27.0				
Max Q Clear Time (g_c+10)	4	10.1			0.0	11.8		8.2				
Green Ext Time (p_c), s	0.0	9.6			0.0	13.3		0.2				
Intersection Summary												
HCM 2010 Ctrl Delay				10.7								
HCM 2010 LOS				B								
Notes												

HCM 2010 Signalized Intersection Summary
27: Reservation Road & Watkins Gate Road

Cumulative with Eastside Parkway, AM
06/11/2019



Movement	EBL	EBR	NBL	NBT	SBT	SBR		
Lane Configurations								
Traffic Volume (veh/h)	10	250	160	1480	990	60		
Future Volume (veh/h)	10	250	160	1480	990	60		
Number	5	12	3	8	4	14		
Initial Q (Qb), veh	0	0	0	0	0	0		
Ped-Bike Adj(A_pbT)	1.00	1.00	1.00			1.00		
Parking Bus, Adj	1.00	1.00	1.00	1.00	1.00	1.00		
Adj Sat Flow, veh/h/ln	1863	1863	1863	1863	1863	1900		
Adj Flow Rate, veh/h	11	44	174	1609	1076	58		
Adj No. of Lanes	1	1	1	2	2	0		
Peak Hour Factor	0.92	0.92	0.92	0.92	0.92	0.92		
Percent Heavy Veh, %	2	2	2	2	2	2		
Cap, veh/h	89	80	217	2583	1843	99		
Arrive On Green	0.05	0.05	0.12	0.73	0.54	0.54		
Sat Flow, veh/h	1774	1583	1774	3632	3509	184		
Grp Volume(v), veh/h	11	44	174	1609	557	577		
Grp Sat Flow(s),veh/h/ln	1774	1583	1774	1770	1770	1830		
Q Serve(g_s), s	0.4	1.6	5.6	13.3	12.5	12.5		
Cycle Q Clear(g_c), s	0.4	1.6	5.6	13.3	12.5	12.5		
Prop In Lane	1.00	1.00	1.00			0.10		
Lane Grp Cap(c), veh/h	89	80	217	2583	955	988		
V/C Ratio(X)	0.12	0.55	0.80	0.62	0.58	0.58		
Avail Cap(c_a), veh/h	555	496	540	4102	1392	1440		
HCM Platoon Ratio	1.00	1.00	1.00	1.00	1.00	1.00		
Upstream Filter(I)	1.00	1.00	1.00	1.00	1.00	1.00		
Uniform Delay (d), s/veh	26.8	27.4	25.2	4.0	9.1	9.1		
Incr Delay (d2), s/veh	0.2	2.2	2.6	0.4	0.9	0.9		
Initial Q Delay(d3),s/veh	0.0	0.0	0.0	0.0	0.0	0.0		
%ile BackOfQ(50%),veh/ln	0.2	0.7	2.9	6.4	6.3	6.5		
LnGrp Delay(d),s/veh	27.0	29.6	27.8	4.4	10.0	10.0		
LnGrp LOS	C	C	C	A	B	B		
Approach Vol, veh/h	55			1783	1134			
Approach Delay, s/veh	29.1			6.6	10.0			
Approach LOS	C			A	B			
Timer	1	2	3	4	5	6	7	8
Assigned Phs		2	3	4				8
Phs Duration (G+Y+Rc), s		9.5	11.2	38.4				49.6
Change Period (Y+Rc), s		6.5	4.0	6.5				6.5
Max Green Setting (Gmax), s		18.5	18.0	46.5				68.5
Max Q Clear Time (g_c+I1), s		3.6	7.6	14.5				15.3
Green Ext Time (p_c), s		0.0	0.0	12.5				27.8
Intersection Summary								
HCM 2010 Ctrl Delay			8.4					
HCM 2010 LOS			A					

HCM 2010 Signalized Intersection Summary
28: Davis Road & Reservation Road

Cumulative with Eastside Parkway, AM
06/11/2019



Movement	EBL	EBT	EBR	WBL	WBT	WBR	NBL	NBT	NBR	SBL	SBT	SBR
Lane Configurations												
Traffic Volume (veh/h)	650	310	10	10	560	90	10	10	10	150	10	750
Future Volume (veh/h)	650	310	10	10	560	90	10	10	10	150	10	750
Number	5	2	12	1	6	16	3	8	18	7	4	14
Initial Q (Qb), veh	0	0	0	0	0	0	0	0	0	0	0	0
Ped-Bike Adj(A_pbT)	1.00		1.00	1.00		1.00	1.00		1.00	1.00		1.00
Parking Bus, Adj	1.00	1.00	1.00	1.00	1.00	1.00	1.00	1.00	1.00	1.00	1.00	1.00
Adj Sat Flow, veh/h/ln	1863	1863	1900	1863	1863	1900	1900	1900	1900	1900	1845	1845
Adj Flow Rate, veh/h	756	360	12	12	651	105	12	12	9	174	12	630
Adj No. of Lanes	1	2	0	1	1	0	0	1	0	0	1	1
Peak Hour Factor	0.86	0.86	0.86	0.86	0.86	0.86	0.86	0.86	0.86	0.86	0.86	0.86
Percent Heavy Veh, %	2	2	2	2	2	2	0	0	0	3	3	3
Cap, veh/h	376	2185	73	19	664	107	17	17	12	350	24	665
Arrive On Green	0.21	0.62	0.62	0.01	0.42	0.42	0.03	0.03	0.03	0.21	0.21	0.21
Sat Flow, veh/h	1774	3496	116	1774	1566	253	648	648	486	1649	114	1568
Grp Volume(v), veh/h	756	182	190	12	0	756	33	0	0	186	0	630
Grp Sat Flow(s),veh/h/ln	1774	1770	1842	1774	0	1818	1782	0	0	1762	0	1568
Q Serve(g_s), s	30.0	6.1	6.1	1.0	0.0	58.0	2.6	0.0	0.0	13.1	0.0	30.0
Cycle Q Clear(g_c), s	30.0	6.1	6.1	1.0	0.0	58.0	2.6	0.0	0.0	13.1	0.0	30.0
Prop In Lane	1.00		0.06	1.00		0.14	0.36		0.27	0.94		1.00
Lane Grp Cap(c), veh/h	376	1106	1151	19	0	771	46	0	0	374	0	665
V/C Ratio(X)	2.01	0.16	0.17	0.64	0.00	0.98	0.72	0.00	0.00	0.50	0.00	0.95
Avail Cap(c_a), veh/h	376	1106	1151	376	0	771	378	0	0	374	0	665
HCM Platoon Ratio	1.00	1.00	1.00	1.00	1.00	1.00	1.00	1.00	1.00	1.00	1.00	1.00
Upstream Filter(I)	1.00	1.00	1.00	1.00	0.00	1.00	1.00	0.00	0.00	1.00	0.00	1.00
Uniform Delay (d), s/veh	55.7	11.1	11.1	69.7	0.0	40.1	68.4	0.0	0.0	49.1	0.0	39.2
Incr Delay (d2), s/veh	463.3	0.1	0.1	12.4	0.0	27.5	7.7	0.0	0.0	0.4	0.0	22.5
Initial Q Delay(d3),s/veh	0.0	0.0	0.0	0.0	0.0	0.0	0.0	0.0	0.0	0.0	0.0	0.0
%ile BackOfQ(50%),veh/ln	63.1	3.0	3.1	0.5	0.0	34.9	1.4	0.0	0.0	6.4	0.0	27.9
LnGrp Delay(d),s/veh	519.0	11.2	11.2	82.1	0.0	67.7	76.1	0.0	0.0	49.5	0.0	61.6
LnGrp LOS	F	B	B	F		E	E			D		E
Approach Vol, veh/h		1128			768			33			816	
Approach Delay, s/veh		351.5			67.9			76.1			58.9	
Approach LOS		F			E			E			E	
Timer	1	2	3	4	5	6	7	8				
Assigned Phs	1	2		4	5	6		8				
Phs Duration (G+Y+Rc), s	5.4	93.4		35.0	33.8	65.0		7.6				
Change Period (Y+Rc), s	3.9	5.0		5.0	* 3.8	5.0		4.0				
Max Green Setting (Gmax), s	30	60.0		30.0	* 30	60.0		30.0				
Max Q Clear Time (g_c+13), s	13.5	8.1		32.0	32.0	60.0		4.6				
Green Ext Time (p_c), s	0.0	3.3		0.0	0.0	0.0		0.0				
Intersection Summary												
HCM 2010 Ctrl Delay			181.9									
HCM 2010 LOS			F									
Notes												

HCM 2010 Signalized Intersection Summary
29: 2nd Avenue & Divarty Street

Cumulative with Eastside Parkway, AM
06/11/2019



Movement	EBL	EBT	EBR	WBL	WBT	WBR	NBL	NBT	NBR	SBL	SBT	SBR
Lane Configurations		↕			↕	↕	↕	↕		↕	↕	
Traffic Volume (veh/h)	80	10	40	40	20	20	130	560	80	20	890	250
Future Volume (veh/h)	80	10	40	40	20	20	130	560	80	20	890	250
Number	5	2	12	1	6	16	3	8	18	7	4	14
Initial Q (Qb), veh	0	0	0	0	0	0	0	0	0	0	0	0
Ped-Bike Adj(A_pbT)	1.00		1.00	1.00		1.00	1.00		1.00	1.00		1.00
Parking Bus, Adj	1.00	1.00	1.00	1.00	1.00	1.00	1.00	1.00	1.00	1.00	1.00	1.00
Adj Sat Flow, veh/h/ln	1900	1667	1900	1900	1900	1900	1863	1863	1900	1881	1881	1900
Adj Flow Rate, veh/h	88	11	44	44	22	22	143	615	88	22	978	275
Adj No. of Lanes	0	1	0	0	1	1	1	2	0	1	2	0
Peak Hour Factor	0.91	0.91	0.91	0.91	0.91	0.91	0.91	0.91	0.91	0.91	0.91	0.91
Percent Heavy Veh, %	14	14	14	0	0	0	2	2	2	1	1	1
Cap, veh/h	219	38	69	276	118	285	185	1739	248	46	1327	372
Arrive On Green	0.18	0.18	0.18	0.18	0.18	0.18	0.10	0.56	0.56	0.03	0.48	0.48
Sat Flow, veh/h	656	217	388	961	669	1612	1774	3109	444	1792	2758	772
Grp Volume(v), veh/h	143	0	0	66	0	22	143	350	353	22	632	621
Grp Sat Flow(s),veh/h/ln	1262	0	0	1630	0	1612	1774	1770	1783	1792	1787	1743
Q Serve(g_s), s	4.3	0.0	0.0	0.0	0.0	0.6	4.5	6.1	6.2	0.7	16.1	16.3
Cycle Q Clear(g_c), s	6.1	0.0	0.0	1.8	0.0	0.6	4.5	6.1	6.2	0.7	16.1	16.3
Prop In Lane	0.62		0.31	0.67		1.00	1.00		0.25	1.00		0.44
Lane Grp Cap(c), veh/h	325	0	0	394	0	285	185	990	998	46	860	839
V/C Ratio(X)	0.44	0.00	0.00	0.17	0.00	0.08	0.77	0.35	0.35	0.48	0.74	0.74
Avail Cap(c_a), veh/h	897	0	0	1059	0	996	360	1249	1259	364	1261	1230
HCM Platoon Ratio	1.00	1.00	1.00	1.00	1.00	1.00	1.00	1.00	1.00	1.00	1.00	1.00
Upstream Filter(I)	1.00	0.00	0.00	1.00	0.00	1.00	1.00	1.00	1.00	1.00	1.00	1.00
Uniform Delay (d), s/veh	21.7	0.0	0.0	19.9	0.0	19.5	24.7	6.9	6.9	27.2	11.8	11.9
Incr Delay (d2), s/veh	0.9	0.0	0.0	0.2	0.0	0.1	6.8	0.2	0.2	7.4	1.3	1.3
Initial Q Delay(d3),s/veh	0.0	0.0	0.0	0.0	0.0	0.0	0.0	0.0	0.0	0.0	0.0	0.0
%ile BackOfQ(50%),veh/ln	2.1	0.0	0.0	0.9	0.0	0.3	2.5	3.0	3.0	0.4	8.2	8.1
LnGrp Delay(d),s/veh	22.7	0.0	0.0	20.1	0.0	19.6	31.5	7.1	7.1	34.6	13.1	13.2
LnGrp LOS	C			C		B	C	A	A	C	B	B
Approach Vol, veh/h		143			88			846			1275	
Approach Delay, s/veh		22.7			20.0			11.2			13.5	
Approach LOS		C			B			B			B	
Timer	1	2	3	4	5	6	7	8				
Assigned Phs		2	3	4		6	7	8				
Phs Duration (G+Y+Rc), s		15.0	9.4	32.3		15.0	5.0	36.7				
Change Period (Y+Rc), s		5.0	3.5	5.0		5.0	3.5	5.0				
Max Green Setting (Gmax), s		35.0	11.5	40.0		35.0	11.5	40.0				
Max Q Clear Time (g_c+I1), s		8.1	6.5	18.3		3.8	2.7	8.2				
Green Ext Time (p_c), s		0.8	0.1	9.0		0.4	0.0	4.7				
Intersection Summary												
HCM 2010 Ctrl Delay				13.5								
HCM 2010 LOS				B								

Intersection												
Intersection Delay, s/veh	10.1											
Intersection LOS	B											

Movement	EBL	EBT	EBR	WBL	WBT	WBR	NBL	NBT	NBR	SBL	SBT	SBR
Lane Configurations		↕			↕		↗	↘		↗	↘	
Traffic Vol, veh/h	10	10	20	40	10	10	30	240	20	10	190	20
Future Vol, veh/h	10	10	20	40	10	10	30	240	20	10	190	20
Peak Hour Factor	0.91	0.91	0.91	0.91	0.91	0.91	0.91	0.91	0.91	0.91	0.91	0.91
Heavy Vehicles, %	0	0	0	1	1	1	2	2	2	1	1	1
Mvmt Flow	11	11	22	44	11	11	33	264	22	11	209	22
Number of Lanes	0	1	0	0	1	0	1	1	0	1	1	0

Approach	EB	WB	NB	SB
Opposing Approach	WB	EB	SB	NB
Opposing Lanes	1	1	2	2
Conflicting Approach Left	SB	NB	EB	WB
Conflicting Lanes Left	2	2	1	1
Conflicting Approach Right	NB	SB	WB	EB
Conflicting Lanes Right	2	2	1	1
HCM Control Delay	8.5	9	10.7	10
HCM LOS	A	A	B	A

Lane	NBLn1	NBLn2	EBLn1	WBLn1	SBLn1	SBLn2
Vol Left, %	100%	0%	25%	67%	100%	0%
Vol Thru, %	0%	92%	25%	17%	0%	90%
Vol Right, %	0%	8%	50%	17%	0%	10%
Sign Control	Stop	Stop	Stop	Stop	Stop	Stop
Traffic Vol by Lane	30	260	40	60	10	210
LT Vol	30	0	10	40	10	0
Through Vol	0	240	10	10	0	190
RT Vol	0	20	20	10	0	20
Lane Flow Rate	33	286	44	66	11	231
Geometry Grp	7	7	2	2	7	7
Degree of Util (X)	0.051	0.395	0.062	0.098	0.017	0.322
Departure Headway (Hd)	5.531	4.974	5.081	5.34	5.587	5.017
Convergence, Y/N	Yes	Yes	Yes	Yes	Yes	Yes
Cap	647	723	701	668	640	715
Service Time	3.271	2.714	3.141	3.397	3.329	2.759
HCM Lane V/C Ratio	0.051	0.396	0.063	0.099	0.017	0.323
HCM Control Delay	8.6	10.9	8.5	9	8.4	10.1
HCM Lane LOS	A	B	A	A	A	B
HCM 95th-tile Q	0.2	1.9	0.2	0.3	0.1	1.4

HCM 2010 Signalized Intersection Summary
31: 1st Avenue & Lightfighter Drive

Cumulative with Eastside Parkway, AM
06/11/2019



Movement	EBL	EBT	EBR	WBL	WBT	WBR	NBL	NBT	NBR	SBL	SBT	SBR
Lane Configurations		↑↑	↑	↑	↑↑		↑		↑	↑	↑	↑
Traffic Volume (veh/h)	0	1180	130	20	1190	0	160	0	20	120	30	100
Future Volume (veh/h)	0	1180	130	20	1190	0	160	0	20	120	30	100
Number	7	4	14	3	8	18	5	2	12	1	6	16
Initial Q (Qb), veh	0	0	0	0	0	0	0	0	0	0	0	0
Ped-Bike Adj(A_pbT)	1.00		1.00	1.00		1.00	1.00		1.00	1.00		1.00
Parking Bus, Adj	1.00	1.00	1.00	1.00	1.00	1.00	1.00	1.00	1.00	1.00	1.00	1.00
Adj Sat Flow, veh/h/ln	0	1863	1863	1863	1863	0	1863	0	1863	1792	1792	1792
Adj Flow Rate, veh/h	0	1405	0	24	1417	0	190	0	10	143	36	100
Adj No. of Lanes	0	2	1	1	2	0	1	0	1	1	1	1
Peak Hour Factor	0.84	0.84	0.84	0.84	0.84	0.84	0.84	0.84	0.84	0.84	0.84	0.84
Percent Heavy Veh, %	0	2	2	2	2	0	2	0	2	6	6	6
Cap, veh/h	0	2198	983	27	2486	0	0	0	0	212	222	189
Arrive On Green	0.00	0.62	0.00	0.02	0.70	0.00	0.00	0.00	0.00	0.12	0.12	0.12
Sat Flow, veh/h	0	3632	1583	1774	3632	0		0		1707	1792	1524
Grp Volume(v), veh/h	0	1405	0	24	1417	0		0.0		143	36	100
Grp Sat Flow(s),veh/h/ln	0	1770	1583	1774	1770	0				1707	1792	1524
Q Serve(g_s), s	0.0	13.2	0.0	0.7	10.5	0.0				4.2	1.0	3.3
Cycle Q Clear(g_c), s	0.0	13.2	0.0	0.7	10.5	0.0				4.2	1.0	3.3
Prop In Lane	0.00		1.00	1.00		0.00				1.00		1.00
Lane Grp Cap(c), veh/h	0	2198	983	27	2486	0				212	222	189
V/C Ratio(X)	0.00	0.64	0.00	0.88	0.57	0.00				0.68	0.16	0.53
Avail Cap(c_a), veh/h	0	3004	1344	669	3004	0				805	845	718
HCM Platoon Ratio	1.00	1.00	1.00	1.00	1.00	1.00				1.00	1.00	1.00
Upstream Filter(I)	0.00	1.00	0.00	1.00	1.00	0.00				1.00	1.00	1.00
Uniform Delay (d), s/veh	0.0	6.3	0.0	26.1	3.9	0.0				22.2	20.8	21.8
Incr Delay (d2), s/veh	0.0	0.4	0.0	26.7	0.3	0.0				1.4	0.1	0.9
Initial Q Delay(d3),s/veh	0.0	0.0	0.0	0.0	0.0	0.0				0.0	0.0	0.0
%ile BackOfQ(50%),veh/lr	0.0	6.4	0.0	0.5	5.0	0.0				2.1	0.5	1.4
LnGrp Delay(d),s/veh	0.0	6.8	0.0	52.7	4.2	0.0				23.6	20.9	22.6
LnGrp LOS		A		D	A					C	C	C
Approach Vol, veh/h		1405			1441						279	
Approach Delay, s/veh		6.8			5.0						22.9	
Approach LOS		A			A						C	
Timer	1	2	3	4	5	6	7	8				
Assigned Phs			3	4		6		8				
Phs Duration (G+Y+Rc), s			4.3	37.5		11.2		41.8				
Change Period (Y+Rc), s			3.5	4.6		4.6		4.6				
Max Green Setting (Gmax), s			20.0	45.0		25.0		45.0				
Max Q Clear Time (g_c+I1), s			2.7	15.2		6.2		12.5				
Green Ext Time (p_c), s			0.0	17.7		0.4		17.8				
Intersection Summary												
HCM 2010 Ctrl Delay			7.4									
HCM 2010 LOS			A									

HCM 2010 Signalized Intersection Summary
32: 2nd Avenue & Lightfighter Drive

Cumulative with Eastside Parkway, AM
06/11/2019



Movement	EBL	EBT	EBR	WBL	WBT	WBR	NBL	NBT	NBR	SBL	SBT	SBR
Lane Configurations												
Traffic Volume (veh/h)	340	970	10	40	760	190	20	20	50	350	10	490
Future Volume (veh/h)	340	970	10	40	760	190	20	20	50	350	10	490
Number	5	2	12	1	6	16	3	8	18	7	4	14
Initial Q (Qb), veh	0	0	0	0	0	0	0	0	0	0	0	0
Ped-Bike Adj(A_pbT)	1.00		1.00	1.00		1.00	1.00		1.00	1.00		1.00
Parking Bus, Adj	1.00	1.00	1.00	1.00	1.00	1.00	1.00	1.00	1.00	1.00	1.00	1.00
Adj Sat Flow, veh/h/ln	1863	1863	1900	1827	1827	1900	1900	1900	1900	1881	1881	1881
Adj Flow Rate, veh/h	378	1078	11	44	844	202	22	22	55	389	11	268
Adj No. of Lanes	1	2	0	1	2	0	0	1	0	1	1	1
Peak Hour Factor	0.90	0.90	0.90	0.90	0.90	0.90	0.90	0.90	0.90	0.90	0.90	0.90
Percent Heavy Veh, %	2	2	2	4	4	4	0	0	0	1	1	1
Cap, veh/h	220	1909	19	56	1223	293	123	132	264	489	572	486
Arrive On Green	0.12	0.53	0.53	0.03	0.44	0.44	0.30	0.30	0.30	0.30	0.30	0.30
Sat Flow, veh/h	1774	3589	37	1740	2780	665	261	434	869	1330	1881	1599
Grp Volume(v), veh/h	378	531	558	44	527	519	99	0	0	389	11	268
Grp Sat Flow(s),veh/h/ln	1774	1770	1856	1740	1736	1710	1564	0	0	1330	1881	1599
Q Serve(g_s), s	12.4	20.1	20.1	2.5	24.4	24.4	0.0	0.0	0.0	23.2	0.4	14.0
Cycle Q Clear(g_c), s	12.4	20.1	20.1	2.5	24.4	24.4	4.2	0.0	0.0	27.4	0.4	14.0
Prop In Lane	1.00		0.02	1.00		0.39	0.22		0.56	1.00		1.00
Lane Grp Cap(c), veh/h	220	941	988	56	763	752	520	0	0	489	572	486
V/C Ratio(X)	1.72	0.56	0.56	0.79	0.69	0.69	0.19	0.00	0.00	0.79	0.02	0.55
Avail Cap(c_a), veh/h	220	941	988	216	763	752	671	0	0	622	760	646
HCM Platoon Ratio	1.00	1.00	1.00	1.00	1.00	1.00	1.00	1.00	1.00	1.00	1.00	1.00
Upstream Filter(I)	0.57	0.57	0.57	0.09	0.09	0.09	1.00	0.00	0.00	0.57	0.57	0.57
Uniform Delay (d), s/veh	43.8	15.7	15.7	48.1	22.5	22.5	25.7	0.0	0.0	33.4	24.4	29.1
Incr Delay (d2), s/veh	334.0	1.4	1.3	0.9	0.5	0.5	0.1	0.0	0.0	2.5	0.0	0.2
Initial Q Delay(d3),s/veh	0.0	0.0	0.0	0.0	0.0	0.0	0.0	0.0	0.0	0.0	0.0	0.0
%ile BackOfQ(50%),veh/ln	26.5	10.1	10.6	1.2	11.8	11.6	2.0	0.0	0.0	10.7	0.2	6.2
LnGrp Delay(d),s/veh	377.8	17.1	17.0	49.0	23.0	23.0	25.7	0.0	0.0	35.8	24.4	29.3
LnGrp LOS	F	B	B	D	C	C	C			D	C	C
Approach Vol, veh/h		1467			1090			99			668	
Approach Delay, s/veh		110.0			24.0			25.7			33.0	
Approach LOS		F			C			C			C	
Timer	1	2	3	4	5	6	7	8				
Assigned Phs	1	2		4	5	6		8				
Phs Duration (G+Y+Rc), s	7.2	57.8		35.0	16.4	48.6		35.0				
Change Period (Y+Rc), s	4.0	4.6		4.6	4.0	4.6		4.6				
Max Green Setting (Gmax), s	2.4	34.0		40.4	12.4	24.4		40.4				
Max Q Clear Time (g_c+14), s	14.5	22.1		29.4	14.4	26.4		6.2				
Green Ext Time (p_c), s	0.0	3.5		1.0	0.0	0.0		0.4				
Intersection Summary												
HCM 2010 Ctrl Delay			63.8									
HCM 2010 LOS			E									

HCM 2010 Signalized Intersection Summary
 33: General Jim Moore Boulevard & Lightfighter Drive

Cumulative with Eastside Parkway, AM
 06/11/2019



Movement	EBL	EBT	EBR	WBL	WBT	WBR	NBL	NBT	NBR	SBL	SBT	SBR
Lane Configurations												
Traffic Volume (veh/h)	80	280	710	20	210	60	760	90	10	30	80	70
Future Volume (veh/h)	80	280	710	20	210	60	760	90	10	30	80	70
Number	3	8	18	7	4	14	1	6	16	5	2	12
Initial Q (Qb), veh	0	0	0	0	0	0	0	0	0	0	0	0
Ped-Bike Adj(A_pbT)	1.00		1.00	1.00		1.00	1.00		1.00	1.00		1.00
Parking Bus, Adj	1.00	1.00	1.00	1.00	1.00	1.00	1.00	1.00	1.00	1.00	1.00	1.00
Adj Sat Flow, veh/h/ln	1863	1863	1863	1792	1792	1900	1881	1881	1900	1863	1863	1900
Adj Flow Rate, veh/h	90	315	0	22	236	65	854	101	10	34	90	79
Adj No. of Lanes	1	1	1	1	1	0	2	1	0	1	2	0
Peak Hour Factor	0.89	0.89	0.89	0.89	0.89	0.89	0.89	0.89	0.89	0.89	0.89	0.89
Percent Heavy Veh, %	2	2	2	6	6	6	1	1	1	2	2	2
Cap, veh/h	118	538	458	36	330	91	696	504	50	53	242	192
Arrive On Green	0.07	0.29	0.00	0.02	0.24	0.24	0.20	0.30	0.30	0.03	0.13	0.13
Sat Flow, veh/h	1774	1863	1583	1707	1352	372	3476	1685	167	1774	1872	1489
Grp Volume(v), veh/h	90	315	0	22	0	301	854	0	111	34	85	84
Grp Sat Flow(s),veh/h/ln	1774	1863	1583	1707	0	1725	1738	0	1851	1774	1770	1592
Q Serve(g_s), s	2.5	7.2	0.0	0.6	0.0	8.0	10.0	0.0	2.2	0.9	2.2	2.4
Cycle Q Clear(g_c), s	2.5	7.2	0.0	0.6	0.0	8.0	10.0	0.0	2.2	0.9	2.2	2.4
Prop In Lane	1.00		1.00	1.00		0.22	1.00		0.09	1.00		0.94
Lane Grp Cap(c), veh/h	118	538	458	36	0	420	696	0	554	53	228	206
V/C Ratio(X)	0.76	0.59	0.00	0.61	0.00	0.72	1.23	0.00	0.20	0.64	0.37	0.41
Avail Cap(c_a), veh/h	711	1119	951	684	0	1036	696	0	1112	533	1063	956
HCM Platoon Ratio	1.00	1.00	1.00	1.00	1.00	1.00	1.00	1.00	1.00	1.00	1.00	1.00
Upstream Filter(I)	1.00	1.00	0.00	1.00	0.00	1.00	1.00	0.00	1.00	1.00	1.00	1.00
Uniform Delay (d), s/veh	22.9	15.2	0.0	24.2	0.0	17.3	20.0	0.0	13.0	23.9	19.9	20.0
Incr Delay (d2), s/veh	9.8	1.2	0.0	6.1	0.0	2.8	114.5	0.0	0.4	4.6	1.2	1.6
Initial Q Delay(d3),s/veh	0.0	0.0	0.0	0.0	0.0	0.0	0.0	0.0	0.0	0.0	0.0	0.0
%ile BackOfQ(50%),veh/ln	1.5	3.9	0.0	0.4	0.0	4.1	15.8	0.0	1.2	0.5	1.1	1.1
LnGrp Delay(d),s/veh	32.7	16.4	0.0	30.3	0.0	20.1	134.4	0.0	13.4	28.5	21.1	21.6
LnGrp LOS	C	B		C		C	F		B	C	C	C
Approach Vol, veh/h		405			323			965			203	
Approach Delay, s/veh		20.0			20.8			120.5			22.5	
Approach LOS		C			C			F			C	
Timer	1	2	3	4	5	6	7	8				
Assigned Phs	1	2	3	4	5	6	7	8				
Phs Duration (G+Y+Rc), s	4.5	10.9	7.8	16.7	6.0	19.4	5.6	18.9				
Change Period (Y+Rc), s	4.5	4.5	4.5	4.5	4.5	4.5	4.5	4.5				
Max Green Setting (Gmax), s	30.0	30.0	20.0	30.0	15.0	30.0	20.0	30.0				
Max Q Clear Time (g_c+1), s	4.4	4.5	10.0	2.9	4.2	2.6	9.2					
Green Ext Time (p_c), s	0.0	1.1	0.2	2.2	0.0	1.0	0.0	2.0				
Intersection Summary												
HCM 2010 Ctrl Delay				71.6								
HCM 2010 LOS				E								

Intersection

Intersection Delay, s/veh 13.1

Intersection LOS B

Movement	WBL	WBR	NBT	NBR	SBL	SBT
Lane Configurations	Y		B			A
Traffic Vol, veh/h	30	240	50	20	270	50
Future Vol, veh/h	30	240	50	20	270	50
Peak Hour Factor	0.77	0.77	0.77	0.77	0.77	0.77
Heavy Vehicles, %	4	4	3	3	2	2
Mvmt Flow	39	312	65	26	351	65
Number of Lanes	1	0	1	0	0	1

Approach	WB	NB	SB
Opposing Approach		SB	NB
Opposing Lanes	0	1	1
Conflicting Approach Left NB			WB
Conflicting Lanes Left	1	0	1
Conflicting Approach Right SB		WB	
Conflicting Lanes Right	1	1	0
HCM Control Delay	11.8	9.1	15.1
HCM LOS	B	A	C

Lane	NBLn1	WBLn1	SBLn1
Vol Left, %	0%	11%	84%
Vol Thru, %	71%	0%	16%
Vol Right, %	29%	89%	0%
Sign Control	Stop	Stop	Stop
Traffic Vol by Lane	70	270	320
LT Vol	0	30	270
Through Vol	50	0	50
RT Vol	20	240	0
Lane Flow Rate	91	351	416
Geometry Grp	1	1	1
Degree of Util (X)	0.133	0.46	0.583
Departure Headway (Hd)	5.285	4.723	5.054
Convergence, Y/N	Yes	Yes	Yes
Cap	683	757	706
Service Time	3.285	2.797	3.149
HCM Lane V/C Ratio	0.133	0.464	0.589
HCM Control Delay	9.1	11.8	15.1
HCM Lane LOS	A	B	C
HCM 95th-tile Q	0.5	2.4	3.8

Intersection						
Int Delay, s/veh	1.6					
Movement	EBT	EBR	WBL	WBT	NBL	NBR
Lane Configurations						
Traffic Vol, veh/h	260	30	20	250	30	30
Future Vol, veh/h	260	30	20	250	30	30
Conflicting Peds, #/hr	0	0	0	0	0	0
Sign Control	Free	Free	Free	Free	Stop	Stop
RT Channelized	-	None	-	None	-	None
Storage Length	-	-	-	-	0	-
Veh in Median Storage, #	0	-	-	0	0	-
Grade, %	0	-	-	0	0	-
Peak Hour Factor	78	78	78	78	78	78
Heavy Vehicles, %	5	5	4	4	0	0
Mvmt Flow	333	38	26	321	38	38

Major/Minor	Major1	Major2	Minor1	Minor2	Minor3
Conflicting Flow All	0	0	371	0	725
Stage 1	-	-	-	-	352
Stage 2	-	-	-	-	373
Critical Hdwy	-	-	4.14	-	6.4
Critical Hdwy Stg 1	-	-	-	-	5.4
Critical Hdwy Stg 2	-	-	-	-	5.4
Follow-up Hdwy	-	-	2.236	-	3.5
Pot Cap-1 Maneuver	-	-	1177	-	395
Stage 1	-	-	-	-	716
Stage 2	-	-	-	-	701
Platoon blocked, %	-	-	-	-	-
Mov Cap-1 Maneuver	-	-	1177	-	384
Mov Cap-2 Maneuver	-	-	-	-	384
Stage 1	-	-	-	-	697
Stage 2	-	-	-	-	701

Approach	EB	WB	NB
HCM Control Delay, s	0	0.6	13.6
HCM LOS			B

Minor Lane/Major Mvmt	NBLn1	EBT	EBR	WBL	WBT
Capacity (veh/h)	495	-	-	1177	-
HCM Lane V/C Ratio	0.155	-	-	0.022	-
HCM Control Delay (s)	13.6	-	-	8.1	0
HCM Lane LOS	B	-	-	A	A
HCM 95th %tile Q(veh)	0.5	-	-	0.1	-

Intersection	
Intersection Delay, s/veh	12.7
Intersection LOS	B

Movement	EBL	EBT	EBR	WBL	WBT	WBR	NBL	NBT	NBR	SBL	SBT	SBR
Lane Configurations		↕			↕			↕			↕	
Traffic Vol, veh/h	10	250	30	10	190	10	50	70	20	10	50	30
Future Vol, veh/h	10	250	30	10	190	10	50	70	20	10	50	30
Peak Hour Factor	0.79	0.79	0.79	0.79	0.79	0.79	0.79	0.79	0.79	0.79	0.79	0.79
Heavy Vehicles, %	6	6	6	4	4	4	20	20	20	2	2	2
Mvmt Flow	13	316	38	13	241	13	63	89	25	13	63	38
Number of Lanes	0	1	0	0	1	0	0	1	0	0	1	0

Approach	EB	WB	NB	SB
Opposing Approach	WB	EB	SB	NB
Opposing Lanes	1	1	1	1
Conflicting Approach Left	SB	NB	EB	WB
Conflicting Lanes Left	1	1	1	1
Conflicting Approach Right	NB	SB	WB	EB
Conflicting Lanes Right	1	1	1	1
HCM Control Delay	14.3	12	11.8	10.2
HCM LOS	B	B	B	B

Lane	NBLn1	EBLn1	WBLn1	SBLn1
Vol Left, %	36%	3%	5%	11%
Vol Thru, %	50%	86%	90%	56%
Vol Right, %	14%	10%	5%	33%
Sign Control	Stop	Stop	Stop	Stop
Traffic Vol by Lane	140	290	210	90
LT Vol	50	10	10	10
Through Vol	70	250	190	50
RT Vol	20	30	10	30
Lane Flow Rate	177	367	266	114
Geometry Grp	1	1	1	1
Degree of Util (X)	0.302	0.536	0.399	0.184
Departure Headway (Hd)	6.129	5.257	5.405	5.814
Convergence, Y/N	Yes	Yes	Yes	Yes
Cap	585	686	665	614
Service Time	4.183	3.3	3.452	3.875
HCM Lane V/C Ratio	0.303	0.535	0.4	0.186
HCM Control Delay	11.8	14.3	12	10.2
HCM Lane LOS	B	B	B	B
HCM 95th-tile Q	1.3	3.2	1.9	0.7

Intersection												
Int Delay, s/veh	12											
Movement	EBL	EBT	EBR	WBL	WBT	WBR	NBL	NBT	NBR	SBL	SBT	SBR
Lane Configurations		↕			↕			↕			↕	
Traffic Vol, veh/h	70	110	90	10	110	20	50	60	20	10	60	40
Future Vol, veh/h	70	110	90	10	110	20	50	60	20	10	60	40
Conflicting Peds, #/hr	0	0	0	0	0	0	0	0	1	1	0	0
Sign Control	Stop	Stop	Stop	Stop	Stop	Stop	Free	Free	Free	Free	Free	Free
RT Channelized	-	-	None	-	-	None	-	-	None	-	-	None
Storage Length	-	-	-	-	-	-	-	-	-	-	-	-
Veh in Median Storage, #	-	0	-	-	0	-	-	0	-	-	0	-
Grade, %	-	0	-	-	0	-	-	0	-	-	0	-
Peak Hour Factor	82	82	82	82	82	82	82	82	82	82	82	82
Heavy Vehicles, %	12	12	12	0	0	0	10	10	10	10	10	10
Mvmt Flow	85	134	110	12	134	24	61	73	24	12	73	49

Major/Minor	Minor2		Minor1		Major1			Major2				
Conflicting Flow All	408	342	98	452	354	86	122	0	0	98	0	0
Stage 1	122	122	-	208	208	-	-	-	-	-	-	-
Stage 2	286	220	-	244	146	-	-	-	-	-	-	-
Critical Hdwy	7.22	6.62	6.32	7.1	6.5	6.2	4.2	-	-	4.2	-	-
Critical Hdwy Stg 1	6.22	5.62	-	6.1	5.5	-	-	-	-	-	-	-
Critical Hdwy Stg 2	6.22	5.62	-	6.1	5.5	-	-	-	-	-	-	-
Follow-up Hdwy	3.608	4.108	3.408	3.5	4	3.3	2.29	-	-	2.29	-	-
Pot Cap-1 Maneuver	536	564	931	521	574	978	1417	-	-	1446	-	-
Stage 1	859	776	-	799	734	-	-	-	-	-	-	-
Stage 2	700	703	-	764	780	-	-	-	-	-	-	-
Platoon blocked, %								-	-	-	-	-
Mov Cap-1 Maneuver	406	532	931	355	542	977	1417	-	-	1445	-	-
Mov Cap-2 Maneuver	406	532	-	355	542	-	-	-	-	-	-	-
Stage 1	819	769	-	761	700	-	-	-	-	-	-	-
Stage 2	526	670	-	551	773	-	-	-	-	-	-	-

Approach	EB		WB		NB		SB	
HCM Control Delay, s	19.8		14.3		2.9		0.7	
HCM LOS	C		B					

Minor Lane/Major Mvmt	NBL	NBT	NBR	EBLn1WBLn1	SBL	SBT	SBR
Capacity (veh/h)	1417	-	-	567	556	1445	-
HCM Lane V/C Ratio	0.043	-	-	0.581	0.307	0.008	-
HCM Control Delay (s)	7.7	0	-	19.8	14.3	7.5	0
HCM Lane LOS	A	A	-	C	B	A	A
HCM 95th %tile Q(veh)	0.1	-	-	3.7	1.3	0	-

Intersection						
Int Delay, s/veh	3.7					
Movement	EBL	EBR	NBL	NBT	SBT	SBR
Lane Configurations	T			T		
Traffic Vol, veh/h	130	10	10	220	370	130
Future Vol, veh/h	130	10	10	220	370	130
Conflicting Peds, #/hr	0	0	0	0	0	0
Sign Control	Stop	Stop	Free	Free	Free	Free
RT Channelized	-	None	-	None	-	None
Storage Length	0	-	-	-	-	-
Veh in Median Storage, #	0	-	-	0	0	-
Grade, %	0	-	-	0	0	-
Peak Hour Factor	89	89	89	89	89	89
Heavy Vehicles, %	13	13	2	2	0	0
Mvmt Flow	146	11	11	247	416	146























Major/Minor	Minor2	Major1		Major2	
Conflicting Flow All	758	489	562	0	0
Stage 1	489	-	-	-	-
Stage 2	269	-	-	-	-
Critical Hdwy	6.53	6.33	4.12	-	-
Critical Hdwy Stg 1	5.53	-	-	-	-
Critical Hdwy Stg 2	5.53	-	-	-	-
Follow-up Hdwy	3.617	3.417	2.218	-	-
Pot Cap-1 Maneuver	360	557	1009	-	-
Stage 1	594	-	-	-	-
Stage 2	751	-	-	-	-
Platoon blocked, %				-	-
Mov Cap-1 Maneuver	355	557	1009	-	-
Mov Cap-2 Maneuver	355	-	-	-	-
Stage 1	586	-	-	-	-
Stage 2	751	-	-	-	-

Approach	EB	NB	SB
HCM Control Delay, s	22.2	0.4	0
HCM LOS	C		

Minor Lane/Major Mvmt	NBL	NBT	EBLn1	SBT	SBR
Capacity (veh/h)	1009	-	364	-	-
HCM Lane V/C Ratio	0.011	-	0.432	-	-
HCM Control Delay (s)	8.6	0	22.2	-	-
HCM Lane LOS	A	A	C	-	-
HCM 95th %tile Q(veh)	0	-	2.1	-	-

HCM 2010 Signalized Intersection Summary
 39: General Jim Moore Boulevard & Gigling Road

Cumulative with Eastside Parkway, AM
 06/11/2019

												
Movement	EBL	EBT	EBR	WBL	WBT	WBR	NBL	NBT	NBR	SBL	SBT	SBR
Lane Configurations												
Traffic Volume (veh/h)	30	100	80	430	40	450	50	350	270	330	480	50
Future Volume (veh/h)	30	100	80	430	40	450	50	350	270	330	480	50
Number	3	8	18	7	4	14	1	6	16	5	2	12
Initial Q (Qb), veh	0	0	0	0	0	0	0	0	0	0	0	0
Ped-Bike Adj(A_pbT)	1.00		1.00	1.00		1.00	1.00		1.00	1.00		1.00
Parking Bus, Adj	1.00	1.00	1.00	1.00	1.00	1.00	1.00	1.00	1.00	1.00	1.00	1.00
Adj Sat Flow, veh/h/ln	1810	1810	1900	1863	1863	1863	1881	1881	1881	1863	1863	1863
Adj Flow Rate, veh/h	34	115	60	494	46	0	57	402	0	379	552	0
Adj No. of Lanes	1	2	0	1	2	1	1	2	1	1	2	1
Peak Hour Factor	0.87	0.87	0.87	0.87	0.87	0.87	0.87	0.87	0.87	0.87	0.87	0.87
Percent Heavy Veh, %	5	5	5	2	2	2	1	1	1	2	2	2
Cap, veh/h	60	193	95	518	1219	545	86	514	230	392	1121	502
Arrive On Green	0.03	0.09	0.09	0.29	0.34	0.00	0.05	0.14	0.00	0.22	0.32	0.00
Sat Flow, veh/h	1723	2232	1098	1774	3539	1583	1792	3574	1599	1774	3539	1583
Grp Volume(v), veh/h	34	87	88	494	46	0	57	402	0	379	552	0
Grp Sat Flow(s),veh/h/ln	1723	1719	1611	1774	1770	1583	1792	1787	1599	1774	1770	1583
Q Serve(g_s), s	1.4	3.4	3.7	19.2	0.6	0.0	2.2	7.6	0.0	14.9	8.9	0.0
Cycle Q Clear(g_c), s	1.4	3.4	3.7	19.2	0.6	0.0	2.2	7.6	0.0	14.9	8.9	0.0
Prop In Lane	1.00		0.68	1.00		1.00	1.00		1.00	1.00		1.00
Lane Grp Cap(c), veh/h	60	149	140	518	1219	545	86	514	230	392	1121	502
V/C Ratio(X)	0.57	0.58	0.63	0.95	0.04	0.00	0.67	0.78	0.00	0.97	0.49	0.00
Avail Cap(c_a), veh/h	258	760	712	518	2068	925	140	1274	570	392	1766	790
HCM Platoon Ratio	1.00	1.00	1.00	1.00	1.00	1.00	1.00	1.00	1.00	1.00	1.00	1.00
Upstream Filter(I)	1.00	1.00	1.00	1.00	1.00	0.00	1.00	1.00	0.00	1.00	1.00	0.00
Uniform Delay (d), s/veh	33.4	30.8	31.0	24.4	15.3	0.0	32.9	29.0	0.0	27.1	19.4	0.0
Incr Delay (d2), s/veh	3.2	1.3	1.7	27.8	0.0	0.0	3.3	1.0	0.0	36.5	0.1	0.0
Initial Q Delay(d3),s/veh	0.0	0.0	0.0	0.0	0.0	0.0	0.0	0.0	0.0	0.0	0.0	0.0
%ile BackOfQ(50%),veh/ln	0.7	1.7	1.7	13.3	0.3	0.0	1.2	3.8	0.0	11.2	4.3	0.0
LnGrp Delay(d),s/veh	36.5	32.2	32.7	52.2	15.3	0.0	36.1	30.0	0.0	63.6	19.5	0.0
LnGrp LOS	D	C	C	D	B		D	C		E	B	
Approach Vol, veh/h		209			540			459			931	
Approach Delay, s/veh		33.1			49.0			30.7			37.5	
Approach LOS		C			D			C			D	
Timer	1	2	3	4	5	6	7	8				
Assigned Phs	1	2	3	4	5	6	7	8				
Phs Duration (G+Y+Rc), s	7.9	26.7	6.9	28.7	20.0	14.6	25.0	10.6				
Change Period (Y+Rc), s	4.5	4.5	4.5	4.5	4.5	4.5	4.5	4.5				
Max Green Setting (Gmax), s	5.5	35.0	10.5	41.0	15.5	25.0	20.5	31.0				
Max Q Clear Time (g_c+I1), s	4.2	10.9	3.4	2.6	16.9	9.6	21.2	5.7				
Green Ext Time (p_c), s	0.0	0.7	0.0	0.1	0.0	0.5	0.0	0.2				
Intersection Summary												
HCM 2010 Ctrl Delay				38.5								
HCM 2010 LOS				D								

HCM 2010 Signalized Intersection Summary
40: Malmedy Road & Gigling Road

Cumulative with Eastside Parkway, AM
06/11/2019



Movement	EBL	EBT	EBR	WBL	WBT	WBR	NBL	NBT	NBR	SBL	SBT	SBR
Lane Configurations		↔↑			↔↑			↔			↔	
Traffic Volume (veh/h)	20	610	30	50	850	10	20	30	30	10	60	30
Future Volume (veh/h)	20	610	30	50	850	10	20	30	30	10	60	30
Number	7	4	14	3	8	18	5	2	12	1	6	16
Initial Q (Qb), veh	0	0	0	0	0	0	0	0	0	0	0	0
Ped-Bike Adj(A_pbT)	1.00		1.00	1.00		1.00	1.00		1.00	1.00		1.00
Parking Bus, Adj	1.00	1.00	1.00	1.00	1.00	1.00	1.00	1.00	1.00	1.00	1.00	1.00
Adj Sat Flow, veh/h/ln	1900	1845	1900	1900	1845	1900	1900	1863	1900	1900	1827	1900
Adj Flow Rate, veh/h	23	693	34	57	966	11	23	34	34	11	68	34
Adj No. of Lanes	0	2	0	0	2	0	0	1	0	0	1	0
Peak Hour Factor	0.88	0.88	0.88	0.88	0.88	0.88	0.88	0.88	0.88	0.88	0.88	0.88
Percent Heavy Veh, %	3	3	3	3	3	3	2	2	2	4	4	4
Cap, veh/h	195	1279	63	228	1320	15	267	117	102	206	176	84
Arrive On Green	0.41	0.41	0.41	0.41	0.41	0.41	0.17	0.17	0.17	0.17	0.17	0.17
Sat Flow, veh/h	36	3132	155	96	3234	36	325	710	618	116	1065	509
Grp Volume(v), veh/h	389	0	361	528	0	506	91	0	0	113	0	0
Grp Sat Flow(s),veh/h/ln	1672	0	1651	1694	0	1672	1653	0	0	1690	0	0
Q Serve(g_s), s	0.1	0.0	3.5	1.6	0.0	5.4	0.0	0.0	0.0	0.2	0.0	0.0
Cycle Q Clear(g_c), s	5.6	0.0	3.5	5.3	0.0	5.4	1.0	0.0	0.0	1.2	0.0	0.0
Prop In Lane	0.06		0.09	0.11		0.02	0.25		0.37	0.10		0.30
Lane Grp Cap(c), veh/h	863	0	674	881	0	683	487	0	0	467	0	0
V/C Ratio(X)	0.45	0.00	0.54	0.60	0.00	0.74	0.19	0.00	0.00	0.24	0.00	0.00
Avail Cap(c_a), veh/h	4094	0	3950	4010	0	4001	2509	0	0	2607	0	0
HCM Platoon Ratio	1.00	1.00	1.00	1.00	1.00	1.00	1.00	1.00	1.00	1.00	1.00	1.00
Upstream Filter(I)	1.00	0.00	1.00	1.00	0.00	1.00	1.00	0.00	0.00	1.00	0.00	0.00
Uniform Delay (d), s/veh	4.7	0.0	4.7	5.2	0.0	5.3	7.8	0.0	0.0	7.9	0.0	0.0
Incr Delay (d2), s/veh	0.1	0.0	0.2	0.2	0.0	0.6	0.1	0.0	0.0	0.1	0.0	0.0
Initial Q Delay(d3),s/veh	0.0	0.0	0.0	0.0	0.0	0.0	0.0	0.0	0.0	0.0	0.0	0.0
%ile BackOfQ(50%),veh/ln	1.7	0.0	1.6	2.6	0.0	2.5	0.5	0.0	0.0	0.6	0.0	0.0
LnGrp Delay(d),s/veh	4.8	0.0	5.0	5.4	0.0	5.9	7.8	0.0	0.0	8.0	0.0	0.0
LnGrp LOS	A		A	A		A	A			A		
Approach Vol, veh/h		750			1034			91			113	
Approach Delay, s/veh		4.9			5.7			7.8			8.0	
Approach LOS		A			A			A			A	
Timer	1	2	3	4	5	6	7	8				
Assigned Phs		2		4		6		8				
Phs Duration (G+Y+Rc), s		8.0		13.1		8.0		13.1				
Change Period (Y+Rc), s		4.5		4.5		4.5		4.5				
Max Green Setting (Gmax), s		30.5		50.5		30.5		50.5				
Max Q Clear Time (g_c+I1), s		3.0		7.6		3.2		7.4				
Green Ext Time (p_c), s		0.1		0.8		0.1		1.1				
Intersection Summary												
HCM 2010 Ctrl Delay				5.6								
HCM 2010 LOS				A								

HCM 2010 Signalized Intersection Summary
41: Parker Flatts Cut Off Road & Gigling Road

Cumulative with Eastside Parkway, AM
06/11/2019



Movement	EBL	EBT	EBR	WBL	WBT	WBR	NBL	NBT	NBR	SBL	SBT	SBR
Lane Configurations		↕↕			↕↕			↕	↕		↕↕	
Traffic Volume (veh/h)	10	560	80	110	850	10	40	10	50	10	30	10
Future Volume (veh/h)	10	560	80	110	850	10	40	10	50	10	30	10
Number	7	4	14	3	8	18	5	2	12	1	6	16
Initial Q (Qb), veh	0	0	0	0	0	0	0	0	0	0	0	0
Ped-Bike Adj(A_pbT)	1.00		1.00	1.00		1.00	1.00		1.00	1.00		1.00
Parking Bus, Adj	1.00	1.00	1.00	1.00	1.00	1.00	1.00	1.00	1.00	1.00	1.00	1.00
Adj Sat Flow, veh/h/ln	1900	1845	1900	1900	1863	1900	1900	1863	1863	1900	1900	1900
Adj Flow Rate, veh/h	12	667	95	131	1012	12	48	12	60	12	36	12
Adj No. of Lanes	0	2	0	0	2	0	0	1	1	0	1	0
Peak Hour Factor	0.84	0.84	0.84	0.84	0.84	0.84	0.84	0.84	0.84	0.84	0.84	0.84
Percent Heavy Veh, %	3	3	3	2	2	2	2	2	2	0	0	0
Cap, veh/h	163	1416	200	288	1362	16	426	67	231	218	167	51
Arrive On Green	0.48	0.48	0.48	0.48	0.48	0.48	0.15	0.15	0.15	0.15	0.15	0.15
Sat Flow, veh/h	16	2976	420	213	2863	34	1052	457	1583	250	1139	347
Grp Volume(v), veh/h	411	0	363	559	0	596	60	0	60	60	0	0
Grp Sat Flow(s),veh/h/ln1807	0	1605	1421	0	1689	1509	0	1583	1737	0	0	0
Q Serve(g_s), s	0.0	0.0	3.7	4.1	0.0	6.8	0.0	0.0	0.8	0.0	0.0	0.0
Cycle Q Clear(g_c), s	3.6	0.0	3.7	7.8	0.0	6.8	0.7	0.0	0.8	0.7	0.0	0.0
Prop In Lane	0.03		0.26	0.23		0.02	0.80		1.00	0.20		0.20
Lane Grp Cap(c), veh/h	1015	0	763	863	0	804	493	0	231	435	0	0
V/C Ratio(X)	0.40	0.00	0.48	0.65	0.00	0.74	0.12	0.00	0.26	0.14	0.00	0.00
Avail Cap(c_a), veh/h	4215	0	3741	3353	0	3938	1816	0	1696	2009	0	0
HCM Platoon Ratio	1.00	1.00	1.00	1.00	1.00	1.00	1.00	1.00	1.00	1.00	1.00	1.00
Upstream Filter(I)	1.00	0.00	1.00	1.00	0.00	1.00	1.00	0.00	1.00	1.00	0.00	0.00
Uniform Delay (d), s/veh	4.2	0.0	4.2	5.1	0.0	5.1	9.0	0.0	9.0	9.0	0.0	0.0
Incr Delay (d2), s/veh	0.1	0.0	0.2	0.3	0.0	0.5	0.0	0.0	0.2	0.1	0.0	0.0
Initial Q Delay(d3),s/veh	0.0	0.0	0.0	0.0	0.0	0.0	0.0	0.0	0.0	0.0	0.0	0.0
%ile BackOfQ(50%),veh/ln1.7	0.0	1.5	3.0	0.0	3.1	0.4	0.0	0.4	0.4	0.4	0.0	0.0
LnGrp Delay(d),s/veh	4.3	0.0	4.4	5.4	0.0	5.6	9.0	0.0	9.2	9.0	0.0	0.0
LnGrp LOS	A		A	A		A	A		A	A		
Approach Vol, veh/h		774			1155			120			60	
Approach Delay, s/veh		4.3			5.5			9.1			9.0	
Approach LOS		A			A			A			A	
Timer	1	2	3	4	5	6	7	8				
Assigned Phs		2		4		6		8				
Phs Duration (G+Y+Rc), s		8.0		15.8		8.0		15.8				
Change Period (Y+Rc), s		4.5		4.5		4.5		4.5				
Max Green Setting (Gmax), s		25.5		55.5		25.5		55.5				
Max Q Clear Time (g_c+I1), s		2.8		5.7		2.7		9.8				
Green Ext Time (p_c), s		0.0		0.8		0.0		1.6				
Intersection Summary												
HCM 2010 Ctrl Delay				5.4								
HCM 2010 LOS				A								

HCM 2010 Signalized Intersection Summary
42: 6th Avenue & Gigling Road

Cumulative with Eastside Parkway, AM
06/11/2019



Movement	EBL	EBT	EBR	WBL	WBT	WBR	NBL	NBT	NBR	SBL	SBT	SBR
Lane Configurations		↔			↔			↔	↔		↔	
Traffic Volume (veh/h)	90	520	10	30	850	10	10	10	10	10	10	120
Future Volume (veh/h)	90	520	10	30	850	10	10	10	10	10	10	120
Number	7	4	14	3	8	18	5	2	12	1	6	16
Initial Q (Qb), veh	0	0	0	0	0	0	0	0	0	0	0	0
Ped-Bike Adj(A_pbT)	1.00		1.00	1.00		1.00	1.00		1.00	1.00		1.00
Parking Bus, Adj	1.00	1.00	1.00	1.00	1.00	1.00	1.00	1.00	1.00	1.00	1.00	1.00
Adj Sat Flow, veh/h/ln	1900	1845	1900	1900	1863	1900	1900	1429	1429	1900	1863	1900
Adj Flow Rate, veh/h	101	584	11	34	955	11	11	11	0	11	11	135
Adj No. of Lanes	0	2	0	0	2	0	0	1	1	0	1	0
Peak Hour Factor	0.89	0.89	0.89	0.89	0.89	0.89	0.89	0.89	0.89	0.89	0.89	0.89
Percent Heavy Veh, %	3	3	3	2	2	2	33	33	33	2	2	2
Cap, veh/h	282	1063	21	201	1416	16	321	142	198	192	23	223
Arrive On Green	0.42	0.42	0.42	0.42	0.42	0.42	0.16	0.16	0.00	0.16	0.16	0.16
Sat Flow, veh/h	150	2546	50	53	3393	39	423	869	1214	79	144	1368
Grp Volume(v), veh/h	329	0	367	519	0	481	22	0	0	157	0	0
Grp Sat Flow(s),veh/h/ln	1076	0	1670	1796	0	1688	1292	0	1214	1591	0	0
Q Serve(g_s), s	0.9	0.0	3.5	0.1	0.0	5.0	0.0	0.0	0.0	1.0	0.0	0.0
Cycle Q Clear(g_c), s	5.9	0.0	3.5	4.8	0.0	5.0	0.3	0.0	0.0	2.0	0.0	0.0
Prop In Lane	0.31		0.03	0.07		0.02	0.50		1.00	0.07		0.86
Lane Grp Cap(c), veh/h	668	0	697	928	0	705	462	0	198	439	0	0
V/C Ratio(X)	0.49	0.00	0.53	0.56	0.00	0.68	0.05	0.00	0.00	0.36	0.00	0.00
Avail Cap(c_a), veh/h	2793	0	3927	4254	0	3971	1894	0	1725	2427	0	0
HCM Platoon Ratio	1.00	1.00	1.00	1.00	1.00	1.00	1.00	1.00	1.00	1.00	1.00	1.00
Upstream Filter(I)	1.00	0.00	1.00	1.00	0.00	1.00	1.00	0.00	0.00	1.00	0.00	0.00
Uniform Delay (d), s/veh	4.6	0.0	4.7	5.1	0.0	5.1	7.6	0.0	0.0	8.3	0.0	0.0
Incr Delay (d2), s/veh	0.2	0.0	0.2	0.2	0.0	0.4	0.0	0.0	0.0	0.2	0.0	0.0
Initial Q Delay(d3),s/veh	0.0	0.0	0.0	0.0	0.0	0.0	0.0	0.0	0.0	0.0	0.0	0.0
%ile BackOfQ(50%),veh/ln	1.4	0.0	1.6	2.5	0.0	2.4	0.1	0.0	0.0	0.9	0.0	0.0
LnGrp Delay(d),s/veh	4.8	0.0	4.9	5.2	0.0	5.5	7.6	0.0	0.0	8.5	0.0	0.0
LnGrp LOS	A		A	A		A	A			A		
Approach Vol, veh/h		696			1000			22			157	
Approach Delay, s/veh		4.8			5.4			7.6			8.5	
Approach LOS		A			A			A			A	
Timer	1	2	3	4	5	6	7	8				
Assigned Phs		2		4		6		8				
Phs Duration (G+Y+Rc), s		8.0		13.5		8.0		13.5				
Change Period (Y+Rc), s		4.5		4.5		4.5		4.5				
Max Green Setting (Gmax), s		30.5		50.5		30.5		50.5				
Max Q Clear Time (g_c+I1), s		2.3		7.9		4.0		7.0				
Green Ext Time (p_c), s		0.0		1.1		0.2		1.0				
Intersection Summary												
HCM 2010 Ctrl Delay				5.5								
HCM 2010 LOS				A								

HCM 2010 Signalized Intersection Summary
43: Gigling Road & 7th Avenue

Cumulative with Eastside Parkway, AM
06/11/2019

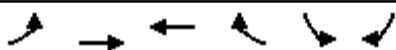

Movement	EBL	EBT	WBT	WBR	SBL	SBR		
Lane Configurations		↑↑	↑↑		↑↑			
Traffic Volume (veh/h)	100	450	750	10	10	130		
Future Volume (veh/h)	100	450	750	10	10	130		
Number	7	4	8	18	1	16		
Initial Q (Qb), veh	0	0	0	0	0	0		
Ped-Bike Adj(A_pbT)	1.00			1.00	1.00	1.00		
Parking Bus, Adj	1.00	1.00	1.00	1.00	1.00	1.00		
Adj Sat Flow, veh/h/ln	1900	1845	1900	1900	1759	1900		
Adj Flow Rate, veh/h	116	523	872	12	12	151		
Adj No. of Lanes	0	2	2	0	0	0		
Peak Hour Factor	0.86	0.86	0.86	0.86	0.86	0.86		
Percent Heavy Veh, %	3	3	0	0	0	0		
Cap, veh/h	331	979	1455	20	17	208		
Arrive On Green	0.40	0.40	0.40	0.40	0.15	0.15		
Sat Flow, veh/h	208	2537	3741	50	110	1389		
Grp Volume(v), veh/h	312	327	432	452	164	0		
Grp Sat Flow(s),veh/h/ln	1067	1595	1805	1891	1509	0		
Q Serve(g_s), s	1.2	3.1	3.8	3.8	2.1	0.0		
Cycle Q Clear(g_c), s	4.9	3.1	3.8	3.8	2.1	0.0		
Prop In Lane	0.37			0.03	0.07	0.92		
Lane Grp Cap(c), veh/h	673	636	720	755	226	0		
V/C Ratio(X)	0.46	0.51	0.60	0.60	0.73	0.00		
Avail Cap(c_a), veh/h	3208	4438	5023	5263	1929	0		
HCM Platoon Ratio	1.00	1.00	1.00	1.00	1.00	1.00		
Upstream Filter(I)	1.00	1.00	1.00	1.00	1.00	0.00		
Uniform Delay (d), s/veh	4.6	4.5	4.7	4.7	8.1	0.0		
Incr Delay (d2), s/veh	0.2	0.2	0.3	0.3	1.7	0.0		
Initial Q Delay(d3),s/veh	0.0	0.0	0.0	0.0	0.0	0.0		
%ile BackOfQ(50%),veh/ln	1.4	1.3	1.9	1.9	0.9	0.0		
LnGrp Delay(d),s/veh	4.8	4.8	5.0	5.0	9.8	0.0		
LnGrp LOS	A	A	A	A	A			
Approach Vol, veh/h		639	884		164			
Approach Delay, s/veh		4.8	5.0		9.8			
Approach LOS		A	A		A			
Timer	1	2	3	4	5	6	7	8
Assigned Phs				4		6		8
Phs Duration (G+Y+Rc), s				12.5		7.5		12.5
Change Period (Y+Rc), s				4.5		4.5		4.5
Max Green Setting (Gmax), s				55.5		25.5		55.5
Max Q Clear Time (g_c+I1), s				6.9		4.1		5.8
Green Ext Time (p_c), s				1.0		0.0		0.8
Intersection Summary								
HCM 2010 Ctrl Delay			5.4					
HCM 2010 LOS			A					
Notes								

HCM 2010 Signalized Intersection Summary
44: 8th Avenue & Gigling Road

Cumulative with Eastside Parkway, AM
06/11/2019



Movement	EBL	EBT	EBR	WBL	WBT	WBR	NBL	NBT	NBR	SBL	SBT	SBR
Lane Configurations		↕↕			↕↕			↕			↕	
Traffic Volume (veh/h)	220	240	10	10	400	10	10	10	10	10	10	360
Future Volume (veh/h)	220	240	10	10	400	10	10	10	10	10	10	360
Number	7	4	14	3	8	18	5	2	12	1	6	16
Initial Q (Qb), veh	0	0	0	0	0	0	0	0	0	0	0	0
Ped-Bike Adj(A_pbT)	1.00		1.00	1.00		1.00	1.00		1.00	1.00		1.00
Parking Bus, Adj	1.00	1.00	1.00	1.00	1.00	1.00	1.00	1.00	1.00	1.00	1.00	1.00
Adj Sat Flow, veh/h/ln	1900	1863	1900	1900	1863	1900	1900	1900	1900	1900	1900	1900
Adj Flow Rate, veh/h	259	282	12	12	471	12	12	12	12	12	12	248
Adj No. of Lanes	0	2	0	0	2	0	0	1	0	0	1	0
Peak Hour Factor	0.85	0.85	0.85	0.85	0.85	0.85	0.85	0.85	0.85	0.85	0.85	0.85
Percent Heavy Veh, %	2	2	2	2	2	2	0	0	0	0	0	0
Cap, veh/h	586	737	32	150	1537	39	240	188	126	146	24	325
Arrive On Green	0.45	0.45	0.45	0.45	0.45	0.45	0.22	0.22	0.22	0.22	0.22	0.22
Sat Flow, veh/h	720	1636	70	26	3413	86	293	855	574	36	107	1482
Grp Volume(v), veh/h	265	0	288	260	0	235	36	0	0	272	0	0
Grp Sat Flow(s),veh/h/ln	743	0	1683	1844	0	1680	1722	0	0	1626	0	0
Q Serve(g_s), s	6.9	0.0	3.1	0.0	0.0	2.4	0.0	0.0	0.0	1.3	0.0	0.0
Cycle Q Clear(g_c), s	9.4	0.0	3.1	2.4	0.0	2.4	0.4	0.0	0.0	4.3	0.0	0.0
Prop In Lane	0.98		0.04	0.05		0.05	0.33		0.33	0.04		0.91
Lane Grp Cap(c), veh/h	596	0	758	969	0	757	554	0	0	495	0	0
V/C Ratio(X)	0.44	0.00	0.38	0.27	0.00	0.31	0.06	0.00	0.00	0.55	0.00	0.00
Avail Cap(c_a), veh/h	1379	0	2191	2504	0	2187	2701	0	0	2836	0	0
HCM Platoon Ratio	1.00	1.00	1.00	1.00	1.00	1.00	1.00	1.00	1.00	1.00	1.00	1.00
Upstream Filter(I)	1.00	0.00	1.00	1.00	0.00	1.00	1.00	0.00	0.00	1.00	0.00	0.00
Uniform Delay (d), s/veh	7.7	0.0	5.0	4.8	0.0	4.8	8.5	0.0	0.0	10.0	0.0	0.0
Incr Delay (d2), s/veh	0.2	0.0	0.1	0.1	0.0	0.1	0.0	0.0	0.0	0.4	0.0	0.0
Initial Q Delay(d3),s/veh	0.0	0.0	0.0	0.0	0.0	0.0	0.0	0.0	0.0	0.0	0.0	0.0
%ile BackOfQ(50%),veh/ln	1.7	0.0	1.4	1.2	0.0	1.1	0.2	0.0	0.0	1.9	0.0	0.0
LnGrp Delay(d),s/veh	7.9	0.0	5.1	4.8	0.0	4.9	8.5	0.0	0.0	10.3	0.0	0.0
LnGrp LOS	A		A	A		A	A			B		
Approach Vol, veh/h		553			495			36			272	
Approach Delay, s/veh		6.4			4.9			8.5			10.3	
Approach LOS		A			A			A			B	
Timer	1	2	3	4	5	6	7	8				
Assigned Phs		2		4		6		8				
Phs Duration (G+Y+Rc), s		10.5		16.8		10.5		16.8				
Change Period (Y+Rc), s		4.5		4.5		4.5		4.5				
Max Green Setting (Gmax), s		45.5		35.5		45.5		35.5				
Max Q Clear Time (g_c+I1), s		2.4		11.4		6.3		4.4				
Green Ext Time (p_c), s		0.0		0.9		0.4		0.6				
Intersection Summary												
HCM 2010 Ctrl Delay				6.7								
HCM 2010 LOS				A								

HCM 2010 Signalized Intersection Summary
45: Eastside Parkway & Gigling Road

Cumulative with Eastside Parkway, AM
06/11/2019



Movement	EBL	EBT	EBR	WBL	WBT	WBR	NBL	NBT	NBR	SBL	SBT	SBR
Lane Configurations												
Traffic Volume (veh/h)	230	10	10	10	10	10	10	180	10	10	280	390
Future Volume (veh/h)	230	10	10	10	10	10	10	180	10	10	280	390
Number	7	4	14	3	8	18	5	2	12	1	6	16
Initial Q (Qb), veh	0	0	0	0	0	0	0	0	0	0	0	0
Ped-Bike Adj(A_pbT)	1.00		1.00	1.00		1.00	1.00		1.00	1.00		1.00
Parking Bus, Adj	1.00	1.00	1.00	1.00	1.00	1.00	1.00	1.00	1.00	1.00	1.00	1.00
Adj Sat Flow, veh/h/ln	1863	1863	1900	1900	1863	1900	1863	1863	1900	1863	1863	1863
Adj Flow Rate, veh/h	250	11	11	11	11	11	11	196	11	11	304	299
Adj No. of Lanes	1	2	0	0	1	0	1	1	0	1	1	1
Peak Hour Factor	0.92	0.92	0.92	0.92	0.92	0.92	0.92	0.92	0.92	0.92	0.92	0.92
Percent Heavy Veh, %	2	2	2	2	2	2	2	2	2	2	2	2
Cap, veh/h	322	327	282	23	23	23	26	433	24	26	462	393
Arrive On Green	0.18	0.18	0.18	0.04	0.04	0.04	0.01	0.25	0.25	0.01	0.25	0.25
Sat Flow, veh/h	1774	1803	1555	577	577	577	1774	1747	98	1774	1863	1583
Grp Volume(v), veh/h	250	11	11	33	0	0	11	0	207	11	304	299
Grp Sat Flow(s),veh/h/ln	1774	1770	1588	1732	0	0	1774	0	1845	1774	1863	1583
Q Serve(g_s), s	4.2	0.2	0.2	0.6	0.0	0.0	0.2	0.0	2.9	0.2	4.5	5.4
Cycle Q Clear(g_c), s	4.2	0.2	0.2	0.6	0.0	0.0	0.2	0.0	2.9	0.2	4.5	5.4
Prop In Lane	1.00		0.98	0.33		0.33	1.00		0.05	1.00		1.00
Lane Grp Cap(c), veh/h	322	321	288	69	0	0	26	0	458	26	462	393
V/C Ratio(X)	0.78	0.03	0.04	0.48	0.00	0.00	0.43	0.00	0.45	0.43	0.66	0.76
Avail Cap(c_a), veh/h	1373	1370	1230	1033	0	0	315	0	1548	315	1562	1328
HCM Platoon Ratio	1.00	1.00	1.00	1.00	1.00	1.00	1.00	1.00	1.00	1.00	1.00	1.00
Upstream Filter(l)	1.00	1.00	1.00	1.00	0.00	0.00	1.00	0.00	1.00	1.00	1.00	1.00
Uniform Delay (d), s/veh	12.1	10.5	10.5	14.6	0.0	0.0	15.1	0.0	9.9	15.1	10.5	10.8
Incr Delay (d2), s/veh	1.5	0.0	0.0	1.9	0.0	0.0	10.7	0.0	0.3	10.7	0.6	1.2
Initial Q Delay(d3),s/veh	0.0	0.0	0.0	0.0	0.0	0.0	0.0	0.0	0.0	0.0	0.0	0.0
%ile BackOfQ(50%),veh/ln	2.2	0.1	0.1	0.3	0.0	0.0	0.2	0.0	1.5	0.2	2.4	2.5
LnGrp Delay(d),s/veh	13.6	10.5	10.5	16.5	0.0	0.0	25.8	0.0	10.1	25.8	11.1	12.0
LnGrp LOS	B	B	B	B			C		B	C	B	B
Approach Vol, veh/h		272			33			218			614	
Approach Delay, s/veh		13.4			16.5			10.9			11.8	
Approach LOS		B			B			B			B	
Timer	1	2	3	4	5	6	7	8				
Assigned Phs	1	2		4	5	6		8				
Phs Duration (G+Y+Rc), s	4.5	11.7		9.6	4.5	11.7		5.2				
Change Period (Y+Rc), s	4.0	4.0		4.0	4.0	4.0		4.0				
Max Green Setting (Gmax), s	5	26.0		24.0	5.5	26.0		18.5				
Max Q Clear Time (g_c+1/2), s	12.2	4.9		6.2	2.2	7.4		2.6				
Green Ext Time (p_c), s	0.0	0.2		0.1	0.0	0.3		0.0				
Intersection Summary												
HCM 2010 Ctrl Delay				12.1								
HCM 2010 LOS				B								

HCM 2010 Signalized Intersection Summary
 46: General Jim Moore Boulevard & Normandy Road

Cumulative with Eastside Parkway, AM
 06/11/2019



Movement	EBL	EBT	EBR	WBL	WBT	WBR	NBL	NBT	NBR	SBL	SBT	SBR
Lane Configurations		↕			↕		↕	↕↕		↕	↕↕	↕
Traffic Volume (veh/h)	90	110	150	370	80	40	200	380	320	80	730	250
Future Volume (veh/h)	90	110	150	370	80	40	200	380	320	80	730	250
Number	3	8	18	7	4	14	1	6	16	5	2	12
Initial Q (Qb), veh	0	0	0	0	0	0	0	0	0	0	0	0
Ped-Bike Adj(A_pbT)	0.99		0.98	0.99		0.98	1.00		0.99	1.00		0.99
Parking Bus, Adj	1.00	1.00	1.00	1.00	1.00	1.00	1.00	1.00	1.00	1.00	1.00	1.00
Adj Sat Flow, veh/h/ln	1900	1881	1900	1900	1863	1900	1881	1881	1900	1863	1863	1863
Adj Flow Rate, veh/h	115	141	163	474	103	47	256	487	383	103	936	252
Adj No. of Lanes	0	1	0	0	1	0	1	2	0	1	2	1
Peak Hour Factor	0.78	0.78	0.78	0.78	0.78	0.78	0.78	0.78	0.78	0.78	0.78	0.78
Percent Heavy Veh, %	1	1	1	2	2	2	1	1	1	2	2	2
Cap, veh/h	231	283	289	418	73	33	187	539	423	196	1029	455
Arrive On Green	0.43	0.43	0.43	0.43	0.43	0.43	0.10	0.28	0.28	0.11	0.29	0.29
Sat Flow, veh/h	398	658	673	781	170	77	1792	1896	1488	1774	3539	1564
Grp Volume(v), veh/h	419	0	0	624	0	0	256	459	411	103	936	252
Grp Sat Flow(s),veh/h/ln	1729	0	0	1028	0	0	1792	1787	1597	1774	1770	1564
Q Serve(g_s), s	0.0	0.0	0.0	19.0	0.0	0.0	8.0	19.0	19.1	4.2	19.6	10.5
Cycle Q Clear(g_c), s	14.0	0.0	0.0	33.0	0.0	0.0	8.0	19.0	19.1	4.2	19.6	10.5
Prop In Lane	0.27		0.39	0.76		0.08	1.00		0.93	1.00		1.00
Lane Grp Cap(c), veh/h	802	0	0	524	0	0	187	508	454	196	1029	455
V/C Ratio(X)	0.52	0.00	0.00	1.19	0.00	0.00	1.37	0.90	0.90	0.53	0.91	0.55
Avail Cap(c_a), veh/h	802	0	0	524	0	0	187	593	530	196	1174	519
HCM Platoon Ratio	1.00	1.00	1.00	1.00	1.00	1.00	1.00	1.00	1.00	1.00	1.00	1.00
Upstream Filter(I)	1.00	0.00	0.00	1.00	0.00	0.00	1.00	1.00	1.00	1.00	1.00	1.00
Uniform Delay (d), s/veh	16.5	0.0	0.0	25.6	0.0	0.0	34.4	26.5	26.5	32.3	26.3	23.0
Incr Delay (d2), s/veh	0.3	0.0	0.0	103.8	0.0	0.0	197.8	14.5	16.1	1.3	9.0	0.4
Initial Q Delay(d3),s/veh	0.0	0.0	0.0	0.0	0.0	0.0	0.0	0.0	0.0	0.0	0.0	0.0
%ile BackOfQ(50%),veh/ln	6.7	0.0	0.0	26.0	0.0	0.0	14.1	11.4	10.4	2.1	10.8	4.5
LnGrp Delay(d),s/veh	16.8	0.0	0.0	129.4	0.0	0.0	232.2	41.0	42.6	33.6	35.3	23.4
LnGrp LOS	B			F			F	D	D	C	D	C
Approach Vol, veh/h		419		624			1126			1291		
Approach Delay, s/veh		16.8		129.4			85.0			32.8		
Approach LOS		B		F			F			C		
Timer	1	2	3	4	5	6	7	8				
Assigned Phs	1	2		4	5	6		8				
Phs Duration (G+Y+Rc), s	2.5	26.8		37.5	13.0	26.4		37.5				
Change Period (Y+Rc), s	4.5	4.5		4.5	4.5	4.5		4.5				
Max Green Setting (Gmax), s	3.0	25.5		33.0	8.0	25.5		33.0				
Max Q Clear Time (g_c+110), s	11.0	21.6		35.0	6.2	21.1		16.0				
Green Ext Time (p_c), s	0.0	0.8		0.0	0.0	0.6		0.6				
Intersection Summary												
HCM 2010 Ctrl Delay			65.3									
HCM 2010 LOS			E									

HCM 2010 Signalized Intersection Summary
 47: General Jim Moore Boulevard & Coe Avenue

Cumulative with Eastside Parkway, AM
 06/11/2019



Movement	EBL	EBT	EBR	WBL	WBT	WBR	NBL	NBT	NBR	SBL	SBT	SBR
Lane Configurations												
Traffic Volume (veh/h)	100	10	430	370	10	10	230	460	250	10	1040	90
Future Volume (veh/h)	100	10	430	370	10	10	230	460	250	10	1040	90
Number	3	8	18	7	4	14	1	6	16	5	2	12
Initial Q (Qb), veh	0	0	0	0	0	0	0	0	0	0	0	0
Ped-Bike Adj(A_pbT)	1.00		1.00	1.00		1.00	1.00		1.00	1.00		1.00
Parking Bus, Adj	1.00	1.00	1.00	1.00	1.00	1.00	1.00	1.00	1.00	1.00	1.00	1.00
Adj Sat Flow, veh/h/ln	1881	1863	1881	1863	1863	1863	1881	1881	1863	1863	1863	1863
Adj Flow Rate, veh/h	111	11	367	411	11	11	256	511	244	11	1156	39
Adj No. of Lanes	1	1	1	1	1	1	1	2	1	1	2	1
Peak Hour Factor	0.90	0.90	0.90	0.90	0.90	0.90	0.90	0.90	0.90	0.90	0.90	0.90
Percent Heavy Veh, %	1	2	1	2	2	2	1	1	2	2	2	2
Cap, veh/h	625	750	644	466	750	638	257	1641	727	23	1163	520
Arrive On Green	0.40	0.40	0.40	0.40	0.40	0.40	0.14	0.46	0.46	0.01	0.33	0.33
Sat Flow, veh/h	1398	1863	1598	1000	1863	1583	1792	3574	1583	1774	3539	1583
Grp Volume(v), veh/h	111	11	367	411	11	11	256	511	244	11	1156	39
Grp Sat Flow(s),veh/h/ln	1398	1863	1598	1000	1863	1583	1792	1787	1583	1774	1770	1583
Q Serve(g_s), s	5.6	0.4	19.2	43.1	0.4	0.5	15.4	9.7	10.6	0.7	35.2	1.8
Cycle Q Clear(g_c), s	6.0	0.4	19.2	43.5	0.4	0.5	15.4	9.7	10.6	0.7	35.2	1.8
Prop In Lane	1.00		1.00	1.00		1.00	1.00		1.00	1.00		1.00
Lane Grp Cap(c), veh/h	625	750	644	466	750	638	257	1641	727	23	1163	520
V/C Ratio(X)	0.18	0.01	0.57	0.88	0.01	0.02	1.00	0.31	0.34	0.48	0.99	0.07
Avail Cap(c_a), veh/h	625	750	644	466	750	638	257	1641	727	90	1163	520
HCM Platoon Ratio	1.00	1.00	1.00	1.00	1.00	1.00	1.00	1.00	1.00	1.00	1.00	1.00
Upstream Filter(I)	1.00	1.00	1.00	1.00	1.00	1.00	1.00	1.00	1.00	1.00	1.00	1.00
Uniform Delay (d), s/veh	21.2	19.4	25.0	33.1	19.4	19.4	46.2	18.4	18.7	52.9	36.1	24.9
Incr Delay (d2), s/veh	0.0	0.0	0.8	17.1	0.0	0.0	54.8	0.0	0.1	5.5	24.8	0.0
Initial Q Delay(d3),s/veh	0.0	0.0	0.0	0.0	0.0	0.0	0.0	0.0	0.0	0.0	0.0	0.0
%ile BackOfQ(50%),veh/ln	2.2	0.2	8.5	14.4	0.2	0.2	11.5	4.8	4.6	0.4	21.2	0.8
LnGrp Delay(d),s/veh	21.2	19.4	25.8	50.1	19.4	19.4	101.0	18.5	18.8	58.5	60.9	25.0
LnGrp LOS	C	B	C	D	B	B	F	B	B	E	E	C
Approach Vol, veh/h		489			433			1011			1206	
Approach Delay, s/veh		24.6			48.6			39.4			59.7	
Approach LOS		C			D			D			E	
Timer	1	2	3	4	5	6	7	8				
Assigned Phs	1	2		4	5	6		8				
Phs Duration (G+Y+Rc), s	30.0	40.0		48.0	5.9	54.1		48.0				
Change Period (Y+Rc), s	4.5	4.5		4.5	4.5	4.5		4.5				
Max Green Setting (Gmax), s	35.5	35.5		43.5	5.5	45.5		43.5				
Max Q Clear Time (g_c+11), s	11.4	37.2		45.5	2.7	12.6		21.2				
Green Ext Time (p_c), s	0.0	0.0		0.0	0.0	0.5		0.1				
Intersection Summary												
HCM 2010 Ctrl Delay			46.2									
HCM 2010 LOS			D									



Movement	EBL	EBT	EBR	WBL	WBT	WBR	NBL	NBT	NBR	SBL	SBT	SBR
Lane Configurations												
Traffic Volume (veh/h)	80	100	140	120	220	30	230	670	140	10	1000	70
Future Volume (veh/h)	80	100	140	120	220	30	230	670	140	10	1000	70
Number	7	4	14	3	8	18	5	2	12	1	6	16
Initial Q (Qb), veh	0	0	0	0	0	0	0	0	0	0	0	0
Ped-Bike Adj(A_pbT)	1.00		0.95	1.00		0.97	1.00		0.99	1.00		0.98
Parking Bus, Adj	1.00	1.00	1.00	1.00	1.00	1.00	1.00	1.00	1.00	1.00	1.00	1.00
Adj Sat Flow, veh/h/ln	1845	1845	1845	1900	1881	1900	1827	1827	1900	1827	1827	1827
Adj Flow Rate, veh/h	88	110	65	132	242	31	253	736	139	11	1099	10
Adj No. of Lanes	1	1	1	0	1	0	1	2	0	1	2	1
Peak Hour Factor	0.91	0.91	0.91	0.91	0.91	0.91	0.91	0.91	0.91	0.91	0.91	0.91
Percent Heavy Veh, %	3	3	3	1	1	1	4	4	4	4	4	4
Cap, veh/h	202	212	172	133	244	31	425	1444	273	18	880	388
Arrive On Green	0.11	0.11	0.11	0.22	0.22	0.22	0.24	0.50	0.50	0.01	0.25	0.25
Sat Flow, veh/h	1757	1845	1494	594	1088	139	1740	2908	549	1740	3471	1529
Grp Volume(v), veh/h	88	110	65	405	0	0	253	439	436	11	1099	10
Grp Sat Flow(s),veh/h/ln	1757	1845	1494	1822	0	0	1740	1736	1721	1740	1736	1529
Q Serve(g_s), s	5.8	7.0	5.0	27.7	0.0	0.0	16.1	21.3	21.3	0.8	31.7	0.6
Cycle Q Clear(g_c), s	5.8	7.0	5.0	27.7	0.0	0.0	16.1	21.3	21.3	0.8	31.7	0.6
Prop In Lane	1.00		1.00	0.33		0.08	1.00		0.32	1.00		1.00
Lane Grp Cap(c), veh/h	202	212	172	408	0	0	425	862	855	18	880	388
V/C Ratio(X)	0.44	0.52	0.38	0.99	0.00	0.00	0.59	0.51	0.51	0.62	1.25	0.03
Avail Cap(c_a), veh/h	436	457	371	408	0	0	425	862	855	209	880	388
HCM Platoon Ratio	1.00	1.00	1.00	1.00	1.00	1.00	1.00	1.00	1.00	1.00	1.00	1.00
Upstream Filter(I)	0.76	0.76	0.76	1.00	0.00	0.00	1.00	1.00	1.00	1.00	1.00	1.00
Uniform Delay (d), s/veh	51.6	52.1	51.2	48.4	0.0	0.0	41.8	21.2	21.2	61.6	46.7	35.0
Incr Delay (d2), s/veh	1.1	1.5	1.1	42.5	0.0	0.0	1.6	2.1	2.2	12.5	121.3	0.1
Initial Q Delay(d3),s/veh	0.0	0.0	0.0	0.0	0.0	0.0	0.0	0.0	0.0	0.0	0.0	0.0
%ile BackOfQ(50%),veh/ln	2.9	3.7	2.1	18.8	0.0	0.0	7.9	10.8	10.7	0.4	30.0	0.3
LnGrp Delay(d),s/veh	52.7	53.6	52.3	90.9	0.0	0.0	43.3	23.3	23.4	74.2	167.9	35.2
LnGrp LOS	D	D	D	F			D	C	C	E	F	D
Approach Vol, veh/h		263			405			1128			1120	
Approach Delay, s/veh		53.0			90.9			27.8			165.8	
Approach LOS		D			F			C			F	
Timer	1	2	3	4	5	6	7	8				
Assigned Phs	1	2		4	5	6		8				
Phs Duration (G+Y+Rc), s	5.5	67.4		19.0	35.9	37.0		33.1				
Change Period (Y+Rc), s	4.2	5.3		* 4.7	5.3	* 5.3		5.1				
Max Green Setting (Gmax), s	15	31.7		* 31	15.0	* 32		28.0				
Max Q Clear Time (g_c+1/2), s	12.8	23.3		9.0	18.1	33.7		29.7				
Green Ext Time (p_c), s	0.0	3.0		1.0	0.0	0.0		0.0				
Intersection Summary												
HCM 2010 Ctrl Delay				91.9								
HCM 2010 LOS				F								
Notes												

HCM 2010 Signalized Intersection Summary
 49: Highway 1 SB On-Ramp & Highway 1 NB Off-Ramp/Monterey Road

Cumulative with Eastside Parkway, AM
 06/11/2019



Movement	EBL	EBT	EBR	WBL	WBT	WBR	NBL	NBT	NBR	SBL	SBT	SBR
Lane Configurations		↕↕	↗	↖		↗		↕	↗		↕	
Traffic Volume (veh/h)	10	200	100	240	0	380	0	50	120	10	10	0
Future Volume (veh/h)	10	200	100	240	0	380	0	50	120	10	10	0
Number	1	6	16	5	2	12	7	4	14	3	8	18
Initial Q (Qb), veh	0	0	0	0	0	0	0	0	0	0	0	0
Ped-Bike Adj(A_pbT)	1.00		1.00	1.00		1.00	1.00		1.00	1.00		1.00
Parking Bus, Adj	1.00	1.00	1.00	1.00	1.00	1.00	1.00	1.00	1.00	1.00	1.00	1.00
Adj Sat Flow, veh/h/ln	1900	1845	1845	1863	0	1863	0	1845	1845	1900	1900	0
Adj Flow Rate, veh/h	10	206	9	247	0	253	0	52	21	10	10	0
Adj No. of Lanes	0	2	1	1	0	1	0	1	1	0	1	0
Peak Hour Factor	0.97	0.97	0.97	0.97	0.97	0.97	0.97	0.97	0.97	0.97	0.97	0.97
Percent Heavy Veh, %	3	3	3	2	0	2	0	3	3	0	0	0
Cap, veh/h	136	2942	1343	0	0	0	0	122	104	74	60	0
Arrive On Green	0.86	0.86	0.86	0.00	0.00	0.00	0.00	0.07	0.07	0.07	0.07	0.00
Sat Flow, veh/h	159	3430	1566				0	1845	1568	466	899	0
Grp Volume(v), veh/h	116	100	9		0.0		0	52	21	20	0	0
Grp Sat Flow(s),veh/h/ln	1837	1752	1566				0	1845	1568	1365	0	0
Q Serve(g_s), s	1.2	1.1	0.1				0.0	3.4	1.6	0.0	0.0	0.0
Cycle Q Clear(g_c), s	1.2	1.1	0.1				0.0	3.4	1.6	3.4	0.0	0.0
Prop In Lane	0.09		1.00				0.00		1.00	0.50		0.00
Lane Grp Cap(c), veh/h	1575	1503	1343				0	122	104	134	0	0
V/C Ratio(X)	0.07	0.07	0.01				0.00	0.43	0.20	0.15	0.00	0.00
Avail Cap(c_a), veh/h	1575	1503	1343				0	148	125	155	0	0
HCM Platoon Ratio	1.00	1.00	1.00				1.00	1.00	1.00	1.00	1.00	1.00
Upstream Filter(I)	1.00	1.00	1.00				0.00	1.00	1.00	1.00	0.00	0.00
Uniform Delay (d), s/veh	1.4	1.3	1.3				0.0	56.1	55.2	55.1	0.0	0.0
Incr Delay (d2), s/veh	0.0	0.0	0.0				0.0	0.9	0.4	0.2	0.0	0.0
Initial Q Delay(d3),s/veh	0.0	0.0	0.0				0.0	0.0	0.0	0.0	0.0	0.0
%ile BackOfQ(50%),veh/ln	0.6	0.5	0.0				0.0	1.8	0.7	0.7	0.0	0.0
LnGrp Delay(d),s/veh	1.4	1.3	1.3				0.0	56.9	55.6	55.3	0.0	0.0
LnGrp LOS	A	A	A					E	E	E		
Approach Vol, veh/h		225						73			20	
Approach Delay, s/veh		1.4						56.5			55.3	
Approach LOS		A						E			E	
Timer	1	2	3	4	5	6	7	8				
Assigned Phs				4		6		8				
Phs Duration (G+Y+Rc), s				12.5		112.5		12.5				
Change Period (Y+Rc), s				* 4.2		5.3		* 4.2				
Max Green Setting (Gmax), s				* 10		21.0		* 10				
Max Q Clear Time (g_c+I1), s				5.4		3.2		5.4				
Green Ext Time (p_c), s				0.1		0.7		0.0				
Intersection Summary												
HCM 2010 Ctrl Delay			17.4									
HCM 2010 LOS			B									
Notes												

HCM 2010 Signalized Intersection Summary

Cumulative with Eastside Parkway, AM

50: Reservation Road & SR 68 WB On Ramp/SR 68 WB Off Ramp

06/11/2019























Movement	EBL	EBT	EBR	WBL	WBT	WBR	NBL	NBT	NBR	SBL	SBT	SBR
Lane Configurations					↕	↕	↕	↑			↕	
Traffic Volume (veh/h)	0	0	0	260	10	310	120	400	0	0	350	120
Future Volume (veh/h)	0	0	0	260	10	310	120	400	0	0	350	120
Number				7	4	14	1	6	16	5	2	12
Initial Q (Qb), veh				0	0	0	0	0	0	0	0	0
Ped-Bike Adj(A_pbT)				1.00		1.00	1.00		1.00	1.00		1.00
Parking Bus, Adj				1.00	1.00	1.00	1.00	1.00	1.00	1.00	1.00	1.00
Adj Sat Flow, veh/h/ln				1900	1827	1827	1863	1863	0	0	1827	1900
Adj Flow Rate, veh/h				274	11	74	126	421	0	0	368	117
Adj No. of Lanes				0	1	1	1	1	0	0	1	0
Peak Hour Factor				0.95	0.95	0.95	0.95	0.95	0.95	0.95	0.95	0.95
Percent Heavy Veh, %				4	4	4	2	2	0	0	4	4
Cap, veh/h				389	16	360	211	1006	0	0	462	147
Arrive On Green				0.23	0.23	0.23	0.12	0.54	0.00	0.00	0.35	0.35
Sat Flow, veh/h				1676	67	1553	1774	1863	0	0	1330	423
Grp Volume(v), veh/h				285	0	74	126	421	0	0	0	485
Grp Sat Flow(s),veh/h/ln				1743	0	1553	1774	1863	0	0	0	1752
Q Serve(g_s), s				7.2	0.0	1.8	3.2	6.4	0.0	0.0	0.0	11.9
Cycle Q Clear(g_c), s				7.2	0.0	1.8	3.2	6.4	0.0	0.0	0.0	11.9
Prop In Lane				0.96		1.00	1.00		0.00	0.00		0.24
Lane Grp Cap(c), veh/h				404	0	360	211	1006	0	0	0	609
V/C Ratio(X)				0.71	0.00	0.21	0.60	0.42	0.00	0.00	0.00	0.80
Avail Cap(c_a), veh/h				1460	0	1300	966	1482	0	0	0	1394
HCM Platoon Ratio				1.00	1.00	1.00	1.00	1.00	1.00	1.00	1.00	1.00
Upstream Filter(I)				1.00	0.00	1.00	1.00	1.00	0.00	0.00	0.00	1.00
Uniform Delay (d), s/veh				16.8	0.0	14.8	20.0	6.5	0.0	0.0	0.0	14.1
Incr Delay (d2), s/veh				2.3	0.0	0.3	1.0	0.3	0.0	0.0	0.0	2.4
Initial Q Delay(d3),s/veh				0.0	0.0	0.0	0.0	0.0	0.0	0.0	0.0	0.0
%ile BackOfQ(50%),veh/ln				3.7	0.0	0.8	1.6	3.4	0.0	0.0	0.0	6.1
LnGrp Delay(d),s/veh				19.1	0.0	15.1	21.0	6.8	0.0	0.0	0.0	16.5
LnGrp LOS				B		B	C	A				B
Approach Vol, veh/h					359			547			485	
Approach Delay, s/veh					18.3			10.1			16.5	
Approach LOS					B			B			B	
Timer	1	2	3	4	5	6	7	8				
Assigned Phs	1	2		4		6						
Phs Duration (G+Y+Rc), s	9.2	22.6		16.0		31.8						
Change Period (Y+Rc), s	3.5	6.0		4.9		6.0						
Max Green Setting (Gmax), s	26.0	38.0		40.0		38.0						
Max Q Clear Time (g_c+15), s	15.2	13.9		9.2		8.4						
Green Ext Time (p_c), s	0.1	2.7		2.0		2.2						
Intersection Summary												
HCM 2010 Ctrl Delay				14.4								
HCM 2010 LOS				B								



Movement	EBL	EBT	EBR	WBL	WBT	WBR	NBL	NBT	NBR	SBL	SBT	SBR
Lane Configurations		↕	↗					↑	↗	↖	↑	
Traffic Volume (veh/h)	120	10	110	0	0	0	0	390	660	230	370	0
Future Volume (veh/h)	120	10	110	0	0	0	0	390	660	230	370	0
Number	3	8	18				1	6	16	5	2	12
Initial Q (Qb), veh	0	0	0				0	0	0	0	0	0
Ped-Bike Adj(A_pbT)	1.00		1.00				1.00		1.00	1.00		1.00
Parking Bus, Adj	1.00	1.00	1.00				1.00	1.00	1.00	1.00	1.00	1.00
Adj Sat Flow, veh/h/ln	1900	1881	1881				0	1881	1881	1827	1827	0
Adj Flow Rate, veh/h	130	11	19				0	424	388	250	402	0
Adj No. of Lanes	0	1	1				0	1	1	1	1	0
Peak Hour Factor	0.92	0.92	0.92				0.92	0.92	0.92	0.92	0.92	0.92
Percent Heavy Veh, %	1	1	1				0	1	1	4	4	0
Cap, veh/h	190	16	183				0	650	553	327	1137	0
Arrive On Green	0.11	0.11	0.11				0.00	0.35	0.35	0.19	0.62	0.00
Sat Flow, veh/h	1658	140	1599				0	1881	1599	1740	1827	0
Grp Volume(v), veh/h	141	0	19				0	424	388	250	402	0
Grp Sat Flow(s),veh/h/ln	1798	0	1599				0	1881	1599	1740	1827	0
Q Serve(g_s), s	3.1	0.0	0.4				0.0	7.9	8.7	5.7	4.4	0.0
Cycle Q Clear(g_c), s	3.1	0.0	0.4				0.0	7.9	8.7	5.7	4.4	0.0
Prop In Lane	0.92		1.00				0.00		1.00	1.00		0.00
Lane Grp Cap(c), veh/h	206	0	183				0	650	553	327	1137	0
V/C Ratio(X)	0.68	0.00	0.10				0.00	0.65	0.70	0.77	0.35	0.00
Avail Cap(c_a), veh/h	1735	0	1543				0	1679	1427	1007	1630	0
HCM Platoon Ratio	1.00	1.00	1.00				1.00	1.00	1.00	1.00	1.00	1.00
Upstream Filter(l)	1.00	0.00	1.00				0.00	1.00	1.00	1.00	1.00	0.00
Uniform Delay (d), s/veh	17.6	0.0	16.4				0.0	11.5	11.7	16.0	3.8	0.0
Incr Delay (d2), s/veh	1.5	0.0	0.1				0.0	1.1	1.6	3.8	0.2	0.0
Initial Q Delay(d3),s/veh	0.0	0.0	0.0				0.0	0.0	0.0	0.0	0.0	0.0
%ile BackOfQ(50%),veh/ln	1.6	0.0	0.2				0.0	4.2	4.0	3.0	2.2	0.0
LnGrp Delay(d),s/veh	19.1	0.0	16.5				0.0	12.6	13.4	19.7	4.0	0.0
LnGrp LOS	B		B					B	B	B	A	
Approach Vol, veh/h		160						812			652	
Approach Delay, s/veh		18.8						13.0			10.0	
Approach LOS		B						B			B	
Timer	1	2	3	4	5	6	7	8				
Assigned Phs		2			5	6		8				
Phs Duration (G+Y+Rc), s		31.8			11.5	20.3		9.7				
Change Period (Y+Rc), s		6.0			3.7	6.0		4.9				
Max Green Setting (Gmax), s		37.0			24.0	37.0		40.0				
Max Q Clear Time (g_c+I1), s		6.4			7.7	10.7		5.1				
Green Ext Time (p_c), s		2.2			0.6	3.6		0.5				
Intersection Summary												
HCM 2010 Ctrl Delay			12.4									
HCM 2010 LOS			B									

HCM 2010 Signalized Intersection Summary
 1: Del Monte Boulevard & Reindollar Avenue

Cumulative with Eastside Parkway, PM
 06/11/2019

												
Movement	EBL	EBT	EBR	WBL	WBT	WBR	NBL	NBT	NBR	SBL	SBT	SBR
Lane Configurations												
Traffic Volume (veh/h)	0	0	0	190	0	450	10	1290	340	400	840	0
Future Volume (veh/h)	0	0	0	190	0	450	10	1290	340	400	840	0
Number				3	8	18	1	6	16	5	2	12
Initial Q (Qb), veh				0	0	0	0	0	0	0	0	0
Ped-Bike Adj(A_pbT)				1.00		0.99	1.00		1.00	1.00		1.00
Parking Bus, Adj				1.00	1.00	1.00	1.00	1.00	1.00	1.00	1.00	1.00
Adj Sat Flow, veh/h/ln				1881	1881	1900	1881	1881	1881	1881	1881	0
Adj Flow Rate, veh/h				198	0	397	10	1344	271	417	875	0
Adj No. of Lanes				1	1	0	1	2	1	1	2	0
Peak Hour Factor				0.96	0.96	0.96	0.96	0.96	0.96	0.96	0.96	0.96
Percent Heavy Veh, %				1	1	1	1	1	1	1	1	0
Cap, veh/h				501	0	444	22	1145	512	458	2015	0
Arrive On Green				0.28	0.00	0.28	0.01	0.32	0.32	0.26	0.56	0.00
Sat Flow, veh/h				1792	0	1585	1792	3574	1599	1792	3668	0
Grp Volume(v), veh/h				198	0	397	10	1344	271	417	875	0
Grp Sat Flow(s),veh/h/ln				1792	0	1585	1792	1787	1599	1792	1787	0
Q Serve(g_s), s				8.4	0.0	22.5	0.5	30.0	13.0	21.1	13.2	0.0
Cycle Q Clear(g_c), s				8.4	0.0	22.5	0.5	30.0	13.0	21.1	13.2	0.0
Prop In Lane				1.00		1.00	1.00		1.00	1.00		0.00
Lane Grp Cap(c), veh/h				501	0	444	22	1145	512	458	2015	0
V/C Ratio(X)				0.39	0.00	0.89	0.46	1.17	0.53	0.91	0.43	0.00
Avail Cap(c_a), veh/h				574	0	508	574	1145	512	574	2015	0
HCM Platoon Ratio				1.00	1.00	1.00	1.00	1.00	1.00	1.00	1.00	1.00
Upstream Filter(I)				1.00	0.00	1.00	1.00	1.00	1.00	1.00	1.00	0.00
Uniform Delay (d), s/veh				27.3	0.0	32.4	45.9	31.8	26.0	33.8	11.8	0.0
Incr Delay (d2), s/veh				0.5	0.0	16.8	14.1	87.7	1.0	16.2	0.1	0.0
Initial Q Delay(d3),s/veh				0.0	0.0	0.0	0.0	0.0	0.0	0.0	0.0	0.0
%ile BackOfQ(50%),veh/ln				4.2	0.0	11.9	0.3	28.6	5.9	12.5	6.5	0.0
LnGrp Delay(d),s/veh				27.8	0.0	49.2	60.0	119.5	27.1	50.0	11.9	0.0
LnGrp LOS				C		D	E	F	C	D	B	
Approach Vol, veh/h					595			1625			1292	
Approach Delay, s/veh					42.1			103.8			24.2	
Approach LOS					D			F			C	
Timer	1	2	3	4	5	6	7	8				
Assigned Phs	1	2			5	6		8				
Phs Duration (G+Y+Rc), s	4.6	57.8			27.5	35.0		31.2				
Change Period (Y+Rc), s	3.5	5.0			3.5	5.0		5.0				
Max Green Setting (Gmax), s	30.0	30.0			30.0	30.0		30.0				
Max Q Clear Time (g_c+I1), s	2.5	15.2			23.1	32.0		24.5				
Green Ext Time (p_c), s	0.0	5.4			0.8	0.0		1.7				
Intersection Summary												
HCM 2010 Ctrl Delay				64.1								
HCM 2010 LOS				E								
Notes												

HCM 2010 Signalized Intersection Summary
2: 2nd Avenue & Patton Parkway

Cumulative with Eastside Parkway, PM
06/11/2019



Movement	EBL	EBT	EBR	WBL	WBT	WBR	NBL	NBT	NBR	SBL	SBT	SBR
Lane Configurations												
Traffic Volume (veh/h)	50	50	60	90	80	80	70	240	90	80	200	50
Future Volume (veh/h)	50	50	60	90	80	80	70	240	90	80	200	50
Number	7	4	14	3	8	18	5	2	12	1	6	16
Initial Q (Qb), veh	0	0	0	0	0	0	0	0	0	0	0	0
Ped-Bike Adj(A_pbT)	1.00		1.00	1.00		1.00	1.00		1.00	1.00		1.00
Parking Bus, Adj	1.00	1.00	1.00	1.00	1.00	1.00	1.00	1.00	1.00	1.00	1.00	1.00
Adj Sat Flow, veh/h/ln	1863	1863	1900	1863	1863	1900	1863	1863	1900	1863	1863	1900
Adj Flow Rate, veh/h	54	54	65	98	87	87	76	261	98	87	217	54
Adj No. of Lanes	1	1	0	1	1	0	1	1	0	1	1	0
Peak Hour Factor	0.92	0.92	0.92	0.92	0.92	0.92	0.92	0.92	0.92	0.92	0.92	0.92
Percent Heavy Veh, %	2	2	2	2	2	2	2	2	2	2	2	2
Cap, veh/h	96	163	196	137	201	201	119	356	134	128	405	101
Arrive On Green	0.05	0.21	0.21	0.08	0.23	0.23	0.07	0.28	0.28	0.07	0.28	0.28
Sat Flow, veh/h	1774	771	928	1774	856	856	1774	1292	485	1774	1441	359
Grp Volume(v), veh/h	54	0	119	98	0	174	76	0	359	87	0	271
Grp Sat Flow(s),veh/h/ln	1774	0	1699	1774	0	1712	1774	0	1777	1774	0	1799
Q Serve(g_s), s	1.4	0.0	2.8	2.5	0.0	4.0	2.0	0.0	8.6	2.2	0.0	6.0
Cycle Q Clear(g_c), s	1.4	0.0	2.8	2.5	0.0	4.0	2.0	0.0	8.6	2.2	0.0	6.0
Prop In Lane	1.00		0.55	1.00		0.50	1.00		0.27	1.00		0.20
Lane Grp Cap(c), veh/h	96	0	359	137	0	402	119	0	490	128	0	505
V/C Ratio(X)	0.56	0.00	0.33	0.72	0.00	0.43	0.64	0.00	0.73	0.68	0.00	0.54
Avail Cap(c_a), veh/h	228	0	1290	228	0	1300	228	0	1349	228	0	1366
HCM Platoon Ratio	1.00	1.00	1.00	1.00	1.00	1.00	1.00	1.00	1.00	1.00	1.00	1.00
Upstream Filter(I)	1.00	0.00	1.00	1.00	0.00	1.00	1.00	0.00	1.00	1.00	0.00	1.00
Uniform Delay (d), s/veh	21.6	0.0	15.6	21.1	0.0	15.2	21.3	0.0	15.4	21.2	0.0	14.2
Incr Delay (d2), s/veh	5.1	0.0	0.5	6.9	0.0	0.7	5.6	0.0	2.1	6.1	0.0	0.9
Initial Q Delay(d3),s/veh	0.0	0.0	0.0	0.0	0.0	0.0	0.0	0.0	0.0	0.0	0.0	0.0
%ile BackOfQ(50%),veh/ln	0.8	0.0	1.3	1.5	0.0	2.0	1.1	0.0	4.5	1.3	0.0	3.1
LnGrp Delay(d),s/veh	26.7	0.0	16.2	27.9	0.0	16.0	26.8	0.0	17.5	27.3	0.0	15.1
LnGrp LOS	C		B	C		B	C		B	C		B
Approach Vol, veh/h		173			272			435			358	
Approach Delay, s/veh		19.5			20.3			19.1			18.1	
Approach LOS		B			C			B			B	
Timer	1	2	3	4	5	6	7	8				
Assigned Phs	1	2	3	4	5	6	7	8				
Phs Duration (G+Y+Rc), s	7.4	17.4	7.6	14.4	7.1	17.6	6.5	15.5				
Change Period (Y+Rc), s	4.0	4.5	4.0	4.5	4.0	4.5	4.0	4.5				
Max Green Setting (Gmax), s	35.5	35.5	6.0	35.5	6.0	35.5	6.0	35.5				
Max Q Clear Time (g_c+14), s	10.6	10.6	4.5	4.8	4.0	8.0	3.4	6.0				
Green Ext Time (p_c), s	0.0	2.3	0.0	0.7	0.0	1.7	0.0	1.1				
Intersection Summary												
HCM 2010 Ctrl Delay				19.1								
HCM 2010 LOS				B								

HCM 2010 Signalized Intersection Summary
 3: SR 1 SB On-Ramp/SR 1 SB Off-Ramp & Imjin Parkway

Cumulative with Eastside Parkway, PM
 06/11/2019



Movement	EBL	EBT	EBR	WBL	WBT	WBR	NBL	NBT	NBR	SBL	SBT	SBR
Lane Configurations					↕						↕	
Traffic Volume (veh/h)	0	0	0	1200	0	0	0	0	0	680	10	0
Future Volume (veh/h)	0	0	0	1200	0	0	0	0	0	680	10	0
Number				1	6	16				7	4	14
Initial Q (Qb), veh				0	0	0				0	0	0
Ped-Bike Adj(A_pbT)				1.00		1.00				1.00		1.00
Parking Bus, Adj				1.00	1.00	1.00				1.00	1.00	1.00
Adj Sat Flow, veh/h/ln				1900	1881	0				1900	1863	0
Adj Flow Rate, veh/h				1319	0	0				747	11	0
Adj No. of Lanes				0	1	0				0	1	0
Peak Hour Factor				0.91	0.91	0.91				0.91	0.91	0.91
Percent Heavy Veh, %				1	1	0				2	2	0
Cap, veh/h				1015	0	0				661	10	0
Arrive On Green				0.57	0.00	0.00				0.38	0.38	0.00
Sat Flow, veh/h				1792	0	0				1750	26	0
Grp Volume(v), veh/h				1319	0	0				758	0	0
Grp Sat Flow(s),veh/h/ln				1792	0	0				1775	0	0
Q Serve(g_s), s				90.0	0.0	0.0				60.0	0.0	0.0
Cycle Q Clear(g_c), s				90.0	0.0	0.0				60.0	0.0	0.0
Prop In Lane				1.00		0.00				0.99		0.00
Lane Grp Cap(c), veh/h				1015	0	0				671	0	0
V/C Ratio(X)				1.30	0.00	0.00				1.13	0.00	0.00
Avail Cap(c_a), veh/h				1015	0	0				671	0	0
HCM Platoon Ratio				1.00	1.00	1.00				1.00	1.00	1.00
Upstream Filter(I)				1.00	0.00	0.00				1.00	0.00	0.00
Uniform Delay (d), s/veh				34.4	0.0	0.0				49.4	0.0	0.0
Incr Delay (d2), s/veh				141.9	0.0	0.0				76.4	0.0	0.0
Initial Q Delay(d3),s/veh				0.0	0.0	0.0				0.0	0.0	0.0
%ile BackOfQ(50%),veh/ln				84.3	0.0	0.0				43.5	0.0	0.0
LnGrp Delay(d),s/veh				176.3	0.0	0.0				125.8	0.0	0.0
LnGrp LOS				F						F		
Approach Vol, veh/h					1319						758	
Approach Delay, s/veh					176.3						125.8	
Approach LOS					F						F	
Timer	1	2	3	4	5	6	7	8				
Assigned Phs				4		6						
Phs Duration (G+Y+Rc), s				64.4		94.4						
Change Period (Y+Rc), s				4.4		4.4						
Max Green Setting (Gmax), s				60.0		90.0						
Max Q Clear Time (g_c+I1), s				62.0		92.0						
Green Ext Time (p_c), s				0.0		0.0						
Intersection Summary												
HCM 2010 Ctrl Delay				157.8								
HCM 2010 LOS				F								

Intersection												
Int Delay, s/veh	0.9											
Movement	EBL	EBT	EBR	WBL	WBT	WBR	NBL	NBT	NBR	SBL	SBT	SBR
Lane Configurations		↕			↑	↗		↕	↗			
Traffic Vol, veh/h	10	660	0	0	1180	840	10	10	1180	0	0	0
Future Vol, veh/h	10	660	0	0	1180	840	10	10	1180	0	0	0
Conflicting Peds, #/hr	0	0	1	1	0	0	0	0	0	0	0	0
Sign Control	Free	Free	Free	Free	Free	Free	Stop	Stop	Stop	Stop	Stop	Stop
RT Channelized	-	-	None	-	-	Free	-	-	Free	-	-	None
Storage Length	-	-	-	-	-	0	-	-	800	-	-	-
Veh in Median Storage, #	-	0	-	-	0	-	-	0	-	-	16965	-
Grade, %	-	0	-	-	0	-	-	0	-	-	0	-
Peak Hour Factor	95	95	95	95	95	95	95	95	95	95	95	95
Heavy Vehicles, %	2	2	2	1	1	1	1	1	1	2	2	2
Mvmt Flow	11	695	0	0	1242	884	11	11	1242	0	0	0

Major/Minor	Major1	Major2	Minor1
Conflicting Flow All	1242	0	-
Stage 1	-	-	-
Stage 2	-	-	-
Critical Hdwy	4.12	-	-
Critical Hdwy Stg 1	-	-	-
Critical Hdwy Stg 2	-	-	-
Follow-up Hdwy	2.218	-	-
Pot Cap-1 Maneuver	561	0	0
Stage 1	-	0	0
Stage 2	-	0	0
Platoon blocked, %	-	-	-
Mov Cap-1 Maneuver	561	-	-
Mov Cap-2 Maneuver	-	-	-
Stage 1	-	-	-
Stage 2	-	-	-

Approach	EB	WB	NB
HCM Control Delay, s	0.2	0	80.1
HCM LOS			F

Minor Lane/Major Mvmt	NBLn1	NBLn2	EBL	EBT	WBT
Capacity (veh/h)	68	-	561	-	-
HCM Lane V/C Ratio	0.31	-	0.019	-	-
HCM Control Delay (s)	80.1	0	11.5	0	-
HCM Lane LOS	F	A	B	A	-
HCM 95th %tile Q(veh)	1.1	-	0.1	-	-

HCM 2010 Signalized Intersection Summary
5: 2nd Avenue & Imjin Parkway

Cumulative with Eastside Parkway, PM
06/11/2019

Movement	EBL	EBT	EBR	WBL	WBT	WBR	NBL	NBT	NBR	SBL	SBT	SBR
Lane Configurations												
Traffic Volume (veh/h)	140	990	720	330	1030	140	840	110	480	90	90	150
Future Volume (veh/h)	140	990	720	330	1030	140	840	110	480	90	90	150
Number	5	2	12	1	6	16	3	8	18	7	4	14
Initial Q (Qb), veh	0	0	0	0	0	0	0	0	0	0	0	0
Ped-Bike Adj(A_pbT)	1.00		1.00	1.00		0.99	1.00		0.99	1.00		0.98
Parking Bus, Adj	1.00	1.00	1.00	1.00	1.00	1.00	1.00	1.00	1.00	1.00	1.00	1.00
Adj Sat Flow, veh/h/ln	1881	1881	1881	1881	1881	1900	1900	1900	1900	1900	1900	1900
Adj Flow Rate, veh/h	146	1031	550	344	1073	146	875	115	266	94	94	125
Adj No. of Lanes	1	2	1	2	2	0	2	1	1	1	2	0
Peak Hour Factor	0.96	0.96	0.96	0.96	0.96	0.96	0.96	0.96	0.96	0.96	0.96	0.96
Percent Heavy Veh, %	1	1	1	1	1	1	0	0	0	0	0	0
Cap, veh/h	184	1213	540	416	1127	153	794	503	424	133	202	178
Arrive On Green	0.10	0.34	0.34	0.12	0.36	0.36	0.23	0.26	0.26	0.07	0.11	0.11
Sat Flow, veh/h	1792	3574	1592	3476	3160	429	3510	1900	1602	1810	1805	1585
Grp Volume(v), veh/h	146	1031	550	344	606	613	875	115	266	94	94	125
Grp Sat Flow(s),veh/h/ln	1792	1787	1592	1738	1787	1802	1755	1900	1602	1810	1805	1585
Q Serve(g_s), s	7.0	23.7	30.0	8.5	29.2	29.3	20.0	4.2	12.9	4.5	4.3	6.7
Cycle Q Clear(g_c), s	7.0	23.7	30.0	8.5	29.2	29.3	20.0	4.2	12.9	4.5	4.3	6.7
Prop In Lane	1.00		1.00	1.00		0.24	1.00		1.00	1.00		1.00
Lane Grp Cap(c), veh/h	184	1213	540	416	637	643	794	503	424	133	202	178
V/C Ratio(X)	0.80	0.85	1.02	0.83	0.95	0.95	1.10	0.23	0.63	0.71	0.46	0.70
Avail Cap(c_a), veh/h	304	1213	540	590	637	643	794	503	424	205	429	377
HCM Platoon Ratio	1.00	1.00	1.00	1.00	1.00	1.00	1.00	1.00	1.00	1.00	1.00	1.00
Upstream Filter(I)	1.00	1.00	1.00	1.00	1.00	1.00	1.00	1.00	1.00	1.00	1.00	1.00
Uniform Delay (d), s/veh	38.8	27.1	29.2	38.0	27.7	27.7	34.2	25.4	28.6	40.0	36.8	37.8
Incr Delay (d2), s/veh	3.0	5.6	43.3	4.5	23.9	24.3	63.4	0.1	2.2	2.6	0.6	1.9
Initial Q Delay(d3),s/veh	0.0	0.0	0.0	0.0	0.0	0.0	0.0	0.0	0.0	0.0	0.0	0.0
%ile BackOfQ(50%),veh/ln	3.6	12.5	19.6	4.4	18.5	18.8	16.6	2.2	5.9	2.3	2.2	3.0
LnGrp Delay(d),s/veh	41.7	32.7	72.5	42.5	51.6	52.0	97.6	25.5	30.8	42.6	37.4	39.7
LnGrp LOS	D	C	F	D	D	D	F	C	C	D	D	D
Approach Vol, veh/h		1727			1563			1256			313	
Approach Delay, s/veh		46.1			49.8			76.9			39.9	
Approach LOS		D			D			E			D	
Timer	1	2	3	4	5	6	7	8				
Assigned Phs	1	2	3	4	5	6	7	8				
Phs Duration (G+Y+Rc), s	15.1	35.3	23.5	14.5	13.6	36.8	10.0	28.0				
Change Period (Y+Rc), s	4.5	5.3	3.5	4.6	4.5	5.3	3.5	4.6				
Max Green Setting (Gmax), s	15.0	30.0	20.0	21.0	15.0	30.0	10.0	21.0				
Max Q Clear Time (g_c+I1), s	10.5	32.0	22.0	8.7	9.0	31.3	6.5	14.9				
Green Ext Time (p_c), s	0.0	0.0	0.0	0.2	0.0	0.0	0.0	0.1				
Intersection Summary												
HCM 2010 Ctrl Delay			54.8									
HCM 2010 LOS			D									

HCM 2010 Signalized Intersection Summary
6: 3rd Avenue & Imjin Parkway

Cumulative with Eastside Parkway, PM
06/11/2019



Movement	EBL	EBT	EBR	WBL	WBT	WBR	NBL	NBT	NBR	SBL	SBT	SBR
Lane Configurations	↖	↗		↖	↗		↖	↗		↖	↗	
Traffic Volume (veh/h)	50	1380	170	90	1100	20	220	10	140	10	10	50
Future Volume (veh/h)	50	1380	170	90	1100	20	220	10	140	10	10	50
Number	5	2	12	1	6	16	3	8	18	7	4	14
Initial Q (Qb), veh	0	0	0	0	0	0	0	0	0	0	0	0
Ped-Bike Adj(A_pbT)	1.00		0.98	1.00		1.00	1.00		1.00	1.00		1.00
Parking Bus, Adj	1.00	1.00	1.00	1.00	1.00	1.00	1.00	1.00	1.00	1.00	1.00	1.00
Adj Sat Flow, veh/h/ln	1881	1881	1900	1881	1881	1900	1900	1900	1900	1900	1900	1900
Adj Flow Rate, veh/h	51	1408	165	92	1122	19	224	10	31	10	10	10
Adj No. of Lanes	1	2	0	1	2	0	1	1	0	1	1	0
Peak Hour Factor	0.98	0.98	0.98	0.98	0.98	0.98	0.98	0.98	0.98	0.98	0.98	0.98
Percent Heavy Veh, %	1	1	1	1	1	1	0	0	0	0	0	0
Cap, veh/h	116	1546	180	118	1731	29	407	82	256	387	176	176
Arrive On Green	0.06	0.48	0.48	0.07	0.48	0.48	0.20	0.20	0.20	0.20	0.20	0.20
Sat Flow, veh/h	1792	3218	374	1792	3597	61	1412	408	1266	1386	872	872
Grp Volume(v), veh/h	51	776	797	92	557	584	224	0	41	10	0	20
Grp Sat Flow(s),veh/h/ln	1792	1787	1805	1792	1787	1870	1412	0	1674	1386	0	1745
Q Serve(g_s), s	1.5	21.4	22.0	2.7	12.6	12.6	8.2	0.0	1.1	0.3	0.0	0.5
Cycle Q Clear(g_c), s	1.5	21.4	22.0	2.7	12.6	12.6	8.6	0.0	1.1	1.4	0.0	0.5
Prop In Lane	1.00		0.21	1.00		0.03	1.00		0.76	1.00		0.50
Lane Grp Cap(c), veh/h	116	858	867	118	860	900	407	0	338	387	0	352
V/C Ratio(X)	0.44	0.90	0.92	0.78	0.65	0.65	0.55	0.00	0.12	0.03	0.00	0.06
Avail Cap(c_a), veh/h	385	1084	1095	385	1084	1134	846	0	859	818	0	895
HCM Platoon Ratio	1.00	1.00	1.00	1.00	1.00	1.00	1.00	1.00	1.00	1.00	1.00	1.00
Upstream Filter(I)	1.00	1.00	1.00	1.00	1.00	1.00	1.00	0.00	1.00	1.00	0.00	1.00
Uniform Delay (d), s/veh	24.1	12.8	12.9	24.7	10.5	10.5	20.7	0.0	17.5	18.1	0.0	17.3
Incr Delay (d2), s/veh	1.0	8.0	9.3	4.2	0.4	0.4	0.4	0.0	0.1	0.0	0.0	0.0
Initial Q Delay(d3),s/veh	0.0	0.0	0.0	0.0	0.0	0.0	0.0	0.0	0.0	0.0	0.0	0.0
%ile BackOfQ(50%),veh/ln	0.8	12.3	13.1	1.5	6.1	6.4	3.2	0.0	0.5	0.1	0.0	0.2
LnGrp Delay(d),s/veh	25.1	20.8	22.3	28.9	10.9	10.9	21.2	0.0	17.5	18.1	0.0	17.3
LnGrp LOS	C	C	C	C	B	B	C		B	B		B
Approach Vol, veh/h		1624			1233			265			30	
Approach Delay, s/veh		21.7			12.2			20.6			17.5	
Approach LOS		C			B			C			B	
Timer	1	2	3	4	5	6	7	8				
Assigned Phs	1	2		4	5	6		8				
Phs Duration (G+Y+Rc), s	7.0	31.2		15.3	7.0	31.3		15.3				
Change Period (Y+Rc), s	3.5	5.5		4.5	3.5	5.5		4.5				
Max Green Setting (Gmax), s	1.5	32.5		27.5	11.5	32.5		27.5				
Max Q Clear Time (g_c+14), s	14.5	24.0		3.4	3.5	14.6		10.6				
Green Ext Time (p_c), s	0.0	1.7		0.0	0.0	0.8		0.1				
Intersection Summary												
HCM 2010 Ctrl Delay				17.8								
HCM 2010 LOS				B								

HCM 2010 Signalized Intersection Summary
7: 4th Avenue & Imjin Parkway

Cumulative with Eastside Parkway, PM
06/11/2019



Movement	EBL	EBT	EBR	WBL	WBT	WBR	NBL	NBT	NBR	SBL	SBT	SBR
Lane Configurations												
Traffic Volume (veh/h)	10	1520	10	10	1170	10	20	10	10	10	10	10
Future Volume (veh/h)	10	1520	10	10	1170	10	20	10	10	10	10	10
Number	5	2	12	1	6	16	3	8	18	7	4	14
Initial Q (Qb), veh	0	0	0	0	0	0	0	0	0	0	0	0
Ped-Bike Adj(A_pbT)	1.00		1.00	1.00		0.98	1.00		1.00	1.00		1.00
Parking Bus, Adj	1.00	1.00	1.00	1.00	1.00	1.00	1.00	1.00	1.00	1.00	1.00	1.00
Adj Sat Flow, veh/h/ln	1881	1881	1900	1881	1881	1900	1900	1900	1900	1900	1900	1900
Adj Flow Rate, veh/h	10	1567	10	10	1206	10	21	10	8	10	10	10
Adj No. of Lanes	1	2	0	1	2	0	0	1	0	0	1	0
Peak Hour Factor	0.97	0.97	0.97	0.97	0.97	0.97	0.97	0.97	0.97	0.97	0.97	0.97
Percent Heavy Veh, %	1	1	1	1	1	1	0	0	0	0	0	0
Cap, veh/h	14	1789	11	14	1784	15	233	24	19	191	33	33
Arrive On Green	0.01	0.49	0.49	0.01	0.49	0.49	0.06	0.06	0.06	0.06	0.06	0.06
Sat Flow, veh/h	1792	3641	23	1792	3632	30	880	419	335	570	570	570
Grp Volume(v), veh/h	10	769	808	10	593	623	39	0	0	30	0	0
Grp Sat Flow(s),veh/h/ln	1792	1787	1877	1792	1787	1875	1634	0	0	1711	0	0
Q Serve(g_s), s	0.2	11.7	11.7	0.2	7.7	7.7	0.2	0.0	0.0	0.0	0.0	0.0
Cycle Q Clear(g_c), s	0.2	11.7	11.7	0.2	7.7	7.7	0.6	0.0	0.0	0.5	0.0	0.0
Prop In Lane	1.00		0.01	1.00		0.02	0.54		0.21	0.33		0.33
Lane Grp Cap(c), veh/h	14	878	922	14	878	921	276	0	0	257	0	0
V/C Ratio(X)	0.70	0.88	0.88	0.70	0.68	0.68	0.14	0.00	0.00	0.12	0.00	0.00
Avail Cap(c_a), veh/h	676	1904	2000	676	1904	1998	1589	0	0	1624	0	0
HCM Platoon Ratio	1.00	1.00	1.00	1.00	1.00	1.00	1.00	1.00	1.00	1.00	1.00	1.00
Upstream Filter(I)	1.00	1.00	1.00	1.00	1.00	1.00	1.00	0.00	0.00	1.00	0.00	0.00
Uniform Delay (d), s/veh	15.1	6.9	6.9	15.1	5.9	5.9	13.8	0.0	0.0	13.8	0.0	0.0
Incr Delay (d2), s/veh	20.3	1.1	1.1	20.3	0.3	0.3	0.1	0.0	0.0	0.1	0.0	0.0
Initial Q Delay(d3),s/veh	0.0	0.0	0.0	0.0	0.0	0.0	0.0	0.0	0.0	0.0	0.0	0.0
%ile BackOfQ(50%),veh/ln	0.2	5.8	6.1	0.2	3.7	3.9	0.3	0.0	0.0	0.2	0.0	0.0
LnGrp Delay(d),s/veh	35.4	8.1	8.0	35.4	6.2	6.2	13.9	0.0	0.0	13.8	0.0	0.0
LnGrp LOS	D	A	A	D	A	A	B			B		
Approach Vol, veh/h		1587			1226			39			30	
Approach Delay, s/veh		8.2			6.5			13.9			13.8	
Approach LOS		A			A			B			B	
Timer	1	2	3	4	5	6	7	8				
Assigned Phs	1	2		4	5	6		8				
Phs Duration (G+Y+Rc), s	3.7	20.5		6.3	3.7	20.5		6.3				
Change Period (Y+Rc), s	3.5	5.5		4.5	3.5	5.5		4.5				
Max Green Setting (Gmax), s	1.5	32.5		27.5	11.5	32.5		27.5				
Max Q Clear Time (g_c+1), s	12.2	13.7		2.5	2.2	9.7		2.6				
Green Ext Time (p_c), s	0.0	1.2		0.0	0.0	0.9		0.0				
Intersection Summary												
HCM 2010 Ctrl Delay				7.6								
HCM 2010 LOS				A								

HCM 2010 Signalized Intersection Summary
 8: 5th Avenue/California Avenue & Imjin Parkway

Cumulative with Eastside Parkway, PM
 06/11/2019



Movement	EBL	EBT	EBR	WBL	WBT	WBR	NBL	NBT	NBR	SBL	SBT	SBR
Lane Configurations												
Traffic Volume (veh/h)	320	1140	10	10	950	80	20	50	10	40	40	240
Future Volume (veh/h)	320	1140	10	10	950	80	20	50	10	40	40	240
Number	5	2	12	1	6	16	3	8	18	7	4	14
Initial Q (Qb), veh	0	0	0	0	0	0	0	0	0	0	0	0
Ped-Bike Adj(A_pbT)	1.00		1.00	1.00		1.00	1.00		1.00	1.00		0.98
Parking Bus, Adj	1.00	1.00	1.00	1.00	1.00	1.00	1.00	1.00	1.00	1.00	1.00	1.00
Adj Sat Flow, veh/h/ln	1881	1881	1900	1881	1881	1900	1900	1900	1900	1900	1881	1900
Adj Flow Rate, veh/h	330	1175	10	10	979	76	21	52	7	41	41	78
Adj No. of Lanes	1	2	0	1	2	0	0	1	0	0	1	0
Peak Hour Factor	0.97	0.97	0.97	0.97	0.97	0.97	0.97	0.97	0.97	0.97	0.97	0.97
Percent Heavy Veh, %	1	1	1	1	1	1	0	0	0	1	1	1
Cap, veh/h	393	1993	17	14	1134	88	144	186	22	146	72	109
Arrive On Green	0.22	0.55	0.55	0.01	0.34	0.34	0.14	0.14	0.14	0.14	0.14	0.14
Sat Flow, veh/h	1792	3632	31	1792	3360	261	296	1352	158	308	521	789
Grp Volume(v), veh/h	330	578	607	10	521	534	80	0	0	160	0	0
Grp Sat Flow(s),veh/h/ln	1792	1787	1876	1792	1787	1834	1806	0	0	1618	0	0
Q Serve(g_s), s	7.7	9.5	9.5	0.2	11.9	11.9	0.0	0.0	0.0	2.4	0.0	0.0
Cycle Q Clear(g_c), s	7.7	9.5	9.5	0.2	11.9	11.9	1.7	0.0	0.0	4.1	0.0	0.0
Prop In Lane	1.00		0.02	1.00		0.14	0.26		0.09	0.26		0.49
Lane Grp Cap(c), veh/h	393	980	1029	14	603	619	352	0	0	326	0	0
V/C Ratio(X)	0.84	0.59	0.59	0.71	0.86	0.86	0.23	0.00	0.00	0.49	0.00	0.00
Avail Cap(c_a), veh/h	613	1224	1284	613	1224	1256	884	0	0	827	0	0
HCM Platoon Ratio	1.00	1.00	1.00	1.00	1.00	1.00	1.00	1.00	1.00	1.00	1.00	1.00
Upstream Filter(I)	1.00	1.00	1.00	1.00	1.00	1.00	1.00	0.00	0.00	1.00	0.00	0.00
Uniform Delay (d), s/veh	16.4	6.6	6.6	21.7	13.6	13.6	17.0	0.0	0.0	18.0	0.0	0.0
Incr Delay (d2), s/veh	3.5	0.2	0.2	21.6	1.5	1.4	0.1	0.0	0.0	0.4	0.0	0.0
Initial Q Delay(d3),s/veh	0.0	0.0	0.0	0.0	0.0	0.0	0.0	0.0	0.0	0.0	0.0	0.0
%ile BackOfQ(50%),veh/ln	4.1	4.6	4.8	0.2	6.0	6.2	0.9	0.0	0.0	1.9	0.0	0.0
LnGrp Delay(d),s/veh	19.8	6.8	6.8	43.3	15.1	15.0	17.1	0.0	0.0	18.4	0.0	0.0
LnGrp LOS	B	A	A	D	B	B	B			B		
Approach Vol, veh/h		1515			1065			80			160	
Approach Delay, s/veh		9.6			15.3			17.1			18.4	
Approach LOS		A			B			B			B	
Timer	1	2	3	4	5	6	7	8				
Assigned Phs	1	2		4	5	6		8				
Phs Duration (G+Y+Rc), s	3.8	29.3		10.6	13.1	20.1		10.6				
Change Period (Y+Rc), s	3.5	5.3		4.6	3.5	5.3		4.6				
Max Green Setting (Gmax), s	5.0	30.0		20.0	15.0	30.0		20.0				
Max Q Clear Time (g_c+1/2), s	11.5	11.5		6.1	9.7	13.9		3.7				
Green Ext Time (p_c), s	0.0	0.8		0.1	0.1	0.8		0.1				
Intersection Summary												
HCM 2010 Ctrl Delay				12.5								
HCM 2010 LOS				B								

Intersection						
Int Delay, s/veh	0.6					
Movement	EBL	EBR	NBL	NBT	SBT	SBR
Lane Configurations	W		W	↑	↑	
Traffic Vol, veh/h	10	10	20	410	240	10
Future Vol, veh/h	10	10	20	410	240	10
Conflicting Peds, #/hr	0	0	0	0	0	0
Sign Control	Stop	Stop	Free	Free	Free	Free
RT Channelized	-	None	-	None	-	None
Storage Length	0	-	155	-	-	-
Veh in Median Storage, #	0	-	-	0	0	-
Grade, %	0	-	-	0	0	-
Peak Hour Factor	92	92	92	92	92	92
Heavy Vehicles, %	2	2	2	2	2	2
Mvmt Flow	11	11	22	446	261	11











Major/Minor	Minor2	Major1	Major2			
Conflicting Flow All	757	267	272	0	-	0
Stage 1	267	-	-	-	-	-
Stage 2	490	-	-	-	-	-
Critical Hdwy	6.42	6.22	4.12	-	-	-
Critical Hdwy Stg 1	5.42	-	-	-	-	-
Critical Hdwy Stg 2	5.42	-	-	-	-	-
Follow-up Hdwy	3.518	3.318	2.218	-	-	-
Pot Cap-1 Maneuver	375	772	1291	-	-	-
Stage 1	778	-	-	-	-	-
Stage 2	616	-	-	-	-	-
Platoon blocked, %				-	-	-
Mov Cap-1 Maneuver	369	772	1291	-	-	-
Mov Cap-2 Maneuver	369	-	-	-	-	-
Stage 1	765	-	-	-	-	-
Stage 2	616	-	-	-	-	-

Approach	EB	NB	SB
HCM Control Delay, s	12.5	0.4	0
HCM LOS	B		

Minor Lane/Major Mvmt	NBL	NBT	EBLn1	SBT	SBR
Capacity (veh/h)	1291	-	499	-	-
HCM Lane V/C Ratio	0.017	-	0.044	-	-
HCM Control Delay (s)	7.8	-	12.5	-	-
HCM Lane LOS	A	-	B	-	-
HCM 95th %tile Q(veh)	0.1	-	0.1	-	-

HCM 2010 Signalized Intersection Summary
 10: Imjin Road & Imjin Parkway

Cumulative with Eastside Parkway, PM
 06/11/2019

								
Movement	EBT	EBR	WBL	WBT	NBL	NBR		
Lane Configurations								
Traffic Volume (veh/h)	1110	70	70	860	150	360		
Future Volume (veh/h)	1110	70	70	860	150	360		
Number	2	12	1	6	3	18		
Initial Q (Qb), veh	0	0	0	0	0	0		
Ped-Bike Adj(A_pbT)		1.00	1.00		1.00	1.00		
Parking Bus, Adj	1.00	1.00	1.00	1.00	1.00	1.00		
Adj Sat Flow, veh/h/ln	1881	1900	1881	1881	1881	1881		
Adj Flow Rate, veh/h	1168	71	74	905	157	314		
Adj No. of Lanes	2	0	1	2	1	2		
Peak Hour Factor	0.95	0.95	0.95	0.95	0.95	0.95		
Percent Heavy Veh, %	1	1	1	1	1	1		
Cap, veh/h	1351	82	91	2118	267	476		
Arrive On Green	0.39	0.39	0.05	0.59	0.15	0.15		
Sat Flow, veh/h	3518	208	1792	3668	1792	3198		
Grp Volume(v), veh/h	609	630	74	905	157	314		
Grp Sat Flow(s),veh/h/ln	1787	1844	1792	1787	1792	1599		
Q Serve(g_s), s	11.3	11.3	1.5	5.0	2.9	3.3		
Cycle Q Clear(g_c), s	11.3	11.3	1.5	5.0	2.9	3.3		
Prop In Lane		0.11	1.00		1.00	1.00		
Lane Grp Cap(c), veh/h	705	728	91	2118	267	476		
V/C Ratio(X)	0.86	0.86	0.82	0.43	0.59	0.66		
Avail Cap(c_a), veh/h	1490	1538	996	2979	1095	1955		
HCM Platoon Ratio	1.00	1.00	1.00	1.00	1.00	1.00		
Upstream Filter(I)	1.00	1.00	1.00	1.00	1.00	1.00		
Uniform Delay (d), s/veh	10.0	10.0	16.9	4.0	14.3	14.5		
Incr Delay (d2), s/veh	1.3	1.2	6.5	0.1	0.8	0.6		
Initial Q Delay(d3),s/veh	0.0	0.0	0.0	0.0	0.0	0.0		
%ile BackOfQ(50%),veh/ln	5.7	5.8	0.9	2.4	1.5	1.5		
LnGrp Delay(d),s/veh	11.3	11.3	23.4	4.0	15.1	15.0		
LnGrp LOS	B	B	C	A	B	B		
Approach Vol, veh/h	1239			979	471			
Approach Delay, s/veh	11.3			5.5	15.0			
Approach LOS	B			A	B			
Timer	1	2	3	4	5	6	7	8
Assigned Phs	1	2				6		8
Phs Duration (G+Y+Rc), s	7.1	19.5				26.6		9.4
Change Period (Y+Rc), s	5.3	* 5.3				5.3		4.0
Max Green Setting (Gmax), s	20.0	* 30				30.0		22.0
Max Q Clear Time (g_c+I1), s	3.5	13.3				7.0		5.3
Green Ext Time (p_c), s	0.0	0.9				1.0		0.1
Intersection Summary								
HCM 2010 Ctrl Delay			9.8					
HCM 2010 LOS			A					
Notes								

HCM 2010 Signalized Intersection Summary
 11: Abrams Drive & Imjin Parkway

Cumulative with Eastside Parkway, PM
 06/11/2019



Movement	EBL	EBT	EBR	WBL	WBT	WBR	NBL	NBT	NBR	SBL	SBT	SBR
Lane Configurations	↔↔	↑↔		↔↔	↑↔		↔	↑	↔	↔	↑	↔
Traffic Volume (veh/h)	130	1090	180	160	730	120	120	30	180	60	20	120
Future Volume (veh/h)	130	1090	180	160	730	120	120	30	180	60	20	120
Number	5	2	12	1	6	16	3	8	18	7	4	14
Initial Q (Qb), veh	0	0	0	0	0	0	0	0	0	0	0	0
Ped-Bike Adj(A_pbT)	1.00		1.00	1.00		1.00	1.00		1.00	1.00		1.00
Parking Bus, Adj	1.00	1.00	1.00	1.00	1.00	1.00	1.00	1.00	1.00	1.00	1.00	1.00
Adj Sat Flow, veh/h/ln	1881	1881	1900	1881	1881	1900	1881	1881	1881	1863	1863	1863
Adj Flow Rate, veh/h	140	1172	145	172	785	109	129	32	0	65	22	0
Adj No. of Lanes	2	2	0	2	2	0	1	1	1	1	1	1
Peak Hour Factor	0.93	0.93	0.93	0.93	0.93	0.93	0.93	0.93	0.93	0.93	0.93	0.93
Percent Heavy Veh, %	1	1	1	1	1	1	1	1	1	2	2	2
Cap, veh/h	286	1937	239	260	1861	258	275	248	210	266	245	208
Arrive On Green	0.08	0.60	0.60	0.07	0.59	0.59	0.13	0.13	0.00	0.13	0.13	0.00
Sat Flow, veh/h	3476	3203	395	3476	3153	438	1395	1881	1599	1369	1863	1583
Grp Volume(v), veh/h	140	653	664	172	445	449	129	32	0	65	22	0
Grp Sat Flow(s),veh/h/ln	1738	1787	1811	1738	1787	1804	1395	1881	1599	1369	1863	1583
Q Serve(g_s), s	2.6	15.4	15.5	3.3	9.2	9.2	6.1	1.0	0.0	3.0	0.7	0.0
Cycle Q Clear(g_c), s	2.6	15.4	15.5	3.3	9.2	9.2	6.8	1.0	0.0	4.0	0.7	0.0
Prop In Lane	1.00		0.22	1.00		0.24	1.00		1.00	1.00		1.00
Lane Grp Cap(c), veh/h	286	1081	1095	260	1054	1064	275	248	210	266	245	208
V/C Ratio(X)	0.49	0.60	0.61	0.66	0.42	0.42	0.47	0.13	0.00	0.24	0.09	0.00
Avail Cap(c_a), veh/h	1025	1318	1336	1025	1318	1330	709	832	708	691	824	701
HCM Platoon Ratio	1.00	1.00	1.00	1.00	1.00	1.00	1.00	1.00	1.00	1.00	1.00	1.00
Upstream Filter(I)	1.00	1.00	1.00	1.00	1.00	1.00	1.00	1.00	0.00	1.00	1.00	0.00
Uniform Delay (d), s/veh	29.8	8.3	8.4	30.5	7.6	7.6	28.8	26.0	0.0	27.8	25.9	0.0
Incr Delay (d2), s/veh	0.5	0.2	0.2	1.1	0.1	0.1	0.5	0.1	0.0	0.2	0.1	0.0
Initial Q Delay(d3),s/veh	0.0	0.0	0.0	0.0	0.0	0.0	0.0	0.0	0.0	0.0	0.0	0.0
%ile BackOfQ(50%),veh/ln	1.3	7.5	7.6	1.6	4.5	4.5	2.4	0.5	0.0	1.1	0.4	0.0
LnGrp Delay(d),s/veh	30.2	8.5	8.6	31.6	7.7	7.7	29.3	26.1	0.0	27.9	25.9	0.0
LnGrp LOS	C	A	A	C	A	A	C	C		C	C	
Approach Vol, veh/h		1457			1066			161			87	
Approach Delay, s/veh		10.6			11.5			28.7			27.4	
Approach LOS		B			B			C			C	
Timer	1	2	3	4	5	6	7	8				
Assigned Phs	1	2		4	5	6		8				
Phs Duration (G+Y+Rc), s	8.6	46.3		12.9	9.6	45.3		12.9				
Change Period (Y+Rc), s	3.5	5.3		4.0	4.0	5.3		4.0				
Max Green Setting (Gmax), s	20.0	50.0		30.0	20.0	50.0		30.0				
Max Q Clear Time (g_c+15), s	15.3	17.5		6.0	4.6	11.2		8.8				
Green Ext Time (p_c), s	0.0	1.0		0.0	0.0	0.6		0.0				
Intersection Summary												
HCM 2010 Ctrl Delay				12.6								
HCM 2010 LOS				B								













HCM 2010 Signalized Intersection Summary
 12: Reservation Road & Imjin Parkway

Cumulative with Eastside Parkway, PM
 06/11/2019



Movement	EBL	EBT	EBR	WBL	WBT	WBR	NBL	NBT	NBR	SBL	SBT	SBR
Lane Configurations												
Traffic Volume (veh/h)	120	20	1190	10	40	30	780	630	10	20	940	180
Future Volume (veh/h)	120	20	1190	10	40	30	780	630	10	20	940	180
Number	3	8	18	7	4	14	1	6	16	5	2	12
Initial Q (Qb), veh	0	0	0	0	0	0	0	0	0	0	0	0
Ped-Bike Adj(A_pbT)	1.00		1.00	1.00		0.99	1.00		1.00	1.00		1.00
Parking Bus, Adj	1.00	1.00	1.00	1.00	1.00	1.00	1.00	1.00	1.00	1.00	1.00	1.00
Adj Sat Flow, veh/h/ln	1881	1881	1881	1827	1827	1827	1881	1881	1881	1881	1881	1881
Adj Flow Rate, veh/h	135	22	936	11	45	12	876	708	10	22	1056	68
Adj No. of Lanes	2	1	2	1	1	1	2	2	1	2	2	1
Peak Hour Factor	0.89	0.89	0.89	0.89	0.89	0.89	0.89	0.89	0.89	0.89	0.89	0.89
Percent Heavy Veh, %	1	1	1	4	4	4	1	1	1	1	1	1
Cap, veh/h	802	434	1296	75	79	66	802	2048	916	55	1280	572
Arrive On Green	0.23	0.23	0.23	0.04	0.04	0.04	0.23	0.57	0.57	0.02	0.36	0.36
Sat Flow, veh/h	3476	1881	2802	1740	1827	1531	3476	3574	1599	3476	3574	1599
Grp Volume(v), veh/h	135	22	936	11	45	12	876	708	10	22	1056	68
Grp Sat Flow(s),veh/h/ln	1738	1881	1401	1740	1827	1531	1738	1787	1599	1738	1787	1599
Q Serve(g_s), s	4.7	1.4	35.0	0.9	3.7	1.1	35.0	16.0	0.4	1.0	40.8	4.3
Cycle Q Clear(g_c), s	4.7	1.4	35.0	0.9	3.7	1.1	35.0	16.0	0.4	1.0	40.8	4.3
Prop In Lane	1.00		1.00	1.00		1.00	1.00		1.00	1.00		1.00
Lane Grp Cap(c), veh/h	802	434	1296	75	79	66	802	2048	916	55	1280	572
V/C Ratio(X)	0.17	0.05	0.72	0.15	0.57	0.18	1.09	0.35	0.01	0.40	0.83	0.12
Avail Cap(c_a), veh/h	802	434	1296	356	373	313	802	2048	916	458	1414	633
HCM Platoon Ratio	1.00	1.00	1.00	1.00	1.00	1.00	1.00	1.00	1.00	1.00	1.00	1.00
Upstream Filter(I)	1.00	1.00	1.00	1.00	1.00	1.00	1.00	1.00	1.00	1.00	1.00	1.00
Uniform Delay (d), s/veh	46.7	45.4	33.0	69.9	71.2	70.0	58.3	17.3	13.9	73.9	44.4	32.6
Incr Delay (d2), s/veh	0.0	0.0	1.7	0.3	2.4	0.5	59.9	0.3	0.0	1.7	5.0	0.3
Initial Q Delay(d3),s/veh	0.0	0.0	0.0	0.0	0.0	0.0	0.0	0.0	0.0	0.0	0.0	0.0
%ile BackOfQ(50%),veh/ln	2.3	0.7	16.1	0.5	1.9	0.5	23.4	7.9	0.2	0.5	21.0	1.9
LnGrp Delay(d),s/veh	46.7	45.4	34.7	70.2	73.5	70.4	118.2	17.5	13.9	75.6	49.3	32.9
LnGrp LOS	D	D	C	E	E	E	F	B	B	E	D	C
Approach Vol, veh/h		1093			68			1594			1146	
Approach Delay, s/veh		36.4			72.5			72.8			48.9	
Approach LOS		D			E			E			D	
Timer	1	2	3	4	5	6	7	8				
Assigned Phs	1	2		4	5	6		8				
Phs Duration (G+Y+Rc), s	39.1	60.5		11.6	6.5	93.1		40.5				
Change Period (Y+Rc), s	4.1	* 6.2		5.0	4.1	* 6.2		5.5				
Max Green Setting (Gmax), s	35.0	* 60		31.0	20.0	* 50		35.0				
Max Q Clear Time (g_c+Q), s	37.0	42.8		5.7	3.0	18.0		37.0				
Green Ext Time (p_c), s	0.0	11.5		0.2	0.0	10.6		0.0				
Intersection Summary												
HCM 2010 Ctrl Delay			55.6									
HCM 2010 LOS			E									
Notes												

HCM 2010 Signalized Intersection Summary
 13: Reservation Road & Blanco Road

								
Movement	EBL	EBT	WBT	WBR	SBL	SBR		
Lane Configurations								
Traffic Volume (veh/h)	1120	930	400	50	40	1030		
Future Volume (veh/h)	1120	930	400	50	40	1030		
Number	5	2	6	16	7	14		
Initial Q (Qb), veh	0	0	0	0	0	0		
Ped-Bike Adj(A_pbT)	1.00			1.00	1.00	1.00		
Parking Bus, Adj	1.00	1.00	1.00	1.00	1.00	1.00		
Adj Sat Flow, veh/h/ln	1881	1881	1863	1863	1863	1863		
Adj Flow Rate, veh/h	1191	989	426	29	43	0		
Adj No. of Lanes	2	2	1	1	2	2		
Peak Hour Factor	0.94	0.94	0.94	0.94	0.94	0.94		
Percent Heavy Veh, %	1	1	2	2	2	2		
Cap, veh/h	1318	2780	537	457	124	100		
Arrive On Green	0.38	0.78	0.29	0.29	0.04	0.00		
Sat Flow, veh/h	3476	3668	1863	1583	3442	2787		
Grp Volume(v), veh/h	1191	989	426	29	43	0		
Grp Sat Flow(s),veh/h/ln	1738	1787	1863	1583	1721	1393		
Q Serve(g_s), s	16.2	4.2	10.5	0.7	0.6	0.0		
Cycle Q Clear(g_c), s	16.2	4.2	10.5	0.7	0.6	0.0		
Prop In Lane	1.00			1.00	1.00	1.00		
Lane Grp Cap(c), veh/h	1318	2780	537	457	124	100		
V/C Ratio(X)	0.90	0.36	0.79	0.06	0.35	0.00		
Avail Cap(c_a), veh/h	2785	4295	2239	1903	1861	1507		
HCM Platoon Ratio	1.00	1.00	1.00	1.00	1.00	1.00		
Upstream Filter(I)	1.00	1.00	1.00	1.00	1.00	0.00		
Uniform Delay (d), s/veh	14.6	1.7	16.4	12.9	23.5	0.0		
Incr Delay (d2), s/veh	1.0	0.1	2.0	0.0	0.6	0.0		
Initial Q Delay(d3),s/veh	0.0	0.0	0.0	0.0	0.0	0.0		
%ile BackOfQ(50%),veh/ln	7.8	1.9	5.6	0.3	0.3	0.0		
LnGrp Delay(d),s/veh	15.6	1.8	18.4	12.9	24.1	0.0		
LnGrp LOS	B	A	B	B	C			
Approach Vol, veh/h		2180	455		43			
Approach Delay, s/veh		9.3	18.0		24.1			
Approach LOS		A	B		C			
Timer	1	2	3	4	5	6	7	8
Assigned Phs		2		4	5	6		
Phs Duration (G+Y+Rc), s		44.6		5.3	24.4	20.2		
Change Period (Y+Rc), s		5.8		3.5	5.5	5.8		
Max Green Setting (Gmax), s		60.0		27.0	40.0	60.0		
Max Q Clear Time (g_c+I1), s		6.2		2.6	18.2	12.5		
Green Ext Time (p_c), s		5.6		0.0	0.8	1.9		
Intersection Summary								
HCM 2010 Ctrl Delay			11.1					
HCM 2010 LOS			B					

HCM 2010 Signalized Intersection Summary
 14: Reservation Road & Inter-Garrison Road

Cumulative with Eastside Parkway, PM
 06/11/2019



Movement	EBL	EBR	NBL	NBT	SBT	SBR		
Lane Configurations								
Traffic Volume (veh/h)	80	870	510	380	860	210		
Future Volume (veh/h)	80	870	510	380	860	210		
Number	3	18	1	6	2	12		
Initial Q (Qb), veh	0	0	0	0	0	0		
Ped-Bike Adj(A_pbT)	1.00	1.00	1.00			1.00		
Parking Bus, Adj	1.00	1.00	1.00	1.00	1.00	1.00		
Adj Sat Flow, veh/h/ln	1881	1881	1845	1845	1881	1900		
Adj Flow Rate, veh/h	98	906	622	463	1049	247		
Adj No. of Lanes	1	1	1	2	2	0		
Peak Hour Factor	0.82	0.82	0.82	0.82	0.82	0.82		
Percent Heavy Veh, %	1	1	3	3	1	1		
Cap, veh/h	423	658	308	2342	1299	305		
Arrive On Green	0.24	0.24	0.18	0.67	0.45	0.45		
Sat Flow, veh/h	1792	1599	1757	3597	2969	674		
Grp Volume(v), veh/h	98	906	622	463	650	646		
Grp Sat Flow(s),veh/h/ln	1792	1599	1757	1752	1787	1762		
Q Serve(g_s), s	5.0	27.0	20.0	5.8	35.8	36.2		
Cycle Q Clear(g_c), s	5.0	27.0	20.0	5.8	35.8	36.2		
Prop In Lane	1.00	1.00	1.00			0.38		
Lane Grp Cap(c), veh/h	423	658	308	2342	808	796		
V/C Ratio(X)	0.23	1.38	2.02	0.20	0.81	0.81		
Avail Cap(c_a), veh/h	423	658	308	2342	939	926		
HCM Platoon Ratio	1.00	1.00	1.00	1.00	1.00	1.00		
Upstream Filter(I)	1.00	1.00	1.00	1.00	1.00	1.00		
Uniform Delay (d), s/veh	35.2	33.6	47.1	7.2	27.0	27.1		
Incr Delay (d2), s/veh	0.3	179.1	471.2	0.1	5.5	5.8		
Initial Q Delay(d3),s/veh	0.0	0.0	0.0	0.0	0.0	0.0		
%ile BackOfQ(50%),veh/ln	2.5	53.4	49.9	2.8	18.8	18.9		
LnGrp Delay(d),s/veh	35.5	212.7	518.3	7.3	32.5	32.9		
LnGrp LOS	D	F	F	A	C	C		
Approach Vol, veh/h	1004			1085	1296			
Approach Delay, s/veh	195.4			300.3	32.7			
Approach LOS	F			F	C			
Timer	1	2	3	4	5	6	7	8
Assigned Phs	1	2				6		8
Phs Duration (G+Y+Rc), s	4.7	58.0				82.7		31.5
Change Period (Y+Rc), s	4.7	6.4				6.4		4.5
Max Green Setting (Gmax), s	26	60.0				60.0		27.0
Max Q Clear Time (g_c+Yc), s	22.5	38.2				7.8		29.0
Green Ext Time (p_c), s	0.0	13.4				5.4		0.0
Intersection Summary								
HCM 2010 Ctrl Delay			166.7					
HCM 2010 LOS			F					
Notes								

HCM 2010 Signalized Intersection Summary
15: 2nd Avenue & 9th Street

Cumulative with Eastside Parkway, PM
06/11/2019



Movement	EBL	EBT	EBR	WBL	WBT	WBR	NBL	NBT	NBR	SBL	SBT	SBR
Lane Configurations		↔	↔		↔		↔	↕↔		↔	↕↔	
Traffic Volume (veh/h)	10	10	30	40	10	20	20	650	50	40	550	10
Future Volume (veh/h)	10	10	30	40	10	20	20	650	50	40	550	10
Number	5	2	12	1	6	16	3	8	18	7	4	14
Initial Q (Qb), veh	0	0	0	0	0	0	0	0	0	0	0	0
Ped-Bike Adj(A_pbT)	1.00		0.99	1.00		1.00	1.00		0.97	1.00		1.00
Parking Bus, Adj	1.00	1.00	1.00	1.00	1.00	1.00	1.00	1.00	1.00	1.00	1.00	1.00
Adj Sat Flow, veh/h/ln	1900	1900	1900	1900	1900	1900	1881	1881	1900	1827	1827	1900
Adj Flow Rate, veh/h	11	11	23	44	11	3	22	714	51	44	604	-1
Adj No. of Lanes	0	1	1	0	1	0	1	2	0	1	2	0
Peak Hour Factor	0.91	0.91	0.91	0.91	0.91	0.91	0.91	0.91	0.91	0.91	0.91	0.91
Percent Heavy Veh, %	0	0	0	0	0	0	1	1	1	4	4	4
Cap, veh/h	267	212	305	375	81	15	49	1266	90	86	1379	0
Arrive On Green	0.19	0.19	0.19	0.19	0.19	0.19	0.03	0.38	0.38	0.05	0.40	0.00
Sat Flow, veh/h	594	1102	1591	1016	421	78	1792	3375	241	1740	3563	0
Grp Volume(v), veh/h	22	0	23	58	0	0	22	378	387	44	603	0
Grp Sat Flow(s),veh/h/ln	1696	0	1591	1515	0	0	1792	1787	1829	1740	1736	0
Q Serve(g_s), s	0.0	0.0	0.4	0.4	0.0	0.0	0.4	5.9	5.9	0.9	4.5	0.0
Cycle Q Clear(g_c), s	0.3	0.0	0.4	1.0	0.0	0.0	0.4	5.9	5.9	0.9	4.5	0.0
Prop In Lane	0.50		1.00	0.76		0.05	1.00		0.13	1.00		0.00
Lane Grp Cap(c), veh/h	479	0	305	471	0	0	49	670	686	86	1379	0
V/C Ratio(X)	0.05	0.00	0.08	0.12	0.00	0.00	0.45	0.56	0.56	0.51	0.44	0.00
Avail Cap(c_a), veh/h	1780	0	1581	1655	0	0	585	2030	2078	568	3943	0
HCM Platoon Ratio	1.00	1.00	1.00	1.00	1.00	1.00	1.00	1.00	1.00	1.00	1.00	1.00
Upstream Filter(l)	1.00	0.00	1.00	1.00	0.00	0.00	1.00	1.00	1.00	1.00	1.00	0.00
Uniform Delay (d), s/veh	11.6	0.0	11.7	11.9	0.0	0.0	16.9	8.7	8.7	16.3	7.7	0.0
Incr Delay (d2), s/veh	0.0	0.0	0.1	0.1	0.0	0.0	6.2	0.7	0.7	4.6	0.2	0.0
Initial Q Delay(d3),s/veh	0.0	0.0	0.0	0.0	0.0	0.0	0.0	0.0	0.0	0.0	0.0	0.0
%ile BackOfQ(50%),veh/ln	0.2	0.0	0.2	0.5	0.0	0.0	0.3	3.0	3.0	0.5	2.1	0.0
LnGrp Delay(d),s/veh	11.7	0.0	11.8	12.0	0.0	0.0	23.1	9.5	9.5	20.9	8.0	0.0
LnGrp LOS	B		B	B			C	A	A	C	A	
Approach Vol, veh/h		45			58			787			647	
Approach Delay, s/veh		11.7			12.0			9.8			8.8	
Approach LOS		B			B			A			A	
Timer	1	2	3	4	5	6	7	8				
Assigned Phs		2	3	4		6	7	8				
Phs Duration (G+Y+Rc), s		11.8	4.5	19.0		11.8	5.2	18.2				
Change Period (Y+Rc), s		5.0	3.5	5.0		5.0	3.5	5.0				
Max Green Setting (Gmax), s		35.0	11.5	40.0		35.0	11.5	40.0				
Max Q Clear Time (g_c+I1), s		2.4	2.4	6.5		3.0	2.9	7.9				
Green Ext Time (p_c), s		0.1	0.0	4.4		0.3	0.0	5.2				
Intersection Summary												
HCM 2010 Ctrl Delay			9.6									
HCM 2010 LOS			A									

HCM 2010 Signalized Intersection Summary
 16: 2nd Avenue & 8th Street

Cumulative with Eastside Parkway, PM
 06/11/2019



Movement	WBL	WBR	NBT	NBR	SBL	SBT		
Lane Configurations								
Traffic Volume (veh/h)	40	40	580	220	30	480		
Future Volume (veh/h)	40	40	580	220	30	480		
Number	1	16	8	18	7	4		
Initial Q (Qb), veh	0	0	0	0	0	0		
Ped-Bike Adj(A_pbT)	1.00	1.00		0.97	1.00			
Parking Bus, Adj	1.00	1.00	1.00	1.00	1.00	1.00		
Adj Sat Flow, veh/h/ln	1900	1900	1881	1900	1827	1827		
Adj Flow Rate, veh/h	43	9	617	203	32	511		
Adj No. of Lanes	1	1	2	0	1	2		
Peak Hour Factor	0.94	0.94	0.94	0.94	0.94	0.94		
Percent Heavy Veh, %	0	0	1	1	4	4		
Cap, veh/h	106	95	1176	386	68	2099		
Arrive On Green	0.06	0.06	0.45	0.45	0.04	0.60		
Sat Flow, veh/h	1810	1615	2721	863	1740	3563		
Grp Volume(v), veh/h	43	9	419	401	32	511		
Grp Sat Flow(s),veh/h/ln	1810	1615	1787	1703	1740	1736		
Q Serve(g_s), s	0.7	0.2	5.0	5.0	0.5	2.0		
Cycle Q Clear(g_c), s	0.7	0.2	5.0	5.0	0.5	2.0		
Prop In Lane	1.00	1.00		0.51	1.00			
Lane Grp Cap(c), veh/h	106	95	800	762	68	2099		
V/C Ratio(X)	0.40	0.09	0.52	0.53	0.47	0.24		
Avail Cap(c_a), veh/h	1828	1631	2707	2579	674	7011		
HCM Platoon Ratio	1.00	1.00	1.00	1.00	1.00	1.00		
Upstream Filter(I)	1.00	1.00	1.00	1.00	1.00	1.00		
Uniform Delay (d), s/veh	13.5	13.2	5.9	5.9	14.0	2.7		
Incr Delay (d2), s/veh	2.5	0.4	0.5	0.6	5.0	0.1		
Initial Q Delay(d3),s/veh	0.0	0.0	0.0	0.0	0.0	0.0		
%ile BackOfQ(50%),veh/ln	0.4	0.2	2.6	2.5	0.3	0.9		
LnGrp Delay(d),s/veh	15.9	13.7	6.5	6.5	19.0	2.8		
LnGrp LOS	B	B	A	A	B	A		
Approach Vol, veh/h	52		820			543		
Approach Delay, s/veh	15.5		6.5			3.7		
Approach LOS	B		A			A		
Timer	1	2	3	4	5	6	7	8
Assigned Phs				4		6	7	8
Phs Duration (G+Y+Rc), s				23.0		6.7	4.7	18.3
Change Period (Y+Rc), s				5.0		5.0	3.5	5.0
Max Green Setting (Gmax), s				60.0		30.0	11.5	45.0
Max Q Clear Time (g_c+I1), s				4.0		2.7	2.5	7.0
Green Ext Time (p_c), s				3.8		0.1	0.0	6.0
Intersection Summary								
HCM 2010 Ctrl Delay			5.8					
HCM 2010 LOS			A					

Intersection	
Intersection Delay, s/veh	9.2
Intersection LOS	A

Movement	EBT	EBR	WBL	WBT	NBL	NBR
Lane Configurations	↑	↑	↑	↑	↑	↑
Traffic Vol, veh/h	220	30	70	40	30	90
Future Vol, veh/h	220	30	70	40	30	90
Peak Hour Factor	0.92	0.92	0.92	0.92	0.92	0.92
Heavy Vehicles, %	2	2	2	2	2	2
Mvmt Flow	239	33	76	43	33	98
Number of Lanes	1	1	1	1	1	1

Approach	EB	WB	NB
Opposing Approach	WB	EB	
Opposing Lanes	2	2	0
Conflicting Approach Left		NB	EB
Conflicting Lanes Left	0	2	2
Conflicting Approach Right	NB		WB
Conflicting Lanes Right	2	0	2
HCM Control Delay	9.8	8.8	8.4
HCM LOS	A	A	A

Lane	NBLn1	NBLn2	EBLn1	EBLn2	WBLn1	WBLn2
Vol Left, %	100%	0%	0%	0%	100%	0%
Vol Thru, %	0%	0%	100%	0%	0%	100%
Vol Right, %	0%	100%	0%	100%	0%	0%
Sign Control	Stop	Stop	Stop	Stop	Stop	Stop
Traffic Vol by Lane	30	90	220	30	70	40
LT Vol	30	0	0	0	70	0
Through Vol	0	0	220	0	0	40
RT Vol	0	90	0	30	0	0
Lane Flow Rate	33	98	239	33	76	43
Geometry Grp	7	7	7	7	7	7
Degree of Util (X)	0.054	0.13	0.331	0.039	0.119	0.062
Departure Headway (Hd)	5.992	4.786	4.982	4.279	5.607	5.104
Convergence, Y/N	Yes	Yes	Yes	Yes	Yes	Yes
Cap	598	748	722	836	640	702
Service Time	3.725	2.519	2.71	2.007	3.339	2.836
HCM Lane V/C Ratio	0.055	0.131	0.331	0.039	0.119	0.061
HCM Control Delay	9.1	8.2	10.2	7.2	9.1	8.2
HCM Lane LOS	A	A	B	A	A	A
HCM 95th-tile Q	0.2	0.4	1.4	0.1	0.4	0.2

Intersection				
Intersection Delay, s/veh	6.5			
Intersection LOS	A			
Approach	EB	WB	NB	SB
Entry Lanes	1	1	1	1
Conflicting Circle Lanes	1	1	1	1
Adj Approach Flow, veh/h	295	228	66	141
Demand Flow Rate, veh/h	304	230	66	144
Vehicles Circulating, veh/h	129	293	373	74
Vehicles Exiting, veh/h	89	146	60	449
Follow-Up Headway, s	3.186	3.186	3.186	3.186
Ped Vol Crossing Leg, #/h	0	0	0	0
Ped Cap Adj	1.000	1.000	1.000	1.000
Approach Delay, s/veh	6.9	7.3	5.5	4.8
Approach LOS	A	A	A	A
Lane	Left	Left	Left	Left
Designated Moves	LTR	LTR	LTR	LTR
Assumed Moves	LTR	LTR	LTR	LTR
RT Channelized				
Lane Util	1.000	1.000	1.000	1.000
Critical Headway, s	5.193	5.193	5.193	5.193
Entry Flow, veh/h	304	230	66	144
Cap Entry Lane, veh/h	993	843	778	1049
Entry HV Adj Factor	0.970	0.990	1.000	0.976
Flow Entry, veh/h	295	228	66	141
Cap Entry, veh/h	964	834	778	1025
V/C Ratio	0.306	0.273	0.085	0.137
Control Delay, s/veh	6.9	7.3	5.5	4.8
LOS	A	A	A	A
95th %tile Queue, veh	1	1	0	0

HCM 2010 Signalized Intersection Summary
 19: 2nd Avenue & Inter-Garrison Road

Cumulative with Eastside Parkway, PM
 06/11/2019



Movement	WBL	WBR	NBT	NBR	SBL	SBT		
Lane Configurations								
Traffic Volume (veh/h)	70	30	780	80	30	510		
Future Volume (veh/h)	70	30	780	80	30	510		
Number	1	16	8	18	7	4		
Initial Q (Qb), veh	0	0	0	0	0	0		
Ped-Bike Adj(A_pbT)	1.00	1.00		1.00	1.00			
Parking Bus, Adj	1.00	1.00	1.00	1.00	1.00	1.00		
Adj Sat Flow, veh/h/ln	1900	1900	1881	1900	1863	1863		
Adj Flow Rate, veh/h	72	7	804	74	31	526		
Adj No. of Lanes	1	1	2	0	1	2		
Peak Hour Factor	0.97	0.97	0.97	0.97	0.97	0.97		
Percent Heavy Veh, %	0	0	1	1	2	2		
Cap, veh/h	278	248	1392	128	66	1977		
Arrive On Green	0.15	0.15	0.42	0.42	0.04	0.56		
Sat Flow, veh/h	1810	1615	3404	305	1774	3632		
Grp Volume(v), veh/h	72	7	434	444	31	526		
Grp Sat Flow(s),veh/h/ln	1810	1615	1787	1827	1774	1770		
Q Serve(g_s), s	1.2	0.1	6.5	6.5	0.6	2.7		
Cycle Q Clear(g_c), s	1.2	0.1	6.5	6.5	0.6	2.7		
Prop In Lane	1.00	1.00		0.17	1.00			
Lane Grp Cap(c), veh/h	278	248	752	769	66	1977		
V/C Ratio(X)	0.26	0.03	0.58	0.58	0.47	0.27		
Avail Cap(c_a), veh/h	1823	1627	2058	2104	587	5603		
HCM Platoon Ratio	1.00	1.00	1.00	1.00	1.00	1.00		
Upstream Filter(I)	1.00	1.00	1.00	1.00	1.00	1.00		
Uniform Delay (d), s/veh	13.0	12.5	7.7	7.7	16.4	4.0		
Incr Delay (d2), s/veh	0.5	0.0	0.7	0.7	5.1	0.1		
Initial Q Delay(d3),s/veh	0.0	0.0	0.0	0.0	0.0	0.0		
%ile BackOfQ(50%),veh/ln	0.6	0.1	3.3	3.4	0.4	1.3		
LnGrp Delay(d),s/veh	13.4	12.5	8.4	8.4	21.5	4.0		
LnGrp LOS	B	B	A	A	C	A		
Approach Vol, veh/h	79		878			557		
Approach Delay, s/veh	13.4		8.4			5.0		
Approach LOS	B		A			A		
Timer	1	2	3	4	5	6	7	8
Assigned Phs				4		6	7	8
Phs Duration (G+Y+Rc), s				24.4		10.3	4.8	19.6
Change Period (Y+Rc), s				5.0		5.0	3.5	5.0
Max Green Setting (Gmax), s				55.0		35.0	11.5	40.0
Max Q Clear Time (g_c+I1), s				4.7		3.2	2.6	8.5
Green Ext Time (p_c), s				3.9		0.2	0.0	6.2
Intersection Summary								
HCM 2010 Ctrl Delay			7.4					
HCM 2010 LOS			A					

Intersection												
Intersection Delay, s/veh 10.1												
Intersection LOS B												























Movement	EBL	EBT	EBR	WBL	WBT	WBR	NBL	NBT	NBR	SBL	SBT	SBR
Lane Configurations		↕			↕			↕			↕	
Traffic Vol, veh/h	10	60	30	150	40	10	20	50	150	20	60	10
Future Vol, veh/h	10	60	30	150	40	10	20	50	150	20	60	10
Peak Hour Factor	0.82	0.82	0.82	0.82	0.82	0.82	0.82	0.82	0.82	0.82	0.82	0.82
Heavy Vehicles, %	1	1	1	1	1	1	3	3	3	0	0	0
Mvmt Flow	12	73	37	183	49	12	24	61	183	24	73	12
Number of Lanes	0	1	0	0	1	0	0	1	0	0	1	0

Approach	EB	WB	NB	SB
Opposing Approach	WB	EB	SB	NB
Opposing Lanes	1	1	1	1
Conflicting Approach Left	SB	NB	EB	WB
Conflicting Lanes Left	1	1	1	1
Conflicting Approach Right	NB	SB	WB	EB
Conflicting Lanes Right	1	1	1	1
HCM Control Delay	9.1	10.9	10.1	9.2
HCM LOS	A	B	B	A

Lane	NBLn1	EBLn1	WBLn1	SBLn1
Vol Left, %	9%	10%	75%	22%
Vol Thru, %	23%	60%	20%	67%
Vol Right, %	68%	30%	5%	11%
Sign Control	Stop	Stop	Stop	Stop
Traffic Vol by Lane	220	100	200	90
LT Vol	20	10	150	20
Through Vol	50	60	40	60
RT Vol	150	30	10	10
Lane Flow Rate	268	122	244	110
Geometry Grp	1	1	1	1
Degree of Util (X)	0.344	0.169	0.344	0.156
Departure Headway (Hd)	4.62	4.981	5.082	5.131
Convergence, Y/N	Yes	Yes	Yes	Yes
Cap	770	711	700	690
Service Time	2.695	3.077	3.168	3.225
HCM Lane V/C Ratio	0.348	0.172	0.349	0.159
HCM Control Delay	10.1	9.1	10.9	9.2
HCM Lane LOS	B	A	B	A
HCM 95th-tile Q	1.5	0.6	1.5	0.6

HCM 2010 Signalized Intersection Summary
 21: 7th Avenue/8th Street & Inter-Garrison Road

Cumulative with Eastside Parkway, PM
 07/12/2019

												
Movement	EBL	EBT	EBR	WBL	WBT	WBR	NBL	NBT	NBR	SBL	SBT	SBR
Lane Configurations												
Traffic Volume (veh/h)	10	240	70	80	160	30	50	120	170	90	10	10
Future Volume (veh/h)	10	240	70	80	160	30	50	120	170	90	10	10
Number	5	2	12	1	6	16	3	8	18	7	4	14
Initial Q (Qb), veh	0	0	0	0	0	0	0	0	0	0	0	0
Ped-Bike Adj(A_pbT)	1.00		0.99	1.00		0.99	1.00		0.97	1.00		1.00
Parking Bus, Adj	1.00	1.00	1.00	1.00	1.00	1.00	1.00	1.00	1.00	1.00	1.00	1.00
Adj Sat Flow, veh/h/ln	1881	1881	1900	1827	1827	1900	1810	1810	1810	1900	1900	1900
Adj Flow Rate, veh/h	11	258	69	86	172	17	54	129	111	97	11	2
Adj No. of Lanes	1	1	0	1	1	0	1	1	1	1	1	0
Peak Hour Factor	0.93	0.93	0.93	0.93	0.93	0.93	0.93	0.93	0.93	0.93	0.93	0.93
Percent Heavy Veh, %	1	1	1	4	4	4	5	5	5	0	0	0
Cap, veh/h	21	402	107	108	542	54	215	267	221	191	201	37
Arrive On Green	0.01	0.28	0.28	0.06	0.33	0.33	0.12	0.15	0.15	0.11	0.13	0.13
Sat Flow, veh/h	1792	1429	382	1740	1636	162	1723	1810	1498	1810	1564	284
Grp Volume(v), veh/h	11	0	327	86	0	189	54	129	111	97	0	13
Grp Sat Flow(s),veh/h/ln	1792	0	1811	1740	0	1797	1723	1810	1498	1810	0	1849
Q Serve(g_s), s	0.2	0.0	6.3	1.9	0.0	3.1	1.1	2.6	2.7	2.0	0.0	0.2
Cycle Q Clear(g_c), s	0.2	0.0	6.3	1.9	0.0	3.1	1.1	2.6	2.7	2.0	0.0	0.2
Prop In Lane	1.00		0.21	1.00		0.09	1.00		1.00	1.00		0.15
Lane Grp Cap(c), veh/h	21	0	509	108	0	596	215	267	221	191	0	237
V/C Ratio(X)	0.53	0.00	0.64	0.80	0.00	0.32	0.25	0.48	0.50	0.51	0.00	0.05
Avail Cap(c_a), veh/h	181	0	1477	431	0	1729	313	1005	832	452	0	1153
HCM Platoon Ratio	1.00	1.00	1.00	1.00	1.00	1.00	1.00	1.00	1.00	1.00	1.00	1.00
Upstream Filter(I)	1.00	0.00	1.00	1.00	0.00	1.00	1.00	1.00	1.00	1.00	0.00	1.00
Uniform Delay (d), s/veh	19.5	0.0	12.5	18.3	0.0	9.9	15.7	15.5	15.5	16.7	0.0	15.1
Incr Delay (d2), s/veh	19.7	0.0	1.4	12.5	0.0	0.3	0.6	1.4	1.8	2.1	0.0	0.1
Initial Q Delay(d3),s/veh	0.0	0.0	0.0	0.0	0.0	0.0	0.0	0.0	0.0	0.0	0.0	0.0
%ile BackOfQ(50%),veh/ln	0.2	0.0	3.3	1.3	0.0	1.6	0.6	1.4	1.2	1.1	0.0	0.1
LnGrp Delay(d),s/veh	39.2	0.0	13.9	30.9	0.0	10.2	16.3	16.9	17.3	18.8	0.0	15.2
LnGrp LOS	D		B	C		B	B	B	B	B		B
Approach Vol, veh/h		338			275			294			110	
Approach Delay, s/veh		14.7			16.7			16.9			18.4	
Approach LOS		B			B			B			B	
Timer	1	2	3	4	5	6	7	8				
Assigned Phs	1	2	3	4	5	6	7	8				
Phs Duration (G+Y+Rc), s	6.0	16.1	8.4	9.1	4.0	18.1	7.7	9.8				
Change Period (Y+Rc), s	3.5	5.0	3.5	4.0	3.5	5.0	3.5	4.0				
Max Green Setting (Gmax), s	9.8	32.3	7.2	24.7	4.0	38.1	9.9	22.0				
Max Q Clear Time (g_c+I1), s	3.9	8.3	3.1	2.2	2.2	5.1	4.0	4.7				
Green Ext Time (p_c), s	0.1	1.9	0.0	0.0	0.0	1.1	0.1	1.0				
Intersection Summary												
HCM 2010 Ctrl Delay			16.3									
HCM 2010 LOS			B									

Intersection			
Intersection Delay, s/veh	14.7		
Intersection LOS	B		
Approach	EB	WB	NB
Entry Lanes	1	1	1
Conflicting Circle Lanes	1	1	1
Adj Approach Flow, veh/h	515	567	526
Demand Flow Rate, veh/h	525	578	526
Vehicles Circulating, veh/h	368	62	378
Vehicles Exiting, veh/h	272	842	515
Follow-Up Headway, s	3.186	3.186	3.186
Ped Vol Crossing Leg, #/h	0	0	0
Ped Cap Adj	1.000	1.000	1.000
Approach Delay, s/veh	17.1	10.2	17.3
Approach LOS	C	B	C
Lane	Left	Left	Left
Designated Moves	TR	LT	LR
Assumed Moves	TR	LT	LR
RT Channelized			
Lane Util	1.000	1.000	1.000
Critical Headway, s	5.193	5.193	5.193
Entry Flow, veh/h	525	578	526
Cap Entry Lane, veh/h	782	1062	774
Entry HV Adj Factor	0.980	0.981	1.000
Flow Entry, veh/h	515	567	526
Cap Entry, veh/h	767	1042	774
V/C Ratio	0.671	0.544	0.679
Control Delay, s/veh	17.1	10.2	17.3
LOS	C	B	C
95th %tile Queue, veh	5	3	5

HCM 2010 Signalized Intersection Summary
 23: Inter-Garrison Road & Abrams Drive

Cumulative with Eastside Parkway, PM
 06/11/2019

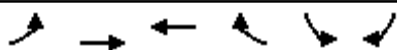

Movement	EBL	EBT	WBT	WBR	SBL	SBR		
Lane Configurations								
Traffic Volume (veh/h)	300	510	300	140	130	260		
Future Volume (veh/h)	300	510	300	140	130	260		
Number	5	2	6	16	7	14		
Initial Q (Qb), veh	0	0	0	0	0	0		
Ped-Bike Adj(A_pbT)	1.00			0.98	1.00	1.00		
Parking Bus, Adj	1.00	1.00	1.00	1.00	1.00	1.00		
Adj Sat Flow, veh/h/ln	1863	1863	1792	1792	1827	1827		
Adj Flow Rate, veh/h	316	537	316	121	137	51		
Adj No. of Lanes	1	1	1	1	2	1		
Peak Hour Factor	0.95	0.95	0.95	0.95	0.95	0.95		
Percent Heavy Veh, %	2	2	6	6	4	4		
Cap, veh/h	388	1185	554	461	340	157		
Arrive On Green	0.22	0.64	0.31	0.31	0.10	0.10		
Sat Flow, veh/h	1774	1863	1792	1491	3375	1553		
Grp Volume(v), veh/h	316	537	316	121	137	51		
Grp Sat Flow(s),veh/h/ln	1774	1863	1792	1491	1688	1553		
Q Serve(g_s), s	5.5	4.8	4.8	2.0	1.2	1.0		
Cycle Q Clear(g_c), s	5.5	4.8	4.8	2.0	1.2	1.0		
Prop In Lane	1.00			1.00	1.00	1.00		
Lane Grp Cap(c), veh/h	388	1185	554	461	340	157		
V/C Ratio(X)	0.81	0.45	0.57	0.26	0.40	0.33		
Avail Cap(c_a), veh/h	631	3456	2494	2075	3288	1513		
HCM Platoon Ratio	1.00	1.00	1.00	1.00	1.00	1.00		
Upstream Filter(I)	1.00	1.00	1.00	1.00	1.00	1.00		
Uniform Delay (d), s/veh	12.0	3.0	9.4	8.4	13.6	13.5		
Incr Delay (d2), s/veh	1.6	0.1	0.3	0.1	0.3	0.4		
Initial Q Delay(d3),s/veh	0.0	0.0	0.0	0.0	0.0	0.0		
%ile BackOfQ(50%),veh/ln	2.8	2.4	2.3	0.8	0.6	0.9		
LnGrp Delay(d),s/veh	13.6	3.1	9.7	8.5	13.9	14.0		
LnGrp LOS	B	A	A	A	B	B		
Approach Vol, veh/h		853	437		188			
Approach Delay, s/veh		7.0	9.4		13.9			
Approach LOS		A	A		B			
Timer	1	2	3	4	5	6	7	8
Assigned Phs		2		4	5	6		
Phs Duration (G+Y+Rc), s		25.6		6.8	10.6	15.0		
Change Period (Y+Rc), s		5.0		3.5	3.5	5.0		
Max Green Setting (Gmax), s		60.0		31.5	11.5	45.0		
Max Q Clear Time (g_c+I1), s		6.8		3.2	7.5	6.8		
Green Ext Time (p_c), s		0.5		0.0	0.0	0.3		
Intersection Summary								
HCM 2010 Ctrl Delay			8.6					
HCM 2010 LOS			A					
Notes								

HCM 2010 Signalized Intersection Summary
 24: Inter-Garrison Road & Schoonover Road

Cumulative with Eastside Parkway, PM
 06/11/2019



Movement	EBL	EBT	EBR	WBL	WBT	WBR	NBL	NBT	NBR	SBL	SBT	SBR
Lane Configurations												
Traffic Volume (veh/h)	110	450	110	330	250	40	120	30	740	30	20	40
Future Volume (veh/h)	110	450	110	330	250	40	120	30	740	30	20	40
Number	5	2	12	1	6	16	3	8	18	7	4	14
Initial Q (Qb), veh	0	0	0	0	0	0	0	0	0	0	0	0
Ped-Bike Adj(A_pbT)	1.00		1.00	1.00		1.00	1.00		1.00	1.00		1.00
Parking Bus, Adj	1.00	1.00	1.00	1.00	1.00	1.00	1.00	1.00	1.00	1.00	1.00	1.00
Adj Sat Flow, veh/h/ln	1881	1878	1900	1863	1810	1810	1863	1863	1863	1900	1711	1624
Adj Flow Rate, veh/h	128	523	93	384	291	30	140	35	0	35	23	33
Adj No. of Lanes	1	2	0	1	2	1	1	1	1	0	1	1
Peak Hour Factor	0.86	0.86	0.86	0.86	0.86	0.86	0.86	0.86	0.86	0.86	0.86	0.86
Percent Heavy Veh, %	1	1	1	2	5	5	2	2	2	2	2	17
Cap, veh/h	163	623	110	428	1223	547	260	273	232	124	81	171
Arrive On Green	0.09	0.21	0.21	0.24	0.36	0.36	0.15	0.15	0.00	0.12	0.12	0.12
Sat Flow, veh/h	1792	3030	537	1774	3438	1538	1774	1863	1583	1002	659	1380
Grp Volume(v), veh/h	128	307	309	384	291	30	140	35	0	58	0	33
Grp Sat Flow(s),veh/h/ln	1792	1784	1783	1774	1719	1538	1774	1863	1583	1661	0	1380
Q Serve(g_s), s	4.6	10.8	10.9	13.7	3.9	0.8	4.8	1.1	0.0	2.1	0.0	1.4
Cycle Q Clear(g_c), s	4.6	10.8	10.9	13.7	3.9	0.8	4.8	1.1	0.0	2.1	0.0	1.4
Prop In Lane	1.00		0.30	1.00		1.00	1.00		1.00	0.60		1.00
Lane Grp Cap(c), veh/h	163	367	367	428	1223	547	260	273	232	205	0	171
V/C Ratio(X)	0.78	0.84	0.84	0.90	0.24	0.05	0.54	0.13	0.00	0.28	0.00	0.19
Avail Cap(c_a), veh/h	836	818	818	936	1735	776	1085	1139	969	686	0	570
HCM Platoon Ratio	1.00	1.00	1.00	1.00	1.00	1.00	1.00	1.00	1.00	1.00	1.00	1.00
Upstream Filter(I)	1.00	1.00	1.00	1.00	1.00	1.00	1.00	1.00	0.00	1.00	0.00	1.00
Uniform Delay (d), s/veh	29.1	24.9	25.0	24.0	14.8	13.8	25.9	24.3	0.0	26.0	0.0	25.7
Incr Delay (d2), s/veh	3.1	2.0	2.0	2.8	0.0	0.0	0.6	0.1	0.0	0.3	0.0	0.2
Initial Q Delay(d3),s/veh	0.0	0.0	0.0	0.0	0.0	0.0	0.0	0.0	0.0	0.0	0.0	0.0
%ile BackOfQ(50%),veh/ln	2.4	5.5	5.5	7.0	1.9	0.4	2.4	0.6	0.0	1.0	0.0	0.5
LnGrp Delay(d),s/veh	32.2	26.9	27.0	26.8	14.9	13.9	26.5	24.3	0.0	26.3	0.0	25.9
LnGrp LOS	C	C	C	C	B	B	C	C		C		C
Approach Vol, veh/h		744			705			175			91	
Approach Delay, s/veh		27.9			21.3			26.1			26.2	
Approach LOS		C			C			C			C	
Timer	1	2	3	4	5	6	7	8				
Assigned Phs	1	2		4	5	6		8				
Phs Duration (G+Y+Rc), s	19.3	18.4		13.1	9.5	28.3		14.6				
Change Period (Y+Rc), s	3.5	5.0		5.0	3.5	5.0		5.0				
Max Green Setting (Gmax), s	31.5	30.0		27.0	30.5	33.0		40.0				
Max Q Clear Time (g_c+1.5), s	11.5	12.9		4.1	6.6	5.9		6.8				
Green Ext Time (p_c), s	0.1	0.6		0.0	0.0	0.3		0.0				
Intersection Summary												
HCM 2010 Ctrl Delay				24.9								
HCM 2010 LOS				C								

Intersection						
Intersection Delay, s/veh	273					
Intersection LOS	F					

Movement	EBL	EBT	WBT	WBR	SBL	SBR
Lane Configurations						
Traffic Vol, veh/h	900	270	160	100	130	410
Future Vol, veh/h	900	270	160	100	130	410
Peak Hour Factor	0.87	0.87	0.87	0.87	0.87	0.87
Heavy Vehicles, %	1	1	6	6	3	3
Mvmt Flow	1034	310	184	115	149	471
Number of Lanes	1	1	1	0	1	1

Approach	EB	WB	SB
Opposing Approach	WB	EB	
Opposing Lanes	1	2	0
Conflicting Approach Left	SB		WB
Conflicting Lanes Left	2	0	1
Conflicting Approach Right		SB	EB
Conflicting Lanes Right	0	2	2
HCM Control Delay	437.3	21.4	38.2
HCM LOS	F	C	E

Lane	EBLn1	EBLn2	WBLn1	SBLn1	SBLn2
Vol Left, %	100%	0%	0%	100%	0%
Vol Thru, %	0%	100%	62%	0%	0%
Vol Right, %	0%	0%	38%	0%	100%
Sign Control	Stop	Stop	Stop	Stop	Stop
Traffic Vol by Lane	900	270	260	130	410
LT Vol	900	0	0	130	0
Through Vol	0	270	160	0	0
RT Vol	0	0	100	0	410
Lane Flow Rate	1034	310	299	149	471
Geometry Grp	7	7	4	7	7
Degree of Util (X)	2.196	0.615	0.589	0.328	0.878
Departure Headway (Hd)	7.643	7.131	7.801	9.098	7.861
Convergence, Y/N	Yes	Yes	Yes	Yes	Yes
Cap	486	506	466	397	467
Service Time	5.381	4.869	5.801	6.798	5.561
HCM Lane V/C Ratio	2.128	0.613	0.642	0.375	1.009
HCM Control Delay	562.3	20.6	21.4	16.2	45.2
HCM Lane LOS	F	C	C	C	E
HCM 95th-tile Q	75.2	4.1	3.7	1.4	9.3

HCM 2010 Signalized Intersection Summary
 26: East Garrison Road & Reservation Road

Cumulative with Eastside Parkway, PM
 06/11/2019



Movement	EBL	EBT	EBR	WBL	WBT	WBR	NBL	NBT	NBR	SBL	SBT	SBR
Lane Configurations												
Traffic Volume (veh/h)	0	1510	130	230	760	0	110	0	150	0	0	0
Future Volume (veh/h)	0	1510	130	230	760	0	110	0	150	0	0	0
Number	5	2	12	1	6	16	3	8	18			
Initial Q (Qb), veh	0	0	0	0	0	0	0	0	0			
Ped-Bike Adj(A_pbT)	1.00		1.00	1.00		1.00	1.00		1.00			
Parking Bus, Adj	1.00	1.00	1.00	1.00	1.00	1.00	1.00	1.00	1.00			
Adj Sat Flow, veh/h/ln	1863	1863	1900	1881	1881	0	1845	0	1845			
Adj Flow Rate, veh/h	0	1557	132	237	784	0	113	0	126			
Adj No. of Lanes	1	2	0	1	2	0	1	0	1			
Peak Hour Factor	0.97	0.97	0.97	0.97	0.97	0.97	0.97	0.97	0.97			
Percent Heavy Veh, %	2	2	2	1	1	0	3	0	3			
Cap, veh/h	2	1972	166	271	2815	0	178	0	159			
Arrive On Green	0.00	0.60	0.60	0.15	0.79	0.00	0.10	0.00	0.10			
Sat Flow, veh/h	1774	3305	278	1792	3668	0	1757	0	1568			
Grp Volume(v), veh/h	0	828	861	237	784	0	113	0	126			
Grp Sat Flow(s),veh/h/ln	1774	1770	1814	1792	1787	0	1757	0	1568			
Q Serve(g_s), s	0.0	32.3	33.2	11.8	5.4	0.0	5.6	0.0	7.1			
Cycle Q Clear(g_c), s	0.0	32.3	33.2	11.8	5.4	0.0	5.6	0.0	7.1			
Prop In Lane	1.00		0.15	1.00		0.00	1.00		1.00			
Lane Grp Cap(c), veh/h	2	1056	1082	271	2815	0	178	0	159			
V/C Ratio(X)	0.00	0.78	0.80	0.87	0.28	0.00	0.63	0.00	0.79			
Avail Cap(c_a), veh/h	390	1166	1195	394	2815	0	521	0	465			
HCM Platoon Ratio	1.00	1.00	1.00	1.00	1.00	1.00	1.00	1.00	1.00			
Upstream Filter(I)	0.00	1.00	1.00	1.00	1.00	0.00	1.00	0.00	1.00			
Uniform Delay (d), s/veh	0.0	13.9	14.1	37.8	2.6	0.0	39.3	0.0	40.0			
Incr Delay (d2), s/veh	0.0	3.9	4.1	10.4	0.1	0.0	1.4	0.0	3.3			
Initial Q Delay(d3),s/veh	0.0	0.0	0.0	0.0	0.0	0.0	0.0	0.0	0.0			
%ile BackOfQ(50%),veh/ln	0.0	16.8	17.7	6.6	2.6	0.0	2.8	0.0	3.3			
LnGrp Delay(d),s/veh	0.0	17.8	18.2	48.1	2.7	0.0	40.7	0.0	43.3			
LnGrp LOS		B	B	D	A		D		D			
Approach Vol, veh/h		1689			1021			239				
Approach Delay, s/veh		18.0			13.2			42.0				
Approach LOS		B			B			D				
Timer	1	2	3	4	5	6	7	8				
Assigned Phs	1	2			5	6		8				
Phs Duration (G+Y+Rc), s	7.4	59.7			0.0	77.1		13.9				
Change Period (Y+Rc), s	3.6	5.4			3.5	5.4		4.7				
Max Green Setting (Gmax), s	20	60.0			20.0	60.0		27.0				
Max Q Clear Time (g_c+113), s	113	35.2			0.0	7.4		9.1				
Green Ext Time (p_c), s	0.0	19.1			0.0	7.0		0.1				
Intersection Summary												
HCM 2010 Ctrl Delay				18.3								
HCM 2010 LOS				B								
Notes												

HCM 2010 Signalized Intersection Summary
27: Reservation Road & Watkins Gate Road

Cumulative with Eastside Parkway, PM
06/11/2019



Movement	EBL	EBR	NBL	NBT	SBT	SBR		
Lane Configurations								
Traffic Volume (veh/h)	10	220	210	1190	2120	60		
Future Volume (veh/h)	10	220	210	1190	2120	60		
Number	5	12	3	8	4	14		
Initial Q (Qb), veh	0	0	0	0	0	0		
Ped-Bike Adj(A_pbT)	1.00	1.00	1.00			1.00		
Parking Bus, Adj	1.00	1.00	1.00	1.00	1.00	1.00		
Adj Sat Flow, veh/h/ln	1863	1863	1881	1881	1863	1900		
Adj Flow Rate, veh/h	11	32	228	1293	2304	62		
Adj No. of Lanes	1	1	1	2	2	0		
Peak Hour Factor	0.92	0.92	0.92	0.92	0.92	0.92		
Percent Heavy Veh, %	2	2	1	1	2	2		
Cap, veh/h	53	47	243	3117	2486	67		
Arrive On Green	0.03	0.03	0.14	0.87	0.71	0.71		
Sat Flow, veh/h	1774	1583	1792	3668	3615	94		
Grp Volume(v), veh/h	11	32	228	1293	1153	1213		
Grp Sat Flow(s),veh/h/ln	1774	1583	1792	1787	1770	1846		
Q Serve(g_s), s	0.8	2.7	16.7	9.6	72.8	74.7		
Cycle Q Clear(g_c), s	0.8	2.7	16.7	9.6	72.8	74.7		
Prop In Lane	1.00	1.00	1.00			0.05		
Lane Grp Cap(c), veh/h	53	47	243	3117	1249	1303		
V/C Ratio(X)	0.21	0.67	0.94	0.41	0.92	0.93		
Avail Cap(c_a), veh/h	274	245	243	3140	1261	1316		
HCM Platoon Ratio	1.00	1.00	1.00	1.00	1.00	1.00		
Upstream Filter(I)	1.00	1.00	1.00	1.00	1.00	1.00		
Uniform Delay (d), s/veh	62.8	63.7	56.7	1.7	16.4	16.7		
Incr Delay (d2), s/veh	0.7	6.0	40.3	0.1	11.5	12.0		
Initial Q Delay(d3),s/veh	0.0	0.0	0.0	0.0	0.0	0.0		
%ile BackOfQ(50%),veh/ln	0.4	1.2	11.0	4.7	38.9	41.8		
LnGrp Delay(d),s/veh	63.5	69.7	97.1	1.8	27.9	28.7		
LnGrp LOS	E	E	F	A	C	C		
Approach Vol, veh/h	43			1521	2366			
Approach Delay, s/veh	68.1			16.1	28.3			
Approach LOS	E			B	C			
Timer	1	2	3	4	5	6	7	8
Assigned Phs		2	3	4				8
Phs Duration (G+Y+Rc), s		10.5	22.0	100.1				122.1
Change Period (Y+Rc), s		6.5	4.0	6.5				6.5
Max Green Setting (Gmax), s		20.5	18.0	94.5				116.5
Max Q Clear Time (g_c+11), s		4.7	18.7	76.7				11.6
Green Ext Time (p_c), s		0.0	0.0	16.9				22.1
Intersection Summary								
HCM 2010 Ctrl Delay			24.0					
HCM 2010 LOS			C					

HCM 2010 Signalized Intersection Summary
 28: Davis Road & Reservation Road

Cumulative with Eastside Parkway, PM
 06/11/2019



Movement	EBL	EBT	EBR	WBL	WBT	WBR	NBL	NBT	NBR	SBL	SBT	SBR
Lane Configurations												
Traffic Volume (veh/h)	1260	510	10	10	350	100	10	10	10	120	10	720
Future Volume (veh/h)	1260	510	10	10	350	100	10	10	10	120	10	720
Number	5	2	12	1	6	16	3	8	18	7	4	14
Initial Q (Qb), veh	0	0	0	0	0	0	0	0	0	0	0	0
Ped-Bike Adj(A_pbT)	1.00		1.00	1.00		1.00	1.00		1.00	1.00		1.00
Parking Bus, Adj	1.00	1.00	1.00	1.00	1.00	1.00	1.00	1.00	1.00	1.00	1.00	1.00
Adj Sat Flow, veh/h/ln	1863	1863	1900	1827	1835	1900	1900	1900	1900	1900	1881	1881
Adj Flow Rate, veh/h	1340	543	11	11	372	106	11	11	9	128	11	631
Adj No. of Lanes	1	2	0	1	1	0	0	1	0	0	1	1
Peak Hour Factor	0.94	0.94	0.94	0.94	0.94	0.94	0.94	0.94	0.94	0.94	0.94	0.94
Percent Heavy Veh, %	2	2	2	4	4	4	0	0	0	1	1	1
Cap, veh/h	453	1970	40	18	427	122	17	17	14	423	36	816
Arrive On Green	0.26	0.56	0.56	0.01	0.31	0.31	0.03	0.03	0.03	0.26	0.26	0.26
Sat Flow, veh/h	1774	3548	72	1740	1374	392	631	631	516	1656	142	1599
Grp Volume(v), veh/h	1340	271	283	11	0	478	31	0	0	139	0	631
Grp Sat Flow(s),veh/h/ln	1774	1770	1850	1740	0	1766	1777	0	0	1798	0	1599
Q Serve(g_s), s	30.0	9.4	9.5	0.7	0.0	30.1	2.0	0.0	0.0	7.3	0.0	30.0
Cycle Q Clear(g_c), s	30.0	9.4	9.5	0.7	0.0	30.1	2.0	0.0	0.0	7.3	0.0	30.0
Prop In Lane	1.00		0.04	1.00		0.22	0.35		0.29	0.92		1.00
Lane Grp Cap(c), veh/h	453	982	1027	18	0	549	48	0	0	459	0	816
V/C Ratio(X)	2.96	0.28	0.28	0.62	0.00	0.87	0.64	0.00	0.00	0.30	0.00	0.77
Avail Cap(c_a), veh/h	453	982	1027	444	0	901	454	0	0	459	0	816
HCM Platoon Ratio	1.00	1.00	1.00	1.00	1.00	1.00	1.00	1.00	1.00	1.00	1.00	1.00
Upstream Filter(I)	1.00	1.00	1.00	1.00	0.00	1.00	1.00	0.00	0.00	1.00	0.00	1.00
Uniform Delay (d), s/veh	43.8	13.7	13.7	57.9	0.0	38.3	56.6	0.0	0.0	35.3	0.0	23.3
Incr Delay (d2), s/veh	887.8	0.2	0.2	12.1	0.0	7.5	5.2	0.0	0.0	0.1	0.0	4.2
Initial Q Delay(d3),s/veh	0.0	0.0	0.0	0.0	0.0	0.0	0.0	0.0	0.0	0.0	0.0	0.0
%ile BackOfQ(50%),veh/ln	26.2	4.7	4.9	0.4	0.0	15.7	1.1	0.0	0.0	3.6	0.0	17.3
LnGrp Delay(d),s/veh	931.6	14.0	14.0	70.0	0.0	45.7	61.9	0.0	0.0	35.5	0.0	27.5
LnGrp LOS	F	B	B	E		D	E			D		C
Approach Vol, veh/h		1894			489			31			770	
Approach Delay, s/veh		663.2			46.3			61.9			28.9	
Approach LOS		F			D			E			C	
Timer	1	2	3	4	5	6	7	8				
Assigned Phs	1	2		4	5	6		8				
Phs Duration (G+Y+Rc), s	5.1	70.3		35.0	33.8	41.6		7.2				
Change Period (Y+Rc), s	3.9	5.0		5.0	* 3.8	5.0		4.0				
Max Green Setting (Gmax), s	30	60.0		30.0	* 30	60.0		30.0				
Max Q Clear Time (g_c+1/2), s	11.5	11.5		32.0	32.0	32.1		4.0				
Green Ext Time (p_c), s	0.0	5.2		0.0	0.0	4.5		0.0				
Intersection Summary												
HCM 2010 Ctrl Delay				409.2								
HCM 2010 LOS				F								
Notes												

HCM 2010 Signalized Intersection Summary
29: 2nd Avenue & Divarty Street

Cumulative with Eastside Parkway, PM
06/11/2019



Movement	EBL	EBT	EBR	WBL	WBT	WBR	NBL	NBT	NBR	SBL	SBT	SBR
Lane Configurations		↕			↕	↕	↕	↕↔		↕	↕↔	
Traffic Volume (veh/h)	200	10	80	80	10	20	40	640	60	20	460	100
Future Volume (veh/h)	200	10	80	80	10	20	40	640	60	20	460	100
Number	5	2	12	1	6	16	3	8	18	7	4	14
Initial Q (Qb), veh	0	0	0	0	0	0	0	0	0	0	0	0
Ped-Bike Adj(A_pbT)	1.00		1.00	1.00		1.00	1.00		0.99	1.00		0.99
Parking Bus, Adj	1.00	1.00	1.00	1.00	1.00	1.00	1.00	1.00	1.00	1.00	1.00	1.00
Adj Sat Flow, veh/h/ln	1900	1900	1900	1900	1900	1900	1900	1900	1900	1881	1881	1900
Adj Flow Rate, veh/h	213	11	85	85	11	21	43	681	64	21	489	106
Adj No. of Lanes	0	1	0	0	1	1	1	2	0	1	2	0
Peak Hour Factor	0.94	0.94	0.94	0.94	0.94	0.94	0.94	0.94	0.94	0.94	0.94	0.94
Percent Heavy Veh, %	0	0	0	0	0	0	0	0	0	1	1	1
Cap, veh/h	415	42	119	547	62	510	85	1136	107	46	934	201
Arrive On Green	0.32	0.32	0.32	0.32	0.32	0.32	0.05	0.34	0.34	0.03	0.32	0.32
Sat Flow, veh/h	858	131	375	1224	195	1607	1810	3334	313	1792	2923	630
Grp Volume(v), veh/h	309	0	0	96	0	21	43	368	377	21	298	297
Grp Sat Flow(s),veh/h/ln	1365	0	0	1419	0	1607	1810	1805	1843	1792	1787	1765
Q Serve(g_s), s	6.9	0.0	0.0	0.0	0.0	0.4	1.0	7.2	7.2	0.5	5.8	5.9
Cycle Q Clear(g_c), s	8.9	0.0	0.0	2.0	0.0	0.4	1.0	7.2	7.2	0.5	5.8	5.9
Prop In Lane	0.69		0.28	0.89		1.00	1.00		0.17	1.00		0.36
Lane Grp Cap(c), veh/h	576	0	0	609	0	510	85	615	628	46	571	564
V/C Ratio(X)	0.54	0.00	0.00	0.16	0.00	0.04	0.51	0.60	0.60	0.45	0.52	0.53
Avail Cap(c_a), veh/h	1309	0	0	1294	0	1317	487	1690	1725	482	1464	1446
HCM Platoon Ratio	1.00	1.00	1.00	1.00	1.00	1.00	1.00	1.00	1.00	1.00	1.00	1.00
Upstream Filter(I)	1.00	0.00	0.00	1.00	0.00	1.00	1.00	1.00	1.00	1.00	1.00	1.00
Uniform Delay (d), s/veh	13.3	0.0	0.0	10.6	0.0	10.1	19.9	11.7	11.7	20.5	11.9	11.9
Incr Delay (d2), s/veh	0.8	0.0	0.0	0.1	0.0	0.0	4.6	0.9	0.9	6.8	0.7	0.8
Initial Q Delay(d3),s/veh	0.0	0.0	0.0	0.0	0.0	0.0	0.0	0.0	0.0	0.0	0.0	0.0
%ile BackOfQ(50%),veh/ln	3.3	0.0	0.0	0.8	0.0	0.2	0.6	3.7	3.8	0.3	2.9	2.9
LnGrp Delay(d),s/veh	14.1	0.0	0.0	10.7	0.0	10.1	24.5	12.6	12.6	27.3	12.6	12.6
LnGrp LOS	B			B		B	C	B	B	C	B	B
Approach Vol, veh/h		309			117			788			616	
Approach Delay, s/veh		14.1			10.6			13.3			13.1	
Approach LOS		B			B			B			B	
Timer	1	2	3	4	5	6	7	8				
Assigned Phs		2	3	4		6	7	8				
Phs Duration (G+Y+Rc), s		18.6	5.5	18.7		18.6	4.6	19.6				
Change Period (Y+Rc), s		5.0	3.5	5.0		5.0	3.5	5.0				
Max Green Setting (Gmax), s		35.0	11.5	35.0		35.0	11.5	40.0				
Max Q Clear Time (g_c+I1), s		10.9	3.0	7.9		4.0	2.5	9.2				
Green Ext Time (p_c), s		1.9	0.0	3.7		0.6	0.0	4.9				
Intersection Summary												
HCM 2010 Ctrl Delay				13.2								
HCM 2010 LOS				B								

Intersection												
Intersection Delay, s/veh	10.6											
Intersection LOS	B											

Movement	EBL	EBT	EBR	WBL	WBT	WBR	NBL	NBT	NBR	SBL	SBT	SBR
Lane Configurations		↕			↕		↕	↕		↕	↕	
Traffic Vol, veh/h	20	10	30	30	10	10	20	200	60	10	210	20
Future Vol, veh/h	20	10	30	30	10	10	20	200	60	10	210	20
Peak Hour Factor	0.85	0.85	0.85	0.85	0.85	0.85	0.85	0.85	0.85	0.85	0.85	0.85
Heavy Vehicles, %	0	0	0	1	1	1	0	0	0	1	1	1
Mvmt Flow	24	12	35	35	12	12	24	235	71	12	247	24
Number of Lanes	0	1	0	0	1	0	1	1	0	1	1	0

Approach	EB	WB	NB	SB
Opposing Approach	WB	EB	SB	NB
Opposing Lanes	1	1	2	2
Conflicting Approach Left	SB	NB	EB	WB
Conflicting Lanes Left	2	2	1	1
Conflicting Approach Right	NB	SB	WB	EB
Conflicting Lanes Right	2	2	1	1
HCM Control Delay	8.9	9.1	11	10.9
HCM LOS	A	A	B	B

Lane	NBLn1	NBLn2	EBLn1	WBLn1	SBLn1	SBLn2
Vol Left, %	100%	0%	33%	60%	100%	0%
Vol Thru, %	0%	77%	17%	20%	0%	91%
Vol Right, %	0%	23%	50%	20%	0%	9%
Sign Control	Stop	Stop	Stop	Stop	Stop	Stop
Traffic Vol by Lane	20	260	60	50	10	230
LT Vol	20	0	20	30	10	0
Through Vol	0	200	10	10	0	210
RT Vol	0	60	30	10	0	20
Lane Flow Rate	24	306	71	59	12	271
Geometry Grp	7	7	2	2	7	7
Degree of Util (X)	0.037	0.419	0.102	0.089	0.018	0.382
Departure Headway (Hd)	5.595	4.93	5.204	5.472	5.649	5.085
Convergence, Y/N	Yes	Yes	Yes	Yes	Yes	Yes
Cap	638	728	684	650	631	704
Service Time	3.346	2.68	3.274	3.545	3.404	2.839
HCM Lane V/C Ratio	0.038	0.42	0.104	0.091	0.019	0.385
HCM Control Delay	8.6	11.2	8.9	9.1	8.5	11
HCM Lane LOS	A	B	A	A	A	B
HCM 95th-tile Q	0.1	2.1	0.3	0.3	0.1	1.8

HCM 2010 Signalized Intersection Summary
31: 1st Avenue & Lightfighter Drive

Cumulative with Eastside Parkway, PM
06/11/2019



Movement	EBL	EBT	EBR	WBL	WBT	WBR	NBL	NBT	NBR	SBL	SBT	SBR
Lane Configurations		↑↑	↑	↑	↑↑		↑		↑	↑	↑	↑
Traffic Volume (veh/h)	0	1140	110	20	1430	0	200	0	30	60	50	80
Future Volume (veh/h)	0	1140	110	20	1430	0	200	0	30	60	50	80
Number	7	4	14	3	8	18	5	2	12	1	6	16
Initial Q (Qb), veh	0	0	0	0	0	0	0	0	0	0	0	0
Ped-Bike Adj(A_pbT)	1.00		1.00	1.00		1.00	1.00		1.00	1.00		1.00
Parking Bus, Adj	1.00	1.00	1.00	1.00	1.00	1.00	1.00	1.00	1.00	1.00	1.00	1.00
Adj Sat Flow, veh/h/ln	0	1881	1881	1881	1881	0	1881	0	1881	1810	1810	1810
Adj Flow Rate, veh/h	0	1200	0	21	1505	0	211	0	14	63	53	64
Adj No. of Lanes	0	2	1	1	2	0	1	0	1	1	1	1
Peak Hour Factor	0.95	0.95	0.95	0.95	0.95	0.95	0.95	0.95	0.95	0.95	0.95	0.95
Percent Heavy Veh, %	0	1	1	1	1	0	1	0	1	5	5	5
Cap, veh/h	0	2194	982	23	2527	0	0	0	0	142	149	127
Arrive On Green	0.00	0.61	0.00	0.01	0.71	0.00	0.00	0.00	0.00	0.08	0.08	0.08
Sat Flow, veh/h	0	3668	1599	1792	3668	0		0		1723	1810	1538
Grp Volume(v), veh/h	0	1200	0	21	1505	0		0.0		63	53	64
Grp Sat Flow(s),veh/h/ln	0	1787	1599	1792	1787	0				1723	1810	1538
Q Serve(g_s), s	0.0	8.5	0.0	0.5	9.3	0.0				1.5	1.2	1.7
Cycle Q Clear(g_c), s	0.0	8.5	0.0	0.5	9.3	0.0				1.5	1.2	1.7
Prop In Lane	0.00		1.00	1.00		0.00				1.00		1.00
Lane Grp Cap(c), veh/h	0	2194	982	23	2527	0				142	149	127
V/C Ratio(X)	0.00	0.55	0.00	0.90	0.60	0.00				0.44	0.36	0.50
Avail Cap(c_a), veh/h	0	3681	1647	820	3681	0				986	1035	880
HCM Platoon Ratio	1.00	1.00	1.00	1.00	1.00	1.00				1.00	1.00	1.00
Upstream Filter(I)	0.00	1.00	0.00	1.00	1.00	0.00				1.00	1.00	1.00
Uniform Delay (d), s/veh	0.0	4.9	0.0	21.5	3.2	0.0				19.1	18.9	19.2
Incr Delay (d2), s/veh	0.0	0.3	0.0	32.9	0.3	0.0				0.8	0.5	1.2
Initial Q Delay(d3),s/veh	0.0	0.0	0.0	0.0	0.0	0.0				0.0	0.0	0.0
%ile BackOfQ(50%),veh/ln	0.0	4.1	0.0	0.5	4.5	0.0				0.7	0.6	0.8
LnGrp Delay(d),s/veh	0.0	5.2	0.0	54.5	3.6	0.0				19.9	19.5	20.3
LnGrp LOS		A		D	A					B	B	C
Approach Vol, veh/h		1200			1526						180	
Approach Delay, s/veh		5.2			4.3						19.9	
Approach LOS		A			A						B	
Timer	1	2	3	4	5	6	7	8				
Assigned Phs			3	4		6		8				
Phs Duration (G+Y+Rc), s			4.1	31.4		8.2		35.5				
Change Period (Y+Rc), s			3.5	4.6		4.6		4.6				
Max Green Setting (Gmax), s			20.0	45.0		25.0		45.0				
Max Q Clear Time (g_c+I1), s			2.5	10.5		3.7		11.3				
Green Ext Time (p_c), s			0.0	15.8		0.3		19.6				
Intersection Summary												
HCM 2010 Ctrl Delay			5.6									
HCM 2010 LOS			A									

HCM 2010 Signalized Intersection Summary
 32: 2nd Avenue & Lightfighter Drive

Cumulative with Eastside Parkway, PM
 06/11/2019



Movement	EBL	EBT	EBR	WBL	WBT	WBR	NBL	NBT	NBR	SBL	SBT	SBR
Lane Configurations												
Traffic Volume (veh/h)	290	940	10	80	1150	220	20	20	50	220	30	330
Future Volume (veh/h)	290	940	10	80	1150	220	20	20	50	220	30	330
Number	5	2	12	1	6	16	3	8	18	7	4	14
Initial Q (Qb), veh	0	0	0	0	0	0	0	0	0	0	0	0
Ped-Bike Adj(A_pbT)	1.00		1.00	1.00		1.00	1.00		0.99	1.00		0.99
Parking Bus, Adj	1.00	1.00	1.00	1.00	1.00	1.00	1.00	1.00	1.00	1.00	1.00	1.00
Adj Sat Flow, veh/h/ln	1881	1881	1900	1881	1881	1900	1900	1900	1900	1845	1845	1845
Adj Flow Rate, veh/h	305	989	11	84	1211	227	21	21	47	232	32	244
Adj No. of Lanes	1	2	0	1	2	0	0	1	0	1	1	1
Peak Hour Factor	0.95	0.95	0.95	0.95	0.95	0.95	0.95	0.95	0.95	0.95	0.95	0.95
Percent Heavy Veh, %	1	1	1	1	1	1	0	0	0	3	3	3
Cap, veh/h	222	2215	25	108	1648	307	93	97	163	340	362	306
Arrive On Green	0.12	0.61	0.61	0.06	0.55	0.55	0.20	0.20	0.20	0.20	0.20	0.20
Sat Flow, veh/h	1792	3621	40	1792	3009	560	246	497	831	1308	1845	1558
Grp Volume(v), veh/h	305	488	512	84	716	722	89	0	0	232	32	244
Grp Sat Flow(s),veh/h/ln	1792	1787	1874	1792	1787	1782	1574	0	0	1308	1845	1558
Q Serve(g_s), s	12.4	14.6	14.6	4.6	30.2	30.8	0.0	0.0	0.0	12.0	1.4	14.9
Cycle Q Clear(g_c), s	12.4	14.6	14.6	4.6	30.2	30.8	4.4	0.0	0.0	16.3	1.4	14.9
Prop In Lane	1.00		0.02	1.00		0.31	0.24		0.53	1.00		1.00
Lane Grp Cap(c), veh/h	222	1093	1146	108	979	976	354	0	0	340	362	306
V/C Ratio(X)	1.37	0.45	0.45	0.78	0.73	0.74	0.25	0.00	0.00	0.68	0.09	0.80
Avail Cap(c_a), veh/h	222	1093	1146	222	979	976	666	0	0	611	745	630
HCM Platoon Ratio	1.00	1.00	1.00	1.00	1.00	1.00	1.00	1.00	1.00	1.00	1.00	1.00
Upstream Filter(I)	0.75	0.75	0.75	0.09	0.09	0.09	1.00	0.00	0.00	0.85	0.85	0.85
Uniform Delay (d), s/veh	43.8	10.4	10.4	46.4	17.1	17.2	34.0	0.0	0.0	38.6	32.9	38.3
Incr Delay (d2), s/veh	187.8	1.0	0.9	0.4	0.4	0.5	0.1	0.0	0.0	0.8	0.0	1.6
Initial Q Delay(d3),s/veh	0.0	0.0	0.0	0.0	0.0	0.0	0.0	0.0	0.0	0.0	0.0	0.0
%ile BackOfQ(50%),veh/ln	7.7	7.5	7.8	2.3	14.8	15.2	2.1	0.0	0.0	6.3	0.7	6.5
LnGrp Delay(d),s/veh	231.6	11.4	11.3	46.8	17.5	17.7	34.2	0.0	0.0	39.3	32.9	39.9
LnGrp LOS	F	B	B	D	B	B	C			D	C	D
Approach Vol, veh/h		1305			1522			89			508	
Approach Delay, s/veh		62.8			19.2			34.2			39.2	
Approach LOS		E			B			C			D	
Timer	1	2	3	4	5	6	7	8				
Assigned Phs	1	2		4	5	6		8				
Phs Duration (G+Y+Rc), s	0.0	65.8		24.2	16.4	59.4		24.2				
Change Period (Y+Rc), s	4.0	4.6		4.6	4.0	4.6		4.6				
Max Green Setting (Gmax), s	2.4	34.0		40.4	12.4	24.4		40.4				
Max Q Clear Time (g_c+10), s	16.6	16.6		18.3	14.4	32.8		6.4				
Green Ext Time (p_c), s	0.0	3.6		0.9	0.0	0.0		0.3				
Intersection Summary												
HCM 2010 Ctrl Delay				39.2								
HCM 2010 LOS				D								

HCM 2010 Signalized Intersection Summary
 33: General Jim Moore Boulevard & Lightfighter Drive

Cumulative with Eastside Parkway, PM
 06/11/2019



Movement	EBL	EBT	EBR	WBL	WBT	WBR	NBL	NBT	NBR	SBL	SBT	SBR
Lane Configurations												
Traffic Volume (veh/h)	130	270	740	40	270	50	630	80	20	60	100	70
Future Volume (veh/h)	130	270	740	40	270	50	630	80	20	60	100	70
Number	3	8	18	7	4	14	1	6	16	5	2	12
Initial Q (Qb), veh	0	0	0	0	0	0	0	0	0	0	0	0
Ped-Bike Adj(A_pbT)	1.00		1.00	1.00		1.00	1.00		1.00	1.00		1.00
Parking Bus, Adj	1.00	1.00	1.00	1.00	1.00	1.00	1.00	1.00	1.00	1.00	1.00	1.00
Adj Sat Flow, veh/h/ln	1881	1881	1881	1900	1900	1900	1881	1881	1900	1900	1900	1900
Adj Flow Rate, veh/h	135	281	0	42	281	51	656	83	19	62	104	-39
Adj No. of Lanes	1	1	1	1	1	0	2	1	0	1	2	0
Peak Hour Factor	0.96	0.96	0.96	0.96	0.96	0.96	0.96	0.96	0.96	0.96	0.96	0.96
Percent Heavy Veh, %	1	1	1	0	0	0	1	1	1	0	0	0
Cap, veh/h	179	590	502	63	389	71	666	387	89	82	415	0
Arrive On Green	0.10	0.31	0.00	0.03	0.25	0.25	0.19	0.26	0.26	0.05	0.11	0.00
Sat Flow, veh/h	1792	1881	1599	1810	1566	284	3476	1482	339	1810	3705	0
Grp Volume(v), veh/h	135	281	0	42	0	332	656	0	102	62	65	0
Grp Sat Flow(s),veh/h/ln	1792	1881	1599	1810	0	1850	1738	0	1821	1810	1805	0
Q Serve(g_s), s	3.8	6.3	0.0	1.2	0.0	8.6	9.8	0.0	2.3	1.8	0.8	0.0
Cycle Q Clear(g_c), s	3.8	6.3	0.0	1.2	0.0	8.6	9.8	0.0	2.3	1.8	0.8	0.0
Prop In Lane	1.00		1.00	1.00		0.15	1.00		0.19	1.00		0.00
Lane Grp Cap(c), veh/h	179	590	502	63	0	460	666	0	475	82	415	0
V/C Ratio(X)	0.75	0.48	0.00	0.66	0.00	0.72	0.99	0.00	0.21	0.75	0.16	0.00
Avail Cap(c_a), veh/h	686	1081	919	693	0	1063	666	0	1047	520	2075	0
HCM Platoon Ratio	1.00	1.00	1.00	1.00	1.00	1.00	1.00	1.00	1.00	1.00	1.00	1.00
Upstream Filter(l)	1.00	1.00	0.00	1.00	0.00	1.00	1.00	0.00	1.00	1.00	1.00	0.00
Uniform Delay (d), s/veh	22.9	14.5	0.0	24.9	0.0	18.0	21.0	0.0	15.1	24.6	20.8	0.0
Incr Delay (d2), s/veh	6.2	0.7	0.0	4.4	0.0	2.6	31.0	0.0	0.5	5.1	0.2	0.0
Initial Q Delay(d3),s/veh	0.0	0.0	0.0	0.0	0.0	0.0	0.0	0.0	0.0	0.0	0.0	0.0
%ile BackOfQ(50%),veh/ln	2.2	3.4	0.0	0.7	0.0	4.7	7.5	0.0	1.2	1.0	0.4	0.0
LnGrp Delay(d),s/veh	29.1	15.2	0.0	29.3	0.0	20.6	52.1	0.0	15.6	29.8	21.0	0.0
LnGrp LOS	C	B		C		C	D		B	C	C	
Approach Vol, veh/h		416			374			758			127	
Approach Delay, s/veh		19.7			21.5			47.2			25.3	
Approach LOS		B			C			D			C	
Timer	1	2	3	4	5	6	7	8				
Assigned Phs	1	2	3	4	5	6	7	8				
Phs Duration (G+Y+Rc), s	4.5	10.5	9.7	17.5	6.9	18.1	6.3	20.9				
Change Period (Y+Rc), s	4.5	4.5	4.5	4.5	4.5	4.5	4.5	4.5				
Max Green Setting (Gmax), s	30.0	30.0	20.0	30.0	15.0	30.0	20.0	30.0				
Max Q Clear Time (g_c+I1), s	2.8	5.8	5.8	10.6	3.8	4.3	3.2	8.3				
Green Ext Time (p_c), s	0.0	0.4	0.3	2.4	0.0	0.9	0.0	1.8				
Intersection Summary												
HCM 2010 Ctrl Delay			33.0									
HCM 2010 LOS			C									

Intersection	
Intersection Delay, s/veh	12.3
Intersection LOS	B

Movement	WBL	WBR	NBT	NBR	SBL	SBT
Lane Configurations	W		T			T
Traffic Vol, veh/h	10	290	60	20	300	50
Future Vol, veh/h	10	290	60	20	300	50
Peak Hour Factor	0.88	0.88	0.88	0.88	0.88	0.88
Heavy Vehicles, %	0	0	2	2	1	1
Mvmt Flow	11	330	68	23	341	57
Number of Lanes	1	0	1	0	0	1

Approach	WB	NB	SB
Opposing Approach		SB	NB
Opposing Lanes	0	1	1
Conflicting Approach Left	NB		WB
Conflicting Lanes Left	1	0	1
Conflicting Approach Right	SB	WB	
Conflicting Lanes Right	1	1	0
HCM Control Delay	11	9	14.1
HCM LOS	B	A	B

Lane	NBLn1	WBLn1	SBLn1
Vol Left, %	0%	3%	86%
Vol Thru, %	75%	0%	14%
Vol Right, %	25%	97%	0%
Sign Control	Stop	Stop	Stop
Traffic Vol by Lane	80	300	350
LT Vol	0	10	300
Through Vol	60	0	50
RT Vol	20	290	0
Lane Flow Rate	91	341	398
Geometry Grp	1	1	1
Degree of Util (X)	0.131	0.43	0.551
Departure Headway (Hd)	5.19	4.538	4.984
Convergence, Y/N	Yes	Yes	Yes
Cap	695	788	716
Service Time	3.19	2.603	3.071
HCM Lane V/C Ratio	0.131	0.433	0.556
HCM Control Delay	9	11	14.1
HCM Lane LOS	A	B	B
HCM 95th-tile Q	0.4	2.2	3.4

Intersection						
Int Delay, s/veh	1.6					
Movement	EBT	EBR	WBL	WBT	NBL	NBR
Lane Configurations						
Traffic Vol, veh/h	280	40	30	270	30	30
Future Vol, veh/h	280	40	30	270	30	30
Conflicting Peds, #/hr	0	0	0	0	0	0
Sign Control	Free	Free	Free	Free	Stop	Stop
RT Channelized	-	None	-	None	-	None
Storage Length	-	-	-	-	0	-
Veh in Median Storage, #	0	-	-	0	0	-
Grade, %	0	-	-	0	0	-
Peak Hour Factor	85	85	85	85	85	85
Heavy Vehicles, %	0	0	0	0	0	0
Mvmt Flow	329	47	35	318	35	35

Major/Minor	Major1	Major2	Minor1	Minor2	Minor3
Conflicting Flow All	0	0	376	0	741
Stage 1	-	-	-	-	353
Stage 2	-	-	-	-	388
Critical Hdwy	-	-	4.1	-	6.4
Critical Hdwy Stg 1	-	-	-	-	5.4
Critical Hdwy Stg 2	-	-	-	-	5.4
Follow-up Hdwy	-	-	2.2	-	3.5
Pot Cap-1 Maneuver	-	-	1194	-	387
Stage 1	-	-	-	-	716
Stage 2	-	-	-	-	690
Platoon blocked, %	-	-	-	-	-
Mov Cap-1 Maneuver	-	-	1194	-	373
Mov Cap-2 Maneuver	-	-	-	-	373
Stage 1	-	-	-	-	690
Stage 2	-	-	-	-	690

Approach	EB	WB	NB
HCM Control Delay, s	0	0.8	13.7
HCM LOS			B

Minor Lane/Major Mvmt	NBLn1	EBT	EBR	WBL	WBT
Capacity (veh/h)	485	-	-	1194	-
HCM Lane V/C Ratio	0.146	-	-	0.03	-
HCM Control Delay (s)	13.7	-	-	8.1	0
HCM Lane LOS	B	-	-	A	A
HCM 95th %tile Q(veh)	0.5	-	-	0.1	-

Intersection	
Intersection Delay, s/veh	13.1
Intersection LOS	B

Movement	EBL	EBT	EBR	WBL	WBT	WBR	NBL	NBT	NBR	SBL	SBT	SBR
Lane Configurations		↕			↕			↕			↕	
Traffic Vol, veh/h	10	240	60	30	230	10	50	60	20	10	80	20
Future Vol, veh/h	10	240	60	30	230	10	50	60	20	10	80	20
Peak Hour Factor	0.82	0.82	0.82	0.82	0.82	0.82	0.82	0.82	0.82	0.82	0.82	0.82
Heavy Vehicles, %	0	0	0	0	0	0	2	2	2	0	0	0
Mvmt Flow	12	293	73	37	280	12	61	73	24	12	98	24
Number of Lanes	0	1	0	0	1	0	0	1	0	0	1	0

Approach	EB	WB	NB	SB
Opposing Approach	WB	EB	SB	NB
Opposing Lanes	1	1	1	1
Conflicting Approach Left	SB	NB	EB	WB
Conflicting Lanes Left	1	1	1	1
Conflicting Approach Right	NB	SB	WB	EB
Conflicting Lanes Right	1	1	1	1
HCM Control Delay	14.4	13.5	11.3	10.8
HCM LOS	B	B	B	B

Lane	NBLn1	EBLn1	WBLn1	SBLn1
Vol Left, %	38%	3%	11%	9%
Vol Thru, %	46%	77%	85%	73%
Vol Right, %	15%	19%	4%	18%
Sign Control	Stop	Stop	Stop	Stop
Traffic Vol by Lane	130	310	270	110
LT Vol	50	10	30	10
Through Vol	60	240	230	80
RT Vol	20	60	10	20
Lane Flow Rate	159	378	329	134
Geometry Grp	1	1	1	1
Degree of Util (X)	0.266	0.546	0.491	0.223
Departure Headway (Hd)	6.042	5.195	5.366	5.994
Convergence, Y/N	Yes	Yes	Yes	Yes
Cap	591	692	668	596
Service Time	4.11	3.248	3.42	4.065
HCM Lane V/C Ratio	0.269	0.546	0.493	0.225
HCM Control Delay	11.3	14.4	13.5	10.8
HCM Lane LOS	B	B	B	B
HCM 95th-tile Q	1.1	3.3	2.7	0.8

Intersection												
Int Delay, s/veh	22											
Movement	EBL	EBT	EBR	WBL	WBT	WBR	NBL	NBT	NBR	SBL	SBT	SBR
Lane Configurations		↕			↕			↕			↕	
Traffic Vol, veh/h	60	160	50	30	130	10	90	60	20	10	20	30
Future Vol, veh/h	60	160	50	30	130	10	90	60	20	10	20	30
Conflicting Peds, #/hr	0	0	0	0	0	0	0	0	0	0	0	0
Sign Control	Stop	Stop	Stop	Stop	Stop	Stop	Free	Free	Free	Free	Free	Free
RT Channelized	-	-	None	-	-	None	-	-	None	-	-	None
Storage Length	-	-	-	-	-	-	-	-	-	-	-	-
Veh in Median Storage, #	-	0	-	-	0	-	-	0	-	-	0	-
Grade, %	-	0	-	-	0	-	-	0	-	-	0	-
Peak Hour Factor	74	74	74	74	74	74	74	74	74	74	74	74
Heavy Vehicles, %	3	3	3	2	2	2	3	3	3	8	8	8
Mvmt Flow	81	216	68	41	176	14	122	81	27	14	27	41

Major/Minor	Minor2		Minor1		Major1			Major2				
Conflicting Flow All	510	428	48	557	435	95	68	0	0	108	0	0
Stage 1	76	76	-	339	339	-	-	-	-	-	-	-
Stage 2	434	352	-	218	96	-	-	-	-	-	-	-
Critical Hdwy	7.13	6.53	6.23	7.12	6.52	6.22	4.13	-	-	4.18	-	-
Critical Hdwy Stg 1	6.13	5.53	-	6.12	5.52	-	-	-	-	-	-	-
Critical Hdwy Stg 2	6.13	5.53	-	6.12	5.52	-	-	-	-	-	-	-
Follow-up Hdwy	3.527	4.027	3.327	3.518	4.018	3.318	2.227	-	-	2.272	-	-
Pot Cap-1 Maneuver	472	518	1018	441	514	962	1527	-	-	1446	-	-
Stage 1	931	830	-	676	640	-	-	-	-	-	-	-
Stage 2	598	630	-	784	815	-	-	-	-	-	-	-
Platoon blocked, %								-	-	-	-	-
Mov Cap-1 Maneuver	307	469	1018	246	466	962	1527	-	-	1446	-	-
Mov Cap-2 Maneuver	307	469	-	246	466	-	-	-	-	-	-	-
Stage 1	852	822	-	619	586	-	-	-	-	-	-	-
Stage 2	378	576	-	534	807	-	-	-	-	-	-	-

Approach	EB		WB		NB		SB	
HCM Control Delay, s	36.5		24.1		4		1.3	
HCM LOS	E		C					

Minor Lane/Major Mvmt	NBL	NBT	NBR	EBLn1WBLn1	SBL	SBT	SBR
Capacity (veh/h)	1527	-	-	461	413	1446	-
HCM Lane V/C Ratio	0.08	-	-	0.791	0.556	0.009	-
HCM Control Delay (s)	7.6	0	-	36.5	24.1	7.5	0
HCM Lane LOS	A	A	-	E	C	A	A
HCM 95th %tile Q(veh)	0.3	-	-	7.1	3.3	0	-

Intersection						
Int Delay, s/veh	4.7					
Movement	EBL	EBR	NBL	NBT	SBT	SBR
Lane Configurations	T			T		T
Traffic Vol, veh/h	180	10	10	250	190	160
Future Vol, veh/h	180	10	10	250	190	160
Conflicting Peds, #/hr	0	0	0	0	0	0
Sign Control	Stop	Stop	Free	Free	Free	Free
RT Channelized	-	None	-	None	-	None
Storage Length	0	-	-	-	-	-
Veh in Median Storage, #	0	-	-	0	0	-
Grade, %	0	-	-	0	0	-
Peak Hour Factor	88	88	88	88	88	88
Heavy Vehicles, %	0	0	2	2	1	1
Mvmt Flow	205	11	11	284	216	182























Major/Minor	Minor2	Major1		Major2	
Conflicting Flow All	613	307	398	0	0
Stage 1	307	-	-	-	-
Stage 2	306	-	-	-	-
Critical Hdwy	6.4	6.2	4.12	-	-
Critical Hdwy Stg 1	5.4	-	-	-	-
Critical Hdwy Stg 2	5.4	-	-	-	-
Follow-up Hdwy	3.5	3.3	2.218	-	-
Pot Cap-1 Maneuver	459	738	1161	-	-
Stage 1	751	-	-	-	-
Stage 2	751	-	-	-	-
Platoon blocked, %				-	-
Mov Cap-1 Maneuver	454	738	1161	-	-
Mov Cap-2 Maneuver	454	-	-	-	-
Stage 1	743	-	-	-	-
Stage 2	751	-	-	-	-

Approach	EB	NB	SB
HCM Control Delay, s	19.4	0.3	0
HCM LOS	C		

Minor Lane/Major Mvmt	NBL	NBT	EBLn1	SBT	SBR
Capacity (veh/h)	1161	-	463	-	-
HCM Lane V/C Ratio	0.01	-	0.466	-	-
HCM Control Delay (s)	8.1	0	19.4	-	-
HCM Lane LOS	A	A	C	-	-
HCM 95th %tile Q(veh)	0	-	2.4	-	-

HCM 2010 Signalized Intersection Summary
 39: General Jim Moore Boulevard & Gigling Road

Cumulative with Eastside Parkway, PM
 06/11/2019

												
Movement	EBL	EBT	EBR	WBL	WBT	WBR	NBL	NBT	NBR	SBL	SBT	SBR
Lane Configurations												
Traffic Volume (veh/h)	20	20	30	220	50	410	60	270	390	540	260	50
Future Volume (veh/h)	20	20	30	220	50	410	60	270	390	540	260	50
Number	3	8	18	7	4	14	1	6	16	5	2	12
Initial Q (Qb), veh	0	0	0	0	0	0	0	0	0	0	0	0
Ped-Bike Adj(A_pbT)	1.00		0.99	1.00		1.00	1.00		1.00	1.00		1.00
Parking Bus, Adj	1.00	1.00	1.00	1.00	1.00	1.00	1.00	1.00	1.00	1.00	1.00	1.00
Adj Sat Flow, veh/h/ln	1776	1776	1900	1881	1881	1881	1863	1863	1863	1863	1863	1863
Adj Flow Rate, veh/h	22	22	3	247	56	0	67	303	0	607	292	0
Adj No. of Lanes	1	2	0	1	2	1	1	2	1	1	2	1
Peak Hour Factor	0.89	0.89	0.89	0.89	0.89	0.89	0.89	0.89	0.89	0.89	0.89	0.89
Percent Heavy Veh, %	7	7	7	1	1	1	2	2	2	2	2	2
Cap, veh/h	45	268	36	303	831	372	110	494	221	393	1060	474
Arrive On Green	0.03	0.09	0.09	0.17	0.23	0.00	0.06	0.14	0.00	0.22	0.30	0.00
Sat Flow, veh/h	1691	2991	399	1792	3574	1599	1774	3539	1583	1774	3539	1583
Grp Volume(v), veh/h	22	12	13	247	56	0	67	303	0	607	292	0
Grp Sat Flow(s),veh/h/ln	1691	1687	1703	1792	1787	1599	1774	1770	1583	1774	1770	1583
Q Serve(g_s), s	0.6	0.3	0.3	6.3	0.6	0.0	1.7	3.8	0.0	10.5	3.0	0.0
Cycle Q Clear(g_c), s	0.6	0.3	0.3	6.3	0.6	0.0	1.7	3.8	0.0	10.5	3.0	0.0
Prop In Lane	1.00		0.23	1.00		1.00	1.00		1.00	1.00		1.00
Lane Grp Cap(c), veh/h	45	151	153	303	831	372	110	494	221	393	1060	474
V/C Ratio(X)	0.49	0.08	0.08	0.81	0.07	0.00	0.61	0.61	0.00	1.54	0.28	0.00
Avail Cap(c_a), veh/h	732	1086	1096	775	2300	1029	393	1904	852	393	1904	852
HCM Platoon Ratio	1.00	1.00	1.00	1.00	1.00	1.00	1.00	1.00	1.00	1.00	1.00	1.00
Upstream Filter(I)	1.00	1.00	1.00	1.00	1.00	0.00	1.00	1.00	0.00	1.00	1.00	0.00
Uniform Delay (d), s/veh	22.8	19.8	19.8	19.0	14.2	0.0	21.7	19.2	0.0	18.4	12.7	0.0
Incr Delay (d2), s/veh	3.0	0.1	0.1	2.0	0.0	0.0	2.0	0.5	0.0	257.3	0.1	0.0
Initial Q Delay(d3),s/veh	0.0	0.0	0.0	0.0	0.0	0.0	0.0	0.0	0.0	0.0	0.0	0.0
%ile BackOfQ(50%),veh/ln	0.3	0.1	0.2	3.3	0.3	0.0	0.9	1.9	0.0	33.1	1.5	0.0
LnGrp Delay(d),s/veh	25.8	19.9	19.9	21.0	14.2	0.0	23.7	19.6	0.0	275.7	12.7	0.0
LnGrp LOS	C	B	B	C	B		C	B		F	B	
Approach Vol, veh/h		47			303			370			899	
Approach Delay, s/veh		22.6			19.7			20.4			190.3	
Approach LOS		C			B			C			F	
Timer	1	2	3	4	5	6	7	8				
Assigned Phs	1	2	3	4	5	6	7	8				
Phs Duration (G+Y+Rc), s	7.4	18.7	5.8	15.5	15.0	11.1	12.5	8.7				
Change Period (Y+Rc), s	4.5	4.5	4.5	4.5	4.5	4.5	4.5	4.5				
Max Green Setting (Gmax), s	10.5	25.5	20.5	30.5	10.5	25.5	20.5	30.5				
Max Q Clear Time (g_c+I1), s	3.7	5.0	2.6	2.6	12.5	5.8	8.3	2.3				
Green Ext Time (p_c), s	0.0	0.3	0.0	0.1	0.0	0.4	0.1	0.0				
Intersection Summary												
HCM 2010 Ctrl Delay	114.7											
HCM 2010 LOS	F											
Notes												

HCM 2010 Signalized Intersection Summary
40: Malmedy Road & Gigling Road

Cumulative with Eastside Parkway, PM
06/11/2019



Movement	EBL	EBT	EBR	WBL	WBT	WBR	NBL	NBT	NBR	SBL	SBT	SBR
Lane Configurations		↔			↔			↔			↔	
Traffic Volume (veh/h)	20	920	10	30	650	10	30	60	50	10	40	10
Future Volume (veh/h)	20	920	10	30	650	10	30	60	50	10	40	10
Number	7	4	14	3	8	18	5	2	12	1	6	16
Initial Q (Qb), veh	0	0	0	0	0	0	0	0	0	0	0	0
Ped-Bike Adj(A_pbT)	1.00		1.00	1.00		1.00	1.00		1.00	1.00		1.00
Parking Bus, Adj	1.00	1.00	1.00	1.00	1.00	1.00	1.00	1.00	1.00	1.00	1.00	1.00
Adj Sat Flow, veh/h/ln	1900	1863	1900	1900	1881	1900	1900	1900	1900	1900	1810	1900
Adj Flow Rate, veh/h	22	1011	11	33	714	11	33	66	55	11	44	11
Adj No. of Lanes	0	2	0	0	2	0	0	1	0	0	1	0
Peak Hour Factor	0.91	0.91	0.91	0.91	0.91	0.91	0.91	0.91	0.91	0.91	0.91	0.91
Percent Heavy Veh, %	2	2	2	1	1	1	0	0	0	5	5	5
Cap, veh/h	189	1386	15	205	1283	20	256	136	103	232	210	49
Arrive On Green	0.40	0.40	0.40	0.40	0.40	0.40	0.17	0.17	0.17	0.17	0.17	0.17
Sat Flow, veh/h	30	3438	37	50	3182	50	290	792	601	193	1222	283
Grp Volume(v), veh/h	544	0	500	386	0	372	154	0	0	66	0	0
Grp Sat Flow(s),veh/h/ln	1816	0	1688	1580	0	1703	1683	0	0	1699	0	0
Q Serve(g_s), s	0.3	0.0	5.3	0.3	0.0	3.5	1.1	0.0	0.0	0.0	0.0	0.0
Cycle Q Clear(g_c), s	5.2	0.0	5.3	5.6	0.0	3.5	1.7	0.0	0.0	0.7	0.0	0.0
Prop In Lane	0.04		0.02	0.09		0.03	0.21		0.36	0.17		0.17
Lane Grp Cap(c), veh/h	909	0	681	822	0	686	495	0	0	490	0	0
V/C Ratio(X)	0.60	0.00	0.74	0.47	0.00	0.54	0.31	0.00	0.00	0.13	0.00	0.00
Avail Cap(c_a), veh/h	4384	0	4030	3920	0	4065	2601	0	0	2564	0	0
HCM Platoon Ratio	1.00	1.00	1.00	1.00	1.00	1.00	1.00	1.00	1.00	1.00	1.00	1.00
Upstream Filter(I)	1.00	0.00	1.00	1.00	0.00	1.00	1.00	0.00	0.00	1.00	0.00	0.00
Uniform Delay (d), s/veh	5.3	0.0	5.4	4.8	0.0	4.8	8.0	0.0	0.0	7.5	0.0	0.0
Incr Delay (d2), s/veh	0.2	0.0	0.6	0.2	0.0	0.2	0.1	0.0	0.0	0.0	0.0	0.0
Initial Q Delay(d3),s/veh	0.0	0.0	0.0	0.0	0.0	0.0	0.0	0.0	0.0	0.0	0.0	0.0
%ile BackOfQ(50%),veh/ln	2.6	0.0	2.5	1.6	0.0	1.6	0.8	0.0	0.0	0.3	0.0	0.0
LnGrp Delay(d),s/veh	5.6	0.0	5.9	4.9	0.0	5.1	8.1	0.0	0.0	7.6	0.0	0.0
LnGrp LOS	A		A	A		A	A			A		
Approach Vol, veh/h		1044			758			154			66	
Approach Delay, s/veh		5.7			5.0			8.1			7.6	
Approach LOS		A			A			A			A	
Timer	1	2	3	4	5	6	7	8				
Assigned Phs		2		4		6		8				
Phs Duration (G+Y+Rc), s		8.1		13.0		8.1		13.0				
Change Period (Y+Rc), s		4.5		4.5		4.5		4.5				
Max Green Setting (Gmax), s		30.5		50.5		30.5		50.5				
Max Q Clear Time (g_c+I1), s		3.7		7.3		2.7		7.6				
Green Ext Time (p_c), s		0.2		1.0		0.1		0.8				
Intersection Summary												
HCM 2010 Ctrl Delay				5.7								
HCM 2010 LOS				A								

HCM 2010 Signalized Intersection Summary
 41: Parker Flatts Cut Off Road & Gigling Road

Cumulative with Eastside Parkway, PM
 06/11/2019



Movement	EBL	EBT	EBR	WBL	WBT	WBR	NBL	NBT	NBR	SBL	SBT	SBR
Lane Configurations		↔			↔			↔	↔		↔	
Traffic Volume (veh/h)	10	940	30	50	600	10	90	20	90	10	20	10
Future Volume (veh/h)	10	940	30	50	600	10	90	20	90	10	20	10
Number	7	4	14	3	8	18	5	2	12	1	6	16
Initial Q (Qb), veh	0	0	0	0	0	0	0	0	0	0	0	0
Ped-Bike Adj(A_pbT)	1.00		1.00	1.00		1.00	1.00		1.00	1.00		1.00
Parking Bus, Adj	1.00	1.00	1.00	1.00	1.00	1.00	1.00	1.00	1.00	1.00	1.00	1.00
Adj Sat Flow, veh/h/ln	1900	1863	1900	1900	1881	1900	1900	1900	1900	1900	1900	1900
Adj Flow Rate, veh/h	11	1056	34	56	674	11	101	22	101	11	22	11
Adj No. of Lanes	0	2	0	0	2	0	0	1	1	0	1	0
Peak Hour Factor	0.89	0.89	0.89	0.89	0.89	0.89	0.89	0.89	0.89	0.89	0.89	0.89
Percent Heavy Veh, %	2	2	2	1	1	1	0	0	0	0	0	0
Cap, veh/h	163	1439	46	213	1241	21	497	69	302	241	193	80
Arrive On Green	0.42	0.42	0.42	0.42	0.42	0.42	0.19	0.19	0.19	0.19	0.19	0.19
Sat Flow, veh/h	11	3401	109	79	2933	50	1139	368	1611	249	1029	426
Grp Volume(v), veh/h	578	0	523	364	0	377	123	0	101	44	0	0
Grp Sat Flow(s),veh/h/ln	1846	0	1675	1359	0	1703	1507	0	1611	1704	0	0
Q Serve(g_s), s	0.0	0.0	6.0	0.6	0.0	3.8	1.1	0.0	1.3	0.0	0.0	0.0
Cycle Q Clear(g_c), s	6.0	0.0	6.0	6.7	0.0	3.8	1.6	0.0	1.3	0.5	0.0	0.0
Prop In Lane	0.02		0.07	0.15		0.03	0.82		1.00	0.25		0.25
Lane Grp Cap(c), veh/h	940	0	709	754	0	720	566	0	302	514	0	0
V/C Ratio(X)	0.62	0.00	0.74	0.48	0.00	0.52	0.22	0.00	0.33	0.09	0.00	0.00
Avail Cap(c_a), veh/h	4131	0	3660	3118	0	3720	2222	0	2125	2361	0	0
HCM Platoon Ratio	1.00	1.00	1.00	1.00	1.00	1.00	1.00	1.00	1.00	1.00	1.00	1.00
Upstream Filter(I)	1.00	0.00	1.00	1.00	0.00	1.00	1.00	0.00	1.00	1.00	0.00	0.00
Uniform Delay (d), s/veh	5.6	0.0	5.6	4.9	0.0	4.9	8.2	0.0	8.1	7.8	0.0	0.0
Incr Delay (d2), s/veh	0.2	0.0	0.6	0.2	0.0	0.2	0.1	0.0	0.2	0.0	0.0	0.0
Initial Q Delay(d3),s/veh	0.0	0.0	0.0	0.0	0.0	0.0	0.0	0.0	0.0	0.0	0.0	0.0
%ile BackOfQ(50%),veh/ln	3.0	0.0	2.9	1.7	0.0	1.7	0.7	0.0	0.6	0.2	0.0	0.0
LnGrp Delay(d),s/veh	5.8	0.0	6.2	5.0	0.0	5.2	8.3	0.0	8.4	7.8	0.0	0.0
LnGrp LOS	A		A	A		A	A		A	A		
Approach Vol, veh/h		1101			741			224			44	
Approach Delay, s/veh		6.0			5.1			8.3			7.8	
Approach LOS		A			A			A			A	
Timer	1	2	3	4	5	6	7	8				
Assigned Phs		2		4		6		8				
Phs Duration (G+Y+Rc), s		8.8		14.3		8.8		14.3				
Change Period (Y+Rc), s		4.5		4.5		4.5		4.5				
Max Green Setting (Gmax), s		30.5		50.5		30.5		50.5				
Max Q Clear Time (g_c+I1), s		3.6		8.0		2.5		8.7				
Green Ext Time (p_c), s		0.1		1.1		0.0		1.0				
Intersection Summary												
HCM 2010 Ctrl Delay				6.0								
HCM 2010 LOS				A								

HCM 2010 Signalized Intersection Summary
42: 6th Avenue & Gigling Road

Cumulative with Eastside Parkway, PM
06/11/2019



Movement	EBL	EBT	EBR	WBL	WBT	WBR	NBL	NBT	NBR	SBL	SBT	SBR
Lane Configurations		↔			↔			↔	↔		↔	
Traffic Volume (veh/h)	140	900	10	10	520	10	10	10	20	10	10	140
Future Volume (veh/h)	140	900	10	10	520	10	10	10	20	10	10	140
Number	7	4	14	3	8	18	5	2	12	1	6	16
Initial Q (Qb), veh	0	0	0	0	0	0	0	0	0	0	0	0
Ped-Bike Adj(A_pbT)	1.00		1.00	1.00		1.00	1.00		1.00	1.00		1.00
Parking Bus, Adj	1.00	1.00	1.00	1.00	1.00	1.00	1.00	1.00	1.00	1.00	1.00	1.00
Adj Sat Flow, veh/h/ln	1900	1881	1900	1900	1863	1900	1900	1900	1900	1900	1900	1900
Adj Flow Rate, veh/h	147	947	11	11	547	11	11	11	0	11	11	147
Adj No. of Lanes	0	2	0	0	2	0	0	1	1	0	1	0
Peak Hour Factor	0.95	0.95	0.95	0.95	0.95	0.95	0.95	0.95	0.95	0.95	0.95	0.95
Percent Heavy Veh, %	1	1	1	2	2	2	0	0	0	0	0	0
Cap, veh/h	331	1287	15	174	1514	30	327	187	258	181	22	225
Arrive On Green	0.44	0.44	0.44	0.44	0.44	0.44	0.16	0.16	0.00	0.16	0.16	0.16
Sat Flow, veh/h	291	2902	33	20	3412	68	557	1175	1615	74	138	1412
Grp Volume(v), veh/h	544	0	561	297	0	272	22	0	0	169	0	0
Grp Sat Flow(s),veh/h/ln	1520	0	1706	1818	0	1683	1733	0	1615	1624	0	0
Q Serve(g_s), s	4.3	0.0	6.2	0.0	0.0	2.4	0.0	0.0	0.0	1.1	0.0	0.0
Cycle Q Clear(g_c), s	6.7	0.0	6.2	2.4	0.0	2.4	0.2	0.0	0.0	2.2	0.0	0.0
Prop In Lane	0.27		0.02	0.04		0.04	0.50		1.00	0.07		0.87
Lane Grp Cap(c), veh/h	876	0	757	971	0	747	514	0	258	428	0	0
V/C Ratio(X)	0.62	0.00	0.74	0.31	0.00	0.36	0.04	0.00	0.00	0.39	0.00	0.00
Avail Cap(c_a), veh/h	3411	0	3799	4043	0	3748	2299	0	2172	2342	0	0
HCM Platoon Ratio	1.00	1.00	1.00	1.00	1.00	1.00	1.00	1.00	1.00	1.00	1.00	1.00
Upstream Filter(I)	1.00	0.00	1.00	1.00	0.00	1.00	1.00	0.00	0.00	1.00	0.00	0.00
Uniform Delay (d), s/veh	5.2	0.0	5.2	4.2	0.0	4.2	8.1	0.0	0.0	8.9	0.0	0.0
Incr Delay (d2), s/veh	0.3	0.0	0.5	0.1	0.0	0.1	0.0	0.0	0.0	0.2	0.0	0.0
Initial Q Delay(d3),s/veh	0.0	0.0	0.0	0.0	0.0	0.0	0.0	0.0	0.0	0.0	0.0	0.0
%ile BackOfQ(50%),veh/ln	2.8	0.0	2.9	1.2	0.0	1.1	0.1	0.0	0.0	1.0	0.0	0.0
LnGrp Delay(d),s/veh	5.5	0.0	5.8	4.2	0.0	4.3	8.1	0.0	0.0	9.2	0.0	0.0
LnGrp LOS	A		A	A		A	A			A		
Approach Vol, veh/h		1105			569			22			169	
Approach Delay, s/veh		5.6			4.3			8.1			9.2	
Approach LOS		A			A			A			A	
Timer	1	2	3	4	5	6	7	8				
Assigned Phs		2		4		6		8				
Phs Duration (G+Y+Rc), s		8.1		14.6		8.1		14.6				
Change Period (Y+Rc), s		4.5		4.5		4.5		4.5				
Max Green Setting (Gmax), s		30.5		50.5		30.5		50.5				
Max Q Clear Time (g_c+I1), s		2.2		8.7		4.2		4.4				
Green Ext Time (p_c), s		0.0		1.4		0.2		0.5				
Intersection Summary												
HCM 2010 Ctrl Delay				5.6								
HCM 2010 LOS				A								

HCM 2010 Signalized Intersection Summary
43: Gigling Road & 7th Avenue

Cumulative with Eastside Parkway, PM
06/11/2019

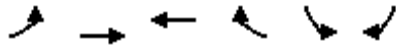

Movement	EBL	EBT	WBT	WBR	SBL	SBR		
Lane Configurations		↑↑	↑↑		↑↑			
Traffic Volume (veh/h)	140	790	450	10	10	90		
Future Volume (veh/h)	140	790	450	10	10	90		
Number	7	4	8	18	1	16		
Initial Q (Qb), veh	0	0	0	0	0	0		
Ped-Bike Adj(A_pbT)	1.00			1.00	1.00	1.00		
Parking Bus, Adj	1.00	1.00	1.00	1.00	1.00	1.00		
Adj Sat Flow, veh/h/ln	1900	1863	1881	1900	1827	1900		
Adj Flow Rate, veh/h	146	823	469	10	10	94		
Adj No. of Lanes	0	2	2	0	0	0		
Peak Hour Factor	0.96	0.96	0.96	0.96	0.96	0.96		
Percent Heavy Veh, %	2	2	1	1	0	0		
Cap, veh/h	376	1192	1515	32	17	160		
Arrive On Green	0.42	0.42	0.42	0.42	0.11	0.11		
Sat Flow, veh/h	322	2901	3673	76	149	1405		
Grp Volume(v), veh/h	497	472	234	245	105	0		
Grp Sat Flow(s),veh/h/ln	1527	1610	1787	1868	1570	0		
Q Serve(g_s), s	3.2	4.7	1.7	1.7	1.2	0.0		
Cycle Q Clear(g_c), s	5.1	4.7	1.7	1.7	1.2	0.0		
Prop In Lane	0.29			0.04	0.10	0.90		
Lane Grp Cap(c), veh/h	886	682	757	791	179	0		
V/C Ratio(X)	0.56	0.69	0.31	0.31	0.59	0.00		
Avail Cap(c_a), veh/h	4349	4593	5098	5327	2057	0		
HCM Platoon Ratio	1.00	1.00	1.00	1.00	1.00	1.00		
Upstream Filter(I)	1.00	1.00	1.00	1.00	1.00	0.00		
Uniform Delay (d), s/veh	4.6	4.6	3.7	3.7	8.2	0.0		
Incr Delay (d2), s/veh	0.2	0.5	0.1	0.1	1.1	0.0		
Initial Q Delay(d3),s/veh	0.0	0.0	0.0	0.0	0.0	0.0		
%ile BackOfQ(50%),veh/ln	2.1	2.1	0.8	0.8	0.6	0.0		
LnGrp Delay(d),s/veh	4.8	5.1	3.8	3.8	9.3	0.0		
LnGrp LOS	A	A	A	A	A			
Approach Vol, veh/h		969	479		105			
Approach Delay, s/veh		4.9	3.8		9.3			
Approach LOS		A	A		A			
Timer	1	2	3	4	5	6	7	8
Assigned Phs				4		6		8
Phs Duration (G+Y+Rc), s				12.7		6.7		12.7
Change Period (Y+Rc), s				4.5		4.5		4.5
Max Green Setting (Gmax), s				55.5		25.5		55.5
Max Q Clear Time (g_c+I1), s				7.1		3.2		3.7
Green Ext Time (p_c), s				1.1		0.0		0.4
Intersection Summary								
HCM 2010 Ctrl Delay			4.9					
HCM 2010 LOS			A					
Notes								

HCM 2010 Signalized Intersection Summary
44: 8th Avenue & Gigling Road

Cumulative with Eastside Parkway, PM
06/11/2019



Movement	EBL	EBT	EBR	WBL	WBT	WBR	NBL	NBT	NBR	SBL	SBT	SBR
Lane Configurations		↔			↔			↔			↔	
Traffic Volume (veh/h)	250	550	10	10	280	10	10	10	10	10	10	180
Future Volume (veh/h)	250	550	10	10	280	10	10	10	10	10	10	180
Number	7	4	14	3	8	18	5	2	12	1	6	16
Initial Q (Qb), veh	0	0	0	0	0	0	0	0	0	0	0	0
Ped-Bike Adj(A_pbT)	1.00		1.00	1.00		1.00	1.00		1.00	1.00		1.00
Parking Bus, Adj	1.00	1.00	1.00	1.00	1.00	1.00	1.00	1.00	1.00	1.00	1.00	1.00
Adj Sat Flow, veh/h/ln	1900	1863	1900	1900	1863	1900	1900	1900	1900	1900	1881	1900
Adj Flow Rate, veh/h	275	604	11	11	308	11	11	11	11	11	11	110
Adj No. of Lanes	0	2	0	0	2	0	0	1	0	0	1	0
Peak Hour Factor	0.91	0.91	0.91	0.91	0.91	0.91	0.91	0.91	0.91	0.91	0.91	0.91
Percent Heavy Veh, %	2	2	2	2	2	2	0	0	0	1	1	1
Cap, veh/h	572	996	19	188	1507	53	278	101	82	190	24	193
Arrive On Green	0.45	0.45	0.45	0.45	0.45	0.45	0.14	0.14	0.14	0.14	0.14	0.14
Sat Flow, veh/h	685	2206	42	35	3338	117	433	705	569	103	165	1341
Grp Volume(v), veh/h	443	0	447	173	0	157	33	0	0	132	0	0
Grp Sat Flow(s),veh/h/ln	1245	0	1688	1817	0	1674	1708	0	0	1609	0	0
Q Serve(g_s), s	5.5	0.0	4.4	0.0	0.0	1.3	0.0	0.0	0.0	1.0	0.0	0.0
Cycle Q Clear(g_c), s	6.8	0.0	4.4	1.3	0.0	1.3	0.4	0.0	0.0	1.7	0.0	0.0
Prop In Lane	0.62		0.02	0.06		0.07	0.33		0.33	0.08		0.83
Lane Grp Cap(c), veh/h	825	0	762	993	0	756	461	0	0	407	0	0
V/C Ratio(X)	0.54	0.00	0.59	0.17	0.00	0.21	0.07	0.00	0.00	0.32	0.00	0.00
Avail Cap(c_a), veh/h	2837	0	3453	3733	0	3425	2731	0	0	2731	0	0
HCM Platoon Ratio	1.00	1.00	1.00	1.00	1.00	1.00	1.00	1.00	1.00	1.00	1.00	1.00
Upstream Filter(I)	1.00	0.00	1.00	1.00	0.00	1.00	1.00	0.00	0.00	1.00	0.00	0.00
Uniform Delay (d), s/veh	5.2	0.0	4.6	3.7	0.0	3.7	8.3	0.0	0.0	8.9	0.0	0.0
Incr Delay (d2), s/veh	0.2	0.0	0.3	0.0	0.0	0.0	0.0	0.0	0.0	0.2	0.0	0.0
Initial Q Delay(d3),s/veh	0.0	0.0	0.0	0.0	0.0	0.0	0.0	0.0	0.0	0.0	0.0	0.0
%ile BackOfQ(50%),veh/ln	2.3	0.0	2.0	0.6	0.0	0.6	0.2	0.0	0.0	0.8	0.0	0.0
LnGrp Delay(d),s/veh	5.4	0.0	4.8	3.7	0.0	3.7	8.3	0.0	0.0	9.0	0.0	0.0
LnGrp LOS	A		A	A		A	A			A		
Approach Vol, veh/h		890			330			33			132	
Approach Delay, s/veh		5.1			3.7			8.3			9.0	
Approach LOS		A			A			A			A	
Timer	1	2	3	4	5	6	7	8				
Assigned Phs		2		4		6		8				
Phs Duration (G+Y+Rc), s		7.7		14.5		7.7		14.5				
Change Period (Y+Rc), s		4.5		4.5		4.5		4.5				
Max Green Setting (Gmax), s		35.5		45.5		35.5		45.5				
Max Q Clear Time (g_c+I1), s		2.4		8.8		3.7		3.3				
Green Ext Time (p_c), s		0.0		1.1		0.2		0.4				
Intersection Summary												
HCM 2010 Ctrl Delay				5.2								
HCM 2010 LOS				A								

HCM 2010 Signalized Intersection Summary
45: Eastside Parkway & Gigling Road

Cumulative with Eastside Parkway, PM
06/11/2019



Movement	EBL	EBT	EBR	WBL	WBT	WBR	NBL	NBT	NBR	SBL	SBT	SBR
Lane Configurations												
Traffic Volume (veh/h)	540	10	10	10	10	10	10	350	10	10	190	270
Future Volume (veh/h)	540	10	10	10	10	10	10	350	10	10	190	270
Number	7	4	14	3	8	18	5	2	12	1	6	16
Initial Q (Qb), veh	0	0	0	0	0	0	0	0	0	0	0	0
Ped-Bike Adj(A_pbT)	1.00		1.00	1.00		1.00	1.00		1.00	1.00		1.00
Parking Bus, Adj	1.00	1.00	1.00	1.00	1.00	1.00	1.00	1.00	1.00	1.00	1.00	1.00
Adj Sat Flow, veh/h/ln	1863	1863	1900	1900	1863	1900	1863	1863	1900	1863	1863	1863
Adj Flow Rate, veh/h	587	11	11	11	11	11	11	380	11	11	207	206
Adj No. of Lanes	1	2	0	0	1	0	1	1	0	1	1	1
Peak Hour Factor	0.92	0.92	0.92	0.92	0.92	0.92	0.92	0.92	0.92	0.92	0.92	0.92
Percent Heavy Veh, %	2	2	2	2	2	2	2	2	2	2	2	2
Cap, veh/h	640	651	561	21	21	21	25	451	13	25	467	397
Arrive On Green	0.36	0.36	0.36	0.04	0.04	0.04	0.01	0.25	0.25	0.01	0.25	0.25
Sat Flow, veh/h	1774	1803	1555	577	577	577	1774	1801	52	1774	1863	1583
Grp Volume(v), veh/h	587	11	11	33	0	0	11	0	391	11	207	206
Grp Sat Flow(s),veh/h/ln	1774	1770	1588	1732	0	0	1774	0	1854	1774	1863	1583
Q Serve(g_s), s	15.0	0.2	0.2	0.9	0.0	0.0	0.3	0.0	9.5	0.3	4.4	5.3
Cycle Q Clear(g_c), s	15.0	0.2	0.2	0.9	0.0	0.0	0.3	0.0	9.5	0.3	4.4	5.3
Prop In Lane	1.00		0.98	0.33		0.33	1.00		0.03	1.00		1.00
Lane Grp Cap(c), veh/h	640	639	573	64	0	0	25	0	464	25	467	397
V/C Ratio(X)	0.92	0.02	0.02	0.51	0.00	0.00	0.44	0.00	0.84	0.44	0.44	0.52
Avail Cap(c_a), veh/h	1877	1872	1681	821	0	0	209	0	1008	206	1009	858
HCM Platoon Ratio	1.00	1.00	1.00	1.00	1.00	1.00	1.00	1.00	1.00	1.00	1.00	1.00
Upstream Filter(I)	1.00	1.00	1.00	1.00	0.00	0.00	1.00	0.00	1.00	1.00	1.00	1.00
Uniform Delay (d), s/veh	14.5	9.7	9.8	22.4	0.0	0.0	23.2	0.0	16.9	23.2	15.0	15.3
Incr Delay (d2), s/veh	2.3	0.0	0.0	2.3	0.0	0.0	11.4	0.0	1.6	11.4	0.2	0.4
Initial Q Delay(d3),s/veh	0.0	0.0	0.0	0.0	0.0	0.0	0.0	0.0	0.0	0.0	0.0	0.0
%ile BackOfQ(50%),veh/ln	7.6	0.1	0.1	0.5	0.0	0.0	0.2	0.0	5.0	0.2	2.3	2.3
LnGrp Delay(d),s/veh	16.8	9.8	9.8	24.7	0.0	0.0	34.6	0.0	18.5	34.6	15.2	15.7
LnGrp LOS	B	A	A	C			C		B	C	B	B
Approach Vol, veh/h		609			33			402			424	
Approach Delay, s/veh		16.6			24.7			19.0			16.0	
Approach LOS		B			C			B			B	
Timer	1	2	3	4	5	6	7	8				
Assigned Phs	1	2		4	5	6		8				
Phs Duration (G+Y+Rc), s	4.7	15.9		21.1	4.7	15.9		5.8				
Change Period (Y+Rc), s	4.0	4.0		4.0	4.0	4.0		4.0				
Max Green Setting (Gmax), s	5.5	25.8		50.2	5.6	25.7		22.5				
Max Q Clear Time (g_c+1/2), s	12.3	11.5		17.0	2.3	7.3		2.9				
Green Ext Time (p_c), s	0.0	0.4		0.1	0.0	0.2		0.0				
Intersection Summary												
HCM 2010 Ctrl Delay			17.2									
HCM 2010 LOS			B									

HCM 2010 Signalized Intersection Summary
 46: General Jim Moore Boulevard & Normandy Road

Cumulative with Eastside Parkway, PM
 06/11/2019



Movement	EBL	EBT	EBR	WBL	WBT	WBR	NBL	NBT	NBR	SBL	SBT	SBR
Lane Configurations		↕			↕		↕	↕↕		↕	↕↕	↕
Traffic Volume (veh/h)	150	40	100	300	50	10	90	730	310	30	430	80
Future Volume (veh/h)	150	40	100	300	50	10	90	730	310	30	430	80
Number	3	8	18	7	4	14	1	6	16	5	2	12
Initial Q (Qb), veh	0	0	0	0	0	0	0	0	0	0	0	0
Ped-Bike Adj(A_pbT)	1.00		1.00	1.00		1.00	1.00		1.00	1.00		1.00
Parking Bus, Adj	1.00	1.00	1.00	1.00	1.00	1.00	1.00	1.00	1.00	1.00	1.00	1.00
Adj Sat Flow, veh/h/ln	1900	1863	1900	1900	1881	1900	1881	1881	1900	1900	1900	1900
Adj Flow Rate, veh/h	163	43	84	326	54	8	98	793	314	33	467	28
Adj No. of Lanes	0	1	0	0	1	0	1	2	0	1	2	1
Peak Hour Factor	0.92	0.92	0.92	0.92	0.92	0.92	0.92	0.92	0.92	0.92	0.92	0.92
Percent Heavy Veh, %	2	2	2	1	1	1	1	1	1	0	0	0
Cap, veh/h	389	112	158	512	63	9	395	901	356	67	637	284
Arrive On Green	0.33	0.33	0.33	0.33	0.33	0.33	0.22	0.36	0.36	0.04	0.18	0.18
Sat Flow, veh/h	832	339	477	1145	190	28	1792	2502	990	1810	3610	1610
Grp Volume(v), veh/h	290	0	0	388	0	0	98	566	541	33	467	28
Grp Sat Flow(s),veh/h/ln	1648	0	0	1362	0	0	1792	1787	1705	1810	1805	1610
Q Serve(g_s), s	0.0	0.0	0.0	6.3	0.0	0.0	2.2	14.7	14.7	0.9	6.1	0.7
Cycle Q Clear(g_c), s	6.8	0.0	0.0	13.1	0.0	0.0	2.2	14.7	14.7	0.9	6.1	0.7
Prop In Lane	0.56		0.29	0.84		0.02	1.00		0.58	1.00		1.00
Lane Grp Cap(c), veh/h	659	0	0	584	0	0	395	643	614	67	637	284
V/C Ratio(X)	0.44	0.00	0.00	0.66	0.00	0.00	0.25	0.88	0.88	0.50	0.73	0.10
Avail Cap(c_a), veh/h	1148	0	0	1031	0	0	395	919	877	292	1857	828
HCM Platoon Ratio	1.00	1.00	1.00	1.00	1.00	1.00	1.00	1.00	1.00	1.00	1.00	1.00
Upstream Filter(l)	1.00	0.00	0.00	1.00	0.00	0.00	1.00	1.00	1.00	1.00	1.00	1.00
Uniform Delay (d), s/veh	13.3	0.0	0.0	15.4	0.0	0.0	15.9	14.9	14.9	23.4	19.3	17.1
Incr Delay (d2), s/veh	0.2	0.0	0.0	0.5	0.0	0.0	0.1	5.5	5.8	2.1	0.6	0.1
Initial Q Delay(d3),s/veh	0.0	0.0	0.0	0.0	0.0	0.0	0.0	0.0	0.0	0.0	0.0	0.0
%ile BackOfQ(50%),veh/ln	3.2	0.0	0.0	4.9	0.0	0.0	1.1	8.2	7.9	0.5	3.0	0.3
LnGrp Delay(d),s/veh	13.5	0.0	0.0	15.9	0.0	0.0	16.1	20.3	20.7	25.5	19.9	17.2
LnGrp LOS	B			B			B	C	C	C	B	B
Approach Vol, veh/h		290			388			1205			528	
Approach Delay, s/veh		13.5			15.9			20.1			20.1	
Approach LOS		B			B			C			C	
Timer	1	2	3	4	5	6	7	8				
Assigned Phs	1	2		4	5	6		8				
Phs Duration (G+Y+Rc), s	5.4	13.2		20.9	6.3	22.3		20.9				
Change Period (Y+Rc), s	4.5	4.5		4.5	4.5	4.5		4.5				
Max Green Setting (Gmax), s	30	25.5		33.0	8.0	25.5		33.0				
Max Q Clear Time (g_c+14), s	14.2	8.1		15.1	2.9	16.7		8.8				
Green Ext Time (p_c), s	0.0	0.6		0.6	0.0	1.0		0.4				
Intersection Summary												
HCM 2010 Ctrl Delay			18.7									
HCM 2010 LOS			B									

HCM 2010 Signalized Intersection Summary
 47: General Jim Moore Boulevard & Coe Avenue

Cumulative with Eastside Parkway, PM
 06/11/2019



Movement	EBL	EBT	EBR	WBL	WBT	WBR	NBL	NBT	NBR	SBL	SBT	SBR
Lane Configurations	↖	↑	↗	↖	↑	↗	↖	↑↑	↗	↖	↑↑	↗
Traffic Volume (veh/h)	60	10	100	300	10	10	150	1030	490	10	490	60
Future Volume (veh/h)	60	10	100	300	10	10	150	1030	490	10	490	60
Number	3	8	18	7	4	14	1	6	16	5	2	12
Initial Q (Qb), veh	0	0	0	0	0	0	0	0	0	0	0	0
Ped-Bike Adj(A_pbT)	1.00		0.99	0.99		1.00	1.00		0.99	1.00		0.99
Parking Bus, Adj	1.00	1.00	1.00	1.00	1.00	1.00	1.00	1.00	1.00	1.00	1.00	1.00
Adj Sat Flow, veh/h/ln	1881	1863	1881	1863	1863	1863	1881	1881	1863	1863	1881	1881
Adj Flow Rate, veh/h	67	11	11	337	11	11	169	1157	524	11	551	31
Adj No. of Lanes	1	1	1	1	1	1	1	2	1	1	2	1
Peak Hour Factor	0.89	0.89	0.89	0.89	0.89	0.89	0.89	0.89	0.89	0.89	0.89	0.89
Percent Heavy Veh, %	1	2	1	2	2	2	1	1	2	2	1	1
Cap, veh/h	574	570	486	567	570	485	208	1410	621	25	1046	464
Arrive On Green	0.31	0.31	0.31	0.31	0.31	0.31	0.12	0.39	0.39	0.01	0.29	0.29
Sat Flow, veh/h	1398	1863	1586	1374	1863	1583	1792	3574	1573	1774	3574	1585
Grp Volume(v), veh/h	67	11	11	337	11	11	169	1157	524	11	551	31
Grp Sat Flow(s),veh/h/ln	1398	1863	1586	1374	1863	1583	1792	1787	1573	1774	1787	1585
Q Serve(g_s), s	1.7	0.2	0.2	10.7	0.2	0.2	4.4	13.7	14.3	0.3	6.1	0.7
Cycle Q Clear(g_c), s	1.9	0.2	0.2	10.9	0.2	0.2	4.4	13.7	14.3	0.3	6.1	0.7
Prop In Lane	1.00		1.00	1.00		1.00	1.00		1.00	1.00		1.00
Lane Grp Cap(c), veh/h	574	570	486	567	570	485	208	1410	621	25	1046	464
V/C Ratio(X)	0.12	0.02	0.02	0.59	0.02	0.02	0.81	0.82	0.84	0.44	0.53	0.07
Avail Cap(c_a), veh/h	1489	1790	1524	1466	1790	1521	208	2680	1180	206	2680	1189
HCM Platoon Ratio	1.00	1.00	1.00	1.00	1.00	1.00	1.00	1.00	1.00	1.00	1.00	1.00
Upstream Filter(I)	1.00	1.00	1.00	1.00	1.00	1.00	1.00	1.00	1.00	1.00	1.00	1.00
Uniform Delay (d), s/veh	12.1	11.5	11.5	15.3	11.5	11.5	20.4	12.8	13.0	23.2	14.0	12.1
Incr Delay (d2), s/veh	0.0	0.0	0.0	0.4	0.0	0.0	19.8	0.5	1.2	4.3	0.2	0.0
Initial Q Delay(d3),s/veh	0.0	0.0	0.0	0.0	0.0	0.0	0.0	0.0	0.0	0.0	0.0	0.0
%ile BackOfQ(50%),veh/ln	0.6	0.1	0.1	4.1	0.1	0.1	3.3	6.7	6.3	0.2	3.0	0.3
LnGrp Delay(d),s/veh	12.1	11.5	11.5	15.7	11.5	11.5	40.2	13.3	14.3	27.5	14.2	12.1
LnGrp LOS	B	B	B	B	B	B	D	B	B	C	B	B
Approach Vol, veh/h		89			359			1850			593	
Approach Delay, s/veh		12.0			15.4			16.0			14.3	
Approach LOS		B			B			B			B	
Timer	1	2	3	4	5	6	7	8				
Assigned Phs	1	2		4	5	6		8				
Phs Duration (G+Y+Rc), s	0.0	18.4		19.0	5.2	23.2		19.0				
Change Period (Y+Rc), s	4.5	4.5		4.5	4.5	4.5		4.5				
Max Green Setting (Gmax), s	5.5	35.5		45.5	5.5	35.5		45.5				
Max Q Clear Time (g_c+1), s	10.4	8.1		12.9	2.3	16.3		3.9				
Green Ext Time (p_c), s	0.0	0.6		0.1	0.0	1.3		0.0				
Intersection Summary												
HCM 2010 Ctrl Delay				15.5								
HCM 2010 LOS				B								



Movement	EBL	EBT	EBR	WBL	WBT	WBR	NBL	NBT	NBR	SBL	SBT	SBR
Lane Configurations												
Traffic Volume (veh/h)	220	170	70	90	100	70	110	1180	230	40	700	170
Future Volume (veh/h)	220	170	70	90	100	70	110	1180	230	40	700	170
Number	7	4	14	3	8	18	5	2	12	1	6	16
Initial Q (Qb), veh	0	0	0	0	0	0	0	0	0	0	0	0
Ped-Bike Adj(A_pbT)	1.00		0.98	1.00		0.99	1.00		0.99	1.00		0.99
Parking Bus, Adj	1.00	1.00	1.00	1.00	1.00	1.00	1.00	1.00	1.00	1.00	1.00	1.00
Adj Sat Flow, veh/h/ln	1881	1881	1881	1900	1900	1900	1881	1881	1900	1863	1863	1863
Adj Flow Rate, veh/h	201	211	25	93	103	66	113	1216	225	41	722	103
Adj No. of Lanes	1	1	1	0	1	0	1	2	0	1	2	1
Peak Hour Factor	0.97	0.97	0.97	0.97	0.97	0.97	0.97	0.97	0.97	0.97	0.97	0.97
Percent Heavy Veh, %	1	1	1	0	0	0	1	1	1	2	2	2
Cap, veh/h	265	278	231	105	117	75	597	1512	278	53	671	297
Arrive On Green	0.15	0.15	0.15	0.17	0.17	0.17	0.33	0.50	0.50	0.03	0.19	0.19
Sat Flow, veh/h	1792	1881	1565	634	702	450	1792	3013	553	1774	3539	1568
Grp Volume(v), veh/h	201	211	25	262	0	0	113	717	724	41	722	103
Grp Sat Flow(s),veh/h/ln	1792	1881	1565	1785	0	0	1792	1787	1780	1774	1770	1568
Q Serve(g_s), s	13.5	13.5	1.7	17.9	0.0	0.0	5.6	41.8	42.7	2.9	23.7	7.1
Cycle Q Clear(g_c), s	13.5	13.5	1.7	17.9	0.0	0.0	5.6	41.8	42.7	2.9	23.7	7.1
Prop In Lane	1.00		1.00	0.35		0.25	1.00		0.31	1.00		1.00
Lane Grp Cap(c), veh/h	265	278	231	297	0	0	597	897	893	53	671	297
V/C Ratio(X)	0.76	0.76	0.11	0.88	0.00	0.00	0.19	0.80	0.81	0.78	1.08	0.35
Avail Cap(c_a), veh/h	573	602	501	357	0	0	597	897	893	241	671	297
HCM Platoon Ratio	1.00	1.00	1.00	1.00	1.00	1.00	1.00	1.00	1.00	1.00	1.00	1.00
Upstream Filter(I)	0.69	0.69	0.69	1.00	0.00	0.00	1.00	1.00	1.00	1.00	1.00	1.00
Uniform Delay (d), s/veh	51.1	51.1	46.1	50.9	0.0	0.0	29.7	25.9	26.1	60.2	50.7	43.9
Incr Delay (d2), s/veh	3.1	3.0	0.1	20.8	0.0	0.0	0.1	7.4	7.9	8.8	57.0	3.2
Initial Q Delay(d3),s/veh	0.0	0.0	0.0	0.0	0.0	0.0	0.0	0.0	0.0	0.0	0.0	0.0
%ile BackOfQ(50%),veh/ln	6.9	7.2	0.8	10.6	0.0	0.0	2.8	22.4	22.9	1.5	16.9	3.4
LnGrp Delay(d),s/veh	54.2	54.1	46.3	71.7	0.0	0.0	29.7	33.3	34.0	69.1	107.6	47.1
LnGrp LOS	D	D	D	E			C	C	C	E	F	D
Approach Vol, veh/h		437			262			1554			866	
Approach Delay, s/veh		53.7			71.7			33.4			98.6	
Approach LOS		D			E			C			F	
Timer	1	2	3	4	5	6	7	8				
Assigned Phs	1	2		4	5	6		8				
Phs Duration (G+Y+Rc), s	7.9	68.0		23.2	46.9	29.0		25.9				
Change Period (Y+Rc), s	4.2	5.3		* 4.7	5.3	* 5.3		5.1				
Max Green Setting (Gmax), s	13	23.7		* 40	17.0	* 24		25.0				
Max Q Clear Time (g_c+14), s	14.5	44.7		15.5	7.6	25.7		19.9				
Green Ext Time (p_c), s	0.0	0.0		1.9	0.1	0.0		0.8				

Intersection Summary

HCM 2010 Ctrl Delay	57.6
HCM 2010 LOS	E

Notes

HCM 2010 Signalized Intersection Summary
 49: Highway 1 SB On-Ramp & Highway 1 NB Off-Ramp/Monterey Road

Cumulative with Eastside Parkway, PM
 06/11/2019



Movement	EBL	EBT	EBR	WBL	WBT	WBR	NBL	NBT	NBR	SBL	SBT	SBR
Lane Configurations		↔↔	↗	↖		↗		↕	↗		↖	
Traffic Volume (veh/h)	10	150	120	280	0	130	0	120	300	10	10	0
Future Volume (veh/h)	10	150	120	280	0	130	0	120	300	10	10	0
Number	1	6	16	5	2	12	7	4	14	3	8	18
Initial Q (Qb), veh	0	0	0	0	0	0	0	0	0	0	0	0
Ped-Bike Adj(A_pbT)	1.00		1.00	1.00		1.00	1.00		1.00	1.00		1.00
Parking Bus, Adj	1.00	1.00	1.00	1.00	1.00	1.00	1.00	1.00	1.00	1.00	1.00	1.00
Adj Sat Flow, veh/h/ln	1900	1863	1863	1900	0	1900	0	1881	1881	1900	1900	0
Adj Flow Rate, veh/h	11	165	14	308	0	69	0	132	51	11	11	0
Adj No. of Lanes	0	2	1	1	0	1	0	1	1	0	1	0
Peak Hour Factor	0.91	0.91	0.91	0.91	0.91	0.91	0.91	0.91	0.91	0.91	0.91	0.91
Percent Heavy Veh, %	2	2	2	0	0	0	0	1	1	0	0	0
Cap, veh/h	181	2850	1323	0	0	0	0	164	139	57	43	0
Arrive On Green	0.84	0.84	0.84	0.00	0.00	0.00	0.00	0.09	0.09	0.09	0.09	0.00
Sat Flow, veh/h	216	3406	1580		0		0	1881	1599	155	496	0
Grp Volume(v), veh/h	94	82	14		0.0		0	132	51	22	0	0
Grp Sat Flow(s),veh/h/ln	1852	1770	1580				0	1881	1599	651	0	0
Q Serve(g_s), s	1.1	1.0	0.2				0.0	8.6	3.8	0.1	0.0	0.0
Cycle Q Clear(g_c), s	1.1	1.0	0.2				0.0	8.6	3.8	8.7	0.0	0.0
Prop In Lane	0.12		1.00				0.00		1.00	0.50		0.00
Lane Grp Cap(c), veh/h	1550	1481	1323				0	164	139	100	0	0
V/C Ratio(X)	0.06	0.06	0.01				0.00	0.81	0.37	0.22	0.00	0.00
Avail Cap(c_a), veh/h	1550	1481	1323				0	271	230	125	0	0
HCM Platoon Ratio	1.00	1.00	1.00				1.00	1.00	1.00	1.00	1.00	1.00
Upstream Filter(I)	1.00	1.00	1.00				0.00	1.00	1.00	1.00	0.00	0.00
Uniform Delay (d), s/veh	1.8	1.7	1.7				0.0	56.0	53.8	52.9	0.0	0.0
Incr Delay (d2), s/veh	0.0	0.0	0.0				0.0	3.5	0.6	0.4	0.0	0.0
Initial Q Delay(d3),s/veh	0.0	0.0	0.0				0.0	0.0	0.0	0.0	0.0	0.0
%ile BackOfQ(50%),veh/ln	0.6	0.5	0.1				0.0	4.6	1.7	0.7	0.0	0.0
LnGrp Delay(d),s/veh	1.8	1.7	1.7				0.0	59.5	54.4	53.3	0.0	0.0
LnGrp LOS	A	A	A					E	D	D		
Approach Vol, veh/h		190						183			22	
Approach Delay, s/veh		1.7						58.1			53.3	
Approach LOS		A						E			D	
Timer	1	2	3	4	5	6	7	8				
Assigned Phs				4		6		8				
Phs Duration (G+Y+Rc), s				15.1		109.9		15.1				
Change Period (Y+Rc), s				* 4.2		5.3		* 4.2				
Max Green Setting (Gmax), s				* 18		21.0		* 13				
Max Q Clear Time (g_c+I1), s				10.6		3.1		10.7				
Green Ext Time (p_c), s				0.3		0.6		0.0				
Intersection Summary												
HCM 2010 Ctrl Delay			30.7									
HCM 2010 LOS			C									
Notes												























Movement	EBL	EBT	EBR	WBL	WBT	WBR	NBL	NBT	NBR	SBL	SBT	SBR
Lane Configurations					↕	↕	↕	↕			↕	
Traffic Volume (veh/h)	0	0	0	410	10	250	130	240	0	0	520	170
Future Volume (veh/h)	0	0	0	410	10	250	130	240	0	0	520	170
Number				7	4	14	1	6	16	5	2	12
Initial Q (Qb), veh				0	0	0	0	0	0	0	0	0
Ped-Bike Adj(A_pbT)				1.00		1.00	1.00		1.00	1.00		1.00
Parking Bus, Adj				1.00	1.00	1.00	1.00	1.00	1.00	1.00	1.00	1.00
Adj Sat Flow, veh/h/ln				1900	1863	1863	1845	1845	0	0	1827	1900
Adj Flow Rate, veh/h				436	11	84	138	255	0	0	553	171
Adj No. of Lanes				0	1	1	1	1	0	0	1	0
Peak Hour Factor				0.94	0.94	0.94	0.94	0.94	0.94	0.94	0.94	0.94
Percent Heavy Veh, %				2	2	2	3	3	0	0	4	4
Cap, veh/h				485	12	443	172	1091	0	0	606	187
Arrive On Green				0.28	0.28	0.28	0.03	0.20	0.00	0.00	0.45	0.45
Sat Flow, veh/h				1732	44	1581	1757	1845	0	0	1340	414
Grp Volume(v), veh/h				447	0	84	138	255	0	0	0	724
Grp Sat Flow(s),veh/h/ln				1776	0	1581	1757	1845	0	0	0	1754
Q Serve(g_s), s				20.6	0.0	3.4	6.6	9.9	0.0	0.0	0.0	32.7
Cycle Q Clear(g_c), s				20.6	0.0	3.4	6.6	9.9	0.0	0.0	0.0	32.7
Prop In Lane				0.98		1.00	1.00		0.00	0.00		0.24
Lane Grp Cap(c), veh/h				498	0	443	172	1091	0	0	0	793
V/C Ratio(X)				0.90	0.00	0.19	0.80	0.23	0.00	0.00	0.00	0.91
Avail Cap(c_a), veh/h				564	0	502	248	1091	0	0	0	793
HCM Platoon Ratio				1.00	1.00	1.00	0.33	0.33	1.00	1.00	1.00	1.00
Upstream Filter(I)				1.00	0.00	1.00	0.95	0.95	0.00	0.00	0.00	1.00
Uniform Delay (d), s/veh				29.4	0.0	23.3	40.3	18.0	0.0	0.0	0.0	21.7
Incr Delay (d2), s/veh				15.9	0.0	0.2	6.8	0.5	0.0	0.0	0.0	16.7
Initial Q Delay(d3),s/veh				0.0	0.0	0.0	0.0	0.0	0.0	0.0	0.0	0.0
%ile BackOfQ(50%),veh/ln				12.3	0.0	1.5	3.6	5.2	0.0	0.0	0.0	19.4
LnGrp Delay(d),s/veh				45.4	0.0	23.5	47.1	18.4	0.0	0.0	0.0	38.4
LnGrp LOS				D		C	D	B				D
Approach Vol, veh/h					531			393			724	
Approach Delay, s/veh					41.9			28.5			38.4	
Approach LOS					D			C			D	
Timer	1	2	3	4	5	6	7	8				
Assigned Phs	1	2		4		6						
Phs Duration (G+Y+Rc), s	1.8	44.4		28.7		56.3						
Change Period (Y+Rc), s	3.5	6.0		4.9		6.0						
Max Green Setting (Gmax), s	2.0	31.6		27.0		47.1						
Max Q Clear Time (g_c+1.0), s	1.6	34.7		22.6		11.9						
Green Ext Time (p_c), s	0.0	0.0		1.2		1.3						
Intersection Summary												
HCM 2010 Ctrl Delay				37.2								
HCM 2010 LOS				D								



Movement	EBL	EBT	EBR	WBL	WBT	WBR	NBL	NBT	NBR	SBL	SBT	SBR
Lane Configurations		↕	↗					↑	↗	↖	↑	
Traffic Volume (veh/h)	100	10	180	0	0	0	0	300	320	260	670	0
Future Volume (veh/h)	100	10	180	0	0	0	0	300	320	260	670	0
Number	3	8	18				1	6	16	5	2	12
Initial Q (Qb), veh	0	0	0				0	0	0	0	0	0
Ped-Bike Adj(A_pbT)	1.00		1.00				1.00		1.00	1.00		1.00
Parking Bus, Adj	1.00	1.00	1.00				1.00	1.00	1.00	1.00	1.00	1.00
Adj Sat Flow, veh/h/ln	1900	1863	1863				0	1845	1845	1827	1827	0
Adj Flow Rate, veh/h	106	11	12				0	319	201	277	713	0
Adj No. of Lanes	0	1	1				0	1	1	1	1	0
Peak Hour Factor	0.94	0.94	0.94				0.94	0.94	0.94	0.94	0.94	0.94
Percent Heavy Veh, %	2	2	2				0	3	3	4	4	0
Cap, veh/h	144	15	141				0	1038	882	307	1430	0
Arrive On Green	0.09	0.09	0.09				0.00	0.56	0.56	0.35	1.00	0.00
Sat Flow, veh/h	1614	168	1583				0	1845	1568	1740	1827	0
Grp Volume(v), veh/h	117	0	12				0	319	201	277	713	0
Grp Sat Flow(s),veh/h/ln	1782	0	1583				0	1845	1568	1740	1827	0
Q Serve(g_s), s	5.4	0.0	0.6				0.0	7.8	5.5	12.8	0.0	0.0
Cycle Q Clear(g_c), s	5.4	0.0	0.6				0.0	7.8	5.5	12.8	0.0	0.0
Prop In Lane	0.91		1.00				0.00		1.00	1.00		0.00
Lane Grp Cap(c), veh/h	159	0	141				0	1038	882	307	1430	0
V/C Ratio(X)	0.74	0.00	0.08				0.00	0.31	0.23	0.90	0.50	0.00
Avail Cap(c_a), veh/h	524	0	466				0	1038	882	348	1430	0
HCM Platoon Ratio	1.00	1.00	1.00				1.00	1.00	1.00	2.00	2.00	1.00
Upstream Filter(I)	1.00	0.00	1.00				0.00	1.00	1.00	0.15	0.15	0.00
Uniform Delay (d), s/veh	37.7	0.0	35.5				0.0	9.8	9.3	26.8	0.0	0.0
Incr Delay (d2), s/veh	6.5	0.0	0.3				0.0	0.8	0.6	5.0	0.2	0.0
Initial Q Delay(d3),s/veh	0.0	0.0	0.0				0.0	0.0	0.0	0.0	0.0	0.0
%ile BackOfQ(50%),veh/ln	3.0	0.0	0.3				0.0	4.1	2.5	6.5	0.1	0.0
LnGrp Delay(d),s/veh	44.2	0.0	35.8				0.0	10.6	9.9	31.8	0.2	0.0
LnGrp LOS	D		D					B	A	C	A	
Approach Vol, veh/h		129						520			990	
Approach Delay, s/veh		43.4						10.3			9.0	
Approach LOS		D						B			A	
Timer	1	2	3	4	5	6	7	8				
Assigned Phs		2			5	6		8				
Phs Duration (G+Y+Rc), s		72.5			18.7	53.8		12.5				
Change Period (Y+Rc), s		6.0			3.7	6.0		4.9				
Max Green Setting (Gmax), s		43.1			17.0	28.4		25.0				
Max Q Clear Time (g_c+I1), s		2.0			14.8	9.8		7.4				
Green Ext Time (p_c), s		4.9			0.2	2.1		0.5				
Intersection Summary												
HCM 2010 Ctrl Delay			12.1									
HCM 2010 LOS			B									

HCM 2010 Signalized Intersection Summary Cumulative with Eastside Parkway with Project, AM
 1: Del Monte Boulevard & Reindollar Avenue 06/11/2019

												
Movement	EBL	EBT	EBR	WBL	WBT	WBR	NBL	NBT	NBR	SBL	SBT	SBR
Lane Configurations												
Traffic Volume (veh/h)	0	0	0	450	0	420	10	650	120	410	1180	0
Future Volume (veh/h)	0	0	0	450	0	420	10	650	120	410	1180	0
Number				3	8	18	1	6	16	5	2	12
Initial Q (Qb), veh				0	0	0	0	0	0	0	0	0
Ped-Bike Adj(A_pbT)				1.00		0.99	1.00		1.00	1.00		1.00
Parking Bus, Adj				1.00	1.00	1.00	1.00	1.00	1.00	1.00	1.00	1.00
Adj Sat Flow, veh/h/ln				1900	1900	1900	1863	1863	1863	1845	1845	0
Adj Flow Rate, veh/h				468	54	429	11	730	68	461	1326	0
Adj No. of Lanes				1	1	0	1	2	1	1	2	0
Peak Hour Factor				0.89	0.89	0.89	0.89	0.89	0.89	0.89	0.89	0.89
Percent Heavy Veh, %				0	0	0	2	2	2	3	3	0
Cap, veh/h				573	58	459	24	900	401	498	1839	0
Arrive On Green				0.32	0.32	0.32	0.01	0.25	0.25	0.28	0.52	0.00
Sat Flow, veh/h				1810	183	1451	1774	3539	1577	1757	3597	0
Grp Volume(v), veh/h				468	0	483	11	730	68	461	1326	0
Grp Sat Flow(s),veh/h/ln				1810	0	1634	1774	1770	1577	1757	1752	0
Q Serve(g_s), s				22.1	0.0	26.6	0.6	18.0	3.1	23.6	26.8	0.0
Cycle Q Clear(g_c), s				22.1	0.0	26.6	0.6	18.0	3.1	23.6	26.8	0.0
Prop In Lane				1.00		0.89	1.00		1.00	1.00		0.00
Lane Grp Cap(c), veh/h				573	0	517	24	900	401	498	1839	0
V/C Ratio(X)				0.82	0.00	0.93	0.47	0.81	0.17	0.92	0.72	0.00
Avail Cap(c_a), veh/h				585	0	529	574	1145	510	568	1839	0
HCM Platoon Ratio				1.00	1.00	1.00	1.00	1.00	1.00	1.00	1.00	1.00
Upstream Filter(I)				1.00	0.00	1.00	1.00	1.00	1.00	1.00	1.00	0.00
Uniform Delay (d), s/veh				29.2	0.0	30.8	45.4	32.5	27.0	32.3	16.9	0.0
Incr Delay (d2), s/veh				8.7	0.0	23.7	13.6	3.6	0.2	19.8	1.4	0.0
Initial Q Delay(d3),s/veh				0.0	0.0	0.0	0.0	0.0	0.0	0.0	0.0	0.0
%ile BackOfQ(50%),veh/ln				12.4	0.0	15.3	0.4	9.2	1.4	14.1	13.3	0.0
LnGrp Delay(d),s/veh				37.9	0.0	54.4	59.0	36.1	27.2	52.0	18.3	0.0
LnGrp LOS				D		D	E	D	C	D	B	
Approach Vol, veh/h					951			809			1787	
Approach Delay, s/veh					46.3			35.6			27.0	
Approach LOS					D			D			C	
Timer	1	2	3	4	5	6	7	8				
Assigned Phs	1	2			5	6		8				
Phs Duration (G+Y+Rc), s	4.7	53.7			29.8	28.6		34.4				
Change Period (Y+Rc), s	3.5	5.0			3.5	5.0		5.0				
Max Green Setting (Gmax), s	30.0	30.0			30.0	30.0		30.0				
Max Q Clear Time (g_c+I1), s	2.6	28.8			25.6	20.0		28.6				
Green Ext Time (p_c), s	0.0	0.9			0.7	3.6		0.8				
Intersection Summary												
HCM 2010 Ctrl Delay				34.1								
HCM 2010 LOS				C								
Notes												

HCM 2010 Signalized Intersection Summary Cumulative with Eastside Parkway with Project, AM
 2: 2nd Avenue & Patton Parkway 06/11/2019



Movement	EBL	EBT	EBR	WBL	WBT	WBR	NBL	NBT	NBR	SBL	SBT	SBR
Lane Configurations	↖	↗		↖	↗		↖	↗		↖	↗	
Traffic Volume (veh/h)	50	90	60	30	90	100	70	220	100	90	200	50
Future Volume (veh/h)	50	90	60	30	90	100	70	220	100	90	200	50
Number	7	4	14	3	8	18	5	2	12	1	6	16
Initial Q (Qb), veh	0	0	0	0	0	0	0	0	0	0	0	0
Ped-Bike Adj(A_pbT)	1.00		1.00	1.00		1.00	1.00		1.00	1.00		1.00
Parking Bus, Adj	1.00	1.00	1.00	1.00	1.00	1.00	1.00	1.00	1.00	1.00	1.00	1.00
Adj Sat Flow, veh/h/ln	1863	1863	1900	1863	1863	1900	1863	1863	1900	1863	1863	1900
Adj Flow Rate, veh/h	54	98	65	33	98	109	76	239	109	98	217	54
Adj No. of Lanes	1	1	0	1	1	0	1	1	0	1	1	0
Peak Hour Factor	0.92	0.92	0.92	0.92	0.92	0.92	0.92	0.92	0.92	0.92	0.92	0.92
Percent Heavy Veh, %	2	2	2	2	2	2	2	2	2	2	2	2
Cap, veh/h	97	247	164	67	177	197	121	330	151	139	407	101
Arrive On Green	0.05	0.24	0.24	0.04	0.22	0.22	0.07	0.27	0.27	0.08	0.28	0.28
Sat Flow, veh/h	1774	1046	694	1774	807	897	1774	1212	553	1774	1441	359
Grp Volume(v), veh/h	54	0	163	33	0	207	76	0	348	98	0	271
Grp Sat Flow(s),veh/h/ln	1774	0	1740	1774	0	1704	1774	0	1765	1774	0	1799
Q Serve(g_s), s	1.3	0.0	3.6	0.8	0.0	4.9	1.9	0.0	8.1	2.4	0.0	5.8
Cycle Q Clear(g_c), s	1.3	0.0	3.6	0.8	0.0	4.9	1.9	0.0	8.1	2.4	0.0	5.8
Prop In Lane	1.00		0.40	1.00		0.53	1.00		0.31	1.00		0.20
Lane Grp Cap(c), veh/h	97	0	411	67	0	374	121	0	481	139	0	509
V/C Ratio(X)	0.56	0.00	0.40	0.50	0.00	0.55	0.63	0.00	0.72	0.71	0.00	0.53
Avail Cap(c_a), veh/h	235	0	1364	235	0	1336	235	0	1384	235	0	1411
HCM Platoon Ratio	1.00	1.00	1.00	1.00	1.00	1.00	1.00	1.00	1.00	1.00	1.00	1.00
Upstream Filter(I)	1.00	0.00	1.00	1.00	0.00	1.00	1.00	0.00	1.00	1.00	0.00	1.00
Uniform Delay (d), s/veh	20.9	0.0	14.6	21.4	0.0	15.7	20.5	0.0	14.9	20.4	0.0	13.7
Incr Delay (d2), s/veh	5.0	0.0	0.6	5.6	0.0	1.3	5.3	0.0	2.1	6.4	0.0	0.9
Initial Q Delay(d3),s/veh	0.0	0.0	0.0	0.0	0.0	0.0	0.0	0.0	0.0	0.0	0.0	0.0
%ile BackOfQ(50%),veh/ln	0.8	0.0	1.8	0.5	0.0	2.4	1.1	0.0	4.1	1.4	0.0	3.0
LnGrp Delay(d),s/veh	25.9	0.0	15.2	27.0	0.0	17.0	25.9	0.0	17.0	26.8	0.0	14.6
LnGrp LOS	C		B	C		B	C		B	C		B
Approach Vol, veh/h		217			240			424			369	
Approach Delay, s/veh		17.8			18.4			18.6			17.8	
Approach LOS		B			B			B			B	
Timer	1	2	3	4	5	6	7	8				
Assigned Phs	1	2	3	4	5	6	7	8				
Phs Duration (G+Y+Rc), s	7.5	16.8	5.7	15.2	7.1	17.3	6.5	14.4				
Change Period (Y+Rc), s	4.0	4.5	4.0	4.5	4.0	4.5	4.0	4.5				
Max Green Setting (Gmax), s	6.0	35.5	6.0	35.5	6.0	35.5	6.0	35.5				
Max Q Clear Time (g_c+14), s	14.4	10.1	2.8	5.6	3.9	7.8	3.3	6.9				
Green Ext Time (p_c), s	0.0	2.2	0.0	1.0	0.0	1.7	0.0	1.3				
Intersection Summary												
HCM 2010 Ctrl Delay			18.2									
HCM 2010 LOS			B									

HCM 2010 Signalized Intersection Summary Cumulative with Eastside Parkway with Project, AM
 3: SR 1 SB On-Ramp/SR 1 SB Off-Ramp & Imjin Parkway 06/11/2019



Movement	EBL	EBT	EBR	WBL	WBT	WBR	NBL	NBT	NBR	SBL	SBT	SBR
Lane Configurations					↕						↕	
Traffic Volume (veh/h)	0	0	0	1040	0	0	0	0	0	1000	10	0
Future Volume (veh/h)	0	0	0	1040	0	0	0	0	0	1000	10	0
Number				1	6	16				7	4	14
Initial Q (Qb), veh				0	0	0				0	0	0
Ped-Bike Adj(A_pbT)				1.00		1.00				1.00		1.00
Parking Bus, Adj				1.00	1.00	1.00				1.00	1.00	1.00
Adj Sat Flow, veh/h/ln				1900	1845	0				1900	1845	0
Adj Flow Rate, veh/h				1143	0	0				1099	11	0
Adj No. of Lanes				0	1	0				0	1	0
Peak Hour Factor				0.91	0.91	0.91				0.91	0.91	0.91
Percent Heavy Veh, %				3	3	0				3	3	0
Cap, veh/h				996	0	0				658	7	0
Arrive On Green				0.57	0.00	0.00				0.38	0.38	0.00
Sat Flow, veh/h				1757	0	0				1740	17	0
Grp Volume(v), veh/h				1143	0	0				1110	0	0
Grp Sat Flow(s),veh/h/ln				1757	0	0				1758	0	0
Q Serve(g_s), s				90.0	0.0	0.0				60.0	0.0	0.0
Cycle Q Clear(g_c), s				90.0	0.0	0.0				60.0	0.0	0.0
Prop In Lane				1.00		0.00				0.99		0.00
Lane Grp Cap(c), veh/h				996	0	0				664	0	0
V/C Ratio(X)				1.15	0.00	0.00				1.67	0.00	0.00
Avail Cap(c_a), veh/h				996	0	0				664	0	0
HCM Platoon Ratio				1.00	1.00	1.00				1.00	1.00	1.00
Upstream Filter(I)				1.00	0.00	0.00				1.00	0.00	0.00
Uniform Delay (d), s/veh				34.4	0.0	0.0				49.4	0.0	0.0
Incr Delay (d2), s/veh				78.5	0.0	0.0				308.7	0.0	0.0
Initial Q Delay(d3),s/veh				0.0	0.0	0.0				0.0	0.0	0.0
%ile BackOfQ(50%),veh/ln				65.1	0.0	0.0				85.9	0.0	0.0
LnGrp Delay(d),s/veh				112.9	0.0	0.0				358.1	0.0	0.0
LnGrp LOS				F						F		
Approach Vol, veh/h					1143						1110	
Approach Delay, s/veh					112.9						358.1	
Approach LOS					F						F	
Timer	1	2	3	4	5	6	7	8				
Assigned Phs				4		6						
Phs Duration (G+Y+Rc), s				64.4		94.4						
Change Period (Y+Rc), s				4.4		4.4						
Max Green Setting (Gmax), s				60.0		90.0						
Max Q Clear Time (g_c+I1), s				62.0		92.0						
Green Ext Time (p_c), s				0.0		0.0						
Intersection Summary												
HCM 2010 Ctrl Delay				233.7								
HCM 2010 LOS				F								























Intersection												
Int Delay, s/veh	1.1											
Movement	EBL	EBT	EBR	WBL	WBT	WBR	NBL	NBT	NBR	SBL	SBT	SBR
Lane Configurations		↕			↑	↗		↕	↗			
Traffic Vol, veh/h	10	1010	0	0	990	470	10	10	960	0	0	0
Future Vol, veh/h	10	1010	0	0	990	470	10	10	960	0	0	0
Conflicting Peds, #/hr	0	0	3	3	0	0	0	0	0	0	0	0
Sign Control	Free	Free	Free	Free	Free	Free	Stop	Stop	Stop	Stop	Stop	Stop
RT Channelized	-	-	None	-	-	Free	-	-	Free	-	-	None
Storage Length	-	-	-	-	-	0	-	-	800	-	-	-
Veh in Median Storage, #	-	0	-	-	0	-	-	0	-	-	16965	-
Grade, %	-	0	-	-	0	-	-	0	-	-	0	-
Peak Hour Factor	97	97	97	97	97	97	97	97	97	97	97	97
Heavy Vehicles, %	3	3	3	3	3	3	2	2	2	2	2	2
Mvmt Flow	10	1041	0	0	1021	485	10	10	990	0	0	0

Major/Minor	Major1	Major2	Minor1
Conflicting Flow All	1021	0	-
Stage 1	-	-	-
Stage 2	-	-	-
Critical Hdwy	4.13	-	-
Critical Hdwy Stg 1	-	-	-
Critical Hdwy Stg 2	-	-	-
Follow-up Hdwy	2.227	-	-
Pot Cap-1 Maneuver	676	0	0
Stage 1	-	0	0
Stage 2	-	0	0
Platoon blocked, %	-	-	-
Mov Cap-1 Maneuver	676	-	-
Mov Cap-2 Maneuver	-	-	-
Stage 1	-	-	-
Stage 2	-	-	-

Approach	EB	WB	NB
HCM Control Delay, s	0.1	0	102.8
HCM LOS			F

Minor Lane/Major Mvmt	NBLn1	NBLn2	EBL	EBT	WBT
Capacity (veh/h)	56	-	676	-	-
HCM Lane V/C Ratio	0.368	-	0.015	-	-
HCM Control Delay (s)	102.8	0	10.4	0	-
HCM Lane LOS	F	A	B	A	-
HCM 95th %tile Q(veh)	1.3	-	0	-	-

HCM 2010 Signalized Intersection Summary Cumulative with Eastside Parkway with Project, AM
 5: 2nd Avenue & Imjin Parkway 06/11/2019

												
Movement	EBL	EBT	EBR	WBL	WBT	WBR	NBL	NBT	NBR	SBL	SBT	SBR
Lane Configurations												
Traffic Volume (veh/h)	180	1050	910	460	860	120	420	90	200	50	100	210
Future Volume (veh/h)	180	1050	910	460	860	120	420	90	200	50	100	210
Number	5	2	12	1	6	16	3	8	18	7	4	14
Initial Q (Qb), veh	0	0	0	0	0	0	0	0	0	0	0	0
Ped-Bike Adj(A_pbT)	1.00		1.00	1.00		1.00	1.00		1.00	1.00		1.00
Parking Bus, Adj	1.00	1.00	1.00	1.00	1.00	1.00	1.00	1.00	1.00	1.00	1.00	1.00
Adj Sat Flow, veh/h/ln	1863	1863	1863	1863	1863	1900	1810	1810	1810	1900	1900	1900
Adj Flow Rate, veh/h	184	1071	710	469	878	122	429	92	82	51	102	209
Adj No. of Lanes	1	2	1	2	2	0	2	1	1	1	2	0
Peak Hour Factor	0.98	0.98	0.98	0.98	0.98	0.98	0.98	0.98	0.98	0.98	0.98	0.98
Percent Heavy Veh, %	2	2	2	2	2	2	5	5	5	0	0	0
Cap, veh/h	220	1202	538	537	1160	161	497	455	386	91	276	246
Arrive On Green	0.12	0.34	0.34	0.16	0.37	0.37	0.15	0.25	0.25	0.05	0.15	0.15
Sat Flow, veh/h	1774	3539	1583	3442	3122	434	3343	1810	1536	1810	1805	1612
Grp Volume(v), veh/h	184	1071	710	469	498	502	429	92	82	51	102	209
Grp Sat Flow(s),veh/h/ln	1774	1770	1583	1721	1770	1786	1672	1810	1536	1810	1805	1612
Q Serve(g_s), s	8.9	25.3	30.0	11.8	21.7	21.7	11.1	3.5	3.7	2.4	4.5	11.1
Cycle Q Clear(g_c), s	8.9	25.3	30.0	11.8	21.7	21.7	11.1	3.5	3.7	2.4	4.5	11.1
Prop In Lane	1.00		1.00	1.00		0.24	1.00		1.00	1.00		1.00
Lane Grp Cap(c), veh/h	220	1202	538	537	658	664	497	455	386	91	276	246
V/C Ratio(X)	0.83	0.89	1.32	0.87	0.76	0.76	0.86	0.20	0.21	0.56	0.37	0.85
Avail Cap(c_a), veh/h	301	1202	538	585	658	664	757	455	386	205	429	383
HCM Platoon Ratio	1.00	1.00	1.00	1.00	1.00	1.00	1.00	1.00	1.00	1.00	1.00	1.00
Upstream Filter(I)	1.00	1.00	1.00	1.00	1.00	1.00	1.00	1.00	1.00	1.00	1.00	1.00
Uniform Delay (d), s/veh	37.8	27.6	29.2	36.4	24.3	24.3	36.7	26.1	26.1	41.0	33.6	36.4
Incr Delay (d2), s/veh	10.3	8.3	156.7	12.1	4.5	4.5	4.3	0.1	0.1	2.0	0.3	6.1
Initial Q Delay(d3),s/veh	0.0	0.0	0.0	0.0	0.0	0.0	0.0	0.0	0.0	0.0	0.0	0.0
%ile BackOfQ(50%),veh/ln	5.0	13.7	36.5	6.5	11.3	11.4	5.4	1.8	1.6	1.3	2.3	5.4
LnGrp Delay(d),s/veh	48.1	35.9	185.8	48.5	28.8	28.7	41.0	26.2	26.2	43.0	33.9	42.5
LnGrp LOS	D	D	F	D	C	C	D	C	C	D	C	D
Approach Vol, veh/h		1965			1469			603			362	
Approach Delay, s/veh		91.2			35.1			36.8			40.2	
Approach LOS		F			D			D			D	
Timer	1	2	3	4	5	6	7	8				
Assigned Phs	1	2	3	4	5	6	7	8				
Phs Duration (G+Y+Rc), s	18.3	35.3	16.6	18.1	15.5	38.1	7.9	26.8				
Change Period (Y+Rc), s	4.5	5.3	3.5	4.6	4.5	5.3	3.5	4.6				
Max Green Setting (Gmax), s	15.0	30.0	20.0	21.0	15.0	30.0	10.0	21.0				
Max Q Clear Time (g_c+I1), s	13.8	32.0	13.1	13.1	10.9	23.7	4.4	5.7				
Green Ext Time (p_c), s	0.0	0.0	0.1	0.3	0.0	0.9	0.0	0.1				
Intersection Summary												
HCM 2010 Ctrl Delay			60.8									
HCM 2010 LOS			E									

HCM 2010 Signalized Intersection Summary Cumulative with Eastside Parkway with Project, AM
6: 3rd Avenue & Imjin Parkway

06/11/2019



Movement	EBL	EBT	EBR	WBL	WBT	WBR	NBL	NBT	NBR	SBL	SBT	SBR
Lane Configurations	↔	↕		↔	↕		↔	↕		↔	↕	
Traffic Volume (veh/h)	50	900	220	340	1300	30	130	10	60	10	10	40
Future Volume (veh/h)	50	900	220	340	1300	30	130	10	60	10	10	40
Number	5	2	12	1	6	16	3	8	18	7	4	14
Initial Q (Qb), veh	0	0	0	0	0	0	0	0	0	0	0	0
Ped-Bike Adj(A_pbT)	1.00		1.00	1.00		1.00	1.00		1.00	1.00		1.00
Parking Bus, Adj	1.00	1.00	1.00	1.00	1.00	1.00	1.00	1.00	1.00	1.00	1.00	1.00
Adj Sat Flow, veh/h/ln	1863	1863	1900	1863	1863	1900	1810	1810	1900	1863	1863	1900
Adj Flow Rate, veh/h	52	938	200	354	1354	30	135	10	8	10	10	7
Adj No. of Lanes	1	2	0	1	2	0	1	1	0	1	1	0
Peak Hour Factor	0.96	0.96	0.96	0.96	0.96	0.96	0.96	0.96	0.96	0.96	0.96	0.96
Percent Heavy Veh, %	2	2	2	2	2	2	5	5	5	2	2	2
Cap, veh/h	63	1066	227	398	1969	44	324	135	108	328	147	103
Arrive On Green	0.04	0.37	0.37	0.22	0.56	0.56	0.14	0.14	0.14	0.14	0.14	0.14
Sat Flow, veh/h	1774	2904	618	1774	3540	78	1345	930	744	1384	1020	714
Grp Volume(v), veh/h	52	571	567	354	676	708	135	0	18	10	0	17
Grp Sat Flow(s),veh/h/ln	1774	1770	1753	1774	1770	1849	1345	0	1675	1384	0	1733
Q Serve(g_s), s	1.5	15.4	15.5	9.9	14.1	14.1	4.9	0.0	0.5	0.3	0.0	0.4
Cycle Q Clear(g_c), s	1.5	15.4	15.5	9.9	14.1	14.1	5.4	0.0	0.5	0.8	0.0	0.4
Prop In Lane	1.00		0.35	1.00		0.04	1.00		0.44	1.00		0.41
Lane Grp Cap(c), veh/h	63	650	644	398	984	1028	324	0	242	328	0	251
V/C Ratio(X)	0.82	0.88	0.88	0.89	0.69	0.69	0.42	0.00	0.07	0.03	0.00	0.07
Avail Cap(c_a), veh/h	398	1123	1112	398	1123	1173	852	0	899	871	0	931
HCM Platoon Ratio	1.00	1.00	1.00	1.00	1.00	1.00	1.00	1.00	1.00	1.00	1.00	1.00
Upstream Filter(I)	1.00	1.00	1.00	1.00	1.00	1.00	1.00	0.00	1.00	1.00	0.00	1.00
Uniform Delay (d), s/veh	24.5	15.1	15.2	19.2	8.2	8.2	21.2	0.0	18.9	19.3	0.0	18.9
Incr Delay (d2), s/veh	9.4	1.9	1.9	20.4	1.1	1.0	0.3	0.0	0.0	0.0	0.0	0.0
Initial Q Delay(d3),s/veh	0.0	0.0	0.0	0.0	0.0	0.0	0.0	0.0	0.0	0.0	0.0	0.0
%ile BackOfQ(50%),veh/ln	0.9	7.8	7.7	7.1	7.1	7.4	1.9	0.0	0.2	0.1	0.0	0.2
LnGrp Delay(d),s/veh	33.9	17.0	17.1	39.6	9.2	9.2	21.6	0.0	19.0	19.3	0.0	19.0
LnGrp LOS	C	B	B	D	A	A	C		B	B		B
Approach Vol, veh/h		1190			1738			153			27	
Approach Delay, s/veh		17.8			15.4			21.3			19.1	
Approach LOS		B			B			C			B	
Timer	1	2	3	4	5	6	7	8				
Assigned Phs	1	2		4	5	6		8				
Phs Duration (G+Y+Rc), s	5.0	24.3		11.9	5.3	34.0		11.9				
Change Period (Y+Rc), s	3.5	5.5		4.5	3.5	5.5		4.5				
Max Green Setting (Gmax), s	1.5	32.5		27.5	11.5	32.5		27.5				
Max Q Clear Time (g_c+I1), s	1.5	17.5		2.8	3.5	16.1		7.4				
Green Ext Time (p_c), s	0.0	1.3		0.0	0.0	1.0		0.0				
Intersection Summary												
HCM 2010 Ctrl Delay				16.6								
HCM 2010 LOS				B								

HCM 2010 Signalized Intersection Summary Cumulative with Eastside Parkway with Project, AM
7: 4th Avenue & Imjin Parkway

06/11/2019



Movement	EBL	EBT	EBR	WBL	WBT	WBR	NBL	NBT	NBR	SBL	SBT	SBR
Lane Configurations												
Traffic Volume (veh/h)	10	990	20	10	1590	10	10	10	10	10	10	10
Future Volume (veh/h)	10	990	20	10	1590	10	10	10	10	10	10	10
Number	5	2	12	1	6	16	3	8	18	7	4	14
Initial Q (Qb), veh	0	0	0	0	0	0	0	0	0	0	0	0
Ped-Bike Adj(A_pbT)	1.00		1.00	1.00		1.00	1.00		1.00	1.00		1.00
Parking Bus, Adj	1.00	1.00	1.00	1.00	1.00	1.00	1.00	1.00	1.00	1.00	1.00	1.00
Adj Sat Flow, veh/h/ln	1863	1863	1900	1863	1863	1900	1900	1267	1900	1900	1900	1900
Adj Flow Rate, veh/h	10	1031	20	10	1656	9	10	10	9	10	10	10
Adj No. of Lanes	1	2	0	1	2	0	0	1	0	0	1	0
Peak Hour Factor	0.96	0.96	0.96	0.96	0.96	0.96	0.96	0.96	0.96	0.96	0.96	0.96
Percent Heavy Veh, %	2	2	2	2	2	2	50	50	50	0	0	0
Cap, veh/h	14	1831	36	14	1861	10	172	20	18	181	30	30
Arrive On Green	0.01	0.52	0.52	0.01	0.52	0.52	0.05	0.05	0.05	0.05	0.05	0.05
Sat Flow, veh/h	1774	3551	69	1774	3609	20	390	390	351	579	579	579
Grp Volume(v), veh/h	10	514	537	10	812	853	29	0	0	30	0	0
Grp Sat Flow(s),veh/h/ln	1774	1770	1851	1774	1770	1859	1130	0	0	1736	0	0
Q Serve(g_s), s	0.2	6.3	6.3	0.2	13.0	13.0	0.3	0.0	0.0	0.0	0.0	0.0
Cycle Q Clear(g_c), s	0.2	6.3	6.3	0.2	13.0	13.0	0.8	0.0	0.0	0.5	0.0	0.0
Prop In Lane	1.00		0.04	1.00		0.01	0.34		0.31	0.33		0.33
Lane Grp Cap(c), veh/h	14	912	954	14	912	959	210	0	0	240	0	0
V/C Ratio(X)	0.71	0.56	0.56	0.71	0.89	0.89	0.14	0.00	0.00	0.13	0.00	0.00
Avail Cap(c_a), veh/h	643	1812	1895	643	1812	1904	1090	0	0	1560	0	0
HCM Platoon Ratio	1.00	1.00	1.00	1.00	1.00	1.00	1.00	1.00	1.00	1.00	1.00	1.00
Upstream Filter(I)	1.00	1.00	1.00	1.00	1.00	1.00	1.00	0.00	0.00	1.00	0.00	0.00
Uniform Delay (d), s/veh	15.7	5.2	5.2	15.7	6.9	6.9	14.6	0.0	0.0	14.5	0.0	0.0
Incr Delay (d2), s/veh	21.1	0.2	0.2	21.1	1.2	1.2	0.1	0.0	0.0	0.1	0.0	0.0
Initial Q Delay(d3),s/veh	0.0	0.0	0.0	0.0	0.0	0.0	0.0	0.0	0.0	0.0	0.0	0.0
%ile BackOfQ(50%),veh/ln	0.2	3.0	3.2	0.2	6.4	6.7	0.2	0.0	0.0	0.3	0.0	0.0
LnGrp Delay(d),s/veh	36.8	5.5	5.4	36.8	8.1	8.1	14.7	0.0	0.0	14.6	0.0	0.0
LnGrp LOS	D	A	A	D	A	A	B			B		
Approach Vol, veh/h		1061			1675			29			30	
Approach Delay, s/veh		5.7			8.3			14.7			14.6	
Approach LOS		A			A			B			B	
Timer	1	2	3	4	5	6	7	8				
Assigned Phs	1	2		4	5	6		8				
Phs Duration (G+Y+Rc), s	3.8	21.9		6.1	3.8	21.9		6.1				
Change Period (Y+Rc), s	3.5	5.5		4.5	3.5	5.5		4.5				
Max Green Setting (Gmax), s	1.5	32.5		27.5	11.5	32.5		27.5				
Max Q Clear Time (g_c+1), s	1.2	8.3		2.5	2.2	15.0		2.8				
Green Ext Time (p_c), s	0.0	0.7		0.0	0.0	1.3		0.0				
Intersection Summary												
HCM 2010 Ctrl Delay				7.4								
HCM 2010 LOS				A								

HCM 2010 Signalized Intersection Summary Cumulative with Eastside Parkway with Project, AM
 8: 5th Avenue/California Avenue & Imjin Parkway 06/11/2019



Movement	EBL	EBT	EBR	WBL	WBT	WBR	NBL	NBT	NBR	SBL	SBT	SBR
Lane Configurations												
Traffic Volume (veh/h)	140	890	20	10	1000	80	20	20	10	100	160	460
Future Volume (veh/h)	140	890	20	10	1000	80	20	20	10	100	160	460
Number	5	2	12	1	6	16	3	8	18	7	4	14
Initial Q (Qb), veh	0	0	0	0	0	0	0	0	0	0	0	0
Ped-Bike Adj(A_pbT)	1.00		0.98	1.00		1.00	1.00		0.99	1.00		1.00
Parking Bus, Adj	1.00	1.00	1.00	1.00	1.00	1.00	1.00	1.00	1.00	1.00	1.00	1.00
Adj Sat Flow, veh/h/ln	1881	1881	1900	1863	1863	1900	1900	1624	1900	1900	1881	1900
Adj Flow Rate, veh/h	147	937	19	11	1053	78	21	21	10	105	168	410
Adj No. of Lanes	1	2	0	1	2	0	0	1	0	0	1	0
Peak Hour Factor	0.95	0.95	0.95	0.95	0.95	0.95	0.95	0.95	0.95	0.95	0.95	0.95
Percent Heavy Veh, %	1	1	1	2	2	2	17	17	17	1	1	1
Cap, veh/h	186	1583	32	15	1158	86	174	152	58	135	149	323
Arrive On Green	0.10	0.44	0.44	0.01	0.35	0.35	0.33	0.33	0.33	0.33	0.33	0.33
Sat Flow, veh/h	1792	3581	73	1774	3341	247	275	461	175	201	452	981
Grp Volume(v), veh/h	147	468	488	11	558	573	52	0	0	683	0	0
Grp Sat Flow(s),veh/h/ln	1792	1787	1867	1774	1770	1819	912	0	0	1634	0	0
Q Serve(g_s), s	4.9	12.0	12.0	0.4	18.3	18.3	0.0	0.0	0.0	16.2	0.0	0.0
Cycle Q Clear(g_c), s	4.9	12.0	12.0	0.4	18.3	18.3	1.4	0.0	0.0	20.0	0.0	0.0
Prop In Lane	1.00		0.04	1.00		0.14	0.40		0.19	0.15		0.60
Lane Grp Cap(c), veh/h	186	790	825	15	613	630	383	0	0	606	0	0
V/C Ratio(X)	0.79	0.59	0.59	0.74	0.91	0.91	0.14	0.00	0.00	1.13	0.00	0.00
Avail Cap(c_a), veh/h	442	882	921	438	873	898	383	0	0	606	0	0
HCM Platoon Ratio	1.00	1.00	1.00	1.00	1.00	1.00	1.00	1.00	1.00	1.00	1.00	1.00
Upstream Filter(I)	1.00	1.00	1.00	1.00	1.00	1.00	1.00	0.00	0.00	1.00	0.00	0.00
Uniform Delay (d), s/veh	26.6	12.8	12.8	30.1	18.9	18.9	14.2	0.0	0.0	21.5	0.0	0.0
Incr Delay (d2), s/veh	2.8	0.4	0.4	23.2	8.2	8.0	0.1	0.0	0.0	76.9	0.0	0.0
Initial Q Delay(d3),s/veh	0.0	0.0	0.0	0.0	0.0	0.0	0.0	0.0	0.0	0.0	0.0	0.0
%ile BackOfQ(50%),veh/ln	2.6	5.9	6.2	0.3	10.2	10.5	0.6	0.0	0.0	22.9	0.0	0.0
LnGrp Delay(d),s/veh	29.4	13.3	13.2	53.2	27.1	27.0	14.2	0.0	0.0	98.3	0.0	0.0
LnGrp LOS	C	B	B	D	C	C	B			F		
Approach Vol, veh/h		1103			1142			52			683	
Approach Delay, s/veh		15.4			27.3			14.2			98.3	
Approach LOS		B			C			B			F	
Timer	1	2	3	4	5	6	7	8				
Assigned Phs	1	2		4	5	6		8				
Phs Duration (G+Y+Rc), s	4.0	32.2		24.6	9.8	26.4		24.6				
Change Period (Y+Rc), s	3.5	5.3		4.6	3.5	5.3		4.6				
Max Green Setting (Gmax), s	30.0	30.0		20.0	15.0	30.0		20.0				
Max Q Clear Time (g_c+1), s	12.4	14.0		22.0	6.9	20.3		3.4				
Green Ext Time (p_c), s	0.0	0.7		0.0	0.0	0.8		0.1				
Intersection Summary												
HCM 2010 Ctrl Delay			38.9									
HCM 2010 LOS			D									

Intersection						
Int Delay, s/veh	1.4					
Movement	EBL	EBR	NBL	NBT	SBT	SBR
Lane Configurations	Y		Y	↑	↑	
Traffic Vol, veh/h	30	30	30	230	630	80
Future Vol, veh/h	30	30	30	230	630	80
Conflicting Peds, #/hr	0	0	0	0	0	0
Sign Control	Stop	Stop	Free	Free	Free	Free
RT Channelized	-	None	-	None	-	None
Storage Length	0	-	155	-	-	-
Veh in Median Storage, #	0	-	-	0	0	-
Grade, %	0	-	-	0	0	-
Peak Hour Factor	92	92	92	92	92	92
Heavy Vehicles, %	2	2	2	2	2	2
Mvmt Flow	33	33	33	250	685	87











Major/Minor	Minor2	Major1	Major2			
Conflicting Flow All	1045	729	772	0	-	0
Stage 1	729	-	-	-	-	-
Stage 2	316	-	-	-	-	-
Critical Hdwy	6.42	6.22	4.12	-	-	-
Critical Hdwy Stg 1	5.42	-	-	-	-	-
Critical Hdwy Stg 2	5.42	-	-	-	-	-
Follow-up Hdwy	3.518	3.318	2.218	-	-	-
Pot Cap-1 Maneuver	253	423	843	-	-	-
Stage 1	477	-	-	-	-	-
Stage 2	739	-	-	-	-	-
Platoon blocked, %				-	-	-
Mov Cap-1 Maneuver	243	423	843	-	-	-
Mov Cap-2 Maneuver	243	-	-	-	-	-
Stage 1	458	-	-	-	-	-
Stage 2	739	-	-	-	-	-

Approach	EB	NB	SB
HCM Control Delay, s	19.7	1.1	0
HCM LOS	C		

Minor Lane/Major Mvmt	NBL	NBT	EBLn1	SBT	SBR
Capacity (veh/h)	843	-	309	-	-
HCM Lane V/C Ratio	0.039	-	0.211	-	-
HCM Control Delay (s)	9.4	-	19.7	-	-
HCM Lane LOS	A	-	C	-	-
HCM 95th %tile Q(veh)	0.1	-	0.8	-	-

HCM 2010 Signalized Intersection Summary Cumulative with Eastside Parkway with Project, AM
 10: Imjin Road & Imjin Parkway

06/11/2019

								
Movement	EBT	EBR	WBL	WBT	NBL	NBR		
Lane Configurations								
Traffic Volume (veh/h)	790	230	420	990	110	120		
Future Volume (veh/h)	790	230	420	990	110	120		
Number	2	12	1	6	3	18		
Initial Q (Qb), veh	0	0	0	0	0	0		
Ped-Bike Adj(A_pbT)		1.00	1.00		1.00	1.00		
Parking Bus, Adj	1.00	1.00	1.00	1.00	1.00	1.00		
Adj Sat Flow, veh/h/ln	1863	1900	1845	1845	1810	1810		
Adj Flow Rate, veh/h	832	229	442	1042	158	81		
Adj No. of Lanes	2	0	1	2	2	1		
Peak Hour Factor	0.95	0.95	0.95	0.95	0.95	0.95		
Percent Heavy Veh, %	2	2	3	3	5	5		
Cap, veh/h	938	258	495	2554	302	135		
Arrive On Green	0.34	0.34	0.28	0.73	0.09	0.09		
Sat Flow, veh/h	2837	755	1757	3597	3447	1538		
Grp Volume(v), veh/h	536	525	442	1042	158	81		
Grp Sat Flow(s),veh/h/ln	1770	1730	1757	1752	1723	1538		
Q Serve(g_s), s	14.5	14.5	12.2	5.8	2.2	2.6		
Cycle Q Clear(g_c), s	14.5	14.5	12.2	5.8	2.2	2.6		
Prop In Lane		0.44	1.00		1.00	1.00		
Lane Grp Cap(c), veh/h	605	591	495	2554	302	135		
V/C Ratio(X)	0.89	0.89	0.89	0.41	0.52	0.60		
Avail Cap(c_a), veh/h	1049	1025	694	2554	1498	668		
HCM Platoon Ratio	1.00	1.00	1.00	1.00	1.00	1.00		
Upstream Filter(I)	1.00	1.00	1.00	1.00	1.00	1.00		
Uniform Delay (d), s/veh	15.7	15.7	17.4	2.7	22.1	22.2		
Incr Delay (d2), s/veh	2.2	2.3	8.5	0.0	0.5	1.6		
Initial Q Delay(d3),s/veh	0.0	0.0	0.0	0.0	0.0	0.0		
%ile BackOfQ(50%),veh/ln	7.4	7.2	7.1	2.8	1.1	1.1		
LnGrp Delay(d),s/veh	18.0	18.1	25.9	2.7	22.6	23.8		
LnGrp LOS	B	B	C	A	C	C		
Approach Vol, veh/h	1061			1484	239			
Approach Delay, s/veh	18.0			9.6	23.0			
Approach LOS	B			A	C			
Timer	1	2	3	4	5	6	7	8
Assigned Phs	1	2				6		8
Phs Duration (G+Y+Rc), s	19.6	22.6				42.2		8.4
Change Period (Y+Rc), s	5.3	* 5.3				5.3		4.0
Max Green Setting (Gmax), s	20.0	* 30				30.0		22.0
Max Q Clear Time (g_c+I1), s	14.2	16.5				7.8		4.6
Green Ext Time (p_c), s	0.1	0.8				1.2		0.0
Intersection Summary								
HCM 2010 Ctrl Delay			14.0					
HCM 2010 LOS			B					
Notes								

HCM 2010 Signalized Intersection Summary Cumulative with Eastside Parkway with Project, AM
 11: Abrams Drive & Imjin Parkway

06/11/2019



Movement	EBL	EBT	EBR	WBL	WBT	WBR	NBL	NBT	NBR	SBL	SBT	SBR
Lane Configurations	↔	↑		↔	↑		↔	↑	↔	↔	↑	↔
Traffic Volume (veh/h)	50	630	70	80	970	70	290	30	160	90	50	250
Future Volume (veh/h)	50	630	70	80	970	70	290	30	160	90	50	250
Number	5	2	12	1	6	16	3	8	18	7	4	14
Initial Q (Qb), veh	0	0	0	0	0	0	0	0	0	0	0	0
Ped-Bike Adj(A_pbT)	1.00		1.00	1.00		1.00	1.00		1.00	1.00		1.00
Parking Bus, Adj	1.00	1.00	1.00	1.00	1.00	1.00	1.00	1.00	1.00	1.00	1.00	1.00
Adj Sat Flow, veh/h/ln	1881	1881	1900	1863	1863	1900	1845	1845	1845	1863	1863	1863
Adj Flow Rate, veh/h	54	677	63	86	1043	70	312	32	0	97	54	0
Adj No. of Lanes	2	2	0	2	2	0	1	1	1	1	1	1
Peak Hour Factor	0.93	0.93	0.93	0.93	0.93	0.93	0.93	0.93	0.93	0.93	0.93	0.93
Percent Heavy Veh, %	1	1	1	2	2	2	3	3	3	2	2	2
Cap, veh/h	183	1721	160	146	1696	114	429	509	433	451	514	437
Arrive On Green	0.05	0.52	0.52	0.04	0.50	0.50	0.28	0.28	0.00	0.28	0.28	0.00
Sat Flow, veh/h	3476	3306	307	3442	3366	226	1330	1845	1568	1370	1863	1583
Grp Volume(v), veh/h	54	366	374	86	548	565	312	32	0	97	54	0
Grp Sat Flow(s),veh/h/ln	1738	1787	1827	1721	1770	1823	1330	1845	1568	1370	1863	1583
Q Serve(g_s), s	1.2	9.8	9.8	1.9	17.7	17.7	18.1	1.0	0.0	4.5	1.7	0.0
Cycle Q Clear(g_c), s	1.2	9.8	9.8	1.9	17.7	17.7	19.9	1.0	0.0	5.5	1.7	0.0
Prop In Lane	1.00		0.17	1.00		0.12	1.00		1.00	1.00		1.00
Lane Grp Cap(c), veh/h	183	930	951	146	892	918	429	509	433	451	514	437
V/C Ratio(X)	0.30	0.39	0.39	0.59	0.61	0.62	0.73	0.06	0.00	0.21	0.11	0.00
Avail Cap(c_a), veh/h	876	1125	1150	867	1114	1148	565	697	592	591	704	598
HCM Platoon Ratio	1.00	1.00	1.00	1.00	1.00	1.00	1.00	1.00	1.00	1.00	1.00	1.00
Upstream Filter(I)	1.00	1.00	1.00	1.00	1.00	1.00	1.00	1.00	0.00	1.00	1.00	0.00
Uniform Delay (d), s/veh	36.2	11.5	11.5	37.3	14.2	14.2	28.8	21.2	0.0	23.2	21.4	0.0
Incr Delay (d2), s/veh	0.3	0.1	0.1	1.4	0.3	0.3	1.9	0.0	0.0	0.1	0.0	0.0
Initial Q Delay(d3),s/veh	0.0	0.0	0.0	0.0	0.0	0.0	0.0	0.0	0.0	0.0	0.0	0.0
%ile BackOfQ(50%),veh/ln	0.6	4.8	4.9	1.0	8.6	8.9	6.9	0.5	0.0	1.7	0.9	0.0
LnGrp Delay(d),s/veh	36.5	11.6	11.6	38.7	14.4	14.4	30.8	21.2	0.0	23.3	21.5	0.0
LnGrp LOS	D	B	B	D	B	B	C	C		C	C	
Approach Vol, veh/h		794			1199			344			151	
Approach Delay, s/veh		13.3			16.2			29.9			22.6	
Approach LOS		B			B			C			C	
Timer	1	2	3	4	5	6	7	8				
Assigned Phs	1	2		4	5	6		8				
Phs Duration (G+Y+Rc), s	6.9	46.6		25.9	8.2	45.3		25.9				
Change Period (Y+Rc), s	3.5	5.3		4.0	4.0	5.3		4.0				
Max Green Setting (Gmax), s	20.0	50.0		30.0	20.0	50.0		30.0				
Max Q Clear Time (g_c+13), s	13.5	11.8		7.5	3.2	19.7		21.9				
Green Ext Time (p_c), s	0.0	0.5		0.0	0.0	0.8		0.1				
Intersection Summary												
HCM 2010 Ctrl Delay			17.5									
HCM 2010 LOS			B									

HCM 2010 Signalized Intersection Summary Cumulative with Eastside Parkway with Project, AM
 12: Reservation Road & Imjin Parkway

06/11/2019



Movement	EBL	EBT	EBR	WBL	WBT	WBR	NBL	NBT	NBR	SBL	SBT	SBR
Lane Configurations	↖↗	↑	↖↗	↖	↑	↖	↖↗	↑↑	↖	↖↗	↑↑	↖
Traffic Volume (veh/h)	190	50	670	10	20	30	950	880	20	60	590	90
Future Volume (veh/h)	190	50	670	10	20	30	950	880	20	60	590	90
Number	3	8	18	7	4	14	1	6	16	5	2	12
Initial Q (Qb), veh	0	0	0	0	0	0	0	0	0	0	0	0
Ped-Bike Adj(A_pbT)	1.00		1.00	1.00		0.99	1.00		1.00	1.00		0.98
Parking Bus, Adj	1.00	1.00	1.00	1.00	1.00	1.00	1.00	1.00	1.00	1.00	1.00	1.00
Adj Sat Flow, veh/h/ln	1863	1863	1863	1638	1638	1638	1863	1863	1863	1863	1863	1863
Adj Flow Rate, veh/h	204	54	306	11	22	19	1022	946	16	65	634	34
Adj No. of Lanes	2	1	2	1	1	1	2	2	1	2	2	1
Peak Hour Factor	0.93	0.93	0.93	0.93	0.93	0.93	0.93	0.93	0.93	0.93	0.93	0.93
Percent Heavy Veh, %	2	2	2	16	16	16	2	2	2	2	2	2
Cap, veh/h	378	205	1200	57	60	51	1105	2057	919	124	1048	462
Arrive On Green	0.11	0.11	0.11	0.04	0.04	0.04	0.32	0.58	0.58	0.04	0.30	0.30
Sat Flow, veh/h	3442	1863	2774	1560	1638	1383	3442	3539	1581	3442	3539	1558
Grp Volume(v), veh/h	204	54	306	11	22	19	1022	946	16	65	634	34
Grp Sat Flow(s),veh/h/ln	1721	1863	1387	1560	1638	1383	1721	1770	1581	1721	1770	1558
Q Serve(g_s), s	4.9	2.3	6.2	0.6	1.2	1.2	25.3	13.5	0.4	1.6	13.5	1.4
Cycle Q Clear(g_c), s	4.9	2.3	6.2	0.6	1.2	1.2	25.3	13.5	0.4	1.6	13.5	1.4
Prop In Lane	1.00		1.00	1.00		1.00	1.00		1.00	1.00		1.00
Lane Grp Cap(c), veh/h	378	205	1200	57	60	51	1105	2057	919	124	1048	462
V/C Ratio(X)	0.54	0.26	0.26	0.19	0.37	0.37	0.92	0.46	0.02	0.52	0.60	0.07
Avail Cap(c_a), veh/h	1367	740	1997	549	576	486	1367	2057	919	781	2409	1061
HCM Platoon Ratio	1.00	1.00	1.00	1.00	1.00	1.00	1.00	1.00	1.00	1.00	1.00	1.00
Upstream Filter(I)	1.00	1.00	1.00	1.00	1.00	1.00	1.00	1.00	1.00	1.00	1.00	1.00
Uniform Delay (d), s/veh	37.1	36.0	16.0	41.2	41.5	41.5	28.9	10.5	7.8	41.7	26.6	22.3
Incr Delay (d2), s/veh	0.4	0.3	0.0	0.6	1.4	1.7	8.5	0.4	0.0	1.3	1.6	0.2
Initial Q Delay(d3),s/veh	0.0	0.0	0.0	0.0	0.0	0.0	0.0	0.0	0.0	0.0	0.0	0.0
%ile BackOfQ(50%),veh/ln	2.4	1.2	2.4	0.3	0.5	0.5	13.2	6.7	0.2	0.8	6.8	0.6
LnGrp Delay(d),s/veh	37.6	36.2	16.1	41.8	42.8	43.2	37.4	11.0	7.8	43.0	28.1	22.5
LnGrp LOS	D	D	B	D	D	D	D	B	A	D	C	C
Approach Vol, veh/h		564			52			1984			733	
Approach Delay, s/veh		25.8			42.7			24.6			29.2	
Approach LOS		C			D			C			C	
Timer	1	2	3	4	5	6	7	8				
Assigned Phs	1	2		4	5	6		8				
Phs Duration (G+Y+Rc), s	32.4	32.3		8.2	7.3	57.4		15.2				
Change Period (Y+Rc), s	4.1	* 6.2		5.0	4.1	* 6.2		5.5				
Max Green Setting (Gmax), s	35.0	* 60		31.0	20.0	* 50		35.0				
Max Q Clear Time (g_c+Q), s	27.3	15.5		3.2	3.6	15.5		8.2				
Green Ext Time (p_c), s	1.0	10.6		0.1	0.0	15.5		1.2				
Intersection Summary												
HCM 2010 Ctrl Delay			26.1									
HCM 2010 LOS			C									
Notes												

HCM 2010 Signalized Intersection Summary Cumulative with Eastside Parkway with Project, AM
 13: Reservation Road & Blanco Road

06/11/2019

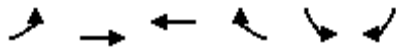

Movement	EBL	EBT	WBT	WBR	SBL	SBR		
Lane Configurations	↖↖	↑↑	↑	↑	↘↘	↘↘		
Traffic Volume (veh/h)	990	300	500	40	40	1340		
Future Volume (veh/h)	990	300	500	40	40	1340		
Number	5	2	6	16	7	14		
Initial Q (Qb), veh	0	0	0	0	0	0		
Ped-Bike Adj(A_pbT)	1.00			1.00	1.00	1.00		
Parking Bus, Adj	1.00	1.00	1.00	1.00	1.00	1.00		
Adj Sat Flow, veh/h/ln	1863	1863	1845	1845	1845	1845		
Adj Flow Rate, veh/h	1065	323	538	24	43	0		
Adj No. of Lanes	2	2	1	1	2	2		
Peak Hour Factor	0.93	0.93	0.93	0.93	0.93	0.93		
Percent Heavy Veh, %	2	2	3	3	3	3		
Cap, veh/h	1182	2811	645	548	120	97		
Arrive On Green	0.34	0.79	0.35	0.35	0.04	0.00		
Sat Flow, veh/h	3442	3632	1845	1568	3408	2760		
Grp Volume(v), veh/h	1065	323	538	24	43	0		
Grp Sat Flow(s),veh/h/ln	1721	1770	1845	1568	1704	1380		
Q Serve(g_s), s	16.0	1.1	14.6	0.6	0.7	0.0		
Cycle Q Clear(g_c), s	16.0	1.1	14.6	0.6	0.7	0.0		
Prop In Lane	1.00			1.00	1.00	1.00		
Lane Grp Cap(c), veh/h	1182	2811	645	548	120	97		
V/C Ratio(X)	0.90	0.11	0.83	0.04	0.36	0.00		
Avail Cap(c_a), veh/h	2527	3899	2032	1727	1689	1368		
HCM Platoon Ratio	1.00	1.00	1.00	1.00	1.00	1.00		
Upstream Filter(I)	1.00	1.00	1.00	1.00	1.00	0.00		
Uniform Delay (d), s/veh	17.0	1.3	16.3	11.7	25.7	0.0		
Incr Delay (d2), s/veh	1.1	0.0	2.2	0.0	0.7	0.0		
Initial Q Delay(d3),s/veh	0.0	0.0	0.0	0.0	0.0	0.0		
%ile BackOfQ(50%),veh/ln	7.7	0.5	7.7	0.2	0.3	0.0		
LnGrp Delay(d),s/veh	18.1	1.3	18.4	11.7	26.4	0.0		
LnGrp LOS	B	A	B	B	C			
Approach Vol, veh/h		1388	562		43			
Approach Delay, s/veh		14.2	18.1		26.4			
Approach LOS		B	B		C			
Timer	1	2	3	4	5	6	7	8
Assigned Phs		2		4	5	6		
Phs Duration (G+Y+Rc), s		49.1		5.4	24.2	24.9		
Change Period (Y+Rc), s		5.8		3.5	5.5	5.8		
Max Green Setting (Gmax), s		60.0		27.0	40.0	60.0		
Max Q Clear Time (g_c+I1), s		3.1		2.7	18.0	16.6		
Green Ext Time (p_c), s		1.5		0.0	0.7	2.5		
Intersection Summary								
HCM 2010 Ctrl Delay			15.6					
HCM 2010 LOS			B					

HCM 2010 Signalized Intersection Summary Cumulative with Eastside Parkway with Project, AM
 14: Reservation Road & Inter-Garrison Road

06/11/2019



Movement	EBL	EBR	NBL	NBT	SBT	SBR		
Lane Configurations								
Traffic Volume (veh/h)	110	610	900	460	260	160		
Future Volume (veh/h)	110	610	900	460	260	160		
Number	3	18	1	6	2	12		
Initial Q (Qb), veh	0	0	0	0	0	0		
Ped-Bike Adj(A_pbT)	1.00	1.00	1.00			1.00		
Parking Bus, Adj	1.00	1.00	1.00	1.00	1.00	1.00		
Adj Sat Flow, veh/h/ln	1845	1845	1863	1863	1845	1900		
Adj Flow Rate, veh/h	117	610	957	489	277	154		
Adj No. of Lanes	1	1	1	2	2	0		
Peak Hour Factor	0.94	0.94	0.94	0.94	0.94	0.94		
Percent Heavy Veh, %	3	3	2	2	3	3		
Cap, veh/h	550	913	478	1912	456	247		
Arrive On Green	0.31	0.31	0.27	0.54	0.21	0.21		
Sat Flow, veh/h	1757	1568	1774	3632	2291	1188		
Grp Volume(v), veh/h	117	610	957	489	219	212		
Grp Sat Flow(s),veh/h/ln	1757	1568	1774	1770	1752	1635		
Q Serve(g_s), s	3.6	19.7	20.0	5.5	8.4	8.8		
Cycle Q Clear(g_c), s	3.6	19.7	20.0	5.5	8.4	8.8		
Prop In Lane	1.00	1.00	1.00			0.73		
Lane Grp Cap(c), veh/h	550	913	478	1912	364	339		
V/C Ratio(X)	0.21	0.67	2.00	0.26	0.60	0.62		
Avail Cap(c_a), veh/h	639	993	478	2861	1416	1322		
HCM Platoon Ratio	1.00	1.00	1.00	1.00	1.00	1.00		
Upstream Filter(I)	1.00	1.00	1.00	1.00	1.00	1.00		
Uniform Delay (d), s/veh	18.8	10.6	27.1	9.1	26.6	26.8		
Incr Delay (d2), s/veh	0.2	1.6	458.4	0.1	3.0	3.5		
Initial Q Delay(d3),s/veh	0.0	0.0	0.0	0.0	0.0	0.0		
%ile BackOfQ(50%),veh/ln	1.8	8.9	70.6	2.7	4.4	4.3		
LnGrp Delay(d),s/veh	19.0	12.2	485.5	9.2	29.6	30.3		
LnGrp LOS	B	B	F	A	C	C		
Approach Vol, veh/h	727			1446	431			
Approach Delay, s/veh	13.2			324.4	29.9			
Approach LOS	B			F	C			
Timer	1	2	3	4	5	6	7	8
Assigned Phs	1	2				6		8
Phs Duration (G+Y+Rc), s	24.7	21.8				46.5		27.7
Change Period (Y+Rc), s	4.7	6.4				6.4		4.5
Max Green Setting (Gmax), s	26	60.0				60.0		27.0
Max Q Clear Time (g_c+Yc), s	22.6	10.8				7.5		21.7
Green Ext Time (p_c), s	0.0	4.6				5.8		1.5
Intersection Summary								
HCM 2010 Ctrl Delay			188.8					
HCM 2010 LOS			F					
Notes								

HCM 2010 Signalized Intersection Summary Cumulative with Eastside Parkway with Project, AM
 15: 2nd Avenue & 9th Street

06/11/2019



Movement	EBL	EBT	EBR	WBL	WBT	WBR	NBL	NBT	NBR	SBL	SBT	SBR
Lane Configurations		↕	↗		↕		↖	↕		↖	↕	
Traffic Volume (veh/h)	10	10	10	260	10	20	20	400	30	40	880	10
Future Volume (veh/h)	10	10	10	260	10	20	20	400	30	40	880	10
Number	5	2	12	1	6	16	3	8	18	7	4	14
Initial Q (Qb), veh	0	0	0	0	0	0	0	0	0	0	0	0
Ped-Bike Adj(A_pbT)	0.99		1.00	0.99		0.99	1.00		0.99	1.00		0.99
Parking Bus, Adj	1.00	1.00	1.00	1.00	1.00	1.00	1.00	1.00	1.00	1.00	1.00	1.00
Adj Sat Flow, veh/h/ln	1900	1881	1881	1900	1900	1900	1881	1881	1900	1863	1863	1900
Adj Flow Rate, veh/h	11	11	-24	277	11	20	21	426	27	43	936	4
Adj No. of Lanes	0	1	1	0	1	0	1	2	0	1	2	0
Peak Hour Factor	0.94	0.94	0.94	0.94	0.94	0.94	0.94	0.94	0.94	0.94	0.94	0.94
Percent Heavy Veh, %	1	1	1	0	0	0	1	1	1	2	2	2
Cap, veh/h	322	286	453	520	15	27	46	1303	82	81	1453	6
Arrive On Green	0.28	0.28	0.00	0.28	0.28	0.28	0.03	0.38	0.38	0.05	0.40	0.40
Sat Flow, veh/h	728	1009	1599	1318	52	95	1792	3413	216	1774	3614	15
Grp Volume(v), veh/h	22	0	-24	308	0	0	21	222	231	43	458	482
Grp Sat Flow(s),veh/h/ln	1737	0	1599	1466	0	0	1792	1787	1841	1774	1770	1860
Q Serve(g_s), s	0.0	0.0	0.0	8.5	0.0	0.0	0.5	4.1	4.1	1.1	9.8	9.8
Cycle Q Clear(g_c), s	0.4	0.0	0.0	8.9	0.0	0.0	0.5	4.1	4.1	1.1	9.8	9.8
Prop In Lane	0.50		1.00	0.90		0.06	1.00		0.12	1.00		0.01
Lane Grp Cap(c), veh/h	607	0	453	561	0	0	46	682	703	81	712	748
V/C Ratio(X)	0.04	0.00	-0.05	0.55	0.00	0.00	0.46	0.33	0.33	0.53	0.64	0.64
Avail Cap(c_a), veh/h	1180	0	1028	1085	0	0	441	1723	1775	437	1706	1793
HCM Platoon Ratio	1.00	1.00	1.00	1.00	1.00	1.00	1.00	1.00	1.00	1.00	1.00	1.00
Upstream Filter(I)	1.00	0.00	0.00	1.00	0.00	0.00	1.00	1.00	1.00	1.00	1.00	1.00
Uniform Delay (d), s/veh	12.1	0.0	0.0	15.1	0.0	0.0	22.4	10.2	10.2	21.8	11.3	11.3
Incr Delay (d2), s/veh	0.0	0.0	0.0	0.8	0.0	0.0	7.0	0.3	0.3	5.3	1.0	0.9
Initial Q Delay(d3),s/veh	0.0	0.0	0.0	0.0	0.0	0.0	0.0	0.0	0.0	0.0	0.0	0.0
%ile BackOfQ(50%),veh/ln	0.2	0.0	0.0	3.7	0.0	0.0	0.4	2.0	2.1	0.7	4.9	5.1
LnGrp Delay(d),s/veh	12.2	0.0	0.0	16.0	0.0	0.0	29.4	10.5	10.5	27.0	12.2	12.2
LnGrp LOS	B			B			C	B	B	C	B	B
Approach Vol, veh/h		-2			308			474			983	
Approach Delay, s/veh		-133.8			16.0			11.3			12.9	
Approach LOS		A			B			B			B	
Timer	1	2	3	4	5	6	7	8				
Assigned Phs		2	3	4		6	7	8				
Phs Duration (G+Y+Rc), s		18.2	4.7	23.8		18.2	5.6	22.8				
Change Period (Y+Rc), s		5.0	3.5	5.0		5.0	3.5	5.0				
Max Green Setting (Gmax), s		30.0	11.5	45.0		30.0	11.5	45.0				
Max Q Clear Time (g_c+I1), s		2.4	2.5	11.8		10.9	3.1	6.1				
Green Ext Time (p_c), s		0.1	0.0	6.7		1.6	0.0	2.8				
Intersection Summary												
HCM 2010 Ctrl Delay				13.2								
HCM 2010 LOS				B								

HCM 2010 Signalized Intersection Summary Cumulative with Eastside Parkway with Project, AM
 16: 2nd Avenue & 8th Street

06/11/2019



Movement	WBL	WBR	NBT	NBR	SBL	SBT		
Lane Configurations								
Traffic Volume (veh/h)	230	40	480	130	80	920		
Future Volume (veh/h)	230	40	480	130	80	920		
Number	1	16	8	18	7	4		
Initial Q (Qb), veh	0	0	0	0	0	0		
Ped-Bike Adj(A_pbT)	1.00	1.00		1.00	1.00			
Parking Bus, Adj	1.00	1.00	1.00	1.00	1.00	1.00		
Adj Sat Flow, veh/h/ln	1583	1583	1863	1900	1881	1881		
Adj Flow Rate, veh/h	242	26	505	121	84	968		
Adj No. of Lanes	1	1	2	0	1	2		
Peak Hour Factor	0.95	0.95	0.95	0.95	0.95	0.95		
Percent Heavy Veh, %	20	20	2	2	1	1		
Cap, veh/h	321	286	917	219	143	1796		
Arrive On Green	0.21	0.21	0.32	0.32	0.08	0.50		
Sat Flow, veh/h	1508	1346	2930	676	1792	3668		
Grp Volume(v), veh/h	242	26	314	312	84	968		
Grp Sat Flow(s),veh/h/ln	1508	1346	1770	1743	1792	1787		
Q Serve(g_s), s	5.3	0.5	5.1	5.2	1.6	6.5		
Cycle Q Clear(g_c), s	5.3	0.5	5.1	5.2	1.6	6.5		
Prop In Lane	1.00	1.00		0.39	1.00			
Lane Grp Cap(c), veh/h	321	286	572	563	143	1796		
V/C Ratio(X)	0.75	0.09	0.55	0.55	0.59	0.54		
Avail Cap(c_a), veh/h	1288	1150	2268	2234	587	6107		
HCM Platoon Ratio	1.00	1.00	1.00	1.00	1.00	1.00		
Upstream Filter(I)	1.00	1.00	1.00	1.00	1.00	1.00		
Uniform Delay (d), s/veh	13.0	11.1	9.8	9.8	15.6	6.0		
Incr Delay (d2), s/veh	3.6	0.1	0.8	0.9	3.8	0.3		
Initial Q Delay(d3),s/veh	0.0	0.0	0.0	0.0	0.0	0.0		
%ile BackOfQ(50%),veh/ln	2.5	0.5	2.6	2.6	0.9	3.2		
LnGrp Delay(d),s/veh	16.6	11.2	10.6	10.6	19.4	6.2		
LnGrp LOS	B	B	B	B	B	A		
Approach Vol, veh/h	268		626			1052		
Approach Delay, s/veh	16.0		10.6			7.3		
Approach LOS	B		B			A		
Timer	1	2	3	4	5	6	7	8
Assigned Phs				4		6	7	8
Phs Duration (G+Y+Rc), s				22.6		12.5	6.3	16.3
Change Period (Y+Rc), s				5.0		5.0	3.5	5.0
Max Green Setting (Gmax), s				60.0		30.0	11.5	45.0
Max Q Clear Time (g_c+11), s				8.5		7.3	3.6	7.2
Green Ext Time (p_c), s				8.5		0.8	0.1	4.2
Intersection Summary								
HCM 2010 Ctrl Delay			9.6					
HCM 2010 LOS			A					

Intersection	
Intersection Delay, s/veh	12
Intersection LOS	B

Movement	EBT	EBR	WBL	WBT	NBL	NBR
Lane Configurations	↑	↑	↑	↑	↑	↑
Traffic Vol, veh/h	130	80	270	230	40	180
Future Vol, veh/h	130	80	270	230	40	180
Peak Hour Factor	0.92	0.92	0.92	0.92	0.92	0.92
Heavy Vehicles, %	2	2	2	2	2	2
Mvmt Flow	141	87	293	250	43	196
Number of Lanes	1	1	1	1	1	1

Approach	EB	WB	NB
Opposing Approach	WB	EB	
Opposing Lanes	2	2	0
Conflicting Approach Left		NB	EB
Conflicting Lanes Left	0	2	2
Conflicting Approach Right	NB		WB
Conflicting Lanes Right	2	0	2
HCM Control Delay	9.9	13.3	11
HCM LOS	A	B	B

Lane	NBLn1	NBLn2	EBLn1	EBLn2	WBLn1	WBLn2
Vol Left, %	100%	0%	0%	0%	100%	0%
Vol Thru, %	0%	0%	100%	0%	0%	100%
Vol Right, %	0%	100%	0%	100%	0%	0%
Sign Control	Stop	Stop	Stop	Stop	Stop	Stop
Traffic Vol by Lane	40	180	130	80	270	230
LT Vol	40	0	0	0	270	0
Through Vol	0	0	130	0	0	230
RT Vol	0	180	0	80	0	0
Lane Flow Rate	43	196	141	87	293	250
Geometry Grp	7	7	7	7	7	7
Degree of Util (X)	0.084	0.312	0.234	0.127	0.494	0.385
Departure Headway (Hd)	6.953	5.74	5.965	5.255	6.056	5.551
Convergence, Y/N	Yes	Yes	Yes	Yes	Yes	Yes
Cap	516	626	603	683	596	650
Service Time	4.683	3.47	3.693	2.983	3.777	3.272
HCM Lane V/C Ratio	0.083	0.313	0.234	0.127	0.492	0.385
HCM Control Delay	10.3	11.1	10.5	8.8	14.6	11.7
HCM Lane LOS	B	B	B	A	B	B
HCM 95th-tile Q	0.3	1.3	0.9	0.4	2.7	1.8

Intersection				
Intersection Delay, s/veh	10.3			
Intersection LOS	B			
Approach	EB	WB	NB	SB
Entry Lanes	1	1	1	1
Conflicting Circle Lanes	1	1	1	1
Adj Approach Flow, veh/h	197	321	49	605
Demand Flow Rate, veh/h	203	338	49	611
Vehicles Circulating, veh/h	412	126	578	142
Vehicles Exiting, veh/h	341	501	37	322
Follow-Up Headway, s	3.186	3.186	3.186	3.186
Ped Vol Crossing Leg, #/h	0	0	0	0
Ped Cap Adj	1.000	1.000	1.000	1.000
Approach Delay, s/veh	8.1	7.4	6.5	12.8
Approach LOS	A	A	A	B
Lane	Left	Left	Left	Left
Designated Moves	LTR	LTR	LTR	LTR
Assumed Moves	LTR	LTR	LTR	LTR
RT Channelized				
Lane Util	1.000	1.000	1.000	1.000
Critical Headway, s	5.193	5.193	5.193	5.193
Entry Flow, veh/h	203	338	49	611
Cap Entry Lane, veh/h	748	996	634	980
Entry HV Adj Factor	0.971	0.951	1.000	0.990
Flow Entry, veh/h	197	321	49	605
Cap Entry, veh/h	726	947	634	971
V/C Ratio	0.271	0.339	0.077	0.623
Control Delay, s/veh	8.1	7.4	6.5	12.8
LOS	A	A	A	B
95th %tile Queue, veh	1	2	0	5

HCM 2010 Signalized Intersection Summary Cumulative with Eastside Parkway with Project, AM
 19: 2nd Avenue & Inter-Garrison Road

06/11/2019



Movement	WBL	WBR	NBT	NBR	SBL	SBT		
Lane Configurations								
Traffic Volume (veh/h)	30	30	620	60	30	1140		
Future Volume (veh/h)	30	30	620	60	30	1140		
Number	1	16	8	18	7	4		
Initial Q (Qb), veh	0	0	0	0	0	0		
Ped-Bike Adj(A_pbT)	1.00	1.00		1.00	1.00			
Parking Bus, Adj	1.00	1.00	1.00	1.00	1.00	1.00		
Adj Sat Flow, veh/h/ln	1900	1900	1881	1900	1881	1881		
Adj Flow Rate, veh/h	32	8	667	57	32	1226		
Adj No. of Lanes	1	1	2	0	1	2		
Peak Hour Factor	0.93	0.93	0.93	0.93	0.93	0.93		
Percent Heavy Veh, %	0	0	1	1	1	1		
Cap, veh/h	167	149	1573	134	69	2192		
Arrive On Green	0.09	0.09	0.47	0.47	0.04	0.61		
Sat Flow, veh/h	1810	1615	3428	285	1792	3668		
Grp Volume(v), veh/h	32	8	357	367	32	1226		
Grp Sat Flow(s),veh/h/ln	1810	1615	1787	1831	1792	1787		
Q Serve(g_s), s	0.6	0.2	4.5	4.5	0.6	6.9		
Cycle Q Clear(g_c), s	0.6	0.2	4.5	4.5	0.6	6.9		
Prop In Lane	1.00	1.00		0.16	1.00			
Lane Grp Cap(c), veh/h	167	149	843	864	69	2192		
V/C Ratio(X)	0.19	0.05	0.42	0.42	0.47	0.56		
Avail Cap(c_a), veh/h	1863	1663	2103	2155	606	5783		
HCM Platoon Ratio	1.00	1.00	1.00	1.00	1.00	1.00		
Upstream Filter(I)	1.00	1.00	1.00	1.00	1.00	1.00		
Uniform Delay (d), s/veh	14.2	14.1	5.9	5.9	16.0	3.9		
Incr Delay (d2), s/veh	0.5	0.1	0.3	0.3	4.8	0.2		
Initial Q Delay(d3),s/veh	0.0	0.0	0.0	0.0	0.0	0.0		
%ile BackOfQ(50%),veh/ln	0.3	0.1	2.3	2.3	0.4	3.3		
LnGrp Delay(d),s/veh	14.8	14.2	6.3	6.3	20.8	4.1		
LnGrp LOS	B	B	A	A	C	A		
Approach Vol, veh/h	40		724			1258		
Approach Delay, s/veh	14.7		6.3			4.5		
Approach LOS	B		A			A		
Timer	1	2	3	4	5	6	7	8
Assigned Phs				4		6	7	8
Phs Duration (G+Y+Rc), s				25.8		8.1	4.8	21.0
Change Period (Y+Rc), s				5.0		5.0	3.5	5.0
Max Green Setting (Gmax), s				55.0		35.0	11.5	40.0
Max Q Clear Time (g_c+I1), s				8.9		2.6	2.6	6.5
Green Ext Time (p_c), s				12.0		0.1	0.0	4.8
Intersection Summary								
HCM 2010 Ctrl Delay			5.3					
HCM 2010 LOS			A					

Intersection												
Intersection Delay, s/veh	10.4											
Intersection LOS	B											























Movement	EBL	EBT	EBR	WBL	WBT	WBR	NBL	NBT	NBR	SBL	SBT	SBR
Lane Configurations		↕			↕			↕			↕	
Traffic Vol, veh/h	10	20	10	70	10	30	20	180	100	30	160	10
Future Vol, veh/h	10	20	10	70	10	30	20	180	100	30	160	10
Peak Hour Factor	0.85	0.85	0.85	0.85	0.85	0.85	0.85	0.85	0.85	0.85	0.85	0.85
Heavy Vehicles, %	6	6	6	2	2	2	4	4	4	0	0	0
Mvmt Flow	12	24	12	82	12	35	24	212	118	35	188	12
Number of Lanes	0	1	0	0	1	0	0	1	0	0	1	0

Approach	EB	WB	NB	SB
Opposing Approach	WB	EB	SB	NB
Opposing Lanes	1	1	1	1
Conflicting Approach Left	SB	NB	EB	WB
Conflicting Lanes Left	1	1	1	1
Conflicting Approach Right	NB	SB	WB	EB
Conflicting Lanes Right	1	1	1	1
HCM Control Delay	9	9.6	11.2	10
HCM LOS	A	A	B	A

Lane	NBLn1	EBLn1	WBLn1	SBLn1
Vol Left, %	7%	25%	64%	15%
Vol Thru, %	60%	50%	9%	80%
Vol Right, %	33%	25%	27%	5%
Sign Control	Stop	Stop	Stop	Stop
Traffic Vol by Lane	300	40	110	200
LT Vol	20	10	70	30
Through Vol	180	20	10	160
RT Vol	100	10	30	10
Lane Flow Rate	353	47	129	235
Geometry Grp	1	1	1	1
Degree of Util (X)	0.444	0.071	0.19	0.312
Departure Headway (Hd)	4.527	5.436	5.292	4.766
Convergence, Y/N	Yes	Yes	Yes	Yes
Cap	791	651	672	748
Service Time	2.582	3.534	3.376	2.828
HCM Lane V/C Ratio	0.446	0.072	0.192	0.314
HCM Control Delay	11.2	9	9.6	10
HCM Lane LOS	B	A	A	A
HCM 95th-tile Q	2.3	0.2	0.7	1.3

HCM 2010 Signalized Intersection Summary
 21: 7th Avenue/8th Street & Inter-Garrison Road

07/12/2019

												
Movement	EBL	EBT	EBR	WBL	WBT	WBR	NBL	NBT	NBR	SBL	SBT	SBR
Lane Configurations												
Traffic Volume (veh/h)	10	90	50	340	210	30	80	160	140	120	170	10
Future Volume (veh/h)	10	90	50	340	210	30	80	160	140	120	170	10
Number	5	2	12	1	6	16	3	8	18	7	4	14
Initial Q (Qb), veh	0	0	0	0	0	0	0	0	0	0	0	0
Ped-Bike Adj(A_pbT)	1.00		0.99	1.00		0.98	1.00		1.00	1.00		1.00
Parking Bus, Adj	1.00	1.00	1.00	1.00	1.00	1.00	1.00	1.00	1.00	1.00	1.00	1.00
Adj Sat Flow, veh/h/ln	1759	1759	1900	1845	1845	1900	1597	1597	1597	1776	1776	1900
Adj Flow Rate, veh/h	12	111	53	420	259	22	99	198	140	148	210	5
Adj No. of Lanes	1	1	0	1	1	0	1	1	1	1	1	0
Peak Hour Factor	0.81	0.81	0.81	0.81	0.81	0.81	0.81	0.81	0.81	0.81	0.81	0.81
Percent Heavy Veh, %	8	8	8	3	3	3	19	19	19	7	7	7
Cap, veh/h	20	206	98	478	741	63	120	274	233	185	349	8
Arrive On Green	0.01	0.18	0.18	0.27	0.44	0.44	0.08	0.17	0.17	0.11	0.20	0.20
Sat Flow, veh/h	1675	1123	536	1757	1673	142	1521	1597	1357	1691	1727	41
Grp Volume(v), veh/h	12	0	164	420	0	281	99	198	140	148	0	215
Grp Sat Flow(s),veh/h/ln	1675	0	1659	1757	0	1815	1521	1597	1357	1691	0	1768
Q Serve(g_s), s	0.4	0.0	5.4	13.9	0.0	6.2	3.9	7.1	5.8	5.2	0.0	6.7
Cycle Q Clear(g_c), s	0.4	0.0	5.4	13.9	0.0	6.2	3.9	7.1	5.8	5.2	0.0	6.7
Prop In Lane	1.00		0.32	1.00		0.08	1.00		1.00	1.00		0.02
Lane Grp Cap(c), veh/h	20	0	304	478	0	804	120	274	233	185	0	357
V/C Ratio(X)	0.59	0.00	0.54	0.88	0.00	0.35	0.82	0.72	0.60	0.80	0.00	0.60
Avail Cap(c_a), veh/h	111	0	903	594	0	1482	188	579	493	237	0	671
HCM Platoon Ratio	1.00	1.00	1.00	1.00	1.00	1.00	1.00	1.00	1.00	1.00	1.00	1.00
Upstream Filter(I)	1.00	0.00	1.00	1.00	0.00	1.00	1.00	1.00	1.00	1.00	0.00	1.00
Uniform Delay (d), s/veh	29.8	0.0	22.4	21.1	0.0	11.1	27.5	23.7	23.2	26.4	0.0	22.0
Incr Delay (d2), s/veh	24.7	0.0	1.5	12.1	0.0	0.3	15.0	3.6	2.5	13.9	0.0	1.6
Initial Q Delay(d3),s/veh	0.0	0.0	0.0	0.0	0.0	0.0	0.0	0.0	0.0	0.0	0.0	0.0
%ile BackOfQ(50%),veh/ln	0.3	0.0	2.6	8.3	0.0	3.1	2.1	3.4	2.3	3.1	0.0	3.4
LnGrp Delay(d),s/veh	54.5	0.0	23.9	33.3	0.0	11.4	42.5	27.3	25.7	40.2	0.0	23.6
LnGrp LOS	D		C	C		B	D	C	C	D		C
Approach Vol, veh/h		176			701			437			363	
Approach Delay, s/veh		26.0			24.5			30.2			30.4	
Approach LOS		C			C			C			C	
Timer	1	2	3	4	5	6	7	8				
Assigned Phs	1	2	3	4	5	6	7	8				
Phs Duration (G+Y+Rc), s	20.0	16.1	8.3	16.2	4.2	31.8	10.1	14.4				
Change Period (Y+Rc), s	3.5	5.0	3.5	4.0	3.5	5.0	3.5	4.0				
Max Green Setting (Gmax), s	20.5	33.0	7.5	23.0	4.0	49.5	8.5	22.0				
Max Q Clear Time (g_c+I1), s	15.9	7.4	5.9	8.7	2.4	8.2	7.2	9.1				
Green Ext Time (p_c), s	0.6	0.9	0.0	0.9	0.0	1.8	0.0	1.3				
Intersection Summary												
HCM 2010 Ctrl Delay			27.4									
HCM 2010 LOS			C									

Intersection			
Intersection Delay, s/veh	65.8		
Intersection LOS	F		
Approach	EB	WB	NB
Entry Lanes	1	1	1
Conflicting Circle Lanes	1	1	1
Adj Approach Flow, veh/h	391	1207	390
Demand Flow Rate, veh/h	488	1219	402
Vehicles Circulating, veh/h	604	59	316
Vehicles Exiting, veh/h	674	659	776
Follow-Up Headway, s	3.186	3.186	3.186
Ped Vol Crossing Leg, #/h	0	0	0
Ped Cap Adj	1.000	1.000	1.000
Approach Delay, s/veh	33.4	93.9	11.2
Approach LOS	D	F	B
Lane	Left	Left	Left
Designated Moves	TR	LT	LR
Assumed Moves	TR	LT	LR
RT Channelized			
Lane Util	1.000	1.000	1.000
Critical Headway, s	5.193	5.193	5.193
Entry Flow, veh/h	488	1219	402
Cap Entry Lane, veh/h	618	1065	824
Entry HV Adj Factor	0.801	0.990	0.970
Flow Entry, veh/h	391	1207	390
Cap Entry, veh/h	495	1055	799
V/C Ratio	0.790	1.144	0.488
Control Delay, s/veh	33.4	93.9	11.2
LOS	D	F	B
95th %tile Queue, veh	7	33	3

HCM 2010 Signalized Intersection Summary Cumulative with Eastside Parkway with Project, AM
 23: Inter-Garrison Road & Abrams Drive

06/11/2019

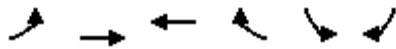

Movement	EBL	EBT	WBT	WBR	SBL	SBR		
Lane Configurations								
Traffic Volume (veh/h)	170	340	700	70	100	350		
Future Volume (veh/h)	170	340	700	70	100	350		
Number	5	2	6	16	7	14		
Initial Q (Qb), veh	0	0	0	0	0	0		
Ped-Bike Adj(A_pbT)	1.00			1.00	1.00	1.00		
Parking Bus, Adj	1.00	1.00	1.00	1.00	1.00	1.00		
Adj Sat Flow, veh/h/ln	1759	1759	1881	1881	1881	1881		
Adj Flow Rate, veh/h	200	400	824	76	118	194		
Adj No. of Lanes	1	1	1	1	2	1		
Peak Hour Factor	0.85	0.85	0.85	0.85	0.85	0.85		
Percent Heavy Veh, %	8	8	1	1	1	1		
Cap, veh/h	245	1200	881	749	536	247		
Arrive On Green	0.15	0.68	0.47	0.47	0.15	0.15		
Sat Flow, veh/h	1675	1759	1881	1599	3476	1599		
Grp Volume(v), veh/h	200	400	824	76	118	194		
Grp Sat Flow(s),veh/h/ln	1675	1759	1881	1599	1738	1599		
Q Serve(g_s), s	6.0	4.9	21.5	1.4	1.5	6.1		
Cycle Q Clear(g_c), s	6.0	4.9	21.5	1.4	1.5	6.1		
Prop In Lane	1.00			1.00	1.00	1.00		
Lane Grp Cap(c), veh/h	245	1200	881	749	536	247		
V/C Ratio(X)	0.82	0.33	0.93	0.10	0.22	0.79		
Avail Cap(c_a), veh/h	371	2033	1630	1386	2108	970		
HCM Platoon Ratio	1.00	1.00	1.00	1.00	1.00	1.00		
Upstream Filter(I)	1.00	1.00	1.00	1.00	1.00	1.00		
Uniform Delay (d), s/veh	21.5	3.4	13.0	7.7	19.2	21.1		
Incr Delay (d2), s/veh	4.7	0.1	2.4	0.0	0.1	2.1		
Initial Q Delay(d3),s/veh	0.0	0.0	0.0	0.0	0.0	0.0		
%ile BackOfQ(50%),veh/ln	3.1	2.4	11.6	0.6	0.7	5.3		
LnGrp Delay(d),s/veh	26.2	3.5	15.5	7.7	19.3	23.2		
LnGrp LOS	C	A	B	A	B	C		
Approach Vol, veh/h		600	900		312			
Approach Delay, s/veh		11.0	14.8		21.7			
Approach LOS		B	B		C			
Timer	1	2	3	4	5	6	7	8
Assigned Phs		2		4	5	6		
Phs Duration (G+Y+Rc), s		40.4		11.5	11.1	29.3		
Change Period (Y+Rc), s		5.0		3.5	3.5	5.0		
Max Green Setting (Gmax), s		60.0		31.5	11.5	45.0		
Max Q Clear Time (g_c+I1), s		6.9		8.1	8.0	23.5		
Green Ext Time (p_c), s		0.4		0.0	0.0	0.8		
Intersection Summary								
HCM 2010 Ctrl Delay			14.8					
HCM 2010 LOS			B					

HCM 2010 Signalized Intersection Summary Cumulative with Eastside Parkway with Project, AM
 24: Inter-Garrison Road & Schoonover Road

06/11/2019



Movement	EBL	EBT	EBR	WBL	WBT	WBR	NBL	NBT	NBR	SBL	SBT	SBR
Lane Configurations												
Traffic Volume (veh/h)	70	330	60	640	540	10	60	20	380	60	100	160
Future Volume (veh/h)	70	330	60	640	540	10	60	20	380	60	100	160
Number	5	2	12	1	6	16	3	8	18	7	4	14
Initial Q (Qb), veh	0	0	0	0	0	0	0	0	0	0	0	0
Ped-Bike Adj(A_pbT)	1.00		1.00	1.00		1.00	1.00		1.00	1.00		1.00
Parking Bus, Adj	1.00	1.00	1.00	1.00	1.00	1.00	1.00	1.00	1.00	1.00	1.00	1.00
Adj Sat Flow, veh/h/ln	1810	1818	1900	1863	1881	1881	1863	1863	1863	1900	1856	1845
Adj Flow Rate, veh/h	89	418	51	810	684	9	76	25	0	76	127	140
Adj No. of Lanes	1	2	0	1	2	1	1	1	1	0	1	1
Peak Hour Factor	0.79	0.79	0.79	0.79	0.79	0.79	0.79	0.79	0.79	0.79	0.79	0.79
Percent Heavy Veh, %	5	5	5	2	1	1	2	2	2	2	2	3
Cap, veh/h	112	481	58	797	1928	862	159	167	142	90	150	205
Arrive On Green	0.06	0.16	0.16	0.45	0.54	0.54	0.09	0.09	0.00	0.13	0.13	0.13
Sat Flow, veh/h	1723	3101	376	1774	3574	1599	1774	1863	1583	682	1140	1564
Grp Volume(v), veh/h	89	232	237	810	684	9	76	25	0	203	0	140
Grp Sat Flow(s),veh/h/ln	1723	1727	1751	1774	1787	1599	1774	1863	1583	1822	0	1564
Q Serve(g_s), s	5.4	13.9	14.0	47.5	11.5	0.3	4.3	1.3	0.0	11.5	0.0	9.0
Cycle Q Clear(g_c), s	5.4	13.9	14.0	47.5	11.5	0.3	4.3	1.3	0.0	11.5	0.0	9.0
Prop In Lane	1.00		0.21	1.00		1.00	1.00		1.00	0.37		1.00
Lane Grp Cap(c), veh/h	112	268	272	797	1928	862	159	167	142	239	0	205
V/C Ratio(X)	0.80	0.87	0.87	1.02	0.35	0.01	0.48	0.15	0.00	0.85	0.00	0.68
Avail Cap(c_a), veh/h	252	490	497	797	2095	937	453	475	404	465	0	399
HCM Platoon Ratio	1.00	1.00	1.00	1.00	1.00	1.00	1.00	1.00	1.00	1.00	1.00	1.00
Upstream Filter(I)	1.00	1.00	1.00	1.00	1.00	1.00	1.00	1.00	0.00	1.00	0.00	1.00
Uniform Delay (d), s/veh	48.8	43.6	43.7	29.1	13.9	11.3	45.8	44.4	0.0	44.9	0.0	43.8
Incr Delay (d2), s/veh	4.8	3.3	3.5	36.2	0.0	0.0	0.8	0.2	0.0	3.2	0.0	1.5
Initial Q Delay(d3),s/veh	0.0	0.0	0.0	0.0	0.0	0.0	0.0	0.0	0.0	0.0	0.0	0.0
%ile BackOfQ(50%),veh/ln	2.7	6.9	7.1	31.0	5.7	0.1	2.1	0.7	0.0	6.0	0.0	4.0
LnGrp Delay(d),s/veh	53.6	46.9	47.1	65.3	13.9	11.3	46.6	44.6	0.0	48.1	0.0	45.3
LnGrp LOS	D	D	D	F	B	B	D	D		D		D
Approach Vol, veh/h		558			1503			101			343	
Approach Delay, s/veh		48.1			41.6			46.1			47.0	
Approach LOS		D			D			D			D	
Timer	1	2	3	4	5	6	7	8				
Assigned Phs	1	2		4	5	6		8				
Phs Duration (G+Y+Rc), s	51.0	21.4		18.9	10.4	62.1		14.5				
Change Period (Y+Rc), s	3.5	5.0		5.0	3.5	5.0		5.0				
Max Green Setting (Gmax), s	47.5	30.0		27.0	15.5	62.0		27.0				
Max Q Clear Time (g_c+19.5), s	19.5	16.0		13.5	7.4	13.5		6.3				
Green Ext Time (p_c), s	0.0	0.4		0.2	0.0	0.9		0.0				
Intersection Summary												
HCM 2010 Ctrl Delay				44.0								
HCM 2010 LOS				D								

Intersection	
Intersection Delay, s/veh	296.6
Intersection LOS	F

Movement	EBL	EBT	WBT	WBR	SBL	SBR
Lane Configurations						
Traffic Vol, veh/h	600	130	310	130	90	820
Future Vol, veh/h	600	130	310	130	90	820
Peak Hour Factor	0.82	0.82	0.82	0.82	0.82	0.82
Heavy Vehicles, %	5	5	1	1	0	0
Mvmt Flow	732	159	378	159	110	1000
Number of Lanes	1	1	1	0	1	1

Approach	EB	WB	SB
Opposing Approach	WB	EB	
Opposing Lanes	1	2	0
Conflicting Approach Left	SB		WB
Conflicting Lanes Left	2	0	1
Conflicting Approach Right		SB	EB
Conflicting Lanes Right	0	2	2
HCM Control Delay	282	101.2	402.8
HCM LOS	F	F	F

Lane	EBLn1	EBLn2	WBLn1	SBLn1	SBLn2
Vol Left, %	100%	0%	0%	100%	0%
Vol Thru, %	0%	100%	70%	0%	0%
Vol Right, %	0%	0%	30%	0%	100%
Sign Control	Stop	Stop	Stop	Stop	Stop
Traffic Vol by Lane	600	130	440	90	820
LT Vol	600	0	0	90	0
Through Vol	0	130	310	0	0
RT Vol	0	0	130	0	820
Lane Flow Rate	732	159	537	110	1000
Geometry Grp	7	7	4	7	7
Degree of Util (X)	1.671	0.34	1.077	0.249	1.932
Departure Headway (Hd)	10.487	9.96	9.811	9.013	7.762
Convergence, Y/N	Yes	Yes	Yes	Yes	Yes
Cap	351	363	376	401	480
Service Time	8.187	7.66	7.811	6.713	5.462
HCM Lane V/C Ratio	2.085	0.438	1.428	0.274	2.083
HCM Control Delay	339.3	17.7	101.2	14.7	445.4
HCM Lane LOS	F	C	F	B	F
HCM 95th-tile Q	34.9	1.5	14.1	1	59.7

HCM 2010 Signalized Intersection Summary Cumulative with Eastside Parkway with Project, AM
 26: East Garrison Road & Reservation Road 06/11/2019



Movement	EBL	EBT	EBR	WBL	WBT	WBR	NBL	NBT	NBR	SBL	SBT	SBR
Lane Configurations	↖	↗		↖	↗		↖		↗			
Traffic Volume (veh/h)	0	730	80	150	1210	0	130	0	260	0	0	0
Future Volume (veh/h)	0	730	80	150	1210	0	130	0	260	0	0	0
Number	5	2	12	1	6	16	3	8	18			
Initial Q (Qb), veh	0	0	0	0	0	0	0	0	0			
Ped-Bike Adj(A_pbT)	1.00		1.00	1.00		1.00	1.00		1.00			
Parking Bus, Adj	1.00	1.00	1.00	1.00	1.00	1.00	1.00	1.00	1.00			
Adj Sat Flow, veh/h/ln	1827	1827	1900	1863	1863	0	1881	0	1881			
Adj Flow Rate, veh/h	0	820	88	169	1360	0	146	0	220			
Adj No. of Lanes	1	2	0	1	2	0	1	0	1			
Peak Hour Factor	0.89	0.89	0.89	0.89	0.89	0.89	0.89	0.89	0.89			
Percent Heavy Veh, %	4	4	4	2	2	0	1	0	1			
Cap, veh/h	3	1425	153	213	2259	0	309	0	275			
Arrive On Green	0.00	0.45	0.45	0.12	0.64	0.00	0.17	0.00	0.17			
Sat Flow, veh/h	1740	3163	339	1774	3632	0	1792	0	1599			
Grp Volume(v), veh/h	0	450	458	169	1360	0	146	0	220			
Grp Sat Flow(s),veh/h/ln	1740	1736	1767	1774	1770	0	1792	0	1599			
Q Serve(g_s), s	0.0	10.3	10.3	4.9	12.0	0.0	3.9	0.0	7.0			
Cycle Q Clear(g_c), s	0.0	10.3	10.3	4.9	12.0	0.0	3.9	0.0	7.0			
Prop In Lane	1.00		0.19	1.00		0.00	1.00		1.00			
Lane Grp Cap(c), veh/h	3	782	796	213	2259	0	309	0	275			
V/C Ratio(X)	0.00	0.58	0.58	0.79	0.60	0.00	0.47	0.00	0.80			
Avail Cap(c_a), veh/h	653	1953	1988	665	3982	0	907	0	810			
HCM Platoon Ratio	1.00	1.00	1.00	1.00	1.00	1.00	1.00	1.00	1.00			
Upstream Filter(I)	0.00	1.00	1.00	1.00	1.00	0.00	1.00	0.00	1.00			
Uniform Delay (d), s/veh	0.0	10.9	10.9	22.8	5.7	0.0	19.9	0.0	21.2			
Incr Delay (d2), s/veh	0.0	1.2	1.2	2.5	0.3	0.0	0.4	0.0	2.0			
Initial Q Delay(d3),s/veh	0.0	0.0	0.0	0.0	0.0	0.0	0.0	0.0	0.0			
%ile BackOfQ(50%),veh/ln	0.0	5.1	5.2	2.5	5.8	0.0	2.0	0.0	3.2			
LnGrp Delay(d),s/veh	0.0	12.1	12.1	25.3	6.0	0.0	20.3	0.0	23.2			
LnGrp LOS		B	B	C	A		C		C			
Approach Vol, veh/h		908			1529			366				
Approach Delay, s/veh		12.1			8.1			22.1				
Approach LOS		B			A			C				
Timer	1	2	3	4	5	6	7	8				
Assigned Phs	1	2			5	6		8				
Phs Duration (G+Y+Rc), s	0.0	29.4			0.0	39.4		13.9				
Change Period (Y+Rc), s	3.6	5.4			3.5	5.4		4.7				
Max Green Setting (Gmax), s	20	60.0			20.0	60.0		27.0				
Max Q Clear Time (g_c+10), s	12.3				0.0	14.0		9.0				
Green Ext Time (p_c), s	0.0	11.8			0.0	15.5		0.2				
Intersection Summary												
HCM 2010 Ctrl Delay					11.2							
HCM 2010 LOS					B							
Notes												

HCM 2010 Signalized Intersection Summary Cumulative with Eastside Parkway with Project, AM
 27: Reservation Road & Watkins Gate Road

06/11/2019



Movement	EBL	EBR	NBL	NBT	SBT	SBR		
Lane Configurations								
Traffic Volume (veh/h)	10	250	160	1600	1100	60		
Future Volume (veh/h)	10	250	160	1600	1100	60		
Number	5	12	3	8	4	14		
Initial Q (Qb), veh	0	0	0	0	0	0		
Ped-Bike Adj(A_pbT)	1.00	1.00	1.00			1.00		
Parking Bus, Adj	1.00	1.00	1.00	1.00	1.00	1.00		
Adj Sat Flow, veh/h/ln	1863	1863	1863	1863	1863	1900		
Adj Flow Rate, veh/h	11	44	174	1739	1196	58		
Adj No. of Lanes	1	1	1	2	2	0		
Peak Hour Factor	0.92	0.92	0.92	0.92	0.92	0.92		
Percent Heavy Veh, %	2	2	2	2	2	2		
Cap, veh/h	86	77	216	2651	1942	94		
Arrive On Green	0.05	0.05	0.12	0.75	0.57	0.57		
Sat Flow, veh/h	1774	1583	1774	3632	3530	167		
Grp Volume(v), veh/h	11	44	174	1739	615	639		
Grp Sat Flow(s),veh/h/ln	1774	1583	1774	1770	1770	1833		
Q Serve(g_s), s	0.4	1.7	6.1	15.6	14.9	14.9		
Cycle Q Clear(g_c), s	0.4	1.7	6.1	15.6	14.9	14.9		
Prop In Lane	1.00	1.00	1.00			0.09		
Lane Grp Cap(c), veh/h	86	77	216	2651	1000	1036		
V/C Ratio(X)	0.13	0.57	0.81	0.66	0.62	0.62		
Avail Cap(c_a), veh/h	511	456	497	3773	1281	1327		
HCM Platoon Ratio	1.00	1.00	1.00	1.00	1.00	1.00		
Upstream Filter(I)	1.00	1.00	1.00	1.00	1.00	1.00		
Uniform Delay (d), s/veh	29.3	29.9	27.5	4.0	9.3	9.3		
Incr Delay (d2), s/veh	0.2	2.5	2.7	0.4	1.0	1.0		
Initial Q Delay(d3),s/veh	0.0	0.0	0.0	0.0	0.0	0.0		
%ile BackOfQ(50%),veh/ln	0.2	0.8	3.2	7.4	7.5	7.7		
LnGrp Delay(d),s/veh	29.5	32.4	30.2	4.4	10.3	10.3		
LnGrp LOS	C	C	C	A	B	B		
Approach Vol, veh/h	55			1913	1254			
Approach Delay, s/veh	31.8			6.8	10.3			
Approach LOS	C			A	B			
Timer	1	2	3	4	5	6	7	8
Assigned Phs		2	3	4				8
Phs Duration (G+Y+Rc), s		9.6	11.8	42.8				54.6
Change Period (Y+Rc), s		6.5	4.0	6.5				6.5
Max Green Setting (Gmax), s		18.5	18.0	46.5				68.5
Max Q Clear Time (g_c+I1), s		3.7	8.1	16.9				17.6
Green Ext Time (p_c), s		0.0	0.0	13.8				30.6
Intersection Summary								
HCM 2010 Ctrl Delay			8.6					
HCM 2010 LOS			A					

HCM 2010 Signalized Intersection Summary Cumulative with Eastside Parkway with Project, AM
 28: Davis Road & Reservation Road

06/11/2019



Movement	EBL	EBT	EBR	WBL	WBT	WBR	NBL	NBT	NBR	SBL	SBT	SBR
Lane Configurations												
Traffic Volume (veh/h)	750	320	10	10	570	90	10	10	10	150	10	850
Future Volume (veh/h)	750	320	10	10	570	90	10	10	10	150	10	850
Number	5	2	12	1	6	16	3	8	18	7	4	14
Initial Q (Qb), veh	0	0	0	0	0	0	0	0	0	0	0	0
Ped-Bike Adj(A_pbT)	1.00		1.00	1.00		1.00	1.00		1.00	1.00		1.00
Parking Bus, Adj	1.00	1.00	1.00	1.00	1.00	1.00	1.00	1.00	1.00	1.00	1.00	1.00
Adj Sat Flow, veh/h/ln	1863	1863	1900	1863	1863	1900	1900	1900	1900	1900	1845	1845
Adj Flow Rate, veh/h	872	372	12	12	663	105	12	12	9	174	12	746
Adj No. of Lanes	1	2	0	1	1	0	0	1	0	0	1	1
Peak Hour Factor	0.86	0.86	0.86	0.86	0.86	0.86	0.86	0.86	0.86	0.86	0.86	0.86
Percent Heavy Veh, %	2	2	2	2	2	2	0	0	0	3	3	3
Cap, veh/h	376	2187	70	19	666	105	17	17	12	350	24	665
Arrive On Green	0.21	0.63	0.63	0.01	0.42	0.42	0.03	0.03	0.03	0.21	0.21	0.21
Sat Flow, veh/h	1774	3500	113	1774	1570	249	648	648	486	1649	114	1568
Grp Volume(v), veh/h	872	188	196	12	0	768	33	0	0	186	0	746
Grp Sat Flow(s),veh/h/ln	1774	1770	1843	1774	0	1819	1782	0	0	1762	0	1568
Q Serve(g_s), s	30.0	6.3	6.3	1.0	0.0	59.5	2.6	0.0	0.0	13.1	0.0	30.0
Cycle Q Clear(g_c), s	30.0	6.3	6.3	1.0	0.0	59.5	2.6	0.0	0.0	13.1	0.0	30.0
Prop In Lane	1.00		0.06	1.00		0.14	0.36		0.27	0.94		1.00
Lane Grp Cap(c), veh/h	376	1106	1152	19	0	772	46	0	0	374	0	665
V/C Ratio(X)	2.32	0.17	0.17	0.64	0.00	1.00	0.72	0.00	0.00	0.50	0.00	1.12
Avail Cap(c_a), veh/h	376	1106	1152	376	0	772	378	0	0	374	0	665
HCM Platoon Ratio	1.00	1.00	1.00	1.00	1.00	1.00	1.00	1.00	1.00	1.00	1.00	1.00
Upstream Filter(I)	1.00	1.00	1.00	1.00	0.00	1.00	1.00	0.00	0.00	1.00	0.00	1.00
Uniform Delay (d), s/veh	55.7	11.1	11.1	69.7	0.0	40.6	68.4	0.0	0.0	49.1	0.0	40.7
Incr Delay (d2), s/veh	601.1	0.1	0.1	12.4	0.0	31.2	7.7	0.0	0.0	0.4	0.0	73.3
Initial Q Delay(d3),s/veh	0.0	0.0	0.0	0.0	0.0	0.0	0.0	0.0	0.0	0.0	0.0	0.0
%ile BackOfQ(50%),veh/ln	17.5	3.1	3.3	0.5	0.0	36.6	1.4	0.0	0.0	6.4	0.0	39.5
LnGrp Delay(d),s/veh	656.8	11.2	11.2	82.1	0.0	71.8	76.1	0.0	0.0	49.5	0.0	114.0
LnGrp LOS	F	B	B	F		E	E			D		F
Approach Vol, veh/h		1256			780			33			932	
Approach Delay, s/veh		459.4			71.9			76.1			101.1	
Approach LOS		F			E			E			F	
Timer	1	2	3	4	5	6	7	8				
Assigned Phs	1	2		4	5	6		8				
Phs Duration (G+Y+Rc), s	5.4	93.4		35.0	33.8	65.0		7.6				
Change Period (Y+Rc), s	3.9	5.0		5.0	* 3.8	5.0		4.0				
Max Green Setting (Gmax), s	30	60.0		30.0	* 30	60.0		30.0				
Max Q Clear Time (g_c+13), s	3.0	8.3		32.0	32.0	61.5		4.6				
Green Ext Time (p_c), s	0.0	3.4		0.0	0.0	0.0		0.0				
Intersection Summary												
HCM 2010 Ctrl Delay			243.2									
HCM 2010 LOS			F									
Notes												

HCM 2010 Signalized Intersection Summary Cumulative with Eastside Parkway with Project, AM
 29: 2nd Avenue & Divarty Street

06/11/2019



Movement	EBL	EBT	EBR	WBL	WBT	WBR	NBL	NBT	NBR	SBL	SBT	SBR
Lane Configurations		↕			↕	↕	↕	↕		↕	↕	
Traffic Volume (veh/h)	80	10	40	70	20	20	130	580	130	20	900	250
Future Volume (veh/h)	80	10	40	70	20	20	130	580	130	20	900	250
Number	5	2	12	1	6	16	3	8	18	7	4	14
Initial Q (Qb), veh	0	0	0	0	0	0	0	0	0	0	0	0
Ped-Bike Adj(A_pbT)	1.00		1.00	1.00		1.00	1.00		1.00	1.00		1.00
Parking Bus, Adj	1.00	1.00	1.00	1.00	1.00	1.00	1.00	1.00	1.00	1.00	1.00	1.00
Adj Sat Flow, veh/h/ln	1900	1667	1900	1900	1900	1900	1863	1863	1900	1881	1881	1900
Adj Flow Rate, veh/h	88	11	44	77	22	22	143	637	143	22	989	275
Adj No. of Lanes	0	1	0	0	1	1	1	2	0	1	2	0
Peak Hour Factor	0.91	0.91	0.91	0.91	0.91	0.91	0.91	0.91	0.91	0.91	0.91	0.91
Percent Heavy Veh, %	14	14	14	0	0	0	2	2	2	1	1	1
Cap, veh/h	202	36	62	308	75	298	184	1603	359	46	1327	367
Arrive On Green	0.18	0.18	0.18	0.18	0.18	0.18	0.10	0.56	0.56	0.03	0.48	0.48
Sat Flow, veh/h	555	196	334	1073	407	1612	1774	2873	644	1792	2766	766
Grp Volume(v), veh/h	143	0	0	99	0	22	143	392	388	22	638	626
Grp Sat Flow(s),veh/h/ln1084	0	0	1480	0	1612	1774	1770	1748	1792	1787	1744	
Q Serve(g_s), s	4.6	0.0	0.0	0.0	0.0	0.7	4.6	7.3	7.4	0.7	16.8	17.0
Cycle Q Clear(g_c), s	7.9	0.0	0.0	3.3	0.0	0.7	4.6	7.3	7.4	0.7	16.8	17.0
Prop In Lane	0.62		0.31	0.78		1.00	1.00		0.37	1.00		0.44
Lane Grp Cap(c), veh/h	300	0	0	383	0	298	184	987	975	46	857	837
V/C Ratio(X)	0.48	0.00	0.00	0.26	0.00	0.07	0.78	0.40	0.40	0.48	0.74	0.75
Avail Cap(c_a), veh/h	839	0	0	991	0	969	350	1215	1200	354	1227	1198
HCM Platoon Ratio	1.00	1.00	1.00	1.00	1.00	1.00	1.00	1.00	1.00	1.00	1.00	1.00
Upstream Filter(I)	1.00	0.00	0.00	1.00	0.00	1.00	1.00	1.00	1.00	1.00	1.00	1.00
Uniform Delay (d), s/veh	23.0	0.0	0.0	20.6	0.0	19.6	25.4	7.3	7.3	28.0	12.3	12.3
Incr Delay (d2), s/veh	1.2	0.0	0.0	0.4	0.0	0.1	6.8	0.3	0.3	7.5	1.5	1.6
Initial Q Delay(d3),s/veh	0.0	0.0	0.0	0.0	0.0	0.0	0.0	0.0	0.0	0.0	0.0	0.0
%ile BackOfQ(50%),veh/ln2.3	0.0	0.0	1.4	0.0	0.3	2.6	3.6	3.5	0.4	8.5	8.4	
LnGrp Delay(d),s/veh	24.1	0.0	0.0	21.0	0.0	19.7	32.3	7.6	7.6	35.5	13.7	13.9
LnGrp LOS	C			C		B	C	A	A	D	B	B
Approach Vol, veh/h		143			121			923			1286	
Approach Delay, s/veh		24.1			20.8			11.4			14.2	
Approach LOS		C			C			B			B	
Timer	1	2	3	4	5	6	7	8				
Assigned Phs		2	3	4		6	7	8				
Phs Duration (G+Y+Rc), s		15.8	9.6	32.9		15.8	5.0	37.5				
Change Period (Y+Rc), s		5.0	3.5	5.0		5.0	3.5	5.0				
Max Green Setting (Gmax), s		35.0	11.5	40.0		35.0	11.5	40.0				
Max Q Clear Time (g_c+I1), s		9.9	6.6	19.0		5.3	2.7	9.4				
Green Ext Time (p_c), s		0.8	0.1	9.0		0.6	0.0	5.3				
Intersection Summary												
HCM 2010 Ctrl Delay				14.0								
HCM 2010 LOS				B								

Intersection												
Intersection Delay, s/veh	10.2											
Intersection LOS	B											

Movement	EBL	EBT	EBR	WBL	WBT	WBR	NBL	NBT	NBR	SBL	SBT	SBR
Lane Configurations		↕			↕		↕	↕		↕	↕	
Traffic Vol, veh/h	10	10	20	10	10	20	30	260	10	20	200	20
Future Vol, veh/h	10	10	20	10	10	20	30	260	10	20	200	20
Peak Hour Factor	0.91	0.91	0.91	0.91	0.91	0.91	0.91	0.91	0.91	0.91	0.91	0.91
Heavy Vehicles, %	0	0	0	1	1	1	2	2	2	1	1	1
Mvmt Flow	11	11	22	11	11	22	33	286	11	22	220	22
Number of Lanes	0	1	0	0	1	0	1	1	0	1	1	0

Approach	EB	WB	NB	SB
Opposing Approach	WB	EB	SB	NB
Opposing Lanes	1	1	2	2
Conflicting Approach Left	SB	NB	EB	WB
Conflicting Lanes Left	2	2	1	1
Conflicting Approach Right	NB	SB	WB	EB
Conflicting Lanes Right	2	2	1	1
HCM Control Delay	8.5	8.5	10.8	10.1
HCM LOS	A	A	B	B

Lane	NBLn1	NBLn2	EBLn1	WBLn1	SBLn1	SBLn2
Vol Left, %	100%	0%	25%	25%	100%	0%
Vol Thru, %	0%	96%	25%	25%	0%	91%
Vol Right, %	0%	4%	50%	50%	0%	9%
Sign Control	Stop	Stop	Stop	Stop	Stop	Stop
Traffic Vol by Lane	30	270	40	40	20	220
LT Vol	30	0	10	10	20	0
Through Vol	0	260	10	10	0	200
RT Vol	0	10	20	20	0	20
Lane Flow Rate	33	297	44	44	22	242
Geometry Grp	7	7	2	2	7	7
Degree of Util (X)	0.05	0.408	0.062	0.063	0.034	0.333
Departure Headway (Hd)	5.481	4.953	5.103	5.121	5.524	4.958
Convergence, Y/N	Yes	Yes	Yes	Yes	Yes	Yes
Cap	653	727	699	697	648	725
Service Time	3.214	2.685	3.153	3.169	3.258	2.691
HCM Lane V/C Ratio	0.051	0.409	0.063	0.063	0.034	0.334
HCM Control Delay	8.5	11.1	8.5	8.5	8.5	10.2
HCM Lane LOS	A	B	A	A	A	B
HCM 95th-tile Q	0.2	2	0.2	0.2	0.1	1.5

HCM 2010 Signalized Intersection Summary Cumulative with Eastside Parkway with Project, AM
 31: 1st Avenue & Lightfighter Drive

06/11/2019



Movement	EBL	EBT	EBR	WBL	WBT	WBR	NBL	NBT	NBR	SBL	SBT	SBR
Lane Configurations		↑↑	↑	↑	↑↑		↑		↑	↑	↑	↑
Traffic Volume (veh/h)	0	1310	130	20	1300	0	160	0	20	120	30	100
Future Volume (veh/h)	0	1310	130	20	1300	0	160	0	20	120	30	100
Number	7	4	14	3	8	18	5	2	12	1	6	16
Initial Q (Qb), veh	0	0	0	0	0	0	0	0	0	0	0	0
Ped-Bike Adj(A_pbT)	1.00		1.00	1.00		1.00	1.00		1.00	1.00		1.00
Parking Bus, Adj	1.00	1.00	1.00	1.00	1.00	1.00	1.00	1.00	1.00	1.00	1.00	1.00
Adj Sat Flow, veh/h/ln	0	1863	1863	1863	1863	0	1863	0	1863	1792	1792	1792
Adj Flow Rate, veh/h	0	1560	0	24	1548	0	190	0	10	143	36	100
Adj No. of Lanes	0	2	1	1	2	0	1	0	1	1	1	1
Peak Hour Factor	0.84	0.84	0.84	0.84	0.84	0.84	0.84	0.84	0.84	0.84	0.84	0.84
Percent Heavy Veh, %	0	2	2	2	2	0	2	0	2	6	6	6
Cap, veh/h	0	2268	1015	27	2540	0	0	0	0	207	218	185
Arrive On Green	0.00	0.64	0.00	0.02	0.72	0.00	0.00	0.00	0.00	0.12	0.12	0.12
Sat Flow, veh/h	0	3632	1583	1774	3632	0		0		1707	1792	1524
Grp Volume(v), veh/h	0	1560	0	24	1548	0		0.0		143	36	100
Grp Sat Flow(s),veh/h/ln	0	1770	1583	1774	1770	0				1707	1792	1524
Q Serve(g_s), s	0.0	16.2	0.0	0.8	12.5	0.0				4.6	1.0	3.5
Cycle Q Clear(g_c), s	0.0	16.2	0.0	0.8	12.5	0.0				4.6	1.0	3.5
Prop In Lane	0.00		1.00	1.00		0.00				1.00		1.00
Lane Grp Cap(c), veh/h	0	2268	1015	27	2540	0				207	218	185
V/C Ratio(X)	0.00	0.69	0.00	0.88	0.61	0.00				0.69	0.17	0.54
Avail Cap(c_a), veh/h	0	2787	1247	621	2787	0				747	784	666
HCM Platoon Ratio	1.00	1.00	1.00	1.00	1.00	1.00				1.00	1.00	1.00
Upstream Filter(I)	0.00	1.00	0.00	1.00	1.00	0.00				1.00	1.00	1.00
Uniform Delay (d), s/veh	0.0	6.6	0.0	28.1	4.1	0.0				24.1	22.5	23.6
Incr Delay (d2), s/veh	0.0	0.7	0.0	25.7	0.4	0.0				1.5	0.1	0.9
Initial Q Delay(d3),s/veh	0.0	0.0	0.0	0.0	0.0	0.0				0.0	0.0	0.0
%ile BackOfQ(50%),veh/lr	0.0	8.0	0.0	0.6	6.2	0.0				2.2	0.5	1.5
LnGrp Delay(d),s/veh	0.0	7.3	0.0	53.7	4.5	0.0				25.6	22.6	24.5
LnGrp LOS		A		D	A					C	C	C
Approach Vol, veh/h		1560			1572						279	
Approach Delay, s/veh		7.3			5.2						24.8	
Approach LOS		A			A						C	
Timer	1	2	3	4	5	6	7	8				
Assigned Phs			3	4		6		8				
Phs Duration (G+Y+Rc), s			4.4	41.2		11.5		45.6				
Change Period (Y+Rc), s			3.5	4.6		4.6		4.6				
Max Green Setting (Gmax), s			20.0	45.0		25.0		45.0				
Max Q Clear Time (g_c+I1), s			2.8	18.2		6.6		14.5				
Green Ext Time (p_c), s			0.0	18.5		0.4		19.0				
Intersection Summary												
HCM 2010 Ctrl Delay			7.8									
HCM 2010 LOS			A									

HCM 2010 Signalized Intersection Summary Cumulative with Eastside Parkway with Project, AM
 32: 2nd Avenue & Lightfighter Drive

06/11/2019



Movement	EBL	EBT	EBR	WBL	WBT	WBR	NBL	NBT	NBR	SBL	SBT	SBR
Lane Configurations												
Traffic Volume (veh/h)	330	1100	10	40	870	190	20	20	50	350	10	490
Future Volume (veh/h)	330	1100	10	40	870	190	20	20	50	350	10	490
Number	5	2	12	1	6	16	3	8	18	7	4	14
Initial Q (Qb), veh	0	0	0	0	0	0	0	0	0	0	0	0
Ped-Bike Adj(A_pbT)	1.00		1.00	1.00		1.00	1.00		1.00	1.00		1.00
Parking Bus, Adj	1.00	1.00	1.00	1.00	1.00	1.00	1.00	1.00	1.00	1.00	1.00	1.00
Adj Sat Flow, veh/h/ln	1863	1863	1900	1827	1827	1900	1900	1900	1900	1881	1881	1881
Adj Flow Rate, veh/h	367	1222	11	44	967	202	22	22	55	389	11	268
Adj No. of Lanes	1	2	0	1	2	0	0	1	0	1	1	1
Peak Hour Factor	0.90	0.90	0.90	0.90	0.90	0.90	0.90	0.90	0.90	0.90	0.90	0.90
Percent Heavy Veh, %	2	2	2	4	4	4	0	0	0	1	1	1
Cap, veh/h	220	1912	17	56	1258	262	123	132	264	489	572	486
Arrive On Green	0.12	0.53	0.53	0.03	0.44	0.44	0.30	0.30	0.30	0.30	0.30	0.30
Sat Flow, veh/h	1774	3594	32	1740	2861	597	261	434	869	1330	1881	1599
Grp Volume(v), veh/h	367	602	631	44	586	583	99	0	0	389	11	268
Grp Sat Flow(s),veh/h/ln	1774	1770	1857	1740	1736	1722	1564	0	0	1330	1881	1599
Q Serve(g_s), s	12.4	24.1	24.1	2.5	28.6	28.7	0.0	0.0	0.0	23.2	0.4	14.0
Cycle Q Clear(g_c), s	12.4	24.1	24.1	2.5	28.6	28.7	4.2	0.0	0.0	27.4	0.4	14.0
Prop In Lane	1.00		0.02	1.00		0.35	0.22		0.56	1.00		1.00
Lane Grp Cap(c), veh/h	220	941	988	56	763	757	520	0	0	489	572	486
V/C Ratio(X)	1.67	0.64	0.64	0.79	0.77	0.77	0.19	0.00	0.00	0.79	0.02	0.55
Avail Cap(c_a), veh/h	220	941	988	216	763	757	671	0	0	622	760	646
HCM Platoon Ratio	1.00	1.00	1.00	1.00	1.00	1.00	1.00	1.00	1.00	1.00	1.00	1.00
Upstream Filter(I)	0.43	0.43	0.43	0.09	0.09	0.09	1.00	0.00	0.00	0.56	0.56	0.56
Uniform Delay (d), s/veh	43.8	16.6	16.6	48.1	23.7	23.7	25.7	0.0	0.0	33.4	24.4	29.1
Incr Delay (d2), s/veh	309.4	1.5	1.4	0.9	0.7	0.7	0.1	0.0	0.0	2.4	0.0	0.2
Initial Q Delay(d3),s/veh	0.0	0.0	0.0	0.0	0.0	0.0	0.0	0.0	0.0	0.0	0.0	0.0
%ile BackOfQ(50%),veh/ln	25.0	12.1	12.7	1.2	13.8	13.7	2.0	0.0	0.0	10.7	0.2	6.2
LnGrp Delay(d),s/veh	353.2	18.0	18.0	49.0	24.4	24.4	25.7	0.0	0.0	35.8	24.4	29.3
LnGrp LOS	F	B	B	D	C	C	C			D	C	C
Approach Vol, veh/h		1600			1213			99			668	
Approach Delay, s/veh		94.9			25.3			25.7			33.0	
Approach LOS		F			C			C			C	
Timer	1	2	3	4	5	6	7	8				
Assigned Phs	1	2		4	5	6		8				
Phs Duration (G+Y+Rc), s	7.2	57.8		35.0	16.4	48.6		35.0				
Change Period (Y+Rc), s	4.0	4.6		4.6	4.0	4.6		4.6				
Max Green Setting (Gmax), s	2.4	34.0		40.4	12.4	24.4		40.4				
Max Q Clear Time (g_c+14), s	14.5	26.1		29.4	14.4	30.7		6.2				
Green Ext Time (p_c), s	0.0	3.3		1.0	0.0	0.0		0.4				
Intersection Summary												
HCM 2010 Ctrl Delay				57.8								
HCM 2010 LOS				E								

HCM 2010 Signalized Intersection Summary Cumulative with Eastside Parkway with Project, AM
 33: General Jim Moore Boulevard & Lightfighter Drive

06/11/2019



Movement	EBL	EBT	EBR	WBL	WBT	WBR	NBL	NBT	NBR	SBL	SBT	SBR
Lane Configurations												
Traffic Volume (veh/h)	50	280	830	20	170	70	960	60	10	40	50	20
Future Volume (veh/h)	50	280	830	20	170	70	960	60	10	40	50	20
Number	3	8	18	7	4	14	1	6	16	5	2	12
Initial Q (Qb), veh	0	0	0	0	0	0	0	0	0	0	0	0
Ped-Bike Adj(A_pbT)	1.00		1.00	1.00		1.00	1.00		1.00	1.00		1.00
Parking Bus, Adj	1.00	1.00	1.00	1.00	1.00	1.00	1.00	1.00	1.00	1.00	1.00	1.00
Adj Sat Flow, veh/h/ln	1863	1863	1863	1792	1792	1900	1881	1881	1900	1863	1863	1900
Adj Flow Rate, veh/h	56	315	0	22	191	77	1079	67	10	45	56	22
Adj No. of Lanes	1	1	1	1	1	0	2	1	0	1	2	0
Peak Hour Factor	0.89	0.89	0.89	0.89	0.89	0.89	0.89	0.89	0.89	0.89	0.89	0.89
Percent Heavy Veh, %	2	2	2	6	6	6	1	1	1	2	2	2
Cap, veh/h	78	467	397	36	277	111	735	495	74	67	343	127
Arrive On Green	0.04	0.25	0.00	0.02	0.23	0.23	0.21	0.31	0.31	0.04	0.14	0.14
Sat Flow, veh/h	1774	1863	1583	1707	1214	489	3476	1600	239	1774	2524	938
Grp Volume(v), veh/h	56	315	0	22	0	268	1079	0	77	45	38	40
Grp Sat Flow(s),veh/h/ln	1774	1863	1583	1707	0	1704	1738	0	1839	1774	1770	1692
Q Serve(g_s), s	1.5	7.2	0.0	0.6	0.0	6.8	10.0	0.0	1.4	1.2	0.9	1.0
Cycle Q Clear(g_c), s	1.5	7.2	0.0	0.6	0.0	6.8	10.0	0.0	1.4	1.2	0.9	1.0
Prop In Lane	1.00		1.00	1.00		0.29	1.00		0.13	1.00		0.55
Lane Grp Cap(c), veh/h	78	467	397	36	0	388	735	0	569	67	240	230
V/C Ratio(X)	0.72	0.67	0.00	0.61	0.00	0.69	1.47	0.00	0.14	0.67	0.16	0.17
Avail Cap(c_a), veh/h	751	1182	1005	722	0	1081	735	0	1167	563	1123	1074
HCM Platoon Ratio	1.00	1.00	1.00	1.00	1.00	1.00	1.00	1.00	1.00	1.00	1.00	1.00
Upstream Filter(I)	1.00	1.00	0.00	1.00	0.00	1.00	1.00	0.00	1.00	1.00	1.00	1.00
Uniform Delay (d), s/veh	22.3	16.0	0.0	22.9	0.0	16.7	18.6	0.0	11.8	22.5	18.0	18.1
Incr Delay (d2), s/veh	11.5	2.1	0.0	5.9	0.0	2.7	217.8	0.0	0.2	4.3	0.4	0.4
Initial Q Delay(d3),s/veh	0.0	0.0	0.0	0.0	0.0	0.0	0.0	0.0	0.0	0.0	0.0	0.0
%ile BackOfQ(50%),veh/ln	1.0	3.9	0.0	0.3	0.0	3.5	26.9	0.0	0.8	0.7	0.5	0.5
LnGrp Delay(d),s/veh	33.8	18.0	0.0	28.9	0.0	19.4	236.4	0.0	12.0	26.7	18.4	18.5
LnGrp LOS	C	B		C		B	F		B	C	B	B
Approach Vol, veh/h		371			290			1156			123	
Approach Delay, s/veh		20.4			20.1			221.5			21.5	
Approach LOS		C			C			F			C	
Timer	1	2	3	4	5	6	7	8				
Assigned Phs	1	2	3	4	5	6	7	8				
Phs Duration (G+Y+Rc), s	4.5	10.9	6.6	15.3	6.3	19.1	5.5	16.3				
Change Period (Y+Rc), s	4.5	4.5	4.5	4.5	4.5	4.5	4.5	4.5				
Max Green Setting (Gmax), s	30.0	30.0	20.0	30.0	15.0	30.0	20.0	30.0				
Max Q Clear Time (g_c+1), s	3.0	3.5	8.8	3.2	3.4	2.6	9.2					
Green Ext Time (p_c), s	0.0	0.4	0.1	2.0	0.0	0.6	0.0	2.0				
Intersection Summary												
HCM 2010 Ctrl Delay			140.2									
HCM 2010 LOS			F									

Intersection

Intersection Delay, s/veh 12.5
 Intersection LOS B

Movement	WBL	WBR	NBT	NBR	SBL	SBT
Lane Configurations						
Traffic Vol, veh/h	20	200	60	10	260	70
Future Vol, veh/h	20	200	60	10	260	70
Peak Hour Factor	0.77	0.77	0.77	0.77	0.77	0.77
Heavy Vehicles, %	4	4	3	3	2	2
Mvmt Flow	26	260	78	13	338	91
Number of Lanes	1	0	1	0	0	1

Approach	WB	NB	SB
Opposing Approach		SB	NB
Opposing Lanes	0	1	1
Conflicting Approach Left NB			WB
Conflicting Lanes Left	1	0	1
Conflicting Approach Right SB		WB	
Conflicting Lanes Right	1	1	0
HCM Control Delay	10.6	8.9	14.6
HCM LOS	B	A	B

Lane	NBLn1	WBLn1	SBLn1
Vol Left, %	0%	9%	79%
Vol Thru, %	86%	0%	21%
Vol Right, %	14%	91%	0%
Sign Control	Stop	Stop	Stop
Traffic Vol by Lane	70	220	330
LT Vol	0	20	260
Through Vol	60	0	70
RT Vol	10	200	0
Lane Flow Rate	91	286	429
Geometry Grp	1	1	1
Degree of Util (X)	0.128	0.374	0.582
Departure Headway (Hd)	5.086	4.709	4.886
Convergence, Y/N	Yes	Yes	Yes
Cap	696	760	733
Service Time	3.18	2.771	2.958
HCM Lane V/C Ratio	0.131	0.376	0.585
HCM Control Delay	8.9	10.6	14.6
HCM Lane LOS	A	B	B
HCM 95th-tile Q	0.4	1.7	3.8

Intersection						
Int Delay, s/veh	1.7					
Movement	EBT	EBR	WBL	WBT	NBL	NBR
Lane Configurations						
Traffic Vol, veh/h	240	30	20	190	30	30
Future Vol, veh/h	240	30	20	190	30	30
Conflicting Peds, #/hr	0	0	0	0	0	0
Sign Control	Free	Free	Free	Free	Stop	Stop
RT Channelized	-	None	-	None	-	None
Storage Length	-	-	-	-	0	-
Veh in Median Storage, #	0	-	-	0	0	-
Grade, %	0	-	-	0	0	-
Peak Hour Factor	78	78	78	78	78	78
Heavy Vehicles, %	5	5	4	4	0	0
Mvmt Flow	308	38	26	244	38	38

Major/Minor	Major1	Major2	Minor1		
Conflicting Flow All	0	0	346	0	623
Stage 1	-	-	-	-	327
Stage 2	-	-	-	-	296
Critical Hdwy	-	-	4.14	-	6.4
Critical Hdwy Stg 1	-	-	-	-	5.4
Critical Hdwy Stg 2	-	-	-	-	5.4
Follow-up Hdwy	-	-	2.236	-	3.5
Pot Cap-1 Maneuver	-	-	1202	-	453
Stage 1	-	-	-	-	735
Stage 2	-	-	-	-	759
Platoon blocked, %	-	-	-	-	-
Mov Cap-1 Maneuver	-	-	1202	-	442
Mov Cap-2 Maneuver	-	-	-	-	442
Stage 1	-	-	-	-	717
Stage 2	-	-	-	-	759

Approach	EB	WB	NB
HCM Control Delay, s	0	0.8	12.7
HCM LOS			B

Minor Lane/Major Mvmt	NBLn1	EBT	EBR	WBL	WBT
Capacity (veh/h)	547	-	-	1202	-
HCM Lane V/C Ratio	0.141	-	-	0.021	-
HCM Control Delay (s)	12.7	-	-	8.1	0
HCM Lane LOS	B	-	-	A	A
HCM 95th %tile Q(veh)	0.5	-	-	0.1	-

Intersection	
Intersection Delay, s/veh	12.3
Intersection LOS	B

Movement	EBL	EBT	EBR	WBL	WBT	WBR	NBL	NBT	NBR	SBL	SBT	SBR
Lane Configurations		↕			↕			↕			↕	
Traffic Vol, veh/h	10	230	30	10	120	10	50	100	20	10	80	40
Future Vol, veh/h	10	230	30	10	120	10	50	100	20	10	80	40
Peak Hour Factor	0.79	0.79	0.79	0.79	0.79	0.79	0.79	0.79	0.79	0.79	0.79	0.79
Heavy Vehicles, %	6	6	6	4	4	4	20	20	20	2	2	2
Mvmt Flow	13	291	38	13	152	13	63	127	25	13	101	51
Number of Lanes	0	1	0	0	1	0	0	1	0	0	1	0

Approach	EB	WB	NB	SB
Opposing Approach	WB	EB	SB	NB
Opposing Lanes	1	1	1	1
Conflicting Approach Left	SB	NB	EB	WB
Conflicting Lanes Left	1	1	1	1
Conflicting Approach Right	NB	SB	WB	EB
Conflicting Lanes Right	1	1	1	1
HCM Control Delay	13.9	10.8	12.3	10.6
HCM LOS	B	B	B	B

Lane	NBLn1	EBLn1	WBLn1	SBLn1
Vol Left, %	29%	4%	7%	8%
Vol Thru, %	59%	85%	86%	62%
Vol Right, %	12%	11%	7%	31%
Sign Control	Stop	Stop	Stop	Stop
Traffic Vol by Lane	170	270	140	130
LT Vol	50	10	10	10
Through Vol	100	230	120	80
RT Vol	20	30	10	40
Lane Flow Rate	215	342	177	165
Geometry Grp	1	1	1	1
Degree of Util (X)	0.356	0.509	0.277	0.257
Departure Headway (Hd)	5.958	5.363	5.626	5.614
Convergence, Y/N	Yes	Yes	Yes	Yes
Cap	603	670	636	637
Service Time	4.014	3.411	3.683	3.672
HCM Lane V/C Ratio	0.357	0.51	0.278	0.259
HCM Control Delay	12.3	13.9	10.8	10.6
HCM Lane LOS	B	B	B	B
HCM 95th-tile Q	1.6	2.9	1.1	1

Intersection												
Int Delay, s/veh	10											
Movement	EBL	EBT	EBR	WBL	WBT	WBR	NBL	NBT	NBR	SBL	SBT	SBR
Lane Configurations		↕			↕			↕			↕	
Traffic Vol, veh/h	80	80	90	10	70	20	50	120	20	0	0	0
Future Vol, veh/h	80	80	90	10	70	20	50	120	20	0	0	0
Conflicting Peds, #/hr	0	0	0	0	0	0	0	0	1	1	0	0
Sign Control	Stop	Stop	Stop	Stop	Stop	Stop	Free	Free	Free	Free	Free	Free
RT Channelized	-	-	None	-	-	None	-	-	None	-	-	None
Storage Length	-	-	-	-	-	-	-	-	-	-	-	-
Veh in Median Storage, #	-	0	-	-	0	-	-	0	-	-	0	-
Grade, %	-	0	-	-	0	-	-	0	-	-	0	-
Peak Hour Factor	82	82	82	82	82	82	82	82	82	82	82	82
Heavy Vehicles, %	12	12	12	0	0	0	10	10	10	10	10	10
Mvmt Flow	98	98	110	12	85	24	61	146	24	0	0	0

Major/Minor	Minor2		Minor1		Major1			Major2				
Conflicting Flow All	336	294	1	386	282	159	1	0	0	171	0	0
Stage 1	1	1	-	281	281	-	-	-	-	-	-	-
Stage 2	335	293	-	105	1	-	-	-	-	-	-	-
Critical Hdwy	7.22	6.62	6.32	7.1	6.5	6.2	4.2	-	-	4.2	-	-
Critical Hdwy Stg 1	6.22	5.62	-	6.1	5.5	-	-	-	-	-	-	-
Critical Hdwy Stg 2	6.22	5.62	-	6.1	5.5	-	-	-	-	-	-	-
Follow-up Hdwy	3.608	4.108	3.408	3.5	4	3.3	2.29	-	-	2.29	-	-
Pot Cap-1 Maneuver	599	601	1055	576	630	892	1571	-	-	1359	-	-
Stage 1	997	875	-	730	682	-	-	-	-	-	-	-
Stage 2	658	653	-	906	899	-	-	-	-	-	-	-
Platoon blocked, %								-	-	-	-	-
Mov Cap-1 Maneuver	503	575	1055	434	602	891	1571	-	-	1358	-	-
Mov Cap-2 Maneuver	503	575	-	434	602	-	-	-	-	-	-	-
Stage 1	954	875	-	698	652	-	-	-	-	-	-	-
Stage 2	532	624	-	721	899	-	-	-	-	-	-	-

Approach	EB		WB		NB		SB	
HCM Control Delay, s	15.3		12.3		1.9		0	
HCM LOS	C		B					

Minor Lane/Major Mvmt	NBL	NBT	NBR	EBLn1WBLn1	SBL	SBT	SBR
Capacity (veh/h)	1571	-	-	652	618	1358	-
HCM Lane V/C Ratio	0.039	-	-	0.468	0.197	-	-
HCM Control Delay (s)	7.4	0	-	15.3	12.3	0	-
HCM Lane LOS	A	A	-	C	B	A	-
HCM 95th %tile Q(veh)	0.1	-	-	2.5	0.7	0	-

Intersection						
Int Delay, s/veh	3					
Movement	EBL	EBR	NBL	NBT	SBT	SBR
Lane Configurations	T			T		T
Traffic Vol, veh/h	100	10	10	230	510	100
Future Vol, veh/h	100	10	10	230	510	100
Conflicting Peds, #/hr	0	0	0	0	0	0
Sign Control	Stop	Stop	Free	Free	Free	Free
RT Channelized	-	None	-	None	-	None
Storage Length	0	-	-	-	-	-
Veh in Median Storage, #	0	-	-	0	0	-
Grade, %	0	-	-	0	0	-
Peak Hour Factor	89	89	89	89	89	89
Heavy Vehicles, %	13	13	2	2	0	0
Mvmt Flow	112	11	11	258	573	112























Major/Minor	Minor2	Major1	Major2			
Conflicting Flow All	909	629	685	0	-	0
Stage 1	629	-	-	-	-	-
Stage 2	280	-	-	-	-	-
Critical Hdwy	6.53	6.33	4.12	-	-	-
Critical Hdwy Stg 1	5.53	-	-	-	-	-
Critical Hdwy Stg 2	5.53	-	-	-	-	-
Follow-up Hdwy	3.617	3.417	2.218	-	-	-
Pot Cap-1 Maneuver	292	463	908	-	-	-
Stage 1	511	-	-	-	-	-
Stage 2	743	-	-	-	-	-
Platoon blocked, %				-	-	-
Mov Cap-1 Maneuver	288	463	908	-	-	-
Mov Cap-2 Maneuver	288	-	-	-	-	-
Stage 1	504	-	-	-	-	-
Stage 2	743	-	-	-	-	-

Approach	EB	NB	SB
HCM Control Delay, s	25.4	0.4	0
HCM LOS	D		

Minor Lane/Major Mvmt	NBL	NBT	EBLn1	SBT	SBR
Capacity (veh/h)	908	-	298	-	-
HCM Lane V/C Ratio	0.012	-	0.415	-	-
HCM Control Delay (s)	9	0	25.4	-	-
HCM Lane LOS	A	A	D	-	-
HCM 95th %tile Q(veh)	0	-	2	-	-

HCM 2010 Signalized Intersection Summary Cumulative with Eastside Parkway with Project, AM
 39: General Jim Moore Boulevard & Gigling Road

06/11/2019

												
Movement	EBL	EBT	EBR	WBL	WBT	WBR	NBL	NBT	NBR	SBL	SBT	SBR
Lane Configurations												
Traffic Volume (veh/h)	30	100	80	460	40	630	50	340	300	430	470	50
Future Volume (veh/h)	30	100	80	460	40	630	50	340	300	430	470	50
Number	3	8	18	7	4	14	1	6	16	5	2	12
Initial Q (Qb), veh	0	0	0	0	0	0	0	0	0	0	0	0
Ped-Bike Adj(A_pbT)	1.00		1.00	1.00		1.00	1.00		1.00	1.00		1.00
Parking Bus, Adj	1.00	1.00	1.00	1.00	1.00	1.00	1.00	1.00	1.00	1.00	1.00	1.00
Adj Sat Flow, veh/h/ln	1810	1810	1900	1863	1863	1863	1881	1881	1881	1863	1863	1863
Adj Flow Rate, veh/h	34	115	60	529	46	0	57	391	0	494	540	0
Adj No. of Lanes	1	2	0	1	2	1	1	2	1	1	2	1
Peak Hour Factor	0.87	0.87	0.87	0.87	0.87	0.87	0.87	0.87	0.87	0.87	0.87	0.87
Percent Heavy Veh, %	5	5	5	2	2	2	1	1	1	2	2	2
Cap, veh/h	60	194	95	520	1223	547	86	503	225	393	1113	498
Arrive On Green	0.03	0.09	0.09	0.29	0.35	0.00	0.05	0.14	0.00	0.22	0.31	0.00
Sat Flow, veh/h	1723	2232	1098	1774	3539	1583	1792	3574	1599	1774	3539	1583
Grp Volume(v), veh/h	34	87	88	529	46	0	57	391	0	494	540	0
Grp Sat Flow(s),veh/h/ln	1723	1719	1611	1774	1770	1583	1792	1787	1599	1774	1770	1583
Q Serve(g_s), s	1.4	3.4	3.7	20.5	0.6	0.0	2.2	7.4	0.0	15.5	8.6	0.0
Cycle Q Clear(g_c), s	1.4	3.4	3.7	20.5	0.6	0.0	2.2	7.4	0.0	15.5	8.6	0.0
Prop In Lane	1.00		0.68	1.00		1.00	1.00		1.00	1.00		1.00
Lane Grp Cap(c), veh/h	60	149	140	520	1223	547	86	503	225	393	1113	498
V/C Ratio(X)	0.57	0.58	0.63	1.02	0.04	0.00	0.66	0.78	0.00	1.26	0.49	0.00
Avail Cap(c_a), veh/h	259	762	715	520	2076	929	141	1278	572	393	1772	793
HCM Platoon Ratio	1.00	1.00	1.00	1.00	1.00	1.00	1.00	1.00	1.00	1.00	1.00	1.00
Upstream Filter(I)	1.00	1.00	1.00	1.00	1.00	0.00	1.00	1.00	0.00	1.00	1.00	0.00
Uniform Delay (d), s/veh	33.2	30.7	30.8	24.7	15.2	0.0	32.7	29.0	0.0	27.2	19.4	0.0
Incr Delay (d2), s/veh	3.2	1.3	1.7	43.7	0.0	0.0	3.3	1.0	0.0	134.3	0.1	0.0
Initial Q Delay(d3),s/veh	0.0	0.0	0.0	0.0	0.0	0.0	0.0	0.0	0.0	0.0	0.0	0.0
%ile BackOfQ(50%),veh/ln	0.7	1.7	1.7	16.1	0.3	0.0	1.2	3.7	0.0	22.1	4.2	0.0
LnGrp Delay(d),s/veh	36.4	32.0	32.6	68.4	15.2	0.0	36.0	30.0	0.0	161.5	19.5	0.0
LnGrp LOS	D	C	C	F	B		D	C		F	B	
Approach Vol, veh/h		209			575			448			1034	
Approach Delay, s/veh		33.0			64.2			30.7			87.4	
Approach LOS		C			E			C			F	
Timer	1	2	3	4	5	6	7	8				
Assigned Phs	1	2	3	4	5	6	7	8				
Phs Duration (G+Y+Rc), s	7.8	26.5	6.9	28.6	20.0	14.3	25.0	10.6				
Change Period (Y+Rc), s	4.5	4.5	4.5	4.5	4.5	4.5	4.5	4.5				
Max Green Setting (Gmax), s	5.5	35.0	10.5	41.0	15.5	25.0	20.5	31.0				
Max Q Clear Time (g_c+I1), s	4.2	10.6	3.4	2.6	17.5	9.4	22.5	5.7				
Green Ext Time (p_c), s	0.0	0.7	0.0	0.1	0.0	0.5	0.0	0.2				
Intersection Summary												
HCM 2010 Ctrl Delay				65.3								
HCM 2010 LOS				E								

HCM 2010 Signalized Intersection Summary Cumulative with Eastside Parkway with Project, AM
40: Malmedy Road & Gigling Road

06/11/2019



Movement	EBL	EBT	EBR	WBL	WBT	WBR	NBL	NBT	NBR	SBL	SBT	SBR
Lane Configurations		↔↔			↔↔			↔			↔	
Traffic Volume (veh/h)	10	740	30	50	1080	20	20	30	30	20	60	20
Future Volume (veh/h)	10	740	30	50	1080	20	20	30	30	20	60	20
Number	7	4	14	3	8	18	5	2	12	1	6	16
Initial Q (Qb), veh	0	0	0	0	0	0	0	0	0	0	0	0
Ped-Bike Adj(A_pbT)	1.00		1.00	1.00		1.00	1.00		1.00	1.00		1.00
Parking Bus, Adj	1.00	1.00	1.00	1.00	1.00	1.00	1.00	1.00	1.00	1.00	1.00	1.00
Adj Sat Flow, veh/h/ln	1900	1845	1900	1900	1845	1900	1900	1863	1900	1900	1827	1900
Adj Flow Rate, veh/h	11	841	34	57	1227	23	23	34	34	23	68	23
Adj No. of Lanes	0	2	0	0	2	0	0	1	0	0	1	0
Peak Hour Factor	0.88	0.88	0.88	0.88	0.88	0.88	0.88	0.88	0.88	0.88	0.88	0.88
Percent Heavy Veh, %	3	3	3	3	3	3	2	2	2	4	4	4
Cap, veh/h	158	1572	63	195	1537	29	235	112	96	218	167	52
Arrive On Green	0.47	0.47	0.47	0.47	0.47	0.47	0.15	0.15	0.15	0.15	0.15	0.15
Sat Flow, veh/h	12	3315	133	72	3241	60	317	723	621	256	1083	338
Grp Volume(v), veh/h	463	0	423	669	0	638	91	0	0	114	0	0
Grp Sat Flow(s),veh/h/ln	1805	0	1655	1704	0	1668	1661	0	0	1677	0	0
Q Serve(g_s), s	0.0	0.0	4.4	2.4	0.0	7.9	0.0	0.0	0.0	0.3	0.0	0.0
Cycle Q Clear(g_c), s	4.3	0.0	4.4	7.8	0.0	7.9	1.1	0.0	0.0	1.4	0.0	0.0
Prop In Lane	0.02		0.08	0.09		0.04	0.25		0.37	0.20		0.20
Lane Grp Cap(c), veh/h	1008	0	785	970	0	791	443	0	0	437	0	0
V/C Ratio(X)	0.46	0.00	0.54	0.69	0.00	0.81	0.21	0.00	0.00	0.26	0.00	0.00
Avail Cap(c_a), veh/h	3766	0	3448	3514	0	3475	2192	0	0	2243	0	0
HCM Platoon Ratio	1.00	1.00	1.00	1.00	1.00	1.00	1.00	1.00	1.00	1.00	1.00	1.00
Upstream Filter(I)	1.00	0.00	1.00	1.00	0.00	1.00	1.00	0.00	0.00	1.00	0.00	0.00
Uniform Delay (d), s/veh	4.5	0.0	4.5	5.3	0.0	5.4	9.1	0.0	0.0	9.3	0.0	0.0
Incr Delay (d2), s/veh	0.1	0.0	0.2	0.3	0.0	0.8	0.1	0.0	0.0	0.1	0.0	0.0
Initial Q Delay(d3),s/veh	0.0	0.0	0.0	0.0	0.0	0.0	0.0	0.0	0.0	0.0	0.0	0.0
%ile BackOfQ(50%),veh/ln	2.1	0.0	1.9	3.6	0.0	3.7	0.5	0.0	0.0	0.7	0.0	0.0
LnGrp Delay(d),s/veh	4.6	0.0	4.7	5.6	0.0	6.2	9.2	0.0	0.0	9.4	0.0	0.0
LnGrp LOS	A		A	A		A	A			A		
Approach Vol, veh/h		886			1307			91			114	
Approach Delay, s/veh		4.7			5.9			9.2			9.4	
Approach LOS		A			A			A			A	
Timer	1	2	3	4	5	6	7	8				
Assigned Phs		2		4		6		8				
Phs Duration (G+Y+Rc), s		8.2		16.0		8.2		16.0				
Change Period (Y+Rc), s		4.5		4.5		4.5		4.5				
Max Green Setting (Gmax), s		30.5		50.5		30.5		50.5				
Max Q Clear Time (g_c+I1), s		3.1		6.4		3.4		9.9				
Green Ext Time (p_c), s		0.1		0.9		0.1		1.6				
Intersection Summary												
HCM 2010 Ctrl Delay				5.7								
HCM 2010 LOS				A								

HCM 2010 Signalized Intersection Summary Cumulative with Eastside Parkway with Project, AM
 41: Parker Flatts Cut Off Road & Gigling Road

06/11/2019



Movement	EBL	EBT	EBR	WBL	WBT	WBR	NBL	NBT	NBR	SBL	SBT	SBR
Lane Configurations		↕↕			↕↕			↕	↕		↕↕	
Traffic Volume (veh/h)	10	700	80	110	1090	10	40	10	50	10	30	10
Future Volume (veh/h)	10	700	80	110	1090	10	40	10	50	10	30	10
Number	7	4	14	3	8	18	5	2	12	1	6	16
Initial Q (Qb), veh	0	0	0	0	0	0	0	0	0	0	0	0
Ped-Bike Adj(A_pbT)	1.00		1.00	1.00		1.00	1.00		1.00	1.00		1.00
Parking Bus, Adj	1.00	1.00	1.00	1.00	1.00	1.00	1.00	1.00	1.00	1.00	1.00	1.00
Adj Sat Flow, veh/h/ln	1900	1845	1900	1900	1863	1900	1900	1863	1863	1900	1900	1900
Adj Flow Rate, veh/h	12	833	95	131	1298	12	48	12	60	12	36	12
Adj No. of Lanes	0	2	0	0	2	0	0	1	1	0	1	0
Peak Hour Factor	0.84	0.84	0.84	0.84	0.84	0.84	0.84	0.84	0.84	0.84	0.84	0.84
Percent Heavy Veh, %	3	3	3	2	2	2	2	2	2	0	0	0
Cap, veh/h	136	1685	191	246	1611	15	367	64	211	184	154	46
Arrive On Green	0.55	0.55	0.55	0.55	0.55	0.55	0.13	0.13	0.13	0.13	0.13	0.13
Sat Flow, veh/h	11	3065	346	173	2929	27	1040	478	1583	240	1153	348
Grp Volume(v), veh/h	496	0	444	698	0	743	60	0	60	60	0	0
Grp Sat Flow(s),veh/h/ln	1805	0	1617	1439	0	1690	1518	0	1583	1741	0	0
Q Serve(g_s), s	0.0	0.0	4.8	6.6	0.0	10.0	0.0	0.0	1.0	0.0	0.0	0.0
Cycle Q Clear(g_c), s	4.7	0.0	4.8	11.5	0.0	10.0	0.8	0.0	1.0	0.8	0.0	0.0
Prop In Lane	0.02		0.21	0.19		0.02	0.80		1.00	0.20		0.20
Lane Grp Cap(c), veh/h	1122	0	889	942	0	929	431	0	211	384	0	0
V/C Ratio(X)	0.44	0.00	0.50	0.74	0.00	0.80	0.14	0.00	0.28	0.16	0.00	0.00
Avail Cap(c_a), veh/h	3511	0	3159	2816	0	3301	1523	0	1421	1684	0	0
HCM Platoon Ratio	1.00	1.00	1.00	1.00	1.00	1.00	1.00	1.00	1.00	1.00	1.00	1.00
Upstream Filter(I)	1.00	0.00	1.00	1.00	0.00	1.00	1.00	0.00	1.00	1.00	0.00	0.00
Uniform Delay (d), s/veh	3.9	0.0	4.0	5.1	0.0	5.1	11.0	0.0	11.1	11.0	0.0	0.0
Incr Delay (d2), s/veh	0.1	0.0	0.2	0.4	0.0	0.6	0.1	0.0	0.3	0.1	0.0	0.0
Initial Q Delay(d3),s/veh	0.0	0.0	0.0	0.0	0.0	0.0	0.0	0.0	0.0	0.0	0.0	0.0
%ile BackOfQ(50%),veh/ln	2.4	0.0	2.1	4.6	0.0	4.7	0.4	0.0	0.4	0.4	0.0	0.0
LnGrp Delay(d),s/veh	4.0	0.0	4.1	5.5	0.0	5.7	11.1	0.0	11.4	11.1	0.0	0.0
LnGrp LOS	A		A	A		A	B		B	B		
Approach Vol, veh/h		940			1441			120			60	
Approach Delay, s/veh		4.1			5.6			11.2			11.1	
Approach LOS		A			A			B			B	
Timer	1	2	3	4	5	6	7	8				
Assigned Phs		2		4		6		8				
Phs Duration (G+Y+Rc), s		8.3		20.1		8.3		20.1				
Change Period (Y+Rc), s		4.5		4.5		4.5		4.5				
Max Green Setting (Gmax), s		25.5		55.5		25.5		55.5				
Max Q Clear Time (g_c+11), s		3.0		6.8		2.8		13.5				
Green Ext Time (p_c), s		0.0		1.0		0.0		2.1				
Intersection Summary												
HCM 2010 Ctrl Delay				5.5								
HCM 2010 LOS				A								

HCM 2010 Signalized Intersection Summary Cumulative with Eastside Parkway with Project, AM
 42: 6th Avenue & Gigling Road

06/11/2019



Movement	EBL	EBT	EBR	WBL	WBT	WBR	NBL	NBT	NBR	SBL	SBT	SBR
Lane Configurations		↔			↔			↔	↔		↔	
Traffic Volume (veh/h)	120	640	10	30	1060	10	10	10	10	10	10	150
Future Volume (veh/h)	120	640	10	30	1060	10	10	10	10	10	10	150
Number	7	4	14	3	8	18	5	2	12	1	6	16
Initial Q (Qb), veh	0	0	0	0	0	0	0	0	0	0	0	0
Ped-Bike Adj(A_pbT)	1.00		1.00	1.00		1.00	1.00		1.00	1.00		1.00
Parking Bus, Adj	1.00	1.00	1.00	1.00	1.00	1.00	1.00	1.00	1.00	1.00	1.00	1.00
Adj Sat Flow, veh/h/ln	1900	1845	1900	1900	1863	1900	1900	1429	1429	1900	1863	1900
Adj Flow Rate, veh/h	135	719	11	34	1191	11	11	11	0	11	11	169
Adj No. of Lanes	0	2	0	0	2	0	0	1	1	0	1	0
Peak Hour Factor	0.89	0.89	0.89	0.89	0.89	0.89	0.89	0.89	0.89	0.89	0.89	0.89
Percent Heavy Veh, %	3	3	3	2	2	2	33	33	33	2	2	2
Cap, veh/h	255	1192	19	154	1759	16	260	151	203	144	22	235
Arrive On Green	0.51	0.51	0.51	0.51	0.51	0.51	0.17	0.17	0.00	0.17	0.17	0.17
Sat Flow, veh/h	157	2319	37	39	3421	31	414	902	1214	54	129	1407
Grp Volume(v), veh/h	365	0	500	641	0	595	22	0	0	191	0	0
Grp Sat Flow(s),veh/h/ln	840	0	1672	1801	0	1690	1316	0	1214	1591	0	0
Q Serve(g_s), s	3.3	0.0	5.9	0.0	0.0	7.5	0.0	0.0	0.0	1.3	0.0	0.0
Cycle Q Clear(g_c), s	10.8	0.0	5.9	7.2	0.0	7.5	0.4	0.0	0.0	3.2	0.0	0.0
Prop In Lane	0.37		0.02	0.05		0.02	0.50		1.00	0.06		0.88
Lane Grp Cap(c), veh/h	607	0	860	1060	0	869	411	0	203	401	0	0
V/C Ratio(X)	0.60	0.00	0.58	0.60	0.00	0.69	0.05	0.00	0.00	0.48	0.00	0.00
Avail Cap(c_a), veh/h	1716	0	2990	3250	0	3021	1432	0	1311	1843	0	0
HCM Platoon Ratio	1.00	1.00	1.00	1.00	1.00	1.00	1.00	1.00	1.00	1.00	1.00	1.00
Upstream Filter(I)	1.00	0.00	1.00	1.00	0.00	1.00	1.00	0.00	0.00	1.00	0.00	0.00
Uniform Delay (d), s/veh	4.8	0.0	4.8	5.1	0.0	5.1	9.9	0.0	0.0	11.1	0.0	0.0
Incr Delay (d2), s/veh	0.4	0.0	0.2	0.2	0.0	0.4	0.0	0.0	0.0	0.3	0.0	0.0
Initial Q Delay(d3),s/veh	0.0	0.0	0.0	0.0	0.0	0.0	0.0	0.0	0.0	0.0	0.0	0.0
%ile BackOfQ(50%),veh/ln	1.7	0.0	2.7	3.6	0.0	3.4	0.1	0.0	0.0	1.4	0.0	0.0
LnGrp Delay(d),s/veh	5.1	0.0	5.0	5.3	0.0	5.5	10.0	0.0	0.0	11.4	0.0	0.0
LnGrp LOS	A		A	A		A	A			B		
Approach Vol, veh/h		865			1236			22			191	
Approach Delay, s/veh		5.1			5.4			10.0			11.4	
Approach LOS		A			A			A			B	
Timer	1	2	3	4	5	6	7	8				
Assigned Phs		2		4		6		8				
Phs Duration (G+Y+Rc), s		9.2		19.0		9.2		19.0				
Change Period (Y+Rc), s		4.5		4.5		4.5		4.5				
Max Green Setting (Gmax), s		30.5		50.5		30.5		50.5				
Max Q Clear Time (g_c+I1), s		2.4		12.8		5.2		9.5				
Green Ext Time (p_c), s		0.0		1.8		0.3		1.3				
Intersection Summary												
HCM 2010 Ctrl Delay				5.8								
HCM 2010 LOS				A								

HCM 2010 Signalized Intersection Summary Cumulative with Eastside Parkway with Project, AM
 43: Gigling Road & 7th Avenue

06/11/2019

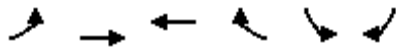

Movement	EBL	EBT	WBT	WBR	SBL	SBR		
Lane Configurations		↑↑	↑↑		↑↑			
Traffic Volume (veh/h)	160	500	1020	10	10	70		
Future Volume (veh/h)	160	500	1020	10	10	70		
Number	7	4	8	18	1	16		
Initial Q (Qb), veh	0	0	0	0	0	0		
Ped-Bike Adj(A_pbT)	1.00			1.00	1.00	1.00		
Parking Bus, Adj	1.00	1.00	1.00	1.00	1.00	1.00		
Adj Sat Flow, veh/h/ln	1900	1845	1900	1900	1759	1900		
Adj Flow Rate, veh/h	186	581	1186	12	12	81		
Adj No. of Lanes	0	2	2	0	0	0		
Peak Hour Factor	0.86	0.86	0.86	0.86	0.86	0.86		
Percent Heavy Veh, %	3	3	0	0	0	0		
Cap, veh/h	374	1126	2250	23	17	118		
Arrive On Green	0.61	0.61	0.61	0.61	0.09	0.09		
Sat Flow, veh/h	287	1916	3756	37	194	1309		
Grp Volume(v), veh/h	277	490	585	613	94	0		
Grp Sat Flow(s),veh/h/ln	525	1595	1805	1893	1519	0		
Q Serve(g_s), s	9.0	5.2	5.6	5.6	1.8	0.0		
Cycle Q Clear(g_c), s	14.6	5.2	5.6	5.6	1.8	0.0		
Prop In Lane	0.67			0.02	0.13	0.86		
Lane Grp Cap(c), veh/h	520	980	1109	1164	137	0		
V/C Ratio(X)	0.53	0.50	0.53	0.53	0.69	0.00		
Avail Cap(c_a), veh/h	1258	2905	3288	3449	1271	0		
HCM Platoon Ratio	1.00	1.00	1.00	1.00	1.00	1.00		
Upstream Filter(I)	1.00	1.00	1.00	1.00	1.00	0.00		
Uniform Delay (d), s/veh	5.4	3.3	3.3	3.3	13.4	0.0		
Incr Delay (d2), s/veh	0.3	0.1	0.1	0.1	2.3	0.0		
Initial Q Delay(d3),s/veh	0.0	0.0	0.0	0.0	0.0	0.0		
%ile BackOfQ(50%),veh/ln	2.0	2.2	2.6	2.8	0.8	0.0		
LnGrp Delay(d),s/veh	5.8	3.4	3.5	3.5	15.7	0.0		
LnGrp LOS	A	A	A	A	B			
Approach Vol, veh/h		767	1198		94			
Approach Delay, s/veh		4.3	3.5		15.7			
Approach LOS		A	A		B			
Timer	1	2	3	4	5	6	7	8
Assigned Phs				4		6		8
Phs Duration (G+Y+Rc), s				23.2		7.2		23.2
Change Period (Y+Rc), s				4.5		4.5		4.5
Max Green Setting (Gmax), s				55.5		25.5		55.5
Max Q Clear Time (g_c+I1), s				16.6		3.8		7.6
Green Ext Time (p_c), s				2.1		0.0		1.2
Intersection Summary								
HCM 2010 Ctrl Delay				4.3				
HCM 2010 LOS				A				
Notes								

HCM 2010 Signalized Intersection Summary Cumulative with Eastside Parkway with Project, AM
 44: 8th Avenue & Gigling Road

06/11/2019



Movement	EBL	EBT	EBR	WBL	WBT	WBR	NBL	NBT	NBR	SBL	SBT	SBR
Lane Configurations		↔			↔			↔			↔	
Traffic Volume (veh/h)	220	290	10	10	530	10	10	10	10	10	10	510
Future Volume (veh/h)	220	290	10	10	530	10	10	10	10	10	10	510
Number	7	4	14	3	8	18	5	2	12	1	6	16
Initial Q (Qb), veh	0	0	0	0	0	0	0	0	0	0	0	0
Ped-Bike Adj(A_pbT)	1.00		1.00	1.00		1.00	1.00		1.00	1.00		1.00
Parking Bus, Adj	1.00	1.00	1.00	1.00	1.00	1.00	1.00	1.00	1.00	1.00	1.00	1.00
Adj Sat Flow, veh/h/ln	1900	1863	1900	1900	1863	1900	1900	1900	1900	1900	1900	1900
Adj Flow Rate, veh/h	259	341	12	12	624	12	12	12	12	12	12	247
Adj No. of Lanes	0	2	0	0	2	0	0	1	0	0	1	0
Peak Hour Factor	0.85	0.85	0.85	0.85	0.85	0.85	0.85	0.85	0.85	0.85	0.85	0.85
Percent Heavy Veh, %	2	2	2	2	2	2	0	0	0	0	0	0
Cap, veh/h	531	829	29	125	1742	33	217	180	124	124	24	319
Arrive On Green	0.51	0.51	0.51	0.51	0.51	0.51	0.22	0.22	0.22	0.22	0.22	0.22
Sat Flow, veh/h	611	1640	58	18	3447	66	316	838	577	34	110	1482
Grp Volume(v), veh/h	263	0	349	340	0	308	36	0	0	271	0	0
Grp Sat Flow(s),veh/h/ln	625	0	1685	1848	0	1684	1731	0	0	1626	0	0
Q Serve(g_s), s	9.5	0.0	4.2	0.0	0.0	3.6	0.0	0.0	0.0	1.4	0.0	0.0
Cycle Q Clear(g_c), s	13.1	0.0	4.2	3.6	0.0	3.6	0.5	0.0	0.0	5.0	0.0	0.0
Prop In Lane	0.98		0.03	0.04		0.04	0.33		0.33	0.04		0.91
Lane Grp Cap(c), veh/h	538	0	851	1049	0	851	522	0	0	467	0	0
V/C Ratio(X)	0.49	0.00	0.41	0.32	0.00	0.36	0.07	0.00	0.00	0.58	0.00	0.00
Avail Cap(c_a), veh/h	1013	0	1858	2131	0	1856	2297	0	0	2402	0	0
HCM Platoon Ratio	1.00	1.00	1.00	1.00	1.00	1.00	1.00	1.00	1.00	1.00	1.00	1.00
Upstream Filter(I)	1.00	0.00	1.00	1.00	0.00	1.00	1.00	0.00	0.00	1.00	0.00	0.00
Uniform Delay (d), s/veh	8.7	0.0	5.0	4.8	0.0	4.8	10.1	0.0	0.0	11.9	0.0	0.0
Incr Delay (d2), s/veh	0.3	0.0	0.1	0.1	0.0	0.1	0.0	0.0	0.0	0.4	0.0	0.0
Initial Q Delay(d3),s/veh	0.0	0.0	0.0	0.0	0.0	0.0	0.0	0.0	0.0	0.0	0.0	0.0
%ile BackOfQ(50%),veh/ln	2.1	0.0	1.9	1.8	0.0	1.6	0.3	0.0	0.0	2.3	0.0	0.0
LnGrp Delay(d),s/veh	9.0	0.0	5.1	4.9	0.0	4.9	10.1	0.0	0.0	12.3	0.0	0.0
LnGrp LOS	A		A	A		A	B			B		
Approach Vol, veh/h		612			648			36			271	
Approach Delay, s/veh		6.8			4.9			10.1			12.3	
Approach LOS		A			A			B			B	
Timer	1	2	3	4	5	6	7	8				
Assigned Phs		2		4		6		8				
Phs Duration (G+Y+Rc), s		11.4		20.8		11.4		20.8				
Change Period (Y+Rc), s		4.5		4.5		4.5		4.5				
Max Green Setting (Gmax), s		45.5		35.5		45.5		35.5				
Max Q Clear Time (g_c+I1), s		2.5		15.1		7.0		5.6				
Green Ext Time (p_c), s		0.0		1.2		0.4		0.8				
Intersection Summary												
HCM 2010 Ctrl Delay				7.0								
HCM 2010 LOS				A								

HCM 2010 Signalized Intersection Summary Cumulative with Eastside Parkway with Project, AM
 45: Eastside Parkway & Gigling Road

06/11/2019



Movement	EBL	EBT	EBR	WBL	WBT	WBR	NBL	NBT	NBR	SBL	SBT	SBR
Lane Configurations												
Traffic Volume (veh/h)	280	10	10	10	10	10	20	180	10	10	280	520
Future Volume (veh/h)	280	10	10	10	10	10	20	180	10	10	280	520
Number	7	4	14	3	8	18	5	2	12	1	6	16
Initial Q (Qb), veh	0	0	0	0	0	0	0	0	0	0	0	0
Ped-Bike Adj(A_pbT)	1.00		1.00	1.00		1.00	1.00		1.00	1.00		1.00
Parking Bus, Adj	1.00	1.00	1.00	1.00	1.00	1.00	1.00	1.00	1.00	1.00	1.00	1.00
Adj Sat Flow, veh/h/ln	1863	1863	1900	1900	1863	1900	1863	1863	1900	1863	1863	1863
Adj Flow Rate, veh/h	304	11	11	11	11	11	22	196	11	11	304	402
Adj No. of Lanes	1	2	0	0	1	0	1	1	0	1	1	1
Peak Hour Factor	0.92	0.92	0.92	0.92	0.92	0.92	0.92	0.92	0.92	0.92	0.92	0.92
Percent Heavy Veh, %	2	2	2	2	2	2	2	2	2	2	2	2
Cap, veh/h	374	381	328	22	22	22	48	542	30	26	553	470
Arrive On Green	0.21	0.21	0.21	0.04	0.04	0.04	0.03	0.31	0.31	0.01	0.30	0.30
Sat Flow, veh/h	1774	1803	1555	577	577	577	1774	1747	98	1774	1863	1583
Grp Volume(v), veh/h	304	11	11	33	0	0	22	0	207	11	304	402
Grp Sat Flow(s),veh/h/ln	1774	1770	1588	1732	0	0	1774	0	1845	1774	1863	1583
Q Serve(g_s), s	6.1	0.2	0.2	0.7	0.0	0.0	0.5	0.0	3.3	0.2	5.2	9.0
Cycle Q Clear(g_c), s	6.1	0.2	0.2	0.7	0.0	0.0	0.5	0.0	3.3	0.2	5.2	9.0
Prop In Lane	1.00		0.98	0.33		0.33	1.00		0.05	1.00		1.00
Lane Grp Cap(c), veh/h	374	373	335	67	0	0	48	0	572	26	553	470
V/C Ratio(X)	0.81	0.03	0.03	0.49	0.00	0.00	0.45	0.00	0.36	0.43	0.55	0.85
Avail Cap(c_a), veh/h	1133	1130	1014	853	0	0	260	0	1277	260	1289	1096
HCM Platoon Ratio	1.00	1.00	1.00	1.00	1.00	1.00	1.00	1.00	1.00	1.00	1.00	1.00
Upstream Filter(I)	1.00	1.00	1.00	1.00	0.00	0.00	1.00	0.00	1.00	1.00	1.00	1.00
Uniform Delay (d), s/veh	14.1	11.8	11.8	17.7	0.0	0.0	18.0	0.0	10.1	18.4	11.1	12.4
Incr Delay (d2), s/veh	1.6	0.0	0.0	2.1	0.0	0.0	6.5	0.0	0.1	11.0	0.3	1.8
Initial Q Delay(d3),s/veh	0.0	0.0	0.0	0.0	0.0	0.0	0.0	0.0	0.0	0.0	0.0	0.0
%ile BackOfQ(50%),veh/ln	3.1	0.1	0.1	0.4	0.0	0.0	0.3	0.0	1.7	0.2	2.7	4.1
LnGrp Delay(d),s/veh	15.7	11.8	11.8	19.8	0.0	0.0	24.5	0.0	10.2	29.3	11.4	14.2
LnGrp LOS	B	B	B	B			C		B	C	B	B
Approach Vol, veh/h		326			33			229			717	
Approach Delay, s/veh		15.5			19.8			11.6			13.2	
Approach LOS		B			B			B			B	
Timer	1	2	3	4	5	6	7	8				
Assigned Phs	1	2		4	5	6		8				
Phs Duration (G+Y+Rc), s	4.5	15.6		11.9	5.0	15.2		5.5				
Change Period (Y+Rc), s	4.0	4.0		4.0	4.0	4.0		4.0				
Max Green Setting (Gmax), s	5.5	26.0		24.0	5.5	26.0		18.5				
Max Q Clear Time (g_c+1/2), s	12.2	5.3		8.1	2.5	11.0		2.7				
Green Ext Time (p_c), s	0.0	0.1		0.1	0.0	0.2		0.0				
Intersection Summary												
HCM 2010 Ctrl Delay				13.7								
HCM 2010 LOS				B								

HCM 2010 Signalized Intersection Summary Cumulative with Eastside Parkway with Project, AM
 46: General Jim Moore Boulevard & Normandy Road

06/11/2019



Movement	EBL	EBT	EBR	WBL	WBT	WBR	NBL	NBT	NBR	SBL	SBT	SBR
Lane Configurations		↕			↕		↕	↕↕		↕	↕↕	↕
Traffic Volume (veh/h)	90	110	150	380	80	40	200	420	310	80	760	250
Future Volume (veh/h)	90	110	150	380	80	40	200	420	310	80	760	250
Number	3	8	18	7	4	14	1	6	16	5	2	12
Initial Q (Qb), veh	0	0	0	0	0	0	0	0	0	0	0	0
Ped-Bike Adj(A_pbT)	0.99		0.98	0.99		0.98	1.00		0.99	1.00		0.99
Parking Bus, Adj	1.00	1.00	1.00	1.00	1.00	1.00	1.00	1.00	1.00	1.00	1.00	1.00
Adj Sat Flow, veh/h/ln	1900	1881	1900	1900	1863	1900	1881	1881	1900	1863	1863	1863
Adj Flow Rate, veh/h	115	141	163	487	103	47	256	538	370	103	974	252
Adj No. of Lanes	0	1	0	0	1	0	1	2	0	1	2	1
Peak Hour Factor	0.78	0.78	0.78	0.78	0.78	0.78	0.78	0.78	0.78	0.78	0.78	0.78
Percent Heavy Veh, %	1	1	1	2	2	2	1	1	1	2	2	2
Cap, veh/h	229	279	286	412	70	32	184	588	404	197	1061	469
Arrive On Green	0.42	0.42	0.42	0.42	0.42	0.42	0.10	0.29	0.29	0.11	0.30	0.30
Sat Flow, veh/h	400	658	674	779	165	75	1792	2017	1387	1774	3539	1565
Grp Volume(v), veh/h	419	0	0	637	0	0	256	477	431	103	974	252
Grp Sat Flow(s),veh/h/ln	1732	0	0	1019	0	0	1792	1787	1617	1774	1770	1565
Q Serve(g_s), s	0.0	0.0	0.0	18.7	0.0	0.0	8.0	20.1	20.1	4.3	20.7	10.5
Cycle Q Clear(g_c), s	14.3	0.0	0.0	33.0	0.0	0.0	8.0	20.1	20.1	4.3	20.7	10.5
Prop In Lane	0.27		0.39	0.76		0.07	1.00		0.86	1.00		1.00
Lane Grp Cap(c), veh/h	793	0	0	514	0	0	184	521	471	197	1061	469
V/C Ratio(X)	0.53	0.00	0.00	1.24	0.00	0.00	1.39	0.92	0.92	0.52	0.92	0.54
Avail Cap(c_a), veh/h	793	0	0	514	0	0	184	586	530	197	1160	513
HCM Platoon Ratio	1.00	1.00	1.00	1.00	1.00	1.00	1.00	1.00	1.00	1.00	1.00	1.00
Upstream Filter(I)	1.00	0.00	0.00	1.00	0.00	0.00	1.00	1.00	1.00	1.00	1.00	1.00
Uniform Delay (d), s/veh	17.0	0.0	0.0	26.2	0.0	0.0	34.9	26.6	26.7	32.6	26.3	22.7
Incr Delay (d2), s/veh	0.3	0.0	0.0	123.9	0.0	0.0	205.4	17.0	18.4	1.2	10.4	0.4
Initial Q Delay(d3),s/veh	0.0	0.0	0.0	0.0	0.0	0.0	0.0	0.0	0.0	0.0	0.0	0.0
%ile BackOfQ(50%),veh/ln	6.8	0.0	0.0	28.5	0.0	0.0	14.4	12.3	11.3	2.2	11.5	4.5
LnGrp Delay(d),s/veh	17.3	0.0	0.0	150.1	0.0	0.0	240.3	43.6	45.1	33.8	36.8	23.1
LnGrp LOS	B			F			F	D	D	C	D	C
Approach Vol, veh/h		419			637			1164			1329	
Approach Delay, s/veh		17.3			150.1			87.4			34.0	
Approach LOS		B			F			F			C	
Timer	1	2	3	4	5	6	7	8				
Assigned Phs	1	2		4	5	6		8				
Phs Duration (G+Y+Rc), s	2.5	27.8		37.5	13.2	27.2		37.5				
Change Period (Y+Rc), s	4.5	4.5		4.5	4.5	4.5		4.5				
Max Green Setting (Gmax), s	30.0	25.5		33.0	8.0	25.5		33.0				
Max Q Clear Time (g_c+110), s	11.0	22.7		35.0	6.3	22.1		16.3				
Green Ext Time (p_c), s	0.0	0.6		0.0	0.0	0.5		0.6				
Intersection Summary												
HCM 2010 Ctrl Delay				70.4								
HCM 2010 LOS				E								

HCM 2010 Signalized Intersection Summary Cumulative with Eastside Parkway with Project, AM
 47: General Jim Moore Boulevard & Coe Avenue 06/11/2019



Movement	EBL	EBT	EBR	WBL	WBT	WBR	NBL	NBT	NBR	SBL	SBT	SBR
Lane Configurations												
Traffic Volume (veh/h)	100	10	430	380	10	10	230	480	260	10	1060	90
Future Volume (veh/h)	100	10	430	380	10	10	230	480	260	10	1060	90
Number	3	8	18	7	4	14	1	6	16	5	2	12
Initial Q (Qb), veh	0	0	0	0	0	0	0	0	0	0	0	0
Ped-Bike Adj(A_pbT)	1.00		1.00	1.00		1.00	1.00		1.00	1.00		1.00
Parking Bus, Adj	1.00	1.00	1.00	1.00	1.00	1.00	1.00	1.00	1.00	1.00	1.00	1.00
Adj Sat Flow, veh/h/ln	1881	1863	1881	1863	1863	1863	1881	1881	1863	1863	1863	1863
Adj Flow Rate, veh/h	111	11	367	422	11	11	256	533	255	11	1178	39
Adj No. of Lanes	1	1	1	1	1	1	1	2	1	1	2	1
Peak Hour Factor	0.90	0.90	0.90	0.90	0.90	0.90	0.90	0.90	0.90	0.90	0.90	0.90
Percent Heavy Veh, %	1	2	1	2	2	2	1	1	2	2	2	2
Cap, veh/h	625	750	644	466	750	638	257	1641	727	23	1163	520
Arrive On Green	0.40	0.40	0.40	0.40	0.40	0.40	0.14	0.46	0.46	0.01	0.33	0.33
Sat Flow, veh/h	1398	1863	1598	1000	1863	1583	1792	3574	1583	1774	3539	1583
Grp Volume(v), veh/h	111	11	367	422	11	11	256	533	255	11	1178	39
Grp Sat Flow(s),veh/h/ln	1398	1863	1598	1000	1863	1583	1792	1787	1583	1774	1770	1583
Q Serve(g_s), s	5.6	0.4	19.2	43.1	0.4	0.5	15.4	10.2	11.2	0.7	35.5	1.8
Cycle Q Clear(g_c), s	6.0	0.4	19.2	43.5	0.4	0.5	15.4	10.2	11.2	0.7	35.5	1.8
Prop In Lane	1.00		1.00	1.00		1.00	1.00		1.00	1.00		1.00
Lane Grp Cap(c), veh/h	625	750	644	466	750	638	257	1641	727	23	1163	520
V/C Ratio(X)	0.18	0.01	0.57	0.91	0.01	0.02	1.00	0.32	0.35	0.48	1.01	0.07
Avail Cap(c_a), veh/h	625	750	644	466	750	638	257	1641	727	90	1163	520
HCM Platoon Ratio	1.00	1.00	1.00	1.00	1.00	1.00	1.00	1.00	1.00	1.00	1.00	1.00
Upstream Filter(I)	1.00	1.00	1.00	1.00	1.00	1.00	1.00	1.00	1.00	1.00	1.00	1.00
Uniform Delay (d), s/veh	21.2	19.4	25.0	33.6	19.4	19.4	46.2	18.6	18.8	52.9	36.3	24.9
Incr Delay (d2), s/veh	0.0	0.0	0.8	20.6	0.0	0.0	54.8	0.0	0.1	5.5	29.5	0.0
Initial Q Delay(d3),s/veh	0.0	0.0	0.0	0.0	0.0	0.0	0.0	0.0	0.0	0.0	0.0	0.0
%ile BackOfQ(50%),veh/ln	2.2	0.2	8.5	15.2	0.2	0.2	11.5	5.0	4.9	0.4	22.1	0.8
LnGrp Delay(d),s/veh	21.2	19.4	25.8	54.2	19.4	19.4	101.0	18.6	18.9	58.5	65.8	25.0
LnGrp LOS	C	B	C	D	B	B	F	B	B	E	F	C
Approach Vol, veh/h		489			444			1044			1228	
Approach Delay, s/veh		24.6			52.5			38.9			64.4	
Approach LOS		C			D			D			E	
Timer	1	2	3	4	5	6	7	8				
Assigned Phs	1	2		4	5	6		8				
Phs Duration (G+Y+Rc), s	30.0	40.0		48.0	5.9	54.1		48.0				
Change Period (Y+Rc), s	4.5	4.5		4.5	4.5	4.5		4.5				
Max Green Setting (Gmax), s	5.5	35.5		43.5	5.5	45.5		43.5				
Max Q Clear Time (g_c+I1), s	11.4	37.5		45.5	2.7	13.2		21.2				
Green Ext Time (p_c), s	0.0	0.0		0.0	0.0	0.5		0.1				
Intersection Summary												
HCM 2010 Ctrl Delay			48.4									
HCM 2010 LOS			D									

HCM 2010 Signalized Intersection Summary Cumulative with Eastside Parkway with Project, AM
 48: Fremont Boulevard/Hwy 1 SB Off-Ramp/ NB On-Ramp & Monterey Road 06/11/2019



Movement	EBL	EBT	EBR	WBL	WBT	WBR	NBL	NBT	NBR	SBL	SBT	SBR
Lane Configurations												
Traffic Volume (veh/h)	80	100	140	120	210	30	230	690	140	10	1020	70
Future Volume (veh/h)	80	100	140	120	210	30	230	690	140	10	1020	70
Number	7	4	14	3	8	18	5	2	12	1	6	16
Initial Q (Qb), veh	0	0	0	0	0	0	0	0	0	0	0	0
Ped-Bike Adj(A_pbT)	1.00		0.95	1.00		0.97	1.00		0.99	1.00		0.98
Parking Bus, Adj	1.00	1.00	1.00	1.00	1.00	1.00	1.00	1.00	1.00	1.00	1.00	1.00
Adj Sat Flow, veh/h/ln	1845	1845	1845	1900	1881	1900	1827	1827	1900	1827	1827	1827
Adj Flow Rate, veh/h	88	110	65	132	231	31	253	758	139	11	1121	10
Adj No. of Lanes	1	1	1	0	1	0	1	2	0	1	2	1
Peak Hour Factor	0.91	0.91	0.91	0.91	0.91	0.91	0.91	0.91	0.91	0.91	0.91	0.91
Percent Heavy Veh, %	3	3	3	1	1	1	4	4	4	4	4	4
Cap, veh/h	202	212	172	137	239	32	425	1452	266	18	880	388
Arrive On Green	0.11	0.11	0.11	0.22	0.22	0.22	0.24	0.50	0.50	0.01	0.25	0.25
Sat Flow, veh/h	1757	1845	1494	610	1067	143	1740	2924	536	1740	3471	1529
Grp Volume(v), veh/h	88	110	65	394	0	0	253	450	447	11	1121	10
Grp Sat Flow(s),veh/h/ln	1757	1845	1494	1820	0	0	1740	1736	1724	1740	1736	1529
Q Serve(g_s), s	5.8	7.0	5.0	26.8	0.0	0.0	16.1	22.0	22.0	0.8	31.7	0.6
Cycle Q Clear(g_c), s	5.8	7.0	5.0	26.8	0.0	0.0	16.1	22.0	22.0	0.8	31.7	0.6
Prop In Lane	1.00		1.00	0.34		0.08	1.00		0.31	1.00		1.00
Lane Grp Cap(c), veh/h	202	212	172	408	0	0	425	862	856	18	880	388
V/C Ratio(X)	0.44	0.52	0.38	0.97	0.00	0.00	0.59	0.52	0.52	0.62	1.27	0.03
Avail Cap(c_a), veh/h	436	457	371	408	0	0	425	862	856	209	880	388
HCM Platoon Ratio	1.00	1.00	1.00	1.00	1.00	1.00	1.00	1.00	1.00	1.00	1.00	1.00
Upstream Filter(I)	0.76	0.76	0.76	1.00	0.00	0.00	1.00	1.00	1.00	1.00	1.00	1.00
Uniform Delay (d), s/veh	51.6	52.1	51.2	48.0	0.0	0.0	41.8	21.4	21.4	61.6	46.7	35.0
Incr Delay (d2), s/veh	1.1	1.5	1.1	35.9	0.0	0.0	1.6	2.3	2.3	12.5	131.9	0.1
Initial Q Delay(d3),s/veh	0.0	0.0	0.0	0.0	0.0	0.0	0.0	0.0	0.0	0.0	0.0	0.0
%ile BackOfQ(50%),veh/ln	2.9	3.7	2.1	17.5	0.0	0.0	7.9	11.0	11.0	0.4	31.3	0.3
LnGrp Delay(d),s/veh	52.7	53.6	52.3	83.9	0.0	0.0	43.3	23.6	23.7	74.2	178.6	35.2
LnGrp LOS	D	D	D	F			D	C	C	E	F	D
Approach Vol, veh/h		263			394			1150			1142	
Approach Delay, s/veh		53.0			83.9			28.0			176.3	
Approach LOS		D			F			C			F	
Timer	1	2	3	4	5	6	7	8				
Assigned Phs	1	2		4	5	6		8				
Phs Duration (G+Y+Rc), s	5.5	67.4		19.0	35.9	37.0		33.1				
Change Period (Y+Rc), s	4.2	5.3		* 4.7	5.3	* 5.3		5.1				
Max Green Setting (Gmax), s	15	31.7		* 31	15.0	* 32		28.0				
Max Q Clear Time (g_c+1/2), s	12.8	24.0		9.0	18.1	33.7		28.8				
Green Ext Time (p_c), s	0.0	2.9		1.0	0.0	0.0		0.0				
Intersection Summary												
HCM 2010 Ctrl Delay			95.1									
HCM 2010 LOS			F									
Notes												

HCM 2010 Signalized Intersection Summary Cumulative with Eastside Parkway with Project, AM
 49: Highway 1 SB On-Ramp & Highway 1 NB Off-Ramp/Monterey Road 06/11/2019



Movement	EBL	EBT	EBR	WBL	WBT	WBR	NBL	NBT	NBR	SBL	SBT	SBR
Lane Configurations		↕↕	↗	↖		↗		↕	↗		↕	
Traffic Volume (veh/h)	10	200	100	240	0	370	0	50	120	10	10	0
Future Volume (veh/h)	10	200	100	240	0	370	0	50	120	10	10	0
Number	1	6	16	5	2	12	7	4	14	3	8	18
Initial Q (Qb), veh	0	0	0	0	0	0	0	0	0	0	0	0
Ped-Bike Adj(A_pbT)	1.00		1.00	1.00		1.00	1.00		1.00	1.00		1.00
Parking Bus, Adj	1.00	1.00	1.00	1.00	1.00	1.00	1.00	1.00	1.00	1.00	1.00	1.00
Adj Sat Flow, veh/h/ln	1900	1845	1845	1863	0	1863	0	1845	1845	1900	1900	0
Adj Flow Rate, veh/h	10	206	9	247	0	242	0	52	21	10	10	0
Adj No. of Lanes	0	2	1	1	0	1	0	1	1	0	1	0
Peak Hour Factor	0.97	0.97	0.97	0.97	0.97	0.97	0.97	0.97	0.97	0.97	0.97	0.97
Percent Heavy Veh, %	3	3	3	2	0	2	0	3	3	0	0	0
Cap, veh/h	136	2942	1343	0	0	0	0	122	104	74	60	0
Arrive On Green	0.86	0.86	0.86	0.00	0.00	0.00	0.00	0.07	0.07	0.07	0.07	0.00
Sat Flow, veh/h	159	3430	1566		0		0	1845	1568	466	899	0
Grp Volume(v), veh/h	116	100	9		0.0		0	52	21	20	0	0
Grp Sat Flow(s),veh/h/ln	1837	1752	1566				0	1845	1568	1365	0	0
Q Serve(g_s), s	1.2	1.1	0.1				0.0	3.4	1.6	0.0	0.0	0.0
Cycle Q Clear(g_c), s	1.2	1.1	0.1				0.0	3.4	1.6	3.4	0.0	0.0
Prop In Lane	0.09		1.00				0.00		1.00	0.50		0.00
Lane Grp Cap(c), veh/h	1575	1503	1343				0	122	104	134	0	0
V/C Ratio(X)	0.07	0.07	0.01				0.00	0.43	0.20	0.15	0.00	0.00
Avail Cap(c_a), veh/h	1575	1503	1343				0	148	125	155	0	0
HCM Platoon Ratio	1.00	1.00	1.00				1.00	1.00	1.00	1.00	1.00	1.00
Upstream Filter(I)	1.00	1.00	1.00				0.00	1.00	1.00	1.00	0.00	0.00
Uniform Delay (d), s/veh	1.4	1.3	1.3				0.0	56.1	55.2	55.1	0.0	0.0
Incr Delay (d2), s/veh	0.0	0.0	0.0				0.0	0.9	0.4	0.2	0.0	0.0
Initial Q Delay(d3),s/veh	0.0	0.0	0.0				0.0	0.0	0.0	0.0	0.0	0.0
%ile BackOfQ(50%),veh/ln	0.6	0.5	0.0				0.0	1.8	0.7	0.7	0.0	0.0
LnGrp Delay(d),s/veh	1.4	1.3	1.3				0.0	56.9	55.6	55.3	0.0	0.0
LnGrp LOS	A	A	A					E	E	E		
Approach Vol, veh/h		225						73			20	
Approach Delay, s/veh		1.4						56.5			55.3	
Approach LOS		A						E			E	
Timer	1	2	3	4	5	6	7	8				
Assigned Phs				4		6		8				
Phs Duration (G+Y+Rc), s				12.5		112.5		12.5				
Change Period (Y+Rc), s				* 4.2		5.3		* 4.2				
Max Green Setting (Gmax), s				* 10		21.0		* 10				
Max Q Clear Time (g_c+I1), s				5.4		3.2		5.4				
Green Ext Time (p_c), s				0.1		0.7		0.0				
Intersection Summary												
HCM 2010 Ctrl Delay			17.4									
HCM 2010 LOS			B									
Notes												

HCM 2010 Signalized Intersection Summary Cumulative with Eastside Parkway with Project, AM
 50: Reservation Road & SR 68 WB On Ramp/SR 68 WB Off Ramp

06/11/2019



Movement	EBL	EBT	EBR	WBL	WBT	WBR	NBL	NBT	NBR	SBL	SBT	SBR
Lane Configurations					↕	↕	↕	↕			↕	
Traffic Volume (veh/h)	0	0	0	260	10	310	120	410	0	0	360	130
Future Volume (veh/h)	0	0	0	260	10	310	120	410	0	0	360	130
Number				7	4	14	1	6	16	5	2	12
Initial Q (Qb), veh				0	0	0	0	0	0	0	0	0
Ped-Bike Adj(A_pbT)				1.00		1.00	1.00		1.00	1.00		1.00
Parking Bus, Adj				1.00	1.00	1.00	1.00	1.00	1.00	1.00	1.00	1.00
Adj Sat Flow, veh/h/ln				1900	1827	1827	1863	1863	0	0	1827	1900
Adj Flow Rate, veh/h				274	11	74	126	432	0	0	379	128
Adj No. of Lanes				0	1	1	1	1	0	0	1	0
Peak Hour Factor				0.95	0.95	0.95	0.95	0.95	0.95	0.95	0.95	0.95
Percent Heavy Veh, %				4	4	4	2	2	0	0	4	4
Cap, veh/h				386	15	357	208	1021	0	0	470	159
Arrive On Green				0.23	0.23	0.23	0.12	0.55	0.00	0.00	0.36	0.36
Sat Flow, veh/h				1676	67	1553	1774	1863	0	0	1307	442
Grp Volume(v), veh/h				285	0	74	126	432	0	0	0	507
Grp Sat Flow(s),veh/h/ln				1743	0	1553	1774	1863	0	0	0	1749
Q Serve(g_s), s				7.4	0.0	1.9	3.3	6.7	0.0	0.0	0.0	12.8
Cycle Q Clear(g_c), s				7.4	0.0	1.9	3.3	6.7	0.0	0.0	0.0	12.8
Prop In Lane				0.96		1.00	1.00		0.00	0.00		0.25
Lane Grp Cap(c), veh/h				401	0	357	208	1021	0	0	0	629
V/C Ratio(X)				0.71	0.00	0.21	0.61	0.42	0.00	0.00	0.00	0.81
Avail Cap(c_a), veh/h				1420	0	1265	939	1442	0	0	0	1354
HCM Platoon Ratio				1.00	1.00	1.00	1.00	1.00	1.00	1.00	1.00	1.00
Upstream Filter(I)				1.00	0.00	1.00	1.00	1.00	0.00	0.00	0.00	1.00
Uniform Delay (d), s/veh				17.4	0.0	15.3	20.6	6.5	0.0	0.0	0.0	14.2
Incr Delay (d2), s/veh				2.3	0.0	0.3	1.1	0.3	0.0	0.0	0.0	2.5
Initial Q Delay(d3),s/veh				0.0	0.0	0.0	0.0	0.0	0.0	0.0	0.0	0.0
%ile BackOfQ(50%),veh/ln				3.7	0.0	0.8	1.7	3.4	0.0	0.0	0.0	6.5
LnGrp Delay(d),s/veh				19.7	0.0	15.6	21.7	6.8	0.0	0.0	0.0	16.7
LnGrp LOS				B		B	C	A				B
Approach Vol, veh/h					359			558			507	
Approach Delay, s/veh					18.9			10.2			16.7	
Approach LOS					B			B			B	
Timer	1	2	3	4	5	6	7	8				
Assigned Phs	1	2		4		6						
Phs Duration (G+Y+Rc), s	9.2	23.7		16.2		32.9						
Change Period (Y+Rc), s	3.5	6.0		4.9		6.0						
Max Green Setting (Gmax), s	26.0	38.0		40.0		38.0						
Max Q Clear Time (g_c+1), s	15.3	14.8		9.4		8.7						
Green Ext Time (p_c), s	0.1	2.8		2.0		2.3						
Intersection Summary												
HCM 2010 Ctrl Delay				14.7								
HCM 2010 LOS				B								





















HCM 2010 Signalized Intersection Summary Cumulative with Eastside Parkway with Project, AM
 51: River Road/Reservation Road & SR 68 Off Ramp/SR 68 EB On Ramp 06/11/2019



Movement	EBL	EBT	EBR	WBL	WBT	WBR	NBL	NBT	NBR	SBL	SBT	SBR
Lane Configurations		↕	↗					↑	↗	↖	↑	
Traffic Volume (veh/h)	130	10	110	0	0	0	0	390	660	240	370	0
Future Volume (veh/h)	130	10	110	0	0	0	0	390	660	240	370	0
Number	3	8	18				1	6	16	5	2	12
Initial Q (Qb), veh	0	0	0				0	0	0	0	0	0
Ped-Bike Adj(A_pbT)	1.00		1.00				1.00		1.00	1.00		1.00
Parking Bus, Adj	1.00	1.00	1.00				1.00	1.00	1.00	1.00	1.00	1.00
Adj Sat Flow, veh/h/ln	1900	1881	1881				0	1881	1881	1827	1827	0
Adj Flow Rate, veh/h	141	11	19				0	424	388	261	402	0
Adj No. of Lanes	0	1	1				0	1	1	1	1	0
Peak Hour Factor	0.92	0.92	0.92				0.92	0.92	0.92	0.92	0.92	0.92
Percent Heavy Veh, %	1	1	1				0	1	1	4	4	0
Cap, veh/h	204	16	196				0	644	547	338	1138	0
Arrive On Green	0.12	0.12	0.12				0.00	0.34	0.34	0.19	0.62	0.00
Sat Flow, veh/h	1668	130	1599				0	1881	1599	1740	1827	0
Grp Volume(v), veh/h	152	0	19				0	424	388	261	402	0
Grp Sat Flow(s),veh/h/ln	1798	0	1599				0	1881	1599	1740	1827	0
Q Serve(g_s), s	3.5	0.0	0.5				0.0	8.2	9.0	6.1	4.6	0.0
Cycle Q Clear(g_c), s	3.5	0.0	0.5				0.0	8.2	9.0	6.1	4.6	0.0
Prop In Lane	0.93		1.00				0.00		1.00	1.00		0.00
Lane Grp Cap(c), veh/h	220	0	196				0	644	547	338	1138	0
V/C Ratio(X)	0.69	0.00	0.10				0.00	0.66	0.71	0.77	0.35	0.00
Avail Cap(c_a), veh/h	1680	0	1494				0	1626	1382	975	1579	0
HCM Platoon Ratio	1.00	1.00	1.00				1.00	1.00	1.00	1.00	1.00	1.00
Upstream Filter(l)	1.00	0.00	1.00				0.00	1.00	1.00	1.00	1.00	0.00
Uniform Delay (d), s/veh	18.0	0.0	16.7				0.0	12.0	12.2	16.4	3.9	0.0
Incr Delay (d2), s/veh	1.4	0.0	0.1				0.0	1.2	1.7	3.8	0.2	0.0
Initial Q Delay(d3),s/veh	0.0	0.0	0.0				0.0	0.0	0.0	0.0	0.0	0.0
%ile BackOfQ(50%),veh/ln	1.8	0.0	0.2				0.0	4.4	4.1	3.3	2.3	0.0
LnGrp Delay(d),s/veh	19.4	0.0	16.8				0.0	13.1	13.9	20.1	4.1	0.0
LnGrp LOS	B		B					B	B	C	A	
Approach Vol, veh/h		171						812			663	
Approach Delay, s/veh		19.2						13.5			10.4	
Approach LOS		B						B			B	
Timer	1	2	3	4	5	6	7	8				
Assigned Phs		2			5	6		8				
Phs Duration (G+Y+Rc), s		32.7			12.0	20.7		10.1				
Change Period (Y+Rc), s		6.0			3.7	6.0		4.9				
Max Green Setting (Gmax), s		37.0			24.0	37.0		40.0				
Max Q Clear Time (g_c+I1), s		6.6			8.1	11.0		5.5				
Green Ext Time (p_c), s		2.2			0.6	3.6		0.6				
Intersection Summary												
HCM 2010 Ctrl Delay			12.8									
HCM 2010 LOS			B									

HCM 2010 Signalized Intersection Summary Cumulative with Eastside Parkway with Project, PM
 1: Del Monte Boulevard & Reindollar Avenue

06/11/2019

												
Movement	EBL	EBT	EBR	WBL	WBT	WBR	NBL	NBT	NBR	SBL	SBT	SBR
Lane Configurations												
Traffic Volume (veh/h)	0	0	0	190	0	450	10	1310	340	400	850	0
Future Volume (veh/h)	0	0	0	190	0	450	10	1310	340	400	850	0
Number				3	8	18	1	6	16	5	2	12
Initial Q (Qb), veh				0	0	0	0	0	0	0	0	0
Ped-Bike Adj(A_pbT)				1.00		0.99	1.00		1.00	1.00		1.00
Parking Bus, Adj				1.00	1.00	1.00	1.00	1.00	1.00	1.00	1.00	1.00
Adj Sat Flow, veh/h/ln				1881	1881	1900	1881	1881	1881	1881	1881	0
Adj Flow Rate, veh/h				198	0	397	10	1365	271	417	885	0
Adj No. of Lanes				1	1	0	1	2	1	1	2	0
Peak Hour Factor				0.96	0.96	0.96	0.96	0.96	0.96	0.96	0.96	0.96
Percent Heavy Veh, %				1	1	1	1	1	1	1	1	0
Cap, veh/h				501	0	444	22	1145	512	458	2015	0
Arrive On Green				0.28	0.00	0.28	0.01	0.32	0.32	0.26	0.56	0.00
Sat Flow, veh/h				1792	0	1585	1792	3574	1599	1792	3668	0
Grp Volume(v), veh/h				198	0	397	10	1365	271	417	885	0
Grp Sat Flow(s),veh/h/ln				1792	0	1585	1792	1787	1599	1792	1787	0
Q Serve(g_s), s				8.4	0.0	22.5	0.5	30.0	13.0	21.1	13.4	0.0
Cycle Q Clear(g_c), s				8.4	0.0	22.5	0.5	30.0	13.0	21.1	13.4	0.0
Prop In Lane				1.00		1.00	1.00		1.00	1.00		0.00
Lane Grp Cap(c), veh/h				501	0	444	22	1145	512	458	2015	0
V/C Ratio(X)				0.39	0.00	0.89	0.46	1.19	0.53	0.91	0.44	0.00
Avail Cap(c_a), veh/h				574	0	508	574	1145	512	574	2015	0
HCM Platoon Ratio				1.00	1.00	1.00	1.00	1.00	1.00	1.00	1.00	1.00
Upstream Filter(l)				1.00	0.00	1.00	1.00	1.00	1.00	1.00	1.00	0.00
Uniform Delay (d), s/veh				27.3	0.0	32.4	45.9	31.8	26.0	33.8	11.8	0.0
Incr Delay (d2), s/veh				0.5	0.0	16.8	14.1	95.4	1.0	16.2	0.2	0.0
Initial Q Delay(d3),s/veh				0.0	0.0	0.0	0.0	0.0	0.0	0.0	0.0	0.0
%ile BackOfQ(50%),veh/ln				4.2	0.0	11.9	0.3	29.8	5.9	12.5	6.7	0.0
LnGrp Delay(d),s/veh				27.8	0.0	49.2	60.0	127.2	27.1	50.0	12.0	0.0
LnGrp LOS				C		D	E	F	C	D	B	
Approach Vol, veh/h					595			1646			1302	
Approach Delay, s/veh					42.1			110.3			24.2	
Approach LOS					D			F			C	
Timer	1	2	3	4	5	6	7	8				
Assigned Phs	1	2			5	6		8				
Phs Duration (G+Y+Rc), s	4.6	57.8			27.5	35.0		31.2				
Change Period (Y+Rc), s	3.5	5.0			3.5	5.0		5.0				
Max Green Setting (Gmax), s	30.0	30.0			30.0	30.0		30.0				
Max Q Clear Time (g_c+I1), s	2.5	15.4			23.1	32.0		24.5				
Green Ext Time (p_c), s	0.0	5.4			0.8	0.0		1.7				
Intersection Summary												
HCM 2010 Ctrl Delay				67.2								
HCM 2010 LOS				E								
Notes												

HCM 2010 Signalized Intersection Summary Cumulative with Eastside Parkway with Project, PM
 2: 2nd Avenue & Patton Parkway

06/11/2019



Movement	EBL	EBT	EBR	WBL	WBT	WBR	NBL	NBT	NBR	SBL	SBT	SBR
Lane Configurations												
Traffic Volume (veh/h)	50	50	60	90	80	80	70	240	90	80	200	50
Future Volume (veh/h)	50	50	60	90	80	80	70	240	90	80	200	50
Number	7	4	14	3	8	18	5	2	12	1	6	16
Initial Q (Qb), veh	0	0	0	0	0	0	0	0	0	0	0	0
Ped-Bike Adj(A_pbT)	1.00		1.00	1.00		1.00	1.00		1.00	1.00		1.00
Parking Bus, Adj	1.00	1.00	1.00	1.00	1.00	1.00	1.00	1.00	1.00	1.00	1.00	1.00
Adj Sat Flow, veh/h/ln	1863	1863	1900	1863	1863	1900	1863	1863	1900	1863	1863	1900
Adj Flow Rate, veh/h	54	54	65	98	87	87	76	261	98	87	217	54
Adj No. of Lanes	1	1	0	1	1	0	1	1	0	1	1	0
Peak Hour Factor	0.92	0.92	0.92	0.92	0.92	0.92	0.92	0.92	0.92	0.92	0.92	0.92
Percent Heavy Veh, %	2	2	2	2	2	2	2	2	2	2	2	2
Cap, veh/h	96	163	196	137	201	201	119	356	134	128	405	101
Arrive On Green	0.05	0.21	0.21	0.08	0.23	0.23	0.07	0.28	0.28	0.07	0.28	0.28
Sat Flow, veh/h	1774	771	928	1774	856	856	1774	1292	485	1774	1441	359
Grp Volume(v), veh/h	54	0	119	98	0	174	76	0	359	87	0	271
Grp Sat Flow(s),veh/h/ln	1774	0	1699	1774	0	1712	1774	0	1777	1774	0	1799
Q Serve(g_s), s	1.4	0.0	2.8	2.5	0.0	4.0	2.0	0.0	8.6	2.2	0.0	6.0
Cycle Q Clear(g_c), s	1.4	0.0	2.8	2.5	0.0	4.0	2.0	0.0	8.6	2.2	0.0	6.0
Prop In Lane	1.00		0.55	1.00		0.50	1.00		0.27	1.00		0.20
Lane Grp Cap(c), veh/h	96	0	359	137	0	402	119	0	490	128	0	505
V/C Ratio(X)	0.56	0.00	0.33	0.72	0.00	0.43	0.64	0.00	0.73	0.68	0.00	0.54
Avail Cap(c_a), veh/h	228	0	1290	228	0	1300	228	0	1349	228	0	1366
HCM Platoon Ratio	1.00	1.00	1.00	1.00	1.00	1.00	1.00	1.00	1.00	1.00	1.00	1.00
Upstream Filter(I)	1.00	0.00	1.00	1.00	0.00	1.00	1.00	0.00	1.00	1.00	0.00	1.00
Uniform Delay (d), s/veh	21.6	0.0	15.6	21.1	0.0	15.2	21.3	0.0	15.4	21.2	0.0	14.2
Incr Delay (d2), s/veh	5.1	0.0	0.5	6.9	0.0	0.7	5.6	0.0	2.1	6.1	0.0	0.9
Initial Q Delay(d3),s/veh	0.0	0.0	0.0	0.0	0.0	0.0	0.0	0.0	0.0	0.0	0.0	0.0
%ile BackOfQ(50%),veh/ln	0.8	0.0	1.3	1.5	0.0	2.0	1.1	0.0	4.5	1.3	0.0	3.1
LnGrp Delay(d),s/veh	26.7	0.0	16.2	27.9	0.0	16.0	26.8	0.0	17.5	27.3	0.0	15.1
LnGrp LOS	C		B	C		B	C		B	C		B
Approach Vol, veh/h		173			272			435			358	
Approach Delay, s/veh		19.5			20.3			19.1			18.1	
Approach LOS		B			C			B			B	
Timer	1	2	3	4	5	6	7	8				
Assigned Phs	1	2	3	4	5	6	7	8				
Phs Duration (G+Y+Rc), s	7.4	17.4	7.6	14.4	7.1	17.6	6.5	15.5				
Change Period (Y+Rc), s	4.0	4.5	4.0	4.5	4.0	4.5	4.0	4.5				
Max Green Setting (Gmax), s	35.5	35.5	6.0	35.5	6.0	35.5	6.0	35.5				
Max Q Clear Time (g_c+14), s	10.6	10.6	4.5	4.8	4.0	8.0	3.4	6.0				
Green Ext Time (p_c), s	0.0	2.3	0.0	0.7	0.0	1.7	0.0	1.1				
Intersection Summary												
HCM 2010 Ctrl Delay				19.1								
HCM 2010 LOS				B								

HCM 2010 Signalized Intersection Summary Cumulative with Eastside Parkway with Project, PM
 3: SR 1 SB On-Ramp/SR 1 SB Off-Ramp & Imjin Parkway 06/11/2019



Movement	EBL	EBT	EBR	WBL	WBT	WBR	NBL	NBT	NBR	SBL	SBT	SBR
Lane Configurations					↕						↕	
Traffic Volume (veh/h)	0	0	0	1170	0	0	0	0	0	720	10	0
Future Volume (veh/h)	0	0	0	1170	0	0	0	0	0	720	10	0
Number				1	6	16				7	4	14
Initial Q (Qb), veh				0	0	0				0	0	0
Ped-Bike Adj(A_pbT)				1.00		1.00				1.00		1.00
Parking Bus, Adj				1.00	1.00	1.00				1.00	1.00	1.00
Adj Sat Flow, veh/h/ln				1900	1881	0				1900	1863	0
Adj Flow Rate, veh/h				1286	0	0				791	11	0
Adj No. of Lanes				0	1	0				0	1	0
Peak Hour Factor				0.91	0.91	0.91				0.91	0.91	0.91
Percent Heavy Veh, %				1	1	0				2	2	0
Cap, veh/h				1015	0	0				662	9	0
Arrive On Green				0.57	0.00	0.00				0.38	0.38	0.00
Sat Flow, veh/h				1792	0	0				1751	24	0
Grp Volume(v), veh/h				1286	0	0				802	0	0
Grp Sat Flow(s),veh/h/ln				1792	0	0				1775	0	0
Q Serve(g_s), s				90.0	0.0	0.0				60.0	0.0	0.0
Cycle Q Clear(g_c), s				90.0	0.0	0.0				60.0	0.0	0.0
Prop In Lane				1.00		0.00				0.99		0.00
Lane Grp Cap(c), veh/h				1015	0	0				671	0	0
V/C Ratio(X)				1.27	0.00	0.00				1.20	0.00	0.00
Avail Cap(c_a), veh/h				1015	0	0				671	0	0
HCM Platoon Ratio				1.00	1.00	1.00				1.00	1.00	1.00
Upstream Filter(I)				1.00	0.00	0.00				1.00	0.00	0.00
Uniform Delay (d), s/veh				34.4	0.0	0.0				49.4	0.0	0.0
Incr Delay (d2), s/veh				127.8	0.0	0.0				102.2	0.0	0.0
Initial Q Delay(d3),s/veh				0.0	0.0	0.0				0.0	0.0	0.0
%ile BackOfQ(50%),veh/ln				80.3	0.0	0.0				48.3	0.0	0.0
LnGrp Delay(d),s/veh				162.2	0.0	0.0				151.6	0.0	0.0
LnGrp LOS				F						F		
Approach Vol, veh/h					1286						802	
Approach Delay, s/veh					162.2						151.6	
Approach LOS					F						F	
Timer	1	2	3	4	5	6	7	8				
Assigned Phs				4		6						
Phs Duration (G+Y+Rc), s				64.4		94.4						
Change Period (Y+Rc), s				4.4		4.4						
Max Green Setting (Gmax), s				60.0		90.0						
Max Q Clear Time (g_c+I1), s				62.0		92.0						
Green Ext Time (p_c), s				0.0		0.0						
Intersection Summary												
HCM 2010 Ctrl Delay				158.1								
HCM 2010 LOS				F								

Intersection												
Int Delay, s/veh	0.9											
Movement	EBL	EBT	EBR	WBL	WBT	WBR	NBL	NBT	NBR	SBL	SBT	SBR
Lane Configurations		↔			↑	↗		↖	↗			
Traffic Vol, veh/h	10	700	0	0	1150	950	10	10	1210	0	0	0
Future Vol, veh/h	10	700	0	0	1150	950	10	10	1210	0	0	0
Conflicting Peds, #/hr	0	0	1	1	0	0	0	0	0	0	0	0
Sign Control	Free	Free	Free	Free	Free	Free	Stop	Stop	Stop	Stop	Stop	Stop
RT Channelized	-	-	None	-	-	Free	-	-	Free	-	-	None
Storage Length	-	-	-	-	-	0	-	-	800	-	-	-
Veh in Median Storage, #	-	0	-	-	0	-	-	0	-	-	16965	-
Grade, %	-	0	-	-	0	-	-	0	-	-	0	-
Peak Hour Factor	95	95	95	95	95	95	95	95	95	95	95	95
Heavy Vehicles, %	2	2	2	1	1	1	1	1	1	2	2	2
Mvmt Flow	11	737	0	0	1211	1000	11	11	1274	0	0	0

Major/Minor	Major1	Major2	Minor1
Conflicting Flow All	1211	0	-
Stage 1	-	-	-
Stage 2	-	-	-
Critical Hdwy	4.12	-	-
Critical Hdwy Stg 1	-	-	-
Critical Hdwy Stg 2	-	-	-
Follow-up Hdwy	2.218	-	-
Pot Cap-1 Maneuver	576	0	0
Stage 1	-	0	0
Stage 2	-	0	0
Platoon blocked, %	-	-	-
Mov Cap-1 Maneuver	576	-	-
Mov Cap-2 Maneuver	-	-	-
Stage 1	-	-	-
Stage 2	-	-	-

Approach	EB	WB	NB
HCM Control Delay, s	0.2	0	81.6
HCM LOS			F

Minor Lane/Major Mvmt	NBLn1	NBLn2	EBL	EBT	WBT
Capacity (veh/h)	67	-	576	-	-
HCM Lane V/C Ratio	0.314	-	0.018	-	-
HCM Control Delay (s)	81.6	0	11.4	0	-
HCM Lane LOS	F	A	B	A	-
HCM 95th %tile Q(veh)	1.1	-	0.1	-	-

HCM 2010 Signalized Intersection Summary Cumulative with Eastside Parkway with Project, PM
 5: 2nd Avenue & Imjin Parkway 06/11/2019

Movement	EBL	EBT	EBR	WBL	WBT	WBR	NBL	NBT	NBR	SBL	SBT	SBR
Lane Configurations												
Traffic Volume (veh/h)	140	1010	760	330	1060	140	900	110	500	90	100	150
Future Volume (veh/h)	140	1010	760	330	1060	140	900	110	500	90	100	150
Number	5	2	12	1	6	16	3	8	18	7	4	14
Initial Q (Qb), veh	0	0	0	0	0	0	0	0	0	0	0	0
Ped-Bike Adj(A_pbT)	1.00		1.00	1.00		0.99	1.00		0.99	1.00		0.98
Parking Bus, Adj	1.00	1.00	1.00	1.00	1.00	1.00	1.00	1.00	1.00	1.00	1.00	1.00
Adj Sat Flow, veh/h/ln	1881	1881	1881	1881	1881	1900	1900	1900	1900	1900	1900	1900
Adj Flow Rate, veh/h	146	1052	592	344	1104	146	938	115	287	94	104	125
Adj No. of Lanes	1	2	1	2	2	0	2	1	1	1	2	0
Peak Hour Factor	0.96	0.96	0.96	0.96	0.96	0.96	0.96	0.96	0.96	0.96	0.96	0.96
Percent Heavy Veh, %	1	1	1	1	1	1	0	0	0	0	0	0
Cap, veh/h	184	1213	540	416	1131	149	794	503	425	133	203	178
Arrive On Green	0.10	0.34	0.34	0.12	0.36	0.36	0.23	0.26	0.26	0.07	0.11	0.11
Sat Flow, veh/h	1792	3574	1592	3476	3172	419	3510	1900	1602	1810	1805	1585
Grp Volume(v), veh/h	146	1052	592	344	621	629	938	115	287	94	104	125
Grp Sat Flow(s),veh/h/ln	1792	1787	1592	1738	1787	1804	1755	1900	1602	1810	1805	1585
Q Serve(g_s), s	7.0	24.4	30.0	8.5	30.3	30.4	20.0	4.2	14.2	4.5	4.8	6.7
Cycle Q Clear(g_c), s	7.0	24.4	30.0	8.5	30.3	30.4	20.0	4.2	14.2	4.5	4.8	6.7
Prop In Lane	1.00		1.00	1.00		0.23	1.00		1.00	1.00		1.00
Lane Grp Cap(c), veh/h	184	1213	540	416	637	643	794	503	425	133	203	178
V/C Ratio(X)	0.80	0.87	1.10	0.83	0.97	0.98	1.18	0.23	0.68	0.71	0.51	0.70
Avail Cap(c_a), veh/h	304	1213	540	590	637	643	794	503	425	205	429	376
HCM Platoon Ratio	1.00	1.00	1.00	1.00	1.00	1.00	1.00	1.00	1.00	1.00	1.00	1.00
Upstream Filter(I)	1.00	1.00	1.00	1.00	1.00	1.00	1.00	1.00	1.00	1.00	1.00	1.00
Uniform Delay (d), s/veh	38.8	27.3	29.2	38.0	28.0	28.1	34.2	25.4	29.1	40.0	37.0	37.8
Incr Delay (d2), s/veh	3.0	6.6	67.5	4.5	29.1	29.7	94.3	0.1	3.5	2.6	0.7	1.9
Initial Q Delay(d3),s/veh	0.0	0.0	0.0	0.0	0.0	0.0	0.0	0.0	0.0	0.0	0.0	0.0
%ile BackOfQ(50%),veh/ln	3.6	13.1	23.2	4.4	20.0	20.3	20.0	2.2	6.6	2.3	2.4	3.0
LnGrp Delay(d),s/veh	41.7	33.9	96.7	42.6	57.1	57.8	128.5	25.5	32.6	42.6	37.7	39.7
LnGrp LOS	D	C	F	D	E	E	F	C	C	D	D	D
Approach Vol, veh/h		1790			1594			1340			323	
Approach Delay, s/veh		55.3			54.3			99.1			39.9	
Approach LOS		E			D			F			D	
Timer	1	2	3	4	5	6	7	8				
Assigned Phs	1	2	3	4	5	6	7	8				
Phs Duration (G+Y+Rc), s	15.1	35.3	23.5	14.5	13.6	36.8	10.0	28.0				
Change Period (Y+Rc), s	4.5	5.3	3.5	4.6	4.5	5.3	3.5	4.6				
Max Green Setting (Gmax), s	15.0	30.0	20.0	21.0	15.0	30.0	10.0	21.0				
Max Q Clear Time (g_c+I1), s	10.5	32.0	22.0	8.7	9.0	32.4	6.5	16.2				
Green Ext Time (p_c), s	0.0	0.0	0.0	0.2	0.0	0.0	0.0	0.1				
Intersection Summary												
HCM 2010 Ctrl Delay			65.6									
HCM 2010 LOS			E									

HCM 2010 Signalized Intersection Summary Cumulative with Eastside Parkway with Project, PM
6: 3rd Avenue & Imjin Parkway

06/11/2019



Movement	EBL	EBT	EBR	WBL	WBT	WBR	NBL	NBT	NBR	SBL	SBT	SBR
Lane Configurations	↖	↗		↖	↗		↖	↗		↖	↗	
Traffic Volume (veh/h)	50	1430	160	90	1150	20	220	10	140	10	10	50
Future Volume (veh/h)	50	1430	160	90	1150	20	220	10	140	10	10	50
Number	5	2	12	1	6	16	3	8	18	7	4	14
Initial Q (Qb), veh	0	0	0	0	0	0	0	0	0	0	0	0
Ped-Bike Adj(A_pbT)	1.00		0.98	1.00		1.00	1.00		1.00	1.00		1.00
Parking Bus, Adj	1.00	1.00	1.00	1.00	1.00	1.00	1.00	1.00	1.00	1.00	1.00	1.00
Adj Sat Flow, veh/h/ln	1881	1881	1900	1881	1881	1900	1900	1900	1900	1900	1900	1900
Adj Flow Rate, veh/h	51	1459	155	92	1173	19	224	10	31	10	10	10
Adj No. of Lanes	1	2	0	1	2	0	1	1	0	1	1	0
Peak Hour Factor	0.98	0.98	0.98	0.98	0.98	0.98	0.98	0.98	0.98	0.98	0.98	0.98
Percent Heavy Veh, %	1	1	1	1	1	1	0	0	0	0	0	0
Cap, veh/h	114	1591	168	118	1767	29	401	82	255	381	176	176
Arrive On Green	0.06	0.49	0.49	0.07	0.49	0.49	0.20	0.20	0.20	0.20	0.20	0.20
Sat Flow, veh/h	1792	3256	343	1792	3600	58	1412	408	1266	1386	872	872
Grp Volume(v), veh/h	51	795	819	92	582	610	224	0	41	10	0	20
Grp Sat Flow(s),veh/h/ln	1792	1787	1811	1792	1787	1871	1412	0	1674	1386	0	1745
Q Serve(g_s), s	1.5	22.6	23.3	2.8	13.6	13.6	8.4	0.0	1.1	0.3	0.0	0.5
Cycle Q Clear(g_c), s	1.5	22.6	23.3	2.8	13.6	13.6	8.9	0.0	1.1	1.4	0.0	0.5
Prop In Lane	1.00		0.19	1.00		0.03	1.00		0.76	1.00		0.50
Lane Grp Cap(c), veh/h	114	873	885	118	877	918	401	0	337	381	0	351
V/C Ratio(X)	0.45	0.91	0.93	0.78	0.66	0.66	0.56	0.00	0.12	0.03	0.00	0.06
Avail Cap(c_a), veh/h	373	1051	1065	373	1051	1100	820	0	833	792	0	868
HCM Platoon Ratio	1.00	1.00	1.00	1.00	1.00	1.00	1.00	1.00	1.00	1.00	1.00	1.00
Upstream Filter(I)	1.00	1.00	1.00	1.00	1.00	1.00	1.00	0.00	1.00	1.00	0.00	1.00
Uniform Delay (d), s/veh	24.9	13.0	13.2	25.4	10.6	10.6	21.4	0.0	18.1	18.7	0.0	17.8
Incr Delay (d2), s/veh	1.0	9.4	10.9	4.2	0.7	0.7	0.5	0.0	0.1	0.0	0.0	0.0
Initial Q Delay(d3),s/veh	0.0	0.0	0.0	0.0	0.0	0.0	0.0	0.0	0.0	0.0	0.0	0.0
%ile BackOfQ(50%),veh/ln	0.8	13.3	14.1	1.5	6.8	7.1	3.3	0.0	0.5	0.1	0.0	0.2
LnGrp Delay(d),s/veh	26.0	22.4	24.1	29.6	11.4	11.3	21.9	0.0	18.1	18.7	0.0	17.9
LnGrp LOS	C	C	C	C	B	B	C		B	B		B
Approach Vol, veh/h		1665			1284			265			30	
Approach Delay, s/veh		23.3			12.6			21.3			18.1	
Approach LOS		C			B			C			B	
Timer	1	2	3	4	5	6	7	8				
Assigned Phs	1	2		4	5	6		8				
Phs Duration (G+Y+Rc), s	7.1	32.5		15.6	7.0	32.6		15.6				
Change Period (Y+Rc), s	3.5	5.5		4.5	3.5	5.5		4.5				
Max Green Setting (Gmax), s	1.5	32.5		27.5	11.5	32.5		27.5				
Max Q Clear Time (g_c+14), s	14.8	25.3		3.4	3.5	15.6		10.9				
Green Ext Time (p_c), s	0.0	1.7		0.0	0.0	0.9		0.1				
Intersection Summary												
HCM 2010 Ctrl Delay				18.9								
HCM 2010 LOS				B								

HCM 2010 Signalized Intersection Summary Cumulative with Eastside Parkway with Project, PM
 7: 4th Avenue & Imjin Parkway 06/11/2019



Movement	EBL	EBT	EBR	WBL	WBT	WBR	NBL	NBT	NBR	SBL	SBT	SBR
Lane Configurations												
Traffic Volume (veh/h)	10	1580	10	10	1220	10	20	10	10	10	10	10
Future Volume (veh/h)	10	1580	10	10	1220	10	20	10	10	10	10	10
Number	5	2	12	1	6	16	3	8	18	7	4	14
Initial Q (Qb), veh	0	0	0	0	0	0	0	0	0	0	0	0
Ped-Bike Adj(A_pbT)	1.00		1.00	1.00		0.98	1.00		1.00	1.00		1.00
Parking Bus, Adj	1.00	1.00	1.00	1.00	1.00	1.00	1.00	1.00	1.00	1.00	1.00	1.00
Adj Sat Flow, veh/h/ln	1881	1881	1900	1881	1881	1900	1900	1900	1900	1900	1900	1900
Adj Flow Rate, veh/h	10	1629	10	10	1258	10	21	10	8	10	10	10
Adj No. of Lanes	1	2	0	1	2	0	0	1	0	0	1	0
Peak Hour Factor	0.97	0.97	0.97	0.97	0.97	0.97	0.97	0.97	0.97	0.97	0.97	0.97
Percent Heavy Veh, %	1	1	1	1	1	1	0	0	0	0	0	0
Cap, veh/h	14	1841	11	14	1837	15	227	24	19	185	33	33
Arrive On Green	0.01	0.51	0.51	0.01	0.51	0.51	0.06	0.06	0.06	0.06	0.06	0.06
Sat Flow, veh/h	1792	3642	22	1792	3634	29	880	419	335	571	571	571
Grp Volume(v), veh/h	10	799	840	10	619	649	39	0	0	30	0	0
Grp Sat Flow(s),veh/h/ln	1792	1787	1877	1792	1787	1875	1634	0	0	1712	0	0
Q Serve(g_s), s	0.2	12.6	12.6	0.2	8.2	8.2	0.2	0.0	0.0	0.0	0.0	0.0
Cycle Q Clear(g_c), s	0.2	12.6	12.6	0.2	8.2	8.2	0.7	0.0	0.0	0.5	0.0	0.0
Prop In Lane	1.00		0.01	1.00		0.02	0.54		0.21	0.33		0.33
Lane Grp Cap(c), veh/h	14	903	949	14	903	948	270	0	0	251	0	0
V/C Ratio(X)	0.70	0.88	0.89	0.70	0.68	0.69	0.14	0.00	0.00	0.12	0.00	0.00
Avail Cap(c_a), veh/h	655	1846	1939	655	1846	1937	1540	0	0	1574	0	0
HCM Platoon Ratio	1.00	1.00	1.00	1.00	1.00	1.00	1.00	1.00	1.00	1.00	1.00	1.00
Upstream Filter(I)	1.00	1.00	1.00	1.00	1.00	1.00	1.00	0.00	0.00	1.00	0.00	0.00
Uniform Delay (d), s/veh	15.6	7.0	7.0	15.6	5.9	5.9	14.3	0.0	0.0	14.2	0.0	0.0
Incr Delay (d2), s/veh	20.4	1.2	1.1	20.4	0.3	0.3	0.1	0.0	0.0	0.1	0.0	0.0
Initial Q Delay(d3),s/veh	0.0	0.0	0.0	0.0	0.0	0.0	0.0	0.0	0.0	0.0	0.0	0.0
%ile BackOfQ(50%),veh/ln	0.2	6.3	6.6	0.2	4.0	4.2	0.3	0.0	0.0	0.3	0.0	0.0
LnGrp Delay(d),s/veh	35.9	8.2	8.1	35.9	6.2	6.2	14.4	0.0	0.0	14.3	0.0	0.0
LnGrp LOS	D	A	A	D	A	A	B			B		
Approach Vol, veh/h		1649			1278			39			30	
Approach Delay, s/veh		8.3			6.5			14.4			14.3	
Approach LOS		A			A			B			B	
Timer	1	2	3	4	5	6	7	8				
Assigned Phs	1	2		4	5	6		8				
Phs Duration (G+Y+Rc), s	3.8	21.4		6.3	3.8	21.4		6.3				
Change Period (Y+Rc), s	3.5	5.5		4.5	3.5	5.5		4.5				
Max Green Setting (Gmax), s	1.5	32.5		27.5	11.5	32.5		27.5				
Max Q Clear Time (g_c+12.2), s	1.5	14.6		2.5	2.2	10.2		2.7				
Green Ext Time (p_c), s	0.0	1.3		0.0	0.0	0.9		0.0				
Intersection Summary												
HCM 2010 Ctrl Delay				7.7								
HCM 2010 LOS				A								

HCM 2010 Signalized Intersection Summary Cumulative with Eastside Parkway with Project, PM
 8: 5th Avenue/California Avenue & Imjin Parkway 06/11/2019



Movement	EBL	EBT	EBR	WBL	WBT	WBR	NBL	NBT	NBR	SBL	SBT	SBR
Lane Configurations												
Traffic Volume (veh/h)	300	1230	10	10	990	100	20	50	10	70	40	230
Future Volume (veh/h)	300	1230	10	10	990	100	20	50	10	70	40	230
Number	5	2	12	1	6	16	3	8	18	7	4	14
Initial Q (Qb), veh	0	0	0	0	0	0	0	0	0	0	0	0
Ped-Bike Adj(A_pbT)	1.00		1.00	1.00		1.00	1.00		1.00	1.00		0.98
Parking Bus, Adj	1.00	1.00	1.00	1.00	1.00	1.00	1.00	1.00	1.00	1.00	1.00	1.00
Adj Sat Flow, veh/h/ln	1881	1881	1900	1881	1881	1900	1900	1900	1900	1900	1881	1900
Adj Flow Rate, veh/h	309	1268	10	10	1021	97	21	52	7	72	41	68
Adj No. of Lanes	1	2	0	1	2	0	0	1	0	0	1	0
Peak Hour Factor	0.97	0.97	0.97	0.97	0.97	0.97	0.97	0.97	0.97	0.97	0.97	0.97
Percent Heavy Veh, %	1	1	1	1	1	1	0	0	0	1	1	1
Cap, veh/h	369	2000	16	14	1162	110	141	208	24	189	71	90
Arrive On Green	0.21	0.55	0.55	0.01	0.35	0.35	0.15	0.15	0.15	0.15	0.15	0.15
Sat Flow, veh/h	1792	3635	29	1792	3298	313	280	1375	159	526	469	599
Grp Volume(v), veh/h	309	623	655	10	553	565	80	0	0	181	0	0
Grp Sat Flow(s),veh/h/ln	1792	1787	1876	1792	1787	1824	1814	0	0	1594	0	0
Q Serve(g_s), s	7.6	11.1	11.1	0.3	13.4	13.4	0.0	0.0	0.0	3.2	0.0	0.0
Cycle Q Clear(g_c), s	7.6	11.1	11.1	0.3	13.4	13.4	1.7	0.0	0.0	4.9	0.0	0.0
Prop In Lane	1.00		0.02	1.00		0.17	0.26		0.09	0.40		0.38
Lane Grp Cap(c), veh/h	369	984	1033	14	630	643	373	0	0	350	0	0
V/C Ratio(X)	0.84	0.63	0.63	0.71	0.88	0.88	0.21	0.00	0.00	0.52	0.00	0.00
Avail Cap(c_a), veh/h	583	1163	1221	583	1163	1187	846	0	0	783	0	0
HCM Platoon Ratio	1.00	1.00	1.00	1.00	1.00	1.00	1.00	1.00	1.00	1.00	1.00	1.00
Upstream Filter(I)	1.00	1.00	1.00	1.00	1.00	1.00	1.00	0.00	0.00	1.00	0.00	0.00
Uniform Delay (d), s/veh	17.6	7.2	7.2	22.8	14.0	14.0	17.4	0.0	0.0	18.6	0.0	0.0
Incr Delay (d2), s/veh	3.3	0.5	0.4	21.9	1.6	1.6	0.1	0.0	0.0	0.4	0.0	0.0
Initial Q Delay(d3),s/veh	0.0	0.0	0.0	0.0	0.0	0.0	0.0	0.0	0.0	0.0	0.0	0.0
%ile BackOfQ(50%),veh/ln	4.1	5.5	5.8	0.2	6.7	6.9	0.9	0.0	0.0	2.3	0.0	0.0
LnGrp Delay(d),s/veh	20.8	7.6	7.6	44.7	15.6	15.6	17.5	0.0	0.0	19.1	0.0	0.0
LnGrp LOS	C	A	A	D	B	B	B			B		
Approach Vol, veh/h		1587			1128			80			181	
Approach Delay, s/veh		10.2			15.9			17.5			19.1	
Approach LOS		B			B			B			B	
Timer	1	2	3	4	5	6	7	8				
Assigned Phs	1	2		4	5	6		8				
Phs Duration (G+Y+Rc), s	3.9	30.7		11.6	13.0	21.5		11.6				
Change Period (Y+Rc), s	3.5	5.3		4.6	3.5	5.3		4.6				
Max Green Setting (Gmax), s	30.0	30.0		20.0	15.0	30.0		20.0				
Max Q Clear Time (g_c+1/2), s	13.1	13.1		6.9	9.6	15.4		3.7				
Green Ext Time (p_c), s	0.0	0.9		0.1	0.0	0.8		0.1				
Intersection Summary												
HCM 2010 Ctrl Delay				13.1								
HCM 2010 LOS				B								

Intersection						
Int Delay, s/veh	0.6					
Movement	EBL	EBR	NBL	NBT	SBT	SBR
Lane Configurations	↔		↔	↑	↑	
Traffic Vol, veh/h	10	10	20	420	270	10
Future Vol, veh/h	10	10	20	420	270	10
Conflicting Peds, #/hr	0	0	0	0	0	0
Sign Control	Stop	Stop	Free	Free	Free	Free
RT Channelized	-	None	-	None	-	None
Storage Length	0	-	155	-	-	-
Veh in Median Storage, #	0	-	-	0	0	-
Grade, %	0	-	-	0	0	-
Peak Hour Factor	92	92	92	92	92	92
Heavy Vehicles, %	2	2	2	2	2	2
Mvmt Flow	11	11	22	457	293	11

Major/Minor	Minor2	Major1		Major2	
Conflicting Flow All	800	299	304	0	0
Stage 1	299	-	-	-	-
Stage 2	501	-	-	-	-
Critical Hdwy	6.42	6.22	4.12	-	-
Critical Hdwy Stg 1	5.42	-	-	-	-
Critical Hdwy Stg 2	5.42	-	-	-	-
Follow-up Hdwy	3.518	3.318	2.218	-	-
Pot Cap-1 Maneuver	354	741	1257	-	-
Stage 1	752	-	-	-	-
Stage 2	609	-	-	-	-
Platoon blocked, %				-	-
Mov Cap-1 Maneuver	348	741	1257	-	-
Mov Cap-2 Maneuver	348	-	-	-	-
Stage 1	738	-	-	-	-
Stage 2	609	-	-	-	-

Approach	EB	NB	SB
HCM Control Delay, s	13	0.4	0
HCM LOS	B		

Minor Lane/Major Mvmt	NBL	NBT	EBLn1	SBT	SBR
Capacity (veh/h)	1257	-	474	-	-
HCM Lane V/C Ratio	0.017	-	0.046	-	-
HCM Control Delay (s)	7.9	-	13	-	-
HCM Lane LOS	A	-	B	-	-
HCM 95th %tile Q(veh)	0.1	-	0.1	-	-

HCM 2010 Signalized Intersection Summary Cumulative with Eastside Parkway with Project, PM
 10: Imjin Road & Imjin Parkway

06/11/2019

	→	↘	↙	←	↖	↗		
Movement	EBT	EBR	WBL	WBT	NBL	NBR		
Lane Configurations	↑↑		↖	↑↑	↖↗	↗		
Traffic Volume (veh/h)	1170	130	160	830	270	610		
Future Volume (veh/h)	1170	130	160	830	270	610		
Number	2	12	1	6	3	18		
Initial Q (Qb), veh	0	0	0	0	0	0		
Ped-Bike Adj(A_pbT)		1.00	1.00		1.00	1.00		
Parking Bus, Adj	1.00	1.00	1.00	1.00	1.00	1.00		
Adj Sat Flow, veh/h/ln	1881	1900	1881	1881	1881	1881		
Adj Flow Rate, veh/h	1232	134	168	874	284	576		
Adj No. of Lanes	2	0	1	2	1	2		
Peak Hour Factor	0.95	0.95	0.95	0.95	0.95	0.95		
Percent Heavy Veh, %	1	1	1	1	1	1		
Cap, veh/h	1341	145	212	2231	378	675		
Arrive On Green	0.41	0.41	0.12	0.62	0.21	0.21		
Sat Flow, veh/h	3347	353	1792	3668	1792	3198		
Grp Volume(v), veh/h	675	691	168	874	284	576		
Grp Sat Flow(s),veh/h/ln	1787	1819	1792	1787	1792	1599		
Q Serve(g_s), s	20.2	20.3	5.2	6.9	8.4	9.8		
Cycle Q Clear(g_c), s	20.2	20.3	5.2	6.9	8.4	9.8		
Prop In Lane		0.19	1.00		1.00	1.00		
Lane Grp Cap(c), veh/h	737	750	212	2231	378	675		
V/C Ratio(X)	0.92	0.92	0.79	0.39	0.75	0.85		
Avail Cap(c_a), veh/h	949	966	634	2231	698	1246		
HCM Platoon Ratio	1.00	1.00	1.00	1.00	1.00	1.00		
Upstream Filter(I)	1.00	1.00	1.00	1.00	1.00	1.00		
Uniform Delay (d), s/veh	15.7	15.7	24.2	5.3	20.9	21.4		
Incr Delay (d2), s/veh	9.9	10.4	2.6	0.0	1.1	1.2		
Initial Q Delay(d3),s/veh	0.0	0.0	0.0	0.0	0.0	0.0		
%ile BackOfQ(50%),veh/ln	11.8	12.1	2.7	3.3	4.2	4.4		
LnGrp Delay(d),s/veh	25.6	26.1	26.8	5.3	22.0	22.6		
LnGrp LOS	C	C	C	A	C	C		
Approach Vol, veh/h	1366			1042	860			
Approach Delay, s/veh	25.9			8.8	22.4			
Approach LOS	C			A	C			
Timer	1	2	3	4	5	6	7	8
Assigned Phs	1	2				6		8
Phs Duration (G+Y+Rc), s	12.0	28.6				40.6		15.9
Change Period (Y+Rc), s	5.3	* 5.3				5.3		4.0
Max Green Setting (Gmax), s	20.0	* 30				30.0		22.0
Max Q Clear Time (g_c+I1), s	7.2	22.3				8.9		11.8
Green Ext Time (p_c), s	0.0	0.9				0.9		0.1
Intersection Summary								
HCM 2010 Ctrl Delay			19.5					
HCM 2010 LOS			B					
Notes								

HCM 2010 Signalized Intersection Summary Cumulative with Eastside Parkway with Project, PM
 11: Abrams Drive & Imjin Parkway

06/11/2019



Movement	EBL	EBT	EBR	WBL	WBT	WBR	NBL	NBT	NBR	SBL	SBT	SBR
Lane Configurations	↖ ↗	↗		↖ ↗	↗		↖	↗	↗	↖	↗	↗
Traffic Volume (veh/h)	130	1180	250	170	770	120	170	30	200	60	20	130
Future Volume (veh/h)	130	1180	250	170	770	120	170	30	200	60	20	130
Number	5	2	12	1	6	16	3	8	18	7	4	14
Initial Q (Qb), veh	0	0	0	0	0	0	0	0	0	0	0	0
Ped-Bike Adj(A_pbT)	1.00		1.00	1.00		1.00	1.00		1.00	1.00		1.00
Parking Bus, Adj	1.00	1.00	1.00	1.00	1.00	1.00	1.00	1.00	1.00	1.00	1.00	1.00
Adj Sat Flow, veh/h/ln	1881	1881	1900	1881	1881	1900	1881	1881	1881	1863	1863	1863
Adj Flow Rate, veh/h	140	1269	220	183	828	109	183	32	0	65	22	0
Adj No. of Lanes	2	2	0	2	2	0	1	1	1	1	1	1
Peak Hour Factor	0.93	0.93	0.93	0.93	0.93	0.93	0.93	0.93	0.93	0.93	0.93	0.93
Percent Heavy Veh, %	1	1	1	1	1	1	1	1	1	2	2	2
Cap, veh/h	276	1751	301	270	1795	236	322	315	268	312	312	265
Arrive On Green	0.08	0.57	0.57	0.08	0.57	0.57	0.17	0.17	0.00	0.17	0.17	0.00
Sat Flow, veh/h	3476	3051	525	3476	3176	418	1395	1881	1599	1369	1863	1583
Grp Volume(v), veh/h	140	739	750	183	466	471	183	32	0	65	22	0
Grp Sat Flow(s),veh/h/ln	1738	1787	1789	1738	1787	1807	1395	1881	1599	1369	1863	1583
Q Serve(g_s), s	2.7	21.3	21.8	3.6	10.9	10.9	9.0	1.0	0.0	3.0	0.7	0.0
Cycle Q Clear(g_c), s	2.7	21.3	21.8	3.6	10.9	10.9	9.7	1.0	0.0	4.0	0.7	0.0
Prop In Lane	1.00		0.29	1.00		0.23	1.00		1.00	1.00		1.00
Lane Grp Cap(c), veh/h	276	1026	1027	270	1010	1021	322	315	268	312	312	265
V/C Ratio(X)	0.51	0.72	0.73	0.68	0.46	0.46	0.57	0.10	0.00	0.21	0.07	0.00
Avail Cap(c_a), veh/h	982	1262	1263	982	1262	1277	679	797	678	662	790	671
HCM Platoon Ratio	1.00	1.00	1.00	1.00	1.00	1.00	1.00	1.00	1.00	1.00	1.00	1.00
Upstream Filter(I)	1.00	1.00	1.00	1.00	1.00	1.00	1.00	1.00	0.00	1.00	1.00	0.00
Uniform Delay (d), s/veh	31.3	11.0	11.1	31.8	9.1	9.1	28.9	24.9	0.0	26.6	24.8	0.0
Incr Delay (d2), s/veh	0.5	1.1	1.2	1.1	0.1	0.1	0.6	0.1	0.0	0.1	0.0	0.0
Initial Q Delay(d3),s/veh	0.0	0.0	0.0	0.0	0.0	0.0	0.0	0.0	0.0	0.0	0.0	0.0
%ile BackOfQ(50%),veh/ln	1.3	10.6	11.0	1.8	5.3	5.4	3.5	0.5	0.0	1.1	0.4	0.0
LnGrp Delay(d),s/veh	31.8	12.0	12.3	32.9	9.2	9.2	29.5	25.0	0.0	26.8	24.8	0.0
LnGrp LOS	C	B	B	C	A	A	C	C		C	C	
Approach Vol, veh/h		1629			1120			215			87	
Approach Delay, s/veh		13.8			13.1			28.8			26.3	
Approach LOS		B			B			C			C	
Timer	1	2	3	4	5	6	7	8				
Assigned Phs	1	2		4	5	6		8				
Phs Duration (G+Y+Rc), s	9.0	45.9		15.9	9.6	45.3		15.9				
Change Period (Y+Rc), s	3.5	5.3		4.0	4.0	5.3		4.0				
Max Green Setting (Gmax), s	20.0	50.0		30.0	20.0	50.0		30.0				
Max Q Clear Time (g_c+15), s	15.6	23.8		6.0	4.7	12.9		11.7				
Green Ext Time (p_c), s	0.0	1.2		0.0	0.0	0.7		0.0				
Intersection Summary												
HCM 2010 Ctrl Delay				15.0								
HCM 2010 LOS				B								













HCM 2010 Signalized Intersection Summary Cumulative with Eastside Parkway with Project, PM
 12: Reservation Road & Imjin Parkway

06/11/2019



Movement	EBL	EBT	EBR	WBL	WBT	WBR	NBL	NBT	NBR	SBL	SBT	SBR
Lane Configurations	↖↗	↑	↖↗	↖	↑	↖	↖↗	↑↑	↖	↖↗	↑↑	↖
Traffic Volume (veh/h)	110	20	1280	10	40	30	820	630	10	20	940	190
Future Volume (veh/h)	110	20	1280	10	40	30	820	630	10	20	940	190
Number	3	8	18	7	4	14	1	6	16	5	2	12
Initial Q (Qb), veh	0	0	0	0	0	0	0	0	0	0	0	0
Ped-Bike Adj(A_pbT)	1.00		1.00	1.00		0.99	1.00		1.00	1.00		1.00
Parking Bus, Adj	1.00	1.00	1.00	1.00	1.00	1.00	1.00	1.00	1.00	1.00	1.00	1.00
Adj Sat Flow, veh/h/ln	1881	1881	1881	1827	1827	1827	1881	1881	1881	1881	1881	1881
Adj Flow Rate, veh/h	124	22	1037	11	45	12	921	708	10	22	1056	79
Adj No. of Lanes	2	1	2	1	1	1	2	2	1	2	2	1
Peak Hour Factor	0.89	0.89	0.89	0.89	0.89	0.89	0.89	0.89	0.89	0.89	0.89	0.89
Percent Heavy Veh, %	1	1	1	4	4	4	1	1	1	1	1	1
Cap, veh/h	802	434	1296	75	79	66	802	2048	916	55	1281	573
Arrive On Green	0.23	0.23	0.23	0.04	0.04	0.04	0.23	0.57	0.57	0.02	0.36	0.36
Sat Flow, veh/h	3476	1881	2802	1740	1827	1531	3476	3574	1599	3476	3574	1599
Grp Volume(v), veh/h	124	22	1037	11	45	12	921	708	10	22	1056	79
Grp Sat Flow(s),veh/h/ln	1738	1881	1401	1740	1827	1531	1738	1787	1599	1738	1787	1599
Q Serve(g_s), s	4.3	1.4	35.0	0.9	3.7	1.1	35.0	16.0	0.4	1.0	40.8	5.1
Cycle Q Clear(g_c), s	4.3	1.4	35.0	0.9	3.7	1.1	35.0	16.0	0.4	1.0	40.8	5.1
Prop In Lane	1.00		1.00	1.00		1.00	1.00		1.00	1.00		1.00
Lane Grp Cap(c), veh/h	802	434	1296	75	79	66	802	2048	916	55	1281	573
V/C Ratio(X)	0.15	0.05	0.80	0.15	0.57	0.18	1.15	0.35	0.01	0.40	0.82	0.14
Avail Cap(c_a), veh/h	802	434	1296	356	373	313	802	2048	916	458	1414	632
HCM Platoon Ratio	1.00	1.00	1.00	1.00	1.00	1.00	1.00	1.00	1.00	1.00	1.00	1.00
Upstream Filter(I)	1.00	1.00	1.00	1.00	1.00	1.00	1.00	1.00	1.00	1.00	1.00	1.00
Uniform Delay (d), s/veh	46.6	45.4	34.9	69.9	71.2	70.0	58.4	17.2	13.9	73.9	44.3	32.9
Incr Delay (d2), s/veh	0.0	0.0	3.4	0.3	2.4	0.5	81.2	0.3	0.0	1.7	5.0	0.3
Initial Q Delay(d3),s/veh	0.0	0.0	0.0	0.0	0.0	0.0	0.0	0.0	0.0	0.0	0.0	0.0
%ile BackOfQ(50%),veh/ln	2.1	0.7	19.1	0.5	1.9	0.5	25.7	7.9	0.2	0.5	21.0	2.3
LnGrp Delay(d),s/veh	46.6	45.4	38.3	70.2	73.6	70.5	139.5	17.5	13.9	75.6	49.3	33.2
LnGrp LOS	D	D	D	E	E	E	F	B	B	E	D	C
Approach Vol, veh/h		1183			68			1639			1157	
Approach Delay, s/veh		39.3			72.5			86.1			48.7	
Approach LOS		D			E			F			D	
Timer	1	2	3	4	5	6	7	8				
Assigned Phs	1	2		4	5	6		8				
Phs Duration (G+Y+Rc), s	39.1	60.6		11.6	6.5	93.1		40.5				
Change Period (Y+Rc), s	4.1	* 6.2		5.0	4.1	* 6.2		5.5				
Max Green Setting (Gmax), s	35.0	* 60		31.0	20.0	* 50		35.0				
Max Q Clear Time (g_c+Q), s	37.0	42.8		5.7	3.0	18.0		37.0				
Green Ext Time (p_c), s	0.0	11.5		0.2	0.0	10.6		0.0				
Intersection Summary												
HCM 2010 Ctrl Delay			61.5									
HCM 2010 LOS			E									
Notes												

HCM 2010 Signalized Intersection Summary
13: Reservation Road & Blanco Road

								
Movement	EBL	EBT	WBT	WBR	SBL	SBR		
Lane Configurations								
Traffic Volume (veh/h)	1140	1010	400	50	40	1060		
Future Volume (veh/h)	1140	1010	400	50	40	1060		
Number	5	2	6	16	7	14		
Initial Q (Qb), veh	0	0	0	0	0	0		
Ped-Bike Adj(A_pbT)	1.00			1.00	1.00	1.00		
Parking Bus, Adj	1.00	1.00	1.00	1.00	1.00	1.00		
Adj Sat Flow, veh/h/ln	1881	1881	1863	1863	1863	1863		
Adj Flow Rate, veh/h	1213	1074	426	29	43	0		
Adj No. of Lanes	2	2	1	1	2	2		
Peak Hour Factor	0.94	0.94	0.94	0.94	0.94	0.94		
Percent Heavy Veh, %	1	1	2	2	2	2		
Cap, veh/h	1337	2791	536	455	123	100		
Arrive On Green	0.38	0.78	0.29	0.29	0.04	0.00		
Sat Flow, veh/h	3476	3668	1863	1583	3442	2787		
Grp Volume(v), veh/h	1213	1074	426	29	43	0		
Grp Sat Flow(s),veh/h/ln	1738	1787	1863	1583	1721	1393		
Q Serve(g_s), s	16.7	4.8	10.7	0.7	0.6	0.0		
Cycle Q Clear(g_c), s	16.7	4.8	10.7	0.7	0.6	0.0		
Prop In Lane	1.00			1.00	1.00	1.00		
Lane Grp Cap(c), veh/h	1337	2791	536	455	123	100		
V/C Ratio(X)	0.91	0.38	0.80	0.06	0.35	0.00		
Avail Cap(c_a), veh/h	2742	4229	2204	1873	1832	1484		
HCM Platoon Ratio	1.00	1.00	1.00	1.00	1.00	1.00		
Upstream Filter(I)	1.00	1.00	1.00	1.00	1.00	0.00		
Uniform Delay (d), s/veh	14.7	1.7	16.7	13.1	23.9	0.0		
Incr Delay (d2), s/veh	1.0	0.1	2.0	0.0	0.6	0.0		
Initial Q Delay(d3),s/veh	0.0	0.0	0.0	0.0	0.0	0.0		
%ile BackOfQ(50%),veh/ln	8.1	2.3	5.7	0.3	0.3	0.0		
LnGrp Delay(d),s/veh	15.8	1.8	18.7	13.2	24.5	0.0		
LnGrp LOS	B	A	B	B	C			
Approach Vol, veh/h		2287	455		43			
Approach Delay, s/veh		9.2	18.4		24.5			
Approach LOS		A	B		C			
Timer	1	2	3	4	5	6	7	8
Assigned Phs		2		4	5	6		
Phs Duration (G+Y+Rc), s		45.4		5.3	25.0	20.4		
Change Period (Y+Rc), s		5.8		3.5	5.5	5.8		
Max Green Setting (Gmax), s		60.0		27.0	40.0	60.0		
Max Q Clear Time (g_c+I1), s		6.8		2.6	18.7	12.7		
Green Ext Time (p_c), s		6.3		0.0	0.8	1.9		
Intersection Summary								
HCM 2010 Ctrl Delay			10.9					
HCM 2010 LOS			B					

HCM 2010 Signalized Intersection Summary Cumulative with Eastside Parkway with Project, PM
 14: Reservation Road & Inter-Garrison Road

06/11/2019



Movement	EBL	EBR	NBL	NBT	SBT	SBR		
Lane Configurations								
Traffic Volume (veh/h)	80	960	620	380	940	210		
Future Volume (veh/h)	80	960	620	380	940	210		
Number	3	18	1	6	2	12		
Initial Q (Qb), veh	0	0	0	0	0	0		
Ped-Bike Adj(A_pbT)	1.00	1.00	1.00			1.00		
Parking Bus, Adj	1.00	1.00	1.00	1.00	1.00	1.00		
Adj Sat Flow, veh/h/ln	1881	1881	1845	1845	1881	1900		
Adj Flow Rate, veh/h	98	1016	756	463	1146	247		
Adj No. of Lanes	1	1	1	2	2	0		
Peak Hour Factor	0.82	0.82	0.82	0.82	0.82	0.82		
Percent Heavy Veh, %	1	1	3	3	1	1		
Cap, veh/h	412	640	299	2374	1368	293		
Arrive On Green	0.23	0.23	0.17	0.68	0.47	0.47		
Sat Flow, veh/h	1792	1599	1757	3597	3024	627		
Grp Volume(v), veh/h	98	1016	756	463	696	697		
Grp Sat Flow(s),veh/h/ln	1792	1599	1757	1752	1787	1770		
Q Serve(g_s), s	5.2	27.0	20.0	5.8	39.9	40.7		
Cycle Q Clear(g_c), s	5.2	27.0	20.0	5.8	39.9	40.7		
Prop In Lane	1.00	1.00	1.00			0.35		
Lane Grp Cap(c), veh/h	412	640	299	2374	835	827		
V/C Ratio(X)	0.24	1.59	2.53	0.20	0.83	0.84		
Avail Cap(c_a), veh/h	412	640	299	2374	913	904		
HCM Platoon Ratio	1.00	1.00	1.00	1.00	1.00	1.00		
Upstream Filter(I)	1.00	1.00	1.00	1.00	1.00	1.00		
Uniform Delay (d), s/veh	36.8	35.2	48.7	7.0	27.3	27.5		
Incr Delay (d2), s/veh	0.3	271.9	697.0	0.1	7.1	7.7		
Initial Q Delay(d3),s/veh	0.0	0.0	0.0	0.0	0.0	0.0		
%ile BackOfQ(50%),veh/ln	2.6	69.0	67.6	2.8	21.2	21.5		
LnGrp Delay(d),s/veh	37.1	307.1	745.7	7.1	34.4	35.2		
LnGrp LOS	D	F	F	A	C	D		
Approach Vol, veh/h	1114			1219	1393			
Approach Delay, s/veh	283.4			465.2	34.8			
Approach LOS	F			F	C			
Timer	1	2	3	4	5	6	7	8
Assigned Phs	1	2				6		8
Phs Duration (G+Y+Rc), s	4.7	61.2				85.9		31.5
Change Period (Y+Rc), s	4.7	6.4				6.4		4.5
Max Green Setting (Gmax), s	26	60.0				60.0		27.0
Max Q Clear Time (g_c+Yc), s	22.6	42.7				7.8		29.0
Green Ext Time (p_c), s	0.0	12.2				5.4		0.0
Intersection Summary								
HCM 2010 Ctrl Delay			249.9					
HCM 2010 LOS			F					
Notes								

HCM 2010 Signalized Intersection Summary Cumulative with Eastside Parkway with Project, PM
 15: 2nd Avenue & 9th Street

06/11/2019



Movement	EBL	EBT	EBR	WBL	WBT	WBR	NBL	NBT	NBR	SBL	SBT	SBR
Lane Configurations		↔	↔		↔		↔	↕		↔	↕	
Traffic Volume (veh/h)	10	10	30	40	10	20	20	750	50	40	610	10
Future Volume (veh/h)	10	10	30	40	10	20	20	750	50	40	610	10
Number	5	2	12	1	6	16	3	8	18	7	4	14
Initial Q (Qb), veh	0	0	0	0	0	0	0	0	0	0	0	0
Ped-Bike Adj(A_pbT)	1.00		0.98	1.00		1.00	1.00		0.97	1.00		1.00
Parking Bus, Adj	1.00	1.00	1.00	1.00	1.00	1.00	1.00	1.00	1.00	1.00	1.00	1.00
Adj Sat Flow, veh/h/ln	1900	1900	1900	1900	1900	1900	1881	1881	1900	1827	1827	1900
Adj Flow Rate, veh/h	11	11	23	44	11	3	22	824	51	44	670	-1
Adj No. of Lanes	0	1	1	0	1	0	1	2	0	1	2	0
Peak Hour Factor	0.91	0.91	0.91	0.91	0.91	0.91	0.91	0.91	0.91	0.91	0.91	0.91
Percent Heavy Veh, %	0	0	0	0	0	0	1	1	1	4	4	4
Cap, veh/h	256	204	297	359	78	15	49	1381	85	85	1481	0
Arrive On Green	0.19	0.19	0.19	0.19	0.19	0.19	0.03	0.40	0.40	0.05	0.43	0.00
Sat Flow, veh/h	600	1094	1591	1020	416	78	1792	3412	211	1740	3563	0
Grp Volume(v), veh/h	22	0	23	58	0	0	22	432	443	44	669	0
Grp Sat Flow(s),veh/h/ln	1694	0	1591	1514	0	0	1792	1787	1836	1740	1736	0
Q Serve(g_s), s	0.0	0.0	0.4	0.4	0.0	0.0	0.5	7.1	7.1	0.9	5.1	0.0
Cycle Q Clear(g_c), s	0.4	0.0	0.4	1.1	0.0	0.0	0.5	7.1	7.1	0.9	5.1	0.0
Prop In Lane	0.50		1.00	0.76		0.05	1.00		0.12	1.00		0.00
Lane Grp Cap(c), veh/h	460	0	297	451	0	0	49	724	743	85	1481	0
V/C Ratio(X)	0.05	0.00	0.08	0.13	0.00	0.00	0.45	0.60	0.60	0.52	0.45	0.00
Avail Cap(c_a), veh/h	1668	0	1482	1552	0	0	548	1903	1955	533	3696	0
HCM Platoon Ratio	1.00	1.00	1.00	1.00	1.00	1.00	1.00	1.00	1.00	1.00	1.00	1.00
Upstream Filter(I)	1.00	0.00	1.00	1.00	0.00	0.00	1.00	1.00	1.00	1.00	1.00	0.00
Uniform Delay (d), s/veh	12.6	0.0	12.6	12.8	0.0	0.0	18.0	8.8	8.8	17.4	7.7	0.0
Incr Delay (d2), s/veh	0.0	0.0	0.1	0.1	0.0	0.0	6.3	0.8	0.8	4.8	0.2	0.0
Initial Q Delay(d3),s/veh	0.0	0.0	0.0	0.0	0.0	0.0	0.0	0.0	0.0	0.0	0.0	0.0
%ile BackOfQ(50%),veh/ln	0.2	0.0	0.2	0.5	0.0	0.0	0.3	3.6	3.7	0.6	2.5	0.0
LnGrp Delay(d),s/veh	12.6	0.0	12.7	13.0	0.0	0.0	24.3	9.6	9.5	22.2	7.9	0.0
LnGrp LOS	B		B	B			C	A	A	C	A	
Approach Vol, veh/h		45			58			897			713	
Approach Delay, s/veh		12.7			13.0			9.9			8.8	
Approach LOS		B			B			A			A	
Timer	1	2	3	4	5	6	7	8				
Assigned Phs		2	3	4		6	7	8				
Phs Duration (G+Y+Rc), s		12.0	4.5	21.0		12.0	5.3	20.2				
Change Period (Y+Rc), s		5.0	3.5	5.0		5.0	3.5	5.0				
Max Green Setting (Gmax), s		35.0	11.5	40.0		35.0	11.5	40.0				
Max Q Clear Time (g_c+I1), s		2.4	2.5	7.1		3.1	2.9	9.1				
Green Ext Time (p_c), s		0.1	0.0	5.0		0.3	0.0	6.1				
Intersection Summary												
HCM 2010 Ctrl Delay			9.6									
HCM 2010 LOS			A									

HCM 2010 Signalized Intersection Summary Cumulative with Eastside Parkway with Project, PM
 16: 2nd Avenue & 8th Street

06/11/2019



Movement	WBL	WBR	NBT	NBR	SBL	SBT		
Lane Configurations								
Traffic Volume (veh/h)	40	80	600	220	70	490		
Future Volume (veh/h)	40	80	600	220	70	490		
Number	1	16	8	18	7	4		
Initial Q (Qb), veh	0	0	0	0	0	0		
Ped-Bike Adj(A_pbT)	1.00	1.00		0.97	1.00			
Parking Bus, Adj	1.00	1.00	1.00	1.00	1.00	1.00		
Adj Sat Flow, veh/h/ln	1900	1900	1881	1900	1827	1827		
Adj Flow Rate, veh/h	43	51	638	203	74	521		
Adj No. of Lanes	1	1	2	0	1	2		
Peak Hour Factor	0.94	0.94	0.94	0.94	0.94	0.94		
Percent Heavy Veh, %	0	0	1	1	4	4		
Cap, veh/h	158	141	1148	365	129	2126		
Arrive On Green	0.09	0.09	0.43	0.43	0.07	0.61		
Sat Flow, veh/h	1810	1615	2745	843	1740	3563		
Grp Volume(v), veh/h	43	51	430	411	74	521		
Grp Sat Flow(s),veh/h/ln	1810	1615	1787	1707	1740	1736		
Q Serve(g_s), s	0.7	1.0	6.0	6.0	1.4	2.3		
Cycle Q Clear(g_c), s	0.7	1.0	6.0	6.0	1.4	2.3		
Prop In Lane	1.00	1.00		0.49	1.00			
Lane Grp Cap(c), veh/h	158	141	774	739	129	2126		
V/C Ratio(X)	0.27	0.36	0.56	0.56	0.57	0.25		
Avail Cap(c_a), veh/h	1630	1455	2415	2306	601	6254		
HCM Platoon Ratio	1.00	1.00	1.00	1.00	1.00	1.00		
Upstream Filter(I)	1.00	1.00	1.00	1.00	1.00	1.00		
Uniform Delay (d), s/veh	14.2	14.3	7.0	7.1	14.9	2.9		
Incr Delay (d2), s/veh	0.9	1.6	0.6	0.7	3.9	0.1		
Initial Q Delay(d3),s/veh	0.0	0.0	0.0	0.0	0.0	0.0		
%ile BackOfQ(50%),veh/ln	0.4	1.0	3.0	2.9	0.8	1.1		
LnGrp Delay(d),s/veh	15.1	15.9	7.7	7.7	18.8	3.0		
LnGrp LOS	B	B	A	A	B	A		
Approach Vol, veh/h	94		841			595		
Approach Delay, s/veh	15.5		7.7			5.0		
Approach LOS	B		A			A		
Timer	1	2	3	4	5	6	7	8
Assigned Phs				4		6	7	8
Phs Duration (G+Y+Rc), s				25.4		7.9	6.0	19.4
Change Period (Y+Rc), s				5.0		5.0	3.5	5.0
Max Green Setting (Gmax), s				60.0		30.0	11.5	45.0
Max Q Clear Time (g_c+I1), s				4.3		3.0	3.4	8.0
Green Ext Time (p_c), s				3.8		0.2	0.1	6.1
Intersection Summary								
HCM 2010 Ctrl Delay			7.1					
HCM 2010 LOS			A					

Intersection	
Intersection Delay, s/veh	11.3
Intersection LOS	B

Movement	EBT	EBR	WBL	WBT	NBL	NBR
Lane Configurations	↑	↑	↑	↑	↑	↑
Traffic Vol, veh/h	220	70	180	40	80	220
Future Vol, veh/h	220	70	180	40	80	220
Peak Hour Factor	0.92	0.92	0.92	0.92	0.92	0.92
Heavy Vehicles, %	2	2	2	2	2	2
Mvmt Flow	239	76	196	43	87	239
Number of Lanes	1	1	1	1	1	1

Approach	EB	WB	NB
Opposing Approach	WB	EB	
Opposing Lanes	2	2	0
Conflicting Approach Left		NB	EB
Conflicting Lanes Left	0	2	2
Conflicting Approach Right	NB		WB
Conflicting Lanes Right	2	0	2
HCM Control Delay	11.2	11.8	10.9
HCM LOS	B	B	B

Lane	NBLn1	NBLn2	EBLn1	EBLn2	WBLn1	WBLn2
Vol Left, %	100%	0%	0%	0%	100%	0%
Vol Thru, %	0%	0%	100%	0%	0%	100%
Vol Right, %	0%	100%	0%	100%	0%	0%
Sign Control	Stop	Stop	Stop	Stop	Stop	Stop
Traffic Vol by Lane	80	220	220	70	180	40
LT Vol	80	0	0	0	180	0
Through Vol	0	0	220	0	0	40
RT Vol	0	220	0	70	0	0
Lane Flow Rate	87	239	239	76	196	43
Geometry Grp	7	7	7	7	7	7
Degree of Util (X)	0.158	0.355	0.386	0.108	0.346	0.071
Departure Headway (Hd)	6.555	5.345	5.806	5.097	6.374	5.867
Convergence, Y/N	Yes	Yes	Yes	Yes	Yes	Yes
Cap	548	674	622	704	565	611
Service Time	4.283	3.072	3.53	2.821	4.101	3.594
HCM Lane V/C Ratio	0.159	0.355	0.384	0.108	0.347	0.07
HCM Control Delay	10.5	11	12.1	8.4	12.4	9
HCM Lane LOS	B	B	B	A	B	A
HCM 95th-tile Q	0.6	1.6	1.8	0.4	1.5	0.2

Intersection				
Intersection Delay, s/veh	8.2			
Intersection LOS	A			
Approach	EB	WB	NB	SB
Entry Lanes	1	1	1	1
Conflicting Circle Lanes	1	1	1	1
Adj Approach Flow, veh/h	353	352	61	232
Demand Flow Rate, veh/h	364	356	61	236
Vehicles Circulating, veh/h	202	302	508	98
Vehicles Exiting, veh/h	132	267	58	560
Follow-Up Headway, s	3.186	3.186	3.186	3.186
Ped Vol Crossing Leg, #/h	0	0	0	0
Ped Cap Adj	1.000	1.000	1.000	1.000
Approach Delay, s/veh	8.6	9.7	6.3	5.8
Approach LOS	A	A	A	A
Lane	Left	Left	Left	Left
Designated Moves	LTR	LTR	LTR	LTR
Assumed Moves	LTR	LTR	LTR	LTR
RT Channelized				
Lane Util	1.000	1.000	1.000	1.000
Critical Headway, s	5.193	5.193	5.193	5.193
Entry Flow, veh/h	364	356	61	236
Cap Entry Lane, veh/h	923	835	680	1024
Entry HV Adj Factor	0.969	0.990	1.000	0.981
Flow Entry, veh/h	353	352	61	232
Cap Entry, veh/h	895	827	680	1005
V/C Ratio	0.394	0.426	0.090	0.230
Control Delay, s/veh	8.6	9.7	6.3	5.8
LOS	A	A	A	A
95th %tile Queue, veh	2	2	0	1

HCM 2010 Signalized Intersection Summary Cumulative with Eastside Parkway with Project, PM
 19: 2nd Avenue & Inter-Garrison Road

06/11/2019



Movement	WBL	WBR	NBT	NBR	SBL	SBT		
Lane Configurations								
Traffic Volume (veh/h)	70	30	790	50	30	510		
Future Volume (veh/h)	70	30	790	50	30	510		
Number	1	16	8	18	7	4		
Initial Q (Qb), veh	0	0	0	0	0	0		
Ped-Bike Adj(A_pbT)	1.00	1.00		1.00	1.00			
Parking Bus, Adj	1.00	1.00	1.00	1.00	1.00	1.00		
Adj Sat Flow, veh/h/ln	1900	1900	1881	1900	1863	1863		
Adj Flow Rate, veh/h	72	7	814	44	31	526		
Adj No. of Lanes	1	1	2	0	1	2		
Peak Hour Factor	0.97	0.97	0.97	0.97	0.97	0.97		
Percent Heavy Veh, %	0	0	1	1	2	2		
Cap, veh/h	279	249	1427	77	66	1958		
Arrive On Green	0.15	0.15	0.41	0.41	0.04	0.55		
Sat Flow, veh/h	1810	1615	3543	186	1774	3632		
Grp Volume(v), veh/h	72	7	422	436	31	526		
Grp Sat Flow(s),veh/h/ln	1810	1615	1787	1848	1774	1770		
Q Serve(g_s), s	1.2	0.1	6.2	6.2	0.6	2.7		
Cycle Q Clear(g_c), s	1.2	0.1	6.2	6.2	0.6	2.7		
Prop In Lane	1.00	1.00		0.10	1.00			
Lane Grp Cap(c), veh/h	279	249	739	764	66	1958		
V/C Ratio(X)	0.26	0.03	0.57	0.57	0.47	0.27		
Avail Cap(c_a), veh/h	1852	1653	2090	2162	597	5692		
HCM Platoon Ratio	1.00	1.00	1.00	1.00	1.00	1.00		
Upstream Filter(I)	1.00	1.00	1.00	1.00	1.00	1.00		
Uniform Delay (d), s/veh	12.7	12.3	7.7	7.7	16.1	4.0		
Incr Delay (d2), s/veh	0.5	0.0	0.7	0.7	5.1	0.1		
Initial Q Delay(d3),s/veh	0.0	0.0	0.0	0.0	0.0	0.0		
%ile BackOfQ(50%),veh/ln	0.6	0.1	3.1	3.3	0.4	1.3		
LnGrp Delay(d),s/veh	13.2	12.3	8.4	8.4	21.2	4.1		
LnGrp LOS	B	B	A	A	C	A		
Approach Vol, veh/h	79		858			557		
Approach Delay, s/veh	13.1		8.4			5.0		
Approach LOS	B		A			A		
Timer	1	2	3	4	5	6	7	8
Assigned Phs				4		6	7	8
Phs Duration (G+Y+Rc), s				23.9		10.3	4.8	19.1
Change Period (Y+Rc), s				5.0		5.0	3.5	5.0
Max Green Setting (Gmax), s				55.0		35.0	11.5	40.0
Max Q Clear Time (g_c+I1), s				4.7		3.2	2.6	8.2
Green Ext Time (p_c), s				3.9		0.2	0.0	5.9
Intersection Summary								
HCM 2010 Ctrl Delay			7.4					
HCM 2010 LOS			A					

Intersection												
Intersection Delay, s/veh	9.5											
Intersection LOS	A											























Movement	EBL	EBT	EBR	WBL	WBT	WBR	NBL	NBT	NBR	SBL	SBT	SBR
Lane Configurations		↕			↕			↕			↕	
Traffic Vol, veh/h	10	20	30	120	30	20	20	80	100	20	90	10
Future Vol, veh/h	10	20	30	120	30	20	20	80	100	20	90	10
Peak Hour Factor	0.82	0.82	0.82	0.82	0.82	0.82	0.82	0.82	0.82	0.82	0.82	0.82
Heavy Vehicles, %	1	1	1	1	1	1	3	3	3	0	0	0
Mvmt Flow	12	24	37	146	37	24	24	98	122	24	110	12
Number of Lanes	0	1	0	0	1	0	0	1	0	0	1	0

Approach	EB	WB	NB	SB
Opposing Approach	WB	EB	SB	NB
Opposing Lanes	1	1	1	1
Conflicting Approach Left	SB	NB	EB	WB
Conflicting Lanes Left	1	1	1	1
Conflicting Approach Right	NB	SB	WB	EB
Conflicting Lanes Right	1	1	1	1
HCM Control Delay	8.4	10.1	9.6	9.1
HCM LOS	A	B	A	A

Lane	NBLn1	EBLn1	WBLn1	SBLn1
Vol Left, %	10%	17%	71%	17%
Vol Thru, %	40%	33%	18%	75%
Vol Right, %	50%	50%	12%	8%
Sign Control	Stop	Stop	Stop	Stop
Traffic Vol by Lane	200	60	170	120
LT Vol	20	10	120	20
Through Vol	80	20	30	90
RT Vol	100	30	20	10
Lane Flow Rate	244	73	207	146
Geometry Grp	1	1	1	1
Degree of Util (X)	0.308	0.098	0.287	0.198
Departure Headway (Hd)	4.552	4.838	4.982	4.871
Convergence, Y/N	Yes	Yes	Yes	Yes
Cap	785	733	717	732
Service Time	2.608	2.916	3.047	2.935
HCM Lane V/C Ratio	0.311	0.1	0.289	0.199
HCM Control Delay	9.6	8.4	10.1	9.1
HCM Lane LOS	A	A	B	A
HCM 95th-tile Q	1.3	0.3	1.2	0.7

HCM 2010 Signalized Intersection Summary
 21: 7th Avenue/8th Street & Inter-Garrison Road

07/12/2019

												
Movement	EBL	EBT	EBR	WBL	WBT	WBR	NBL	NBT	NBR	SBL	SBT	SBR
Lane Configurations												
Traffic Volume (veh/h)	10	230	80	230	150	50	60	180	370	60	110	10
Future Volume (veh/h)	10	230	80	230	150	50	60	180	370	60	110	10
Number	5	2	12	1	6	16	3	8	18	7	4	14
Initial Q (Qb), veh	0	0	0	0	0	0	0	0	0	0	0	0
Ped-Bike Adj(A_pbT)	1.00		0.99	1.00		1.00	1.00		0.98	1.00		1.00
Parking Bus, Adj	1.00	1.00	1.00	1.00	1.00	1.00	1.00	1.00	1.00	1.00	1.00	1.00
Adj Sat Flow, veh/h/ln	1881	1881	1900	1827	1827	1900	1810	1810	1810	1900	1900	1900
Adj Flow Rate, veh/h	11	247	80	247	161	39	65	194	326	65	118	2
Adj No. of Lanes	1	1	0	1	1	0	1	1	1	1	1	0
Peak Hour Factor	0.93	0.93	0.93	0.93	0.93	0.93	0.93	0.93	0.93	0.93	0.93	0.93
Percent Heavy Veh, %	1	1	1	4	4	4	5	5	5	0	0	0
Cap, veh/h	20	341	110	300	585	142	81	478	397	83	490	8
Arrive On Green	0.01	0.25	0.25	0.17	0.41	0.41	0.05	0.26	0.26	0.05	0.26	0.26
Sat Flow, veh/h	1792	1359	440	1740	1420	344	1723	1810	1502	1810	1863	32
Grp Volume(v), veh/h	11	0	327	247	0	200	65	194	326	65	0	120
Grp Sat Flow(s),veh/h/ln	1792	0	1799	1740	0	1764	1723	1810	1502	1810	0	1894
Q Serve(g_s), s	0.4	0.0	10.0	8.2	0.0	4.5	2.2	5.3	12.2	2.1	0.0	3.0
Cycle Q Clear(g_c), s	0.4	0.0	10.0	8.2	0.0	4.5	2.2	5.3	12.2	2.1	0.0	3.0
Prop In Lane	1.00		0.24	1.00		0.19	1.00		1.00	1.00		0.02
Lane Grp Cap(c), veh/h	20	0	451	300	0	727	81	478	397	83	0	498
V/C Ratio(X)	0.55	0.00	0.72	0.82	0.00	0.28	0.81	0.41	0.82	0.79	0.00	0.24
Avail Cap(c_a), veh/h	120	0	992	421	0	1282	130	665	552	136	0	696
HCM Platoon Ratio	1.00	1.00	1.00	1.00	1.00	1.00	1.00	1.00	1.00	1.00	1.00	1.00
Upstream Filter(I)	1.00	0.00	1.00	1.00	0.00	1.00	1.00	1.00	1.00	1.00	0.00	1.00
Uniform Delay (d), s/veh	29.4	0.0	20.5	23.9	0.0	11.7	28.3	18.2	20.7	28.3	0.0	17.4
Incr Delay (d2), s/veh	21.5	0.0	2.2	8.9	0.0	0.2	17.0	0.6	6.9	15.1	0.0	0.2
Initial Q Delay(d3),s/veh	0.0	0.0	0.0	0.0	0.0	0.0	0.0	0.0	0.0	0.0	0.0	0.0
%ile BackOfQ(50%),veh/ln	0.3	0.0	5.2	4.7	0.0	2.2	1.4	2.7	5.7	1.4	0.0	1.6
LnGrp Delay(d),s/veh	50.9	0.0	22.8	32.8	0.0	11.9	45.3	18.7	27.6	43.4	0.0	17.6
LnGrp LOS	D		C	C		B	D	B	C	D		B
Approach Vol, veh/h		338			447			585			185	
Approach Delay, s/veh		23.7			23.4			26.6			26.7	
Approach LOS		C			C			C			C	
Timer	1	2	3	4	5	6	7	8				
Assigned Phs	1	2	3	4	5	6	7	8				
Phs Duration (G+Y+Rc), s	13.8	20.0	6.3	19.7	4.2	29.7	6.2	19.8				
Change Period (Y+Rc), s	3.5	5.0	3.5	4.0	3.5	5.0	3.5	4.0				
Max Green Setting (Gmax), s	14.5	33.0	4.5	22.0	4.0	43.5	4.5	22.0				
Max Q Clear Time (g_c+I1), s	10.2	12.0	4.2	5.0	2.4	6.5	4.1	14.2				
Green Ext Time (p_c), s	0.3	1.9	0.0	0.5	0.0	1.3	0.0	1.5				
Intersection Summary												
HCM 2010 Ctrl Delay			25.1									
HCM 2010 LOS			C									

Intersection			
Intersection Delay, s/veh	22.0		
Intersection LOS	C		
Approach	EB	WB	NB
Entry Lanes	1	1	1
Conflicting Circle Lanes	1	1	1
Adj Approach Flow, veh/h	680	681	495
Demand Flow Rate, veh/h	694	695	495
Vehicles Circulating, veh/h	295	62	610
Vehicles Exiting, veh/h	462	1043	379
Follow-Up Headway, s	3.186	3.186	3.186
Ped Vol Crossing Leg, #/h	0	0	0
Ped Cap Adj	1.000	1.000	1.000
Approach Delay, s/veh	25.4	13.0	29.8
Approach LOS	D	B	D
Lane	Left	Left	Left
Designated Moves	TR	LT	LR
Assumed Moves	TR	LT	LR
RT Channelized			
Lane Util	1.000	1.000	1.000
Critical Headway, s	5.193	5.193	5.193
Entry Flow, veh/h	694	695	495
Cap Entry Lane, veh/h	841	1062	614
Entry HV Adj Factor	0.980	0.980	1.000
Flow Entry, veh/h	680	681	495
Cap Entry, veh/h	824	1041	614
V/C Ratio	0.825	0.654	0.806
Control Delay, s/veh	25.4	13.0	29.8
LOS	D	B	D
95th %tile Queue, veh	9	5	8

Intersection			
Intersection Delay, s/veh	33.9		
Intersection LOS	D		
Approach	EB	WB	NB
Entry Lanes	1	1	1
Conflicting Circle Lanes	1	1	1
Adj Approach Flow, veh/h	608	680	711
Demand Flow Rate, veh/h	620	693	711
Vehicles Circulating, veh/h	525	72	410
Vehicles Exiting, veh/h	240	1049	735
Follow-Up Headway, s	3.186	3.186	3.186
Ped Vol Crossing Leg, #/h	0	0	0
Ped Cap Adj	1.000	1.000	1.000
Approach Delay, s/veh	44.4	13.3	44.6
Approach LOS	E	B	E
Lane	Left	Left	Left
Designated Moves	TR	LT	LR
Assumed Moves	TR	LT	LR
RT Channelized			
Lane Util	1.000	1.000	1.000
Critical Headway, s	5.193	5.193	5.193
Entry Flow, veh/h	620	693	711
Cap Entry Lane, veh/h	668	1051	750
Entry HV Adj Factor	0.981	0.981	1.000
Flow Entry, veh/h	608	680	711
Cap Entry, veh/h	655	1031	750
V/C Ratio	0.928	0.659	0.948
Control Delay, s/veh	44.4	13.3	44.6
LOS	E	B	E
95th %tile Queue, veh	12	5	14

HCM 2010 Signalized Intersection Summary Cumulative with Eastside Parkway with Project, PM
 23: Inter-Garrison Road & Abrams Drive

06/11/2019

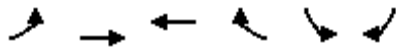

Movement	EBL	EBT	WBT	WBR	SBL	SBR		
Lane Configurations								
Traffic Volume (veh/h)	390	620	400	140	120	260		
Future Volume (veh/h)	390	620	400	140	120	260		
Number	5	2	6	16	7	14		
Initial Q (Qb), veh	0	0	0	0	0	0		
Ped-Bike Adj(A_pbT)	1.00			0.98	1.00	1.00		
Parking Bus, Adj	1.00	1.00	1.00	1.00	1.00	1.00		
Adj Sat Flow, veh/h/ln	1863	1863	1792	1792	1827	1827		
Adj Flow Rate, veh/h	411	653	421	121	126	51		
Adj No. of Lanes	1	1	1	1	2	1		
Peak Hour Factor	0.95	0.95	0.95	0.95	0.95	0.95		
Percent Heavy Veh, %	2	2	6	6	4	4		
Cap, veh/h	484	1232	516	429	318	146		
Arrive On Green	0.27	0.66	0.29	0.29	0.09	0.09		
Sat Flow, veh/h	1774	1863	1792	1491	3375	1553		
Grp Volume(v), veh/h	411	653	421	121	126	51		
Grp Sat Flow(s),veh/h/ln	1774	1863	1792	1491	1688	1553		
Q Serve(g_s), s	7.6	6.4	7.6	2.2	1.2	1.1		
Cycle Q Clear(g_c), s	7.6	6.4	7.6	2.2	1.2	1.1		
Prop In Lane	1.00			1.00	1.00	1.00		
Lane Grp Cap(c), veh/h	484	1232	516	429	318	146		
V/C Ratio(X)	0.85	0.53	0.82	0.28	0.40	0.35		
Avail Cap(c_a), veh/h	587	3216	2321	1931	3060	1408		
HCM Platoon Ratio	1.00	1.00	1.00	1.00	1.00	1.00		
Upstream Filter(I)	1.00	1.00	1.00	1.00	1.00	1.00		
Uniform Delay (d), s/veh	12.0	3.1	11.5	9.6	14.8	14.7		
Incr Delay (d2), s/veh	8.4	0.1	1.2	0.1	0.3	0.5		
Initial Q Delay(d3),s/veh	0.0	0.0	0.0	0.0	0.0	0.0		
%ile BackOfQ(50%),veh/ln	4.8	3.1	3.9	0.9	0.6	0.9		
LnGrp Delay(d),s/veh	20.4	3.2	12.7	9.7	15.1	15.3		
LnGrp LOS	C	A	B	A	B	B		
Approach Vol, veh/h		1064	542		177			
Approach Delay, s/veh		9.8	12.1		15.1			
Approach LOS		A	B		B			
Timer	1	2	3	4	5	6	7	8
Assigned Phs		2		4	5	6		
Phs Duration (G+Y+Rc), s		28.0		6.8	13.0	15.0		
Change Period (Y+Rc), s		5.0		3.5	3.5	5.0		
Max Green Setting (Gmax), s		60.0		31.5	11.5	45.0		
Max Q Clear Time (g_c+I1), s		8.4		3.2	9.6	9.6		
Green Ext Time (p_c), s		0.6		0.0	0.0	0.4		
Intersection Summary								
HCM 2010 Ctrl Delay			11.0					
HCM 2010 LOS			B					
Notes								

HCM 2010 Signalized Intersection Summary Cumulative with Eastside Parkway with Project, PM
 24: Inter-Garrison Road & Schoonover Road 06/11/2019



Movement	EBL	EBT	EBR	WBL	WBT	WBR	NBL	NBT	NBR	SBL	SBT	SBR
Lane Configurations												
Traffic Volume (veh/h)	200	470	110	380	330	40	120	60	870	20	30	70
Future Volume (veh/h)	200	470	110	380	330	40	120	60	870	20	30	70
Number	5	2	12	1	6	16	3	8	18	7	4	14
Initial Q (Qb), veh	0	0	0	0	0	0	0	0	0	0	0	0
Ped-Bike Adj(A_pbT)	1.00		1.00	1.00		1.00	1.00		1.00	1.00		1.00
Parking Bus, Adj	1.00	1.00	1.00	1.00	1.00	1.00	1.00	1.00	1.00	1.00	1.00	1.00
Adj Sat Flow, veh/h/ln	1881	1878	1900	1863	1810	1810	1863	1863	1863	1900	1760	1624
Adj Flow Rate, veh/h	233	547	93	442	384	33	140	70	0	23	35	57
Adj No. of Lanes	1	2	0	1	2	1	1	1	1	0	1	1
Peak Hour Factor	0.86	0.86	0.86	0.86	0.86	0.86	0.86	0.86	0.86	0.86	0.86	0.86
Percent Heavy Veh, %	1	1	1	2	5	5	2	2	2	2	2	17
Cap, veh/h	275	639	108	481	1123	502	243	255	217	86	130	173
Arrive On Green	0.15	0.21	0.21	0.27	0.33	0.33	0.14	0.14	0.00	0.13	0.13	0.13
Sat Flow, veh/h	1792	3053	517	1774	3438	1538	1774	1863	1583	684	1041	1380
Grp Volume(v), veh/h	233	319	321	442	384	33	140	70	0	58	0	57
Grp Sat Flow(s),veh/h/ln	1792	1784	1786	1774	1719	1538	1774	1863	1583	1726	0	1380
Q Serve(g_s), s	9.1	12.4	12.5	17.4	6.1	1.1	5.3	2.4	0.0	2.2	0.0	2.7
Cycle Q Clear(g_c), s	9.1	12.4	12.5	17.4	6.1	1.1	5.3	2.4	0.0	2.2	0.0	2.7
Prop In Lane	1.00		0.29	1.00		1.00	1.00		1.00	0.40		1.00
Lane Grp Cap(c), veh/h	275	373	374	481	1123	502	243	255	217	216	0	173
V/C Ratio(X)	0.85	0.85	0.86	0.92	0.34	0.07	0.58	0.27	0.00	0.27	0.00	0.33
Avail Cap(c_a), veh/h	761	745	746	852	1579	707	988	1037	882	649	0	519
HCM Platoon Ratio	1.00	1.00	1.00	1.00	1.00	1.00	1.00	1.00	1.00	1.00	1.00	1.00
Upstream Filter(I)	1.00	1.00	1.00	1.00	1.00	1.00	1.00	1.00	0.00	1.00	0.00	1.00
Uniform Delay (d), s/veh	29.6	27.4	27.4	25.4	18.3	16.6	29.0	27.8	0.0	28.4	0.0	28.7
Incr Delay (d2), s/veh	2.8	2.2	2.3	4.4	0.1	0.0	0.8	0.2	0.0	0.2	0.0	0.4
Initial Q Delay(d3),s/veh	0.0	0.0	0.0	0.0	0.0	0.0	0.0	0.0	0.0	0.0	0.0	0.0
%ile BackOfQ(50%),veh/ln	4.7	6.3	6.4	9.1	2.9	0.5	2.7	1.3	0.0	1.1	0.0	1.0
LnGrp Delay(d),s/veh	32.4	29.5	29.7	29.8	18.4	16.7	29.8	28.0	0.0	28.7	0.0	29.1
LnGrp LOS	C	C	C	C	B	B	C	C		C		C
Approach Vol, veh/h		873			859			210			115	
Approach Delay, s/veh		30.3			24.2			29.2			28.9	
Approach LOS		C			C			C			C	
Timer	1	2	3	4	5	6	7	8				
Assigned Phs	1	2		4	5	6		8				
Phs Duration (G+Y+Rc), s	23.0	20.0		14.0	14.5	28.5		14.8				
Change Period (Y+Rc), s	3.5	5.0		5.0	3.5	5.0		5.0				
Max Green Setting (Gmax), s	31.5	30.0		27.0	30.5	33.0		40.0				
Max Q Clear Time (g_c+1), s	19.4	14.5		4.7	11.1	8.1		7.3				
Green Ext Time (p_c), s	0.1	0.6		0.0	0.1	0.5		0.0				
Intersection Summary												
HCM 2010 Ctrl Delay			27.6									
HCM 2010 LOS			C									

Intersection	
Intersection Delay, s/veh	37.1
Intersection LOS	F

Movement	EBL	EBT	WBT	WBR	SBL	SBR
Lane Configurations	↙	↑	↘		↙	↘
Traffic Vol, veh/h	990	270	160	100	120	520
Future Vol, veh/h	990	270	160	100	120	520
Peak Hour Factor	0.87	0.87	0.87	0.87	0.87	0.87
Heavy Vehicles, %	1	1	6	6	3	3
Mvmt Flow	1138	310	184	115	138	598
Number of Lanes	1	1	1	0	1	1

Approach	EB	WB	SB
Opposing Approach	WB	EB	
Opposing Lanes	1	2	0
Conflicting Approach Left	SB		WB
Conflicting Lanes Left	2	0	1
Conflicting Approach Right		SB	EB
Conflicting Lanes Right	0	2	2
HCM Control Delay	527.6	23.2	89.6
HCM LOS	F	C	F

Lane	EBLn1	EBLn2	WBLn1	SBLn1	SBLn2
Vol Left, %	100%	0%	0%	100%	0%
Vol Thru, %	0%	100%	62%	0%	0%
Vol Right, %	0%	0%	38%	0%	100%
Sign Control	Stop	Stop	Stop	Stop	Stop
Traffic Vol by Lane	990	270	260	120	520
LT Vol	990	0	0	120	0
Through Vol	0	270	160	0	0
RT Vol	0	0	100	0	520
Lane Flow Rate	1138	310	299	138	598
Geometry Grp	7	7	4	7	7
Degree of Util (X)	2.425	0.618	0.603	0.304	1.119
Departure Headway (Hd)	8.119	7.605	8.349	9.298	8.059
Convergence, Y/N	Yes	Yes	Yes	Yes	Yes
Cap	455	478	436	389	454
Service Time	5.819	5.305	6.349	6.998	5.759
HCM Lane V/C Ratio	2.501	0.649	0.686	0.355	1.317
HCM Control Delay	665.6	21.8	23.2	16	106.6
HCM Lane LOS	F	C	C	C	F
HCM 95th-tile Q	83.8	4.1	3.9	1.3	17.4

HCM 2010 Signalized Intersection Summary Cumulative with Eastside Parkway with Project, PM
 26: East Garrison Road & Reservation Road

06/11/2019



Movement	EBL	EBT	EBR	WBL	WBT	WBR	NBL	NBT	NBR	SBL	SBT	SBR
Lane Configurations												
Traffic Volume (veh/h)	0	1680	130	230	880	0	110	0	150	0	0	0
Future Volume (veh/h)	0	1680	130	230	880	0	110	0	150	0	0	0
Number	5	2	12	1	6	16	3	8	18			
Initial Q (Qb), veh	0	0	0	0	0	0	0	0	0			
Ped-Bike Adj(A_pbT)	1.00		1.00	1.00		1.00	1.00		1.00			
Parking Bus, Adj	1.00	1.00	1.00	1.00	1.00	1.00	1.00	1.00	1.00			
Adj Sat Flow, veh/h/ln	1863	1863	1900	1881	1881	0	1845	0	1845			
Adj Flow Rate, veh/h	0	1732	132	237	907	0	113	0	126			
Adj No. of Lanes	1	2	0	1	2	0	1	0	1			
Peak Hour Factor	0.97	0.97	0.97	0.97	0.97	0.97	0.97	0.97	0.97			
Percent Heavy Veh, %	2	2	2	1	1	0	3	0	3			
Cap, veh/h	2	2021	152	270	2838	0	177	0	158			
Arrive On Green	0.00	0.61	0.61	0.15	0.79	0.00	0.10	0.00	0.10			
Sat Flow, veh/h	1774	3336	252	1792	3668	0	1757	0	1568			
Grp Volume(v), veh/h	0	910	954	237	907	0	113	0	126			
Grp Sat Flow(s),veh/h/ln	1774	1770	1818	1792	1787	0	1757	0	1568			
Q Serve(g_s), s	0.0	39.9	41.7	12.4	6.7	0.0	5.9	0.0	7.5			
Cycle Q Clear(g_c), s	0.0	39.9	41.7	12.4	6.7	0.0	5.9	0.0	7.5			
Prop In Lane	1.00		0.14	1.00		0.00	1.00		1.00			
Lane Grp Cap(c), veh/h	2	1072	1102	270	2838	0	177	0	158			
V/C Ratio(X)	0.00	0.85	0.87	0.88	0.32	0.00	0.64	0.00	0.80			
Avail Cap(c_a), veh/h	371	1109	1139	374	2838	0	495	0	442			
HCM Platoon Ratio	1.00	1.00	1.00	1.00	1.00	1.00	1.00	1.00	1.00			
Upstream Filter(I)	0.00	1.00	1.00	1.00	1.00	0.00	1.00	0.00	1.00			
Uniform Delay (d), s/veh	0.0	15.3	15.6	39.8	2.7	0.0	41.4	0.0	42.1			
Incr Delay (d2), s/veh	0.0	6.7	7.6	12.7	0.1	0.0	1.4	0.0	3.5			
Initial Q Delay(d3),s/veh	0.0	0.0	0.0	0.0	0.0	0.0	0.0	0.0	0.0			
%ile BackOfQ(50%),veh/ln	0.0	21.2	23.0	7.1	3.3	0.0	3.0	0.0	3.4			
LnGrp Delay(d),s/veh	0.0	22.0	23.2	52.5	2.8	0.0	42.8	0.0	45.6			
LnGrp LOS		C	C	D	A		D		D			
Approach Vol, veh/h		1864			1144			239				
Approach Delay, s/veh		22.6			13.1			44.3				
Approach LOS		C			B			D				
Timer	1	2	3	4	5	6	7	8				
Assigned Phs	1	2			5	6		8				
Phs Duration (G+Y+Rc), s	8.0	63.4			0.0	81.4		14.3				
Change Period (Y+Rc), s	3.6	5.4			3.5	5.4		4.7				
Max Green Setting (Gmax), s	20	60.0			20.0	60.0		27.0				
Max Q Clear Time (g_c+1/4), s	14.4	43.7			0.0	8.7		9.5				
Green Ext Time (p_c), s	0.0	14.4			0.0	8.5		0.1				
Intersection Summary												
HCM 2010 Ctrl Delay				20.9								
HCM 2010 LOS				C								
Notes												

HCM 2010 Signalized Intersection Summary Cumulative with Eastside Parkway with Project, PM
 27: Reservation Road & Watkins Gate Road

06/11/2019



Movement	EBL	EBR	NBL	NBT	SBT	SBR		
Lane Configurations								
Traffic Volume (veh/h)	10	220	210	1310	2280	60		
Future Volume (veh/h)	10	220	210	1310	2280	60		
Number	5	12	3	8	4	14		
Initial Q (Qb), veh	0	0	0	0	0	0		
Ped-Bike Adj(A_pbT)	1.00	1.00	1.00			1.00		
Parking Bus, Adj	1.00	1.00	1.00	1.00	1.00	1.00		
Adj Sat Flow, veh/h/ln	1863	1863	1881	1881	1863	1900		
Adj Flow Rate, veh/h	11	32	228	1424	2478	62		
Adj No. of Lanes	1	1	1	2	2	0		
Peak Hour Factor	0.92	0.92	0.92	0.92	0.92	0.92		
Percent Heavy Veh, %	2	2	1	1	2	2		
Cap, veh/h	53	47	242	3119	2498	62		
Arrive On Green	0.03	0.03	0.13	0.87	0.71	0.71		
Sat Flow, veh/h	1774	1583	1792	3668	3622	88		
Grp Volume(v), veh/h	11	32	228	1424	1237	1303		
Grp Sat Flow(s),veh/h/ln	1774	1583	1792	1787	1770	1847		
Q Serve(g_s), s	0.8	2.7	16.8	11.2	90.6	93.2		
Cycle Q Clear(g_c), s	0.8	2.7	16.8	11.2	90.6	93.2		
Prop In Lane	1.00	1.00	1.00			0.05		
Lane Grp Cap(c), veh/h	53	47	242	3119	1253	1308		
V/C Ratio(X)	0.21	0.68	0.94	0.46	0.99	1.00		
Avail Cap(c_a), veh/h	272	243	242	3119	1253	1308		
HCM Platoon Ratio	1.00	1.00	1.00	1.00	1.00	1.00		
Upstream Filter(I)	1.00	1.00	1.00	1.00	1.00	1.00		
Uniform Delay (d), s/veh	63.2	64.1	57.2	1.8	18.9	19.3		
Incr Delay (d2), s/veh	0.7	6.1	42.1	0.2	22.5	23.9		
Initial Q Delay(d3),s/veh	0.0	0.0	0.0	0.0	0.0	0.0		
%ile BackOfQ(50%),veh/ln	0.4	1.2	11.2	5.4	51.5	55.4		
LnGrp Delay(d),s/veh	63.9	70.2	99.3	2.0	41.4	43.2		
LnGrp LOS	E	E	F	A	D	D		
Approach Vol, veh/h	43			1652	2540			
Approach Delay, s/veh	68.6			15.4	42.3			
Approach LOS	E			B	D			
Timer	1	2	3	4	5	6	7	8
Assigned Phs		2	3	4				8
Phs Duration (G+Y+Rc), s		10.5	22.0	101.0				123.0
Change Period (Y+Rc), s		6.5	4.0	6.5				6.5
Max Green Setting (Gmax), s		20.5	18.0	94.5				116.5
Max Q Clear Time (g_c+I1), s		4.7	18.8	95.2				13.2
Green Ext Time (p_c), s		0.0	0.0	0.0				27.0
Intersection Summary								
HCM 2010 Ctrl Delay			32.1					
HCM 2010 LOS			C					

HCM 2010 Signalized Intersection Summary Cumulative with Eastside Parkway with Project, PM
 28: Davis Road & Reservation Road

06/11/2019



Movement	EBL	EBT	EBR	WBL	WBT	WBR	NBL	NBT	NBR	SBL	SBT	SBR
Lane Configurations												
Traffic Volume (veh/h)	1410	520	10	10	370	100	10	10	10	120	10	830
Future Volume (veh/h)	1410	520	10	10	370	100	10	10	10	120	10	830
Number	5	2	12	1	6	16	3	8	18	7	4	14
Initial Q (Qb), veh	0	0	0	0	0	0	0	0	0	0	0	0
Ped-Bike Adj(A_pbT)	1.00		1.00	1.00		1.00	1.00		1.00	1.00		1.00
Parking Bus, Adj	1.00	1.00	1.00	1.00	1.00	1.00	1.00	1.00	1.00	1.00	1.00	1.00
Adj Sat Flow, veh/h/ln	1863	1863	1900	1827	1834	1900	1900	1900	1900	1900	1881	1881
Adj Flow Rate, veh/h	1500	553	11	11	394	106	11	11	9	128	11	748
Adj No. of Lanes	1	2	0	1	1	0	0	1	0	0	1	1
Peak Hour Factor	0.94	0.94	0.94	0.94	0.94	0.94	0.94	0.94	0.94	0.94	0.94	0.94
Percent Heavy Veh, %	2	2	2	4	4	4	0	0	0	1	1	1
Cap, veh/h	445	1996	40	18	450	121	17	17	14	415	36	802
Arrive On Green	0.25	0.56	0.56	0.01	0.32	0.32	0.03	0.03	0.03	0.25	0.25	0.25
Sat Flow, veh/h	1774	3549	71	1740	1393	375	631	631	516	1656	142	1599
Grp Volume(v), veh/h	1500	276	288	11	0	500	31	0	0	139	0	748
Grp Sat Flow(s),veh/h/ln	1774	1770	1850	1740	0	1768	1777	0	0	1798	0	1599
Q Serve(g_s), s	30.0	9.7	9.7	0.8	0.0	31.9	2.1	0.0	0.0	7.5	0.0	30.0
Cycle Q Clear(g_c), s	30.0	9.7	9.7	0.8	0.0	31.9	2.1	0.0	0.0	7.5	0.0	30.0
Prop In Lane	1.00		0.04	1.00		0.21	0.35		0.29	0.92		1.00
Lane Grp Cap(c), veh/h	445	995	1041	18	0	571	48	0	0	451	0	802
V/C Ratio(X)	3.37	0.28	0.28	0.62	0.00	0.88	0.65	0.00	0.00	0.31	0.00	0.93
Avail Cap(c_a), veh/h	445	995	1041	436	0	887	446	0	0	451	0	802
HCM Platoon Ratio	1.00	1.00	1.00	1.00	1.00	1.00	1.00	1.00	1.00	1.00	1.00	1.00
Upstream Filter(I)	1.00	1.00	1.00	1.00	0.00	1.00	1.00	0.00	0.00	1.00	0.00	1.00
Uniform Delay (d), s/veh	44.8	13.6	13.6	59.0	0.0	38.2	57.6	0.0	0.0	36.4	0.0	27.9
Incr Delay (d2), s/veh	1072.9	0.2	0.2	12.2	0.0	8.3	5.4	0.0	0.0	0.1	0.0	17.3
Initial Q Delay(d3),s/veh	0.0	0.0	0.0	0.0	0.0	0.0	0.0	0.0	0.0	0.0	0.0	0.0
%ile BackOfQ(50%),veh/ln	17.2	4.7	5.0	0.4	0.0	16.9	1.1	0.0	0.0	3.8	0.0	26.8
LnGrp Delay(d),s/veh	1117.7	13.8	13.8	71.2	0.0	46.5	63.0	0.0	0.0	36.5	0.0	45.2
LnGrp LOS	F	B	B	E		D	E			D		D
Approach Vol, veh/h	2064				511		31				887	
Approach Delay, s/veh	816.1				47.1		63.0				43.9	
Approach LOS	F				D		E				D	
Timer	1	2	3	4	5	6	7	8				
Assigned Phs	1	2			4	5	6			8		
Phs Duration (G+Y+Rc), s	5.1	72.3			35.0	33.8	43.6			7.2		
Change Period (Y+Rc), s	3.9	5.0			5.0	* 3.8	5.0			4.0		
Max Green Setting (Gmax), s	30	60.0			30.0	* 30	60.0			30.0		
Max Q Clear Time (g_c+1/2), s	11.7	11.7			32.0	32.0	33.9			4.1		
Green Ext Time (p_c), s	0.0	5.3			0.0	0.0	4.7			0.0		
Intersection Summary												
HCM 2010 Ctrl Delay			500.8									
HCM 2010 LOS			F									
Notes												

HCM 2010 Signalized Intersection Summary Cumulative with Eastside Parkway with Project, PM
 29: 2nd Avenue & Divarty Street

06/11/2019



Movement	EBL	EBT	EBR	WBL	WBT	WBR	NBL	NBT	NBR	SBL	SBT	SBR
Lane Configurations		↕			↕	↕	↕	↕↔		↕	↕↔	
Traffic Volume (veh/h)	200	10	80	150	10	30	40	610	110	30	460	100
Future Volume (veh/h)	200	10	80	150	10	30	40	610	110	30	460	100
Number	5	2	12	1	6	16	3	8	18	7	4	14
Initial Q (Qb), veh	0	0	0	0	0	0	0	0	0	0	0	0
Ped-Bike Adj(A_pbT)	1.00		1.00	1.00		1.00	1.00		0.99	1.00		0.99
Parking Bus, Adj	1.00	1.00	1.00	1.00	1.00	1.00	1.00	1.00	1.00	1.00	1.00	1.00
Adj Sat Flow, veh/h/ln	1900	1900	1900	1900	1900	1900	1900	1900	1900	1881	1881	1900
Adj Flow Rate, veh/h	213	11	85	160	11	32	43	649	117	32	489	106
Adj No. of Lanes	0	1	0	0	1	1	1	2	0	1	2	0
Peak Hour Factor	0.94	0.94	0.94	0.94	0.94	0.94	0.94	0.94	0.94	0.94	0.94	0.94
Percent Heavy Veh, %	0	0	0	0	0	0	0	0	0	1	1	1
Cap, veh/h	387	38	114	587	36	569	82	1018	183	65	947	204
Arrive On Green	0.35	0.35	0.35	0.35	0.35	0.35	0.05	0.33	0.33	0.04	0.32	0.32
Sat Flow, veh/h	740	107	321	1255	101	1608	1810	3054	550	1792	2923	630
Grp Volume(v), veh/h	309	0	0	171	0	32	43	383	383	32	298	297
Grp Sat Flow(s),veh/h/ln	1168	0	0	1356	0	1608	1810	1805	1799	1792	1787	1765
Q Serve(g_s), s	8.3	0.0	0.0	0.0	0.0	0.6	1.1	8.8	8.8	0.9	6.6	6.7
Cycle Q Clear(g_c), s	12.8	0.0	0.0	4.5	0.0	0.6	1.1	8.8	8.8	0.9	6.6	6.7
Prop In Lane	0.69		0.28	0.94		1.00	1.00		0.31	1.00		0.36
Lane Grp Cap(c), veh/h	538	0	0	623	0	569	82	601	599	65	579	572
V/C Ratio(X)	0.57	0.00	0.00	0.27	0.00	0.06	0.52	0.64	0.64	0.50	0.51	0.52
Avail Cap(c_a), veh/h	1066	0	0	1112	0	1155	427	1481	1476	423	1283	1267
HCM Platoon Ratio	1.00	1.00	1.00	1.00	1.00	1.00	1.00	1.00	1.00	1.00	1.00	1.00
Upstream Filter(I)	1.00	0.00	0.00	1.00	0.00	1.00	1.00	1.00	1.00	1.00	1.00	1.00
Uniform Delay (d), s/veh	15.5	0.0	0.0	11.6	0.0	10.4	22.8	13.8	13.8	23.1	13.4	13.4
Incr Delay (d2), s/veh	1.0	0.0	0.0	0.2	0.0	0.0	5.1	1.1	1.1	5.8	0.7	0.7
Initial Q Delay(d3),s/veh	0.0	0.0	0.0	0.0	0.0	0.0	0.0	0.0	0.0	0.0	0.0	0.0
%ile BackOfQ(50%),veh/ln	3.9	0.0	0.0	1.7	0.0	0.3	0.7	4.6	4.5	0.5	3.3	3.3
LnGrp Delay(d),s/veh	16.4	0.0	0.0	11.8	0.0	10.4	27.9	14.9	14.9	28.8	14.1	14.1
LnGrp LOS	B			B		B	C	B	B	C	B	B
Approach Vol, veh/h		309			203			809			627	
Approach Delay, s/veh		16.4			11.6			15.6			14.9	
Approach LOS		B			B			B			B	
Timer	1	2	3	4	5	6	7	8				
Assigned Phs		2	3	4		6	7	8				
Phs Duration (G+Y+Rc), s		22.3	5.7	20.8		22.3	5.3	21.2				
Change Period (Y+Rc), s		5.0	3.5	5.0		5.0	3.5	5.0				
Max Green Setting (Gmax), s		35.0	11.5	35.0		35.0	11.5	40.0				
Max Q Clear Time (g_c+I1), s		14.8	3.1	8.7		6.5	2.9	10.8				
Green Ext Time (p_c), s		1.8	0.0	3.7		1.1	0.0	5.1				
Intersection Summary												
HCM 2010 Ctrl Delay				15.1								
HCM 2010 LOS				B								

Intersection	
Intersection Delay, s/veh	10
Intersection LOS	A

Movement	EBL	EBT	EBR	WBL	WBT	WBR	NBL	NBT	NBR	SBL	SBT	SBR
Lane Configurations		↕			↕		↕	↕		↕	↕	
Traffic Vol, veh/h	20	10	40	10	10	10	30	180	10	10	220	20
Future Vol, veh/h	20	10	40	10	10	10	30	180	10	10	220	20
Peak Hour Factor	0.85	0.85	0.85	0.85	0.85	0.85	0.85	0.85	0.85	0.85	0.85	0.85
Heavy Vehicles, %	0	0	0	1	1	1	0	0	0	1	1	1
Mvmt Flow	24	12	47	12	12	12	35	212	12	12	259	24
Number of Lanes	0	1	0	0	1	0	1	1	0	1	1	0

Approach	EB	WB	NB	SB
Opposing Approach	WB	EB	SB	NB
Opposing Lanes	1	1	2	2
Conflicting Approach Left	SB	NB	EB	WB
Conflicting Lanes Left	2	2	1	1
Conflicting Approach Right	NB	SB	WB	EB
Conflicting Lanes Right	2	2	1	1
HCM Control Delay	8.7	8.6	9.8	10.8
HCM LOS	A	A	A	B

Lane	NBLn1	NBLn2	EBLn1	WBLn1	SBLn1	SBLn2
Vol Left, %	100%	0%	29%	33%	100%	0%
Vol Thru, %	0%	95%	14%	33%	0%	92%
Vol Right, %	0%	5%	57%	33%	0%	8%
Sign Control	Stop	Stop	Stop	Stop	Stop	Stop
Traffic Vol by Lane	30	190	70	30	10	240
LT Vol	30	0	20	10	10	0
Through Vol	0	180	10	10	0	220
RT Vol	0	10	40	10	0	20
Lane Flow Rate	35	224	82	35	12	282
Geometry Grp	7	7	2	2	7	7
Degree of Util (X)	0.054	0.311	0.114	0.051	0.018	0.391
Departure Headway (Hd)	5.554	5.014	4.978	5.223	5.548	4.986
Convergence, Y/N	Yes	Yes	Yes	Yes	Yes	Yes
Cap	644	715	717	682	645	720
Service Time	3.295	2.754	3.027	3.28	3.287	2.725
HCM Lane V/C Ratio	0.054	0.313	0.114	0.051	0.019	0.392
HCM Control Delay	8.6	10	8.7	8.6	8.4	10.9
HCM Lane LOS	A	A	A	A	A	B
HCM 95th-tile Q	0.2	1.3	0.4	0.2	0.1	1.9

HCM 2010 Signalized Intersection Summary Cumulative with Eastside Parkway with Project, PM
 31: 1st Avenue & Lightfighter Drive

06/11/2019



Movement	EBL	EBT	EBR	WBL	WBT	WBR	NBL	NBT	NBR	SBL	SBT	SBR
Lane Configurations		↑↑	↑	↑	↑↑		↑		↑	↑	↑	↑
Traffic Volume (veh/h)	0	1250	110	20	1560	0	200	0	30	60	50	80
Future Volume (veh/h)	0	1250	110	20	1560	0	200	0	30	60	50	80
Number	7	4	14	3	8	18	5	2	12	1	6	16
Initial Q (Qb), veh	0	0	0	0	0	0	0	0	0	0	0	0
Ped-Bike Adj(A_pbT)	1.00		1.00	1.00		1.00	1.00		1.00	1.00		1.00
Parking Bus, Adj	1.00	1.00	1.00	1.00	1.00	1.00	1.00	1.00	1.00	1.00	1.00	1.00
Adj Sat Flow, veh/h/ln	0	1881	1881	1881	1881	0	1881	0	1881	1810	1810	1810
Adj Flow Rate, veh/h	0	1316	0	21	1642	0	211	0	14	63	53	64
Adj No. of Lanes	0	2	1	1	2	0	1	0	1	1	1	1
Peak Hour Factor	0.95	0.95	0.95	0.95	0.95	0.95	0.95	0.95	0.95	0.95	0.95	0.95
Percent Heavy Veh, %	0	1	1	1	1	0	1	0	1	5	5	5
Cap, veh/h	0	2274	1017	23	2586	0	0	0	0	139	146	124
Arrive On Green	0.00	0.64	0.00	0.01	0.72	0.00	0.00	0.00	0.00	0.08	0.08	0.08
Sat Flow, veh/h	0	3668	1599	1792	3668	0		0		1723	1810	1538
Grp Volume(v), veh/h	0	1316	0	21	1642	0		0.0		63	53	64
Grp Sat Flow(s),veh/h/ln	0	1787	1599	1792	1787	0				1723	1810	1538
Q Serve(g_s), s	0.0	10.0	0.0	0.6	11.0	0.0				1.6	1.3	1.9
Cycle Q Clear(g_c), s	0.0	10.0	0.0	0.6	11.0	0.0				1.6	1.3	1.9
Prop In Lane	0.00		1.00	1.00		0.00				1.00		1.00
Lane Grp Cap(c), veh/h	0	2274	1017	23	2586	0				139	146	124
V/C Ratio(X)	0.00	0.58	0.00	0.90	0.63	0.00				0.45	0.36	0.52
Avail Cap(c_a), veh/h	0	3420	1530	762	3420	0				916	962	818
HCM Platoon Ratio	1.00	1.00	1.00	1.00	1.00	1.00				1.00	1.00	1.00
Upstream Filter(I)	0.00	1.00	0.00	1.00	1.00	0.00				1.00	1.00	1.00
Uniform Delay (d), s/veh	0.0	4.9	0.0	23.2	3.3	0.0				20.6	20.5	20.7
Incr Delay (d2), s/veh	0.0	0.3	0.0	31.9	0.4	0.0				0.9	0.6	1.2
Initial Q Delay(d3),s/veh	0.0	0.0	0.0	0.0	0.0	0.0				0.0	0.0	0.0
%ile BackOfQ(50%),veh/ln	0.0	4.9	0.0	0.5	5.4	0.0				0.8	0.7	0.8
LnGrp Delay(d),s/veh	0.0	5.3	0.0	55.1	3.7	0.0				21.5	21.0	22.0
LnGrp LOS		A		E	A					C	C	C
Approach Vol, veh/h		1316			1663						180	
Approach Delay, s/veh		5.3			4.3						21.5	
Approach LOS		A			A						C	
Timer	1	2	3	4	5	6	7	8				
Assigned Phs			3	4		6		8				
Phs Duration (G+Y+Rc), s			4.1	34.5		8.4		38.6				
Change Period (Y+Rc), s			3.5	4.6		4.6		4.6				
Max Green Setting (Gmax), s			20.0	45.0		25.0		45.0				
Max Q Clear Time (g_c+I1), s			2.6	12.0		3.9		13.0				
Green Ext Time (p_c), s			0.0	17.4		0.3		21.0				
Intersection Summary												
HCM 2010 Ctrl Delay			5.7									
HCM 2010 LOS			A									

HCM 2010 Signalized Intersection Summary Cumulative with Eastside Parkway with Project, PM
 32: 2nd Avenue & Lightfighter Drive 06/11/2019



Movement	EBL	EBT	EBR	WBL	WBT	WBR	NBL	NBT	NBR	SBL	SBT	SBR
Lane Configurations												
Traffic Volume (veh/h)	290	1050	10	80	1290	220	20	20	50	220	30	330
Future Volume (veh/h)	290	1050	10	80	1290	220	20	20	50	220	30	330
Number	5	2	12	1	6	16	3	8	18	7	4	14
Initial Q (Qb), veh	0	0	0	0	0	0	0	0	0	0	0	0
Ped-Bike Adj(A_pbT)	1.00		1.00	1.00		1.00	1.00		0.99	1.00		0.99
Parking Bus, Adj	1.00	1.00	1.00	1.00	1.00	1.00	1.00	1.00	1.00	1.00	1.00	1.00
Adj Sat Flow, veh/h/ln	1881	1881	1900	1881	1881	1900	1900	1900	1900	1845	1845	1845
Adj Flow Rate, veh/h	305	1105	11	84	1358	227	21	21	47	232	32	244
Adj No. of Lanes	1	2	0	1	2	0	0	1	0	1	1	1
Peak Hour Factor	0.95	0.95	0.95	0.95	0.95	0.95	0.95	0.95	0.95	0.95	0.95	0.95
Percent Heavy Veh, %	1	1	1	1	1	1	0	0	0	3	3	3
Cap, veh/h	222	2218	22	108	1682	278	93	97	163	340	362	306
Arrive On Green	0.12	0.61	0.61	0.06	0.55	0.55	0.20	0.20	0.20	0.20	0.20	0.20
Sat Flow, veh/h	1792	3626	36	1792	3070	508	246	497	831	1308	1845	1558
Grp Volume(v), veh/h	305	545	571	84	784	801	89	0	0	232	32	244
Grp Sat Flow(s),veh/h/ln	1792	1787	1875	1792	1787	1791	1574	0	0	1308	1845	1558
Q Serve(g_s), s	12.4	17.0	17.0	4.6	35.4	36.6	0.0	0.0	0.0	12.0	1.4	14.9
Cycle Q Clear(g_c), s	12.4	17.0	17.0	4.6	35.4	36.6	4.4	0.0	0.0	16.3	1.4	14.9
Prop In Lane	1.00		0.02	1.00		0.28	0.24		0.53	1.00		1.00
Lane Grp Cap(c), veh/h	222	1093	1147	108	979	981	354	0	0	340	362	306
V/C Ratio(X)	1.37	0.50	0.50	0.78	0.80	0.82	0.25	0.00	0.00	0.68	0.09	0.80
Avail Cap(c_a), veh/h	222	1093	1147	222	979	981	666	0	0	611	745	630
HCM Platoon Ratio	1.00	1.00	1.00	1.00	1.00	1.00	1.00	1.00	1.00	1.00	1.00	1.00
Upstream Filter(I)	0.70	0.70	0.70	0.09	0.09	0.09	1.00	0.00	0.00	0.86	0.86	0.86
Uniform Delay (d), s/veh	43.8	10.8	10.8	46.4	18.2	18.5	34.0	0.0	0.0	38.6	32.9	38.3
Incr Delay (d2), s/veh	186.6	1.1	1.1	0.4	0.7	0.7	0.1	0.0	0.0	0.8	0.0	1.6
Initial Q Delay(d3),s/veh	0.0	0.0	0.0	0.0	0.0	0.0	0.0	0.0	0.0	0.0	0.0	0.0
%ile BackOfQ(50%),veh/ln	7.6	8.7	9.1	2.3	17.4	18.2	2.1	0.0	0.0	6.3	0.7	6.5
LnGrp Delay(d),s/veh	230.4	12.0	11.9	46.8	18.9	19.2	34.2	0.0	0.0	39.4	32.9	39.9
LnGrp LOS	F	B	B	D	B	B	C			D	C	D
Approach Vol, veh/h		1421			1669			89			508	
Approach Delay, s/veh		58.8			20.5			34.2			39.2	
Approach LOS		E			C			C			D	
Timer	1	2	3	4	5	6	7	8				
Assigned Phs	1	2		4	5	6		8				
Phs Duration (G+Y+Rc), s	0.0	65.8		24.2	16.4	59.4		24.2				
Change Period (Y+Rc), s	4.0	4.6		4.6	4.0	4.6		4.6				
Max Green Setting (Gmax), s	2.4	34.0		40.4	12.4	24.4		40.4				
Max Q Clear Time (g_c+10), s	10.6	19.0		18.3	14.4	38.6		6.4				
Green Ext Time (p_c), s	0.0	4.0		0.9	0.0	0.0		0.3				
Intersection Summary												
HCM 2010 Ctrl Delay				38.2								
HCM 2010 LOS				D								

HCM 2010 Signalized Intersection Summary Cumulative with Eastside Parkway with Project, PM
 33: General Jim Moore Boulevard & Lightfighter Drive

06/11/2019



Movement	EBL	EBT	EBR	WBL	WBT	WBR	NBL	NBT	NBR	SBL	SBT	SBR
Lane Configurations												
Traffic Volume (veh/h)	50	230	940	40	240	50	750	60	20	60	100	40
Future Volume (veh/h)	50	230	940	40	240	50	750	60	20	60	100	40
Number	3	8	18	7	4	14	1	6	16	5	2	12
Initial Q (Qb), veh	0	0	0	0	0	0	0	0	0	0	0	0
Ped-Bike Adj(A_pbT)	1.00		1.00	1.00		1.00	1.00		1.00	1.00		1.00
Parking Bus, Adj	1.00	1.00	1.00	1.00	1.00	1.00	1.00	1.00	1.00	1.00	1.00	1.00
Adj Sat Flow, veh/h/ln	1881	1881	1881	1900	1900	1900	1881	1881	1900	1900	1900	1900
Adj Flow Rate, veh/h	52	240	0	42	250	51	781	62	19	62	104	-70
Adj No. of Lanes	1	1	1	1	1	0	2	1	0	1	2	0
Peak Hour Factor	0.96	0.96	0.96	0.96	0.96	0.96	0.96	0.96	0.96	0.96	0.96	0.96
Percent Heavy Veh, %	1	1	1	0	0	0	1	1	1	0	0	0
Cap, veh/h	75	458	389	65	364	74	737	404	124	85	459	0
Arrive On Green	0.04	0.24	0.00	0.04	0.24	0.24	0.21	0.29	0.29	0.05	0.13	0.00
Sat Flow, veh/h	1792	1881	1599	1810	1532	313	3476	1383	424	1810	3705	0
Grp Volume(v), veh/h	52	240	0	42	0	301	781	0	81	62	34	0
Grp Sat Flow(s),veh/h/ln	1792	1881	1599	1810	0	1845	1738	0	1806	1810	1805	0
Q Serve(g_s), s	1.4	5.2	0.0	1.1	0.0	7.0	10.0	0.0	1.6	1.6	0.4	0.0
Cycle Q Clear(g_c), s	1.4	5.2	0.0	1.1	0.0	7.0	10.0	0.0	1.6	1.6	0.4	0.0
Prop In Lane	1.00		1.00	1.00		0.17	1.00		0.23	1.00		0.00
Lane Grp Cap(c), veh/h	75	458	389	65	0	438	737	0	527	85	459	0
V/C Ratio(X)	0.69	0.52	0.00	0.65	0.00	0.69	1.06	0.00	0.15	0.73	0.07	0.00
Avail Cap(c_a), veh/h	759	1196	1017	767	0	1173	737	0	1149	575	2296	0
HCM Platoon Ratio	1.00	1.00	1.00	1.00	1.00	1.00	1.00	1.00	1.00	1.00	1.00	1.00
Upstream Filter(I)	1.00	1.00	0.00	1.00	0.00	1.00	1.00	0.00	1.00	1.00	1.00	0.00
Uniform Delay (d), s/veh	22.3	15.5	0.0	22.4	0.0	16.4	18.6	0.0	12.4	22.2	18.1	0.0
Incr Delay (d2), s/veh	10.8	1.1	0.0	4.0	0.0	2.3	50.3	0.0	0.3	4.3	0.1	0.0
Initial Q Delay(d3),s/veh	0.0	0.0	0.0	0.0	0.0	0.0	0.0	0.0	0.0	0.0	0.0	0.0
%ile BackOfQ(50%),veh/ln	0.9	2.8	0.0	0.6	0.0	3.8	9.8	0.0	0.8	0.9	0.2	0.0
LnGrp Delay(d),s/veh	33.1	16.6	0.0	26.4	0.0	18.7	68.8	0.0	12.7	26.5	18.2	0.0
LnGrp LOS	C	B		C		B	F		B	C	B	
Approach Vol, veh/h		292			343			862			96	
Approach Delay, s/veh		19.5			19.7			63.6			23.6	
Approach LOS		B			B			E			C	
Timer	1	2	3	4	5	6	7	8				
Assigned Phs	1	2	3	4	5	6	7	8				
Phs Duration (G+Y+Rc), s	4.5	10.5	6.5	15.7	6.7	18.3	6.2	16.0				
Change Period (Y+Rc), s	4.5	4.5	4.5	4.5	4.5	4.5	4.5	4.5				
Max Green Setting (Gmax), s	30.0	30.0	20.0	30.0	15.0	30.0	20.0	30.0				
Max Q Clear Time (g_c+1), s	2.4	3.4	3.4	9.0	3.6	3.6	3.1	7.2				
Green Ext Time (p_c), s	0.0	0.1	0.1	2.2	0.0	0.7	0.0	1.5				
Intersection Summary												
HCM 2010 Ctrl Delay			43.6									
HCM 2010 LOS			D									

Intersection

Intersection Delay, s/veh 10.9
 Intersection LOS B

Movement	WBL	WBR	NBT	NBR	SBL	SBT
Lane Configurations						
Traffic Vol, veh/h	10	240	90	10	240	70
Future Vol, veh/h	10	240	90	10	240	70
Peak Hour Factor	0.88	0.88	0.88	0.88	0.88	0.88
Heavy Vehicles, %	0	0	2	2	1	1
Mvmt Flow	11	273	102	11	273	80
Number of Lanes	1	0	1	0	0	1

Approach	WB	NB	SB
Opposing Approach		SB	NB
Opposing Lanes	0	1	1
Conflicting Approach Left	NB		WB
Conflicting Lanes Left	1	0	1
Conflicting Approach Right	SB	WB	
Conflicting Lanes Right	1	1	0
HCM Control Delay	9.9	9	12.3
HCM LOS	A	A	B

Lane	NBLn1	WBLn1	SBLn1
Vol Left, %	0%	4%	77%
Vol Thru, %	90%	0%	23%
Vol Right, %	10%	96%	0%
Sign Control	Stop	Stop	Stop
Traffic Vol by Lane	100	250	310
LT Vol	0	10	240
Through Vol	90	0	70
RT Vol	10	240	0
Lane Flow Rate	114	284	352
Geometry Grp	1	1	1
Degree of Util (X)	0.157	0.352	0.475
Departure Headway (Hd)	4.959	4.46	4.857
Convergence, Y/N	Yes	Yes	Yes
Cap	717	801	736
Service Time	3.035	2.51	2.922
HCM Lane V/C Ratio	0.159	0.355	0.478
HCM Control Delay	9	9.9	12.3
HCM Lane LOS	A	A	B
HCM 95th-tile Q	0.6	1.6	2.6

Intersection						
Int Delay, s/veh	1.7					
Movement	EBT	EBR	WBL	WBT	NBL	NBR
Lane Configurations						
Traffic Vol, veh/h	210	40	30	220	30	30
Future Vol, veh/h	210	40	30	220	30	30
Conflicting Peds, #/hr	0	0	0	0	0	0
Sign Control	Free	Free	Free	Free	Stop	Stop
RT Channelized	-	None	-	None	-	None
Storage Length	-	-	-	-	0	-
Veh in Median Storage, #	0	-	-	0	0	-
Grade, %	0	-	-	0	0	-
Peak Hour Factor	85	85	85	85	85	85
Heavy Vehicles, %	0	0	0	0	0	0
Mvmt Flow	247	47	35	259	35	35

Major/Minor	Major1	Major2	Minor1		
Conflicting Flow All	0	0	294	0	600
Stage 1	-	-	-	-	271
Stage 2	-	-	-	-	329
Critical Hdwy	-	-	4.1	-	6.4
Critical Hdwy Stg 1	-	-	-	-	5.4
Critical Hdwy Stg 2	-	-	-	-	5.4
Follow-up Hdwy	-	-	2.2	-	3.5
Pot Cap-1 Maneuver	-	-	1279	-	467
Stage 1	-	-	-	-	779
Stage 2	-	-	-	-	734
Platoon blocked, %	-	-	-	-	-
Mov Cap-1 Maneuver	-	-	1279	-	452
Mov Cap-2 Maneuver	-	-	-	-	452
Stage 1	-	-	-	-	754
Stage 2	-	-	-	-	734

Approach	EB	WB	NB
HCM Control Delay, s	0	0.9	12.2
HCM LOS			B

Minor Lane/Major Mvmt	NBLn1	EBT	EBR	WBL	WBT
Capacity (veh/h)	570	-	-	1279	-
HCM Lane V/C Ratio	0.124	-	-	0.028	-
HCM Control Delay (s)	12.2	-	-	7.9	0
HCM Lane LOS	B	-	-	A	A
HCM 95th %tile Q(veh)	0.4	-	-	0.1	-

Intersection	
Intersection Delay, s/veh	12.3
Intersection LOS	B

Movement	EBL	EBT	EBR	WBL	WBT	WBR	NBL	NBT	NBR	SBL	SBT	SBR
Lane Configurations		↕			↕			↕			↕	
Traffic Vol, veh/h	10	170	60	30	180	10	50	100	20	10	130	30
Future Vol, veh/h	10	170	60	30	180	10	50	100	20	10	130	30
Peak Hour Factor	0.82	0.82	0.82	0.82	0.82	0.82	0.82	0.82	0.82	0.82	0.82	0.82
Heavy Vehicles, %	0	0	0	0	0	0	2	2	2	0	0	0
Mvmt Flow	12	207	73	37	220	12	61	122	24	12	159	37
Number of Lanes	0	1	0	0	1	0	0	1	0	0	1	0

Approach	EB	WB	NB	SB
Opposing Approach	WB	EB	SB	NB
Opposing Lanes	1	1	1	1
Conflicting Approach Left	SB	NB	EB	WB
Conflicting Lanes Left	1	1	1	1
Conflicting Approach Right	NB	SB	WB	EB
Conflicting Lanes Right	1	1	1	1
HCM Control Delay	12.8	12.7	11.9	11.7
HCM LOS	B	B	B	B

Lane	NBLn1	EBLn1	WBLn1	SBLn1
Vol Left, %	29%	4%	14%	6%
Vol Thru, %	59%	71%	82%	76%
Vol Right, %	12%	25%	5%	18%
Sign Control	Stop	Stop	Stop	Stop
Traffic Vol by Lane	170	240	220	170
LT Vol	50	10	30	10
Through Vol	100	170	180	130
RT Vol	20	60	10	30
Lane Flow Rate	207	293	268	207
Geometry Grp	1	1	1	1
Degree of Util (X)	0.338	0.442	0.418	0.332
Departure Headway (Hd)	5.866	5.439	5.611	5.757
Convergence, Y/N	Yes	Yes	Yes	Yes
Cap	610	659	639	620
Service Time	3.941	3.507	3.681	3.83
HCM Lane V/C Ratio	0.339	0.445	0.419	0.334
HCM Control Delay	11.9	12.8	12.7	11.7
HCM Lane LOS	B	B	B	B
HCM 95th-tile Q	1.5	2.3	2.1	1.5

Intersection												
Int Delay, s/veh	12.4											
Movement	EBL	EBT	EBR	WBL	WBT	WBR	NBL	NBT	NBR	SBL	SBT	SBR
Lane Configurations		↕			↕			↕			↕	
Traffic Vol, veh/h	60	90	50	30	80	10	90	120	20	0	0	0
Future Vol, veh/h	60	90	50	30	80	10	90	120	20	0	0	0
Conflicting Peds, #/hr	0	0	0	0	0	0	0	0	0	0	0	0
Sign Control	Stop	Stop	Stop	Stop	Stop	Stop	Free	Free	Free	Free	Free	Free
RT Channelized	-	-	None	-	-	None	-	-	None	-	-	None
Storage Length	-	-	-	-	-	-	-	-	-	-	-	-
Veh in Median Storage, #	-	0	-	-	0	-	-	0	-	-	0	-
Grade, %	-	0	-	-	0	-	-	0	-	-	0	-
Peak Hour Factor	74	74	74	74	74	74	74	74	74	74	74	74
Heavy Vehicles, %	3	3	3	2	2	2	3	3	3	8	8	8
Mvmt Flow	81	122	68	41	108	14	122	162	27	0	0	0

Major/Minor	Minor2		Minor1		Major1			Major2				
Conflicting Flow All	482	434	1	516	421	176	1	0	0	189	0	0
Stage 1	1	1	-	420	420	-	-	-	-	-	-	-
Stage 2	481	433	-	96	1	-	-	-	-	-	-	-
Critical Hdwy	7.13	6.53	6.23	7.12	6.52	6.22	4.13	-	-	4.18	-	-
Critical Hdwy Stg 1	6.13	5.53	-	6.12	5.52	-	-	-	-	-	-	-
Critical Hdwy Stg 2	6.13	5.53	-	6.12	5.52	-	-	-	-	-	-	-
Follow-up Hdwy	3.527	4.027	3.327	3.518	4.018	3.318	2.227	-	-	2.272	-	-
Pot Cap-1 Maneuver	493	514	1081	470	524	867	1615	-	-	1350	-	-
Stage 1	1019	893	-	611	589	-	-	-	-	-	-	-
Stage 2	564	580	-	911	895	-	-	-	-	-	-	-
Platoon blocked, %								-	-	-	-	-
Mov Cap-1 Maneuver	376	470	1081	331	479	867	1615	-	-	1350	-	-
Mov Cap-2 Maneuver	376	470	-	331	479	-	-	-	-	-	-	-
Stage 1	932	893	-	559	539	-	-	-	-	-	-	-
Stage 2	406	531	-	738	895	-	-	-	-	-	-	-

Approach	EB		WB		NB		SB	
HCM Control Delay, s	20.2		17.6		2.9		0	
HCM LOS	C		C					

Minor Lane/Major Mvmt	NBL	NBT	NBR	EBLn1	WBLn1	SBL	SBT	SBR
Capacity (veh/h)	1615	-	-	503	446	1350	-	-
HCM Lane V/C Ratio	0.075	-	-	0.537	0.364	-	-	-
HCM Control Delay (s)	7.4	0	-	20.2	17.6	0	-	-
HCM Lane LOS	A	A	-	C	C	A	-	-
HCM 95th %tile Q(veh)	0.2	-	-	3.1	1.6	0	-	-

Intersection						
Int Delay, s/veh	2.9					
Movement	EBL	EBR	NBL	NBT	SBT	SBR
Lane Configurations	T			T		T
Traffic Vol, veh/h	110	10	10	280	290	110
Future Vol, veh/h	110	10	10	280	290	110
Conflicting Peds, #/hr	0	0	0	0	0	0
Sign Control	Stop	Stop	Free	Free	Free	Free
RT Channelized	-	None	-	None	-	None
Storage Length	0	-	-	-	-	-
Veh in Median Storage, #	0	-	-	0	0	-
Grade, %	0	-	-	0	0	-
Peak Hour Factor	88	88	88	88	88	88
Heavy Vehicles, %	0	0	2	2	1	1
Mvmt Flow	125	11	11	318	330	125























Major/Minor	Minor2	Major1		Major2	
Conflicting Flow All	733	393	455	0	0
Stage 1	393	-	-	-	-
Stage 2	340	-	-	-	-
Critical Hdwy	6.4	6.2	4.12	-	-
Critical Hdwy Stg 1	5.4	-	-	-	-
Critical Hdwy Stg 2	5.4	-	-	-	-
Follow-up Hdwy	3.5	3.3	2.218	-	-
Pot Cap-1 Maneuver	391	660	1106	-	-
Stage 1	686	-	-	-	-
Stage 2	725	-	-	-	-
Platoon blocked, %				-	-
Mov Cap-1 Maneuver	386	660	1106	-	-
Mov Cap-2 Maneuver	386	-	-	-	-
Stage 1	678	-	-	-	-
Stage 2	725	-	-	-	-

Approach	EB	NB	SB
HCM Control Delay, s	18.6	0.3	0
HCM LOS	C		

Minor Lane/Major Mvmt	NBL	NBT	EBLn1	SBT	SBR
Capacity (veh/h)	1106	-	400	-	-
HCM Lane V/C Ratio	0.01	-	0.341	-	-
HCM Control Delay (s)	8.3	0	18.6	-	-
HCM Lane LOS	A	A	C	-	-
HCM 95th %tile Q(veh)	0	-	1.5	-	-

HCM 2010 Signalized Intersection Summary Cumulative with Eastside Parkway with Project, PM
 39: General Jim Moore Boulevard & Gigling Road

06/11/2019

												
Movement	EBL	EBT	EBR	WBL	WBT	WBR	NBL	NBT	NBR	SBL	SBT	SBR
Lane Configurations												
Traffic Volume (veh/h)	20	20	30	270	50	530	60	260	430	750	250	50
Future Volume (veh/h)	20	20	30	270	50	530	60	260	430	750	250	50
Number	3	8	18	7	4	14	1	6	16	5	2	12
Initial Q (Qb), veh	0	0	0	0	0	0	0	0	0	0	0	0
Ped-Bike Adj(A_pbT)	1.00		0.99	1.00		1.00	1.00		1.00	1.00		1.00
Parking Bus, Adj	1.00	1.00	1.00	1.00	1.00	1.00	1.00	1.00	1.00	1.00	1.00	1.00
Adj Sat Flow, veh/h/ln	1776	1776	1900	1881	1881	1881	1863	1863	1863	1863	1863	1863
Adj Flow Rate, veh/h	22	22	3	303	56	0	67	292	0	843	281	0
Adj No. of Lanes	1	2	0	1	2	1	1	2	1	1	2	1
Peak Hour Factor	0.89	0.89	0.89	0.89	0.89	0.89	0.89	0.89	0.89	0.89	0.89	0.89
Percent Heavy Veh, %	7	7	7	1	1	1	2	2	2	2	2	2
Cap, veh/h	45	263	35	360	939	420	108	476	213	377	1013	453
Arrive On Green	0.03	0.09	0.09	0.20	0.26	0.00	0.06	0.13	0.00	0.21	0.29	0.00
Sat Flow, veh/h	1691	2991	399	1792	3574	1599	1774	3539	1583	1774	3539	1583
Grp Volume(v), veh/h	22	12	13	303	56	0	67	292	0	843	281	0
Grp Sat Flow(s),veh/h/ln	1691	1687	1703	1792	1787	1599	1774	1770	1583	1774	1770	1583
Q Serve(g_s), s	0.6	0.3	0.3	8.0	0.6	0.0	1.8	3.8	0.0	10.5	3.0	0.0
Cycle Q Clear(g_c), s	0.6	0.3	0.3	8.0	0.6	0.0	1.8	3.8	0.0	10.5	3.0	0.0
Prop In Lane	1.00		0.23	1.00		1.00	1.00		1.00	1.00		1.00
Lane Grp Cap(c), veh/h	45	148	150	360	939	420	108	476	213	377	1013	453
V/C Ratio(X)	0.49	0.08	0.09	0.84	0.06	0.00	0.62	0.61	0.00	2.24	0.28	0.00
Avail Cap(c_a), veh/h	701	1041	1050	743	2205	986	377	1825	817	377	1825	817
HCM Platoon Ratio	1.00	1.00	1.00	1.00	1.00	1.00	1.00	1.00	1.00	1.00	1.00	1.00
Upstream Filter(I)	1.00	1.00	1.00	1.00	1.00	0.00	1.00	1.00	0.00	1.00	1.00	0.00
Uniform Delay (d), s/veh	23.7	20.7	20.7	19.0	13.7	0.0	22.7	20.2	0.0	19.5	13.7	0.0
Incr Delay (d2), s/veh	3.1	0.1	0.1	2.1	0.0	0.0	2.2	0.5	0.0	565.3	0.1	0.0
Initial Q Delay(d3),s/veh	0.0	0.0	0.0	0.0	0.0	0.0	0.0	0.0	0.0	0.0	0.0	0.0
%ile BackOfQ(50%),veh/ln	0.3	0.2	0.2	4.2	0.3	0.0	1.0	1.9	0.0	64.2	1.5	0.0
LnGrp Delay(d),s/veh	26.8	20.8	20.8	21.0	13.7	0.0	24.8	20.7	0.0	584.8	13.7	0.0
LnGrp LOS	C	C	C	C	B		C	C		F	B	
Approach Vol, veh/h		47			359			359			1124	
Approach Delay, s/veh		23.6			19.9			21.4			442.0	
Approach LOS		C			B			C			F	
Timer	1	2	3	4	5	6	7	8				
Assigned Phs	1	2	3	4	5	6	7	8				
Phs Duration (G+Y+Rc), s	7.5	18.6	5.8	17.5	15.0	11.2	14.4	8.8				
Change Period (Y+Rc), s	4.5	4.5	4.5	4.5	4.5	4.5	4.5	4.5				
Max Green Setting (Gmax), s	10.5	25.5	20.5	30.5	10.5	25.5	20.5	30.5				
Max Q Clear Time (g_c+I1), s	3.8	5.0	2.6	2.6	12.5	5.8	10.0	2.3				
Green Ext Time (p_c), s	0.0	0.3	0.0	0.1	0.0	0.3	0.1	0.0				
Intersection Summary												
HCM 2010 Ctrl Delay			271.5									
HCM 2010 LOS			F									
Notes												

HCM 2010 Signalized Intersection Summary Cumulative with Eastside Parkway with Project, PM
 40: Malmedy Road & Gigling Road

06/11/2019



Movement	EBL	EBT	EBR	WBL	WBT	WBR	NBL	NBT	NBR	SBL	SBT	SBR
Lane Configurations		↔			↔			↔			↔	
Traffic Volume (veh/h)	10	1180	10	30	820	30	30	60	50	30	40	10
Future Volume (veh/h)	10	1180	10	30	820	30	30	60	50	30	40	10
Number	7	4	14	3	8	18	5	2	12	1	6	16
Initial Q (Qb), veh	0	0	0	0	0	0	0	0	0	0	0	0
Ped-Bike Adj(A_pbT)	1.00		1.00	1.00		1.00	1.00		1.00	1.00		1.00
Parking Bus, Adj	1.00	1.00	1.00	1.00	1.00	1.00	1.00	1.00	1.00	1.00	1.00	1.00
Adj Sat Flow, veh/h/ln	1900	1863	1900	1900	1881	1900	1900	1900	1900	1900	1810	1900
Adj Flow Rate, veh/h	11	1297	11	33	901	33	33	66	55	33	44	11
Adj No. of Lanes	0	2	0	0	2	0	0	1	0	0	1	0
Peak Hour Factor	0.91	0.91	0.91	0.91	0.91	0.91	0.91	0.91	0.91	0.91	0.91	0.91
Percent Heavy Veh, %	2	2	2	1	1	1	0	0	0	5	5	5
Cap, veh/h	153	1642	14	172	1459	55	224	133	100	278	159	34
Arrive On Green	0.47	0.47	0.47	0.47	0.47	0.47	0.16	0.16	0.16	0.16	0.16	0.16
Sat Flow, veh/h	9	3496	30	34	3107	117	280	811	606	469	966	205
Grp Volume(v), veh/h	690	0	629	492	0	475	154	0	0	88	0	0
Grp Sat Flow(s),veh/h/ln	1844	0	1690	1567	0	1691	1697	0	0	1640	0	0
Q Serve(g_s), s	0.0	0.0	7.7	0.6	0.0	5.1	0.9	0.0	0.0	0.0	0.0	0.0
Cycle Q Clear(g_c), s	7.7	0.0	7.7	8.3	0.0	5.1	2.0	0.0	0.0	1.1	0.0	0.0
Prop In Lane	0.02		0.02	0.07		0.07	0.21		0.36	0.37		0.12
Lane Grp Cap(c), veh/h	1015	0	794	892	0	794	457	0	0	471	0	0
V/C Ratio(X)	0.68	0.00	0.79	0.55	0.00	0.60	0.34	0.00	0.00	0.19	0.00	0.00
Avail Cap(c_a), veh/h	3868	0	3469	3312	0	3472	2240	0	0	2094	0	0
HCM Platoon Ratio	1.00	1.00	1.00	1.00	1.00	1.00	1.00	1.00	1.00	1.00	1.00	1.00
Upstream Filter(I)	1.00	0.00	1.00	1.00	0.00	1.00	1.00	0.00	0.00	1.00	0.00	0.00
Uniform Delay (d), s/veh	5.5	0.0	5.5	4.7	0.0	4.8	9.4	0.0	0.0	9.0	0.0	0.0
Incr Delay (d2), s/veh	0.3	0.0	0.7	0.2	0.0	0.3	0.2	0.0	0.0	0.1	0.0	0.0
Initial Q Delay(d3),s/veh	0.0	0.0	0.0	0.0	0.0	0.0	0.0	0.0	0.0	0.0	0.0	0.0
%ile BackOfQ(50%),veh/ln	3.9	0.0	3.6	2.4	0.0	2.3	1.0	0.0	0.0	0.5	0.0	0.0
LnGrp Delay(d),s/veh	5.8	0.0	6.2	4.9	0.0	5.1	9.6	0.0	0.0	9.1	0.0	0.0
LnGrp LOS	A		A	A		A	A			A		
Approach Vol, veh/h		1319			967			154			88	
Approach Delay, s/veh		6.0			5.0			9.6			9.1	
Approach LOS		A			A			A			A	
Timer	1	2	3	4	5	6	7	8				
Assigned Phs		2		4		6		8				
Phs Duration (G+Y+Rc), s		8.5		16.1		8.5		16.1				
Change Period (Y+Rc), s		4.5		4.5		4.5		4.5				
Max Green Setting (Gmax), s		30.5		50.5		30.5		50.5				
Max Q Clear Time (g_c+I1), s		4.0		9.7		3.1		10.3				
Green Ext Time (p_c), s		0.2		1.4		0.1		1.1				
Intersection Summary												
HCM 2010 Ctrl Delay				5.9								
HCM 2010 LOS				A								

HCM 2010 Signalized Intersection Summary Cumulative with Eastside Parkway with Project, PM
 41: Parker Flatts Cut Off Road & Gigling Road

06/11/2019



Movement	EBL	EBT	EBR	WBL	WBT	WBR	NBL	NBT	NBR	SBL	SBT	SBR
Lane Configurations		↔			↔			↔	↔		↔	
Traffic Volume (veh/h)	10	1220	30	50	780	10	90	20	90	10	20	10
Future Volume (veh/h)	10	1220	30	50	780	10	90	20	90	10	20	10
Number	7	4	14	3	8	18	5	2	12	1	6	16
Initial Q (Qb), veh	0	0	0	0	0	0	0	0	0	0	0	0
Ped-Bike Adj(A_pbT)	1.00		1.00	1.00		1.00	1.00		1.00	1.00		1.00
Parking Bus, Adj	1.00	1.00	1.00	1.00	1.00	1.00	1.00	1.00	1.00	1.00	1.00	1.00
Adj Sat Flow, veh/h/ln	1900	1863	1900	1900	1881	1900	1900	1900	1900	1900	1900	1900
Adj Flow Rate, veh/h	11	1371	34	56	876	11	101	22	101	11	22	11
Adj No. of Lanes	0	2	0	0	2	0	0	1	1	0	1	0
Peak Hour Factor	0.89	0.89	0.89	0.89	0.89	0.89	0.89	0.89	0.89	0.89	0.89	0.89
Percent Heavy Veh, %	2	2	2	1	1	1	0	0	0	0	0	0
Cap, veh/h	136	1739	43	174	1492	19	436	59	270	204	174	72
Arrive On Green	0.51	0.51	0.51	0.51	0.51	0.51	0.17	0.17	0.17	0.17	0.17	0.17
Sat Flow, veh/h	8	3435	85	54	2947	39	1181	349	1610	244	1036	427
Grp Volume(v), veh/h	742	0	674	456	0	487	123	0	101	44	0	0
Grp Sat Flow(s),veh/h/ln	1848	0	1680	1335	0	1705	1530	0	1610	1706	0	0
Q Serve(g_s), s	0.0	0.0	9.1	1.4	0.0	5.4	1.1	0.0	1.5	0.0	0.0	0.0
Cycle Q Clear(g_c), s	9.0	0.0	9.1	10.5	0.0	5.4	1.9	0.0	1.5	0.6	0.0	0.0
Prop In Lane	0.01		0.05	0.12		0.02	0.82		1.00	0.25		0.25
Lane Grp Cap(c), veh/h	1067	0	850	822	0	863	494	0	270	449	0	0
V/C Ratio(X)	0.70	0.00	0.79	0.55	0.00	0.56	0.25	0.00	0.37	0.10	0.00	0.00
Avail Cap(c_a), veh/h	3462	0	3073	2508	0	3119	1866	0	1779	1978	0	0
HCM Platoon Ratio	1.00	1.00	1.00	1.00	1.00	1.00	1.00	1.00	1.00	1.00	1.00	1.00
Upstream Filter(I)	1.00	0.00	1.00	1.00	0.00	1.00	1.00	0.00	1.00	1.00	0.00	0.00
Uniform Delay (d), s/veh	5.6	0.0	5.6	4.6	0.0	4.7	10.3	0.0	10.2	9.8	0.0	0.0
Incr Delay (d2), s/veh	0.3	0.0	0.6	0.2	0.0	0.2	0.1	0.0	0.3	0.0	0.0	0.0
Initial Q Delay(d3),s/veh	0.0	0.0	0.0	0.0	0.0	0.0	0.0	0.0	0.0	0.0	0.0	0.0
%ile BackOfQ(50%),veh/ln	4.6	0.0	4.3	2.2	0.0	2.5	0.8	0.0	0.7	0.3	0.0	0.0
LnGrp Delay(d),s/veh	5.9	0.0	6.3	4.8	0.0	4.9	10.4	0.0	10.5	9.8	0.0	0.0
LnGrp LOS	A		A	A		A	B		B	A		
Approach Vol, veh/h		1416			943			224			44	
Approach Delay, s/veh		6.1			4.9			10.4			9.8	
Approach LOS		A			A			B			A	
Timer	1	2	3	4	5	6	7	8				
Assigned Phs		2		4		6		8				
Phs Duration (G+Y+Rc), s		9.1		18.5		9.1		18.5				
Change Period (Y+Rc), s		4.5		4.5		4.5		4.5				
Max Green Setting (Gmax), s		30.5		50.5		30.5		50.5				
Max Q Clear Time (g_c+I1), s		3.9		11.1		2.6		12.5				
Green Ext Time (p_c), s		0.1		1.5		0.0		1.4				
Intersection Summary												
HCM 2010 Ctrl Delay				6.1								
HCM 2010 LOS				A								

HCM 2010 Signalized Intersection Summary Cumulative with Eastside Parkway with Project, PM
 42: 6th Avenue & Gigling Road

06/11/2019



Movement	EBL	EBT	EBR	WBL	WBT	WBR	NBL	NBT	NBR	SBL	SBT	SBR
Lane Configurations		↔			↔			↑	↗		↔	
Traffic Volume (veh/h)	180	1140	10	10	660	10	10	10	20	10	10	180
Future Volume (veh/h)	180	1140	10	10	660	10	10	10	20	10	10	180
Number	7	4	14	3	8	18	5	2	12	1	6	16
Initial Q (Qb), veh	0	0	0	0	0	0	0	0	0	0	0	0
Ped-Bike Adj(A_pbT)	1.00		1.00	1.00		1.00	1.00		1.00	1.00		1.00
Parking Bus, Adj	1.00	1.00	1.00	1.00	1.00	1.00	1.00	1.00	1.00	1.00	1.00	1.00
Adj Sat Flow, veh/h/ln	1900	1881	1900	1900	1863	1900	1900	1900	1900	1900	1900	1900
Adj Flow Rate, veh/h	189	1200	11	11	695	11	11	11	0	11	11	189
Adj No. of Lanes	0	2	0	0	2	0	0	1	1	0	1	0
Peak Hour Factor	0.95	0.95	0.95	0.95	0.95	0.95	0.95	0.95	0.95	0.95	0.95	0.95
Percent Heavy Veh, %	1	1	1	2	2	2	0	0	0	0	0	0
Cap, veh/h	304	1507	14	120	1901	30	267	203	282	123	22	254
Arrive On Green	0.55	0.55	0.55	0.55	0.55	0.55	0.17	0.17	0.00	0.17	0.17	0.17
Sat Flow, veh/h	297	2727	25	13	3440	54	592	1162	1615	45	125	1456
Grp Volume(v), veh/h	662	0	738	373	0	344	22	0	0	211	0	0
Grp Sat Flow(s),veh/h/ln	1342	0	1707	1822	0	1686	1754	0	1615	1625	0	0
Q Serve(g_s), s	10.4	0.0	11.2	0.0	0.0	3.8	0.0	0.0	0.0	1.4	0.0	0.0
Cycle Q Clear(g_c), s	14.2	0.0	11.2	3.7	0.0	3.8	0.3	0.0	0.0	4.0	0.0	0.0
Prop In Lane	0.29		0.01	0.03		0.03	0.50		1.00	0.05		0.90
Lane Grp Cap(c), veh/h	882	0	943	1119	0	931	470	0	282	398	0	0
V/C Ratio(X)	0.75	0.00	0.78	0.33	0.00	0.37	0.05	0.00	0.00	0.53	0.00	0.00
Avail Cap(c_a), veh/h	2166	0	2615	2792	0	2582	1574	0	1494	1610	0	0
HCM Platoon Ratio	1.00	1.00	1.00	1.00	1.00	1.00	1.00	1.00	1.00	1.00	1.00	1.00
Upstream Filter(I)	1.00	0.00	1.00	1.00	0.00	1.00	1.00	0.00	0.00	1.00	0.00	0.00
Uniform Delay (d), s/veh	6.2	0.0	5.8	4.1	0.0	4.1	11.4	0.0	0.0	12.9	0.0	0.0
Incr Delay (d2), s/veh	0.5	0.0	0.5	0.1	0.0	0.1	0.0	0.0	0.0	0.4	0.0	0.0
Initial Q Delay(d3),s/veh	0.0	0.0	0.0	0.0	0.0	0.0	0.0	0.0	0.0	0.0	0.0	0.0
%ile BackOfQ(50%),veh/ln	5.3	0.0	5.3	1.9	0.0	1.7	0.2	0.0	0.0	1.9	0.0	0.0
LnGrp Delay(d),s/veh	6.7	0.0	6.4	4.2	0.0	4.2	11.4	0.0	0.0	13.3	0.0	0.0
LnGrp LOS	A		A	A		A	B			B		
Approach Vol, veh/h		1400			717			22			211	
Approach Delay, s/veh		6.5			4.2			11.4			13.3	
Approach LOS		A			A			B			B	
Timer	1	2	3	4	5	6	7	8				
Assigned Phs		2		4		6		8				
Phs Duration (G+Y+Rc), s		10.3		22.7		10.3		22.7				
Change Period (Y+Rc), s		4.5		4.5		4.5		4.5				
Max Green Setting (Gmax), s		30.5		50.5		30.5		50.5				
Max Q Clear Time (g_c+I1), s		2.3		16.2		6.0		5.8				
Green Ext Time (p_c), s		0.0		2.0		0.3		0.7				
Intersection Summary												
HCM 2010 Ctrl Delay				6.5								
HCM 2010 LOS				A								

HCM 2010 Signalized Intersection Summary Cumulative with Eastside Parkway with Project, PM
 43: Gigling Road & 7th Avenue

06/11/2019

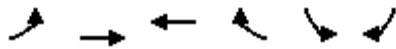

Movement	EBL	EBT	WBT	WBR	SBL	SBR		
Lane Configurations		↑↑	↑↑		↘			
Traffic Volume (veh/h)	200	970	610	10	10	70		
Future Volume (veh/h)	200	970	610	10	10	70		
Number	7	4	8	18	1	16		
Initial Q (Qb), veh	0	0	0	0	0	0		
Ped-Bike Adj(A_pbT)	1.00			1.00	1.00	1.00		
Parking Bus, Adj	1.00	1.00	1.00	1.00	1.00	1.00		
Adj Sat Flow, veh/h/ln	1900	1863	1881	1900	1827	1900		
Adj Flow Rate, veh/h	208	1010	635	10	10	73		
Adj No. of Lanes	0	2	2	0	0	0		
Peak Hour Factor	0.96	0.96	0.96	0.96	0.96	0.96		
Percent Heavy Veh, %	2	2	1	1	0	0		
Cap, veh/h	394	1355	1889	30	17	127		
Arrive On Green	0.52	0.52	0.52	0.52	0.09	0.09		
Sat Flow, veh/h	356	2668	3696	57	187	1368		
Grp Volume(v), veh/h	591	627	315	330	84	0		
Grp Sat Flow(s),veh/h/ln	1329	1610	1787	1871	1574	0		
Q Serve(g_s), s	6.2	7.1	2.4	2.4	1.2	0.0		
Cycle Q Clear(g_c), s	8.6	7.1	2.4	2.4	1.2	0.0		
Prop In Lane	0.35			0.03	0.12	0.87		
Lane Grp Cap(c), veh/h	904	845	937	981	146	0		
V/C Ratio(X)	0.65	0.74	0.34	0.34	0.58	0.00		
Avail Cap(c_a), veh/h	3205	3802	4220	4418	1707	0		
HCM Platoon Ratio	1.00	1.00	1.00	1.00	1.00	1.00		
Upstream Filter(I)	1.00	1.00	1.00	1.00	1.00	0.00		
Uniform Delay (d), s/veh	4.4	4.4	3.2	3.2	10.2	0.0		
Incr Delay (d2), s/veh	0.3	0.5	0.1	0.1	1.3	0.0		
Initial Q Delay(d3),s/veh	0.0	0.0	0.0	0.0	0.0	0.0		
%ile BackOfQ(50%),veh/ln	3.0	3.1	1.2	1.2	0.6	0.0		
LnGrp Delay(d),s/veh	4.7	4.8	3.3	3.3	11.6	0.0		
LnGrp LOS	A	A	A	A	B			
Approach Vol, veh/h		1218	645		84			
Approach Delay, s/veh		4.8	3.3		11.6			
Approach LOS		A	A		B			
Timer	1	2	3	4	5	6	7	8
Assigned Phs				4		6		8
Phs Duration (G+Y+Rc), s				16.8		6.7		16.8
Change Period (Y+Rc), s				4.5		4.5		4.5
Max Green Setting (Gmax), s				55.5		25.5		55.5
Max Q Clear Time (g_c+I1), s				10.6		3.2		4.4
Green Ext Time (p_c), s				1.8		0.0		0.6
Intersection Summary								
HCM 2010 Ctrl Delay				4.6				
HCM 2010 LOS				A				
Notes								

HCM 2010 Signalized Intersection Summary Cumulative with Eastside Parkway with Project, PM
 44: 8th Avenue & Gigling Road 06/11/2019



Movement	EBL	EBT	EBR	WBL	WBT	WBR	NBL	NBT	NBR	SBL	SBT	SBR
Lane Configurations		↔			↔			↔			↔	
Traffic Volume (veh/h)	270	710	10	10	340	10	10	10	10	10	10	280
Future Volume (veh/h)	270	710	10	10	340	10	10	10	10	10	10	280
Number	7	4	14	3	8	18	5	2	12	1	6	16
Initial Q (Qb), veh	0	0	0	0	0	0	0	0	0	0	0	0
Ped-Bike Adj(A_pbT)	1.00		1.00	1.00		1.00	1.00		1.00	1.00		1.00
Parking Bus, Adj	1.00	1.00	1.00	1.00	1.00	1.00	1.00	1.00	1.00	1.00	1.00	1.00
Adj Sat Flow, veh/h/ln	1900	1863	1900	1900	1863	1900	1900	1900	1900	1900	1881	1900
Adj Flow Rate, veh/h	297	780	11	11	374	11	11	11	11	11	11	132
Adj No. of Lanes	0	2	0	0	2	0	0	1	0	0	1	0
Peak Hour Factor	0.91	0.91	0.91	0.91	0.91	0.91	0.91	0.91	0.91	0.91	0.91	0.91
Percent Heavy Veh, %	2	2	2	2	2	2	0	0	0	1	1	1
Cap, veh/h	537	1142	17	160	1715	50	243	108	82	161	21	197
Arrive On Green	0.51	0.51	0.51	0.51	0.51	0.51	0.14	0.14	0.14	0.14	0.14	0.14
Sat Flow, veh/h	624	2245	33	26	3372	98	398	755	576	80	150	1380
Grp Volume(v), veh/h	518	0	570	207	0	189	33	0	0	154	0	0
Grp Sat Flow(s),veh/h/ln	1213	0	1689	1818	0	1678	1729	0	0	1610	0	0
Q Serve(g_s), s	8.0	0.0	6.5	0.0	0.0	1.6	0.0	0.0	0.0	1.2	0.0	0.0
Cycle Q Clear(g_c), s	9.6	0.0	6.5	1.6	0.0	1.6	0.4	0.0	0.0	2.3	0.0	0.0
Prop In Lane	0.57		0.02	0.05		0.06	0.33		0.33	0.07		0.86
Lane Grp Cap(c), veh/h	836	0	859	1071	0	853	433	0	0	379	0	0
V/C Ratio(X)	0.62	0.00	0.66	0.19	0.00	0.22	0.08	0.00	0.00	0.41	0.00	0.00
Avail Cap(c_a), veh/h	2389	0	2975	3208	0	2955	2341	0	0	2349	0	0
HCM Platoon Ratio	1.00	1.00	1.00	1.00	1.00	1.00	1.00	1.00	1.00	1.00	1.00	1.00
Upstream Filter(I)	1.00	0.00	1.00	1.00	0.00	1.00	1.00	0.00	0.00	1.00	0.00	0.00
Uniform Delay (d), s/veh	5.5	0.0	4.7	3.5	0.0	3.5	9.7	0.0	0.0	10.5	0.0	0.0
Incr Delay (d2), s/veh	0.3	0.0	0.3	0.0	0.0	0.0	0.0	0.0	0.0	0.3	0.0	0.0
Initial Q Delay(d3),s/veh	0.0	0.0	0.0	0.0	0.0	0.0	0.0	0.0	0.0	0.0	0.0	0.0
%ile BackOfQ(50%),veh/ln	3.1	0.0	2.9	0.8	0.0	0.7	0.2	0.0	0.0	1.1	0.0	0.0
LnGrp Delay(d),s/veh	5.8	0.0	5.0	3.5	0.0	3.6	9.7	0.0	0.0	10.7	0.0	0.0
LnGrp LOS	A		A	A		A	A			B		
Approach Vol, veh/h		1088			396			33			154	
Approach Delay, s/veh		5.4			3.6			9.7			10.7	
Approach LOS		A			A			A			B	
Timer	1	2	3	4	5	6	7	8				
Assigned Phs		2		4		6		8				
Phs Duration (G+Y+Rc), s		8.2		17.6		8.2		17.6				
Change Period (Y+Rc), s		4.5		4.5		4.5		4.5				
Max Green Setting (Gmax), s		35.5		45.5		35.5		45.5				
Max Q Clear Time (g_c+I1), s		2.4		11.6		4.3		3.6				
Green Ext Time (p_c), s		0.0		1.4		0.2		0.5				
Intersection Summary												
HCM 2010 Ctrl Delay				5.5								
HCM 2010 LOS				A								

HCM 2010 Signalized Intersection Summary Cumulative with Eastside Parkway with Project, PM
 45: Eastside Parkway & Gigling Road

06/11/2019



Movement	EBL	EBT	EBR	WBL	WBT	WBR	NBL	NBT	NBR	SBL	SBT	SBR
Lane Configurations												
Traffic Volume (veh/h)	700	10	20	10	10	10	20	350	10	10	190	330
Future Volume (veh/h)	700	10	20	10	10	10	20	350	10	10	190	330
Number	7	4	14	3	8	18	5	2	12	1	6	16
Initial Q (Qb), veh	0	0	0	0	0	0	0	0	0	0	0	0
Ped-Bike Adj(A_pbT)	1.00		1.00	1.00		1.00	1.00		1.00	1.00		1.00
Parking Bus, Adj	1.00	1.00	1.00	1.00	1.00	1.00	1.00	1.00	1.00	1.00	1.00	1.00
Adj Sat Flow, veh/h/ln	1863	1863	1900	1900	1863	1900	1863	1863	1900	1863	1863	1863
Adj Flow Rate, veh/h	761	11	15	11	11	11	22	380	11	11	207	250
Adj No. of Lanes	1	2	0	0	1	0	1	1	0	1	1	1
Peak Hour Factor	0.92	0.92	0.92	0.92	0.92	0.92	0.92	0.92	0.92	0.92	0.92	0.92
Percent Heavy Veh, %	2	2	2	2	2	2	2	2	2	2	2	2
Cap, veh/h	797	795	711	20	20	20	45	432	13	25	425	361
Arrive On Green	0.45	0.45	0.45	0.04	0.04	0.04	0.03	0.24	0.24	0.01	0.23	0.23
Sat Flow, veh/h	1774	1770	1583	577	577	577	1774	1801	52	1774	1863	1583
Grp Volume(v), veh/h	761	11	15	33	0	0	22	0	391	11	207	250
Grp Sat Flow(s),veh/h/ln	1774	1770	1583	1732	0	0	1774	0	1854	1774	1863	1583
Q Serve(g_s), s	25.3	0.2	0.3	1.1	0.0	0.0	0.7	0.0	12.4	0.4	5.9	8.8
Cycle Q Clear(g_c), s	25.3	0.2	0.3	1.1	0.0	0.0	0.7	0.0	12.4	0.4	5.9	8.8
Prop In Lane	1.00		1.00	0.33		0.33	1.00		0.03	1.00		1.00
Lane Grp Cap(c), veh/h	797	795	711	61	0	0	45	0	445	25	425	361
V/C Ratio(X)	0.95	0.01	0.02	0.54	0.00	0.00	0.49	0.00	0.88	0.44	0.49	0.69
Avail Cap(c_a), veh/h	1457	1453	1300	638	0	0	163	0	782	160	783	666
HCM Platoon Ratio	1.00	1.00	1.00	1.00	1.00	1.00	1.00	1.00	1.00	1.00	1.00	1.00
Upstream Filter(I)	1.00	1.00	1.00	1.00	0.00	0.00	1.00	0.00	1.00	1.00	1.00	1.00
Uniform Delay (d), s/veh	16.2	9.3	9.4	29.0	0.0	0.0	29.4	0.0	22.4	29.9	20.5	21.6
Incr Delay (d2), s/veh	4.7	0.0	0.0	2.8	0.0	0.0	7.9	0.0	2.3	12.0	0.3	0.9
Initial Q Delay(d3),s/veh	0.0	0.0	0.0	0.0	0.0	0.0	0.0	0.0	0.0	0.0	0.0	0.0
%ile BackOfQ(50%),veh/ln	8.3	0.1	0.1	0.6	0.0	0.0	0.5	0.0	6.6	0.3	3.0	3.9
LnGrp Delay(d),s/veh	20.9	9.3	9.4	31.8	0.0	0.0	37.3	0.0	24.6	41.9	20.8	22.5
LnGrp LOS	C	A	A	C			D		C	D	C	C
Approach Vol, veh/h		787			33			413			468	
Approach Delay, s/veh		20.5			31.8			25.3			22.2	
Approach LOS		C			C			C			C	
Timer	1	2	3	4	5	6	7	8				
Assigned Phs	1	2		4	5	6		8				
Phs Duration (G+Y+Rc), s	4.9	18.7		31.5	5.6	18.0		6.1				
Change Period (Y+Rc), s	4.0	4.0		4.0	4.0	4.0		4.0				
Max Green Setting (Gmax), s	5.5	25.8		50.2	5.6	25.7		22.5				
Max Q Clear Time (g_c+1/2), s	12.4	14.4		27.3	2.7	10.8		3.1				
Green Ext Time (p_c), s	0.0	0.2		0.2	0.0	0.1		0.0				
Intersection Summary												
HCM 2010 Ctrl Delay			22.4									
HCM 2010 LOS			C									
Notes												

HCM 2010 Signalized Intersection Summary Cumulative with Eastside Parkway with Project, PM
 46: General Jim Moore Boulevard & Normandy Road

06/11/2019



Movement	EBL	EBT	EBR	WBL	WBT	WBR	NBL	NBT	NBR	SBL	SBT	SBR
Lane Configurations		↕			↕		↕	↕↕		↕	↕↕	↕
Traffic Volume (veh/h)	140	40	100	290	50	10	90	790	320	30	480	80
Future Volume (veh/h)	140	40	100	290	50	10	90	790	320	30	480	80
Number	3	8	18	7	4	14	1	6	16	5	2	12
Initial Q (Qb), veh	0	0	0	0	0	0	0	0	0	0	0	0
Ped-Bike Adj(A_pbT)	1.00		1.00	1.00		1.00	1.00		1.00	1.00		1.00
Parking Bus, Adj	1.00	1.00	1.00	1.00	1.00	1.00	1.00	1.00	1.00	1.00	1.00	1.00
Adj Sat Flow, veh/h/ln	1900	1863	1900	1900	1881	1900	1881	1881	1900	1900	1900	1900
Adj Flow Rate, veh/h	152	43	84	315	54	8	98	859	325	33	522	28
Adj No. of Lanes	0	1	0	0	1	0	1	2	0	1	2	1
Peak Hour Factor	0.92	0.92	0.92	0.92	0.92	0.92	0.92	0.92	0.92	0.92	0.92	0.92
Percent Heavy Veh, %	2	2	2	1	1	1	1	1	1	0	0	0
Cap, veh/h	367	113	160	494	63	9	403	962	363	66	686	306
Arrive On Green	0.32	0.32	0.32	0.32	0.32	0.32	0.23	0.38	0.38	0.04	0.19	0.19
Sat Flow, veh/h	802	351	497	1134	194	29	1792	2540	958	1810	3610	1611
Grp Volume(v), veh/h	279	0	0	377	0	0	98	604	580	33	522	28
Grp Sat Flow(s),veh/h/ln	1649	0	0	1357	0	0	1792	1787	1711	1810	1805	1611
Q Serve(g_s), s	0.0	0.0	0.0	6.5	0.0	0.0	2.3	16.3	16.4	0.9	7.1	0.7
Cycle Q Clear(g_c), s	6.8	0.0	0.0	13.4	0.0	0.0	2.3	16.3	16.4	0.9	7.1	0.7
Prop In Lane	0.54		0.30	0.84		0.02	1.00		0.56	1.00		1.00
Lane Grp Cap(c), veh/h	640	0	0	566	0	0	403	677	648	66	686	306
V/C Ratio(X)	0.44	0.00	0.00	0.67	0.00	0.00	0.24	0.89	0.90	0.50	0.76	0.09
Avail Cap(c_a), veh/h	1106	0	0	991	0	0	403	884	846	281	1786	797
HCM Platoon Ratio	1.00	1.00	1.00	1.00	1.00	1.00	1.00	1.00	1.00	1.00	1.00	1.00
Upstream Filter(I)	1.00	0.00	0.00	1.00	0.00	0.00	1.00	1.00	1.00	1.00	1.00	1.00
Uniform Delay (d), s/veh	14.1	0.0	0.0	16.3	0.0	0.0	16.4	15.0	15.0	24.4	19.8	17.2
Incr Delay (d2), s/veh	0.2	0.0	0.0	0.5	0.0	0.0	0.1	7.8	8.5	2.2	0.7	0.0
Initial Q Delay(d3),s/veh	0.0	0.0	0.0	0.0	0.0	0.0	0.0	0.0	0.0	0.0	0.0	0.0
%ile BackOfQ(50%),veh/ln	3.2	0.0	0.0	5.0	0.0	0.0	1.2	9.4	9.3	0.5	3.5	0.3
LnGrp Delay(d),s/veh	14.3	0.0	0.0	16.8	0.0	0.0	16.5	22.9	23.5	26.5	20.4	17.2
LnGrp LOS	B			B			B	C	C	C	C	B
Approach Vol, veh/h		279			377			1282			583	
Approach Delay, s/veh		14.3			16.8			22.7			20.6	
Approach LOS		B			B			C			C	
Timer	1	2	3	4	5	6	7	8				
Assigned Phs	1	2		4	5	6		8				
Phs Duration (G+Y+Rc), s	6.1	14.3		21.1	6.4	24.0		21.1				
Change Period (Y+Rc), s	4.5	4.5		4.5	4.5	4.5		4.5				
Max Green Setting (Gmax), s	30.0	25.5		33.0	8.0	25.5		33.0				
Max Q Clear Time (g_c+14), s	14.3	9.1		15.4	2.9	18.4		8.8				
Green Ext Time (p_c), s	0.0	0.6		0.5	0.0	1.1		0.4				
Intersection Summary												
HCM 2010 Ctrl Delay				20.4								
HCM 2010 LOS				C								

HCM 2010 Signalized Intersection Summary Cumulative with Eastside Parkway with Project, PM
 47: General Jim Moore Boulevard & Coe Avenue

06/11/2019



Movement	EBL	EBT	EBR	WBL	WBT	WBR	NBL	NBT	NBR	SBL	SBT	SBR
Lane Configurations												
Traffic Volume (veh/h)	60	10	100	310	10	10	150	1080	500	10	530	60
Future Volume (veh/h)	60	10	100	310	10	10	150	1080	500	10	530	60
Number	3	8	18	7	4	14	1	6	16	5	2	12
Initial Q (Qb), veh	0	0	0	0	0	0	0	0	0	0	0	0
Ped-Bike Adj(A_pbT)	1.00		0.99	0.99		1.00	1.00		0.99	1.00		0.99
Parking Bus, Adj	1.00	1.00	1.00	1.00	1.00	1.00	1.00	1.00	1.00	1.00	1.00	1.00
Adj Sat Flow, veh/h/ln	1881	1863	1881	1863	1863	1863	1881	1881	1863	1863	1881	1881
Adj Flow Rate, veh/h	67	11	11	348	11	11	169	1213	535	11	596	31
Adj No. of Lanes	1	1	1	1	1	1	1	2	1	1	2	1
Peak Hour Factor	0.89	0.89	0.89	0.89	0.89	0.89	0.89	0.89	0.89	0.89	0.89	0.89
Percent Heavy Veh, %	1	2	1	2	2	2	1	1	2	2	1	1
Cap, veh/h	577	581	495	569	581	494	200	1427	628	25	1078	478
Arrive On Green	0.31	0.31	0.31	0.31	0.31	0.31	0.11	0.40	0.40	0.01	0.30	0.30
Sat Flow, veh/h	1398	1863	1587	1374	1863	1583	1792	3574	1573	1774	3574	1586
Grp Volume(v), veh/h	67	11	11	348	11	11	169	1213	535	11	596	31
Grp Sat Flow(s),veh/h/ln	1398	1863	1587	1374	1863	1583	1792	1787	1573	1774	1787	1586
Q Serve(g_s), s	1.7	0.2	0.2	11.5	0.2	0.2	4.5	15.2	15.2	0.3	6.9	0.7
Cycle Q Clear(g_c), s	1.9	0.2	0.2	11.7	0.2	0.2	4.5	15.2	15.2	0.3	6.9	0.7
Prop In Lane	1.00		1.00	1.00		1.00	1.00		1.00	1.00		1.00
Lane Grp Cap(c), veh/h	577	581	495	569	581	494	200	1427	628	25	1078	478
V/C Ratio(X)	0.12	0.02	0.02	0.61	0.02	0.02	0.84	0.85	0.85	0.44	0.55	0.06
Avail Cap(c_a), veh/h	1435	1724	1469	1412	1724	1466	200	2581	1136	199	2581	1145
HCM Platoon Ratio	1.00	1.00	1.00	1.00	1.00	1.00	1.00	1.00	1.00	1.00	1.00	1.00
Upstream Filter(l)	1.00	1.00	1.00	1.00	1.00	1.00	1.00	1.00	1.00	1.00	1.00	1.00
Uniform Delay (d), s/veh	12.4	11.7	11.7	15.8	11.7	11.7	21.4	13.4	13.4	24.0	14.4	12.2
Incr Delay (d2), s/veh	0.0	0.0	0.0	0.4	0.0	0.0	25.3	0.6	1.3	4.4	0.2	0.0
Initial Q Delay(d3),s/veh	0.0	0.0	0.0	0.0	0.0	0.0	0.0	0.0	0.0	0.0	0.0	0.0
%ile BackOfQ(50%),veh/ln	0.7	0.1	0.1	4.4	0.1	0.1	3.7	7.5	6.8	0.2	3.4	0.3
LnGrp Delay(d),s/veh	12.4	11.7	11.7	16.2	11.7	11.7	46.7	14.0	14.7	28.4	14.6	12.2
LnGrp LOS	B	B	B	B	B	B	D	B	B	C	B	B
Approach Vol, veh/h		89			370			1917			638	
Approach Delay, s/veh		12.2			15.9			17.1			14.7	
Approach LOS		B			B			B			B	
Timer	1	2	3	4	5	6	7	8				
Assigned Phs	1	2		4	5	6		8				
Phs Duration (G+Y+Rc), s	0.0	19.3		19.8	5.2	24.1		19.8				
Change Period (Y+Rc), s	4.5	4.5		4.5	4.5	4.5		4.5				
Max Green Setting (Gmax), s	5.5	35.5		45.5	5.5	35.5		45.5				
Max Q Clear Time (g_c+10), s	5.5	8.9		13.7	2.3	17.2		3.9				
Green Ext Time (p_c), s	0.0	0.7		0.1	0.0	1.4		0.0				
Intersection Summary												
HCM 2010 Ctrl Delay				16.3								
HCM 2010 LOS				B								

HCM 2010 Signalized Intersection Summary Cumulative with Eastside Parkway with Project, PM
 48: Fremont Boulevard/Highway 1 Southbound Off-Ramp & Monterey Road 06/11/2019



Movement	EBL	EBT	EBR	WBL	WBT	WBR	NBL	NBT	NBR	SBL	SBT	SBR
Lane Configurations												
Traffic Volume (veh/h)	230	160	70	90	100	70	110	1200	230	50	720	170
Future Volume (veh/h)	230	160	70	90	100	70	110	1200	230	50	720	170
Number	7	4	14	3	8	18	5	2	12	1	6	16
Initial Q (Qb), veh	0	0	0	0	0	0	0	0	0	0	0	0
Ped-Bike Adj(A_pbT)	1.00		0.98	1.00		0.99	1.00		0.99	1.00		0.99
Parking Bus, Adj	1.00	1.00	1.00	1.00	1.00	1.00	1.00	1.00	1.00	1.00	1.00	1.00
Adj Sat Flow, veh/h/ln	1881	1881	1881	1900	1900	1900	1881	1881	1900	1863	1863	1863
Adj Flow Rate, veh/h	201	215	25	93	103	66	113	1237	225	52	742	103
Adj No. of Lanes	1	1	1	0	1	0	1	2	0	1	2	1
Peak Hour Factor	0.97	0.97	0.97	0.97	0.97	0.97	0.97	0.97	0.97	0.97	0.97	0.97
Percent Heavy Veh, %	1	1	1	0	0	0	1	1	1	2	2	2
Cap, veh/h	269	282	235	105	117	75	593	1486	268	67	671	297
Arrive On Green	0.15	0.15	0.15	0.17	0.17	0.17	0.33	0.49	0.49	0.04	0.19	0.19
Sat Flow, veh/h	1792	1881	1565	634	702	450	1792	3023	545	1774	3539	1568
Grp Volume(v), veh/h	201	215	25	262	0	0	113	727	735	52	742	103
Grp Sat Flow(s),veh/h/ln	1792	1881	1565	1785	0	0	1792	1787	1781	1774	1770	1568
Q Serve(g_s), s	13.4	13.7	1.7	17.9	0.0	0.0	5.6	43.6	44.6	3.6	23.7	7.1
Cycle Q Clear(g_c), s	13.4	13.7	1.7	17.9	0.0	0.0	5.6	43.6	44.6	3.6	23.7	7.1
Prop In Lane	1.00		1.00	0.35		0.25	1.00		0.31	1.00		1.00
Lane Grp Cap(c), veh/h	269	282	235	297	0	0	593	879	876	67	671	297
V/C Ratio(X)	0.75	0.76	0.11	0.88	0.00	0.00	0.19	0.83	0.84	0.77	1.11	0.35
Avail Cap(c_a), veh/h	573	602	501	357	0	0	593	879	876	241	671	297
HCM Platoon Ratio	1.00	1.00	1.00	1.00	1.00	1.00	1.00	1.00	1.00	1.00	1.00	1.00
Upstream Filter(I)	0.69	0.69	0.69	1.00	0.00	0.00	1.00	1.00	1.00	1.00	1.00	1.00
Uniform Delay (d), s/veh	50.9	51.0	45.9	50.9	0.0	0.0	29.8	27.2	27.5	59.6	50.7	43.9
Incr Delay (d2), s/veh	2.9	3.0	0.1	20.8	0.0	0.0	0.1	8.8	9.5	6.9	67.4	3.2
Initial Q Delay(d3),s/veh	0.0	0.0	0.0	0.0	0.0	0.0	0.0	0.0	0.0	0.0	0.0	0.0
%ile BackOfQ(50%),veh/ln	6.9	7.3	0.8	10.6	0.0	0.0	2.8	23.6	24.1	1.9	17.8	3.4
LnGrp Delay(d),s/veh	53.8	54.0	46.0	71.7	0.0	0.0	29.9	36.1	37.0	66.5	118.0	47.1
LnGrp LOS	D	D	D	E			C	D	D	E	F	D
Approach Vol, veh/h		441			262			1575			897	
Approach Delay, s/veh		53.4			71.7			36.1			106.9	
Approach LOS		D			E			D			F	
Timer	1	2	3	4	5	6	7	8				
Assigned Phs	1	2		4	5	6		8				
Phs Duration (G+Y+Rc), s	8.9	66.8		23.4	46.7	29.0		25.9				
Change Period (Y+Rc), s	4.2	5.3		* 4.7	5.3	* 5.3		5.1				
Max Green Setting (Gmax), s	13	23.7		* 40	17.0	* 24		25.0				
Max Q Clear Time (g_c+15), s	15.6	46.6		15.7	7.6	25.7		19.9				
Green Ext Time (p_c), s	0.0	0.0		1.9	0.1	0.0		0.8				
Intersection Summary												
HCM 2010 Ctrl Delay				61.4								
HCM 2010 LOS				E								
Notes												

HCM 2010 Signalized Intersection Summary Cumulative with Eastside Parkway with Project, PM
 49: Highway 1 SB On-Ramp & Highway 1 NB Off-Ramp/Monterey Road 06/11/2019



Movement	EBL	EBT	EBR	WBL	WBT	WBR	NBL	NBT	NBR	SBL	SBT	SBR
Lane Configurations		↔↔	↗	↖		↗		↕	↗		↖	
Traffic Volume (veh/h)	10	140	120	280	0	130	0	120	300	10	10	0
Future Volume (veh/h)	10	140	120	280	0	130	0	120	300	10	10	0
Number	1	6	16	5	2	12	7	4	14	3	8	18
Initial Q (Qb), veh	0	0	0	0	0	0	0	0	0	0	0	0
Ped-Bike Adj(A_pbT)	1.00		1.00	1.00		1.00	1.00		1.00	1.00		1.00
Parking Bus, Adj	1.00	1.00	1.00	1.00	1.00	1.00	1.00	1.00	1.00	1.00	1.00	1.00
Adj Sat Flow, veh/h/ln	1900	1863	1863	1900	0	1900	0	1881	1881	1900	1900	0
Adj Flow Rate, veh/h	11	154	14	308	0	69	0	132	51	11	11	0
Adj No. of Lanes	0	2	1	1	0	1	0	1	1	0	1	0
Peak Hour Factor	0.91	0.91	0.91	0.91	0.91	0.91	0.91	0.91	0.91	0.91	0.91	0.91
Percent Heavy Veh, %	2	2	2	0	0	0	0	1	1	0	0	0
Cap, veh/h	193	2838	1323	0	0	0	0	164	139	57	43	0
Arrive On Green	0.84	0.84	0.84	0.00	0.00	0.00	0.00	0.09	0.09	0.09	0.09	0.00
Sat Flow, veh/h	230	3391	1580				0	1881	1599	155	496	0
Grp Volume(v), veh/h	88	77	14		0.0		0	132	51	22	0	0
Grp Sat Flow(s),veh/h/ln	1851	1770	1580				0	1881	1599	651	0	0
Q Serve(g_s), s	1.0	0.9	0.2				0.0	8.6	3.8	0.1	0.0	0.0
Cycle Q Clear(g_c), s	1.0	0.9	0.2				0.0	8.6	3.8	8.7	0.0	0.0
Prop In Lane	0.12		1.00				0.00		1.00	0.50		0.00
Lane Grp Cap(c), veh/h	1549	1481	1323				0	164	139	100	0	0
V/C Ratio(X)	0.06	0.05	0.01				0.00	0.81	0.37	0.22	0.00	0.00
Avail Cap(c_a), veh/h	1549	1481	1323				0	271	230	125	0	0
HCM Platoon Ratio	1.00	1.00	1.00				1.00	1.00	1.00	1.00	1.00	1.00
Upstream Filter(I)	1.00	1.00	1.00				0.00	1.00	1.00	1.00	0.00	0.00
Uniform Delay (d), s/veh	1.7	1.7	1.7				0.0	56.0	53.8	52.9	0.0	0.0
Incr Delay (d2), s/veh	0.0	0.0	0.0				0.0	3.5	0.6	0.4	0.0	0.0
Initial Q Delay(d3),s/veh	0.0	0.0	0.0				0.0	0.0	0.0	0.0	0.0	0.0
%ile BackOfQ(50%),veh/ln	0.5	0.4	0.1				0.0	4.6	1.7	0.7	0.0	0.0
LnGrp Delay(d),s/veh	1.8	1.7	1.7				0.0	59.5	54.4	53.3	0.0	0.0
LnGrp LOS	A	A	A					E	D	D		
Approach Vol, veh/h		179						183			22	
Approach Delay, s/veh		1.7						58.1			53.3	
Approach LOS		A						E			D	
Timer	1	2	3	4	5	6	7	8				
Assigned Phs				4		6		8				
Phs Duration (G+Y+Rc), s				15.1		109.9		15.1				
Change Period (Y+Rc), s				* 4.2		5.3		* 4.2				
Max Green Setting (Gmax), s				* 18		21.0		* 13				
Max Q Clear Time (g_c+I1), s				10.6		3.0		10.7				
Green Ext Time (p_c), s				0.3		0.5		0.0				
Intersection Summary												
HCM 2010 Ctrl Delay			31.6									
HCM 2010 LOS			C									
Notes												

HCM 2010 Signalized Intersection Summary Cumulative with Eastside Parkway with Project, PM
 50: Reservation Road & SR 68 WB On Ramp/SR 68 WB Off Ramp

06/11/2019



Movement	EBL	EBT	EBR	WBL	WBT	WBR	NBL	NBT	NBR	SBL	SBT	SBR
Lane Configurations					↕	↕	↕	↕			↕	
Traffic Volume (veh/h)	0	0	0	410	10	250	130	250	0	0	530	180
Future Volume (veh/h)	0	0	0	410	10	250	130	250	0	0	530	180
Number				7	4	14	1	6	16	5	2	12
Initial Q (Qb), veh				0	0	0	0	0	0	0	0	0
Ped-Bike Adj(A_pbT)				1.00		1.00	1.00		1.00	1.00		1.00
Parking Bus, Adj				1.00	1.00	1.00	1.00	1.00	1.00	1.00	1.00	1.00
Adj Sat Flow, veh/h/ln				1900	1863	1863	1845	1845	0	0	1827	1900
Adj Flow Rate, veh/h				436	11	84	138	266	0	0	564	181
Adj No. of Lanes				0	1	1	1	1	0	0	1	0
Peak Hour Factor				0.94	0.94	0.94	0.94	0.94	0.94	0.94	0.94	0.94
Percent Heavy Veh, %				2	2	2	3	3	0	0	4	4
Cap, veh/h				485	12	443	172	1091	0	0	600	192
Arrive On Green				0.28	0.28	0.28	0.03	0.20	0.00	0.00	0.45	0.45
Sat Flow, veh/h				1732	44	1581	1757	1845	0	0	1326	426
Grp Volume(v), veh/h				447	0	84	138	266	0	0	0	745
Grp Sat Flow(s),veh/h/ln				1776	0	1581	1757	1845	0	0	0	1752
Q Serve(g_s), s				20.6	0.0	3.4	6.6	10.4	0.0	0.0	0.0	34.5
Cycle Q Clear(g_c), s				20.6	0.0	3.4	6.6	10.4	0.0	0.0	0.0	34.5
Prop In Lane				0.98		1.00	1.00		0.00	0.00		0.24
Lane Grp Cap(c), veh/h				498	0	443	172	1091	0	0	0	792
V/C Ratio(X)				0.90	0.00	0.19	0.80	0.24	0.00	0.00	0.00	0.94
Avail Cap(c_a), veh/h				564	0	502	248	1091	0	0	0	792
HCM Platoon Ratio				1.00	1.00	1.00	0.33	0.33	1.00	1.00	1.00	1.00
Upstream Filter(I)				1.00	0.00	1.00	0.95	0.95	0.00	0.00	0.00	1.00
Uniform Delay (d), s/veh				29.4	0.0	23.3	40.3	18.1	0.0	0.0	0.0	22.2
Incr Delay (d2), s/veh				15.9	0.0	0.2	6.8	0.5	0.0	0.0	0.0	20.4
Initial Q Delay(d3),s/veh				0.0	0.0	0.0	0.0	0.0	0.0	0.0	0.0	0.0
%ile BackOfQ(50%),veh/ln				12.3	0.0	1.5	3.6	5.5	0.0	0.0	0.0	21.0
LnGrp Delay(d),s/veh				45.4	0.0	23.5	47.1	18.6	0.0	0.0	0.0	42.6
LnGrp LOS				D		C	D	B				D
Approach Vol, veh/h					531			404			745	
Approach Delay, s/veh					41.9			28.4			42.6	
Approach LOS					D			C			D	
Timer	1	2	3	4	5	6	7	8				
Assigned Phs	1	2		4		6						
Phs Duration (G+Y+Rc), s	1.8	44.4		28.7		56.3						
Change Period (Y+Rc), s	3.5	6.0		4.9		6.0						
Max Green Setting (Gmax), s	2.0	31.6		27.0		47.1						
Max Q Clear Time (g_c+1.0), s	1.6	36.5		22.6		12.4						
Green Ext Time (p_c), s	0.0	0.0		1.2		1.3						
Intersection Summary												
HCM 2010 Ctrl Delay				38.9								
HCM 2010 LOS				D								

HCM 2010 Signalized Intersection Summary Cumulative with Eastside Parkway with Project, PM
 51: River Road/Reservation Road & SR 68 Off Ramp/SR 68 EB On Ramp 06/11/2019



Movement	EBL	EBT	EBR	WBL	WBT	WBR	NBL	NBT	NBR	SBL	SBT	SBR
Lane Configurations		↖	↗					↑	↗	↖	↑	
Traffic Volume (veh/h)	100	10	180	0	0	0	0	300	320	260	680	0
Future Volume (veh/h)	100	10	180	0	0	0	0	300	320	260	680	0
Number	3	8	18				1	6	16	5	2	12
Initial Q (Qb), veh	0	0	0				0	0	0	0	0	0
Ped-Bike Adj(A_pbT)	1.00		1.00				1.00		1.00	1.00		1.00
Parking Bus, Adj	1.00	1.00	1.00				1.00	1.00	1.00	1.00	1.00	1.00
Adj Sat Flow, veh/h/ln	1900	1863	1863				0	1845	1845	1827	1827	0
Adj Flow Rate, veh/h	106	11	12				0	319	201	277	723	0
Adj No. of Lanes	0	1	1				0	1	1	1	1	0
Peak Hour Factor	0.94	0.94	0.94				0.94	0.94	0.94	0.94	0.94	0.94
Percent Heavy Veh, %	2	2	2				0	3	3	4	4	0
Cap, veh/h	144	15	141				0	1038	882	307	1430	0
Arrive On Green	0.09	0.09	0.09				0.00	0.56	0.56	0.35	1.00	0.00
Sat Flow, veh/h	1614	168	1583				0	1845	1568	1740	1827	0
Grp Volume(v), veh/h	117	0	12				0	319	201	277	723	0
Grp Sat Flow(s),veh/h/ln	1782	0	1583				0	1845	1568	1740	1827	0
Q Serve(g_s), s	5.4	0.0	0.6				0.0	7.8	5.5	12.8	0.0	0.0
Cycle Q Clear(g_c), s	5.4	0.0	0.6				0.0	7.8	5.5	12.8	0.0	0.0
Prop In Lane	0.91		1.00				0.00		1.00	1.00		0.00
Lane Grp Cap(c), veh/h	159	0	141				0	1038	882	307	1430	0
V/C Ratio(X)	0.74	0.00	0.08				0.00	0.31	0.23	0.90	0.51	0.00
Avail Cap(c_a), veh/h	524	0	466				0	1038	882	348	1430	0
HCM Platoon Ratio	1.00	1.00	1.00				1.00	1.00	1.00	2.00	2.00	1.00
Upstream Filter(I)	1.00	0.00	1.00				0.00	1.00	1.00	0.09	0.09	0.00
Uniform Delay (d), s/veh	37.7	0.0	35.5				0.0	9.8	9.3	26.8	0.0	0.0
Incr Delay (d2), s/veh	6.5	0.0	0.3				0.0	0.8	0.6	3.1	0.1	0.0
Initial Q Delay(d3),s/veh	0.0	0.0	0.0				0.0	0.0	0.0	0.0	0.0	0.0
%ile BackOfQ(50%),veh/ln	3.0	0.0	0.3				0.0	4.1	2.5	6.3	0.0	0.0
LnGrp Delay(d),s/veh	44.2	0.0	35.8				0.0	10.6	9.9	29.9	0.1	0.0
LnGrp LOS	D		D					B	A	C	A	
Approach Vol, veh/h		129						520			1000	
Approach Delay, s/veh		43.4						10.3			8.4	
Approach LOS		D						B			A	
Timer	1	2	3	4	5	6	7	8				
Assigned Phs		2			5	6		8				
Phs Duration (G+Y+Rc), s		72.5			18.7	53.8		12.5				
Change Period (Y+Rc), s		6.0			3.7	6.0		4.9				
Max Green Setting (Gmax), s		43.1			17.0	28.4		25.0				
Max Q Clear Time (g_c+I1), s		2.0			14.8	9.8		7.4				
Green Ext Time (p_c), s		5.0			0.2	2.1		0.5				
Intersection Summary												
HCM 2010 Ctrl Delay			11.7									
HCM 2010 LOS			B									

**APPENDIX F: ASSOCIATION OF MONTEREY BAY AREA GOVERNMENTS
TRAVEL MODEL VALIDATION**





MEMORANDUM

Date: June 10, 2019

To: Anya Spear and Matt McCluney, California State University Monterey Bay
Steve Lohr and Dawn Theodora, California State University Office of the Chancellor
Ann Sansevero, Dudek

From: Bryan Esparza, Daniel Rubins, and Matt Haynes, Fehr & Peers

Subject: California State University Monterey Bay Master Plan EIR – AMBAG Model Review and Documentation

SJ17-1728

Fehr & Peers reviewed the Association of Bay Area Governments (AMBAG) regional travel model to evaluate its suitability for developing long-range traffic forecast for streets and highways within the greater Monterey Bay Area. Fehr & Peers reviewed the primary model inputs in the project area (such as base and future year land use inputs and roadway network assumptions) and also checked the performance of the model against typical validation thresholds. Modifications to the AMBAG regional travel model land use and transportation network inputs were completed to improve the validation of the daily, peak period and peak hour travel models. These changes to the AMBAG regional travel model are documented in this memorandum for application within the CSUMB study area.

REVIEW OF AMBAG REGIONAL TRAVEL MODEL INPUTS

The AMBAG regional travel model was fully updated in 2014, with minor updates incorporating more recent estimates of existing and future land uses per the Fort Ord Reuse Authority (FORA) travel model update completed in 2017. The AMBAG regional travel model as-received includes a 2010 base year and a 2035 future year. A screen capture of the 2010 base year model near the CSUMB campus and region wide is shown in **Attachments A** and **B**, respectively. The 2010 base year model contains freeways, arterials, and local streets within the Monterey County and the land use is summarized in traffic analysis zones. The model includes similar detail in the rest of the AMBAG region of Santa Cruz and San Benito counties. Fehr & Peers reviewed the street network coding including the number of lanes, vehicle speed, and vehicle capacity, and the land use in puts in the traffic analysis zones near the CSUMB campus.



The existing and future land use inputs are summarized into traffic analysis zones (TAZs). **Table 1** summarizes the as-received version of the land use inputs under existing and future years for the AMBAG regional travel model. The AMBAG regional travel model is based on the *2014 Regional Growth Forecast* (AMBAG, 2014) with land use projections for 2010 and 2035. The AMBAG base travel model (2010) includes social and demographic information from the 2010 Census (*Association of Monterey Bay Area Governments Regional Travel Demand Model Technical Report*, 2014).

TABLE 1: AMBAG Model Residential and Employment Land Uses

Land Use Category	2010			2035		
	Monterey County	Santa Cruz County	San Benito County	Monterey County	Santa Cruz County	San Benito County
Residential						
Total Households	126,180	94,130	16,910	143,390	111,000	23,970
Total Population	385,050	246,240	54,400	444,080	292,790	75,830
Employment						
Agricultural	45,100	9,600	1,600	48,670	10,230	1,500
Construction	4,300	3,000	800	6,220	4,320	960
Industrial	5,600	5,300	2,500	5,420	4,490	2,790
Retail	20,100	14,900	2,400	23,910	15,640	2,790
Service	60,900	43,700	5,100	77,810	50,370	6,730
Public	46,000	33,700	3,800	60,140	46,090	4,780
Total	182,000	110,200	16,200	222,170	131,140	19,550

Notes: All values have been rounded to the nearest 10.

Monterey County TAZs in **Attachment M**

Santa Cruz County TAZs in **Attachment N**

San Benito County TAZs in **Attachment O**

Based on summary of AMBAG TAZs ranging between 3 and 1839.

Source: AMBAG regional travel model.

The review and update of the AMBAG regional travel model involved several steps. The land use allocation for the base year (2010) model and future year was reviewed. The travel model land use changes from base year to future year (2035) models were updated to be consistent with the FORA version of the AMBAG model and adjacent city approved and pending project lists. All of these steps are described in more detail in the following sections of the memorandum.

MODEL VALIDATION GUIDELINES

The AMBAG regional travel model is one of the only tools available for estimating long-range traffic forecasts for streets and highways in the greater Monterey Bay area. The review and refinement of



the AMBAG regional travel model is intended to provide more accurate forecasts than are currently available for non-regional (i.e., local) streets in Marina, Salinas, and Seaside. Since it would be impossible for any travel forecasting model to precisely replicate all counts within a given roadway network, two-way morning peak hour, evening peak hour, and daily validation guidelines have been established by Caltrans and other agencies. These guidelines are meant to measure the travel model's relative performance in forecasting existing travel volumes as compared to existing counts while maintaining sensitivity to land use and roadway network changes. Key static validation standards for daily travel models based on Caltrans guidelines¹ are summarized below.

- At least 75 percent of the roadway links for which counts are available should be within the maximum desirable deviation, which ranges from approximately 13 to 68 percent depending on total roadway volume (the larger the volume, the less deviation is permitted).
- The correlation coefficient between the actual ground counts and the estimated traffic volumes should be greater than 88 percent.
- The Root Mean Square Error (RMSE) should not exceed 40 percent. This measure of effectiveness (MOE) is most important for screenlines, but is also used to describe the certainty of functional classification and volume ranges.

Although not stated in the Caltrans standards, additional Fehr & Peers validation guidelines were applied to the TDF model:

- The two-way sum of the volumes on all roadway links for which counts are available should be within 10 percent of the counts.
- All roadway screenlines should be within the maximum desirable deviation, which ranges from approximately 17 to 64 percent depending on total screenline volume.

INITIAL BASE MODEL RUN

We began with the base year (Year 2010) model provided by AMBAG. This as-is model represents the model as received from AMBAG, with no changes made. The initial sub-area validation results from this version of the model are presented in **Table 2** for daily and the morning and evening peak hours. The statistics show that while most of the measures are met, some are not.

The AMBAG model generates volumes for four time periods. These periods are the Morning Peak Period (6:00 to 9:00 AM), Midday Peak Period (9:00 AM to 4:00 PM), Evening Peak Period (4:00 to 7:00 PM), and Nighttime (7:00 PM to 6:00 AM). In order to convert these period volumes to peak hour volumes, Fehr & Peers used a peak period to peak hour factor of 0.51 for the morning peak

¹ Static Validation Criteria and Thresholds, *2017 California Regional Transportation Plan Guidelines*, California Transportation Commission, January 2017.



hour and 0.40 for the evening peak hour informed by the volume-to-count ratio of all the 2017 validation count locations. This is a similar method to how the AMBAG regional travel model converts peak period volumes to peak hour volume within the travel model.

Fehr & Peers collected traffic count data in between 2015 and 2017 specifically for the purpose of model validation of the roadways within the study area. These roadway counts were supplemented with annual monitoring counts from the Transportation Agency Monterey County (TAMC) for calibration of regional freeways and ramps.

As shown in **Table 2**, for each of the validation periods, some of the static validation statistics (i.e., percent of links within Caltrans deviation allowance and percent of screenlines within maximum deviation) are not met. And for the daily model results the volume-to-count ratio is not met. In addition to the model-wide statistics, the detailed results by Functional Classification, Volume Range, Two-Way Total Traffic Volume, and Screenlines are attached **Attachment C, D, E** and **F**.

Table 2: SUB-AREA TDF MODEL STATIC VALIDATION SUMMARY (RUN 00)

Validation Item	Threshold	AM Peak Hour	PM Peak Hour	Daily
Summary Statistics				
Local Street Count Locations	N/A	40	40	40
Freeway and Ramp Count Locations	N/A	10	10	10
Model/Count Ratio	N/A	1.00	1.00	0.87
Static Validation Statistics				
Percent of Links Within Caltrans Deviation Allowance =	At Least 75%	48%	42%	54%
Correlation Coefficient =	At Least 0.88	0.98	0.98	0.99
Percent Root Mean Square Error (RMSE) =	Below 40%	32%	32%	26%
Volume-to-Count Ratio (Sum of all Locations) =	Within ±10%	0	0	-13%
Percent of Screenlines Within Maximum Deviation =	100% of links between 17% to 64%	80%	65%	79%

Notes:

1. **Bold text** indicates model validation meets guidelines.

Source: Fehr & Peers, 2019.



In general, the base year model overestimated volumes on most freeway facilities in the project area for the daily, AM peak hour, and PM peak hour model runs. The local roadways were generally underestimated for each time period too.

BASE MODEL INPUT ADJUSTMENTS

To improve model validation, adjustments were made to several model components, including the roadway network inputs and CSUMB campus trip generation. These changes are described below and include land use and population changes, as well as roadway network changes.

BASE MODEL LAND USE CHANGES

Based on information received from CSUMB staff and comparing land uses in the model to aerials of Existing Conditions, land use and population adjustments were made to the as-is Existing Conditions TDF model (Run 00). These edits are presented in **Table 3**.

TABLE 3: BASE MODEL LAND USE CHANGES

TAZ	Jurisdiction	Description of Edit
1056	Monterey County	<ul style="list-style-type: none"> Increase Public Employment from 0 to 13 Increase K-12 enrollment from 0 to 30
808	Marina	<ul style="list-style-type: none"> Adjust Industry Employment to 30 employees Adjust Administrative Employment to 7 employees
878	Monterey County	<ul style="list-style-type: none"> Adjust Service Employment to 50 employees
863	Monterey County	<ul style="list-style-type: none"> Adjust Employment to zero
806	CSUMB	<ul style="list-style-type: none"> Adjusted University Enrollment to 2,322
826	CSUMB	<ul style="list-style-type: none"> Adjusted University Enrollment to 995
847	CSUMB	<ul style="list-style-type: none"> Increase University Enrollment from 0 to 3,317
765	Seaside	<ul style="list-style-type: none"> Shift 56 Public Employees from TAZ 765 to TAZ 762
749	Seaside	<ul style="list-style-type: none"> Increase Public Employment 0 to 150
743	Seaside	<ul style="list-style-type: none"> Shift 304 K-12 Enrollment from TAZ 743 to TAZ 749
729	Santa Cruz County	<ul style="list-style-type: none"> Shift 47 Public Employees from TAZ 729 to TAZ 755 Shift 229 K-12 Enrollment from TAZ 729 to TAZ 755



BASE MODEL ROADWAY NETWORK CHANGES

Roadway network edits were made to improve model validation, improve consistency with local traffic counts, and more accurately represent existing roadways within the study area. These changes are presented on **Table 4**.

TABLE 4: BASE MODEL ROADWAY NETWORK CHANGES

Facility Type	Attribute Edited	Description
Roadway Network	Road Expansion	Changed Imjin Parkway from Reservation Road to Imjin Road to be a 2-lane minor arterial.
Roadway Network	Road Expansion	Changed Imjin Parkway from Imjin Road to Highway 1 to be a 4-lane minor arterial.
Roadway Network	Speed Increase	Increase speed on Del Monte Boulevard from Reservation Road to Marina Green Road from 35 miles per hour (mph) to 40 mph.
Roadway Network	Bike Class	Adjust bicycle facility type on Imjin Road from Imjin Road to Reservation Parkway to Bike Class II.
Roadway Network	Node	Adjust centroid connector placement from node 3568 to node 37011.
Roadway Network	Node	Adjust centroid connector placement from node 8071 to node 37004.
Roadway Network	Node	Adjust centroid connector placement from node 33033 to node 37006.
Roadway Network	Node	Adjust centroid connector placement from node 33036 to node 37005.
Roadway Network	Node	Adjust centroid connector placement from node 33034 to node 37007.
Roadway Network	Node	Adjust centroid connector placement from node 3087 to node 37008.
Roadway Network	Node	Adjust centroid connector placement from node 3190 to node 37009.
Roadway Network	Node	Adjust centroid connector placement from node 2672 to node 37010.
Roadway Network	Functional Class	Changed from Local Road to Transit Only Link on Divarty Street between Engineer Lane and 4 th Street to reflect existing limited access conditions.
Roadway Network	Functional Class	Changed from Local Road to Transit Only Link on 6 th Avenue between A Street and B Street to reflect existing limited access conditions.

Source: Fehr & Peers, 2019.



CSUMB CAMPUS TRIP GENERATION CHANGES

The Existing Conditions external trip generation for the CSUMB campus described in the *California State University Monterey Bay Master Plan EIR – Trip Generation Evaluation Methods and Estimates* memorandum is implemented by factoring the morning and evening peak hour vehicle trip matrices for the traffic analysis zones 806, 826, 847, 908, and 913.

UPDATED BASE MODEL RUN (RUN 01) VALIDATION RESULTS

By making adjustments described in the previous sections, the model performance was slightly improved for each time period. The revised base year model sub-area validation results classified by Functional Class Volume Range, Two-Way Total Traffic Volume, and Screenlines are attached (see **Attachments G, H, I and J**), and are referred to as Run 01, which includes daily, AM and PM peak hour. For all time periods the amount of two-way roadway model to count volume ratios within deviation increased. Validation results by functional class for both the PM peak hour and Daily show increase number of RSME values within deviation. AM peak hour and Daily have more screenlines within deviation. The model validation results for the updated base model given in **Table 5** presents the validation results for all validation locations regardless of functional class or volume.



ABLE 5: SUB-AREA TDF MODEL STATIC VALIDATION SUMMARY (Run 01)

Validation Item	Threshold	AM Peak Hour	PM Peak Hour	Daily
Summary Statistics				
Local Street Count Locations	N/A	40	40	40
Freeway and Ramp Count Locations	N/A	10	10	10
Model/Count Ratio	N/A	1.02	1.02	0.88
Static Validation Statistics				
Percent of Links Within Caltrans Deviation Allowance =	At Least 75%	<u>48%</u>	<u>48%</u>	<u>58%</u>
Correlation Coefficient =	At Least 0.88	0.98	0.98	0.99
Percent Root Mean Square Error (RMSE) =	Below 40%	34%	35%	24%
Volume-to-Count Ratio (Sum of all Locations) =	Within ±10%	2%	2%	<u>-11%</u>
Percent of Screenlines Within Maximum Deviation =	100% of links between 17% to 64%	<u>75%</u>	85%	79%

Notes:

1. **Bold text** indicates model validation meet guidelines.
 2. Underlined text indicates model validation results improved from Run 00.
- Source Fehr & Peers, 2019

For each of the validation periods, some of the static validation statistics (i.e., percent of links within Caltrans deviation allowance and percent of screenlines within maximum deviation) are not met; however, the results do show improvement compared to Run 00. Percent root mean square error is still below the 40% threshold and has shown further improvement in Run 01. Similar to the Run 00 results, the revised base year TDF model (Run 01) overestimated volumes on most freeway/expressway facilities in the Marina area for the daily, AM peak hour, and PM peak hour model runs. The local roadways were generally underestimated for the three time periods.

Fehr & Peers was able to improve the validation and reduce the overall error in the model for street and highway segments within the study area. Therefore, this updated Association of Bay Area Governments (AMBAG) regional travel model is the best tool available for developing long-range traffic forecast for streets and highways within the greater Monterey Bay Area.



FUTURE YEAR MODEL INPUT ADJUSTMENTS

The future year (Year 2035) model was provided by AMBAG. This as-is model represents the model as received from AMBAG, with no changes made. Fehr & Peers updated and added land use and roadway coding according to the Regional Transportation Plan (RTP) planned and funded street improvements planned by the Fort Ord Reuse Authority (FORA), City of Marina, and the AMBAG Regional Transportation Plan (RTP). The future year model update incorporates land use and network changes per the (FORA) travel model update completed in 2017. Fehr & Peers also adjusted the external trip generation for the CSUMB campus to represent future conditions.

FUTURE MODEL LAND USE CHANGES

Land use and population refinements were made based on information received from CSUMB staff and comparing land uses in the model to other models including the FORA AMBAG regional travel model. **Table 6** presents these changes.



TABLE 6: FUTURE YEAR MODEL LAND USE CHANGES

TAZ	Jurisdiction	Description
826	Marina	<ul style="list-style-type: none"> Add 508 K-12 Student Enrollment
1803	Seaside	<ul style="list-style-type: none"> Add 214 Retail Employment Add 375 Service Employment Add 100 Industrial Employment
1035, 1039, 1042, 1052, 1063, 1065, 1068, 1070,	Monterey County	<p>The following land uses were spread amongst the listed TAZs:</p> <ul style="list-style-type: none"> Add 167 Public Employment Add 167 Service Employment Add 161 Industrial Employment
790	Marina	<ul style="list-style-type: none"> Add 500 Hotel Rooms
832	Marina	<ul style="list-style-type: none"> Add 21 Public Employment Add 135 Industrial Employment
836	Marina	<ul style="list-style-type: none"> Add 48 Public Employment Add 135 Industrial Employment
819	Marina	<ul style="list-style-type: none"> Edit number of K-12 Enrollment to be 86 from 3 Edit Retail Employment to be 86 from 0 Edit Service Employment to be 360 from 233 Edit Industrial Employment to be 1,304 from 24
788	Marina	<ul style="list-style-type: none"> Edit number of Retail Employment to be 127 from 0 Edit number of Hotel Rooms to be 100 from 0
791	Marina	<ul style="list-style-type: none"> Edit number of Retail Employment to be 126 from 0 Edit number of Hotel Rooms to be 100 from 0
710	Seaside	<ul style="list-style-type: none"> Edit number of Industrial Employment to be 148 from 0
761	Seaside	<ul style="list-style-type: none"> Edit number of Service Employment to be 74 from 0

Source: Fehr & Peers, 2019.

FUTURE YEAR ROADWAY NETWORK CHANGES

The future year transportation network includes the planned and funded street improvements planned by the Fort Ord Reuse Authority (FORA), City of Marina, and the AMBAG Regional Transportation Plan (RTP) (see **Attachment K** and **L** for a description of the Cumulative without Project Conditions transportation improvements list). **Table 7** summarizes the roadway network edits to the 2035 roadway network near the study area.



TABLE 7: FUTURE YEAR MODEL ROADWAY NETWORK CORRECTIONS

Attributes Edited	Description
Road Classification/Speed	Changed Eastside Parkway classification from a Local Road to a Minor Arterial with posted speeds of 45 mph from the end of the existing Eucalyptus Road to Inter Garrison Road.
Road Addition	Add Watkins Gate Road to the model from Sloat Street to Reservation Road. Classification is coded in as a local road with two lanes.
Road Expansion	Changed Imjin Parkway from Reservation Road to Highway 1 from a Local Road classification to a 4-lane Minor Arterial with a posted speed of 40 mph.
Road Classification/Speed	Changed Lightfighter Drive from Highway 1 SB Ramps to General Jim Moore Boulevard from a Local Roadway to a Principal Arterial with a posted speed of 40 mph.
Road Expansion	Widened 2 nd Avenue between Lightfighter Drive to Imjin Parkway to four lanes.
Bike Facility Classification	Change Bike Lane Facility to Class II on Imjin Parkway from Imjin Road to 2nd Avenue.
Bike Facility Classification	Change Bike Lane Facility to Class II on Giggling Road from 6th Division Road to General Jim Moore Boulevard.
Bike Facility Classification	Change Bike Lane Facility to Class II on General Jim Moore Boulevard from Giggling Road to Inter-Garrison Road.
Bike Facility Classification	Change Bike Lane Facility to Class III on A Street from 7th Avenue to Divarty Street.
Bike Facility Classification	Change Bike Lane Facility to Class III on Divarty Street from General Jim Moore Boulevard to 5th Avenue.
Bike Facility Classification	Change Bike Lane Facility to Class I on Beach Range Road from 1st Street to Highway 1.
Node	Adjust centroid connector placement for node 39023 in order to correctly load volumes onto roadway network.
Node	Adjust centroid connector placement from node 33033 to node 39025.
Node	Adjust centroid connector placement from node 33036 to node 39024.
Node	Adjust centroid connector placement from node 33034 to node 39026.
Node	Adjust centroid connector placement from node 3087 to node 39027.
Node	Adjust centroid connector placement from node 3190 to node 39028.
Node	Adjust centroid connector placement from node 2672 to node 39029.
Node	Adjust centroid connector placement from node 3568 to node 39030.

Source: Fehr & Peers, 2019



ATTACHMENTS:

- Attachment A: AMBAG Base Year Model Network and TAZs Near the CSUMB Campus
- Attachment B: AMBAG Base Year Model Network and TAZs Regionwide
- Attachment C: Initial Model Validation Results: Functional Classification, Run 00
- Attachment D: Initial Model Validation Results: Roadway Volume Range, Run 00
- Attachment E: Initial Model Validation Results: Screenlines Using Two-Way Volume, Run 00
- Attachment F: Initial Model Validation Results: By Link Using Two-Way Volume, Run 00
- Attachment G: Final Model Validation Results: Functional Classification, Run 01
- Attachment H: Final Model Validation Results: Roadway Volume Range, Run 01
- Attachment I: Final Model Validation Results: Screenlines Using Two-Way Volume, Run 01
- Attachment J: Final Model Validation Results: By Link Using Two-Way Volume, Run 01
- Attachment K: Cumulative without Project Conditions Roadway Improvements
- Attachment L: Cumulative without Project Conditions Intersection Improvements
- Attachment M: Monterey County List of TAZs
- Attachment N: San Benito County List of TAZs
- Attachment O: Santa Cruz County List of TAZs

**ATTACHMENT A: AMBAG BASE YEAR MODEL NETWORK AND
TAZS NEAR THE CSUMB CAMPUS**

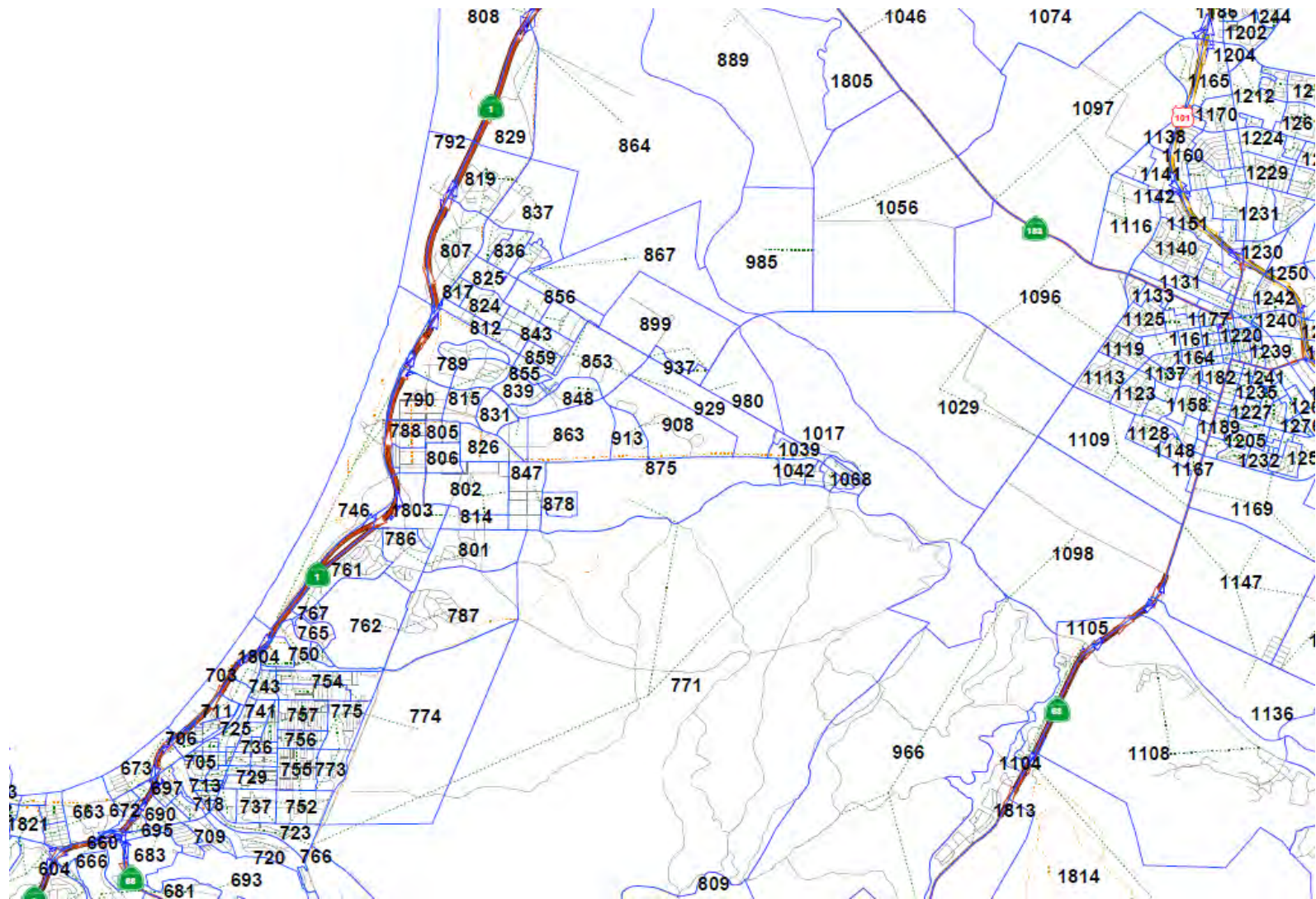

**ATTACHMENT B: AMBAG BASE YEAR MODEL NETWORK AND
TAZS REGIONWIDE**

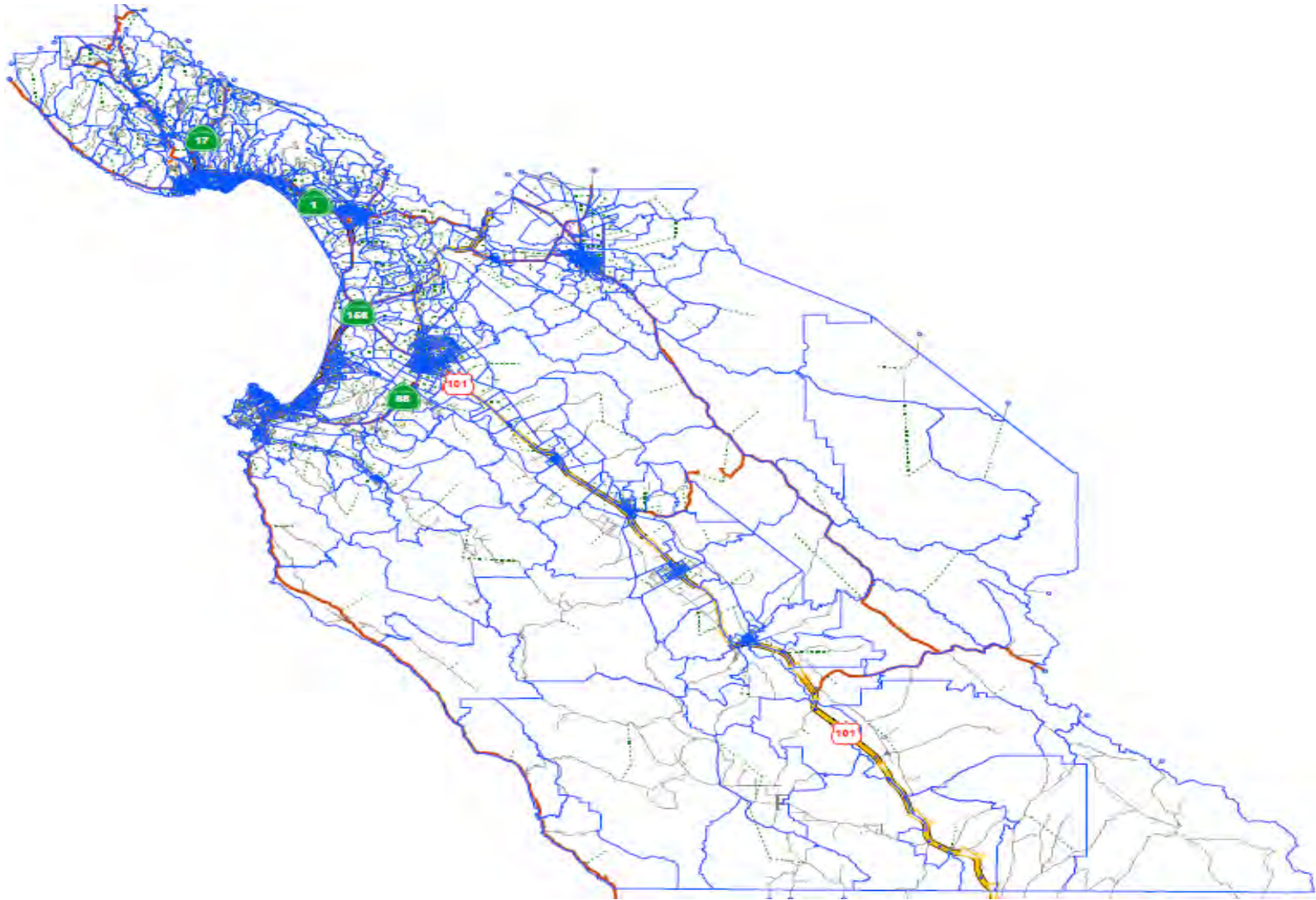

**ATTACHMENT C: INITIAL MODEL VALIDATION RESULTS:
FUNCTIONAL CLASSIFICATION, RUN 00**

Table C1: Results of AM Peak-Hour Model Area Validation by Functional Class, Run 00							
Functional Class	Links	Volume-to-Count Ratio			Root Mean Square Error		
		Criteria	%	Valid?	%	Maximum	Valid?
Freeway or Expressway	9	16%	10%	Yes	14%	40%	Yes
Principal Arterial	10	29%	3%	Yes	35%	40%	Yes
Minor Arterial	6	48%	-3%	Yes	39%	40%	Yes
Local Roadway	18	48%	-58%	No	89%	40%	No
Major Collector	6	48%	-11%	Yes	91%	40%	No
Ramp	1	28%	-23%	Yes	23%	40%	Yes
Total	50	10%	0%	Yes	32%	40%	Yes

Table C2: Results of PM Peak-Hour Model Area Validation by Functional Class, Run 00							
Functional Class	Links	Volume-to-Count Ratio			Root Mean Square Error		
		Criteria	%	Valid?	%	Maximum	Valid?
Freeway or Expressway	9	16%	14%	Yes	18%	40%	Yes
Principal Arterial	10	29%	-9%	Yes	28%	40%	Yes
Minor Arterial	6	48%	-1%	Yes	41%	40%	No
Local Roadway	18	48%	-53%	No	87%	40%	No
Major Collector	6	48%	-25%	Yes	42%	40%	No
Ramp	1	28%	-13%	Yes	13%	40%	Yes
Total	50	10%	0%	Yes	32%	40%	Yes

Table C3: Results of Daily Model Area Validation by Functional Class, Run 00							
Functional Class	Links	Volume-to-Count Ratio			Root Mean Square Error		
		Criteria	%	Valid?	%	Maximum	Valid?
Freeway or Expressway	9	16%	-5%	Yes	12%	40%	Yes
Principal Arterial	10	29%	-20%	Yes	27%	40%	Yes
Minor Arterial	6	48%	-13%	Yes	36%	40%	Yes
Local Roadway	18	48%	-51%	No	88%	40%	No
Major Collector	6	48%	-29%	Yes	43%	40%	No
Ramp	1	28%	-39%	No	39%	40%	Yes
Total	50	10%	-13%	No	26%	40%	Yes

**ATTACHMENT D: INITIAL MODEL VALIDATION RESULTS:
ROADWAY VOLUME RANGE, RUN 00**

Table D1: Results of AM Peak-Hour Model Area Validation by Roadway Volume, Run 00							
Functional Class	Counts	Volume-to-Count Ratio			Root Mean Square Error		
		Criteria	%	Valid?	%	Maximum	Valid?
Less than 1,000	30	34%	-30%	Yes	81%	116%	Yes
1,000 to 2,499	10	25%	-6%	Yes	38%	116%	Yes
2,500 to 4,999	2	19%	9%	Yes	28%	116%	Yes
5,000 to 10,000	8	14%	9%	Yes	13%	43%	Yes
Total	50						

Table D2: Results of PM Peak-Hour Model Area Validation by Roadway Volume, Run 00							
Functional Class	Links	Volume-to-Count Ratio			Root Mean Square Error		
		Criteria	%	Valid	%	Maximum	Valid?
Less than 1,000	27	34%	-33%	Yes	69%	116%	Yes
1,000 to 2,499	13	25%	-12%	Yes	32%	116%	Yes
2,500 to 4,999	3	19%	20%	No	36%	116%	Yes
5,000 to 10,000	7	14%	10%	Yes	13%	43%	Yes
Total	50						

Table D3: Results of Daily Model Area Validation by Roadway Volume, Run 00							
Functional Class	Counts	Volume-to-Count Ratio			Root Mean Square Error		
		Criteria	%	Valid?	%	Maximum	Valid?
Less than 1,000	3	34%	291%	No	81%	116%	Yes
1,000 to 2,499	0	25%	NA	N/A	68%	116%	N/A
2,500 to 4,999	11	19%	-56%	No	74%	116%	Yes
5,000 to 9,999	15	14%	-30%	No	48%	43%	No
10,000 to 19,999	5	14%	-26%	No	38%	28%	No
20,000 to 24,999	3	14%	-36%	No	36%	25%	No
25,000 to 39,999	4	14%	-21%	No	25%	25%	Yes
40,000 to 49,999	0	14%	N/A	N/A	NA	30%	N/A
50,000 to 59,999	1	14%	2%	Yes	2%	30%	Yes
60,000 to 89,999	5	14%	2%	Yes	8%	19%	Yes
Total	47						

**ATTACHMENT E: INITIAL MODEL VALIDATION RESULTS:
SCREENLINES USING TWO-WAY VOLUME, RUN 00**

Table E1: Results of Screenline AM Peak Hour - Two-Way Volume, Run 00											
Count ID	Direction	Location	Model Volume	Traffic Count	Delta AM	Delta/Count AM	Maximum Deviation	Within Deviation	Model-Count	Difference Squared	Percent RSME
Screenline 1: East of Reservation Road between Blanco Road and SR-68											
40543	NB	Blanco Road between Cooper Road and Reservation Road	1,090	997	93	0.093	0.55	YES	93	8,632	
40543	SB	Blanco Road between Cooper Road and Reservation Road	1,179	998	181	0.181	0.55	YES	181	32,610	
13421	NB	Davis Road just north of Reservation Road	413	280	133	0.476	0.63	YES	133	17,757	
13421	SB	Davis Road just north of Reservation Road	563	406	157	0.386	0.62	YES	157	24,545	
4810	EB	Reservation Road just west of SR-68	224	420	-196	-0.466	0.62	YES	-196	38,289	
4810	WB	Reservation Road just west of SR-68	274	648	-374	-0.577	0.59	YES	-374	139,971	
Screenline 1: East of Reservation Road between Blanco Road and SR-68			3,743	3,749	-6	-0.002	0.35	YES	-6	41	0%
Screenline 2: 6th Ave between Inter-Garrison Road and Imjin Parkway											
12644	SB	Imjin Road between Imjin Parkway and Eight Street	65	50	15	0.291	0.64	YES	15	212	
12644	NB	Imjin Road between Imjin Parkway and Eight Street	31	310	-279	-0.899	0.63	NO	-279	77,665	
4020	NB	Inter-Garrison between Eight Avenue and Abrams Drive	418	139	279	2.006	0.64	NO	279	77,716	
4020	EB	Inter-Garrison between Eight Avenue and Abrams Drive	262	990	-728	-0.735	0.55	NO	-728	530,167	
3700	WB	Imjin Parkway between Abrams Drive and Imjin Road	741	797	-56	-0.070	0.57	YES	-56	3,154	
3700	EB	Imjin Parkway between Abrams Drive and Imjin Road	575	1,127	-552	-0.490	0.54	YES	-552	304,582	
Screenline 2: 6th Ave between Inter-Garrison Road and Imjin Parkway			2,091	3,413	-1,322	-0.387	0.37	NO	-1,322	1,746,479	39%
Screenline 3: US-1 between Del Monte Boulevard and Fremont Boulevard											
41432	NB	Del Monte Boulevard between Reindollar Avenue and SR 1	477	953	-476	-0.500	0.56	YES	-476	226,797	
10104	SB	Del Monte Boulevard between Reindollar Avenue and SR 1	959	901	58	0.064	0.56	YES	58	3,364	
45007	EB	Imjin Parkway between Second Avenue and Highway 1	932	1,288	-356	-0.276	0.52	YES	-356	126,776	
45007	WB	Imjin Parkway between Second Avenue and Highway 1	1,032	1,212	-180	-0.149	0.53	YES	-180	32,397	
10078	WB	Light Fighter Drive between Highway 1 and First Avenue	308	382	-74	-0.195	0.62	YES	-74	5,536	
10078	EB	Light Fighter Drive between Highway 1 and First Avenue	121	587	-466	-0.793	0.6	NO	-466	216,906	
13637	NB	Fremont Boulevard	574	826	-252	-0.305	0.57	YES	-252	63,361	
13637	SB	Fremont Boulevard	786	943	-157	-0.166	0.56	YES	-157	24,515	
Screenline 3: US-1 between Del Monte Boulevard and Fremont Boulevard			5,189	7,092	-1,903	-0.268	0.26	NO	-1,903	3,620,287	38%

Table E2: Results of Screenline PM Peak Hour - Two-Way Volume, Run 00											
Count ID	Direction	Location	Model Volume	Traffic Count	Delta AM	Delta/Count AM	Maximum Deviation	Within Deviation	Model-Count	Difference Squared	Percent RSME
Screenline 1: East of Reservation Road between Blanco Road and SR-68											
40543	NB	Blanco Road between Cooper Road and Reservation Road	1,145	972	173	0.178	0.55	YES	173	30,038	
40543	SB	Blanco Road between Cooper Road and Reservation Road	1,054	972	82	0.084	0.55	YES	82	6,678	
13421	NB	Davis Road just north of Reservation Road	693	392	301	0.767	0.62	NO	301	90,322	
13421	SB	Davis Road just north of Reservation Road	547	282	265	0.939	0.63	NO	265	70,188	
4810	EB	Reservation Road just west of SR-68	280	615	-335	-0.544	0.6	YES	-335	112,083	
4810	WB	Reservation Road just west of SR-68	255	455	-200	-0.439	0.61	YES	-200	39,947	
Screenline 1: East of Reservation Road between Blanco Road and SR-68			3,974	3,688	286	0.078	0.36	YES	286	81,707	11%
Screenline 2: 6th Ave between Inter-Garrison Road and Imjin Parkway											
12644	SB	Imjin Road between Imjin Parkway and Eight Street	47	197	-150	-0.762	0.64	NO	-150	22,552	
12644	NB	Imjin Road between Imjin Parkway and Eight Street	37	153	-116	-0.759	0.64	NO	-116	13,473	
4020	WB	Inter-Garrison between Eight Avenue and Abrams Drive	284	782	-498	-0.636	0.58	NO	-498	247,709	
4020	EB	Inter-Garrison between Eight Avenue and Abrams Drive	405	244	161	0.661	0.64	NO	161	26,032	
3700	WB	Imjin Parkway between Abrams Drive and Imjin Road	576	980	-404	-0.412	0.55	YES	-404	163,412	
3700	EB	Imjin Parkway between Abrams Drive and Imjin Road	678	840	-162	-0.193	0.57	YES	-162	26,330	
Screenline 2: 6th Ave between Inter-Garrison Road and Imjin Parkway			2,027	3,196	-1,169	-0.366	0.38	YES	-1,169	1,366,827	37%
Screenline 3: US-1 between Del Monte Boulevard and Fremont Boulevard											
41432	NB	Del Monte Boulevard between Reindollar Avenue and SR 1	1,132	1,071	61	0.057	0.54	YES	61	3,715	
10104	SB	Del Monte Boulevard between Reindollar Avenue and SR 1	699	1,033	-334	-0.324	0.55	YES	-334	111,717	
45007	EB	Imjin Parkway between Second Avenue and Highway 1	1,036	1,326	-290	-0.219	0.51	YES	-290	84,266	
45007	WB	Imjin Parkway between Second Avenue and Highway 1	940	1,398	-458	-0.328	0.5	YES	-458	210,056	
10078	WB	Light Fighter Drive between Highway 1 and First Avenue	248	572	-324	-0.567	0.6	YES	-324	105,269	
10078	EB	Light Fighter Drive between Highway 1 and First Avenue	117	733	-616	-0.841	0.58	NO	-616	379,955	
13637	NB	Fremont Boulevard	894	1,317	-423	-0.321	0.52	YES	-423	178,783	
13637	SB	Fremont Boulevard	568	717	-149	-0.208	0.58	YES	-149	22,300	
Screenline 3: US-1 between Del Monte Boulevard and Fremont Boulevard			5,632	8,167	-2,535	-0.310	0.25	NO	-2,535	6,425,771	44%

Table E3: Results of Screenline Daily - Two-Way Volume, Run 00											
Count ID	Direction	Location	Model Volume	Traffic Count	Delta AM	Delta/Count AM	Maximum Deviation	Within Deviation	Model-Count	Difference Squared	Percent RSME
Screenline 1: East of Reservation Road between Blanco Road and SR-68											
40543	NB	Blanco Road between Cooper Road and Reservation Road	11,511	13,770	-2,259	-0.164	0.53	YES	173	30,038	
40543	SB	Blanco Road between Cooper Road and Reservation Road	11,225	13,769	-2,544	-0.185	0.53	YES	82	6,678	
13421	NB	Davis Road just north of Reservation Road	5,063	N/A	N/A	0.000	N/A	N/A	301	90,322	
13421	SB	Davis Road just north of Reservation Road	5,093	N/A	N/A	0.000	N/A	N/A	265	70,188	
4810	EB	Reservation Road just west of SR-68	2,678	N/A	N/A	0.000	N/A	N/A	-335	112,083	
4810	WB	Reservation Road just west of SR-68	2,824	N/A	N/A	0.000	N/A	N/A	-200	39,947	
Screenline 1: East of Reservation Road between Blanco Road and SR-68			38,395	27,539	-4,804	-0.174	0.17	NO	10,856	117,852,409	56%
Screenline 2: 6th Ave between Inter-Garrison Road and Imjin Parkway											
12644	SB	Imjin Road between Imjin Parkway and Eight Street	65	50	15	0.291	0.64	YES	15	212	
12644	NB	Imjin Road between Imjin Parkway and Eight Street	31	310	-279	-0.899	0.63	NO	-279	77,665	
4020	WB	Inter-Garrison between Eight Avenue and Abrams Drive	418	139	279	2.006	0.64	NO	279	77,716	
4020	EB	Inter-Garrison between Eight Avenue and Abrams Drive	262	990	-728	-0.735	0.55	NO	-728	530,167	
3700	WB	Imjin Parkway between Abrams Drive and Imjin Road	741	797	-56	-0.070	0.57	YES	-56	3,154	
3700	EB	Imjin Parkway between Abrams Drive and Imjin Road	575	1,127	-552	-0.490	0.54	YES	-552	304,582	
Screenline 2: 6th Ave between Inter-Garrison Road and Imjin Parkway			2,091	3,413	-1,322	-0.387	0.37	NO	-1,322	1,746,479	39%
Screenline 3: US-1 between Del Monte Boulevard and Fremont Boulevard											
41432	NB	Del Monte Boulevard between Reindollar Avenue and SR 1	8,061	13,945	-5,884	-0.422	0.54	YES	-5,884	3,715	
10104	SB	Del Monte Boulevard between Reindollar Avenue and SR 1	8,393	12,841	-4,448	-0.346	0.55	YES	-4,448	111,717	
45007	EB	Imjin Parkway between Second Avenue and Highway 1	10,630	14,435	-3,805	-0.264	0.51	YES	-3,805	84,266	
45007	WB	Imjin Parkway between Second Avenue and Highway 1	10,176	13,788	-3,612	-0.262	0.5	YES	-3,612	210,056	
10078	WB	Light Fighter Drive between Highway 1 and First Avenue	3,104	6,315	-3,211	-0.508	0.6	YES	-3,211	105,269	
10078	EB	Light Fighter Drive between Highway 1 and First Avenue	1,207	8,687	-7,480	-0.861	0.58	NO	-7,480	379,955	
13637	NB	Fremont Boulevard	8,055	N/A	N/A	N/A	0.52	N/A	N/A	178,783	
13637	SB	Fremont Boulevard	7,567	N/A	N/A	N/A	0.58	N/A	N/A	22,300	
Screenline 3: US-1 between Del Monte Boulevard and Fremont Boulevard			57,193	70,011	-28,439	-0.406	0.17	NO	-12,818	164,288,520	26%

**ATTACHMENT F: INITIAL MODEL VALIDATION RESULTS: BY LINK
USING TWO-WAY VOLUME, RUN 00**

Table F1: Results of AM Peak-Hour Model Area Validation by Two-Way Volume, Run 00

ID	Direction	Description		Model Volume	Traffic Count	Model/Count	Maximum Deviation	Withing Deviation	Model-Count	Difference Squared
		Roadway	Location							
1	SB/NB	Highway 1	between Del Monte Boulevard and Reservation Road	5,016	3,875	1.295	0.21	NO	1,141	1,302,556
2	SB/NB	Highway 1	between Imjin Parkway and Del Monte Boulevard	6,452	5,777	1.117	0.17	YES	675	455,713
3	SB/NB	Highway 1	between Light Fighter Drive and Imjin Parkway	7,728	6,955	1.111	0.15	YES	773	597,656
4	SB/NB	Highway 1	between Del Monte Boulevard and Light Fighter Drive	8,047	7,484	1.075	0.14	YES	563	316,696
5	SB/NB	Highway 1	between Canyon Del Rey Boulevard and Del Monte Boulevard	7,072	6,296	1.123	0.16	YES	776	602,928
6	SB/NB	Highway 1	between Del Monte Boulevard and Canyon Del Rey Boulevard	7,242	6,388	1.134	0.16	YES	854	729,527
7	SB/NB	Highway 1	between Casa Verde Way and Del Monte Boulevard	6,606	5,620	1.175	0.18	NO	986	972,328
8	SB/NB	Highway 1	between SR 68 and Casa Verde Way	6,758	5,600	1.207	0.18	NO	1,158	1,339,990
9	SB/NB	Highway 1	between SR 68 and Fremont Street	7,546	8,584	0.879	0.14	YES	-1,038	1,077,881
10	NB/SB	Del Monte Boulevard	between Beach Road and Reservation Road	112	609	0.185	0.44	NO	-497	246,644
11	NB/SB	Del Monte Boulevard	between Reindollar Avenue and SR 1	1,436	1,854	0.774	0.28	YES	-418	174,917
12	SB/NB	Second Avenue	between Imjin Parkway and Tenth Street	480	217	2.212	0.63	NO	263	69,203
13	NB/SB	Second Avenue	between Eight Street and Fifth Street	127	817	0.156	0.38	NO	-690	476,023
14	SB/NB	Second Avenue	between Divarty Street and Light Fighter Drive	110	147	0.746	0.63	YES	-37	1,389
15	SB/NB	General Jim Moore	between Divarty Street and Light Fighter Drive	802	441	1.818	0.48	NO	361	130,167
16	NB/SB	General Jim Moore Boulevard	between Light Fighter Drive and Gigling Road	536	730	0.735	0.41	YES	-194	37,497
17	SB/NB	General Jim Moore Boulevard	between Normandy Road and Coe Avenue	545	700	0.779	0.41	YES	-155	23,914
18	SB/NB	General Jim Moore Boulevard	between Coe Avenue and San Pablo Avenue	625	432	1.447	0.52	YES	193	37,352
19	NB/SB	California Avenue	between Reservation Road and Windsor Court	218	430	0.506	0.52	YES	-212	45,126
20	NB/SB	California Avenue	between Reindollar Avenue and Imjin Parkway	294	398	0.738	0.52	YES	-104	10,914
21	SB/NB	California Avenue	between Imjin Parkway and Fifth Avenue	51	158	0.322	0.63	NO	-107	11,478
22	SB/NB	Imjin Road	between Imjin Parkway and Eight Street	96	360	0.266	0.52	NO	-264	69,770
23	NB/SB	Abram Drive	between Imjin Parkway and Bunker Hill Drive	185	389	0.475	0.52	NO	-204	41,728
24	NB/SB	Abram Drive	between Manassas Drive and Inter-Garrison Road	178	466	0.383	0.48	NO	-288	82,665
25	NB/SB	Blanco Road	between Cooper Road and Reservation Road	2,268	1,995	1.137	0.27	YES	273	74,797
26	EB/WB	Reservation Road	between Highway 1 and Cardoza Avenue	1,239	418	2.964	0.52	NO	821	673,846
27	WB/EB	Reservation Road	between Robinin Drive and Del Monte Boulevard	787	557	1.413	0.44	YES	230	53,009
28	WB/EB	Reservation Road	between Del Monte Boulevard and Vista Del Camino	1,460	1,606	0.909	0.29	YES	-146	21,246
29	EB/WB	Reservation Road	between Salinas Avenue and Imjin Parkway	1,432	1,526	0.938	0.29	YES	-94	8,918
30	EB/WB	Reservation Road	between Imjin Parkway and Blanco Road	2,587	1,224	2.113	0.31	NO	1,363	1,857,546
31	EB/WB	Reservation Road	between Blanco Road and Inter-Garrison Road	535	752	0.712	0.41	YES	-217	46,915
32	EB/WB	Reservation Road	between Inter-Garrison Road and East Garrison Road	1,118	1,160	0.964	0.33	YES	-42	1,772
33	WB/NB	Reindollar Avenue	between Del Monte Boulevard and Sunset Avenue	251	371	0.677	0.52	YES	-120	14,376
34	EB/WB	Imjin Parkway	between Second Avenue and Highway 1	1,964	2,500	0.786	0.25	YES	-536	287,346
35	EB/WB	Imjin Parkway	between Fourth Avenue and Third Avenue	1,656	1,570	1.055	0.29	YES	86	7,456
36	WB/EB	Imjin Parkway	between Abrams Drive and Imjin Road	1,316	1,924	0.684	0.27	NO	-608	369,729
37	SB/NB	Imjin Parkway	between Reservation Road and Preston Drive	1,284	934	1.375	0.36	NO	350	122,825
38	WB/EB	Inter-Garrison Road	between Second Avenue and Third Avenue	152	147	1.033	0.63	YES	5	24
39	WB/EB	Inter-Garrison Road	between Sixth Avenue and Seventh Avenue	620	277	2.240	0.58	NO	343	117,943
40	WB/EB	Inter-Garrison Road	between Eight Avenue and Abrams Drive	680	1,129	0.602	0.33	NO	-449	201,916
41	WB/EB	Lightfighter Drive	between Highway 1 and First Avenue	429	969	0.443	0.36	NO	-540	291,750
42	EB/WB	Lightfighter Drive	between Second Avenue and General Jim Moore Boulevard	628	1,503	0.418	0.29	NO	-875	766,146
43	EB/WB	Lightfighter Drive	between General Jim Moore Blvd and Colonel Durham Street	0	463	0.000	0.48	NO	-463	214,249
44	WB/EB	Gigling Road	between General Jim Moore Boulevard and Malmedy Road	0	895	0.000	0.36	NO	-895	800,640
45	NB/SB	Monterey Road	between Buna Road and Noumea Road	26	217	0.118	0.63	NO	-191	36,592
46	WB/EB	Coe Avenue	between Buttercup Boulevard and Coe Avenue	98	506	0.193	0.48	NO	-408	166,705
47	EB/WB	San Pablo	between Nadina Street and General Jim Moore Boulevard	169	728	0.232	0.41	NO	-559	312,463
48	EB/WB	Broadway Avenue	between Mescal Street and General Jim Moore Boulevard	398	582	0.684	0.44	YES	-184	33,885
49	SB/NB	Eight Avenue	between Inter-Garrison Road and A Street	25	828	0.030	0.38	NO	-803	645,591

Local Roadway/Freeway/Ramp Results:

89,384 89,508

Model/Count Ratio = 1.00 0%
 Percent Within Caltrans Maximum Deviation = 48% <75%
 Percent Root Mean Square Error = 0.32 <40%
 Correlation Coefficient = 0.98 >0.88

Total Count= 49
 Link within Deviation= 24
 Link Outside Deviation= 25

Local Roadway Results:

25,481 31,075

Model/Count Ratio = 0.82 -28%
 Percent Within Caltrans Maximum Deviation = 43% <75%
 Percent Root Mean Square Error = 32% <40%
 Correlation Coefficient = 0.98 >0.88

Total Count= 39
 Link within Deviation= 17
 Link Outside Deviation= 22

Table F2: Results of PM Peak Hour Two-Way Total Traffic Volumes, Run 00

ID	Direction	Description		Model Volume	Traffic Count	Model/Count	Maximum Deviation	Withing Deviation	Model-Count	Difference Squared
		Roadway	Location							
1	SB/NB	Highway 1	between Del Monte Boulevard and Reservation Road	4,945	4,088	1.210	0.21	NO	857	733,817
2	SB/NB	Highway 1	between Imjin Parkway and Del Monte Boulevard	6,775	6,318	1.072	0.16	YES	457	209,160
3	SB/NB	Highway 1	between Light Fighter Drive and Imjin Parkway	8,000	7,763	1.031	0.14	YES	237	56,124
4	SB/NB	Highway 1	between Del Monte Boulevard and Light Fighter Drive	8,187	7,903	1.036	0.14	YES	284	80,667
5	SB/NB	Highway 1	between Canyon Del Rey Boulevard and Del Monte Boulevard	7,057	5,729	1.232	0.17	NO	1,328	1,764,186
6	SB/NB	Highway 1	between Del Monte Boulevard and Canyon Del Rey Boulevard	7,207	5,945	1.212	0.17	NO	1,262	1,592,780
7	SB/NB	Highway 1	between Casa Verde Way and Del Monte Boulevard	6,257	5,027	1.245	0.19	NO	1,230	1,512,766
8	SB/NB	Highway 1	between SR 68 and Casa Verde Way	6,930	4,774	1.452	0.20	NO	2,156	4,646,740
9	SB/NB	Highway 1	between SR 68 and Fremont Street	7,601	7,792	0.976	0.14	YES	-191	36,436
10	NB/SB	Del Monte Boulevard	between Beach Road and Reservation Road	152	634	0.240	0.44	NO	-482	231,992
11	NB/SB	Del Monte Boulevard	between Reindollar Avenue and SR 1	1,831	2,104	0.870	0.26	YES	-273	74,688
12	SB/NB	Second Avenue	between Imjin Parkway and Tenth Street	567	290	1.955	0.58	NO	277	76,652
13	NB/SB	Second Avenue	between Eight Street and Fifth Street	138	554	0.250	0.44	NO	-416	172,835
14	SB/NB	Second Avenue	between Divarty Street and Light Fighter Drive	130	142	0.912	0.63	YES	-12	156
15	SB/NB	General Jim Moore	between Divarty Street and Light Fighter Drive	793	384	2.065	0.52	NO	409	167,132
16	NB/SB	General Jim Moore Boulevard	between Light Fighter Drive and Gigling Road	630	896	0.704	0.36	YES	-266	70,504
17	SB/NB	General Jim Moore Boulevard	between Normandy Road and Coe Avenue	706	722	0.977	0.41	YES	-16	266
18	SB/NB	General Jim Moore Boulevard	between Coe Avenue and San Pablo Avenue	806	554	1.454	0.44	NO	252	63,314
19	NB/SB	California Avenue	between Reservation Road and Windsor Court	233	505	0.461	0.48	NO	-272	74,053
20	NB/SB	California Avenue	between Reindollar Avenue and Imjin Parkway	329	562	0.586	0.44	YES	-233	54,159
21	SB/NB	California Avenue	between Imjin Parkway and Fifth Avenue	57	77	0.738	0.68	YES	-20	409
22	SB/NB	Imjin Road	between Imjin Parkway and Eight Street	84	350	0.239	0.52	NO	-266	70,887
23	NB/SB	Abram Drive	between Imjin Parkway and Bunker Hill Drive	198	496	0.400	0.48	NO	-298	88,546
24	NB/SB	Abram Drive	between Manassas Drive and Inter-Garrison Road	198	446	0.445	0.48	NO	-248	61,308
25	NB/SB	Blanco Road	between Cooper Road and Reservation Road	2,199	1,944	1.131	0.27	YES	255	65,041
26	EB/WB	Reservation Road	between Highway 1 and Cardoza Avenue	1,267	1,104	1.148	0.33	YES	163	26,719
27	WB/EB	Reservation Road	between Robinin Drive and Del Monte Boulevard	821	734	1.119	0.41	YES	87	7,648
28	WB/EB	Reservation Road	between Del Monte Boulevard and Vista Del Camino	1,775	1,873	0.948	0.27	YES	-98	9,515
29	EB/WB	Reservation Road	between Salinas Avenue and Imjin Parkway	1,717	1,670	1.028	0.28	YES	47	2,212
30	EB/WB	Reservation Road	between Imjin Parkway and Blanco Road	2,783	2,001	1.391	0.27	NO	782	612,245
31	EB/WB	Reservation Road	between Blanco Road and Inter-Garrison Road	480	789	0.609	0.38	NO	-309	95,414
32	EB/WB	Reservation Road	between Inter-Garrison Road and East Garrison Road	1,393	1,166	1.195	0.33	YES	227	51,586
33	WB/NB	Reindollar Avenue	between Del Monte Boulevard and Sunset Avenue	283	581	0.487	0.44	NO	-298	88,860
34	EB/WB	Imjin Parkway	between Second Avenue and Highway 1	1,975	2,724	0.725	0.24	NO	-749	560,408
35	EB/WB	Imjin Parkway	between Fourth Avenue and Third Avenue	1,643	2,001	0.821	0.27	YES	-358	128,364
36	WB/EB	Imjin Parkway	between Abrams Drive and Imjin Road	1,253	1,820	0.689	0.28	NO	-567	320,930
37	SB/NB	Imjin Parkway	between Reservation Road and Preston Drive	1,211	2,098	0.577	0.26	NO	-887	786,426
38	WB/EB	Inter-Garrison Road	between Second Avenue and Third Avenue	159	169	0.943	0.63	YES	-10	93
39	WB/EB	Inter-Garrison Road	between Sixth Avenue and Seventh Avenue	621	230	2.700	0.58	NO	391	152,812
40	WB/EB	Inter-Garrison Road	between Eight Avenue and Abrams Drive	690	1,026	0.672	0.34	YES	-336	113,138
41	WB/EB	Lightfighter Drive	between Highway 1 and First Avenue	364	1,305	0.279	0.31	NO	-941	885,212
42	EB/WB	Lightfighter Drive	between Second Avenue and General Jim Moore Boulevard	635	1,326	0.479	0.30	NO	-691	477,302
43	EB/WB	Lightfighter Drive	between General Jim Moore Blvd and Colonel Durham Street	0	390	0.000	0.52	NO	-390	152,040
44	WB/EB	Gigling Road	between General Jim Moore Boulevard and Malmedy Road	20	786	0.026	0.38	NO	-766	586,164
45	NB/SB	Monterey Road	between Buna Road and Noumea Road	31	307	0.101	0.58	NO	-276	76,212
46	WB/EB	Coe Avenue	between Buttercup Boulevard and Coe Avenue	113	279	0.405	0.58	NO	-166	27,535
47	EB/WB	San Pablo	between Nadina Street and General Jim Moore Boulevard	201	391	0.514	0.52	YES	-190	36,101
48	EB/WB	Broadway Avenue	between Mescal Street and General Jim Moore Boulevard	436	612	0.713	0.44	YES	-176	30,912
49	SB/NB	Eight Avenue	between Inter-Garrison Road and A Street	41	635	0.065	0.44	NO	-594	352,789

Local Roadway/Freeway/Ramp Results:

91,925 92,016
 Model/Count Ratio= 1.00 0%
 Percent within Caltrans Maximum Deviation= 100% <75%
 Percent Root Mean Square Error (RSME)= 32% <40%
 Correlation Coefficient = 98% >0.88
 Total Count= 49
 Link within Deviation= 21
 Link Outside Deviation= 28

Local Roadway Results:

27,136 34,573
 Model/Count Ratio = 0.78 -32%
 Percent Within Caltrans Maximum Deviation = 45% <75%
 Percent Root Mean Square Error = 32% <40%
 Correlation Coefficient = 0.26 <0.88
 Total Count= 39
 Link within Deviation= 16
 Link Outside Deviation= 23

Table F3: Results of Daily Two-Way Total Traffic Volumes, Run 00

ID	Direction	Description		Model Volume	Traffic Count	Model Delta	Model Delta/Count	Maximum Deviation	Withing Deviation	Model-Count	Difference Squared
		Roadway	Location								
1	SB/NB	Highway 1	between Del Monte Boulevard and Reservation Road	5,016	3,875	1,141	0.295	0.20	NO	1,141	1,145,744
2	SB/NB	Highway 1	between Imjin Parkway and Del Monte Boulevard	69,091	76,532	-7,441	-0.097	0.15	YES	-7,441	55,368,834
3	SB/NB	Highway 1	between Light Fighter Drive and Imjin Parkway	82,256	93,403	-11,147	-0.119	0.14	YES	-11,147	124,247,799
4	SB/NB	Highway 1	between Del Monte Boulevard and Light Fighter Drive	85,460	96,962	-11,502	-0.119	0.14	YES	-11,502	132,304,298
5	SB/NB	Highway 1	between Canyon Del Rey Boulevard and Del Monte Boulevard	75,157	69,564	5,593	0.080	0.17	YES	5,593	31,276,992
6	SB/NB	Highway 1	between Del Monte Boulevard and Canyon Del Rey Boulevard	77,936	77,104	832	0.011	0.15	YES	832	692,144
7	SB/NB	Highway 1	between Casa Verde Way and Del Monte Boulevard	69,306	68,590	716	0.010	0.17	YES	716	512,955
8	SB/NB	Highway 1	between SR 68 and Casa Verde Way	73,941	66,292	7,649	0.115	0.17	YES	7,649	58,506,054
9	SB/NB	Highway 1	between SR 68 and Fremont Street	81,385	100,509	-19,124	-0.190	0.14	NO	-19,124	365,738,798
10	NB/SB	Del Monte Boulevard	between Beach Road and Reservation Road	1,614	7,580	-5,966	-0.787	0.41	NO	-5,966	35,589,710
11	NB/SB	Del Monte Boulevard	between Reindollar Avenue and SR 1	16,455	26,786	-10,331	-0.386	0.25	NO	-10,331	106,738,197
12	SB/NB	Second Avenue	between Imjin Parkway and Tenth Street	5,999	3,274	2,725	0.832	0.58	NO	2,725	7,424,982
13	NB/SB	Second Avenue	between Eight Street and Fifth Street	1,412	6,331	-4,919	-0.777	0.44	NO	-4,919	24,198,334
14	SB/NB	Second Avenue	between Divarty Street and Light Fighter Drive	1,486	2,502	-1,016	-0.406	0.58	YES	-1,016	1,031,457
15	SB/NB	General Jim Moore	between Divarty Street and Light Fighter Drive	8,304	5,232	3,072	0.587	0.48	NO	3,072	9,434,882
16	NB/SB	General Jim Moore Boulevard	between Light Fighter Drive and Gigling Road	5,835	9,611	-3,776	-0.393	0.38	NO	-3,776	14,256,535
17	SB/NB	General Jim Moore Boulevard	between Normandy Road and Coe Avenue	6,384	6,683	-299	-0.045	0.44	YES	-299	89,661
18	SB/NB	General Jim Moore Boulevard	between Coe Avenue and San Pablo Avenue	7,752	7,004	748	0.107	0.44	YES	748	559,265
19	NB/SB	California Avenue	between Reservation Road and Windsor Court	2,318	4,672	-2,354	-0.504	0.52	YES	-2,354	5,543,078
20	NB/SB	California Avenue	between Reindollar Avenue and Imjin Parkway	3,373	5,915	-2,542	-0.430	0.48	YES	-2,542	6,464,031
21	SB/NB	California Avenue	between Imjin Parkway and Fifth Avenue	562	992	-430	-0.433	0.68	YES	-430	184,820
22	SB/NB	Imjin Road	between Imjin Parkway and Eight Street	1,126	4,122	-2,996	-0.727	0.52	NO	-2,996	8,975,291
23	NB/SB	Abram Drive	between Imjin Parkway and Bunker Hill Drive	2,033	5,616	-3,583	-0.638	0.48	NO	-3,583	12,836,338
24	NB/SB	Abram Drive	between Manassas Drive and Inter-Garrison Road	1,842	4,486	-2,644	-0.589	0.52	NO	-2,644	6,992,550
25	NB/SB	Blanco Road	between Cooper Road and Reservation Road	22,735	27,539	-4,804	-0.174	0.25	YES	-4,804	23,073,720
26	EB/WB	Reservation Road	between Highway 1 and Cardoza Avenue	13,571	12,776	795	0.062	0.33	YES	795	631,535
27	WB/EB	Reservation Road	between Robinin Drive and Del Monte Boulevard	8,706	8,470	236	0.028	0.41	YES	236	55,668
28	WB/EB	Reservation Road	between Del Monte Boulevard and Vista Del Camino	15,968	17,396	-1,428	-0.082	0.29	YES	-1,428	2,038,365
29	EB/WB	Reservation Road	between Salinas Avenue and Imjin Parkway	14,726	16,489	-1,763	-0.107	0.29	YES	-1,763	3,107,636
30	EB/WB	Reservation Road	between Imjin Parkway and Blanco Road	26,211	26,567	-356	-0.013	0.25	YES	-356	126,736
31	EB/WB	Reservation Road	between Blanco Road and Inter-Garrison Road	4,057	6,224	-2,167	-0.348	0.48	YES	-2,167	4,697,697
32	EB/WB	Reservation Road	between Inter-Garrison Road and East Garrison Road	11,526	9,844	1,682	0.171	0.38	YES	1,682	2,828,111
33	WB/NB	Reindollar Avenue	between Del Monte Boulevard and Sunset Avenue	2,865	6,441	-3,576	-0.555	0.44	NO	-3,576	12,787,665
34	EB/WB	Imjin Parkway	between Second Avenue and Highway 1	20,806	28,223	-7,417	-0.263	0.25	NO	-7,417	55,007,516
35	EB/WB	Imjin Parkway	between Fourth Avenue and Third Avenue	17,056	22,817	-5,761	-0.252	0.27	YES	-5,761	33,192,375
36	WB/EB	Imjin Parkway	between Abrams Drive and Imjin Road	13,312	23,570	-10,258	-0.435	0.27	NO	-10,258	105,231,784
37	SB/NB	Imjin Parkway	between Reservation Road and Preston Drive	13,005	20,860	-7,855	-0.377	0.28	NO	-7,855	61,703,185
38	WB/EB	Inter-Garrison Road	between Second Avenue and Third Avenue	1,722	2,630	-908	-0.345	0.58	YES	-908	825,229
39	WB/EB	Inter-Garrison Road	between Sixth Avenue and Seventh Avenue	6,398	665	5,733	8.621	0.68	NO	5,733	32,863,491
40	WB/EB	Inter-Garrison Road	between Eighth Avenue and Abrams Drive	6,762	8,450	-1,688	-0.200	0.41	YES	-1,688	2,849,131
41	WB/EB	Lightfighter Drive	between Highway 1 and First Avenue	4,311	15,002	-10,691	-0.713	0.30	NO	-10,691	114,291,943
42	EB/WB	Lightfighter Drive	between Second Avenue and General Jim Moore Boulevard	6,865	13,257	-6,392	-0.482	0.33	NO	-6,392	40,852,192
43	EB/WB	Lightfighter Drive	between General Jim Moore Blvd and Colonel Durham Street	1	3,746	-3,745	-1.000	0.58	NO	-3,745	14,027,031
44	WB/EB	Gigling Road	between General Jim Moore Boulevard and Malmedy Road	53	6,281	-6,228	-0.992	0.44	NO	-6,228	38,789,101
45	NB/SB	Monterey Road	between Buna Road and Noumea Road	270	3,280	-3,010	-0.918	0.58	NO	-3,010	9,059,431
46	WB/EB	Coe Avenue	between Buttercup Boulevard and Coe Avenue	993	2,950	-1,957	-0.663	0.58	NO	-1,957	3,827,956
47	EB/WB	San Pablo	between Nadina Street and General Jim Moore Boulevard	1,948	3,963	-2,015	-0.508	0.52	YES	-2,015	4,060,689
48	EB/WB	Broadway Avenue	between Mescal Street and General Jim Moore Boulevard	4,622	7,304	-2,682	-0.367	0.44	YES	-2,682	7,192,084
49	SB/NB	Eight Avenue	between Inter-Garrison Road and A Street	151	4,578	-4,427	-0.967	0.52	NO	-4,427	19,601,879

Local Roadway/Freeway/Ramp Results:

904,681 1,052,959

Model/Count Ratio= 0.86
 Percent within Caltrans Maximum Deviation= 100% <75%
 Percent Root Mean Square Error (RSME)= 26% <40%
 Correlation Coefficient = 99% >0.88

Total Count= 49
 Link within Deviation= 26
 Link Outside Deviation= 23

Local Roadway Results:

268,678 373,342

Model/Count Ratio = 0.72
 Percent Within Caltrans Maximum Deviation = 43% <75%
 Percent Root Mean Square Error = 27% <40%
 Correlation Coefficient = 0.99 >0.88

Total Count= 39
 Link within Deviation= 19
 Link Outside Deviation= 20

**ATTACHMENT G: FINAL MODEL VALIDATION RESULTS: FUNCTIONAL
CLASSIFICATION, RUN 01**

Table C1: Results of AM Peak-Hour Model Area Validation by Functional Class, Run 01							
Functional Class	Links	Volume-to-Count Ratio			Root Mean Square Error		
		Criteria	%	Valid?	%	Maximum	Valid?
Freeway or Expressway	9	16%	11%	Yes	14%	40%	Yes
Principal Arterial	10	29%	9%	Yes	47%	40%	No
Minor Arterial	6	48%	-14%	Yes	32%	40%	Yes
Local Roadway	18	48%	-52%	No	90%	40%	No
Major Collector	6	48%	-16%	Yes	82%	40%	No
Ramp	1	28%	-26%	Yes	26%	40%	Yes
Total	50	10%	2%	Yes	34%	40%	Yes

Table C2: Results of PM Peak-Hour Model Area Validation by Functional Class, Run 01							
Functional Class	Links	Volume-to-Count Ratio			Root Mean Square Error		
		Criteria	%	Valid?	%	Maximum	Valid?
Freeway or Expressway	9	16%	16%	Yes	21%	40%	Yes
Principal Arterial	10	29%	-6%	Yes	25%	40%	Yes
Minor Arterial	6	48%	-17%	Yes	38%	40%	Yes
Local Roadway	18	48%	-43%	Yes	86%	40%	No
Major Collector	6	48%	-30%	Yes	46%	40%	No
Ramp	1	28%	-31%	No	31%	40%	Yes
Total	50	10%	0%	Yes	35%	40%	Yes

Table C3: Results of Daily Model Area Validation by Functional Class, Run 01							
Functional Class	Links	Volume-to-Count Ratio			Root Mean Square Error		
		Criteria	%	Valid?	%	Maximum	Valid?
Freeway or Expressway	9	16%	-4%	Yes	11%	40%	Yes
Principal Arterial	10	29%	-12%	Yes	18%	40%	Yes
Minor Arterial	6	48%	-15%	Yes	29%	40%	Yes
Local Roadway	18	48%	-47%	Yes	88%	40%	No
Major Collector	6	48%	-32%	Yes	44%	40%	No
Ramp	1	28%	-37%	No	37%	40%	Yes
Total	50	10%	-11%	No	24%	40%	Yes

**ATTACHMENT H: FINAL MODEL VALIDATION RESULTS: ROADWAY
VOLUME RANGE, RUN 01**

Table D1: Results of AM Peak-Hour Model Area Validation by Roadway Volume, Run 01							
Functional Class	Counts	Volume-to-Count Ratio			Root Mean Square Error		
		Criteria	%	Valid?	%	Maximum	Valid?
Less than 1,000	30	34%	-27%	Yes	86%	116%	Yes
1,000 to 2,499	10	25%	-6%	Yes	47%	116%	Yes
2,500 to 4,999	2	19%	17%	Yes	26%	116%	Yes
5,000 to 10,000	8	14%	10%	Yes	13%	43%	Yes
Total	50						

Table D2: Results of PM Peak-Hour Model Area Validation by Roadway Volume, Run 01							
Functional Class	Links	Volume-to-Count Ratio			Root Mean Square Error		
		Criteria	%	Valid	%	Maximum	Valid?
Less than 1,000	27	34%	-36%	No	74%	116%	Yes
1,000 to 2,499	13	25%	-13%	Yes	31%	116%	Yes
2,500 to 4,999	3	19%	27%	No	35%	116%	Yes
5,000 to 10,000	7	14%	12%	Yes	17%	43%	Yes
Total	50						

Table D3: Results of Daily Model Area Validation by Roadway Volume, Run 01							
Functional Class	Counts	Volume-to-Count Ratio			Root Mean Square Error		
		Criteria	%	Valid?	%	Maximum	Valid?
Less than 1,000	3	34%	186%	No	86%	116%	Yes
1,000 to 2,499	0	25%	NA	N/A	84%	116%	N/A
2,500 to 4,999	11	19%	-48%	No	96%	116%	Yes
5,000 to 9,999	15	14%	-28%	No	45%	43%	No
10,000 to 19,999	5	14%	-25%	No	35%	28%	No
20,000 to 24,999	3	14%	-22%	No	23%	25%	Yes
25,000 to 39,999	4	14%	-14%	No	21%	25%	Yes
40,000 to 49,999	0	14%	N/A	N/A	NA	30%	N/A
50,000 to 59,999	1	14%	4%	Yes	4%	30%	Yes
60,000 to 89,999	5	14%	3%	Yes	7%	19%	Yes
Total	47						

**ATTACHMENT I: FINAL MODEL VALIDATION RESULTS: SCREENLINES
USING TWO-WAY VOLUME, RUN 01**

Table E1: Results of Screenline AM Peak Hour - Two-Way Volume, Run 01

Count ID	Direction	Location	Model Volume	Traffic Count	Delta AM	Delta/Count AM	Maximum Deviation	Within Deviation	Model-Count	Difference Squared	Percent RSME
Screenline 1: East of Reservation Road between Blanco Road and SR-68											
40543	NB	Blanco Road between Cooper Road and Reservation Road	1,223	997	226	0.227	0.55	YES	226	51,044	
40543	SB	Blanco Road between Cooper Road and Reservation Road	1,453	998	455	0.456	0.55	YES	455	207,189	
13421	NB	Davis Road just north of Reservation Road	123	280	-157	-0.560	0.63	YES	-157	24,553	
13421	SB	Davis Road just north of Reservation Road	206	406	-200	-0.492	0.62	YES	-200	39,920	
4810	EB	Reservation Road just west of SR-68	231	420	-189	-0.449	0.62	YES	-189	35,540	
4810	WB	Reservation Road just west of SR-68	267	648	-381	-0.588	0.59	YES	-381	145,273	
Screenline 1: East of Reservation Road between Blanco Road and SR-68			3,504	3,749	-245	-0.065	0.35	YES	-245	60,051	9%
Screenline 2: 6th Ave between Inter-Garrison Road and Imjin Parkway											
12644	SB	Imjin Road between Imjin Parkway and Eight Street	171	50	121	2.422	0.64	NO	121	14,669	
12644	NB	Imjin Road between Imjin Parkway and Eight Street	43	310	-267	-0.861	0.63	NO	-267	71,276	
4020	WB	Inter-Garrison between Eight Avenue and Abrams Drive	338	139	199	1.435	0.64	NO	199	39,764	
4020	EB	Inter-Garrison between Eight Avenue and Abrams Drive	85	990	-905	-0.915	0.55	NO	-905	819,736	
3700	WB	Imjin Parkway between Abrams Drive and Imjin Road	1,035	797	238	0.299	0.57	YES	238	56,787	
3700	EB	Imjin Parkway between Abrams Drive and Imjin Road	588	1,127	-539	-0.478	0.54	YES	-539	290,273	
Screenline 2: 6th Ave between Inter-Garrison Road and Imjin Parkway			2,261	3,413	-1,152	-0.338	0.37	YES	-1,152	1,327,826	34%
Screenline 3: US-1 between Del Monte Boulevard and Fremont Boulevard											
41432	NB	Del Monte Boulevard between Reindollar Avenue and SR 1	486	953	-467	-0.490	0.56	YES	-467	218,447	
10104	SB	Del Monte Boulevard between Reindollar Avenue and SR 1	889	901	-12	-0.013	0.56	YES	-12	136	
45007	EB	Imjin Parkway between Second Avenue and Highway 1	1,126	1,288	-162	-0.126	0.52	YES	-162	26,379	
45007	WB	Imjin Parkway between Second Avenue and Highway 1	1,329	1,212	117	0.096	0.53	YES	117	13,607	
10078	WB	Light Fighter Drive between Highway 1 and First Avenue	234	382	-148	-0.388	0.62	YES	-148	22,022	
10078	EB	Light Fighter Drive between Highway 1 and First Avenue	121	587	-466	-0.795	0.6	NO	-466	217,559	
13637	NB	Fremont Boulevard	570	826	-256	-0.310	0.57	YES	-256	65,740	
13637	SB	Fremont Boulevard	756	943	-187	-0.199	0.56	YES	-187	35,154	
Screenline 3: US-1 between Del Monte Boulevard and Fremont Boulevard			5,508	7,092	-1,584	-0.223	0.26	YES	-1,584	2,507,536	32%

Table E2: Results of Screenline PM Peak Hour - Two-Way Volume, Run 01

Count ID	Direction	Location	Model Volume	Traffic Count	Delta AM	Delta/Count AM	Maximum Deviation	Within Deviation	Model-Count	Difference Squared	Percent RSME
Screenline 1: East of Reservation Road between Blanco Road and SR-68											
40543	NB	Blanco Road between Cooper Road and Reservation Road	1,307	972	335	0.345	0.55	YES	335	112,276	
40543	SB	Blanco Road between Cooper Road and Reservation Road	1,225	972	253	0.260	0.55	YES	253	63,783	
13421	NB	Davis Road just north of Reservation Road	395	392	3	0.009	0.62	YES	3	12	
13421	SB	Davis Road just north of Reservation Road	185	282	-97	-0.345	0.63	YES	-97	9,486	
4810	EB	Reservation Road just west of SR-68	268	615	-347	-0.564	0.6	YES	-347	120,436	
4810	WB	Reservation Road just west of SR-68	251	455	-204	-0.449	0.61	YES	-204	41,782	
Screenline 1: East of Reservation Road between Blanco Road and SR-68			3,630	3,688	-58	-0.016	0.36	YES	-58	3,342	2%
Screenline 2: 6th Ave between Inter-Garrison Road and Imjin Parkway											
12644	SB	Imjin Road between Imjin Parkway and Eight Street	84	197	-113	-0.576	0.64	YES	-113	12,865	
12644	NB	Imjin Road between Imjin Parkway and Eight Street	145	153	-8	-0.052	0.64	YES	-8	64	
4020	WB	Inter-Garrison between Eight Avenue and Abrams Drive	138	782	-644	-0.823	0.58	NO	-644	414,341	
4020	EB	Inter-Garrison between Eight Avenue and Abrams Drive	441	244	197	0.807	0.64	NO	197	38,747	
3700	WB	Imjin Parkway between Abrams Drive and Imjin Road	703	980	-277	-0.283	0.55	YES	-277	76,761	
3700	EB	Imjin Parkway between Abrams Drive and Imjin Road	1,051	840	211	0.251	0.57	YES	211	44,438	
Screenline 2: 6th Ave between Inter-Garrison Road and Imjin Parkway			2,561	3,196	-635	-0.199	0.38	YES	-635	402,602	20%
Screenline 3: US-1 between Del Monte Boulevard and Fremont Boulevard											
41432	NB	Del Monte Boulevard between Reindollar Avenue and SR 1	805	1,071	-266	-0.248	0.54	YES	-266	70,770	
10104	SB	Del Monte Boulevard between Reindollar Avenue and SR 1	647	1,033	-386	-0.374	0.55	YES	-386	149,081	
45007	EB	Imjin Parkway between Second Avenue and Highway 1	1,504	1,326	178	0.134	0.51	YES	178	31,605	
45007	WB	Imjin Parkway between Second Avenue and Highway 1	1,187	1,398	-211	-0.151	0.5	YES	-211	44,713	
10078	WB	Light Fighter Drive between Highway 1 and First Avenue	279	572	-293	-0.511	0.6	YES	-293	85,580	
10078	EB	Light Fighter Drive between Highway 1 and First Avenue	111	733	-622	-0.849	0.58	NO	-622	387,008	
13637	NB	Fremont Boulevard	816	1,317	-501	-0.380	0.52	YES	-501	250,889	
13637	SB	Fremont Boulevard	676	717	-41	-0.057	0.58	YES	-41	1,683	
Screenline 3: US-1 between Del Monte Boulevard and Fremont Boulevard			6,025	8,167	-2,142	-0.262	0.25	NO	-2,142	4,589,730	37%

Table E3: Results of Screenline Daily - Two-Way Volume, Run 01											
Count ID	Direction	Location	Model Volume	Traffic Count	Delta AM	Delta/Count AM	Maximum Deviation	Within Deviation	Model-Count	Difference Squared	Percent RSME
Screenline 1: East of Reservation Road between Blanco Road and SR-68											
40543	NB	Blanco Road between Cooper Road and Reservation Road	11,537	13,770	-2,233	-0.162	0.53	YES	335	112,276	
40543	SB	Blanco Road between Cooper Road and Reservation Road	11,141	13,769	-2,628	-0.191	0.53	YES	253	63,783	
13421	NB	Davis Road just north of Reservation Road	5,077	N/A	N/A	0.000	N/A	N/A	3	12	
13421	SB	Davis Road just north of Reservation Road	5,261	N/A	N/A	0.000	N/A	N/A	-97	9,486	
4810	EB	Reservation Road just west of SR-68	2,690	N/A	N/A	0.000	N/A	N/A	-347	120,436	
4810	WB	Reservation Road just west of SR-68	2,856	N/A	N/A	0.000	N/A	N/A	-204	41,782	
Screenline 1: East of Reservation Road between Blanco Road and SR-68			38,561	27,539	-4,861	-0.177	0.17	NO	11,022	121,494,873	57%
Screenline 2: 6th Ave between Inter-Garrison Road and Imjin Parkway											
12644	SB	Imjin Road between Imjin Parkway and Eight Street	171	50	121	2.422	0.64	NO	121	14,669	
12644	NB	Imjin Road between Imjin Parkway and Eight Street	43	310	-267	-0.861	0.63	NO	-267	71,276	
4020	WB	Inter-Garrison between Eight Avenue and Abrams Drive	338	139	199	1.435	0.64	NO	199	39,764	
4020	EB	Inter-Garrison between Eight Avenue and Abrams Drive	85	990	-905	-0.915	0.55	NO	-905	819,736	
3700	WB	Imjin Parkway between Abrams Drive and Imjin Road	1,035	797	238	0.299	0.57	YES	238	56,787	
3700	EB	Imjin Parkway between Abrams Drive and Imjin Road	588	1,127	-539	-0.478	0.54	YES	-539	290,273	
Screenline 2: 6th Ave between Inter-Garrison Road and Imjin Parkway			2,261	3,413	-1,152	-0.338	0.37	YES	-1,152	1,327,826	34%
Screenline 3: US-1 between Del Monte Boulevard and Fremont Boulevard											
41432	NB	Del Monte Boulevard between Reindollar Avenue and SR 1	8,137	13,945	-5,808	-0.416	0.54	YES	-5,808	70,770	
10104	SB	Del Monte Boulevard between Reindollar Avenue and SR 1	8,871	12,841	-3,970	-0.309	0.55	YES	-3,970	149,081	
45007	EB	Imjin Parkway between Second Avenue and Highway 1	13,230	14,435	-1,205	-0.083	0.51	YES	-1,205	31,605	
45007	WB	Imjin Parkway between Second Avenue and Highway 1	11,885	13,788	-1,903	-0.138	0.5	YES	-1,903	44,713	
10078	WB	Light Fighter Drive between Highway 1 and First Avenue	2,986	6,315	-3,329	-0.527	0.6	YES	-3,329	85,580	
10078	EB	Light Fighter Drive between Highway 1 and First Avenue	1,344	8,687	-7,343	-0.845	0.58	NO	-7,343	387,008	
13637	NB	Fremont Boulevard	7,970	N/A	N/A	N/A	0.52	N/A	N/A	250,889	
13637	SB	Fremont Boulevard	7,531	N/A	N/A	N/A	0.58	N/A	N/A	1,683	
Screenline 3: US-1 between Del Monte Boulevard and Fremont Boulevard			61,954	70,011	-23,558	-0.336	0.17	NO	-8,057	64,917,957	16%

**ATTACHMENT J: FINAL MODEL VALIDATION RESULTS: BY LINK USING
TWO-WAY VOLUME, RUN 01**

Table F1: Results of AM Peak-Hour Model Area Validation by Two-Way Volume, Run 01

ID	Direction	Description		Model Volume	Traffic Count	Model Delta	Model Delta/Count	Maximum Deviation	Withing Deviation	Model-Count	Difference Squared
		Roadway	Location								
1	SB/NB	Highway 1	between Del Monte Boulevard and Reservation Road	5,032	3,875	1,157	0.299	0.21	NO	1,157	1,338,354
2	SB/NB	Highway 1	between Imjin Parkway and Del Monte Boulevard	6,407	5,777	630	0.109	0.17	YES	630	396,696
3	SB/NB	Highway 1	between Light Fighter Drive and Imjin Parkway	7,596	6,955	641	0.092	0.15	YES	641	411,052
4	SB/NB	Highway 1	between Del Monte Boulevard and Light Fighter Drive	7,861	7,484	377	0.050	0.14	YES	377	141,866
5	SB/NB	Highway 1	between Canyon Del Rey Boulevard and Del Monte Boulevard	6,963	6,296	667	0.106	0.16	YES	667	445,228
6	SB/NB	Highway 1	between Del Monte Boulevard and Canyon Del Rey Boulevard	7,529	6,388	1,141	0.179	0.16	NO	1,141	1,301,752
7	SB/NB	Highway 1	between Casa Verde Way and Del Monte Boulevard	6,728	5,620	1,108	0.197	0.18	NO	1,108	1,228,432
8	SB/NB	Highway 1	between SR 68 and Casa Verde Way	6,914	5,600	1,314	0.235	0.18	NO	1,314	1,727,244
9	SB/NB	Highway 1	between SR 68 and Fremont Street	8,027	8,584	-557	-0.065	0.14	YES	-557	310,316
10	NB/SB	Del Monte Boulevard	between Beach Road and Reservation Road	749	609	140	0.230	0.44	YES	140	19,563
11	NB/SB	Del Monte Boulevard	between Reindollar Avenue and SR 1	1,375	1,854	-479	-0.258	0.28	YES	-479	229,474
12	NB/SB	Second Avenue	between Imjin Parkway and Tenth Street	976	217	759	3.500	0.63	NO	759	576,724
13	NB/SB	Second Avenue	between Eight Street and Fifth Street	231	817	-586	-0.718	0.38	NO	-586	343,944
14	SB/NB	Second Avenue	between Divarty Street and Light Fighter Drive	51	147	-96	-0.651	0.63	NO	-96	9,171
15	SB/NB	General Jim Moore	between Divarty Street and Light Fighter Drive	629	441	188	0.427	0.48	YES	188	35,397
16	NB/SB	General Jim Moore Boulevard	between Light Fighter Drive and Gigling Road	611	730	-119	-0.163	0.41	YES	-119	14,244
17	SB/NB	General Jim Moore Boulevard	between Normandy Road and Coe Avenue	487	700	-213	-0.304	0.41	YES	-213	45,166
18	SB/NB	General Jim Moore Boulevard	between Coe Avenue and San Pablo Avenue	496	432	64	0.148	0.52	YES	64	4,103
19	NB/SB	California Avenue	between Reservation Road and Windsor Court	207	430	-223	-0.519	0.52	YES	-223	49,840
20	NB/SB	California Avenue	between Reindollar Avenue and Imjin Parkway	263	398	-135	-0.338	0.52	YES	-135	18,124
21	SB/NB	California Avenue	between Imjin Parkway and Fifth Avenue	53	158	-105	-0.666	0.63	NO	-105	11,065
22	SB/NB	Imjin Road	between Imjin Parkway and Eight Street	214	360	-146	-0.405	0.52	YES	-146	21,275
23	NB/SB	Abram Drive	between Imjin Parkway and Bunker Hill Drive	493	389	104	0.267	0.52	YES	104	10,752
24	NB/SB	Abram Drive	between Manassas Drive and Inter-Garrison Road	287	466	-179	-0.383	0.48	YES	-179	31,868
25	NB/SB	Blanco Road	between Cooper Road and Reservation Road	2,676	1,995	681	0.341	0.27	NO	681	463,909
26	EB/WB	Reservation Road	between Highway 1 and Cardoza Avenue	1,119	418	701	1.677	0.52	NO	701	491,434
27	WB/EB	Reservation Road	between Robinin Drive and Del Monte Boulevard	175	557	-382	-0.685	0.44	NO	-382	145,638
28	WB/EB	Reservation Road	between Del Monte Boulevard and Vista Del Camino	1,267	1,606	-339	-0.211	0.29	YES	-339	114,596
29	EB/WB	Reservation Road	between Salinas Avenue and Imjin Parkway	1,166	1,526	-360	-0.236	0.29	YES	-360	129,341
30	EB/WB	Reservation Road	between Imjin Parkway and Blanco Road	2,881	1,224	1,657	1.354	0.31	NO	1,657	2,745,640
31	EB/WB	Reservation Road	between Blanco Road and Inter-Garrison Road	281	752	-471	-0.626	0.41	NO	-471	221,689
32	EB/WB	Reservation Road	between Inter-Garrison Road and East Garrison Road	470	1,160	-690	-0.594	0.33	NO	-690	475,559
33	WB/NB	Reindollar Avenue	between Del Monte Boulevard and Sunset Avenue	251	371	-120	-0.322	0.52	YES	-120	14,311
34	EB/WB	Imjin Parkway	between Second Avenue and Highway 1	2,454	2,500	-46	-0.018	0.25	YES	-46	2,095
35	EB/WB	Imjin Parkway	between Fourth Avenue and Third Avenue	1,861	1,570	291	0.185	0.29	YES	291	84,413
36	WB/EB	Imjin Parkway	between Abrams Drive and Imjin Road	1,624	1,924	-300	-0.156	0.27	YES	-300	90,282
37	SB/NB	Imjin Parkway	between Reservation Road and Preston Drive	1,849	934	915	0.979	0.36	NO	915	836,580
38	WB/EB	Inter-Garrison Road	between Second Avenue and Third Avenue	0	147	-147	-0.999	0.63	NO	-147	21,546
39	WB/EB	Inter-Garrison Road	between Sixth Avenue and Seventh Avenue	174	277	-103	-0.371	0.58	YES	-103	10,579
40	WB/EB	Inter-Garrison Road	between Eighth Avenue and Abrams Drive	423	1,129	-706	-0.625	0.33	NO	-706	498,413
41	WB/EB	Lightfighter Drive	between Highway 1 and First Avenue	354	969	-615	-0.634	0.36	NO	-615	378,016
42	EB/WB	Lightfighter Drive	between Second Avenue and General Jim Moore Boulevard	851	1,503	-652	-0.434	0.29	NO	-652	425,683
43	EB/WB	Lightfighter Drive	between General Jim Moore Blvd and Colonel Durham Street	87	463	-376	-0.813	0.48	NO	-376	141,693
44	WB/EB	Gigling Road	between General Jim Moore Boulevard and Malmedy Road	38	895	-857	-0.958	0.36	NO	-857	735,189
45	NB/SB	Monterey Road	between Buna Road and Noumea Road	14	217	-203	-0.937	0.63	NO	-203	41,385
46	WB/EB	Coe Avenue	between Buttercup Boulevard and Coe Avenue	131	506	-375	-0.740	0.48	NO	-375	140,284
47	EB/WB	San Pablo	between Nadina Street and General Jim Moore Boulevard	128	728	-600	-0.824	0.41	NO	-600	359,435
48	EB/WB	Broadway Avenue	between Mescal Street and General Jim Moore Boulevard	331	582	-251	-0.431	0.44	YES	-251	62,783
49	SB/NB	Eight Avenue	between Inter-Garrison Road and A Street	8	828	-820	-0.990	0.38	NO	-820	671,803

Local Roadway/Freeway/Ramp Results:

90,795 89,508

Model/Count Ratio = **1.02**
 Percent Within Caltrans Maximum Deviation = **48% <75%**
 Percent Root Mean Square Error = **0.34 <40%**
 Correlation Coefficient = **0.98 >0.88**

Total Count= **49**
 Link within Deviation= **24**
 Link Outside Deviation= **25**

Local Roadway Results:

26,362 31,075

Model/Count Ratio = **0.85**
 Percent Within Caltrans Maximum Deviation = **43% <75%**
 Percent Root Mean Square Error = **34% <40%**
 Correlation Coefficient = **0.98 >0.88**

Total Count= **39**
 Link within Deviation= **17**
 Link Outside Deviation= **22**

Table F2: Results of PM Peak Hour Two-Way Total Traffic Volumes, Run 01

ID	Direction	Description		Model Volume	Traffic Count	Model Delta	Model Delta/Count	Maximum Deviation	Withing Deviation	Model-Count	Difference Squared
		Roadway	Location								
1	SB/NB	Highway 1	between Del Monte Boulevard and Reservation Road	5,032	3,875	1,157	0.299	0.21	NO	1,157	955,546
2	SB/NB	Highway 1	between Imjin Parkway and Del Monte Boulevard	6,517	6,318	199	0.032	0.16	YES	199	39,754
3	SB/NB	Highway 1	between Light Fighter Drive and Imjin Parkway	7,800	7,763	37	0.005	0.14	YES	37	1,364
4	SB/NB	Highway 1	between Del Monte Boulevard and Light Fighter Drive	8,036	7,903	133	0.017	0.14	YES	133	17,613
5	SB/NB	Highway 1	between Canyon Del Rey Boulevard and Del Monte Boulevard	7,170	5,729	1,441	0.252	0.17	NO	1,441	2,077,581
6	SB/NB	Highway 1	between Del Monte Boulevard and Canyon Del Rey Boulevard	7,785	5,945	1,840	0.310	0.17	NO	1,840	3,386,106
7	SB/NB	Highway 1	between Casa Verde Way and Del Monte Boulevard	6,862	5,027	1,835	0.365	0.19	NO	1,835	3,367,686
8	SB/NB	Highway 1	between SR 68 and Casa Verde Way	6,914	4,774	2,140	0.448	0.20	NO	2,140	4,580,283
9	SB/NB	Highway 1	between SR 68 and Fremont Street	7,949	7,792	157	0.020	0.14	YES	157	24,774
10	NB/SB	Del Monte Boulevard	between Beach Road and Reservation Road	714	634	80	-0.126	0.44	YES	80	6,360
11	NB/SB	Del Monte Boulevard	between Reindollar Avenue and SR 1	1,452	2,104	-652	-0.310	0.26	NO	-652	425,281
12	SB/NB	Second Avenue	between Imjin Parkway and Tenth Street	1,113	290	823	2.840	0.58	NO	823	678,125
13	NB/SB	Second Avenue	between Eight Street and Fifth Street	215	554	-339	-0.611	0.44	NO	-339	114,597
14	SB/NB	Second Avenue	between Divarty Street and Light Fighter Drive	71	142	-71	-0.499	0.63	YES	-71	5,022
15	SB/NB	General Jim Moore	between Divarty Street and Light Fighter Drive	707	384	323	0.842	0.52	NO	323	104,515
16	NB/SB	General Jim Moore Boulevard	between Light Fighter Drive and Gigling Road	653	896	-243	-0.272	0.36	YES	-243	59,212
17	SB/NB	General Jim Moore Boulevard	between Normandy Road and Coe Avenue	518	722	-204	-0.282	0.41	YES	-204	41,475
18	SB/NB	General Jim Moore Boulevard	between Coe Avenue and San Pablo Avenue	546	554	-8	-0.014	0.44	YES	-8	59
19	NB/SB	California Avenue	between Reservation Road and Windsor Court	215	505	-290	-0.574	0.48	NO	-290	84,086
20	NB/SB	California Avenue	between Reindollar Avenue and Imjin Parkway	322	562	-240	-0.427	0.44	YES	-240	57,645
21	SB/NB	California Avenue	between Imjin Parkway and Fifth Avenue	54	77	-23	-0.297	0.68	YES	-23	523
22	SB/NB	Imjin Road	between Imjin Parkway and Eight Street	229	350	-121	-0.347	0.52	YES	-121	14,739
23	NB/SB	Abram Drive	between Imjin Parkway and Bunker Hill Drive	380	496	-116	-0.234	0.48	YES	-116	13,528
24	NB/SB	Abram Drive	between Manassas Drive and Inter-Garrison Road	367	446	-79	-0.176	0.48	YES	-79	6,170
25	NB/SB	Blanco Road	between Cooper Road and Reservation Road	2,532	1,944	588	0.302	0.27	NO	588	345,307
26	EB/WB	Reservation Road	between Highway 1 and Cardoza Avenue	1,199	1,104	95	0.086	0.33	YES	95	9,022
27	WB/EB	Reservation Road	between Robinin Drive and Del Monte Boulevard	192	734	-542	-0.738	0.41	NO	-542	293,538
28	WB/EB	Reservation Road	between Del Monte Boulevard and Vista Del Camino	1,331	1,873	-542	-0.289	0.27	NO	-542	293,432
29	EB/WB	Reservation Road	between Salinas Avenue and Imjin Parkway	1,205	1,670	-465	-0.278	0.28	YES	-465	216,178
30	EB/WB	Reservation Road	between Imjin Parkway and Blanco Road	2,754	2,001	753	0.376	0.27	NO	753	566,829
31	EB/WB	Reservation Road	between Blanco Road and Inter-Garrison Road	235	789	-554	-0.702	0.38	NO	-554	307,026
32	EB/WB	Reservation Road	between Inter-Garrison Road and East Garrison Road	746	1,166	-420	-0.360	0.33	NO	-420	175,997
33	WB/NB	Reindollar Avenue	between Del Monte Boulevard and Sunset Avenue	279	581	-302	-0.520	0.44	NO	-302	91,170
34	EB/WB	Imjin Parkway	between Second Avenue and Highway 1	2,690	2,724	-34	-0.012	0.24	YES	-34	1,134
35	EB/WB	Imjin Parkway	between Fourth Avenue and Third Avenue	2,061	2,001	60	0.030	0.27	YES	60	3,637
36	WB/EB	Imjin Parkway	between Abrams Drive and Imjin Road	1,754	1,820	-66	-0.036	0.28	YES	-66	4,390
37	SB/NB	Imjin Parkway	between Reservation Road and Preston Drive	1,693	2,098	-405	-0.193	0.26	YES	-405	164,227
38	WB/EB	Inter-Garrison Road	between Second Avenue and Third Avenue	1	169	-168	-0.997	0.63	NO	-168	28,382
39	WB/EB	Inter-Garrison Road	between Sixth Avenue and Seventh Avenue	343	230	113	0.492	0.58	YES	113	12,825
40	WB/EB	Inter-Garrison Road	between Eight Avenue and Abrams Drive	579	1,026	-447	-0.436	0.34	NO	-447	199,674
41	WB/EB	Lightfighter Drive	between Highway 1 and First Avenue	390	1,305	-915	-0.701	0.31	NO	-915	836,567
42	EB/WB	Lightfighter Drive	between Second Avenue and General Jim Moore Boulevard	936	1,326	-390	-0.294	0.30	YES	-390	152,100
43	EB/WB	Lightfighter Drive	between General Jim Moore Blvd and Colonel Durham Street	82	390	-308	-0.789	0.52	NO	-308	94,744
44	WB/EB	Gigling Road	between General Jim Moore Boulevard and Malmedy Road	38	786	-748	-0.951	0.38	NO	-748	559,201
45	NB/SB	Monterey Road	between Buna Road and Noumea Road	16	307	-291	-0.947	0.58	NO	-291	84,514
46	WB/EB	Coe Avenue	between Buttercup Boulevard and Coe Avenue	140	279	-139	-0.498	0.58	YES	-139	19,306
47	EB/WB	San Pablo	between Nadina Street and General Jim Moore Boulevard	149	391	-242	-0.620	0.52	NO	-242	58,797
48	EB/WB	Broadway Avenue	between Mescal Street and General Jim Moore Boulevard	358	612	-254	-0.416	0.44	YES	-254	64,747
49	SB/NB	Eight Avenue	between Inter-Garrison Road and A Street	9	635	-626	-0.986	0.44	NO	-626	392,117

Local Roadway/Freeway/Ramp Results: 93,336 91,803
 Model/Count Ratio= 1.02
 Percent within Caltrans Maximum Deviation= 48% <75%
 Percent Root Mean Square Error (RSME)= 35% <40%
 Correlation Coefficient = 98% >0.88

Total Count= 49
 Link within Deviation= 24
 Link Outside Deviation= 25

Local Roadway Results: 27,818 34,573
 Model/Count Ratio = 0.80
 Percent Within Caltrans Maximum Deviation = 45% <75%
 Percent Root Mean Square Error = 35% <40%
 Correlation Coefficient = 0.25 <0.88

Total Count= 39
 Link within Deviation= 16
 Link Outside Deviation= 23

Table F3: Results of Daily Two-Way Total Traffic Volumes, Run 01

ID	Direction	Description		Model Volume	Traffic Count	Model Delta	Model Delta/Count	Maximum Deviation	Withing Deviation	Model-Count	Difference Squared
		Roadway	Location								
1	SB/NB	Highway 1	between Del Monte Boulevard and Reservation Road	5,032	3,875	1,157	0.299	0.20	NO	1,157	4,639,956
2	SB/NB	Highway 1	between Imjin Parkway and Del Monte Boulevard	70,728	76,532	-5,804	-0.076	0.15	YES	-5,804	33,680,668
3	SB/NB	Highway 1	between Light Fighter Drive and Imjin Parkway	84,273	93,403	-9,130	-0.098	0.14	YES	-9,130	83,357,546
4	SB/NB	Highway 1	between Del Monte Boulevard and Light Fighter Drive	86,270	96,962	-10,692	-0.110	0.14	YES	-10,692	114,321,860
5	SB/NB	Highway 1	between Canyon Del Rey Boulevard and Del Monte Boulevard	75,470	69,564	5,906	0.085	0.17	YES	5,906	34,876,378
6	SB/NB	Highway 1	between Del Monte Boulevard and Canyon Del Rey Boulevard	77,964	77,104	860	0.011	0.15	YES	860	739,346
7	SB/NB	Highway 1	between Casa Verde Way and Del Monte Boulevard	69,295	68,590	705	0.010	0.17	YES	705	497,188
8	SB/NB	Highway 1	between SR 68 and Casa Verde Way	73,901	66,292	7,609	0.115	0.17	YES	7,609	57,898,475
9	SB/NB	Highway 1	between SR 68 and Fremont Street	81,515	100,509	-18,994	-0.189	0.14	NO	-18,994	360,759,040
10	NB/SB	Del Monte Boulevard	between Beach Road and Reservation Road	8,054	7,580	474	0.063	0.41	YES	474	224,762
11	NB/SB	Del Monte Boulevard	between Reindollar Avenue and SR 1	17,008	26,786	-9,778	-0.365	0.25	NO	-9,778	95,600,690
12	SB/NB	Second Avenue	between Imjin Parkway and Tenth Street	10,768	3,274	7,494	2.289	0.58	NO	7,494	56,158,747
13	NB/SB	Second Avenue	between Eight Street and Fifth Street	1,822	6,331	-4,509	-0.712	0.44	NO	-4,509	20,330,549
14	SB/NB	Second Avenue	between Divarty Street and Light Fighter Drive	1,294	2,502	-1,208	-0.483	0.58	YES	-1,208	1,459,429
15	SB/NB	General Jim Moore	between Divarty Street and Light Fighter Drive	6,722	5,232	1,490	0.285	0.48	YES	1,490	2,220,977
16	NB/SB	General Jim Moore Boulevard	between Light Fighter Drive and Gigling Road	7,554	9,611	-2,057	-0.214	0.38	YES	-2,057	4,229,235
17	SB/NB	General Jim Moore Boulevard	between Normandy Road and Coe Avenue	6,486	6,683	-197	-0.029	0.44	YES	-197	38,736
18	SB/NB	General Jim Moore Boulevard	between Coe Avenue and San Pablo Avenue	7,653	7,004	649	0.093	0.44	YES	649	420,864
19	NB/SB	California Avenue	between Reservation Road and Windsor Court	2,289	4,672	-2,383	-0.510	0.52	YES	-2,383	5,677,280
20	NB/SB	California Avenue	between Reindollar Avenue and Imjin Parkway	2,682	5,915	-3,233	-0.547	0.48	NO	-3,233	10,455,452
21	SB/NB	California Avenue	between Imjin Parkway and Fifth Avenue	535	992	-457	-0.461	0.68	YES	-457	208,735
22	SB/NB	Imjin Road	between Imjin Parkway and Eight Street	300	4,122	-3,822	-0.927	0.52	NO	-3,822	14,611,359
23	NB/SB	Abram Drive	between Imjin Parkway and Bunker Hill Drive	1,873	5,616	-3,743	-0.666	0.48	NO	-3,743	14,008,267
24	NB/SB	Abram Drive	between Manassas Drive and Inter-Garrison Road	1,995	4,486	-2,491	-0.555	0.52	NO	-2,491	6,204,223
25	NB/SB	Blanco Road	between Cooper Road and Reservation Road	22,678	27,539	-4,861	-0.177	0.25	YES	-4,861	23,299,870
26	EB/WB	Reservation Road	between Highway 1 and Cardoza Avenue	12,612	12,776	-164	-0.013	0.33	YES	-164	26,924
27	WB/EB	Reservation Road	between Robinin Drive and Del Monte Boulevard	2,247	8,470	-6,223	-0.735	0.41	NO	-6,223	38,731,652
28	WB/EB	Reservation Road	between Del Monte Boulevard and Vista Del Camino	15,574	17,396	-1,822	-0.105	0.29	YES	-1,822	3,321,463
29	EB/WB	Reservation Road	between Salinas Avenue and Imjin Parkway	13,629	16,489	-2,860	-0.173	0.29	YES	-2,860	8,178,238
30	EB/WB	Reservation Road	between Imjin Parkway and Blanco Road	28,507	26,567	1,940	0.073	0.25	YES	1,940	3,764,027
31	EB/WB	Reservation Road	between Blanco Road and Inter-Garrison Road	6,589	6,224	365	0.059	0.48	YES	365	133,545
32	EB/WB	Reservation Road	between Inter-Garrison Road and East Garrison Road	11,862	9,844	2,018	0.205	0.38	YES	2,018	4,074,212
33	WB/NB	Reindollar Avenue	between Del Monte Boulevard and Sunset Avenue	2,906	6,441	-3,535	-0.549	0.44	NO	-3,535	12,498,625
34	EB/WB	Imjin Parkway	between Second Avenue and Highway 1	25,115	28,223	-3,108	-0.110	0.25	YES	-3,108	9,659,074
35	EB/WB	Imjin Parkway	between Fourth Avenue and Third Avenue	19,390	22,817	-3,427	-0.150	0.27	YES	-3,427	11,744,532
36	WB/EB	Imjin Parkway	between Abrams Drive and Imjin Road	16,832	23,570	-6,738	-0.286	0.27	NO	-6,738	45,400,059
37	SB/NB	Imjin Parkway	between Reservation Road and Preston Drive	16,307	20,860	-4,553	-0.218	0.28	YES	-4,553	20,731,768
38	WB/EB	Inter-Garrison Road	between Second Avenue and Third Avenue	6	2,630	-2,624	-0.998	0.58	NO	-2,624	6,885,675
39	WB/EB	Inter-Garrison Road	between Sixth Avenue and Seventh Avenue	3,844	665	3,179	4.781	0.68	NO	3,179	10,107,214
40	WB/EB	Inter-Garrison Road	between Eighth Avenue and Abrams Drive	5,508	8,450	-2,942	-0.348	0.41	YES	-2,942	8,654,687
41	WB/EB	Lightfighter Drive	between Highway 1 and First Avenue	4,329	15,002	-10,673	-0.711	0.30	NO	-10,673	113,905,231
42	EB/WB	Lightfighter Drive	between Second Avenue and General Jim Moore Boulevard	9,936	13,257	-3,321	-0.251	0.33	YES	-3,321	11,029,613
43	EB/WB	Lightfighter Drive	between General Jim Moore Blvd and Colonel Durham Street	780	3,746	-2,966	-0.792	0.58	NO	-2,966	8,799,186
44	WB/EB	Gigling Road	between General Jim Moore Boulevard and Malmedy Road	638	6,281	-5,643	-0.898	0.44	NO	-5,643	31,846,968
45	NB/SB	Monterey Road	between Buna Road and Noumea Road	258	3,280	-3,022	-0.921	0.58	NO	-3,022	9,130,486
46	WB/EB	Coe Avenue	between Buttercup Boulevard and Coe Avenue	1,000	2,950	-1,950	-0.661	0.58	NO	-1,950	3,802,154
47	EB/WB	San Pablo	between Nadina Street and General Jim Moore Boulevard	1,780	3,963	-2,183	-0.551	0.52	NO	-2,183	4,765,298
48	EB/WB	Broadway Avenue	between Mescal Street and General Jim Moore Boulevard	4,526	7,304	-2,778	-0.380	0.44	YES	-2,778	7,716,210
49	SB/NB	Eight Avenue	between Inter-Garrison Road and A Street	371	4,578	-4,207	-0.919	0.52	NO	-4,207	17,700,546
Local Roadway/Freeway/Ramp Results:				928,708	1,052,959				Model/Count Ratio= 0.88		
							Percent within Caltrans Maximum Deviation= 48% <75%				
							Percent Root Mean Square Error (RSME)= 24% <40%				
							Correlation Coefficient = 99% >0.88				
							Total Count= 49				
							Link within Deviation= 28				
							Link Outside Deviation= 21				
Local Roadway Results:				287,252	373,342				Model/Count Ratio = 0.77		
							Percent Within Caltrans Maximum Deviation = 43% <75%				
							Percent Root Mean Square Error = 25% <40%				
							Correlation Coefficient = 0.99 >0.88				
							Total Count= 39				
							Link within Deviation= 19				
							Link Outside Deviation= 20				

**ATTACHMENT K: CUMULATIVE WITHOUT PROJECT CONDITIONS
ROADWAY IMPROVEMENTS**

TABLE K: CUMULATIVE WITHOUT PROJECT CONDITIONS ROADWAY IMPROVEMENTS

Project Number ¹	Name	Description	Sources ²			Included in Cumulative without Project Conditions?	Included in Cumulative without Project Conditions and Eastside Parkway?	Notes
			City ³	FORA ⁴	RTP ⁵			
City of Marina Capital Improvement Program								
R 05	Second Avenue Extension	Extend Second Avenue as a 2-lane arterial between Imjin Parkway and Reindollar Avenue	X	X		Yes	Yes	
R 34	Eighth Street	Upgrade/construct Eighth Street as a 2-lane arterial from Second Avenue to Inter-Garrison Road	X	X		Yes	Yes	
R 37	Patton Parkway Extension	Extension of Patton Parkway from Del Monte Boulevard to Crescent Street	X	X		Yes	Yes	
R49	Del Monte/Imjin Parkway & SR 1 Interchange	Construct new/consolidate interchange. On Caltrans Regional Transportation Improvement Program	X			No	No	Project is planned, funding projected between 2020 to 2035. Marina Capital Improvement Plan (CIP) describes project as being on the Caltrans Regional Transportation Improvement Program, though this improvement is not found in Caltrans State Transportation Improvement Program (2016) and Interregional Transportation Strategic Plan (2016).
R59	Imjin Road Widening	Reconstruct and widen Imjin Road to four lanes from Imjin Parkway to Eighth Street	X			No	No	Project is planned, funding projected between 2020 and 2035.
R 61	Second Avenue Widening	Widen Second Avenue from Tenth street to Inter-Garrison Road. Remove Class II bike lanes and restripe for two lanes each direction	X			Yes	Yes	Project is planned, funding projected between 2020 and 2035.
T 22 / T 23	Imjin Parkway/SR 1 Improvements	Accommodate a second westbound left turn lane onto SR 1 southbound. Convert SR 1 southbound off-ramp to a loop ramp (or the functional equivalent). Widen SR 1 southbound on-ramp from 1 lane to 2 lanes	X			No	No	
Fort Ord Reuse Authority (FORA)								
FO 6	Inter-Garrison Road Widening	Widen Inter-Garrison Road to a 4-lane arterial from Eastside Parkway to Reservation Road		X		Yes	Yes	Partially completed between Sherman Blvd to Reservation Road
FO 7	Gigling Road	Widen Gigling Road to a 4-lane arterial from General Jim Moore Boulevard to Future Eastside Parkway near Eighth Avenue		X		Yes	Yes	
FO 12	Eucalyptus Road	Upgrade Eucalyptus Road to 2-lane collector from General Jim Moore Blvd to Eastside Parkway to Parker Flatts Cut-Off Road		X		No	Yes	Partially completed from General Jim Moore Boulevard to approx. 700 feet east of Parker Flatts Cut-Off Road.

TABLE K: CUMULATIVE WITHOUT PROJECT CONDITIONS ROADWAY IMPROVEMENTS

Project Number ¹	Name	Description	Sources ²			Included in Cumulative without Project Conditions?	Included in Cumulative without Project Conditions and Eastside Parkway?	Notes
			City ³	FORA ⁴	RTP ⁵			
FO 13B	Eastside Parkway	Construct new 2-lane arterial from Eucalyptus Road at Parker Flatts Cut-Off Road to Schoonover Drive		X		No	Yes	
AMBAG Regional Transportation Plan (RTP)								
MON-MAR001-MA	Reservation Road Widening	Widen Reservation Road to 4 lanes between East Garrison Gate and Davis Road		X	X	Yes	Yes	
MON-MAR001-MA	Imjin Parkway Widening	Widen Imjin Parkway to four lanes from Imjin Road to Reservation Road	X		X	Yes	Yes	
MON-MAR115-MA	Imjin Parkway Widening	Widen Imjin Parkway from 4 lanes to 6 lanes and construct turning lanes at intersections between Second Avenue and Imjin Road.	X		X	No	No	Described as obligatory in Marina 5 year Capital Improvement Plan (CIP), and as an unconstrained transportation project in the 2035 Metropolitan Transportation Plan / Sustainable Communities Strategy (2014).
MON-CT045-MA	SR 1/Monterey Road Interchange Improvements	New interchange at Monterey Road between Lightfighter Road interchange and the Fremont Boulevard Interchange		X	X	No	No	All on- and off-ramps shown as diagonal ramps in Fort Ord Reuse Authority Fee Reallocation Study: Deficiency Analysis and Fee Reallocation (2017).

Notes:

1. Project ID Number based on leading agency from source document.
2. Projects appearing in multiple source lists are described and denoted by source.
3. Listed in City of Marina's 5 Year Capital Improvement Project List, Revised March 2016.
4. Listed in Fort Ord Reuse Authority's Capital Improvement Program Fiscal Year 2017/18 through 2027/28, and Fort Ord Reuse Authority Fee Reallocation Study: Deficiency Analysis and Fee Reallocation (2017).
5. Listed in the 2035 Metropolitan Transportation Plan / Sustainable Communities Strategy (2014).

Source: Fehr & Peers, 2019.

**ATTACHMENT L: CUMULATIVE WITHOUT PROJECT CONDITIONS
INTERSECTION IMPROVEMENTS**

TABLE L. CUMULATIVE WITHOUT PROJECT CONDITIONS INTERSECTION IMPROVEMENTS

Project Number ¹	Project Name	Project Description	Sources ²			Estimated Construction Date	Intersection	Geometry Changes	Intersection Control Changes	Included in Cumulative without Project Conditions?	Included in Cumulative without Project Conditions and Eastside Parkway?	Notes
			City ³	FORA ⁴	RTP ⁵							
City of Marina Capital Improvement Program												
R 05	Second Avenue Extension	Extend Second Avenue as a 2 lane arterial between Imjin Parkway and Reindollar Avenue	X	X		2035	2 Patton Parkway and Second Avenue Extension (Future Intersection)	3-way signalized intersection (NB, SB, and EB legs), one lane in each direction with left turn pockets with 120 feet of vehicle storage	Signalized ⁶	Yes	Yes	
R 34	Eighth Street	Upgrade/construct Eighth Street as a 2-lane arterial from Second Avenue to Inter-Garrison Road	X	X		2035	16 Eighth Street and Second Avenue	See Improvement R 61	Signalized	Yes	Yes	Signalization part of project TI 18 in the City of Marina Capital Improvement Program
							18 Eighth Street and Imjin Road	Southbound: change from a shared through-left and right turn to one lane entering the roundabout Eastbound: change from a shared through-left and right turn to one lane entering the roundabout Westbound: change from a shared through-left and right turn to one lane entering the roundabout	Roundabout	Yes	Yes	Roundabout part of project TI 08 in the City of Marina Capital Improvement Program
R 37	Patton Parkway Extension	Extension of Patton Parkway from Del Monte Boulevard to Crescent Street	X	X		2035	2 Patton Parkway and Second Avenue Extension (Future Intersection)	See Improvement R 05	See Improvement 1	Yes	Yes	
R 61	Second Avenue Widening	Widen Second Avenue from Tenth Street to Inter-Garrison Road. Remove Class II bike lanes and restripe for two lanes each direction	X			2035	15 Ninth Street and Second Avenue	Southbound: change from a shared through-left and 1 right turn to 1 left, 1 through, 1 shared through-right Northbound: change from 1 left turn and 1 through/right to 1 left, 1 through and 1 a shared through-right	Signalized	Yes	Yes	
							16 Eighth Street and Second Avenue	Southbound: Change to 2 through lanes and 1 left turn lane Northbound: Change to 2 through lanes and 1 right turn lane	Signalized	Yes	Yes	Signalization part of project TI 18 in the City of Marina Capital Improvement Program
							19 Inter-Garrison Road and Second Avenue	Southbound: from 1 left turn and 1 through to 1 left, 2 through lanes Northbound: from 1 through and 1 right turn lanes to 1 through and 1 shared through-right lanes	Signalized	Yes	Yes	

TABLE L. CUMULATIVE WITHOUT PROJECT CONDITIONS INTERSECTION IMPROVEMENTS

Project Number ¹	Project Name	Project Description	Sources ²			Estimated Construction Date	Intersection	Geometry Changes	Intersection Control Changes	Included in Cumulative without Project Conditions?	Included in Cumulative without Project Conditions and Eastside Parkway?	Notes
			City ³	FORA ⁴	RTP ⁵							
TI 06	Traffic Intersection	Intersection Improvement	X			2035	6	Imjin Parkway and Third Avenue	No geometry changes	Signalized	Yes	Yes
TI 09	Traffic Intersection	Intersection Improvement	X			2035	7	Imjin Parkway and Fourth Avenue	No geometry changes	Signalized	Yes	Yes
TI 27	Traffic Intersection	Intersection Improvement	X			2035	11	Imjin Parkway and Abrams Drive	Install double left turn and right turn lanes on Imjin Pkwy, left and right turn lanes on Abrams Drive, signalize, and restripe	Signalized	Yes	Yes
TI 44	Traffic Intersection	Intersection Improvement	X			2035	23	Inter-Garrison Road and Abrams Drive	Signalize, add southbound free right turn, 2nd southbound left-turn.	Signalized	Yes	Yes
TI 42	Traffic Intersection	Intersection Improvement	X			2035	21	Inter-Garrison Road and Eighth Street/Seventh Avenue	Signalize, add eastbound and westbound left-turn pockets, westbound free right	Signalized	Yes	Yes
TI 45	Traffic Intersection	Intersection Improvement	X			2035	30	Divarty Street and Second Avenue	No geometry changes	Signalized	Yes	Yes
Fort Ord Reuse Authority (FORA)												
FO 13B	Eastside Parkway	Construct new 2 lane arterial from Eucalyptus Road at Parker Flats Cut-Off Road to Schoonover Drive		X		2035	48	Coe Avenue and General Jim Moore Boulevard	Westbound: through lane, right turn lane, and left turn pocket Eastbound: left turn pocket, through lane, and right lane Southbound: add left turn pocket Northbound: add right turn pocket	AWSC ⁶	No	Yes
FO 12	Eucalyptus Road	Upgrade Eucalyptus Road to 2 lane collector from General Jim Moore Blvd to Eastside Rd to Parker Flats Cut-Off Road		X		2025	46	Gigling Road and Eastside Parkway	All approaches: 1 shared right-through-left lane	AWSC ⁶	No	Yes
							25	Inter-Garrison Road and Eastside Parkway (Future Intersection)	Northbound: right turn lane and left turn pocket Westbound: left turn pocket and 2 through lanes Eastbound: left turn pocket, 1 through right	AWSC ⁶	No	Yes
FO 6	Inter-Garrison Road Widening	Widen Inter-Garrison Road to a 4 lane arterial from Eastside Parkway to Reservation Road		X		2035	26	Inter-Garrison Road and Inter-Garrison Road Connection	Westbound: 1 through, 1 shared through-right Eastbound: 1 left turn lane and 1 through lane	AWSC	Yes	Yes
FO 7	Gigling Road	Widen Gigling Road to a 4-lane arterial from General Jim Moore Boulevard to Future Eastside Parkway near Eighth Avenue		X		2035	40-45	Gigling from General Jim Moore Boulevard to Eastside Parkway	Add a through lane both eastbound/westbound on Gigling	AWSC	Yes	Yes

TABLE L. CUMULATIVE WITHOUT PROJECT CONDITIONS INTERSECTION IMPROVEMENTS

Project Number ¹	Project Name	Project Description	Sources ²			Estimated Construction Date	Intersection	Geometry Changes	Intersection Control Changes	Included in Cumulative without Project Conditions?	Included in Cumulative without Project Conditions and Eastside Parkway?	Notes
			City ³	FORA ⁴	RTP ⁵							
AMBAG Regional Transportation Plan (RTP)												
MON-MAR001-MA	Reservation Road Widening	Widen Reservation Road to 4 lanes between East Garrison Gate and Davis Road	X	X	2035	28	Watkins Gate Road and Reservation Road	Northbound: from one shared through/right/left lane to 1 through, 1 through/right and 1 left turn lane Southbound: from one shared through/right/left lane to 1 through, 1 through/right and 1 left turn lane Eastbound: 1 left turn and 1 right turn lane	None	Yes	Yes	
						29	Reservation Road and Davis Road	Southbound: from 1 left turn lane and a through lane to 1 left turn lane, 1 through lane, and 1 shared through-right Northbound: from 1 left turn lane and a through lane to 1 left turn lane, 1 through lane, 1 shared through-right Eastbound and westbound remain the same	None	Yes	Yes	
MON-MAR001-MA	Imjin Parkway Widening	Widen Imjin Parkway to four lanes from Imjin Road to Reservation Road	X	X	2025	11	Imjin Parkway and Abrams Drive	Eastbound and westbound: Install 1 left turn lane, 1 through lane, and 1 shared through/right Northbound and Southbound: left and right turn lanes on Abrams Drive	None	Yes	Yes	Marina CIP - Funded
						12	Imjin Parkway and Reservation Road	Westbound: Change to 2 left turn lanes, 1 through lane, and 2 right turn lanes	None	Yes	Yes	

Notes:

1. Project ID Number based on leading agency from source document.
2. Projects appearing in multiple source lists are described and denoted by source.
3. Listed in City of Marina's 5 Year Capital Improvement Project List, Revised March 2016.
4. Listed in Fort Ord Reuse Authority's Capital Improvement Program Fiscal Year 2017/18 through 2027/28, and *Fort Ord Reuse Authority Fee Reallocation Study: Deficiency Analysis and Fee Reallocation* (2017).
5. Listed in the *2035 Metropolitan Transportation Plan / Sustainable Communities Strategy* (2014).
6. Improvement from source does not define control.

Source: Fehr & Peers, 2019.

ATTACHMENT M: MONTEREY COUNTY LIST OF TAZS

List of Monterey County TAZs	
ID	TAZ Number
1	375
2	383
3	415
4	439
5	448
6	457
7	469
8	471
9	479
10	486
11	489
12	502
13	507
14	512
15	527
16	538
17	539
18	547
19	551
20	553
21	554
22	556
23	562
24	563
25	564
26	566
27	569
28	572
29	573
30	574
31	575
32	576
33	577
34	579
35	580
36	581
37	582
38	585
39	586
40	587
41	588
42	591
43	595
44	597
45	601

List of Monterey County TAZs	
ID	TAZ Number
46	603
47	604
48	607
49	608
50	609
51	611
52	612
53	613
54	615
55	616
56	619
57	620
58	621
59	622
60	623
61	625
62	627
63	628
64	629
65	630
66	633
67	634
68	635
69	637
70	638
71	639
72	640
73	642
74	643
75	645
76	658
77	660
78	661
79	663
80	666
81	669
82	670
83	672
84	673
85	674
86	675
87	679
88	680
89	681
90	683

List of Monterey County TAZs	
ID	TAZ Number
91	684
92	687
93	690
94	693
95	695
96	697
97	698
98	702
99	704
100	709
101	714
102	726
103	742
104	746
105	766
106	770
107	771
108	778
109	779
110	795
111	796
112	799
113	804
114	809
115	818
116	829
117	850
118	851
119	861
120	863
121	864
122	868
123	875
124	876
125	878
126	880
127	887
128	889
129	908
130	909
131	913
132	917
133	922
134	923
135	925

List of Monterey County TAZs	
ID	TAZ Number
136	928
137	929
138	930
139	936
140	943
141	954
142	965
143	966
144	971
145	973
146	977
147	980
148	981
149	985
150	987
151	992
152	995
153	997
154	1002
155	1003
156	1006
157	1012
158	1015
159	1017
160	1018
161	1022
162	1028
163	1029
164	1035
165	1039
166	1042
167	1044
168	1045
169	1046
170	1047
171	1050
172	1051
173	1052
174	1054
175	1055
176	1056
177	1058
178	1059
179	1060
180	1062

List of Monterey County TAZs	
ID	TAZ Number
181	1063
182	1064
183	1065
184	1066
185	1068
186	1069
187	1070
188	1071
189	1072
190	1073
191	1074
192	1075
193	1076
194	1078
195	1081
196	1082
197	1083
198	1084
199	1086
200	1088
201	1096
202	1097
203	1098
204	1100
205	1104
206	1105
207	1106
208	1108
209	1109
210	1110
211	1111
212	1112
213	1114
214	1118
215	1122
216	1124
217	1126
218	1130
219	1132
220	1134
221	1136
222	1146
223	1147
224	1149
225	1150

List of Monterey County TAZs	
ID	TAZ Number
226	1155
227	1156
228	1159
229	1166
230	1169
231	1178
232	1181
233	1193
234	1233
235	1243
236	1248
237	1256
238	1258
239	1265
240	1266
241	1269
242	1271
243	1279
244	1286
245	1292
246	1293
247	1301
248	1304
249	1314
250	1316
251	1335
252	1339
253	1346
254	1350
255	1355
256	1359
257	1362
258	1364
259	1365
260	1366
261	1367
262	1368
263	1369
264	1372
265	1373
266	1375
267	1376
268	1379
269	1383
270	1393

List of Monterey County TAZs	
ID	TAZ Number
271	1395
272	1403
273	1406
274	1407
275	1408
276	1411
277	1413
278	1418
279	1423
280	1428
281	1429
282	1438
283	1475
284	1551
285	1604
286	1631
287	1635
288	1640
289	1643
290	1645
291	1649
292	1652
293	1663
294	1667
295	1675
296	1677
297	1679
298	1685
299	1686
300	1700
301	1704
302	1711
303	1714
304	1716
305	1718
306	1720
307	1728
308	1749
309	1756
310	1761
311	1764
312	1769
313	1774
314	1777
315	1782

List of Monterey County TAZs	
ID	TAZ Number
316	1792
317	1799
318	1805
319	1808
320	1809
321	1810
322	1813
323	1814
324	1815
325	1816
326	1817
327	1819
328	1820
329	1821
330	1822
331	1823
332	1826
333	1827
334	1828
335	1829
336	1830
337	1831
338	1835
339	1837
340	1838
341	1839

ATTACHMENT N: SAN BENITO COUNTY LIST OF TAZS

List of San Benito County TAZs	
ID	TAZ Number
1	1275
2	1303
3	1321
4	1322
5	1349
6	1361
7	1370
8	1371
9	1374
10	1377
11	1378
12	1380
13	1381
14	1385
15	1402
16	1404
17	1409
18	1410
19	1412
20	1414
21	1415
22	1419
23	1420
24	1421
25	1424
26	1425
27	1431
28	1439
29	1444
30	1452
31	1453
32	1458
33	1465
34	1466
35	1474
36	1490
37	1492
38	1505
39	1512
40	1514
41	1521
42	1539
43	1570
44	1575
45	1578

List of San Benito County TAZs	
ID	TAZ Number
46	1581
47	1583
48	1584
49	1588
50	1593
51	1597
52	1606
53	1607
54	1619
55	1621
56	1623
57	1624
58	1625
59	1626
60	1627
61	1628
62	1629
63	1630
64	1632
65	1633
66	1634
67	1636
68	1639
69	1642
70	1644
71	1646
72	1655
73	1669
74	1673
75	1676
76	1680
77	1681
78	1687
79	1754
80	1760
81	1767
82	1768
83	1770
84	1781

ATTACHMENT O: SANTA CRUZ COUNTY LIST OF TAZS

Santa Cruz County	
ID	TAZ Number
1	3
2	5
3	7
4	9
5	11
6	12
7	13
8	14
9	15
10	16
11	17
12	18
13	19
14	20
15	21
16	22
17	25
18	27
19	28
20	29
21	30
22	31
23	32
24	33
25	34
26	35
27	36
28	37
29	38
30	39
31	40
32	41
33	42
34	43
35	44
36	45
37	46
38	47
39	48
40	49
41	50
42	51
43	52
44	53
45	54

Santa Cruz County	
ID	TAZ Number
46	55
47	56
48	57
49	59
50	60
51	61
52	62
53	63
54	64
55	65
56	66
57	68
58	69
59	70
60	72
61	73
62	74
63	75
64	76
65	77
66	78
67	79
68	80
69	81
70	82
71	83
72	84
73	85
74	86
75	87
76	88
77	89
78	91
79	92
80	93
81	94
82	96
83	97
84	98
85	100
86	103
87	105
88	114
89	119
90	134

Santa Cruz County	
ID	TAZ Number
91	135
92	138
93	163
94	178
95	180
96	197
97	207
98	226
99	227
100	238
101	240
102	265
103	286
104	295
105	307
106	309
107	310
108	311
109	312
110	314
111	315
112	318
113	319
114	321
115	324
116	326
117	327
118	328
119	330
120	331
121	332
122	333
123	334
124	335
125	336
126	337
127	338
128	339
129	340
130	341
131	342
132	343
133	344
134	345
135	348

Santa Cruz County	
ID	TAZ Number
136	349
137	350
138	351
139	352
140	353
141	354
142	355
143	356
144	357
145	358
146	360
147	361
148	362
149	363
150	364
151	365
152	366
153	367
154	368
155	369
156	371
157	372
158	373
159	374
160	376
161	377
162	378
163	379
164	380
165	381
166	384
167	385
168	386
169	387
170	388
171	389
172	390
173	392
174	394
175	395
176	397
177	399
178	400
179	406
180	407

Santa Cruz County	
ID	TAZ Number
181	408
182	409
183	414
184	422
185	424
186	426
187	431
188	432
189	442
190	443
191	447
192	454
193	456
194	458
195	462
196	466
197	467
198	468
199	470
200	476
201	481
202	488
203	492
204	496
205	498
206	508
207	515
208	526
209	529
210	530
211	536
212	548
213	549
214	558
215	560
216	578
217	584
218	590
219	593
220	594
221	596
222	598
223	600
224	605
225	606

Santa Cruz County	
ID	TAZ Number
226	614
227	617
228	618
229	624
230	626
231	631
232	632
233	641
234	647
235	649
236	650
237	651
238	653
239	654
240	655
241	657
242	662
243	664
244	665
245	668
246	671
247	676
248	682
249	685
250	686
251	688
252	689
253	691
254	692
255	694
256	696
257	699
258	700
259	701
260	708
261	717
262	719
263	722
264	730
265	735
266	739
267	740
268	751
269	758
270	759

Santa Cruz County

ID	TAZ Number
271	763
272	764
273	768
274	772
275	776
276	777
277	780
278	782
279	783
280	785
281	793
282	798
283	800
284	803
285	810
286	811
287	820
288	828
289	830
290	834
291	844
292	857
293	901
294	903
295	905
296	911
297	932
298	940
299	945
300	946
301	1020
302	1027
303	1036
304	1037
305	1061
306	1077
307	1080
308	1089
309	1099
310	1811
311	1812

**APPENDIX G: VMT ANALYSIS FOR GREENHOUSE GASES AND VMT
FORECASTING OUTLINE**



VMT ANALYSIS FOR GREENHOUSE GASES

VMT ESTIMATION PROCESS FOR GHG ANALYSIS

Daily VMT estimates are used as an input into the air quality, noise and greenhouse gas (GHG) analyses. The process by which daily VMT is estimated for these uses is described below.

TOTAL VMT ACCOUNTING METHOD

The total VMT accounting method is often used as an input for the air quality and greenhouse gas analysis and is the method to be used in analyzing the Project's air quality, noise, and GHG analyses

Under the total VMT accounting method, vehicle trips are placed into three categories based on whether their origin and destination are internal or external to the geographic area in question. Trips that have an origin and a destination outside the area are not included in the VMT estimate under this method. Other trips are either wholly or partially included as described below:

- Internal-internal (II): The full length of all trips made entirely within the geographic area limits is counted.
- Internal-external (IX): The full length of trips with an origin within the geographic area and destination outside of the area is counted. This assumes that the geographic area bears all the responsibility for trips traveling to other areas.
- External-internal (XI): The full length of trips with an origin outside of the geographic area and destination within the area is counted. Similar to the IX trips, this assumes that the geographic area bears the full responsibility for trips traveling to it from other areas.

This "total accounting" method therefore captures the complete length of all trips that begin or end within the geographic area of study. This method is similar, but not identical, to the Project generated VMT estimation used for the SB 743 VMT assessment.

VMT ESTIMATES FOR GHG ANALYSIS

The results of the total VMT accounting methods are presented in **Table G-1**. This VMT is used for the GHG analysis.

The Existing and Existing with Project Conditions results support the concept that providing housing near jobs increases the likelihood that trips can remain within a local area, thus shortening travel distances and increasing residents' ability to accomplish some travel needs by walking, cycling, or using short-distance transit. The Cumulative with Project and without Eastside Parkway Conditions provide more housing near

jobs, which results in VMT per service population that is closer to that without the Project, with a difference of 0.1.

TABLE G-1: TOTAL VMT ACCOUNTING

	Existing Conditions	Existing with Project Conditions	Cumulative Conditions	Cumulative with Project and without Eastside Parkway Conditions
CSUMB Campus				
Vehicle Miles Traveled (A) ¹	160,800	279,400	162,400	297,800
Service Population (B) ^{1,2}	8,000	14,600	8,000	14,600
VMT per Service Population (A/B = C)	20.10	19.13	20.30	20.40

Notes:

1. Rounded service population and VMT to nearest 100.
2. Service population is defined as the sum of all employees, residents and students (K to University).

Source: Fehr & Peers, June 2019.

VMT Forecasting Outline Using the AMBAG Regional Travel Model

The AMBAG regional travel forecasting model was used to develop daily vehicle miles traveled (VMT) and traffic forecasts within the CSUMB campus and the Project study area. The travel forecasting model used for this analysis includes a 2017 base year, and a 2035 future year that reflect growth in the AMBAG region (Santa Cruz, Monterey and San Benito counties). The weekday daily model assignment is the sum of four time periods including: 1) morning peak period (6:00 to 9:00 AM), 2) mid-day peak period (9:00 AM to 4:00 PM), 3) evening peak period (4:00 to 7:00 PM), and 4) evening off-peak period (7:00 PM to 6:00 AM).

Fehr & Peers reviewed the Association of Bay Area Governments (AMBAG) regional travel model to evaluate its suitability for developing long-range traffic forecast for streets and highways within the greater Monterey Bay Area. Fehr & Peers reviewed the primary model inputs in the project area (such as base and future year land use inputs and roadway network assumptions) and also checked the performance of the model against typical validation thresholds. Modifications to the AMBAG regional travel model land use and transportation network inputs were completed to improve the validation of the daily, peak period and peak hour travel models. These changes to the AMBAG regional travel model are documented in a memorandum included in **Appendix F**.

The following steps were taken estimate the Project generated VMT and Project effect on VMT within specified geographic areas.

- Land Use Inputs: CSUMB transportation analysis (TAZ) land use inputs for base year and future year are summarized in **Table G-2**. The base and future land use by county is shown in **Table G-3**. The data dictionary for the land use codes is shown **Table G-4**. **Appendix F** also documents the land use changes.

TABLE G-2: CSUMB LAND USE CHANGES

TAZ	Description of Edit
Main Campus	
806	<ul style="list-style-type: none"> • Baseline University Enrollment is 2,322 • Project University Enrollment is 4,445
826	<ul style="list-style-type: none"> • Baseline University Enrollment is 995 • Project University Enrollment is 1,905
847	<ul style="list-style-type: none"> • Baseline University Enrollment is 3,317 • Project University Enrollment is 6,350
East Campus	
908 and 913	<ul style="list-style-type: none"> • Baseline Students is 1,380 • Baseline Faculty, Staff and Community Partners is 743 • Project Students is 0 • Project Faculty, Staff, and Community Housing Partners is 1,220

Note: Land use added to the TAZs where the campus parking locations are located.

Source: Fehr & Peers, 2019.

TABLE G-3: AMBAG Model Residential and Employment Land Uses

Land Use Category	2010			2035		
	Monterey County	Santa Cruz County	San Benito County	Monterey County	Santa Cruz County	San Benito County
Residential						
Total Households	126,180	94,130	16,910	143,390	111,000	23,970
Total Population	385,050	246,240	54,400	444,080	292,790	75,830
Employment						
Agricultural	45,100	9,600	1,600	48,670	10,230	1,500
Construction	4,300	3,000	800	6,220	4,320	960
Industrial	5,600	5,300	2,500	5,420	4,490	2,790
Retail	20,100	14,900	2,400	23,910	15,640	2,790
Service	60,900	43,700	5,100	77,810	50,370	6,730
Public	46,000	33,700	3,800	60,140	46,090	4,780
Total	182,000	110,200	16,200	222,170	131,140	19,550

Notes: All values have been rounded to the nearest 10.

Source: AMBAG regional travel model. Fehr & Peers, 2019.

TABLE G-4: LAND USE CATEGORIES

Attribute	Description	Unit
Population	Total population in TAZ	People
Households	Total households in TAZ	Household
Retail Employment	Retail trade	Job
Service Employment	Service trade	Job
Public Employment	Public trade	Job
University Enrollment	University students	Student

Source: Fehr & Peers, 2019

- **Transportation Network Inputs:** The future year travel mode includes funded street improvements planned by the Fort Ord Reuse Authority (FORA), City of Marina, and the *2040 Metropolitan Transportation Plan / Sustainable Communities Strategy (2018)* as described in **Chapter 4** of the Transportation Analysis Report. The project specific transportation improvements are described in **Chapter 1** of the Transportation Analysis report. **Appendix F** also documents the network changes.
- **Campus Trip Generation Adjustments:** The AMBAG base and future models without and with the project were run. Each peak period vehicle trip matrix was adjusted using the Fratar method for the traffic analysis zones (TAZs) 802, 806, 826, 847, 908, and 913 to match the daily and peak hour

trip generation estimates presented in **Appendix A**. This method included factoring the morning and evening peak hour vehicle trip matrices until the trip generation from the CSUMB campus TAZs matched the estimated project trip generation values. A map showing TAZs for the CSUMB campus is shown in **Figure G-1**.

- **Project Generated VMT Estimation:** A select zone analysis was conducted for each geographic area (e.g., City, County or Region) to estimate Project generated VMT as specified in **Chapter 4**. The Project generated VMT was adjusted at the model edges to include the full length of trips that leave the AMBAG region (Santa Cruz County, Monterey County, and San Benito County). Adjacent jurisdictions (e.g., San Mateo County, Santa Clara County, Merced County, Fresno County, Kings County, and San Luis Obispo County) are represented by external stations or gateways where major roadways provide access into the overall model area. These stations capture the traffic entering, exiting, or passing through the model area on major county and state roadways (e.g. Highway 1, US 101, State Route 9, State Route 25, State Route 152, State Route 156, State Route 198, Skyline Boulevard, Frazier Lake Road, and San Felipe Road). To include VMT outside of the AMBAG region, the distances listed in **Table G-5** were used to estimate VMT for CSUMB campus or Monterey County trips occurring outside of the AMBAG region. The Project generated VMT metric for Monterey County is illustrated in **Figure G-2**.

TABLE G-5: EXTERNAL STATION DISTANCES

External Station Location	Distance (miles)	Origin/Destination City ¹
Highway 1 Northbound	75	Marin County
State Route 9	25	San Jose
Skyline Boulevard	20	San Jose
State Route 152	40	San Jose
US 101 Northbound	40	San Jose
State Route 25	40	San Jose
Frazier Lake Road	40	San Jose
San Felipe Road	40	San Jose
State Route 156	75	Merced
State Route 198	90	Fresno
Highway 1 Southbound	95	Santa Maria
US 101 Southbound	60	Santa Maria

Notes:

1. Distances measured from external station edge of AMBAG region to larger urban destination.

Source: Fehr & Peers, 2019

- **Project Effect on VMT (Boundary VMT):** As described in **Chapter 4**, the Project's effect on VMT, or cumulative impact, is evaluated using the boundary VMT, which captures all VMT on a roadway network within a specified geographic area, including local trips plus interregional travel that does not have an origin or destination within the area. The geographical boundary method only considers traffic within the physical limits of the selected study area and does not include the impact of vehicles once they travel outside the area limits. The use of boundary VMT is a more

complete evaluation of the potential effects of the project because it captures the combined effect of new VMT, shifting existing VMT to/from other neighborhoods, and/or shifts in existing traffic to alternate travel routes or modes. The Project generated VMT metric for Monterey County is illustrated in **Figure G-2**.

- VMT for Greenhouse Gas (GHG) Analysis (Total VMT Accounting): As described earlier in **Appendix G**, vehicle trips are placed into three categories based on whether their origin and destination are internal or external to the geographic area in question. Trips that have an origin and destination outside the area are not included in the VMT estimates under this method. The “total accounting” method therefore captures the complete length of all trips that begin or end within the geographic area to study.

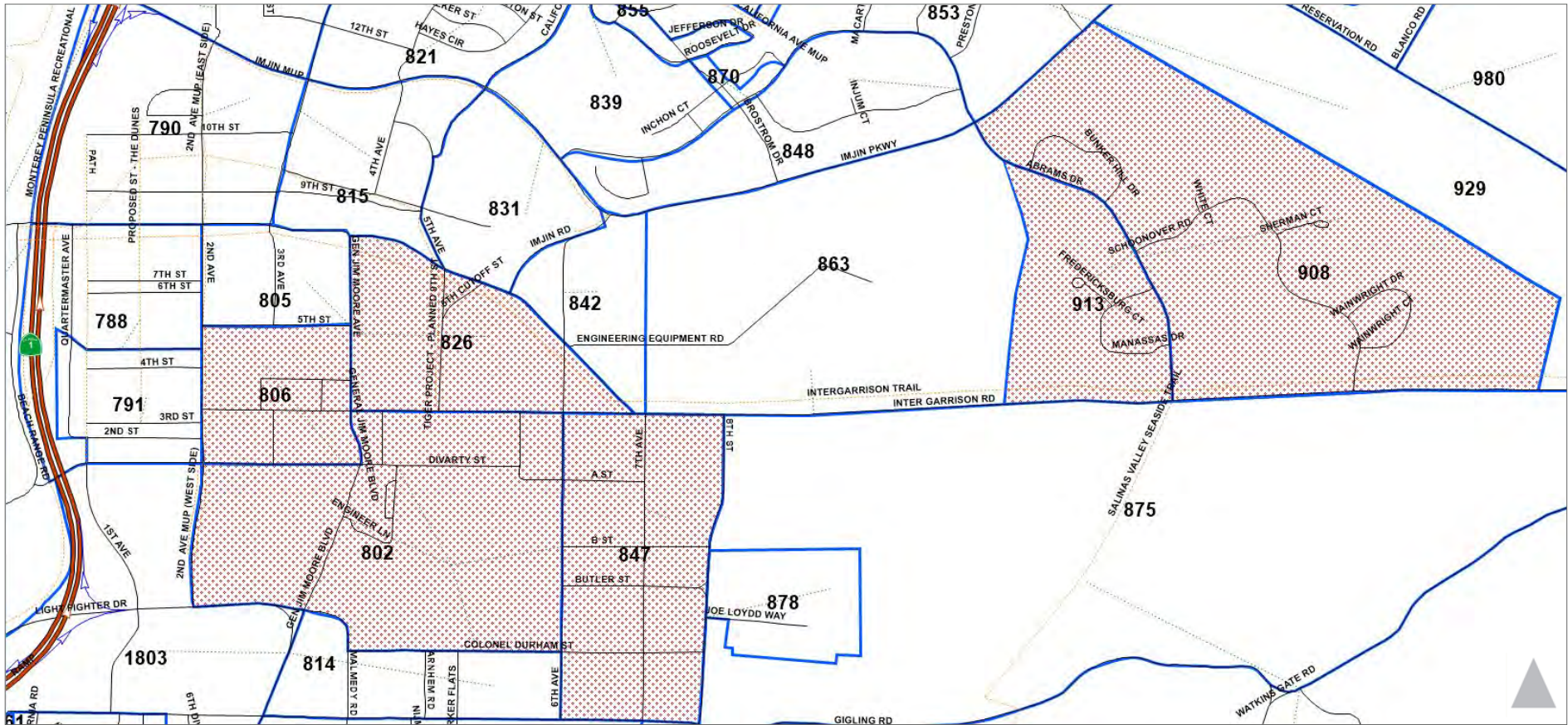

 CSUMB Campus TAZs selected based on Parking Locations



Figure G-1
TAZs used for CSUMB Campus

W:\Projects\03\pamc.local\Data\Projects_SJ17_1728_CSUMB_Master_Plan_EIR\Graphics\GIS\WXDS\17_1728_VMT_Basemap.mxd

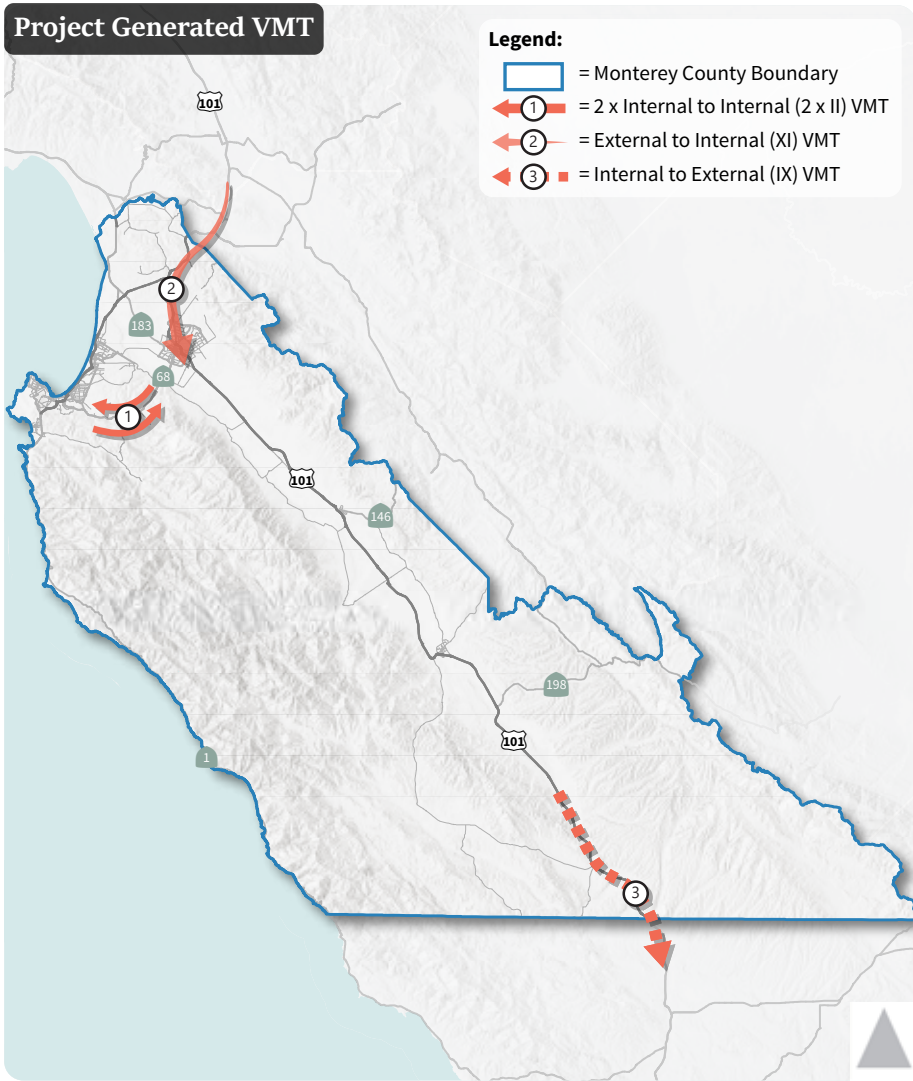

Notes: External to External (XX) trips are excluded from this VMT metric. Adjustments to project generated VMT made to include the full length of trips that leave Monterey County to capture inter-regional travel.

Monterey County Boundary



Notes: Boundary VMT is all the VMT within Monterey County.

Monterey County Boundary



Figure 1
Title

Figure 2
Title
Measuring Vehicle Miles Traveled (VMT)

APPENDIX H: CSUMB DRAFT PARKING SUPPLY SCENARIOS





MEMORANDUM

Date: August 25, 2015
To: Philip Perlin, Page/BMS
From: Anais Schenk and Matt Haynes, Fehr & Peers
Subject: **CSUMB Draft Parking Supply Scenarios**

SJ15-1576

The following parking scenarios were developed for the California State University, Monterey Bay (CSUMB) Master Plan update planning process. CSUMB currently has the highest parking ratio in the CSU system at approximately 0.65 spaces per full time equivalent (FTE).¹ However, CSUMB stakeholders have expressed a strong desire to transition the campus from being mostly auto-oriented to a bicycle, pedestrian and transit friendly environment consistent with the Master Plan's sustainability goals. In order to help achieve this goal, the new Master Plan will seek to proactively manage campus parking supply and reduce the corresponding number of single occupancy vehicles entering campus.

As part of the Master Plan, the campus will also be considering new transportation demand management (TDM) measures as part of the overall effort to increase the use of alternative transportation modes. Currently, CSUMB offers a limited range of TDM measures such as rideshare matching services and resources for commuters wishing to use transit or bicycle to campus. While these TDM measures are responsive to the needs of commuters, the new Master Plan will need to include a broader and more comprehensive TDM program to improve transportation choices for students, staff and faculty.

In a campus setting, the most effective TDM measures relate to managing parking supply and pricing. The strategies presented below therefore seek to better manage both the supply and price of parking on the CSUMB campus.

¹ The current CSUMB parking ratio varies from 0.6 to 0.7 depending on the source of information for full time equivalent students and the existing number of parking spaces.



PARKING SUPPLY ALTERNATIVES

Three parking scenarios are provided below for consideration in developing the land use program for the CSUMB Master Plan. The parking ratios are within the range of those achieved by other CSU campuses in suburban land use contexts. Cal State East Bay, Fullerton, Humboldt and Stanislaus all currently have parking ratios around 0.3 per FTE. CSUs that currently have a ratio close to 0.4 include Bakersfield, Fresno, Long Beach and San Diego. See **Figure 1** below.

Figure 1: CSU Parking Ratios per FTE

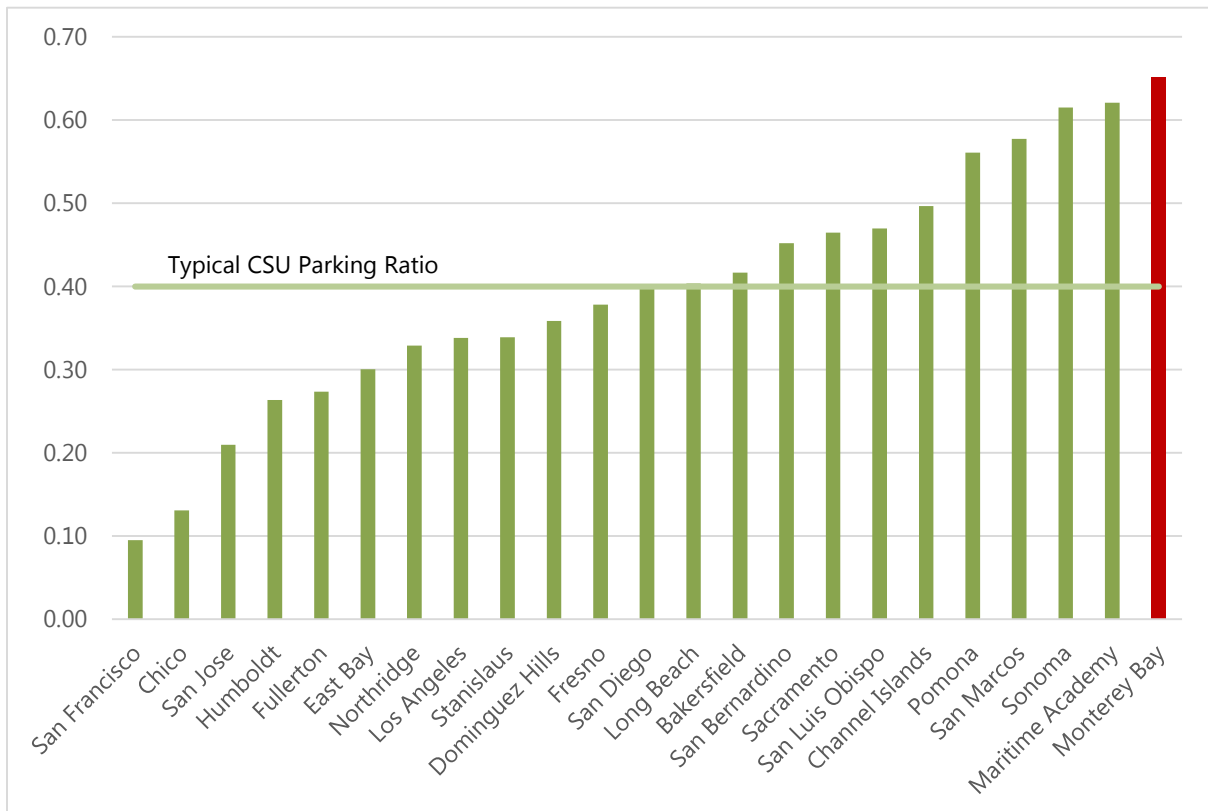

Source: California State University Financing and Treasury Department (July 2013) and California State University Analytic Studies (2013-2014).

Examples from other CSUs demonstrate that parking ratios between 0.3 and 0.4 are realistic and achievable within the context of suburban campus environments. **Table 1** below shows the results of three different parking ratios: 0.3, 0.35 and 0.4.



TABLE 1: PARKING SUPPLY SCENARIOS AT MASTER PLAN BUILDOUT¹

Scenario	Parking Pricing Strategy ²	Parking Ratio per FTE	Residential Parking Supply	Non-Residential Parking Supply	Total Campus Stalls	Total Supply in Acres ³
Alternative 1: Aggressive Parking Management	High Cost with Tiered Pricing	0.30	1,020	2,770	3,790	27
Alternative 2: Moderate Parking Management	Moderate Cost with Limited Tiered Pricing	0.35	1,650	2,770	4,420	32
Alternative 3: Typical CSU Parking Supply	Moderate Cost (Comparable to Other CSUs)	0.40	1,760	3,290	5,050	36

Notes:

1. The number of spaces shown are for stalls on campus (excluding East Campus) and do not include parking spaces provided by garages or driveways in campus faculty/staff housing.
 2. See Table 2 for details on pricing and corresponding strategies.
 3. The total number of acres was calculated assuming 140 parking spaces are accommodated in one acre for surface lots.
- Source: Fehr & Peers, 2015

The total number of parking stalls for each scenario were divided amongst residential and non-residential users based on the following assumptions:

- Population totals of 12,631 full time equivalent students and 1,421 staff/faculty positions as provided by Page/BMS.
- Sixty percent of students will be housed on campus.
- Campus housing for staff and faculty provides driveways or garages to house their vehicles.
- In addition to current on-campus housing for staff and faculty, we assume East Campus housing will be converted to staff and faculty housing.
- In order to achieve the Moderate and Aggressive parking alternatives, the Master Plan will need to incorporate a robust TDM program that achieves a 45-50 percent single occupancy vehicle mode share target along with a 10 percent rideshare mode share. The Typical CSU Parking Supply alternative will need to achieve an approximately 55 percent single occupancy vehicle mode share.



There are varying sources of information for existing parking spaces on the CSUMB campus. Current parking estimates range from 3,645² to 4,398.³ If the actual parking supply is on the higher end of this range of estimates than CSUMB may already have enough parking supply to accommodate either the aggressive or the moderate scenarios shown above. If CSUMB chose to adopt the aggressive scenario than new buildings could be constructed by removing surface lots without replacing lost parking stalls. An aggressive approach to managing campus parking supply, along with a robust TDM program, would therefore limit the amount of resources needed to construct additional surface parking during buildout of the Master Plan.

PARKING PRICING OPTIONS

There are several options for parking pricing that can be considered in conjunction with each parking supply scenario. These options are closely linked to the parking supply options presented above. For example, an aggressive parking supply alternative will also necessitate an aggressive approach to parking pricing.

Most CSUs charge for parking on a semester or quarter basis and have lower cost parking for evening and summer sessions when there is less overall demand for parking. CSUMB recently raised the price of parking permits to \$108 per semester for students and \$54 to \$58 per semester for employees. Current parking permit costs for other CSUs range anywhere from \$80 to over \$300 per semester. Some CSUs such as Chico, San Luis Obispo and San Jose charge more for on campus resident permits which discourage student auto ownership. Some universities offer location and time-based parking pricing such as MIT, UCLA and University of Colorado, Boulder. Because there are numerous ways to structure pricing to disincentivize driving the suggested pricing alternatives below are presented as ranges that would need to be refined as part of a future more detailed parking management and implementation strategy.

² California State University Financing and Treasury Department (July 2013). The ratio of 0.65 per FTE is from the CSU data as shown above in Figure 1.

³ California State University, Monterey Bay: Draft Parking Management Plan (2012).



TABLE 2: PARKING PRICING SCENARIOS PER SEMESTER

Scenario	Parking Ratio per FTE	Range of Permit Cost (Student)	Range of Permit Cost (Staff/Faculty)	Pricing and Management Strategies
Alternative 1: Aggressive Parking Management	0.30	\$425-500	\$200-250	<ul style="list-style-type: none"> Higher prices for on-campus resident permits. No vehicles for freshman on campus. No on-campus permits for East Campus residents. Tiered parking pricing based on distance to academic core. Tiered pricing for limited days of week. (1 day, 2 days, etc.) Increased citation costs.
Alternative 2: Moderate Parking Management	0.35	\$325-400	\$150-200	<ul style="list-style-type: none"> Higher prices for on campus resident permits. No vehicles for freshman on campus. No on-campus permits for East Campus residents. Tiered parking pricing based on distance to academic core.
Alternative 3: Typical CSU Parking Supply	0.40	\$200-250	\$100-150	<ul style="list-style-type: none"> Higher prices for on campus resident permits. No vehicles for freshman on campus. Limited on-campus permits for East Campus residents.

Source: Fehr & Peers, 2015

SUMMARY

Fehr & Peers has provided these preliminary parking ratios and pricing schemes in order to engage stakeholders and University staff in a conversation about a proactive approach to parking. Subsequent to Master Plan adoption, CSUMB should develop a Parking Management Plan to guide and implement campus wide parking policies including pricing, permitting and enforcement. This would be best achieved through a Transportation and Parking Services (TAPS) department which would be charged with implementing the parking management strategies and managing parking revenue. Under this structure, parking revenue could be directed towards transportation systems that reinforce the long term sustainable transportation goals of the campus.

APPENDIX I: PARKING DEMAND AND SUPPLY CALCULATIONS



TABLE 11: CSUMB EXISTING AND FUTURE ACADEMIC PARKING DEMAND AND SUPPLY

Item	Value
Existing Peak Parking Demand (A)	2,396 spaces
Existing Students, Faculty and Staff Population (B)	7,886 FTE
Existing Parking Demand Rate (A/B = C)	0.313 spaces per FTE
Future Students, Faculty and Staff (D)	14,476 FTE
Future Base Parking Demand (D x C = E)	4,531 spaces
Circulation Factor (F)	0.05
Future Parking Supply (E x (1+F)=G)	4,758 spaces
Existing Parking Supply	3,730 spaces
Excess/Shortage Parking Supply	-1,028 spaces

Source: Fehr & Peers, June 2019.

TABLE 12: CSUMB EXISTING AND FUTURE RESIDENTIAL PARKING DEMAND AND SUPPLY

Item	Value
Existing Peak Parking Demand (A)	525 spaces
Existing Residential Students, Faculty and Staff Population (B)	2,600 Main Campus Residents
Existing Parking Demand Rate (A/B = C)	0.202 spaces per resident
Future Students, Faculty and Staff (D)	7,620 Main Campus Residents
Future Base Parking Demand (D x C = E)	1,539 spaces
Circulation Factor (F)	0.05
Future Parking Supply (E x (1+F)=G)	1,616 spaces
Existing Parking Supply	991 spaces
Excess/Shortage Parking Supply	-625 spaces

Source: Fehr & Peers, June 2019.

TABLE 13: FUTURE PARKING SUPPLY SUMMARY

Parking Summary	Academic	Residential	Total
Existing	3,730	991	4,721
Future Base on Land Area Allocated in MP Guidelines	4,451	1,200	5,651
Future Based on Existing Parking Demand	4,758	1,616	6,374

Source: Fehr & Peers, June 2019.

Table 15: CSUMB Main Campus External AM Vehicle Trips

Parking Areas	Students				Faculty/Staff			
	SOV	Carpool	Transit	Percent of total trips	SOV	Carpool	Transit	Percent of total trips
Parking Area 1	416 (28%)	0 (0%)	0 (0%)	416 (28%)	100 (14%)	0 (0%)	0 (0%)	100 (7%)
Parking Area 2	164 (11%)	67 (5%)	4 (0%)	235 (16%)	35 (5%)	31 (4%)	1 (0%)	67 (5%)
Parking Area 3	100 (7%)	93 (6%)	5 (0%)	198 (14%)	102 (15%)	44 (6%)	2 (0%)	148 (10%)
Parking Area 4	416 (28%)	0 (0%)	0 (0%)	416 (28%)	198 (28%)	0 (0%)	0 (0%)	198 (14%)
Parking Area 5	52 (4%)	0 (0%)	0 (0%)	52 (4%)	105 (15%)	0 (0%)	0 (0%)	105 (7%)
Parking Area 6	103 (7%)	0 (0%)	0 (0%)	103 (7%)	77 (11%)	0 (0%)	0 (0%)	77 (5%)
Parking Area 7	44 (3%)	0 (0%)	0 (0%)	44 (3%)	0 (0%)	0 (0%)	0 (0%)	0 (0%)
Total	1,295 (88%)	160 (11%)	9 (1%)	1,464 (100%)	617 (89%)	75 (11%)	3 (0%)	695 (47%)

Notes:

1. Promontory is a residential only lot for students living on the Main Campus. Trips are only for travel off-campus and east-campus, trips into the campus are not expected to occur for students living on the Main Campus.

Source: Fehr & Peers, June 2019.

TABLE 16. PARKING DEMAND BY LOT

Parking Lot	Future Parking Supply based on Land Area Allocated in Master Plan ¹ [A]			Future Parking Supply Based on Existing Parking Demand for Use in TA ² [B]			Excess/ Supply Shortage [A-B]		
	Academic	Residential	Total	Academic	Residential	Total	Academic	Residential	Total
Parking Area 1	475 (11%)	775 (65%)	1,250 (22%)	1,190 (25%)	1,234 (76%)	2,424 (38%)	-715	-459	-1,174
Parking Area 2	1,188 (27%)	-	1,188 (21%)	714 (15%)	-	714 (11%)	474	-	474
Parking Area 3	463 (10%)	-	463 (8%)	760 (16%)	-	760 (12%)	-297	-	-297
Parking Area 4	1,450 (33%)	-	1,450 (26%)	1,380 (29%)	-	1,380 (22%)	70	-	70
Parking Area 5	500 (11%)	-	500 (9%)	333 (7%)	-	333 (5%)	167	-	167
Parking Area 6	375 (8%)	-	375 (7%)	381 (8%)	-	381 (6%)	-6	-	-6
Parking Area 7	-	425 (35%)	425 (8%)	-	382 (24%)	382 (6%)	-	43	43
Total	4,451 100%	1,200 100%	5,651 100%	4,758 100%	1,616 100%	6374 100%	-308	-416	-723

Notes:

1. Future Parking Supply estimated by Master Plan land are allocation provided by CSUMB on June 2018.
2. Future Parking Supply estimated by campus population growth based on estimated parking area size calculated using methodology described in **Chapter 2 and Chapter 7**.

Source: CSUMB, June 2018. Fehr & Peers, June 2019.

**APPENDIX J: CALIFORNIA STATE UNIVERSITY, MONTEREY BAY
HOUSING AND PARKING MANAGEMENT GUIDELINES**

Refer to Appendix C-2 of the CSUMB Master Plan EIR



APPENDIX K: INTERSECTION VOLUME FIGURES



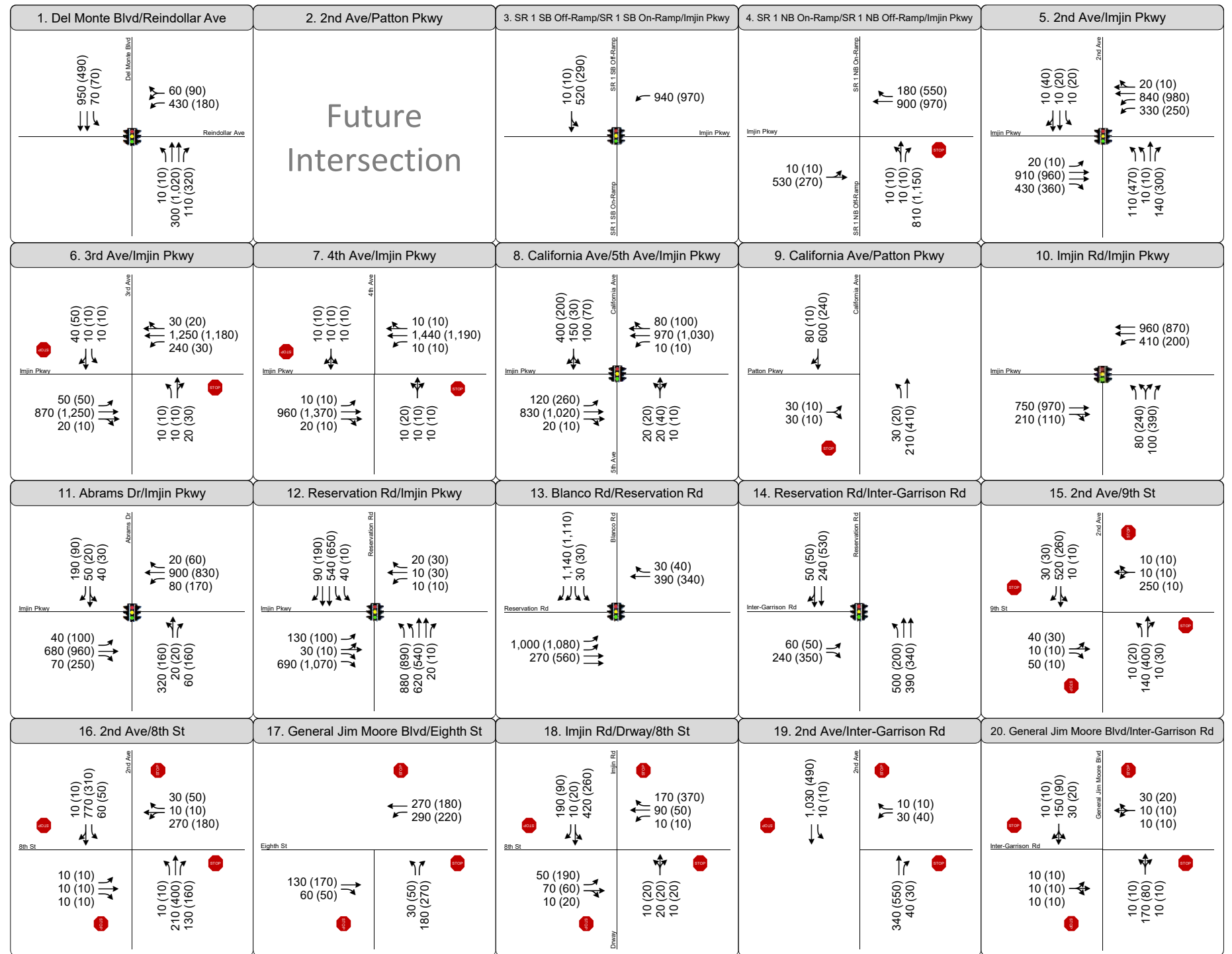
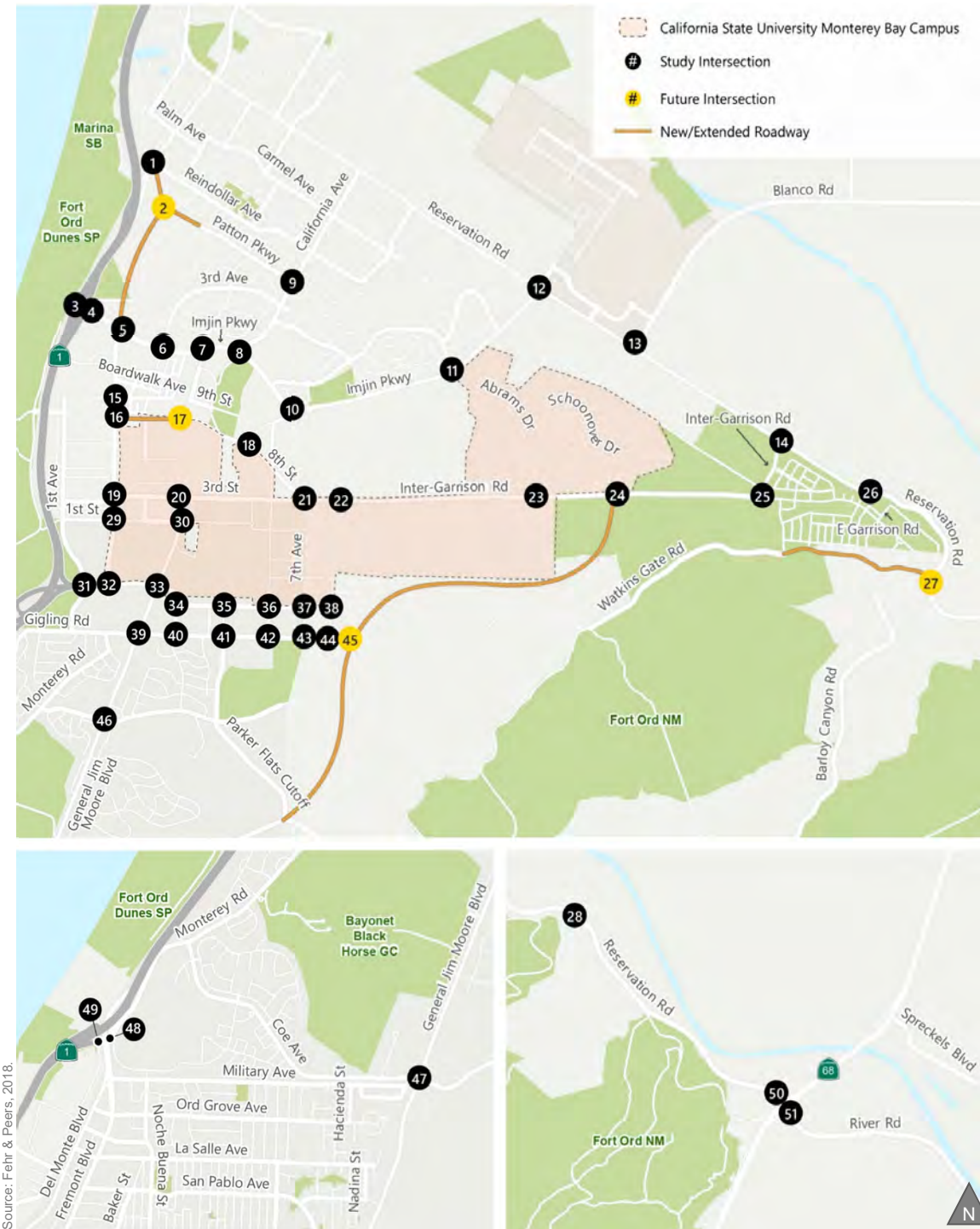

- LEGEND**
- AM (PM) Peak Hour Traffic Volume
 - Lane Configuration
 - Stop Sign Controlled
 - Signalized
 - Roundabout

Figure K-1a
Study Intersection Peak Hour Traffic Volumes and Lane Configurations
Existing with Project Conditions



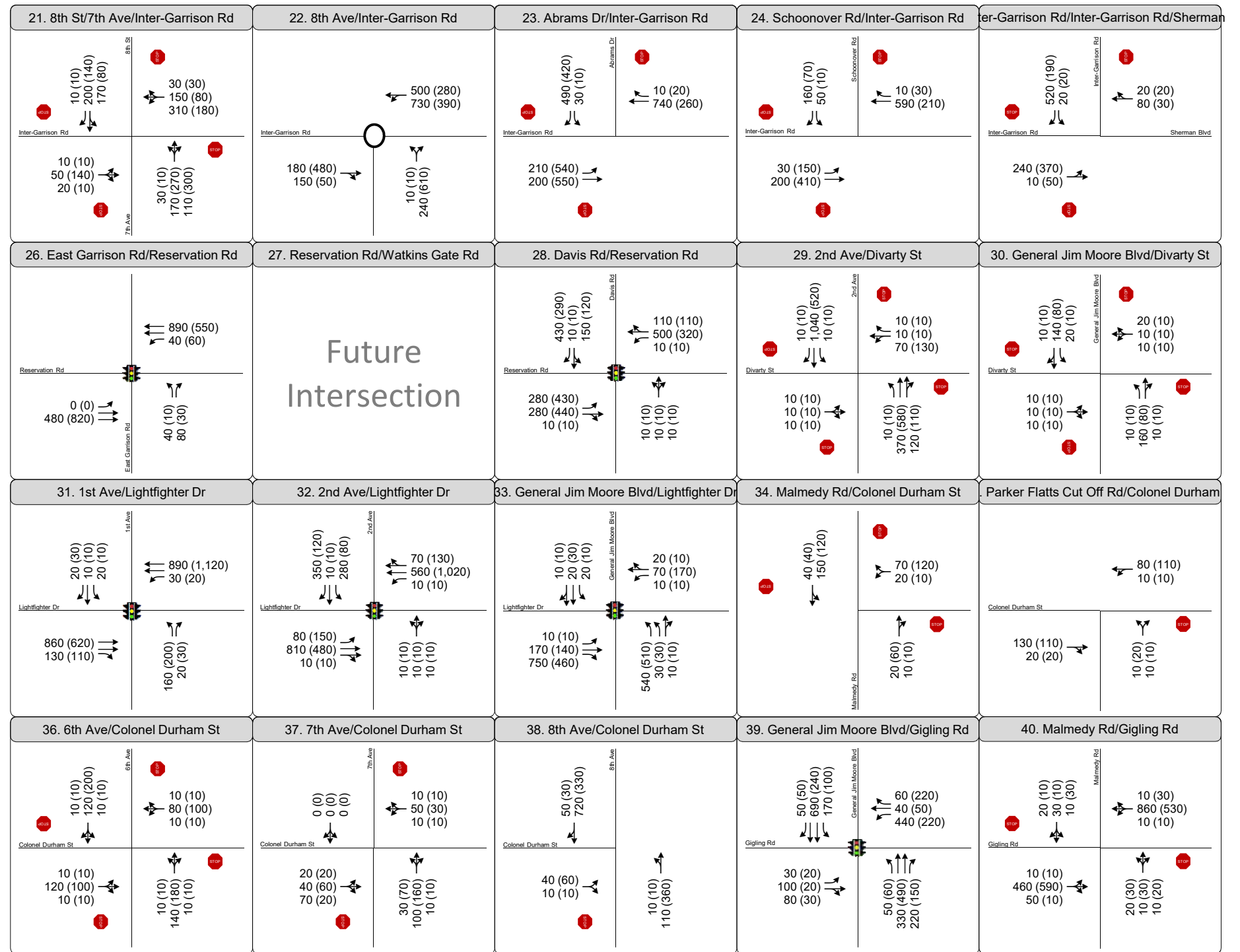
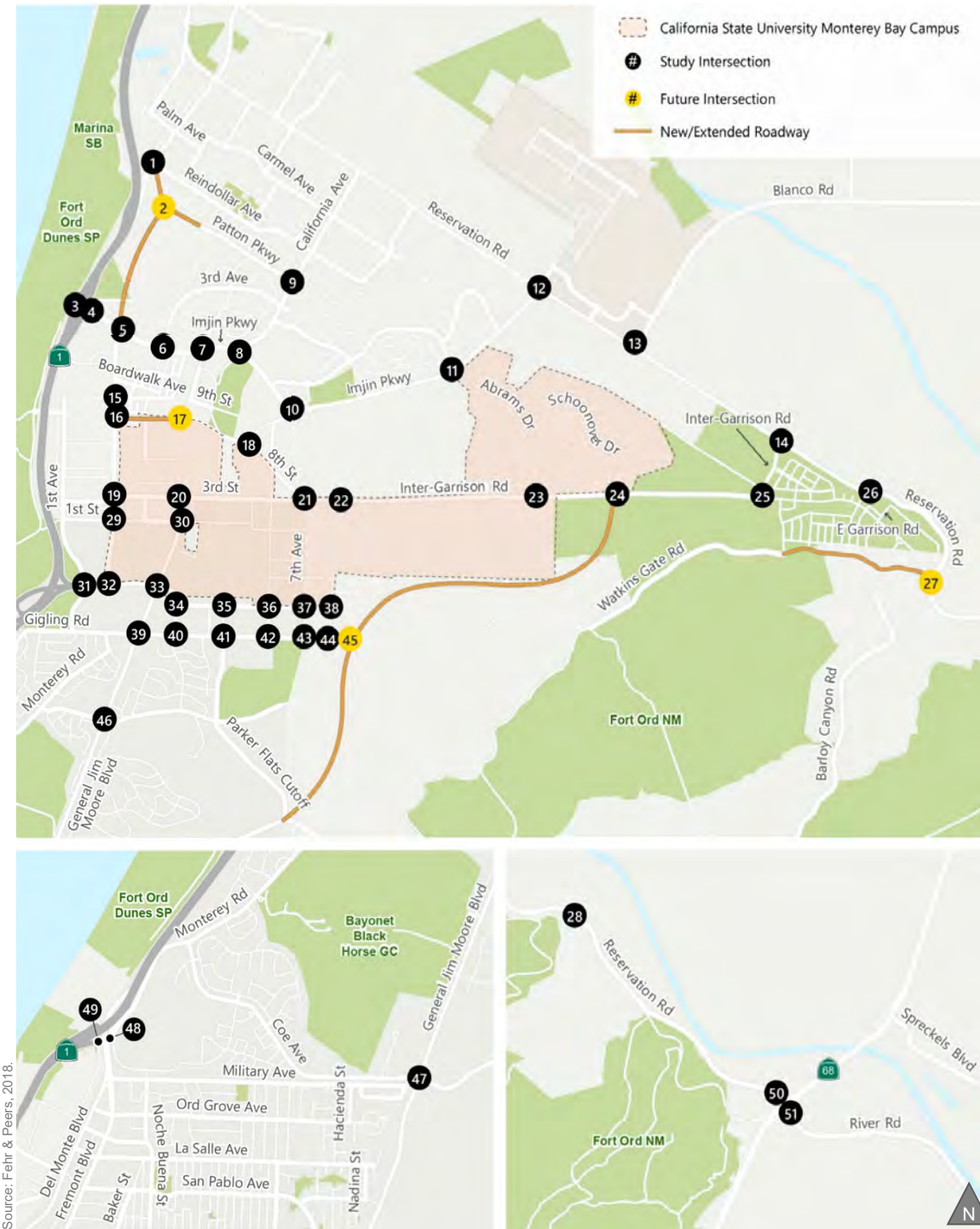

- LEGEND**
- AM (PM) Peak Hour Traffic Volume
 - Lane Configuration
 - Stop Sign Controlled
 - Signalized
 - Roundabout

Figure K-1b
Study Intersection Peak Hour Traffic Volumes and Lane Configurations
Existing with Project Conditions

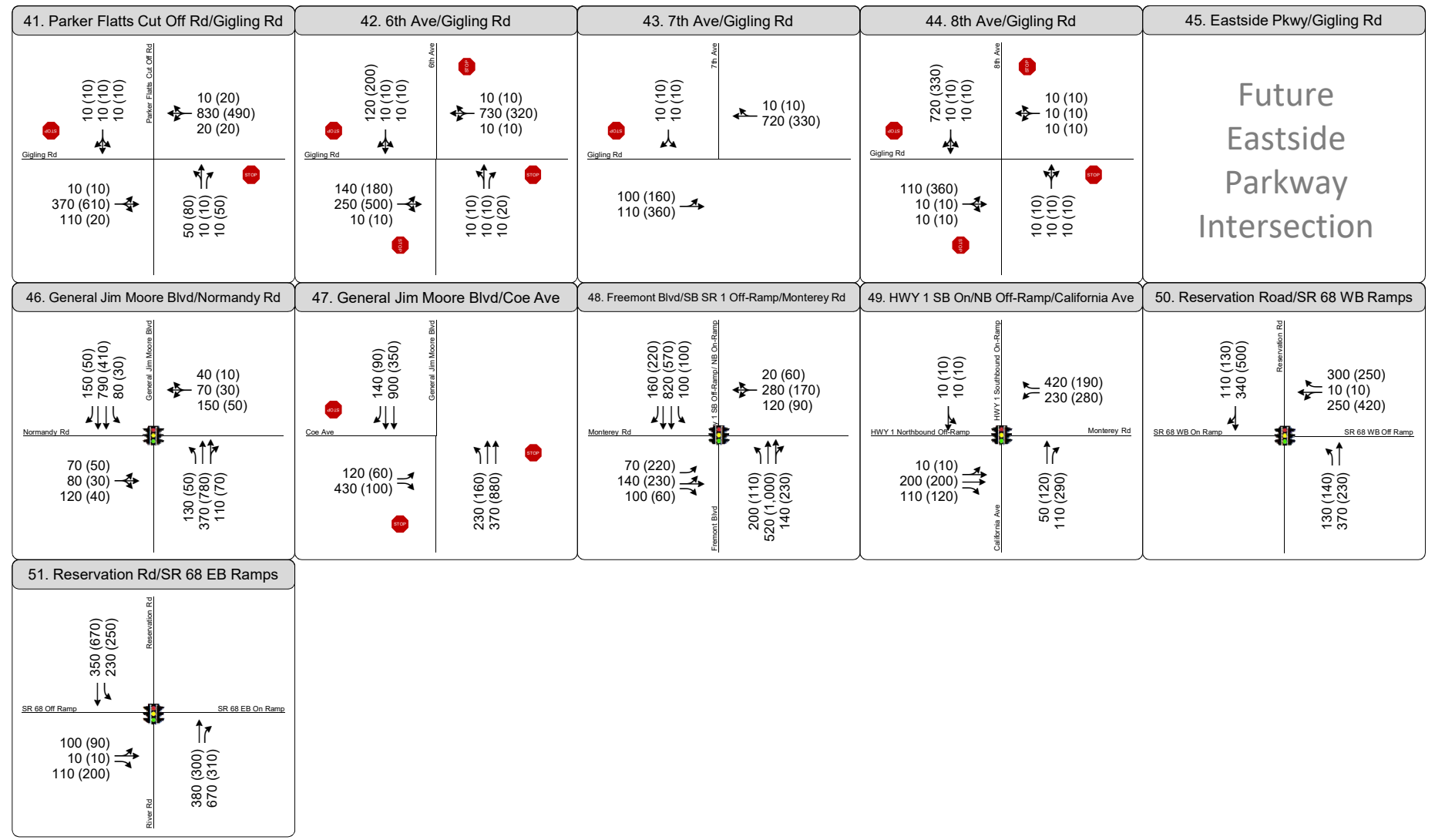
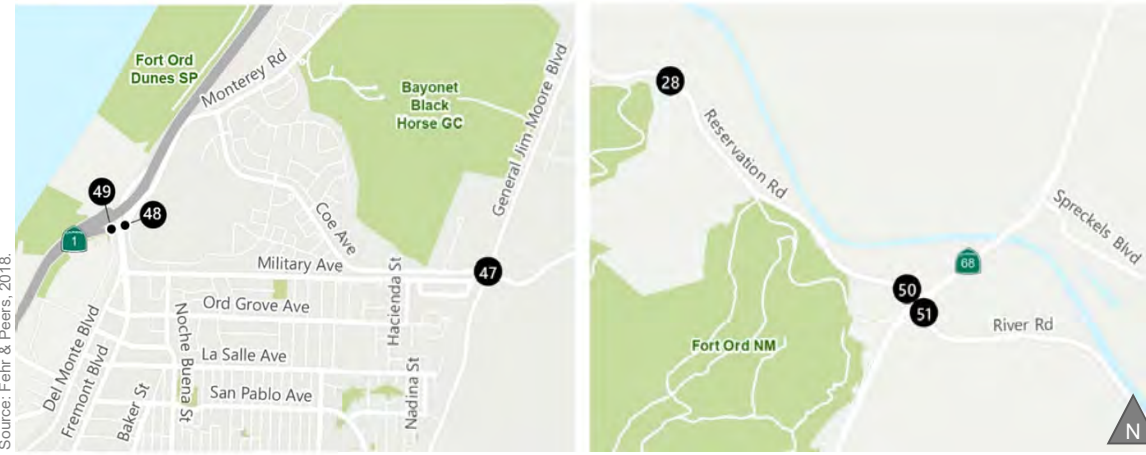
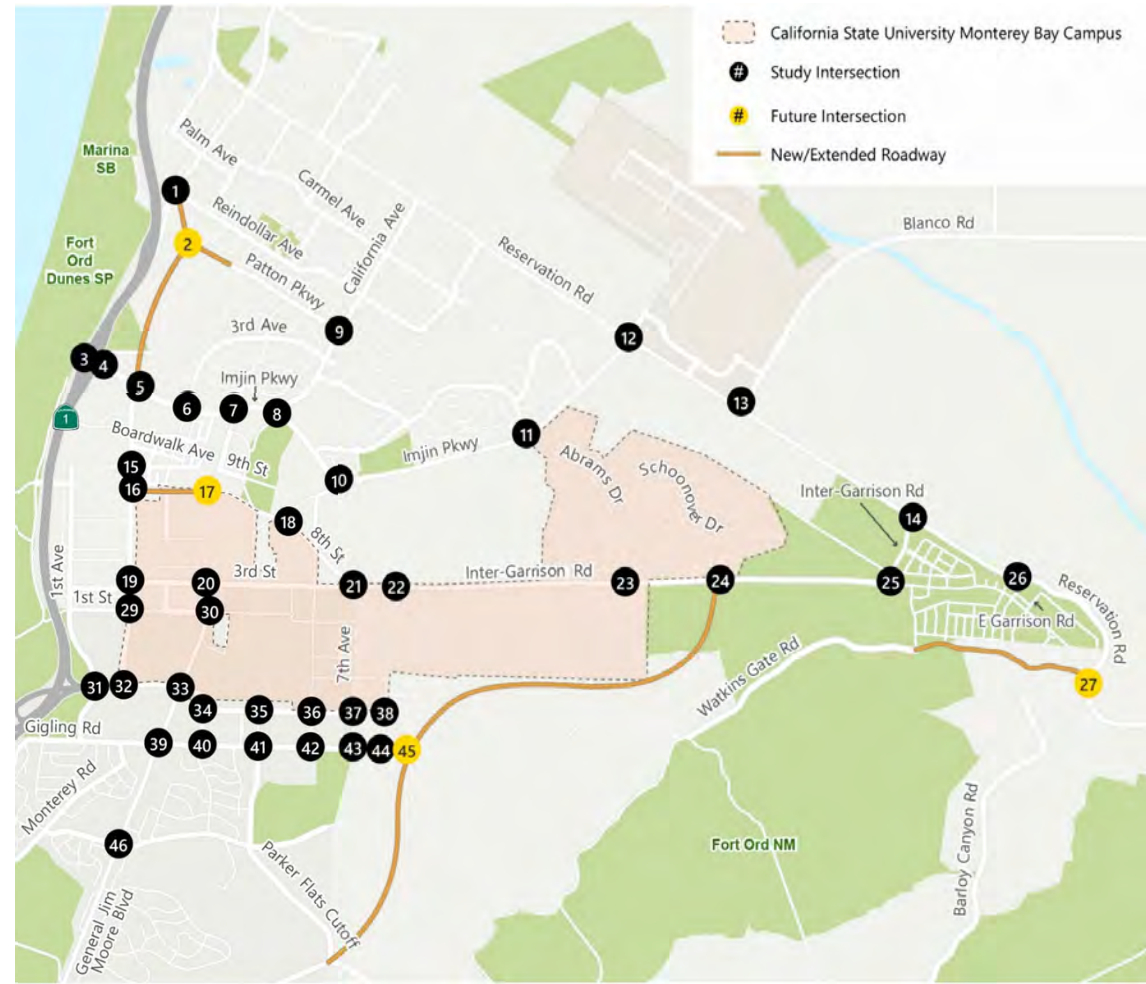

- LEGEND**
- AM (PM) Peak Hour Traffic Volume
 - Lane Configuration
 - Stop Sign Controlled
 - Signalized
 - Roundabout

Figure K-1c
Study Intersection Peak Hour Traffic Volumes and Lane Configurations
Existing with Project Conditions



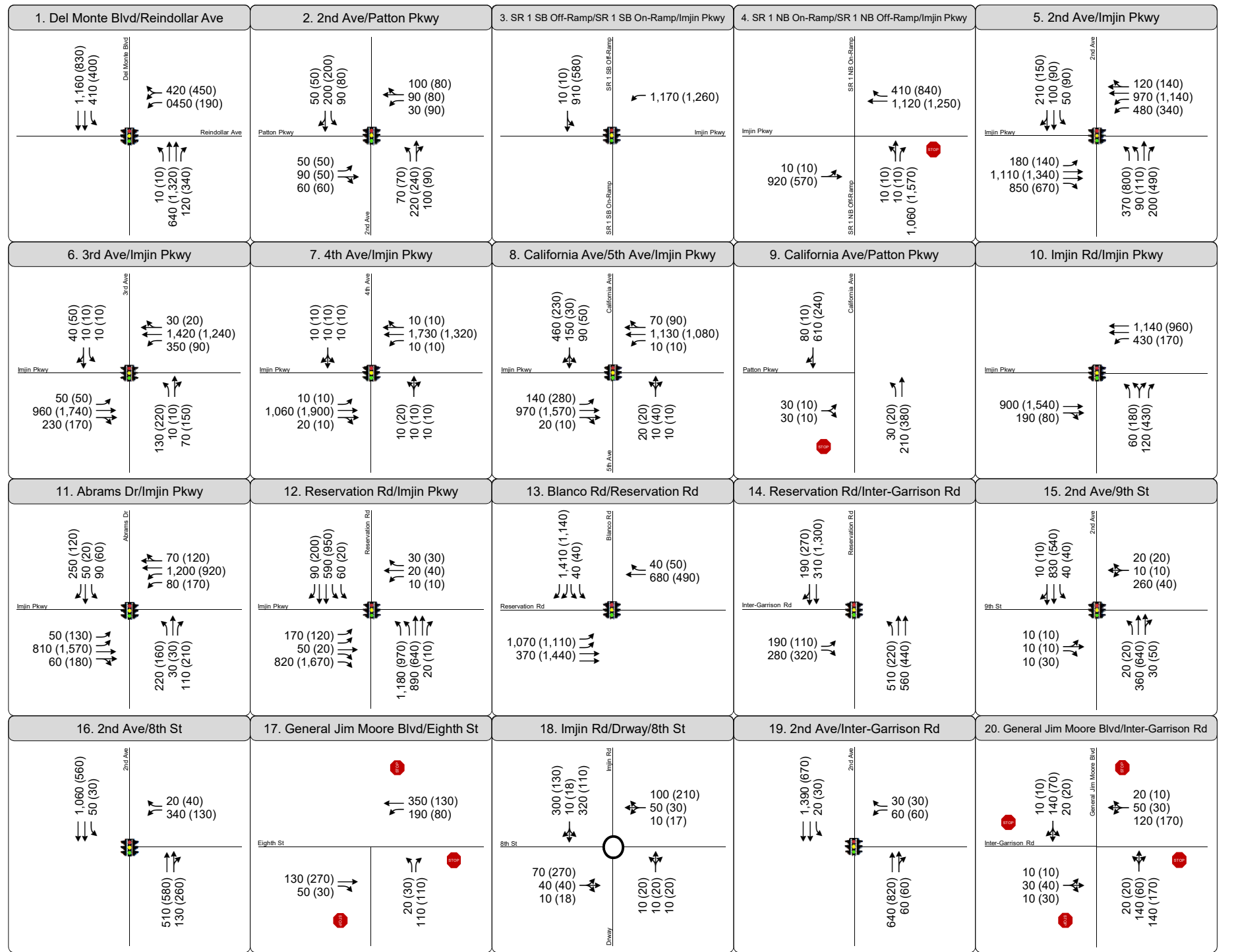
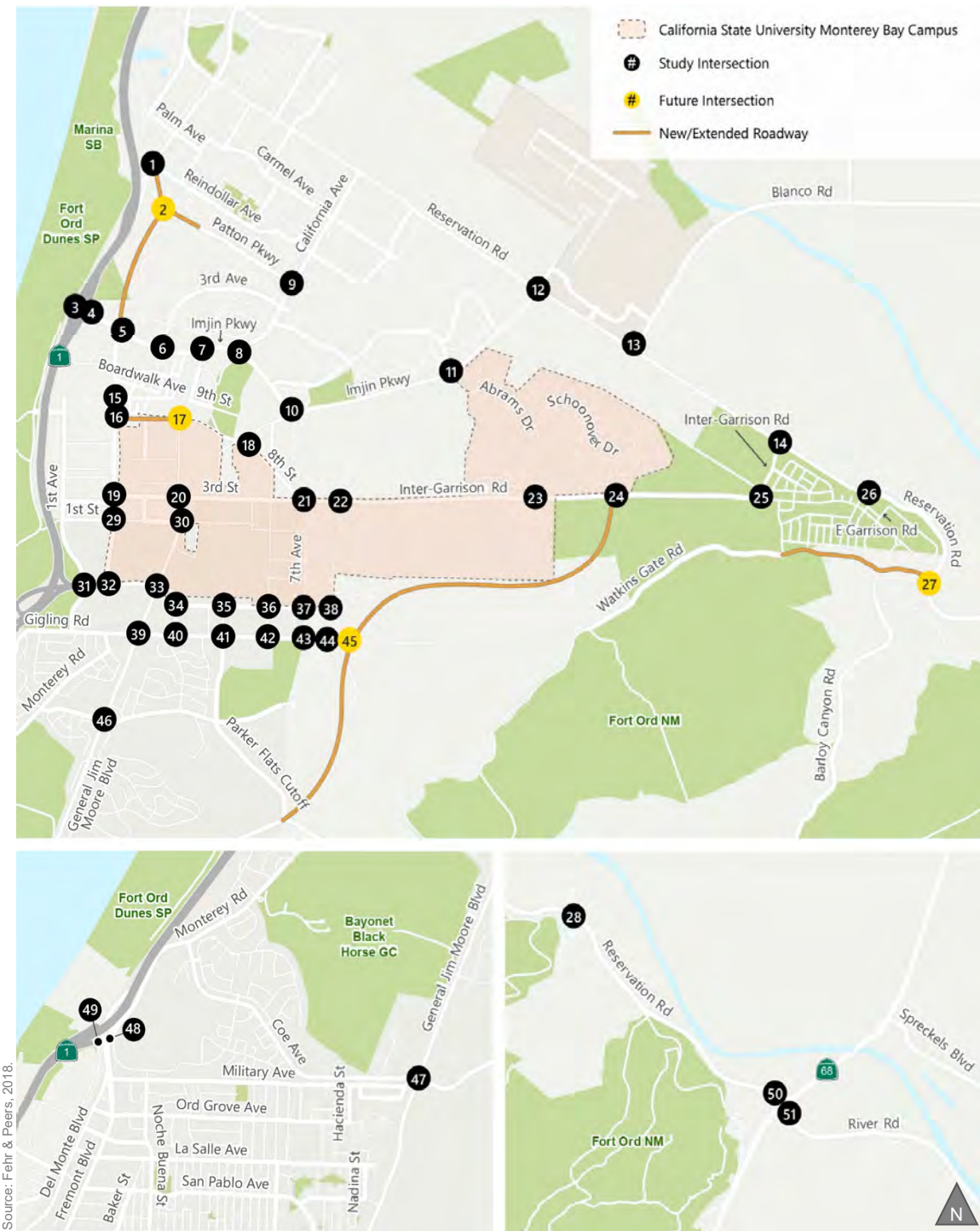

LEGEND

- AM (PM) Peak Hour Traffic Volume
- Lane Configuration
- Stop Sign Controlled
- Signalized
- Roundabout

Figure K-2a
Study Intersection Peak Hour Traffic Volumes and Lane Configurations
Cumulative without Project and without Eastside Parkway Conditions



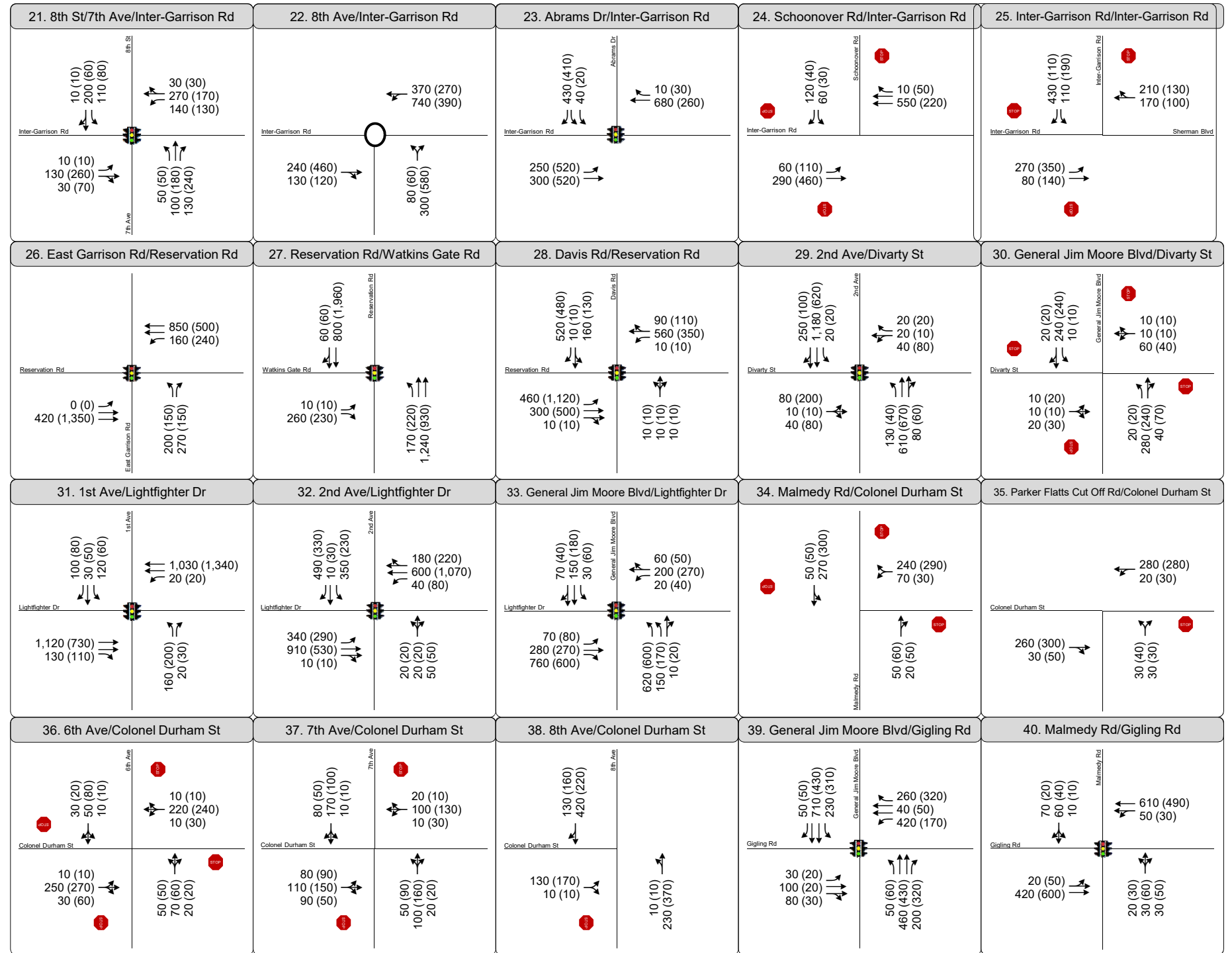
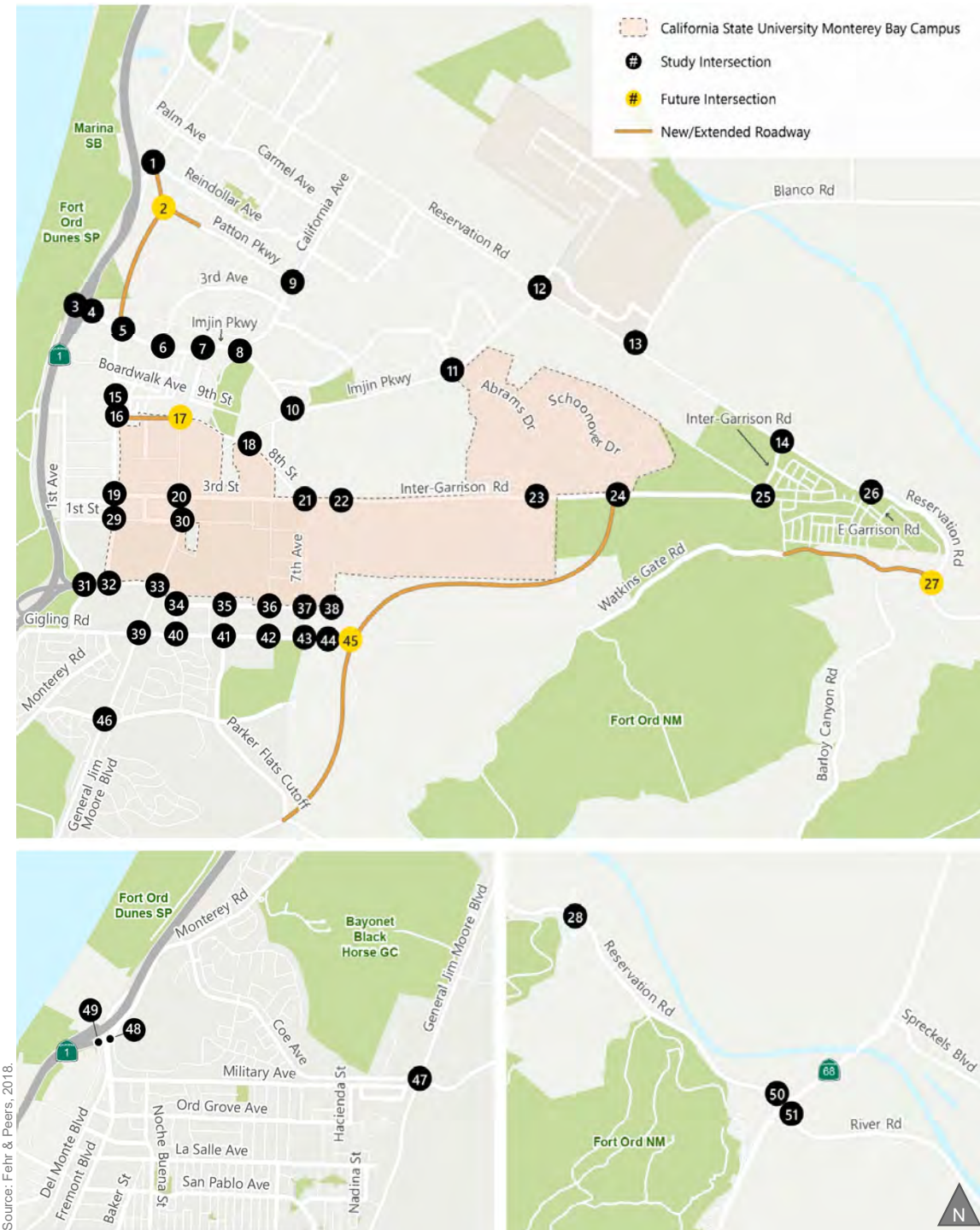

- LEGEND**
- AM (PM) Peak Hour Traffic Volume
 - Lane Configuration
 - Stop Sign Controlled
 - Signalized
 - Roundabout

Figure K-2b
Study Intersection Peak Hour Traffic Volumes and Lane Configurations
Cumulative without Project and without Eastside Parkway Conditions

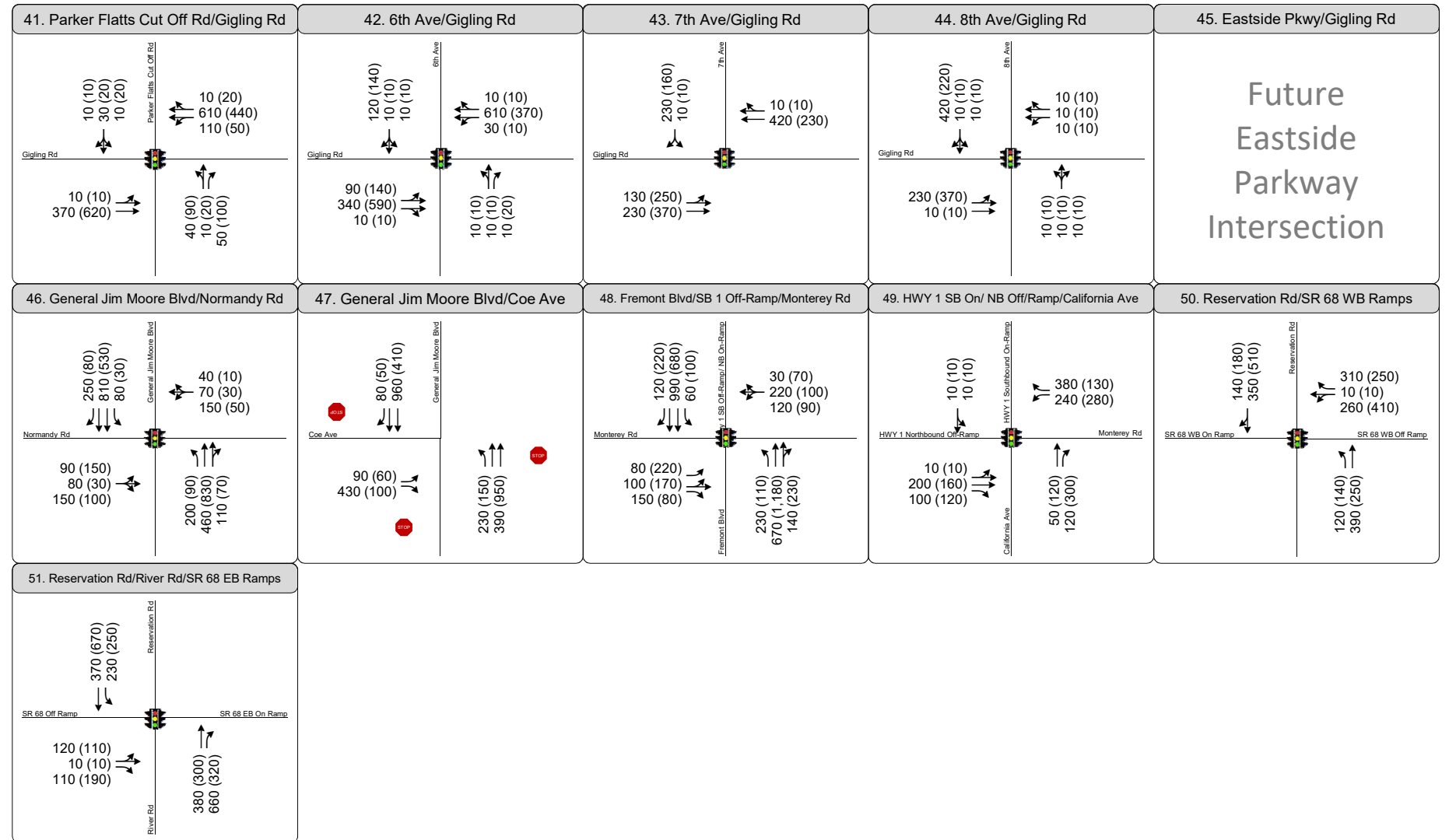
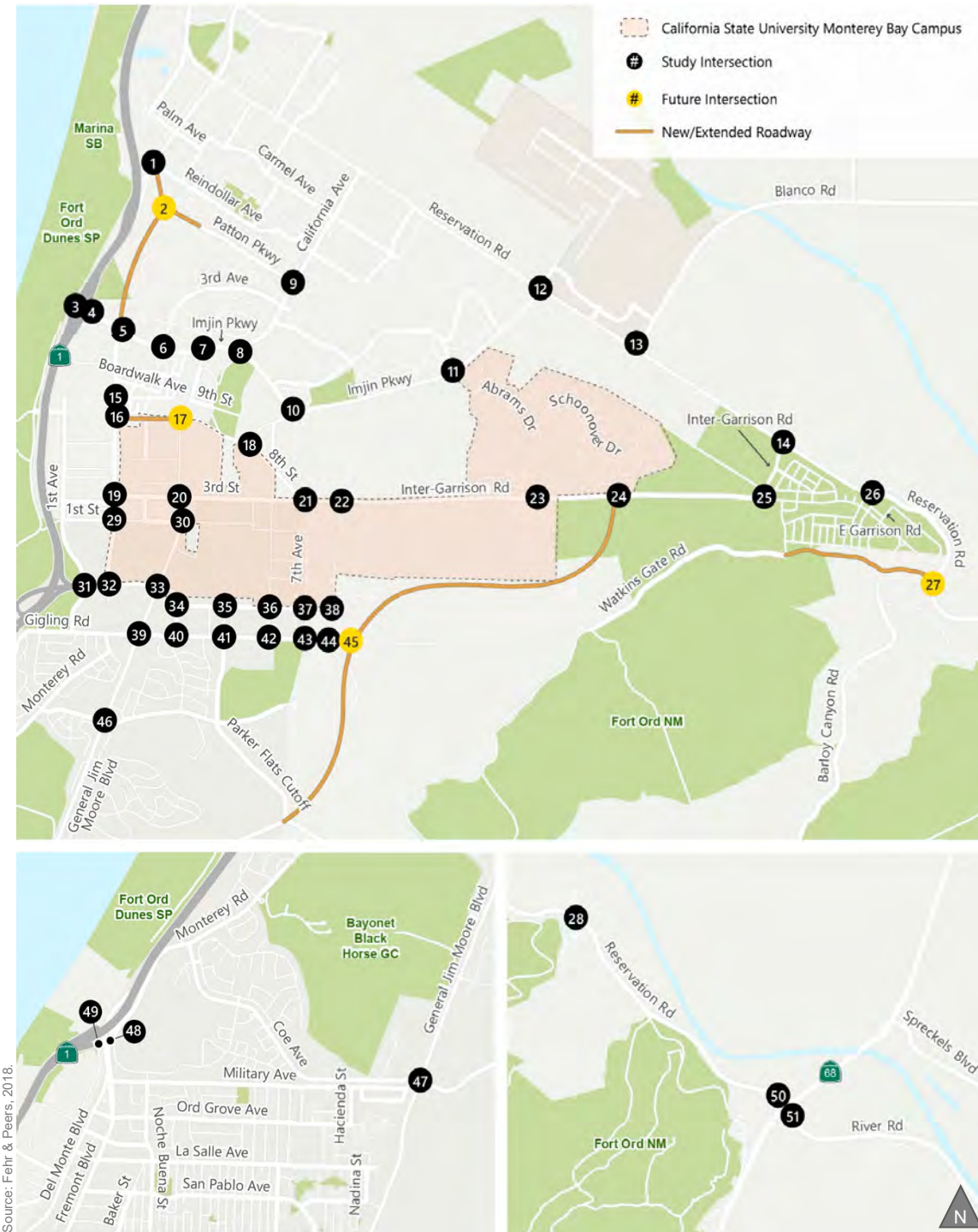

LEGEND

- AM (PM) Peak Hour Traffic Volume
- Lane Configuration
- Stop Sign Controlled
- Signalized
- Roundabout



Figure K-2C
Study Intersection Peak Hour Traffic Volumes and Lane Configurations
Cumulative without Project and without Eastside Parkway Conditions

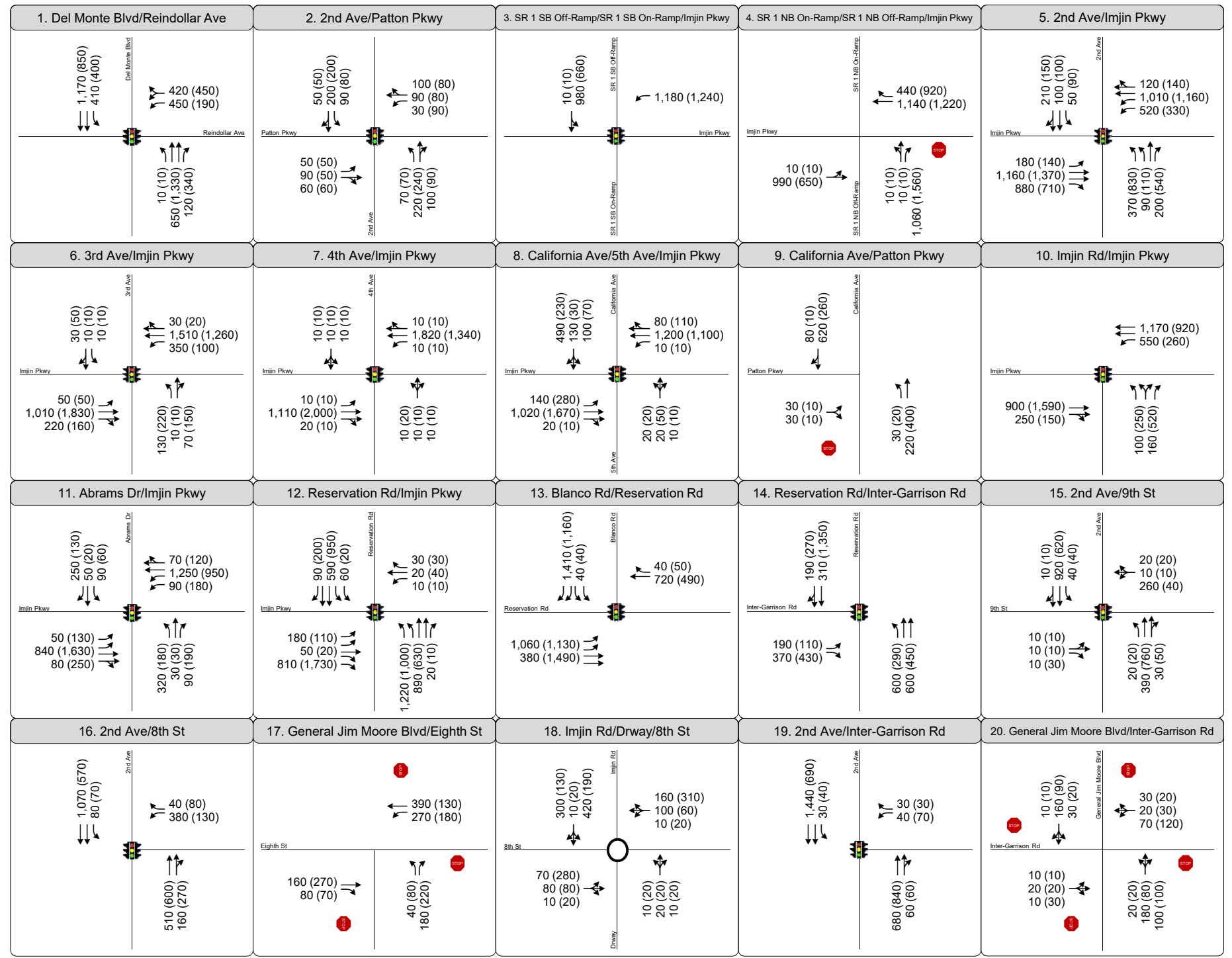
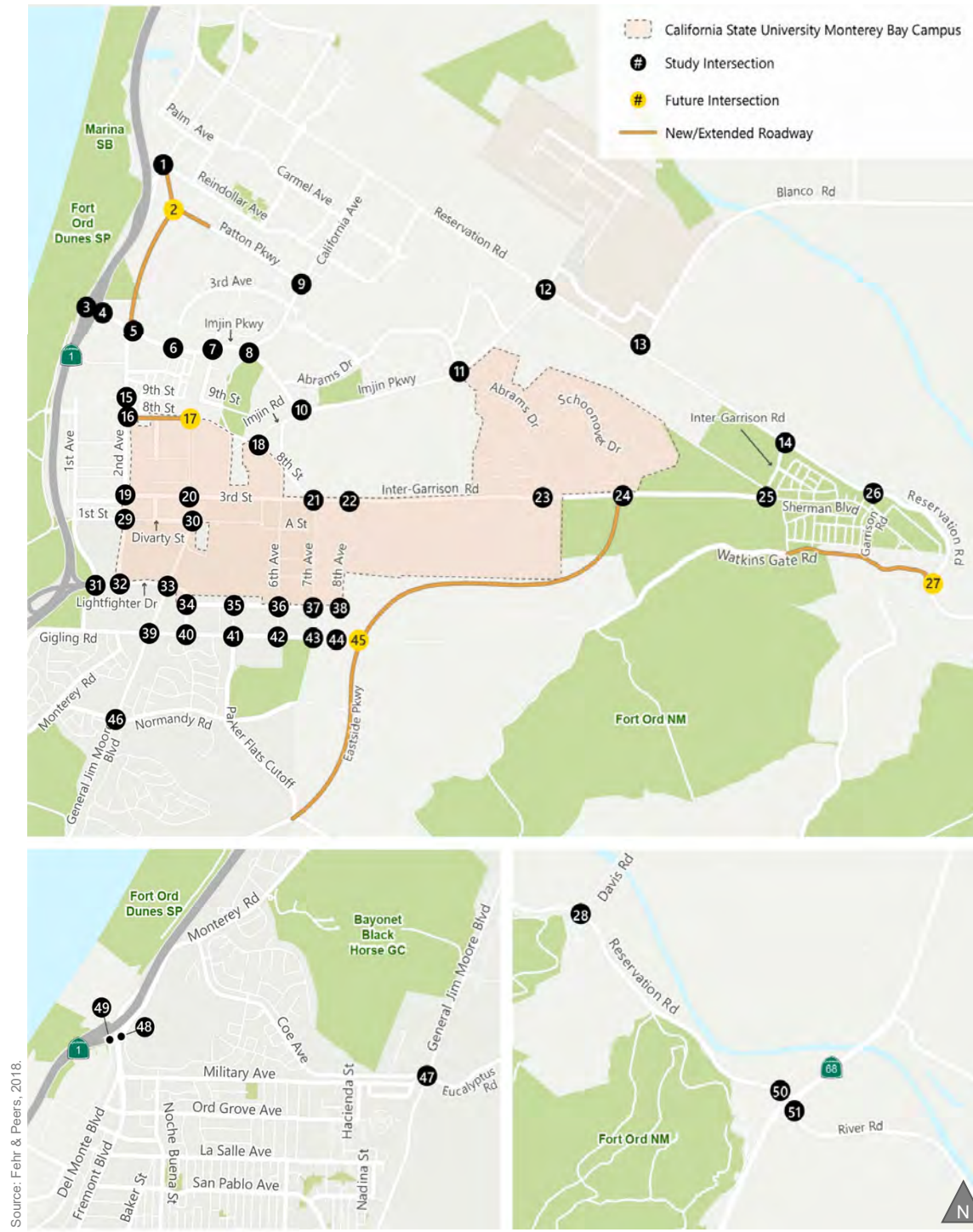

- LEGEND**
- AM (PM) Peak Hour Traffic Volume
 - Lane Configuration
 - Stop Sign Controlled
 - Signalized
 - Roundabout

Figure K-3a
Study Intersection Peak Hour Traffic Volumes and Lane Configurations
Cumulative with Project and without Eastside Parkway Conditions



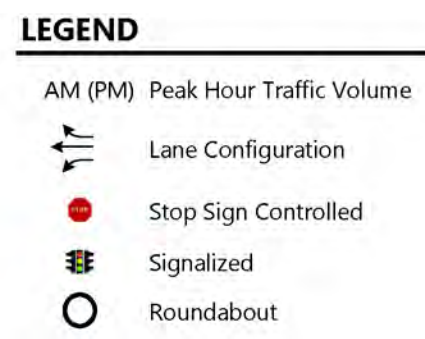
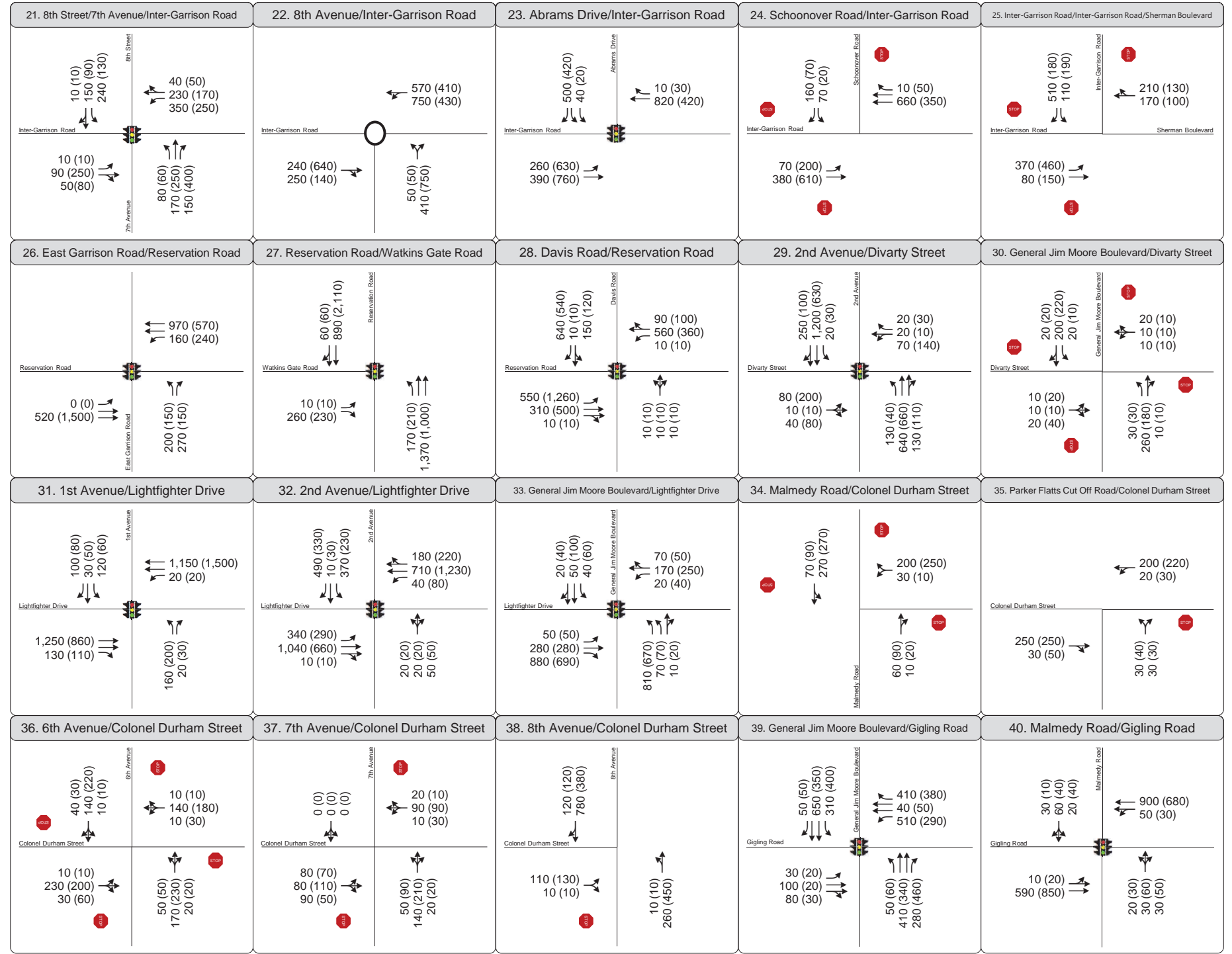
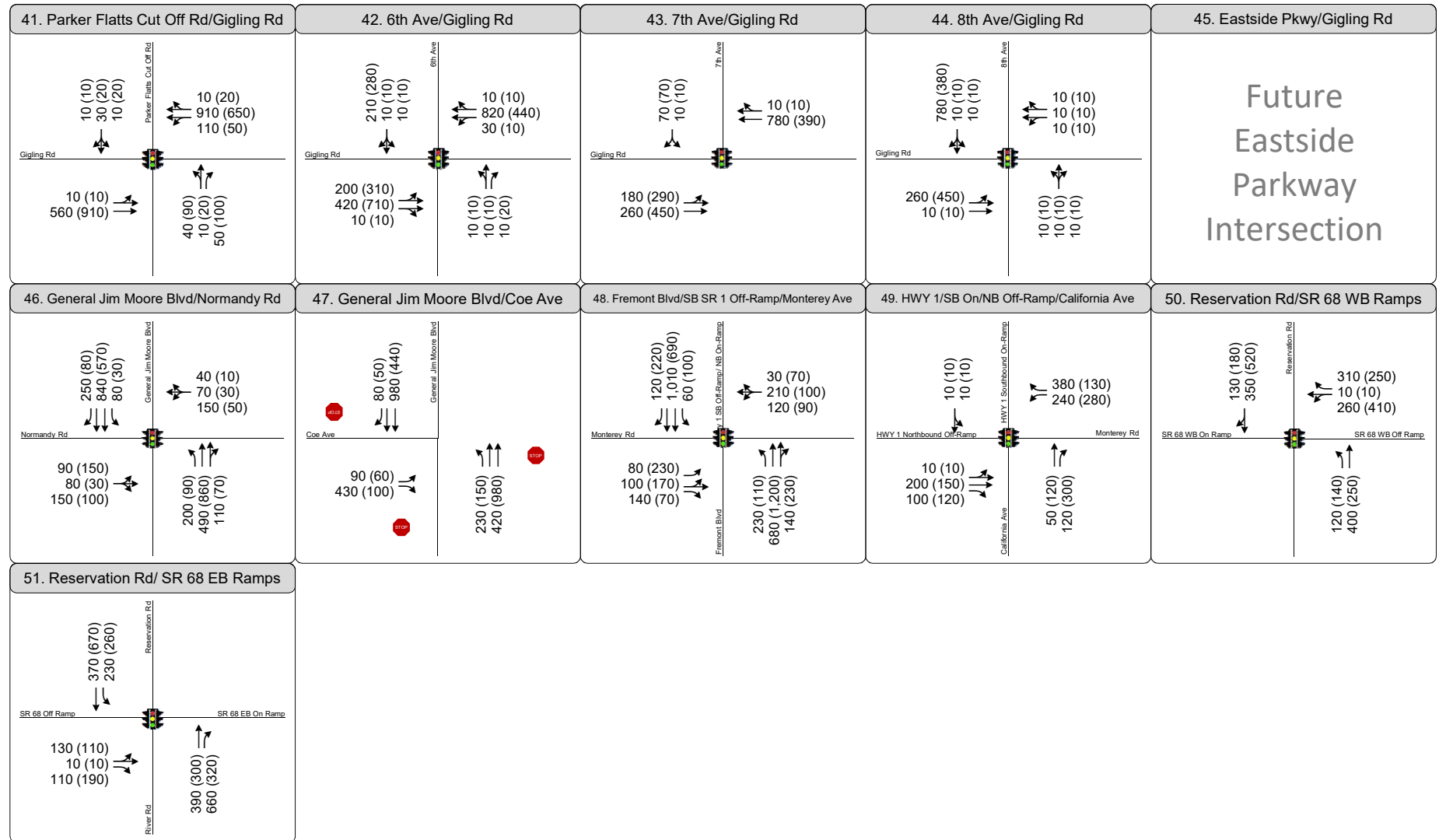
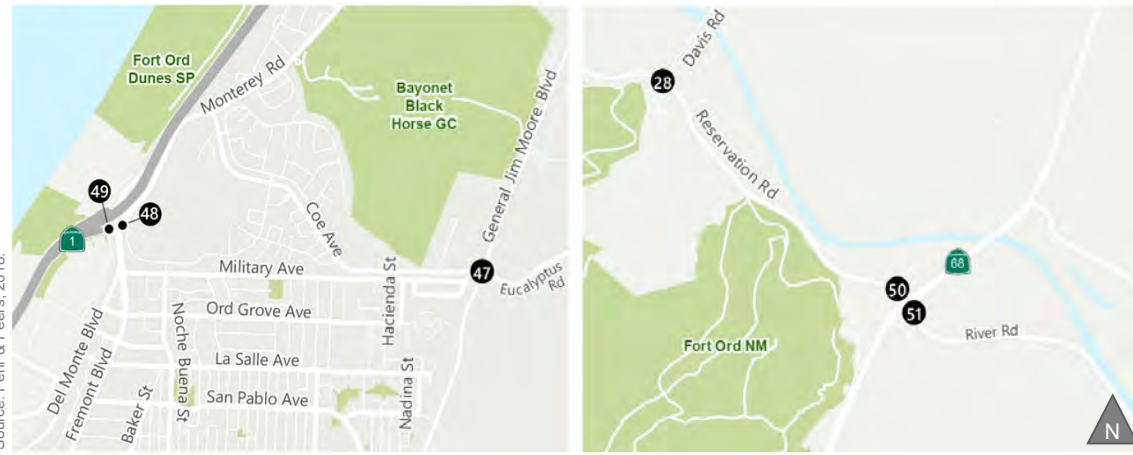
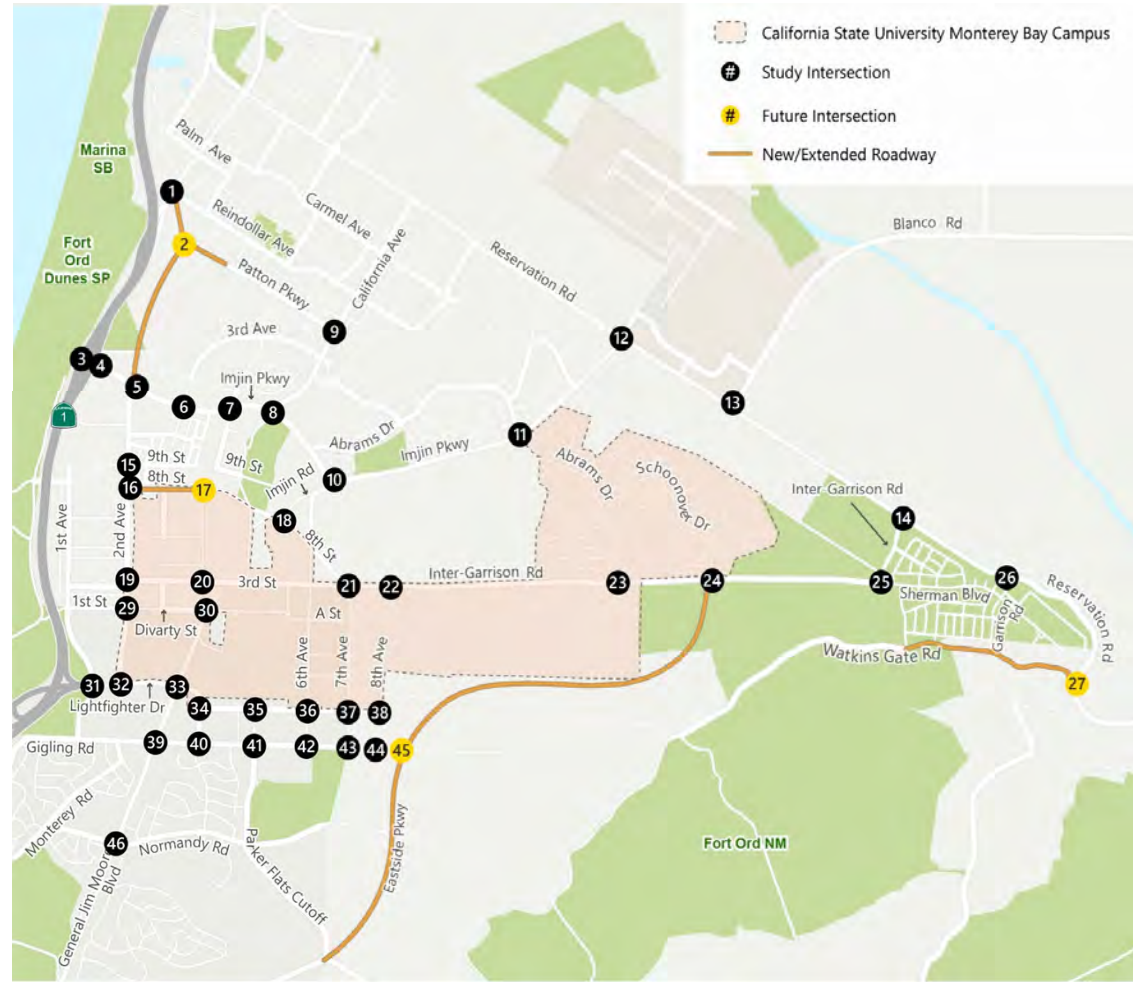

Figure K-3b
Study Intersection Peak Hour Traffic Volumes and Lane Configurations
Cumulative with Project and without East Parkway Conditions





LEGEND

AM (PM) Peak Hour Traffic Volume

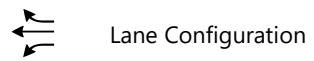

Source: Fehr & Peers, 2018.



Figure K-3c
Study Intersection Peak Hour Traffic Volumes and Lane Configurations
Cumulative with Project and without Eastside Parkway Conditions

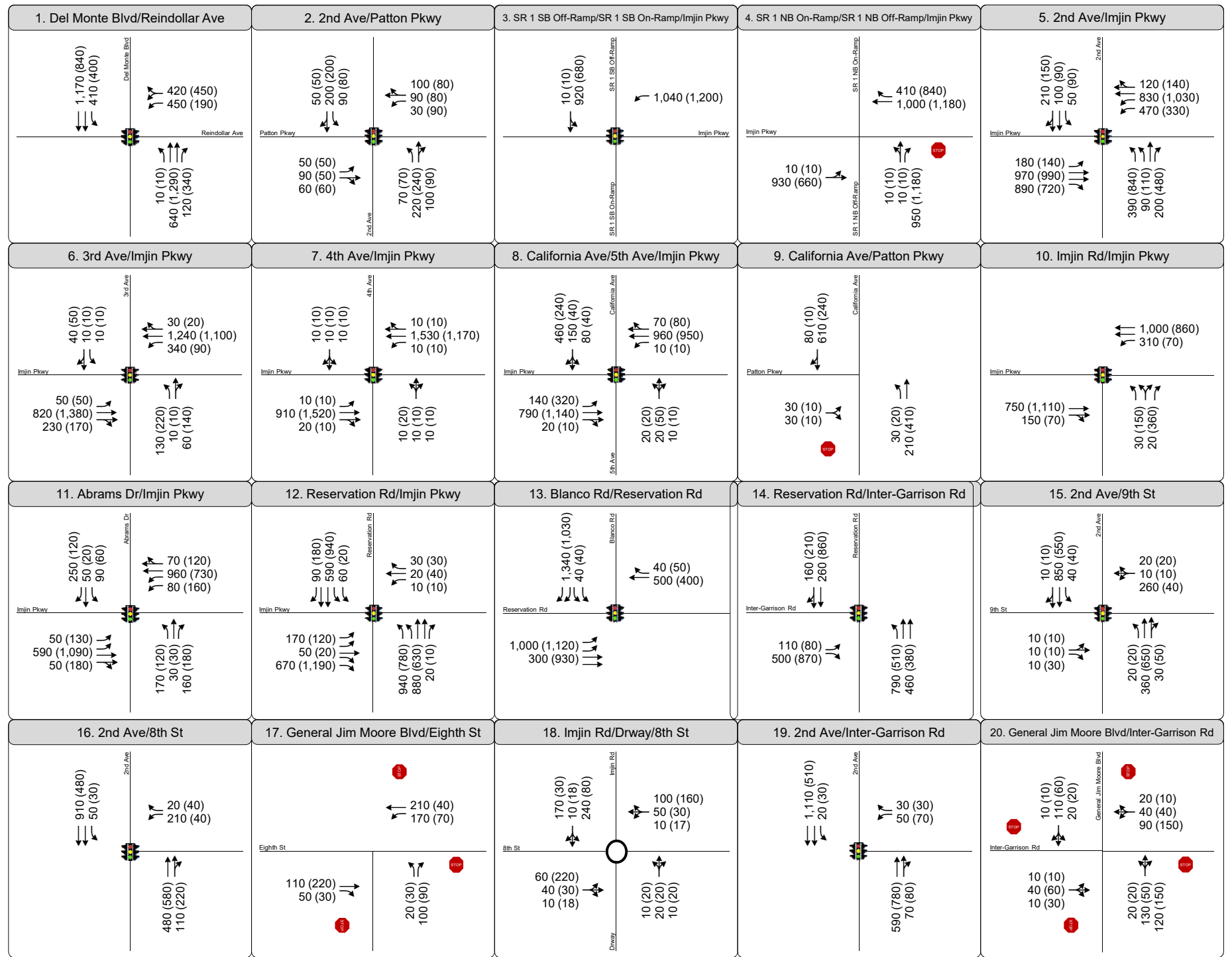
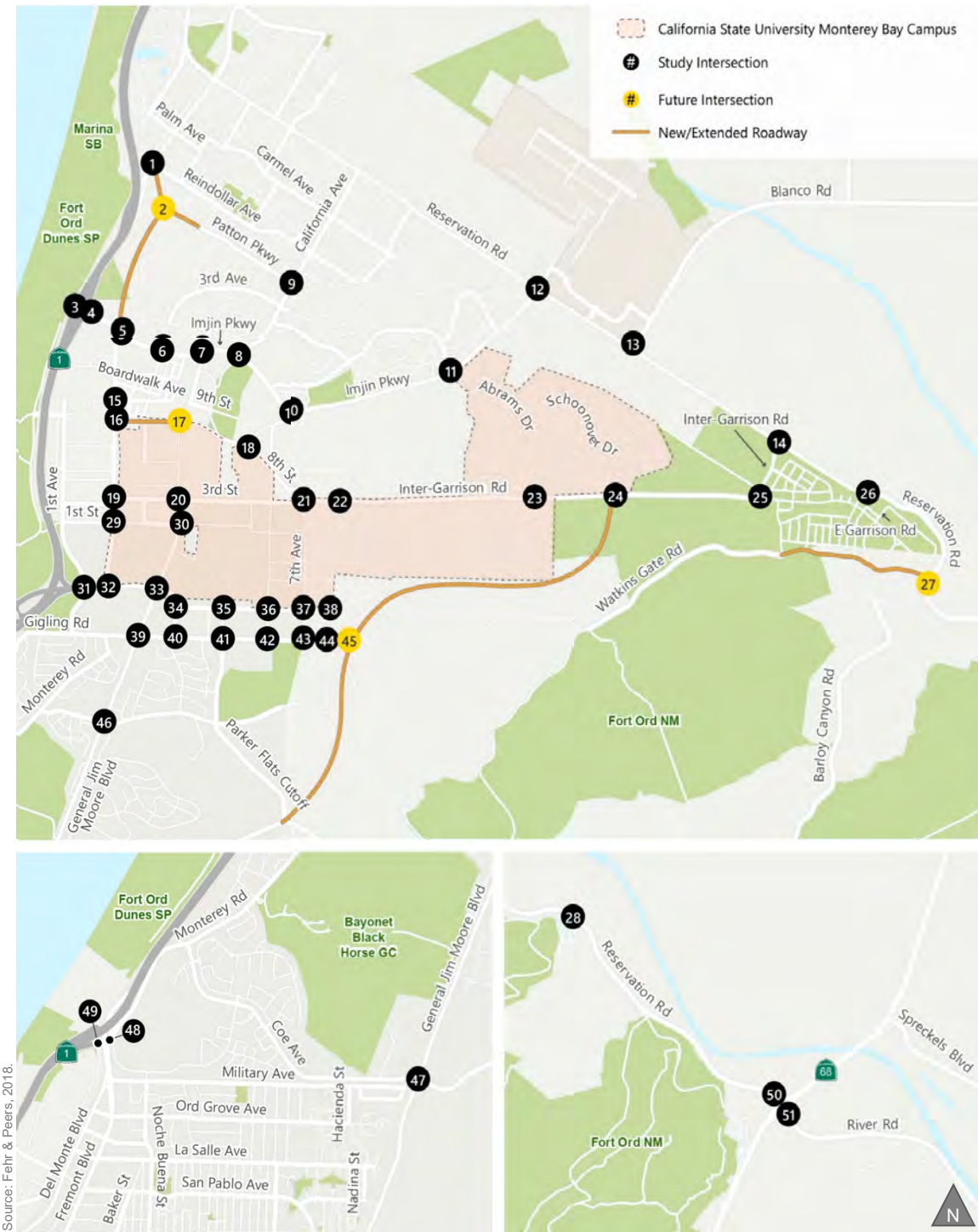

LEGEND

- AM (PM) Peak Hour Traffic Volume
- Lane Configuration
- Stop Sign Controlled
- Signalized
- Roundabout

Figure K-4a
Study Intersection Peak Hour Traffic Volumes and Lane Configurations
Cumulative without Project and with Eastside Parkway Conditions



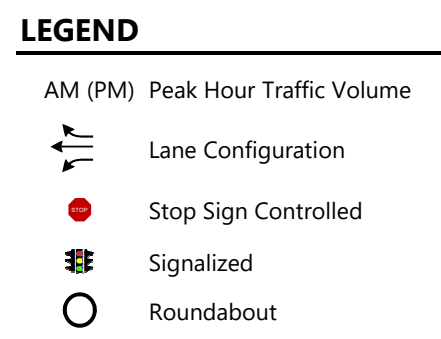
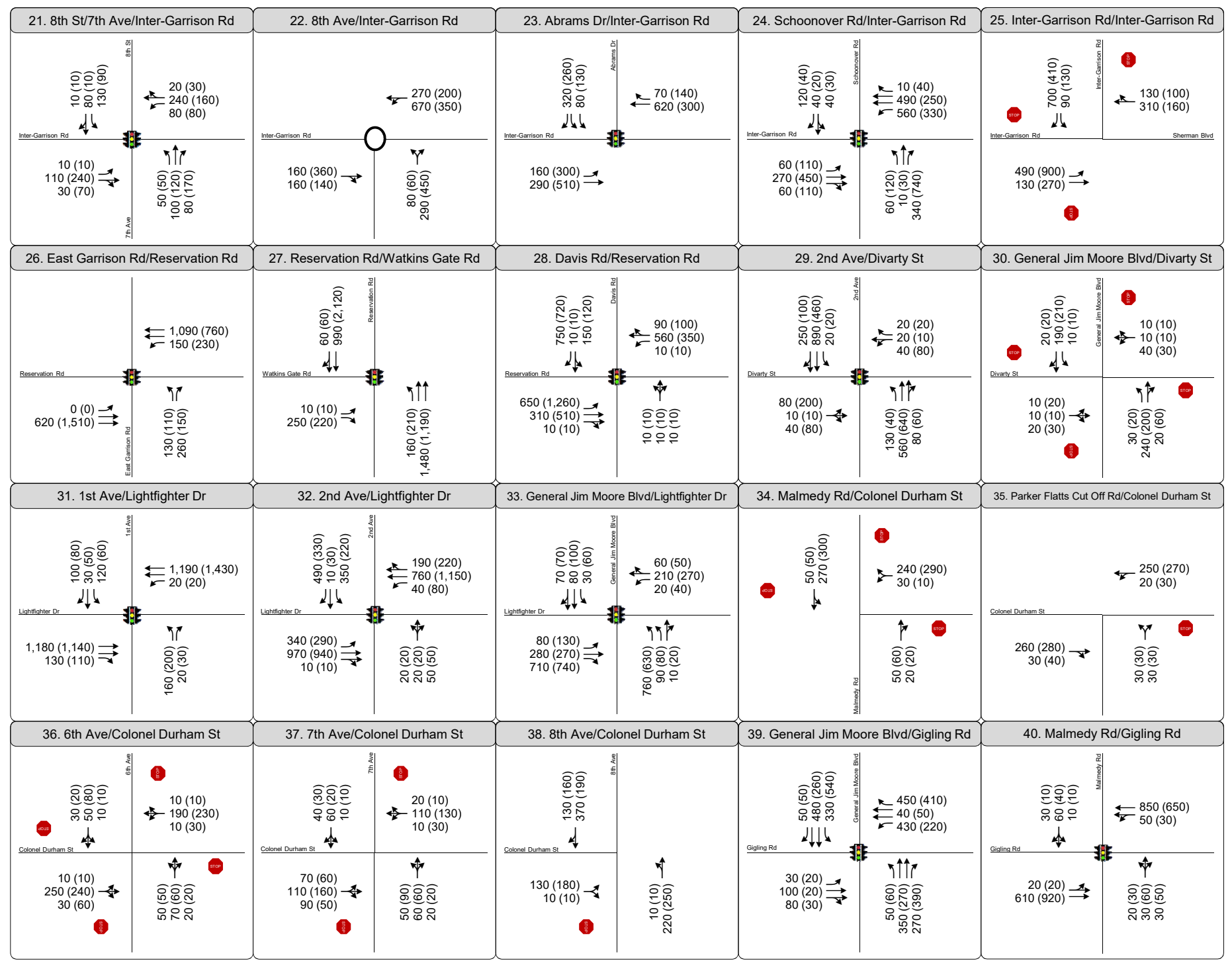
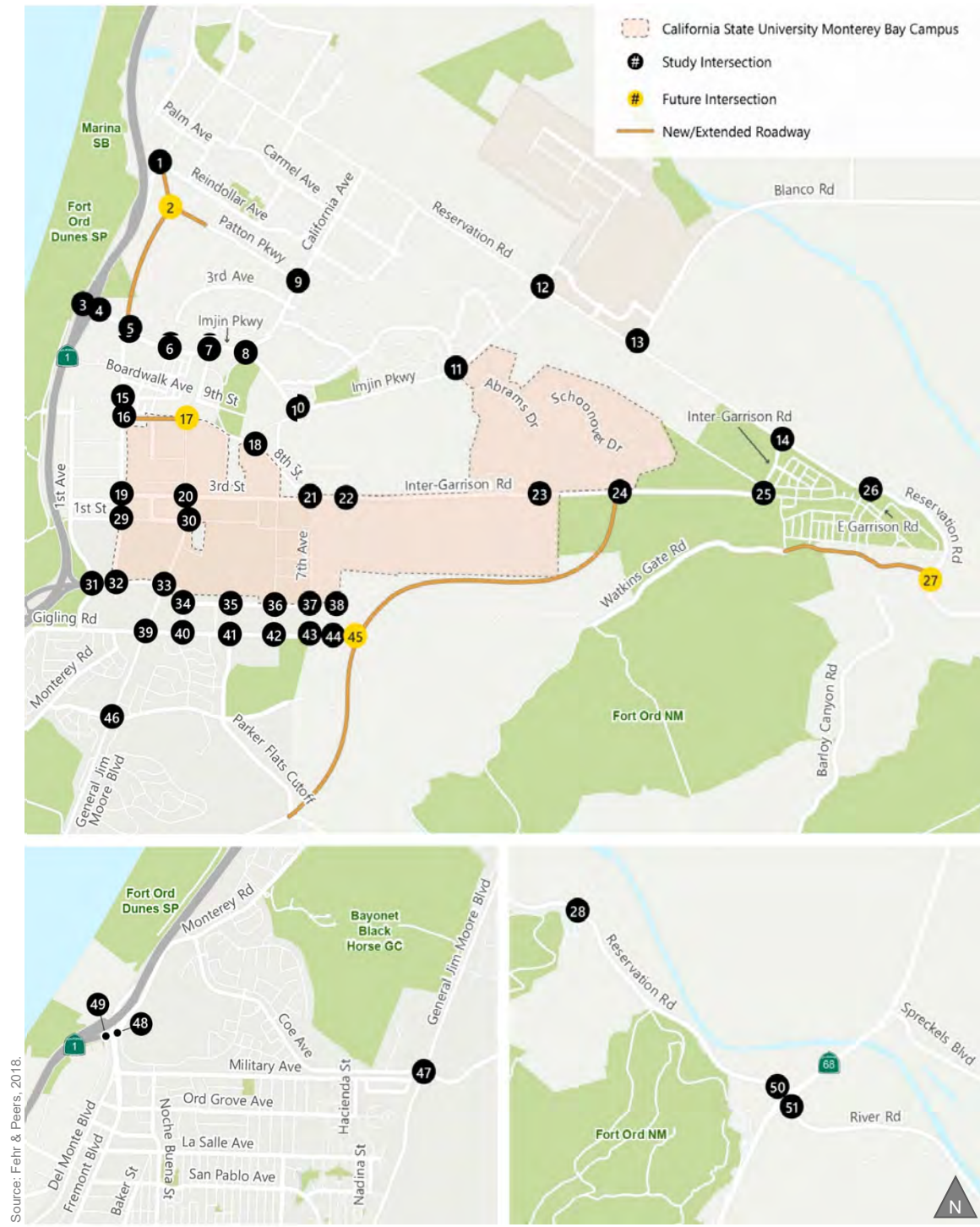
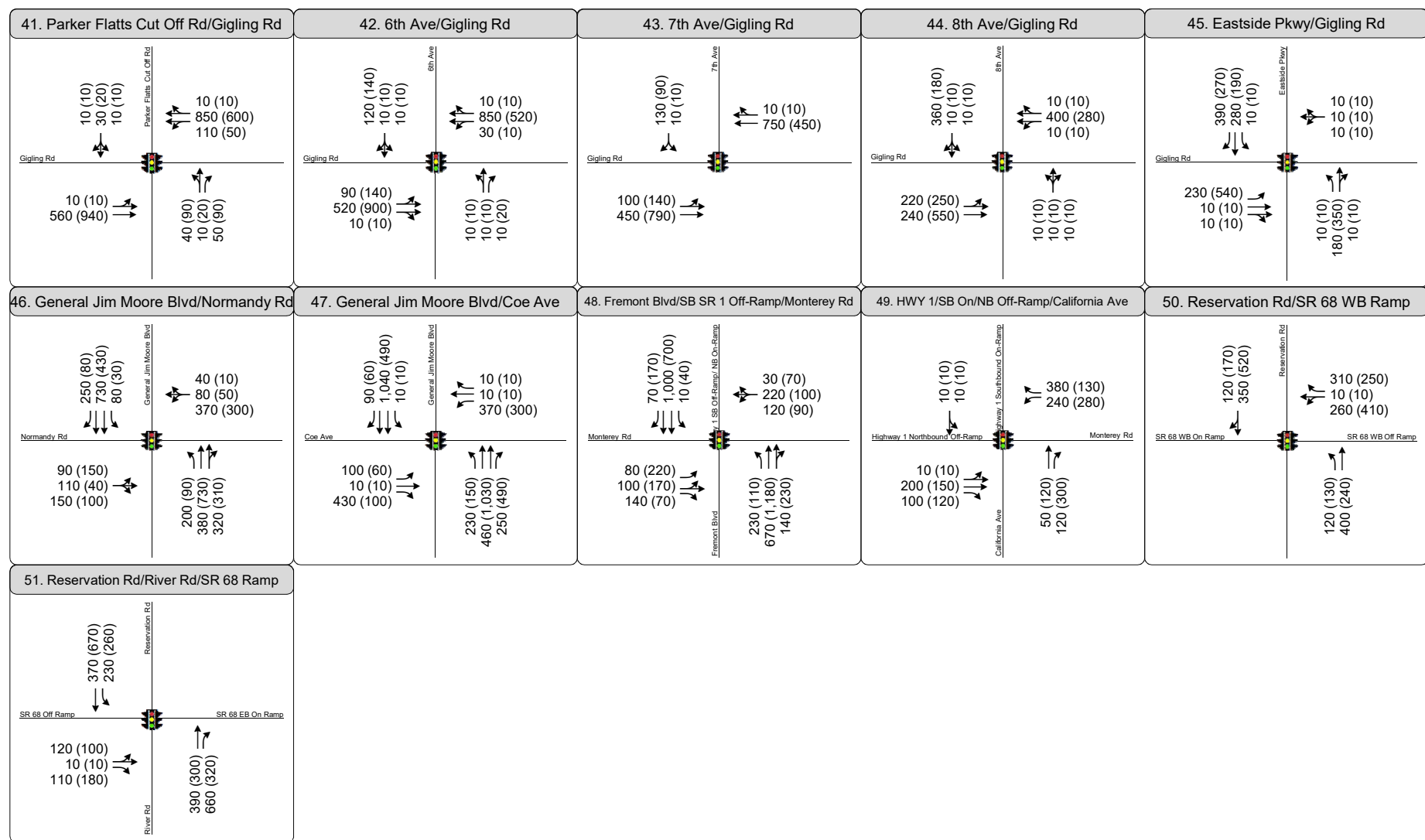
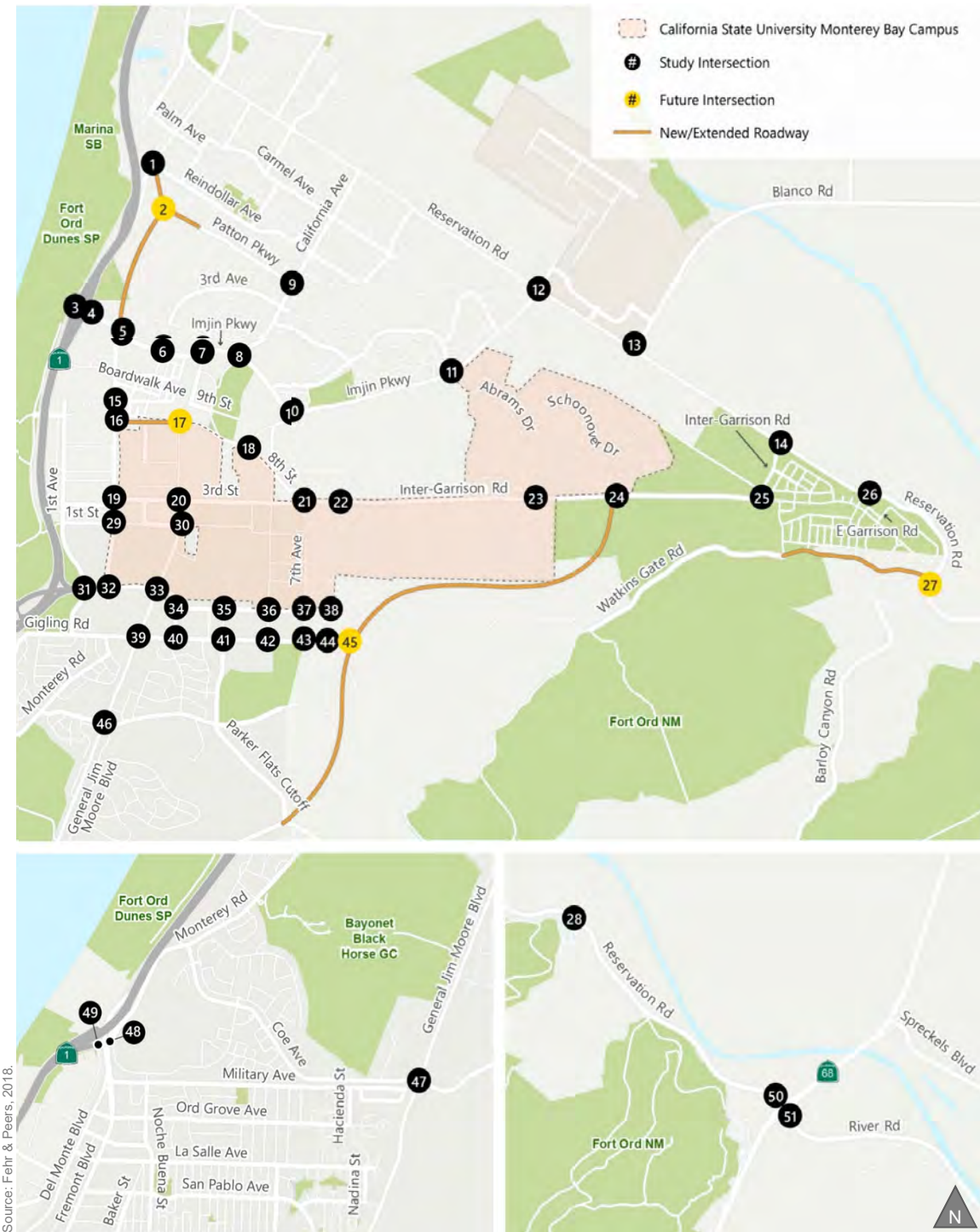

Figure K-4b
Study Intersection Peak Hour Traffic Volumes and Lane Configurations
Cumulative without Project and with Eastside Parkway Conditions





- LEGEND**
- AM (PM) Peak Hour Traffic Volume
 - Lane Configuration
 - Stop Sign Controlled
 - Signalized
 - Roundabout

Figure K-4c
Study Intersection Peak Hour Traffic Volumes and Lane Configurations
Cumulative without Project and with Eastside Parkway Conditions

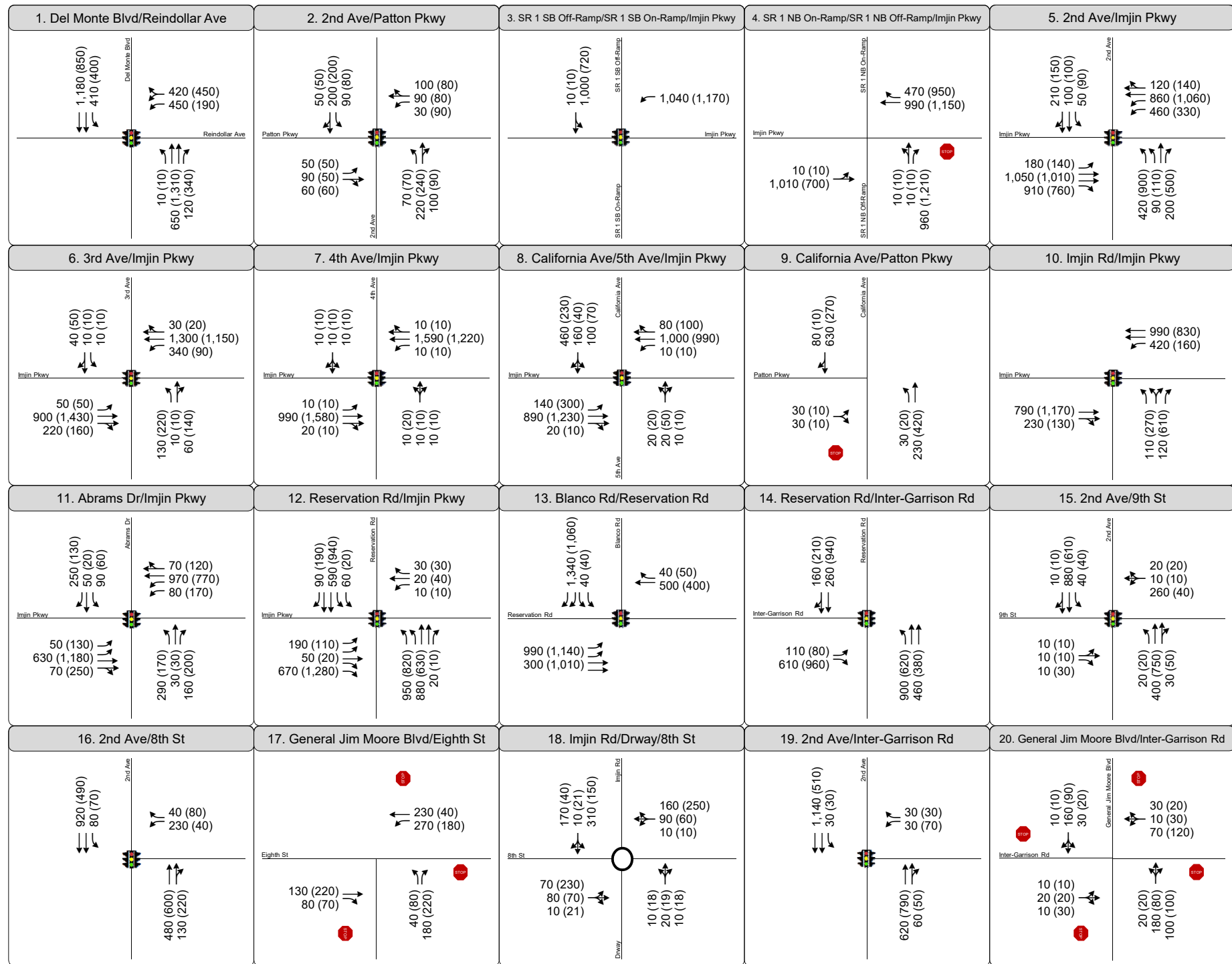
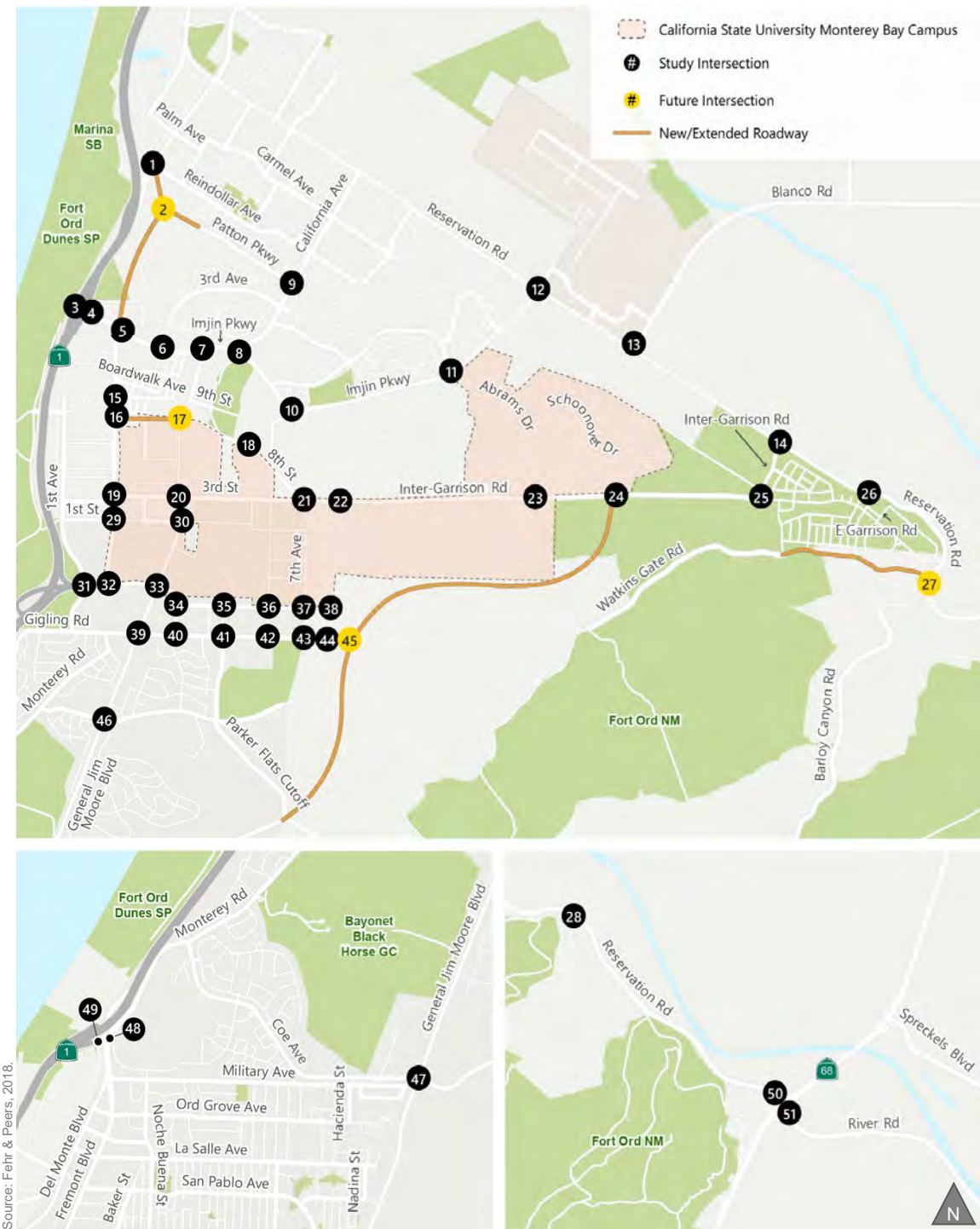

LEGEND

- AM (PM) Peak Hour Traffic Volume
- Lane Configuration
- Stop Sign Controlled
- Signalized
- Roundabout

Figure K-5a
Study Intersection Peak Hour Traffic Volumes and Lane Configurations
Cumulative with Project and with Eastside Parkway Conditions



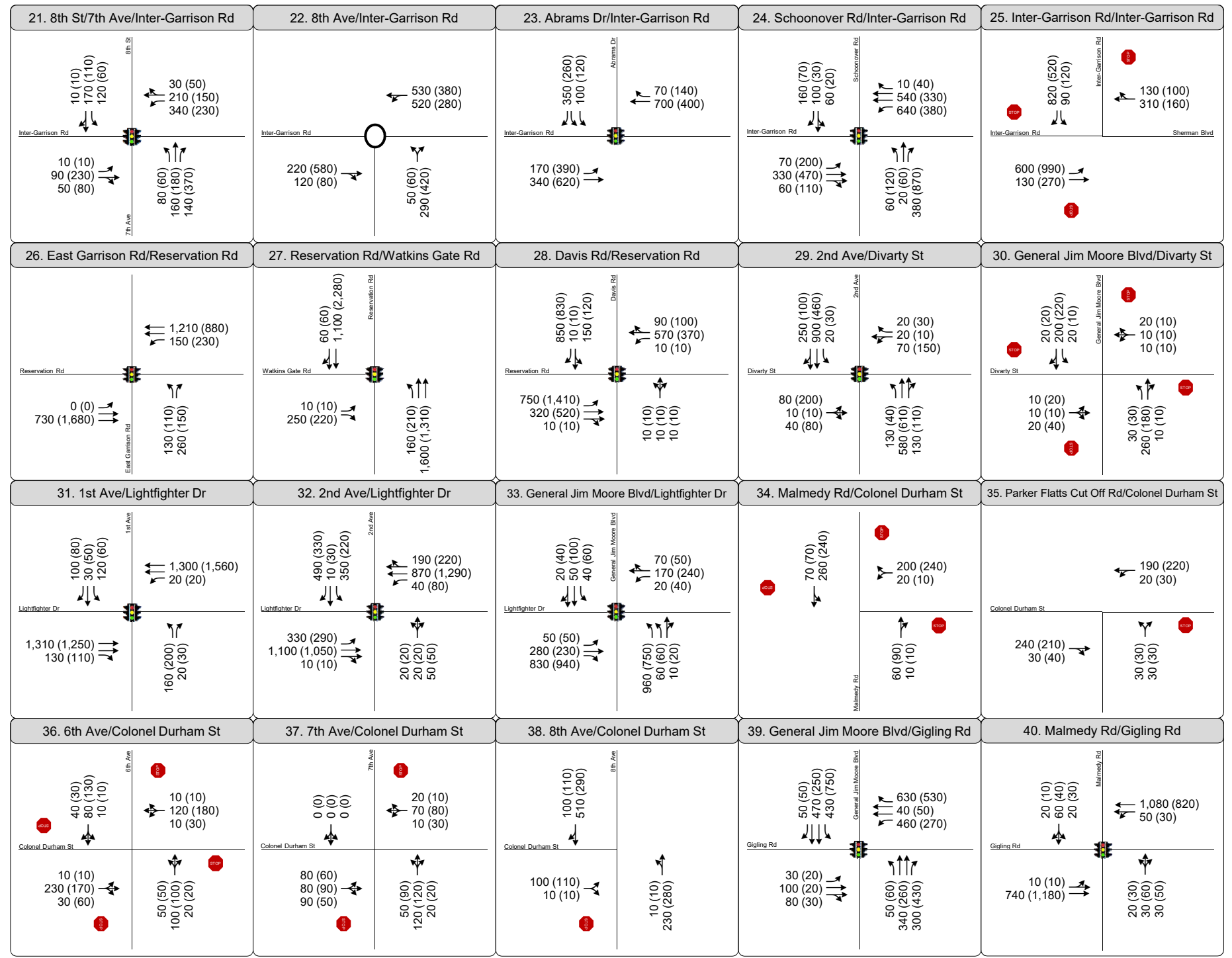
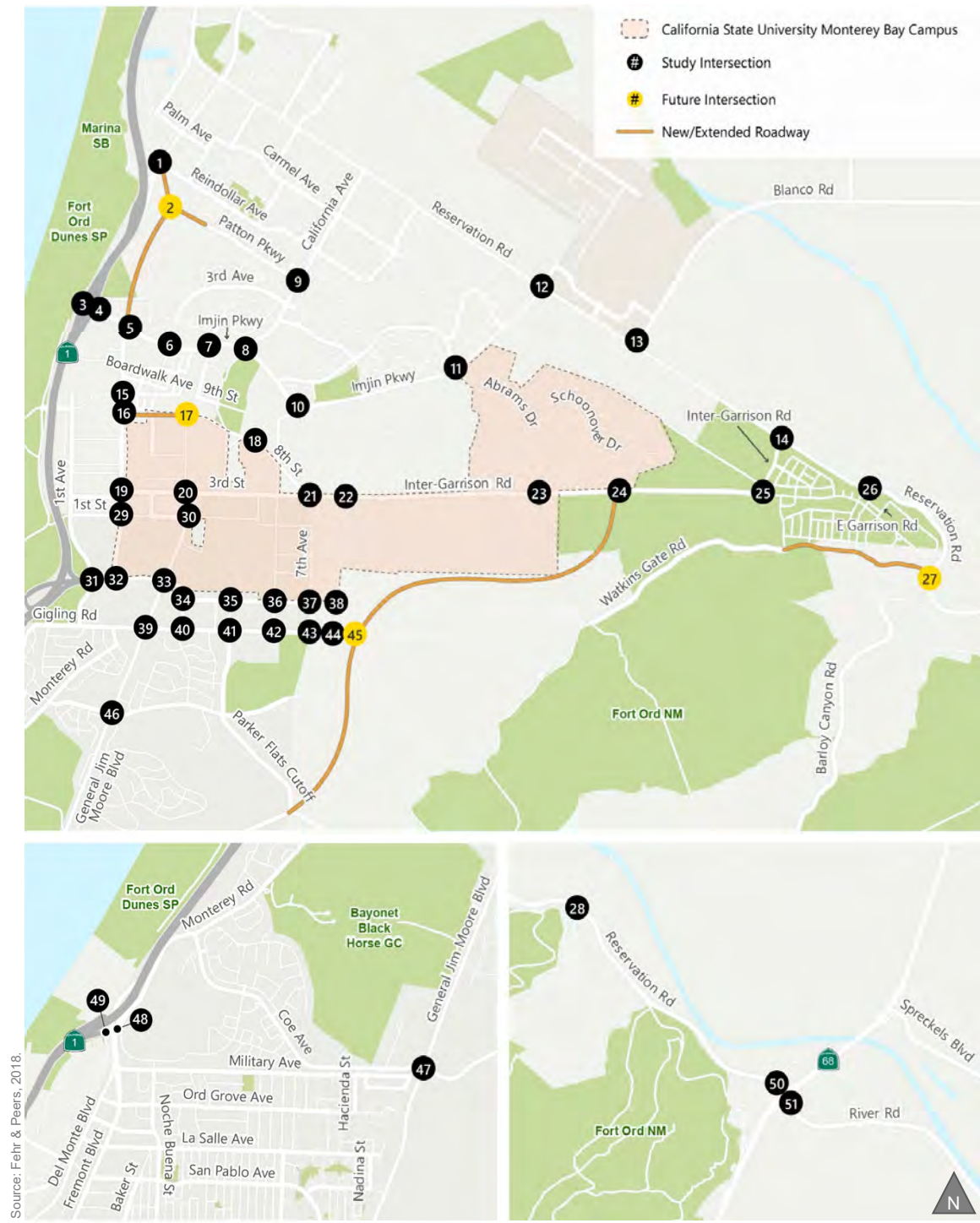

- LEGEND**
- AM (PM) Peak Hour Traffic Volume
 - Lane Configuration
 - Stop Sign Controlled
 - Signalized
 - Roundabout

Figure K-5b
Study Intersection Peak Hour Traffic Volumes and Lane Configurations
Cumulative with Project and with Eastside Parkway Conditions



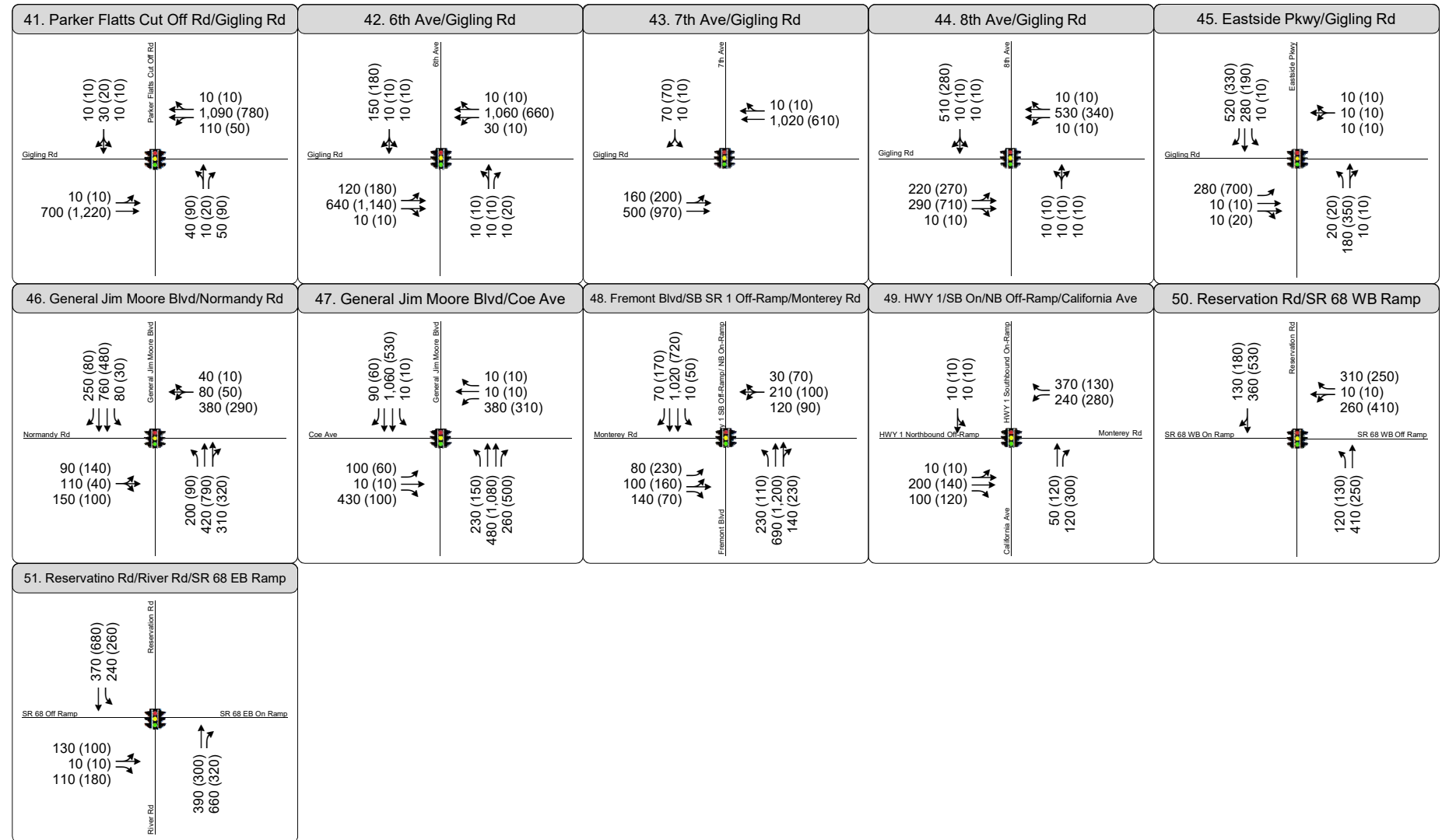
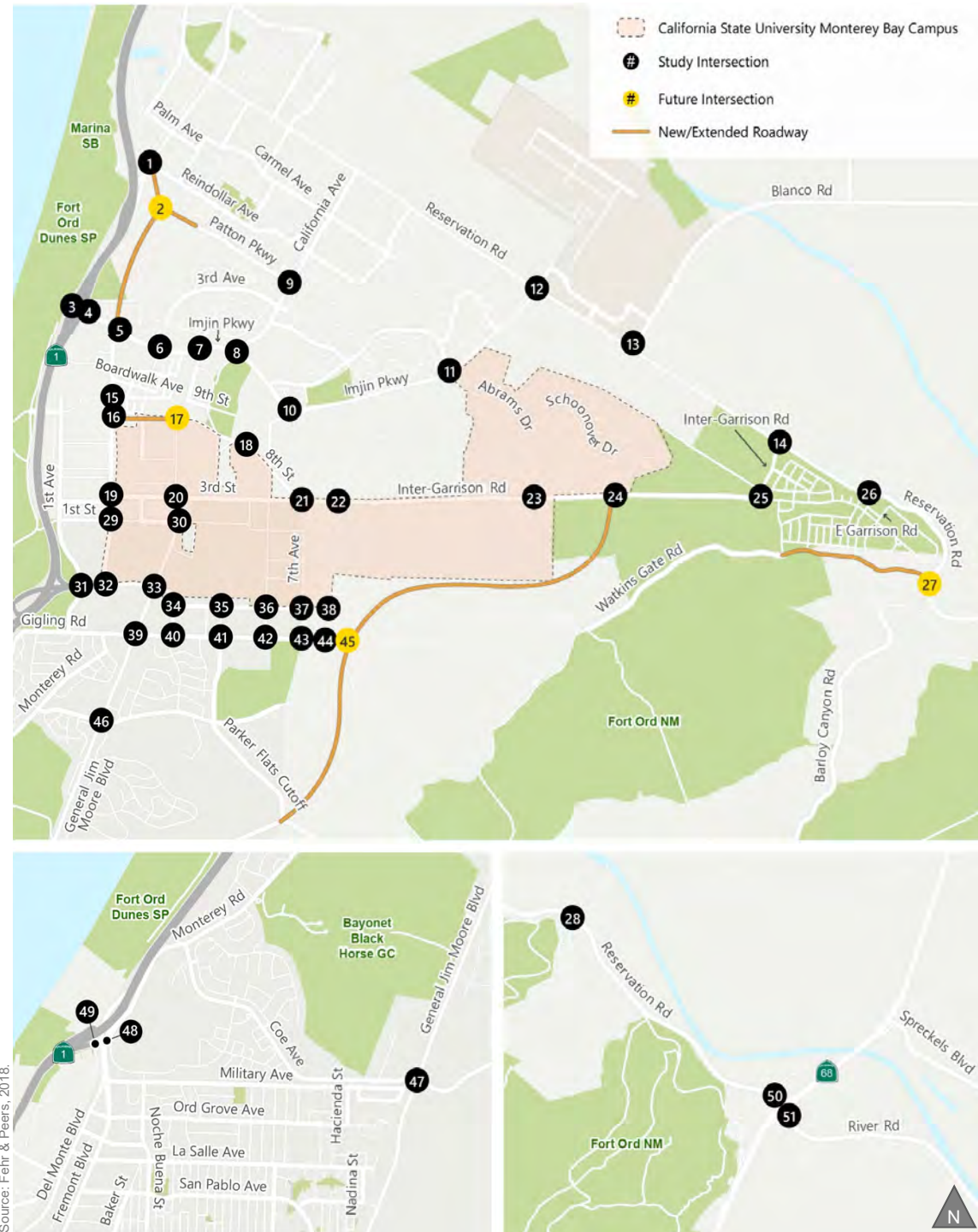

LEGEND

- AM (PM) Peak Hour Traffic Volume
- Lane Configuration
- Stop Sign Controlled
- Signalized
- Roundabout

Figure K-5c
Study Intersection Peak Hour Traffic Volumes and Lane Configurations
Cumulative with Project and with Eastside Parkway Conditions

APPENDIX L: INTERSECTION LEVEL OF SERVICE TABLES



EXISTING INTERSECTION LEVELS OF SERVICE

TABLE L-1: EXISTING INTERSECTION LEVEL OF SERVICE

#	Intersection	Count Date	Intersection Control ¹	Jurisdiction (LOS Standard) ²	Peak Hour ³	Delay ⁴	LOS ⁵
1	Del Monte Boulevard and Reindollar Avenue	4/25/2018	Signalized	M (D)	AM PM	11.6 8.9	B A
2	Second Avenue Extension and Patton Parkway	Future	Signalized	M (D)	AM PM	Future Intersection	
3	SR 1 Southbound Ramps and Imjin Parkway	5/3/2017	Signalized	M (D)	AM PM	36.6 17.2	D B
4	SR 1 Northbound Ramps and Imjin Parkway	5/3/2017	SSS	M (D)	AM PM	0.0 (0.1) 0.2 (26.7)	A (A) A (D)
5	Second Avenue and Imjin Parkway	4/27/2017	Signalized	M (D)	AM PM	12.5 16.3	B B
6	Third Avenue and Imjin Parkway	4/27/2017	SSS	M (D)	AM PM	3.7 (103.6) 1.3 (43.2)	A (F) A (E)
7	Fourth Avenue and Imjin Parkway	5/3/2017	SSS	M (D)	AM PM	0.4 (88.9) 1.4 (>120)	A (F) A (F)
8	California Avenue and Imjin Parkway	4/27/2017	Signalized	M (D)	AM PM	20.2 10.0	C A
9	California Avenue and Patton Parkway	4/25/2018	SSS	MC (D)	AM PM	1.4 (17.4) 0.4 (10.4)	A (C) A (B)
10	Imjin Road and Imjin Parkway	4/27/2017	Signalized	MC (D)	AM PM	7.4 7.6	A A
11	Abrams Drive and Imjin Parkway	4/27/2017	Signalized	M (D)	AM PM	14.5 17.4	B B
12	Reservation Road and Imjin Parkway	4/27/2017	Signalized	M (D)	AM PM	22.5 32.9	C C
13	Blanco Road and Reservation Road	4/25/2018	Signalized	M / CSUMB (D)	AM PM	13.1 11.0	B B
14	Inter-Garrison Road and Reservation Road	4/27/2017	Signalized	M (D)	AM PM	10.4 10.2	B B
15	Second Avenue and Ninth Street	4/27/2017	AWSC	M (D)	AM PM	21.9 11.4	C B
16	Second Avenue and Eighth Street	4/27/2017	AWSC	M/ CSUMB (D)	AM PM	56.3 12.8	F B
17	Fourth Avenue and Eighth Street	Future	AWSC	MC / M / CSUMB (D)	AM PM	Project Intersection	
18	Imjin Road and Eighth Street	4/27/2017	AWSC	CSUMB (D)	AM PM	17.9 9.3	C A
19	Second Avenue and Inter-Garrison Road	4/27/2017	AWSC	MC / CSUMB (D)	AM PM	26.5 9.8	D A

TABLE L-1: EXISTING INTERSECTION LEVEL OF SERVICE

#	Intersection	Count Date	Intersection Control ¹	Jurisdiction (LOS Standard) ²	Peak Hour ³	Delay ⁴	LOS ⁵
20	General Jim Moore Boulevard and Inter-Garrison Road	4/25/2018	AWSC	MC (D)	AM PM	8.5 9.9	A A
21	Eighth Street/Seventh Avenue and Inter-Garrison Road	4/25/2018	AWSC	MC (D)	AM PM	12.9 8.9	B A
22	Eighth Avenue and Inter-Garrison Road	4/25/2018	Roundabout	MC (D)	AM PM	32.1 8.6	D A
23	Abrams Drive and Inter-Garrison Road	4/27/2017	AWSC	MC (D)	AM PM	60.3 12.8	F B
24	Schoonover Road and Inter-Garrison Road	4/27/2017	AWSC	MC (D)	AM PM	20.8 11.1	C B
25	Inter-Garrison Road Connection and Inter-Garrison Road	4/27/2017	AWSC	M / CSUMB (D)	AM PM	11.8 11.1	B B
26	East Garrison Road and Reservation Road	4/25/2018	Signalized	M / CSUMB (D)	AM PM	5.0 5.6	A A
27	Reservation Road and Watkins Gate Road	Future	Signalized	S (C)	AM PM	Future Intersection	
28	Davis Road and Reservation Road	4/25/2018	Signalized	S (C)	AM PM	18.2 15.9	B B
29	Second Avenue and Divarty Street	4/27/2017	AWSC	S (C)	AM PM	31.1 9.4	D A
30	General Jim Moore Boulevard and Divarty Street	4/27/2017	AWSC	S (C)	AM PM	9.1 10.2	A B
31	First Avenue and Lightfighter Drive	4/27/2017	Signalized	S (C)	AM PM	4.0 3.4	A A
32	Second Avenue and Lightfighter Drive	4/27/2017	Signalized	S (C)	AM PM	18.3 14.2	B B
33	General Jim Moore Boulevard and Lightfighter Drive	4/27/2017	Signalized	S (C)	AM PM	20.0 22.6	B C
34	Malmedy Road and Colonel Durham Street	4/25/2018	AWSC	MC (D)	AM PM	9.9 8.3	A A
35	Parker Flatts Cut Off Road and Colonel Durham Street	4/25/2018	SSS	S (C)	AM PM	0.4 (10.9) 1.1 (10.1)	A (B) A (B)
36	Sixth Avenue and Colonel Durham Street	4/25/2018	AWSC	S (C)	AM PM	8.9 7.8	A A
37	Seventh Avenue and Colonel Durham Street	4/25/2018	SSS	S (C)	AM PM	6.6 (12.3) 7.0 (10.5)	A (B) A (B)
38	Eighth Avenue and Colonel Durham Street	4/25/2018	SSS	S (C)	AM PM	0.6 (14.5) 2.0 (13.9)	A (B) A (B)
39	General Jim Moore Boulevard and Gigling Road	4/27/2017	Signalized	S (C)	AM PM	25.9 14.8	C B
40	Malmedy Road and Gigling Road	4/25/2018	SSS	MC (D)	AM PM	3.7 (24.9) 2.0 (18.0)	A (C) A (C)

TABLE L-1: EXISTING INTERSECTION LEVEL OF SERVICE

#	Intersection	Count Date	Intersection Control ¹	Jurisdiction (LOS Standard) ²	Peak Hour ³	Delay ⁴	LOS ⁵
41	Parker Flatts Cut Off Road and Gigling Road	4/25/2018	SSS	MC (D)	AM PM	2.0 (23.6) 2.8 (17.6)	A (C) A (C)
42	Sixth Avenue and Gigling Road	4/25/2018	AWSC	S (C)	AM PM	13.3 10.2	B B
43	Seventh Avenue and Gigling Road	4/25/2018	SSS	S (C)	AM PM	2.1 (12.7) 0.9 (9.0)	A (B) A (A)
44	Eighth Avenue and Gigling Road	4/25/2018	AWSC	Cal / Sand City (C)	AM PM	9.9 10.3	A B
45	Eastside Parkway and Gigling Road	Future	AWSC	Cal / S (C)	AM PM	Future Intersection	
46	General Jim Moore Boulevard and Normandy Road	4/25/2018	Signalized	Cal / MC (C)	AM PM	22.0 9.9	C A
47	General Jim Moore Boulevard and Coe Avenue	4/25/2018	AWSC	Cal / MC (C)	AM PM	92.2 18.4	F C
48	Fremont Boulevard - Southbound SR 1 Off-Ramp and Monterey Road	4/25/2018	Signalized	M (D)	AM PM	65.8 50.5	E D
49	California Avenue and Monterey Road - Northbound SR 1 Off-Ramp	4/25/2018	Signalized	M (D)	AM PM	12.1 24.5	B C
50	Reservation Road and State Route 68 Westbound Ramps	4/25/2018	Signalized	M (D)	AM PM	13.6 33.0	B C
51	Reservation Road and State Route 68 Eastbound Ramps	4/25/2018	Signalized	M (D)	AM PM	11.4 12.2	B B

Notes: **Bold text** indicates intersection operates at unacceptable level of service.

1. SSS = Side Street Stop Controlled, AWSC = All Way Stop Controlled, Signalized = Signalized intersection
2. Intersection jurisdiction and associated LOS threshold applied.
 - i. City of Marina = M
 - ii. City of Seaside = S
 - iii. California State University Monterey Bay = CSUMB
 - iv. Monterey County = MC
 - v. Caltrans = Cal
3. AM = morning peak hour, PM = evening peak hour.
4. Whole intersection weighted average control delay expressed in seconds per vehicle calculated using methods described in the 2010 *Highway Capacity Manual* for signalized intersections and all-way stop-controlled intersections. For side-street stop-controlled intersections, average control delay and total delay for the worst movement are reported as "average control delay (worst movement total delay)."
5. LOS = Level of Service. LOS calculations conducted using the Synchro 10 analysis software packages, which apply the methods described in the 2010 *Highway Capacity Manual*. For side-street stop-controlled intersections, average control LOS and total LOS for the worst movement are reported as "average control LOS (worst movement total LOS)."

Source: Fehr & Peers, June 2019.

EXISTING WITH PROJECT INTERSECTION LEVELS OF SERVICE

The results of the LOS calculations indicate many of the study intersections will operate at levels of service meeting the applicable local jurisdiction’s LOS threshold under Existing with Project Conditions.

Intersections that exceed the applicable LOS thresholds are:

- Int 3. SR 1 Southbound Ramps and Imjin Parkway (AM peak hour)
- Int 4. SR 1 Northbound Ramps and Imjin Parkway (AM and PM peak hour)
- Int 6. Third Avenue and Imjin Parkway (AM peak hour)
- Int 7. Fourth Avenue and Imjin Parkway (AM and PM peak hour)
- Int 15. Second Avenue and Ninth Street (AM peak hour)
- Int 16. Second Avenue and Eighth Street (AM peak hour)
- Int 18. Imjin Road and Eighth Street (AM peak hour)
- Int 19. Second Avenue and Inter-Garrison Road (AM peak hour)
- Int 21. Eighth Street/Seventh Avenue and Inter-Garrison Road (AM and PM peak hour)
- Int 22. Eighth Avenue and Inter-Garrison Road (AM and PM peak hour)
- Int 23. Abrams Drive and Inter-Garrison Road (AM and PM peak hour)
- Int 24. Schoonover Road and Inter-Garrison Road (AM peak hour)
- Int 29. Second Avenue and Divarty Street (AM and PM peak hour)
- Int 40. Malmedy Road and Gigling Road (AM and PM peak hour)
- Int 41. Parker Flatts Cut Off Road and Gigling Road (AM and PM peak hour)
- Int 42. Sixth Avenue and Gigling Road (AM and PM peak hour)
- Int 44. Eighth Avenue and Gigling Road (AM peak hour)
- Int 47. General Jim Moore Boulevard and Coe Avenue (AM peak hour)
- Int 48. Fremont Boulevard - Southbound SR 1 Off-Ramp and Monterey Road (AM peak hour)

TABLE L-2: EXISTING INTERSECTION LEVEL OF SERVICE WITH AND WITHOUT PROJECT

#	Intersection	Intersect- ion Control ¹	Jurisdiction (LOS Standard) ²	Peak Hour ³	Existing		Existing with Project	
					Delay ⁴	LOS ⁵	Delay ⁴	LOS ⁵
1	Del Monte Boulevard and Reindollar Avenue	Signalized	M (D)	AM PM	11.6 8.9	B A	11.9 9.0	B A
2	Second Avenue Extension and Patton Parkway	Signalized	M (D)	AM PM		Future Intersection		
3	SR 1 Southbound Ramps and Imjin Parkway	Signalized	M (D)	AM PM	36.6 17.2	D B	61.3 19.6	E B
4	SR 1 Northbound Ramps and Imjin Parkway	SSS	M (D)	AM PM	0.0 (0.1) 0.2 (26.7)	A (A) A (D)	0.6 (37.0) 0.5 (29.3)	A (E) A (D)
5	Second Avenue and Imjin Parkway	Signalized	M (D)	AM PM	12.5 16.3	B B	13.0 17.3	B B

TABLE L-2: EXISTING INTERSECTION LEVEL OF SERVICE WITH AND WITHOUT PROJECT

#	Intersection	Intersect- ion Control ¹	Jurisdiction (LOS Standard) ²	Peak Hour ³	Existing		Existing with Project	
					Delay ⁴	LOS ⁵	Delay ⁴	LOS ⁵
6	Third Avenue and Imjin Parkway	SSS	M (D)	AM PM	3.7 (103.6) 1.3 (43.2)	A (F) A (E)	1.4 (2) 7.1 (>120)	A (A) A (F)
7	Fourth Avenue and Imjin Parkway	SSS	M (D)	AM PM	0.4 (88.9) 1.4 (>120)	A (F) A (F)	17.3 (>120) 13.1 (>120)	C (F) B (F)
8	California Avenue and Imjin Parkway	Signalized	M (D)	AM PM	20.2 10.0	C A	26.1 11.5	C B
9	California Avenue and Patton Parkway	SSS	MC (D)	AM PM	1.4 (17.4) 0.4 (10.4)	A (C) A (B)	1.4 (18.6) 0.6 (12.5)	A (C) A (B)
10	Imjin Road and Imjin Parkway	Signalized	MC (D)	AM PM	7.4 7.6	A A	12.1 12.7	B B
11	Abrams Drive and Imjin Parkway	Signalized	M (D)	AM PM	14.5 17.4	B B	33.6 28.1	C C
12	Reservation Road and Imjin Parkway	Signalized	M (D)	AM PM	22.5 32.9	C C	22.5 40.1	C D
13	Blanco Road and Reservation Road	Signalized	M / CSUMB (D)	AM PM	13.1 11.0	B B	13.1 11.0	B B
14	Inter-Garrison Road and Reservation Road	Signalized	M (D)	AM PM	10.4 10.2	B B	14.6 13.8	B B
15	Second Avenue and Ninth Street	AWSC	M (D)	AM PM	21.9 11.4	C B	39.4 14.3	E B
16	Second Avenue and Eighth Street	AWSC	M/ CSUMB (D)	AM PM	56.3 12.8	F B	>120 23.3	F C
17	Fourth Avenue and Eighth Street	AWSC	MC / M / CSUMB (D)	AM PM	Project Intersection		12.5 12.3	B B
18	Imjin Road and Eighth Street	AWSC	CSUMB (D)	AM PM	17.9 9.3	C A	374.3 21.6	ED C
19	Second Avenue and Inter-Garrison Road	AWSC	MC / CSUMB (D)	AM PM	26.5 9.8	D A	>120 22.3	F C
20	General Jim Moore Boulevard and Inter-Garrison Road	AWSC	MC (D)	AM PM	8.5 9.9	A A	8.9 7.9	A A
21	Eighth Street/Seventh Avenue and Inter-Garrison Road	AWSC	MC (D)	AM PM	12.9 8.9	B A	98.4 51.6 114.3	F F
22	Eighth Avenue and Inter-Garrison Road	Round-about	MC (D)	AM PM	32.1 8.6	D A	114.3 51.6 25.9	F D
23	Abrams Drive and Inter-Garrison Road	AWSC	MC (D)	AM PM	60.3 12.8	F B	>120 78.8	F F
24	Schoonover Road and Inter-Garrison Road	AWSC	MC (D)	AM PM	20.8 11.1	C B	79.1 13.9	F B
25	Inter-Garrison Road Connection and Inter-Garrison Road	AWSC	M / CSUMB (D)	AM PM	11.8 11.1	B B	27.0 13.7	D B

TABLE L-2: EXISTING INTERSECTION LEVEL OF SERVICE WITH AND WITHOUT PROJECT

#	Intersection	Intersect- ion Control ¹	Jurisdiction (LOS Standard) ²	Peak Hour ³	Existing		Existing with Project	
					Delay ⁴	LOS ⁵	Delay ⁴	LOS ⁵
26	East Garrison Road and Reservation Road	Signalized	M / CSUMB (D)	AM PM	5.0 5.6	A A	5.2 4.9	A A
27	Reservation Road and Watkins Gate Road	Signalized	S (C)	AM PM	Future Intersection			
28	Davis Road and Reservation Road	Signalized	S (C)	AM PM	18.2 15.9	B B	30.7 23.4	C C
29	Second Avenue and Divarty Street	AWSC	S (C)	AM PM	31.1 9.4	D A	>120 50.9	F F
30	General Jim Moore Boulevard and Divarty Street	AWSC	S (C)	AM PM	9.1 10.2	A B	8.8 8.0	A A
31	First Avenue and Lightfighter Drive	Signalized	S (C)	AM PM	4.0 3.4	A A	4.1 3.8	A A
32	Second Avenue and Lightfighter Drive	Signalized	S (C)	AM PM	18.3 14.2	B B	18.4 14.6	B B
33	General Jim Moore Boulevard and Lightfighter Drive	Signalized	S (C)	AM PM	20.0 22.6	B C	17.8 15.7	B B
34	Malmedy Road and Colonel Durham Street	AWSC	MC (D)	AM PM	9.9 8.3	A A	8.7 8.2	A A
35	Parker Flatts Cut Off Road and Colonel Durham Street	SSS	S (C)	AM PM	0.4 (10.9) 1.1 (10.1)	A (B) A (B)	1.1 (9.9) 1.3 (10)	A (A) A (A)
36	Sixth Avenue and Colonel Durham Street	AWSC	S (C)	AM PM	8.9 7.8	A A	9.9 10.6	A B
37	Seventh Avenue and Colonel Durham Street	SSS	S (C)	AM PM	6.6 (12.3) 7.0 (10.5)	A (B) A (B)	6.9 (11) 6.5 (13.9)	A (B) A (B)
38	Eighth Avenue and Colonel Durham Street	SSS	S (C)	AM PM	0.6 (14.5) 2.0 (13.9)	A (B) A (B)	1.3 (21.6) 1.6 (17.5)	A (C) A (C)
39	General Jim Moore Boulevard and Gigling Road	Signalized	S (C)	AM PM	25.9 14.8	C B	32.8 16.4	C B
40	Malmedy Road and Gigling Road	SSS	MC (D)	AM PM	3.7 (24.9) 2.0 (18.0)	A (C) A (C)	5.4 (91.7) 5.1 (51)	A (F) A (F)
41	Parker Flatts Cut Off Road and Gigling Road	SSS	MC (D)	AM PM	2.0 (23.6) 2.8 (17.6)	A (C) A (C)	8.9 (>120) 9.1 (78.5)	A (F) A (F)
42	Sixth Avenue and Gigling Road	AWSC	S (C)	AM PM	13.3 10.2	B B	86.8 55.1	F F
43	Seventh Avenue and Gigling Road	SSS	S (C)	AM PM	2.1 (12.7) 0.9 (9.0)	A (B) A (A)	1.5 (22.7) 1.9 (17.2)	A (C) A (C)
44	Eighth Avenue and Gigling Road	AWSC	Cal / Sand City (C)	AM PM	9.9 10.3	A B	32.8 13.6	D B
45	Eastside Parkway and Gigling Road	AWSC	Cal / S (C)	AM PM	Future Intersection			
46	General Jim Moore Boulevard and Normandy Road	Signalized	Cal / MC (C)	AM PM	22.0 9.9	C A	25.1 10.1	C B

TABLE L-2: EXISTING INTERSECTION LEVEL OF SERVICE WITH AND WITHOUT PROJECT

#	Intersection	Intersect- ion Control ¹	Jurisdiction (LOS Standard) ²	Peak Hour ³	Existing		Existing with Project	
					Delay ⁴	LOS ⁵	Delay ⁴	LOS ⁵
47	General Jim Moore Boulevard and Coe Avenue	AWSC	Cal / MC (C)	AM PM	92.2 18.4	F C	103.2 23.0	F C
48	Fremont Boulevard - Southbound SR 1 Off-Ramp and Monterey Road	Signalized	M (D)	AM PM	65.8 50.5	E D	68.5 53.7	E D
49	California Avenue and Monterey Road - Northbound SR 1 Off-Ramp	Signalized	M (D)	AM PM	12.1 24.5	B C	15.6 26.5	B C
50	Reservation Road and State Route 68 Westbound Ramps	Signalized	M (D)	AM PM	13.6 33.0	B C	14.2 35.3	B D
51	Reservation Road and State Route 68 Eastbound Ramps	Signalized	M (D)	AM PM	11.4 12.2	B B	11.9 12.8	B B

Notes: **Bold text** indicates intersection operates at unacceptable level of service. **Bold and highlighted text** indicates an intersection deficiency when the addition of Project traffic degrades the operations from acceptable level of service to unacceptable level of service; or when the addition of Project traffic further exacerbates unacceptable operations.

1. SSS = Side Street Stop Controlled, AWSC = All Way Stop Controlled, Signalized = Signalized intersection
2. Intersection jurisdiction and associated LOS threshold applied.
 - i. City of Marina = M
 - ii. City of Seaside = S
 - iii. California State University Monterey Bay = CSUMB
 - iv. Monterey County = MC
 - v. Caltrans = Cal
3. AM = morning peak hour, PM = evening peak hour.
4. Whole intersection weighted average control delay expressed in seconds per vehicle calculated using methods described in the 2010 *Highway Capacity Manual* for signalized intersections and all-way stop-controlled intersections. For side-street stop-controlled intersections, average control delay and total delay for the worst movement are reported as "average control delay (worst movement total delay)."
5. LOS = Level of Service. LOS calculations conducted using the Synchro 10 analysis software packages, which apply the methods described in the 2010 *Highway Capacity Manual*. For side-street stop-controlled intersections, average control LOS and total LOS for the worst movement are reported as "average control LOS (worst movement total LOS)."

Source: Fehr & Peers, June 2019.

CUMULATIVE WITHOUT AND WITH PROJECT AND WITHOUT EASTSIDE PARKWAY CONDITIONS INTERSECTION LEVELS OF SERVICE

The results of the LOS calculations indicate many of the study intersections will operate at levels of service meeting the applicable local jurisdiction's LOS threshold under Cumulative with Project and without Eastside Parkway Conditions. Intersections that exceed the applicable LOS thresholds under Cumulative with Project and without Eastside Parkway Conditions are:

- Int 1. Del Monte Boulevard and Reindollar Avenue (PM peak hour)
- Int 3. SR 1 Southbound Ramps and Imjin Parkway (AM and PM peak hour)
- Int 4. SR 1 Northbound Ramps and Imjin Parkway (AM and PM peak hour)
- Int 5. Second Avenue and Imjin Parkway (AM and PM peak hour)
- Int 10. Imjin Road and Imjin Parkway (PM peak hour)
- Int 12. Reservation Road and Imjin Parkway (PM peak hour)
- Int 14. Inter-Garrison Road and Reservation Road (AM and PM peak hour)
- Int 17. Fourth Avenue and Eighth Street (AM peak hour)
- Int 21. Eighth Street/Seventh Avenue and Inter-Garrison Road (AM peak hour)
- Int 22. Eighth Avenue and Inter-Garrison Road (AM and PM peak hour)
- Int 23. Abrams Drive and Inter-Garrison Road (AM and PM peak hour)
- Int 24. Schoonover Road and Inter-Garrison Road (AM and PM peak hour)
- Int 25. Inter-Garrison Road Connection and Inter-Garrison Road (AM peak hour)
- Int 28. Davis Road and Reservation Road (AM and PM peak hour)
- Int 32. Second Avenue and Lightfighter Drive (AM and PM peak hour)
- Int 33. General Jim Moore Boulevard and Lightfighter Drive (AM peak hour)
- Int 37. Seventh Avenue and Colonel Durham Street (PM peak hour)
- Int 38. Eighth Avenue and Colonel Durham Street (AM and PM peak hour)
- Int 39. General Jim Moore Boulevard and Gigling Road (AM and PM peak hour)
- Int 46. General Jim Moore Boulevard and Normandy Road (AM peak hour)
- Int 47. General Jim Moore Boulevard and Coe Avenue (AM and PM peak hour)
- Int 48. Fremont Boulevard - Southbound SR 1 Off-Ramp and Monterey Road (AM and PM peak hour)
- Int 50. Reservation Road and State Route 68 Westbound Ramps (PM peak hour)

TABLE L-3: CUMULATIVE INTERSECTION LEVEL OF SERVICE

#	Intersection	Intersect- ion Control ¹	Jurisdiction (LOS Standard) ²	Peak Hour ³	Cumulative without Project		Cumulative with Project	
					Delay ⁴	LOS ⁵	Delay ⁴	LOS ⁵
1	Del Monte Boulevard and Reindollar Avenue	Signalized	M (D)	AM PM	33.8 69.1	C E	34.1 70.4	C E
2	Second Avenue Extension and Patton Parkway	Signalized	M (D)	AM PM	18.2 19.1	B B	18.2 19.1	B B
3	SR 1 Southbound Ramps and Imjin Parkway	Signalized	M (D)	AM PM	> 120 > 120	F F	> 120 > 120	F F
4	SR 1 Northbound Ramps and Imjin Parkway	SSS	M (D)	AM PM	1.1 (110.9) 0.9 (77.2)	A (F) A (F)	1.3 (> 120) 1.0 (84.9)	A (F) A (F)
5	Second Avenue and Imjin Parkway	Signalized	M (D)	AM PM	51.2 73.6	D E	59.9 81.2	E F
6	Third Avenue and Imjin Parkway	SSS	M (D)	AM PM	19.6 36.1	B D	20.2 45.7	C D
7	Fourth Avenue and Imjin Parkway	SSS	M (D)	AM PM	8.0 10.1	A B	9.2 11.7	A B
8	California Avenue and Imjin Parkway	Signalized	M (D)	AM PM	40.2 13.2	D B	52.1 15.7	D B
9	California Avenue and Patton Parkway	SSS	MC (D)	AM PM	1.4 (18.8) 0.6 (12.3)	A (C) A (B)	1.4 (19.3) 0.6 (12.7)	A (C) A (B)
10	Imjin Road and Imjin Parkway	Signalized	MC (D)	AM PM	14.4 24.7	B C	28.3 62.2	C E
11	Abrams Drive and Imjin Parkway	Signalized	M (D)	AM PM	15.3 17.4	B B	20.9 23.9	C C
12	Reservation Road and Imjin Parkway	Signalized	M (D)	AM PM	43.8 107.0	D F	48.4 119.7	D F
13	Blanco Road and Reservation Road	Signalized	M / CSUMB (D)	AM PM	26.1 11.1	C B	29.4 11.1	C B
14	Inter-Garrison Road and Reservation Road	Signalized	M (D)	AM PM	22.1 41.8	C D	43.3 80.4	D F
15	Second Avenue and Ninth Street	Signalized	M (D)	AM PM	12.7 9.5	B A	13.3 9.6	B A
16	Second Avenue and Eighth Street	Signalized	M/ CSUMB (D)	AM PM	12.0 7.2	B A	13.7 8.3	B A
17	Fourth Avenue and Eighth Street	AWSC	MC / M / CSUMB (D)	AM PM	11.7 10.2	B B	14.9 12.3	B B
18	Imjin Road and Eighth Street	Round- about	CSUMB (D)	AM PM	13.9 7.7	B A	25.7 10.4	D B
19	Second Avenue and Inter-Garrison Road	Signalized	MC / CSUMB (D)	AM PM	6.1 6.9	A A	5.6 7.4	A A
20	General Jim Moore Boulevard and Inter-Garrison Road	AWSC	MC (D)	AM PM	11.3 10.5	B B	10.5 9.5	B A

TABLE L-3: CUMULATIVE INTERSECTION LEVEL OF SERVICE

#	Intersection	Intersect- ion Control ¹	Jurisdiction (LOS Standard) ²	Peak Hour ³	Cumulative without Project		Cumulative with Project	
					Delay ⁴	LOS ⁵	Delay ⁴	LOS ⁵
21	Eighth Street/Seventh Avenue and Inter-Garrison Road	Signalized	MC (D)	AM PM	17.7 17.8	B B	33.5 33.7	C C
22	Eighth Avenue and Inter-Garrison Road	Round-about	MC (D)	AM PM	107.6 28.5	F D	> 120 >120 114.3	F F
23	Abrams Drive and Inter-Garrison Road	Signalized	MC (D)	AM PM	33.4 32.6	C C	76.9 74.1	E E
24	Schoonover Road and Inter-Garrison Road	AWSC	MC (D)	AM PM	21.1 19.8	C C	49.4 67.1	E F
25	Inter-Garrison Road Connection and Inter-Garrison Road	AWSC	M / CSUMB (D)	AM PM	39.9 17.3	E C	80.7 34.5	F D
26	East Garrison Road and Reservation Road	Signalized	M / CSUMB (D)	AM PM	10.8 20.1	B C	11.3 22.4	B C
27	Reservation Road and Watkins Gate Road	Signalized	S (C)	AM PM	8.6 22.6	A C	8.6 26.0	A C
28	Davis Road and Reservation Road	Signalized	S (C)	AM PM	88.8 > 120	F F	> 120 > 120	F F
29	Second Avenue and Divarty Street	Signalized	S (C)	AM PM	16.5 13.5	B B	19.3 15.5	B B
30	General Jim Moore Boulevard and Divarty Street	AWSC	S (C)	AM PM	11.6 11.9	B B	10.2 10.0	B A
31	First Avenue and Lightfighter Drive	Signalized	S (C)	AM PM	7.3 5.4	A A	7.5 5.4	A A
32	Second Avenue and Lightfighter Drive	Signalized	S (C)	AM PM	66.7 44.0	E D	63.7 42.2	E D
33	General Jim Moore Boulevard and Lightfighter Drive	Signalized	S (C)	AM PM	33.7 24.4	C C	79.6 29.1	E C
34	Malmedy Road and Colonel Durham Street	AWSC	MC (D)	AM PM	14.6 13.0	B B	13.1 12.1	B B
35	Parker Flatts Cut Off Road and Colonel Durham Street	SSS	S (C)	AM PM	1.5 (13.9) 1.8 (15)	A (B) A (B)	1.7 (12.9) 1.9 (13.4)	A (B) A (B)
36	Sixth Avenue and Colonel Durham Street	AWSC	S (C)	AM PM	13.1 14.2	B B	15.9 22.0	C C
37	Seventh Avenue and Colonel Durham Street	SSS	S (C)	AM PM	18.3 (44.1) 97.6 (> 120)	C (E) F (F)	10.4 (16.4) 18.5 (38)	B (C) C (E)
38	Eighth Avenue and Colonel Durham Street	SSS	S (C)	AM PM	3.9 (25.1) 5.1 (26.1)	A (D) A (D)	6.3 (66.4) 4.7 (36.6)	A (F) A (E)
39	General Jim Moore Boulevard and Gigling Road	Signalized	S (C)	AM PM	30.6 22.5	C C	51.8 56.0	D E
40	Malmedy Road and Gigling Road	Signalized	MC (D)	AM PM	5.7 5.6	A A	5.7 5.9	A A

TABLE L-3: CUMULATIVE INTERSECTION LEVEL OF SERVICE

#	Intersection	Intersect- ion Control ¹	Jurisdiction (LOS Standard) ²	Peak Hour ³	Cumulative without Project		Cumulative with Project	
					Delay ⁴	LOS ⁵	Delay ⁴	LOS ⁵
41	Parker Flatts Cut Off Road and Gigling Road	Signalized	MC (D)	AM PM	5.3 5.9	A A	5.4 6.0	A A
42	Sixth Avenue and Gigling Road	Signalized	S (C)	AM PM	5.4 5.4	A A	7.7 8.8	A A
43	Seventh Avenue and Gigling Road	Signalized	S (C)	AM PM	6.5 5.6	A A	4.4 4.5	A A
44	Eighth Avenue and Gigling Road	Signalized	Cal / Sand City (C)	AM PM	7.7 6.9	A A	21.1 10.2	C B
45	Eastside Parkway and Gigling Road	AWSC	Cal / S (C)	AM PM	Future Intersection with Eastside Parkway			
46	General Jim Moore Boulevard and Normandy Road	Signalized	Cal / MC (C)	AM PM	38.2 11.8	D B	40.6 12.0	D B
47	General Jim Moore Boulevard and Coe Avenue	AWSC	Cal / MC (C)	AM PM	113.7 30.4	F D	> 120 35.2	F E
48	Fremont Boulevard - Southbound SR 1 Off-Ramp and Monterey Road	Signalized	M (D)	AM PM	89.2 59.5	F E	92.6 61.7	F E
49	California Avenue and Monterey Road - Northbound SR 1 Off-Ramp	Signalized	M (D)	AM PM	17.4 29.9	B C	17.4 30.7	B C
50	Reservation Road and State Route 68 Westbound Ramps	Signalized	M (D)	AM PM	14.7 38.5	B D	14.6 39.5	B D
51	Reservation Road and State Route 68 Eastbound Ramps	Signalized	M (D)	AM PM	12.3 12.2	B B	12.6 12.3	B B

Notes: **Bold text** indicates intersection operates at unacceptable level of service. **Bold and highlighted text** indicates an intersection deficiency when the addition of Project traffic degrades the operations from acceptable level of service to unacceptable level of service; or when the addition of Project traffic further exacerbates unacceptable operations.

SSS = Side Street Stop Controlled, AWSC = All Way Stop Controlled, Signalized = Signalized intersection

1. Intersection jurisdiction and associated LOS threshold applied.
 - i. City of Marina = M
 - ii. City of Seaside = S
 - iii. California State University Monterey Bay = CSUMB
 - iv. Monterey County = MC
 - v. Caltrans = Cal
2. AM = morning peak hour, PM = evening peak hour.
3. Whole intersection weighted average control delay expressed in seconds per vehicle calculated using methods described in the 2010 *Highway Capacity Manual* for signalized intersections and all-way stop-controlled intersections. For side-street stop-controlled intersections, average control delay and total delay for the worst movement are reported as "average control delay (worst movement total delay)."
4. LOS = Level of Service. LOS calculations conducted using the Synchro 10 analysis software packages, which apply the methods described in the 2010 *Highway Capacity Manual*. For side-street stop-controlled intersections, average control LOS and total LOS for the worst movement are reported as "average control LOS (worst movement total LOS)."

Source: Fehr & Peers, June 2019.

CUMULATIVE WITHOUT AND WITH PROJECT AND WITH EASTSIDE PARKWAY CONDITIONS INTERSECTION LEVELS OF SERVICE

TABLE L-4: CUMULATIVE WITH EASTSIDE PARKWAY INTERSECTION LEVEL OF SERVICE

#	Intersection	Intersect- ion Control	Jurisdiction (LOS Standard) ¹	Peak Hour ²	Cumulative without Project and with Eastside Parkway		Cumulative with Project and with Eastside Parkway	
					Delay ³	LOS ⁴	Delay ³	LOS ⁴
1	Del Monte Boulevard and Reindollar Avenue	Signalized	M (D)	AM PM	33.8 64.1	C E	34.1 67.2	C E
2	Second Avenue Extension and Patton Parkway	Future	M (D)	AM PM	18.2 19.1	B B	18.2 19.1	B B
3	SR 1 Southbound Ramps and Imjin Parkway	Signalized	M (D)	AM PM	> 120 > 120	F F	> 120 > 120	F F
4	SR 1 Northbound Ramps and Imjin Parkway	SSS	M (D)	AM PM	0.9 (87.8) 0.9 (80.1)	A (F) A (F)	1.1 (102.8) 0.9 (81.6)	A (F) A (F)
5	Second Avenue and Imjin Parkway	Signalized	M (D)	AM PM	55.3 54.8	E D	60.8 65.6	E E
6	Third Avenue and Imjin Parkway	SSS	M (D)	AM PM	15.6 17.8	B B	16.6 18.9	B B
7	Fourth Avenue and Imjin Parkway	SSS	M (D)	AM PM	7.4 7.6	A A	7.4 7.7	A A
8	California Avenue and Imjin Parkway	Signalized	M (D)	AM PM	32.0 12.5	C B	38.9 13.1	D B
9	California Avenue and Patton Parkway	SSS	MC (D)	AM PM	1.4 (18.8) 0.6 (12.5)	A (C) A (B)	1.4 (19.7) 0.6 (13)	A (C) A (B)
10	Imjin Road and Imjin Parkway	Signalized	MC (D)	AM PM	8.2 9.8	A A	14.0 19.5	B B
11	Abrams Drive and Imjin Parkway	Signalized	M (D)	AM PM	13.3 12.6	B B	17.5 15.0	B B
12	Reservation Road and Imjin Parkway	Signalized	M (D)	AM PM	25.7 55.6	C E	26.1 61.5	C E
13	Blanco Road and Reservation Road	Signalized	M / CSUMB (D)	AM PM	15.7 11.1	B B	15.6 10.9	B B
14	Inter-Garrison Road and Reservation Road	Signalized	M (D)	AM PM	117.8 > 120	F F	> 120 > 120	F F
15	Second Avenue and Ninth Street	Signalized	M (D)	AM PM	13.1 9.6	B A	13.2 9.6	B A
16	Second Avenue and Eighth Street	Signalized	M/ CSUMB (D)	AM PM	8.6 5.8	A A	9.6 7.1	A A
17	Fourth Avenue and Eighth Street	AWSC	MC / M / CSUMB (D)	AM PM	9.7 9.2	A A	12.0 11.3	B B

TABLE L-4: CUMULATIVE WITH EASTSIDE PARKWAY INTERSECTION LEVEL OF SERVICE

#	Intersection	Intersect- ion Control	Jurisdiction (LOS Standard) ¹	Peak Hour ²	Cumulative without Project and with Eastside Parkway		Cumulative with Project and with Eastside Parkway	
					Delay ³	LOS ⁴	Delay ³	LOS ⁴
18	Imjin Road and Eighth Street	Round- about	CSUMB (D)	AM PM	8.0 6.5	A A	10.3 8.2	B A
19	Second Avenue and Inter- Garrison Road	Signalized	MC / CSUMB (D)	AM PM	5.9 7.4	A A	5.3 7.4	A A
20	General Jim Moore Boulevard and Inter-Garrison Road	AWSC	MC (D)	AM PM	10.1 10.1	B B	10.4 9.5	B A
21	Eighth Street/Seventh Avenue and Inter-Garrison Road	Signalized	MC (D)	AM PM	17.9 16.3	B B	27.4 25.1	C C
22	Eighth Avenue and Inter- Garrison Road	Round- about	MC (D)	AM PM	50.5 14.7	F B	65.8 22.0	F C
23	Abrams Drive and Inter- Garrison Road	Signalized	MC (D)	AM PM	11.8 8.6	B A	14.8 11.0	B B
24	Schoonover Road and Inter- Garrison Road	Signalized	MC (D)	AM PM	30.5 24.9	C C	44.0 27.6	D C
25	Inter-Garrison Road Connection and Inter- Garrison Road	AWSC	M / CSUMB (D)	AM PM	> 120 > 120	F F	> 120 > 120	F F
26	East Garrison Road and Reservation Road	Signalized	M / CSUMB (D)	AM PM	10.7 18.3	B B	11.2 20.9	B C
27	Reservation Road and Watkins Gate Road	Signalized	S (C)	AM PM	8.4 24.0	A C	8.6 32.1	A C
28	Davis Road and Reservation Road	Signalized	S (C)	AM PM	> 120 > 120	F F	> 120 > 120	F F
29	Second Avenue and Divarty Street	Signalized	S (C)	AM PM	13.5 13.2	B B	14.0 15.1	B B
30	General Jim Moore Boulevard and Divarty Street	AWSC	S (C)	AM PM	10.1 10.6	B B	10.2 10.0	B A
31	First Avenue and Lightfighter Drive	Signalized	S (C)	AM PM	7.4 5.6	A A	7.8 5.7	A A
32	Second Avenue and Lightfighter Drive	Signalized	S (C)	AM PM	63.8 39.2	E D	57.8 38.2	E D
33	General Jim Moore Boulevard and Lightfighter Drive	Signalized	S (C)	AM PM	71.6 33.0	E C	> 120 43.6	F D
34	Malmedy Road and Colonel Durham Street	AWSC	MC (D)	AM PM	13.1 12.3	B B	12.5 10.9	B B
35	Parker Flatts Cut Off Road and Colonel Durham Street	SSS	S (C)	AM PM	1.6 (13.6) 1.6 (13.7)	A (B) A (B)	1.7 (12.7) 1.7 (12.2)	A (B) A (B)
36	Sixth Avenue and Colonel Durham Street	AWSC	S (C)	AM PM	12.7 13.1	B B	12.3 12.3	B B

TABLE L-4: CUMULATIVE WITH EASTSIDE PARKWAY INTERSECTION LEVEL OF SERVICE

#	Intersection	Intersect- ion Control	Jurisdiction (LOS Standard) ¹	Peak Hour ²	Cumulative without Project and with Eastside Parkway		Cumulative with Project and with Eastside Parkway	
					Delay ³	LOS ⁴	Delay ³	LOS ⁴
37	Seventh Avenue and Colonel Durham Street	SSS	S (C)	AM PM	12.0 (19.8) 22.0 (36.5)	B (C) C (E)	10.0 (15.3) 12.4 (20.2)	A (C) B (C)
38	Eighth Avenue and Colonel Durham Street	SSS	S (C)	AM PM	3.7 (22.2) 4.7 (19.4)	A (C) A (C)	3.0 (25.4) 2.9 (18.6)	A (D) A (C)
39	General Jim Moore Boulevard and Gigling Road	Signalized	S (C)	AM PM	38.5 114.7	D F	65.3 >120	E F
40	Malmedy Road and Gigling Road	Signalized	MC (D)	AM PM	5.6 5.7	A A	5.7 5.9	A A
41	Parker Flatts Cut Off Road and Gigling Road	Signalized	MC (D)	AM PM	5.4 6.0	A A	5.5 6.1	A A
42	Sixth Avenue and Gigling Road	Signalized	S (C)	AM PM	5.5 5.6	A A	5.8 6.5	A A
43	Seventh Avenue and Gigling Road	Signalized	S (C)	AM PM	5.4 4.9	A A	4.3 4.6	A A
44	Eighth Avenue and Gigling Road	Signalized	Cal / Sand City (C)	AM PM	6.7 5.2	A A	7.0 5.5	A A
45	Eastside Parkway and Gigling Road	Signalized	Cal / S (C)	AM PM	12.1 17.2	B B	13.7 22.4	B C
46	General Jim Moore Boulevard and Normandy Road	Signalized	Cal / MC (C)	AM PM	65.3 18.7	E B	70.4 20.4	E C
47	General Jim Moore Boulevard and Coe Avenue	Signalized	Cal / MC (C)	AM PM	46.2 15.5	D B	48.4 16.3	D B
48	Fremont Boulevard - Southbound SR 1 Off-Ramp and Monterey Road	Signalized	M (D)	AM PM	91.9 57.6	F E	95.1 61.4	F E
49	California Avenue and Monterey Road - Northbound SR 1 Off-Ramp	Signalized	M (D)	AM PM	17.4 30.7	B C	17.4 31.6	B C
50	Reservation Road and State Route 68 Westbound Ramps	Signalized	M (D)	AM PM	14.4 37.2	B D	14.7 38.9	B D
51	Reservation Road and State Route 68 Eastbound Ramps	Signalized	M (D)	AM PM	12.4 12.1	B B	12.8 11.7	B B

Notes: **Bold text** indicates intersection operates at unacceptable level of service. **Bold and highlighted text** indicates an intersection deficiency when the addition of Project traffic degrades the operations from acceptable level of service to unacceptable level of service; or when the addition of Project traffic further exacerbates unacceptable operations.

1. Intersection jurisdiction and associated LOS threshold applied.
 - i. City of Marina = M
 - ii. City of Seaside = S
 - iii. California State University Monterey Bay = CSUMB
 - iv. Monterey County = MC
 - v. Caltrans = Cal
2. AM = morning peak hour, PM = evening peak hour.

3. Whole intersection weighted average control delay expressed in seconds per vehicle calculated using methods described in the 2010 *Highway Capacity Manual* for signalized intersections and all-way stop-controlled intersections. For side-street stop-controlled intersections, average control delay and total delay for the worst movement are reported as "average control delay (worst movement total delay)."

4. LOS = Level of Service. LOS calculations conducted using the Synchro 10 analysis software packages, which apply the methods described in the 2010 *Highway Capacity Manual*. For side-street stop-controlled intersections, average control LOS and total LOS for the worst movement are reported as "average control LOS (worst movement total LOS)."

Source: Fehr & Peers, June 2019.

TABLE L-5: CUMULATIVE INTERSECTION LEVEL OF SERVICE

#	Intersection	Intersection Control ¹	Jurisdiction (LOS Standard) ²	Peak Hour ³	Cumulative without Project		Cumulative with Project		Cumulative without Project and with Eastside Parkway		Cumulative with Project and with Eastside Parkway	
					Delay ⁴	LOS ⁵	Delay ⁴	LOS ⁵	Average Delay ⁴	LOS ⁵	Average Delay ⁴	LOS ⁵
1	Del Monte Boulevard and Reindollar Avenue	Signalized	M (D)	AM PM	33.8 69.1	C E	34.1 70.4	C E	33.8 64.1	C E	34.1 67.2	C E
2	Second Avenue Extension and Patton Parkway	Future	M (D)	AM PM	18.2 19.1	B B	18.2 19.1	B B	18.2 19.1	B B	18.2 19.1	B B
3	SR 1 Southbound Ramps and Imjin Parkway	Signalized	M (D)	AM PM	> 120 > 120	F F	> 120 > 120	F F	> 120 > 120	F F	> 120 > 120	F F
4	SR 1 Northbound Ramps and Imjin Parkway	SSS	M (D)	AM PM	1.1 (110.9) 0.9 (77.2)	A (F) A (F)	1.3 (>120) 1 (84.9)	A (F) A (F)	0.9 (87.8) 0.9 (80.1)	A (F) A (F)	1.1 (102.8) 0.9 (81.6)	A (F) A (F)
5	Second Avenue and Imjin Parkway	Signalized	M (D)	AM PM	51.2 73.6	D E	59.9 81.2	E F	55.3 54.8	E D	60.8 65.6	E E
6	Third Avenue and Imjin Parkway	SSS	M (D)	AM PM	19.6 36.1	B D	20.2 45.7	C D	15.6 17.8	B B	16.6 18.9	B B
7	Fourth Avenue and Imjin Parkway	SSS	M (D)	AM PM	8.0 10.1	A B	9.2 11.7	A B	7.4 7.6	A A	7.4 7.7	A A
8	California Avenue and Imjin Parkway	Signalized	M (D)	AM PM	40.2 13.2	D B	52.1 15.7	D B	32.0 12.5	C B	38.9 13.1	D B
9	California Avenue and Patton Parkway	SSS	MC (D)	AM PM	1.4 (18.8) 0.6 (12.3)	A (C) A (B)	1.4 (19.3) 0.6 (12.7)	A (C) A (B)	1.4 (18.8) 0.6 (12.5)	A (C) A (B)	1.4 (19.7) 0.6 (13)	A (C) A (B)
10	Imjin Road and Imjin Parkway	Signalized	MC (D)	AM PM	14.4 24.7	B C	28.3 62.2	C E	8.2 9.8	A A	14.0 19.5	B B
11	Abrams Drive and Imjin Parkway	Signalized	M (D)	AM PM	15.3 17.4	B B	20.9 23.9	C C	13.3 12.6	B B	17.5 15.0	B B
12	Reservation Road and Imjin Parkway	Signalized	M (D)	AM PM	43.8 107.0	D F	48.4 119.7	D F	25.7 55.6	C E	26.1 61.5	C E

TABLE L-5: CUMULATIVE INTERSECTION LEVEL OF SERVICE

#	Intersection	Intersection Control ¹	Jurisdiction (LOS Standard) ²	Peak Hour ³	Cumulative without Project		Cumulative with Project		Cumulative without Project and with Eastside Parkway		Cumulative with Project and with Eastside Parkway	
					Delay ⁴	LOS ⁵	Delay ⁴	LOS ⁵	Average Delay ⁴	LOS ⁵	Average Delay ⁴	LOS ⁵
13	Blanco Road and Reservation Road	Signalized	M / CSUMB (D)	AM PM	26.1 11.1	C B	29.4 11.1	C B	15.7 11.1	B B	15.6 10.9	B B
14	Inter-Garrison Road and Reservation Road	Signalized	M (D)	AM PM	22.1 41.8	C D	43.3 80.4	D F	117.8 >120	F F	>120 >120	F F
15	Second Avenue and Ninth Street	Signalized	M (D)	AM PM	12.7 9.5	B A	13.3 9.6	B A	13.1 9.6	B A	13.2 9.6	B A
16	Second Avenue and Eighth Street	Signalized	M/ CSUMB (D)	AM PM	12.0 7.2	B A	13.7 8.3	B A	8.6 5.8	A A	9.6 7.1	A A
17	Fourth Avenue and Eighth Street	AWSC	MC / M / CSUMB (D)	AM PM	11.7 102	B B	14.9 12.3	B B	9.7 9.2	A A	12.0 11.3	B B
18	Imjin Road and Eighth Street	Round-about	CSUMB (D)	AM PM	13.9 7.7	B A	25.7 10.4	D B	8.0 6.5	A A	10.3 8.2	B A
19	Second Avenue and Inter-Garrison Road	Signalized	MC / CSUMB (D)	AM PM	6.1 6.9	A A	5.6 7.4	A A	5.9 7.4	A A	5.3 7.4	A A
20	General Jim Moore Boulevard and Inter-Garrison Road	AWSC	MC (D)	AM PM	11.3 10.5	B B	10.5 9.5	B A	10.1 10.1	B B	10.4 9.5	B A
21	Eighth Street/Seventh Avenue and Inter-Garrison Road	Signalized	MC (D)	AM PM	17.7 17.8	B B	33.5 33.7	C C	17.9 16.3	B B	27.4 25.1	C C
22	Eighth Avenue and Inter-Garrison Road	Round-about	MC (D)	AM PM	107.6 28.5	F D	>120 >120	F F	50.5 14.7	F B	65.8 22.0	F C
23	Abrams Drive and Inter-Garrison Road	Signalized	MC (D)	AM PM	33.4 32.6	C C	76.9 74.1	E E	11.8 8.6	B A	14.8 11.0	B B
24	Schoonover Road and Inter-Garrison Road	Signalized	MC (D)	AM PM	21.1 19.8	C C	49.4 67.1	E F	30.5 24.9	C C	44.0 27.6	D C

TABLE L-5: CUMULATIVE INTERSECTION LEVEL OF SERVICE

#	Intersection	Intersection Control ¹	Jurisdiction (LOS Standard) ²	Peak Hour ³	Cumulative without Project		Cumulative with Project		Cumulative without Project and with Eastside Parkway		Cumulative with Project and with Eastside Parkway	
					Delay ⁴	LOS ⁵	Delay ⁴	LOS ⁵	Average Delay ⁴	LOS ⁵	Average Delay ⁴	LOS ⁵
25	Inter-Garrison Road Connection and Inter-Garrison Road	AWSC	M / CSUMB (D)	AM PM	39.9 17.3	E C	80.7 34.5	F D	>120 >120	F F	>120 >120	F F
26	East Garrison Road and Reservation Road	Signalized	M / CSUMB (D)	AM PM	10.8 20.1	B C	11.3 22.4	B C	10.7 18.3	B B	11.2 20.9	B C
27	Reservation Road and Watkins Gate Road	Signalized	S (C)	AM PM	8.6 22.6	A C	8.6 26.0	A C	8.4 24.0	A C	8.6 32.1	A C
28	Davis Road and Reservation Road	Signalized	S (C)	AM PM	88.8 >120	F F	>120 >120	F F	>120 >120	F F	>120 >120	F F
29	Second Avenue and Divarty Street	Signalized	S (C)	AM PM	16.5 13.5	B B	19.3 15.5	B B	13.5 13.2	B B	14.0 15.1	B B
30	General Jim Moore Boulevard and Divarty Street	AWSC	S (C)	AM PM	11.6 11.9	B B	10.2 10.0	B A	10.1 10.6	B B	10.2 10.0	B A
31	First Avenue and Lightfighter Drive	Signalized	S (C)	AM PM	7.3 5.4	A A	7.5 5.4	A A	7.4 5.6	A A	7.8 5.7	A A
32	Second Avenue and Lightfighter Drive	Signalized	S (C)	AM PM	66.7 44.0	E D	63.7 42.2	E D	63.8 39.2	E D	57.8 38.2	E D
33	General Jim Moore Boulevard and Lightfighter Drive	Signalized	S (C)	AM PM	33.7 24.4	C C	79.6 29.1	E C	71.6 33.0	E C	>120 43.6	F D
34	Malmedy Road and Colonel Durham Street	AWSC	MC (D)	AM PM	14.6 13.0	B B	13.1 12.1	B B	13.1 12.3	B B	12.5 10.9	B B
35	Parker Flatts Cut Off Road and Colonel Durham Street	SSS	S (C)	AM PM	1.5 (13.9) 1.8 (15)	A (B) A (B)	1.7 (12.9) 1.9 (13.4)	A (B) A (B)	1.6 (13.6) 1.6 (13.7)	A (B) A (B)	1.7 (12.7) 1.7 (12.2)	A (B) A (B)
36	Sixth Avenue and Colonel Durham Street	AWSC	S (C)	AM PM	13.1 14.2	B B	15.9 22.0	C C	12.7 13.1	B B	12.3 12.3	B B

TABLE L-5: CUMULATIVE INTERSECTION LEVEL OF SERVICE

#	Intersection	Intersection Control ¹	Jurisdiction (LOS Standard) ²	Peak Hour ³	Cumulative without Project		Cumulative with Project		Cumulative without Project and with Eastside Parkway		Cumulative with Project and with Eastside Parkway	
					Delay ⁴	LOS ⁵	Delay ⁴	LOS ⁵	Average Delay ⁴	LOS ⁵	Average Delay ⁴	LOS ⁵
37	Seventh Avenue and Colonel Durham Street	SSS	S (C)	AM	18.3	C (E)	10.4	B (C)	12.0	B (C)	10.0	A (C)
				PM	97.6	F (F)	(16.4)	C (E)	(19.8)	C (E)	22.0	C (E)
							18.5 (38)		(36.5)		(20.2)	
38	Eighth Avenue and Colonel Durham Street	SSS	S (C)	AM	3.9 (25.1)	A (D)	6.3	A (F)	3.7 (22.2)	A (C)	3.0 (25.4)	A (D)
				PM	5.1 (26.1)	A (D)	(66.4)	A (E)	4.7 (19.4)	A (C)	2.9 (18.6)	A (C)
							(36.6)					
39	General Jim Moore Boulevard and Gigling Road	Signalized	S (C)	AM	30.6	C	51.8	D	38.5	D	65.3	E
				PM	22.5	C	56.0	E	114.7	F	>120	F
40	Malmedy Road and Gigling Road	Signalized	MC (D)	AM	5.7	A	5.7	A	5.6	A	5.7	A
				PM	5.6	A	5.9	A	5.7	A	5.9	A
41	Parker Flatts Cut Off Road and Gigling Road	Signalized	MC (D)	AM	5.3	A	5.4	A	5.4	A	5.5	A
				PM	5.9	A	6.0	A	6.0	A	6.1	A
42	Sixth Avenue and Gigling Road	Signalized	S (C)	AM	5.4	A	7.7	A	5.5	A	5.8	A
				PM	5.4	A	8.8	A	5.6	A	6.5	A
43	Seventh Avenue and Gigling Road	Signalized	S (C)	AM	6.5	A	4.4	A	5.4	A	4.3	A
				PM	5.6	A	4.5	A	4.9	A	4.6	A
44	Eighth Avenue and Gigling Road	Signalized	Cal / Sand City (C)	AM	7.7	A	21.1	C	6.7	A	7.0	A
				PM	6.9	A	10.2	B	5.2	A	5.5	A
45	Eastside Parkway and Gigling Road	Signalized	Cal / S (C)	AM	Future Intersection with Eastside Parkway				12.1	B	13.7	12.1
				PM					17.2	B	22.4	17.2
46	General Jim Moore Boulevard and Normandy Road	Signalized	Cal / MC (C)	AM	38.2	D	40.6	D	65.3	E	70.4	E
				PM	11.8	B	12.0	B	18.7	B	20.4	C
47	General Jim Moore Boulevard and Coe Avenue	AWSC/Signalized	Cal / MC (C)	AM	113.7	F	>120	F	46.2	D	48.4	D
				PM	30.4	D	35.2	E	15.5	B	16.3	B

TABLE L-5: CUMULATIVE INTERSECTION LEVEL OF SERVICE

#	Intersection	Intersection Control ¹	Jurisdiction (LOS Standard) ²	Peak Hour ³	Cumulative without Project		Cumulative with Project		Cumulative without Project and with Eastside Parkway		Cumulative with Project and with Eastside Parkway	
					Delay ⁴	LOS ⁵	Delay ⁴	LOS ⁵	Average Delay ⁴	LOS ⁵	Average Delay ⁴	LOS ⁵
48	Fremont Boulevard - Southbound SR 1 Off-Ramp and Monterey Road	Signalized	M (D)	AM	89.2	F	92.6	F	91.9	F	95.1	F
				PM	59.5	E	61.7	E	57.6	E	61.4	E
49	California Avenue and Monterey Road - Northbound SR 1 Off-Ramp	Signalized	M (D)	AM	17.4	B	17.4	B	17.4	B	17.4	B
				PM	29.9	C	30.7	C	30.7	C	31.6	C
50	Reservation Road and State Route 68 Westbound Ramps	Signalized	M (D)	AM	14.7	B	14.6	B	14.4	B	14.7	B
				PM	38.5	D	39.5	D	37.2	D	38.9	D
51	Reservation Road and State Route 68 Eastbound Ramps	Signalized	M (D)	AM	12.3	B	12.6	B	12.4	B	12.8	B
				PM	12.2	B	12.3	B	12.1	B	11.7	B

Notes: **Bold text** indicates intersection operates at unacceptable level of service. **Bold and highlighted text** indicates an intersection deficiency when the addition of Project traffic degrades the operations from acceptable level of service to unacceptable level of service; or when the addition of Project traffic further exacerbates unacceptable operations.

1. SSS = Side Street Stop Controlled, AWSC = All Way Stop Controlled, Signalized = Signalized intersection
2. Intersection jurisdiction and associated LOS threshold applied.
 - i. City of Marina = M
 - ii. City of Seaside = S
 - iii. California State University Monterey Bay = CSUMB
 - iv. Monterey County = MC
 - v. Caltrans = Cal
3. AM = morning peak hour, PM = evening peak hour.
4. Whole intersection weighted average control delay expressed in seconds per vehicle calculated using methods described in the 2010 *Highway Capacity Manual* for signalized intersections and all-way stop-controlled intersections. For side-street stop-controlled intersections, average control delay and total delay for the worst movement are reported as "average control delay (worst movement total delay)."
5. LOS = Level of Service. LOS calculations conducted using the Synchro 10 analysis software packages, which apply the methods described in the 2010 *Highway Capacity Manual*. For side-street stop-controlled intersections, average control LOS and total LOS for the worst movement are reported as "average control LOS (worst movement total LOS)."

Source: Fehr & Peers, June 2019.

APPENDIX M: FREEWAY ANALYSIS



HCM 2010: Freeway Basic Segment

Basic Operational Analysis

Project	CSUMB Master Plan EIR
Freeway	Southbound State Route 1
Segment	SR 1 between Reservation Road and Del Monte Boulevard
Alternative	Existing
Time period	AM Peak Hour

Flow Inputs and Adjustments

Volume, V	2,705	vph
Peak-hour factor, PHF	0.76	
Peak 15-min volume, v_{15}	890	veh
Trucks and buses	4.7%	
Recreational vehicles	0.0%	
Terrain type	Level	
Grade		
Length		mi
Trucks and buses PCE, E_T	1.5	
Recreational vehicle PCE, E_R	1.2	
Heavy vehicle adjustment, f_{HV}	0.977	
Driver population factor, f_p	1.00	
Flow rate, v_p	3,642	pcph
Number of lanes, N	2	

Speed Inputs and Adjustments

Lane width	12.0	ft
Right-side lateral clearance	>6	ft
Total ramp density, TRD	1.00	ramps/mi
Lane width adjustment, f_{LW}	0.0	mph
Lateral clearance adjustment, f_{LC}	0.0	mph
TRD adjustment	3.2	mph
Calculated free-flow speed, FFS	72.2	mph
Measured free-flow speed, FFS	65.0	mph
Free-flow speed curve	65	mph

Capacity Checks for Segments with Ramps

	Actual		Maximum		Violation?
Entering freeway volume		pcph		pcph	
Exiting freeway volume		pcph		pcph	
On-ramp volume		pcph		pcph	
Off-ramp volume		pcph		pcph	

LOS and Performance Measures

Flow rate, v_p	1,821	pcphpl
Average passenger-car speed, S	62.5	mph
Volume-to-capacity ratio, v/c	0.77	
Density, D	29.1	pcpmpl
Level of service, LOS	D	

HCM 2010: Freeway Basic Segment

Basic Operational Analysis

Project	CSUMB Master Plan EIR
Freeway	Southbound SR 1
Segment	SR 1 between Reservation Road and Del Monte Boulevard
Alternative	Existing
Time period	PM Peak Hour

Flow Inputs and Adjustments

Volume, V	1,418	vph
Peak-hour factor, PHF	0.97	
Peak 15-min volume, v_{15}	365	veh
Trucks and buses	1.0%	
Recreational vehicles	0.0%	
Terrain type	Level	
Grade		
Length		mi
Trucks and buses PCE, E_T	1.5	
Recreational vehicle PCE, E_R	1.2	
Heavy vehicle adjustment, f_{HV}	0.995	
Driver population factor, f_p	1.00	
Flow rate, v_p	1,469	pcph
Number of lanes, N	2	

Speed Inputs and Adjustments

Lane width	12.0	ft
Right-side lateral clearance	>6	ft
Total ramp density, TRD	1.00	ramps/mi
Lane width adjustment, f_{LW}	0.0	mph
Lateral clearance adjustment, f_{LC}	0.0	mph
TRD adjustment	3.2	mph
Calculated free-flow speed, FFS	72.2	mph
Measured free-flow speed, FFS	65.0	mph
Free-flow speed curve	65	mph

Capacity Checks for Segments with Ramps

	Actual		Maximum		Violation?
Entering freeway volume		pcph		pcph	
Exiting freeway volume		pcph		pcph	
On-ramp volume		pcph		pcph	
Off-ramp volume		pcph		pcph	

LOS and Performance Measures

Flow rate, v_p	735	pcphpl
Average passenger-car speed, S	65.0	mph
Volume-to-capacity ratio, v/c	0.31	
Density, D	11.3	pcpmpl
Level of service, LOS	B	

HCM 2010: Freeway Basic Segment

Basic Operational Analysis

Project	CSUMB Master Plan EIR
Freeway	Southbound State Route 1
Segment	SR 1 between Del Monte Boulevard and Imjin Parkway
Alternative	Existing
Time period	AM Peak Hour

Flow Inputs and Adjustments

Volume, V	4,055	vph
Peak-hour factor, PHF	0.81	
Peak 15-min volume, v_{15}	1,252	veh
Trucks and buses	3.9%	
Recreational vehicles	0.0%	
Terrain type	Level	
Grade		
Length		mi
Trucks and buses PCE, E_T	1.5	
Recreational vehicle PCE, E_R	1.2	
Heavy vehicle adjustment, f_{HV}	0.981	
Driver population factor, f_p	1.00	
Flow rate, v_p	5,104	pcph
Number of lanes, N	3	

Speed Inputs and Adjustments

Lane width	12.0	ft
Right-side lateral clearance	>6	ft
Total ramp density, TRD	1.17	ramps/mi
Lane width adjustment, f_{LW}	0.0	mph
Lateral clearance adjustment, f_{LC}	0.0	mph
TRD adjustment	3.7	mph
Calculated free-flow speed, FFS	71.7	mph
Measured free-flow speed, FFS	65.0	mph
Free-flow speed curve	65	mph

Capacity Checks for Segments with Ramps

	Actual		Maximum		Violation?
Entering freeway volume		pcph		pcph	
Exiting freeway volume		pcph		pcph	
On-ramp volume		pcph		pcph	
Off-ramp volume		pcph		pcph	

LOS and Performance Measures

Flow rate, v_p	1,701	pcphpl
Average passenger-car speed, S	63.7	mph
Volume-to-capacity ratio, v/c	0.72	
Density, D	26.7	pcpmpl
Level of service, LOS	D	

HCM 2010: Freeway Basic Segment

Basic Operational Analysis

Project	CSUMB Master Plan EIR
Freeway	Southbound SR 1
Segment	SR 1 between Del Monte Boulevard and Imjin Parkway
Alternative	Existing
Time period	PM Peak Hour

Flow Inputs and Adjustments

Volume, V	2,088	vph
Peak-hour factor, PHF	0.95	
Peak 15-min volume, v_{15}	549	veh
Trucks and buses	1.4%	
Recreational vehicles	0.0%	
Terrain type	Level	
Grade		
Length		mi
Trucks and buses PCE, E_T	1.5	
Recreational vehicle PCE, E_R	1.2	
Heavy vehicle adjustment, f_{HV}	0.993	
Driver population factor, f_p	1.00	
Flow rate, v_p	2,213	pcph
Number of lanes, N	3	

Speed Inputs and Adjustments

Lane width	12.0	ft
Right-side lateral clearance	>6	ft
Total ramp density, TRD	1.17	ramps/mi
Lane width adjustment, f_{LW}	0.0	mph
Lateral clearance adjustment, f_{LC}	0.0	mph
TRD adjustment	3.7	mph
Calculated free-flow speed, FFS	71.7	mph
Measured free-flow speed, FFS	65.0	mph
Free-flow speed curve	65	mph

Capacity Checks for Segments with Ramps

	Actual		Maximum		Violation?
Entering freeway volume		pcph		pcph	
Exiting freeway volume		pcph		pcph	
On-ramp volume		pcph		pcph	
Off-ramp volume		pcph		pcph	

LOS and Performance Measures

Flow rate, v_p	738	pcphpl
Average passenger-car speed, S	65.0	mph
Volume-to-capacity ratio, v/c	0.31	
Density, D	11.3	pcpmpl
Level of service, LOS	B	

HCM 2010: Freeway Basic Segment

Basic Operational Analysis

Project	CSUMB Master Plan EIR
Freeway	Southbound State Route 1
Segment	SR 1 between Imjin Parkway and Lightfighter Drive
Alternative	Existing
Time period	AM Peak Hour

Flow Inputs and Adjustments

Volume, V	4,560	vph
Peak-hour factor, PHF	0.83	
Peak 15-min volume, v_{15}	1,373	veh
Trucks and buses	3.5%	
Recreational vehicles	0.0%	
Terrain type	Level	
Grade		
Length		mi
Trucks and buses PCE, E_T	1.5	
Recreational vehicle PCE, E_R	1.2	
Heavy vehicle adjustment, f_{HV}	0.983	
Driver population factor, f_p	1.00	
Flow rate, v_p	5,591	pcph
Number of lanes, N	3	

Speed Inputs and Adjustments

Lane width	12.0	ft
Right-side lateral clearance	>6	ft
Total ramp density, TRD	1.17	ramps/mi
Lane width adjustment, f_{LW}	0.0	mph
Lateral clearance adjustment, f_{LC}	0.0	mph
TRD adjustment	3.7	mph
Calculated free-flow speed, FFS	71.7	mph
Measured free-flow speed, FFS	65.0	mph
Free-flow speed curve	65	mph

Capacity Checks for Segments with Ramps

	Actual		Maximum		Violation?
Entering freeway volume		pcph		pcph	
Exiting freeway volume		pcph		pcph	
On-ramp volume		pcph		pcph	
Off-ramp volume		pcph		pcph	

LOS and Performance Measures

Flow rate, v_p	1,864	pcphpl
Average passenger-car speed, S	62.0	mph
Volume-to-capacity ratio, v/c	0.79	
Density, D	30.1	pcpmpl
Level of service, LOS	D	

HCM 2010: Freeway Basic Segment

Basic Operational Analysis

Project	CSUMB Master Plan EIR
Freeway	Southbound SR 1
Segment	SR 1 between Imjin Parkway and Lightfighter Drive
Alternative	Existing
Time period	PM Peak Hour

Flow Inputs and Adjustments

Volume, V	2,859	vph
Peak-hour factor, PHF	0.95	
Peak 15-min volume, v_{15}	752	veh
Trucks and buses	1.3%	
Recreational vehicles	0.0%	
Terrain type	Level	
Grade		
Length		mi
Trucks and buses PCE, E_T	1.5	
Recreational vehicle PCE, E_R	1.2	
Heavy vehicle adjustment, f_{HV}	0.994	
Driver population factor, f_p	1.00	
Flow rate, v_p	3,028	pcph
Number of lanes, N	3	

Speed Inputs and Adjustments

Lane width	12.0	ft
Right-side lateral clearance	>6	ft
Total ramp density, TRD	1.17	ramps/mi
Lane width adjustment, f_{LW}	0.0	mph
Lateral clearance adjustment, f_{LC}	0.0	mph
TRD adjustment	3.7	mph
Calculated free-flow speed, FFS	71.7	mph
Measured free-flow speed, FFS	65.0	mph
Free-flow speed curve	65	mph

Capacity Checks for Segments with Ramps

	Actual		Maximum		Violation?
Entering freeway volume		pcph		pcph	
Exiting freeway volume		pcph		pcph	
On-ramp volume		pcph		pcph	
Off-ramp volume		pcph		pcph	

LOS and Performance Measures

Flow rate, v_p	1,009	pcphpl
Average passenger-car speed, S	65.0	mph
Volume-to-capacity ratio, v/c	0.43	
Density, D	15.5	pcpmpl
Level of service, LOS	B	

HCM 2010: Freeway Basic Segment

Basic Operational Analysis

Project	CSUMB Master Plan EIR
Freeway	Southbound State Route 1
Segment	SR 1 between Lightfighter Drive and Del Monte Boulevard
Alternative	Existing
Time period	AM Peak Hour

Flow Inputs and Adjustments

Volume, V	4,778	vph
Peak-hour factor, PHF	0.86	
Peak 15-min volume, v_{15}	1,389	veh
Trucks and buses	3.2%	
Recreational vehicles	0.0%	
Terrain type	Level	
Grade		
Length		mi
Trucks and buses PCE, E_T	1.5	
Recreational vehicle PCE, E_R	1.2	
Heavy vehicle adjustment, f_{HV}	0.984	
Driver population factor, f_p	1.00	
Flow rate, v_p	5,645	pcph
Number of lanes, N	3	

Speed Inputs and Adjustments

Lane width	12.0	ft
Right-side lateral clearance	>6	ft
Total ramp density, TRD	1.33	ramps/mi
Lane width adjustment, f_{LW}	0.0	mph
Lateral clearance adjustment, f_{LC}	0.0	mph
TRD adjustment	4.1	mph
Calculated free-flow speed, FFS	71.3	mph
Measured free-flow speed, FFS	65.0	mph
Free-flow speed curve	65	mph

Capacity Checks for Segments with Ramps

	Actual		Maximum		Violation?
Entering freeway volume		pcph		pcph	
Exiting freeway volume		pcph		pcph	
On-ramp volume		pcph		pcph	
Off-ramp volume		pcph		pcph	

LOS and Performance Measures

Flow rate, v_p	1,882	pcphpl
Average passenger-car speed, S	61.7	mph
Volume-to-capacity ratio, v/c	0.80	
Density, D	30.5	pcpmpl
Level of service, LOS	D	

HCM 2010: Freeway Basic Segment

Basic Operational Analysis

Project	CSUMB Master Plan EIR
Freeway	Southbound SR 1
Segment	SR 1 between Lightfighter Drive and Del Monte Boulevard
Alternative	Existing
Time period	PM Peak Hour

Flow Inputs and Adjustments

Volume, V	3,177	vph
Peak-hour factor, PHF	0.97	
Peak 15-min volume, v_{15}	819	veh
Trucks and buses	1.1%	
Recreational vehicles	0.0%	
Terrain type	Level	
Grade		
Length		mi
Trucks and buses PCE, E_T	1.5	
Recreational vehicle PCE, E_R	1.2	
Heavy vehicle adjustment, f_{HV}	0.994	
Driver population factor, f_p	1.00	
Flow rate, v_p	3,294	pcph
Number of lanes, N	3	

Speed Inputs and Adjustments

Lane width	12.0	ft
Right-side lateral clearance	>6	ft
Total ramp density, TRD	1.33	ramps/mi
Lane width adjustment, f_{LW}	0.0	mph
Lateral clearance adjustment, f_{LC}	0.0	mph
TRD adjustment	4.1	mph
Calculated free-flow speed, FFS	71.3	mph
Measured free-flow speed, FFS	65.0	mph
Free-flow speed curve	65	mph

Capacity Checks for Segments with Ramps

	Actual		Maximum		Violation?
Entering freeway volume		pcph		pcph	
Exiting freeway volume		pcph		pcph	
On-ramp volume		pcph		pcph	
Off-ramp volume		pcph		pcph	

LOS and Performance Measures

Flow rate, v_p	1,098	pcphpl
Average passenger-car speed, S	65.0	mph
Volume-to-capacity ratio, v/c	0.47	
Density, D	16.9	pcpmpl
Level of service, LOS	B	

HCM 2010: Freeway Basic Segment

Basic Operational Analysis

Project	CSUMB Master Plan EIR
Freeway	Southbound State Route 1
Segment	SR 1 between Del Monte Boulevard and Canyon Del Rey Boulevard
Alternative	Existing
Time period	AM Peak Hour

Flow Inputs and Adjustments

Volume, V	3,843	vph
Peak-hour factor, PHF	0.95	
Peak 15-min volume, v_{15}	1,011	veh
Trucks and buses	2.4%	
Recreational vehicles	0.0%	
Terrain type	Level	
Grade		
Length		mi
Trucks and buses PCE, E_T	1.5	
Recreational vehicle PCE, E_R	1.2	
Heavy vehicle adjustment, f_{HV}	0.988	
Driver population factor, f_p	1.00	
Flow rate, v_p	4,095	pcph
Number of lanes, N	2	

Speed Inputs and Adjustments

Lane width	12.0	ft
Right-side lateral clearance	5.0	ft
Total ramp density, TRD	2.17	ramps/mi
Lane width adjustment, f_{LW}	0.0	mph
Lateral clearance adjustment, f_{LC}	0.6	mph
TRD adjustment	6.2	mph
Calculated free-flow speed, FFS	68.6	mph
Measured free-flow speed, FFS	65.0	mph
Free-flow speed curve	65	mph

Capacity Checks for Segments with Ramps

	Actual		Maximum		Violation?
Entering freeway volume		pcph		pcph	
Exiting freeway volume		pcph		pcph	
On-ramp volume		pcph		pcph	
Off-ramp volume		pcph		pcph	

LOS and Performance Measures

Flow rate, v_p	2,047	pcphpl
Average passenger-car speed, S	59.1	mph
Volume-to-capacity ratio, v/c	0.87	
Density, D	34.7	pcpmpl
Level of service, LOS	D	

HCM 2010: Freeway Basic Segment

Basic Operational Analysis

Project	CSUMB Master Plan EIR
Freeway	Southbound SR 1
Segment	SR 1 between Del Monte Boulevard and Canyon Del Rey Boulevard
Alternative	Existing
Time period	PM Peak Hour

Flow Inputs and Adjustments

Volume, V	2,629	vph
Peak-hour factor, PHF	0.96	
Peak 15-min volume, v_{15}	685	veh
Trucks and buses	1.0%	
Recreational vehicles	0.0%	
Terrain type	Level	
Grade		
Length		mi
Trucks and buses PCE, E_T	1.5	
Recreational vehicle PCE, E_R	1.2	
Heavy vehicle adjustment, f_{HV}	0.995	
Driver population factor, f_p	1.00	
Flow rate, v_p	2,752	pcph
Number of lanes, N	2	

Speed Inputs and Adjustments

Lane width	12.0	ft
Right-side lateral clearance	5.0	ft
Total ramp density, TRD	2.17	ramps/mi
Lane width adjustment, f_{LW}	0.0	mph
Lateral clearance adjustment, f_{LC}	0.6	mph
TRD adjustment	6.2	mph
Calculated free-flow speed, FFS	68.6	mph
Measured free-flow speed, FFS	65.0	mph
Free-flow speed curve	65	mph

Capacity Checks for Segments with Ramps

	Actual		Maximum		Violation?
Entering freeway volume		pcph		pcph	
Exiting freeway volume		pcph		pcph	
On-ramp volume		pcph		pcph	
Off-ramp volume		pcph		pcph	

LOS and Performance Measures

Flow rate, v_p	1,376	pcphpl
Average passenger-car speed, S	65.0	mph
Volume-to-capacity ratio, v/c	0.59	
Density, D	21.2	pcpmpl
Level of service, LOS	C	

HCM 2010: Freeway Basic Segment

Basic Operational Analysis

Project	CSUMB Master Plan EIR
Freeway	Northbound State Route 1
Segment	SR 1 between Reservation Road and Del Monte Boulevard
Alternative	Existing
Time period	AM Peak Hour

Flow Inputs and Adjustments

Volume, V	1,172	vph
Peak-hour factor, PHF	0.97	
Peak 15-min volume, v_{15}	302	veh
Trucks and buses	6.4%	
Recreational vehicles	0.0%	
Terrain type	Level	
Grade		
Length		mi
Trucks and buses PCE, E_T	1.5	
Recreational vehicle PCE, E_R	1.2	
Heavy vehicle adjustment, f_{HV}	0.969	
Driver population factor, f_p	1.00	
Flow rate, v_p	1,247	pcph
Number of lanes, N	2	

Speed Inputs and Adjustments

Lane width	12.0	ft
Right-side lateral clearance	>6	ft
Total ramp density, TRD	1.00	ramps/mi
Lane width adjustment, f_{LW}	0.0	mph
Lateral clearance adjustment, f_{LC}	0.0	mph
TRD adjustment	3.2	mph
Calculated free-flow speed, FFS	72.2	mph
Measured free-flow speed, FFS	65.0	mph
Free-flow speed curve	65	mph

Capacity Checks for Segments with Ramps

	Actual		Maximum		Violation?
Entering freeway volume		pcph		pcph	
Exiting freeway volume		pcph		pcph	
On-ramp volume		pcph		pcph	
Off-ramp volume		pcph		pcph	

LOS and Performance Measures

Flow rate, v_p	623	pcphpl
Average passenger-car speed, S	65.0	mph
Volume-to-capacity ratio, v/c	0.27	
Density, D	9.6	pcpmpl
Level of service, LOS	A	

HCM 2010: Freeway Basic Segment

Basic Operational Analysis

Project	CSUMB Master Plan EIR
Freeway	Northbound State Route 1
Segment	SR 1 between Reservation Road and Del Monte Boulevard
Alternative	Existing
Time period	PM Peak Hour

Flow Inputs and Adjustments

Volume, V	2,671	vph
Peak-hour factor, PHF	0.98	
Peak 15-min volume, v_{15}	681	veh
Trucks and buses	2.2%	
Recreational vehicles	0.0%	
Terrain type	Level	
Grade		
Length		mi
Trucks and buses PCE, E_T	1.5	
Recreational vehicle PCE, E_R	1.2	
Heavy vehicle adjustment, f_{HV}	0.989	
Driver population factor, f_p	1.00	
Flow rate, v_p	2,755	pcph
Number of lanes, N	2	

Speed Inputs and Adjustments

Lane width	12.0	ft
Right-side lateral clearance	>6	ft
Total ramp density, TRD	1.00	ramps/mi
Lane width adjustment, f_{LW}	0.0	mph
Lateral clearance adjustment, f_{LC}	0.0	mph
TRD adjustment	3.2	mph
Calculated free-flow speed, FFS	72.2	mph
Measured free-flow speed, FFS	65.0	mph
Free-flow speed curve	65	mph

Capacity Checks for Segments with Ramps

	Actual		Maximum		Violation?
Entering freeway volume		pcph		pcph	
Exiting freeway volume		pcph		pcph	
On-ramp volume		pcph		pcph	
Off-ramp volume		pcph		pcph	

LOS and Performance Measures

Flow rate, v_p	1,378	pcphpl
Average passenger-car speed, S	65.0	mph
Volume-to-capacity ratio, v/c	0.59	
Density, D	21.2	pcpmpl
Level of service, LOS	C	

HCM 2010: Freeway Basic Segment

Basic Operational Analysis

Project	CSUMB Master Plan EIR
Freeway	Northbound State Route 1
Segment	SR 1 between Del Monte Boulevard and Imjin Parkway
Alternative	Existing
Time period	AM Peak Hour

Flow Inputs and Adjustments

Volume, V	1,725	vph
Peak-hour factor, PHF	0.92	
Peak 15-min volume, v_{15}	469	veh
Trucks and buses	5.7%	
Recreational vehicles	0.0%	
Terrain type	Level	
Grade		
Length		mi
Trucks and buses PCE, E_T	1.5	
Recreational vehicle PCE, E_R	1.2	
Heavy vehicle adjustment, f_{HV}	0.972	
Driver population factor, f_p	1.00	
Flow rate, v_p	1,929	pcph
Number of lanes, N	3	

Speed Inputs and Adjustments

Lane width	12.0	ft
Right-side lateral clearance	>6	ft
Total ramp density, TRD	1.20	ramps/mi
Lane width adjustment, f_{LW}	0.0	mph
Lateral clearance adjustment, f_{LC}	0.0	mph
TRD adjustment	3.8	mph
Calculated free-flow speed, FFS	71.6	mph
Measured free-flow speed, FFS	65.0	mph
Free-flow speed curve	65	mph

Capacity Checks for Segments with Ramps

	Actual		Maximum		Violation?
Entering freeway volume		pcph		pcph	
Exiting freeway volume		pcph		pcph	
On-ramp volume		pcph		pcph	
Off-ramp volume		pcph		pcph	

LOS and Performance Measures

Flow rate, v_p	643	pcphpl
Average passenger-car speed, S	65.0	mph
Volume-to-capacity ratio, v/c	0.27	
Density, D	9.9	pcpmpl
Level of service, LOS	A	

HCM 2010: Freeway Basic Segment

Basic Operational Analysis

Project	CSUMB Master Plan EIR
Freeway	Northbound State Route 1
Segment	SR 1 between Del Monte Boulevard and Imjin Parkway
Alternative	Existing
Time period	PM Peak Hour

Flow Inputs and Adjustments

Volume, V	4,231	vph
Peak-hour factor, PHF	0.96	
Peak 15-min volume, v_{15}	1,102	veh
Trucks and buses	1.9%	
Recreational vehicles	0.0%	
Terrain type	Level	
Grade		
Length		mi
Trucks and buses PCE, E_T	1.5	
Recreational vehicle PCE, E_R	1.2	
Heavy vehicle adjustment, f_{HV}	0.991	
Driver population factor, f_p	1.00	
Flow rate, v_p	4,449	pcph
Number of lanes, N	3	

Speed Inputs and Adjustments

Lane width	12.0	ft
Right-side lateral clearance	>6	ft
Total ramp density, TRD	1.17	ramps/mi
Lane width adjustment, f_{LW}	0.0	mph
Lateral clearance adjustment, f_{LC}	0.0	mph
TRD adjustment	3.7	mph
Calculated free-flow speed, FFS	71.7	mph
Measured free-flow speed, FFS	65.0	mph
Free-flow speed curve	65	mph

Capacity Checks for Segments with Ramps

	Actual		Maximum		Violation?
Entering freeway volume		pcph		pcph	
Exiting freeway volume		pcph		pcph	
On-ramp volume		pcph		pcph	
Off-ramp volume		pcph		pcph	

LOS and Performance Measures

Flow rate, v_p	1,483	pcphpl
Average passenger-car speed, S	64.9	mph
Volume-to-capacity ratio, v/c	0.63	
Density, D	22.8	pcpmpl
Level of service, LOS	C	

HCM 2010: Freeway Basic Segment

Basic Operational Analysis

Project	CSUMB Master Plan EIR
Freeway	Northbound State Route 1
Segment	SR 1 between Imjin Parkway and Lightfighter Drive
Alternative	Existing
Time period	AM Peak Hour

Flow Inputs and Adjustments

Volume, V	2,397	vph
Peak-hour factor, PHF	0.92	
Peak 15-min volume, v_{15}	653	veh
Trucks and buses	3.8%	
Recreational vehicles	0.0%	
Terrain type	Level	
Grade		
Length		mi
Trucks and buses PCE, E_T	1.5	
Recreational vehicle PCE, E_R	1.2	
Heavy vehicle adjustment, f_{HV}	0.982	
Driver population factor, f_p	1.00	
Flow rate, v_p	2,661	pcph
Number of lanes, N	3	

Speed Inputs and Adjustments

Lane width	12.0	ft
Right-side lateral clearance	>6	ft
Total ramp density, TRD	1.17	ramps/mi
Lane width adjustment, f_{LW}	0.0	mph
Lateral clearance adjustment, f_{LC}	0.0	mph
TRD adjustment	3.7	mph
Calculated free-flow speed, FFS	71.7	mph
Measured free-flow speed, FFS	65.0	mph
Free-flow speed curve	65	mph

Capacity Checks for Segments with Ramps

	Actual		Maximum		Violation?
Entering freeway volume		pcph		pcph	
Exiting freeway volume		pcph		pcph	
On-ramp volume		pcph		pcph	
Off-ramp volume		pcph		pcph	

LOS and Performance Measures

Flow rate, v_p	887	pcphpl
Average passenger-car speed, S	65.0	mph
Volume-to-capacity ratio, v/c	0.38	
Density, D	13.6	pcpmpl
Level of service, LOS	B	

HCM 2010: Freeway Basic Segment

Basic Operational Analysis

Project	CSUMB Master Plan EIR
Freeway	Northbound State Route 1
Segment	SR 1 between Imjin Parkway and Lightfighter Drive
Alternative	Existing
Time period	PM Peak Hour

Flow Inputs and Adjustments

Volume, V	4,906	vph
Peak-hour factor, PHF	0.97	
Peak 15-min volume, v_{15}	1,264	veh
Trucks and buses	1.7%	
Recreational vehicles	0.0%	
Terrain type	Level	
Grade		
Length		mi
Trucks and buses PCE, E_T	1.5	
Recreational vehicle PCE, E_R	1.2	
Heavy vehicle adjustment, f_{HV}	0.991	
Driver population factor, f_p	1.00	
Flow rate, v_p	5,102	pcph
Number of lanes, N	3	

Speed Inputs and Adjustments

Lane width	12.0	ft
Right-side lateral clearance	>6	ft
Total ramp density, TRD	1.17	ramps/mi
Lane width adjustment, f_{LW}	0.0	mph
Lateral clearance adjustment, f_{LC}	0.0	mph
TRD adjustment	3.7	mph
Calculated free-flow speed, FFS	71.7	mph
Measured free-flow speed, FFS	65.0	mph
Free-flow speed curve	65	mph

Capacity Checks for Segments with Ramps

	Actual		Maximum		Violation?
Entering freeway volume		pcph		pcph	
Exiting freeway volume		pcph		pcph	
On-ramp volume		pcph		pcph	
Off-ramp volume		pcph		pcph	

LOS and Performance Measures

Flow rate, v_p	1,701	pcphpl
Average passenger-car speed, S	63.7	mph
Volume-to-capacity ratio, v/c	0.72	
Density, D	26.7	pcpmpl
Level of service, LOS	D	

HCM 2010: Freeway Basic Segment

Basic Operational Analysis

Project	CSUMB Master Plan EIR
Freeway	Northbound State Route 1
Segment	SR 1 between Lightfighter Drive and Del Monte Boulevard
Alternative	Existing
Time period	AM Peak Hour

Flow Inputs and Adjustments

Volume, V	2,708	vph
Peak-hour factor, PHF	0.93	
Peak 15-min volume, v_{15}	725	veh
Trucks and buses	3.8%	
Recreational vehicles	0.0%	
Terrain type	Level	
Grade		
Length		mi
Trucks and buses PCE, E_T	1.5	
Recreational vehicle PCE, E_R	1.2	
Heavy vehicle adjustment, f_{HV}	0.982	
Driver population factor, f_p	1.00	
Flow rate, v_p	2,955	pcph
Number of lanes, N	3	

Speed Inputs and Adjustments

Lane width	12.0	ft
Right-side lateral clearance	>6	ft
Total ramp density, TRD	1.17	ramps/mi
Lane width adjustment, f_{LW}	0.0	mph
Lateral clearance adjustment, f_{LC}	0.0	mph
TRD adjustment	3.7	mph
Calculated free-flow speed, FFS	71.7	mph
Measured free-flow speed, FFS	65.0	mph
Free-flow speed curve	65	mph

Capacity Checks for Segments with Ramps

	Actual		Maximum		Violation?
Entering freeway volume		pcph		pcph	
Exiting freeway volume		pcph		pcph	
On-ramp volume		pcph		pcph	
Off-ramp volume		pcph		pcph	

LOS and Performance Measures

Flow rate, v_p	985	pcphpl
Average passenger-car speed, S	65.0	mph
Volume-to-capacity ratio, v/c	0.42	
Density, D	15.2	pcpmpl
Level of service, LOS	B	

HCM 2010: Freeway Basic Segment

Basic Operational Analysis

Project	CSUMB Master Plan EIR
Freeway	Northbound State Route 1
Segment	SR 1 between Lightfighter Drive and Del Monte Boulevard
Alternative	Existing
Time period	PM Peak Hour

Flow Inputs and Adjustments

Volume, V	4,728	vph
Peak-hour factor, PHF	0.98	
Peak 15-min volume, v_{15}	1,206	veh
Trucks and buses	1.9%	
Recreational vehicles	0.0%	
Terrain type	Level	
Grade		
Length		mi
Trucks and buses PCE, E_T	1.5	
Recreational vehicle PCE, E_R	1.2	
Heavy vehicle adjustment, f_{HV}	0.991	
Driver population factor, f_p	1.00	
Flow rate, v_p	4,870	pcph
Number of lanes, N	3	

Speed Inputs and Adjustments

Lane width	12.0	ft
Right-side lateral clearance	>6	ft
Total ramp density, TRD	1.17	ramps/mi
Lane width adjustment, f_{LW}	0.0	mph
Lateral clearance adjustment, f_{LC}	0.0	mph
TRD adjustment	3.7	mph
Calculated free-flow speed, FFS	71.7	mph
Measured free-flow speed, FFS	65.0	mph
Free-flow speed curve	65	mph

Capacity Checks for Segments with Ramps

	Actual		Maximum		Violation?
Entering freeway volume		pcph		pcph	
Exiting freeway volume		pcph		pcph	
On-ramp volume		pcph		pcph	
Off-ramp volume		pcph		pcph	

LOS and Performance Measures

Flow rate, v_p	1,623	pcphpl
Average passenger-car speed, S	64.3	mph
Volume-to-capacity ratio, v/c	0.69	
Density, D	25.2	pcpmpl
Level of service, LOS	C	

HCM 2010: Freeway Basic Segment

Basic Operational Analysis

Project	CSUMB Master Plan EIR
Freeway	Northbound State Route 1
Segment	SR 1 between Del Monte Boulevard and Canyon Del Rey Boulevard
Alternative	Existing
Time period	AM Peak Hour

Flow Inputs and Adjustments

Volume, V	2,355	vph
Peak-hour factor, PHF	0.92	
Peak 15-min volume, v_{15}	643	veh
Trucks and buses	3.2%	
Recreational vehicles	0.0%	
Terrain type	Level	
Grade		
Length		mi
Trucks and buses PCE, E_T	1.5	
Recreational vehicle PCE, E_R	1.2	
Heavy vehicle adjustment, f_{HV}	0.984	
Driver population factor, f_p	1.00	
Flow rate, v_p	2,613	pcph
Number of lanes, N	2	

Speed Inputs and Adjustments

Lane width	12.0	ft
Right-side lateral clearance	>6	ft
Total ramp density, TRD	2.00	ramps/mi
Lane width adjustment, f_{LW}	0.0	mph
Lateral clearance adjustment, f_{LC}	0.0	mph
TRD adjustment	5.8	mph
Calculated free-flow speed, FFS	69.6	mph
Measured free-flow speed, FFS	65.0	mph
Free-flow speed curve	65	mph

Capacity Checks for Segments with Ramps

	Actual		Maximum		Violation?
Entering freeway volume		pcph		pcph	
Exiting freeway volume		pcph		pcph	
On-ramp volume		pcph		pcph	
Off-ramp volume		pcph		pcph	

LOS and Performance Measures

Flow rate, v_p	1,307	pcphpl
Average passenger-car speed, S	65.0	mph
Volume-to-capacity ratio, v/c	0.56	
Density, D	20.1	pcpmpl
Level of service, LOS	C	

HCM 2010: Freeway Basic Segment

Basic Operational Analysis

Project	CSUMB Master Plan EIR
Freeway	Northbound State Route 1
Segment	SR 1 between Del Monte Boulevard and Canyon Del Rey Boulevard
Alternative	Existing
Time period	PM Peak Hour

Flow Inputs and Adjustments

Volume, V	3,745	vph
Peak-hour factor, PHF	0.97	
Peak 15-min volume, v_{15}	965	veh
Trucks and buses	2.0%	
Recreational vehicles	0.0%	
Terrain type	Level	
Grade		
Length		mi
Trucks and buses PCE, E_T	1.5	
Recreational vehicle PCE, E_R	1.2	
Heavy vehicle adjustment, f_{HV}	0.990	
Driver population factor, f_p	1.00	
Flow rate, v_p	3,900	pcph
Number of lanes, N	2	

Speed Inputs and Adjustments

Lane width	12.0	ft
Right-side lateral clearance	>6	ft
Total ramp density, TRD	2.00	ramps/mi
Lane width adjustment, f_{LW}	0.0	mph
Lateral clearance adjustment, f_{LC}	0.0	mph
TRD adjustment	5.8	mph
Calculated free-flow speed, FFS	69.6	mph
Measured free-flow speed, FFS	65.0	mph
Free-flow speed curve	65	mph

Capacity Checks for Segments with Ramps

	Actual		Maximum		Violation?
Entering freeway volume		pcph		pcph	
Exiting freeway volume		pcph		pcph	
On-ramp volume		pcph		pcph	
Off-ramp volume		pcph		pcph	

LOS and Performance Measures

Flow rate, v_p	1,950	pcphpl
Average passenger-car speed, S	60.7	mph
Volume-to-capacity ratio, v/c	0.83	
Density, D	32.1	pcpmpl
Level of service, LOS	D	

HCM 2010: Freeway Basic Segment

Basic Operational Analysis

Project	CSUMB Master Plan EIR
Freeway	Southbound State Route 1
Segment	SR 1 between Reservation Road and Del Monte Boulevard
Alternative	Existing with Project
Time period	AM Peak Hour

Flow Inputs and Adjustments

Volume, V	2,790	vph
Peak-hour factor, PHF	0.76	
Peak 15-min volume, v_{15}	918	veh
Trucks and buses	4.7%	
Recreational vehicles	0.0%	
Terrain type	Level	
Grade		
Length		mi
Trucks and buses PCE, E_T	1.5	
Recreational vehicle PCE, E_R	1.2	
Heavy vehicle adjustment, f_{HV}	0.977	
Driver population factor, f_p	1.00	
Flow rate, v_p	3,757	pcph
Number of lanes, N	2	

Speed Inputs and Adjustments

Lane width	12.0	ft
Right-side lateral clearance	>6	ft
Total ramp density, TRD	1.00	ramps/mi
Lane width adjustment, f_{LW}	0.0	mph
Lateral clearance adjustment, f_{LC}	0.0	mph
TRD adjustment	3.2	mph
Calculated free-flow speed, FFS	72.2	mph
Measured free-flow speed, FFS	65.0	mph
Free-flow speed curve	65	mph

Capacity Checks for Segments with Ramps

	<u>Actual</u>		<u>Maximum</u>		<u>Violation?</u>
Entering freeway volume		pcph		pcph	
Exiting freeway volume		pcph		pcph	
On-ramp volume		pcph		pcph	
Off-ramp volume		pcph		pcph	

LOS and Performance Measures

Flow rate, v_p	1,878	pcphpl
Average passenger-car speed, S	61.8	mph
Volume-to-capacity ratio, v/c	0.80	
Density, D	30.4	pcpmpl
Level of service, LOS	D	

HCM 2010: Freeway Basic Segment

Basic Operational Analysis

Project	CSUMB Master Plan EIR
Freeway	Southbound SR 1
Segment	SR 1 between Reservation Road and Del Monte Boulevard
Alternative	Existing with Project
Time period	PM Peak Hour

Flow Inputs and Adjustments

Volume, V	1,420	vph
Peak-hour factor, PHF	0.97	
Peak 15-min volume, v_{15}	366	veh
Trucks and buses	1.0%	
Recreational vehicles	0.0%	
Terrain type	Level	
Grade		
Length		mi
Trucks and buses PCE, E_T	1.5	
Recreational vehicle PCE, E_R	1.2	
Heavy vehicle adjustment, f_{HV}	0.995	
Driver population factor, f_p	1.00	
Flow rate, v_p	1,471	pcph
Number of lanes, N	2	

Speed Inputs and Adjustments

Lane width	12.0	ft
Right-side lateral clearance	>6	ft
Total ramp density, TRD	1.00	ramps/mi
Lane width adjustment, f_{LW}	0.0	mph
Lateral clearance adjustment, f_{LC}	0.0	mph
TRD adjustment	3.2	mph
Calculated free-flow speed, FFS	72.2	mph
Measured free-flow speed, FFS	65.0	mph
Free-flow speed curve	65	mph

Capacity Checks for Segments with Ramps

	<u>Actual</u>		<u>Maximum</u>		<u>Violation?</u>
Entering freeway volume		pcph		pcph	
Exiting freeway volume		pcph		pcph	
On-ramp volume		pcph		pcph	
Off-ramp volume		pcph		pcph	

LOS and Performance Measures

Flow rate, v_p	736	pcphpl
Average passenger-car speed, S	65.0	mph
Volume-to-capacity ratio, v/c	0.31	
Density, D	11.3	pcpmpl
Level of service, LOS	B	

HCM 2010: Freeway Basic Segment

Basic Operational Analysis

Project	CSUMB Master Plan EIR
Freeway	Southbound State Route 1
Segment	SR 1 between Del Monte Boulevard and Imjin Parkway
Alternative	Existing with Project
Time period	AM Peak Hour

Flow Inputs and Adjustments

Volume, V	3,430	vph
Peak-hour factor, PHF	0.81	
Peak 15-min volume, v_{15}	1,059	veh
Trucks and buses	3.9%	
Recreational vehicles	0.0%	
Terrain type	Level	
Grade		
Length		mi
Trucks and buses PCE, E_T	1.5	
Recreational vehicle PCE, E_R	1.2	
Heavy vehicle adjustment, f_{HV}	0.981	
Driver population factor, f_p	1.00	
Flow rate, v_p	4,317	pcph
Number of lanes, N	3	

Speed Inputs and Adjustments

Lane width	12.0	ft
Right-side lateral clearance	>6	ft
Total ramp density, TRD	1.17	ramps/mi
Lane width adjustment, f_{LW}	0.0	mph
Lateral clearance adjustment, f_{LC}	0.0	mph
TRD adjustment	3.7	mph
Calculated free-flow speed, FFS	71.7	mph
Measured free-flow speed, FFS	65.0	mph
Free-flow speed curve	65	mph

Capacity Checks for Segments with Ramps

	<u>Actual</u>		<u>Maximum</u>		<u>Violation?</u>
Entering freeway volume		pcph		pcph	
Exiting freeway volume		pcph		pcph	
On-ramp volume		pcph		pcph	
Off-ramp volume		pcph		pcph	

LOS and Performance Measures

Flow rate, v_p	1,439	pcphpl
Average passenger-car speed, S	65.0	mph
Volume-to-capacity ratio, v/c	0.61	
Density, D	22.1	pcpmpl
Level of service, LOS	C	

HCM 2010: Freeway Basic Segment

Basic Operational Analysis

Project	CSUMB Master Plan EIR
Freeway	Southbound SR 1
Segment	SR 1 between Del Monte Boulevard and Imjin Parkway
Alternative	Existing with Project
Time period	PM Peak Hour

Flow Inputs and Adjustments

Volume, V	2,110	vph
Peak-hour factor, PHF	0.95	
Peak 15-min volume, v_{15}	555	veh
Trucks and buses	1.4%	
Recreational vehicles	0.0%	
Terrain type	Level	
Grade		
Length		mi
Trucks and buses PCE, E_T	1.5	
Recreational vehicle PCE, E_R	1.2	
Heavy vehicle adjustment, f_{HV}	0.993	
Driver population factor, f_p	1.00	
Flow rate, v_p	2,236	pcph
Number of lanes, N	3	

Speed Inputs and Adjustments

Lane width	12.0	ft
Right-side lateral clearance	>6	ft
Total ramp density, TRD	1.17	ramps/mi
Lane width adjustment, f_{LW}	0.0	mph
Lateral clearance adjustment, f_{LC}	0.0	mph
TRD adjustment	3.7	mph
Calculated free-flow speed, FFS	71.7	mph
Measured free-flow speed, FFS	65.0	mph
Free-flow speed curve	65	mph

Capacity Checks for Segments with Ramps

	<u>Actual</u>		<u>Maximum</u>		<u>Violation?</u>
Entering freeway volume		pcph		pcph	
Exiting freeway volume		pcph		pcph	
On-ramp volume		pcph		pcph	
Off-ramp volume		pcph		pcph	

LOS and Performance Measures

Flow rate, v_p	745	pcphpl
Average passenger-car speed, S	65.0	mph
Volume-to-capacity ratio, v/c	0.32	
Density, D	11.5	pcpmpl
Level of service, LOS	B	

HCM 2010: Freeway Basic Segment

Basic Operational Analysis

Project	CSUMB Master Plan EIR
Freeway	Southbound State Route 1
Segment	SR 1 between Imjin Parkway and Lightfighter Drive
Alternative	Existing with Project
Time period	AM Peak Hour

Flow Inputs and Adjustments

Volume, V	4,530	vph
Peak-hour factor, PHF	0.83	
Peak 15-min volume, v_{15}	1,364	veh
Trucks and buses	3.5%	
Recreational vehicles	0.0%	
Terrain type	Level	
Grade		
Length		mi
Trucks and buses PCE, E_T	1.5	
Recreational vehicle PCE, E_R	1.2	
Heavy vehicle adjustment, f_{HV}	0.983	
Driver population factor, f_p	1.00	
Flow rate, v_p	5,554	pcph
Number of lanes, N	3	

Speed Inputs and Adjustments

Lane width	12.0	ft
Right-side lateral clearance	>6	ft
Total ramp density, TRD	1.17	ramps/mi
Lane width adjustment, f_{LW}	0.0	mph
Lateral clearance adjustment, f_{LC}	0.0	mph
TRD adjustment	3.7	mph
Calculated free-flow speed, FFS	71.7	mph
Measured free-flow speed, FFS	65.0	mph
Free-flow speed curve	65	mph

Capacity Checks for Segments with Ramps

	<u>Actual</u>		<u>Maximum</u>		<u>Violation?</u>
Entering freeway volume		pcph		pcph	
Exiting freeway volume		pcph		pcph	
On-ramp volume		pcph		pcph	
Off-ramp volume		pcph		pcph	

LOS and Performance Measures

Flow rate, v_p	1,851	pcphpl
Average passenger-car speed, S	62.1	mph
Volume-to-capacity ratio, v/c	0.79	
Density, D	29.8	pcpmpl
Level of service, LOS	D	

HCM 2010: Freeway Basic Segment

Basic Operational Analysis

Project	CSUMB Master Plan EIR
Freeway	Southbound SR 1
Segment	SR 1 between Imjin Parkway and Lightfighter Drive
Alternative	Existing with Project
Time period	PM Peak Hour

Flow Inputs and Adjustments

Volume, V	2,820	vph
Peak-hour factor, PHF	0.95	
Peak 15-min volume, v_{15}	742	veh
Trucks and buses	1.3%	
Recreational vehicles	0.0%	
Terrain type	Level	
Grade		
Length		mi
Trucks and buses PCE, E_T	1.5	
Recreational vehicle PCE, E_R	1.2	
Heavy vehicle adjustment, f_{HV}	0.994	
Driver population factor, f_p	1.00	
Flow rate, v_p	2,987	pcph
Number of lanes, N	3	

Speed Inputs and Adjustments

Lane width	12.0	ft
Right-side lateral clearance	>6	ft
Total ramp density, TRD	1.17	ramps/mi
Lane width adjustment, f_{LW}	0.0	mph
Lateral clearance adjustment, f_{LC}	0.0	mph
TRD adjustment	3.7	mph
Calculated free-flow speed, FFS	71.7	mph
Measured free-flow speed, FFS	65.0	mph
Free-flow speed curve	65	mph

Capacity Checks for Segments with Ramps

	<u>Actual</u>		<u>Maximum</u>		<u>Violation?</u>
Entering freeway volume		pcph		pcph	
Exiting freeway volume		pcph		pcph	
On-ramp volume		pcph		pcph	
Off-ramp volume		pcph		pcph	

LOS and Performance Measures

Flow rate, v_p	996	pcphpl
Average passenger-car speed, S	65.0	mph
Volume-to-capacity ratio, v/c	0.42	
Density, D	15.3	pcmppl
Level of service, LOS	B	

HCM 2010: Freeway Basic Segment

Basic Operational Analysis

Project	CSUMB Master Plan EIR
Freeway	Southbound State Route 1
Segment	SR 1 between Lightfighter Drive and Del Monte Boulevard
Alternative	Existing with Project
Time period	AM Peak Hour

Flow Inputs and Adjustments

Volume, V	4,850	vph
Peak-hour factor, PHF	0.86	
Peak 15-min volume, v_{15}	1,410	veh
Trucks and buses	3.2%	
Recreational vehicles	0.0%	
Terrain type	Level	
Grade		
Length		mi
Trucks and buses PCE, E_T	1.5	
Recreational vehicle PCE, E_R	1.2	
Heavy vehicle adjustment, f_{HV}	0.984	
Driver population factor, f_P	1.00	
Flow rate, v_p	5,730	pcph
Number of lanes, N	3	

Speed Inputs and Adjustments

Lane width	12.0	ft
Right-side lateral clearance	>6	ft
Total ramp density, TRD	1.33	ramps/mi
Lane width adjustment, f_{LW}	0.0	mph
Lateral clearance adjustment, f_{LC}	0.0	mph
TRD adjustment	4.1	mph
Calculated free-flow speed, FFS	71.3	mph
Measured free-flow speed, FFS	65.0	mph
Free-flow speed curve	65	mph

Capacity Checks for Segments with Ramps

	<u>Actual</u>		<u>Maximum</u>		<u>Violation?</u>
Entering freeway volume		pcph		pcph	
Exiting freeway volume		pcph		pcph	
On-ramp volume		pcph		pcph	
Off-ramp volume		pcph		pcph	

LOS and Performance Measures

Flow rate, v_p	1,910	pcphpl
Average passenger-car speed, S	61.3	mph
Volume-to-capacity ratio, v/c	0.81	
Density, D	31.2	pcpmpl
Level of service, LOS	D	

HCM 2010: Freeway Basic Segment

Basic Operational Analysis

Project	CSUMB Master Plan EIR
Freeway	Southbound SR 1
Segment	SR 1 between Lightfighter Drive and Del Monte Boulevard
Alternative	Existing with Project
Time period	PM Peak Hour

Flow Inputs and Adjustments

Volume, V	3,270	vph
Peak-hour factor, PHF	0.97	
Peak 15-min volume, v_{15}	843	veh
Trucks and buses	1.1%	
Recreational vehicles	0.0%	
Terrain type	Level	
Grade		
Length		mi
Trucks and buses PCE, E_T	1.5	
Recreational vehicle PCE, E_R	1.2	
Heavy vehicle adjustment, f_{HV}	0.994	
Driver population factor, f_p	1.00	
Flow rate, v_p	3,390	pcph
Number of lanes, N	3	

Speed Inputs and Adjustments

Lane width	12.0	ft
Right-side lateral clearance	>6	ft
Total ramp density, TRD	1.33	ramps/mi
Lane width adjustment, f_{LW}	0.0	mph
Lateral clearance adjustment, f_{LC}	0.0	mph
TRD adjustment	4.1	mph
Calculated free-flow speed, FFS	71.3	mph
Measured free-flow speed, FFS	65.0	mph
Free-flow speed curve	65	mph

Capacity Checks for Segments with Ramps

	<u>Actual</u>		<u>Maximum</u>		<u>Violation?</u>
Entering freeway volume		pcph		pcph	
Exiting freeway volume		pcph		pcph	
On-ramp volume		pcph		pcph	
Off-ramp volume		pcph		pcph	

LOS and Performance Measures

Flow rate, v_p	1,130	pcphpl
Average passenger-car speed, S	65.0	mph
Volume-to-capacity ratio, v/c	0.48	
Density, D	17.4	pcpmpl
Level of service, LOS	B	

HCM 2010: Freeway Basic Segment

Basic Operational Analysis

Project	CSUMB Master Plan EIR
Freeway	Southbound State Route 1
Segment	SR 1 between Del Monte Boulevard and Canyon Del Rey Boulevard
Alternative	Existing with Project
Time period	AM Peak Hour

Flow Inputs and Adjustments

Volume, V	3,890	vph
Peak-hour factor, PHF	0.95	
Peak 15-min volume, v_{15}	1,024	veh
Trucks and buses	2.4%	
Recreational vehicles	0.0%	
Terrain type	Level	
Grade		
Length		mi
Trucks and buses PCE, E_T	1.5	
Recreational vehicle PCE, E_R	1.2	
Heavy vehicle adjustment, f_{HV}	0.988	
Driver population factor, f_p	1.00	
Flow rate, v_p	4,145	pcph
Number of lanes, N	2	

Speed Inputs and Adjustments

Lane width	12.0	ft
Right-side lateral clearance	5.0	ft
Total ramp density, TRD	2.17	ramps/mi
Lane width adjustment, f_{LW}	0.0	mph
Lateral clearance adjustment, f_{LC}	0.6	mph
TRD adjustment	6.2	mph
Calculated free-flow speed, FFS	68.6	mph
Measured free-flow speed, FFS	65.0	mph
Free-flow speed curve	65	mph

Capacity Checks for Segments with Ramps

	<u>Actual</u>		<u>Maximum</u>		<u>Violation?</u>
Entering freeway volume		pcph		pcph	
Exiting freeway volume		pcph		pcph	
On-ramp volume		pcph		pcph	
Off-ramp volume		pcph		pcph	

LOS and Performance Measures

Flow rate, v_p	2,072	pcphpl
Average passenger-car speed, S	58.6	mph
Volume-to-capacity ratio, v/c	0.88	
Density, D	35.4	pcpmpl
Level of service, LOS	E	

HCM 2010: Freeway Basic Segment

Basic Operational Analysis

Project	CSUMB Master Plan EIR
Freeway	Southbound SR 1
Segment	SR 1 between Del Monte Boulevard and Canyon Del Rey Boulevard
Alternative	Existing with Project
Time period	PM Peak Hour

Flow Inputs and Adjustments

Volume, V	2,700	vph
Peak-hour factor, PHF	0.96	
Peak 15-min volume, v_{15}	703	veh
Trucks and buses	1.0%	
Recreational vehicles	0.0%	
Terrain type	Level	
Grade		
Length		mi
Trucks and buses PCE, E_T	1.5	
Recreational vehicle PCE, E_R	1.2	
Heavy vehicle adjustment, f_{HV}	0.995	
Driver population factor, f_P	1.00	
Flow rate, v_p	2,827	pcph
Number of lanes, N	2	

Speed Inputs and Adjustments

Lane width	12.0	ft
Right-side lateral clearance	5.0	ft
Total ramp density, TRD	2.17	ramps/mi
Lane width adjustment, f_{LW}	0.0	mph
Lateral clearance adjustment, f_{LC}	0.6	mph
TRD adjustment	6.2	mph
Calculated free-flow speed, FFS	68.6	mph
Measured free-flow speed, FFS	65.0	mph
Free-flow speed curve	65	mph

Capacity Checks for Segments with Ramps

	<u>Actual</u>		<u>Maximum</u>		<u>Violation?</u>
Entering freeway volume		pcph		pcph	
Exiting freeway volume		pcph		pcph	
On-ramp volume		pcph		pcph	
Off-ramp volume		pcph		pcph	

LOS and Performance Measures

Flow rate, v_p	1,413	pcphpl
Average passenger-car speed, S	65.0	mph
Volume-to-capacity ratio, v/c	0.60	
Density, D	21.7	pcmpl
Level of service, LOS	C	

HCM 2010: Freeway Basic Segment

Basic Operational Analysis

Project	CSUMB Master Plan EIR
Freeway	Northbound State Route 1
Segment	SR 1 between Reservation Road and Del Monte Boulevard
Alternative	Existing with Project
Time period	AM Peak Hour

Flow Inputs and Adjustments

Volume, V	1,230	vph
Peak-hour factor, PHF	0.97	
Peak 15-min volume, v_{15}	317	veh
Trucks and buses	6.4%	
Recreational vehicles	0.0%	
Terrain type	Level	
Grade		
Length		mi
Trucks and buses PCE, E_T	1.5	
Recreational vehicle PCE, E_R	1.2	
Heavy vehicle adjustment, f_{HV}	0.969	
Driver population factor, f_P	1.00	
Flow rate, v_p	1,308	pcph
Number of lanes, N	2	

Speed Inputs and Adjustments

Lane width	12.0	ft
Right-side lateral clearance	>6	ft
Total ramp density, TRD	1.00	ramps/mi
Lane width adjustment, f_{LW}	0.0	mph
Lateral clearance adjustment, f_{LC}	0.0	mph
TRD adjustment	3.2	mph
Calculated free-flow speed, FFS	72.2	mph
Measured free-flow speed, FFS	65.0	mph
Free-flow speed curve	65	mph

Capacity Checks for Segments with Ramps

	<u>Actual</u>		<u>Maximum</u>		<u>Violation?</u>
Entering freeway volume		pcph		pcph	
Exiting freeway volume		pcph		pcph	
On-ramp volume		pcph		pcph	
Off-ramp volume		pcph		pcph	

LOS and Performance Measures

Flow rate, v_p	654	pcphpl
Average passenger-car speed, S	65.0	mph
Volume-to-capacity ratio, v/c	0.28	
Density, D	10.1	pcpmpl
Level of service, LOS	A	

HCM 2010: Freeway Basic Segment

Basic Operational Analysis

Project	CSUMB Master Plan EIR
Freeway	Northbound State Route 1
Segment	SR 1 between Reservation Road and Del Monte Boulevard
Alternative	Existing with Project
Time period	PM Peak Hour

Flow Inputs and Adjustments

Volume, V	2,790	vph
Peak-hour factor, PHF	0.98	
Peak 15-min volume, v_{15}	712	veh
Trucks and buses	2.2%	
Recreational vehicles	0.0%	
Terrain type	Level	
Grade		
Length		mi
Trucks and buses PCE, E_T	1.5	
Recreational vehicle PCE, E_R	1.2	
Heavy vehicle adjustment, f_{HV}	0.989	
Driver population factor, f_p	1.00	
Flow rate, v_p	2,878	pcph
Number of lanes, N	2	

Speed Inputs and Adjustments

Lane width	12.0	ft
Right-side lateral clearance	>6	ft
Total ramp density, TRD	1.00	ramps/mi
Lane width adjustment, f_{LW}	0.0	mph
Lateral clearance adjustment, f_{LC}	0.0	mph
TRD adjustment	3.2	mph
Calculated free-flow speed, FFS	72.2	mph
Measured free-flow speed, FFS	65.0	mph
Free-flow speed curve	65	mph

Capacity Checks for Segments with Ramps

	<u>Actual</u>		<u>Maximum</u>		<u>Violation?</u>
Entering freeway volume		pcph		pcph	
Exiting freeway volume		pcph		pcph	
On-ramp volume		pcph		pcph	
Off-ramp volume		pcph		pcph	

LOS and Performance Measures

Flow rate, v_p	1,439	pcphpl
Average passenger-car speed, S	65.0	mph
Volume-to-capacity ratio, v/c	0.61	
Density, D	22.1	pcpmpl
Level of service, LOS	C	

HCM 2010: Freeway Basic Segment

Basic Operational Analysis

Project	CSUMB Master Plan EIR
Freeway	Northbound State Route 1
Segment	SR 1 between Del Monte Boulevard and Imjin Parkway
Alternative	Existing with Project
Time period	AM Peak Hour

Flow Inputs and Adjustments

Volume, V	1,790	vph
Peak-hour factor, PHF	0.92	
Peak 15-min volume, v_{15}	487	veh
Trucks and buses	5.7%	
Recreational vehicles	0.0%	
Terrain type	Level	
Grade		
Length		mi
Trucks and buses PCE, E_T	1.5	
Recreational vehicle PCE, E_R	1.2	
Heavy vehicle adjustment, f_{HV}	0.972	
Driver population factor, f_p	1.00	
Flow rate, v_p	2,002	pcph
Number of lanes, N	3	

Speed Inputs and Adjustments

Lane width	12.0	ft
Right-side lateral clearance	>6	ft
Total ramp density, TRD	1.20	ramps/mi
Lane width adjustment, f_{LW}	0.0	mph
Lateral clearance adjustment, f_{LC}	0.0	mph
TRD adjustment	3.8	mph
Calculated free-flow speed, FFS	71.6	mph
Measured free-flow speed, FFS	65.0	mph
Free-flow speed curve	65	mph

Capacity Checks for Segments with Ramps

	<u>Actual</u>		<u>Maximum</u>		<u>Violation?</u>
Entering freeway volume		pcph		pcph	
Exiting freeway volume		pcph		pcph	
On-ramp volume		pcph		pcph	
Off-ramp volume		pcph		pcph	

LOS and Performance Measures

Flow rate, v_p	667	pcphpl
Average passenger-car speed, S	65.0	mph
Volume-to-capacity ratio, v/c	0.28	
Density, D	10.3	pcpmpl
Level of service, LOS	A	

HCM 2010: Freeway Basic Segment

Basic Operational Analysis

Project	CSUMB Master Plan EIR
Freeway	Northbound State Route 1
Segment	SR 1 between Del Monte Boulevard and Imjin Parkway
Alternative	Existing with Project
Time period	PM Peak Hour

Flow Inputs and Adjustments

Volume, V	4,360	vph
Peak-hour factor, PHF	0.96	
Peak 15-min volume, v_{15}	1,135	veh
Trucks and buses	1.9%	
Recreational vehicles	0.0%	
Terrain type	Level	
Grade		
Length		mi
Trucks and buses PCE, E_T	1.5	
Recreational vehicle PCE, E_R	1.2	
Heavy vehicle adjustment, f_{HV}	0.991	
Driver population factor, f_p	1.00	
Flow rate, v_p	4,585	pcph
Number of lanes, N	3	

Speed Inputs and Adjustments

Lane width	12.0	ft
Right-side lateral clearance	>6	ft
Total ramp density, TRD	1.17	ramps/mi
Lane width adjustment, f_{LW}	0.0	mph
Lateral clearance adjustment, f_{LC}	0.0	mph
TRD adjustment	3.7	mph
Calculated free-flow speed, FFS	71.7	mph
Measured free-flow speed, FFS	65.0	mph
Free-flow speed curve	65	mph

Capacity Checks for Segments with Ramps

	<u>Actual</u>		<u>Maximum</u>		<u>Violation?</u>
Entering freeway volume		pcph		pcph	
Exiting freeway volume		pcph		pcph	
On-ramp volume		pcph		pcph	
Off-ramp volume		pcph		pcph	

LOS and Performance Measures

Flow rate, v_p	1,528	pcphpl
Average passenger-car speed, S	64.8	mph
Volume-to-capacity ratio, v/c	0.65	
Density, D	23.6	pcpmpl
Level of service, LOS	C	

HCM 2010: Freeway Basic Segment

Basic Operational Analysis

Project	CSUMB Master Plan EIR
Freeway	Northbound State Route 1
Segment	SR 1 between Imjin Parkway and Lightfighter Drive
Alternative	Existing with Project
Time period	AM Peak Hour

Flow Inputs and Adjustments

Volume, V	2,410	vph
Peak-hour factor, PHF	0.92	
Peak 15-min volume, v_{15}	657	veh
Trucks and buses	3.8%	
Recreational vehicles	0.0%	
Terrain type	Level	
Grade		
Length		mi
Trucks and buses PCE, E_T	1.5	
Recreational vehicle PCE, E_R	1.2	
Heavy vehicle adjustment, f_{HV}	0.982	
Driver population factor, f_p	1.00	
Flow rate, v_p	2,675	pcph
Number of lanes, N	3	

Speed Inputs and Adjustments

Lane width	12.0	ft
Right-side lateral clearance	>6	ft
Total ramp density, TRD	1.17	ramps/mi
Lane width adjustment, f_{LW}	0.0	mph
Lateral clearance adjustment, f_{LC}	0.0	mph
TRD adjustment	3.7	mph
Calculated free-flow speed, FFS	71.7	mph
Measured free-flow speed, FFS	65.0	mph
Free-flow speed curve	65	mph

Capacity Checks for Segments with Ramps

	<u>Actual</u>		<u>Maximum</u>		<u>Violation?</u>
Entering freeway volume		pcph		pcph	
Exiting freeway volume		pcph		pcph	
On-ramp volume		pcph		pcph	
Off-ramp volume		pcph		pcph	

LOS and Performance Measures

Flow rate, v_p	892	pcphpl
Average passenger-car speed, S	65.0	mph
Volume-to-capacity ratio, v/c	0.38	
Density, D	13.7	pcpmpl
Level of service, LOS	B	

HCM 2010: Freeway Basic Segment

Basic Operational Analysis

Project	CSUMB Master Plan EIR
Freeway	Northbound State Route 1
Segment	SR 1 between Imjin Parkway and Lightfighter Drive
Alternative	Existing with Project
Time period	PM Peak Hour

Flow Inputs and Adjustments

Volume, V	4,880	vph
Peak-hour factor, PHF	0.97	
Peak 15-min volume, v_{15}	1,258	veh
Trucks and buses	1.7%	
Recreational vehicles	0.0%	
Terrain type	Level	
Grade		
Length		mi
Trucks and buses PCE, E_T	1.5	
Recreational vehicle PCE, E_R	1.2	
Heavy vehicle adjustment, f_{HV}	0.991	
Driver population factor, f_p	1.00	
Flow rate, v_p	5,075	pcph
Number of lanes, N	3	

Speed Inputs and Adjustments

Lane width	12.0	ft
Right-side lateral clearance	>6	ft
Total ramp density, TRD	1.17	ramps/mi
Lane width adjustment, f_{LW}	0.0	mph
Lateral clearance adjustment, f_{LC}	0.0	mph
TRD adjustment	3.7	mph
Calculated free-flow speed, FFS	71.7	mph
Measured free-flow speed, FFS	65.0	mph
Free-flow speed curve	65	mph

Capacity Checks for Segments with Ramps

	<u>Actual</u>		<u>Maximum</u>		<u>Violation?</u>
Entering freeway volume		pcph		pcph	
Exiting freeway volume		pcph		pcph	
On-ramp volume		pcph		pcph	
Off-ramp volume		pcph		pcph	

LOS and Performance Measures

Flow rate, v_p	1,692	pcphpl
Average passenger-car speed, S	63.8	mph
Volume-to-capacity ratio, v/c	0.72	
Density, D	26.5	pcpmpl
Level of service, LOS	D	

HCM 2010: Freeway Basic Segment

Basic Operational Analysis

Project	CSUMB Master Plan EIR
Freeway	Northbound State Route 1
Segment	SR 1 between Lightfighter Drive and Del Monte Boulevard
Alternative	Existing with Project
Time period	AM Peak Hour

Flow Inputs and Adjustments

Volume, V	2,810	vph
Peak-hour factor, PHF	0.93	
Peak 15-min volume, v_{15}	752	veh
Trucks and buses	3.8%	
Recreational vehicles	0.0%	
Terrain type	Level	
Grade		
Length		mi
Trucks and buses PCE, E_T	1.5	
Recreational vehicle PCE, E_R	1.2	
Heavy vehicle adjustment, f_{HV}	0.982	
Driver population factor, f_P	1.00	
Flow rate, v_p	3,066	pcph
Number of lanes, N	3	

Speed Inputs and Adjustments

Lane width	12.0	ft
Right-side lateral clearance	>6	ft
Total ramp density, TRD	1.17	ramps/mi
Lane width adjustment, f_{LW}	0.0	mph
Lateral clearance adjustment, f_{LC}	0.0	mph
TRD adjustment	3.7	mph
Calculated free-flow speed, FFS	71.7	mph
Measured free-flow speed, FFS	65.0	mph
Free-flow speed curve	65	mph

Capacity Checks for Segments with Ramps

	<u>Actual</u>		<u>Maximum</u>		<u>Violation?</u>
Entering freeway volume		pcph		pcph	
Exiting freeway volume		pcph		pcph	
On-ramp volume		pcph		pcph	
Off-ramp volume		pcph		pcph	

LOS and Performance Measures

Flow rate, v_p	1,022	pcphpl
Average passenger-car speed, S	65.0	mph
Volume-to-capacity ratio, v/c	0.43	
Density, D	15.7	pcpmpl
Level of service, LOS	B	

HCM 2010: Freeway Basic Segment

Basic Operational Analysis

Project	CSUMB Master Plan EIR
Freeway	Northbound State Route 1
Segment	SR 1 between Lightfighter Drive and Del Monte Boulevard
Alternative	Existing with Project
Time period	PM Peak Hour

Flow Inputs and Adjustments

Volume, V	4,840	vph
Peak-hour factor, PHF	0.98	
Peak 15-min volume, v_{15}	1,235	veh
Trucks and buses	1.9%	
Recreational vehicles	0.0%	
Terrain type	Level	
Grade		
Length		mi
Trucks and buses PCE, E_T	1.5	
Recreational vehicle PCE, E_R	1.2	
Heavy vehicle adjustment, f_{HV}	0.991	
Driver population factor, f_p	1.00	
Flow rate, v_p	4,985	pcph
Number of lanes, N	3	

Speed Inputs and Adjustments

Lane width	12.0	ft
Right-side lateral clearance	>6	ft
Total ramp density, TRD	1.17	ramps/mi
Lane width adjustment, f_{LW}	0.0	mph
Lateral clearance adjustment, f_{LC}	0.0	mph
TRD adjustment	3.7	mph
Calculated free-flow speed, FFS	71.7	mph
Measured free-flow speed, FFS	65.0	mph
Free-flow speed curve	65	mph

Capacity Checks for Segments with Ramps

	<u>Actual</u>		<u>Maximum</u>		<u>Violation?</u>
Entering freeway volume		pcph		pcph	
Exiting freeway volume		pcph		pcph	
On-ramp volume		pcph		pcph	
Off-ramp volume		pcph		pcph	

LOS and Performance Measures

Flow rate, v_p	1,662	pcphpl
Average passenger-car speed, S	64.0	mph
Volume-to-capacity ratio, v/c	0.71	
Density, D	26.0	pcpmpl
Level of service, LOS	C	

HCM 2010: Freeway Basic Segment

Basic Operational Analysis

Project	CSUMB Master Plan EIR
Freeway	Northbound State Route 1
Segment	SR 1 between Del Monte Boulevard and Canyon Del Rey Boulevard
Alternative	Existing with Project
Time period	AM Peak Hour

Flow Inputs and Adjustments

Volume, V	2,440	vph
Peak-hour factor, PHF	0.92	
Peak 15-min volume, v_{15}	666	veh
Trucks and buses	3.2%	
Recreational vehicles	0.0%	
Terrain type	Level	
Grade		
Length		mi
Trucks and buses PCE, E_T	1.5	
Recreational vehicle PCE, E_R	1.2	
Heavy vehicle adjustment, f_{HV}	0.984	
Driver population factor, f_P	1.00	
Flow rate, v_p	2,708	pcph
Number of lanes, N	2	

Speed Inputs and Adjustments

Lane width	12.0	ft
Right-side lateral clearance	>6	ft
Total ramp density, TRD	2.00	ramps/mi
Lane width adjustment, f_{LW}	0.0	mph
Lateral clearance adjustment, f_{LC}	0.0	mph
TRD adjustment	5.8	mph
Calculated free-flow speed, FFS	69.6	mph
Measured free-flow speed, FFS	65.0	mph
Free-flow speed curve	65	mph

Capacity Checks for Segments with Ramps

	<u>Actual</u>		<u>Maximum</u>		<u>Violation?</u>
Entering freeway volume		pcph		pcph	
Exiting freeway volume		pcph		pcph	
On-ramp volume		pcph		pcph	
Off-ramp volume		pcph		pcph	

LOS and Performance Measures

Flow rate, v_p	1,354	pcphpl
Average passenger-car speed, S	65.0	mph
Volume-to-capacity ratio, v/c	0.58	
Density, D	20.8	pcpmpl
Level of service, LOS	C	

HCM 2010: Freeway Basic Segment

Basic Operational Analysis

Project	CSUMB Master Plan EIR
Freeway	Northbound State Route 1
Segment	SR 1 between Del Monte Boulevard and Canyon Del Rey Boulevard
Alternative	Existing with Project
Time period	PM Peak Hour

Flow Inputs and Adjustments

Volume, V	3,820	vph
Peak-hour factor, PHF	0.97	
Peak 15-min volume, v_{15}	985	veh
Trucks and buses	2.0%	
Recreational vehicles	0.0%	
Terrain type	Level	
Grade		
Length		mi
Trucks and buses PCE, E_T	1.5	
Recreational vehicle PCE, E_R	1.2	
Heavy vehicle adjustment, f_{HV}	0.990	
Driver population factor, f_p	1.00	
Flow rate, v_p	3,978	pcph
Number of lanes, N	2	

Speed Inputs and Adjustments

Lane width	12.0	ft
Right-side lateral clearance	>6	ft
Total ramp density, TRD	2.00	ramps/mi
Lane width adjustment, f_{LW}	0.0	mph
Lateral clearance adjustment, f_{LC}	0.0	mph
TRD adjustment	5.8	mph
Calculated free-flow speed, FFS	69.6	mph
Measured free-flow speed, FFS	65.0	mph
Free-flow speed curve	65	mph

Capacity Checks for Segments with Ramps

	<u>Actual</u>		<u>Maximum</u>		<u>Violation?</u>
Entering freeway volume		pcph		pcph	
Exiting freeway volume		pcph		pcph	
On-ramp volume		pcph		pcph	
Off-ramp volume		pcph		pcph	

LOS and Performance Measures

Flow rate, v_p	1,989	pcphpl
Average passenger-car speed, S	60.1	mph
Volume-to-capacity ratio, v/c	0.85	
Density, D	33.1	pcpmpl
Level of service, LOS	D	

HCM 2010: Freeway Basic Segment

Basic Operational Analysis

Project	CSUMB Master Plan EIR
Freeway	Southbound State Route 1
Segment	SR 1 between Reservation Road and Del Monte Boulevard
Alternative	Cumulative
Time period	AM Peak Hour

Flow Inputs and Adjustments

Volume, V	3,480	vph
Peak-hour factor, PHF	0.76	
Peak 15-min volume, v_{15}	1,145	veh
Trucks and buses	4.7%	
Recreational vehicles	0.0%	
Terrain type	Level	
Grade		
Length		mi
Trucks and buses PCE, E_T	1.5	
Recreational vehicle PCE, E_R	1.2	
Heavy vehicle adjustment, f_{HV}	0.977	
Driver population factor, f_P	1.00	
Flow rate, v_p	4,686	pcph
Number of lanes, N	2	

Speed Inputs and Adjustments

Lane width	12.0	ft
Right-side lateral clearance	>6	ft
Total ramp density, TRD	1.00	ramps/mi
Lane width adjustment, f_{LW}	0.0	mph
Lateral clearance adjustment, f_{LC}	0.0	mph
TRD adjustment	3.2	mph
Calculated free-flow speed, FFS	72.2	mph
Measured free-flow speed, FFS	65.0	mph
Free-flow speed curve	65	mph

Capacity Checks for Segments with Ramps

	<u>Actual</u>		<u>Maximum</u>		<u>Violation?</u>
Entering freeway volume		pcph		pcph	
Exiting freeway volume		pcph		pcph	
On-ramp volume		pcph		pcph	
Off-ramp volume		pcph		pcph	

LOS and Performance Measures

Flow rate, v_p	2,343	pcphpl
Average passenger-car speed, S	52.4	mph
Volume-to-capacity ratio, v/c	1.00	
Density, D	44.7	pcpmpl
Level of service, LOS	E	

HCM 2010: Freeway Basic Segment

Basic Operational Analysis

Project	CSUMB Master Plan EIR
Freeway	Southbound SR 1
Segment	SR 1 between Reservation Road and Del Monte Boulevard
Alternative	Cumulative
Time period	PM Peak Hour

Flow Inputs and Adjustments

Volume, V	1,830	vph
Peak-hour factor, PHF	0.97	
Peak 15-min volume, v_{15}	472	veh
Trucks and buses	1.0%	
Recreational vehicles	0.0%	
Terrain type	Level	
Grade		
Length		mi
Trucks and buses PCE, E_T	1.5	
Recreational vehicle PCE, E_R	1.2	
Heavy vehicle adjustment, f_{HV}	0.995	
Driver population factor, f_p	1.00	
Flow rate, v_p	1,896	pcph
Number of lanes, N	2	

Speed Inputs and Adjustments

Lane width	12.0	ft
Right-side lateral clearance	>6	ft
Total ramp density, TRD	1.00	ramps/mi
Lane width adjustment, f_{LW}	0.0	mph
Lateral clearance adjustment, f_{LC}	0.0	mph
TRD adjustment	3.2	mph
Calculated free-flow speed, FFS	72.2	mph
Measured free-flow speed, FFS	65.0	mph
Free-flow speed curve	65	mph

Capacity Checks for Segments with Ramps

	Actual		Maximum		Violation?
Entering freeway volume		pcph		pcph	
Exiting freeway volume		pcph		pcph	
On-ramp volume		pcph		pcph	
Off-ramp volume		pcph		pcph	

LOS and Performance Measures

Flow rate, v_p	948	pcphpl
Average passenger-car speed, S	65.0	mph
Volume-to-capacity ratio, v/c	0.40	
Density, D	14.6	pcpmpl
Level of service, LOS	B	

HCM 2010: Freeway Basic Segment

Basic Operational Analysis

Project	CSUMB Master Plan EIR
Freeway	Southbound State Route 1
Segment	SR 1 between Del Monte Boulevard and Imjin Parkway
Alternative	Cumulative
Time period	AM Peak Hour

Flow Inputs and Adjustments

Volume, V	5,060	vph
Peak-hour factor, PHF	0.81	
Peak 15-min volume, v_{15}	1,562	veh
Trucks and buses	3.9%	
Recreational vehicles	0.0%	
Terrain type	Level	
Grade		
Length		mi
Trucks and buses PCE, E_T	1.5	
Recreational vehicle PCE, E_R	1.2	
Heavy vehicle adjustment, f_{HV}	0.981	
Driver population factor, f_p	1.00	
Flow rate, v_p	6,369	pcph
Number of lanes, N	3	

Speed Inputs and Adjustments

Lane width	12.0	ft
Right-side lateral clearance	>6	ft
Total ramp density, TRD	1.17	ramps/mi
Lane width adjustment, f_{LW}	0.0	mph
Lateral clearance adjustment, f_{LC}	0.0	mph
TRD adjustment	3.7	mph
Calculated free-flow speed, FFS	71.7	mph
Measured free-flow speed, FFS	65.0	mph
Free-flow speed curve	65	mph

Capacity Checks for Segments with Ramps

	<u>Actual</u>		<u>Maximum</u>		<u>Violation?</u>
Entering freeway volume		pcph		pcph	
Exiting freeway volume		pcph		pcph	
On-ramp volume		pcph		pcph	
Off-ramp volume		pcph		pcph	

LOS and Performance Measures

Flow rate, v_p	2,123	pcphpl
Average passenger-car speed, S	57.6	mph
Volume-to-capacity ratio, v/c	0.90	
Density, D	36.9	pcpmpl
Level of service, LOS	E	

HCM 2010: Freeway Basic Segment

Basic Operational Analysis

Project	CSUMB Master Plan EIR
Freeway	Southbound SR 1
Segment	SR 1 between Del Monte Boulevard and Imjin Parkway
Alternative	Cumulative
Time period	PM Peak Hour

Flow Inputs and Adjustments

Volume, V	2,860	vph
Peak-hour factor, PHF	0.95	
Peak 15-min volume, v_{15}	753	veh
Trucks and buses	1.4%	
Recreational vehicles	0.0%	
Terrain type	Level	
Grade		
Length		mi
Trucks and buses PCE, E_T	1.5	
Recreational vehicle PCE, E_R	1.2	
Heavy vehicle adjustment, f_{HV}	0.993	
Driver population factor, f_p	1.00	
Flow rate, v_p	3,031	pcph
Number of lanes, N	3	

Speed Inputs and Adjustments

Lane width	12.0	ft
Right-side lateral clearance	>6	ft
Total ramp density, TRD	1.17	ramps/mi
Lane width adjustment, f_{LW}	0.0	mph
Lateral clearance adjustment, f_{LC}	0.0	mph
TRD adjustment	3.7	mph
Calculated free-flow speed, FFS	71.7	mph
Measured free-flow speed, FFS	65.0	mph
Free-flow speed curve	65	mph

Capacity Checks for Segments with Ramps

	Actual		Maximum		Violation?
Entering freeway volume		pcph		pcph	
Exiting freeway volume		pcph		pcph	
On-ramp volume		pcph		pcph	
Off-ramp volume		pcph		pcph	

LOS and Performance Measures

Flow rate, v_p	1,010	pcphpl
Average passenger-car speed, S	65.0	mph
Volume-to-capacity ratio, v/c	0.43	
Density, D	15.5	pcpmpl
Level of service, LOS	B	

HCM 2010: Freeway Basic Segment

Basic Operational Analysis

Project	CSUMB Master Plan EIR
Freeway	Southbound State Route 1
Segment	SR 1 between Imjin Parkway and Lightfighter Drive
Alternative	Cumulative
Time period	AM Peak Hour

Flow Inputs and Adjustments

Volume, V	5,230	vph
Peak-hour factor, PHF	0.83	
Peak 15-min volume, v_{15}	1,575	veh
Trucks and buses	3.5%	
Recreational vehicles	0.0%	
Terrain type	Level	
Grade		
Length		mi
Trucks and buses PCE, E_T	1.5	
Recreational vehicle PCE, E_R	1.2	
Heavy vehicle adjustment, f_{HV}	0.983	
Driver population factor, f_p	1.00	
Flow rate, v_p	6,412	pcph
Number of lanes, N	3	

Speed Inputs and Adjustments

Lane width	12.0	ft
Right-side lateral clearance	>6	ft
Total ramp density, TRD	1.17	ramps/mi
Lane width adjustment, f_{LW}	0.0	mph
Lateral clearance adjustment, f_{LC}	0.0	mph
TRD adjustment	3.7	mph
Calculated free-flow speed, FFS	71.7	mph
Measured free-flow speed, FFS	65.0	mph
Free-flow speed curve	65	mph

Capacity Checks for Segments with Ramps

	<u>Actual</u>		<u>Maximum</u>		<u>Violation?</u>
Entering freeway volume		pcph		pcph	
Exiting freeway volume		pcph		pcph	
On-ramp volume		pcph		pcph	
Off-ramp volume		pcph		pcph	

LOS and Performance Measures

Flow rate, v_p	2,137	pcphpl
Average passenger-car speed, S	57.3	mph
Volume-to-capacity ratio, v/c	0.91	
Density, D	37.3	pcpmpl
Level of service, LOS	E	

HCM 2010: Freeway Basic Segment

Basic Operational Analysis

Project	CSUMB Master Plan EIR
Freeway	Southbound SR 1
Segment	SR 1 between Imjin Parkway and Lightfighter Drive
Alternative	Cumulative
Time period	PM Peak Hour

Flow Inputs and Adjustments

Volume, V	3,490	vph
Peak-hour factor, PHF	0.95	
Peak 15-min volume, v_{15}	918	veh
Trucks and buses	1.3%	
Recreational vehicles	0.0%	
Terrain type	Level	
Grade		
Length		mi
Trucks and buses PCE, E_T	1.5	
Recreational vehicle PCE, E_R	1.2	
Heavy vehicle adjustment, f_{HV}	0.994	
Driver population factor, f_p	1.00	
Flow rate, v_p	3,697	pcph
Number of lanes, N	3	

Speed Inputs and Adjustments

Lane width	12.0	ft
Right-side lateral clearance	>6	ft
Total ramp density, TRD	1.17	ramps/mi
Lane width adjustment, f_{LW}	0.0	mph
Lateral clearance adjustment, f_{LC}	0.0	mph
TRD adjustment	3.7	mph
Calculated free-flow speed, FFS	71.7	mph
Measured free-flow speed, FFS	65.0	mph
Free-flow speed curve	65	mph

Capacity Checks for Segments with Ramps

	Actual		Maximum		Violation?
Entering freeway volume		pcph		pcph	
Exiting freeway volume		pcph		pcph	
On-ramp volume		pcph		pcph	
Off-ramp volume		pcph		pcph	

LOS and Performance Measures

Flow rate, v_p	1,232	pcphpl
Average passenger-car speed, S	65.0	mph
Volume-to-capacity ratio, v/c	0.52	
Density, D	19.0	pcpmpl
Level of service, LOS	C	

HCM 2010: Freeway Basic Segment

Basic Operational Analysis

Project	CSUMB Master Plan EIR
Freeway	Southbound State Route 1
Segment	SR 1 between Lightfighter Drive and Del Monte Boulevard
Alternative	Cumulative
Time period	AM Peak Hour

Flow Inputs and Adjustments

Volume, V	5,450	vph
Peak-hour factor, PHF	0.86	
Peak 15-min volume, v_{15}	1,584	veh
Trucks and buses	3.2%	
Recreational vehicles	0.0%	
Terrain type	Level	
Grade		
Length		mi
Trucks and buses PCE, E_T	1.5	
Recreational vehicle PCE, E_R	1.2	
Heavy vehicle adjustment, f_{HV}	0.984	
Driver population factor, f_p	1.00	
Flow rate, v_p	6,439	pcph
Number of lanes, N	3	

Speed Inputs and Adjustments

Lane width	12.0	ft
Right-side lateral clearance	>6	ft
Total ramp density, TRD	1.33	ramps/mi
Lane width adjustment, f_{LW}	0.0	mph
Lateral clearance adjustment, f_{LC}	0.0	mph
TRD adjustment	4.1	mph
Calculated free-flow speed, FFS	71.3	mph
Measured free-flow speed, FFS	65.0	mph
Free-flow speed curve	65	mph

Capacity Checks for Segments with Ramps

	<u>Actual</u>		<u>Maximum</u>		<u>Violation?</u>
Entering freeway volume		pcph		pcph	
Exiting freeway volume		pcph		pcph	
On-ramp volume		pcph		pcph	
Off-ramp volume		pcph		pcph	

LOS and Performance Measures

Flow rate, v_p	2,146	pcphpl
Average passenger-car speed, S	57.1	mph
Volume-to-capacity ratio, v/c	0.91	
Density, D	37.6	pcpmpl
Level of service, LOS	E	

HCM 2010: Freeway Basic Segment

Basic Operational Analysis

Project	CSUMB Master Plan EIR
Freeway	Southbound SR 1
Segment	SR 1 between Lightfighter Drive and Del Monte Boulevard
Alternative	Cumulative
Time period	PM Peak Hour

Flow Inputs and Adjustments

Volume, V	3,920	vph
Peak-hour factor, PHF	0.97	
Peak 15-min volume, v_{15}	1,010	veh
Trucks and buses	1.1%	
Recreational vehicles	0.0%	
Terrain type	Level	
Grade		
Length		mi
Trucks and buses PCE, E_T	1.5	
Recreational vehicle PCE, E_R	1.2	
Heavy vehicle adjustment, f_{HV}	0.994	
Driver population factor, f_p	1.00	
Flow rate, v_p	4,064	pcph
Number of lanes, N	3	

Speed Inputs and Adjustments

Lane width	12.0	ft
Right-side lateral clearance	>6	ft
Total ramp density, TRD	1.33	ramps/mi
Lane width adjustment, f_{LW}	0.0	mph
Lateral clearance adjustment, f_{LC}	0.0	mph
TRD adjustment	4.1	mph
Calculated free-flow speed, FFS	71.3	mph
Measured free-flow speed, FFS	65.0	mph
Free-flow speed curve	65	mph

Capacity Checks for Segments with Ramps

	Actual		Maximum		Violation?
Entering freeway volume		pcph		pcph	
Exiting freeway volume		pcph		pcph	
On-ramp volume		pcph		pcph	
Off-ramp volume		pcph		pcph	

LOS and Performance Measures

Flow rate, v_p	1,355	pcphpl
Average passenger-car speed, S	65.0	mph
Volume-to-capacity ratio, v/c	0.58	
Density, D	20.8	pcpmpl
Level of service, LOS	C	

HCM 2010: Freeway Basic Segment

Basic Operational Analysis

Project	CSUMB Master Plan EIR
Freeway	Southbound State Route 1
Segment	SR 1 between Del Monte Boulevard and Canyon Del Rey Boulevard
Alternative	Cumulative
Time period	AM Peak Hour

Flow Inputs and Adjustments

Volume, V	4,470	vph
Peak-hour factor, PHF	0.95	
Peak 15-min volume, v_{15}	1,176	veh
Trucks and buses	2.4%	
Recreational vehicles	0.0%	
Terrain type	Level	
Grade		
Length		mi
Trucks and buses PCE, E_T	1.5	
Recreational vehicle PCE, E_R	1.2	
Heavy vehicle adjustment, f_{HV}	0.988	
Driver population factor, f_P	1.00	
Flow rate, v_p	4,763	pcph
Number of lanes, N	2	

Speed Inputs and Adjustments

Lane width	12.0	ft
Right-side lateral clearance	5.0	ft
Total ramp density, TRD	2.17	ramps/mi
Lane width adjustment, f_{LW}	0.0	mph
Lateral clearance adjustment, f_{LC}	0.6	mph
TRD adjustment	6.2	mph
Calculated free-flow speed, FFS	68.6	mph
Measured free-flow speed, FFS	65.0	mph
Free-flow speed curve	65	mph

Capacity Checks for Segments with Ramps

	<u>Actual</u>		<u>Maximum</u>		<u>Violation?</u>
Entering freeway volume		pcph		pcph	
Exiting freeway volume		pcph		pcph	
On-ramp volume		pcph		pcph	
Off-ramp volume		pcph		pcph	

LOS and Performance Measures

Flow rate, v_p	2,381	pcphpl
Average passenger-car speed, S	-	mph
Volume-to-capacity ratio, v/c	1.01	
Density, D	-	pcpmpl
Level of service, LOS	F	

HCM 2010: Freeway Basic Segment

Basic Operational Analysis

Project	CSUMB Master Plan EIR
Freeway	Southbound SR 1
Segment	SR 1 between Del Monte Boulevard and Canyon Del Rey Boulevard
Alternative	Cumulative
Time period	PM Peak Hour

Flow Inputs and Adjustments

Volume, V	3,170	vph
Peak-hour factor, PHF	0.96	
Peak 15-min volume, v_{15}	826	veh
Trucks and buses	1.0%	
Recreational vehicles	0.0%	
Terrain type	Level	
Grade		
Length		mi
Trucks and buses PCE, E_T	1.5	
Recreational vehicle PCE, E_R	1.2	
Heavy vehicle adjustment, f_{HV}	0.995	
Driver population factor, f_p	1.00	
Flow rate, v_p	3,319	pcph
Number of lanes, N	2	

Speed Inputs and Adjustments

Lane width	12.0	ft
Right-side lateral clearance	5.0	ft
Total ramp density, TRD	2.17	ramps/mi
Lane width adjustment, f_{LW}	0.0	mph
Lateral clearance adjustment, f_{LC}	0.6	mph
TRD adjustment	6.2	mph
Calculated free-flow speed, FFS	68.6	mph
Measured free-flow speed, FFS	65.0	mph
Free-flow speed curve	65	mph

Capacity Checks for Segments with Ramps

	Actual		Maximum		Violation?
Entering freeway volume		pcph		pcph	
Exiting freeway volume		pcph		pcph	
On-ramp volume		pcph		pcph	
Off-ramp volume		pcph		pcph	

LOS and Performance Measures

Flow rate, v_p	1,659	pcphpl
Average passenger-car speed, S	64.0	mph
Volume-to-capacity ratio, v/c	0.71	
Density, D	25.9	pcpmpl
Level of service, LOS	C	

HCM 2010: Freeway Basic Segment

Basic Operational Analysis

Project	CSUMB Master Plan EIR
Freeway	Northbound State Route 1
Segment	SR 1 between Reservation Road and Del Monte Boulevard
Alternative	Cumulative
Time period	AM Peak Hour

Flow Inputs and Adjustments

Volume, V	1,500	vph
Peak-hour factor, PHF	0.97	
Peak 15-min volume, v_{15}	387	veh
Trucks and buses	6.4%	
Recreational vehicles	0.0%	
Terrain type	Level	
Grade		
Length		mi
Trucks and buses PCE, E_T	1.5	
Recreational vehicle PCE, E_R	1.2	
Heavy vehicle adjustment, f_{HV}	0.969	
Driver population factor, f_p	1.00	
Flow rate, v_p	1,596	pcph
Number of lanes, N	2	

Speed Inputs and Adjustments

Lane width	12.0	ft
Right-side lateral clearance	>6	ft
Total ramp density, TRD	1.00	ramps/mi
Lane width adjustment, f_{LW}	0.0	mph
Lateral clearance adjustment, f_{LC}	0.0	mph
TRD adjustment	3.2	mph
Calculated free-flow speed, FFS	72.2	mph
Measured free-flow speed, FFS	65.0	mph
Free-flow speed curve	65	mph

Capacity Checks for Segments with Ramps

	<u>Actual</u>		<u>Maximum</u>		<u>Violation?</u>
Entering freeway volume		pcph		pcph	
Exiting freeway volume		pcph		pcph	
On-ramp volume		pcph		pcph	
Off-ramp volume		pcph		pcph	

LOS and Performance Measures

Flow rate, v_p	798	pcphpl
Average passenger-car speed, S	65.0	mph
Volume-to-capacity ratio, v/c	0.34	
Density, D	12.3	pcpmpl
Level of service, LOS	B	

HCM 2010: Freeway Basic Segment

Basic Operational Analysis

Project	CSUMB Master Plan EIR
Freeway	Northbound State Route 1
Segment	SR 1 between Reservation Road and Del Monte Boulevard
Alternative	Cumulative
Time period	PM Peak Hour

Flow Inputs and Adjustments

Volume, V	2,970	vph
Peak-hour factor, PHF	0.98	
Peak 15-min volume, v_{15}	758	veh
Trucks and buses	2.2%	
Recreational vehicles	0.0%	
Terrain type	Level	
Grade		
Length		mi
Trucks and buses PCE, E_T	1.5	
Recreational vehicle PCE, E_R	1.2	
Heavy vehicle adjustment, f_{HV}	0.989	
Driver population factor, f_p	1.00	
Flow rate, v_p	3,064	pcph
Number of lanes, N	2	

Speed Inputs and Adjustments

Lane width	12.0	ft
Right-side lateral clearance	>6	ft
Total ramp density, TRD	1.00	ramps/mi
Lane width adjustment, f_{LW}	0.0	mph
Lateral clearance adjustment, f_{LC}	0.0	mph
TRD adjustment	3.2	mph
Calculated free-flow speed, FFS	72.2	mph
Measured free-flow speed, FFS	65.0	mph
Free-flow speed curve	65	mph

Capacity Checks for Segments with Ramps

	<u>Actual</u>		<u>Maximum</u>		<u>Violation?</u>
Entering freeway volume		pcph		pcph	
Exiting freeway volume		pcph		pcph	
On-ramp volume		pcph		pcph	
Off-ramp volume		pcph		pcph	

LOS and Performance Measures

Flow rate, v_p	1,532	pcphpl
Average passenger-car speed, S	64.8	mph
Volume-to-capacity ratio, v/c	0.65	
Density, D	23.7	pcpmpl
Level of service, LOS	C	

HCM 2010: Freeway Basic Segment

Basic Operational Analysis

Project	CSUMB Master Plan EIR
Freeway	Northbound State Route 1
Segment	SR 1 between Del Monte Boulevard and Imjin Parkway
Alternative	Cumulative
Time period	AM Peak Hour

Flow Inputs and Adjustments

Volume, V	2,410	vph
Peak-hour factor, PHF	0.92	
Peak 15-min volume, v_{15}	655	veh
Trucks and buses	5.7%	
Recreational vehicles	0.0%	
Terrain type	Level	
Grade		
Length		mi
Trucks and buses PCE, E_T	1.5	
Recreational vehicle PCE, E_R	1.2	
Heavy vehicle adjustment, f_{HV}	0.972	
Driver population factor, f_p	1.00	
Flow rate, v_p	2,695	pcph
Number of lanes, N	3	

Speed Inputs and Adjustments

Lane width	12.0	ft
Right-side lateral clearance	>6	ft
Total ramp density, TRD	1.20	ramps/mi
Lane width adjustment, f_{LW}	0.0	mph
Lateral clearance adjustment, f_{LC}	0.0	mph
TRD adjustment	3.8	mph
Calculated free-flow speed, FFS	71.6	mph
Measured free-flow speed, FFS	65.0	mph
Free-flow speed curve	65	mph

Capacity Checks for Segments with Ramps

	<u>Actual</u>		<u>Maximum</u>		<u>Violation?</u>
Entering freeway volume		pcph		pcph	
Exiting freeway volume		pcph		pcph	
On-ramp volume		pcph		pcph	
Off-ramp volume		pcph		pcph	

LOS and Performance Measures

Flow rate, v_p	898	pcphpl
Average passenger-car speed, S	65.0	mph
Volume-to-capacity ratio, v/c	0.38	
Density, D	13.8	pcpmpl
Level of service, LOS	B	

HCM 2010: Freeway Basic Segment

Basic Operational Analysis

Project	CSUMB Master Plan EIR
Freeway	Northbound State Route 1
Segment	SR 1 between Del Monte Boulevard and Imjin Parkway
Alternative	Cumulative
Time period	PM Peak Hour

Flow Inputs and Adjustments

Volume, V	4,850	vph
Peak-hour factor, PHF	0.96	
Peak 15-min volume, v_{15}	1,263	veh
Trucks and buses	1.9%	
Recreational vehicles	0.0%	
Terrain type	Level	
Grade		
Length		mi
Trucks and buses PCE, E_T	1.5	
Recreational vehicle PCE, E_R	1.2	
Heavy vehicle adjustment, f_{HV}	0.991	
Driver population factor, f_p	1.00	
Flow rate, v_p	5,100	pcph
Number of lanes, N	3	

Speed Inputs and Adjustments

Lane width	12.0	ft
Right-side lateral clearance	>6	ft
Total ramp density, TRD	1.17	ramps/mi
Lane width adjustment, f_{LW}	0.0	mph
Lateral clearance adjustment, f_{LC}	0.0	mph
TRD adjustment	3.7	mph
Calculated free-flow speed, FFS	71.7	mph
Measured free-flow speed, FFS	65.0	mph
Free-flow speed curve	65	mph

Capacity Checks for Segments with Ramps

	<u>Actual</u>		<u>Maximum</u>		<u>Violation?</u>
Entering freeway volume		pcph		pcph	
Exiting freeway volume		pcph		pcph	
On-ramp volume		pcph		pcph	
Off-ramp volume		pcph		pcph	

LOS and Performance Measures

Flow rate, v_p	1,700	pcphpl
Average passenger-car speed, S	63.7	mph
Volume-to-capacity ratio, v/c	0.72	
Density, D	26.7	pcpmpl
Level of service, LOS	D	

HCM 2010: Freeway Basic Segment

Basic Operational Analysis

Project	CSUMB Master Plan EIR
Freeway	Northbound State Route 1
Segment	SR 1 between Imjin Parkway and Lightfighter Drive
Alternative	Cumulative
Time period	AM Peak Hour

Flow Inputs and Adjustments

Volume, V	3,070	vph
Peak-hour factor, PHF	0.92	
Peak 15-min volume, v_{15}	836	veh
Trucks and buses	3.8%	
Recreational vehicles	0.0%	
Terrain type	Level	
Grade		
Length		mi
Trucks and buses PCE, E_T	1.5	
Recreational vehicle PCE, E_R	1.2	
Heavy vehicle adjustment, f_{HV}	0.982	
Driver population factor, f_p	1.00	
Flow rate, v_p	3,408	pcph
Number of lanes, N	3	

Speed Inputs and Adjustments

Lane width	12.0	ft
Right-side lateral clearance	>6	ft
Total ramp density, TRD	1.17	ramps/mi
Lane width adjustment, f_{LW}	0.0	mph
Lateral clearance adjustment, f_{LC}	0.0	mph
TRD adjustment	3.7	mph
Calculated free-flow speed, FFS	71.7	mph
Measured free-flow speed, FFS	65.0	mph
Free-flow speed curve	65	mph

Capacity Checks for Segments with Ramps

	<u>Actual</u>		<u>Maximum</u>		<u>Violation?</u>
Entering freeway volume		pcph		pcph	
Exiting freeway volume		pcph		pcph	
On-ramp volume		pcph		pcph	
Off-ramp volume		pcph		pcph	

LOS and Performance Measures

Flow rate, v_p	1,136	pcphpl
Average passenger-car speed, S	65.0	mph
Volume-to-capacity ratio, v/c	0.48	
Density, D	17.5	pcpmpl
Level of service, LOS	B	

HCM 2010: Freeway Basic Segment

Basic Operational Analysis

Project	CSUMB Master Plan EIR
Freeway	Northbound State Route 1
Segment	SR 1 between Imjin Parkway and Lightfighter Drive
Alternative	Cumulative
Time period	PM Peak Hour

Flow Inputs and Adjustments

Volume, V	5,530	vph
Peak-hour factor, PHF	0.97	
Peak 15-min volume, v_{15}	1,425	veh
Trucks and buses	1.7%	
Recreational vehicles	0.0%	
Terrain type	Level	
Grade		
Length		mi
Trucks and buses PCE, E_T	1.5	
Recreational vehicle PCE, E_R	1.2	
Heavy vehicle adjustment, f_{HV}	0.991	
Driver population factor, f_p	1.00	
Flow rate, v_p	5,750	pcph
Number of lanes, N	3	

Speed Inputs and Adjustments

Lane width	12.0	ft
Right-side lateral clearance	>6	ft
Total ramp density, TRD	1.17	ramps/mi
Lane width adjustment, f_{LW}	0.0	mph
Lateral clearance adjustment, f_{LC}	0.0	mph
TRD adjustment	3.7	mph
Calculated free-flow speed, FFS	71.7	mph
Measured free-flow speed, FFS	65.0	mph
Free-flow speed curve	65	mph

Capacity Checks for Segments with Ramps

	<u>Actual</u>		<u>Maximum</u>		<u>Violation?</u>
Entering freeway volume		pcph		pcph	
Exiting freeway volume		pcph		pcph	
On-ramp volume		pcph		pcph	
Off-ramp volume		pcph		pcph	

LOS and Performance Measures

Flow rate, v_p	1,917	pcphpl
Average passenger-car speed, S	61.2	mph
Volume-to-capacity ratio, v/c	0.82	
Density, D	31.3	pcpmpl
Level of service, LOS	D	

HCM 2010: Freeway Basic Segment

Basic Operational Analysis

Project	CSUMB Master Plan EIR
Freeway	Northbound State Route 1
Segment	SR 1 between Lightfighter Drive and Del Monte Boulevard
Alternative	Cumulative
Time period	AM Peak Hour

Flow Inputs and Adjustments

Volume, V	3,480	vph
Peak-hour factor, PHF	0.93	
Peak 15-min volume, v_{15}	932	veh
Trucks and buses	3.8%	
Recreational vehicles	0.0%	
Terrain type	Level	
Grade		
Length		mi
Trucks and buses PCE, E_T	1.5	
Recreational vehicle PCE, E_R	1.2	
Heavy vehicle adjustment, f_{HV}	0.982	
Driver population factor, f_p	1.00	
Flow rate, v_p	3,797	pcph
Number of lanes, N	3	

Speed Inputs and Adjustments

Lane width	12.0	ft
Right-side lateral clearance	>6	ft
Total ramp density, TRD	1.17	ramps/mi
Lane width adjustment, f_{LW}	0.0	mph
Lateral clearance adjustment, f_{LC}	0.0	mph
TRD adjustment	3.7	mph
Calculated free-flow speed, FFS	71.7	mph
Measured free-flow speed, FFS	65.0	mph
Free-flow speed curve	65	mph

Capacity Checks for Segments with Ramps

	<u>Actual</u>		<u>Maximum</u>		<u>Violation?</u>
Entering freeway volume		pcph		pcph	
Exiting freeway volume		pcph		pcph	
On-ramp volume		pcph		pcph	
Off-ramp volume		pcph		pcph	

LOS and Performance Measures

Flow rate, v_p	1,266	pcphpl
Average passenger-car speed, S	65.0	mph
Volume-to-capacity ratio, v/c	0.54	
Density, D	19.5	pcpmpl
Level of service, LOS	C	

HCM 2010: Freeway Basic Segment

Basic Operational Analysis

Project	CSUMB Master Plan EIR
Freeway	Northbound State Route 1
Segment	SR 1 between Lightfighter Drive and Del Monte Boulevard
Alternative	Cumulative
Time period	PM Peak Hour

Flow Inputs and Adjustments

Volume, V	5,380	vph
Peak-hour factor, PHF	0.98	
Peak 15-min volume, v_{15}	1,372	veh
Trucks and buses	1.9%	
Recreational vehicles	0.0%	
Terrain type	Level	
Grade		
Length		mi
Trucks and buses PCE, E_T	1.5	
Recreational vehicle PCE, E_R	1.2	
Heavy vehicle adjustment, f_{HV}	0.991	
Driver population factor, f_p	1.00	
Flow rate, v_p	5,541	pcph
Number of lanes, N	3	

Speed Inputs and Adjustments

Lane width	12.0	ft
Right-side lateral clearance	>6	ft
Total ramp density, TRD	1.17	ramps/mi
Lane width adjustment, f_{LW}	0.0	mph
Lateral clearance adjustment, f_{LC}	0.0	mph
TRD adjustment	3.7	mph
Calculated free-flow speed, FFS	71.7	mph
Measured free-flow speed, FFS	65.0	mph
Free-flow speed curve	65	mph

Capacity Checks for Segments with Ramps

	<u>Actual</u>		<u>Maximum</u>		<u>Violation?</u>
Entering freeway volume		pcph		pcph	
Exiting freeway volume		pcph		pcph	
On-ramp volume		pcph		pcph	
Off-ramp volume		pcph		pcph	

LOS and Performance Measures

Flow rate, v_p	1,847	pcphpl
Average passenger-car speed, S	62.2	mph
Volume-to-capacity ratio, v/c	0.79	
Density, D	29.7	pcpmpl
Level of service, LOS	D	

HCM 2010: Freeway Basic Segment

Basic Operational Analysis

Project	CSUMB Master Plan EIR
Freeway	Northbound State Route 1
Segment	SR 1 between Del Monte Boulevard and Canyon Del Rey Boulevard
Alternative	Cumulative
Time period	AM Peak Hour

Flow Inputs and Adjustments

Volume, V	2,970	vph
Peak-hour factor, PHF	0.92	
Peak 15-min volume, v_{15}	811	veh
Trucks and buses	3.2%	
Recreational vehicles	0.0%	
Terrain type	Level	
Grade		
Length		mi
Trucks and buses PCE, E_T	1.5	
Recreational vehicle PCE, E_R	1.2	
Heavy vehicle adjustment, f_{HV}	0.984	
Driver population factor, f_p	1.00	
Flow rate, v_p	3,296	pcph
Number of lanes, N	2	

Speed Inputs and Adjustments

Lane width	12.0	ft
Right-side lateral clearance	>6	ft
Total ramp density, TRD	2.00	ramps/mi
Lane width adjustment, f_{LW}	0.0	mph
Lateral clearance adjustment, f_{LC}	0.0	mph
TRD adjustment	5.8	mph
Calculated free-flow speed, FFS	69.6	mph
Measured free-flow speed, FFS	65.0	mph
Free-flow speed curve	65	mph

Capacity Checks for Segments with Ramps

	<u>Actual</u>		<u>Maximum</u>		<u>Violation?</u>
Entering freeway volume		pcph		pcph	
Exiting freeway volume		pcph		pcph	
On-ramp volume		pcph		pcph	
Off-ramp volume		pcph		pcph	

LOS and Performance Measures

Flow rate, v_p	1,648	pcphpl
Average passenger-car speed, S	64.1	mph
Volume-to-capacity ratio, v/c	0.70	
Density, D	25.7	pcpmpl
Level of service, LOS	C	

HCM 2010: Freeway Basic Segment

Basic Operational Analysis

Project	CSUMB Master Plan EIR
Freeway	Northbound State Route 1
Segment	SR 1 between Del Monte Boulevard and Canyon Del Rey Boulevard
Alternative	Cumulative
Time period	PM Peak Hour

Flow Inputs and Adjustments

Volume, V	4,290	vph
Peak-hour factor, PHF	0.97	
Peak 15-min volume, v_{15}	1,106	veh
Trucks and buses	2.0%	
Recreational vehicles	0.0%	
Terrain type	Level	
Grade		
Length		mi
Trucks and buses PCE, E_T	1.5	
Recreational vehicle PCE, E_R	1.2	
Heavy vehicle adjustment, f_{HV}	0.990	
Driver population factor, f_p	1.00	
Flow rate, v_p	4,468	pcph
Number of lanes, N	2	

Speed Inputs and Adjustments

Lane width	12.0	ft
Right-side lateral clearance	>6	ft
Total ramp density, TRD	2.00	ramps/mi
Lane width adjustment, f_{LW}	0.0	mph
Lateral clearance adjustment, f_{LC}	0.0	mph
TRD adjustment	5.8	mph
Calculated free-flow speed, FFS	69.6	mph
Measured free-flow speed, FFS	65.0	mph
Free-flow speed curve	65	mph

Capacity Checks for Segments with Ramps

	<u>Actual</u>		<u>Maximum</u>		<u>Violation?</u>
Entering freeway volume		pcph		pcph	
Exiting freeway volume		pcph		pcph	
On-ramp volume		pcph		pcph	
Off-ramp volume		pcph		pcph	

LOS and Performance Measures

Flow rate, v_p	2,234	pcphpl
Average passenger-car speed, S	55.1	mph
Volume-to-capacity ratio, v/c	0.95	
Density, D	40.5	pcpmpl
Level of service, LOS	E	

HCM 2010: Freeway Basic Segment

Basic Operational Analysis

Project	CSUMB Master Plan EIR
Freeway	Southbound State Route 1
Segment	SR 1 between Reservation Road and Del Monte Boulevard
Alternative	Cuml w/ Eastside Pkwy
Time period	AM Peak Hour

Flow Inputs and Adjustments

Volume, V	3,460	vph
Peak-hour factor, PHF	0.76	
Peak 15-min volume, v_{15}	1,138	veh
Trucks and buses	4.7%	
Recreational vehicles	0.0%	
Terrain type	Level	
Grade		
Length		mi
Trucks and buses PCE, E_T	1.5	
Recreational vehicle PCE, E_R	1.2	
Heavy vehicle adjustment, f_{HV}	0.977	
Driver population factor, f_P	1.00	
Flow rate, v_p	4,659	pcph
Number of lanes, N	2	

Speed Inputs and Adjustments

Lane width	12.0	ft
Right-side lateral clearance	>6	ft
Total ramp density, TRD	1.00	ramps/mi
Lane width adjustment, f_{LW}	0.0	mph
Lateral clearance adjustment, f_{LC}	0.0	mph
TRD adjustment	3.2	mph
Calculated free-flow speed, FFS	72.2	mph
Measured free-flow speed, FFS	65.0	mph
Free-flow speed curve	65	mph

Capacity Checks for Segments with Ramps

	<u>Actual</u>		<u>Maximum</u>		<u>Violation?</u>
Entering freeway volume		pcph		pcph	
Exiting freeway volume		pcph		pcph	
On-ramp volume		pcph		pcph	
Off-ramp volume		pcph		pcph	

LOS and Performance Measures

Flow rate, v_p	2,329	pcphpl
Average passenger-car speed, S	52.8	mph
Volume-to-capacity ratio, v/c	0.99	
Density, D	44.2	pcpmpl
Level of service, LOS	E	

HCM 2010: Freeway Basic Segment

Basic Operational Analysis

Project	CSUMB Master Plan EIR
Freeway	Southbound SR 1
Segment	SR 1 between Reservation Road and Del Monte Boulevard
Alternative	Cuml w/ Eastside Pkwy
Time period	PM Peak Hour

Flow Inputs and Adjustments

Volume, V	1,870	vph
Peak-hour factor, PHF	0.97	
Peak 15-min volume, v_{15}	482	veh
Trucks and buses	1.0%	
Recreational vehicles	0.0%	
Terrain type	Level	
Grade		
Length		mi
Trucks and buses PCE, E_T	1.5	
Recreational vehicle PCE, E_R	1.2	
Heavy vehicle adjustment, f_{HV}	0.995	
Driver population factor, f_p	1.00	
Flow rate, v_p	1,937	pcph
Number of lanes, N	2	

Speed Inputs and Adjustments

Lane width	12.0	ft
Right-side lateral clearance	>6	ft
Total ramp density, TRD	1.00	ramps/mi
Lane width adjustment, f_{LW}	0.0	mph
Lateral clearance adjustment, f_{LC}	0.0	mph
TRD adjustment	3.2	mph
Calculated free-flow speed, FFS	72.2	mph
Measured free-flow speed, FFS	65.0	mph
Free-flow speed curve	65	mph

Capacity Checks for Segments with Ramps

	<u>Actual</u>		<u>Maximum</u>		<u>Violation?</u>
Entering freeway volume		pcph		pcph	
Exiting freeway volume		pcph		pcph	
On-ramp volume		pcph		pcph	
Off-ramp volume		pcph		pcph	

LOS and Performance Measures

Flow rate, v_p	969	pcphpl
Average passenger-car speed, S	65.0	mph
Volume-to-capacity ratio, v/c	0.41	
Density, D	14.9	pcpmpl
Level of service, LOS	B	

HCM 2010: Freeway Basic Segment

Basic Operational Analysis

Project	CSUMB Master Plan EIR
Freeway	Southbound State Route 1
Segment	SR 1 between Del Monte Boulevard and Imjin Parkway
Alternative	Cuml w/ Eastside Pkwy
Time period	AM Peak Hour

Flow Inputs and Adjustments

Volume, V	5,050	vph
Peak-hour factor, PHF	0.81	
Peak 15-min volume, v_{15}	1,559	veh
Trucks and buses	3.9%	
Recreational vehicles	0.0%	
Terrain type	Level	
Grade		
Length		mi
Trucks and buses PCE, E_T	1.5	
Recreational vehicle PCE, E_R	1.2	
Heavy vehicle adjustment, f_{HV}	0.981	
Driver population factor, f_p	1.00	
Flow rate, v_p	6,356	pcph
Number of lanes, N	3	

Speed Inputs and Adjustments

Lane width	12.0	ft
Right-side lateral clearance	>6	ft
Total ramp density, TRD	1.17	ramps/mi
Lane width adjustment, f_{LW}	0.0	mph
Lateral clearance adjustment, f_{LC}	0.0	mph
TRD adjustment	3.7	mph
Calculated free-flow speed, FFS	71.7	mph
Measured free-flow speed, FFS	65.0	mph
Free-flow speed curve	65	mph

Capacity Checks for Segments with Ramps

	<u>Actual</u>		<u>Maximum</u>		<u>Violation?</u>
Entering freeway volume		pcph		pcph	
Exiting freeway volume		pcph		pcph	
On-ramp volume		pcph		pcph	
Off-ramp volume		pcph		pcph	

LOS and Performance Measures

Flow rate, v_p	2,119	pcphpl
Average passenger-car speed, S	57.7	mph
Volume-to-capacity ratio, v/c	0.90	
Density, D	36.7	pcpmpl
Level of service, LOS	E	

HCM 2010: Freeway Basic Segment

Basic Operational Analysis

Project	CSUMB Master Plan EIR
Freeway	Southbound SR 1
Segment	SR 1 between Del Monte Boulevard and Imjin Parkway
Alternative	Cuml w/ Eastside Pkwy
Time period	PM Peak Hour

Flow Inputs and Adjustments

Volume, V	2,910	vph
Peak-hour factor, PHF	0.95	
Peak 15-min volume, v_{15}	766	veh
Trucks and buses	1.4%	
Recreational vehicles	0.0%	
Terrain type	Level	
Grade		
Length		mi
Trucks and buses PCE, E_T	1.5	
Recreational vehicle PCE, E_R	1.2	
Heavy vehicle adjustment, f_{HV}	0.993	
Driver population factor, f_p	1.00	
Flow rate, v_p	3,084	pcph
Number of lanes, N	3	

Speed Inputs and Adjustments

Lane width	12.0	ft
Right-side lateral clearance	>6	ft
Total ramp density, TRD	1.17	ramps/mi
Lane width adjustment, f_{LW}	0.0	mph
Lateral clearance adjustment, f_{LC}	0.0	mph
TRD adjustment	3.7	mph
Calculated free-flow speed, FFS	71.7	mph
Measured free-flow speed, FFS	65.0	mph
Free-flow speed curve	65	mph

Capacity Checks for Segments with Ramps

	<u>Actual</u>		<u>Maximum</u>		<u>Violation?</u>
Entering freeway volume		pcph		pcph	
Exiting freeway volume		pcph		pcph	
On-ramp volume		pcph		pcph	
Off-ramp volume		pcph		pcph	

LOS and Performance Measures

Flow rate, v_p	1,028	pcphpl
Average passenger-car speed, S	65.0	mph
Volume-to-capacity ratio, v/c	0.44	
Density, D	15.8	pcmppl
Level of service, LOS	B	

HCM 2010: Freeway Basic Segment

Basic Operational Analysis

Project	CSUMB Master Plan EIR
Freeway	Southbound State Route 1
Segment	SR 1 between Imjin Parkway and Lightfighter Drive
Alternative	Cuml w/ Eastside Pkwy
Time period	AM Peak Hour

Flow Inputs and Adjustments

Volume, V	5,080	vph
Peak-hour factor, PHF	0.83	
Peak 15-min volume, v_{15}	1,530	veh
Trucks and buses	3.5%	
Recreational vehicles	0.0%	
Terrain type	Level	
Grade		
Length		mi
Trucks and buses PCE, E_T	1.5	
Recreational vehicle PCE, E_R	1.2	
Heavy vehicle adjustment, f_{HV}	0.983	
Driver population factor, f_p	1.00	
Flow rate, v_p	6,229	pcph
Number of lanes, N	3	

Speed Inputs and Adjustments

Lane width	12.0	ft
Right-side lateral clearance	>6	ft
Total ramp density, TRD	1.17	ramps/mi
Lane width adjustment, f_{LW}	0.0	mph
Lateral clearance adjustment, f_{LC}	0.0	mph
TRD adjustment	3.7	mph
Calculated free-flow speed, FFS	71.7	mph
Measured free-flow speed, FFS	65.0	mph
Free-flow speed curve	65	mph

Capacity Checks for Segments with Ramps

	<u>Actual</u>		<u>Maximum</u>		<u>Violation?</u>
Entering freeway volume		pcph		pcph	
Exiting freeway volume		pcph		pcph	
On-ramp volume		pcph		pcph	
Off-ramp volume		pcph		pcph	

LOS and Performance Measures

Flow rate, v_p	2,076	pcphpl
Average passenger-car speed, S	58.5	mph
Volume-to-capacity ratio, v/c	0.88	
Density, D	35.5	pcpmpl
Level of service, LOS	E	

HCM 2010: Freeway Basic Segment

Basic Operational Analysis

Project	CSUMB Master Plan EIR
Freeway	Southbound SR 1
Segment	SR 1 between Imjin Parkway and Lightfighter Drive
Alternative	Cuml w/ Eastside Pkwy
Time period	PM Peak Hour

Flow Inputs and Adjustments

Volume, V	3,380	vph
Peak-hour factor, PHF	0.95	
Peak 15-min volume, v_{15}	889	veh
Trucks and buses	1.3%	
Recreational vehicles	0.0%	
Terrain type	Level	
Grade		
Length		mi
Trucks and buses PCE, E_T	1.5	
Recreational vehicle PCE, E_R	1.2	
Heavy vehicle adjustment, f_{HV}	0.994	
Driver population factor, f_p	1.00	
Flow rate, v_p	3,580	pcph
Number of lanes, N	3	

Speed Inputs and Adjustments

Lane width	12.0	ft
Right-side lateral clearance	>6	ft
Total ramp density, TRD	1.17	ramps/mi
Lane width adjustment, f_{LW}	0.0	mph
Lateral clearance adjustment, f_{LC}	0.0	mph
TRD adjustment	3.7	mph
Calculated free-flow speed, FFS	71.7	mph
Measured free-flow speed, FFS	65.0	mph
Free-flow speed curve	65	mph

Capacity Checks for Segments with Ramps

	<u>Actual</u>		<u>Maximum</u>		<u>Violation?</u>
Entering freeway volume		pcph		pcph	
Exiting freeway volume		pcph		pcph	
On-ramp volume		pcph		pcph	
Off-ramp volume		pcph		pcph	

LOS and Performance Measures

Flow rate, v_p	1,193	pcphpl
Average passenger-car speed, S	65.0	mph
Volume-to-capacity ratio, v/c	0.51	
Density, D	18.4	pcpmpl
Level of service, LOS	C	

HCM 2010: Freeway Basic Segment

Basic Operational Analysis

Project	CSUMB Master Plan EIR
Freeway	Southbound State Route 1
Segment	SR 1 between Lightfighter Drive and Del Monte Boulevard
Alternative	Cuml w/ Eastside Pkwy
Time period	AM Peak Hour

Flow Inputs and Adjustments

Volume, V	5,490	vph
Peak-hour factor, PHF	0.86	
Peak 15-min volume, v_{15}	1,596	veh
Trucks and buses	3.2%	
Recreational vehicles	0.0%	
Terrain type	Level	
Grade		
Length		mi
Trucks and buses PCE, E_T	1.5	
Recreational vehicle PCE, E_R	1.2	
Heavy vehicle adjustment, f_{HV}	0.984	
Driver population factor, f_P	1.00	
Flow rate, v_p	6,486	pcph
Number of lanes, N	3	

Speed Inputs and Adjustments

Lane width	12.0	ft
Right-side lateral clearance	>6	ft
Total ramp density, TRD	1.33	ramps/mi
Lane width adjustment, f_{LW}	0.0	mph
Lateral clearance adjustment, f_{LC}	0.0	mph
TRD adjustment	4.1	mph
Calculated free-flow speed, FFS	71.3	mph
Measured free-flow speed, FFS	65.0	mph
Free-flow speed curve	65	mph

Capacity Checks for Segments with Ramps

	<u>Actual</u>		<u>Maximum</u>		<u>Violation?</u>
Entering freeway volume		pcph		pcph	
Exiting freeway volume		pcph		pcph	
On-ramp volume		pcph		pcph	
Off-ramp volume		pcph		pcph	

LOS and Performance Measures

Flow rate, v_p	2,162	pcphpl
Average passenger-car speed, S	56.8	mph
Volume-to-capacity ratio, v/c	0.92	
Density, D	38.1	pcpmpl
Level of service, LOS	E	

HCM 2010: Freeway Basic Segment

Basic Operational Analysis

Project	CSUMB Master Plan EIR
Freeway	Southbound SR 1
Segment	SR 1 between Lightfighter Drive and Del Monte Boulevard
Alternative	Cuml w/ Eastside Pkwy
Time period	PM Peak Hour

Flow Inputs and Adjustments

Volume, V	3,940	vph
Peak-hour factor, PHF	0.97	
Peak 15-min volume, v_{15}	1,015	veh
Trucks and buses	1.1%	
Recreational vehicles	0.0%	
Terrain type	Level	
Grade		
Length		mi
Trucks and buses PCE, E_T	1.5	
Recreational vehicle PCE, E_R	1.2	
Heavy vehicle adjustment, f_{HV}	0.994	
Driver population factor, f_p	1.00	
Flow rate, v_p	4,085	pcph
Number of lanes, N	3	

Speed Inputs and Adjustments

Lane width	12.0	ft
Right-side lateral clearance	>6	ft
Total ramp density, TRD	1.33	ramps/mi
Lane width adjustment, f_{LW}	0.0	mph
Lateral clearance adjustment, f_{LC}	0.0	mph
TRD adjustment	4.1	mph
Calculated free-flow speed, FFS	71.3	mph
Measured free-flow speed, FFS	65.0	mph
Free-flow speed curve	65	mph

Capacity Checks for Segments with Ramps

	<u>Actual</u>		<u>Maximum</u>		<u>Violation?</u>
Entering freeway volume		pcph		pcph	
Exiting freeway volume		pcph		pcph	
On-ramp volume		pcph		pcph	
Off-ramp volume		pcph		pcph	

LOS and Performance Measures

Flow rate, v_p	1,362	pcphpl
Average passenger-car speed, S	65.0	mph
Volume-to-capacity ratio, v/c	0.58	
Density, D	20.9	pcpmpl
Level of service, LOS	C	

HCM 2010: Freeway Basic Segment

Basic Operational Analysis

Project	CSUMB Master Plan EIR
Freeway	Southbound State Route 1
Segment	SR 1 between Del Monte Boulevard and Canyon Del Rey Boulevard
Alternative	Cuml w/ Eastside Pkwy
Time period	AM Peak Hour

Flow Inputs and Adjustments

Volume, V	4,540	vph
Peak-hour factor, PHF	0.95	
Peak 15-min volume, v_{15}	1,195	veh
Trucks and buses	2.4%	
Recreational vehicles	0.0%	
Terrain type	Level	
Grade		
Length		mi
Trucks and buses PCE, E_T	1.5	
Recreational vehicle PCE, E_R	1.2	
Heavy vehicle adjustment, f_{HV}	0.988	
Driver population factor, f_p	1.00	
Flow rate, v_p	4,837	pcph
Number of lanes, N	2	

Speed Inputs and Adjustments

Lane width	12.0	ft
Right-side lateral clearance	5.0	ft
Total ramp density, TRD	2.17	ramps/mi
Lane width adjustment, f_{LW}	0.0	mph
Lateral clearance adjustment, f_{LC}	0.6	mph
TRD adjustment	6.2	mph
Calculated free-flow speed, FFS	68.6	mph
Measured free-flow speed, FFS	65.0	mph
Free-flow speed curve	65	mph

Capacity Checks for Segments with Ramps

	<u>Actual</u>		<u>Maximum</u>		<u>Violation?</u>
Entering freeway volume		pcph		pcph	
Exiting freeway volume		pcph		pcph	
On-ramp volume		pcph		pcph	
Off-ramp volume		pcph		pcph	

LOS and Performance Measures

Flow rate, v_p	2,419	pcphpl
Average passenger-car speed, S	-	mph
Volume-to-capacity ratio, v/c	1.03	
Density, D	-	pcpmpl
Level of service, LOS	F	

HCM 2010: Freeway Basic Segment

Basic Operational Analysis

Project	CSUMB Master Plan EIR
Freeway	Southbound SR 1
Segment	SR 1 between Del Monte Boulevard and Canyon Del Rey Boulevard
Alternative	Cuml w/ Eastside Pkwy
Time period	PM Peak Hour

Flow Inputs and Adjustments

Volume, V	3,230	vph
Peak-hour factor, PHF	0.96	
Peak 15-min volume, v_{15}	841	veh
Trucks and buses	1.0%	
Recreational vehicles	0.0%	
Terrain type	Level	
Grade		
Length		mi
Trucks and buses PCE, E_T	1.5	
Recreational vehicle PCE, E_R	1.2	
Heavy vehicle adjustment, f_{HV}	0.995	
Driver population factor, f_P	1.00	
Flow rate, v_p	3,381	pcph
Number of lanes, N	2	

Speed Inputs and Adjustments

Lane width	12.0	ft
Right-side lateral clearance	5.0	ft
Total ramp density, TRD	2.17	ramps/mi
Lane width adjustment, f_{LW}	0.0	mph
Lateral clearance adjustment, f_{LC}	0.6	mph
TRD adjustment	6.2	mph
Calculated free-flow speed, FFS	68.6	mph
Measured free-flow speed, FFS	65.0	mph
Free-flow speed curve	65	mph

Capacity Checks for Segments with Ramps

	<u>Actual</u>		<u>Maximum</u>		<u>Violation?</u>
Entering freeway volume		pcph		pcph	
Exiting freeway volume		pcph		pcph	
On-ramp volume		pcph		pcph	
Off-ramp volume		pcph		pcph	

LOS and Performance Measures

Flow rate, v_p	1,691	pcphpl
Average passenger-car speed, S	63.8	mph
Volume-to-capacity ratio, v/c	0.72	
Density, D	26.5	pcpmpl
Level of service, LOS	D	

HCM 2010: Freeway Basic Segment

Basic Operational Analysis

Project	CSUMB Master Plan EIR
Freeway	Northbound State Route 1
Segment	SR 1 between Reservation Road and Del Monte Boulevard
Alternative	Cuml w/ Eastside Pkwy
Time period	AM Peak Hour

Flow Inputs and Adjustments

Volume, V	1,480	vph
Peak-hour factor, PHF	0.97	
Peak 15-min volume, v_{15}	381	veh
Trucks and buses	6.4%	
Recreational vehicles	0.0%	
Terrain type	Level	
Grade		
Length		mi
Trucks and buses PCE, E_T	1.5	
Recreational vehicle PCE, E_R	1.2	
Heavy vehicle adjustment, f_{HV}	0.969	
Driver population factor, f_p	1.00	
Flow rate, v_p	1,574	pcph
Number of lanes, N	2	

Speed Inputs and Adjustments

Lane width	12.0	ft
Right-side lateral clearance	>6	ft
Total ramp density, TRD	1.00	ramps/mi
Lane width adjustment, f_{LW}	0.0	mph
Lateral clearance adjustment, f_{LC}	0.0	mph
TRD adjustment	3.2	mph
Calculated free-flow speed, FFS	72.2	mph
Measured free-flow speed, FFS	65.0	mph
Free-flow speed curve	65	mph

Capacity Checks for Segments with Ramps

	<u>Actual</u>		<u>Maximum</u>		<u>Violation?</u>
Entering freeway volume		pcph		pcph	
Exiting freeway volume		pcph		pcph	
On-ramp volume		pcph		pcph	
Off-ramp volume		pcph		pcph	

LOS and Performance Measures

Flow rate, v_p	787	pcphpl
Average passenger-car speed, S	65.0	mph
Volume-to-capacity ratio, v/c	0.33	
Density, D	12.1	pcpmpl
Level of service, LOS	B	

HCM 2010: Freeway Basic Segment

Basic Operational Analysis

Project	CSUMB Master Plan EIR
Freeway	Northbound State Route 1
Segment	SR 1 between Reservation Road and Del Monte Boulevard
Alternative	Cuml w/ Eastside Pkwy
Time period	PM Peak Hour

Flow Inputs and Adjustments

Volume, V	2,940	vph
Peak-hour factor, PHF	0.98	
Peak 15-min volume, v_{15}	750	veh
Trucks and buses	2.2%	
Recreational vehicles	0.0%	
Terrain type	Level	
Grade		
Length		mi
Trucks and buses PCE, E_T	1.5	
Recreational vehicle PCE, E_R	1.2	
Heavy vehicle adjustment, f_{HV}	0.989	
Driver population factor, f_p	1.00	
Flow rate, v_p	3,033	pcph
Number of lanes, N	2	

Speed Inputs and Adjustments

Lane width	12.0	ft
Right-side lateral clearance	>6	ft
Total ramp density, TRD	1.00	ramps/mi
Lane width adjustment, f_{LW}	0.0	mph
Lateral clearance adjustment, f_{LC}	0.0	mph
TRD adjustment	3.2	mph
Calculated free-flow speed, FFS	72.2	mph
Measured free-flow speed, FFS	65.0	mph
Free-flow speed curve	65	mph

Capacity Checks for Segments with Ramps

	<u>Actual</u>		<u>Maximum</u>		<u>Violation?</u>
Entering freeway volume		pcph		pcph	
Exiting freeway volume		pcph		pcph	
On-ramp volume		pcph		pcph	
Off-ramp volume		pcph		pcph	

LOS and Performance Measures

Flow rate, v_p	1,516	pcphpl
Average passenger-car speed, S	64.8	mph
Volume-to-capacity ratio, v/c	0.65	
Density, D	23.4	pcpmpl
Level of service, LOS	C	

HCM 2010: Freeway Basic Segment

Basic Operational Analysis

Project	CSUMB Master Plan EIR
Freeway	Northbound State Route 1
Segment	SR 1 between Del Monte Boulevard and Imjin Parkway
Alternative	Cuml w/ Eastside Pkwy
Time period	AM Peak Hour

Flow Inputs and Adjustments

Volume, V	2,400	vph
Peak-hour factor, PHF	0.92	
Peak 15-min volume, v_{15}	653	veh
Trucks and buses	5.7%	
Recreational vehicles	0.0%	
Terrain type	Level	
Grade		
Length		mi
Trucks and buses PCE, E_T	1.5	
Recreational vehicle PCE, E_R	1.2	
Heavy vehicle adjustment, f_{HV}	0.972	
Driver population factor, f_p	1.00	
Flow rate, v_p	2,684	pcph
Number of lanes, N	3	

Speed Inputs and Adjustments

Lane width	12.0	ft
Right-side lateral clearance	>6	ft
Total ramp density, TRD	1.20	ramps/mi
Lane width adjustment, f_{LW}	0.0	mph
Lateral clearance adjustment, f_{LC}	0.0	mph
TRD adjustment	3.8	mph
Calculated free-flow speed, FFS	71.6	mph
Measured free-flow speed, FFS	65.0	mph
Free-flow speed curve	65	mph

Capacity Checks for Segments with Ramps

	<u>Actual</u>		<u>Maximum</u>		<u>Violation?</u>
Entering freeway volume		pcph		pcph	
Exiting freeway volume		pcph		pcph	
On-ramp volume		pcph		pcph	
Off-ramp volume		pcph		pcph	

LOS and Performance Measures

Flow rate, v_p	895	pcphpl
Average passenger-car speed, S	65.0	mph
Volume-to-capacity ratio, v/c	0.38	
Density, D	13.8	pcpmpl
Level of service, LOS	B	

HCM 2010: Freeway Basic Segment

Basic Operational Analysis

Project	CSUMB Master Plan EIR
Freeway	Northbound State Route 1
Segment	SR 1 between Del Monte Boulevard and Imjin Parkway
Alternative	Cuml w/ Eastside Pkwy
Time period	PM Peak Hour

Flow Inputs and Adjustments

Volume, V	4,790	vph
Peak-hour factor, PHF	0.96	
Peak 15-min volume, v_{15}	1,247	veh
Trucks and buses	1.9%	
Recreational vehicles	0.0%	
Terrain type	Level	
Grade		
Length		mi
Trucks and buses PCE, E_T	1.5	
Recreational vehicle PCE, E_R	1.2	
Heavy vehicle adjustment, f_{HV}	0.991	
Driver population factor, f_p	1.00	
Flow rate, v_p	5,037	pcph
Number of lanes, N	3	

Speed Inputs and Adjustments

Lane width	12.0	ft
Right-side lateral clearance	>6	ft
Total ramp density, TRD	1.17	ramps/mi
Lane width adjustment, f_{LW}	0.0	mph
Lateral clearance adjustment, f_{LC}	0.0	mph
TRD adjustment	3.7	mph
Calculated free-flow speed, FFS	71.7	mph
Measured free-flow speed, FFS	65.0	mph
Free-flow speed curve	65	mph

Capacity Checks for Segments with Ramps

	<u>Actual</u>		<u>Maximum</u>		<u>Violation?</u>
Entering freeway volume		pcph		pcph	
Exiting freeway volume		pcph		pcph	
On-ramp volume		pcph		pcph	
Off-ramp volume		pcph		pcph	

LOS and Performance Measures

Flow rate, v_p	1,679	pcphpl
Average passenger-car speed, S	63.9	mph
Volume-to-capacity ratio, v/c	0.71	
Density, D	26.3	pcpmpl
Level of service, LOS	D	

HCM 2010: Freeway Basic Segment

Basic Operational Analysis

Project	CSUMB Master Plan EIR
Freeway	Northbound State Route 1
Segment	SR 1 between Imjin Parkway and Lightfighter Drive
Alternative	Cuml w/ Eastside Pkwy
Time period	AM Peak Hour

Flow Inputs and Adjustments

Volume, V	2,950	vph
Peak-hour factor, PHF	0.92	
Peak 15-min volume, v_{15}	804	veh
Trucks and buses	3.8%	
Recreational vehicles	0.0%	
Terrain type	Level	
Grade		
Length		mi
Trucks and buses PCE, E_T	1.5	
Recreational vehicle PCE, E_R	1.2	
Heavy vehicle adjustment, f_{HV}	0.982	
Driver population factor, f_p	1.00	
Flow rate, v_p	3,275	pcph
Number of lanes, N	3	

Speed Inputs and Adjustments

Lane width	12.0	ft
Right-side lateral clearance	>6	ft
Total ramp density, TRD	1.17	ramps/mi
Lane width adjustment, f_{LW}	0.0	mph
Lateral clearance adjustment, f_{LC}	0.0	mph
TRD adjustment	3.7	mph
Calculated free-flow speed, FFS	71.7	mph
Measured free-flow speed, FFS	65.0	mph
Free-flow speed curve	65	mph

Capacity Checks for Segments with Ramps

	<u>Actual</u>		<u>Maximum</u>		<u>Violation?</u>
Entering freeway volume		pcph		pcph	
Exiting freeway volume		pcph		pcph	
On-ramp volume		pcph		pcph	
Off-ramp volume		pcph		pcph	

LOS and Performance Measures

Flow rate, v_p	1,092	pcphpl
Average passenger-car speed, S	65.0	mph
Volume-to-capacity ratio, v/c	0.46	
Density, D	16.8	pcpmpl
Level of service, LOS	B	

HCM 2010: Freeway Basic Segment

Basic Operational Analysis

Project	CSUMB Master Plan EIR
Freeway	Northbound State Route 1
Segment	SR 1 between Imjin Parkway and Lightfighter Drive
Alternative	Cuml w/ Eastside Pkwy
Time period	PM Peak Hour

Flow Inputs and Adjustments

Volume, V	5,080	vph
Peak-hour factor, PHF	0.97	
Peak 15-min volume, v_{15}	1,309	veh
Trucks and buses	1.7%	
Recreational vehicles	0.0%	
Terrain type	Level	
Grade		
Length		mi
Trucks and buses PCE, E_T	1.5	
Recreational vehicle PCE, E_R	1.2	
Heavy vehicle adjustment, f_{HV}	0.991	
Driver population factor, f_p	1.00	
Flow rate, v_p	5,282	pcph
Number of lanes, N	3	

Speed Inputs and Adjustments

Lane width	12.0	ft
Right-side lateral clearance	>6	ft
Total ramp density, TRD	1.17	ramps/mi
Lane width adjustment, f_{LW}	0.0	mph
Lateral clearance adjustment, f_{LC}	0.0	mph
TRD adjustment	3.7	mph
Calculated free-flow speed, FFS	71.7	mph
Measured free-flow speed, FFS	65.0	mph
Free-flow speed curve	65	mph

Capacity Checks for Segments with Ramps

	<u>Actual</u>		<u>Maximum</u>		<u>Violation?</u>
Entering freeway volume		pcph		pcph	
Exiting freeway volume		pcph		pcph	
On-ramp volume		pcph		pcph	
Off-ramp volume		pcph		pcph	

LOS and Performance Measures

Flow rate, v_p	1,761	pcphpl
Average passenger-car speed, S	63.2	mph
Volume-to-capacity ratio, v/c	0.75	
Density, D	27.9	pcpmpl
Level of service, LOS	D	

HCM 2010: Freeway Basic Segment

Basic Operational Analysis

Project	CSUMB Master Plan EIR
Freeway	Northbound State Route 1
Segment	SR 1 between Lightfighter Drive and Del Monte Boulevard
Alternative	Cuml w/ Eastside Pkwy
Time period	AM Peak Hour

Flow Inputs and Adjustments

Volume, V	3,440	vph
Peak-hour factor, PHF	0.93	
Peak 15-min volume, v_{15}	921	veh
Trucks and buses	3.8%	
Recreational vehicles	0.0%	
Terrain type	Level	
Grade		
Length		mi
Trucks and buses PCE, E_T	1.5	
Recreational vehicle PCE, E_R	1.2	
Heavy vehicle adjustment, f_{HV}	0.982	
Driver population factor, f_P	1.00	
Flow rate, v_p	3,753	pcph
Number of lanes, N	3	

Speed Inputs and Adjustments

Lane width	12.0	ft
Right-side lateral clearance	>6	ft
Total ramp density, TRD	1.17	ramps/mi
Lane width adjustment, f_{LW}	0.0	mph
Lateral clearance adjustment, f_{LC}	0.0	mph
TRD adjustment	3.7	mph
Calculated free-flow speed, FFS	71.7	mph
Measured free-flow speed, FFS	65.0	mph
Free-flow speed curve	65	mph

Capacity Checks for Segments with Ramps

	<u>Actual</u>		<u>Maximum</u>		<u>Violation?</u>
Entering freeway volume		pcph		pcph	
Exiting freeway volume		pcph		pcph	
On-ramp volume		pcph		pcph	
Off-ramp volume		pcph		pcph	

LOS and Performance Measures

Flow rate, v_p	1,251	pcphpl
Average passenger-car speed, S	65.0	mph
Volume-to-capacity ratio, v/c	0.53	
Density, D	19.2	pcpmpl
Level of service, LOS	C	

HCM 2010: Freeway Basic Segment

Basic Operational Analysis

Project	CSUMB Master Plan EIR
Freeway	Northbound State Route 1
Segment	SR 1 between Lightfighter Drive and Del Monte Boulevard
Alternative	Cuml w/ Eastside Pkwy
Time period	PM Peak Hour

Flow Inputs and Adjustments

Volume, V	5,360	vph
Peak-hour factor, PHF	0.98	
Peak 15-min volume, v_{15}	1,367	veh
Trucks and buses	1.9%	
Recreational vehicles	0.0%	
Terrain type	Level	
Grade		
Length		mi
Trucks and buses PCE, E_T	1.5	
Recreational vehicle PCE, E_R	1.2	
Heavy vehicle adjustment, f_{HV}	0.991	
Driver population factor, f_p	1.00	
Flow rate, v_p	5,521	pcph
Number of lanes, N	3	

Speed Inputs and Adjustments

Lane width	12.0	ft
Right-side lateral clearance	>6	ft
Total ramp density, TRD	1.17	ramps/mi
Lane width adjustment, f_{LW}	0.0	mph
Lateral clearance adjustment, f_{LC}	0.0	mph
TRD adjustment	3.7	mph
Calculated free-flow speed, FFS	71.7	mph
Measured free-flow speed, FFS	65.0	mph
Free-flow speed curve	65	mph

Capacity Checks for Segments with Ramps

	<u>Actual</u>		<u>Maximum</u>		<u>Violation?</u>
Entering freeway volume		pcph		pcph	
Exiting freeway volume		pcph		pcph	
On-ramp volume		pcph		pcph	
Off-ramp volume		pcph		pcph	

LOS and Performance Measures

Flow rate, v_p	1,840	pcphpl
Average passenger-car speed, S	62.3	mph
Volume-to-capacity ratio, v/c	0.78	
Density, D	29.6	pcpmpl
Level of service, LOS	D	

HCM 2010: Freeway Basic Segment

Basic Operational Analysis

Project	CSUMB Master Plan EIR
Freeway	Northbound State Route 1
Segment	SR 1 between Del Monte Boulevard and Canyon Del Rey Boulevard
Alternative	Cuml w/ Eastside Pkwy
Time period	AM Peak Hour

Flow Inputs and Adjustments

Volume, V	3,000	vph
Peak-hour factor, PHF	0.92	
Peak 15-min volume, v_{15}	819	veh
Trucks and buses	3.2%	
Recreational vehicles	0.0%	
Terrain type	Level	
Grade		
Length		mi
Trucks and buses PCE, E_T	1.5	
Recreational vehicle PCE, E_R	1.2	
Heavy vehicle adjustment, f_{HV}	0.984	
Driver population factor, f_p	1.00	
Flow rate, v_p	3,329	pcph
Number of lanes, N	2	

Speed Inputs and Adjustments

Lane width	12.0	ft
Right-side lateral clearance	>6	ft
Total ramp density, TRD	2.00	ramps/mi
Lane width adjustment, f_{LW}	0.0	mph
Lateral clearance adjustment, f_{LC}	0.0	mph
TRD adjustment	5.8	mph
Calculated free-flow speed, FFS	69.6	mph
Measured free-flow speed, FFS	65.0	mph
Free-flow speed curve	65	mph

Capacity Checks for Segments with Ramps

	<u>Actual</u>		<u>Maximum</u>		<u>Violation?</u>
Entering freeway volume		pcph		pcph	
Exiting freeway volume		pcph		pcph	
On-ramp volume		pcph		pcph	
Off-ramp volume		pcph		pcph	

LOS and Performance Measures

Flow rate, v_p	1,665	pcphpl
Average passenger-car speed, S	64.0	mph
Volume-to-capacity ratio, v/c	0.71	
Density, D	26.0	pcpmpl
Level of service, LOS	D	

HCM 2010: Freeway Basic Segment

Basic Operational Analysis

Project	CSUMB Master Plan EIR
Freeway	Northbound State Route 1
Segment	SR 1 between Del Monte Boulevard and Canyon Del Rey Boulevard
Alternative	Cuml w/ Eastside Pkwy
Time period	PM Peak Hour

Flow Inputs and Adjustments

Volume, V	4,330	vph
Peak-hour factor, PHF	0.97	
Peak 15-min volume, v_{15}	1,116	veh
Trucks and buses	2.0%	
Recreational vehicles	0.0%	
Terrain type	Level	
Grade		
Length		mi
Trucks and buses PCE, E_T	1.5	
Recreational vehicle PCE, E_R	1.2	
Heavy vehicle adjustment, f_{HV}	0.990	
Driver population factor, f_p	1.00	
Flow rate, v_p	4,509	pcph
Number of lanes, N	2	

Speed Inputs and Adjustments

Lane width	12.0	ft
Right-side lateral clearance	>6	ft
Total ramp density, TRD	2.00	ramps/mi
Lane width adjustment, f_{LW}	0.0	mph
Lateral clearance adjustment, f_{LC}	0.0	mph
TRD adjustment	5.8	mph
Calculated free-flow speed, FFS	69.6	mph
Measured free-flow speed, FFS	65.0	mph
Free-flow speed curve	65	mph

Capacity Checks for Segments with Ramps

	<u>Actual</u>		<u>Maximum</u>		<u>Violation?</u>
Entering freeway volume		pcph		pcph	
Exiting freeway volume		pcph		pcph	
On-ramp volume		pcph		pcph	
Off-ramp volume		pcph		pcph	

LOS and Performance Measures

Flow rate, v_p	2,255	pcphpl
Average passenger-car speed, S	54.6	mph
Volume-to-capacity ratio, v/c	0.96	
Density, D	41.3	pcpmpl
Level of service, LOS	E	

HCM 2010: Freeway Basic Segment

Basic Operational Analysis

Project	CSUMB Master Plan EIR
Freeway	Southbound State Route 1
Segment	SR 1 between Reservation Road and Del Monte Boulevard
Alternative	Cuml w/ Proj
Time period	AM Peak Hour

Flow Inputs and Adjustments

Volume, V	3,560	vph
Peak-hour factor, PHF	0.76	
Peak 15-min volume, v_{15}	1,171	veh
Trucks and buses	4.7%	
Recreational vehicles	0.0%	
Terrain type	Level	
Grade		
Length		mi
Trucks and buses PCE, E_T	1.5	
Recreational vehicle PCE, E_R	1.2	
Heavy vehicle adjustment, f_{HV}	0.977	
Driver population factor, f_P	1.00	
Flow rate, v_p	4,793	pcph
Number of lanes, N	2	

Speed Inputs and Adjustments

Lane width	12.0	ft
Right-side lateral clearance	>6	ft
Total ramp density, TRD	1.00	ramps/mi
Lane width adjustment, f_{LW}	0.0	mph
Lateral clearance adjustment, f_{LC}	0.0	mph
TRD adjustment	3.2	mph
Calculated free-flow speed, FFS	72.2	mph
Measured free-flow speed, FFS	65.0	mph
Free-flow speed curve	65	mph

Capacity Checks for Segments with Ramps

	<u>Actual</u>		<u>Maximum</u>		<u>Violation?</u>
Entering freeway volume		pcph		pcph	
Exiting freeway volume		pcph		pcph	
On-ramp volume		pcph		pcph	
Off-ramp volume		pcph		pcph	

LOS and Performance Measures

Flow rate, v_p	2,397	pcphpl
Average passenger-car speed, S	-	mph
Volume-to-capacity ratio, v/c	1.02	
Density, D	-	pcpmpl
Level of service, LOS	F	

HCM 2010: Freeway Basic Segment

Basic Operational Analysis

Project	CSUMB Master Plan EIR
Freeway	Southbound SR 1
Segment	SR 1 between Reservation Road and Del Monte Boulevard
Alternative	Cuml w/ Proj
Time period	PM Peak Hour

Flow Inputs and Adjustments

Volume, V	1,870	vph
Peak-hour factor, PHF	0.97	
Peak 15-min volume, v_{15}	482	veh
Trucks and buses	1.0%	
Recreational vehicles	0.0%	
Terrain type	Level	
Grade		
Length		mi
Trucks and buses PCE, E_T	1.5	
Recreational vehicle PCE, E_R	1.2	
Heavy vehicle adjustment, f_{HV}	0.995	
Driver population factor, f_p	1.00	
Flow rate, v_p	1,937	pcph
Number of lanes, N	2	

Speed Inputs and Adjustments

Lane width	12.0	ft
Right-side lateral clearance	>6	ft
Total ramp density, TRD	1.00	ramps/mi
Lane width adjustment, f_{LW}	0.0	mph
Lateral clearance adjustment, f_{LC}	0.0	mph
TRD adjustment	3.2	mph
Calculated free-flow speed, FFS	72.2	mph
Measured free-flow speed, FFS	65.0	mph
Free-flow speed curve	65	mph

Capacity Checks for Segments with Ramps

	<u>Actual</u>		<u>Maximum</u>		<u>Violation?</u>
Entering freeway volume		pcph		pcph	
Exiting freeway volume		pcph		pcph	
On-ramp volume		pcph		pcph	
Off-ramp volume		pcph		pcph	

LOS and Performance Measures

Flow rate, v_p	969	pcphpl
Average passenger-car speed, S	65.0	mph
Volume-to-capacity ratio, v/c	0.41	
Density, D	14.9	pcpmpl
Level of service, LOS	B	

HCM 2010: Freeway Basic Segment

Basic Operational Analysis

Project	CSUMB Master Plan EIR
Freeway	Southbound State Route 1
Segment	SR 1 between Del Monte Boulevard and Imjin Parkway
Alternative	Cuml w/ Proj
Time period	AM Peak Hour

Flow Inputs and Adjustments

Volume, V	5,150	vph
Peak-hour factor, PHF	0.81	
Peak 15-min volume, v_{15}	1,590	veh
Trucks and buses	3.9%	
Recreational vehicles	0.0%	
Terrain type	Level	
Grade		
Length		mi
Trucks and buses PCE, E_T	1.5	
Recreational vehicle PCE, E_R	1.2	
Heavy vehicle adjustment, f_{HV}	0.981	
Driver population factor, f_p	1.00	
Flow rate, v_p	6,482	pcph
Number of lanes, N	3	

Speed Inputs and Adjustments

Lane width	12.0	ft
Right-side lateral clearance	>6	ft
Total ramp density, TRD	1.17	ramps/mi
Lane width adjustment, f_{LW}	0.0	mph
Lateral clearance adjustment, f_{LC}	0.0	mph
TRD adjustment	3.7	mph
Calculated free-flow speed, FFS	71.7	mph
Measured free-flow speed, FFS	65.0	mph
Free-flow speed curve	65	mph

Capacity Checks for Segments with Ramps

	<u>Actual</u>		<u>Maximum</u>		<u>Violation?</u>
Entering freeway volume		pcph		pcph	
Exiting freeway volume		pcph		pcph	
On-ramp volume		pcph		pcph	
Off-ramp volume		pcph		pcph	

LOS and Performance Measures

Flow rate, v_p	2,161	pcphpl
Average passenger-car speed, S	56.8	mph
Volume-to-capacity ratio, v/c	0.92	
Density, D	38.0	pcpmpl
Level of service, LOS	E	

HCM 2010: Freeway Basic Segment

Basic Operational Analysis

Project	CSUMB Master Plan EIR
Freeway	Southbound SR 1
Segment	SR 1 between Del Monte Boulevard and Imjin Parkway
Alternative	Cuml w/ Proj
Time period	PM Peak Hour

Flow Inputs and Adjustments

Volume, V	2,920	vph
Peak-hour factor, PHF	0.95	
Peak 15-min volume, v_{15}	768	veh
Trucks and buses	1.4%	
Recreational vehicles	0.0%	
Terrain type	Level	
Grade		
Length		mi
Trucks and buses PCE, E_T	1.5	
Recreational vehicle PCE, E_R	1.2	
Heavy vehicle adjustment, f_{HV}	0.993	
Driver population factor, f_p	1.00	
Flow rate, v_p	3,095	pcph
Number of lanes, N	3	

Speed Inputs and Adjustments

Lane width	12.0	ft
Right-side lateral clearance	>6	ft
Total ramp density, TRD	1.17	ramps/mi
Lane width adjustment, f_{LW}	0.0	mph
Lateral clearance adjustment, f_{LC}	0.0	mph
TRD adjustment	3.7	mph
Calculated free-flow speed, FFS	71.7	mph
Measured free-flow speed, FFS	65.0	mph
Free-flow speed curve	65	mph

Capacity Checks for Segments with Ramps

	<u>Actual</u>		<u>Maximum</u>		<u>Violation?</u>
Entering freeway volume		pcph		pcph	
Exiting freeway volume		pcph		pcph	
On-ramp volume		pcph		pcph	
Off-ramp volume		pcph		pcph	

LOS and Performance Measures

Flow rate, v_p	1,032	pcphpl
Average passenger-car speed, S	65.0	mph
Volume-to-capacity ratio, v/c	0.44	
Density, D	15.9	pcpmpl
Level of service, LOS	B	

HCM 2010: Freeway Basic Segment

Basic Operational Analysis

Project	CSUMB Master Plan EIR
Freeway	Southbound State Route 1
Segment	SR 1 between Imjin Parkway and Lightfighter Drive
Alternative	Cuml w/ Proj
Time period	AM Peak Hour

Flow Inputs and Adjustments

Volume, V	5,250	vph
Peak-hour factor, PHF	0.83	
Peak 15-min volume, v_{15}	1,581	veh
Trucks and buses	3.5%	
Recreational vehicles	0.0%	
Terrain type	Level	
Grade		
Length		mi
Trucks and buses PCE, E_T	1.5	
Recreational vehicle PCE, E_R	1.2	
Heavy vehicle adjustment, f_{HV}	0.983	
Driver population factor, f_p	1.00	
Flow rate, v_p	6,437	pcph
Number of lanes, N	3	

Speed Inputs and Adjustments

Lane width	12.0	ft
Right-side lateral clearance	>6	ft
Total ramp density, TRD	1.17	ramps/mi
Lane width adjustment, f_{LW}	0.0	mph
Lateral clearance adjustment, f_{LC}	0.0	mph
TRD adjustment	3.7	mph
Calculated free-flow speed, FFS	71.7	mph
Measured free-flow speed, FFS	65.0	mph
Free-flow speed curve	65	mph

Capacity Checks for Segments with Ramps

	<u>Actual</u>		<u>Maximum</u>		<u>Violation?</u>
Entering freeway volume		pcph		pcph	
Exiting freeway volume		pcph		pcph	
On-ramp volume		pcph		pcph	
Off-ramp volume		pcph		pcph	

LOS and Performance Measures

Flow rate, v_p	2,146	pcphpl
Average passenger-car speed, S	57.1	mph
Volume-to-capacity ratio, v/c	0.91	
Density, D	37.6	pcpmpl
Level of service, LOS	E	

HCM 2010: Freeway Basic Segment

Basic Operational Analysis

Project	CSUMB Master Plan EIR
Freeway	Southbound SR 1
Segment	SR 1 between Imjin Parkway and Lightfighter Drive
Alternative	Cuml w/ Proj
Time period	PM Peak Hour

Flow Inputs and Adjustments

Volume, V	3,450	vph
Peak-hour factor, PHF	0.95	
Peak 15-min volume, v_{15}	908	veh
Trucks and buses	1.3%	
Recreational vehicles	0.0%	
Terrain type	Level	
Grade		
Length		mi
Trucks and buses PCE, E_T	1.5	
Recreational vehicle PCE, E_R	1.2	
Heavy vehicle adjustment, f_{HV}	0.994	
Driver population factor, f_p	1.00	
Flow rate, v_p	3,654	pcph
Number of lanes, N	3	

Speed Inputs and Adjustments

Lane width	12.0	ft
Right-side lateral clearance	>6	ft
Total ramp density, TRD	1.17	ramps/mi
Lane width adjustment, f_{LW}	0.0	mph
Lateral clearance adjustment, f_{LC}	0.0	mph
TRD adjustment	3.7	mph
Calculated free-flow speed, FFS	71.7	mph
Measured free-flow speed, FFS	65.0	mph
Free-flow speed curve	65	mph

Capacity Checks for Segments with Ramps

	<u>Actual</u>		<u>Maximum</u>		<u>Violation?</u>
Entering freeway volume		pcph		pcph	
Exiting freeway volume		pcph		pcph	
On-ramp volume		pcph		pcph	
Off-ramp volume		pcph		pcph	

LOS and Performance Measures

Flow rate, v_p	1,218	pcphpl
Average passenger-car speed, S	65.0	mph
Volume-to-capacity ratio, v/c	0.52	
Density, D	18.7	pcpmpl
Level of service, LOS	C	

HCM 2010: Freeway Basic Segment

Basic Operational Analysis

Project	CSUMB Master Plan EIR
Freeway	Southbound State Route 1
Segment	SR 1 between Lightfighter Drive and Del Monte Boulevard
Alternative	Cuml w/ Proj
Time period	AM Peak Hour

Flow Inputs and Adjustments

Volume, V	5,550	vph
Peak-hour factor, PHF	0.86	
Peak 15-min volume, v_{15}	1,613	veh
Trucks and buses	3.2%	
Recreational vehicles	0.0%	
Terrain type	Level	
Grade		
Length		mi
Trucks and buses PCE, E_T	1.5	
Recreational vehicle PCE, E_R	1.2	
Heavy vehicle adjustment, f_{HV}	0.984	
Driver population factor, f_p	1.00	
Flow rate, v_p	6,557	pcph
Number of lanes, N	3	

Speed Inputs and Adjustments

Lane width	12.0	ft
Right-side lateral clearance	>6	ft
Total ramp density, TRD	1.33	ramps/mi
Lane width adjustment, f_{LW}	0.0	mph
Lateral clearance adjustment, f_{LC}	0.0	mph
TRD adjustment	4.1	mph
Calculated free-flow speed, FFS	71.3	mph
Measured free-flow speed, FFS	65.0	mph
Free-flow speed curve	65	mph

Capacity Checks for Segments with Ramps

	<u>Actual</u>		<u>Maximum</u>		<u>Violation?</u>
Entering freeway volume		pcph		pcph	
Exiting freeway volume		pcph		pcph	
On-ramp volume		pcph		pcph	
Off-ramp volume		pcph		pcph	

LOS and Performance Measures

Flow rate, v_p	2,186	pcphpl
Average passenger-car speed, S	56.2	mph
Volume-to-capacity ratio, v/c	0.93	
Density, D	38.9	pcpmpl
Level of service, LOS	E	

HCM 2010: Freeway Basic Segment

Basic Operational Analysis

Project	CSUMB Master Plan EIR
Freeway	Southbound SR 1
Segment	SR 1 between Lightfighter Drive and Del Monte Boulevard
Alternative	Cuml w/ Proj
Time period	PM Peak Hour

Flow Inputs and Adjustments

Volume, V	4,010	vph
Peak-hour factor, PHF	0.97	
Peak 15-min volume, v_{15}	1,034	veh
Trucks and buses	1.1%	
Recreational vehicles	0.0%	
Terrain type	Level	
Grade		
Length		mi
Trucks and buses PCE, E_T	1.5	
Recreational vehicle PCE, E_R	1.2	
Heavy vehicle adjustment, f_{HV}	0.994	
Driver population factor, f_p	1.00	
Flow rate, v_p	4,157	pcph
Number of lanes, N	3	

Speed Inputs and Adjustments

Lane width	12.0	ft
Right-side lateral clearance	>6	ft
Total ramp density, TRD	1.33	ramps/mi
Lane width adjustment, f_{LW}	0.0	mph
Lateral clearance adjustment, f_{LC}	0.0	mph
TRD adjustment	4.1	mph
Calculated free-flow speed, FFS	71.3	mph
Measured free-flow speed, FFS	65.0	mph
Free-flow speed curve	65	mph

Capacity Checks for Segments with Ramps

	<u>Actual</u>		<u>Maximum</u>		<u>Violation?</u>
Entering freeway volume		pcph		pcph	
Exiting freeway volume		pcph		pcph	
On-ramp volume		pcph		pcph	
Off-ramp volume		pcph		pcph	

LOS and Performance Measures

Flow rate, v_p	1,386	pcphpl
Average passenger-car speed, S	65.0	mph
Volume-to-capacity ratio, v/c	0.59	
Density, D	21.3	pcpmpl
Level of service, LOS	C	

HCM 2010: Freeway Basic Segment

Basic Operational Analysis

Project	CSUMB Master Plan EIR
Freeway	Southbound State Route 1
Segment	SR 1 between Del Monte Boulevard and Canyon Del Rey Boulevard
Alternative	Cuml w/ Proj
Time period	AM Peak Hour

Flow Inputs and Adjustments

Volume, V	4,540	vph
Peak-hour factor, PHF	0.95	
Peak 15-min volume, v_{15}	1,195	veh
Trucks and buses	2.4%	
Recreational vehicles	0.0%	
Terrain type	Level	
Grade		
Length		mi
Trucks and buses PCE, E_T	1.5	
Recreational vehicle PCE, E_R	1.2	
Heavy vehicle adjustment, f_{HV}	0.988	
Driver population factor, f_P	1.00	
Flow rate, v_p	4,837	pcph
Number of lanes, N	2	

Speed Inputs and Adjustments

Lane width	12.0	ft
Right-side lateral clearance	5.0	ft
Total ramp density, TRD	2.17	ramps/mi
Lane width adjustment, f_{LW}	0.0	mph
Lateral clearance adjustment, f_{LC}	0.6	mph
TRD adjustment	6.2	mph
Calculated free-flow speed, FFS	68.6	mph
Measured free-flow speed, FFS	65.0	mph
Free-flow speed curve	65	mph

Capacity Checks for Segments with Ramps

	<u>Actual</u>		<u>Maximum</u>		<u>Violation?</u>
Entering freeway volume		pcph		pcph	
Exiting freeway volume		pcph		pcph	
On-ramp volume		pcph		pcph	
Off-ramp volume		pcph		pcph	

LOS and Performance Measures

Flow rate, v_p	2,419	pcphpl
Average passenger-car speed, S	-	mph
Volume-to-capacity ratio, v/c	1.03	
Density, D	-	pcpmpl
Level of service, LOS	F	

HCM 2010: Freeway Basic Segment

Basic Operational Analysis

Project	CSUMB Master Plan EIR
Freeway	Southbound SR 1
Segment	SR 1 between Del Monte Boulevard and Canyon Del Rey Boulevard
Alternative	Cuml w/ Proj
Time period	PM Peak Hour

Flow Inputs and Adjustments

Volume, V	3,240	vph
Peak-hour factor, PHF	0.96	
Peak 15-min volume, v_{15}	844	veh
Trucks and buses	1.0%	
Recreational vehicles	0.0%	
Terrain type	Level	
Grade		
Length		mi
Trucks and buses PCE, E_T	1.5	
Recreational vehicle PCE, E_R	1.2	
Heavy vehicle adjustment, f_{HV}	0.995	
Driver population factor, f_p	1.00	
Flow rate, v_p	3,392	pcph
Number of lanes, N	2	

Speed Inputs and Adjustments

Lane width	12.0	ft
Right-side lateral clearance	5.0	ft
Total ramp density, TRD	2.17	ramps/mi
Lane width adjustment, f_{LW}	0.0	mph
Lateral clearance adjustment, f_{LC}	0.6	mph
TRD adjustment	6.2	mph
Calculated free-flow speed, FFS	68.6	mph
Measured free-flow speed, FFS	65.0	mph
Free-flow speed curve	65	mph

Capacity Checks for Segments with Ramps

	<u>Actual</u>		<u>Maximum</u>		<u>Violation?</u>
Entering freeway volume		pcph		pcph	
Exiting freeway volume		pcph		pcph	
On-ramp volume		pcph		pcph	
Off-ramp volume		pcph		pcph	

LOS and Performance Measures

Flow rate, v_p	1,696	pcphpl
Average passenger-car speed, S	63.8	mph
Volume-to-capacity ratio, v/c	0.72	
Density, D	26.6	pcpmpl
Level of service, LOS	D	

HCM 2010: Freeway Basic Segment

Basic Operational Analysis

Project	CSUMB Master Plan EIR
Freeway	Northbound State Route 1
Segment	SR 1 between Reservation Road and Del Monte Boulevard
Alternative	Cuml w/ Proj
Time period	AM Peak Hour

Flow Inputs and Adjustments

Volume, V	1,520	vph
Peak-hour factor, PHF	0.97	
Peak 15-min volume, v_{15}	392	veh
Trucks and buses	6.4%	
Recreational vehicles	0.0%	
Terrain type	Level	
Grade		
Length		mi
Trucks and buses PCE, E_T	1.5	
Recreational vehicle PCE, E_R	1.2	
Heavy vehicle adjustment, f_{HV}	0.969	
Driver population factor, f_p	1.00	
Flow rate, v_p	1,617	pcph
Number of lanes, N	2	

Speed Inputs and Adjustments

Lane width	12.0	ft
Right-side lateral clearance	>6	ft
Total ramp density, TRD	1.00	ramps/mi
Lane width adjustment, f_{LW}	0.0	mph
Lateral clearance adjustment, f_{LC}	0.0	mph
TRD adjustment	3.2	mph
Calculated free-flow speed, FFS	72.2	mph
Measured free-flow speed, FFS	65.0	mph
Free-flow speed curve	65	mph

Capacity Checks for Segments with Ramps

	<u>Actual</u>		<u>Maximum</u>		<u>Violation?</u>
Entering freeway volume		pcph		pcph	
Exiting freeway volume		pcph		pcph	
On-ramp volume		pcph		pcph	
Off-ramp volume		pcph		pcph	

LOS and Performance Measures

Flow rate, v_p	808	pcphpl
Average passenger-car speed, S	65.0	mph
Volume-to-capacity ratio, v/c	0.34	
Density, D	12.4	pcpmpl
Level of service, LOS	B	

HCM 2010: Freeway Basic Segment

Basic Operational Analysis

Project	CSUMB Master Plan EIR
Freeway	Northbound State Route 1
Segment	SR 1 between Reservation Road and Del Monte Boulevard
Alternative	Cuml w/ Proj
Time period	PM Peak Hour

Flow Inputs and Adjustments

Volume, V	3,050	vph
Peak-hour factor, PHF	0.98	
Peak 15-min volume, v_{15}	778	veh
Trucks and buses	2.2%	
Recreational vehicles	0.0%	
Terrain type	Level	
Grade		
Length		mi
Trucks and buses PCE, E_T	1.5	
Recreational vehicle PCE, E_R	1.2	
Heavy vehicle adjustment, f_{HV}	0.989	
Driver population factor, f_p	1.00	
Flow rate, v_p	3,146	pcph
Number of lanes, N	2	

Speed Inputs and Adjustments

Lane width	12.0	ft
Right-side lateral clearance	>6	ft
Total ramp density, TRD	1.00	ramps/mi
Lane width adjustment, f_{LW}	0.0	mph
Lateral clearance adjustment, f_{LC}	0.0	mph
TRD adjustment	3.2	mph
Calculated free-flow speed, FFS	72.2	mph
Measured free-flow speed, FFS	65.0	mph
Free-flow speed curve	65	mph

Capacity Checks for Segments with Ramps

	<u>Actual</u>		<u>Maximum</u>		<u>Violation?</u>
Entering freeway volume		pcph		pcph	
Exiting freeway volume		pcph		pcph	
On-ramp volume		pcph		pcph	
Off-ramp volume		pcph		pcph	

LOS and Performance Measures

Flow rate, v_p	1,573	pcphpl
Average passenger-car speed, S	64.6	mph
Volume-to-capacity ratio, v/c	0.67	
Density, D	24.4	pcpmpl
Level of service, LOS	C	

HCM 2010: Freeway Basic Segment

Basic Operational Analysis

Project	CSUMB Master Plan EIR
Freeway	Northbound State Route 1
Segment	SR 1 between Del Monte Boulevard and Imjin Parkway
Alternative	Cuml w/ Proj
Time period	AM Peak Hour

Flow Inputs and Adjustments

Volume, V	2,440	vph
Peak-hour factor, PHF	0.92	
Peak 15-min volume, v_{15}	663	veh
Trucks and buses	5.7%	
Recreational vehicles	0.0%	
Terrain type	Level	
Grade		
Length		mi
Trucks and buses PCE, E_T	1.5	
Recreational vehicle PCE, E_R	1.2	
Heavy vehicle adjustment, f_{HV}	0.972	
Driver population factor, f_p	1.00	
Flow rate, v_p	2,729	pcph
Number of lanes, N	3	

Speed Inputs and Adjustments

Lane width	12.0	ft
Right-side lateral clearance	>6	ft
Total ramp density, TRD	1.20	ramps/mi
Lane width adjustment, f_{LW}	0.0	mph
Lateral clearance adjustment, f_{LC}	0.0	mph
TRD adjustment	3.8	mph
Calculated free-flow speed, FFS	71.6	mph
Measured free-flow speed, FFS	65.0	mph
Free-flow speed curve	65	mph

Capacity Checks for Segments with Ramps

	<u>Actual</u>		<u>Maximum</u>		<u>Violation?</u>
Entering freeway volume		pcph		pcph	
Exiting freeway volume		pcph		pcph	
On-ramp volume		pcph		pcph	
Off-ramp volume		pcph		pcph	

LOS and Performance Measures

Flow rate, v_p	910	pcphpl
Average passenger-car speed, S	65.0	mph
Volume-to-capacity ratio, v/c	0.39	
Density, D	14.0	pcpmpl
Level of service, LOS	B	

HCM 2010: Freeway Basic Segment

Basic Operational Analysis

Project	CSUMB Master Plan EIR
Freeway	Northbound State Route 1
Segment	SR 1 between Del Monte Boulevard and Imjin Parkway
Alternative	Cuml w/ Proj
Time period	PM Peak Hour

Flow Inputs and Adjustments

Volume, V	4,940	vph
Peak-hour factor, PHF	0.96	
Peak 15-min volume, v_{15}	1,286	veh
Trucks and buses	1.9%	
Recreational vehicles	0.0%	
Terrain type	Level	
Grade		
Length		mi
Trucks and buses PCE, E_T	1.5	
Recreational vehicle PCE, E_R	1.2	
Heavy vehicle adjustment, f_{HV}	0.991	
Driver population factor, f_p	1.00	
Flow rate, v_p	5,194	pcph
Number of lanes, N	3	

Speed Inputs and Adjustments

Lane width	12.0	ft
Right-side lateral clearance	>6	ft
Total ramp density, TRD	1.17	ramps/mi
Lane width adjustment, f_{LW}	0.0	mph
Lateral clearance adjustment, f_{LC}	0.0	mph
TRD adjustment	3.7	mph
Calculated free-flow speed, FFS	71.7	mph
Measured free-flow speed, FFS	65.0	mph
Free-flow speed curve	65	mph

Capacity Checks for Segments with Ramps

	<u>Actual</u>		<u>Maximum</u>		<u>Violation?</u>
Entering freeway volume		pcph		pcph	
Exiting freeway volume		pcph		pcph	
On-ramp volume		pcph		pcph	
Off-ramp volume		pcph		pcph	

LOS and Performance Measures

Flow rate, v_p	1,731	pcphpl
Average passenger-car speed, S	63.4	mph
Volume-to-capacity ratio, v/c	0.74	
Density, D	27.3	pcpmpl
Level of service, LOS	D	

HCM 2010: Freeway Basic Segment

Basic Operational Analysis

Project	CSUMB Master Plan EIR
Freeway	Northbound State Route 1
Segment	SR 1 between Imjin Parkway and Lightfighter Drive
Alternative	Cuml w/ Proj
Time period	AM Peak Hour

Flow Inputs and Adjustments

Volume, V	3,070	vph
Peak-hour factor, PHF	0.92	
Peak 15-min volume, v_{15}	836	veh
Trucks and buses	3.8%	
Recreational vehicles	0.0%	
Terrain type	Level	
Grade		
Length		mi
Trucks and buses PCE, E_T	1.5	
Recreational vehicle PCE, E_R	1.2	
Heavy vehicle adjustment, f_{HV}	0.982	
Driver population factor, f_p	1.00	
Flow rate, v_p	3,408	pcph
Number of lanes, N	3	

Speed Inputs and Adjustments

Lane width	12.0	ft
Right-side lateral clearance	>6	ft
Total ramp density, TRD	1.17	ramps/mi
Lane width adjustment, f_{LW}	0.0	mph
Lateral clearance adjustment, f_{LC}	0.0	mph
TRD adjustment	3.7	mph
Calculated free-flow speed, FFS	71.7	mph
Measured free-flow speed, FFS	65.0	mph
Free-flow speed curve	65	mph

Capacity Checks for Segments with Ramps

	<u>Actual</u>		<u>Maximum</u>		<u>Violation?</u>
Entering freeway volume		pcph		pcph	
Exiting freeway volume		pcph		pcph	
On-ramp volume		pcph		pcph	
Off-ramp volume		pcph		pcph	

LOS and Performance Measures

Flow rate, v_p	1,136	pcphpl
Average passenger-car speed, S	65.0	mph
Volume-to-capacity ratio, v/c	0.48	
Density, D	17.5	pcpmpl
Level of service, LOS	B	

HCM 2010: Freeway Basic Segment

Basic Operational Analysis

Project	CSUMB Master Plan EIR
Freeway	Northbound State Route 1
Segment	SR 1 between Imjin Parkway and Lightfighter Drive
Alternative	Cuml w/ Proj
Time period	PM Peak Hour

Flow Inputs and Adjustments

Volume, V	5,520	vph
Peak-hour factor, PHF	0.97	
Peak 15-min volume, v_{15}	1,423	veh
Trucks and buses	1.7%	
Recreational vehicles	0.0%	
Terrain type	Level	
Grade		
Length		mi
Trucks and buses PCE, E_T	1.5	
Recreational vehicle PCE, E_R	1.2	
Heavy vehicle adjustment, f_{HV}	0.991	
Driver population factor, f_p	1.00	
Flow rate, v_p	5,740	pcph
Number of lanes, N	3	

Speed Inputs and Adjustments

Lane width	12.0	ft
Right-side lateral clearance	>6	ft
Total ramp density, TRD	1.17	ramps/mi
Lane width adjustment, f_{LW}	0.0	mph
Lateral clearance adjustment, f_{LC}	0.0	mph
TRD adjustment	3.7	mph
Calculated free-flow speed, FFS	71.7	mph
Measured free-flow speed, FFS	65.0	mph
Free-flow speed curve	65	mph

Capacity Checks for Segments with Ramps

	<u>Actual</u>		<u>Maximum</u>		<u>Violation?</u>
Entering freeway volume		pcph		pcph	
Exiting freeway volume		pcph		pcph	
On-ramp volume		pcph		pcph	
Off-ramp volume		pcph		pcph	

LOS and Performance Measures

Flow rate, v_p	1,913	pcphpl
Average passenger-car speed, S	61.3	mph
Volume-to-capacity ratio, v/c	0.81	
Density, D	31.2	pcpmpl
Level of service, LOS	D	

HCM 2010: Freeway Basic Segment

Basic Operational Analysis

Project	CSUMB Master Plan EIR
Freeway	Northbound State Route 1
Segment	SR 1 between Lightfighter Drive and Del Monte Boulevard
Alternative	Cuml w/ Proj
Time period	AM Peak Hour

Flow Inputs and Adjustments

Volume, V	3,580	vph
Peak-hour factor, PHF	0.93	
Peak 15-min volume, v_{15}	958	veh
Trucks and buses	3.8%	
Recreational vehicles	0.0%	
Terrain type	Level	
Grade		
Length		mi
Trucks and buses PCE, E_T	1.5	
Recreational vehicle PCE, E_R	1.2	
Heavy vehicle adjustment, f_{HV}	0.982	
Driver population factor, f_P	1.00	
Flow rate, v_p	3,906	pcph
Number of lanes, N	3	

Speed Inputs and Adjustments

Lane width	12.0	ft
Right-side lateral clearance	>6	ft
Total ramp density, TRD	1.17	ramps/mi
Lane width adjustment, f_{LW}	0.0	mph
Lateral clearance adjustment, f_{LC}	0.0	mph
TRD adjustment	3.7	mph
Calculated free-flow speed, FFS	71.7	mph
Measured free-flow speed, FFS	65.0	mph
Free-flow speed curve	65	mph

Capacity Checks for Segments with Ramps

	<u>Actual</u>		<u>Maximum</u>		<u>Violation?</u>
Entering freeway volume		pcph		pcph	
Exiting freeway volume		pcph		pcph	
On-ramp volume		pcph		pcph	
Off-ramp volume		pcph		pcph	

LOS and Performance Measures

Flow rate, v_p	1,302	pcphpl
Average passenger-car speed, S	65.0	mph
Volume-to-capacity ratio, v/c	0.55	
Density, D	20.0	pcpmpl
Level of service, LOS	C	

HCM 2010: Freeway Basic Segment

Basic Operational Analysis

Project	CSUMB Master Plan EIR
Freeway	Northbound State Route 1
Segment	SR 1 between Lightfighter Drive and Del Monte Boulevard
Alternative	Cuml w/ Proj
Time period	PM Peak Hour

Flow Inputs and Adjustments

Volume, V	5,470	vph
Peak-hour factor, PHF	0.98	
Peak 15-min volume, v_{15}	1,395	veh
Trucks and buses	1.9%	
Recreational vehicles	0.0%	
Terrain type	Level	
Grade		
Length		mi
Trucks and buses PCE, E_T	1.5	
Recreational vehicle PCE, E_R	1.2	
Heavy vehicle adjustment, f_{HV}	0.991	
Driver population factor, f_p	1.00	
Flow rate, v_p	5,634	pcph
Number of lanes, N	3	

Speed Inputs and Adjustments

Lane width	12.0	ft
Right-side lateral clearance	>6	ft
Total ramp density, TRD	1.17	ramps/mi
Lane width adjustment, f_{LW}	0.0	mph
Lateral clearance adjustment, f_{LC}	0.0	mph
TRD adjustment	3.7	mph
Calculated free-flow speed, FFS	71.7	mph
Measured free-flow speed, FFS	65.0	mph
Free-flow speed curve	65	mph

Capacity Checks for Segments with Ramps

	<u>Actual</u>		<u>Maximum</u>		<u>Violation?</u>
Entering freeway volume		pcph		pcph	
Exiting freeway volume		pcph		pcph	
On-ramp volume		pcph		pcph	
Off-ramp volume		pcph		pcph	

LOS and Performance Measures

Flow rate, v_p	1,878	pcphpl
Average passenger-car speed, S	61.8	mph
Volume-to-capacity ratio, v/c	0.80	
Density, D	30.4	pcpmpl
Level of service, LOS	D	

HCM 2010: Freeway Basic Segment

Basic Operational Analysis

Project	CSUMB Master Plan EIR
Freeway	Northbound State Route 1
Segment	SR 1 between Del Monte Boulevard and Canyon Del Rey Boulevard
Alternative	Cuml w/ Proj
Time period	AM Peak Hour

Flow Inputs and Adjustments

Volume, V	3,040	vph
Peak-hour factor, PHF	0.92	
Peak 15-min volume, v_{15}	830	veh
Trucks and buses	3.2%	
Recreational vehicles	0.0%	
Terrain type	Level	
Grade		
Length		mi
Trucks and buses PCE, E_T	1.5	
Recreational vehicle PCE, E_R	1.2	
Heavy vehicle adjustment, f_{HV}	0.984	
Driver population factor, f_p	1.00	
Flow rate, v_p	3,373	pcph
Number of lanes, N	2	

Speed Inputs and Adjustments

Lane width	12.0	ft
Right-side lateral clearance	>6	ft
Total ramp density, TRD	2.00	ramps/mi
Lane width adjustment, f_{LW}	0.0	mph
Lateral clearance adjustment, f_{LC}	0.0	mph
TRD adjustment	5.8	mph
Calculated free-flow speed, FFS	69.6	mph
Measured free-flow speed, FFS	65.0	mph
Free-flow speed curve	65	mph

Capacity Checks for Segments with Ramps

	<u>Actual</u>		<u>Maximum</u>		<u>Violation?</u>
Entering freeway volume		pcph		pcph	
Exiting freeway volume		pcph		pcph	
On-ramp volume		pcph		pcph	
Off-ramp volume		pcph		pcph	

LOS and Performance Measures

Flow rate, v_p	1,687	pcphpl
Average passenger-car speed, S	63.8	mph
Volume-to-capacity ratio, v/c	0.72	
Density, D	26.4	pcpmpl
Level of service, LOS	D	

HCM 2010: Freeway Basic Segment

Basic Operational Analysis

Project	CSUMB Master Plan EIR
Freeway	Northbound State Route 1
Segment	SR 1 between Del Monte Boulevard and Canyon Del Rey Boulevard
Alternative	Cuml w/ Proj
Time period	PM Peak Hour

Flow Inputs and Adjustments

Volume, V	4,350	vph
Peak-hour factor, PHF	0.97	
Peak 15-min volume, v_{15}	1,121	veh
Trucks and buses	2.0%	
Recreational vehicles	0.0%	
Terrain type	Level	
Grade		
Length		mi
Trucks and buses PCE, E_T	1.5	
Recreational vehicle PCE, E_R	1.2	
Heavy vehicle adjustment, f_{HV}	0.990	
Driver population factor, f_p	1.00	
Flow rate, v_p	4,530	pcph
Number of lanes, N	2	

Speed Inputs and Adjustments

Lane width	12.0	ft
Right-side lateral clearance	>6	ft
Total ramp density, TRD	2.00	ramps/mi
Lane width adjustment, f_{LW}	0.0	mph
Lateral clearance adjustment, f_{LC}	0.0	mph
TRD adjustment	5.8	mph
Calculated free-flow speed, FFS	69.6	mph
Measured free-flow speed, FFS	65.0	mph
Free-flow speed curve	65	mph

Capacity Checks for Segments with Ramps

	<u>Actual</u>		<u>Maximum</u>		<u>Violation?</u>
Entering freeway volume		pcph		pcph	
Exiting freeway volume		pcph		pcph	
On-ramp volume		pcph		pcph	
Off-ramp volume		pcph		pcph	

LOS and Performance Measures

Flow rate, v_p	2,265	pcphpl
Average passenger-car speed, S	54.4	mph
Volume-to-capacity ratio, v/c	0.96	
Density, D	41.6	pcmppl
Level of service, LOS	E	

HCM 2010: Freeway Basic Segment

Basic Operational Analysis

Project	CSUMB Master Plan EIR
Freeway	Southbound State Route 1
Segment	SR 1 between Reservation Road and Del Monte Boulevard
Alternative	Cuml w/ Eastside Pkwy w/ Proj
Time period	AM Peak Hour

Flow Inputs and Adjustments

Volume, V	3,550	vph
Peak-hour factor, PHF	0.76	
Peak 15-min volume, v_{15}	1,168	veh
Trucks and buses	4.7%	
Recreational vehicles	0.0%	
Terrain type	Level	
Grade		
Length		mi
Trucks and buses PCE, E_T	1.5	
Recreational vehicle PCE, E_R	1.2	
Heavy vehicle adjustment, f_{HV}	0.977	
Driver population factor, f_P	1.00	
Flow rate, v_p	4,780	pcph
Number of lanes, N	2	

Speed Inputs and Adjustments

Lane width	12.0	ft
Right-side lateral clearance	>6	ft
Total ramp density, TRD	1.00	ramps/mi
Lane width adjustment, f_{LW}	0.0	mph
Lateral clearance adjustment, f_{LC}	0.0	mph
TRD adjustment	3.2	mph
Calculated free-flow speed, FFS	72.2	mph
Measured free-flow speed, FFS	65.0	mph
Free-flow speed curve	65	mph

Capacity Checks for Segments with Ramps

	<u>Actual</u>		<u>Maximum</u>		<u>Violation?</u>
Entering freeway volume		pcph		pcph	
Exiting freeway volume		pcph		pcph	
On-ramp volume		pcph		pcph	
Off-ramp volume		pcph		pcph	

LOS and Performance Measures

Flow rate, v_p	2,390	pcphpl
Average passenger-car speed, S	-	mph
Volume-to-capacity ratio, v/c	1.02	
Density, D	-	pcpmpl
Level of service, LOS	F	

HCM 2010: Freeway Basic Segment

Basic Operational Analysis

Project	CSUMB Master Plan EIR
Freeway	Southbound SR 1
Segment	SR 1 between Reservation Road and Del Monte Boulevard
Alternative	Cuml w/ Eastside Pkwy w/ Proj
Time period	PM Peak Hour

Flow Inputs and Adjustments

Volume, V	1,890	vph
Peak-hour factor, PHF	0.97	
Peak 15-min volume, v_{15}	487	veh
Trucks and buses	1.0%	
Recreational vehicles	0.0%	
Terrain type	Level	
Grade		
Length		mi
Trucks and buses PCE, E_T	1.5	
Recreational vehicle PCE, E_R	1.2	
Heavy vehicle adjustment, f_{HV}	0.995	
Driver population factor, f_p	1.00	
Flow rate, v_p	1,958	pcph
Number of lanes, N	2	

Speed Inputs and Adjustments

Lane width	12.0	ft
Right-side lateral clearance	>6	ft
Total ramp density, TRD	1.00	ramps/mi
Lane width adjustment, f_{LW}	0.0	mph
Lateral clearance adjustment, f_{LC}	0.0	mph
TRD adjustment	3.2	mph
Calculated free-flow speed, FFS	72.2	mph
Measured free-flow speed, FFS	65.0	mph
Free-flow speed curve	65	mph

Capacity Checks for Segments with Ramps

	<u>Actual</u>		<u>Maximum</u>		<u>Violation?</u>
Entering freeway volume		pcph		pcph	
Exiting freeway volume		pcph		pcph	
On-ramp volume		pcph		pcph	
Off-ramp volume		pcph		pcph	

LOS and Performance Measures

Flow rate, v_p	979	pcphpl
Average passenger-car speed, S	65.0	mph
Volume-to-capacity ratio, v/c	0.42	
Density, D	15.1	pcpmpl
Level of service, LOS	B	

HCM 2010: Freeway Basic Segment

Basic Operational Analysis

Project	CSUMB Master Plan EIR
Freeway	Southbound State Route 1
Segment	SR 1 between Del Monte Boulevard and Imjin Parkway
Alternative	Cuml w/ Eastside Pkwy w/ Proj
Time period	AM Peak Hour

Flow Inputs and Adjustments

Volume, V	5,150	vph
Peak-hour factor, PHF	0.81	
Peak 15-min volume, v_{15}	1,590	veh
Trucks and buses	3.9%	
Recreational vehicles	0.0%	
Terrain type	Level	
Grade		
Length		mi
Trucks and buses PCE, E_T	1.5	
Recreational vehicle PCE, E_R	1.2	
Heavy vehicle adjustment, f_{HV}	0.981	
Driver population factor, f_p	1.00	
Flow rate, v_p	6,482	pcph
Number of lanes, N	3	

Speed Inputs and Adjustments

Lane width	12.0	ft
Right-side lateral clearance	>6	ft
Total ramp density, TRD	1.17	ramps/mi
Lane width adjustment, f_{LW}	0.0	mph
Lateral clearance adjustment, f_{LC}	0.0	mph
TRD adjustment	3.7	mph
Calculated free-flow speed, FFS	71.7	mph
Measured free-flow speed, FFS	65.0	mph
Free-flow speed curve	65	mph

Capacity Checks for Segments with Ramps

	<u>Actual</u>		<u>Maximum</u>		<u>Violation?</u>
Entering freeway volume		pcph		pcph	
Exiting freeway volume		pcph		pcph	
On-ramp volume		pcph		pcph	
Off-ramp volume		pcph		pcph	

LOS and Performance Measures

Flow rate, v_p	2,161	pcphpl
Average passenger-car speed, S	56.8	mph
Volume-to-capacity ratio, v/c	0.92	
Density, D	38.0	pcpmpl
Level of service, LOS	E	

HCM 2010: Freeway Basic Segment

Basic Operational Analysis

Project	CSUMB Master Plan EIR
Freeway	Southbound SR 1
Segment	SR 1 between Del Monte Boulevard and Imjin Parkway
Alternative	Cuml w/ Eastside Pkwy w/ Proj
Time period	PM Peak Hour

Flow Inputs and Adjustments

Volume, V	2,940	vph
Peak-hour factor, PHF	0.95	
Peak 15-min volume, v_{15}	774	veh
Trucks and buses	1.4%	
Recreational vehicles	0.0%	
Terrain type	Level	
Grade		
Length		mi
Trucks and buses PCE, E_T	1.5	
Recreational vehicle PCE, E_R	1.2	
Heavy vehicle adjustment, f_{HV}	0.993	
Driver population factor, f_p	1.00	
Flow rate, v_p	3,116	pcph
Number of lanes, N	3	

Speed Inputs and Adjustments

Lane width	12.0	ft
Right-side lateral clearance	>6	ft
Total ramp density, TRD	1.17	ramps/mi
Lane width adjustment, f_{LW}	0.0	mph
Lateral clearance adjustment, f_{LC}	0.0	mph
TRD adjustment	3.7	mph
Calculated free-flow speed, FFS	71.7	mph
Measured free-flow speed, FFS	65.0	mph
Free-flow speed curve	65	mph

Capacity Checks for Segments with Ramps

	<u>Actual</u>		<u>Maximum</u>		<u>Violation?</u>
Entering freeway volume		pcph		pcph	
Exiting freeway volume		pcph		pcph	
On-ramp volume		pcph		pcph	
Off-ramp volume		pcph		pcph	

LOS and Performance Measures

Flow rate, v_p	1,039	pcphpl
Average passenger-car speed, S	65.0	mph
Volume-to-capacity ratio, v/c	0.44	
Density, D	16.0	pcpmpl
Level of service, LOS	B	

HCM 2010: Freeway Basic Segment

Basic Operational Analysis

Project	CSUMB Master Plan EIR
Freeway	Southbound State Route 1
Segment	SR 1 between Imjin Parkway and Lightfighter Drive
Alternative	Cuml w/ Eastside Pkwy w/ Proj
Time period	AM Peak Hour

Flow Inputs and Adjustments

Volume, V	5,090	vph
Peak-hour factor, PHF	0.83	
Peak 15-min volume, v_{15}	1,533	veh
Trucks and buses	3.5%	
Recreational vehicles	0.0%	
Terrain type	Level	
Grade		
Length		mi
Trucks and buses PCE, E_T	1.5	
Recreational vehicle PCE, E_R	1.2	
Heavy vehicle adjustment, f_{HV}	0.983	
Driver population factor, f_p	1.00	
Flow rate, v_p	6,241	pcph
Number of lanes, N	3	

Speed Inputs and Adjustments

Lane width	12.0	ft
Right-side lateral clearance	>6	ft
Total ramp density, TRD	1.17	ramps/mi
Lane width adjustment, f_{LW}	0.0	mph
Lateral clearance adjustment, f_{LC}	0.0	mph
TRD adjustment	3.7	mph
Calculated free-flow speed, FFS	71.7	mph
Measured free-flow speed, FFS	65.0	mph
Free-flow speed curve	65	mph

Capacity Checks for Segments with Ramps

	<u>Actual</u>		<u>Maximum</u>		<u>Violation?</u>
Entering freeway volume		pcph		pcph	
Exiting freeway volume		pcph		pcph	
On-ramp volume		pcph		pcph	
Off-ramp volume		pcph		pcph	

LOS and Performance Measures

Flow rate, v_p	2,080	pcphpl
Average passenger-car speed, S	58.4	mph
Volume-to-capacity ratio, v/c	0.89	
Density, D	35.6	pcpmpl
Level of service, LOS	E	

HCM 2010: Freeway Basic Segment

Basic Operational Analysis

Project	CSUMB Master Plan EIR
Freeway	Southbound SR 1
Segment	SR 1 between Imjin Parkway and Lightfighter Drive
Alternative	Cuml w/ Eastside Pkwy w/ Proj
Time period	PM Peak Hour

Flow Inputs and Adjustments

Volume, V	3,340	vph
Peak-hour factor, PHF	0.95	
Peak 15-min volume, v_{15}	879	veh
Trucks and buses	1.3%	
Recreational vehicles	0.0%	
Terrain type	Level	
Grade		
Length		mi
Trucks and buses PCE, E_T	1.5	
Recreational vehicle PCE, E_R	1.2	
Heavy vehicle adjustment, f_{HV}	0.994	
Driver population factor, f_p	1.00	
Flow rate, v_p	3,538	pcph
Number of lanes, N	3	

Speed Inputs and Adjustments

Lane width	12.0	ft
Right-side lateral clearance	>6	ft
Total ramp density, TRD	1.17	ramps/mi
Lane width adjustment, f_{LW}	0.0	mph
Lateral clearance adjustment, f_{LC}	0.0	mph
TRD adjustment	3.7	mph
Calculated free-flow speed, FFS	71.7	mph
Measured free-flow speed, FFS	65.0	mph
Free-flow speed curve	65	mph

Capacity Checks for Segments with Ramps

	<u>Actual</u>		<u>Maximum</u>		<u>Violation?</u>
Entering freeway volume		pcph		pcph	
Exiting freeway volume		pcph		pcph	
On-ramp volume		pcph		pcph	
Off-ramp volume		pcph		pcph	

LOS and Performance Measures

Flow rate, v_p	1,179	pcphpl
Average passenger-car speed, S	65.0	mph
Volume-to-capacity ratio, v/c	0.50	
Density, D	18.1	pcpmpl
Level of service, LOS	C	

HCM 2010: Freeway Basic Segment

Basic Operational Analysis

Project	CSUMB Master Plan EIR
Freeway	Southbound State Route 1
Segment	SR 1 between Lightfighter Drive and Del Monte Boulevard
Alternative	Cuml w/ Eastside Pkwy w/ Proj
Time period	AM Peak Hour

Flow Inputs and Adjustments

Volume, V	5,580	vph
Peak-hour factor, PHF	0.86	
Peak 15-min volume, v_{15}	1,622	veh
Trucks and buses	3.2%	
Recreational vehicles	0.0%	
Terrain type	Level	
Grade		
Length		mi
Trucks and buses PCE, E_T	1.5	
Recreational vehicle PCE, E_R	1.2	
Heavy vehicle adjustment, f_{HV}	0.984	
Driver population factor, f_p	1.00	
Flow rate, v_p	6,592	pcph
Number of lanes, N	3	

Speed Inputs and Adjustments

Lane width	12.0	ft
Right-side lateral clearance	>6	ft
Total ramp density, TRD	1.33	ramps/mi
Lane width adjustment, f_{LW}	0.0	mph
Lateral clearance adjustment, f_{LC}	0.0	mph
TRD adjustment	4.1	mph
Calculated free-flow speed, FFS	71.3	mph
Measured free-flow speed, FFS	65.0	mph
Free-flow speed curve	65	mph

Capacity Checks for Segments with Ramps

	<u>Actual</u>		<u>Maximum</u>		<u>Violation?</u>
Entering freeway volume		pcph		pcph	
Exiting freeway volume		pcph		pcph	
On-ramp volume		pcph		pcph	
Off-ramp volume		pcph		pcph	

LOS and Performance Measures

Flow rate, v_p	2,197	pcphpl
Average passenger-car speed, S	56.0	mph
Volume-to-capacity ratio, v/c	0.94	
Density, D	39.3	pcpmpl
Level of service, LOS	E	

HCM 2010: Freeway Basic Segment

Basic Operational Analysis

Project	CSUMB Master Plan EIR
Freeway	Southbound SR 1
Segment	SR 1 between Lightfighter Drive and Del Monte Boulevard
Alternative	Cuml w/ Eastside Pkwy w/ Proj
Time period	PM Peak Hour

Flow Inputs and Adjustments

Volume, V	4,030	vph
Peak-hour factor, PHF	0.97	
Peak 15-min volume, v_{15}	1,039	veh
Trucks and buses	1.1%	
Recreational vehicles	0.0%	
Terrain type	Level	
Grade		
Length		mi
Trucks and buses PCE, E_T	1.5	
Recreational vehicle PCE, E_R	1.2	
Heavy vehicle adjustment, f_{HV}	0.994	
Driver population factor, f_p	1.00	
Flow rate, v_p	4,178	pcph
Number of lanes, N	3	

Speed Inputs and Adjustments

Lane width	12.0	ft
Right-side lateral clearance	>6	ft
Total ramp density, TRD	1.33	ramps/mi
Lane width adjustment, f_{LW}	0.0	mph
Lateral clearance adjustment, f_{LC}	0.0	mph
TRD adjustment	4.1	mph
Calculated free-flow speed, FFS	71.3	mph
Measured free-flow speed, FFS	65.0	mph
Free-flow speed curve	65	mph

Capacity Checks for Segments with Ramps

	<u>Actual</u>		<u>Maximum</u>		<u>Violation?</u>
Entering freeway volume		pcph		pcph	
Exiting freeway volume		pcph		pcph	
On-ramp volume		pcph		pcph	
Off-ramp volume		pcph		pcph	

LOS and Performance Measures

Flow rate, v_p	1,393	pcphpl
Average passenger-car speed, S	65.0	mph
Volume-to-capacity ratio, v/c	0.59	
Density, D	21.4	pcpmpl
Level of service, LOS	C	

HCM 2010: Freeway Basic Segment

Basic Operational Analysis

Project	CSUMB Master Plan EIR
Freeway	Southbound State Route 1
Segment	SR 1 between Del Monte Boulevard and Canyon Del Rey Boulevard
Alternative	Cuml w/ Eastside Pkwy w/ Proj
Time period	AM Peak Hour

Flow Inputs and Adjustments

Volume, V	4,600	vph
Peak-hour factor, PHF	0.95	
Peak 15-min volume, v_{15}	1,211	veh
Trucks and buses	2.4%	
Recreational vehicles	0.0%	
Terrain type	Level	
Grade		
Length		mi
Trucks and buses PCE, E_T	1.5	
Recreational vehicle PCE, E_R	1.2	
Heavy vehicle adjustment, f_{HV}	0.988	
Driver population factor, f_p	1.00	
Flow rate, v_p	4,901	pcph
Number of lanes, N	2	

Speed Inputs and Adjustments

Lane width	12.0	ft
Right-side lateral clearance	5.0	ft
Total ramp density, TRD	2.17	ramps/mi
Lane width adjustment, f_{LW}	0.0	mph
Lateral clearance adjustment, f_{LC}	0.6	mph
TRD adjustment	6.2	mph
Calculated free-flow speed, FFS	68.6	mph
Measured free-flow speed, FFS	65.0	mph
Free-flow speed curve	65	mph

Capacity Checks for Segments with Ramps

	<u>Actual</u>		<u>Maximum</u>		<u>Violation?</u>
Entering freeway volume		pcph		pcph	
Exiting freeway volume		pcph		pcph	
On-ramp volume		pcph		pcph	
Off-ramp volume		pcph		pcph	

LOS and Performance Measures

Flow rate, v_p	2,451	pcphpl
Average passenger-car speed, S	-	mph
Volume-to-capacity ratio, v/c	1.04	
Density, D	-	pcpmpl
Level of service, LOS	F	

HCM 2010: Freeway Basic Segment

Basic Operational Analysis

Project	CSUMB Master Plan EIR
Freeway	Southbound SR 1
Segment	SR 1 between Del Monte Boulevard and Canyon Del Rey Boulevard
Alternative	Cuml w/ Eastside Pkwy w/ Proj
Time period	PM Peak Hour

Flow Inputs and Adjustments

Volume, V	3,300	vph
Peak-hour factor, PHF	0.96	
Peak 15-min volume, v_{15}	859	veh
Trucks and buses	1.0%	
Recreational vehicles	0.0%	
Terrain type	Level	
Grade		
Length		mi
Trucks and buses PCE, E_T	1.5	
Recreational vehicle PCE, E_R	1.2	
Heavy vehicle adjustment, f_{HV}	0.995	
Driver population factor, f_p	1.00	
Flow rate, v_p	3,455	pcph
Number of lanes, N	2	

Speed Inputs and Adjustments

Lane width	12.0	ft
Right-side lateral clearance	5.0	ft
Total ramp density, TRD	2.17	ramps/mi
Lane width adjustment, f_{LW}	0.0	mph
Lateral clearance adjustment, f_{LC}	0.6	mph
TRD adjustment	6.2	mph
Calculated free-flow speed, FFS	68.6	mph
Measured free-flow speed, FFS	65.0	mph
Free-flow speed curve	65	mph

Capacity Checks for Segments with Ramps

	<u>Actual</u>		<u>Maximum</u>		<u>Violation?</u>
Entering freeway volume		pcph		pcph	
Exiting freeway volume		pcph		pcph	
On-ramp volume		pcph		pcph	
Off-ramp volume		pcph		pcph	

LOS and Performance Measures

Flow rate, v_p	1,727	pcphpl
Average passenger-car speed, S	63.5	mph
Volume-to-capacity ratio, v/c	0.74	
Density, D	27.2	pcmpl
Level of service, LOS	D	

HCM 2010: Freeway Basic Segment

Basic Operational Analysis

Project	CSUMB Master Plan EIR
Freeway	Northbound State Route 1
Segment	SR 1 between Del Monte Boulevard and Canyon Del Rey Boulevard
Alternative	Cuml w/ Eastside Pkwy w/ Proj
Time period	PM Peak Hour

Flow Inputs and Adjustments

Volume, V	4,420	vph
Peak-hour factor, PHF	0.97	
Peak 15-min volume, v_{15}	1,139	veh
Trucks and buses	2.0%	
Recreational vehicles	0.0%	
Terrain type	Level	
Grade		
Length		mi
Trucks and buses PCE, E_T	1.5	
Recreational vehicle PCE, E_R	1.2	
Heavy vehicle adjustment, f_{HV}	0.990	
Driver population factor, f_p	1.00	
Flow rate, v_p	4,603	pcph
Number of lanes, N	2	

Speed Inputs and Adjustments

Lane width	12.0	ft
Right-side lateral clearance	>6	ft
Total ramp density, TRD	2.00	ramps/mi
Lane width adjustment, f_{LW}	0.0	mph
Lateral clearance adjustment, f_{LC}	0.0	mph
TRD adjustment	5.8	mph
Calculated free-flow speed, FFS	69.6	mph
Measured free-flow speed, FFS	65.0	mph
Free-flow speed curve	65	mph

Capacity Checks for Segments with Ramps

	<u>Actual</u>		<u>Maximum</u>		<u>Violation?</u>
Entering freeway volume		pcph		pcph	
Exiting freeway volume		pcph		pcph	
On-ramp volume		pcph		pcph	
Off-ramp volume		pcph		pcph	

LOS and Performance Measures

Flow rate, v_p	2,301	pcphpl
Average passenger-car speed, S	53.5	mph
Volume-to-capacity ratio, v/c	0.98	
Density, D	43.0	pcpmpl
Level of service, LOS	E	

APPENDIX N: INTERSECTION SIGNAL WARRANT ANALYSIS



Signal warrant sheets have been added to the report since November 2021

Table N-1: PEAK HOUR SIGNAL WARRANT SUMMARY

	Intersection	Peak Hour ¹	Signal Warrant Met ²		
			Existing with Project Conditions ³	Year 2035 Cumulative with Project ³	Year 2035 Cumulative with Project with Eastside Parkway ³
4	SR 1 Northbound Ramps and Imjin Parkway	AM	No	No	No
		PM	No	No	No
6	Third Avenue and Imjin Parkway	AM	No	N/A	N/A
		PM	No	N/A	N/A
7	Fourth Avenue and Imjin Parkway	AM	No	N/A	N/A
		PM	No	N/A	N/A
15	Second Avenue and Ninth Street	AM	No	Signalized	Signalized
		PM	No		
16	Second Avenue and Eighth Street	AM	Yes	Signalized	Signalized
		PM	Yes		
19	Second Avenue and Inter-Garrison Road	AM	No	Signalized	Signalized
		PM	No		
21	<u>Eighth Street/Seventh Avenue and Inter-Garrison Road</u>	<u>AM</u>	<u>No</u>	<u>Signalized</u>	<u>Signalized</u>
		<u>PM</u>	<u>Yes</u>		
22	Eighth Avenue and Inter-Garrison Road	AM	Yes	Yes	Yes
		PM	Yes	Yes	Yes
23	Abrams Drive and Inter-Garrison Road	AM	Yes	Signalized	Signalized
		PM	Yes		
24	Schoonover Road and Inter-Garrison Road	AM	No	No	Signalized
		PM	No	No	
25	Inter-Garrison Road Connection and Inter-Garrison Road	AM	N/A	Yes	Yes
		PM	N/A	Yes	Yes
29	Second Avenue and Divarty Street	AM	No	Signalized	Signalized
		PM	Yes		
37	Seventh Avenue and Colonel Durham Street	AM	N/A	No	N/A
		PM	N/A	No	N/A
38	Eight Avenue and Colonel Durham Street	AM	N/A	No	N/A
		PM	N/A	No	N/A
40	Malmedy road and Gigling Road	AM	No	Signalized	Signalized
		PM	No		
41	Parker Flatts Cut Off Road and Gigling Road	AM	No	Signalized	Signalized
		PM	No		
42	Sixth Avenue and Gigling Road	AM	No	Signalized	Signalized
		PM	No		
47	General Jim Moore Boulevard and Coe Avenue	AM	Yes	Yes	Signalized
		PM	Yes	Yes	

Notes:

1. AM = morning peak hour, PM = evening peak hour.
2. California MUTCD Section 4C.04: Signal Warrant #3 – Peak Hour Warrant completed for unsignalized intersections.
3. "N/A" indicated intersections that did not have an LOS below its designated LOS threshold in the corresponding scenario. "Signalized" indicates that intersection improvement for the corresponding scenario was to signalize.

Bold text indicates unsignalized warrant is met.

Source: Fehr & Peers, 2019



Major Street **Imjin Parkway**
 Minor Street **SR 1 NB Off-Ramp/SR 1 NB On-Ramp**

Project **CSUMB Master Plan EIR**
 Scenario **Existing Plus Project AM**
 Peak Hour **AM**

Turn Movement Volumes

	NB	SB	EB	WB
Left	10	0	10	0
Through	10	0	530	900
Right	0	0	0	180
Total	20	0	540	1,080

Major Street Direction

	North/South
X	East/West

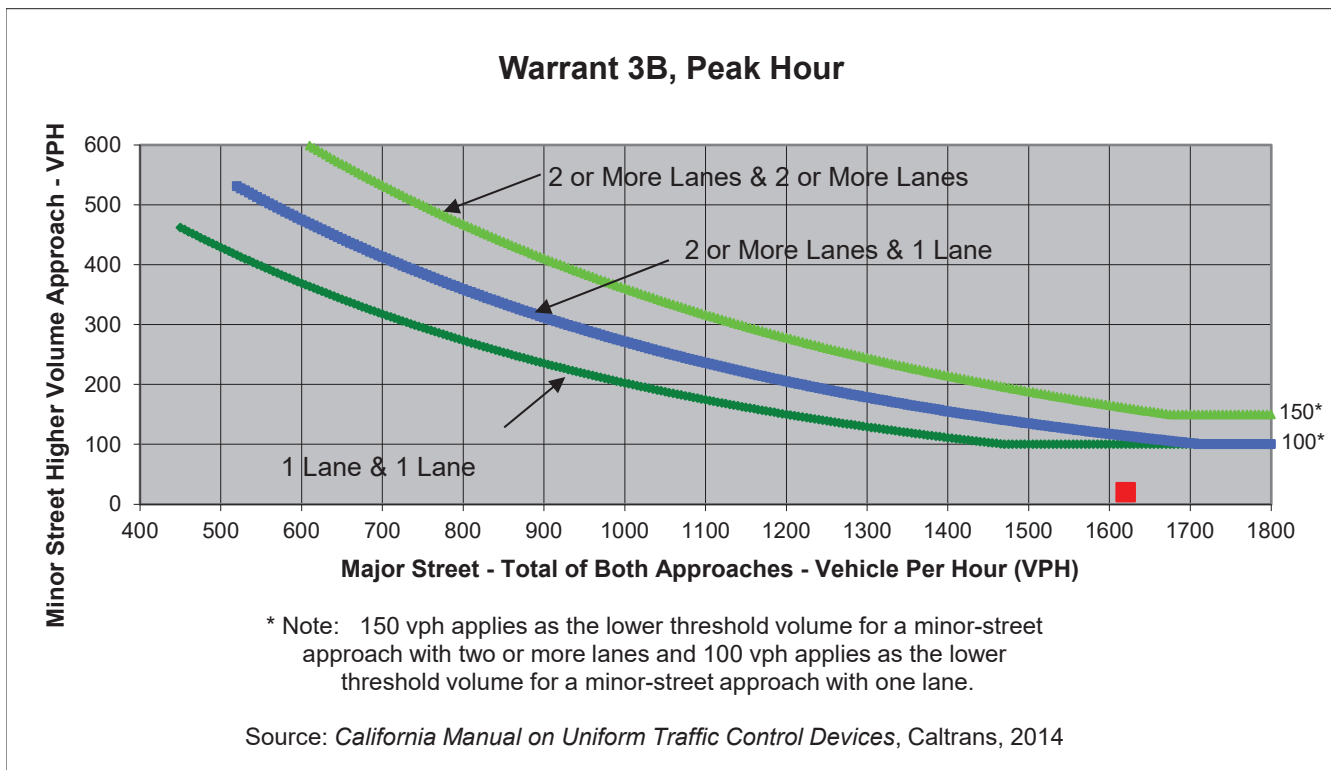

	Major Street	Minor Street	Warrant Met
	Imjin Parkway	SR 1 NB Off-Ramp/SR 1 NB On-Ramp	
Number of Approach Lanes	1	1	<u>NO</u>
Traffic Volume (VPH) *	1,620	20	
* Note: Traffic Volume for Major Street is Total Volume of Both Approches. Traffic Volume for Minor Street is the Volume of High Volume Approach.			



Major Street Imjin Parkway
 Minor Street 3rd Avenue

Project CSUMB Master Plan EIR
 Scenario Existing Plus Project AM
 Peak Hour AM

Turn Movement Volumes

	NB	SB	EB	WB
Left	10	10	50	240
Through	10	10	870	1,250
Right	20	40	20	30
Total	40	60	940	1,520

Major Street Direction

	North/South
X	East/West

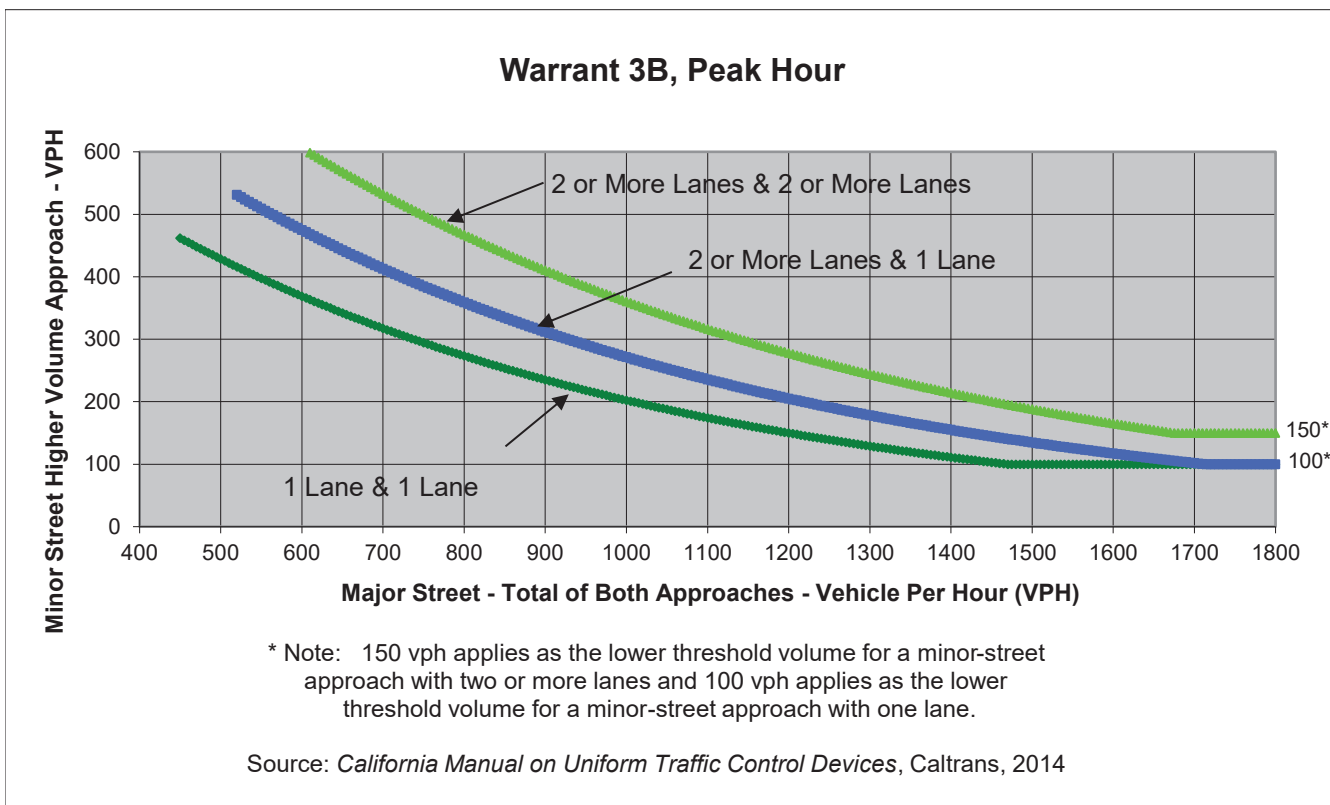

	Major Street	Minor Street	Warrant Met
	Imjin Parkway	3rd Avenue	
Number of Approach Lanes	2	1	<u>NO</u>
Traffic Volume (VPH) *	2,460	60	

* Note: Traffic Volume for Major Street is Total Volume of Both Approaches.
 Traffic Volume for Minor Street is the Volume of High Volume Approach.

Major Street Imjin Parkway
 Minor Street 4th Avenue

Project CSUMB Master Plan EIR
 Scenario Existing Plus Project AM
 Peak Hour AM

Turn Movement Volumes

	NB	SB	EB	WB
Left	10	10	10	10
Through	10	10	960	1,440
Right	10	10	20	10
Total	30	30	990	1,460

Major Street Direction

	North/South
X	East/West

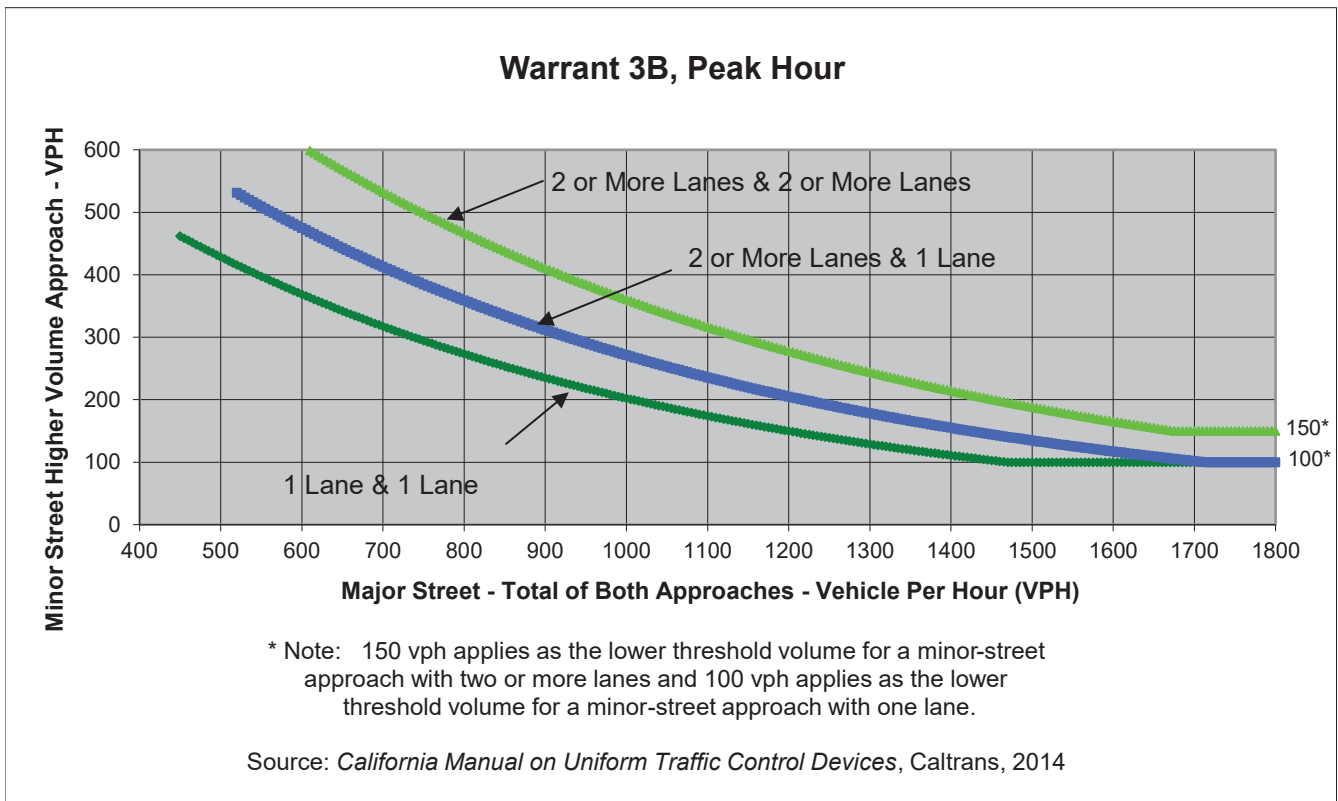

	Major Street	Minor Street	Warrant Met
	Imjin Parkway	4th Avenue	
Number of Approach Lanes	2	1	<u>NO</u>
Traffic Volume (VPH) *	2,450	30	

* Note: Traffic Volume for Major Street is Total Volume of Both Approaches.
 Traffic Volume for Minor Street is the Volume of High Volume Approach.



Major Street 2nd Avenue
 Minor Street 9th Street

Project CSUMB Master Plan EIR
 Scenario Existing Plus Project AM
 Peak Hour AM

Turn Movement Volumes

	NB	SB	EB	WB
Left	10	10	40	250
Through	140	520	10	10
Right	10	30	50	10
Total	160	560	100	270

Major Street Direction

X	North/South
	East/West

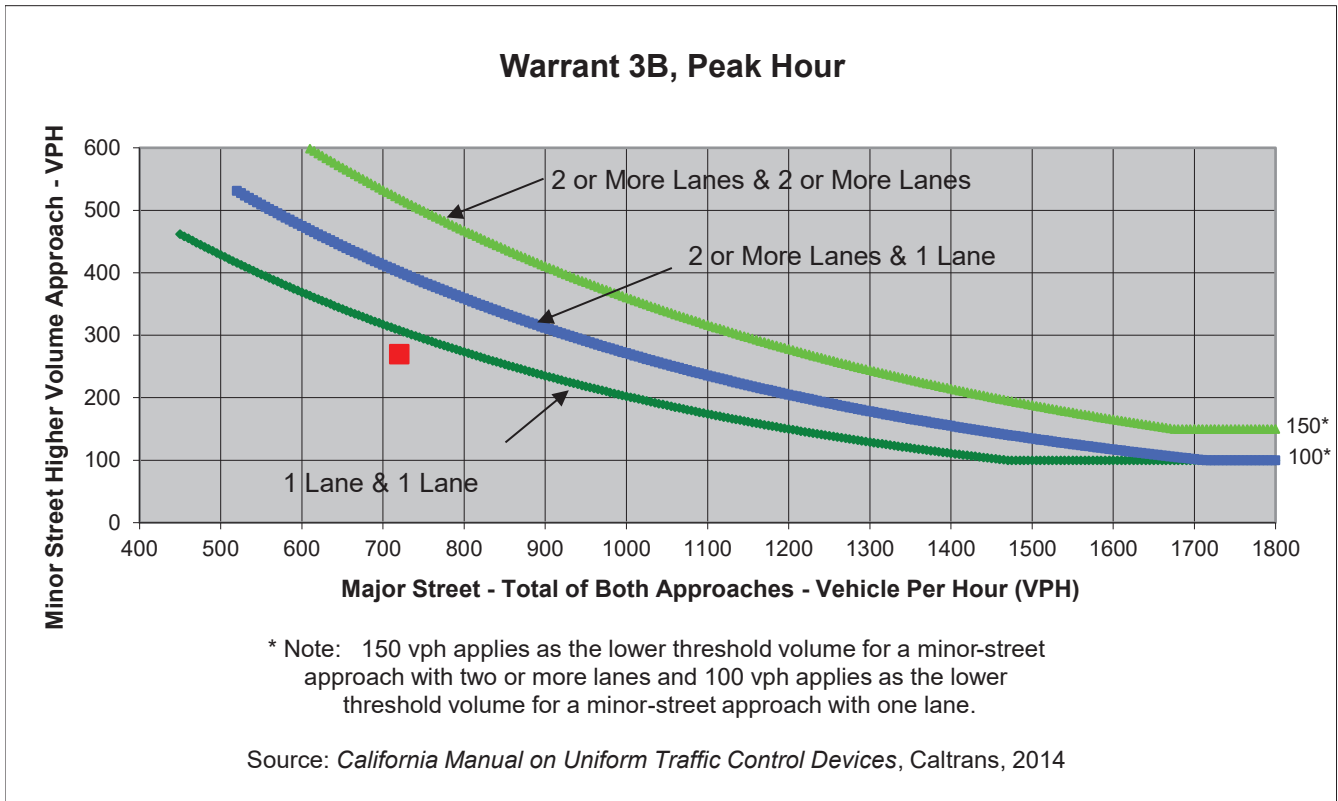

	Major Street	Minor Street	Warrant Met
	2nd Avenue	9th Street	
Number of Approach Lanes	1	1	<u>NO</u>
Traffic Volume (VPH) *	720	270	

* Note: Traffic Volume for Major Street is Total Volume of Both Approaches.
 Traffic Volume for Minor Street is the Volume of High Volume Approach.



Major Street 2nd Avenue
 Minor Street 8th Street

Project CSUMB Master Plan EIR
 Scenario Existing Plus Project AM
 Peak Hour AM

Turn Movement Volumes

	NB	SB	EB	WB
Left	10	60	10	270
Through	210	770	10	10
Right	130	10	10	30
Total	350	840	30	310

Major Street Direction

X	North/South
	East/West

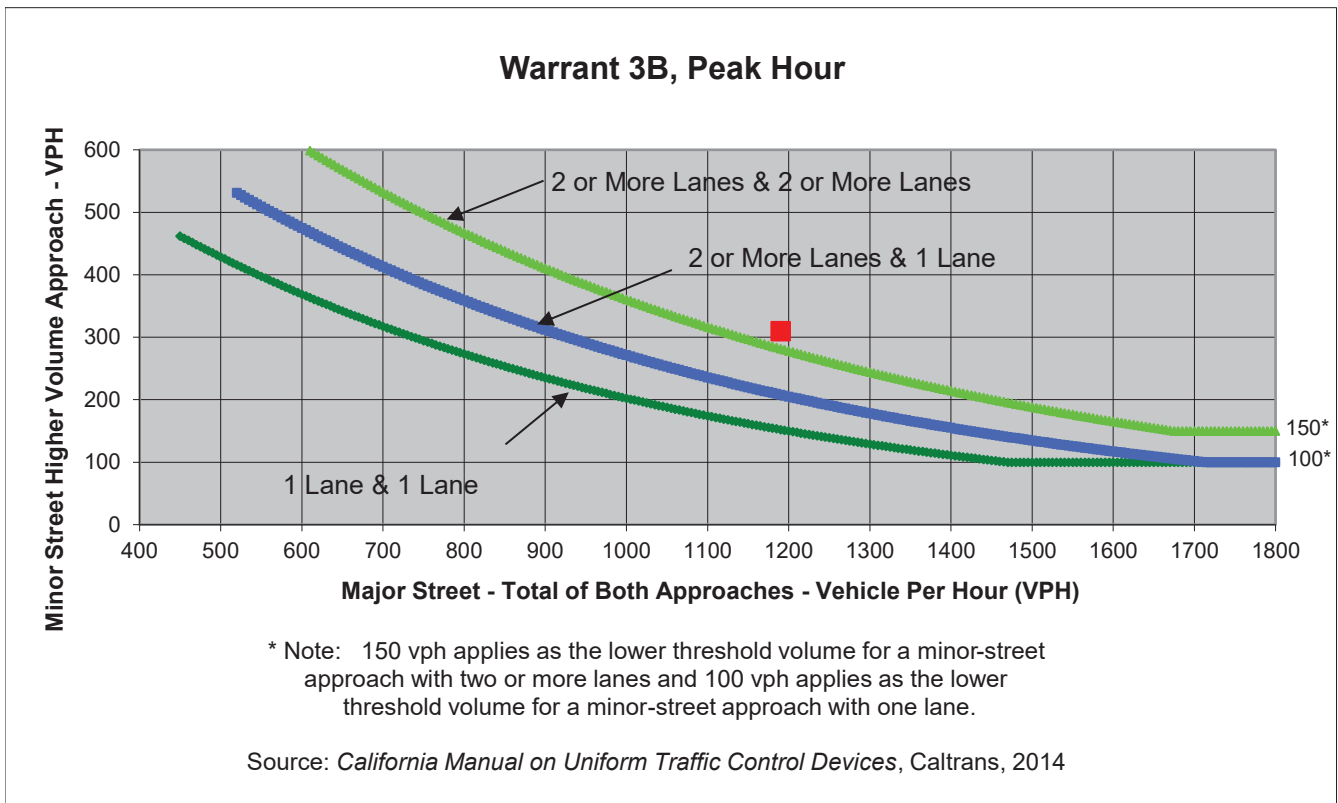

	Major Street	Minor Street	Warrant Met
	2nd Avenue	8th Street	
Number of Approach Lanes	1	1	<u>YES</u>
Traffic Volume (VPH) *	1,190	310	

* Note: Traffic Volume for Major Street is Total Volume of Both Approaches.
 Traffic Volume for Minor Street is the Volume of High Volume Approach.



Major Street 2nd Avenue
 Minor Street Inter-Garrison Road

Project CSUMB Master Plan EIR
 Scenario Existing Plus Project AM
 Peak Hour AM

Turn Movement Volumes

	NB	SB	EB	WB
Left	0	10	0	30
Through	340	1,030	0	0
Right	40	0	0	10
Total	380	1,040	0	40

Major Street Direction

X	North/South
	East/West

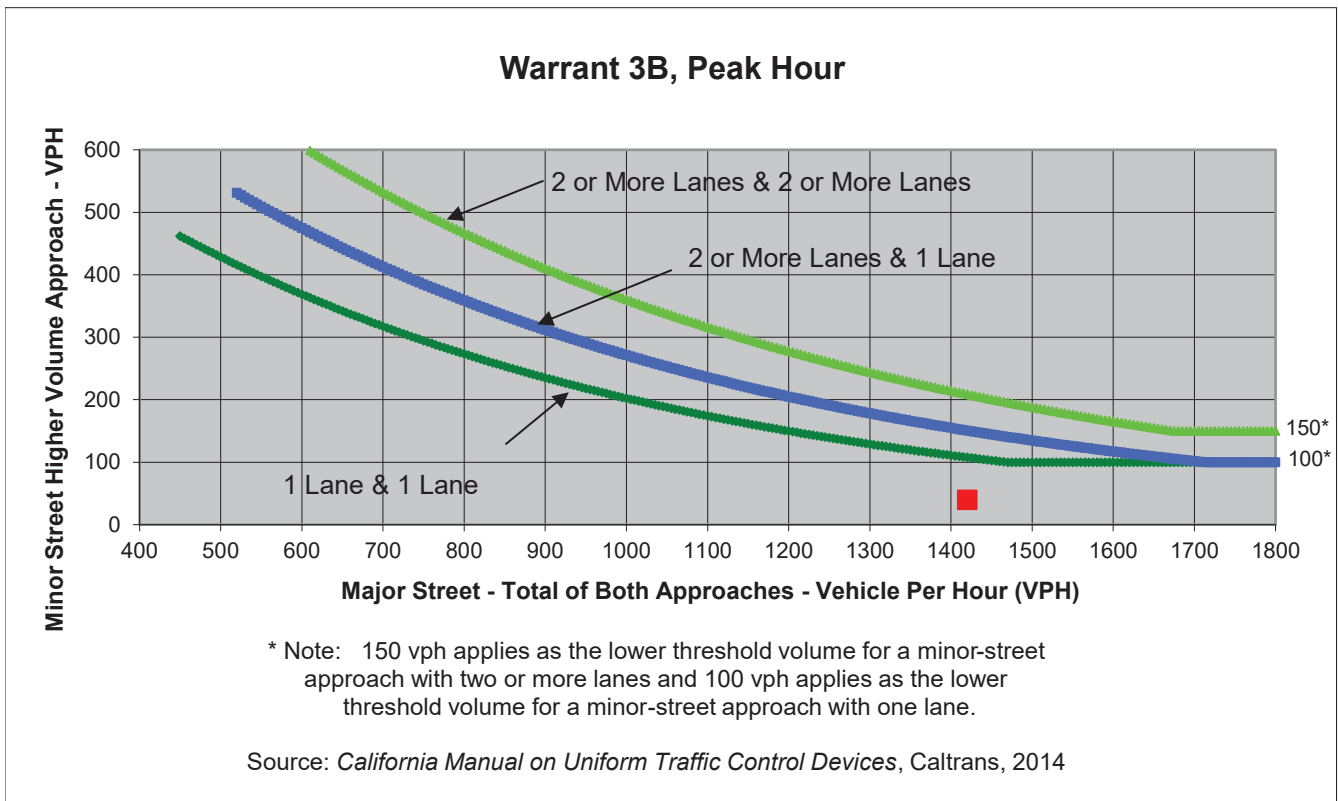

	Major Street	Minor Street	Warrant Met
	2nd Avenue	Inter-Garrison Road	
Number of Approach Lanes	1	1	<u>NO</u>
Traffic Volume (VPH) *	1,420	40	

* Note: Traffic Volume for Major Street is Total Volume of Both Approaches.
 Traffic Volume for Minor Street is the Volume of High Volume Approach.



Major Street **Inter-Garrison Road**
 Minor Street **7th Avenue/8th Street**

Project **CSUMB Master Plan EIR**
 Scenario **Existing Plus Project AM**
 Peak Hour **AM**

Turn Movement Volumes

	NB	SB	EB	WB
Left	30	170	10	310
Through	170	200	50	150
Right	110	10	20	30
Total	310	380	80	490

Major Street Direction

	North/South
X	East/West

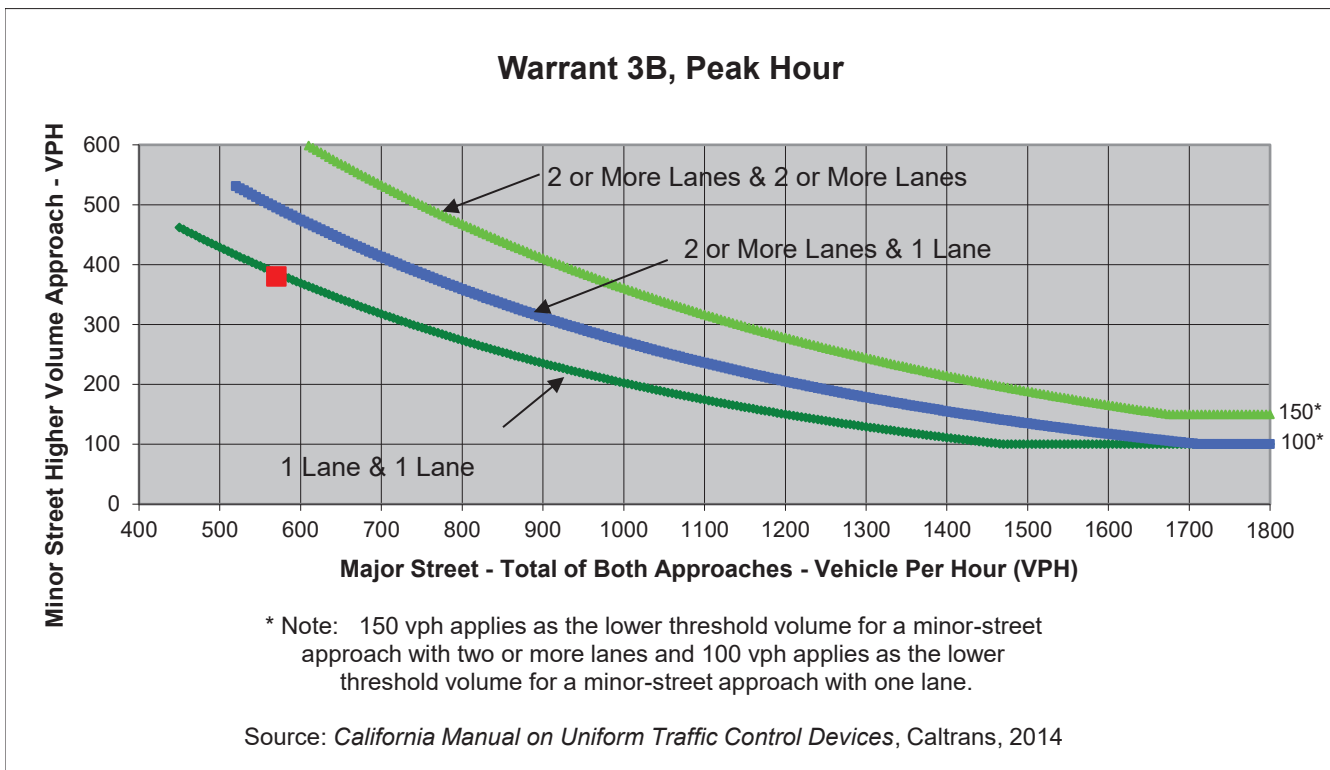

	Major Street	Minor Street	Warrant Met
	Inter-Garrison Road	7th Avenue/8th Street	
Number of Approach Lanes	1	1	<u>NO</u>
Traffic Volume (VPH) *	570	380	

* Note: Traffic Volume for Major Street is Total Volume of Both Approches.
 Traffic Volume for Minor Street is the Volume of High Volume Approach.



Major Street Inter-Garrison Road
 Minor Street 8th Avenue

Project CSUMB Master Plan EIR
 Scenario Existing Plus Project AM
 Peak Hour AM

Turn Movement Volumes

	NB	SB	EB	WB
Left	10	0	0	730
Through	0	0	180	500
Right	240	0	150	0
Total	250	0	330	1,230

Major Street Direction

 North/South
 X East/West

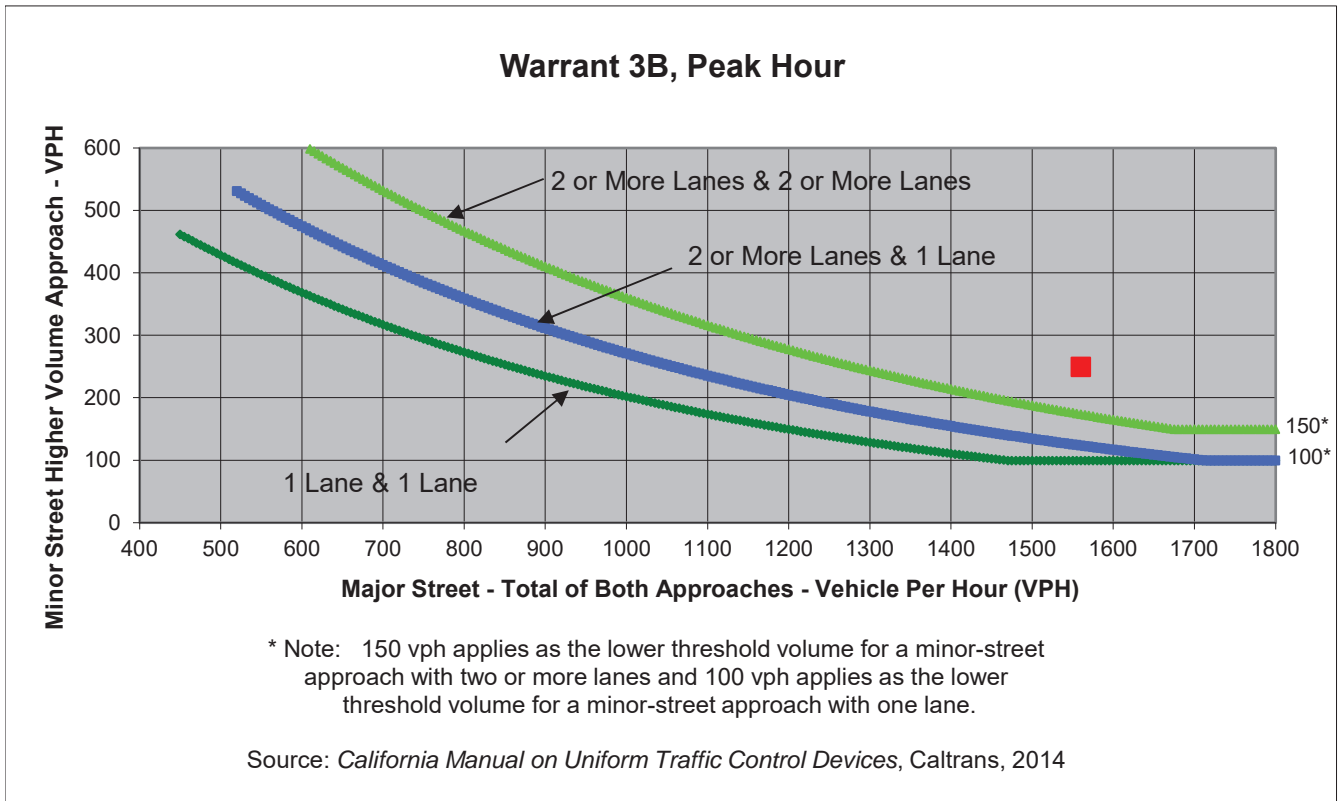

	Major Street	Minor Street	Warrant Met
	Inter-Garrison Road	8th Avenue	
Number of Approach Lanes	1	1	<u>YES</u>
Traffic Volume (VPH) *	1,560	250	

* Note: Traffic Volume for Major Street is Total Volume of Both Approaches.
 Traffic Volume for Minor Street is the Volume of High Volume Approach.

Major Street Inter-Garrison Road
 Minor Street Abrams Drive

Project CSUMB Master Plan EIR
 Scenario Existing Plus Project AM
 Peak Hour AM

Turn Movement Volumes

	NB	SB	EB	WB
Left	0	30	210	0
Through	0	0	200	740
Right	0	490	0	10
Total	0	520	410	750

Major Street Direction

	North/South
X	East/West

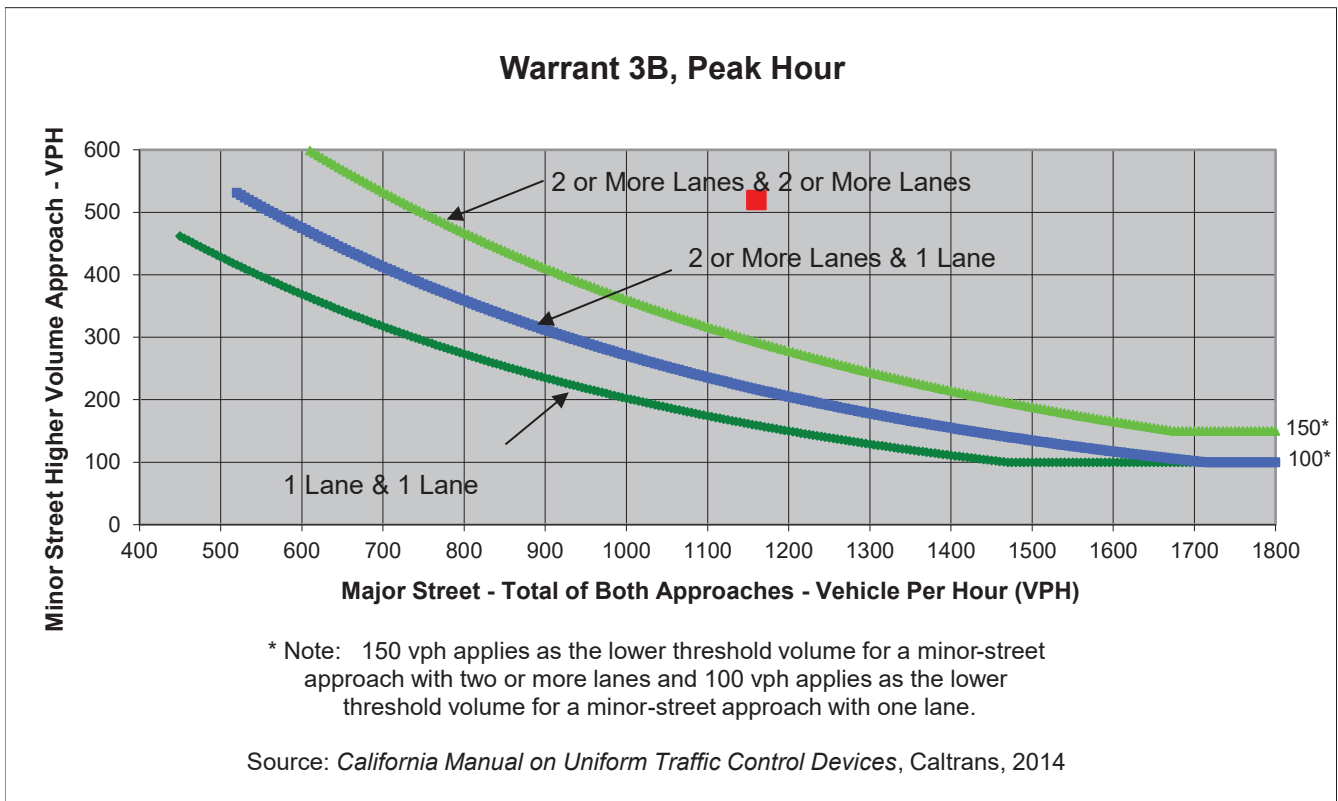

	Major Street	Minor Street	Warrant Met
	Inter-Garrison Road	Abrams Drive	
Number of Approach Lanes	1	1	<u>YES</u>
Traffic Volume (VPH) *	1,160	520	

* Note: Traffic Volume for Major Street is Total Volume of Both Approaches.
 Traffic Volume for Minor Street is the Volume of High Volume Approach.

Major Street Inter-Garrison Road
 Minor Street Schoonover Road

Project CSUMB Master Plan EIR
 Scenario Existing Plus Project AM
 Peak Hour AM

Turn Movement Volumes

	NB	SB	EB	WB
Left	0	50	30	0
Through	0	0	200	590
Right	0	160	0	10
Total	0	210	230	600

Major Street Direction

	North/South
X	East/West

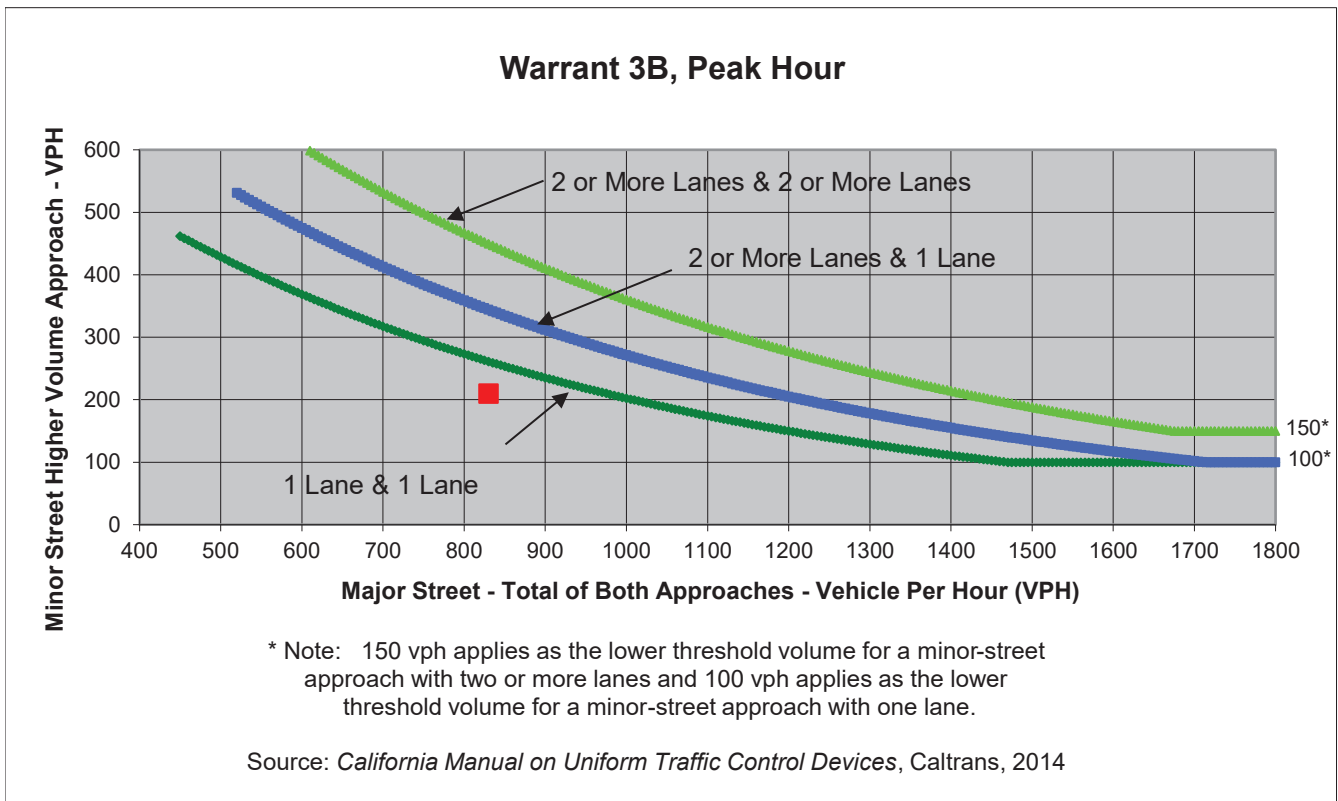

	Major Street	Minor Street	Warrant Met
	Inter-Garrison Road	Schoonover Road	
Number of Approach Lanes	1	1	<u>NO</u>
Traffic Volume (VPH) *	830	210	

* Note: Traffic Volume for Major Street is Total Volume of Both Approaches.
 Traffic Volume for Minor Street is the Volume of High Volume Approach.



Major Street 2nd Avenue
 Minor Street Divarty Street

Project CSUMB Master Plan EIR
 Scenario Existing Plus Project AM
 Peak Hour AM

Turn Movement Volumes

	NB	SB	EB	WB
Left	10	10	10	70
Through	370	1,040	10	10
Right	120	10	10	10
Total	500	1,060	30	90

Major Street Direction

X	North/South
	East/West

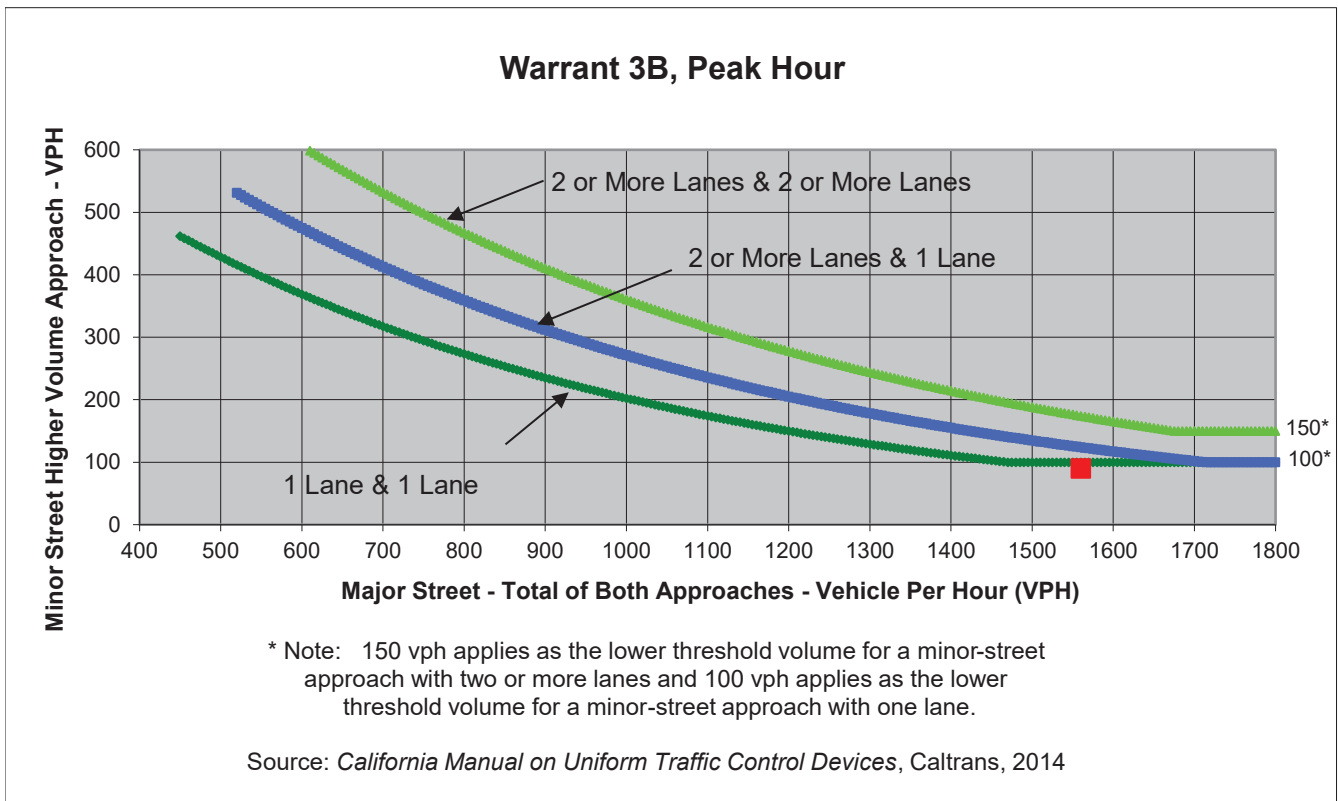

	Major Street	Minor Street	Warrant Met
	2nd Avenue	Divarty Street	
Number of Approach Lanes	1	1	NO
Traffic Volume (VPH) *	1,560	90	

* Note: Traffic Volume for Major Street is Total Volume of Both Approaches.
 Traffic Volume for Minor Street is the Volume of High Volume Approach.



Major Street Gigling Road
 Minor Street Malmedy Road

Project CSUMB Master Plan EIR
 Scenario Existing Plus Project AM
 Peak Hour AM

Turn Movement Volumes

	NB	SB	EB	WB
Left	20	10	10	10
Through	10	30	460	860
Right	10	20	50	10
Total	40	60	520	880

Major Street Direction

	North/South
X	East/West

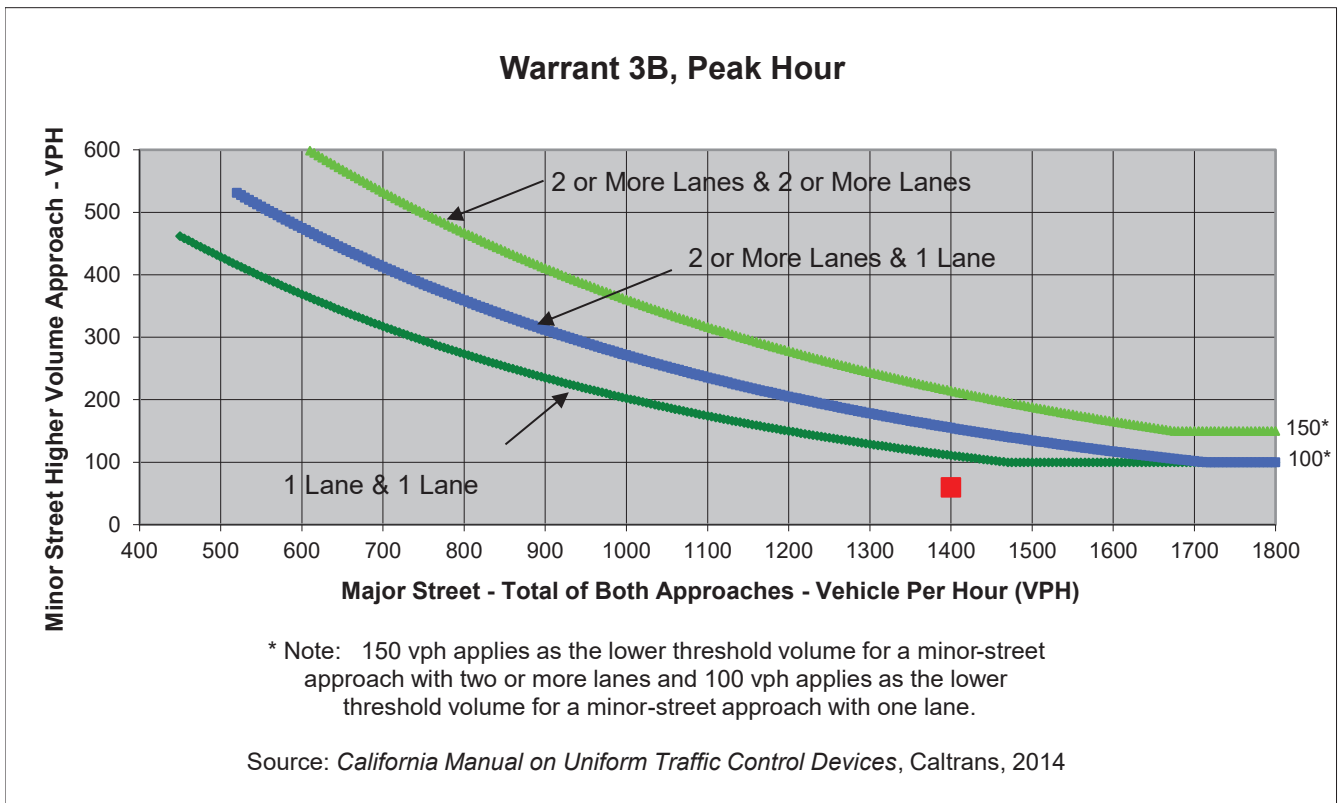

	Major Street	Minor Street	Warrant Met
	Gigling Road	Malmedy Road	
Number of Approach Lanes	1	1	<u>NO</u>
Traffic Volume (VPH) *	1,400	60	

* Note: Traffic Volume for Major Street is Total Volume of Both Approaches.
 Traffic Volume for Minor Street is the Volume of High Volume Approach.



Major Street Gigling Road
 Minor Street Parker Flatts Cut Off Road

Project CSUMB Master Plan EIR
 Scenario Existing Plus Project AM
 Peak Hour AM

Turn Movement Volumes

	NB	SB	EB	WB
Left	50	10	10	20
Through	10	10	370	830
Right	10	10	110	10
Total	70	30	490	860

Major Street Direction

	North/South
X	East/West

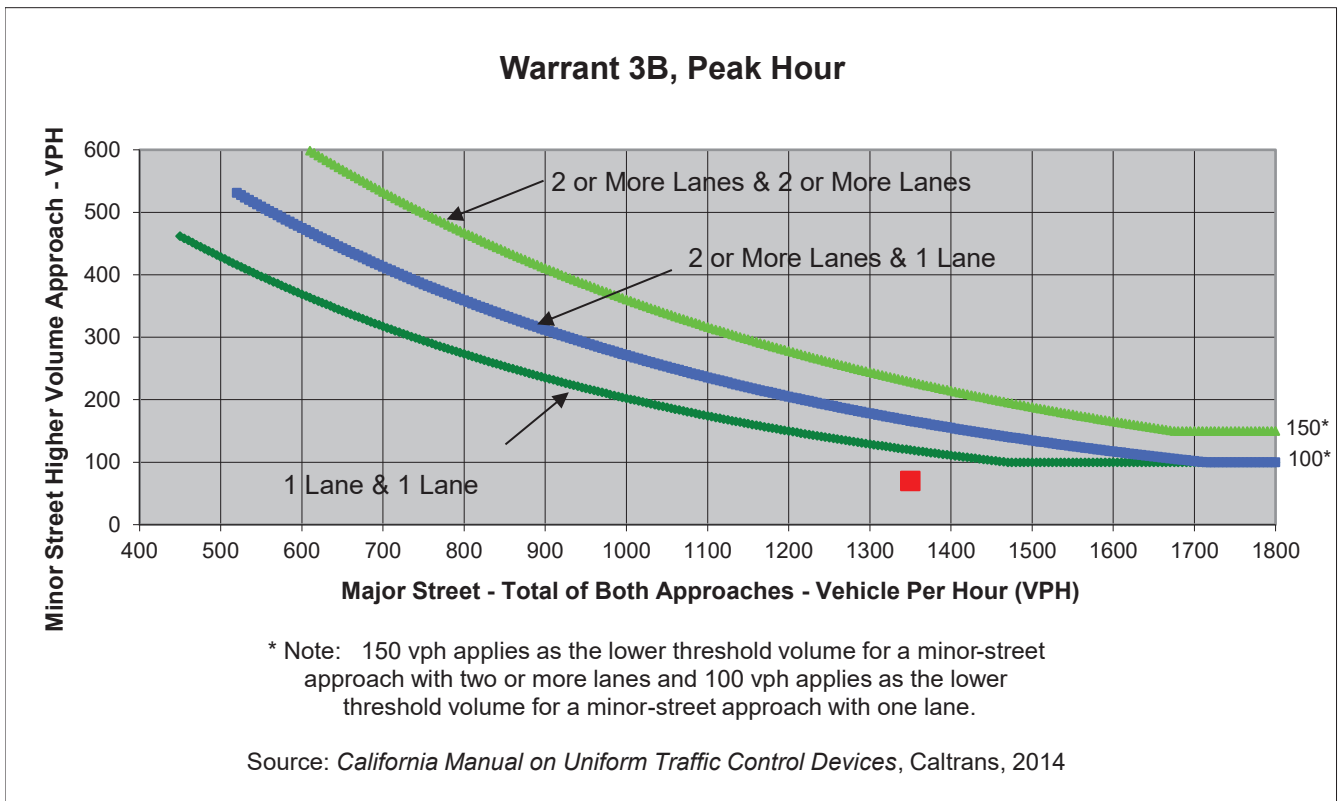

	Major Street	Minor Street	Warrant Met
	Gigling Road	Parker Flatts Cut Off Road	
Number of Approach Lanes	1	1	<u>NO</u>
Traffic Volume (VPH) *	1,350	70	

* Note: Traffic Volume for Major Street is Total Volume of Both Approaches.
 Traffic Volume for Minor Street is the Volume of High Volume Approach.

Major Street Gigling Road
 Minor Street 6th Avenue

Project CSUMB Master Plan EIR
 Scenario Existing Plus Project AM
 Peak Hour AM

Turn Movement Volumes

	NB	SB	EB	WB
Left	10	10	140	10
Through	10	10	250	730
Right	10	120	10	10
Total	30	140	400	750

Major Street Direction

	North/South
X	East/West

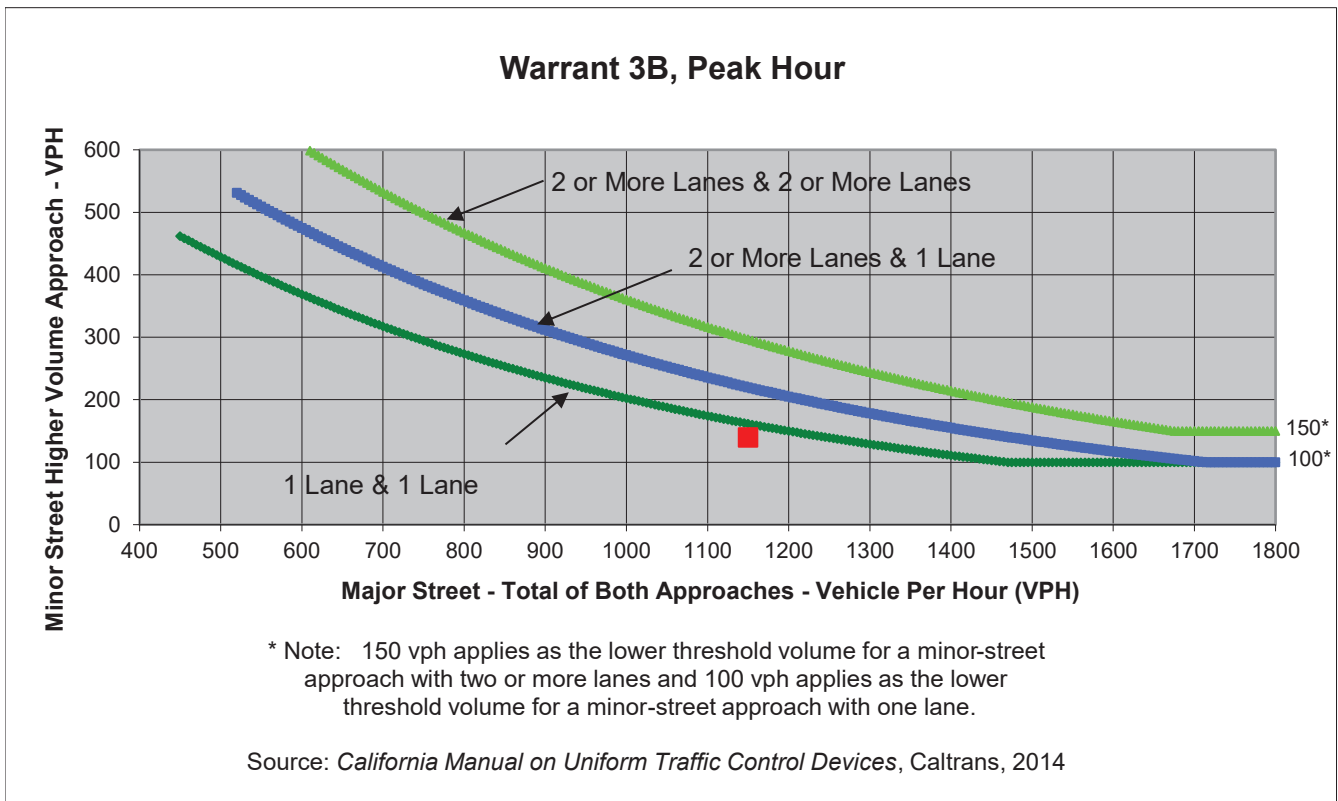

	Major Street	Minor Street	Warrant Met
	Gigling Road	6th Avenue	
Number of Approach Lanes	1	1	NO
Traffic Volume (VPH) *	1,150	140	

* Note: Traffic Volume for Major Street is Total Volume of Both Approaches.
 Traffic Volume for Minor Street is the Volume of High Volume Approach.



Major Street General Jim Moore Boulevard
 Minor Street Coe Avenue

Project CSUMB Master Plan EIR
 Scenario Existing Plus Project AM
 Peak Hour AM

Turn Movement Volumes

	NB	SB	EB	WB
Left	230	0	120	0
Through	370	900	0	0
Right	0	140	430	0
Total	600	1,040	550	0

Major Street Direction

X	North/South
	East/West

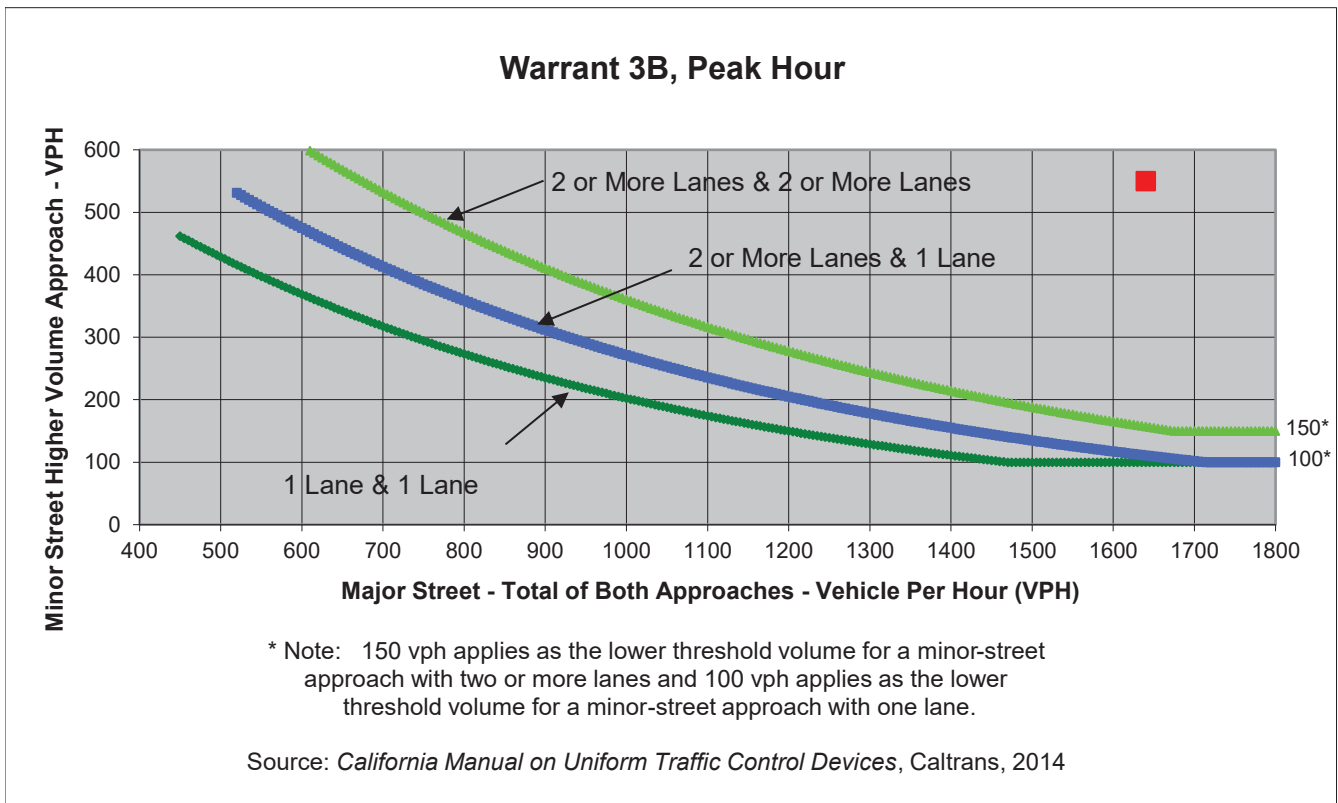

	Major Street	Minor Street	Warrant Met
	General Jim Moore Boulevard	Coe Avenue	
Number of Approach Lanes	2	1	<u>YES</u>
Traffic Volume (VPH) *	1,640	550	

* Note: Traffic Volume for Major Street is Total Volume of Both Approaches.
 Traffic Volume for Minor Street is the Volume of High Volume Approach.



Major Street Imjin Parkway
 Minor Street SR 1 NB Off-Ramp/SR 1 NB On-Ramp

Project CSUMB Master Plan EIR
 Scenario Existing Plus Project PM
 Peak Hour PM

Turn Movement Volumes

	NB	SB	EB	WB
Left	10	0	10	0
Through	10	0	270	970
Right	0	0	0	550
Total	20	0	280	1,520

Major Street Direction

	North/South
X	East/West

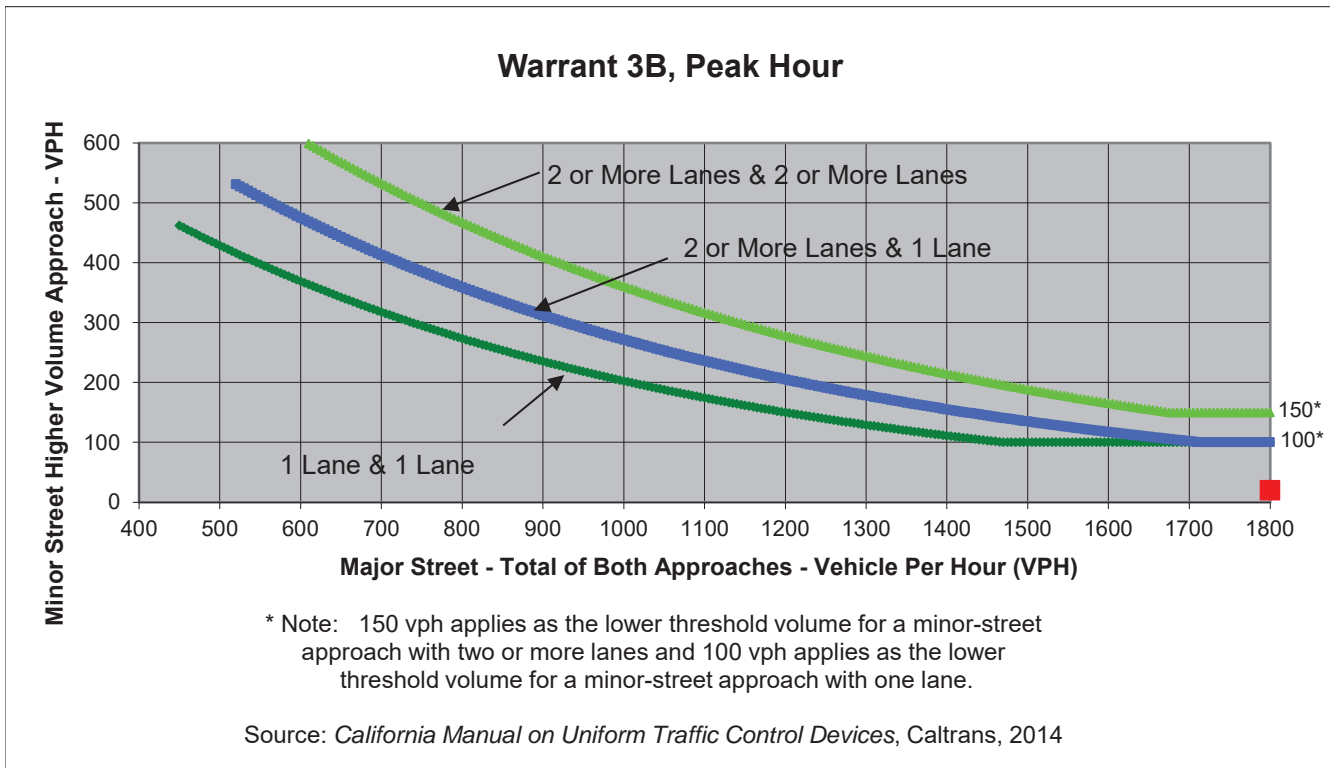

	Major Street	Minor Street	Warrant Met
	Imjin Parkway	SR 1 NB Off-Ramp/SR 1 NB On-Ramp	
Number of Approach Lanes	1	1	<u>NO</u>
Traffic Volume (VPH) *	1,800	20	

* Note: Traffic Volume for Major Street is Total Volume of Both Approches.
 Traffic Volume for Minor Street is the Volume of High Volume Approach.

Major Street Imjin Parkway
 Minor Street 3rd Avenue

Project CSUMB Master Plan EIR
 Scenario Existing Plus Project PM
 Peak Hour PM

Turn Movement Volumes

	NB	SB	EB	WB
Left	10	10	50	30
Through	10	10	1,250	1,180
Right	30	50	10	20
Total	50	70	1,310	1,230

Major Street Direction

	North/South
X	East/West

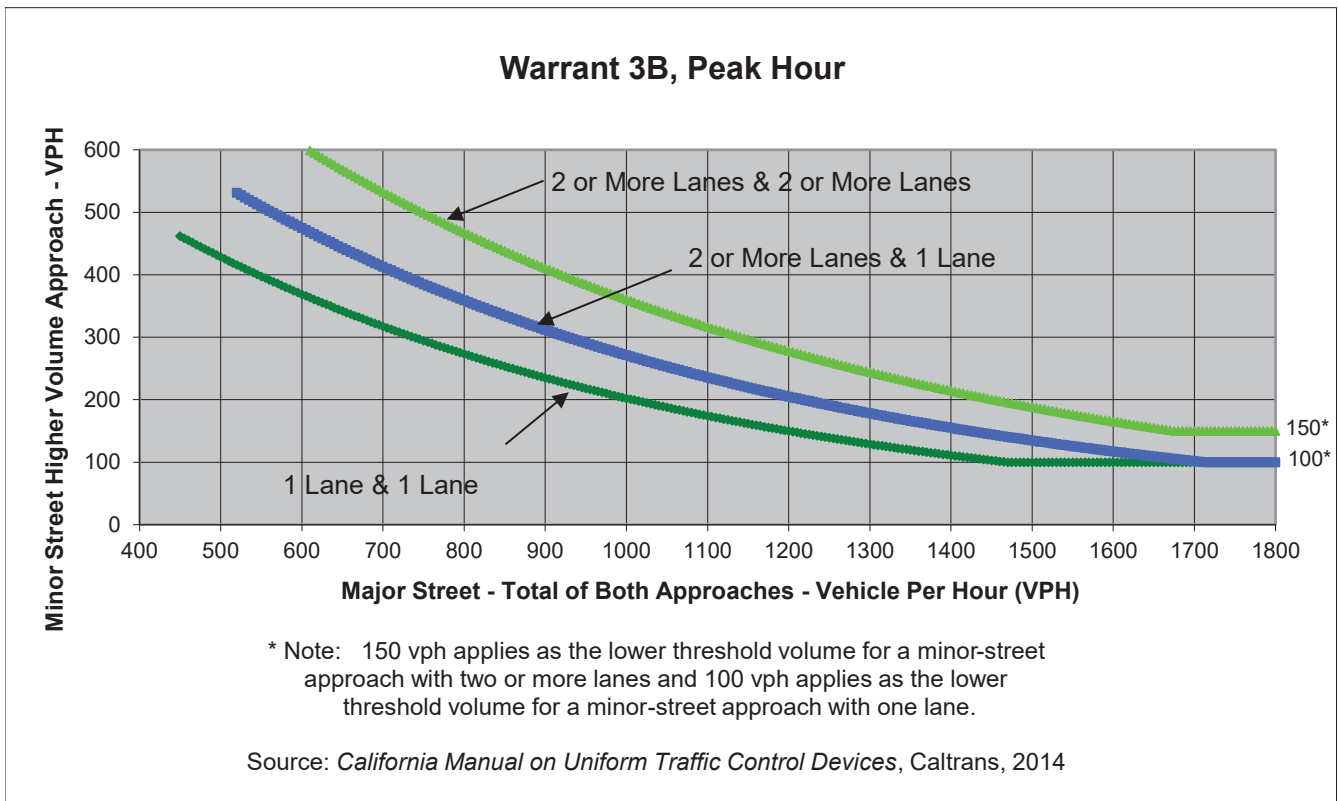

	Major Street	Minor Street	Warrant Met
	Imjin Parkway	3rd Avenue	
Number of Approach Lanes	2	1	<u>NO</u>
Traffic Volume (VPH) *	2,540	70	

* Note: Traffic Volume for Major Street is Total Volume of Both Approaches.
 Traffic Volume for Minor Street is the Volume of High Volume Approach.



Major Street Imjin Parkway
 Minor Street 4th Avenue

Project CSUMB Master Plan EIR
 Scenario Existing Plus Project PM
 Peak Hour PM

Turn Movement Volumes

	NB	SB	EB	WB
Left	20	10	10	10
Through	10	10	1,370	1,190
Right	10	10	10	10
Total	40	30	1,390	1,210

Major Street Direction

	North/South
X	East/West

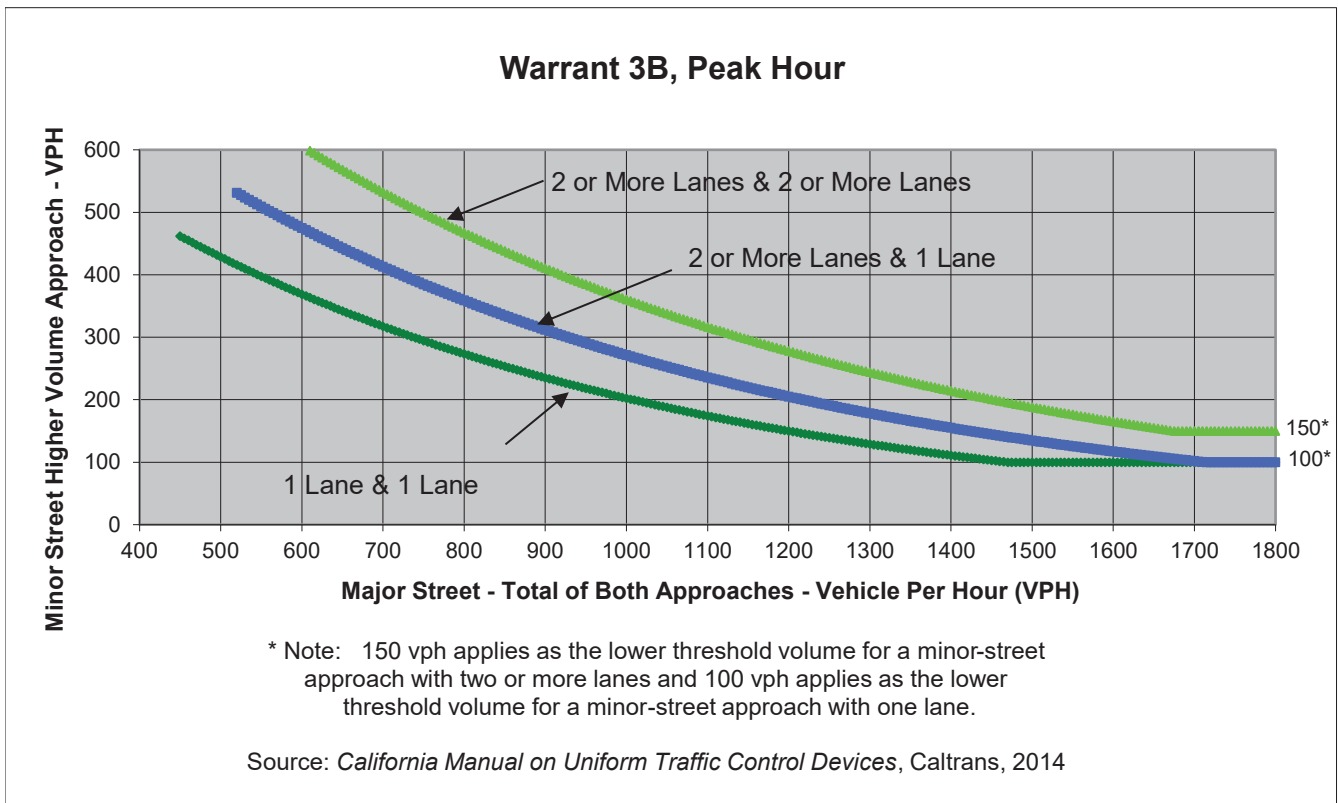

	Major Street	Minor Street	Warrant Met
	Imjin Parkway	4th Avenue	
Number of Approach Lanes	2	1	NO
Traffic Volume (VPH) *	2,600	40	

* Note: Traffic Volume for Major Street is Total Volume of Both Approaches.
 Traffic Volume for Minor Street is the Volume of High Volume Approach.



Major Street 2nd Avenue
 Minor Street 9th Street

Project CSUMB Master Plan EIR
 Scenario Existing Plus Project PM
 Peak Hour PM

Turn Movement Volumes

	NB	SB	EB	WB
Left	20	10	30	10
Through	400	260	10	10
Right	30	30	10	10
Total	450	300	50	30

Major Street Direction

X North/South
 East/West

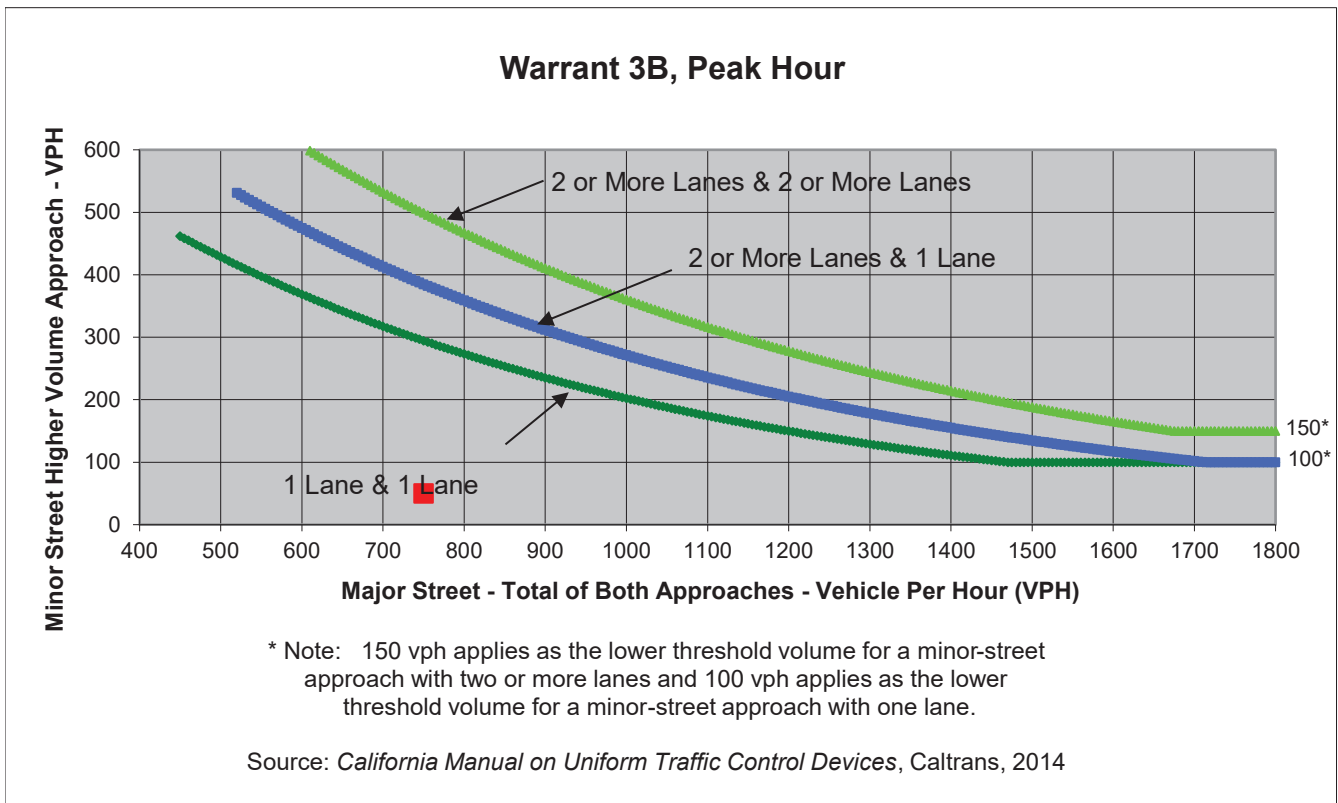

	Major Street	Minor Street	Warrant Met
	2nd Avenue	9th Street	
Number of Approach Lanes	1	1	NO
Traffic Volume (VPH) *	750	50	

* Note: Traffic Volume for Major Street is Total Volume of Both Approaches.
 Traffic Volume for Minor Street is the Volume of High Volume Approach.



Major Street 2nd Avenue
 Minor Street 8th Street

Project CSUMB Master Plan EIR
 Scenario Existing Plus Project PM
 Peak Hour PM

Turn Movement Volumes

	NB	SB	EB	WB
Left	10	50	10	180
Through	400	310	10	10
Right	160	10	10	50
Total	570	370	30	240

Major Street Direction

X	North/South
	East/West

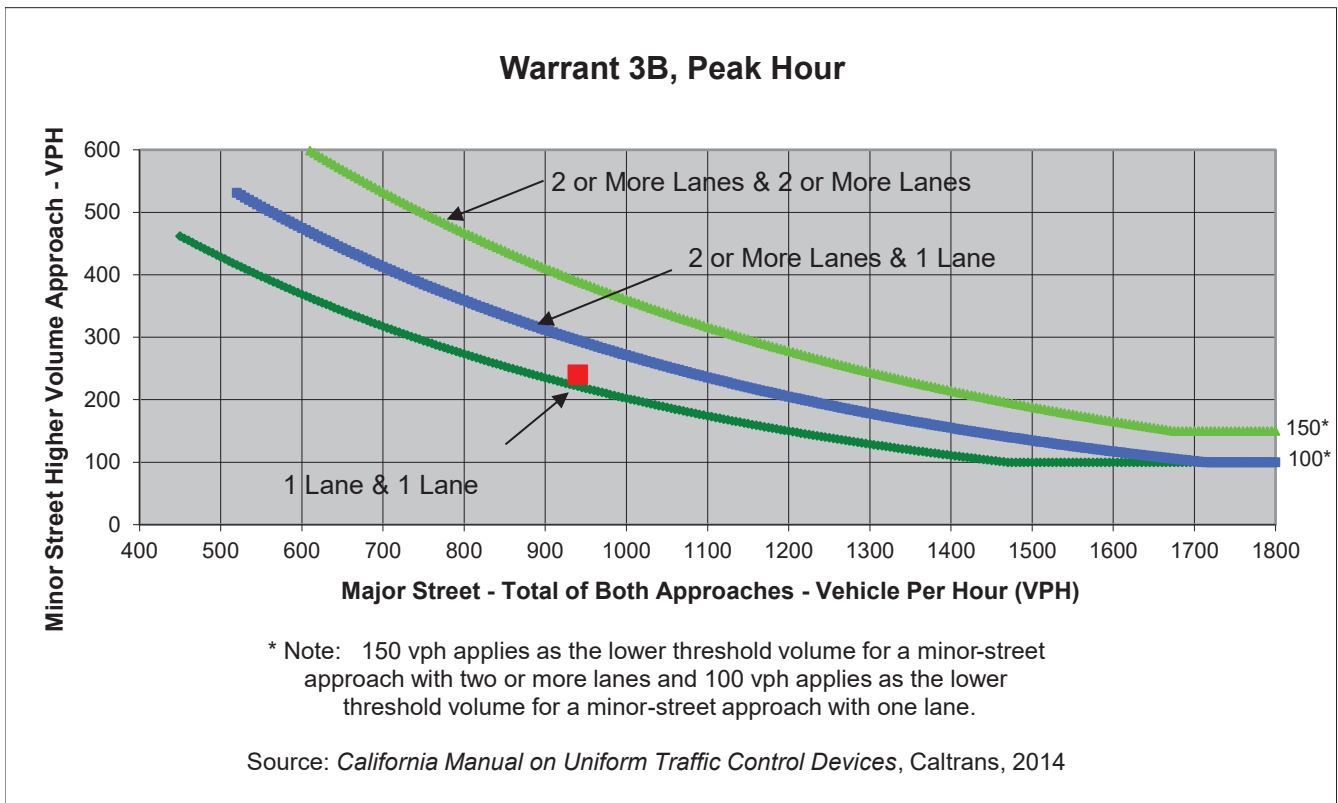

	Major Street	Minor Street	Warrant Met
	2nd Avenue	8th Street	
Number of Approach Lanes	1	1	<u>YES</u>
Traffic Volume (VPH) *	940	240	

* Note: Traffic Volume for Major Street is Total Volume of Both Approaches.
 Traffic Volume for Minor Street is the Volume of High Volume Approach.



Major Street 2nd Avenue
 Minor Street Inter-Garrison Road

Project CSUMB Master Plan EIR
 Scenario Existing Plus Project PM
 Peak Hour PM

Turn Movement Volumes

	NB	SB	EB	WB
Left	0	10	0	40
Through	550	490	0	0
Right	30	0	0	10
Total	580	500	0	50

Major Street Direction

X	North/South
	East/West

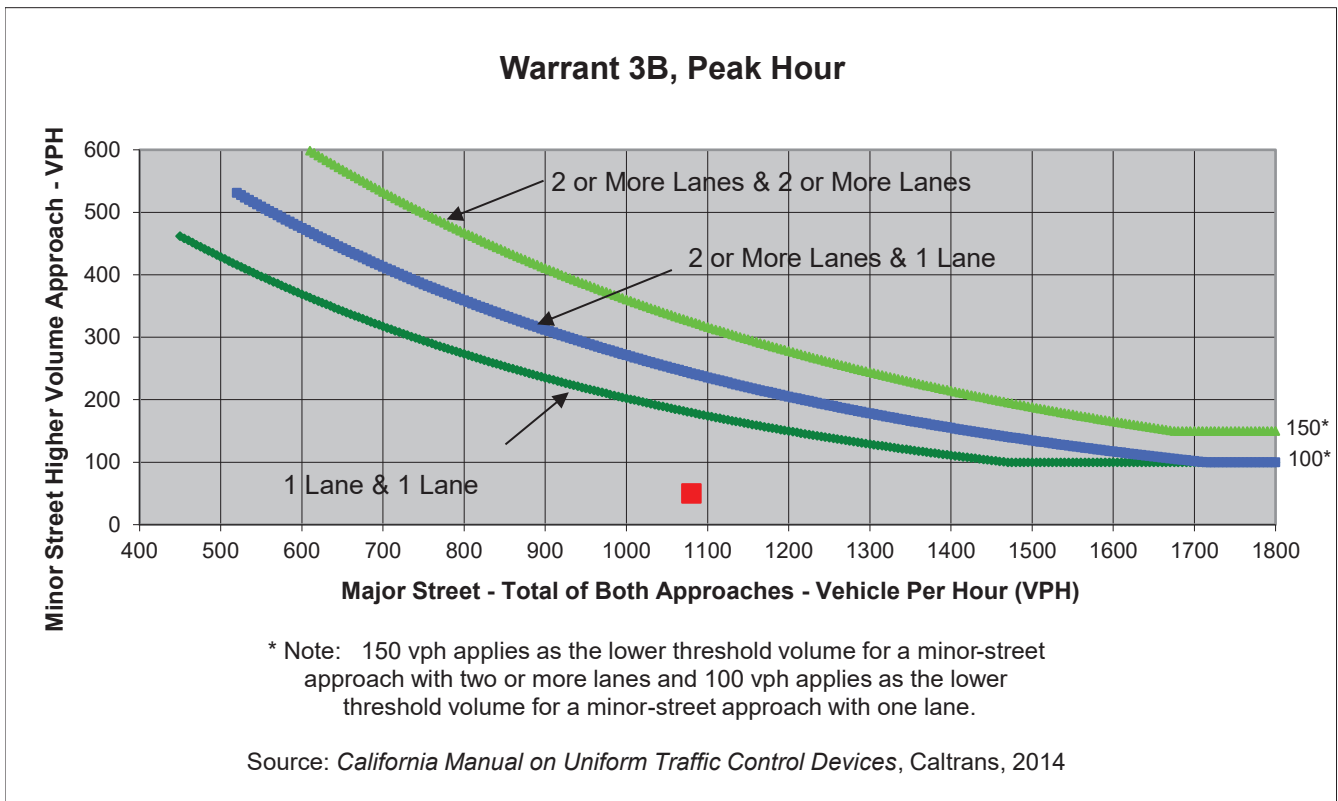

	Major Street	Minor Street	Warrant Met
	2nd Avenue	Inter-Garrison Road	
Number of Approach Lanes	1	1	<u>NO</u>
Traffic Volume (VPH) *	1,080	50	

* Note: Traffic Volume for Major Street is Total Volume of Both Approaches.
 Traffic Volume for Minor Street is the Volume of High Volume Approach.



Major Street **7th Avenue/8th Street**
 Minor Street **Inter-Garrison Road**

Project **CSUMB Master Plan EIR**
 Scenario **Existing Plus Project PM**
 Peak Hour **PM**

Turn Movement Volumes

	NB	SB	EB	WB
Left	10	80	10	180
Through	270	140	140	80
Right	300	10	10	30
Total	580	230	160	290

Major Street Direction

X	North/South
	East/West

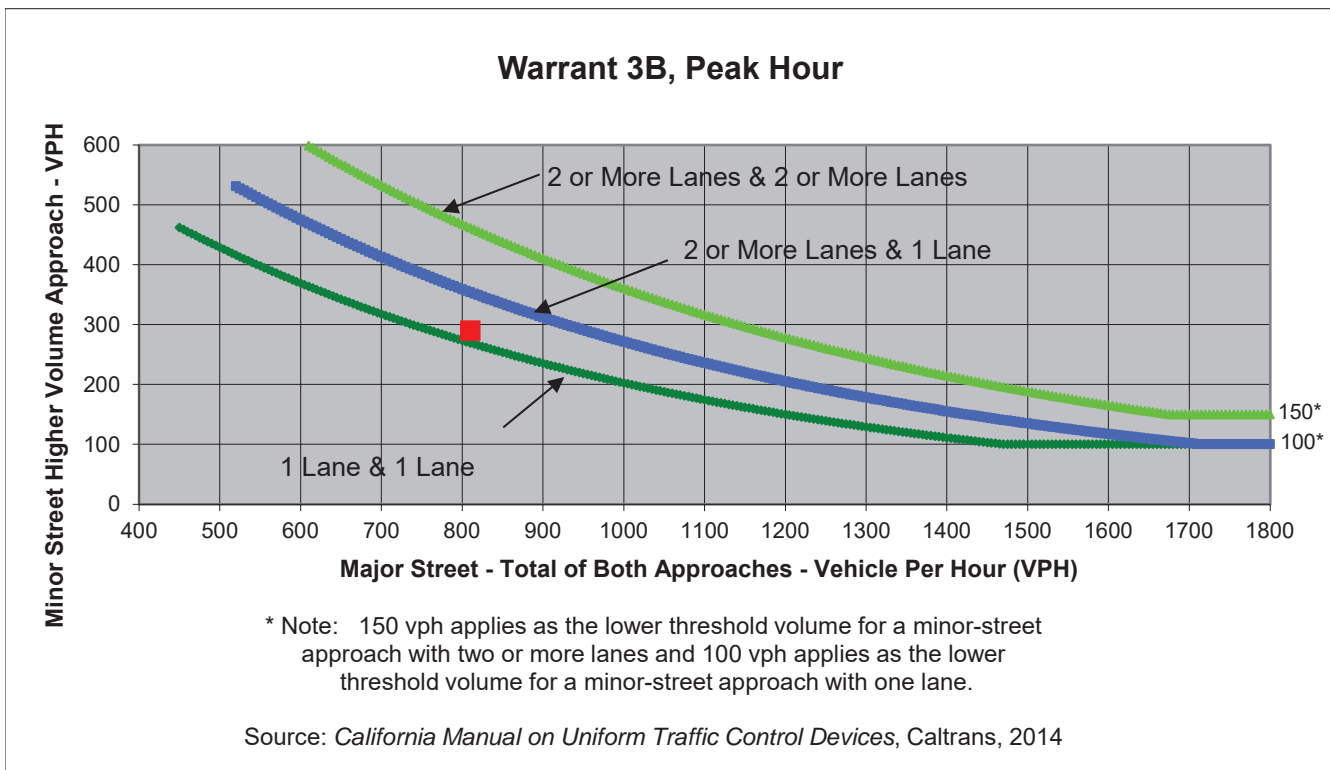

	Major Street 7th Avenue/8th Street	Minor Street Inter-Garrison Road	Warrant Met
Number of Approach Lanes	1	1	
Traffic Volume (VPH) *	810	290	

* Note: Traffic Volume for Major Street is Total Volume of Both Approches.
 Traffic Volume for Minor Street is the Volume of High Volume Approach.



Major Street **Inter-Garrison Road**
 Minor Street **8th Avenue**

Project **CSUMB Master Plan EIR**
 Scenario **Existing Plus Project PM**
 Peak Hour **PM**

Turn Movement Volumes

	NB	SB	EB	WB
Left	10	0	0	390
Through	0	0	480	280
Right	610	0	50	0
Total	620	0	530	670

Major Street Direction

North/South
X East/West

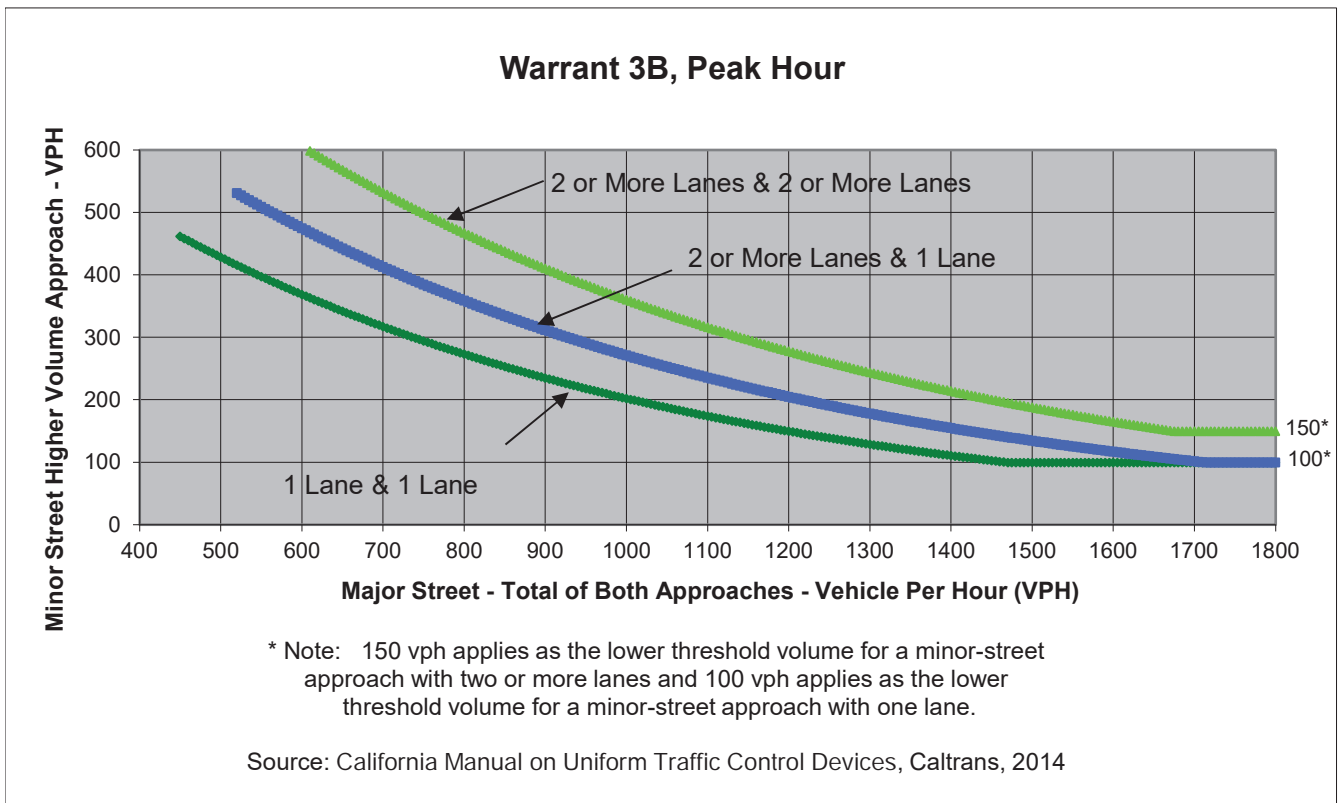

	Major Street	Minor Street	Warrant Met
	Inter-Garrison Road	8th Avenue	
Number of Approach Lanes	1	1	YES
Traffic Volume (VPH) *	1,200	620	

* Note: Traffic Volume for Major Street is Total Volume of Both Approaches.
 Traffic Volume for Minor Street is the Volume of High Volume Approach.

Major Street Inter-Garrison Road
 Minor Street Abrams Drive

Project CSUMB Master Plan EIR
 Scenario Existing Plus Project PM
 Peak Hour PM

Turn Movement Volumes

	NB	SB	EB	WB
Left	0	10	540	0
Through	0	0	550	260
Right	0	420	0	20
Total	0	430	1,090	280

Major Street Direction

	North/South
X	East/West

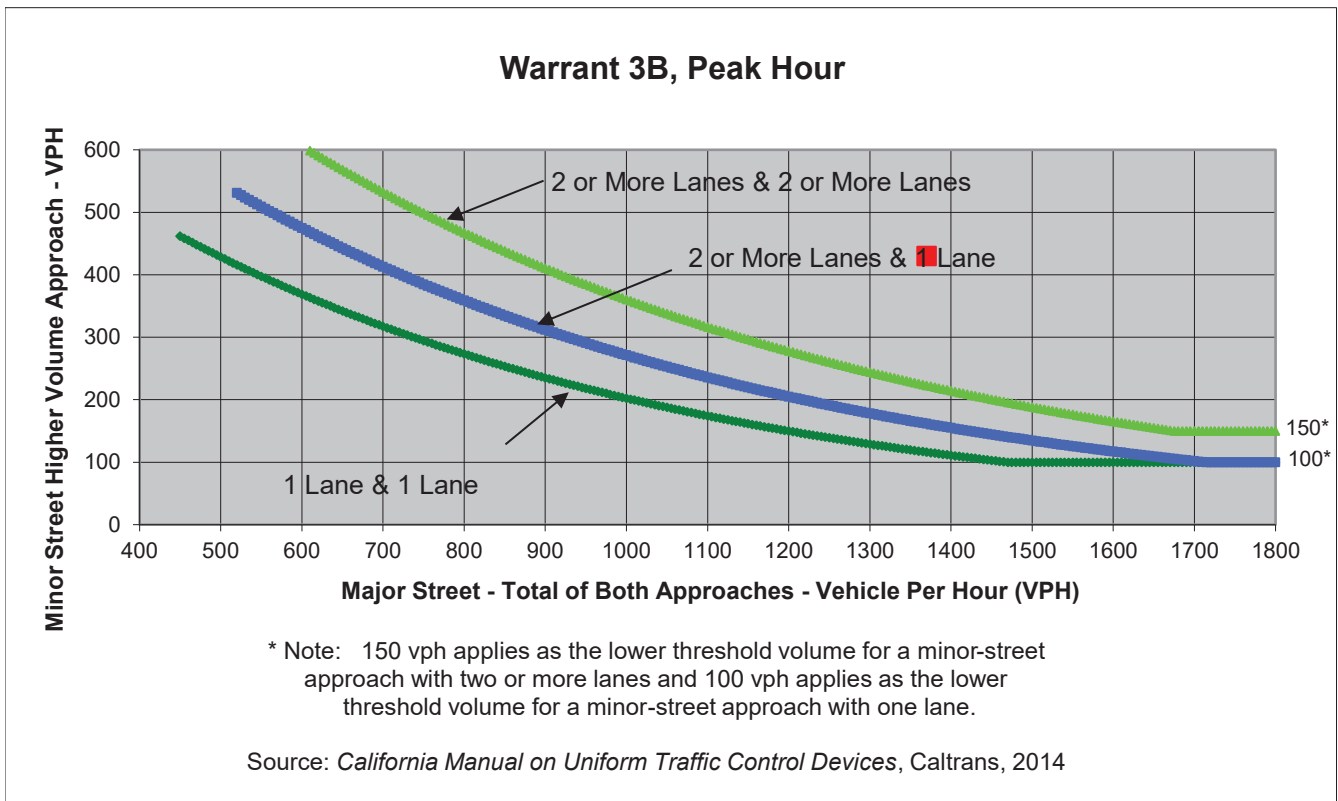

	Major Street	Minor Street	Warrant Met
	Inter-Garrison Road	Abrams Drive	
Number of Approach Lanes	1	1	YES
Traffic Volume (VPH) *	1,370	430	

* Note: Traffic Volume for Major Street is Total Volume of Both Approaches.
 Traffic Volume for Minor Street is the Volume of High Volume Approach.

Major Street Inter-Garrison Road
 Minor Street Schoonover Road

Project CSUMB Master Plan EIR
 Scenario Existing Plus Project PM
 Peak Hour PM

Turn Movement Volumes

	NB	SB	EB	WB
Left	0	10	150	0
Through	0	0	410	210
Right	0	70	0	30
Total	0	80	560	240

Major Street Direction

	North/South
X	East/West

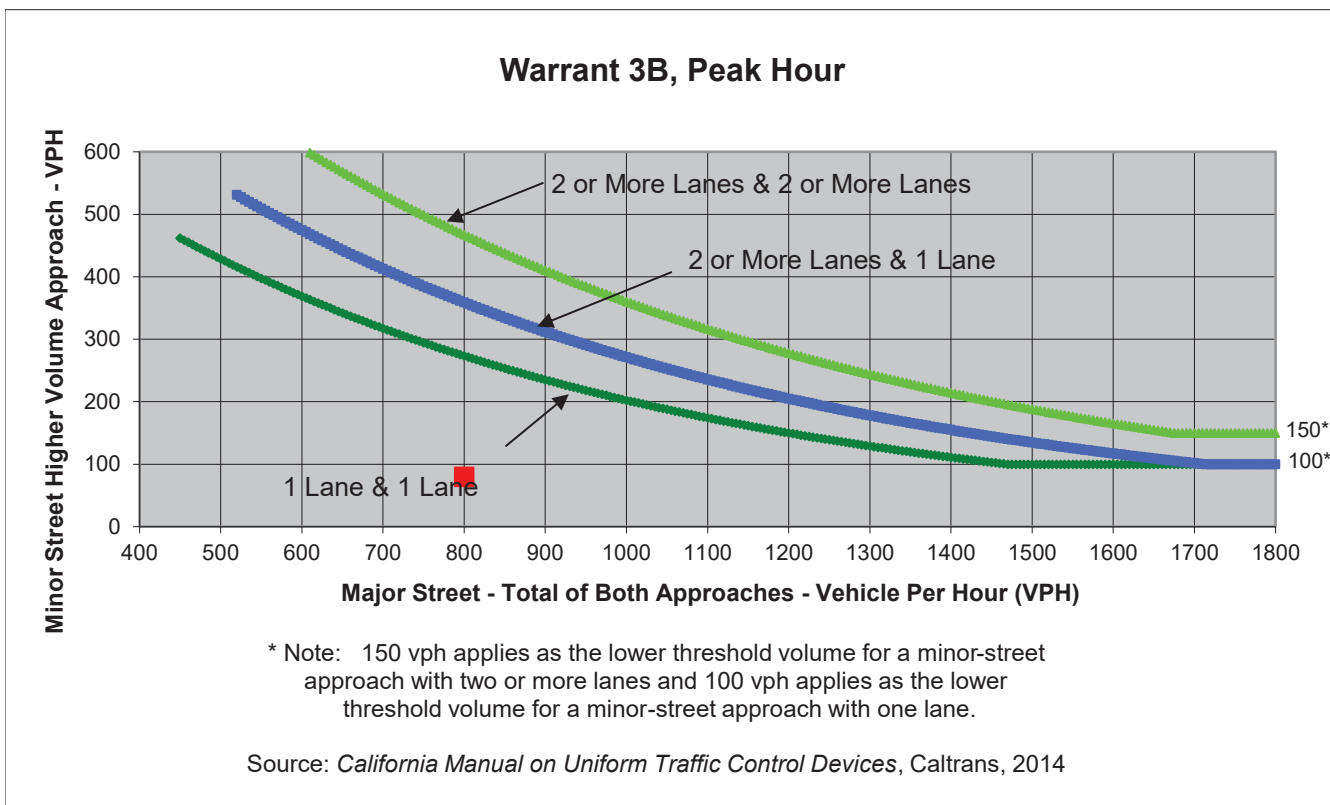

	Major Street	Minor Street	Warrant Met
	Inter-Garrison Road	Schoonover Road	
Number of Approach Lanes	1	1	NO
Traffic Volume (VPH) *	800	80	

* Note: Traffic Volume for Major Street is Total Volume of Both Approaches.
 Traffic Volume for Minor Street is the Volume of High Volume Approach.



Major Street 2nd Avenue
 Minor Street Divarty Street

Project CSUMB Master Plan EIR
 Scenario Existing Plus Project PM
 Peak Hour PM

Turn Movement Volumes

	NB	SB	EB	WB
Left	10	10	10	130
Through	580	520	10	10
Right	110	10	10	10
Total	700	540	30	150

Major Street Direction

X	North/South
	East/West

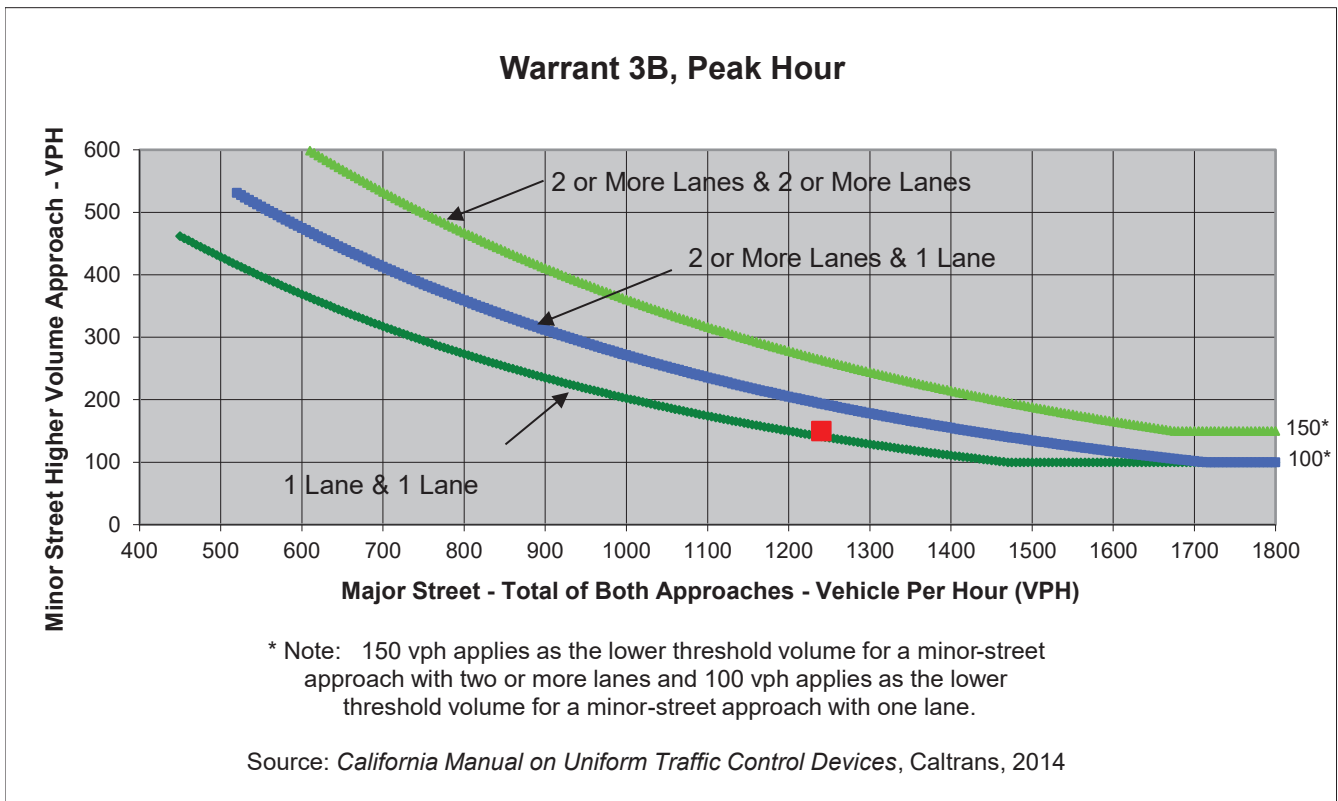

	Major Street	Minor Street	Warrant Met
	2nd Avenue	Divarty Street	
Number of Approach Lanes	1	1	<u>YES</u>
Traffic Volume (VPH) *	1,240	150	

* Note: Traffic Volume for Major Street is Total Volume of Both Approaches.
 Traffic Volume for Minor Street is the Volume of High Volume Approach.



Major Street Gigling Road
 Minor Street Malmedy Road

Project CSUMB Master Plan EIR
 Scenario Existing Plus Project PM
 Peak Hour PM

Turn Movement Volumes

	NB	SB	EB	WB
Left	30	30	10	10
Through	30	10	590	530
Right	20	10	10	30
Total	80	50	610	570

Major Street Direction

	North/South
X	East/West

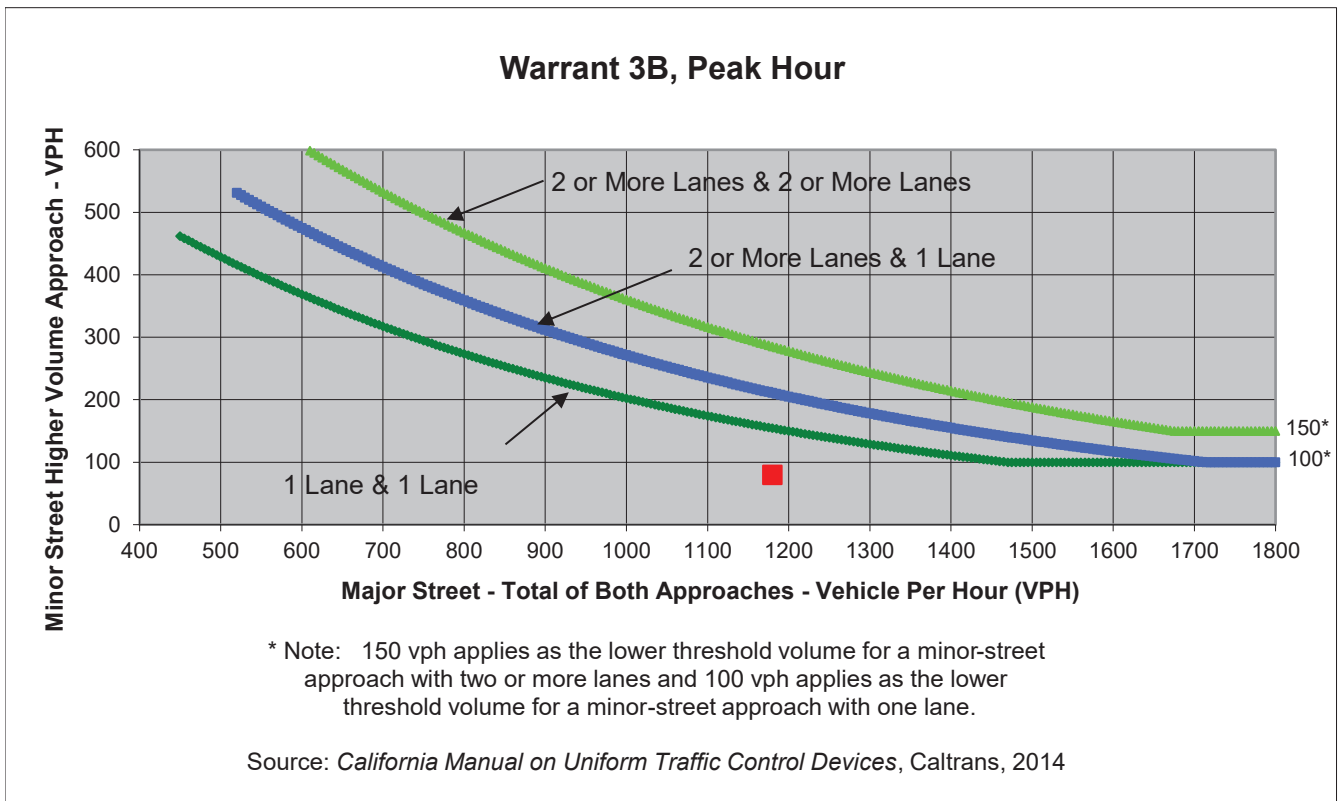

	Major Street	Minor Street	Warrant Met
	Gigling Road	Malmedy Road	
Number of Approach Lanes	1	1	<u>NO</u>
Traffic Volume (VPH) *	1,180	80	

* Note: Traffic Volume for Major Street is Total Volume of Both Approaches.
 Traffic Volume for Minor Street is the Volume of High Volume Approach.



Major Street Gigling Road
 Minor Street Parker Flatts Cut Off Road

Project CSUMB Master Plan EIR
 Scenario Existing Plus Project PM
 Peak Hour PM

Turn Movement Volumes

	NB	SB	EB	WB
Left	80	10	10	20
Through	10	10	610	490
Right	50	10	20	20
Total	140	30	640	530

Major Street Direction

	North/South
X	East/West

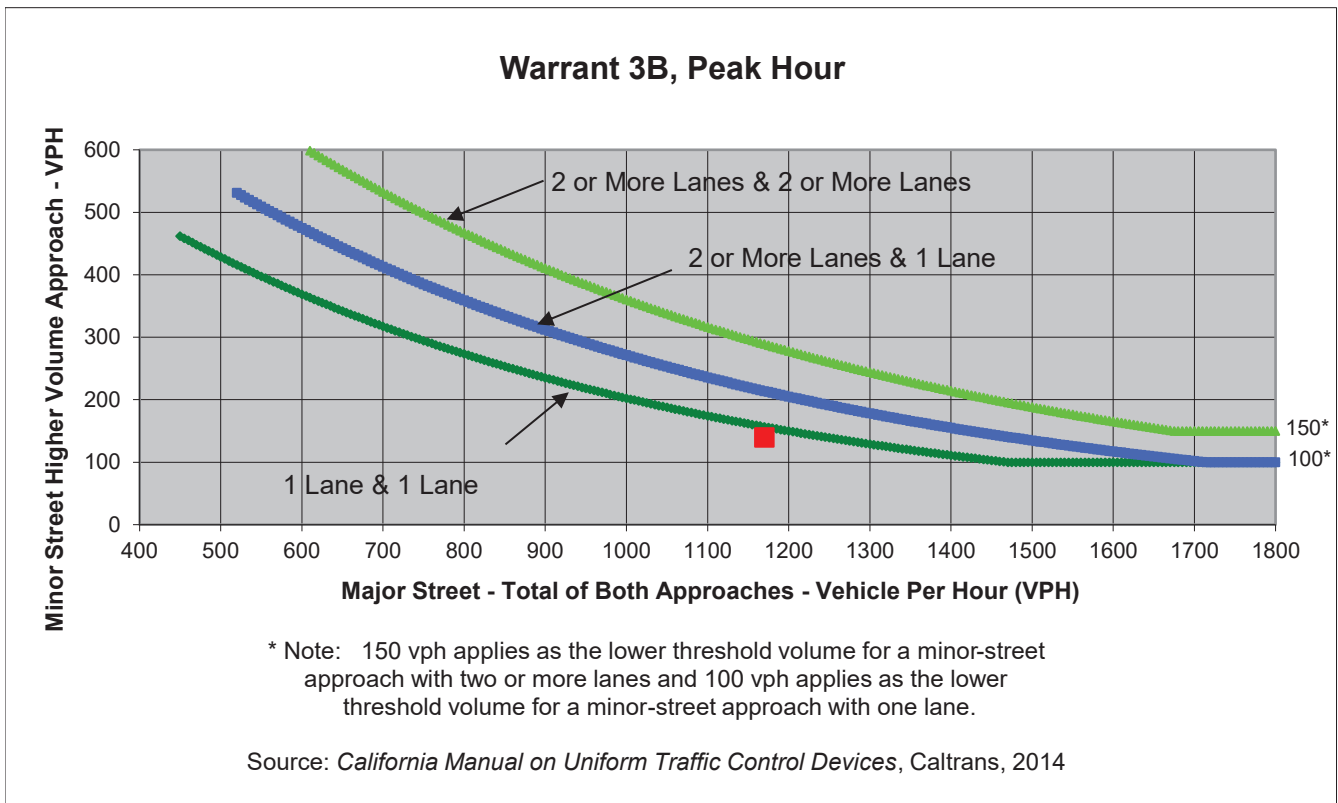

	Major Street	Minor Street	Warrant Met
	Gigling Road	Parker Flatts Cut Off Road	
Number of Approach Lanes	1	1	<u>NO</u>
Traffic Volume (VPH) *	1,170	140	

* Note: Traffic Volume for Major Street is Total Volume of Both Approaches.
 Traffic Volume for Minor Street is the Volume of High Volume Approach.



Major Street Gigling Road
 Minor Street 6th Avenue

Project CSUMB Master Plan EIR
 Scenario Existing Plus Project PM
 Peak Hour PM

Turn Movement Volumes

	NB	SB	EB	WB
Left	10	10	180	10
Through	10	10	500	320
Right	20	200	10	10
Total	40	220	690	340

Major Street Direction

	North/South
X	East/West

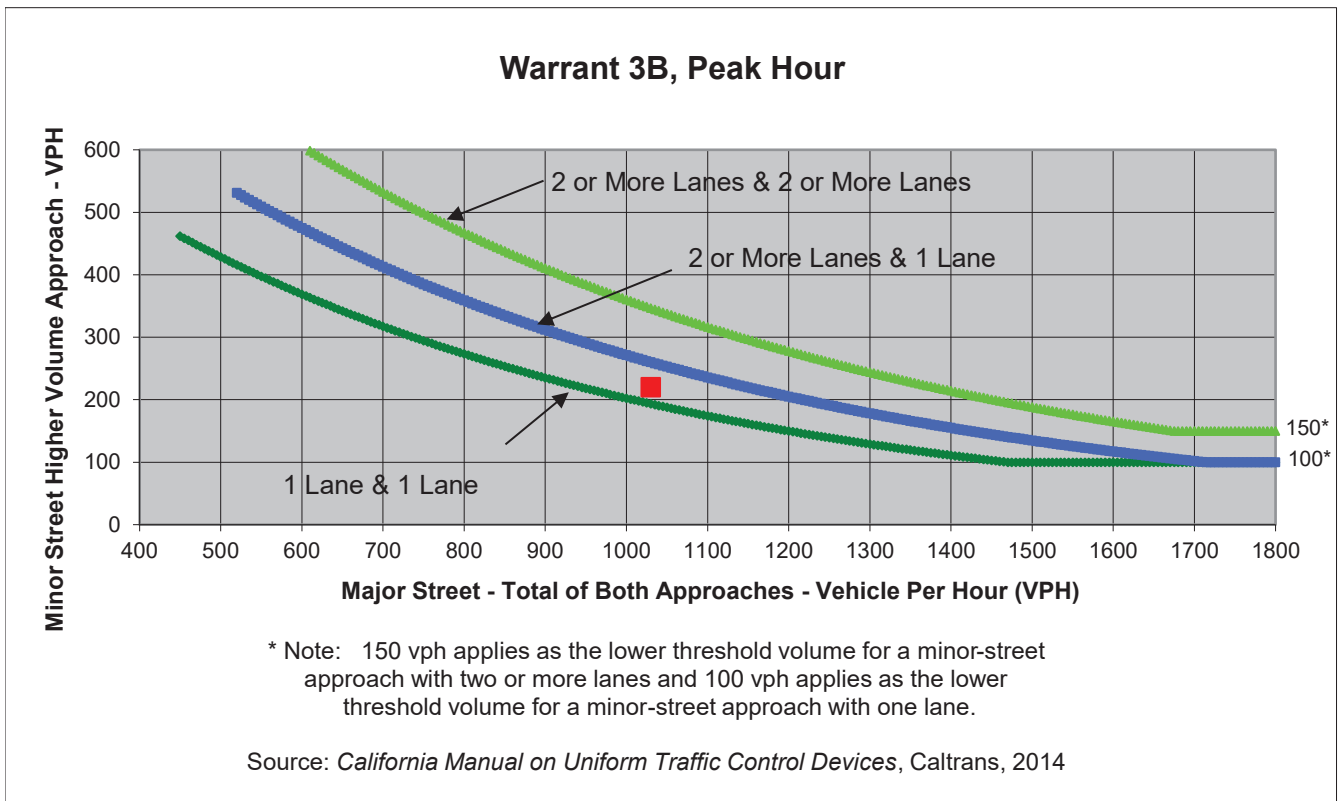

	Major Street	Minor Street	Warrant Met
	Gigling Road	6th Avenue	
Number of Approach Lanes	1	1	<u>YES</u>
Traffic Volume (VPH) *	1,030	220	

* Note: Traffic Volume for Major Street is Total Volume of Both Approaches.
 Traffic Volume for Minor Street is the Volume of High Volume Approach.



Major Street General Jim Moore Boulevard
 Minor Street Coe Avenue

Project CSUMB Master Plan EIR
 Scenario Existing Plus Project PM
 Peak Hour PM

Turn Movement Volumes

	NB	SB	EB	WB
Left	160	0	60	0
Through	880	350	0	0
Right	0	90	100	0
Total	1,040	440	160	0

Major Street Direction

X	North/South
	East/West

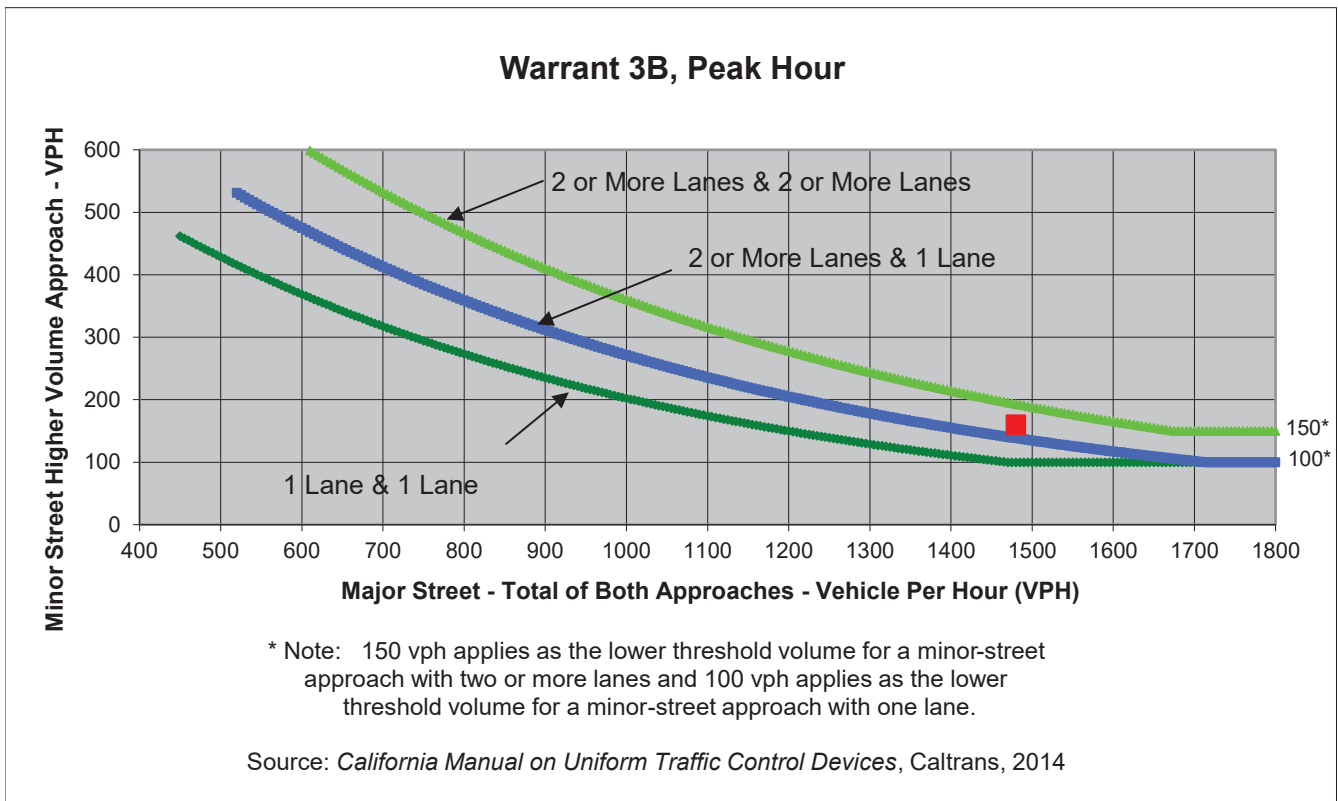

	Major Street	Minor Street	Warrant Met
	General Jim Moore Boulevard	Coe Avenue	
Number of Approach Lanes	2	1	<u>YES</u>
Traffic Volume (VPH) *	1,480	160	

* Note: Traffic Volume for Major Street is Total Volume of Both Approaches.
 Traffic Volume for Minor Street is the Volume of High Volume Approach.



Major Street **Imjin Parkway**
 Minor Street **SR 1 NB Off-Ramp/SR 1 NB On-Ramp**

Project **CSUMB Master Plan EIR**
 Scenario **Cumulative w/ Proj AM**
 Peak Hour **AM**

Turn Movement Volumes

	NB	SB	EB	WB
Left	10	0	10	0
Through	10	0	990	1,140
Right	0	0	0	440
Total	20	0	1,000	1,580

Major Street Direction

	North/South
X	East/West

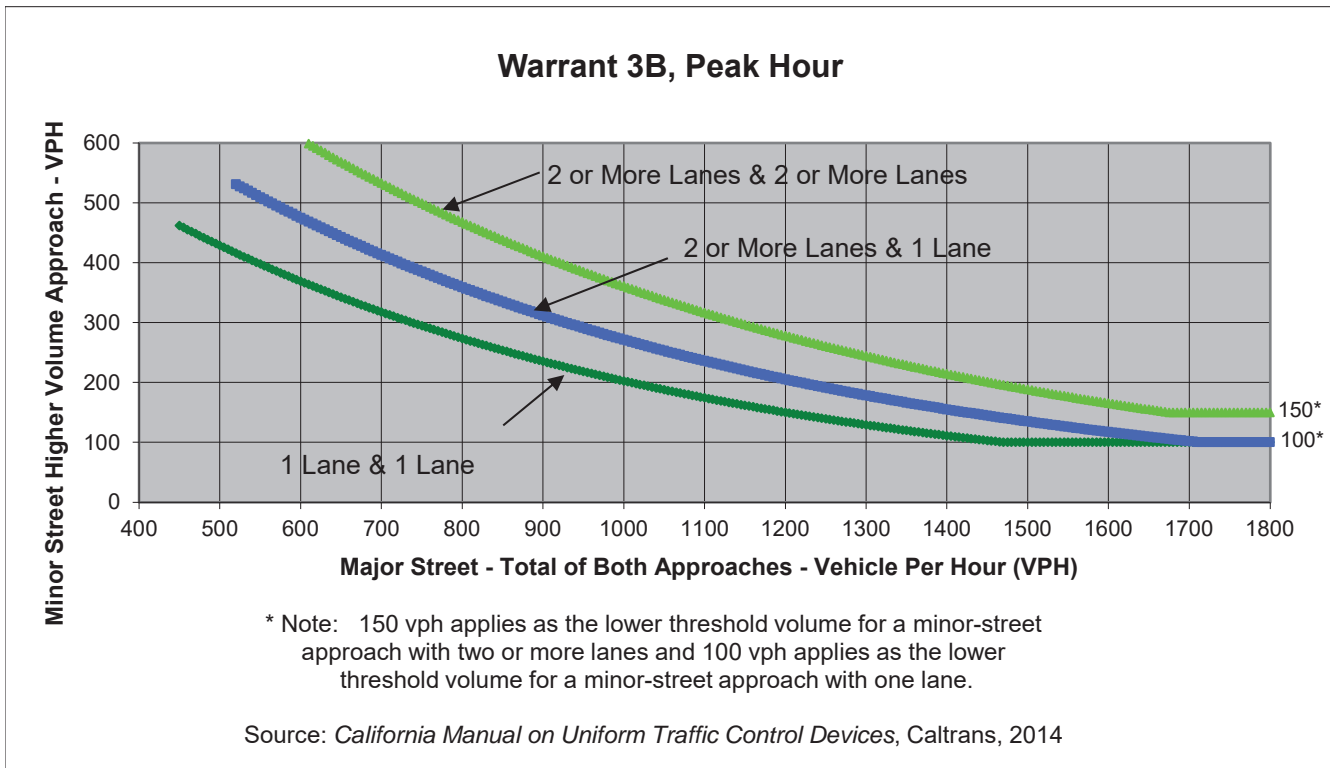

	Major Street	Minor Street	Warrant Met
	Imjin Parkway	SR 1 NB Off-Ramp/SR 1 NB On-Ramp	
Number of Approach Lanes	1	1	<u>NO</u>
Traffic Volume (VPH) *	2,580	20	

* Note: Traffic Volume for Major Street is Total Volume of Both Approches.
 Traffic Volume for Minor Street is the Volume of High Volume Approach.



Major Street **Inter-Garrison Road**
 Minor Street **8th Avenue**

Project **CSUMB Master Plan EIR**
 Scenario **Cumulative w/ Proj AM**
 Peak Hour **AM**

Turn Movement Volumes

	NB	SB	EB	WB
Left	50	0	0	750
Through	0	0	240	570
Right	410	0	250	0
Total	460	0	490	1,320

Major Street Direction

North/South
X East/West

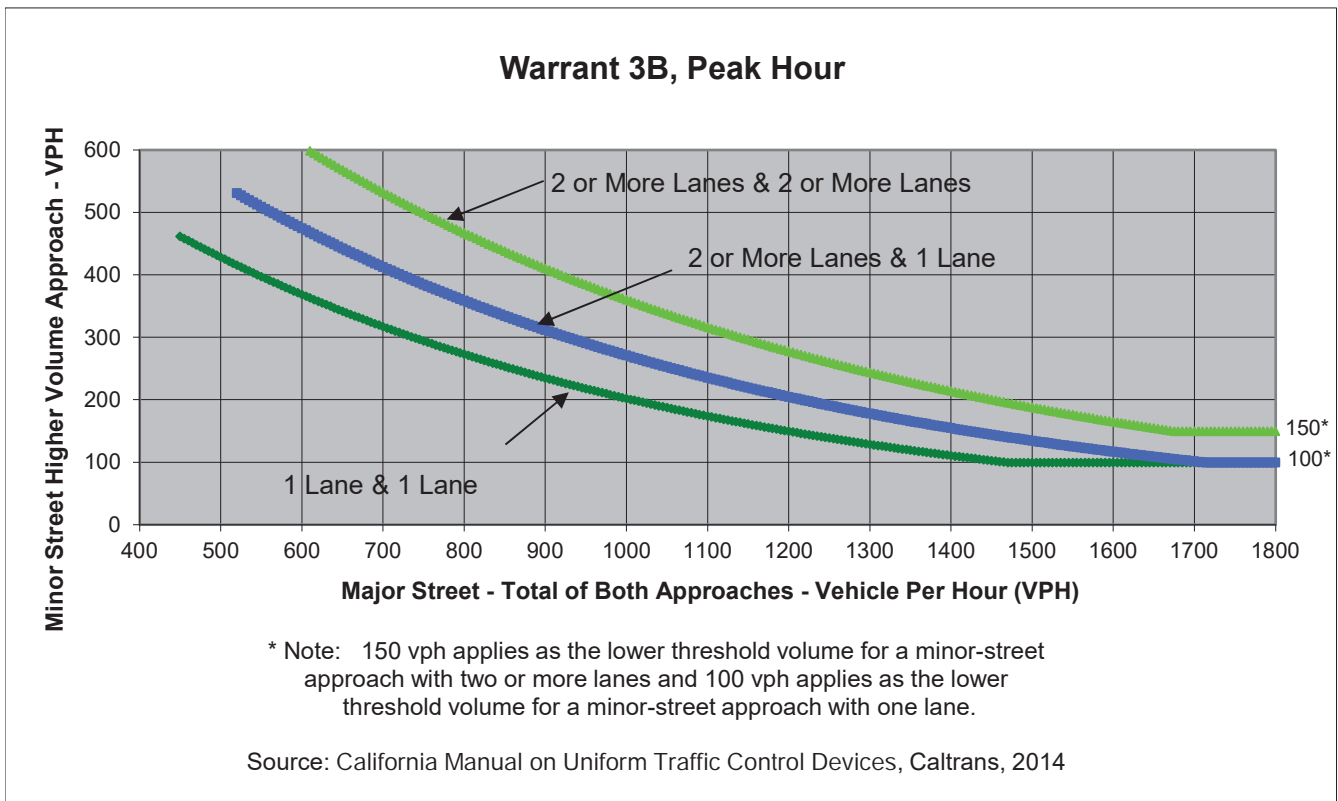

	Major Street	Minor Street	Warrant Met
	Inter-Garrison Road	8th Avenue	
Number of Approach Lanes	1	1	YES
Traffic Volume (VPH) *	1,810	460	

* Note: Traffic Volume for Major Street is Total Volume of Both Approaches.
 Traffic Volume for Minor Street is the Volume of High Volume Approach.



Major Street **Inter-Garrison Road**
 Minor Street **Schoonover Road**

Project **CSUMB Master Plan EIR**
 Scenario **Cumulative w/ Proj AM**
 Peak Hour **AM**

Turn Movement Volumes

	NB	SB	EB	WB
Left	0	70	70	0
Through	0	0	380	660
Right	0	160	0	10
Total	0	230	450	670

Major Street Direction

	North/South
X	East/West

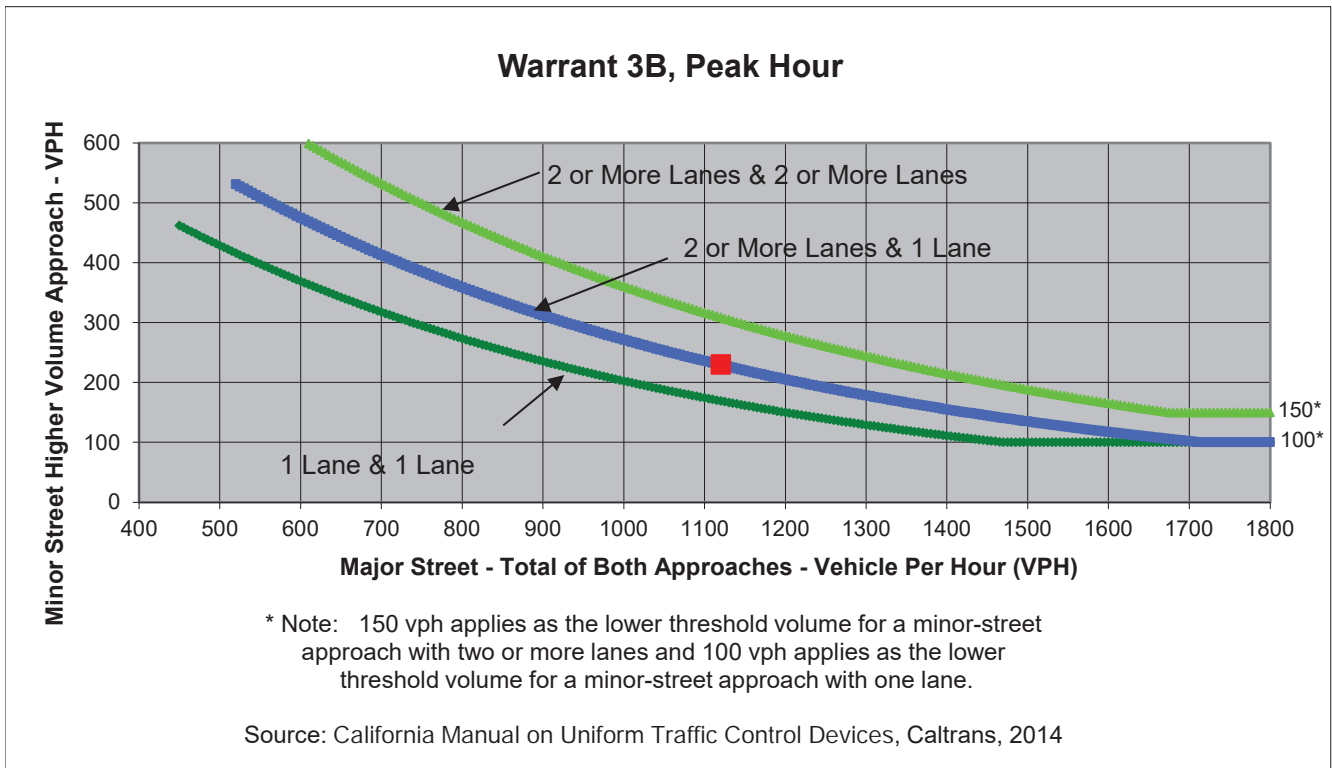

	Major Street Inter-Garrison Road	Minor Street Schoonover Road	Warrant Met
Number of Approach Lanes	2	2	
Traffic Volume (VPH) *	1,120	230	

* Note: Traffic Volume for Major Street is Total Volume of Both Approches.
 Traffic Volume for Minor Street is the Volume of High Volume Approach.

Major Street Inter-Garrison Road/Sherman Boulevard
 Minor Street Inter-Garrison Road

Project Sample Project Title
 Scenario Cumulative PP AM
 Peak Hour AM

Turn Movement Volumes

	NB	SB	EB	WB
Left	0	110	370	0
Through	0	0	80	170
Right	0	510	0	210
Total	0	620	450	380

Major Street Direction

	North/South
X	East/West

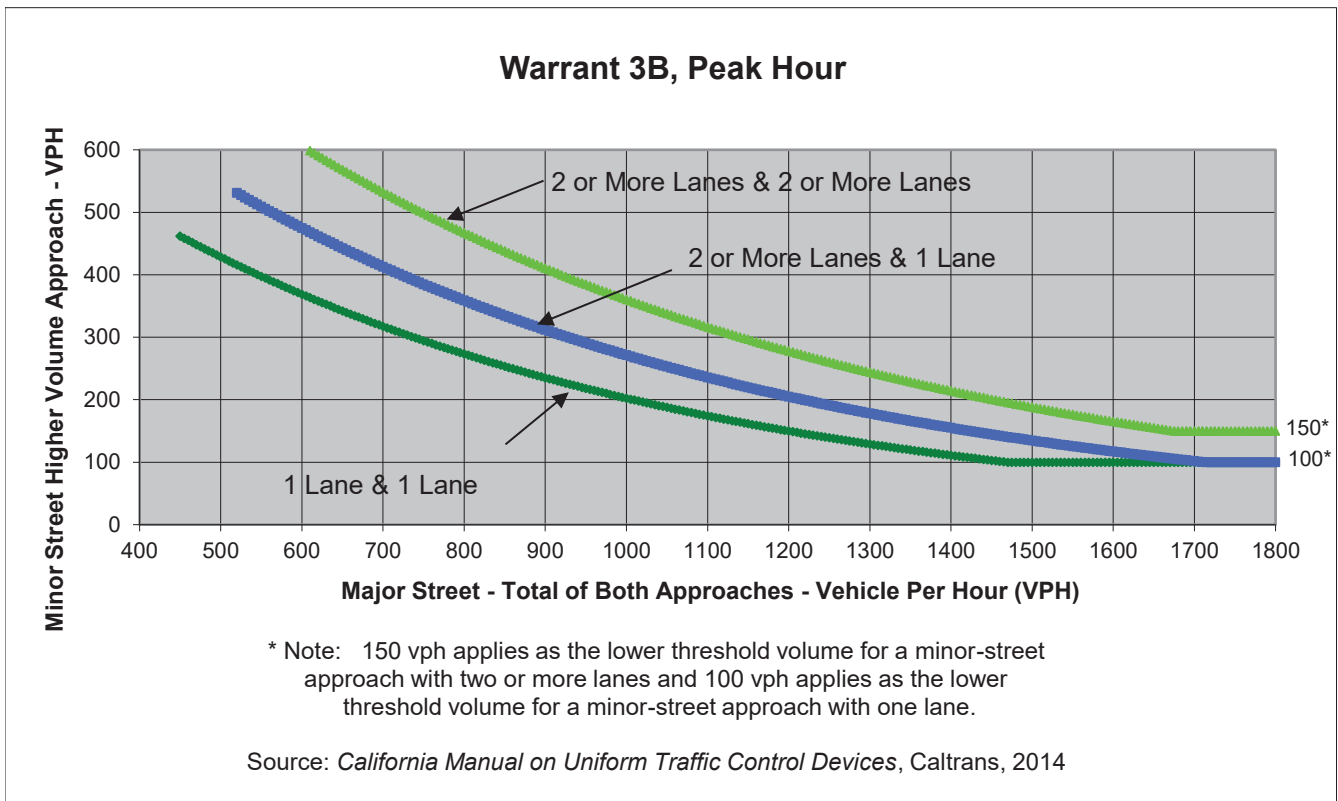

	Major Street	Minor Street	Warrant Met
	Inter-Garrison Road/Sherman Boulevard	Inter-Garrison Road	
Number of Approach Lanes	1	1	<u>YES</u>
Traffic Volume (VPH) *	830	620	
* Note: Traffic Volume for Major Street is Total Volume of Both Approaches. Traffic Volume for Minor Street is the Volume of High Volume Approach.			

Major Street 7th Avenue
 Minor Street Colonel Durham Street

Project Sample Project Title
 Scenario Cumulative PP AM
 Peak Hour AM

Turn Movement Volumes

	NB	SB	EB	WB
Left	50	0	80	10
Through	140	0	80	90
Right	20	0	90	20
Total	210	0	250	120

Major Street Direction

X	North/South
	East/West

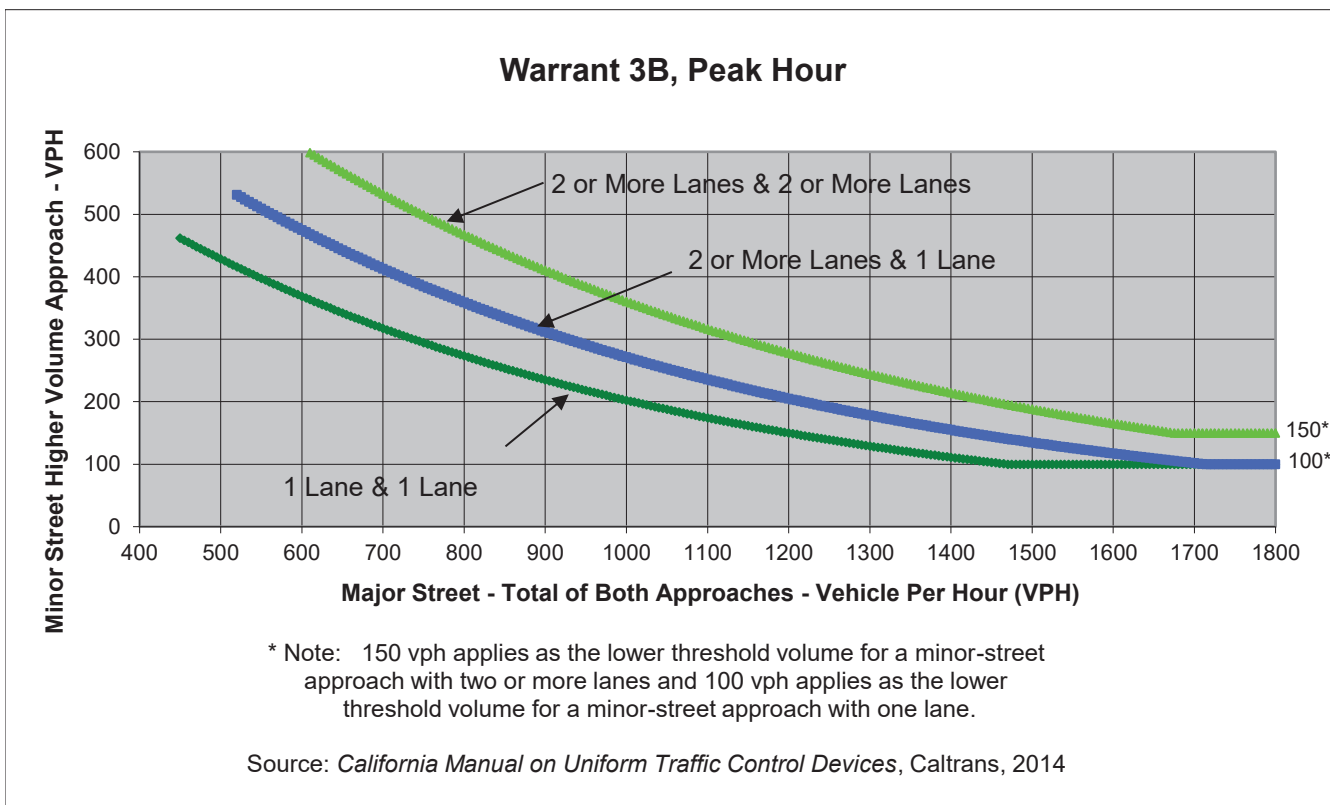

	Major Street	Minor Street	Warrant Met
	7th Avenue	Colonel Durham Street	
Number of Approach Lanes	1	1	<u>NO</u>
Traffic Volume (VPH) *	210	250	

* Note: Traffic Volume for Major Street is Total Volume of Both Approaches.
 Traffic Volume for Minor Street is the Volume of High Volume Approach.



Major Street 8th Avenue
 Minor Street Colonel Durham Street

Project Sample Project Title
 Scenario Cumulative PP AM
 Peak Hour AM

Turn Movement Volumes

	NB	SB	EB	WB
Left	10	0	110	0
Through	260	780	0	0
Right	0	120	10	0
Total	270	900	120	0

Major Street Direction

X North/South
 East/West

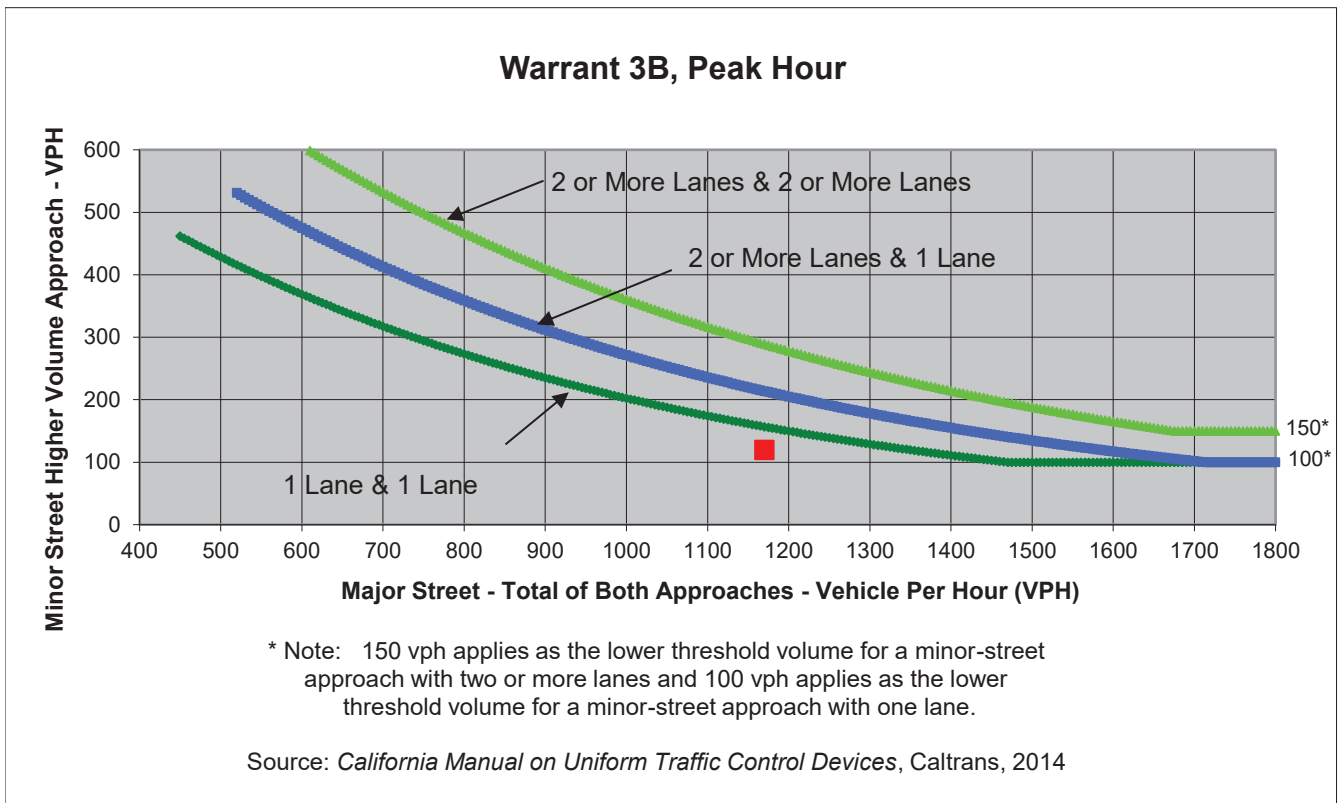

	Major Street	Minor Street	Warrant Met
	8th Avenue	Colonel Durham Street	
Number of Approach Lanes	1	1	<u>NO</u>
Traffic Volume (VPH) *	1,170	120	

* Note: Traffic Volume for Major Street is Total Volume of Both Approaches.
 Traffic Volume for Minor Street is the Volume of High Volume Approach.



Major Street General Jim Moore Boulevard
 Minor Street Coe Avenue

Project Sample Project Title
 Scenario Cumulative PP AM
 Peak Hour AM

Turn Movement Volumes

	NB	SB	EB	WB
Left	230	0	90	0
Through	420	980	0	0
Right	0	80	430	0
Total	650	1,060	520	0

Major Street Direction

X	North/South
	East/West

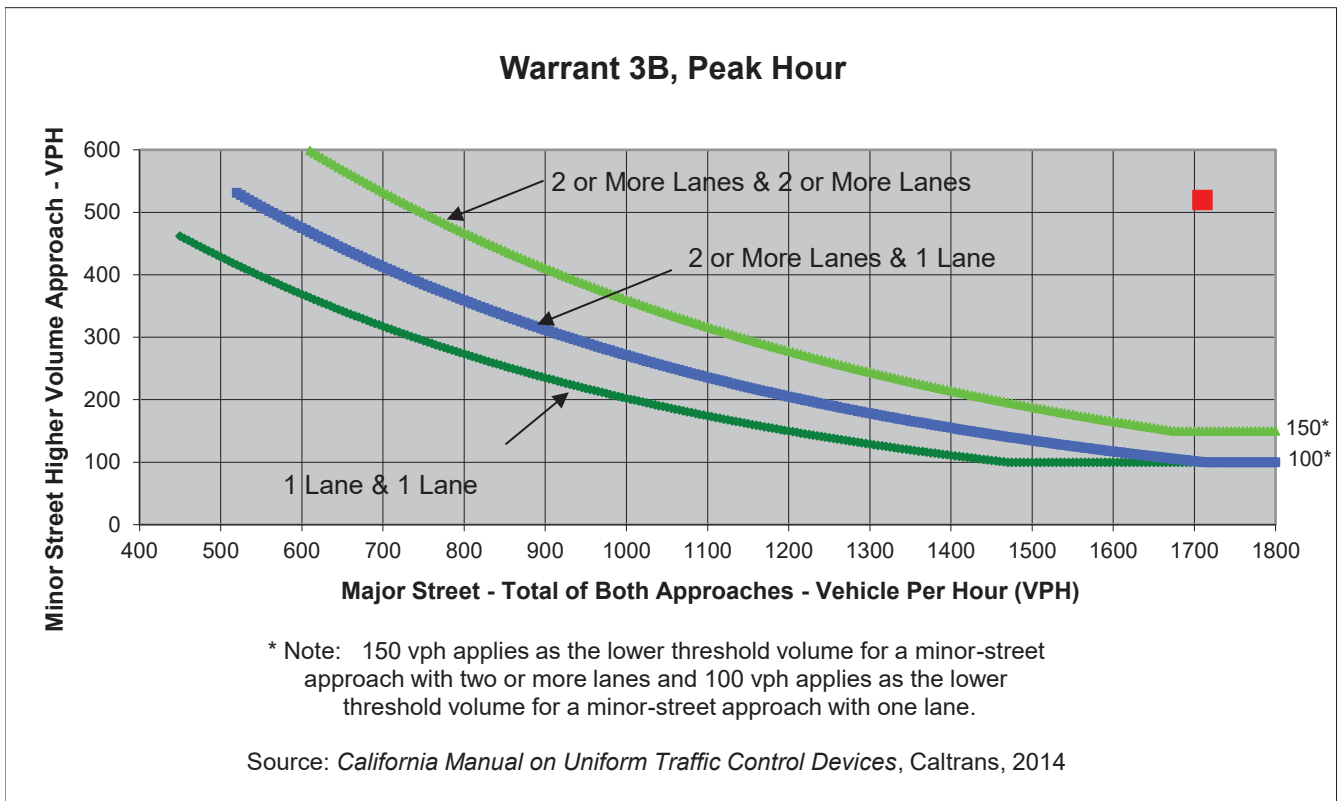

	Major Street	Minor Street	Warrant Met
	General Jim Moore Boulevard	Coe Avenue	
Number of Approach Lanes	2	1	<u>YES</u>
Traffic Volume (VPH) *	1,710	520	
* Note: Traffic Volume for Major Street is Total Volume of Both Approaches. Traffic Volume for Minor Street is the Volume of High Volume Approach.			



Major Street **Imjin Parkway**
 Minor Street **SR 1 NB Off-Ramp/SR 1 NB On-Ramp**

Project **CSUMB Master Plan EIR**
 Scenario **Cumulative w/ Proj PM**
 Peak Hour **PM**

Turn Movement Volumes

	NB	SB	EB	WB
Left	10	0	10	0
Through	10	0	650	1,220
Right	0	0	0	920
Total	20	0	660	2,140

Major Street Direction

	North/South
X	East/West

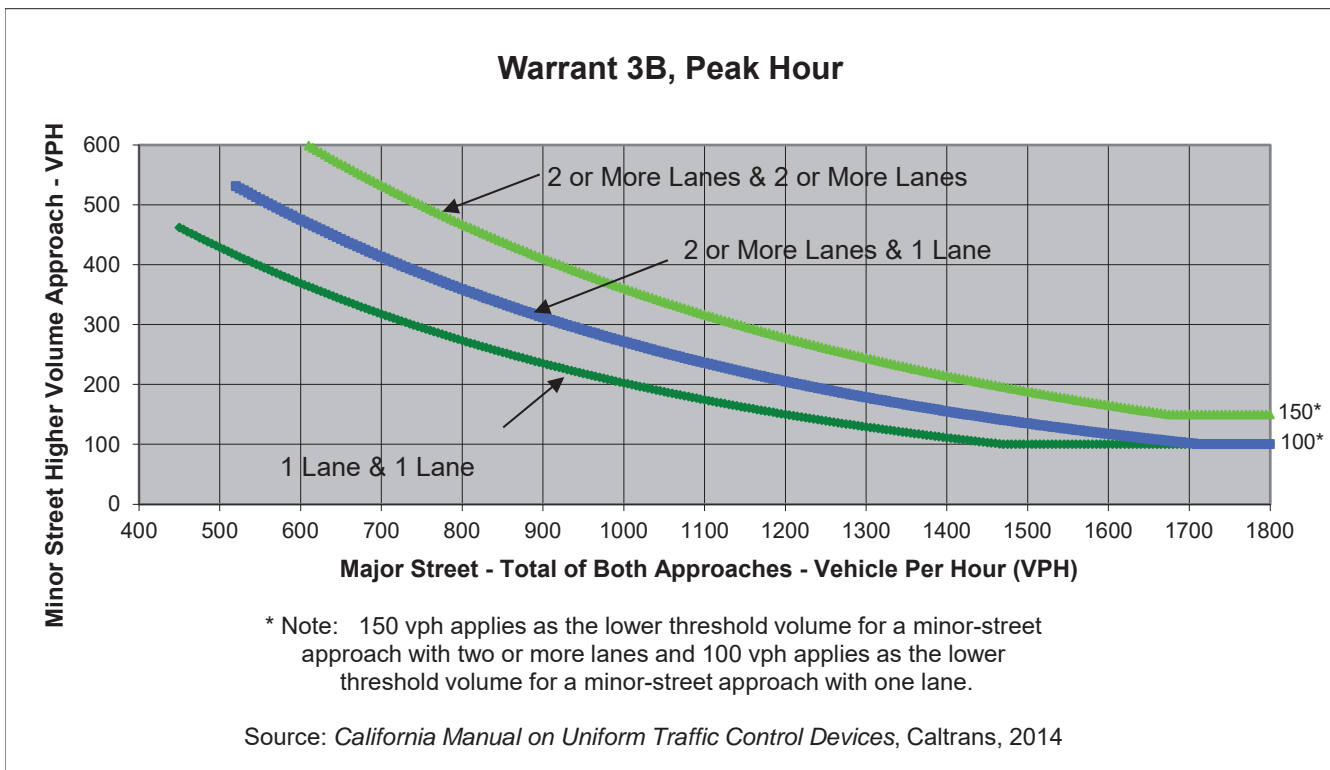

	Major Street	Minor Street	Warrant Met
	Imjin Parkway	SR 1 NB Off-Ramp/SR 1 NB On-Ramp	
Number of Approach Lanes	1	1	<u>NO</u>
Traffic Volume (VPH) *	2,800	20	

* Note: Traffic Volume for Major Street is Total Volume of Both Approches.
 Traffic Volume for Minor Street is the Volume of High Volume Approach.



Major Street **Inter-Garrison Road**
 Minor Street **8th Avenue**

Project **CSUMB Master Plan EIR**
 Scenario **Cumulative w/ Proj PM**
 Peak Hour **PM**

Turn Movement Volumes

	NB	SB	EB	WB
Left	50	0	0	430
Through	0	0	640	410
Right	750	0	140	0
Total	800	0	780	840

Major Street Direction

	North/South
X	East/West

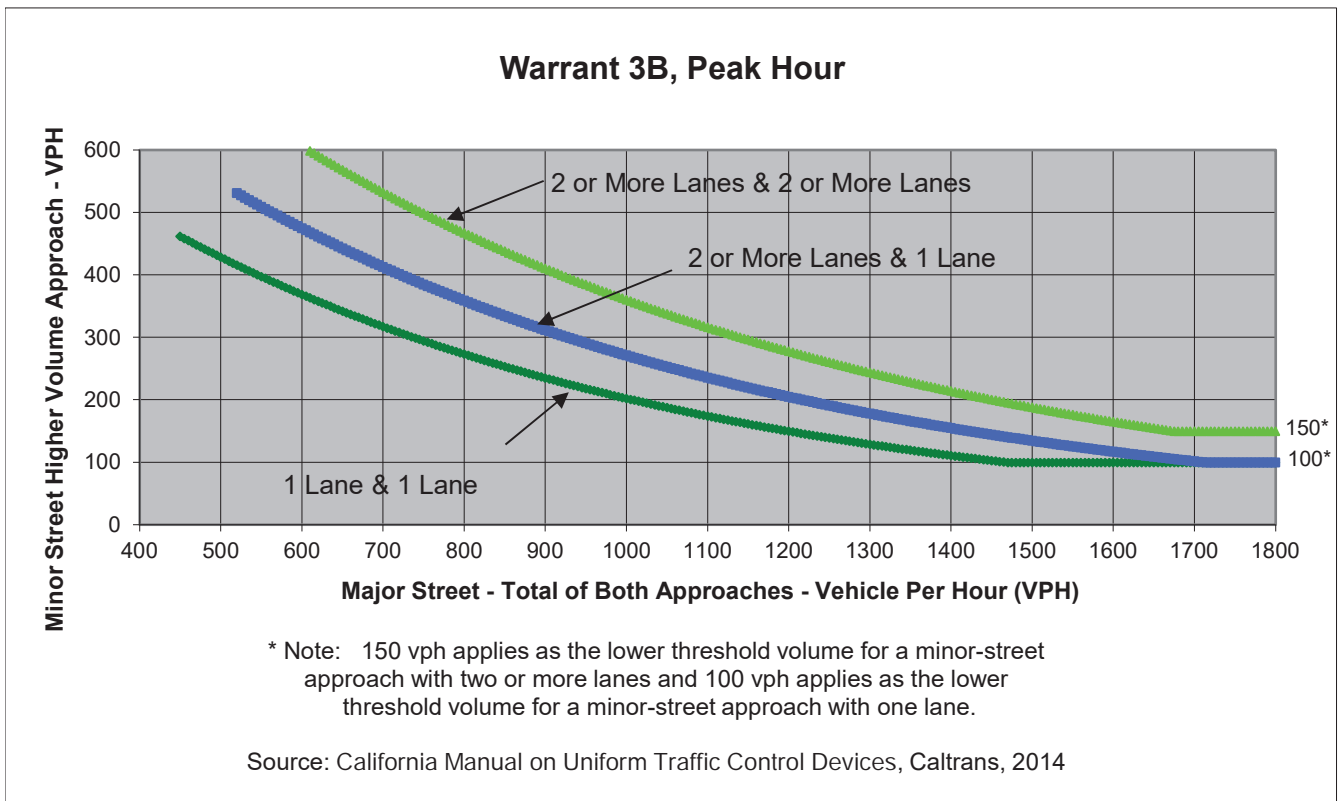

	Major Street	Minor Street	Warrant Met
	Inter-Garrison Road	8th Avenue	
Number of Approach Lanes	1	1	YES
Traffic Volume (VPH) *	1,620	800	

* Note: Traffic Volume for Major Street is Total Volume of Both Approaches.
 Traffic Volume for Minor Street is the Volume of High Volume Approach.



Major Street **Inter-Garrison Road**
 Minor Street **Schoonover Road**

Project **CSUMB Master Plan EIR**
 Scenario **Cumulative w/ Proj PM**
 Peak Hour **PM**

Turn Movement Volumes

	NB	SB	EB	WB
Left	0	20	200	0
Through	0	0	610	350
Right	0	70	0	50
Total	0	90	810	400

Major Street Direction

	North/South
X	East/West

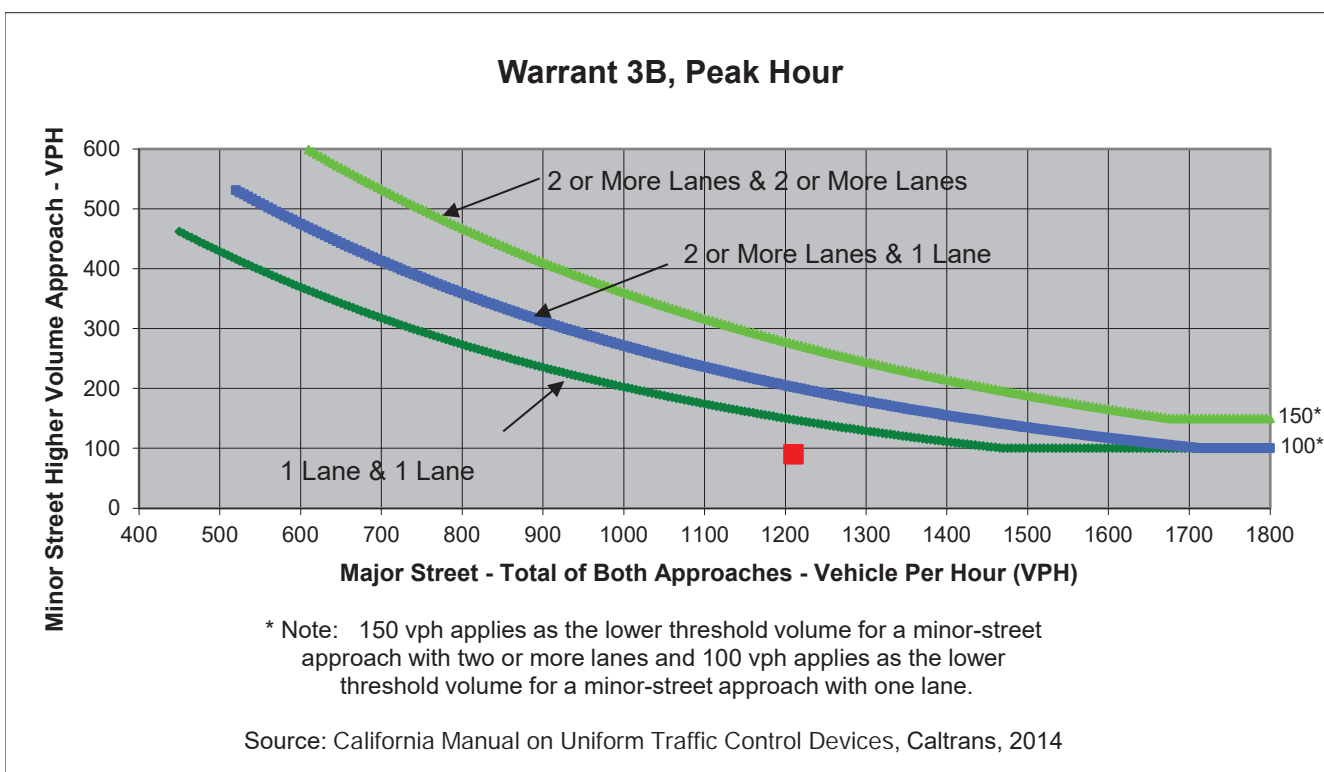

	Major Street	Minor Street	Warrant Met
	Inter-Garrison Road	Schoonover Road	
Number of Approach Lanes	2	2	<u>NO</u>
Traffic Volume (VPH) *	1,210	90	

* Note: Traffic Volume for Major Street is Total Volume of Both Approches.
 Traffic Volume for Minor Street is the Volume of High Volume Approach.

Major Street Inter-Garrison Road/Sherman Boulevard
 Minor Street Inter-Garrison Road

Project Sample Project Title
 Scenario Cumulative PP PM
 Peak Hour PM

Turn Movement Volumes

	NB	SB	EB	WB
Left	0	190	460	0
Through	0	0	150	100
Right	0	180	0	130
Total	0	370	610	230

Major Street Direction

	North/South
X	East/West

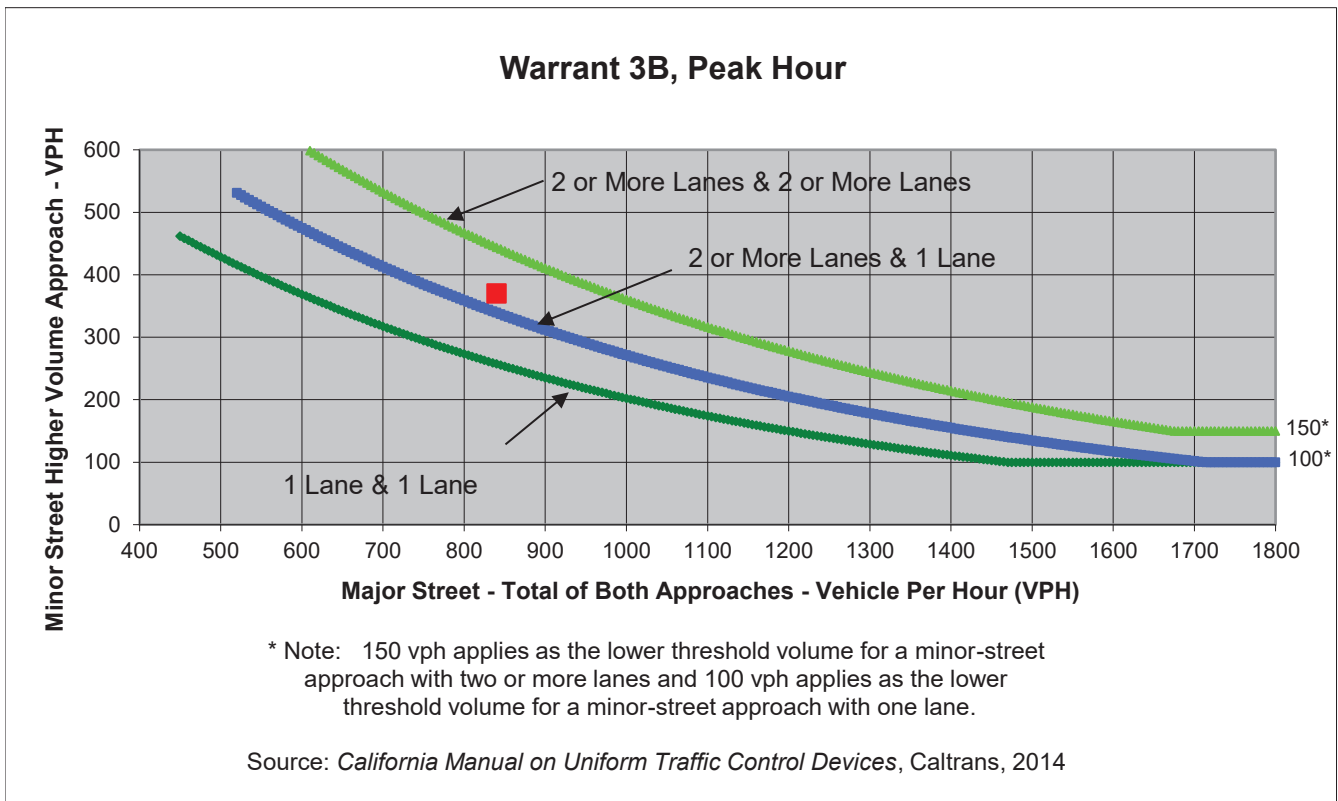

	Major Street	Minor Street	Warrant Met
	Inter-Garrison Road/Sherman Boulevard	Inter-Garrison Road	
Number of Approach Lanes	1	1	YES
Traffic Volume (VPH) *	840	370	
* Note: Traffic Volume for Major Street is Total Volume of Both Approaches. Traffic Volume for Minor Street is the Volume of High Volume Approach.			



Major Street 7th Avenue
 Minor Street Colonel Durham Street

Project Sample Project Title
 Scenario Cumulative PP PM
 Peak Hour PM

Turn Movement Volumes

	NB	SB	EB	WB
Left	90	0	70	30
Through	210	0	110	90
Right	20	0	50	10
Total	320	0	230	130

Major Street Direction

X	North/South
	East/West

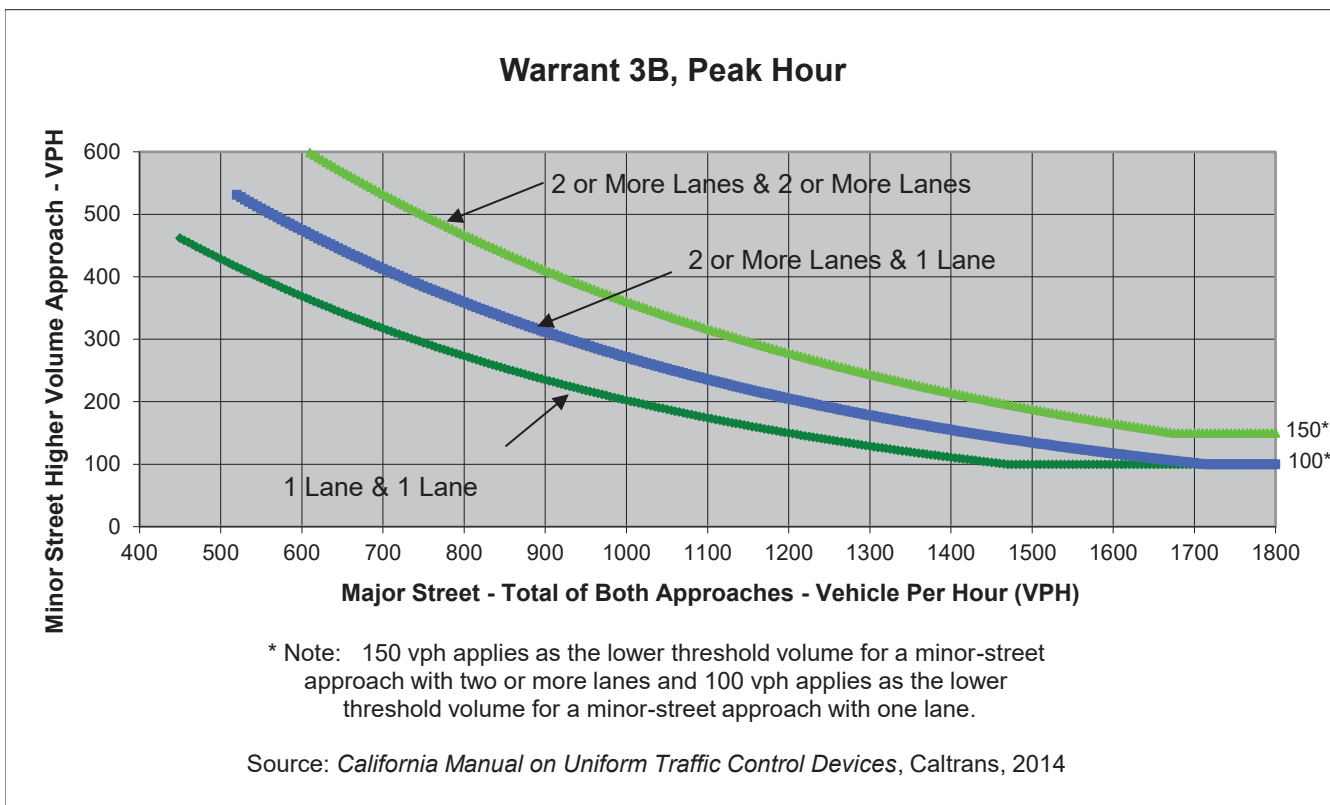

	Major Street	Minor Street	Warrant Met
	7th Avenue	Colonel Durham Street	
Number of Approach Lanes	1	1	<u>NO</u>
Traffic Volume (VPH) *	320	230	

* Note: Traffic Volume for Major Street is Total Volume of Both Approaches.
 Traffic Volume for Minor Street is the Volume of High Volume Approach.



Major Street 8th Avenue
 Minor Street Colonel Durham Street

Project Sample Project Title
 Scenario Cumulative PP PM
 Peak Hour PM

Turn Movement Volumes

	NB	SB	EB	WB
Left	10	0	130	0
Through	450	380	0	0
Right	0	120	10	0
Total	460	500	140	0

Major Street Direction

X	North/South
	East/West

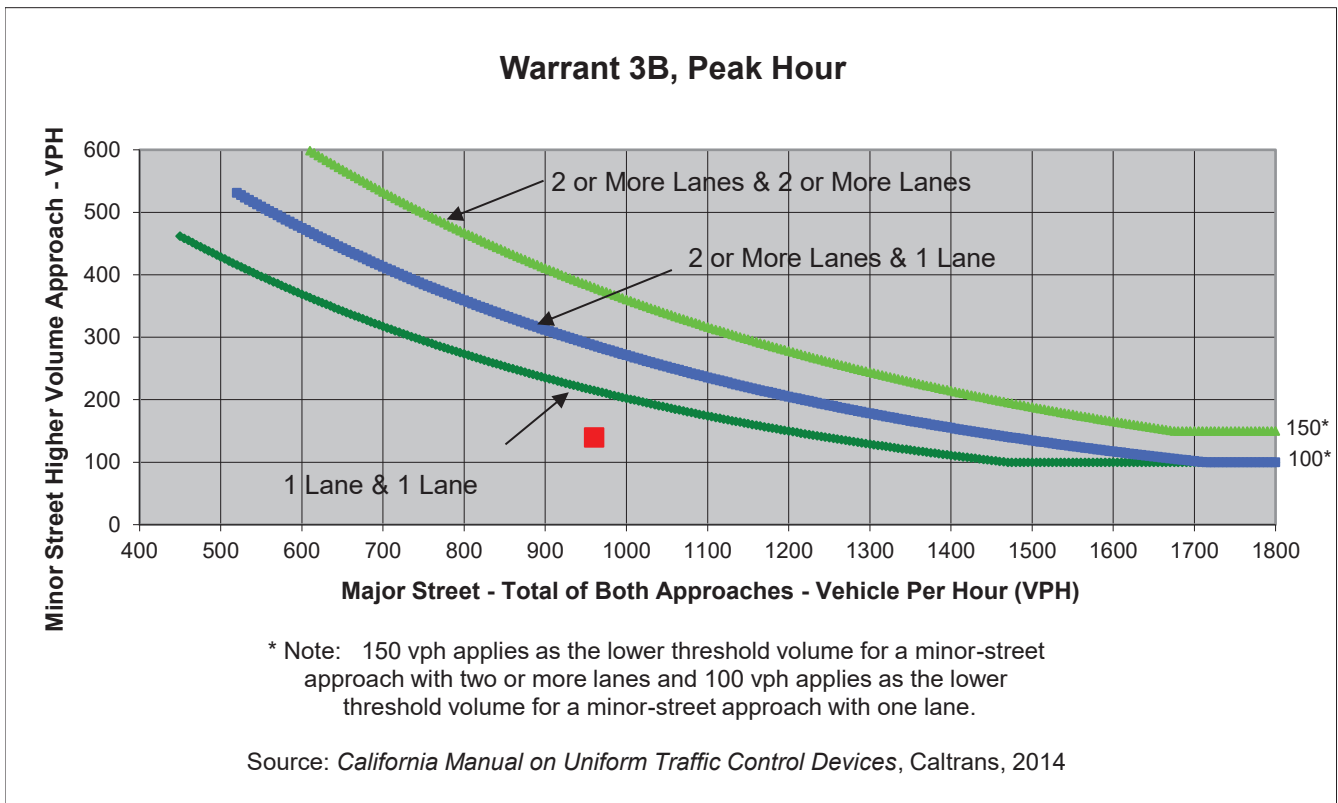

	Major Street	Minor Street	Warrant Met
	8th Avenue	Colonel Durham Street	
Number of Approach Lanes	1	1	<u>NO</u>
Traffic Volume (VPH) *	960	140	

* Note: Traffic Volume for Major Street is Total Volume of Both Approaches.
 Traffic Volume for Minor Street is the Volume of High Volume Approach.



Major Street General Jim Moore Boulevard
 Minor Street Coe Avenue

Project Sample Project Title
 Scenario Cumulative PP PM
 Peak Hour PM

Turn Movement Volumes

	NB	SB	EB	WB
Left	150	0	60	0
Through	980	440	0	0
Right	0	50	100	0
Total	1,130	490	160	0

Major Street Direction

X	North/South
	East/West

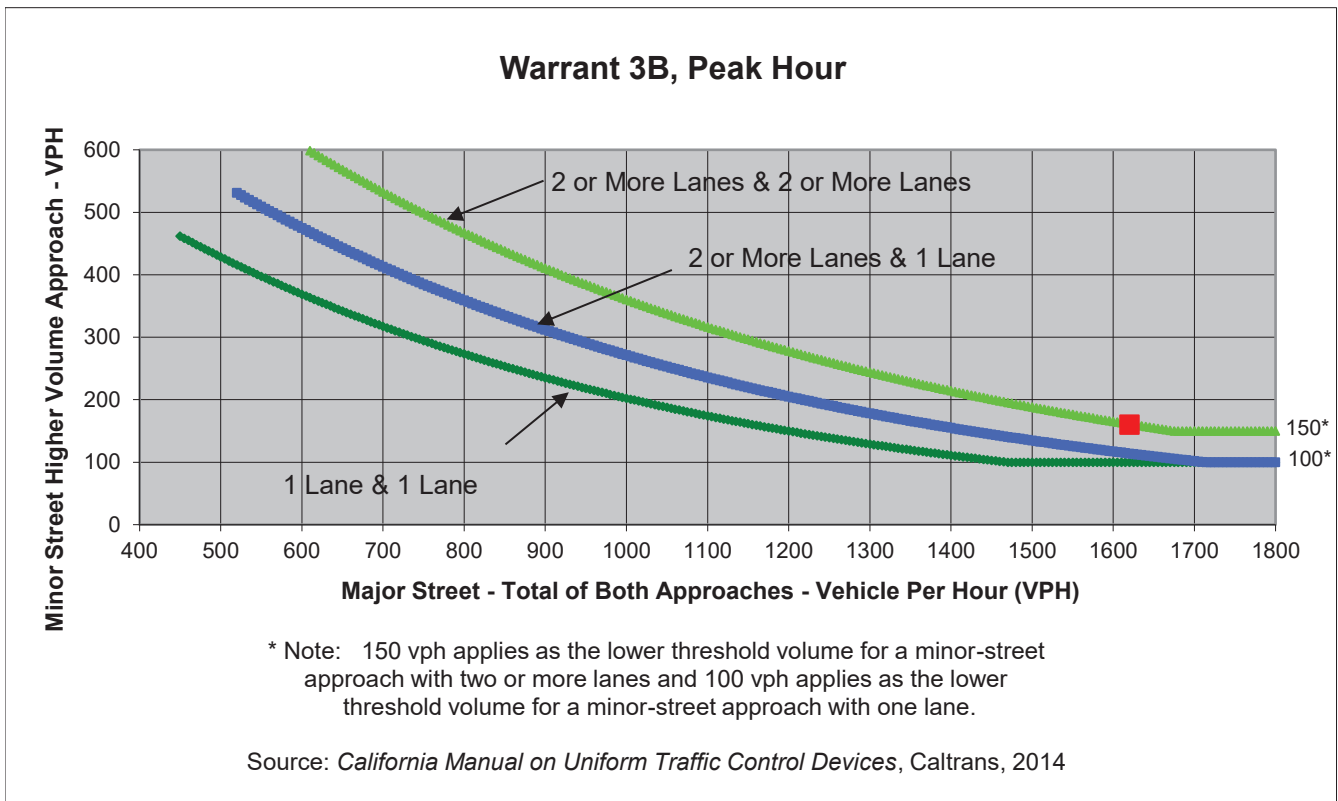

	Major Street	Minor Street	Warrant Met
	General Jim Moore Boulevard	Coe Avenue	
Number of Approach Lanes	2	1	<u>YES</u>
Traffic Volume (VPH) *	1,620	160	

* Note: Traffic Volume for Major Street is Total Volume of Both Approaches.
 Traffic Volume for Minor Street is the Volume of High Volume Approach.



Major Street Imjin Parkway
 Minor Street SR 1 NB Off-Ramp/SR 1 NB On-Ramp

Project Sample Project Title
 Scenario Cumulative PP ESP
 Peak Hour AM

Turn Movement Volumes

	NB	SB	EB	WB
Left	10	0	10	0
Through	10	0	1,010	990
Right	0	0	0	470
Total	20	0	1,020	1,460

Major Street Direction

	North/South
X	East/West

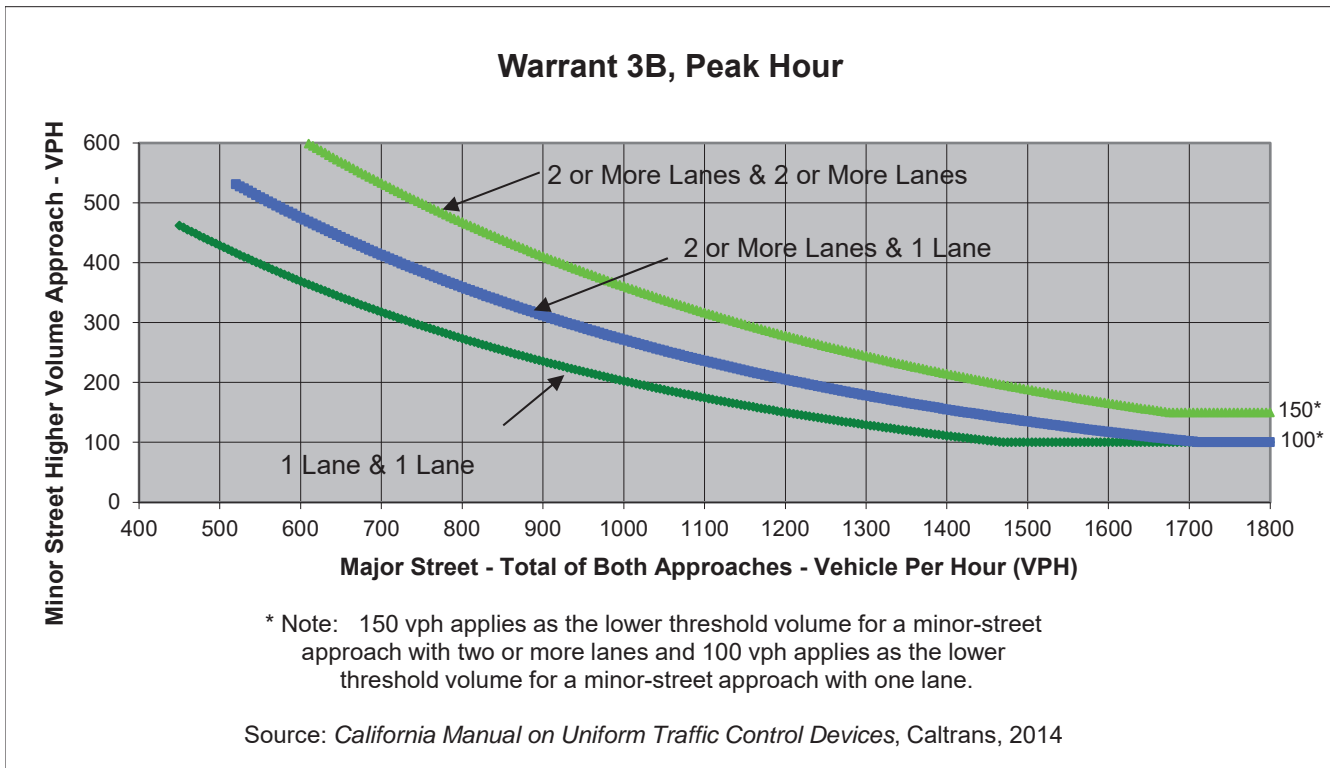

	Major Street	Minor Street	Warrant Met
	Imjin Parkway	SR 1 NB Off-Ramp/SR 1 NB On-Ramp	
Number of Approach Lanes	1	1	<u>NO</u>
Traffic Volume (VPH) *	2,480	20	

* Note: Traffic Volume for Major Street is Total Volume of Both Approches.
 Traffic Volume for Minor Street is the Volume of High Volume Approach.



Major Street **Inter-Garrison Road**
 Minor Street **8th Avenue**

Project **Sample Project Title**
 Scenario **Cumulative PP ESP**
 Peak Hour **AM**

Turn Movement Volumes

	NB	SB	EB	WB
Left	50	0	0	520
Through	0	0	220	530
Right	290	0	120	0
Total	340	0	340	1,050

Major Street Direction

North/South
X East/West

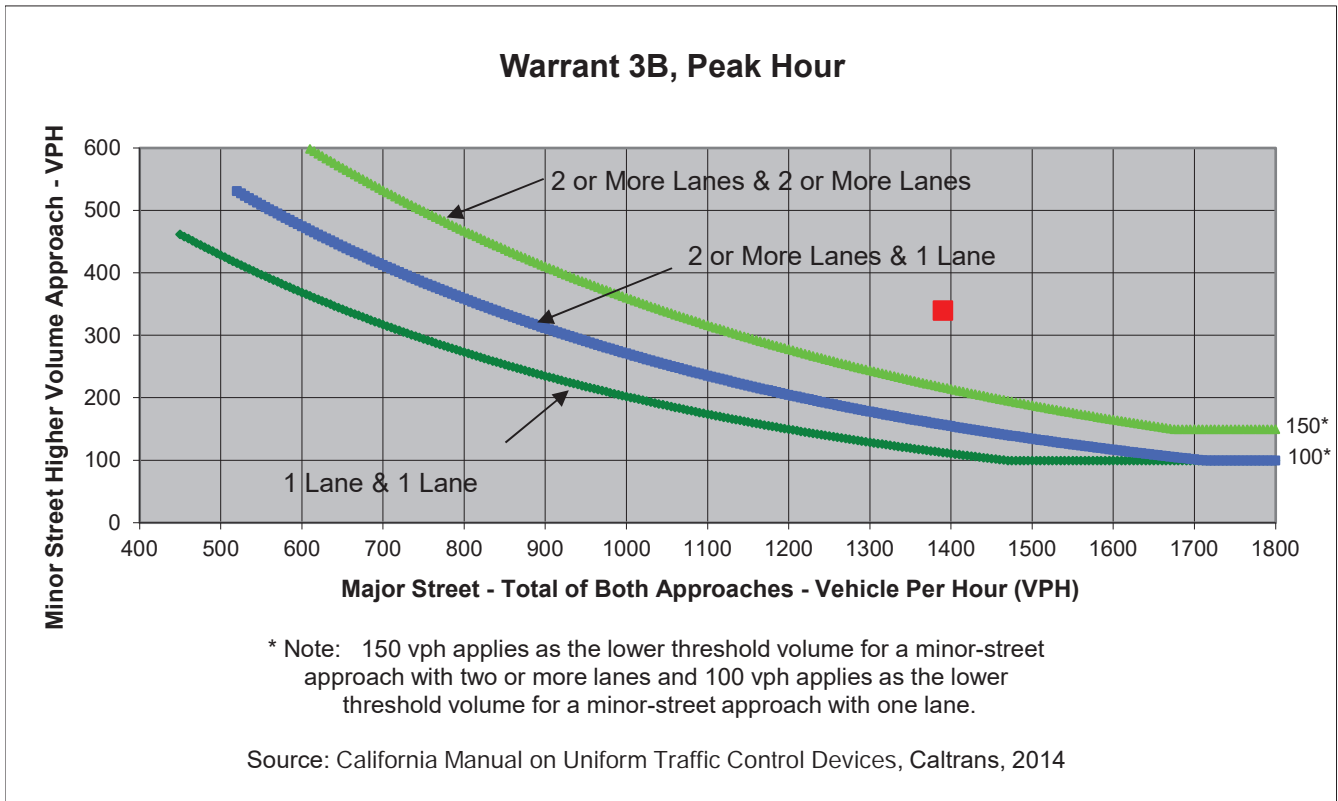

	Major Street	Minor Street	Warrant Met
	Inter-Garrison Road	8th Avenue	
Number of Approach Lanes	1	1	<u>YES</u>
Traffic Volume (VPH) *	1,390	340	

* Note: Traffic Volume for Major Street is Total Volume of Both Approaches.
 Traffic Volume for Minor Street is the Volume of High Volume Approach.

Major Street Inter-Garrison Road/Sherman Boulevard
 Minor Street Inter-Garrison Road

Project Sample Project Title
 Scenario Cumulative PP ESP
 Peak Hour AM

Turn Movement Volumes

	NB	SB	EB	WB
Left	0	90	600	0
Through	0	0	130	310
Right	0	820	0	130
Total	0	910	730	440

Major Street Direction

	North/South
X	East/West

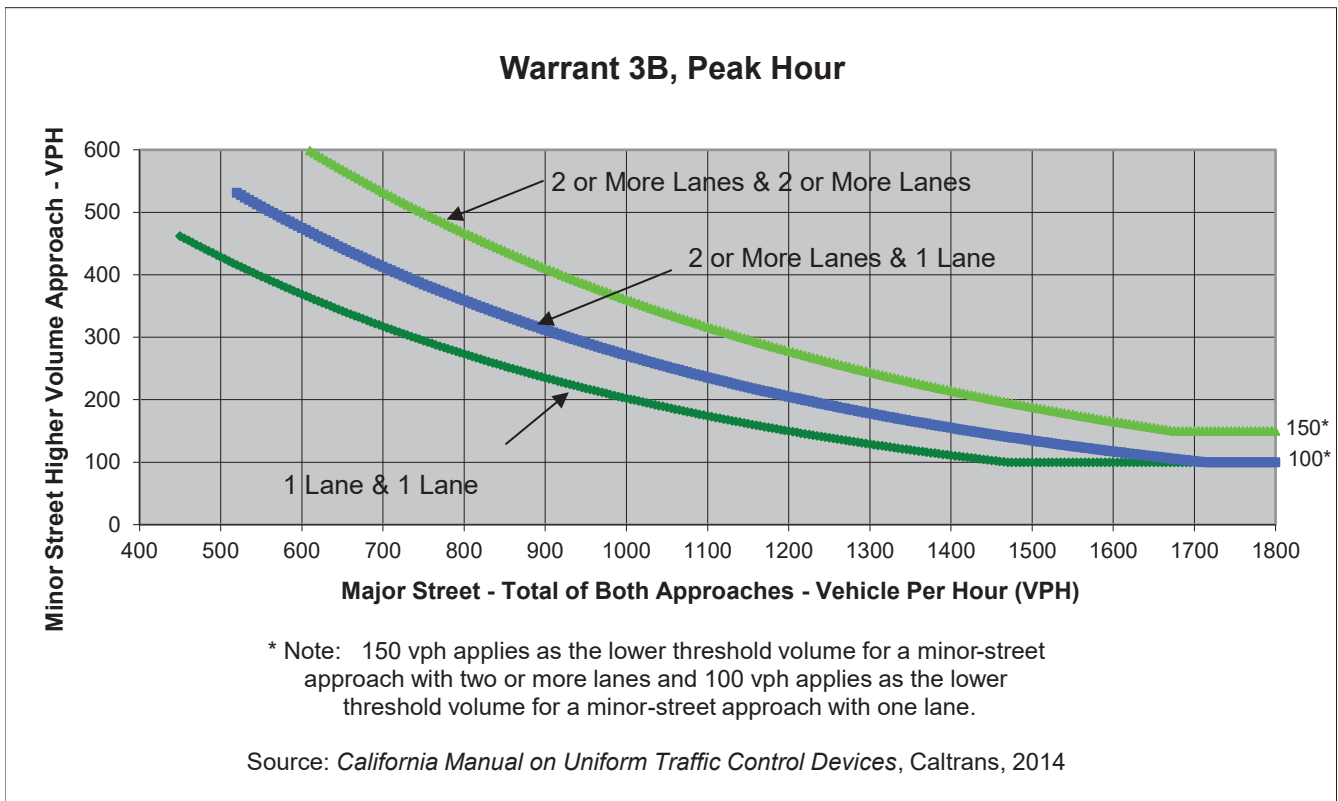

	Major Street	Minor Street	Warrant Met
	Inter-Garrison Road/Sherman Boulevard	Inter-Garrison Road	
Number of Approach Lanes	1	1	<u>YES</u>
Traffic Volume (VPH) *	1,170	910	
* Note: Traffic Volume for Major Street is Total Volume of Both Approaches. Traffic Volume for Minor Street is the Volume of High Volume Approach.			



Major Street Imjin Parkway
 Minor Street SR 1 NB Off-Ramp/SR 1 NB On-Ramp

Project Sample Project Title
 Scenario Cumulative PP ESP
 Peak Hour PM

Turn Movement Volumes

	NB	SB	EB	WB
Left	10	0	10	0
Through	10	0	700	1,150
Right	0	0	0	950
Total	20	0	710	2,100

Major Street Direction

	North/South
X	East/West

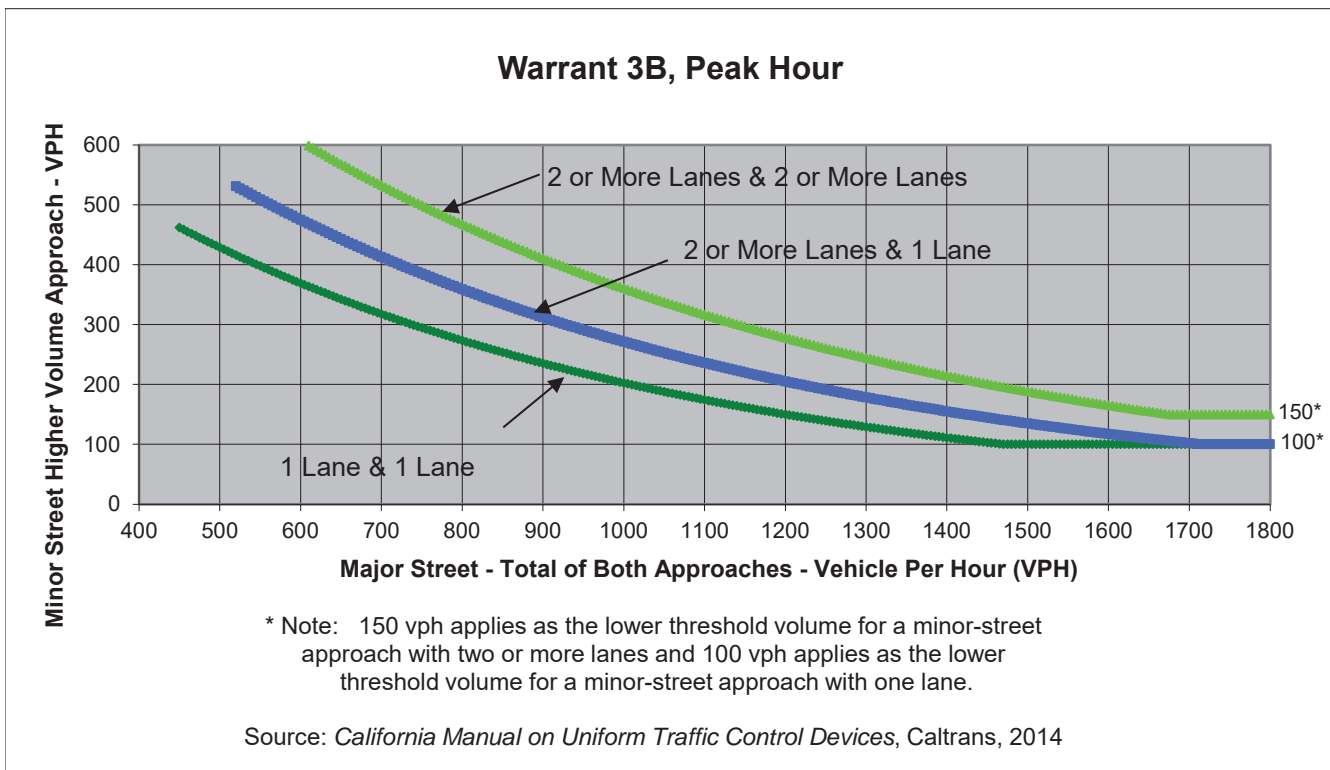

	Major Street	Minor Street	Warrant Met
	Imjin Parkway	SR 1 NB Off-Ramp/SR 1 NB On-Ramp	
Number of Approach Lanes	1	1	<u>NO</u>
Traffic Volume (VPH) *	2,810	20	

* Note: Traffic Volume for Major Street is Total Volume of Both Approches.
 Traffic Volume for Minor Street is the Volume of High Volume Approach.



Major Street Inter-Garrison Road
 Minor Street 8th Avenue

Project Sample Project Title
 Scenario Cumulative PP ESP
 Peak Hour PM

Turn Movement Volumes

	NB	SB	EB	WB
Left	60	0	0	280
Through	0	0	580	380
Right	420	0	80	0
Total	480	0	660	660

Major Street Direction

	North/South
X	East/West

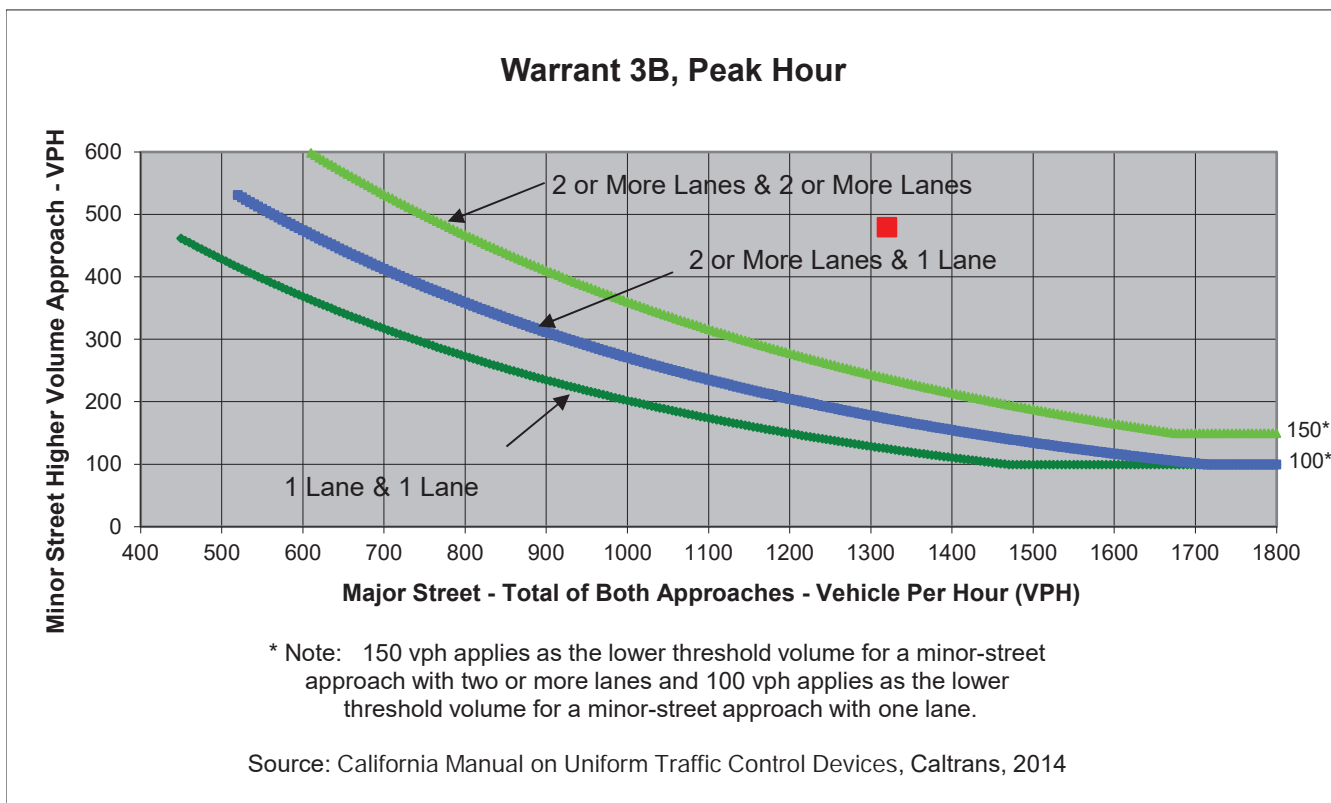

	Major Street	Minor Street	Warrant Met
	Inter-Garrison Road	8th Avenue	
Number of Approach Lanes	1	1	<u>YES</u>
Traffic Volume (VPH) *	1,320	480	
* Note: Traffic Volume for Major Street is Total Volume of Both Approches. Traffic Volume for Minor Street is the Volume of High Volume Approach.			



Major Street Inter-Garrison Road/Sherman Boulevard
 Minor Street Inter-Garrison Road

Project Sample Project Title
 Scenario Cumulative PP ESP
 Peak Hour PM

Turn Movement Volumes

	NB	SB	EB	WB
Left	0	120	990	0
Through	0	0	270	160
Right	0	520	0	100
Total	0	640	1,260	260

Major Street Direction

	North/South
X	East/West

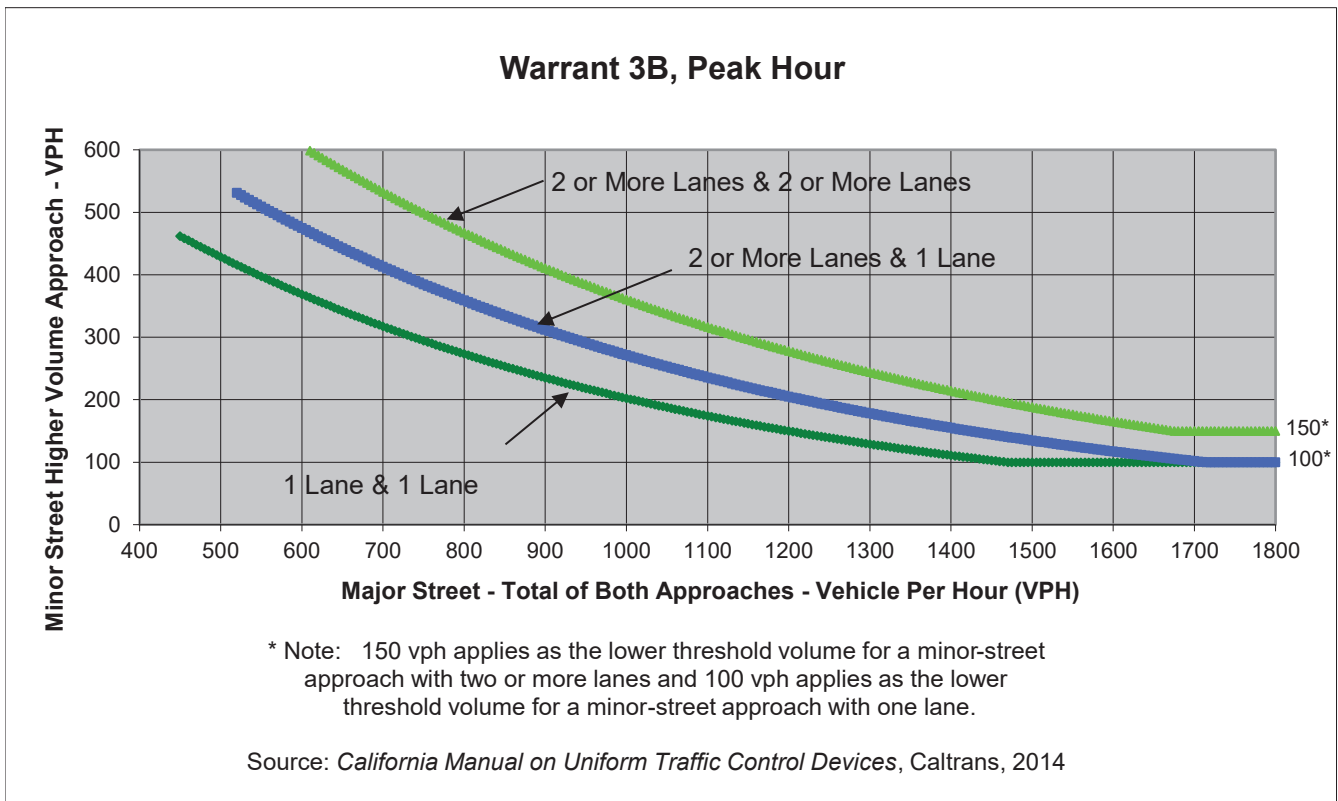

	Major Street	Minor Street	Warrant Met
	Inter-Garrison Road/Sherman Boulevard	Inter-Garrison Road	
Number of Approach Lanes	1	1	<u>YES</u>
Traffic Volume (VPH) *	1,520	640	
* Note: Traffic Volume for Major Street is Total Volume of Both Approaches. Traffic Volume for Minor Street is the Volume of High Volume Approach.			

**APPENDIX O: INTERSECTION WITH IMPROVEMENTS LEVEL OF
SERVICE CALCULATIONS**



HCM 2010 Signalized Intersection Summary
 16: 2nd Avenue & 8th Street





















Existing with Project, AM
 09/18/2019



Movement	EBL	EBT	EBR	WBL	WBT	WBR	NBL	NBT	NBR	SBL	SBT	SBR
Lane Configurations												
Traffic Volume (veh/h)	10	10	10	270	10	30	10	210	130	60	770	10
Future Volume (veh/h)	10	10	10	270	10	30	10	210	130	60	770	10
Number	7	4	14	3	8	18	5	2	12	1	6	16
Initial Q (Qb), veh	0	0	0	0	0	0	0	0	0	0	0	0
Ped-Bike Adj(A_pbT)	1.00		1.00	1.00		1.00	1.00		1.00	1.00		1.00
Parking Bus, Adj	1.00	1.00	1.00	1.00	1.00	1.00	1.00	1.00	1.00	1.00	1.00	1.00
Adj Sat Flow, veh/h/ln	1900	1900	1900	1900	1583	1583	1900	1863	1900	1881	1881	1900
Adj Flow Rate, veh/h	11	11	5	284	11	12	11	221	55	63	811	11
Adj No. of Lanes	1	1	1	0	1	1	0	2	0	1	2	0
Peak Hour Factor	0.95	0.95	0.95	0.95	0.95	0.95	0.95	0.95	0.95	0.95	0.95	0.95
Percent Heavy Veh, %	0	0	0	20	20	20	2	2	2	1	1	1
Cap, veh/h	365	608	517	588	14	431	137	1061	254	603	1423	19
Arrive On Green	0.32	0.32	0.32	0.34	0.32	0.32	0.39	0.39	0.39	0.39	0.39	0.39
Sat Flow, veh/h	1410	1900	1615	1136	44	1346	37	2693	645	1109	3611	49
Grp Volume(v), veh/h	11	11	5	295	0	12	152	0	135	63	401	421
Grp Sat Flow(s),veh/h/ln	1410	1900	1615	1180	0	1346	1795	0	1580	1109	1787	1872
Q Serve(g_s), s	0.2	0.1	0.1	6.9	0.0	0.2	0.0	0.0	1.8	1.3	5.5	5.5
Cycle Q Clear(g_c), s	7.3	0.1	0.1	7.0	0.0	0.2	1.7	0.0	1.8	3.0	5.5	5.5
Prop In Lane	1.00		1.00	0.96		1.00	0.07		0.41	1.00		0.03
Lane Grp Cap(c), veh/h	365	608	517	621	0	431	830	0	623	603	704	738
V/C Ratio(X)	0.03	0.02	0.01	0.48	0.00	0.03	0.18	0.00	0.22	0.10	0.57	0.57
Avail Cap(c_a), veh/h	1146	1659	1410	1281	0	1175	1410	0	1179	993	1334	1397
HCM Platoon Ratio	1.00	1.00	1.00	1.00	1.00	1.00	1.00	1.00	1.00	1.00	1.00	1.00
Upstream Filter(I)	1.00	1.00	1.00	1.00	0.00	1.00	1.00	0.00	1.00	1.00	1.00	1.00
Uniform Delay (d), s/veh	12.9	7.3	7.3	9.5	0.0	7.3	6.3	0.0	6.3	7.3	7.5	7.5
Incr Delay (d2), s/veh	0.0	0.0	0.0	0.6	0.0	0.0	0.1	0.0	0.2	0.1	0.7	0.7
Initial Q Delay(d3),s/veh	0.0	0.0	0.0	0.0	0.0	0.0	0.0	0.0	0.0	0.0	0.0	0.0
%ile BackOfQ(50%),veh/ln	0.1	0.1	0.0	2.3	0.0	0.1	0.9	0.0	0.8	0.4	2.8	2.9
LnGrp Delay(d),s/veh	13.0	7.3	7.3	10.1	0.0	7.4	6.4	0.0	6.5	7.4	8.2	8.2
LnGrp LOS	B	A	A	B		A	A		A	A	A	A
Approach Vol, veh/h		27			307			287			885	
Approach Delay, s/veh		9.6			10.0			6.4			8.1	
Approach LOS		A			A			A			A	
Timer	1	2	3	4	5	6	7	8				
Assigned Phs		2		4		6		8				
Phs Duration (G+Y+Rc), s		16.9		14.6		16.9		14.6				
Change Period (Y+Rc), s		4.5		4.5		4.5		4.5				
Max Green Setting (Gmax), s		23.5		27.5		23.5		27.5				
Max Q Clear Time (g_c+I1), s		3.8		9.3		7.5		9.0				
Green Ext Time (p_c), s		1.5		0.0		4.8		1.6				
Intersection Summary												
HCM 2010 Ctrl Delay				8.2								
HCM 2010 LOS				A								

HCM 2010 Signalized Intersection Summary
 21: 7th Avenue/8th Street & Inter-Garrison Road

Existing with Project, AM
 04/25/2022

												
Movement	EBL	EBT	EBR	WBL	WBT	WBR	NBL	NBT	NBR	SBL	SBT	SBR
Lane Configurations												
Traffic Volume (veh/h)	10	50	20	310	150	30	30	170	110	170	200	10
Future Volume (veh/h)	10	50	20	310	150	30	30	170	110	170	200	10
Number	5	2	12	1	6	16	3	8	18	7	4	14
Initial Q (Qb), veh	0	0	0	0	0	0	0	0	0	0	0	0
Ped-Bike Adj(A_pbT)	1.00		0.99	1.00		1.00	1.00		1.00	1.00		1.00
Parking Bus, Adj	1.00	1.00	1.00	1.00	1.00	1.00	1.00	1.00	1.00	1.00	1.00	1.00
Adj Sat Flow, veh/h/ln	1759	1759	1900	1845	1845	1900	1597	1597	1597	1776	1776	1900
Adj Flow Rate, veh/h	12	62	25	383	185	0	37	210	136	210	247	12
Adj No. of Lanes	1	1	0	1	1	0	1	1	1	1	1	0
Peak Hour Factor	0.81	0.81	0.81	0.81	0.81	0.81	0.81	0.81	0.81	0.81	0.81	0.81
Percent Heavy Veh, %	8	8	8	3	3	3	19	19	19	7	7	7
Cap, veh/h	26	142	57	456	671	0	377	573	487	397	603	29
Arrive On Green	0.02	0.12	0.12	0.26	0.36	0.00	0.36	0.36	0.36	0.36	0.36	0.36
Sat Flow, veh/h	1675	1188	479	1757	1845	0	956	1597	1357	982	1680	82
Grp Volume(v), veh/h	12	0	87	383	185	0	37	210	136	210	0	259
Grp Sat Flow(s),veh/h/ln	1675	0	1668	1757	1845	0	956	1597	1357	982	0	1761
Q Serve(g_s), s	0.4	0.0	2.5	10.6	3.7	0.0	1.6	5.0	3.7	10.3	0.0	5.7
Cycle Q Clear(g_c), s	0.4	0.0	2.5	10.6	3.7	0.0	7.3	5.0	3.7	15.4	0.0	5.7
Prop In Lane	1.00		0.29	1.00		0.00	1.00		1.00	1.00		0.05
Lane Grp Cap(c), veh/h	26	0	199	456	671	0	377	573	487	397	0	633
V/C Ratio(X)	0.47	0.00	0.44	0.84	0.28	0.00	0.10	0.37	0.28	0.53	0.00	0.41
Avail Cap(c_a), veh/h	162	0	1074	709	1753	0	451	697	592	473	0	769
HCM Platoon Ratio	1.00	1.00	1.00	1.00	1.00	1.00	1.00	1.00	1.00	1.00	1.00	1.00
Upstream Filter(I)	1.00	0.00	1.00	1.00	1.00	0.00	1.00	1.00	1.00	1.00	0.00	1.00
Uniform Delay (d), s/veh	25.2	0.0	21.1	18.1	11.6	0.0	15.1	12.2	11.8	17.9	0.0	12.4
Incr Delay (d2), s/veh	12.7	0.0	1.5	5.4	0.2	0.0	0.1	0.4	0.3	1.1	0.0	0.4
Initial Q Delay(d3),s/veh	0.0	0.0	0.0	0.0	0.0	0.0	0.0	0.0	0.0	0.0	0.0	0.0
%ile BackOfQ(50%),veh/ln	0.3	0.0	1.2	5.8	1.9	0.0	0.4	2.2	1.4	2.9	0.0	2.8
LnGrp Delay(d),s/veh	37.8	0.0	22.6	23.4	11.8	0.0	15.3	12.6	12.1	19.0	0.0	12.8
LnGrp LOS	D		C	C	B		B	B	B	B		B
Approach Vol, veh/h		99			568			383			469	
Approach Delay, s/veh		24.4			19.7			12.7			15.6	
Approach LOS		C			B			B			B	
Timer	1	2	3	4	5	6	7	8				
Assigned Phs	1	2		4	5	6		8				
Phs Duration (G+Y+Rc), s	17.9	10.7		23.0	5.3	23.3		23.0				
Change Period (Y+Rc), s	4.5	4.5		4.5	4.5	4.5		4.5				
Max Green Setting (Gmax), s	20.8	33.2		22.5	5.0	49.0		22.5				
Max Q Clear Time (g_c+I1), s	12.6	4.5		17.4	2.4	5.7		9.3				
Green Ext Time (p_c), s	0.8	0.4		1.2	0.0	1.1		1.6				
Intersection Summary												
HCM 2010 Ctrl Delay			16.9									
HCM 2010 LOS			B									



Movement	EBT	EBR	WBL	WBT	NBL	NBR		
Lane Configurations	T			T		T		
Traffic Volume (veh/h)	180	150	730	500	10	240		
Future Volume (veh/h)	180	150	730	500	10	240		
Number	4	14	3	8	5	12		
Initial Q (Qb), veh	0	0	0	0	0	0		
Ped-Bike Adj(A_pbT)		1.00	1.00		1.00	1.00		
Parking Bus, Adj	1.00	1.00	1.00	1.00	1.00	1.00		
Adj Sat Flow, veh/h/ln	1520	1900	1900	1881	1845	1900		
Adj Flow Rate, veh/h	207	121	839	575	11	-29		
Adj No. of Lanes	1	0	0	1	0	0		
Peak Hour Factor	0.87	0.87	0.87	0.87	0.87	0.87		
Percent Heavy Veh, %	25	25	1	1	0	0		
Cap, veh/h	581	340	0	1214	0	491		
Arrive On Green	0.65	0.68	0.00	0.65	0.00	0.00		
Sat Flow, veh/h	901	526	0	1881	-941	2480		
Grp Volume(v), veh/h	0	328	0	575	0	0		
Grp Sat Flow(s),veh/h/ln	0	1427	0	1881	0	0		
Q Serve(g_s), s	0.0	1.3	0.0	2.0	0.0	0.0		
Cycle Q Clear(g_c), s	0.0	1.3	0.0	2.0	0.0	0.0		
Prop In Lane		0.37	0.00		-0.65	1.71		
Lane Grp Cap(c), veh/h	0	921	0	1214	0	0		
V/C Ratio(X)	0.00	0.36	0.00	0.47	0.00	0.00		
Avail Cap(c_a), veh/h	0	6580	0	10083	0	0		
HCM Platoon Ratio	1.00	1.00	1.00	1.00	1.00	1.00		
Upstream Filter(I)	0.00	1.00	0.00	1.00	0.00	0.00		
Uniform Delay (d), s/veh	0.0	1.0	0.0	1.1	0.0	0.0		
Incr Delay (d2), s/veh	0.0	0.2	0.0	0.3	0.0	0.0		
Initial Q Delay(d3),s/veh	0.0	0.0	0.0	0.0	0.0	0.0		
%ile BackOfQ(50%),veh/ln	0.0	0.5	0.0	1.1	0.0	0.0		
LnGrp Delay(d),s/veh	0.0	1.2	0.0	1.4	0.0	0.0		
LnGrp LOS		A		A				
Approach Vol, veh/h	328			575	0			
Approach Delay, s/veh	1.2			1.4	0.0			
Approach LOS	A			A				
Timer	1	2	3	4	5	6	7	8
Assigned Phs		2	3	4				8
Phs Duration (G+Y+Rc), s		0.0	0.0	12.7				12.7
Change Period (Y+Rc), s		4.5	4.5	4.5				4.5
Max Green Setting (Gmax), s		33.0	5.0	58.5				68.0
Max Q Clear Time (g_c+I1), s		0.0	0.0	3.3				4.0
Green Ext Time (p_c), s		0.0	0.0	2.3				4.2
Intersection Summary								
HCM 2010 Ctrl Delay			1.4					
HCM 2010 LOS			A					
Notes								

Intersection				
Intersection Delay, s/veh	14.7			
Intersection LOS	B			
Approach	EB	WB		NB
Entry Lanes	1	2		1
Conflicting Circle Lanes	2	2		2
Adj Approach Flow, veh/h	379	1414		287
Demand Flow Rate, veh/h	474	1428		295
Vehicles Circulating, veh/h	847	11		259
Vehicles Exiting, veh/h	592	543		1062
Follow-Up Headway, s	3.186	3.186		3.186
Ped Vol Crossing Leg, #/h	0	0		0
Ped Cap Adj	1.000	1.000		1.000
Approach Delay, s/veh	30.3	12.1		7.3
Approach LOS	D	B		A
Lane	Left	Left	Right	Left
Designated Moves	TR	L	LTR	LR
Assumed Moves	TR	L	LTR	LR
RT Channelized				
Lane Util	1.000	0.530	0.470	1.000
Critical Headway, s	4.113	4.293	4.113	4.113
Entry Flow, veh/h	474	757	671	295
Cap Entry Lane, veh/h	625	1121	1121	943
Entry HV Adj Factor	0.800	0.990	0.991	0.973
Flow Entry, veh/h	379	750	665	287
Cap Entry, veh/h	500	1110	1111	917
V/C Ratio	0.759	0.675	0.598	0.313
Control Delay, s/veh	30.3	13.1	10.9	7.3
LOS	D	B	B	A
95th %tile Queue, veh	7	6	4	1



Movement	EBL	EBT	WBT	WBR	SBL	SBR		
Lane Configurations								
Traffic Volume (veh/h)	210	200	740	10	30	490		
Future Volume (veh/h)	210	200	740	10	30	490		
Number	5	2	6	16	7	14		
Initial Q (Qb), veh	0	0	0	0	0	0		
Ped-Bike Adj(A_pbT)	1.00			1.00	1.00	1.00		
Parking Bus, Adj	1.00	1.00	1.00	1.00	1.00	1.00		
Adj Sat Flow, veh/h/ln	1759	1759	1881	1881	1881	1881		
Adj Flow Rate, veh/h	247	235	871	10	35	330		
Adj No. of Lanes	1	1	1	1	2	1		
Peak Hour Factor	0.85	0.85	0.85	0.85	0.85	0.85		
Percent Heavy Veh, %	8	8	1	1	1	1		
Cap, veh/h	326	1225	1309	1113	772	355		
Arrive On Green	0.70	0.70	0.70	0.70	0.22	0.22		
Sat Flow, veh/h	593	1759	1881	1599	3476	1599		
Grp Volume(v), veh/h	247	235	871	10	35	330		
Grp Sat Flow(s),veh/h/ln	593	1759	1881	1599	1738	1599		
Q Serve(g_s), s	42.1	4.9	27.3	0.2	0.8	21.0		
Cycle Q Clear(g_c), s	69.3	4.9	27.3	0.2	0.8	21.0		
Prop In Lane	1.00			1.00	1.00	1.00		
Lane Grp Cap(c), veh/h	326	1225	1309	1113	772	355		
V/C Ratio(X)	0.76	0.19	0.67	0.01	0.05	0.93		
Avail Cap(c_a), veh/h	415	1488	1591	1353	1119	515		
HCM Platoon Ratio	1.00	1.00	1.00	1.00	1.00	1.00		
Upstream Filter(I)	1.00	1.00	1.00	1.00	1.00	1.00		
Uniform Delay (d), s/veh	28.6	5.5	8.9	4.8	31.8	39.7		
Incr Delay (d2), s/veh	4.2	0.0	0.5	0.0	0.0	15.2		
Initial Q Delay(d3),s/veh	0.0	0.0	0.0	0.0	0.0	0.0		
%ile BackOfQ(50%),veh/ln	7.2	2.4	14.2	0.1	0.4	10.8		
LnGrp Delay(d),s/veh	32.8	5.6	9.4	4.8	31.8	54.9		
LnGrp LOS	C	A	A	A	C	D		
Approach Vol, veh/h		482	881		365			
Approach Delay, s/veh		19.5	9.4		52.6			
Approach LOS		B	A		D			
Timer	1	2	3	4	5	6	7	8
Assigned Phs		2		4		6		
Phs Duration (G+Y+Rc), s		77.4		26.6		77.4		
Change Period (Y+Rc), s		5.0		3.5		5.0		
Max Green Setting (Gmax), s		88.0		33.5		88.0		
Max Q Clear Time (g_c+I1), s		71.3		23.0		29.3		
Green Ext Time (p_c), s		1.1		0.1		0.9		
Intersection Summary								
HCM 2010 Ctrl Delay			21.3					
HCM 2010 LOS			C					

HCM 2010 Signalized Intersection Summary
 29: 2nd Avenue & Divarty Street

Existing with Project, AM
 09/18/2019



Movement	EBL	EBT	EBR	WBL	WBT	WBR	NBL	NBT	NBR	SBL	SBT	SBR
Lane Configurations		↕			↕	↕	↕	↕↔		↕	↕↔	
Traffic Volume (veh/h)	10	10	10	70	10	10	10	370	120	10	1040	10
Future Volume (veh/h)	10	10	10	70	10	10	10	370	120	10	1040	10
Number	5	2	12	1	6	16	3	8	18	7	4	14
Initial Q (Qb), veh	0	0	0	0	0	0	0	0	0	0	0	0
Ped-Bike Adj(A_pbT)	1.00		1.00	1.00		1.00	1.00		1.00	1.00		1.00
Parking Bus, Adj	1.00	1.00	1.00	1.00	1.00	1.00	1.00	1.00	1.00	1.00	1.00	1.00
Adj Sat Flow, veh/h/ln	1900	1667	1900	1900	1900	1900	1863	1863	1900	1881	1881	1900
Adj Flow Rate, veh/h	11	11	11	77	11	11	11	407	132	11	1143	11
Adj No. of Lanes	0	1	0	0	1	1	1	2	0	1	2	0
Peak Hour Factor	0.91	0.91	0.91	0.91	0.91	0.91	0.91	0.91	0.91	0.91	0.91	0.91
Percent Heavy Veh, %	14	14	14	0	0	0	2	2	2	1	1	1
Cap, veh/h	163	132	93	389	46	303	20	1297	416	20	1786	17
Arrive On Green	0.19	0.19	0.19	0.19	0.19	0.19	0.01	0.49	0.49	0.01	0.49	0.49
Sat Flow, veh/h	286	700	493	1249	244	1613	1774	2636	846	1792	3627	35
Grp Volume(v), veh/h	33	0	0	88	0	11	11	272	267	11	563	591
Grp Sat Flow(s),veh/h/ln1479	0	0	1493	0	1613	1774	1770	1712	1792	1787	1875	
Q Serve(g_s), s	0.0	0.0	0.0	1.3	0.0	0.2	0.3	4.0	4.1	0.3	10.2	10.2
Cycle Q Clear(g_c), s	0.8	0.0	0.0	2.1	0.0	0.2	0.3	4.0	4.1	0.3	10.2	10.2
Prop In Lane	0.33		0.33	0.87		1.00	1.00		0.49	1.00		0.02
Lane Grp Cap(c), veh/h	388	0	0	435	0	303	20	871	843	20	880	923
V/C Ratio(X)	0.09	0.00	0.00	0.20	0.00	0.04	0.54	0.31	0.32	0.54	0.64	0.64
Avail Cap(c_a), veh/h	1125	0	0	1192	0	1142	223	2021	1955	225	2041	2142
HCM Platoon Ratio	1.00	1.00	1.00	1.00	1.00	1.00	1.00	1.00	1.00	1.00	1.00	1.00
Upstream Filter(I)	1.00	0.00	0.00	1.00	0.00	1.00	1.00	1.00	1.00	1.00	1.00	1.00
Uniform Delay (d), s/veh	14.7	0.0	0.0	15.2	0.0	14.5	21.5	6.7	6.7	21.5	8.2	8.2
Incr Delay (d2), s/veh	0.1	0.0	0.0	0.2	0.0	0.0	20.6	0.2	0.2	20.1	0.8	0.7
Initial Q Delay(d3),s/veh	0.0	0.0	0.0	0.0	0.0	0.0	0.0	0.0	0.0	0.0	0.0	0.0
%ile BackOfQ(50%),veh/ln0.3	0.0	0.0	0.9	0.0	0.1	0.2	2.0	2.0	2.0	0.2	5.2	5.4
LnGrp Delay(d),s/veh	14.8	0.0	0.0	15.4	0.0	14.6	42.1	6.9	6.9	41.6	9.0	9.0
LnGrp LOS	B			B		B	D	A	A	D	A	A
Approach Vol, veh/h		33			99			550			1165	
Approach Delay, s/veh		14.8			15.4			7.6			9.3	
Approach LOS		B			B			A			A	
Timer	1	2	3	4	5	6	7	8				
Assigned Phs		2	3	4		6	7	8				
Phs Duration (G+Y+Rc), s		13.2	4.0	26.5		13.2	4.0	26.5				
Change Period (Y+Rc), s		5.0	3.5	5.0		5.0	3.5	5.0				
Max Green Setting (Gmax), s		31.0	5.5	50.0		31.0	5.5	50.0				
Max Q Clear Time (g_c+I1), s		2.8	2.3	12.2		4.1	2.3	6.1				
Green Ext Time (p_c), s		0.1	0.0	9.3		0.4	0.0	3.5				
Intersection Summary												
HCM 2010 Ctrl Delay				9.2								
HCM 2010 LOS				A								

HCM 2010 Signalized Intersection Summary
 47: General Jim Moore Boulevard & Coe Avenue





















Existing with Project, AM
 09/18/2019



Movement	EBL	EBR	NBL	NBT	SBT	SBR		
Lane Configurations								
Traffic Volume (veh/h)	120	430	230	370	900	140		
Future Volume (veh/h)	120	430	230	370	900	140		
Number	3	18	1	6	2	12		
Initial Q (Qb), veh	0	0	0	0	0	0		
Ped-Bike Adj(A_pbT)	1.00	1.00	1.00			1.00		
Parking Bus, Adj	1.00	1.00	1.00	1.00	1.00	1.00		
Adj Sat Flow, veh/h/ln	1881	1881	1881	1881	1863	1863		
Adj Flow Rate, veh/h	133	197	256	411	1000	54		
Adj No. of Lanes	1	1	1	2	2	1		
Peak Hour Factor	0.90	0.90	0.90	0.90	0.90	0.90		
Percent Heavy Veh, %	1	1	1	1	2	2		
Cap, veh/h	293	261	316	2222	1195	535		
Arrive On Green	0.16	0.16	0.18	0.62	0.34	0.34		
Sat Flow, veh/h	1792	1599	1792	3668	3632	1583		
Grp Volume(v), veh/h	133	197	256	411	1000	54		
Grp Sat Flow(s),veh/h/ln	1792	1599	1792	1787	1770	1583		
Q Serve(g_s), s	2.8	4.9	5.8	2.1	10.9	1.0		
Cycle Q Clear(g_c), s	2.8	4.9	5.8	2.1	10.9	1.0		
Prop In Lane	1.00	1.00	1.00			1.00		
Lane Grp Cap(c), veh/h	293	261	316	2222	1195	535		
V/C Ratio(X)	0.45	0.75	0.81	0.18	0.84	0.10		
Avail Cap(c_a), veh/h	1860	1660	663	3882	2999	1342		
HCM Platoon Ratio	1.00	1.00	1.00	1.00	1.00	1.00		
Upstream Filter(I)	1.00	1.00	1.00	1.00	1.00	1.00		
Uniform Delay (d), s/veh	15.8	16.7	16.6	3.4	12.8	9.5		
Incr Delay (d2), s/veh	0.4	1.7	1.9	0.0	0.6	0.0		
Initial Q Delay(d3),s/veh	0.0	0.0	0.0	0.0	0.0	0.0		
%ile BackOfQ(50%),veh/ln	1.4	2.3	3.0	1.0	5.4	0.4		
LnGrp Delay(d),s/veh	16.2	18.4	18.5	3.4	13.4	9.5		
LnGrp LOS	B	B	B	A	B	A		
Approach Vol, veh/h	330			667	1054			
Approach Delay, s/veh	17.5			9.2	13.2			
Approach LOS	B			A	B			
Timer	1	2	3	4	5	6	7	8
Assigned Phs	1	2				6		8
Phs Duration (G+Y+Rc), s	11.9	18.6				30.5		11.3
Change Period (Y+Rc), s	4.5	4.5				4.5		4.5
Max Green Setting (Gmax), s	15.5	35.5				45.5		43.5
Max Q Clear Time (g_c+1), s	17.8	12.9				4.1		6.9
Green Ext Time (p_c), s	0.0	1.2				0.5		0.1
Intersection Summary								
HCM 2010 Ctrl Delay			12.6					
HCM 2010 LOS			B					























HCM 2010 Signalized Intersection Summary
 16: 2nd Avenue & 8th Street

Existing with Project, PM
 09/18/2019

												
Movement	EBL	EBT	EBR	WBL	WBT	WBR	NBL	NBT	NBR	SBL	SBT	SBR
Lane Configurations												
Traffic Volume (veh/h)	10	10	10	180	10	50	10	400	160	50	310	10
Future Volume (veh/h)	10	10	10	180	10	50	10	400	160	50	310	10
Number	7	4	14	3	8	18	5	2	12	1	6	16
Initial Q (Qb), veh	0	0	0	0	0	0	0	0	0	0	0	0
Ped-Bike Adj(A_pbT)	1.00		1.00	1.00		1.00	1.00		1.00	1.00		1.00
Parking Bus, Adj	1.00	1.00	1.00	1.00	1.00	1.00	1.00	1.00	1.00	1.00	1.00	1.00
Adj Sat Flow, veh/h/ln	1900	1900	1900	1900	1583	1583	1900	1863	1900	1881	1881	1900
Adj Flow Rate, veh/h	11	11	4	191	11	17	11	426	64	53	330	11
Adj No. of Lanes	1	1	1	0	1	1	0	2	0	1	2	0
Peak Hour Factor	0.94	0.94	0.94	0.94	0.94	0.94	0.94	0.94	0.94	0.94	0.94	0.94
Percent Heavy Veh, %	0	0	0	20	20	20	2	2	2	1	1	1
Cap, veh/h	434	453	385	586	15	321	182	1042	154	548	1232	41
Arrive On Green	0.24	0.24	0.24	0.22	0.24	0.24	0.35	0.35	0.35	0.35	0.35	0.35
Sat Flow, veh/h	1404	1900	1615	1112	64	1346	28	2986	442	911	3530	117
Grp Volume(v), veh/h	11	11	4	202	0	17	267	0	234	53	167	174
Grp Sat Flow(s),veh/h/ln	1404	1900	1615	1176	0	1346	1840	0	1616	911	1787	1860
Q Serve(g_s), s	0.2	0.1	0.0	3.5	0.0	0.2	0.0	0.0	2.4	1.0	1.5	1.5
Cycle Q Clear(g_c), s	3.7	0.1	0.0	3.6	0.0	0.2	2.4	0.0	2.4	3.4	1.5	1.5
Prop In Lane	1.00		1.00	0.95		1.00	0.04		0.27	1.00		0.06
Lane Grp Cap(c), veh/h	434	453	385	574	0	321	814	0	564	548	623	649
V/C Ratio(X)	0.03	0.02	0.01	0.35	0.00	0.05	0.33	0.00	0.41	0.10	0.27	0.27
Avail Cap(c_a), veh/h	1936	2485	2112	1858	0	1760	2419	0	2002	1359	2214	2305
HCM Platoon Ratio	1.00	1.00	1.00	1.00	1.00	1.00	1.00	1.00	1.00	1.00	1.00	1.00
Upstream Filter(I)	1.00	1.00	1.00	1.00	0.00	1.00	1.00	0.00	1.00	1.00	1.00	1.00
Uniform Delay (d), s/veh	9.4	6.4	6.3	8.0	0.0	6.4	5.4	0.0	5.4	6.7	5.1	5.1
Incr Delay (d2), s/veh	0.0	0.0	0.0	0.4	0.0	0.1	0.2	0.0	0.5	0.1	0.2	0.2
Initial Q Delay(d3),s/veh	0.0	0.0	0.0	0.0	0.0	0.0	0.0	0.0	0.0	0.0	0.0	0.0
%ile BackOfQ(50%),veh/ln	0.1	0.1	0.0	1.2	0.0	0.1	1.2	0.0	1.1	0.3	0.7	0.8
LnGrp Delay(d),s/veh	9.4	6.4	6.4	8.3	0.0	6.5	5.6	0.0	5.9	6.8	5.3	5.3
LnGrp LOS	A	A	A	A		A	A		A	A	A	A
Approach Vol, veh/h		26			219			501			394	
Approach Delay, s/veh		7.7			8.2			5.7			5.5	
Approach LOS		A			A			A			A	
Timer	1	2	3	4	5	6	7	8				
Assigned Phs		2		4		6		8				
Phs Duration (G+Y+Rc), s		12.1		9.7		12.1		9.7				
Change Period (Y+Rc), s		4.5		4.5		4.5		4.5				
Max Green Setting (Gmax), s		27.0		28.5		27.0		28.5				
Max Q Clear Time (g_c+I1), s		4.4		5.7		5.4		5.6				
Green Ext Time (p_c), s		2.9		0.0		2.1		1.1				
Intersection Summary												
HCM 2010 Ctrl Delay			6.2									
HCM 2010 LOS			A									

HCM 2010 Signalized Intersection Summary
 21: 7th Avenue/8th Street & Inter-Garrison Road

Existing with Project, PM
 04/25/2022

												
Movement	EBL	EBT	EBR	WBL	WBT	WBR	NBL	NBT	NBR	SBL	SBT	SBR
Lane Configurations												
Traffic Volume (veh/h)	10	140	10	180	80	30	10	270	300	80	140	10
Future Volume (veh/h)	10	140	10	180	80	30	10	270	300	80	140	10
Number	5	2	12	1	6	16	3	8	18	7	4	14
Initial Q (Qb), veh	0	0	0	0	0	0	0	0	0	0	0	0
Ped-Bike Adj(A_pbT)	1.00		0.99	1.00		1.00	1.00		1.00	1.00		1.00
Parking Bus, Adj	1.00	1.00	1.00	1.00	1.00	1.00	1.00	1.00	1.00	1.00	1.00	1.00
Adj Sat Flow, veh/h/ln	1759	1759	1900	1845	1845	1900	1597	1597	1597	1776	1776	1900
Adj Flow Rate, veh/h	12	173	12	222	99	0	12	333	370	99	173	12
Adj No. of Lanes	1	1	0	1	1	0	1	1	1	1	1	0
Peak Hour Factor	0.81	0.81	0.81	0.81	0.81	0.81	0.81	0.81	0.81	0.81	0.81	0.81
Percent Heavy Veh, %	8	8	8	3	3	3	19	19	19	7	7	7
Cap, veh/h	26	297	21	283	605	0	450	578	491	294	594	41
Arrive On Green	0.02	0.18	0.18	0.16	0.33	0.00	0.36	0.36	0.36	0.36	0.36	0.36
Sat Flow, veh/h	1675	1626	113	1757	1845	0	1023	1597	1357	706	1642	114
Grp Volume(v), veh/h	12	0	185	222	99	0	12	333	370	99	0	185
Grp Sat Flow(s),veh/h/ln	1675	0	1738	1757	1845	0	1023	1597	1357	706	0	1756
Q Serve(g_s), s	0.3	0.0	4.5	5.6	1.7	0.0	0.4	7.7	11.0	6.0	0.0	3.4
Cycle Q Clear(g_c), s	0.3	0.0	4.5	5.6	1.7	0.0	3.8	7.7	11.0	13.7	0.0	3.4
Prop In Lane	1.00		0.06	1.00		0.00	1.00		1.00	1.00		0.06
Lane Grp Cap(c), veh/h	26	0	318	283	605	0	450	578	491	294	0	636
V/C Ratio(X)	0.46	0.00	0.58	0.79	0.16	0.00	0.03	0.58	0.75	0.34	0.00	0.29
Avail Cap(c_a), veh/h	183	0	1213	479	1589	0	571	766	651	377	0	842
HCM Platoon Ratio	1.00	1.00	1.00	1.00	1.00	1.00	1.00	1.00	1.00	1.00	1.00	1.00
Upstream Filter(I)	1.00	0.00	1.00	1.00	1.00	0.00	1.00	1.00	1.00	1.00	0.00	1.00
Uniform Delay (d), s/veh	22.4	0.0	17.1	18.5	10.9	0.0	11.8	11.8	12.8	17.3	0.0	10.4
Incr Delay (d2), s/veh	12.3	0.0	1.7	4.8	0.1	0.0	0.0	0.9	3.5	0.7	0.0	0.3
Initial Q Delay(d3),s/veh	0.0	0.0	0.0	0.0	0.0	0.0	0.0	0.0	0.0	0.0	0.0	0.0
%ile BackOfQ(50%),veh/ln	0.2	0.0	2.3	3.0	0.9	0.0	0.1	3.5	4.5	1.2	0.0	1.7
LnGrp Delay(d),s/veh	34.7	0.0	18.8	23.3	11.1	0.0	11.8	12.7	16.3	18.0	0.0	10.7
LnGrp LOS	C		B	C	B		B	B	B	B		B
Approach Vol, veh/h		197			321			715			284	
Approach Delay, s/veh		19.8			19.5			14.6			13.2	
Approach LOS		B			B			B			B	
Timer	1	2	3	4	5	6	7	8				
Assigned Phs	1	2		4	5	6		8				
Phs Duration (G+Y+Rc), s	11.9	12.9		21.1	5.2	19.6		21.1				
Change Period (Y+Rc), s	4.5	4.5		4.5	4.5	4.5		4.5				
Max Green Setting (Gmax), s	12.5	32.0		22.0	5.0	39.5		22.0				
Max Q Clear Time (g_c+I1), s	7.6	6.5		15.7	2.3	3.7		13.0				
Green Ext Time (p_c), s	0.3	1.0		0.9	0.0	0.5		2.5				
Intersection Summary												
HCM 2010 Ctrl Delay			16.0									
HCM 2010 LOS			B									



Movement	EBT	EBR	WBL	WBT	NBL	NBR		
Lane Configurations	T			T		T		
Traffic Volume (veh/h)	480	50	390	280	10	610		
Future Volume (veh/h)	480	50	390	280	10	610		
Number	4	14	3	8	5	12		
Initial Q (Qb), veh	0	0	0	0	0	0		
Ped-Bike Adj(A_pbT)		1.00	1.00		1.00	1.00		
Parking Bus, Adj	1.00	1.00	1.00	1.00	1.00	1.00		
Adj Sat Flow, veh/h/ln	1520	1900	1900	1881	1845	1900		
Adj Flow Rate, veh/h	495	40	402	289	10	311		
Adj No. of Lanes	1	0	0	1	0	0		
Peak Hour Factor	0.97	0.97	0.97	0.97	0.97	0.97		
Percent Heavy Veh, %	25	25	1	1	0	0		
Cap, veh/h	630	51	0	854	13	401		
Arrive On Green	0.45	0.44	0.00	0.45	0.26	0.25		
Sat Flow, veh/h	1388	112	0	1881	49	1520		
Grp Volume(v), veh/h	0	535	0	289	322	0		
Grp Sat Flow(s),veh/h/ln	0	1500	0	1881	1574	0		
Q Serve(g_s), s	0.0	9.7	0.0	3.2	6.1	0.0		
Cycle Q Clear(g_c), s	0.0	9.7	0.0	3.2	6.1	0.0		
Prop In Lane		0.07	0.00		0.03	0.97		
Lane Grp Cap(c), veh/h	0	681	0	854	415	0		
V/C Ratio(X)	0.00	0.79	0.00	0.34	0.78	0.00		
Avail Cap(c_a), veh/h	0	1153	0	2774	938	0		
HCM Platoon Ratio	1.00	1.00	1.00	1.00	1.00	1.00		
Upstream Filter(I)	0.00	1.00	0.00	1.00	1.00	0.00		
Uniform Delay (d), s/veh	0.0	7.4	0.0	5.6	11.1	0.0		
Incr Delay (d2), s/veh	0.0	2.0	0.0	0.2	3.2	0.0		
Initial Q Delay(d3),s/veh	0.0	0.0	0.0	0.0	0.0	0.0		
%ile BackOfQ(50%),veh/ln	0.0	4.3	0.0	1.7	3.0	0.0		
LnGrp Delay(d),s/veh	0.0	9.4	0.0	5.8	14.3	0.0		
LnGrp LOS		A		A	B			
Approach Vol, veh/h	535			289	322			
Approach Delay, s/veh	9.4			5.8	14.3			
Approach LOS	A			A	B			
Timer	1	2	3	4	5	6	7	8
Assigned Phs		2	3	4				8
Phs Duration (G+Y+Rc), s		12.9	0.0	19.0				19.0
Change Period (Y+Rc), s		4.5	4.5	4.5				4.5
Max Green Setting (Gmax), s		19.0	18.0	24.5				47.0
Max Q Clear Time (g_c+I1), s		8.1	0.0	11.7				5.2
Green Ext Time (p_c), s		0.8	0.0	2.8				1.8
Intersection Summary								
HCM 2010 Ctrl Delay			9.9					
HCM 2010 LOS			A					
Notes								

Intersection				
Intersection Delay, s/veh	23.0			
Intersection LOS	C			
Approach	EB	WB		NB
Entry Lanes	1	2		1
Conflicting Circle Lanes	2	2		2
Adj Approach Flow, veh/h	547	691		639
Demand Flow Rate, veh/h	684	698		658
Vehicles Circulating, veh/h	406	10		619
Vehicles Exiting, veh/h	302	1267		471
Follow-Up Headway, s	3.186	3.186		3.186
Ped Vol Crossing Leg, #/h	0	0		0
Ped Cap Adj	1.000	1.000		1.000
Approach Delay, s/veh	27.4	6.3		37.3
Approach LOS	D	A		E
Lane	Left	Left	Right	Left
Designated Moves	TR	L	LTR	LR
Assumed Moves	TR	L	LTR	LR
RT Channelized				
Lane Util	1.000	0.530	0.470	1.000
Critical Headway, s	4.113	4.293	4.113	4.113
Entry Flow, veh/h	684	370	328	658
Cap Entry Lane, veh/h	850	1122	1122	733
Entry HV Adj Factor	0.800	0.990	0.990	0.971
Flow Entry, veh/h	547	366	325	639
Cap Entry, veh/h	680	1110	1111	711
V/C Ratio	0.804	0.330	0.292	0.898
Control Delay, s/veh	27.4	6.5	6.0	37.3
LOS	D	A	A	E
95th %tile Queue, veh	8	1	1	12



Movement	EBL	EBT	WBT	WBR	SBL	SBR		
Lane Configurations								
Traffic Volume (veh/h)	540	550	260	20	10	420		
Future Volume (veh/h)	540	550	260	20	10	420		
Number	5	2	6	16	7	14		
Initial Q (Qb), veh	0	0	0	0	0	0		
Ped-Bike Adj(A_pbT)	1.00			1.00	1.00	1.00		
Parking Bus, Adj	1.00	1.00	1.00	1.00	1.00	1.00		
Adj Sat Flow, veh/h/ln	1759	1759	1881	1881	1881	1881		
Adj Flow Rate, veh/h	568	579	274	17	11	35		
Adj No. of Lanes	1	1	1	1	2	1		
Peak Hour Factor	0.95	0.95	0.95	0.95	0.95	0.95		
Percent Heavy Veh, %	8	8	1	1	1	1		
Cap, veh/h	869	1154	1234	1049	150	69		
Arrive On Green	0.66	0.66	0.66	0.66	0.04	0.04		
Sat Flow, veh/h	1024	1759	1881	1599	3476	1599		
Grp Volume(v), veh/h	568	579	274	17	11	35		
Grp Sat Flow(s),veh/h/ln	1024	1759	1881	1599	1738	1599		
Q Serve(g_s), s	14.1	4.8	1.7	0.1	0.1	0.6		
Cycle Q Clear(g_c), s	15.7	4.8	1.7	0.1	0.1	0.6		
Prop In Lane	1.00			1.00	1.00	1.00		
Lane Grp Cap(c), veh/h	869	1154	1234	1049	150	69		
V/C Ratio(X)	0.65	0.50	0.22	0.02	0.07	0.51		
Avail Cap(c_a), veh/h	2536	4018	4297	3652	3323	1529		
HCM Platoon Ratio	1.00	1.00	1.00	1.00	1.00	1.00		
Upstream Filter(I)	1.00	1.00	1.00	1.00	1.00	1.00		
Uniform Delay (d), s/veh	5.1	2.5	2.0	1.7	13.0	13.2		
Incr Delay (d2), s/veh	0.3	0.1	0.0	0.0	0.1	2.1		
Initial Q Delay(d3),s/veh	0.0	0.0	0.0	0.0	0.0	0.0		
%ile BackOfQ(50%),veh/ln	8.9	2.3	0.8	0.0	0.0	0.3		
LnGrp Delay(d),s/veh	5.4	2.6	2.0	1.7	13.0	15.4		
LnGrp LOS	A	A	A	A	B	B		
Approach Vol, veh/h		1147	291		46			
Approach Delay, s/veh		4.0	2.0		14.8			
Approach LOS		A	A		B			
Timer	1	2	3	4	5	6	7	8
Assigned Phs		2		4		6		
Phs Duration (G+Y+Rc), s		23.5		4.7		23.5		
Change Period (Y+Rc), s		5.0		3.5		5.0		
Max Green Setting (Gmax), s		64.5		27.0		64.5		
Max Q Clear Time (g_c+I1), s		17.7		2.6		3.7		
Green Ext Time (p_c), s		0.8		0.0		0.2		
Intersection Summary								
HCM 2010 Ctrl Delay			3.9					
HCM 2010 LOS			A					

HCM 2010 Signalized Intersection Summary
 29: 2nd Avenue & Divarty Street

Existing with Project, PM
 09/18/2019



Movement	EBL	EBT	EBR	WBL	WBT	WBR	NBL	NBT	NBR	SBL	SBT	SBR
Lane Configurations		↕			↕	↕	↕	↕		↕	↕	
Traffic Volume (veh/h)	10	10	10	130	10	10	10	580	110	10	520	10
Future Volume (veh/h)	10	10	10	130	10	10	10	580	110	10	520	10
Number	5	2	12	1	6	16	3	8	18	7	4	14
Initial Q (Qb), veh	0	0	0	0	0	0	0	0	0	0	0	0
Ped-Bike Adj(A_pbT)	1.00		1.00	1.00		1.00	1.00		1.00	1.00		1.00
Parking Bus, Adj	1.00	1.00	1.00	1.00	1.00	1.00	1.00	1.00	1.00	1.00	1.00	1.00
Adj Sat Flow, veh/h/ln	1900	1667	1900	1900	1900	1900	1863	1863	1900	1881	1881	1900
Adj Flow Rate, veh/h	11	11	11	138	11	11	11	617	117	11	553	11
Adj No. of Lanes	0	1	0	0	1	1	1	2	0	1	2	0
Peak Hour Factor	0.94	0.94	0.94	0.94	0.94	0.94	0.94	0.94	0.94	0.94	0.94	0.94
Percent Heavy Veh, %	14	14	14	0	0	0	2	2	2	1	1	1
Cap, veh/h	206	169	120	517	34	393	21	1090	206	21	1316	26
Arrive On Green	0.24	0.24	0.24	0.24	0.24	0.24	0.01	0.37	0.37	0.01	0.37	0.37
Sat Flow, veh/h	293	692	492	1324	140	1613	1774	2969	562	1792	3584	71
Grp Volume(v), veh/h	33	0	0	149	0	11	11	367	367	11	276	288
Grp Sat Flow(s),veh/h/ln1477	0	0	0	1464	0	1613	1774	1770	1762	1792	1787	1868
Q Serve(g_s), s	0.0	0.0	0.0	2.4	0.0	0.2	0.2	5.9	6.0	0.2	4.1	4.1
Cycle Q Clear(g_c), s	0.6	0.0	0.0	2.9	0.0	0.2	0.2	5.9	6.0	0.2	4.1	4.1
Prop In Lane	0.33		0.33	0.93		1.00	1.00		0.32	1.00		0.04
Lane Grp Cap(c), veh/h	494	0	0	551	0	393	21	650	647	21	656	686
V/C Ratio(X)	0.07	0.00	0.00	0.27	0.00	0.03	0.54	0.57	0.57	0.53	0.42	0.42
Avail Cap(c_a), veh/h	1656	0	0	1728	0	1714	322	2078	2069	326	2099	2194
HCM Platoon Ratio	1.00	1.00	1.00	1.00	1.00	1.00	1.00	1.00	1.00	1.00	1.00	1.00
Upstream Filter(I)	1.00	0.00	0.00	1.00	0.00	1.00	1.00	1.00	1.00	1.00	1.00	1.00
Uniform Delay (d), s/veh	10.4	0.0	0.0	11.3	0.0	10.3	17.6	9.0	9.0	17.6	8.5	8.5
Incr Delay (d2), s/veh	0.1	0.0	0.0	0.3	0.0	0.0	19.9	0.8	0.8	19.4	0.4	0.4
Initial Q Delay(d3),s/veh	0.0	0.0	0.0	0.0	0.0	0.0	0.0	0.0	0.0	0.0	0.0	0.0
%ile BackOfQ(50%),veh/ln0.3	0.0	0.0	1.2	0.0	0.1	0.2	3.0	3.0	0.2	2.1	2.2	
LnGrp Delay(d),s/veh	10.5	0.0	0.0	11.6	0.0	10.3	37.5	9.8	9.8	37.0	8.9	8.9
LnGrp LOS	B			B		B	D	A	A	D	A	A
Approach Vol, veh/h		33			160			745			575	
Approach Delay, s/veh		10.5			11.5			10.2			9.4	
Approach LOS		B			B			B			A	
Timer	1	2	3	4	5	6	7	8				
Assigned Phs		2	3	4		6	7	8				
Phs Duration (G+Y+Rc), s		13.7	3.9	18.1		13.7	3.9	18.1				
Change Period (Y+Rc), s		5.0	3.5	5.0		5.0	3.5	5.0				
Max Green Setting (Gmax), s		38.0	6.5	42.0		38.0	6.5	42.0				
Max Q Clear Time (g_c+I1), s		2.6	2.2	6.1		4.9	2.2	8.0				
Green Ext Time (p_c), s		0.1	0.0	3.6		0.9	0.0	5.0				
Intersection Summary												
HCM 2010 Ctrl Delay				10.1								
HCM 2010 LOS				B								

HCM 2010 Signalized Intersection Summary
 47: General Jim Moore Boulevard & Coe Avenue

Existing with Project, PM
 09/18/2019



Movement	EBL	EBR	NBL	NBT	SBT	SBR		
Lane Configurations								
Traffic Volume (veh/h)	60	100	160	880	350	90		
Future Volume (veh/h)	60	100	160	880	350	90		
Number	3	18	1	6	2	12		
Initial Q (Qb), veh	0	0	0	0	0	0		
Ped-Bike Adj(A_pbT)	1.00	1.00	1.00			1.00		
Parking Bus, Adj	1.00	1.00	1.00	1.00	1.00	1.00		
Adj Sat Flow, veh/h/ln	1881	1881	1881	1881	1863	1863		
Adj Flow Rate, veh/h	67	15	180	989	393	21		
Adj No. of Lanes	1	1	1	2	2	1		
Peak Hour Factor	0.89	0.89	0.89	0.89	0.89	0.89		
Percent Heavy Veh, %	1	1	1	1	2	2		
Cap, veh/h	157	140	260	1927	734	328		
Arrive On Green	0.09	0.09	0.15	0.54	0.21	0.21		
Sat Flow, veh/h	1792	1599	1792	3668	3632	1583		
Grp Volume(v), veh/h	67	15	180	989	393	21		
Grp Sat Flow(s),veh/h/ln	1792	1599	1792	1787	1770	1583		
Q Serve(g_s), s	0.9	0.2	2.3	4.3	2.4	0.3		
Cycle Q Clear(g_c), s	0.9	0.2	2.3	4.3	2.4	0.3		
Prop In Lane	1.00	1.00	1.00			1.00		
Lane Grp Cap(c), veh/h	157	140	260	1927	734	328		
V/C Ratio(X)	0.43	0.11	0.69	0.51	0.54	0.06		
Avail Cap(c_a), veh/h	3380	3017	409	5262	5210	2331		
HCM Platoon Ratio	1.00	1.00	1.00	1.00	1.00	1.00		
Upstream Filter(I)	1.00	1.00	1.00	1.00	1.00	1.00		
Uniform Delay (d), s/veh	10.4	10.1	9.8	3.5	8.5	7.7		
Incr Delay (d2), s/veh	0.7	0.1	1.2	0.1	0.2	0.0		
Initial Q Delay(d3),s/veh	0.0	0.0	0.0	0.0	0.0	0.0		
%ile BackOfQ(50%),veh/ln	0.4	0.1	1.2	2.1	1.2	0.1		
LnGrp Delay(d),s/veh	11.1	10.3	11.0	3.6	8.7	7.7		
LnGrp LOS	B	B	B	A	A	A		
Approach Vol, veh/h	82			1169	414			
Approach Delay, s/veh	11.0			4.8	8.7			
Approach LOS	B			A	A			
Timer	1	2	3	4	5	6	7	8
Assigned Phs	1	2				6		8
Phs Duration (G+Y+Rc), s	8.0	9.5				17.5		6.6
Change Period (Y+Rc), s	4.5	4.5				4.5		4.5
Max Green Setting (Gmax), s	5.5	35.5				35.5		45.5
Max Q Clear Time (g_c+I), s	11.3	4.4				6.3		2.9
Green Ext Time (p_c), s	0.0	0.4				1.2		0.0
Intersection Summary								
HCM 2010 Ctrl Delay			6.0					
HCM 2010 LOS			A					

HCM 2010 Signalized Intersection Summary
5: 2nd Avenue & Imjin Parkway

Cuml w/ Proj, AM
09/06/2019



Movement	EBL	EBT	EBR	WBL	WBT	WBR	NBL	NBT	NBR	SBL	SBT	SBR
Lane Configurations	↖↗	↑↑↑	↖↗	↖↗↖	↑↑↑	↖↗	↖↗↖	↑	↖↗	↖↗	↑↑	↖↗
Traffic Volume (veh/h)	180	1160	880	520	1010	120	370	90	200	50	100	210
Future Volume (veh/h)	180	1160	880	520	1010	120	370	90	200	50	100	210
Number	5	2	12	1	6	16	3	8	18	7	4	14
Initial Q (Qb), veh	0	0	0	0	0	0	0	0	0	0	0	0
Ped-Bike Adj(A_pbT)	1.00		1.00	1.00		1.00	1.00		1.00	1.00		1.00
Parking Bus, Adj	1.00	1.00	1.00	1.00	1.00	1.00	1.00	1.00	1.00	1.00	1.00	1.00
Adj Sat Flow, veh/h/ln	1863	1863	1863	1863	1863	1863	1810	1810	1810	1900	1900	1900
Adj Flow Rate, veh/h	184	1184	679	531	1031	122	378	92	82	51	102	209
Adj No. of Lanes	2	3	2	3	3	1	3	1	2	2	2	1
Peak Hour Factor	0.98	0.98	0.98	0.98	0.98	0.98	0.98	0.98	0.98	0.98	0.98	0.98
Percent Heavy Veh, %	2	2	2	2	2	2	5	5	5	0	0	0
Cap, veh/h	297	1489	816	690	1752	627	534	378	564	182	544	382
Arrive On Green	0.09	0.29	0.29	0.14	0.34	0.34	0.11	0.21	0.21	0.05	0.15	0.15
Sat Flow, veh/h	3442	5085	2787	5003	5085	1583	4860	1810	2701	3510	3610	1612
Grp Volume(v), veh/h	184	1184	679	531	1031	122	378	92	82	51	102	209
Grp Sat Flow(s),veh/h/ln	1721	1695	1393	1668	1695	1583	1620	1810	1350	1755	1805	1612
Q Serve(g_s), s	3.0	12.4	13.2	5.9	9.7	2.9	4.4	2.5	1.4	0.8	1.4	6.6
Cycle Q Clear(g_c), s	3.0	12.4	13.2	5.9	9.7	2.9	4.4	2.5	1.4	0.8	1.4	6.6
Prop In Lane	1.00		1.00	1.00		1.00	1.00		1.00	1.00		1.00
Lane Grp Cap(c), veh/h	297	1489	816	690	1752	627	534	378	564	182	544	382
V/C Ratio(X)	0.62	0.80	0.83	0.77	0.59	0.19	0.71	0.24	0.15	0.28	0.19	0.55
Avail Cap(c_a), veh/h	392	2025	1110	906	2367	819	628	767	1145	236	1307	723
HCM Platoon Ratio	1.00	1.00	1.00	1.00	1.00	1.00	1.00	1.00	1.00	1.00	1.00	1.00
Upstream Filter(I)	1.00	1.00	1.00	1.00	1.00	1.00	1.00	1.00	1.00	1.00	1.00	1.00
Uniform Delay (d), s/veh	25.6	18.9	19.2	24.1	15.6	11.5	24.9	19.1	18.7	26.5	21.5	19.4
Incr Delay (d2), s/veh	0.8	1.1	3.0	2.0	0.1	0.1	2.1	0.1	0.0	0.3	0.1	0.5
Initial Q Delay(d3),s/veh	0.0	0.0	0.0	0.0	0.0	0.0	0.0	0.0	0.0	0.0	0.0	0.0
%ile BackOfQ(50%),veh/ln	1.5	6.0	5.3	2.8	4.5	1.3	2.0	1.2	0.5	0.4	0.7	3.0
LnGrp Delay(d),s/veh	26.4	20.0	22.2	26.1	15.7	11.5	27.1	19.2	18.8	26.8	21.6	19.9
LnGrp LOS	C	C	C	C	B	B	C	B	B	C	C	B
Approach Vol, veh/h		2047			1684			552			362	
Approach Delay, s/veh		21.3			18.7			24.5			21.3	
Approach LOS		C			B			C			C	
Timer	1	2	3	4	5	6	7	8				
Assigned Phs	1	2	3	4	5	6	7	8				
Phs Duration (G+Y+Rc), s	12.5	22.3	9.9	13.3	9.5	25.3	6.5	16.7				
Change Period (Y+Rc), s	4.5	5.3	3.5	4.6	4.5	5.3	3.5	4.6				
Max Green Setting (Gmax), s	10.5	23.1	7.5	21.0	6.6	27.0	3.9	24.6				
Max Q Clear Time (g_c+1), s	17.5	15.2	6.4	8.6	5.0	11.7	2.8	4.5				
Green Ext Time (p_c), s	0.1	1.8	0.0	0.1	0.0	1.6	0.0	0.1				
Intersection Summary												
HCM 2010 Ctrl Delay					20.7							
HCM 2010 LOS					C							

HCM 2010 Signalized Intersection Summary
 10: Imjin Road & Imjin Parkway

Cuml w/ Proj, AM
 09/06/2019



Movement	EBT	EBR	WBL	WBT	NBL	NBR		
Lane Configurations	↑↑		↵↵	↑↑	↵↵	↵		
Traffic Volume (veh/h)	900	250	550	1170	100	160		
Future Volume (veh/h)	900	250	550	1170	100	160		
Number	2	12	1	6	3	18		
Initial Q (Qb), veh	0	0	0	0	0	0		
Ped-Bike Adj(A_pbT)		1.00	1.00		1.00	1.00		
Parking Bus, Adj	1.00	1.00	1.00	1.00	1.00	1.00		
Adj Sat Flow, veh/h/ln	1863	1900	1845	1845	1810	1810		
Adj Flow Rate, veh/h	947	250	579	1232	91	183		
Adj No. of Lanes	2	0	2	2	1	2		
Peak Hour Factor	0.95	0.95	0.95	0.95	0.95	0.95		
Percent Heavy Veh, %	2	2	3	3	5	5		
Cap, veh/h	1216	320	736	2575	180	321		
Arrive On Green	0.44	0.44	0.22	0.73	0.10	0.10		
Sat Flow, veh/h	2866	730	3408	3597	1723	3076		
Grp Volume(v), veh/h	604	593	579	1232	91	183		
Grp Sat Flow(s),veh/h/ln	1770	1734	1704	1752	1723	1538		
Q Serve(g_s), s	16.3	16.4	9.0	8.0	2.8	3.2		
Cycle Q Clear(g_c), s	16.3	16.4	9.0	8.0	2.8	3.2		
Prop In Lane		0.42	1.00		1.00	1.00		
Lane Grp Cap(c), veh/h	776	760	736	2575	180	321		
V/C Ratio(X)	0.78	0.78	0.79	0.48	0.51	0.57		
Avail Cap(c_a), veh/h	1009	988	1005	3313	557	995		
HCM Platoon Ratio	1.00	1.00	1.00	1.00	1.00	1.00		
Upstream Filter(I)	1.00	1.00	1.00	1.00	1.00	1.00		
Uniform Delay (d), s/veh	13.4	13.4	20.7	3.0	23.7	23.9		
Incr Delay (d2), s/veh	2.9	3.1	2.9	0.1	2.2	1.6		
Initial Q Delay(d3),s/veh	0.0	0.0	0.0	0.0	0.0	0.0		
%ile BackOfQ(50%),veh/ln	8.5	8.4	4.5	3.8	1.4	1.4		
LnGrp Delay(d),s/veh	16.3	16.5	23.7	3.2	25.9	25.5		
LnGrp LOS	B	B	C	A	C	C		
Approach Vol, veh/h	1197			1811	274			
Approach Delay, s/veh	16.4			9.7	25.6			
Approach LOS	B			A	C			
Timer	1	2	3	4	5	6	7	8
Assigned Phs	1	2				6		8
Phs Duration (G+Y+Rc), s	16.6	29.0				45.6		10.3
Change Period (Y+Rc), s	4.5	4.5				4.5		4.5
Max Green Setting (Gmax), s	16.5	31.9				52.9		18.1
Max Q Clear Time (g_c+I1), s	16.5	18.4				10.0		5.2
Green Ext Time (p_c), s	1.1	6.2				10.9		0.8
Intersection Summary								
HCM 2010 Ctrl Delay			13.5					
HCM 2010 LOS			B					
Notes								

HCM 2010 Roundabout
10: Imjin Road & Imjin Parkway

Cumulative with Project (Roundabouts), AM
04/22/2022

Intersection						
Intersection Delay, s/veh	28.7					
Intersection LOS	D					
Approach	EB		WB		NB	
Entry Lanes	2		2		2	
Conflicting Circle Lanes	2		2		2	
Adj Approach Flow, veh/h	1210		1811		273	
Demand Flow Rate, veh/h	1234		1865		286	
Vehicles Circulating, veh/h	596		110		966	
Vehicles Exiting, veh/h	1379		1142		864	
Follow-Up Headway, s	3.186		3.186		3.186	
Ped Vol Crossing Leg, #/h	0		0		0	
Ped Cap Adj	1.000		1.000		1.000	
Approach Delay, s/veh	30.4		30.4		10.4	
Approach LOS	D		D		B	
Lane	Left	Right	Left	Right	Left	Right
Designated Moves	LT	TR	LT	TR	L	TR
Assumed Moves	LT	TR	LT	TR	L	TR
RT Channelized						
Lane Util	0.470	0.530	0.470	0.530	0.385	0.615
Critical Headway, s	4.293	4.113	4.293	4.113	4.293	4.113
Entry Flow, veh/h	580	654	877	988	110	176
Cap Entry Lane, veh/h	723	745	1040	1046	548	575
Entry HV Adj Factor	0.981	0.981	0.971	0.972	0.955	0.955
Flow Entry, veh/h	569	641	851	960	105	168
Cap Entry, veh/h	709	730	1010	1016	523	549
V/C Ratio	0.803	0.878	0.843	0.944	0.201	0.306
Control Delay, s/veh	26.4	33.9	23.4	36.5	9.6	11.0
LOS	D	D	C	E	A	B
95th %tile Queue, veh	8	11	11	16	1	1

HCM 2010 Roundabout
11: Abrams Drive & Imjin Parkway

Cumulative with Project (Roundabouts), AM
04/22/2022

Intersection									
Intersection Delay, s/veh	26.5								
Intersection LOS	D								
Approach	EB		WB		NB		SB		
Entry Lanes	2		2		1		1		
Conflicting Circle Lanes	2		2		2		2		
Adj Approach Flow, veh/h	1043		1516		473		420		
Demand Flow Rate, veh/h	1054		1546		487		428		
Vehicles Circulating, veh/h	253		442		1066		1824		
Vehicles Exiting, veh/h	1725		1011		241		164		
Follow-Up Headway, s	3.186		3.186		3.186		3.186		
Ped Vol Crossing Leg, #/h	0		1		0		1		
Ped Cap Adj	1.000		0.999		1.000		1.000		
Approach Delay, s/veh	11.6		43.3		21.0		8.9		
Approach LOS	B		E		C		A		
Lane	Left	Right	Left	Right	Left	Bypass	Left	Bypass	
Designated Moves	LT	TR	LT	TR	LT	R	LT	R	
Assumed Moves	LT	TR	LT	TR	LT	R	LT	R	
RT Channelized						Free		Free	
Lane Util	0.470	0.530	0.470	0.530	1.000		1.000		
Critical Headway, s	4.293	4.113	4.293	4.113	4.113		4.113		
Entry Flow, veh/h	495	559	727	819	387	100	154	274	
Cap Entry Lane, veh/h	935	947	811	829	536	1957	315	1938	
Entry HV Adj Factor	0.990	0.989	0.980	0.981	0.972	0.971	0.980	0.980	
Flow Entry, veh/h	490	553	713	804	376	97	151	269	
Cap Entry, veh/h	926	936	794	813	521	1900	309	1900	
V/C Ratio	0.530	0.591	0.897	0.988	0.722	0.051	0.489	0.142	
Control Delay, s/veh	10.8	12.2	34.5	51.2	26.5	0.0	24.7	0.0	
LOS	B	B	D	F	D	A	C	A	
95th %tile Queue, veh	3	4	12	17	6	0	3	0	

HCM 2010 Signalized Intersection Summary
 12: Reservation Road & Imjin Parkway

Cuml w/ Proj, AM
 09/06/2019



Movement	EBL	EBT	EBR	WBL	WBT	WBR	NBL	NBT	NBR	SBL	SBT	SBR
Lane Configurations												
Traffic Volume (veh/h)	180	50	810	10	20	30	1220	890	20	60	590	90
Future Volume (veh/h)	180	50	810	10	20	30	1220	890	20	60	590	90
Number	3	8	18	7	4	14	1	6	16	5	2	12
Initial Q (Qb), veh	0	0	0	0	0	0	0	0	0	0	0	0
Ped-Bike Adj(A_pbT)	1.00		1.00	1.00		0.99	1.00		1.00	1.00		0.98
Parking Bus, Adj	1.00	1.00	1.00	1.00	1.00	1.00	1.00	1.00	1.00	1.00	1.00	1.00
Adj Sat Flow, veh/h/ln	1863	1863	1863	1638	1638	1638	1863	1863	1863	1863	1863	1863
Adj Flow Rate, veh/h	194	54	457	11	22	19	1312	957	16	65	634	34
Adj No. of Lanes	2	1	2	1	1	1	2	2	1	2	3	1
Peak Hour Factor	0.93	0.93	0.93	0.93	0.93	0.93	0.93	0.93	0.93	0.93	0.93	0.93
Percent Heavy Veh, %	2	2	2	16	16	16	2	2	2	2	2	2
Cap, veh/h	472	256	1405	55	58	49	1265	2033	908	119	1228	376
Arrive On Green	0.14	0.14	0.14	0.04	0.04	0.04	0.37	0.57	0.57	0.03	0.24	0.24
Sat Flow, veh/h	3442	1863	2777	1560	1638	1382	3442	3539	1581	3442	5085	1557
Grp Volume(v), veh/h	194	54	457	11	22	19	1312	957	16	65	634	34
Grp Sat Flow(s),veh/h/ln	1721	1863	1388	1560	1638	1382	1721	1770	1581	1721	1695	1557
Q Serve(g_s), s	4.9	2.5	9.3	0.7	1.3	1.3	35.0	15.0	0.4	1.8	10.3	1.6
Cycle Q Clear(g_c), s	4.9	2.5	9.3	0.7	1.3	1.3	35.0	15.0	0.4	1.8	10.3	1.6
Prop In Lane	1.00		1.00	1.00		1.00	1.00		1.00	1.00		1.00
Lane Grp Cap(c), veh/h	472	256	1405	55	58	49	1265	2033	908	119	1228	376
V/C Ratio(X)	0.41	0.21	0.33	0.20	0.38	0.39	1.04	0.47	0.02	0.55	0.52	0.09
Avail Cap(c_a), veh/h	1265	684	2044	508	533	450	1265	2033	908	723	3203	981
HCM Platoon Ratio	1.00	1.00	1.00	1.00	1.00	1.00	1.00	1.00	1.00	1.00	1.00	1.00
Upstream Filter(I)	1.00	1.00	1.00	1.00	1.00	1.00	1.00	1.00	1.00	1.00	1.00	1.00
Uniform Delay (d), s/veh	37.6	36.5	14.0	44.6	44.9	44.9	30.1	11.8	8.7	45.3	31.3	28.0
Incr Delay (d2), s/veh	0.2	0.2	0.0	0.7	1.5	1.9	35.5	0.5	0.0	1.5	0.9	0.3
Initial Q Delay(d3),s/veh	0.0	0.0	0.0	0.0	0.0	0.0	0.0	0.0	0.0	0.0	0.0	0.0
%ile BackOfQ(50%),veh/ln	2.4	1.3	3.6	0.3	0.6	0.5	22.8	7.4	0.2	0.9	4.9	0.7
LnGrp Delay(d),s/veh	37.8	36.7	14.0	45.3	46.4	46.8	65.7	12.3	8.7	46.7	32.2	28.3
LnGrp LOS	D	D	B	D	D	D	F	B	A	D	C	C
Approach Vol, veh/h		705			52			2285			733	
Approach Delay, s/veh		22.3			46.3			42.9			33.3	
Approach LOS		C			D			D			C	
Timer	1	2	3	4	5	6	7	8				
Assigned Phs	1	2		4	5	6		8				
Phs Duration (G+Y+Rc), s	39.1	29.2		8.4	7.4	60.9		18.6				
Change Period (Y+Rc), s	4.1	* 6.2		5.0	4.1	* 6.2		5.5				
Max Green Setting (Gmax), s	35.0	* 60		31.0	20.0	* 50		35.0				
Max Q Clear Time (g_c+R), s	17.0	12.3		3.3	3.8	17.0		11.3				
Green Ext Time (p_c), s	0.0	10.6		0.1	0.0	15.4		1.5				
Intersection Summary												
HCM 2010 Ctrl Delay			37.2									
HCM 2010 LOS			D									
Notes												

HCM 2010 Signalized Intersection Summary
 14: Reservation Road & Inter-Garrison Road

Cuml w/ Proj, AM
 09/06/2019



Movement	EBL	EBR	NBL	NBT	SBT	SBR		
Lane Configurations								
Traffic Volume (veh/h)	190	370	600	600	310	190		
Future Volume (veh/h)	190	370	600	600	310	190		
Number	3	18	1	6	2	12		
Initial Q (Qb), veh	0	0	0	0	0	0		
Ped-Bike Adj(A_pbT)	1.00	1.00	1.00			1.00		
Parking Bus, Adj	1.00	1.00	1.00	1.00	1.00	1.00		
Adj Sat Flow, veh/h/ln	1845	1845	1863	1863	1845	1900		
Adj Flow Rate, veh/h	202	355	638	638	330	186		
Adj No. of Lanes	1	2	2	2	2	0		
Peak Hour Factor	0.94	0.94	0.94	0.94	0.94	0.94		
Percent Heavy Veh, %	3	3	2	2	3	3		
Cap, veh/h	323	1146	796	2139	615	340		
Arrive On Green	0.18	0.18	0.23	0.60	0.28	0.28		
Sat Flow, veh/h	1757	2760	3442	3632	2273	1204		
Grp Volume(v), veh/h	202	355	638	638	264	252		
Grp Sat Flow(s),veh/h/ln	1757	1380	1721	1770	1752	1632		
Q Serve(g_s), s	5.5	4.4	9.0	4.5	6.6	6.8		
Cycle Q Clear(g_c), s	5.5	4.4	9.0	4.5	6.6	6.8		
Prop In Lane	1.00	1.00	1.00			0.74		
Lane Grp Cap(c), veh/h	323	1146	796	2139	494	460		
V/C Ratio(X)	0.62	0.31	0.80	0.30	0.53	0.55		
Avail Cap(c_a), veh/h	920	2084	1335	4120	2040	1900		
HCM Platoon Ratio	1.00	1.00	1.00	1.00	1.00	1.00		
Upstream Filter(I)	1.00	1.00	1.00	1.00	1.00	1.00		
Uniform Delay (d), s/veh	19.4	10.1	18.7	4.9	15.6	15.7		
Incr Delay (d2), s/veh	2.0	0.2	0.7	0.1	1.7	1.9		
Initial Q Delay(d3),s/veh	0.0	0.0	0.0	0.0	0.0	0.0		
%ile BackOfQ(50%),veh/ln	2.8	1.7	4.3	2.2	3.4	3.3		
LnGrp Delay(d),s/veh	21.4	10.3	19.4	5.1	17.3	17.6		
LnGrp LOS	C	B	B	A	B	B		
Approach Vol, veh/h	557			1276	516			
Approach Delay, s/veh	14.3			12.2	17.5			
Approach LOS	B			B	B			
Timer	1	2	3	4	5	6	7	8
Assigned Phs	1	2				6		8
Phs Duration (G+Y+Rc), s	6.6	20.9				37.6		14.0
Change Period (Y+Rc), s	4.7	6.4				6.4		4.5
Max Green Setting (Gmax), s	60.0	60.0				60.0		27.0
Max Q Clear Time (g_c+I1), s	8.8	8.8				6.5		7.5
Green Ext Time (p_c), s	0.9	5.8				8.1		2.0
Intersection Summary								
HCM 2010 Ctrl Delay			13.9					
HCM 2010 LOS			B					
Notes								

HCM 2010 Signalized Intersection Summary
 22: 8th Avenue & Inter-Garrison Road

Cuml w/ Proj, AM
 09/06/2019



Movement	EBT	EBR	WBL	WBT	NBL	NBR		
Lane Configurations								
Traffic Volume (veh/h)	240	250	750	570	50	410		
Future Volume (veh/h)	240	250	750	570	50	410		
Number	4	14	3	8	5	12		
Initial Q (Qb), veh	0	0	0	0	0	0		
Ped-Bike Adj(A_pbT)		1.00	1.00		1.00	1.00		
Parking Bus, Adj	1.00	1.00	1.00	1.00	1.00	1.00		
Adj Sat Flow, veh/h/ln	1505	1881	1881	1881	1845	1900		
Adj Flow Rate, veh/h	276	169	862	655	57	230		
Adj No. of Lanes	1	0	2	1	0	0		
Peak Hour Factor	0.87	0.87	0.87	0.87	0.87	0.87		
Percent Heavy Veh, %	25	25	1	1	0	0		
Cap, veh/h	299	183	1029	1362	33	134		
Arrive On Green	0.34	0.34	0.30	0.72	0.10	0.10		
Sat Flow, veh/h	875	536	3476	1881	317	1280		
Grp Volume(v), veh/h	0	445	862	655	288	0		
Grp Sat Flow(s),veh/h/ln	0	1410	1738	1881	1603	0		
Q Serve(g_s), s	0.0	15.9	12.2	7.7	5.5	0.0		
Cycle Q Clear(g_c), s	0.0	15.9	12.2	7.7	5.5	0.0		
Prop In Lane		0.38	1.00		0.20	0.80		
Lane Grp Cap(c), veh/h	0	482	1029	1362	168	0		
V/C Ratio(X)	0.00	0.92	0.84	0.48	1.72	0.00		
Avail Cap(c_a), veh/h	0	484	1192	1451	168	0		
HCM Platoon Ratio	1.00	1.00	1.00	1.00	1.00	1.00		
Upstream Filter(I)	0.00	1.00	1.00	1.00	1.00	0.00		
Uniform Delay (d), s/veh	0.0	16.6	17.3	3.1	23.5	0.0		
Incr Delay (d2), s/veh	0.0	23.4	4.8	0.3	345.7	0.0		
Initial Q Delay(d3),s/veh	0.0	0.0	0.0	0.0	0.0	0.0		
%ile BackOfQ(50%),veh/ln	0.0	9.3	6.4	3.9	18.5	0.0		
LnGrp Delay(d),s/veh	0.0	40.0	22.1	3.3	369.2	0.0		
LnGrp LOS		D	C	A	F			
Approach Vol, veh/h	445			1517	288			
Approach Delay, s/veh	40.0			14.0	369.2			
Approach LOS	D			B	F			
Timer	1	2	3	4	5	6	7	8
Assigned Phs		2	3	4				8
Phs Duration (G+Y+Rc), s		10.0	20.1	22.5				42.5
Change Period (Y+Rc), s		4.5	4.5	4.5				4.5
Max Green Setting (Gmax), s		5.5	18.0	18.0				40.5
Max Q Clear Time (g_c+I1), s		7.5	14.2	17.9				9.7
Green Ext Time (p_c), s		0.0	1.4	0.0				4.8
Intersection Summary								
HCM 2010 Ctrl Delay			64.6					
HCM 2010 LOS			E					
Notes								

Intersection				
Intersection Delay, s/veh	36.2			
Intersection LOS	E			
Approach	EB	WB	NB	
Entry Lanes	1	2	1	
Conflicting Circle Lanes	2	2	2	
Adj Approach Flow, veh/h	563	1517	528	
Demand Flow Rate, veh/h	704	1533	544	
Vehicles Circulating, veh/h	871	59	345	
Vehicles Exiting, veh/h	721	830	1230	
Follow-Up Headway, s	3.186	3.186	3.186	
Ped Vol Crossing Leg, #/h	0	0	0	
Ped Cap Adj	1.000	1.000	1.000	
Approach Delay, s/veh	115.0	14.9	13.6	
Approach LOS	F	B	B	
Lane	Left	Left	Right	Left
Designated Moves	TR	L	LTR	LR
Assumed Moves	TR	L	LTR	LR
RT Channelized				
Lane Util	1.000	0.530	0.470	1.000
Critical Headway, s	4.113	4.293	4.113	4.113
Entry Flow, veh/h	704	812	721	544
Cap Entry Lane, veh/h	614	1081	1084	888
Entry HV Adj Factor	0.800	0.990	0.989	0.971
Flow Entry, veh/h	563	804	713	528
Cap Entry, veh/h	491	1071	1072	861
V/C Ratio	1.146	0.751	0.665	0.613
Control Delay, s/veh	115.0	16.5	13.1	13.6
LOS	F	C	B	B
95th %tile Queue, veh	20	7	5	4

HCM 2010 Signalized Intersection Summary
 23: Inter-Garrison Road & Abrams Drive

Cuml w/ Proj, AM
 09/06/2019



Movement	EBL	EBT	WBT	WBR	SBL	SBR		
Lane Configurations	↖↗	↑	↑	↖	↖↗	↖		
Traffic Volume (veh/h)	260	390	820	10	40	500		
Future Volume (veh/h)	260	390	820	10	40	500		
Number	5	2	6	16	7	14		
Initial Q (Qb), veh	0	0	0	0	0	0		
Ped-Bike Adj(A_pbT)	1.00			1.00	1.00	1.00		
Parking Bus, Adj	1.00	1.00	1.00	1.00	1.00	1.00		
Adj Sat Flow, veh/h/ln	1759	1759	1881	1881	1881	1881		
Adj Flow Rate, veh/h	306	459	965	6	47	370		
Adj No. of Lanes	2	1	1	1	2	1		
Peak Hour Factor	0.85	0.85	0.85	0.85	0.85	0.85		
Percent Heavy Veh, %	8	8	1	1	1	1		
Cap, veh/h	337	1168	986	838	861	396		
Arrive On Green	0.10	0.66	0.52	0.52	0.25	0.25		
Sat Flow, veh/h	3250	1759	1881	1599	3476	1599		
Grp Volume(v), veh/h	306	459	965	6	47	370		
Grp Sat Flow(s),veh/h/ln	1625	1759	1881	1599	1738	1599		
Q Serve(g_s), s	9.0	11.4	48.3	0.2	1.0	21.8		
Cycle Q Clear(g_c), s	9.0	11.4	48.3	0.2	1.0	21.8		
Prop In Lane	1.00			1.00	1.00	1.00		
Lane Grp Cap(c), veh/h	337	1168	986	838	861	396		
V/C Ratio(X)	0.91	0.39	0.98	0.01	0.05	0.93		
Avail Cap(c_a), veh/h	337	1178	996	847	974	448		
HCM Platoon Ratio	1.00	1.00	1.00	1.00	1.00	1.00		
Upstream Filter(I)	1.00	1.00	1.00	1.00	1.00	1.00		
Uniform Delay (d), s/veh	42.7	7.4	22.4	11.0	27.6	35.5		
Incr Delay (d2), s/veh	26.4	0.1	23.2	0.0	0.0	24.1		
Initial Q Delay(d3),s/veh	0.0	0.0	0.0	0.0	0.0	0.0		
%ile BackOfQ(50%),veh/ln	5.3	5.5	31.3	0.1	0.5	20.0		
LnGrp Delay(d),s/veh	69.1	7.4	45.7	11.0	27.6	59.6		
LnGrp LOS	E	A	D	B	C	E		
Approach Vol, veh/h		765	971		417			
Approach Delay, s/veh		32.1	45.4		56.0			
Approach LOS		C	D		E			
Timer	1	2	3	4	5	6	7	8
Assigned Phs		2		4	5	6		
Phs Duration (G+Y+Rc), s		69.0		27.4	13.5	55.5		
Change Period (Y+Rc), s		5.0		3.5	3.5	5.0		
Max Green Setting (Gmax), s		64.5		27.0	10.0	51.0		
Max Q Clear Time (g_c+I1), s		13.4		23.8	11.0	50.3		
Green Ext Time (p_c), s		0.4		0.0	0.0	0.2		
Intersection Summary								
HCM 2010 Ctrl Delay			42.7					
HCM 2010 LOS			D					

HCM 2010 Signalized Intersection Summary
 28: Davis Road & Reservation Road

Cuml w/ Proj, AM
 09/06/2019



Movement	EBL	EBT	EBR	WBL	WBT	WBR	NBL	NBT	NBR	SBL	SBT	SBR
Lane Configurations												
Traffic Volume (veh/h)	550	310	10	10	560	90	10	10	10	150	10	640
Future Volume (veh/h)	550	310	10	10	560	90	10	10	10	150	10	640
Number	5	2	12	1	6	16	3	8	18	7	4	14
Initial Q (Qb), veh	0	0	0	0	0	0	0	0	0	0	0	0
Ped-Bike Adj(A_pbT)	1.00		1.00	1.00		1.00	1.00		1.00	1.00		1.00
Parking Bus, Adj	1.00	1.00	1.00	1.00	1.00	1.00	1.00	1.00	1.00	1.00	1.00	1.00
Adj Sat Flow, veh/h/ln	1863	1863	1900	1863	1863	1900	1900	1900	1900	1900	1845	1845
Adj Flow Rate, veh/h	640	360	12	12	651	105	12	12	9	174	12	502
Adj No. of Lanes	2	2	0	1	1	0	0	1	0	0	1	1
Peak Hour Factor	0.86	0.86	0.86	0.86	0.86	0.86	0.86	0.86	0.86	0.86	0.86	0.86
Percent Heavy Veh, %	2	2	2	2	2	2	0	0	0	3	3	3
Cap, veh/h	684	2155	72	19	672	108	17	17	13	358	25	652
Arrive On Green	0.20	0.62	0.62	0.01	0.43	0.43	0.03	0.03	0.03	0.22	0.22	0.22
Sat Flow, veh/h	3442	3496	116	1774	1566	253	648	648	486	1649	114	1568
Grp Volume(v), veh/h	640	182	190	12	0	756	33	0	0	186	0	502
Grp Sat Flow(s),veh/h/ln	1721	1770	1842	1774	0	1818	1782	0	0	1762	0	1568
Q Serve(g_s), s	25.3	6.1	6.1	0.9	0.0	56.1	2.5	0.0	0.0	12.8	0.0	30.0
Cycle Q Clear(g_c), s	25.3	6.1	6.1	0.9	0.0	56.1	2.5	0.0	0.0	12.8	0.0	30.0
Prop In Lane	1.00		0.06	1.00		0.14	0.36		0.27	0.94		1.00
Lane Grp Cap(c), veh/h	684	1091	1136	19	0	780	46	0	0	383	0	652
V/C Ratio(X)	0.94	0.17	0.17	0.63	0.00	0.97	0.71	0.00	0.00	0.49	0.00	0.77
Avail Cap(c_a), veh/h	748	1091	1136	385	0	790	387	0	0	383	0	652
HCM Platoon Ratio	1.00	1.00	1.00	1.00	1.00	1.00	1.00	1.00	1.00	1.00	1.00	1.00
Upstream Filter(I)	1.00	1.00	1.00	1.00	0.00	1.00	1.00	0.00	0.00	1.00	0.00	1.00
Uniform Delay (d), s/veh	54.4	11.3	11.3	68.0	0.0	38.5	66.7	0.0	0.0	47.3	0.0	34.6
Incr Delay (d2), s/veh	17.4	0.1	0.1	12.2	0.0	24.7	7.3	0.0	0.0	0.4	0.0	5.1
Initial Q Delay(d3),s/veh	0.0	0.0	0.0	0.0	0.0	0.0	0.0	0.0	0.0	0.0	0.0	0.0
%ile BackOfQ(50%),veh/ln	13.7	3.0	3.1	0.5	0.0	33.5	1.3	0.0	0.0	6.2	0.0	17.3
LnGrp Delay(d),s/veh	71.9	11.4	11.4	80.2	0.0	63.2	74.0	0.0	0.0	47.7	0.0	39.7
LnGrp LOS	E	B	B	F		E	E			D		D
Approach Vol, veh/h		1012			768			33			688	
Approach Delay, s/veh		49.7			63.5			74.0			41.8	
Approach LOS		D			E			E			D	
Timer	1	2	3	4	5	6	7	8				
Assigned Phs	1	2		4	5	6		8				
Phs Duration (G+Y+Rc), s	90.1			35.0	31.3	64.2		7.6				
Change Period (Y+Rc), s	3.9	5.0		5.0	* 3.8	5.0		4.0				
Max Green Setting (Gmax), s	30	60.0		30.0	* 30	60.0		30.0				
Max Q Clear Time (g_c+I), s	12.5	8.1		32.0	27.3	58.1		4.5				
Green Ext Time (p_c), s	0.0	3.3		0.0	0.2	1.1		0.0				
Intersection Summary												
HCM 2010 Ctrl Delay				52.1								
HCM 2010 LOS				D								
Notes												

HCM 2010 Signalized Intersection Summary
 33: General Jim Moore Boulevard & Lightfighter Drive

Cuml w/ Proj, AM
 09/06/2019



Movement	EBL	EBT	EBR	WBL	WBT	WBR	NBL	NBT	NBR	SBL	SBT	SBR
Lane Configurations	↖↗	↑	↖	↖↗	↖↗		↖↗	↖↗		↖	↑↑	↖
Traffic Volume (veh/h)	50	280	880	20	170	70	810	70	10	40	50	20
Future Volume (veh/h)	50	280	880	20	170	70	810	70	10	40	50	20
Number	3	8	18	7	4	14	1	6	16	5	2	12
Initial Q (Qb), veh	0	0	0	0	0	0	0	0	0	0	0	0
Ped-Bike Adj(A_pbT)	1.00		1.00	1.00		1.00	1.00		1.00	1.00		0.99
Parking Bus, Adj	1.00	1.00	1.00	1.00	1.00	1.00	1.00	1.00	1.00	1.00	1.00	1.00
Adj Sat Flow, veh/h/ln	1863	1863	1863	1792	1792	1900	1881	1881	1900	1863	1863	1863
Adj Flow Rate, veh/h	56	315	0	22	191	77	910	79	10	45	56	22
Adj No. of Lanes	2	1	1	2	2	0	3	2	0	1	2	1
Peak Hour Factor	0.89	0.89	0.89	0.89	0.89	0.89	0.89	0.89	0.89	0.89	0.89	0.89
Percent Heavy Veh, %	2	2	2	6	6	6	1	1	1	2	2	2
Cap, veh/h	190	423	359	88	475	185	1260	1011	126	84	403	267
Arrive On Green	0.06	0.23	0.00	0.03	0.20	0.20	0.25	0.32	0.32	0.05	0.11	0.11
Sat Flow, veh/h	3442	1863	1583	3312	2395	932	5052	3199	398	1774	3539	1575
Grp Volume(v), veh/h	56	315	0	22	134	134	910	44	45	45	56	22
Grp Sat Flow(s),veh/h/ln	1863	1863	1583	1656	1703	1625	1684	1787	1810	1774	1770	1575
Q Serve(g_s), s	0.7	7.4	0.0	0.3	3.2	3.4	7.7	0.8	0.8	1.2	0.7	0.6
Cycle Q Clear(g_c), s	0.7	7.4	0.0	0.3	3.2	3.4	7.7	0.8	0.8	1.2	0.7	0.6
Prop In Lane	1.00		1.00	1.00		0.57	1.00		0.22	1.00		1.00
Lane Grp Cap(c), veh/h	190	423	359	88	338	322	1260	565	572	84	403	267
V/C Ratio(X)	0.29	0.75	0.00	0.25	0.40	0.42	0.72	0.08	0.08	0.54	0.14	0.08
Avail Cap(c_a), veh/h	366	714	607	353	653	623	1668	1058	1072	234	1394	708
HCM Platoon Ratio	1.00	1.00	1.00	1.00	1.00	1.00	1.00	1.00	1.00	1.00	1.00	1.00
Upstream Filter(I)	1.00	1.00	0.00	1.00	1.00	1.00	1.00	1.00	1.00	1.00	1.00	1.00
Uniform Delay (d), s/veh	21.3	16.9	0.0	22.4	16.4	16.5	16.1	11.3	11.3	21.9	18.7	16.4
Incr Delay (d2), s/veh	0.9	2.6	0.0	1.5	0.8	0.9	1.1	0.1	0.1	5.2	0.2	0.1
Initial Q Delay(d3),s/veh	0.0	0.0	0.0	0.0	0.0	0.0	0.0	0.0	0.0	0.0	0.0	0.0
%ile BackOfQ(50%),veh/ln	0.4	4.1	0.0	0.2	1.6	1.6	3.7	0.4	0.4	0.7	0.3	0.2
LnGrp Delay(d),s/veh	22.2	19.5	0.0	23.9	17.1	17.3	17.2	11.3	11.3	27.1	18.9	16.6
LnGrp LOS	C	B		C	B	B	B	B	B	C	B	B
Approach Vol, veh/h		371			290			999			123	
Approach Delay, s/veh		19.9			17.7			16.7			21.5	
Approach LOS		B			B			B			C	
Timer	1	2	3	4	5	6	7	8				
Assigned Phs	1	2	3	4	5	6	7	8				
Phs Duration (G+Y+Rc), s	16.2	9.8	7.1	13.8	6.7	19.3	5.7	15.2				
Change Period (Y+Rc), s	4.5	4.5	4.5	4.5	4.5	4.5	4.5	4.5				
Max Green Setting (Gmax), s	15.5	18.5	5.0	18.0	6.2	27.8	5.0	18.0				
Max Q Clear Time (g_c+I), s	19.7	2.7	2.7	5.4	3.2	2.8	2.3	9.4				
Green Ext Time (p_c), s	2.0	0.2	0.0	1.3	0.0	0.4	0.0	1.1				
Intersection Summary												
HCM 2010 Ctrl Delay				17.8								
HCM 2010 LOS				B								

HCM 2010 Roundabout
33: General Jim Moore Boulevard & Lightfighter Drive

Cumulative with Project (Roundabouts), AM

04/22/2022

Intersection									
Intersection Delay, s/veh	13.7								
Intersection LOS	B								
Approach	EB		WB		NB		SB		
Entry Lanes	2		2		2		2		
Conflicting Circle Lanes	2		2		2		2		
Adj Approach Flow, veh/h	1360		292		1000		123		
Demand Flow Rate, veh/h	1387		309		1010		125		
Vehicles Circulating, veh/h	126		1056		424		1144		
Vehicles Exiting, veh/h	1143		378		1089		221		
Follow-Up Headway, s	3.186		3.186		3.186		3.186		
Ped Vol Crossing Leg, #/h	2		1		2		0		
Ped Cap Adj	0.998		1.000		0.999		1.000		
Approach Delay, s/veh	14.2		11.7		14.2		9.1		
Approach LOS	B		B		B		A		
Lane	Left	Right	Left	Right	Left	Right	Left	Right	
Designated Moves	LTR	R	LT	TR	L	LTR	LT	TR	
Assumed Moves	LTR	R	LT	TR	L	LTR	LT	TR	
RT Channelized									
Lane Util	0.470	0.530	0.469	0.531	0.530	0.470	0.472	0.528	
Critical Headway, s	4.293	4.113	4.293	4.113	4.293	4.113	4.293	4.113	
Entry Flow, veh/h	652	735	145	164	535	475	59	66	
Cap Entry Lane, veh/h	1028	1035	512	540	822	840	479	507	
Entry HV Adj Factor	0.980	0.980	0.945	0.942	0.991	0.990	0.979	0.987	
Flow Entry, veh/h	639	721	137	155	530	470	58	65	
Cap Entry, veh/h	1006	1012	484	508	813	830	469	501	
V/C Ratio	0.636	0.712	0.283	0.304	0.652	0.566	0.123	0.130	
Control Delay, s/veh	12.8	15.4	11.8	11.7	15.6	12.7	9.4	8.9	
LOS	B	C	B	B	C	B	A	A	
95th %tile Queue, veh	5	6	1	1	5	4	0	0	

HCM 2010 Signalized Intersection Summary
 39: General Jim Moore Boulevard & Gigling Road

Cuml w/ Proj, AM
 09/06/2019



Movement	EBL	EBT	EBR	WBL	WBT	WBR	NBL	NBT	NBR	SBL	SBT	SBR
Lane Configurations												
Traffic Volume (veh/h)	30	100	80	510	40	410	50	410	280	310	650	50
Future Volume (veh/h)	30	100	80	510	40	410	50	410	280	310	650	50
Number	3	8	18	7	4	14	1	6	16	5	2	12
Initial Q (Qb), veh	0	0	0	0	0	0	0	0	0	0	0	0
Ped-Bike Adj(A_pbT)	1.00		1.00	1.00		1.00	1.00		1.00	1.00		1.00
Parking Bus, Adj	1.00	1.00	1.00	1.00	1.00	1.00	1.00	1.00	1.00	1.00	1.00	1.00
Adj Sat Flow, veh/h/ln	1810	1810	1900	1863	1863	1863	1881	1881	1881	1863	1863	1863
Adj Flow Rate, veh/h	34	115	60	586	46	0	57	471	0	356	747	0
Adj No. of Lanes	1	2	0	2	2	1	1	2	1	1	2	1
Peak Hour Factor	0.87	0.87	0.87	0.87	0.87	0.87	0.87	0.87	0.87	0.87	0.87	0.87
Percent Heavy Veh, %	5	5	5	2	2	2	1	1	1	2	2	2
Cap, veh/h	148	205	101	689	730	327	93	608	272	405	1226	548
Arrive On Green	0.09	0.09	0.09	0.20	0.21	0.00	0.05	0.17	0.00	0.23	0.35	0.00
Sat Flow, veh/h	1723	2232	1098	3442	3539	1583	1792	3574	1599	1774	3539	1583
Grp Volume(v), veh/h	34	87	88	586	46	0	57	471	0	356	747	0
Grp Sat Flow(s),veh/h/ln	1723	1719	1611	1721	1770	1583	1792	1787	1599	1774	1770	1583
Q Serve(g_s), s	1.1	2.8	3.0	9.5	0.6	0.0	1.8	7.3	0.0	11.3	10.2	0.0
Cycle Q Clear(g_c), s	1.1	2.8	3.0	9.5	0.6	0.0	1.8	7.3	0.0	11.3	10.2	0.0
Prop In Lane	1.00		0.68	1.00		1.00	1.00		1.00	1.00		1.00
Lane Grp Cap(c), veh/h	148	158	148	689	730	327	93	608	272	405	1226	548
V/C Ratio(X)	0.23	0.55	0.59	0.85	0.06	0.00	0.61	0.77	0.00	0.88	0.61	0.00
Avail Cap(c_a), veh/h	311	917	859	1214	2496	1117	170	1537	688	473	2131	953
HCM Platoon Ratio	1.00	1.00	1.00	1.00	1.00	1.00	1.00	1.00	1.00	1.00	1.00	1.00
Upstream Filter(I)	1.00	1.00	1.00	1.00	1.00	0.00	1.00	1.00	0.00	1.00	1.00	0.00
Uniform Delay (d), s/veh	24.8	25.2	25.3	22.4	18.6	0.0	27.0	23.1	0.0	21.7	15.7	0.0
Incr Delay (d2), s/veh	0.3	1.1	1.4	1.2	0.0	0.0	2.4	0.8	0.0	14.1	0.2	0.0
Initial Q Delay(d3),s/veh	0.0	0.0	0.0	0.0	0.0	0.0	0.0	0.0	0.0	0.0	0.0	0.0
%ile BackOfQ(50%),veh/ln	0.5	1.4	1.4	4.6	0.3	0.0	0.9	3.7	0.0	7.0	4.9	0.0
LnGrp Delay(d),s/veh	25.1	26.3	26.7	23.6	18.6	0.0	29.4	23.9	0.0	35.8	15.9	0.0
LnGrp LOS	C	C	C	C	B		C	C		D	B	
Approach Vol, veh/h		209			632			528			1103	
Approach Delay, s/veh		26.3			23.2			24.5			22.3	
Approach LOS		C			C			C			C	
Timer	1	2	3	4	5	6	7	8				
Assigned Phs	1	2	3	4	5	6	7	8				
Phs Duration (G+Y+Rc), s	7.5	24.6	9.5	16.5	17.8	14.4	16.1	9.9				
Change Period (Y+Rc), s	4.5	4.5	4.5	4.5	4.5	4.5	4.5	4.5				
Max Green Setting (Gmax), s	5.5	35.0	10.5	41.0	15.5	25.0	20.5	31.0				
Max Q Clear Time (g_c+I), s	13.8	12.2	3.1	2.6	13.3	9.3	11.5	5.0				
Green Ext Time (p_c), s	0.0	1.0	0.0	0.1	0.0	0.6	0.1	0.2				
Intersection Summary												
HCM 2010 Ctrl Delay				23.3								
HCM 2010 LOS				C								
Notes												

HCM 2010 Roundabout
39: General Jim Moore Boulevard & Gigling Road

Intersection									
Intersection Delay, s/veh	24.8								
Intersection LOS	C								
Approach	EB		WB		NB		SB		
Entry Lanes	2		2		2		2		
Conflicting Circle Lanes	2		2		2		2		
Adj Approach Flow, veh/h	241		1103		850		1160		
Demand Flow Rate, veh/h	254		1125		859		1183		
Vehicles Circulating, veh/h	1723		570		520		703		
Vehicles Exiting, veh/h	163		809		1457		992		
Follow-Up Headway, s	3.186		3.186		3.186		3.186		
Ped Vol Crossing Leg, #/h	0		0		0		1		
Ped Cap Adj	1.000		1.000		1.000		1.000		
Approach Delay, s/veh	21.0		22.9		13.2		35.9		
Approach LOS	C		C		B		E		
Lane	Left	Right	Left	Right	Left	Right	Left	Right	
Designated Moves	LT	TR	LT	TR	LT	TR	LT	TR	
Assumed Moves	LT	TR	L	TR	LT	TR	LT	TR	
RT Channelized									
Lane Util	0.469	0.531	0.532	0.468	0.470	0.530	0.470	0.530	
Critical Headway, s	4.293	4.113	4.293	4.113	4.293	4.113	4.293	4.113	
Entry Flow, veh/h	119	135	598	527	404	455	556	627	
Cap Entry Lane, veh/h	310	338	737	758	765	785	667	691	
Entry HV Adj Factor	0.953	0.947	0.980	0.981	0.989	0.990	0.981	0.981	
Flow Entry, veh/h	113	128	586	517	400	451	545	615	
Cap Entry, veh/h	296	320	722	744	757	778	654	677	
V/C Ratio	0.383	0.399	0.812	0.695	0.528	0.579	0.834	0.908	
Control Delay, s/veh	21.5	20.5	26.8	18.6	12.6	13.7	31.2	40.2	
LOS	C	C	D	C	B	B	D	E	
95th %tile Queue, veh	2	2	9	6	3	4	9	12	

HCM 2010 Signalized Intersection Summary
 47: General Jim Moore Boulevard & Coe Avenue

Cuml w/ Proj, AM
 09/06/2019



Movement	EBL	EBT	EBR	WBL	WBT	WBR	NBL	NBT	NBR	SBL	SBT	SBR
Lane Configurations												
Traffic Volume (veh/h)	90	0	430	0	0	0	230	420	0	0	980	80
Future Volume (veh/h)	90	0	430	0	0	0	230	420	0	0	980	80
Number	3	8	18				1	6	16	5	2	12
Initial Q (Qb), veh	0	0	0				0	0	0	0	0	0
Ped-Bike Adj(A_pbT)	1.00		1.00				1.00		1.00	1.00		1.00
Parking Bus, Adj	1.00	1.00	1.00				1.00	1.00	1.00	1.00	1.00	1.00
Adj Sat Flow, veh/h/ln	1881	1881	1900				1881	1881	0	0	1863	1863
Adj Flow Rate, veh/h	100	0	367				256	467	0	0	1089	28
Adj No. of Lanes	1	1	0				1	2	0	0	2	1
Peak Hour Factor	0.90	0.92	0.90				0.90	0.90	0.92	0.92	0.90	0.90
Percent Heavy Veh, %	1	2	1				1	1	0	0	2	2
Cap, veh/h	515	0	459				301	2064	0	0	1211	542
Arrive On Green	0.29	0.00	0.29				0.17	0.58	0.00	0.00	0.34	0.34
Sat Flow, veh/h	1792	0	1597				1792	3668	0	0	3632	1583
Grp Volume(v), veh/h	100	0	367				256	467	0	0	1089	28
Grp Sat Flow(s),veh/h/ln	1792	0	1597				1792	1787	0	0	1770	1583
Q Serve(g_s), s	2.8	0.0	14.2				9.2	4.2	0.0	0.0	19.5	0.8
Cycle Q Clear(g_c), s	2.8	0.0	14.2				9.2	4.2	0.0	0.0	19.5	0.8
Prop In Lane	1.00		1.00				1.00		0.00	0.00		1.00
Lane Grp Cap(c), veh/h	515	0	459				301	2064	0	0	1211	542
V/C Ratio(X)	0.19	0.00	0.80				0.85	0.23	0.00	0.00	0.90	0.05
Avail Cap(c_a), veh/h	1129	0	1007				417	2897	0	0	1806	808
HCM Platoon Ratio	1.00	1.00	1.00				1.00	1.00	1.00	1.00	1.00	1.00
Upstream Filter(l)	1.00	0.00	1.00				1.00	1.00	0.00	0.00	1.00	1.00
Uniform Delay (d), s/veh	17.9	0.0	22.0				26.9	6.8	0.0	0.0	20.8	14.7
Incr Delay (d2), s/veh	0.2	0.0	3.2				8.8	0.0	0.0	0.0	3.3	0.0
Initial Q Delay(d3),s/veh	0.0	0.0	0.0				0.0	0.0	0.0	0.0	0.0	0.0
%ile BackOfQ(50%),veh/ln	1.4	0.0	6.6				5.3	2.1	0.0	0.0	9.9	0.3
LnGrp Delay(d),s/veh	18.1	0.0	25.2				35.7	6.9	0.0	0.0	24.2	14.7
LnGrp LOS	B		C				D	A			C	B
Approach Vol, veh/h		467						723			1117	
Approach Delay, s/veh		23.7						17.1			23.9	
Approach LOS		C						B			C	
Timer	1	2	3	4	5	6	7	8				
Assigned Phs	1	2				6		8				
Phs Duration (G+Y+Rc), s	15.7	27.3				43.0		23.7				
Change Period (Y+Rc), s	4.5	4.5				4.5		4.5				
Max Green Setting (Gmax), s	15.5	34.0				54.0		42.0				
Max Q Clear Time (g_c+ll), s	11.2	21.5				6.2		16.2				
Green Ext Time (p_c), s	0.0	1.3				0.5		2.8				
Intersection Summary												
HCM 2010 Ctrl Delay			21.7									
HCM 2010 LOS			C									

HCM 2010 Signalized Intersection Summary
5: 2nd Avenue & Imjin Parkway

Cuml w/ Proj, PM
09/06/2019



Movement	EBL	EBT	EBR	WBL	WBT	WBR	NBL	NBT	NBR	SBL	SBT	SBR
Lane Configurations	↖↗	↖↗↖	↖↗	↖↗↖	↖↗↖	↖↗	↖↗↖	↖	↖↗	↖↗	↖↗	↖
Traffic Volume (veh/h)	140	1370	710	330	1160	140	830	110	540	90	100	150
Future Volume (veh/h)	140	1370	710	330	1160	140	830	110	540	90	100	150
Number	5	2	12	1	6	16	3	8	18	7	4	14
Initial Q (Qb), veh	0	0	0	0	0	0	0	0	0	0	0	0
Ped-Bike Adj(A_pbT)	1.00		1.00	1.00		1.00	1.00		1.00	1.00		1.00
Parking Bus, Adj	1.00	1.00	1.00	1.00	1.00	1.00	1.00	1.00	1.00	1.00	1.00	1.00
Adj Sat Flow, veh/h/ln	1863	1863	1863	1863	1863	1863	1810	1810	1810	1900	1900	1900
Adj Flow Rate, veh/h	146	1427	516	344	1208	146	865	115	437	94	104	151
Adj No. of Lanes	2	3	2	3	3	1	3	1	2	2	2	1
Peak Hour Factor	0.96	0.96	0.96	0.96	0.96	0.96	0.96	0.96	0.96	0.96	0.96	0.96
Percent Heavy Veh, %	2	2	2	2	2	2	5	5	5	0	0	0
Cap, veh/h	242	1643	900	481	1773	640	989	478	714	194	418	300
Arrive On Green	0.07	0.32	0.32	0.10	0.35	0.35	0.20	0.26	0.26	0.06	0.12	0.12
Sat Flow, veh/h	3442	5085	2787	5003	5085	1583	4860	1810	2702	3510	3610	1611
Grp Volume(v), veh/h	146	1427	516	344	1208	146	865	115	437	94	104	151
Grp Sat Flow(s),veh/h/ln	1721	1695	1393	1668	1695	1583	1620	1810	1351	1755	1805	1611
Q Serve(g_s), s	2.8	18.1	10.5	4.6	13.9	4.1	11.8	3.4	9.7	1.8	1.8	5.8
Cycle Q Clear(g_c), s	2.8	18.1	10.5	4.6	13.9	4.1	11.8	3.4	9.7	1.8	1.8	5.8
Prop In Lane	1.00		1.00	1.00		1.00	1.00		1.00	1.00		1.00
Lane Grp Cap(c), veh/h	242	1643	900	481	1773	640	989	478	714	194	418	300
V/C Ratio(X)	0.60	0.87	0.57	0.72	0.68	0.23	0.87	0.24	0.61	0.48	0.25	0.50
Avail Cap(c_a), veh/h	307	2028	1111	519	2102	742	1185	846	1263	292	1107	608
HCM Platoon Ratio	1.00	1.00	1.00	1.00	1.00	1.00	1.00	1.00	1.00	1.00	1.00	1.00
Upstream Filter(I)	1.00	1.00	1.00	1.00	1.00	1.00	1.00	1.00	1.00	1.00	1.00	1.00
Uniform Delay (d), s/veh	30.9	21.8	19.3	30.0	19.0	13.4	26.4	19.8	22.1	31.4	27.6	25.0
Incr Delay (d2), s/veh	0.9	3.1	0.2	3.5	0.5	0.1	5.8	0.1	0.3	0.7	0.1	0.5
Initial Q Delay(d3),s/veh	0.0	0.0	0.0	0.0	0.0	0.0	0.0	0.0	0.0	0.0	0.0	0.0
%ile BackOfQ(50%),veh/ln	4	8.9	4.1	2.3	6.6	1.8	5.8	1.7	3.6	0.9	0.9	2.6
LnGrp Delay(d),s/veh	31.8	24.9	19.5	33.5	19.5	13.5	32.2	19.9	22.4	32.1	27.7	25.5
LnGrp LOS	C	C	B	C	B	B	C	B	C	C	C	C
Approach Vol, veh/h		2089			1698			1417			349	
Approach Delay, s/veh		24.1			21.8			28.2			27.9	
Approach LOS		C			C			C			C	
Timer	1	2	3	4	5	6	7	8				
Assigned Phs	1	2	3	4	5	6	7	8				
Phs Duration (G+Y+Rc), s	11.1	27.4	17.4	12.5	9.3	29.2	7.3	22.7				
Change Period (Y+Rc), s	4.5	5.3	3.5	4.6	4.5	5.3	3.5	4.6				
Max Green Setting (Gmax), s	27.3	16.7	21.0	6.1	28.3	5.7	32.0					
Max Q Clear Time (g_c+1), s	10.6	20.1	13.8	7.8	4.8	15.9	3.8	11.7				
Green Ext Time (p_c), s	0.0	2.0	0.1	0.1	0.0	1.9	0.0	0.2				
Intersection Summary												
HCM 2010 Ctrl Delay					24.7							
HCM 2010 LOS					C							

HCM 2010 Signalized Intersection Summary
 10: Imjin Road & Imjin Parkway

Cuml w/ Proj, PM
 09/06/2019



Movement	EBT	EBR	WBL	WBT	NBL	NBR		
Lane Configurations	↑↑		↵↵	↑↑	↵↵	↵		
Traffic Volume (veh/h)	1590	150	260	920	250	520		
Future Volume (veh/h)	1590	150	260	920	250	520		
Number	2	12	1	6	3	18		
Initial Q (Qb), veh	0	0	0	0	0	0		
Ped-Bike Adj(A_pbT)		1.00	1.00		1.00	1.00		
Parking Bus, Adj	1.00	1.00	1.00	1.00	1.00	1.00		
Adj Sat Flow, veh/h/ln	1863	1900	1845	1845	1810	1810		
Adj Flow Rate, veh/h	1674	145	274	968	263	547		
Adj No. of Lanes	2	0	2	2	1	2		
Peak Hour Factor	0.95	0.95	0.95	0.95	0.95	0.95		
Percent Heavy Veh, %	2	2	3	3	5	5		
Cap, veh/h	1798	154	348	2446	344	615		
Arrive On Green	0.54	0.54	0.10	0.70	0.20	0.20		
Sat Flow, veh/h	3393	283	3408	3597	1723	3076		
Grp Volume(v), veh/h	889	930	274	968	263	547		
Grp Sat Flow(s),veh/h/ln	1770	1813	1704	1752	1723	1538		
Q Serve(g_s), s	40.5	42.2	6.9	10.1	12.7	15.2		
Cycle Q Clear(g_c), s	40.5	42.2	6.9	10.1	12.7	15.2		
Prop In Lane		0.16	1.00		1.00	1.00		
Lane Grp Cap(c), veh/h	964	988	348	2446	344	615		
V/C Ratio(X)	0.92	0.94	0.79	0.40	0.76	0.89		
Avail Cap(c_a), veh/h	980	1004	376	2506	355	633		
HCM Platoon Ratio	1.00	1.00	1.00	1.00	1.00	1.00		
Upstream Filter(I)	1.00	1.00	1.00	1.00	1.00	1.00		
Uniform Delay (d), s/veh	18.3	18.7	38.6	5.5	33.2	34.3		
Incr Delay (d2), s/veh	13.6	16.1	10.0	0.1	9.3	14.5		
Initial Q Delay(d3),s/veh	0.0	0.0	0.0	0.0	0.0	0.0		
%ile BackOfQ(50%),veh/ln	23.2	25.3	3.7	4.9	6.9	7.7		
LnGrp Delay(d),s/veh	32.0	34.8	48.6	5.6	42.5	48.7		
LnGrp LOS	C	C	D	A	D	D		
Approach Vol, veh/h	1819			1242	810			
Approach Delay, s/veh	33.4			15.1	46.7			
Approach LOS	C			B	D			
Timer	1	2	3	4	5	6	7	8
Assigned Phs	1	2				6		8
Phs Duration (G+Y+Rc), s	33.5	52.4				65.9		22.1
Change Period (Y+Rc), s	4.5	4.5				4.5		4.5
Max Green Setting (Gmax), s	48.7					62.9		18.1
Max Q Clear Time (g_c+10), s	44.2					12.1		17.2
Green Ext Time (p_c), s	0.1	3.8				7.7		0.3
Intersection Summary								
HCM 2010 Ctrl Delay			30.3					
HCM 2010 LOS			C					
Notes								

HCM 2010 Roundabout
10: Imjin Road & Imjin Parkway

Cumulative with Project (Roundabouts), PM
04/22/2022

Intersection						
Intersection Delay, s/veh	85.2					
Intersection LOS	F					
Approach	EB		WB		NB	
Entry Lanes	2		2		2	
Conflicting Circle Lanes	2		2		2	
Adj Approach Flow, veh/h	1832		1242		810	
Demand Flow Rate, veh/h	1868		1279		850	
Vehicles Circulating, veh/h	282		276		1707	
Vehicles Exiting, veh/h	1273		2281		443	
Follow-Up Headway, s	3.186		3.186		3.186	
Ped Vol Crossing Leg, #/h	0		0		0	
Ped Cap Adj	1.000		1.000		1.000	
Approach Delay, s/veh	57.2		16.1		254.5	
Approach LOS	F		C		F	
Lane	Left	Right	Left	Right	Left	Right
Designated Moves	LT	TR	LT	TR	L	TR
Assumed Moves	LT	TR	LT	TR	L	TR
RT Channelized						
Lane Util	0.470	0.530	0.470	0.530	0.325	0.675
Critical Headway, s	4.293	4.113	4.293	4.113	4.293	4.113
Entry Flow, veh/h	878	990	601	678	276	574
Cap Entry Lane, veh/h	915	928	919	931	314	342
Entry HV Adj Factor	0.980	0.981	0.971	0.971	0.953	0.953
Flow Entry, veh/h	861	971	584	658	263	547
Cap Entry, veh/h	897	909	892	904	299	326
V/C Ratio	0.960	1.067	0.654	0.728	0.879	1.678
Control Delay, s/veh	42.4	70.3	14.6	17.5	63.3	346.4
LOS	E	F	B	C	F	F
95th %tile Queue, veh	16	23	5	7	8	34

HCM 2010 Roundabout
11: Abrams Drive & Imjin Parkway

Cumulative with Project (Roundabouts), PM
04/22/2022

Intersection									
Intersection Delay, s/veh	71.2								
Intersection LOS	F								
Approach	EB		WB		NB		SB		
Entry Lanes	2		2		1		1		
Conflicting Circle Lanes	2		2		2		2		
Adj Approach Flow, veh/h	2162		1345		430		227		
Demand Flow Rate, veh/h	2184		1372		443		231		
Vehicles Circulating, veh/h	286		374		1978		1440		
Vehicles Exiting, veh/h	1242		1837		492		306		
Follow-Up Headway, s	3.186		3.186		3.186		3.186		
Ped Vol Crossing Leg, #/h	0		1		0		1		
Ped Cap Adj	1.000		0.999		1.000		1.000		
Approach Delay, s/veh	116.2		23.2		30.3		4.7		
Approach LOS	F		C		D		A		
Lane	Left	Right	Left	Right	Left	Bypass	Left	Bypass	
Designated Moves	LT	TR	LT	TR	LT	R	LT	R	
Assumed Moves	LT	TR	LT	TR	LT	R	LT	R	
RT Channelized						Free		Free	
Lane Util	0.470	0.530	0.470	0.530	1.000		1.000		
Critical Headway, s	4.293	4.113	4.293	4.113	4.113		4.113		
Entry Flow, veh/h	1026	1158	645	727	233	210	88	143	
Cap Entry Lane, veh/h	912	925	854	870	283	1957	412	1938	
Entry HV Adj Factor	0.991	0.990	0.980	0.980	0.970	0.971	0.984	0.980	
Flow Entry, veh/h	1016	1146	632	713	226	204	87	140	
Cap Entry, veh/h	903	915	836	852	275	1900	406	1900	
V/C Ratio	1.125	1.252	0.756	0.837	0.823	0.107	0.213	0.074	
Control Delay, s/veh	90.2	139.3	20.1	25.9	57.7	0.0	12.3	0.0	
LOS	F	F	C	D	F	A	B	A	
95th %tile Queue, veh	28	40	7	10	7	0	1	0	

HCM 2010 Signalized Intersection Summary
 12: Reservation Road & Imjin Parkway

Cuml w/ Proj, PM
 09/06/2019



Movement	EBL	EBT	EBR	WBL	WBT	WBR	NBL	NBT	NBR	SBL	SBT	SBR
Lane Configurations												
Traffic Volume (veh/h)	110	20	1730	10	40	30	1000	630	10	20	950	200
Future Volume (veh/h)	110	20	1730	10	40	30	1000	630	10	20	950	200
Number	3	8	18	7	4	14	1	6	16	5	2	12
Initial Q (Qb), veh	0	0	0	0	0	0	0	0	0	0	0	0
Ped-Bike Adj(A_pbT)	1.00		1.00	1.00		0.99	1.00		1.00	1.00		0.98
Parking Bus, Adj	1.00	1.00	1.00	1.00	1.00	1.00	1.00	1.00	1.00	1.00	1.00	1.00
Adj Sat Flow, veh/h/ln	1863	1863	1863	1638	1638	1638	1863	1863	1863	1863	1863	1863
Adj Flow Rate, veh/h	124	22	1511	11	45	21	1124	708	4	22	1067	159
Adj No. of Lanes	2	1	2	1	1	1	2	2	1	2	3	1
Peak Hour Factor	0.89	0.89	0.89	0.89	0.89	0.89	0.89	0.89	0.89	0.89	0.89	0.89
Percent Heavy Veh, %	2	2	2	16	16	16	2	2	2	2	2	2
Cap, veh/h	842	456	1362	68	72	61	842	1946	869	56	1636	501
Arrive On Green	0.24	0.24	0.24	0.04	0.04	0.04	0.24	0.55	0.55	0.02	0.32	0.32
Sat Flow, veh/h	3442	1863	2781	1560	1638	1383	3442	3539	1581	3442	5085	1559
Grp Volume(v), veh/h	124	22	1511	11	45	21	1124	708	4	22	1067	159
Grp Sat Flow(s),veh/h/ln	1721	1863	1390	1560	1638	1383	1721	1770	1581	1721	1695	1559
Q Serve(g_s), s	4.0	1.3	35.0	1.0	3.9	2.1	35.0	16.1	0.2	0.9	25.8	11.0
Cycle Q Clear(g_c), s	4.0	1.3	35.0	1.0	3.9	2.1	35.0	16.1	0.2	0.9	25.8	11.0
Prop In Lane	1.00		1.00	1.00		1.00	1.00		1.00	1.00		1.00
Lane Grp Cap(c), veh/h	842	456	1362	68	72	61	842	1946	869	56	1636	501
V/C Ratio(X)	0.15	0.05	1.11	0.16	0.63	0.35	1.34	0.36	0.00	0.39	0.65	0.32
Avail Cap(c_a), veh/h	842	456	1362	338	355	300	842	1946	869	481	2132	654
HCM Platoon Ratio	1.00	1.00	1.00	1.00	1.00	1.00	1.00	1.00	1.00	1.00	1.00	1.00
Upstream Filter(I)	1.00	1.00	1.00	1.00	1.00	1.00	1.00	1.00	1.00	1.00	1.00	1.00
Uniform Delay (d), s/veh	42.4	41.3	36.6	65.9	67.3	66.4	54.0	18.1	14.5	69.7	41.7	36.7
Incr Delay (d2), s/veh	0.0	0.0	60.2	0.4	3.3	1.3	158.9	0.3	0.0	1.6	1.2	1.0
Initial Q Delay(d3),s/veh	0.0	0.0	0.0	0.0	0.0	0.0	0.0	0.0	0.0	0.0	0.0	0.0
%ile BackOfQ(50%),veh/ln	1.9	0.7	38.3	0.4	1.8	0.8	35.2	8.0	0.1	0.4	12.2	4.9
LnGrp Delay(d),s/veh	42.4	41.3	96.8	66.3	70.6	67.7	213.0	18.4	14.5	71.3	42.9	37.7
LnGrp LOS	D	D	F	E	E	E	F	B	B	E	D	D
Approach Vol, veh/h		1657			77			1836			1248	
Approach Delay, s/veh		92.0			69.2			137.5			42.7	
Approach LOS		F			E			F			D	
Timer	1	2	3	4	5	6	7	8				
Assigned Phs	1	2		4	5	6		8				
Phs Duration (G+Y+Rc), s	39.1	52.2		11.3	6.4	84.9		40.5				
Change Period (Y+Rc), s	4.1	* 6.2		5.0	4.1	* 6.2		5.5				
Max Green Setting (Gmax), s	35.0	* 60		31.0	20.0	* 50		35.0				
Max Q Clear Time (g_c+R), s	17.0	27.8		5.9	2.9	18.1		37.0				
Green Ext Time (p_c), s	0.0	18.2		0.2	0.0	10.5		0.0				
Intersection Summary												
HCM 2010 Ctrl Delay			96.2									
HCM 2010 LOS			F									
Notes												

HCM 2010 Signalized Intersection Summary
 14: Reservation Road & Inter-Garrison Road

Cuml w/ Proj, PM
 09/06/2019



Movement	EBL	EBR	NBL	NBT	SBT	SBR		
Lane Configurations								
Traffic Volume (veh/h)	110	430	290	450	1350	270		
Future Volume (veh/h)	110	430	290	450	1350	270		
Number	3	18	1	6	2	12		
Initial Q (Qb), veh	0	0	0	0	0	0		
Ped-Bike Adj(A_pbT)	1.00	1.00	1.00			1.00		
Parking Bus, Adj	1.00	1.00	1.00	1.00	1.00	1.00		
Adj Sat Flow, veh/h/ln	1845	1845	1863	1863	1845	1900		
Adj Flow Rate, veh/h	134	479	354	549	1646	311		
Adj No. of Lanes	1	2	2	2	2	0		
Peak Hour Factor	0.82	0.82	0.82	0.82	0.82	0.82		
Percent Heavy Veh, %	3	3	2	2	3	3		
Cap, veh/h	318	838	422	2543	1636	300		
Arrive On Green	0.18	0.18	0.12	0.72	0.55	0.55		
Sat Flow, veh/h	1757	2760	3442	3632	3052	542		
Grp Volume(v), veh/h	134	479	354	549	953	1004		
Grp Sat Flow(s),veh/h/ln	1757	1380	1721	1770	1752	1749		
Q Serve(g_s), s	7.3	15.9	10.9	5.6	57.9	60.0		
Cycle Q Clear(g_c), s	7.3	15.9	10.9	5.6	57.9	60.0		
Prop In Lane	1.00	1.00	1.00			0.31		
Lane Grp Cap(c), veh/h	318	838	422	2543	969	967		
V/C Ratio(X)	0.42	0.57	0.84	0.22	0.98	1.04		
Avail Cap(c_a), veh/h	437	1025	634	2543	969	967		
HCM Platoon Ratio	1.00	1.00	1.00	1.00	1.00	1.00		
Upstream Filter(I)	1.00	1.00	1.00	1.00	1.00	1.00		
Uniform Delay (d), s/veh	39.4	31.9	46.6	5.1	23.8	24.3		
Incr Delay (d2), s/veh	0.9	0.6	3.9	0.1	25.1	39.3		
Initial Q Delay(d3),s/veh	0.0	0.0	0.0	0.0	0.0	0.0		
%ile BackOfQ(50%),veh/ln	3.7	6.1	5.4	2.8	34.6	39.3		
LnGrp Delay(d),s/veh	40.3	32.5	50.5	5.2	48.9	63.6		
LnGrp LOS	D	C	D	A	D	F		
Approach Vol, veh/h	613			903	1957			
Approach Delay, s/veh	34.2			22.9	56.4			
Approach LOS	C			C	E			
Timer	1	2	3	4	5	6	7	8
Assigned Phs	1	2				6		8
Phs Duration (G+Y+Rc), s	18.0	66.4				84.4		24.1
Change Period (Y+Rc), s	4.7	6.4				6.4		4.5
Max Green Setting (Gmax), s	26	60.0				60.0		27.0
Max Q Clear Time (g_c+I), s	11.2	62.0				7.6		17.9
Green Ext Time (p_c), s	0.4	0.0				6.7		1.8
Intersection Summary								
HCM 2010 Ctrl Delay			43.8					
HCM 2010 LOS			D					
Notes								

HCM 2010 Signalized Intersection Summary
 22: 8th Avenue & Inter-Garrison Road

Cuml w/ Proj, PM
 09/06/2019



Movement	EBT	EBR	WBL	WBT	NBL	NBR		
Lane Configurations	↑		↔	↑	↔			
Traffic Volume (veh/h)	640	140	430	410	50	750		
Future Volume (veh/h)	640	140	430	410	50	750		
Number	4	14	3	8	5	12		
Initial Q (Qb), veh	0	0	0	0	0	0		
Ped-Bike Adj(A_pbT)		1.00	1.00		1.00	1.00		
Parking Bus, Adj	1.00	1.00	1.00	1.00	1.00	1.00		
Adj Sat Flow, veh/h/ln	1520	1900	1881	1881	1845	1900		
Adj Flow Rate, veh/h	660	131	443	423	52	492		
Adj No. of Lanes	1	0	2	1	0	0		
Peak Hour Factor	0.97	0.97	0.97	0.97	0.97	0.97		
Percent Heavy Veh, %	25	25	1	1	0	0		
Cap, veh/h	545	108	481	1158	48	451		
Arrive On Green	0.44	0.44	0.14	0.62	0.32	0.32		
Sat Flow, veh/h	1232	245	3476	1881	151	1431		
Grp Volume(v), veh/h	0	791	443	423	545	0		
Grp Sat Flow(s),veh/h/ln	0	1477	1738	1881	1585	0		
Q Serve(g_s), s	0.0	57.5	16.4	14.5	41.0	0.0		
Cycle Q Clear(g_c), s	0.0	57.5	16.4	14.5	41.0	0.0		
Prop In Lane		0.17	1.00		0.10	0.90		
Lane Grp Cap(c), veh/h	0	653	481	1158	500	0		
V/C Ratio(X)	0.00	1.21	0.92	0.37	1.09	0.00		
Avail Cap(c_a), veh/h	0	653	481	1158	500	0		
HCM Platoon Ratio	1.00	1.00	1.00	1.00	1.00	1.00		
Upstream Filter(I)	0.00	1.00	1.00	1.00	1.00	0.00		
Uniform Delay (d), s/veh	0.0	36.3	55.3	12.4	44.5	0.0		
Incr Delay (d2), s/veh	0.0	108.7	23.1	0.2	67.1	0.0		
Initial Q Delay(d3),s/veh	0.0	0.0	0.0	0.0	0.0	0.0		
%ile BackOfQ(50%),veh/ln	0.0	43.1	9.4	7.6	27.2	0.0		
LnGrp Delay(d),s/veh	0.0	145.0	78.3	12.6	111.6	0.0		
LnGrp LOS		F	E	B	F			
Approach Vol, veh/h	791			866	545			
Approach Delay, s/veh	145.0			46.2	111.6			
Approach LOS	F			D	F			
Timer	1	2	3	4	5	6	7	8
Assigned Phs		2	3	4				8
Phs Duration (G+Y+Rc), s		45.5	22.5	62.0				84.5
Change Period (Y+Rc), s		4.5	4.5	4.5				4.5
Max Green Setting (Gmax), s		41.0	18.0	57.5				80.0
Max Q Clear Time (g_c+I1), s		43.0	18.4	59.5				16.5
Green Ext Time (p_c), s		0.0	0.0	0.0				2.8
Intersection Summary								
HCM 2010 Ctrl Delay			97.9					
HCM 2010 LOS			F					
Notes								

Intersection				
Intersection Delay, s/veh	106.2			
Intersection LOS	F			
Approach	EB	WB		NB
Entry Lanes	1	2		1
Conflicting Circle Lanes	2	2		2
Adj Approach Flow, veh/h	804	866		825
Demand Flow Rate, veh/h	1005	874		850
Vehicles Circulating, veh/h	447	54		825
Vehicles Exiting, veh/h	481	1621		627
Follow-Up Headway, s	3.186	3.186		3.186
Ped Vol Crossing Leg, #/h	0	0		0
Ped Cap Adj	1.000	1.000		1.000
Approach Delay, s/veh	132.2	7.6		184.3
Approach LOS	F	A		F
Lane	Left	Left	Right	Left
Designated Moves	TR	L	LTR	LR
Assumed Moves	TR	L	LTR	LR
RT Channelized				
Lane Util	1.000	0.530	0.470	1.000
Critical Headway, s	4.113	4.293	4.113	4.113
Entry Flow, veh/h	1005	463	411	850
Cap Entry Lane, veh/h	826	1085	1088	634
Entry HV Adj Factor	0.800	0.991	0.990	0.971
Flow Entry, veh/h	804	459	407	825
Cap Entry, veh/h	661	1075	1077	616
V/C Ratio	1.216	0.427	0.378	1.340
Control Delay, s/veh	132.2	7.9	7.2	184.3
LOS	F	A	A	F
95th %tile Queue, veh	28	2	2	35

HCM 2010 Signalized Intersection Summary
 23: Inter-Garrison Road & Abrams Drive

Cuml w/ Proj, PM
 09/06/2019



Movement	EBL	EBT	WBT	WBR	SBL	SBR		
Lane Configurations								
Traffic Volume (veh/h)	630	760	420	30	20	420		
Future Volume (veh/h)	630	760	420	30	20	420		
Number	5	2	6	16	7	14		
Initial Q (Qb), veh	0	0	0	0	0	0		
Ped-Bike Adj(A_pbT)	1.00			1.00	1.00	1.00		
Parking Bus, Adj	1.00	1.00	1.00	1.00	1.00	1.00		
Adj Sat Flow, veh/h/ln	1759	1759	1881	1881	1881	1881		
Adj Flow Rate, veh/h	663	800	442	27	21	247		
Adj No. of Lanes	2	1	1	1	2	1		
Peak Hour Factor	0.95	0.95	0.95	0.95	0.95	0.95		
Percent Heavy Veh, %	8	8	1	1	1	1		
Cap, veh/h	794	1068	524	446	656	302		
Arrive On Green	0.24	0.61	0.28	0.28	0.19	0.19		
Sat Flow, veh/h	3250	1759	1881	1599	3476	1599		
Grp Volume(v), veh/h	663	800	442	27	21	247		
Grp Sat Flow(s),veh/h/ln	1625	1759	1881	1599	1738	1599		
Q Serve(g_s), s	8.1	13.6	9.2	0.5	0.2	6.2		
Cycle Q Clear(g_c), s	8.1	13.6	9.2	0.5	0.2	6.2		
Prop In Lane	1.00			1.00	1.00	1.00		
Lane Grp Cap(c), veh/h	794	1068	524	446	656	302		
V/C Ratio(X)	0.84	0.75	0.84	0.06	0.03	0.82		
Avail Cap(c_a), veh/h	2148	2727	1514	1287	2255	1037		
HCM Platoon Ratio	1.00	1.00	1.00	1.00	1.00	1.00		
Upstream Filter(I)	1.00	1.00	1.00	1.00	1.00	1.00		
Uniform Delay (d), s/veh	14.9	5.9	14.1	11.0	13.8	16.2		
Incr Delay (d2), s/veh	0.9	0.4	1.4	0.0	0.0	2.1		
Initial Q Delay(d3),s/veh	0.0	0.0	0.0	0.0	0.0	0.0		
%ile BackOfQ(50%),veh/ln	3.7	6.6	5.0	0.2	0.1	5.3		
LnGrp Delay(d),s/veh	15.8	6.3	15.6	11.0	13.8	18.3		
LnGrp LOS	B	A	B	B	B	B		
Approach Vol, veh/h		1463	469		268			
Approach Delay, s/veh		10.6	15.3		18.0			
Approach LOS		B	B		B			
Timer	1	2	3	4	5	6	7	8
Assigned Phs		2		4	5	6		
Phs Duration (G+Y+Rc), s		30.3		11.4	13.7	16.6		
Change Period (Y+Rc), s		5.0		3.5	3.5	5.0		
Max Green Setting (Gmax), s		64.5		27.0	27.5	33.5		
Max Q Clear Time (g_c+I1), s		15.6		8.2	10.1	11.2		
Green Ext Time (p_c), s		0.8		0.1	0.1	0.4		
Intersection Summary								
HCM 2010 Ctrl Delay			12.5					
HCM 2010 LOS			B					

HCM 2010 Signalized Intersection Summary
 28: Davis Road & Reservation Road

Cuml w/ Proj, PM
 09/06/2019



Movement	EBL	EBT	EBR	WBL	WBT	WBR	NBL	NBT	NBR	SBL	SBT	SBR
Lane Configurations												
Traffic Volume (veh/h)	1260	500	10	10	360	100	10	10	10	120	10	540
Future Volume (veh/h)	1260	500	10	10	360	100	10	10	10	120	10	540
Number	5	2	12	1	6	16	3	8	18	7	4	14
Initial Q (Qb), veh	0	0	0	0	0	0	0	0	0	0	0	0
Ped-Bike Adj(A_pbT)	1.00		1.00	1.00		1.00	1.00		1.00	1.00		1.00
Parking Bus, Adj	1.00	1.00	1.00	1.00	1.00	1.00	1.00	1.00	1.00	1.00	1.00	1.00
Adj Sat Flow, veh/h/ln	1863	1863	1900	1863	1863	1900	1900	1900	1900	1900	1845	1845
Adj Flow Rate, veh/h	1340	532	11	11	383	106	11	11	8	128	11	353
Adj No. of Lanes	2	2	0	1	1	0	0	1	0	0	1	1
Peak Hour Factor	0.94	0.94	0.94	0.94	0.94	0.94	0.94	0.94	0.94	0.94	0.94	0.94
Percent Heavy Veh, %	2	2	2	2	2	2	0	0	0	3	3	3
Cap, veh/h	1023	2154	45	19	452	125	18	18	13	287	25	743
Arrive On Green	0.30	0.61	0.61	0.01	0.32	0.32	0.03	0.03	0.03	0.18	0.18	0.18
Sat Flow, veh/h	3442	3546	73	1774	1405	389	654	654	476	1624	140	1568
Grp Volume(v), veh/h	1340	265	278	11	0	489	30	0	0	139	0	353
Grp Sat Flow(s),veh/h/ln	1721	1770	1850	1774	0	1794	1783	0	0	1763	0	1568
Q Serve(g_s), s	30.0	7.0	7.0	0.6	0.0	25.6	1.7	0.0	0.0	7.1	0.0	15.4
Cycle Q Clear(g_c), s	30.0	7.0	7.0	0.6	0.0	25.6	1.7	0.0	0.0	7.1	0.0	15.4
Prop In Lane	1.00		0.04	1.00		0.22	0.37		0.27	0.92		1.00
Lane Grp Cap(c), veh/h	1023	1075	1124	19	0	577	50	0	0	311	0	743
V/C Ratio(X)	1.31	0.25	0.25	0.59	0.00	0.85	0.60	0.00	0.00	0.45	0.00	0.48
Avail Cap(c_a), veh/h	1023	1075	1124	528	0	1067	530	0	0	524	0	933
HCM Platoon Ratio	1.00	1.00	1.00	1.00	1.00	1.00	1.00	1.00	1.00	1.00	1.00	1.00
Upstream Filter(I)	1.00	1.00	1.00	1.00	0.00	1.00	1.00	0.00	0.00	1.00	0.00	1.00
Uniform Delay (d), s/veh	35.4	9.1	9.1	49.7	0.0	31.9	48.5	0.0	0.0	37.1	0.0	18.0
Incr Delay (d2), s/veh	146.3	0.2	0.2	10.5	0.0	5.5	4.1	0.0	0.0	0.4	0.0	0.2
Initial Q Delay(d3),s/veh	0.0	0.0	0.0	0.0	0.0	0.0	0.0	0.0	0.0	0.0	0.0	0.0
%ile BackOfQ(50%),veh/ln	35.0	3.4	3.6	0.4	0.0	13.5	0.9	0.0	0.0	3.5	0.0	6.7
LnGrp Delay(d),s/veh	181.7	9.3	9.3	60.2	0.0	37.4	52.6	0.0	0.0	37.5	0.0	18.2
LnGrp LOS	F	A	A	E		D	D			D		B
Approach Vol, veh/h		1883			500			30			492	
Approach Delay, s/veh		132.0			37.9			52.6			23.7	
Approach LOS		F			D			D			C	
Timer	1	2	3	4	5	6	7	8				
Assigned Phs	1	2		4	5	6		8				
Phs Duration (G+Y+Rc), s	5.0	66.3		22.8	33.8	37.4		6.8				
Change Period (Y+Rc), s	3.9	5.0		5.0	* 3.8	5.0		4.0				
Max Green Setting (Gmax), s	30	60.0		30.0	* 30	60.0		30.0				
Max Q Clear Time (g_c+1/2), s	12.6	9.0		17.4	32.0	27.6		3.7				
Green Ext Time (p_c), s	0.0	5.1		0.4	0.0	4.8		0.0				
Intersection Summary												
HCM 2010 Ctrl Delay				96.6								
HCM 2010 LOS				F								
Notes												

HCM 2010 Signalized Intersection Summary
 33: General Jim Moore Boulevard & Lightfighter Drive

Cuml w/ Proj, PM
 09/06/2019



Movement	EBL	EBT	EBR	WBL	WBT	WBR	NBL	NBT	NBR	SBL	SBT	SBR
Lane Configurations	↖↗	↑	↗	↖↗	↖↗		↖↗	↖↗		↖	↖↗	↗
Traffic Volume (veh/h)	50	280	690	40	250	50	670	70	20	60	100	40
Future Volume (veh/h)	50	280	690	40	250	50	670	70	20	60	100	40
Number	3	8	18	7	4	14	1	6	16	5	2	12
Initial Q (Qb), veh	0	0	0	0	0	0	0	0	0	0	0	0
Ped-Bike Adj(A_pbT)	1.00		1.00	1.00		1.00	1.00		1.00	1.00		0.99
Parking Bus, Adj	1.00	1.00	1.00	1.00	1.00	1.00	1.00	1.00	1.00	1.00	1.00	1.00
Adj Sat Flow, veh/h/ln	1863	1863	1863	1792	1792	1900	1881	1881	1900	1863	1863	1863
Adj Flow Rate, veh/h	52	292	0	42	1000	50	698	73	20	62	104	42
Adj No. of Lanes	2	1	1	2	2	0	3	2	0	1	2	1
Peak Hour Factor	0.96	0.96	0.96	0.96	0.25	0.96	0.96	0.96	0.96	0.96	0.96	0.96
Percent Heavy Veh, %	2	2	2	6	6	6	1	1	1	2	2	2
Cap, veh/h	173	634	539	144	1100	55	909	628	166	100	356	238
Arrive On Green	0.05	0.34	0.00	0.04	0.33	0.33	0.18	0.22	0.22	0.06	0.10	0.10
Sat Flow, veh/h	3442	1863	1583	3312	3301	165	5052	2797	738	1774	3539	1574
Grp Volume(v), veh/h	52	292	0	42	516	534	698	46	47	62	104	42
Grp Sat Flow(s),veh/h/ln	1721	1863	1583	1656	1703	1763	1684	1787	1749	1774	1770	1574
Q Serve(g_s), s	0.8	6.6	0.0	0.7	15.5	15.5	7.0	1.1	1.2	1.8	1.5	1.2
Cycle Q Clear(g_c), s	0.8	6.6	0.0	0.7	15.5	15.5	7.0	1.1	1.2	1.8	1.5	1.2
Prop In Lane	1.00		1.00	1.00		0.09	1.00		0.42	1.00		1.00
Lane Grp Cap(c), veh/h	173	634	539	144	567	587	909	401	392	100	356	238
V/C Ratio(X)	0.30	0.46	0.00	0.29	0.91	0.91	0.77	0.11	0.12	0.62	0.29	0.18
Avail Cap(c_a), veh/h	321	634	539	309	572	592	1028	737	721	228	1196	611
HCM Platoon Ratio	1.00	1.00	1.00	1.00	1.00	1.00	1.00	1.00	1.00	1.00	1.00	1.00
Upstream Filter(I)	1.00	1.00	0.00	1.00	1.00	1.00	1.00	1.00	1.00	1.00	1.00	1.00
Uniform Delay (d), s/veh	24.5	13.8	0.0	24.8	17.1	17.1	20.9	16.5	16.6	24.7	22.3	19.8
Incr Delay (d2), s/veh	1.0	0.5	0.0	1.1	18.5	18.0	3.2	0.1	0.1	6.2	0.5	0.4
Initial Q Delay(d3),s/veh	0.0	0.0	0.0	0.0	0.0	0.0	0.0	0.0	0.0	0.0	0.0	0.0
%ile BackOfQ(50%),veh/ln	0.4	3.4	0.0	0.3	10.1	10.4	3.5	0.5	0.6	1.1	0.7	0.6
LnGrp Delay(d),s/veh	25.5	14.4	0.0	25.9	35.6	35.1	24.1	16.7	16.7	30.9	22.8	20.2
LnGrp LOS	C	B		C	D	D	C	B	B	C	C	C
Approach Vol, veh/h		344			1092			791			208	
Approach Delay, s/veh		16.0			35.0			23.2			24.7	
Approach LOS		B			C			C			C	
Timer	1	2	3	4	5	6	7	8				
Assigned Phs	1	2	3	4	5	6	7	8				
Phs Duration (G+Y+Rc), s	4.1	9.9	7.2	22.4	7.5	16.5	6.8	22.7				
Change Period (Y+Rc), s	4.5	4.5	4.5	4.5	4.5	4.5	4.5	4.5				
Max Green Setting (Gmax), s	10.9	18.1	5.0	18.0	6.9	22.1	5.0	18.0				
Max Q Clear Time (g_c+I), s	19.0	3.5	2.8	17.5	3.8	3.2	2.7	8.6				
Green Ext Time (p_c), s	0.6	0.5	0.0	0.3	0.0	0.4	0.0	1.0				
Intersection Summary												
HCM 2010 Ctrl Delay			27.6									
HCM 2010 LOS			C									

HCM 2010 Roundabout
33: General Jim Moore Boulevard & Lightfighter Drive

Intersection									
Intersection Delay, s/veh	12.2								
Intersection LOS	B								
Approach	EB		WB		NB		SB		
Entry Lanes	2		2		2		2		
Conflicting Circle Lanes	2		2		2		2		
Adj Approach Flow, veh/h	1146		382		854		224		
Demand Flow Rate, veh/h	1168		405		863		228		
Vehicles Circulating, veh/h	230		898		446		1107		
Vehicles Exiting, veh/h	1105		411		952		196		
Follow-Up Headway, s	3.186		3.186		3.186		3.186		
Ped Vol Crossing Leg, #/h	2		1		2		0		
Ped Cap Adj	0.998		1.000		0.999		1.000		
Approach Delay, s/veh	12.9		11.5		12.1		10.4		
Approach LOS	B		B		B		B		
Lane	Left	Right	Left	Right	Left	Right	Left	Right	
Designated Moves	LTR	R	LT	TR	L	LTR	LT	TR	
Assumed Moves	LTR	R	LT	TR	L	LTR	LT	TR	
RT Channelized									
Lane Util	0.470	0.530	0.469	0.531	0.530	0.470	0.469	0.531	
Critical Headway, s	4.293	4.113	4.293	4.113	4.293	4.113	4.293	4.113	
Entry Flow, veh/h	549	619	190	215	457	406	107	121	
Cap Entry Lane, veh/h	951	962	576	603	809	827	493	521	
Entry HV Adj Factor	0.981	0.981	0.945	0.942	0.991	0.989	0.983	0.980	
Flow Entry, veh/h	538	607	180	203	453	401	105	119	
Cap Entry, veh/h	931	942	545	568	800	817	484	510	
V/C Ratio	0.578	0.645	0.330	0.357	0.566	0.492	0.217	0.232	
Control Delay, s/veh	11.9	13.7	11.5	11.6	13.0	11.1	10.6	10.3	
LOS	B	B	B	B	B	B	B	B	
95th %tile Queue, veh	4	5	1	2	4	3	1	1	

HCM 2010 Signalized Intersection Summary
 39: General Jim Moore Boulevard & Gigling Road

Cumulative w/ Proj, PM
 09/06/2019



Movement	EBL	EBT	EBR	WBL	WBT	WBR	NBL	NBT	NBR	SBL	SBT	SBR
Lane Configurations	↖	↗		↖	↗	↖	↖	↗	↖	↖	↗	↖
Traffic Volume (veh/h)	20	20	30	290	50	380	60	340	460	400	350	50
Future Volume (veh/h)	20	20	30	290	50	380	60	340	460	400	350	50
Number	3	8	18	7	4	14	1	6	16	5	2	12
Initial Q (Qb), veh	0	0	0	0	0	0	0	0	0	0	0	0
Ped-Bike Adj(A_pbT)	1.00		1.00	1.00		1.00	1.00		1.00	1.00		1.00
Parking Bus, Adj	1.00	1.00	1.00	1.00	1.00	1.00	1.00	1.00	1.00	1.00	1.00	1.00
Adj Sat Flow, veh/h/ln	1810	1810	1900	1863	1863	1863	1881	1881	1881	1863	1863	1863
Adj Flow Rate, veh/h	22	22	3	326	56	0	67	382	0	449	393	0
Adj No. of Lanes	1	2	0	2	2	1	1	2	1	1	2	1
Peak Hour Factor	0.89	0.89	0.89	0.89	0.89	0.89	0.89	0.89	0.89	0.89	0.89	0.89
Percent Heavy Veh, %	5	5	5	2	2	2	1	1	1	2	2	2
Cap, veh/h	187	267	36	463	404	181	112	553	248	407	1138	509
Arrive On Green	0.11	0.09	0.09	0.13	0.11	0.00	0.06	0.15	0.00	0.23	0.32	0.00
Sat Flow, veh/h	1723	3049	407	3442	3539	1583	1792	3574	1599	1774	3539	1583
Grp Volume(v), veh/h	22	12	13	326	56	0	67	382	0	449	393	0
Grp Sat Flow(s),veh/h/ln	1723	1719	1736	1721	1770	1583	1792	1787	1599	1774	1770	1583
Q Serve(g_s), s	0.5	0.3	0.3	4.1	0.7	0.0	1.7	4.6	0.0	10.5	3.9	0.0
Cycle Q Clear(g_c), s	0.5	0.3	0.3	4.1	0.7	0.0	1.7	4.6	0.0	10.5	3.9	0.0
Prop In Lane	1.00		0.23	1.00		1.00	1.00		1.00	1.00		1.00
Lane Grp Cap(c), veh/h	187	151	152	463	404	181	112	553	248	407	1138	509
V/C Ratio(X)	0.12	0.08	0.08	0.70	0.14	0.00	0.60	0.69	0.00	1.10	0.35	0.00
Avail Cap(c_a), veh/h	772	1146	1157	1542	2359	1055	411	1992	891	407	1972	882
HCM Platoon Ratio	1.00	1.00	1.00	1.00	1.00	1.00	1.00	1.00	1.00	1.00	1.00	1.00
Upstream Filter(I)	1.00	1.00	1.00	1.00	1.00	0.00	1.00	1.00	0.00	1.00	1.00	0.00
Uniform Delay (d), s/veh	18.4	19.2	19.2	18.9	18.2	0.0	20.9	18.3	0.0	17.6	11.8	0.0
Incr Delay (d2), s/veh	0.1	0.1	0.1	0.7	0.1	0.0	1.9	0.6	0.0	75.4	0.1	0.0
Initial Q Delay(d3),s/veh	0.0	0.0	0.0	0.0	0.0	0.0	0.0	0.0	0.0	0.0	0.0	0.0
%ile BackOfQ(50%),veh/ln	0.3	0.1	0.2	2.0	0.3	0.0	0.9	2.3	0.0	13.5	1.9	0.0
LnGrp Delay(d),s/veh	18.5	19.3	19.3	19.7	18.3	0.0	22.8	18.9	0.0	93.1	11.9	0.0
LnGrp LOS	B	B	B	B	B		C	B		F	B	
Approach Vol, veh/h		47			382			449			842	
Approach Delay, s/veh		18.9			19.5			19.5			55.2	
Approach LOS		B			B			B			E	
Timer	1	2	3	4	5	6	7	8				
Assigned Phs	1	2	3	4	5	6	7	8				
Phs Duration (G+Y+Rc), s	7.4	19.2	9.5	9.7	15.0	11.6	10.7	8.5				
Change Period (Y+Rc), s	4.5	4.5	4.5	4.5	4.5	4.5	4.5	4.5				
Max Green Setting (Gmax), s	10.5	25.5	20.5	30.5	10.5	25.5	20.5	30.5				
Max Q Clear Time (g_c+1), s	13.5	5.9	2.5	2.7	12.5	6.6	6.1	2.3				
Green Ext Time (p_c), s	0.0	0.5	0.0	0.1	0.0	0.5	0.1	0.0				
Intersection Summary												
HCM 2010 Ctrl Delay				36.9								
HCM 2010 LOS				D								
Notes												

HCM 2010 Roundabout
39: General Jim Moore Boulevard & Gigling Road

Intersection									
Intersection Delay, s/veh	14.0								
Intersection LOS	B								
Approach	EB		WB		NB		SB		
Entry Lanes	2		2		2		2		
Conflicting Circle Lanes	2		2		2		2		
Adj Approach Flow, veh/h	80		827		989		919		
Demand Flow Rate, veh/h	84		844		999		937		
Vehicles Circulating, veh/h	1219		489		517		468		
Vehicles Exiting, veh/h	186		1027		786		865		
Follow-Up Headway, s	3.186		3.186		3.186		3.186		
Ped Vol Crossing Leg, #/h	0		0		0		1		
Ped Cap Adj	1.000		1.000		1.000		0.999		
Approach Delay, s/veh	9.3		12.5		16.1		13.6		
Approach LOS	A		B		C		B		
Lane	Left	Right	Left	Right	Left	Right	Left	Right	
Designated Moves	LT	TR	LT	TR	LT	TR	LT	TR	
Assumed Moves	LT	TR	LT	R	LT	R	L	TR	
RT Channelized									
Lane Util	0.464	0.536	0.472	0.528	0.465	0.535	0.501	0.499	
Critical Headway, s	4.293	4.113	4.293	4.113	4.293	4.113	4.293	4.113	
Entry Flow, veh/h	39	45	398	446	465	534	469	468	
Cap Entry Lane, veh/h	453	481	783	802	767	787	795	814	
Entry HV Adj Factor	0.962	0.941	0.980	0.980	0.989	0.991	0.981	0.981	
Flow Entry, veh/h	38	42	390	437	460	529	460	459	
Cap Entry, veh/h	436	453	767	786	759	779	780	798	
V/C Ratio	0.086	0.093	0.508	0.556	0.606	0.679	0.590	0.575	
Control Delay, s/veh	9.5	9.2	12.0	12.9	14.8	17.2	14.0	13.3	
LOS	A	A	B	B	B	C	B	B	
95th %tile Queue, veh	0	0	3	3	4	5	4	4	

HCM 2010 Signalized Intersection Summary
 47: General Jim Moore Boulevard & Coe Avenue

Cuml w/ Proj, PM
 09/06/2019



Movement	EBL	EBT	EBR	WBL	WBT	WBR	NBL	NBT	NBR	SBL	SBT	SBR
Lane Configurations	↖	↗					↖	↑↑			↑↑	↗
Traffic Volume (veh/h)	60	0	100	0	0	0	150	980	0	0	440	50
Future Volume (veh/h)	60	0	100	0	0	0	150	980	0	0	440	50
Number	3	8	18				1	6	16	5	2	12
Initial Q (Qb), veh	0	0	0				0	0	0	0	0	0
Ped-Bike Adj(A_pbT)	1.00		1.00				1.00		1.00	1.00		1.00
Parking Bus, Adj	1.00	1.00	1.00				1.00	1.00	1.00	1.00	1.00	1.00
Adj Sat Flow, veh/h/ln	1881	1881	1900				1881	1881	0	0	1863	1863
Adj Flow Rate, veh/h	67	0	0				169	1101	0	0	494	-6
Adj No. of Lanes	1	1	0				1	2	0	0	2	1
Peak Hour Factor	0.89	0.89	0.89				0.89	0.89	0.89	0.89	0.89	0.89
Percent Heavy Veh, %	1	2	1				1	1	0	0	2	2
Cap, veh/h	144	151	0				250	1975	0	0	812	363
Arrive On Green	0.08	0.00	0.00				0.14	0.55	0.00	0.00	0.23	0.00
Sat Flow, veh/h	1792	1881	0				1792	3668	0	0	3632	1583
Grp Volume(v), veh/h	67	0	0				169	1101	0	0	494	-6
Grp Sat Flow(s),veh/h/ln	1792	1881	0				1792	1787	0	0	1770	1583
Q Serve(g_s), s	0.9	0.0	0.0				2.2	4.9	0.0	0.0	3.1	0.0
Cycle Q Clear(g_c), s	0.9	0.0	0.0				2.2	4.9	0.0	0.0	3.1	0.0
Prop In Lane	1.00		0.00				1.00		0.00	0.00		1.00
Lane Grp Cap(c), veh/h	144	151	0				250	1975	0	0	812	363
V/C Ratio(X)	0.47	0.00	0.00				0.68	0.56	0.00	0.00	0.61	-0.02
Avail Cap(c_a), veh/h	3070	3223	0				402	6416	0	0	4909	2196
HCM Platoon Ratio	1.00	1.00	1.00				1.00	1.00	1.00	1.00	1.00	1.00
Upstream Filter(I)	1.00	0.00	0.00				1.00	1.00	0.00	0.00	1.00	0.00
Uniform Delay (d), s/veh	10.8	0.0	0.0				10.0	3.5	0.0	0.0	8.5	0.0
Incr Delay (d2), s/veh	0.9	0.0	0.0				1.2	0.1	0.0	0.0	0.3	0.0
Initial Q Delay(d3),s/veh	0.0	0.0	0.0				0.0	0.0	0.0	0.0	0.0	0.0
%ile BackOfQ(50%),veh/ln	0.5	0.0	0.0				1.2	2.3	0.0	0.0	1.5	0.0
LnGrp Delay(d),s/veh	11.6	0.0	0.0				11.2	3.6	0.0	0.0	8.7	0.0
LnGrp LOS	B						B	A			A	
Approach Vol, veh/h		67						1270			488	
Approach Delay, s/veh		11.6						4.6			8.8	
Approach LOS		B						A			A	
Timer	1	2	3	4	5	6	7	8				
Assigned Phs	1	2				6		8				
Phs Duration (G+Y+Rc), s	7.9	10.1				18.0		6.5				
Change Period (Y+Rc), s	4.5	4.5				4.5		4.5				
Max Green Setting (Gmax), s	5.5	34.0				44.0		42.0				
Max Q Clear Time (g_c+I), s	14.2	5.1				6.9		2.9				
Green Ext Time (p_c), s	0.0	0.6				1.4		0.0				
Intersection Summary												
HCM 2010 Ctrl Delay			6.0									
HCM 2010 LOS			A									

HCM 2010 Signalized Intersection Summary
5: 2nd Avenue & Imjin Parkway

Cuml w/ Eastside Pkwy w/ Proj, AM
09/06/2019



Movement	EBL	EBT	EBR	WBL	WBT	WBR	NBL	NBT	NBR	SBL	SBT	SBR
Lane Configurations	↖↗	↑↑↑	↖↗	↖↗↖	↑↑↑	↖	↖↗↖	↑	↖↗	↖↗	↑↑	↖
Traffic Volume (veh/h)	180	1050	910	460	860	120	420	90	200	50	100	210
Future Volume (veh/h)	180	1050	910	460	860	120	420	90	200	50	100	210
Number	5	2	12	1	6	16	3	8	18	7	4	14
Initial Q (Qb), veh	0	0	0	0	0	0	0	0	0	0	0	0
Ped-Bike Adj(A_pbT)	1.00		1.00	1.00		1.00	1.00		1.00	1.00		1.00
Parking Bus, Adj	1.00	1.00	1.00	1.00	1.00	1.00	1.00	1.00	1.00	1.00	1.00	1.00
Adj Sat Flow, veh/h/ln	1863	1863	1863	1863	1863	1863	1810	1810	1810	1900	1900	1900
Adj Flow Rate, veh/h	184	1071	710	469	878	122	429	92	82	51	102	209
Adj No. of Lanes	2	3	2	3	3	1	3	1	2	2	2	1
Peak Hour Factor	0.98	0.98	0.98	0.98	0.98	0.98	0.98	0.98	0.98	0.98	0.98	0.98
Percent Heavy Veh, %	2	2	2	2	2	2	5	5	5	0	0	0
Cap, veh/h	295	1538	843	629	1742	622	585	398	594	177	542	380
Arrive On Green	0.09	0.30	0.30	0.13	0.34	0.34	0.12	0.22	0.22	0.05	0.15	0.15
Sat Flow, veh/h	3442	5085	2787	5003	5085	1583	4860	1810	2701	3510	3610	1612
Grp Volume(v), veh/h	184	1071	710	469	878	122	429	92	82	51	102	209
Grp Sat Flow(s),veh/h/ln	1721	1695	1393	1668	1695	1583	1620	1810	1350	1755	1805	1612
Q Serve(g_s), s	3.1	11.1	14.2	5.4	8.2	3.0	5.1	2.5	1.5	0.8	1.5	6.8
Cycle Q Clear(g_c), s	3.1	11.1	14.2	5.4	8.2	3.0	5.1	2.5	1.5	0.8	1.5	6.8
Prop In Lane	1.00		1.00	1.00		1.00	1.00		1.00	1.00		1.00
Lane Grp Cap(c), veh/h	295	1538	843	629	1742	622	585	398	594	177	542	380
V/C Ratio(X)	0.62	0.70	0.84	0.75	0.50	0.20	0.73	0.23	0.14	0.29	0.19	0.55
Avail Cap(c_a), veh/h	869	2568	1407	1263	2568	879	1636	640	955	591	1276	708
HCM Platoon Ratio	1.00	1.00	1.00	1.00	1.00	1.00	1.00	1.00	1.00	1.00	1.00	1.00
Upstream Filter(I)	1.00	1.00	1.00	1.00	1.00	1.00	1.00	1.00	1.00	1.00	1.00	1.00
Uniform Delay (d), s/veh	26.2	18.3	19.4	25.1	15.5	11.9	25.2	19.0	18.6	27.2	22.1	19.9
Incr Delay (d2), s/veh	0.8	0.2	1.0	0.7	0.1	0.1	0.7	0.1	0.0	0.3	0.1	0.5
Initial Q Delay(d3),s/veh	0.0	0.0	0.0	0.0	0.0	0.0	0.0	0.0	0.0	0.0	0.0	0.0
%ile BackOfQ(50%),veh/ln	1.5	5.2	5.5	2.5	3.8	1.3	2.3	1.2	0.5	0.4	0.7	3.0
LnGrp Delay(d),s/veh	27.0	18.5	20.4	25.7	15.6	11.9	25.9	19.1	18.7	27.5	22.1	20.4
LnGrp LOS	C	B	C	C	B	B	C	B	B	C	C	C
Approach Vol, veh/h		1965			1469			603			362	
Approach Delay, s/veh		20.0			18.5			23.9			21.9	
Approach LOS		B			B			C			C	
Timer	1	2	3	4	5	6	7	8				
Assigned Phs	1	2	3	4	5	6	7	8				
Phs Duration (G+Y+Rc), s	2.0	23.3	10.7	13.5	9.6	25.6	6.5	17.7				
Change Period (Y+Rc), s	4.5	5.3	3.5	4.6	4.5	5.3	3.5	4.6				
Max Green Setting (Gmax), s	15.0	30.0	20.0	21.0	15.0	30.0	10.0	21.0				
Max Q Clear Time (g_c+1), s	17.5	16.2	7.1	8.8	5.1	10.2	2.8	4.5				
Green Ext Time (p_c), s	0.1	1.8	0.1	0.1	0.0	1.4	0.0	0.1				
Intersection Summary												
HCM 2010 Ctrl Delay				20.2								
HCM 2010 LOS				C								

HCM 2010 Signalized Intersection Summary
 12: Reservation Road & Imjin Parkway

Cuml w/ Eastside Pkwy w/ Proj, AM
 09/06/2019



Movement	EBL	EBT	EBR	WBL	WBT	WBR	NBL	NBT	NBR	SBL	SBT	SBR
Lane Configurations												
Traffic Volume (veh/h)	190	50	670	10	20	30	950	880	20	60	590	90
Future Volume (veh/h)	190	50	670	10	20	30	950	880	20	60	590	90
Number	3	8	18	7	4	14	1	6	16	5	2	12
Initial Q (Qb), veh	0	0	0	0	0	0	0	0	0	0	0	0
Ped-Bike Adj(A_pbT)	1.00		1.00	1.00		0.99	1.00		1.00	1.00		0.98
Parking Bus, Adj	1.00	1.00	1.00	1.00	1.00	1.00	1.00	1.00	1.00	1.00	1.00	1.00
Adj Sat Flow, veh/h/ln	1863	1863	1863	1638	1638	1638	1863	1863	1863	1863	1863	1863
Adj Flow Rate, veh/h	204	54	306	11	22	19	1022	946	16	65	634	34
Adj No. of Lanes	2	1	2	1	1	1	2	2	1	2	3	1
Peak Hour Factor	0.93	0.93	0.93	0.93	0.93	0.93	0.93	0.93	0.93	0.93	0.93	0.93
Percent Heavy Veh, %	2	2	2	16	16	16	2	2	2	2	2	2
Cap, veh/h	388	210	1217	60	63	53	1116	1952	872	131	1350	414
Arrive On Green	0.11	0.11	0.11	0.04	0.04	0.04	0.32	0.55	0.55	0.04	0.27	0.27
Sat Flow, veh/h	3442	1863	2774	1560	1638	1384	3442	3539	1581	3442	5085	1558
Grp Volume(v), veh/h	204	54	306	11	22	19	1022	946	16	65	634	34
Grp Sat Flow(s),veh/h/ln	1721	1863	1387	1560	1638	1384	1721	1770	1581	1721	1695	1558
Q Serve(g_s), s	4.5	2.1	5.6	0.5	1.1	1.1	22.9	13.1	0.4	1.5	8.4	1.3
Cycle Q Clear(g_c), s	4.5	2.1	5.6	0.5	1.1	1.1	22.9	13.1	0.4	1.5	8.4	1.3
Prop In Lane	1.00		1.00	1.00		1.00	1.00		1.00	1.00		1.00
Lane Grp Cap(c), veh/h	388	210	1217	60	63	53	1116	1952	872	131	1350	414
V/C Ratio(X)	0.53	0.26	0.25	0.18	0.35	0.36	0.92	0.48	0.02	0.50	0.47	0.08
Avail Cap(c_a), veh/h	1501	812	2114	603	633	535	1501	2205	985	858	3802	1165
HCM Platoon Ratio	1.00	1.00	1.00	1.00	1.00	1.00	1.00	1.00	1.00	1.00	1.00	1.00
Upstream Filter(I)	1.00	1.00	1.00	1.00	1.00	1.00	1.00	1.00	1.00	1.00	1.00	1.00
Uniform Delay (d), s/veh	33.6	32.5	14.3	37.4	37.6	37.6	26.1	11.0	8.1	37.8	24.7	22.1
Incr Delay (d2), s/veh	0.4	0.2	0.0	0.5	1.2	1.5	6.2	0.5	0.0	1.1	0.7	0.2
Initial Q Delay(d3),s/veh	0.0	0.0	0.0	0.0	0.0	0.0	0.0	0.0	0.0	0.0	0.0	0.0
%ile BackOfQ(50%),veh/ln	2.1	1.1	2.1	0.2	0.5	0.4	11.7	6.4	0.2	0.7	4.0	0.6
LnGrp Delay(d),s/veh	34.0	32.8	14.3	37.9	38.9	39.2	32.3	11.5	8.2	38.9	25.4	22.4
LnGrp LOS	C	C	B	D	D	D	C	B	A	D	C	C
Approach Vol, veh/h		564			52			1984			733	
Approach Delay, s/veh		23.2			38.8			22.2			26.5	
Approach LOS		C			D			C			C	
Timer	1	2	3	4	5	6	7	8				
Assigned Phs	1	2		4	5	6		8				
Phs Duration (G+Y+Rc), s	30.1	27.5		8.1	7.2	50.5		14.6				
Change Period (Y+Rc), s	4.1	* 6.2		5.0	4.1	* 6.2		5.5				
Max Green Setting (Gmax), s	35.0	* 60		31.0	20.0	* 50		35.0				
Max Q Clear Time (g_c+24.9), s	24.9	10.4		3.1	3.5	15.1		7.6				
Green Ext Time (p_c), s	1.1	10.7		0.1	0.0	15.6		1.2				
Intersection Summary												
HCM 2010 Ctrl Delay			23.6									
HCM 2010 LOS			C									
Notes												

HCM 2010 Signalized Intersection Summary
 14: Reservation Road & Inter-Garrison Road

Cuml w/ Eastside Pkwy w/ Proj, AM
 09/06/2019



Movement	EBL	EBR	NBL	NBT	SBT	SBR		
Lane Configurations								
Traffic Volume (veh/h)	110	610	900	460	260	160		
Future Volume (veh/h)	110	610	900	460	260	160		
Number	3	18	1	6	2	12		
Initial Q (Qb), veh	0	0	0	0	0	0		
Ped-Bike Adj(A_pbT)	1.00	1.00	1.00			1.00		
Parking Bus, Adj	1.00	1.00	1.00	1.00	1.00	1.00		
Adj Sat Flow, veh/h/ln	1845	1845	1863	1863	1845	1900		
Adj Flow Rate, veh/h	117	381	957	489	277	154		
Adj No. of Lanes	1	2	2	2	2	0		
Peak Hour Factor	0.94	0.94	0.94	0.94	0.94	0.94		
Percent Heavy Veh, %	3	3	2	2	3	3		
Cap, veh/h	274	1307	1092	2271	522	282		
Arrive On Green	0.16	0.16	0.32	0.64	0.24	0.24		
Sat Flow, veh/h	1757	2760	3442	3632	2291	1188		
Grp Volume(v), veh/h	117	381	957	489	219	212		
Grp Sat Flow(s),veh/h/ln	1757	1380	1721	1770	1752	1635		
Q Serve(g_s), s	3.2	4.5	14.2	3.1	5.9	6.1		
Cycle Q Clear(g_c), s	3.2	4.5	14.2	3.1	5.9	6.1		
Prop In Lane	1.00	1.00	1.00			0.73		
Lane Grp Cap(c), veh/h	274	1307	1092	2271	416	388		
V/C Ratio(X)	0.43	0.29	0.88	0.22	0.53	0.55		
Avail Cap(c_a), veh/h	880	2257	1277	3938	1950	1819		
HCM Platoon Ratio	1.00	1.00	1.00	1.00	1.00	1.00		
Upstream Filter(I)	1.00	1.00	1.00	1.00	1.00	1.00		
Uniform Delay (d), s/veh	20.6	8.7	17.4	4.0	17.9	18.0		
Incr Delay (d2), s/veh	1.0	0.1	5.7	0.1	1.9	2.2		
Initial Q Delay(d3),s/veh	0.0	0.0	0.0	0.0	0.0	0.0		
%ile BackOfQ(50%),veh/ln	1.6	1.7	7.5	1.5	3.0	3.0		
LnGrp Delay(d),s/veh	21.6	8.8	23.1	4.1	19.9	20.3		
LnGrp LOS	C	A	C	A	B	C		
Approach Vol, veh/h	498			1446	431			
Approach Delay, s/veh	11.8			16.7	20.1			
Approach LOS	B			B	C			
Timer	1	2	3	4	5	6	7	8
Assigned Phs	1	2				6		8
Phs Duration (G+Y+Rc), s	11.8	19.2				41.0		12.9
Change Period (Y+Rc), s	4.7	6.4				6.4		4.5
Max Green Setting (Gmax), s	60.0	60.0				60.0		27.0
Max Q Clear Time (g_c+Y+Rc), s	11.8	8.1				5.1		6.5
Green Ext Time (p_c), s	0.9	4.7				5.8		1.9
Intersection Summary								
HCM 2010 Ctrl Delay			16.3					
HCM 2010 LOS			B					
Notes								

HCM 2010 Signalized Intersection Summary
 22: 8th Avenue & Inter-Garrison Road

Cuml w/ Eastside Pkwy w/ Proj, AM
 09/06/2019



Movement	EBT	EBR	WBL	WBT	NBL	NBR		
Lane Configurations								
Traffic Volume (veh/h)	220	120	520	530	50	290		
Future Volume (veh/h)	220	120	520	530	50	290		
Number	4	14	3	8	5	12		
Initial Q (Qb), veh	0	0	0	0	0	0		
Ped-Bike Adj(A_pbT)		1.00	1.00		1.00	1.00		
Parking Bus, Adj	1.00	1.00	1.00	1.00	1.00	1.00		
Adj Sat Flow, veh/h/ln	1520	1900	1881	1881	1845	1900		
Adj Flow Rate, veh/h	253	46	598	609	57	149		
Adj No. of Lanes	1	0	2	1	0	0		
Peak Hour Factor	0.87	0.87	0.87	0.87	0.87	0.87		
Percent Heavy Veh, %	25	25	1	1	0	0		
Cap, veh/h	335	61	865	1171	74	192		
Arrive On Green	0.27	0.27	0.25	0.62	0.17	0.17		
Sat Flow, veh/h	1252	228	3476	1881	445	1164		
Grp Volume(v), veh/h	0	299	598	609	207	0		
Grp Sat Flow(s),veh/h/ln	0	1480	1738	1881	1617	0		
Q Serve(g_s), s	0.0	7.9	6.6	7.7	5.2	0.0		
Cycle Q Clear(g_c), s	0.0	7.9	6.6	7.7	5.2	0.0		
Prop In Lane		0.15	1.00		0.28	0.72		
Lane Grp Cap(c), veh/h	0	396	865	1171	267	0		
V/C Ratio(X)	0.00	0.76	0.69	0.52	0.77	0.00		
Avail Cap(c_a), veh/h	0	855	1861	2294	736	0		
HCM Platoon Ratio	1.00	1.00	1.00	1.00	1.00	1.00		
Upstream Filter(I)	0.00	1.00	1.00	1.00	1.00	0.00		
Uniform Delay (d), s/veh	0.0	14.3	14.4	4.5	16.9	0.0		
Incr Delay (d2), s/veh	0.0	3.0	1.0	0.4	4.8	0.0		
Initial Q Delay(d3),s/veh	0.0	0.0	0.0	0.0	0.0	0.0		
%ile BackOfQ(50%),veh/ln	0.0	3.5	3.3	4.0	2.7	0.0		
LnGrp Delay(d),s/veh	0.0	17.2	15.5	4.8	21.7	0.0		
LnGrp LOS		B	B	A	C			
Approach Vol, veh/h	299			1207	207			
Approach Delay, s/veh	17.2			10.1	21.7			
Approach LOS	B			B	C			
Timer	1	2	3	4	5	6	7	8
Assigned Phs		2	3	4				8
Phs Duration (G+Y+Rc), s		11.5	15.0	15.8				30.9
Change Period (Y+Rc), s		4.5	4.5	4.5				4.5
Max Green Setting (Gmax), s		19.3	22.7	24.5				51.7
Max Q Clear Time (g_c+I1), s		7.2	8.6	9.9				9.7
Green Ext Time (p_c), s		0.5	1.9	1.5				4.5
Intersection Summary								
HCM 2010 Ctrl Delay			12.7					
HCM 2010 LOS			B					
Notes								

Intersection				
Intersection Delay, s/veh	12.2			
Intersection LOS	B			
Approach	EB	WB		NB
Entry Lanes	1	2	1	
Conflicting Circle Lanes	2	2	2	
Adj Approach Flow, veh/h	391	1207	390	
Demand Flow Rate, veh/h	488	1219	402	
Vehicles Circulating, veh/h	604	59	316	
Vehicles Exiting, veh/h	674	659	776	
Follow-Up Headway, s	3.186	3.186	3.186	
Ped Vol Crossing Leg, #/h	0	0	0	
Ped Cap Adj	1.000	1.000	1.000	
Approach Delay, s/veh	20.3	10.4	9.5	
Approach LOS	C	B	A	
Lane	Left	Left	Right	Left
Designated Moves	TR	L	LTR	LR
Assumed Moves	TR	L	TR	LR
RT Channelized				
Lane Util	1.000	0.495	0.505	1.000
Critical Headway, s	4.113	4.293	4.113	4.113
Entry Flow, veh/h	488	604	615	402
Cap Entry Lane, veh/h	740	1081	1084	906
Entry HV Adj Factor	0.801	0.990	0.990	0.970
Flow Entry, veh/h	391	598	609	390
Cap Entry, veh/h	593	1070	1073	879
V/C Ratio	0.659	0.559	0.567	0.444
Control Delay, s/veh	20.3	10.3	10.5	9.5
LOS	C	B	B	A
95th %tile Queue, veh	5	4	4	2

HCM 2010 Signalized Intersection Summary
 25: Inter-Garrison Road & Sherman Boulevard

Cuml w/ Eastside Pkwy w/ Proj, AM
 09/06/2019



Movement	EBL	EBT	WBT	WBR	SBL	SBR		
Lane Configurations								
Traffic Volume (veh/h)	600	130	310	130	90	820		
Future Volume (veh/h)	600	130	310	130	90	820		
Number	7	4	8	18	1	16		
Initial Q (Qb), veh	0	0	0	0	0	0		
Ped-Bike Adj(A_pbT)	1.00			1.00	1.00	1.00		
Parking Bus, Adj	1.00	1.00	1.00	1.00	1.00	1.00		
Adj Sat Flow, veh/h/ln	1810	1810	1881	1900	1900	1900		
Adj Flow Rate, veh/h	732	159	378	146	110	921		
Adj No. of Lanes	1	1	1	0	1	1		
Peak Hour Factor	0.82	0.82	0.82	0.82	0.82	0.82		
Percent Heavy Veh, %	5	5	1	1	0	0		
Cap, veh/h	729	1341	359	139	321	969		
Arrive On Green	0.42	0.74	0.28	0.28	0.18	0.18		
Sat Flow, veh/h	1723	1810	1293	500	1810	1615		
Grp Volume(v), veh/h	732	159	0	524	110	921		
Grp Sat Flow(s),veh/h/ln	1723	1810	0	1793	1810	1615		
Q Serve(g_s), s	46.5	2.7	0.0	30.5	5.9	19.5		
Cycle Q Clear(g_c), s	46.5	2.7	0.0	30.5	5.9	19.5		
Prop In Lane	1.00			0.28	1.00	1.00		
Lane Grp Cap(c), veh/h	729	1341	0	497	321	969		
V/C Ratio(X)	1.00	0.12	0.00	1.05	0.34	0.95		
Avail Cap(c_a), veh/h	729	1341	0	497	321	969		
HCM Platoon Ratio	1.00	1.00	1.00	1.00	1.00	1.00		
Upstream Filter(I)	1.00	1.00	0.00	1.00	1.00	1.00		
Uniform Delay (d), s/veh	31.7	4.0	0.0	39.8	39.6	20.5		
Incr Delay (d2), s/veh	34.5	0.0	0.0	55.3	0.6	18.1		
Initial Q Delay(d3),s/veh	0.0	0.0	0.0	0.0	0.0	0.0		
%ile BackOfQ(50%),veh/ln	29.0	1.4	0.0	22.7	3.0	44.0		
LnGrp Delay(d),s/veh	66.3	4.1	0.0	95.1	40.3	38.6		
LnGrp LOS	F	A		F	D	D		
Approach Vol, veh/h		891	524		1031			
Approach Delay, s/veh		55.2	95.1		38.8			
Approach LOS		E	F		D			
Timer	1	2	3	4	5	6	7	8
Assigned Phs				4		6	7	8
Phs Duration (G+Y+Rc), s				86.0		24.0	51.0	35.0
Change Period (Y+Rc), s				4.5		4.5	4.5	4.5
Max Green Setting (Gmax), s				81.5		19.5	46.5	30.5
Max Q Clear Time (g_c+I1), s				4.7		21.5	48.5	32.5
Green Ext Time (p_c), s				1.1		0.0	0.0	0.0
Intersection Summary								
HCM 2010 Ctrl Delay			56.8					
HCM 2010 LOS			E					

HCM 2010 Signalized Intersection Summary
28: Davis Road & Reservation Road

Cuml w/ Eastside Pkwy w/ Proj, AM
09/06/2019



Movement	EBL	EBT	EBR	WBL	WBT	WBR	NBL	NBT	NBR	SBL	SBT	SBR
Lane Configurations												
Traffic Volume (veh/h)	750	320	10	10	570	90	10	10	10	150	10	850
Future Volume (veh/h)	750	320	10	10	570	90	10	10	10	150	10	850
Number	5	2	12	1	6	16	3	8	18	7	4	14
Initial Q (Qb), veh	0	0	0	0	0	0	0	0	0	0	0	0
Ped-Bike Adj(A_pbT)	1.00		1.00	1.00		1.00	1.00		1.00	1.00		1.00
Parking Bus, Adj	1.00	1.00	1.00	1.00	1.00	1.00	1.00	1.00	1.00	1.00	1.00	1.00
Adj Sat Flow, veh/h/ln	1863	1863	1900	1863	1863	1900	1900	1900	1900	1900	1845	1845
Adj Flow Rate, veh/h	872	372	12	12	663	105	12	12	9	174	12	746
Adj No. of Lanes	2	2	0	1	1	0	0	1	0	0	1	2
Peak Hour Factor	0.86	0.86	0.86	0.86	0.86	0.86	0.86	0.86	0.86	0.86	0.86	0.86
Percent Heavy Veh, %	2	2	2	2	2	2	0	0	0	3	3	3
Cap, veh/h	730	2187	70	19	666	105	17	17	12	350	24	1171
Arrive On Green	0.21	0.63	0.63	0.01	0.42	0.42	0.03	0.03	0.03	0.21	0.21	0.21
Sat Flow, veh/h	3442	3500	113	1774	1570	249	648	648	486	1649	114	2760
Grp Volume(v), veh/h	872	188	196	12	0	768	33	0	0	186	0	746
Grp Sat Flow(s),veh/h/ln	1721	1770	1843	1774	0	1819	1782	0	0	1762	0	1380
Q Serve(g_s), s	30.0	6.3	6.3	1.0	0.0	59.5	2.6	0.0	0.0	13.1	0.0	30.0
Cycle Q Clear(g_c), s	30.0	6.3	6.3	1.0	0.0	59.5	2.6	0.0	0.0	13.1	0.0	30.0
Prop In Lane	1.00		0.06	1.00		0.14	0.36		0.27	0.94		1.00
Lane Grp Cap(c), veh/h	730	1106	1152	19	0	772	46	0	0	374	0	1171
V/C Ratio(X)	1.19	0.17	0.17	0.64	0.00	1.00	0.72	0.00	0.00	0.50	0.00	0.64
Avail Cap(c_a), veh/h	730	1106	1152	376	0	772	378	0	0	374	0	1171
HCM Platoon Ratio	1.00	1.00	1.00	1.00	1.00	1.00	1.00	1.00	1.00	1.00	1.00	1.00
Upstream Filter(I)	1.00	1.00	1.00	1.00	0.00	1.00	1.00	0.00	0.00	1.00	0.00	1.00
Uniform Delay (d), s/veh	55.7	11.1	11.1	69.7	0.0	40.6	68.4	0.0	0.0	49.1	0.0	32.1
Incr Delay (d2), s/veh	100.7	0.1	0.1	12.4	0.0	31.2	7.7	0.0	0.0	0.4	0.0	0.9
Initial Q Delay(d3),s/veh	0.0	0.0	0.0	0.0	0.0	0.0	0.0	0.0	0.0	0.0	0.0	0.0
%ile BackOfQ(50%),veh/ln	24.4	3.1	3.3	0.5	0.0	36.6	1.4	0.0	0.0	6.4	0.0	11.6
LnGrp Delay(d),s/veh	156.4	11.2	11.2	82.1	0.0	71.8	76.1	0.0	0.0	49.5	0.0	33.0
LnGrp LOS	F	B	B	F		E	E			D		C
Approach Vol, veh/h		1256			780			33			932	
Approach Delay, s/veh		112.0			71.9			76.1			36.3	
Approach LOS		F			E			E			D	
Timer	1	2	3	4	5	6	7	8				
Assigned Phs	1	2		4	5	6		8				
Phs Duration (G+Y+Rc), s	5.4	93.4		35.0	33.8	65.0		7.6				
Change Period (Y+Rc), s	3.9	5.0		5.0	* 3.8	5.0		4.0				
Max Green Setting (Gmax), s	30	60.0		30.0	* 30	60.0		30.0				
Max Q Clear Time (g_c+1), s	13	8.3		32.0	32.0	61.5		4.6				
Green Ext Time (p_c), s	0.0	3.4		0.0	0.0	0.0		0.0				
Intersection Summary												
HCM 2010 Ctrl Delay				77.7								
HCM 2010 LOS				E								
Notes												

HCM 2010 Signalized Intersection Summary
 33: General Jim Moore Boulevard & Lightfighter Drive

Cuml w/ Eastside Pkwy w/ Proj, AM
 09/06/2019



Movement	EBL	EBT	EBR	WBL	WBT	WBR	NBL	NBT	NBR	SBL	SBT	SBR
Lane Configurations	↖↗	↑	↗	↖↗	↖↗		↖↗	↖↗		↖	↖↗	↗
Traffic Volume (veh/h)	50	280	830	20	170	70	960	60	10	40	50	20
Future Volume (veh/h)	50	280	830	20	170	70	960	60	10	40	50	20
Number	3	8	18	7	4	14	1	6	16	5	2	12
Initial Q (Qb), veh	0	0	0	0	0	0	0	0	0	0	0	0
Ped-Bike Adj(A_pbT)	1.00		1.00	1.00		0.99	1.00		1.00	1.00		1.00
Parking Bus, Adj	1.00	1.00	1.00	1.00	1.00	1.00	1.00	1.00	1.00	1.00	1.00	1.00
Adj Sat Flow, veh/h/ln	1863	1863	1863	1792	1792	1900	1881	1881	1900	1863	1863	1863
Adj Flow Rate, veh/h	56	315	0	22	191	77	1079	67	10	45	56	22
Adj No. of Lanes	2	1	1	2	2	0	3	2	0	1	2	1
Peak Hour Factor	0.89	0.89	0.89	0.89	0.89	0.89	0.89	0.89	0.89	0.89	0.89	0.89
Percent Heavy Veh, %	2	2	2	6	6	6	1	1	1	2	2	2
Cap, veh/h	148	404	343	70	466	181	1415	1159	169	66	450	201
Arrive On Green	0.04	0.22	0.00	0.02	0.19	0.19	0.28	0.37	0.37	0.04	0.13	0.13
Sat Flow, veh/h	3442	1863	1583	3312	2394	931	5052	3129	457	1774	3539	1576
Grp Volume(v), veh/h	56	315	0	22	134	134	1079	38	39	45	56	22
Grp Sat Flow(s),veh/h/ln	1721	1863	1583	1656	1703	1622	1684	1787	1800	1774	1770	1576
Q Serve(g_s), s	0.8	8.1	0.0	0.3	3.5	3.7	9.9	0.7	0.7	1.3	0.7	0.6
Cycle Q Clear(g_c), s	0.8	8.1	0.0	0.3	3.5	3.7	9.9	0.7	0.7	1.3	0.7	0.6
Prop In Lane	1.00		1.00	1.00		0.57	1.00		0.25	1.00		1.00
Lane Grp Cap(c), veh/h	148	404	343	70	331	316	1415	662	667	66	450	201
V/C Ratio(X)	0.38	0.78	0.00	0.32	0.40	0.42	0.76	0.06	0.06	0.68	0.12	0.11
Avail Cap(c_a), veh/h	271	569	484	261	520	496	1943	1276	1285	220	1605	715
HCM Platoon Ratio	1.00	1.00	1.00	1.00	1.00	1.00	1.00	1.00	1.00	1.00	1.00	1.00
Upstream Filter(I)	1.00	1.00	0.00	1.00	1.00	1.00	1.00	1.00	1.00	1.00	1.00	1.00
Uniform Delay (d), s/veh	23.6	18.7	0.0	24.5	17.9	17.9	16.7	10.3	10.3	24.1	19.6	19.6
Incr Delay (d2), s/veh	1.6	5.1	0.0	1.0	1.0	1.1	1.0	0.1	0.1	4.6	0.1	0.3
Initial Q Delay(d3),s/veh	0.0	0.0	0.0	0.0	0.0	0.0	0.0	0.0	0.0	0.0	0.0	0.0
%ile BackOfQ(50%),veh/ln	0.4	4.7	0.0	0.2	1.7	1.7	4.7	0.3	0.4	0.7	0.4	0.3
LnGrp Delay(d),s/veh	25.2	23.9	0.0	25.4	18.8	19.0	17.7	10.3	10.4	28.7	19.8	19.9
LnGrp LOS	C	C		C	B	B	B	B	B	C	B	B
Approach Vol, veh/h		371			290			1156			123	
Approach Delay, s/veh		24.1			19.4			17.2			23.1	
Approach LOS		C			B			B			C	
Timer	1	2	3	4	5	6	7	8				
Assigned Phs	1	2	3	4	5	6	7	8				
Phs Duration (G+Y+Rc), s	18.7	11.0	6.7	14.4	6.4	23.3	5.6	15.5				
Change Period (Y+Rc), s	4.5	4.5	4.5	4.5	4.5	4.5	4.5	4.5				
Max Green Setting (Gmax), s	19.5	23.0	4.0	15.5	6.3	36.2	4.0	15.5				
Max Q Clear Time (g_c+I1), s	9.5	2.7	2.8	5.7	3.3	2.7	2.3	10.1				
Green Ext Time (p_c), s	2.3	0.3	0.0	1.3	0.0	0.7	0.0	0.9				
Intersection Summary												
HCM 2010 Ctrl Delay				19.2								
HCM 2010 LOS				B								

HCM 2010 Roundabout Cumulative with Eastside Parkway with Project (Roundabouts), AM
 33: General Jim Moore Boulevard & Lightfighter Drive 04/22/2022

Intersection									
Intersection Delay, s/veh	15.1								
Intersection LOS	C								
Approach	EB		WB		NB		SB		
Entry Lanes	2		2		2		2		
Conflicting Circle Lanes	2		2		2		2		
Adj Approach Flow, veh/h	1304		292		1157		123		
Demand Flow Rate, veh/h	1330		309		1169		125		
Vehicles Circulating, veh/h	126		1215		424		1315		
Vehicles Exiting, veh/h	1314		378		1032		209		
Follow-Up Headway, s	3.186		3.186		3.186		3.186		
Ped Vol Crossing Leg, #/h	2		1		2		0		
Ped Cap Adj	0.998		1.000		0.999		1.000		
Approach Delay, s/veh	13.2		13.7		18.1		10.5		
Approach LOS	B		B		C		B		
Lane	Left	Right	Left	Right	Left	Right	Left	Right	
Designated Moves	LTR	R	LT	TR	L	LTR	LT	TR	
Assumed Moves	LTR	R	LT	TR	L	LTR	LT	TR	
RT Channelized									
Lane Util	0.470	0.530	0.469	0.531	0.530	0.470	0.472	0.528	
Critical Headway, s	4.293	4.113	4.293	4.113	4.293	4.113	4.293	4.113	
Entry Flow, veh/h	625	705	145	164	620	549	59	66	
Cap Entry Lane, veh/h	1028	1035	454	483	822	840	421	450	
Entry HV Adj Factor	0.980	0.980	0.945	0.942	0.989	0.991	0.979	0.987	
Flow Entry, veh/h	613	691	137	155	613	544	58	65	
Cap Entry, veh/h	1006	1012	429	455	812	831	413	444	
V/C Ratio	0.609	0.683	0.319	0.340	0.755	0.655	0.140	0.147	
Control Delay, s/veh	12.0	14.3	13.9	13.6	20.5	15.4	10.8	10.2	
LOS	B	B	B	B	C	C	B	B	
95th %tile Queue, veh	4	6	1	1	7	5	0	1	

HCM 2010 Signalized Intersection Summary
 39: General Jim Moore Boulevard & Gigling Road

Cuml w/ Eastside Pkwy w/ Proj, AM
 09/06/2019



Movement	EBL	EBT	EBR	WBL	WBT	WBR	NBL	NBT	NBR	SBL	SBT	SBR
Lane Configurations												
Traffic Volume (veh/h)	30	100	80	460	40	630	50	340	300	430	470	50
Future Volume (veh/h)	30	100	80	460	40	630	50	340	300	430	470	50
Number	3	8	18	7	4	14	1	6	16	5	2	12
Initial Q (Qb), veh	0	0	0	0	0	0	0	0	0	0	0	0
Ped-Bike Adj(A_pbT)	1.00		1.00	1.00		1.00	1.00		1.00	1.00		1.00
Parking Bus, Adj	1.00	1.00	1.00	1.00	1.00	1.00	1.00	1.00	1.00	1.00	1.00	1.00
Adj Sat Flow, veh/h/ln	1810	1810	1810	1863	1863	1863	1881	1881	1881	1863	1863	1863
Adj Flow Rate, veh/h	34	115	60	529	46	0	57	391	0	494	540	0
Adj No. of Lanes	1	1	1	2	2	1	2	3	1	2	3	1
Peak Hour Factor	0.87	0.87	0.87	0.87	0.87	0.87	0.87	0.87	0.87	0.87	0.87	0.87
Percent Heavy Veh, %	5	5	5	2	2	2	1	1	1	2	2	2
Cap, veh/h	66	196	253	660	927	415	195	651	203	625	1282	399
Arrive On Green	0.04	0.11	0.11	0.19	0.26	0.00	0.06	0.13	0.00	0.18	0.25	0.00
Sat Flow, veh/h	1723	1810	1534	3442	3539	1583	3476	5136	1599	3442	5085	1583
Grp Volume(v), veh/h	34	115	60	529	46	0	57	391	0	494	540	0
Grp Sat Flow(s),veh/h/ln	1723	1810	1534	1721	1770	1583	1738	1712	1599	1721	1695	1583
Q Serve(g_s), s	0.9	2.8	1.6	6.8	0.4	0.0	0.7	3.3	0.0	6.3	4.1	0.0
Cycle Q Clear(g_c), s	0.9	2.8	1.6	6.8	0.4	0.0	0.7	3.3	0.0	6.3	4.1	0.0
Prop In Lane	1.00		1.00	1.00		1.00	1.00		1.00	1.00		1.00
Lane Grp Cap(c), veh/h	66	196	253	660	927	415	195	651	203	625	1282	399
V/C Ratio(X)	0.52	0.59	0.24	0.80	0.05	0.00	0.29	0.60	0.00	0.79	0.42	0.00
Avail Cap(c_a), veh/h	229	747	720	1115	2139	957	385	2691	838	1048	3648	1136
HCM Platoon Ratio	1.00	1.00	1.00	1.00	1.00	1.00	1.00	1.00	1.00	1.00	1.00	1.00
Upstream Filter(I)	1.00	1.00	1.00	1.00	1.00	0.00	1.00	1.00	0.00	1.00	1.00	0.00
Uniform Delay (d), s/veh	21.7	19.5	16.7	17.8	12.7	0.0	20.8	19.0	0.0	18.0	14.4	0.0
Incr Delay (d2), s/veh	2.3	1.0	0.2	0.9	0.0	0.0	0.3	0.3	0.0	0.9	0.1	0.0
Initial Q Delay(d3),s/veh	0.0	0.0	0.0	0.0	0.0	0.0	0.0	0.0	0.0	0.0	0.0	0.0
%ile BackOfQ(50%),veh/ln	0.5	1.4	0.7	3.2	0.2	0.0	0.4	1.6	0.0	3.0	1.9	0.0
LnGrp Delay(d),s/veh	24.0	20.5	16.9	18.6	12.7	0.0	21.1	19.3	0.0	18.8	14.5	0.0
LnGrp LOS	C	C	B	B	B		C	B		B	B	
Approach Vol, veh/h		209			575			448			1034	
Approach Delay, s/veh		20.1			18.2			19.5			16.6	
Approach LOS		C			B			B			B	
Timer	1	2	3	4	5	6	7	8				
Assigned Phs	1	2	3	4	5	6	7	8				
Phs Duration (G+Y+Rc), s	7.1	16.1	6.3	16.5	12.9	10.3	13.3	9.5				
Change Period (Y+Rc), s	4.5	4.5	4.5	4.5	4.5	4.5	4.5	4.5				
Max Green Setting (Gmax), s	33.0	33.0	6.1	27.8	14.0	24.1	14.9	19.0				
Max Q Clear Time (g_c+1/2), s	12.5	6.1	2.9	2.4	8.3	5.3	8.8	4.8				
Green Ext Time (p_c), s	0.0	0.8	0.0	0.0	0.1	0.5	0.1	0.1				
Intersection Summary												
HCM 2010 Ctrl Delay				17.9								
HCM 2010 LOS				B								

HCM 2010 Roundabout Cumulative with Eastside Parkway with Project (Roundabouts), AM
 39: General Jim Moore Boulevard & Gigling Road 04/22/2022

Intersection									
Intersection Delay, s/veh	24.6								
Intersection LOS	C								
Approach	EB		WB		NB		SB		
Entry Lanes	2		2		2		2		
Conflicting Circle Lanes	2		2		2		2		
Adj Approach Flow, veh/h	241		1299		793		1091		
Demand Flow Rate, veh/h	254		1325		801		1113		
Vehicles Circulating, veh/h	1595		489		661		645		
Vehicles Exiting, veh/h	163		973		1188		1169		
Follow-Up Headway, s	3.186		3.186		3.186		3.186		
Ped Vol Crossing Leg, #/h	0		0		0		1		
Ped Cap Adj	1.000		1.000		1.000		1.000		
Approach Delay, s/veh	18.2		30.6		14.8		25.8		
Approach LOS	C		D		B		D		
Lane	Left	Right	Left	Right	Left	Right	Left	Right	
Designated Moves	LT	TR	LT	TR	LT	TR	LT	TR	
Assumed Moves	LT	TR	LT	R	LT	TR	LT	TR	
RT Channelized									
Lane Util	0.469	0.531	0.443	0.557	0.469	0.531	0.470	0.530	
Critical Headway, s	4.293	4.113	4.293	4.113	4.293	4.113	4.293	4.113	
Entry Flow, veh/h	119	135	587	738	376	425	523	590	
Cap Entry Lane, veh/h	342	370	783	802	688	711	697	719	
Entry HV Adj Factor	0.953	0.947	0.980	0.981	0.991	0.989	0.981	0.980	
Flow Entry, veh/h	113	128	575	724	373	420	513	578	
Cap Entry, veh/h	325	350	767	787	682	704	683	705	
V/C Ratio	0.348	0.365	0.750	0.920	0.546	0.597	0.751	0.820	
Control Delay, s/veh	18.6	17.9	21.1	38.2	14.2	15.4	23.2	28.1	
LOS	C	C	C	E	B	C	C	D	
95th %tile Queue, veh	2	2	7	13	3	4	7	9	

HCM 2010 Signalized Intersection Summary
 46: General Jim Moore Boulevard & Normandy Road

Cuml w/ Eastside Pkwy w/ Proj, AM
 09/06/2019



Movement	EBL	EBT	EBR	WBL	WBT	WBR	NBL	NBT	NBR	SBL	SBT	SBR
Lane Configurations		↕			↕		↕ ↑↑↑			↕ ↑↑↑		↕
Traffic Volume (veh/h)	90	110	150	380	80	40	200	420	310	80	760	250
Future Volume (veh/h)	90	110	150	380	80	40	200	420	310	80	760	250
Number	3	8	18	7	4	14	1	6	16	5	2	12
Initial Q (Qb), veh	0	0	0	0	0	0	0	0	0	0	0	0
Ped-Bike Adj(A_pbT)	1.00		0.98	0.99		0.98	1.00		0.99	1.00		0.98
Parking Bus, Adj	1.00	1.00	1.00	1.00	1.00	1.00	1.00	1.00	1.00	1.00	1.00	1.00
Adj Sat Flow, veh/h/ln	1900	1881	1900	1900	1863	1900	1881	1881	1900	1863	1863	1863
Adj Flow Rate, veh/h	115	141	163	487	103	47	256	538	370	103	974	252
Adj No. of Lanes	0	1	0	0	1	0	1	3	0	1	3	1
Peak Hour Factor	0.78	0.78	0.78	0.78	0.78	0.78	0.78	0.78	0.78	0.78	0.78	0.78
Percent Heavy Veh, %	1	1	1	2	2	2	1	1	1	2	2	2
Cap, veh/h	283	347	374	513	96	44	205	859	396	128	1060	325
Arrive On Green	0.55	0.55	0.55	0.55	0.55	0.55	0.11	0.25	0.25	0.07	0.21	0.21
Sat Flow, veh/h	434	626	675	821	174	79	1792	3424	1577	1774	5085	1557
Grp Volume(v), veh/h	419	0	0	637	0	0	256	538	370	103	974	252
Grp Sat Flow(s),veh/h/ln	1736	0	0	1074	0	0	1792	1712	1577	1774	1695	1557
Q Serve(g_s), s	0.0	0.0	0.0	45.0	0.0	0.0	12.5	15.3	25.1	6.3	20.5	16.7
Cycle Q Clear(g_c), s	15.5	0.0	0.0	60.5	0.0	0.0	12.5	15.3	25.1	6.3	20.5	16.7
Prop In Lane	0.27		0.39	0.76		0.07	1.00		1.00	1.00		1.00
Lane Grp Cap(c), veh/h	1003	0	0	653	0	0	205	859	396	128	1060	325
V/C Ratio(X)	0.42	0.00	0.00	0.98	0.00	0.00	1.25	0.63	0.94	0.81	0.92	0.78
Avail Cap(c_a), veh/h	1003	0	0	653	0	0	205	893	411	128	1093	335
HCM Platoon Ratio	1.00	1.00	1.00	1.00	1.00	1.00	1.00	1.00	1.00	1.00	1.00	1.00
Upstream Filter(I)	1.00	0.00	0.00	1.00	0.00	0.00	1.00	1.00	1.00	1.00	1.00	1.00
Uniform Delay (d), s/veh	14.3	0.0	0.0	28.3	0.0	0.0	48.4	36.4	40.1	50.0	42.3	40.8
Incr Delay (d2), s/veh	0.1	0.0	0.0	29.0	0.0	0.0	146.0	0.9	27.6	28.5	11.6	9.6
Initial Q Delay(d3),s/veh	0.0	0.0	0.0	0.0	0.0	0.0	0.0	0.0	0.0	0.0	0.0	0.0
%ile BackOfQ(50%),veh/ln	7.4	0.0	0.0	24.4	0.0	0.0	14.5	7.3	13.9	4.1	10.7	8.1
LnGrp Delay(d),s/veh	14.4	0.0	0.0	57.3	0.0	0.0	194.4	37.3	67.6	78.4	54.0	50.4
LnGrp LOS	B			E			F	D	E	E	D	D
Approach Vol, veh/h		419			637			1164			1329	
Approach Delay, s/veh		14.4			57.3			81.5			55.2	
Approach LOS		B			E			F			E	
Timer	1	2	3	4	5	6	7	8				
Assigned Phs	1	2		4	5	6		8				
Phs Duration (G+Y+Rc), s	7.0	27.3		65.0	12.4	31.9		65.0				
Change Period (Y+Rc), s	4.5	4.5		4.5	4.5	4.5		4.5				
Max Green Setting (Gmax), s	12.5	23.5		60.5	7.5	28.5		60.5				
Max Q Clear Time (g_c+1/4), s	14.5	22.5		62.5	8.3	27.1		17.5				
Green Ext Time (p_c), s	0.0	0.3		0.0	0.0	0.3		0.6				
Intersection Summary												
HCM 2010 Ctrl Delay				59.4								
HCM 2010 LOS				E								

HCM 2010 Signalized Intersection Summary
5: 2nd Avenue & Imjin Parkway

Cuml w/ Eastside Pkwy w/ Proj, PM
09/06/2019



Movement	EBL	EBT	EBR	WBL	WBT	WBR	NBL	NBT	NBR	SBL	SBT	SBR
Lane Configurations	↔↔	↑↑↑	↔↔	↔↔↔	↑↑↑	↔↔	↔↔↔	↑	↔↔	↔↔	↑↑	↔
Traffic Volume (veh/h)	140	1010	760	330	1060	140	900	110	500	90	100	150
Future Volume (veh/h)	140	1010	760	330	1060	140	900	110	500	90	100	150
Number	5	2	12	1	6	16	3	8	18	7	4	14
Initial Q (Qb), veh	0	0	0	0	0	0	0	0	0	0	0	0
Ped-Bike Adj(A_pbT)	1.00		0.99	1.00		0.99	1.00		0.99	1.00		0.98
Parking Bus, Adj	1.00	1.00	1.00	1.00	1.00	1.00	1.00	1.00	1.00	1.00	1.00	1.00
Adj Sat Flow, veh/h/ln	1881	1881	1881	1881	1881	1881	1900	1900	1900	1900	1900	1900
Adj Flow Rate, veh/h	146	1052	592	344	1104	146	938	115	287	94	104	125
Adj No. of Lanes	2	3	2	3	3	1	3	1	2	2	2	1
Peak Hour Factor	0.96	0.96	0.96	0.96	0.96	0.96	0.96	0.96	0.96	0.96	0.96	0.96
Percent Heavy Veh, %	1	1	1	1	1	1	0	0	0	0	0	0
Cap, veh/h	259	1356	736	507	1489	555	1091	525	775	209	440	193
Arrive On Green	0.07	0.26	0.26	0.10	0.29	0.29	0.21	0.28	0.28	0.06	0.12	0.12
Sat Flow, veh/h	3476	5136	2788	5052	5136	1585	5103	1900	2806	3510	3610	1587
Grp Volume(v), veh/h	146	1052	592	344	1104	146	938	115	287	94	104	125
Grp Sat Flow(s),veh/h/ln	1738	1712	1394	1684	1712	1585	1701	1900	1403	1755	1805	1587
Q Serve(g_s), s	2.4	11.3	11.8	3.9	11.6	3.9	10.6	2.8	4.9	1.5	1.6	4.5
Cycle Q Clear(g_c), s	2.4	11.3	11.8	3.9	11.6	3.9	10.6	2.8	4.9	1.5	1.6	4.5
Prop In Lane	1.00		1.00	1.00		1.00	1.00		1.00	1.00		1.00
Lane Grp Cap(c), veh/h	259	1356	736	507	1489	555	1091	525	775	209	440	193
V/C Ratio(X)	0.56	0.78	0.80	0.68	0.74	0.26	0.86	0.22	0.37	0.45	0.24	0.65
Avail Cap(c_a), veh/h	874	2581	1401	1270	2581	892	1710	669	987	588	1270	558
HCM Platoon Ratio	1.00	1.00	1.00	1.00	1.00	1.00	1.00	1.00	1.00	1.00	1.00	1.00
Upstream Filter(I)	1.00	1.00	1.00	1.00	1.00	1.00	1.00	1.00	1.00	1.00	1.00	1.00
Uniform Delay (d), s/veh	26.7	20.3	20.5	25.9	19.2	13.9	22.6	16.6	17.4	27.1	23.7	25.0
Incr Delay (d2), s/veh	0.7	0.4	0.8	0.6	0.3	0.1	1.7	0.1	0.1	0.6	0.1	1.3
Initial Q Delay(d3),s/veh	0.0	0.0	0.0	0.0	0.0	0.0	0.0	0.0	0.0	0.0	0.0	0.0
%ile BackOfQ(50%),veh/ln	1.2	5.4	4.6	1.8	5.5	1.7	5.1	1.5	1.9	0.8	0.8	2.0
LnGrp Delay(d),s/veh	27.4	20.7	21.3	26.5	19.4	14.0	24.3	16.7	17.5	27.7	23.8	26.3
LnGrp LOS	C	C	C	C	B	B	C	B	B	C	C	C
Approach Vol, veh/h		1790			1594			1340			323	
Approach Delay, s/veh		21.5			20.5			22.2			25.9	
Approach LOS		C			C			C			C	
Timer	1	2	3	4	5	6	7	8				
Assigned Phs	1	2	3	4	5	6	7	8				
Phs Duration (G+Y+Rc), s	10.5	21.1	16.3	11.9	8.9	22.6	7.1	21.1				
Change Period (Y+Rc), s	4.5	5.3	3.5	4.6	4.5	5.3	3.5	4.6				
Max Green Setting (Gmax), s	15.0	30.0	20.0	21.0	15.0	30.0	10.0	21.0				
Max Q Clear Time (g_c+I), s	15.0	13.8	12.6	6.5	4.4	13.6	3.5	6.9				
Green Ext Time (p_c), s	0.1	1.8	0.2	0.1	0.0	1.7	0.0	0.2				
Intersection Summary												
HCM 2010 Ctrl Delay				21.6								
HCM 2010 LOS				C								

HCM 2010 Signalized Intersection Summary
 12: Reservation Road & Imjin Parkway

Cuml w/ Eastside Pkwy w/ Proj, PM
 09/06/2019



Movement	EBL	EBT	EBR	WBL	WBT	WBR	NBL	NBT	NBR	SBL	SBT	SBR
Lane Configurations												
Traffic Volume (veh/h)	110	20	1280	10	40	30	820	630	10	20	940	190
Future Volume (veh/h)	110	20	1280	10	40	30	820	630	10	20	940	190
Number	3	8	18	7	4	14	1	6	16	5	2	12
Initial Q (Qb), veh	0	0	0	0	0	0	0	0	0	0	0	0
Ped-Bike Adj(A_pbT)	1.00		1.00	1.00		0.99	1.00		1.00	1.00		1.00
Parking Bus, Adj	1.00	1.00	1.00	1.00	1.00	1.00	1.00	1.00	1.00	1.00	1.00	1.00
Adj Sat Flow, veh/h/ln	1881	1881	1881	1827	1827	1827	1881	1881	1881	1881	1881	1881
Adj Flow Rate, veh/h	124	22	1037	11	45	12	921	708	10	22	1056	79
Adj No. of Lanes	2	1	2	1	1	1	2	2	1	2	3	1
Peak Hour Factor	0.89	0.89	0.89	0.89	0.89	0.89	0.89	0.89	0.89	0.89	0.89	0.89
Percent Heavy Veh, %	1	1	1	4	4	4	1	1	1	1	1	1
Cap, veh/h	860	465	1390	76	80	67	860	1949	872	57	1614	503
Arrive On Green	0.25	0.25	0.25	0.04	0.04	0.04	0.25	0.55	0.55	0.02	0.31	0.31
Sat Flow, veh/h	3476	1881	2803	1740	1827	1532	3476	3574	1599	3476	5136	1599
Grp Volume(v), veh/h	124	22	1037	11	45	12	921	708	10	22	1056	79
Grp Sat Flow(s),veh/h/ln	1738	1881	1401	1740	1827	1532	1738	1787	1599	1738	1712	1599
Q Serve(g_s), s	3.9	1.3	35.0	0.9	3.4	1.1	35.0	15.9	0.4	0.9	25.1	5.0
Cycle Q Clear(g_c), s	3.9	1.3	35.0	0.9	3.4	1.1	35.0	15.9	0.4	0.9	25.1	5.0
Prop In Lane	1.00		1.00	1.00		1.00	1.00		1.00	1.00		1.00
Lane Grp Cap(c), veh/h	860	465	1390	76	80	67	860	1949	872	57	1614	503
V/C Ratio(X)	0.14	0.05	0.75	0.14	0.56	0.18	1.07	0.36	0.01	0.39	0.65	0.16
Avail Cap(c_a), veh/h	860	465	1390	381	400	336	860	1949	872	491	2178	678
HCM Platoon Ratio	1.00	1.00	1.00	1.00	1.00	1.00	1.00	1.00	1.00	1.00	1.00	1.00
Upstream Filter(I)	1.00	1.00	1.00	1.00	1.00	1.00	1.00	1.00	1.00	1.00	1.00	1.00
Uniform Delay (d), s/veh	41.5	40.5	28.6	65.1	66.3	65.2	53.2	18.2	14.7	68.9	41.9	35.0
Incr Delay (d2), s/veh	0.0	0.0	2.0	0.3	2.3	0.5	51.5	0.3	0.0	1.6	1.2	0.4
Initial Q Delay(d3),s/veh	0.0	0.0	0.0	0.0	0.0	0.0	0.0	0.0	0.0	0.0	0.0	0.0
%ile BackOfQ(50%),veh/ln	1.9	0.7	16.6	0.4	1.8	0.5	22.9	8.0	0.2	0.4	12.0	2.3
LnGrp Delay(d),s/veh	41.6	40.5	30.6	65.4	68.6	65.6	104.7	18.5	14.7	70.5	43.1	35.4
LnGrp LOS	D	D	C	E	E	E	F	B	B	E	D	D
Approach Vol, veh/h		1183			68			1639			1157	
Approach Delay, s/veh		32.0			67.5			67.0			43.1	
Approach LOS		C			E			E			D	
Timer	1	2	3	4	5	6	7	8				
Assigned Phs	1	2		4	5	6		8				
Phs Duration (G+Y+Rc), s	39.1	50.7		11.2	6.4	83.3		40.5				
Change Period (Y+Rc), s	4.1	* 6.2		5.0	4.1	* 6.2		5.5				
Max Green Setting (Gmax), s	35.0	* 60		31.0	20.0	* 50		35.0				
Max Q Clear Time (g_c+D), s	37.0	27.1		5.4	2.9	17.9		37.0				
Green Ext Time (p_c), s	0.0	17.3		0.2	0.0	10.6		0.0				
Intersection Summary												
HCM 2010 Ctrl Delay			49.9									
HCM 2010 LOS			D									
Notes												

HCM 2010 Signalized Intersection Summary
 14: Reservation Road & Inter-Garrison Road

Cuml w/ Eastside Pkwy w/ Proj, PM
 09/06/2019



Movement	EBL	EBR	NBL	NBT	SBT	SBR		
Lane Configurations								
Traffic Volume (veh/h)	80	960	620	380	940	210		
Future Volume (veh/h)	80	960	620	380	940	210		
Number	3	18	1	6	2	12		
Initial Q (Qb), veh	0	0	0	0	0	0		
Ped-Bike Adj(A_pbT)	1.00	1.00	1.00			1.00		
Parking Bus, Adj	1.00	1.00	1.00	1.00	1.00	1.00		
Adj Sat Flow, veh/h/ln	1881	1881	1845	1845	1881	1900		
Adj Flow Rate, veh/h	98	1016	756	463	1146	247		
Adj No. of Lanes	1	2	2	2	2	0		
Peak Hour Factor	0.82	0.82	0.82	0.82	0.82	0.82		
Percent Heavy Veh, %	1	1	3	3	1	1		
Cap, veh/h	412	1126	580	2374	1368	293		
Arrive On Green	0.23	0.23	0.17	0.68	0.47	0.47		
Sat Flow, veh/h	1792	2814	3408	3597	3024	627		
Grp Volume(v), veh/h	98	1016	756	463	696	697		
Grp Sat Flow(s),veh/h/ln	1792	1407	1704	1752	1787	1770		
Q Serve(g_s), s	5.2	27.0	20.0	5.8	39.9	40.7		
Cycle Q Clear(g_c), s	5.2	27.0	20.0	5.8	39.9	40.7		
Prop In Lane	1.00	1.00	1.00			0.35		
Lane Grp Cap(c), veh/h	412	1126	580	2374	835	827		
V/C Ratio(X)	0.24	0.90	1.30	0.20	0.83	0.84		
Avail Cap(c_a), veh/h	412	1126	580	2374	913	904		
HCM Platoon Ratio	1.00	1.00	1.00	1.00	1.00	1.00		
Upstream Filter(I)	1.00	1.00	1.00	1.00	1.00	1.00		
Uniform Delay (d), s/veh	36.8	33.1	48.7	7.0	27.3	27.5		
Incr Delay (d2), s/veh	0.3	10.1	148.4	0.1	7.1	7.7		
Initial Q Delay(d3),s/veh	0.0	0.0	0.0	0.0	0.0	0.0		
%ile BackOfQ(50%),veh/ln	2.6	17.0	21.3	2.8	21.2	21.5		
LnGrp Delay(d),s/veh	37.1	43.2	197.1	7.1	34.4	35.2		
LnGrp LOS	D	D	F	A	C	D		
Approach Vol, veh/h	1114			1219	1393			
Approach Delay, s/veh	42.7			125.0	34.8			
Approach LOS	D			F	C			
Timer	1	2	3	4	5	6	7	8
Assigned Phs	1	2				6		8
Phs Duration (G+Y+Rc), s	24.7	61.2				85.9		31.5
Change Period (Y+Rc), s	4.7	6.4				6.4		4.5
Max Green Setting (Gmax), s	26	60.0				60.0		27.0
Max Q Clear Time (g_c+Yc), s	22.6	42.7				7.8		29.0
Green Ext Time (p_c), s	0.0	12.2				5.4		0.0
Intersection Summary								
HCM 2010 Ctrl Delay			66.6					
HCM 2010 LOS			E					
Notes								

HCM 2010 Signalized Intersection Summary
 22: 8th Avenue & Inter-Garrison Road

Cuml w/ Eastside Pkwy w/ Proj, PM
 09/06/2019



Movement	EBT	EBR	WBL	WBT	NBL	NBR		
Lane Configurations	↔		↔↔	↑	↔			
Traffic Volume (veh/h)	580	80	280	380	60	420		
Future Volume (veh/h)	580	80	280	380	60	420		
Number	4	14	3	8	5	12		
Initial Q (Qb), veh	0	0	0	0	0	0		
Ped-Bike Adj(A_pbT)		1.00	1.00		1.00	1.00		
Parking Bus, Adj	1.00	1.00	1.00	1.00	1.00	1.00		
Adj Sat Flow, veh/h/ln	1863	1900	1863	1863	1900	1900		
Adj Flow Rate, veh/h	598	62	289	392	62	37		
Adj No. of Lanes	1	0	2	1	0	0		
Peak Hour Factor	0.97	0.97	0.97	0.97	0.97	0.97		
Percent Heavy Veh, %	2	2	2	2	0	0		
Cap, veh/h	756	78	478	1308	88	53		
Arrive On Green	0.46	0.46	0.14	0.70	0.08	0.08		
Sat Flow, veh/h	1660	172	3442	1863	1075	641		
Grp Volume(v), veh/h	0	660	289	392	100	0		
Grp Sat Flow(s),veh/h/ln	0	1832	1721	1863	1733	0		
Q Serve(g_s), s	0.0	12.8	3.3	3.3	2.3	0.0		
Cycle Q Clear(g_c), s	0.0	12.8	3.3	3.3	2.3	0.0		
Prop In Lane		0.09	1.00		0.62	0.37		
Lane Grp Cap(c), veh/h	0	834	478	1308	143	0		
V/C Ratio(X)	0.00	0.79	0.61	0.30	0.70	0.00		
Avail Cap(c_a), veh/h	0	1428	1279	2345	1184	0		
HCM Platoon Ratio	1.00	1.00	1.00	1.00	1.00	1.00		
Upstream Filter(I)	0.00	1.00	1.00	1.00	1.00	0.00		
Uniform Delay (d), s/veh	0.0	9.7	16.9	2.3	18.6	0.0		
Incr Delay (d2), s/veh	0.0	1.7	1.2	0.1	6.1	0.0		
Initial Q Delay(d3),s/veh	0.0	0.0	0.0	0.0	0.0	0.0		
%ile BackOfQ(50%),veh/ln	0.0	6.8	1.6	1.7	1.4	0.0		
LnGrp Delay(d),s/veh	0.0	11.4	18.1	2.5	24.8	0.0		
LnGrp LOS		B	B	A	C			
Approach Vol, veh/h	660			681	100			
Approach Delay, s/veh	11.4			9.1	24.8			
Approach LOS	B			A	C			
Timer	1	2	3	4	5	6	7	8
Assigned Phs		2	3	4				8
Phs Duration (G+Y+Rc), s		7.9	10.3	23.5				33.8
Change Period (Y+Rc), s		4.5	4.5	4.5				4.5
Max Green Setting (Gmax), s		28.5	15.5	32.5				52.5
Max Q Clear Time (g_c+I1), s		4.3	5.3	14.8				5.3
Green Ext Time (p_c), s		0.2	0.7	4.2				2.6
Intersection Summary								
HCM 2010 Ctrl Delay			11.3					
HCM 2010 LOS			B					
Notes								

Intersection				
Intersection Delay, s/veh	14.1			
Intersection LOS	B			
Approach	EB	WB		NB
Entry Lanes	1	2		1
Conflicting Circle Lanes	2	2		2
Adj Approach Flow, veh/h	680	681		495
Demand Flow Rate, veh/h	694	695		495
Vehicles Circulating, veh/h	295	62		610
Vehicles Exiting, veh/h	462	1043		379
Follow-Up Headway, s	3.186	3.186		3.186
Ped Vol Crossing Leg, #/h	0	0		0
Ped Cap Adj	1.000	1.000		1.000
Approach Delay, s/veh	19.0	6.7		17.6
Approach LOS	C	A		C
Lane	Left	Left	Right	Left
Designated Moves	TR	L	LTR	LR
Assumed Moves	TR	L	TR	LR
RT Channelized				
Lane Util	1.000	0.424	0.576	1.000
Critical Headway, s	4.113	4.293	4.113	4.113
Entry Flow, veh/h	694	295	400	495
Cap Entry Lane, veh/h	919	1079	1082	737
Entry HV Adj Factor	0.980	0.980	0.980	1.000
Flow Entry, veh/h	680	289	392	495
Cap Entry, veh/h	901	1057	1061	737
V/C Ratio	0.755	0.274	0.370	0.671
Control Delay, s/veh	19.0	6.1	7.2	17.6
LOS	C	A	A	C
95th %tile Queue, veh	7	1	2	5

HCM 2010 Signalized Intersection Summary
 25: Inter-Garrison Road & Sherman Boulevard

Cuml w/ Eastside Pkwy w/ Proj, PM
 09/06/2019



Movement	EBL	EBT	WBT	WBR	SBL	SBR		
Lane Configurations								
Traffic Volume (veh/h)	990	270	160	100	120	520		
Future Volume (veh/h)	990	270	160	100	120	520		
Number	7	4	8	18	1	16		
Initial Q (Qb), veh	0	0	0	0	0	0		
Ped-Bike Adj(A_pbT)	1.00			1.00	1.00	1.00		
Parking Bus, Adj	1.00	1.00	1.00	1.00	1.00	1.00		
Adj Sat Flow, veh/h/ln	1881	1881	1792	1900	1845	1845		
Adj Flow Rate, veh/h	1138	310	184	100	138	534		
Adj No. of Lanes	1	1	1	0	1	1		
Peak Hour Factor	0.87	0.87	0.87	0.87	0.87	0.87		
Percent Heavy Veh, %	1	1	6	6	3	3		
Cap, veh/h	1106	1525	179	97	227	1171		
Arrive On Green	0.62	0.81	0.16	0.16	0.13	0.13		
Sat Flow, veh/h	1792	1881	1093	594	1757	1568		
Grp Volume(v), veh/h	1138	310	0	284	138	534		
Grp Sat Flow(s),veh/h/ln	1792	1881	0	1688	1757	1568		
Q Serve(g_s), s	92.6	5.6	0.0	24.5	11.1	19.4		
Cycle Q Clear(g_c), s	92.6	5.6	0.0	24.5	11.1	19.4		
Prop In Lane	1.00			0.35	1.00	1.00		
Lane Grp Cap(c), veh/h	1106	1525	0	276	227	1171		
V/C Ratio(X)	1.03	0.20	0.00	1.03	0.61	0.46		
Avail Cap(c_a), veh/h	1106	1525	0	276	227	1171		
HCM Platoon Ratio	1.00	1.00	1.00	1.00	1.00	1.00		
Upstream Filter(I)	1.00	1.00	0.00	1.00	1.00	1.00		
Uniform Delay (d), s/veh	28.7	3.2	0.0	62.8	61.7	7.3		
Incr Delay (d2), s/veh	34.7	0.1	0.0	62.3	11.5	1.3		
Initial Q Delay(d3),s/veh	0.0	0.0	0.0	0.0	0.0	0.0		
%ile BackOfQ(50%),veh/ln	56.1	2.9	0.0	16.2	6.1	28.2		
LnGrp Delay(d),s/veh	63.4	3.3	0.0	125.0	73.2	8.6		
LnGrp LOS	F	A		F	E	A		
Approach Vol, veh/h		1448	284		672			
Approach Delay, s/veh		50.5	125.0		21.9			
Approach LOS		D	F		C			
Timer	1	2	3	4	5	6	7	8
Assigned Phs				4		6	7	8
Phs Duration (G+Y+Rc), s				126.1		23.9	97.1	29.0
Change Period (Y+Rc), s				4.5		4.5	4.5	4.5
Max Green Setting (Gmax), s				121.6		19.4	92.6	24.5
Max Q Clear Time (g_c+I1), s				7.6		21.4	94.6	26.5
Green Ext Time (p_c), s				2.2		0.0	0.0	0.0
Intersection Summary								
HCM 2010 Ctrl Delay			51.3					
HCM 2010 LOS			D					

HCM 2010 Signalized Intersection Summary
 28: Davis Road & Reservation Road

Cuml w/ Eastside Pkwy w/ Proj, PM
 09/06/2019



Movement	EBL	EBT	EBR	WBL	WBT	WBR	NBL	NBT	NBR	SBL	SBT	SBR
Lane Configurations	↔↔	↕↔		↔	↕			↕			↕	↔↔
Traffic Volume (veh/h)	1410	520	10	10	370	100	10	10	10	120	10	830
Future Volume (veh/h)	1410	520	10	10	370	100	10	10	10	120	10	830
Number	5	2	12	1	6	16	3	8	18	7	4	14
Initial Q (Qb), veh	0	0	0	0	0	0	0	0	0	0	0	0
Ped-Bike Adj(A_pbT)	1.00		1.00	1.00		1.00	1.00		1.00	1.00		1.00
Parking Bus, Adj	1.00	1.00	1.00	1.00	1.00	1.00	1.00	1.00	1.00	1.00	1.00	1.00
Adj Sat Flow, veh/h/ln	1863	1863	1900	1827	1834	1900	1900	1900	1900	1900	1881	1881
Adj Flow Rate, veh/h	1500	553	11	11	394	106	11	11	9	128	11	748
Adj No. of Lanes	2	2	0	1	1	0	0	1	0	0	1	2
Peak Hour Factor	0.94	0.94	0.94	0.94	0.94	0.94	0.94	0.94	0.94	0.94	0.94	0.94
Percent Heavy Veh, %	2	2	2	4	4	4	0	0	0	1	1	1
Cap, veh/h	936	2086	41	18	456	123	18	18	14	351	30	1362
Arrive On Green	0.27	0.59	0.59	0.01	0.33	0.33	0.03	0.03	0.03	0.21	0.21	0.21
Sat Flow, veh/h	3442	3549	71	1740	1393	375	631	631	516	1656	142	2814
Grp Volume(v), veh/h	1500	276	288	11	0	500	31	0	0	139	0	748
Grp Sat Flow(s),veh/h/ln	1721	1770	1850	1740	0	1768	1777	0	0	1798	0	1407
Q Serve(g_s), s	30.0	8.4	8.4	0.7	0.0	29.3	1.9	0.0	0.0	7.3	0.0	20.6
Cycle Q Clear(g_c), s	30.0	8.4	8.4	0.7	0.0	29.3	1.9	0.0	0.0	7.3	0.0	20.6
Prop In Lane	1.00		0.04	1.00		0.21	0.35		0.29	0.92		1.00
Lane Grp Cap(c), veh/h	936	1040	1087	18	0	578	49	0	0	381	0	1362
V/C Ratio(X)	1.60	0.26	0.27	0.61	0.00	0.86	0.63	0.00	0.00	0.36	0.00	0.55
Avail Cap(c_a), veh/h	936	1040	1087	473	0	962	483	0	0	489	0	1531
HCM Platoon Ratio	1.00	1.00	1.00	1.00	1.00	1.00	1.00	1.00	1.00	1.00	1.00	1.00
Upstream Filter(I)	1.00	1.00	1.00	1.00	0.00	1.00	1.00	0.00	0.00	1.00	0.00	1.00
Uniform Delay (d), s/veh	40.2	11.1	11.1	54.4	0.0	34.8	53.1	0.0	0.0	37.1	0.0	20.0
Incr Delay (d2), s/veh	276.2	0.2	0.2	11.7	0.0	6.6	4.8	0.0	0.0	0.2	0.0	0.1
Initial Q Delay(d3),s/veh	0.0	0.0	0.0	0.0	0.0	0.0	0.0	0.0	0.0	0.0	0.0	0.0
%ile BackOfQ(50%),veh/ln	50.1	4.1	4.3	0.4	0.0	15.4	1.0	0.0	0.0	3.7	0.0	8.0
LnGrp Delay(d),s/veh	316.4	11.3	11.3	66.0	0.0	41.5	57.8	0.0	0.0	37.3	0.0	20.1
LnGrp LOS	F	B	B	E		D	E			D		C
Approach Vol, veh/h		2064			511			31			887	
Approach Delay, s/veh		233.0			42.0			57.8			22.8	
Approach LOS		F			D			E			C	
Timer	1	2	3	4	5	6	7	8				
Assigned Phs	1	2		4	5	6		8				
Phs Duration (G+Y+Rc), s	5.0	69.8		28.4	33.8	41.1		7.1				
Change Period (Y+Rc), s	3.9	5.0		5.0	* 3.8	5.0		4.0				
Max Green Setting (Gmax), s	30.0	60.0		30.0	* 30	60.0		30.0				
Max Q Clear Time (g_c+1/3), s	10.4	10.4		22.6	32.0	31.3		3.9				
Green Ext Time (p_c), s	0.0	5.3		0.8	0.0	4.8		0.0				
Intersection Summary												
HCM 2010 Ctrl Delay				150.2								
HCM 2010 LOS				F								
Notes												

HCM 2010 Signalized Intersection Summary
 33: General Jim Moore Boulevard & Lightfighter Drive

Cuml w/ Eastside Pkwy w/ Proj, PM
 09/06/2019



Movement	EBL	EBT	EBR	WBL	WBT	WBR	NBL	NBT	NBR	SBL	SBT	SBR
Lane Configurations	↔↔	↑	↗	↔↔	↑↑		↔↔↔	↑↑		↗	↑↑	↗
Traffic Volume (veh/h)	50	230	940	40	240	50	750	60	20	60	100	40
Future Volume (veh/h)	50	230	940	40	240	50	750	60	20	60	100	40
Number	3	8	18	7	4	14	1	6	16	5	2	12
Initial Q (Qb), veh	0	0	0	0	0	0	0	0	0	0	0	0
Ped-Bike Adj(A_pbT)	1.00		1.00	1.00		1.00	1.00		1.00	1.00		1.00
Parking Bus, Adj	1.00	1.00	1.00	1.00	1.00	1.00	1.00	1.00	1.00	1.00	1.00	1.00
Adj Sat Flow, veh/h/ln	1881	1881	1881	1900	1900	1900	1881	1881	1900	1900	1900	1900
Adj Flow Rate, veh/h	52	240	0	42	250	51	781	62	19	62	104	-70
Adj No. of Lanes	2	1	1	2	2	0	3	2	0	1	2	1
Peak Hour Factor	0.96	0.96	0.96	0.96	0.96	0.96	0.96	0.96	0.96	0.96	0.96	0.96
Percent Heavy Veh, %	1	1	1	0	0	0	1	1	1	0	0	0
Cap, veh/h	150	327	278	129	503	101	1173	880	258	88	503	225
Arrive On Green	0.04	0.17	0.00	0.04	0.17	0.17	0.23	0.32	0.32	0.05	0.14	0.00
Sat Flow, veh/h	3476	1881	1599	3510	2997	602	5052	2726	801	1810	3610	1615
Grp Volume(v), veh/h	52	240	0	42	149	152	781	40	41	62	104	-70
Grp Sat Flow(s),veh/h/ln	1738	1881	1599	1755	1805	1794	1684	1787	1740	1810	1805	1615
Q Serve(g_s), s	0.6	5.2	0.0	0.5	3.2	3.3	6.0	0.7	0.7	1.5	1.1	0.0
Cycle Q Clear(g_c), s	0.6	5.2	0.0	0.5	3.2	3.3	6.0	0.7	0.7	1.5	1.1	0.0
Prop In Lane	1.00		1.00	1.00		0.34	1.00		0.46	1.00		1.00
Lane Grp Cap(c), veh/h	150	327	278	129	303	301	1173	577	562	88	503	225
V/C Ratio(X)	0.35	0.73	0.00	0.33	0.49	0.51	0.67	0.07	0.07	0.70	0.21	-0.31
Avail Cap(c_a), veh/h	323	415	353	326	398	396	1302	1120	1090	273	1877	840
HCM Platoon Ratio	1.00	1.00	1.00	1.00	1.00	1.00	1.00	1.00	1.00	1.00	1.00	1.00
Upstream Filter(I)	1.00	1.00	0.00	1.00	1.00	1.00	1.00	1.00	1.00	1.00	1.00	0.00
Uniform Delay (d), s/veh	20.0	16.8	0.0	20.2	16.3	16.3	15.0	10.1	10.1	20.2	16.4	0.0
Incr Delay (d2), s/veh	1.4	5.4	0.0	0.5	1.5	1.6	1.0	0.1	0.1	3.8	0.2	0.0
Initial Q Delay(d3),s/veh	0.0	0.0	0.0	0.0	0.0	0.0	0.0	0.0	0.0	0.0	0.0	0.0
%ile BackOfQ(50%),veh/ln	0.3	3.2	0.0	0.2	1.7	1.8	2.9	0.3	0.4	0.8	0.6	0.0
LnGrp Delay(d),s/veh	21.4	22.3	0.0	20.8	17.8	17.9	16.0	10.2	10.2	24.0	16.7	0.0
LnGrp LOS	C	C		C	B	B	B	B	B	C	B	
Approach Vol, veh/h		292			343			862			96	
Approach Delay, s/veh		22.1			18.2			15.5			33.5	
Approach LOS		C			B			B			C	
Timer	1	2	3	4	5	6	7	8				
Assigned Phs	1	2	3	4	5	6	7	8				
Phs Duration (G+Y+Rc), s	4.5	10.5	6.4	11.7	6.6	18.4	6.1	12.0				
Change Period (Y+Rc), s	4.5	4.5	4.5	4.5	4.5	4.5	4.5	4.5				
Max Green Setting (Gmax), s	10.0	22.4	4.0	9.5	6.5	27.0	4.0	9.5				
Max Q Clear Time (g_c+1/3), s	10.0	3.1	2.6	5.3	3.5	2.7	2.5	7.2				
Green Ext Time (p_c), s	0.9	0.6	0.0	0.7	0.0	0.7	0.0	0.3				
Intersection Summary												
HCM 2010 Ctrl Delay			18.4									
HCM 2010 LOS			B									

HCM 2010 Roundabout Cumulative with Eastside Parkway with Project (Roundabouts), PM
 33: General Jim Moore Boulevard & Lightfighter Drive 04/22/2022

Intersection									
Intersection Delay, s/veh	12.2								
Intersection LOS	B								
Approach	EB		WB		NB		SB		
Entry Lanes	2		2		2		2		
Conflicting Circle Lanes	2		2		2		2		
Adj Approach Flow, veh/h	1271		344		864		208		
Demand Flow Rate, veh/h	1284		344		873		208		
Vehicles Circulating, veh/h	208		905		357		1081		
Vehicles Exiting, veh/h	1081		325		1135		168		
Follow-Up Headway, s	3.186		3.186		3.186		3.186		
Ped Vol Crossing Leg, #/h	0		0		0		0		
Ped Cap Adj	1.000		1.000		1.000		1.000		
Approach Delay, s/veh	14.2		10.1		10.9		9.7		
Approach LOS	B		B		B		A		
Lane	Left	Right	Left	Right	Left	Right	Left	Right	
Designated Moves	LTR	R	LT	TR	L	LTR	LT	TR	
Assumed Moves	LTR	R	LT	TR	L	LTR	LT	TR	
RT Channelized									
Lane Util	0.470	0.530	0.471	0.529	0.530	0.470	0.471	0.529	
Critical Headway, s	4.293	4.113	4.293	4.113	4.293	4.113	4.293	4.113	
Entry Flow, veh/h	603	681	162	182	463	410	98	110	
Cap Entry Lane, veh/h	967	977	573	600	865	880	502	530	
Entry HV Adj Factor	0.990	0.989	0.998	1.002	0.989	0.991	0.998	1.002	
Flow Entry, veh/h	597	673	162	182	458	406	98	110	
Cap Entry, veh/h	957	966	572	601	855	872	501	531	
V/C Ratio	0.624	0.697	0.283	0.303	0.536	0.466	0.195	0.207	
Control Delay, s/veh	12.9	15.3	10.2	10.1	11.6	10.0	9.9	9.6	
LOS	B	C	B	B	B	B	A	A	
95th %tile Queue, veh	5	6	1	1	3	3	1	1	

HCM 2010 Signalized Intersection Summary
 39: General Jim Moore Boulevard & Gigling Road

Cuml w/ Eastside Pkwy w/ Proj, PM
 09/06/2019



Movement	EBL	EBT	EBR	WBL	WBT	WBR	NBL	NBT	NBR	SBL	SBT	SBR
Lane Configurations												
Traffic Volume (veh/h)	20	20	30	270	50	530	60	260	430	750	250	50
Future Volume (veh/h)	20	20	30	270	50	530	60	260	430	750	250	50
Number	3	8	18	7	4	14	1	6	16	5	2	12
Initial Q (Qb), veh	0	0	0	0	0	0	0	0	0	0	0	0
Ped-Bike Adj(A_pbT)	1.00		0.99	1.00		1.00	1.00		1.00	1.00		1.00
Parking Bus, Adj	1.00	1.00	1.00	1.00	1.00	1.00	1.00	1.00	1.00	1.00	1.00	1.00
Adj Sat Flow, veh/h/ln	1776	1776	1776	1881	1881	1881	1863	1863	1863	1863	1863	1863
Adj Flow Rate, veh/h	22	22	3	303	56	0	67	292	0	843	281	0
Adj No. of Lanes	1	1	1	2	2	1	2	3	1	2	3	1
Peak Hour Factor	0.89	0.89	0.89	0.89	0.89	0.89	0.89	0.89	0.89	0.89	0.89	0.89
Percent Heavy Veh, %	7	7	7	1	1	1	2	2	2	2	2	2
Cap, veh/h	45	161	230	433	674	302	214	599	186	962	1704	530
Arrive On Green	0.03	0.09	0.09	0.12	0.19	0.00	0.06	0.12	0.00	0.28	0.33	0.00
Sat Flow, veh/h	1691	1776	1501	3476	3574	1599	3442	5085	1583	3442	5085	1583
Grp Volume(v), veh/h	22	22	3	303	56	0	67	292	0	843	281	0
Grp Sat Flow(s),veh/h/ln	1691	1776	1501	1738	1787	1599	1721	1695	1583	1721	1695	1583
Q Serve(g_s), s	0.6	0.5	0.1	3.9	0.6	0.0	0.9	2.5	0.0	10.9	1.8	0.0
Cycle Q Clear(g_c), s	0.6	0.5	0.1	3.9	0.6	0.0	0.9	2.5	0.0	10.9	1.8	0.0
Prop In Lane	1.00		1.00	1.00		1.00	1.00		1.00	1.00		1.00
Lane Grp Cap(c), veh/h	45	161	230	433	674	302	214	599	186	962	1704	530
V/C Ratio(X)	0.49	0.14	0.01	0.70	0.08	0.00	0.31	0.49	0.00	0.88	0.16	0.00
Avail Cap(c_a), veh/h	208	917	870	711	2139	957	393	2627	818	1815	4729	1472
HCM Platoon Ratio	1.00	1.00	1.00	1.00	1.00	1.00	1.00	1.00	1.00	1.00	1.00	1.00
Upstream Filter(l)	1.00	1.00	1.00	1.00	1.00	0.00	1.00	1.00	0.00	1.00	1.00	0.00
Uniform Delay (d), s/veh	22.3	19.5	16.7	19.5	15.5	0.0	20.8	19.2	0.0	16.0	10.9	0.0
Incr Delay (d2), s/veh	3.0	0.1	0.0	0.8	0.0	0.0	0.3	0.2	0.0	1.0	0.0	0.0
Initial Q Delay(d3),s/veh	0.0	0.0	0.0	0.0	0.0	0.0	0.0	0.0	0.0	0.0	0.0	0.0
%ile BackOfQ(50%),veh/ln	0.3	0.3	0.0	1.9	0.3	0.0	0.4	1.2	0.0	5.3	0.8	0.0
LnGrp Delay(d),s/veh	25.3	19.6	16.7	20.3	15.6	0.0	21.1	19.4	0.0	17.0	10.9	0.0
LnGrp LOS	C	B	B	C	B		C	B		B	B	
Approach Vol, veh/h		47			359			359			1124	
Approach Delay, s/veh		22.1			19.5			19.7			15.5	
Approach LOS		C			B			B			B	
Timer	1	2	3	4	5	6	7	8				
Assigned Phs	1	2	3	4	5	6	7	8				
Phs Duration (G+Y+Rc), s	7.4	20.1	5.7	13.3	17.5	10.0	10.3	8.7				
Change Period (Y+Rc), s	4.5	4.5	4.5	4.5	4.5	4.5	4.5	4.5				
Max Green Setting (Gmax), s	5.3	43.2	5.7	27.8	24.5	24.0	9.5	24.0				
Max Q Clear Time (g_c+1/3), s	12.9	3.8	2.6	2.6	12.9	4.5	5.9	2.5				
Green Ext Time (p_c), s	0.0	0.4	0.0	0.1	0.1	0.4	0.0	0.0				
Intersection Summary												
HCM 2010 Ctrl Delay				17.2								
HCM 2010 LOS				B								
Notes												

HCM 2010 Roundabout Cumulative with Eastside Parkway with Project (Roundabouts), PM
 39: General Jim Moore Boulevard & Gigling Road 04/22/2022

Intersection									
Intersection Delay, s/veh	32.4								
Intersection LOS	D								
Approach	EB		WB		NB		SB		
Entry Lanes	2		2		2		2		
Conflicting Circle Lanes	2		2		2		2		
Adj Approach Flow, veh/h	78		955		842		1180		
Demand Flow Rate, veh/h	84		965		859		1204		
Vehicles Circulating, veh/h	1453		390		908		431		
Vehicles Exiting, veh/h	182		1377		629		924		
Follow-Up Headway, s	3.186		3.186		3.186		3.186		
Ped Vol Crossing Leg, #/h	1		2		0		2		
Ped Cap Adj	1.000		0.998		1.000		0.999		
Approach Delay, s/veh	11.5		14.3		27.4		52.1		
Approach LOS	B		B		D		F		
Lane	Left	Right	Left	Right	Left	Right	Left	Right	
Designated Moves	LT	TR	LT	TR	LT	TR	LT	TR	
Assumed Moves	LT	TR	LT	R	LT	R	L	TR	
RT Channelized									
Lane Util	0.464	0.536	0.376	0.624	0.426	0.574	0.714	0.286	
Critical Headway, s	4.293	4.113	4.293	4.113	4.293	4.113	4.293	4.113	
Entry Flow, veh/h	39	45	363	602	366	493	860	344	
Cap Entry Lane, veh/h	380	409	843	860	572	598	818	836	
Entry HV Adj Factor	0.945	0.924	0.990	0.990	0.981	0.980	0.980	0.981	
Flow Entry, veh/h	37	42	359	596	359	483	843	337	
Cap Entry, veh/h	359	377	834	850	561	586	801	818	
V/C Ratio	0.103	0.110	0.431	0.701	0.640	0.824	1.053	0.412	
Control Delay, s/veh	11.7	11.3	9.7	17.0	20.3	32.6	69.1	9.5	
LOS	B	B	A	C	C	D	F	A	
95th %tile Queue, veh	0	0	2	6	5	8	21	2	

HCM 2010 Signalized Intersection Summary
 46: General Jim Moore Boulevard & Normandy Road

Cuml w/ Eastside Pkwy w/ Proj, PM
 09/06/2019



Movement	EBL	EBT	EBR	WBL	WBT	WBR	NBL	NBT	NBR	SBL	SBT	SBR
Lane Configurations		↕			↕		↕ ↑↑↑			↕ ↑↑↑		↕
Traffic Volume (veh/h)	140	40	100	290	50	10	90	790	320	30	480	80
Future Volume (veh/h)	140	40	100	290	50	10	90	790	320	30	480	80
Number	3	8	18	7	4	14	1	6	16	5	2	12
Initial Q (Qb), veh	0	0	0	0	0	0	0	0	0	0	0	0
Ped-Bike Adj(A_pbT)	1.00		1.00	1.00		1.00	1.00		1.00	1.00		1.00
Parking Bus, Adj	1.00	1.00	1.00	1.00	1.00	1.00	1.00	1.00	1.00	1.00	1.00	1.00
Adj Sat Flow, veh/h/ln	1900	1863	1900	1900	1881	1900	1881	1881	1900	1900	1900	1900
Adj Flow Rate, veh/h	152	43	84	315	54	8	98	859	325	33	522	28
Adj No. of Lanes	0	1	0	0	1	0	1	3	0	1	3	1
Peak Hour Factor	0.92	0.92	0.92	0.92	0.92	0.92	0.92	0.92	0.92	0.92	0.92	0.92
Percent Heavy Veh, %	2	2	2	1	1	1	1	1	1	0	0	0
Cap, veh/h	386	121	159	546	65	10	319	1117	421	69	851	264
Arrive On Green	0.32	0.32	0.32	0.32	0.32	0.32	0.18	0.30	0.30	0.04	0.16	0.16
Sat Flow, veh/h	773	379	497	1190	204	30	1792	3674	1384	1810	5187	1610
Grp Volume(v), veh/h	279	0	0	377	0	0	98	800	384	33	522	28
Grp Sat Flow(s),veh/h/ln	1649	0	0	1424	0	0	1792	1712	1634	1810	1729	1610
Q Serve(g_s), s	0.0	0.0	0.0	4.3	0.0	0.0	1.9	8.5	8.5	0.7	3.7	0.6
Cycle Q Clear(g_c), s	5.3	0.0	0.0	9.5	0.0	0.0	1.9	8.5	8.5	0.7	3.7	0.6
Prop In Lane	0.54		0.30	0.84		0.02	1.00		0.85	1.00		1.00
Lane Grp Cap(c), veh/h	666	0	0	621	0	0	319	1041	497	69	851	264
V/C Ratio(X)	0.42	0.00	0.00	0.61	0.00	0.00	0.31	0.77	0.77	0.48	0.61	0.11
Avail Cap(c_a), veh/h	1409	0	0	1298	0	0	319	2007	958	231	2806	871
HCM Platoon Ratio	1.00	1.00	1.00	1.00	1.00	1.00	1.00	1.00	1.00	1.00	1.00	1.00
Upstream Filter(I)	1.00	0.00	0.00	1.00	0.00	0.00	1.00	1.00	1.00	1.00	1.00	1.00
Uniform Delay (d), s/veh	11.0	0.0	0.0	12.3	0.0	0.0	14.3	12.6	12.6	18.8	15.5	14.2
Incr Delay (d2), s/veh	0.2	0.0	0.0	0.4	0.0	0.0	0.2	0.5	1.0	1.9	0.3	0.1
Initial Q Delay(d3),s/veh	0.0	0.0	0.0	0.0	0.0	0.0	0.0	0.0	0.0	0.0	0.0	0.0
%ile BackOfQ(50%),veh/ln	2.5	0.0	0.0	3.8	0.0	0.0	0.9	4.0	4.0	0.4	1.8	0.3
LnGrp Delay(d),s/veh	11.2	0.0	0.0	12.7	0.0	0.0	14.5	13.1	13.6	20.7	15.8	14.3
LnGrp LOS	B			B			B	B	B	C	B	B
Approach Vol, veh/h		279			377			1282			583	
Approach Delay, s/veh		11.2			12.7			13.3			16.0	
Approach LOS		B			B			B			B	
Timer	1	2	3	4	5	6	7	8				
Assigned Phs	1	2		4	5	6		8				
Phs Duration (G+Y+Rc), s	11.6	11.0		17.3	6.0	16.6		17.3				
Change Period (Y+Rc), s	4.5	4.5		4.5	4.5	4.5		4.5				
Max Green Setting (Gmax), s	21.6	21.6		33.0	5.1	23.4		33.0				
Max Q Clear Time (g_c+I), s	5.7	5.7		11.5	2.7	10.5		7.3				
Green Ext Time (p_c), s	0.0	0.7		0.6	0.0	1.5		0.4				
Intersection Summary												
HCM 2010 Ctrl Delay				13.6								
HCM 2010 LOS				B								

APPENDIX I

2022 California State University Sustainability Policy

INTENTIONALLY LEFT BLANK

California State University Sustainability Policy

Summary

This policy is intended to position the nation's largest university system as a leader in the teaching and use of applied research to educate climate literate students equipped to solve the complex challenges of the world and prepare them for an evolving workforce. In addition, the policy encompasses the tenets of human and ecological health, social justice, economic vitality, and promotes the environmental sustainability of CSU's operations for our built environment.

University Sustainability

1. The CSU will seek to further integrate sustainability and climate literacy into the academic curriculum working within the normal campus consultative process. Activities can include but will not be limited to supporting multi-disciplinary course development, utilizing the campus as a living laboratory model, connecting sustainability with social justice, strengthening community partnerships, and creating appropriate learning outcomes. Progress shall be measured through the use of the AASHE STARS¹ platform. (14-New; 22-Revise)
2. The CSU shall promote environmental and social justice through new and existing Diversity, Equity, & Inclusion (DE&I) programs such as the CSU Basic Needs Initiative. (22-New)
3. The CSU will develop employee and student workforce skills in the green jobs industry, climate-related industry, promote the development of sustainable products and services, and foster economic development. (14-New; 22-Revise)
4. The CSU will pursue sustainable practices, using AASHE STARS for guidance and reporting, in all areas of the university, including:
 - a. business operations such as procurement; information technology; student and employee services; food services; events, habitat and land-use management, facilities operations; design and construction; and
 - b. self-funded entities such as student housing, student unions, parking and transportation, children's centers, and auxiliary operations. (14-New; 22-Revise)
5. Each CSU will designate a sustainability officer/staff member responsible for planning and/or coordinating campus sustainability program efforts. (14-New; 22-Revise)

¹ Association for the Advancement of Sustainability in Higher Education's Sustainability Tracking and Reporting System (STARS). For more information and to access the reporting platform, please visit: <https://stars.aashe.org/>

Climate Action Plan

1. CSU will strive to reduce systemwide facility carbon emissions to forty percent (40%) below 1990 levels consistent with SB 32, California's Global Warming Solutions Act of 2006 (HSC §38566, effective January 1, 2017). Emissions will include both state and auxiliary organization purchases of electricity and natural gas; fleet, marine vessel usage; and other emissions the university or self-support entity has direct control over. The Chancellor's Office staff will provide the baseline 1990 facility emission levels (for purchased electricity and natural gas) for the campuses that existed at that time and assist campuses added to the CSU after 1990 to determine their appropriate baseline. (14-New; 22-Revise)
2. The CSU will strive to reduce facility carbon emissions to eighty percent (80%) below 1990 levels by 2040 in order to achieve carbon neutrality by 2045 in accordance with Statewide mandates. Metrics will include GHG emissions per FTE. (14-New; 22-Revise)

Energy Resilience and Procurement

1. The CSU will pursue energy procurement and production to reduce energy capacity requirements from fossil fuels, enhance electrical demand flexibility, and promote energy resilience using available economically feasible technology for on-site renewable generation, microgrids, and other fossil fuel-free energy storage solutions. The CSU shall endeavor to increase its self-generated renewable energy and battery capacity from 32 to 80 megawatts (MW) by 2030. (05-New; 14-Revise; 22-Revise)
2. The CSU will consider cost effective opportunities to exceed the State of California and California Public Utilities Commission Renewable Portfolio Standard (RPS) sooner than the established goal of procuring sixty percent (60%) of its electricity needs from renewable sources by 2030 consistent with SB 100 (PUC§399.11). (05-New; 14-Revise; 22-Revise)
3. To minimize use of natural gas, campuses will transition from fossil-fuel sourced equipment to electric equipment as replacements or renovations are needed. Any in-kind fossil-fuel sourced equipment will be justified through an analysis which demonstrates why that solution represents the most cost-effective option and what alternatives were analyzed for comparative purposes. The intention of this item shall be limited to no new investment in, or renewal of, natural gas assets or infrastructure as part of campus projects starting July 1, 2035, with the exception of critical academic program needs. (22-New)

Energy Conservation, Carbon Reduction and Utility Management

1. All CSU buildings and facilities, regardless of the source of funding for their operation, will be operated in the most energy efficient manner and transition to a low carbon strategy without endangering public health and safety and without diminishing the quality of education and the academic program. (78-Adopt; 88-Revise; 01-No Change; 04-No Change; 14-Revise; 22-Revise)
2. All CSU campuses shall continue to identify energy efficiency and carbon reduction improvement measures to the greatest extent possible, undertake steps to seek funding for their implementation and, upon securing available funds, expeditiously implement the measures. (78-Adopt; 88-Revise; 01-No Change; 04-No Change; 14-Revise; 22-Revise)
3. The CSU will cooperate with federal, state, and local governments and other appropriate organizations in accomplishing energy conservation, and carbon reduction, and utilities management objectives throughout the state; and inform students, faculty, staff and the general public of the need for and methods of energy conservation, and carbon reduction, and utilities management. (78-Adopt; 88-Revise; 01-No Change, 04-No Change; 14-No Change; 22-Revise)
4. Each CSU campus shall designate an energy/utilities staff with the responsibility and the authority for carrying out energy conservation and utilities management programs. The Chancellor's Office will have the responsibility to coordinate the individual campus programs into a systemwide program. (78-Adopt; 88-Revise; 01-No Change; 04-No Change; 14-No Change; 22-Revise)
5. The CSU will monitor monthly energy and utility usage on all campuses and the Chancellor's Office and will prepare a systemwide annual report on energy utilization and greenhouse gas emissions. The Chancellor's Office will maintain a systemwide energy database in which monthly campus data will be compiled to produce systemwide energy reporting. Campuses will provide the Chancellor's Office the necessary energy and utility data, such as electricity and natural gas consumption; water and sewer usage; fuel consumed by fleet vehicles, boats, and ships; waste disposal for the systemwide database in a timely manner. (78-; 88- Adopt; 01-Revise; 04-No Change; 14-Revise; 22-No Change)
6. Each CSU campus shall develop and maintain a campuswide utility master plan which includes an integrated strategic energy resource plan, with tactical recommendations in the areas of new construction, decarbonization, deferred maintenance, climate resilience, facility renewal, energy projects, water conservation, solid waste management, and an energy management plan. This plan will be updated every 10 years and guide the overall energy and climate action program at each campus. (78-Adopt; 88-Revise; 01-Revise; 04-Revise; 14-Revise; 22-Revise)

Water Conservation

1. All CSU campuses shall pursue cost effective water resource conservation to reduce consumption by ten percent (10%) by 2030, as compared to a 2019 baseline, consistent with AB 1668 (California Water Code § 10609) including steps to develop sustainable, drought tolerant or native landscaping, reduce turf, install controls to optimize irrigation water use, reduce water usage in restrooms, showers, fountains and decorative water features, and promote the use of reclaimed/recycled water. In the event of a declaration of drought, the CSU will cooperate with the state, city, and county governments to the greatest extent possible to reduce water use. (78-; 88-Adopt; 01-No Change; 04-No Change; 14-Revise; 22-Revise)

Sustainable Procurement

1. Campuses shall promote use of suppliers and/or vendors who reduce waste, re-purpose recycled material, or support other environmentally friendly practices in the provision of goods or services to the CSU under contract. This may include additional evaluation points in solicitation evaluations for suppliers integrating sustainable and socially responsible practices. (14-New; 22-Revise)
2. To move to zero waste, campus practices should: (1) encourage use of products that minimize the volume of trash sent to landfill or incinerators; (2) participate in the CalRecycle Buy-Recycled program or equivalent; and (3) increase recycled content purchases in all Buy-Recycled program product categories. (14-New; 22-No Change)
3. Campuses shall continue to report on all recycled content product categories, consistent with PCC § 12153-12217 and shall implement improved tracking and reporting procedures for their recycled content purchases. (14-New; 22-No change)
4. Campuses shall align procedures with state initiatives to report environmental product declarations for select construction materials, consistent with PCC §3500-3505 and state mandates. (22-New)
5. Campuses shall promote circular economies² by seeking to reduce waste when considering materials purchases, including but not limited to, office supplies, equipment, classroom supplies, and promotional and giveaway items by minimizing purchase of items that have a

² Circular economies promote reduced use of resources and generation of waste in products/services, recycling and reuse of materials and products and improved re-generation of waste to promote natural resources.

short useful life, are unable to be recycled, and/or are made of unsustainable or carbon intensive materials. (22-New)

Waste Management

1. Campuses shall seek to reduce landfill bound waste to fifty percent (50%) of total campus waste by 2030, divert at least eighty percent (80%) from landfill by 2040, and move toward zero waste. (14-New; 22-Revise)
2. Campuses shall identify and implement cost effective opportunities for organics diversion, collection, and disposal and shall designate zero waste responsibilities for coordinating campus waste prevention, reduction and diversion efforts. Campuses will continue to report on all disposal activities using the CalRecycle State Agency Reporting Center (SARC) and are encouraged to coordinate and maintain a solid waste management plan as it is a requirement in the utility master plan. (22-New)
3. The CSU will continue to reduce hazardous waste disposal while supporting the academic program. (14-New)

Sustainable Food Service

1. All campus food service organizations should track and increase/improve their sustainable food purchases. (14-New; 22-Revise)
2. Campuses and food service organizations shall collaborate to provide information and/or training to staff and patrons on the benefits of, and how to successfully participate in sustainable food service operations. (14-New; 22-Revise)

Sustainable Building & Lands Practices

1. All future CSU new construction, remodeling, renovation, and repair projects, regardless of funding source, will be designed with consideration of optimum energy utilization, decarbonization, and low life-cycle operating costs and shall exceed all applicable energy codes and regulations (Building Energy Efficiency Standards, Tit. 24 CCR § 6) by ten percent (10%). In the areas of specialized construction that are not regulated through the current energy standards, such as historical buildings, museums, and auditoriums, the CSU will ensure that these facilities are designed to maximize energy efficiency. Energy efficient and sustainable

design features in the project plans and specifications will be considered in balance with the academic program needs of the project within the available project budget. (78-Adopt; 88-Revise; 01-Revise; 04-Revise; 14-Revise; 22-Revise)

2. Capital planning for state, non-state facilities and infrastructure shall consider features of a sustainable and durable design to achieve a low life cycle cost. Campuses shall design, construct, operate, and maintain green building certified high performing buildings, regardless of funding source, that improve occupant productivity and wellness, optimize life-cycle costs, and minimize carbon impact. Principles and best practices established by leading industry standards or professional organizations shall be implemented to the greatest extent possible. (04-Adopt; 14-Move; 22-Return & Revise)
3. Existing building energy performance will be optimized through improved operation, maintenance and repair, and capital improvement, enabling campuses to meet carbon reduction goals. Sustainable design for capital projects is a process of balancing long-term institutional needs for academic and related programs with environmental concerns. In the context of designing to provide for university and academic needs, the following attributes will be considered “sustainable:”
 - a. Siting and design considerations that optimize local geographic features to improve sustainability of the project, such as proximity to public transportation and maximizing use of vistas, microclimate, and prevailing winds;
 - b. Durable systems and finishes with long life cycles that minimize maintenance and replacement.
 - c. Optimization of layouts and designing spaces that can be reconfigured with the expectation that the facility will be renovated and re-used (versus demolished);
 - d. Systems designed for optimization of energy, water, and other natural resources;
 - e. Optimization of indoor environmental quality for occupants;
 - f. Utilization of environmentally preferable products and processes, such as long life-cycle materials and components, recycled-content and recyclable materials;
 - g. Procedures that monitor, trend, and report operational performance as compared to the optimal design and operating parameters.
 - h. Cost-effective design features which align with CSU Basic Needs Initiative and support campus diversity, equity and inclusion efforts. (04-Adopt; 14-Move, 22-Return & Revise)
4. In order to implement the sustainable building goal in a cost-effective manner, the process will: identify economic and environmental performance measures; determine cost savings; use extended life cycle costing; and adopt an integrated systems approach. Such an approach treats the entire building as one system and recognizes that individual building features, such as

lighting, windows, heating and cooling systems, or control systems are not stand-alone systems. (04-Adopt; 14-Move; 22-Return)

5. Capital Planning, Design and Construction in the Chancellor's Office shall monitor building sustainability/energy performance and maintain information on design best practices to support the energy efficiency goals and guidelines of this policy. The sustainability performance shall be based on Leadership in Energy and Environmental Design (LEED) principles with consideration to the physical diversity and microclimates within the CSU. (05-New; 14-Revise; 22-No Change)
6. The CSU shall design and build all new buildings and major renovations to meet or exceed the minimum requirements equivalent to LEED Silver. Each campus shall strive to achieve a higher standard equivalent to LEED Gold or Platinum within project budget constraints. Each campus may pursue external certification through the LEED process or alternative sustainable building rating systems. If the project is not registered through U.S. Green Building Council, then a qualified campus staff member shall evaluate the documentation necessary to determine LEED equivalence and shall attest that equivalence has been achieved. (05-New; 14-Revise; 22-Revise)
7. In informal or unlandscaped areas, and where appropriate, campuses will work to support a naturally functioning habitat, promote biodiversity, and preserve native landscapes. (22-New)

Physical Plant Management

1. Each campus shall operate and maintain a comprehensive energy management system that will provide centralized reporting and control of the campus energy and carbon reduction related activities. (78-Adopt; 88-Revise; 01-Revise; 04-No Change; 14-Revise; 22-Revise)
2. Campus energy/utilities managers will make the necessary arrangements to achieve optimum efficiency in the use of natural gas, electricity, or any other purchased energy resources to meet the heating, cooling, and lighting needs of the buildings and/or facilities. Campuses shall strive to adhere to Statewide energy efficiency guidance regarding appropriate indoor temperature setpoints during heating and cooling periods (State Administrative Manual, Section: 1805.3). Except for areas requiring special operating conditions, such as electronic data processing facilities, or other scientifically critical areas, where rigid temperature controls are required, building and/or facility temperatures will be allowed to fluctuate between the limits stated above. Simultaneous heating and cooling operations to maintain a specific temperature in work

areas will not be allowed unless special operating conditions dictate such a scheme to be implemented. (78-; 88-Adopt; 01-No Change; 04-No Change, 14-Revise; 22- Return & Revise)

3. To the extent possible, academic and non-academic programs will be consolidated in a manner to achieve the highest building utilization. (78-; 88-Adopt; 01-No Change; 04-No Change; 14-Revise; 22-No Change)
4. All CSU campuses shall implement a utilities chargeback system to recover direct and indirect costs of utilities provided to self-supporting and external organizations pursuant to procedures in the CSU Policy Library. (78-; 88-Adopt; 01-No Change; 04-No Change; 14-Revise;22-Revise)

Transportation

1. The CSU will encourage and promote the use of alternative transportation and/or alternative fuels to reduce GHG emissions related to university associated transportation, including commuter and business travel. The Chancellor's Office will establish a baseline for carbon emissions from student, faculty and staff commuting and establish a systemwide reduction target. (14-New; 22-Revise)
2. All CSU campuses shall develop and maintain a transportation demand management (TDM) plan to reduce Vehicle Miles Traveled (VMT) and carbon emissions. This plan will be updated every five years and guide the overall transportation and parking program at each campus. (22-New)
3. Campuses shall strive to increase Electric Vehicle (EV), electric bicycle, and other electric mobility and transportation device charging infrastructure and incentive programs to further support campus carbon reduction strategies. (22-New)
4. Campuses shall strive to develop and maintain a long-range plan for transitioning fleet, and grounds equipment to zero emissions, excluding public safety patrol vehicles if necessary. Fifty percent (50%) of all light duty vehicle purchases will be ZEV by 2035, with no addition of gas-powered light duty vehicles to the fleet after 2035. All small off-road engine (SORE) equipment used for campus grounds will be all-electric by 2035. All buses and heavy-duty vehicles will be ZEV by 2045 in alignment with State regulations. (22-New)



California State University
MONTEREY BAY

Prepared by:

DUDEK

725 Front Street, Suite 400

Santa Cruz, CA 95060

831.600.1400 | HELLO@DUDEK.COM

DUDEK.COM