



NTID300.1

**NOISE FROM CONSTRUCTION EQUIPMENT AND
OPERATIONS, BUILDING EQUIPMENT,
AND HOME APPLIANCES**

DECEMBER 31, 1971

U.S. Environmental Protection Agency
Washington, D.C. 20460

**NOISE FROM CONSTRUCTION EQUIPMENT AND
OPERATIONS, BUILDING EQUIPMENT,
AND HOME APPLIANCES**

DECEMBER 31, 1971

Prepared by

**BOLT, BERANEK AND NEWMAN
under
CONTRACT 68-04-0047**

for the

**U.S. Environmental Protection Agency
Office of Noise Abatement and Control
Washington, D.C. 20460**

This report has been approved for general availability. The contents of this report reflect the views of the contractor, who is responsible for the facts and the accuracy of the data presented herein, and do not necessarily reflect the official views or policy of EPA. This report does not constitute a standard, specification, or regulation.

TABLE OF CONTENTS

	<u>page</u>
PREFACE	iii
ACKNOWLEDGEMENTS	v
LIST OF FIGURES	x
LIST OF TABLES	xiii
SECTION 1. INTRODUCTION	1
1.1 Source Characterization	2
1.2 Impact Evaluation	3
1.3 Industry Assessment	5
SECTION 2. SOURCE CHARACTERIZATION	7
2.1 Construction Equipment and Operation	7
2.2 Home Appliances	27
2.3 Building Equipment	53
SECTION 3. IMPACT	62
3.1 Noise Level Criteria for Impact Evaluation	62
3.2 Construction Noise	70
3.3 Appliances	94
3.4 Projections of Construction and Appliance Noise to the Year 2000	119
SECTION 4. INDUSTRY EFFORTS	130
4.1 Introduction	130
4.2 Construction Industry Efforts	132
4.3 Building Equipment and Appliance Industry Efforts	144

TABLE OF CONTENTS (Continued)

	<u>page</u>
SECTION 5. CONCLUSIONS AND RECOMMENDATIONS	163
5.1 Conclusions	163
5.2 Recommendations	170
5.3 Economic Impact Studies	178
5.4 A Program of Public Support Development ..	180
5.5 Social Impact	182
REFERENCES	185
APPENDIX A. DETAILED SOURCE CHARACTERIZATION	A-1
A.1 Construction Equipment	A-1
A.2 Appliances	A-9
A.3 Typical Equipment in Buildings	A-22
REFERENCES	A-38
APPENDIX B. IMPACT CONSIDERATIONS	B-1
B.1 Interpretation of Impact Estimates	B-1
B.2 Discussion of Construction Data	B-3
B.3 Estimating the Extent of Public Works Construction Noise	B-6
B.4 Propagation Loss Model for Building Construction Sites in Metropolitan Areas	B-8
APPENDIX C. SOUND LEVEL CONSIDERATIONS	C-1
Noise - The Problem Stated	C-1
The Concern for Noise	C-2
What Are Manufacturers Doing About Noise?	C-4
The Complex Answers	C-5
Quieting Current Products	C-7

TABLE OF CONTENTS (Continued)

	<u>page</u>
Future Machine Quietness	C-7
Noise Standards and Regulations	C-8
APPENDIX D. NOISE CONTROL: REGULATION AND STANDARDS	D-1
D.1 Introduction	D-1
D.2 Construction Equipment	D-2
D.3 Noise Standards for Indoor and Outdoor Equipment for Home and Office Use	D-10

LIST OF FIGURES

Figure		page
1.	Construction Equipment Noise Ranges	11
2.	Provisional Criteria Relating NPL to Community Noise Acceptability	17
3.	A Summary of Noise Levels for Appliances Measured at a Distance of 3 ft	31
4.	Sound Pressure Levels of Various Refrigerators (Measured at 3 ft)	32
5.	Schematic View of a Typical Room Air Conditioner	36
6.	Sound Pressure Levels From Air Conditioner on High Cool and High Fan Settings (Measured at 3 ft)	38
7.	Sound Pressure Levels From Air Conditioner on Two Settings (Measured at 3 ft)	40
8.	Graphic Level Recording and Octave Band Sound Pressure Levels of a Dishwasher	42
9.	Sound Pressure Levels of Various Automatic Dishwashers During Wash Cycle (Measured at 3 ft)	43
10.	Sound Pressure Levels From Four Food-Waste Disposers (Measured at 3 ft)	46
11.	Sound Pressure Levels of Canister Vacuum Cleaners Operating on Wood or Tile Floors (Measured at 3 ft)	48
12.	Sound Pressure Levels of Two Upright Vacuum Cleaners (Measured at 3 ft)	49
13.	Time History of the Sound Pressure Level in the 250 Hz Octave Band for a Tank Water Closet	51

LIST OF FIGURES (Continued)

		page
Figure	14. Time History of Sound Pressure Level in 250 Hz Octave Band for a Flush Valve Water Closet	52
	15. Range of Peak Octave Band Sound Pressure Levels in Rooms with Tank Type Water Closets.	54
	16. Range of Peak Octave Band Sound Pressure Levels in Rooms with Flush Valve Water Closets	55
	17. Range of Sound Levels in dB(A) Typical for Building Equipment at 3 ft	57
	18. Cross-Section of a Typical Multistory Building Showing Building Equipment	59
	19. Range of Building Equipment Noise Levels to Which People are Exposed	60
	20. Construction Site Geometry and Attenuation Contours for a Stationary Population within Buildings	79
	21. Percent of Households with Selected Noise-Producing Appliances and Tools	97
	22. Estimated Percent Distribution of Major Appliances by Income Level	98
	23. Noise Profiles From Appliance for Typical Households Per Week (at 3 ft)	105
	24. Number of Building Construction Sites Projected to the Year 2000	123
	25. Projected Change in Exposure to Construction Noise, Assuming No Change in Noise Levels ...	126
	26. Projected Change in Exposure to Appliance Noise, Assuming No Change in Noise Levels ...	128
	27. Cost of Noise Control vs Noise Reduction	172

LIST OF FIGURES (Continued)

	page
Figure A-1 through A-61. Sound Pressure Levels for Various Appliances and Items of Construction Equipment..	A-39 thru A-99
B-1. Linear and Area Distribution of Population in Municipalities (Based on Massachusetts and Pennsylvania Data)	B-11

LIST OF TABLES

Table		page
I-a.	Typical Ranges of Noise Levels at Construction Sites With A 50 dB(A) Ambient Typical of Suburban Residential Areas	19
I-b.	Typical Ranges of Noise Levels at Construction Sites With A 70 dB(A) Ambient Typical of Urban Areas	20
II.	Noisiest Equipment Types Operating at Construction Sites	22
III.	Noise Pollution Levels in dB(A) of Construction Sites, Various Equipment Quieting Strategies	24
IV.	Immediate Abatement Potential of Construction Equipment	26
V.	Noise Control for Construction Equipment ...	28
VI.	Sources of Appliance Noise	34
VII.	Exposure of Building Occupants to the Noise of Building Equipment	58
VIII.	Estimates of Magnitudes of Noise Effects ...	63
IX.	Metropolitan Regions Considered in Construction Noise Exposure Estimate; Statistics as of 1970	72
X.	Annual Construction Activity - 1970	74
XI.	Geographical Distribution of Working-Day Populations	76
XII.	Number of People Per Day Passing A Construction Site	77
XIII.	Level of Annual Construction Activity	78

LIST OF TABLES (Continued)

	page
Table XIV.	Distribution of Stationary Observers Relative to Attenuation Contours 80
XV.	Average and Peak Exposure Levels to Construction Noise 82
XVI.	Estimated Annual Passings of Construction Sites - All Metropolitan Regions 84
XVII.	Order of Magnitude Estimates of Yearly Duration of Construction Noise Exposure 86
XVIII.	Order-of-Magnitude Estimates of Construction Noise Exposure in Millions of Person-Hours Per Week 92
XIX.	Order-of-Magnitude Estimates of Impact of Primary and Secondary Exposure to Construction Noise Expressed in Millions of Person-Hours Per Week 93
XX.	Noncontrollable Household Noise Sources 95
XXI.	Average Hours Per Day Spent on Household Work By 1296 Homemakers, According to Number of Children and Age of Youngest Child, Syracuse, New York Area, 1967-68 102
XXII.	Appliance Usage Source Data 103
XXIII.	Use of Noncontrollable Noise-Producing Appliances and Tools in Typical Households . 104
XXIV.	Number of Individuals Exposed to Indicated Appliances 107
XXV.	Estimated Number of Individuals Exposed to Domestic Appliance Noise 108
XXVI.	Sound Pressure Levels of Home Appliances and Building Equipment Adjusted for Location of Exposure 109

LIST OF TABLES (Continued)

	page
Table XXVII. Order-of-Magnitude Estimates of the Extent and Duration of Exposure to Building Equipment and Home Appliances	110
XXVIII. Order-of-Magnitude Estimates of Exposure to Home Appliance and Building Equipment Noise Expressed in Millions of Person-Hours Per Week	120
A-1. Use of Equipment at Construction Sites	A-4
A-2. Usage Factors of Equipment in Domestic Housing Construction	A-5

1. INTRODUCTION

As a society evolves technologically, the sources of noise grow in number and kind. Noise levels increase and the effects of noise on society become increasingly severe. Concomitantly, society continually requires more machinery, operating at higher speeds with greater power output. Aircraft, for example, have continued to grow in number and noise level, creating almost intolerable conditions for populations living, working, and playing in the vicinity of airports. Trucks and construction equipment require increasingly powerful engines to enable a single operator to move more goods, materials, or earth faster and more economically. The thunder of these engines not only degrades the quality of life in our communities but also causes the operators to incur substantial levels of permanent hearing loss. A profusion of appliances that provide the energy needed to do everything from brushing our teeth and cooling our houses, to washing our dishes, disposing of our garbage, and cutting our grass often generate noise levels that interfere with conversation and disturb neighbors. Even the wilderness, once a refuge from hectic urban life, is now disturbed by the noise of trail bikes, all-terrain vehicles, and snowmobiles.

Given that noise is a serious environmental problem, some appropriate questions one might ask in seeking a comprehensive noise-control objective are: Precisely what are the sources of noise pollution? How many people are exposed to these sources and how are they affected? What can be done to control the noise output of offending sources? This report attempts to answer these questions for the specific categories of construction, home appliances, and building equipment.

1.1 Source Characterization

The two principal objectives in characterizing sources are (1) evaluating noise levels in quantitative terms that may be used to determine the impact on people and (2) obtaining the information needed to assess the noise reduction that can be achieved. Relating measurable aspects of sound to human response is difficult at best. Such impact criteria as speech interference, sleep interruption, and annoyance depend not only on the physical nature of sound such as level, spectral content, and degree of fluctuation but also on the nonphysical aspects of noise such as the information content or implications of the sound. A rattling piece of equipment is often annoying not because of the noise level but primarily because it indicates a malfunction requiring attention.

Several attempts have been made to include various aspects of noise in a single number related to annoyance. Most of these methods try to account for the unequal sensitivity of the human hearing mechanisms to different frequencies and some try to account for fluctuations of level with time. A single number which accounts rather well for the human ear's relative insensitivity to low and very high frequency sound is the A-weighted scale. This weighting has been found to correlate about as well with annoyance as other indices [1]; it is quite widely accepted and can be read on a meter. In this report, we use A-weighting [dB(A)] to characterize noise insofar as impact evaluations are concerned.

Noise spectra are of far more use than single number ratings for assessing the contribution from various components to total noise levels. Pure tones associated with integer multiples of speeds of rotating machinery often appear as identifiable spectral peaks. Exhaust noise from an internal combustion engine

typically contributes the dominant low-frequency component, whereas engine structural radiation and turbocharger whine usually generate the high-frequency levels. Hence, where possible, we provide noise spectra in octave or one-third octave bands.

Once sources have been characterized, we evaluate the abatement potential associated with each. Our evaluation is based on a somewhat broad analysis of the component contributions and to a great extent on judgment developed from experience with similar sources. For example, prior work with internal combustion engines enables us to estimate the benefit achievable from state-of-the-art mufflers or engine enclosures. We estimate our predictions of achievable abatement potential to be within ± 5 dB. A more accurate prediction of noise reduction would require detailed diagnosis of contributions from each source component and implementation of experimental noise-control treatment.

Because of the large number of sources evaluated (see Sec. 2), we place much detailed information (e.g., a number of noise spectra for sources whose impact is small) in Appendix A. Included in Appendix B is the background to the development of impact criteria and in Appendix D a discussion of existing standards.

1.2 Impact Evaluation

We evaluate the impact of noise on people, using two principal measures: intensity and extent. Clearly, it is important to know the levels to which a person may be exposed and the effects of this exposure. Thus, once the sources have been characterized and the relation of a listener to the source has been postulated, we estimate the physiological, psychological, and sociological effects of the noise. For example, permanent hearing damage is likely to occur for a significant percentage of the population

exposed to levels of 90 dB(A) for eight hours a day over an extended period of time. If the exposure time is short (e.g., 15 minutes a day), the noise may or may not contribute to hearing damage, but during exposure one cannot conduct an intelligible conversation. Exposure during evening hours to levels of noise that exceed approximately 70 dB(A) will usually lengthen the time one requires to go to sleep or will awaken someone who is already asleep - especially if the noise is intermittent and the background level is low.

The extent of noise impact is as important as the intensity in assessing the magnitude of noise pollution since this measure gives some perspective to the contribution from various sources. A truly comprehensive assessment would involve a detailed social survey with extensive noise measurements and statistically significant samples from every stratum of society. Such a program would no doubt consume millions of dollars and several calendar years. Clearly, this approach is not feasible in the three-month time period available for this study, nor would it represent an entirely justifiable allocation of resources. The goal of determining the impact of noise can be viewed only as an intermediate step to solving the actual problem: reducing the noise exposure of our population. Hence, an order-of-magnitude assessment of impact is probably an adequate guide to the development of a noise-abatement program. What matters, for example, is that approximately six million workers on night shifts and children under four cannot sleep because of construction noise. One's approach to construction-noise abatement would probably not be different if the figure were two million or ten million. We therefore provide this impact evaluation, not by social survey, but by estimating (1) the noise levels to which people are exposed, (2) the effects of noise on these people, and (3) the number of people

exposed. These estimates are based on measured values of equipment noise, data on human response to noise, statistics of equipment utilization, and statistics of population distributions. The impact of construction, appliances, and building equipment is discussed in Sec. 3.

1.3 Industry Assessment

To bring about control of environmental noise, the EPA must have information not only about the technology of abatement but also about the nature of the industry it may be called upon to influence. An understanding of the pressures for and against noise control is helpful in assessing the extent to which an industry is likely to institute noise control measures on its own and how the industry will be affected if it is compelled to produce quieter products. For example, the principal impact of construction noise, other than hearing-damage risk to operators (who have been amazingly casual about their plight), is on the community rather than the purchaser. The community has been able to exert very little influence on the purchaser or the manufacturer, the result being that very little has been accomplished in quieting construction equipment. For example, diesel-powered equipment is sometimes advertised and sold without even mufflers. A small number of companies, however, have begun to produce quiet equipment; they attribute their recent success in the marketplace to certain local noise legislation and to the threat of such regulations spreading to other communities.

An example of the effects that noise regulations may have on business comes from the home appliance industry. An air-conditioner manufacturer has indicated that certain marketplace pressures inhibit him from implementing additional noise control in bottom-of-the-line items. He argues that more noise control

would increase the price of an item, thereby harming his competitive position. If all manufacturers were required to make their products quieter (and therefore more costly), one could argue that a segment of the population at lower income levels could no longer afford air-conditioners and would be deprived of that comfort.

By interviewing manufacturers of construction equipment, home appliances, and building equipment, we obtained their views of the relevance of noise control to their business. We found a substantial difference between the attitudes of people who manufacture construction equipment and those who manufacture appliances. The former, who find practically no marketplace demand for quiet equipment, are faced with the prospect of a mélange of state and city ordinances; they almost welcome "reasonable" federal standards. The latter find an increasing marketplace demand for quiet appliances and prefer not to see the implementation of federal standards or labeling requirements. Chapter 4 of this report contains an analysis of the pressures on industry to reduce (or not to reduce) noise levels, its response to these pressures, its present achievements, and its potential.

2. SOURCE CHARACTERIZATION

2.1 Construction Equipment and Operation

Construction has become a major noise problem in many cities and towns. The trend toward urban renewal and more high-rise structures has created an almost perpetual din on city streets. Equipment associated with construction projects is more numerous, and the time span for construction at a given site has lengthened. Residents very near a construction site may well plan on two years of intolerable noise levels as a high-rise structure is being built.

In this section, we consider the construction noise problem as it relates to residential and nonresidential buildings, city streets, and public works, because these kinds of project usually take place in areas where the number of people likely to be exposed is very high. Heavy construction, such as highways and civil works, has been omitted from our study because the vast bulk of this activity occurs in thinly populated areas where the noise affects very few people. We view construction as a process that can be categorized according to type and that consists of separate and distinct phases.

2.1.1 The construction process

The basic unit of construction activity is the construction site, which exists in both space and time. The temporal dimension consists of various sequential phases which change the character of the site's noise output as work progresses. These phases are discussed further below. In the case of building construction, the spatial character of the site is self-evident; in the case of sewers and roads, the extent of a site is taken, for reasons explained in Sec. 3.2, to be one standard city block or

about 1/8 of a mile. (That is, if a city reports 40 miles of sewer construction, we consider that project as consisting of 320 separate sites.)

Construction sites are typically classified in the fifteen categories in which construction data is reported by the U.S. Bureau of Census and various state and municipal bodies. The categories are:

- Residential buildings:
 - one- to four-family
 - Five-family and larger
- Nonresidential buildings:
 - Office, bank, professional
 - Hotel, motel, etc.
 - Hospitals and other institutions
 - Schools
 - Public works buildings
 - Industrial
 - Parking garages
 - Religious
 - Recreational
 - Store, mercantile
 - Service, repair station
- Municipal streets
- Public works (e.g., sewers, water mains).

For purposes of allocating construction effort among the different types of sites, it is possible to group the nonresidential sites into four larger categories which are differentiated by the cost of the average building in each category, as well as by the distribution of effort among the various construction

phases. These four groups, in order of decreasing average cost per building, are:

- Office buildings, hospitals, hotels
- Schools, public works buildings
- Industrial buildings, parking garages
- Stores, service stations, recreational buildings, and religious buildings.

Construction is carried out in several reasonably discrete steps, each of which has its own mix of equipment and consequently its own noise characteristics. The phases (some of which can be subdivided) are:

- *Building Construction*

1. a. Clearing
b. Demolition
c. Site preparation
2. Excavation
3. Placing foundations
4. a. Frame erection
b. Floors and roof
c. Skin and windows
5. a. Finishing
b. Cleanup

- *City Streets*

1. Clearing
2. Removing old roadbed
3. Reconditioning old roadbed
4. Laying new subbase, paving
5. Finishing and cleanup

• *Public Works*

1. Clearing
2. Excavation
3. Compacting trench floor
4. Pipe installation, filling trench
5. Finishing and cleanup.

Defining the construction phases as above allows us to account for the variation in site noise output with time. By inventorying the equipment which is to be found at each site in each phase, we can derive a representative source level for each phase by the process described below.

2.1.2 Equipment noise characteristics

Despite the variety in type and size of construction equipment, similarities in the dominant noise sources and in patterns of operation permit one to assign all equipment to a very limited number of categories. These categories are described below and are indicated in Fig. 1, together with corresponding noise level data. Corresponding spectra and the sources of this data are given in Appendix A.

Equipment Powered by Internal Combustion Engines

The most prevalent noise source in construction equipment is the prime mover, i.e., the internal combustion engine (usually of the diesel type) used to provide motive and/or operating power. Engine-powered equipment may be categorized according to its mobility and operating characteristics, as (1) earthmoving equipment (highly mobile), (2) handling equipment (partly mobile), and (3) stationary equipment.

Earthmoving equipment includes excavating machinery (backhoes, bulldozers, shovels, front loaders, etc.) and highway

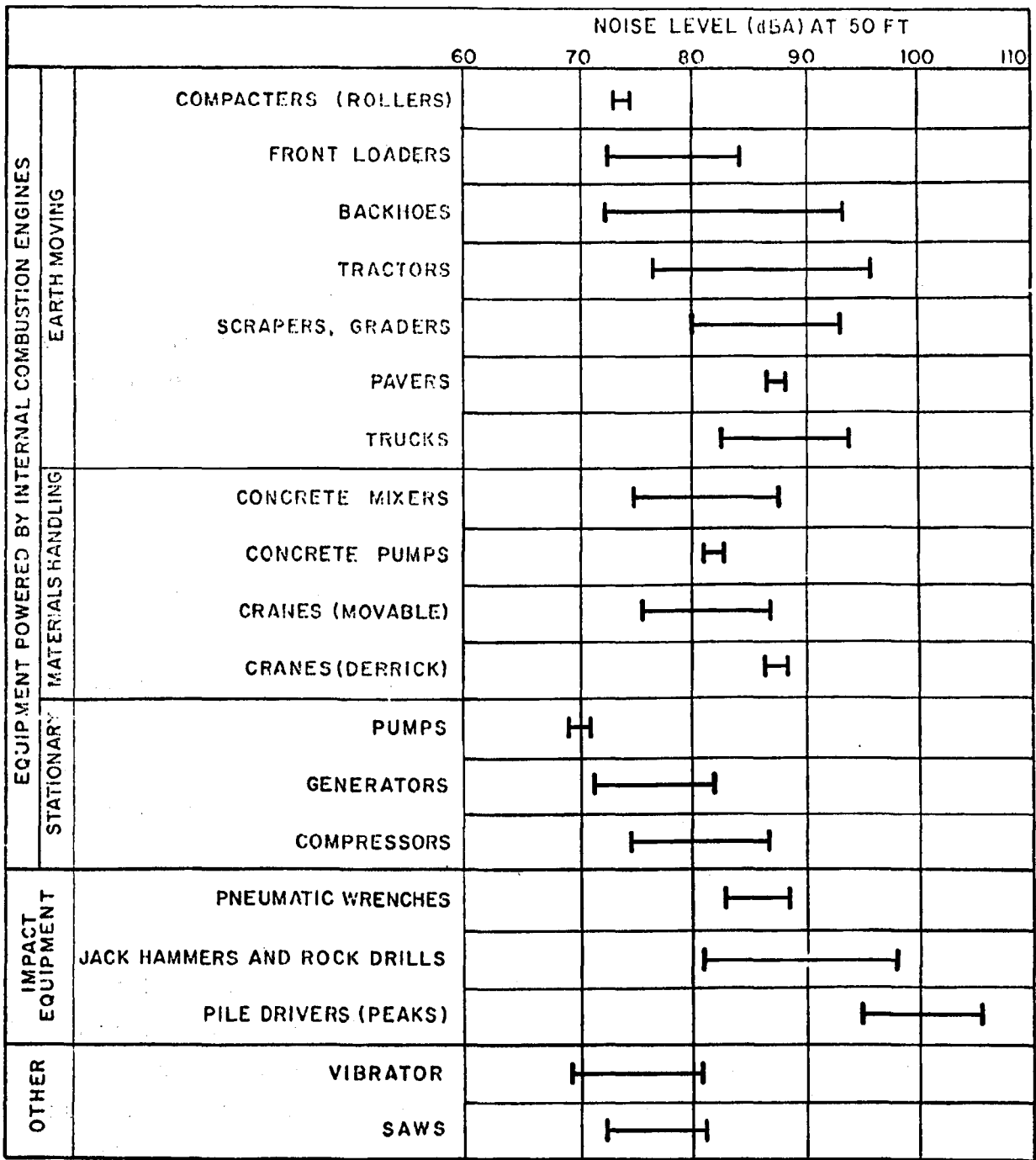

Note: Based on Limited Available Data Samples

FIG. 1. CONSTRUCTION EQUIPMENT NOISE RANGES.

building equipment (compactors, scrapers, graders, pavers, etc.). Internal combustion engines are used for propulsion (either on wheels or tracks) and for powering working mechanisms (buckets, arms, trenchers, etc.). Engine power varies from about 50 hp to over 600 hp. Engine noise typically predominates, with exhaust noise usually being most significant and with inlet noise and structural noise being of secondary importance. Other sources of noise in this equipment include the mechanical and hydraulic transmission and actuation systems, and cooling fans (often very significant). Typical operating cycles may involve one or two minutes of full-power operation, followed by three or four minutes at lower power.

Noise levels at 50 ft from earthmoving equipment range from about 73 to 96 dB(A). The greatest and most direct potential for noise abatement here lies in quieting the engine by use of improved mufflers.

Engine-powered materials-handling equipment such as cranes, derricks, concrete mixers, and concrete pumps, is used in a more-or-less fixed location; mobility of this equipment over the ground is not part of its major work cycle. Although noise from the working process (such as the clanking of aggregate in the concrete mixing bin) often is the most "identifiable" noise component, the dominant source of noise generally is the prime mover. Noise levels at 50 ft range from about 75 to 90 dB(A). The greatest potential abatement for noise again lies in engine quieting, with treatment of power transmission and working mechanisms being of secondary importance.

Stationary equipment, such as pumps, electric power generators and air compressors, generally runs continuously at relatively constant power and speed. Noise levels at 50 ft range

from about 70 to 80 dB(A), with pumps typically at the low end of this range. Stationary equipment, because of its fixed location and constant speed and/or load operation, may be quieted more easily than mobile equipment; engine mufflers can be more effective, and use of enclosures becomes feasible. [In fact, noise from some air compressors, has already been reduced by about 10 dB(A) by use of appropriate enclosures.]

The greatest near-term abatement potential for all current equipment powered by internal combustion engines lies in the use of better exhaust mufflers, intake silencers, and engine enclosures (in conjunction with appropriate cooling system and fan design). Reductions of 5 to 10 dB(A) appear to be achievable, usually without great difficulty. Practical long-term abatement [of about 15 to 20 dB(A)] can probably be achieved by basic engine design changes. Of course, replacement of the internal combustion engine by a quieter prime mover, such as a gas turbine or electric motor, would eliminate the reciprocating-engine noise source altogether.

Impact Equipment and Tools

Conventional pile drivers are either steam-powered or diesel-powered; in both types, the impact of the hammer dropping onto the pile is the dominant noise component. With steam drivers, noise is also generated by the power supply (a boiler) and the release of steam at the head; with diesel drivers, noise is also generated by the combustion explosion that actuates the hammer. Noise levels are difficult to measure or standardize, because they are affected by pile type and length, but peak levels tend to be about 100 dB(A) (or higher) at 50 ft.

Impact-noise is absent in the so-called "sonic" (or vibratory) pile drivers. These do not use a drop hammer, but vibrate the pile at resonance. The noise associated with pile vibrations typically occurs around 150 Hz and is barely audible. The power source, which generally consists of two gasoline engines, is the primary noise source.

Abatement can be accomplished best by substituting use of a sonic pile driver for an impact machine where possible. (Unfortunately, sonic pile drivers are useful only for some soils.) Impact noise reduction at the source generally is very difficult. Substitution of nonimpact tools offers the best practical abatement potential; otherwise, reductions of perhaps 5 dB(A) may be obtained by use of enclosures.

Most impact tools, such as jack hammers, pavement breakers, and rock drills are pneumatically powered, but there are also hydraulic and electric models. The dominant sources of noise in pneumatic tools are the high-pressure exhaust and the impact of the tool bit against the work. Noise levels at 50 ft typically range from 80 to 97 dB(A).

An exhaust muffler on the compressed air exhaust can lower noise levels from the exhaust by up to about 10 dB(A). Pneumatic exhaust noise, of course, is absent in hydraulic or electric impact tools. Reduction of the impact noise from within a tool can be accomplished by means of an external jacket, which can contribute perhaps a 5 dB(A) reduction. Reduction of the noise due to impact between the tool and material being worked upon generally is difficult and requires acoustic barriers enclosing the work area and its immediate vicinity. Depending on the impacted structures, such barriers may reduce noise by 3 to 10 dB(A).

Small hand-held pneumatic tools, such as pneumatic wrenches, generate noise of levels between 84 and 88 dB(A) at 50 ft. The exhaust and the impact are the dominant noise sources. Because of the obvious weight and size limitations to which hand tools are subject, only small and light mufflers can be used with them, limiting the achievable noise reduction to 5 dB(A) at best. The best practical means for reducing the noise from impact tools consists of using other types of tools to accomplish the same functions.

2.1.3 Site noise characteristics

To characterize the noisiness - i.e., the average noise annoyance potential - of the various types of construction sites during each phase of construction, a Noise Pollution Level (NPL) was calculated for each type of site and each construction phase. The NPL used here was taken as the same measure that was used for similar evaluation of traffic noise [2]. The NPL (in dB) is defined as the sum of the A-weighted average sound pressure level and 2.56 times the standard deviation of the A-weighted sound pressure level*; thus, NPL accounts for the effect of steady noise, plus the annoyance due to fluctuations.

Although a thorough study relating NPL to subjective descriptors of annoyance (e.g., acceptable, unacceptable) has not been accomplished, a provisional interpretation of NPL in such terms can be suggested. On the basis of an evaluation of domestic and

*A-weighting refers to a standard weighting of the various frequency components, approximating the behavior of human hearing. The average sound pressure level is computed on the basis of the time-average root-mean-square sound pressure, whereas the standard deviation is calculated from the time-variation of the dB(A) values.

foreign social surveys and psycho-acoustic studies, the Department of Housing and Urban Development has adopted a set of "guideline criteria" [3] for outdoor noise levels in residential areas as shown in Fig. 2 [4]. According to this chart, the community noise situation is evaluated by comparing a measured distribution of A-weighted levels with the criteria curves. The situation is categorized by the region of least desirability penetrated by the actual noise distribution. Since this criterion is based on level distributions, the boundaries between regions of acceptability may be defined in terms of the NPL. Thus, the following descriptors of NPL values may be used in interpreting the site noise NPL levels used in the remainder of this report.

Clearly Acceptable: The noise exposure is such that both the indoor and outdoor environments are pleasant.

NPL less than 62 dB

Normally Acceptable: The noise exposure is great enough to be of some concern but common building constructions will make the indoor environment acceptable, even for sleeping quarters, and the outdoor environment will be reasonably pleasant for recreation and play.

NPL between 62 and 74 dB

Normally Unacceptable: The noise exposure is significantly more severe so that unusual and costly building constructions are necessary to ensure some tranquility indoors, and barriers must be erected between the site and prominent noise sources to make the outdoor environment tolerable.

NPL between 74 and 88 dB

Clearly Unacceptable: The noise exposure at the site is so severe that the construction costs to make the indoor environment acceptable would be prohibitive and the outdoor environment would still be intolerable.

NPL greater than 88 dB

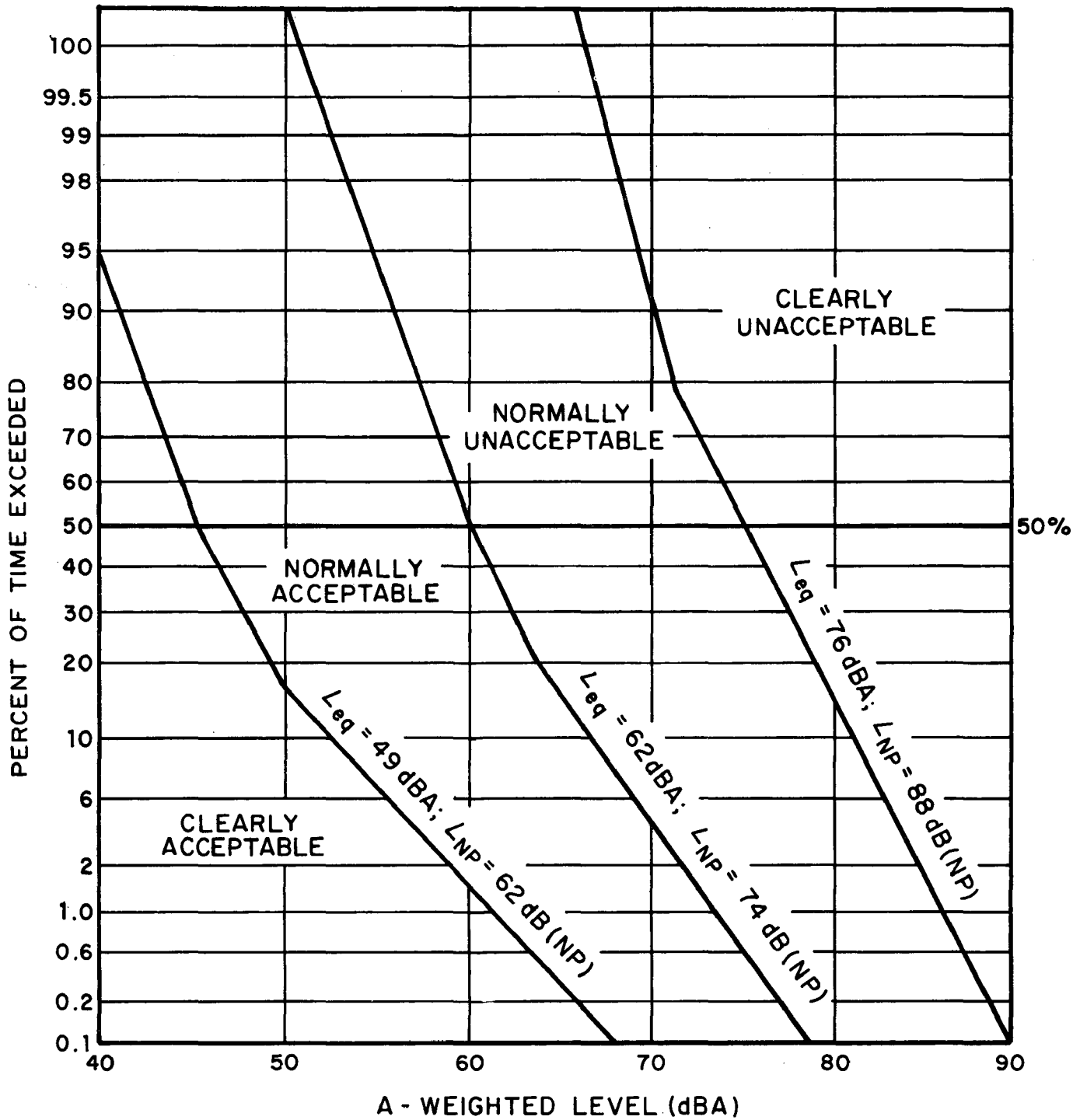

FIG. 2 PROVISIONAL CRITERIA RELATING NPL TO COMMUNITY NOISE ACCEPTABILITY

We must emphasize that these criteria have not been officially or unofficially adopted by HUD or any other government agency. They are presented here solely to enable the reader to interpret NPL values computed in this report.

The aforementioned averages of noise annoyance potential were calculated on the basis of information obtained on (1) the number of each item of equipment typically present at a site (in a given phase), (2) the length of the duty cycles of this equipment, and (3) the average noise levels during operation. For purposes of site characterization, the noisiest piece of equipment was assumed to be located at 50 ft from an observer, and all other equipment was assumed to be located at 200 ft from the observer; ambient noise, of levels depending on the surroundings of the site, was taken to be present in addition to the equipment noise. (Note that pile driver noise was not included in the NPL calculations, because its repetitive impact character makes its intrusion characteristics different from the more continuous noises for which the NPL concept was developed.) Clearly, this construction noise model is not entirely realistic; however, it may be expected to fulfill its intended purposes - that of yielding at least a relative measure of the noise annoyance associated with each type of site and phase for the most adverse conditions likely to be associated with each phase.

Table I shows NPLs calculated for each of five phases for each of four types of construction. For residential housing and public works construction, two NPL values are given in the table; one pertains to a noisy [70 dB(A)] background characteristic of urban conditions, the other to relatively quiet [50 dB(A)] ambient conditions found in suburban environments. As one may expect, the values indicated in the table reflect the fact that a given intruding noise is more annoying if it occurs in a quieter environment.

TABLE I-a. TYPICAL RANGES OF NOISE LEVELS AT CONSTRUCTION SITES WITH A
50 dB(A) AMBIENT TYPICAL OF SUBURBAN RESIDENTIAL AREAS

	Domestic Housing		Office Building, Hotel, Hospital School, Public Works		Industrial Parking Garage, Religious, Amusement & Recreations, Store, Service Station		Public Works Roads & Highways, Sewers, and Trenches		
	I	II	I	II	I	II	I	II	
	Ground Clearing	83 8 103	83 15 122	84 7 101	84 16 123	84 9 106	83 16 124	84 8 103	
Excavation	88 8 109	75 14 111	89 6 105	79 2 85	89 6 105	71 2 77	88 7 106	78 3 86	Energy Average dB(A) Standard Deviation NPL
Foundations	81 10 107	81 17 124	78 3 84	78 3 86	77 4 87	77 5 90	88 8 108	88 8 108	Energy Average dB(A) Standard Deviation NPL
Erection	81 10 107	65 9 87	87 6 99	75 2 79	84 9 107	72 7 91	79 9 103	78 11 108	Energy Average dB(A) Standard Deviation NPL
Finishing	88 7 106	72 12 104	89 7 107	75 8 97	89 7 105	74 10 100	84 7 101	84 8 104	Energy Average dB(A) Standard Deviation NPL

I - All pertinent equipment present at site.

II - Minimum required equipment present at site.

TABLE 1-b. TYPICAL RANGES OF NOISE LEVELS AT CONSTRUCTION SITES WITH A
70 dB(A) AMBIENT TYPICAL OF URBAN AREAS

	Domestic Housing		Office Building, Hotel, Hospital School, Public Works		Industrial, Parking Garage, Religious, Amusement & Recreations, Store, Service Station		Public Works Roads & Highways, Sewers, and Trenches		
	I	II	I	II	I	II	I	II	
Ground Clearing	84 6 100	83 8 103	84 6 99	84 8 103	84 6 101	87 8 103	84 6 100	84 7 101	Energy Average dB(A) Standard Deviation NPL
Excavation	88 7 106	76 5 88	89 6 104	79 2 85	89 7 106	74 1 77	89 6 105	79 2 85	Energy Average dB(A) Standard Deviation NPL
Foundations	81 7 99	81 7 100	78 3 85	78 2 85	78 3 85	78 3 85	88 8 108	88 8 108	Energy Average dB(A) Standard Deviation NPL
Erection	82 6 97	71 1 75	85 5 97	76 1 79	85 7 103	74 2 80	79 3 88	79 4 88	Energy Average dB(A) Standard Deviation NPL
Finishing	88 7 106	74 4 84	89 6 104	76 4 86	89 6 104	75 3 84	84 6 100	84 6 100	Energy Average dB(A) Standard Deviation NPL

I - All pertinent equipment present at site.

II - Minimum required equipment present at site.

The NPL values shown in Table I obviously depend on the previously described model of site noise. For this model, the average sound pressure level depends strongly on the one or two noisiest pieces of equipment, whereas the standard deviation depends largely on the numbers and duty cycles of the less noisy equipment and on the ambient noise level.

As evident from Table I, in building construction, the initial ground clearing and excavation phases tend to be the noisiest, the subsequent foundation and erection phases tend to be somewhat less noisy, and the final finishing phase again tends to be relatively noisy. In public works construction, on the other hand, NPLs are more nearly the same for all phases, except that the erection phase tends to be less noisy.

Table II lists the two noisiest types of equipment for each site type and phase, together with the average A-weighted noise levels (at 50 ft) for this equipment. Inspection of this table indicates that rock drills, which typically are the noisiest equipment, are prevalent in the excavation and finishing phases; trucks, on the other hand, are somewhat less noisy than rock drills or similar equipment but are present in nearly all phases.

Effect of Equipment Quieting

To assess the effect of some quieting strategies on the previously described site noise model, we recalculated the NPL for three "strategies" for each type of site and each phase:

Strategy 1:

- Only the noisiest piece of equipment being quieted by 10 dB(A), with this equipment remaining at the previously specified 50 ft distance from the observer.

TABLE II. NOISIEST EQUIPMENT TYPES OPERATING AT CONSTRUCTION SITES*

		Construction Type							
		<u>Domestic Housing</u>		<u>Office Bldgs.</u>		<u>Industrial</u>		<u>Public Works</u>	
Construction Phase	Ground Clearing	Truck	(91)	Truck	(91)	Truck	(91)	Truck	(91)
		Scraper	(88)	Scraper	(88)	Scraper	(88)	Scraper	(88)
	Excavation	Rock Drill	(98)	Rock Drill	(98)	Rock Drill	(98)	Rock Drill	(98)
		Truck	(91)	Truck	(91)	Truck	(91)	Truck	(91)
	Foundations	Concrete Mixer	(85)	Jack Hammer	(88)	Jack Hammer	(88)	Truck	(91)
		Pneumatic Tools	(85)	Concrete Mixer	(85)	Concrete Mixer	(85)	Scraper	(88)
	Erection	Concrete Mixer	(85)	Derrick Crane	(88)	Derrick Crane	(88)	Paver	(89)
		Pneumatic Tools	(85)	Jack Hammer	(88)	Jack Hammer	(88)	Scraper	(88)
	Finishing	Rock Drill	(98)	Rock Drill	(98)	Rock Drill	(98)	Truck	(91)
		Truck	(91)	Truck	(91)	Truck	(91)	Paver	(89)

*Numbers in parentheses represent typical dB(A) levels at 50 ft. See Table I for definition of construction types.

Strategy 2:

- Only the noisiest piece of equipment being quieted by 10 dB(A), with this equipment moved to 200 ft and with the next noisiest equipment (unquieted) moved to 50 ft from the observer position

Strategy A:

- All items of equipment quieted by 10 dB(A).

The results of these calculations are shown in Table III, together with the NPL values previously obtained without any quieting (Strategy 0). It appears that quieting only the noisiest piece of equipment generally reduces the site NPL relatively little, if other types of equipment can also operate near the observer (compare Strategies 0 and 2). On the other hand, quieting the noisiest equipment and letting no others operate near the observer may result in significant reductions (compare Strategies 0 and 1). Of course, quieting all equipment (Strategy A) results in the lowest NPL values; however, these values are often only slightly lower than those obtained by quieting only the noisiest item (Strategy 1).

The site noise model used here initially assumes the noisiest equipment to be located nearest the observer. It can happen that quieting the noisiest equipment, moving it away from the observer, and moving the second noisiest equipment near the observer (Strategy 2) results in an *increase* in the NPL, if the second noisiest equipment is used more frequently than the noisiest. This peculiarity of the noise model, where equipment quieting seemingly increases the noise, is evident at several places in Table III.

TABLE III. NOISE POLLUTION LEVELS IN dB(A) OF CONSTRUCTION SITES,
VARIOUS EQUIPMENT QUIETING STRATEGIES*

		Domestic Housing								Office Building				Industrial				Public Works							
Ambient		Urban				Rural				Urban				Urban				Urban				Rural			
Quieting Strategy**		0	1	2	A	0	1	2	A	0	1	2	A	0	1	2	A	0	1	2	A	0	1	2	A
Construction Phase	Ground Clearing	100	88	98	85	103	91	101	94	99	86	96	85	101	87	97	85	100	84	87	85	103	87	91	91
	Excavation	106	93	109	92	109	93	111	100	104	91	105	91	106	92	103	91	105	91	98	92	106	92	99	95
	Foundation	99	81	81	81	107	86	83	96	85	80	94	76	85	82	98	76	108	87	96	90	108	89	96	99
	Erection	97	82	88	81	107	105	102	93	97	84	85	85	103	88	84	86	88	81	89	77	103	89	90	84
	Finishing	106	93	99	92	106	93	99	95	104	91	98	92	104	91	97	89	100	89	94	85	101	88	95	92

* See text for site noise model; see Table I for construction type and ambient noise definitions.

** 0 - No quieting

1 - Noisiest equipment, at 50 ft from observer, quieted by 10 dB(A).

2 - Noisiest equipment quieted by 10 dB(A) and moved to 200 ft from observer; second-noisiest equipment (not quieted) moved to 50 ft from observer.

A - All equipment quieted by 10 dB(A).

Other Means for Site Noise Control

The NPL generated by a construction site also may be reduced by means other than quieting the equipment:

- Replacement of individual operations and techniques by less noisy ones - e.g., using welding instead of riveting, mixing concrete offsite instead of onsite, and employing pre-fabricated structures instead of assembling them on site.
- Selecting the quietest of alternate items of equipment - e.g., electric instead of diesel-powered equipment, hydraulic tools instead of pneumatic impact tools.
- Scheduling of equipment operations to keep average levels low, to have noisiest operations coincide with times of highest ambient levels, and to keep noise levels relatively uniform in time; also, turning off idling equipment.
- Keeping noisy equipment as far as possible from site boundaries.
- Providing enclosures for stationary items of equipment and barriers around particularly noisy areas on the site or around the entire site.

Equipment Noise Reduction Potential

Table IV lists the present average noise levels in dB(A) for the various types of construction equipment discussed previously; also listed are the noise levels expected to be achievable in a relatively short time, with limited cost and performance penalties. In addition, the table shows the most significant noise sources for each type of equipment and assigns a numerical "usage" factor to each item, on the basis of which one can assess the significance of quieting of the various individual items. From

TABLE IV. IMMEDIATE ABATEMENT POTENTIAL OF CONSTRUCTION EQUIPMENT

Equipment	Noise Level in dB(A) at 50 ft		Important Noise Sources ²	Usage ³
	Present	With Feasible Noise Control ¹		
Earthmoving				
front loader	79	75	E C F I H	.4
backhoes	85	75	E C F I H	.16
dozers	80	75	E C F I H	.4
tractors	80	75	E C F I W	.4
scrapers	88	80	E C F I W	.4
graders	85	75	E C F I W	.08
truck	91	75	E C F I T	.4
paver	89	80	E D F I	.1
Materials Handling				
concrete mixer	85	75	E C F W T	.4
concrete pump	82	75	E C H	.4
crane	83	75	E C F I T	.16
derrick	88	75	E C F I T	.16
Stationary				
pumps	76	75	E C	1.0
generators	78	75	E C	1.0
compressors	81	75	E C H I	1.0
Impact				
pile drivers	101	95	W P E	.04
jack hammers	88	75	P W E C	.1
rock drills	98	80	W E P	.04
pneumatic tools	86	80	P W E C	.16
Other				
saws	78	75	W	.04
vibrator	76	75	W E C	.4

Notes:

1. Estimated levels obtainable by selecting quieter procedures or machines and implementing noise control features requiring no major redesign or extreme cost.

2. In order of importance:

T Power Transmission System, Gearing	F Cooling Fan
C Engine Casing	W Tool-Work Interaction
E Engine Exhaust	H Hydraulics
P Pneumatic Exhaust	I Engine Intake

3. Percentage of time equipment is operating at noisiest mode in most used phase on site.

this table, one may determine that control of engine noise, and particularly of engine exhaust noise, will affect many items of equipment with high usage factors and thus should be given high priority.

Table V presents a brief listing of the noise control techniques applicable to the sources indicated in Table IV, together with an estimate of the noise reductions that may readily be achieved by means of these techniques.

2.2 Home Appliances

The use of convenient and sometimes necessary appliances constitutes a growing noise problem within the home. Almost without exception, appliances could be significantly quieter. However, manufacturers offer three primary arguments for opposing quieter redesign; they believe

- that the public associates the noise generated by a device with its power;
- that quieter appliances would be marketed at a price disadvantage and since the public has not objected to noise, that the public, in general, is satisfied;
- that since appliances are generally controlled by the operator, the option, as with air conditioners, "to have quiet or to be cool" is "option enough".

Yet, in keeping with the public's growing awareness of noise, many appliances are advertised as being "noiseless", "quiet", "vibration-free".

Although many manufacturers have made detailed acoustic measurements of the noise output of their appliances, very little data has been reported in the open literature. Some of the

TABLE V. NOISE CONTROL FOR CONSTRUCTION EQUIPMENT

<u>Source</u>	<u>Control Techniques</u>	<u>Probable Noise Reduction in dB(A)*</u>
Engine		
exhaust	improved muffler	10
casing	improved design of block enclosure	2
fan (cooling)	redesign	10
	silencers, ducts and mufflers	5
intake	silencers	5
Transmission	redesign, new materials enclosure	7
		7
Hydraulics	redesign, new materials enclosure	7
		10
Exhaust		
(pneumatic)	muffler	5-10
Tool-Work		
interaction	enclosure	7-20
	change in principle	10-30

*Note that noise reductions are not additive. Incremental reductions can be realized only by simultaneous quieting of all sources of equal strength.

literature (especially "nonacoustic" reporting) presents insufficient information to enable utilization of the reported measurements in this study. For example, in one report [5], the noise levels are described as being "recorded at operator's or housewife's normal ear distance"; for those appliances not requiring continual operation, the distance from the exposed person to the appliance is not specified. In other examples drawn from newspapers, trade journals, and magazines measurements are not qualified as to distance from the source, type of instrumentation, and weighting network (if any) that was used. In the following sections, only the literature found to be well-documented and considered accurate will be used in appropriate discussions.

2.2.1 Measurements

Because of the scarcity of reliable data, we measured the noise from thirty types of home appliances and eleven types of home shop tools. Sound levels were measured in dB(A) at a distance of 3 ft from the appliance and a height of 5 ft; this measurement position approximates the location of the operator's ear for those appliances requiring an operator. For those appliances not requiring an operator, this position represents noise levels in the vicinity of the appliance. Noise levels in the reverberant field of the room in which the appliance is being operated may be on the order of 2 to 3 dB(A) less than the measurement at 3 ft.

Noise levels in adjacent rooms with the interconnecting door open may be as much as 10 dB(A) less than the levels at 3 ft or as much as several dB(A) greater than the 3 ft levels, depending upon the details of the installation. For the appliances that are used near the ear (e.g., an electric-shaver), the noise level at the ear may be as much as 10 dB(A) greater than the 3 ft mea-

surements. Figure 3 summarizes the noise measurements made by BBN and some of those reported in the literature. Each point represents a single measurement. Several measurements are given for a single appliance that operates in different modes. The solid circles represent noise levels generated by American appliances; foreign brands are represented by the squares. Problems arise in evaluating this data because the appliances were manufactured in different years by different companies, were scattered through the lines offered by the manufacturers, and may be providing different features. For example, a recently built refrigerator may be frost-free and may have special devices such as ice makers; therefore it may generate more noise than earlier refrigerators. Figure 4 presents octave band spectra for refrigerators that were manufactured through 1958 [6] and in 1965, 1967, and 1970 [7]. Noise generated by this sample of refrigerators demonstrates the problem of data comparison: the unit that was old in 1958 was the noisiest, while the 1970 unit was second noisiest. The quietest refrigerator is the 1965 model. However, there is considerable difference between the physical size of the units, and the newer models incorporate such features automatic defrost, ice-cube maker, water dispenser, and humidified compartment.

2.2.2 Noise abatement potential

The thirty appliances and eleven shop tools surveyed exhibited no apparent acoustical problems that could not be abated through the diligent application of noise control technology. Achieving a cost-effective solution that can be incorporated into the design of an appliance is more difficult but still possible. Standard noise control techniques are readily available; wrapping, damping, flexible connections, vibration isolation, better

A-WEIGHTED SOUND LEVELS AT 3 FT

- FREEZER
- REFRIGERATOR
- HEATER, ELECTRIC
- HAIR CLIPPER
- TOOTHBRUSH, ELECTRIC
- HUMIDIFIER
- FAN
- DEHUMIDIFIER
- CLOTHES DRYER
- AIR CONDITIONER
- SHAVER, ELECTRIC
- WATER FAUCET
- HAIR DRYER
- CLOTHES WASHER
- WATER CLOSET
- DISHWASHER
- CAN OPENER, ELECTRIC
- FOOD MIXER
- KNIFE, ELECTRIC
- KNIFE SHARPENER, ELECTRIC
- SEWING MACHINE
- ORAL LAVAGE
- VACUUM CLEANER
- FOOD BLENDER
- COFFEE MILL
- FOOD WASTE DISPOSER
- EDGER AND TRIMMER
- HOME SHOP TOOLS
- HEDGE CLIPPERS
- LAWN MOWER, ELECTRIC

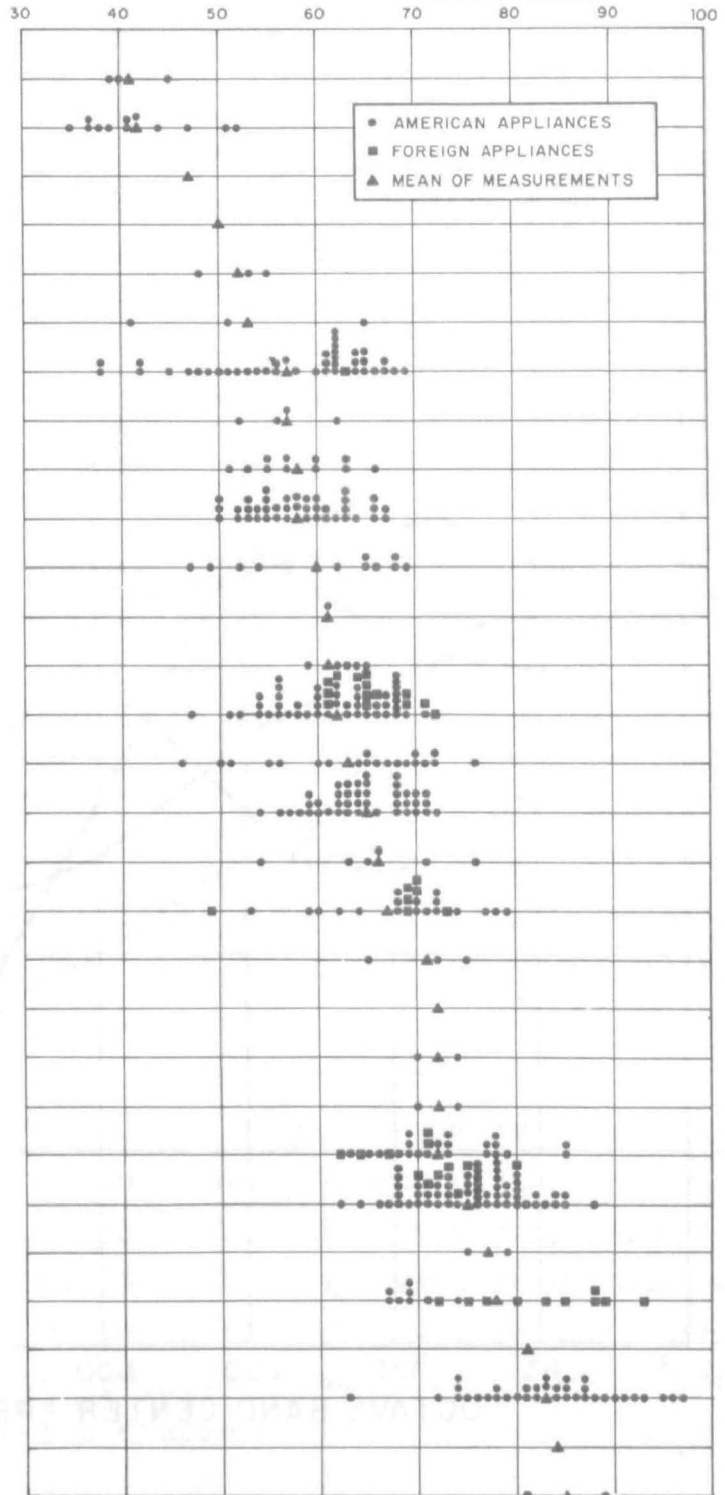

FIG. 3. A SUMMARY OF NOISE LEVELS FOR APPLIANCES MEASURED AT A DISTANCE OF 3 FT.

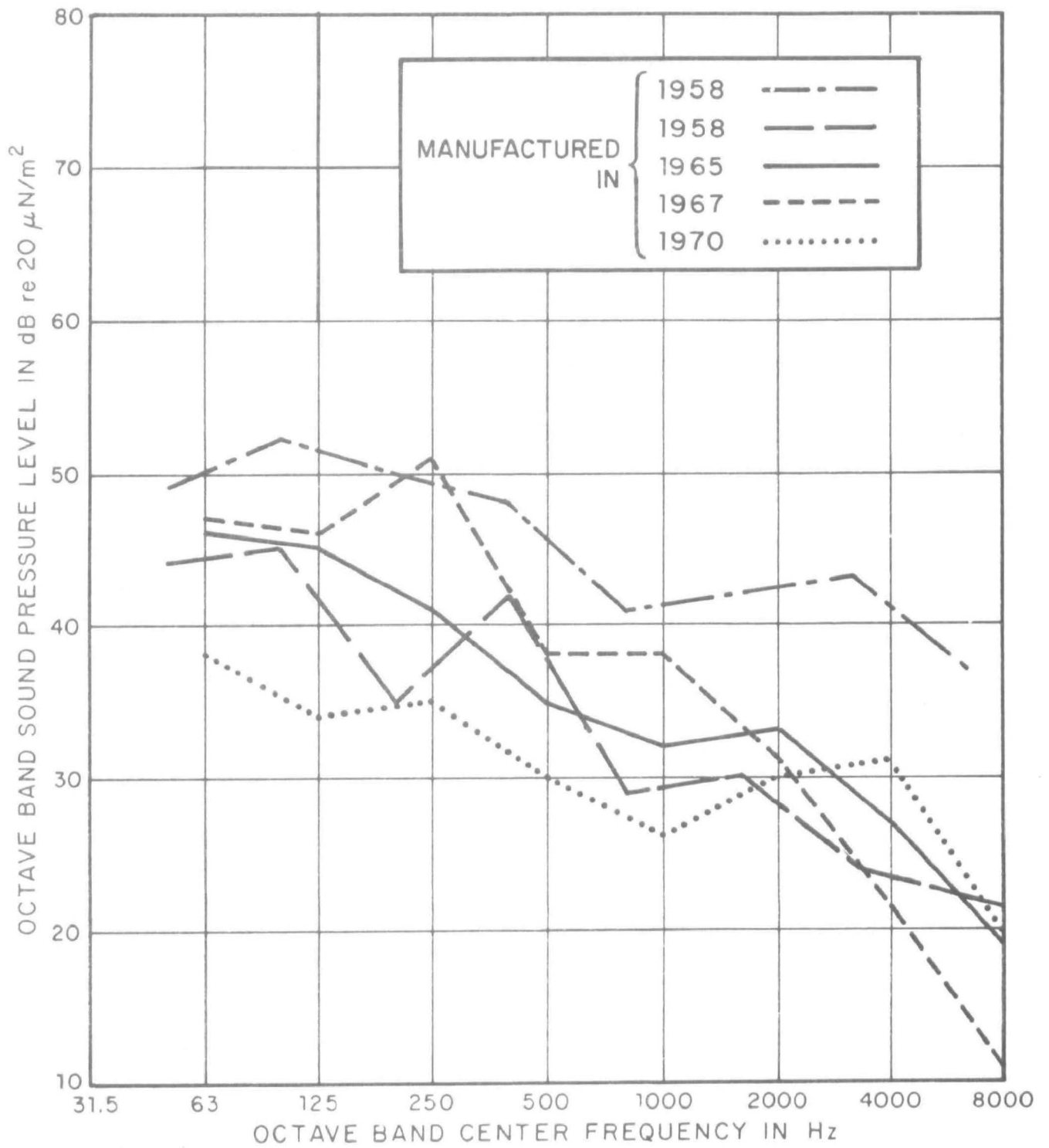

FIG. 4. SOUND PRESSURE LEVELS OF VARIOUS REFRIGERATORS (MEASURED AT 3 ft)

balance, and smoother mechanical connections. Since many appliances have similar mechanisms, noise control techniques used on one appliance can often be applied to another.

After reviewing the operating characteristics and mechanical properties of appliances, we ranked the noise sources in order of their contribution to the total noise generated by an appliance (see Table VI). Definitive measurements are not available to enable a quantitative breakdown of the contribution of individual components. However, in general, motors, fans, knives (or other cutting blades), and air flow are the most frequent sources of noise. Noise radiated from the casing or panels of the appliances and noise radiated from walls, floors, cabinets, sinks (set into vibration by solid structural connections) are also of major importance.

We review here in some detail the noise generating mechanisms of several appliances that have high enough noise levels and exposure time to be considered annoying. Included in this review are air conditioners, dishwashers, food waste disposers, vacuum cleaners, and toilets. Other appliances are discussed in Appendix A.

Room Air Conditioners

Figure 5 is a schematic view of a typical room air conditioner. Basically, warm air in the room or from outside is drawn through a dust filter, blown across cold evaporator coils and distributed back into the room. Fluid in the evaporator, heated by this action, flows to the condenser coils. Outside air is blown across these coils by the propeller fan. The fluid is then compressed and flows back to the evaporator.

TABLE VI. SOURCES OF APPLIANCE NOISE

Appliance	Source	Air Flow	Combustion Roar	Compressor	Fan	Gears	Knives (Cutting Blades)	Motors	Panels	Pump	Structureborne	Water Noise
Can Opener, electric						1		1	2			
Clothes Dryer			1					1	2			
Clothes Washer								2	2	2		1
Coffee Mill												
Dehumidifier		1		3	1			1	2			
Dishwasher					3			3	2	2	2	1
Edger and Trimmer							1	2				
Fan		1			1			2				
Food Blender							1	1	2			
Food Mixer							1	1	2			
Food Waste Disposer							1	2			2	1
Freezer				1	1			1	2			
Hair Clipper						1		1				
Hair Dryer		1			1			2				
Heater, electric		1			1			1	2			
Hedge Clippers						2		1				
Home Shop Tools					1	1		1	1		2	
Humidifier		1			1			1				

TABLE VI (continued)

Appliance	Air Flow	Combustion Roar	Compressor	Fan	Gears	Knives (Cutting Blades)	Motors	Panels	Pump	Structureborne	Water Noise
Knife, electric					1		1				
Knife Sharpener							1				
Lawn Mower					1		1	1			
Oral Lavage							1		1		
Refrigerator			1	1			1				
Room Air- Conditioner	1		2	2			2	3		3	
Sewing Machine							1				
Shaver, electric					1		1				
Toilet										2	1
Toothbrush, electric					1	1					
Vacuum Cleaner	1			1			1	2			
Water Faucet										2	1

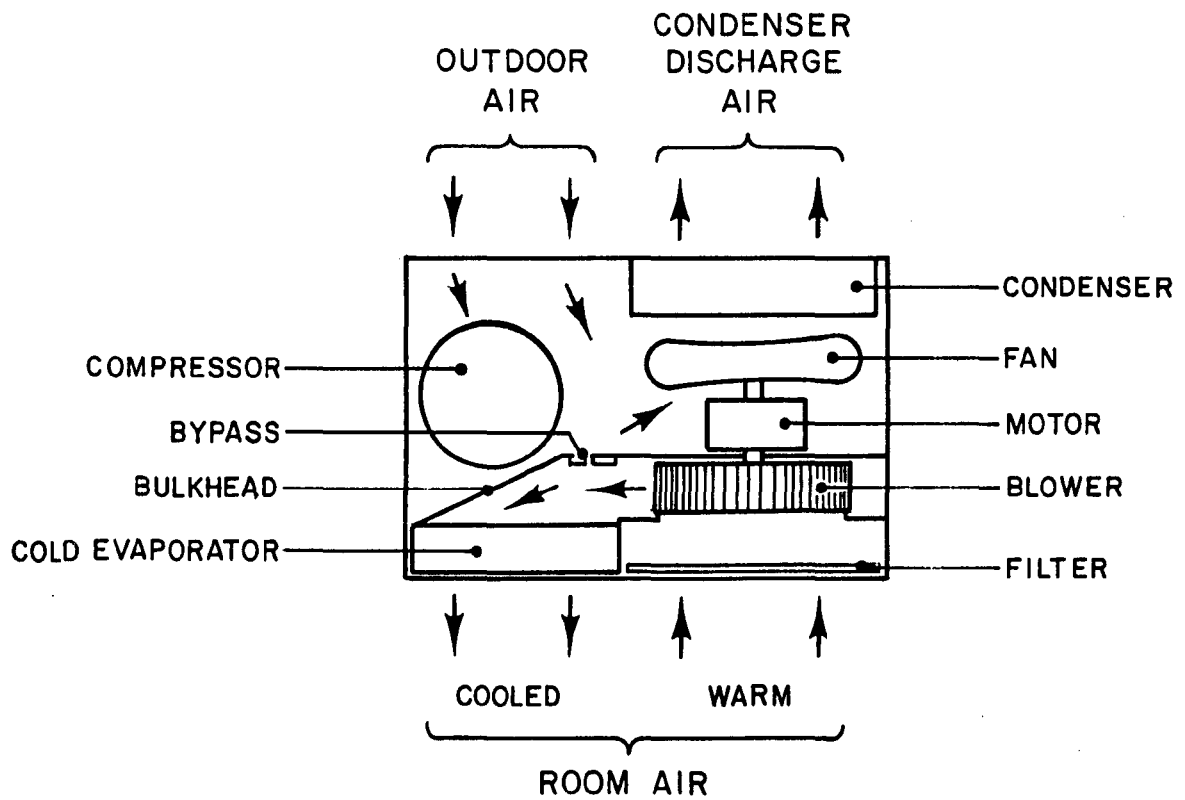

FIG. 5. SCHEMATIC VIEW OF A TYPICAL ROOM AIR CONDITIONER.

The major sources of noise in this process are the motor, the blower (evaporator fan), the propeller fan (condenser fan), the compressor, and the air flow across the evaporator coils. In addition, panels of the housing radiate noise, as does the structure upon which the air conditioning unit is mounted. The character of this noise is complex, consisting of pure tones, pulsating sounds, intermittent clicks, buzzes and rattles, all superimposed on broadband noise [8]. The tonal components and broadband noise represent the primary noises that require noise control treatment; for the most part, buzzes and rattles (often caused by loose parts), intermittent clicks (caused by spring activated thermostat controls and relays), and pulsating noises (generated by the capillary tube and evaporator valves) have been controlled in current models so that they do not dominate the total noise level.

Pure tones may be generated by (1) the motor at multiples of the rotation speed, (2) the compressor at multiples of the pumping fundamental frequency (the speed in revolutions per second times the number of pumping cycles per revolution), and (3) the propeller fan at blade-passage frequency (the speed in revolutions per second times the number of blades). Whether or not these pure tones appear in the spectrum heard indoors depends upon the structural connections between the components and the enclosure panels as well as on connections to supporting structures. In Fig. 6, noise levels measured on a particular unit with the fan on high speed, with and without the compressor, illustrate this concept; the increase in the one-third octave band centered at 63 Hz is due to a lack of sufficient vibration isolation of the compressor from its case and/or insufficient isolation of the casing from the wall supporting it.

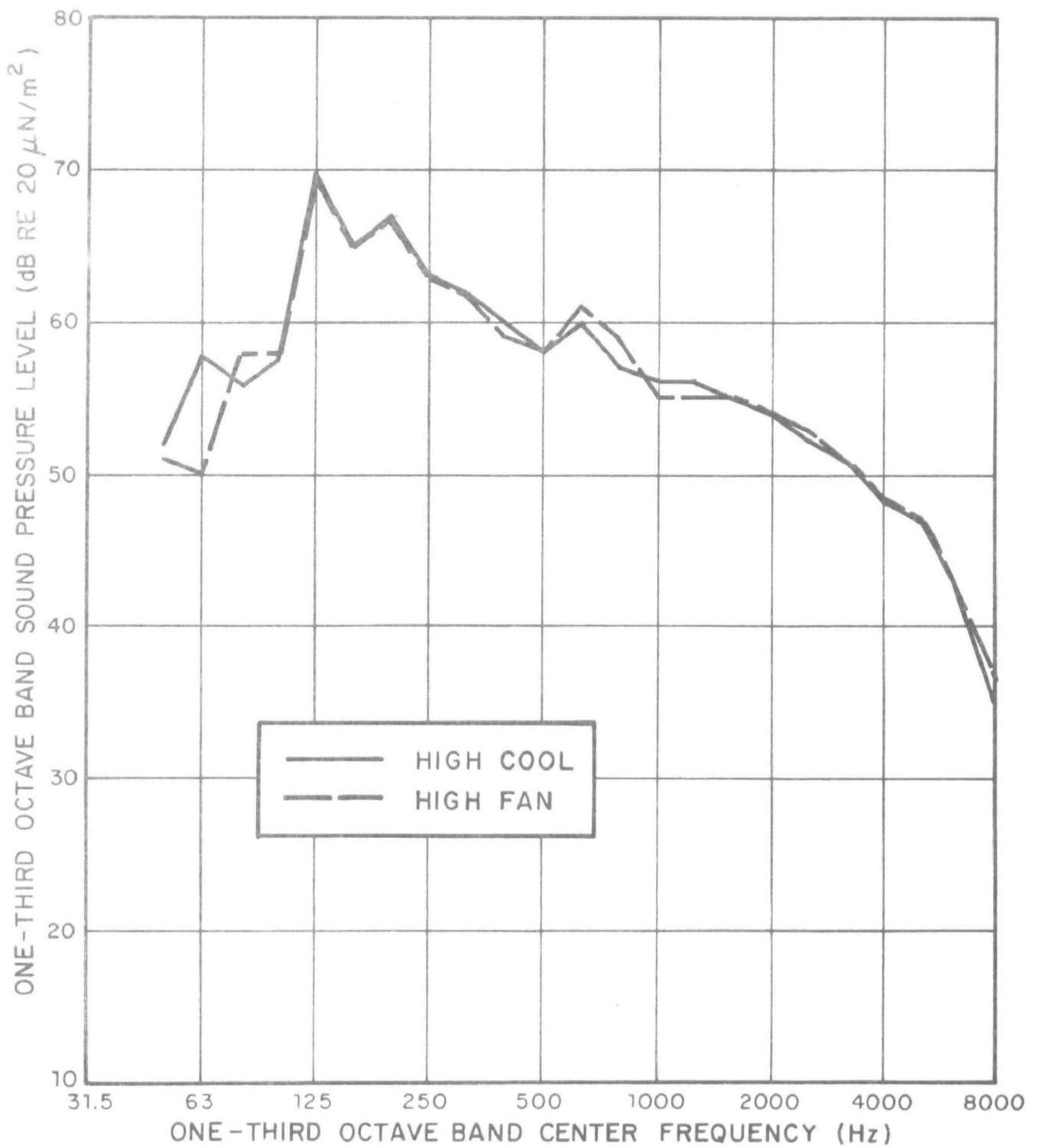

FIG. 6. SOUND PRESSURE LEVELS FROM AIR CONDITIONER ON HIGH COOL AND HIGH FAN SETTINGS (MEASURED AT 3 ft)

Broadband noise is generated by the blower, the flow of air through the evaporator coils, and the deflection of the air into the room. Often the blower can operate at several speeds; the slower the speed, the lower the noise level from both the blower and the air flow (see Fig. 7).

Noise control means that can be applied to motor and compressor noise include better vibration isolation of the motor and fans from the housing through use of rubber or neoprene mounts. Compressors, usually hermetically-sealed, can be mounted on springs internally, and on rubber or neoprene pads externally. A more thorough isolation of the motor, fans, and compressor from the casing and of the complete unit from its support could result in a noise reduction of about 5 dB in the low-frequency region controlled by tonal sounds from these components.

The broadband noise generated by the centrifugal blower and the air flow can be reduced by

- reducing the air velocity by using the low-speed fan (if maximum cool is not required);
- reducing the air velocity by increasing the area of the evaporator coils (perhaps increasing the total size of the unit);
- incorporating sound absorbing material, such as open-cell polyurethane foam, between the evaporator coils and the deflection grids and in the duct passage between the blower and the evaporator coils and the blower and the dust filter; and
- tightening the gasketing system to eliminate rattles.

Broadband noise can be reduced by 10 to 15 dB through effective use of these techniques. Coupled with more effective isolation

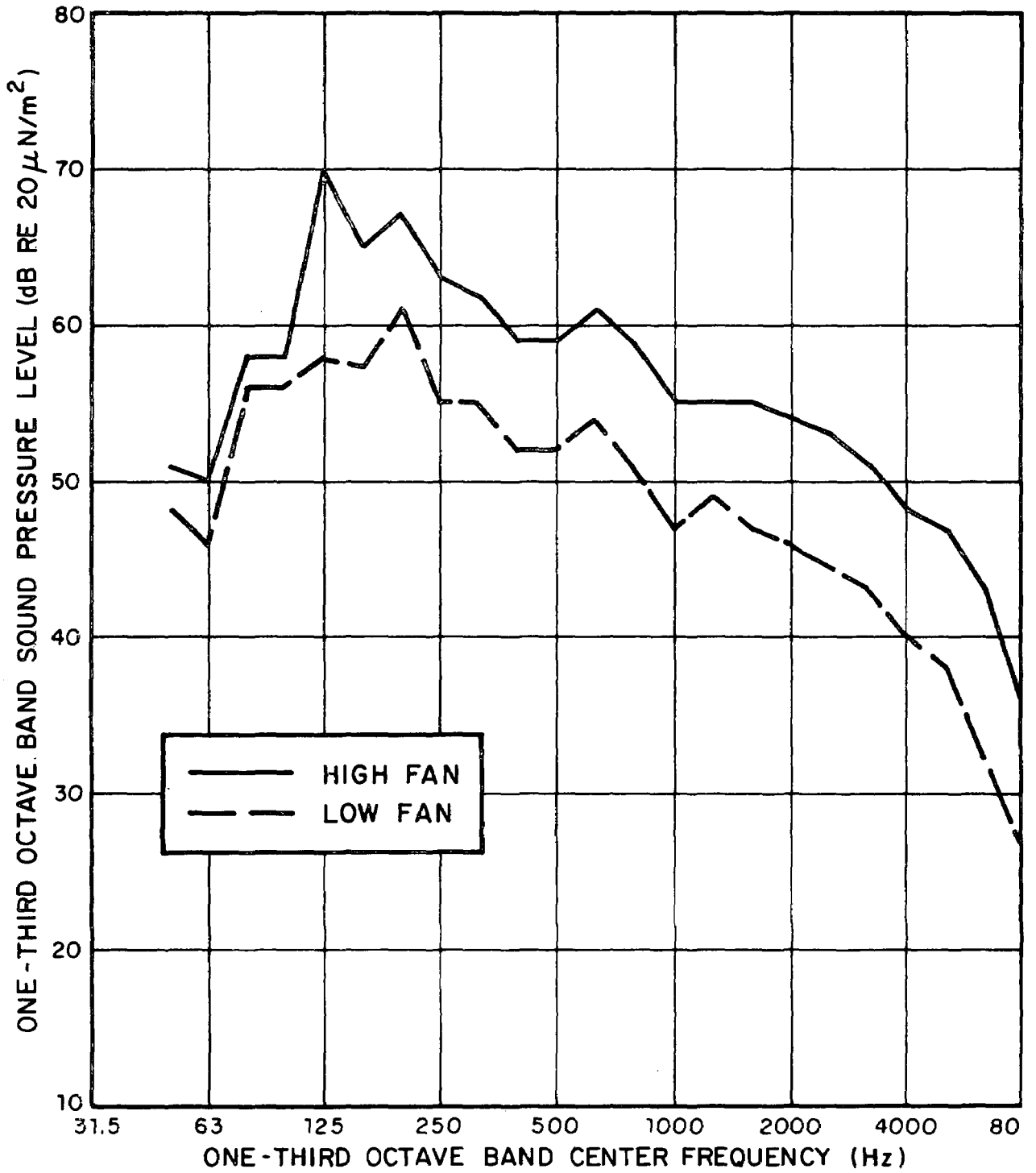

FIG. 7. SOUND PRESSURE LEVELS FROM AIR CONDITIONER ON TWO SETTINGS (MEASURED AT 3 ft)

of the compressor, motor, and fans, a total noise reduction of 10 to 15 dB(A) is not unreasonable. Perhaps an appropriate design goal for high cool operation is 40 dB(A) at 3 ft.

Dishwashers

A dishwasher is essentially a tub equipped with a water spray system that is driven by a motor-pump assembly. Heating coils and a blower are provided to assist in the drying operation. A complete wash may consist of as many as thirteen cycles: rinse, fill, wash, drain, fill, rinse, drain, fill, rinse drain, fill, rinse, drain. Figure 8 plots the noise level in dB(A) as a function of operation [9]. In this example, the wash and rinse cycles are noisier than the drain and fill cycles by about 8 dB(A). Figure 9 presents octave band measurements made during the wash cycle on five different dishwashers. The data varies 5 to 20 dB between the quietest and noisiest dishwasher measured in 1971, depending on the frequency band of interest, representing about 10 dB(A) difference between the quietest and the noisiest. Although the data sample is small, this figure also illustrates, that some newer dishwashers are noisier than older ones.

The noise generating mechanisms in a dishwasher include the impingement of water against the sides and top of the tub, the motor, the pump, the excitation of panel casings, structural connections to water supply, water drain and cabinet, and the blower.

Broadband "water noise" is most important in the frequency range above 300 to 400 Hz; motor-induced noise, often pure tones at the motor rotation frequency and harmonics thereof, dominate the lower frequencies. The kick panel below the loading door on a dishwasher installed in a typical kitchen-cabinet also transmits noise from the motor enclosure into the room.

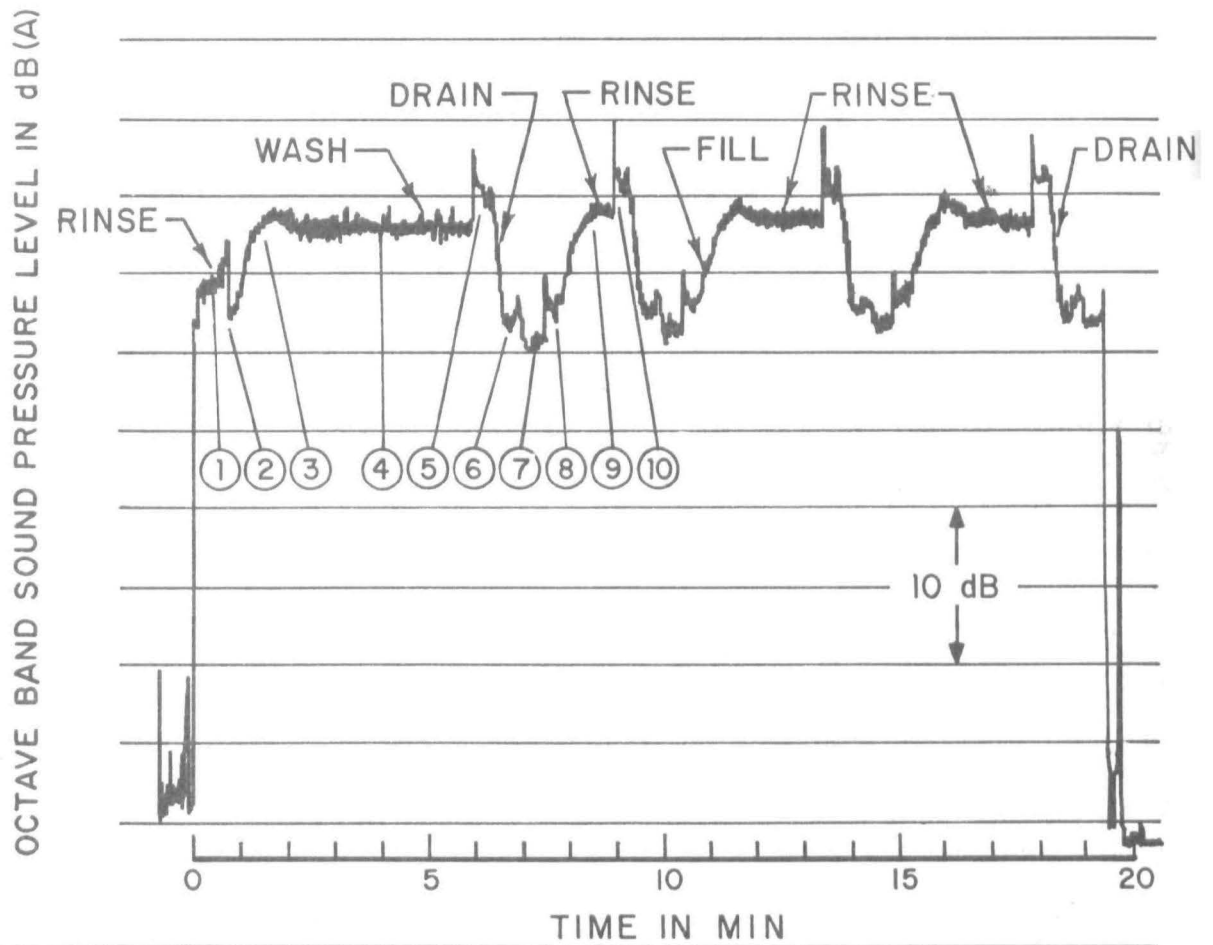

Time in Min	1	2	3	4	5	6	7	8	9	10
31.5	58	55	65	64	64	53	51	55	64	65
63	58	57	62	60	61	53	51	54	62	61
125	62	61	64	60	60	54	58	60	62	61
250	59	60	69	67	70	58	58	59	68	69
500	61	62	66	64	66	60	59	63	66	66
1000	61	59	66	66	68	59	57	59	66	69
2000	60	55	62	61	63	57	54	56	62	63
4000	55	52	59	58	62	52	52	52	59	62
8000	50	49	55	54	58	46	44	49	55	58
Overall	69	68	74	73	75	67	66	67	74	75
A-weighted	66	64	70	69	72	64	62	64	70	72

FIG. 8. GRAPHIC LEVEL RECORDING AND OCTAVE BAND SOUND PRESSURE LEVELS OF A DISHWASHER.

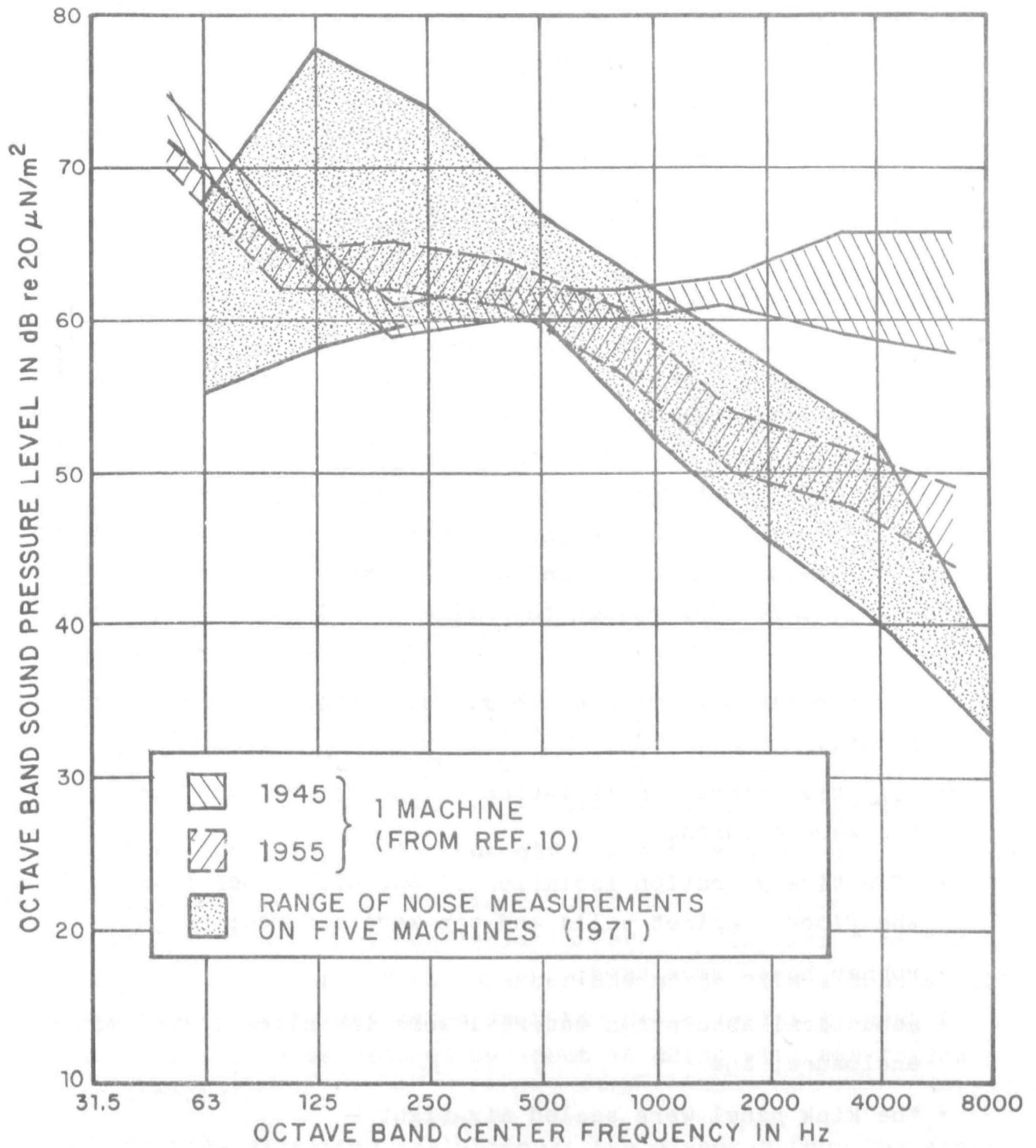

FIG. 9 . SOUND PRESSURE LEVELS OF VARIOUS AUTOMATIC DISHWASHERS DURING WASH CYCLE (MEASURED AT 3 ft)

Through the use of experimental splash curtains, which prevent impingement of the water spray on the tub walls, water noise has been reduced by 6 to 8 dB(A) [11]. The motor-pump assembly is often isolated from the tub by rubber mounts; however, the effectiveness of these mounts can be reduced in the installation process by an insufficient clearance between the motor and the floor.

Often, the sides and top of a dishwasher are brought into contact with the cabinet. A clearance of 1/2 in. all around the machines, with neoprene isolation pads insuring the clearance, will reduce the noise radiated by the cabinet as well as the noise transmitted to other parts of the house. The use of rubber hoses for supply and drainage are an improvement over the copper tubing often provided. The incorporation of acoustic material in the motor-pump enclosure and a kick panel that is sealed (no air leaks) would also reduce the noise. It is anticipated that - if

- water noise were reduced (e.g., by installing splash curtains);
- effective vibration isolation of the motor-pump from the tub were ensured;
- effective vibration isolation of the dishwasher housing from the floor, cabinet walls and top were ensured;
- rubber hoses were used;
- acoustical absorption material were installed in the motor enclosure; and
- the kick panel were sealed air-tight -

the noise levels of a typical dishwasher could be reduced by some 10 to 15 dB(A), from a level in the mid sixties to one in the low

fifties. Because of its intermittent operation, a goal of 45 to 50 dB(A) at 3 ft is probably acceptable.

Food Waste Disposers

Continuous-feed and batch-feed disposers are chambers in which food waste is ground by a motor-driven wheel with cutting edges. Figure 10 presents one-third octave band sound pressure level data for four different disposers. Although the details of the spectra differ, each has a major peak at 125 Hz and several minor peaks at higher frequencies, all superimposed on broadband noise. The peak at 125 Hz is primarily motor noise. The minor peaks can be attributed to the blade-passage frequency of the grind wheel, multiples thereof, and resonances in the sink. The broadband noise is generated by the sloshing of water and waste against the housing of the chamber.

Noise is transmitted up through the mouth of the disposer. Batch-feed disposers, which require the sink cover to be in place before operation, have the potential for being quieter. Continuous-feed units sometimes have partial rubber closures at the mouth of the unit (primarily to prevent food waste from being expelled); for these closures to be effective in controlling noise, they must overlap to shut off the entire opening.

Basic noise control treatments that have been moderately successful include vibration isolation of the disposer from the sink and the enclosure of the chamber and motor with a double wall construction. It is estimated that the noise levels generated by disposers could be reduced by about 10 dB(A) with the following treatments:

- effective vibration isolation of the disposer from the sink;
- damping of the sink;

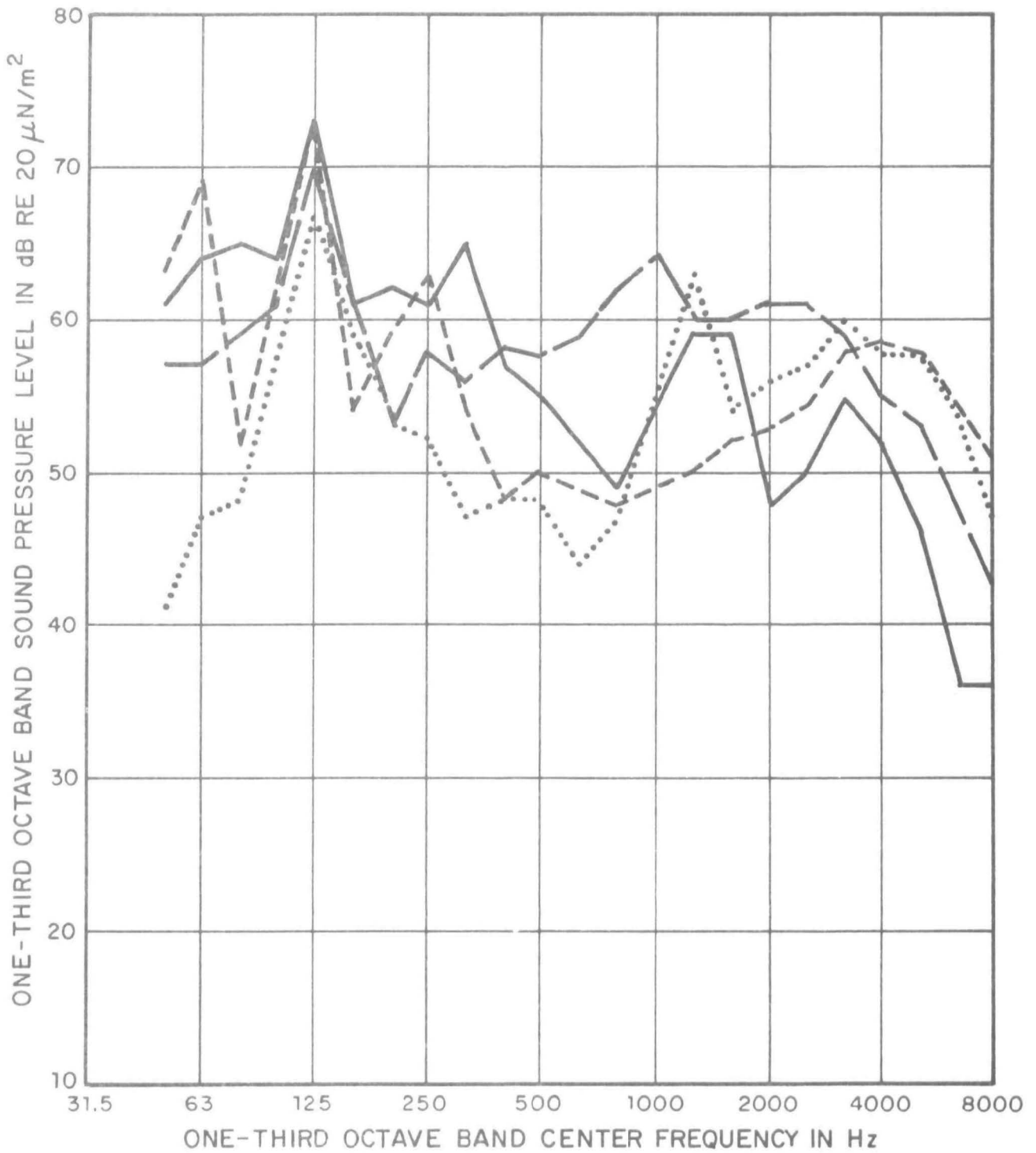

FIG. 10. SOUND PRESSURE LEVELS FROM FOUR FOOD-WASTE DISPOSERS (MEASURED AT 3-ft)

- flexible connections between the disposer and the drain pipe, which will also reduce the noise transmitted to other rooms and/or apartments;
- flexible electrical connection;
- enclosure of both the grinding chamber and motor, with appropriate ventilation; and
- effective closure of the mouth of the disposer.

Vacuum Cleaners

Canister vacuum cleaners consist of a tank (either horizontal or vertical) that provides suction, a connecting hose, and appropriate nozzles. Some recently manufactured canister units also have powered rotating brush attachments for cleaning carpets. Figure 11 presents sound pressure levels measured in one-third octave frequency bands for four canister units. As with other appliances, the peak at 125 Hz is motor-induced noise. The peaks in the 800 to 1600 Hz range are probably caused by the blade-passage frequency of the blower and/or resonances of the unit structure. Through the use of better blower design, more thorough vibration isolation of the motor and blower(s) from the structure, and damping and sealing of the canister structure, the noise generated by canister units could be reduced by 10 dB(A).

In addition to a motor-blower assembly, upright vacuum cleaners have a mechanism (either vibrating agitators or rolling brushes) that beats the carpet to bring dirt to the surface where it is sucked away. Figure 12 presents one-third octave band sound pressure level data for two upright vacuum cleaners - a large unit with a beating mechanism and a small one without a beater. For the larger unit, the low frequency noise is again

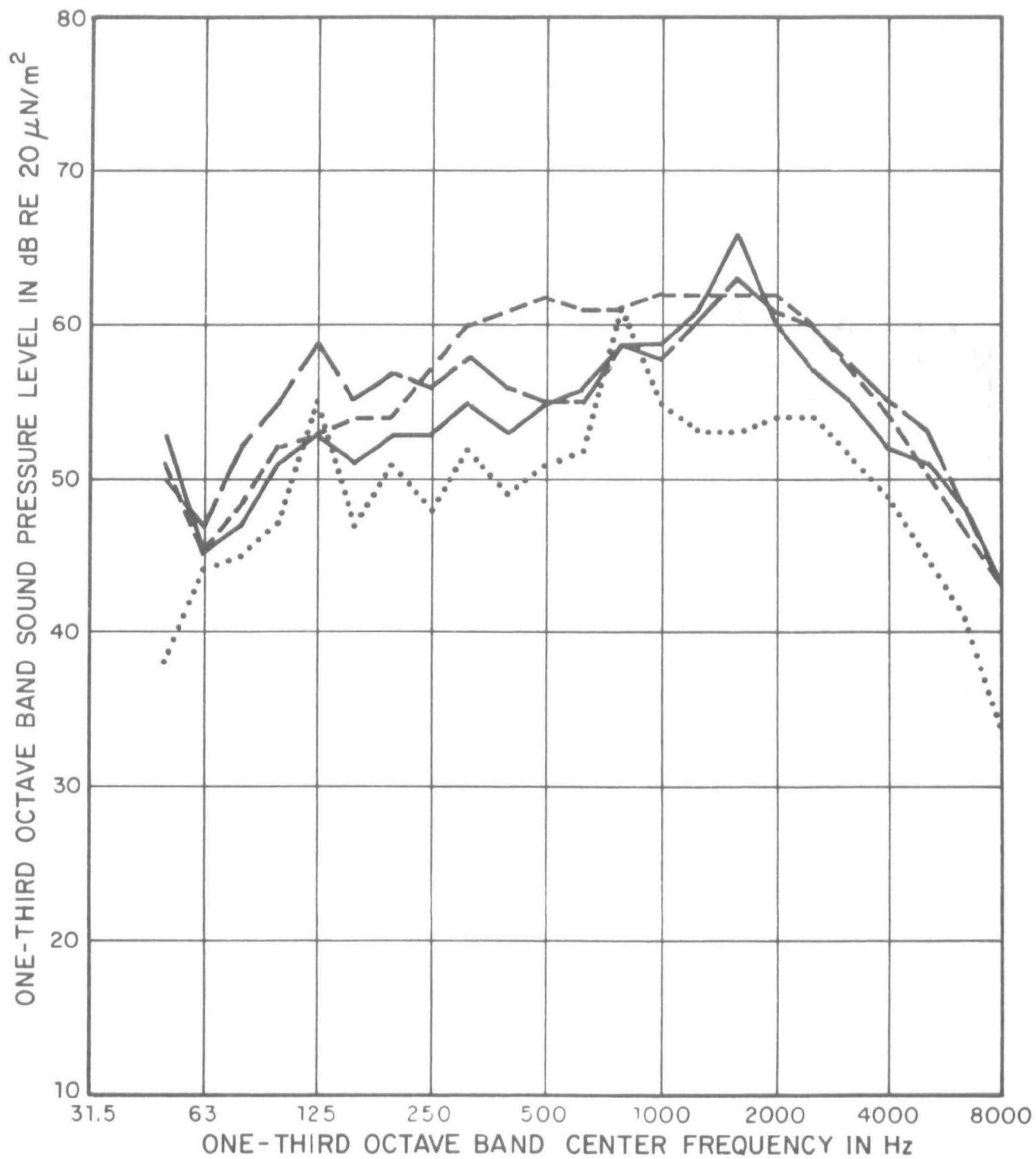

FIG. 11. SOUND PRESSURE LEVELS OF CANISTER VACUUM CLEANERS OPERATING ON WOOD OR TILE FLOORS (MEASURED AT 3 FT)

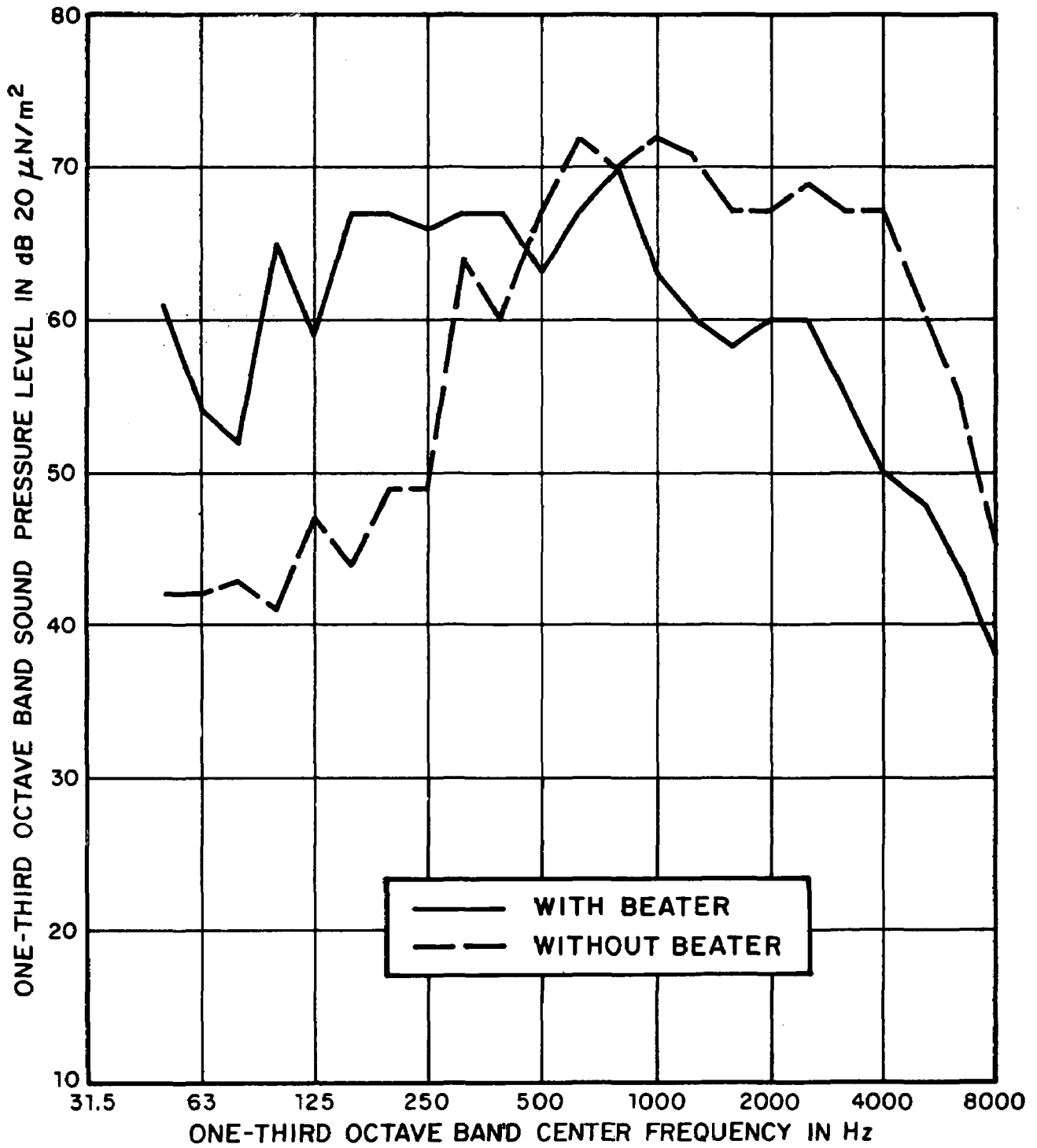

FIG. 12. SOUND PRESSURE LEVELS OF TWO UPRIGHT VACUUM CLEANERS (MEASURED AT 3 FT)

motor-induced. The peaks in the higher frequency range are caused by fan(s) and/or structural radiation. The difference between the two units in the low-frequency bands is due to the difference in capacity as well as to the lack of a beater on one model. Noise control for upright cleaners will be more difficult to achieve than for the canister units because of the location of the beater and the limitations on size. It is anticipated that a 5 dB(A) noise reduction could be achieved on the typical unit.

Water Closets

Water closets are either of the tank type or the valve type and are either floor-mounted or wall-mounted. Figure 13 illustrates the time history of the sound pressure level in the 250 Hz octave band for operation of a tank water closet [12]. Time Period A represents the valve opening and releasing water in the tank to flow into the bowl through an opening in the base of the bowl. The water produces a swirling action in the lower half of the bowl (Time Period B). The valve closes (Time Period C) and the tank and bowl are refilled (Time Period D).

Figure 14 illustrates the time history of the sound pressure level in the 250 Hz octave band for a flush valve water closet [12]. The valve opens (A); air and then water are forced out of the rim supply (B); the valve closes (C) and the bowl is refilled (D). A comparison of these two figures suggests that flush valve water closets generate somewhat higher initial noise levels during an operating cycle but that the noise does not persist as long as with tank water closets. Since the character of the sounds is different, it is not clear at this time which would be more desirable.

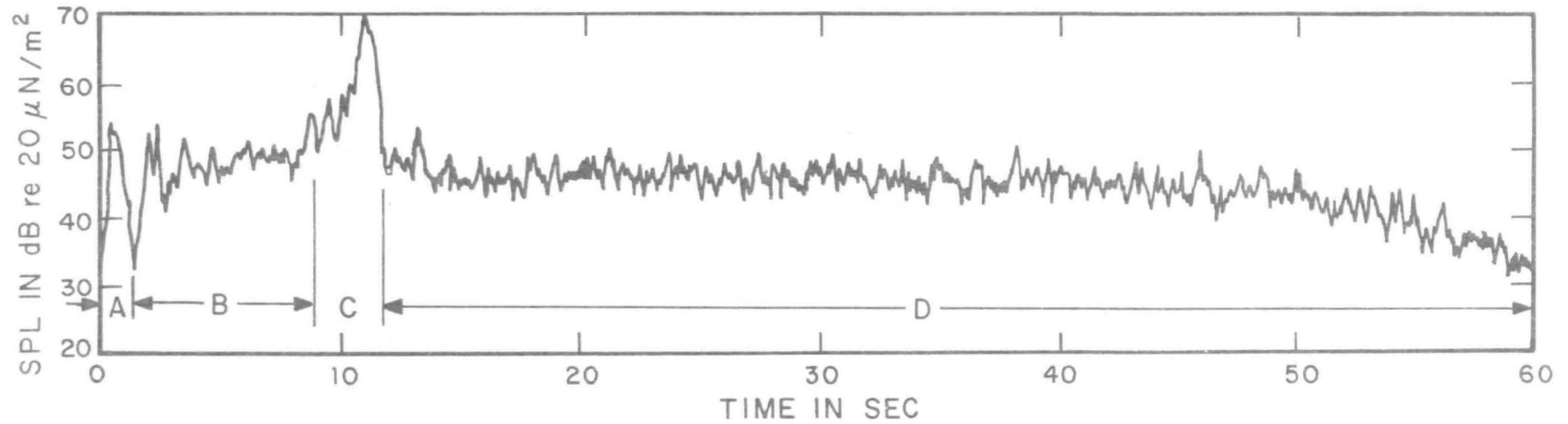

TIME PERIOD

- A = VALVE OPENING
- B = TANK EMPTYING
- C = TANK CLOSED VALVE CLOSING
- D = TANK AND BOWL FILL

FIG. 13. TIME HISTORY OF THE SOUND PRESSURE LEVEL IN THE 250 HZ OCTAVE BAND FOR A TANK WATER CLOSET.

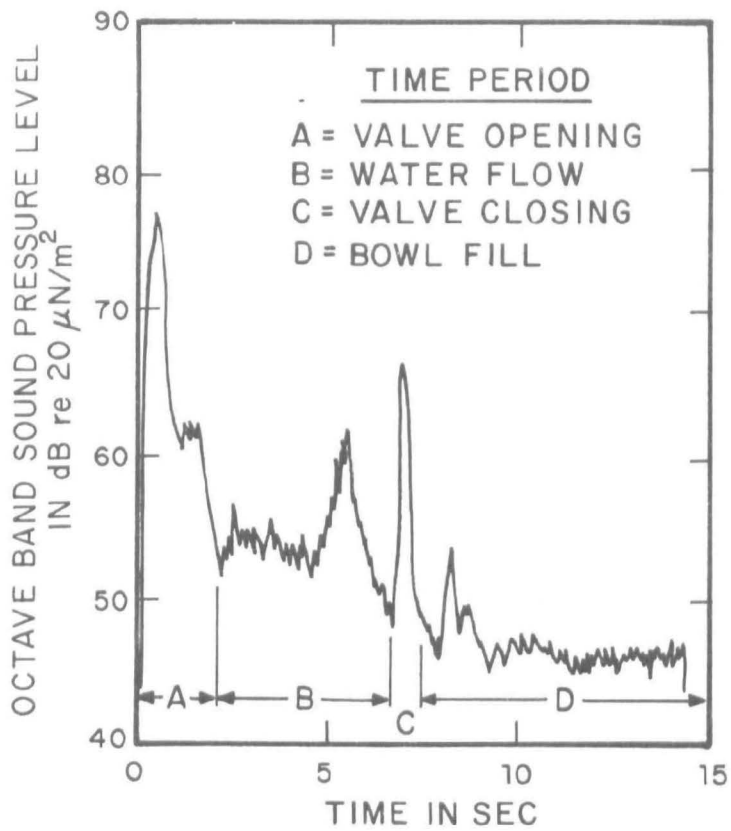

FIG. 14. TIME HISTORY OF SOUND PRESSURE LEVEL IN 250 HZ OCTAVE BAND FOR A FLUSH VALVE WATER CLOSET.

Figure 15 presents peak octave band data for a sampling of tank water closets and Fig. 16 for flush valve water closets. A comparison of these two figures shows that it is possible to have relatively noisy or quiet operation with either type of water closet provided. For tank water closets, water flow control and inlet water pressure are both important variables in the noise generated [12]. For flush valve closets, bowl design was found to be of major importance, with valve type (exposed flush vs recessed flush) and mounting (floor vs wall) of lesser importance. Resilient mounting of water closets and piping was found to be more important for some fixtures than for others - e.g., a range of several dB(A) to 15 dB(A) for valve-operated water closets.

2.3 Building Equipment

The proper operation of large buildings requires a number of different types of electrical and mechanical equipment. In this section, we review the noise levels generated by electrical and mechanical equipment, present noise levels for a typical multi-story building, and discuss the possibilities of noise control through architectural modification. Detailed descriptions of additional building equipment types are given in Appendix A.

2.3.1 Types of equipment

The majority of electrical and mechanical equipment in buildings is used to supply the building occupants with a suitable quantity of air at a comfortable temperature and moisture content. In addition, pumping and piping systems are used for water and fluid circulation, elevators and escalators are used for movement of personnel, and various conveyance systems are used for moving material.

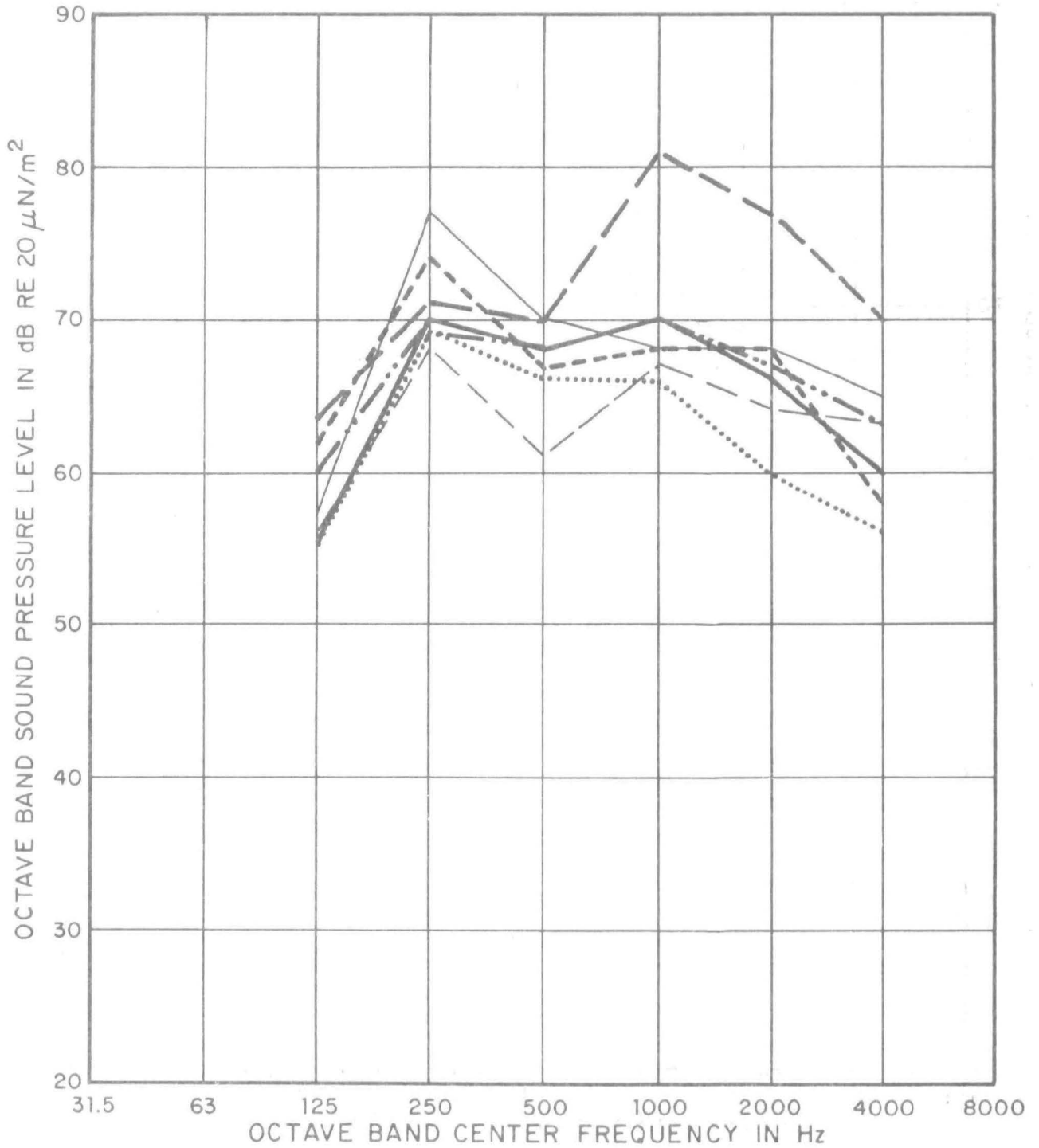

FIG. 15. RANGE OF PEAK OCTAVE BAND SOUND PRESSURE LEVELS IN ROOMS WITH TANK TYPE WATER CLOSETS (MEASURED AT 3 FT)

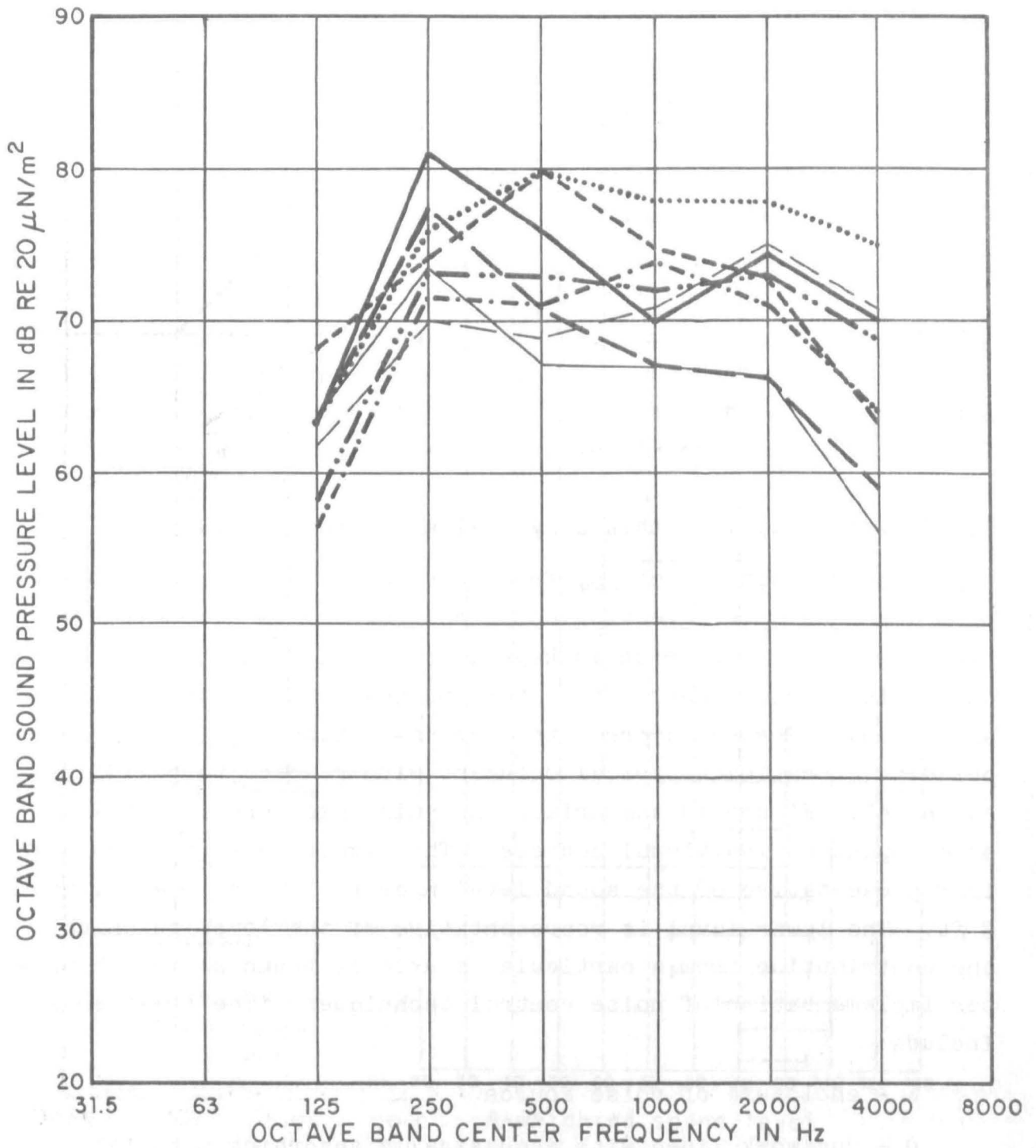

FIG. 16. RANGE OF PEAK OCTAVE BAND SOUND PRESSURE LEVELS IN ROOMS WITH FLUSH VALVE WATER CLOSETS (MEASURED AT 3 FT)

Figure 17 presents the typical range of sound levels in dB(A) at 3 ft for building equipment. Much of this equipment is hidden in mechanical equipment rooms, above ceilings, in walls, or behind cabinet type exterior enclosures. Table VII, which summarizes the exposure of occupants to the noise generated by building equipment, shows that occupants are *directly* exposed to the noise of only about eight different types of equipment. The noise generated by these units is thus of special interest since there are no intervening walls to provide attenuation. The noise generated by building equipment hidden from view can be sufficiently attenuated through the proper use of current architectural techniques. In practice, such techniques are not always implemented.

2.3.2 Noise levels within a typical multistory building

Although details of the frequency spectrum are of considerable importance in selecting noise control treatments, the model presented in this section is keyed, for simplification, to dB(A); it is not intended that this method be used for actual situations. Figure 18 presents a cross-section of a multistory building, locating a typical occupant with respect to building equipment. Figure 19 summarizes the noise exposure in dB(A) of an occupant to individual sources. The higher level in each case is representative of the sound level near the source — e.g., at 3 ft. The lower level is representative of the level to which the contribution from a particular source is reduced through proper implementation of noise control techniques. The treatments include:

- E — enclosure of noise source
- D — ductwork lined with acoustically absorbing material
- W — wall

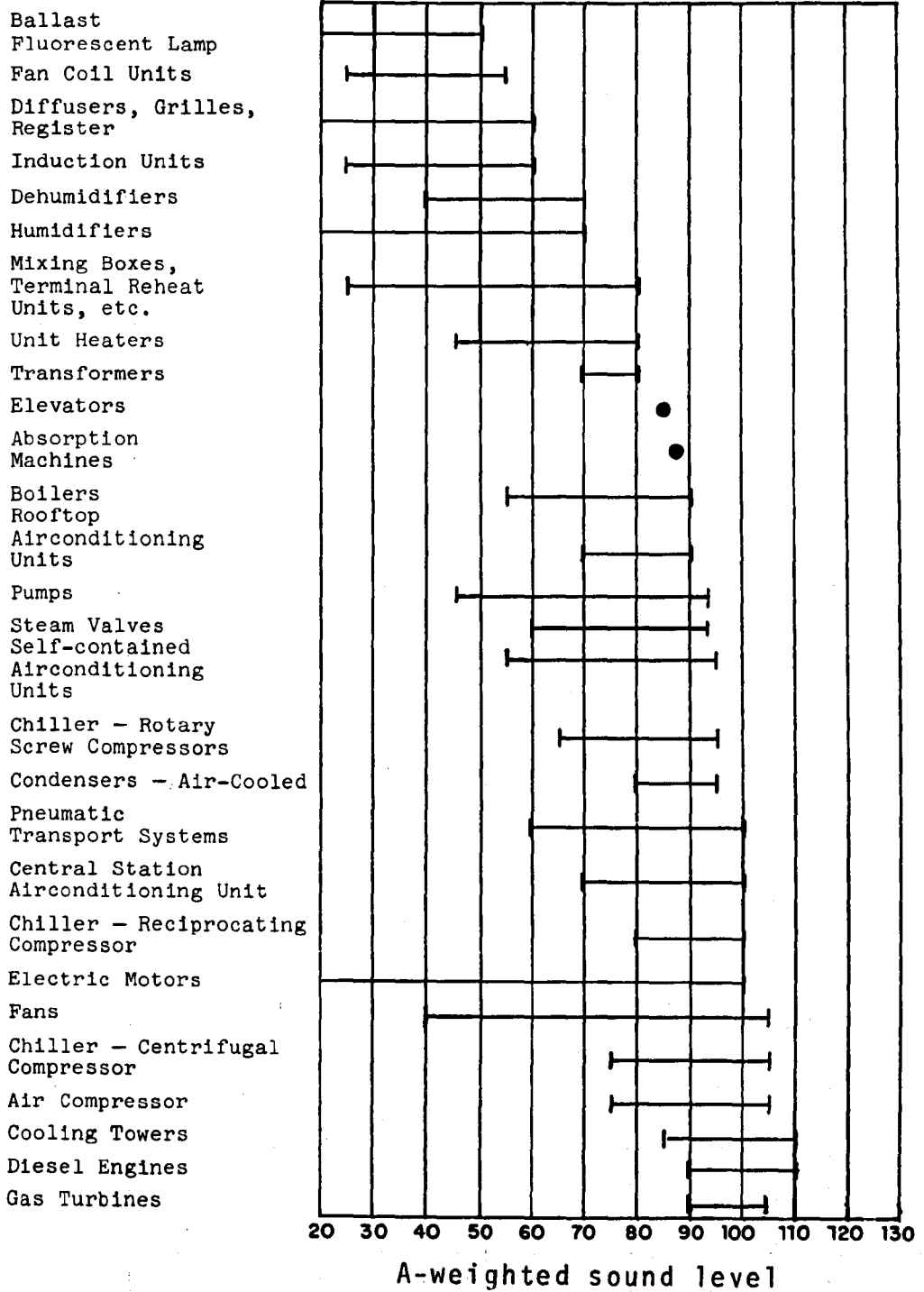

FIG. 17. RANGE OF SOUND LEVELS IN dB(A) TYPICAL FOR BUILDING EQUIPMENT AT 3 FT.

TABLE VII. EXPOSURE OF BUILDING OCCUPANTS TO THE NOISE OF BUILDING EQUIPMENT

Building Equipment	Location	Type of Exposure		
		Direct	Indirect	
			Through Mechanical Distribution System	Through Walls, Floors, etc.
Air Conditioning	MER*		x	x
	Roof. Unit		x	x
	Wind. Unit	x		
Absorption Machines	MER			x
Air Compressor	MER			x
Ballasts	Room	x		
Boilers	MER			x
Boiler Feed System	MER			x
Chillers	MER			x
Condensers	Rooftop			x
Cooling Towers	Rooftop			x
Dehumidifiers	MER		x	x
Diesel Eng.	MER			x
Diffusers	Room	x		
Electric Motors	MER			x
Elevators	Varies	x	x	x
Escalators	Varies	x	x	x
Fans	MER		x	x
	Room	x		
Furnaces	MER			x
Gas Turbines	MER			x
Heat Pumps	MER			x
Humidifiers	MER		x	x
Mixing Boxes and Air Control Units	Varies	x	x	
Pneumatic Transporter System	Varies		x	x
Pumps	MER			x
Steam Valves	MER			x
Transformers	MER			x
Unit Vent and Unit Heat	Room	x		

*Mechanical Equipment Room

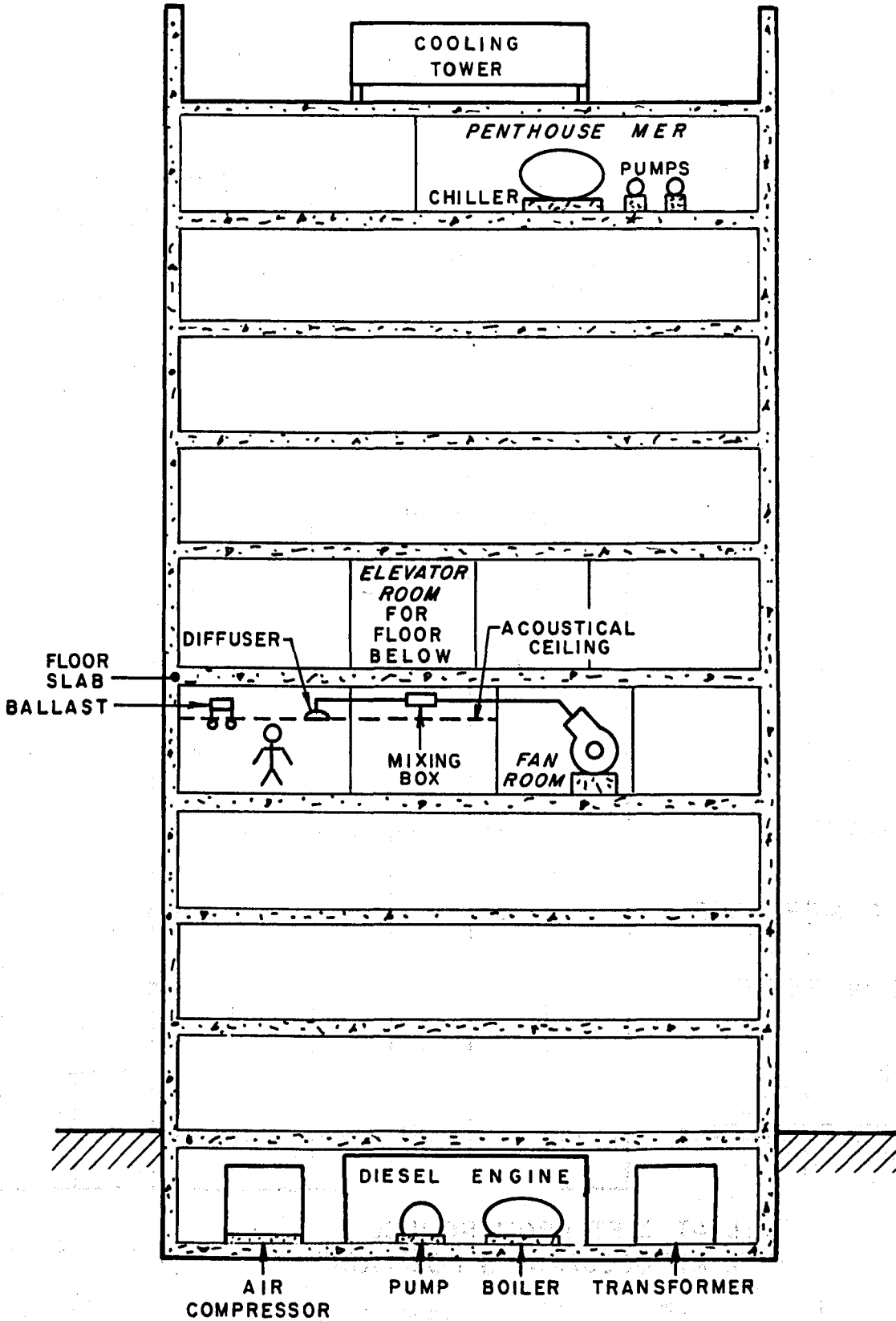
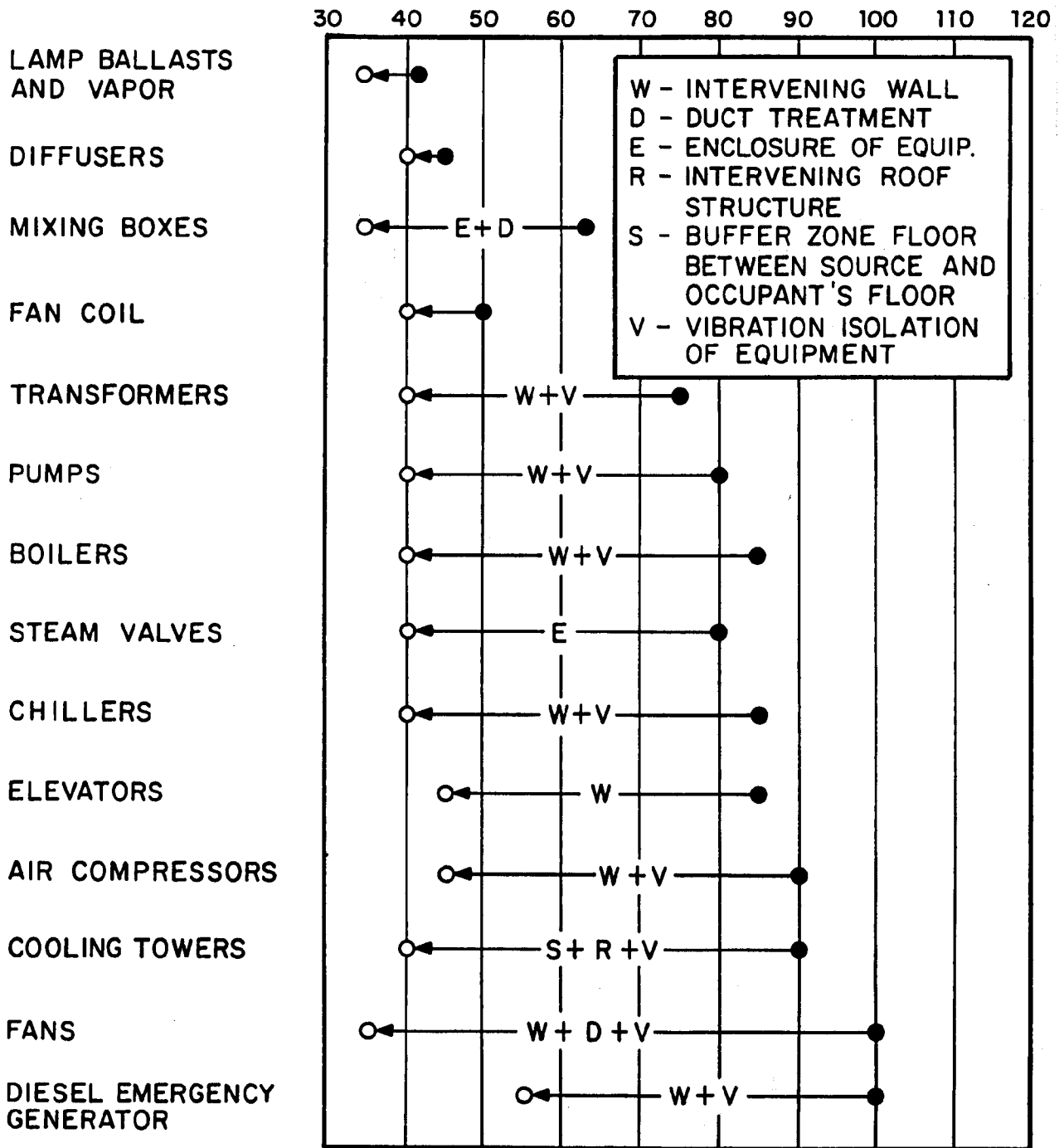

FIG. 18. CROSS-SECTION OF A TYPICAL MULTISTORY BUILDING SHOWING BUILDING EQUIPMENT.

A-WEIGHTED SOUND LEVEL



● SOUND LEVEL AT 3 FT FROM SOURCE
 ○ SOUND LEVEL AT OCCUPANT'S POSITION

FIG. 19. RANGE OF BUILDING EQUIPMENT NOISE LEVELS TO WHICH PEOPLE ARE EXPOSED.

R - roof slab

S - intervening story - e.g., the penthouse mechanical equipment floor

V - vibration isolation.

Goals for acceptable noise levels vary with the activities to be held in a space. If one is interested in increasing the speech privacy within an office, then a higher noise level of an appropriate spectral shape would be appropriate. On the other hand, if one is performing certain types of tests or listening to critical sounds, a quieter environment is required. Through the use of current technology, it is possible to achieve virtually any noise goal, if the owner of the building is willing to bear the cost and space requirements of the treatment. Of course, by specifying quiet equipment, the owner may minimize these requirements.

3. IMPACT

3.1 Noise Level Criteria for Impact Evaluation

In this report, the impact of noise exposure upon people is evaluated primarily in terms of three direct effects and secondarily in terms of a number of indirect consequences. The three major effects are hearing-damage risk, speech interference, and sleep interference. The rationale for emphasizing these effects is twofold. First, they are among the most salient and tangible consequences of noise exposure and thus can be most readily interpreted in nontechnical terms. Evidence that they are widely understood by the public may be found in their frequent mention in noise complaints. Secondly, research on these three effects has been more extensive than on other noise effects; therefore, clearer predictions can be made with greater confidence.

Although the three primary effects are used to summarize the major impact of noise exposure, the indirect consequences of exposure also demand consideration. These effects include physiological stress, annoyance, startle, and task interference. They are termed "indirect" in that they are not produced exclusively by noise, nor are they simple functions of the physical magnitude of noise exposure. Further, relatively little systematic information about these effects is available; thus, specification of precise levels of noise exposure leading to particular levels of effect is a somewhat speculative matter. However, one may not assume that these secondary consequences are unimportant merely because they are difficult to quantify.

The following table presents the physical levels at which it is felt that each of the above-mentioned effects of noise exposure achieves (1) a moderate level of effect and (2) an appreciable level of effect. The decisions leading to these specifications are discussed below.

TABLE VIII. ESTIMATES OF MAGNITUDES OF NOISE EFFECTS
[IN dB(A)]

<u>Effect</u>	<u>Moderate Level</u>	<u>Appreciable Level</u>
Hearing Damage Risk	70	90
Speech Interference	45	60
Sleep Interference	40	70
Physiological Stress	*	90
Startle	*	110
Annoyance	40	60
Task Interference	55	75

3.1.1. Hearing-damage risk

The hearing-damage risk levels specified in Table VIII were selected on the basis of eight hours of daily exposure. Exposure durations of this order are chosen as representative of the amount of time usually spent in home and work environments. Since hearing-damage risk is cumulative over long periods of time [13], the recommendations are intended to account for prolonged noise exposure over a period of years.

The estimate of the level at which hearing-damage risk commences was determined on a rather stringent basis. The Walsh-Healey Public Contracts Act, as amended to include noise limits for hearing conservation, is based on a CHABA report [14], which permits permanent threshold shifts up to 10 dB at frequencies

*Effects at low levels are at best weak functions of the physical intensity of noise. They are determined far more strongly by factors such as the meaning associated with the acoustic signal, attitudes toward the source, rise time of the signal, unexpectedness of the signal, and so forth. It therefore makes little sense to specify discrete levels in these cases.

below 1000 Hz; up to 15 dB at 2000 Hz, and up to 20 dB at frequencies above 3000 Hz. Hearing losses of these magnitudes are considered inconsequential in the sense that they are ineligible for compensation under the terms of the legislation. Even these surprisingly lax limits are based on the questionable assumption of a sixteen-hour daily recovery period of little or no noise exposure [13]. Further, the CHABA report [14] is intended to afford this partial protection to only half of the population exposed to noise. Clearly, these criteria are neither applicable to individual circumstances nor capable of protecting many people from sizeable hearing losses.

Kryter's published redefinition of the hearing-damage risk criteria [15] maintains that no permanent threshold shift whatever is tolerable at frequencies below 2000 Hz and that no more than a 10 dB shift is tolerable at higher frequencies. Kryter also applies the protection afforded by his definition to 75% of the population rather than 50%. He states that the "threshold" of hearing-damage risk for eight hours of daily exposure is 67 dB(A). Cohen *et al* [13] operating under similar assumptions specify 75 dB(A) as the level at which hearing-damage risk commences. Miller [16] believes that a level of 70 dB(A) represents a level of noise exposure above which hearing-damage risk becomes nonnegligible. In Miller's terminology, habitual exposure to levels between 70 and 80 dB(A) represents yellow (i.e., cautionary) risk of hearing damage; exposure to levels between 80 and 90 dB(A) entails "orange" risk; while exposure to levels in excess of 90 dB(A) involves "red" (serious) risk.

The estimate of Table VIII for the onset of hearing-damage risk agrees with Miller's estimate. The estimate of the level at which appreciable risk of hearing damage occurs agrees both

with Miller's estimate and the provisions of the Walsh-Healey Act. The latter criteria, based on a report of the NAS-NRC Committee on Hearing, Bioacoustics, and Biomechanics [14], indicates that eight hours of daily exposure to levels in excess of 90 dB(A) constitutes a serious risk of hearing damage to one-half of the population.

3.1.2 Speech interference

The levels specified in Table VIII for speech interference are the most straightforward and readily defensible of all of the estimates. A criterion for adequate verbal communication in the home was taken to be comprehension of 98% of all sentences or an equivalent rate of comprehension of 85% of the words of a standard phonetically balanced (PB) list. In terms of nominal vocal effort [approximately 65 dB(A) at a distance of one meter], such a level of speech intelligibility would be sustained at a speaker-listener distance of approximately five meters in a noise background of 45 dB(A) [17]. Five meters was taken to be the maximal distance at which conversation in normal levels might reasonably be expected to be held in a quiet outdoor (nonreverberant) environment.* The level of appreciable effect specified in Table VIII was derived by assuming that noise-induced speech interference would be intolerable if conversation at nominal levels of vocal effort were precluded at speaker-listener distances greater than one meter. Such conditions prevail in noise environments in excess of 60 dB(A) [17].

*Greater speaker-listener distances would be possible indoors at the same levels of vocal effort and speech intelligibility, because sound pressure levels diminish more slowly than predicted by the inverse square law.

It should be pointed out that selection of the above criterion represents a belief that the 70% comprehension of PB words suggested by Webster [17] and Beranek [18] does not provide for a reasonable standard of communication in the home. Webster's criterion was established for "barely adequate communication" and is inappropriately applied to the home environment. The levels recommended in this report are thus 6 dB lower than Webster's.

3.1.3 Sleep interference

Two principal ways in which noise exposure can interfere with sleep are to delay the onset of sleep and to shift sleep "stages". Scores of studies are available on the sleep-delaying and stage-shift effects of noise exposure. Although there is frequently broad agreement among studies, detailed agreement is lacking. Discrepancies among outcomes of similar studies are attributable to incomparable control conditions, differences in experimental design, and the host of individual differences which beset sleep research.

For example, it is universally observed that the initial time required for subjects to fall asleep increases monotonically with exposure to increasing noise levels. Unfortunately, different studies produce estimates of the sleep-delaying effects of noise that are more than 35 dB apart. Thus, two studies report delays in onset of sleep from 20 to 90 minutes [19,20], corresponding to exposure to continuous noise at levels of 35 dB(A) and 50 dB(A), respectively. Other studies, [21-23] however, report that subjects can fall asleep in as little as twelve minutes despite exposure to noise levels of 70 dB(A).

Further, prolonged exposure to high noise levels can produce tinnitus (ringing in the ears), which has been claimed to delay

the onset of sleep [24]. In other words, aftereffects of noise, even in the absence of *any* noise exposure at bedtime, can impede sleep. It is also claimed in the literature that levels as low as 35 dB(A) can either induce a shift from a "deeper" to a "lighter" level of sleep or awaken certain people [25]. Pronounced differences in sensitivity to noise during sleep have been observed as a function of age as well.

An absolute criterion for noise exposure levels in sleeping quarters is obviously unjustifiable on the basis of extant research. A conservative criterion for noise exposure (from the point of view of minimizing sleep interference) might be based on the lowest levels at which sleep interference have been reported. According to the Wilson Report [26], levels of 40 dB(A) have been known to awaken approximately 25% of the sleeping population, while levels of 45 dB(A) appear to keep about 20% of the population from falling asleep immediately. These considerations have led to the adoption of 40 dB(A) as a criterion level for the onset of sleep interference effects. According to the Wilson Report data, a little more than half of the population may be awakened by noise exposure to levels of 70 dB(A), while a little less than half of the population will find some difficulty in falling asleep when exposed to such levels. These data led to adoption of 70 dB(A) as the level at which sleep interference effects become considerable.

3.1.4 Physiological stress

The amount of stress produced by low-level acoustic signals is primarily determined by their meaning. A footfall in one's bedroom at night, or a growling animal, or one's boss's voice can excite stress mechanisms by virtue of their implications rather

than their physical attributes. Since it is the learned and instinctive associations to sounds which are largely responsible for their ability to create stress, no level of minimal effect has been specified.

At high noise levels a somewhat stronger case may be made for specification of a criterion. Studies of physiological correlates of noise-related stress in animals suggest that noise levels in the vicinity of 90 dB(A) produce strong effects [27]. Pupillary dilation, increased pulse pressure and heart rate, and pulse volume changes have been observed in humans exposed to noise levels of approximately 70 dB(A) [28]. There can be little argument that at even higher levels noise stimulation induces stress in and of itself, rather than as an exclusive function of its meaning. Extremely intense noise fields can cause auditory and bodily pain. Such intense fields commonly are associated with strong vibrational components, which can also be harmful.

3.1.5 Startle

The arguments above about the relative roles of meaning and levels of acoustic signals in determining stress also apply to startle. For the same reasons, therefore, no minimal level of effect can be specified.

A major obstacle to establishing a firm criterion for the startling effects of high level noise is the phenomenon of habituation. In general, humans display a marked decrease in sensitivity to repeated exposure to startling sounds. Expectedness, regularity, familiarity, arousal level, and numerous other factors strongly mediate startle effects. Even at high absolute noise levels, startle is as much affected by signal-to-noise ratio considerations as it is by the level of the startling signal.

Thus, an exploding paper bag would almost certainly produce more startle in a library than in a boiler factory.

The level recommended in Table VIII is therefore chosen to represent a noise level sufficiently rarely heard and of a signal-to-noise ratio sufficiently great to make a significant startle reaction highly probable.

3.1.6 Annoyance

The levels recommended in Table VIII for gauging annoyance effects are intended to reflect the lowest level at which any of the other tabled effects can occur. In other words, one is expected to be annoyed by a noise sufficiently intense to produce sleep interruption, speech interference, etc.

It is, of course, also true that long-term exposure to very low level noises can be annoying. A dripping faucet or a chalk squeak can be exceptionally irritating. Once again, however, it is the meaning of the acoustic signal rather than its level *per se* which plays a major role in determining the magnitude of annoyance. Also, the spectral composition and temporal density of noise heavily influences its annoyance value. Unfortunately, temporal and spectral factors cannot be adequately expressed in dB(A).

3.1.7 Task interference

The literature on the effects of noise on human performance contains numerous conflicting and inconclusive reports. By and large, high-intensity, aperiodic, intermittent noise is reported to impede efficient work to a greater extent than low-intensity, steady-state noise [29]. Nonetheless, numerous studies find no effects of noise on performance, while a few studies find

paradoxical improvements in performance attributable to noise exposure [30]. Of course, improvements in performance when an environment is changed (presumably worsened) are often due to changes in the level of attention perceived by the subject and their attendant reaction. The nature of the task at hand and the duration of noise exposure also influence the extent of task interference.

It is our feeling that the most sensitive and complex tasks (of the nature of brain surgery, diamond cutting, etc.) might be sensitive to interference from noise at levels as low as 55 dB(A). Although most published studies which report task interference give levels in the vicinity of 90 to 110 dB(A), it is felt that certain tasks might prove susceptible to appreciable interference at approximately 75 dB(A).

3.2 Construction Noise

3.2.1 Extent of exposure

Our determination of the impact of construction noise on the American public is based on information obtained about the number of people exposed to such noise and the extent of their exposure. This information was gathered in four steps:

- We determined the number of construction sites of various types in various geographical regions.
- We determined the density of people in the geographical regions (two classes of people were considered: stationary population such as workers and residents and transient population such as drivers and pedestrians).
- We postulated a model of sound propagation around a typical construction site.

- We combined the information obtained in the first three steps with the site source level data presented in Sec. 2.1 to determine the number of people exposed to given levels of noise.

For the purpose of gathering and analyzing population and construction site statistics, we divided the U.S. into five regions. These regions are based on those defined by the U.S. Bureaus of the Budget [31] and of the Census [32]. A key to understanding the rationale used for establishing these regions is the concept of Standard Metropolitan Statistical Area (SMSA). An SMSA is a group of contiguous counties which contains at least one central city of 50,000 inhabitants or more, or "twin cities" with a combined population of 50,000 or more. There are 233 SMSAs containing 65% of the nation's population and about 10% of the land area. The population density in the nonmetropolitan areas is too low to create much construction noise exposure or to allow meaningful computation of the exposure that does exist. This study, therefore, restricts itself to construction occurring within the SMSAs (see Table IX).

Classification of Construction Sites

As explained in Sec. 2.1, four major categories of construction were studied:

- Residential buildings
- Nonresidential buildings
- Municipal roads
- Public works

Certain heavy construction and large civil works, such as dams and bridges, were omitted because this type of construction

TABLE IX. METROPOLITAN REGIONS CONSIDERED IN
CONSTRUCTION NOISE EXPOSURE ESTIMATE;
STATISTICS AS OF 1970*

	<u>Population (thousands)</u>	<u>Area (sq. mi.)</u>	<u>Population Density (people per sq. mi.)</u>
Large High-Density Central Cities** (12)	22,250	1,468	15,160
Large Low-Density Central Cities (14)	10,530	2,389	4,410
All Other SMSA Central Cities (186)	25,820	6,981	3,710
Urban Fringe	49,680	14,707	3,380
Met. Area Outside Urban Fringe	22,320	179,276	125

*Population figures are extrapolated to 1970 from 1969 Census figures according to recent growth rates.

**Large cities are those whose metropolitan area population exceeded 1,000,000 in 1960.

High-Density: Baltimore, Boston, Buffalo, Chicago, Cleveland, Detroit, New York, Philadelphia, Pittsburgh, San Francisco, St. Louis, Washington.

Low-Density: Atlanta, Cincinnati, Dallas, Denver, Houston, Kansas City, Los Angeles, Milwaukee, Minneapolis-St. Paul, Miami-Ft. Lauderdale, New Orleans, St. Petersburg-Tampa, San Diego, Seattle-Tacoma.

rarely takes place in heavily populated areas. The residential and nonresidential building categories were further subdivided into specific types of buildings to account for variations in the duration of construction and the mix of machinery at different kinds of sites.

The Number of Construction Sites

Data on the annual number of building sites on which construction was begun in 1970 was collected from the U.S. Business and Defense Services Administration [33] and from unpublished compilations made by the Bureau of the Census. Data for large central cities and for the nation as a whole were directly available; sites were ascribed to "other central cities", "urban fringe", and "nonurbanized metropolitan area" on the basis of population distribution. The number of residential and nonresidential building sites in the five metropolitan-area regions is shown in the first two columns of Table X, as well as the average cost of construction for each case. A more detailed breakdown by type of building is given in Appendix B.

Data on total municipal road construction [34] was apportioned among the various metropolitan regions by assuming a constant ratio of miles of road constructed to miles of road in place. The number of miles of such work performed in 1969 is shown in the third column of Table X.

Unlike the case with buildings and roads, data on construction and maintenance of public works such as sewers and water mains is not collected on a national basis. The extent of this construction, therefore, has been estimated first by determining the ratio of sewer construction to street construction for several cities in the Boston area and then by using this ratio to

TABLE X. ANNUAL CONSTRUCTION ACTIVITY — 1970*

Metropolitan Regions	Residential Buildings (no. of sites)	Nonresidential Buildings (no. of sites)	Municipal Streets (miles)	Public Works (miles)
Large high-density central cities	8,708	1,952	273	398
Large low-density central cities	21,578	4,903	2,150	3,140
Other central cities	102,559	12,021	6,000	8,700
Urban fringe	262,800	30,915	11,800	16,865
Met. area outside urban fringe	<u>118,779</u>	<u>13,758</u>	<u>21,700</u>	<u>31,550</u>
Total	514,424	62,549	41,923	60,653

* All figures are in thousands.

estimate the miles of sewer construction nationwide for 1970. These figures are contained in the fourth column of Table X. A more detailed description of this computation is contained in Appendix B.

Construction Phases

Construction of buildings and other works is carried out in discrete stages, each of which has its own characteristic mix of equipment. Because of the items of equipment on a site change as construction progresses, the noise output from the site also changes with time. As explained in Sec. 2.1, we have characterized the noise output from each site according to construction phase:

- Clearing and demolition
- Excavation
- Placement of foundations
- Erection of frame, floors, roof, and skin
- Finishing and cleanup.

These phase descriptions are used for road and sewer construction, even though the actual operations are different from those for buildings, so as to allow a consistent analysis of the various types of sites. (See Sec. 2.1 for a more complete description.) A list of the equipment commonly found in each phase is given in Table A-1.

Number of Individuals Exposed

We obtained the number of people exposed to various levels of noise from construction sites by combining information on

population density, the number of sites active per year, and the sound propagation model described below.

We revised the population figures in Table IX, which represent the residential distribution of the U.S. population, to reflect the net transfer [35] of people from suburbs to central city during the average working day, the period when most construction noise is produced. These revised density figures are given in Table XI in terms of people per square mile and people per one-eighth mile of street (assuming the entire metropolitan area to be divided into city blocks one-eighth of a mile long).

TABLE XI. GEOGRAPHICAL DISTRIBUTION OF WORKING-DAY POPULATIONS

	<u>People per square mile</u>	<u>People per 1/8 mile of street (approximate)</u>
Large high-density central cities	16,650	120
Large low-density central cities	4,860	40
All other central cities	4,070	32
Urban fringe	3,100	24
Met. area outside urban fringe	114	--

Note that the number of people per city block in the metropolitan area outside the urban fringe is negligible and therefore is disregarded in the following discussions.

In addition to the working-day population density estimate given in Table XI, we must also account for the number of passers-by who are exposed to construction noise. Since there are no data on typical driver and pedestrian distributions, a definitive estimate of this type of exposure is not possible. We have, however, made an order-of-magnitude estimate on the basis of some survey work performed by the Boston Traffic Department (1970). Although incomplete, these surveys report seemingly reasonable numbers, which are therefore offered in Table XII as preliminary estimates.

TABLE XII. NUMBER OF PEOPLE PER DAY
PASSING A CONSTRUCTION SITE

	<u>Drivers and Passengers</u>	<u>Pedestrians</u>
Large high-density central cities	3000	1000
Large low-density central cities	3000	1000
Other central cities	1500	500
Urban fringe	500	100

Table XIII presents the total number of building construction sites active in 1970 (see Table X) for all metropolitan regions. In the case of roads and sewers, the definition of a "construction site" is somewhat obscure, since such projects extend linearly for some distance with construction usually occurring one section at a time. The area of influence of construction on one section is about one-eighth of a mile. We therefore consider each eighth-mile of street and sewer construction as an independent site.

TABLE XIII. LEVEL OF ANNUAL CONSTRUCTION ACTIVITY

<u>Type of Site</u>	<u>Number of Sites (National Total)</u>
Residential Building	514,424
Nonresidential	62,549
Municipal Streets	336,000
Public Works	485,000

The level of exposure to noise from a construction site depends on one's distance from the site and the nature of his immediate environment. In city streets, it has been found experimentally that sound intensity decreases as the inverse square of the distance from the source [36]. In logarithmic units, this amounts to a 6 dB reduction per distance doubled. This model has been adopted for open-air propagation, which is significant in the case of pedestrians. In addition, a factor of 20 dB(A) attenuation has been included for people who are inside buildings with closed windows and 15 dB(A) for people inside cars with closed windows [37]. Construction noise is assumed to propagate along the street adjacent to the site, but to be heavily attenuated in the direction transverse to the street; in effect, only the people along the street adjacent to the site are affected by the noise. A further assumption is that the sound is reduced 10 dB(A) when one crosses a street intersection [36].

Using these parameters, we illustrate in Fig. 20 a representative geometry for a building construction site and contours of attenuation for observers. Details of the computations involved in constructing this diagram are given in Appendix B. Assuming a uniform distribution of observers along the sides of

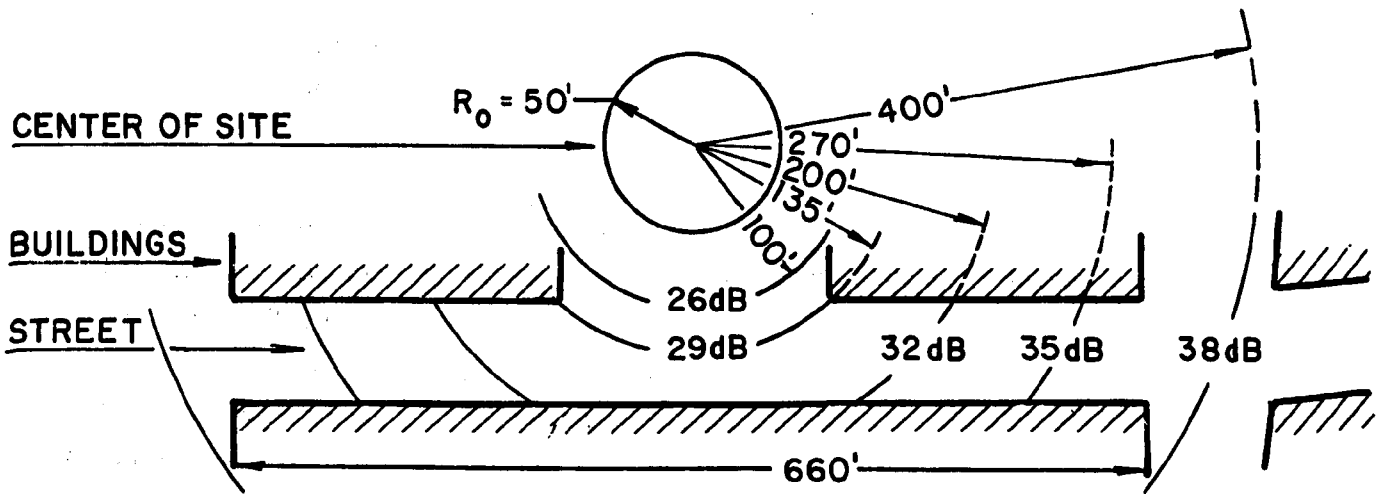

FIG. 20. CONSTRUCTION SITE GEOMETRY AND ATTENUATION CONTOURS FOR A STATIONARY POPULATION WITHIN BUILDINGS. (SEE APPENDIX B FOR METHOD OF COMPUTATION.)

the street, we can determine the fraction of people within each set of attenuation contours. These proportions, which are shown in Table XIV below, apply only to observers in buildings with closed windows adjacent to the street on which building construction is taking place; drivers and pedestrians move relative to the site, crossing contours as they go.

TABLE XIV. DISTRIBUTION OF STATIONARY OBSERVERS
RELATIVE TO ATTENUATION CONTOURS

<u>Attenuation Interval</u>	<u>Percent of Observers</u>
26 - 29 dB	15%
29 - 32 dB	35%
32 - 35 dB	32%
35 - 40 dB	18%

All observers more than 40 dB away from the site have been disregarded, as they are assumed to be unaffected by the noise. The actual number of people within each pair of attenuation contours can be obtained by multiplying the percentages in Table XIV by the number of people per 1/8 mile of city street for the appropriate metropolitan area (as given in Table XI).

In the case of street and sewer construction, operation is typically distributed along the length of the street and cannot be modeled as a point source. Accordingly, all the people in the eighth-mile of city street adjoining the site are assumed to be exposed to the same noise level. This level is taken to be the source level of the site diminished 20 dB to account for attenuation within buildings with closed windows.

The noise exposure of pedestrians and drivers cannot be computed by the above model, since, as noted above, their distance from the site varies with time. In these cases, we consider the peak exposure experienced by the transient observer. For pedestrians, this exposure is 6 dB less than the site source level referenced to 50 ft; for drivers, it is 20 dB less.

Noise Exposure Estimates

The above figures on observer densities, number of sites, and attenuation have been combined with the data on average and peak site source levels presented in Sec. 2.1 to determine the number of people exposed to particular levels of noise. Table XV shows the national noise exposure of the stationary population due to residential building, nonresidential building, municipal street, and public works construction. The noise levels are broken down into the five phases of construction described above.

To compute exposure of drivers and pedestrians, one multiplies the number of people per day passing each site by the number of sites. This gives the number of passersby exposed per day of site operation. Multiplying this number by the average number of days each site is operated gives the total annual number of instances in which an individual passes a construction site and is thus exposed to noise. For this computation, we use the number of sites from Table X and the number of passersby from Table XII. The duration of construction on the average site is not available from survey data but the following figures are considered typical:

- Residential buildings (single-family only) - 27 days
- Nonresidential buildings and multifamily dwellings - 170 days
- Streets and Public Works - 7 days.

TABLE XV. AVERAGE AND PEAK EXPOSURE LEVELS TO CONSTRUCTION NOISE

<u>Number of People</u>	Average Levels					Peak Levels				
	<u>Construction Phase</u>					<u>Construction Phase</u>				
	I	II	III	IV	V	I	II	III	IV	V
RESIDENTIAL BUILDING CONSTRUCTION										
1,725,000	56.5	54.5	54.5	47.5	54.5	63.5	70.5	57.5	57.5	70.5
4,025,000	53.5	51.5	51.5	44.5	51.5	60.5	67.5	54.5	54.5	67.5
3,680,000	50.5	48.5	48.5	41.5	48.5	57.5	64.5	51.5	51.5	64.5
<u>2,070,000</u>	47.5	45.5	45.5	38.5	45.5	54.5	61.5	48.5	48.5	61.5
11,500,000										
NONRESIDENTIAL BUILDING CONSTRUCTION										
225,000	56.0	57.5	50.5	51.0	56.5	63.5	70.5	60.5	60.5	70.5
525,000	53.0	54.5	47.5	48.0	53.5	60.5	67.5	57.5	57.5	67.5
480,000	50.0	51.5	44.5	45.0	50.5	57.5	64.5	54.5	54.5	64.5
<u>270,000</u>	47.0	48.5	41.5	42.0	47.5	54.5	61.5	51.5	51.5	61.5
1,500,000										
MUNICIPAL STREET AND PUBLIC WORKS CONSTRUCTION										
14,500,000*	63.0	65.0	68.0	58.0	64.0	71.0	78.0	71.0	69.0	71.0
FEDERAL AND STATE HIGHWAY CONSTRUCTION										
7,000,000*	63.0	65.0	68.0	58.0	64.0	71.0	78.0	71.0	69.0	71.0

*Assuming homogeneous exposure of all people indoors with windows shut.

The estimated number of occasions per year in which a driver or pedestrian passes a site is shown in Table XVI below. These figures do *not* represent the number of people who pass construction sites, since one person may pass many sites, or one site many times. If one divides the grand total of Table XVI, 24.7 billion passings, by the total national metropolitan population of 137 million, it is seen that the average inhabitant of metropolitan areas passes a construction site approximately 180 times per year.

3.2.2. Impact assessment

Determining the impact of construction noise on people is a multistage process. The procedures by which estimates of levels and durations of noise exposures were derived are discussed in the preceding section (3.2.1). Development of the criteria by which the severity of noise effects are judged is discussed in Sec. 3.1. In this section, we explicitly combine the exposure data with the criteria; Appendix B contains a number of important comments on the inferences which may be prudently drawn from the findings reported here.

Table XV of Sec. 3.2.1 and Table XVII of this section provide an overview of the exposure data as they pertain to impact assessment. The tables contain information about the number of people who receive primary and secondary exposure to construction site noise and the levels of noise to which they are exposed *in their listening environments*. Estimates of the duration of noise exposures are also presented in the tables. The following discussion is organized according to strength of impact.

TABLE XVI. ESTIMATED ANNUAL PASSINGS OF CONSTRUCTION SITES —
ALL METROPOLITAN REGIONS* (MILLIONS OF OCCURRENCES)

	<u>Residential Buildings</u>	<u>Nonresidential Buildings</u>	<u>Municipal Streets and Public Works</u>	<u>Total</u>
Drivers and Passengers	8,300	8,160	1,980	18,440
Pedestrians	2,760	2,700	882	<u>6,342</u>
			Grand Total	24,782

*A "passing" is defined as one person passing one site by car or foot.

Speech Interference

Perhaps the single most obvious effect of exposure to construction site noise is speech interference. Even cursory examination of Table XV reveals that in almost all phases of construction, noise levels associated with construction activity are capable of degrading speech communication. In many instances - specifically, those in which construction noise produces levels approaching or exceeding 60 dB(A) in the listening environment - degradation of speech communication is severe. When one considers that the "average" levels of Table XVII are energy averages, it is clear that peak levels of construction noise, although infrequent, can preclude speech communication completely.

It is apparent from Table XVII that for those people who live or work in the vicinity of construction sites (i.e., those who receive primary exposure to construction noise), the duration of speech interference effects can be considerable. It seems safe to state that approximately 34 million people suffer a total of several hundred hours of speech interference yearly as a result of exposure to construction site noise in the United States. Approximately 20 million of these people must communicate in noise environments which seriously degrade speech intelligibility and/or demand significantly increased vocal effort.

In contrast to those who must endure such speech interference on a relatively long term basis, there are many more people who suffer the same effects on a briefer time scale. These people are the passersby who are exposed to construction site noise for a matter of minutes daily. Although the actual number of different individuals who pass by construction sites on foot or in vehicles is difficult to estimate, there are probably on the order of 25 billion such brief encounters yearly. The prin-

TABLE XVII. ORDER OF MAGNITUDE ESTIMATES OF YEARLY DURATION OF CONSTRUCTION NOISE EXPOSURE

	<u>Source</u>	<u>Number of People</u>	<u>Hours of Exposure by Construction Phase</u>				
			I	II	III	IV	V
	Primary (Stationary) Exposure to Domestic Construction Noise	11,500,000	24	24	40	80	40
	Primary (Stationary) Exposure to All Other Building Construction	1,500,000	80	320	320	480	160
	Primary (Stationary) Exposure to All Other Construction in SMSA Areas	14,500,000	8	8	16	16	8
	Municipal Public Works		12	12	24	24	12
∞	Federal and State Highway	<u>7,000,000</u>	250	250	500	500	250
	Subtotal						
	Secondary (Passerby) Exposure of Pedestrians to Construction in All SMSA Areas	6,342,000,000*	Five minutes' exposure to levels approximately 30 dB higher than those of Table XV				
	Secondary (Passerby) Exposure of Drivers and Passengers to All Construction in SMSA Areas	<u>18,440,000,000*</u>	Thirty seconds' exposure to levels approximately 15 dB higher than those of Table XV				
	Subtotal						

*These figures represent the number of annual occurrences of exposure, defined as the product of the number of people exposed and the frequency of their exposure.

cipal effect of such transient exposure to construction noise is probably interruption of conversation.

Applying state-of-the-art noise reduction techniques to the major sources of construction noise could provide a meaningful reduction of both the severity of speech interference and the number of people exposed to speech interference effects. Quietening all construction equipment by 10 dB(A) would lower peak construction noise levels by an equivalent amount and average levels by a somewhat lesser amount (due to overlapping temporal patterns of use). Nonetheless, speech interference effects increase sharply in the range between 40 and 60 dB(A), so that a noise reduction of about 10 dB(A) could be highly beneficial. Interestingly enough, the advantages of reducing construction noise an additional 10 dB(A) might not be as great. Although 20 dB(A) reduction of construction noise would clearly result in even less speech interference than would a 10 dB(A) reduction, at the resulting levels construction noise might well be submerged in background noise a good part of the time. Additional reductions [beyond the first 10 dB(A)] might be necessary for the benefit of those who operate the equipment, however.

Sleep Interference

To the extent that construction activity and sleep do not commonly occur during the same hours, construction noise does not interfere with sleep. However, daytime sleeping needs of the very young, the sick, and people working irregular or night hours, and emergency and other nighttime construction work must be taken into account. The total number of adults so affected by construction is estimated to be about 3 million. Judging from the ratio of people exposed to construction noise to the total population of the country, approximately 15% of the children four years of

age or younger, or about 2.5 million, might also be exposed to sleep interference from construction noise.

The 5.5 million people attempting to sleep during exposure to construction noise are likely to encounter substantial interference. Even at relatively great distances from construction sites, levels in the vicinity of 50 dB(A) are encountered. Such levels are capable of significantly lengthening the time required to fall asleep and of awakening roughly 40% of sleeping persons.

Nonetheless, the usefulness of reducing average construction noise levels by 10 dB(A) (possible through state-of-the-art noise reduction procedures) appears marginal. The number of people whose sleep is disturbed by construction noise is relatively small, and the shallow slope of the function relating the number of people awakened to noise levels argues that construction noise would have to be reduced by much more than 10 dB(A) to effect a significant reduction of sleep interference.

Hearing-Damage Risk

The risk of hearing damage from construction noise for those not directly concerned with construction activity does not seem very great. In most cases the distance between the construction site and people exposed to its noise and the transmission loss of the buildings or vehicles are sufficiently great to minimize the probability of hearing damage. It is possible that peak noise levels from construction sites might present some risk to those who are frequently in close proximity to the site. The greater number of such people (presumably pedestrians), however, are subject only to short exposure durations.

If state-of-the-art noise reduction techniques were applied to the major sources of construction noise, exposure levels would

probably be sufficiently reduced to render hearing damage a remote risk. In short, construction noise does not pose a major hearing-damage risk for the public.

Other Indirect Effects

Without doubt, a major consequence of exposure to construction noise for many people is annoyance. Both those who are exposed to construction noise on a regular, long-term basis as well as those who are exposed to it on a transient basis are annoyed by their exposure. Annoyance is particularly great if the noise intrusion from the construction site is perceived as unnecessary or inappropriate. People who must endure weeks or months of construction noise exposure may exhibit some form of habituation to the noise, but despite the commonly expressed attitude toward noise of "you get used to it", it is doubtful that construction noise ever loses all of its annoyance value.

In relative terms, annoyance from construction noise probably represents less of a problem than annoyance produced by aircraft or traffic noise. Nonetheless, both individual complaint behavior and community action could conceivably result from the annoyance of exposure to construction noise.

One measure formulated to provide some degree of quantification for annoyance due to noise exposure is the Noise Pollution Level [2]. Table I contains NPL's encountered in the immediate vicinity of construction sites. Unfortunately, interpretation of NPL's is not a straightforward procedure. Relative interpretations of two or more noise situations are readily enough made through use of the NPL index. Few grounds exist, however, for absolute interpretations. It has been suggested that long-term exposure to noise levels characterized by an NPL value of 72

(computed from A-level measurements) is "acceptable" [2]. By this criterion, noise levels in the immediate vicinity of construction sites are clearly "unacceptable" on a long-term basis. However, the bulk of exposure to construction noise of such high levels is of a transitory nature. Residents or transients exposed to construction noise would be exposed to levels about 30 dB lower. Although it would be tempting to assert that such exposure (to NPL's in the range of 60-70) would be marginally acceptable, only meager evidence could be marshalled to support such a claim.

It is distinctly possible for exposure to construction noise to result in task interference. It seems plausible that among the approximately 20 million people exposed on a long-term basis to the highest levels of construction noise (Table XV), some might be engaged in exacting manual or mental work which could be sensitive to interference. Such tasks might include medical operations, library use, scholarly activities, and the like. Unfortunately, one cannot quantify the amount of task interference produced by construction noise by applying the usual procedures of estimation and assumption.

Similar comments apply to the potential startle and physiological stress produced by exposure to construction noise. Although startle does not seem to be a very common consequence of exposure to construction noise, it is nevertheless possible for startle to result from unexpectedly or intermittently high-level noise. The size of the standard deviations of distributions of construction noise levels discussed in Sec. 3.2.1 makes the occurrence of unusually high noise levels reasonably probable events.

As for the stressful consequences of exposure to construction noise, we can offer only informed conjecture. Noise-induced

physiological stress is known to be cumulative, and exposure to construction noise is only one determinant. Perhaps some of the people who are faced with exposure to construction noise at work every day for months must also face noisy home environments. For such people, exposure to construction noise could constitute a major source of stress.

Tables XVIII and XIX summarize the impact of construction noise on people. A composite quantity intended to reflect both the extent and duration of exposure to specific noise sources was developed to permit concise summation. The quantity is defined as the product of the estimated number of people exposed to noise from a particular source and the estimated duration of individual exposure to the same source. The statistic expressing the quantity is called (for lack of a better term) the "person-hour".

Extreme caution must be used in interpreting figures expressed in terms of person-hours. First, figures so expressed are intended only as order-of-magnitude estimates rather than as precise quantities. Second, inferences about the equivalence of number of people and duration of exposure in assessing psychological or physiological impact are completely unjustified. No compensatory model of number of people exposed and exposure duration is intended. Third, comparison of person-hour figures for exposure to noise from one source with person-hour figures for exposure to noise of another source is without theoretical foundation. Thus, comparisons of impact among different sources expressed in common terms of person-hours should be performed in a fashion similar to "addition" of apples and oranges. In other words, inferences about severity of impact may be drawn only within person-hour estimates of similar origin.

TABLE XVIII. ORDER-OF-MAGNITUDE ESTIMATES OF CONSTRUCTION
NOISE EXPOSURE IN MILLIONS OF PERSON-HOURS PER WEEK

<u>Source</u>	<u>Millions of Person-Hours Per Week</u>
Primary (Stationary) Exposure to Domestic Construction Noise	46
Primary (Stationary) Exposure to All Other Building Construction	39
Primary (Stationary) Exposure to All Other Construction in SMSA Areas	<u>16</u>
Subtotal	101
Secondary (Passerby) Exposure to Pedestrians to All Construction in SMSA Areas	10
Secondary (Passerby) Exposure of Drivers and Passengers to All Construction in SMSA Areas	0.3

TABLE XIX. ORDER-OF-MAGNITUDE ESTIMATES OF IMPACT OF PRIMARY AND SECONDARY EXPOSURE TO CONSTRUCTION NOISE EXPRESSED IN MILLIONS OF PERSON-HOURS PER WEEK

<u>Noise Source</u>	<u>Speech Interference*</u>		<u>Sleep Interference*</u>		<u>Hearing Damage Risk</u>	
	<u>Moderate</u>	<u>Severe</u>	<u>Slight</u>	<u>Moderate</u>	<u>Slight</u>	<u>Moderate</u>
	(45-60)	(>60)	(35-50)	(50-70)	(70-80)	(80-90)
Primary (Stationary) Exposure to Domestic Construction Noise	44			2	0	
Primary (Stationary) Exposure to All Other Building Construction	38			2	0	
Primary (Stationary) Exposure to All Other Construction in SMSA Areas	14			1	0	
Secondary (Passerby) Exposure of Pedestrians to Construction in All SMSA Areas		10	0			10
Secondary (Passerby) Exposure of Drivers and Passengers to all Construction in SMSA Areas		0.3	0			0.3

*Entries in these columns may not be interpreted directly as person-hours of direct speech or sleep interference (see text).

With these restrictions firmly in mind, the reader is referred to Tables XVIII and XIX for a concise summary of the impact of construction noise on people. Table XVIII expresses the impact of construction noise in terms of millions of person-hours per week. (It may be useful to bear in mind that a week in the United States contains approximately 35 billion person-hours.) Table XIX relates the impact of construction noise directly to the principal criteria of Sec. 3.1 in terms of person-hours per week. Entries for speech interference and sleep interference effects reflect the number of person-hours of potential impact, which may be interpreted as upper bounds.

3.3 Appliances

3.3.1 Extent of exposure

This section is concerned primarily with power tools and household appliances whose volume cannot be controlled by the user. Therefore, volume-controllable equipment such as televisions, radios, and stereos are not included, nor are gasoline-engine powered outdoor equipment and audible signaling mechanisms (bells, alarms, etc.). It should be noted, however, that non-controllable noise-producing devices often raise the background level of noise to such a degree that volume-controllable sound has to be increased in level to be heard and, hence, is more apt to affect neighbors. An estimate of the number of noncontrollable noise-producing devices being used in the United States in 1971 is given in Table XX.

To determine the extent of exposure to home appliance and tool noise, we gathered three kinds of data: The distribution of appliances and tools over family units, the time that the devices are typically in use, and the exposure of people who are

TABLE XX. NONCONTROLLABLE HOUSEHOLD NOISE SOURCES (1971) [31]

	<u>Number (thousands)</u>	<u>Percent of Homes</u>
Wired Households	62,800	100
Complete Plumbing	58,000	93
Major Appliances		
Refrigerator	62,600	99.8
Clothes Washer	57,600	91.9
Vacuum Cleaner	56,900	90.7
Clothes Dryer	25,300	40.3
Freezer	20,000	30.0
Air Conditioner	18,000	29.6
Dishwasher	14,900	23.7
Food Disposer	14,400	22.9
Trash Disposer	(introduced in 1970)	
Other Appliances		
Food Mixer	51,200	81.7
Can Opener	27,100	43.2
Sewing Machine	31,300	50.0
Food Blender	19,900	31.7
Electric Shaver	25,000	40.0
Slicing Knife	25,000	40.0
Floor Polisher	10,000	16.0
Power Tools		
Saw, Drill, etc.	12,500	20.0
Outdoor Equipment		
Electric Mower	2,000*	3.2
Edger	1,000	1.6
Trimmer	4,000	6.4
Building Equipment (residential)		
Fan	50,000	80.0
Humidifier	4,600	7.4
Dehumidifier	4,200	6.7

*There are approximately 37 million powered mowers in use.

in the home. In collecting this information, we found that the variables, particularly with regard to personal behavior, covered a very large range. We therefore created a simplified model to show the extent of household noise.

Data were obtained from a variety of sources. Statistical information was collected from government sources, such as the Bureau of the Census. Of particular help was information provided by Cornell University's College of Human Ecology on domestic living patterns. Industry information was obtained from various trade and business publications. Individual company material was used in instances where the material was applicable to the whole industry and was available to the public. Various organizations representing consumers and home economists were contacted. We also conducted our own survey of appliance use in 20 households.

Appliances, Tools, and Building Equipment

The dimensions used by industry to analyze household appliance purchase and use patterns usually include home ownership, age of the head of the family, size of family, and family income. Since these dimensions are interrelated, we chose only one - family income level - for our analysis. We treat the time that appliances are used as a function of the age of the homemaker and of the number of school and pre-school children in the family. Figure 21 shows the trend toward greater use of home appliances and power tools. Figure 22 gives the distribution of some common appliances as a function of income level.

Noise-producing devices used in and around the home are usually classified as

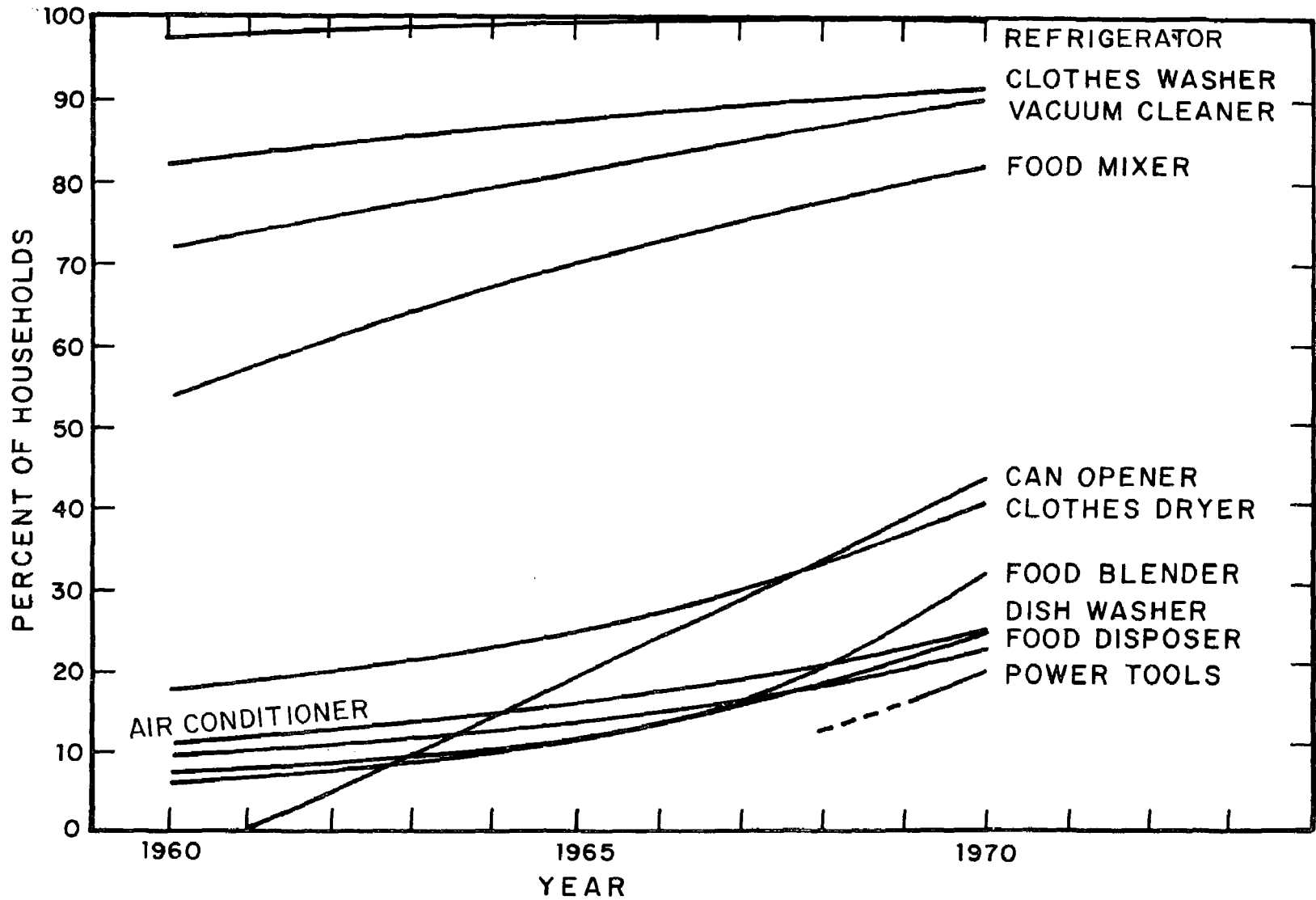

FIG. 21. PERCENT OF HOUSEHOLDS WITH SELECTED NOISE-PRODUCING APPLIANCES AND TOOLS.

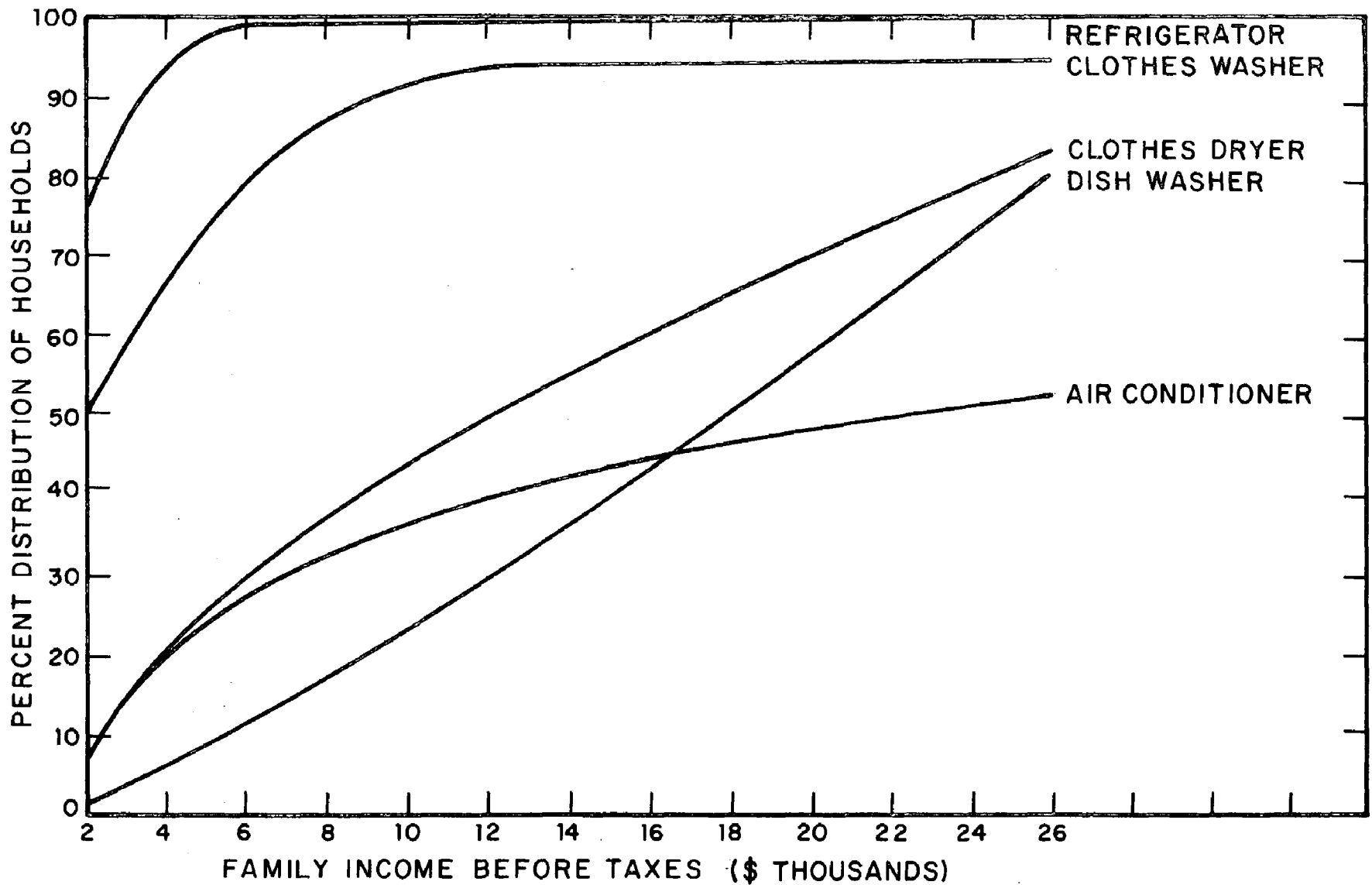

FIG. 22. ESTIMATED PERCENT-DISTRIBUTION OF MAJOR APPLIANCES BY INCOME LEVEL.

- Major Appliances (including clothes washers, clothes dryers, refrigerators and freezers, air conditioners, dishwashers, vacuum cleaners, disposers, dehumidifiers, and compactors)
- Other Household Appliances
- Power Tools
- Outdoor Equipment
- Building Equipment

Other convenient classifications are based on time mode of operation (continuous or intermittent) and method of operation (manual or automatic).

Analysis of the noise-producing building equipment used in homes is complicated by interaction of the equipment with the structure of the house, by do-it-yourself modifications of equipment, and by differences in the adequacy of equipment maintenance. Size of housing is also a factor in noise level. Smaller housing units are apt to be noisier because of reverberant buildup of sound levels. Larger housing units on the other hand, frequently reflecting a higher standard of living, tend to have more appliances and more frequent exposure but lower noise levels for any particular appliance owing to the larger space and to the room separation from the various sources. Multiple-family housing units are subject to higher levels of noise from the building equipment.

In heating systems either the heating source or distribution system or both are common sources of noise; however, the number of factors involved is too great to allow a precise analysis of the extent of heating noise. Electric heating, which is essentially noiseless, is currently being used by 4.4 million customers.

(It should be noted, however, that electric heating customers are likely to be high users of electric appliances. Furthermore, humidity control, ventilating, and/or air cleaning, which are often used in conjunction with electric heating, require air circulation; therefore, fan noise is present where these additional functions are performed.) The more common heating systems generate burner noise, fan/duct noise (in hot-air systems), and pipe, valve, and pump noise (in hot water and steam systems).

Twenty-one percent of all households have one or more room air conditioners. Location of these air conditioners is distributed approximately [38]:

Living Room	35%	Kitchen	7%
Master Bedroom	27%	Playroom	4%
Other Bedroom	5%	Other	22%

All dehumidifiers and many humidifiers are substantial noise sources. Frequently, dehumidifiers are located in the basement and therefore direct exposure to the noise is small. Dehumidifiers are used in 6.7% of homes; humidifiers in 7.4% [38].

Living patterns, equipment installations, etc. are variables that make it difficult to estimate the extent of plumbing noise. The typical range of toilet flushes is 10 to 50 per day. Complete plumbing (hot and cold water, bath or shower, toilet) is found in 82% of all rental units and in 93% of all owner-occupied units in the United States.

The number of fans being used in this country far exceeds the total number of households. Many fans are part of other appliances, but many are used for immediate air circulation (i.e., cooling fans, kitchen fans, etc.).

Use of Domestic Appliances and Tools

The extent to which appliances are used is an important factor in assessing the total noise exposure. Statistical information is scarce, but we have found the following sources useful:

- BBN survey (in-depth study of noise levels and appliance use in 20 homes).
- New York State College of Human Ecology, Cornell University (both published and unpublished data gathered as part of a 1296-household survey of Syracuse, New York).
- Department of Agriculture information based on studies of home activities (a long-term interest, which is now being continued under the Agriculture Research Service Division of the Department of Agriculture).
- Potomac Electric Power Company (an informal survey conducted by their Home Services Department).
- Manufacturer's industry information.

Although many factors affect the range of appliance use, there is a tendency for people in the family-raising years to have increased incomes, own their homes, and possess more appliances. The time a homemaker spends in household activities is a strong function of age, number of children, and the presence of pre-school children, as shown in Table XXI. Table XXII presents the information on which we base our estimate of typical use of appliances; Table XXIII gives our estimate of appliance use in two typical households; appliance operating times are estimated from Table XXII. Using the values of appliance use (total minutes per week) and of average noise levels given in Table XXIII, we present in Fig. 23 a schematic illustration of the noise levels of the two typical households.

TABLE XXI. AVERAGE HOURS PER DAY SPENT ON HOUSEHOLD WORK BY
 1296 HOMEMAKERS, ACCORDING TO NUMBER OF CHILDREN AND AGE OF
 YOUNGEST CHILD, SYRACUSE, NEW YORK AREA, 1967-68 [39]

	Hours
All homemakers	7.3
<u>Number of children</u>	
0	4.8
1	6.8
2	7.8
3	7.7
4	8.2
5 or 6	8.5
7 to 9	9.2
<u>Age of youngest child</u>	
Under 1 year	9.3
1 year	8.3
2 to 5 years	7.7
6 to 11 years	7.1
12 to 17 years	6.0

Level of Exposure

We have selected two criteria to show different measures of exposure. A *potential exposure* represents the number of people likely to be exposed to an appliance and depends solely on an average distribution of the population and the percentage of households that possess the particular appliance. A *primary exposure* is estimated by the normal mode of operation, the location

TABLE XXII. APPLIANCE USAGE SOURCE DATA (TIMES PER DAY UNLESS INDICATED)

Appliance	Cornell University Data, 1296 Homes* (N.Y. State College of Human Ecology)										Potomac Electric Co., Home Services Dept. (informal estimate for home with 2-3 children)	BBN estimate of use for family with 3 children	
	Percent of homes with appliance	Percent used var- ious day (of 1296)	Number of days in one week which appliance was used.										Ave.
			0	1	2	3	4	5	6	7			
Clothes washer†		62	135	104	167	197	163	163	178	189		2	1.5
Clothes dryer		43											1
Dishwasher	30		931	4	5	13	33	25	14	272		2	1.5
Food disposer	24	22	1002	1	5	2	5	3	10	268		6-7	6
Vacuum cleaner	97	48	111	211	275	260	164	76	80	119		3/wk	3/wk
Room air conditioner	17												
Trash disposer													
Food mixer }	98	28	277	226	286	207	153	80	28	39	1-2/wk	2/wk	
Food blender }													3/wk
Can opener											2	2	
Sewing machine												1/wk	
Slicing knife												1/wk	
Floor polisher	48	3	1161	107	17	6	1	0	0	4		1/mo	
Electric shaver												1	
Power tools (saw, etc.)												2/mo	
Mower	72											1/wk	
†No. of Loads	Loads	0	1	2	3	4	5	6	7	8	Ave.		
on One Day	Homes	502	210	263	159	82	44	18	6	4	1.50		

*Sample selected to give equal numbers of homes with different number of children; therefore, sample shows homes with more persons than national average.

TABLE XXIII. USE OF NONCONTROLLABLE NOISE-PRODUCING APPLIANCES AND TOOLS IN TYPICAL HOUSEHOLDS

	Household No. 1*				Household No. 2†			
	Average dB(A) ¹	Times Used Per Week ²	Minutes Per Use ³	Total Minutes Per Week	Times Used Per Week	Minutes Per Use	Total Minutes Per Week	
Major Appliances								
Clothes washer	64	10.5	30	315	7	30	210	
Vacuum cleaner	70	3	30	90	2	25	50	
Clothes dryer	57	7	30	210				
Room air conditioner	58	(full-time - seasonal)						
Dishwasher	65	10.5	45	472				
Food disposer	70	6	0.2	1				
Household Appliances								
Food mixer	69	2	5	10	3	5	15	
Can opener	69	14	0.2	2				
Sewing machine	72	1	15	15	0.5	15	15	
Food blender	76	3	1	3				
Electric shaver	64	7	2	14				
Slicing knife	71	1	1	1				
Floor polisher		1	10	10				
Trash disposer		14	1	14				
Power Tools								
Saw, drill, etc.	83	0.5	20	10				
Mower		1	30	30				
Edger	81	0.75	5	4				
Trimmer	81	0.25	15	4				

*2 Adults, 3 children (1 pre-school age), family income \$16,000.

†2 Adults, family income \$8,000.

¹Measurements taken 3 ft from source during BBN household survey.

²Based on data from BBN survey, Cornell Univ. survey of Syracuse, N.Y., and Potomac Electric Power Company information.

³Based on average cycle times of current model appliances.

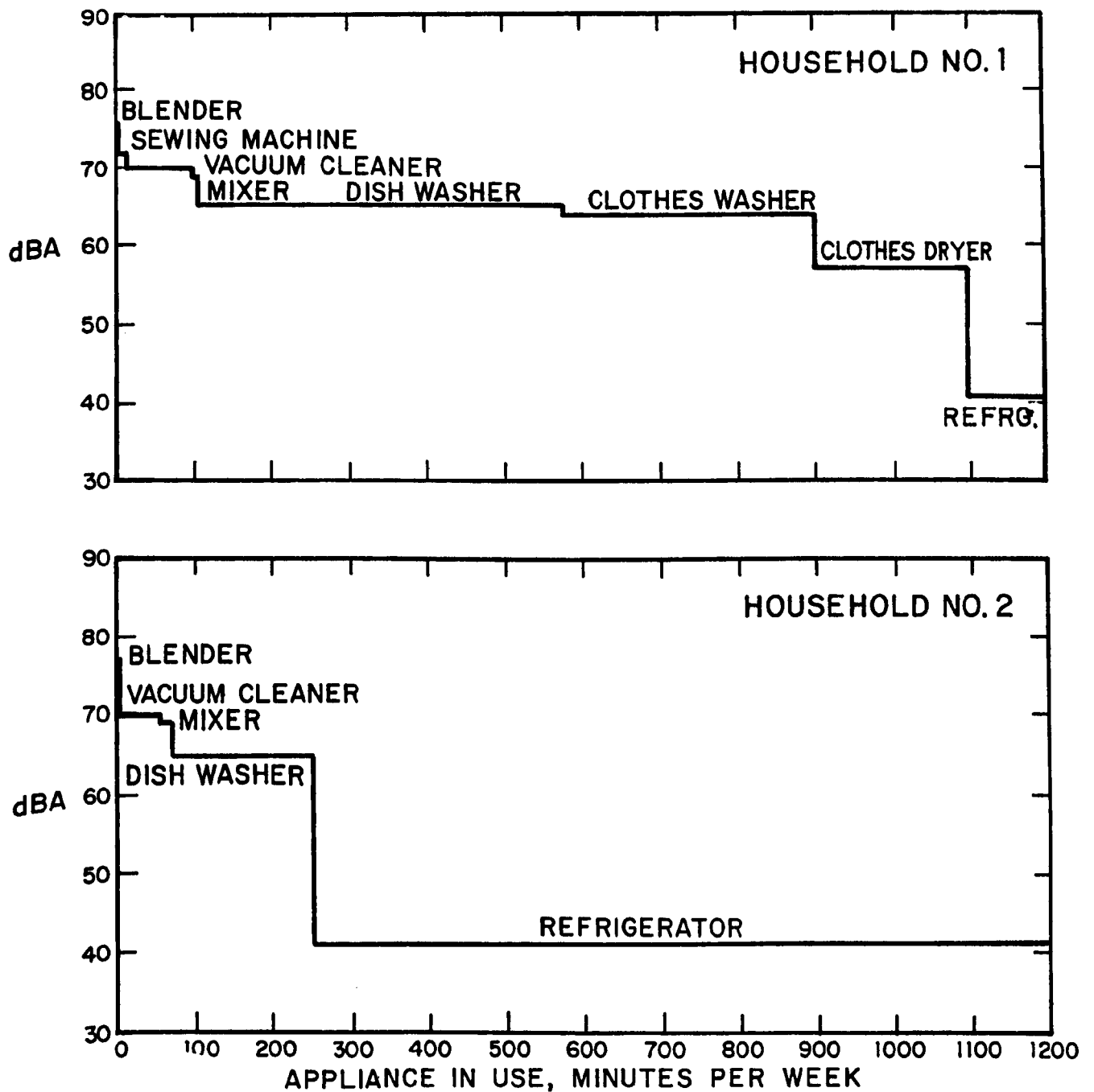

FIG. 23. NOISE PROFILES FROM APPLIANCE FOR TYPICAL HOUSEHOLDS PER WEEK (AT 3 ft)
 No. 1: AVERAGE-INCOME FAMILY WITH CHILDREN
 No. 2: LOWER-THAN-AVERAGE-INCOME FAMILY WITHOUT CHILDREN

of the appliance, and the number of operators and observers likely to be exposed to noise when the appliance is operating. Table XXIV gives these two kinds of exposure for each appliance; Table XXV relates exposure to income level.

3.3.2 Impact assessment

The estimates of the extensiveness of distribution, duration of exposure, and noise levels of a variety of building equipment and home appliances are discussed here with a view toward assessing the impact of noise from these sources on people in the home environment. To approximate the environment in which noises are heard, we had to adjust the noise levels from the standardized values used in previous sections (i.e., levels recorded at a measurement position 3 ft from the source). Thus, 10 dB was added to the noise levels of hand-held appliances, such as electric shavers, to obtain a fair representation of noise levels at the user's ear. Similarly, 2 dB was subtracted from levels for exposure to noise in a highly reverberant field, such as a kitchen or bathroom; 3 dB from standardized measurements to account for noise exposure in less reverberant spaces, such as carpeted (living room) or open areas; 10 dB from the standard values to compensate for exposure in adjacent rooms connected by open doors; and 20 dB to represent the transmission loss of a typical frame house to noise from external sources (such as powered yard tools). Levels for about thirty typical home appliance and building noise sources adjusted in this manner appear in Table XXVI.

Table XXVII classifies the noise sources discussed in the previous section of this report into four categories: (1) Quiet Major Equipment and Appliances, characterized by operating levels lower than 60 dB(A); (2) Quiet Equipment and Small Appliances,

TABLE XXIV. NUMBER OF INDIVIDUALS EXPOSED TO
INDICATED APPLIANCES (MILLIONS - 1970) [39]

	Potential Exposure	Primary Exposure
Major Appliances		
Refrigerator	199	70
Clothes washer	183	65
Vacuum cleaner	181	66
Clothes dryer	80	28
Freezer	63	23
Air conditioner	60	21
Dishwasher	47	17
Food disposer	46	17
Trash disposer	-	-
Household Appliances		
Food mixer	163	59
Can opener	86	31
Sewing machine	100	36
Food blender	63	23
Electric shaver	80	25
Slicing knife	80	80
Floor polisher	32	40
Power Tools		
Saw, drill, etc.	40	13
Outdoor Equipment		
Electric Mower	6	2
Edger	3	1
Trimmer	12	4
Building Equipment (residential)		
Fan	160	90
Humidifier	15	5
Dehumidifier	13	1

TABLE XXV. ESTIMATED NUMBER OF INDIVIDUALS EXPOSED TO
DOMESTIC APPLIANCE NOISE (MILLIONS - 1965)*

Family Income (\$ thousands)	Typical Appliance Possession	Total House- holds	Potential Secondary Exposure	Potential Primary Exposure			Total Persons Primary Exposed
				"Home- makers"	Children Under 6 yrs.	Night Workers	
Under 5	Mostly only essential	12.6	41	12.6	2.9	0.6	9.9
5 - 10 } 10 - 15 }	Wide variety of appliances	21.2	71	21.2	6.0	1.0	18.8
		16.8	55	16.8	5.0	0.8	14.4
15 and over	Often most appliances	12.0	39	12.0	3.8	0.6	10.5
Total		62.8	200	62.8	17.7	3.0	83.5

108

*Calculated from average distributions and income information in Ref. 36.

TABLE XXVI. SOUND PRESSURE LEVELS OF HOME APPLIANCES AND BUILDING EQUIPMENT ADJUSTED FOR LOCATION OF EXPOSURE [IN dB(A)]

<u>Noise Source</u>	<u>Level of Operator Exposure</u>	<u>Level of Exposure to People in Other Rooms</u>
Group I: Quiet Major Equipment and Appliances		
Refrigerator	40	32
Freezer	41	33
Electric Heater	44	37
Humidifier	50	43
Floor Fan	51	44
Dehumidifier	52	45
Window Fan	54	47
Clothes Dryer	55	48
Air Conditioner	55	48
Group II: Quiet Equipment and Small Appliances		
Hair Clipper	60	40
Clothes Washer	60	52
Stove Hood Exhaust Fan	61	53
Electric Toothbrush	62	42
Water Closet	62	54
Dishwasher	64	56
Electric Can Opener	64	56
Food Mixer	65	57
Hair Dryer	66	51
Faucet	66	51
Vacuum Cleaner	67	60
Electric Knife	68	60
Group III: Noisy Small Appliances		
Electric Knife Sharpener	70	62
Sewing Machine	70	62
Oral Lavage	72	62
Food Blender	73	65
Electric Shaver	75	52
Electric Lawn Mower	75	55
Food Disposal (Grinder)	76	68
Group IV: Noisy Electric Tools		
Electric Edger and Trimmer	81	61
Hedge Clippers	84	64
Home Shop Tools	85	75

TABLE XXVII. ORDER-OF-MAGNITUDE ESTIMATES OF THE EXTENT AND DURATION OF EXPOSURE TO BUILDING EQUIPMENT AND HOME APPLIANCES

	<u>NOISE SOURCE</u>	<u>PRIMARY EXPOSURE*</u>	<u>DURATION[†]</u>	<u>SECONDARY EXPOSURE*</u>	<u>DURATION[†]</u>
	Group I: Quiet Major Equipment and Appliances				
	Refrigerator	70	25	200	10
	Fans	90	10	178	5
	Air Conditioner	21	3	80	1
	Humidifier	5	3	15	5
	Clothes Dryer	28	0.5	80	1
	Freezer	23	0.25	20	0.50
	Group II: Quiet Equipment and Small Appliances				
	Plumbing (Faucets, Toilets)	200	2	200	5
	Vacuum Cleaner	66	1.5	181	1.0
	Dishwasher	17	5	47	8
	Clothes Washer	65	.5	183	1
	Electric Food Mixer	59	0.15	163	0.10
110	Electric Can Opener	31	0.03	86	0.02
	Electric Knife	80	0.02	80	0.01
	Group III: Noisy Small Appliances				
	Sewing Machine	36	0.25	100	0.10
	Electric Shaver	25	0.25	80	0.10
	Food Blender	23	0.02	63	0.02
	Food Disposer	17	0.10	46	0.05
	Electric Lawn Mower	2.0	0.50	4	0.25
	Group IV: Noisy Electric Tools				
	Home Shop Tools	13	0.10	40	0.10
	Electric Yard Care Tools	5	0.10	10	0.10

*In millions of persons

†In hours per week

characterized by noise levels between 60 and 70 dB(A); (3) Noisy Small Appliances, characterized by noise levels between 70 and 80 dB(A); and (4) Noisy Electric Tools, characterized by noise levels in excess of 80 dB(A).

Group I: Quiet Major Equipment and Appliances

Group I contains the noise sources to which people are exposed for the greatest lengths of time in the home environment. Most building climate-control equipment, food-refrigeration appliances, and clothes dryers fall into this category. In view of the widespread distribution of equipment in Group I, it is indeed fortunate that this equipment is among the least noisy in the home.

In general, due to the low levels of noise produced by equipment and appliances in Group I, effects of exposure are either negligible or mild. Noise sources in Group I present no appreciable risk of hearing damage under conventional operating conditions. Under certain conditions, however, these noise sources can affect sleep. Of the noisier sources in Group I, only fans and air conditioners are likely to be present in sleeping quarters at night. These devices are characterized by nearly steady-state spectra because of their continuous operation. Differences in levels among operating cycles are small, so that peak noise levels are usually within a few dB of average levels. As such, these devices may delay the onset of sleep, but are unlikely to awaken many people. They may, in fact, facilitate sleep for those directly exposed to their noise, since they function as sources of masking noise which can suppress interference from other sources.

The major effect of exposure to noise from Group I equipment is speech interference. Conversations in the immediate vicinity of the noisier sources of Group I would have to be conducted in somewhat higher than normal levels, or at slightly shorter than normal speaking distances.

The annoyance value of exposure to noise from Group I appliances is also minimal. The steady-state nature of their amplitude and frequently spectra are highly conducive to rapid habituation. Only rarely does one become sufficiently aware of refrigerator noise, for example, to become annoyed by it. Indeed, it is the noise sources of Group I which define the background noise environment of many homes.

Exposure to Group I noise sources has little or no bearing on startle and stress. Very few people are startled by the noise of their air conditioners or feel menaced by the implications of their refrigerator's whirring.

Considering the mild nature of most of the effects of exposure to noise from Group I sources, noise reduction is not an urgent need. Many appliances in Group I already operate at or near the level of background noise in the home, so that submerging them further into the background noise environment would serve little purpose. Those few noise sources in Group I which do produce noise levels appreciably above background levels could probably profit greatly from approximately 10 dB(A) of quieting. Such noise reduction, well within the capabilities of existing technology, would alleviate the undesirable effects of noise exposure from this group of appliances.

Group II: Quiet Equipment and Small Appliances

Most of the noise sources of Group II are found in many American homes, although not all of the sources are as common as the major equipment and appliances of Group I. Noise levels in Group II are sufficiently elevated to render certain appreciable effects, particularly speech interference and annoyance. Fortunately, the typical pattern of exposure is an infrequent, brief encounter.

Of the three major effects by which noise impact is gauged in this report, noise sources in Group II produce only speech interference in significant measure. Hearing-damage risk is negligible, both for operators and for others who may experience secondary exposure. Since most of the appliances in this group require an operator, sleep interference is not a serious consequence of primary exposure. Secondary exposure probably affects daytime sleeping to some slight extent. Secondary exposure to plumbing noise in multi-unit residences could conceivably awaken as many as 35% of sleepers, although habituation probably reduces the percentage dramatically.

Operators of the appliances in Group II would find speech communication during operation quite difficult; conversations would have to be conducted with significantly greater than normal vocal effort or at very short ranges, and the intelligibility of fixed level speech (such as radio or television) would become marginal. The obvious mitigating circumstances, however, is the brevity of noise exposure typical of this group of appliances. In practical terms, the most likely consequence of exposure to this sort of short duration appliance noise is a temporary interruption of conversation.

Annoyance is the most significant of the indirect consequences of exposure to noise from Group II appliances. While the operator may be summarily annoyed by the brief speech interference effects, people experiencing secondary exposure may be equally, if not more, annoyed. The annoyance of these people (such as neighbors in multi-unit residences or other family members in different rooms) is conditioned in part by the intrusive nature of the exposure and in part by feelings of lack of control of the noise source. Feelings of helplessness, exasperation, or frustration are themselves unpleasant and can produce further annoyance. Should secondary exposure become unduly or unreasonably common, physiological stress from emotional arousal might develop.

Primary exposure to the noise of these appliances is not likely to result in much task interference. This is true simply because it is the undemanding and highly practiced task at hand that is generating the noise. Exposure to appliance noise for people other than the operator could interfere with certain highly sensitive tasks. Generally, however, considering the usual brevity of exposure, such task interference would be the exception rather than the rule.

A 10 dB(A) reduction of noise levels produced by appliances of Group II would be a useful and worthwhile endeavor. Many of the effects of secondary exposure would become negligible, while the speech interference effects for the operator would be considerably reduced. It is clear from Table XXVII that the single most common source of noise exposure in the home is plumbing. Better design of plumbing fixtures would have a gradual but significant effect in making multifamily residences less noisy. Sales resistance to less noisy products (including the much-discussed "quiet vacuum cleaner") may be expected to diminish as the public becomes more noise conscious.

Group III: Noisy Small Appliances

The distribution and exposure patterns of noise sources in Group III continue the trend observed in Group II. Group III appliances are found in fewer homes than the appliances of the preceding group. Exposure to their noise is for equally brief periods at long intervals. Both of these factors tend to moderate the impact of the relatively high-level noise developed by these appliances.

Hearing-damage risk can no longer be dismissed as of minor importance for this group of noise sources. While it is true that average exposure is measured in fractions of hours per week, it is very likely that certain elements of the population are exposed to one or another of Group III source for prolonged periods of time. Home seamstresses, for example, could easily be exposed to several hours of sewing machine noise daily. Yard care specialists might be exposed to equivalent amounts of lawn mower noise. Although even these exposure durations would not constitute an imminent hazard to hearing (in the sense that they would be unlikely to lead to sizeable permanent threshold shifts for many years), they would nevertheless hasten eventual hearing damage in the context of cumulative exposure from many sources. In Miller's [16] terminology, noise sources in Group III would be rated "yellow" (cautionary) with respect to hearing-damage risk.

Speech interference is severe. Operators receiving primary exposure to noise sources of Group III would not attempt conversation during the brief periods in which the appliances are used, although communication by shouting would still be possible. Secondary exposure to the noise of Group III sources would also interfere somewhat with verbal communication. The principal

form of interference, however, would be degradation of speech intelligibility rather than more severe disruptions of conversation.

Since appliances of Group III require operators, sleep interference effects of primary exposure to their noise are negligible. Sleep interference effects of secondary exposure to this set of appliance noises also tend to be low, both because the noise exposure often occurs during hours during which sleep is uncommon and because the very brief periods of exposure occur only infrequently. Of course, the tendency for more mothers to be employed outside the home during the day constrains their use of appliances to evening hours, when the attendant noise levels may interfere with family social activities and the sleep of young children.

Annoyance is once again the chief indirect effect of exposure to noise from Group III sources. The operator himself may find the noise signature of the appliance unpleasant, particularly if it contains pure tone components or a highly variable temporal distribution of levels. Secondary exposure to these noises is also likely to be annoying, particularly if the people exposed to the noise feel that they are deriving none of the benefits of the appliance's use.

Task interference, startle, and stress reactions are all plausible consequences of exposure to this sort of noise. As usual, however, difficulties in assessing the unexpectedness of the intruding signal or the nature of background activity make precise prediction of the magnitude of these effects impractical.

Reduction of noise produced by appliances of Group III could substantially reduce the levels of hearing-damage risk and speech interference. The operator's annoyance with the noise signature of an appliance could also be affected by noise reduc-

tion, but special attention would have to be paid to the spectral characteristics of the appliance. All of the effects of secondary exposure to noise from this appliance group would be significantly lessened by a 10 dB(A) reduction of noise output levels.

Group IV: Noisy Electric Tools

Group IV contains the appliances which produce the highest levels of noise exposure in the home environment. Considering the potentially serious effects of exposure to such levels, it is fortunate that the distribution of sources is quite restricted. As may be seen from Table XXVII, only about 250,000 electric yard care tools have been sold, and only about 12 million electric shop tools are in use. Further, the use of such tools is probably concentrated in nonurban areas where secondary exposure effects are not as widespread as they might be in multi-unit residences.

Hearing-damage risk can be great if exposure to the noise levels of Group IV sources is habitual or prolonged. Hobbyists who engage in regular use of power tools are likely to receive considerably more than the average six minutes per week exposure noted in Table XXVII. Many such tools (saws, drills, routers, etc.) are operated within a few feet of the user's ear, making hearing-damage risk even more probable. In Miller's (1971) terminology, such tools can produce "orange" or even "red" hearing damage risk if exposure is prolonged. It is doubtful that any major risk of hearing damage is encountered in secondary exposure, owing to the much lower levels experienced.

Speech interference effects of exposure to noise of Group IV sources can be of sufficient magnitude to preclude verbal communication in any form other than shouting directly into the

ear. Even the speech interference effects of secondary exposure can be great enough to require conversation to be conducted at high levels of vocal effort or at very short distances. As was pointed out earlier, however, relatively few people are affected by such secondary exposure, and those who are affected are exposed for very brief intervals.

Sleep interference effects of exposure to Group IV sources would be quite serious were the hours of use of Group IV appliances to coincide with hours of attempted sleep. Primary exposure, of course, is not a problem here, but even secondary exposure can reach levels in the vicinity of 60 to 70 dB(A). Data from the Wilson report [26] may be interpreted as predicting that such levels will awaken one-half of all sleepers and about one-third of all people would find it difficult to fall asleep. Use of electric yard care tools at night is unlikely, but home shop tools are often used at night.

To the extent that noise exposure to such high levels is perceived as avoidable or unnecessary, annoyance effects are probably quite pronounced. A neighbor's noise, particularly at such high levels, is rarely welcome. The high noise levels produced by these tools may also interfere with the very tasks the operators are attempting to accomplish. If noise levels are sufficiently high to mask warning signals or other unexpected acoustic signs of danger, the safety of the operator and his efficiency may be compromised. Stress produced through prolonged exposure to noise levels characteristic of Group IV tools may be appreciable, particularly if exposure is involuntary.

Considering the seriousness of the effects of exposure to noise of appliances in Group IV, application of noise reduction techniques is urgently needed. Reduction of noise levels by as

little as 10 dB(A) would have immediate benefits in reducing the hearing-damage risk to the operator and reduction of the speech interference and annoyance-related effects for those receiving secondary exposure.

Summary of Effects of Appliance Noise on People

Tables XXVI and XXVII summarize the impact of appliance noise on people in concise terms. Table XXVII contains an account of the extent and duration of noise exposure from all four appliance groups in terms of millions of person-hours per week. The reader is reminded of the cautions expressed in the summary of Sec. 3.2.1 for the interpretations of figures expressed in person-hours. Table XXVIII relates person-hours of exposure directly to the major criteria of Sec. 3.1.

3.4 Projections of Construction and Appliance Noise to the Year 2000

Projecting conditions to the year 2000 involves a number of uncertainties. One of these is the exponential rate at which technology is evolving and affecting society. As pointed out by Sir Arthur Clark*, life in the year 2001 will be as different from the present as the present is from 1890. Who - in 1890 - could have realized the impact that electricity and the automobile would have both on life style and on the environment? Technological innovation, however, is not the only factor to be considered. One simply cannot account for future changes in social attitudes. Although a few far-sighted technologists may have predicted in 1940 the capability to transport passengers at

*Lecture to the Arlington Library Association, Arlington, Mass. (Sept. 1970).

TABLE XXVIII. ORDER-OF-MAGNITUDE ESTIMATES OF EXPOSURE TO HOME APPLIANCE AND BUILDING EQUIPMENT NOISE EXPRESSED IN MILLIONS OF PERSON-HOURS PER WEEK

Noise Source	Speech Interference*		Sleep Interference*		Hearing Damage Risk	
	Moderate (45-60)	Severe (>60)	Slight (35-50)	Moderate (50-70)	Slight (70-80)	Moderate (80-90)
Group I: Quiet Major Equipment and Appliances						
Fans	1200		0		0	
Air Conditioner	242		121		0	
Clothes Dryer	94		10		0	
Humidifier	10		15		0	
Freezer	0		0		0	
Refrigerator	0		0		0	
Group II: Quiet Equipment and Small Appliances						
Plumbing (Faucets, Toilets)		535	267		0	
Dishwasher		461	4		0	
Vacuum Cleaner		280	0.5		0	
Electric Food Mixer		222	1		0	
Clothes Washer		215	0.5		0	
Electric Can Opener		117	0.2		0	
Electric Knife		1	0.1		0	
Group III: Noisy Small Appliances						
Sewing Machine		19		0.5	9	
Electric Shaver		6		1	5	
Food Blender		2		0.2	0.5	
Electric Lawn Mower		1		1	0.3	
Food Disposer		0.5		0.5	0.5	
Group IV: Noisy Electric Tools						
Home Shop Tools		5		2		1
Electric Yard Care Tools		1.5		.1		0.4

120

*These figures are not directly interpretable in terms of person-hours of lost sleep or speech interference (see text).

supersonic speeds, it is doubtful that they could have predicted that such a technologically feasible system would be abandoned largely because it was expected to make too much noise.

Although any long-term predictions are fraught with such difficulties, one can still make educated guesses with a reasonable level of confidence. Rather than merely extrapolate existing conditions to the indefinite future, we try to be somewhat quantitative by projecting the impact of construction and appliance noise on the basis of existing forecasts of population, family size, gross national product, and trends toward urbanization. Construction activities will continue to follow such growth patterns, although the character of construction may change significantly with greater use of prefabricated materials and the introduction of new kinds of equipment. Similarly, ownership of appliances has been found to be a function of family income level, and we use their relationship to project the growth of appliance use in the generally more affluent households predicted for the year 2000. Also, rather than trying to account for conflicting trends and changing attitudes, we project the extent of exposure with the assumption of no change in noise level for a given equipment or appliance type and consider only major trends that can be easily identified.

We use the following data, taken from the U.S. Census Bureau, for projecting the increase in exposure to construction and appliance noise:

	<u>1970</u>	<u>2000</u>	<u>Ratio</u>
GNP (billions of 1958 dollars)	720	2240	3.2
Total Population (millions)	200	293	1.45
Total Number of Households (millions)	63	104	1.65
People per Household	3.17	2.8	0.9

3.4.1 Construction activity

Given the predicted increase in population and in financial resources, one can expect fairly extensive building activity. However, the urban areas have limited space available for new building; thus, the trend is for areas outside those now identified as central cities to become urbanized. Figure 24 illustrates this trend for single-family, multi-family, and nonresidential construction activities. With available land becoming more and more scarce within the central city, the building of single-family and multi-family dwellings will continue to decrease sharply. In 2000, we can expect to find approximately one-third the number of residential construction sites as were active in 1970. Nonresidential building is expected to increase. In areas outside the central cities, both residential and nonresidential construction should increase significantly. Nonresidential building activity is expected to increase by over 50% as the present suburbs become urbanized. With this general trend in mind, we use the data given above to project the expected increase in exposure to noise from construction activities.

Nonresidential

We assume that the level of nonresidential construction activity in any given year is proportional to the real Gross National Product (GNP) for that year. To find the nonresidential construction activity for any particular year, the ratio of the GNP for that year to the 1970 GNP is multiplied by the number of nonresidential sites built in 1970 (Table X). The resulting total construction figures are apportioned between "central cities" and "other metropolitan areas" in the same proportions as occurred in 1970. Despite the expected decrease in total con-

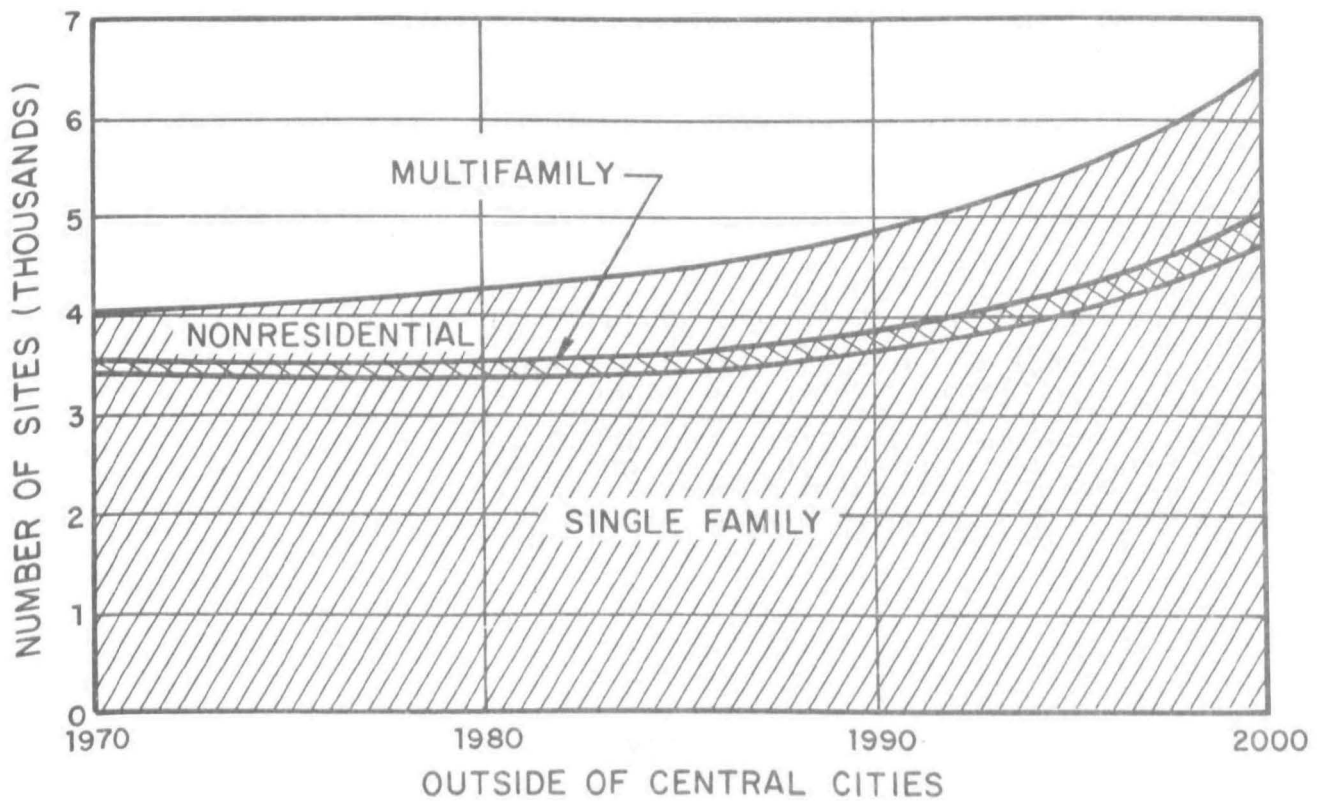
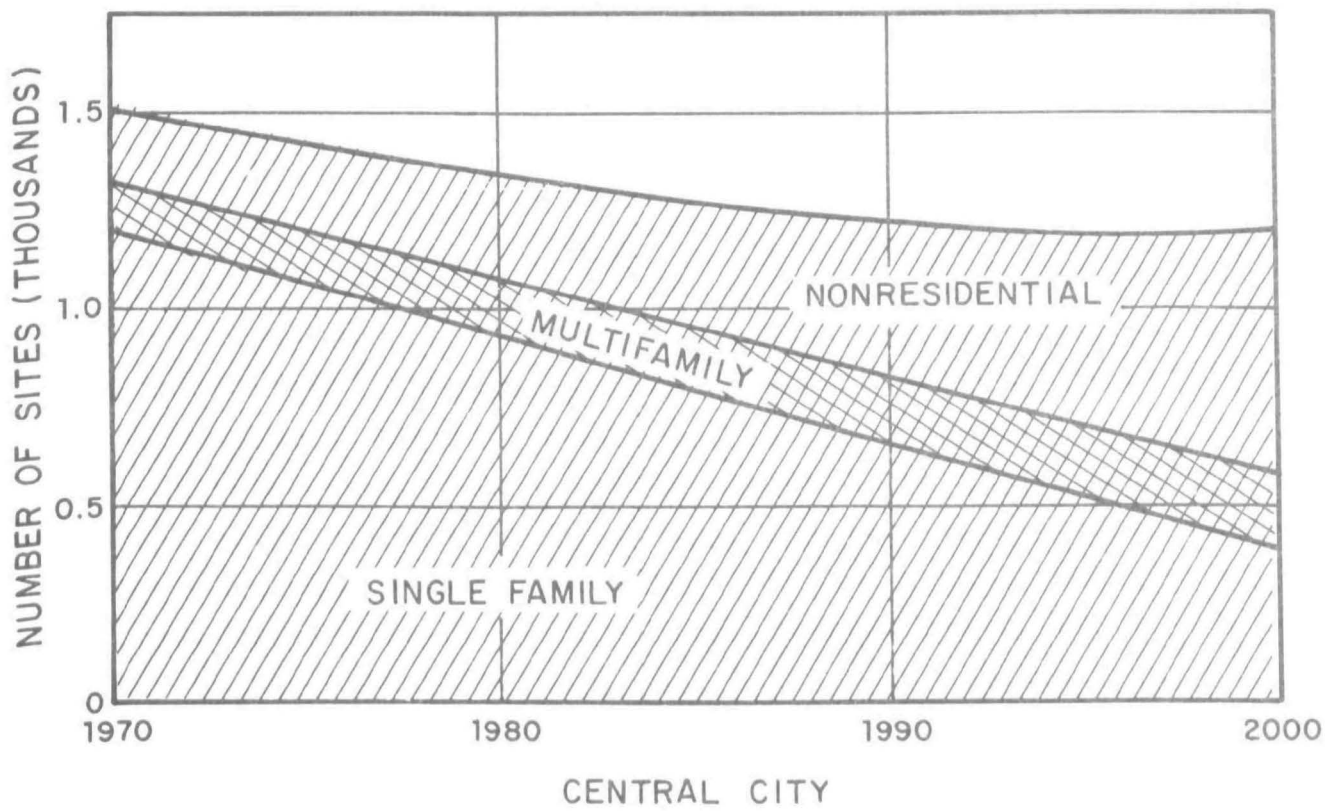

FIG. 24. NUMBER OF BUILDING CONSTRUCTION SITES PROJECTED TO THE YEAR 2000.

struction site within the central city, nonresidential sites are expected to increase.

Residential

We assume that the population and population density of central cities will remain at their present levels until the year 2000, and that most residential construction in central cities will be for the purpose of replacing decayed units rather than for housing new population. The number of construction sites will decrease due to the established trend toward an increasing population of multi-family dwellings over single-family dwellings. (Two- to four-family houses, which represent a negligible fraction of total construction, are here included in the total for single-family housing.)

For metropolitan areas other than suburbs, the number of units constructed in any one year is assumed to be proportional to the population increase in the previous ten years. To estimate this increase, we project the total metropolitan population by multiplying the projected total national population by the estimated proportion of the population living in metropolitan areas. All the increase in metropolitan areas population for a particular year is ascribed to noncentral city areas.

Roads

A simple but plausible indication of road construction activity, is the population level. Clearly additional people will require additional roads, the capability of rapid transit being small at present. However, the urban areas have limited space for new roads, and urban residents are expressing increasing opposition to new road construction on grounds of aesthetics,

pollution, and the community dismemberment concomitant with the installation of limited access highways. Thus, it would seem unlikely that road construction will rise as fast as other measures such as the GNP. We therefore project the future level by multiplying the present level of activity by the ratio of the projected population divided by the current population.

The number of people affected by construction sites is computed in the manner described in Sec. 3.2.1. Population densities for all metropolitan areas are assumed to be constant with time - 4500 people/sq mi for central cities and 2400 people/sq mi for other metropolitan areas. At any one site, people are apportioned to specific transmission loss intervals according to the method shown in Fig. 20. The resulting exposure to construction noise is given in Fig. 25 in person-hours. In this figure, multi-family residential construction has been included with nonresidential construction, since these types of building activities are quite similar. Note that the number of people exposed to noise from single-family dwelling construction declines steadily with time. This trend is more than compensated for by the rapid increase in nonresidential and multi-family sites - for which the duration of construction is typically six times greater than the duration for single-family houses. Thus, the number of person-hours of exposure is expected to increase by about 50% in the next 30 years.

3.4.2 Appliance use

We assume that the probability of future appliance ownership as a function of income level will remain the same and that appliance costs will remain approximately the same in current dollars. With these assumptions in mind, we base our approximation of appliance use on projected population, family income,

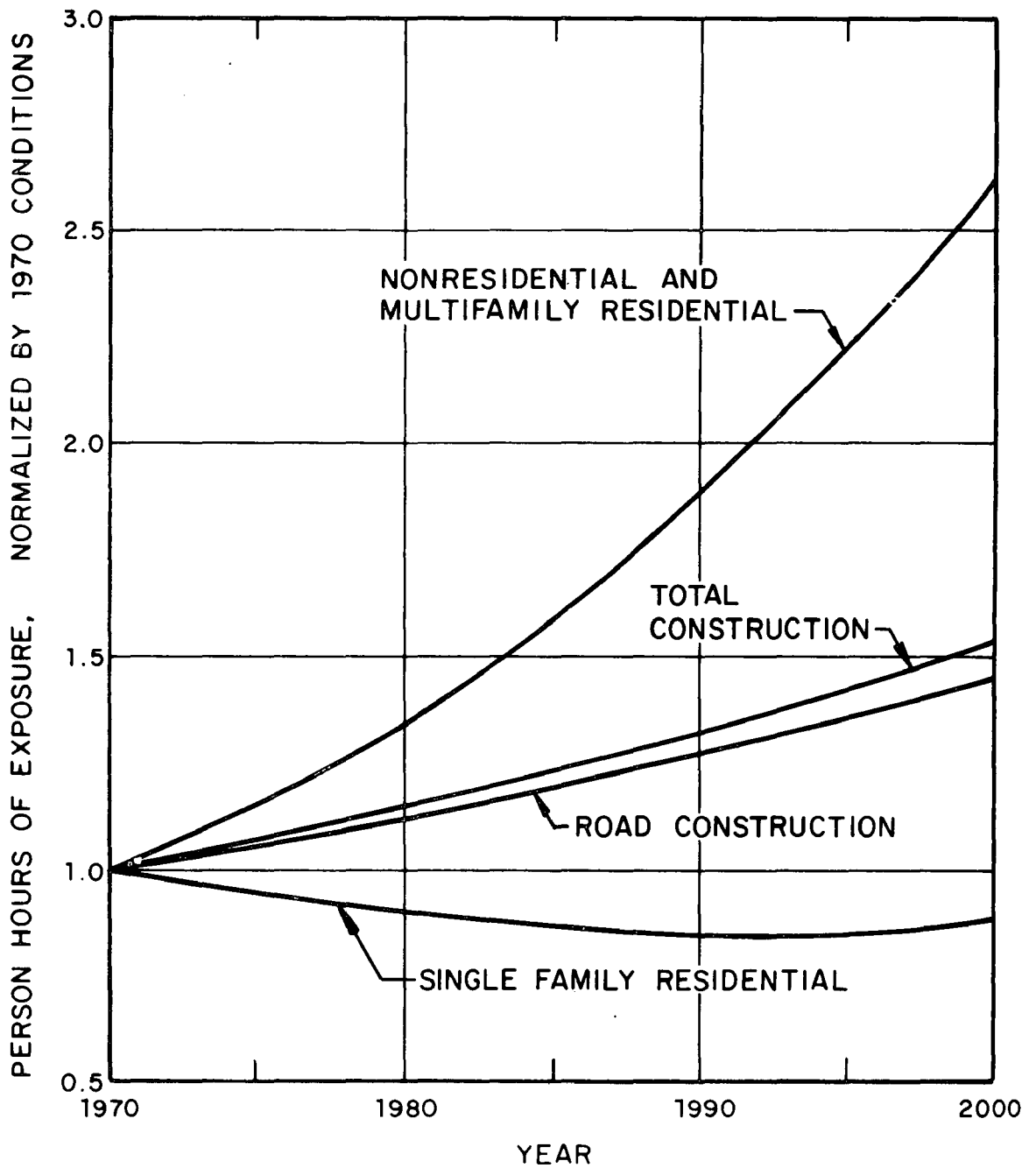

FIG. 25. PROJECTED CHANGE IN EXPOSURE TO CONSTRUCTION NOISE, ASSUMING NO CHANGE IN NOISE LEVELS.

and income distribution. This estimation is likely conservative as some appliances are continuing to increase their acceptance in all income levels, although their growth of acceptance is low at the higher income levels where some appliances have nearly saturated the market. For those appliances for which insufficient information is available on appliance possession at the various income levels to make the projection described above, we estimate future possession from current marketing information on percentage of replacement sales and on market penetration.

In projecting future impact, we estimate that the appliance usage will remain approximately at current levels. Supporting this assumption is the little deviation shown in average time spent by homemakers over the last forty years.

Figure 26 illustrates the increase in exposure to appliance noise by plotting hearing-damage risk and speech and sleep interference in person-hours of exposure. As explained in Sec. 3.1, these three effects are among the most salient and tangible consequences of noise exposure and thus can be most readily interpreted in nontechnical terms. As can be seen on Fig. 26, we project that number of person hours during which people will be exposed to the risk of hearing damage will more than double in the next thirty years, as will the number of person-hours during which normal conversation will be difficult and people will be either awakened or prevented from falling asleep.

As explained previously, we have not taken into account certain trends, discussed in Sec. 4, which are having some effect on the noise levels produced by construction equipment and appliances. However, one should note, when reviewing these projections, that industries are becoming sensitive to a growing concern about noise pollution among the general population. For

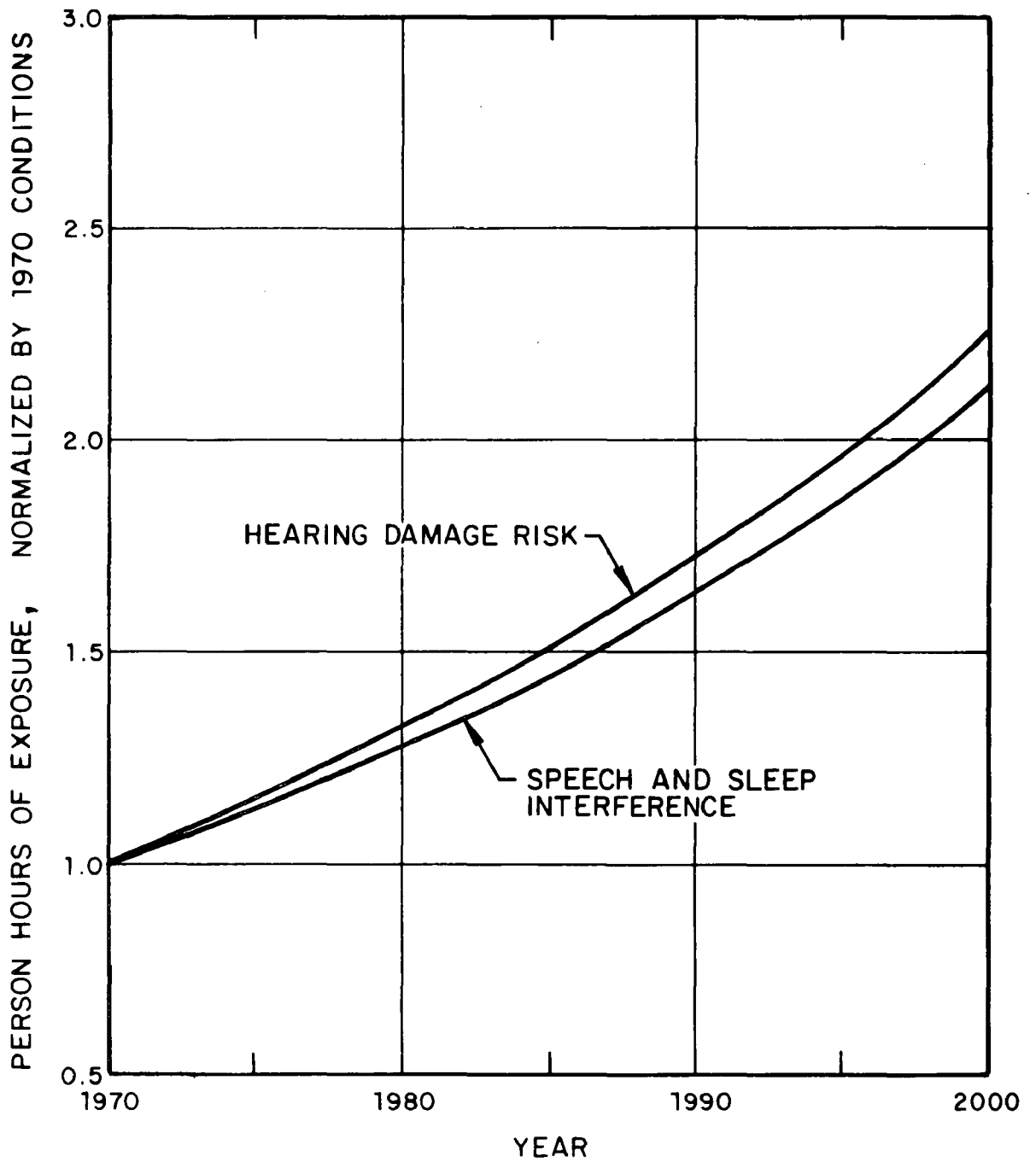

FIG. 26. PROJECTED CHANGE IN EXPOSURE TO APPLIANCE NOISE, ASSUMING NO CHANGE IN NOISE LEVELS.

example, construction equipment has become noisier as it has become more powerful; yet, one manufacturer has developed and is marketing a quiet air compressor. Conversely, refrigerators and air conditioners have become noisier as manufacturers have strived to meet market-place demands for extra features and smaller size. Thus, rather than try to account for an infinite number of variables, we have assumed no change in noise levels for both construction equipment and appliances. We feel that this method has resulted in reasonable near-term projections, if no noise control action is taken.

4. INDUSTRY EFFORTS

4.1 Introduction

Efforts by industry to quiet products are usually motivated by two factors: market place demand and government regulation. The consumer can exert pressure on industry by electing to buy or not to buy or by selecting a competitive brand that produces less annoying noise levels. This kind of "consumer regulation" can be very effective -- particularly with regard to appliances -- in that manufacturers are quick to respond to consumer tastes. However, consumer pressure can also subvert efforts a manufacturer may wish to make; for example, housewives often associate the noise produced by a vacuum cleaner with its ability to clean -- the noisier the machine, the more satisfied a homemaker may be with its performance. In any event, the purchaser can apply direct pressure to the industry.

Public pressure, on the other hand, is usually very ineffective. The only recourse for people who do not own the noise sources to which they are exposed is to register a complaint. Such complaints have no effect whatsoever unless enough exposed people organize and concentrate their efforts on a particular source. This kind of community response may eventually result in government regulation.

Our analysis of industry efforts to quiet construction equipment, appliances, and building equipment was organized as follows:

- We constructed a matrix of common products and significant manufacturers.

- We rank-ordered products as to approximate magnitude of noise impact or need for quieting.
- We rank-ordered manufacturers as to their importance in the product area.
- We examined the resulting manufacturer/product "intersections" with a view toward organizing a number of interviews that would cover important products and leading firms and still be within the time and effort constraints of the study.
- We developed an extensive interview format both to guide the interview and to provide a standardized method of reporting. (Full use of this format was not possible within the constraints of this study; it could be useful, however, in the event that industry efforts are to be examined in more detail.)
- Under guidance of the format developed, we collected subjective data and objective observations; this information forms the basis for representative generalizations cited in this report.

As expected, the industry is concerned about releasing data which might disclose proprietary ideas or expose a competitively sensitive area of operations. Accordingly, identity of sources is carefully safeguarded herein. This need for corporate security has limited our collection of statistically meaningful data; the trends observed, however, are clear and, in themselves, undoubtedly represent the noise control environment in industry.

4.2 Construction Industry Efforts

We view the construction industry as consisting of two major sectors: equipment manufacturing and equipment operation (i.e., building construction). The functions of these two sectors of the industry are so different as to warrant separate discussion.

4.2.1 Equipment operation

Section 3.2 describes this sector of the construction industry in detail, identifying types and phases of site activity and describing the areas in which noise abatement can be achieved.

The industry has, in fact, done almost nothing to quiet site operations. Its attitude may be attributed in part to the fact that quiet equipment has not yet been made available on a cost-effective basis; however, a limited capability does exist for quieting a site by relocating or rescheduling equipment. This sector has not exercised its influence as a "consumer" to bring pressure to bear on the equipment manufacturers, nor has it responded to public complaints. Hence, regulatory measures may be the only solution to the problem of construction site noise, and such regulations are imminent.

4.2.2 Equipment manufacturers

There are approximately 2000 manufacturers* of construction equipment in the U.S. In total, these companies offer about 200 different products. For the purposes of assessing the state of noise control in this sector of the construction industry, we

*Defined by counting separately certain divisions of larger firms which have a highly identifiable product line.

categorized 48 general types of products that are potentially significant noise sources. We group these product types into three orders of classification: (1) class of noise problem anticipated, (2) relation of equipment to function at the site, and (3) specific equipment names.

I. Engines and power trains

A. Excavating equipment

1. backhoes
2. clamshells
3. dozers
4. draglines
5. loaders
6. rippers
7. (power) shovels

B. Highway equipment

1. compacters
2. graders
3. pavers
4. pipe layers
5. pulverizer/mixers
6. rollers
7. rotary borers and drills
8. scrapers
9. street sweepers
10. trenchers and backfillers

C. Equipment to handle finished materials

1. cranes
2. fork (and similar) lifts
3. travel lifts

D. Mobile units

1. tractors, crawler
2. tractors, wheel
3. trucks

E. Power supplies

1. compressors
2. electric-power generators

- II. Interaction between equipment and materials (may include engines and power trains)
 - A. Equipment to handle bulk materials
 - 1. bins (and hoppers)
 - 2. concrete mixers
 - 3. conveyors
 - B. Large impact tools
 - 1. drop hammers
 - 2. pile drivers
 - C. Medium impact tools
 - 1. jack hammers
 - 2. rock (vibrating) drills
 - D. Small impact tools (power)
 - 1. impact hammers
 - 2. impact wrenches
 - 3. riveters
 - 4. stud drivers
 - E. Rotary tools
 - 1. bench drills
 - 2. grinders
 - 3. hand drills
 - 4. hand saws
 - 5. table saws
- III. Miscellaneous (may include sources characteristic of I and II above)
 - A. Pumps
 - 1. concrete pumps
 - 2. stripping pumps
 - 3. well-point pumps
 - B. Other
 - 1. burners and heaters
 - 2. sand blasters
 - 3. screeds
 - 4. concrete vibrators

Two assumptions underlie the terminology selected:

(1) equipment in transit under its own power is a truck or tractor, even though when working it may be a dozer or a crane, and (2) classification by function at the site is arbitrary since many types of equipment have several uses.

Manufacturers of construction equipment can be classified according to size/type of equipment produced as

- large companies producing large volumes of essentially similar, large items of machinery;
- medium-size companies producing "customized" production runs of more limited numbers, usually of smaller machinery; and
- manufacturers of power hand tools and pneumatic equipment.

Our interview program was organized to cover the two major acoustic source types (prime-movers and power trains) and the forty-eight types of products and three classes of companies identified above. We concentrated our efforts on significant leaders in the industry and companies producing a wide variety of products that have high levels of noise output:

- Of the ten manufacturers intensively interviewed, about eighty product analyses resulted.
- Eight of the firms produced equipment in which the prime-mover or power train is a significant source of noise; two companies produced only power hand tools.

- Three companies were high-production manufacturers; seven manufactured customized equipment.
- Three-quarters of all the products were subjected to specific analysis, covering all significant noise sources except impact tools and pumps.
- The ten firms represent a significant part of the industry: Of the two thousand firms nominally in the industry, about twenty comprise the industry "core". Eight of the ten interviewed are part of this core.

Our overview of the equipment manufacturing industry showed that:

1. Large companies closely resemble the Detroit assembly-line manufacturing concept. They tend to have large engineering staffs and are quite advanced in their efforts toward developing quieter products. They are aware of the competitive advantage of quieting equipment but are also sensitive to price competition from smaller companies and foreign manufacturers.

2. Medium-size companies producing "customized" items tend to feel more keenly the competitive pressures of the market place. Competition comes not only from domestic and foreign companies but also from other types of equipment that can perform the same operation. Engineering staffs tend to be small and product-oriented, interested only in improvements that incorporate new technology (e.g., hydraulic vs mechanical drive). Little effort has been made toward quieting products, with pressures of current and planned noise control legislation being passed on to their suppliers. They generally have no plans or see no need for developing greater noise control technology.

3. Manufacturers of hand power tools and pneumatic equipment fall into two categories: Large multiproduct companies which tend to mount considerable R&D efforts and smaller companies which are not so innovative but which do follow trends developed by the larger companies. Noise control has been pursued rather vigorously by these larger companies as part of their product improvement programs, but effective quieting of hand tools is difficult because of such practical constraints as size and weight.

Our in-depth interviews revealed that in the past the industry's concern with noise problems has been directed primarily to protection of the equipment operator. The impetus for this concern came largely from noise codes imposed by foreign countries, where some U.S. equipment has had to be "reworked" by foreign distributors. Three of the eight "large equipment" companies interviewed had previously quieted equipment to enter European markets. Switzerland and Belgium, for example, specify permissible noise levels for such machinery; in addition, foreign manufacturers make quieter machines and set a competitive pace in foreign markets. American manufacturers seem to have met this competition by custom-designing equipment for export. There is an implication here, of course, that many American machines marketed abroad have been quieter than counterparts that were marketed domestically; however, this implication has not been verified by this study.

Half the companies interviewed are currently undertaking programs to quiet their products for the domestic market for the first time. Many of the present programs have been started this past year and are aimed primarily at protecting operators, so as to conform to impending legislation/regulation regarding occupational health and safety. Only one of the companies indicated

that purchasers complain about protection for operators on their own initiative, and only one case emerged where a union had lodged a formal complaint. Six of the eight companies described pressures on behalf of operators that originated with existing or proposed governmental action.

Many manufacturers feel that the efforts they are now making on behalf of equipment operators will pay off in meeting future noise limits designed to protect the public. Perhaps, one of the most promising future approaches has been taken by one of the manufacturers of large equipment, who has charged design teams with the responsibility of integrating noise control into the overall design of his next generation of products and has set up review boards to evaluate new designs from all standpoints, including noise.

Four of the eight companies specifically mentioned the recently enacted Chicago noise ordinance as contributing to their specific future objectives. The industry generally anticipates EPA-administered federal control; the visits of our interviewers reinforced this feeling. Two companies believe that pressures for quieting will increase with time - apparently as a result of an increasing public awareness of noise as an environmental pollutant.

Although the industry has become increasingly aware of the pressures for noise control and has already made some efforts in this area, manufacturers must cope with economic pressures that argue against noise abatement. Some companies feel that the intensity of competition sets the limits on what price the market will bear. One of the industry's leaders was concerned that purchasers will continue using old equipment if prices rise significantly. Other industry leaders point out that foreign-made machines (some of them already quieted) will enter

the American market if prices rise appreciably. One company predicted that a small rise in the price of truck-mounted concrete mixers would lead to the introduction of alternative methods for handling concrete delivery and production.

Companies who feel that the demand for their products is great enough plan to pass quieting costs onto the consumer, although such threats as foreign competition and alternative methods put limits on this process. The question here is how fast the industry dares to move. One limit on rapid movement is price competition. One company may be able to beat its competitors to the market with a quiet machine, but it does not dare raise prices substantially in the face of competition. Different companies approach this problem differently. Most express the intention to meet or exceed the competition, but they feel that any great competitive advantage they gain through an all-out effort to quiet their products would be short-lived. One company sees its competition as being extremely severe, and fears that it may not be prepared for the next round of quieting, while another company has actively launched a program designed to produce quieter machines than its competitors at lower costs than the competitor will incur.

This company and some others expressed the concern that often accompanies any industry leadership; i.e., a company may invest large sums in quieting which will thus increase the cost of products, while another company that refuses to quiet products keeps its prices low and may successfully challenge noise regulation in the courts.

While all companies regard cost as an immediate - and perhaps as the ultimate - constraint, two other constraints become paramount if and as costs diminish: time and technology. Three companies, each in a different fashion, represented that costs can be traded for development time; i.e., more time for development would reduce the cost of competition, allowing quieting techniques to be integrated into planned engineering efforts and to be an integral part of the seasonal progression of models. The very company that is setting out to achieve the most quieting for the least cost is the one that feels that technology will eventually supercede cost as the principal factor that limits quieter equipment.

At another firm, the technical limitations are spelled out in terms of: (1) loss of equipment power through increased muffling; (2) increase in the difficulties and cost of maintenance; (3) fire hazards through using insulating materials that can become oil-soaked; (4) unsafe operation by suppressing or distorting the noise "signals" upon which operators depend for safety; and (5) ineffective operation, by disturbing these same "signals", thus hindering the ability of the operator to tell how effectively he is operating.

The industry also voiced concern over the feasibility of noise abatement where equipment and materials being worked interact to become prominent sources of noise; e.g., concrete mixers (where the structure may be the noise radiator); jack hammers (where the tool and its driving media may be the offender); riveters (where the structure of the building may be the primary source); and pile drivers (where both the structure and the media may be significant sources). This "interaction" type noise source may be very difficult to quiet.

However, no firm interviewed condemned noise limits out-of-hand, nor did they deny their inevitability. Six of the eight companies expressed the opinion that unless they quieted their products, their markets would disappear. Feelings varied from acceptance of inevitable reality to enthusiastic approval of the trend.

During the course of this study, members of the BBN team were actively engaged in the regulatory efforts of three cities and one state - Boston, Chicago, San Francisco, and Illinois. This work provided an insight into the mechanism of regulatory control from outside the construction industry. In addition, discussions were held with the Construction Industry Manufacturer's Association (CIMA) to obtain information about controls within the industry.

There are potentially four levels of regulatory bodies outside the industry: federal, state, city/town, and specialized local departments (city departments of health, air pollution control, zoning/building, etc.). The regulatory power exercised by these bodies is generally graduated into four steps: general standards (setting goals), enabling powers (granting power to a lower body), specific regulations (against which are judged infractions), and procedures (for measuring performance).

The target of the regulatory powers is either basic equipment performance (i.e., noise of new equipment as sold by manufacturer) or equipment operation (e.g., total noise emitted from a site). Regulations are usually aimed toward protecting (1) health (as in the hearing-protection section of the Federal Public Contracts Act) and (2) environmental quality (as in the construction site operating limits proposed for the city of Boston).

No fixed pattern has yet emerged which interrelates the regulatory bodies, nature of powers, targets, or degree of protection. Current activity at all levels, however, has alerted the industry that controls are imminent. One significant set of controls already in existence limits the noise from new construction equipment sold in Chicago; dual controls are being proposed in Boston, to limit site operation noise and to restrict noise from new equipment. Enabling legislation exists (as in the General Laws of the General Court of Massachusetts), and enabling powers have been passed on through city ordinance (again as in Boston). Even though the Federal Public Contracts Act does not apply to local construction, its philosophy is impressed on the industry, and its effect is increasingly noted in the carryover of standards into new federal occupational health and safety legislation.

In summary, the regulatory bodies outside the construction industry have begun to exercise some influence in the area of noise abatement.

CIMA and the national standards-setting bodies of ASTM/SAE are both actively addressing the problems of measuring equipment noise and recommending quieting standards. The equipment manufacturing industry would like to coordinate its activities with those of its closely related standards-setting bodies (see Appendix B for discussion of a paper prepared by CIMA). Self-regulation via industry-initiated standards is presumably somewhat hindered by federal anti-trust provisions.

As yet, no broad controls have been established. It is assumed that the example set by the City of Chicago equipment noise ordinance will stimulate other similar action, eventually resulting in a proliferation of standards put forth at the local

level. As an alternative, the industry would welcome one comprehensive overriding standard. However, some anxiety was expressed as to the reasonableness of future legislation, specifically that sufficient time would not be allowed to conform to such a standard. Typical new product lead-times are on the order of five years. Industry believes it could meet noise goals without excessive cost to the consumer, if given enough time.

In general, it appears that industry is aware that it will be forced to comply with ever-tightening noise standards. While this fact seems to worry everyone to some extent, most manufacturers are confident that they will meet the limits set by current and anticipated legislation/regulations/standards. In fact, all but one of the companies interviewed stated their noise control goals in terms of such limits, frequently specifying either the levels stated in the Walsh-Healey Public Contracts Act for operators or those set forth by the Chicago ordinance for public exposure.

Early abatement efforts made by the manufacturers have been highly successful; thus, the industry is somewhat optimistic about its ability to cope with pressures for noise control. However, it is important to note that the industry has begun with the most obvious and the easiest tasks it must accomplish. Future tasks are apt to be far more difficult and costly; therefore, future struggles to comply with more stringent standards could possibly influence company attitudes, making them less receptive to regulation.

4.3 Building Equipment and Appliance Industry Efforts

Throughout this study we have viewed the home appliance industry as consisting of two major sectors: owner-controlled appliances and major building equipment (such as heating and plumbing systems in multifamily dwellings). We continue this division, since (even though certain large companies produce both types of equipment) the nature of the marketing and of the pressures for noise control are quite different.

4.3.1 Building equipment

The quieting of building equipment involves the contributions and decisions of an interdependent chain that consists of owner, regulatory body, architect, engineer (both mechanical and structural), equipment, and manufacturer. For purposes of analyzing industry programs, three sectors of this network are significant: (1) the equipment manufacturing sector; (2) the design sector, and (3) the control sector.

Overall, quieting of the equipment in a building thus becomes a compromise between the elements of the chain on matters of design, budget and technical performance.

Manufacturing Sector

Manufacturers of building environmental control and services equipment are currently aware of the significance of quieting their products; they realize that they have a role to play in quieting at the source. The manufacturer does not have complete control over the quieting of the finished system; here, he is dependent on the architect and the mechanical/structural engineers as to location, local architectural treatment, and surrounding structural design.

Given this ambiguity, manufacturers in the past have been uncertain as to what to quiet, how much to quiet, and even how to measure progress in quieting. In a recent review of a wide variety of currently available equipment from a variety of manufacturers, several types of equipment showed spreads as large as 10 dB within the type. However, no line of equipment from a single manufacturer was characteristically noisy or quiet.

Currently, manufacturers are trying to solve problems of rating their equipment. This effort is being channeled largely through the trade associations and the technical societies. The fundamental aim of this effort is to furnish the architect and engineer with ratings that they can utilize in designing their equipment layouts and in specifying their equipment.

In the compressor industry this step has been substantially achieved. The result is that competitive criteria have become clearer and that the major technical barrier to quieting is common to the industry as a whole. (It is the blade-rate scream from the impeller.) It is apparent that if a manufacturer could make a technical breakthrough in this area, he would achieve a strong competitive advantage. There is some question, however, as to whether any single manufacturer can afford the development costs that such a breakthrough would entail.

When rating methods have been developed and when, as a result, the technical problems become better defined, manufacturers of building equipment will face three basic alternatives in reducing the noise from their products that reaches the building's occupant: (1) redesign of the equipment, (2) enclosure of the noise source by the manufacturer and (3) passing the problem along to the building designer.

Design Sector

The mechanical engineer is starting to add acoustic performance of equipment to the list of building specifications. These specifications are passed back to equipment manufacturers.

The mechanical and structural engineer interface with the equipment manufacturer in the area of containment of noise vs quieting at the source. Trade-off between the two approaches must be considered on both sides. Enclosures, if chosen often become a manufacturer's problem because of the need to bring proper controls and services through the enclosure.

The same two factors face each other regarding size of equipment. The design sector wants compact equipment in order to increase usable space as well as be able to move through doors, while the manufacturer tends toward larger equipment to favor quieting.

The architect meets the manufacturer at another interface that concerns equipment location, local architectural treatment and selection of structural system. Acoustically remote spaces are often not possible to be allotted to house equipment in view of the high cost of building space and the attendant desire to maximize revenue-bearing space. Architectural taste for openness in design and novel structural systems can often make the isolation of equipment spaces more expensive.

The designer faces a unique combination of equipment for every structure he designs. These combinations create unique problems of design. They also create unique patterns of emission. Thus in one building, the designer may be able to afford a fairly noisy piece of equipment because it will operate by itself or because it will operate in relative isolation. In another

building he may require a very quiet piece of equipment to perform the same function because it may be operating alongside other noisy machinery or in a location that makes the building users vulnerable.

Control Sector

Controls regarding building equipment acoustic performance emanate from four sources: (1) trade associations within the building equipment industry; (2) specialized technical societies also within that industry; (3) generalized professional technical societies (such as ASME, IEEE, etc.) serving all U.S. equipment industries; and (4) regulatory bodies (Federal, state and local).

The role of the trade associations is to set standards for rating the performance of equipment and to evolve guidelines for proper application of the equipment. Among the most active in dealing with noise control are:

- . Air Conditioning and Refrigeration Institute
- . Air Moving and Conditioning Association
- . Air Diffusion Council
- . Compressed Air and Gas Institute
- . American Gear Manufacturers Association
- . National Fluid Power Association
- . Hydraulic Institute
- . National Electrical Manufacturers Association

In contrast, the technical societies both within the building equipment industry and outside, serving all industries, are dedicated to developing measurement procedures and standardizing the

techniques for making measurements and reporting results. Most active in the measurement area are:

- American Society of Heating and Refrigerating and Air Conditioning Engineers
- Institute of Electrical and Electronics Engineers
- American Society of Mechanical Engineers
- American National Standards Institute
- American Society for Testing Materials

Government agencies exercise control in three ways: (1) as regulatory agencies concerned with occupational health; (2) again as regulatory bodies concerned with community noise; and (3) as significant purchasers of equipment for use in public buildings or publically financed projects. The occupational health and noise control aspects of the Walsh-Healey Public Contracts Act has served as a pace-setter for establishing targets for the building equipment industry, although the federal act itself generally has little direct applicability to most of equipment currently sold.

As state and local governments extend their protection against occupational health hazards, they are tending to adopt the Walsh-Healey criteria. These enactments tend to put pressure on manufacturers and designers alike. The most active current issue arises from the establishment of a stringent specification (80 dB(A) at three feet) by the General Services Administration for machine noise in federal buildings.

Manufacturers are having difficulty meeting the G.S.A. standards through quieting at source, but G.S.A. replies that containment will solve the problem. In one instance, however,

a substantial federal building project has not been able to attract qualified equipment bidders. Minimum property standards for FHA-assisted dwelling units have been in effect for a number of years. Some latitude regarding enforcement appears to be permitted to the directors of regional offices.

In total, the criteria for acoustic performance of building equipment are still in a state of evolution. More detailed discussion of standards is contained elsewhere in this report. Measurement procedures are still under development, and the current acoustic performance of standard equipment is still not fully understood within the various sectors of the industry. A system for rating equipment by category is seriously needed to give the control sector, designer and manufacturer a common language. The divergence of the city codes that do exist (15 dB spread) needs to be eliminated to reduce customizing requirements on the equipment manufacturers.

Summary of Pressures For/Against Quieting

a. For

- Quieting deemed a "necessity", no longer a "luxury"; tenants now in second or third generation of air conditioned buildings, and attitude toward quiet has matured to this point of view.
- Architectural desire for openness of design, new lightweight structural systems and economy of nonrevenue bearing space places premium on quieting of source.
- Mechanical engineers increasingly aware of need for quieting, hence now specifying acoustical performance.
- Occupational health and safety pressures spreading, following example set by Walsh-Healey Act.

- Codes at city level to enhance community quiet.
- Quieting generally becoming cost-beneficial in eyes of building owners.

b. Against

- Technical barriers make next step too expensive for single manufacturer to attempt by himself.
- Lightweight and small equipment desired to fit into small allocated spaces and remain tolerant of light foundations.
- Specific quieting goals are not clearly set, and codes and regulations are confusing and contradictory.

c. Trade-off Must be Examined

- Containment via enclosure vs quieting source - which is more cost effective?

4.3.2 Home appliances

There are approximately 70 to 80 important manufacturers* of home appliances in the U.S. These companies offer 30 to 40 different products that are potentially significant noise sources. For the purposes of assessing the state of noise control within this industry, we rank-ordered specific appliances according to their relative importance with regard to noise abatement in and around the home.

- air conditioners,
- dishwashers,
- water closets,

*Defined by observing company names and appliance categories in various well-established consumer journals.

- other major appliances (clothes washers, dryers, refrigerators), and
- appliances whose noise output is interpreted as a measure of its efficiency (vacuum cleaners, blenders).

The industry is characterized by four major company/product mix categories:

- large, multidivisional companies producing a broad range of products;
- medium-size companies formerly specializing in a well-known product but now branching out to take advantage of a good name in the consumer market;
- small and medium-size firms who maintain a certain leadership character through continued specialization; and
- companies manufacturing "private label" appliances to be sold by others, usually by large retailers who contract for and control the product policies of a large volume of home appliances.

Our interview program was organized to cover leading manufacturers of a range of equipment as well as retailers and industry associations. We interviewed eleven manufacturers (or manufacturing divisions of large companies), two major retailers, and two industry associations. Twenty-nine products and ninety-six product/manufacturers were covered by this survey.

Our overview of the industry's attitude toward noise control shows it to be so direct a function of market place pressure that noise control technology often exceeds application. Appliance manufacturers tend to maintain sophisticated R&D and product engineering staffs that are capable of delivering more noise reduction than market strategy can justify. In fact, some companies have tried - unsuccessfully - to market quiet products, such as air conditioners, vacuum cleaners, blenders, and hair dryers; others have developed a number of quiet prototypes that were not put into production.

Consumer research shows low noise levels are not highly valued by most customers. Several companies keep systematic track of customer correspondence, while the industry itself maintains a Major Appliance Consumer Action Panel (MACAP) that acts as a clearinghouse for complaints. These records, all of which concern major appliances, show relatively little complaint about noise. For example, only 5% of the letters to MACAP in the first eight months of 1971 were about noise.

The objectives for quieting household appliances seem to vary with the market pressures on particular products. With this observation in mind, we organize our discussion of noise control efforts around the "problem" appliances identified above.

Air Conditioners

There is probably more market pressure to quiet air conditioners than to quiet any other household appliance. Since air conditioners emit noise both indoors and out, they frequently affect not only the purchaser and his family, but also neighbors and passersby. Both kinds of emissions generate pressures for

noise reduction. Pressure from neighbors takes the form of local noise ordinances that specify maximum sound-emission levels at a property line; this pressure is passed on to the manufacturer, as one company pointed out, by dealers or marketing men who are aware of the ordinances.

Dollar sales of room air conditioners grew almost eight-fold in the decade of the 1960's; during that time, indoor quiet emerged as a competitive dimension. Several manufacturers are currently engaged in competitive advertising campaigns to sell the quietness of their room air conditioners and are giving their products brand or model names that imply the quietness. Two large appliance manufacturers independently volunteered the opinion that quiet is becoming more important to purchasers every year. One of these indicated that the fact that air conditioning allows one to close the house against outside noise may soon become a sales argument in air conditioner merchandising. However, one leader in the current "quiet" race indicated that their top-line model is not selling well.

Most quieting effort for air conditioners takes place in modest engineering laboratories that are attached to the local production facilities. One such laboratory reports spending three man-years per year on air conditioner noise control; one man-year per year was a more frequently mentioned level of effort. While the product policy people generally reported that they were making maximal use of available quieting technology, the study project acousticians who initiated the interviews felt that current state-of-the-art technology was not being universally applied.

Two estimates we received indicate that quieting room air conditioners adds 10 to 15% to their price. There may also be an inherent trade-off between quietness and efficiency (since one way to reduce air noise is to decrease air velocity). Sometimes, quieting results in increasing the air conditioner's physical dimensions, thus detracting from appearance as well as from convenience and ease of installation. There may also be a trend toward model lines differentiated by noise output - i.e., an expensive quiet air conditioner and a cheaper noisier model. One manager pointed out that there are anti-trust constraints against organizing industry consensus on noise levels.

Dishwashers and Food Disposers

The mechanical differences between dishwashers and disposers do not alter the fact that noise control pressures are similar and that the manufacturers' approach to quieting is similar. Thus our survey indicates that these two appliances logically group together.

Quiet is a saleable characteristic of dishwashers and disposers, although the pressures for quieting are not so great as for air conditioners. While we are aware of no advertising campaigns built exclusively on quiet, it is advertised with the same prominence given to power and reliability.

Noise levels from dishwashers and disposers are not currently under public regulation, hence the incentive for quiet comes almost exclusively from the purchaser. This gives rise to marked differences between models; if one wishes, one can buy an inexpensive, noisy dishwasher or disposer. Reports from the industry indicate that landlords frequently do just that.

Noise emissions from these two appliances are not so completely under the control of manufacturers as in the case of other appliances; the manner of installation greatly influences structureborne and plumbing-borne noises.

Dishwashers, however, present a promising example of industry's response to the purchaser's desire for lower noise levels. In a 1970 survey by the United States Steel Co., 48% of dishwasher owners had no complaints about their appliance, but of those who did, more complained about noise than about any other aspect of its operation. Both survey data and marketing "lore" indicate that the purchaser who has previously used these appliances puts a higher value on quietness than does the new user.

The costs of quieting were estimated by one dishwasher manufacturer to be 10% and by another to add \$1 to \$2 to manufacturing costs. A disposer manufacturer felt that quieting would add 12% to a product cost, whereas a retailer of disposers estimated 18%. Quietening these machines might deny their availability to those least able to pay.

In the case of dishwashers, one manufacturer indicated the possibility of trade-offs between noise and maintenance costs, and reliability. Another indicated a trade-off between water velocity and quiet but expressed the opinion that there are no serious technical restraints to quieting dishwashers.

In the case of disposers, industry claims inherent problems with water and grinding noise (especially with the noise of grinding bones). Some noise is considered necessary to the user's safety, so he will know when the disposer is operating and when it has finished grinding.

So far, a number of sophisticated techniques have been applied to dishwashers: isolation, damping, and parts re-design. Manufacturers of both dishwashers and disposers have tried to improve the quality of installation by providing carefully drawn instructions and flexible fittings. One company has reduced noise on its top-line dishwasher from 82 to 76 dB(A) (at an unspecified distance) since 1967 and plans a further reduction in the next few years. Another manufacturer expressed only the desire to keep abreast of the competition; this company tests each machine for noise, rejecting something under 1%.

None of the manufacturers interviewed intends to give up his noisier "economy" lines; goals did not seem to be appreciably influenced by the prospects of noise regulation.

The companies interviewed claimed to have adequate acoustic test facilities, although the efforts devoted to testing and to development varied widely in quantity and quality.

Water Closets

If evidence from mail order catalogues is reliable, quietness in water closets is a marketable attribute. Two top-line, "low profile" models prominently feature quiet in their advertising. One manufacturer indicated in an interview that placement of the height of the tank involves a trade-off between quiet and efficiency, and indicated that quiet designs may be less reliable, less efficient, and more expensive. Like dishwashers and food-waste disposers, economy-models are noisier than more expensive ones.

Currently, one company is trying to eliminate a water hiss that occurs when the tank is full.

Other Major Appliances

Quieter clothes washers, clothes dryers, and refrigerators tend to be by-products of engineering originally undertaken with other objectives in mind. The classic case is a washing machine model that was incidentally quieted when two gears were removed from the power train to save cost. In the context of product improvement, noise is generally treated as a secondary design goal, although manufacturers are concerned that engineering changes may produce noisier products. For example, refrigerators are becoming larger *and* noisier as manufacturers seek to meet the demand for special options such as ice makers; a spinner-type washing machine produced higher noise levels when spinner speed was increased to 2000 rpm.

Two of four manufacturers interviewed make quiet models of washing machines that sell at a \$10 to \$20 premium; sales for both lines are disappointing. None of the other models of these companies is marketed on the basis of quiet nor do the mail-order catalogues feature quiet. The single exception is a spinner-type washer in which "quiet operation" appears in the small-type description. There is, then, relatively little evidence of pressure for quieting appliances of this type.

Yet, despite the weakness of market pressures, considerable quieting effort has gone into the design of these appliances, especially washing machines. One manufacturer mentioned six different quieting projects that have recently been completed or are underway. A refrigerator manufacturer mentioned an effort to avoid strange or unidentifiable noise. No specific efforts to quiet dryers were uncovered.

Vacuum Cleaners

The manufacturers of vacuum cleaners believe that the market pressures are for noisy machines. The three manufacturers and one large retailer interviewed are all convinced that customers use noise as the basis for judging a machine's power. For example, after concentrated technical effort, a manufacturer had significantly reduced the noise from a canister model without reducing its cleaning capability. Housewives who participated in a marketing trial wanted to know "if the machines were really cleaning".

Neither of the large "private label" retailers we consulted mention quiet as a design goal. In fact, in advertising a nap adjuster, one company writes "... just slide the bar across until you hear the right cleaning purr". One company that carefully analyzes its correspondence from customers finds virtually no noise complaints about vacuum cleaners or any of its other portable appliances.

A reasonable level of engineering effort has produced feasible solutions to vacuum cleaner noise problems; according to all interviewed, however, these solutions are not being applied to products that are sold, because vacuum cleaner manufacturers and retailers do not sense a demand for quieter products. In fact, the sale of upright cleaners, whose beaters make them noisier, is growing at the expense of the sale of canister models. Apparently, the beater action of upright cleaners can better handle the new deep-pile weaves that make modern carpets harder to clean. There are technological limits to the quieting of upright vacuum cleaners, because of the interaction between the beater and the carpet, but the noise levels of production models seems to be determined by customer usage demand rather than by technological limitations.

The company that developed the quiet canister cleaner employs a physicist who works full-time on noise-control studies. The company calls in noise consultants about four times a year and samples its customers at six-month and two-year intervals. They have given considerable attention to the problem of beater noise and estimate that solutions that would not reduce a machine's efficiency would add 50% to its price.

Another large company made a study ten years ago (at a cost of about \$30,000) in which they developed ways of reducing vacuum cleaner noise in middle and high frequencies by about 10 dB(A). They have just contracted for a study of their competitors' canister machines and of the effect of using alternate motors in their own machines. Although they have available technical staff and laboratory facilities in-house, they have never applied the results of their studies to the products they market because of customer attitude toward noise.

Small Appliances

During the interviews incidental information was gathered from five different companies concerning eleven small appliances: blenders, can openers, coffee mills, electric knives, fans, hair dryers, ice crushers, knife sharpeners, mixers, oral lavages, and electric tooth brushes. Manufacturers feel that there is public pressure for these appliances to sound as though they are "really doing their jobs". One manufacturer offered the generalization that, in the small appliance field, the quality of the sound is more important than the quantity. An appliance must sound "right". Some must sound powerful, some reliable, and none as though they are malfunctioning or undergoing excessive wear. This manufacturer expressed the belief that an accurate interpretation of the customers' desires in these areas is a condition for remaining in business.

This market pressure leads to diverse noise-control objectives, both among companies and between product lines produced by a single company. Customer complaints were reported about the noise from fans and hair dryers, and one marketing executive was quoted as believing that quiet is a saleable aspect of mixers. One company which does not manufacture the ice crusher that is sold under its label put a fairly high value on quietness in selecting the model it sells. Yet, none of these small appliances was described as quiet in either of the two mail-order catalogues that we examined. Blenders and electric can openers were specifically described by the managers interviewed as being appropriately noisy. A company which we did not interview was cited as having quieted a blender; in so doing, they slowed it down so that it became less efficient. At least one laboratory is seeking entirely new ways of comminuting foods that could be both quieter and cheaper than blenders. Another is designing a screw-type crushing tool that will substitute a growling sound for the raucous sound of the chipper that current ice crushers employ.

There is also a search for fan blade configurations that will eliminate certain predominant frequencies and produce a more pleasing sound. In addition to room fans, this experimentation includes hair dryers, where quieter designs for air passages are also being sought.

Rubber feet have been added to electric coffee mills to reduce vibration noise, but shielding is not being used because of its adverse effects on costs, size, and aesthetic design. Plastic beaters for mixers promise to reduce both noise and costs.

Many of these appliances are powered by universal-type motors, which are inexpensive, powerful for their size, but noisy. The size-power ratio considered important in such appliances as hand mixers, electric knives, can openers, and motor-in-the-bonnet hair dryers. Conventional hair dryers also embody a trade-off between speed and quiet; one hair dryer model that was marketed as "quiet" took 30 to 75 minutes longer to dry hair than faster, noisier models.

Speed or the potential power that speed permits was cited as important to electric knives, can openers, and blenders. In the case of blenders, one engineer argued that, if they were slowed down, the intensity of the noise would simply be traded for noise duration with no lessening of resulting impact. There is also reported to be a trade-off for electric tooth brushes between noise and cleansing effectiveness.

Cases of limitations on quieting were pointed out for knife sharpeners where there is grinder-blade interaction, as well as for blenders where rotating knives are essential and a glass casing is necessary if the housewife is to monitor the process visually. In the case of blenders, there is hesitation to experiment with consumer preferences since the already intense domestic competition is being raised by the entrance of Japanese products into the market.

Small appliance manufacturers make frequent use of subjective noise judgements in their developmental work. Their product laboratories tend to be less sophisticated than those for major appliances, although many have access to central acoustical laboratories of great sophistication. One small appliance manufacturer tests new products in his employees' homes. If employees object to the noise the new model makes

they are asked if they would be willing to pay for a quieter product. The general result of this approach is to make this manufacturer pessimistic about the economic pay-off from quieter products.

Although specific noise goals are hard to identify in the appliance industry and although some manufacturers seem discouraged with the return on their efforts to date, all those interviewed plan to persist in quieting efforts. Technological limits have not yet been reached. One manufacturer believes that the earlier competition which emphasized compactness has now been replaced with an emphasis on quiet. Accordingly, industry generally plans to hold the size of future models constant and to concentrate on producing quieter models, while presumably keeping prices within competitive limits.

5. CONCLUSIONS AND RECOMMENDATIONS

This report has presented a broad range of facets concerning the noise characteristics of construction, appliances, and building equipment, the influence of this noise on our lives, and the nature of the industries producing and using this machinery. In this section, we summarize our findings and recommend what we believe to be a balanced noise abatement program that may be pursued by EPA.

5.1 Conclusions

One of the most striking factors to emerge from this study is the monumental complexity of the physical, social, and industrial system that we have attempted to understand. There is a wide spectrum of noise-producing machinery types utilized for many different purposes in a nearly endless number of situations. This heterogeneity makes a characterization of even the average properties of the sources and transmission paths difficult at best. Of course, nobody is exposed to average conditions but rather to some part of a multi-variable distribution of circumstances, making some notion of the range of source/path/receiver situation desirable. Furthermore, human response to noise varies widely among individuals and depends not only on the readily measurable aspects of sound such as level and spectrum, but also on such factors as attitudes, predispositions, the information content of the sound, and concurrent nonauditory stimuli. The industrial situation is equally complex, the judgement of industrial leaders and their concomitant directives being influenced by marketplace and legislative demands, as well as by their own personal attitudes. In presenting what we feel are the salient features of this complex system, we claim to have observed no more than the top of the iceberg - and even that at some distance.

5.1.1 Sources

Despite the tremendous range of equipment, the noise-producing mechanisms are often similar and may be identified as part of a much smaller class. The principal source of noise in many types of construction equipment, for example, is the diesel engine. Exhaust noise is most readily identifiable with structural sound radiation and inlet noise is also of importance. Additionally, the hydraulics, fans, and transmissions of construction equipment generate loud and identifiable noise levels. Such heavy equipment often creates levels in excess of 90 dB(A) at 50 ft. Drilling and cutting machinery are also extremely noisy as are impact tools such as riveters, pavement breakers, certain powered wrenches, and most pile drivers. Noise from jack hammers and rock drills often lies between 80 and 100 dB(A) at 50 ft; pile driver noise can exceed 100 dB(A). Almost invariably, construction equipment, regardless of its size, is noisy.

In evaluating the control technology of construction noise, one finds that approximately 10 dB(A) of noise reduction are generally achievable using state-of-the-art techniques; 20 dB(A) could no doubt be achieved with a certain level of technology development. Of course, these are average values. For some equipment, such as that sold without exhaust mufflers, greater noise reduction would probably be easily achieved; for others, such as riveters, considerable effort would be required to meet these objectives.

The noise levels of home appliances span a much broader range than those of construction equipment. Certain appliances such as food freezers or refrigerators are rather quiet at 30 to 40 dB(A), measured at 3 ft; other items such as food blenders can be as noisy as 80 to 90 dB(A) depending on the type, speed,

and food being processed. Garbage disposers may even exceed 90 dB(A). By and large, the noisiest classes of home equipment are powered garden and shop tools. Noise from electric lawn mowers, hedge trimmers, and grass edgers all measured between 80 and 90 dB(A). Some shop tools generated nearly 100 dB(A).

Noise from appliances is attributable to electric motors and cooling fans, plus the components being driven by the motors. For refrigeration equipment, these components are compressors and blowers; for food-waste disposers, they are grinders; for shop tools they are typically cutting or grinding elements, often connected to the motor by noise-producing gears. As with construction equipment, noise reduction levels of 10 dB(A) are generally achievable with state-of-the-art techniques; 20 dB(A) often requires either extensive application of existing techniques or the development of new technology to obtain the same results at less cost.

Building equipment probably has as large a range of noise-making devices and noise levels as construction and appliances combined. Diesel engines, gas turbines, and large electric generators or motors are all utilized, especially in so-called "total energy systems" which supply both electric power and temperature control for buildings. Refrigeration and heating equipment, blowers, diffusers, and fluorescent light transformers all generate noise. Fortunately, the noisiest sources of building equipment are usually remotely located, typically in mechanical equipment rooms. Isolating people from this noise is mainly done through architectural treatment.

5.1.2 Impact

We have tried to measure the impact of noise on people in terms of the levels to which they are exposed, the duration, and the number of people. In a one year period approximately 30 million Americans will find themselves living or working near a construction site. The noise from this site will be sufficiently high to interfere with their conversation most of the day. Three million workers with night shifts and 2.5 million children under four who may require naps live near these sites. Many will either find it more difficult to fall asleep or be awakened during their sleep because of construction noise. On the average, a metropolitan-area resident or worker passes a construction site every other day. Pedestrians can be exposed to noise levels in excess of 90 dB(A). Automobile drivers and passengers will often close their windows, thereby reducing the exposure to approximately 80 dB(A). Although many operators of heavy construction equipment are losing their hearing because of noise [29], hearing damage to persons in the environs of construction sites does not appear to be a substantial problem. Most people residing or working in buildings neighboring construction sites are exposed to less than 70 dB(A) most of the time. Some pedestrians are exposed to levels that could contribute to hearing loss particularly if these people are exposed to high noise levels during other times of the day.

One of the most significant aspects of construction noise is that, in any year, 15% of the population are exposed roughly eight hours a day, five days a week for many weeks or months. They have no control over the noise nor do they have much respite from it. The argument that construction is temporary has little appeal to people living near a several year project or one series of projects after another located all around them - after all, they argue, life itself is temporary.

Appliances have an impact on people in a rather different way. Most appliances affect only the people using them and only for a relatively brief time while they are in operation. For example, a food blender may generate 80 dB(A), but only for 30 seconds, at the end of which the user has a desired product. This leads to quite different attitudes toward appliances *vis a vis* construction equipment as bothersome noise sources. Of course, not all appliances affect only the user and his family. Appliances which affect neighbors are typically those which are built in to the home structure or plumbing and those which are used outside. Thus, food-waste disposers, dishwashers, water valves, and toilets are found to annoy and sometimes interfere with the sleep of people in multifamily dwellings. Powered garden tools such as lawn mowers, hedge clippers, and edge trimmers as well as power tools used outdoors (e.g., circular saws, drills, sanders) also generate sufficiently high noise levels to awaken or annoy neighbors.

One of the most striking aspect of appliances is their number. Roughly one billion appliances now are used in homes throughout the U.S. Virtually everyone owns at least some; e.g., 99.8% of homes are equipped with a refrigerator, over 90% have vacuum cleaners. By and large, people in the upper socio-economic stratum have more appliances. However, the generally increasing affluence of the nation coupled with the relatively constant price of appliances over the past 15 years (despite the inflationary growth of most other consumer items) has stimulated the profusion of appliances into homes at every economic level. This large number of appliances and their year-round use (with certain obvious exceptions) has made the exposure to appliance noise very large indeed. In fact, appliances account for more person-hours of speech interference, sleep interruption, and hearing damage than construction.

However, the impact in terms of annoyance is probably not so great, owing in large part to the controllability of many appliance operation times. For example, one does not have to run the dishwasher while listening to T.V., but it is difficult to ask the pile driver operator outside to cease work until a program of interest is over.

5.1.3 Industry programs

Industry activities in product quieting can best be understood by first considering the pressures they perceive. Demand for quiet appliances reaches manufacturers directly from the purchasers in the marketplace. The people who are exposed to noise, for the most part, are also those who purchase the appliance, or at least influence its selection. Demand for quiet construction equipment is also made by people living or working near construction sites. They generally have no economic influence on the building contractor or equipment manufacturer. Hence, their demands have largely gone unheeded and have been redirected through legislative bodies. A few successes in this arena have begun to create a marketplace demand for quiet equipment by contractors who "see the handwriting on the wall" and are willing to pay something of a premium for equipment that will not be illegal to operate in a few years when anticipated wider-ranging legislative controls are enacted.

The response to pressure for quiet has varied within and across the appliance and construction industries. Some appliance manufacturers have made a credible effort to develop capabilities to deal with noise-control problems and to design appropriate noise-control measures into their products. This has been especially true in the major appliance industry where air conditioners

and, more recently, dish-washers and food-waste disposers are being treated. As one might expect, the objective of disposer treatment is to reduce noise within the kitchen containing the unit. We know of no disposer designed to reduce transmission of noise through plumbing and into adjacent apartments. The disposers that incorporate airborne sound suppression are top-of-the-line items designed for use by the purchaser. Bottom-of-the-line disposers often have no noise treatment whatsoever and are usually installed in multifamily dwellings. Generally speaking, when noise control is introduced in appliances, it is in top-of-the-line items. There, it serves partly as an added luxury and partly as a test of market acceptability. If successful, it will often be introduced in other line items; if unsuccessful (for whatever reason) the notion will often develop and persist that consumers simply do not care about noise.

The construction equipment industry also shows a spectrum of levels of response to pressure for product quieting. A very few companies have foreseen the demand for quiet equipment and have begun a line of products that are significantly quieter than competitive models. Some companies have conducted experimental noise control projects, often with only a modicum of success. Several companies appear to have given noise-control very little effort (e.g., some heavy construction equipment does not even use exhaust mufflers for diesel engines). On the whole, noise has only begun to become a serious factor in the construction industry, which lacks much of the expertise required to deal successfully with it.

5.2 Recommendations

Most of the work presented in this report is of the nature of background material that must be applied to the problem of noise reduction to be of real value. Our recommendations therefore relate to the application of this information and the steps that we feel ought to proceed from it.

There appear to be two primary means by which the EPA can influence industry to bring about noise control. The first is to regulate the maximum allowable noise levels that can be produced by new equipment. The second is by instituting a mechanism for disseminating information to the consumer: namely, requiring the labeling of noisy products. In situations where the party exposed to noise is not the purchaser of the noisy equipment and is not in a position to influence the noise level or operation of the equipment, it appears that noise standards must be generated and applied to bring about noise reduction. This is largely the case in the construction industry, where the principal recourse to construction noise control by the community has been through local legislation. On the other hand, when the purchaser is, for all practical purposes, the only party affected by a noisy source and that source is not likely to contribute seriously to hearing damage, then standards appear to constrain unnecessarily one's freedom of choice. Rather it would seem appropriate to ensure that the purchaser is informed of the levels to which he will be exposed, but that he be allowed the freedom to weigh noise against other factors (e.g., price, size, durability) in reaching a decision among alternative products.

Setting standards and labeling requirements is no mean task. There are technical issues that must be resolved involving the conditions under which noise is to be measured. For example,

the type of sink in which a garbage disposer is installed and the character of food waste being disposed of, must be carefully specified to obtain meaningful and uniform results. Somewhat more difficult is the task of determining the maximum allowable levels for different kinds of equipment. In a sense, these levels invariably represent a compromise between desired values and values that are economically acceptable. This concept may be illustrated qualitatively by Fig. 27 in which we plot cost vs noise reduction. Cost is used to include capital, operation, and maintenance expenditures owing to the application of noise control treatment and whatever performance degradation might occur because of such treatment. Automobile mufflers are a good example; they increase the price of an automobile, often require replacement during the life of an automobile, and slightly degrade engine performance. Results achievable by application of state-of-the-art noise-control techniques are represented by an exponentially increasing curve. The first few dB of noise reduction are typically achieved at low cost; costs gain substantially as greater levels of quieting are sought. Also shown in the Fig. 27 is a cost vs noise reduction curve that might be achievable subsequent to noise-control research and development. In fact, it can probably be said that the sole objective of R&D should be to lower the state-of-the-art curve. The third curve in Fig. 27 shows a relation between cost and noise reduction deemed acceptable by the decision-makers. The curve is concave downward illustrating the notion that as a machine is made quieter, each increment of noise reduction is worth less and less. The intersection of the state-of-the-art curve with the acceptable cost vs noise reduction curve determines the noise reduction one is willing to specify. If this level of reduction is inadequate,

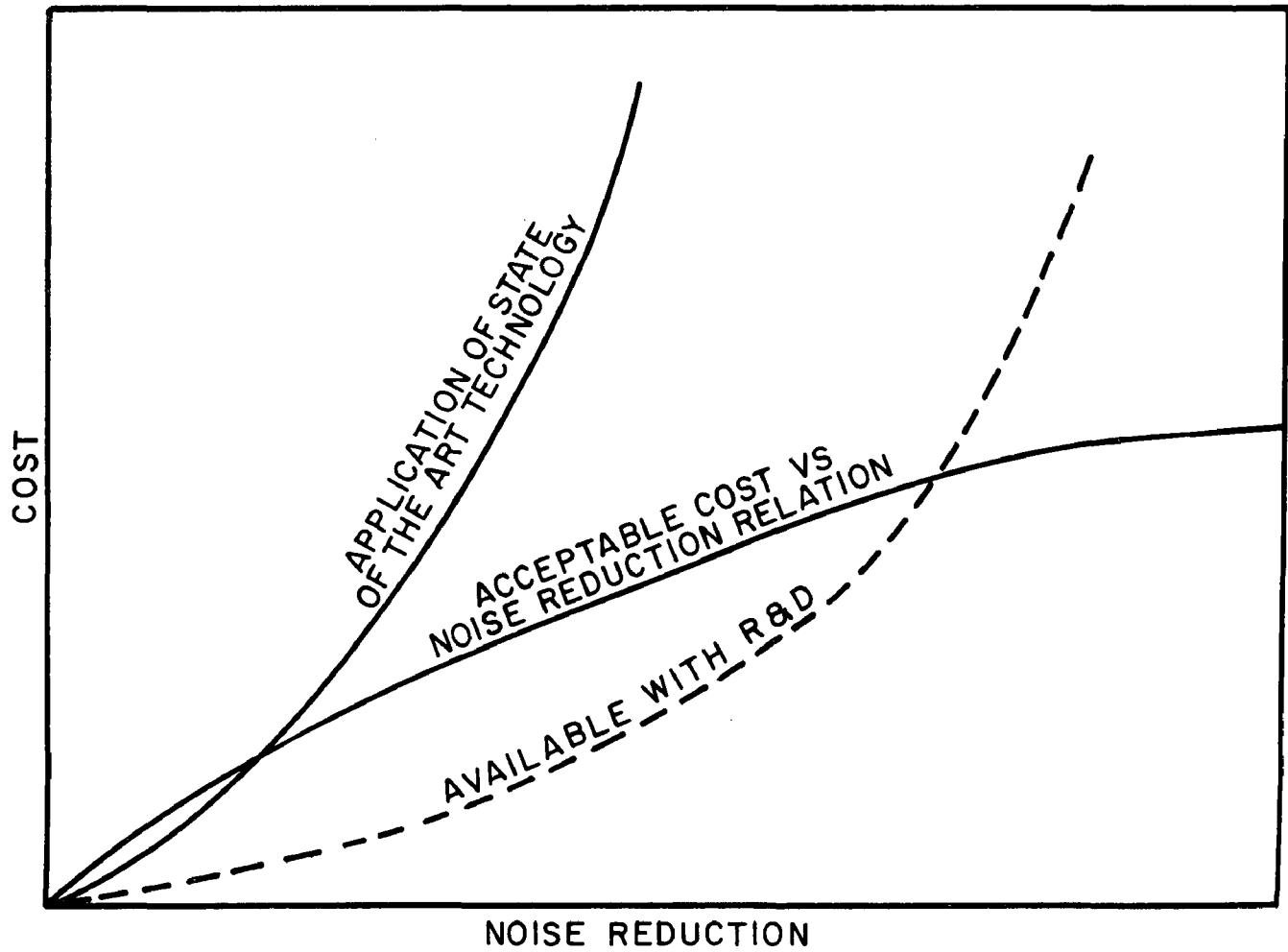

FIG. 27. COST OF NOISE CONTROL VS NOISE REDUCTION

it is necessary to conduct R&D to achieve a lower state-of-the-art curve and increase the level of noise reduction that can be justified economically.

Each party has its own view of the level of the acceptable cost vs noise reduction curve. For equipment manufacturers who find little marketplace demand for quiet products, the curve is low. People living or working near noisy equipment would naturally draw the curve at a higher level, especially if they did not have to bear a significant part of the cost for quieting the machinery. One of the problems that EPA will have to face is to develop an acceptability curve that is, in some sense, fair to all parties. Although it is difficult, if not impossible, to develop such curves quantitatively, it will be necessary for a decision maker to be aware of the pertinent relations between cost and noise reduction and to account for them in selecting the levels to be achieved. To assist in this process, we recommend here studies of the technology and economics of noise abatement, the economic impact of noise control, the type of improved noise criteria that ought to be developed, and social-indicator studies to measure the attitudes of the public to noise and noise control. First, let us consider which equipment ought to be regulated by standards and which by labeling.

5.2.1 Standards and labeling

We recommend that noise sources having a significant impact on parties who derive little direct benefit from the source ought to be controlled by the establishment of maximum allowable noise levels. This would include most construction equipment, construction sites, and certain types of appliances. Among the items of construction equipment requiring standards are all machinery powered by internal combustion engines as well as tools

utilizing impact or cutting mechanisms, such as drills, pavement breakers, and saws. Construction site noise levels ought to be regulated to ensure that the contractor deploy and utilize his machinery in a way that minimizes community noise exposure. Typical appliances requiring regulation are electric garden tools (e.g., lawn mowers, hedge clippers, edge trimmers), food-waste disposers, dishwashers, air conditioners, and shop tools. Because the noise of hazardous tools also serves to inform the user of their operation, minimum as well as maximum levels out to be set.

For standards to be applied in a way that may reasonably be met by industry and yet are sufficient to have an impact, we recommend the establishment of a three-phase program. A decreasing sequence of levels would be established and would go into effect approximately, one, four, and seven years subsequent to the time at which the levels are publicly announced.

One Year

The purpose of the first phase is to ensure that highly effective off-the-shelf noise control equipment is utilized on all new machinery. Thus, all machinery powered by internal combustion engines would be required to be equipped with high-quality mufflers, for example. (This contrasts with the current situation in which some construction equipment is advertised and sold without any muffling whatsoever.) One year appears adequate for manufacturers to order, receive, and install such equipment.

Four Years

The second phase would become effective approximately four years after announcement of levels. These levels would be selected to ensure that state-of-the-art noise control techniques are

incorporated in equipment. To achieve these levels, the manufacturer might have to use sound-absorptive engine enclosures, for example. Appliances might have to incorporate vibration isolators for all motors and pumps. Since the type of treatment envisioned here requires minor changes to equipment, four years appears adequate for manufacturers to design noise treatment and retool selected items of their production lines.

Seven Years

The levels to become effective after a period of seven years should largely represent state-of-the-art advances and should have a significant impact on the level generated by the noise source. Twenty dB(A) of noise reduction for the most offensive construction equipment and appliances would seem reasonable. Seven years allows sufficient time for the research and development needed for state-of-the-art advances and the incorporation of the fruits of this work in production items.

We also recommend labeling of appliances generating significant noise levels affecting primarily the user. Included in a list of items to be labeled are all items controlled by standards, as well as shop tools, vacuum cleaners, food blenders, fans, and hair dryers. Our rationale for labeling rather than standard setting is that a person should be informed of the noise to which he will expose himself and then be free to consider noise as but one of a number of factors accounting for his selection of a particular brand. Noise-control standards would no doubt raise appliance prices, unnecessarily restricting the consumer's range of choice.

5.2.2 Technology evaluation, demonstration, and development

We recommend the expenditure of appropriate levels of effort to evaluate, demonstrate, and develop technology in support of the establishment of standards. These studies are as follows:

Labeling

To make labeling meaningful, a consistent set of test procedures should be developed for each type of appliance or item of building equipment. This is especially important for appliances whose noise characteristics depend heavily on the installation. Prominent among these are food-waste disposers, dishwashers, plumbing fixtures, and vacuum cleaners (which may rest on a rug or a hard floor).

Standards - Phase I

The first recommended phase of standard setting establishes noise levels that can be met if highly effective off-the-shelf noise control devices are used on all equipment. Prior to the establishment of such standards, a program to measure the noise generated by selected machinery samples targeted for incorporation of such devices would seem appropriate.

Standards - Phase II

The second phase of standards would specify levels requiring the application of noise-control treatment. We recommend that EPA conduct noise-control demonstration projects on selected items for three reasons. First, achievable levels of noise reduction can be accurately evaluated, and accordingly specified, only by means of such programs. Without actually implementing noise-reduction techniques there would probably be an unacceptable

level of uncertainty associated with predictions. Furthermore, practical implementation problems are often not uncovered until treatment is actually put into practice. Second, such demonstration of results achievable by means of state-of-the-art noise treatment would put to rest any objections raised by the affected industry concerning the technological feasibility of achieving specified levels. Finally, the technical information generated by a demonstration program would be valuable across the affected industry, especially to small companies who often lack the requisite technical capability in noise control.

Standards - Phase III

The third recommended phase of standards is designed to have a significant impact on noise levels and will probably be achievable only through state-of-the-art advances in noise-control technology. To ensure that the state-of-the-art is appropriately advanced in sufficient time for implementation in new machinery we recommend the immediate commencement of R&D programs dealing with the following important aspects of construction and appliance noise (in approximate order of priority):

- diesel engines
- mufflers
- hydraulic systems
- cooling systems
- impact and cutting tools
- other power plants:
 - gas turbines (for nonaircraft use)
 - electric motors

- transmissions (gears)
- water valves

5.3 Economic Impact Studies

Determining the optimum balance between public's desire for quiet and the distributed costs required to achieve it by means of rigorous systems analysis effort would require a large-scale simulation of the economics of the construction industry and its place in the U.S. economy. Such a study is not feasible if usable results are required in a short time or if expenditure of funds is limited. It is possible, however, to make some choices as to what to quiet and how to quiet it, by doing some fairly unsophisticated investigation of how the quieting costs get distributed through the industry and the economy. We recommend treatment of:

- The impact of noise on various segments of the population. (This has largely been performed under the existing EPA contract and needs but a little expansion.)
- Estimated costs of quieting selected pieces of equipment as a function of degree of quieting. (This would be an order-of-magnitude estimate. Data can be obtained from price information on existing mufflers, heavy casings, absorptive materials, etc., as well as a study of price differentials between existing quieted and unquieted machinery – not just construction equipment. Costs of nonhardware guiding techniques, such as scheduling site operations to avoid using many pieces of equipment at once, would be estimated by constructing typical scenarios and consulting with industry representatives to determine increases in construction cost increases (or decreases). Allowance should be made for uses

in which a change in equipment design or operation results in greater productivity, reliability, etc. The effect of such an occurrence could be a net *negative* quieting cost.)

- The distribution of increased equipment cost among producers, purchasers and the purchaser's customers. (Part of the cost will be absorbed by each, depending on the demand elasticity of the commodity. This information exists in published studies of the economics of the construction industry.)
- Allocation of increased equipment costs/rentals among various types of construction. (The resulting increase in construction costs are a strong function of what is being built. Equipment rental typically makes up 20% of the cost of civil works constructions, 10% of the cost of highways, but only 2% in the case of buildings.)

The above data would be used to compute the economic effect of quieting equipment on the public. The outputs would be:

- The expected increase in costs and rentals of housing, offices, industrial space, etc., as a function of the degree and method of site quieting. Also of interest is the degree of intersection of the sets of: (1) surrounding inhabitants, who get the benefits of quiet sites, and (2) building users, who pay the cost, or part of it.
- Expected increase in state, municipal, and federal taxes as a result of increased cost of public works construction, etc.

The net result of the study would be recommendations for an orderly construction quieting program based on the information developed above. The criteria by which specific techniques or regulations would be judged are:

- Cost-effectiveness (the degree of quieting achieved per dollar expended).
- Cost-benefits (the reduction in community noise exposure as a function of quieting cost).
- Equitability (the degree to which the beneficiaries of a quieting program bear the expense of that program).

5.4 A Program of Public Support Development

Our contact with managers of construction equipment and home appliance manufacturing companies has convinced us that their perspective on and attitudes toward noise control programs will strongly influence the efforts they make to quiet their products. This is even more true of the values they hold regarding the legitimacy and worth of quiet environments. Indeed, we regard the public support of noise abatement efforts as a crucial variable in the success of these efforts.

We would, therefore, recommend a continuous program to diagnose and develop public support for noise abatement. Such a program would embrace five activities:

Exploration of Programs in Other Areas

We visualize this as an inquiry both into the theory of public opinion, attitude change, and shifts in basic values and into the actual techniques of public support development that have been employed in other contexts.

A Continuous Inventory of Opinion-Leader Attitudes

This would be a program of interviews with opinion leaders who are dealing with noise abatement. It would include leaders

in government, business, relevant professions, and consumer- and ecology-advocate groups.

A Continuous Inventory of Public Awareness, Attitudes, and Values

These should be measured on a well-designed material sample on a continuous basis so that trends over time could be assessed concerning public knowledge, attitudes, and values.

Program Development

A program, based on information obtained from the three activities above, should be developed (1) to optimize the kind and degree of regulation which can be supported by the public opinion that exists, (2) to prescribe a public information program that will improve the quality of public opinion, and (3) to identify profitable areas for demonstration programs.

The Development and Administration of Pilot Programs of Noise Abatement

These pilot programs should test the relation of regulation to various levels of public support in the same sense that pilot programs that test innovative technological prototypes are developed.

We should like to say a word regarding the usefulness and feasibility of the continuous inventories of leader opinion and public opinion - activities 2 and 3 above.

Field research in the behavioral sciences has now reached the point that useful social indicators can often be developed if their development is undertaken on a pragmatic basis. We do

not visualize that these survey activities will be conducted at the level of public-opinion polls. Again, the behavioral sciences have matured to the point that much more useful kinds of information can be gathered. We know from previous noise surveys that socio-economic status and attitudes toward noise makers influence noise annoyance and noise complaints. A recent study of motor vehicle noise that we have conducted indicates that the necessity of the noise, and the degree to which one perceives the noise as an intrusion, influences the level of annoyance. The survey efforts proposed would tap values that would assist in the formulation of noise criteria. Are people willing to put up with "bearable" levels of noise or do they now demand reduction to "comfortable" levels? Of greatest importance may be attitudes toward the regulating process itself. By now it is well-established in social psychology that basic orientations towards the sources of influence alter behavior. With regard to the product manufacturer who promises to become an object of regulation, theory would predict that one's enforcement problems would be quite different if the manufacturers complied to regulation because of fear, because compliance was expected by his reference groups, or because his own values induced compliance. These psychological orientations can be measured through interviews.

5.5 Social Impact

The following recommendations are made to evaluate the impact of noise not only from the sources under consideration in the current report but also from other sources.

1. The most fundamental action that can be taken to further the assessment of noise impact is to initiate research leading

to development of an absolute scale of annoyance for all noise exposure. The first stage of such a research program would obviously be a planning effort to structure the task and prepare detailed plans for its execution.

The need for such research is immediate. Existing methods for estimating annoyance are relative rather than absolute, limited in scope and application, not widely accepted, and of dubious utility. The intended research would entail simultaneous measurement of both complaint behavior and the offending acoustic signals producing complaints, *at the time of annoyance*. A continuous survey of residential noise annoyance over a considerable period of time is needed, as are surveys of noise annoyance in other environments. Until a well-founded research program of this sort is undertaken, one must continue to rely upon personal experience or the distortions of the popular press for estimates of the true magnitude of the annoyance problem.

2. Since speech interference proved to be such a widespread consequence of exposure to the noise sources considered in this report, research should be conducted to determine how accurately speech interference predictions made on the basis of laboratory data may be extended to real-life situations. Almost all current knowledge of speech interference effects has been produced by studies employing steady-state noise as the interfering signal. No research has been conducted on potentially crucial effects of temporal parameters of noise distributions (including frequency, duration, and periodicity of interference) on verbal communication. Further, little if anything is known of the annoyance value of speech interference. Trade-offs governing the relative annoyance of frequent but short interruptions vs infrequent but long interruptions of verbal communication have not been investigated. It therefore remains impossible to predict whether people would

suffer more speech interference from one type of appliance than another; whether redesign of machinery for longer duration but lower level noise output would be helpful; whether scheduling changes in the operation of construction machinery would reduce speech interference; and so forth.

3. Noise education programs should be designed to provide the public with the information needed to make decisions about the desirability of noise exposure. A noise-conscious public can exercise a modicum of control over its noise exposure through its purchasing power and its demands for noise control legislation. Consideration should be given to preparation of public information pamphlets, recordings, or other means of increasing public awareness of noise exposure.

REFERENCES

1. Schultz, T.J., "Community Noise Ratings: A Review," Supplement No. 1, *Applied Acoustics*, 1971.
2. Robinson, D.W., "The Concept of Noise Pollution Level," National Physics Laboratory Aero Report AC 38, March 1969.
3. Schultz, T.J., "Technical Background for Noise Abatement in HUD's Operating Programs," BBN Report No. 2005, September 1970.
4. Beranek, L.L., *Noise and Vibration Control*, McGraw-Hill Book Company, New York (1971).
5. "The Auditory Environment in the Home," a report by the Environmental Design Department, University of Wisconsin for Koss Electronics, Inc., Milwaukee, Wisconsin.
6. Mikeska, E.E., "Noise in the Modern Home," *Noise Control*, May 1958, p. 40.
7. BBN data measured in 1971.
8. Mikeska, E.E., "Noise Levels in Homes," *Noise Control*, May 1957, pp. 11-14.
9. "Field Study of Residential Acoustics: Acoustical Performance of Apartments and Occupants' Responses," NAHB Research Foundation, Inc., Rockville, Maryland, 1967.
10. Beranek, L.L., *Noise Reduction*, McGraw-Hill Book Company, New York (1960).
11. "Noise Study of a Domestic Dishwasher," BBN Rept. No. 979, March 1963.
12. "Water Closet Noise Studies," BBN Rept. No. 1402, Dec. 1968.
13. Cohen *et al*, "Sociocusis-Hearing Loss from Non-Occupational Noise Exposure," *Sound and Vibration*, November 1970, pp. 12-20.
14. Kryter, K., "Hazardous Exposure to Intermittent and Steady-State Noise," Report of Working Group 46 NAS-NSC Committee on Hearing and Bioacoustics, January 1965.

REFERENCES (Continued)

15. Kryter, K., *The Effects of Noise on Man* (Academic Press, N.Y., 1970).
16. Miller, J., personal communication, 1971.
17. Webster, J.C., "SIL - Past, Present and Future," *Sound and Vibration* 3(8):22-26, August 1969.
18. Beranek, L.L., "Criteria for Office Quieting Based on Questionnaire Rating Studies," *J. Acoust. Soc. Amer.*, 28, Sept. 1956, pp. 833-852.
19. "Urban Traffic Noise: Status of Research and Legislation in Different Countries," Draft Report of the Consultative Group on Transportation Research, DAS/CSI/68.47 Revised; Organisation for Economic Cooperation and Development, Paris, France, 4 March 1969.
20. Lang, J., and Jansen, G., "Report on the Environmental Health Aspects of Noise Research and Noise Control," United Nations, World Health Organization, May 1967.
21. Schieber, J.P., "Problemes Acoustiques du Confort de Nuit", (Acoustical Problems Concerning Nighttime Comfort), Cahiers du Centre Scientifique et Technique du Batiment, No. 100; Cahier 869, June 1969, Paris; p. 36.
22. Metz, B., "Étude Analytique en Laboratoire de l'Influence du Bruit sur le Sommeil," (Analytical Laboratory Study of the Influence of Noise on Sleep), No. 63 FR 138, University of Strasbourg, 1968.
23. Schieber, J.P., "Contributions des Études de la Physiologie au Probleme de la Determination des Zones de Confort Acoustique au Cours de Sommeil," (Contributions of Physiological Studies to the Problem of Determining Areas of Acoustic Comfort during Sleep), presented at a Colloquium on the Definition of Human Requirements with Regard to Noise, 18 & 19 November 1968, Paris; published in *Revue d'Acoustique* 3(10): 104-112 (1970).
24. Hildebrand, J., "Noise Pollution: An Introduction to the Problem and an Outline for Future Legal Research," *Columbia Law Review* 70, April 1970.

REFERENCES (Continued)

25. Kryter, K., "Laboratory Tests of Physiological-Psychological Reactions to Sonic Booms," *J. Acoust. Soc. Amer.*, 39(5) 1966.
26. *Noise: Final Report*, Committee on the Problem of Noise, Sir Alan Wilson, Chairman, Her Majesty's Stationery Office, London, July 1963.
27. Geber, W., Anderson, T., Van Dyne, B., and Vermillion, S., "Physiologic Responses of the Albino Rat to Chronic Noise Stress," *Arch. Environ. Health*, 12:751, 1966.
28. Dougherty, J., in "Human Response to Sonic Booms: A Research Program Plan," FAA Report No. 70-2, 1970 (BBN Report No. 1831).
29. Woodhead, M.M., "Effect of Brief Loud Noise on Decision Making," *J. Acoust. Soc. Amer.*, 31(10):1329-1331, 1959.
30. Corcoran, D., "Noise and Loss of Sleep," *Quarterly J. Exp. Psych.* (14) 1962.
31. Bureau of the Budget, *Standard Metropolitan Statistical Areas*, 1967.
32. Bureau of the Census, *Statistical Abstract of the United States*, 1970.
33. Business and Defense Services Administration, *Construction Review*, April 1971.
34. *Highway Statistics/1969*, U.S. Dept. of Transportation, Federal Highway Administration, Washington, D.C., Table OMB, p. 167.
35. Bureau of the Census, *U.S. Census of Population*, 1, 1960.
36. Wiener, F.M., Malme, C.I., and Gogos, C.M., "Sound Propagation in Urban Areas," *J. Acoust. Soc. Amer.*, 37, 1965.
37. *Noise in Urban and Suburban Areas: Results of Field Studies*, BBN Report 1395, 1967.

REFERENCES (*Continued*)

38. Department of Agriculture information based on studies of home activities (a long-term interest, which is now being continued under the Agriculture Research Service Division of the Department of Agriculture).
39. New York State College of Human Ecology, Cornell University (both published and unpublished data gathered as part of a 1296-household survey of Syracuse, New York).

APPENDIX A — DETAILED SOURCE CHARACTERIZATION

A.1 Construction Equipment

Of the considerable body of data on the noise of construction equipment, most pertains to the operator position; the available data on noise radiated by this equipment to its surroundings is very limited. The data presented in Fig. 1 (main text) and in this appendix were obtained from

- The open literature [1-4].
- Reports, including those submitted by various manufacturers at the EPA hearings on construction equipment held in Atlanta, Georgia, July 8 and 9, 1971.
- Field measurements conducted for this project at a number of construction sites in the vicinity of Boston.*

A.1.1 Noise spectra

Much of the equipment used at construction sites is powered by diesel engines, which generally constitute the predominant noise sources. Figure A.1 shows the envelope of the 1/3-octave band spectra of noise from 23 different items of diesel-powered construction equipment, rated from 45 to 770 hp and operating at between 1100 and 2700 rpm, at a variety of conditions (i.e., with various degrees of loading, ranging from none to heavy). These spectra were obtained at various locations around the equipment items, which also varied in the degree of exhaust muffling present.

*These measurements were made with a 1-in. Bruel and Kjaer type 4131 condenser microphone, coupled to a Bruel and Kjaer type 2203 sound level meter. The signals were recorded on a Kudelski Nagra type III tape recorder, and later analyzed in the laboratory by means of a General Radio Corp. "Real-Time Analyzer". Calibration was accomplished with the aid of a Bruel and Kjaer type 4220 piston phone.

Figures A.2, A.3, and A.4 show the noise spectra from some typical engine-powered items of equipment. The low-frequency peaks typically correspond to the firing frequency (the number of power strokes per unit time - which depends on the engine speed, number of cylinders, and on the number of power strokes per revolution) and its harmonics. Figure A.2 illustrates the noise made by two tracked bulldozers under various working conditions. These spectra reflect not only the diesel noise but also some noise due to tracks, gears, and scraping of metal components against rock.

Gasoline (spark-ignition) engines have noise spectra that are similar to those of diesel engines. In construction equipment, however, diesel engines tend to be used for all of the higher power applications, with spark-ignition engines relegated to lower power equipment. Spectra corresponding to two types of gasoline-engine powered equipment are shown in Fig. A.3.

Noise spectra for two air compressors - one diesel, one gasoline-engine powered - incorporating no special noise control provisions are shown in Fig. A.4. Figure A.5 shows the noise spectra associated with several pumps and generators; Fig. A.6 shows those levels produced by a vibrator acting on a plywood framework and by various saws cutting wood. Noise spectra produced by various pneumatic tools are shown in Fig. A.7.

The noise from conventional pile drivers is characterized by intense peaks associated with the impacts of the hammer against the pile. The peak levels associated with these impacts are indicated in Fig. A.8 for two conventional pile drivers, together with the noise levels produced by a sonic (vibratory, nonimpact) pile driver.

A.1.2 Average construction site noise pollution levels

Based on an analysis of the activities that occur during each phase of construction at the various types of sites, a listing of the equipment active during each phase was developed. This listing, together with an estimate of the fractional number of sites that involve each equipment item, appears in Table A-1.

For site noise analysis, this large table was simplified by averaging equipment usage over similar sites and by grouping together equipment items with similar noise characteristics. For the calculations, equipment with noise characteristics that were not known directly was replaced by equipment expected to have similar (known) noise characteristics (e.g., back fillers and trenchers were replaced by backhoes and loaders). Equipment known to be extremely quiet (e.g., electric cranes, electric fork lifts) was totally omitted from the calculations.

Since a given item of equipment is present at only a fraction of all sites and only during part of each phase, and since it only operates part of the time that it is present, a usage factor was assigned to each equipment item. This factor was calculated as the product of three factors: (1) the fractional number of sites at which the equipment is used (based on Table A-1), (2) the estimated fraction of the phase duration during which the equipment is on site and (3) the duty cycle, i.e., the fractional time that this equipment is operating while on site [5]. The resulting usage factors are summarized in Table A-2.

In order to calculate the site NPL, defined as the sum of the energy-average SPL in dB(A) and 2.56 times the Standard Deviation of A-scale SPL [6], one needs to know not only the average sound

TABLE A-1. USE OF EQUIPMENT AT CONSTRUCTION SITES

Type of Construction Equipment	Domestic Housing		Nonresidential Buildings				Public Works	
	One to Four Family Dwellings (\$15-50K) ^x	Five or More Family Dwellings (\$180-720K) ^x	Office Building, Hotel, Hospital (\$190-4,000K) ^x	School, Public Works Building (\$280-1,090K) ^x	Industrial, Parking Garage (\$120-820K) ^x	Religious, Recreational, Store, Service Station (\$30-400K) ^x	Municipal Roads and Highways	Municipal Sewers and Trenches
Backfiller	[X] ⁵	(X) ⁵	(X) ⁵	(X) ⁵	[X] ⁵	(X) ⁵	(X) ⁵	X ⁵
Breaker, Paving	[X] ⁵	(X) ⁵	X ^{2,3,4,5}	X ^{2,3,4,5}	X ^{2,3,4,5}	X ^{2,3,4,5}	X ^{2,3,4,5}	X ^{2,3,4,5}
Burner, Aspirated	[X] ⁵	[X] ⁵	(X) ^{3,4,5}	(X) ^{3,4,5}	(X) ^{3,4,5}	(X) ^{3,4,5}	X ^{3,4,5}	(X) ^{3,4,5}
Compressor, Air	[X] ^{2,4}	(X) ^{2,4}	(m2) X ^{2,3,4,5}	(m2) X ^{2,3,4,5}	X ^{2,3,4,5}	X ^{2,3,4,5}	(m?) X ^{2,3,4,5}	X ^{2,3,4,5}
Conveyor (Electric)		X ^{2,5}	(m2)(X) ^{2,5}	(m2)(X) ^{2,5}	(m2)(X) ^{2,5}	(X) ^{2,5}	[X]	
Crane								
Climbing (Electric)			X ^{2,5}	[X] ^{2,5}	[X] ^{2,5}	[X] ^{2,5}		
Crawler-Mounted (Diesel)	[X] ^{2,5}	(X) ^{2,5}	(X) ^{2,5}	(X) ^{2,5}	(X) ^{2,5}	[X] ^{2,5}	(X) ⁴	(X) ⁴
Truck-Mounted (Diesel)	(X) ^{2,5}	X ^{2,5}	(X) ^{2,5}	(X) ^{2,5}	(X) ^{2,5}	X ^{2,5}	X ⁴	X ⁴
Drill								
Rotary	[X] ^{2,5}	[X] ^{2,5}	[X] ^{2,5}	[X] ^{2,5}	[X] ^{2,5}	[X] ^{2,5}	(X) ²	(X) ²
Pneumatic, Rock	[X] ^{2,5}	(X) ^{2,5}	X ² [X] ³	X ^{2,5}	X ² [X] ³	(X) ² [X] ⁵	X ²	(X) ²
Elevator, Exterior (Electric)			X ^{2,5}	(X) ^{2,5}	(X) ^{2,5}	(X) ^{2,5}		
Fork-Lift (Electric)		X ^{3,4,5}	X ^{3,4,5}	X ^{3,4,5}	X ^{3,4,5}	X ^{3,4,5}	(X) ^{2,5}	
Generator, Electric	(X) ¹	(X) ¹	(m2)(X) ^{1,2}	(X) ^{1,2}	(X) ^{1,2}	(X) ^{1,2}	(m?) X ^{1,2,3,4,5}	X ^{1,2,3,4,5}
Grader	[X] ^{1,5}	(X) ^{1,5}	(X) ^{1,5}	X ^{1,5}	[X] ^{1,5}	(X) ^{1,5}	X ^{1,5}	(X) ^{1,5}
Hammer, Pile-Driving		[X] ¹	(m2) X ¹	(X) ¹	(X) ¹	(X) ¹	(m?) [X] ¹	(X) ¹
Mixer, Concrete	(X) ^{2,5}	(X) ^{2,5}	[X] ^{2,3,4,5}	[X] ^{2,4,5}	[X] ^{2,3,4,5}	(X) ^{2,3,4,5}	(m?) X ^{2,5}	(X) ^{2,3,4,5}
Paver	[X] ⁵	(X) ⁵	X ⁵	X ⁵	X ⁵	(X) ⁵	(m?) X ⁵	X ⁵
Pump								
Water (Electric)	(X) ^{2,4}	(m2) X ^{2,4}	(m2) X ^{2,4,5}	(m2) X ^{2,4,5}	(m2) X ^{2,4,5}	X ^{2,4,5}	(m?) X ^{2,4,5}	(m?) X ^{2,4,5}
Concrete (Diesel)	[X] ^{2,5}	X ^{2,5}	(m2) X ^{2,3,4,5}	(m2) X ^{2,3,4,5}	(m2) X ^{2,3,4,5}	X ^{2,3,4,5}	(m?) X ^{2,3,4,5}	(m?) X ^{2,3,4,5}
Wellpoint (Electric)	(X) ^{2,4}	(X) ^{2,4}	(m2)(X) ^{2,4,5}	(m2)(X) ^{2,4,5}	(m2)(X) ^{2,4,5}	(X) ^{2,4,5}	(m?) X ^{2,4,5}	(m?) (X) ^{2,4,5}
Ripper, Earth & Rock							(X) ²	(X) ²
Roller	(X) ⁵	(X) ⁵	X ⁵	X ⁵	X ⁵	X ⁵	(X) ⁵	(X) ⁵
Saw, Pavement		[X] ⁵	(X) ^{2,5}	(X) ^{2,5}	(X) ^{2,5}	(X) ⁵	(X) ⁵	X ^{1,2,5}
Sandblaster			(X) ⁵	(X) ⁵	[X] ⁵	[X] ⁵	[X] ⁵	
Scraper	[X] ^{1,5}	(X) ^{1,5}	X ^{1,5}	X ^{1,5}	X ^{1,5}	(X) ^{1,5}	X ^{1,2,3,4,5}	(X) ⁵
Screed, Vibrating	(X) ^{3,4}	X ^{3,4}	X ^{3,4,5}	(X) ^{3,4,5}	X ^{3,4,5}	(X) ^{3,4,5}	X ⁵	(X) ^{3,4,5}
Shovel								
Truck - Mounted		(X) ²	X ²	X ²	X ²	(X) ²	X ^{1,2,5}	(X) ²
Crawler - Mounted		[X] ²	(X) ^{2,5}	(X) ^{2,5}	(X) ^{2,5}	[X] ^{2,5}	(X) ^{1,2,5}	[X] ^{2,5}
Sweeper		[X] ⁵	X ⁵	X ⁵	X ⁵	(X) ⁵	X ⁵	(X) ⁵
Tamper (ram)		(X) ⁵	(X) ^{4,5}	(X) ^{4,5}	(X) ^{4,5}	(X) ^{4,5}	X ^{4,5}	X ^{4,5}
Tools								
Pneumatic, Impact	(m) (X) ^{2,5}	(m) X ^{2,5}	(m) X ^{2,5}	(m) X ^{2,5}	(m) X ^{2,5}	(m) X ^{2,5}	(m) X ^{1,2,5}	(m) (X) ^{2,5}
Hammer	(m) X ^{3,4,5}	(m) X ^{3,4,5}	(m) X ^{3,4,5}	(m) X ^{3,4,5}	(m) X ^{3,4,5}	(m) X ^{3,4,5}	(m) X ³	(m) X ³
Saw (Electric)	(m) X ^{3,4,5}	(m) X ^{3,4,5}	(m) X ^{3,4,5}	(m) X ^{3,4,5}	(m) X ^{3,4,5}	(m) X ^{3,4,5}	(m) X ³	(m) X ³
Tractor								
Wheeled	(X) ^{1,2,5}	(X) ^{1,2,5}	(X) ^{1,2,5}	[X] ^{1,2,5}	[X] ^{1,2,5}	[X] ^{1,2,5}	(X) ^{1,2,3,4,5}	(X) ^{1,2,3,4,5}
Crawler	X ^{1,2,5}	X ^{1,2,5}	X ^{1,2,5}	X ^{1,2,5}	X ^{1,2,5}	X ^{1,2,5}	X ^{1,2,3,4,5}	X ^{1,2,3,4,5}
Tractor, Accessory								
Backhoe	[X] ^{1,2,5}	(X) ^{1,2,5}	(X) ^{1,2,5}	(X) ^{1,2,5}	(X) ^{1,2,5}	(X) ^{1,2,5}	X ^{1,2,5}	X ^{1,2,5}
Dozer	X ^{1,2,5}	X ^{1,2,5}	X ^{1,2,5}	X ^{1,2,5}	X ^{1,2,5}	X ^{1,2,5}	X ^{1,2,5}	X ^{1,2,5}
Loader	X ^{1,2,5}	X ^{1,2,5}	X ^{1,2,5}	X ^{1,2,5}	X ^{1,2,5}	X ^{1,2,5}	X ^{1,2,5}	X ^{1,2,5}
Trencher		[X] ^{2,5}	(X) ^{2,5}	(X) ^{2,5}	(X) ^{2,5}	[X] ^{2,5}	X ^{2,5}	X ²
Truck								
Dump, Off-Highway	[X] ^{1,2,5}	(X) ^{1,2,5}	(m2)(X) ^{1,2,5}	(m2)(X) ^{1,2,5}	(m2)(X) ^{1,2,5}	(X) ^{1,2,5}	(m) X ^{1,2,3,4,5}	(X) ^{1,2,5}
Dump, On-Highway	X ^{1,2,5}	X ^{1,2,5}	(m2) X ^{1,2,5}	(m2) X ^{1,2,5}	(m2) X ^{1,2,5}	X ^{1,2,5}	(m) X ^{1,2,3,4,5}	X ^{1,2,5}
Mixer, Concrete	X ^{2,5}	X ^{2,5}	(m2) X ^{2,3,4,5}	(m2) X ^{2,3,4,5}	(m2) X ^{2,3,4,5}	X ^{2,3,4,5}	(m) X ^{2,3,4,5}	(X) ^{1,5}
Flat-Bed	X ^{1,2,5}	X ^{1,2,5}	(m2) X ^{1,2,5}	(m2) X ^{1,2,5}	(m2) X ^{1,2,5}	X ^{1,2,5}	(m) X ^{1,2,5}	X ^{1,2,5}
Vibrators, Concrete	(X) ^{2,5}	X ^{2,5}	(m) X ^{1,2,5}	(m) X ^{1,2,5}	(m) X ^{1,2,5}	X ^{2,3,4,5}	(m) X ^{1,2,5}	(X) ^{1,2,5}
Warning Devices		[X] ^{1,2,3,4,5}	(m) X ^{1,2,3,4,5}	(m) (X) ^{1,2,3,4,5}	(X) ^{1,2,3,4,5}	[X] ^{1,2,3,4,5}	(m) X ^{1,2,3,4,5}	(X) ^{1,2,3,4,5}
Other								
Chain Saw	(X) ¹	(X) ¹					(m) X ¹	(X) ¹
Explosives	[X] ^{1,2}	[X] ^{1,2}	[X] ^{1,2}	[X] ^{1,2}	[X] ^{1,2}	[X] ^{1,2}	X ^{1,2}	(X) ^{1,2}
Net Acoustic Rating [dB(A)]								

A-4

* X - Present at all sites
 (X) - May be present
 [X] - Infrequently present

Numerical Superscript for Phase of Construction Most Important Phase is Underlined

¹Ground Clearing
²Excavation
³Foundations
⁴Pre-tilt
⁵Finishing

(m) = multiple presence - although separate physically (e.g. several simultaneous cranes)

X^{1,2,3,4,5} = average noise within all five phases of construction

TABLE A-2a. USAGE FACTORS OF EQUIPMENT
IN DOMESTIC HOUSING CONSTRUCTION*

Equipment†	Construction Phase				
	Clearing	Excavation	Foundation	Erection	Finishing
Air Compressor [81]		.1			.25
Backhoe [85]	.02	.04			.02
Concrete Mixer [85]			.4	.08	.16
Concrete Pump [82]					
Concrete Vibrator [76]					
Crane, Derrick [88]					
Crane, Mobile [83]				.1	.04
Dozer [80]	.04	.08			.04
Generator [78]	.4				
Grader [85]	.05				.02
Jack Hammer [88]					.025
Loader [79]	.04	.08			.04
Paver [89]					.025
Pile Driver [101]					
Pneumatic Tool [85]			.04	.1	.04
Pump [76]		.4	.7		
Rock Drill [98]		.01			.005
Roller [74]					.04
Saw [78]			.04(2)	.1(2)	.04(2)
Scraper [88]	.05				.01
Shovel [82]		.02			
Truck [91]	.16	.4			.16

* Numbers in parentheses represent average number of items in use, if that number is greater than one. Blanks indicate zero or very rare usage.

† Numbers in brackets [] represent average noise levels [db(A)] at 50 ft.

TABLE A-2b. USAGE FACTORS OF EQUIPMENT
IN NONRESIDENTIAL CONSTRUCTION*

Equipment [†]	Construction Phase				
	Clearing	Excavation	Foundation	Erection	Finishing
Air Compressor [81]		1.0(2)	1.0(2)	1.0(2)	.4(2)
Backhoe [85]	.04	.16			.04
Concrete Mixer [85]			.4	.4	.16
Concrete Pump [82]			.4	.08	.08
Concrete Vibrator [76]			.4	.1	.04
Crane, Derrick [88]				.16	.04
Crane, Mobile [83]				.16(2)	.04(2)
Dozer [80]	.16	.4			.16
Generator [78]	.4(2)	1.0(2)			
Grader [85]	.08				.02
Jack Hammer [88]		.1	.04	.04	.04
Loader [79]	.16	.4			.16
Paver [89]					.1
Pile Driver [101]			.04		
Pneumatic Tool [85]			.04	.16(2)	.04(2)
Pump [76]		1.0(2)	1.0(2)	.4	
Rock Drill [98]		.04			.005
Roller [74]					
Saw [78]			.04(3)	1.0(3)	
Scraper [88]	.55				
Shovel [82]		.4			
Truck [91]	.16(2)	.4			.16

* Numbers in parentheses represent average number of items in use, if that number is greater than one. Blanks indicate zero or very rare usage.

† Numbers in brackets [] represent average noise levels [db(A)] at 50 ft.

TABLE A-2c. USAGE FACTORS OF EQUIPMENT
IN INDUSTRIAL CONSTRUCTION*

Equipment†	Construction Phase				
	Clearing	Excavation	Foundation	Erection	Finishing
Air Compressor [81]		1.0	.4	.4	.4
Backhoe [85]	.04	.16			.04
Concrete Mixer [85]			.4	.16	.16
Concrete Pump [82]			.4		.08
Concrete Vibrator [76]					
Crane, Derrick [88]				.04	.02
Crane, Mobile [83]				.08	.04
Dozer [80]	.04	.16			.04
Generator [78]	.4	.4			
Grader [85]	.05				.02
Jack Hammer [88]		.1	.04	.04	.04
Loader [79]	.16	.16			.04
Paver [89]					.12
Pile Driver [101]			.04		
Pneumatic Tool [85]			.04	.1(3)	.04(2)
Pump [76]		.4	1.0(2)	.4	
Rock Drill [98]		.04			.05
Roller [74]					.1
Saw [78]			.04(2)	.1(2)	
Scraper [88]	.14				.08
Shovel [82]		.2			.06
Truck [91]	.16(2)	.16(2)			.16

* Numbers in parentheses represent average number of items in use, if that number is greater than one. Blanks indicate zero or very rare usage.

† Numbers in brackets [] represent average noise levels [db(A)] at 50 ft.

TABLE A-2d. USAGE FACTORS OF EQUIPMENT
IN PUBLIC WORKS CONSTRUCTION*

Equipment [†]	Construction Phase				
	Clearing	Excavation	Foundation	Erection	Finishing
Air Compressor [81]		1.0(2)	.4	.4	.4(2)
Backhoe [85]	.04	.4			.16
Concrete Mixer [85]			.16(2)	.4(2)	.16(2)
Concrete Pump [82]					
Concrete Vibrator [76]					
Crane, Derrick [88]		0.1	.04	.04	
Crane, Mobile [83]				.16	
Dozer [80]	.04	.4			.16
Generator [78]	1.0(2)	.4(2)	.4(2)	.4	.4(2)
Grader [85]	.08			.2	.08
Jack Hammer [88]				.04	.1(2)
Loader [79]	.04	.4			.16
Paver [89]					
Pile Driver [101]					
Pneumatic Tool [85]			.04(2)	.1	.04
Pump [76]		.4(2)	1.0(2)	.4(2)	
Rock Drill [98]		.04			
Roller [74]			.01		
Saw [78]			.04(2)		
Scraper [88]	.08		.2	.08	.08
Shovel [82]	.04	.4	.04		.04
Truck [91]	.16(2)	.16	.4(2)		.16(2)

* Numbers in parentheses represent average number of items in use, if that number is greater than one. Blanks indicate zero or very rare usage.

† Numbers in brackets [] represent average noise levels [db(A)] at 50 ft.

pressure, but also enough about its time-variation so that one can determine its standard deviation. In addition, the background noise levels enter in the evaluation of both of these quantities. Accordingly, representative background noise levels were selected as 50 dB(A) for residential, suburban, and rural sites and 70 dB(A) for commercial and industrial (urban) sites, on the basis of data for various U.S. and foreign locations [7].

Representative time-variations of noise were generated by dividing each construction phase into 50 equal time intervals. The start (or "turn-on") times for each individual item listed in Table A-2 were determined at random (by means of a computer random number generator), and the fractional "on-time" duration for each item was taken as its usage factor (Table A-2). From the noise level for each item of equipment, the total noise level in each time interval was then calculated, and from this ensemble of values the desired average and standard deviations were evaluated. For test purposes, the calculations for several sites/phases were repeated several times, with different randomly selected start times; the resulting NPL values were always found to lie within a 3 dB(A) interval. Although such repetitive calculations were not carried out for all sites/phases, the reported site NPL values may be considered as valid within ± 2 dB(A).

A.2 Appliances

In the following sections, brief discussions are presented of appliances not covered in the body of the report. We measured the noise levels of many of these appliances; these measurements are presented here as 1/3-octave band sound pressure data.

A.2.1 Can opener, electric

Noise of electric can openers is generated by the reducing gears, the electric motor, and the grating of the clamp against the moving lip of the can. Additional noise is radiated from the plastic or metal panels of the unit. Can openers are usually mounted on small rubber feet which partially isolate the vibration from the work surface; however, wall mounting of the opener can short-circuit this isolation. The A-weighted sound level at a distance of 3 ft was measured for seven electric can openers; the mean level was 66 dB(A).

Figure A.9 shows 1/3-octave band plots of the sound pressure levels measured at a distance of 3 ft for two different can openers. The peaks at 63 and 125 Hz are probably motor-induced while the higher frequency peaks are probably related to the number of teeth in the reducing gears.

A.2.2 Clothes dryer

Clothes dryers are relatively quiet appliances which consist of a rotating drum within a metal enclosure; heat is supplied by either electric coils or a gas flame. The constant noise of the motor and the rumble of the drum, plus the combustion roar in a gas dryer, are punctuated by the noise of buttons or zippers impacting with the metal chamber. A range of sound levels from 51 dB(A) to 66 dB(A), with a mean level of 58 dB(A), was measured at a distance of 3 ft for eleven gas and electric dryers. Figure A.10 shows 1/3-octave band sound pressure level data for five different dryers.

A.2.3 Clothes washer

The noise generating components of clothes washers include:

- water noise during the filling, agitation, and spinning cycles
- unbalanced loads, which cause excessive vibration to be transmitted into piping and floor
- motor
- pump

Figure A.11 presents the noise levels for the wash cycle of five different machines; Fig. A.12 shows noise levels for the spin cycle of four of these five machines. The peaks in the low-frequency bands probably represent motor-induced noise while those in the mid-frequency bands may be related to spinning of the tub.

A.2.4 Coffee mill

A coffee mill consists of a grinding mechanism that is driven by a motor to produce fine to coarse ground coffee. Motor-induced noise is radiated from the casing and the coffee bean enclosure. Rubber feet are provided for vibration isolation. Measurements were made at a 3 ft distance on two coffee mills: the two sound levels were 75 dB(A) and 78 dB(A).

A.2.5 Dehumidifier

In a home humidifier, a small fan draws air across condensing coils, collecting the moisture in a removable pan. Noise measurements were made of four dehumidifiers; the noise varied from 52 dB(A) to 62 dB(A).

Figure A.13 present 1/3-octave band data for the quietest of these units. The broad peak in the vicinity of 120 Hz is motor induced; mid-frequency noise is dominated by the fan. Although compressors may be vibration isolated, the casing of a unit is likely an important radiator.

A.2.6 Edger and trimmer

An edger and trimmer consists of a high-speed motor directly driving a two-bladed knife. This lawn tool is used to trim the grass along walkways and the brush along garden paths.

Figure A.14 presents 1/3-octave band data on one unit; the sound level was 81 dB(A). The peaks in the frequency spectrum seem to be the 1st, 2nd, 3rd, 6th, and 20th harmonics of 400 Hz. It is anticipated that narrower band analysis would reveal more tonal components that are related to the blade passage of the cutting edge.

A.2.7 Fan

There are three general categories of fans found in the home: window fans, floor fans, and stove hood and bathroom exhaust fans.

- Window fans are usually standardized to a 14-in. or 22-in. size (12-in. and 20-in. diameter blades respectively). Features on deluxe models include thermostatic control and reversible direction of air flow. Twelve noise measurements of window fans ranged from 47 dB(A) to 66 dB(A); the mean was 57 dB(A). Low-speed to high-speed mean values showed a spread of 17 dB(A).

Figure A.15 presents 1/3-octave band noise measurements for three window fans for both low and high speed. The tonal components are likely related to the blade passage frequency of the fan, the motor, the blade tip velocity, and the blade design.

- Floor fans or table fans usually consist of a base, a small electric motor, and a blade with protective cage. They often rotate back and forth to spread air movement around an arc of 90° or so and are usually designed to run at various operating speeds. Twenty-two measurements at a 3 ft distance yielded a range of sound levels from 38 dB(A) to 67 dB(A); the mean level was 54 dB(A).

Figure A.16 presents 1/3-octave band data for three floor fans for both low and high speed. The noise sources are very similar to those of window fans.

- Stove hood exhaust fans and bathroom exhausts are typically small axial flow fans mounted directly above the stove to exhaust cooking odors or in the bathroom ceiling to exhaust hot air. The mean dB(A) level of ten measurements at a 3 ft distance was 63 dB(A).

Figure A.17 presents narrowband data for four speeds for one particular stove hood exhaust fan. Again, the tones are related to motor noise and blade passage fan noise. Through the use of appropriate lining it should be possible to reduce the noise of stove hood exhaust fans and bathroom exhaust fans by up to 15 dB(A).

A.2.8 Food blender

The electrical motor control system on food blenders is designed to drive the cutting blades (located at the bottom of a removable container) at a wide range of speeds in order to perform various food blending tasks. Speed control may be achieved by using a variable-speed motor or solid state electronic networks. The primary sources of noise are the motor, the whirling of the blades causing radiated noise, structureborne noise, and agitating noise of the fluid. From measurements of the noise generated by foreign and domestic food blenders, the sound level ranged from 62 to 88 dB(A) with a mean level of 75 dB(A). The container was half full of water during most of these measurements. Figure A.18 presents a series of narrowband measurements representing the noise levels generated by one food blender running at each of nine different speeds. The peaks in the spectrum shift upward in frequency with increased speed, suggesting a dependence on the blade passage frequency of the cutting edges. Figure A.19 shows the variation in noise level for a maximum speed setting for five food blenders of different manufacture.

A.2.9 Food mixer

Food mixers are available in both portable and table model styles. Portable mixers are lightweight versions of table models - they have no base but consist of the same basic mechanisms: a set of beaters and a variable-speed motor or a single-speed motor with reduction gears. Twenty-five sound level measurements were made at a 3 ft distance on domestic and foreign, portable and table model food mixers. The mixer was operated in a bowl half-full of water for most of the measurements. The sound level ranged from 49 dB(A) to 79 dB(A) with a mean level of 67 dB(A). Figure A.20 shows narrowband analysis of mixer noise at low speed and at high speed.

A.2.10 Freezer

The mechanical components of a freezer are a compressor, evaporative coils, condensing coils, and one or two fans, as in a refrigerator. Small freezers have the condensing coils spread over the back of the machine. On larger units, with their requirement for forced cooling, the condenser coils are grouped at the bottom and cooled by a fan that also cools the compressor. With the compressor in operation, the sound levels generated by three home freezers were measured; the mean level was 41 dB(A) with a range of 39 to 45 dB(A) at a 3-ft distance. Figure A.21 shows narrowband data for two of the three freezers. The primary noise generators are the motor, fans, and compressor, with some radiation from the casing.

A.2.11 Hair clipper

A measurement of the noise generated by a hair clipper was made at a distance of 3 ft; the sound level was 59 dB(A). The noise is generated by the motor and gears which enable the clipping blades to vibrate.

A.2.12 Hair dryer

Different models of hair dryers all share the design objective of forcing warmed air over wet hair. Table models have a hard-shelled enclosure like that of a professional hairdressers machine. Portable dryers have plastic bonnets connected to the fan and heater by a flexible hose. Noise is generated by the fan, motor and air flow. A faster drying rate is achieved by greater air flow and higher temperatures; this, however, means increased noise from the fan. The latest development of a totally portable unit - with motor and blower attached directly to the bonnet - is the noisiest arrangement because it puts the noise source directly by the ear of the user. Six hair

dryers were measured at a 3-ft distance; the mean level was 61 dB(A). Figure A.22 shows 1/3-octave band sound pressure levels measured at a distance of 3 ft from three units. The low-frequency tonal components are probably motor related, while the high-frequency peaks may relate to the blade passage of the blower.

A.2.13 Heater, electric

Electric heaters used to heat a single room typically have small single-speed fans that blow air past electric coils into the room. The noise generated by these heaters is due to the electric motors, the fans, air flow, and, often, rattling metallic parts. A noise level of 47 dB(A) was measured at 3 ft from an electric heater.

A.2.14 Hedge clippers

The noise of hedge clippers, in which an electric motor runs one or two cutter bars, is mainly generated by the motor and reciprocating gear action. On some models, one bar moves back and forth against a stationary bar; on other models, two cutters reciprocate. Since the latter is a more balanced action, vibration to the user is reduced. We measured a noise level of 84 dB(A) at 3 ft from one unit.

A.2.15 Home shop tools

Electrically-powered shop tools such as drills, saws, sanders, grinders, lathes, and routers have similar noise generating mechanisms. In general, portable shop tools, due to their requirement to be lightweight and high-powered, require forced cooling of the motor and use high-speed universal motors which are often noisy

even when running free. Table model shop tools generally use induction motors which are relatively low speed and quiet when running free.

The portable straight-line or vibration sander is relatively quiet when running free [63 dB(A) at 3 ft] because it has a lower power requirement than most power tools and requires no forced cooling. Figure A.23 shows narrowband data for two operations of a belt sander: running free [82 dB(A)] and sanding wood [86 dB(A)]. The primary noise is the vibrating action of the sander foot.

In drills the gears add to the noise - the more sets of gears required, the noisier the operation. The noise generated by four 1/4-in. drills with a single set of gears measured 76 to 80 dB(A), the noise of two 3/8-in. drills with two sets of gears measured 83 dB(A), and the noise of two 1/2-in. drills with three sets of gears measured 84 and 87 dB(A). Figure A.24 presents noise levels measured near a 1/4-in., a 3/8-in., and a 1/2-in. drill; the peaks in the spectrum are probably related to the speed and the teeth ratios of the gears. Figure A.25 presents narrowband data on two different drill presses, one working metal, the other wood.

Noise levels generated by three different grinders working metal [87 to 97 dB(A)] are shown in Fig. A.26. In Fig. A.27 the noise levels generated by a router running free [81 dB(A)] are compared with the levels when it is working wood [88 dB(A)]. Noise levels of a small metal lathe are shown in Fig. A.28 for a running free condition and for cutting metal. Figure A.29 shows the narrowband data for a sabre saw running free and cutting wood.

Noise levels associated with the cutting of wood by a jig saw, a radial saw, a table saw, and a band saw are shown in Fig. A.30. The tone at 3150 Hz for the table saw may correspond to the frequency of teeth passing a given point [8].

Tools such as a table grinder, lathe, table jig saw, and table band saw generate noise levels in the mid-sixty to mid-seventy dB(A) range at a 3-ft distance while running free. The larger portable tools especially drills and grinders, generate noise levels of 80 to over 90 dB(A) running free.

A.2.16 Humidifier

Room size humidifiers are relatively simple mechanical devices in which a fan forces air through a wetted pad. Humidifiers exemplify the recurring noise problem from air circulation caused by fan, motor, and air movement noise. Figure A.31 shows narrowband data - 41, 51, and 65 dB(A) - for three settings of one humidifier. The higher levels are associated with higher fan speeds and thereby increased flow noise.

A.2.17 Knife, electric

For easy handling in the home, electric knives are designed to be small and lightweight. Therefore, the electric motor and gears for reciprocating blade action are encased in lightweight plastic. While the noise of an electric knife [with a range of 65 to 75 dB(A) and a mean level of 70 dB(A) at 3 ft] can be annoying, it also acts as a signal that the knife is in operation. Figure A.32 shows narrowband data for two of the three samples.

A.2.18 Knife sharpener

Electric knife sharpeners are often attached to electric can openers as well as being separate appliances. The rotation of sharpening stones alone is very quiet since just the motor and shaft rotate; however, the interaction between the stone and the knife during the sharpening process makes an unavoidable grating noise. A single measurement was made at a 3-ft distance; while the noise levels vary depending on the pressure of the knife against the stone, 72 dB(A) is representative of a typical sharpening operation.

A.2.19 Lawn mower, electric

The gears and the A.C. or battery powered engine of the rotary type electric lawn mower are the main sources of noise. The rattling of the engine housing and other metal parts plus the whirling sound of the blade are also identifiable. Although an electric lawn mower is often quieter than a gasoline-powered lawn mower, the two electric ones that were measured registered 81 and 89 dB(A) at a 3-ft distance. The larger the lawn mower, the more powerful an engine is needed to rotate the blade, and thus the noisier the device. Certain possibilities appear feasible for quieting the electric lawn mower such as changes in blade design and speed to reduce vortex noise, tighter construction of the tool, and sound damping for the motor housing and blade covering.

A.2.20 Oral lavage

An oral lavage is a device that uses the squirting force of water to cleanse the mouth. The motor drives a reciprocating pump, connected to a water supply, which forces a tiny stream of water out the end of a tube. Two measurements gave values of 70 and 72 dB(A).

A.2.21 Refrigerator

The majority of the refrigerators sold today are automatically defrosting. Cooling coils are located outside the freezer storage area and cold air is circulated through the freezer unit by a fan. The automatic defrost mechanism periodically melts the ice which forms on the coils. The trend in recent years has been to larger refrigerators with features such as automatic ice cube tray filling, ice cube making, and defrosting. Refrigerators with such features require more power and thus larger compressors with resulting higher noise levels. Better sound isolation around the machinery compartment, sound absorbing material in the machinery compartment, and resilient mounting of the motor and compressor have prevented the noise of the newer machines from greatly increasing. Twelve refrigerators were measured at a distance of 3 ft from the front. The levels ranged from 35 dB(A) to 52 dB(A) with a mean level of 42 dB(A). Figure A.33 presents narrowband data for two refrigerators.

A.2.22 Sewing machine

Sewing machines from the simplest to the most sophisticated and complex ones all have variable-speed electric motors, necessary gear and drive mechanisms, and auxiliary accessories. There is a wide range of controls available such as stitch tension, variable stitch length and width, zig-zag stitching, forward-reverse action, needle orientation, etc. The more versatile sewing machines have insertable cams which can be changed for different stitching patterns. Measurements on two sewing machines in operation gave values of 70 dB(A) and 74 dB(A) measured 3 ft from the machine. Figure A.34 shows narrowband data for these two machines.

Possible noise control measures are to reduce noise from the motor, linkages, gears, and clutch by use of different materials and more effective enclosures. Resilient mounting of vibrating parts to reduce structureborne vibration noise is presently used.

A.2.23 Shaver, electric

Electric shavers are run by a compact but powerful electric motor, powered from house current or a rechargeable battery. While shaving mechanisms may vary - using either rotary blades or oscillatory cutting action - the noise is generated by the motor and gears. The mean sound level for men's and women's shavers was 60 dB(A) at a 3 ft distance; the range was 47 to 69 dB(A). Figure A.35 shows narrowband data for four men's shavers and Fig. A.36 presents data for two women's shavers.

A.2.24 Toothbrush, electric

A small, lightweight high-speed motor run by either A.C. power or rechargeable batteries drives the detachable toothbrush. The less expensive models allow rotation in only one plane perpendicular to the axis of the toothbrush. With additional gearing, the more expensive models simultaneously rotate and move laterally to provide better cleaning action.

The main noise sources of an electric toothbrush are the motor and the gears. Typically, the devices with more gears are noisier. The mean sound level of three different electric toothbrushes at a 3 ft distance in bathrooms was 52 dB(A) with a range of 48 to 55 dB(A). At the user distance of about 3 in. from the device, the sound level is about 10 dB(A) higher. Figure A.37 shows narrowband data for an electric toothbrush.

Due to the overriding requirements for small size and light weight, noise control techniques such as improving the sound transmission loss of the casing or adding sound absorptive material are impractical. The most promising noise reduction possibilities will likely come from the development of quieter gear operations through the use of different materials or through designing the gears with closer tolerances or a different configuration.

A.2.25 Water faucets

Noise from water faucets includes water hammer, turbulence and cavitation noise. For particular values of pressure drop, a valve can be designed to minimize cavitation and its resulting noise; however, no valve configuration has been developed to minimize the noise for the full range of pressures that a valve experiences. The measured sound level at a distance of 3 ft for two water faucets was 61 dB(A). If die-casted brass fittings could replace sand-casted ones, there would be a smoother interior finish which would result in less turbulent flow and quieter operation.

A.3 Typical Equipment in Buildings

Many different types of electrical and mechanical equipment are required for the proper operation of modern large buildings. Much of this equipment is hidden in equipment rooms, behind ceilings, in walls, or behind cabinet type exterior enclosures, but the total cost and volume associated with such equipment represents a significant part of the cost and utility of a successful building. The majority of the equipment (including most of the basic heating and cooling system components) is for supplying the building occupants with a suitable amount of air at a comfortable temperature and moisture content. In addition, pumping and piping systems are

used for water and fluid circulation, elevators and escalators are used for movement of persons, and various conveyance systems are used for movement of material. In this section, the use and function of building equipment are briefly described. Where available, typical noise levels are presented for the equipment. For detailed information and procedures, the reader is referred to Refs. 9, 10, 11, and 12 at the end of this Appendix.

A.3.1 Prime movers

The function of prime movers is to transform energy - in the form of electric power or combustible fuel - into rotational movement for use in driving other equipment.

Electric Motors are the most widely used of the prime mover devices. They range in capacity from fractional hp up to several thousand hp; most motors fall in the speed range of about 450-3600 rpm. Motor noise is generated by aerodynamic, mechanical, and electrical forces. Aerodynamic noise, often the most prominent noise source, is generated by air turbulence due to movement of the blades of the cooling fan and the slots in the rotor. Recent designs have used higher cooling air velocities, thereby increasing the noise level.

Mechanical noise is due to bearings and shaft unbalance. Although mechanical noise can be identified in rotating machinery, low-frequency vibration rather than noise *per se* is the usual problem. Bearing noise is due to the sliding contact of sleeve bearings and the rolling contact of ball and roller bearings. When new, precision ball bearings are often quieter than sleeve bearings; however, after much use, they are much noisier. In new equipment, unbalance forces are usually small. Wear or build-up of dirt on the rotating component often increases the unbalance in a motor,

resulting in the generation of vibration at the rotational frequency and its integral multiples; e.g., since the shaft of a 3600 rpm motor turns at $3600 \text{ rpm} \div 60 \frac{\text{sec}}{\text{min}} = 60 \frac{\text{rev}}{\text{sec}}$, energy will be concentrated at 60, 120, 180 Hz, etc. with the 60-Hz component being the strongest.

Electrical noise is generated by magnetostriction — where a component (iron laminations) contracts and expands in response to an alternating magnetic field. Such effects are particularly noticeable when D.C. or variable-speed motors are supplied rectified A.C. current. The wave-form of the rectified current contains high-frequency components that generate noise in the more audible frequency ranges. The primary excitation frequency for magnetostriction is twice the main power frequency, e.g., in the USA, $2 \times 60 \text{ Hz}$ or 120 Hz.

In the past, motor noise was generally less than the noise produced by the driven component. However, motors designed for high-temperature rises or powered by rectified current may now be the controlling noise sources. Even in the case of relatively quiet motors, motor noise often becomes predominant when the driven component is quieted. Figure A.38 presents a range of noise levels typical of a 3 ft measurement position for the many different sizes of motors used in buildings.

Diesel and Natural or LP (Liquified Propane) Gas Internal Combustion Engines are sometimes used when special conditions make them economically feasible. They are often used in emergency power systems, in total energy systems, and for driving large machines such as chillers. Noise generated by internal combustion engines consists of contributions from the intake and the exhaust and radiation from the casing. Although improperly muffled exhaust may be a source of community concern, the intake and radiation from

the casing are typically greater problems for buildings and considerable detail must be given to controlling the noise. Figure A.39 shows a range of noise levels measured at 3 ft from internal combustion engines found in buildings.

Gas Turbines are used almost exclusively in emergency power and "total energy" systems. A total energy system makes use of the fact that only about 20-30% of the heat energy of most fuels can be turned into mechanical power; the rest is rejected in the form of heat to cooling water and exhaust gases. A total energy system salvages some of the energy which is usually lost and uses it to heat water, etc. The advantages of turbines over equivalent internal combustion engines are their light weight, smaller size, and lower vibration, which can be governing factors for upper story installations. Figure A.40 presents noise levels representative of the noise generated by gas turbines.

Steam Turbines are sometimes used as high horsepower (over 50 hp) prime movers when high-pressure steam is available as a public utility service. Figure A.41 shows the range of noise levels typically found near steam turbines.

Transformers, although their function differs from that of the prime movers listed above, supply primary electrical input power; their output is an altered form of electrical power (higher amperage and lower voltage) rather than motion. The use of transformers permits large amounts of electrical energy to be supplied to a building with relatively small supply cables. Noise generated by transformers is due primarily to the magnetostrictive effect in the transformer cores. Thus, the noise consists of a harmonic series of component tones with a fundamental frequency equal to

twice the main power frequency. The range of noise levels generated by transformers typically housed in buildings is presented in Fig. A.42.

Generators or Convertors are used to produce local electricity in emergencies when electrical power is unavailable from outside sources, to produce direct current electricity, or to convert power from one frequency to another. The noise generating characteristics and noise levels of generators are similar to those of electrical motors.

A.3.2 Fluid handling units

Pumps may be the common centrifugal type that uses an electric motor drive, or the diaphragm or piston or gear-rotor types that are positive displacement units. Many of the pumps in a building are part of the overall air-conditioning system. They convey water to and from cooling towers, chillers, boilers, and coil decks in airconditioners, humidifiers, unit heaters, unit ventilators, and induction units. Pumps may also be used to supply fuel oil to boilers, domestic water to upper floors, emergency fire-fighting water, hot water for various uses such as convectors, ice melting, radiant heating, etc., and for sewerage ejection from low levels.

Noise problems due to pumps are usually caused by mechanical forces and turbulence. Noise is radiated by the casing of the pump and associated piping. In order to prevent the tonal components at the impeller passage frequency (the impeller speed in revolutions per second multiplied by the number of impellers) from being detectable at remote locations, a vibration break of flexible connections in the piping is sometimes provided. However, sound

energy in the fluid may flank this flexible connection so that the pipe walls are excited downstream of the pipe break. Figure A.43 shows a range of noise levels typical of many pumps used in buildings.

Steam Valves may be used either to control volume flow or to reduce the pressure from the main supply system. A steam valve, like any valve, is noisiest when there is a large pressure differential between the upstream and downstream of the valve. A typical spectrum for steam valve noise is presented in Fig. A.44.

A.3.3 Air handling

Fans are the driving mechanism for moving air about a building. Propeller-type fans may be used to distribute large quantities of air at little pressure drop across the fan; centrifugal and axial-flow type fans may build up relatively large static pressures in an air handling system and thus are used mostly in ducted ventilation systems in large buildings. In a ducted system, the air will tend to flow toward regions of lesser static pressure, eventually to be released at ambient pressure in the building proper.

Fan noise is generated by mechanical and aerodynamic sources. Bearings and unbalanced shafts are the primary mechanical sources; with proper construction and maintenance, fan noise from these sources can be minimized. Aerodynamic noise may be divided into components due to rotation and due to vortex shedding. Since an impulse is imparted to the air each time a fan blade passes a given point, the rotational component consists of a series of tones at multiples of the blade passage frequency (rotational speed in revolutions per second times the number of blades). The vortex

component is primarily the result of the shedding of vortices from the fan blades; it is an example of broadband random noise. Depending upon the type, size, and geometry of a particular fan, the total noise generated will have varying contributions from vortex and rotational noise.

The horsepower, volume flow, and static pressure, and thus the mechanical efficiency, are important indicators of the noise that will be generated by a particular type of fan. Figure A.45 shows estimated levels for a range of fans utilized in buildings. The noise problems that do occur are usually due to either a failure by the mechanical or acoustical system designer to consider an important source or path, or a failure of the builder to incorporate properly the designed noise control features in the building.

Air Control Units and Mixing Boxes comprise a family of supply air control and treatment devices that provide air at the proper volume, pressure, and temperature to a room. These devices include: constant volume control (CVCs), terminal reheat units (TRs), variable volume controls (VVCs), and dual duct mixing boxes. Their function, in many instances, is analogous to steam valves - they take air which has passed through a small duct at high velocity and pressure and reduce its pressure and control its volume flow. A constant volume control takes in air at varying pressure (caused by changing demands elsewhere in the system) and discharges a constant volume of air at a constant pressure. A terminal reheat unit adds the capability of heating the air by passing it over an electric or hot water coil before it is discharged. A variable volume control meters out an amount of heating or cooling air as demanded by a local thermostat and reduces the static pressure of the air to obtain the desired volume. Each of these units is usually located toward the end of supply ducts

near the space it serves. Noise generated by air control units and mixing boxes is a function of the pressure drop across the device and the volume of air flow. Figure A.46 presents a range of noise levels typical of a 3 ft distance from these units.

Diffusers, Grilles, Registers, and Louvers. After a supply of air at the correct pressure, temperature, and volume has been provided to the vicinity of a room, it must be introduced and distributed into the room without causing drafts. Portions of the air should be directed toward windows and other exterior surfaces that are too cold in the winter and too hot in the summer, while all the air should be distributed so as to provide ventilation to all parts of the space. This is done with various diffusing or direction-controlling devices, usually fabricated from sheet metal, consisting of fins, blades, vanes, etc., that are located at the end of the duct. Perforated grilles, registers, or other similar devices are used to receive the air to be returned to the distribution system. The noise generated by terminal devices, such as diffusers, is dependent on the pressure drop across the device, the volume of air flow, the cross-sectional area, and the spacing between vanes. Figure A.47 illustrates the range of noise levels possible with various diffusers, grilles, etc.

Air Compressors are the source of high-pressure air which is used by many large buildings as an energy source for pneumatic control devices throughout the ventilation system. Such controllers include fresh air intake dampers, zone control dampers, induction units, unit ventilators, mixing valves in mixing boxes, and control valves in CVC and VVC units. The high-pressure air provided by the compressor must be piped throughout the building, first to thermostats and then to the pneumatic operators. Buildings which

have laboratory or workshop facilities usually supply compressed air to those spaces. Air compressors are most often of the piston type and, depending upon the size of the unit, the reciprocating action of this type of compressor may make satisfactory vibration isolation difficult. Figure A.48 is an example of noise levels generated by reciprocating compressors.

A.3.4 Airconditioners

The usual functions of an airconditioner are to filter particulate matter and odors from the air, to regulate air temperature and humidity, and to propel the conditioned air to its destination. The fan in the airconditioner serves two purposes:

1) to move the air through the filters and heating and cooling coils, and 2) to provide enough static pressure to push the air throughout the duct system to the desired spaces. The heating and cooling coils are liquid-to-air heat exchangers, receiving warm or cold water or refrigerant from other machines and transferring warmth to or from the air carried past them.

Central Station. Strictly speaking, "central station" refers to the entire collection of equipment that has a part in conditioning the air that is ultimately distributed to the building. In its more limited use here, "central station" refers to the fan plenum equipment of the airconditioner. The equipment includes controllers and filters on the inlet side and heating and cooling coils, and temperature controllers and, possibly, zone controllers on the discharge side. The cooling coils act as dehumidifiers in that warm, moisture-laden air condenses on them. Occasionally, a humidifier is incorporated to add humidity for special needs. Central station units are most common in large multistory buildings. The size of a particular unit will depend upon the service that it is supplying. Noise levels for units typically found in buildings are presented in Fig. A.49.

Unitary Rooftop Units are usually found on one- or two-story buildings. They perform the same function as the larger central station units but do not rely on other machines to provide hot or cold fluid to their heating and cooling coils; in other words, these units include their own compressors, condensers, etc. In a large one-story building or building complex, this can represent a savings on the heating and cooling water piping which would be needed if the units were dependent on other machines. Figure A.50 presents noise levels measured near both small (the lower curve) and large units.

Unitary Split System Units are usually found in small buildings. They are almost identical in function to rooftop units, but they are located on occupied floors in the building. Thus, a remote heat exchanger (either a condenser or cooling tower) must be provided to reject waste heat when the units are cooling. The refrigerant compressor may be located remote from the unit together with the condenser.

Fan Coil Units are rather like miniature central station air-conditioners in that they draw in fresh air and rely on outside sources for hot water, cold water, or steam for their heating and cooling coils. They are small units, usually enclosed within a cabinet and placed under or near windows. Some units, rather than relying on hot water, use electric heating coils. Typical noise levels for fan coil units are presented in Fig. A.51.

Induction Units are similar in appearance and location to fan coil units but receive air from a central station unit at a rather high pressure, 1 to 4-in. static pressure, as compared to less than 1-in. operating static pressure for unit ventilators. This

air is used to induce circulation of the room air. Such units are also provided with heating and cooling coils to temper the air which they receive from the central supply. A range of noise levels for typical induction units are shown in Fig. A-52.

Humidifiers, Dehumidifiers, Heaters and Furnaces, although grouped under the heading of air conditioners, have only one function: to increase or decrease humidity, or to heat.

- *Humidifiers* are of two general types: 1) those that add steam to the air, and 2) those that blow the air through or over moist surfaces to add water to the air. Both types can be built into ductwork or can stand alone to serve a particular space. The steam type consists of a steam nozzle, a control valve, and possibly a fan. The moist surface type consists of a fan (if not located in ductwork), a water pump, and a moving porous belt or disk which passes through the water and then through the moving air.
- *Dehumidifiers*, if required, may be located in the ductwork where air flow is provided by the system fan. The primary element is a cooling coil which condenses moisture out of the passing air. In such an installation, a heating coil may be provided to temper the excessively cooled air that leaves the cooling coil. A self-contained unit will include a fan but usually not a heating coil.

Unit Heaters consist of a remote fan and heating coil, which may be either electric or mechanical, and receive hot water or steam from an external source. Such units are often used in little-occupied spaces such as mechanical equipment rooms, storage spaces, garages, stairways, etc.

- *Warm Air Furnaces* burn gaseous or oil fuel and use an integral air-to-air heat exchanger to heat the air. They usually have two built-in-fans, one to circulate the air, the other to provide air for combustion. They are often used in small buildings which do not have access to large quantities of hot water or steam.

A.3.5 Boilers

For supplying warm air to a building, most air conditioning systems use hot water or steam supplied by a boiler that may be located either nearby or remote from the building. (In total energy systems, waste heat from the engines may be captured to heat water in place of or in addition to a boiler.) Boilers heat water or generate steam by burning a fuel and passing the water through or around the fire in a gas-to-liquid heat exchanger. There are two principal types of boilers: water tube and fire tube. In the water tube boiler the tubes are filled with water and pass through the fire. In the fire tube boiler, the boiler is filled with water and combustion takes place in tubes that pass through the water. Steam boilers are usually of the water tube type, while hot water boilers may be either type. Figure A-53 shows a range of noise levels typical of boiler operations; fire tube boilers are represented by the upper part of this range and water tube boilers by the lower parts. Gas-fired burners in boilers are much quieter than oil-fired burners.

A.3.6 Refrigeration machines or chillers

Refrigeration machines or chillers use various methods to remove heat from water supplied to cooling coils (the "chilled water") and transfer that heat to other water for eventual rejection.

Absorption/Cycle Machines use heat energy and a salt solution to transfer heat from the chilled water system to the reject heat system. The machine is composed of tanks, condensers, evaporators, heat exchangers, pumps, and controls. On a per ton capacity basis, they are larger than vapor compression cycle machines. Figure A-54 presents noise levels typical of these machines for building use.

Vapor Compression Cycle Machines, which are commonly called chillers, use a compressor to compress the refrigerant; the resulting hot compressed gas passes through a condenser where it is cooled and changed to a liquid. The refrigerant is then allowed to expand, further cooling it. The "chilled water" is then passed through a heat exchanger with the cooled gas and is cooled. The resulting heated refrigerant is again compressed and the cycle repeated. Chillers use various types of compressors: the positive displacement (piston and rotary screw) and the centrifugal types; noise levels representative of these types are presented in Figs. A-55, A-56, and A-57 respectively.

Small Hermetic Refrigerant Compressors are used in small airconditioners in conjunction with integral or remote air-cooled condensers. These units function exactly the same as the compressors in vapor compression cycle machines except that the refrigerant is cooled in an air-cooled condenser rather than by a reject-heat water-circuit condenser.

A.3.7 Heat rejectors

In most refrigeration machines, rejected heat is transferred to water, which may be used once, e.g., river water, or repeatedly, in which case it must be cooled for re-use. Cooling towers, spray ponds, and air-cooled condensers are used to cool the water.

Cooling Towers receive large volumes of warm (typically 85° to 75°F) water and cool it a few degrees. In the process, the incoming warm water is sprayed onto the cooling tower "fill," a stack of wood, plastic planks or sheets, or ceramic blocks which have a large surface area. Typically, a fan is used to force air through the fill, cooling the water by evaporation. The air is expelled in a saturated or near-saturated condition and is usually a few degrees warmer. Noise is generated by the fan and by the water falling into the basin. Centrifugal cooling towers (using centrifugal fans) are quieter than propeller-fan towers. Figure A-58 presents a range of noise levels typical for both centrifugal and propeller towers.

Condensers of the liquid-cooled type are used in all large refrigeration machines; smaller machines use directly air-cooled condensers. In a condenser, the entering gaseous refrigerant is cooled as it passes through the gas-to-air exchanger, where the gas condenses to its liquid form, and the resulting liquid is returned to the refrigeration machine. A fan is frequently used to force air flow through the heat exchanger. Figure A-59 presents a range of noise levels representative of air-cooled condenser noise.

A.3.8 Conveyance systems

In multistory buildings, it is necessary to transport large numbers of people quickly. It is also desirable to transport heavy objects from one floor to another, and in hotels, hospitals, and apartments, to transport trash and soiled laundry to their respective collection areas from many locations in the buildings. Elevators, escalators, and pneumatic transport systems are examples of the conveyance systems used in buildings.

Elevators consist of three major components: the cab, hoist cables and counterweights, and the hoist motors or hydraulic lift piston. The weight of the cab is partially balanced by the counterweights which are lowered as the cab is raised. The hoist motors are DC-powered, which is best suited to the frequent starting, acceleration, and stopping operations of elevators. Supply current is generated by accompanying motor-generator sets (using standard AC motor drives) or large rectifiers. The hoist motors are located directly over the elevator shaft, usually on the roof of a building, or at various upper floor levels. Hydraulic power is sometimes used for distances of under 60 ft. A hydraulic pump provides the driving force. Figure A-60 presents noise levels typically found in elevator machinery rooms.

Escalators are comprised of two major components: the stairs with tracks and the drive motors. The motors are usually located beneath the lowest flight, the upper flights being driven by those below.

Pneumatic Transport Systems use low-pressure differentials exerted over large or small areas to move comparable sized loads. The chief components are a high-pressure fan, a duct system, loading and unloading stations, and control devices. In a typical system, the fan is run at an idle speed (say 1/2 full speed which requires only 1/8 of the full-speed hp) until the loading station signals for full-speed operation. The load is then conveyed through the duct system to the desired unloading station. At the unloading station, the passage of the load signals the blower which then drops to idle speed.

A.3.9 Ballasts

Fluorescent and mercury arc lights require higher voltage power than the normal 115v line current. Ballasts are essentially small transformers which alter the voltage to suit this need. Ballasts are usually mounted rigidly to light sheet metal panels in order to provide the required cooling area. These panels often serve as very effective radiators of sound; thus, the noise levels may vary considerably. Figure A-61 presents measured data for one installation. Noise levels in other installations with different ballasts and fixtures may be as much as 10 dB quieter or noisier than the curve presented.

REFERENCES

1. Rathé, E.J., "Gerauschnessungen an Baumaschinen," *Acustica* 23(3) 1970, pp. 149-155.
2. "Sound Data from Nebraska Tests," *Implement and Tractor*, April 7, 1971.
3. *Noise: Final Report*, Committee on the Problem of Noise, Sir Alan Wilson, Chairman, Her Majesty's Stationery Office, London, July 1963.
4. LaBenz, P., Cohen, A., and Pearson, B., "A Noise and Hearing Survey of Earth-Moving Equipment Operators," *Amer. Ind. Hygiene J.*, March-April 1967.
5. Based on estimates, including those appearing in "A Study of Noise-Induced Hearing-Damage Risk for Operators of Farm and Construction Equipment, Southwest Research Institute for the Society of Automobile Engineers," Technical Report, SAE Research Project R-4, December 1969.
6. Robinson, D.W., "The Concept of Noise Pollution Level," National Physics Laboratory Aero Report AC 38, March 1969.
7. Schultz, T.J., "Technical Background for Noise Abatement in HUD's Operating Programs," BBN Report No. 2005, September 1970.
8. Dugdale, D.S., "Discrete Frequency Noise from Free Running Circular Saws," *J. Sound Vib.* 10(2):296-304 (1969).
9. Beranek, L.L., *Noise Reduction*, McGraw-Hill Book Company, New York (1960).
10. Beranek, L.L., *Noise and Vibration Control*, McGraw-Hill Book Company, New York (1971).
11. Miller, L.N., "Noise and Vibration Control for Mechanical and Electrical Equipment in Buildings," Bolt Beranek and Newman Inc. TIR No. 73, February 1970.
12. *ASHRAE Guide and Data Book-Systems* (1970).

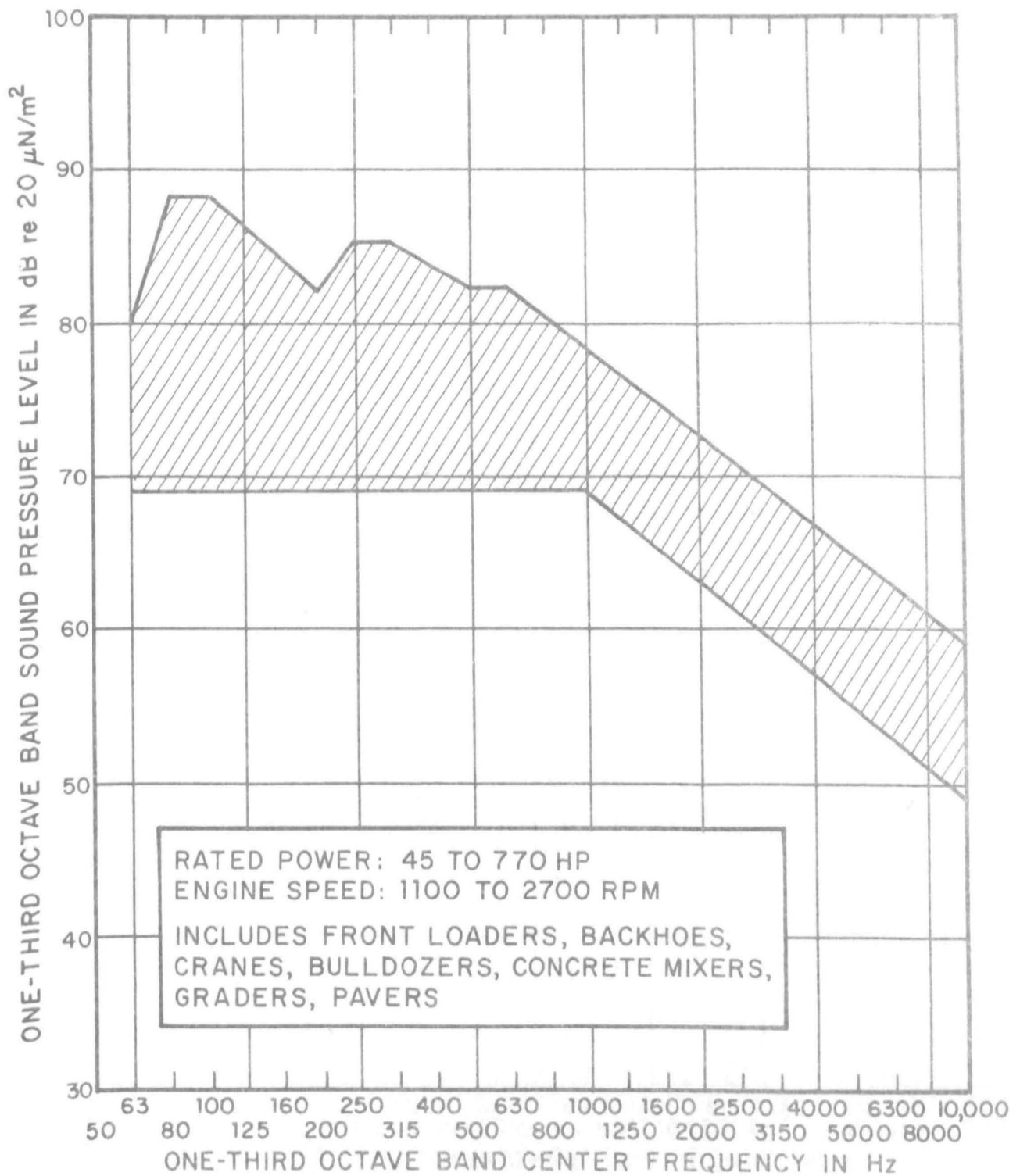

FIG. A.1 ENVELOPE OF SOUND PRESSURE LEVELS FROM 29 DIESEL-POWERED ITEMS OR CONSTRUCTION EQUIPMENT (MEASURED AT 50 FT)

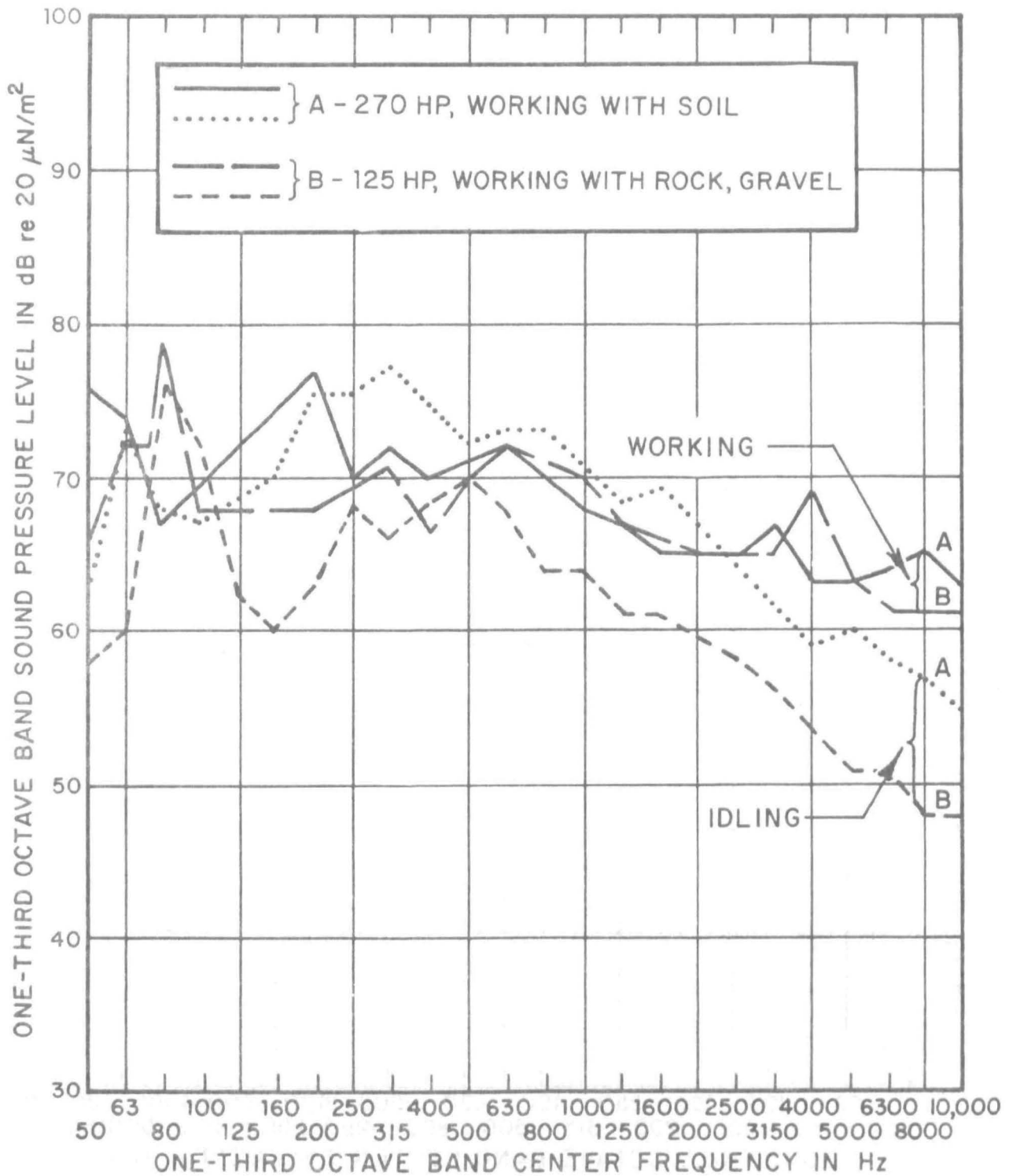

FIG. A.2 SOUND PRESSURE LEVELS FROM TWO BULLDOZERS UNDER VARIOUS CONDITIONS (MEASURED AT 50 FT)

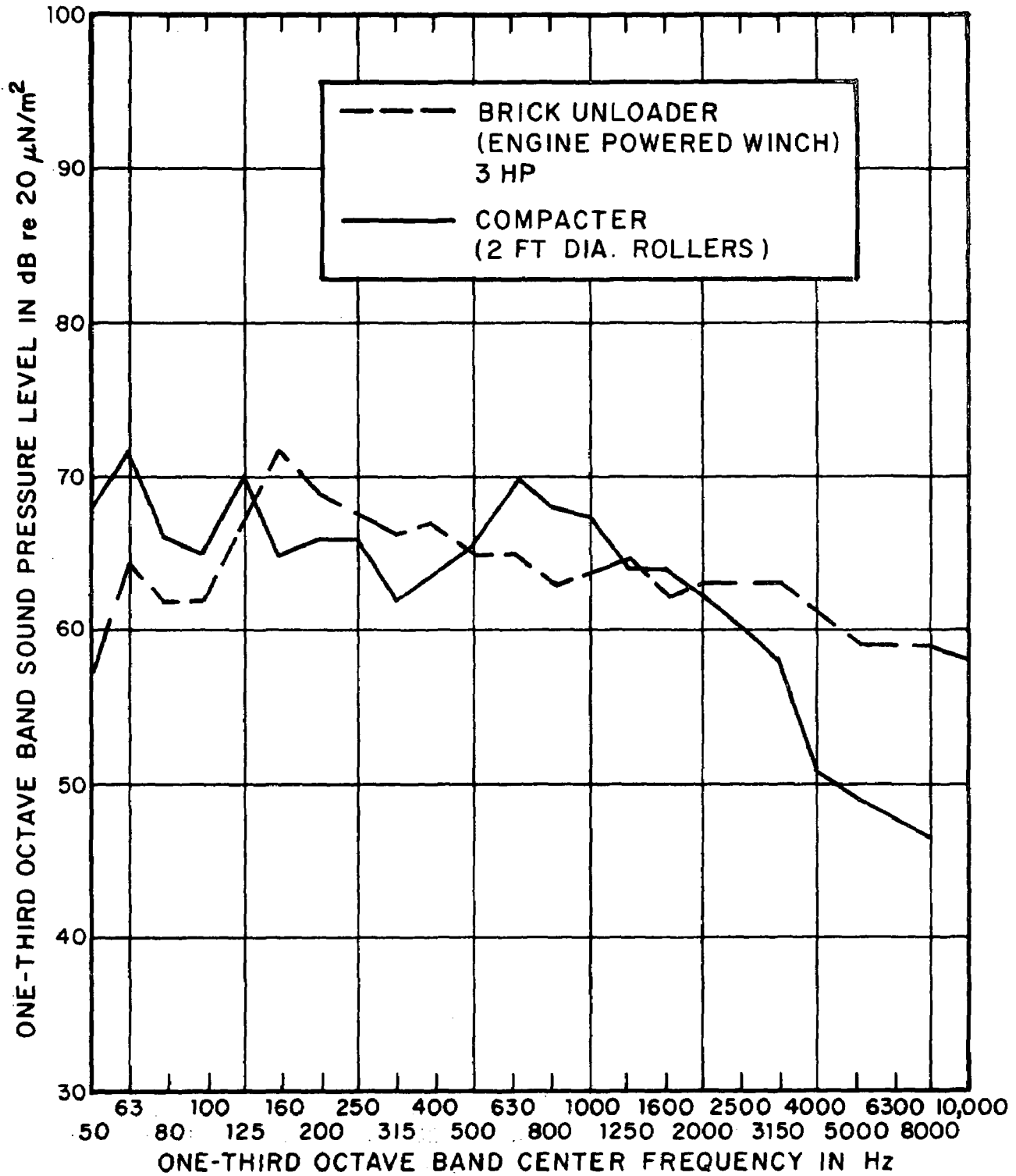

FIG. A.3 SOUND PRESSURE LEVELS FROM TWO GASOLINE-ENGINE POWERED ITEMS OR CONSTRUCTION EQUIPMENT (MEASURED AT 50 FT)

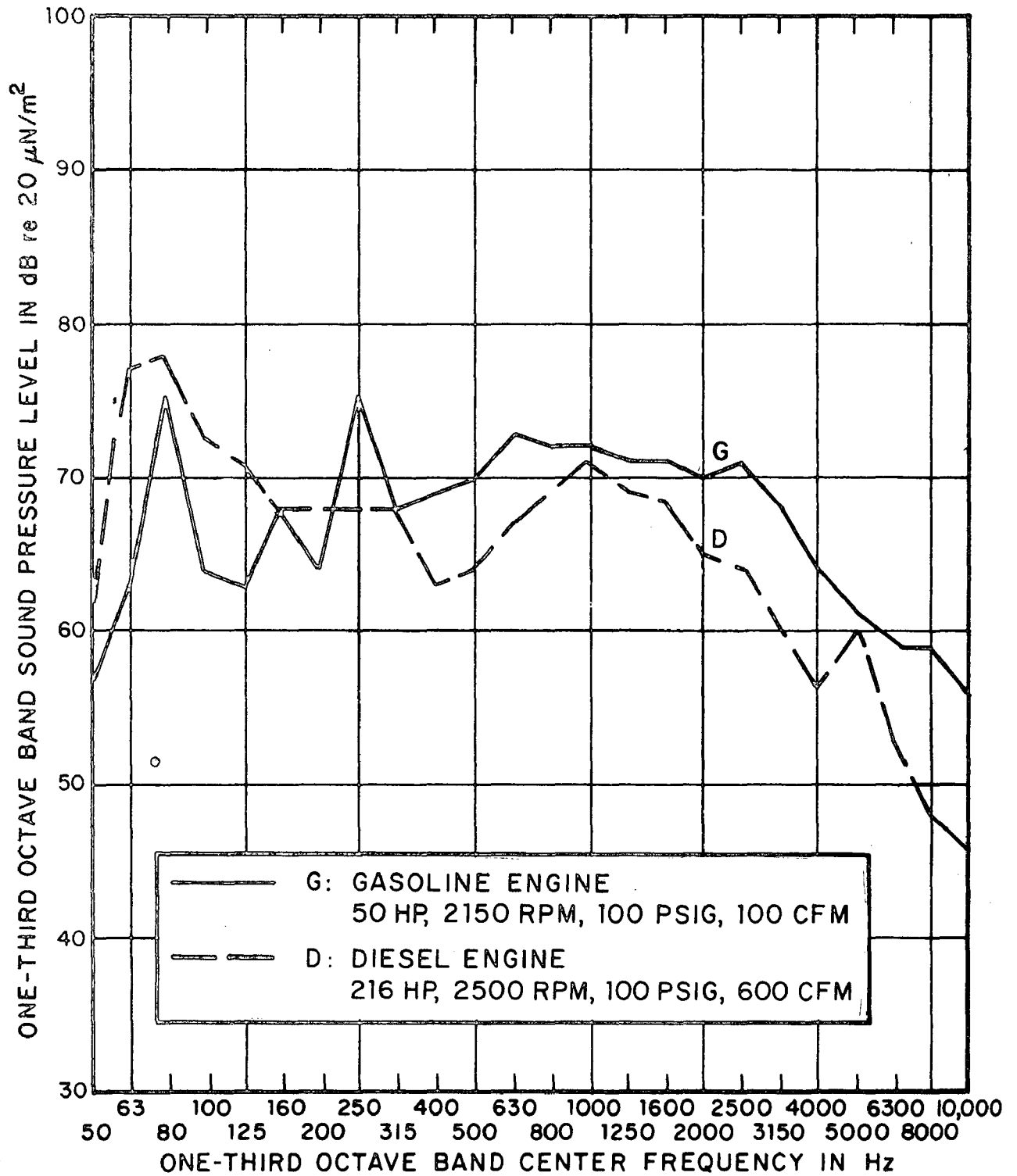

FIG. A.4 SOUND PRESSURE LEVELS FROM TWO AIR COMPRESSORS (MEASURED AT 50 FT)

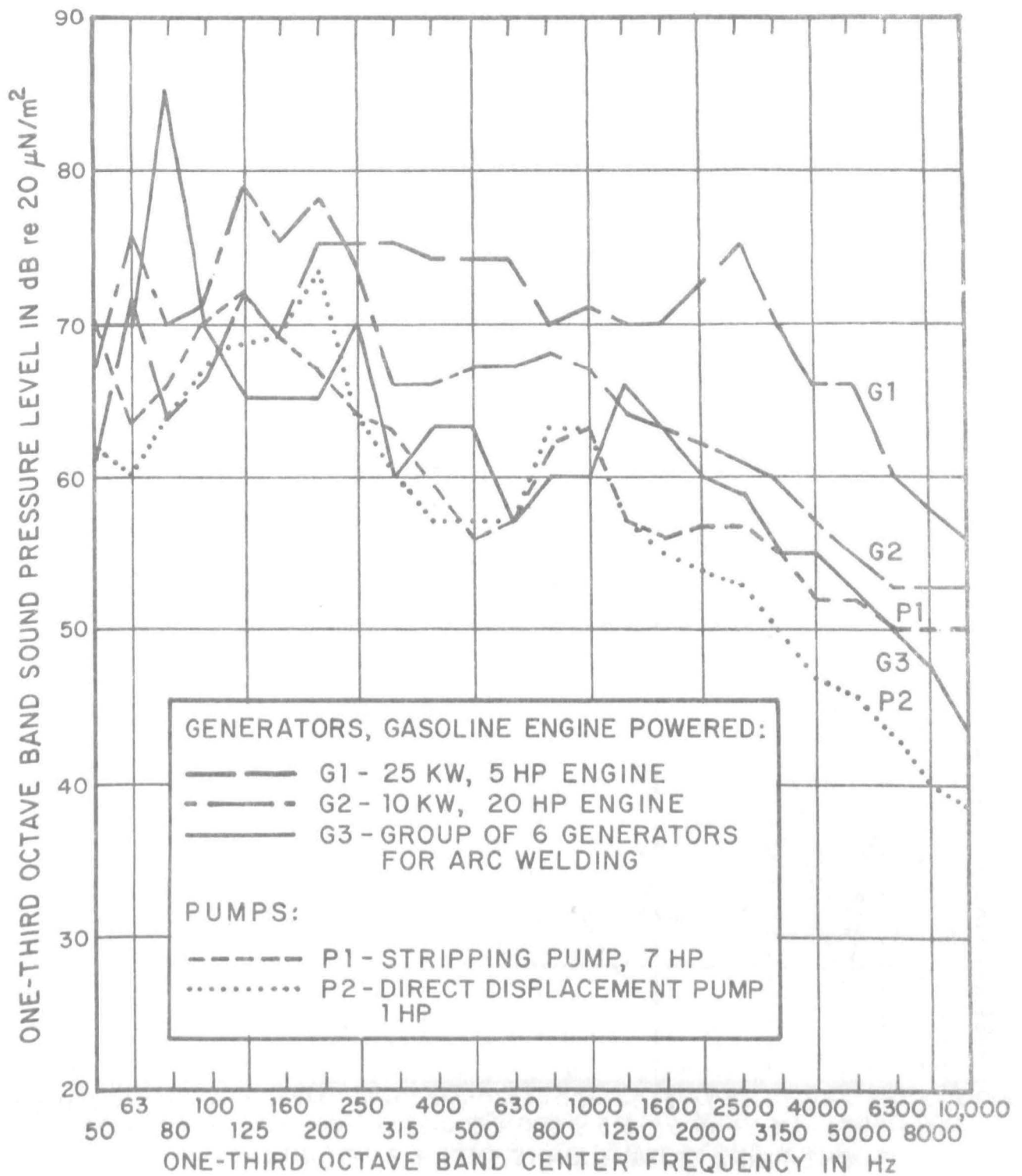

FIG. A.5 SOUND PRESSURE LEVELS FROM GENERATORS AND PUMPS (MEASURED AT 50 FT)

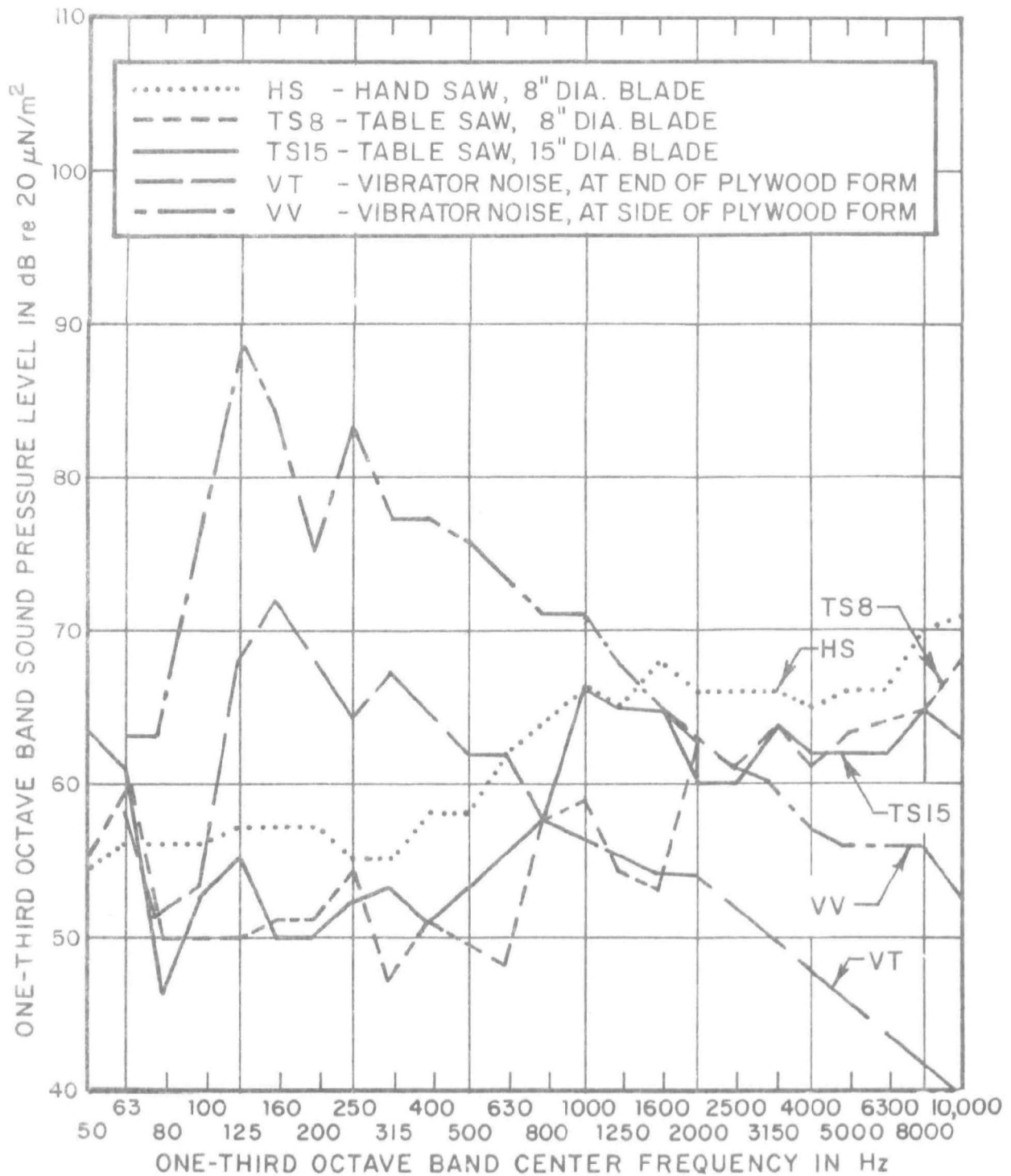

FIG. A.6 SOUND PRESSURE LEVELS FROM VIBRATOR AND SAWS
(MEASURED AT 50 FT)

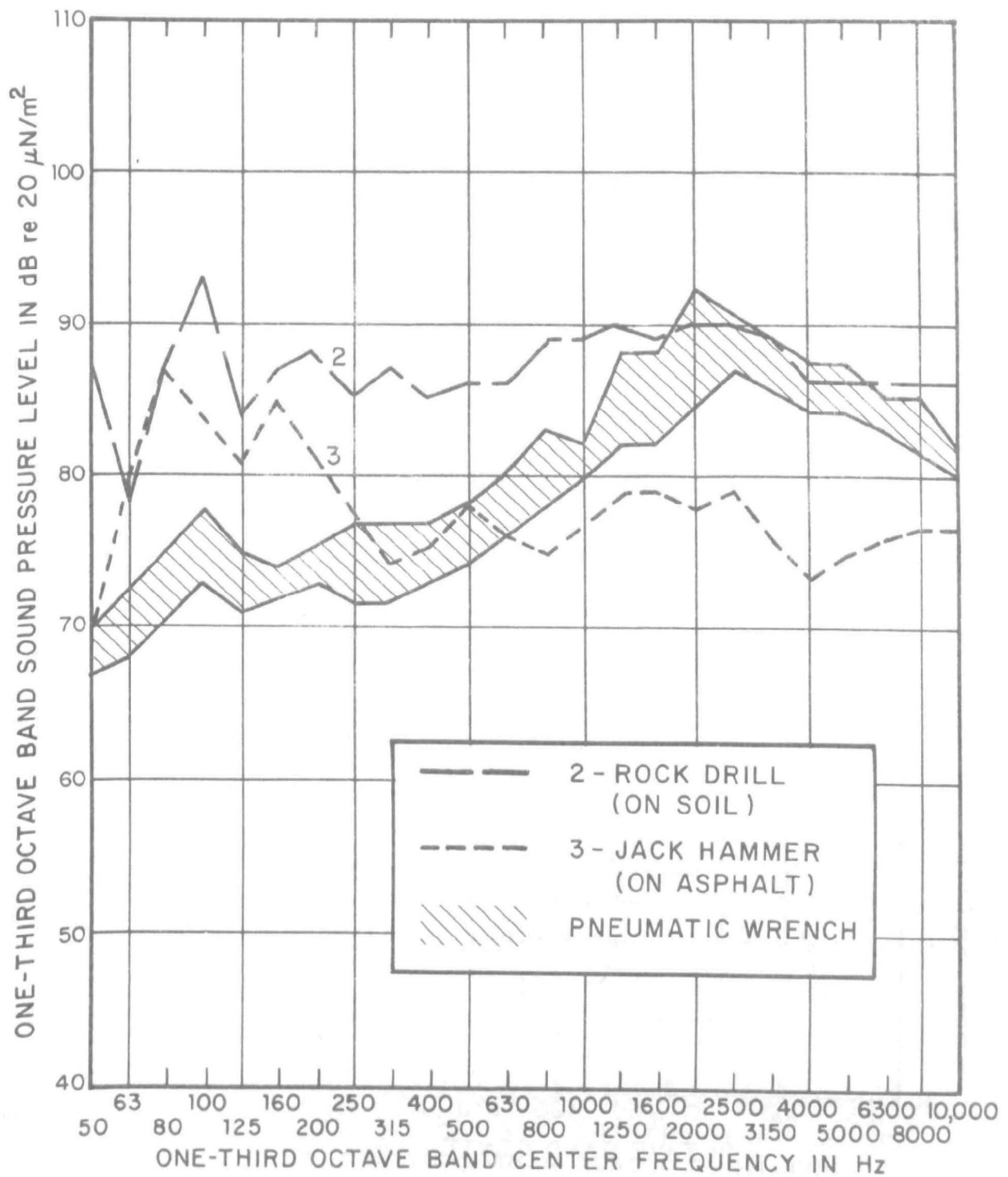

FIG. A.7 SOUND PRESSURE LEVELS FROM VARIOUS PNEUMATIC TOOLS (MEASURED AT 50 FT)

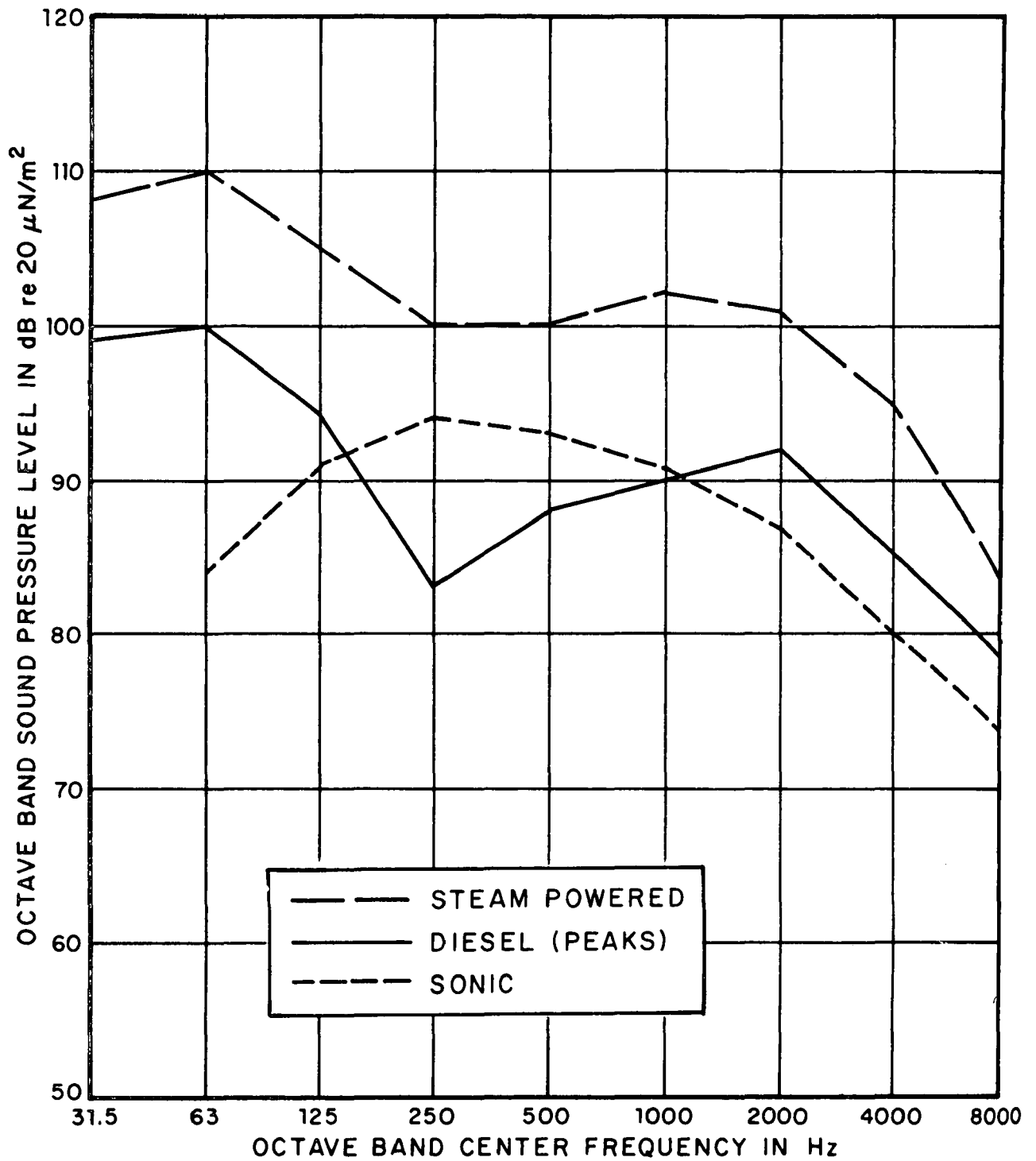

FIG. A.8 PEAK SOUND PRESSURE LEVELS FROM PILE DRIVERS, DRIVING 14-IN. DIAMETER PIPE PILES (MEASURED AT 50 FT)

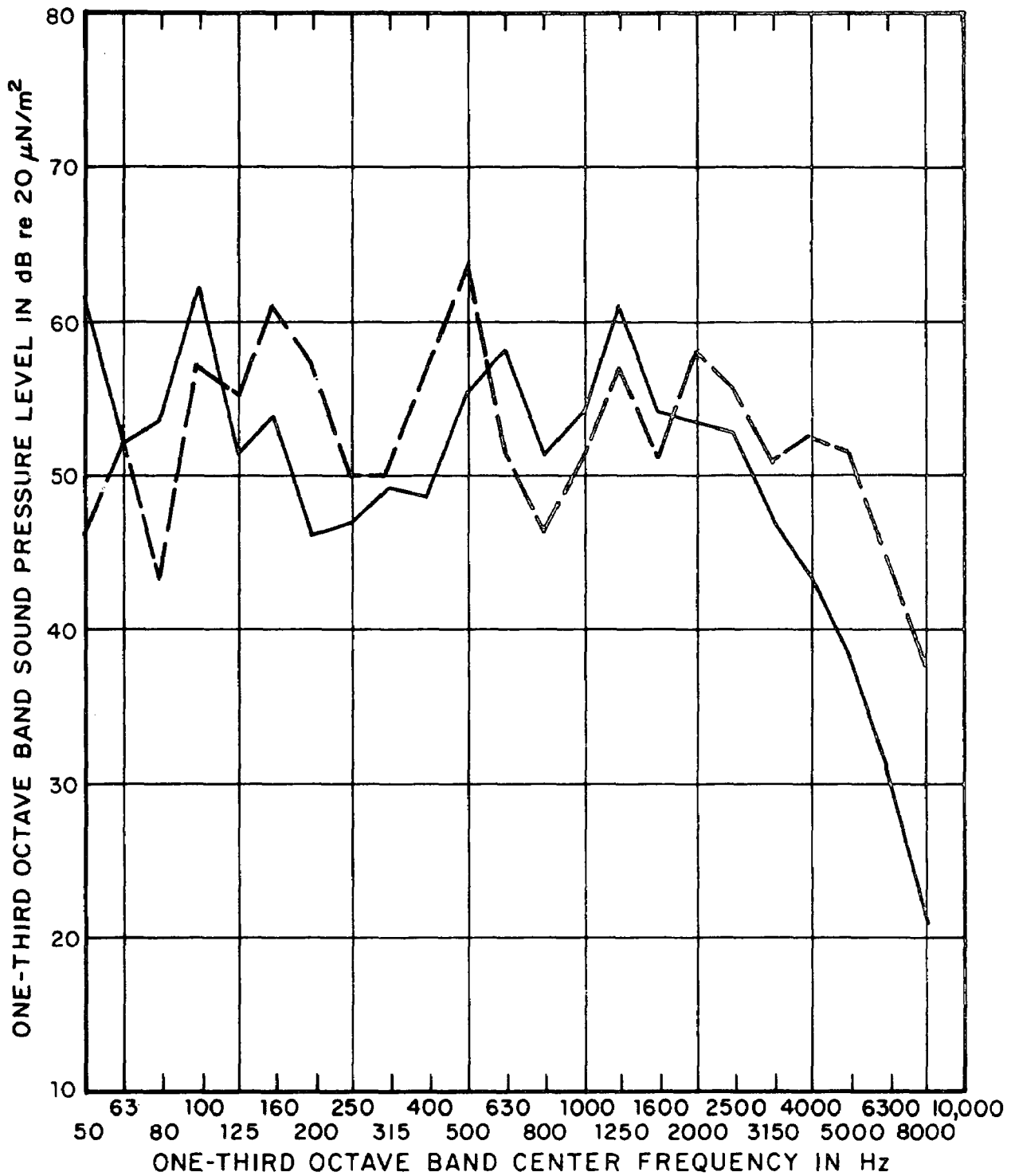

FIG. A.9 SOUND PRESSURE LEVELS FROM TWO CAN OPENERS
(MEASURED AT 3 FT)

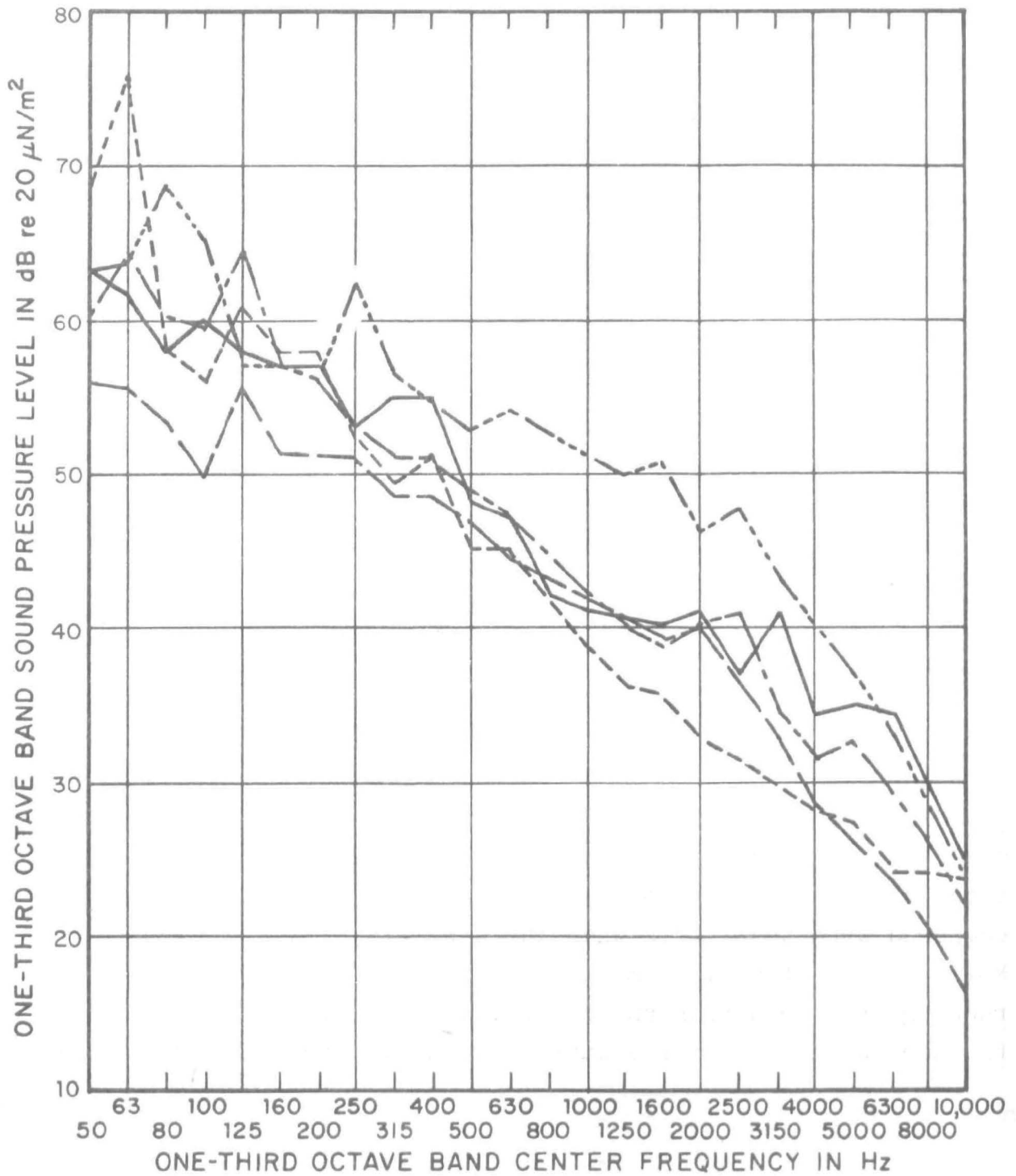

FIG. A.10 SOUND PRESSURE LEVELS FROM FIVE CLOTHES DRYERS (MEASURED AT 3 FT)

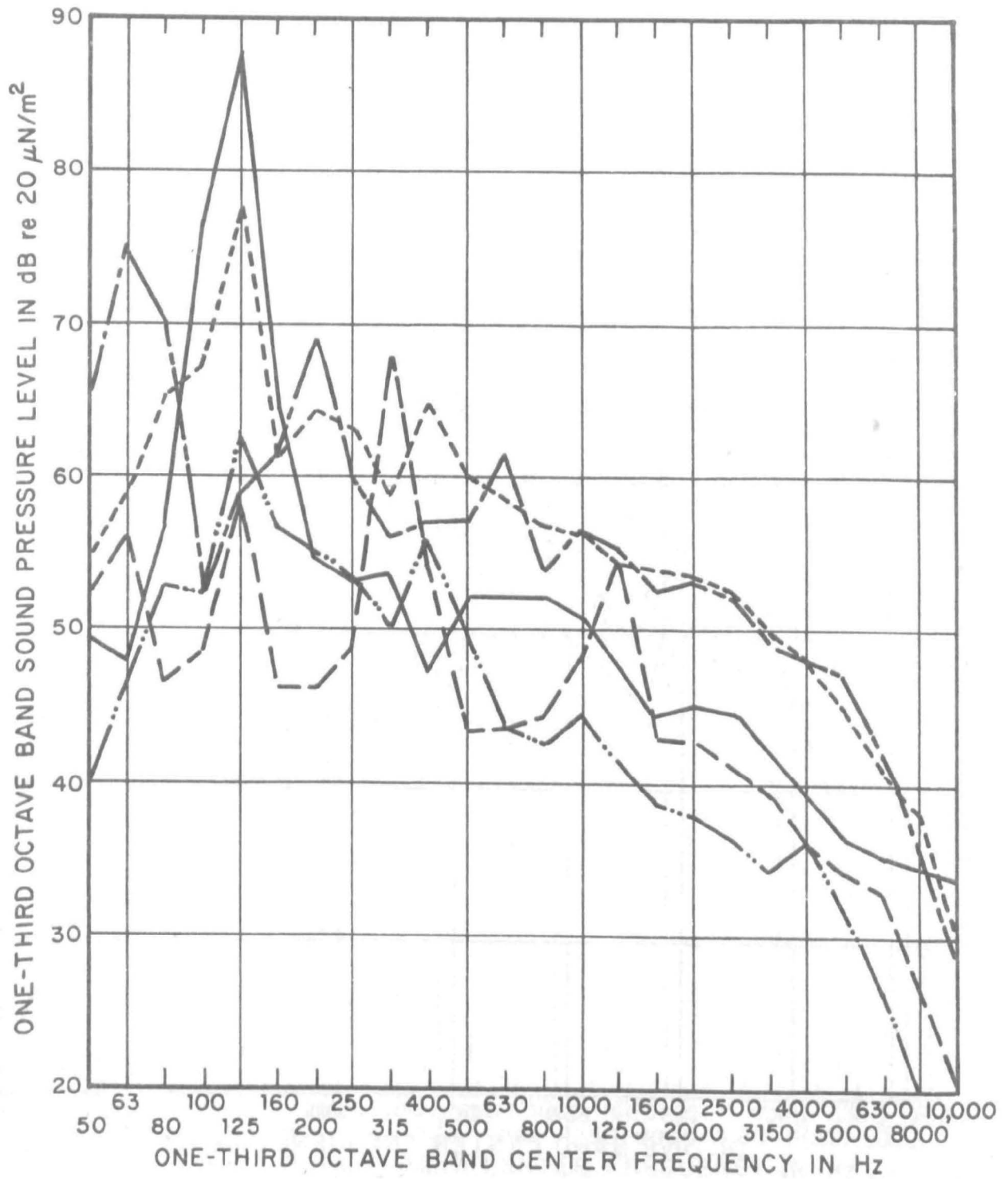

FIG. A.11 SOUND PRESSURE LEVELS FROM FIVE CLOTHES WASHERS DURING THE WASH CYCLE (MEASURED AT 3 FT)

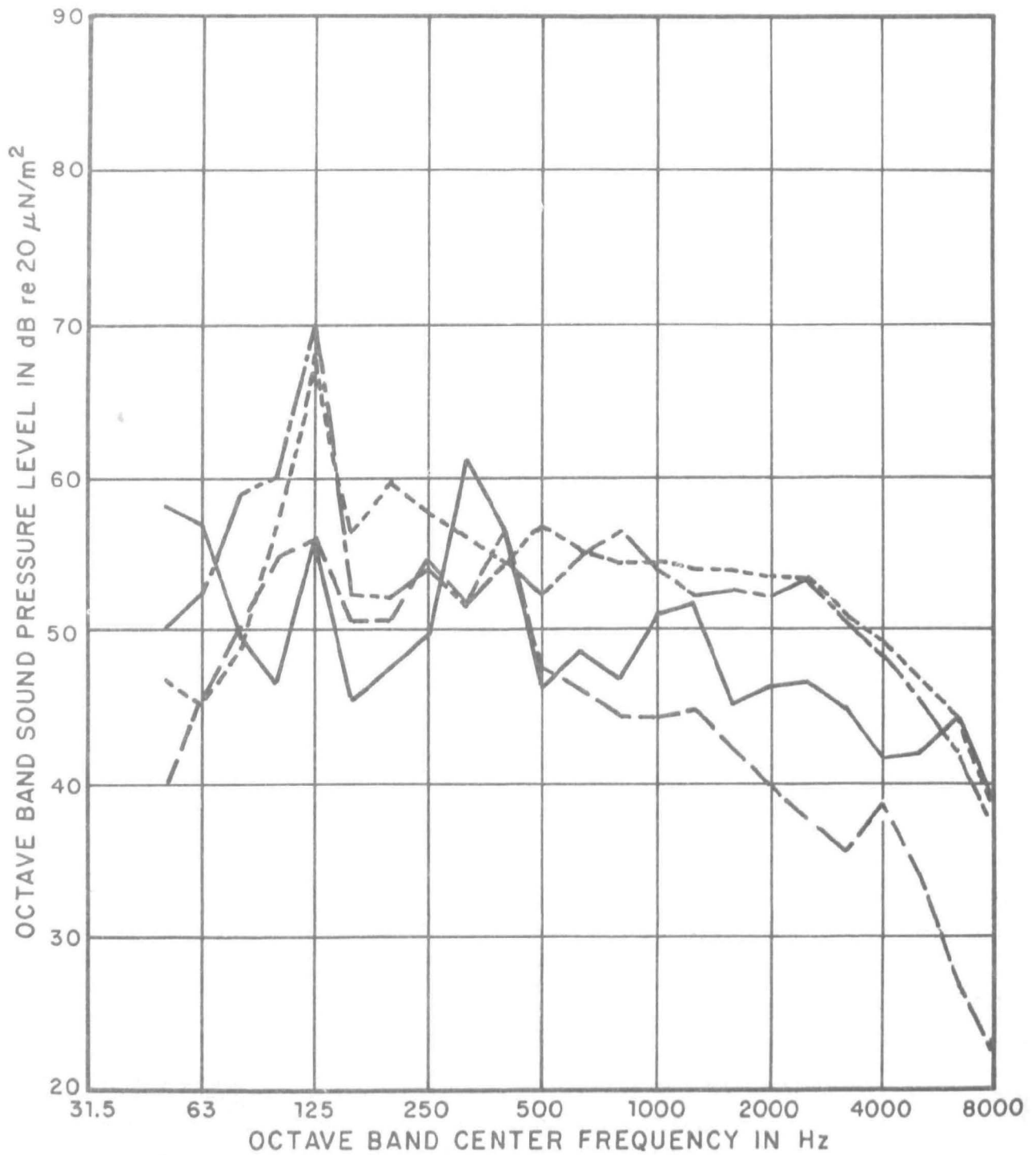

FIG. A.12 SOUND PRESSURE LEVELS FROM FOUR CLOTHES WASHERS DURING THE SPIN CYCLE (MEASURED AT 3 FT)

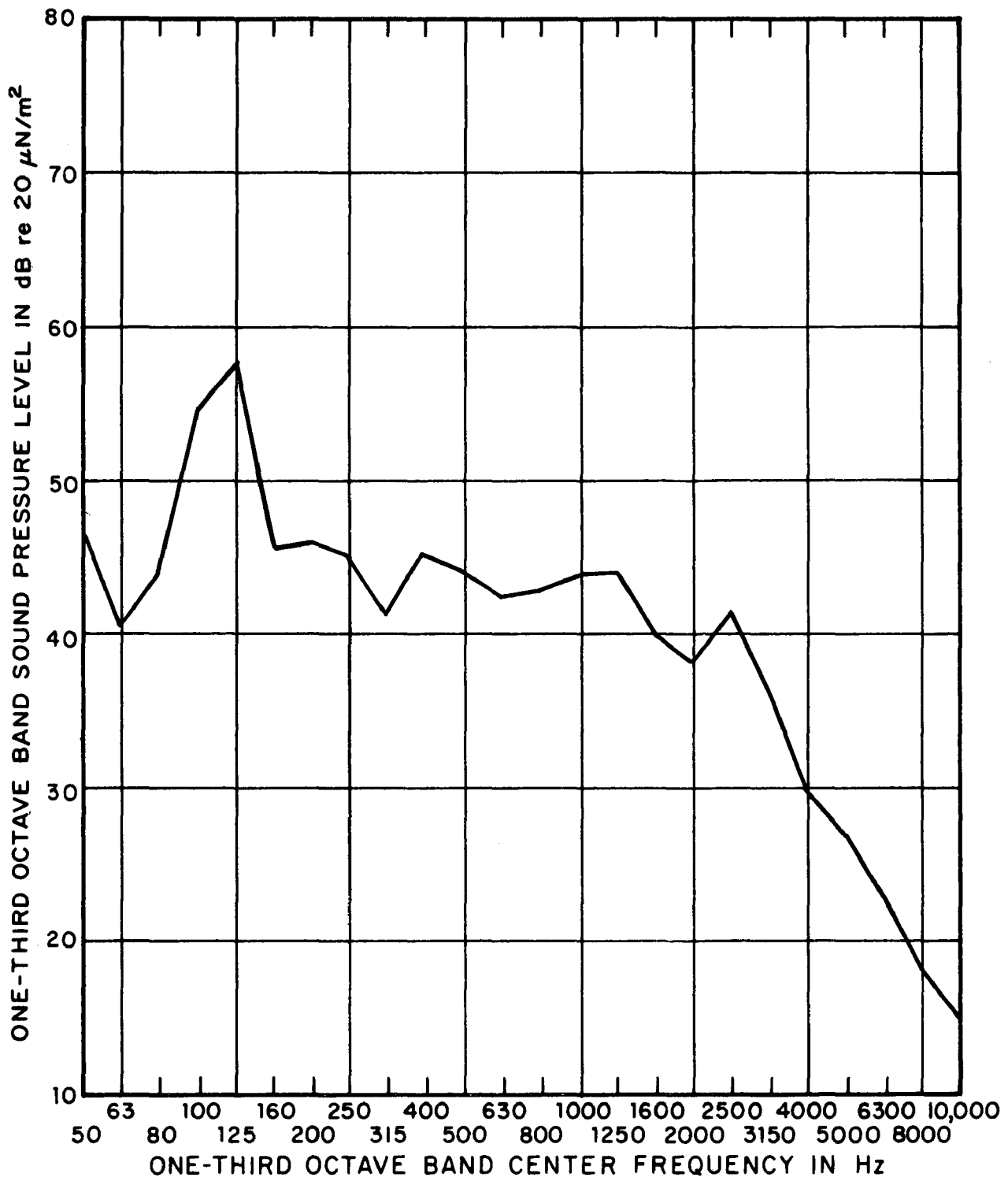

FIG. A.13 SOUND PRESSURE LEVELS FROM A DEHUMIDIFIER
(MEASURED AT 3 FT)

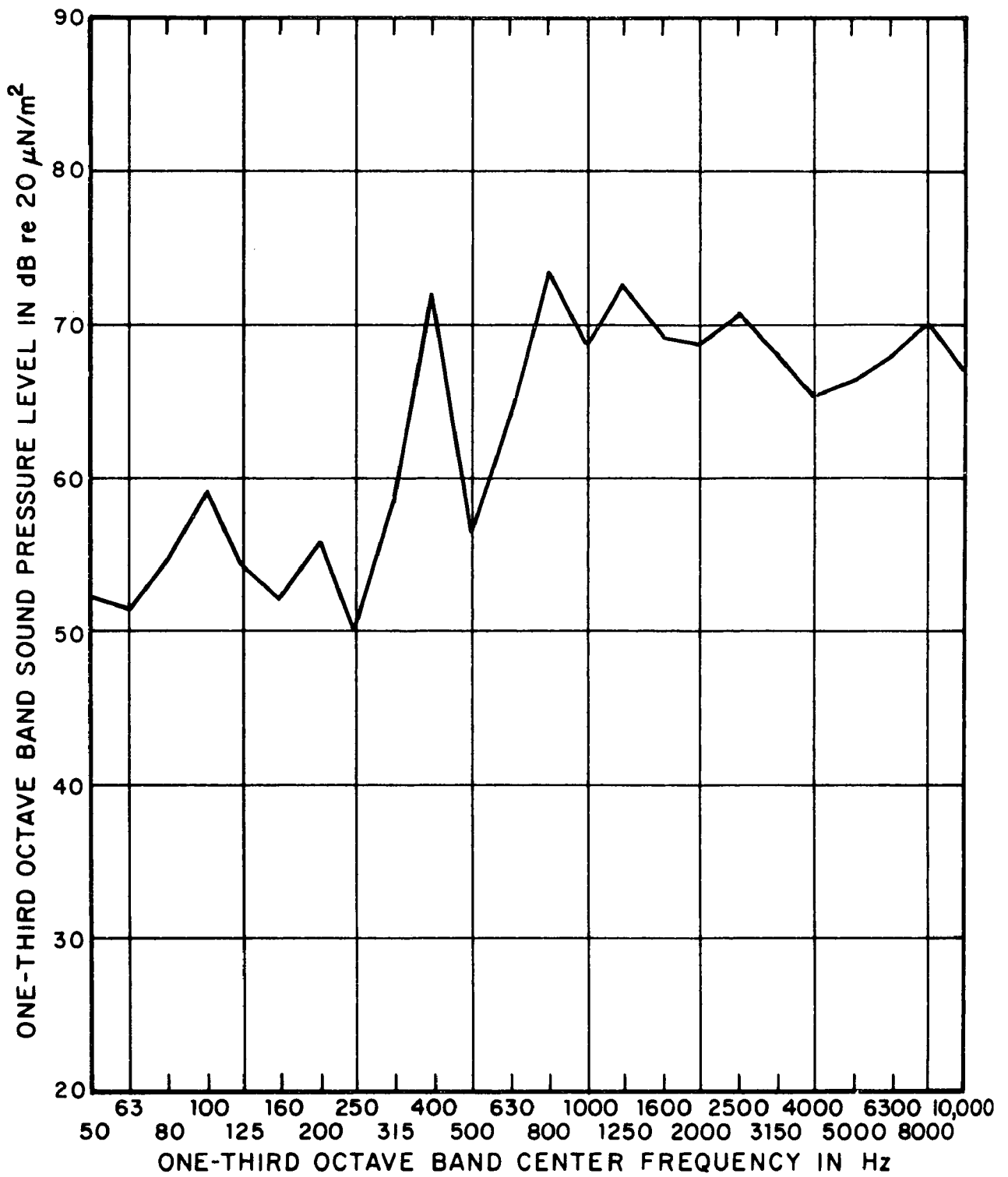

FIG. A.14 SOUND PRESSURE LEVELS FROM AN EDGER AND TRIMMER (MEASURED AT 3 FT)

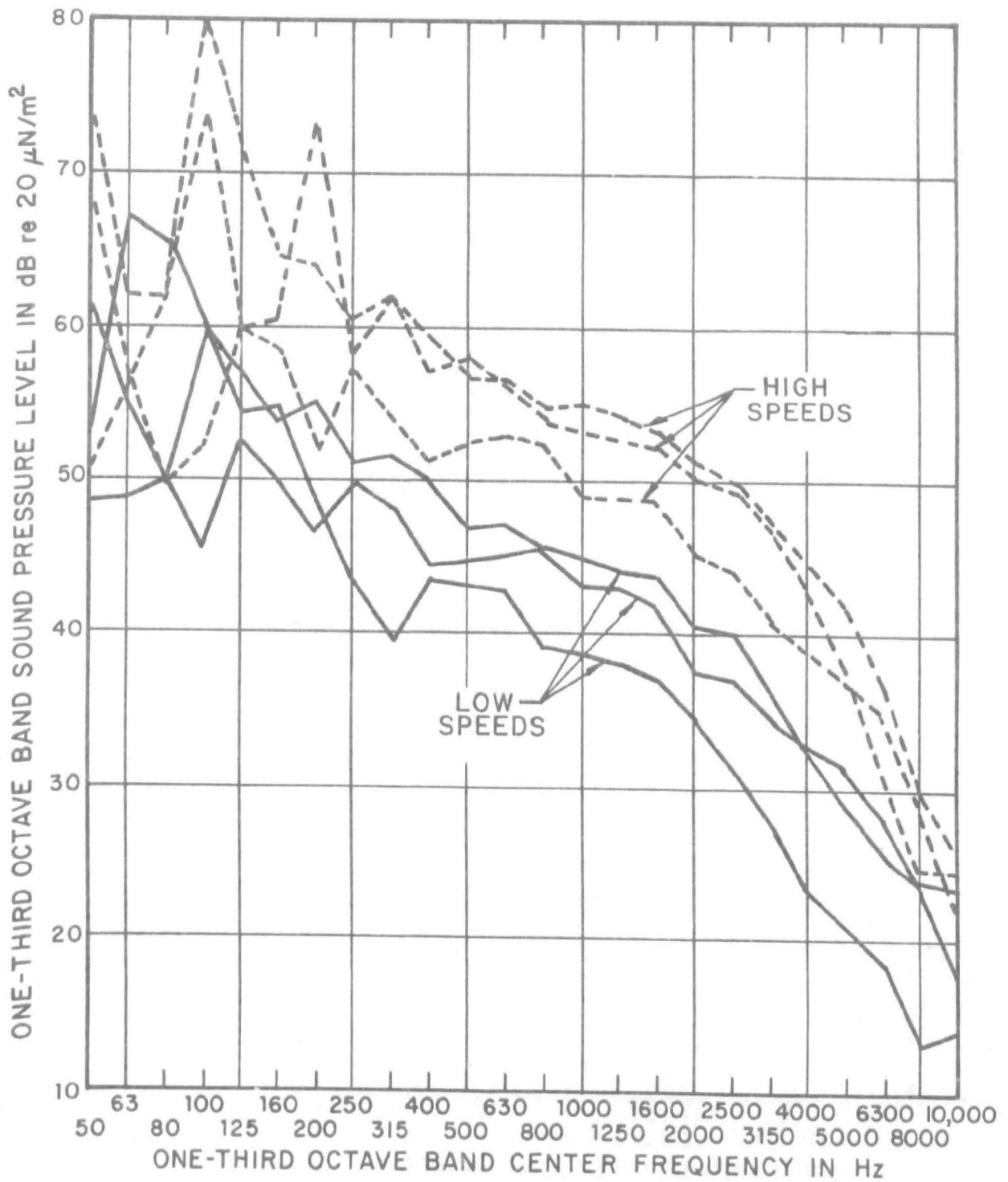

FIG. A.15 SOUND PRESSURE LEVELS OF THREE WINDOW FANS (MEASURED AT 3 FT)

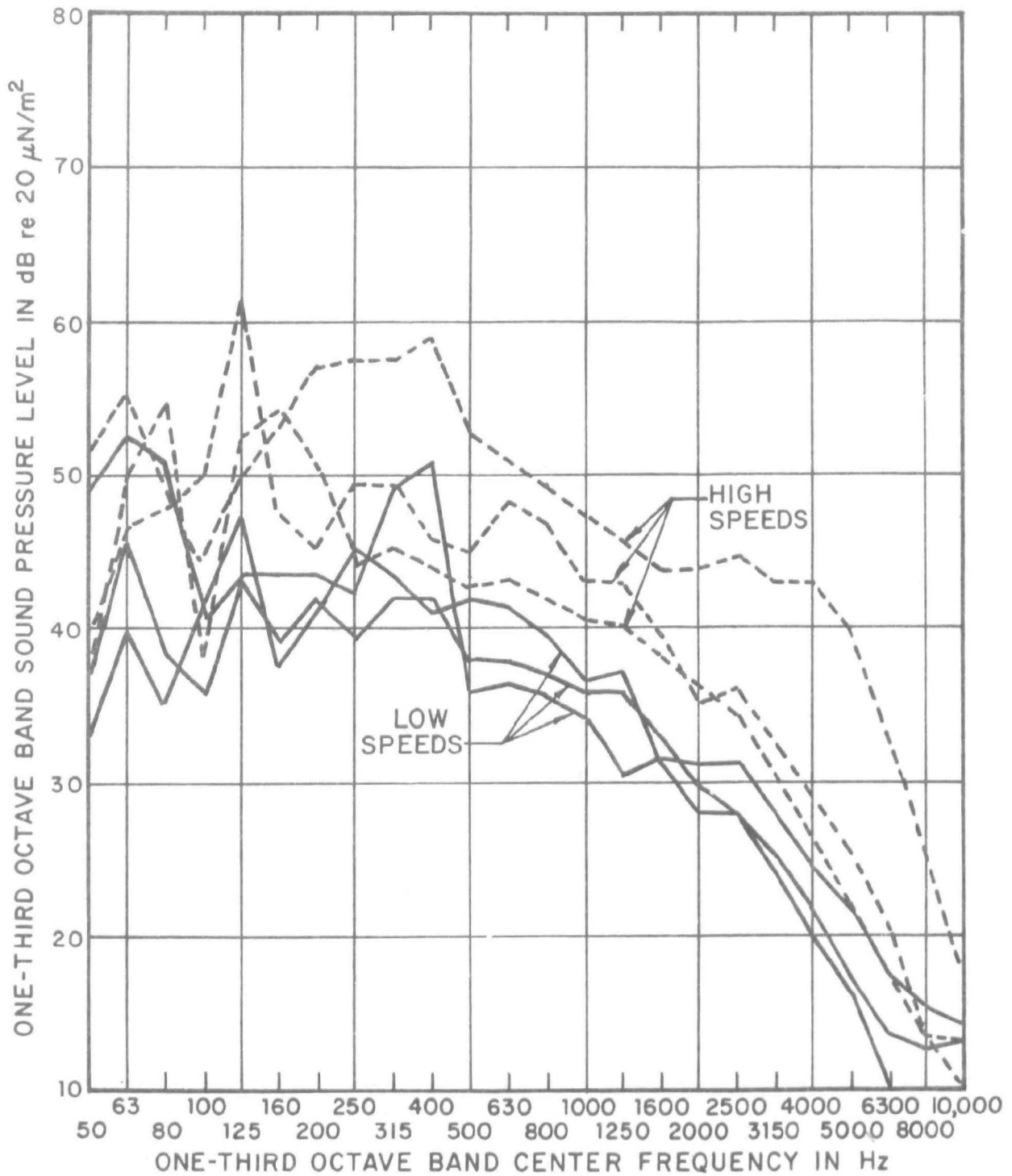

FIG. A.16 SOUND PRESSURE LEVELS OF THREE FLOOR FANS (MEASURED AT 3 FT)

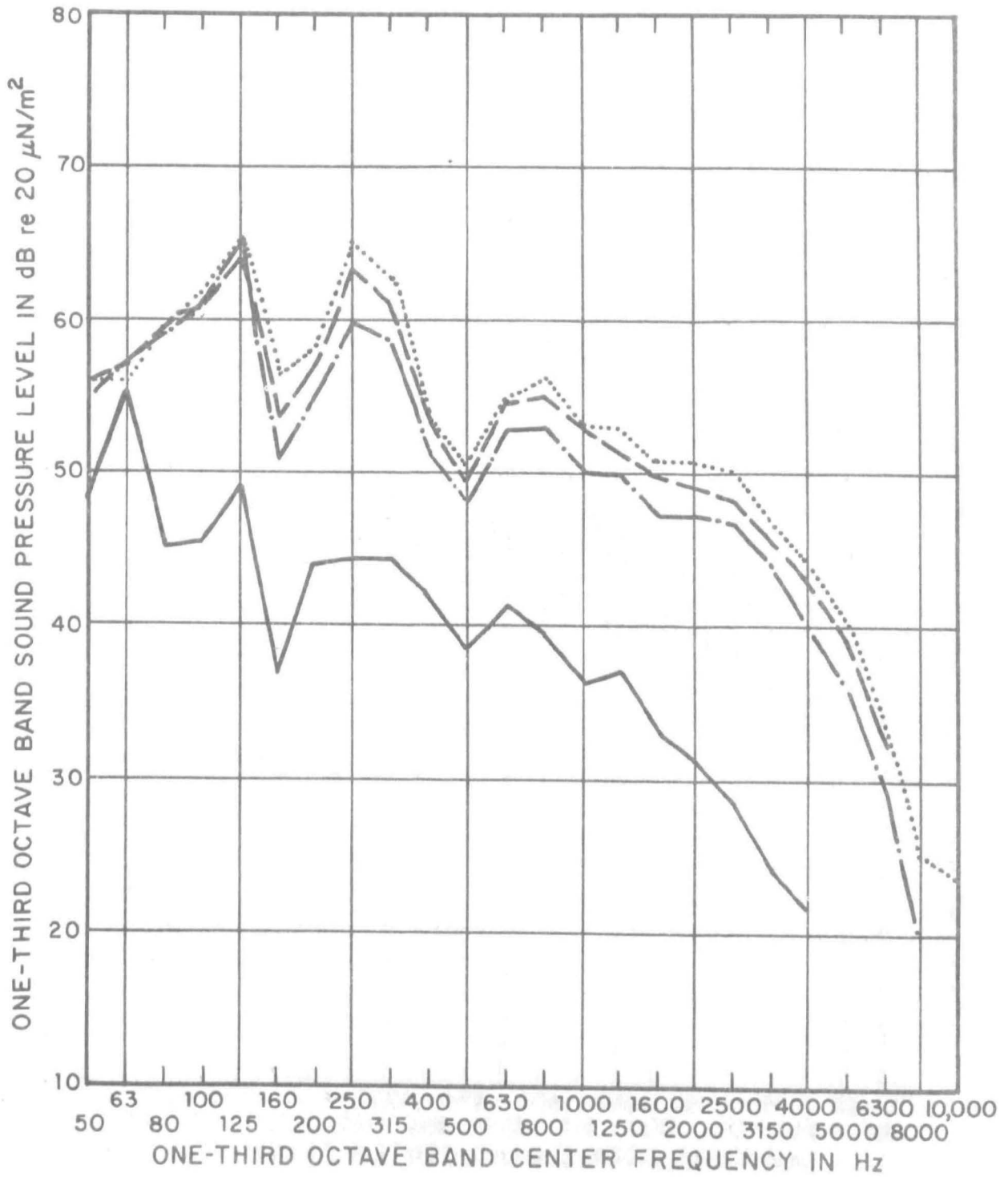

FIG. A.17 SOUND PRESSURE LEVELS FROM A STOVE HOOD EXHAUST FAN - 4 SPEEDS (MEASURED AT 3 FT)

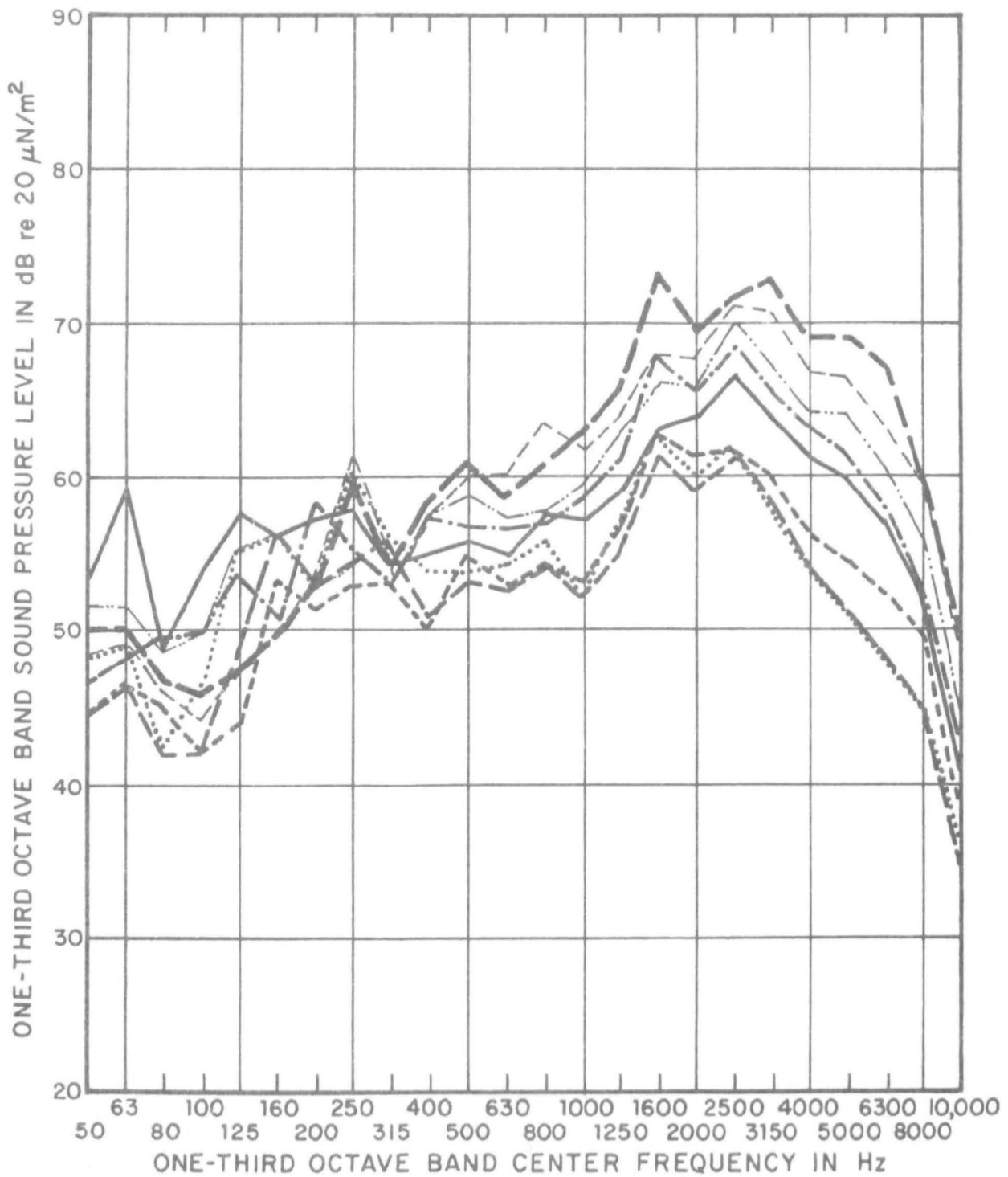

FIG. A.18 SOUND PRESSURE LEVELS FROM A FOOD BLENDER EIGHT DIFFERENT SPEEDS (MEASURED AT 3 FT)

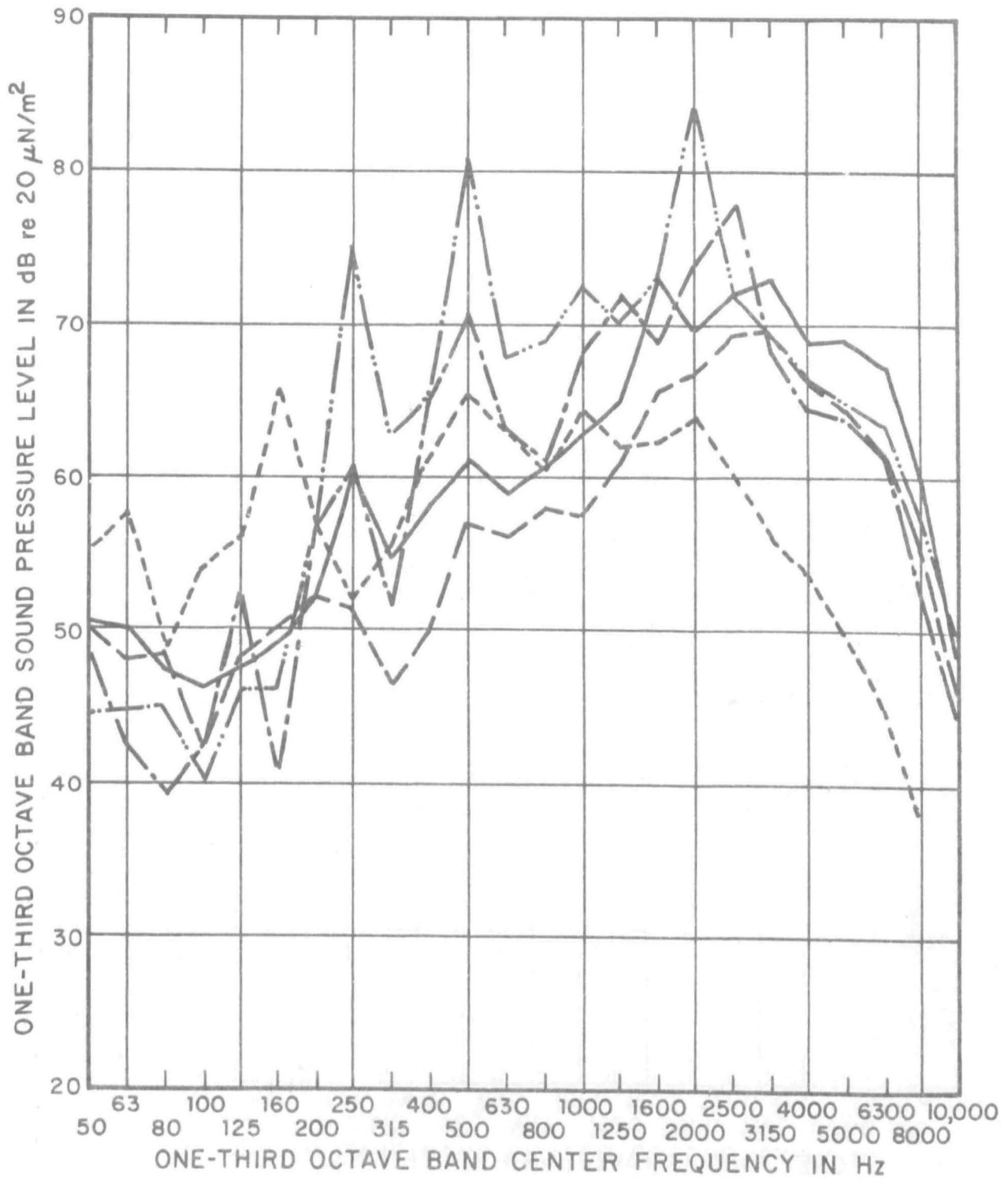

FIG. A.19 SOUND PRESSURE LEVELS FROM FIVE BLENDERS AT MAXIMUM SPEED (MEASURED AT 3 FT)

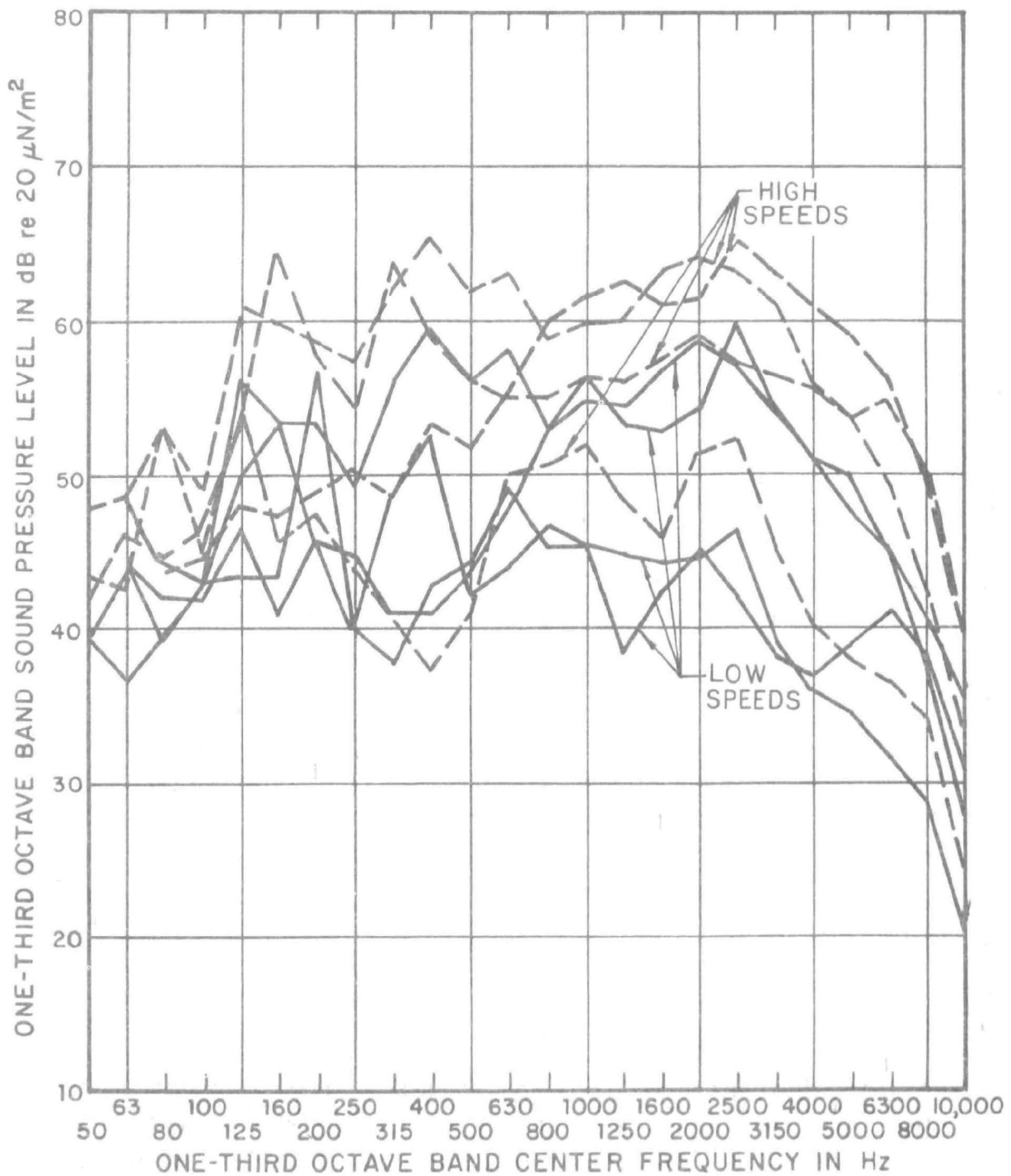

FIG. A.20 SOUND PRESSURE LEVELS FROM FOUR FOOD MIXERS AT LOW AND HIGH SPEED (MEASURED AT 3 FT)

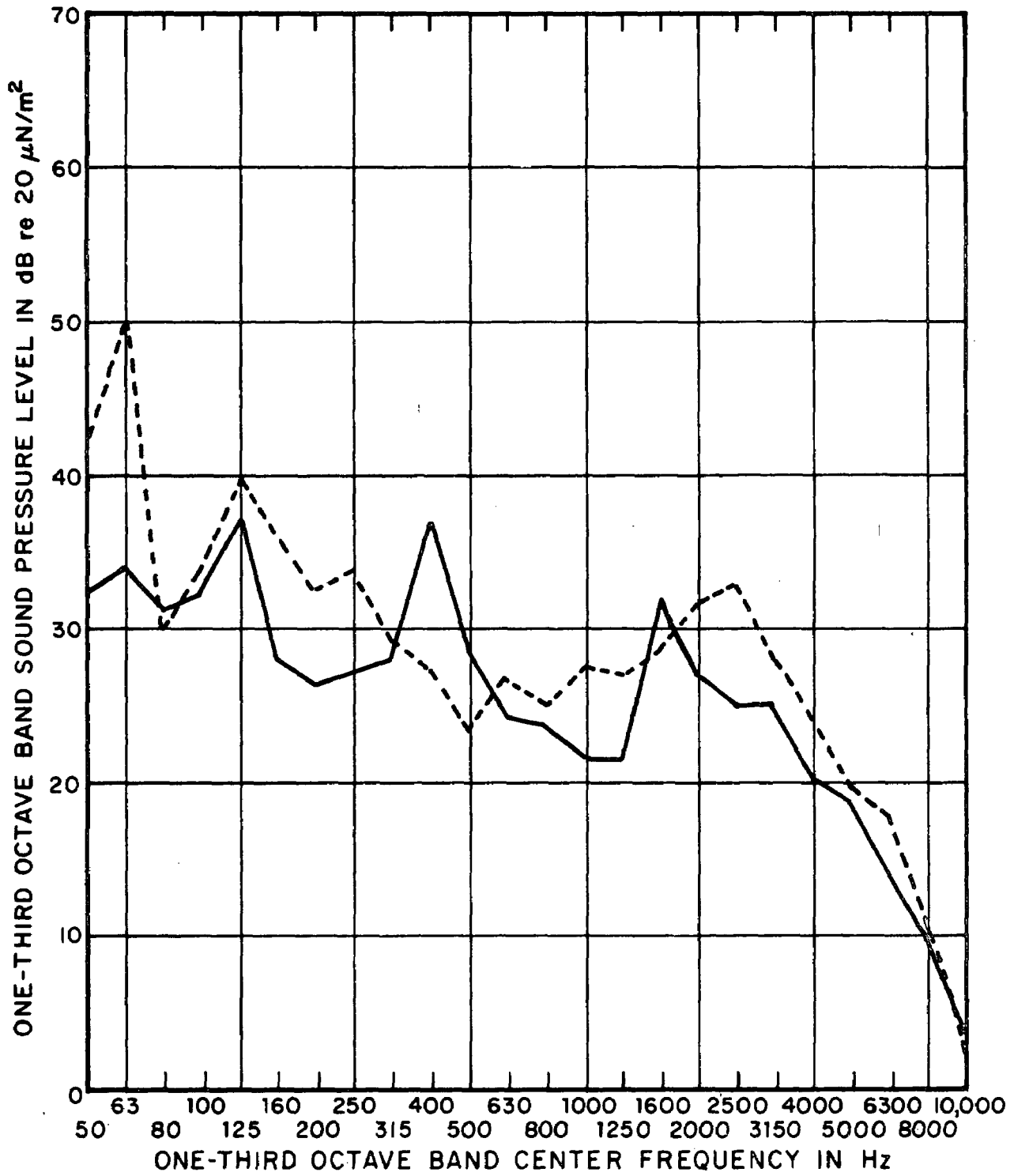

FIG. A.21 SOUND PRESSURE LEVELS FROM TWO FREEZERS
(MEASURED AT 3 FT)

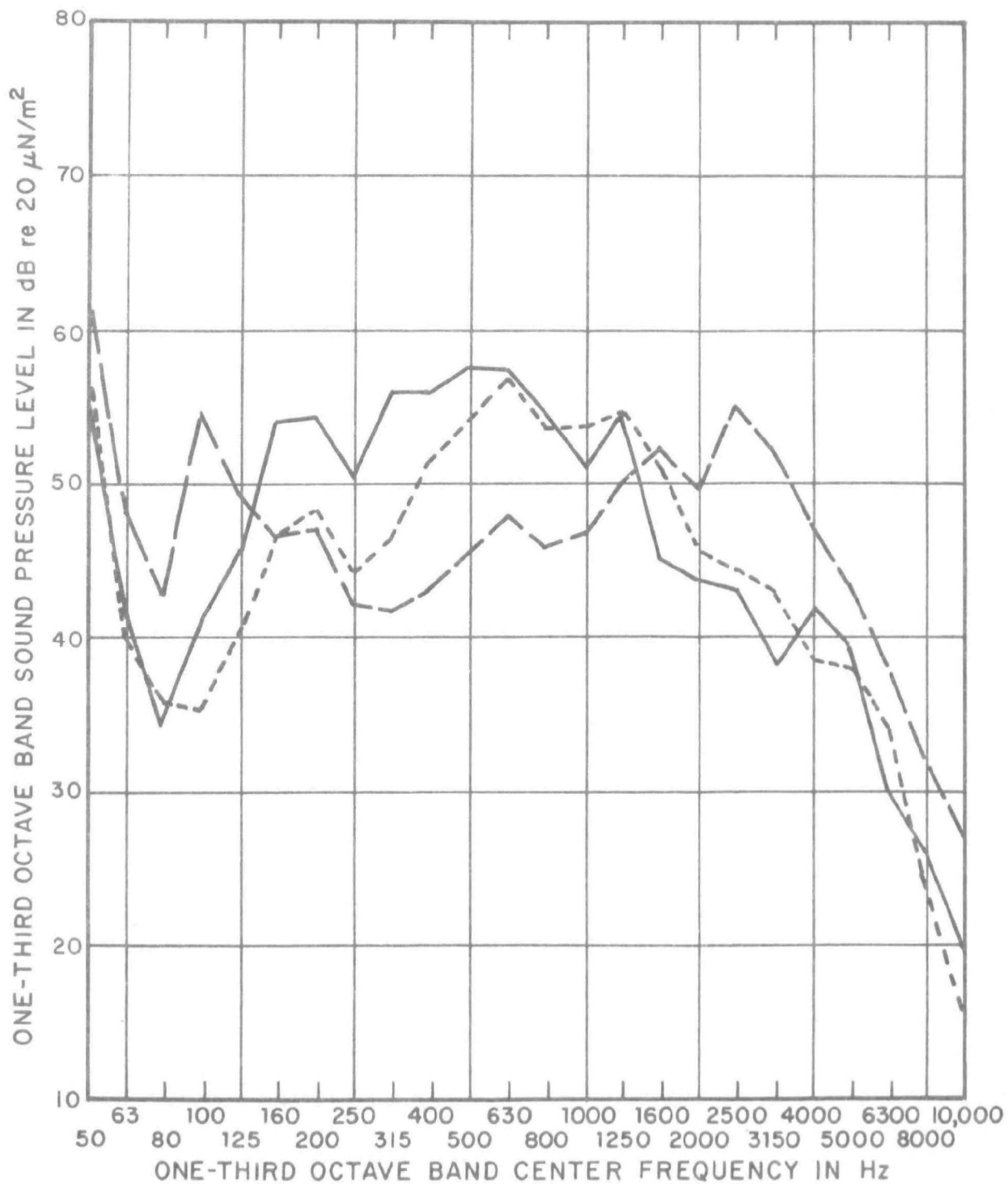

FIG. A.22 SOUND PRESSURE LEVELS FROM THREE HAIR DRYERS (MEASURED AT 3 FT)

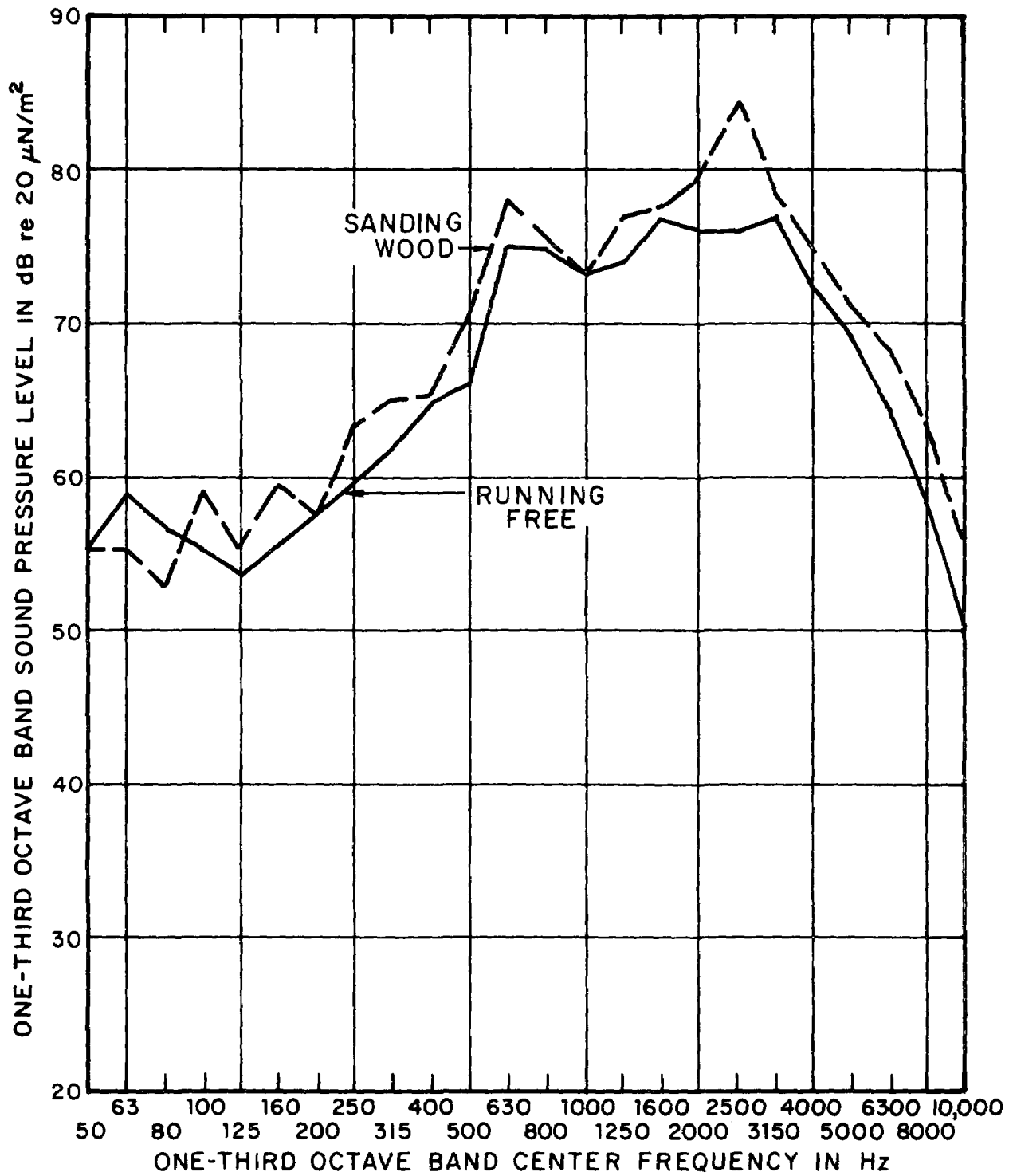

FIG. A.23 SOUND PRESSURE LEVELS FOR A BELT SANDER
 RUNNING FREE AND SANDING WOOD (MEASURED AT
 3 FT)

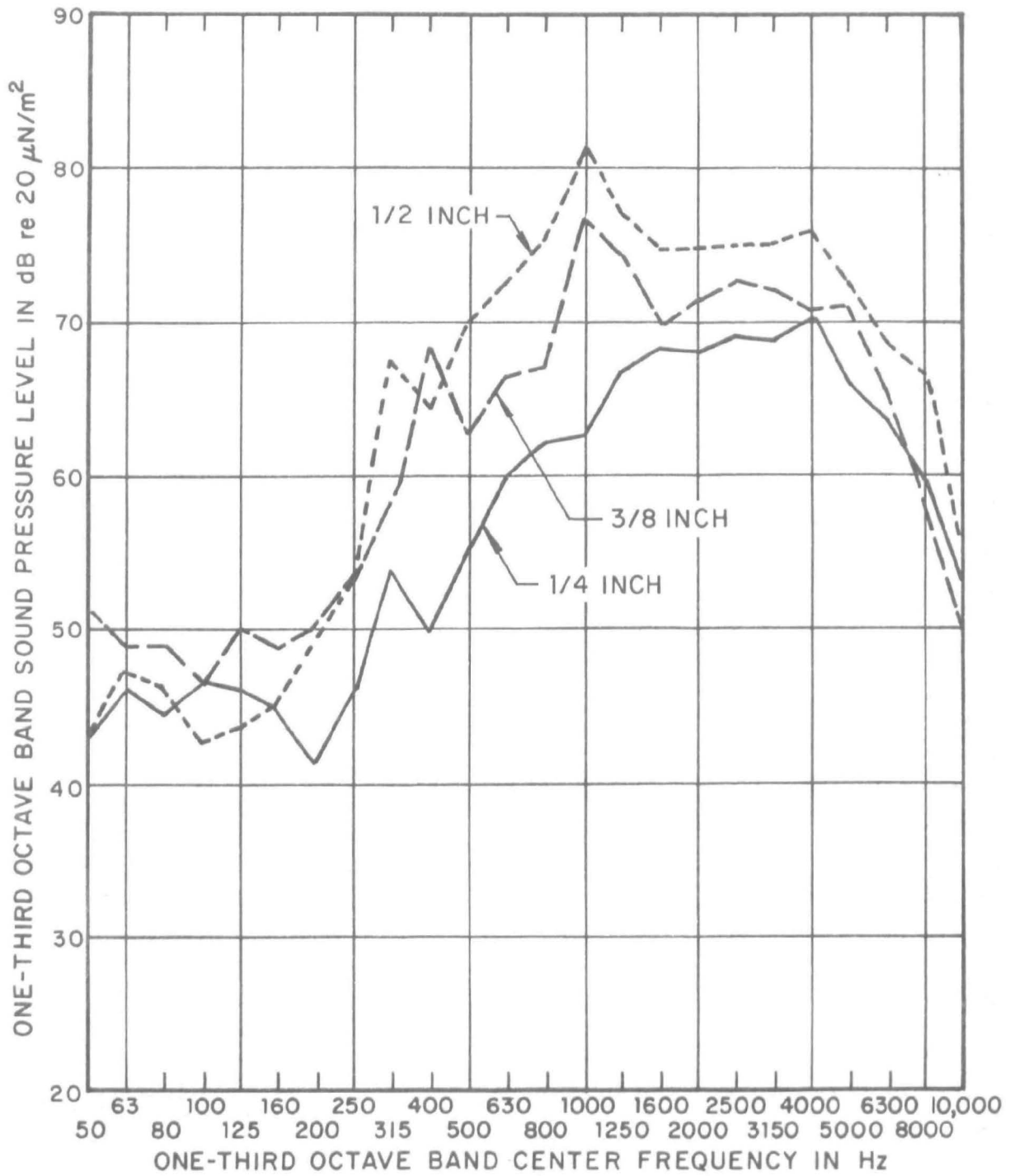

FIG. A.24 SOUND PRESSURE LEVELS FROM THREE DRILLS
(MEASURED AT 3 FT)

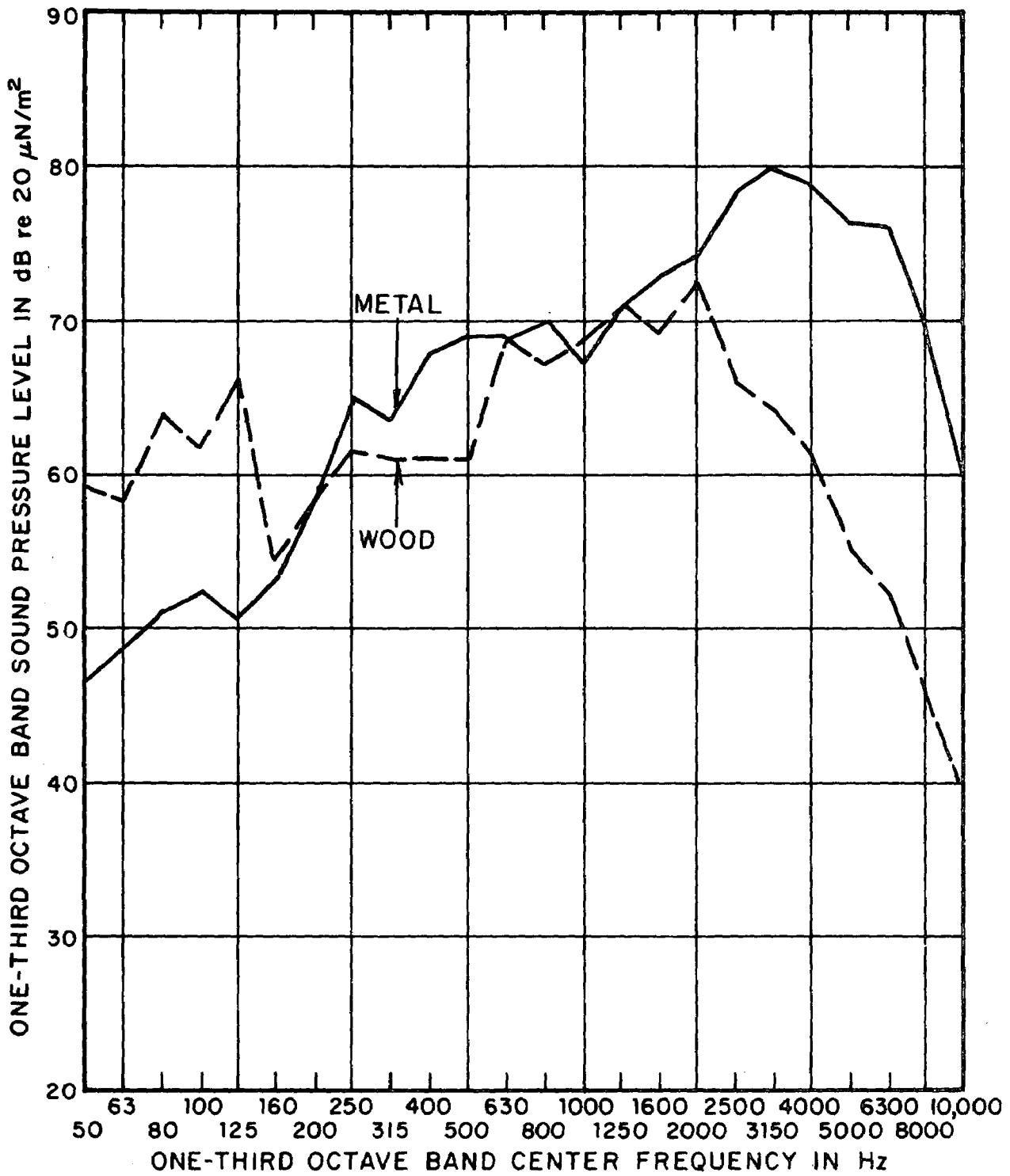

FIG. A.25 SOUND PRESSURE LEVELS FROM TWO DRILL PRESSES DRILLING THROUGH WOOD AND METAL (MEASURED AT 3 FT)

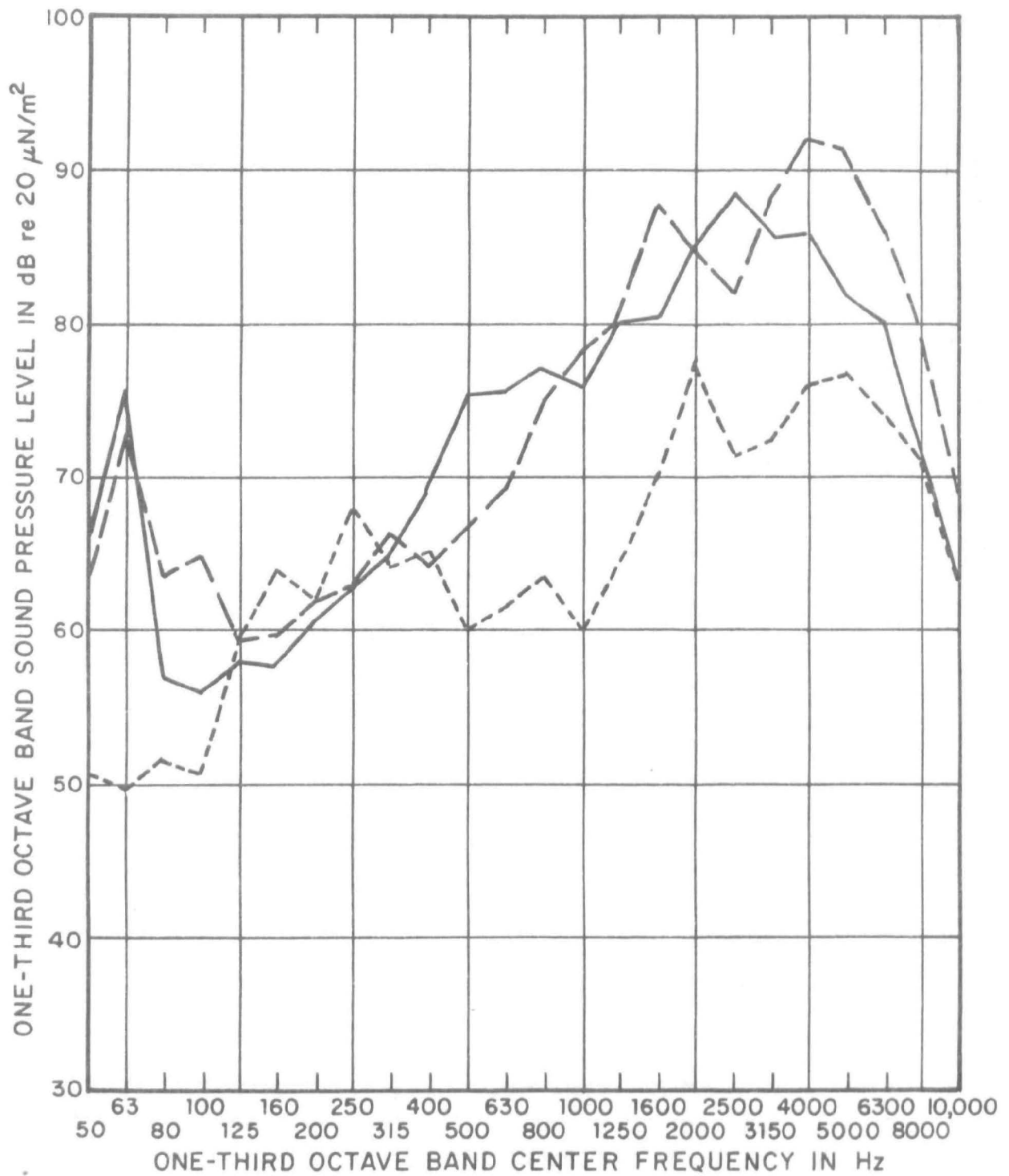

FIG. A.26 SOUND PRESSURE LEVELS FROM THREE GRINDERS GRINDING METAL STOCK (MEASURED AT 3 FT)

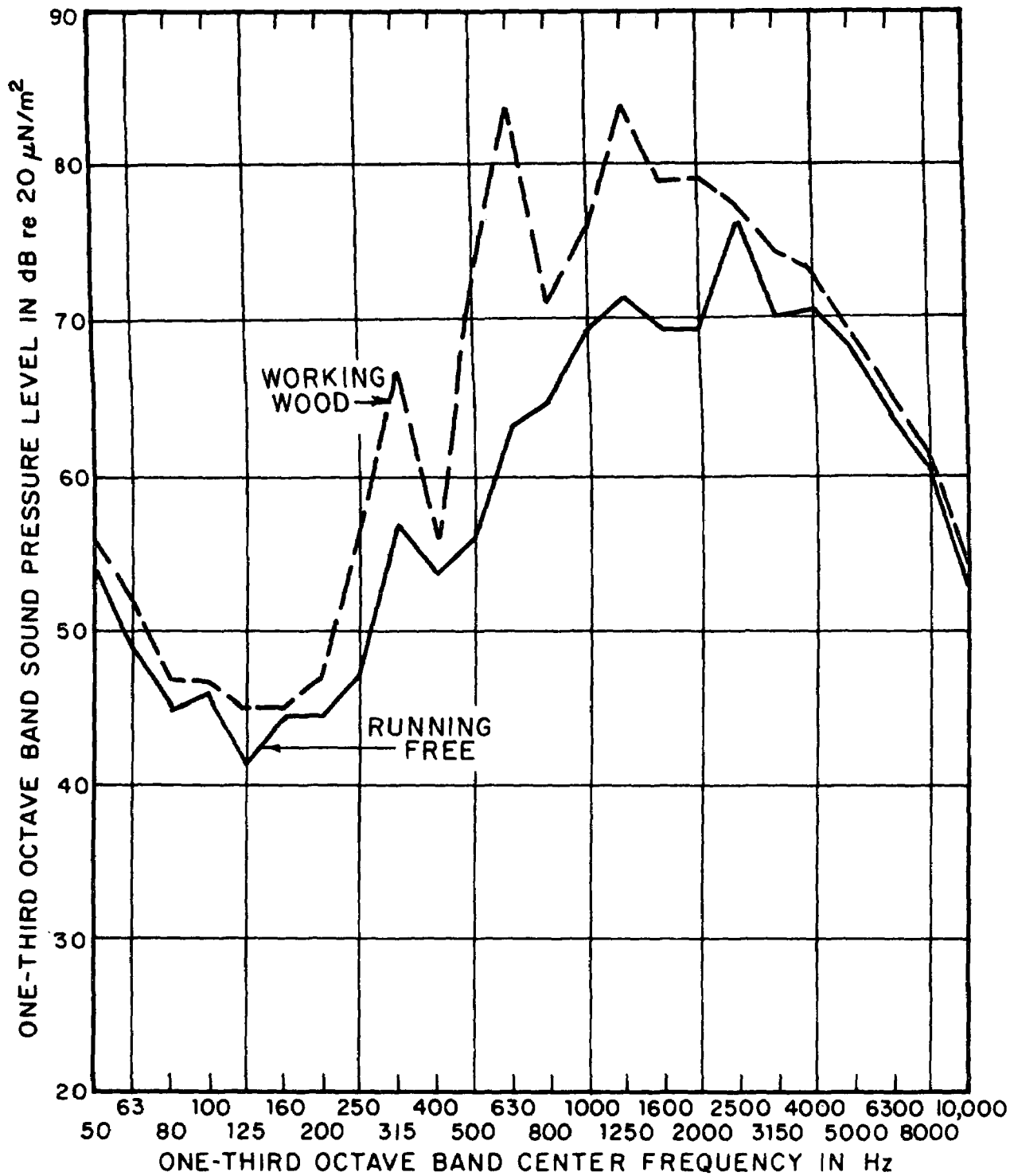

FIG. A.27 SOUND PRESSURE LEVELS FROM A ROUTER RUNNING FREE AND WORKING WOOD (MEASURED AT 3 FT)

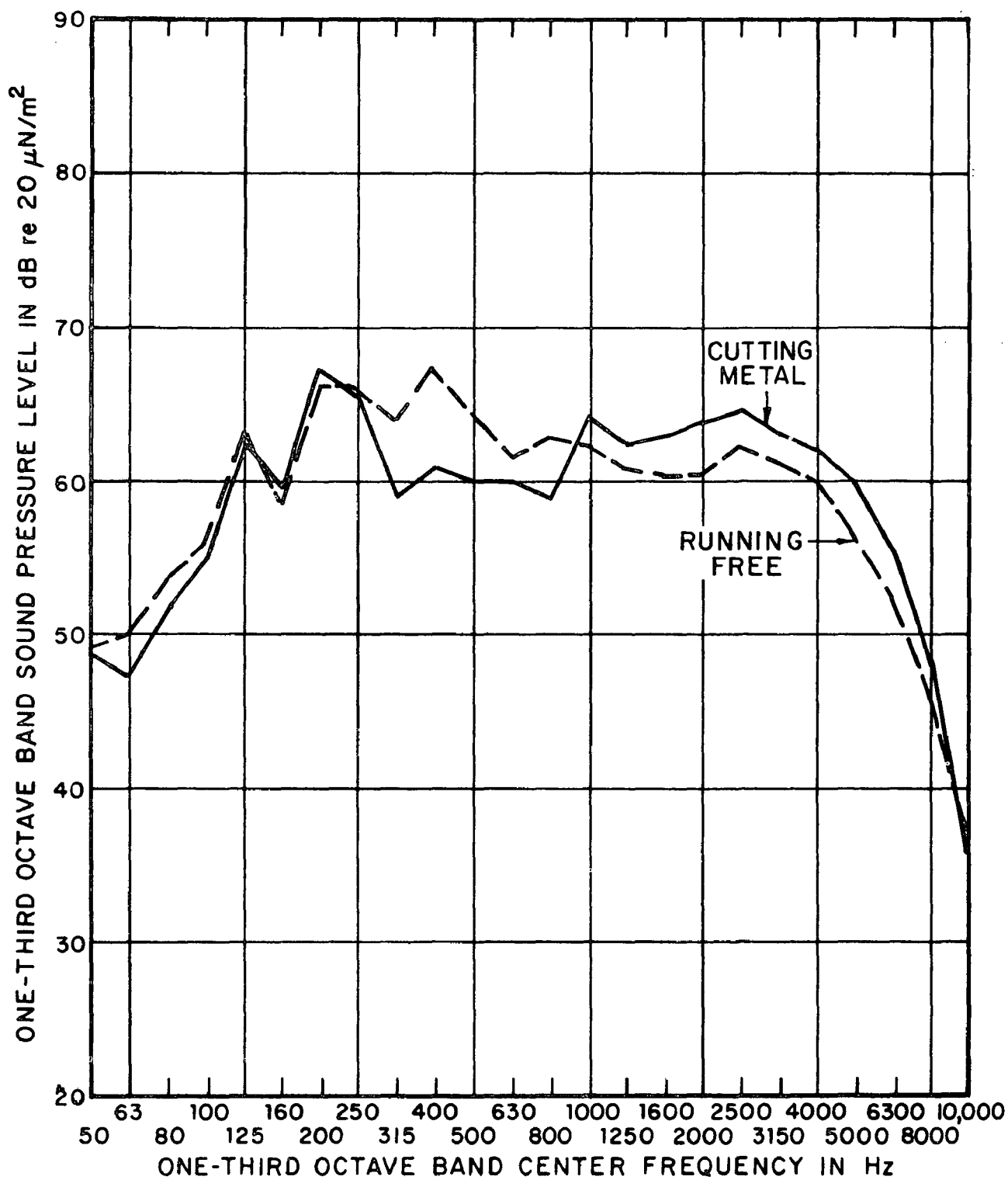

FIG. A.28 SOUND PRESSURE LEVELS FROM A SMALL METAL LATHE RUNNING FREE AND CUTTING (MEASURED AT 3 FT)

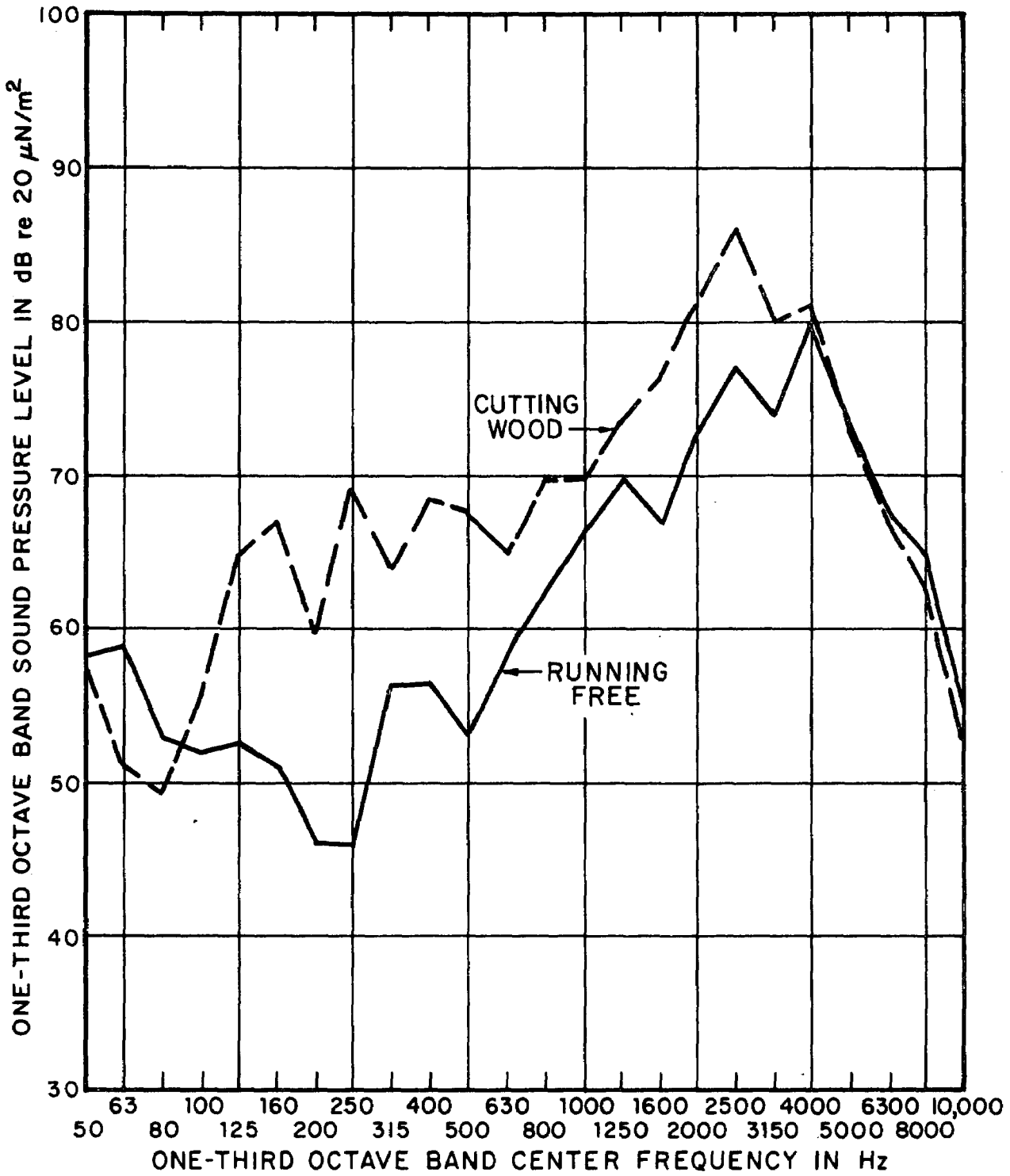

FIG. A.29 SOUND PRESSURE LEVELS FROM A SABRE SAW RUNNING FREE AND CUTTING WOOD (MEASURED AT 3 FT)

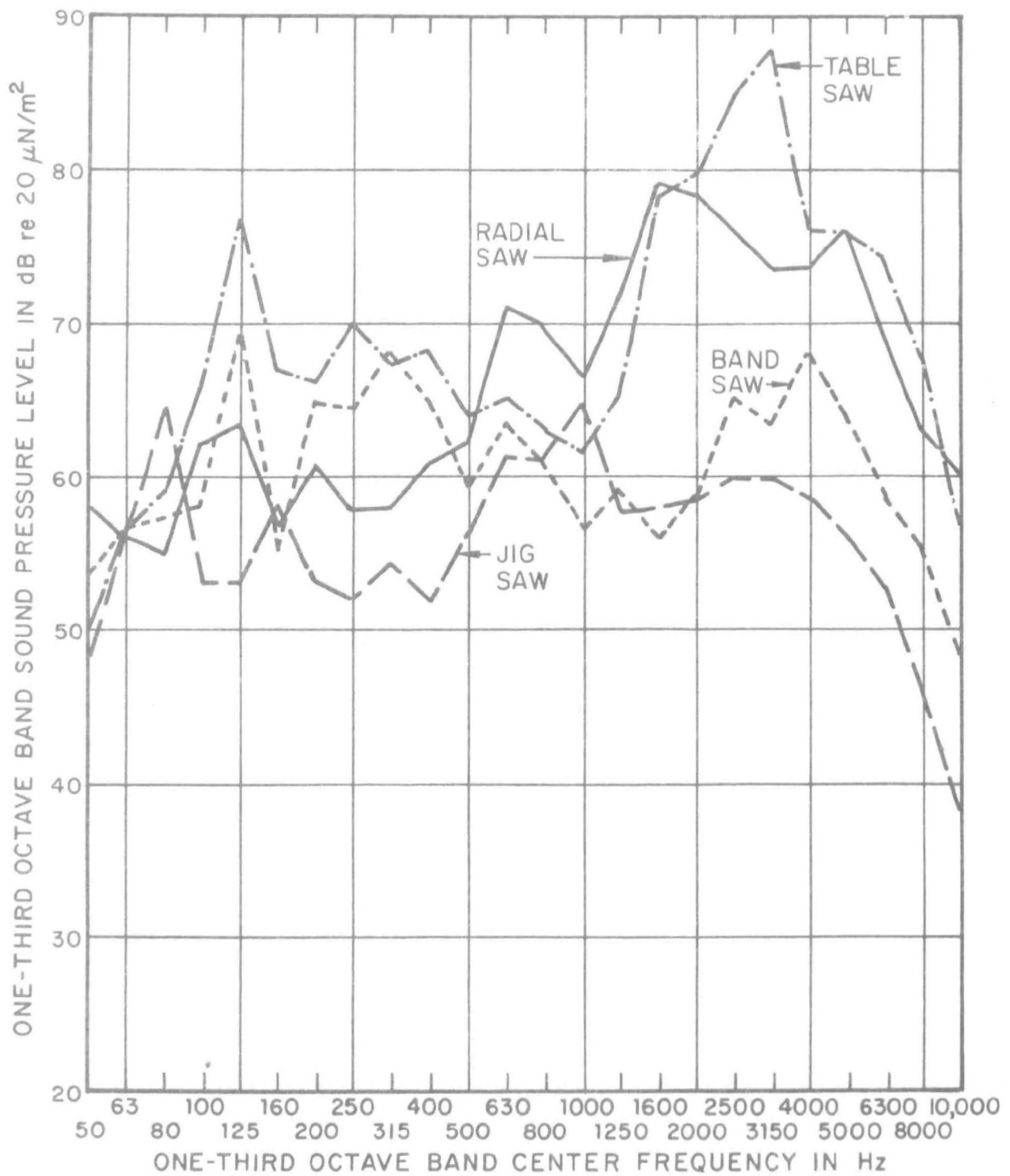

FIG. A.30 SOUND PRESSURE LEVELS FROM FOUR DIFFERENT SAWS CUTTING WOOD (MEASURED AT 3 FT)

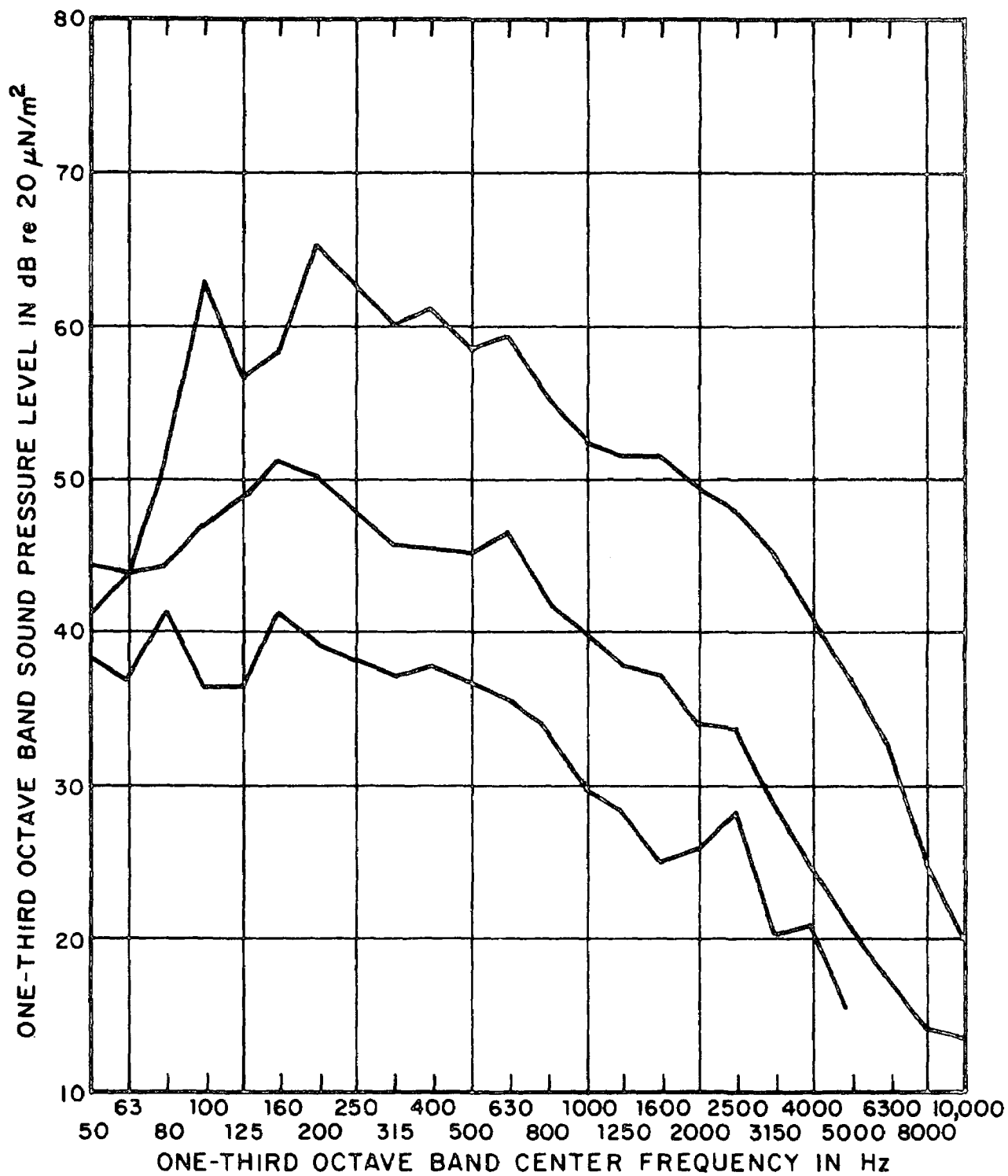

FIG. A.31 SOUND PRESSURE LEVELS FROM A ROOM DEHUMIDIFIER FOR THREE SETTINGS (MEASURED AT 3 FT)

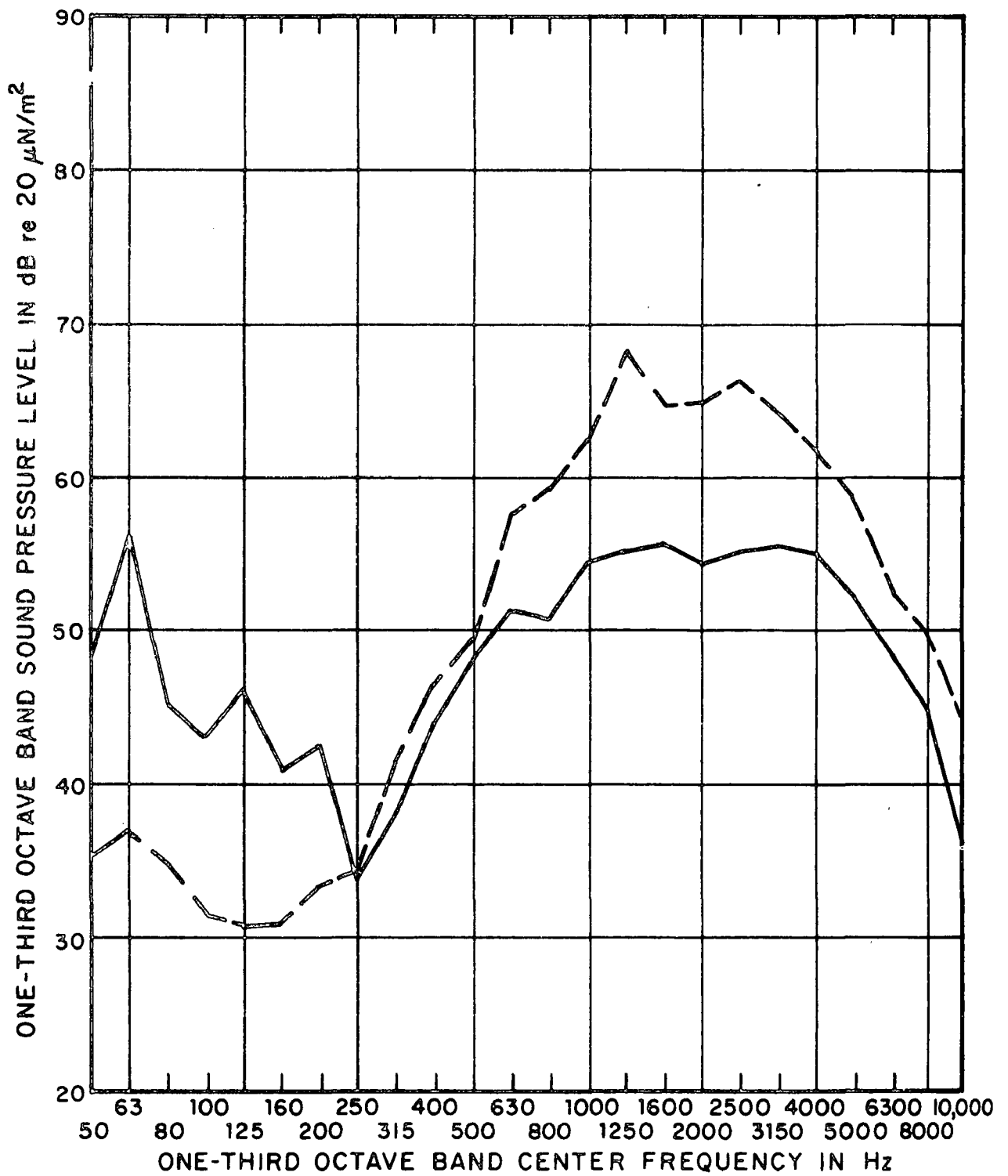

FIG. A.32 SOUND PRESSURE LEVELS FROM TWO ELECTRIC KNIVES (MEASURED AT 3 FT)

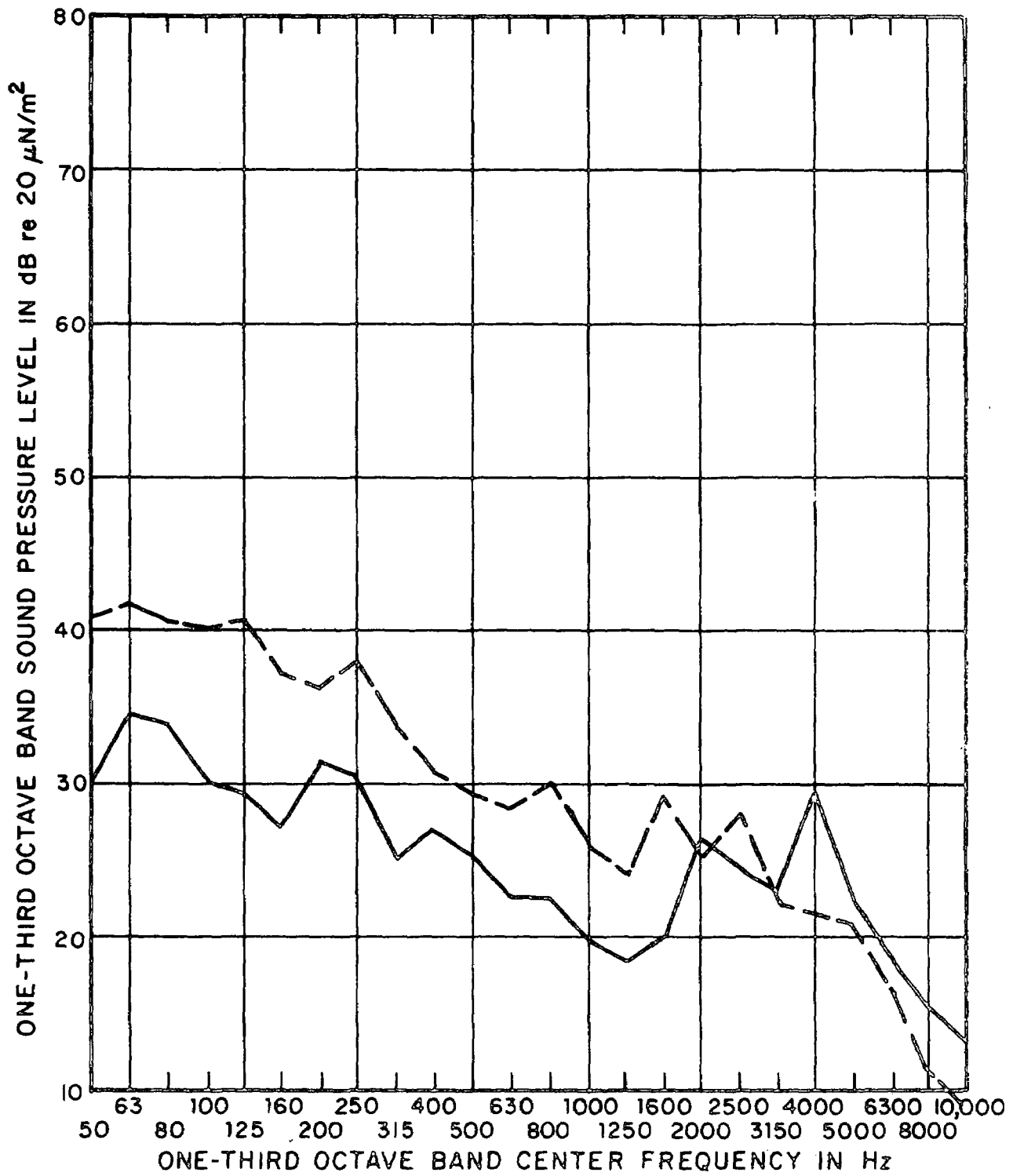

FIG. A.33 SOUND PRESSURE LEVELS FROM TWO REFRIGERATORS
(MEASURED AT 3 FT)

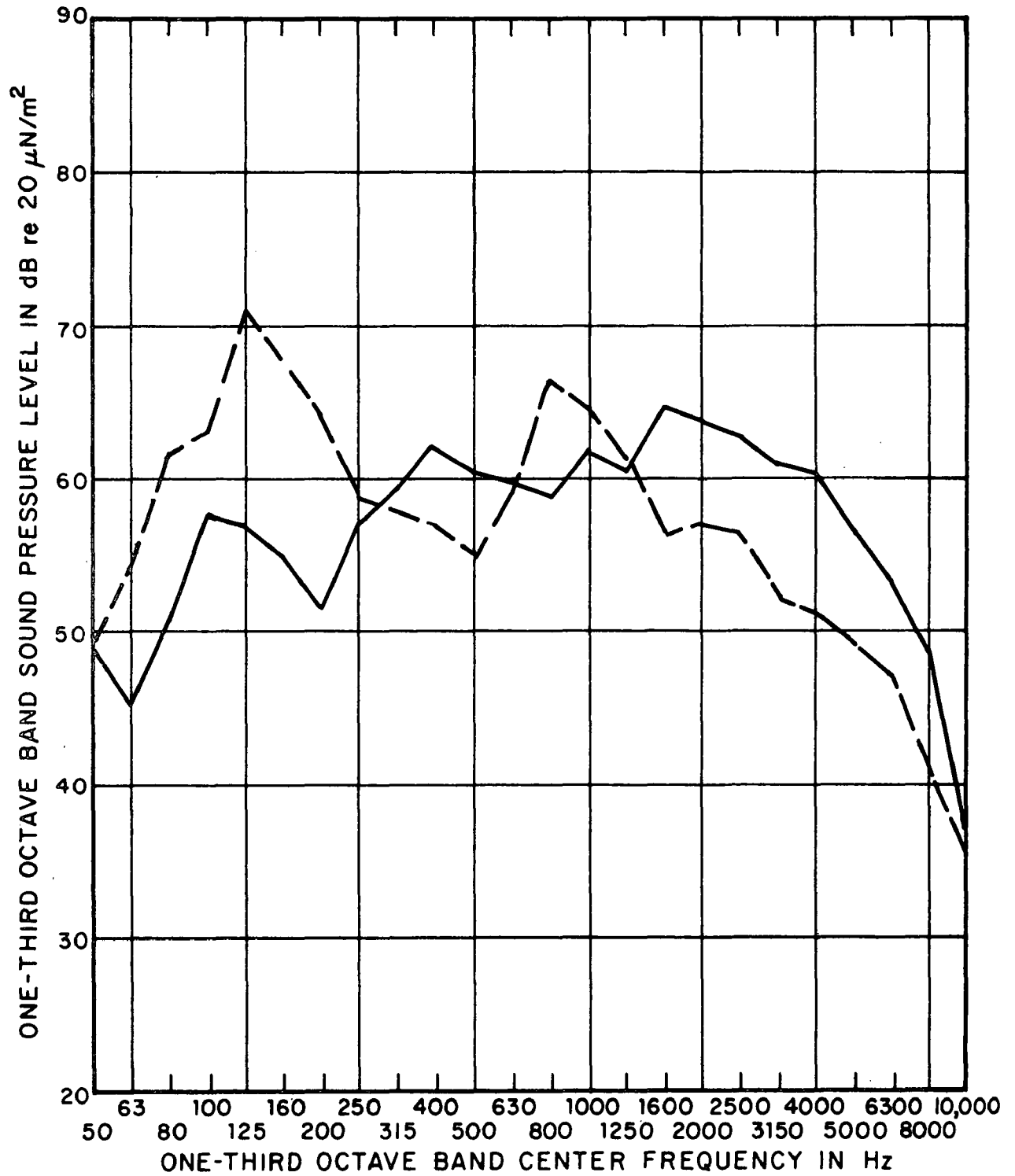

FIG. A.34 SOUND PRESSURE LEVELS FROM TWO SEWING MACHINES (MEASURED AT 3 FT)

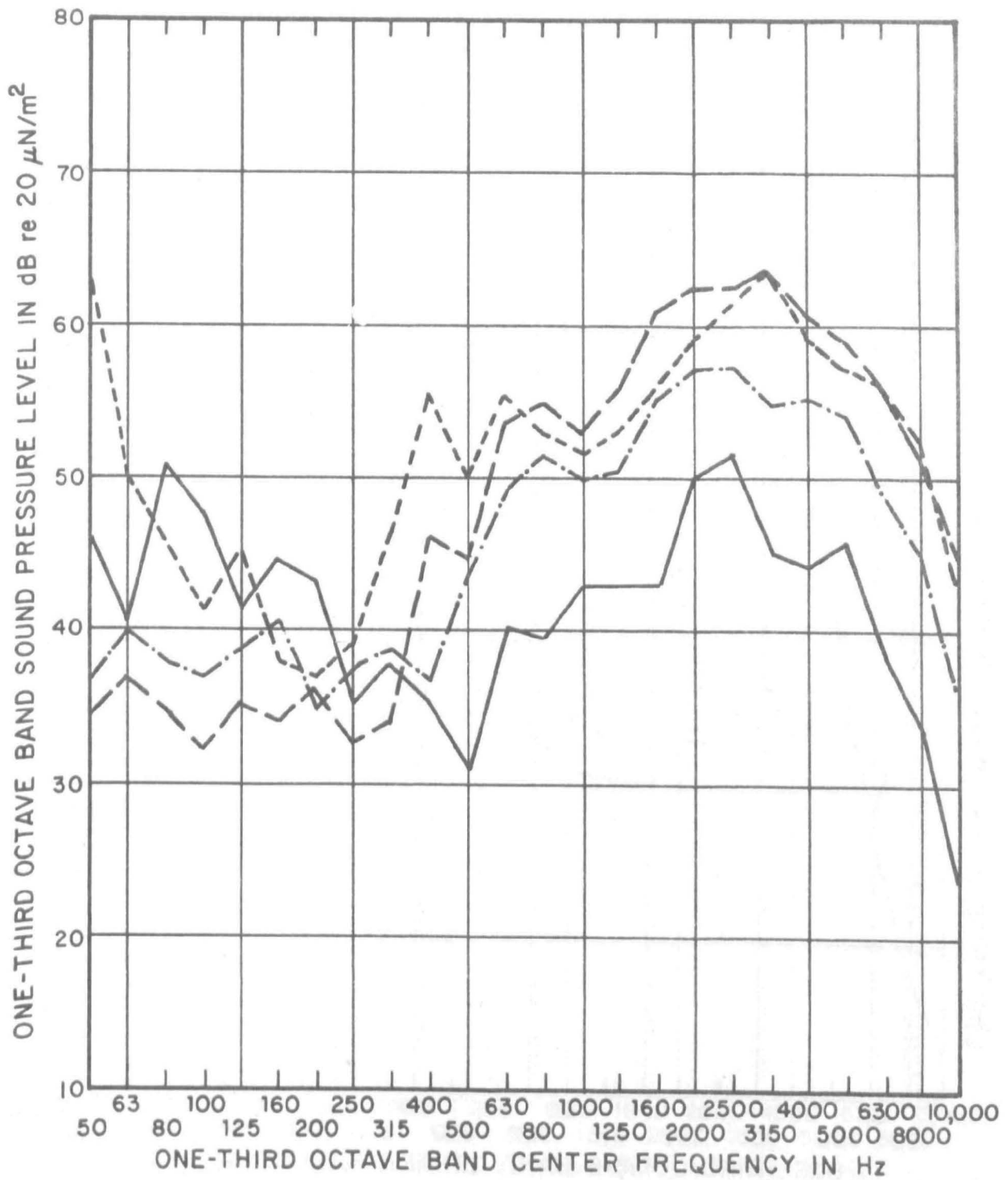

FIG. A.35 SOUND PRESSURE LEVELS FROM FOUR MEN'S ELECTRIC SHAVERS (MEASURED AT 3 FT)

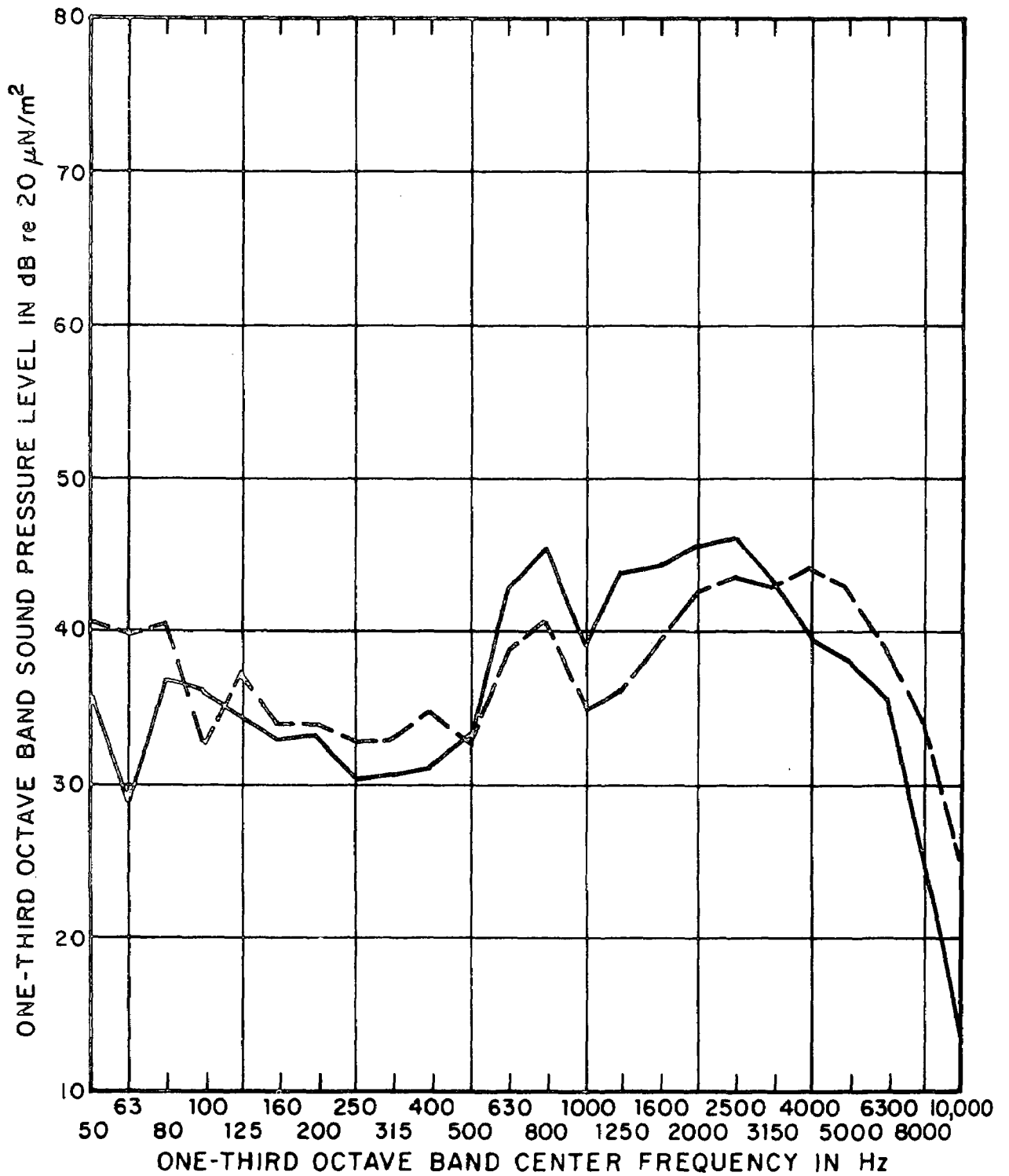

FIG. A.36 SOUND PRESSURE LEVELS FROM TWO WOMEN'S ELECTRIC SHAVERS (MEASURED AT 3 FT)

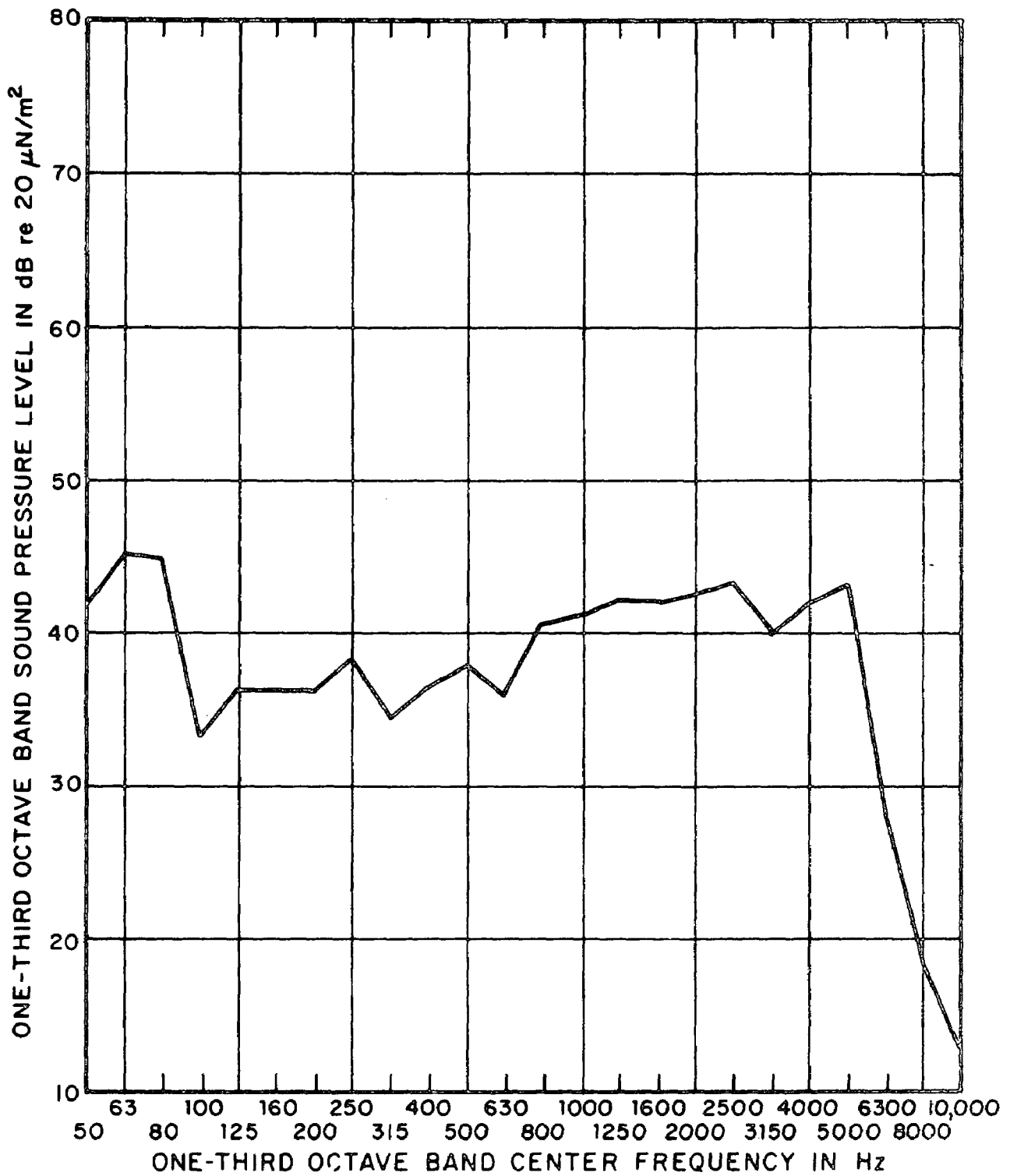

FIG. A.37 SOUND PRESSURE LEVELS FROM AN ELECTRIC TOOTHBRUSH (MEASURED AT 3 FT)

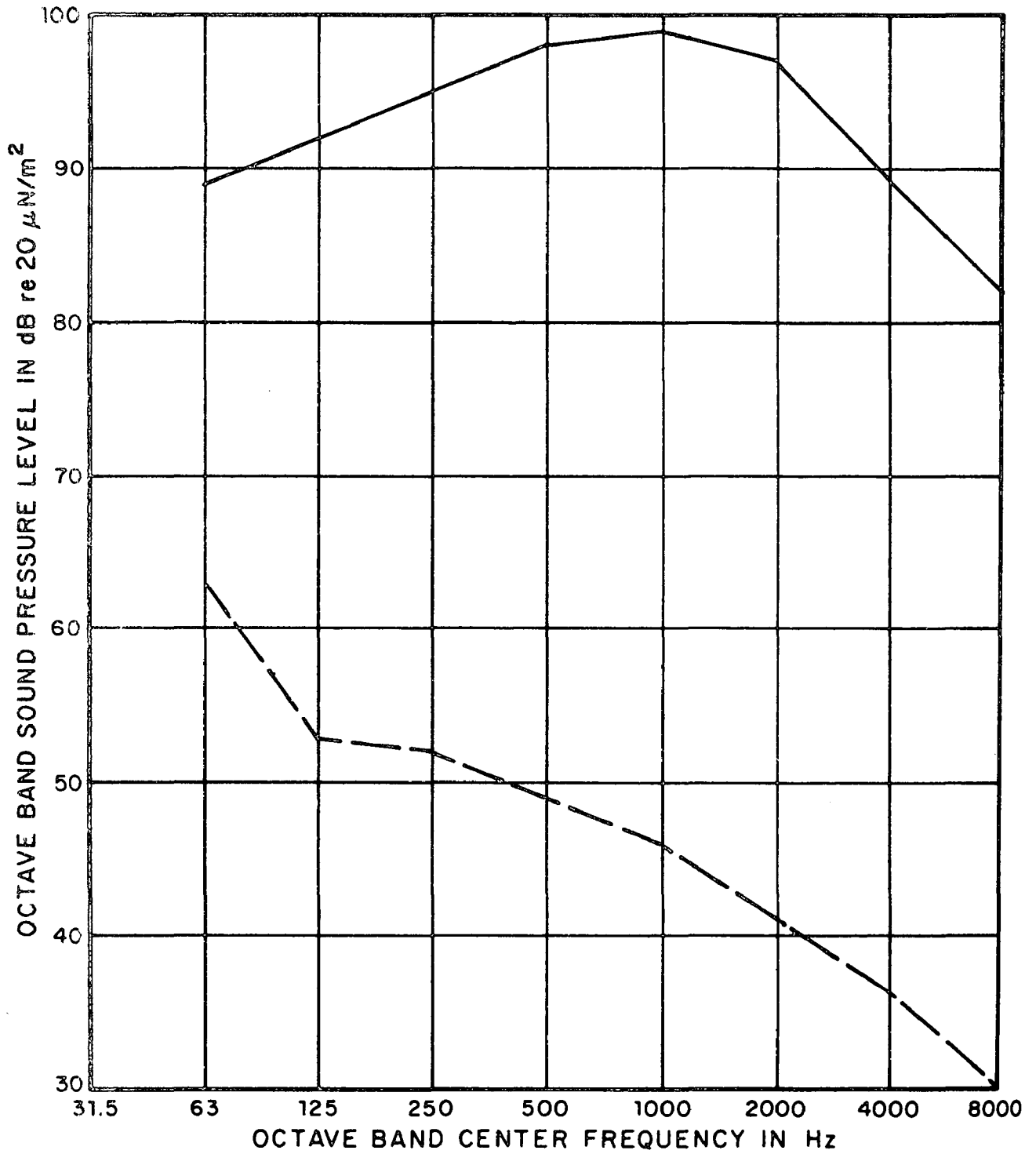

FIG. A.38 RANGE OF SOUND PRESSURE LEVELS FROM DIFFERENT SIZES OF MOTORS (MEASURED AT 3 FT)

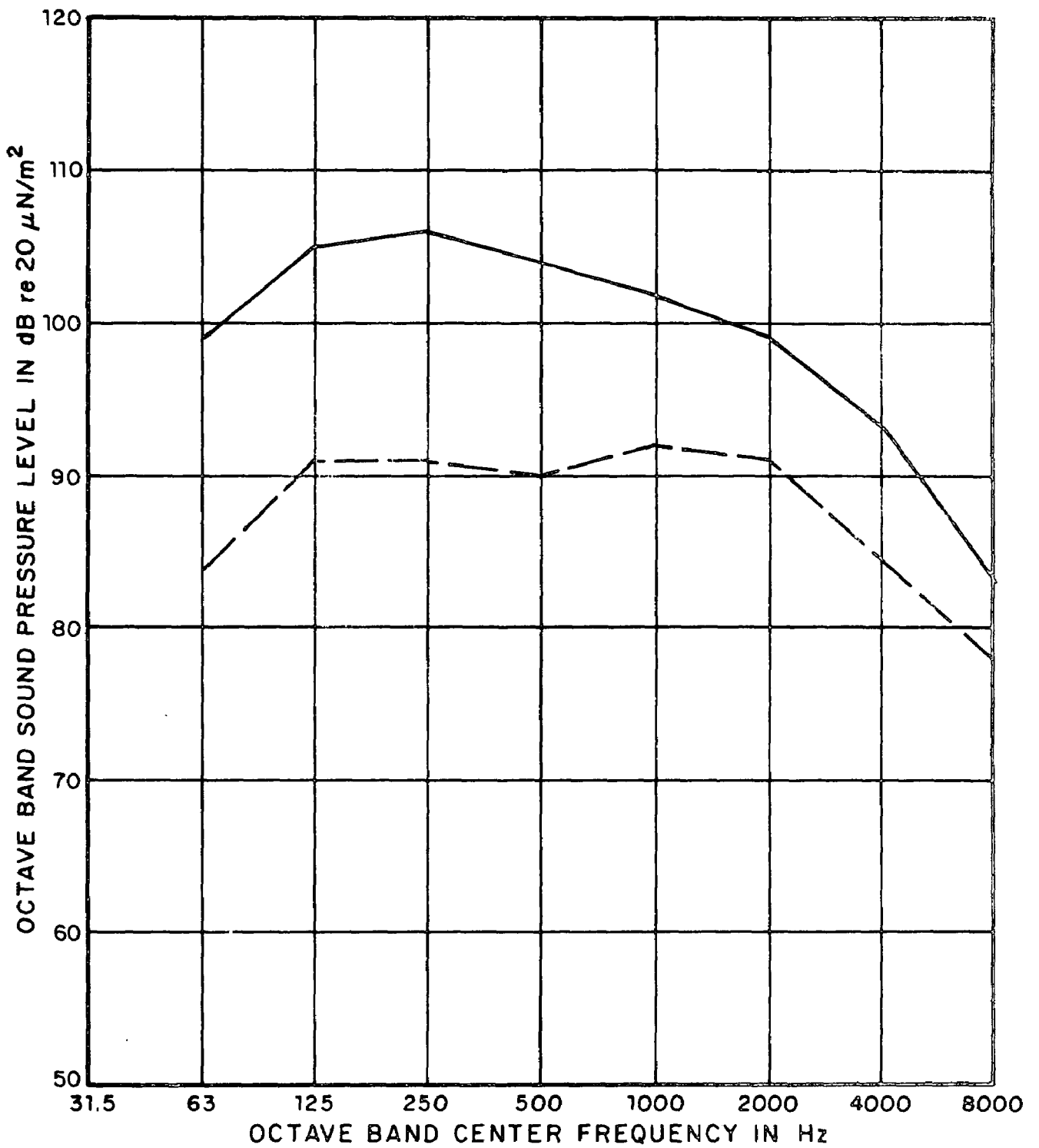

FIG. A.39 RANGE OF SOUND PRESSURE LEVELS FROM INTERNAL COMBUSTION ENGINES (MEASURED AT 3 FT)

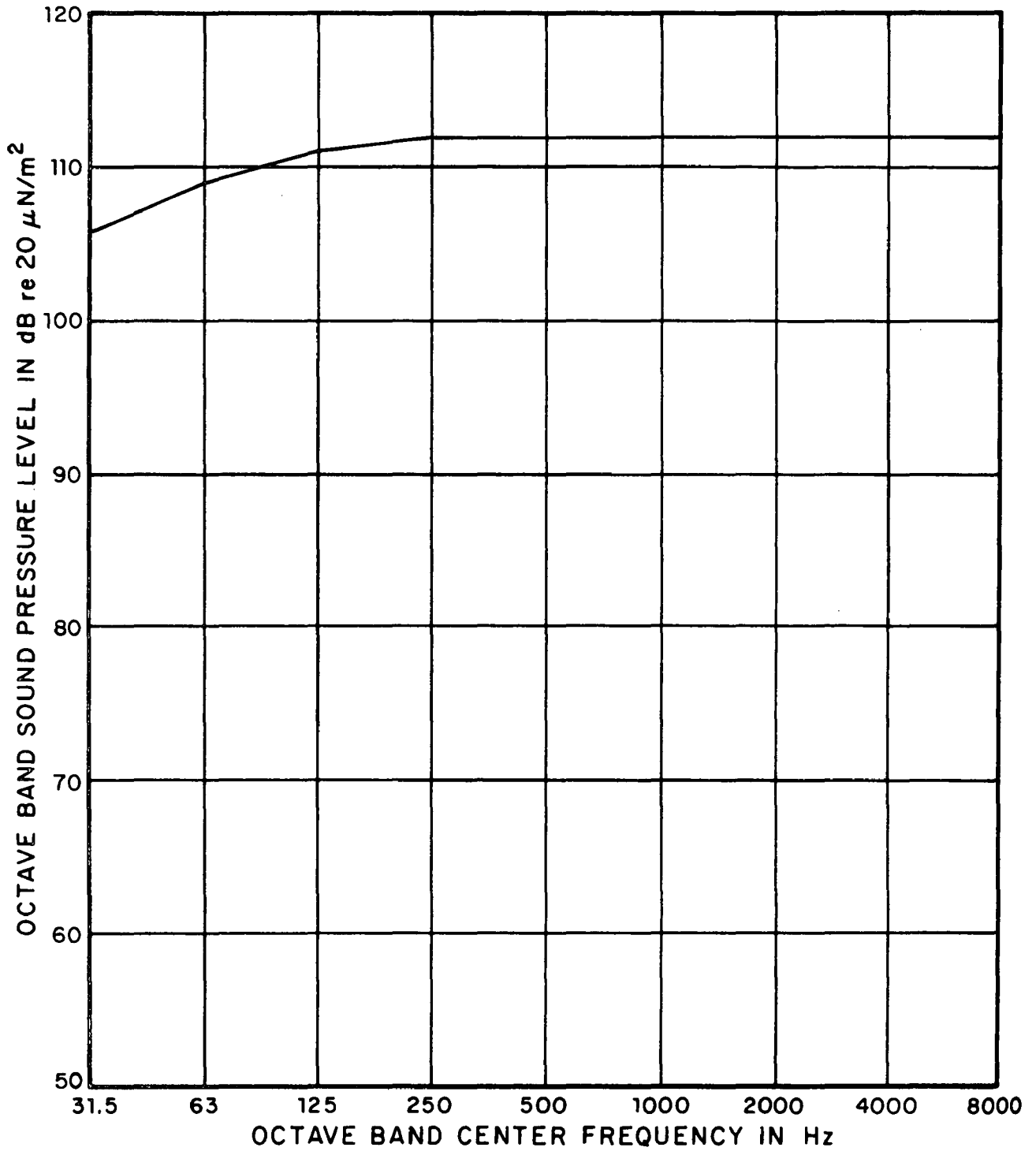

FIG. A.40 TYPICAL SOUND PRESSURE LEVELS FROM GAS TURBINES (MEASURED AT 3 FT)

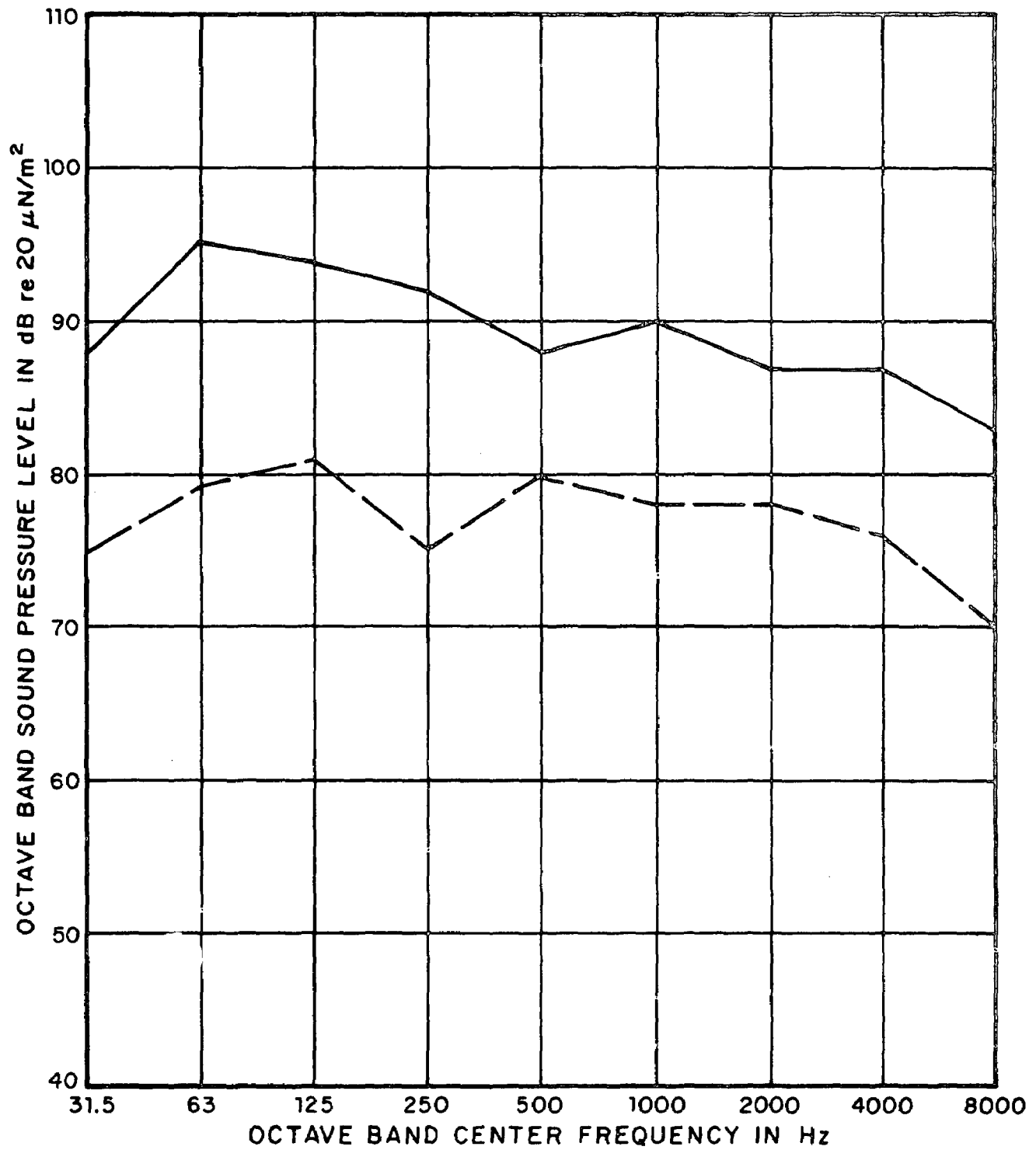

FIG. A.41 RANGE OF SOUND PRESSURE LEVELS FROM STEAM TURBINES (MEASURED AT 3 FT)

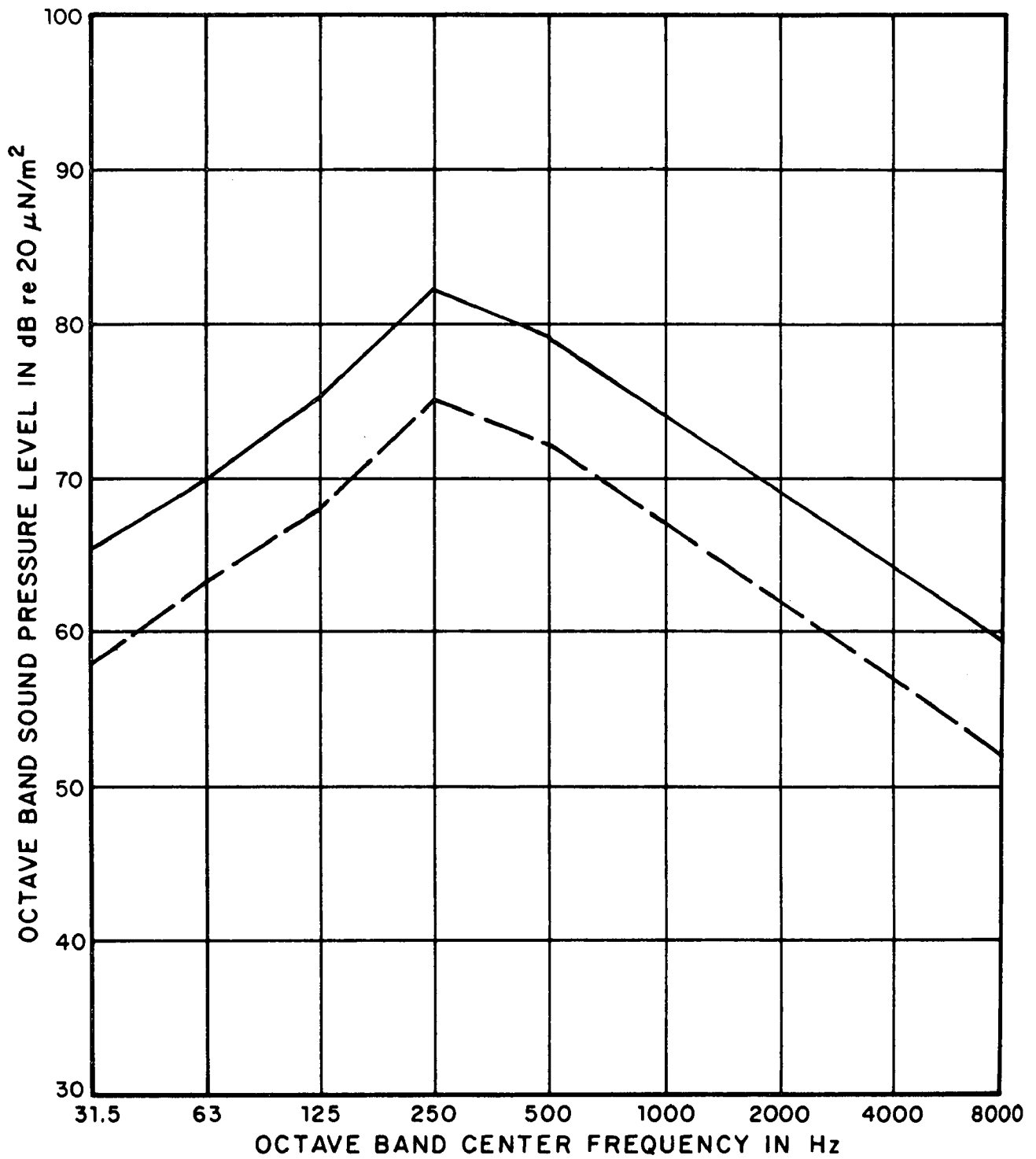

FIG. A.42 RANGE OF SOUND PRESSURE LEVELS FROM TRANSFORMERS (MEASURED AT 3 FT)

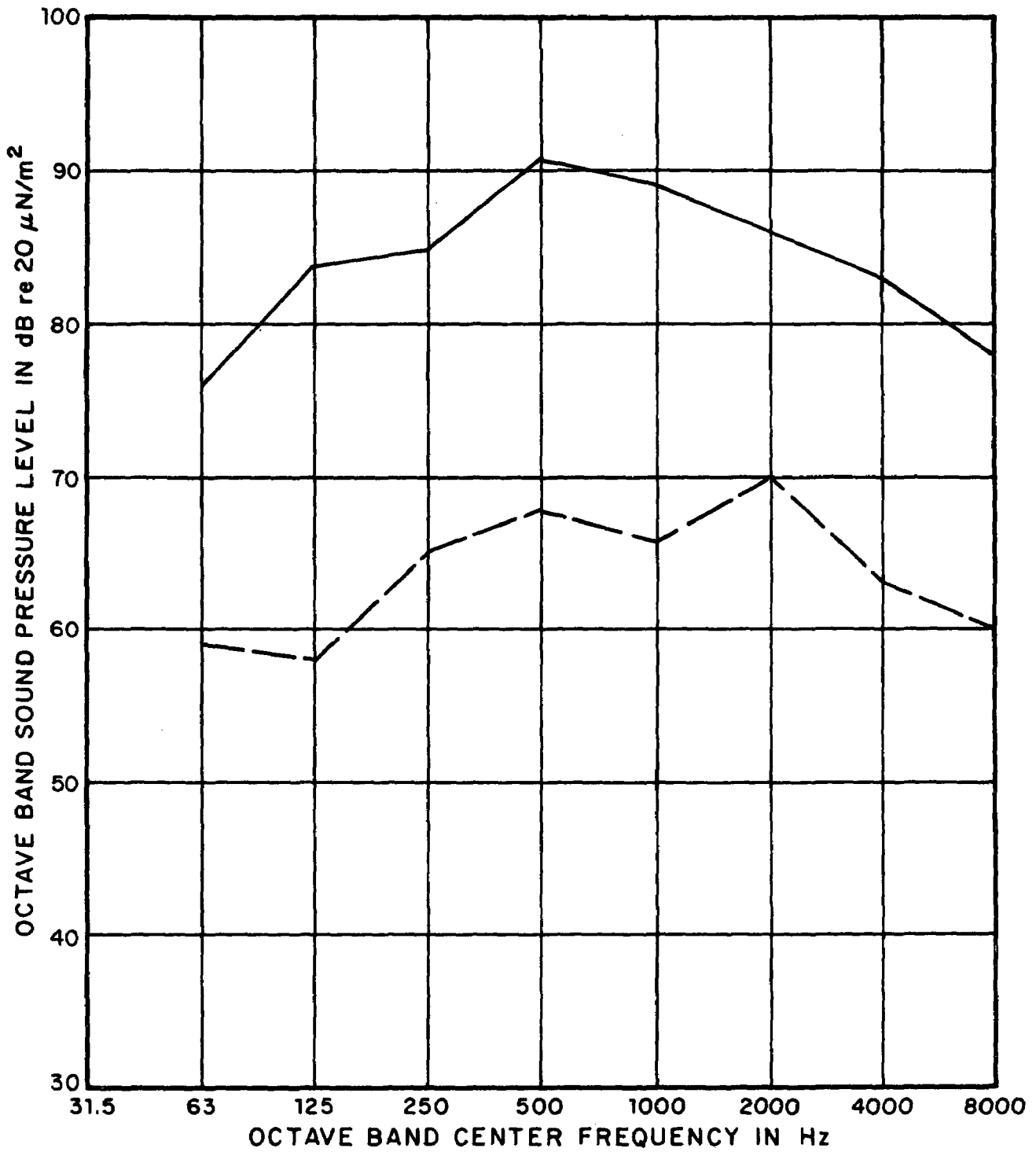

FIG. A.43 RANGE OF SOUND PRESSURE LEVELS FROM PUMPS
(MEASURED AT 3 FT)

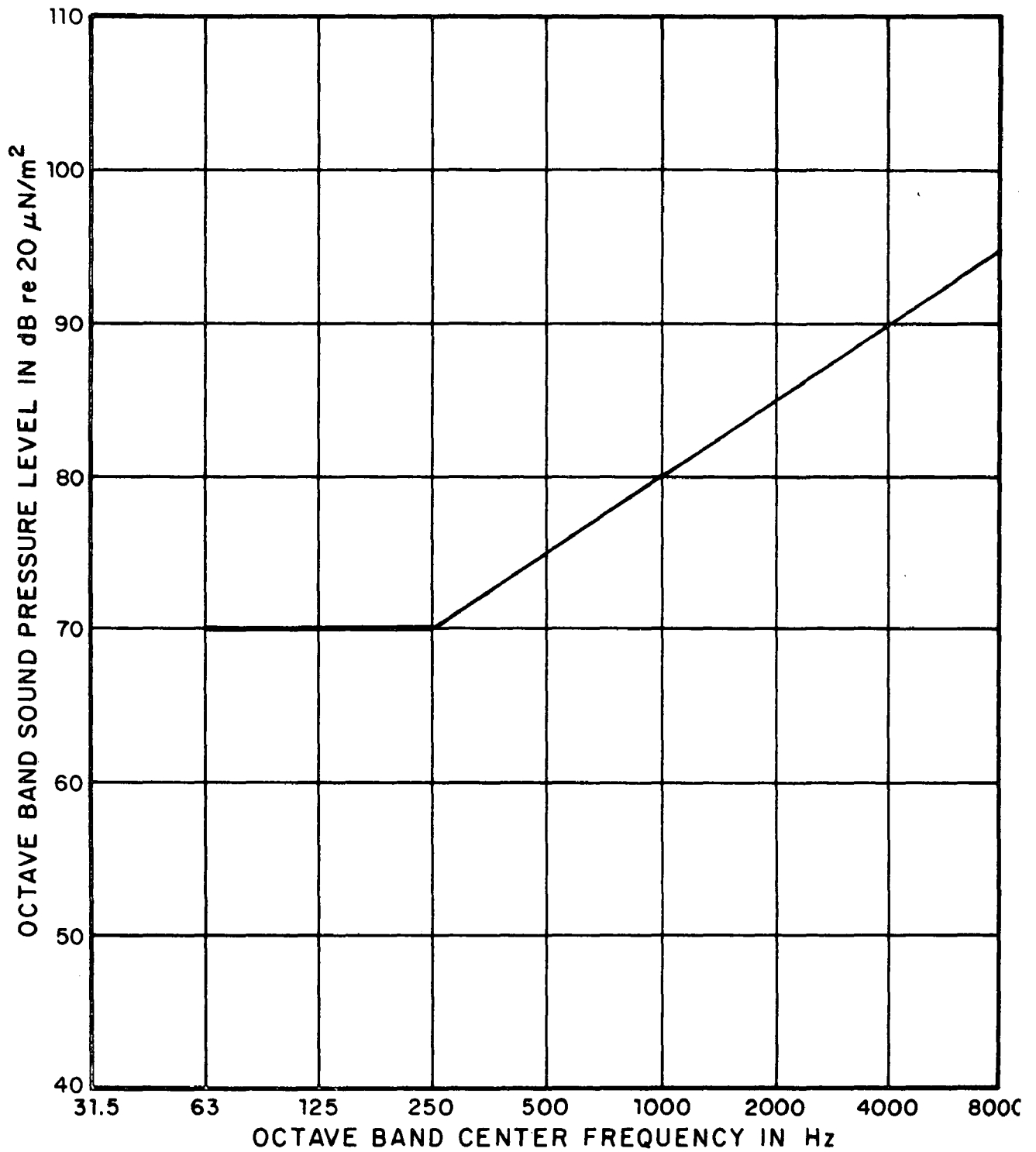

FIG. A.44 TYPICAL SOUND PRESSURE LEVEL FROM STEAM VALVE
(MEASURED AT 3 FT)

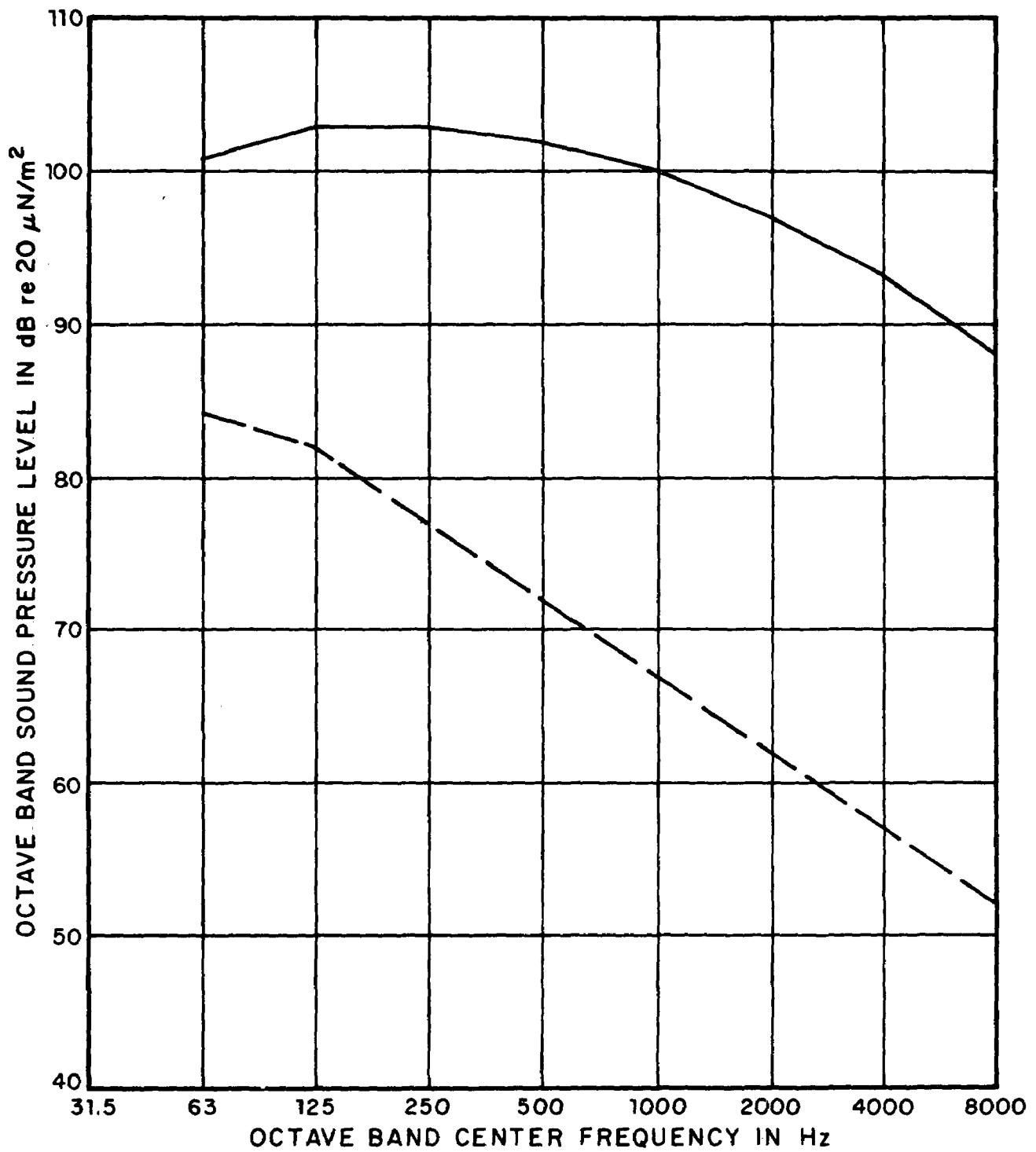

FIG. A.45 RANGE OF SOUND PRESSURE LEVELS FROM FANS
(MEASURED AT 3 FT)

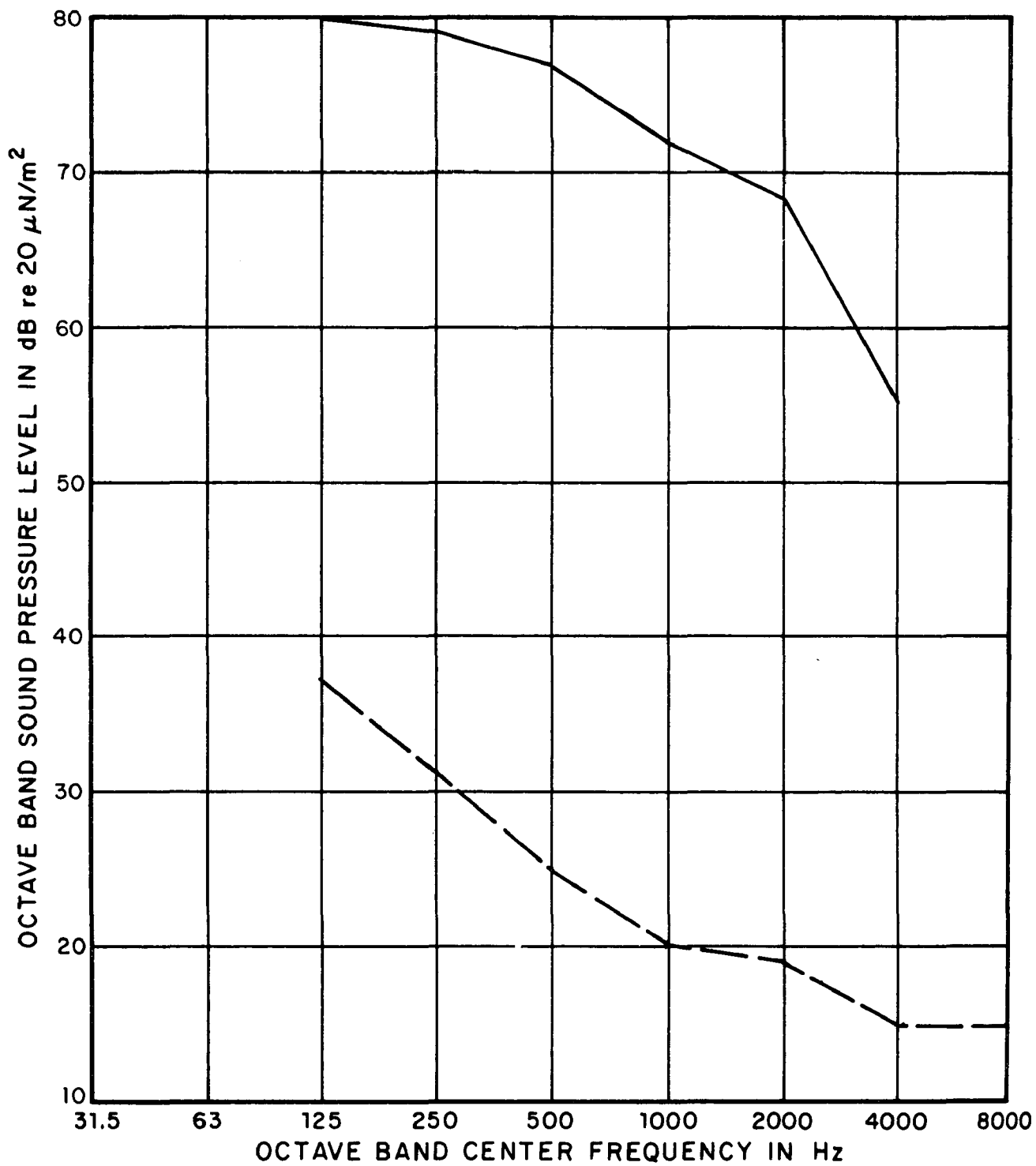

FIG. A.46 RANGE OF SOUND PRESSURE LEVELS FROM AIR CONTROL UNITS AND MIXING BOXES (MEASURED AT 3 FT)

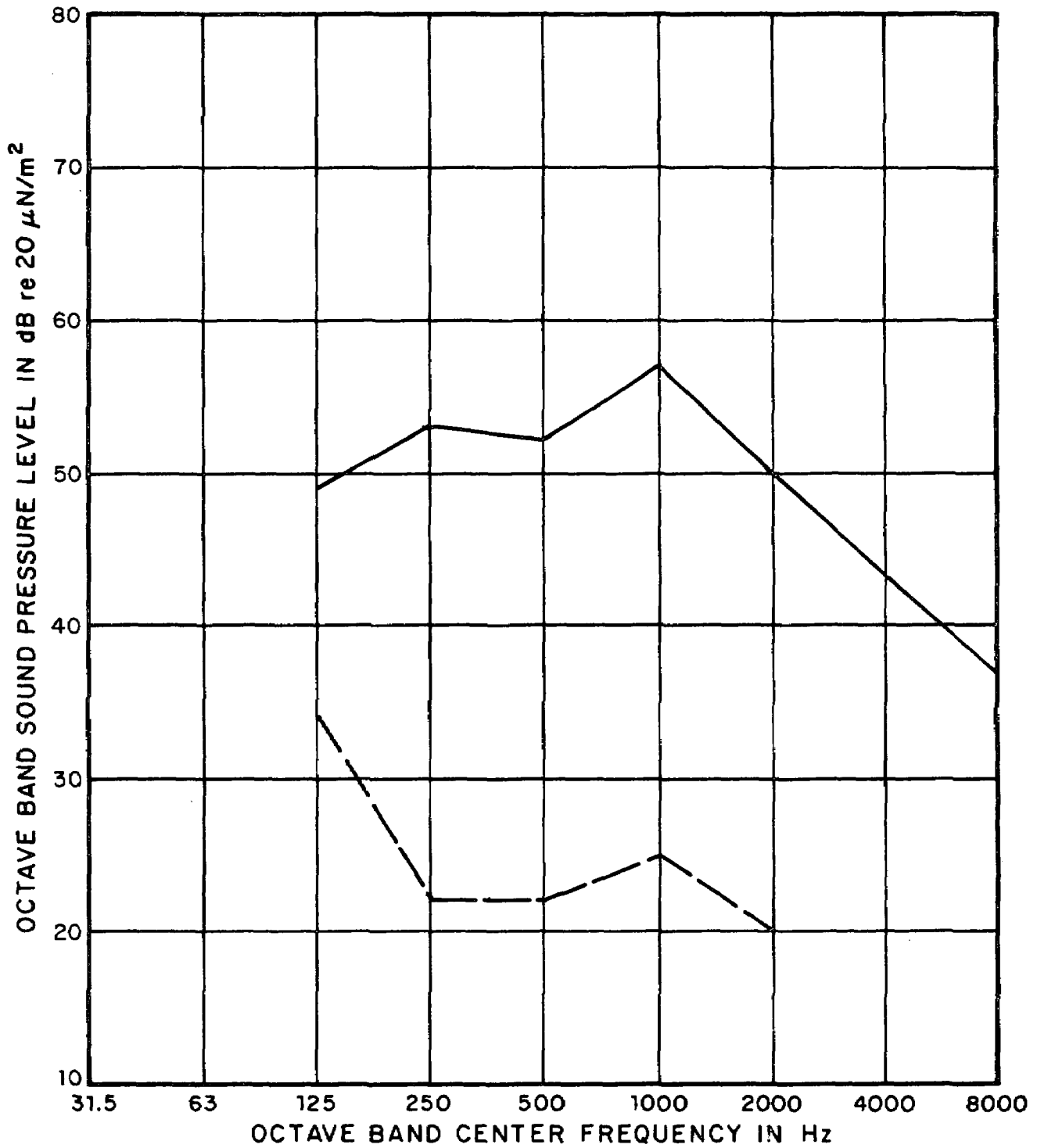

FIG. A.47 RANGE OF SOUND PRESSURE LEVELS FROM DIFFUSERS, GRILLS, REGISTERS, AND LOUVERS (MEASURED AT 3 FT)

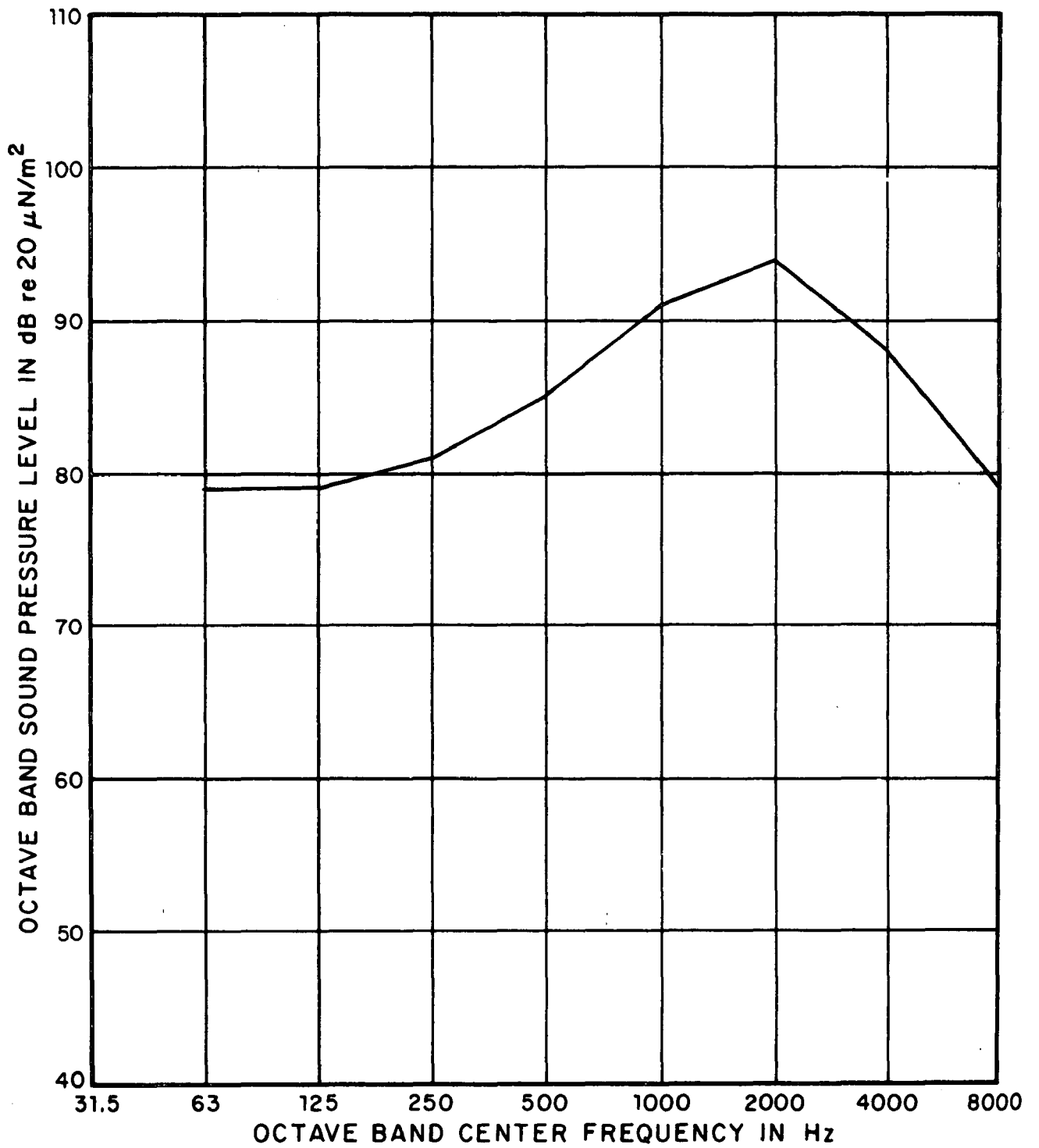

FIG. A.48 TYPICAL SOUND PRESSURE LEVELS FROM RECIPROCATING AIR COMPRESSORS (MEASURED AT 3 FT)

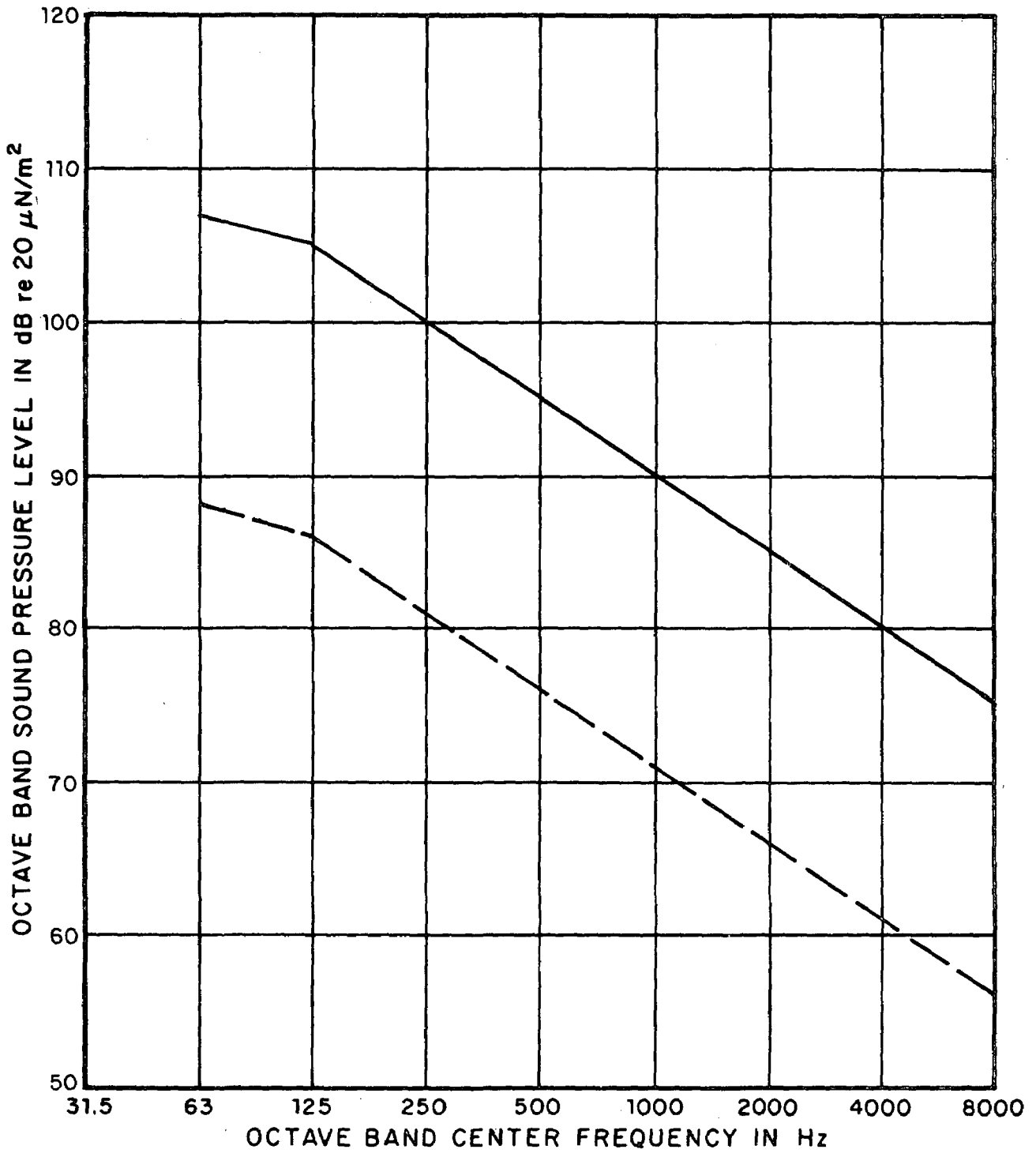

FIG. A.49 RANGE OF SOUND PRESSURE LEVELS FOR CENTRAL STATION AIRCONDITIONING UNITS (MEASURED AT 3 FT)

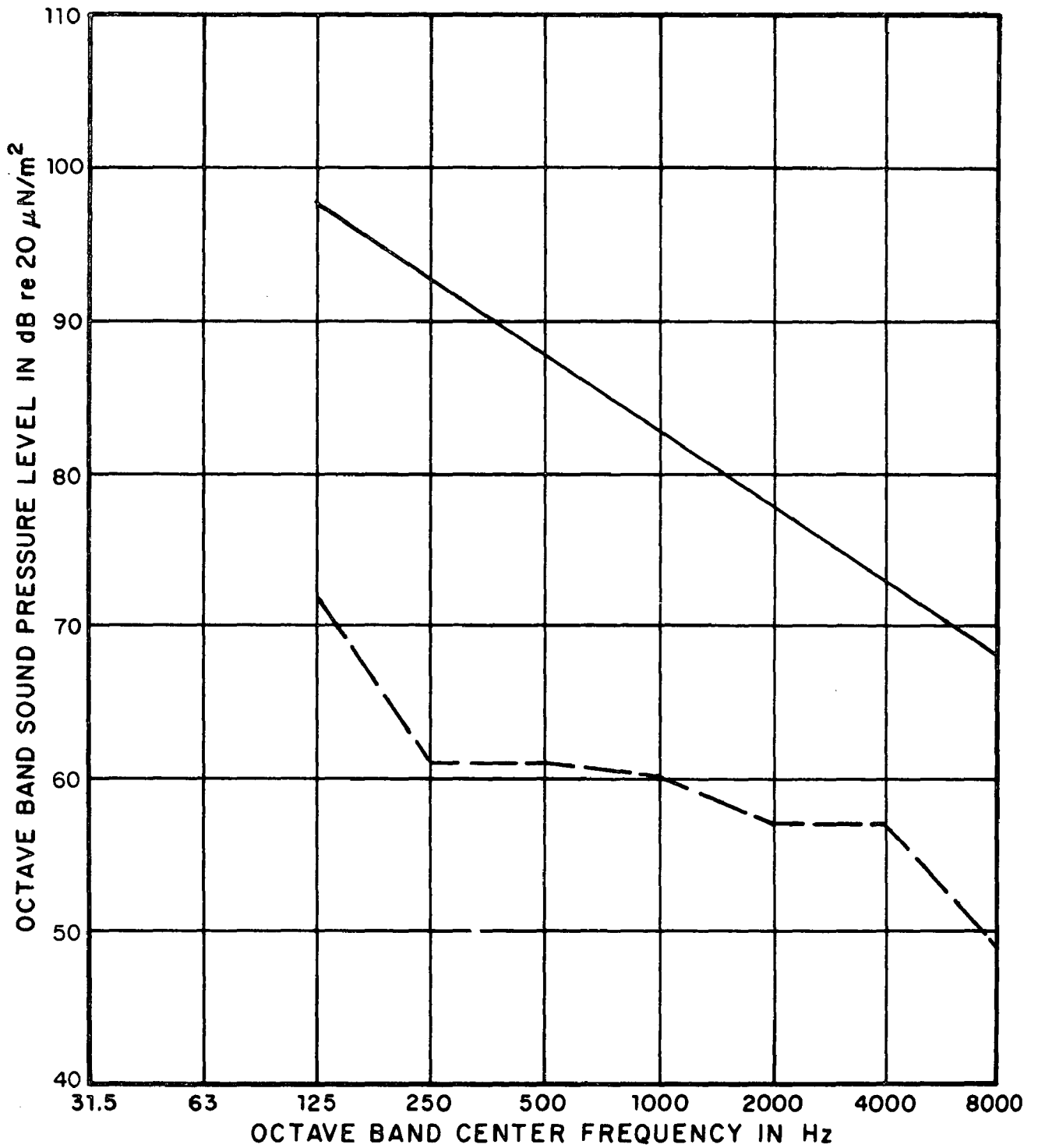

FIG. A.50 SOUND PRESSURE LEVELS FROM UNITARY ROOFTOP AIRCONDITIONING UNITS (MEASURED AT 3 FT)

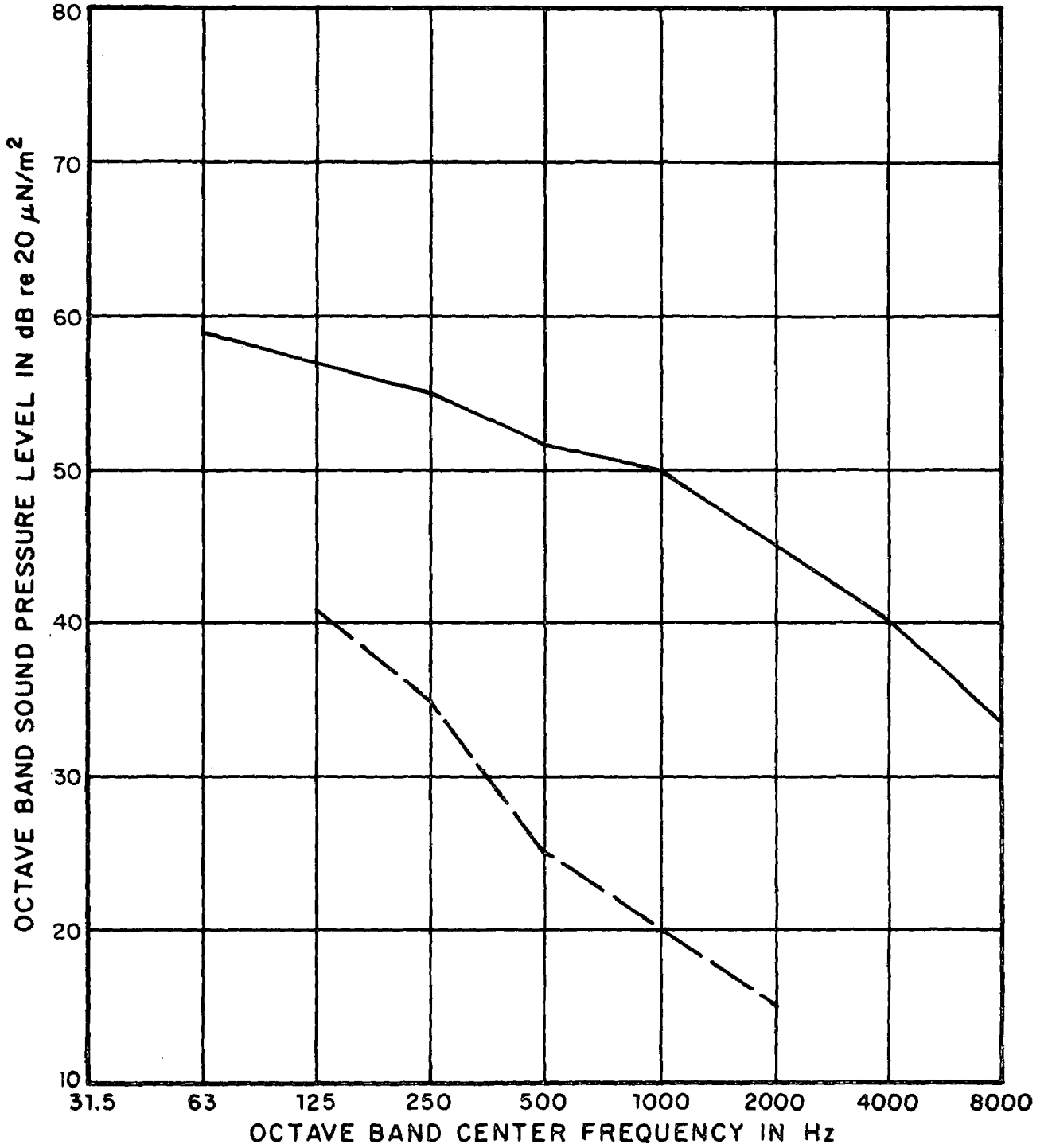

FIG. A.51 RANGE OF SOUND PRESSURE LEVELS FROM FAN COIL UNITS (MEASURED AT 3 FT)

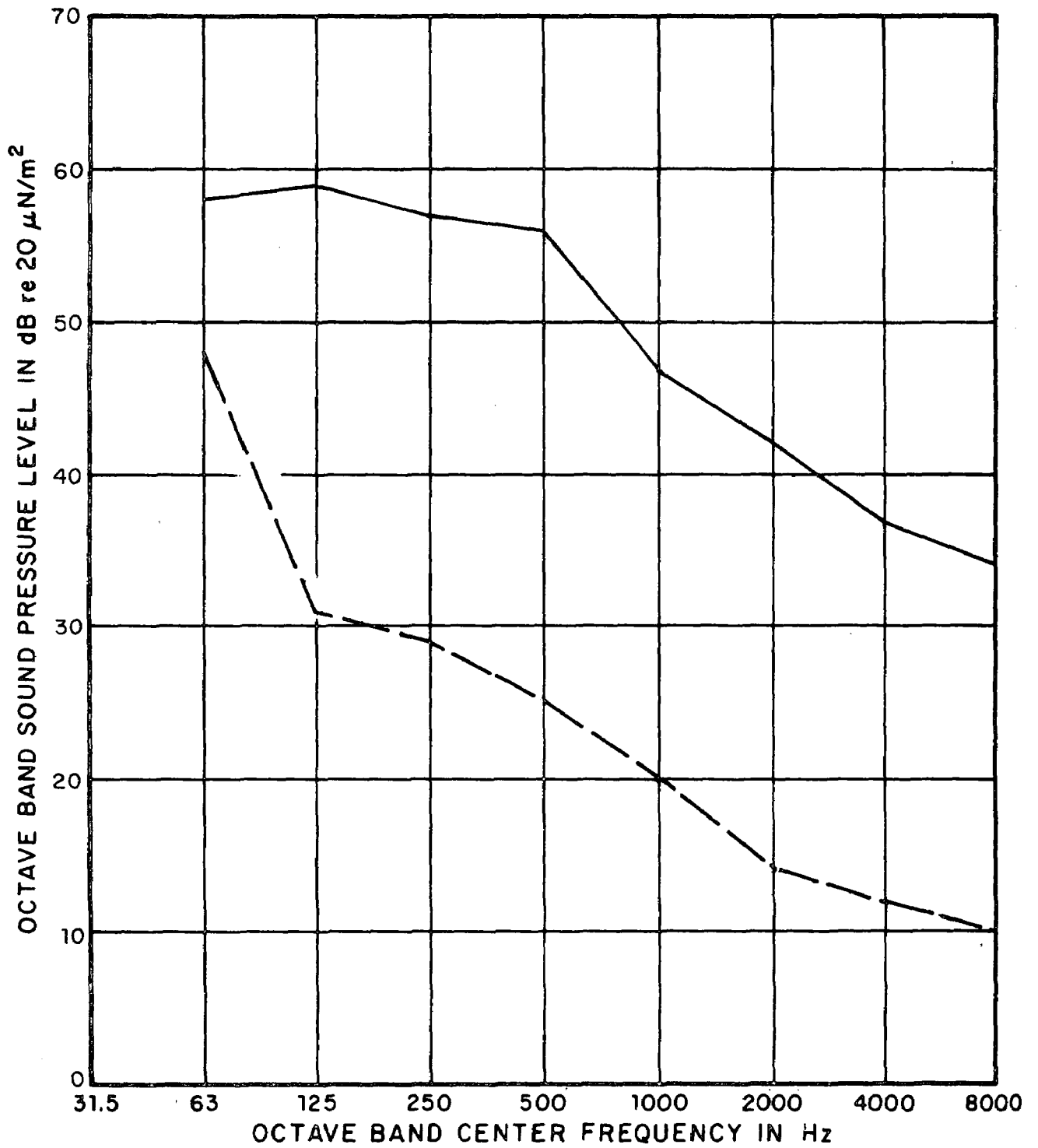

FIG. A.52 RANGE OF SOUND PRESSURE LEVELS FROM INDUCTION UNITS (MEASURED AT 3 FT)

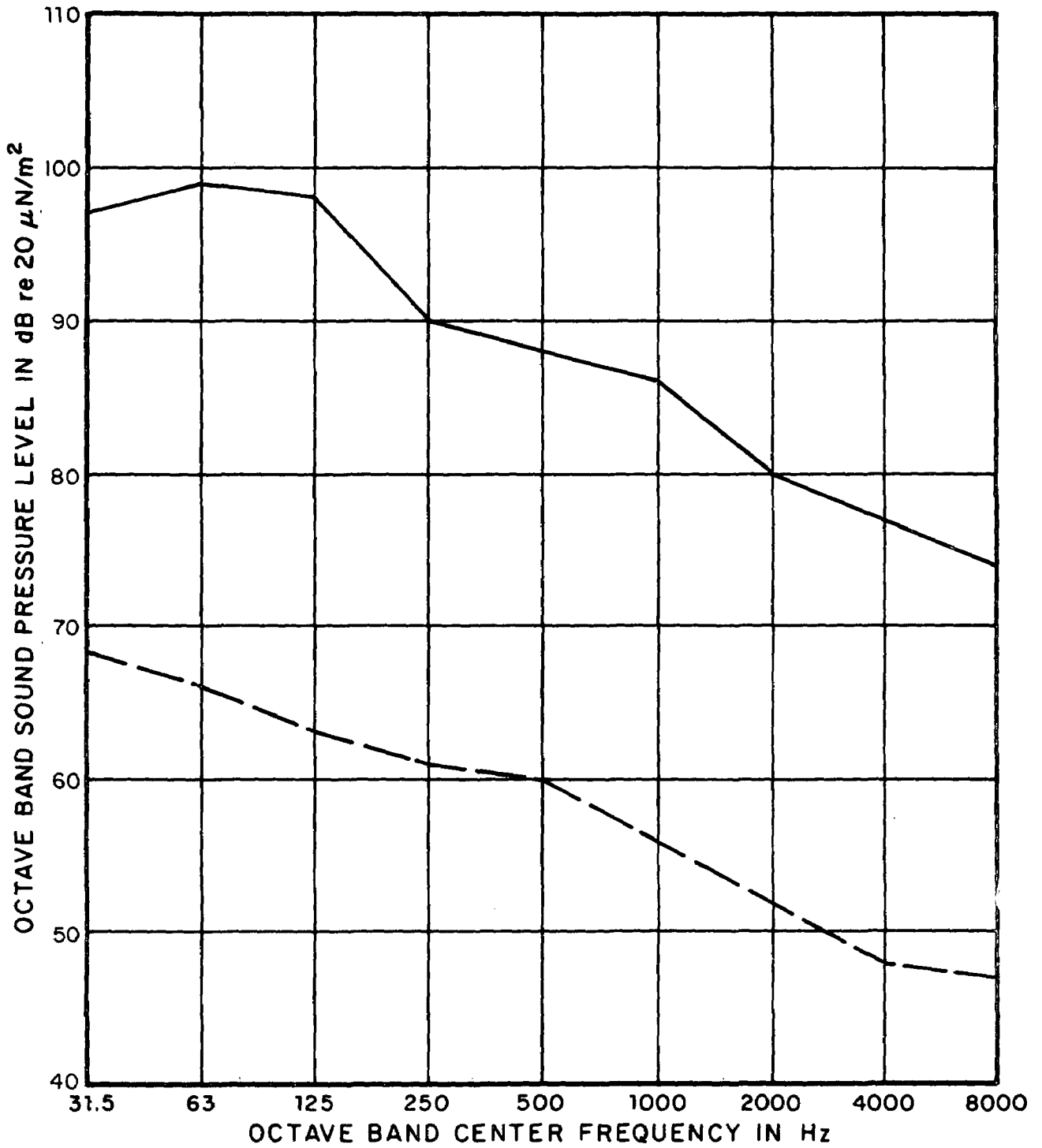

FIG. A.53 RANGE OF SOUND PRESSURE LEVELS FROM BOILERS
(MEASURED AT 3 FT)

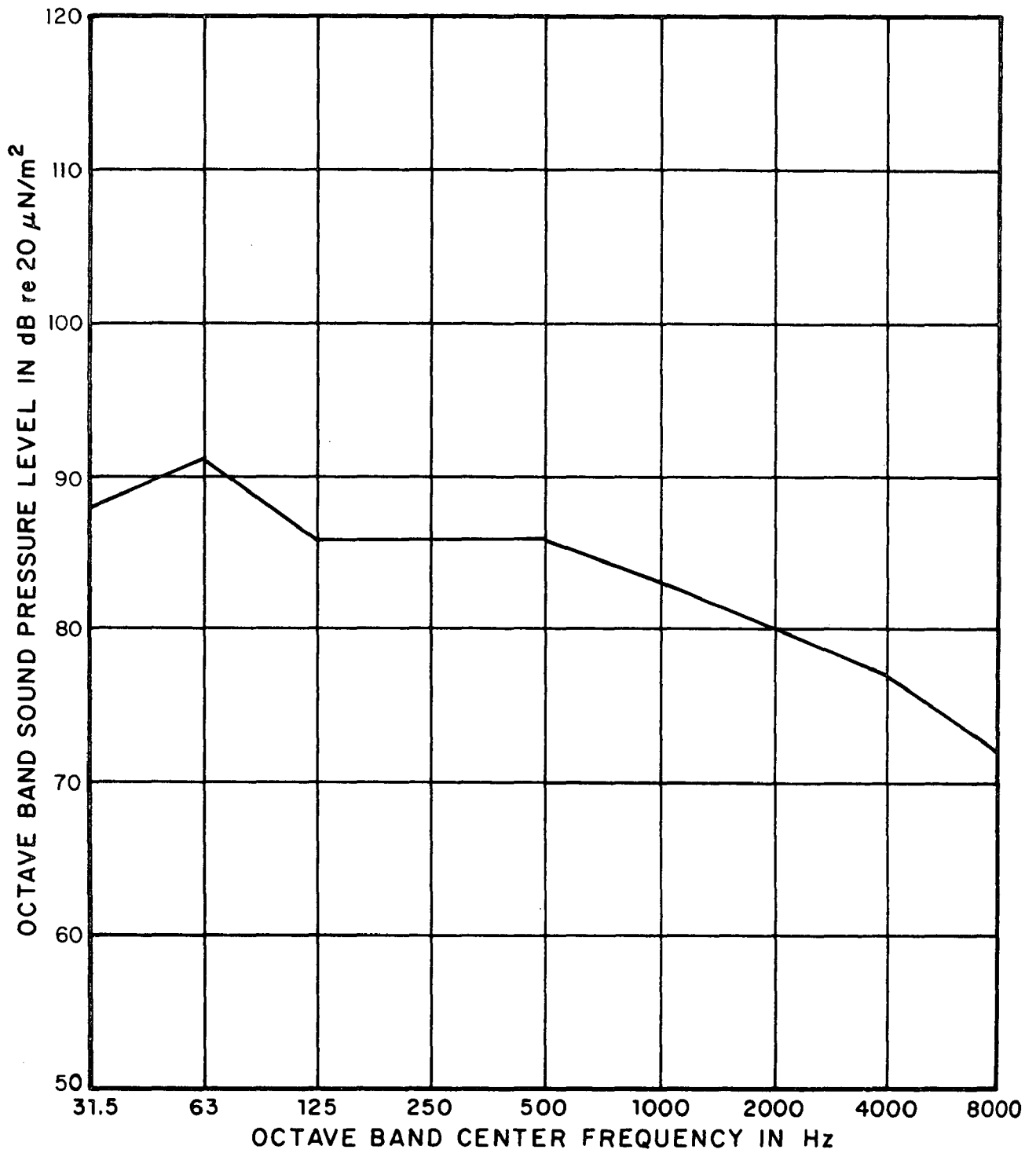

FIG. A.54 TYPICAL SOUND PRESSURE LEVELS FROM ABSORPTION/CYCLE REFRIGERATION MACHINES (MEASURED AT 3 FT)

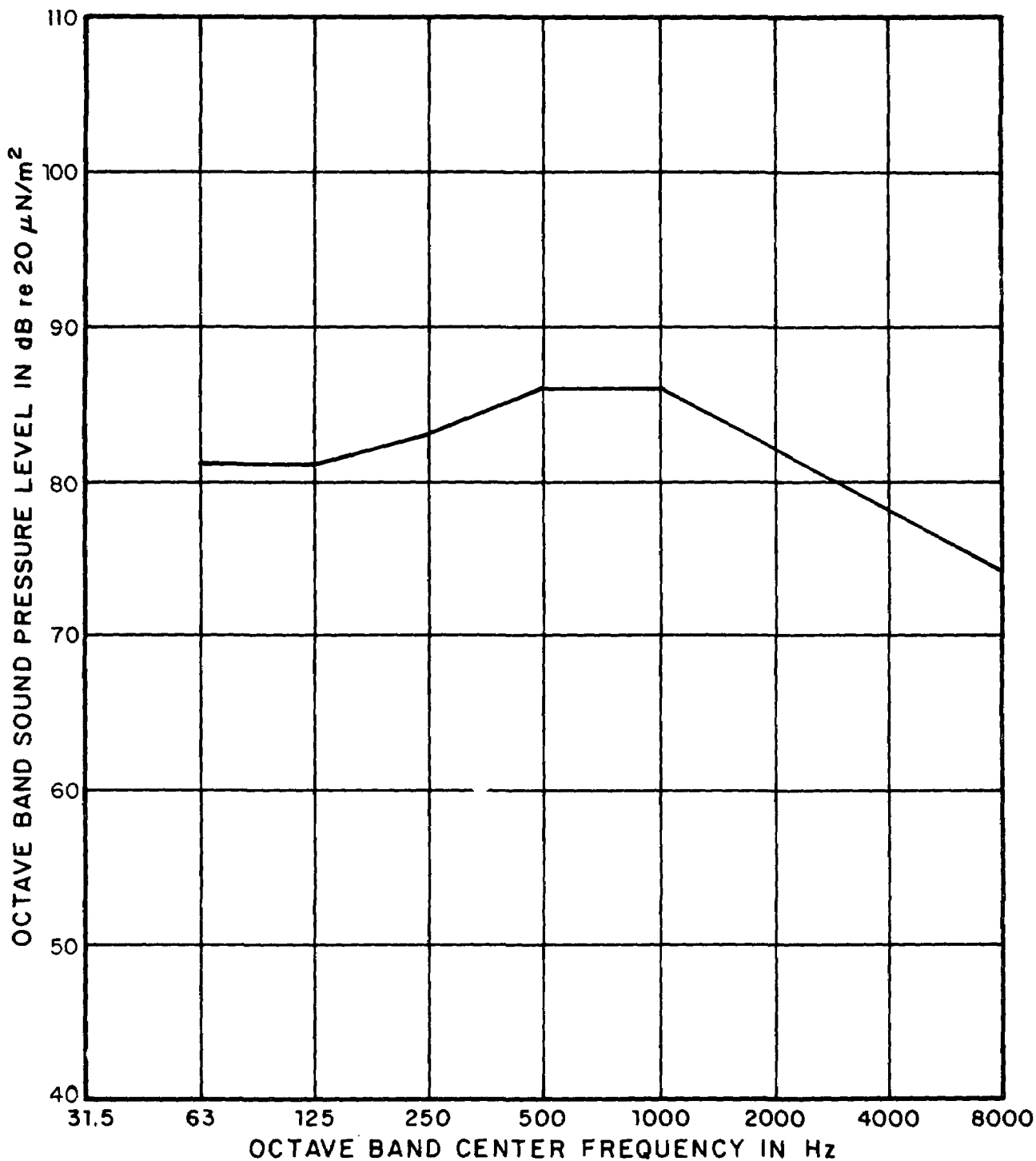

FIG. A.55 TYPICAL SOUND PRESSURE LEVELS FROM CHILLER WITH RECIPROCATING COMPRESSOR (MEASURED AT 3 FT)

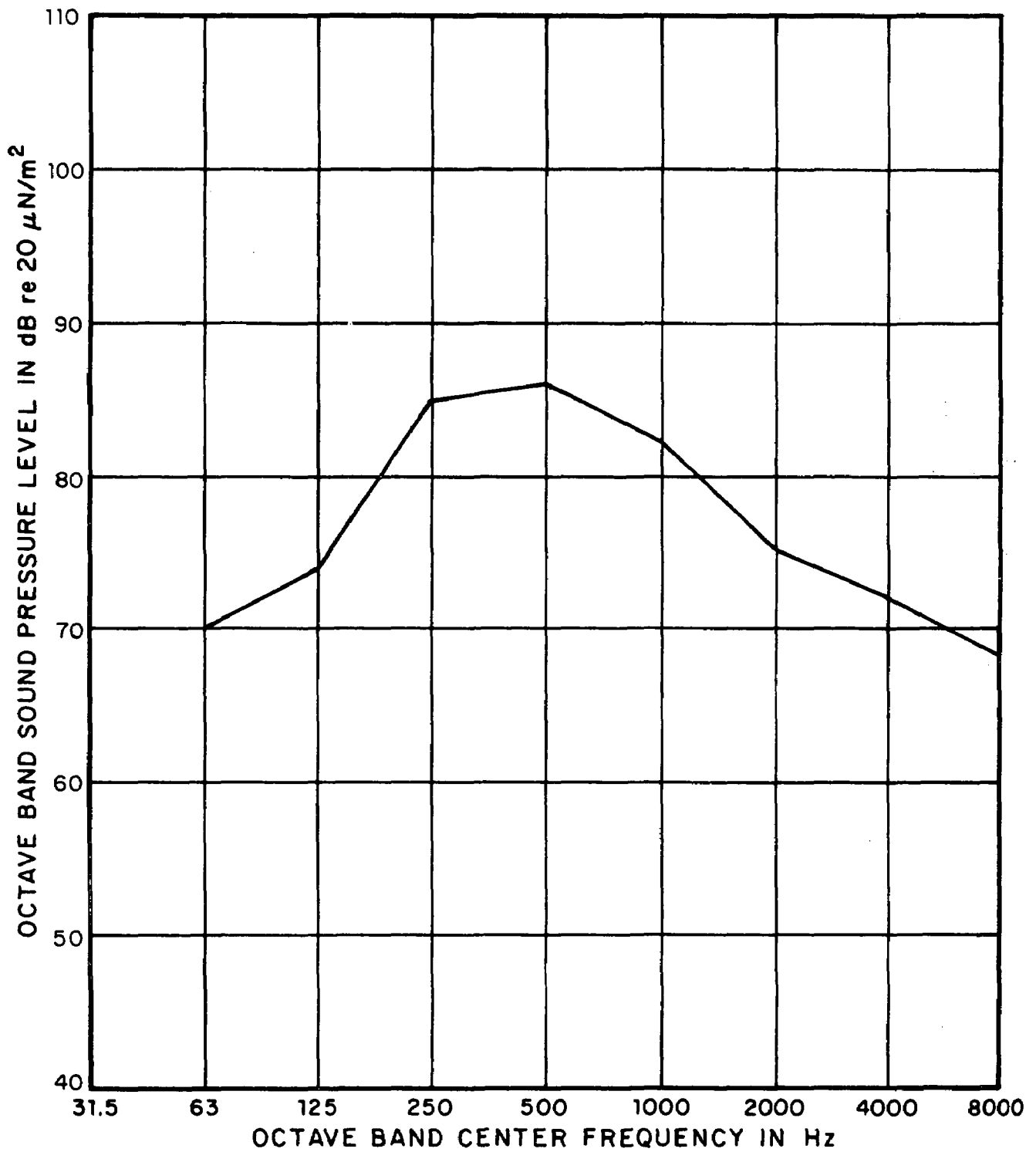

FIG. A.56 TYPICAL SOUND PRESSURE LEVELS FROM CHILLER WITH ROTARY-SCREW COMPRESSOR (MEASURED AT 3 FT)

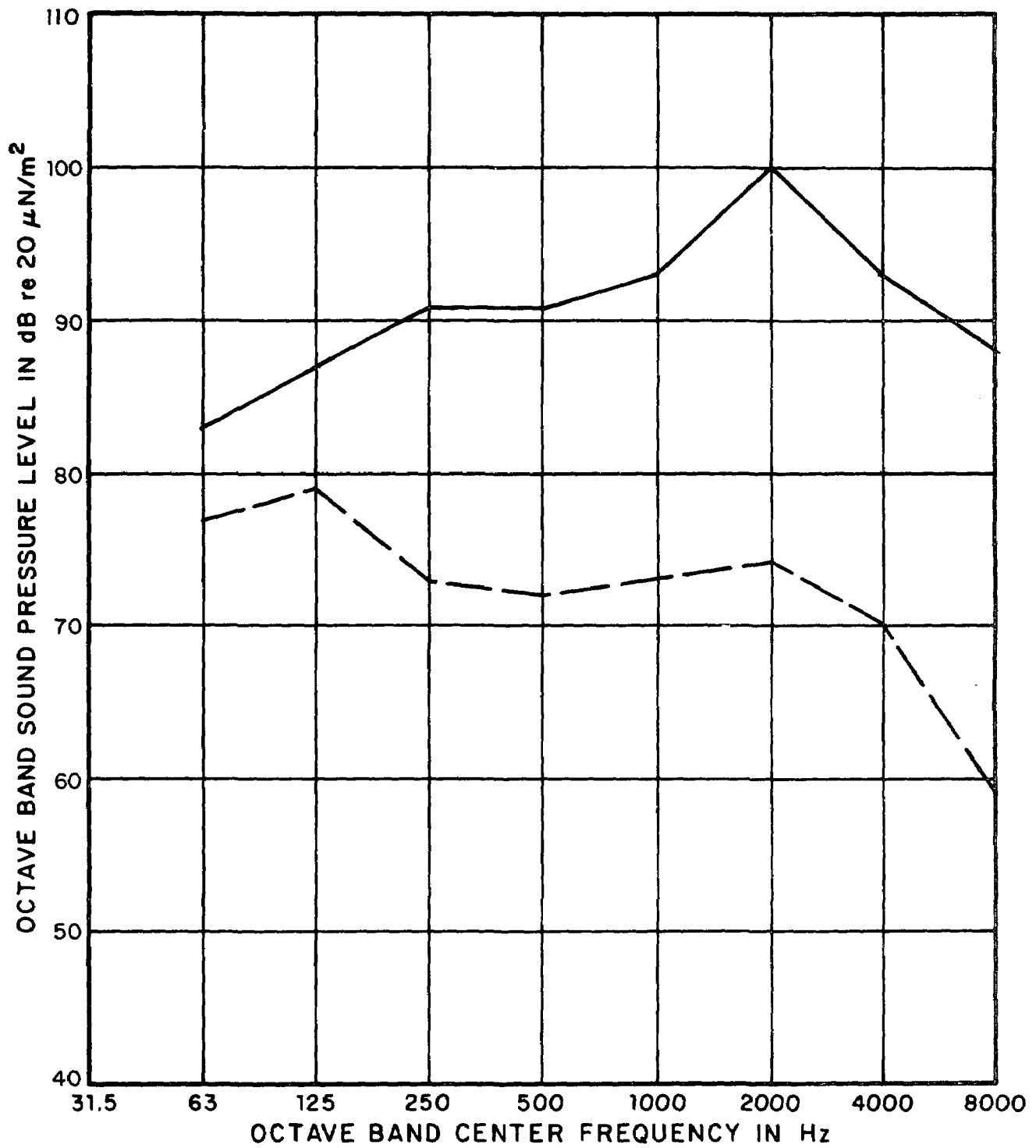

FIG. A.57 RANGE OF SOUND PRESSURE LEVELS FROM CHILLER WITH CENTRIFUGAL COMPRESSOR (MEASURED AT 3 FT)

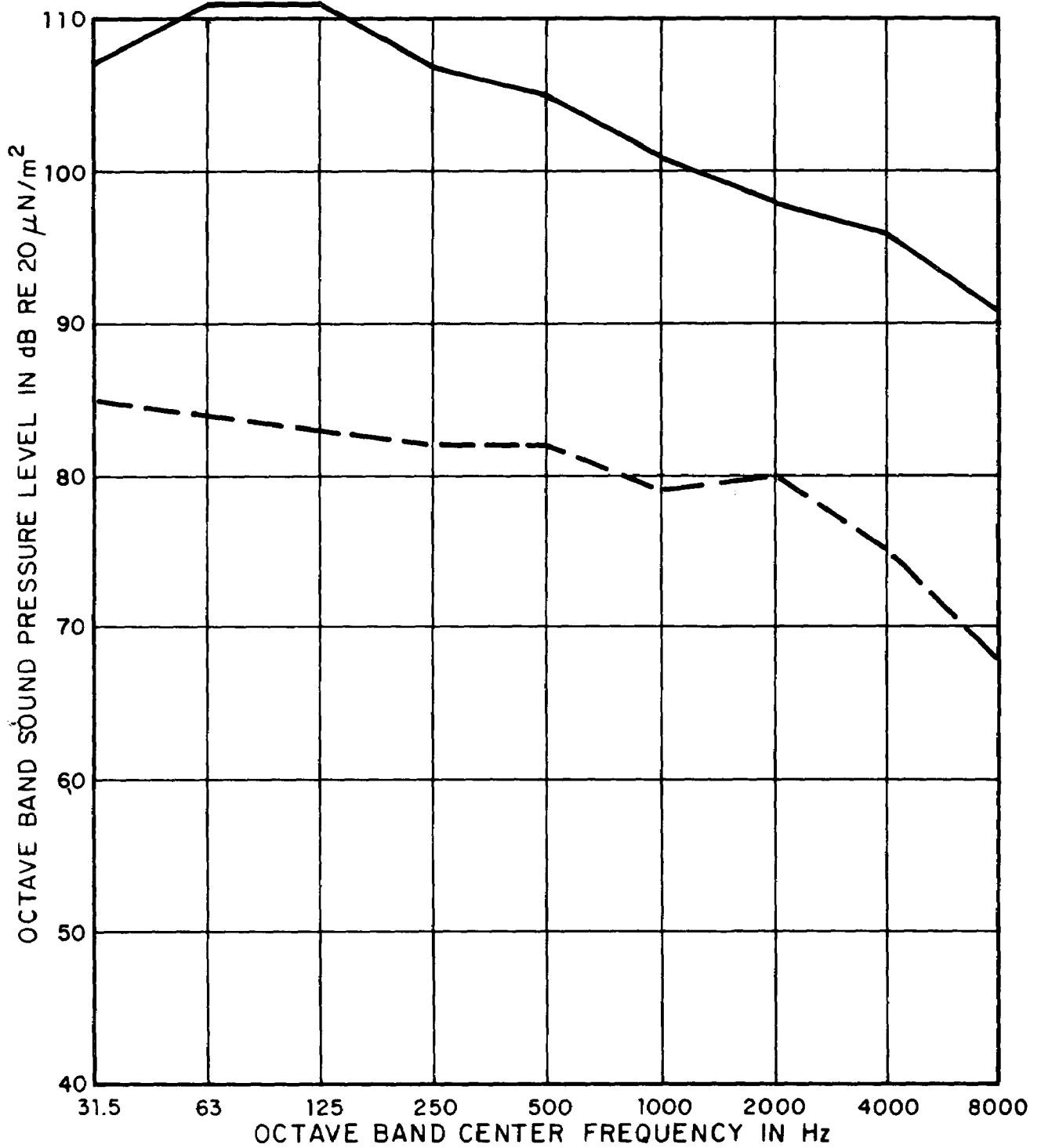

FIG. A.58 RANGE OF SOUND PRESSURE LEVELS FROM COOLING TOWERS (MEASURED AT 3 FT)

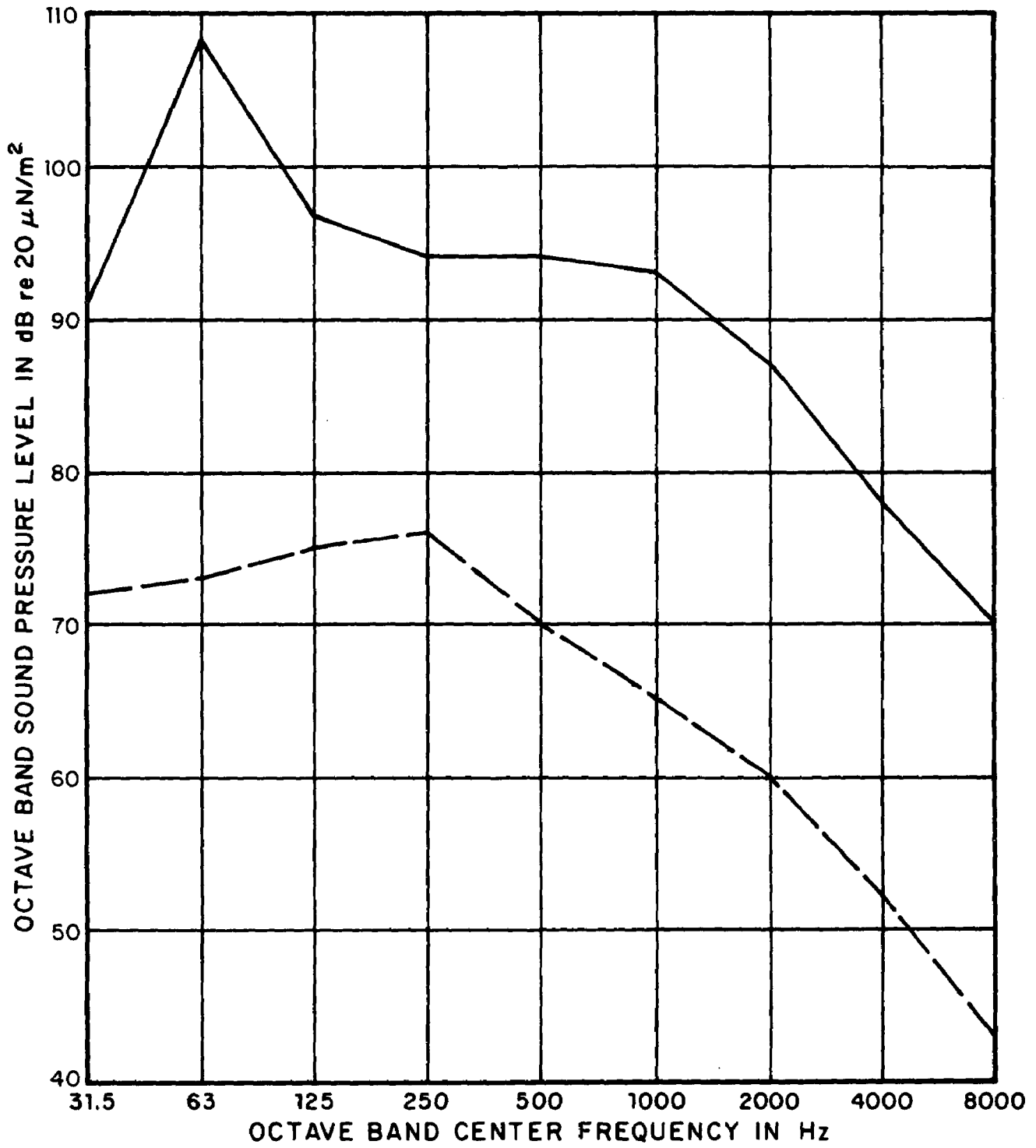

FIG. A.59 RANGE OF SOUND PRESSURE LEVELS FROM AIR-COOLED CONDENSERS (MEASURED AT 3 FT)

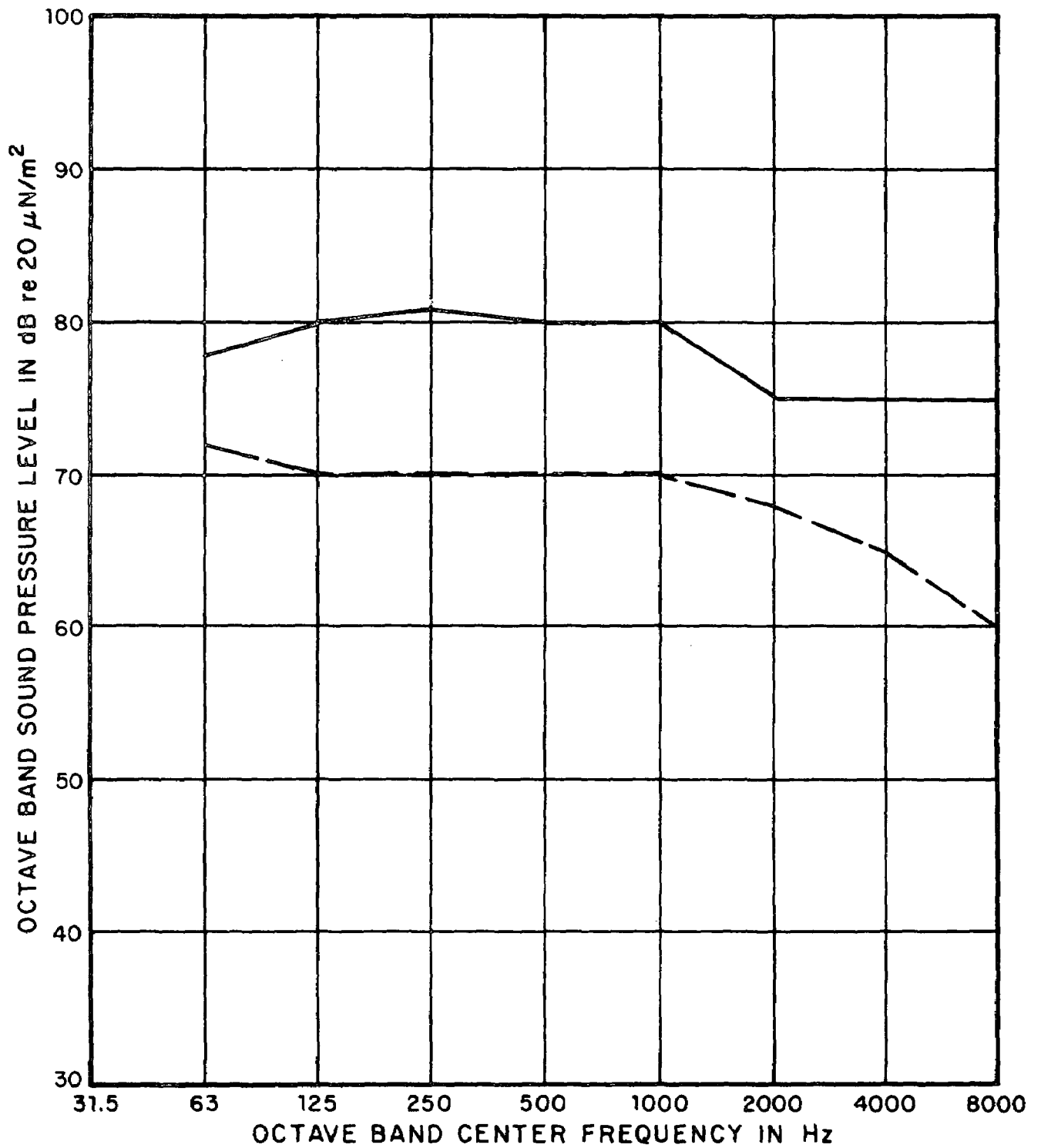

FIG. A.60 RANGE OF SOUND PRESSURE LEVELS FROM ELEVATOR ROOM (MEASURED AT 3 FT)

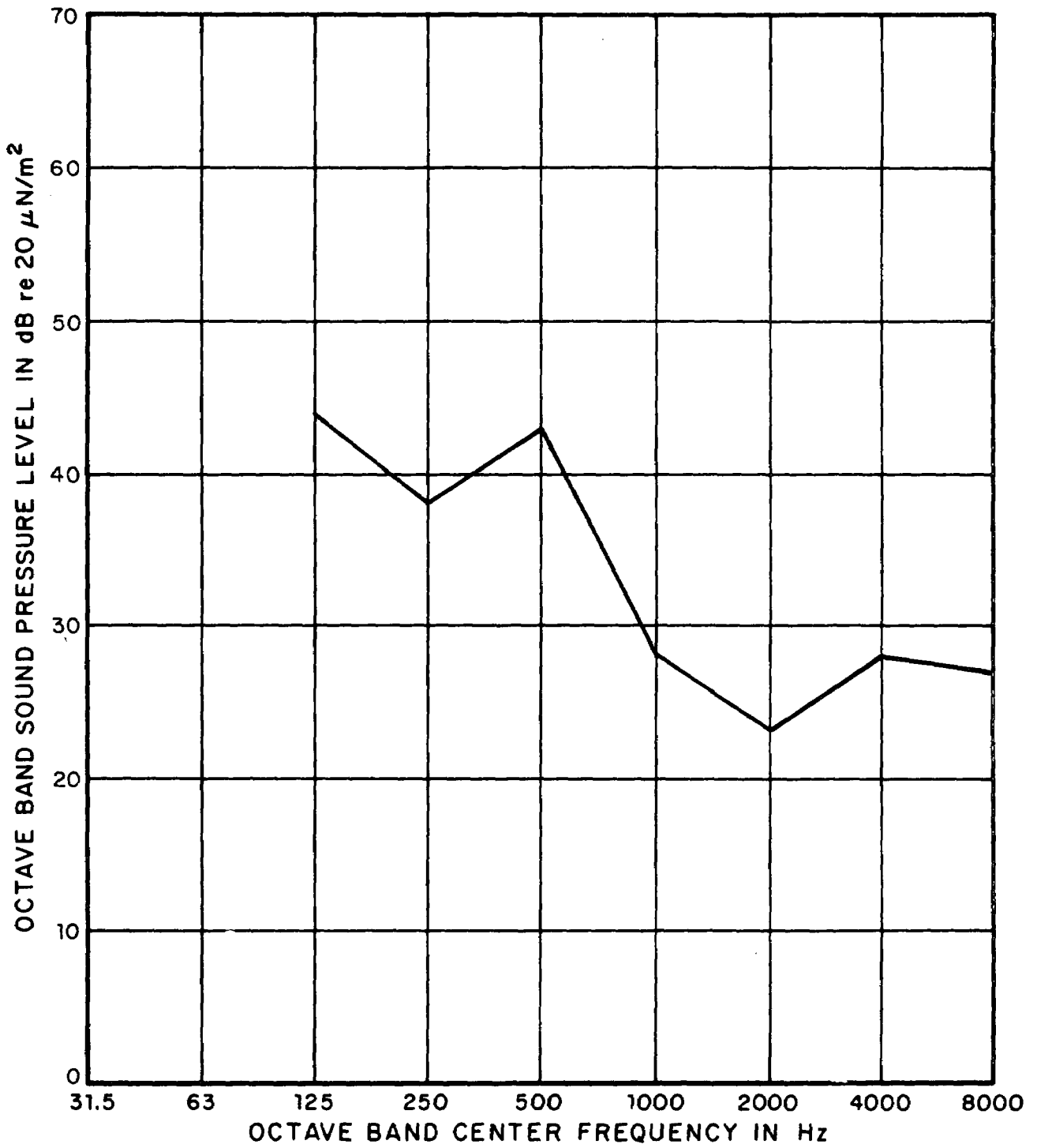

FIG. A.61 SOUND PRESSURE LEVELS FROM BALLASTS
(MEASURED AT 3 FT)

APPENDIX B - IMPACT CONSIDERATIONS

B.1 Interpretation of Impact Estimates

Sections 3.2.2 and 3.3.2 of this report have provided detailed breakdowns of the impact on people of exposure to a variety of noise sources. This section of the report is intended to permit the reader to gain an appreciation for the significance of these estimates. It therefore consists primarily of caveats.

First, it must be stressed that both the physical levels of the noise sources and the levels at which effects on people are specified are, at best, imperfect estimates. Every attempt has been made to obtain unbiased and statistically sufficient estimates. Nonetheless, the actual levels mentioned in the text cannot be regarded as exact. Variability is inherent not only in the measurement process, but also in the noise sources, the propagation paths by which their sounds are transmitted to people, and of course in the responses of people. Thus, individual instances of extreme sensitivity to noise effects are to be expected, as are cases of excessively noisy and quiet sources. In some situations the total amount of variability may be so great as to transform assessment of noise impact, *a priori*, into an imponderable issue. It is important to acknowledge that the impact estimation of Sections 3.2.2 and 3.3.2 can pertain only to the general, rather than the specific, instance.

It must also be understood that research on the effects of noise on people has been conducted for the most part under controlled and simplified conditions. The application of knowledge gained from such experimentation to heterogeneous populations living in complex environments necessarily entails

a fair amount of interpretation and approximation. Disagreement among experts on matters of detail is probably unavoidable.

Yet another important consideration to bear in mind when reading the sections on the impact of home appliance, building equipment, and construction noise on people is that these noises comprise only a fraction of most people's daily noise exposure. Since many noise effects are cumulative in nature, discussion of the impact of exposure to restricted classes of noise is both artificial and potentially misleading. It is not safe to assume, for example, that hearing damage is not a substantial risk to the public at large merely because the risk from construction noise exposure is negligible.

In short, it has been necessary to make a large number of assumptions in preparing most sections of this report. Assumptions are the coin with which conclusions are purchased. The reader must understand the assumptions before he can decide for himself whether the conclusions are worth the price.

The final caution is perhaps the most basic. Stated simply, it is that no attempt has been made in this report to address the crucial issues of social desirability and costs of noise impacts. Such issues were purposely avoided as inappropriate and far beyond the scope of the current report. Value judgments about how much noise exposure is tolerable must inevitably be made, however, if this report is to be fully useful. Administrative or legislative bodies must eventually decide how much hearing loss workers must suffer to maintain industrial productivity; how much annoyance, stress, and task interference the public must endure; how much sleep interference is too much; and so forth. The authors hope that this report will provide the data and conclusions essential for intelligent actions on these issues.

B.2 Discussion of Construction Data

Table B-1 tabulates nonresidential building construction in 1970 by the nature of metropolitan region in which eleven major categories of buildings were constructed. Construction effort in each building category is characterized both by the number of sites and the total construction cost in each region. The average cost of each type of building in each region is also presented in Table B-1. The cost estimates are necessary for accurate estimation of the number of machine-hours of equipment operation at each site. The wide variability of building costs deserves special note. Office buildings in large, high-density central cities cost an average of \$1.9 million while the same type of building costs an average of only \$.67 million in low-density central cities.

The sources of the data in Table B-1 include the following:

- Columns 1 and 2: Unpublished tabulation by U.S. Bureau of the Census of all nonresidential building permits for 1970;
- Columns 3, 4, 5 and 6: Estimates based on population ratios, construction level ratios (where known), and assumptions about probable unit costs; and
- Column 7: *Construction Review*, except for lines 2, 5, and 7, which were estimated on the basis of known ratios of large city to national construction ratios.

Two categories of nonresidential building are recognized by the Bureau of the Census but are not discussed in this report. One is "residential garages and carports", of which 150,885 were authorized in 1970, at an average cost of \$1600. Carport construction was judged to contribute negligibly to construction noise problems. The second category of buildings recognized by

TABLE B-1. GEOGRAPHIC DISTRIBUTION OF MAJOR NONRESIDENTIAL CONSTRUCTION
BY TYPE OF BUILDING (1970)

Type of Building	Large High-Density Central Cities			Large Low-Density Central Cities			Other Cen- tral Cities (Est.)	
	Bldg.	Cost	Avg. Cost	Bldg.	Cost	Avg. Cost	Bldg.	Cost
Office, Bank, Professional	235	\$438M	\$1863K	815	\$559M	\$ 686K	1998	\$378M
Hotel, Motel, etc.	27	108	4015	56	76	1335	137	127
Hospitals and Institutions	123	326	2647	120	103	861	294	233
Schools	67	73	1091	149	40	267	366	106
Public Works Bldg.	58	48	822	107	64	601	262	75
Industrial	362	92	253	800	93	116	1961	306
Parking Garage	82	33	398	114	49	429	279	48
Religious	81	21	255	160	24	149	392	40
Recreational	43	17	402	380	25	66	932	65
Store, Mercantile Bldg.	533	84	159	1649	205	124	4045	352
Service, Repair Station	341	12	44	553	13	23	1355	41

Type of Building	Urban Fringe (Est.)		Nonurbanized Metropolitan Area (Est.)		Outside Metro- politan Area (Est.)		National Total	
	Bldg.	Cost	Bldg.	Cost	Bldg.	Cost	Bldg.	Cost
Office, Bank, Professional	3168	\$600M	1424	\$270M	2260	\$456M	9900	\$2701M
Hotel, Motel, etc.	344	320	154	143	207	157	929	931
Hospitals and Institutions	5590	468	265	210	411	272	1803	1611
Schools	687	197	309	88	465	102	2043	606
Public Works Bldg.	689	196	310	88	421	95	1847	566
Industrial	6370	989	2867	446	3706	391	16336	2316
Parking Garage	841	146	379	66	500	72	2195	414
Religious	1826	185	823	83	970	71	4252	423
Recreational	1395	99	628	44	998	51	4376	301
Store, Mercantile Bldg.	11425	998	5148	449	7258	424	29058	2512
Service, Repair Station	3220	97	1451	43	2050	42	8970	247

TABLE B-2. GEOGRAPHIC DISTRIBUTION OF RESIDENTIAL BUILDING
CONSTRUCTION BY TYPE OF BUILDING (1970)

<u>Type of Building</u>	Large High-Density Central Cities*			Large Low-Density Central Cities		
	<u>Bldg.</u>	<u>Total Const. Cost</u>	<u>Avg. Const. Cost</u>	<u>Bldg.</u>	<u>Total Const. Cost</u>	<u>Avg. Const. Cost</u>
Single-Unit	5742	\$ 86M	\$ 15.1K	17213	\$ 330M	\$ 19.2K
Two-Unit	2044	46	22.7	1076	32	29.8
Three- and Four-Unit	177	9	51.2	277	13	46.2
Five-Unit and Larger	745	532	716.0	3012	802	266.0

<u>Type of Building</u>	Other Central Cities			Urban Fringe (Est.)		
	<u>Bldg.</u>	<u>Total Const. Cost</u>	<u>Avg. Const. Cost</u>	<u>Bldg.</u>	<u>Total Const. Cost</u>	<u>Avg. Const. Cost</u>
Single-Unit	85776	\$1478M	\$ 17.0K	241800	\$4820M	\$ 19.9K
Two-Unit	4776	92	19.3	6190	140	22.6
Three- and Four-Unit	3266	109	33.4	3542	127	35.8
Five-Unit and Larger	9496	1083	190.0	11470	2123	185.2

<u>Type of Building</u>	Nonurbanized Metropolitan Area (Est.)			Outside Metropolitan Area		
	<u>Bldg.</u>	<u>Total Const. Cost</u>	<u>Avg. Const. Cost</u>	<u>Bldg.</u>	<u>Total Const. Cost</u>	<u>Avg. Const. Cost</u>
Single-Unit	109018	\$2171M	\$ 19.9K	165218	\$2720M	\$ 16.4K
Two-Unit	2800	63	22.6	5455	109	20.0
Three- and Four-Unit	1593	57	35.8	2720	90	33.1
Five-Unit and Larger	5166	957	185.2	33.21	612	184.7

<u>Type of Building</u>	National Total	
	<u>Bldg.</u>	<u>Total Const. Cost</u>
Single-Unit	624767	\$11605
Two-Unit	22231	482
Three- and Four-Unit	11595	404
Five-Unit and Larger	32465	6109

*See Sec. 3.2.1.2, Table IX, for definitions of large high-density and large low-density central cities.

the Census but not discussed in the current report is "all other nonresidential buildings", of which 259,814 were authorized at an average cost of \$6,760. The latter category of construction was considered too heterogeneous in nature to permit reasonable estimation of the nature of construction noise at a "typical" site.

Table B-2 presents data on the construction effort involved in erecting residential buildings as a function of the type of metropolitan region in which the construction occurs. The data of Table B-2 were obtained from unpublished Bureau of the Census tabulations and from the Census publication *Construction Reports: Housing Authorized by Building Permits and Public Contracts, 1970*

B.3 Estimating the Extent of Public Works Construction Noise

The public is exposed to construction noise not only from operations of erecting buildings of various sorts, but also from operations arising from public works construction. Such operations include road, highway, street, and sidewalk construction and maintenance, as well as sewerage, water works, and utilities installation and maintenance. The noise created by these construction activities is frequently prolonged and intense. Even small repair jobs on water works create considerable noise as sections of pavement are ripped up to gain access to buried pipes.

Estimation of the amount of noise created by such activities required that a number of assumptions be made about the distribution of construction noise from public works sites. The most important assumption was that federal and state public works activity could be neglected for the purposes of this study since it occurs primarily in rural regions of low population density. Attention was therefore concentrated on municipal public works activities within SMSAs.

Although summary reports contain ample information on federal and state public works activities, comparable municipal data are available only from individual municipalities. We have been able to obtain fairly complete data on municipal public works construction and maintenance for two large, high-density cities: the central city, Boston, Massachusetts, and the adjacent city of Cambridge. We have used this information, together with the figure of 42,000 miles for municipal street construction throughout the country in 1969, published by the Federal Highway Administration, to estimate total sewerage and water works activity (in terms of miles of pipe and mains laid) for the country.

In carrying out these calculations, we assumed average values of 1.0 miles each of water and of sewer main per mile of new street. We further assumed that on the average, water and sewer main additions per year would be 2% and 1.5% of existing footage, respectively, as opposed to 7.5% for the annual increase in length of municipal street systems. This gave estimated country-wide values of some 11,000 miles of water mains and 8,000 miles of sewage mains. These estimates are considered reasonable in that they are about half as great as would be obtained if the respective annual U.S. expenditure for water works and sewer construction were allocated solely to the installation of mains. Moreover, some mains would be installed concurrently with street construction and, as a consequence, not constitute separate sources of noise pollution.

Inherent in our approach to the estimation of exposure of the population to municipal construction noise is the assumption that the locus of both municipal construction and of population exposed is the street system of a municipality. We have therefore focused on the numbers of inhabitants distributed in permanent residence along the streets of a municipality as an index of the impact of

street-associated municipal construction noise. In order to facilitate the use of this approach, we developed a correlation (see Fig. B-1) between population density and the quantities, miles of street per square mile and inhabitants per mile of street for several dozen cities, towns and counties in Massachusetts and Pennsylvania for which we had data available.

Using the above correlation, together with the amounts of municipal public works construction estimated earlier, we arrived at the impact estimates presented in Table B-3. The indicated exposures of residents along streets where municipal public works construction is taking place are 10 million and 4.4 million individuals, for street and water works and sewer construction, respectively, making a total of 14.4 million individuals exposed to public works construction noise.

B.4 Propagation Loss Model For Building Construction Sites In Metropolitan Areas

Two classes of people are exposed to construction noise: the stationary population which inhabits the region around the construction site (workers and residents) and the transient population which passes by the site (drivers, passengers, and pedestrians.) Two models were constructed to estimate the extent to which site noise is attenuated for each class of observers.

Stationary Population

The entire stationary population around a construction site was assumed to be indoors with closed windows. Acoustic propagation loss was modeled by postulating a representative site geometry and applying the formula

$$H = 20 \log \frac{R}{R_0} + 20 \text{ dB}$$

TABLE B-3. ANNUAL EXPOSURE OF PERSONS IN METROPOLITAN AREAS TO
MUNICIPAL CONSTRUCTION NOISE

LENGTH OF MUNICIPAL CONSTRUCTION (MILES)

Activity	Large, High-Density Central Cities	Large, Low-Density Central Cities	All Other Central Cities	Urban Fringes	Met. Areas Outside Urban Fringes	Total
Street, highway	273	2,150	6,000	11,800	21,700	41,923
Sewerage & Water	<u>125</u>	<u>990</u>	<u>2,700</u>	<u>5,065</u>	<u>9,850</u>	<u>18,730</u>
	398	3,140	8,700	16,865	31,550	60,653
Population Density (people/sq. mi.)	15,160	4,410	3,710	3,380	125	
Area (sq. mi.)	1,468	2,389	6,981	14,707	179,276	
Street Distribution (miles of street/ sq. mi.)	21	10.2	9.5	8.9	1.35	
Linear Distribution of Population (people/mile of street)	720	430	390	380	93	

PERSONS EXPOSED TO MUNICIPAL CONSTRUCTION NOISE (X10⁻³)

Activity	Large High-Density Central Cities	Large, Low-Density Central Cities	All Other Central Cities	Urban Fringes	Met. Areas Outside Urban Fringes	Total
Street, highway	196	925	2,340	4,470	2,020	9,951
Sewerage & Water	<u>90</u>	<u>425</u>	<u>1,050</u>	<u>1,920</u>	<u>920</u>	<u>4,403</u>
	286	1,350	3,390	6,390	2,940	14,356

∴ About 14.5 million people exposed to municipal construction noise.

where H = total propagation loss

R = range from source to observer

R₀ = reference range at which site source level
was measured (50 ft).

Twenty dB was added to account for the loss through building walls with closed windows. The resulting transmission loss contours are shown in Figure 19 of the main text.

Transient Population

People passing by a construction site continuously vary their distance from the site. A model such as the above is not directly applicable. The peak noise level to which passersby are exposed, however, can be computed from the propagation loss at the passerby's closest point of approach (CPA) to the site. This propagation loss is computed from the formula

$$H = 20 \log \frac{R_1}{R_0} + H'$$

where H = total propagation loss

R₁ = range at CPA

R₀ = reference range at which site source level
was measured (50 ft)

H' = is a term included to account for baffling or
obstructions between source and observer

In the case of pedestrians, we assume that R₁ = 100 feet and H' is zero. H is therefore 6 dB. For drivers, we have assumed R₁ = 100 feet and H' = 15 dB to account for attenuation caused by the transmission loss of an automobile. For this case, H = 21 dB, which was rounded to 20 dB to emphasize that the figure is only an estimate.

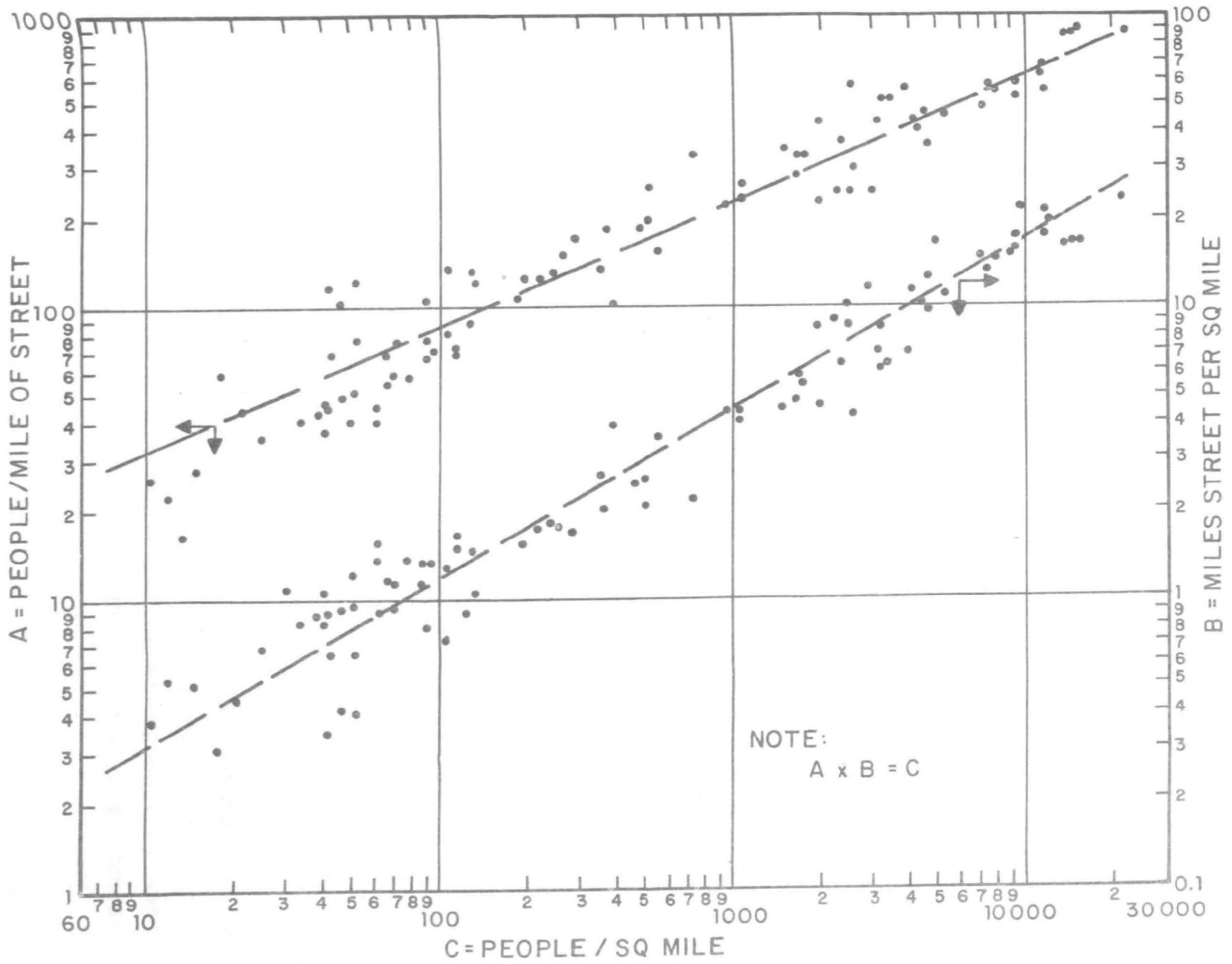

FIG.B-1 LINEAR AND AREA DISTRIBUTION OF POPULATION IN MUNICIPALITIES (BASED ON MASSACHUSETTS AND PENNSYLVANIA DATA)

APPENDIX C - SOUND LEVEL CONSIDERATIONS
BY AMERICAN CONSTRUCTION MACHINERY MANUFACTURERS

by

H.T. Larmore
Deputy Director for Technical & Safety Services
Construction Industry Manufacturers Association
Milwaukee, Wisconsin

Presented at
The American Industrial Hygiene Association Conference
Toronto, Ontario

May 24, 1971

This presentation will attempt to place the problem of noise into its proper perspective relative to construction and construction machines - both as a potential cause of hearing loss for workers and as an air pollutant for the nearby community at construction sites.

NOISE - THE PROBLEM STATED

Unwanted sound - is not new to the construction industry. Construction sites are noisy. Likewise, it is not new to heavy machines used in the construction of buildings, highways, sewer and water systems, airports and the like. Indeed, it has been a criterion by which some machines have been operated. A skilled operator often relies upon the sound of his equipment for proper operation. Also, noise is often associated with power in the purchase of machines.

These philosophical concepts and the public demand for lower construction costs do not excuse construction machinery from being noisy, but they have contributed to the major emphasis by manufacturers over the past decade to design for greater productivity

rather than to build quieter machines. The transitory and temporary nature of construction has also allowed a lack of concern for noise. While any particular contract is underway, the workers and neighbors might well be annoyed by the noise. But relief comes when the job is completed and the big machines move on. Next job site - there are new workers; new neighbors.

During the past few decades, the public demand has been for more production with less labor and less cost. This prompted the development of today's remarkable machines with more power, automation and speed than ever before. But machine "improvements" to effect this demand generally tended to increase noise levels. Larger engines produced more noise both internally and from the exhaust. More automation was accomplished through more use of hydraulic power which also is a noise generator. Larger engines and more hydraulic power increased the heat which must be dissipated through larger quantities of air being driven by noisier fans through larger radiators. Increased speed means increased vibration frequencies which tend to concentrate in the audible hearing range.

THE CONCERN FOR NOISE

The concern for noise, only recently voiced by the public and expressed now in actual or proposed legislation at all levels of government would seem to have created a major shift from the "productive Sixties" to the "silent Seventies". Fortunately, our industry is geared to respond to our customer requirements and, hopefully, to recognize changing requirements soon enough to accommodate the necessary lead times for research and development, testing, tooling, manufacturing and distribution. Noise abatement, although recognized by manufacturers of construction

machines as a legitimate environmental concern, has been and still is difficult to define in precise engineering and machine requirements - how much - how fast - what costs and trade-offs are acceptable - cost/effectiveness ratios - all tend to remain fuzzy with even man/noise effects far from being accurately determined.

The manufacturers of construction machines, without waiting for all the answers, recognized in the late sixties the need for the basic tools for all change and/or regulation - Measurement Standards. Without such tools, base lines cannot be established or progress measured.

Through the Construction Industry Manufacturers Association (CIMA) - the necessary machinery and policies were established some four years ago to recognize needs for Performance or Safety Standards and to promote development of such Standards by nationally recognized technical and Standards writing bodies. Among these were the basic noise measurement Standards as voluntary guidelines for both industry and government authors. These were accepted for development by the Society of Automotive Engineers (SAE). They include for construction machines:

1. Noise measurement at operator station
2. Noise measurement at 50 foot radius
3. Construction job site noise measurement
4. Cumulative operator noise exposure measurement along with standardized reporting methods

Substantial progress has been made by SAE with completion and publication of some of these Standards expected in the near future.

The measurement of noise levels either at the operator's station or at a distance from the machine is no simple matter. A machine can be subjected to many operational variables. Engine at rated speed, acceleration, full power drawbar load, power take-off load, hydraulic load, idling engine, idling transmission, transport, addition of a cab, roll-over protective structures, windows open - these are some of the variables which affect noise levels. For that reason, a uniform procedure for noise measurement is most important.

There are currently under consideration at least four Federal Bills and twenty State Legislative Bills which can regulate noise on construction machinery. Consequently, there is a real need for uniformity not only in measurement methods but in noise limit levels. It can be appreciated that legislators are concerned with protecting operators and others from hearing damage and the nuisance of excessive noise. However, a mass of legislation and regulations which are nonuniform are more of a liability than an asset in reducing noise levels on construction machines. Nonuniformity with little or no lead time for making the changes is leading to stop-gap measures which have unpredictable durability and effectiveness, and which perhaps introduce unwanted trade-offs and compromises through overheating, fire hazards, maintenance interference and reduced output.

WHAT ARE MANUFACTURERS DOING ABOUT NOISE?

So - what are construction machinery manufacturers doing individually and as an industry?

Individually they are:

1. Evaluating the many noise sources peculiar to each machine.

2. Developing operator enclosures for current products.
3. Developing procedures for customizing current products off the production lines.
4. Developing quieter components and systems for quieter machines in the future.

Through CIMA they are:

1. Seeking new and updated SAE Standards and Recommended Practices for operator and exterior noise levels.
2. Organizing a cooperative effort among government, noise specialists, contractors and machinery manufacturers to accumulate the great masses of actual on-the-job noise data required by industrial hygienists in their evaluation of the man/noise effects in the construction environment.
3. Creating information on construction machine noise for use by regulatory bodies, consumers, and information media.
4. Investigating a means to express machinery noise sources in a uniform, usable and reliable manner.

THE COMPLEX ANSWERS

These individual and collective efforts are not simple nor do results come easily or cheaply. As a beginning, component noise sources are rapidly being isolated and evaluated. Oversimplification of the problem frequently leads many to believe that engine exhaust noises are the culprit and that larger mufflers would turn the trick. To be sure, this is part of the problem. However, noise reduction of the exhaust permits other machine

noises to become dominant. Larger mufflers also create a visibility problem since they usually end up directly in front of or behind the operator.

There are several other noise sources which are the same order of magnitude as exhaust noises, depending on the machine and its configuration.

These are:

1. Internal engine noises exclusive of the combustion itself.
2. Engine air inlet
3. Transmission and other gear noises.
4. Hydraulic system noises including the pump, tubes, valves, cylinders and hydraulic motors.
5. Air noise from the fan and radiator.
6. Various moving mechanical elements such as crawler tracks, or scraper elevators.

It is very likely that on a large machine today, each of these noises is individually in excess of 90 dB(A) (decibels on "A" rating scale). In the case of two equal noise source levels, the sum is about 3 dBA higher than either source alone. For four equal noise sources, the sum is about 6 dBA higher. And this in reverse acts much the same way. Suppose the total noise of a machine is 100 dBA composed of four equal noise sources. Let's say the exhaust, engine noises, gear and hydraulic noises and fan noises are these four. If by some magic the exhaust and internal engine noises could be reduced to zero, the machine would still have a noise level of 97 dBA. So, this is the

challenge to the engineers who are studying each noise source and striving for noise reduction of each component.

QUIETING CURRENT PRODUCTS

For quieting current production machines, some manufacturers are starting to use off-line, extra cost customizing. This may consist of one or more of the following: An isolation mounted cab; larger muffler; sound deadening material around noisy components; and vibration isolation of noise components. These methods are expensive and can have only minimal effect on the total problem. Also, the sound absorbing insulation causes some components to run hotter and can possibly absorb spilled petroleum products. This can be a fire hazard. One would not normally expect to replace such insulation during a machine's expected useful lifetime but durability of such materials and installation techniques are not broadly known.

FUTURE MACHINE QUIETNESS

For future machines, larger capacity cooling fans with non-resonant frequencies are being developed. These would utilize larger volumes of air at lower velocities, new radiator fin designs and more efficient shrouds.

Some gears must be changed from one form to another and perhaps made with more precision. Much noise is generated from variable gear loadings and from gear idling. Gears are designed to transmit a given power level at a required speed. Variations of these will set up vibrations which cause noise. Here again, isolation and insulation seem like possible temporary solutions but heat and flexibility can lead to premature failure and other new problems.

Hydraulic pumps, transmission lines, valves, cylinders and motors are all noise generators. Oil flowing in a smooth, uniform path should be one of the quietest methods of generating, transmitting and utilizing energy. However, each component has complicated restrictions which induce vibration. If all of the hydraulically performed functions were uniform and continuous, the noise would be minimal. But ease and flexibility of control are reasons for the many applications. Noise reduction programs for hydraulics are underway, but they will take time for development, testing and adopting.

Mechanical components such as the tracks of crawler tractors are noisy but fortunately are of lower frequencies. These types of mechanisms are just not readily quieted and do not lend themselves to encapsulation treatment. The long range, practical solution for all these problems may well dictate future machines of entirely new configurations.

NOISE STANDARDS AND REGULATIONS

Because of the many noise sources which add up to a single composite noise at an individual's ear, a unique but uniform measurement is necessary. For this purpose the SAE Standards are a very practical solution. The development of these Standards requires inputs from a broad spectrum of individuals with various areas of interest. One company cannot develop such Standards nor can just the machine manufacturers' industry. But, through CIMA, the industry is promoting and lending its support to the development of meaningful noise Standards by independent Standards writing bodies which include experts from manufacturers, government, public, users and labor.

As previously stated, these are noise measurement and reporting Standards being developed by engineers and other highly knowledgeable people in the construction field. Obviously, their efforts must be teamed with practical and effective noise limit Standards developed by the experts in the field of Industrial Hygiene. Such limits should be in keeping with the peculiar type of exposure found in the construction environment. Only when these two tasks are completed can effective and practical noise control programs and regulations be designed and implemented.

For Community Noise Control we visualize total construction job site limits geared to the particular needs of the surrounding community. This would create a natural demand for quieter machines yet still allow contractors and users to utilize their well demonstrated versatility and ingenuity to get the job done in compliance with realistic job site noise limits even with existing machines by using new job layout and operational techniques.

For control of hearing damage risk we would urge that the current Walsh-Healey noise exposure tables might be modified for construction workers to more accurately reflect their unique exposure to intermittent, variable intensity noise and the large seasonable fluctuations in noise dosages. These factors are covered in some detail in a CIMA sponsored study published by SAE, December 1969, as Technical Report - SAE Research Project R-4 and titled "A Study of Noise Induced Hearing Damage Risk, for Operators of Farm and Construction Equipment". This report is available from the Society of Automotive Engineers, Inc., Two Pennsylvania Plaza, New York, New York.

In summary, we have attempted to briefly review the background of construction machinery and the relatively recent public concern for noise.

We have outlined the complex and sophisticated industry problems involved and our concern that the public may be moving from apathy to overkill in one easy lesson.

We have indicated an industry recognition of the responsibility to help shape noise abatement legislation and regulation into reasonable and responsible instruments; also, our past and continuing active participation, through CIMA, to effectively utilize our industry expertise in major and necessary Standards activities.

We spoke of the industry efforts, both from individual manufacturers and collectively through CIMA to create quieter machines except as a stop gap, high cost measure.

We outlined the need for new noise limit criteria designed in consideration of the unique types of noise exposure and dosage for construction workers.

It is obvious that construction machine designers and industrial hygienists in both the government and private sectors are operating at the threshold of the art relative to *noise*. We believe there is real and urgent need for a combining of these two groups into a teamwork effort. Through such a combined grouping of expertise can come the tools and procedures to effectively reach our common noise abatement objectives - and to do so with full consideration of the total needs of our society and at costs and compromises satisfactory to the public.

APPENDIX D — NOISE CONTROL: REGULATION AND STANDARDS

D.1 Introduction

Control of the noise produced by construction activity, building equipment, and home appliances cannot be expected to proceed in an orderly fashion without supporting guidance in the form of noise criteria, noise standards, and noise limits. This section of the report presents information on the status of currently available guidance for noise control. Trends in development of criteria, standards, and limits are discussed. Where possible, future requirements for noise control guidance are anticipated.

A fundamental distinction must be made among the three basic forms of guidance necessary for systematic noise control. Noise criteria are defined as statements of the effects produced by various levels of noise exposure. Criteria are based on the effects of noise on people, as discussed in Section 3.1 of this report. Noise standards describe the properties of noise environments that are considered desirable. Standards are usually presented as long-term goals that a regulatory program may be designed to attain. Noise limits are in effect regulatory documents intended to limit public exposure to individual noise sources. The limits entail not only a knowledge of the existing noise environment, but also technological and economic constraints on noise abatement. It is intended by writers of noise limits that the noise environment should approach the goals of noise standards in a systematic fashion.

The next section will discuss the elements involved in the development and support of regulatory noise limits for construction equipment; the third section of this appendix will discuss those elements appropriate to building equipment and appliances.

D.2 Construction Equipment

The body of this report has included discussion of criteria in the estimation and evaluation of the impact of construction equipment noise. The criteria appropriate to construction equipment noise are not unique to such noise sources, of course. The selection of standards for noise exposure must take into account the characteristics of the combined impact of the many noise sources that pollute our environment, and most importantly, must be keyed to the business and recreational activities and situations in society that are to be protected from noise. Thus, the development of a set of standards for the protection of human activity from noise pollution is beyond the scope of the present project and report; indeed, the ultimate selection will be based on further legislation incorporating decisions of national policy. It is our intention here to describe the relationship between the various elements in an environmental regulatory scheme, and to identify their present state of development by scientific and engineering groups, and by State and local governments.

The third of these elements is the noise limit itself, which provides quantitative restriction of noise emissions through incorporation in legally enforceable rules, regulations, and laws. Quantitative limits must be directed at an identifiable legal entity (such as manufacturer, vendor or user), and must be accompanied by specific test and measurement procedures. Although no nationwide noise regulations for construction or other powered outdoor equipment now exist, several states are considering such noise limits, and a number of larger cities have recently enacted or proposed limits for construction equipment.

The next section of this Appendix will review the recent regulatory activities at the State and local levels that apply. Since procedures for construction equipment noise measurement are so important to the successful implementation of source limitations, the last section will discuss these in more detail.

State and Local Regulations

In the last two years, considerable activity has taken place at the State and local level with regard to reducing the noise of outdoor construction, maintenance, and repair activities.

Both the State of Illinois and the State of Hawaii enacted statutes in 1970 which grant broad regulatory powers over noise to specific state agencies. At this time neither the Illinois Pollution Control Board nor the Hawaii Dept. of Health have adopted any rules or regulations to control construction noise. The Illinois Institute for Environmental Quality has initiated a study of noise sources (including construction and other outdoor powered equipment) that could be covered by State regulations, and proposed limits for such equipment are being studied.

In the State of California, a report to the 1971 Legislature on the Subject of Noise was prepared by the State Dept. of Public Health. This report includes in its recommendations the establishment of noise emission standards for all noise-producing objects now in use as well as to be admitted in the future to California. The construction noise sources identified in the report include all diesel-engine powered equipment, such as generators, compressors, off-highway trucks, bulldozers, loaders, scrapers, power shovels and other excavating equipment, as well as piledrivers, riveting machines, jack hammers, elevators, cement mixers, hammers, power saws, drills, and nailers. Other State legislatures have or will consider a variety of proposed construction noise bills; a bill submitted to the New York State Legislature in 1968 would have limited construction noise as measured at the nearest multiple dwelling.

Because construction-equipment noise is especially severe in urban areas, limits have been proposed or adopted in several larger cities. New York City has proposed coverage of construction sites by permit, and limits for air-compressor and paving-breaker

equipment in a new noise code; public hearings are scheduled to begin in the City Council Committee on Environmental Protection on 9 September 1971. The City of Boston Air Pollution Control Commission has recently completed a study of community noise and, as part of its plan for noise control, will begin hearings 27 September 1971 on proposed regulations which include limitations on noise of both construction/outdoor powered equipment and on the operation of a construction site. The latter limits, in brief, apply at any nearby area open to the public except public ways, or at a 1000-ft radius from the site, whichever is nearer.

The City of Chicago adopted a comprehensive noise ordinance, effective 1 July 1971. Section 17-4.8 provides that "No person shall sell or lease,...any powered equipment or powered hand tool that produces a maximum noise level exceeding the following noise limits at a distance of 50 ft, under test procedures established by...this chapter." and there follows a table of limits in dB(A) for four categories of equipment. Two categories "Construction and Industrial Machinery" (#1) and "Commercial Service Machinery" (#3) cover the bulk of construction equipment.

"Construction and Industrial Machinery" includes powered outdoor equipment, mobile or stationary, associated with construction sites or industrial operations. Such equipment includes crawler-tractors, dozers, rotary drills, and augers, loaders, power shovels, cranes, derricks, motor graders, paving machines, off-highway trucks, ditchers, trenchers, compactors, scrapers, wagons, compressors, pavement breakers, pneumatic-powered equipment, etc. Specifically excluded are pile drivers.

"Commercial Service Machinery" includes powered equipment of 20 hp or less intended for infrequent service in residential areas, typically requiring commercial or skilled operators. Such equipment includes chain saws, light pavement breakers, log chippers, powered hand tools, etc.

The limits that apply to these categories are keyed to the date of manufacture of the equipment and provide a timetable for noise reduction as follows:

Manufactured after	Construction and Industrial Machinery	Commercial Service Machinery
1 Jan. 1972	94 dB(A)	88 dB(A)
1 Jan. 1973	88 dB(A)	84 dB(A)
1 Jan. 1975	86 dB(A)	--
1 Jan. 1978	--	--
1 Jan. 1980	80 dB(A)	80 dB(A)

The application of the limits to equipment for lease is most appropriate in the case of construction machinery; such equipment is usually leased rather than sold. Since the limits only apply to equipment manufactured after 1 January 1972, it is too early to look for compiled results, but several contractors in the Chicago area are now asking for "quieted" equipment that will meet these limits, and intend to use such equipment, insofar as possible, to reduce or eliminate community noise complaints. This provides very desirable pressure in the market place for such "quiet" equipment, encouraging manufacturers to offer noise control packages on their construction equipment before the required date.

Measurement Procedures

Since quantitative limits must be applied to the noise source, most test codes and recommended practices for measurement apply to the operation of an individual item of construction equipment. The following noise measurement procedures are of this form:

SAE Standard J952a Sound Levels for Engine Powered Equipment*

Scope: For engine powered equipment including mobile construction and industrial machinery, but not covering machinery designed for operation on highways, or within factories and building areas.

Test Type: Outdoor free-field measurement on level ground. Measurement distance 50 ft. Equipment operation at speed and load producing maximum sound level.

Data: A-weighted sound level.

City of Chicago Environmental Control Ordinance, Article IV[†] Test Procedures for Noise Emitted by Engine-Powered Equipment and Powered Hand Tools

Scope: For engine-powered equipment, including construction and industrial machinery (not including pile drivers) agricultural tractors and equipment, powered commercial equipment of 20 hp or less, and powered equipment for use in residential areas.

*Society of Automotive Engineers, Inc., NYC, N.Y. 10001

[†]Sec. 17-4.26 and corresponding section of DEC Code of Recommended Practice. Chicago Department of Environmental Control, Chicago, Ill. 60610.

Test Type: Outdoor free-field measurement on level surface. Measurement distance 50 ft. Both stationary test and acceleration test (for rubber-tired mobile equipment) at load and speed producing maximum sound level. Pneumatic equipment operated as specified in CAGI-PNEURO P Test Code.

Data: A-weighted sound level.

ANSI S1.19/193 (Proposed) Test-Site Measurement of Noise Emitted by Engine Powered Equipment*

Scope: For determining maximum noise emitted by construction and industrial machinery, transportation and recreation vehicles, and other engine-powered equipment.

Test Type: Outdoor free-field on reflecting ground. Measurement distance 15 meters (50 ft). Moving and stationary tests for construction equipment (Sec. 4.4).

Data: A-weighted sound level

CAGI-PNEURO P[†] Test Code for the Measurement of Sound from Pneumatic Equipment

Scope: Applies to compressors, percussive and nonpercussive pneumatic equipment. Specifies procedures and operating conditions, not always including process noise.

*American National Standards Institute, NYC, N.Y. 10018

†Compressed Air and Gas Institute, NYC, N.Y. 10017

Test Type: Indoor or outdoor, measurements in direct field at five positions at 1 meter from equipment. Secondary measurement at 7 meters distance. Non-percussive tools measured running free and with "quiet" work process.

Data: A-weighted and Octave-band sound pressure levels for each measurement point.

The procedures adopted by the City of Chicago are based on the SAE J952 standard and the revisions now under consideration by the SAE Agricultural and Construction Machinery Sound Level Subcommittee. Substantially the same measurement procedures have been proposed by the City of Boston Air Pollution Control Commission in their *Test Procedure for Measurement of Noise from Powered Devices*.

While SAE J952a contained specific noise limits, there are being separated in a later revision now under consideration, and the test procedure will appear separately. This procedure recommends an additional 2 dB tolerance for such noise measurements; this provision has been deliberately omitted in both the Chicago and Boston test procedures, and left to administrative decision. This is more appropriate, and not unlike the enforcement measurement procedures for vehicular speed limits.

Another approach to construction equipment noise measurement is to apply the measurement to the combined operators of all construction equipment at a single test site. At the request of CIMA (Construction Industry Manufacturers' Association) the SAE is developing such a test procedure.

SAE Recommended Practice (Proposed) Construction Site Sound Level Measurements

Scope: For sites where construction machinery is operated.
Measures noise radiated off-site.

Test Type: Field measurement of radiated sound levels at four nearest inhabited locations to any centerpoint of construction activity. If no inhabited locations closer than 1000 ft to a centerpoint, measurements made at 4 locations spaced 90° on 1000 ft radius circle.

Data: A-weighted sound levels at each measurement point define "Construction Site Operational Sound Levels". Provision for a record of "Construction Site Baseline Sound Levels" allows limits to be expressed as change in ambient as well as absolute terms.

The combined-operations measurement procedure is presently being proposed for use by the City of Boston, and the City of Chicago plans a test of the latest SAE draft procedure as part of a feasibility study of noise limitations on construction sites. The Federal Highway Administration is considering this procedure as a basis for regulation of noise from Federal-aid highway construction.

D.3 Noise Standards for Indoor and Outdoor Equipment for Home and Office Use

The impetus for development of standards for measuring and rating the noise produced by many types of equipment has come from the manufacturers of noise sources. For example, the manufacturers of air conditioning and ventilation appliances are by far the most conscious of the impact of their equipment on the noise environment of the home and office. Within the past decade at least ten different "standard" procedures have been formulated for measuring and rating the noise of various types of air conditioning and ventilating equipment. The automotive and airframe industries have been similarly conscious of the noise impact of their equipment and sophisticated noise standards exist for these sources. By contrast, only one standard has appeared to deal with the noise of rotating electrical machinery; one to deal with gas turbines; one for gear noise; one standard of a general nature, produced by official American National Standards Institute (ANSI), intended to guide noise measurement of practically any piece of machinery; and a draft procedure is under consideration by ANSI to rate the noise of all engine-powered equipment.

Such standards are of two types. Measurement standards specify the manner in which meaningful and reliable acoustical data may be obtained. Rating standards apply these acoustical data to produce ratings, usually single-numbered, that are supposed to correlate with subjective response to equipment noise, thus permitting at least rank-ordering of equipment noise on a justifiable basis.

Both sorts of standards are necessary and form the basis for yet a third class of standards (applications standards) that are used by architects, consultants, building codes, noise

ordinances and similar organizations. Factors which are considered in developing application standards include the economic, social, and political. Applications standards represent an equilibrium between the costs of reducing noise exposure and the feasible noise reduction made possible by acoustic technology.

The following summaries indicate the general nature of existing U.S. noise measurement and rating standards for domestic and office equipment.

ASHRAE 36-62 Measurement of Sound Power Radiated from Heating, Refrigerating and Air-Conditioning Equipment*

Scope: For unitary, unducted equipment, large or small, for indoor or outdoor use.

Test Type: Reverberation room, substitution method.

Data: Total radiated sound power level in octave or 1/3-octave bands.

ASHRAE 36A-63 Method of Determining Sound Power Levels of Room Air Conditioners and Other Ductless, Through-the-Wall Equipment*

Scope: For room air conditioners, window or attic fans, and other ductless wall- or ceiling-mounted equipment that radiate sound directly both to the conditioned space and the outdoors.

Test Type: Reverberation room, substitution method (2 rooms needed).

Data: Total sound power level radiated to indoors and outdoors, separately, in 1/3-octave bands.

* American Society of Heating, Refrigerating and Air-Conditioning Engineers, Inc., 345 East 47th Street, New York, N.Y. 10017.

ASHRAE 36B-63 Method of Testing for Rating the Acoustic Performance of Air Control and Terminal Devices and Similar Equipment

Scope: For air control and terminal devices normally mounted in or connected to duct systems.

Test Type: Reverberation room, substitution method.

Data: Total sound power level radiated into the room served by the device, in octave bands.

AMCA 300-67 Test Code for Sound Rating Air Moving Devices*

Scope: For central station air conditioning and heating and ventilating units, for centrifugal fans, axial and propeller fans, power roof and wall ventilators, steam and hot water unit heaters (but not unit ventilators, room fan-coil units, room air induction units and air cooled refrigerant condensers).

Test Type: Reverberation room, substitution method, based on ASHRAE 36-62.

Data: Total radiated sound power level, in octave bands (including the sound radiated into the ducts, for ducted equipment).

AMCA 301-65 Method of Publishing Sound Ratings for Air Moving Devices*

Ratings for Centrifugal Fans, Axial and Propeller Fans, Power Roof and Wall Ventilators, Steam and Hot Water Unit Heaters; not yet suitable for central station A/C or H/V units.

Ratings: based on octave-band sound power levels, per AMCA 300-67:

For ducted devices, the eight octave-band sound power levels;

*Air Moving and Conditioning Association, 205 West Touhy Ave., Park Ridge, Ill. 60068

For unducted devices, the loudness in sones at a reference distance of 5 ft, as calculated from the sound power level data.

AMCA 302 *"Application of Sone Loudness Ratings for Nonducted Air-Moving Devices"*

Reference material covering applications of the loudness rating in sones (examples, combinations of sources, prediction of sound loudness indoors and outdoors, variation with fan speed.

AMCA 303 *"Application of Sound Power Level Ratings for Ducted Air Moving Devices"*

Reference material covering significance and accuracy of sound power level ratings, particularly their relation to sound as heard.

ANSI*S1.2 - 1962 *"American Standard Method for the Physical Measurement of Sound"*

Scope: For all devices, machines or apparatus.

Several test procedures are described:

Test Type: Free-field; free-field above reflecting plane; semi-reverberant field; or reverberation room. The semi-reverberant field procedure is similar to that of ASHRAE 36-62.

Data: Sound pressure levels at specific locations, or total sound power levels in octave bands (1/2-octave or 1/3-octave analysis optional); and directivity of the source.

* American National Standards Institute, 10 East 40th Street,
New York, N.Y. 10016

IEEE* #85 "Airborne Noise Measurements on Rotating Electric Machinery"

Scope: For rotating electrical machinery of all sizes
Several test procedures are described:

Test Type: Free field; free field above reflecting plane; semi-reverberant field; or reverberation room. (Similar to ANSI S1.2-1962, but more detailed.)

Data: Sound levels or sound pressure levels in frequency bands (octave, 1/3-octave, or "narrow") at specified locations or total sound power level, overall or analyzed into frequency bands, and directivity of source.

ANSI S1.19/193 "Test-Site Measurement of Noise Emitted by Engine-Powered Equipment" (Draft only.)

Scope: For residential equipment (Section 4.5) [Other sections deal with automobiles, motorcycles, construction and industrial machinery and recreational equipment]

Test Type: Sound levels measured on flat test site with hard ground surface, free of large reflecting obstacles within 30 meters of equipment under test.

Data: A-weighted sound level measured at a point 50 ft from center of equipment and 4 ft above ground, for noisiest direction and noisiest operating conditions.

ARI† 443-66 "Standard for Sound Rating of Room Fan-Coil Air-Conditioners"

Scope: For room fan-coil air conditioners.

* Institute of Electrical and Electronic Engineers, 345 East 47th Street, New York, N.Y. 10017

† Air-Conditioning and Refrigeration Institute, 1815 North Fort Meyer Drive, Arlington, Virginia 22209

Test Type: Reverberation room, substitution method, in accordance with ASHRAE 36-62

Data: Octave-band sound power levels, computed from 1/3-octave band data corrected for presence of pure tones.

ARI 270-67 Standard for Sound Rating of Outdoor Unitary Equipment

Scope: Outdoor sections of factory-made equipment, such as unitary air-conditioners or heat pumps.

Test Type: Reverberation room, substitution method, in accordance with ASHRAE 36-62 or ASHRAE 36A-63.

Data: Sound power levels in 1/3-octave bands.

Rating: Single-number rating based on the 1/3-octave band sound power levels (corrected for the presence of pure tones), by a calculation like the ANSI Standard S3.4, "Computation of Loudness of Noise".

ARI 275-69 Standard for Application of Sound Rated Outdoor Unitary Equipment

Reference material (related to ARI 270-67) establishing a method for predicting annoyance due to operation of outdoor unitary equipment, and providing recommendations for application of such equipment.

Calculation of annoyance level (ANL), taking into account distance, reflections, location of equipment, shielding by barriers, location of observer, multiple units, etc.

AHAM SR-1 Room Air-Conditioner Sound Rating*

Scope: Room air conditioners

Test Type: Reverberation room, substitution method, in accordance with ASHRAE 36A-63

Data: Single number (or letter) ratings based on the 1/3-octave band sound power levels (corrected for the presence of pure tones), by a calculation like the ANSI Standard S3.4 "Computation of Loudness of Noise"; the calculations are different for the indoor side and the outdoor side of the unit, such that the two sound ratings would be the same if the sound power levels radiated indoors were all 15 dB less than the levels in corresponding frequency bands radiated to the outdoors. The outdoor calculation is the same as that of ARI 270-67. The indoor sound rating (a number) is converted to a letter rating (11=A, 12=B, 13=C, etc.) for publication purposes.

HVI†#1966-1 Sound Test Procedure

Scope: For home ventilating equipment.

Test Type: Reverberation room, substitution method, similar to ASHRAE 36-62

Data: Octave band sound power levels, calculated from 1/3-octave band sound pressure levels, are used to compute octave-band free-field sound pressure levels at a reference 5-foot distance.

Rating: The nominal free-field octave-band SPL's at 5 foot are used to calculate loudness in sones, a single number,

* Association of Home Appliance Manufacturers, 20 North Wacker Drive, Chicago, Illinois 60606

+ Home Ventilating Institute

according to ANSI S3.4 - 1968, "Computation of Loudness of Noise."

ADC Test Code 1062 R1 Equipment Test Code*

Scope: For air distribution and control devices (high pressure units).

Test Type: Reverberation room, substitution method, in accordance with ASHRE 36B-63 (except that the ASHRAE test for attenuation of terminal devices is not used).

Data: Total sound power level radiated into room, in octave bands.

* * * *

In addition to these standards for measuring and rating noise from various kinds of ventilation equipment, both the Home Ventilating Institute and the Air Conditioning and Refrigeration Institute have published directories of equipment, giving noise ratings for each model tested (a large proportion of the manufactured models); and both the Air Conditioning and Refrigeration Institute and the Association of Home Appliance Manufacturers offer guidance for the writers of noise ordinances dealing with their equipment types, to indicate achievable goals and the necessary wording in terms of existing standards, to make the model ordinances enforceable.

At the present time, the existence of several different measurement and rating standards in the ventilating/air-conditioning field is something of an embarrassment, since they are not

* Air Diffusion Council, 435 North Michigan Ave., Chicago, Ill. 60611

mutually consistent nor even compatible, but are competing for general acceptance. In an attempt to deal with this situation, an ad hoc working group of ANSI is currently trying to draft a standard for both measurement and rating of equipment noise that exhibits the best features of the already existing standards and that, it is hoped, will be found acceptable by the various organizations that have pioneered in the standardization effort in the United States. It is still too early to predict whether this action will be successful.

In spite of the slightly chaotic present situation, it is clear that a great deal of careful thinking has been done about how to measure equipment noise in the United States; indeed, in this area the U. S. is somewhat in advance of the European practice.