

Appendix R Sewer System Analysis

Appendices

This page intentionally left blank.

TECHNICAL MEMORANDUM

To: Elizabeth Kim
From: Kim Alexander
Date: March 3, 2022
Subject: Brea 265 Sewer System Analysis

Tributary Sewer System

The western portion of the Brea 265 Project (Project), located west of Valencia Avenue, is tributary to the City of Brea sewer system pipelines shown on Figure 1. The nearest sewer to the Project is an 8-inch pipeline that extends through the Brea Sports Park up to the southern edge of the Project boundary. This pipeline currently serves the Brea Sports Park and Thompson Energy operations. The 8-inch pipeline discharges south to the 8-inch pipeline along Birch Street and continues east approximately 1,050 feet to Flower Hill Street where the system routes through the residential neighborhood located north of Birch Street. The 8-inch pipeline transitions into a 10-inch pipeline within the neighborhood at Primrose Avenue and Foxglove Street. At this location, a substantial amount of additional sewer flow enters from the Blackstone development located north of Lambert Road. The 10-inch pipeline turns south on Starflower Street which transitions into Ranger Avenue (at the intersection of Birch Street) and continues south in Ranger to a 15-inch pipeline along north side of the Loftus Diversion Channel. The 15-inch pipeline along the channel also serves the industrial area located north of the channel and flows west to Kraemer Boulevard. Just upstream of Kraemer, the 15-inch pipeline transitions to a short reach of 12-inch pipeline with a steep slope then the sewer flows south in a 15-inch pipeline in Kraemer to Orange County Sanitation District’s (OCSD) trunk sewer at Imperial Highway.

As-built drawings were provided by the City for the tributary sewer system for input into InfoSewer modeling software. The pipeline lengths and slopes were entered in the model based on these drawings where available. There are reaches of the system where plans could not be located and for these reaches the pipe length and slope were entered based on the City’s model data presented in the City’s 2021 Sewer Master Plan (SMP). These reaches for which as-built drawings were not available are highlighted on Figure 1.

The OCSD Carbon Canyon Interceptor runs through the eastern portion of the Project, located east of Valencia Avenue. The former OCSD Carbon Canyon Lift Station and its associated force main were eliminated with the construction of this gravity main system through the Project property. In exchange for allowing a right-of-way through the property, OCSD agreed to allow the Project to discharge to the Carbon Canyon Interceptor and included stub-outs for future sewer connections at their manholes within the Project.

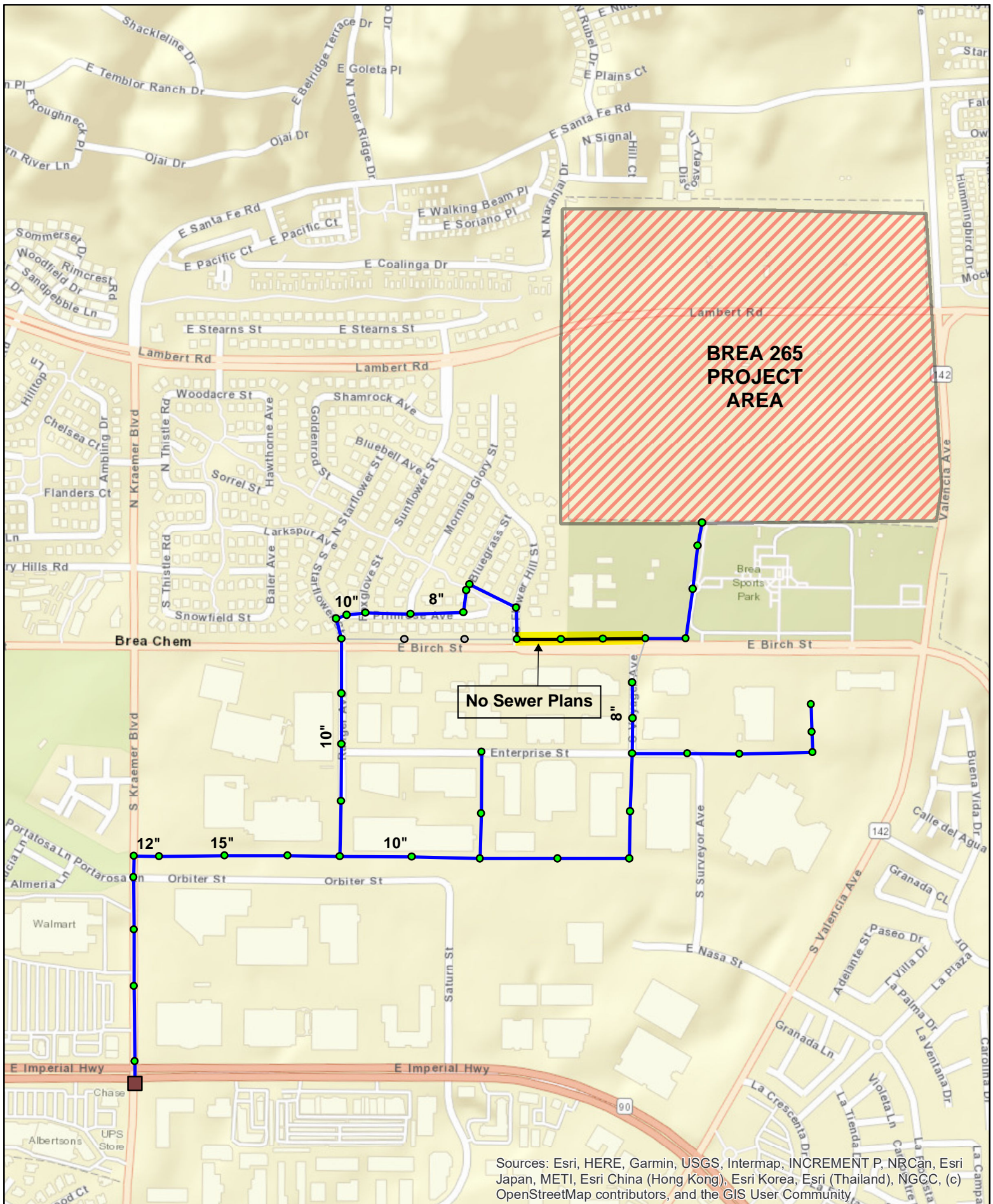

Sources: Esri, HERE, Garmin, USGS, Intermap, INCREMENT P, NRCan, Esri Japan, METI, Esri China (Hong Kong), Esri Korea, Esri (Thailand), NGCC, (c) OpenStreetMap contributors, and the GIS User Community

Flow Monitoring

As part of this study, flow monitoring was conducted by ADS from September 12 to October 1, 2019, in the southern tributary sewer system toward Birch Street where the western Project area flow will discharge. Flow monitoring locations were selected to calibrate the sewer model and determine appropriate flow factors for the land uses in the tributary area. Figure 2 shows flow monitoring (FM) locations and the various tributary sub-basins color coded by flow monitoring station and labeled by the street name of the station. The most upstream FM station is along Birch Street, downstream the Brea Sports Park. This location was selected to determine the flow from the oil operations within the park area as well as from the park itself (pink area on Figure 2).

The next monitoring location downstream was along Ranger Avenue. This location was selected to measure the primarily residential flow from the neighborhood just north of Birch, and the Blackstone residential development located north of Lambert Road that is tributary to the study area sewer system (brown area on Figure 2). The non-residential flow also contributing to the cumulative flows measured at the Ranger FM station include an elementary school and a small amount of industrial use adjacent to Ranger Avenue, in addition to the flows measured at the Birch FM station. The third and final downstream station was located along Kraemer Boulevard which collects the Ranger flows and the additional tributary basin area that contains a combination of residential and industrial flows (blue area on Figure 2). A summary of the average and peak flows from the FM data are shown on Table 1. The ADS flow monitoring report is included in Appendix A. The data shows only limited fluctuation in the flows at the Birch Street location, typical residential peaking at the Ranger Avenue location with peak flows occurring in the morning and evening, and similar morning and evening peaking at the Kraemer Boulevard location, apparently dominated by residential flow. The incremental flow (non-cumulative) from each sub-basin tributary to each FM station is estimated by subtracting the flow at the upstream station (sub-basin) from the flow at the downstream station. The sub-basins tributary to each FM station are shown on Figure 2, and will be referred to as the Birch basin, Ranger basin, and Kraemer basin.

TABLE 1 - FLOW MONITORING DATA SUMMARY (MGD)

FM Station Flow	Avg	Peak	Peak to Avg
Birch Street	0.106	0.135	1.27
Ranger Avenue	0.241	0.390	1.62
Kraemer Boulevard	0.370	0.649	1.75
Tributary Sub-Basin Flow ⁽¹⁾	Avg	Peak	Peak to Avg
Birch Street	0.106	0.135	1.27
Ranger Avenue	0.135	0.255	1.89
Kraemer Boulevard	0.129	0.259	2.01

(1) Equal to FM station flow less the upstream station flow.

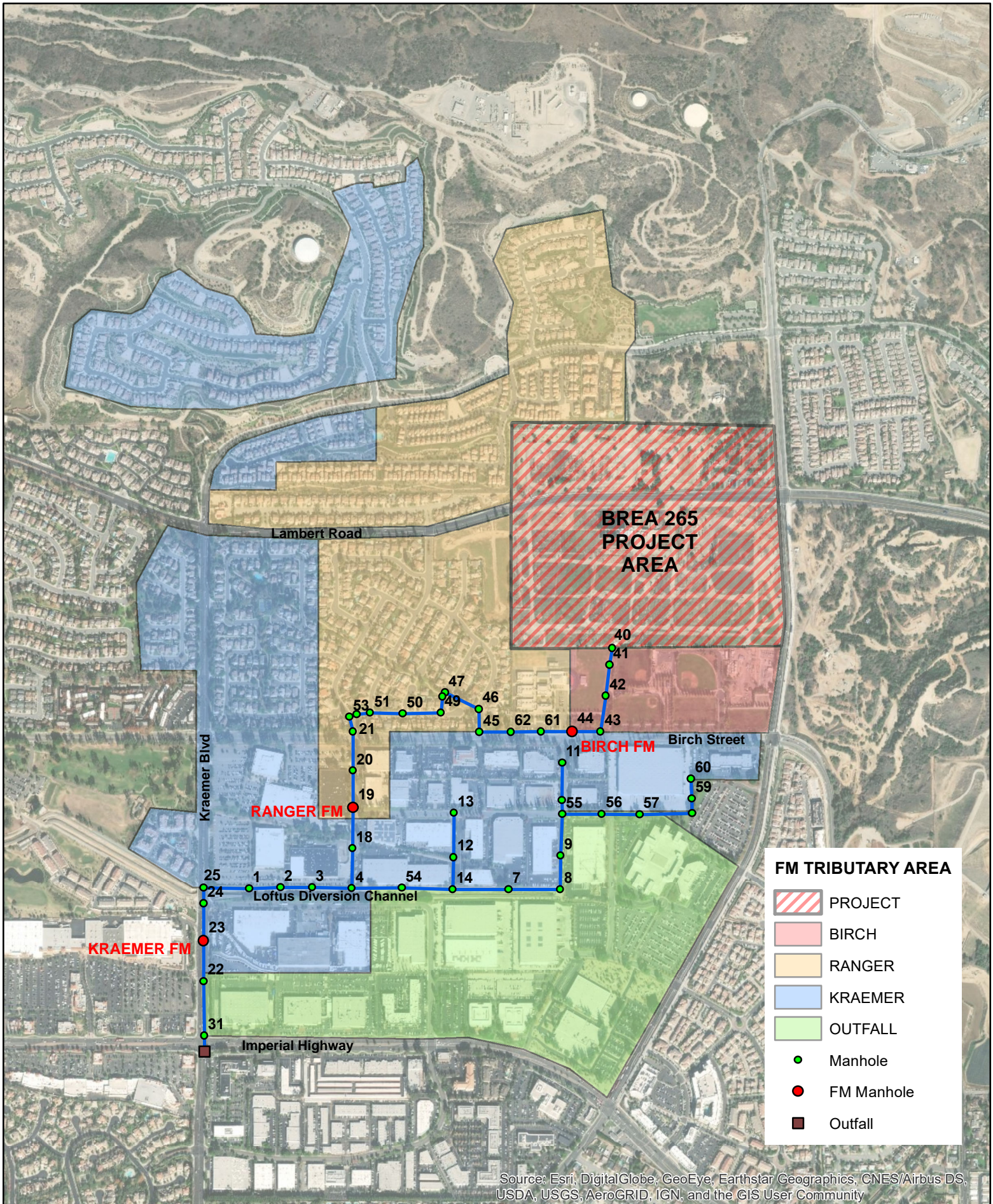

Figure 2
FM Tributary Basins

Model Flow Factor Estimates

Flow factors were estimated based on the monitoring data for each of the tributary basins shown on Figure 2 and the corresponding land use within each of the areas. The tributary area to each FM station was estimated based on sewer plans and sewer GIS information provided by the City. An iterative, trial and error method was used within Excel to select flow factors to match average flow monitoring data as close as possible. Flow factors were varied up and down within typical ranges used for residential and industrial land use categories. A year's worth of metered water use data for 2018 was provided by the City for planning areas within the Blackstone development as well as other newer residential developments in the City (summarized in Appendix B). A percentage of the water demand will be for outdoor use with the indoor use discharging to the sewers. The dwelling units (du's) were counted within the FM tributary areas and factors (per du) applied based on both density and metered water use data.

The average and peak flows for the Birch FM station were utilized in the model for loading the sewer generated within the park area. Estimates were then made to calibrate the residential flow to the FM station along Ranger which include portions of Blackstone and the neighborhood along Birch. Residential densities include low density with approximately 3 dwelling units per acre (du/ac) and cluster homes with approximately 5 du/ac. Following this same process, residential flow factors were applied to the basin tributary to Kraemer. The residential land uses in the Kraemer area include the same cluster homes as the Ranger basin with approximately 5 du/ac and single-family homes on slightly smaller lots than the Ranger basin with a density of approximately 4 du/ac. The single-family residential use in the Kraemer basin area was reduced slightly based on the higher density. The remaining flow to the Kraemer station was attributed to the industrial uses.

The estimated flow factors developed from the monitoring data and by land use are shown in Table 2. These factors were used to calibrate the model of the tributary sewer system to the monitored flow data. A low density residential (LDR) flow factor of 250 gpd/du was used for the largest lots within the Ranger basin. The slightly higher density LDR lots within the Kraemer basin were given a factor of 200 gpd/du. Based on the metered water use data for similar density lots provided by the City, these sewer factors represent an indoor use equal to approximately 60% of the total water use, which is within the expected range for low density lots. An estimated factor of 130 gpd/du is used for cluster homes within both the Ranger and Kraemer basins. These homes are within Blackstone PA3 and have an average water use of 145 gpd/du, resulting in 90% of the water use contributing to sewer flow. A factor of 110 gpd/du was assumed for all apartments and is equal to 90% of high-density water use data provided by the City of 122 gpd/du. An indoor use percentage of 90% is typical for higher density lots with limited outdoor irrigation. The industrial flow within the study area was estimated using a flow factor of 700 gallons per day per acre. Using these factors, the resulting average flow rates are shown in Table 2. The resulting flows are conservatively greater than the observed flows recorded for the Ranger and Kraemer stations, also shown in Table 2, but still within 10 percent.

TABLE 2 - MODEL FLOW FACTOR DATA

MH# ¹	Land Use	Units ²	Density (du/ac)	Factor (gpd/du)	Average Flow		Peak Flow		Development/Street Location
					gpd	gpm	gpd	gpm	
Birch FM Basin Area									
40	<i>Birch Street FM Actual</i>				106,000	74	135,000	94	<i>Sports Park and Thompson Energy</i>
Range FM Basin Area									
61	Elementary School	640		10	6,400	4	12,160	8	
46	LDR	77	2.9	250	19,250	13	36,575	25	Flower Hill
49	LDR	33	2.9	250	8,250	6	15,675	11	Bluegrass
53	LDR	78	2.9	250	19,500	14	37,050	26	Starflower
51	LDR	54	3.2	250	13,500	9	25,650	18	Blackstone/Stearns
51	LDR	59	2.9	250	14,750	10	28,025	19	PA1 Blackstone/Rubel
51	MDR/Cluster	196	5.3	130	25,480	18	48,412	34	PA3 Blackstone/Coalinga/Walking Beam
51	Appartments	94	18.8	110	10,340	7	19,646	14	PA2 Blackstone
20	Industrial	30.4		700	21,287	15	40,445	28	Ranger
19	Ranger FM Calculated				308,827	170	398,638	277	
19	<i>Ranger FM Actual</i>				241,000	167	390,000	271	<i>Ranger Flow Meter</i>
Kraemer FM Basin Area									
25	MDR/Cluster	65	5.3	130	8450	6	16,055	11	PA3 Blackstone/Pacific Court
25	MDR	188	4.0	200	37600	26	71,440	50	PA4 and PA5 Blackstone
25	MDR	140	3.6	200	28000	19	53,200	37	Kraemer East @ Edgemont
25	MDR	54	3.9	200	10800	8	20,520	14	Kraemer West @ Edgemont
25	Appartments	115	17.4	110	12650	9	24,035	17	Kraemer West @ Channel
2	Industrial	15.3		700	10703	7	20,336	14	Kraemer East @ Channel
1	Industrial	17.6		700	12334	9	23,435	16	Orbiter St
55	Industrial	22.7		700	15897	11	30,204	21	Voyager
13	Industrial	14.3		700	10038	7	19,072	13	Enterprise
4	Industrial	23.3		700	16278.5	11	30,929	21	Ranger
23	Kraemer FM Calculated				542,761	283	707,864	492	
23	<i>Kraemer FM Actual</i>				370,000	257	649,000	451	<i>Kraemer Flow Meter</i>

1) MH# is for loading the model and corresponds to Figure 2

2) Units are dwelling units for residential use, acreage for industrial use, and students for Elementary School.

Project Flows

The City's 2021 SMP requires potential developers to perform a sewer generation analysis incorporating details of the specific development area and conduct a hydraulic analysis to verify available downstream system capacity. The 94.5-acre western Project area that is tributary to the study sewer system has planned residential land uses as shown in Table 3 below. The housing products include low density residential (LDR) and medium density residential (MDR) homes. The number of dwelling units and densities by residential land use type were obtained from the Brea 265 Specific Plan dated October 14, 2021 and are also included in Table 3. The LDR land use area identified in the Specific Plan includes a 1.0-acre reserved site for public safety/civic uses. City staff estimated that 6 personnel would be on duty at any one time. Project flows were estimated based on water use data provided by the City for other new developments (summarized in Appendix B) and the calibrated flow factors for the study area tributary basins as described above. The resulting flow factor estimates are 230 gpd/du for LDR and 130 gpd/du for MDR. These factors are similar to those used for the Kraemer basin residential land use mix which has higher density residential uses than the Ranger basin making these factors more appropriate. Using these factors, the resulting average sewer flow for the western Project area equals 90,390 gpd. The estimated population for this same area equals 1,726 people based on 2.82 persons per dwelling unit from the City of Brea General Plan 2021-2029 Housing Element (consistent with the Brea 265 EIR). The resulting per capita sewer generation rate is equal to 52 gallons per day. This estimate is within State regulations which call for indoor water use of 55 gallons per capita per day (gpcd) through 2025 decreasing to 50 gpcd by 2030.

The Brea 265 Project was identified in the 2021 SMP and evaluated as a near-term project to determine any resulting capacity constraints. The SMP projected an average sewer flow rate of 145,000 gpd for the western portion of the Project and 114,600 gpd for the eastern portion of the Project. SMP loading factors for residential land uses equal 270 gpd/du for single-family residential (1.0 to 6.0 du/ac), 248 gpd/du for multi-family residential (6.1 to 12.0 du/ac), and 210 gpd/du for high density residential (12.1 to 24.9 du/ac). These factors were utilized in this analysis and applied based on residential land use density. It should be noted, however, that the SMP factors for multi-family density products exceed metered water use for similar new developments, with water use ranging from 144 to 218 gpd/du (Appendix B). The SMP factor for parks was also utilized and is equal to 10.5 gpd/acre. The estimated lower factors, based on flow monitoring and metered water use for similar products, were presented as a realistic projection of the future flows while the factors presented in Table 3 from the 2021 SMP are used as a conservative planning estimate, consistent with the SMP analysis. Table 3 shows the average and peak dry weather sewer generation for the Project area using the 2021 SMP factors. The resulting average dry weather flow (ADWF) for the western study area is 154,553 gpd, or 89.6 gpcd using the population estimate of 1,726. Peak dry weather flows (PDWF) are also calculated using the SMP peaking criteria ($Q_{pk} = 1.777 \times Q_{avg}^{0.92}$, Q in cfs).

TABLE 3 – BREA 265 WESTERN AREA ESTIMATED SEWER LOADING

Proposed Land Use	Acres	du/ac	DU's	Factor	Average Flow		Peak Dry Flow	
				(gpd/unit)	gpd	gpm	gpd	gpm
WESTERN PROJECT AREA								
Low Density Residential	25.2	4.2	105	270	28,350	19.7	56,487	39.2
Public Safety/Civic ⁽¹⁾					330	0.2	658	0.5
Medium Density Residential	49	10.3	507	248	125,736	87.3	250,528	174.0
Parks/Recreation	13.0			10.5	137	0.1	272	0.2
Open Space and ROW	7.3							
Total	94.5		612		154,553	107.3	307,945	213.9

(1) Included in LDR land use in Specific Plan (PA 11). Average flow assumes 6 personnel and 55 gpcc.

Similarly, sewer flow for the eastern Project area is projected using Specific Plan land use and SMP loading factors as shown in Table 4. It is assumed that these flows will discharge to OCSD's Carbon Canyon Interceptor which runs through the eastern portion of the Project. The location of the connection point or points, along with the on-site sewer collection system, are to be determined during preliminary design.

TABLE 4 - BREA 265 EASTERN AREA ESTIMATED SEWER LOADING - SMP FACTORS

Proposed Land Use	Acres	du/ac	DU's	Factor	Average Flow		Peak Dry Flow	
				(gpd/unit)	gpd	gpm	gpd	gpm
EASTERN PROJECT AREA								
Low Density Residential	109.9	3.1	345	270	93,150	64.7	188,349	130.8
Medium Density Residential	13.9	10.0	143	248	35,464	24.6	71,708	49.8
Parks/Recreation	2.1			10.5	22	0.0	45	0.0
Open Space and ROW	41.7							
Total	167.6		488		128,636	89.3	260,098	180.6

Model Analysis

The sewer model for the western Project tributary sewer was updated with the existing sewer loads based on the flow factors shown in Table 2 for existing land use to calibrate to the flow monitoring data. Project flow was estimated using the SMP flow factors presented in Table 3. The SMP criteria uses PDWF and peak wet weather flow (PWWF) to evaluate pipe capacity. PWWF is calculated by multiplying the PDWF by 1.25. The capacity criteria requires a PDWF d/D at or below 0.64 and a PWWF d/D at or below 0.75. Simulations were run utilizing the updated flow factors for existing loads and adding the estimated Project sewer loads to the model at MH 40. Sewer model output for simulated PDWF and PWWF with and without the Project is included in Appendix C along with the corresponding model sewer map showing manhole numbers. This model output assumes all sewer flow for the Project area located west of Valencia Avenue discharges south to MH 40.

Model output indicates capacity constraints due to Project sewer flows along Birch Street and through the neighborhood north of Birch Street. As shown in the model output (Appendix C), all but four sewer reaches from MH 44 downstream to MH 21 (Ranger and Birch) exceed the City's d/D capacity criteria. The deficient reaches are illustrated on Figure 3 in red. Two potential capital improvements appear feasible to solve the capacity limitations along Birch Street:

1. Construct a new sewer in Birch Street diverting all flow tributary to MH 44 westerly in Birch Street to MH 21 at Birch and Ranger.
2. Construct a new diversion MH just downstream of MH 44 that would send the total flow southerly in Voyager Avenue to MH 11.

The two alternative capital improvements are illustrated on Figures 4 and 5. Figure 4 illustrates the first alternative that involves construction of approximately 1,900 feet of new 10-inch pipeline along Birch Street from MH 44 to Ranger. There are no plans available for the identified deficient reaches along Birch Street so it is recommended that the manholes be surveyed to confirm manhole inverts, pipeline slopes, and modeling results. Alternative 1 model output is summarized in Table 5 with the upsized diameters highlighted. The second alternative improvement, shown on Figure 5, diverts the sewer in Birch Street to the sewer in Voyager Avenue at MH 44 by constructing approximately 300 feet of 8-inch pipeline from MH 44 to MH 11 in Voyager Avenue. All flow originating upstream of MH 44, including the Project, would be diverted to Voyager Avenue with the existing pipeline that continues down Birch Street plugged at MH 44. Alternative 2 results are shown in Table 6. Of these two alternatives, Alternative 2 is recommended due to the shorter length of pipeline improvements and eliminating the construction of a new pipeline along Birch Street.

The following items related to Project sewer improvements should be considered during the preliminary design phase:

- The on-site sewer in the western portion of the Project will have to cross Lambert Road, a major 4-lane roadway. The conceptual crossing location is included in the Brea 265 Specific Plan.
- The eastern portion of the Project will discharge to the OCSD Carbon Canyon Interceptor at a location or locations to be determined during the preliminary design phase. The conceptual sewer system alignment for the eastern Project area is included in the Brea 265 Specific Plan.
- It was assumed in this analysis that all downstream OCSD pipelines have sufficient capacity for the additional Project flows.
- Bridge Energy currently sewers its operation north of Lambert Road across Lambert Road and then across Valencia where it combines with its other operations and sewers directly to an OCSD trunk sewer. Once that portion of the Brea 265 development is under construction, Bridge Energy will no longer be able to sewer in this manner and will have



Figure 3
Project Deficient Pipelines



Figure 4
Alternative 1 Improvement

From ID	To ID	From Inv	To Inv	Diameter (in)	Length (ft)	Slope	PDWF (gpm)	d/D	PWWF (gpm)	d/D
40	41	449.77	447.33	8	145.6	0.017	307.9	0.46	361.3	0.51
41	42	447.16	445.07	8	266.8	0.008	307.9	0.58	361.3	0.65
42	43	444.9	441.18	8	307.8	0.012	307.9	0.51	361.3	0.56
43	44	441.02	437.69	8	246.8	0.013	307.9	0.49	361.3	0.54
44	61	437.69	436.5	10	240.0	0.005	307.9	0.47	361.3	0.51
61	62	436.33	434.86	10	295.0	0.005	315.9	0.47	371.3	0.52
62	45	432.3	431.49	10	253.0	0.003	315.9	0.54	371.3	0.60
45	68	431.49	426.65	10	360.0	0.013	315.9	0.36	371.3	0.39
68	70	426.65	421.81	10	360.0	0.013	315.9	0.36	371.3	0.39
70	21	421.81	416.97	10	360.0	0.013	315.9	0.36	371.3	0.39
21	20	416.97	414.62	10	335.3	0.007	462.9	0.54	555.1	0.60
20	19	414.54	405.73	10	314.4	0.028	490.9	0.37	590.1	0.41
19	18	405.65	391.2	10	348.2	0.042	490.9	0.34	590.1	0.37
18	4	391.12	381.46	10	321.9	0.030	490.9	0.37	590.1	0.41
4	3	380.99	379.59	15	284.6	0.005	545.9	0.35	658.8	0.39
3	2	379.57	377.59	15	400.0	0.005	545.9	0.35	658.8	0.39
2	1	377.57	375.59	15	400.0	0.005	559.9	0.36	676.3	0.40
1	25	375.46	365.92	12	162.0	0.060	575.9	0.26	696.3	0.29
25	24	365.92	365.13	15	131.3	0.006	704.9	0.38	857.6	0.43
24	23	365.13	363.53	15	320.5	0.005	704.9	0.40	857.6	0.45
23	22	363.53	361.1	15	347.2	0.007	704.9	0.37	857.6	0.41
22	31	361.1	357.86	15	462.9	0.007	704.9	0.37	857.6	0.41
31	32	357.86	357.45	21	135.1	0.003	738.9	0.30	900.1	0.33

NOTE: Improved diameters are shaded.



Figure 5
Alternative 2 Improvement

Table 6 - Alternative 2										
From ID	To ID	From Inv	To Inv	Diameter (in)	Length (ft)	Slope	PDWF (gpm)	d/D	PWWF (gpm)	d/D
40	41	449.77	447.33	8	145.6	0.017	307.9	0.46	361.3	0.51
41	42	447.16	445.07	8	266.8	0.008	307.9	0.58	361.3	0.65
42	43	444.9	441.18	8	307.8	0.012	307.9	0.51	361.3	0.56
43	44	441.02	437.69	8	246.8	0.013	307.9	0.49	361.3	0.54
44	11	437.69	428.08	8	282.2	0.034	307.9	0.38	361.3	0.42
11	10	428.08	416.64	8	220.0	0.052	307.9	0.34	361.3	0.37
10	55	416.64	404.93	8	225.1	0.052	307.9	0.34	361.3	0.37
55	9	404.74	398.24	8	406.0	0.016	328.9	0.49	387.6	0.54
9	8	398.15	394.94	8	311.8	0.010	328.9	0.56	387.6	0.62
8	7	394.94	390.15	10	462.7	0.010	328.9	0.39	387.6	0.43
7	14	390.03	387.08	10	462.3	0.006	328.9	0.45	387.6	0.50
14	54	386.98	384.33	10	417.7	0.006	341.9	0.46	403.8	0.51
54	4	384.23	381.47	10	435.4	0.006	164.5	0.31	403.8	0.51
4	3	380.99	379.59	15	284.6	0.005	545.9	0.35	658.8	0.39
3	2	379.57	377.59	15	400.0	0.005	545.9	0.35	658.8	0.39
2	1	377.57	375.59	15	400.0	0.005	559.9	0.36	676.3	0.40
1	25	375.46	365.92	12	158.0	0.060	575.9	0.26	696.3	0.29
25	24	365.92	365.13	15	131.3	0.006	704.9	0.38	857.6	0.43
24	23	365.13	363.53	15	320.5	0.005	704.9	0.40	857.6	0.45
23	22	363.53	361.1	15	347.2	0.007	704.9	0.37	857.6	0.41
22	31	361.1	357.86	15	462.9	0.007	704.9	0.37	857.6	0.41
31	32	357.86	357.45	21	135.1	0.003	738.9	0.30	900.1	0.33

NOTE: Proposed pipeline shaded.

to find an alternative sewage disposal solution. Note that flows from Bridge Energy were not included in the tributary pipeline system evaluated in this analysis.

- Project flows in this analysis are based on very conservative SMP loading factors that exceed State standards for indoor per capita water use. It is anticipated that actual Project flows will be less and conform with State regulations.

cc: Mike Swan, PSOMAS

APPENDIX A
Flow Monitoring Report

Birch St. Sewer Flow Study 2019
Brea, CA
Final Report
September 12, 2019 – October 01, 2019

Submitted to:
PSOMAS
October 14, 2019

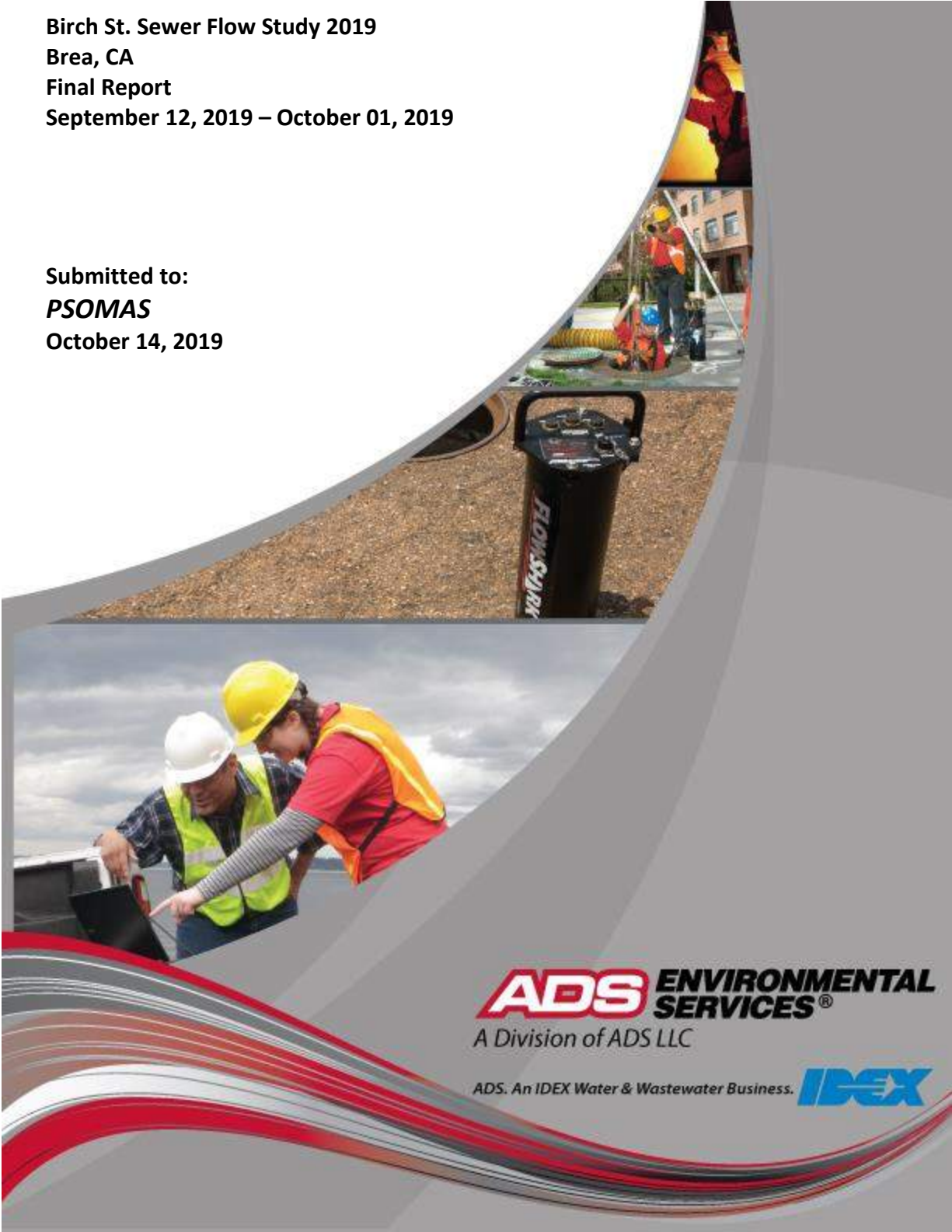

ADS ENVIRONMENTAL SERVICES®
A Division of ADS LLC

ADS. An IDEX Water & Wastewater Business. **IDEX**

Birch St. Sewer Flow Study 2019 Brea, CA

Prepared for:

Mike D. Swan, P.E. ENV SP
PSOMAS | Balancing the Natural and Built Environment
Senior Project Manager
Water & Wastewater Infrastructure
3 Hutton Centre Drive, Suite 200
Santa Ana, CA 92707
714.481.7979

Prepared by:

ADS, LLC
15201 Springdale Street
Huntington Beach, CA 92649



October 14, 2019

Mike D. Swan, P.E. ENV SP
PSOMAS / Balancing the Natural and Built Environment
Senior Project Manager
Water & Wastewater Infrastructure
3 Hutton Centre Drive, Suite 200
Santa Ana, CA 92707

SUBJECT: Birch St. Sewer Flow Study 2019 - Brea, CA

Dear Mike,

ADS is pleased to submit the report for the Birch St. Sewer Flow Study conducted on behalf of PSOMAS. The metering was contracted for fourteen (14) days at three(3) locations. Additional data days have been provided for each location. The study period is September 12, 2019 - October 01, 2019 .

The report contains 5-minute averaged depth, velocity, and quantity hydrographs as well as daily long tables for the metering period in pdf format. An Excel file containing depth, quantity, and velocity entities for the monitoring location in 5-minute format was previously provided.

In addition, we would be happy to further explain any details about the report that may seem unclear. Should you have any questions or comments, you may contact the Project Manager, Paul Mitchell at (714) 379-9778 ext 223.

It has been our pleasure to serve you in the performance of this project. Thank you for choosing ADS products and services to meet your flow monitoring needs.

Sincerely,
ADS ENVIRONMENTAL SERVICES

Latisha Bennett
Data Analyst III

Introduction

PSOMAS entered into an agreement with ADS Environmental Services to conduct flow monitoring at three (3) metering points in the Brea, CA Collection System. The study was contracted for a fourteen (14) day period. Several additional data days have been provided for all locations. The primary objective of the monitoring was to determine current flows for development planning purposes.

Project Scope

The scope of this study involved using flow monitors to quantify wastewater flows at the designated locations. Specifically, the study included the following key components.

- Investigate the proposed flow-monitoring sites for adequate hydraulic conditions.
- Flow monitor installations.
- Flow monitor confirmations and data collections.
- Flow data analysis.

Equipment installation was completed on September 11, 2019. The study period began on September 12, 2019 and was completed on October 01, 2019 .

Flow Monitoring Equipment



The **ADS FlowShark Triton** monitor was selected for this project. This flow monitor is an area velocity flow monitor that uses both the Continuity and Manning's equations to measure flow.

The ADS FlowShark Triton monitor consists of data acquisition sensors and a battery-powered microcomputer. The microcomputer includes a processor unit, data storage, and an on-board clock to control and synchronize the sensor recordings. The monitor was programmed to acquire and store depth of flow and velocity readings at 5-minute intervals.

The FS Triton monitor features cross-checking using multiple technologies in each sensor for continuous running of comparisons and tolerances. The FS Triton monitor can support two (2) sets of sensors. The sensor option used for this project was:

The Peak Combo Sensor installed at the bottom of the pipe includes three types of data acquisition technologies.

The **up looking ultrasonic depth** uses sound waves from two independent transceivers to measure the distance from the sensor upward toward the flow surface; applying the speed of sound in the water and the temperature measured by sensor to calculate depth.

The **pressure depth** is calculated by using a piezo-resistive crystal to determine the difference between hydrostatic and atmospheric pressure. The pressure sensor is temperature compensated and vented to the atmosphere through a desiccant filled breather tube.

To obtain **peak velocity**, the sensor sends an ultrasonic signal at an angle upward through the widest cross-section of the oncoming flow. The signal is reflected by suspended particles, air bubbles, or organic matter with a frequency shift proportional to the velocity of the reflecting objects. The reflected signal is received by the sensor and processed using digital spectrum analysis to determine the peak flow velocity.

Installation

Installation of flow monitoring equipment typically proceeds in four steps. First, the site is investigated for safety and to determine physical and hydraulic suitability for the flow monitoring equipment. Second, the equipment is physically installed at the selected location. Third, the monitor is tested to assure proper operation of the velocity and depth of flow sensors and verify that the monitor clock is operational and synchronized to the master computer clock. Fourth, the depth and velocity sensors are confirmed and line confirmations are performed.

In pipes up to 42 inches in diameter, the sensors were mounted on expandable stainless steel rings, inserted at least a foot upstream into influent pipes and tightened against the inside walls of the pipes. Influent pipe installations reduce the influences of turbulence and backwater often caused by changes in channel geometry in manholes.



Data Collection, Confirmation, and Quality Assurance

Data collection was done remotely via wireless connect on a weekly basis via ADS Representatives. During the monitoring period, field crews visit each monitoring location to verify proper monitor operation and document field conditions. The following quality assurance steps are taken to assure the integrity of the collected data:

Measure power supplies: monitors were powered by dry cell battery packs. Voltages were recorded and battery packs replaced, as necessary. Separate batteries provided back-up power to memory allowing primary batteries to be replaced without loss of data.

Clock synchronization: Field crews synchronized monitor clocks to master clocks.

Confirm depth and velocity readings: Field crews descended into meter manholes to manually measure depths and velocities and compare them meter readings to confirm that they agreed. They also measured silt levels, if any, in the inverts of the pipes. Silt areas were subtracted from flow areas to compute true areas of flow.

Confirm average velocities through cross-sectional velocity profiles: Since ADS velocity sensors measure peak velocity, field crews collected cross-sectional velocity profiles in order to develop a relationship between peak and average velocity in lines that meet the hydraulic criteria.

Upload and Review Data: Data collected from the monitors were uploaded and reviewed by a Data Analyst for completeness, outliers and deviations in the flow patterns, which indicate system anomalies or equipment failure.

Flow Quantification Methods

There are two main equations used to measure open channel flow: the **Continuity Equation** and the **Manning Equation**. The Continuity Equation, which is considered the most accurate, can be used if both depth of flow and velocity are available. In cases where velocity measurements are not available or not practical to obtain, the Manning Equation can be used to estimate velocity from the depth data based on certain physical characteristics of the pipe (i.e. the slope and roughness of the pipe being measured). However, the Manning equation assumes uniform, steady flow hydraulic conditions with non-varying roughness, which are typically invalid assumptions in most sanitary sewers. The Continuity Equation was used exclusively for this study.

Continuity Equation

The Continuity Equation states that the flow quantity (Q) is equal to the wetted area (A) multiplied by the average velocity (V) of the flow.

$$Q = A * V$$

This equation is applicable in a variety of conditions including backwater, surcharge, and reverse flow.

Data Analysis and Presentation

Data Analysis

A flow monitor is typically programmed to collect data at 5-minute intervals throughout the monitoring period. The monitor stores raw data consisting of (1) the ultrasonic depth, (2) the peak velocity and (3) the pressure depth. The data is imported into ADS's proprietary software and is examined by a data analyst to verify its integrity. The data analyst also reviews the daily field reports and site visit records to identify conditions that would affect the collected data.

Velocity profiles and the line confirmation data developed by the field personnel are reviewed by the data analyst to identify inconsistencies and verify data integrity. Velocity profiles are reviewed and an average to peak velocity ratio is calculated for the site. This ratio is used in converting the peak velocity measured by the sensor to the average velocity

used in the Continuity equation. The data analyst selects which depth sensor entity will be used to calculate the final depth information. Silt levels present at each site visit are reviewed and representative silt levels established.

Occasionally the velocity sensor's performance may be compromised resulting in invalid readings sporadically during the monitoring period. This is generally caused by excessive debris (silt) blocking the sensor's crystals, shallow flows ($\sim < 2''$) that may drop below the top of the sensor or very clear flows lacking the particles needed to measure rate. In order to use the Continuity equation to quantify the flow during these periods, a Data Analyst and/or Engineer will use the site's historical pipe curve (depth vs. velocity) data along with valid field confirmations to reconstitute and replace the false velocity recordings with expected velocity readings for a given historical depth along the curve.

Selections for the above parameters can be constant or can change during the monitoring period. While the data analysis process is described in a linear manner, it often requires an iterative approach to accurately complete.

Data Presentation

This type of flow monitoring project generates a large volume of data. To facilitate review of the data, results have been provided in graphical and tabular formats. The flow data is presented graphically in the form of scattergraphs and hydrographs. Hydrographs are based on 5-minute averaging. Tables are provided in daily average format. These tables show the flow rate for each day, along with the daily minimum and maximums, the times they were observed, the total daily flow, and total flow for the month (or monitoring period). The following explanation of terms may aid in interpretation of the tables and hydrographs.

DEPTH - Final calculated depth measurement (in inches)

QUANTITY - Final calculated flow rate (in MGD)

VELOCITY - Final calculated flow velocity (in feet per second)

REPORT TOTAL - Total volume of flow recorded for the indicated time period (in MG)

Site Commentary

Site Information

Birch01	
Pipe Dimensions	7.88
Silt Level	0.00"

Overview

Site Birch01 functioned under normal conditions during the period Thursday, September 12, 2019 to Tuesday, October 1, 2019 . No surcharge conditions were experienced at this location. This site does not exhibit a typical diurnal pattern indicating non residential contributors to this line. The ADS crew reported the presence of an oil and tar like substance in the flow. Review of the scattergraph shows that both free flow and backwater flow conditions were recorded during the study period.

Flow depth and velocity measurements recorded by the flow monitor are consistent with field confirmations conducted to date and support the relative accuracy of the flow monitor at this location. Line confirmations were made more difficult that normal due to the oil and tar like substance in the flow.

This location was installed upstream of site Range02. (See Range02 Site Commentary for More Details).

Observations

Average flow depth, velocity, and quantity data observed during Thursday, September 12, 2019 to Tuesday, October 1, 2019 , along with observed minimum and maximum data, are provided in the following table.

Observed Flow Conditions			
Item	Depth (in)	Velocity (ft/s)	Quantity (MGD)
Average	2.07	2.31	0.106
Minimum	1.45	1.58	0.045
Maximum	2.30	2.83	0.135
Time of Minimum	9/25/2019 12:35 AM	9/25/2019 12:15 AM	9/25/2019 12:35 AM
Time of Maximum	9/13/2019 9:00 AM	9/29/2019 3:50 PM	9/29/2019 3:50 PM

Data Quality

Data uptime observed during the Thursday, September 12, 2019 to the Tuesday, October 1, 2019 monitoring period is provided in the table below. Based upon the quality and consistency of the observed flow depth and velocity data, the Continuity equation was used to calculate flow rate and quantities during the monitoring period.

Percent Uptime	
Depth (in)	100
Velocity (ft/s)	100
Quantity (MGD)	100

Project Name: Brea Psomas TFM 2019		City: Brea		Agency: Brea		FM Initials: SK	
Site Name: Birch01		Install Date: 9/11/19		Monitor Type		Peak Doppler	
Address/Location: E Birch St & Voyager Ave				Monitor Model		Triton+	
				Data Acquisition		Manual Collect/Wireless	
				Manhole ID		Unknown	
Access: Drive	Type of System:	Sanitary <input checked="" type="checkbox"/>	Storm <input type="checkbox"/>	Combined <input type="checkbox"/>	Pipe Height:		7.88 "
					Pipe Width:		7.88 "

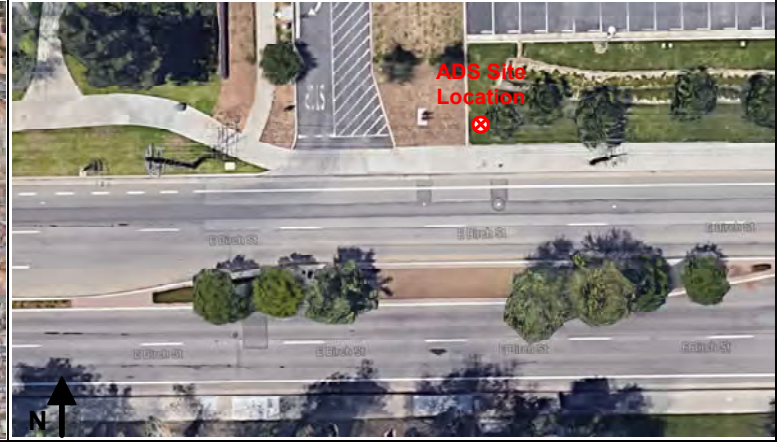

Investigation Information: Manhole Information:

Date/Time of Investigation:		9/5/19 @ 0450		Manhole Depth:		8'			
Site Hydraulics:		Good straight through flow.		Manhole Material / Condition		Precast/ Fair			
Upstream Input: (L/S, P/S)		DNI		Pipe Material / Condition: VCP/ Fair					
Upstream Manhole:		DNI		Land Use:		Residential <input checked="" type="checkbox"/>	Commercial <input type="checkbox"/>	Industrial <input type="checkbox"/>	Trunk <input type="checkbox"/>
Downstream Manhole:		DNI		Oxygen: 20.9		H2S: 0	LEL: 0	CO: 0	
Depth of Flow:	2.00 " +/-		Safety Notes: Very hot and oil based flow.						
Range (Air DOF):	+/-								
Peak Velocity:	1.49 fps								
Silt:	0 Inches								

Other Information:

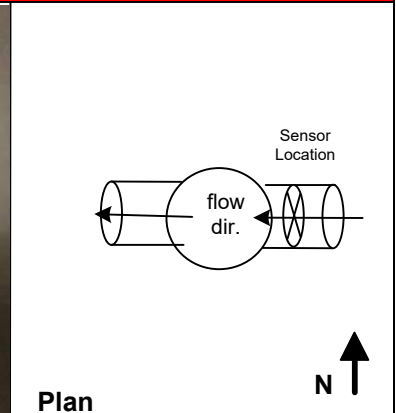
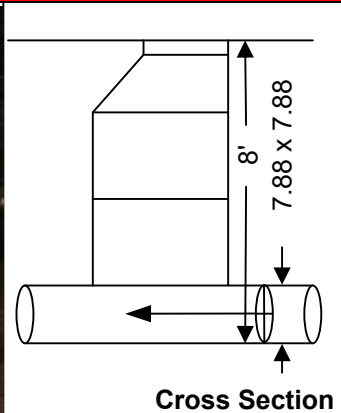

Installation Information		Backup	Yes	No	?	Distance
Installation Type:	Standard	Trunk	<input type="checkbox"/>	<input checked="" type="checkbox"/>	<input type="checkbox"/>	
Sensors Devices:	Ultrasonic / Pressure/Velocity	Lift / Pump Station	<input type="checkbox"/>	<input checked="" type="checkbox"/>	<input type="checkbox"/>	
Surcharge Height:	0	WWTP	<input type="checkbox"/>	<input checked="" type="checkbox"/>	<input type="checkbox"/>	
Rain Gauge Zone:		Other	<input type="checkbox"/>	<input checked="" type="checkbox"/>	<input type="checkbox"/>	

Additional Site Information / Comments:

SCATTERGRAPH REPORT

Birch01

Flow Monitor
Birch01

Pipe Height
7.88 in

Report Period
9/12/2019
To
10/1/2019

Legend
○ Depth - Velocity
--- Iso-Q™
--- Silt
▼ Min-Max Depth

ADS ENVIRONMENTAL SERVICES

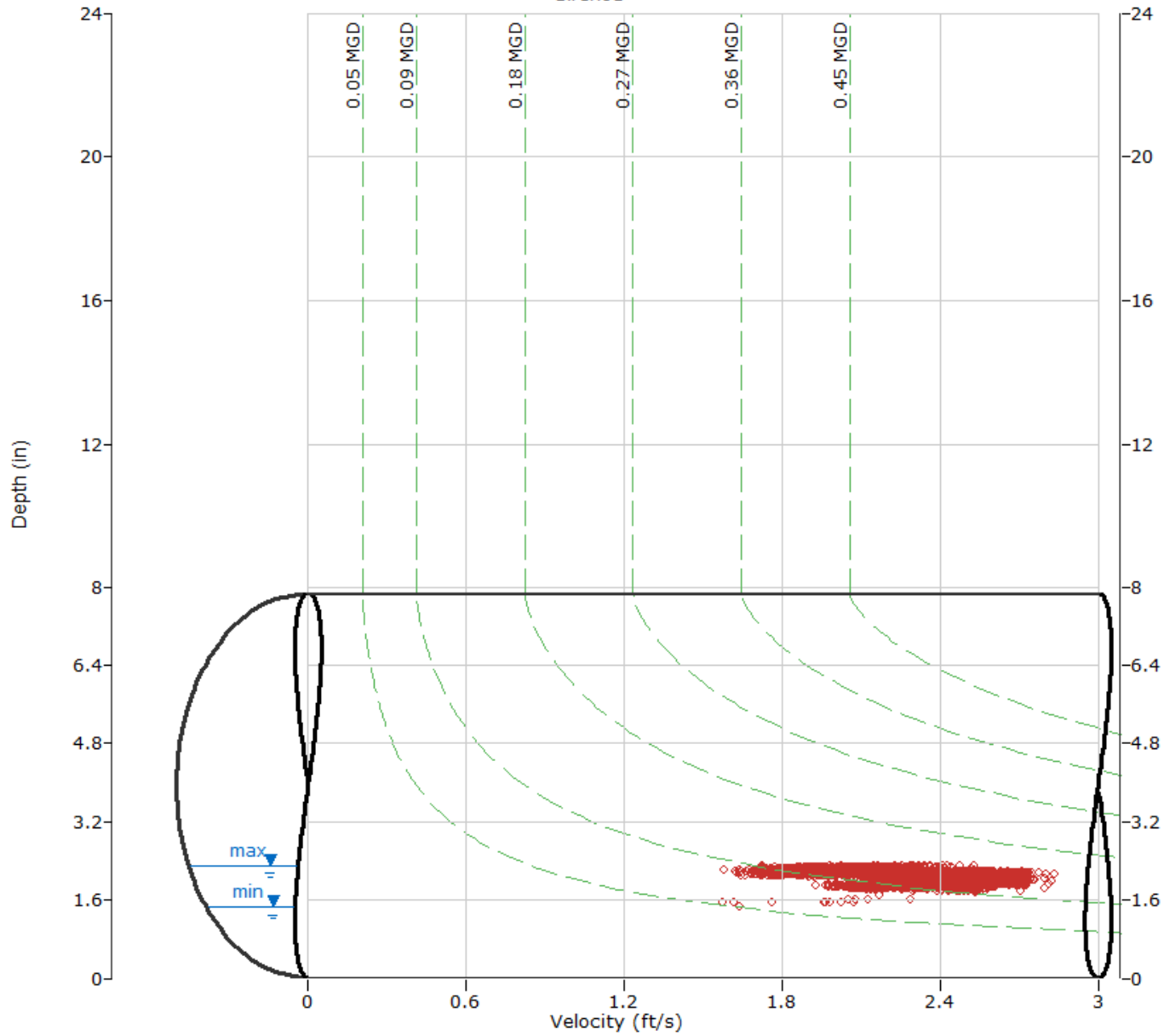

HYDROGRAPH REPORT

Birch01

Flow Monitor
Birch01

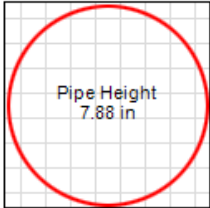

Report Period
9/12/2019
To
10/1/2019

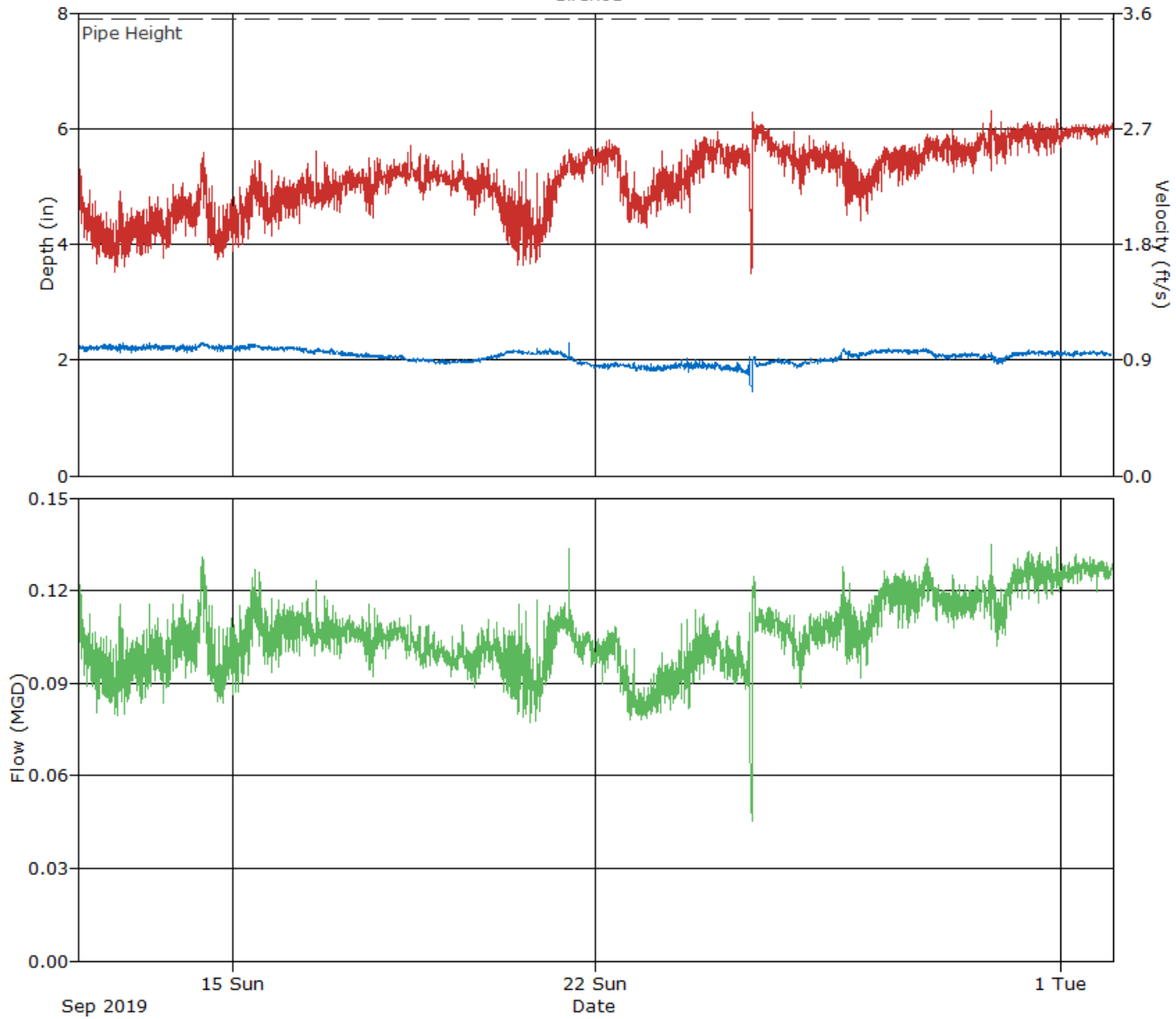

Daily Tabular Report For The Period 09/12/2019 00:00 - 10/01/2019 23:59

Birch01, Pipe Height: 7.88 in, Silt: 0.00 in

Daily Tabular Report

Date	Depth (in)					Velocity (ft/s)					Quantity (MGD - Total MG)					Rain (in)	
	Time	Min	Time	Max	Avg	Time	Min	Time	Max	Avg	Time	Min	Time	Max	Avg	Total	Total
09/12/2019	19:30	2.14	21:05	2.29	2.21	17:05	1.58	00:55	2.39	1.92	18:35	0.079	00:25	0.122	0.097	0.097	
09/13/2019	01:05	2.14	09:00	2.30	2.21	15:35	1.69	20:00	2.27	1.96	15:35	0.083	09:00	0.115	0.099	0.099	
09/14/2019	02:35	2.13	10:30	2.30	2.22	16:30	1.68	10:20	2.52	2.03	19:35	0.083	09:45	0.131	0.103	0.103	
09/15/2019	03:00	2.15	08:35	2.27	2.21	02:15	1.78	12:05	2.45	2.10	02:15	0.087	10:25	0.127	0.106	0.106	
09/16/2019	12:55	2.10	02:45	2.23	2.17	06:50	1.96	14:40	2.52	2.20	06:50	0.099	14:40	0.123	0.108	0.108	
09/17/2019	22:55	2.02	00:15	2.16	2.08	16:55	2.00	19:10	2.47	2.28	16:55	0.092	14:40	0.115	0.105	0.105	
09/18/2019	21:55	1.94	06:05	2.08	2.01	16:25	2.15	10:20	2.56	2.34	16:25	0.095	10:20	0.112	0.103	0.103	
09/19/2019	04:20	1.94	23:50	2.07	1.99	16:00	2.02	10:25	2.50	2.28	16:00	0.088	22:15	0.111	0.099	0.099	
09/20/2019	00:05	2.02	20:50	2.19	2.12	11:40	1.64	02:25	2.39	2.00	17:40	0.077	20:50	0.117	0.094	0.094	
09/21/2019	23:50	1.86	11:50	2.29	2.03	00:40	1.85	22:05	2.55	2.34	00:40	0.089	11:50	0.134	0.105	0.105	
09/22/2019	19:05	1.82	18:00	1.97	1.89	23:45	1.93	06:45	2.61	2.30	21:00	0.078	09:05	0.108	0.093	0.093	
09/23/2019	19:05	1.80	18:35	2.02	1.88	04:20	2.01	22:05	2.62	2.28	01:40	0.080	22:10	0.114	0.091	0.091	
09/24/2019	23:55	1.54	23:15	2.06	1.86	23:55	1.98	08:25	2.68	2.49	23:55	0.060	23:15	0.113	0.098	0.098	
09/25/2019	00:35	1.45	01:40	2.07	1.94	00:15	1.58	01:00	2.83	2.53	00:35	0.045	01:40	0.125	0.106	0.106	
09/26/2019	00:00	1.92	19:15	2.20	2.02	20:35	2.02	03:00	2.64	2.44	00:00	0.094	18:55	0.128	0.108	0.108	
09/27/2019	02:05	2.03	15:55	2.19	2.14	02:50	1.98	22:45	2.57	2.37	02:50	0.092	22:45	0.126	0.114	0.114	
09/28/2019	20:05	2.00	08:15	2.19	2.11	01:00	2.30	21:30	2.68	2.52	01:00	0.108	09:45	0.130	0.119	0.119	
09/29/2019	18:40	1.92	15:50	2.12	2.05	07:30	2.35	15:50	2.83	2.57	18:20	0.102	15:50	0.135	0.117	0.117	
09/30/2019	00:40	2.05	09:15	2.17	2.11	17:10	2.49	22:10	2.78	2.65	00:40	0.114	22:10	0.134	0.125	0.125	
10/01/2019	05:20	2.06	15:30	2.15	2.11	16:45	2.58	23:45	2.75	2.68	16:45	0.119	06:45	0.132	0.127	0.127	

Report Summary For The Period 09/12/2019 00:00 - 10/01/2019 23:59

	Depth (in)	Velocity (ft/s)	Quantity (MGD - Total MG)
Total			2.116
Avg	2.07	2.31	0.106

Site Commentary

Site Information

Range02	
Pipe Dimensions	10.13
Silt Level	0.00"

Overview

Site Range02 functioned under normal conditions during the period Thursday, September 12, 2019 to Tuesday, October 1, 2019 . No surcharge conditions were experienced at this location. The ADS crew reported the presence of an oil and tar like substance in this stretch of pipe. Review of the scattergraph shows that free flow conditions were maintained throughout the study period.

Flow depth and velocity measurements recorded by the flow monitor are consistent with field confirmations conducted to date and support the relative accuracy of the flow monitor at this location. Line confirmations were made more difficult that normal due to the oil and tar like substance in the flow.

This location was installed downstream of site Birch01. A check of balancing showed no problems.

Observations

Average flow depth, velocity, and quantity data observed during Thursday, September 12, 2019 to Tuesday, October 1, 2019 , along with observed minimum and maximum data, are provided in the following table.

Observed Flow Conditions			
Item	Depth (in)	Velocity (ft/s)	Quantity (MGD)
Average	1.89	5.18	0.241
Minimum	1.54	3.87	0.138
Maximum	2.34	6.27	0.390
Time of Minimum	9/13/2019 4:25 AM	9/14/2019 5:20 AM	9/19/2019 2:10 AM
Time of Maximum	9/26/2019 9:25 AM	9/17/2019 8:35 AM	9/26/2019 9:25 AM

Data Quality

Data uptime observed during the Thursday, September 12, 2019 to the Tuesday, October 1, 2019 monitoring period is provided in the table below. Based upon the quality and consistency of the observed flow depth and velocity data, the Continuity equation was used to calculate flow rate and quantities during the monitoring period.

Percent Uptime	
Depth (in)	100
Velocity (ft/s)	100
Quantity (MGD)	100

Project Name: Brea Psomas TFM 2019		City: Brea		Agency: Brea		FM Initials: SK	
Site Name: Range02		Install Date: 9/11/19		Monitor Type		Peak Doppler	
Address/Location: 199 Ranger St				Monitor Model		Triton+	
				Data Acquisition		Manual Collect/Wireless	
				Manhole ID		Unknown	
Access: Drive		Type of System:		Pipe Height:		10.13 "	
		Sanitary <input checked="" type="checkbox"/> Storm <input type="checkbox"/> Combined <input type="checkbox"/>		Pipe Width:		10.00 "	

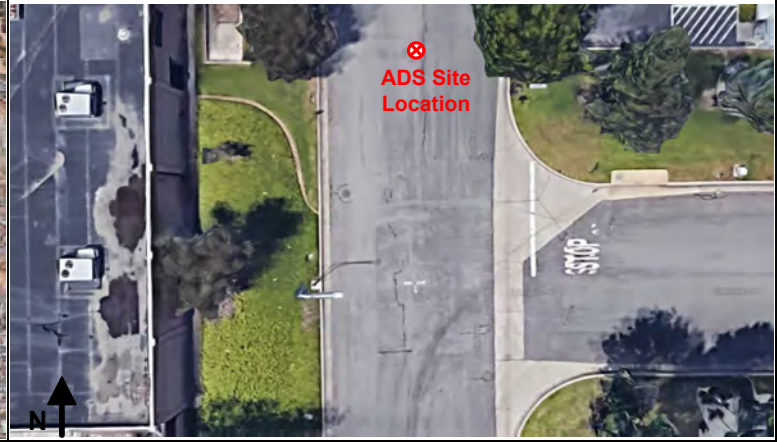

Investigation Information: Manhole Information:

Date/Time of Investigation: 9/5/19 @ 0600		Manhole Depth: 8'	
Site Hydraulics: Good straight through flow.		Manhole Material / Condition: Precast/ Fair	
Upstream Input: (L/S, P/S) DNI		Pipe Material / Condition: VCP/ Fair	
Upstream Manhole: DNI		Land Use: Residential <input type="checkbox"/> Commercial <input type="checkbox"/> Industrial <input checked="" type="checkbox"/> Trunk <input type="checkbox"/>	
Downstream Manhole: DNI		Oxygen: 20.9 H2S: 0 LEL: 0 CO: 0	
Depth of Flow:	2.25 " +/-	Safety Notes: Very hot and oil based flow.	
Range (Air DOF):	+/-		
Peak Velocity:	6.05 fps		
Silt:	0 Inches		

Other Information:

Cross Section

Plan

Installation Information		Backup		Yes	No	?	Distance
Installation Type:	Standard	Trunk		<input type="checkbox"/>	<input checked="" type="checkbox"/>	<input type="checkbox"/>	
Sensors Devices:	Ultrasonic / Pressure/Velocity	Lift / Pump Station		<input type="checkbox"/>	<input checked="" type="checkbox"/>	<input type="checkbox"/>	
Surcharge Height:	0	WWTP		<input type="checkbox"/>	<input checked="" type="checkbox"/>	<input type="checkbox"/>	
Rain Gauge Zone:		Other		<input type="checkbox"/>	<input checked="" type="checkbox"/>	<input type="checkbox"/>	

Additional Site Information / Comments:

SCATTERGRAPH REPORT

Range02

Flow Monitor
Range02

Pipe Height
10.13 in

Report Period
9/12/2019
To
10/1/2019

Legend
○ Depth - Velocity
--- Iso-Q™
--- Silt
▼ Min-Max Depth

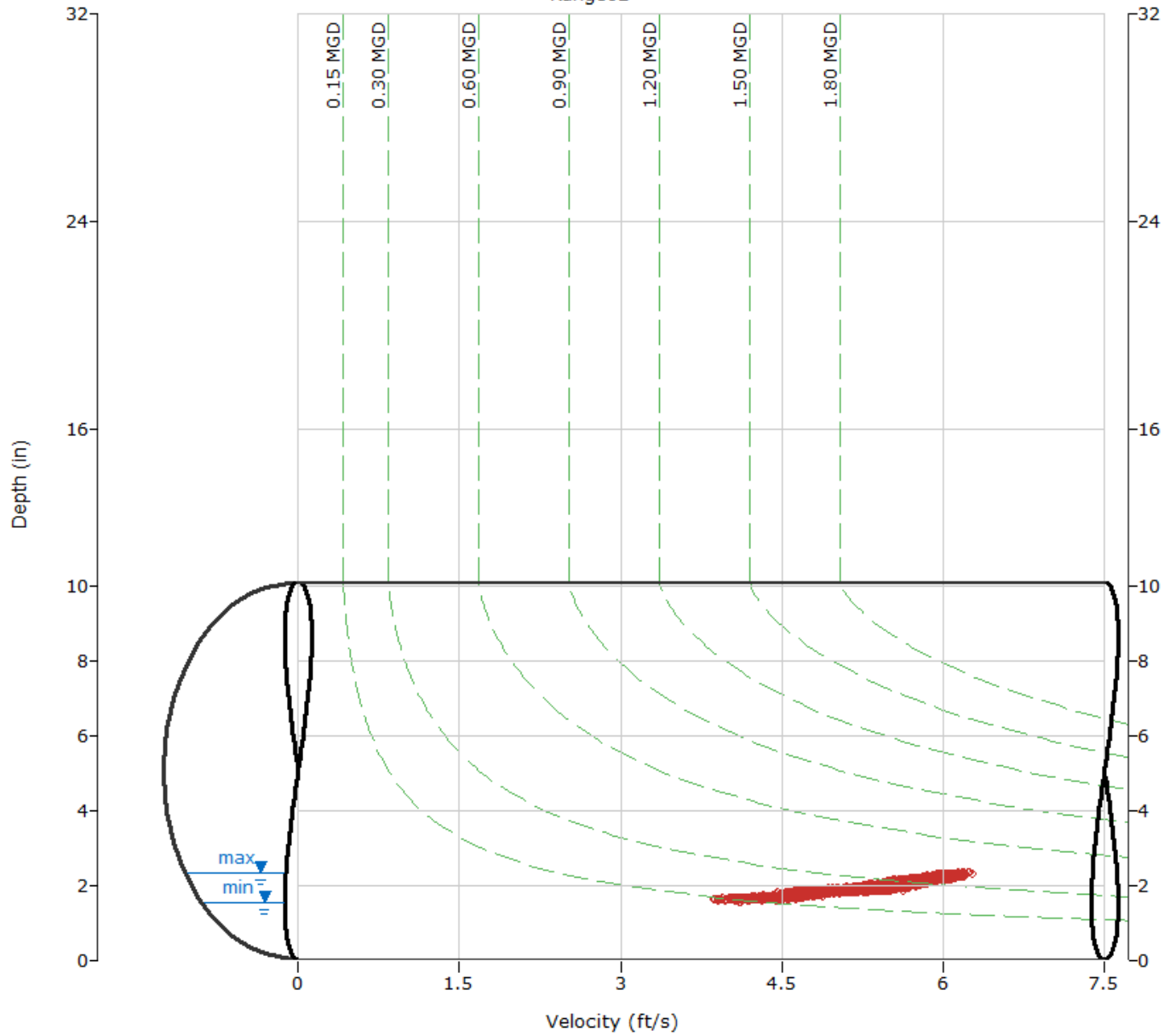

HYDROGRAPH REPORT

Range02

Flow Monitor
Range02

Pipe Height
10.13 in.

Report Period
9/12/2019
To
10/1/2019

Legend
— Depth
— Velocity
— Quantity
- - - Pipe Height

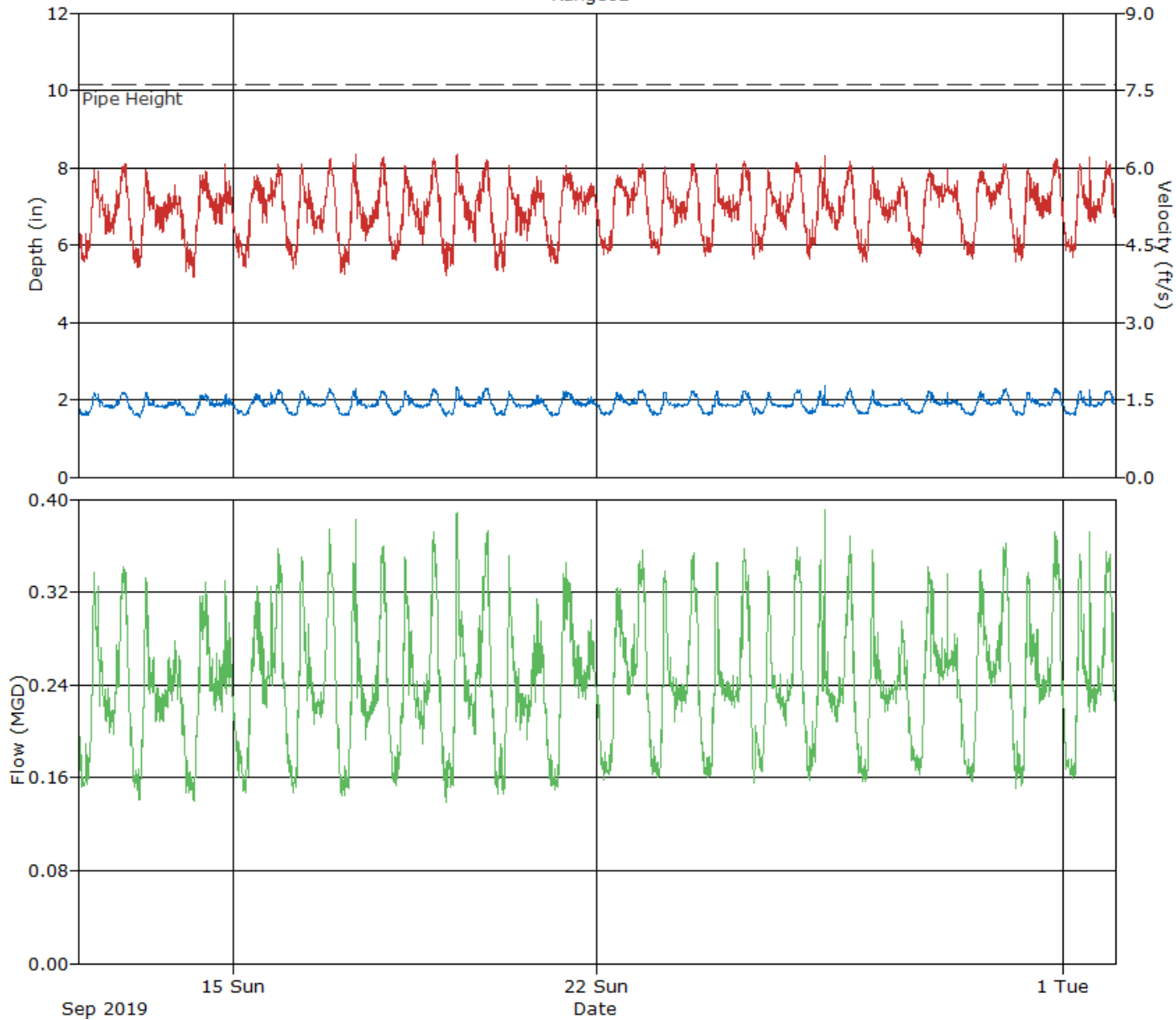

Daily Tabular Report For The Period 09/12/2019 00:00 - 10/01/2019 23:59

Range02, Pipe Height: 10.13 in, Silt: 0.00 in

Daily Tabular Report

Date	Depth (in)				Velocity (ft/s)				Quantity (MGD - Total MG)					Rain (in)			
	Time	Min	Time	Max	Avg	Time	Min	Time	Max	Avg	Time	Min	Time	Max	Avg	Total	Total
09/12/2019	01:55	1.59	21:05	2.19	1.88	02:45	4.18	21:55	6.08	5.13	01:55	0.152	21:10	0.342	0.237	0.237	
09/13/2019	04:25	1.54	07:25	2.18	1.84	03:35	4.06	07:20	5.97	5.05	04:25	0.141	07:25	0.332	0.225	0.225	
09/14/2019	05:40	1.59	10:45	2.15	1.86	05:20	3.87	19:50	6.08	5.10	05:40	0.139	19:50	0.330	0.233	0.233	
09/15/2019	04:35	1.59	20:45	2.25	1.90	05:30	4.06	20:45	6.06	5.20	05:30	0.147	20:45	0.357	0.244	0.244	
09/16/2019	03:15	1.60	20:25	2.30	1.91	03:25	4.03	20:55	6.18	5.14	03:25	0.147	20:25	0.374	0.243	0.243	
09/17/2019	04:25	1.60	08:35	2.30	1.88	03:20	3.93	08:35	6.27	5.08	02:10	0.145	08:35	0.383	0.237	0.237	
09/18/2019	02:00	1.61	20:35	2.28	1.90	03:30	4.19	20:55	6.18	5.17	03:30	0.153	20:20	0.372	0.243	0.243	
09/19/2019	02:10	1.58	07:10	2.33	1.91	02:10	3.91	07:15	6.24	5.17	02:10	0.138	07:15	0.388	0.247	0.247	
09/20/2019	02:30	1.61	07:30	2.22	1.86	04:50	3.99	07:25	6.05	5.05	04:50	0.146	07:30	0.351	0.229	0.229	
09/21/2019	03:40	1.58	08:50	2.20	1.88	04:35	4.15	10:00	6.04	5.20	04:35	0.149	10:00	0.345	0.241	0.241	
09/22/2019	05:50	1.61	21:15	2.24	1.91	03:25	4.30	21:15	6.08	5.28	03:25	0.158	21:15	0.357	0.250	0.250	
09/23/2019	02:10	1.60	20:50	2.23	1.88	04:40	4.30	19:55	6.07	5.22	04:40	0.161	20:50	0.354	0.242	0.242	
09/24/2019	03:25	1.61	20:30	2.23	1.88	02:05	4.30	20:35	6.13	5.22	03:20	0.161	20:30	0.358	0.241	0.241	
09/25/2019	01:05	1.61	20:35	2.25	1.88	00:30	4.22	20:40	6.09	5.23	01:05	0.156	20:35	0.359	0.242	0.242	
09/26/2019	02:20	1.63	09:25	2.34	1.89	02:20	4.24	09:25	6.24	5.21	02:20	0.158	09:25	0.390	0.243	0.243	
09/27/2019	04:10	1.62	07:45	2.26	1.85	03:10	4.17	07:20	6.01	5.15	04:15	0.157	07:45	0.357	0.232	0.232	
09/28/2019	03:40	1.64	09:35	2.22	1.88	05:25	4.27	18:35	5.96	5.27	05:25	0.162	09:35	0.341	0.243	0.243	
09/29/2019	05:10	1.62	21:10	2.27	1.91	05:40	4.23	21:30	6.08	5.30	05:40	0.156	21:30	0.362	0.251	0.251	
09/30/2019	02:05	1.59	20:10	2.30	1.91	02:00	4.18	20:35	6.18	5.27	02:05	0.151	20:10	0.372	0.250	0.250	
10/01/2019	05:10	1.61	12:15	2.27	1.90	04:15	4.26	12:15	6.21	5.24	04:15	0.159	12:15	0.371	0.246	0.246	

Report Summary For The Period 09/12/2019 00:00 - 10/01/2019 23:59

	Depth (in)	Velocity (ft/s)	Quantity (MGD - Total MG)
Total			4.820
Avg	1.89	5.18	0.241

Site Commentary

Site Information

Kraem03	
Pipe Dimensions	15.13
Silt Level	0.00"

Overview

Site Kraem03 functioned under normal conditions during the period Thursday, September 12, 2019 to Tuesday, October 1, 2019 . No surcharge conditions were experienced at this location. The ADS crew reported the presence of an oil and tar like substance in this stretch of pipe. Review of the scattergraph shows that free flow conditions were maintained throughout the study period.

Flow depth and velocity measurements recorded by the flow monitor are consistent with field confirmations conducted to date and support the relative accuracy of the flow monitor at this location. Line confirmations were made more difficult that normal due to the oil and tar like substance in the flow.

This location was installed downstream of site Range02. A check of balancing showed no problems.

Observations

Average flow depth, velocity, and quantity data observed during Thursday, September 12, 2019 to Tuesday, October 1, 2019 , along with observed minimum and maximum data, are provided in the following table.

Observed Flow Conditions			
Item	Depth (in)	Velocity (ft/s)	Quantity (MGD)
Average	2.64	3.80	0.370
Minimum	2.01	2.92	0.191
Maximum	3.70	4.31	0.649
Time of Minimum	9/21/2019 4:20 AM	9/15/2019 5:50 AM	9/15/2019 5:50 AM
Time of Maximum	9/26/2019 9:55 AM	10/1/2019 10:55 AM	9/26/2019 9:55 AM

Data Quality

Data uptime observed during the Thursday, September 12, 2019 to the Tuesday, October 1, 2019 monitoring period is provided in the table below. Based upon the quality and consistency of the observed flow depth and velocity data, the Continuity equation was used to calculate flow rate and quantities during the monitoring period.

Percent Uptime	
Depth (in)	100
Velocity (ft/s)	100
Quantity (MGD)	100

Project Name: Brea Psomas TFM 2019		City: Brea		Agency: Brea		FM Initials: SK	
Site Name: Kraem03		Install Date: 9/11/19		Monitor Type		Peak Doppler	
Address/Location: 418 Kraemer Blvd				Monitor Model		Triton+	
				Data Acquisition		Manual Collect/Wireless	
				Manhole ID		Unknown	
Access: Drive	Type of System:	Sanitary <input checked="" type="checkbox"/>	Storm <input type="checkbox"/>	Combined <input type="checkbox"/>	Pipe Height:		15.13 "
					Pipe Width:		15.25 "



Investigation Information: Manhole Information:

Date/Time of Investigation:		9/5/19 @ 0400		Manhole Depth:		12'			
Site Hydraulics:		Good straight through flow.		Manhole Material / Condition		Precast/ Fair			
Upstream Input: (L/S, P/S)		DNI		Pipe Material / Condition: VCP/ Fair					
Upstream Manhole:		DNI		Land Use:		Residential <input type="checkbox"/>	Commercial <input checked="" type="checkbox"/>	Industrial <input type="checkbox"/>	Trunk <input type="checkbox"/>
Downstream Manhole:		DNI		Oxygen: 20.9		H2S: 0	LEL: 0	CO: 0	
Depth of Flow:	1.75 " +/-		Safety Notes: Very hot and oil based flow.						
Range (Air DOF):	+/-								
Peak Velocity:	3.24 fps								
Silt:	0 Inches								

Other Information:

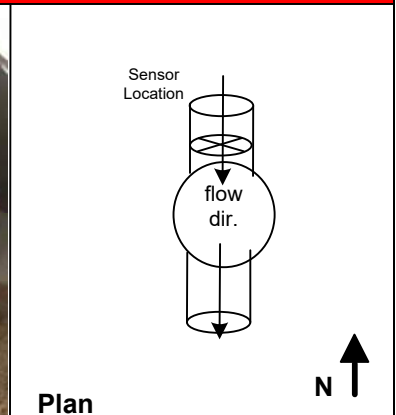
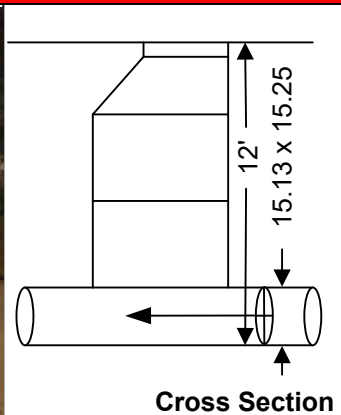

Installation Information		Backup	Yes	No	?	Distance
Installation Type:	Standard	Trunk	<input type="checkbox"/>	<input checked="" type="checkbox"/>	<input type="checkbox"/>	
Sensors Devices:	Ultrasonic / Pressure/Velocity	Lift / Pump Station	<input type="checkbox"/>	<input checked="" type="checkbox"/>	<input type="checkbox"/>	
Surcharge Height:	0	WWTP	<input type="checkbox"/>	<input checked="" type="checkbox"/>	<input type="checkbox"/>	
Rain Gauge Zone:		Other	<input type="checkbox"/>	<input checked="" type="checkbox"/>	<input type="checkbox"/>	

Additional Site Information / Comments:

SCATTERGRAPH REPORT

Kraem03

Flow Monitor
Kraem03

Pipe Height
15.13 in

Report Period
9/12/2019
To
10/1/2019

Legend

- Depth - Velocity
- - - Iso-Q™
- - - Silt
- ▼ Min-Max Depth

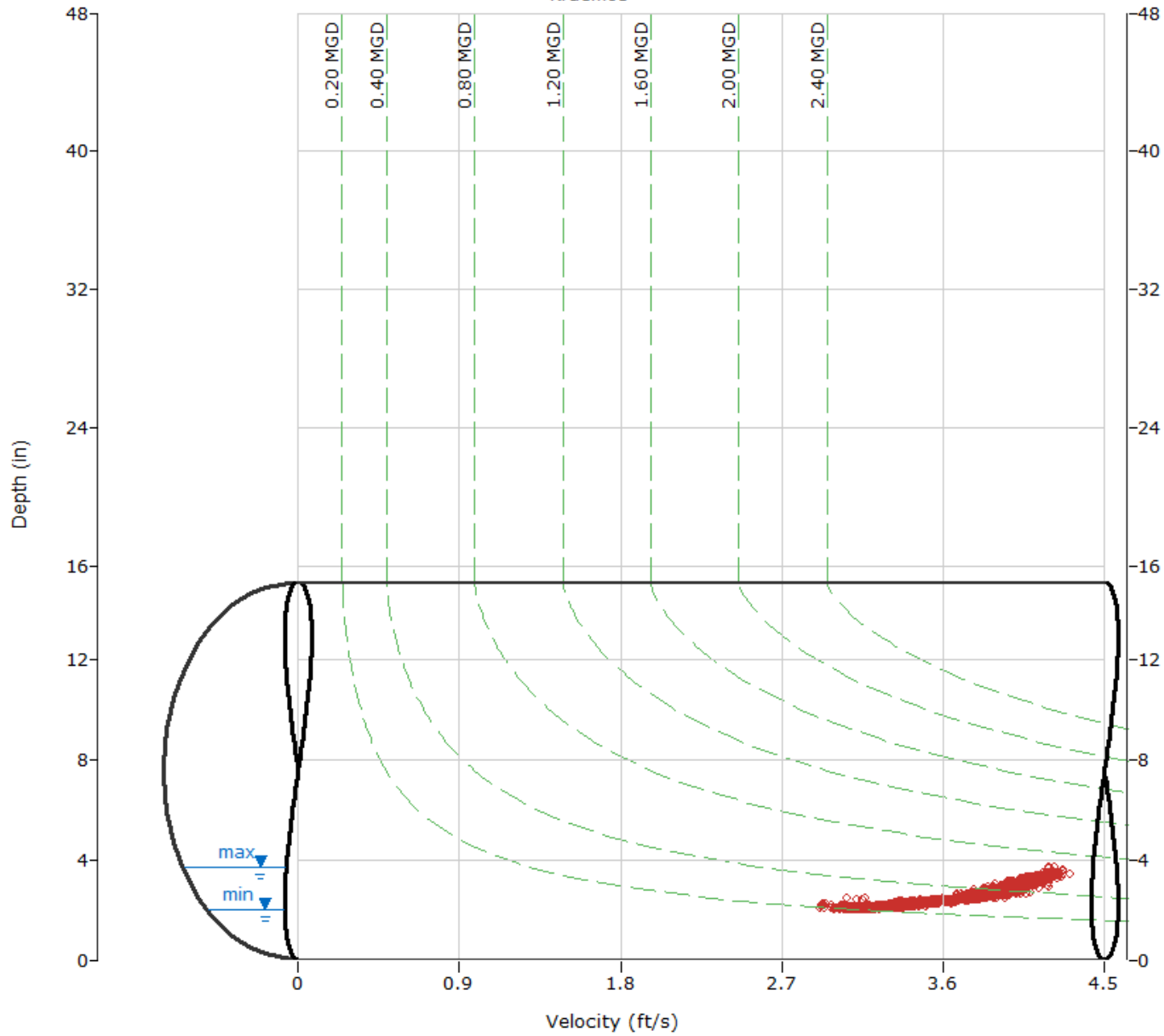

HYDROGRAPH REPORT

Kraem03

Flow Monitor
Kraem03

Pipe Height
15.13 in

Report Period
9/12/2019
To
10/1/2019

Legend

- Depth
- Velocity
- Quantity
- - - Pipe Height

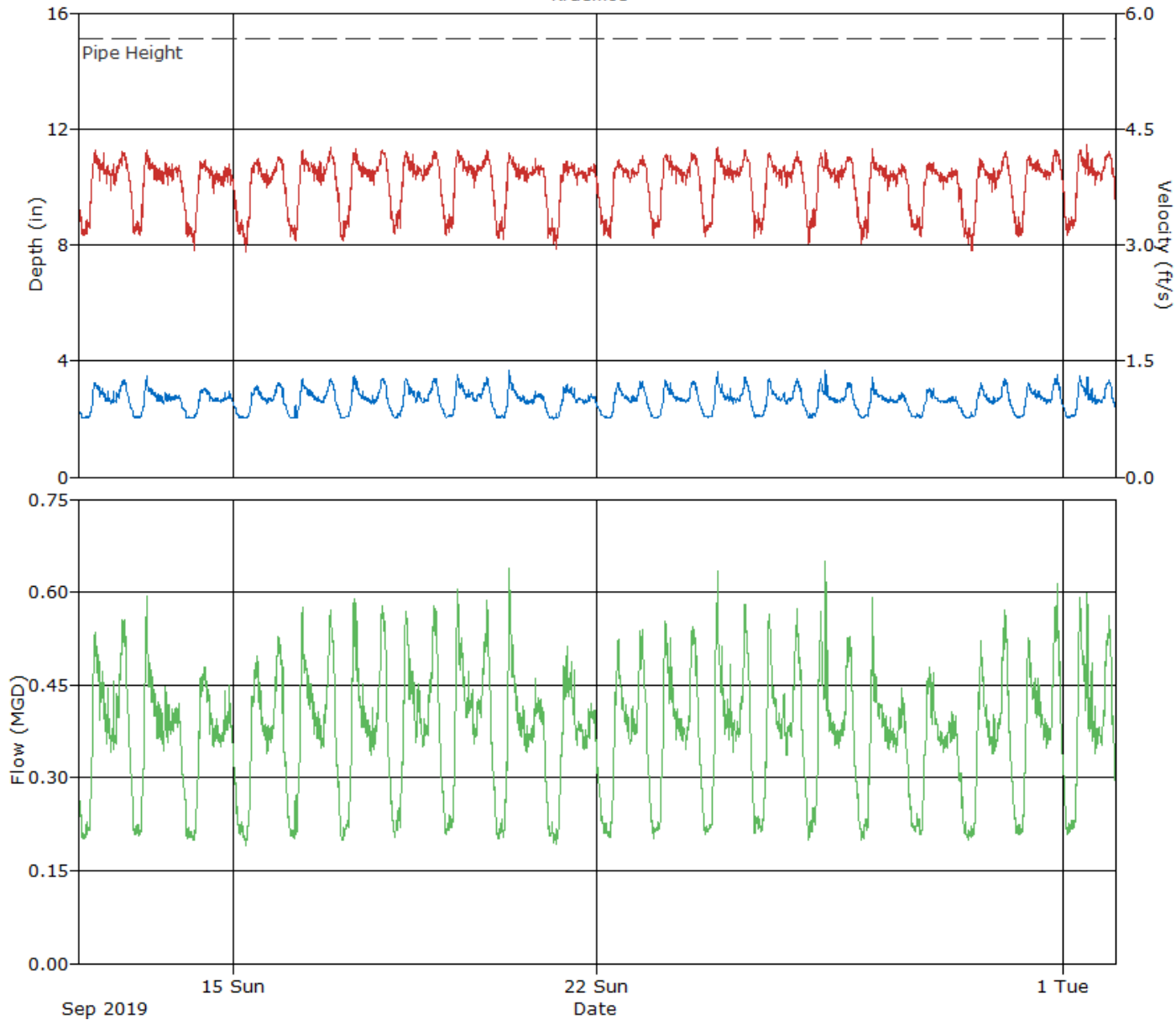

Daily Tabular Report For The Period 09/12/2019 00:00 - 10/01/2019 23:59

Kraem03, Pipe Height: 15.13 in, Silt: 0.00 in

Daily Tabular Report

Date	Depth (in)				Velocity (ft/s)				Quantity (MGD - Total MG)					Rain (in)			
	Time	Min	Time	Max	Avg	Time	Min	Time	Max	Avg	Time	Min	Time	Max	Avg	Total	Total
09/12/2019	02:50	2.02	21:20	3.33	2.68	03:10	3.13	08:00	4.23	3.82	02:30	0.202	21:20	0.555	0.380	0.380	
09/13/2019	02:30	2.04	07:35	3.47	2.63	04:40	3.13	07:40	4.22	3.80	03:50	0.207	07:35	0.593	0.366	0.366	
09/14/2019	05:00	2.02	10:25	3.05	2.56	05:45	2.92	10:55	4.10	3.73	05:15	0.199	10:25	0.478	0.347	0.347	
09/15/2019	04:50	2.03	20:30	3.25	2.61	05:50	2.92	20:55	4.14	3.73	05:50	0.191	20:40	0.527	0.358	0.358	
09/16/2019	03:15	2.02	07:45	3.39	2.69	04:45	3.06	20:45	4.26	3.82	04:00	0.202	07:45	0.576	0.383	0.383	
09/17/2019	02:30	2.03	07:35	3.47	2.68	03:00	3.05	08:45	4.25	3.83	02:25	0.200	07:35	0.589	0.382	0.382	
09/18/2019	02:45	2.03	20:45	3.40	2.72	02:45	3.15	07:50	4.22	3.85	02:45	0.204	20:45	0.577	0.390	0.390	
09/19/2019	02:15	2.05	07:40	3.52	2.73	02:25	3.12	07:35	4.23	3.85	02:10	0.207	07:40	0.604	0.394	0.394	
09/20/2019	02:40	2.04	07:35	3.67	2.62	05:00	3.07	07:40	4.19	3.80	02:35	0.202	07:35	0.638	0.365	0.365	
09/21/2019	04:20	2.01	10:10	3.19	2.56	05:05	2.94	10:10	4.09	3.74	05:05	0.192	10:10	0.512	0.348	0.348	
09/22/2019	05:55	2.04	20:05	3.30	2.63	06:30	3.09	21:30	4.15	3.78	05:40	0.204	21:25	0.540	0.364	0.364	
09/23/2019	02:25	2.03	07:45	3.33	2.67	02:15	3.08	20:00	4.18	3.83	02:15	0.202	07:45	0.553	0.379	0.379	
09/24/2019	03:50	2.06	07:55	3.61	2.69	02:15	3.10	08:00	4.27	3.83	02:15	0.208	07:55	0.634	0.382	0.382	
09/25/2019	01:10	2.06	20:45	3.40	2.67	00:45	3.09	20:35	4.20	3.82	01:15	0.211	20:45	0.573	0.378	0.378	
09/26/2019	02:15	2.04	09:55	3.70	2.67	02:10	3.02	09:55	4.22	3.82	02:15	0.200	09:55	0.649	0.376	0.376	
09/27/2019	03:25	2.02	07:35	3.45	2.59	02:30	3.01	07:35	4.24	3.78	02:30	0.200	07:35	0.591	0.355	0.355	
09/28/2019	05:40	2.06	09:45	3.07	2.52	06:20	3.10	10:00	4.07	3.73	06:20	0.207	09:45	0.478	0.337	0.337	
09/29/2019	03:40	2.04	20:40	3.40	2.60	05:20	2.92	21:15	4.21	3.73	03:55	0.199	20:40	0.572	0.355	0.355	
09/30/2019	02:35	2.05	21:10	3.55	2.68	03:00	3.10	20:20	4.23	3.83	03:40	0.207	21:10	0.613	0.382	0.382	
10/01/2019	03:05	2.06	07:30	3.48	2.68	02:00	3.13	10:55	4.31	3.83	02:05	0.208	10:55	0.598	0.382	0.382	

Report Summary For The Period 09/12/2019 00:00 - 10/01/2019 23:59

	Depth (in)	Velocity (ft/s)	Quantity (MGD - Total MG)
Total			7.400
Avg	2.64	3.80	0.370

APPENDIX B

2018 Average Metered Water Use

2018 AVERAGE WATER USE BY RESIDENTIAL DEVELOPMENT

Development	Land Use	DU's	Average Density (du/ac)	Average Use (gpd/du)
Olinda Ranch	VLDR	63	1.5	762
PA 6 Blackstone	LDR	93	2.8	407
PA 5 Blackstone	LDR	100	4.0	352
PA 8 La Floresta	Z Lot Line SFD	77	6.0	218
PA 3 Blackstone	SFD Cluster	261	6.5	145
PA 3 La Floresta	SFD Cluster	89	8.5	144
PA 7 La Floresta	Townhomes		15.0	122

APPENDIX C

Sewer Model Output

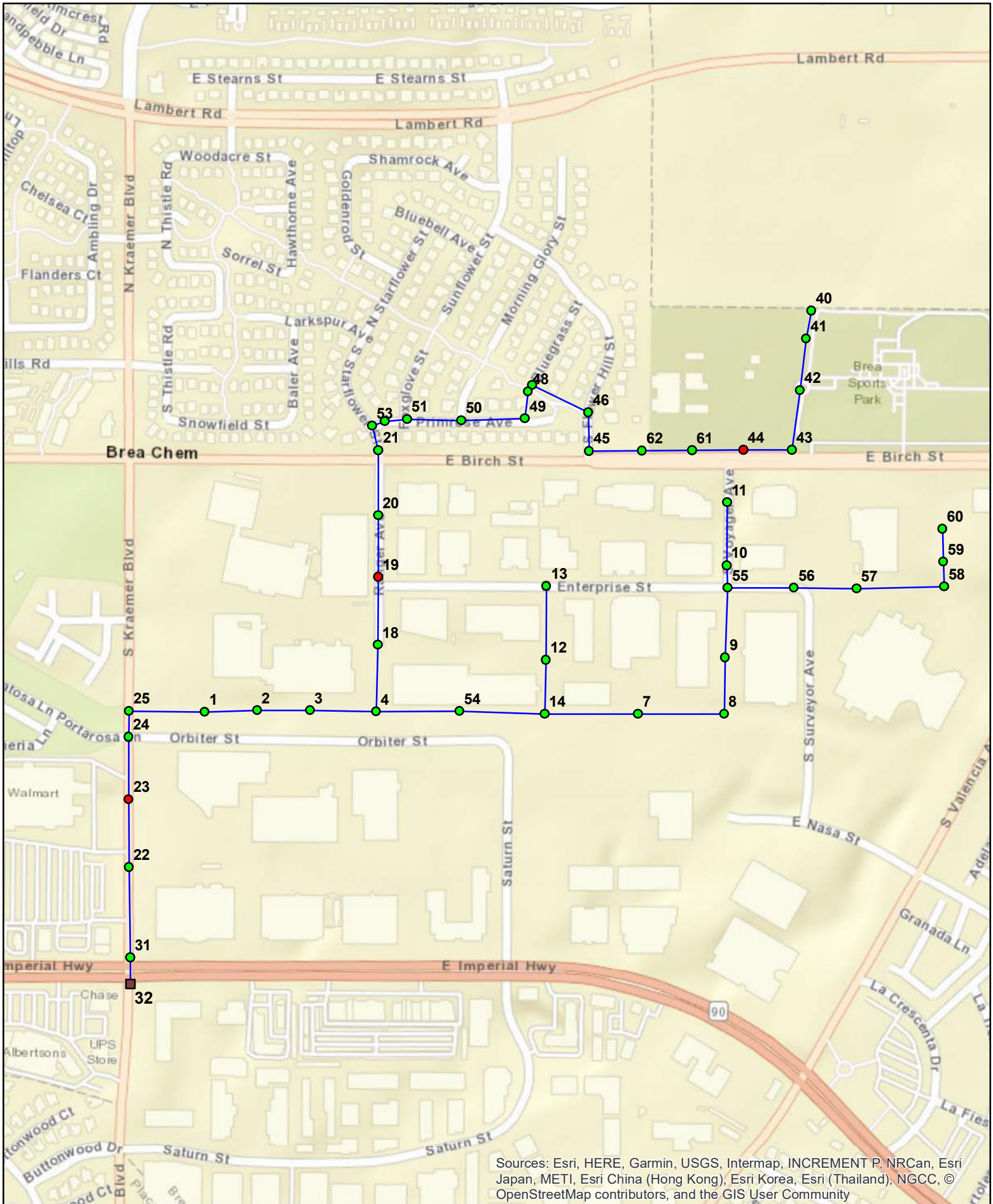

Sources: Esri, HERE, Garmin, USGS, Intermap, INCREMENT P, NRCan, Esri Japan, METI, Esri China (Hong Kong), Esri Korea, Esri (Thailand), NGCC, © OpenStreetMap contributors, and the GIS User Community

Flow Model Output - Existing and Existing plus Project														
From ID	To ID	From Inv	To Inv	Diameter (in)	Length (ft)	Slope	Existing				Existing plus Project			
							PDWF	d/D	PWWF	d/D	PDWF	d/D	PWWF	d/D
40	41	449.8	447.3	8	145.6	0.017	94.0	0.25	94.0	0.25	307.9	0.46	361.3	0.51
41	42	447.2	445.1	8	266.8	0.008	94.0	0.30	94.0	0.30	307.9	0.58	361.3	0.65
42	43	444.9	441.2	8	307.8	0.012	94.0	0.27	94.0	0.27	307.9	0.51	361.3	0.56
43	44	441.0	437.7	8	246.8	0.013	94.0	0.26	94.0	0.26	307.9	0.49	361.3	0.54
44	61	437.7	436.5	8	240.0	0.005	94.0	0.34	94.0	0.34	307.9	0.68	361.3	0.77
61	62	436.3	434.9	8	295.0	0.005	102.0	0.35	104.0	0.36	315.9	0.69	371.3	0.79
62	45	432.3	431.5	8	253.0	0.003	102.0	0.40	104.0	0.40	315.9	1.00	371.3	1.00
45	46	431.5	430.9	8	197.1	0.003	102.0	0.41	104.0	0.41	315.9	1.00	371.3	1.00
46	47	430.6	429.6	8	320.0	0.003	127.0	0.45	135.3	0.46	340.9	1.00	402.6	1.00
47	48	429.5	429.1	8	39.0	0.011	127.0	0.32	135.3	0.33	340.9	0.56	402.6	0.62
48	49	428.9	428.2	8	139.8	0.005	127.0	0.39	135.3	0.41	340.9	0.73	402.6	1.00
49	50	428.0	426.0	8	325.3	0.006	138.0	0.39	149.0	0.40	351.9	0.68	416.3	0.79
50	51	425.9	418.7	8	277.8	0.026	138.0	0.27	149.0	0.28	351.9	0.44	416.3	0.49
51	52	418.4	418.0	10	115.2	0.004	223.0	0.42	255.3	0.45	436.9	0.62	522.6	0.71
52	53	417.9	417.6	10	68.6	0.005	223.0	0.39	255.3	0.42	436.9	0.58	522.6	0.66
53	21	417.5	417.0	10	129.3	0.004	249.0	0.45	287.8	0.49	462.9	0.65	555.1	0.75
21	20	417.0	414.6	10	335.3	0.007	249.0	0.38	287.8	0.41	462.9	0.54	555.1	0.60
20	19	414.5	405.7	10	314.4	0.028	277.0	0.28	322.8	0.30	490.9	0.37	590.1	0.41
19	18	405.7	391.2	10	348.2	0.042	277.0	0.25	322.8	0.27	490.9	0.34	590.1	0.37
18	4	391.1	381.5	10	321.9	0.030	277.0	0.27	322.8	0.30	490.9	0.37	590.1	0.41
4	3	381.0	379.6	15	284.6	0.005	332.0	0.27	391.5	0.30	545.9	0.35	658.8	0.39
3	2	379.6	377.6	15	400.0	0.005	332.0	0.27	391.5	0.30	545.9	0.35	658.8	0.39
2	1	377.6	375.6	15	400.0	0.005	346.0	0.28	409.0	0.31	559.9	0.36	676.3	0.40
1	25	375.5	365.9	12	162.0	0.060	362.0	0.21	429.0	0.23	575.9	0.26	696.3	0.29
25	24	365.9	365.1	15	131.3	0.006	491.0	0.32	590.3	0.36	704.9	0.39	857.6	0.44
24	23	365.1	363.5	15	320.5	0.005	491.0	0.33	590.3	0.37	704.9	0.40	857.6	0.45
23	22	363.5	361.1	15	347.2	0.007	491.0	0.31	590.3	0.34	704.9	0.38	857.6	0.42
22	31	361.1	357.9	15	462.9	0.007	491.0	0.31	590.3	0.34	704.9	0.37	857.6	0.41
31	32	357.9	357.5	21	135.1	0.003	525.0	0.25	632.8	0.28	738.9	0.30	900.1	0.33

NOTE: Deficient reaches are shaded.