

GEOTECHNICAL INVESTIGATION

**U STOR IT – TORREY PINES
11391 SORRENTO VALLEY ROAD
SAN DIEGO, CALIFORNIA**



GEOCON
INCORPORATED

GEOTECHNICAL
ENVIRONMENTAL
MATERIALS

PREPARED FOR

**CHICAGO CAPITAL FUNDS, LLC
SAN DIEGO, CALIFORNIA**

**MARCH 8, 2022
PROJECT NO. G2740-52-01**



Project No. G2740-52-01
March 8, 2022

Chicago Capital Funds, LLC
501 W. Broadway STE 2020
San Diego, California 92101

Attention: Mr. Larry Nora

Subject: GEOTECHNICAL INVESTIGATION
U STOR IT – TORREY PINES
11391 SORRENTO VALLEY ROAD
SAN DIEGO, CALIFORNIA

Dear Mr. Nora:

In accordance with your request and authorization of our Proposal No. LG-21239 dated May 11, 2021, we herein submit the results of our geotechnical investigation for the subject project. We performed our investigation to evaluate the underlying soil and geologic conditions and potential geologic hazards, and to assist in the design of the proposed building and associated improvements.

The accompanying report presents the results of our study and conclusions and recommendations pertaining to geotechnical aspects of the proposed project. The site is suitable for the proposed buildings and improvements provided the recommendations of this report are incorporated into the design and construction of the planned project.

Should you have questions regarding this report, or if we may be of further service, please contact the undersigned at your convenience.

Very truly yours,

GEOCON INCORPORATED

Matt Love
RCE 84154

ML:SFW:JH:arm

(e-mail) Addressee

Shawn Foy Weedon
GE 2714

John Hoops
CEG 1524

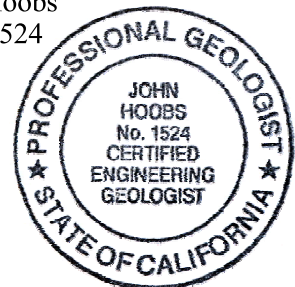

TABLE OF CONTENTS

1.	PURPOSE AND SCOPE	1
2.	SITE AND PROJECT DESCRIPTION.....	2
3.	GEOLOGIC SETTING.....	3
4.	SOIL AND GEOLOGIC CONDITIONS	4
4.1	Undocumented Fill (Qudf)	4
4.2	Old Paralic Deposits (Qop).....	4
4.3	Torrey Sandstone (Tt).....	5
5.	GROUNDWATER	5
6.	GEOLOGIC HAZARDS	5
6.1	Geologic Hazard Category	5
6.2	Regional Faulting and Seismicity.....	6
6.3	Ground Rupture	8
6.4	Liquefaction.....	8
6.5	Hydrocollapse.....	8
6.6	Storm Surge, Tsunamis, and Seiches.....	8
6.7	Landslides.....	9
6.8	Erosion.....	9
7.	CONCLUSIONS AND RECOMMENDATIONS.....	10
7.1	General.....	10
7.2	Excavation and Soil Characteristics	11
7.3	Grading	12
7.4	Excavation Slopes, Shoring and Tiebacks.....	14
7.5	Seismic Design Criteria – 2019 California Building Code.....	20
7.6	Shallow Foundations	21
7.7	Concrete Slabs-On-Grade.....	23
7.8	Exterior Concrete Flatwork	24
7.9	Retaining Walls	25
7.10	Lateral Loading.....	29
7.11	Preliminary Pavement Recommendations	29
7.12	Site Drainage and Moisture Protection.....	32
7.13	Grading and Foundation Plan Review	33
7.14	Testing and Observation Services During Construction.....	33

LIMITATIONS AND UNIFORMITY OF CONDITIONS

MAPS AND ILLUSTRATIONS

Figure 1, Geologic Map

Figure 2, Geologic Cross Section

APPENDIX A

FIELD INVESTIGATION

APPENDIX B

LABORATORY TESTING

APPENDIX C

RECOMMENDED GRADING SPECIFICATIONS

LIST OF REFERENCES

GEOTECHNICAL INVESTIGATION

1. PURPOSE AND SCOPE

This report presents the results of our geotechnical investigation for the proposed self-storage facility located in the Sorrento Valley area of San Diego, California (see Vicinity Map).



Vicinity Map

The purpose of the geotechnical investigation is to evaluate the surface and subsurface soil conditions and general site geology, and to identify geotechnical constraints that may affect development of the property including faulting, liquefaction and seismic shaking based on the 2019 CBC seismic design criteria. In addition, we provided recommendations for remedial grading, shallow foundations, concrete slab-on-grade, temporary shoring, concrete flatwork, preliminary pavement, and retaining walls.

The scope of this investigation included reviewing readily available published and unpublished geologic literature (see List of References), performing engineering analyses and preparing this report. We also advanced 6 exploratory borings to a maximum depth of about 23 feet, sampled soil and performed laboratory testing. Appendix A presents the exploratory boring logs and details of the field

investigation. The details of the laboratory tests and a summary of the test results are shown in Appendix B and on the boring logs in Appendix A. The results of our Storm Water Management Investigation are provided in a separate report.

2. SITE AND PROJECT DESCRIPTION

The subject property is located at 11391 Sorrento Valley Road in San Diego, California and is located north and south of existing commercial buildings, west of Interstate 5 and east of Sorrento Valley Road. The site is occupied by a single-story commercial building with accommodating driveways, surface parking, utilities and landscaping. We expect the existing structure is supported on conventional shallow foundations with a concrete slab-on-grade. The property is relatively flat at an elevation of about 60 to 65 feet above Mean Sea Level (MSL) at the southwest and northeast ends of the site, respectively. A 10- to 15-foot fill slope exists on the western portion of the site that descends to Sorrento Valley Road. A retaining wall (about 30 feet high) is present on the east side of the property that supports the adjacent Interstate 5 Bypass. The Existing Site Plan shows the current site configuration.



Existing Site Map

We understand the project will consist of demolishing the existing structure and improvements at the site and constructing a new self-storage facility. Based on the referenced plans, we understand the proposed building will be 2 to 4 stories above grade situated over 1 to 3 subterranean levels. The site development will also include utilities, sidewalks and other associated improvements.

The locations, site descriptions, and proposed development are based on our site reconnaissance, review of published geologic literature, field investigations, and discussions with project personnel. If development plans differ from those described herein, Geocon Incorporated should be contacted for review of the plans and possible revisions to this report.

3. GEOLOGIC SETTING

Regionally, the site is located in the Peninsular Ranges geomorphic province. The province is bounded by the Transverse Ranges to the north, the San Jacinto Fault Zone on the east, the Pacific Ocean coastline on the west, and the Baja California on the south. The province is characterized by elongated northwest-trending mountain ridges separated by straight-sided sediment-filled valleys. The northwest trend is further reflected in the direction of the dominant geologic structural features of the province that are northwest to west-northwest trending folds and faults, such as the nearby Rose Canyon fault zone.

Locally, the site is within the coastal plain of San Diego County. The coastal plain is underlain by a thick sequence of relatively undisturbed and non-conformable sedimentary bedrock units that thicken to the west and range in age from Upper Cretaceous age through the Pleistocene age which have been deposited on Cretaceous to Jurassic age igneous and volcanic bedrock. Geomorphically, the coastal plain is characterized by a series of twenty-one, stair-stepped marine terraces (younger to the west) that have been dissected by west flowing rivers. The coastal plain is a relatively stable block that is dissected by relatively few faults consisting of the potentially active La Nacion Fault Zone and the active Rose Canyon Fault Zone. The Regional Geologic Map shows the geologic units in the area of the site.

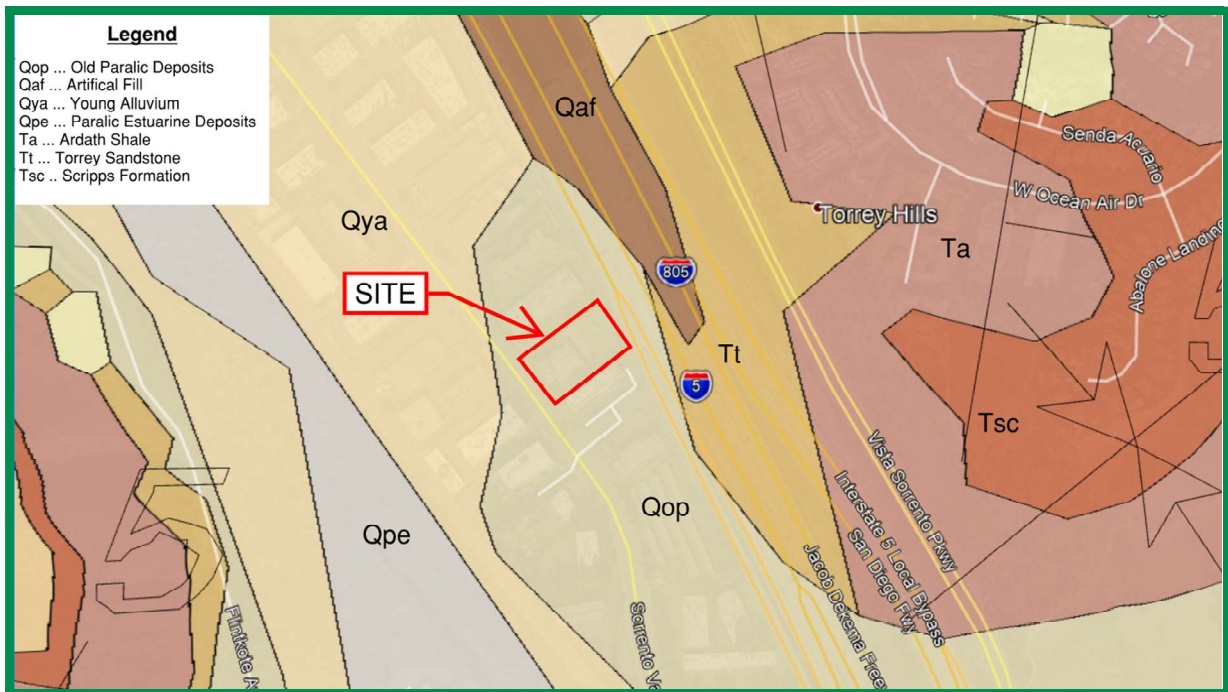

Regional Geologic Map

The site is located on the western portion of the coastal plain. Marine sedimentary units make up the geologic sequence encountered on the site and consist of Pleistocene-age Old Paralic Deposits. The Old Paralic Deposits are upper Pleistocene-age shallow marine and non-marine deposits generally consisting of clayey sand and silty sand interfingering with layers of silt and clay. This unit is likely underlain by Torrey Sandstone.

4. SOIL AND GEOLOGIC CONDITIONS

Based on our review of published geologic maps and previous investigations near the site, we expect the site is underlain by one surficial soil type (consisting of undocumented fill) and two formational units (consisting of the Old Paralic Deposits and the Torrey Sandstone). The occurrence, distribution, and description of each unit encountered is shown on the Geologic Map, Figure 1 and on the boring logs in Appendix A. The Geologic Cross-Section, Figure 2, shows the approximate subsurface relationship between the geologic units. We prepared the geologic cross-section using interpolation between exploratory excavations and observations; therefore, actual geotechnical conditions may vary from those illustrated and should be considered approximate. The surficial soil and geologic units are described herein in order of increasing age.

4.1 Undocumented Fill (Qudf)

We expect shallow undocumented fill, associated with the existing building and site improvements, is present across the majority of the site. The fill is likely 2 to 4 feet thick with larger fills on the order of 10 to 15 feet along the western side of the site in the area of the existing fill slope. The fill generally consists of very loose to medium dense, silty to clayey sand. The undocumented fill is not considered suitable in its current condition for the support of foundations or structural fill and remedial grading will be required. We expect that the majority of the undocumented fill will be removed during site excavations for the building subterranean levels. The undocumented fill can be reused for new compacted fill during grading operations, if necessary, provided it is generally free of roots and debris.

4.2 Old Paralic Deposits (Qop)

The Quaternary-age Old Paralic Deposits is near the surface on the east side of the site and is below the undocumented fill. The Old Paralic Deposits generally consist of moderately cemented, very dense, yellowish brown to reddish brown, silty to clayey, fine-grained sand and sandy clay. This unit also possesses interfingering beds of silt/sandy silt and moderately cemented gravel and cobble layers. We encountered abundant gravel and refusal during our drilling operations. The Old Paralic Deposits possess a “very low” to “medium” expansion potential (expansion index of 90 or less). Old Paralic Deposits are considered suitable for direct support of structural loads.

4.3 Torrey Sandstone (Tt)

Although not encountered during our drilling operations, we expect that formational materials of the Tertiary-age Torrey Sandstone underlie the Old Paralac Deposits at depths greater than 30 feet below existing grade (elevation of about 30 feet MSL). The Torrey Sandstone consists of dense to very dense, damp to wet, olive to yellowish and reddish brown, uncemented, fine to medium sandstone and weakly to strongly cemented, fine- to medium-grained sandstone with local, thin interbeds of sandy siltstone. Soil generated from this formation generally possesses a “very low” to “low” expansive potential (expansion index of 50 or less). We consider the formational materials to be adequate for the support of structural loads and compacted fill.

5. GROUNDWATER

We did not encounter groundwater or seepage during our site investigation. A river exists about 800 feet to the west that has a water elevation of about 25 feet MSL; therefore, we expect groundwater is situated at least 30 feet below existing grade based on our previous experience within the project area. However, it is not uncommon for shallow seepage conditions to develop where none previously existed when sites are irrigated or infiltration is implemented. Seepage is dependent on seasonal precipitation, irrigation, land use, among other factors, and varies as a result. Proper surface drainage will be important to future performance of the project. We do not expect groundwater to be encountered during construction of the proposed development due to the dense formational materials. However, the contractor should be prepared for the potential of minor to heavy seepage during excavations for the building subterranean levels.

6. GEOLOGIC HAZARDS

6.1 Geologic Hazard Category

The City of San Diego Seismic Safety Study, Geologic Hazards and Faults, Sheet 34 defines the site with *Hazard Category 53: Level or sloping terrain, unfavorable geologic structure, Low to moderate Risk* (as shown on the Hazard Category Map). Based on a review of the map, a fault does not traverse the planned development area.

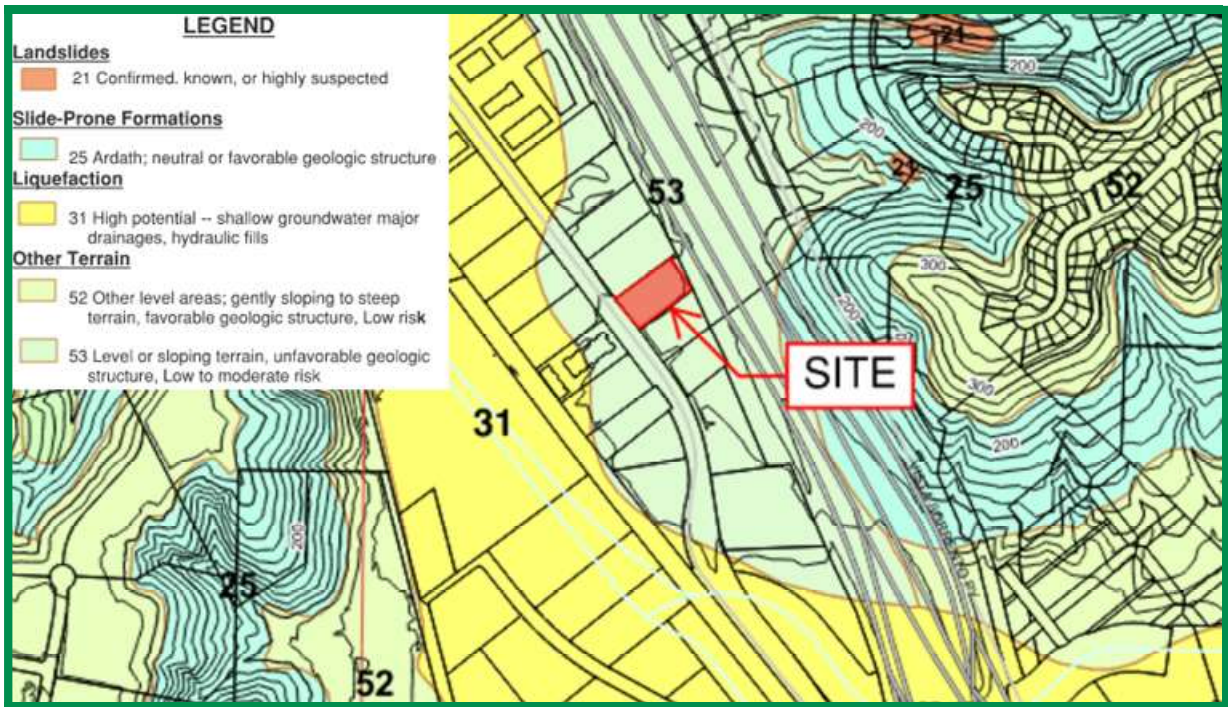

Hazard Category Map

6.2 Regional Faulting and Seismicity

A review of the referenced geologic materials and our knowledge of the general area indicate that the site is not underlain by active, potentially active, or inactive faults. An active fault is defined by the California Geological Survey (CGS) as a fault showing evidence for activity within the last 11,700 years. The site is not located within a State of California Earthquake Fault Zone.

The USGS has developed a program to evaluate the approximate location of faulting in the area of properties. The following figure shows the location of the existing faulting in the San Diego County and Southern California region. The fault traces are shown as solid, dashed and dotted that represent well-constrained, moderately constrained and inferred, respectively. The fault line colors represent fault with ages less than 150 years (red), 15,000 years (orange), 130,000 years (green), 750,000 years (blue) and 1.6 million years (black).

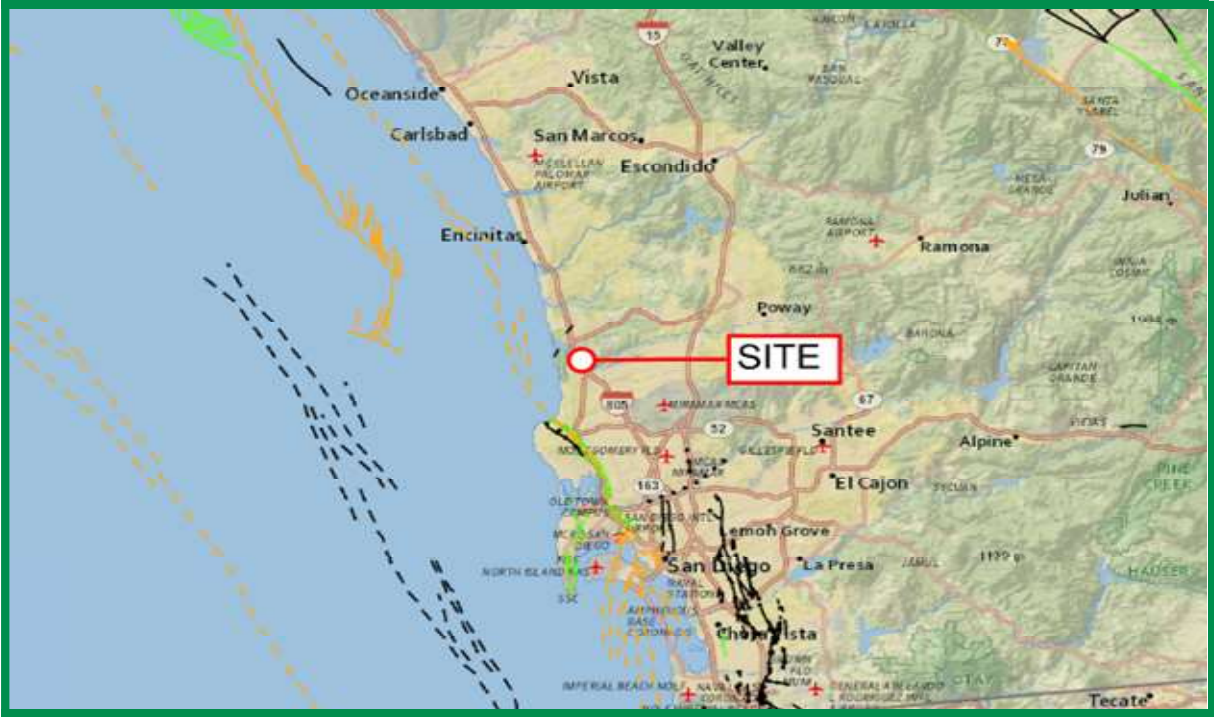

Faults in Southern California

The San Diego County and Southern California region is seismically active. The following figure presents the occurrence of earthquakes with a magnitude greater than 2.5 from the period of 1900 through 2015 according to the Bay Area Earthquake Alliance website.

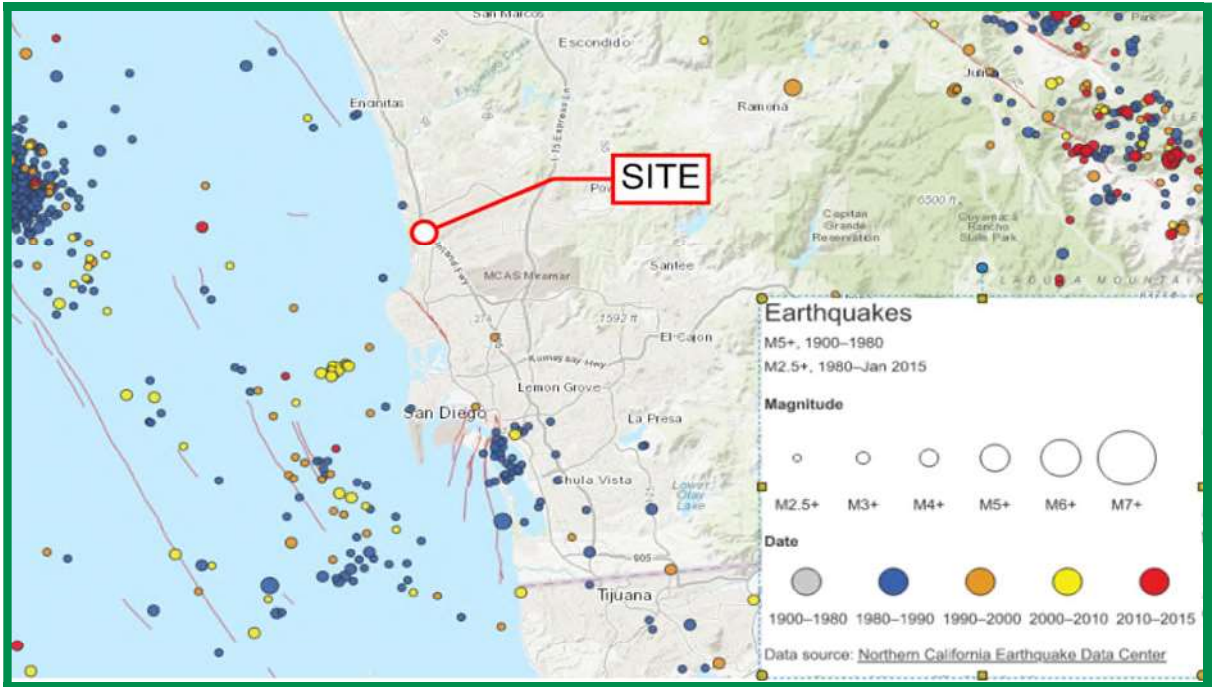

Earthquakes in Southern California

Considerations important in seismic design include the frequency and duration of motion and the soil conditions underlying the site. Seismic design of structures should be evaluated in accordance with the California Building Code (CBC) guidelines currently adopted by the local agency.

6.3 Ground Rupture

Ground surface rupture occurs when movement along a fault is sufficient to cause a gap or rupture where the upper edge of the fault zone intersects the ground surface. The potential for ground rupture is considered to be very low due to the absence of active faults at the subject site.

6.4 Liquefaction

Liquefaction typically occurs when a site is located in a zone with seismic activity, onsite soils are cohesionless or silt/clay with low plasticity, groundwater is encountered within 50 feet of the surface and soil densities are less than about 70 percent of the maximum dry densities. If the four previous criteria are met, a seismic event could result in a rapid pore water pressure increase from the earthquake-generated ground accelerations. Due to the lack of a permanent, near-surface groundwater table and the very dense nature of the underlying Old Paralic Deposits, liquefaction potential for the site is considered very low.

6.5 Hydrocollapse

Hydrocollapse is the tendency of unsaturated soil structure to collapse upon saturation resulting in the overall settlement of the effected soil and overlying foundations or improvements supported thereon. Potentially compressible surficial soil underlying the proposed structures and existing fill is typically removed and recompactd during remedial site grading. However, if compressible soil is left in-place, a potential for settlement due to hydrocollapse of the soil exists. The potential for hydrocollapse can be mitigated by remedial grading and the use of stiffer foundation systems. Based on the laboratory test results, the potential for hydrocollapse ranges from 0 percent to 2 percent within the sandy portions of the Old Paralic Deposits. We expect the majority of these materials to be removed during excavations for the subterranean levels. Therefore, we consider the potential for hydrocollapse at the site to be minimal.

6.6 Storm Surge, Tsunamis, and Seiches

Storm surges are large ocean waves that sweep across coastal areas when storms make landfall. Storm surges can cause inundation, severe erosion and backwater flooding along the water front. The site is located approximately 1½ miles from the Pacific Ocean and is at an elevation of above about 40 feet MSL. Therefore, the potential of storm surges affecting the site is considered negligible.

A tsunami is a series of long period waves generated in the ocean by a sudden displacement of large volumes of water. Causes of tsunamis include underwater earthquakes, volcanic eruptions, or offshore slope failures. The first-order driving force for locally generated tsunamis offshore southern California is expected to be tectonic deformation from large earthquakes (Legg, *et al.*, 2002). We consider the risk of a tsunami hazard at the site to be negligible due to the distance from the ocean and the site elevation.

A seiche is a run-up of water within a lake or embayment triggered by fault- or landslide-induced ground displacement. The site is not located near an inland body of water. Therefore, we consider the potential for seiches to impact the site is very low.

6.7 Landslides

We did not observe evidence of previous or incipient slope instability at the site during our study and the property is relatively flat. Published geologic mapping indicates landslides are not present on or adjacent to the site. Therefore, we opine the potential for a landslide is not a significant concern for this project.

6.8 Erosion

The site is relatively flat and is not located adjacent to the Pacific Ocean coast or a free-flowing drainage where active erosion is occurring. Provided the engineering recommendations herein are followed and the project civil engineer prepares the grading plans in accordance with generally-accepted regional standards, we do not expect erosion to be a major impact to site development. In addition, we expect the proposed development would not increase the potential for erosion if properly designed.

7. CONCLUSIONS AND RECOMMENDATIONS

7.1 General

- 7.1.1 We did not encounter soil or geologic conditions during our exploration that would preclude the proposed development, provided the recommendations presented herein are followed and implemented during design and construction. We will provide supplemental recommendations if we observe variable or undesirable conditions during construction, or if the proposed construction will differ from that anticipated herein.
- 7.1.2 With the exception of possible moderate to strong seismic shaking, we did not observe or know of significant geologic hazards to exist on the site that would adversely affect the proposed project.
- 7.1.3 The undocumented fill is potentially compressible and unsuitable in the present condition for the support of compacted fill or settlement-sensitive improvements. We expect these materials will be removed during excavations for the building subterranean levels. However, where left in place, remedial grading of these materials should be performed as discussed herein. The Old Paralic Deposits are considered suitable for the support of proposed fill and structural loads.
- 7.1.4 We did not encounter groundwater during our subsurface exploration and we do not expect it to be a constraint to project development. However, seepage within existing materials may be encountered during the subterranean-level excavation and grading operations, especially during the rainy seasons.
- 7.1.5 Excavation of the undocumented fill and Old Paralic Deposits should generally be possible with moderate to heavy effort using conventional, heavy-duty equipment during grading and trenching operations. We expect very heavy effort with possible refusal in localized areas for excavations into strongly cemented portions of the Old Paralic Deposits and Torrey Sandstone, if encountered.
- 7.1.6 Proper drainage should be maintained in order to preserve the engineering properties of the fill in both the building pads and slope areas. Recommendations for site drainage are provided herein.
- 7.1.7 We performed a storm water management investigation under a separate report to help evaluate the potential for infiltration on the property. The project civil engineer should use that report to help design the storm water management devices.

7.1.8 We opine the planned development can be constructed in accordance with our recommendations provided herein. We do not expect the planned development will destabilize or result in settlement of adjacent properties if properly constructed.

7.1.9 Surface settlement monuments and canyon subdrains will not be required on this project.

7.2 Excavation and Soil Characteristics

7.2.1 Excavation of the in-situ soil should be possible with moderate to heavy effort using conventional heavy-duty equipment. Excavation of the formational materials will require very heavy effort and may generate abundant gravel, rock and oversized material using conventional heavy-duty equipment during the grading operations. Oversized rock (rocks greater than 12-inches in dimension) may be generated with the Old Paralic Deposits that can be incorporated into landscape use or deep compacted fill areas, if available.

7.2.2 The soil encountered in the field investigation is considered to be “non-expansive” and “expansive” (expansion index [EI] of 20 or less and greater than 20, respectively) as defined by 2019 California Building Code (CBC) Section 1803.5.3. We expect a majority of the soil encountered possess a “very low” to “medium” expansion potential (EI of 90 or less) in accordance with ASTM D 4829. Table 7.2 presents soil classifications based on the expansion index.

**TABLE 7.2
EXPANSION CLASSIFICATION BASED ON EXPANSION INDEX**

Expansion Index (EI)	ASTM D 4829 Expansion Classification	2019 CBC Expansion Classification
0 – 20	Very Low	Non-Expansive
21 – 50	Low	Expansive
51 – 90	Medium	
91 – 130	High	
Greater Than 130	Very High	

7.2.3 We performed laboratory tests on samples of the site materials to evaluate the percentage of water-soluble sulfate content. Appendix B presents results of the laboratory water-soluble sulfate content tests. The test results indicate the on-site materials at the locations tested possess “S0” sulfate exposure to concrete structures as defined by 2019 CBC Section 1904 and ACI 318-14 Chapter 19.

- 7.2.4 We tested samples for potential of hydrogen (pH) and resistivity laboratory tests to aid in evaluating the corrosion potential to subsurface metal structures. Appendix B presents the laboratory test results.
- 7.2.5 Geocon Incorporated does not practice in the field of corrosion engineering. Therefore, further evaluation by a corrosion engineer may be performed if improvements susceptible to corrosion are planned.

7.3 Grading

- 7.3.1 Grading should be performed in accordance with the recommendations provided in this report, the Recommended Grading Specifications contained in Appendix C and the City of San Diego's Grading Ordinance. Geocon Incorporated should observe the grading operations on a full-time basis and provide testing during the fill placement.
- 7.3.2 Prior to commencing grading, a preconstruction conference should be held at the site with the city inspector, developer, grading and underground contractors, civil engineer, and geotechnical engineer in attendance. Special soil handling and/or the grading plans can be discussed at that time.
- 7.3.3 Site preparation should begin with the removal of deleterious material, debris, and vegetation. The depth of vegetation removal should be such that material exposed in cut areas or soil to be used as fill is relatively free of organic matter. Material generated during stripping and/or site demolition should be exported from the site. Asphalt and concrete should not be mixed with the fill soil unless approved by the Geotechnical Engineer.
- 7.3.4 Abandoned foundations and buried utilities (if encountered) should be removed and the resultant depressions and/or trenches should be backfilled with properly compacted material as part of the remedial grading if located below the proposed improvements.
- 7.3.5 We expect excavations for the planned building and subterranean parking garage will remove the existing undocumented fill and expose the underlying Old Paralac Deposits. The excavations can be performed to finish grade for the subterranean parking level without performing remedial grading operations if Old Paralac Deposits are present at the pad elevations. If the bottom of the excavation is disturbed during excavation and export operations, then processing and compaction of the finish grade soil will be required. We will evaluate if additional removals below the building area will be required during the grading operations.

7.3.6 In areas of proposed ancillary structures and improvements outside of the building areas (trash enclosure, concrete flatwork and driveways), the upper 1 to 2 feet of the existing materials should be removed and replaced with properly compacted fill materials. Deeper removals may be required in areas where loose or saturated materials are encountered. The removals should extend at least 2 feet outside of the improvement area, where possible. Table 7.3.1 provides a summary of the grading recommendations.

**TABLE 7.3.1
SUMMARY OF GRADING RECOMMENDATIONS**

Area	Grading Excavation Requirements
Building Pad	Excavate to Pad Grade
Ancillary Structures and Improvement Areas	Process Upper 1 to 2 Feet of Existing Materials
Grading Limits	2 Feet Outside of Improvement Areas, Where Possible
Exposed Bottoms of Remedial Grading (Not within Building Pad)	Scarify Upper 12 Inches

7.3.7 Prior to fill soil being placed (where necessary), the existing ground surface should be scarified, moisture conditioned as necessary, and compacted to a depth of at least 12 inches. Deeper removals may be required if saturated or loose fill soil is encountered. A representative of Geocon should be on-site during removals to evaluate the limits of the remedial grading.

7.3.8 Fill and backfill materials should be compacted to a dry density of at least 90 percent of the laboratory maximum dry density near to slightly above optimum moisture content as determined by ASTM Test Method D 1557. The upper 12 inches of fill beneath pavement areas should be compacted to a dry density of at least 95 percent of the laboratory maximum dry density near to slightly above optimum moisture content shortly before paving operations.

7.3.9 While we do not anticipate that groundwater will be encountered during site excavations, the contractor should be prepared to accommodate seepage in project excavations with one or more of the following conventional measures, if needed. Where minor seepage is encountered during excavation, sloping excavation bottoms to a sump and pumping from the sump can be utilized. In this case, an approximately 1-foot-thick layer of freely draining gravel or crushed rock placed on the excavation bottom would help groundwater to flow toward the sump and provide a working pad. If migration of contaminants along a utility alignment is a concern, a 12-inch wide bentonite slurry barrier can be installed every 20 feet of trench as part of the excavation bottom. A sump would need to be installed within that 20-foot length in order to remove water during construction.

7.3.10 Import fill (if necessary) should consist of the characteristics presented in Table 7.3.2. Geocon Incorporated should be notified of the import soil source and should perform laboratory testing of import soil prior to its arrival at the site to determine its suitability as fill material.

**TABLE 7.3.2
SUMMARY OF IMPORT FILL RECOMMENDATIONS**

Soil Characteristic	Values
Expansion Potential	“Very Low” to “Medium” (Expansion Index of 90 or less)
Particle Size	Maximum Dimension Less Than 3 Inches
	Generally Free of Debris

7.4 Excavation Slopes, Shoring and Tiebacks

7.4.1 The recommendations included herein are provided for stable excavations. It is the responsibility of the contractor and their competent person to ensure all excavations, temporary slopes and trenches are properly constructed and maintained in accordance with applicable OSHA guidelines in order to maintain safety and the stability of the excavations and adjacent improvements. These excavations should not be allowed to become saturated or to dry out. Surcharge loads should not be permitted to a distance equal to the height of the excavation from the top of the excavation. The top of the excavation should be a minimum of 15 feet from the edge of existing improvements. Excavations steeper than those recommended or closer than 15 feet from an existing surface improvement should be shored in accordance with applicable OSHA codes and regulations.

7.4.2 The stability of the excavations is dependent on the design and construction of the shoring system and site conditions. Therefore, Geocon Incorporated cannot be responsible for site safety and the stability of the proposed excavations.

7.4.3 The design of temporary shoring is governed by soil and groundwater conditions, and by the depth and width of the excavated area. Continuous support of the excavation face can be provided by a system of soldier piles and wood lagging or sheet piles. Excavations exceeding 15 feet may require soil nails, tieback anchors or internal bracing to provide additional wall restraint.

7.4.4 The condition of existing buildings, streets, sidewalks, and other structures/improvements around the perimeter of the planned excavation should be documented prior to the start of shoring and excavation work. Special attention should be given to documenting existing cracks or other indications of differential settlement within these adjacent structures,

pavements and other improvements. Underground utilities sensitive to settlement should be videotaped prior to construction to check the integrity of pipes. In addition, monitoring points should be established indicating location and elevation around the excavation and upon existing buildings. These points should be monitored on a weekly basis during excavation work and on a monthly basis thereafter.

7.4.5 In general, ground conditions are moderately suited for soldier pile and tieback anchor wall construction techniques. However, gravel, cobble, and oversized material may be encountered in the existing materials that could be difficult to drill. Additionally, if cohesionless sands are encountered, some raveling may result along the unsupported portions of excavations.

7.4.6 Temporary shoring with a level backfill should be designed using a lateral pressure envelope acting on the back of the shoring as presented in Table 7.4.1 assuming a level backfill. The distributions are shown on the Active Pressures for Temporary Shoring. Triangular distribution should be used for cantilevered shoring and, the trapezoidal and rectangular distribution should be used for multi-braced systems such as tieback anchors and rakers. The project shoring engineer should determine the applicable soil distribution for the design of the temporary shoring system. Additional lateral earth pressure due to the surcharging effects from construction equipment, sloping backfill, planned stockpiles, adjacent structures and/or traffic loads should be considered, where appropriate, during design of the shoring system.

**TABLE 7.4.1
SUMMARY OF TEMPORARY SHORING WALL RECOMMENDATIONS**

Parameter	Value
Triangular Distribution, A	27H psf
Rectangular Distribution, B	18H psf
Trapezoidal Distribution, C	22H psf
Passive Pressure, P	$375D + 500$ psf
Effective Zone Angle, E	30 degrees
Maximum Design Lateral Movement	1 Inch
Maximum Design Vertical Movement	½ Inch
Maximum Design Retained Height, H	35 Feet

H equals the height of the retaining portion of the wall in feet

D equals the embedment depth of the retaining wall in feet

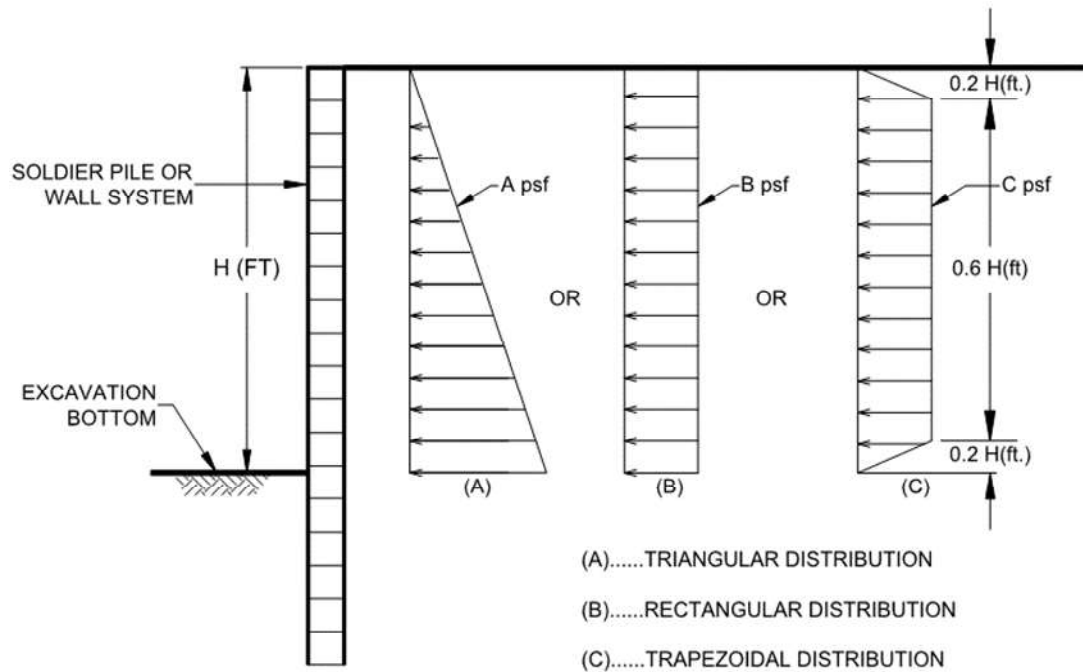

Active Pressures on Temporary Shoring

7.4.7 The passive resistance can be assumed to act over a width of three pile diameters. Typically, soldier piles are embedded a minimum of 0.5 times the maximum height of the excavation (this depth is to include footing excavations) if tieback anchors are not employed. The project structural engineer should determine the actual embedment depth.

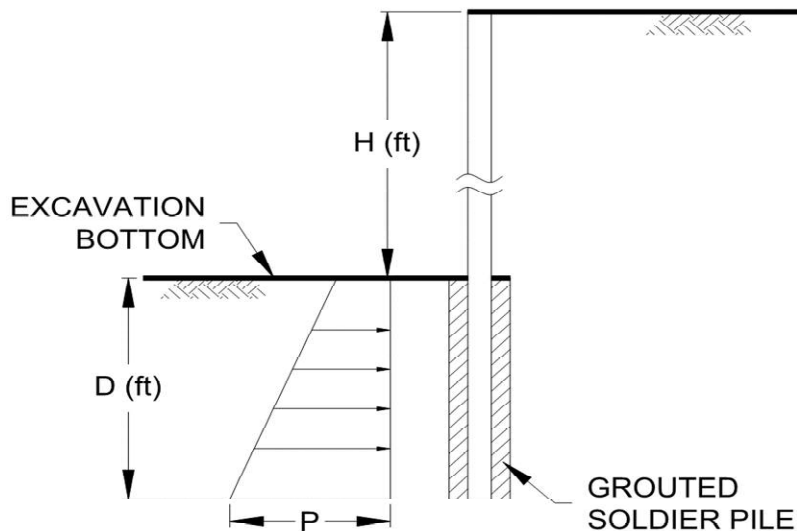

Passive Pressures on Temporary Shoring

7.4.8 We should observe the drilled shafts for the soldier piles prior to the placement of steel reinforcement to check that the exposed soil conditions are similar to those expected and that

footing excavations have been extended to the appropriate bearing strata and design depths. If unexpected soil conditions are encountered, foundation modifications may be required.

- 7.4.9 Lateral movement of shoring is associated with vertical ground settlement outside of the excavation. Therefore, it is essential that the soldier pile and tieback system allow very limited amounts of lateral displacement. Earth pressures acting on a lagging wall can cause movement of the shoring toward the excavation and result in ground subsidence outside of the excavation. Consequently, horizontal movements of the shoring wall should be accurately monitored and recorded during excavation and anchor construction.
- 7.4.10 The proposed excavations and shoring system should take into account the potential surcharge loads due to the existing retaining wall for Interstate 5/805. Additionally, the design team should determine if additional requirements or more stringent allowable deflections will need to be incorporated into the design of the shoring wall to accommodate the existing wall.
- 7.4.11 Survey points should be established at the top of the pile on at least 20 percent of the soldier piles. An additional point located at an intermediate point between the top of the pile and the base of the excavation should be monitored on at least 20 percent of the piles if tieback anchors will be used. These points should be monitored on a weekly basis during excavation work and on a monthly basis thereafter until the permanent support system is constructed.
- 7.4.12 The project civil engineer should provide the approximate location, depth, and pipe type of the underground utilities to the shoring engineer to help select the shoring type and shoring design. The shoring system should be designed to limit horizontal soldier pile movement to a maximum of 1 inch. The amount of horizontal deflection can be assumed to be essentially zero along the Active Zone and Effective Zone boundary. The magnitude of movement for intermediate depths and distances from the shoring wall can be linearly interpolated.
- 7.4.13 Tieback anchors employed in shoring should be designed such that anchors fully penetrate the Active Zone behind the shoring. The Active Zone can be considered the wedge of soil from the face of the shoring to a plane extending upward from the base of the excavation as shown on the Active Zone Detail. Normally, tieback anchors are contractor-designed and installed, and there are numerous anchor construction methods available. Non-shrinkage grout should be used for the construction of the tieback anchors.

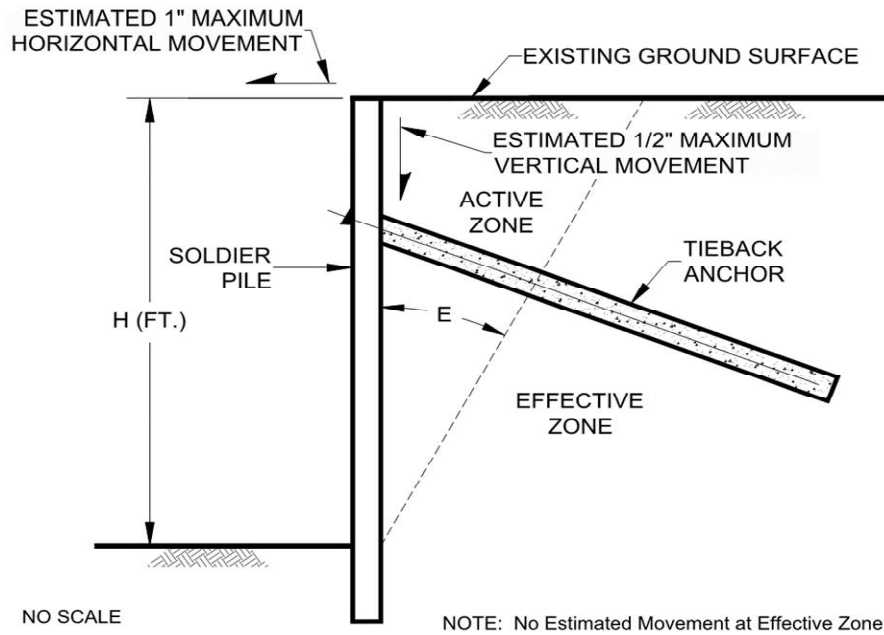

Active Zone Detail

7.4.14 Experience has shown that the use of pressure grouting during formation of the bonded portion of the anchor will increase the soil-grout bond stress. A pressure grouting tube should be installed during the construction of the tieback. Post grouting should be performed if adequate capacity cannot be obtained by other construction methods.

7.4.15 Anchor capacity is a function of construction method, depth of anchor, batter, diameter of the bonded section and the length of the bonded section. Anchor capacity should be evaluated using the strength parameters shown in Table 7.4.2.

TABLE 7.4.2
SOIL STRENGTH PARAMETERS FOR TEMPORARY SHORING

Description	Cohesion (psf)	Friction Angle (Degrees)
Undocumented Fill	100	28
Old Paralic Deposits	450	30

7.4.16 Grout should only be placed in the tieback anchor's bonded section prior to testing. Tieback anchors should be proof-tested to at least 130 percent of the anchor's design working load. Following a successful proof test, the tieback anchors should be locked off at 80 percent of the allowable working load. Tieback anchor test failure criteria should be established in project plans and specifications. The tieback anchor test failure criteria should be based upon a maximum allowable displacement at 130 percent of the anchor's working load

(anchor creep) and a maximum residual displacement within the anchor following stressing. Tieback anchor stressing should only be conducted after sufficient hydration has occurred within the grout. Tieback anchors that fail to meet project specified test criteria should be replaced or additional anchors should be constructed.

7.4.17 Lagging should keep pace with excavation. The excavation should not be advanced deeper than three feet below the bottom of lagging at any time. These unlagged gaps of up to three feet should only be allowed to stand for short periods of time in order to decrease the probability of soil instability and should never be unsupported overnight. Backfilling should be conducted when necessary between the back of lagging and excavation sidewalls to reduce sloughing in this zone and all voids should be filled by the end of each day. Further, the excavation should not be advanced further than four feet below a row of tiebacks prior to those tiebacks being proof tested and locked off unless otherwise specific by the shoring engineer. Surface sloughing may occur during the excavation process.

7.4.18 If tieback anchors are employed, an accurate survey of existing utilities and other underground structures adjacent to the shoring wall should be conducted. The survey should include both locations and depths of existing utilities. Locations of anchors should be adjusted as necessary during the design and construction process to accommodate the existing and proposed utilities.

7.4.19 The shoring system should incorporate a drainage system for the proposed retaining wall as shown herein.

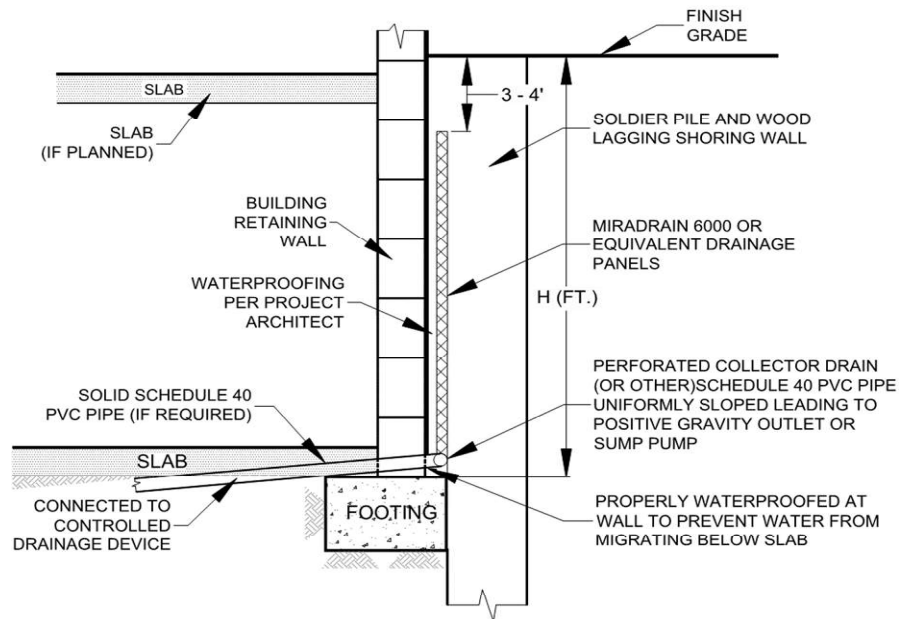

Shoring Retaining Wall Drainage Detail

7.5 Seismic Design Criteria – 2019 California Building Code

7.5.1 Table 7.5.1 summarizes site-specific design criteria obtained from the 2019 California Building Code (CBC; Based on the 2018 International Building Code [IBC] and ASCE 7-16), Chapter 16 Structural Design, Section 1613 Earthquake Loads. We used the computer program *U.S. Seismic Design Maps*, provided by the Structural Engineers Association (SEA) to calculate the seismic design parameters. The short spectral response uses a period of 0.2 second. The Site Class should be evaluated during the geotechnical investigation; however, for this preliminary evaluation we expect the property will likely possess a Site Class of C. We evaluated the Site Class based on the discussion in Section 1613.2.2 of the 2019 CBC and Table 20.3-1 of ASCE 7-16. The values presented herein are for the risk-targeted maximum considered earthquake (MCE_R). Sites designated as Site Class D, E and F may require additional analyses if requested by the project structural engineer and client.

**TABLE 7.5.1
2019 CBC SEISMIC DESIGN PARAMETERS**

Parameter	Value	2019 CBC Reference
Site Class	C	Section 1613.2.2
MCE_R Ground Motion Spectral Response Acceleration – Class B (short), S_S	1.161g	Figure 1613.2.1(1)
MCE_R Ground Motion Spectral Response Acceleration – Class B (1 sec), S_1	0.411g	Figure 1613.2.1(2)
Site Coefficient, F_A	1.200	Table 1613.2.3(1)
Site Coefficient, F_V	1.500	Table 1613.2.3(2)
Site Class Modified MCE_R Spectral Response Acceleration (short), S_{MS}	1.393g	Section 1613.2.3 (Eqn 16-36)
Site Class Modified MCE_R Spectral Response Acceleration – (1 sec), S_{M1}	0.616g	Section 1613.2.3 (Eqn 16-37)
5% Damped Design Spectral Response Acceleration (short), S_{DS}	0.929g	Section 1613.2.4 (Eqn 16-38)
5% Damped Design Spectral Response Acceleration (1 sec), S_{D1}	0.411g	Section 1613.2.4 (Eqn 16-39)

***Note:** Using the code-based values presented in this table, in lieu of a performing a ground motion hazard analysis, requires the exceptions outlined in ASCE 7-16 Section 11.4.8 be followed by the project structural engineer. Per Section 11.4.8 of ASCE/SEI 7-16, a ground motion hazard analysis should be performed for projects for Site Class “E” sites with S_S greater than or equal to 1.0g and for Site Class “D” and “E” sites with S_1 greater than 0.2g. Section 11.4.8 also provides exceptions which indicates that the ground motion hazard analysis may be waived provided the exceptions are followed.

7.5.2 Table 7.5.2 presents the mapped maximum considered geometric mean (MCE_G) seismic design parameters for projects located in Seismic Design Categories of D through F in accordance with ASCE 7-16.

**TABLE 7.5.2
ASCE 7-16 PEAK GROUND ACCELERATION**

Parameter	Value	ASCE 7-16 Reference
Mapped MCE_G Peak Ground Acceleration, PGA	0.521g	Figure 22-7
Site Coefficient, F_{PGA}	1.200	Table 11.8-1
Site Class Modified MCE_G Peak Ground Acceleration, PGA_M	0.625g	Section 11.8.3 (Eqn 11.8-1)

7.5.3 Conformance to the criteria in Tables 7.5.1 and 7.5.2 for seismic design does not constitute any kind of guarantee or assurance that significant structural damage or ground failure will not occur in the event of a large earthquake. The primary goal of seismic design is to protect life, not to avoid all damage, since such design may be economically prohibitive.

7.6 Shallow Foundations

7.6.1 The proposed structure can be supported on a shallow foundation system founded in the formational materials. We understand that the foundations will be situated at least 10 feet below existing grades (1 to 2 levels subterranean). Foundations for the structure should consist of continuous strip footings and/or isolated spread footings. Table 7.6 provides a summary of the foundation design recommendations.

**TABLE 7.6
SUMMARY OF FOUNDATION RECOMMENDATIONS**

Parameter	Value
Minimum Continuous Foundation Width, W_C	18 inches
Minimum Isolated Foundation Width, W_I	24 inches
Minimum Foundation Depth, D	24 Inches Below Lowest Adjacent Grade
Minimum Steel Reinforcement	4 No. 5 Bars, 2 at the Top and 2 at the Bottom
Allowable Bearing Capacity*	7,000 psf
Bearing Capacity Increase	500 psf per Foot of Depth
	300 psf per Foot of Width
Maximum Allowable Bearing Capacity *	9,000 psf
Estimated Total Settlement	1 Inch
Estimated Differential Settlement	½ Inch in 40 Feet
Footing Size Used for Settlement	6-Foot Square
Design Expansion Index	90 or less

* Assuming foundations will be situated at a depth of at least 20 feet below grade.

- 7.6.2 The foundations should be embedded in accordance with the recommendations herein and the Wall/Column Footing Dimension Detail. The embedment depths should be measured from the lowest adjacent pad grade for both interior and exterior footings. Footings should be deepened such that the bottom outside edge of the footing is at least 7 feet horizontally from the face of the slope (unless designed with a post-tensioned foundation system as discussed herein).

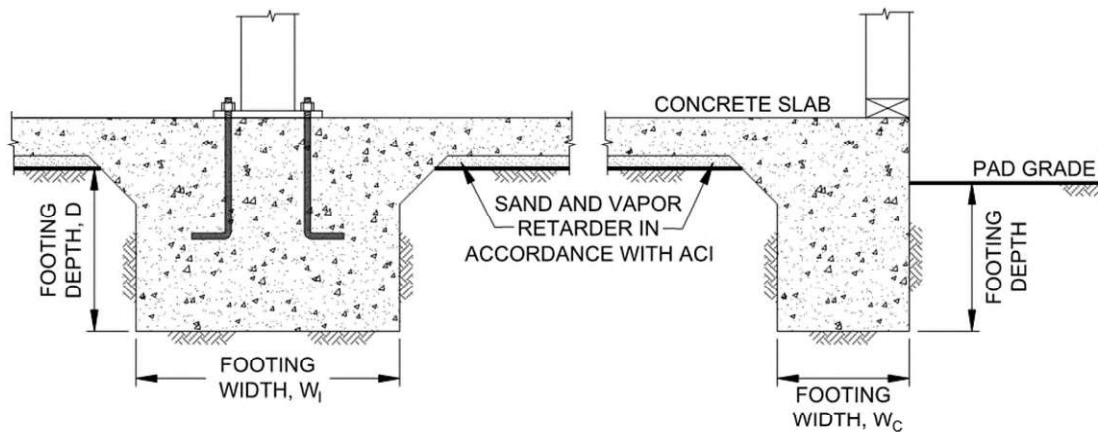

Wall/Column Footing Dimension Detail

- 7.6.3 The bearing capacity values presented herein are for dead plus live loads and may be increased by one-third when considering transient loads due to wind or seismic forces.
- 7.6.4 Overexcavation of the footings and replacement with slurry can be performed in areas where formational materials are not encountered at the bottom of the footing. Minimum two-sack slurry can be placed in the excavations for the conventional foundations to the bottom of proposed footing elevation. We expect that this condition might be present on the western portion of the site and that the depth of the overexcavation may be on the order of 5 to 10 feet.
- 7.6.5 We should observe the foundation excavations prior to the placement of reinforcing steel and concrete to check that the exposed soil conditions are similar to those expected and that they have been extended to the appropriate bearing strata. Foundation modifications may be required if unexpected soil conditions are encountered.
- 7.6.6 Geocon Incorporated should be consulted to provide additional design parameters as required by the structural engineer.

7.7 Concrete Slabs-On-Grade

7.7.1 Concrete slabs-on-grade for the structures should be constructed in accordance with Table 7.7.

**TABLE 7.7
MINIMUM CONCRETE SLAB-ON-GRADE RECOMMENDATIONS**

Parameter	Value
Minimum Concrete Slab Thickness	5 inches
Minimum Steel Reinforcement	No. 4 Bars 18 Inches on Center, Both Directions
Typical Slab Underlayment	3 to 4 Inches of Sand/Gravel/Base
Design Expansion Index	90 or less

7.7.2 Slabs that may receive moisture-sensitive floor coverings or may be used to store moisture-sensitive materials should be underlain by a vapor retarder. The vapor retarder design should be consistent with the guidelines presented in the American Concrete Institute's (ACI) *Guide for Concrete Slabs that Receive Moisture-Sensitive Flooring Materials* (ACI 302.2R-06). In addition, the membrane should be installed in accordance with manufacturer's recommendations and ASTM requirements and installed in a manner that prevents puncture. The vapor retarder used should be specified by the project architect or developer based on the type of floor covering that will be installed and if the structure will possess a humidity controlled environment.

7.7.3 The bedding sand thickness should be determined by the project foundation engineer, architect, and/or developer. It is common to have 3 to 4 inches of sand in the southern California region. However, we should be contacted to provide recommendations if the bedding sand is thicker than 6 inches. The foundation design engineer should provide appropriate concrete mix design criteria and curing measures to assure proper curing of the slab by reducing the potential for rapid moisture loss and subsequent cracking and/or slab curl. We suggest that the foundation design engineer present the concrete mix design and proper curing methods on the foundation plans. It is critical that the foundation contractor understands and follows the recommendations presented on the foundation plans.

7.7.4 Concrete slabs should be provided with adequate crack-control joints, construction joints and/or expansion joints to reduce unsightly shrinkage cracking. The design of joints should consider criteria of the American Concrete Institute (ACI) when establishing crack-control spacing. Crack-control joints should be spaced at intervals no greater than 12 feet. Additional steel reinforcing, concrete admixtures and/or closer crack control joint spacing should be considered where concrete-exposed finished floors are planned.

- 7.7.5 Special subgrade presaturation is not deemed necessary prior to placing concrete; however, the exposed foundation and slab subgrade soil should be moisturized to maintain a moist condition as would be expected in any such concrete placement.
- 7.7.6 The concrete slab-on-grade recommendations are based on soil support characteristics only. The project structural engineer should evaluate the structural requirements of the concrete slabs for supporting expected loads.
- 7.7.7 The recommendations of this report are intended to reduce the potential for cracking of slabs due to expansive soil (if present), differential settlement of existing soil or soil with varying thicknesses. However, even with the incorporation of the recommendations presented herein, foundations, stucco walls, and slabs-on-grade placed on such conditions may still exhibit some cracking due to soil movement and/or shrinkage. The occurrence of concrete shrinkage cracks is independent of the supporting soil characteristics. Their occurrence may be reduced and/or controlled by limiting the slump of the concrete, proper concrete placement and curing, and by the placement of crack control joints at periodic intervals, in particular, where re-entrant slab corners occur.

7.8 Exterior Concrete Flatwork

- 7.8.1 Exterior concrete flatwork not subject to vehicular traffic should be constructed in accordance with the recommendations presented in Table 7.8. The recommended steel reinforcement would help reduce the potential for cracking.

**TABLE 7.8
MINIMUM CONCRETE FLATWORK RECOMMENDATIONS**

Expansion Index, EI	Minimum Steel Reinforcement* Options	Minimum Thickness
EI ≤ 90	6x6-W2.9/W2.9 (6x6-6/6) welded wire mesh	4 Inches
	No. 3 Bars 18 inches on center, Both Directions	

*In excess of 8 feet square.

- 7.8.2 The subgrade soil should be properly moisturized and compacted prior to the placement of steel and concrete. The subgrade soil should be compacted to a dry density of at least 90 percent of the laboratory maximum dry density near to slightly above optimum moisture content in accordance with ASTM D 1557.
- 7.8.3 Even with the incorporation of the recommendations of this report, the exterior concrete flatwork has a potential to experience some uplift due to expansive soil beneath grade. The

steel reinforcement should overlap continuously in flatwork to reduce the potential for vertical offsets within flatwork. Additionally, flatwork should be structurally connected to the curbs, where possible, to reduce the potential for offsets between the curbs and the flatwork.

7.8.4 Concrete flatwork should be provided with crack control joints to reduce and/or control shrinkage cracking. Crack control spacing should be determined by the project structural engineer based upon the slab thickness and intended usage. Criteria of the American Concrete Institute (ACI) should be taken into consideration when establishing crack control spacing. Subgrade soil for exterior slabs not subjected to vehicle loads should be compacted in accordance with criteria presented in the grading section prior to concrete placement. Subgrade soil should be properly compacted and the moisture content of subgrade soil should be verified prior to placing concrete. Base materials will not be required below concrete improvements.

7.8.5 Where exterior flatwork abuts the structure at entrant or exit points, the exterior slab should be dowelled into the structure's foundation stemwall. This recommendation is intended to reduce the potential for differential elevations that could result from differential settlement or minor heave of the flatwork. Dowelling details should be designed by the project structural engineer.

7.8.6 The recommendations presented herein are intended to reduce the potential for cracking of exterior slabs as a result of differential movement. However, even with the incorporation of the recommendations presented herein, slabs-on-grade will still crack. The occurrence of concrete shrinkage cracks is independent of the soil supporting characteristics. Their occurrence may be reduced and/or controlled by limiting the slump of the concrete, the use of crack control joints and proper concrete placement and curing. Crack control joints should be spaced at intervals no greater than 12 feet. Literature provided by the Portland Concrete Association (PCA) and American Concrete Institute (ACI) present recommendations for proper concrete mix, construction, and curing practices, and should be incorporated into project construction.

7.9 Retaining Walls

7.9.1 Retaining walls should be designed using the values presented in Table 7.9. Soil with an expansion index (EI) of greater than 90 should not be used as backfill material behind retaining walls.

**TABLE 7.9
RETAINING WALL DESIGN RECOMMENDATIONS**

Parameter	Value
Active Soil Pressure, A (Fluid Density, Level Backfill)	40 pcf
Active Soil Pressure, A (Fluid Density, 2:1 Sloping Backfill)	55 pcf
Seismic Pressure, S	15H psf
At-Rest/Restrained Walls Additional Uniform Pressure (0 to 8 Feet High)	7H psf
At-Rest/Restrained Walls Additional Uniform Pressure (8+ Feet High)	13H psf
Expected Expansion Index for the Subject Property	$EI \leq 90$

H equals the height of the retaining portion of the wall

7.9.2 The project retaining walls should be designed as shown in the Retaining Wall Loading Diagram.

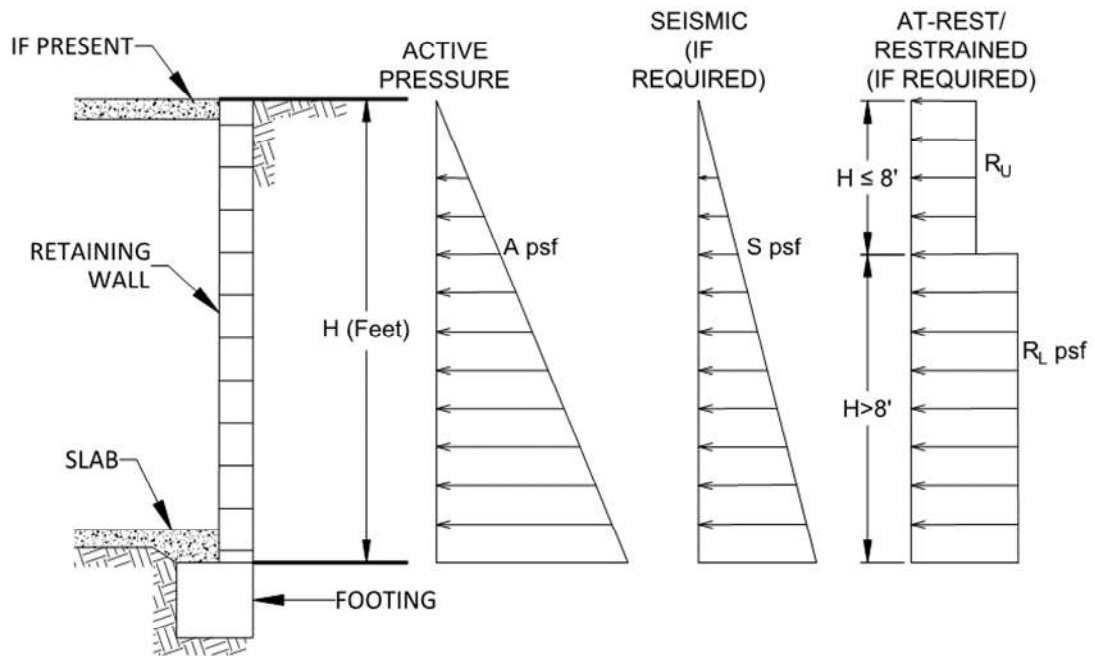

Retaining Wall Loading Diagram

7.9.3 It is common to see retaining walls constructed in the areas of the elevator pits. The retaining walls should be properly drained and designed in accordance with the recommendations presented herein. If the elevator pit walls are not drained, the walls should be designed with an increased active pressure with an equivalent fluid density of 90 pcf. It is also common to see seepage and water collection within the elevator pit. The pit should be designed and properly waterproofed to prevent seepage and water migration into the elevator pit.

- 7.9.4 Unrestrained walls are those that are allowed to rotate more than $0.001H$ (where H equals the height of the retaining portion of the wall) at the top of the wall. Where walls are restrained from movement at the top (at-rest condition), an additional uniform pressure should be applied to the wall.
- 7.9.5 Lateral earth pressure due to the surcharging effects from sloping backfill, adjacent structures and/or traffic loads should be considered, where appropriate, during design of the retaining wall. For retaining walls subject to vehicular loads within a horizontal distance equal to two-thirds the wall height, a surcharge equivalent to 2 feet of fill soil should be added to the upper 10 feet of the wall.
- 7.9.6 The structural engineer should determine the Seismic Design Category for the project in accordance with Section 1613.3.5 of the 2019 CBC or Section 11.6 of ASCE 7-10. For structures assigned to Seismic Design Category of D, E, or F, retaining walls that support more than 6 feet of backfill should be designed with seismic lateral pressure in accordance with Section 1803.5.12 of the 2019 CBC. The seismic load is dependent on the retained height where H is the height of the wall, in feet, and the calculated loads result in pounds per square foot (psf) exerted at the base of the wall and zero at the top of the wall.
- 7.9.7 Retaining walls should be designed to ensure stability against overturning sliding, and excessive foundation pressure. Where a keyway is extended below the wall base with the intent to engage passive pressure and enhance sliding stability, it is not necessary to consider active pressure on the keyway.
- 7.9.8 Drainage openings through the base of the wall (weep holes) should not be used where the seepage could be a nuisance or otherwise adversely affect the property adjacent to the base of the wall. The recommendations herein assume a properly compacted granular (EI of 90 or less) free-draining backfill material with no hydrostatic forces or imposed surcharge load. The retaining wall should be properly drained as shown in the Typical Retaining Wall Drainage Detail. If conditions different than those described are expected, or if specific drainage details are desired, Geocon Incorporated should be contacted for additional recommendations.

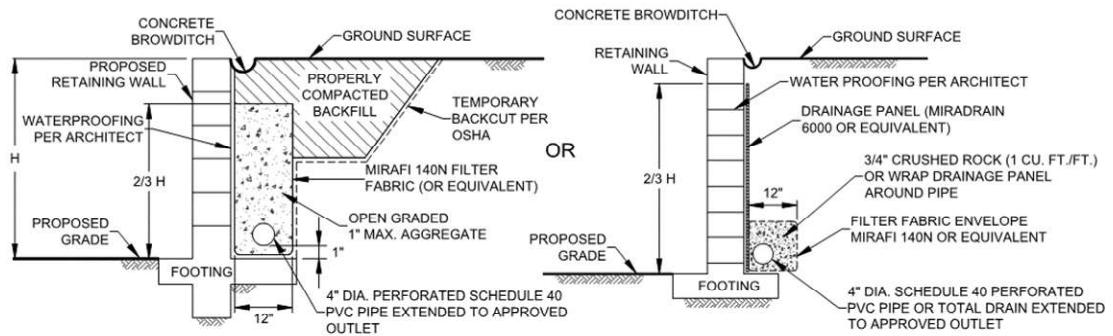

Typical Retaining Wall Drainage Detail

- 7.9.9 The retaining walls may be designed using either the active and restrained (at-rest) loading condition or the active and seismic loading condition as suggested by the structural engineer. Typically, it appears the design of the restrained condition for retaining wall loading may be adequate for the seismic design of the retaining walls. However, the active earth pressure combined with the seismic design load should be reviewed and also considered in the design of the retaining walls.
- 7.9.10 The recommendations presented herein are generally applicable to the design of rigid concrete or masonry retaining walls. In the event that other types of walls (such as mechanically stabilized earth [MSE] walls, soil nail walls, or soldier pile walls) are planned, Geocon Incorporated should be consulted for additional recommendations.
- 7.9.11 Unrestrained walls will move laterally when backfilled and loading is applied. The amount of lateral deflection is dependent on the wall height, the type of soil used for backfill, and loads acting on the wall. The retaining walls and improvements above the retaining walls should be designed to incorporate an appropriate amount of lateral deflection as determined by the structural engineer.
- 7.9.12 Soil contemplated for use as retaining wall backfill, including import materials, should be identified in the field prior to backfill. At that time, Geocon Incorporated should obtain samples for laboratory testing to evaluate its suitability. Modified lateral earth pressures may be necessary if the backfill soil does not meet the required expansion index or shear strength. City or regional standard wall designs, if used, are based on a specific active lateral earth pressure and/or soil friction angle. In this regard, on-site soil to be used as backfill may or may not meet the values for standard wall designs. Geocon Incorporated should be consulted to assess the suitability of the on-site soil for use as wall backfill if standard wall designs will be used.

7.10 Lateral Loading

- 7.10.1 Table 7.10 should be used to help design the proposed structures and improvements to resist lateral loads for the design of footings or shear keys. The allowable passive pressure assumes a horizontal surface extending at least 5 feet, or three times the surface generating the passive pressure, whichever is greater. The upper 12 inches of material in areas not protected by floor slabs or pavement should not be included in design for passive resistance.

**TABLE 7.10
SUMMARY OF LATERAL LOAD DESIGN RECOMMENDATIONS**

Parameter	Value
Passive Pressure Fluid Density	350 pcf
Coefficient of Friction (Concrete and Soil)	0.35
Coefficient of Friction (Along Vapor Barrier)	0.2 to 0.25*

*Per manufacturer's recommendations.

- 7.10.2 The passive and frictional resistant loads can be combined for design purposes. The lateral passive pressures may be increased by one-third when considering transient loads due to wind or seismic forces.

7.11 Preliminary Pavement Recommendations

- 7.11.1 We calculated the flexible pavement sections in general conformance with the *Caltrans Method of Flexible Pavement Design* (Highway Design Manual, Section 608.4) using an estimated Traffic Index (TI) of 5.0, 5.5, 6.0 and 7.0 for parking stalls, driveways, medium truck traffic areas, and heavy truck traffic areas, respectively. The project civil engineer and owner should review the pavement designations to determine appropriate locations for pavement thickness. The final pavement sections for the parking lot should be based on the R-Value of the subgrade soil encountered at final subgrade elevation. We assumed an R-Value of 5 (based on laboratory testing) and 78 for the subgrade soil and base materials, respectively, for the purposes of this preliminary analysis. Table 7.11.1 presents the preliminary flexible pavement sections.

**TABLE 7.11.1
PRELIMINARY FLEXIBLE PAVEMENT SECTION**

Location	Assumed Traffic Index	Assumed Subgrade R-Value	Asphalt Concrete (inches)	Class 2 Aggregate Base (inches)
Parking stalls for automobiles and light-duty vehicles	5.0	5	3	10
Driveways for automobiles and light-duty vehicles	5.5	5	3	12
Medium truck traffic areas	6.0	5	3½	13
Driveways for heavy truck traffic	7.0	5	4	16

7.11.2 Prior to placing base materials, the upper 12 inches of the subgrade soil should be scarified, moisture conditioned as necessary, and recompacted to a dry density of at least 95 percent of the laboratory maximum dry density near to slightly above optimum moisture content as determined by ASTM D 1557. Similarly, the base material should be compacted to a dry density of at least 95 percent of the laboratory maximum dry density near to slightly above optimum moisture content. Asphalt concrete should be compacted to a density of at least 95 percent of the laboratory Hveem density in accordance with ASTM D 2726.

7.11.3 A rigid Portland cement concrete (PCC) pavement section should be placed in roadway aprons and cross gutters. We calculated the rigid pavement section in general conformance with the procedure recommended by the American Concrete Institute report ACI 330R-08 Guide for Design and Construction of Concrete Parking Lots using the parameters presented in Table 7.11.2.

**TABLE 7.11.2
RIGID PAVEMENT DESIGN PARAMETERS**

Design Parameter	Design Value
Modulus of subgrade reaction, k	50 pci
Modulus of rupture for concrete, M _R	500 psi
Concrete Compressive Strength	3,000 psi
Traffic Category, TC	A and C
Average daily truck traffic, ADTT	10 and 100

7.11.4 Based on the criteria presented herein, the PCC pavement sections should have a minimum thickness as presented in Table 7.11.3.

**TABLE 7.11.3
RIGID VEHICULAR PAVEMENT RECOMMENDATIONS**

Location	Portland Cement Concrete (inches)
Automobile Parking Stalls (TC=A, ADTT=10)	6.0
Driveways (Includes Fire Truck Loading) (TC=C, ADTT=100)	7.5

- 7.11.5 The PCC vehicular pavement should be placed over subgrade soil that is compacted to a dry density of at least 95 percent of the laboratory maximum dry density near to slightly above optimum moisture content.
- 7.11.6 The rigid pavement should also be designed and constructed incorporating the parameters presented in Table 7.11.4.

**TABLE 7.11.4
ADDITIONAL RIGID PAVEMENT RECOMMENDATIONS**

Subject	Value
Thickened Edge	1.2 Times Slab Thickness
	Minimum Increase of 2 Inches
	4 Feet Wide
Crack Control Joint Spacing	30 Times Slab Thickness
	Max. Spacing of 12 feet for 5.5-Inch-Thick
	Max. Spacing of 15 Feet for Slabs 6 Inches and Thicker
Crack Control Joint Depth	Per ACI 330R-08
	1 Inch Using Early-Entry Saws on Slabs Less Than 9 Inches Thick
Crack Control Joint Width	¼-Inch for Sealed Joints
	⅜-Inch is Common for Sealed Joints
	1/10- to 1/8-Inch is Common for Unsealed Joints

- 7.11.7 Reinforcing steel will not be necessary within the concrete for geotechnical purposes with the possible exception of dowels at construction joints as discussed herein.
- 7.11.8 To control the location and spread of concrete shrinkage cracks, crack-control joints (weakened plane joints) should be included in the design of the concrete pavement slab. Crack-control joints should be sealed with an appropriate sealant to prevent the migration of water through the control joint to the subgrade materials. The depth of the crack-control joints should be determined by the referenced ACI report.

- 7.11.9 To provide load transfer between adjacent pavement slab sections, a butt-type construction joint should be constructed. The butt-type joint should be thickened by at least 20 percent at the edge and taper back at least 4 feet from the face of the slab. As an alternative to the butt-type construction joint, dowelling can be used between construction joints for pavements of 7 inches or thicker. As discussed in the referenced ACI guide, dowels should consist of smooth, 1-inch-diameter reinforcing steel 14 inches long embedded a minimum of 6 inches into the slab on either side of the construction joint. Dowels should be located at the midpoint of the slab, spaced at 12 inches on center and lubricated to allow joint movement while still transferring loads. In addition, tie bars should be installed as recommended in Section 3.8.3 of the referenced ACI guide. The structural engineer should provide other alternative recommendations for load transfer.
- 7.11.10 Concrete curb/gutter should be placed on soil subgrade compacted to a dry density of at least 90 percent of the laboratory maximum dry density near to slightly above optimum moisture content. Cross-gutters that receives vehicular should be placed on subgrade soil compacted to a dry density of at least 95 percent of the laboratory maximum dry density near to slightly above optimum moisture content. Base materials should not be placed below the curb/gutter, or cross-gutters so water is not able to migrate from the adjacent parkways to the pavement sections. Where flatwork is located directly adjacent to the curb/gutter, the concrete flatwork should be structurally connected to the curbs to help reduce the potential for offsets between the curbs and the flatwork.

7.12 Site Drainage and Moisture Protection

- 7.12.1 Adequate site drainage is critical to reduce the potential for differential soil movement, erosion and subsurface seepage. Under no circumstances should water be allowed to pond adjacent to footings. The site should be graded and maintained such that surface drainage is directed away from structures in accordance with 2019 CBC 1804.4 or other applicable standards. In addition, surface drainage should be directed away from the top of slopes into swales or other controlled drainage devices. Roof and pavement drainage should be directed into conduits that carry runoff away from the proposed structure.
- 7.12.2 In the case of basement walls or building walls retaining landscaping areas, a water-proofing system should be used on the wall and joints, and a Miradrain drainage panel (or similar) should be placed over the waterproofing. The project architect or civil engineer should provide detailed specifications on the plans for all waterproofing and drainage.
- 7.12.3 Underground utilities should be leak free. Utility and irrigation lines should be checked periodically for leaks, and detected leaks should be repaired promptly. Detrimental soil movement could occur if water is allowed to infiltrate the soil for prolonged periods of time.

7.12.4 Landscaping planters adjacent to paved areas are not recommended due to the potential for surface or irrigation water to infiltrate the pavement's subgrade and base course. Area drains to collect excess irrigation water and transmit it to drainage structures or impervious above-grade planter boxes can be used. In addition, where landscaping is planned adjacent to the pavement, construction of a cutoff wall along the edge of the pavement that extends at least 6 inches below the bottom of the base material should be considered.

7.12.5 We should prepare a storm water infiltration feasibility report of storm water management devices are planned.

7.13 Grading and Foundation Plan Review

7.13.1 Geocon Incorporated should review the grading and building foundation plans for the project prior to final design submittal to evaluate if additional analyses and/or recommendations are required.

7.14 Testing and Observation Services During Construction

7.14.1 Geocon Incorporated should provide geotechnical testing and observation services during the grading operations, foundation construction, utility installation, retaining wall backfill and pavement installation. Table 7.14 presents the typical geotechnical observations we would expect for the proposed improvements.

**TABLE 7.14
EXPECTED GEOTECHNICAL TESTING AND OBSERVATION SERVICES**

Construction Phase	Observations	Expected Time Frame
Grading	Base of Removal	Part Time During Removals
	Fill Placement and Soil Compaction	Full Time
Soldier Piles	Solder Pile Drilling Depth	Part Time
Tieback Anchors	Tieback Drilling and Installation	Full Time
	Tieback Testing	Full Time
Foundations	Foundation Excavation Observations	Part Time
Utility Backfill	Fill Placement and Soil Compaction	Part Time to Full Time
Retaining Wall Backfill	Fill Placement and Soil Compaction	Part Time to Full Time
Subgrade for Sidewalks, Curb/Gutter and Pavement	Soil Compaction	Part Time
Pavement Construction	Base Placement and Compaction	Part Time
	Asphalt Concrete Placement and Compaction	Full Time

LIMITATIONS AND UNIFORMITY OF CONDITIONS

1. The firm that performed the geotechnical investigation for the project should be retained to provide testing and observation services during construction to provide continuity of geotechnical interpretation and to check that the recommendations presented for geotechnical aspects of site development are incorporated during site grading, construction of improvements, and excavation of foundations. If another geotechnical firm is selected to perform the testing and observation services during construction operations, that firm should prepare a letter indicating their intent to assume the responsibilities of project geotechnical engineer of record. A copy of the letter should be provided to the regulatory agency for their records. In addition, that firm should provide revised recommendations concerning the geotechnical aspects of the proposed development, or a written acknowledgement of their concurrence with the recommendations presented in our report. They should also perform additional analyses deemed necessary to assume the role of Geotechnical Engineer of Record.
2. The recommendations of this report pertain only to the site investigated and are based upon the assumption that the soil conditions do not deviate from those disclosed in the investigation. If any variations or undesirable conditions are encountered during construction, or if the proposed construction will differ from that anticipated herein, Geocon Incorporated should be notified so that supplemental recommendations can be given. The evaluation or identification of the potential presence of hazardous or corrosive materials was not part of the scope of services provided by Geocon Incorporated.
3. This report is issued with the understanding that it is the responsibility of the owner or his representative to ensure that the information and recommendations contained herein are brought to the attention of the architect and engineer for the project and incorporated into the plans, and the necessary steps are taken to see that the contractor and subcontractors carry out such recommendations in the field.
4. The findings of this report are valid as of the present date. However, changes in the conditions of a property can occur with the passage of time, whether they be due to natural processes or the works of man on this or adjacent properties. In addition, changes in applicable or appropriate standards may occur, whether they result from legislation or the broadening of knowledge. Accordingly, the findings of this report may be invalidated wholly or partially by changes outside our control. Therefore, this report is subject to review and should not be relied upon after a period of three years.

U STOR II - TORREY PINES
 11391 SORRENTO VALLEY ROAD
 SAN DIEGO, CALIFORNIA

**APPROX. LIMITS
 OF GRADING**

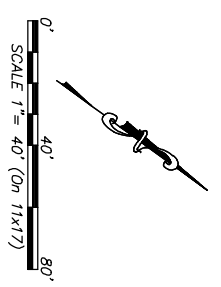
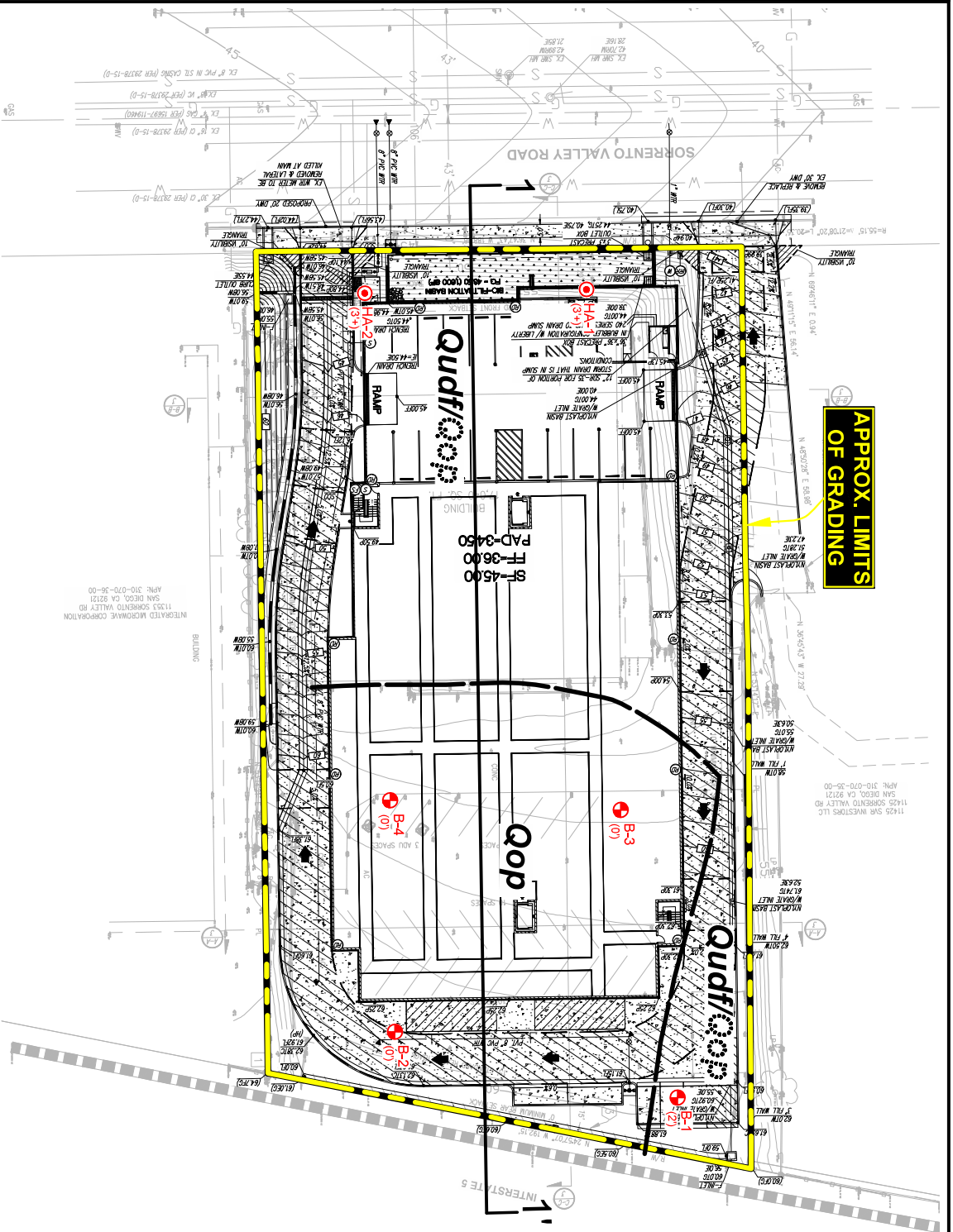

- GEOCON LEGEND**
- Qudf** UNDOCUMENTED FILL
 - Qop** OLD PARALIC DEPOSITS
 (dotted where buried)
 - B-4** APPROX. LOCATION OF BORING
 - HA-2** APPROX. LOCATION OF HAND AUGER BORING
 - (2)** APPROX. DEPTH TO FORMATION (in Feet)
 - APPROX. LOCATION OF GEOLOGIC CONTACT
 - - -** APPROX. LOCATION OF GEOLOGIC CROSS-SECTION

GEOCON
 INCORPORATED
 GEOTECHNICAL ■ ENVIRONMENTAL ■ MATERIALS
 4500 LA JOLLA VILLAGE DRIVE, SUITE 100
 SAN DIEGO, CALIFORNIA 92121-2974
 PHONE (619) 524-6000 FAX (619) 524-4189
 PROJECT NO. G2740-52-01
 FIGURE 1
 DATE 03 - 08 - 2022

U STOR IT - TORREY PINES
 11391 SORRENTO VALLEY ROAD
 SAN DIEGO, CALIFORNIA

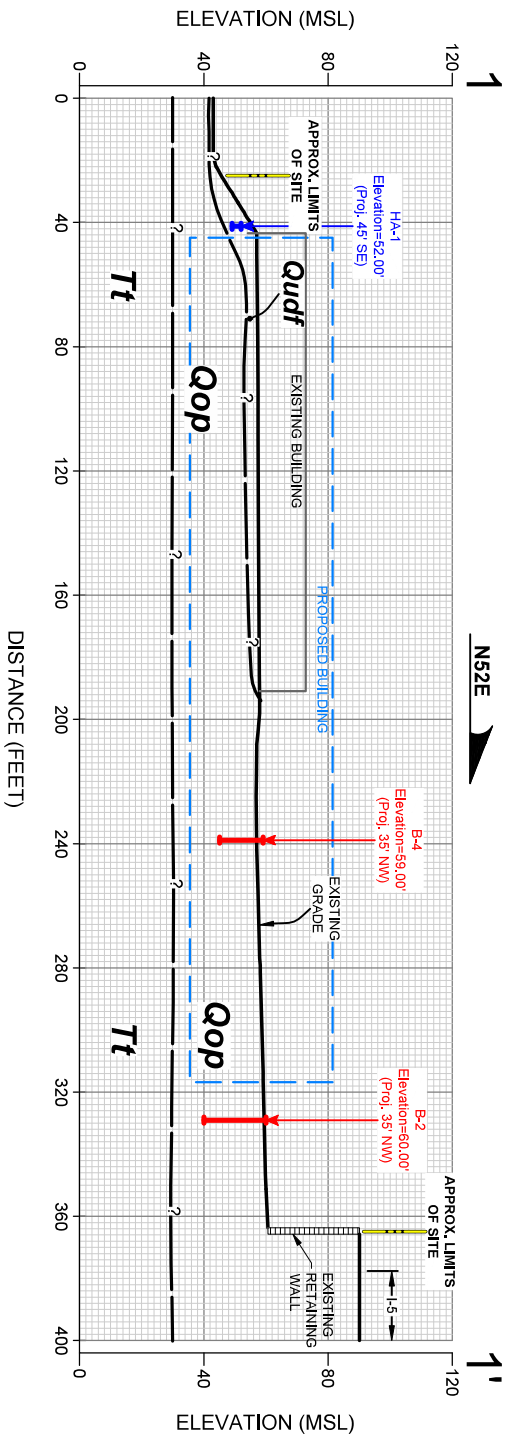

GEOLOGIC CROSS-SECTION 1-1'

SCALE: 1" = 40' (Vert. = Horiz.)

- GEOCON LEGEND**
- Qudf** UNDOCUMENTED FILL
 - Qop** OLD PARALIC DEPOSITS
 - Tt** TORREY SANDSTONE
 - B-4** APPROX. LOCATION OF BORING
 - HA-1** APPROX. LOCATION OF HAND AUGER BORING
 - APPROX. LOCATION OF GEOLOGIC CONTACT (Queried Where Uncertain)

GEOLOGIC CROSS - SECTION

DATE 03 - 08 - 2022

Plotted: 03/08/2022 10:53AM | By: JOHAN HAN WILMINS | File Location: Y:\PROJECTS\G27\465241 U STOR IT\SOURCE\SECTION\G27\465241 Profile.dwg

GEOCON
 INCORPORATED

GEOTECHNICAL ■ ENVIRONMENTAL ■ MATERIALS
 6700 LA JOLLA VILLAGE DRIVE, SUITE 200, SAN DIEGO, CA 92121-2974
 PHONE: 619.526.6900 FAX: 619.526.6901
 PROJECT NO.: G27/40 - 52 - 01



APPENDIX

A

APPENDIX A

FIELD INVESTIGATION

We performed the drilling operations on June 30, 2021 using a CME 75 drill rig equipped with hollow-stem augers or a hand auger with Baja Exploration. Borings extended to maximum depth of approximately 23 feet. The locations of the current exploratory borings are shown on the Geologic Map, Figure 1. The boring logs and are presented in this Appendix. We located the borings in the field using a measuring tape and existing reference points; therefore, actual boring locations may deviate slightly.

We obtained samples during our subsurface exploration in the borings using a California sampler. California samplers are composed of steel and are driven to obtain ring samples. The California sampler has an inside diameter of 2.5 inches and an outside diameter of 3 inches. Up to 18 rings are placed inside the sampler that is 2.4 inches in diameter and 1 inch in height. We obtained ring samples at appropriate intervals, placed them in moisture-tight containers, and transported them to the laboratory for testing. The type of sample is noted on the exploratory boring logs.







The samplers were driven 12 inches. The sampler is connected to A rods and driven into the bottom of the excavation using a 140-pound hammer with a 30-inch drop. Blow counts are recorded for every 6 inches the sampler is driven. The penetration resistances shown on the boring logs are shown in terms of blows per foot. The values indicated on the boring logs are the sum of the last 12 inches of the sampler. If the sampler was not driven for 12 inches, an approximate value is calculated in term of blows per foot or the final 6-inch interval is reported. These values are not to be taken as N-values as adjustments have not been applied. We estimated elevations shown on the boring logs either from a topographic map or by using a benchmark. Each excavation was backfilled as noted on the boring logs.

We visually examined, classified, and logged the soil encountered in the borings in general accordance with American Society for Testing and Materials (ASTM) practice for Description and Identification of Soils (Visual-Manual Procedure D 2488). The logs depict the soil and geologic conditions observed and the depth at which samples were obtained.

DEPTH IN FEET	SAMPLE NO.	LITHOLOGY	GROUNDWATER	SOIL CLASS (USCS)	BORING B 1			PENETRATION RESISTANCE (BLOWS/FT.)	DRY DENSITY (P.C.F.)	MOISTURE CONTENT (%)
					ELEV. (MSL.) <u>60'</u>	DATE COMPLETED <u>06-30-2021</u>	EQUIPMENT <u>CME 75</u> BY: <u>B. KUNA</u>			
					MATERIAL DESCRIPTION					
0				SM	3" ASPHALT CONCRETE over SUBGRADE SOIL					
2	B1-1			CL/SC	UNDOCUMENTED FILL (Qudf) Medium dense, moist, brown, Silty, fine to medium SAND OLD PARALIC DEPOSITS (Qop) Very stiff and dense, damp to moist, reddish to yellowish brown, Sandy CLAY and Clayey SAND -Decrease in fines content			48	103.7	14.1
4	B1-2									
6	B1-3							64	107.3	8.8
8										
10	B1-4							62	115.7	12.7
12										
14										
16				SC	Very dense, damp, reddish brown, Clayey, fine to coarse SAND with abundant gravel -Abundant gravel and small cobbles, sampling unsuccessful -Refusal on gravel at 23 feet			82		
18										
20										
22										
					BORING TERMINATED AT 23 FEET No groundwater encountered					

Figure A-1,
Log of Boring B 1, Page 1 of 1

G2740-52-01.GPJ

SAMPLE SYMBOLS	 ... SAMPLING UNSUCCESSFUL	 ... STANDARD PENETRATION TEST	 ... DRIVE SAMPLE (UNDISTURBED)
	 ... DISTURBED OR BAG SAMPLE	 ... CHUNK SAMPLE	 ... WATER TABLE OR  ... SEEPAGE

NOTE: THE LOG OF SUBSURFACE CONDITIONS SHOWN HEREON APPLIES ONLY AT THE SPECIFIC BORING OR TRENCH LOCATION AND AT THE DATE INDICATED. IT IS NOT WARRANTED TO BE REPRESENTATIVE OF SUBSURFACE CONDITIONS AT OTHER LOCATIONS AND TIMES.











DEPTH IN FEET	SAMPLE NO.	LITHOLOGY	GROUNDWATER	SOIL CLASS (USCS)	BORING B 2		PENETRATION RESISTANCE (BLOWS/FT.)	DRY DENSITY (P.C.F.)	MOISTURE CONTENT (%)
					ELEV. (MSL.) <u>60'</u>	DATE COMPLETED <u>06-30-2021</u>			
					EQUIPMENT <u>CME 75</u> BY: <u>B. KUNA</u>				
MATERIAL DESCRIPTION									
0				CL	3" ASPHALT CONCRETE over SUBGRADE SOIL				
2	B2-1				OLD PARALIC DEPOSITS (Qop) Very stiff, moist to wet, grayish brown, Silty CLAY; few white stringers		27	101.1	22.8
4	B2-2			SM	Medium dense, moist, brown, Silty, fine SAND; some iron oxide staining		26	110.2	11.9
10	B2-3			CL	Very stiff, moist, grayish brown, Silty CLAY; little fine sand		24	110.2	17.7
14	B2-4			SP	Medium dense, damp, light grayish brown to light yellowish brown, fine SAND; little cohesion		37		3.8
20					-Becomes very gravelly at 19 feet; practical refusal on gravel at 20 feet REFUSAL AT 20 FEET No groundwater encountered Backfilled with drill cuttings mixed with bentonite chips				

Figure A-2,
Log of Boring B 2, Page 1 of 1

G2740-52-01.GPJ

SAMPLE SYMBOLS		... SAMPLING UNSUCCESSFUL		... STANDARD PENETRATION TEST		... DRIVE SAMPLE (UNDISTURBED)
		... DISTURBED OR BAG SAMPLE		... CHUNK SAMPLE		... WATER TABLE OR  ... SEEPAGE

NOTE: THE LOG OF SUBSURFACE CONDITIONS SHOWN HEREON APPLIES ONLY AT THE SPECIFIC BORING OR TRENCH LOCATION AND AT THE DATE INDICATED. IT IS NOT WARRANTED TO BE REPRESENTATIVE OF SUBSURFACE CONDITIONS AT OTHER LOCATIONS AND TIMES.











DEPTH IN FEET	SAMPLE NO.	LITHOLOGY	GROUNDWATER	SOIL CLASS (USCS)	BORING B 3		PENETRATION RESISTANCE (BLOWS/FT.)	DRY DENSITY (P.C.F.)	MOISTURE CONTENT (%)
					ELEV. (MSL.) <u>57'</u>	DATE COMPLETED <u>06-30-2021</u>			
					EQUIPMENT <u>CME 75</u> BY: <u>B. KUNA</u>				
MATERIAL DESCRIPTION									
0				SM	3" ASPHALT CONCRETE over SUBGRADE SOIL				
2	B3-1				OLD PARALIC DEPOSITS (Qop) Medium dense, moist, grayish brown, Silty, fine SAND; some iron oxide staining		24	113.4	12.6
4	B3-2						20	113.3	15.5
8				SP	Medium dense, moist, light yellowish brown and light grayish brown, fine to medium SAND; little cohesion, some gravel at 11 feet				
10	B3-3				-Some gravel at 11 feet		37	98.2	8.2
12					-Becomes very gravelly at 13 feet				
14	B3-4				-Sampling unsuccessful; practical refusal on gravel at 16 feet		71		
16					REFUSAL AT 16 FEET No groundwater encountered Backfilled with drill cuttings mixed with bentonite chips				

Figure A-3,
Log of Boring B 3, Page 1 of 1

G2740-52-01.GPJ

SAMPLE SYMBOLS		... SAMPLING UNSUCCESSFUL		... STANDARD PENETRATION TEST		... DRIVE SAMPLE (UNDISTURBED)
		... DISTURBED OR BAG SAMPLE		... CHUNK SAMPLE		... WATER TABLE OR  ... SEEPAGE

NOTE: THE LOG OF SUBSURFACE CONDITIONS SHOWN HEREON APPLIES ONLY AT THE SPECIFIC BORING OR TRENCH LOCATION AND AT THE DATE INDICATED. IT IS NOT WARRANTED TO BE REPRESENTATIVE OF SUBSURFACE CONDITIONS AT OTHER LOCATIONS AND TIMES.







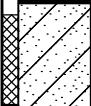
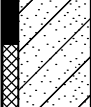
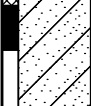
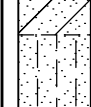
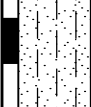
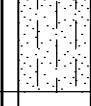

DEPTH IN FEET	SAMPLE NO.	LITHOLOGY	GROUNDWATER	SOIL CLASS (USCS)	BORING B 4		PENETRATION RESISTANCE (BLOWS/FT.)	DRY DENSITY (P.C.F.)	MOISTURE CONTENT (%)
					ELEV. (MSL.) <u>59'</u>	DATE COMPLETED <u>06-30-2021</u>			
					EQUIPMENT <u>CME 75</u> BY: <u>B. KUNA</u>				
MATERIAL DESCRIPTION									
0	B4-1			CL	3" ASPHALT CONCRETE over SUBGRADE SOIL				
2	B4-2				OLD PARALIC DEPOSITS (Qop) Medium dense to very stiff, moist to wet, grayish brown, Sandy CLAY; little iron oxide staining		30	104.6	20.0
4	B4-3						35	106.9	9.5
6									
8				SM	Medium dense, damp to moist, grayish brown, Silty, fine to medium SAND				
10	B4-4				-Becomes very gravelly at 13 feet; practical refusal on gravel at 13 feet		37	105.5	4.6
12									
14					REFUSAL AT 14 FEET No groundwater encountered Backfilled with drill cuttings mixed with bentonite chips				

Figure A-4,
Log of Boring B 4, Page 1 of 1

G2740-52-01.GPJ

SAMPLE SYMBOLS		... SAMPLING UNSUCCESSFUL		... STANDARD PENETRATION TEST		... DRIVE SAMPLE (UNDISTURBED)
		... DISTURBED OR BAG SAMPLE		... CHUNK SAMPLE		... WATER TABLE OR  ... SEEPAGE

NOTE: THE LOG OF SUBSURFACE CONDITIONS SHOWN HEREON APPLIES ONLY AT THE SPECIFIC BORING OR TRENCH LOCATION AND AT THE DATE INDICATED. IT IS NOT WARRANTED TO BE REPRESENTATIVE OF SUBSURFACE CONDITIONS AT OTHER LOCATIONS AND TIMES.









DEPTH IN FEET	SAMPLE NO.	LITHOLOGY	GROUNDWATER	SOIL CLASS (USCS)	BORING HA 1		PENETRATION RESISTANCE (BLOWS/FT.)	DRY DENSITY (P.C.F.)	MOISTURE CONTENT (%)
					ELEV. (MSL.) <u>52'</u>	DATE COMPLETED <u>06-30-2021</u>			
					EQUIPMENT <u>HAND AUGER</u> BY: <u>D. GITHENS</u>				
MATERIAL DESCRIPTION									
0	HA1-1			SC	UNDOCUMENTED FILL (Qudf) Loose to medium dense, damp, light brown to light yellowish brown, Silty to Clayey, fine SAND with trace gravel up to 1"				
2									
					BORING TERMINATED AT 3 FEET Refusal on cobble or concrete				

Figure A-5,
Log of Boring HA 1, Page 1 of 1

G2740-52-01.GPJ

SAMPLE SYMBOLS	 ... SAMPLING UNSUCCESSFUL	 ... STANDARD PENETRATION TEST	 ... DRIVE SAMPLE (UNDISTURBED)
	 ... DISTURBED OR BAG SAMPLE	 ... CHUNK SAMPLE	 ... WATER TABLE OR  ... SEEPAGE

NOTE: THE LOG OF SUBSURFACE CONDITIONS SHOWN HEREON APPLIES ONLY AT THE SPECIFIC BORING OR TRENCH LOCATION AND AT THE DATE INDICATED. IT IS NOT WARRANTED TO BE REPRESENTATIVE OF SUBSURFACE CONDITIONS AT OTHER LOCATIONS AND TIMES.







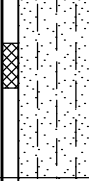

DEPTH IN FEET	SAMPLE NO.	LITHOLOGY	GROUNDWATER	SOIL CLASS (USCS)	BORING HA 2		PENETRATION RESISTANCE (BLOWS/FT.)	DRY DENSITY (P.C.F.)	MOISTURE CONTENT (%)
					ELEV. (MSL.) <u>46'</u>	DATE COMPLETED <u>06-30-2021</u>			
					EQUIPMENT <u>HAND AUGER</u> BY: <u>D. GITHENS</u>				
					MATERIAL DESCRIPTION				
0	HA2-1			SM	UNDOCUMENTED FILL (Qudf) Loose to medium dense, light brown to light yellowish brown, Silty, fine to coarse SAND with little gravel up to 2.5"				
2					-Becomes damp to moist				
4					BORING TERMINATED AT 4 FEET Refusal on rock or concrete Backfilled with spoils				

Figure A-6,
Log of Boring HA 2, Page 1 of 1

G2740-52-01.GPJ

SAMPLE SYMBOLS	 ... SAMPLING UNSUCCESSFUL	 ... STANDARD PENETRATION TEST	 ... DRIVE SAMPLE (UNDISTURBED)
	 ... DISTURBED OR BAG SAMPLE	 ... CHUNK SAMPLE	 ... WATER TABLE OR  ... SEEPAGE

NOTE: THE LOG OF SUBSURFACE CONDITIONS SHOWN HEREON APPLIES ONLY AT THE SPECIFIC BORING OR TRENCH LOCATION AND AT THE DATE INDICATED. IT IS NOT WARRANTED TO BE REPRESENTATIVE OF SUBSURFACE CONDITIONS AT OTHER LOCATIONS AND TIMES.

APPENDIX



B

APPENDIX B

LABORATORY TESTING

We performed laboratory tests in accordance with generally accepted test methods of the American Society for Testing and Materials (ASTM) or other suggested procedures. We tested selected soil samples for in-place dry density/moisture content, maximum density/optimum moisture content, direct shear strength, expansion index, pH, resistivity, water-soluble sulfate, water-soluble chloride ion content, plasticity index, R-Value, unconfined compressive strength, and gradation characteristics. The results of our current laboratory tests are presented herein. The in-place dry density and moisture content of the samples tested are presented on the boring logs in Appendix A.

SUMMARY OF LABORATORY MAXIMUM DRY DENSITY AND OPTIMUM MOISTURE CONTENT TEST RESULTS ASTM D 1557

Sample No.	Description	Maximum Dry Density (pcf)	Optimum Moisture Content (% dry wt.)
B1-3	Reddish to Yellowish Brown, Sandy CLAY (Qop)	126.1	10.6
B4-1	Grayish Brown, Clayey SAND (Qop)	127.2	10.9

SUMMARY OF LABORATORY EXPANSION INDEX TEST RESULTS ASTM D 4829

Sample No.	Moisture Content (%)		Dry Density (pcf)	Expansion Index	2019 CBC Expansion Classification	ASTM Soil Expansion Classification
	Before Test	After Test				
B1-3	11.9	22.6	104.5	44	Expansive	Low
B4-1	11.6	24.0	105.3	71	Expansive	Medium

SUMMARY OF LABORATORY WATER-SOLUBLE SULFATE TEST RESULTS CALIFORNIA TEST NO. 417

Sample No.	Depth (feet)	Geologic Unit	Water-Soluble Sulfate (%)	ACI 318 Sulfate Exposure
B1-3	6-8	Qop	0.009	S0
B4-1	0-5	Qop	0.005	S0

**SUMMARY OF LABORATORY CHLORIDE TEST RESULTS
AASHTO T 291**

Sample No.	Depth (Feet)	Geologic Unit	Chloride Ion Content (ppm)	Chloride Ion Content (%)
B1-3	6-8	Qop	82	0.008

**SUMMARY OF LABORATORY POTENTIAL OF
HYDROGEN (PH) AND RESISTIVITY TEST RESULTS
CALIFORNIA TEST NO. 643**

Sample No.	Depth (Feet)	Geologic Unit	pH	Minimum Resistivity (ohm-centimeters)
B1-3	6-8	Qop	1200	7.97

**SUMMARY OF LABORATORY RESISTANCE VALUE (R-VALUE) TEST RESULTS
ASTM D 2844**

Sample No.	Depth (Feet)	Description (Geologic Unit)	R-Value
B4-1	0-5	Grayish brown, Sandy Clay (Qop)	5

**SUMMARY OF LABORATORY UNCONFINED COMPRESSIVE STRENGTH TEST RESULTS
ASTM D 1558**

Sample No.	Depth (feet)	Geologic Unit	Hand Penetrometer Reading/Unconfined Compression Strength (tsf) and Undrained Shear Strength (ksf)
B1-1	2.5	Qop	4.5+
B1-4	10	Qop	4.5+
B2-1	2.5	Qop	4.5+
B2-2	5	Qop	4.5+
B2-3	10	Qop	4.5+
B3-1	2.5	Qop	4.5+
B3-2	5	Qop	4.5+
B4-2	2.5	Qop	4.5+

SAMPLE NO.: **BI-2** GEOLOGIC UNIT: **Qop**
 SAMPLE DEPTH (FT): **5'** NATURAL/REMOLDED: **N**

INITIAL CONDITIONS				
NORMAL STRESS TEST LOAD	1 K	2 K	4 K	AVERAGE
ACTUAL NORMAL STRESS (PSF):	1000	2000	4000	--
WATER CONTENT (%):	7.4	13.6	5.3	8.8
DRY DENSITY (PCF):	105.9	112.2	103.8	107.3

AFTER TEST CONDITIONS				
NORMAL STRESS TEST LOAD	1 K	2 K	4 K	AVERAGE
WATER CONTENT (%):	19.5	19.5	21.2	20.1
PEAK SHEAR STRESS (PSF):	1323	3026	3231	--
ULT.-E.O.T. SHEAR STRESS (PSF):	1167	1859	2981	--

RESULTS		
PEAK	COHESION, C (PSF)	750
	FRICTION ANGLE (DEGREES)	31
ULTIMATE	COHESION, C (PSF)	650
	FRICTION ANGLE (DEGREES)	30

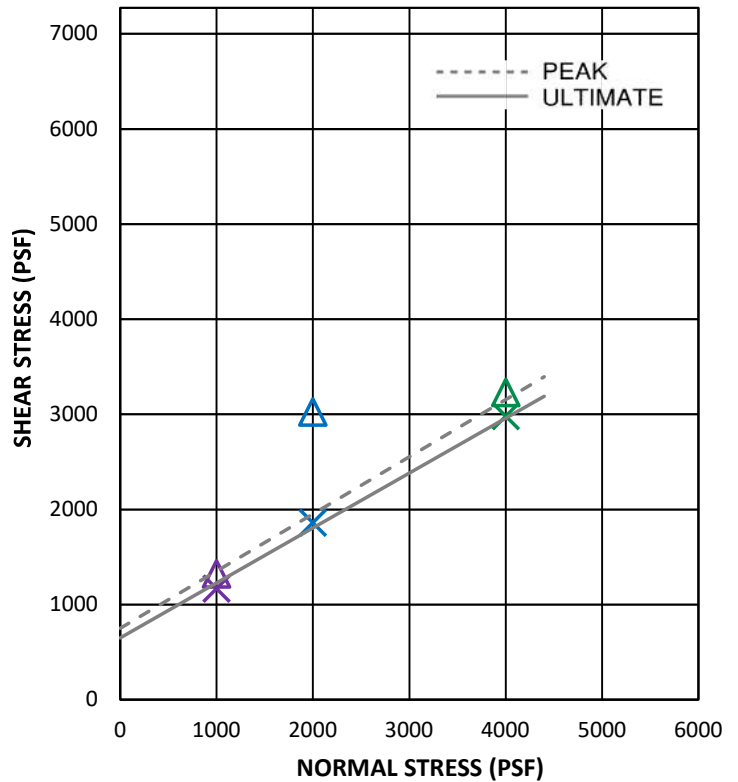
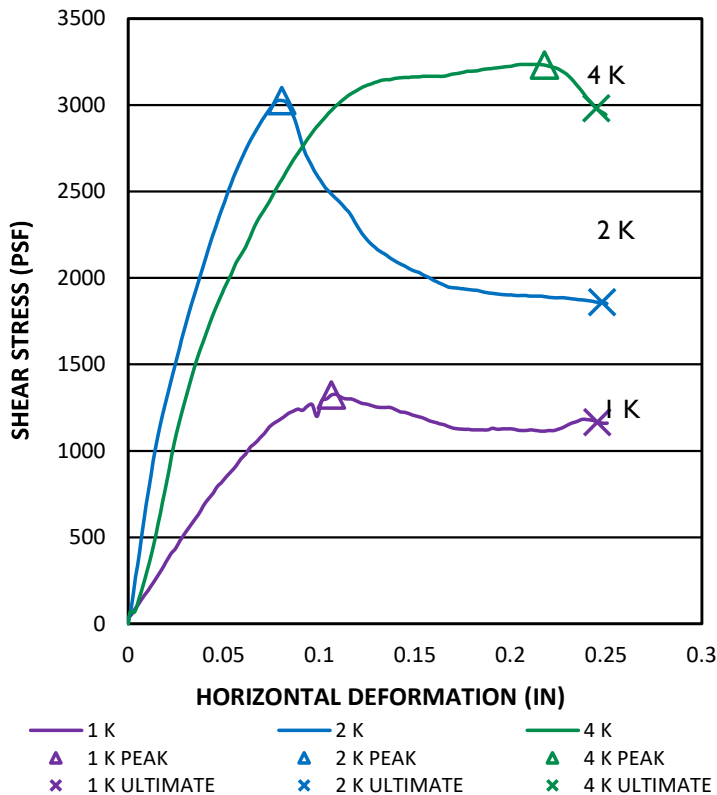

DIRECT SHEAR - ASTM D 3080

GEOCON
INCORPORATED



GEOTECHNICAL CONSULTANTS
 6960 FLANDERS DRIVE - SAN DIEGO, CALIFORNIA 92121-2974
 PHONE 858 558-6900 - FAX 858 558-6159

U STOR IT - TORREY PINES

PROJECT NO.: G2740-52-01

SAMPLE NO.: **B4-3** GEOLOGIC UNIT: **Qop**
 SAMPLE DEPTH (FT): **5'** NATURAL/REMOLDED: **N**

INITIAL CONDITIONS				
NORMAL STRESS TEST LOAD	1 K	2 K	4 K	AVERAGE
ACTUAL NORMAL STRESS (PSF):	1000	2000	4000	--
WATER CONTENT (%):	9.3	9.1	10.0	9.5
DRY DENSITY (PCF):	107.2	107.7	105.8	106.9

AFTER TEST CONDITIONS				
NORMAL STRESS TEST LOAD	1 K	2 K	4 K	AVERAGE
WATER CONTENT (%):	19.8	20.4	21.1	20.4
PEAK SHEAR STRESS (PSF):	1183	1664	3179	--
ULT.-E.O.T. SHEAR STRESS (PSF):	917	1645	3179	--

RESULTS		
PEAK	COHESION, C (PSF)	450
	FRICTION ANGLE (DEGREES)	34
ULTIMATE	COHESION, C (PSF)	350
	FRICTION ANGLE (DEGREES)	34

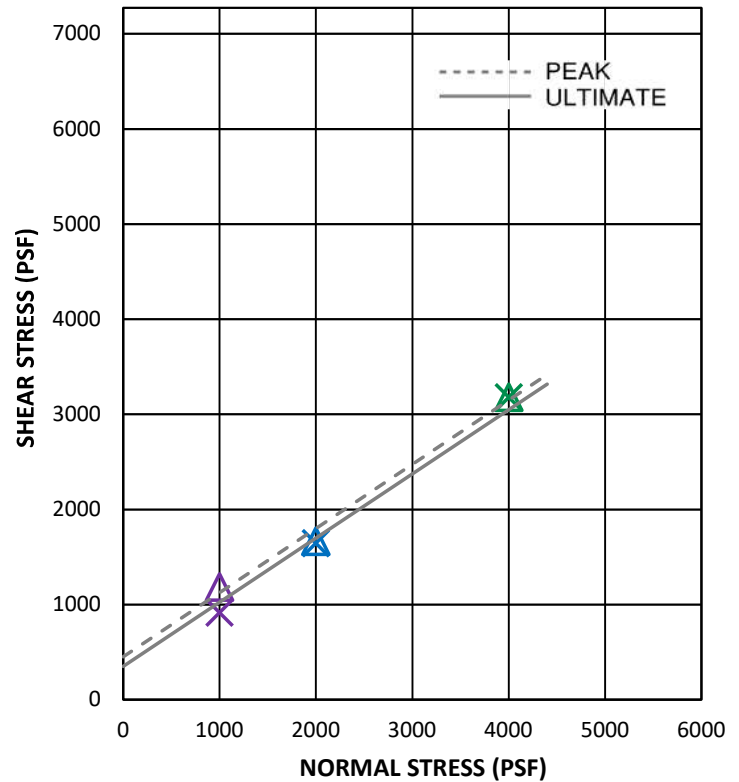
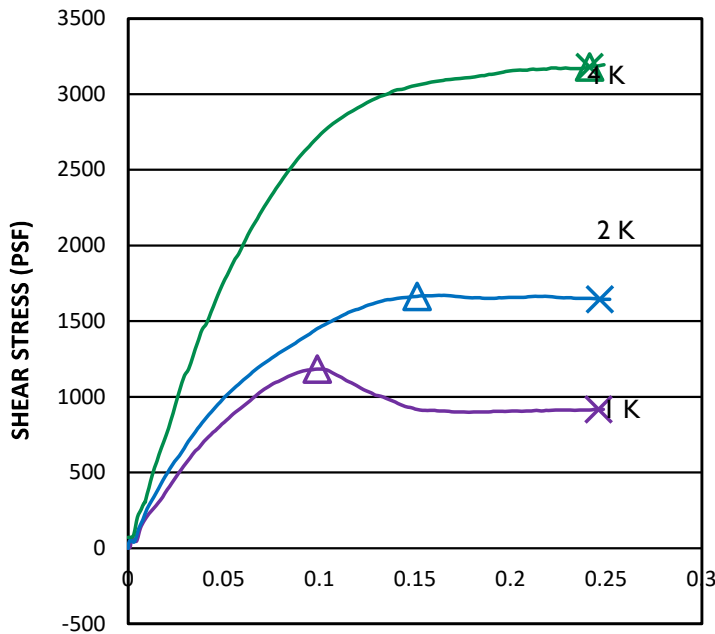

HORIZONTAL DEFORMATION (IN)

— 1 K — 2 K — 4 K
 ▲ 1 K PEAK ▲ 2 K PEAK ▲ 4 K PEAK
 × 1 K ULTIMATE × 2 K ULTIMATE × 4 K ULTIMATE

DIRECT SHEAR - ASTM D 3080

U STOR IT - TORREY PINES

PROJECT NO.: G2740-52-01

GEOCON
INCORPORATED



GEOTECHNICAL CONSULTANTS
 6960 FLANDERS DRIVE - SAN DIEGO, CALIFORNIA 92121-2974
 PHONE 858 558-6900 - FAX 858 558-6159

SAMPLE NO.: **B4-4**
 SAMPLE DEPTH (FT): **10'**

GEOLOGIC UNIT: **Qop**

TEST INFORMATION	
INITIAL DRY DENSITY (PCF):	105.5
INITIAL WATER CONTENT (%):	4.6%
SAMPLE SATURATED AT (KSF):	2.0
INITIAL SATURATION (%):	21.2%

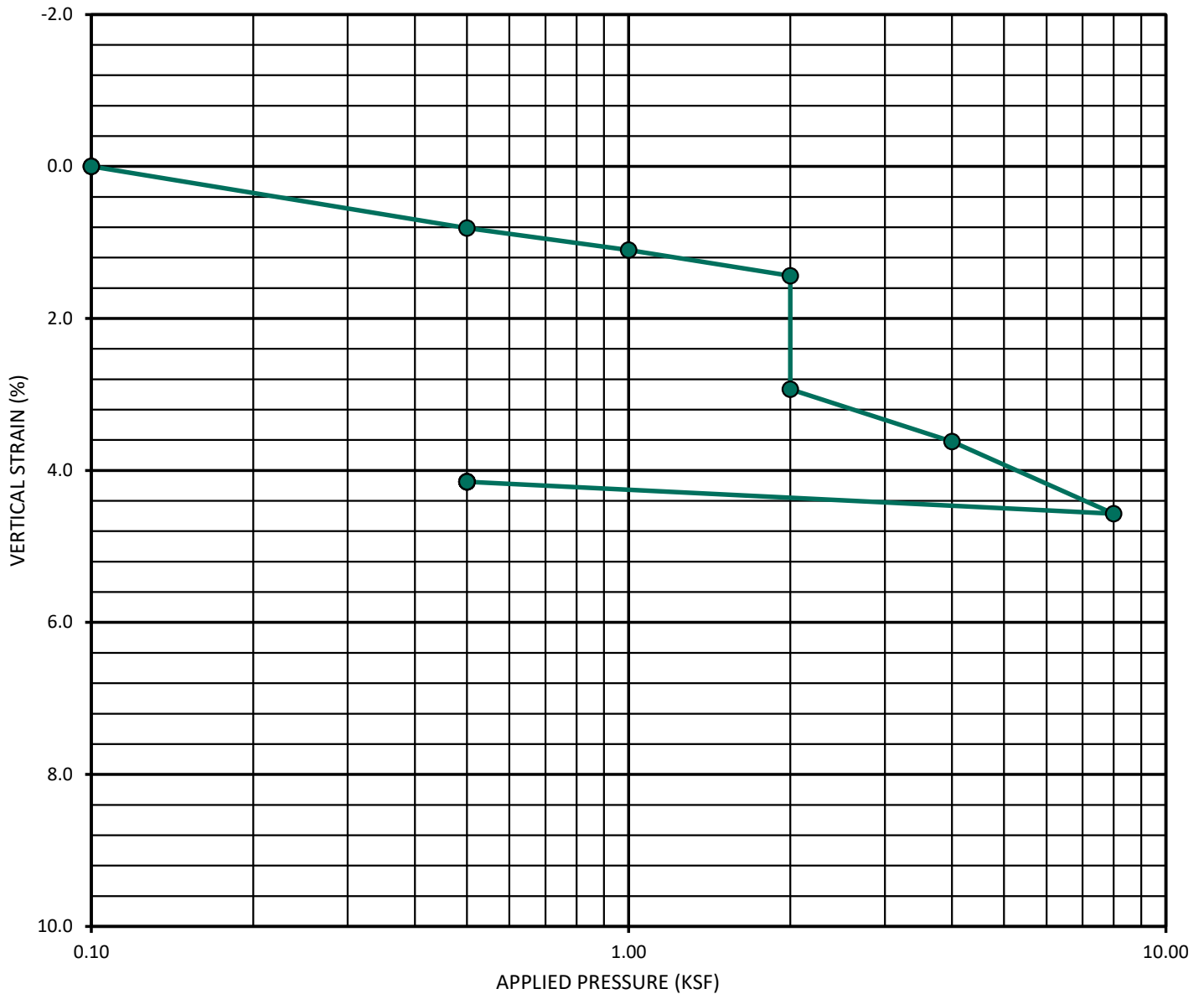

CONSOLIDATION CURVE - ASTM D 2435

U STOR IT - TORREY PINES

PROJECT NO.: G2740-52-01

GEOCON
 INCORPORATED



GEOTECHNICAL CONSULTANTS
 6960 FLANDERS DRIVE - SAN DIEGO, CALIFORNIA 92121 - 2974
 PHONE 858 558-6900 - FAX 858 558-6159

SAMPLE NO.: HAI-1
 SAMPLE DEPTH (FT.): 1'

GEOLOGIC UNIT: Qudf

GRAVEL		SAND			SILT OR CLAY
COARSE	FINE	COARSE	MEDIUM	FINE	

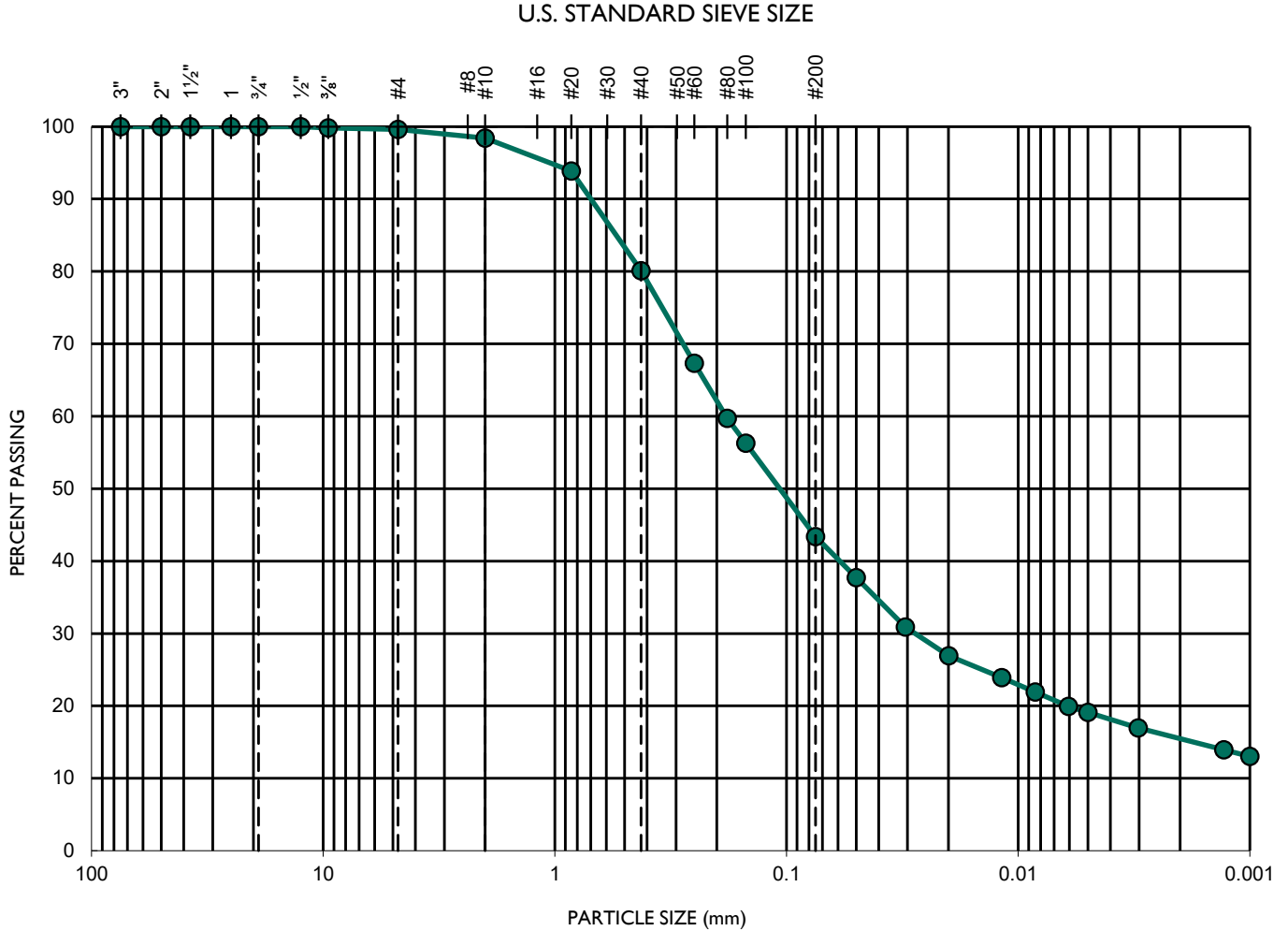

APPENDIX

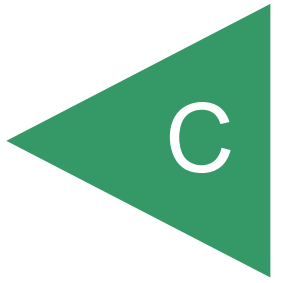

APPENDIX C

RECOMMENDED GRADING SPECIFICATIONS

FOR

U STOR IT
11391 SORRENTO VALLEY ROAD
SAN DIEGO, CALIFORNIA

PROJECT NO. G2740-52-01

RECOMMENDED GRADING SPECIFICATIONS

1. GENERAL

- 1.1 These Recommended Grading Specifications shall be used in conjunction with the Geotechnical Report for the project prepared by Geocon. The recommendations contained in the text of the Geotechnical Report are a part of the earthwork and grading specifications and shall supersede the provisions contained hereinafter in the case of conflict.
- 1.2 Prior to the commencement of grading, a geotechnical consultant (Consultant) shall be employed for the purpose of observing earthwork procedures and testing the fills for substantial conformance with the recommendations of the Geotechnical Report and these specifications. The Consultant should provide adequate testing and observation services so that they may assess whether, in their opinion, the work was performed in substantial conformance with these specifications. It shall be the responsibility of the Contractor to assist the Consultant and keep them apprised of work schedules and changes so that personnel may be scheduled accordingly.
- 1.3 It shall be the sole responsibility of the Contractor to provide adequate equipment and methods to accomplish the work in accordance with applicable grading codes or agency ordinances, these specifications and the approved grading plans. If, in the opinion of the Consultant, unsatisfactory conditions such as questionable soil materials, poor moisture condition, inadequate compaction, and/or adverse weather result in a quality of work not in conformance with these specifications, the Consultant will be empowered to reject the work and recommend to the Owner that grading be stopped until the unacceptable conditions are corrected.

2. DEFINITIONS

- 2.1 **Owner** shall refer to the owner of the property or the entity on whose behalf the grading work is being performed and who has contracted with the Contractor to have grading performed.
- 2.2 **Contractor** shall refer to the Contractor performing the site grading work.
- 2.3 **Civil Engineer** or **Engineer of Work** shall refer to the California licensed Civil Engineer or consulting firm responsible for preparation of the grading plans, surveying and verifying as-graded topography.
- 2.4 **Consultant** shall refer to the soil engineering and engineering geology consulting firm retained to provide geotechnical services for the project.

- 2.5 **Soil Engineer** shall refer to a California licensed Civil Engineer retained by the Owner, who is experienced in the practice of geotechnical engineering. The Soil Engineer shall be responsible for having qualified representatives on-site to observe and test the Contractor's work for conformance with these specifications.
- 2.6 **Engineering Geologist** shall refer to a California licensed Engineering Geologist retained by the Owner to provide geologic observations and recommendations during the site grading.
- 2.7 **Geotechnical Report** shall refer to a soil report (including all addenda) which may include a geologic reconnaissance or geologic investigation that was prepared specifically for the development of the project for which these Recommended Grading Specifications are intended to apply.

3. MATERIALS

- 3.1 Materials for compacted fill shall consist of any soil excavated from the cut areas or imported to the site that, in the opinion of the Consultant, is suitable for use in construction of fills. In general, fill materials can be classified as *soil* fills, *soil-rock* fills or *rock* fills, as defined below.
- 3.1.1 **Soil fills** are defined as fills containing no rocks or hard lumps greater than 12 inches in maximum dimension and containing at least 40 percent by weight of material smaller than $\frac{3}{4}$ inch in size.
- 3.1.2 **Soil-rock fills** are defined as fills containing no rocks or hard lumps larger than 4 feet in maximum dimension and containing a sufficient matrix of soil fill to allow for proper compaction of soil fill around the rock fragments or hard lumps as specified in Paragraph 6.2. **Oversize rock** is defined as material greater than 12 inches.
- 3.1.3 **Rock fills** are defined as fills containing no rocks or hard lumps larger than 3 feet in maximum dimension and containing little or no fines. Fines are defined as material smaller than $\frac{3}{4}$ inch in maximum dimension. The quantity of fines shall be less than approximately 20 percent of the rock fill quantity.
- 3.2 Material of a perishable, spongy, or otherwise unsuitable nature as determined by the Consultant shall not be used in fills.
- 3.3 Materials used for fill, either imported or on-site, shall not contain hazardous materials as defined by the California Code of Regulations, Title 22, Division 4, Chapter 30, Articles 9

and 10; 40CFR; and any other applicable local, state or federal laws. The Consultant shall not be responsible for the identification or analysis of the potential presence of hazardous materials. However, if observations, odors or soil discoloration cause Consultant to suspect the presence of hazardous materials, the Consultant may request from the Owner the termination of grading operations within the affected area. Prior to resuming grading operations, the Owner shall provide a written report to the Consultant indicating that the suspected materials are not hazardous as defined by applicable laws and regulations.

- 3.4 The outer 15 feet of *soil-rock* fill slopes, measured horizontally, should be composed of properly compacted *soil* fill materials approved by the Consultant. *Rock* fill may extend to the slope face, provided that the slope is not steeper than 2:1 (horizontal:vertical) and a soil layer no thicker than 12 inches is track-walked onto the face for landscaping purposes. This procedure may be utilized provided it is acceptable to the governing agency, Owner and Consultant.
- 3.5 Samples of soil materials to be used for fill should be tested in the laboratory by the Consultant to determine the maximum density, optimum moisture content, and, where appropriate, shear strength, expansion, and gradation characteristics of the soil.
- 3.6 During grading, soil or groundwater conditions other than those identified in the Geotechnical Report may be encountered by the Contractor. The Consultant shall be notified immediately to evaluate the significance of the unanticipated condition.

4. CLEARING AND PREPARING AREAS TO BE FILLED

- 4.1 Areas to be excavated and filled shall be cleared and grubbed. Clearing shall consist of complete removal above the ground surface of trees, stumps, brush, vegetation, man-made structures, and similar debris. Grubbing shall consist of removal of stumps, roots, buried logs and other unsuitable material and shall be performed in areas to be graded. Roots and other projections exceeding 1½ inches in diameter shall be removed to a depth of 3 feet below the surface of the ground. Borrow areas shall be grubbed to the extent necessary to provide suitable fill materials.
- 4.2 Asphalt pavement material removed during clearing operations should be properly disposed at an approved off-site facility or in an acceptable area of the project evaluated by Geocon and the property owner. Concrete fragments that are free of reinforcing steel may be placed in fills, provided they are placed in accordance with Section 6.2 or 6.3 of this document.

- 4.3 After clearing and grubbing of organic matter and other unsuitable material, loose or porous soils shall be removed to the depth recommended in the Geotechnical Report. The depth of removal and compaction should be observed and approved by a representative of the Consultant. The exposed surface shall then be plowed or scarified to a minimum depth of 6 inches and until the surface is free from uneven features that would tend to prevent uniform compaction by the equipment to be used.
- 4.4 Where the slope ratio of the original ground is steeper than 5:1 (horizontal:vertical), or where recommended by the Consultant, the original ground should be benched in accordance with the following illustration.

TYPICAL BENCHING DETAIL

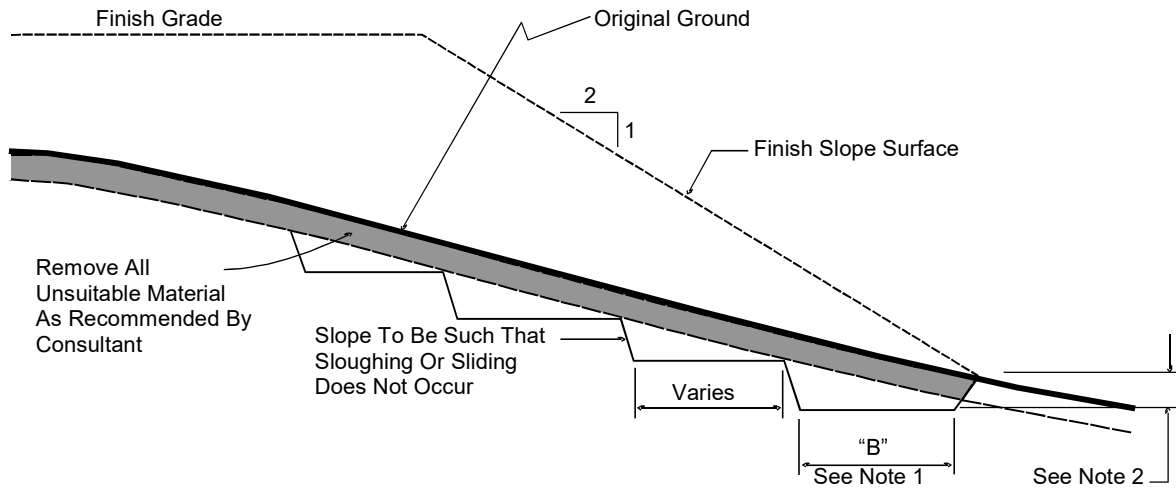

No Scale

- DETAIL NOTES:
- (1) Key width "B" should be a minimum of 10 feet, or sufficiently wide to permit complete coverage with the compaction equipment used. The base of the key should be graded horizontal, or inclined slightly into the natural slope.
 - (2) The outside of the key should be below the topsoil or unsuitable surficial material and at least 2 feet into dense formational material. Where hard rock is exposed in the bottom of the key, the depth and configuration of the key may be modified as approved by the Consultant.

- 4.5 After areas to receive fill have been cleared and scarified, the surface should be moisture conditioned to achieve the proper moisture content, and compacted as recommended in Section 6 of these specifications.

5. COMPACTION EQUIPMENT

- 5.1 Compaction of *soil* or *soil-rock* fill shall be accomplished by sheepsfoot or segmented-steel wheeled rollers, vibratory rollers, multiple-wheel pneumatic-tired rollers, or other types of acceptable compaction equipment. Equipment shall be of such a design that it will be capable of compacting the *soil* or *soil-rock* fill to the specified relative compaction at the specified moisture content.
- 5.2 Compaction of *rock* fills shall be performed in accordance with Section 6.3.

6. PLACING, SPREADING AND COMPACTION OF FILL MATERIAL

- 6.1 *Soil* fill, as defined in Paragraph 3.1.1, shall be placed by the Contractor in accordance with the following recommendations:
- 6.1.1 *Soil* fill shall be placed by the Contractor in layers that, when compacted, should generally not exceed 8 inches. Each layer shall be spread evenly and shall be thoroughly mixed during spreading to obtain uniformity of material and moisture in each layer. The entire fill shall be constructed as a unit in nearly level lifts. Rock materials greater than 12 inches in maximum dimension shall be placed in accordance with Section 6.2 or 6.3 of these specifications.
- 6.1.2 In general, the *soil* fill shall be compacted at a moisture content at or above the optimum moisture content as determined by ASTM D 1557.
- 6.1.3 When the moisture content of *soil* fill is below that specified by the Consultant, water shall be added by the Contractor until the moisture content is in the range specified.
- 6.1.4 When the moisture content of the *soil* fill is above the range specified by the Consultant or too wet to achieve proper compaction, the *soil* fill shall be aerated by the Contractor by blading/mixing, or other satisfactory methods until the moisture content is within the range specified.
- 6.1.5 After each layer has been placed, mixed, and spread evenly, it shall be thoroughly compacted by the Contractor to a relative compaction of at least 90 percent. Relative compaction is defined as the ratio (expressed in percent) of the in-place dry density of the compacted fill to the maximum laboratory dry density as determined in accordance with ASTM D 1557. Compaction shall be continuous over the entire area, and compaction equipment shall make sufficient passes so that the specified minimum relative compaction has been achieved throughout the entire fill.

- 6.1.6 Where practical, soils having an Expansion Index greater than 50 should be placed at least 3 feet below finish pad grade and should be compacted at a moisture content generally 2 to 4 percent greater than the optimum moisture content for the material.
 - 6.1.7 Properly compacted *soil* fill shall extend to the design surface of fill slopes. To achieve proper compaction, it is recommended that fill slopes be over-built by at least 3 feet and then cut to the design grade. This procedure is considered preferable to track-walking of slopes, as described in the following paragraph.
 - 6.1.8 As an alternative to over-building of slopes, slope faces may be back-rolled with a heavy-duty loaded sheepsfoot or vibratory roller at maximum 4-foot fill height intervals. Upon completion, slopes should then be track-walked with a D-8 dozer or similar equipment, such that a dozer track covers all slope surfaces at least twice.
- 6.2 *Soil-rock* fill, as defined in Paragraph 3.1.2, shall be placed by the Contractor in accordance with the following recommendations:
- 6.2.1 Rocks larger than 12 inches but less than 4 feet in maximum dimension may be incorporated into the compacted *soil* fill, but shall be limited to the area measured 15 feet minimum horizontally from the slope face and 5 feet below finish grade or 3 feet below the deepest utility, whichever is deeper.
 - 6.2.2 Rocks or rock fragments up to 4 feet in maximum dimension may either be individually placed or placed in windrows. Under certain conditions, rocks or rock fragments up to 10 feet in maximum dimension may be placed using similar methods. The acceptability of placing rock materials greater than 4 feet in maximum dimension shall be evaluated during grading as specific cases arise and shall be approved by the Consultant prior to placement.
 - 6.2.3 For individual placement, sufficient space shall be provided between rocks to allow for passage of compaction equipment.
 - 6.2.4 For windrow placement, the rocks should be placed in trenches excavated in properly compacted *soil* fill. Trenches should be approximately 5 feet wide and 4 feet deep in maximum dimension. The voids around and beneath rocks should be filled with approved granular soil having a Sand Equivalent of 30 or greater and should be compacted by flooding. Windrows may also be placed utilizing an "open-face" method in lieu of the trench procedure, however, this method should first be approved by the Consultant.

- 6.2.5 Windrows should generally be parallel to each other and may be placed either parallel to or perpendicular to the face of the slope depending on the site geometry. The minimum horizontal spacing for windrows shall be 12 feet center-to-center with a 5-foot stagger or offset from lower courses to next overlying course. The minimum vertical spacing between windrow courses shall be 2 feet from the top of a lower windrow to the bottom of the next higher windrow.
- 6.2.6 Rock placement, fill placement and flooding of approved granular soil in the windrows should be continuously observed by the Consultant.
- 6.3 *Rock* fills, as defined in Section 3.1.3, shall be placed by the Contractor in accordance with the following recommendations:
- 6.3.1 The base of the *rock* fill shall be placed on a sloping surface (minimum slope of 2 percent). The surface shall slope toward suitable subdrainage outlet facilities. The *rock* fills shall be provided with subdrains during construction so that a hydrostatic pressure buildup does not develop. The subdrains shall be permanently connected to controlled drainage facilities to control post-construction infiltration of water.
- 6.3.2 *Rock* fills shall be placed in lifts not exceeding 3 feet. Placement shall be by rock trucks traversing previously placed lifts and dumping at the edge of the currently placed lift. Spreading of the *rock* fill shall be by dozer to facilitate *seating* of the rock. The *rock* fill shall be watered heavily during placement. Watering shall consist of water trucks traversing in front of the current rock lift face and spraying water continuously during rock placement. Compaction equipment with compactive energy comparable to or greater than that of a 20-ton steel vibratory roller or other compaction equipment providing suitable energy to achieve the required compaction or deflection as recommended in Paragraph 6.3.3 shall be utilized. The number of passes to be made should be determined as described in Paragraph 6.3.3. Once a *rock* fill lift has been covered with *soil* fill, no additional *rock* fill lifts will be permitted over the *soil* fill.
- 6.3.3 Plate bearing tests, in accordance with ASTM D 1196, may be performed in both the compacted *soil* fill and in the *rock* fill to aid in determining the required minimum number of passes of the compaction equipment. If performed, a minimum of three plate bearing tests should be performed in the properly compacted *soil* fill (minimum relative compaction of 90 percent). Plate bearing tests shall then be performed on areas of *rock* fill having two passes, four passes and six passes of the compaction equipment, respectively. The number of passes required for the *rock* fill shall be determined by comparing the results of the plate bearing tests for the *soil* fill and the *rock* fill and by evaluating the deflection

variation with number of passes. The required number of passes of the compaction equipment will be performed as necessary until the plate bearing deflections are equal to or less than that determined for the properly compacted *soil* fill. In no case will the required number of passes be less than two.

- 6.3.4 A representative of the Consultant should be present during *rock* fill operations to observe that the minimum number of “passes” have been obtained, that water is being properly applied and that specified procedures are being followed. The actual number of plate bearing tests will be determined by the Consultant during grading.
- 6.3.5 Test pits shall be excavated by the Contractor so that the Consultant can state that, in their opinion, sufficient water is present and that voids between large rocks are properly filled with smaller rock material. In-place density testing will not be required in the *rock* fills.
- 6.3.6 To reduce the potential for “piping” of fines into the *rock* fill from overlying *soil* fill material, a 2-foot layer of graded filter material shall be placed above the uppermost lift of *rock* fill. The need to place graded filter material below the *rock* should be determined by the Consultant prior to commencing grading. The gradation of the graded filter material will be determined at the time the *rock* fill is being excavated. Materials typical of the *rock* fill should be submitted to the Consultant in a timely manner, to allow design of the graded filter prior to the commencement of *rock* fill placement.
- 6.3.7 *Rock* fill placement should be continuously observed during placement by the Consultant.

7. SUBDRAINS

- 7.1 The geologic units on the site may have permeability characteristics and/or fracture systems that could be susceptible under certain conditions to seepage. The use of canyon subdrains may be necessary to mitigate the potential for adverse impacts associated with seepage conditions. Canyon subdrains with lengths in excess of 500 feet or extensions of existing offsite subdrains should use 8-inch-diameter pipes. Canyon subdrains less than 500 feet in length should use 6-inch-diameter pipes.

TYPICAL CANYON DRAIN DETAIL

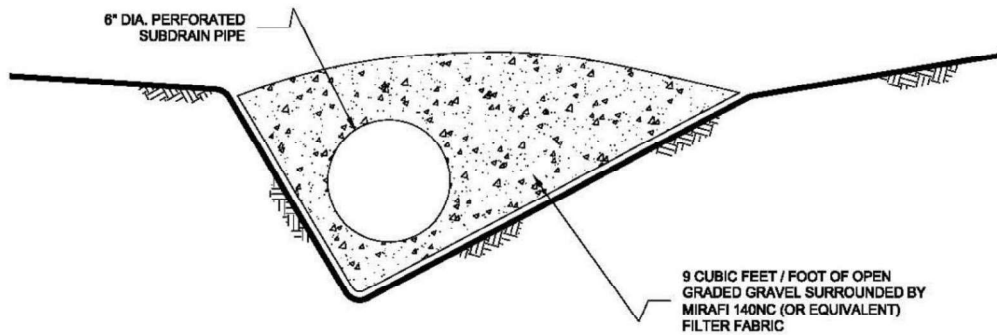
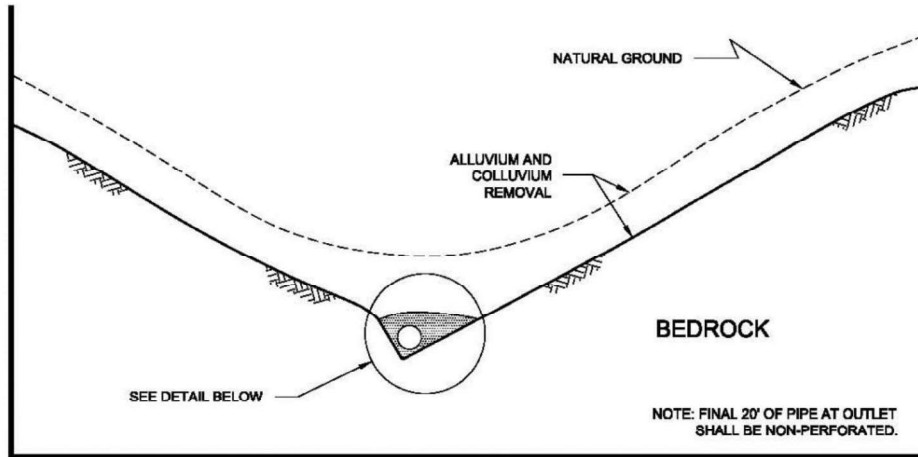

NOTES:

- 1.....6-INCH DIAMETER, SCHEDULE 80 PVC PERFORATED PIPE FOR FILLS IN EXCESS OF 100-FEET IN DEPTH OR A PIPE LENGTH OF LONGER THAN 500 FEET.
- 2.....6-INCH DIAMETER, SCHEDULE 40 PVC PERFORATED PIPE FOR FILLS LESS THAN 100-FEET IN DEPTH OR A PIPE LENGTH SHORTER THAN 500 FEET.

NO SCALE

7.2 Slope drains within stability fill keyways should use 4-inch-diameter (or larger) pipes.

TYPICAL STABILITY FILL DETAIL

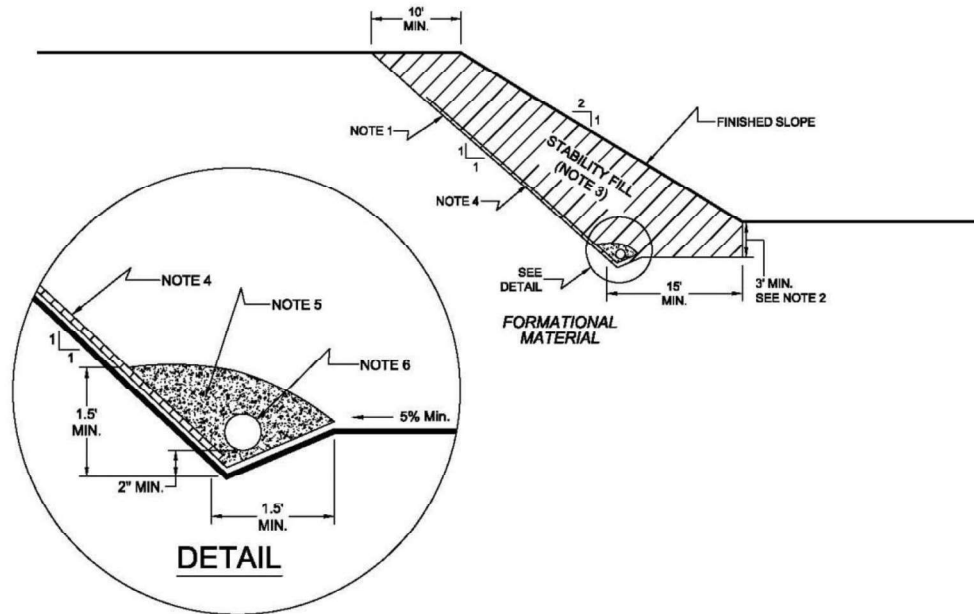

NOTES:

- 1.....EXCAVATE BACKCUT AT 1:1 INCLINATION (UNLESS OTHERWISE NOTED).
- 2.....BASE OF STABILITY FILL TO BE 3 FEET INTO FORMATIONAL MATERIAL, SLOPING A MINIMUM 5% INTO SLOPE.
- 3.....STABILITY FILL TO BE COMPOSED OF PROPERLY COMPACTED GRANULAR SOIL.
- 4.....CHIMNEY DRAINS TO BE APPROVED PREFABRICATED CHIMNEY DRAIN PANELS (MIRADRAIN G200N OR EQUIVALENT) SPACED APPROXIMATELY 20 FEET CENTER TO CENTER AND 4 FEET WIDE. CLOSER SPACING MAY BE REQUIRED IF SEEPAGE IS ENCOUNTERED.
- 5.....FILTER MATERIAL TO BE 3/4-INCH, OPEN-GRADED CRUSHED ROCK ENCLOSED IN APPROVED FILTER FABRIC (MIRAFI 140NC).
- 6.....COLLECTOR PIPE TO BE 4-INCH MINIMUM DIAMETER, PERFORATED, THICK-WALLED PVC SCHEDULE 40 OR EQUIVALENT, AND SLOPED TO DRAIN AT 1 PERCENT MINIMUM TO APPROVED OUTLET.

NO SCALE

- 7.3 The actual subdrain locations will be evaluated in the field during the remedial grading operations. Additional drains may be necessary depending on the conditions observed and the requirements of the local regulatory agencies. Appropriate subdrain outlets should be evaluated prior to finalizing 40-scale grading plans.
- 7.4 *Rock fill or soil-rock fill* areas may require subdrains along their down-slope perimeters to mitigate the potential for buildup of water from construction or landscape irrigation. The subdrains should be at least 6-inch-diameter pipes encapsulated in gravel and filter fabric. *Rock fill* drains should be constructed using the same requirements as canyon subdrains.

7.5 Prior to outletting, the final 20-foot segment of a subdrain that will not be extended during future development should consist of non-perforated drainpipe. At the non-perforated/perforated interface, a seepage cutoff wall should be constructed on the downslope side of the pipe.

TYPICAL CUT OFF WALL DETAIL

FRONT VIEW

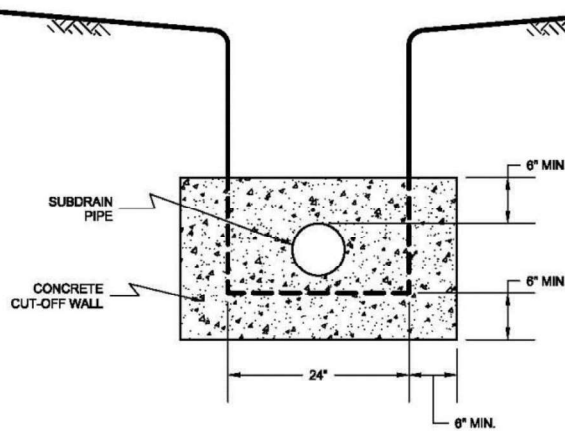

NO SCALE

SIDE VIEW

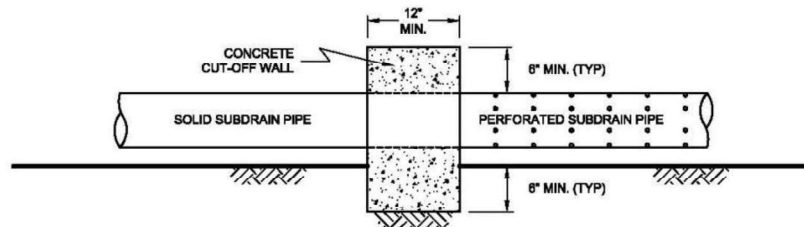

NO SCALE

7.6 Subdrains that discharge into a natural drainage course or open space area should be provided with a permanent headwall structure.

TYPICAL HEADWALL DETAIL

FRONT VIEW

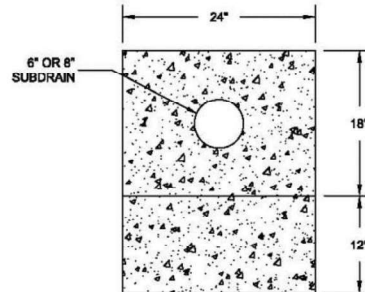

NO SCALE

SIDE VIEW

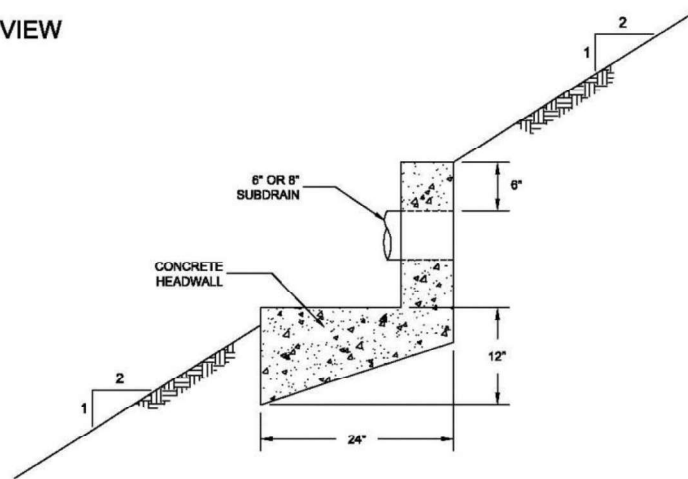

NOTE: HEADWALL SHOULD OUTLET AT TOE OF FILL SLOPE
OR INTO CONTROLLED SURFACE DRAINAGE

NO SCALE

- 7.7 The final grading plans should show the location of the proposed subdrains. After completion of remedial excavations and subdrain installation, the project civil engineer should survey the drain locations and prepare an “as-built” map showing the drain locations. The final outlet and connection locations should be determined during grading operations. Subdrains that will be extended on adjacent projects after grading can be placed on formational material and a vertical riser should be placed at the end of the subdrain. The grading contractor should consider videoing the subdrains shortly after burial to check proper installation and functionality. The contractor is responsible for the performance of the drains.

8. OBSERVATION AND TESTING

- 8.1 The Consultant shall be the Owner's representative to observe and perform tests during clearing, grubbing, filling, and compaction operations. In general, no more than 2 feet in vertical elevation of *soil* or *soil-rock* fill should be placed without at least one field density test being performed within that interval. In addition, a minimum of one field density test should be performed for every 2,000 cubic yards of *soil* or *soil-rock* fill placed and compacted.
- 8.2 The Consultant should perform a sufficient distribution of field density tests of the compacted *soil* or *soil-rock* fill to provide a basis for expressing an opinion whether the fill material is compacted as specified. Density tests shall be performed in the compacted materials below any disturbed surface. When these tests indicate that the density of any layer of fill or portion thereof is below that specified, the particular layer or areas represented by the test shall be reworked until the specified density has been achieved.
- 8.3 During placement of *rock* fill, the Consultant should observe that the minimum number of passes have been obtained per the criteria discussed in Section 6.3.3. The Consultant should request the excavation of observation pits and may perform plate bearing tests on the placed *rock* fills. The observation pits will be excavated to provide a basis for expressing an opinion as to whether the *rock* fill is properly seated and sufficient moisture has been applied to the material. When observations indicate that a layer of *rock* fill or any portion thereof is below that specified, the affected layer or area shall be reworked until the *rock* fill has been adequately seated and sufficient moisture applied.
- 8.4 A settlement monitoring program designed by the Consultant may be conducted in areas of *rock* fill placement. The specific design of the monitoring program shall be as recommended in the Conclusions and Recommendations section of the project Geotechnical Report or in the final report of testing and observation services performed during grading.
- 8.5 We should observe the placement of subdrains, to check that the drainage devices have been placed and constructed in substantial conformance with project specifications.
- 8.6 Testing procedures shall conform to the following Standards as appropriate:

8.6.1 Soil and Soil-Rock Fills:

- 8.6.1.1 Field Density Test, ASTM D 1556, *Density of Soil In-Place By the Sand-Cone Method.*

- 8.6.1.2 Field Density Test, Nuclear Method, ASTM D 6938, *Density of Soil and Soil-Aggregate In-Place by Nuclear Methods (Shallow Depth)*.
- 8.6.1.3 Laboratory Compaction Test, ASTM D 1557, *Moisture-Density Relations of Soils and Soil-Aggregate Mixtures Using 10-Pound Hammer and 18-Inch Drop*.
- 8.6.1.4. Expansion Index Test, ASTM D 4829, *Expansion Index Test*.

9. PROTECTION OF WORK

- 9.1 During construction, the Contractor shall properly grade all excavated surfaces to provide positive drainage and prevent ponding of water. Drainage of surface water shall be controlled to avoid damage to adjoining properties or to finished work on the site. The Contractor shall take remedial measures to prevent erosion of freshly graded areas until such time as permanent drainage and erosion control features have been installed. Areas subjected to erosion or sedimentation shall be properly prepared in accordance with the Specifications prior to placing additional fill or structures.
- 9.2 After completion of grading as observed and tested by the Consultant, no further excavation or filling shall be conducted except in conjunction with the services of the Consultant.

10. CERTIFICATIONS AND FINAL REPORTS

- 10.1 Upon completion of the work, Contractor shall furnish Owner a certification by the Civil Engineer stating that the lots and/or building pads are graded to within 0.1 foot vertically of elevations shown on the grading plan and that all tops and toes of slopes are within 0.5 foot horizontally of the positions shown on the grading plans. After installation of a section of subdrain, the project Civil Engineer should survey its location and prepare an *as-built* plan of the subdrain location. The project Civil Engineer should verify the proper outlet for the subdrains and the Contractor should ensure that the drain system is free of obstructions.
- 10.2 The Owner is responsible for furnishing a final as-graded soil and geologic report satisfactory to the appropriate governing or accepting agencies. The as-graded report should be prepared and signed by a California licensed Civil Engineer experienced in geotechnical engineering and by a California Certified Engineering Geologist, indicating that the geotechnical aspects of the grading were performed in substantial conformance with the Specifications or approved changes to the Specifications.

LIST OF REFERENCES

1. *2019 California Building Code, California Code of Regulations, Title 24, Part 2, based on the 2018 International Building Code*, prepared by California Building Standards Commission, dated July 2019.
2. *ACI 318-19, Commentary on Building Code Requirements for Structural Concrete*, prepared by the American Concrete Institute, dated May 2019.
3. American Concrete Institute, *ACI 330-08, Guide for the Design and Construction of Concrete Parking Lots*, dated June, 2008.
4. American Society of Civil Engineers (ASCE), *ASCE 7-16, Minimum Design Loads and Associated Criteria for Buildings and Other Structures*, 2017.
5. California Department of Conservation, Division of Mines and Geology, *Probabilistic Seismic Hazard Assessment for the State of California*, Open File Report 96-08, 1996.
6. California Geological Survey, *Seismic Shaking Hazards in California*, Based on the USGS/CGS Probabilistic Seismic Hazards Assessment (PSHA) Model, 2002 (revised April 2003). 10% probability of being exceeded in 50 years.
<http://redirect.conservation.ca.gov/cgs/rghm/pshamap/pshamain.html>
7. County of San Diego, *San Diego County Multi Jurisdiction Hazard Mitigation Plan, San Diego, California – Final Draft*, dated 2017.
8. Historical Aerial Photos. <http://www.historicaerials.com>
9. Jennings, C. W., 1994, California Division of Mines and Geology, *Fault Activity Map of California and Adjacent Areas*, California Geologic Data Map Series Map No. 6.
10. Kennedy, M. P., and S. S. Tan, 2008, *Geologic Map of the San Diego 30'x60' Quadrangle, California*, USGS Regional Map Series Map No. 3, Scale 1:100,000.
11. Special Publication 117A, *Guidelines For Evaluating and Mitigating Seismic Hazards in California 2008*, California Geological Survey, Revised and Re-adopted September 11, 2008.
12. Unpublished reports, aerial photographs, and maps on file with Geocon Incorporated.
13. USGS computer program, Seismic Hazard Curves and Uniform Hazard Response Spectra, <http://geohazards.usgs.gov/designmaps/us/application.php>.