

# Appendix A

---

Air Quality Study

**Air Quality Study**  
**for the**  
**Rio Urbana Project**

**Prepared for:**

The Pacific West Communities  
430 E. State Street, Suite 100  
Eagle, Idaho 83616

**Prepared by:**

Meridian Consultants, LLC  
910 Hampshire Road, Suite V  
Westlake Village, CA 91361

**August 2017**



# Table of Contents

Section	Page
Executive Summary.....	1
Introduction .....	2
Project Description .....	2
Air Quality .....	2
Ambient Air Quality .....	4
Air Quality Standards .....	8
Ventura County Air Pollution Control District .....	8
California Air Pollution Control Officers Association .....	9
Methodology.....	9
Significance Thresholds.....	9
Air Quality Modeling.....	9
Data Summary .....	10
Assumptions.....	10
Air Quality Modeling Results .....	11
Construction.....	11
Operation.....	12
Toxic Air Contaminants .....	13
AQMP Consistency.....	13
Odors.....	14
Cumulative Impacts .....	14
Regulatory Measures .....	15
<b>Appendix</b>	
A    CalEEMod Air Quality and Greenhouse Gas Emissions Files	

## Figures

Figure		Page
1	Regional Location Map .....	5
2	Project Site Aerial.....	6

## Tables

Table		Page
1	Ambient Air Quality at the El Rio Monitoring Station.....	7
2	Ventura County Attainment Status.....	8
3	Maximum Construction Emissions.....	12
4	Maximum Operational Emissions .....	12
5	Localized Emissions.....	13

## EXECUTIVE SUMMARY

This Air Quality Study assesses and discusses the potential air quality impacts that may occur with the implementation of the Rio Urbana Project (“Project”), located in Oxnard, California. The analysis estimates future emission levels at surrounding land uses resulting from construction and operation of the Project, and identifies the potential for significant impacts. An evaluation of the Project’s contribution to potential cumulative air quality impacts is also provided. Air quality worksheets are provided in the Appendix.

This report summarizes the potential for the Project to conflict with an applicable air quality plan, violate an air quality standard or threshold, result in a cumulatively net increase of criteria pollutant emissions, expose sensitive receptors to substantial pollutant concentrations, or create objectionable odors affecting a substantial number of people. The findings of the analyses are as follows:

- The Project would be consistent with air quality policies set forth by the Ventura County Air Pollution Control District (VCAPCD) and the Southern California Association of Governments (SCAG).
- Construction emissions would not contribute to long-term emissions that would increase the carcinogenic effects on sensitive receptors. Emissions associated with operation would not exceed the VCAPCD-recommended thresholds. Thus, the Project would not result in a regional violation of applicable air quality standards or jeopardize the timely attainment of such standards in the South Central Coast Air Basin (“Basin”).
- Operation of the Project will not employ toxic air contaminant (TAC)-emitting processes. No substantial pollutant concentration would be generated.
- Project construction and operations would not result in significant levels of odors.
- The Project would result in less than significant cumulative air quality impacts during construction and operation of the Project.

## INTRODUCTION

The purpose of this Air Quality Study is to assess and discuss the potential air quality impacts that may occur with the implementation of the Rio Urbana Project, located in Oxnard, California. The regional location of the proposed Project is depicted in **Figure 1, Regional Location Map**. The Project site is located to the northeast of Ventura Freeway (US Route 101 [US 101]), within the VCAPCD. Furthermore, the Project site is located along E. Vineyard Avenue and bounded by Rio School Lane to the north (refer to **Figure 2, Project Site Aerial**). This report includes an analysis of estimated emissions of criteria air pollutants (CAPs) that will be generated by the Project during construction and operation.

## Project Description

The Project site consists of approximately 10.24 acres of developed land with numerous vacant buildings (cafeteria, administration, classrooms, and two portable buildings) that was formerly the El Rio Elementary School Campus. The school has been closed since 2008 and is currently utilized for storage and as a dispatch for school buses. The proposed Project would include demolition of the existing uses to allow the construction of a new mixed-use development that includes 182 condominium residential units and a 15,000-square-foot office building containing the Rio School District administrative offices.

The surrounding environment includes residential development to the north and west, commercial development to the south, and industrial uses to the east. Regional access to the Project site is provided by US 101 to the south.

## AIR QUALITY

Air pollutant emissions within the region are primarily generated by stationary and mobile sources. Stationary sources can be divided into two major subcategories: point and area sources. Point sources occur at a specific location and are often identified by an exhaust vent or stack at a facility. Area sources are widely distributed and can include such sources as residential and commercial water heaters, painting operations, lawn mowers, agricultural fields, parking lots, and some consumer products.

Mobile sources refer to emissions from motor vehicles, including tailpipe and evaporative emissions, and are classified as either on road or off road. On-road sources may be legally operated on roadways and highways. Off-road sources include aircraft, ships, trains, and self-propelled construction equipment.

Air pollutants can also be generated by the natural environment, such as when high winds suspend fine dust particles. The main source of pollutants near the Project site area includes mobile emissions generated from on-road vehicles. Traffic-congested roadways and intersections have the potential to generate localized high levels of carbon monoxide (CO). Localized areas where ambient concentrations exceed state and/or federal standards are termed CO “hot spots.”

The US Environmental Protection Agency (USEPA) is the federal agency responsible for setting the National Ambient Air Quality Standards (NAAQS). Air quality of a region is considered to be in attainment of the NAAQS if the measured ambient air pollutant levels are not exceeded more than once per year, except for levels of ozone, particulate matter (PM10), and fine particulate matter (PM2.5), and those based on annual averages or arithmetic mean. The NAAQS for ozone, PM10, and PM2.5 are based on statistical calculations over 1- to 3-year periods, depending on the pollutant. The California Air Resources Board (CARB) is the state agency responsible for setting the California Ambient Air Quality Standards (CAAQS). Air quality of a region is considered to be in attainment of the CAAQS if the measured ambient air pollutant levels for ozone (O3), CO, nitrogen dioxide (NO2), sulfur dioxide (SO2), PM10, PM2.5, and lead (Pb) are not exceeded, and all other standards are not equaled or exceeded at any time in any consecutive 3-year period.

A brief description of the criteria pollutants is provided below.

- **Ozone** is a gas formed when volatile organic compounds (VOCs) and oxides of nitrogen (NOx), both byproducts of internal combustion engine exhaust and other sources, undergo slow photochemical reactions in the presence of sunlight. O3 concentrations are generally highest during the summer months, when direct sunlight, light wind, and warm temperature conditions are favorable to the formation of this pollutant.
- **Volatile Organic Compounds** are compounds composed primarily of atoms of hydrogen and carbon. Internal combustion associated with motor vehicle usage is the major source of hydrocarbons. Adverse effects on human health are not caused directly by VOCs, but rather by reactions of VOCs to form secondary air pollutants, including O3. VOCs are also referred to as reactive organic compounds (ROCs) or reactive organic gases (ROGs). VOCs themselves are not “criteria” pollutants; however, they contribute to the formation of O3.
- **Nitrogen Dioxide** is a reddish-brown, highly reactive gas that forms in the ambient air through the oxidation of nitric oxide (NO). NO2 is also a byproduct of fuel combustion. The principle form of NO2 produced by combustion is NO, but NO reacts quickly to form NO2, creating the mixture of NO and NO2 referred to as NOx. NO2 acts as an acute irritant and, in equal concentrations, is more injurious than NO. At atmospheric concentrations, however, NOx is only potentially irritating. NO2 absorbs blue light, the result of which is a brownish-red cast to the atmosphere and reduced visibility.
- **Carbon Monoxide** is a colorless, odorless gas produced by the incomplete combustion of fuels. CO concentrations tend to be the highest during winter mornings with little to no wind, when surface-based inversions trap the pollutant at ground levels. Because CO is emitted directly from internal combustion engines, unlike O3, and motor vehicles operating at slow speeds are the primary source of CO in the Basin, the highest ambient CO concentrations are generally found near congested transportation corridors and intersections.

- **Sulfur dioxide** is a colorless, highly irritating gas or liquid. It enters the atmosphere as a pollutant mainly from burning high-sulfur-content fuel oils and coal and from chemical processes occurring at chemical plants and refineries. When SO<sub>2</sub> oxidizes in the atmosphere, it forms sulfates (SO<sub>4</sub>).
- **Respirable Particulate Matter** consists of extremely small, suspended particles or droplets 10 microns or smaller in diameter. Some sources of PM<sub>10</sub>, like pollen and windstorms, are naturally occurring. However, in populated areas, most PM<sub>10</sub> is caused by road dust, diesel soot, combustion products, abrasion of tires and brakes, and construction activities.
- **Fine Particulate Matter** refers to particulate matter that is 2.5 micrometers or smaller in size. The sources of PM<sub>2.5</sub> include fuel combustion from automobiles, power plants, wood burning, industrial processes, and diesel-powered vehicles such as buses and trucks. These fine particles are also formed in the atmosphere when gases such as sulfur dioxide, NO<sub>x</sub>, and VOCs are transformed in the air by chemical reactions.
- **Lead** occurs in the atmosphere as particulate matter. The combustion of leaded gasoline is the primary source of airborne lead in the Basin. The use of leaded gasoline is no longer permitted for on-road motor vehicles; thus, most such combustion emissions are associated with off-road vehicles, such as racecars, that use leaded gasoline. Other sources of Pb include the manufacturing and recycling of batteries, paint, ink, ceramics, ammunition, and secondary lead smelters.

## **AMBIENT AIR QUALITY**

Ventura County is designated under the federal standard as nonattainment for 1-hour and 8-hour ozone. State nonattainment designations are in effect for ozone, PM<sub>2.5</sub>, and PM<sub>10</sub> within Ventura County.

To identify ambient concentrations of criteria pollutants, the VCAPCD operates eight air quality monitoring stations throughout the County. The monitoring station is located closest to the proposed project and most representative of air quality within the City of Oxnard is the El Rio Monitoring station, located approximately 1.75 miles to the north of the Project site. This station currently monitoring the ambient concentration levels of O<sub>3</sub>, NO<sub>2</sub>, and particulate matters (PM<sub>10</sub> and PM<sub>2.5</sub>.) **Table 1, Ambient Air Quality at the El Rio Monitoring Station**, summarizes the annual air quality data for 2014–2016 in the local airshed for the criteria pollutants of greatest concern in Ventura County.

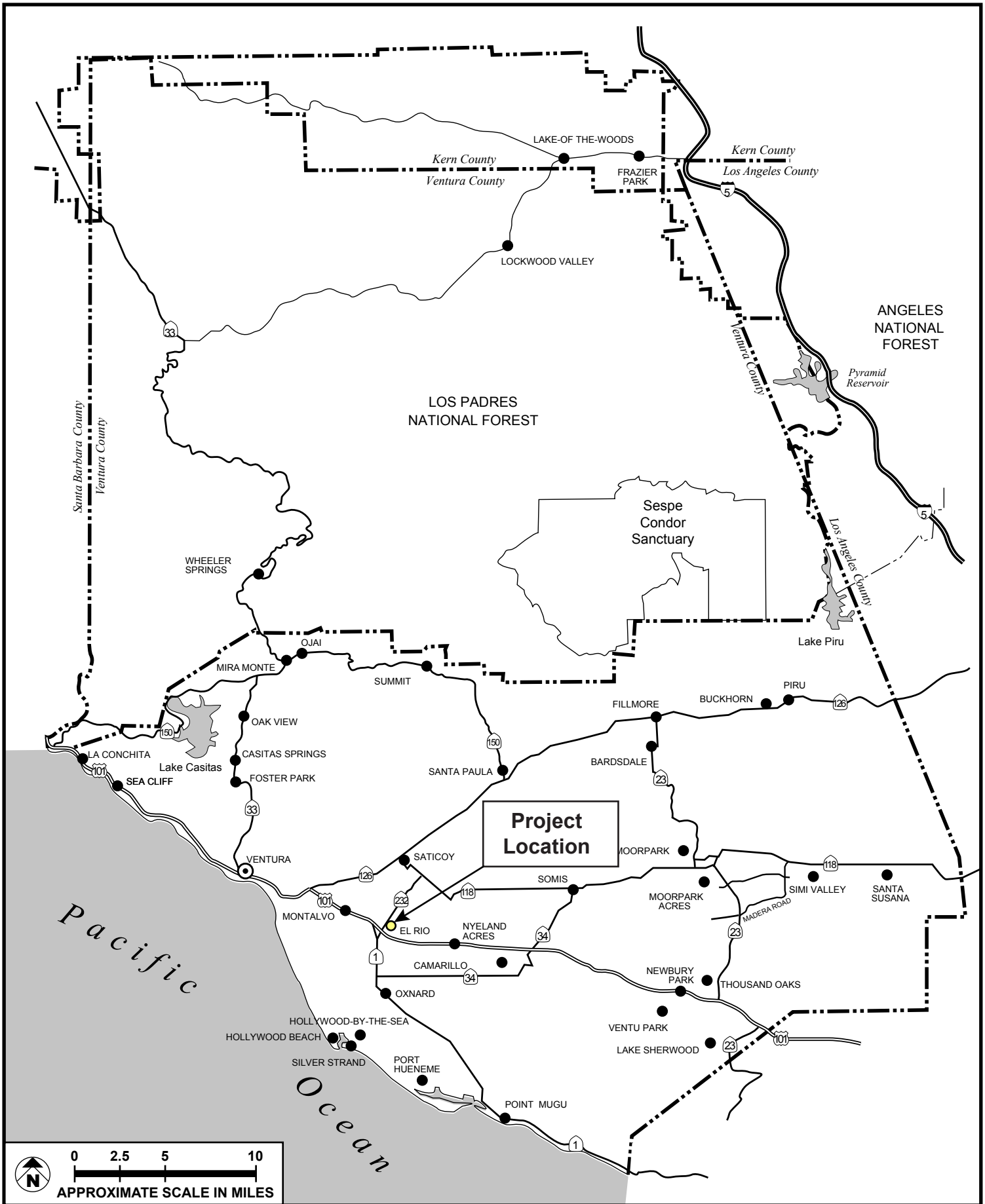

SOURCE: Meridian Consultants, LLC - August 2017

FIGURE 1





FIGURE 2



**Table 1**  
**Ambient Air Quality at the El Rio Monitoring Station**

Air Pollutant	Average Time (Units)	2014	2015	2016
Ozone (O3)	State Max 1 hour (ppm)	0.112	0.070	0.084
	Days > CAAQS threshold (0.09 ppm)	1	0	0
	National Max 8 hour (ppm)	0.077	0.066	0.071
	Days > NAAQS threshold (0.075 ppm)	2	0	1
	State Max 8 hour (ppm)	0.077	0.066	0.071
	Days > CAAQS threshold (0.07 ppm)	2	0	1
Nitrogen dioxide (NO2)	National Max 1 hour (ppm)	0.039	0.036	0.033
	Days > NAAQS threshold (0.1 ppm)	0	0	0
	State Max 1 hour (ppm)	0.039	0.036	0.033
	Days > CAAQS threshold (0.18 ppm)	0	0	0
Respirable particulate matter (PM10)	National Max ( $\mu\text{g}/\text{m}^3$ )	51.1	93.3	105.0
	National Annual Average ( $\mu\text{g}/\text{m}^3$ )	18.1	25.8	24.6
	Days > NAAQS threshold ( $150 \mu\text{g}/\text{m}^3$ )	0	0	0
	State Max ( $\mu\text{g}/\text{m}^3$ )	115.3	92.0	101.6
	State Annual Average ( $\mu\text{g}/\text{m}^3$ )	27.4	25.6	ND
	Days > CAAQS threshold ( $50 \mu\text{g}/\text{m}^3$ )	7	6	14
Fine particulate matter (PM2.5)	National Max ( $\mu\text{g}/\text{m}^3$ )	22.2	25.5	22.7
	National Annual Average ( $\mu\text{g}/\text{m}^3$ )	9.3	9.6	8.1
	Days > NAAQS threshold ( $35 \mu\text{g}/\text{m}^3$ )	0	0	0
	State Max ( $\mu\text{g}/\text{m}^3$ )	22.2	25.5	22.7
	State Annual Average ( $\mu\text{g}/\text{m}^3$ )	9.4	9.7	8.2

Source: California Air Resources Board (CARB), "Historical Data by Year," El Rio-Rio Mesa School #2.

Notes: > = exceed; CAAQS = California Ambient Air Quality Standards; max = maximum; mean = annual arithmetic mean;  $\mu\text{g}/\text{m}^3$  = micrograms per cubic meter; ND = no data; NAAQS = National Ambient Air Quality Standards; ppm = parts per million.

The attainment designations for the Basin are shown in **Table 2, Ventura County Attainment Status**. USEPA and CARB designate air basins where ambient air quality standards are exceeded as "nonattainment" areas. If standards are met, the area is designated as an "attainment" area. If there are inadequate or inconclusive data to make definitive attainment designation, they are considered "unclassified." Areas where air pollution persistently exceed the State or national ambient air quality standards are designated "nonattainment." Federal nonattainment areas are further designated as marginal, moderate, serious, severe, or extreme as a function of deviation from standards. Ventura County is designated under the federal standard as nonattainment for 8-hour ozone. State nonattainment designations are in effect for ozone and PM10 within Ventura County.

Individuals who are sensitive to air pollution include children, the elderly, and persons with preexisting respiratory or cardiovascular illness. The VCAPCD considers a sensitive receptor to be a location where a sensitive individual could remain for 24 hours, such as residences, hospitals, or convalescent facilities. Commercial and industrial facilities are not included in the definition because employees do not typically remain on site for 24 hours. However, when assessing the impact of pollutants with 1-hour or 8-hour standards (such as nitrogen dioxide and carbon monoxide), commercial and/or industrial facilities would be considered sensitive receptors for those purposes.

**Table 2**  
**Ventura County Attainment Status**

<b>Pollutant</b>	<b>State Status</b>	<b>National Status</b>
Ozone	Nonattainment	Nonattainment
Carbon Monoxide	Attainment	Unclassified/Attainment
Nitrogen Dioxide	Attainment	Unclassified/Attainment
Sulfur Dioxide	Attainment	Attainment
Lead	Attainment	Unclassified/Attainment
PM10	Nonattainment	Unclassified
PM2.5	Attainment	Unclassified/Attainment

*Source: CARB, Area Designations Maps/State and National, <https://www.arb.ca.gov/design/adm/adm.htm>.*

## **AIR QUALITY STANDARDS**

### **Ventura County Air Pollution Control District**

The VCAPCD is the agency principally responsible for comprehensive air pollution control in the Basin. As a regional agency, the VCAPCD works directly with SCAG, county transportation commissions, and local governments and cooperates actively with all federal and State government agencies. The VCAPCD develops rules and regulations to reduce emissions, protect public health and agriculture, and achieve and maintain State and federal air quality standards. In addition, the VCAPCD establishes permitting requirements for stationary sources, inspects emissions sources, and enforces such measures through educational programs or fines when necessary.

The VCAPCD is directly responsible for reducing emissions from stationary, area, and mobile sources. It has responded to this requirement by preparing a sequence of AQMPs. The most recent of these was the 2016 Ventura County Air Quality Management Plan (“2016 AQMP”) adopted by the Governing Board of the VCAPCD in February 2017.<sup>1</sup> The 2016 AQMP is based on growth projections for Ventura County and

<sup>1</sup> VCAPCD, *Final 2016 Ventura County Air Quality Management Plan* (adopted February 14, 2017).

subareas within the County that have been agreed to by both the County and the SCAG. As such, the 2016 AQMP presents Ventura County's (1) strategy to attain the 2008 federal 8-hour ozone standard; (2) attainment demonstration for the federal 8-hour ozone standard; and (3) reasonable further progress demonstration for the federal 8-hour ozone standard.

## **California Air Pollution Control Officers Association**

In its January 2008 CEQA and Climate Change white paper, the California Air Pollution Control Officers Association (CAPCOA) identified a number of potential approaches for determining the significance of GHG emissions in CEQA documents. CAPCOA suggests making significance determinations on a case-by-case basis when no significance thresholds have been formally adopted by a lead agency. Although GHG emissions can be quantified, CARB, VCAPCD, and the City of Oxnard have yet to adopt project-level significance thresholds for GHG emissions that would be applicable to the Project. Assessing the significance of a project's contribution to cumulative global climate change involves (1) evaluating the project's sources of GHG emissions; and (2) considering project consistency with applicable emission reduction strategies and goals, such as those set forth by the lead agency or other regional or State agency.

Local and regional agencies and the State-recommended general policies and measures to minimize and reduce GHG emissions from land use development projects. Thus, if the Project were designed in accordance and not in conflict with applicable policies and measures, it would be consistent with the strategies and actions to reduce GHG emission.

## **METHODOLOGY**

### **Significance Thresholds**

To analyze Project-generated emissions, the VCAPCD's *Air Quality Assessment Guidelines* ("VPAPCD Guidelines") recommend significance thresholds for projects proposed in Ventura County. Under these guidelines, projects that generate more than 25 pounds per day (lb/day) of ROG or NO<sub>x</sub> are considered to individually and cumulatively jeopardize attainment of the federal O<sub>3</sub> standard and thus have a significant adverse impact on air quality. The VCAPCD's 25 lb/day threshold for ROG and NO<sub>x</sub> do not apply to construction emissions because such emissions are not permanent. Nevertheless, for construction impacts, the VCAPCD recommends imposition of mitigation if emissions of either pollutant exceed 25 lb/day. The VCAPCD requires minimizing fugitive dust through various dust control measures as documented in Rule 55.

### **Air Quality Modeling**

The emissions for the Project site were calculated according to the VCAPCD Guidelines and construction emission factors contained in the CARB-approved California Emissions Estimator Model (CalEEMod).

Operational emissions would be generated by both stationary and mobile sources as a result of normal day-to-day use of the proposed facilities after occupancy. Stationary emissions would be generated by the consumption of natural gas for space and water heating equipment. Mobile emissions would be generated by motor vehicles traveling to and from the Project site. The analysis of daily operational emissions has been prepared using the data and methodologies identified in the VCAPCD Guidelines and current motor vehicle emission factors in the CalEEMod model. CalEEMod is designed to model construction and operational emissions for land use development projects and allows for the input of project-specific information when it is known. The program contains default settings specific to the air district, air basin, or State level using approved vehicle emissions factors (EMFAC2014), established methodologies, and the latest survey data.

## **Data Summary**

The Project's air emissions are reported in relation to the ambient concentrations of the six primary CAPs (ROGs, NO<sub>x</sub>, CO, SO<sub>x</sub>, PM<sub>10</sub>, and PM<sub>2.5</sub>) identified by the VCAPCD.

## **Assumptions**

The following assumptions were made in the CalEEMod computer program:

### ***Land Uses***

#### **Existing**

- 44,637 square feet of building to be demolished
- 147,667 square feet of other surface (concrete, asphalt, awnings) to be demolished

#### **Proposed**

- 15,100-square-foot office building
- 182-unit condo/townhouse
- 463 parking spaces

### ***Construction***

Construction would occur over six phases beginning the first quarter of 2018: (1) demolition, which would last approximately 20 days; (2) site preparation, which would last approximately 3 days; (3) grading, which would last approximately 6 days; (4) building construction, which would last approximately 220 days; (5) architectural coating, which would last approximately 30 days; and (6) paving, which would last approximately 10 days.

Each phase of construction would result in vary levels of intensity and number of construction personnel. The construction workforce would consist of 13 worker trips per day and 875 total hauling trips during demolition; 8 worker trips per day during site preparation; 10 worker trips per day and 2,125 total hauling trips during grading; 214 worker trips per day and 54 vendor trips per day during building construction; 43 worker trips per day during architectural coating; and 15 worker trips per day during paving.

## **AIR QUALITY MODELING RESULTS**

### **Construction**

Construction emissions would be temporary in nature and would occur within the Project area. The primary source of ROG, NO<sub>x</sub>, CO, and SO<sub>x</sub> emissions is from internal combustion of construction equipment exhaust and on-road haul-truck trips, while the majority of particulate matter emissions would occur as a result of fugitive dust emissions generated during grading and excavation activities. Primary sources of PM<sub>10</sub> and PM<sub>2.5</sub> emissions would be clearing activities, excavation and grading operations, construction vehicle traffic on unpaved ground, and wind blowing over exposed earth surfaces.

As shown in **Table 3, Maximum Construction Emissions**, the Project would generate up to 80.2 lb/day of ROG and 130.2 lb/day of NO<sub>x</sub>. As discussed above, the VCAPCD's 25 lb/day threshold for ROG and NO<sub>x</sub> does not apply to construction emissions because such emissions are temporary. Emissions of TACs are localized, not regional, in nature; impacts related to construction activities would be limited to the area immediately surrounding the construction site within the Project area, and the VCAPCD does not recommend any thresholds of significance for their associated emissions. Instead, the VCAPCD bases the determination of significance on a consideration of the control measures to be implemented. If all appropriate emissions control measures recommended by the VCAPCD Guidelines are implemented for a project, then construction emissions are not considered significant. Recommendations include dust control measures, such as watering graded areas, covering trucks hauling excavated soil, soil stabilization methods, and street sweeping; and construction equipment controls, such as minimizing idle time, maintaining equipment engines, using alternatively fueled equipment, and minimizing the number of pieces of equipment operated simultaneously. All construction activities would adhere to the VCAPCD Rule 50 for Opacity, Rule 51 for Nuisance, and Rule 55 for Fugitive Dust. Therefore, impacts would not considered significant.

**Table 3  
Maximum Construction Emissions**

Source	ROG	NOx	CO	SOx	PM10	PM2.5
	pounds/day					
<b>Maximum Winter Emissions</b>						
2018	80.2	130.2	35.9	0.3	10.1	4.1
2019	80.1	29.3	26.7	0.1	3.4	1.6
<b>Maximum Summer Emissions</b>						
2018	80.0	128.7	34.1	0.3	10.0	4.1
2019	79.9	29.2	26.6	0.1	3.4	1.6
<b>VCAPCD Threshold</b>	<b>25</b>	<b>25</b>	—	—	—	—
<b>Threshold Exceeded?</b>	<b>Yes</b>	<b>Yes</b>	—	—	—	—

*Note: Refer to Appendices A2 (Summer) through A3 (Winter), Section 2.1, Overall Construction, for maximum construction emissions during both the summer and winter seasons.*

## Operation

The estimated operational emissions based on the development of the Project are presented in **Table 4, Maximum Operational Emissions**, and are compared to the VCAPCD-established operational significance thresholds. Operational emissions will consist primarily from passenger vehicles traveling to and from the Project site. As shown in **Table 4**, the emissions associated with the Project would not exceed the VCAPCD-recommended operational emission thresholds.

**Table 4  
Maximum Operational Emissions**

Source	ROG	NOx	CO	SOx	PM10	PM2.5
	pounds/day					
<b>Maximum Winter Emissions</b>						
	12.3	6.8	50.0	0.1	7.3	2.1
<b>Maximum Summer Emissions</b>						
	12.4	6.4	48.4	0.1	7.3	2.1
<b>VCAPCD Threshold</b>	<b>25</b>	<b>25</b>	—	—	—	—
<b>Threshold Exceeded?</b>	<b>No</b>	<b>No</b>	—	—	—	—

*Note: Refer to Appendices A2 (Summer) through A3 (Winter), Section 2.1, Overall Construction, for maximum existing operational emissions during both the summer and winter seasons.*

## Toxic Air Contaminants

Project construction would result in short-term emissions of diesel particulate matter (DPM), which is a TAC. As shown in **Table 5, Localized Emissions**, localized DPM emissions would be minimal. In addition, the Project would comply with the CARB Airborne Toxic Control Measures’ anti-idling measure, which limits idling to no more than 5 minutes at any location for diesel-fueled commercial vehicles. The Project would also comply with the required and applicable Best Available Control Technology and the In-Use Off-Road Diesel Vehicle Regulation.

During long-term operations, TACs could be emitted as part of periodic maintenance operations, cleaning, painting, etc., and from periodic by from delivery trucks and service vehicles. However, these uses are expected to be occasional and result in minimal exposure to off-site sensitive receptors. Given that the Project consists of residential and office uses, the Project would not include sources of substantive TAC emissions identified by the VCAPCD- or CARB-siting recommendations.

**Table 5  
Localized Emissions**

Source	NOx	CO	PM10	PM2.5
	pounds/day			
<b>Construction</b>				
Maximum on-site emissions	21.2	15.4	4.5	1.8
<b>Operational</b>				
Maximum area/energy emissions	1.1	15.5	0.2	0.2

*Note: Refer to **Appendix A2 (summer)** and **Appendix A3 (winter)**, Sections 3.2 through 3.7, for maximum construction localized emissions.*

## AQMP Consistency

According to the VCAPCD Guidelines, to be consistent with the AQMP, a project must conform to the local general plan and must not result in or contribute to an exceedance of the County’s projected population growth forecast. A discussion of AQMP consistency would be required to determine the significance of cumulative impacts. The Project would develop 182 residential dwelling units that would accommodate approximately 557 people by Project buildout. This would increase the County’s population to 823,899 people.

The VCAPCD’s AQMP considers regional population forecasts developed by SCAG. SCAG’s most recent population forecast was adopted in April 2016 as part of the *2016–2040 Regional Transportation Plan/Sustainable Communities Strategy*. The 2016 SCAG growth forecast projects a population in Oxnard

of 200,100 people for 2012 and 237,300 people for 2040.<sup>2</sup> The population increase of 557 that could result from the construction of the new residential housing and employment opportunities associated with the Project, in addition, the existing population is within SCAG's most recent growth projections for the City of Oxnard. As such, the growth forecast is also within the population growth parameters considered in the AQMP, which is updated by the VCAPCD to manage air emissions in the County of Ventura in accordance with local, State, and federal standards. Development of the Project will not obstruct implementation of the AQMP or attainment of State or federal air quality standards. Therefore, the Project would be consistent with the applicable air quality plans.

## **Odors**

Potential activities that may emit odors during construction activities includes the use of architectural coatings and solvents and the combustion of diesel fuel in on- and off-road equipment. VCAPCD Rule 74.2 would limit the amount of ROG's in architectural coatings and solvents. In addition, the Project would comply with the applicable provisions of the CARB Air Toxics Control Measure regarding idling limitations for diesel trucks. Through mandatory compliance with VCAPCD Rules, no construction activities or materials are expected to create objectionable odors affecting a substantial number of people.

Land uses more likely to produce odors include agriculture, chemical plants, composting operations, dairies, fiberglass molding, landfills, refineries, rendering plants, rail yards, and wastewater treatment plants. The Project would allow residential and office development, none of which contains any active manufacturing activities. No impacts due to odors would occur with the implementation of the Project.

## **CUMULATIVE IMPACTS**

The Basin is currently a nonattainment area both the federal and State standards for O<sub>3</sub> and the State standard for PM<sub>10</sub>. With regard to determining the significance of the proposed Project's contribution, the VCAPCD neither recommends quantified analyses of cumulative operational emissions nor provides methodologies or threshold of significance to be used to assess cumulative construction or operational impacts. Instead, the VCAPCD recommends that a project's contribution to cumulative impacts should be assessed utilizing the same significance criteria as those for project specific impacts. Therefore, this study assumes that individual development projects that generate operational emission that exceed the VCAPCD-recommended daily thresholds for project-specific impacts would also cause a cumulatively considerable increase in emissions for those pollutants for which the Basin is in nonattainment. As

---

2 Southern California Association of Government, *2016-2040 Regional Transportation Plan/Sustain Communities Strategy* (April 2016).



discussed previously, operational daily emission associated with the Project would not exceed VCAPCD significance thresholds. As such, cumulative impacts would not be considered significant.

## REGULATORY MEASURES

Potential impacts from implementation of the Project will result in increased air quality emissions during construction. In addition, the mitigation measures identified in the Specific Plan are applicable to this Project. As such, the following regulatory measures would reduce construction-related emissions:

**AQ-1:** During clearing, grading, earthmoving, or excavation operations, excessive fugitive dust emissions shall be controlled by regular watering or other dust-preventative measures using the following procedures as specified by the Ventura County Air Pollution Control District (VCAPCD), including, without limitation, VCAPCD Rule 50 (Opacity), Rule 51 (Nuisance), and Rule 55 (Fugitive Dust):

- On-site vehicle speed shall not exceed 15 miles per hour (the Project site will contain posted signs with the speed limit).
- All on-site construction roads with vehicle traffic shall be watered periodically.
- Streets adjacent to the Project site shall be swept as needed to remove silt that may have accumulated from construction activities to prevent excessive amounts of dust.
- All material excavated or graded shall be sufficiently watered to prevent excessive amounts of dust. Watering shall occur at least twice daily with complete coverage, preferably in the late morning and after work is done for the day.
- All clearing, grading, earthmoving, or excavation activities shall cease during periods of high winds (i.e., greater than 25 miles per hour averaged over 1 hour) to prevent excessive amounts of dust (contact the VCAPCD meteorologist for current information about average wind speeds).
- All material transported off site shall be either sufficiently watered or securely covered to prevent excessive amounts of dust.
- The area disturbed by clearing, grading, earthmoving, or excavation operations shall be minimized to prevent excessive amounts of dust.

These control techniques shall be indicated on Project grading plans. The Applicant and/or its contractor shall be responsible for implementing these measures, and compliance with this measure will be subject to periodic site inspections by the City.

- AQ-2:** Project grading plans shall show that for the duration of construction, ozone precursor emissions from construction equipment vehicles must be controlled by maintaining equipment engines in good condition and in proper tune per manufacturer's specifications, to the satisfaction of the City Engineer. Compliance with this measure will be subject to periodic inspections of construction equipment vehicles by the Public Works Department.
- AQ-3:** Construction equipment shall be outfitted with Best Available Control Technology devices, including a California Air Resources Board–certified Level 3 Diesel Particulate Filter or equivalent control device.
- AQ-4:** All trucks that will haul excavated or graded material on site shall comply with California Vehicle Code Section 23114, with special attention to subsections 2311(b)(F), (e)(2), and (e)(4) as amended, regarding the prevention of such material spilling onto public streets and roads.
- AQ-5:** The construction contractor shall adhere to VCAPCD Rule 74.2 (Architectural Coatings) for limiting volatile organic compounds from architectural coatings. This rule specifies architectural coatings storage, clean up, and labeling requirements.

**APPENDIX A**

---

**CalEEMod Air Quality and Greenhouse Gas Emissions Files**



Rio Urbana Mixed Use (Proposed) - Ventura County APCD Air District, Annual

**Rio Urbana Mixed Use (Proposed)**  
**Ventura County APCD Air District, Annual**

**1.0 Project Characteristics**

**1.1 Land Usage**

Land Uses	Size	Metric	Lot Acreage	Floor Surface Area	Population
General Office Building	15.10	1000sqft	0.18	15,100.00	0
Enclosed Parking with Elevator	463.00	Space	0.00	185,200.00	0
Condo/Townhouse	182.00	Dwelling Unit	2.64	182,000.00	557

**1.2 Other Project Characteristics**

<b>Urbanization</b>	Urban	<b>Wind Speed (m/s)</b>	2.6	<b>Precipitation Freq (Days)</b>	31
<b>Climate Zone</b>	8	<b>Operational Year</b>		2021	
<b>Utility Company</b>	Southern California Edison				
<b>CO2 Intensity (lb/MW hr)</b>	702.44	<b>CH4 Intensity (lb/MW hr)</b>	0.029	<b>N2O Intensity (lb/MW hr)</b>	0.006

**1.3 User Entered Comments & Non-Default Data**

Project Characteristics - Construction to be completed 2020.

Land Use - Total Project are = 10.49 acres

Lot coverage: School office = 7,830 sq. ft.; apartment = 115,026 sq. ft.

Construction Phase - Architectural coating to take place intermittently towards the tail end of building construction

Off-road Equipment - No Cranes

Grading - +/- 17,000 cy of import

Vehicle Trips - Based on Traffic Study

Energy Use -



tblConstEquipMitigation	Tier	No Change	Tier 2
tblConstEquipMitigation	Tier	No Change	Tier 2
tblConstEquipMitigation	Tier	No Change	Tier 2
tblConstEquipMitigation	Tier	No Change	Tier 2
tblConstEquipMitigation	Tier	No Change	Tier 2
tblConstEquipMitigation	Tier	No Change	Tier 2
tblConstEquipMitigation	Tier	No Change	Tier 2
tblConstEquipMitigation	Tier	No Change	Tier 2
tblConstructionPhase	NumDays	10.00	30.00
tblConstructionPhase	PhaseEndDate	2/12/2019	1/25/2019
tblConstructionPhase	PhaseStartDate	1/30/2019	12/15/2018
tblGrading	MaterialImported	0.00	17,000.00
tblLandUse	LotAcreage	0.35	0.18
tblLandUse	LotAcreage	4.17	0.00
tblLandUse	LotAcreage	11.38	2.64
tblProjectCharacteristics	OperationalYear	2018	2021
tblVehicleTrips	WD_TR	11.03	11.65

## 2.0 Emissions Summary

### 2.1 Overall Construction

#### Baseline Construction

	ROG	NOx	CO	SO2	Fugitive PM10	Exhaust PM10	PM10 Total	Fugitive PM2.5	Exhaust PM2.5	PM2.5 Total	Bio- CO2	NBio- CO2	Total CO2	CH4	N2O	CO2e
Year	tons/yr										MT/yr					
2018	0.9037	3.7752	2.8825	7.3800e-003	0.3646	0.1616	0.5261	0.0913	0.1543	0.2456	0.0000	670.3661	670.3661	0.0848	0.0000	672.4864
2019	0.7682	0.2234	0.2187	4.6000e-004	0.0153	0.0113	0.0265	4.1100e-003	0.0107	0.0148	0.0000	40.8830	40.8830	6.0300e-003	0.0000	41.0339

Maximum	0.9037	3.7752	2.8825	7.3800e-003	0.3646	0.1616	0.5261	0.0913	0.1543	0.2456	0.0000	670.3661	670.3661	0.0848	0.0000	672.4864
---------	--------	--------	--------	-------------	--------	--------	--------	--------	--------	--------	--------	----------	----------	--------	--------	----------

## Regulatory Compliance Construction

	ROG	NOx	CO	SO2	Fugitive PM10	Exhaust PM10	PM10 Total	Fugitive PM2.5	Exhaust PM2.5	PM2.5 Total	Bio- CO2	NBio- CO2	Total CO2	CH4	N2O	CO2e
Year	tons/yr										MT/yr					
2018	0.6749	3.6525	2.8597	7.3800e-003	0.2919	0.1054	0.3973	0.0760	0.1049	0.1810	0.0000	670.3658	670.3658	0.0848	0.0000	672.4861
2019	0.7554	0.2498	0.2250	4.6000e-004	0.0153	8.5700e-003	0.0239	4.1100e-003	8.5500e-003	0.0127	0.0000	40.8830	40.8830	6.0300e-003	0.0000	41.0339
Maximum	0.7554	3.6525	2.8597	7.3800e-003	0.2919	0.1054	0.3973	0.0760	0.1049	0.1810	0.0000	670.3658	670.3658	0.0848	0.0000	672.4861

	ROG	NOx	CO	SO2	Fugitive PM10	Exhaust PM10	PM10 Total	Fugitive PM2.5	Exhaust PM2.5	PM2.5 Total	Bio- CO2	NBio- CO2	Total CO2	CH4	N2O	CO2e
Percent Reduction	14.46	2.41	0.53	0.00	19.12	34.05	23.79	16.02	31.22	25.65	0.00	0.00	0.00	0.00	0.00	0.00

Quarter	Start Date	End Date	Maximum Baseline ROG + NOX (tons/quarter)	Maximum Regulatory Compliance ROG + NOX (tons/quarter)
1	2-1-2018	4-30-2018	1.4114	1.2881
2	5-1-2018	7-31-2018	1.0488	0.9625
3	8-1-2018	10-31-2018	1.0517	0.9654
4	11-1-2018	1-31-2019	2.1309	2.0881
		Highest	2.1309	2.0881

## 2.2 Overall Operational

### Baseline Operational

	ROG	NOx	CO	SO2	Fugitive PM10	Exhaust PM10	PM10 Total	Fugitive PM2.5	Exhaust PM2.5	PM2.5 Total	Bio- CO2	NBio- CO2	Total CO2	CH4	N2O	CO2e
--	-----	-----	----	-----	---------------	--------------	------------	----------------	---------------	-------------	----------	-----------	-----------	-----	-----	------



Category	tons/yr									MT/yr						
Area	0.9397	0.0157	1.3587	7.000e-005		7.4800e-003	7.4800e-003	7.4800e-003	7.4800e-003	0.0000	2.2160	2.2160	2.1600e-003	0.0000	2.2700	
Energy	0.0212	0.1818	0.0802	1.1600e-003		0.0147	0.0147	0.0147	0.0147	0.0000	984.4889	984.4889	0.0360	0.0105	988.5078	
Mobile	0.5838	0.9807	5.7407	0.0124	1.1894	0.0108	1.2001	0.3174	0.0100	0.3275	0.0000	1,123.2342	1,123.2342	0.0754	0.0000	1,125.1188
Waste						0.0000	0.0000		0.0000	0.0000	19.8444	0.0000	19.8444	1.1728	0.0000	49.1637
Water						0.0000	0.0000		0.0000	0.0000	4.6135	92.6165	97.2300	0.4777	0.0120	112.7416
<b>Total</b>	<b>1.5447</b>	<b>1.1782</b>	<b>7.1796</b>	<b>0.0136</b>	<b>1.1894</b>	<b>0.0329</b>	<b>1.2223</b>	<b>0.3174</b>	<b>0.0322</b>	<b>0.3496</b>	<b>24.4579</b>	<b>2,202.5556</b>	<b>2,227.0134</b>	<b>1.7640</b>	<b>0.0225</b>	<b>2,277.8019</b>

### Regulatory Compliance Operational

Category	ROG	NOx	CO	SO2	Fugitive PM10	Exhaust PM10	PM10 Total	Fugitive PM2.5	Exhaust PM2.5	PM2.5 Total	Bio- CO2	NBio- CO2	Total CO2	CH4	N2O	CO2e
	tons/yr										MT/yr					
Area	0.8821	0.0157	1.3587	7.000e-005		7.4800e-003	7.4800e-003	7.4800e-003	7.4800e-003	0.0000	2.2160	2.2160	2.1600e-003	0.0000	2.2700	
Energy	0.0189	0.1615	0.0712	1.0300e-003		0.0130	0.0130	0.0130	0.0130	0.0130	0.0000	885.9115	885.9115	0.0325	9.4000e-003	889.5223
Mobile	0.5838	0.9807	5.7407	0.0124	1.1894	0.0108	1.2001	0.3174	0.0100	0.3275	0.0000	1,123.2342	1,123.2342	0.0754	0.0000	1,125.1188
Waste						0.0000	0.0000		0.0000	0.0000	19.8444	0.0000	19.8444	1.1728	0.0000	49.1637
Water						0.0000	0.0000		0.0000	0.0000	3.6908	78.5810	82.2717	0.3823	9.6200e-003	94.6971
<b>Total</b>	<b>1.4848</b>	<b>1.1579</b>	<b>7.1705</b>	<b>0.0135</b>	<b>1.1894</b>	<b>0.0313</b>	<b>1.2206</b>	<b>0.3174</b>	<b>0.0306</b>	<b>0.3480</b>	<b>23.5352</b>	<b>2,089.9426</b>	<b>2,113.4777</b>	<b>1.6651</b>	<b>0.0190</b>	<b>2,160.7719</b>

	ROG	NOx	CO	SO2	Fugitive PM10	Exhaust PM10	PM10 Total	Fugitive PM2.5	Exhaust PM2.5	PM2.5 Total	Bio- CO2	NBio- CO2	Total CO2	CH4	N2O	CO2e
<b>Percent Reduction</b>	<b>3.88</b>	<b>1.72</b>	<b>0.13</b>	<b>0.96</b>	<b>0.00</b>	<b>4.98</b>	<b>0.13</b>	<b>0.00</b>	<b>5.09</b>	<b>0.47</b>	<b>3.77</b>	<b>5.11</b>	<b>5.10</b>	<b>5.61</b>	<b>15.28</b>	<b>5.14</b>

### 3.0 Construction Detail

**Construction Phase**

Phase Number	Phase Name	Phase Type	Start Date	End Date	Num Days Week	Num Days	Phase Description
1	Demolition	Demolition	2/1/2018	2/28/2018	5	20	
2	Site Preparation	Site Preparation	3/1/2018	3/5/2018	5	3	
3	Grading	Grading	3/6/2018	3/13/2018	5	6	
4	Building Construction	Building Construction	3/14/2018	4/15/2019	5	220	
5	Paving	Paving	1/16/2019	1/29/2019	5	10	
6	Architectural Coating	Architectural Coating	12/15/2018	1/25/2019	5	30	

**Acres of Grading (Site Preparation Phase): 4.5**

**Acres of Grading (Grading Phase): 3**

**Acres of Paving: 0**

**Residential Indoor: 368,550; Residential Outdoor: 122,850; Non-Residential Indoor: 22,650; Non-Residential Outdoor: 7,550; Striped**

**OffRoad Equipment**

Phase Name	Offroad Equipment Type	Amount	Usage Hours	Horse Power	Load Factor
Demolition	Concrete/Industrial Saws	1	8.00	81	0.73
Demolition	Rubber Tired Dozers	1	8.00	247	0.40
Demolition	Tractors/Loaders/Backhoes	3	8.00	97	0.37
Site Preparation	Graders	1	8.00	187	0.41
Site Preparation	Scrapers	1	8.00	367	0.48
Site Preparation	Tractors/Loaders/Backhoes	1	7.00	97	0.37
Grading	Graders	1	8.00	187	0.41
Grading	Rubber Tired Dozers	1	8.00	247	0.40
Grading	Tractors/Loaders/Backhoes	2	7.00	97	0.37
Building Construction	Forklifts	2	7.00	89	0.20
Building Construction	Generator Sets	1	8.00	84	0.74
Building Construction	Tractors/Loaders/Backhoes	1	6.00	97	0.37
Building Construction	Welders	3	8.00	46	0.45

Paving	Cement and Mortar Mixers	1	8.00	9	0.56
Paving	Pavers	1	8.00	130	0.42
Paving	Paving Equipment	1	8.00	132	0.36
Paving	Rollers	2	8.00	80	0.38
Paving	Tractors/Loaders/Backhoes	1	8.00	97	0.37
Architectural Coating	Air Compressors	1	6.00	78	0.48
Building Construction	Cranes	1	8.00	231	0.29

### Trips and VMT

Phase Name	Offroad Equipment Count	Worker Trip Number	Vendor Trip Number	Hauling Trip Number	Worker Trip Length	Vendor Trip Length	Hauling Trip Length	Worker Vehicle Class	Vendor Vehicle Class	Hauling Vehicle Class
Demolition	5	13.00	0.00	875.00	10.80	7.30	20.00	LD_Mix	HDT_Mix	HHDT
Site Preparation	3	8.00	0.00	0.00	10.80	7.30	20.00	LD_Mix	HDT_Mix	HHDT
Grading	4	10.00	0.00	2,125.00	10.80	7.30	20.00	LD_Mix	HDT_Mix	HHDT
Building Construction	8	214.00	52.00	0.00	10.80	7.30	20.00	LD_Mix	HDT_Mix	HHDT
Paving	6	15.00	0.00	0.00	10.80	7.30	20.00	LD_Mix	HDT_Mix	HHDT
Architectural Coating	1	43.00	0.00	0.00	10.80	7.30	20.00	LD_Mix	HDT_Mix	HHDT

### 3.1 Mitigation Measures Construction

Use Cleaner Engines for Construction Equipment

Water Exposed Area

Reduce Vehicle Speed on Unpaved Roads

Clean Paved Roads

### 3.2 Demolition - 2018

#### Baseline Construction On-Site

	ROG	NOx	CO	SO2	Fugitive PM10	Exhaust PM10	PM10 Total	Fugitive PM2.5	Exhaust PM2.5	PM2.5 Total	Bio- CO2	NBio- CO2	Total CO2	CH4	N2O	CO2e
--	-----	-----	----	-----	---------------	--------------	------------	----------------	---------------	-------------	----------	-----------	-----------	-----	-----	------

Category	tons/yr										MT/yr					
Fugitive Dust					0.0958	0.0000	0.0958	0.0145	0.0000	0.0145	0.0000	0.0000	0.0000	0.0000	0.0000	0.0000
Off-Road	0.0248	0.2436	0.1511	2.4000e-004		0.0144	0.0144		0.0134	0.0134	0.0000	21.6923	21.6923	5.5000e-003	0.0000	21.8297
<b>Total</b>	<b>0.0248</b>	<b>0.2436</b>	<b>0.1511</b>	<b>2.4000e-004</b>	<b>0.0958</b>	<b>0.0144</b>	<b>0.1102</b>	<b>0.0145</b>	<b>0.0134</b>	<b>0.0279</b>	<b>0.0000</b>	<b>21.6923</b>	<b>21.6923</b>	<b>5.5000e-003</b>	<b>0.0000</b>	<b>21.8297</b>

**Baseline Construction Off-Site**

Category	ROG	NOx	CO	SO2	Fugitive PM10	Exhaust PM10	PM10 Total	Fugitive PM2.5	Exhaust PM2.5	PM2.5 Total	Bio- CO2	NBio- CO2	Total CO2	CH4	N2O	CO2e
	tons/yr										MT/yr					
Hauling	3.8300e-003	0.1400	0.0277	3.4000e-004	7.5000e-003	7.5000e-004	8.2400e-003	2.0600e-003	7.2000e-004	2.7700e-003	0.0000	33.1966	33.1966	3.2600e-003	0.0000	33.2781
Vendor	0.0000	0.0000	0.0000	0.0000	0.0000	0.0000	0.0000	0.0000	0.0000	0.0000	0.0000	0.0000	0.0000	0.0000	0.0000	0.0000
Worker	5.6000e-004	4.1000e-004	4.2400e-003	1.0000e-005	1.0500e-003	1.0000e-005	1.0600e-003	2.8000e-004	1.0000e-005	2.9000e-004	0.0000	0.9532	0.9532	3.0000e-005	0.0000	0.9539
<b>Total</b>	<b>4.3900e-003</b>	<b>0.1405</b>	<b>0.0319</b>	<b>3.5000e-004</b>	<b>8.5500e-003</b>	<b>7.6000e-004</b>	<b>9.3000e-003</b>	<b>2.3400e-003</b>	<b>7.3000e-004</b>	<b>3.0600e-003</b>	<b>0.0000</b>	<b>34.1498</b>	<b>34.1498</b>	<b>3.2900e-003</b>	<b>0.0000</b>	<b>34.2320</b>

**Regulatory Compliance Construction On-Site**

Category	ROG	NOx	CO	SO2	Fugitive PM10	Exhaust PM10	PM10 Total	Fugitive PM2.5	Exhaust PM2.5	PM2.5 Total	Bio- CO2	NBio- CO2	Total CO2	CH4	N2O	CO2e
	tons/yr										MT/yr					
Fugitive Dust					0.0374	0.0000	0.0374	5.6600e-003	0.0000	5.6600e-003	0.0000	0.0000	0.0000	0.0000	0.0000	0.0000
Off-Road	8.8600e-003	0.2121	0.1542	2.4000e-004		7.1800e-003	7.1800e-003		7.1800e-003	7.1800e-003	0.0000	21.6923	21.6923	5.5000e-003	0.0000	21.8297

Total	8.8600e-003	0.2121	0.1542	2.4000e-004	0.0374	7.1800e-003	0.0446	5.6600e-003	7.1800e-003	0.0128	0.0000	21.6923	21.6923	5.5000e-003	0.0000	21.8297
-------	-------------	--------	--------	-------------	--------	-------------	--------	-------------	-------------	--------	--------	---------	---------	-------------	--------	---------

### Regulatory Compliance Construction Off-Site

	ROG	NOx	CO	SO2	Fugitive PM10	Exhaust PM10	PM10 Total	Fugitive PM2.5	Exhaust PM2.5	PM2.5 Total	Bio- CO2	NBio- CO2	Total CO2	CH4	N2O	CO2e
Category	tons/yr										MT/yr					
Hauling	3.8300e-003	0.1400	0.0277	3.4000e-004	7.5000e-003	7.5000e-004	8.2400e-003	2.0600e-003	7.2000e-004	2.7700e-003	0.0000	33.1966	33.1966	3.2600e-003	0.0000	33.2781
Vendor	0.0000	0.0000	0.0000	0.0000	0.0000	0.0000	0.0000	0.0000	0.0000	0.0000	0.0000	0.0000	0.0000	0.0000	0.0000	0.0000
Worker	5.6000e-004	4.1000e-004	4.2400e-003	1.0000e-005	1.0500e-003	1.0000e-005	1.0600e-003	2.8000e-004	1.0000e-005	2.9000e-004	0.0000	0.9532	0.9532	3.0000e-005	0.0000	0.9539
<b>Total</b>	<b>4.3900e-003</b>	<b>0.1405</b>	<b>0.0319</b>	<b>3.5000e-004</b>	<b>8.5500e-003</b>	<b>7.6000e-004</b>	<b>9.3000e-003</b>	<b>2.3400e-003</b>	<b>7.3000e-004</b>	<b>3.0600e-003</b>	<b>0.0000</b>	<b>34.1498</b>	<b>34.1498</b>	<b>3.2900e-003</b>	<b>0.0000</b>	<b>34.2320</b>

### 3.3 Site Preparation - 2018

#### Baseline Construction On-Site

	ROG	NOx	CO	SO2	Fugitive PM10	Exhaust PM10	PM10 Total	Fugitive PM2.5	Exhaust PM2.5	PM2.5 Total	Bio- CO2	NBio- CO2	Total CO2	CH4	N2O	CO2e
Category	tons/yr										MT/yr					
Fugitive Dust					2.3900e-003	0.0000	2.3900e-003	2.6000e-004	0.0000	2.6000e-004	0.0000	0.0000	0.0000	0.0000	0.0000	0.0000
Off-Road	2.8500e-003	0.0354	0.0191	4.0000e-005		1.4300e-003	1.4300e-003		1.3200e-003	1.3200e-003	0.0000	3.3590	3.3590	1.0500e-003	0.0000	3.3851
<b>Total</b>	<b>2.8500e-003</b>	<b>0.0354</b>	<b>0.0191</b>	<b>4.0000e-005</b>	<b>2.3900e-003</b>	<b>1.4300e-003</b>	<b>3.8200e-003</b>	<b>2.6000e-004</b>	<b>1.3200e-003</b>	<b>1.5800e-003</b>	<b>0.0000</b>	<b>3.3590</b>	<b>3.3590</b>	<b>1.0500e-003</b>	<b>0.0000</b>	<b>3.3851</b>

#### Baseline Construction Off-Site

	ROG	NOx	CO	SO2	Fugitive PM10	Exhaust PM10	PM10 Total	Fugitive PM2.5	Exhaust PM2.5	PM2.5 Total	Bio- CO2	NBio- CO2	Total CO2	CH4	N2O	CO2e
Category	tons/yr										MT/yr					
Hauling	0.0000	0.0000	0.0000	0.0000	0.0000	0.0000	0.0000	0.0000	0.0000	0.0000	0.0000	0.0000	0.0000	0.0000	0.0000	0.0000
Vendor	0.0000	0.0000	0.0000	0.0000	0.0000	0.0000	0.0000	0.0000	0.0000	0.0000	0.0000	0.0000	0.0000	0.0000	0.0000	0.0000
Worker	5.0000e-005	4.0000e-005	3.9000e-004	0.0000	1.0000e-004	0.0000	1.0000e-004	3.0000e-005	0.0000	3.0000e-005	0.0000	0.0880	0.0880	0.0000	0.0000	0.0881
<b>Total</b>	<b>5.0000e-005</b>	<b>4.0000e-005</b>	<b>3.9000e-004</b>	<b>0.0000</b>	<b>1.0000e-004</b>	<b>0.0000</b>	<b>1.0000e-004</b>	<b>3.0000e-005</b>	<b>0.0000</b>	<b>3.0000e-005</b>	<b>0.0000</b>	<b>0.0880</b>	<b>0.0880</b>	<b>0.0000</b>	<b>0.0000</b>	<b>0.0881</b>

**Regulatory Compliance Construction On-Site**

	ROG	NOx	CO	SO2	Fugitive PM10	Exhaust PM10	PM10 Total	Fugitive PM2.5	Exhaust PM2.5	PM2.5 Total	Bio- CO2	NBio- CO2	Total CO2	CH4	N2O	CO2e
Category	tons/yr										MT/yr					
Fugitive Dust					9.3000e-004	0.0000	9.3000e-004	1.0000e-004	0.0000	1.0000e-004	0.0000	0.0000	0.0000	0.0000	0.0000	0.0000
Off-Road	9.9000e-004	0.0300	0.0205	4.0000e-005		7.5000e-004	7.5000e-004		7.5000e-004	7.5000e-004	0.0000	3.3590	3.3590	1.0500e-003	0.0000	3.3851
<b>Total</b>	<b>9.9000e-004</b>	<b>0.0300</b>	<b>0.0205</b>	<b>4.0000e-005</b>	<b>9.3000e-004</b>	<b>7.5000e-004</b>	<b>1.6800e-003</b>	<b>1.0000e-004</b>	<b>7.5000e-004</b>	<b>8.5000e-004</b>	<b>0.0000</b>	<b>3.3590</b>	<b>3.3590</b>	<b>1.0500e-003</b>	<b>0.0000</b>	<b>3.3851</b>

**Regulatory Compliance Construction Off-Site**

	ROG	NOx	CO	SO2	Fugitive PM10	Exhaust PM10	PM10 Total	Fugitive PM2.5	Exhaust PM2.5	PM2.5 Total	Bio- CO2	NBio- CO2	Total CO2	CH4	N2O	CO2e
Category	tons/yr										MT/yr					

Hauling	0.0000	0.0000	0.0000	0.0000	0.0000	0.0000	0.0000	0.0000	0.0000	0.0000	0.0000	0.0000	0.0000	0.0000	0.0000	0.0000
Vendor	0.0000	0.0000	0.0000	0.0000	0.0000	0.0000	0.0000	0.0000	0.0000	0.0000	0.0000	0.0000	0.0000	0.0000	0.0000	0.0000
Worker	5.0000e-005	4.0000e-005	3.9000e-004	0.0000	1.0000e-004	0.0000	1.0000e-004	3.0000e-005	0.0000	3.0000e-005	0.0000	0.0880	0.0880	0.0000	0.0000	0.0881
<b>Total</b>	<b>5.0000e-005</b>	<b>4.0000e-005</b>	<b>3.9000e-004</b>	<b>0.0000</b>	<b>1.0000e-004</b>	<b>0.0000</b>	<b>1.0000e-004</b>	<b>3.0000e-005</b>	<b>0.0000</b>	<b>3.0000e-005</b>	<b>0.0000</b>	<b>0.0880</b>	<b>0.0880</b>	<b>0.0000</b>	<b>0.0000</b>	<b>0.0881</b>

### 3.4 Grading - 2018

#### Baseline Construction On-Site

	ROG	NOx	CO	SO2	Fugitive PM10	Exhaust PM10	PM10 Total	Fugitive PM2.5	Exhaust PM2.5	PM2.5 Total	Bio- CO2	NBio- CO2	Total CO2	CH4	N2O	CO2e
Category	tons/yr										MT/yr					
Fugitive Dust					0.0209	0.0000	0.0209	0.0103	0.0000	0.0103	0.0000	0.0000	0.0000	0.0000	0.0000	0.0000
Off-Road	6.4500e-003	0.0729	0.0311	6.0000e-005		3.5000e-003	3.5000e-003		3.2200e-003	3.2200e-003	0.0000	5.6539	5.6539	1.7600e-003	0.0000	5.6979
<b>Total</b>	<b>6.4500e-003</b>	<b>0.0729</b>	<b>0.0311</b>	<b>6.0000e-005</b>	<b>0.0209</b>	<b>3.5000e-003</b>	<b>0.0244</b>	<b>0.0103</b>	<b>3.2200e-003</b>	<b>0.0135</b>	<b>0.0000</b>	<b>5.6539</b>	<b>5.6539</b>	<b>1.7600e-003</b>	<b>0.0000</b>	<b>5.6979</b>

#### Baseline Construction Off-Site

	ROG	NOx	CO	SO2	Fugitive PM10	Exhaust PM10	PM10 Total	Fugitive PM2.5	Exhaust PM2.5	PM2.5 Total	Bio- CO2	NBio- CO2	Total CO2	CH4	N2O	CO2e
Category	tons/yr										MT/yr					
Hauling	9.2900e-003	0.3401	0.0672	8.2000e-004	0.0182	1.8200e-003	0.0200	4.9900e-003	1.7400e-003	6.7300e-003	0.0000	80.6203	80.6203	7.9200e-003	0.0000	80.8182
Vendor	0.0000	0.0000	0.0000	0.0000	0.0000	0.0000	0.0000	0.0000	0.0000	0.0000	0.0000	0.0000	0.0000	0.0000	0.0000	0.0000
Worker	1.3000e-004	9.0000e-005	9.8000e-004	0.0000	2.4000e-004	0.0000	2.4000e-004	6.0000e-005	0.0000	7.0000e-005	0.0000	0.2200	0.2200	1.0000e-005	0.0000	0.2201
<b>Total</b>	<b>9.4200e-003</b>	<b>0.3402</b>	<b>0.0682</b>	<b>8.2000e-004</b>	<b>0.0184</b>	<b>1.8200e-003</b>	<b>0.0203</b>	<b>5.0500e-003</b>	<b>1.7400e-003</b>	<b>6.8000e-003</b>	<b>0.0000</b>	<b>80.8402</b>	<b>80.8402</b>	<b>7.9300e-003</b>	<b>0.0000</b>	<b>81.0384</b>

### Regulatory Compliance Construction On-Site

	ROG	NOx	CO	SO2	Fugitive PM10	Exhaust PM10	PM10 Total	Fugitive PM2.5	Exhaust PM2.5	PM2.5 Total	Bio- CO2	NBio- CO2	Total CO2	CH4	N2O	CO2e
Category	tons/yr										MT/yr					
Fugitive Dust					8.1300e-003	0.0000	8.1300e-003	4.0100e-003	0.0000	4.0100e-003	0.0000	0.0000	0.0000	0.0000	0.0000	0.0000
Off-Road	1.8800e-003	0.0543	0.0364	6.0000e-005		1.4600e-003	1.4600e-003		1.4600e-003	1.4600e-003	0.0000	5.6539	5.6539	1.7600e-003	0.0000	5.6979
<b>Total</b>	<b>1.8800e-003</b>	<b>0.0543</b>	<b>0.0364</b>	<b>6.0000e-005</b>	<b>8.1300e-003</b>	<b>1.4600e-003</b>	<b>9.5900e-003</b>	<b>4.0100e-003</b>	<b>1.4600e-003</b>	<b>5.4700e-003</b>	<b>0.0000</b>	<b>5.6539</b>	<b>5.6539</b>	<b>1.7600e-003</b>	<b>0.0000</b>	<b>5.6979</b>

### Regulatory Compliance Construction Off-Site

	ROG	NOx	CO	SO2	Fugitive PM10	Exhaust PM10	PM10 Total	Fugitive PM2.5	Exhaust PM2.5	PM2.5 Total	Bio- CO2	NBio- CO2	Total CO2	CH4	N2O	CO2e
Category	tons/yr										MT/yr					
Hauling	9.2900e-003	0.3401	0.0672	8.2000e-004	0.0182	1.8200e-003	0.0200	4.9900e-003	1.7400e-003	6.7300e-003	0.0000	80.6203	80.6203	7.9200e-003	0.0000	80.8182
Vendor	0.0000	0.0000	0.0000	0.0000	0.0000	0.0000	0.0000	0.0000	0.0000	0.0000	0.0000	0.0000	0.0000	0.0000	0.0000	0.0000
Worker	1.3000e-004	9.0000e-005	9.8000e-004	0.0000	2.4000e-004	0.0000	2.4000e-004	6.0000e-005	0.0000	7.0000e-005	0.0000	0.2200	0.2200	1.0000e-005	0.0000	0.2201
<b>Total</b>	<b>9.4200e-003</b>	<b>0.3402</b>	<b>0.0682</b>	<b>8.2000e-004</b>	<b>0.0184</b>	<b>1.8200e-003</b>	<b>0.0203</b>	<b>5.0500e-003</b>	<b>1.7400e-003</b>	<b>6.8000e-003</b>	<b>0.0000</b>	<b>80.8402</b>	<b>80.8402</b>	<b>7.9300e-003</b>	<b>0.0000</b>	<b>81.0384</b>

## 3.5 Building Construction - 2018

### Baseline Construction On-Site



	ROG	NOx	CO	SO2	Fugitive PM10	Exhaust PM10	PM10 Total	Fugitive PM2.5	Exhaust PM2.5	PM2.5 Total	Bio- CO2	NBio- CO2	Total CO2	CH4	N2O	CO2e
Category	tons/yr										MT/yr					
Off-Road	0.3044	2.1640	1.6426	2.6100e-003		0.1314	0.1314		0.1259	0.1259	0.0000	220.8646	220.8646	0.0476	0.0000	222.0541
<b>Total</b>	<b>0.3044</b>	<b>2.1640</b>	<b>1.6426</b>	<b>2.6100e-003</b>		<b>0.1314</b>	<b>0.1314</b>		<b>0.1259</b>	<b>0.1259</b>	<b>0.0000</b>	<b>220.8646</b>	<b>220.8646</b>	<b>0.0476</b>	<b>0.0000</b>	<b>222.0541</b>

### Baseline Construction Off-Site

	ROG	NOx	CO	SO2	Fugitive PM10	Exhaust PM10	PM10 Total	Fugitive PM2.5	Exhaust PM2.5	PM2.5 Total	Bio- CO2	NBio- CO2	Total CO2	CH4	N2O	CO2e
Category	tons/yr										MT/yr					
Hauling	0.0000	0.0000	0.0000	0.0000	0.0000	0.0000	0.0000	0.0000	0.0000	0.0000	0.0000	0.0000	0.0000	0.0000	0.0000	0.0000
Vendor	0.0248	0.6965	0.1904	1.4100e-003	0.0362	6.1300e-003	0.0423	0.0104	5.8700e-003	0.0163	0.0000	136.6102	136.6102	0.0123	0.0000	136.9180
Worker	0.0968	0.0704	0.7299	1.8200e-003	0.1803	1.3300e-003	0.1817	0.0479	1.2300e-003	0.0491	0.0000	163.9697	163.9697	5.2100e-003	0.0000	164.1000
<b>Total</b>	<b>0.1216</b>	<b>0.7669</b>	<b>0.9203</b>	<b>3.2300e-003</b>	<b>0.2165</b>	<b>7.4600e-003</b>	<b>0.2240</b>	<b>0.0583</b>	<b>7.1000e-003</b>	<b>0.0654</b>	<b>0.0000</b>	<b>300.5799</b>	<b>300.5799</b>	<b>0.0175</b>	<b>0.0000</b>	<b>301.0180</b>

### Regulatory Compliance Construction On-Site

	ROG	NOx	CO	SO2	Fugitive PM10	Exhaust PM10	PM10 Total	Fugitive PM2.5	Exhaust PM2.5	PM2.5 Total	Bio- CO2	NBio- CO2	Total CO2	CH4	N2O	CO2e
Category	tons/yr										MT/yr					
Off-Road	0.0990	2.0949	1.6102	2.6100e-003		0.0855	0.0855		0.0855	0.0855	0.0000	220.8644	220.8644	0.0476	0.0000	222.0539

Total	0.0990	2.0949	1.6102	2.6100e-003		0.0855	0.0855		0.0855	0.0855	0.0000	220.8644	220.8644	0.0476	0.0000	222.0539
-------	--------	--------	--------	-------------	--	--------	--------	--	--------	--------	--------	----------	----------	--------	--------	----------

### Regulatory Compliance Construction Off-Site

	ROG	NOx	CO	SO2	Fugitive PM10	Exhaust PM10	PM10 Total	Fugitive PM2.5	Exhaust PM2.5	PM2.5 Total	Bio- CO2	NBio- CO2	Total CO2	CH4	N2O	CO2e
Category	tons/yr										MT/yr					
Hauling	0.0000	0.0000	0.0000	0.0000	0.0000	0.0000	0.0000	0.0000	0.0000	0.0000	0.0000	0.0000	0.0000	0.0000	0.0000	0.0000
Vendor	0.0248	0.6965	0.1904	1.4100e-003	0.0362	6.1300e-003	0.0423	0.0104	5.8700e-003	0.0163	0.0000	136.6102	136.6102	0.0123	0.0000	136.9180
Worker	0.0968	0.0704	0.7299	1.8200e-003	0.1803	1.3300e-003	0.1817	0.0479	1.2300e-003	0.0491	0.0000	163.9697	163.9697	5.2100e-003	0.0000	164.1000
<b>Total</b>	<b>0.1216</b>	<b>0.7669</b>	<b>0.9203</b>	<b>3.2300e-003</b>	<b>0.2165</b>	<b>7.4600e-003</b>	<b>0.2240</b>	<b>0.0583</b>	<b>7.1000e-003</b>	<b>0.0654</b>	<b>0.0000</b>	<b>300.5799</b>	<b>300.5799</b>	<b>0.0175</b>	<b>0.0000</b>	<b>301.0180</b>

### 3.5 Building Construction - 2019

#### Baseline Construction On-Site

	ROG	NOx	CO	SO2	Fugitive PM10	Exhaust PM10	PM10 Total	Fugitive PM2.5	Exhaust PM2.5	PM2.5 Total	Bio- CO2	NBio- CO2	Total CO2	CH4	N2O	CO2e
Category	tons/yr										MT/yr					
Off-Road	0.0141	0.1040	0.0839	1.4000e-004		6.0000e-003	6.0000e-003		5.7500e-003	5.7500e-003	0.0000	11.5365	11.5365	2.4000e-003	0.0000	11.5965
<b>Total</b>	<b>0.0141</b>	<b>0.1040</b>	<b>0.0839</b>	<b>1.4000e-004</b>		<b>6.0000e-003</b>	<b>6.0000e-003</b>		<b>5.7500e-003</b>	<b>5.7500e-003</b>	<b>0.0000</b>	<b>11.5365</b>	<b>11.5365</b>	<b>2.4000e-003</b>	<b>0.0000</b>	<b>11.5965</b>

#### Baseline Construction Off-Site

	ROG	NOx	CO	SO2	Fugitive PM10	Exhaust PM10	PM10 Total	Fugitive PM2.5	Exhaust PM2.5	PM2.5 Total	Bio- CO2	NBio- CO2	Total CO2	CH4	N2O	CO2e
Category	tons/yr										MT/yr					
Hauling	0.0000	0.0000	0.0000	0.0000	0.0000	0.0000	0.0000	0.0000	0.0000	0.0000	0.0000	0.0000	0.0000	0.0000	0.0000	0.0000
Vendor	1.1900e-003	0.0345	9.2800e-003	7.0000e-005	1.9000e-003	2.8000e-004	2.1800e-003	5.5000e-004	2.7000e-004	8.1000e-004	0.0000	7.1549	7.1549	6.3000e-004	0.0000	7.1705
Worker	4.6700e-003	3.2800e-003	0.0345	9.0000e-005	9.4900e-003	7.0000e-005	9.5600e-003	2.5200e-003	6.0000e-005	2.5800e-003	0.0000	8.3962	8.3962	2.5000e-004	0.0000	8.4023
<b>Total</b>	<b>5.8600e-003</b>	<b>0.0378</b>	<b>0.0438</b>	<b>1.6000e-004</b>	<b>0.0114</b>	<b>3.5000e-004</b>	<b>0.0117</b>	<b>3.0700e-003</b>	<b>3.3000e-004</b>	<b>3.3900e-003</b>	<b>0.0000</b>	<b>15.5510</b>	<b>15.5510</b>	<b>8.8000e-004</b>	<b>0.0000</b>	<b>15.5728</b>

**Regulatory Compliance Construction On-Site**

	ROG	NOx	CO	SO2	Fugitive PM10	Exhaust PM10	PM10 Total	Fugitive PM2.5	Exhaust PM2.5	PM2.5 Total	Bio- CO2	NBio- CO2	Total CO2	CH4	N2O	CO2e
Category	tons/yr										MT/yr					
Off-Road	5.2100e-003	0.1103	0.0847	1.4000e-004		4.5000e-003	4.5000e-003		4.5000e-003	4.5000e-003	0.0000	11.5365	11.5365	2.4000e-003	0.0000	11.5965
<b>Total</b>	<b>5.2100e-003</b>	<b>0.1103</b>	<b>0.0847</b>	<b>1.4000e-004</b>		<b>4.5000e-003</b>	<b>4.5000e-003</b>		<b>4.5000e-003</b>	<b>4.5000e-003</b>	<b>0.0000</b>	<b>11.5365</b>	<b>11.5365</b>	<b>2.4000e-003</b>	<b>0.0000</b>	<b>11.5965</b>

**Regulatory Compliance Construction Off-Site**

	ROG	NOx	CO	SO2	Fugitive PM10	Exhaust PM10	PM10 Total	Fugitive PM2.5	Exhaust PM2.5	PM2.5 Total	Bio- CO2	NBio- CO2	Total CO2	CH4	N2O	CO2e
Category	tons/yr										MT/yr					

Hauling	0.0000	0.0000	0.0000	0.0000	0.0000	0.0000	0.0000	0.0000	0.0000	0.0000	0.0000	0.0000	0.0000	0.0000	0.0000	0.0000
Vendor	1.1900e-003	0.0345	9.2800e-003	7.0000e-005	1.9000e-003	2.8000e-004	2.1800e-003	5.5000e-004	2.7000e-004	8.1000e-004	0.0000	7.1549	7.1549	6.3000e-004	0.0000	7.1705
Worker	4.6700e-003	3.2800e-003	0.0345	9.0000e-005	9.4900e-003	7.0000e-005	9.5600e-003	2.5200e-003	6.0000e-005	2.5800e-003	0.0000	8.3962	8.3962	2.5000e-004	0.0000	8.4023
<b>Total</b>	<b>5.8600e-003</b>	<b>0.0378</b>	<b>0.0438</b>	<b>1.6000e-004</b>	<b>0.0114</b>	<b>3.5000e-004</b>	<b>0.0117</b>	<b>3.0700e-003</b>	<b>3.3000e-004</b>	<b>3.3900e-003</b>	<b>0.0000</b>	<b>15.5510</b>	<b>15.5510</b>	<b>8.8000e-004</b>	<b>0.0000</b>	<b>15.5728</b>

### 3.6 Paving - 2019

#### Baseline Construction On-Site

	ROG	NOx	CO	SO2	Fugitive PM10	Exhaust PM10	PM10 Total	Fugitive PM2.5	Exhaust PM2.5	PM2.5 Total	Bio- CO2	NBio- CO2	Total CO2	CH4	N2O	CO2e
Category	tons/yr										MT/yr					
Off-Road	6.2300e-003	0.0628	0.0593	9.0000e-005		3.6500e-003	3.6500e-003		3.3600e-003	3.3600e-003	0.0000	7.9208	7.9208	2.4600e-003	0.0000	7.9823
Paving	0.0000					0.0000	0.0000		0.0000	0.0000	0.0000	0.0000	0.0000	0.0000	0.0000	0.0000
<b>Total</b>	<b>6.2300e-003</b>	<b>0.0628</b>	<b>0.0593</b>	<b>9.0000e-005</b>		<b>3.6500e-003</b>	<b>3.6500e-003</b>		<b>3.3600e-003</b>	<b>3.3600e-003</b>	<b>0.0000</b>	<b>7.9208</b>	<b>7.9208</b>	<b>2.4600e-003</b>	<b>0.0000</b>	<b>7.9823</b>

#### Baseline Construction Off-Site

	ROG	NOx	CO	SO2	Fugitive PM10	Exhaust PM10	PM10 Total	Fugitive PM2.5	Exhaust PM2.5	PM2.5 Total	Bio- CO2	NBio- CO2	Total CO2	CH4	N2O	CO2e
Category	tons/yr										MT/yr					
Hauling	0.0000	0.0000	0.0000	0.0000	0.0000	0.0000	0.0000	0.0000	0.0000	0.0000	0.0000	0.0000	0.0000	0.0000	0.0000	0.0000
Vendor	0.0000	0.0000	0.0000	0.0000	0.0000	0.0000	0.0000	0.0000	0.0000	0.0000	0.0000	0.0000	0.0000	0.0000	0.0000	0.0000
Worker	3.0000e-004	2.1000e-004	2.2000e-003	1.0000e-005	6.0000e-004	0.0000	6.1000e-004	1.6000e-004	0.0000	1.6000e-004	0.0000	0.5350	0.5350	2.0000e-005	0.0000	0.5354
<b>Total</b>	<b>3.0000e-004</b>	<b>2.1000e-004</b>	<b>2.2000e-003</b>	<b>1.0000e-005</b>	<b>6.0000e-004</b>	<b>0.0000</b>	<b>6.1000e-004</b>	<b>1.6000e-004</b>	<b>0.0000</b>	<b>1.6000e-004</b>	<b>0.0000</b>	<b>0.5350</b>	<b>0.5350</b>	<b>2.0000e-005</b>	<b>0.0000</b>	<b>0.5354</b>

**Regulatory Compliance Construction On-Site**

	ROG	NOx	CO	SO2	Fugitive PM10	Exhaust PM10	PM10 Total	Fugitive PM2.5	Exhaust PM2.5	PM2.5 Total	Bio- CO2	NBio- CO2	Total CO2	CH4	N2O	CO2e
Category	tons/yr										MT/yr					
Off-Road	3.6700e-003	0.0781	0.0649	9.0000e-005		2.7900e-003	2.7900e-003		2.7900e-003	2.7900e-003	0.0000	7.9208	7.9208	2.4600e-003	0.0000	7.9823
Paving	0.0000					0.0000	0.0000		0.0000	0.0000	0.0000	0.0000	0.0000	0.0000	0.0000	0.0000
<b>Total</b>	<b>3.6700e-003</b>	<b>0.0781</b>	<b>0.0649</b>	<b>9.0000e-005</b>		<b>2.7900e-003</b>	<b>2.7900e-003</b>		<b>2.7900e-003</b>	<b>2.7900e-003</b>	<b>0.0000</b>	<b>7.9208</b>	<b>7.9208</b>	<b>2.4600e-003</b>	<b>0.0000</b>	<b>7.9823</b>

**Regulatory Compliance Construction Off-Site**

	ROG	NOx	CO	SO2	Fugitive PM10	Exhaust PM10	PM10 Total	Fugitive PM2.5	Exhaust PM2.5	PM2.5 Total	Bio- CO2	NBio- CO2	Total CO2	CH4	N2O	CO2e
Category	tons/yr										MT/yr					
Hauling	0.0000	0.0000	0.0000	0.0000	0.0000	0.0000	0.0000	0.0000	0.0000	0.0000	0.0000	0.0000	0.0000	0.0000	0.0000	0.0000
Vendor	0.0000	0.0000	0.0000	0.0000	0.0000	0.0000	0.0000	0.0000	0.0000	0.0000	0.0000	0.0000	0.0000	0.0000	0.0000	0.0000
Worker	3.0000e-004	2.1000e-004	2.2000e-003	1.0000e-005	6.0000e-004	0.0000	6.1000e-004	1.6000e-004	0.0000	1.6000e-004	0.0000	0.5350	0.5350	2.0000e-005	0.0000	0.5354
<b>Total</b>	<b>3.0000e-004</b>	<b>2.1000e-004</b>	<b>2.2000e-003</b>	<b>1.0000e-005</b>	<b>6.0000e-004</b>	<b>0.0000</b>	<b>6.1000e-004</b>	<b>1.6000e-004</b>	<b>0.0000</b>	<b>1.6000e-004</b>	<b>0.0000</b>	<b>0.5350</b>	<b>0.5350</b>	<b>2.0000e-005</b>	<b>0.0000</b>	<b>0.5354</b>

**3.7 Architectural Coating - 2018**

**Baseline Construction On-Site**



Off-Road	6.3000e-004	0.0129	0.0101	2.0000e-005		5.2000e-004	5.2000e-004		5.2000e-004	5.2000e-004	0.0000	1.4043	1.4043	1.3000e-004	0.0000	1.4076
<b>Total</b>	<b>0.4277</b>	<b>0.0129</b>	<b>0.0101</b>	<b>2.0000e-005</b>		<b>5.2000e-004</b>	<b>5.2000e-004</b>		<b>5.2000e-004</b>	<b>5.2000e-004</b>	<b>0.0000</b>	<b>1.4043</b>	<b>1.4043</b>	<b>1.3000e-004</b>	<b>0.0000</b>	<b>1.4076</b>

**Regulatory Compliance Construction Off-Site**

	ROG	NOx	CO	SO2	Fugitive PM10	Exhaust PM10	PM10 Total	Fugitive PM2.5	Exhaust PM2.5	PM2.5 Total	Bio- CO2	NBio- CO2	Total CO2	CH4	N2O	CO2e
Category	tons/yr										MT/yr					
Hauling	0.0000	0.0000	0.0000	0.0000	0.0000	0.0000	0.0000	0.0000	0.0000	0.0000	0.0000	0.0000	0.0000	0.0000	0.0000	0.0000
Vendor	0.0000	0.0000	0.0000	0.0000	0.0000	0.0000	0.0000	0.0000	0.0000	0.0000	0.0000	0.0000	0.0000	0.0000	0.0000	0.0000
Worker	1.0200e-003	7.4000e-004	7.7200e-003	2.0000e-005	1.9100e-003	1.0000e-005	1.9200e-003	5.1000e-004	1.0000e-005	5.2000e-004	0.0000	1.7341	1.7341	6.0000e-005	0.0000	1.7354
<b>Total</b>	<b>1.0200e-003</b>	<b>7.4000e-004</b>	<b>7.7200e-003</b>	<b>2.0000e-005</b>	<b>1.9100e-003</b>	<b>1.0000e-005</b>	<b>1.9200e-003</b>	<b>5.1000e-004</b>	<b>1.0000e-005</b>	<b>5.2000e-004</b>	<b>0.0000</b>	<b>1.7341</b>	<b>1.7341</b>	<b>6.0000e-005</b>	<b>0.0000</b>	<b>1.7354</b>

**3.7 Architectural Coating - 2019**

**Baseline Construction On-Site**

	ROG	NOx	CO	SO2	Fugitive PM10	Exhaust PM10	PM10 Total	Fugitive PM2.5	Exhaust PM2.5	PM2.5 Total	Bio- CO2	NBio- CO2	Total CO2	CH4	N2O	CO2e
Category	tons/yr										MT/yr					
Archit. Coating	0.7376					0.0000	0.0000		0.0000	0.0000	0.0000	0.0000	0.0000	0.0000	0.0000	0.0000
Off-Road	2.5300e-003	0.0174	0.0175	3.0000e-005		1.2200e-003	1.2200e-003		1.2200e-003	1.2200e-003	0.0000	2.4256	2.4256	2.0000e-004	0.0000	2.4307
<b>Total</b>	<b>0.7401</b>	<b>0.0174</b>	<b>0.0175</b>	<b>3.0000e-005</b>		<b>1.2200e-003</b>	<b>1.2200e-003</b>		<b>1.2200e-003</b>	<b>1.2200e-003</b>	<b>0.0000</b>	<b>2.4256</b>	<b>2.4256</b>	<b>2.0000e-004</b>	<b>0.0000</b>	<b>2.4307</b>

**Baseline Construction Off-Site**

	ROG	NOx	CO	SO2	Fugitive PM10	Exhaust PM10	PM10 Total	Fugitive PM2.5	Exhaust PM2.5	PM2.5 Total	Bio- CO2	NBio- CO2	Total CO2	CH4	N2O	CO2e
Category	tons/yr										MT/yr					
Hauling	0.0000	0.0000	0.0000	0.0000	0.0000	0.0000	0.0000	0.0000	0.0000	0.0000	0.0000	0.0000	0.0000	0.0000	0.0000	0.0000
Vendor	0.0000	0.0000	0.0000	0.0000	0.0000	0.0000	0.0000	0.0000	0.0000	0.0000	0.0000	0.0000	0.0000	0.0000	0.0000	0.0000
Worker	1.6200e-003	1.1400e-003	0.0120	3.0000e-005	3.2900e-003	2.0000e-005	3.3200e-003	8.7000e-004	2.0000e-005	9.0000e-004	0.0000	2.9141	2.9141	9.0000e-005	0.0000	2.9162
<b>Total</b>	<b>1.6200e-003</b>	<b>1.1400e-003</b>	<b>0.0120</b>	<b>3.0000e-005</b>	<b>3.2900e-003</b>	<b>2.0000e-005</b>	<b>3.3200e-003</b>	<b>8.7000e-004</b>	<b>2.0000e-005</b>	<b>9.0000e-004</b>	<b>0.0000</b>	<b>2.9141</b>	<b>2.9141</b>	<b>9.0000e-005</b>	<b>0.0000</b>	<b>2.9162</b>

**Regulatory Compliance Construction On-Site**

	ROG	NOx	CO	SO2	Fugitive PM10	Exhaust PM10	PM10 Total	Fugitive PM2.5	Exhaust PM2.5	PM2.5 Total	Bio- CO2	NBio- CO2	Total CO2	CH4	N2O	CO2e
Category	tons/yr										MT/yr					
Archit. Coating	0.7376					0.0000	0.0000		0.0000	0.0000	0.0000	0.0000	0.0000	0.0000	0.0000	0.0000
Off-Road	1.0800e-003	0.0224	0.0174	3.0000e-005		9.0000e-004	9.0000e-004		9.0000e-004	9.0000e-004	0.0000	2.4256	2.4256	2.0000e-004	0.0000	2.4307
<b>Total</b>	<b>0.7387</b>	<b>0.0224</b>	<b>0.0174</b>	<b>3.0000e-005</b>		<b>9.0000e-004</b>	<b>9.0000e-004</b>		<b>9.0000e-004</b>	<b>9.0000e-004</b>	<b>0.0000</b>	<b>2.4256</b>	<b>2.4256</b>	<b>2.0000e-004</b>	<b>0.0000</b>	<b>2.4307</b>

**Regulatory Compliance Construction Off-Site**

	ROG	NOx	CO	SO2	Fugitive PM10	Exhaust PM10	PM10 Total	Fugitive PM2.5	Exhaust PM2.5	PM2.5 Total	Bio- CO2	NBio- CO2	Total CO2	CH4	N2O	CO2e
Category	tons/yr										MT/yr					



Hauling	0.0000	0.0000	0.0000	0.0000	0.0000	0.0000	0.0000	0.0000	0.0000	0.0000	0.0000	0.0000	0.0000	0.0000	0.0000	0.0000
Vendor	0.0000	0.0000	0.0000	0.0000	0.0000	0.0000	0.0000	0.0000	0.0000	0.0000	0.0000	0.0000	0.0000	0.0000	0.0000	0.0000
Worker	1.6200e-003	1.1400e-003	0.0120	3.0000e-005	3.2900e-003	2.0000e-005	3.3200e-003	8.7000e-004	2.0000e-005	9.0000e-004	0.0000	2.9141	2.9141	9.0000e-005	0.0000	2.9162
<b>Total</b>	<b>1.6200e-003</b>	<b>1.1400e-003</b>	<b>0.0120</b>	<b>3.0000e-005</b>	<b>3.2900e-003</b>	<b>2.0000e-005</b>	<b>3.3200e-003</b>	<b>8.7000e-004</b>	<b>2.0000e-005</b>	<b>9.0000e-004</b>	<b>0.0000</b>	<b>2.9141</b>	<b>2.9141</b>	<b>9.0000e-005</b>	<b>0.0000</b>	<b>2.9162</b>

#### 4.0 Operational Detail - Mobile

#### 4.1 Mitigation Measures Mobile

	ROG	NOx	CO	SO2	Fugitive PM10	Exhaust PM10	PM10 Total	Fugitive PM2.5	Exhaust PM2.5	PM2.5 Total	Bio- CO2	NBio- CO2	Total CO2	CH4	N2O	CO2e
Category	tons/yr										MT/yr					
Regulatory Compliance	0.5838	0.9807	5.7407	0.0124	1.1894	0.0108	1.2001	0.3174	0.0100	0.3275	0.0000	1,123.2342	1,123.2342	0.0754	0.0000	1,125.1188
Baseline	0.5838	0.9807	5.7407	0.0124	1.1894	0.0108	1.2001	0.3174	0.0100	0.3275	0.0000	1,123.2342	1,123.2342	0.0754	0.0000	1,125.1188

#### 4.2 Trip Summary Information

Land Use	Average Daily Trip Rate			Baseline	Regulatory Compliance
	Weekday	Saturday	Sunday	Annual VMT	Annual VMT
Condo/Townhouse	1,057.42	1,031.94	880.88	2,841,986	2,841,986
Enclosed Parking with Elevator	0.00	0.00	0.00		
General Office Building	175.92	37.15	15.86	318,375	318,375
<b>Total</b>	<b>1,233.34</b>	<b>1,069.09</b>	<b>896.74</b>	<b>3,160,361</b>	<b>3,160,361</b>

#### 4.3 Trip Type Information

Miles	Trip %	Trip Purpose %
-------	--------	----------------

Land Use	H-W or C-W	H-S or C-C	H-O or C-NW	H-W or C-	H-S or C-C	H-O or C-NW	Primary	Diverted	Pass-by
Condo/Townhouse	10.80	7.30	7.50	32.90	18.00	49.10	86	11	3
Enclosed Parking with Elevator	9.50	7.30	7.30	0.00	0.00	0.00	0	0	0
General Office Building	9.50	7.30	7.30	33.00	48.00	19.00	77	19	4

#### 4.4 Fleet Mix

Land Use	LDA	LDT1	LDT2	MDV	LHD1	LHD2	MHD	HHD	OBUS	UBUS	MCY	SBUS	MH
General Office Building	0.572490	0.044826	0.170628	0.127143	0.022859	0.006230	0.012809	0.005255	0.000798	0.000322	0.029094	0.000351	0.007194
Enclosed Parking with Elevator	0.572490	0.044826	0.170628	0.127143	0.022859	0.006230	0.012809	0.005255	0.000798	0.000322	0.029094	0.000351	0.007194
Condo/Townhouse	0.572490	0.044826	0.170628	0.127143	0.022859	0.006230	0.012809	0.005255	0.000798	0.000322	0.029094	0.000351	0.007194

#### 5.0 Energy Detail

Historical Energy Use: N

#### 5.1 Mitigation Measures Energy

Exceed Title 24

Install High Efficiency Lighting

	ROG	NOx	CO	SO2	Fugitive PM10	Exhaust PM10	PM10 Total	Fugitive PM2.5	Exhaust PM2.5	PM2.5 Total	Bio- CO2	NBio- CO2	Total CO2	CH4	N2O	CO2e
Category	tons/yr										MT/yr					
Electricity Regulatory						0.0000	0.0000		0.0000	0.0000	0.0000	699.2320	699.2320	0.0289	5.9700e-003	701.7335
Electricity Baseline						0.0000	0.0000		0.0000	0.0000	0.0000	774.3982	774.3982	0.0320	6.6100e-003	777.1686
NaturalGas Regulatory	0.0189	0.1615	0.0712	1.0300e-003		0.0130	0.0130		0.0130	0.0130	0.0000	186.6794	186.6794	3.5800e-003	3.4200e-003	187.7888
NaturalGas Baseline	0.0212	0.1818	0.0802	1.1600e-003		0.0147	0.0147		0.0147	0.0147	0.0000	210.0907	210.0907	4.0300e-003	3.8500e-003	211.3392

#### 5.2 Energy by Land Use - NaturalGas

**Baseline**

	Natural Gas Use	ROG	NOx	CO	SO2	Fugitive PM10	Exhaust PM10	PM10 Total	Fugitive PM2.5	Exhaust PM2.5	PM2.5 Total	Bio- CO2	NBio- CO2	Total CO2	CH4	N2O	CO2e
Land Use	kBTU/yr	tons/yr										MT/yr					
Condo/Townhouse	3.79833e+006	0.0205	0.1750	0.0745	1.1200e-003		0.0142	0.0142		0.0142	0.0142	0.0000	202.6935	202.6935	3.8800e-003	3.7200e-003	203.8980
Enclosed Parking with Elevator	0	0.0000	0.0000	0.0000	0.0000		0.0000	0.0000		0.0000	0.0000	0.0000	0.0000	0.0000	0.0000	0.0000	0.0000
General Office Building	138618	7.5000e-004	6.8000e-003	5.7100e-003	4.0000e-005		5.2000e-004	5.2000e-004		5.2000e-004	5.2000e-004	0.0000	7.3972	7.3972	1.4000e-004	1.4000e-004	7.4411
<b>Total</b>		<b>0.0212</b>	<b>0.1818</b>	<b>0.0802</b>	<b>1.1600e-003</b>		<b>0.0147</b>	<b>0.0147</b>		<b>0.0147</b>	<b>0.0147</b>	<b>0.0000</b>	<b>210.0907</b>	<b>210.0907</b>	<b>4.0200e-003</b>	<b>3.8600e-003</b>	<b>211.3392</b>

**Regulatory Compliance**

	Natural Gas Use	ROG	NOx	CO	SO2	Fugitive PM10	Exhaust PM10	PM10 Total	Fugitive PM2.5	Exhaust PM2.5	PM2.5 Total	Bio- CO2	NBio- CO2	Total CO2	CH4	N2O	CO2e
Land Use	kBTU/yr	tons/yr										MT/yr					
Condo/Townhouse	3.37917e+006	0.0182	0.1557	0.0663	9.9000e-004		0.0126	0.0126		0.0126	0.0126	0.0000	180.3254	180.3254	3.4600e-003	3.3100e-003	181.3969
Enclosed Parking with Elevator	0	0.0000	0.0000	0.0000	0.0000		0.0000	0.0000		0.0000	0.0000	0.0000	0.0000	0.0000	0.0000	0.0000	0.0000
General Office Building	119071	6.4000e-004	5.8400e-003	4.9000e-003	4.0000e-005		4.4000e-004	4.4000e-004		4.4000e-004	4.4000e-004	0.0000	6.3541	6.3541	1.2000e-004	1.2000e-004	6.3918
<b>Total</b>		<b>0.0189</b>	<b>0.1616</b>	<b>0.0712</b>	<b>1.0300e-003</b>		<b>0.0130</b>	<b>0.0130</b>		<b>0.0130</b>	<b>0.0130</b>	<b>0.0000</b>	<b>186.6794</b>	<b>186.6794</b>	<b>3.5800e-003</b>	<b>3.4300e-003</b>	<b>187.7888</b>

**5.3 Energy by Land Use - Electricity**

**Baseline**

Electricity Use	Total CO2	CH4	N2O	CO2e
-----------------	-----------	-----	-----	------

Land Use	kWh/yr	MT/yr			
Condo/Townhouse	965683	307.6873	0.0127	2.6300e-003	308.7880
Enclosed Parking with Elevator	1.24825e+006	397.7186	0.0164	3.4000e-003	399.1414
General Office Building	216534	68.9924	2.8500e-003	5.9000e-004	69.2392
<b>Total</b>		<b>774.3982</b>	<b>0.0320</b>	<b>6.6200e-003</b>	<b>777.1686</b>

## Regulatory Compliance

Land Use	Electricity Use kWh/yr	Total CO2	CH4	N2O	CO2e
Condo/Townhouse	933022	297.2809	0.0123	2.5400e-003	298.3444
Enclosed Parking with Elevator	1.06629e+006	339.7425	0.0140	2.9000e-003	340.9580
General Office Building	195243	62.2086	2.5700e-003	5.3000e-004	62.4312
<b>Total</b>		<b>699.2320</b>	<b>0.0289</b>	<b>5.9700e-003</b>	<b>701.7335</b>

## 6.0 Area Detail

### 6.1 Mitigation Measures Area

- Use Low VOC Paint - Residential Interior
- Use Low VOC Paint - Residential Exterior
- Use Low VOC Paint - Non-Residential Interior
- Use Low VOC Paint - Non-Residential Exterior
- Use Low VOC Cleaning Supplies

	ROG	NOx	CO	SO2	Fugitive PM10	Exhaust PM10	PM10 Total	Fugitive PM2.5	Exhaust PM2.5	PM2.5 Total	Bio- CO2	NBio- CO2	Total CO2	CH4	N2O	CO2e
Category	tons/yr										MT/yr					
Regulatory Compliance	0.8821	0.0157	1.3587	7.0000e-005		7.4800e-003	7.4800e-003		7.4800e-003	7.4800e-003	0.0000	2.2160	2.2160	2.1600e-003	0.0000	2.2700
Baseline	0.9397	0.0157	1.3587	7.0000e-005		7.4800e-003	7.4800e-003		7.4800e-003	7.4800e-003	0.0000	2.2160	2.2160	2.1600e-003	0.0000	2.2700

## 6.2 Area by SubCategory

### Baseline

	ROG	NOx	CO	SO2	Fugitive PM10	Exhaust PM10	PM10 Total	Fugitive PM2.5	Exhaust PM2.5	PM2.5 Total	Bio- CO2	NBio- CO2	Total CO2	CH4	N2O	CO2e
SubCategory	tons/yr										MT/yr					
Architectural Coating	0.1165					0.0000	0.0000		0.0000	0.0000	0.0000	0.0000	0.0000	0.0000	0.0000	0.0000
Consumer Products	0.7818					0.0000	0.0000		0.0000	0.0000	0.0000	0.0000	0.0000	0.0000	0.0000	0.0000
Hearth	0.0000	0.0000	0.0000	0.0000		0.0000	0.0000		0.0000	0.0000	0.0000	0.0000	0.0000	0.0000	0.0000	0.0000
Landscaping	0.0415	0.0157	1.3587	7.0000e-005		7.4800e-003	7.4800e-003		7.4800e-003	7.4800e-003	0.0000	2.2160	2.2160	2.1600e-003	0.0000	2.2700
<b>Total</b>	<b>0.9397</b>	<b>0.0157</b>	<b>1.3587</b>	<b>7.0000e-005</b>		<b>7.4800e-003</b>	<b>7.4800e-003</b>		<b>7.4800e-003</b>	<b>7.4800e-003</b>	<b>0.0000</b>	<b>2.2160</b>	<b>2.2160</b>	<b>2.1600e-003</b>	<b>0.0000</b>	<b>2.2700</b>

### Regulatory Compliance

	ROG	NOx	CO	SO2	Fugitive PM10	Exhaust PM10	PM10 Total	Fugitive PM2.5	Exhaust PM2.5	PM2.5 Total	Bio- CO2	NBio- CO2	Total CO2	CH4	N2O	CO2e
SubCategory	tons/yr										MT/yr					
Architectural Coating	0.1165					0.0000	0.0000		0.0000	0.0000	0.0000	0.0000	0.0000	0.0000	0.0000	0.0000
Consumer Products	0.7242					0.0000	0.0000		0.0000	0.0000	0.0000	0.0000	0.0000	0.0000	0.0000	0.0000
Hearth	0.0000	0.0000	0.0000	0.0000		0.0000	0.0000		0.0000	0.0000	0.0000	0.0000	0.0000	0.0000	0.0000	0.0000
Landscaping	0.0415	0.0157	1.3587	7.0000e-005		7.4800e-003	7.4800e-003		7.4800e-003	7.4800e-003	0.0000	2.2160	2.2160	2.1600e-003	0.0000	2.2700
<b>Total</b>	<b>0.8821</b>	<b>0.0157</b>	<b>1.3587</b>	<b>7.0000e-005</b>		<b>7.4800e-003</b>	<b>7.4800e-003</b>		<b>7.4800e-003</b>	<b>7.4800e-003</b>	<b>0.0000</b>	<b>2.2160</b>	<b>2.2160</b>	<b>2.1600e-003</b>	<b>0.0000</b>	<b>2.2700</b>

## 7.0 Water Detail

### 7.1 Mitigation Measures Water

- Install Low Flow Bathroom Faucet
- Install Low Flow Kitchen Faucet
- Install Low Flow Toilet
- Install Low Flow Shower
- Use Water Efficient Irrigation System

	Total CO2	CH4	N2O	CO2e
Category	MT/yr			
Regulatory Compliance	82.2717	0.3823	9.6200e-003	94.6971
Baseline	97.2300	0.4777	0.0120	112.7416

## 7.2 Water by Land Use

### Baseline

	Indoor/Outdoor Use	Total CO2	CH4	N2O	CO2e
Land Use	Mgal	MT/yr			
Condo/Townhouse	11.858 / 7.47572	79.4214	0.3895	9.7700e-003	92.0708
Enclosed Parking with Elevator	0 / 0	0.0000	0.0000	0.0000	0.0000
General Office Building	2.68378 / 1.6449	17.8086	0.0882	2.2100e-003	20.6709
<b>Total</b>		<b>97.2300</b>	<b>0.4777</b>	<b>0.0120</b>	<b>112.7416</b>

### Regulatory Compliance

	Indoor/Outdoor Use	Total CO2	CH4	N2O	CO2e
Land Use	Mgal	MT/yr			
Condo/Townhouse	9.48643 / 7.0197	67.2155	0.3118	7.8500e-003	77.3482
Enclosed Parking with Elevator	0 / 0	0.0000	0.0000	0.0000	0.0000
General Office Building	2.14702 / 1.54456	15.0562	0.0706	1.7700e-003	17.3489
<b>Total</b>		<b>82.2717</b>	<b>0.3823</b>	<b>9.6200e-003</b>	<b>94.6971</b>

## 8.0 Waste Detail

### 8.1 Mitigation Measures Waste

## Category/Year

	Total CO2	CH4	N2O	CO2e
	MT/yr			
Regulatory Compliance	19.8444	1.1728	0.0000	49.1637
Baseline	19.8444	1.1728	0.0000	49.1637

## 8.2 Waste by Land Use

### Baseline

	Waste Disposed	Total CO2	CH4	N2O	CO2e
Land Use	tons	MT/yr			
Condo/Townhouse	83.72	16.9944	1.0043	0.0000	42.1029
Enclosed Parking with Elevator	0	0.0000	0.0000	0.0000	0.0000
General Office Building	14.04	2.8500	0.1684	0.0000	7.0607
<b>Total</b>		<b>19.8444</b>	<b>1.1728</b>	<b>0.0000</b>	<b>49.1637</b>

### Regulatory Compliance

	Waste Disposed	Total CO2	CH4	N2O	CO2e
--	----------------	-----------	-----	-----	------



Land Use	tons	MT/yr			
Condo/Townhouse	83.72	16.9944	1.0043	0.0000	42.1029
Enclosed Parking with Elevator	0	0.0000	0.0000	0.0000	0.0000
General Office Building	14.04	2.8500	0.1684	0.0000	7.0607
<b>Total</b>		<b>19.8444</b>	<b>1.1728</b>	<b>0.0000</b>	<b>49.1637</b>

## 9.0 Operational Offroad

---

Equipment Type	Number	Hours/Day	Days/Year	Horse Power	Load Factor	Fuel Type
----------------	--------	-----------	-----------	-------------	-------------	-----------

## 10.0 Stationary Equipment

---

### Fire Pumps and Emergency Generators

Equipment Type	Number	Hours/Day	Hours/Year	Horse Power	Load Factor	Fuel Type
----------------	--------	-----------	------------	-------------	-------------	-----------

### Boilers

Equipment Type	Number	Heat Input/Day	Heat Input/Year	Boiler Rating	Fuel Type
----------------	--------	----------------	-----------------	---------------	-----------

### User Defined Equipment

Equipment Type	Number
----------------	--------

## 11.0 Vegetation

---



Rio Urbana Mixed Use (Proposed) - Ventura County APCD Air District, Summer

**Rio Urbana Mixed Use (Proposed)**  
**Ventura County APCD Air District, Summer**

**1.0 Project Characteristics**

**1.1 Land Usage**

Land Uses	Size	Metric	Lot Acreage	Floor Surface Area	Population
General Office Building	15.10	1000sqft	0.18	15,100.00	0
Enclosed Parking with Elevator	463.00	Space	0.00	185,200.00	0
Condo/Townhouse	182.00	Dwelling Unit	2.64	182,000.00	557

**1.2 Other Project Characteristics**

<b>Urbanization</b>	Urban	<b>Wind Speed (m/s)</b>	2.6	<b>Precipitation Freq (Days)</b>	31
<b>Climate Zone</b>	8	<b>Operational Year</b>		2021	
<b>Utility Company</b>	Southern California Edison				
<b>CO2 Intensity (lb/MW hr)</b>	702.44	<b>CH4 Intensity (lb/MW hr)</b>	0.029	<b>N2O Intensity (lb/MW hr)</b>	0.006

**1.3 User Entered Comments & Non-Default Data**

Project Characteristics - Construction to be completed 2020.

Land Use - Total Project are = 10.49 acres

Lot coverage: School office = 7,830 sq. ft.; apartment = 115,026 sq. ft.

Construction Phase - Architectural coating to take place intermittently towards the tail end of building construction

Off-road Equipment - No Cranes

Grading - +/- 17,000 cy of import

Vehicle Trips - Based on Traffic Study

Energy Use -



tblConstEquipMitigation	Tier	No Change	Tier 2
tblConstEquipMitigation	Tier	No Change	Tier 2
tblConstEquipMitigation	Tier	No Change	Tier 2
tblConstEquipMitigation	Tier	No Change	Tier 2
tblConstEquipMitigation	Tier	No Change	Tier 2
tblConstEquipMitigation	Tier	No Change	Tier 2
tblConstEquipMitigation	Tier	No Change	Tier 2
tblConstEquipMitigation	Tier	No Change	Tier 2
tblConstructionPhase	NumDays	10.00	30.00
tblConstructionPhase	PhaseEndDate	2/12/2019	1/25/2019
tblConstructionPhase	PhaseStartDate	1/30/2019	12/15/2018
tblGrading	MaterialImported	0.00	17,000.00
tblLandUse	LotAcreage	0.35	0.18
tblLandUse	LotAcreage	4.17	0.00
tblLandUse	LotAcreage	11.38	2.64
tblProjectCharacteristics	OperationalYear	2018	2021
tblVehicleTrips	WD_TR	11.03	11.65

## 2.0 Emissions Summary

### 2.1 Overall Construction (Maximum Daily Emission)

#### Baseline Construction

	ROG	NOx	CO	SO2	Fugitive PM10	Exhaust PM10	PM10 Total	Fugitive PM2.5	Exhaust PM2.5	PM2.5 Total	Bio- CO2	NBio- CO2	Total CO2	CH4	N2O	CO2e
Year	lb/day										lb/day					
2018	82.1874	134.8786	32.3089	0.2955	13.1999	1.7679	14.9678	5.1379	1.6485	6.7863	0.0000	31,973.5628	31,973.5628	3.5108	0.0000	32,061.3328
2019	81.6896	27.5568	26.4796	0.0626	2.4627	1.2841	3.7467	0.6611	1.2355	1.8966	0.0000	6,148.7051	6,148.7051	0.6875	0.0000	6,165.8932

<b>Maximum</b>	82.1874	134.8786	32.3089	0.2955	13.1999	1.7679	14.9678	5.1379	1.6485	6.7863	0.0000	31,973.56 28	31,973.562 8	3.5108	0.0000	32,061.33 28
----------------	---------	----------	---------	--------	---------	--------	---------	--------	--------	--------	--------	-----------------	-----------------	--------	--------	-----------------

### Regulatory Compliance Construction

	ROG	NOx	CO	SO2	Fugitive PM10	Exhaust PM10	PM10 Total	Fugitive PM2.5	Exhaust PM2.5	PM2.5 Total	Bio- CO2	NBio- CO2	Total CO2	CH4	N2O	CO2e
Year	lb/day										lb/day					
2018	80.0371	128.6941	34.0735	0.2955	8.9602	1.0846	10.0448	3.0469	1.0587	4.1056	0.0000	31,973.56 28	31,973.562 8	3.5108	0.0000	32,061.33 28
2019	79.9261	29.2100	26.6243	0.0626	2.4627	0.9780	3.4407	0.6611	0.9747	1.6358	0.0000	6,148.705 1	6,148.7051	0.6875	0.0000	6,165.893 2
<b>Maximum</b>	80.0371	128.6941	34.0735	0.2955	8.9602	1.0846	10.0448	3.0469	1.0587	4.1056	0.0000	31,973.56 28	31,973.562 8	3.5108	0.0000	32,061.33 28

	ROG	NOx	CO	SO2	Fugitive PM10	Exhaust PM10	PM10 Total	Fugitive PM2.5	Exhaust PM2.5	PM2.5 Total	Bio- CO2	NBio- CO2	Total CO2	CH4	N2O	CO2e
<b>Percent Reduction</b>	2.39	2.79	-3.25	0.00	27.07	32.42	27.94	36.06	29.50	33.88	0.00	0.00	0.00	0.00	0.00	0.00

## 2.2 Overall Operational

### Baseline Operational

	ROG	NOx	CO	SO2	Fugitive PM10	Exhaust PM10	PM10 Total	Fugitive PM2.5	Exhaust PM2.5	PM2.5 Total	Bio- CO2	NBio- CO2	Total CO2	CH4	N2O	CO2e
Category	lb/day										lb/day					
Area	5.3822	0.1742	15.0969	8.0000e-004		0.0831	0.0831		0.0831	0.0831	0.0000	27.1412	27.1412	0.0265	0.0000	27.8031
Energy	0.1163	0.9963	0.4394	6.3400e-003		0.0804	0.0804		0.0804	0.0804		1,268.960 8	1,268.9608	0.0243	0.0233	1,276.501 6
Mobile	3.5403	5.3281	32.9460	0.0746	7.0396	0.0626	7.1022	1.8760	0.0584	1.9343		7,460.600 5	7,460.6005	0.4757		7,472.492 6
<b>Total</b>	9.0388	6.4985	48.4823	0.0817	7.0396	0.2261	7.2657	1.8760	0.2219	2.0978	0.0000	8,756.702 4	8,756.7024	0.5265	0.0233	8,776.797 2

## Regulatory Compliance Operational

	ROG	NOx	CO	SO2	Fugitive PM10	Exhaust PM10	PM10 Total	Fugitive PM2.5	Exhaust PM2.5	PM2.5 Total	Bio- CO2	NBio- CO2	Total CO2	CH4	N2O	CO2e
Category	lb/day										lb/day					
Area	8.7338	0.1742	15.0969	8.0000e-004		0.0831	0.0831		0.0831	0.0831	0.0000	27.1412	27.1412	0.0265	0.0000	27.8031
Energy	0.1034	0.8852	0.3899	5.6400e-003		0.0714	0.0714		0.0714	0.0714		1,127.5554	1,127.5554	0.0216	0.0207	1,134.2559
Mobile	3.5403	5.3281	32.9460	0.0746	7.0396	0.0626	7.1022	1.8760	0.0584	1.9343		7,460.6005	7,460.6005	0.4757		7,472.4926
<b>Total</b>	<b>12.3775</b>	<b>6.3875</b>	<b>48.4328</b>	<b>0.0810</b>	<b>7.0396</b>	<b>0.2171</b>	<b>7.2567</b>	<b>1.8760</b>	<b>0.2129</b>	<b>2.0888</b>	<b>0.0000</b>	<b>8,615.2971</b>	<b>8,615.2971</b>	<b>0.5238</b>	<b>0.0207</b>	<b>8,634.5516</b>

	ROG	NOx	CO	SO2	Fugitive PM10	Exhaust PM10	PM10 Total	Fugitive PM2.5	Exhaust PM2.5	PM2.5 Total	Bio- CO2	NBio-CO2	Total CO2	CH4	N2O	CO2e
<b>Percent Reduction</b>	<b>-36.94</b>	<b>1.71</b>	<b>0.10</b>	<b>0.86</b>	<b>0.00</b>	<b>3.96</b>	<b>0.12</b>	<b>0.00</b>	<b>4.04</b>	<b>0.43</b>	<b>0.00</b>	<b>1.61</b>	<b>1.61</b>	<b>0.51</b>	<b>11.13</b>	<b>1.62</b>

## 3.0 Construction Detail

### Construction Phase

Phase Number	Phase Name	Phase Type	Start Date	End Date	Num Days Week	Num Days	Phase Description
1	Demolition	Demolition	2/1/2018	2/28/2018	5	20	
2	Site Preparation	Site Preparation	3/1/2018	3/5/2018	5	3	
3	Grading	Grading	3/6/2018	3/13/2018	5	6	
4	Building Construction	Building Construction	3/14/2018	1/15/2019	5	220	
5	Paving	Paving	1/16/2019	1/29/2019	5	10	
6	Architectural Coating	Architectural Coating	12/15/2018	1/25/2019	5	30	

Acres of Grading (Site Preparation Phase): 4.5

Acres of Grading (Grading Phase): 3

Acres of Paving: 0

Residential Indoor: 368,550; Residential Outdoor: 122,850; Non-Residential Indoor: 22,650; Non-Residential Outdoor: 7,550; Striped

**OffRoad Equipment**

Phase Name	Offroad Equipment Type	Amount	Usage Hours	Horse Power	Load Factor
Demolition	Concrete/Industrial Saws	1	8.00	81	0.73
Demolition	Rubber Tired Dozers	1	8.00	247	0.40
Demolition	Tractors/Loaders/Backhoes	3	8.00	97	0.37
Site Preparation	Graders	1	8.00	187	0.41
Site Preparation	Scrapers	1	8.00	367	0.48
Site Preparation	Tractors/Loaders/Backhoes	1	7.00	97	0.37
Grading	Graders	1	8.00	187	0.41
Grading	Rubber Tired Dozers	1	8.00	247	0.40
Grading	Tractors/Loaders/Backhoes	2	7.00	97	0.37
Building Construction	Forklifts	2	7.00	89	0.20
Building Construction	Generator Sets	1	8.00	84	0.74
Building Construction	Tractors/Loaders/Backhoes	1	6.00	97	0.37
Building Construction	Welders	3	8.00	46	0.45
Paving	Cement and Mortar Mixers	1	8.00	9	0.56
Paving	Pavers	1	8.00	130	0.42
Paving	Paving Equipment	1	8.00	132	0.36
Paving	Rollers	2	8.00	80	0.38
Paving	Tractors/Loaders/Backhoes	1	8.00	97	0.37
Architectural Coating	Air Compressors	1	6.00	78	0.48
Building Construction	Cranes	1	8.00	231	0.29

**Trips and VMT**

Phase Name	Offroad Equipment Count	Worker Trip Number	Vendor Trip Number	Hauling Trip Number	Worker Trip Length	Vendor Trip Length	Hauling Trip Length	Worker Vehicle Class	Vendor Vehicle Class	Hauling Vehicle Class
Demolition	5	13.00	0.00	875.00	10.80	7.30	20.00	LD_Mix	HDT_Mix	HHDT





Category	lb/day										lb/day					
Hauling	0.3773	13.6576	2.6673	0.0339	0.7618	0.0740	0.8358	0.2086	0.0708	0.2794		3,682.6399	3,682.6399	0.3535		3,691.4766
Vendor	0.0000	0.0000	0.0000	0.0000	0.0000	0.0000	0.0000	0.0000	0.0000	0.0000		0.0000	0.0000	0.0000		0.0000
Worker	0.0557	0.0361	0.4372	1.1000e-003	0.1068	7.7000e-004	0.1076	0.0283	7.1000e-004	0.0290		109.5240	109.5240	3.4400e-003		109.6099
<b>Total</b>	<b>0.4330</b>	<b>13.6937</b>	<b>3.1045</b>	<b>0.0350</b>	<b>0.8686</b>	<b>0.0748</b>	<b>0.9434</b>	<b>0.2369</b>	<b>0.0715</b>	<b>0.3084</b>		<b>3,792.1639</b>	<b>3,792.1639</b>	<b>0.3569</b>		<b>3,801.0865</b>

**Regulatory Compliance Construction On-Site**

	ROG	NOx	CO	SO2	Fugitive PM10	Exhaust PM10	PM10 Total	Fugitive PM2.5	Exhaust PM2.5	PM2.5 Total	Bio- CO2	NBio- CO2	Total CO2	CH4	N2O	CO2e
Category	lb/day										lb/day					
Fugitive Dust					3.7373	0.0000	3.7373	0.5660	0.0000	0.5660			0.0000			0.0000
Off-Road	0.8857	21.2053	15.4154	0.0241		0.7182	0.7182		0.7182	0.7182	0.0000	2,391.1659	2,391.1659	0.6058		2,406.3105
<b>Total</b>	<b>0.8857</b>	<b>21.2053</b>	<b>15.4154</b>	<b>0.0241</b>	<b>3.7373</b>	<b>0.7182</b>	<b>4.4555</b>	<b>0.5660</b>	<b>0.7182</b>	<b>1.2841</b>	<b>0.0000</b>	<b>2,391.1659</b>	<b>2,391.1659</b>	<b>0.6058</b>		<b>2,406.3105</b>

**Regulatory Compliance Construction Off-Site**

	ROG	NOx	CO	SO2	Fugitive PM10	Exhaust PM10	PM10 Total	Fugitive PM2.5	Exhaust PM2.5	PM2.5 Total	Bio- CO2	NBio- CO2	Total CO2	CH4	N2O	CO2e
Category	lb/day										lb/day					
Hauling	0.3773	13.6576	2.6673	0.0339	0.7618	0.0740	0.8358	0.2086	0.0708	0.2794		3,682.6399	3,682.6399	0.3535		3,691.4766
Vendor	0.0000	0.0000	0.0000	0.0000	0.0000	0.0000	0.0000	0.0000	0.0000	0.0000		0.0000	0.0000	0.0000		0.0000
Worker	0.0557	0.0361	0.4372	1.1000e-003	0.1068	7.7000e-004	0.1076	0.0283	7.1000e-004	0.0290		109.5240	109.5240	3.4400e-003		109.6099

Total	0.4330	13.6937	3.1045	0.0350	0.8686	0.0748	0.9434	0.2369	0.0715	0.3084		3,792.1639	3,792.1639	0.3569		3,801.0865
-------	--------	---------	--------	--------	--------	--------	--------	--------	--------	--------	--	------------	------------	--------	--	------------

### 3.3 Site Preparation - 2018

#### Baseline Construction On-Site

	ROG	NOx	CO	SO2	Fugitive PM10	Exhaust PM10	PM10 Total	Fugitive PM2.5	Exhaust PM2.5	PM2.5 Total	Bio- CO2	NBio- CO2	Total CO2	CH4	N2O	CO2e
Category	lb/day										lb/day					
Fugitive Dust					1.5908	0.0000	1.5908	0.1718	0.0000	0.1718			0.0000			0.0000
Off-Road	1.8995	23.6201	12.7461	0.0245		0.9540	0.9540		0.8777	0.8777		2,468.4131	2,468.4131	0.7685		2,487.6244
<b>Total</b>	<b>1.8995</b>	<b>23.6201</b>	<b>12.7461</b>	<b>0.0245</b>	<b>1.5908</b>	<b>0.9540</b>	<b>2.5448</b>	<b>0.1718</b>	<b>0.8777</b>	<b>1.0494</b>		<b>2,468.4131</b>	<b>2,468.4131</b>	<b>0.7685</b>		<b>2,487.6244</b>

#### Baseline Construction Off-Site

	ROG	NOx	CO	SO2	Fugitive PM10	Exhaust PM10	PM10 Total	Fugitive PM2.5	Exhaust PM2.5	PM2.5 Total	Bio- CO2	NBio- CO2	Total CO2	CH4	N2O	CO2e
Category	lb/day										lb/day					
Hauling	0.0000	0.0000	0.0000	0.0000	0.0000	0.0000	0.0000	0.0000	0.0000	0.0000		0.0000	0.0000	0.0000		0.0000
Vendor	0.0000	0.0000	0.0000	0.0000	0.0000	0.0000	0.0000	0.0000	0.0000	0.0000		0.0000	0.0000	0.0000		0.0000
Worker	0.0343	0.0222	0.2691	6.8000e-004	0.0657	4.8000e-004	0.0662	0.0174	4.4000e-004	0.0179		67.3994	67.3994	2.1100e-003		67.4522
<b>Total</b>	<b>0.0343</b>	<b>0.0222</b>	<b>0.2691</b>	<b>6.8000e-004</b>	<b>0.0657</b>	<b>4.8000e-004</b>	<b>0.0662</b>	<b>0.0174</b>	<b>4.4000e-004</b>	<b>0.0179</b>		<b>67.3994</b>	<b>67.3994</b>	<b>2.1100e-003</b>		<b>67.4522</b>

#### Regulatory Compliance Construction On-Site

	ROG	NOx	CO	SO2	Fugitive PM10	Exhaust PM10	PM10 Total	Fugitive PM2.5	Exhaust PM2.5	PM2.5 Total	Bio- CO2	NBio- CO2	Total CO2	CH4	N2O	CO2e
Category	lb/day										lb/day					
Fugitive Dust					0.6204	0.0000	0.6204	0.0670	0.0000	0.0670			0.0000			0.0000
Off-Road	0.6625	20.0179	13.6431	0.0245		0.4988	0.4988		0.4988	0.4988	0.0000	2,468.4131	2,468.4131	0.7685		2,487.6244
<b>Total</b>	<b>0.6625</b>	<b>20.0179</b>	<b>13.6431</b>	<b>0.0245</b>	<b>0.6204</b>	<b>0.4988</b>	<b>1.1191</b>	<b>0.0670</b>	<b>0.4988</b>	<b>0.5657</b>	<b>0.0000</b>	<b>2,468.4131</b>	<b>2,468.4131</b>	<b>0.7685</b>		<b>2,487.6244</b>

**Regulatory Compliance Construction Off-Site**

	ROG	NOx	CO	SO2	Fugitive PM10	Exhaust PM10	PM10 Total	Fugitive PM2.5	Exhaust PM2.5	PM2.5 Total	Bio- CO2	NBio- CO2	Total CO2	CH4	N2O	CO2e
Category	lb/day										lb/day					
Hauling	0.0000	0.0000	0.0000	0.0000	0.0000	0.0000	0.0000	0.0000	0.0000	0.0000		0.0000	0.0000	0.0000		0.0000
Vendor	0.0000	0.0000	0.0000	0.0000	0.0000	0.0000	0.0000	0.0000	0.0000	0.0000		0.0000	0.0000	0.0000		0.0000
Worker	0.0343	0.0222	0.2691	6.8000e-004	0.0657	4.8000e-004	0.0662	0.0174	4.4000e-004	0.0179		67.3994	67.3994	2.1100e-003		67.4522
<b>Total</b>	<b>0.0343</b>	<b>0.0222</b>	<b>0.2691</b>	<b>6.8000e-004</b>	<b>0.0657</b>	<b>4.8000e-004</b>	<b>0.0662</b>	<b>0.0174</b>	<b>4.4000e-004</b>	<b>0.0179</b>		<b>67.3994</b>	<b>67.3994</b>	<b>2.1100e-003</b>		<b>67.4522</b>

**3.4 Grading - 2018**

**Baseline Construction On-Site**

	ROG	NOx	CO	SO2	Fugitive PM10	Exhaust PM10	PM10 Total	Fugitive PM2.5	Exhaust PM2.5	PM2.5 Total	Bio- CO2	NBio- CO2	Total CO2	CH4	N2O	CO2e
Category	lb/day										lb/day					

Fugitive Dust					6.9505	0.0000	6.9505	3.4278	0.0000	3.4278			0.0000			0.0000
Off-Road	2.1515	24.2895	10.3804	0.0206		1.1683	1.1683		1.0748	1.0748		2,077.4666	2,077.4666	0.6467		2,093.6352
<b>Total</b>	<b>2.1515</b>	<b>24.2895</b>	<b>10.3804</b>	<b>0.0206</b>	<b>6.9505</b>	<b>1.1683</b>	<b>8.1188</b>	<b>3.4278</b>	<b>1.0748</b>	<b>4.5026</b>		<b>2,077.4666</b>	<b>2,077.4666</b>	<b>0.6467</b>		<b>2,093.6352</b>

**Baseline Construction Off-Site**

	ROG	NOx	CO	SO2	Fugitive PM10	Exhaust PM10	PM10 Total	Fugitive PM2.5	Exhaust PM2.5	PM2.5 Total	Bio- CO2	NBio- CO2	Total CO2	CH4	N2O	CO2e
Category	lb/day										lb/day					
Hauling	3.0545	110.5613	21.5921	0.2741	6.1673	0.5990	6.7663	1.6883	0.5731	2.2614		29,811.8470	29,811.8470	2.8614		29,883.3823
Vendor	0.0000	0.0000	0.0000	0.0000	0.0000	0.0000	0.0000	0.0000	0.0000	0.0000		0.0000	0.0000	0.0000		0.0000
Worker	0.0428	0.0278	0.3363	8.5000e-004	0.0822	6.0000e-004	0.0827	0.0218	5.5000e-004	0.0223		84.2492	84.2492	2.6400e-003		84.3153
<b>Total</b>	<b>3.0973</b>	<b>110.5891</b>	<b>21.9285</b>	<b>0.2749</b>	<b>6.2495</b>	<b>0.5996</b>	<b>6.8490</b>	<b>1.7101</b>	<b>0.5736</b>	<b>2.2837</b>		<b>29,896.0962</b>	<b>29,896.0962</b>	<b>2.8641</b>		<b>29,967.6976</b>

**Regulatory Compliance Construction On-Site**

	ROG	NOx	CO	SO2	Fugitive PM10	Exhaust PM10	PM10 Total	Fugitive PM2.5	Exhaust PM2.5	PM2.5 Total	Bio- CO2	NBio- CO2	Total CO2	CH4	N2O	CO2e
Category	lb/day										lb/day					
Fugitive Dust					2.7107	0.0000	2.7107	1.3368	0.0000	1.3368			0.0000			0.0000
Off-Road	0.6262	18.1050	12.1450	0.0206		0.4850	0.4850		0.4850	0.4850	0.0000	2,077.4666	2,077.4666	0.6467		2,093.6352
<b>Total</b>	<b>0.6262</b>	<b>18.1050</b>	<b>12.1450</b>	<b>0.0206</b>	<b>2.7107</b>	<b>0.4850</b>	<b>3.1957</b>	<b>1.3368</b>	<b>0.4850</b>	<b>1.8219</b>	<b>0.0000</b>	<b>2,077.4666</b>	<b>2,077.4666</b>	<b>0.6467</b>		<b>2,093.6352</b>

**Regulatory Compliance Construction Off-Site**

	ROG	NOx	CO	SO2	Fugitive PM10	Exhaust PM10	PM10 Total	Fugitive PM2.5	Exhaust PM2.5	PM2.5 Total	Bio- CO2	NBio- CO2	Total CO2	CH4	N2O	CO2e
Category	lb/day										lb/day					
Hauling	3.0545	110.5613	21.5921	0.2741	6.1673	0.5990	6.7663	1.6883	0.5731	2.2614		29,811.8470	29,811.8470	2.8614		29,883.3823
Vendor	0.0000	0.0000	0.0000	0.0000	0.0000	0.0000	0.0000	0.0000	0.0000	0.0000		0.0000	0.0000	0.0000		0.0000
Worker	0.0428	0.0278	0.3363	8.5000e-004	0.0822	6.0000e-004	0.0827	0.0218	5.5000e-004	0.0223		84.2492	84.2492	2.6400e-003		84.3153
<b>Total</b>	<b>3.0973</b>	<b>110.5891</b>	<b>21.9285</b>	<b>0.2749</b>	<b>6.2495</b>	<b>0.5996</b>	<b>6.8490</b>	<b>1.7101</b>	<b>0.5736</b>	<b>2.2837</b>		<b>29,896.0962</b>	<b>29,896.0962</b>	<b>2.8641</b>		<b>29,967.6976</b>

**3.5 Building Construction - 2018**

**Baseline Construction On-Site**

	ROG	NOx	CO	SO2	Fugitive PM10	Exhaust PM10	PM10 Total	Fugitive PM2.5	Exhaust PM2.5	PM2.5 Total	Bio- CO2	NBio- CO2	Total CO2	CH4	N2O	CO2e
Category	lb/day										lb/day					
Off-Road	2.9127	20.7077	15.7183	0.0250		1.2575	1.2575		1.2051	1.2051		2,329.7759	2,329.7759	0.5019		2,342.3232
<b>Total</b>	<b>2.9127</b>	<b>20.7077</b>	<b>15.7183</b>	<b>0.0250</b>		<b>1.2575</b>	<b>1.2575</b>		<b>1.2051</b>	<b>1.2051</b>		<b>2,329.7759</b>	<b>2,329.7759</b>	<b>0.5019</b>		<b>2,342.3232</b>

**Baseline Construction Off-Site**

	ROG	NOx	CO	SO2	Fugitive PM10	Exhaust PM10	PM10 Total	Fugitive PM2.5	Exhaust PM2.5	PM2.5 Total	Bio- CO2	NBio- CO2	Total CO2	CH4	N2O	CO2e
--	-----	-----	----	-----	---------------	--------------	------------	----------------	---------------	-------------	----------	-----------	-----------	-----	-----	------

Category	lb/day										lb/day					
Hauling	0.0000	0.0000	0.0000	0.0000	0.0000	0.0000	0.0000	0.0000	0.0000	0.0000	0.0000	0.0000	0.0000	0.0000	0.0000	0.0000
Vendor	0.2324	6.5562	1.7188	0.0136	0.3514	0.0581	0.4096	0.1011	0.0556	0.1567	1,455.4054	1,455.4054	0.1260		1,458.5560	
Worker	0.9167	0.5947	7.1974	0.0181	1.7580	0.0128	1.7707	0.4663	0.0118	0.4781	1,802.9328	1,802.9328	0.0566		1,804.3470	
<b>Total</b>	<b>1.1491</b>	<b>7.1509</b>	<b>8.9162</b>	<b>0.0317</b>	<b>2.1094</b>	<b>0.0709</b>	<b>2.1803</b>	<b>0.5674</b>	<b>0.0674</b>	<b>0.6348</b>	<b>3,258.3382</b>	<b>3,258.3382</b>	<b>0.1826</b>		<b>3,262.9029</b>	

**Regulatory Compliance Construction On-Site**

	ROG	NOx	CO	SO2	Fugitive PM10	Exhaust PM10	PM10 Total	Fugitive PM2.5	Exhaust PM2.5	PM2.5 Total	Bio- CO2	NBio- CO2	Total CO2	CH4	N2O	CO2e
Category	lb/day										lb/day					
Off-Road	0.9471	20.0464	15.4081	0.0250		0.8178	0.8178		0.8178	0.8178	0.0000	2,329.7759	2,329.7759	0.5019		2,342.3232
<b>Total</b>	<b>0.9471</b>	<b>20.0464</b>	<b>15.4081</b>	<b>0.0250</b>		<b>0.8178</b>	<b>0.8178</b>		<b>0.8178</b>	<b>0.8178</b>	<b>0.0000</b>	<b>2,329.7759</b>	<b>2,329.7759</b>	<b>0.5019</b>		<b>2,342.3232</b>

**Regulatory Compliance Construction Off-Site**

	ROG	NOx	CO	SO2	Fugitive PM10	Exhaust PM10	PM10 Total	Fugitive PM2.5	Exhaust PM2.5	PM2.5 Total	Bio- CO2	NBio- CO2	Total CO2	CH4	N2O	CO2e
Category	lb/day										lb/day					
Hauling	0.0000	0.0000	0.0000	0.0000	0.0000	0.0000	0.0000	0.0000	0.0000	0.0000		0.0000	0.0000	0.0000		0.0000
Vendor	0.2324	6.5562	1.7188	0.0136	0.3514	0.0581	0.4096	0.1011	0.0556	0.1567	1,455.4054	1,455.4054	0.1260			1,458.5560
Worker	0.9167	0.5947	7.1974	0.0181	1.7580	0.0128	1.7707	0.4663	0.0118	0.4781	1,802.9328	1,802.9328	0.0566			1,804.3470

Total	1.1491	7.1509	8.9162	0.0317	2.1094	0.0709	2.1803	0.5674	0.0674	0.6348		3,258.338 2	3,258.3382	0.1826		3,262.902 9
-------	--------	--------	--------	--------	--------	--------	--------	--------	--------	--------	--	----------------	------------	--------	--	----------------

### 3.5 Building Construction - 2019

#### Baseline Construction On-Site

	ROG	NOx	CO	SO2	Fugitive PM10	Exhaust PM10	PM10 Total	Fugitive PM2.5	Exhaust PM2.5	PM2.5 Total	Bio- CO2	NBio- CO2	Total CO2	CH4	N2O	CO2e
Category	lb/day										lb/day					
Off-Road	2.5581	18.9103	15.2545	0.0250		1.0901	1.0901		1.0449	1.0449		2,312.145 4	2,312.1454	0.4810		2,324.170 5
<b>Total</b>	<b>2.5581</b>	<b>18.9103</b>	<b>15.2545</b>	<b>0.0250</b>		<b>1.0901</b>	<b>1.0901</b>		<b>1.0449</b>	<b>1.0449</b>		<b>2,312.145 4</b>	<b>2,312.1454</b>	<b>0.4810</b>		<b>2,324.170 5</b>

#### Baseline Construction Off-Site

	ROG	NOx	CO	SO2	Fugitive PM10	Exhaust PM10	PM10 Total	Fugitive PM2.5	Exhaust PM2.5	PM2.5 Total	Bio- CO2	NBio- CO2	Total CO2	CH4	N2O	CO2e
Category	lb/day										lb/day					
Hauling	0.0000	0.0000	0.0000	0.0000	0.0000	0.0000	0.0000	0.0000	0.0000	0.0000		0.0000	0.0000	0.0000		0.0000
Vendor	0.2118	6.1793	1.5911	0.0135	0.3515	0.0500	0.4014	0.1011	0.0478	0.1489		1,448.488 0	1,448.4880	0.1218		1,451.532 0
Worker	0.8414	0.5262	6.4888	0.0176	1.7580	0.0127	1.7706	0.4663	0.0117	0.4780		1,754.153 5	1,754.1535	0.0508		1,755.423 2
<b>Total</b>	<b>1.0532</b>	<b>6.7054</b>	<b>8.0799</b>	<b>0.0311</b>	<b>2.1094</b>	<b>0.0626</b>	<b>2.1721</b>	<b>0.5674</b>	<b>0.0595</b>	<b>0.6269</b>		<b>3,202.641 5</b>	<b>3,202.6415</b>	<b>0.1725</b>		<b>3,206.955 1</b>

#### Regulatory Compliance Construction On-Site



	ROG	NOx	CO	SO2	Fugitive PM10	Exhaust PM10	PM10 Total	Fugitive PM2.5	Exhaust PM2.5	PM2.5 Total	Bio- CO2	NBio- CO2	Total CO2	CH4	N2O	CO2e
Category	lb/day										lb/day					
Off-Road	0.9471	20.0464	15.4081	0.0250		0.8178	0.8178		0.8178	0.8178	0.0000	2,312.1454	2,312.1454	0.4810		2,324.1705
<b>Total</b>	<b>0.9471</b>	<b>20.0464</b>	<b>15.4081</b>	<b>0.0250</b>		<b>0.8178</b>	<b>0.8178</b>		<b>0.8178</b>	<b>0.8178</b>	<b>0.0000</b>	<b>2,312.1454</b>	<b>2,312.1454</b>	<b>0.4810</b>		<b>2,324.1705</b>

**Regulatory Compliance Construction Off-Site**

	ROG	NOx	CO	SO2	Fugitive PM10	Exhaust PM10	PM10 Total	Fugitive PM2.5	Exhaust PM2.5	PM2.5 Total	Bio- CO2	NBio- CO2	Total CO2	CH4	N2O	CO2e
Category	lb/day										lb/day					
Hauling	0.0000	0.0000	0.0000	0.0000	0.0000	0.0000	0.0000	0.0000	0.0000	0.0000		0.0000	0.0000	0.0000		0.0000
Vendor	0.2118	6.1793	1.5911	0.0135	0.3515	0.0500	0.4014	0.1011	0.0478	0.1489		1,448.4880	1,448.4880	0.1218		1,451.5320
Worker	0.8414	0.5262	6.4888	0.0176	1.7580	0.0127	1.7706	0.4663	0.0117	0.4780		1,754.1535	1,754.1535	0.0508		1,755.4232
<b>Total</b>	<b>1.0532</b>	<b>6.7054</b>	<b>8.0799</b>	<b>0.0311</b>	<b>2.1094</b>	<b>0.0626</b>	<b>2.1721</b>	<b>0.5674</b>	<b>0.0595</b>	<b>0.6269</b>		<b>3,202.6415</b>	<b>3,202.6415</b>	<b>0.1725</b>		<b>3,206.9551</b>

**3.6 Paving - 2019**

**Baseline Construction On-Site**

	ROG	NOx	CO	SO2	Fugitive PM10	Exhaust PM10	PM10 Total	Fugitive PM2.5	Exhaust PM2.5	PM2.5 Total	Bio- CO2	NBio- CO2	Total CO2	CH4	N2O	CO2e
Category	lb/day										lb/day					

Off-Road	1.2453	12.5685	11.8507	0.0178		0.7301	0.7301		0.6728	0.6728		1,746.2432	1,746.2432	0.5418		1,759.7870
Paving	0.0000					0.0000	0.0000		0.0000	0.0000			0.0000			0.0000
<b>Total</b>	<b>1.2453</b>	<b>12.5685</b>	<b>11.8507</b>	<b>0.0178</b>		<b>0.7301</b>	<b>0.7301</b>		<b>0.6728</b>	<b>0.6728</b>		<b>1,746.2432</b>	<b>1,746.2432</b>	<b>0.5418</b>		<b>1,759.7870</b>

**Baseline Construction Off-Site**

	ROG	NOx	CO	SO2	Fugitive PM10	Exhaust PM10	PM10 Total	Fugitive PM2.5	Exhaust PM2.5	PM2.5 Total	Bio- CO2	NBio- CO2	Total CO2	CH4	N2O	CO2e
Category	lb/day										lb/day					
Hauling	0.0000	0.0000	0.0000	0.0000	0.0000	0.0000	0.0000	0.0000	0.0000	0.0000		0.0000	0.0000	0.0000		0.0000
Vendor	0.0000	0.0000	0.0000	0.0000	0.0000	0.0000	0.0000	0.0000	0.0000	0.0000		0.0000	0.0000	0.0000		0.0000
Worker	0.0590	0.0369	0.4548	1.2300e-003	0.1232	8.9000e-004	0.1241	0.0327	8.2000e-004	0.0335		122.9547	122.9547	3.5600e-003		123.0437
<b>Total</b>	<b>0.0590</b>	<b>0.0369</b>	<b>0.4548</b>	<b>1.2300e-003</b>	<b>0.1232</b>	<b>8.9000e-004</b>	<b>0.1241</b>	<b>0.0327</b>	<b>8.2000e-004</b>	<b>0.0335</b>		<b>122.9547</b>	<b>122.9547</b>	<b>3.5600e-003</b>		<b>123.0437</b>

**Regulatory Compliance Construction On-Site**

	ROG	NOx	CO	SO2	Fugitive PM10	Exhaust PM10	PM10 Total	Fugitive PM2.5	Exhaust PM2.5	PM2.5 Total	Bio- CO2	NBio- CO2	Total CO2	CH4	N2O	CO2e
Category	lb/day										lb/day					
Off-Road	0.7344	15.6108	12.9737	0.0178		0.5580	0.5580		0.5580	0.5580	0.0000	1,746.2432	1,746.2432	0.5418		1,759.7870
Paving	0.0000					0.0000	0.0000		0.0000	0.0000			0.0000			0.0000
<b>Total</b>	<b>0.7344</b>	<b>15.6108</b>	<b>12.9737</b>	<b>0.0178</b>		<b>0.5580</b>	<b>0.5580</b>		<b>0.5580</b>	<b>0.5580</b>	<b>0.0000</b>	<b>1,746.2432</b>	<b>1,746.2432</b>	<b>0.5418</b>		<b>1,759.7870</b>

**Regulatory Compliance Construction Off-Site**

	ROG	NOx	CO	SO2	Fugitive PM10	Exhaust PM10	PM10 Total	Fugitive PM2.5	Exhaust PM2.5	PM2.5 Total	Bio- CO2	NBio- CO2	Total CO2	CH4	N2O	CO2e
Category	lb/day										lb/day					
Hauling	0.0000	0.0000	0.0000	0.0000	0.0000	0.0000	0.0000	0.0000	0.0000	0.0000		0.0000	0.0000	0.0000		0.0000
Vendor	0.0000	0.0000	0.0000	0.0000	0.0000	0.0000	0.0000	0.0000	0.0000	0.0000		0.0000	0.0000	0.0000		0.0000
Worker	0.0590	0.0369	0.4548	1.2300e-003	0.1232	8.9000e-004	0.1241	0.0327	8.2000e-004	0.0335		122.9547	122.9547	3.5600e-003		123.0437
<b>Total</b>	<b>0.0590</b>	<b>0.0369</b>	<b>0.4548</b>	<b>1.2300e-003</b>	<b>0.1232</b>	<b>8.9000e-004</b>	<b>0.1241</b>	<b>0.0327</b>	<b>8.2000e-004</b>	<b>0.0335</b>		<b>122.9547</b>	<b>122.9547</b>	<b>3.5600e-003</b>		<b>123.0437</b>

**3.7 Architectural Coating - 2018**

**Baseline Construction On-Site**

	ROG	NOx	CO	SO2	Fugitive PM10	Exhaust PM10	PM10 Total	Fugitive PM2.5	Exhaust PM2.5	PM2.5 Total	Bio- CO2	NBio- CO2	Total CO2	CH4	N2O	CO2e
Category	lb/day										lb/day					
Archit. Coating	77.6428					0.0000	0.0000		0.0000	0.0000			0.0000			0.0000
Off-Road	0.2986	2.0058	1.8542	2.9700e-003		0.1506	0.1506		0.1506	0.1506		281.4485	281.4485	0.0267		282.1171
<b>Total</b>	<b>77.9415</b>	<b>2.0058</b>	<b>1.8542</b>	<b>2.9700e-003</b>		<b>0.1506</b>	<b>0.1506</b>		<b>0.1506</b>	<b>0.1506</b>		<b>281.4485</b>	<b>281.4485</b>	<b>0.0267</b>		<b>282.1171</b>

**Baseline Construction Off-Site**

	ROG	NOx	CO	SO2	Fugitive PM10	Exhaust PM10	PM10 Total	Fugitive PM2.5	Exhaust PM2.5	PM2.5 Total	Bio- CO2	NBio- CO2	Total CO2	CH4	N2O	CO2e
--	-----	-----	----	-----	---------------	--------------	------------	----------------	---------------	-------------	----------	-----------	-----------	-----	-----	------

Category	lb/day										lb/day					
Hauling	0.0000	0.0000	0.0000	0.0000	0.0000	0.0000	0.0000	0.0000	0.0000	0.0000	0.0000	0.0000	0.0000	0.0000		0.0000
Vendor	0.0000	0.0000	0.0000	0.0000	0.0000	0.0000	0.0000	0.0000	0.0000	0.0000	0.0000	0.0000	0.0000	0.0000		0.0000
Worker	0.1842	0.1195	1.4462	3.6400e-003	0.3532	2.5600e-003	0.3558	0.0937	2.3600e-003	0.0961		362.2715	362.2715	0.0114		362.5557
<b>Total</b>	<b>0.1842</b>	<b>0.1195</b>	<b>1.4462</b>	<b>3.6400e-003</b>	<b>0.3532</b>	<b>2.5600e-003</b>	<b>0.3558</b>	<b>0.0937</b>	<b>2.3600e-003</b>	<b>0.0961</b>		<b>362.2715</b>	<b>362.2715</b>	<b>0.0114</b>		<b>362.5557</b>

**Regulatory Compliance Construction On-Site**

	ROG	NOx	CO	SO2	Fugitive PM10	Exhaust PM10	PM10 Total	Fugitive PM2.5	Exhaust PM2.5	PM2.5 Total	Bio- CO2	NBio- CO2	Total CO2	CH4	N2O	CO2e
Category	lb/day										lb/day					
Archit. Coating	77.6428					0.0000	0.0000		0.0000	0.0000			0.0000			0.0000
Off-Road	0.1139	2.3524	1.8324	2.9700e-003		0.0951	0.0951		0.0951	0.0951	0.0000	281.4485	281.4485	0.0267		282.1171
<b>Total</b>	<b>77.7567</b>	<b>2.3524</b>	<b>1.8324</b>	<b>2.9700e-003</b>		<b>0.0951</b>	<b>0.0951</b>		<b>0.0951</b>	<b>0.0951</b>	<b>0.0000</b>	<b>281.4485</b>	<b>281.4485</b>	<b>0.0267</b>		<b>282.1171</b>

**Regulatory Compliance Construction Off-Site**

	ROG	NOx	CO	SO2	Fugitive PM10	Exhaust PM10	PM10 Total	Fugitive PM2.5	Exhaust PM2.5	PM2.5 Total	Bio- CO2	NBio- CO2	Total CO2	CH4	N2O	CO2e
Category	lb/day										lb/day					
Hauling	0.0000	0.0000	0.0000	0.0000	0.0000	0.0000	0.0000	0.0000	0.0000	0.0000		0.0000	0.0000	0.0000		0.0000
Vendor	0.0000	0.0000	0.0000	0.0000	0.0000	0.0000	0.0000	0.0000	0.0000	0.0000		0.0000	0.0000	0.0000		0.0000
Worker	0.1842	0.1195	1.4462	3.6400e-003	0.3532	2.5600e-003	0.3558	0.0937	2.3600e-003	0.0961		362.2715	362.2715	0.0114		362.5557

<b>Total</b>	<b>0.1842</b>	<b>0.1195</b>	<b>1.4462</b>	<b>3.6400e-003</b>	<b>0.3532</b>	<b>2.5600e-003</b>	<b>0.3558</b>	<b>0.0937</b>	<b>2.3600e-003</b>	<b>0.0961</b>		<b>362.2715</b>	<b>362.2715</b>	<b>0.0114</b>		<b>362.5557</b>
--------------	---------------	---------------	---------------	--------------------	---------------	--------------------	---------------	---------------	--------------------	---------------	--	-----------------	-----------------	---------------	--	-----------------

### 3.7 Architectural Coating - 2019

#### Baseline Construction On-Site

	ROG	NOx	CO	SO2	Fugitive PM10	Exhaust PM10	PM10 Total	Fugitive PM2.5	Exhaust PM2.5	PM2.5 Total	Bio- CO2	NBio- CO2	Total CO2	CH4	N2O	CO2e
<b>Category</b>	<b>lb/day</b>										<b>lb/day</b>					
Archit. Coating	77.6428					0.0000	0.0000		0.0000	0.0000			0.0000			0.0000
Off-Road	0.2664	1.8354	1.8413	2.9700e-003		0.1288	0.1288		0.1288	0.1288		281.4481	281.4481	0.0238		282.0423
<b>Total</b>	<b>77.9093</b>	<b>1.8354</b>	<b>1.8413</b>	<b>2.9700e-003</b>		<b>0.1288</b>	<b>0.1288</b>		<b>0.1288</b>	<b>0.1288</b>		<b>281.4481</b>	<b>281.4481</b>	<b>0.0238</b>		<b>282.0423</b>

#### Baseline Construction Off-Site

	ROG	NOx	CO	SO2	Fugitive PM10	Exhaust PM10	PM10 Total	Fugitive PM2.5	Exhaust PM2.5	PM2.5 Total	Bio- CO2	NBio- CO2	Total CO2	CH4	N2O	CO2e
<b>Category</b>	<b>lb/day</b>										<b>lb/day</b>					
Hauling	0.0000	0.0000	0.0000	0.0000	0.0000	0.0000	0.0000	0.0000	0.0000	0.0000		0.0000	0.0000	0.0000		0.0000
Vendor	0.0000	0.0000	0.0000	0.0000	0.0000	0.0000	0.0000	0.0000	0.0000	0.0000		0.0000	0.0000	0.0000		0.0000
Worker	0.1691	0.1057	1.3038	3.5400e-003	0.3532	2.5400e-003	0.3558	0.0937	2.3400e-003	0.0960		352.4701	352.4701	0.0102		352.7252
<b>Total</b>	<b>0.1691</b>	<b>0.1057</b>	<b>1.3038</b>	<b>3.5400e-003</b>	<b>0.3532</b>	<b>2.5400e-003</b>	<b>0.3558</b>	<b>0.0937</b>	<b>2.3400e-003</b>	<b>0.0960</b>		<b>352.4701</b>	<b>352.4701</b>	<b>0.0102</b>		<b>352.7252</b>

#### Regulatory Compliance Construction On-Site

	ROG	NOx	CO	SO2	Fugitive PM10	Exhaust PM10	PM10 Total	Fugitive PM2.5	Exhaust PM2.5	PM2.5 Total	Bio- CO2	NBio- CO2	Total CO2	CH4	N2O	CO2e
Category	lb/day										lb/day					
Archit. Coating	77.6428					0.0000	0.0000		0.0000	0.0000			0.0000			0.0000
Off-Road	0.1139	2.3524	1.8324	2.9700e-003		0.0951	0.0951		0.0951	0.0951	0.0000	281.4481	281.4481	0.0238		282.0423
<b>Total</b>	<b>77.7567</b>	<b>2.3524</b>	<b>1.8324</b>	<b>2.9700e-003</b>		<b>0.0951</b>	<b>0.0951</b>		<b>0.0951</b>	<b>0.0951</b>	<b>0.0000</b>	<b>281.4481</b>	<b>281.4481</b>	<b>0.0238</b>		<b>282.0423</b>

### Regulatory Compliance Construction Off-Site

	ROG	NOx	CO	SO2	Fugitive PM10	Exhaust PM10	PM10 Total	Fugitive PM2.5	Exhaust PM2.5	PM2.5 Total	Bio- CO2	NBio- CO2	Total CO2	CH4	N2O	CO2e
Category	lb/day										lb/day					
Hauling	0.0000	0.0000	0.0000	0.0000	0.0000	0.0000	0.0000	0.0000	0.0000	0.0000		0.0000	0.0000	0.0000		0.0000
Vendor	0.0000	0.0000	0.0000	0.0000	0.0000	0.0000	0.0000	0.0000	0.0000	0.0000		0.0000	0.0000	0.0000		0.0000
Worker	0.1691	0.1057	1.3038	3.5400e-003	0.3532	2.5400e-003	0.3558	0.0937	2.3400e-003	0.0960		352.4701	352.4701	0.0102		352.7252
<b>Total</b>	<b>0.1691</b>	<b>0.1057</b>	<b>1.3038</b>	<b>3.5400e-003</b>	<b>0.3532</b>	<b>2.5400e-003</b>	<b>0.3558</b>	<b>0.0937</b>	<b>2.3400e-003</b>	<b>0.0960</b>		<b>352.4701</b>	<b>352.4701</b>	<b>0.0102</b>		<b>352.7252</b>

## 4.0 Operational Detail - Mobile

### 4.1 Mitigation Measures Mobile

	ROG	NOx	CO	SO2	Fugitive PM10	Exhaust PM10	PM10 Total	Fugitive PM2.5	Exhaust PM2.5	PM2.5 Total	Bio- CO2	NBio- CO2	Total CO2	CH4	N2O	CO2e
Category	lb/day										lb/day					
Regulatory Compliance	3.5403	5.3281	32.9460	0.0746	7.0396	0.0626	7.1022	1.8760	0.0584	1.9343		7,460.6005	7,460.6005	0.4757		7,472.4926
Baseline	3.5403	5.3281	32.9460	0.0746	7.0396	0.0626	7.1022	1.8760	0.0584	1.9343		7,460.6005	7,460.6005	0.4757		7,472.4926

## 4.2 Trip Summary Information

Land Use	Average Daily Trip Rate			Baseline	Regulatory Compliance
	Weekday	Saturday	Sunday	Annual VMT	Annual VMT
Condo/Townhouse	1,057.42	1,031.94	880.88	2,841,986	2,841,986
Enclosed Parking with Elevator	0.00	0.00	0.00		
General Office Building	175.92	37.15	15.86	318,375	318,375
Total	1,233.34	1,069.09	896.74	3,160,361	3,160,361

## 4.3 Trip Type Information

Land Use	Miles			Trip %			Trip Purpose %		
	H-W or C-W	H-S or C-C	H-O or C-NW	H-W or C-W	H-S or C-C	H-O or C-NW	Primary	Diverted	Pass-by
Condo/Townhouse	10.80	7.30	7.50	32.90	18.00	49.10	86	11	3
Enclosed Parking with Elevator	9.50	7.30	7.30	0.00	0.00	0.00	0	0	0
General Office Building	9.50	7.30	7.30	33.00	48.00	19.00	77	19	4

## 4.4 Fleet Mix

Land Use	LDA	LDT1	LDT2	MDV	LHD1	LHD2	MHD	HHD	OBUS	UBUS	MCY	SBUS	MH
General Office Building	0.572490	0.044826	0.170628	0.127143	0.022859	0.006230	0.012809	0.005255	0.000798	0.000322	0.029094	0.000351	0.007194
Enclosed Parking with Elevator	0.572490	0.044826	0.170628	0.127143	0.022859	0.006230	0.012809	0.005255	0.000798	0.000322	0.029094	0.000351	0.007194
Condo/Townhouse	0.572490	0.044826	0.170628	0.127143	0.022859	0.006230	0.012809	0.005255	0.000798	0.000322	0.029094	0.000351	0.007194

## 5.0 Energy Detail

Historical Energy Use: N

### 5.1 Mitigation Measures Energy

Exceed Title 24

Install High Efficiency Lighting

	ROG	NOx	CO	SO2	Fugitive PM10	Exhaust PM10	PM10 Total	Fugitive PM2.5	Exhaust PM2.5	PM2.5 Total	Bio- CO2	NBio- CO2	Total CO2	CH4	N2O	CO2e
Category	lb/day										lb/day					
NaturalGas Regulatory	0.1034	0.8852	0.3899	5.6400e-003		0.0714	0.0714		0.0714	0.0714		1,127.5554	1,127.5554	0.0216	0.0207	1,134.2559
NaturalGas Baseline	0.1163	0.9963	0.4394	6.3400e-003		0.0804	0.0804		0.0804	0.0804		1,268.9608	1,268.9608	0.0243	0.0233	1,276.5016

### 5.2 Energy by Land Use - NaturalGas

#### Baseline

	NaturalGas Use	ROG	NOx	CO	SO2	Fugitive PM10	Exhaust PM10	PM10 Total	Fugitive PM2.5	Exhaust PM2.5	PM2.5 Total	Bio- CO2	NBio- CO2	Total CO2	CH4	N2O	CO2e
Land Use	kBTU/yr	lb/day										lb/day					
Condo/Townhouse	10406.4	0.1122	0.9590	0.4081	6.1200e-003		0.0775	0.0775		0.0775	0.0775		1,224.2813	1,224.2813	0.0235	0.0225	1,231.5566
Enclosed Parking with Elevator	0	0.0000	0.0000	0.0000	0.0000		0.0000	0.0000		0.0000	0.0000		0.0000	0.0000	0.0000	0.0000	0.0000
General Office Building	379.775	4.1000e-003	0.0372	0.0313	2.2000e-004		2.8300e-003	2.8300e-003		2.8300e-003	2.8300e-003		44.6795	44.6795	8.6000e-004	8.2000e-004	44.9450







Landscaping	0.4605	0.1742	15.0969	8.0000e-004		0.0831	0.0831		0.0831	0.0831		27.1412	27.1412	0.0265		27.8031
<b>Total</b>	<b>8.7338</b>	<b>0.1742</b>	<b>15.0969</b>	<b>8.0000e-004</b>		<b>0.0831</b>	<b>0.0831</b>		<b>0.0831</b>	<b>0.0831</b>	<b>0.0000</b>	<b>27.1412</b>	<b>27.1412</b>	<b>0.0265</b>	<b>0.0000</b>	<b>27.8031</b>

## 7.0 Water Detail

### 7.1 Mitigation Measures Water

- Install Low Flow Bathroom Faucet
- Install Low Flow Kitchen Faucet
- Install Low Flow Toilet
- Install Low Flow Shower
- Use Water Efficient Irrigation System

## 8.0 Waste Detail

### 8.1 Mitigation Measures Waste

## 9.0 Operational Offroad

Equipment Type	Number	Hours/Day	Days/Year	Horse Power	Load Factor	Fuel Type
----------------	--------	-----------	-----------	-------------	-------------	-----------

## 10.0 Stationary Equipment

### Fire Pumps and Emergency Generators

Equipment Type	Number	Hours/Day	Hours/Year	Horse Power	Load Factor	Fuel Type
----------------	--------	-----------	------------	-------------	-------------	-----------

### Boilers

Equipment Type	Number	Heat Input/Day	Heat Input/Year	Boiler Rating	Fuel Type
----------------	--------	----------------	-----------------	---------------	-----------

### User Defined Equipment

Equipment Type	Number
----------------	--------

## 11.0 Vegetation





Rio Urbana Mixed Use (Proposed) - Ventura County APCD Air District, Winter

**Rio Urbana Mixed Use (Proposed)**  
**Ventura County APCD Air District, Winter**

**1.0 Project Characteristics**

**1.1 Land Usage**

Land Uses	Size	Metric	Lot Acreage	Floor Surface Area	Population
General Office Building	15.10	1000sqft	0.18	15,100.00	0
Enclosed Parking with Elevator	463.00	Space	0.00	185,200.00	0
Condo/Townhouse	182.00	Dwelling Unit	2.64	182,000.00	557

**1.2 Other Project Characteristics**

<b>Urbanization</b>	Urban	<b>Wind Speed (m/s)</b>	2.6	<b>Precipitation Freq (Days)</b>	31
<b>Climate Zone</b>	8	<b>Operational Year</b>		2021	
<b>Utility Company</b>	Southern California Edison				
<b>CO2 Intensity (lb/MW hr)</b>	702.44	<b>CH4 Intensity (lb/MW hr)</b>	0.029	<b>N2O Intensity (lb/MW hr)</b>	0.006

**1.3 User Entered Comments & Non-Default Data**

Project Characteristics - Construction to be completed 2020.

Land Use - Total Project are = 10.49 acres

Lot coverage: School office = 7,830 sq. ft.; apartment = 115,026 sq. ft.

Construction Phase - Architectural coating to take place intermittently towards the tail end of building construction

Off-road Equipment - No Cranes

Grading - +/- 17,000 cy of import

Vehicle Trips - Based on Traffic Study

Energy Use -



tblConstEquipMitigation	Tier	No Change	Tier 2
tblConstEquipMitigation	Tier	No Change	Tier 2
tblConstEquipMitigation	Tier	No Change	Tier 2
tblConstEquipMitigation	Tier	No Change	Tier 2
tblConstEquipMitigation	Tier	No Change	Tier 2
tblConstEquipMitigation	Tier	No Change	Tier 2
tblConstEquipMitigation	Tier	No Change	Tier 2
tblConstEquipMitigation	Tier	No Change	Tier 2
tblConstructionPhase	NumDays	10.00	30.00
tblConstructionPhase	PhaseEndDate	2/12/2019	1/25/2019
tblConstructionPhase	PhaseStartDate	1/30/2019	12/15/2018
tblGrading	MaterialImported	0.00	17,000.00
tblLandUse	LotAcreage	0.35	0.18
tblLandUse	LotAcreage	4.17	0.00
tblLandUse	LotAcreage	11.38	2.64
tblProjectCharacteristics	OperationalYear	2018	2021
tblVehicleTrips	WD_TR	11.03	11.65

## 2.0 Emissions Summary

### 2.1 Overall Construction (Maximum Daily Emission)

#### Baseline Construction

	ROG	NOx	CO	SO2	Fugitive PM10	Exhaust PM10	PM10 Total	Fugitive PM2.5	Exhaust PM2.5	PM2.5 Total	Bio- CO2	NBio- CO2	Total CO2	CH4	N2O	CO2e
Year	lb/day										lb/day					
2018	82.3462	136.3765	34.1592	0.2913	13.1999	1.7849	14.9848	5.1379	1.6647	6.8026	0.0000	31,519.54 37	31,519.543 7	3.6225	0.0000	31,610.10 62
2019	81.8353	27.6845	26.5194	0.0613	2.4627	1.2854	3.7480	0.6611	1.2367	1.8978	0.0000	6,012.179 5	6,012.1795	0.6939	0.0000	6,029.526 4



<b>Maximum</b>	82.3462	136.3765	34.1592	0.2913	13.1999	1.7849	14.9848	5.1379	1.6647	6.8026	0.0000	31,519.54 37	31,519.543 7	3.6225	0.0000	31,610.10 62
----------------	---------	----------	---------	--------	---------	--------	---------	--------	--------	--------	--------	-----------------	-----------------	--------	--------	-----------------

### Regulatory Compliance Construction

	ROG	NOx	CO	SO2	Fugitive PM10	Exhaust PM10	PM10 Total	Fugitive PM2.5	Exhaust PM2.5	PM2.5 Total	Bio- CO2	NBio- CO2	Total CO2	CH4	N2O	CO2e
Year	lb/day										lb/day					
2018	80.1959	130.1920	35.9238	0.2913	8.9602	1.1016	10.0617	3.0469	1.0749	4.1218	0.0000	31,519.54 37	31,519.543 7	3.6225	0.0000	31,610.10 62
2019	80.0719	29.3377	26.6641	0.0613	2.4627	0.9793	3.4420	0.6611	0.9759	1.6370	0.0000	6,012.179 5	6,012.1795	0.6939	0.0000	6,029.526 4
<b>Maximum</b>	80.1959	130.1920	35.9238	0.2913	8.9602	1.1016	10.0617	3.0469	1.0749	4.1218	0.0000	31,519.54 37	31,519.543 7	3.6225	0.0000	31,610.10 62

	ROG	NOx	CO	SO2	Fugitive PM10	Exhaust PM10	PM10 Total	Fugitive PM2.5	Exhaust PM2.5	PM2.5 Total	Bio- CO2	NBio- CO2	Total CO2	CH4	N2O	CO2e
<b>Percent Reduction</b>	2.38	2.76	-3.15	0.00	27.07	32.22	27.91	36.06	29.32	33.81	0.00	0.00	0.00	0.00	0.00	0.00

## 2.2 Overall Operational

### Baseline Operational

	ROG	NOx	CO	SO2	Fugitive PM10	Exhaust PM10	PM10 Total	Fugitive PM2.5	Exhaust PM2.5	PM2.5 Total	Bio- CO2	NBio- CO2	Total CO2	CH4	N2O	CO2e
Category	lb/day										lb/day					
Area	5.3822	0.1742	15.0969	8.0000e-004		0.0831	0.0831		0.0831	0.0831	0.0000	27.1412	27.1412	0.0265	0.0000	27.8031
Energy	0.1163	0.9963	0.4394	6.3400e-003		0.0804	0.0804		0.0804	0.0804		1,268.960 8	1,268.9608	0.0243	0.0233	1,276.501 6
Mobile	3.4482	5.7688	34.4890	0.0715	7.0396	0.0628	7.1024	1.8760	0.0586	1.9345		7,150.557 4	7,150.5574	0.4927		7,162.875 7
<b>Total</b>	8.9468	6.9392	50.0253	0.0786	7.0396	0.2263	7.2659	1.8760	0.2221	2.0980	0.0000	8,446.659 4	8,446.6594	0.5435	0.0233	8,467.180 4

## Regulatory Compliance Operational

	ROG	NOx	CO	SO2	Fugitive PM10	Exhaust PM10	PM10 Total	Fugitive PM2.5	Exhaust PM2.5	PM2.5 Total	Bio- CO2	NBio- CO2	Total CO2	CH4	N2O	CO2e
Category	lb/day										lb/day					
Area	8.7338	0.1742	15.0969	8.0000e-004		0.0831	0.0831		0.0831	0.0831	0.0000	27.1412	27.1412	0.0265	0.0000	27.8031
Energy	0.1034	0.8852	0.3899	5.6400e-003		0.0714	0.0714		0.0714	0.0714		1,127.5554	1,127.5554	0.0216	0.0207	1,134.2559
Mobile	3.4482	5.7688	34.4890	0.0715	7.0396	0.0628	7.1024	1.8760	0.0586	1.9345		7,150.5574	7,150.5574	0.4927		7,162.8757
<b>Total</b>	<b>12.2854</b>	<b>6.8282</b>	<b>49.9758</b>	<b>0.0779</b>	<b>7.0396</b>	<b>0.2174</b>	<b>7.2569</b>	<b>1.8760</b>	<b>0.2131</b>	<b>2.0890</b>	<b>0.0000</b>	<b>8,305.2540</b>	<b>8,305.2540</b>	<b>0.5408</b>	<b>0.0207</b>	<b>8,324.9347</b>

	ROG	NOx	CO	SO2	Fugitive PM10	Exhaust PM10	PM10 Total	Fugitive PM2.5	Exhaust PM2.5	PM2.5 Total	Bio- CO2	NBio-CO2	Total CO2	CH4	N2O	CO2e
<b>Percent Reduction</b>	<b>-37.32</b>	<b>1.60</b>	<b>0.10</b>	<b>0.89</b>	<b>0.00</b>	<b>3.96</b>	<b>0.12</b>	<b>0.00</b>	<b>4.03</b>	<b>0.43</b>	<b>0.00</b>	<b>1.67</b>	<b>1.67</b>	<b>0.50</b>	<b>11.13</b>	<b>1.68</b>

## 3.0 Construction Detail

### Construction Phase

Phase Number	Phase Name	Phase Type	Start Date	End Date	Num Days Week	Num Days	Phase Description
1	Demolition	Demolition	2/1/2018	2/28/2018	5	20	
2	Site Preparation	Site Preparation	3/1/2018	3/5/2018	5	3	
3	Grading	Grading	3/6/2018	3/13/2018	5	6	
4	Building Construction	Building Construction	3/14/2018	1/15/2019	5	220	
5	Paving	Paving	1/16/2019	1/29/2019	5	10	
6	Architectural Coating	Architectural Coating	12/15/2018	1/25/2019	5	30	

Acres of Grading (Site Preparation Phase): 4.5

Acres of Grading (Grading Phase): 3

Acres of Paving: 0

Residential Indoor: 368,550; Residential Outdoor: 122,850; Non-Residential Indoor: 22,650; Non-Residential Outdoor: 7,550; Striped

**OffRoad Equipment**

Phase Name	Offroad Equipment Type	Amount	Usage Hours	Horse Power	Load Factor
Demolition	Concrete/Industrial Saws	1	8.00	81	0.73
Demolition	Rubber Tired Dozers	1	8.00	247	0.40
Demolition	Tractors/Loaders/Backhoes	3	8.00	97	0.37
Site Preparation	Graders	1	8.00	187	0.41
Site Preparation	Scrapers	1	8.00	367	0.48
Site Preparation	Tractors/Loaders/Backhoes	1	7.00	97	0.37
Grading	Graders	1	8.00	187	0.41
Grading	Rubber Tired Dozers	1	8.00	247	0.40
Grading	Tractors/Loaders/Backhoes	2	7.00	97	0.37
Building Construction	Forklifts	2	7.00	89	0.20
Building Construction	Generator Sets	1	8.00	84	0.74
Building Construction	Tractors/Loaders/Backhoes	1	6.00	97	0.37
Building Construction	Welders	3	8.00	46	0.45
Paving	Cement and Mortar Mixers	1	8.00	9	0.56
Paving	Pavers	1	8.00	130	0.42
Paving	Paving Equipment	1	8.00	132	0.36
Paving	Rollers	2	8.00	80	0.38
Paving	Tractors/Loaders/Backhoes	1	8.00	97	0.37
Architectural Coating	Air Compressors	1	6.00	78	0.48
Building Construction	Cranes	1	8.00	231	0.29

**Trips and VMT**

Phase Name	Offroad Equipment Count	Worker Trip Number	Vendor Trip Number	Hauling Trip Number	Worker Trip Length	Vendor Trip Length	Hauling Trip Length	Worker Vehicle Class	Vendor Vehicle Class	Hauling Vehicle Class
Demolition	5	13.00	0.00	875.00	10.80	7.30	20.00	LD_Mix	HDT_Mix	HHDT



Category	lb/day										lb/day				
Hauling	0.3896	13.8420	2.8965	0.0333	0.7618	0.0761	0.8379	0.2086	0.0728	0.2814	3,627.0586	3,627.0586	0.3673		3,636.2405
Vendor	0.0000	0.0000	0.0000	0.0000	0.0000	0.0000	0.0000	0.0000	0.0000	0.0000	0.0000	0.0000	0.0000		0.0000
Worker	0.0631	0.0423	0.4298	1.0500e-003	0.1068	7.7000e-004	0.1076	0.0283	7.1000e-004	0.0290	104.2264	104.2264	3.3400e-003		104.3099
<b>Total</b>	<b>0.4527</b>	<b>13.8844</b>	<b>3.3263</b>	<b>0.0344</b>	<b>0.8686</b>	<b>0.0769</b>	<b>0.9455</b>	<b>0.2369</b>	<b>0.0735</b>	<b>0.3104</b>	<b>3,731.2850</b>	<b>3,731.2850</b>	<b>0.3706</b>		<b>3,740.5504</b>

**Regulatory Compliance Construction On-Site**

	ROG	NOx	CO	SO2	Fugitive PM10	Exhaust PM10	PM10 Total	Fugitive PM2.5	Exhaust PM2.5	PM2.5 Total	Bio- CO2	NBio- CO2	Total CO2	CH4	N2O	CO2e
Category	lb/day										lb/day					
Fugitive Dust					3.7373	0.0000	3.7373	0.5660	0.0000	0.5660			0.0000			0.0000
Off-Road	0.8857	21.2053	15.4154	0.0241		0.7182	0.7182		0.7182	0.7182	0.0000	2,391.1659	2,391.1659	0.6058		2,406.3105
<b>Total</b>	<b>0.8857</b>	<b>21.2053</b>	<b>15.4154</b>	<b>0.0241</b>	<b>3.7373</b>	<b>0.7182</b>	<b>4.4555</b>	<b>0.5660</b>	<b>0.7182</b>	<b>1.2841</b>	<b>0.0000</b>	<b>2,391.1659</b>	<b>2,391.1659</b>	<b>0.6058</b>		<b>2,406.3105</b>

**Regulatory Compliance Construction Off-Site**

	ROG	NOx	CO	SO2	Fugitive PM10	Exhaust PM10	PM10 Total	Fugitive PM2.5	Exhaust PM2.5	PM2.5 Total	Bio- CO2	NBio- CO2	Total CO2	CH4	N2O	CO2e
Category	lb/day										lb/day					
Hauling	0.3896	13.8420	2.8965	0.0333	0.7618	0.0761	0.8379	0.2086	0.0728	0.2814	3,627.0586	3,627.0586	0.3673			3,636.2405
Vendor	0.0000	0.0000	0.0000	0.0000	0.0000	0.0000	0.0000	0.0000	0.0000	0.0000	0.0000	0.0000	0.0000			0.0000
Worker	0.0631	0.0423	0.4298	1.0500e-003	0.1068	7.7000e-004	0.1076	0.0283	7.1000e-004	0.0290	104.2264	104.2264	3.3400e-003			104.3099

Total	0.4527	13.8844	3.3263	0.0344	0.8686	0.0769	0.9455	0.2369	0.0735	0.3104		3,731.2850	3,731.2850	0.3706		3,740.5504
-------	--------	---------	--------	--------	--------	--------	--------	--------	--------	--------	--	------------	------------	--------	--	------------

### 3.3 Site Preparation - 2018

#### Baseline Construction On-Site

	ROG	NOx	CO	SO2	Fugitive PM10	Exhaust PM10	PM10 Total	Fugitive PM2.5	Exhaust PM2.5	PM2.5 Total	Bio- CO2	NBio- CO2	Total CO2	CH4	N2O	CO2e
Category	lb/day										lb/day					
Fugitive Dust					1.5908	0.0000	1.5908	0.1718	0.0000	0.1718			0.0000			0.0000
Off-Road	1.8995	23.6201	12.7461	0.0245		0.9540	0.9540		0.8777	0.8777		2,468.4131	2,468.4131	0.7685		2,487.6244
<b>Total</b>	<b>1.8995</b>	<b>23.6201</b>	<b>12.7461</b>	<b>0.0245</b>	<b>1.5908</b>	<b>0.9540</b>	<b>2.5448</b>	<b>0.1718</b>	<b>0.8777</b>	<b>1.0494</b>		<b>2,468.4131</b>	<b>2,468.4131</b>	<b>0.7685</b>		<b>2,487.6244</b>

#### Baseline Construction Off-Site

	ROG	NOx	CO	SO2	Fugitive PM10	Exhaust PM10	PM10 Total	Fugitive PM2.5	Exhaust PM2.5	PM2.5 Total	Bio- CO2	NBio- CO2	Total CO2	CH4	N2O	CO2e
Category	lb/day										lb/day					
Hauling	0.0000	0.0000	0.0000	0.0000	0.0000	0.0000	0.0000	0.0000	0.0000	0.0000		0.0000	0.0000	0.0000		0.0000
Vendor	0.0000	0.0000	0.0000	0.0000	0.0000	0.0000	0.0000	0.0000	0.0000	0.0000		0.0000	0.0000	0.0000		0.0000
Worker	0.0388	0.0261	0.2645	6.4000e-004	0.0657	4.8000e-004	0.0662	0.0174	4.4000e-004	0.0179		64.1393	64.1393	2.0600e-003		64.1907
<b>Total</b>	<b>0.0388</b>	<b>0.0261</b>	<b>0.2645</b>	<b>6.4000e-004</b>	<b>0.0657</b>	<b>4.8000e-004</b>	<b>0.0662</b>	<b>0.0174</b>	<b>4.4000e-004</b>	<b>0.0179</b>		<b>64.1393</b>	<b>64.1393</b>	<b>2.0600e-003</b>		<b>64.1907</b>

#### Regulatory Compliance Construction On-Site

	ROG	NOx	CO	SO2	Fugitive PM10	Exhaust PM10	PM10 Total	Fugitive PM2.5	Exhaust PM2.5	PM2.5 Total	Bio- CO2	NBio- CO2	Total CO2	CH4	N2O	CO2e
Category	lb/day										lb/day					
Fugitive Dust					0.6204	0.0000	0.6204	0.0670	0.0000	0.0670			0.0000			0.0000
Off-Road	0.6625	20.0179	13.6431	0.0245		0.4988	0.4988		0.4988	0.4988	0.0000	2,468.4131	2,468.4131	0.7685		2,487.6244
<b>Total</b>	<b>0.6625</b>	<b>20.0179</b>	<b>13.6431</b>	<b>0.0245</b>	<b>0.6204</b>	<b>0.4988</b>	<b>1.1191</b>	<b>0.0670</b>	<b>0.4988</b>	<b>0.5657</b>	<b>0.0000</b>	<b>2,468.4131</b>	<b>2,468.4131</b>	<b>0.7685</b>		<b>2,487.6244</b>

**Regulatory Compliance Construction Off-Site**

	ROG	NOx	CO	SO2	Fugitive PM10	Exhaust PM10	PM10 Total	Fugitive PM2.5	Exhaust PM2.5	PM2.5 Total	Bio- CO2	NBio- CO2	Total CO2	CH4	N2O	CO2e
Category	lb/day										lb/day					
Hauling	0.0000	0.0000	0.0000	0.0000	0.0000	0.0000	0.0000	0.0000	0.0000	0.0000		0.0000	0.0000	0.0000		0.0000
Vendor	0.0000	0.0000	0.0000	0.0000	0.0000	0.0000	0.0000	0.0000	0.0000	0.0000		0.0000	0.0000	0.0000		0.0000
Worker	0.0388	0.0261	0.2645	6.4000e-004	0.0657	4.8000e-004	0.0662	0.0174	4.4000e-004	0.0179		64.1393	64.1393	2.0600e-003		64.1907
<b>Total</b>	<b>0.0388</b>	<b>0.0261</b>	<b>0.2645</b>	<b>6.4000e-004</b>	<b>0.0657</b>	<b>4.8000e-004</b>	<b>0.0662</b>	<b>0.0174</b>	<b>4.4000e-004</b>	<b>0.0179</b>		<b>64.1393</b>	<b>64.1393</b>	<b>2.0600e-003</b>		<b>64.1907</b>

**3.4 Grading - 2018**

**Baseline Construction On-Site**

	ROG	NOx	CO	SO2	Fugitive PM10	Exhaust PM10	PM10 Total	Fugitive PM2.5	Exhaust PM2.5	PM2.5 Total	Bio- CO2	NBio- CO2	Total CO2	CH4	N2O	CO2e
Category	lb/day										lb/day					

Fugitive Dust					6.9505	0.0000	6.9505	3.4278	0.0000	3.4278			0.0000			0.0000
Off-Road	2.1515	24.2895	10.3804	0.0206		1.1683	1.1683		1.0748	1.0748		2,077.4666	2,077.4666	0.6467		2,093.6352
<b>Total</b>	<b>2.1515</b>	<b>24.2895</b>	<b>10.3804</b>	<b>0.0206</b>	<b>6.9505</b>	<b>1.1683</b>	<b>8.1188</b>	<b>3.4278</b>	<b>1.0748</b>	<b>4.5026</b>		<b>2,077.4666</b>	<b>2,077.4666</b>	<b>0.6467</b>		<b>2,093.6352</b>

**Baseline Construction Off-Site**

	ROG	NOx	CO	SO2	Fugitive PM10	Exhaust PM10	PM10 Total	Fugitive PM2.5	Exhaust PM2.5	PM2.5 Total	Bio- CO2	NBio- CO2	Total CO2	CH4	N2O	CO2e
Category	lb/day										lb/day					
Hauling	3.1542	112.0544	23.4482	0.2699	6.1673	0.6160	6.7833	1.6883	0.5893	2.2776		29,361.9030	29,361.9030	2.9732		29,436.2326
Vendor	0.0000	0.0000	0.0000	0.0000	0.0000	0.0000	0.0000	0.0000	0.0000	0.0000		0.0000	0.0000	0.0000		0.0000
Worker	0.0485	0.0326	0.3306	8.1000e-004	0.0822	6.0000e-004	0.0827	0.0218	5.5000e-004	0.0223		80.1742	80.1742	2.5700e-003		80.2384
<b>Total</b>	<b>3.2027</b>	<b>112.0870</b>	<b>23.7788</b>	<b>0.2707</b>	<b>6.2495</b>	<b>0.6166</b>	<b>6.8660</b>	<b>1.7101</b>	<b>0.5899</b>	<b>2.3000</b>		<b>29,442.0771</b>	<b>29,442.0771</b>	<b>2.9758</b>		<b>29,516.4710</b>

**Regulatory Compliance Construction On-Site**

	ROG	NOx	CO	SO2	Fugitive PM10	Exhaust PM10	PM10 Total	Fugitive PM2.5	Exhaust PM2.5	PM2.5 Total	Bio- CO2	NBio- CO2	Total CO2	CH4	N2O	CO2e
Category	lb/day										lb/day					
Fugitive Dust					2.7107	0.0000	2.7107	1.3368	0.0000	1.3368			0.0000			0.0000
Off-Road	0.6262	18.1050	12.1450	0.0206		0.4850	0.4850		0.4850	0.4850	0.0000	2,077.4666	2,077.4666	0.6467		2,093.6352
<b>Total</b>	<b>0.6262</b>	<b>18.1050</b>	<b>12.1450</b>	<b>0.0206</b>	<b>2.7107</b>	<b>0.4850</b>	<b>3.1957</b>	<b>1.3368</b>	<b>0.4850</b>	<b>1.8219</b>	<b>0.0000</b>	<b>2,077.4666</b>	<b>2,077.4666</b>	<b>0.6467</b>		<b>2,093.6352</b>



**Regulatory Compliance Construction Off-Site**

	ROG	NOx	CO	SO2	Fugitive PM10	Exhaust PM10	PM10 Total	Fugitive PM2.5	Exhaust PM2.5	PM2.5 Total	Bio- CO2	NBio- CO2	Total CO2	CH4	N2O	CO2e
Category	lb/day										lb/day					
Hauling	3.1542	112.0544	23.4482	0.2699	6.1673	0.6160	6.7833	1.6883	0.5893	2.2776		29,361.9030	29,361.9030	2.9732		29,436.2326
Vendor	0.0000	0.0000	0.0000	0.0000	0.0000	0.0000	0.0000	0.0000	0.0000	0.0000		0.0000	0.0000	0.0000		0.0000
Worker	0.0485	0.0326	0.3306	8.1000e-004	0.0822	6.0000e-004	0.0827	0.0218	5.5000e-004	0.0223		80.1742	80.1742	2.5700e-003		80.2384
<b>Total</b>	<b>3.2027</b>	<b>112.0870</b>	<b>23.7788</b>	<b>0.2707</b>	<b>6.2495</b>	<b>0.6166</b>	<b>6.8660</b>	<b>1.7101</b>	<b>0.5899</b>	<b>2.3000</b>		<b>29,442.0771</b>	<b>29,442.0771</b>	<b>2.9758</b>		<b>29,516.4710</b>

**3.5 Building Construction - 2018**

**Baseline Construction On-Site**

	ROG	NOx	CO	SO2	Fugitive PM10	Exhaust PM10	PM10 Total	Fugitive PM2.5	Exhaust PM2.5	PM2.5 Total	Bio- CO2	NBio- CO2	Total CO2	CH4	N2O	CO2e
Category	lb/day										lb/day					
Off-Road	2.9127	20.7077	15.7183	0.0250		1.2575	1.2575		1.2051	1.2051		2,329.7759	2,329.7759	0.5019		2,342.3232
<b>Total</b>	<b>2.9127</b>	<b>20.7077</b>	<b>15.7183</b>	<b>0.0250</b>		<b>1.2575</b>	<b>1.2575</b>		<b>1.2051</b>	<b>1.2051</b>		<b>2,329.7759</b>	<b>2,329.7759</b>	<b>0.5019</b>		<b>2,342.3232</b>

**Baseline Construction Off-Site**

	ROG	NOx	CO	SO2	Fugitive PM10	Exhaust PM10	PM10 Total	Fugitive PM2.5	Exhaust PM2.5	PM2.5 Total	Bio- CO2	NBio- CO2	Total CO2	CH4	N2O	CO2e
--	-----	-----	----	-----	---------------	--------------	------------	----------------	---------------	-------------	----------	-----------	-----------	-----	-----	------

Category	lb/day										lb/day				
Hauling	0.0000	0.0000	0.0000	0.0000	0.0000	0.0000	0.0000	0.0000	0.0000	0.0000	0.0000	0.0000	0.0000	0.0000	0.0000
Vendor	0.2450	6.5837	1.9373	0.0133	0.3514	0.0595	0.4110	0.1011	0.0569	0.1581	1,421.1632	1,421.1632	0.1347		1,424.5315
Worker	1.0385	0.6971	7.0750	0.0172	1.7580	0.0128	1.7707	0.4663	0.0118	0.4781	1,715.7273	1,715.7273	0.0550		1,717.1017
<b>Total</b>	<b>1.2834</b>	<b>7.2808</b>	<b>9.0122</b>	<b>0.0305</b>	<b>2.1094</b>	<b>0.0723</b>	<b>2.1817</b>	<b>0.5674</b>	<b>0.0687</b>	<b>0.6361</b>	<b>3,136.8905</b>	<b>3,136.8905</b>	<b>0.1897</b>		<b>3,141.6332</b>

**Regulatory Compliance Construction On-Site**

	ROG	NOx	CO	SO2	Fugitive PM10	Exhaust PM10	PM10 Total	Fugitive PM2.5	Exhaust PM2.5	PM2.5 Total	Bio- CO2	NBio- CO2	Total CO2	CH4	N2O	CO2e
Category	lb/day										lb/day					
Off-Road	0.9471	20.0464	15.4081	0.0250		0.8178	0.8178		0.8178	0.8178	0.0000	2,329.7759	2,329.7759	0.5019		2,342.3232
<b>Total</b>	<b>0.9471</b>	<b>20.0464</b>	<b>15.4081</b>	<b>0.0250</b>		<b>0.8178</b>	<b>0.8178</b>		<b>0.8178</b>	<b>0.8178</b>	<b>0.0000</b>	<b>2,329.7759</b>	<b>2,329.7759</b>	<b>0.5019</b>		<b>2,342.3232</b>

**Regulatory Compliance Construction Off-Site**

	ROG	NOx	CO	SO2	Fugitive PM10	Exhaust PM10	PM10 Total	Fugitive PM2.5	Exhaust PM2.5	PM2.5 Total	Bio- CO2	NBio- CO2	Total CO2	CH4	N2O	CO2e
Category	lb/day										lb/day					
Hauling	0.0000	0.0000	0.0000	0.0000	0.0000	0.0000	0.0000	0.0000	0.0000	0.0000		0.0000	0.0000	0.0000		0.0000
Vendor	0.2450	6.5837	1.9373	0.0133	0.3514	0.0595	0.4110	0.1011	0.0569	0.1581	1,421.1632	1,421.1632	0.1347			1,424.5315
Worker	1.0385	0.6971	7.0750	0.0172	1.7580	0.0128	1.7707	0.4663	0.0118	0.4781	1,715.7273	1,715.7273	0.0550			1,717.1017

<b>Total</b>	<b>1.2834</b>	<b>7.2808</b>	<b>9.0122</b>	<b>0.0305</b>	<b>2.1094</b>	<b>0.0723</b>	<b>2.1817</b>	<b>0.5674</b>	<b>0.0687</b>	<b>0.6361</b>		<b>3,136.8905</b>	<b>3,136.8905</b>	<b>0.1897</b>		<b>3,141.6332</b>
--------------	---------------	---------------	---------------	---------------	---------------	---------------	---------------	---------------	---------------	---------------	--	-------------------	-------------------	---------------	--	-------------------

### 3.5 Building Construction - 2019

#### Baseline Construction On-Site

	ROG	NOx	CO	SO2	Fugitive PM10	Exhaust PM10	PM10 Total	Fugitive PM2.5	Exhaust PM2.5	PM2.5 Total	Bio- CO2	NBio- CO2	Total CO2	CH4	N2O	CO2e
<b>Category</b>	<b>lb/day</b>										<b>lb/day</b>					
Off-Road	2.5581	18.9103	15.2545	0.0250		1.0901	1.0901		1.0449	1.0449		2,312.1454	2,312.1454	0.4810		2,324.1705
<b>Total</b>	<b>2.5581</b>	<b>18.9103</b>	<b>15.2545</b>	<b>0.0250</b>		<b>1.0901</b>	<b>1.0901</b>		<b>1.0449</b>	<b>1.0449</b>		<b>2,312.1454</b>	<b>2,312.1454</b>	<b>0.4810</b>		<b>2,324.1705</b>

#### Baseline Construction Off-Site

	ROG	NOx	CO	SO2	Fugitive PM10	Exhaust PM10	PM10 Total	Fugitive PM2.5	Exhaust PM2.5	PM2.5 Total	Bio- CO2	NBio- CO2	Total CO2	CH4	N2O	CO2e
<b>Category</b>	<b>lb/day</b>										<b>lb/day</b>					
Hauling	0.0000	0.0000	0.0000	0.0000	0.0000	0.0000	0.0000	0.0000	0.0000	0.0000		0.0000	0.0000	0.0000		0.0000
Vendor	0.2233	6.1980	1.7952	0.0132	0.3515	0.0512	0.4027	0.1011	0.0490	0.1502		1,413.9399	1,413.9399	0.1300		1,417.1902
Worker	0.9532	0.6169	6.3520	0.0168	1.7580	0.0127	1.7706	0.4663	0.0117	0.4780		1,669.2384	1,669.2384	0.0492		1,670.4686
<b>Total</b>	<b>1.1765</b>	<b>6.8149</b>	<b>8.1473</b>	<b>0.0300</b>	<b>2.1094</b>	<b>0.0639</b>	<b>2.1733</b>	<b>0.5674</b>	<b>0.0607</b>	<b>0.6281</b>		<b>3,083.1783</b>	<b>3,083.1783</b>	<b>0.1792</b>		<b>3,087.6587</b>

#### Regulatory Compliance Construction On-Site

	ROG	NOx	CO	SO2	Fugitive PM10	Exhaust PM10	PM10 Total	Fugitive PM2.5	Exhaust PM2.5	PM2.5 Total	Bio- CO2	NBio- CO2	Total CO2	CH4	N2O	CO2e
Category	lb/day										lb/day					
Off-Road	0.9471	20.0464	15.4081	0.0250		0.8178	0.8178		0.8178	0.8178	0.0000	2,312.1454	2,312.1454	0.4810		2,324.1705
<b>Total</b>	<b>0.9471</b>	<b>20.0464</b>	<b>15.4081</b>	<b>0.0250</b>		<b>0.8178</b>	<b>0.8178</b>		<b>0.8178</b>	<b>0.8178</b>	<b>0.0000</b>	<b>2,312.1454</b>	<b>2,312.1454</b>	<b>0.4810</b>		<b>2,324.1705</b>

**Regulatory Compliance Construction Off-Site**

	ROG	NOx	CO	SO2	Fugitive PM10	Exhaust PM10	PM10 Total	Fugitive PM2.5	Exhaust PM2.5	PM2.5 Total	Bio- CO2	NBio- CO2	Total CO2	CH4	N2O	CO2e
Category	lb/day										lb/day					
Hauling	0.0000	0.0000	0.0000	0.0000	0.0000	0.0000	0.0000	0.0000	0.0000	0.0000		0.0000	0.0000	0.0000		0.0000
Vendor	0.2233	6.1980	1.7952	0.0132	0.3515	0.0512	0.4027	0.1011	0.0490	0.1502		1,413.9399	1,413.9399	0.1300		1,417.1902
Worker	0.9532	0.6169	6.3520	0.0168	1.7580	0.0127	1.7706	0.4663	0.0117	0.4780		1,669.2384	1,669.2384	0.0492		1,670.4686
<b>Total</b>	<b>1.1765</b>	<b>6.8149</b>	<b>8.1473</b>	<b>0.0300</b>	<b>2.1094</b>	<b>0.0639</b>	<b>2.1733</b>	<b>0.5674</b>	<b>0.0607</b>	<b>0.6281</b>		<b>3,083.1783</b>	<b>3,083.1783</b>	<b>0.1792</b>		<b>3,087.6587</b>

**3.6 Paving - 2019**

**Baseline Construction On-Site**

	ROG	NOx	CO	SO2	Fugitive PM10	Exhaust PM10	PM10 Total	Fugitive PM2.5	Exhaust PM2.5	PM2.5 Total	Bio- CO2	NBio- CO2	Total CO2	CH4	N2O	CO2e
Category	lb/day										lb/day					

Off-Road	1.2453	12.5685	11.8507	0.0178		0.7301	0.7301		0.6728	0.6728		1,746.2432	1,746.2432	0.5418		1,759.7870
Paving	0.0000					0.0000	0.0000		0.0000	0.0000			0.0000			0.0000
<b>Total</b>	<b>1.2453</b>	<b>12.5685</b>	<b>11.8507</b>	<b>0.0178</b>		<b>0.7301</b>	<b>0.7301</b>		<b>0.6728</b>	<b>0.6728</b>		<b>1,746.2432</b>	<b>1,746.2432</b>	<b>0.5418</b>		<b>1,759.7870</b>

**Baseline Construction Off-Site**

	ROG	NOx	CO	SO2	Fugitive PM10	Exhaust PM10	PM10 Total	Fugitive PM2.5	Exhaust PM2.5	PM2.5 Total	Bio- CO2	NBio- CO2	Total CO2	CH4	N2O	CO2e
Category	lb/day										lb/day					
Hauling	0.0000	0.0000	0.0000	0.0000	0.0000	0.0000	0.0000	0.0000	0.0000	0.0000		0.0000	0.0000	0.0000		0.0000
Vendor	0.0000	0.0000	0.0000	0.0000	0.0000	0.0000	0.0000	0.0000	0.0000	0.0000		0.0000	0.0000	0.0000		0.0000
Worker	0.0668	0.0432	0.4452	1.1800e-003	0.1232	8.9000e-004	0.1241	0.0327	8.2000e-004	0.0335		117.0027	117.0027	3.4500e-003		117.0889
<b>Total</b>	<b>0.0668</b>	<b>0.0432</b>	<b>0.4452</b>	<b>1.1800e-003</b>	<b>0.1232</b>	<b>8.9000e-004</b>	<b>0.1241</b>	<b>0.0327</b>	<b>8.2000e-004</b>	<b>0.0335</b>		<b>117.0027</b>	<b>117.0027</b>	<b>3.4500e-003</b>		<b>117.0889</b>

**Regulatory Compliance Construction On-Site**

	ROG	NOx	CO	SO2	Fugitive PM10	Exhaust PM10	PM10 Total	Fugitive PM2.5	Exhaust PM2.5	PM2.5 Total	Bio- CO2	NBio- CO2	Total CO2	CH4	N2O	CO2e
Category	lb/day										lb/day					
Off-Road	0.7344	15.6108	12.9737	0.0178		0.5580	0.5580		0.5580	0.5580	0.0000	1,746.2432	1,746.2432	0.5418		1,759.7870
Paving	0.0000					0.0000	0.0000		0.0000	0.0000			0.0000			0.0000
<b>Total</b>	<b>0.7344</b>	<b>15.6108</b>	<b>12.9737</b>	<b>0.0178</b>		<b>0.5580</b>	<b>0.5580</b>		<b>0.5580</b>	<b>0.5580</b>	<b>0.0000</b>	<b>1,746.2432</b>	<b>1,746.2432</b>	<b>0.5418</b>		<b>1,759.7870</b>

**Regulatory Compliance Construction Off-Site**

	ROG	NOx	CO	SO2	Fugitive PM10	Exhaust PM10	PM10 Total	Fugitive PM2.5	Exhaust PM2.5	PM2.5 Total	Bio- CO2	NBio- CO2	Total CO2	CH4	N2O	CO2e
Category	lb/day										lb/day					
Hauling	0.0000	0.0000	0.0000	0.0000	0.0000	0.0000	0.0000	0.0000	0.0000	0.0000		0.0000	0.0000	0.0000		0.0000
Vendor	0.0000	0.0000	0.0000	0.0000	0.0000	0.0000	0.0000	0.0000	0.0000	0.0000		0.0000	0.0000	0.0000		0.0000
Worker	0.0668	0.0432	0.4452	1.1800e-003	0.1232	8.9000e-004	0.1241	0.0327	8.2000e-004	0.0335		117.0027	117.0027	3.4500e-003		117.0889
<b>Total</b>	<b>0.0668</b>	<b>0.0432</b>	<b>0.4452</b>	<b>1.1800e-003</b>	<b>0.1232</b>	<b>8.9000e-004</b>	<b>0.1241</b>	<b>0.0327</b>	<b>8.2000e-004</b>	<b>0.0335</b>		<b>117.0027</b>	<b>117.0027</b>	<b>3.4500e-003</b>		<b>117.0889</b>

**3.7 Architectural Coating - 2018**

**Baseline Construction On-Site**

	ROG	NOx	CO	SO2	Fugitive PM10	Exhaust PM10	PM10 Total	Fugitive PM2.5	Exhaust PM2.5	PM2.5 Total	Bio- CO2	NBio- CO2	Total CO2	CH4	N2O	CO2e
Category	lb/day										lb/day					
Archit. Coating	77.6428					0.0000	0.0000		0.0000	0.0000			0.0000			0.0000
Off-Road	0.2986	2.0058	1.8542	2.9700e-003		0.1506	0.1506		0.1506	0.1506		281.4485	281.4485	0.0267		282.1171
<b>Total</b>	<b>77.9415</b>	<b>2.0058</b>	<b>1.8542</b>	<b>2.9700e-003</b>		<b>0.1506</b>	<b>0.1506</b>		<b>0.1506</b>	<b>0.1506</b>		<b>281.4485</b>	<b>281.4485</b>	<b>0.0267</b>		<b>282.1171</b>

**Baseline Construction Off-Site**

	ROG	NOx	CO	SO2	Fugitive PM10	Exhaust PM10	PM10 Total	Fugitive PM2.5	Exhaust PM2.5	PM2.5 Total	Bio- CO2	NBio- CO2	Total CO2	CH4	N2O	CO2e
--	-----	-----	----	-----	---------------	--------------	------------	----------------	---------------	-------------	----------	-----------	-----------	-----	-----	------

Category	lb/day										lb/day					
Hauling	0.0000	0.0000	0.0000	0.0000	0.0000	0.0000	0.0000	0.0000	0.0000	0.0000	0.0000	0.0000	0.0000	0.0000	0.0000	0.0000
Vendor	0.0000	0.0000	0.0000	0.0000	0.0000	0.0000	0.0000	0.0000	0.0000	0.0000	0.0000	0.0000	0.0000	0.0000	0.0000	0.0000
Worker	0.2087	0.1401	1.4216	3.4600e-003	0.3532	2.5600e-003	0.3558	0.0937	2.3600e-003	0.0961		344.7490	344.7490	0.0111		345.0251
<b>Total</b>	<b>0.2087</b>	<b>0.1401</b>	<b>1.4216</b>	<b>3.4600e-003</b>	<b>0.3532</b>	<b>2.5600e-003</b>	<b>0.3558</b>	<b>0.0937</b>	<b>2.3600e-003</b>	<b>0.0961</b>		<b>344.7490</b>	<b>344.7490</b>	<b>0.0111</b>		<b>345.0251</b>

**Regulatory Compliance Construction On-Site**

Category	ROG	NOx	CO	SO2	Fugitive PM10	Exhaust PM10	PM10 Total	Fugitive PM2.5	Exhaust PM2.5	PM2.5 Total	Bio- CO2	NBio- CO2	Total CO2	CH4	N2O	CO2e
Category	lb/day										lb/day					
Archit. Coating	77.6428					0.0000	0.0000		0.0000	0.0000			0.0000			0.0000
Off-Road	0.1139	2.3524	1.8324	2.9700e-003		0.0951	0.0951		0.0951	0.0951	0.0000	281.4485	281.4485	0.0267		282.1171
<b>Total</b>	<b>77.7567</b>	<b>2.3524</b>	<b>1.8324</b>	<b>2.9700e-003</b>		<b>0.0951</b>	<b>0.0951</b>		<b>0.0951</b>	<b>0.0951</b>	<b>0.0000</b>	<b>281.4485</b>	<b>281.4485</b>	<b>0.0267</b>		<b>282.1171</b>

**Regulatory Compliance Construction Off-Site**

Category	ROG	NOx	CO	SO2	Fugitive PM10	Exhaust PM10	PM10 Total	Fugitive PM2.5	Exhaust PM2.5	PM2.5 Total	Bio- CO2	NBio- CO2	Total CO2	CH4	N2O	CO2e
Category	lb/day										lb/day					
Hauling	0.0000	0.0000	0.0000	0.0000	0.0000	0.0000	0.0000	0.0000	0.0000	0.0000		0.0000	0.0000	0.0000		0.0000
Vendor	0.0000	0.0000	0.0000	0.0000	0.0000	0.0000	0.0000	0.0000	0.0000	0.0000		0.0000	0.0000	0.0000		0.0000
Worker	0.2087	0.1401	1.4216	3.4600e-003	0.3532	2.5600e-003	0.3558	0.0937	2.3600e-003	0.0961		344.7490	344.7490	0.0111		345.0251

<b>Total</b>	<b>0.2087</b>	<b>0.1401</b>	<b>1.4216</b>	<b>3.4600e-003</b>	<b>0.3532</b>	<b>2.5600e-003</b>	<b>0.3558</b>	<b>0.0937</b>	<b>2.3600e-003</b>	<b>0.0961</b>		<b>344.7490</b>	<b>344.7490</b>	<b>0.0111</b>		<b>345.0251</b>
--------------	---------------	---------------	---------------	--------------------	---------------	--------------------	---------------	---------------	--------------------	---------------	--	-----------------	-----------------	---------------	--	-----------------

### 3.7 Architectural Coating - 2019

#### Baseline Construction On-Site

	ROG	NOx	CO	SO2	Fugitive PM10	Exhaust PM10	PM10 Total	Fugitive PM2.5	Exhaust PM2.5	PM2.5 Total	Bio- CO2	NBio- CO2	Total CO2	CH4	N2O	CO2e	
<b>Category</b>	<b>lb/day</b>										<b>lb/day</b>						
Archit. Coating	77.6428					0.0000	0.0000		0.0000	0.0000			0.0000			0.0000	
Off-Road	0.2664	1.8354	1.8413	2.9700e-003		0.1288	0.1288		0.1288	0.1288			281.4481	281.4481	0.0238		282.0423
<b>Total</b>	<b>77.9093</b>	<b>1.8354</b>	<b>1.8413</b>	<b>2.9700e-003</b>		<b>0.1288</b>	<b>0.1288</b>		<b>0.1288</b>	<b>0.1288</b>			<b>281.4481</b>	<b>281.4481</b>	<b>0.0238</b>		<b>282.0423</b>

#### Baseline Construction Off-Site

	ROG	NOx	CO	SO2	Fugitive PM10	Exhaust PM10	PM10 Total	Fugitive PM2.5	Exhaust PM2.5	PM2.5 Total	Bio- CO2	NBio- CO2	Total CO2	CH4	N2O	CO2e	
<b>Category</b>	<b>lb/day</b>										<b>lb/day</b>						
Hauling	0.0000	0.0000	0.0000	0.0000	0.0000	0.0000	0.0000	0.0000	0.0000	0.0000			0.0000	0.0000		0.0000	
Vendor	0.0000	0.0000	0.0000	0.0000	0.0000	0.0000	0.0000	0.0000	0.0000	0.0000			0.0000	0.0000		0.0000	
Worker	0.1915	0.1240	1.2763	3.3700e-003	0.3532	2.5400e-003	0.3558	0.0937	2.3400e-003	0.0960			335.4077	335.4077	9.8900e-003		335.6549
<b>Total</b>	<b>0.1915</b>	<b>0.1240</b>	<b>1.2763</b>	<b>3.3700e-003</b>	<b>0.3532</b>	<b>2.5400e-003</b>	<b>0.3558</b>	<b>0.0937</b>	<b>2.3400e-003</b>	<b>0.0960</b>			<b>335.4077</b>	<b>335.4077</b>	<b>9.8900e-003</b>		<b>335.6549</b>

#### Regulatory Compliance Construction On-Site



	ROG	NOx	CO	SO2	Fugitive PM10	Exhaust PM10	PM10 Total	Fugitive PM2.5	Exhaust PM2.5	PM2.5 Total	Bio- CO2	NBio- CO2	Total CO2	CH4	N2O	CO2e
Category	lb/day										lb/day					
Archit. Coating	77.6428					0.0000	0.0000		0.0000	0.0000			0.0000			0.0000
Off-Road	0.1139	2.3524	1.8324	2.9700e-003		0.0951	0.0951		0.0951	0.0951	0.0000	281.4481	281.4481	0.0238		282.0423
<b>Total</b>	<b>77.7567</b>	<b>2.3524</b>	<b>1.8324</b>	<b>2.9700e-003</b>		<b>0.0951</b>	<b>0.0951</b>		<b>0.0951</b>	<b>0.0951</b>	<b>0.0000</b>	<b>281.4481</b>	<b>281.4481</b>	<b>0.0238</b>		<b>282.0423</b>

### Regulatory Compliance Construction Off-Site

	ROG	NOx	CO	SO2	Fugitive PM10	Exhaust PM10	PM10 Total	Fugitive PM2.5	Exhaust PM2.5	PM2.5 Total	Bio- CO2	NBio- CO2	Total CO2	CH4	N2O	CO2e
Category	lb/day										lb/day					
Hauling	0.0000	0.0000	0.0000	0.0000	0.0000	0.0000	0.0000	0.0000	0.0000	0.0000		0.0000	0.0000	0.0000		0.0000
Vendor	0.0000	0.0000	0.0000	0.0000	0.0000	0.0000	0.0000	0.0000	0.0000	0.0000		0.0000	0.0000	0.0000		0.0000
Worker	0.1915	0.1240	1.2763	3.3700e-003	0.3532	2.5400e-003	0.3558	0.0937	2.3400e-003	0.0960		335.4077	335.4077	9.8900e-003		335.6549
<b>Total</b>	<b>0.1915</b>	<b>0.1240</b>	<b>1.2763</b>	<b>3.3700e-003</b>	<b>0.3532</b>	<b>2.5400e-003</b>	<b>0.3558</b>	<b>0.0937</b>	<b>2.3400e-003</b>	<b>0.0960</b>		<b>335.4077</b>	<b>335.4077</b>	<b>9.8900e-003</b>		<b>335.6549</b>

## 4.0 Operational Detail - Mobile

### 4.1 Mitigation Measures Mobile

	ROG	NOx	CO	SO2	Fugitive PM10	Exhaust PM10	PM10 Total	Fugitive PM2.5	Exhaust PM2.5	PM2.5 Total	Bio- CO2	NBio- CO2	Total CO2	CH4	N2O	CO2e
Category	lb/day										lb/day					
Regulatory Compliance	3.4482	5.7688	34.4890	0.0715	7.0396	0.0628	7.1024	1.8760	0.0586	1.9345		7,150.5574	7,150.5574	0.4927		7,162.8757
Baseline	3.4482	5.7688	34.4890	0.0715	7.0396	0.0628	7.1024	1.8760	0.0586	1.9345		7,150.5574	7,150.5574	0.4927		7,162.8757

#### 4.2 Trip Summary Information

Land Use	Average Daily Trip Rate			Baseline	Regulatory Compliance
	Weekday	Saturday	Sunday	Annual VMT	Annual VMT
Condo/Townhouse	1,057.42	1,031.94	880.88	2,841,986	2,841,986
Enclosed Parking with Elevator	0.00	0.00	0.00		
General Office Building	175.92	37.15	15.86	318,375	318,375
Total	1,233.34	1,069.09	896.74	3,160,361	3,160,361

#### 4.3 Trip Type Information

Land Use	Miles			Trip %			Trip Purpose %		
	H-W or C-W	H-S or C-C	H-O or C-NW	H-W or C-W	H-S or C-C	H-O or C-NW	Primary	Diverted	Pass-by
Condo/Townhouse	10.80	7.30	7.50	32.90	18.00	49.10	86	11	3
Enclosed Parking with Elevator	9.50	7.30	7.30	0.00	0.00	0.00	0	0	0
General Office Building	9.50	7.30	7.30	33.00	48.00	19.00	77	19	4

#### 4.4 Fleet Mix

Land Use	LDA	LDT1	LDT2	MDV	LHD1	LHD2	MHD	HHD	OBUS	UBUS	MCY	SBUS	MH
General Office Building	0.572490	0.044826	0.170628	0.127143	0.022859	0.006230	0.012809	0.005255	0.000798	0.000322	0.029094	0.000351	0.007194
Enclosed Parking with Elevator	0.572490	0.044826	0.170628	0.127143	0.022859	0.006230	0.012809	0.005255	0.000798	0.000322	0.029094	0.000351	0.007194
Condo/Townhouse	0.572490	0.044826	0.170628	0.127143	0.022859	0.006230	0.012809	0.005255	0.000798	0.000322	0.029094	0.000351	0.007194

## 5.0 Energy Detail

Historical Energy Use: N

### 5.1 Mitigation Measures Energy

Exceed Title 24

Install High Efficiency Lighting

	ROG	NOx	CO	SO2	Fugitive PM10	Exhaust PM10	PM10 Total	Fugitive PM2.5	Exhaust PM2.5	PM2.5 Total	Bio- CO2	NBio- CO2	Total CO2	CH4	N2O	CO2e
Category	lb/day										lb/day					
NaturalGas Regulatory	0.1034	0.8852	0.3899	5.6400e-003		0.0714	0.0714		0.0714	0.0714		1,127.5554	1,127.5554	0.0216	0.0207	1,134.2559
NaturalGas Baseline	0.1163	0.9963	0.4394	6.3400e-003		0.0804	0.0804		0.0804	0.0804		1,268.9608	1,268.9608	0.0243	0.0233	1,276.5016

### 5.2 Energy by Land Use - NaturalGas

#### Baseline

	NaturalGas Use	ROG	NOx	CO	SO2	Fugitive PM10	Exhaust PM10	PM10 Total	Fugitive PM2.5	Exhaust PM2.5	PM2.5 Total	Bio- CO2	NBio- CO2	Total CO2	CH4	N2O	CO2e
Land Use	kBTU/yr	lb/day										lb/day					
Condo/Townhouse	10406.4	0.1122	0.9590	0.4081	6.1200e-003		0.0775	0.0775		0.0775	0.0775		1,224.2813	1,224.2813	0.0235	0.0225	1,231.5566
Enclosed Parking with Elevator	0	0.0000	0.0000	0.0000	0.0000		0.0000	0.0000		0.0000	0.0000		0.0000	0.0000	0.0000	0.0000	0.0000
General Office Building	379.775	4.1000e-003	0.0372	0.0313	2.2000e-004		2.8300e-003	2.8300e-003		2.8300e-003	2.8300e-003		44.6795	44.6795	8.6000e-004	8.2000e-004	44.9450





Landscaping	0.4605	0.1742	15.0969	8.0000e-004		0.0831	0.0831		0.0831	0.0831		27.1412	27.1412	0.0265		27.8031
<b>Total</b>	<b>8.7338</b>	<b>0.1742</b>	<b>15.0969</b>	<b>8.0000e-004</b>		<b>0.0831</b>	<b>0.0831</b>		<b>0.0831</b>	<b>0.0831</b>	<b>0.0000</b>	<b>27.1412</b>	<b>27.1412</b>	<b>0.0265</b>	<b>0.0000</b>	<b>27.8031</b>

## 7.0 Water Detail

### 7.1 Mitigation Measures Water

- Install Low Flow Bathroom Faucet
- Install Low Flow Kitchen Faucet
- Install Low Flow Toilet
- Install Low Flow Shower
- Use Water Efficient Irrigation System

## 8.0 Waste Detail

### 8.1 Mitigation Measures Waste

## 9.0 Operational Offroad

Equipment Type	Number	Hours/Day	Days/Year	Horse Power	Load Factor	Fuel Type
----------------	--------	-----------	-----------	-------------	-------------	-----------

## 10.0 Stationary Equipment

### Fire Pumps and Emergency Generators

Equipment Type	Number	Hours/Day	Hours/Year	Horse Power	Load Factor	Fuel Type
----------------	--------	-----------	------------	-------------	-------------	-----------

### Boilers

Equipment Type	Number	Heat Input/Day	Heat Input/Year	Boiler Rating	Fuel Type
----------------	--------	----------------	-----------------	---------------	-----------

### User Defined Equipment

Equipment Type	Number
----------------	--------

## 11.0 Vegetation



# Appendix B

---

Health Risk Assessment of Diesel Emissions



# **Rio Urbana Mixed Use**

## **Health Risk Assessment of Diesel Emissions**

Prepared by:

Meridian Consultants LLC  
910 Hampshire Road, Suite V  
Westlake Village, California, 91361

**July 2017**



## Table of Contents

Section	Page
Executive Summary.....	1
Introduction .....	1
Project Description.....	1
Health Risk Assessment .....	5
Introduction .....	5
Significance Criteria .....	7
Freeway Exposure Health Risk and Hazards .....	7
Criteria Pollutant Exposures .....	7
Recommendations .....	10
Conclusion.....	12

### Appendices

- A     Methodology
- B     Emission Factor Rates/Mobile Emissions/Chronic and Acute Exposure/Caltrans Traffic Volume
- C     EMFAC2014 Worksheets
- D     Health Risk Calculations

### Figures

Figure	Page
1     Regional Location Map .....	3
2     Sensitive Receptor Locations .....	4

### Tables

Table	Page
1     Traffic Volumes .....	6
2     Estimated Inhalation Cancer Risk and Chronic Hazards .....	7
3     California Ambient Air Quality Standards .....	8
4     Ventura County–Oxnard Monitoring Summary.....	9
5     Air Quality Significance Thresholds.....	10
6     Reduced Estimated Inhalation Cancer Risk .....	12

## EXECUTIVE SUMMARY

This Health Risk Assessment (HRA) assesses potential health risk impacts on future residents from exposure to diesel emissions generated by vehicles on the US Route 101 (US 101) freeway. The AERMOD dispersion model was used to determine concentrations of diesel particulate matter generated by US 101 at the Project area. The AERMOD model takes into account both terrain and atmospheric conditions.

This study identifies the level of air filtration required in the heating ventilating and air conditioning (HVAC) system. Limiting particulate infiltration can be accomplished by installing and maintain air filtration systems with a minimum efficiency reporting value (MERV) 9 or higher as defined by the American Society of Heating, Refrigerating and Air Conditioning Engineers (ASHRAE) Standard 52.2. These filters are rated to remove a portion of the ultrafine and submicron particles, such as diesel particulate matter emitted from mobile sources.

With installation of MERV 9 or higher filters, potential cancer risks would be well below the significant criterion of 10 per 1 million, depending on the amount of time a resident has the window open and the level of MERV filtration added.

## INTRODUCTION

This HRA has been prepared for the Rio Urbana Mixed-Use Project (“Project”) to assess potential health risk impacts on future residents from exposure to diesel emissions generated by vehicles on US 101. Based on the California Air Resources Board’s (CARB) *Air Quality and Land Use Handbook: A Community Perspective*, siting sensitive land uses such as residential uses close to freeways and high-traffic roads can increase the potential for adverse health effects.<sup>1</sup> The Project consists of the construction of a mixed-use development that includes 182 condominium residential units and a 15,000-square-foot building containing the Rio School District administrative offices.

## PROJECT LOCATION

The Project is located in the City of Oxnard (“City”), within the Ventura County Air Pollution Control District (VCAPCD), as shown in **Figure 1, Regional Location Map**. Regional access to the Project site is provided by the Ventura Freeway (US 101). The Project site consists of the two parcels bounded by Rio School Lane and E. Vineyard Avenue. Surrounding uses include residential development to the north and west, commercial development to the south, and industrial uses to the east. The US 101 freeway corridor and the E. Vineyard Boulevard US 101 northbound off-ramp are located approximately 1,250 feet and 925 feet

---

1 California Air Resources Board, *Air Quality and Land Use Handbook: A Community Health Perspective* (April 2005).

to the south of the Project site, respectively. The US 101 is situated approximately 7 feet lower than the Project site.

## **PROJECT DESCRIPTION**

The Project site is currently developed with numerous vacant buildings (cafeteria, administration, classrooms, and two portable buildings) that made up the former El Rio Elementary School campus, as shown in **Figure 2, Project Site Aerial**. The proposed Project would involve the demolition of the existing uses to allow the construction of a new mixed-use development that includes 182 condominium residential units and a 15,000-square-foot building containing the Rio School District Administrative Offices.

Construction would occur during the first quarter of 2018, with Project building occupancy expected in 2020.

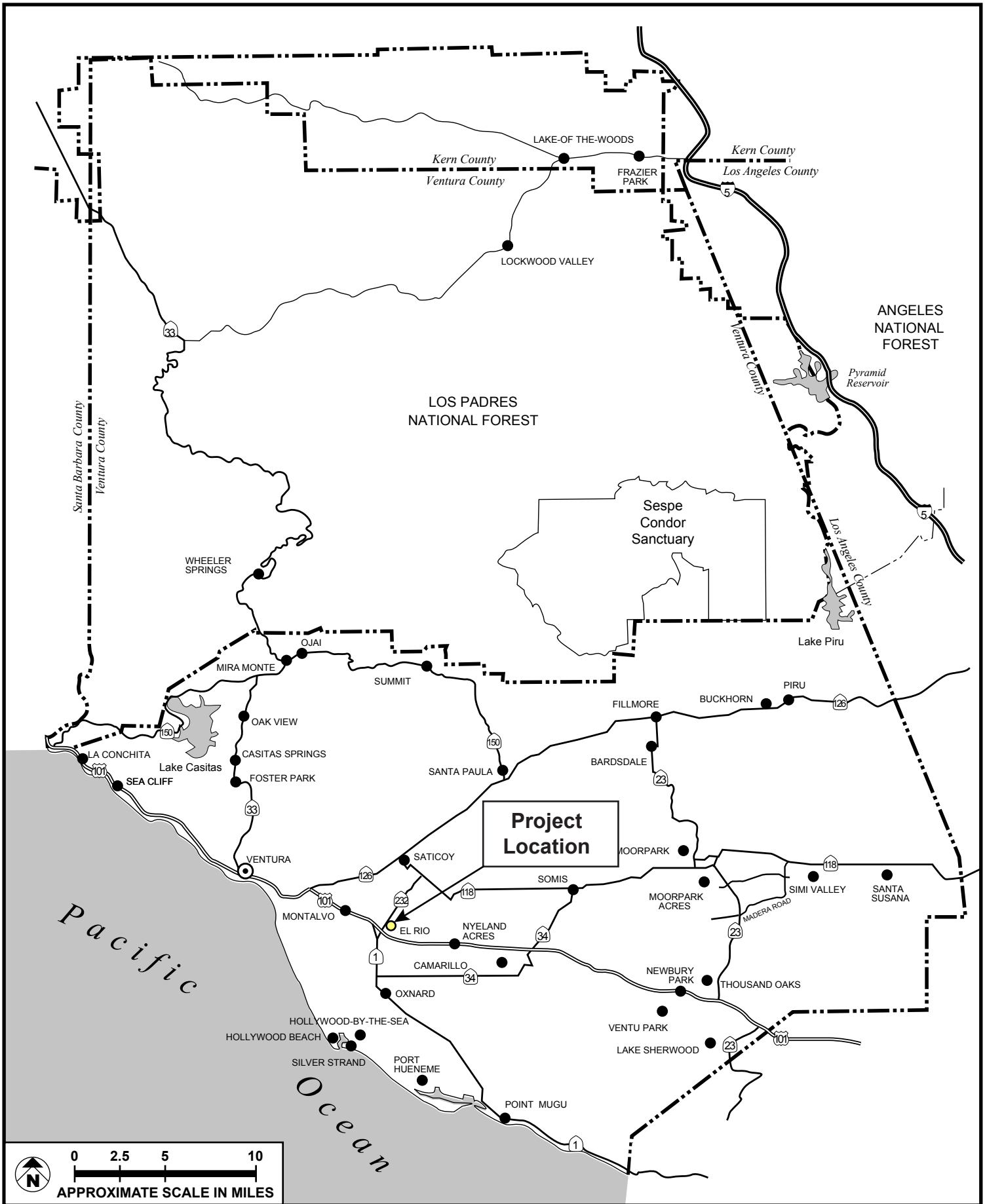

SOURCE: Meridian Consultants, LLC - July 2017

FIGURE 1





SOURCE: Google Earth - 2017

FIGURE 2



# HEALTH RISK ASSESSMENT

## Introduction

The primary toxic air contaminant (TAC) of concern from diesel exhaust is diesel particulate matter (DPM). In 1998, CARB identified DPM from diesel-powered engines as a TAC based on its potential to result in an increased cancer risk, as well as other noncancer adverse health effects, due to prolonged exposure. Some short-term (acute) effects of DPM exposure include eye, nose, throat, and lung irritation; coughs; headaches; light-headedness; and nausea. Long-term (chronic) effects include aggravation of existing respiratory and cardiovascular disease; alteration in the body's defense systems against foreign materials; damage to lung tissue and reduced lung function; carcinogenesis; premature birth rates; and premature death.

TAC generators located with the South Central Coast Air Basin are associated with diesel-fueled vehicles producing DPM, as well as with specific types of facilities, such as dry cleaners, gas stations, distribution centers, and ports. The CARB has made specific recommendations with respect to siting new sensitive uses near existing TAC-emitting facilities. Among other specific recommendations, CARB suggests siting sensitive receptors (such as residences) no less than 500 feet from freeways or major roadways.

This HRA evaluates the potential for increased health risks to future residents of the proposed Project resulting from exposure to diesel exhaust emissions (a TAC) generated by vehicles on the US 101 freeway and E. Vineyard Boulevard US 101 northbound off-ramp, which are located approximately 1,250 feet and 925 feet south of the Project site, respectively. Because the Project is not located within the buffer distance of any other major TAC-emitting facilities, this HRA is limited to the impacts from DPM associated with the US 101 freeway.

Average daily trips for the analyzed segments are presented in **Table 1, Traffic Volumes**. As shown in **Table 1**, annual average daily trips along this segment of US 101 is approximately 140,000 vehicles.<sup>2</sup> Of these, 6,635 annual average daily trips are contributed by trucks.<sup>3</sup>

---

2 Caltrans, "2015 Traffic Volumes (for all Vehicles on California State Highways), Postmile 22.006." Available at [http://www.dot.ca.gov/trafficops/census/docs/2015\\_aadt\\_volumes.pdf](http://www.dot.ca.gov/trafficops/census/docs/2015_aadt_volumes.pdf).

3 Caltrans, "2015 Annual Average Daily Truck Traffic, Postmile 22.006." Available at [http://www.dot.ca.gov/trafficops/census/docs/2015\\_aadt\\_truck.pdf](http://www.dot.ca.gov/trafficops/census/docs/2015_aadt_truck.pdf)

**Table 1**  
**Traffic Volumes**

Segment	Annual Average Daily Trips
US-101 NB	140,000
US-101 SB	140,000
US-101 SB on from NB Vineyard Ave	9,701
US 101 NB off to Vineyard Ave	9,501
US-101 NB on from SB Vineyard Ave	4,201
US-101 SB off to Vineyard Ave	5,901

*Sources:*

*Caltrans, "2015 Traffic Volumes on California State Highways, Postmile 22.006." Available at [http://www.dot.ca.gov/trafficops/census/docs/2015\\_aadt\\_volumes.pdf](http://www.dot.ca.gov/trafficops/census/docs/2015_aadt_volumes.pdf).*

*Caltrans "2015 Ramp Volumes on the California State Freeway System District 7." Available at <http://www.dot.ca.gov/trafficops/census/docs/2015-ramp-vol-district07.pdf>*

Because diesel-powered trucks are the primary contributors of DPM on roadways and freeways, this HRA analysis evaluates the cancer risk and noncancer health effects of the future residents' increased exposure to DPM associated with vehicles traveling along US 101. Adverse health risks are discussed in terms of noncancer and cancer risks. Noncancer health risks can be measured quantitatively, with the risk designated as a hazard quotient (HQ). The HQ is the ratio of the calculated concentration to a threshold concentration that has been identified as having some level of adverse health affect.

Cancer risks have no set thresholds because carcinogens are considered to be nonthreshold pollutants. This means that for any nonzero concentration of a carcinogen, there is an increased risk of developing cancer. Therefore, significance exposure to a carcinogen is evaluated based on the increase in risk. The increased risk is determined by multiplying a calculated dose with the cancer potency factor and then by 1 million to express risk in the common term of the risk per million people. An HRA evaluates the increased cancer risk from the continuous exposure to a pollutant over a lifetime.

Inhalable particulate matter equal to or less than 10 microns in diameter (PM10) from diesel exhaust is used as a surrogate for evaluating the cancer and chronic noncancer (HQ) risk from DPM exposure. The health risks for the proposed Project are evaluated by first estimating the DPM emissions produced by diesel vehicles that are currently traveling on the segment of US 101 that passes by the Project site. Dispersion modeling is then used to convert those emissions to ambient (existing background) concentrations. Finally, the ambient concentrations are used to determine whether the future residents of the proposed Project would be exposed to an increased potential for health risks from existing conditions at the Project site.



## Significance Criteria

Neither the State of California nor the VCAPCD has developed a quantitative threshold for the purposes of evaluating the health impacts on residential developments from exposure to TAC emissions associated with a nearby freeway or high-volume roadway. However, in absence of a threshold specific to assessing health impacts from a freeway, the State's significant risk for exposures to carcinogens thresholds of 10 per 1 million for cancer risk and 1 for hazard index (HI) would serve as the most appropriate thresholds for use in this HRA analysis.

## Freeway Exposure Health Risks and Hazards

**Table 2, Estimated Inhalation Cancer Risk and Chronic Hazards**, shows the cancer risk and chronic HI for future residents of the proposed Project. It is important to note that the cancer risk and chronic HI for the on-site residential receptors would gradually decrease as their distance from the freeway increases across the Project site. As shown in **Table 2**, the maximally exposed individual receptor (MEIR) is represented by the proposed residential dwelling unit located approximately 1,250 feet from the nearest travel lane on the US 101 Freeway and 925 feet from the Vineyard Avenue US 101 northbound off-ramp.

As shown in **Table 2**, the maximum cancer risks at the Project site from DPM emissions generated by diesel-vehicle travel along US 101 is 1.06 per 100,000. The cancer risk for residents at the site would exceed the State's significance criteria of 10 per 1 million. Additionally, the maximum noncancer HI for the Project's residents are 0.18 for the MEIR receptors. An HI of less than 1 is considered to be inconsequential.

---

**Table 2**  
**Estimated Inhalation Cancer Risk and Chronic Hazards**

Receptor	Cancer Risk	Chronic Noncancer Hazard Index (HI)
Resident MEIR	1.06 E-05	0.18

*Notes: See Appendix D for calculations. MEIR = maximally exposed individual receptor.*

---

## Criteria Pollutant Exposures

The State of California has promulgated strict ambient air quality standards for various pollutants. These standards were established to safeguard the public's health and welfare, with specific emphasis on protecting those individuals susceptible to respiratory distress, such as asthmatics, the young, the elderly, and those with existing conditions that may be affected by increased pollutant concentrations. However, recent research has shown that unhealthful respiratory responses occur with exposures to pollutants at

levels that only marginally exceed clean air standards. **Table 3, California Ambient Air Quality Standards**, presents the California Ambient Air Quality Standards (CAAQS) for the criteria pollutants considered in the analysis.

**Table 3**  
**California Ambient Air Quality Standards**

<b>Pollutant</b>	<b>Standard</b>	<b>Health Effects</b>
Particulates (PM10)	>50 µg/m <sup>3</sup> (24 hour average) > 20 µg/m <sup>3</sup> (Annual)	<ol style="list-style-type: none"> <li>1. Excess deaths from short-term exposures and the exacerbation of symptoms in sensitive individuals with respiratory disease.</li> <li>2. Excess seasonal declines in pulmonary function especially in children.</li> </ol>
Particulates (PM2.5)	> 12 µg/m <sup>3</sup> (Annual)	<ol style="list-style-type: none"> <li>1. Excess deaths and illness from long-term exposures and the exacerbation of symptoms in sensitive individuals with respiratory and cardio pulmonary disease.</li> </ol>
Carbon Monoxide (CO)	> 9.0 ppm (8 hour average) > 20.0 ppm (1 hour average)	<ol style="list-style-type: none"> <li>1. Aggravation of angina pectoris and other aspects of coronary heart disease.</li> <li>2. Decreased exercise tolerance in persons with peripheral vascular disease and lung disease.</li> <li>3. Impairment of central nervous system functions.</li> <li>4. Possible increased risk to fetuses.</li> </ol>
Nitrogen Dioxide (NO2)	> 0.18 ppm (1 hour average)	<ol style="list-style-type: none"> <li>1. Potential to aggravate chronic respiratory disease and respiratory symptoms in sensitive groups.</li> <li>2. Risk to public health implied by pulmonary and extra-pulmonary biochemical and cellular changes and pulmonary structure changes</li> </ol>

*Source: California Code of Regulations, Title 17, Section 70200.*  
*Notes: ppm: parts per million; µg/m<sup>3</sup>: micrograms per cubic meter.*

Pollutant emissions are considered to have a significant effect on the environment if they result in concentrations that create either a violation of an ambient air quality standard, contribute to an existing air quality violation or expose sensitive receptors to substantive pollutant concentrations. Should ambient air quality already exceed existing standards, the VCAPCD has established significance criteria for selected compounds to account for the continued degradation of local air quality. Background concentrations are based on the highest observed value for the most recent 3-year period. Annual exposures were not considered because event scenarios were based on single-day activities; it would be speculative to forecast concentration estimates without information and schedules to reflect reasonable assumptions associated with seasonal event activities.

**Table 4, Ventura County–Oxnard Monitoring Summary**, shows the pollutant concentrations collected at the El Rio-Rio Mesa School #2 monitoring station for the last three years of available data. **Table 5, Air Quality Significance Thresholds** outlines the relevant significance thresholds considered to affect local air quality.

**Table 4**  
**Ventura County–Oxnard Monitoring Summary**

Pollutant/Averaging Time	2014	Year 2015	2016	Maximum
Particulates (PM10)				
24-hour	115.3	92.0	101.6	115.3
# of days above 24-hour standard	7	6	14	14
Particulates (PM2.5)				
24-hour	22.2	25.5	22.7	25.5
# of days above 24-hour standard	0	0	0	0
Carbon monoxide (CO)				
1-hour	N/A	N/A	N/A	N/A
Nitrogen dioxide (NO2)				
1-hour	39	36	33	39
# of days above 24-hour standard	0	0	0	0

*Source: California Air Resources Board; US Environmental Protection Agency.*

*Note: PM10 and PM2.5 concentrations are expressed in micrograms per cubic meter ( $\mu\text{g}/\text{m}^3$ ). All others are expressed in parts per billion (ppb).*

**Table 5**  
**Air Quality Significance Thresholds**

<b>Pollutant</b>	<b>Averaging Time</b>	<b>Pollutant Concentration</b>
Particulates (PM10)	24 hours	2.5 µg/m <sup>3</sup> (operation)
Particulates (PM2.5)		
Particulates (PM10)	Annual	1.0 µg/m <sup>3</sup>
Carbon monoxide (CO)	1 hour	Area is in attainment; impacts are significant if they cause or contribute to an exceedance of the following attainment standards of 20 ppm (1-hour) and 9 ppm (8-hour).
	8 hours	
Nitrogen dioxide (NO <sub>2</sub> )	1 hour	Area is in attainment; impacts are significant if they cause or contribute to an exceedance of the following attainment standard of 0.18 ppm.

*Source: Ventura County Air Pollution District.*

*Notes: ppm = parts per million; µg/m<sup>3</sup> = micrograms per cubic meter.*

For the maximum exposed residential units, results of the analysis predicted freeway emissions will produce maximum PM10 concentrations of 3.5 µg/m<sup>3</sup> and 1.2 µg/m<sup>3</sup> for the 24-hour and annual averaging times, respectively. These values would exceed the 24-hour and annual significance thresholds of 2.5 µg/m<sup>3</sup> and 1.0 µg/m<sup>3</sup>, respectively, without air filtration. For PM2.5, a maximum 24-hour average concentration of 2.7 µg/m<sup>3</sup> was predicted. This value exceeds the significance threshold of 2.5 µg/m<sup>3</sup> without air filtration.

The maximum modeled 1-hour concentration for CO of 0.2 ppm (256.8 µg/m<sup>3</sup>) would not exceed the CAAQS of 20 ppm. For the 8-hour averaging time, the maximum predicted concentration of 0.1 ppm (131.9 µg/m<sup>3</sup>) would not exceed the CAAQS of 9 ppm.

The maximum 1-hour concentration for NO<sub>2</sub> of 0.01 ppm (23.7 µg/m<sup>3</sup>) would not exceed the CAAQS of 0.18 ppm.

## Recommendations

As stated previously, with respect to cancer risk, any nonzero concentration of a carcinogen represents an increased risk of developing cancer. Therefore, to minimize adverse health effects associated with exposure of future Project residents to DPM concentrations from the US 101 freeway, it is recommended that the Project incorporate the following design features to reduce potential cancer risk:

- Plant vegetation between residential receptors and the freeway;
- Install, operate, and maintain an HVAC system that uses high-efficiency filters of MERV 9 or higher for the residential units;

- Locate the air intakes for the residential units as far from the freeway as possible; and
- Provide a disclosure letter to all new residents that (1) discusses the potential risk from living close to the US-101 freeway, and (2) points out that opening windows reduces the effectiveness of implemented reduction measures and increases individuals' exposure and hence risk.

High-efficiency (MERV 9 or higher) pleated particle filters for residential uses located near busy roadways would generally be considered the most effective approach to filtration because these filters can remove the very small particles emitted by motor vehicles without emitting ozone, formaldehyde, or other harmful by-products. Such high-efficiency filtration can reduce indoor PM<sub>2.5</sub> and ultrafine particle levels by up to 90 percent (MERV 12) relative to incoming outdoor levels when doors and windows are kept mostly closed. However, only those particles in the airstream actually passing through the filter are removed. Consequently, because most residential occupants of the proposed Project are anticipated to open their windows or doors at least part of the day, any pollutant reduction attained through the use of high-efficiency filters would be compromised based on the amount of time doors and windows are left open. **Table 6, Reduced Estimated Inhalation Cancer Risk**, identified the reduction in risk associated with incorporation of MERV 9 through MERV 12 filters when windows are open 25 percent, 50 percent, and 75 percent of the time.

Limiting particulate infiltration will be accomplished by installing and maintain air filtration systems with efficiencies of MERV 9 or higher as defined by ASHRAE Standard 52.2. These filters are rated to remove a portion of the ultrafine and submicron particles, such as diesel particulate matter emitted from mobile sources. MERV 9 or higher air filtration systems are capable of removing 50 percent of particles between 0.3 and 1.0 microns, and 85 percent or more of particles between 1.0 and 10.0 microns. With installation of MERV 9 air filtration systems, PM<sub>10</sub> concentrations for the maximum exposed residential units would be 1.8 µg/m<sup>3</sup> and 0.6 µg/m<sup>3</sup> for the 24-hour and annual averaging times, respectively. These values would not exceed the 24-hour and annual significance thresholds of 2.5 µg/m<sup>3</sup> and 1.0 µg/m<sup>3</sup>, respectively. Furthermore, PM<sub>2.5</sub> concentrations for the maximum exposed residential units would be 0.27 µg/m<sup>3</sup>, below the significance threshold of 2.5 µg/m<sup>3</sup>.

**Table 6**  
**Reduced Estimated Inhalation Cancer Risk**

Receptor	MERV 9	MERV 10	MERV 11	MERV 12
<b><i>Windows open 25 percent of the time</i></b>				
Resident MEIR	7.41E-06	6.50E-06	5.28E-06	4.98E-06
<b><i>Windows open 50 percent of the time</i></b>				
Resident MEIR	8.42E-06	7.81E-06	7.00E-06	6.80E-06
<b><i>Windows open 75 percent of the time</i></b>				
Resident MEIR	9.43E-06	9.13E-06	8.72E-06	8.62E-06

*Notes: See Appendix B for calculations. MEIR = maximally exposed individual receptor.*

## CONCLUSION

The estimated maximum cancer risk for the Project's residential MEIR is 1.06 per 100,000, which would exceed the significance criterion of 10 per 1 million. The maximum noncancer HI for the Project's MEIR would be 0.18, which is also below the significance criterion of 1.

To reduce the exposure of the Project's on-site residents to DPM emissions, it is recommended that high-efficiency filters (MERV 9 or higher) be installed; communal outdoor areas and air intakes be located as far as from the freeway as possible; and a letter identifying the increased risk from DPM exposure be provided to all future residents. The implementation of these measures will reduce risk exposure at the MEIR to between 4.98 and 9.43 per 1 million, below the significance criterion of 10 per 1 million, depending on the amount of time a resident has the window open and the level of MERV filtration added.



## **HRA METHODOLOGY**

The methodologies and assumptions used in this Health Risk Assessment (HRA) are consistent with the guidance recommended by the Ventura County Air Pollution Control District (VCAPCD) Air Toxics “Hot Spots” Information and Assessment Act, Ventura County Air Quality Assessment Guidelines<sup>1</sup>, and the California Environmental Protection Agency’s Office of Environmental Health Hazard Assessment (OEHHA) Air Toxic Hot Spots Program Risk Assessment Guidelines.<sup>2</sup> The methodology used in this assessment uses a dose-response assessment to characterize risk from cancer due to inhaled toxic air contaminants (TACs) and the assessment of acute and chronic noncancer from diesel particulate matter (DPM). Based on the OEHHA guidance, the evaluation of potential health risks uses the following standard four-step risk assessment process: (1) Hazard Identification; (2) Exposure Assessment; (3) Dose-Response Assessment; and (4) Risk Characterization.

### **Hazard Identification**

The hazard identification process is undertaken to determine what TACs are potentially present in the assessment areas and, if so, to identify what the pollutants of concern are along with their potential adverse health effects. In this HRA, the primary hazard is DPM emissions from vehicular sources (specifically diesel-powered trucks) along the US 101 freeway corridor and the E. Vineyard Boulevard US 101 northbound off-ramp, located approximately 1,250 feet and 925 feet to the south of the Project site, respectively. CARB identified DPM as a TAC with a potential cancer and chronic non-cancer effects.

DPM historically has been used a surrogate measure of exposure for whole diesel exhaust emissions. Diesel exhaust is a complex mixture of thousands of gases and fine particles (commonly known as soot). Diesel exhaust particles and gases are suspended in the air due to thermal buoyancy and the small size of the particles. The composition of diesel exhaust varies depending on engine type, operating conditions, fuel composition, lubricating oil, and presence of an emission control system. One of the main characteristics of diesel exhaust is the release of particles at a relative rate approximately 20 times greater than that by gasoline-fueled vehicles, on an equivalent fuel basis. Diesel particulates are mainly aggregates of spherical carbon particles coated with inorganic and organic substances. The inorganic fraction primarily consists of small carbon (elemental carbon) particles ranging from 0.01 to 0.08 microns in diameter. The organic fraction consists of soluble organic compounds.

---

1 Available at [http://www.vcapcd.org/air\\_toxics.htm](http://www.vcapcd.org/air_toxics.htm).

2 California Environmental Protection Agency, Office of Environmental Health Hazard Assessment (OEHHA), *Air Toxic Hot Spots Program Risk Assessment Guideline*, (May 2015).



## **Exposure Assessment**

The degree of the Project's exposure to DPM from existing vehicle traffic on US 101 was evaluated under the exposure assessment portion of the HRA. This assessment starts with the quantification of DPM emissions, followed by dispersion modeling and an estimation of long-term exposure levels. The amount of DPM emissions generated by vehicle traffic on US 101 was determined using PM10 from diesel exhaust as a surrogate.

### ***Detailed Modeling***

Air dispersion modeling was conducted using the American Meteorological Society/Environmental Protection Agency Regulator Model (AERMOD v. 9.4.0). This model is a steady-state, multiple-source, Gaussian dispersion model designed for use with emission sources situated in terrain where ground elevations can exceed the release heights of the emission sources (i.e., complex terrain). AERMOD is the US Environmental Protection Agency's (USEPA) regulatory dispersion model specified in the Guideline for Air Quality Methods.<sup>3</sup> AERMOD is recommended for use by the California Air Resources Board (CARB) and the VCAPCD.

### ***Emission Sources***

Within AERMOD, diesel vehicle traffic was modeled as a line source comprising separate volume sources along the stretch of US 101 freeway corridor and the E. Vineyard Boulevard US 101 northbound off-ramp that is located approximately 1,250 feet and 925 feet to the south of the Project boundary. Diesel exhaust emissions were modeling using a release height of 7.41 feet (2.26 meters), which is the weighted average height of an exhaust stack above ground level for the combined diesel car and truck traffic along this stretch of freeway. The plume height and width used for each volume sources was 14.86 feet and 73.75 feet (4.53 and 22.48 meters), respectively. Based on guidance, the plume height was determined by multiplying the average stack height by a factor of 2, while the plume width was determined by adding 19.69 feet (6 meters) to the freeway width.

### ***Emission Rates***

The quantification of diesel exhaust emissions requires a diesel exhaust emission rate (in grams per second) from trucks. To estimate this emission rate, emission factors (in grams per mile) for the various vehicle classes of diesel-powered trucks and cars were first obtained from the EMFAC2014 web database.<sup>4</sup> Pollutant emission rates were identified for total organic gases (TOG), diesel particulates,

---

<sup>3</sup> U.S. EPA Code of Federal Regulations, Title 40, Part 51, Appendix W

<sup>4</sup> EMFAC2014 is the California Air Resources Boards' tool for estimating emissions from on-road vehicles. The 2014 version was released April of 2015. Available at <https://www.arb.ca.gov/emfac/2014/>.

particulates (PM<sub>10</sub> and PM<sub>2.5</sub>), carbon monoxide (CO) and nitrogen oxide (NO<sub>x</sub>) compounds. Using these emission factors and the available average daily vehicle traffic counts published by the California Department of Transportation (Caltrans) along with the distance of the US 101 corridor to be modeled, the total grams of diesel exhaust emissions that would be generated along the US 101 segment to be modeled were obtained. In turn, the total emissions amount was then converted into an exhaust emission rate in grams per second.

A conservative route speed of 65 miles per hour (mph) was assumed for the northbound and southbound lanes on US 101. For congested or minimum speed conditions, 10 and 5 miles per hour were identified and used for the north and southbound routes, respectively. Ramp volumes were assumed to have a uniform distribution and were averaged to produce an hourly traffic profile.

For particulates (PM<sub>10</sub> and PM<sub>2.5</sub>), emissions were quantified through the reentrainment of paved roadway dust. The predictive emission equation developed by the USEPA (AP-42, Section 13.2.1) was used to generate particulate source strength. To account for the mass rate emissions entrained from the roadway surface, the contribution from exhaust, brake and tire wear were added to the AP-42 emission factor equation.

### ***Meteorological Data***

To run AERMOD, the following hourly surface meteorological data are required: wind speed, wind direction, ambient temperature, and opaque cloud cover. These meteorological variables are used to estimate air dispersion of pollutants in the atmosphere. Wind speed determines how rapidly pollutants are diluted and influences the rise of the emission plume in the air, thus affecting downwind pollutant concentrations. Wind direction determines where pollutants will be transported. The opaque cloud cover and upper air surrounding data are used in calculations to determine other important dispersion parameters. These include atmospheric stability (a measure of turbulence and the rate at which pollutants disperse laterally and vertically) and mixing height (the vertical depth of the atmosphere within which dispersion occurs). The greater the mixing height is, the larger the volume of atmosphere is available to dilute the pollutant concentration.

The dispersion modeling for the Project utilized preprocessed meteorological data from the Oxnard Airport Meteorological Station, which is the station nearest to the Project site (located approximately 2.7 miles to the southeast).

### ***Sensitive Receptors***

To determine the DPM concentrations at the Project site, discrete receptors were placed inside the boundary of the Project site at areas where future residences would be located. Based on VCAPCD's

AERMOD modeling guidance, all receptors should be set to a height of 0 feet (0 meters) so that ground-level concentrations are analyzed. To fulfill VCAPCD's requirements and accurately characterize the risk throughout the Project site, a 32.81-by-32.81-foot (10-by-10-meter) receptor grid was placed over the Project site (including site boundaries). The receptor grid was then converted to discrete receptors to maintain spacing and provide for ease in determining the maximum exposed individual (MEI).

### ***Terrain Data***

The modeling analysis also included terrain data to accurately assess impacts in three dimensions. The terrain data used for the analysis was from the digital elevation model data for the Los Angeles 1 degree quadrangles obtained through the AERMOD program.

### ***Urban/Rural***

The AERMOD model requires that the user specify whether a site should be modeled as either urban or rural. The urban option allows the user to incorporate the effects of increased surface heating from an urban area on pollutant dispersion under stable atmospheric conditions. This surface heating typically causes better dispersion, which results in lower pollutant concentrations.

Based on VCAPCD's AERMOD modeling guidance, all air quality impact analyses in the South Central Coast Air Basin should be executed using the urban modeling option. In addition, all sources should be modeled with urban effects using the population of the city or county where the project is located. The 2040 population of 237,300 for Oxnard<sup>5</sup> was used in the AERMOD run.

### ***Dose-Response Assessment***

The dose-response assessment in the process of characterizing the relationship between exposure to diesel exhaust and the incidence of an adverse health effect in the exposed populations.

The estimation of potential inhalation cancer risk posed by exposure to DPM requires a cancer potency factor. Cancer potency factors are expressed as the upper bound probability of developing cancer, assuming continuous lifetime exposure to diesel exhaust at a dose of 1 milligram per kilogram of body weight, and are expressed in units of inverse dose as a potency slope (i.e., [mg/kg/day]<sup>-1</sup>). A cancer potency factor when multiplied by the dose of a carcinogen gives the associated lifetime cancer risk. The cancer potency factor for DPM is 1.1 (mg/kg/day)<sup>-1</sup>.<sup>6</sup> The estimation of potential inhalation chronic noncancer effects posed by exposure to DPM requires a chronic reference exposure level (REL). A chronic

---

5 Southern California Association of Governments, *Final 2016–2040 Regional Transportation Plan/Sustainable Communities Strategy* (adopted April 2016), Appendix: Demographics and Growth Forecast.

6 OEHHA, *Air Toxics Hot Spots Program Guidance Manual for Preparation of Health Risk Assessments* (August 2003).

REL is a concentration level (expressed in units of micrograms per cubic meter [ $\mu\text{g}/\text{m}^3$ ] for inhalation exposures) at or below which no adverse health effects are anticipated following long-term exposure. The chronic REL for DPM is  $5 \mu\text{g}/\text{m}^3$ .<sup>7</sup> The chronic hazard index target organ for DPM is the respiratory system.

### ***Risk Characterization***

Risk characterization combines the maximum annual average ground-level DPM concentration from the exposure assessment and the cancer potency factor and chronic REL from the dose-response analysis to estimate the potential inhalation cancer risk and chronic hazard index (HI) from the exposure to DPM emissions.

For the Project's health risk evaluation, MEI was assumed to reside at the same receptor location for 70 years. This is a conservative assumption because, typically speaking, people no longer spend their entire life in one location.

The equation used to calculate the potential excess lifetime cancer risk for the residential inhalation pathway is as follows:

$$Dose = (C_{air} \times DBR \times A \times EF \times ED \times CF) / AT$$

where:

Dose = Dose through inhalation (milligrams per kilogram-day [ $\text{mg}/\text{kg}/\text{day}$ ])

$C_{air}$  = Concentration of DPM in air (micrograms per cubic meter [ $\mu\text{g}/\text{m}^3$ ] = from AERMOD)

DBR = Daily breathing rate, or the average amount of air inhaled daily (liters per kilograms body weight-day [ $\text{L}/\text{kg}$  body weight-day]) = 302 L/kg)

A = Inhalation absorption factor (unitless), the potential for absorption into the body through the lungs = 1

EF = Exposure frequency (days per year [ $\text{days}/\text{yr}$ ]) = 350 days/year

ED = Exposure duration (years[yr]) = 70 years

CF = Composite conversion factor (micrograms per cubic meters – milligram per 1,000 liter [ $\text{mg}/\mu\text{g} \times \text{m}^3/\text{L}$ ]) =  $1 \times 10^{-6}$

AT = Averaging time period over which exposure is averaged (number of days over total exposure period; for lifetime cancer risk, averaging time is 70 regardless of exposure duration) = 25,550 days

The following equation was used to estimate the excess cancer risk for a resident at the Project based upon the calculated dosage:

---

7 OEHHA, *Air Toxics Hot Spots Program Guidance Manual for Preparation of Health Risk Assessments* (August 2003).

$$\text{Cancer Risk} = \text{Dose} \times \text{CPF}$$

where:

Cancer Risk = Risk (potential chances per million)

Dose = Dose from inhalation (mg/kg-day)

CPF = Chemical or compound cancer potency factor = (1 mg/kg-day<sup>-1</sup>)

Finally, the potential noncancer health risk for chronic exposure to DPM was evaluated by calculating the hazard quotient (HQ) using the following equation:

$$HQ = C_{\text{airi}} / REL$$

where:

HQ = Hazard quotient for DPM (unitless)

$C_{\text{airi}}$  = Increase in average annual PM10 concentration ( $\mu\text{g}/\text{m}^3$ ) from air dispersion model at the MEI

REL = Reference exposure level for DPM ( $5 \mu\text{g}/\text{m}^3$ )

**APPENDIX B**

---

**Emission Factor Rates/Mobile Emissions/Chronic and  
Acute Exposure/Caltrans Traffic Volume**

**Emission Factor Rate Adjustment**

**CO Emissions**

Acceleration/On-Ramp (15 - 45 mph)

$Emfac (gr/mi) = (emfac \text{ at average link speed} \times 16/60) \times (0.027) \times (exp (.058 \times acceleration \text{ speed product})) \times (60 \text{ min/hr}) / (average \text{ link speed})$   
 Emfac at link speed **0.586** FROM EMFAC SHEET: Value at 45 mph  
 Speed (mph) 45  
 acceleration time (sec) 18  
 acceleration rate (mph/sec) 2.5

Emfac (gr/mi) **2.345**

**Deceleration/Off-Ramp**

$Emfac (gr/mi) = (emfac \text{ at idle speed} \times 1.5)$

Emfac idle speed (gr/mi) **2.94** FROM EMFAC SHEET: Value at 5 mph

Emfac Deceleration (gr/mi) **4.410**

**NOX Emissions**

Acceleration/On-Ramp (15 - 45 mph)

$Emfac (ar/mi) = (emfac \text{ at average link speed} \times 16/60) \times (0.027) \times (exp (.058 \times acceleration \text{ speed product})) \times (60 \text{ min/hr}) / (average \text{ link speed})$   
 Emfac at link speed **0.254**  
 Speed (mph) 45  
 acceleration time (sec) 18  
 acceleration rate (mph/sec) 2.5

Emfac (gr/mi) **0.695**

**Deceleration/Off-Ramp**

$Emfac (gr/mi) = (emfac \text{ at idle speed} \times 1.5)$

Emfac idle speed (gr/mi) **1.48**

Emfac Deceleration (gr/mi) **2.220**

**PM10 Emissions**

Acceleration/On-Ramp (15 - 45 mph)

$Emfac (ar/mi) = (emfac \text{ at average link speed} \times 16/60) \times (0.027) \times (exp (.058 \times acceleration \text{ speed product})) \times (60 \text{ min/hr}) / (average \text{ link speed})$   
 Emfac at link speed **0.00282**  
 Speed (mph) 45  
 acceleration time (sec) 18  
 acceleration rate (mph/sec) 2.5

Emfac (gr/mi) **0.0079**

**Deceleration/Off-Ramp**

$Emfac (ar/mi) = (emfac \text{ at idle speed} \times 1.5)$

Emfac idle speed (gr/mi) **0.0253**

Emfac Deceleration (gr/mi) **0.0380**

**PM2.5 Emissions**

Acceleration/On-Ramp (15 - 45 mph)

$Emfac (ar/mi) = (emfac \text{ at average link speed} \times 16/60) \times (0.027) \times (exp (.058 \times acceleration \text{ speed product})) \times (60 \text{ min/hr}) / (average \text{ link speed})$   
 Emfac at link speed **0.00265**  
 Speed (mph) 45  
 acceleration time (sec) 18  
 acceleration rate (mph/sec) 2.5

Emfac (gr/mi) **0.0075**

**Deceleration/Off-Ramp**

$Emfac (ar/mi) = (emfac \text{ at idle speed} \times 1.5)$

Emfac idle speed (gr/mi) **0.0238**

Emfac Deceleration (gr/mi) **0.0360**

**TOG GAS Emissions**

Acceleration/On-Ramp (15 - 45 mph)

$Emfac (ar/mi) = (emfac \text{ at average link speed} \times 16/60) \times (0.027) \times (exp (.058 \times acceleration \text{ speed product})) \times (60 \text{ min/hr}) / (average \text{ link speed})$   
 Emfac at link speed **0.0376**  
 Speed (mph) 45  
 acceleration time (sec) 18  
 acceleration rate (mph/sec) 2.5

Emfac (gr/mi) **0.089**

**Deceleration/Off-Ramp**

$Emfac (ar/mi) = (emfac \text{ at idle speed} \times 1.5)$

Emfac idle speed (gr/mi) **0.318**

Emfac Deceleration (gr/mi) **0.477**

**TOG DSL Emissions**

Acceleration/On-Ramp (15 - 45 mph)

$Emfac (ar/mi) = (emfac \text{ at average link speed} \times 16/60) \times (0.027) \times (exp (.058 \times acceleration \text{ speed product})) \times (60 \text{ min/hr}) / (average \text{ link speed})$   
 Emfac at link speed **0.00503**  
 Speed (mph) 45  
 acceleration time (sec) 18  
 acceleration rate (mph/sec) 2.5

Emfac (gr/mi) **0.012**

**Deceleration/Off-Ramp**

$Emfac (ar/mi) = (emfac \text{ at idle speed} \times 1.5)$

Emfac idle speed (gr/mi) **2.11**

Emfac Deceleration (gr/mi) **3.165**

**DSL Particulate Emissions**

Acceleration/On-Ramp (15 - 45 mph)

$Emfac (ar/mi) = (emfac \text{ at average link speed} \times 16/60) \times (0.027) \times (exp (.058 \times acceleration \text{ speed product})) \times (60 \text{ min/hr}) / (average \text{ link speed})$   
 Emfac at link speed **0.00149**  
 Speed (mph) 45  
 acceleration time (sec) 18  
 acceleration rate (mph/sec) 2.5

Emfac (gr/mi) **0.004**

**Deceleration/Off-Ramp**

$Emfac (ar/mi) = (emfac \text{ at idle speed} \times 1.5)$

Emfac idle speed (gr/mi) **0.107**

Emfac Deceleration (gr/mi) **0.161**







# Emission Factor Profile Worksheet

## Chronic Exposure

TOG - Toxic Emissions

Gasoline/Toxic Fractions/Hot Stabilized Exhaust

Year	Benzene	Formaldehyde	1,3-Butadiene	Acetaldehyde	Acrolein
2004	0.028414	0.021422	0.006603	0.005511	0.001533
2005	0.028205	0.021200	0.006551	0.005450	0.001520
2006	0.027938	0.021000	0.006483	0.005350	0.001510
2007	0.027660	0.020700	0.006410	0.005250	0.001490
2008	0.027338	0.020300	0.006326	0.005120	0.001470
2009	0.026849	0.019800	0.006190	0.004870	0.001450
2010	0.026521	0.019400	0.006105	0.004750	0.001430
2011	0.026521	0.019400	0.006105	0.004750	0.001430
2012	0.025656	0.018500	0.005873	0.004370	0.001380
2013	0.025656	0.018500	0.005873	0.004370	0.001380
2014	0.025656	0.018500	0.005873	0.004370	0.001380
2015	0.024349	0.017100	0.005530	0.003850	0.001310
2016	0.024349	0.017100	0.005530	0.003850	0.001310
2017	0.024349	0.017100	0.005530	0.003850	0.001310
2018	0.022182	0.014700	0.004944	0.002860	0.001190
2019	0.022182	0.014700	0.004944	0.002860	0.001130
2020	0.021079	0.013600	0.004659	0.002450	0.001130
2021	0.021079	0.013600	0.004659	0.002450	0.001130
2022	0.021079	0.013600	0.004659	0.002450	0.001130
2023	0.021079	0.013600	0.004659	0.002450	0.001130
2024	0.021079	0.013600	0.004659	0.002450	0.001130
2025	0.021079	0.013600	0.004659	0.002450	0.001130
2026	0.021079	0.013600	0.004659	0.002450	0.001130
2027	0.021079	0.013600	0.004659	0.002450	0.001130
2028	0.021079	0.013600	0.004659	0.002450	0.001130
2029	0.021079	0.013600	0.004659	0.002450	0.001130
2030	0.021079	0.013600	0.004659	0.002450	0.001130

Analysis Year

2020	0.021079	0.013600	0.004659	0.002450	0.001130
------	----------	----------	----------	----------	----------

### TOG Emission Rate - gr/mi

Speed (MPH)	Acceleration	0.089434979	
	Deceleration	0.477	
	65	0.0446	FROM EMFAC SHEET (TOG_GAS_RUNEX)

### Toxic Emission Rate - gr/mi

	Acceleration	Deceleration	65
Benzene	0.0018852	0.010054683	0.000940123
Formaldehyde	0.001216316	0.0064872	0.00060656
1,3-Butadiene	0.000416678	0.002222343	0.000207791
Acetaldehyde	0.000219116	0.00116865	0.00010927
Acrolein	0.000101062	0.00053901	0.000050398

### Toxic Emission Rate - gr/mi

Speed (MPH)	Acceleration	0.00383837
	Deceleration	0.020471886
	65	0.001914143

Weight Fraction/Speciation

Benzene	0.491
Formaldehyde	0.317
1,3-Butadiene	0.020
Acetaldehyde	0.057
Acrolein	0.026

**Diesel Particulate Emissions - PM10**

PM10 Emission Rate - gr/mi	Acceleration	0.003544099	
Speed (MPH)	Deceleration	0.1605	
	15	0.011	FROM EMFAC SHEET (PM10_DSL_RUNEX)
	65	0.0018	FROM EMFAC SHEET (PM10_DSL_RUNEX)

Source: TOG/toxic fraction from UC Davis-Caltrans Air Quality Project, *Estimating Mobile Source Air Toxic Emissions: A Step-by-Step Project Analysis Methodology*. Task Order No. 61.

**Emission Factor Profile Worksheet**  
**Acute/8-hour Exposure**

TOG - Toxic Emissions

Gasoline/Toxic Fractions/Hot Stabilized Exhaust

Year	Benzene	Formaldehyde	1,3-Butadiene	Acetaldehyde	Acrolein
2004	0.028414	0.021422	0.006603	0.005511	0.001533
2005	0.028205	0.021200	0.006551	0.005450	0.001520
2006	0.027938	0.021000	0.006483	0.005350	0.001510
2007	0.027660	0.020700	0.006410	0.005250	0.001490
2008	0.027338	0.020300	0.006326	0.005120	0.001470
2009	0.026849	0.019800	0.006190	0.004870	0.001450
2010	0.026521	0.019400	0.006105	0.004750	0.001430
2011	0.026521	0.019400	0.006105	0.004750	0.001430
2012	0.025656	0.018500	0.005873	0.004370	0.001380
2013	0.025656	0.018500	0.005873	0.004370	0.001380
2014	0.025656	0.018500	0.005873	0.004370	0.001380
2015	0.024349	0.017100	0.005530	0.003850	0.001310
2016	0.024349	0.017100	0.005530	0.003850	0.001310
2017	0.024349	0.017100	0.005530	0.003850	0.001310
2018	0.022182	0.014700	0.004944	0.002860	0.001190
2019	0.022182	0.014700	0.004944	0.002860	0.001130
2020	0.021079	0.013600	0.004659	0.002450	0.001130
2021	0.021079	0.013600	0.004659	0.002450	0.001130
2022	0.021079	0.013600	0.004659	0.002450	0.001130
2023	0.021079	0.013600	0.004659	0.002450	0.001130
2024	0.021079	0.013600	0.004659	0.002450	0.001130
2025	0.021079	0.013600	0.004659	0.002450	0.001130
2026	0.021079	0.013600	0.004659	0.002450	0.001130
2027	0.021079	0.013600	0.004659	0.002450	0.001130
2028	0.021079	0.013600	0.004659	0.002450	0.001130
2029	0.021079	0.013600	0.004659	0.002450	0.001130
2030	0.021079	0.013600	0.004659	0.002450	0.001130

Analysis Year

2020	0.021079	0.013600	0.004659	0.002450	0.001130
------	----------	----------	----------	----------	----------

**TOG Emission Rate - gr/mi**

Speed (MPH)	Acceleration	0.089		
	Deceleration	0.477		
	15	0.116		FROM EMFAC SHEET (TOG_GAS_RUNEX)
	65	0.0446		FROM EMFAC SHEET (TOG_GAS_RUNEX)

**Toxic Emission Rate - gr/mi**

	Acceleration	Deceleration	15	65
Benzene	0.0018852	0.010054683	0.0024452	0.000940123
Formaldehyde	0.001216316	0.0064872	0.0015776	0.00060656
1,3-Butadiene	0.000416678	0.002222343	0.0005404	0.000207791
Acetaldehyde	0.000219116	0.00116865	0.0002842	0.00010927
Acrolein	0.000101062	0.00053901	0.0001311	0.000050398

**Toxic Emission Rate - gr/mi**

Speed (MPH)	Acceleration	0.00383837
	Deceleration	0.020471886
	15	0.004978488
	65	0.001914143

Weight Fraction/Speciation

Benzene	0.491
Formaldehyde	0.317
1,3-Butadiene	0.020
Acetaldehyde	0.057
Acrolein	0.026

Source: TOG/toxic fraction from UC Davis-Caltrans Air Quality Project, *Estimating Mobile Source Air Toxic Emissions: A Step-by-Step Project Analysis Methodology*. Task Order No. 61.

**Emission Factor Profile Worksheet**  
**Acute/8-hour Exposure**

TOG - Toxic Emissions

Diesel/Toxic Fractions/Hot Stabilized Exhaust

Year	Benzene	Formaldehyde	1,3-Butadiene	Acetaldehyde	Acrolein
2004	0.020009	0.147133	0.001900	0.073526	0
2005	0.020009	0.147133	0.001900	0.073526	0
2006	0.020009	0.147133	0.001900	0.073526	0
2007	0.020009	0.147133	0.001900	0.073526	0
2008	0.020009	0.147133	0.001900	0.073526	0
2009	0.020009	0.147133	0.001900	0.073526	0
2010	0.020009	0.147133	0.001900	0.073526	0
2011	0.020009	0.147133	0.001900	0.073526	0
2012	0.020009	0.147133	0.001900	0.073526	0
2013	0.020009	0.147133	0.001900	0.073526	0
2014	0.020009	0.147133	0.001900	0.073526	0
2015	0.020009	0.147133	0.001900	0.073526	0
2016	0.020009	0.147133	0.001900	0.073526	0
2017	0.020009	0.147133	0.001900	0.073526	0
2018	0.020009	0.147133	0.001900	0.073526	0
2019	0.020009	0.147133	0.001900	0.073526	0
2020	0.020009	0.147133	0.001900	0.073526	0
2021	0.020009	0.147133	0.001900	0.073526	0
2022	0.020009	0.147133	0.001900	0.073526	0
2023	0.020009	0.147133	0.001900	0.073526	0
2024	0.020009	0.147133	0.001900	0.073526	0
2025	0.020009	0.147133	0.001900	0.073526	0
2026	0.020009	0.147133	0.001900	0.073526	0
2027	0.020009	0.147133	0.001900	0.073526	0
2028	0.020009	0.147133	0.001900	0.073526	0
2029	0.020009	0.147133	0.001900	0.073526	0
2030	0.020009	0.147133	0.001900	0.073526	0

Analysis Year

2020	0.020009	0.147133	0.001900	0.073526	0.0
------	----------	----------	----------	----------	-----

**TOG Emission Rate - gr/mi**

Speed (MPH)	Acceleration	0.012	
	Deceleration	3.165	
	15	0.102	FROM EMFAC SHEET (TOG_DSL_RUNEX)
	65	0.00401	FROM EMFAC SHEET (TOG_DSL_RUNEX)

**Toxic Emission Rate - gr/mi**

	Acceleration	Deceleration	15	65
Benzene	0.000239394	0.063328485	0.0020409	8.02361E-05
Formaldehyde	0.001760344	0.465675945	0.0150076	0.000590003
1,3-Butadiene	2.27322E-05	0.0060135	0.0001938	0.000007619
Acetaldehyde	0.000879688	0.23270979	0.0074997	0.000294839
Acrolein	0	0	0	0

**Toxic Emission Rate - gr/mi**

Speed (MPH)	Acceleration	0.002902158
	Deceleration	0.76772772
	15	0.024741936
	65	0.000972698

Weight Fraction/Speciation

Benzene	0.082
Formaldehyde	0.607
1,3-Butadiene	0.008

Acetaldehyde	0.303
Acrolein	0

Source: TOG/toxic fraction from UC Davis-Caltrans Air Quality Project, *Estimating Mobile Source Air Toxic Emissions: A Step-by-Step Project Analysis Methodology*. Task Order No. 61.

### 2015 Traffic Volumes on California State Highways

Distance	Route	County	Postmile	Description	Back Peak Hour	Back Peak Month	Back AADT	Ahead Peak Hour	Ahead Peak Month	Ahead AADT
7	101	VEN	22.006	OXNARD, JCT. RTE. 232	10900	143000	140000	10300	132000	129000
7	101	VEN	22.729	OXNARD, JCT. RTE. 1 SOUTH	10300	132000	129000	12000	153000	151000

Source: 2015 Traffic Volumes on California State Highways

### Caltrans Traffic Volumes for Ramp

Post Mile	Description	2006 ADT	2007 ADT	2008 ADT	2009 ADT	2010 ADT	2011 ADT	2012 ADT	2013 ADT	2014 ADT	2015 ADT
21.78	SB On from NB Vineyard Ave		10400						9701		
21.847	NB Off to Vineyard Ave		10200						9501		
21.966	NB On from NB Vineyard Ave		4700						5001		
22.031	SB On from SB Vineyard Ave		3200						3001		
22.179	NB On from SB Vineyard Ave		3900						4201		
22.18	SB Off to Vineyard Ave		5500						5901		

Source: 2015 Ramp Volumes on the California State Freeway System District 7 (Includes Counties: Los Angeles, Ventura)



**APPENDIX C**

---

**EMFAC2014 Worksheets**



EMFAC2014 (v1.0.7) Emission Rates

Region Type: Air Basin

Region: South Central Coast

Calendar Year: 2020

Season: Annual

Vehicle Classification: EMFAC2011 Categories

Units: miles/day for VMT, g/mile for RUNEX, PMBW and PMTW

Region	CalYr	VehClass	MdlYr	Speed	Fuel	VMT	%VMT	ROG_RUNEX	TOG_RUNEX	CO_RUNEX	NOx_RUNEX	CO2_RUNEX	PM10_RUNEX	PM2_5_RUNEX
South Central Coast	2020	All Other Buses	Aggregated	5	DSL	180.8862445	0.001642599	0.560019343	0.637539393	1.74031424	11.42367766	2295.240526	0.038088684	0.036440984
South Central Coast	2020	LDA	Aggregated	5	GAS	50605.54666	0.459540784	0.090017929	0.131218426	1.293290727	0.118775154	893.8973222	0.012022687	0.011054823
South Central Coast	2020	LDA	Aggregated	5	DSL	614.5010167	0.005580184	0.248834368	0.283281385	3.593435744	0.215620848	691.5390147	0.055764443	0.053352098
South Central Coast	2020	LDT1	Aggregated	5	GAS	3482.362914	0.031622774	0.195826744	0.285163277	3.154347926	0.297773361	1062.80499	0.016186552	0.014885005
South Central Coast	2020	LDT1	Aggregated	5	DSL	4.443188573	4.03479E-05	0.881331682	1.003337525	4.010897884	0.851621526	941.0437973	0.6467712	0.618792164
South Central Coast	2020	LDT2	Aggregated	5	GAS	18031.93576	0.163745092	0.146879491	0.214141335	2.039798394	0.252655354	1221.264529	0.012210409	0.011227588
South Central Coast	2020	LDT2	Aggregated	5	DSL	34.73918433	0.000315461	0.266265876	0.303125997	2.367625607	0.167371025	871.2532393	0.02051689	0.019629338
South Central Coast	2020	LHD1	Aggregated	5	GAS	8154.108956	0.074046145	0.390818039	0.568198207	4.50141129	0.751718567	1397.220885	0.010747149	0.009883682
South Central Coast	2020	LHD1	Aggregated	5	DSL	5696.197007	0.051726244	0.813585473	0.92621297	3.467862399	3.390144418	1279.415701	0.123331531	0.117996263
South Central Coast	2020	LHD2	Aggregated	5	GAS	1324.953023	0.012031684	0.173074278	0.252515697	1.731279223	0.455930892	1473.206945	0.007229983	0.006647736
South Central Coast	2020	LHD2	Aggregated	5	DSL	1901.130952	0.017263863	0.770168868	0.876786052	3.25548552	2.356786471	1330.793476	0.085603797	0.081900615
South Central Coast	2020	MCY	Aggregated	5	GAS	453.1598245	0.004115071	13.03840831	15.88553476	56.52041614	1.522474497	547.5471201	0.010737725	0.010078837
South Central Coast	2020	MDV	Aggregated	5	GAS	11207.57556	0.101774181	0.276574125	0.390842738	3.553298072	0.416828369	1642.764742	0.012039285	0.011079104
South Central Coast	2020	MDV	Aggregated	5	DSL	192.2242052	0.001745557	0.21936376	0.249731056	3.68267928	0.168467935	1069.193804	0.025283634	0.024189875
South Central Coast	2020	MH	Aggregated	5	GAS	247.0641048	0.002243549	0.912917582	1.293011892	15.91680625	1.186766215	3917.246298	0.013337584	0.012289464
South Central Coast	2020	MH	Aggregated	5	DSL	60.44646594	0.000548905	1.184916711	1.348948897	2.521448028	16.37884364	2101.437035	0.402948079	0.385516723
South Central Coast	2020	Motor Coach	Aggregated	5	DSL	57.3632825	0.000520907	1.098850595	1.250957757	4.019508654	18.74466764	3297.054997	0.045016004	0.043068631
South Central Coast	2020	OBUS	Aggregated	5	GAS	216.1640761	0.001962951	0.417820447	0.609358878	3.391643472	0.866525557	3836.225507	0.005628873	0.005175759
South Central Coast	2020	SBUS	Aggregated	5	GAS	197.1065112	0.001789892	0.395583009	0.577233798	2.982605396	0.897693071	1854.717758	0.004116589	0.003785051
South Central Coast	2020	SBUS	Aggregated	5	DSL	241.5727959	0.002193683	0.769333868	0.875828046	1.337419362	18.22287032	2313.531577	0.137402764	0.131458782
South Central Coast	2020	T6 Ag	Aggregated	5	DSL	45.48860608	0.000413075	4.353952967	4.956644024	5.357457267	17.39274324	2359.617266	1.020812984	0.976653066
South Central Coast	2020	T6 CAIRP heavy	Aggregated	5	DSL	3.879657094	3.52305E-05	0.335291577	0.381703938	1.356342548	9.458115184	2211.470234	0.016729669	0.016005951
South Central Coast	2020	T6 CAIRP small	Aggregated	5	DSL	11.90958975	0.000108149	0.594632043	0.676943317	1.604552097	9.190545141	2191.712348	0.042563616	0.040722333
South Central Coast	2020	T6 instate construction heavy	Aggregated	5	DSL	65.71213459	0.000596721	0.528310841	0.610441677	1.539854456	11.59220833	2268.607194	0.043183714	0.041315606
South Central Coast	2020	T6 instate construction small	Aggregated	5	DSL	195.9940561	0.00177979	0.885163551	1.007691323	2.03255732	10.16988262	2230.005038	0.067237081	0.064328435
South Central Coast	2020	T6 instate heavy	Aggregated	5	DSL	644.4999605	0.0058526	0.498117952	0.567069371	1.654124079	10.83190784	2272.53526	0.033315039	0.031873845
South Central Coast	2020	T6 instate small	Aggregated	5	DSL	1589.44141	0.01443346	1.069752668	1.217831982	2.243854286	11.09355968	2242.511013	0.090274515	0.086369279
South Central Coast	2020	T6 OOS heavy	Aggregated	5	DSL	2.222897711	2.01858E-05	0.339442145	0.386429043	1.35872247	9.567046472	2214.641449	0.017517236	0.016759448
South Central Coast	2020	T6 OOS small	Aggregated	5	DSL	6.823747346	6.19653E-05	0.594632043	0.676943317	1.604552097	9.190545141	2191.712348	0.042563616	0.040722333
South Central Coast	2020	T6 Public	Aggregated	5	DSL	52.6415742	0.00047803	0.469227833	0.534180169	1.007681765	13.96240418	2311.886692	0.080789249	0.077294342
South Central Coast	2020	T6 utility	Aggregated	5	DSL	12.10457006	0.00010992	0.182249724	0.207477438	0.959302719	5.722746116	2240.187357	0.003936834	0.003766528
South Central Coast	2020	T6TS	Aggregated	5	GAS	407.4135068	0.003699656	0.829122029	1.209852919	7.380432092	1.561888476	3842.735616	0.007950075	0.0073098
South Central Coast	2020	T7 Ag	Aggregated	5	DSL	16.38764801	0.000148814	9.062942206	10.31746982	14.42297713	32.14994564	3497.54275	1.986665637	1.900723361
South Central Coast	2020	T7 CAIRP	Aggregated	5	DSL	287.4298795	0.002610104	1.006295733	1.145591092	4.466045942	22.13738833	3111.492597	0.03622772	0.034660525
South Central Coast	2020	T7 CAIRP construction	Aggregated	5	DSL	25.066023	0.000227621	1.021564255	1.162973142	4.155117087	21.65691268	3107.388264	0.038694071	0.037020183
South Central Coast	2020	T7 NNOOS	Aggregated	5	DSL	356.4134082	0.003236533	0.611466196	0.696107719	3.27323215	17.76298801	2883.035934	0.014646957	0.014013336
South Central Coast	2020	T7 NOOS	Aggregated	5	DSL	113.5347176	0.00103099	1.007264203	1.146693621	4.461582841	22.27684842	3116.529952	0.03690385	0.035307406
South Central Coast	2020	T7 other port	Aggregated	5	DSL	76.61289336	0.000695709	1.278523731	1.455501945	4.810117766	20.9076247	3235.615845	0.045837615	0.0438547
South Central Coast	2020	T7 POLA	Aggregated	5	DSL	8.793658985	7.98538E-05	1.4466950849	1.647243398	5.161227385	21.75859822	3300.190131	0.054243747	0.051897186
South Central Coast	2020	T7 Public	Aggregated	5	DSL	50.86569614	0.000461903	0.85388134	0.972078907	2.028684555	26.66870568	3439.160916	0.16480586	0.157676432
South Central Coast	2020	T7 Single	Aggregated	5	DSL	292.9187292	0.002659948	1.059007152	1.20559903	3.081135297	21.54046407	3329.455728	0.107679077	0.103020927
South Central Coast	2020	T7 single construction	Aggregated	5	DSL	64.84250348	0.000588824	0.837239983	0.953133989	3.008695835	17.01593696	3181.590202	0.048526522	0.046427286
South Central Coast	2020	T7 SWCV	Aggregated	5	DSL	1618.562141	0.014697901	0.609633713	9.569594379	23.29013385	17.4802484	6469.209019	0.021753837	0.020812776
South Central Coast	2020	T7 tractor	Aggregated	5	DSL	355.0417961	0.003224077	1.212707299	1.380574947	4.536477182	21.9181079	3188.172555	0.057682383	0.055187068
South Central Coast	2020	T7 tractor construction	Aggregated	5	DSL	48.34487885	0.000439012	1.20635296	1.373341016	4.22916929	22.19364021	3207.892989	0.059990898	0.057395719
South Central Coast	2020	T7 utility	Aggregated	5	DSL	3.011532864	2.73472E-05	0.370919385	0.422263484	2.190192799	8.833045462	3104.324239	0.006033554	0.005772545
South Central Coast	2020	T7IS	Aggregated	5	GAS	29.91147253	0.000271621	3.280289804	4.754416806	62.62991623	6.27893701	4158.892072	0.005199614	0.004789657
South Central Coast	2020	UBUS	Aggregated	5	GAS	308.9065924	0.002805131	1.852358709	2.702511908	10.73577503	1.805289416	3842.687046	0.007237997	0.006655291
South Central Coast	2020	UBUS	Aggregated	5	DSL	523.7352656	0.004755955	2.586122717	8.900520166	23.39097017	22.99575954	3556.385302	0.546888205	0.523230063
Composite								3.18E-01	5.70E-01	2.94E+00	1.48E+00	1.30E+03	2.53E-02	2.38E-02

EMFAC2014 (v1.0.7) Emission Rates

Region Type: Air Basin

Region: South Central Coast

Calendar Year: 2020

Season: Annual

Vehicle Classification: EMFAC2011 Categories

Units: miles/day for VMT, g/mile for RUNEX, PMBW and PMTW

Region	CalYr	VehClass	MdlYr	Speed	Fuel	VMT	%VMT	ROG_RUNEX	TOG_RUNEX	CO_RUNEX	NOx_RUNEX	CO2_RUNEX	PM10_RUNEX	PM2_5_RUNEX
South Central Coast	2020	LDA	Aggregated	5	GAS	50605.54666	0.534568218	0.090017929	0.131218426	1.293290727	0.118775154	893.8973222	0.012022687	0.011054823
South Central Coast	2020	LDT1	Aggregated	5	GAS	3482.362914	0.036785702	0.195826744	0.285163277	3.154347926	0.297773361	1062.80499	0.016186552	0.014885005
South Central Coast	2020	LDT2	Aggregated	5	GAS	18031.93576	0.190479116	0.146879491	0.214141335	2.039798394	0.252655354	1221.264529	0.012210409	0.011227588
South Central Coast	2020	LHD1	Aggregated	5	GAS	8154.108956	0.08613537	0.390818039	0.568198207	4.50141129	0.751718567	1397.220885	0.010747149	0.009883682
South Central Coast	2020	LHD2	Aggregated	5	GAS	1324.953023	0.01399605	0.173074278	0.252515697	1.731279223	0.455930892	1473.206945	0.007229983	0.006647736
South Central Coast	2020	MCY	Aggregated	5	GAS	453.1598245	0.004786923	13.03840831	15.88553476	56.52041614	1.522474497	547.5471201	0.010737725	0.01007837
South Central Coast	2020	MDV	Aggregated	5	GAS	11207.57556	0.118390455	0.276574125	0.390842738	3.553298072	0.416828369	1642.764742	0.012039285	0.011079104
South Central Coast	2020	MH	Aggregated	5	GAS	247.0641048	0.002609845	0.912917582	1.293011892	15.91680625	1.186766215	3917.246298	0.013337584	0.012289464
South Central Coast	2020	OBUS	Aggregated	5	GAS	216.1640761	0.002283434	0.417820447	0.609358878	3.391643472	0.866525557	3836.225507	0.005628873	0.005175759
South Central Coast	2020	SBUS	Aggregated	5	GAS	197.1065112	0.002082121	0.395583009	0.577233798	2.982605396	0.897693071	1854.717758	0.004116589	0.003785051
South Central Coast	2020	T6TS	Aggregated	5	GAS	407.4135068	0.004303685	0.829122029	1.209852919	7.380432092	1.561888476	3842.735616	0.007950075	0.0073098
South Central Coast	2020	T7IS	Aggregated	5	GAS	29.91147253	0.000315968	3.280289804	4.754416806	62.62991623	6.27893701	4158.892072	0.005199614	0.004789657
South Central Coast	2020	UBUS	Aggregated	5	GAS	308.9065924	0.003263114	1.852358709	2.702511908	10.73577503	1.805289416	3842.687046	0.007237997	0.006655291
Composite								2.29E-01	3.18E-01	2.44E+00	2.72E-01	1.14E+03	1.20E-02	1.10E-02

EMFAC2014 (v1.0.7) Emission Rates

Region Type: Air Basin

Region: South Central Coast

Calendar Year: 2020

Season: Annual

Vehicle Classification: EMFAC2011 Categories

Units: miles/day for VMT, g/mile for RUNEX, PMBW and PMTW

Region	CalYr	VehClass	MdlYr	Speed	Fuel	VMT	%VMT	ROG_RUNEX	TOG_RUNEX	CO_RUNEX	NOx_RUNEX	CO2_RUNEX	PM10_RUNEX	PM2_5_RUNEX
South Central Coast	2020	All Other Buses	Aggregated	5	DSL	180.8862445	0.011703467	0.560019343	0.637539393	1.74031424	11.42367766	2295.240526	0.038088684	0.036440984
South Central Coast	2020	LDA	Aggregated	5	DSL	614.5010167	0.039758646	0.248834368	0.283281385	3.593435744	0.215620848	691.5390147	0.055764443	0.053352098
South Central Coast	2020	LDT1	Aggregated	5	DSL	4.443188573	0.000287477	0.881331682	1.003337525	4.010897884	0.851621526	941.0437973	0.6467712	0.618792164
South Central Coast	2020	LDT2	Aggregated	5	DSL	34.73918433	0.00224765	0.266265876	0.303125997	2.367625607	0.167371025	871.2532393	0.02051689	0.019629338
South Central Coast	2020	LHD1	Aggregated	5	DSL	5696.197007	0.368547934	0.813585473	0.92621297	3.467862399	3.390144418	1279.415701	0.123331531	0.117996263
South Central Coast	2020	LHD2	Aggregated	5	DSL	1901.130952	0.123004503	0.770168868	0.876786052	3.25548552	2.356786471	1330.793476	0.085603797	0.081900615
South Central Coast	2020	MDV	Aggregated	5	DSL	192.2242052	0.012437041	0.21936376	0.249731056	3.68267928	0.168467935	1069.193804	0.025283634	0.024189875
South Central Coast	2020	MH	Aggregated	5	DSL	60.44646594	0.003910929	1.184916711	1.348948897	2.521448028	16.37884364	2101.437035	0.402948079	0.385516723
South Central Coast	2020	Motor Coach	Aggregated	5	DSL	57.3632825	0.003711445	1.098850595	1.250957757	4.019508654	18.74466764	3297.054997	0.045016004	0.043068631
South Central Coast	2020	SBUS	Aggregated	5	DSL	241.5727959	0.015629929	0.769333868	0.875828046	1.337419362	18.22287032	2313.531577	0.137402764	0.131458782
South Central Coast	2020	T6 Ag	Aggregated	5	DSL	45.48860608	0.002943145	4.353952967	4.956644024	5.357457267	17.39274324	2359.617266	1.020812984	0.976653066
South Central Coast	2020	T6 CAIRP heavy	Aggregated	5	DSL	3.879657094	0.000251017	0.335291577	0.381703938	1.356342548	9.458115184	2211.470234	0.016729669	0.016005951
South Central Coast	2020	T6 CAIRP small	Aggregated	5	DSL	11.90958975	0.000770559	0.594632043	0.676943317	1.604552097	9.190545141	2191.712348	0.042563616	0.040722333
South Central Coast	2020	T6 instate construction heavy	Aggregated	5	DSL	65.71213459	0.004251621	0.528310841	0.601441677	1.539854456	11.59220833	2268.607194	0.043183714	0.041315606
South Central Coast	2020	T6 instate construction small	Aggregated	5	DSL	195.9940561	0.012680953	0.885163551	1.007691323	2.03255732	10.16988262	2230.005038	0.067237081	0.064328435
South Central Coast	2020	T6 instate heavy	Aggregated	5	DSL	644.4999605	0.041699599	0.498117952	0.567069371	1.654124079	10.83190784	2272.53526	0.033315039	0.031873845
South Central Coast	2020	T6 instate small	Aggregated	5	DSL	1589.44141	0.102837972	1.069752668	1.217831982	2.243854286	11.09355968	2242.511013	0.090274515	0.086369279
South Central Coast	2020	T6 OOS heavy	Aggregated	5	DSL	2.222897711	0.000143823	0.339442145	0.386429043	1.35872247	9.567046472	2214.641449	0.017517236	0.016759448
South Central Coast	2020	T6 OOS small	Aggregated	5	DSL	6.823747346	0.000441501	0.594632043	0.676943317	1.604552097	9.190545141	2191.712348	0.042563616	0.040722333
South Central Coast	2020	T6 Public	Aggregated	5	DSL	52.6415742	0.003405947	0.469227833	0.534180169	1.007681765	13.96240418	2311.886692	0.080789249	0.077294342
South Central Coast	2020	T6 utility	Aggregated	5	DSL	12.10457006	0.000783174	0.182249724	0.207477438	0.959302719	5.722746116	2240.187357	0.003936834	0.003766528
South Central Coast	2020	T7 Ag	Aggregated	5	DSL	16.38764801	0.001060292	9.062942206	10.31746982	14.42297713	32.14994564	3497.54275	1.986665637	1.900723361
South Central Coast	2020	T7 CAIRP	Aggregated	5	DSL	287.4298795	0.018596914	1.006295733	1.145591092	4.466045942	22.13738833	3111.492597	0.03622772	0.034660525
South Central Coast	2020	T7 CAIRP construction	Aggregated	5	DSL	25.066023	0.001621789	1.021564255	1.162973142	4.155117087	21.65691268	3107.388264	0.038694071	0.037020183
South Central Coast	2020	T7 NNOOS	Aggregated	5	DSL	356.4134082	0.023060197	0.611466196	0.696107719	3.27323215	17.76298801	2883.035934	0.014646957	0.014013336
South Central Coast	2020	T7 NOOS	Aggregated	5	DSL	113.5347176	0.007345776	1.007264203	1.146693621	4.461582841	22.27684842	3116.529952	0.03690385	0.035307406
South Central Coast	2020	T7 other port	Aggregated	5	DSL	76.61289336	0.004956908	1.278523731	1.455501945	4.810117766	20.9076247	3235.615845	0.045837615	0.0438547
South Central Coast	2020	T7 POLA	Aggregated	5	DSL	8.793658985	0.000568956	1.446950849	1.647243398	5.161227385	21.75859822	3300.190131	0.054243747	0.051897186
South Central Coast	2020	T7 Public	Aggregated	5	DSL	50.86569614	0.003291046	0.85388134	0.972078907	2.028684555	26.66870568	3439.160916	0.16480586	0.157676432
South Central Coast	2020	T7 Single	Aggregated	5	DSL	292.9187292	0.018952047	1.059007152	1.20559903	3.081135297	21.54046407	3329.455728	0.107679077	0.103020927
South Central Coast	2020	T7 single construction	Aggregated	5	DSL	64.84250348	0.004195355	0.837239983	0.953133989	3.008695835	17.01593696	3181.590202	0.048526522	0.046427286
South Central Coast	2020	T7 SWCV	Aggregated	5	DSL	1618.562141	0.104722104	0.609633713	9.569594379	23.29013385	17.4802484	6469.209019	0.021753837	0.020812776
South Central Coast	2020	T7 tractor	Aggregated	5	DSL	355.0417961	0.022971453	1.212707299	1.380574947	4.536477182	21.9181079	3188.172555	0.057682383	0.055187068
South Central Coast	2020	T7 tractor construction	Aggregated	5	DSL	48.34487885	0.003127948	1.20635296	1.373341016	4.22916929	22.19364021	3207.892989	0.059990989	0.057395719
South Central Coast	2020	T7 utility	Aggregated	5	DSL	3.011532864	0.000194848	0.370919385	0.422263484	2.190192799	8.833045462	3104.324239	0.006033554	0.005772545
South Central Coast	2020	UBUS	Aggregated	5	DSL	523.7352656	0.033886038	2.586122717	8.900520166	23.39097017	22.99575954	3556.385302	0.546888205	0.523230063
Composite								8.63E-01	2.11E+00	5.96E+00	8.91E+00	2.29E+03	1.07E-01	1.02E-01



EMFAC2014 (v1.0.7) Emission Rates

Region Type: Air Basin

Region: South Central Coast

Calendar Year: 2020

Season: Annual

Vehicle Classification: EMFAC2011 Categories

Units: miles/day for VMT, g/mile for RUXEX, PMBW and PMTW

Region	CalYr	VehClass	MdlYr	Speed	Fuel	VMT	%VMT	ROG_RUXEX	TOG_RUXEX	CO_RUXEX	NOx_RUXEX	CO2_RUXEX	PM10_RUXEX	PM2_5_RUXEX
South Central Coast	2020	All Other Buses	Aggregated	10	DSL	896.712905	0.00343418	0.447991636	0.510004376	1.411183545	9.340498931	2041.838351	0.033253163	0.031814646
South Central Coast	2020	LDA	Aggregated	10	DSL	1306.015607	0.005001705	0.181064951	0.206130408	2.65842985	0.191859426	572.3009661	0.039587374	0.037874842
South Central Coast	2020	LDT1	Aggregated	10	DSL	9.07917786	3.47709E-05	0.584624475	0.665556097	2.773291441	0.852989228	783.5022184	0.418077544	0.399991694
South Central Coast	2020	LDT2	Aggregated	10	DSL	75.0246522	0.000287325	0.196440022	0.223633904	1.747053509	0.140342583	728.690547	0.014658061	0.01402396
South Central Coast	2020	LHD1	Aggregated	10	DSL	16665.94559	0.063826295	0.582323107	0.662936142	2.516179038	3.557138964	1076.285111	0.089048164	0.08519598
South Central Coast	2020	LHD2	Aggregated	10	DSL	5511.76517	0.021108646	0.559889796	0.637397309	2.392094973	2.425716683	1183.774954	0.063701455	0.060945759
South Central Coast	2020	MDV	Aggregated	10	DSL	416.589908	0.001595432	0.161947615	0.184366593	2.73765302	0.142278547	905.2899585	0.018816826	0.018002818
South Central Coast	2020	MH	Aggregated	10	DSL	273.5560067	0.001047649	0.90028345	1.024912853	2.056008818	13.75249237	1908.269373	0.348061277	0.3330043
South Central Coast	2020	Motor Coach	Aggregated	10	DSL	281.7948114	0.001079202	0.883014968	1.005245325	3.252348886	15.27215309	2932.520928	0.040420437	0.038671867
South Central Coast	2020	SBUS	Aggregated	10	DSL	846.7002679	0.003242645	0.592694475	0.674737543	1.108333258	14.83933753	2076.476784	0.113674364	0.108756861
South Central Coast	2020	T6 Ag	Aggregated	10	DSL	217.2965253	0.00083219	3.390134879	3.859410498	4.660912877	14.3327608	2111.485232	0.860209232	0.822996961
South Central Coast	2020	T6 CAIRP heavy	Aggregated	10	DSL	18.5329048	7.09763E-05	0.269541214	0.306852155	1.097637753	7.51122348	1963.517833	0.014941689	0.014295318
South Central Coast	2020	T6 CAIRP small	Aggregated	10	DSL	56.89144367	0.00021788	0.461223528	0.525067877	1.286554266	7.237692805	1947.387884	0.040017387	0.038286253
South Central Coast	2020	T6 instate construction heavy	Aggregated	10	DSL	304.7752007	0.001167211	0.419752764	0.47785657	1.249956853	9.422921344	2020.110468	0.037351761	0.035735941
South Central Coast	2020	T6 instate construction small	Aggregated	10	DSL	936.2526365	0.003585607	0.681322553	0.775633864	1.622312807	8.160956138	1983.919789	0.063537116	0.060788528
South Central Coast	2020	T6 instate heavy	Aggregated	10	DSL	2907.83698	0.01113627	0.401999818	0.457646192	1.342157818	8.936232537	2021.734543	0.030169261	0.028864152
South Central Coast	2020	T6 instate small	Aggregated	10	DSL	7149.941761	0.027382442	0.826373803	0.94076367	1.796535508	9.038438838	1998.596739	0.08571384	0.082005897
South Central Coast	2020	T6 OOS heavy	Aggregated	10	DSL	10.61865795	4.06667E-05	0.272452469	0.310166396	1.099518396	7.609309708	1966.620896	0.015614365	0.014938895
South Central Coast	2020	T6 OOS small	Aggregated	10	DSL	32.59665915	0.000124837	0.461223528	0.525067877	1.286554266	7.237692805	1947.387884	0.040017387	0.038286253
South Central Coast	2020	T6 Public	Aggregated	10	DSL	242.965106	0.000930494	0.372149704	0.423664109	0.833911089	11.58600626	2073.006091	0.069066256	0.066078481
South Central Coast	2020	T6 utility	Aggregated	10	DSL	57.82285367	0.000221447	0.147603061	0.16803485	0.776934058	4.447050696	1986.335371	0.003541349	0.003388152
South Central Coast	2020	T7 Ag	Aggregated	10	DSL	54.52735377	0.000208826	7.076392772	8.055934507	12.739752	26.3284313	3134.921711	1.684005251	1.611155929
South Central Coast	2020	T7 CAIRP	Aggregated	10	DSL	956.3782863	0.003662683	0.810092428	0.922228565	3.610788358	17.73562521	2764.240487	0.032528532	0.031121362
South Central Coast	2020	T7 CAIRP construction	Aggregated	10	DSL	83.4032988	0.000319413	0.820024911	0.933535939	3.361572267	17.28594161	2762.940056	0.03485777	0.033349838
South Central Coast	2020	T7 NNOOS	Aggregated	10	DSL	1185.910265	0.004541732	0.493610979	0.561938525	2.648299589	13.73681299	2557.741496	0.013253889	0.012680532
South Central Coast	2020	T7 NOOS	Aggregated	10	DSL	377.769141	0.001446759	0.810208313	0.92236049	3.607314957	17.85783363	2769.009182	0.03308949	0.031658053
South Central Coast	2020	T7 other port	Aggregated	10	DSL	254.9175047	0.000976269	1.034496424	1.177695432	3.894863417	17.01623295	2875.401845	0.041250376	0.039465903
South Central Coast	2020	T7 POLA	Aggregated	10	DSL	29.25953463	0.000112057	1.170584243	1.332621054	4.178953592	17.87126952	2934.172368	0.048817811	0.046705974
South Central Coast	2020	T7 Public	Aggregated	10	DSL	169.2495231	0.000648182	0.673259371	0.766454544	1.707250874	21.92543222	3087.944475	0.141032714	0.134931701
South Central Coast	2020	T7 Single	Aggregated	10	DSL	965.5171812	0.003697683	0.848284254	0.965707051	2.527758588	17.91363225	2980.982327	0.09622661	0.092063889
South Central Coast	2020	T7 single construction	Aggregated	10	DSL	215.7533603	0.00082628	0.667319204	0.759692116	2.441122987	13.71091285	2832.651771	0.041928542	0.040114731
South Central Coast	2020	T7 SWCV	Aggregated	10	DSL	3889.815284	0.014896994	0.47617	7.631363115	18.86547771	14.52945136	5796.610095	0.018672582	0.017864815
South Central Coast	2020	T7 tractor	Aggregated	10	DSL	1181.346439	0.004524254	0.973098009	1.10779801	3.670423218	17.81829104	2835.803278	0.051120047	0.048908617
South Central Coast	2020	T7 tractor construction	Aggregated	10	DSL	160.8600765	0.000616053	0.962505967	1.095739776	3.423726107	18.00185593	2856.946138	0.053116059	0.050818281
South Central Coast	2020	T7 utility	Aggregated	10	DSL	10.02040792	3.83756E-05	0.304005594	0.341988901	1.773825245	6.903718087	2752.550593	0.005427438	0.005192649
South Central Coast	2020	UBUS	Aggregated	10	DSL	1715.31519	0.006569217	1.971616987	6.595383363	18.25616711	19.2445194	3233.999306	0.457717325	0.437916676
Composite								2.51E-01	4.50E-01	2.50E+00	1.71E+00	1.12E+03	2.27E-02	2.15E-02

EMFAC2014 (v1.0.7) Emission Rates

Region Type: Air Basin

Region: South Central Coast

Calendar Year: 2020

Season: Annual

Vehicle Classification: EMFAC2011 Categories

Units: miles/day for VMT, g/mile for RUNEX, PMBW and PMTW

Region	CalYr	VehClass	MdlYr	Speed	Fuel	VMT	%VMT	ROG_RUNEX	TOG_RUNEX	CO_RUNEX	NOx_RUNEX	CO2_RUNEX	PM10_RUNEX	PM2_5_RUNEX
South Central Coast	2020	LDA	Aggregated	10	GAS	110977.1044	0.425013834	0.056603055	0.082503387	1.151953388	0.100450884	662.5644838	0.007622916	0.00700928
South Central Coast	2020	LDT1	Aggregated	10	GAS	7874.504943	0.030157333	0.125626442	0.182953762	2.684551214	0.246105279	786.8677224	0.010576455	0.009726018
South Central Coast	2020	LDT2	Aggregated	10	GAS	39252.70126	0.150327774	0.087237349	0.127192042	1.691677719	0.196147879	900.3460893	0.00764343	0.007028188
South Central Coast	2020	LHD1	Aggregated	10	GAS	19367.46105	0.074172406	0.256581911	0.37300361	3.531596884	0.66273987	1374.284412	0.006846635	0.006296638
South Central Coast	2020	LHD2	Aggregated	10	GAS	3130.678978	0.011989697	0.111509603	0.162689935	1.402800682	0.396266076	1528.944336	0.004575181	0.004206735
South Central Coast	2020	MCY	Aggregated	10	GAS	979.7833397	0.003752319	8.514022005	10.38762618	41.450427	1.39492541	407.2271384	0.007022801	0.006590106
South Central Coast	2020	MDV	Aggregated	10	GAS	24237.41646	0.092823086	0.170911032	0.241022937	2.923887724	0.334946889	1214.157244	0.0076044	0.006998259
South Central Coast	2020	MH	Aggregated	10	GAS	1103.637849	0.00422665	0.627981338	0.888695483	12.21086776	1.103868195	3344.288532	0.008843992	0.008150083
South Central Coast	2020	OBUS	Aggregated	10	GAS	1022.290425	0.00391511	0.271580631	0.396160488	3.077399528	0.775081402	3277.371209	0.003543409	0.00325812
South Central Coast	2020	SBUS	Aggregated	10	GAS	690.8482191	0.002645771	0.249414591	0.363945186	2.721703396	0.776940943	1583.304623	0.002590148	0.002381545
South Central Coast	2020	T6TS	Aggregated	10	GAS	1887.637551	0.007229167	0.540475634	0.788660776	6.498668952	1.394111536	3282.50373	0.005076075	0.004667263
South Central Coast	2020	T7IS	Aggregated	10	GAS	111.7743819	0.000428067	2.141911226	3.102932387	56.7388282	5.527548113	3539.939155	0.003274434	0.003016965
South Central Coast	2020	UBUS	Aggregated	10	GAS	1009.502629	0.003866136	1.263439842	1.84329394	8.583113868	1.629951873	3280.949507	0.004680869	0.004304042
Composite								1.23E-01	1.71E-01	1.71E+00	1.98E-01	7.44E+02	6.12E-03	5.63E-03



EMFAC2014 (v1.0.7) Emission Rates

Region Type: Air Basin

Region: South Central Coast

Calendar Year: 2020

Season: Annual

Vehicle Classification: EMFAC2011 Categories

Units: miles/day for VMT, g/mile for RUNEX, PMBW and PMTW

Region	CalYr	VehClass	MdYr	Speed	Fuel	VMT	%VMT	ROG_RUNEX	TOG_RUNEX	CO_RUNEX	NOX_RUNEX	CO2_RUNEX	PM10_RUNEX	PM2_5_RUNEX
South Central Coast	2020	All Other Buses	Aggregated	10	DSL	896.712905	0.00343418	0.447991636	0.510004376	1.411183545	9.340498931	2041.838351	0.033253163	0.031814646
South Central Coast	2020	LDA	Aggregated	10	DSL	1306.015607	0.005001705	0.181064951	0.206130408	2.65842985	0.191859426	572.3009661	0.039587374	0.037874842
South Central Coast	2020	LDT1	Aggregated	10	DSL	9.07917786	3.47709E-05	0.584624475	0.665556097	2.773291441	0.852989228	783.5022184	0.418077544	0.399991694
South Central Coast	2020	LDT2	Aggregated	10	DSL	75.0246522	0.000287325	0.196440022	0.223633904	1.747053509	0.140342583	728.690547	0.014658061	0.01402396
South Central Coast	2020	LHD1	Aggregated	10	DSL	16665.94559	0.063826295	0.582323107	0.662936142	2.516179038	3.557138964	1076.285111	0.089048164	0.08519598
South Central Coast	2020	LHD2	Aggregated	10	DSL	5511.76517	0.021108646	0.559889796	0.637397309	2.392094973	2.425716683	1183.774954	0.063701455	0.060945759
South Central Coast	2020	MDV	Aggregated	10	DSL	416.589908	0.001595432	0.161947615	0.184366593	2.73765302	0.142278547	905.2899585	0.018816826	0.018002818
South Central Coast	2020	MH	Aggregated	10	DSL	273.556007	0.001047649	0.90028345	1.024912853	2.056008818	13.75249237	1908.269373	0.348061277	0.3330043
South Central Coast	2020	Motor Coach	Aggregated	10	DSL	281.7948114	0.001079202	0.883014968	1.005245325	3.252348886	15.27215309	2932.520928	0.040420437	0.038671867
South Central Coast	2020	SBUS	Aggregated	10	DSL	846.7002679	0.003242645	0.592694475	0.674737543	1.108333258	14.83933753	2076.476784	0.113674364	0.108756861
South Central Coast	2020	T6 Ag	Aggregated	10	DSL	217.2965253	0.00083219	3.390134879	3.859410498	4.660912877	14.3327608	2111.485232	0.860209232	0.822996961
South Central Coast	2020	T6 CAIRP heavy	Aggregated	10	DSL	18.5329048	7.09763E-05	0.269541214	0.306852155	1.097637753	7.51122348	1963.517833	0.014941689	0.014295318
South Central Coast	2020	T6 CAIRP small	Aggregated	10	DSL	56.89144367	0.00021788	0.461223528	0.525067877	1.286554266	7.237692805	1947.387884	0.040017387	0.038286253
South Central Coast	2020	T6 instate construction heavy	Aggregated	10	DSL	304.7752007	0.001167211	0.419752764	0.47785657	1.249956853	9.422921344	2020.110468	0.037351761	0.035735941
South Central Coast	2020	T6 instate construction small	Aggregated	10	DSL	936.2526365	0.003585607	0.681322553	0.775633864	1.622312807	8.160956138	1983.919789	0.063537116	0.060788528
South Central Coast	2020	T6 instate heavy	Aggregated	10	DSL	2907.83698	0.01113627	0.401999818	0.457646192	1.342157818	8.936232537	2021.734543	0.030169261	0.028864152
South Central Coast	2020	T6 instate small	Aggregated	10	DSL	7149.941761	0.027382442	0.826373803	0.94076367	1.796535508	9.038438838	1998.596739	0.08571384	0.082005897
South Central Coast	2020	T6 OOS heavy	Aggregated	10	DSL	10.61865795	4.06667E-05	0.272452469	0.310166396	1.099518396	7.609309708	1966.620896	0.015614365	0.014938895
South Central Coast	2020	T6 OOS small	Aggregated	10	DSL	32.59665915	0.000124837	0.461223528	0.525067877	1.286554266	7.237692805	1947.387884	0.040017387	0.038286253
South Central Coast	2020	T6 Public	Aggregated	10	DSL	242.965106	0.000930494	0.372149704	0.423664109	0.833911089	11.58600626	2073.006091	0.069066256	0.066078481
South Central Coast	2020	T6 utility	Aggregated	10	DSL	57.82285367	0.000221447	0.147603061	0.16803485	0.776934058	4.447050696	1986.335371	0.003541349	0.003388152
South Central Coast	2020	T7 Ag	Aggregated	10	DSL	54.52735377	0.000208826	7.076392772	8.055934507	12.739752	26.3284313	3134.921711	1.684005251	1.611155929
South Central Coast	2020	T7 CAIRP	Aggregated	10	DSL	956.3782863	0.003662683	0.810092428	0.922228565	3.610788358	17.73562521	2764.240487	0.032528532	0.031121362
South Central Coast	2020	T7 CAIRP construction	Aggregated	10	DSL	83.4032988	0.000319413	0.820024911	0.933535939	3.361572267	17.28594161	2762.940056	0.03485777	0.033349838
South Central Coast	2020	T7 NNOOS	Aggregated	10	DSL	1185.910265	0.004541732	0.493610979	0.561938525	2.648299589	13.73681299	2557.741496	0.013253889	0.012680532
South Central Coast	2020	T7 NOOS	Aggregated	10	DSL	377.769141	0.001446759	0.810208313	0.92236049	3.607314957	17.85783363	2769.009182	0.03308949	0.031658053
South Central Coast	2020	T7 other port	Aggregated	10	DSL	254.9175047	0.000976269	1.034496424	1.177695432	3.894863417	17.01623295	2875.401845	0.041250376	0.039465903
South Central Coast	2020	T7 POLA	Aggregated	10	DSL	29.25953463	0.000112057	1.170584243	1.332621054	4.178953592	17.87126952	2934.172368	0.048817811	0.046705974
South Central Coast	2020	T7 Public	Aggregated	10	DSL	169.2495231	0.000648182	0.673259371	0.766454544	1.707250874	21.92543222	3087.944475	0.141032714	0.134931701
South Central Coast	2020	T7 Single	Aggregated	10	DSL	965.5171812	0.003697683	0.848284254	0.965707051	2.527758588	17.91363225	2980.982327	0.09622661	0.092063889
South Central Coast	2020	T7 single construction	Aggregated	10	DSL	215.7533603	0.00082628	0.667319204	0.759692116	2.441122987	13.71091285	2832.651771	0.041928542	0.040114731
South Central Coast	2020	T7 SWCV	Aggregated	10	DSL	3889.815284	0.014896994	0.47617	7.631363115	18.86547771	14.52945136	5796.610095	0.018672582	0.017864815
South Central Coast	2020	T7 tractor	Aggregated	10	DSL	1181.346439	0.004524254	0.973098009	1.10779801	3.670423218	17.81829104	2835.803278	0.051120047	0.048908617
South Central Coast	2020	T7 tractor construction	Aggregated	10	DSL	160.8600765	0.000616053	0.962505967	1.095739776	3.423726107	18.00185593	2856.946138	0.053116059	0.050818281
South Central Coast	2020	T7 utility	Aggregated	10	DSL	10.02040792	3.83756E-05	0.300405594	0.341988901	1.773825245	6.903718087	2752.550593	0.005427438	0.005192649
South Central Coast	2020	UBUS	Aggregated	10	DSL	1715.31519	0.006569217	1.971616987	6.595383363	18.25616711	19.2445194	3233.999306	0.457717325	0.437916676
Composite								1.27E-01	2.79E-01	7.91E-01	1.51E+00	3.77E+02	1.66E-02	1.59E-02



EMFAC2014 (v1.0.7) Emission Rates

Region Type: Air Basin

Region: South Central Coast

Calendar Year: 2020

Season: Annual

Vehicle Classification: EMFAC2011 Categories

Units: miles/day for VMT, g/mile for RUNEX, PMBW and PMTW

Region	CalYr	VehClass	MdYr	Speed	Fuel	VMT	%VMT	ROG_RUNEX	TOG_RUNEX	CO_RUNEX	NOx_RUNEX	CO2_RUNEX	PM10_RUNEX	PM2_5_RUNEX
South Central Coast	2020	All Other Buses	Aggregated	15	DSL	1163.133951	0.002148307	0.300952023	0.34261097	0.989602013	6.63231589	1715.212428	0.026216571	0.025082454
South Central Coast	2020	LDA	Aggregated	15	DSL	2764.299126	0.005105657	0.098736468	0.112404904	1.343850104	0.157321586	469.4960519	0.02990706	0.028613294
South Central Coast	2020	LDT1	Aggregated	15	DSL	19.08601855	3.52519E-05	0.404436616	0.460424198	1.920140617	0.869220938	646.8610566	0.296692816	0.283858016
South Central Coast	2020	LDT2	Aggregated	15	DSL	160.0928898	0.000295691	0.097780551	0.111316657	0.860578566	0.100771558	603.3610878	0.011468231	0.010972121
South Central Coast	2020	LHD1	Aggregated	15	DSL	38487.27381	0.071085949	0.373527832	0.425236603	1.647073671	3.639238425	702.6909777	0.06582444	0.062976904
South Central Coast	2020	LHD2	Aggregated	15	DSL	12780.94731	0.023606394	0.329129476	0.374692026	1.434256748	2.416839251	787.6911327	0.048081871	0.046001871
South Central Coast	2020	MDV	Aggregated	15	DSL	884.7233591	0.001634083	0.082016625	0.093370475	1.347441479	0.103087847	766.1241032	0.014477433	0.013851146
South Central Coast	2020	MH	Aggregated	15	DSL	385.4908106	0.000712001	0.459915798	0.523583559	1.310053939	9.641990776	1566.88554	0.252167168	0.241258528
South Central Coast	2020	Motor Coach	Aggregated	15	DSL	327.9713485	0.000605763	0.604225741	0.687865012	2.275897746	10.7884707	2464.276067	0.034225956	0.032745356
South Central Coast	2020	SBUS	Aggregated	15	DSL	1693.400536	0.003127709	0.333894997	0.380114038	0.781955129	10.15758012	1725.642791	0.07576731	0.07248965
South Central Coast	2020	T6 Ag	Aggregated	15	DSL	289.0945054	0.000533957	1.885414262	2.146400617	3.554998253	10.06519369	1756.996086	0.598865471	0.572958816
South Central Coast	2020	T6 CAIRP heavy	Aggregated	15	DSL	24.65645016	4.55404E-05	0.183501579	0.208902579	0.771239911	4.97947695	1647.545476	0.011962334	0.011444849
South Central Coast	2020	T6 CAIRP small	Aggregated	15	DSL	75.68921659	0.000139798	0.272111777	0.309778544	0.859088096	4.680573687	1631.91328	0.035535907	0.033998639
South Central Coast	2020	T6 instate construction heavy	Aggregated	15	DSL	418.8231383	0.000773566	0.273796993	0.311697034	0.874454189	6.553153967	1694.149267	0.028536014	0.027301559
South Central Coast	2020	T6 instate construction small	Aggregated	15	DSL	1245.60433	0.00230063	0.390449225	0.444496721	1.060488126	5.505854159	1661.834696	0.057267067	0.054789719
South Central Coast	2020	T6 instate heavy	Aggregated	15	DSL	4056.582177	0.007492502	0.267970572	0.305604098	0.940816577	6.295628751	1696.630954	0.02322161	0.022217053
South Central Coast	2020	T6 instate small	Aggregated	15	DSL	9996.060933	0.018462713	0.460065891	0.523749996	1.159511129	6.108346535	1671.210454	0.07480744	0.071571304
South Central Coast	2020	T6 OOS heavy	Aggregated	15	DSL	14.12721931	2.6093E-05	0.184568799	0.210117528	0.77197646	5.060514372	1649.864606	0.012478358	0.01193855
South Central Coast	2020	T6 OOS small	Aggregated	15	DSL	43.36707659	8.00989E-05	0.272111777	0.309778544	0.859088096	4.680573687	1631.91328	0.035535907	0.033998639
South Central Coast	2020	T6 Public	Aggregated	15	DSL	333.9356401	0.000616779	0.222806086	0.253647769	0.590495974	8.049377403	1725.850416	0.048108484	0.046027332
South Central Coast	2020	T6 utility	Aggregated	15	DSL	76.92837821	0.000142087	0.103953428	0.118343065	0.547176718	2.828614884	1666.519691	0.003043096	0.002911453
South Central Coast	2020	T7 Ag	Aggregated	15	DSL	78.02146018	0.000144106	3.933903667	4.478449871	10.0035075	18.50514233	2598.41964	1.193357057	1.141732959
South Central Coast	2020	T7 CAIRP	Aggregated	15	DSL	1368.451341	0.002527528	0.556954797	0.63405064	2.542290078	12.09659129	2320.440468	0.026713621	0.025558001
South Central Coast	2020	T7 CAIRP construction	Aggregated	15	DSL	119.3391336	0.000220419	0.55881542	0.636168817	2.351326607	11.69250002	2318.852226	0.029626669	0.028345032
South Central Coast	2020	T7 NNOOS	Aggregated	15	DSL	1696.881365	0.003134138	0.344476945	0.39216078	1.863863333	8.655188353	2146.182051	0.011437165	0.010942398
South Central Coast	2020	T7 NOOS	Aggregated	15	DSL	540.5378761	0.000998373	0.555329839	0.632200749	2.538538709	12.19336163	2324.072001	0.027110902	0.025938096
South Central Coast	2020	T7 other port	Aggregated	15	DSL	364.7533682	0.000673699	0.726127083	0.82664041	2.740232964	12.11561635	2421.094166	0.035462151	0.033928074
South Central Coast	2020	T7 POLA	Aggregated	15	DSL	41.8665396	7.73274E-05	0.821165545	0.934834464	2.939379444	12.97434108	2472.390902	0.041969992	0.040154388
South Central Coast	2020	T7 Public	Aggregated	15	DSL	241.4170791	0.000445897	0.396660648	0.451567954	1.250020383	15.1748755	2557.078027	0.098600875	0.094335444
South Central Coast	2020	T7 Single	Aggregated	15	DSL	1366.775675	0.002524433	0.526214336	0.599054965	1.798463809	12.3252178	2486.672808	0.066286755	0.063419219
South Central Coast	2020	T7 single construction	Aggregated	15	DSL	308.7146368	0.000570196	0.440497356	0.501472708	1.710598203	9.419641824	2374.348008	0.032017142	0.030632095
South Central Coast	2020	T7 SWCV	Aggregated	15	DSL	1777.72268	0.003283452	0.287913569	5.053259531	13.28625723	10.37726089	4817.136575	0.013802661	0.013205564
South Central Coast	2020	T7 tractor	Aggregated	15	DSL	1690.351131	0.003122077	0.660216674	0.751606426	2.585158831	12.48018583	2381.197942	0.040287096	0.038544294
South Central Coast	2020	T7 tractor construction	Aggregated	15	DSL	230.1695788	0.000425123	0.639727641	0.728281222	2.388213643	12.55968113	2395.734266	0.043152339	0.041285588
South Central Coast	2020	T7 utility	Aggregated	15	DSL	14.33788371	2.64821E-05	0.211568723	0.240854887	1.249264164	4.476234546	2309.368212	0.004663821	0.004462066
South Central Coast	2020	UBUS	Aggregated	15	DSL	2942.38835	0.005434588	1.035273015	3.401834296	10.8633441	13.49476271	2652.630038	0.302111322	0.28904212
Composite								1.49E-01	2.18E-01	1.81E+00	1.02E+00	7.69E+02	1.52E-02	1.44E-02

EMFAC2014 (v1.0.7) Emission Rates

Region Type: Air Basin

Region: South Central Coast

Calendar Year: 2020

Season: Annual

Vehicle Classification: EMFAC2011 Categories

Units: miles/day for VMT, g/mile for RUNEX, PMBW and PMTW

Region	CalYr	VehClass	MdlYr	Speed	Fuel	VMT	%VMT	ROG_RUNEX	TOG_RUNEX	CO_RUNEX	NOx_RUNEX	CO2_RUNEX	PM10_RUNEX	PM2_5_RUNEX
South Central Coast	2020	LDA	Aggregated	15	GAS	237126.0161	0.43797147	0.03740133	0.054510282	1.031135661	0.08687194	510.0103283	0.005083491	0.004674296
South Central Coast	2020	LDT1	Aggregated	15	GAS	17151.27266	0.03167838	0.086503128	0.125972857	2.364938121	0.212611579	606.1149777	0.00723947	0.0066574
South Central Coast	2020	LDT2	Aggregated	15	GAS	83206.40349	0.153682128	0.055855317	0.081434817	1.459860839	0.161014248	691.4698187	0.005051023	0.004644457
South Central Coast	2020	LHD1	Aggregated	15	GAS	46612.66531	0.086093537	0.177995997	0.258697548	2.906619634	0.598137406	954.7069379	0.004609341	0.00423916
South Central Coast	2020	LHD2	Aggregated	15	GAS	7549.35659	0.013943653	0.07648234	0.111585476	1.192158463	0.355179053	1075.642435	0.003057062	0.002810873
South Central Coast	2020	MCY	Aggregated	15	GAS	1994.049847	0.003683008	5.885731606	7.177066029	32.61233233	1.297602858	313.693497	0.004884902	0.004584559
South Central Coast	2020	MDV	Aggregated	15	GAS	51257.99769	0.094673461	0.113473729	0.159681473	2.513215071	0.283624708	933.73526	0.005079421	0.004674805
South Central Coast	2020	MH	Aggregated	15	GAS	1489.981931	0.002751995	0.433043285	0.612294528	9.287788472	0.995030607	2305.181897	0.005957123	0.00549056
South Central Coast	2020	OBUS	Aggregated	15	GAS	1304.664877	0.002409714	0.178135672	0.259779793	2.694514422	0.667189549	2257.785201	0.002358356	0.002168526
South Central Coast	2020	SBUS	Aggregated	15	GAS	1381.696438	0.002551992	0.165555455	0.241578131	2.485371104	0.685996907	1091.374766	0.001719278	0.001580813
South Central Coast	2020	T6TS	Aggregated	15	GAS	2440.100847	0.004506863	0.357995479	0.522386163	5.592925883	1.2090779	2261.19485	0.003378242	0.003106169
South Central Coast	2020	T7IS	Aggregated	15	GAS	147.2060169	0.000271889	1.384797438	2.00509718	50.00541943	4.784838531	2540.583218	0.002237716	0.002061838
South Central Coast	2020	UBUS	Aggregated	15	GAS	1734.437164	0.003203503	0.888590518	1.296402635	7.04381554	1.488504431	2261.276954	0.003172875	0.002917454
Composite								8.34E-02	1.16E-01	1.48E+00	1.75E-01	5.68E+02	4.22E-03	3.88E-03

EMFAC2014 (v1.0.7) Emission Rates

Region Type: Air Basin

Region: South Central Coast

Calendar Year: 2020

Season: Annual

Vehicle Classification: EMFAC2011 Categories

Units: miles/day for VMT, g/mile for RUNEX, PMBW and PMTW

Region	CalYr	VehClass	MdlYr	Speed	Fuel	VMT	%VMT	ROG_RUNEX	TOG_RUNEX	CO_RUNEX	NOx_RUNEX	CO2_RUNEX	PM10_RUNEX	PM2_5_RUNEX
South Central Coast	2020	All Other Buses	Aggregated	15	DSL	1163.133951	0.002148307	0.300952023	0.34261097	0.989602013	6.63231589	1715.212428	0.026216571	0.025082454
South Central Coast	2020	LDA	Aggregated	15	DSL	2764.299126	0.005105657	0.098736468	0.112404904	1.343850104	0.157321586	469.4960519	0.02990706	0.028613294
South Central Coast	2020	LDT1	Aggregated	15	DSL	19.08601855	3.52519E-05	0.404436616	0.460424198	1.920140617	0.869220938	646.8610566	0.296692816	0.283858016
South Central Coast	2020	LDT2	Aggregated	15	DSL	160.0928898	0.000295691	0.097780551	0.111316657	0.860578566	0.100771558	603.3610878	0.011468231	0.010972121
South Central Coast	2020	LHD1	Aggregated	15	DSL	38487.27381	0.071085949	0.373527832	0.425236603	1.647073671	3.639238425	702.6909777	0.06582444	0.062976904
South Central Coast	2020	LHD2	Aggregated	15	DSL	12780.94731	0.023606394	0.329129476	0.374692026	1.434256748	2.416839251	787.6911327	0.048081871	0.046001871
South Central Coast	2020	MDV	Aggregated	15	DSL	884.7233591	0.001634083	0.082016625	0.093370475	1.347441479	0.103087847	766.1241032	0.014477433	0.013851146
South Central Coast	2020	MH	Aggregated	15	DSL	385.4908106	0.000712001	0.459915798	0.523583559	1.310053939	9.641990776	1566.88554	0.252167168	0.241258526
South Central Coast	2020	Motor Coach	Aggregated	15	DSL	327.9713485	0.000605763	0.604225741	0.687865012	2.275897746	10.7884707	2464.276067	0.034225956	0.032745356
South Central Coast	2020	SBUS	Aggregated	15	DSL	1693.400536	0.003127709	0.333894997	0.380114038	0.781955129	10.15758012	1725.642791	0.07576731	0.07248965
South Central Coast	2020	T6 Ag	Aggregated	15	DSL	289.0945054	0.000533957	1.885414262	2.146400617	3.554998253	10.06519369	1756.996086	0.598865471	0.572958816
South Central Coast	2020	T6 CAIRP heavy	Aggregated	15	DSL	24.65645016	4.55404E-05	0.183501579	0.208902579	0.771239911	4.97947695	1647.545476	0.011962334	0.011444849
South Central Coast	2020	T6 CAIRP small	Aggregated	15	DSL	75.68921659	0.000139798	0.272111777	0.309778544	0.859088096	4.680573687	1631.91328	0.035535907	0.033998639
South Central Coast	2020	T6 instate construction heavy	Aggregated	15	DSL	418.8231383	0.000773566	0.273796993	0.311697034	0.874454189	6.553153967	1694.149267	0.028536014	0.027301559
South Central Coast	2020	T6 instate construction small	Aggregated	15	DSL	1245.60433	0.00230063	0.390449225	0.444496721	1.060488126	5.505854159	1661.834696	0.057267067	0.054789719
South Central Coast	2020	T6 instate heavy	Aggregated	15	DSL	4056.582177	0.007492502	0.267970572	0.305064098	0.940816577	6.295628751	1696.630954	0.02322161	0.022217053
South Central Coast	2020	T6 instate small	Aggregated	15	DSL	9996.060933	0.018462713	0.460065891	0.523749996	1.159511129	6.108346535	1671.210454	0.07480744	0.071571304
South Central Coast	2020	T6 OOS heavy	Aggregated	15	DSL	14.12721931	2.6093E-05	0.184568799	0.210117528	0.77197646	5.060514372	1649.864606	0.012478358	0.01193855
South Central Coast	2020	T6 OOS small	Aggregated	15	DSL	43.36707659	8.00989E-05	0.272111777	0.309778544	0.859088096	4.680573687	1631.91328	0.035535907	0.033998639
South Central Coast	2020	T6 Public	Aggregated	15	DSL	333.9356401	0.000616779	0.222806086	0.253647769	0.590495974	8.049377403	1725.850416	0.048108484	0.046027332
South Central Coast	2020	T6 utility	Aggregated	15	DSL	76.92837821	0.000142087	0.103953428	0.118343065	0.547176718	2.828614884	1666.519691	0.003043096	0.002911453
South Central Coast	2020	T7 Ag	Aggregated	15	DSL	78.02146018	0.000144106	3.933903667	4.478449871	10.0035075	18.50514233	2598.41964	1.193357057	1.141732959
South Central Coast	2020	T7 CAIRP	Aggregated	15	DSL	1368.451341	0.002527528	0.556954797	0.63405064	2.542290078	12.09659129	2320.440468	0.026713621	0.025558001
South Central Coast	2020	T7 CAIRP construction	Aggregated	15	DSL	119.3391336	0.000220419	0.55881542	0.636168817	2.351326607	11.69250002	2318.852226	0.029626669	0.028345032
South Central Coast	2020	T7 NNOOS	Aggregated	15	DSL	1696.881365	0.003134138	0.344476945	0.39216078	1.863863333	8.655188353	2146.182051	0.011437165	0.010942398
South Central Coast	2020	T7 NOOS	Aggregated	15	DSL	540.5378761	0.000998373	0.555329839	0.632200749	2.538538709	12.19336163	2324.072001	0.027110902	0.025938096
South Central Coast	2020	T7 other port	Aggregated	15	DSL	364.7533682	0.000673699	0.726127083	0.82664041	2.740232964	12.11561635	2421.094166	0.035462151	0.033928074
South Central Coast	2020	T7 POLA	Aggregated	15	DSL	41.8665396	7.73274E-05	0.821165545	0.934834464	2.939379444	12.97434108	2472.390902	0.041969992	0.040154388
South Central Coast	2020	T7 Public	Aggregated	15	DSL	241.4170791	0.000445897	0.396660648	0.451567954	1.250020383	15.1748755	2557.078027	0.098600875	0.094335444
South Central Coast	2020	T7 Single	Aggregated	15	DSL	1366.775675	0.002524433	0.526214336	0.599054965	1.798463809	12.3252178	2486.672808	0.066286755	0.063419219
South Central Coast	2020	T7 single construction	Aggregated	15	DSL	308.7146368	0.000570196	0.440497356	0.501472708	1.710598203	9.419641824	2374.348008	0.032017142	0.030632095
South Central Coast	2020	T7 SWCV	Aggregated	15	DSL	1777.72268	0.003283452	0.287913569	0.503259531	13.28625723	10.37726089	4817.136575	0.013802661	0.013205564
South Central Coast	2020	T7 tractor	Aggregated	15	DSL	1690.351131	0.003122077	0.660216674	0.751606426	2.585158831	12.48018583	2381.197942	0.040287096	0.038544294
South Central Coast	2020	T7 tractor construction	Aggregated	15	DSL	230.1695788	0.000425123	0.639727641	0.728281222	2.388213643	12.55968113	2395.734266	0.043152339	0.041285588
South Central Coast	2020	T7 utility	Aggregated	15	DSL	14.33788371	2.64821E-05	0.211568723	0.240854887	1.249264164	4.476234546	2309.368212	0.004663821	0.004462066
South Central Coast	2020	UBUS	Aggregated	15	DSL	2942.38835	0.005434588	1.035273015	3.401834296	10.8633441	13.49476271	2652.630038	0.302111322	0.28904212
Composite								6.52E-02	1.02E-01	3.38E-01	8.45E-01	2.01E+02	1.10E-02	1.05E-02



EMFAC2014 (v1.0.7) Emission Rates

Region Type: Air Basin

Region: South Central Coast

Calendar Year: 2020

Season: Annual

Vehicle Classification: EMFAC2011 Categories

Units: miles/day for VMT, g/mile for RUNEX, PMBW and PMTW

Region	CalYr	VehClass	MdYr	Speed	Fuel	VMT	%VMT	ROG_RUNEX	TOG_RUNEX	CO_RUNEX	NOx_RUNEX	CO2_RUNEX	PM10_RUNEX	PM2_5_RUNEX
South Central Coast	2020	All Other Buses	Aggregated	45	DSL	2421.941986	0.00055337	0.047600974	0.054190085	0.168075571	2.692317926	1132.315953	0.014391524	0.013768953
South Central Coast	2020	LDA	Aggregated	45	GAS	2461143.355	0.562326632	0.011114023	0.016190038	0.648750618	0.063655138	232.0306983	0.001356073	0.001246936
South Central Coast	2020	LDA	Aggregated	45	DSL	29942.65165	0.006841353	0.018821928	0.021427513	0.195438563	0.137493159	231.122074	0.012212104	0.011683814
South Central Coast	2020	LDT1	Aggregated	45	GAS	162577.8995	0.037146102	0.025756777	0.037465624	1.346579506	0.144230432	274.8277068	0.001922023	0.001767634
South Central Coast	2020	LDT1	Aggregated	45	DSL	213.0808704	4.86851E-05	0.16214611	0.184592566	0.948307623	1.1885558	318.7921575	0.129025814	0.123444215
South Central Coast	2020	LDT2	Aggregated	45	GAS	895074.1437	0.204508213	0.019729818	0.028750201	1.02931613	0.138121938	317.7663181	0.001429426	0.001314423
South Central Coast	2020	LDT2	Aggregated	45	DSL	1672.003405	0.000382022	0.012166223	0.013850436	0.100773688	0.052401345	293.7704538	0.005732004	0.00548404
South Central Coast	2020	LHD1	Aggregated	45	GAS	23416.07797	0.005350149	0.050222945	0.072662009	1.429053496	0.393231098	682.0662028	0.001165666	0.001072406
South Central Coast	2020	LHD1	Aggregated	45	DSL	28691.42389	0.00655547	0.102955069	0.117207502	0.597690324	4.00996638	454.2621466	0.023901048	0.022867099
South Central Coast	2020	LHD2	Aggregated	45	GAS	5118.026525	0.001169376	0.017172348	0.025056711	0.517330259	0.208852067	732.6462632	0.000719093	0.00066118
South Central Coast	2020	LHD2	Aggregated	45	DSL	10428.03053	0.002382616	0.0724092	0.082433061	0.408410925	2.49405214	495.5813625	0.017931442	0.017155736
South Central Coast	2020	MCY	Aggregated	45	GAS	25392.82976	0.005801801	1.917279245	2.320233827	18.30598277	1.155188923	142.2748866	0.001583121	0.001488775
South Central Coast	2020	MDV	Aggregated	45	GAS	557129.2285	0.127293927	0.037675053	0.052306815	1.617805685	0.226805815	426.5368508	0.001421507	0.00130896
South Central Coast	2020	MDV	Aggregated	45	DSL	9439.207591	0.002156688	0.01166914	0.013284541	0.155879206	0.05959653	383.1299393	0.00693741	0.00663731
South Central Coast	2020	MH	Aggregated	45	GAS	4912.161276	0.00112234	0.138575457	0.194727205	4.663946791	0.795557457	1037.516835	0.001744017	0.00160855
South Central Coast	2020	MH	Aggregated	45	DSL	1250.348209	0.000285682	0.073142599	0.083267986	0.39072954	5.037073635	941.9221494	0.135382882	0.129526278
South Central Coast	2020	Motor Coach	Aggregated	45	DSL	759.7225905	0.000173583	0.096671173	0.110052772	0.381004818	4.029842632	1627.424904	0.021865976	0.020919796
South Central Coast	2020	OBUS	Aggregated	45	GAS	3754.346658	0.0008578	0.044358675	0.064583391	1.483610997	0.416340522	1013.799208	0.00063919	0.000587809
South Central Coast	2020	SBUS	Aggregated	45	GAS	1180.678254	0.000269764	0.043356564	0.063265797	1.518560862	0.458743377	491.4129197	0.00045228	0.000415854
South Central Coast	2020	SBUS	Aggregated	45	DSL	1447.033613	0.000330621	0.051230667	0.058322215	0.183395252	5.959557959	1092.229771	0.026673151	0.025519283
South Central Coast	2020	T6 Ag	Aggregated	45	DSL	767.5299346	0.000175367	0.347392103	0.395479465	1.126211534	5.21880308	1136.785884	0.228957784	0.219053171
South Central Coast	2020	T6 CAIRP heavy	Aggregated	45	DSL	65.4615125	1.49568E-05	0.029108762	0.033138109	0.126983669	1.211171361	1079.559662	0.006850656	0.0065543
South Central Coast	2020	T6 CAIRP small	Aggregated	45	DSL	200.950687	4.59136E-05	0.0508394	0.057876787	0.20588055	0.988874722	1094.020237	0.032834635	0.031414223
South Central Coast	2020	T6 instate construction heavy	Aggregated	45	DSL	1243.906191	0.00028421	0.043756978	0.049813989	0.157486735	2.649503174	1114.422708	0.0153432	0.01467946
South Central Coast	2020	T6 instate construction small	Aggregated	45	DSL	3307.010657	0.000755592	0.075900013	0.086406387	0.290724824	1.548268339	1104.950606	0.055113953	0.052729748
South Central Coast	2020	T6 instate heavy	Aggregated	45	DSL	13915.36912	0.00317941	0.041561768	0.047314909	0.157049639	2.208132402	1096.048497	0.011958741	0.011441411
South Central Coast	2020	T6 instate small	Aggregated	45	DSL	34722.32974	0.007933423	0.087246873	0.099323923	0.332427956	1.783445997	1105.124462	0.066704297	0.063818699
South Central Coast	2020	T6 OOS heavy	Aggregated	45	DSL	37.50698652	8.56967E-06	0.029394169	0.033463024	0.12832428	1.267674157	1080.275629	0.007266869	0.006952507
South Central Coast	2020	T6 OOS small	Aggregated	45	DSL	115.1371916	2.63068E-05	0.0508394	0.057876787	0.20588055	0.988874722	1094.020237	0.032834635	0.031414223
South Central Coast	2020	T6 Public	Aggregated	45	DSL	1028.401198	0.000234971	0.03563648	0.040569419	0.126082304	4.233362948	1102.610577	0.019860323	0.019001174
South Central Coast	2020	T6 utility	Aggregated	45	DSL	204.2405926	4.66653E-05	0.016253327	0.018503176	0.085552178	0.363860769	1130.102491	0.001849443	0.001769437
South Central Coast	2020	T6TS	Aggregated	45	GAS	7615.718549	0.001740054	0.094244391	0.137521194	3.126179356	0.796568812	1016.611597	0.000901424	0.000828826
South Central Coast	2020	T7 Ag	Aggregated	45	DSL	791.7292854	0.000180896	0.70784628	0.805829107	3.387748617	9.93633728	1653.635401	0.479249671	0.458517542
South Central Coast	2020	T7 CAIRP	Aggregated	45	DSL	13886.47431	0.003172808	0.088297214	0.100519657	0.414576217	3.337582676	1510.496647	0.016356628	0.015649047
South Central Coast	2020	T7 CAIRP construction	Aggregated	45	DSL	1211.003828	0.000276692	0.089854611	0.102292635	0.394855468	3.373153645	1539.871146	0.01967159	0.018820606
South Central Coast	2020	T7 NNOOS	Aggregated	45	DSL	17219.24542	0.003934285	0.05444486	0.061981328	0.296901665	1.242418767	1415.40298	0.00745163	0.007129276
South Central Coast	2020	T7 NOOS	Aggregated	45	DSL	5485.153256	0.001253258	0.088195232	0.100403558	0.416070526	3.387353892	1512.197378	0.016661122	0.015940369
South Central Coast	2020	T7 other port	Aggregated	45	DSL	3701.365276	0.000845695	0.113938957	0.129710829	0.432740482	4.488396316	1600.354375	0.0216677	0.020730365
South Central Coast	2020	T7 POLA	Aggregated	45	DSL	424.8442082	9.70692E-05	0.128932603	0.146779954	0.465293197	5.301819503	1625.478144	0.025660897	0.024550818
South Central Coast	2020	T7 Public	Aggregated	45	DSL	2446.97733	0.00055909	0.068392652	0.077859828	0.313598698	8.462926179	1613.426271	0.041764173	0.039957473
South Central Coast	2020	T7 Single	Aggregated	45	DSL	13853.64686	0.003165307	0.085425044	0.09724991	0.362616758	5.807133429	1608.95863	0.030511724	0.0291918
South Central Coast	2020	T7 single construction	Aggregated	45	DSL	3132.707568	0.000715767	0.069876151	0.079548679	0.299523109	3.628553973	1563.093739	0.01715614	0.016413973
South Central Coast	2020	T7 SWCV	Aggregated	45	DSL	3846.031908	0.000878749	0.044511053	0.78650885	2.085896779	6.252851018	3076.438402	0.007023049	0.006719235
South Central Coast	2020	T7 tractor	Aggregated	45	DSL	17152.97932	0.003919145	0.104457293	0.118916676	0.43226787	4.565897233	1533.983894	0.02277529	0.021790041
South Central Coast	2020	T7 tractor construction	Aggregated	45	DSL	2335.66503	0.000533657	0.103434764	0.117752605	0.422576711	4.667043995	1574.185361	0.026880302	0.025717472
South Central Coast	2020	T7 utility	Aggregated	45	DSL	145.4948728	3.32429E-05	0.033079194	0.037658145	0.195324958	0.660930345	1566.031762	0.002834438	0.002711822
South Central Coast	2020	T7IS	Aggregated	45	GAS	1062.409366	0.000242741	0.374777418	0.540730777	30.2849704	3.242651651	1661.898142	0.000619231	0.00057105
South Central Coast	2020	UBUS	Aggregated	45	GAS	307.8914691	7.03476E-05	0.31648843	0.461738964	4.050714329	1.205642997	1018.073022	0.000941699	0.000865898
South Central Coast	2020	UBUS	Aggregated	45	DSL	523.5345598	0.000119618	0.173430813	0.543675002	2.80495642	8.595740684	1593.218423	0.09440747	0.090323444

Composite 3.17E-02 4.26E-02 9.86E-01 2.54E-01 3.23E+02 2.82E-03 2.65E-03

EMFAC2014 (v1.0.7) Emission Rates

Region Type: Air Basin

Region: South Central Coast

Calendar Year: 2020

Season: Annual

Vehicle Classification: EMFAC2011 Categories

Units: miles/day for VMT, g/mile for RUNEX, PMBW and PMTW

Region	CalYr	VehClass	MdlYr	Speed	Fuel	VMT	%VMT	ROG_RUNEX	TOG_RUNEX	CO_RUNEX	NOx_RUNEX	CO2_RUNEX	PM10_RUNEX	PM2_5_RUNEX
South Central Coast	2020	LDA	Aggregated	45	GAS	2461143.355	0.562326632	0.011114023	0.016190038	0.648750618	0.063655138	232.0306983	0.001356073	0.001246936
South Central Coast	2020	LDT1	Aggregated	45	GAS	162577.8995	0.037146102	0.025756777	0.037465624	1.346579506	0.144230432	274.8277068	0.001922023	0.001767634
South Central Coast	2020	LDT2	Aggregated	45	GAS	895074.1437	0.204508213	0.019729818	0.028750201	1.02931613	0.138121938	317.7663181	0.001429426	0.001314423
South Central Coast	2020	LHD1	Aggregated	45	GAS	23416.07797	0.005350149	0.050222945	0.072662009	1.429053496	0.393231098	682.0662028	0.001165666	0.001072406
South Central Coast	2020	LHD2	Aggregated	45	GAS	5118.026525	0.001169376	0.017172348	0.025056711	0.517330259	0.208852067	732.6462632	0.000719093	0.00066118
South Central Coast	2020	MCY	Aggregated	45	GAS	25392.82976	0.005801801	1.917279245	2.320233827	18.30598277	1.155188923	142.2748866	0.001583121	0.001488775
South Central Coast	2020	MDV	Aggregated	45	GAS	557129.2285	0.127293927	0.037675053	0.052306815	1.617085685	0.226805815	426.5368508	0.001421507	0.00130896
South Central Coast	2020	MH	Aggregated	45	GAS	4912.161276	0.00112234	0.138575457	0.194727205	4.663946791	0.795557457	1037.516835	0.001744017	0.00160855
South Central Coast	2020	OBUS	Aggregated	45	GAS	3754.346658	0.0008578	0.044358675	0.064583391	1.483610997	0.416340522	1013.799208	0.00063919	0.000587809
South Central Coast	2020	SBUS	Aggregated	45	GAS	1180.678254	0.000269764	0.043356564	0.063265797	1.518560862	0.458743377	491.4129197	0.00045228	0.000415854
South Central Coast	2020	T6TS	Aggregated	45	GAS	7615.718549	0.001740054	0.094244391	0.137521194	3.126179356	0.796568812	1016.611597	0.000901424	0.000828826
South Central Coast	2020	T7IS	Aggregated	45	GAS	1062.409366	0.000242741	0.374777418	0.540730777	30.2849704	3.242651651	1661.898142	0.000619231	0.00057105
South Central Coast	2020	UBUS	Aggregated	45	GAS	307.8914691	7.03476E-05	0.31648843	0.461738964	4.050714329	1.205642997	1018.073022	0.000941699	0.000865898
Composite								2.79E-02	3.76E-02	9.66E-01	1.11E-01	2.70E+02	1.33E-03	1.22E-03



EMFAC2014 (v1.0.7) Emission Rates

Region Type: Air Basin

Region: South Central Coast

Calendar Year: 2020

Season: Annual

Vehicle Classification: EMFAC2011 Categories

Units: miles/day for VMT, g/mile for RUNEX, PMBW and PMTW

Region	CalYr	VehClass	MdYr	Speed	Fuel	VMT	%VMT	ROG_RUNEX	TOG_RUNEX	CO_RUNEX	NOx_RUNEX	CO2_RUNEX	PM10_RUNEX	PM2_5_RUNEX
South Central Coast	2020	All Other Buses	Aggregated	45	DSL	2421.941986	0.00055337	0.047600974	0.054190085	0.168075571	2.692317926	1132.315953	0.014391524	0.013768953
South Central Coast	2020	LDA	Aggregated	45	DSL	29942.65165	0.006841353	0.018821928	0.021427513	0.195438563	0.137493159	231.122074	0.012212104	0.011683814
South Central Coast	2020	LDT1	Aggregated	45	DSL	213.0808704	4.86851E-05	0.16214611	0.184592566	0.948307623	1.1885558	318.7921575	0.129025814	0.123444215
South Central Coast	2020	LDT2	Aggregated	45	DSL	1672.003405	0.000382022	0.012166223	0.013850436	0.100773688	0.052401345	293.7704538	0.005732004	0.00548404
South Central Coast	2020	LHD1	Aggregated	45	DSL	28691.42389	0.00655547	0.102955069	0.117207502	0.597690324	4.00996638	454.2621466	0.023901048	0.022867099
South Central Coast	2020	LHD2	Aggregated	45	DSL	10428.03053	0.002382616	0.0724092	0.082433061	0.408410925	2.49405214	495.5813625	0.017931442	0.017155736
South Central Coast	2020	MDV	Aggregated	45	DSL	9439.207591	0.002156688	0.01166914	0.013284541	0.155879206	0.05959653	383.1299393	0.00693742	0.00663731
South Central Coast	2020	MH	Aggregated	45	DSL	1250.348209	0.000285682	0.073142599	0.083267986	0.39072954	5.037073635	941.9221494	0.135382882	0.129526278
South Central Coast	2020	Motor Coach	Aggregated	45	DSL	759.7225905	0.000173583	0.096671173	0.110052772	0.381004818	4.029842632	1627.424904	0.021865697	0.020919796
South Central Coast	2020	SBUS	Aggregated	45	DSL	1447.033613	0.000330621	0.051230667	0.058322215	0.183395252	5.959557959	1092.229771	0.026673151	0.025519283
South Central Coast	2020	T6 Ag	Aggregated	45	DSL	767.5299346	0.000175367	0.347392103	0.395479465	1.126211534	5.21880308	1136.785884	0.228957784	0.219053171
South Central Coast	2020	T6 CAIRP heavy	Aggregated	45	DSL	65.4615125	1.49568E-05	0.029108762	0.033138109	0.126983669	1.211171361	1079.559662	0.006850656	0.0065543
South Central Coast	2020	T6 CAIRP small	Aggregated	45	DSL	200.950687	4.59136E-05	0.0508394	0.057876787	0.20588055	0.988874722	1094.020237	0.032834635	0.031414223
South Central Coast	2020	T6 instate construction heavy	Aggregated	45	DSL	1243.906191	0.00028421	0.043756978	0.049813989	0.157486735	2.649503174	1114.422708	0.0153432	0.01467946
South Central Coast	2020	T6 instate construction small	Aggregated	45	DSL	3307.010657	0.000755592	0.075900013	0.086406387	0.290724824	1.548268339	1104.950606	0.055113953	0.052729748
South Central Coast	2020	T6 instate heavy	Aggregated	45	DSL	13915.36912	0.00317941	0.041561768	0.047314909	0.157049639	2.208132402	1096.048497	0.011958741	0.011441411
South Central Coast	2020	T6 instate small	Aggregated	45	DSL	34722.32974	0.007933423	0.087246873	0.099323923	0.332427956	1.783445997	1105.124462	0.066704297	0.063818699
South Central Coast	2020	T6 OOS heavy	Aggregated	45	DSL	37.50698652	8.56967E-06	0.029394169	0.033463024	0.12832428	1.267674157	1080.275629	0.007266689	0.006952507
South Central Coast	2020	T6 OOS small	Aggregated	45	DSL	115.1371916	2.63068E-05	0.0508394	0.057876787	0.20588055	0.988874722	1094.020237	0.032834635	0.031414223
South Central Coast	2020	T6 Public	Aggregated	45	DSL	1028.401198	0.000234971	0.03563648	0.040569419	0.126082304	4.233362948	1102.610577	0.019860323	0.019001174
South Central Coast	2020	T6 utility	Aggregated	45	DSL	204.2405926	4.66653E-05	0.016253327	0.018503176	0.085552178	0.363860769	1130.102491	0.001849443	0.001769437
South Central Coast	2020	T7 Ag	Aggregated	45	DSL	791.7292854	0.000180896	0.70784628	0.805829107	3.387748617	9.93633728	1653.635401	0.479249671	0.458517542
South Central Coast	2020	T7 CAIRP	Aggregated	45	DSL	13886.47431	0.003172808	0.088297214	0.100519657	0.414576217	3.337582676	1510.496647	0.016356628	0.015649047
South Central Coast	2020	T7 CAIRP construction	Aggregated	45	DSL	1211.003828	0.000276692	0.089854611	0.102292635	0.394855468	3.373153645	1539.871146	0.01967159	0.018820606
South Central Coast	2020	T7 NNOOS	Aggregated	45	DSL	17219.24542	0.003934285	0.05444486	0.061981328	0.296901665	1.242418767	1415.40298	0.00745163	0.007129276
South Central Coast	2020	T7 NOOS	Aggregated	45	DSL	5485.153256	0.001253258	0.088195232	0.100403558	0.416070526	3.387353892	1512.197378	0.016661122	0.015940369
South Central Coast	2020	T7 other port	Aggregated	45	DSL	3701.365276	0.000845695	0.113938957	0.129710829	0.432740482	4.488396316	1600.354375	0.0216677	0.020730365
South Central Coast	2020	T7 POLA	Aggregated	45	DSL	424.8442082	9.70692E-05	0.128932603	0.146779954	0.465293197	5.301819503	1625.478144	0.025660897	0.024550818
South Central Coast	2020	T7 Public	Aggregated	45	DSL	2446.977733	0.00055909	0.068392652	0.077859828	0.313598698	8.462926179	1613.426271	0.041764173	0.039957473
South Central Coast	2020	T7 Single	Aggregated	45	DSL	13853.64686	0.003165307	0.085425044	0.09724991	0.362616758	5.807133429	1608.95863	0.030511724	0.0291918
South Central Coast	2020	T7 single construction	Aggregated	45	DSL	3132.707568	0.000715767	0.069876151	0.079548679	0.299523109	3.628553973	1563.093739	0.01715614	0.016413973
South Central Coast	2020	T7 SWCV	Aggregated	45	DSL	3846.031908	0.000878749	0.044511053	0.78650885	2.085896779	6.252851018	3076.438402	0.007023049	0.006719235
South Central Coast	2020	T7 tractor	Aggregated	45	DSL	17152.97932	0.003919145	0.104457293	0.118916676	0.43226787	4.565897233	1533.983894	0.02277529	0.021790041
South Central Coast	2020	T7 tractor construction	Aggregated	45	DSL	2335.66503	0.000533657	0.103434764	0.117752605	0.422576711	4.667043995	1574.185361	0.026880302	0.025717472
South Central Coast	2020	T7 utility	Aggregated	45	DSL	145.4948728	3.32429E-05	0.033079194	0.037658145	0.195324958	0.660930345	1566.031762	0.002834438	0.002711822
South Central Coast	2020	UBUS	Aggregated	45	DSL	523.5345598	0.000119618	0.173430813	0.543675002	2.80495642	8.595740684	1593.218423	0.09440747	0.090323444
Composite								3.81E-03	5.03E-03	2.04E-02	1.43E-01	5.37E+01	1.49E-03	1.43E-03



EMFAC2014 (v1.0.7) Emission Rates

Region Type: Air Basin

Region: South Central Coast

Calendar Year: 2020

Season: Annual

Vehicle Classification: EMFAC2011 Categories

Units: miles/day for VMT, g/mile for RUXEJ, PMBW and PMTW

Region	CalYr	VehClass	MdlYr	Speed	Fuel	VMT	%VMT	ROG_RUXEJ	TOG_RUXEJ	CO_RUXEJ	NOx_RUXEJ	CO2_RUXEJ	PM10_RUXEJ	PM2_5_RUXEJ
South Central Coast	2020	All Other Buses	Aggregated	65	DSL	1311.22884	0.000297557	0.025635331	0.029183873	0.09054711	2.420220382	1050.762568	0.014370205	0.013748557
South Central Coast	2020	LDA	Aggregated	65	DSL	30200.30711	0.006853341	0.020960103	0.023861684	0.22520406	0.153946476	295.6916546	0.014762644	0.014124019
South Central Coast	2020	LDT1	Aggregated	65	DSL	216.3535445	4.9097E-05	0.214101512	0.243740337	1.71703729	1.389620432	406.6219864	0.170990844	0.163593856
South Central Coast	2020	LDT2	Aggregated	65	DSL	1685.082004	0.000382395	0.010748715	0.012236698	0.093718897	0.054113913	374.7105733	0.006097193	0.005833431
South Central Coast	2020	LHD1	Aggregated	65	DSL	53421.05876	0.012122815	0.11716073	0.133379701	0.940871572	4.187352862	506.6067915	0.027262222	0.02608287
South Central Coast	2020	LHD2	Aggregated	65	DSL	20514.09992	0.004655255	0.078192915	0.089017435	0.608086999	2.59039089	532.3752569	0.019409499	0.018569852
South Central Coast	2020	MDV	Aggregated	65	DSL	9488.918095	0.002153316	0.011108216	0.012645965	0.141332408	0.062247348	494.0401547	0.007598469	0.007269762
South Central Coast	2020	MH	Aggregated	65	DSL	1192.193382	0.000270544	0.079411743	0.090404989	0.390266958	5.013607194	923.4008319	0.222208794	0.21259614
South Central Coast	2020	Motor Coach	Aggregated	65	DSL	571.8201781	0.000129763	0.04863433	0.055366482	0.201515527	3.557937046	1509.275478	0.021382375	0.020457383
South Central Coast	2020	SBUS	Aggregated	65	DSL	0	0	0	0	0	0	0	0	0
South Central Coast	2020	T6 Ag	Aggregated	65	DSL	594.9932391	0.000135022	0.341179002	0.388406323	0.887347992	5.116729879	1072.137071	0.24767418	0.236959904
South Central Coast	2020	T6 CAIRP heavy	Aggregated	65	DSL	50.74610853	1.15158E-05	0.014414865	0.016410227	0.063445318	0.967757838	999.7539364	0.006436889	0.006158432
South Central Coast	2020	T6 CAIRP small	Aggregated	65	DSL	155.7780287	3.53506E-05	0.033120536	0.037705209	0.164032803	0.801210814	1021.116455	0.042770449	0.040920218
South Central Coast	2020	T6 instate construction heavy	Aggregated	65	DSL	1096.074414	0.000248732	0.025530021	0.029063985	0.092059309	2.438082916	1037.035581	0.016662359	0.015941553
South Central Coast	2020	T6 instate construction small	Aggregated	65	DSL	2563.612041	0.000581759	0.05195929	0.059151697	0.255431201	1.341231315	1031.423093	0.072987877	0.069830453
South Central Coast	2020	T6 instate heavy	Aggregated	65	DSL	13585.08885	0.003082858	0.020600632	0.023452251	0.079956338	1.807115098	1011.378135	0.010898965	0.010427481
South Central Coast	2020	T6 instate small	Aggregated	65	DSL	34181.99451	0.007756903	0.059733828	0.068002416	0.295539056	1.451494401	1032.666959	0.086524991	0.082781958
South Central Coast	2020	T6 OOS heavy	Aggregated	65	DSL	29.07561307	6.59811E-06	0.014828345	0.016880942	0.065413364	1.027142334	1000.764751	0.007109287	0.006801742
South Central Coast	2020	T6 OOS small	Aggregated	65	DSL	89.25495604	2.02546E-05	0.033120536	0.037705209	0.164032803	0.801210814	1021.116455	0.042770449	0.040920218
South Central Coast	2020	T6 Public	Aggregated	65	DSL	929.2249913	0.000210869	0.026218043	0.029847246	0.08349754	4.008441975	1036.33649	0.022039622	0.021086198
South Central Coast	2020	T6 utility	Aggregated	65	DSL	158.3283808	3.59294E-05	0.007577135	0.008625991	0.03988355	0.238601574	1053.519295	0.00159796	0.001528833
South Central Coast	2020	T7 Ag	Aggregated	65	DSL	716.5951328	0.000162617	0.687094207	0.782204452	2.663877349	9.814598201	1569.121671	0.500391969	0.478745234
South Central Coast	2020	T7 CAIRP	Aggregated	65	DSL	12568.66467	0.002852201	0.043140361	0.049112017	0.205954473	2.662221166	1397.456536	0.014831644	0.014190034
South Central Coast	2020	T7 CAIRP construction	Aggregated	65	DSL	1096.081028	0.000248733	0.045576356	0.051885212	0.209948303	2.888113433	1432.115946	0.020054639	0.019187084
South Central Coast	2020	T7 NNOOS	Aggregated	65	DSL	15585.15983	0.003536733	0.026041142	0.029645858	0.143400793	0.911171621	1311.832833	0.006933427	0.00663349
South Central Coast	2020	T7 NOOS	Aggregated	65	DSL	4964.61884	0.001126619	0.043529289	0.049554782	0.20899036	2.71657058	1399.666542	0.015468226	0.014799077
South Central Coast	2020	T7 other port	Aggregated	65	DSL	3350.110184	0.000760239	0.053569975	0.060985339	0.205866798	3.895073462	1478.77177	0.018865131	0.018049034
South Central Coast	2020	T7 POLA	Aggregated	65	DSL	384.5270062	8.72605E-05	0.060708958	0.069112527	0.222401684	4.655787613	1499.164684	0.022362678	0.021395278
South Central Coast	2020	T7 Public	Aggregated	65	DSL	2181.48341	0.000495043	0.052103023	0.059315325	0.213411937	7.833093937	1522.234908	0.043544768	0.04166104
South Central Coast	2020	T7 Single	Aggregated	65	DSL	11786.50763	0.002674706	0.04967502	0.056551229	0.203603038	4.726540972	1502.726299	0.02740019	0.02621487
South Central Coast	2020	T7 single construction	Aggregated	65	DSL	2835.417405	0.00064344	0.039206919	0.044634093	0.168351168	3.323474244	1456.014933	0.018584119	0.017780178
South Central Coast	2020	T7 SWCV	Aggregated	65	DSL	0	0	0	0	0	0	0	0	0
South Central Coast	2020	T7 tractor	Aggregated	65	DSL	15525.18231	0.003523122	0.053037097	0.060378698	0.222184804	3.859790264	1416.41564	0.021088577	0.020176294
South Central Coast	2020	T7 tractor construction	Aggregated	65	DSL	2114.013241	0.000479732	0.056264725	0.064053107	0.242659254	4.175711446	1464.98031	0.028652928	0.027413415
South Central Coast	2020	T7 utility	Aggregated	65	DSL	131.6875851	2.98838E-05	0.015421182	0.017555842	0.091058497	0.441928236	1459.907124	0.002449018	0.002343075
South Central Coast	2020	UBUS	Aggregated	65	DSL	347.3296978	7.88194E-05	0.228290626	1.036857494	4.015606609	7.255180171	1469.401074	0.083839483	0.080212624
Composite								3.68E-02	4.86E-02	9.02E-01	2.62E-01	3.80E+02	3.37E-03	3.16E-03

EMFAC2014 (v1.0.7) Emission Rates

Region Type: Air Basin

Region: South Central Coast

Calendar Year: 2020

Season: Annual

Vehicle Classification: EMFAC2011 Categories

Units: miles/day for VMT, g/mile for RUNEX, PMBW and PMTW

Region	CalYr	VehClass	MdlYr	Speed	Fuel	VMT	%VMT	ROG_RUNEX	TOG_RUNEX	CO_RUNEX	NOx_RUNEX	CO2_RUNEX	PM10_RUNEX	PM2_5_RUNEX
South Central Coast	2020	LDA	Aggregated	65	GAS	2472719.636	0.56113305	0.012968312	0.018886947	0.516535482	0.069151982	288.209176	0.001611708	0.001482007
South Central Coast	2020	LDT1	Aggregated	65	GAS	163337.9057	0.037066191	0.029217339	0.042474273	1.211142569	0.170897285	341.4917294	0.002226374	0.002047603
South Central Coast	2020	LDT2	Aggregated	65	GAS	898282.3099	0.203846762	0.022599812	0.032924702	0.845474416	0.155452656	394.9562382	0.001684373	0.001548876
South Central Coast	2020	LHD1	Aggregated	65	GAS	26060.86204	0.005913979	0.061071232	0.088173275	1.761563812	0.417703991	779.0242217	0.001387081	0.001276257
South Central Coast	2020	LHD2	Aggregated	65	GAS	6051.585607	0.001373283	0.019793023	0.028881933	0.495684693	0.219098816	814.6363405	0.000844169	0.000776183
South Central Coast	2020	MCY	Aggregated	65	GAS	25208.97522	0.00572066	2.444600545	2.953308134	27.52780285	1.28580648	176.9536848	0.002019547	0.001899937
South Central Coast	2020	MDV	Aggregated	65	GAS	559515.6799	0.126970618	0.044999796	0.062106224	1.52299559	0.256768814	530.1107315	0.0016888	0.001555344
South Central Coast	2020	MH	Aggregated	65	GAS	3057.336716	0.0006938	0.16056671	0.224412604	6.342885687	0.819154257	967.0176488	0.002031996	0.001874687
South Central Coast	2020	OBUS	Aggregated	65	GAS	1890.751947	0.000429067	0.045178321	0.065534445	1.038440025	0.381496229	941.3953902	0.000775042	0.000712872
South Central Coast	2020	T6TS	Aggregated	65	GAS	4218.646186	0.000957335	0.10159568	0.148248178	2.464677924	0.782626452	945.4611628	0.001046927	0.000962611
South Central Coast	2020	T7IS	Aggregated	65	GAS	465.7391937	0.00010569	0.399564427	0.576099624	22.70359486	3.218056177	1558.140488	0.000780026	0.000719072
South Central Coast	2020	UBUS	Aggregated	65	GAS	222.7409499	5.05465E-05	0.202045173	0.294773369	2.912912707	1.006619159	942.8399359	0.000913972	0.000840388
Composite								3.33E-02	4.46E-02	8.79E-01	1.21E-01	3.31E+02	1.57E-03	1.44E-03

EMFAC2014 (v1.0.7) Emission Rates

Region Type: Air Basin

Region: South Central Coast

Calendar Year: 2020

Season: Annual

Vehicle Classification: EMFAC2011 Categories

Units: miles/day for VMT, g/mile for RUNEX, PMBW and PMTW

Region	CalYr	VehClass	MdYr	Speed	Fuel	VMT	%VMT	ROG_RUNEX	TOG_RUNEX	CO_RUNEX	NOx_RUNEX	CO2_RUNEX	PM10_RUNEX	PM2_5_RUNEX
South Central Coast	2020	All Other Buses	Aggregated	65	DSL	1311.22884	0.000297557	0.025635331	0.029183873	0.09054711	2.420220382	1050.762568	0.014370205	0.013748557
South Central Coast	2020	LDA	Aggregated	65	DSL	30200.30711	0.006853341	0.020960103	0.023861684	0.22520406	0.153946476	295.6916546	0.014762644	0.014124019
South Central Coast	2020	LDT1	Aggregated	65	DSL	216.3535445	4.9097E-05	0.214101512	0.243740337	1.71703729	1.389620432	406.6219864	0.170990844	0.163593856
South Central Coast	2020	LDT2	Aggregated	65	DSL	1685.082004	0.000382395	0.010748715	0.012236698	0.093718897	0.054113913	374.7105733	0.006097193	0.005833431
South Central Coast	2020	LHD1	Aggregated	65	DSL	53421.05876	0.012122815	0.11716073	0.133379701	0.940871572	4.187352862	506.6067915	0.027262222	0.02608287
South Central Coast	2020	LHD2	Aggregated	65	DSL	20514.09992	0.004655255	0.078192915	0.089017435	0.608086999	2.59039089	532.3752569	0.019409499	0.018569852
South Central Coast	2020	MDV	Aggregated	65	DSL	9488.918095	0.002153316	0.011108216	0.012645965	0.141332408	0.062247348	494.0401547	0.007598469	0.007269762
South Central Coast	2020	MH	Aggregated	65	DSL	1192.193382	0.000270544	0.079411743	0.090404989	0.390266958	5.013607194	923.4008319	0.222208794	0.21259614
South Central Coast	2020	Motor Coach	Aggregated	65	DSL	571.8201781	0.000129763	0.04863433	0.055366482	0.201515527	3.557937046	1509.275478	0.021382375	0.020457383
South Central Coast	2020	SBUS	Aggregated	65	DSL	0	0	0	0	0	0	0	0	0
South Central Coast	2020	T6 Ag	Aggregated	65	DSL	594.9932391	0.000135022	0.341179002	0.388406323	0.887347992	5.116729879	1072.137071	0.24767418	0.236959904
South Central Coast	2020	T6 CAIRP heavy	Aggregated	65	DSL	50.74610853	1.15158E-05	0.014414865	0.016410227	0.063445318	0.967757838	999.7539364	0.006436889	0.006158432
South Central Coast	2020	T6 CAIRP small	Aggregated	65	DSL	155.7780287	3.53506E-05	0.033120536	0.037705209	0.164032803	0.801210814	1021.116455	0.042770449	0.040920218
South Central Coast	2020	T6 instate construction heavy	Aggregated	65	DSL	1096.074414	0.000248732	0.025530021	0.029063985	0.092059309	2.438082916	1037.035581	0.016662359	0.015941553
South Central Coast	2020	T6 instate construction small	Aggregated	65	DSL	2563.612041	0.000581759	0.05195929	0.059151697	0.255431201	1.341231315	1031.423093	0.072987877	0.069830453
South Central Coast	2020	T6 instate heavy	Aggregated	65	DSL	13585.08885	0.003082858	0.020600632	0.023452251	0.079956338	1.807115098	1011.378135	0.010898965	0.010427481
South Central Coast	2020	T6 instate small	Aggregated	65	DSL	34181.99451	0.007756903	0.059733828	0.068002416	0.295539056	1.451494401	1032.666959	0.086524991	0.082781958
South Central Coast	2020	T6 OOS heavy	Aggregated	65	DSL	29.07561307	6.59811E-06	0.014828345	0.016880942	0.065413364	1.027142334	1000.764751	0.007109287	0.006801742
South Central Coast	2020	T6 OOS small	Aggregated	65	DSL	89.25495604	2.02546E-05	0.033120536	0.037705209	0.164032803	0.801210814	1021.116455	0.042770449	0.040920218
South Central Coast	2020	T6 Public	Aggregated	65	DSL	929.2249913	0.000210869	0.026218043	0.029847246	0.08349754	4.008441975	1036.33649	0.022039622	0.021086198
South Central Coast	2020	T6 utility	Aggregated	65	DSL	158.3283808	3.59294E-05	0.007577135	0.008625991	0.03988355	0.238601574	1053.519295	0.00159796	0.001528833
South Central Coast	2020	T7 Ag	Aggregated	65	DSL	716.5951328	0.000162617	0.687094207	0.782204452	2.663877349	9.814598201	1569.121671	0.500391969	0.478745234
South Central Coast	2020	T7 CAIRP	Aggregated	65	DSL	12568.66467	0.002852201	0.043140361	0.049112017	0.205954473	2.662221166	1397.456536	0.014831644	0.014190034
South Central Coast	2020	T7 CAIRP construction	Aggregated	65	DSL	1096.081028	0.000248733	0.045576356	0.051885212	0.209948303	2.888113433	1432.115946	0.020054639	0.019187084
South Central Coast	2020	T7 NNOOS	Aggregated	65	DSL	15585.15983	0.003536733	0.026041142	0.029645858	0.143400793	0.911171621	1311.832833	0.006933427	0.00663349
South Central Coast	2020	T7 NOOS	Aggregated	65	DSL	4964.61884	0.001126619	0.043529289	0.049554782	0.20899036	2.71657058	1399.666542	0.015468226	0.014799077
South Central Coast	2020	T7 other port	Aggregated	65	DSL	3350.110184	0.000760239	0.053569975	0.060985339	0.205866798	3.895073462	1478.77177	0.018865131	0.018049034
South Central Coast	2020	T7 POLA	Aggregated	65	DSL	384.5270062	8.72605E-05	0.060708958	0.069112527	0.222401684	4.655787613	1499.164684	0.022362678	0.021395278
South Central Coast	2020	T7 Public	Aggregated	65	DSL	2181.48341	0.000495043	0.052103023	0.059315325	0.213411937	7.833093937	1522.234908	0.043544768	0.04166104
South Central Coast	2020	T7 Single	Aggregated	65	DSL	11786.50763	0.002674706	0.04967502	0.056551229	0.203603038	4.726540972	1502.726299	0.02740019	0.02621487
South Central Coast	2020	T7 single construction	Aggregated	65	DSL	2835.417405	0.00064344	0.039206919	0.044634093	0.168351168	3.323474244	1456.014933	0.018584119	0.017780178
South Central Coast	2020	T7 SWCV	Aggregated	65	DSL	0	0	0	0	0	0	0	0	0
South Central Coast	2020	T7 tractor	Aggregated	65	DSL	15525.18231	0.003523122	0.053037097	0.060378698	0.222184804	3.859790264	1416.41564	0.021088577	0.020176294
South Central Coast	2020	T7 tractor construction	Aggregated	65	DSL	2114.013241	0.000479732	0.056264725	0.064053107	0.242659254	4.175711446	1464.98031	0.028652928	0.027413415
South Central Coast	2020	T7 utility	Aggregated	65	DSL	131.6875851	2.98838E-05	0.015421182	0.017555842	0.091058497	0.441928236	1459.907124	0.002449018	0.002343075
South Central Coast	2020	UBUS	Aggregated	65	DSL	347.3296978	7.88194E-05	0.228290626	1.036857494	4.015606609	7.255180171	1469.401074	0.083839483	0.080212624

Composite	3.47E-03	4.01E-03	2.32E-02	1.41E-01	4.87E+01	1.80E-03	1.72E-03
-----------	----------	----------	----------	----------	----------	----------	----------

**APPENDIX D**

---

**Health Risk Calculations**

Table  
Quantification of Carcinogenic Risks and Noncarcinogenic Hazards  
30 Year Exposure Scenario / Maximum Residential Receptor at Ground Level

Source (a)	Concentration		Weight Fraction (d)	Contaminant (e)	Carcinogenic Risk				Noncarcinogenic Hazards/ Toxicological Endpoints*									
	(ug/m <sup>3</sup> ) (b)	(mg/m <sup>3</sup> ) (c)			URF (ug/m <sup>3</sup> ) <sup>-1</sup> (f)	CPF (mg/kg/day) <sup>-1</sup> (g)	DOSE (mg/kg-day) (h)	RISK (i)	REL (ug/m <sup>3</sup> ) (j)	RfD (mg/kg/day) (k)	RESP (l)	CNS/PNS (m)	CV/BL (n)	IMMUN (o)	KIDN (p)	GI/LV (q)	REPRO (r)	EYES (s)
	Freeway	0.03223			3.2E-05	4.91E-01 3.17E-01 2.00E-02 5.70E-02 2.60E-02 1.00E+00	Benzene Formaldehyde 1,3-Butadiene Acetaldehyde Acrolein Diesel Particulates	2.9E-05 6.0E-06 1.7E-04 2.7E-06 0.0E+00 3.0E-04	1.0E-01 2.1E-02 6.0E-01 9.5E-03 0.0E+00 1.1E+00	4.6E-06 3.0E-06 1.9E-07 5.3E-07 2.4E-07 9.3E-06	4.7E-07 6.2E-08 1.1E-07 5.0E-09 0.0E+00 9.8E-06	3.0E+00 9.0E+00 2.0E+00 1.4E+02 3.5E-01 5.0E+00	8.6E-04 2.6E-03 5.7E-04 4.0E-02 1.0E-04 1.4E-03	5.3E-03 1.1E-03 3.2E-04 1.3E-05 2.4E-03 0.0E+00				
TOTAL								1.0E-05			9.1E-03							

\* Key to Toxicological Endpoints

RESP Respiratory System  
 CNS/PNS Central/Peripheral Nervous System  
 CV/BL Cardiovascular/Blood System  
 IMMUN Immune System  
 KIDN Kidney  
 GI/LV Gastrointestinal System/Liver  
 REPRO Reproductive System (e.g. teratogenic and developmental effects)  
 EYES Eye irritation and/or other effects

$$\text{Dose} = (\text{Cair} \times \text{DBR} \times \text{A} \times \text{EF} \times \text{ED} \times \text{CF}) / \text{AT}$$

Note: Exposure factors used to calculate contaminant intake

EF	exposure frequency (days/year)	350
	exposure duration (years)	30
DBR	Daily Breathing Rate	302
	inhalation rate (L/kg-day)	20
A	inhalation absorption factor	1
ED	averaging time (years)	70
	fraction of time at home	1
	age sensitivity factor (third trimester to 2 years)	10
	breathing rate third trimester	361
	breathing rate 0-2	1090
	weighted breathing rate	20
AT	Averaging time period	25550
CF	Composite Conversion Factor	1.00E-06

## MEIR Health Risk Calculations

### Cancer Risk Computation

Cancer Risk 1.04E-05 FALSE  
 1.00E-05

### Reduced Risk

Risk Reduction - Cancer risk \* reduction potential

Filtration	%windows closed				Less than 1.00 E-05?			
	100%	75%	50%	25%	100%	75%	50%	25%
MERV 12	3.16E-06	4.98E-06	6.80E-06	8.62E-06	TRUE	TRUE	TRUE	TRUE
MERV 11	3.56E-06	5.28E-06	7.00E-06	8.72E-06	TRUE	TRUE	TRUE	TRUE
MERV 10	5.18E-06	6.50E-06	7.81E-06	9.13E-06	TRUE	TRUE	TRUE	TRUE
MERV 9	6.40E-06	7.41E-06	8.42E-06	9.43E-06	TRUE	TRUE	TRUE	TRUE

Reduction Assumptions:

1. Assumes 77% of day is spent indoors
- 2a. Sealed HVAC system with MERV 12 or higher rated filters (90% reduction on particulates less than 0.3 microns or larger), effectiveness.
- 2b. Sealed HVAC system with MERV 11 or higher rated filters (80% reduction on particulates less than 0.3 microns or larger), effectiveness.
- 2c. Sealed HVAC system with MERV 10 or higher rated filters (65% reduction on particulates less than 0.3 microns or larger), effectiveness.
- 2d. Sealed HVAC system with MERV 9 or higher rated filters (50% reduction on particulates less than 0.3 microns or larger), effectiveness.
3. Institute tiered vegetation along the perimeter of the Project area.

Reduction	Time Windows Closed			
	100%	75%	50%	25%
	0.775	0.58125	0.3875	0.19375
	0.9	0.9	0.9	0.9
	0.85	0.85	0.85	0.85
	0.65	0.65	0.65	0.65
	0.5	0.5	0.5	0.5
N/A	N/A	N/A	N/A	NA

Total Percent Reduction 2a (1*2a)	0.6975	0.5231	0.3488	0.1744
Total Percent Reduction 2b (1*2b)	0.6588	0.4941	0.3294	0.1647
Total Percent Reduction 2c (1*2c)	0.5038	0.3778	0.2519	0.1259
Total Percent Reduction 2d (1*2d)	0.3875	0.2906	0.1938	0.0969

### Hazard Index Computation

Resident Adult

Chronic hazard index

Inhalation chronic risk = Cair/Inhalation Chronic REL

Cair	0.876522	µg/m3
REL	5	µg/m3

Increase in average annual PM10 concentration from air dispersion model at the MEI

Reference exposure level for DPM

HQ

0.1753044

Hazard Quotient for DPM

### Source

- 1 U.S. Department of Labor, Bureau of Labor Statistics. American Time Use Survey - 2012 Results, USLD-13-1178. Released June 20, 2013
- 2 National Air Filtration Association. User Guide for ANSI/ASHRAE Standard 52.2 - 1999 Method of Testing General Ventilation Air-Cleaning Devices for Removal Efficiency by Particle Size. Retried from [http://www.filtera-b2b.com/businessfilters/PDFfiles/NAFA\\_Filter\\_Guide.pdf](http://www.filtera-b2b.com/businessfilters/PDFfiles/NAFA_Filter_Guide.pdf)
- 3 CARB, 2012. Status of Research on Potential Mitigation Concepts to Reduce Exposure to Nearby Traffic Pollution. August 23



# Appendix C

---

Biological Assessment Report



July 17, 2019

Tony Locacciato, Partner  
Meridian Consultants  
910 Hampshire Road, Suite V  
Westlake Village, California 91361

**RE: Biological Assessment Report for the Rio Urbana Mixed Use Project, Oxnard, California**

Dear Mr. Locacciato:

This biological assessment documents and describes the existing conditions of biological resources associated with the Rio Urbana Mixed Use Project (Project). BioResource Consultants Inc., (BRC) has prepared this report for the analysis of biological resources, including the potential occurrence of special-status species and their habitats within the survey area.

### **PROJECT LOCATION**

The Project is located within the City of Oxnard at 2741 East Vineyard Avenue, Ventura County, California (Figure 1). The Project area includes the entire El Rio Elementary School property, which was closed in 2008. The property is a 10.24 acres site that has undergone heavy use and disturbance.

### **PROJECT DESCRIPTION**

The Project site consists of approximately 10.24 acres of developed land with numerous vacant buildings (cafeteria, administration, classrooms, and two portable buildings) that were formerly the El Rio Elementary School campus. The school has been closed since 2008 and is currently utilized as a dispatch for school buses and storage. The proposed Project would include demolition of the existing facilities to allow for the construction of a new mixed-use development, which will include 182 condominium residential units and a 15,000-square-foot office building containing the Rio School District Administrative Offices.

### **METHODOLOGY**

Prior to implementing biological surveys, standard database searches were conducted and previous surveys in the area were reviewed to obtain pertinent information regarding habitat types. The results of these preliminary database searches provided a basis for addressing the appropriate special-status species within the Project area.

#### **Literature and Database Review**

BRC performed a review of special-status species and habitats within the survey area using information obtained from the California Natural Diversity Database (CNDDDB; CDFW 2017). The CNDDDB search included the *Oxnard* and surrounding U.S. Geological Survey 7.5-minute quadrangles.

Additional literature and databases referenced include:

- California Native Plant Society's Inventory of Rare and Endangered Vascular Plants of California (CNPS 2010)
- The Jepson Manual: Higher Plants of California (Baldwin 2012)
- A Manual of California Vegetation (Sawyer et al. 2009)
- The CalFlora Database (CalFlora 2017)
- eBird website (Cornell Lab of Ornithology and National Audubon Society, Inc., 2017)
- California Herps: A Guide to the Amphibians and Reptiles of California website (California Herps 2017)
- USFWS Critical Habitat Portal website (USFWS 2017)

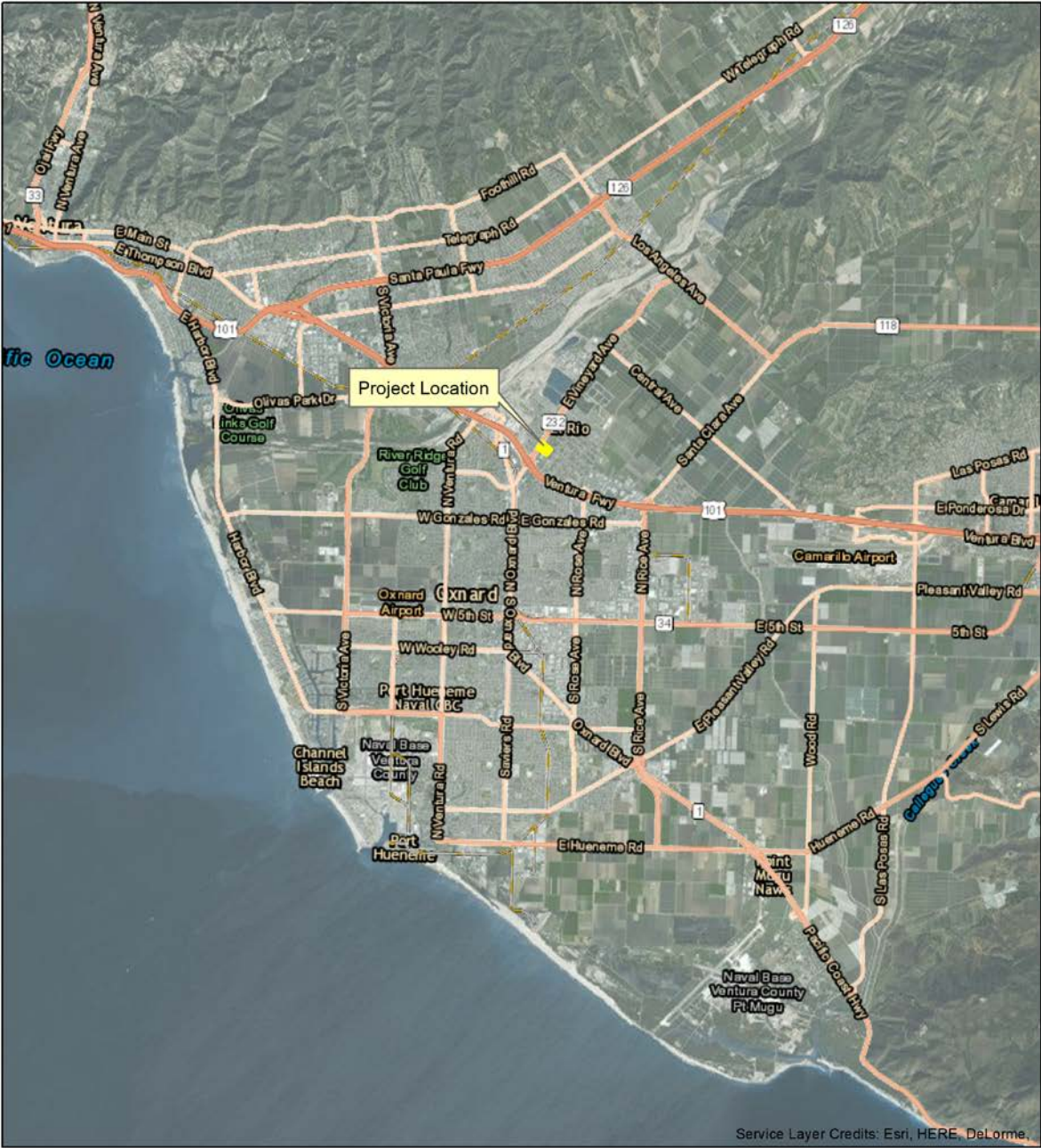

 Project Location



FIGURE 1. RIO URBANA MIXED-USE PROJECT VICINITY MAP





- Survey Area
- Photo Location

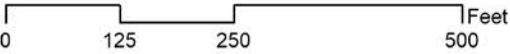

FIGURE 2. RIO URBANA MIXED-USE PROJECT LOCATION MAP

## **Survey Methods**

On July 7, 2017, BRC biologist Colleen Del Vecchio conducted reconnaissance-level surveys for special-status species at the Project site. Plant species were identified, either in the field or following collection for subsequent identification, using the identification keys described in Hickman (1993) and Baldwin (2012). Nomenclature generally follows Sawyer et al. (2009) for vegetation types and communities and Calflora (2017), Baldwin (2012), and current scientific data (e.g., scientific journals) for plant species. The survey procedure for wildlife species included searching for and identifying species' diagnostic signs, including audible calls prints, scat, nests, skeletal remains, burrows, and habitat features (i.e. rock or debris piles, cavities, and rock outcrops) that may attract and/or support special-status species. Taxonomy and nomenclature for wildlife generally follows Collins and Taggert (2009) for amphibians and reptiles, American Ornithologists Union (AOU 1998) for birds, and Baker et al. (2003) for mammals.

## **Special-Status Plants and Wildlife**

Plants or wildlife may be considered to have special-status due to declining populations, vulnerability to habitat change, restricted distributions, or insufficient knowledge of the species' biological status.

Using information from the various listed sources and floral and faunal surveys of the area, the potential for special-status species documented to occur within three miles of the Project site was assessed as Occurs, Likely, Unlikely, or Does Not Occur based on the following criteria:

- Occurs – The species and/or conclusive sign was observed on-site during the survey.
- Likely – This species is expected to occur in the proposed survey areas based on presence of suitable habitat, and/or based on professional expertise specific to the site or species, and nearby, recent (in the last decade) recorded occurrences for the species.
- Unlikely – This species may have been recorded in the project vicinity, but the project is on the periphery of the species range, or there are older records (greater than 10 years) on/near the project site, but there is currently marginal suitable habitat on-site (habitat is highly disturbed, degraded, or limited).
- Does Not Occur – This species is not expected to occur in the proposed survey area. Suitable habitat was not observed in the survey area during the survey. The survey area is outside of the currently known range of the species.

Special-status plant and wildlife species that are known to occur or have the potential to occur in the survey area are listed in Attachment A, Table 1. Mapped CNDDDB documented occurrences of special-status species within the vicinity of the survey area are provided in Figure 3.

## **EXISTING ENVIRONMENT**

The Project is largely located in commercial and urban area dominated by ornamental and ruderal vegetation communities (Attachment B: Photos 1-14). There are no areas with strictly native vegetation and no drainages or waterways are present on the property. Elevation along the Project area is 88 feet above mean sea level (amsl). The entire property had been previously graded and the terrain is flat.

Vegetation within the survey area consists mainly of ruderal fields dominated by fox tail brome (*Bromus madritensis*), hairy crabgrass (*Digitaria sanguinalis*), and common Mediterranean grass (*Shismus barbatus*). The vegetation community is best described as a Red Brome or Mediterranean Grass Grasslands (*Bromus rubens* - *Schismus [arabicus, barbatus]* Herbaceous Semi-Natural Alliance; Sawyer 2009). Within this community, additional species varied depending on the area's past disturbance, such as stockpiling of materials (Attachment B, Photos 6, 7, 10, 11), or a field made for recreational baseball (Attachment B, Photo 9). These species include sweet white clover (*Melilotus albus*), sow thistle (*Sonchus oleraceus*), yellow star thistle (*Centaurea solstitialis*), black medick (*Medicago lupulina*), red-stemmed filaree (*Erodium cicutarium*), and rattlesnake sandmat (*Cuphorbia albomarginata*).



Near the current school buildings, vegetation of ornamental shrubs border most fence lines, buildings, and parking lots. On the southeast border of the property, there is a row of tamarisk trees (*Tamarix ramosissima*); on the northeastern border is four o'clock (*Mirabilis jalapa*); on the western border are Canary Island pine trees (*Pinus canariensis*); and on the northwestern border are Chinese tallow trees (*Tridaica sebifera*).

Within the fielded areas, there are three Heritage trees as defined by the Ventura County Tree Protection Ordinance (VC 2014). Heritage trees can be a tree of any species that is 90 inches in circumference for a single trunk. Heritage trees within the Project area include a single coast live oak (*Quercus agrifolia*) and two velvet ash (*Fraxinus velutina*). All three of these trees are native and provide nesting habitat for birds. Northern mockingbird (*Mimus polyglottos*) fledglings were observed foraging in two of the Heritage trees, in addition to many other adult birds. The coast live oak (Figure 4, Heritage Tree 1) is 91 inches in circumference, approximately 27 feet wide, and 35 feet tall. The velvet ash (Figure 4, Heritage Tree 2) adjacent to the oak is 118 inches in circumference, approximately 25 feet wide, and 60 feet tall. The second velvet ash (Figure 4, Heritage Tree 3) is located adjacent to the front parking lot and is 184 inches in circumference, approximately 40 feet wide, and 80 feet tall.

Throughout the area with school buildings, house sparrows (*Passer domesticus*) were observed nesting. These birds are not protected by the Migratory Bird Act; moreover they commonly harass native birds and take over their active nests. Additionally, an inactive American crow (*Corvus brachyrhynchos*) nest was observed in the larger Heritage velvet ash tree. Courting behavior was observed in the field by Anna's hummingbirds (*Calypte anna*) and Cassin's kingbirds (*Tyrannus vociferans*). Nesting habitat does occur where tall, dense vegetation occurs on this property. However, due to the high disturbance in this urban area and disconnect this property has from any wildlife corridors, it is unlikely that a special-status bird would be nesting in this marginal habitat. Nesting raptors could occur adjacent to the property in eucalyptus trees along Rio School Lane on the northeast border.

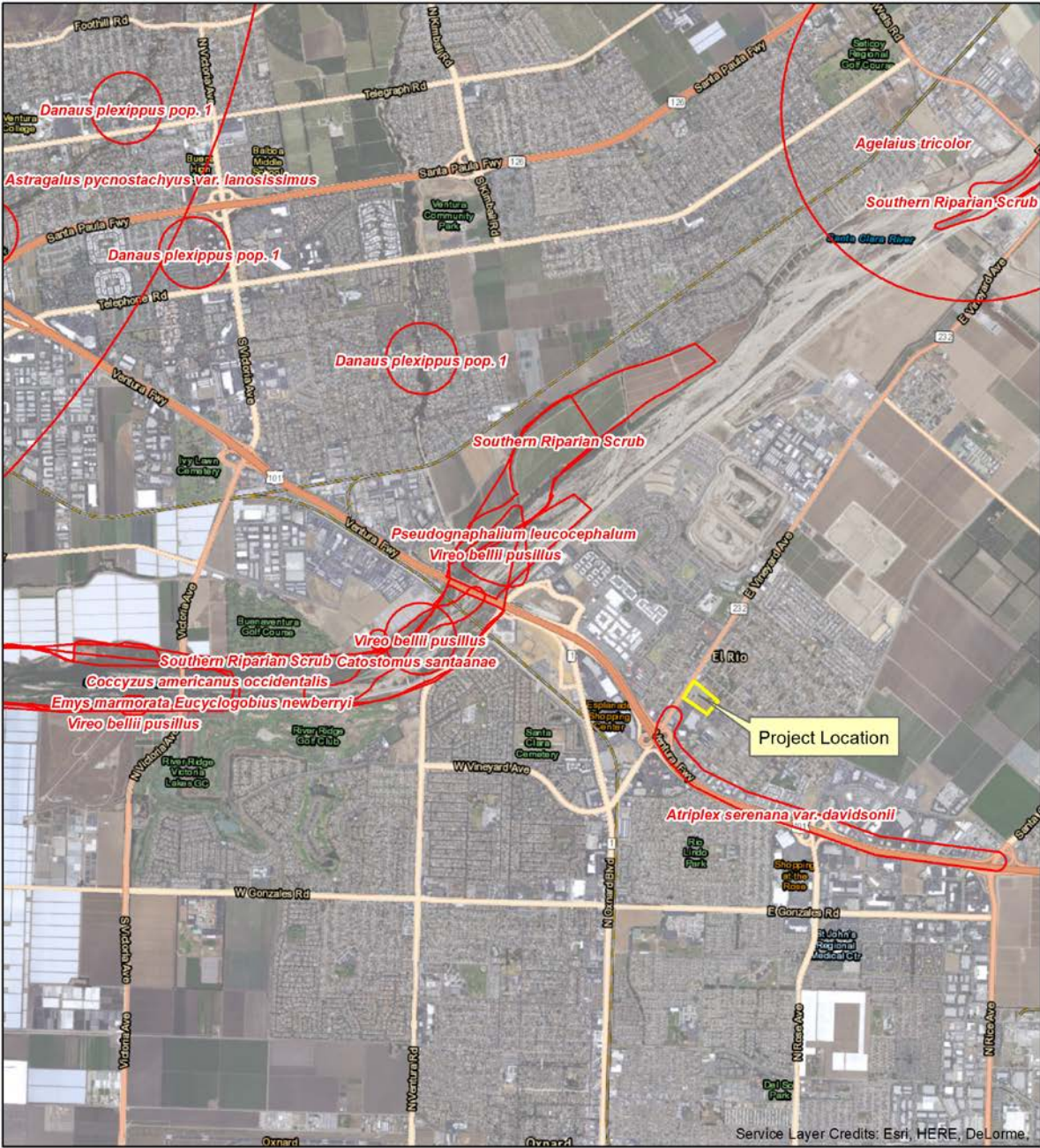



-  Project Location
-  CNDDDB Occurrence

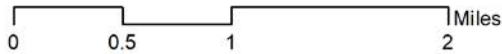

FIGURE 3. RIO URBANA MIXED-USE PROJECT CNDDDB MAP



### **Special-Status Biological Resources**

The Project site is not located within any USFWS-designated critical habitat. A review of the CNDDDB and other existing records within the vicinity of the proposed action area resulted in 116 species having previously been reported in the area (Attachment A, Table 3). Of these, 2 species have suitable habitat at the proposed action areas and will be discussed further.

**Davidson's saltscale.** Status: CRPR 1B.2. Davidson's saltscale (*Atriplex serenana* var. *davidsonii*) is an annual herb native to California that blooms between April and October. Its habitat is described as coastal scrub or coastal bluff with alkaline soil at elevations ranging from 0 to 1,500 feet amsl (CDFW 2017, CNPS 2015). CNDDDB Occurrence No. 35 is recorded within 0.20 miles of the Project area. This species was observed in a disturbed area alongside Ventura Boulevard north of the Ventura freeway. The exact location of this occurrence is unknown. The Project area has marginal habitat for this species to occur.

**Monarch Overwintering Population 1.** Status: California Special Animal (SA). Monarch butterflies (*Danaus plexippus* pop. 1) winter along the Californian coast from Mendocino County to Baja California, Mexico. The roosts are located in wind-protected tree groves (eucalyptus, Monterey pine, cypress), with nectar and water sources nearby. Two monarch butterflies were observed in the Project area. Along Rio School Lane on the northeast side of the property, there is a eucalyptus stand measuring approximately 300 feet long. These trees were observed to be unhealthy and potentially dying; however, they could provide marginal roosting habitat for this species in such an urban setting. CNDDDB Occurrence No. 170 is recorded approximately 2.75 miles northwest of the Project site within a barranca.



- Survey Area
- Heritage Tree Location
- ▲ Monarch Butterfly Location

  
BioResource Consultants Inc.

  
N

  
0 125 250 500 Feet

FIGURE 4. RIO URBANA MIXED-USE PROJECT SPECIAL-STATUS SPECIES OBSERVATION MAP

## **AVOIDANCE AND MINIMIZATION MEASURES**

To minimize effects to special-status biological resources in general, the following avoidance and minimization measures should be implemented:

- If the proposed action is planned to occur within the general bird nesting season, a pre-construction nesting bird survey should be conducted by a qualified biologist. The nesting season is generally considered February 1 through August 31, with a peak from March to June; however, these dates vary by year depending on prey availability, weather, and other factors. In the event an active bird is observed in the habitats to be removed or in other habitats within 100 feet for songbirds and 500 feet for raptors of the construction work areas, the Project has the option of delaying all construction work in the suitable habitat or within 100 feet/500 feet of the suitable habitat until after September 1st, or continuing the surveys in order to locate any nests. If an active nest is found, clearing and construction within 100 feet/500 feet of the nest shall be postponed until the nest is vacated and juveniles have fledged, and when there is no evidence of a second attempt at nesting. Limits of construction to avoid a nest site shall be established in the field with flagging and stakes or construction fencing. Construction personnel shall be instructed on the ecological sensitivity of the area.
- Heritage trees are protected by the Ventura County Tree Protection Ordinance and can require surveying by a certified arborist, and/or special permitting for trimming, removal, or construction that may negatively impact the tree's health.
- Crews will enter and exit the project site via the same trail/footpath.
- Crews should avoid contact with any wildlife encountered and allow wildlife to escape the work area unharmed. All wildlife encounters and sightings shall be reported to the biological monitor.
- All trash shall be contained and removed from the proposed action area and properly disposed. Special attention should be given to leaving no micro-trash.

## **CONCLUSION**

Marginal habitat is present for special-status plant and wildlife species within the Project area. However, as noted above, the Project area consists mainly of ruderal and ornamental vegetation. It provides suitable habitat for nesting birds, but other special-status species are unlikely to be present due to the high level of disturbance. Implementation of the avoidance and minimization measures listed above would reduce adverse impacts to special-status species and nesting birds as a result of the Project to an insignificant level.

Please let me know if you have any questions regarding this biological assessment.

Sincerely,



Colleen Del Vecchio, Biologist

cc: Brian E. Holly, Vice President, Senior Ecologist

## REFERENCES

- American Ornithologists' Union. 1998. Check-list of North American Birds. Seventh edition. American Ornithologists' Union, Washington, D.C. 829 pp. Available at: <http://www.aou.org/checklist/north/index.php>
- Baker, Robert, Lisa C. Bradley, Robert D. Bradley, Jerry W. Dragoo, Mark D. Engstrom Robert S. Hoffmann, Cheria. Jones, Fiona Reid, Dale W. Rice, and Clyde Jones. 2003. Revised checklist of North American mammals north of Mexico. Museum of Texas Tech University. Accessed July 2017.
- Baldwin, B. G. [ed], Goldman, D. [ed], Keil, D. J., Patterson, R. [ed], Rosatti, T. J. [ed], Wilken, D. [ed], 2012. The Jepson Manual: Vascular Plants of California: Second Edition University of California Press. Berkeley and Los Angeles, CA.
- CalFlora. 2017. The CalFlora Database: information on California plants for education, research and conservation [web application]. The CalFlora Database, Berkeley, California. <http://www.calflora.org/>. Accessed July 2017.
- California Department of Fish and Wildlife (CDFW); formerly California Department of Fish and Game). 2017. California Department of Fish and Game Natural Diversity Database. California Department of Fish and Game, Sacramento, CA.
- CDFW, Biogeographic Data Branch, "California Wildlife Habitat Relationship (CWHR) Life History Accounts and Range Maps". These life history accounts and range maps represent updated versions of the species information in the three-volume set "California's Wildlife" edited by Zeiner, D.C. et al 1988-1990. <<http://www.dfg.ca.gov/biogeodata/cwhr/cawildlife.aspx>>. Accessed July 2017.
- CDFW. 2012. Life History Accounts and Range Maps – California Wildlife Habitat Relationships System. <http://www.dfg.ca.gov/biogeodata/cwhr/cawildlife.aspx>. Accessed July 2017.
- California Native Plant Society. 2017. Inventory of Rare and Endangered Plants of California (seventh edition, online version 7-010d). California Native Plant Society, Sacramento, CA. <http://cnps.web.aplus.net/cgi-bin/inv/inventory.cgi>. Accessed July 2017.
- Collins, Joseph T. and Travis W. Taggart. 2009. Standard Common & Current Scientific Names for North American Amphibians, Turtles, Reptiles, and Corcodilians. Sixth Edition. Publication of the Center for North American Herpetology, Lawrence. iv + 44 pp. Available at: <http://www.cnah.org/index.asp>
- Cornell Lab of Ornithology and National Audubon Society, Inc. eBird. <http://ebird.org/content/ebird>. Accessed July 2017.
- Cornell Lab of Ornithology and the American Ornithologists Union. "The Birds of North American Online". <http://bna.birds.cornell.edu/bna/home/> Accessed July 2017.
- Sawyer, J., T. Keeler-Wolf, and J Evens. 2009. A Manual of California Vegetation, Second Edition. California Native Plant Society. Sacramento, CA.
- Ventura County. "Ventura County Tree Protection Ordinance - Frequently Asked Questions". <http://vcrma.org/planning/pdf/permits/tree/Tree-FAQs.pdf>. Access July 2017.

**ATTACHMENT A:  
Observed and Potential Species Occurrences  
in the Project Vicinity**

**Table 1. California Natural Diversity Database occurrences within the Oxnard and surrounding USGS 7.5-minute quadrangles.**

Common Name	Scientific Name	Status	Potential to Occur
<b>Plants</b>			
red sand-verbena	<i>Abronia maritima</i>	CRPR 4.2	Does Not Occur
aphanisma	<i>Aphanisma blitoides</i>	CRPR 1B.2	Does Not Occur
Braunton's milk-vetch	<i>Astragalus brauntonii</i>	FE, CRPR 1B.1	Does Not Occur
Ventura Marsh milk-vetch	<i>Astragalus pycnostachyus</i> var. <i>lanosissimus</i>	FE, SE, CRPR 1B.1	Does Not Occur
Coulter's saltbush	<i>Atriplex coulteri</i>	CRPR 1B.2	Does Not Occur
south coast saltscale	<i>Atriplex pacifica</i>	CRPR 1B.2	Does Not Occur
Davidson's saltscale	<i>Atriplex serenana</i> var. <i> davidsonii</i>	CRPR 1B.2	Unlikely
Catalina mariposa-lily	<i>Calochortus catalinae</i>	CRPR 4.2	Does Not Occur
late-flowered mariposa-lily	<i>Calochortus fimbriatus</i>	CRPR 1B.3	Does Not Occur
Plummer's mariposa-lily	<i>Calochortus plummerae</i>	CRPR 4.2	Does Not Occur
Peirson's morning-glory	<i>Calystegia peirsonii</i>	CRPR 4.2	Does Not Occur
Orcutt's pincushion	<i>Chaenactis glabriuscula</i> var. <i>orcuttiana</i>	CRPR 1B.1	Does Not Occur
salt marsh bird's-beak	<i>Chloropyron maritimum</i> ssp. <i>maritimum</i>	FE, SE, CRPR 1B.2	Does Not Occur
seaside cistanthe	<i>Cistanthe maritima</i>	CRPR 4.2	Does Not Occur
small-flowered morning-glory	<i>Convolvulus simulans</i>	CRPR 4.2	Does Not Occur
western dichondra	<i>Dichondra occidentalis</i>	CRPR 4.2	Does Not Occur
Blochman's dudleya	<i>Dudleya blochmaniae</i> ssp. <i>blochmaniae</i>	CRPR 1B.1	Does Not Occur
Verity's dudleya	<i>Dudleya verityi</i>	FT, CRPR 1B.1	Does Not Occur
small spikerush	<i>Eleocharis parvula</i>	CRPR 4.3	Does Not Occur
conejo buckwheat	<i>Eriogonum crocatum</i>	CRPR 1B.2	Does Not Occur
island wallflower	<i>Erysimum insulare</i>	CRPR 1B.3	Does Not Occur
suffrutescent wallflower	<i>Erysimum suffrutescens</i>	CRPR 4.2	Does Not Occur
beach goldenaster	<i>Heterotheca sessiliflora</i> ssp. <i>sessiliflora</i>	CRPR 1B.1	Does Not Occur
southern California black walnut	<i>Juglans californica</i>	CRPR 4.2	Does Not Occur
southwestern spiny rush	<i>Juncus acutus</i> ssp. <i>leopoldii</i>	CRPR 4.2	Does Not Occur
Coulter's goldfields	<i>Lasthenia glabrata</i> ssp. <i>coulteri</i>	CRPR 1B.1	Does Not Occur
fragrant pitcher sage	<i>Lepechinia fragrans</i>	CRPR 4.2	Does Not Occur
Mexican malacothrix	<i>Malacothrix similis</i>	CRPR 2A	Does Not Occur
white-veined monardella	<i>Monardella hypoleuca</i> ssp. <i>hypoleuca</i>	CRPR 1B.3	Does Not Occur
Gerry's curly-leaved monardella	<i>Monardella sinuata</i> ssp. <i>gerryi</i>	CRPR 1B.1	Does Not Occur
Ojai navarretia	<i>Navarretia ojaiensis</i>	CRPR 1B.1	Does Not Occur
white rabbit-tobacco	<i>Pseudognaphalium leucocephalum</i>	CRPR 2B.2	Does Not Occur

Common Name	Scientific Name	Status	Potential to Occur
chaparral ragwort	<i>Senecio aphanactis</i>	CRPR 2B.2	Does Not Occur
California seablite	<i>Suaeda californica</i>	FE, CRPR 1B.1	Does Not Occur
estuary seablite	<i>Suaeda esteroa</i>	CRPR 1B.2	Does Not Occur
woolly seablite	<i>Suaeda taxifolia</i>	CRPR 4.2	Does Not Occur
woven-spored lichen	<i>Texosporium sancti-jacobi</i>	CRPR 3	Does Not Occur
<b>Invertebrates</b>			
Crotch bumble bee	<i>Bombus crotchii</i>	SA	Does Not Occur
western tidal-flat tiger beetle	<i>Cicindela gabbii</i>	SA	Does Not Occur
sandy beach tiger beetle	<i>Cicindela hirticollis gravida</i>	SA	Does Not Occur
senile tiger beetle	<i>Cicindela senilis frosti</i>	SA	Does Not Occur
globose dune beetle	<i>Coelus globosus</i>	SA	Does Not Occur
monarch - California overwintering population	<i>Danaus plexippus</i> pop. 1	SA	Occurs
Trask shoulderband	<i>Helminthoglypta traskii traskii</i>	SA	Does Not Occur
wandering (=saltmarsh) skipper	<i>Panoquina errans</i>	SA	Does Not Occur
Santa Monica grasshopper	<i>Trimerotropis occidentiloides</i>	SA	Does Not Occur
mimic tryonia (=California brackishwater snail)	<i>Tryonia imitator</i>	SA	Does Not Occur
<b>Fish</b>			
Santa Ana sucker	<i>Catostomus santaanae</i>	FT	Does Not Occur
tidewater goby	<i>Eucyclogobius newberryi</i>	FE, SSC	Does Not Occur
resident threespine stickleback	<i>Gasterosteus aculeatus microcephalus</i>	SA	Does Not Occur
unarmored threespine stickleback	<i>Gasterosteus aculeatus williamsoni</i>	FE, SE, FP	Does Not Occur
arroyo chub	<i>Gila orcuttii</i>	SSC	Does Not Occur
steelhead - southern California DPS	<i>Oncorhynchus mykiss irideus</i>	FE	Does Not Occur
<b>Amphibians</b>			
arroyo toad	<i>Anaxyrus californicus</i>	FE, SSC	Does Not Occur
California red-legged frog	<i>Rana draytonii</i>	FT, SSC	Does Not Occur
<b>Reptiles</b>			
California legless lizard	<i>Anniella</i> sp. 1	SSC	Does Not Occur
southern California legless lizard	<i>Anniella stebbinsi</i>	SSC	Does Not Occur
San Bernardino ringneck snake	<i>Diadophis punctatus modestus</i>	SA	Does Not Occur
western pond turtle	<i>Emys marmorata</i>	SSC	Does Not Occur
two-striped gartersnake	<i>Thamnophis hammondi</i>	SSC	Does Not Occur
south coast gartersnake	<i>Thamnophis sirtalis</i> ssp.	SSC	Does Not Occur
coast horned lizard	<i>Phrynosoma blainvillii</i>	SSC	Does Not Occur
coastal whiptail	<i>Aspidoscelis tigris stejnegeri</i>	SSC	Does Not Occur

Common Name	Scientific Name	Status	Potential to Occur
<b>Birds</b>			
Cooper's hawk	<i>Accipiter cooperii</i>	WL	Does Not Occur
tricolored blackbird	<i>Agelaius tricolor</i>	SC, SSC	Does Not Occur
southern California rufous-crowned sparrow	<i>Aimophila ruficeps canescens</i>	WL	Does Not Occur
golden eagle	<i>Aquila chrysaetos</i>	FP ; WL	Does Not Occur
great egret	<i>Ardea alba</i>	SA	Does Not Occur
great blue heron	<i>Ardea herodias</i>	SA	Does Not Occur
long-eared owl	<i>Asio otus</i>	SSC	Does Not Occur
burrowing owl	<i>Athene cunicularia</i>	SSC	Does Not Occur
canvasback	<i>Aythya valisineria</i>	SA	Does Not Occur
oak titmouse	<i>Baeolophus inornatus</i>	SA	Does Not Occur
American bittern	<i>Botaurus lentiginosus</i>	SA	Does Not Occur
ferruginous hawk	<i>Buteo regalis</i>	WL	Does Not Occur
Vaux's swift	<i>Chaetura vauxi</i>	SSC	Does Not Occur
western snowy plover	<i>Charadrius alexandrinus nivosus</i>	FT, SSC	Does Not Occur
mountain plover	<i>Charadrius montanus</i>	SSC	Does Not Occur
northern harrier	<i>Circus cyaneus</i>	SSC	Does Not Occur
western yellow-billed cuckoo	<i>Coccyzus americanus occidentalis</i>	FT, SE	Does Not Occur
snowy egret	<i>Egretta thula</i>	SA	Does Not Occur
white-tailed kite	<i>Elanus leucurus</i>	FP	Does Not Occur
willow flycatcher	<i>Empidonax traillii</i>	SE	Does Not Occur
southwestern willow flycatcher	<i>Empidonax traillii extimus</i>	FE, SE	Does Not Occur
California horned lark	<i>Eremophila alpestris actia</i>	WL	Does Not Occur
prairie falcon	<i>Falco mexicanus</i>	WL	Does Not Occur
American peregrine falcon	<i>Falco peregrinus anatum</i>	FD, SD, FP	Does Not Occur
California condor	<i>Gymnogyps californianus</i>	FE, SE, FP	Does Not Occur
Caspian tern	<i>Hydroprogne caspia</i>	SA	Does Not Occur
yellow-breasted chat	<i>Icteria virens</i>	SSC	Does Not Occur
loggerhead shrike	<i>Lanius ludovicianus</i>	SSC	Does Not Occur
California gull	<i>Larus californicus</i>	WL	Does Not Occur
California black rail	<i>Laterallus jamaicensis coturniculus</i>	FP	Does Not Occur
black-crowned night heron	<i>Nycticorax nycticorax</i>	SA	Does Not Occur
ashy storm-petrel	<i>Oceanodroma homochroa</i>	SSC	Does Not Occur
Belding's savannah sparrow	<i>Passerculus sandwichensis beldingi</i>	SE	Does Not Occur
California brown pelican	<i>Pelecanus occidentalis californicus</i>	FP	Does Not Occur
double-crested cormorant	<i>Phalacrocorax auritus</i>	WL	Does Not Occur
yellow-billed magpie	<i>Pica nuttalli</i>	SA	Does Not Occur



Common Name	Scientific Name	Status	Potential to Occur
summer tanager	<i>Piranga rubra</i>	SSC	Does Not Occur
white-faced ibis	<i>Plegadis chihi</i>	WL	Does Not Occur
coastal California gnatcatcher	<i>Poliophtila californica californica</i>	FT, SSC	Does Not Occur
vermillion flycatcher	<i>Pyrocephalus rubinus</i>	SSC	Does Not Occur
light-footed Ridgway's rail	<i>Rallus obsoletus levipes</i>	FE, SE, FP	Does Not Occur
bank swallow	<i>Riparia riparia</i>	ST	Does Not Occur
yellow warbler	<i>Setophaga petechia</i>	SSC	Does Not Occur
California least tern	<i>Sternula antillarum browni</i>	FE, SE, FP	Does Not Occur
least Bell's vireo	<i>Vireo bellii pusillus</i>	FE, SE	Does Not Occur
<b>Mammals</b>			
pallid bat	<i>Antrozous pallidus</i>	SSC	Does Not Occur
Dulzura pocket mouse	<i>Chaetodipus californicus femoralis</i>	SSC	Does Not Occur
Mexican long-tongued bat	<i>Choeronycteris mexicana</i>	SSC	Does Not Occur
western mastiff bat	<i>Eumops perotis californicus</i>	SSC	Does Not Occur
south coast marsh vole	<i>Microtus californicus stephensi</i>	SSC	Does Not Occur
Yuma myotis	<i>Myotis yumanensis</i>	SA	Does Not Occur
southern California saltmarsh shrew	<i>Sorex ornatus salicornicus</i>	SSC	Does Not Occur
American badger	<i>Taxidea taxus</i>	SSC	Does Not Occur

Status Key:

FE = Federal Endangered  
 FT = Federal Threatened  
 FC = Federal Candidate  
 FD = Federal Delisted  
 SE = California Endangered  
 ST = California Threatened  
 SD = California Delisted  
 SC = California Candidate for Listing  
 SSC = California Special Concern Species  
 SWL = California Watch List Species  
 SFP = California Fully Protected Species

California Rare Plant Ranks:

1B = Rare, Threatened or Endangered in California and elsewhere  
 2B = Rare, Threatened or Endangered in California, but more common elsewhere  
 3 = Plants about which more information is needed - A Review List  
 4 = Plants of limited distribution - A Watch List  
     .1 = seriously threatened in California  
     .2 = fairly threatened in California  
     .3 = not very threatened in California

**Table 2. Plants observed within the Project survey area.**

Common Name	Scientific Name
amaranth	<i>Amaranth</i> sp.
hairy beggarticks	<i>Bidens pilosa</i>
bougainvillea	<i>Bougainvillea</i> sp.
black mustard	<i>Brassica negra</i>
fox tail brome	<i>bromus madritensis</i>
Cheatgrass	<i>bromus tectorum</i>
shepard's purse	<i>Casdsella bursa-pastoris</i>
yellow star thistle	<i>Centaurea solstitialis</i>
rattlesnake sandmat	<i>Cuphorbia albomarginata</i>
hairy crabgrass	<i>Digitaria sanguinalis</i>
Mexian tea	<i>Dysphania ambrosiodes</i>
Canada horseweed	<i>Erigeron canadensis</i>
red stemmed filaree	<i>Erodium cicutarium</i>
Coral tree	<i>Erythrina</i> sp.
euphorbia	<i>Euphorbia</i> sp.
velvet ash	<i>Fraxinus velutina</i>
English Ivy	<i>Hedera helix</i>
privet	<i>Lingustrum</i> sp.
cheeseweed	<i>Malva parviflora</i>
black medick	<i>Medicago lupulina</i>
white sweet clover	<i>Melilotus albus</i>
four o'clock	<i>Mirabilis jalapa</i>
tree tobacco	<i>Nicotina glauca</i>
dallis grass	<i>Paspalum dilatatum</i>
Canary Island pine	<i>Pinus canariensis</i>
cudweed	<i>Pseudognaphalium</i> sp.
coast live oak	<i>Quercus agrifolia</i>
jointed charlock	<i>Raphanus raphanistrum</i>
castor bean	<i>Ricinus communis</i>
curly dock	<i>Rumex crispus</i>
thistle	<i>Salsola</i> sp.
common Mediterranean grass	<i>Shismus barbatus</i>
sow thistle	<i>Sonchus oleraceus</i>
tamarisk	<i>Tamarix ramosissima</i>
Chinese tallow	<i>Tridaica sebifera</i>
nasturtium	<i>Tropaeolum majus</i>
Chinese elm	<i>Ulmus parvifolia</i>

**Table 3. Wildlife observed within the Project survey area.**

Common Name	Scientific Name
<b>Invertebrates</b>	
monarch	<i>Danaus plexippus</i>
painted lady butterfly	<i>Cynthia</i> sp.
<b>Reptiles</b>	
coast range fence lizard	<i>Sceloporus occidentalis bocourtii</i>
<b>Birds</b>	
Anna's hummingbird	<i>Calypte anna</i>
American crow	<i>Corvus brachyrhynchos</i>
house finch	<i>Haemorhous mexicanus</i>
western gull	<i>Larus occidentalis</i>
northern mockingbird	<i>Mimus polyglottos</i>
house sparrow	<i>Passer domesticus</i>
bushtit	<i>Psaltriparus minimus</i>
black phoebe	<i>Sayornis nigricans</i>
Eurasian collared dove	<i>Streptopelia decaocto</i>
Cassin's kingbird	<i>Tyrannus vociferans</i>
<b>Mammals</b>	
domestic cat	<i>Felis catus</i>
California ground squirrel*	<i>Otospermophilus beecheyi</i>

\*Only signs, tracks, or scats observed

**ATTACHMENT B:  
Photographs of Proposed Project Area**



**Photo 1.** Vegetation surrounding El Rio Elementary School buildings, facing southwest.



**Photo 2.** Vegetation along northeast border for Project area, facing southeast.





**Photo 3.** Dying stand of Eucalyptus along Rio School Lane.



**Photo 4.** Vegetation facing northwest from edge of Project boundary, velvet ash and coast live oak Heritage trees in photo.





**Photo 5.** Tamarisk stand along southeastern edge of Project area.



**Photo 6.** Rubbish pile in back field of Project area, facing northwest.





**Photo 7.** Old playground and stockpile of concrete/dirt, facing north.



**Photo 8.** Heritage velvet ash (center), adjacent to coast live oak (right), facing south.





**Photo 9.** Old baseball field, facing east toward tamarisk border.



**Photo 10.** Second stockpile of rubble and dirt on west side of property, facing north northwest.



**Photo 11.** Adjacent to the large stockpile of dirt is a stock yard with wood chips, fencing materials, storage containers and plastic tubing on concrete, facing west.



**Photo 12.** Stand of Canary island pine on west side of parking lot along border of Project area, facing west.





**Photo 13.** Vegetation and concrete in side field, facing east.



**Photo 14.** Heritage velvet ash tree adjacent to front parking lot and school buildings, facing north.

# Appendix D

---

Climate Change and Greenhouse Gas Study

**Climate Change and Greenhouse Gas Study**  
**for the**  
**Rio Urbana Project**

**Prepared for:**

The Pacific West Communities  
430 E. State Street, Suite 100  
Eagle, Idaho 83616

**Prepared by:**

Meridian Consultants, LLC  
910 Hampshire Road, Suite V  
Westlake Village, CA 91361

**August 2017**

## Table of Contents

Section	Page
Executive Summary.....	1
Introduction .....	2
Project Description .....	2
Existing Conditions.....	5
Emissions Inventory and Trends .....	8
Greenhouse Gas Standards.....	8
VCAPCD Greenhouse Gas Emission Guidance .....	8
California Air Pollution Control Officers Association .....	9
Methodology.....	9
Greenhouse Gas Emission Modeling .....	9
Assumptions.....	10
Project Design Features .....	11
Greenhouse Gas Analysis.....	11
Greenhouse Gas Emission Modeling Results.....	12
Consistency Analysis .....	13
City of Oxnard 2030 General Plan.....	13
California Climate Action Team (CAT) Strategies.....	14
California Attorney General–Recommended Reduction Measures .....	16
Southern California Association of Government's Sustainable Communities Strategy (SCS) .....	16
Cumulative Analysis .....	17

### **Appendix**

A CalEEMod Air Quality and Greenhouse Gas Emissions Files

## Figures

Figure		Page
1	Regional Location Map .....	3
2	Project Site Aerial.....	4

## Tables

Table		Page
1	Atmospheric Lifetimes and Global Warming Potentials of GHGs.....	6
2	Greenhouse Gases .....	7
3	California GHG Inventory 2010–2015 .....	8
4	Construction GHG Emissions .....	12
5	Estimated Greenhouse Gas Emissions .....	13
6	City of Oxnard 2030 General Plan Consistency.....	14
7	Project's Consistency with Recommendations Presented in the Climate Action Team Report .....	15

## EXECUTIVE SUMMARY

This Greenhouse Gas (GHG) Study assesses and discusses the potential GHG impacts that may occur with implementation of the Rio Urbana Project (“Project”), located in Oxnard, California. The analysis estimates future emission levels at surrounding land uses resulting from construction and operation of the Project, and identifies the potential for significant impacts. An evaluation of the Project’s contribution to potential cumulative GHG impacts is also provided. Air quality worksheets are provided in **Appendix A**.

This report also summarizes the potential for the Project to generate GHG emissions that may impact the environment; conflict with an applicable plan, policy, or regulation or with State goals for reducing GHG emissions in California; and contribute or be subject to potential secondary effects of climate change. The findings of the analysis are as follows:

- The Project’s GHG emissions resulting from construction, motor vehicles, energy (i.e., electricity, natural gas), water conveyance, and waste sources would not generate GHG emissions, either directly or indirectly, that would have a significant impact on the environment.
- The Project would be consistent with State-applicable plans, policies and regulations adopted for the purpose of reducing GHG emissions.



## INTRODUCTION

The purpose of this Greenhouse Gas Study is to assess and discuss the impact of potential air quality impacts that may occur with the implementation of the Rio Urbana Project (“Project”), located in Oxnard, California. The regional location of the proposed Project is depicted in **Figure 1, Regional Location Map**. The Project site is located to the northeast of Ventura Freeway (US Route 101 [US 101]), within the Ventura County Air Pollution District (VCAPD). The Project site is located along E. Vineyard Avenue and bounded by Rio School Lane to the north (refer to **Figure 2, Project Site Aerial**). This report includes an analysis of GHGs that would result from Project implementation.

### Project Description

The Project site consists of approximately 10.24 acres of developed land with numerous vacant buildings (cafeteria, administration, classrooms, and two portable buildings) that was formerly the El Rio Elementary School campus. The school has been closed since 2008 and is currently utilized as a dispatch for school buses and storage. The proposed Project would include demolition of the existing uses to allow the construction of a new mixed-use development that would include 182 condominium residential units and a 15,000-square-foot office building containing the Rio School District Administrative offices.

The surrounding environment includes residential development to the north and west; commercial development to the south; and industrial uses to the east. Regional access to the Project site is provided by US Highway 101 (US 101) to the south.

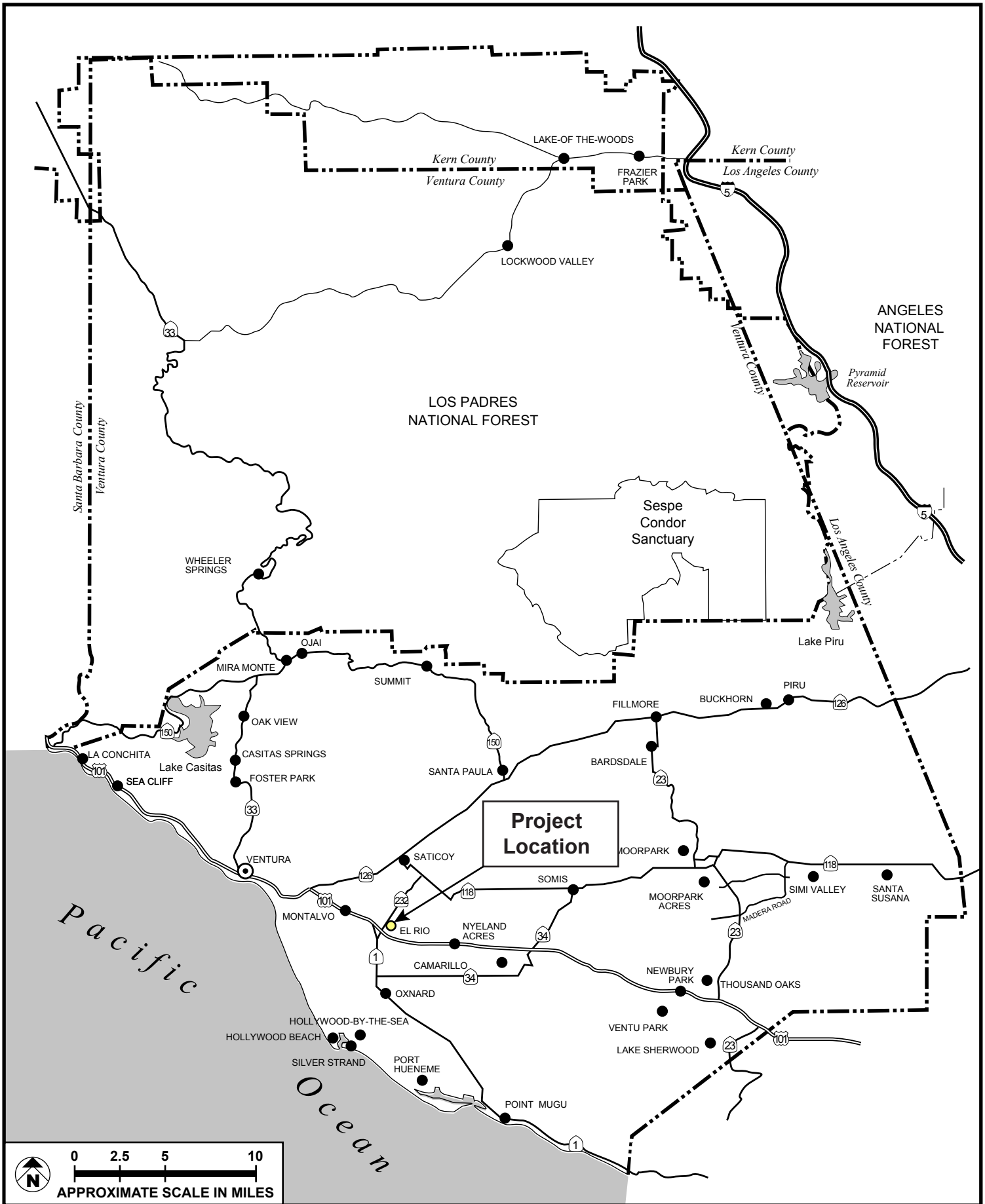

SOURCE: Meridian Consultants, LLC - August 2017

FIGURE 1





FIGURE 2



## EXISTING CONDITIONS

Climate change is a change in the average climatic conditions on Earth that may be measured by changes in wind patterns, storms, precipitation, and temperature. These changes are assessed using historical records of temperature changes that have occurred in the past, such as during previous ice ages. Many of the concerns regarding climate change use this data to extrapolate a level of statistical significance, specifically focusing on temperature records from the last 150 years (the Industrial Age) that differ from previous climate changes in rate and magnitude.

The United Nations Intergovernmental Panel on Climate Change (IPCC) considered six alternative future GHG scenarios that would stabilize global temperatures and climate change impacts. The IPCC predicted that global mean temperature change from 1990 to 2100, for the six scenarios considered, could range from 1.5 degrees Celsius (°C) to 2.0°C. Global average temperatures and sea levels are expected to rise under all scenarios.<sup>1</sup>

In California, climate change may result in consequences such as the following:

- A reduction in the quality and supply of water to the State from the Sierra snowpack
- Increased risk of large wildfires
- Reductions in the quality and quantity of certain agricultural products
- Exacerbation of air quality problems
- A rise in sea levels, resulting in the displacement of coastal businesses and residences
- Damage to marine ecosystems and the natural environment
- An increase in infections, disease, asthma, and other health-related problems
- A decrease in the health and productivity of California's forests

GHGs are gases that trap heat in the atmosphere; the effect is analogous to the way a greenhouse retains heat. Common GHGs include water vapor, carbon dioxide (CO<sub>2</sub>), methane (CH<sub>4</sub>), nitrous oxides, chlorofluorocarbons, hydrofluorocarbons, perfluorocarbons, sulfur hexafluoride, ozone, and aerosols. The presence of these GHGs in the atmosphere affects the earth's surface temperature, which would be about 34°C cooler without the natural heat-trapping effect of GHGs.<sup>2</sup> Both natural processes and human

---

1 Intergovernmental Panel on Climate Change, "Summary for Policymakers," in *Climate Change 2013: The Physical Science Basis, Contribution of Working Group I to the Fifth Assessment Report of the Intergovernmental Panel on Climate Change*, (Cambridge University Press: Cambridge, UK and New York,).

2 California Environmental Protection Agency, Climate Action Team, *Climate Action Team Report to Governor Schwarzenegger and the California Legislature*, <http://www.energy.ca.gov/2010publications/CAT-1000-2010-005/CAT-1000-2010-005.PDF>, (December 2010), accessed July 27, 2017.

activities emit GHGs. However, it is believed that emissions from human activities, such as electricity production and vehicle use, have elevated the concentration of these gases in the atmosphere beyond the level of naturally occurring concentrations.

The global warming potential (GWP) is the potential of a gas or aerosol to trap heat in the atmosphere. The GWP compares the amount of heat trapped by a certain mass of the gas in question to the amount of heat trapped by a similar mass of carbon dioxide. A GWP is calculated over a specific time interval, commonly 20, 100, or 500 years. GWP is expressed as a factor of carbon dioxide (whose GWP is standardized to 1). For example, the 100-year GWP of methane is 21, which means that if the same mass of methane and carbon dioxide were introduced into the atmosphere, that methane will trap 21 times more heat than the carbon dioxide over the next 100 years.<sup>3</sup> A summary of the atmospheric lifetime and GWP of selected gases is presented in **Table 1, Atmospheric Lifetimes and Global Warming Potentials of GHGs**. As indicated, GWP ranges from 1 to 23,900.

**Table 1**  
**Atmospheric Lifetimes and Global Warming Potentials of GHGs**

Gas	Atmospheric Lifetime (years)	Global Warming Potential (100-year time horizon)
Carbon dioxide (CO <sub>2</sub> )	50–200	1
Methane (CH <sub>4</sub> )	12 (+/-3)	21
Nitrous oxide	114	310
HFC-23	270	11,700
HFC-134a	14	1,300
HFC-152a	1.4	140
PFC: Tetrafluoromethane (CF <sub>4</sub> )	50,000	6,500
PFC: Hexafluoromethane (C <sub>2</sub> F <sub>6</sub> )	10,000	9,200
Sulfur Hexafluoride (SF <sub>6</sub> )	3,200	23,900

*Source: Intergovernmental Panel on Climate Change, IPCC Fifth Assessment Report: Climate Change 2013.*

Individual GHG compounds have varying GWP and atmospheric lifetimes. The calculation of the carbon dioxide equivalent (CO<sub>2</sub>e) is a consistent methodology for comparing GHG emissions because it normalizes various GHG emissions to a consistent metric. Methane’s warming potential of 21 indicates that methane has a warming effect that is 21 times greater than carbon dioxide on a molecule-per-molecule basis. A carbon dioxide equivalent is the mass emissions of an individual GHG multiplied by its GWP.

<sup>3</sup> Working Group, *Fifth Assessment Report of the Intergovernmental Panel on Climate Change*, 2013.

The GHGs of most concern are identified in **Table 2, Greenhouse Gases**. Of the two primary sources of GHG in CO<sub>2</sub> and methane, CO<sub>2</sub> would be generated by sources associated with the Project, while methane would not be generated in any substantial amount.

**Table 2  
Greenhouse Gases**

Greenhouse Gas	Description and Physical Properties	Sources
Carbon dioxide (CO <sub>2</sub> )	Carbon dioxide is an odorless, colorless, natural GHG. GWP = 1.	Carbon dioxide is emitted from natural and anthropogenic sources. Natural sources include decomposition of dead organic matter; respiration of bacteria, plants, animals, and fungus; evaporation from oceans; and volcanic outgassing. Anthropogenic sources are from burning coal, oil, natural gas, and wood. The concentration in 2005 was 379 ppm, which is an increase of about 1.4 ppm per year since 1960.
Haloalkanes	Haloalkanes (also known as halogenoalkanes or alkyl halides) are colorless, relatively odorless, and hydrophobic.	Mostly human produced, haloalkanes include flame retardants, fire extinguishants, refrigerants, propellants, solvents, and pharmaceuticals. Nonartificial-source haloalkanes do occur, mostly through enzyme-mediated synthesis by bacteria, fungi, and especially sea microalgae (seaweeds).
Methane (CH <sub>4</sub> )	Methane is a flammable gas and is the main component of natural gas. GWP = 21.	Methane is produced naturally by the anaerobic decay of organic matter and is extracted from geological deposits (natural gas fields). Other sources are from landfills, fermentation of manure, and cattle.
Nitrous oxide (N <sub>2</sub> O)	Nitrous oxide is also known as laughing gas and is a colorless GHG. GWP = 310.	Nitrous oxide is produced by microbial processes in soil and water, fuel combustion, and industrial processes.
Perfluorocarbons (PFCs)	Perfluorocarbons liquids are colorless with high density, up to more than twice that of water. It is also an odorless, nonflammable, unreactive gas.	PFCs are man-made compounds containing just fluorine and carbon. They are used mainly in the electronics sector in semiconductor manufacture, with significant usage as refrigerants.
Sulfur hexafluoride (SF <sub>6</sub> )	Sulfur hexafluoride is an inorganic, colorless, odorless, non-flammable, extremely potent GHG that is an excellent electrical insulator. GWP = 23,900	Sulfur hexafluoride emissions are virtually all of anthropogenic origin including electricity sector, magnesium industry, electronics industry, and adiabatic property.

*Source: Intergovernmental Panel on Climate Change, Summary for Policymakers, Climate Change 2013: The Physical Science Basis, Contribution of Working Group I to the Fifth Assessment Report of the Intergovernmental Panel on Climate Change (Cambridge University Press: Cambridge, United Kingdom and New York, NY, USA).*

*Notes: ppm = parts per million; ppt = parts per trillion (measure of concentration in the atmosphere); GWP = global warming potential.*

## Emissions Inventory and Trends

The California Air Resources Board (CARB) Statewide inventory of GHGs for the most recent data available is shown in **Table 3, California GHG Inventory 2010–2015**. As shown in **Table 3**, California produced 440.36 million metric tons of carbon dioxide equivalents (MMTCO<sub>2e</sub>), including imported electricity and excluding combustion of international fuels and carbon sinks or storage. The major source of GHGs in California is transportation, contributing to 37 percent of the State’s total GHG emissions. Industrial generation is the second largest source, contributing to 21 percent of the State’s GHG emissions.

**Table 3**  
**California GHG Inventory 2010–2015**

Main Sector	2010	2011	2012	2013	2014	2015
Transportation <sup>a</sup>	163.01	159.68	159.44	158.14	160.03	164.63
Industrial <sup>b,e</sup>	91.01	90.65	90.90	93.48	93.77	91.71
Electric power	90.34	88.06	95.09	89.65	88.24	83.67
Commercial and Residential	45.05	45.50	42.89	43.54	37.37	37.92
Agriculture	34.64	35.28	36.42	34.93	36.03	34.65
High GWP <sup>c,d</sup>	13.64	14.74	15.74	16.82	17.82	19.05
Recycling and Waste	8.37	8.47	8.49	8.52	8.59	8.73
Total Emissions	446.06	442.38	448.97	445.08	441.85	440.36

Source: California Air Resources Board (CARB), *California Greenhouse Gas Inventory for 2000–2015 by Category as Defined in the 2008 Scoping Plan*, [https://www.arb.ca.gov/cc/inventory/data/tables/ghg\\_inventory\\_scopingplan\\_sum\\_2000-15.pdf](https://www.arb.ca.gov/cc/inventory/data/tables/ghg_inventory_scopingplan_sum_2000-15.pdf).

<sup>a</sup> Includes equipment used in construction, mining, oil drilling, industrial and airport ground operations.

<sup>b</sup> Reflects emissions from combustion of natural gas, diesel, and lease fuel plus fugitive emissions.

<sup>c</sup> These categories are listed in the Industrial sector of CARB’s GHG Emission Inventory sectors.

<sup>d</sup> This category is listed in the Electric Power sector of CARB’s GHG Emission Inventory sectors.

<sup>e</sup> The exceptional Aliso Canyon natural gas leak even released 1.96 MMTCO<sub>2e</sub> of unanticipated emission in calendar year 2015 and an additional 0.52 MMTCO<sub>2e</sub> in 2016. These emissions will be mitigated in the future according to legal settlement and are presented alongside but tracked separately from routine inventory emissions.

## GREENHOUSE GAS STANDARDS

### VCAPCD Greenhouse Gas Emission Guidance

For GHG emissions and global warming, there is not, at this time, one established, universally agreed-upon “threshold of significance” by which to measure an impact. While the CARB published some draft thresholds several years ago, they were never adopted, and the CARB recommended that local air districts and lead agencies adopt their own thresholds for GHG impacts.

The City of Oxnard (“City”) relies on the expert guidance of the VCAPCD regarding the methodology and thresholds of significance for the evaluation of air quality impacts within Ventura County. GHG emissions

are air pollutants that are subject to local control by the VCAPCD. As such, the City looks to the VCAPCD for guidance in the evaluation of GHG impacts.

In September 2011, the Ventura County Air Pollution Control Board requested that VCAPCD staff report back on possible GHG significance thresholds for evaluating GHG impacts of land use projects in Ventura County under CEQA. VCAPCD staff responded to this request by preparing a report titled *Greenhouse Gas Thresholds of Significance Options for Land Use Development Projects in Ventura County*. This report presents a number of options for GHG significance thresholds and summarizes the most prominent approaches and options either adopted or being considered by all other air districts throughout California. Similar to other air districts, VCAPCD staff members are considering a tiered approach, with the main components involving consistency with a locally adopted GHG reduction plan followed by a bright-line threshold for land use projects that would capture 90 percent of project GHG emissions. VCAPCD staff members are also exploring an efficiency-based metric (e.g., GHG emissions per capita) for land use projects and plans.

## **California Air Pollution Control Officers Association**

In its January 2008 *CEQA and Climate Change* white paper, the California Air Pollution Control Officers Association (CAPCOA) identified a number of potential approaches for determining the significance of GHG emissions in CEQA documents. CAPCOA suggests making significance determinations on a case-by-case basis when no significance thresholds have been formally adopted by a lead agency. Although GHG emissions can be quantified, CARB, the South Coast Air Quality Management District (SCAQMD), and the City of Oxnard have yet to adopt project-level significance thresholds for GHG emission that would be applicable to the Project. Assessing the significance of a project's contribution to cumulative global climate change involves (1) evaluating the project's sources of GHG emissions; and (2) considering project consistency with applicable emission reduction strategies and goals, such as those set forth by the lead agency or other regional or State agency.

Local and regional agencies and the State recommended general policies and measures to minimize and reduce GHG emissions from land use development projects. Thus, if the Project were designed in accordance and not in conflict with applicable policies and measures, it would be consistent with the strategies and actions to reduce GHG emission.

## **METHODOLOGY**

### **Greenhouse Gas Emission Modeling**

For modeling purposes, the Project was assumed to start construction in 2018 and be operational in 2020. Operational emissions would be generated by both area and mobile sources due to normal day-to-day



activities. Area source emissions would be generated by the consumption of natural gas for space and water-heaters. Area source emissions are based on emission factors contained in CalEEMod. Mobile emissions would be generated by motor vehicles traveling to and from the Project area. Based on the traffic study,<sup>4</sup> the Project would generate 1,232 total trips.

The Project would also result in indirect GHG emissions due to electricity demand, water consumption, and waste generation. The emission factor for CO<sub>2</sub> due to electrical demand from Southern California Edison was selected in the CalEEMod model. Electricity consumption was based on default data found in CalEEMod for the respective land use types. In addition, the Project would also result in indirect GHG emissions due to water consumption, wastewater treatment, and solid waste generation.

## **Assumptions**

The following assumptions were made in the CalEEMod computer program:

### ***Land Uses***

#### **Existing**

- 44,637 square feet of building to be demolished
- 147,667 square feet of other surface (concrete, asphalt, awnings) to be demolished

#### **Proposed**

- 15,100-square-foot office building
- 182-unit condo/townhouse
- 463 parking spaces

---

4 Associated Transportation Engineers, *Rio Urbana Residential and Office Development Traffic and Circulation Study* (July 25, 2017).

## **Construction**

Construction would occur over six phases for beginning the first quarter of 2018: (1) demolition, which would last approximately 20 days; (2) site preparation, which would last approximately 3 days; (3) grading, which would last approximately 6 days; (4) building construction, which would last approximately 220 days; (5) architectural coating, which would last approximately 30 days; and (6) paving, which would last approximately 10 days.

Each phase of construction would result in vary levels of intensity and number of construction personnel. The construction workforce would consist of 13 worker trips per day and 875 total hauling trips during demolition; 8 worker trips per day during site preparation; 10 worker trips per day and 2,125 total hauling trips during grading; 214 worker trips per day and 54 vendor trips per day during building construction; 43 worker trips per day during architectural coating; and 15 worker trips per day during paving.

## **Project Design Features**

The following Project Design Features will be incorporated to the Project:

- PDF-1:** Residential units will be supplied with demand response thermostats and Energy Star appliances
- PDF-2:** Office building will be solar ready; solar not anticipated on residential units due to limited availability of suitable mounting locations as a result of sloped tile roofs
- PDF-3:** Low-flow plumbing fixtures and high-efficiency lighting compliant with the latest Title 24 requirements
- PDF-4:** Low-e window glazing
- PDF-5:** Bioswale components in landscape design at paved areas (parking courts)

## **Greenhouse Gas Analysis**

The CARB, VCAPCD, and the City have yet to formally adopt a GHG significance threshold for land use development projects (e.g., residential/commercial projects). Ventura County is adjacent to the SCAQMD jurisdiction and is part of the Southern California Association of Governments (SCAG) region. As such, VCAPCD staff believes it makes sense to set local GHG emission thresholds of significance for land use developments projects at levels consistent with those set by the SCAQMD and SCAG. Given the lack of a formally adopted VCAPCD numerical significance threshold applicable to this Project, the significance of the Project is evaluated based on the SCAQMD proposed screening level of 3,000 MTCO<sub>2e</sub> per year. Also, Project characteristics were compared to applicable State, regional and local policies aimed at GHG

emission reduction. These policies include the 2030 General Plan, Climate Action Team (CAT) strategies, Attorney General–recommended reduction measures, and SCAG’s Sustainable Communities Strategy (SCS).

## GREENHOUSE GAS EMISSION MODELING RESULTS

The current accepted method for accounting for the construction GHG emissions within a project area is to annualize these emissions over a project’s operational lifetime, which is generally defined as 30 years for analysis purposes. Emissions were calculated to determine the Project’s annual GHG emissions inventory. A summary of the GHG emissions for the construction phases is provided in **Table 4, Construction GHG Emissions**. As shown, total construction emissions would be approximately 713.5 MTCO<sub>2</sub>e per year. Construction emissions amortized over 30 years would be approximately 23.8 MTCO<sub>2</sub>e per year.

**Table 4**  
**Construction GHG Emissions**

Year	CO <sub>2</sub> e Emissions (Metric Tons per Year)
2018	672.5
2019	41.0
Total Construction GHG Emissions	713.5
Annualized over Project’s Lifetime	23.8

*Refer to **Appendix A (Annual)**, Section 2.1, Overall Construction.*

As described above, the CARB, VCAPCD, and the City have yet to formally adopt a GHG significance threshold for land use development projects (e.g., residential/commercial projects). Ventura County is adjacent to the SCAQMD jurisdiction and is part of the SCAG region. As such, VCAPCD staff believes it makes sense to set local GHG emission thresholds of significance for land use developments projects at levels consistent with those set by the SCAQMD and the SCAG region. Given the lack of a formally adopted VCAPCD numerical significance threshold applicable to this Project, the significance of the Project is evaluated based on the SCAQMD’s proposed screening level of 3,000 MTCO<sub>2</sub>e per year.

The annual GHG emissions associated with the operation of the Project site are provided in **Table 5, Estimated Greenhouse Gas Emissions**. As shown in **Table 5**, the GHG emissions associated with the Project would result in 2,184.7 MTCO<sub>2</sub>e per year, below the SCAQMD-recommended screening level threshold of 3,000 MTCO<sub>2</sub>e per year and an efficiency target of 4.8 MTCO<sub>2</sub>e per year per service population. In addition, the Project would have an increase of 557 residents. The per service population emissions would equal to 3.1 MTCO<sub>2</sub>e per year, below the SCAQMD-recommended Tier 4 efficiency target of 4.8 MTCO<sub>2</sub>e per year per service population.

**Table 5**  
**Estimated Greenhouse Gas Emissions**

GHG Emissions Source	Emissions (MTCO <sub>2</sub> e/year)
Construction (amortized)	23.8
Operational (Mobile) sources <sup>a</sup>	1,125.2
Area sources	2.3
Energy	889.5
Waste	49.2
Water	94.7
<b>Annual Total</b>	<b>2,184.7</b>
Per Service Population (557 residents)	3.1

*Notes: Emissions calculations are provided in **Appendix A**, Section 2.2, Overall Operational. Totals in table may not appear to add exactly due to rounding in the computer model calculations. The emissions of the Project represent the net difference between the existing GHG emissions generated by existing uses that would be removed and the Project GHG emissions.*

<sup>a</sup> N<sub>2</sub>O emissions account for 0.05 MTCO<sub>2</sub>e/year.

## CONSISTENCY ANALYSIS

The CAPCOA suggests making significance determinations on a case-by-case basis when no significance threshold have been formally adopted by a lead agency. This includes evaluating a project’s sources of GHG emissions and considering project consistency with applicable emission reduction strategies and goals. The following plans all apply to the Project and are all intended to reduce GHG emission to meet the Statewide targets set forth in Assembly Bill (AB) 32.

### City of Oxnard 2030 General Plan

The Sustainable Communities chapter addresses energy issues of climate change mitigation and adaptation, sea level rise, and energy conservation and generation (“green” buildings). Furthermore, the chapter includes goals and policies for incorporation into an Oxnard Climate Action and Adaptation Plan. The applicable goals and consistency with this Project are shown in **Table 6, City of Oxnard 2030 General Plan Consistency**. As shown, the Project would be consistent with the policies identified in the City’s General Plan.

**Table 6**  
**City of Oxnard 2030 General Plan Consistency**

Goal/Policy	Consistency
Goal SC-3: Energy efficiency performance standards and generation from renewable sources	
<b>Policy SC-3.4:</b> Alternative Energy for Public Buildings	<b>Consistent.</b> As described in <b>PDF-2</b> , the Rio School District Administrative office would be equipped with solar ready panels.
Goal SC-4: Implementation of the California Green Building Code	
<b>Policy SC-4.1:</b> Green Building Code Implementation	<b>Consistent.</b> As described in <b>PDF-1</b> through <b>PDF-5</b> , the Project would implement features consistent with the latest requirements of the 2016 California Green Building Code.

*Source: City of Oxnard, 2030 General Plan Goals & Policies, adopted October 2011, amended December 2016.*

## California Climate Action Team (CAT) Strategies

The CAT report provides recommendations for specific emission reduction strategies for reducing GHG emissions and reaching the targets established in AB 32, Executive Order (EO) S-3-05, and EO B-30-15. Recent studies have shown that the State’s existing and proposed regulatory framework will allow the State to reduce its GHG emissions level to 40 percent below 1990 levels by 2030, and to 80 percent below 1990 levels by 2050. Even though these studies do not provide an exact regulatory and technological roadmap to achieve the 2030 and 2050 goals, they demonstrate that various combinations of policies could allow the Statewide emission levels to remain very low through 2050, suggesting that the combination of new technologies, regulations, and strategies not analyzed in the studies could allow the State to meet the 2030 and 2050 targets.<sup>5</sup> A discussion of the Project’s consistency with these strategies for reducing GHG emissions is provided in **Table 7, Project’s Consistency with Recommendations Presented in the Climate Action Team Report**. Therefore, the Project’s post-2020 emissions trajectory is expected to follow a declining trend, consistent with the 2030 and 2050 targets and EO S-3-05 and EO B-30-15.

5 Greenblatt, Jeffrey, “Modeling California Impacts on Greenhouse Gas Emissions,” *Energy Policy* 78: 158–72.

**Table 7**  
**Project's Consistency with Recommendations Presented in the Climate Action Team Report**

<b>Strategies for Reducing GHG Emissions</b>	<b>Project Conformance</b>
<b>Diesel Anti-Idling</b>	
Reduce GHG emissions from diesel-fueled commercial motor vehicle idling, by reducing idling times and electrifying truck stops	Consistent with Sections 2485 in Title 13 of the California Code of Regulations, the idling of all diesel fueled commercial vehicles (weighing more than 10,000 pounds) during construction shall be limited to 5 minutes at any location.
<b>Alternative Fuels: Biodiesel Blends and Ethanol</b>	
Increase the use of alternative fuels that are less GHG intensive by adopting regulations to require the use of biodiesel to displace California diesel fuel, increasing the number of flexible fueled vehicles present in California, and increasing the percentage of ethanol used in gasoline.	While this requirement would be implemented at the State level through regulatory adoption, the Project, as required by the Los Angeles Green Building Code, would include a minimum number of EV-ready parking spaces equal to 5 percent of the total number of parking spaces.
<b>Achieve 50 Percent Statewide Recycling Goal</b>	
Achieve California's 50 percent waste diversion mandate (AB 939, Integrated Waste Management Act of 1989) to reduce GHG emissions associated with virgin material extraction. AB 939 required each city or county plan to include an implementation schedule that showed 50 percent diversion of all solid waste by January 1, 2000, through source reduction, recycling, and composting.	The Project will be consistent with the applicable regulations associated with solid waste. Specifically, the Project would provide adequate storage areas in accordance with the City of Los Angeles Space Allocation Ordinance (Ordinance No. 171,687), which requires that developments include a recycling area or room of specified size on the Project site. Furthermore, as part of the Project, construction materials would be recycled in accordance with the City of Oxnard Building Code, which requires a minimum construction waste reduction of approximately 50 percent. The Project would also promote compliance with AB 939, AB 341, and City waste diversion goals by providing clearly marked, source-sorted receptacles to facilitate recycling. Thus, the Project would support the City's achievement of goals of the California Integrated Waste Management Act.
<b>Water-Use Efficiency</b>	
Implement efficient water management practices and incentives, as saving water saves energy and GHG emissions.	The Project includes several design features to support water conservation, including the use of low-flow plumbing fixtures as described in <b>PDF-3</b> and installation of bioswale components in the landscape as design as described in <b>PDF-5</b> .
<b>Building Energy Efficiency Standards in Place and in Progress</b>	
Reduce GHG emissions from electricity by reducing energy demand. The California Energy Commission updates building energy efficiency standards that apply to newly constructed buildings and additions to and alterations to existing buildings. Both the Energy Action Plan and the Integrated Energy Policy Report call for ongoing updating of the standards.	As described in <b>PDF-3</b> , the Project would comply with the latest Title 24 standard requirements for energy efficiency.

*Note: Climate Action Team strategies not listed are not applicable to this Project.*

## California Attorney General—Recommended Reduction Measures

In addition to the measures listed in the Scoping Plan, other State offices have provided recommended measures that would assist lead agencies in determining consistency with the State’s GHG reduction goals. The California Attorney General’s Office (AGO) has stated that lead agencies can play an important role in helping to “move the State away from ‘business as usual’ and toward a low-carbon future.”<sup>6</sup> The AGO has released a guidance document that provides information to lead agencies that may be helpful in carrying out their duties under CEQA with respect to GHGs and climate change impacts. Provided in the document are measures that can be included as project design features, required changes to the project, or mitigation measures at the project level and at the general-plan level. The measures are not intended to be exhaustive and are not applicable to every project or general plan. The AGO affirms that “the decision of whether to approve a project—as proposed or with required changes or mitigation—is for the local agency, exercising its informed judgment in compliance with the law and balancing a variety of public objectives.”<sup>7</sup>

The Project as proposed is considered consistent with the goals of AB 32. The Project would incorporate energy reduction and water conservation measures, identified in the City’s General Plan, that reduce GHG emissions compared to a conventional project of similar size and scope. These measures and features are consistent with existing recommendations to reduce GHG emissions.

## Southern California Association of Governments’ Sustainable Communities Strategy

SCAG’s most recent population forecast was adopted in April 2016 as part of the *2016–2040 Regional Transportation Plan/Sustainable Communities Strategy* (2016 RTP/SCS). The 2016 SCAG growth forecast projects a population in Oxnard of 200,100 people for 2012 and 237,300 people for 2040.<sup>8</sup> The population increase of 557 that could result from the construction of the new residential housing and employment opportunities associated with the Project, in addition, the existing population is within SCAG’s most recent growth projections for the City of Oxnard. As such, the growth forecast is also within the population growth parameters considered in the Air Quality Management Plan (AQMP), which is updated by the VCAPCD to manage air emissions in the County of Ventura in accordance with local, State, and federal

---

6 California Office of the Attorney General, “Addressing Global Warming Impacts at the Local Agency Level” (January 2010), [http://ag.ca.gov/globalwarming/pdf/GW\\_mitigation\\_measures.pdf](http://ag.ca.gov/globalwarming/pdf/GW_mitigation_measures.pdf).

7 California Office of the Attorney General, “Addressing Global Warming Impacts” (January 2010), [http://ag.ca.gov/globalwarming/pdf/GW\\_mitigation\\_measures.pdf](http://ag.ca.gov/globalwarming/pdf/GW_mitigation_measures.pdf).

8 Southern California Association of Government, *2016-2040 Regional Transportation Plan/Sustain Communities Strategy* (April 2016).

standards. Development of the Project will not obstruct implementation of the AQMP or attainment of State or federal air quality standards. Therefore, the Project would be consistent with the 2016 RTP/SCS.

## **CUMULATIVE ANALYSIS**

Climate change is a cumulative impact from various global sources of activities that incrementally contribute to global GHG concentrations. Individual projects provide a small addition to total concentrations but contribute cumulatively to a global phenomenon. According to CAPCOA, GHG impacts are exclusively cumulative impacts; there are no non-cumulative GHG emission impacts from a climate change perspective.<sup>9</sup> The goal of AB 32 is to require GHG emission reductions from existing conditions. As a result, cumulative GHG and climate change impacts must be analyzed from the perspective of whether they would impede the State's ability to meet its emission reduction goals.

To achieve Statewide goals, CARB is in the process of implementing regulations to reduce Statewide GHG emissions. However, currently, no applicable significance thresholds, specific reduction targets, and approved policies or guidance are in place to assist in determining significance at the project or cumulative level. Additionally, currently no generally accepted methodology exists to determine whether GHG emissions associated with a specific project represent new emissions or existing and/or displaced emissions.

In conformance with City of Oxnard goals and policies, GHG emissions reductions would be achieved through energy-efficient lighting, installation of low-flow appliances, and water conservation. The methods used to establish this relative reduction are consistent with the approach used in the CARB's Scoping Plan for the implementation of AB 32 through 2020. The Project's design features and GHG reduction measures make the Project consistent with the goals of AB 32.

The Project is consistent with the approach outlined in the CARB's Scoping Plan, particularly its emphasis on the identification of emissions reduction opportunities that promote economic growth while achieving greater energy efficiency and accelerating the transition to a low-carbon economy. The location and design of the Project reflect and support these core objectives. In addition, as recommended by CARB's Scoping Plan, the Project would use green building features as a framework for achieving crosscutting emissions reductions.

---

9 CAPCOA, *Evaluating and Addressing Greenhouse Gas Emissions from Projects Subject to the California Environmental Quality Act* (January 2008).



**APPENDIX A**

---

**CalEEMod Air Quality and Greenhouse Gas Emissions Files**

Rio Urbana Mixed Use (Proposed) - Ventura County APCD Air District, Annual

**Rio Urbana Mixed Use (Proposed)**  
**Ventura County APCD Air District, Annual**

**1.0 Project Characteristics**

**1.1 Land Usage**

Land Uses	Size	Metric	Lot Acreage	Floor Surface Area	Population
General Office Building	15.10	1000sqft	0.18	15,100.00	0
Enclosed Parking with Elevator	463.00	Space	0.00	185,200.00	0
Condo/Townhouse	182.00	Dwelling Unit	2.64	182,000.00	557

**1.2 Other Project Characteristics**

<b>Urbanization</b>	Urban	<b>Wind Speed (m/s)</b>	2.6	<b>Precipitation Freq (Days)</b>	31
<b>Climate Zone</b>	8	<b>Operational Year</b>		2021	
<b>Utility Company</b>	Southern California Edison				
<b>CO2 Intensity (lb/MW hr)</b>	702.44	<b>CH4 Intensity (lb/MW hr)</b>	0.029	<b>N2O Intensity (lb/MW hr)</b>	0.006

**1.3 User Entered Comments & Non-Default Data**

Project Characteristics - Construction to be completed 2020.

Land Use - Total Project are = 10.49 acres

Lot coverage: School office = 7,830 sq. ft.; apartment = 115,026 sq. ft.

Construction Phase - Architectural coating to take place intermittently towards the tail end of building construction

Off-road Equipment - No Cranes

Grading - +/- 17,000 cy of import

Vehicle Trips - Based on Traffic Study

Energy Use -



tblConstEquipMitigation	Tier	No Change	Tier 2
tblConstEquipMitigation	Tier	No Change	Tier 2
tblConstEquipMitigation	Tier	No Change	Tier 2
tblConstEquipMitigation	Tier	No Change	Tier 2
tblConstEquipMitigation	Tier	No Change	Tier 2
tblConstEquipMitigation	Tier	No Change	Tier 2
tblConstEquipMitigation	Tier	No Change	Tier 2
tblConstEquipMitigation	Tier	No Change	Tier 2
tblConstructionPhase	NumDays	10.00	30.00
tblConstructionPhase	PhaseEndDate	2/12/2019	1/25/2019
tblConstructionPhase	PhaseStartDate	1/30/2019	12/15/2018
tblGrading	MaterialImported	0.00	17,000.00
tblLandUse	LotAcreage	0.35	0.18
tblLandUse	LotAcreage	4.17	0.00
tblLandUse	LotAcreage	11.38	2.64
tblProjectCharacteristics	OperationalYear	2018	2021
tblVehicleTrips	WD_TR	11.03	11.65

## 2.0 Emissions Summary

### 2.1 Overall Construction

#### Baseline Construction

	ROG	NOx	CO	SO2	Fugitive PM10	Exhaust PM10	PM10 Total	Fugitive PM2.5	Exhaust PM2.5	PM2.5 Total	Bio- CO2	NBio- CO2	Total CO2	CH4	N2O	CO2e
Year	tons/yr										MT/yr					
2018	0.9037	3.7752	2.8825	7.3800e-003	0.3646	0.1616	0.5261	0.0913	0.1543	0.2456	0.0000	670.3661	670.3661	0.0848	0.0000	672.4864
2019	0.7682	0.2234	0.2187	4.6000e-004	0.0153	0.0113	0.0265	4.1100e-003	0.0107	0.0148	0.0000	40.8830	40.8830	6.0300e-003	0.0000	41.0339

Maximum	0.9037	3.7752	2.8825	7.3800e-003	0.3646	0.1616	0.5261	0.0913	0.1543	0.2456	0.0000	670.3661	670.3661	0.0848	0.0000	672.4864
---------	--------	--------	--------	-------------	--------	--------	--------	--------	--------	--------	--------	----------	----------	--------	--------	----------

## Regulatory Compliance Construction

	ROG	NOx	CO	SO2	Fugitive PM10	Exhaust PM10	PM10 Total	Fugitive PM2.5	Exhaust PM2.5	PM2.5 Total	Bio- CO2	NBio- CO2	Total CO2	CH4	N2O	CO2e
Year	tons/yr										MT/yr					
2018	0.6749	3.6525	2.8597	7.3800e-003	0.2919	0.1054	0.3973	0.0760	0.1049	0.1810	0.0000	670.3658	670.3658	0.0848	0.0000	672.4861
2019	0.7554	0.2498	0.2250	4.6000e-004	0.0153	8.5700e-003	0.0239	4.1100e-003	8.5500e-003	0.0127	0.0000	40.8830	40.8830	6.0300e-003	0.0000	41.0339
Maximum	0.7554	3.6525	2.8597	7.3800e-003	0.2919	0.1054	0.3973	0.0760	0.1049	0.1810	0.0000	670.3658	670.3658	0.0848	0.0000	672.4861

	ROG	NOx	CO	SO2	Fugitive PM10	Exhaust PM10	PM10 Total	Fugitive PM2.5	Exhaust PM2.5	PM2.5 Total	Bio- CO2	NBio- CO2	Total CO2	CH4	N2O	CO2e
Percent Reduction	14.46	2.41	0.53	0.00	19.12	34.05	23.79	16.02	31.22	25.65	0.00	0.00	0.00	0.00	0.00	0.00

Quarter	Start Date	End Date	Maximum Baseline ROG + NOX (tons/quarter)	Maximum Regulatory Compliance ROG + NOX (tons/quarter)
1	2-1-2018	4-30-2018	1.4114	1.2881
2	5-1-2018	7-31-2018	1.0488	0.9625
3	8-1-2018	10-31-2018	1.0517	0.9654
4	11-1-2018	1-31-2019	2.1309	2.0881
		Highest	2.1309	2.0881

## 2.2 Overall Operational

### Baseline Operational

	ROG	NOx	CO	SO2	Fugitive PM10	Exhaust PM10	PM10 Total	Fugitive PM2.5	Exhaust PM2.5	PM2.5 Total	Bio- CO2	NBio- CO2	Total CO2	CH4	N2O	CO2e
--	-----	-----	----	-----	---------------	--------------	------------	----------------	---------------	-------------	----------	-----------	-----------	-----	-----	------

Category	tons/yr									MT/yr						
Area	0.9397	0.0157	1.3587	7.000e-005		7.4800e-003	7.4800e-003	7.4800e-003	7.4800e-003	0.0000	2.2160	2.2160	2.1600e-003	0.0000	2.2700	
Energy	0.0212	0.1818	0.0802	1.1600e-003		0.0147	0.0147	0.0147	0.0147	0.0000	984.4889	984.4889	0.0360	0.0105	988.5078	
Mobile	0.5838	0.9807	5.7407	0.0124	1.1894	0.0108	1.2001	0.3174	0.0100	0.3275	0.0000	1,123.2342	1,123.2342	0.0754	0.0000	1,125.1188
Waste						0.0000	0.0000		0.0000	0.0000	19.8444	0.0000	19.8444	1.1728	0.0000	49.1637
Water						0.0000	0.0000		0.0000	0.0000	4.6135	92.6165	97.2300	0.4777	0.0120	112.7416
<b>Total</b>	<b>1.5447</b>	<b>1.1782</b>	<b>7.1796</b>	<b>0.0136</b>	<b>1.1894</b>	<b>0.0329</b>	<b>1.2223</b>	<b>0.3174</b>	<b>0.0322</b>	<b>0.3496</b>	<b>24.4579</b>	<b>2,202.5556</b>	<b>2,227.0134</b>	<b>1.7640</b>	<b>0.0225</b>	<b>2,277.8019</b>

### Regulatory Compliance Operational

Category	ROG	NOx	CO	SO2	Fugitive PM10	Exhaust PM10	PM10 Total	Fugitive PM2.5	Exhaust PM2.5	PM2.5 Total	Bio- CO2	NBio- CO2	Total CO2	CH4	N2O	CO2e
	tons/yr										MT/yr					
Area	0.8821	0.0157	1.3587	7.000e-005		7.4800e-003	7.4800e-003	7.4800e-003	7.4800e-003	0.0000	2.2160	2.2160	2.1600e-003	0.0000	2.2700	
Energy	0.0189	0.1615	0.0712	1.0300e-003		0.0130	0.0130	0.0130	0.0130	0.0130	0.0000	885.9115	885.9115	0.0325	9.4000e-003	889.5223
Mobile	0.5838	0.9807	5.7407	0.0124	1.1894	0.0108	1.2001	0.3174	0.0100	0.3275	0.0000	1,123.2342	1,123.2342	0.0754	0.0000	1,125.1188
Waste						0.0000	0.0000		0.0000	0.0000	19.8444	0.0000	19.8444	1.1728	0.0000	49.1637
Water						0.0000	0.0000		0.0000	0.0000	3.6908	78.5810	82.2717	0.3823	9.6200e-003	94.6971
<b>Total</b>	<b>1.4848</b>	<b>1.1579</b>	<b>7.1705</b>	<b>0.0135</b>	<b>1.1894</b>	<b>0.0313</b>	<b>1.2206</b>	<b>0.3174</b>	<b>0.0306</b>	<b>0.3480</b>	<b>23.5352</b>	<b>2,089.9426</b>	<b>2,113.4777</b>	<b>1.6651</b>	<b>0.0190</b>	<b>2,160.7719</b>

	ROG	NOx	CO	SO2	Fugitive PM10	Exhaust PM10	PM10 Total	Fugitive PM2.5	Exhaust PM2.5	PM2.5 Total	Bio- CO2	NBio- CO2	Total CO2	CH4	N2O	CO2e
<b>Percent Reduction</b>	<b>3.88</b>	<b>1.72</b>	<b>0.13</b>	<b>0.96</b>	<b>0.00</b>	<b>4.98</b>	<b>0.13</b>	<b>0.00</b>	<b>5.09</b>	<b>0.47</b>	<b>3.77</b>	<b>5.11</b>	<b>5.10</b>	<b>5.61</b>	<b>15.28</b>	<b>5.14</b>

### 3.0 Construction Detail

**Construction Phase**

Phase Number	Phase Name	Phase Type	Start Date	End Date	Num Days Week	Num Days	Phase Description
1	Demolition	Demolition	2/1/2018	2/28/2018	5	20	
2	Site Preparation	Site Preparation	3/1/2018	3/5/2018	5	3	
3	Grading	Grading	3/6/2018	3/13/2018	5	6	
4	Building Construction	Building Construction	3/14/2018	4/15/2019	5	220	
5	Paving	Paving	1/16/2019	1/29/2019	5	10	
6	Architectural Coating	Architectural Coating	12/15/2018	1/25/2019	5	30	

**Acres of Grading (Site Preparation Phase): 4.5**

**Acres of Grading (Grading Phase): 3**

**Acres of Paving: 0**

**Residential Indoor: 368,550; Residential Outdoor: 122,850; Non-Residential Indoor: 22,650; Non-Residential Outdoor: 7,550; Striped**

**OffRoad Equipment**

Phase Name	Offroad Equipment Type	Amount	Usage Hours	Horse Power	Load Factor
Demolition	Concrete/Industrial Saws	1	8.00	81	0.73
Demolition	Rubber Tired Dozers	1	8.00	247	0.40
Demolition	Tractors/Loaders/Backhoes	3	8.00	97	0.37
Site Preparation	Graders	1	8.00	187	0.41
Site Preparation	Scrapers	1	8.00	367	0.48
Site Preparation	Tractors/Loaders/Backhoes	1	7.00	97	0.37
Grading	Graders	1	8.00	187	0.41
Grading	Rubber Tired Dozers	1	8.00	247	0.40
Grading	Tractors/Loaders/Backhoes	2	7.00	97	0.37
Building Construction	Forklifts	2	7.00	89	0.20
Building Construction	Generator Sets	1	8.00	84	0.74
Building Construction	Tractors/Loaders/Backhoes	1	6.00	97	0.37
Building Construction	Welders	3	8.00	46	0.45

Paving	Cement and Mortar Mixers	1	8.00	9	0.56
Paving	Pavers	1	8.00	130	0.42
Paving	Paving Equipment	1	8.00	132	0.36
Paving	Rollers	2	8.00	80	0.38
Paving	Tractors/Loaders/Backhoes	1	8.00	97	0.37
Architectural Coating	Air Compressors	1	6.00	78	0.48
Building Construction	Cranes	1	8.00	231	0.29

### Trips and VMT

Phase Name	Offroad Equipment Count	Worker Trip Number	Vendor Trip Number	Hauling Trip Number	Worker Trip Length	Vendor Trip Length	Hauling Trip Length	Worker Vehicle Class	Vendor Vehicle Class	Hauling Vehicle Class
Demolition	5	13.00	0.00	875.00	10.80	7.30	20.00	LD_Mix	HDT_Mix	HHDT
Site Preparation	3	8.00	0.00	0.00	10.80	7.30	20.00	LD_Mix	HDT_Mix	HHDT
Grading	4	10.00	0.00	2,125.00	10.80	7.30	20.00	LD_Mix	HDT_Mix	HHDT
Building Construction	8	214.00	52.00	0.00	10.80	7.30	20.00	LD_Mix	HDT_Mix	HHDT
Paving	6	15.00	0.00	0.00	10.80	7.30	20.00	LD_Mix	HDT_Mix	HHDT
Architectural Coating	1	43.00	0.00	0.00	10.80	7.30	20.00	LD_Mix	HDT_Mix	HHDT

### 3.1 Mitigation Measures Construction

Use Cleaner Engines for Construction Equipment

Water Exposed Area

Reduce Vehicle Speed on Unpaved Roads

Clean Paved Roads

### 3.2 Demolition - 2018

#### Baseline Construction On-Site

	ROG	NOx	CO	SO2	Fugitive PM10	Exhaust PM10	PM10 Total	Fugitive PM2.5	Exhaust PM2.5	PM2.5 Total	Bio- CO2	NBio- CO2	Total CO2	CH4	N2O	CO2e
--	-----	-----	----	-----	---------------	--------------	------------	----------------	---------------	-------------	----------	-----------	-----------	-----	-----	------



Category	tons/yr										MT/yr					
Fugitive Dust					0.0958	0.0000	0.0958	0.0145	0.0000	0.0145	0.0000	0.0000	0.0000	0.0000	0.0000	0.0000
Off-Road	0.0248	0.2436	0.1511	2.4000e-004		0.0144	0.0144		0.0134	0.0134	0.0000	21.6923	21.6923	5.5000e-003	0.0000	21.8297
<b>Total</b>	<b>0.0248</b>	<b>0.2436</b>	<b>0.1511</b>	<b>2.4000e-004</b>	<b>0.0958</b>	<b>0.0144</b>	<b>0.1102</b>	<b>0.0145</b>	<b>0.0134</b>	<b>0.0279</b>	<b>0.0000</b>	<b>21.6923</b>	<b>21.6923</b>	<b>5.5000e-003</b>	<b>0.0000</b>	<b>21.8297</b>

**Baseline Construction Off-Site**

Category	ROG	NOx	CO	SO2	Fugitive PM10	Exhaust PM10	PM10 Total	Fugitive PM2.5	Exhaust PM2.5	PM2.5 Total	Bio- CO2	NBio- CO2	Total CO2	CH4	N2O	CO2e
	tons/yr										MT/yr					
Hauling	3.8300e-003	0.1400	0.0277	3.4000e-004	7.5000e-003	7.5000e-004	8.2400e-003	2.0600e-003	7.2000e-004	2.7700e-003	0.0000	33.1966	33.1966	3.2600e-003	0.0000	33.2781
Vendor	0.0000	0.0000	0.0000	0.0000	0.0000	0.0000	0.0000	0.0000	0.0000	0.0000	0.0000	0.0000	0.0000	0.0000	0.0000	0.0000
Worker	5.6000e-004	4.1000e-004	4.2400e-003	1.0000e-005	1.0500e-003	1.0000e-005	1.0600e-003	2.8000e-004	1.0000e-005	2.9000e-004	0.0000	0.9532	0.9532	3.0000e-005	0.0000	0.9539
<b>Total</b>	<b>4.3900e-003</b>	<b>0.1405</b>	<b>0.0319</b>	<b>3.5000e-004</b>	<b>8.5500e-003</b>	<b>7.6000e-004</b>	<b>9.3000e-003</b>	<b>2.3400e-003</b>	<b>7.3000e-004</b>	<b>3.0600e-003</b>	<b>0.0000</b>	<b>34.1498</b>	<b>34.1498</b>	<b>3.2900e-003</b>	<b>0.0000</b>	<b>34.2320</b>

**Regulatory Compliance Construction On-Site**

Category	ROG	NOx	CO	SO2	Fugitive PM10	Exhaust PM10	PM10 Total	Fugitive PM2.5	Exhaust PM2.5	PM2.5 Total	Bio- CO2	NBio- CO2	Total CO2	CH4	N2O	CO2e
	tons/yr										MT/yr					
Fugitive Dust					0.0374	0.0000	0.0374	5.6600e-003	0.0000	5.6600e-003	0.0000	0.0000	0.0000	0.0000	0.0000	0.0000
Off-Road	8.8600e-003	0.2121	0.1542	2.4000e-004		7.1800e-003	7.1800e-003		7.1800e-003	7.1800e-003	0.0000	21.6923	21.6923	5.5000e-003	0.0000	21.8297

Total	8.8600e-003	0.2121	0.1542	2.4000e-004	0.0374	7.1800e-003	0.0446	5.6600e-003	7.1800e-003	0.0128	0.0000	21.6923	21.6923	5.5000e-003	0.0000	21.8297
-------	-------------	--------	--------	-------------	--------	-------------	--------	-------------	-------------	--------	--------	---------	---------	-------------	--------	---------

### Regulatory Compliance Construction Off-Site

	ROG	NOx	CO	SO2	Fugitive PM10	Exhaust PM10	PM10 Total	Fugitive PM2.5	Exhaust PM2.5	PM2.5 Total	Bio- CO2	NBio- CO2	Total CO2	CH4	N2O	CO2e
Category	tons/yr										MT/yr					
Hauling	3.8300e-003	0.1400	0.0277	3.4000e-004	7.5000e-003	7.5000e-004	8.2400e-003	2.0600e-003	7.2000e-004	2.7700e-003	0.0000	33.1966	33.1966	3.2600e-003	0.0000	33.2781
Vendor	0.0000	0.0000	0.0000	0.0000	0.0000	0.0000	0.0000	0.0000	0.0000	0.0000	0.0000	0.0000	0.0000	0.0000	0.0000	0.0000
Worker	5.6000e-004	4.1000e-004	4.2400e-003	1.0000e-005	1.0500e-003	1.0000e-005	1.0600e-003	2.8000e-004	1.0000e-005	2.9000e-004	0.0000	0.9532	0.9532	3.0000e-005	0.0000	0.9539
<b>Total</b>	<b>4.3900e-003</b>	<b>0.1405</b>	<b>0.0319</b>	<b>3.5000e-004</b>	<b>8.5500e-003</b>	<b>7.6000e-004</b>	<b>9.3000e-003</b>	<b>2.3400e-003</b>	<b>7.3000e-004</b>	<b>3.0600e-003</b>	<b>0.0000</b>	<b>34.1498</b>	<b>34.1498</b>	<b>3.2900e-003</b>	<b>0.0000</b>	<b>34.2320</b>

### 3.3 Site Preparation - 2018

#### Baseline Construction On-Site

	ROG	NOx	CO	SO2	Fugitive PM10	Exhaust PM10	PM10 Total	Fugitive PM2.5	Exhaust PM2.5	PM2.5 Total	Bio- CO2	NBio- CO2	Total CO2	CH4	N2O	CO2e
Category	tons/yr										MT/yr					
Fugitive Dust					2.3900e-003	0.0000	2.3900e-003	2.6000e-004	0.0000	2.6000e-004	0.0000	0.0000	0.0000	0.0000	0.0000	0.0000
Off-Road	2.8500e-003	0.0354	0.0191	4.0000e-005		1.4300e-003	1.4300e-003		1.3200e-003	1.3200e-003	0.0000	3.3590	3.3590	1.0500e-003	0.0000	3.3851
<b>Total</b>	<b>2.8500e-003</b>	<b>0.0354</b>	<b>0.0191</b>	<b>4.0000e-005</b>	<b>2.3900e-003</b>	<b>1.4300e-003</b>	<b>3.8200e-003</b>	<b>2.6000e-004</b>	<b>1.3200e-003</b>	<b>1.5800e-003</b>	<b>0.0000</b>	<b>3.3590</b>	<b>3.3590</b>	<b>1.0500e-003</b>	<b>0.0000</b>	<b>3.3851</b>

#### Baseline Construction Off-Site

	ROG	NOx	CO	SO2	Fugitive PM10	Exhaust PM10	PM10 Total	Fugitive PM2.5	Exhaust PM2.5	PM2.5 Total	Bio- CO2	NBio- CO2	Total CO2	CH4	N2O	CO2e
Category	tons/yr										MT/yr					
Hauling	0.0000	0.0000	0.0000	0.0000	0.0000	0.0000	0.0000	0.0000	0.0000	0.0000	0.0000	0.0000	0.0000	0.0000	0.0000	0.0000
Vendor	0.0000	0.0000	0.0000	0.0000	0.0000	0.0000	0.0000	0.0000	0.0000	0.0000	0.0000	0.0000	0.0000	0.0000	0.0000	0.0000
Worker	5.0000e-005	4.0000e-005	3.9000e-004	0.0000	1.0000e-004	0.0000	1.0000e-004	3.0000e-005	0.0000	3.0000e-005	0.0000	0.0880	0.0880	0.0000	0.0000	0.0881
<b>Total</b>	<b>5.0000e-005</b>	<b>4.0000e-005</b>	<b>3.9000e-004</b>	<b>0.0000</b>	<b>1.0000e-004</b>	<b>0.0000</b>	<b>1.0000e-004</b>	<b>3.0000e-005</b>	<b>0.0000</b>	<b>3.0000e-005</b>	<b>0.0000</b>	<b>0.0880</b>	<b>0.0880</b>	<b>0.0000</b>	<b>0.0000</b>	<b>0.0881</b>

**Regulatory Compliance Construction On-Site**

	ROG	NOx	CO	SO2	Fugitive PM10	Exhaust PM10	PM10 Total	Fugitive PM2.5	Exhaust PM2.5	PM2.5 Total	Bio- CO2	NBio- CO2	Total CO2	CH4	N2O	CO2e
Category	tons/yr										MT/yr					
Fugitive Dust					9.3000e-004	0.0000	9.3000e-004	1.0000e-004	0.0000	1.0000e-004	0.0000	0.0000	0.0000	0.0000	0.0000	0.0000
Off-Road	9.9000e-004	0.0300	0.0205	4.0000e-005		7.5000e-004	7.5000e-004		7.5000e-004	7.5000e-004	0.0000	3.3590	3.3590	1.0500e-003	0.0000	3.3851
<b>Total</b>	<b>9.9000e-004</b>	<b>0.0300</b>	<b>0.0205</b>	<b>4.0000e-005</b>	<b>9.3000e-004</b>	<b>7.5000e-004</b>	<b>1.6800e-003</b>	<b>1.0000e-004</b>	<b>7.5000e-004</b>	<b>8.5000e-004</b>	<b>0.0000</b>	<b>3.3590</b>	<b>3.3590</b>	<b>1.0500e-003</b>	<b>0.0000</b>	<b>3.3851</b>

**Regulatory Compliance Construction Off-Site**

	ROG	NOx	CO	SO2	Fugitive PM10	Exhaust PM10	PM10 Total	Fugitive PM2.5	Exhaust PM2.5	PM2.5 Total	Bio- CO2	NBio- CO2	Total CO2	CH4	N2O	CO2e
Category	tons/yr										MT/yr					

Hauling	0.0000	0.0000	0.0000	0.0000	0.0000	0.0000	0.0000	0.0000	0.0000	0.0000	0.0000	0.0000	0.0000	0.0000	0.0000	0.0000
Vendor	0.0000	0.0000	0.0000	0.0000	0.0000	0.0000	0.0000	0.0000	0.0000	0.0000	0.0000	0.0000	0.0000	0.0000	0.0000	0.0000
Worker	5.0000e-005	4.0000e-005	3.9000e-004	0.0000	1.0000e-004	0.0000	1.0000e-004	3.0000e-005	0.0000	3.0000e-005	0.0000	0.0880	0.0880	0.0000	0.0000	0.0881
<b>Total</b>	<b>5.0000e-005</b>	<b>4.0000e-005</b>	<b>3.9000e-004</b>	<b>0.0000</b>	<b>1.0000e-004</b>	<b>0.0000</b>	<b>1.0000e-004</b>	<b>3.0000e-005</b>	<b>0.0000</b>	<b>3.0000e-005</b>	<b>0.0000</b>	<b>0.0880</b>	<b>0.0880</b>	<b>0.0000</b>	<b>0.0000</b>	<b>0.0881</b>

### 3.4 Grading - 2018

#### Baseline Construction On-Site

	ROG	NOx	CO	SO2	Fugitive PM10	Exhaust PM10	PM10 Total	Fugitive PM2.5	Exhaust PM2.5	PM2.5 Total	Bio- CO2	NBio- CO2	Total CO2	CH4	N2O	CO2e
Category	tons/yr										MT/yr					
Fugitive Dust					0.0209	0.0000	0.0209	0.0103	0.0000	0.0103	0.0000	0.0000	0.0000	0.0000	0.0000	0.0000
Off-Road	6.4500e-003	0.0729	0.0311	6.0000e-005		3.5000e-003	3.5000e-003		3.2200e-003	3.2200e-003	0.0000	5.6539	5.6539	1.7600e-003	0.0000	5.6979
<b>Total</b>	<b>6.4500e-003</b>	<b>0.0729</b>	<b>0.0311</b>	<b>6.0000e-005</b>	<b>0.0209</b>	<b>3.5000e-003</b>	<b>0.0244</b>	<b>0.0103</b>	<b>3.2200e-003</b>	<b>0.0135</b>	<b>0.0000</b>	<b>5.6539</b>	<b>5.6539</b>	<b>1.7600e-003</b>	<b>0.0000</b>	<b>5.6979</b>

#### Baseline Construction Off-Site

	ROG	NOx	CO	SO2	Fugitive PM10	Exhaust PM10	PM10 Total	Fugitive PM2.5	Exhaust PM2.5	PM2.5 Total	Bio- CO2	NBio- CO2	Total CO2	CH4	N2O	CO2e
Category	tons/yr										MT/yr					
Hauling	9.2900e-003	0.3401	0.0672	8.2000e-004	0.0182	1.8200e-003	0.0200	4.9900e-003	1.7400e-003	6.7300e-003	0.0000	80.6203	80.6203	7.9200e-003	0.0000	80.8182
Vendor	0.0000	0.0000	0.0000	0.0000	0.0000	0.0000	0.0000	0.0000	0.0000	0.0000	0.0000	0.0000	0.0000	0.0000	0.0000	0.0000
Worker	1.3000e-004	9.0000e-005	9.8000e-004	0.0000	2.4000e-004	0.0000	2.4000e-004	6.0000e-005	0.0000	7.0000e-005	0.0000	0.2200	0.2200	1.0000e-005	0.0000	0.2201
<b>Total</b>	<b>9.4200e-003</b>	<b>0.3402</b>	<b>0.0682</b>	<b>8.2000e-004</b>	<b>0.0184</b>	<b>1.8200e-003</b>	<b>0.0203</b>	<b>5.0500e-003</b>	<b>1.7400e-003</b>	<b>6.8000e-003</b>	<b>0.0000</b>	<b>80.8402</b>	<b>80.8402</b>	<b>7.9300e-003</b>	<b>0.0000</b>	<b>81.0384</b>

**Regulatory Compliance Construction On-Site**

	ROG	NOx	CO	SO2	Fugitive PM10	Exhaust PM10	PM10 Total	Fugitive PM2.5	Exhaust PM2.5	PM2.5 Total	Bio- CO2	NBio- CO2	Total CO2	CH4	N2O	CO2e
Category	tons/yr										MT/yr					
Fugitive Dust					8.1300e-003	0.0000	8.1300e-003	4.0100e-003	0.0000	4.0100e-003	0.0000	0.0000	0.0000	0.0000	0.0000	0.0000
Off-Road	1.8800e-003	0.0543	0.0364	6.0000e-005		1.4600e-003	1.4600e-003		1.4600e-003	1.4600e-003	0.0000	5.6539	5.6539	1.7600e-003	0.0000	5.6979
<b>Total</b>	<b>1.8800e-003</b>	<b>0.0543</b>	<b>0.0364</b>	<b>6.0000e-005</b>	<b>8.1300e-003</b>	<b>1.4600e-003</b>	<b>9.5900e-003</b>	<b>4.0100e-003</b>	<b>1.4600e-003</b>	<b>5.4700e-003</b>	<b>0.0000</b>	<b>5.6539</b>	<b>5.6539</b>	<b>1.7600e-003</b>	<b>0.0000</b>	<b>5.6979</b>

**Regulatory Compliance Construction Off-Site**

	ROG	NOx	CO	SO2	Fugitive PM10	Exhaust PM10	PM10 Total	Fugitive PM2.5	Exhaust PM2.5	PM2.5 Total	Bio- CO2	NBio- CO2	Total CO2	CH4	N2O	CO2e
Category	tons/yr										MT/yr					
Hauling	9.2900e-003	0.3401	0.0672	8.2000e-004	0.0182	1.8200e-003	0.0200	4.9900e-003	1.7400e-003	6.7300e-003	0.0000	80.6203	80.6203	7.9200e-003	0.0000	80.8182
Vendor	0.0000	0.0000	0.0000	0.0000	0.0000	0.0000	0.0000	0.0000	0.0000	0.0000	0.0000	0.0000	0.0000	0.0000	0.0000	0.0000
Worker	1.3000e-004	9.0000e-005	9.8000e-004	0.0000	2.4000e-004	0.0000	2.4000e-004	6.0000e-005	0.0000	7.0000e-005	0.0000	0.2200	0.2200	1.0000e-005	0.0000	0.2201
<b>Total</b>	<b>9.4200e-003</b>	<b>0.3402</b>	<b>0.0682</b>	<b>8.2000e-004</b>	<b>0.0184</b>	<b>1.8200e-003</b>	<b>0.0203</b>	<b>5.0500e-003</b>	<b>1.7400e-003</b>	<b>6.8000e-003</b>	<b>0.0000</b>	<b>80.8402</b>	<b>80.8402</b>	<b>7.9300e-003</b>	<b>0.0000</b>	<b>81.0384</b>

**3.5 Building Construction - 2018**

**Baseline Construction On-Site**

	ROG	NOx	CO	SO2	Fugitive PM10	Exhaust PM10	PM10 Total	Fugitive PM2.5	Exhaust PM2.5	PM2.5 Total	Bio- CO2	NBio- CO2	Total CO2	CH4	N2O	CO2e
Category	tons/yr										MT/yr					
Off-Road	0.3044	2.1640	1.6426	2.6100e-003		0.1314	0.1314		0.1259	0.1259	0.0000	220.8646	220.8646	0.0476	0.0000	222.0541
<b>Total</b>	<b>0.3044</b>	<b>2.1640</b>	<b>1.6426</b>	<b>2.6100e-003</b>		<b>0.1314</b>	<b>0.1314</b>		<b>0.1259</b>	<b>0.1259</b>	<b>0.0000</b>	<b>220.8646</b>	<b>220.8646</b>	<b>0.0476</b>	<b>0.0000</b>	<b>222.0541</b>

### Baseline Construction Off-Site

	ROG	NOx	CO	SO2	Fugitive PM10	Exhaust PM10	PM10 Total	Fugitive PM2.5	Exhaust PM2.5	PM2.5 Total	Bio- CO2	NBio- CO2	Total CO2	CH4	N2O	CO2e
Category	tons/yr										MT/yr					
Hauling	0.0000	0.0000	0.0000	0.0000	0.0000	0.0000	0.0000	0.0000	0.0000	0.0000	0.0000	0.0000	0.0000	0.0000	0.0000	0.0000
Vendor	0.0248	0.6965	0.1904	1.4100e-003	0.0362	6.1300e-003	0.0423	0.0104	5.8700e-003	0.0163	0.0000	136.6102	136.6102	0.0123	0.0000	136.9180
Worker	0.0968	0.0704	0.7299	1.8200e-003	0.1803	1.3300e-003	0.1817	0.0479	1.2300e-003	0.0491	0.0000	163.9697	163.9697	5.2100e-003	0.0000	164.1000
<b>Total</b>	<b>0.1216</b>	<b>0.7669</b>	<b>0.9203</b>	<b>3.2300e-003</b>	<b>0.2165</b>	<b>7.4600e-003</b>	<b>0.2240</b>	<b>0.0583</b>	<b>7.1000e-003</b>	<b>0.0654</b>	<b>0.0000</b>	<b>300.5799</b>	<b>300.5799</b>	<b>0.0175</b>	<b>0.0000</b>	<b>301.0180</b>

### Regulatory Compliance Construction On-Site

	ROG	NOx	CO	SO2	Fugitive PM10	Exhaust PM10	PM10 Total	Fugitive PM2.5	Exhaust PM2.5	PM2.5 Total	Bio- CO2	NBio- CO2	Total CO2	CH4	N2O	CO2e
Category	tons/yr										MT/yr					
Off-Road	0.0990	2.0949	1.6102	2.6100e-003		0.0855	0.0855		0.0855	0.0855	0.0000	220.8644	220.8644	0.0476	0.0000	222.0539

Total	0.0990	2.0949	1.6102	2.6100e-003		0.0855	0.0855		0.0855	0.0855	0.0000	220.8644	220.8644	0.0476	0.0000	222.0539
-------	--------	--------	--------	-------------	--	--------	--------	--	--------	--------	--------	----------	----------	--------	--------	----------

### Regulatory Compliance Construction Off-Site

	ROG	NOx	CO	SO2	Fugitive PM10	Exhaust PM10	PM10 Total	Fugitive PM2.5	Exhaust PM2.5	PM2.5 Total	Bio- CO2	NBio- CO2	Total CO2	CH4	N2O	CO2e
Category	tons/yr										MT/yr					
Hauling	0.0000	0.0000	0.0000	0.0000	0.0000	0.0000	0.0000	0.0000	0.0000	0.0000	0.0000	0.0000	0.0000	0.0000	0.0000	0.0000
Vendor	0.0248	0.6965	0.1904	1.4100e-003	0.0362	6.1300e-003	0.0423	0.0104	5.8700e-003	0.0163	0.0000	136.6102	136.6102	0.0123	0.0000	136.9180
Worker	0.0968	0.0704	0.7299	1.8200e-003	0.1803	1.3300e-003	0.1817	0.0479	1.2300e-003	0.0491	0.0000	163.9697	163.9697	5.2100e-003	0.0000	164.1000
<b>Total</b>	<b>0.1216</b>	<b>0.7669</b>	<b>0.9203</b>	<b>3.2300e-003</b>	<b>0.2165</b>	<b>7.4600e-003</b>	<b>0.2240</b>	<b>0.0583</b>	<b>7.1000e-003</b>	<b>0.0654</b>	<b>0.0000</b>	<b>300.5799</b>	<b>300.5799</b>	<b>0.0175</b>	<b>0.0000</b>	<b>301.0180</b>

### 3.5 Building Construction - 2019

#### Baseline Construction On-Site

	ROG	NOx	CO	SO2	Fugitive PM10	Exhaust PM10	PM10 Total	Fugitive PM2.5	Exhaust PM2.5	PM2.5 Total	Bio- CO2	NBio- CO2	Total CO2	CH4	N2O	CO2e
Category	tons/yr										MT/yr					
Off-Road	0.0141	0.1040	0.0839	1.4000e-004		6.0000e-003	6.0000e-003		5.7500e-003	5.7500e-003	0.0000	11.5365	11.5365	2.4000e-003	0.0000	11.5965
<b>Total</b>	<b>0.0141</b>	<b>0.1040</b>	<b>0.0839</b>	<b>1.4000e-004</b>		<b>6.0000e-003</b>	<b>6.0000e-003</b>		<b>5.7500e-003</b>	<b>5.7500e-003</b>	<b>0.0000</b>	<b>11.5365</b>	<b>11.5365</b>	<b>2.4000e-003</b>	<b>0.0000</b>	<b>11.5965</b>

#### Baseline Construction Off-Site

	ROG	NOx	CO	SO2	Fugitive PM10	Exhaust PM10	PM10 Total	Fugitive PM2.5	Exhaust PM2.5	PM2.5 Total	Bio- CO2	NBio- CO2	Total CO2	CH4	N2O	CO2e
Category	tons/yr										MT/yr					
Hauling	0.0000	0.0000	0.0000	0.0000	0.0000	0.0000	0.0000	0.0000	0.0000	0.0000	0.0000	0.0000	0.0000	0.0000	0.0000	0.0000
Vendor	1.1900e-003	0.0345	9.2800e-003	7.0000e-005	1.9000e-003	2.8000e-004	2.1800e-003	5.5000e-004	2.7000e-004	8.1000e-004	0.0000	7.1549	7.1549	6.3000e-004	0.0000	7.1705
Worker	4.6700e-003	3.2800e-003	0.0345	9.0000e-005	9.4900e-003	7.0000e-005	9.5600e-003	2.5200e-003	6.0000e-005	2.5800e-003	0.0000	8.3962	8.3962	2.5000e-004	0.0000	8.4023
<b>Total</b>	<b>5.8600e-003</b>	<b>0.0378</b>	<b>0.0438</b>	<b>1.6000e-004</b>	<b>0.0114</b>	<b>3.5000e-004</b>	<b>0.0117</b>	<b>3.0700e-003</b>	<b>3.3000e-004</b>	<b>3.3900e-003</b>	<b>0.0000</b>	<b>15.5510</b>	<b>15.5510</b>	<b>8.8000e-004</b>	<b>0.0000</b>	<b>15.5728</b>

**Regulatory Compliance Construction On-Site**

	ROG	NOx	CO	SO2	Fugitive PM10	Exhaust PM10	PM10 Total	Fugitive PM2.5	Exhaust PM2.5	PM2.5 Total	Bio- CO2	NBio- CO2	Total CO2	CH4	N2O	CO2e
Category	tons/yr										MT/yr					
Off-Road	5.2100e-003	0.1103	0.0847	1.4000e-004		4.5000e-003	4.5000e-003		4.5000e-003	4.5000e-003	0.0000	11.5365	11.5365	2.4000e-003	0.0000	11.5965
<b>Total</b>	<b>5.2100e-003</b>	<b>0.1103</b>	<b>0.0847</b>	<b>1.4000e-004</b>		<b>4.5000e-003</b>	<b>4.5000e-003</b>		<b>4.5000e-003</b>	<b>4.5000e-003</b>	<b>0.0000</b>	<b>11.5365</b>	<b>11.5365</b>	<b>2.4000e-003</b>	<b>0.0000</b>	<b>11.5965</b>

**Regulatory Compliance Construction Off-Site**

	ROG	NOx	CO	SO2	Fugitive PM10	Exhaust PM10	PM10 Total	Fugitive PM2.5	Exhaust PM2.5	PM2.5 Total	Bio- CO2	NBio- CO2	Total CO2	CH4	N2O	CO2e
Category	tons/yr										MT/yr					



Hauling	0.0000	0.0000	0.0000	0.0000	0.0000	0.0000	0.0000	0.0000	0.0000	0.0000	0.0000	0.0000	0.0000	0.0000	0.0000	0.0000
Vendor	1.1900e-003	0.0345	9.2800e-003	7.0000e-005	1.9000e-003	2.8000e-004	2.1800e-003	5.5000e-004	2.7000e-004	8.1000e-004	0.0000	7.1549	7.1549	6.3000e-004	0.0000	7.1705
Worker	4.6700e-003	3.2800e-003	0.0345	9.0000e-005	9.4900e-003	7.0000e-005	9.5600e-003	2.5200e-003	6.0000e-005	2.5800e-003	0.0000	8.3962	8.3962	2.5000e-004	0.0000	8.4023
<b>Total</b>	<b>5.8600e-003</b>	<b>0.0378</b>	<b>0.0438</b>	<b>1.6000e-004</b>	<b>0.0114</b>	<b>3.5000e-004</b>	<b>0.0117</b>	<b>3.0700e-003</b>	<b>3.3000e-004</b>	<b>3.3900e-003</b>	<b>0.0000</b>	<b>15.5510</b>	<b>15.5510</b>	<b>8.8000e-004</b>	<b>0.0000</b>	<b>15.5728</b>

### 3.6 Paving - 2019

#### Baseline Construction On-Site

	ROG	NOx	CO	SO2	Fugitive PM10	Exhaust PM10	PM10 Total	Fugitive PM2.5	Exhaust PM2.5	PM2.5 Total	Bio- CO2	NBio- CO2	Total CO2	CH4	N2O	CO2e
Category	tons/yr										MT/yr					
Off-Road	6.2300e-003	0.0628	0.0593	9.0000e-005		3.6500e-003	3.6500e-003		3.3600e-003	3.3600e-003	0.0000	7.9208	7.9208	2.4600e-003	0.0000	7.9823
Paving	0.0000					0.0000	0.0000		0.0000	0.0000	0.0000	0.0000	0.0000	0.0000	0.0000	0.0000
<b>Total</b>	<b>6.2300e-003</b>	<b>0.0628</b>	<b>0.0593</b>	<b>9.0000e-005</b>		<b>3.6500e-003</b>	<b>3.6500e-003</b>		<b>3.3600e-003</b>	<b>3.3600e-003</b>	<b>0.0000</b>	<b>7.9208</b>	<b>7.9208</b>	<b>2.4600e-003</b>	<b>0.0000</b>	<b>7.9823</b>

#### Baseline Construction Off-Site

	ROG	NOx	CO	SO2	Fugitive PM10	Exhaust PM10	PM10 Total	Fugitive PM2.5	Exhaust PM2.5	PM2.5 Total	Bio- CO2	NBio- CO2	Total CO2	CH4	N2O	CO2e
Category	tons/yr										MT/yr					
Hauling	0.0000	0.0000	0.0000	0.0000	0.0000	0.0000	0.0000	0.0000	0.0000	0.0000	0.0000	0.0000	0.0000	0.0000	0.0000	0.0000
Vendor	0.0000	0.0000	0.0000	0.0000	0.0000	0.0000	0.0000	0.0000	0.0000	0.0000	0.0000	0.0000	0.0000	0.0000	0.0000	0.0000
Worker	3.0000e-004	2.1000e-004	2.2000e-003	1.0000e-005	6.0000e-004	0.0000	6.1000e-004	1.6000e-004	0.0000	1.6000e-004	0.0000	0.5350	0.5350	2.0000e-005	0.0000	0.5354
<b>Total</b>	<b>3.0000e-004</b>	<b>2.1000e-004</b>	<b>2.2000e-003</b>	<b>1.0000e-005</b>	<b>6.0000e-004</b>	<b>0.0000</b>	<b>6.1000e-004</b>	<b>1.6000e-004</b>	<b>0.0000</b>	<b>1.6000e-004</b>	<b>0.0000</b>	<b>0.5350</b>	<b>0.5350</b>	<b>2.0000e-005</b>	<b>0.0000</b>	<b>0.5354</b>

**Regulatory Compliance Construction On-Site**

	ROG	NOx	CO	SO2	Fugitive PM10	Exhaust PM10	PM10 Total	Fugitive PM2.5	Exhaust PM2.5	PM2.5 Total	Bio- CO2	NBio- CO2	Total CO2	CH4	N2O	CO2e
Category	tons/yr										MT/yr					
Off-Road	3.6700e-003	0.0781	0.0649	9.0000e-005		2.7900e-003	2.7900e-003		2.7900e-003	2.7900e-003	0.0000	7.9208	7.9208	2.4600e-003	0.0000	7.9823
Paving	0.0000					0.0000	0.0000		0.0000	0.0000	0.0000	0.0000	0.0000	0.0000	0.0000	0.0000
<b>Total</b>	<b>3.6700e-003</b>	<b>0.0781</b>	<b>0.0649</b>	<b>9.0000e-005</b>		<b>2.7900e-003</b>	<b>2.7900e-003</b>		<b>2.7900e-003</b>	<b>2.7900e-003</b>	<b>0.0000</b>	<b>7.9208</b>	<b>7.9208</b>	<b>2.4600e-003</b>	<b>0.0000</b>	<b>7.9823</b>

**Regulatory Compliance Construction Off-Site**

	ROG	NOx	CO	SO2	Fugitive PM10	Exhaust PM10	PM10 Total	Fugitive PM2.5	Exhaust PM2.5	PM2.5 Total	Bio- CO2	NBio- CO2	Total CO2	CH4	N2O	CO2e
Category	tons/yr										MT/yr					
Hauling	0.0000	0.0000	0.0000	0.0000	0.0000	0.0000	0.0000	0.0000	0.0000	0.0000	0.0000	0.0000	0.0000	0.0000	0.0000	0.0000
Vendor	0.0000	0.0000	0.0000	0.0000	0.0000	0.0000	0.0000	0.0000	0.0000	0.0000	0.0000	0.0000	0.0000	0.0000	0.0000	0.0000
Worker	3.0000e-004	2.1000e-004	2.2000e-003	1.0000e-005	6.0000e-004	0.0000	6.1000e-004	1.6000e-004	0.0000	1.6000e-004	0.0000	0.5350	0.5350	2.0000e-005	0.0000	0.5354
<b>Total</b>	<b>3.0000e-004</b>	<b>2.1000e-004</b>	<b>2.2000e-003</b>	<b>1.0000e-005</b>	<b>6.0000e-004</b>	<b>0.0000</b>	<b>6.1000e-004</b>	<b>1.6000e-004</b>	<b>0.0000</b>	<b>1.6000e-004</b>	<b>0.0000</b>	<b>0.5350</b>	<b>0.5350</b>	<b>2.0000e-005</b>	<b>0.0000</b>	<b>0.5354</b>

**3.7 Architectural Coating - 2018**

**Baseline Construction On-Site**



Off-Road	6.3000e-004	0.0129	0.0101	2.0000e-005		5.2000e-004	5.2000e-004		5.2000e-004	5.2000e-004	0.0000	1.4043	1.4043	1.3000e-004	0.0000	1.4076
<b>Total</b>	<b>0.4277</b>	<b>0.0129</b>	<b>0.0101</b>	<b>2.0000e-005</b>		<b>5.2000e-004</b>	<b>5.2000e-004</b>		<b>5.2000e-004</b>	<b>5.2000e-004</b>	<b>0.0000</b>	<b>1.4043</b>	<b>1.4043</b>	<b>1.3000e-004</b>	<b>0.0000</b>	<b>1.4076</b>

**Regulatory Compliance Construction Off-Site**

	ROG	NOx	CO	SO2	Fugitive PM10	Exhaust PM10	PM10 Total	Fugitive PM2.5	Exhaust PM2.5	PM2.5 Total	Bio- CO2	NBio- CO2	Total CO2	CH4	N2O	CO2e
Category	tons/yr										MT/yr					
Hauling	0.0000	0.0000	0.0000	0.0000	0.0000	0.0000	0.0000	0.0000	0.0000	0.0000	0.0000	0.0000	0.0000	0.0000	0.0000	0.0000
Vendor	0.0000	0.0000	0.0000	0.0000	0.0000	0.0000	0.0000	0.0000	0.0000	0.0000	0.0000	0.0000	0.0000	0.0000	0.0000	0.0000
Worker	1.0200e-003	7.4000e-004	7.7200e-003	2.0000e-005	1.9100e-003	1.0000e-005	1.9200e-003	5.1000e-004	1.0000e-005	5.2000e-004	0.0000	1.7341	1.7341	6.0000e-005	0.0000	1.7354
<b>Total</b>	<b>1.0200e-003</b>	<b>7.4000e-004</b>	<b>7.7200e-003</b>	<b>2.0000e-005</b>	<b>1.9100e-003</b>	<b>1.0000e-005</b>	<b>1.9200e-003</b>	<b>5.1000e-004</b>	<b>1.0000e-005</b>	<b>5.2000e-004</b>	<b>0.0000</b>	<b>1.7341</b>	<b>1.7341</b>	<b>6.0000e-005</b>	<b>0.0000</b>	<b>1.7354</b>

**3.7 Architectural Coating - 2019**

**Baseline Construction On-Site**

	ROG	NOx	CO	SO2	Fugitive PM10	Exhaust PM10	PM10 Total	Fugitive PM2.5	Exhaust PM2.5	PM2.5 Total	Bio- CO2	NBio- CO2	Total CO2	CH4	N2O	CO2e
Category	tons/yr										MT/yr					
Archit. Coating	0.7376					0.0000	0.0000		0.0000	0.0000	0.0000	0.0000	0.0000	0.0000	0.0000	0.0000
Off-Road	2.5300e-003	0.0174	0.0175	3.0000e-005		1.2200e-003	1.2200e-003		1.2200e-003	1.2200e-003	0.0000	2.4256	2.4256	2.0000e-004	0.0000	2.4307
<b>Total</b>	<b>0.7401</b>	<b>0.0174</b>	<b>0.0175</b>	<b>3.0000e-005</b>		<b>1.2200e-003</b>	<b>1.2200e-003</b>		<b>1.2200e-003</b>	<b>1.2200e-003</b>	<b>0.0000</b>	<b>2.4256</b>	<b>2.4256</b>	<b>2.0000e-004</b>	<b>0.0000</b>	<b>2.4307</b>

**Baseline Construction Off-Site**

	ROG	NOx	CO	SO2	Fugitive PM10	Exhaust PM10	PM10 Total	Fugitive PM2.5	Exhaust PM2.5	PM2.5 Total	Bio- CO2	NBio- CO2	Total CO2	CH4	N2O	CO2e
Category	tons/yr										MT/yr					
Hauling	0.0000	0.0000	0.0000	0.0000	0.0000	0.0000	0.0000	0.0000	0.0000	0.0000	0.0000	0.0000	0.0000	0.0000	0.0000	0.0000
Vendor	0.0000	0.0000	0.0000	0.0000	0.0000	0.0000	0.0000	0.0000	0.0000	0.0000	0.0000	0.0000	0.0000	0.0000	0.0000	0.0000
Worker	1.6200e-003	1.1400e-003	0.0120	3.0000e-005	3.2900e-003	2.0000e-005	3.3200e-003	8.7000e-004	2.0000e-005	9.0000e-004	0.0000	2.9141	2.9141	9.0000e-005	0.0000	2.9162
<b>Total</b>	<b>1.6200e-003</b>	<b>1.1400e-003</b>	<b>0.0120</b>	<b>3.0000e-005</b>	<b>3.2900e-003</b>	<b>2.0000e-005</b>	<b>3.3200e-003</b>	<b>8.7000e-004</b>	<b>2.0000e-005</b>	<b>9.0000e-004</b>	<b>0.0000</b>	<b>2.9141</b>	<b>2.9141</b>	<b>9.0000e-005</b>	<b>0.0000</b>	<b>2.9162</b>

**Regulatory Compliance Construction On-Site**

	ROG	NOx	CO	SO2	Fugitive PM10	Exhaust PM10	PM10 Total	Fugitive PM2.5	Exhaust PM2.5	PM2.5 Total	Bio- CO2	NBio- CO2	Total CO2	CH4	N2O	CO2e
Category	tons/yr										MT/yr					
Archit. Coating	0.7376					0.0000	0.0000		0.0000	0.0000	0.0000	0.0000	0.0000	0.0000	0.0000	0.0000
Off-Road	1.0800e-003	0.0224	0.0174	3.0000e-005		9.0000e-004	9.0000e-004		9.0000e-004	9.0000e-004	0.0000	2.4256	2.4256	2.0000e-004	0.0000	2.4307
<b>Total</b>	<b>0.7387</b>	<b>0.0224</b>	<b>0.0174</b>	<b>3.0000e-005</b>		<b>9.0000e-004</b>	<b>9.0000e-004</b>		<b>9.0000e-004</b>	<b>9.0000e-004</b>	<b>0.0000</b>	<b>2.4256</b>	<b>2.4256</b>	<b>2.0000e-004</b>	<b>0.0000</b>	<b>2.4307</b>

**Regulatory Compliance Construction Off-Site**

	ROG	NOx	CO	SO2	Fugitive PM10	Exhaust PM10	PM10 Total	Fugitive PM2.5	Exhaust PM2.5	PM2.5 Total	Bio- CO2	NBio- CO2	Total CO2	CH4	N2O	CO2e
Category	tons/yr										MT/yr					

Hauling	0.0000	0.0000	0.0000	0.0000	0.0000	0.0000	0.0000	0.0000	0.0000	0.0000	0.0000	0.0000	0.0000	0.0000	0.0000	0.0000
Vendor	0.0000	0.0000	0.0000	0.0000	0.0000	0.0000	0.0000	0.0000	0.0000	0.0000	0.0000	0.0000	0.0000	0.0000	0.0000	0.0000
Worker	1.6200e-003	1.1400e-003	0.0120	3.0000e-005	3.2900e-003	2.0000e-005	3.3200e-003	8.7000e-004	2.0000e-005	9.0000e-004	0.0000	2.9141	2.9141	9.0000e-005	0.0000	2.9162
<b>Total</b>	<b>1.6200e-003</b>	<b>1.1400e-003</b>	<b>0.0120</b>	<b>3.0000e-005</b>	<b>3.2900e-003</b>	<b>2.0000e-005</b>	<b>3.3200e-003</b>	<b>8.7000e-004</b>	<b>2.0000e-005</b>	<b>9.0000e-004</b>	<b>0.0000</b>	<b>2.9141</b>	<b>2.9141</b>	<b>9.0000e-005</b>	<b>0.0000</b>	<b>2.9162</b>

## 4.0 Operational Detail - Mobile

### 4.1 Mitigation Measures Mobile

	ROG	NOx	CO	SO2	Fugitive PM10	Exhaust PM10	PM10 Total	Fugitive PM2.5	Exhaust PM2.5	PM2.5 Total	Bio- CO2	NBio- CO2	Total CO2	CH4	N2O	CO2e
Category	tons/yr										MT/yr					
Regulatory Compliance	0.5838	0.9807	5.7407	0.0124	1.1894	0.0108	1.2001	0.3174	0.0100	0.3275	0.0000	1,123.2342	1,123.2342	0.0754	0.0000	1,125.1188
Baseline	0.5838	0.9807	5.7407	0.0124	1.1894	0.0108	1.2001	0.3174	0.0100	0.3275	0.0000	1,123.2342	1,123.2342	0.0754	0.0000	1,125.1188

### 4.2 Trip Summary Information

Land Use	Average Daily Trip Rate			Baseline	Regulatory Compliance
	Weekday	Saturday	Sunday	Annual VMT	Annual VMT
Condo/Townhouse	1,057.42	1,031.94	880.88	2,841,986	2,841,986
Enclosed Parking with Elevator	0.00	0.00	0.00		
General Office Building	175.92	37.15	15.86	318,375	318,375
<b>Total</b>	<b>1,233.34</b>	<b>1,069.09</b>	<b>896.74</b>	<b>3,160,361</b>	<b>3,160,361</b>

### 4.3 Trip Type Information

Miles	Trip %	Trip Purpose %
-------	--------	----------------

Land Use	H-W or C-W	H-S or C-C	H-O or C-NW	H-W or C-	H-S or C-C	H-O or C-NW	Primary	Diverted	Pass-by
Condo/Townhouse	10.80	7.30	7.50	32.90	18.00	49.10	86	11	3
Enclosed Parking with Elevator	9.50	7.30	7.30	0.00	0.00	0.00	0	0	0
General Office Building	9.50	7.30	7.30	33.00	48.00	19.00	77	19	4

#### 4.4 Fleet Mix

Land Use	LDA	LDT1	LDT2	MDV	LHD1	LHD2	MHD	HHD	OBUS	UBUS	MCY	SBUS	MH
General Office Building	0.572490	0.044826	0.170628	0.127143	0.022859	0.006230	0.012809	0.005255	0.000798	0.000322	0.029094	0.000351	0.007194
Enclosed Parking with Elevator	0.572490	0.044826	0.170628	0.127143	0.022859	0.006230	0.012809	0.005255	0.000798	0.000322	0.029094	0.000351	0.007194
Condo/Townhouse	0.572490	0.044826	0.170628	0.127143	0.022859	0.006230	0.012809	0.005255	0.000798	0.000322	0.029094	0.000351	0.007194

#### 5.0 Energy Detail

Historical Energy Use: N

#### 5.1 Mitigation Measures Energy

Exceed Title 24

Install High Efficiency Lighting

	ROG	NOx	CO	SO2	Fugitive PM10	Exhaust PM10	PM10 Total	Fugitive PM2.5	Exhaust PM2.5	PM2.5 Total	Bio- CO2	NBio- CO2	Total CO2	CH4	N2O	CO2e
Category	tons/yr										MT/yr					
Electricity Regulatory						0.0000	0.0000		0.0000	0.0000	0.0000	699.2320	699.2320	0.0289	5.9700e-003	701.7335
Electricity Baseline						0.0000	0.0000		0.0000	0.0000	0.0000	774.3982	774.3982	0.0320	6.6100e-003	777.1686
NaturalGas Regulatory	0.0189	0.1615	0.0712	1.0300e-003		0.0130	0.0130		0.0130	0.0130	0.0000	186.6794	186.6794	3.5800e-003	3.4200e-003	187.7888
NaturalGas Baseline	0.0212	0.1818	0.0802	1.1600e-003		0.0147	0.0147		0.0147	0.0147	0.0000	210.0907	210.0907	4.0300e-003	3.8500e-003	211.3392

#### 5.2 Energy by Land Use - NaturalGas

**Baseline**

	Natural Gas Use	ROG	NOx	CO	SO2	Fugitive PM10	Exhaust PM10	PM10 Total	Fugitive PM2.5	Exhaust PM2.5	PM2.5 Total	Bio- CO2	NBio- CO2	Total CO2	CH4	N2O	CO2e
Land Use	kBTU/yr	tons/yr										MT/yr					
Condo/Townhouse	3.79833e+006	0.0205	0.1750	0.0745	1.1200e-003		0.0142	0.0142		0.0142	0.0142	0.0000	202.6935	202.6935	3.8800e-003	3.7200e-003	203.8980
Enclosed Parking with Elevator	0	0.0000	0.0000	0.0000	0.0000		0.0000	0.0000		0.0000	0.0000	0.0000	0.0000	0.0000	0.0000	0.0000	0.0000
General Office Building	138618	7.5000e-004	6.8000e-003	5.7100e-003	4.0000e-005		5.2000e-004	5.2000e-004		5.2000e-004	5.2000e-004	0.0000	7.3972	7.3972	1.4000e-004	1.4000e-004	7.4411
<b>Total</b>		<b>0.0212</b>	<b>0.1818</b>	<b>0.0802</b>	<b>1.1600e-003</b>		<b>0.0147</b>	<b>0.0147</b>		<b>0.0147</b>	<b>0.0147</b>	<b>0.0000</b>	<b>210.0907</b>	<b>210.0907</b>	<b>4.0200e-003</b>	<b>3.8600e-003</b>	<b>211.3392</b>

**Regulatory Compliance**

	Natural Gas Use	ROG	NOx	CO	SO2	Fugitive PM10	Exhaust PM10	PM10 Total	Fugitive PM2.5	Exhaust PM2.5	PM2.5 Total	Bio- CO2	NBio- CO2	Total CO2	CH4	N2O	CO2e
Land Use	kBTU/yr	tons/yr										MT/yr					
Condo/Townhouse	3.37917e+006	0.0182	0.1557	0.0663	9.9000e-004		0.0126	0.0126		0.0126	0.0126	0.0000	180.3254	180.3254	3.4600e-003	3.3100e-003	181.3969
Enclosed Parking with Elevator	0	0.0000	0.0000	0.0000	0.0000		0.0000	0.0000		0.0000	0.0000	0.0000	0.0000	0.0000	0.0000	0.0000	0.0000
General Office Building	119071	6.4000e-004	5.8400e-003	4.9000e-003	4.0000e-005		4.4000e-004	4.4000e-004		4.4000e-004	4.4000e-004	0.0000	6.3541	6.3541	1.2000e-004	1.2000e-004	6.3918
<b>Total</b>		<b>0.0189</b>	<b>0.1616</b>	<b>0.0712</b>	<b>1.0300e-003</b>		<b>0.0130</b>	<b>0.0130</b>		<b>0.0130</b>	<b>0.0130</b>	<b>0.0000</b>	<b>186.6794</b>	<b>186.6794</b>	<b>3.5800e-003</b>	<b>3.4300e-003</b>	<b>187.7888</b>

**5.3 Energy by Land Use - Electricity**

**Baseline**

Electricity Use	Total CO2	CH4	N2O	CO2e
-----------------	-----------	-----	-----	------



Land Use	kWh/yr	MT/yr			
Condo/Townhouse	965683	307.6873	0.0127	2.6300e-003	308.7880
Enclosed Parking with Elevator	1.24825e+006	397.7186	0.0164	3.4000e-003	399.1414
General Office Building	216534	68.9924	2.8500e-003	5.9000e-004	69.2392
<b>Total</b>		<b>774.3982</b>	<b>0.0320</b>	<b>6.6200e-003</b>	<b>777.1686</b>

## Regulatory Compliance

Land Use	Electricity Use kWh/yr	Total CO2	CH4	N2O	CO2e
Condo/Townhouse	933022	297.2809	0.0123	2.5400e-003	298.3444
Enclosed Parking with Elevator	1.06629e+006	339.7425	0.0140	2.9000e-003	340.9580
General Office Building	195243	62.2086	2.5700e-003	5.3000e-004	62.4312
<b>Total</b>		<b>699.2320</b>	<b>0.0289</b>	<b>5.9700e-003</b>	<b>701.7335</b>

## 6.0 Area Detail

### 6.1 Mitigation Measures Area

- Use Low VOC Paint - Residential Interior
- Use Low VOC Paint - Residential Exterior
- Use Low VOC Paint - Non-Residential Interior
- Use Low VOC Paint - Non-Residential Exterior
- Use Low VOC Cleaning Supplies

	ROG	NOx	CO	SO2	Fugitive PM10	Exhaust PM10	PM10 Total	Fugitive PM2.5	Exhaust PM2.5	PM2.5 Total	Bio- CO2	NBio- CO2	Total CO2	CH4	N2O	CO2e
Category	tons/yr										MT/yr					
Regulatory Compliance	0.8821	0.0157	1.3587	7.0000e-005		7.4800e-003	7.4800e-003		7.4800e-003	7.4800e-003	0.0000	2.2160	2.2160	2.1600e-003	0.0000	2.2700
Baseline	0.9397	0.0157	1.3587	7.0000e-005		7.4800e-003	7.4800e-003		7.4800e-003	7.4800e-003	0.0000	2.2160	2.2160	2.1600e-003	0.0000	2.2700

## 6.2 Area by SubCategory

### Baseline

	ROG	NOx	CO	SO2	Fugitive PM10	Exhaust PM10	PM10 Total	Fugitive PM2.5	Exhaust PM2.5	PM2.5 Total	Bio- CO2	NBio- CO2	Total CO2	CH4	N2O	CO2e
SubCategory	tons/yr										MT/yr					
Architectural Coating	0.1165					0.0000	0.0000		0.0000	0.0000	0.0000	0.0000	0.0000	0.0000	0.0000	0.0000
Consumer Products	0.7818					0.0000	0.0000		0.0000	0.0000	0.0000	0.0000	0.0000	0.0000	0.0000	0.0000
Hearth	0.0000	0.0000	0.0000	0.0000		0.0000	0.0000		0.0000	0.0000	0.0000	0.0000	0.0000	0.0000	0.0000	0.0000
Landscaping	0.0415	0.0157	1.3587	7.0000e-005		7.4800e-003	7.4800e-003		7.4800e-003	7.4800e-003	0.0000	2.2160	2.2160	2.1600e-003	0.0000	2.2700
<b>Total</b>	<b>0.9397</b>	<b>0.0157</b>	<b>1.3587</b>	<b>7.0000e-005</b>		<b>7.4800e-003</b>	<b>7.4800e-003</b>		<b>7.4800e-003</b>	<b>7.4800e-003</b>	<b>0.0000</b>	<b>2.2160</b>	<b>2.2160</b>	<b>2.1600e-003</b>	<b>0.0000</b>	<b>2.2700</b>

### Regulatory Compliance

	ROG	NOx	CO	SO2	Fugitive PM10	Exhaust PM10	PM10 Total	Fugitive PM2.5	Exhaust PM2.5	PM2.5 Total	Bio- CO2	NBio- CO2	Total CO2	CH4	N2O	CO2e
SubCategory	tons/yr										MT/yr					
Architectural Coating	0.1165					0.0000	0.0000		0.0000	0.0000	0.0000	0.0000	0.0000	0.0000	0.0000	0.0000
Consumer Products	0.7242					0.0000	0.0000		0.0000	0.0000	0.0000	0.0000	0.0000	0.0000	0.0000	0.0000
Hearth	0.0000	0.0000	0.0000	0.0000		0.0000	0.0000		0.0000	0.0000	0.0000	0.0000	0.0000	0.0000	0.0000	0.0000
Landscaping	0.0415	0.0157	1.3587	7.0000e-005		7.4800e-003	7.4800e-003		7.4800e-003	7.4800e-003	0.0000	2.2160	2.2160	2.1600e-003	0.0000	2.2700
<b>Total</b>	<b>0.8821</b>	<b>0.0157</b>	<b>1.3587</b>	<b>7.0000e-005</b>		<b>7.4800e-003</b>	<b>7.4800e-003</b>		<b>7.4800e-003</b>	<b>7.4800e-003</b>	<b>0.0000</b>	<b>2.2160</b>	<b>2.2160</b>	<b>2.1600e-003</b>	<b>0.0000</b>	<b>2.2700</b>

## 7.0 Water Detail

### 7.1 Mitigation Measures Water

- Install Low Flow Bathroom Faucet
- Install Low Flow Kitchen Faucet
- Install Low Flow Toilet
- Install Low Flow Shower
- Use Water Efficient Irrigation System

	Total CO2	CH4	N2O	CO2e
Category	MT/yr			
Regulatory Compliance	82.2717	0.3823	9.6200e-003	94.6971
Baseline	97.2300	0.4777	0.0120	112.7416

## 7.2 Water by Land Use

### Baseline

	Indoor/Outdoor Use	Total CO2	CH4	N2O	CO2e
Land Use	Mgal	MT/yr			
Condo/Townhouse	11.858 / 7.47572	79.4214	0.3895	9.7700e-003	92.0708
Enclosed Parking with Elevator	0 / 0	0.0000	0.0000	0.0000	0.0000
General Office Building	2.68378 / 1.6449	17.8086	0.0882	2.2100e-003	20.6709
<b>Total</b>		<b>97.2300</b>	<b>0.4777</b>	<b>0.0120</b>	<b>112.7416</b>

### Regulatory Compliance

	Indoor/Outdoor Use	Total CO2	CH4	N2O	CO2e
Land Use	Mgal	MT/yr			
Condo/Townhouse	9.48643 / 7.0197	67.2155	0.3118	7.8500e-003	77.3482
Enclosed Parking with Elevator	0 / 0	0.0000	0.0000	0.0000	0.0000
General Office Building	2.14702 / 1.54456	15.0562	0.0706	1.7700e-003	17.3489
<b>Total</b>		<b>82.2717</b>	<b>0.3823</b>	<b>9.6200e-003</b>	<b>94.6971</b>

## 8.0 Waste Detail

### 8.1 Mitigation Measures Waste

## Category/Year

	Total CO2	CH4	N2O	CO2e
	MT/yr			
Regulatory Compliance	19.8444	1.1728	0.0000	49.1637
Baseline	19.8444	1.1728	0.0000	49.1637

## 8.2 Waste by Land Use

### Baseline

	Waste Disposed	Total CO2	CH4	N2O	CO2e
Land Use	tons	MT/yr			
Condo/Townhouse	83.72	16.9944	1.0043	0.0000	42.1029
Enclosed Parking with Elevator	0	0.0000	0.0000	0.0000	0.0000
General Office Building	14.04	2.8500	0.1684	0.0000	7.0607
<b>Total</b>		<b>19.8444</b>	<b>1.1728</b>	<b>0.0000</b>	<b>49.1637</b>

### Regulatory Compliance

	Waste Disposed	Total CO2	CH4	N2O	CO2e
--	----------------	-----------	-----	-----	------

Land Use	tons	MT/yr			
Condo/Townhouse	83.72	16.9944	1.0043	0.0000	42.1029
Enclosed Parking with Elevator	0	0.0000	0.0000	0.0000	0.0000
General Office Building	14.04	2.8500	0.1684	0.0000	7.0607
<b>Total</b>		<b>19.8444</b>	<b>1.1728</b>	<b>0.0000</b>	<b>49.1637</b>

## 9.0 Operational Offroad

---

Equipment Type	Number	Hours/Day	Days/Year	Horse Power	Load Factor	Fuel Type
----------------	--------	-----------	-----------	-------------	-------------	-----------

## 10.0 Stationary Equipment

---

### Fire Pumps and Emergency Generators

Equipment Type	Number	Hours/Day	Hours/Year	Horse Power	Load Factor	Fuel Type
----------------	--------	-----------	------------	-------------	-------------	-----------

### Boilers

Equipment Type	Number	Heat Input/Day	Heat Input/Year	Boiler Rating	Fuel Type
----------------	--------	----------------	-----------------	---------------	-----------

### User Defined Equipment

Equipment Type	Number
----------------	--------

## 11.0 Vegetation

---

# Appendix E

---

Phase I Cultural Resource Assessment and Paleontological Resource Assessment

# **Phase I Cultural Resource Assessment for the Rio Urbana Mixed Use Project, Ventura County, California**

Roberta Thomas, M.A., RPA, and Justin Castells, M.A.

Prepared By



**Applied EarthWorks, Inc.**  
133 N. San Gabriel Blvd., Suite 201  
Pasadena, CA 91107-3414

Prepared For

**Meridian Consultants, LLC**  
Attn: Christ Kirikian  
910 Hampshire Road, Suite V  
Westlake Village, CA 91361

August 2017



## MANAGEMENT SUMMARY

Pacific West Communities proposes construction of a mixed-use development on the former El Rio Elementary School Campus near the city of Oxnard, Ventura County, California. Applied EarthWorks, Inc. (Æ) was retained to conduct a cultural resource investigation of the Rio Urbana Mixed Use Project (Project) in accordance with the California Environmental Quality Act (CEQA).

An archaeological literature and records search conducted at the South Central Coastal Information Center (SCCIC) indicated that eight cultural resources are present within a 1-mile radius of the Project area; however, no previously documented resources are located within the Project limits. Æ also requested a search of the Sacred Lands File from the Native American Heritage Commission (NAHC), which found that no Native American cultural resources are known to exist within the immediate Project area. Native American individuals and organizations were contacted to elicit information regarding cultural resource issues related to the proposed Project. Of the six groups and/or individuals contacted, the Santa Ynez Band of Chumash Indians is the only tribal group to respond to date. The Santa Ynez Band of Chumash Indians deferred to the local tribes in the Oxnard area.

Æ archaeologist Gena Granger performed an intensive cultural resource pedestrian survey of the Project area by on August 10, 2017. As part of the Project, Æ documented the El Rio School Campus and evaluated its significance and eligibility for listing on the California Register of Historical Resources (CRHR). The El Rio School Campus is not recommended eligible for listing on the CRHR and, as such, no further cultural resource management is recommended for the resource. The cultural resource survey of the Project area did not identify any prehistoric or historical archaeological resources; however, the records search indicated a potential to uncover such resources below the surface in the immediate vicinity of the Project area and, as such, cultural resource monitoring is recommended during any Project-related ground-disturbing activity.

Field notes documenting the current investigation are on file at Æ's Pasadena office. A copy of this report will be placed on file at the SCCIC of the California Historical Resources Information System, housed at California State University, Fullerton.

# CONTENTS

<b>1</b>	<b>INTRODUCTION.....</b>	<b>1</b>
1.1	PROJECT DESCRIPTION AND LOCATION.....	1
1.2	REGULATORY CONTEXT.....	4
1.2.1	California Environmental Quality Act.....	4
1.3	REPORT ORGANIZATION.....	5
<b>2</b>	<b>SETTING.....</b>	<b>6</b>
2.1	ENVIRONMENTAL SETTING .....	6
2.2	PREHISTORIC SETTING .....	6
2.3	ETHNOGRAPHIC SETTING.....	9
2.4	HISTORICAL SETTING .....	10
<b>3</b>	<b>CULTURAL RESOURCE LITERATURE AND RECORDS SEARCH.....</b>	<b>13</b>
3.1	PREVIOUS INVESTIGATIONS.....	13
3.2	RESOURCES REPORTED WITHIN 1 MILE OF THE PROJECT AREA.....	15
<b>4</b>	<b>NATIVE AMERICAN CONSULTATION .....</b>	<b>17</b>
<b>5</b>	<b>SURVEY METHODS AND RESULTS.....</b>	<b>18</b>
5.1	SURVEY METHODS .....	18
5.2	SURVEY RESULTS .....	18
5.2.1	El Rio School Campus.....	20
<b>6</b>	<b>RESOURCE EVALUATION .....</b>	<b>23</b>
6.1	EL RIO SCHOOL CAMPUS .....	23
<b>7</b>	<b>MANAGEMENT RECOMMENDATIONS .....</b>	<b>24</b>
<b>8</b>	<b>REFERENCES.....</b>	<b>25</b>

## APPENDICES

- A Native American Coordination**
- B Non-confidential DPR Form**

**FIGURES**

Figure 1-1 Project Vicinity Map ..... 2  
Figure 1-2 Project Location Map ..... 3  
Figure 5-1 Overview of the Project area (school buildings in the distance)..... 19  
Figure 5-2 School Building in the Project area; view to the southeast ..... 19  
Figure 5-3 North and west elevations of Building A, facing southeast..... 20  
Figure 5-4 South and east elevations of Building C, facing northwest. .... 21  
Figure 5-5 North and east elevations of Building F, facing southwest..... 22

**TABLES**

Table 3-1 Previous Cultural Studies within the Project Study Area..... 13  
Table 3-2 Cultural Resources within the Project Study Area ..... 16

# 1 INTRODUCTION

The Pacific West Communities proposes to develop a new mixed-use development which includes 182 condominium residential units and a 15,000-square foot office building containing the Rio School District Administrative Offices on the former El Rio Elementary School Campus near the city of Oxnard, Ventura County, California. Applied EarthWorks, Inc. (Æ) was retained by Meridian Consultants, LLC, to conduct a cultural resource investigation of the Rio Urbana Mixed Use Project (hereafter “Project”). The study consisted of records searches, Native American coordination, a Phase I survey of the Project area, and documentation and evaluation of the El Rio Elementary School Campus. The Project requires discretionary approval from the City of Oxnard thus is subject to compliance with the California Environmental Quality Act (CEQA), as amended. This report summarizes the methods and results of the cultural resource study and provides Project-specific management recommendations.

## 1.1 PROJECT DESCRIPTION AND LOCATION

The Project is located in the community of El Rio within the City of Oxnard Sphere of Influence. It is situated along East Vineyard Avenue, northeast of U.S. Route 101 and southwest of Rio School Lane, approximately one mile east of the Santa Clara River (Figure 1-1). Specifically, the Project is mapped within portions of the Santa Clara del Norte Landgrant on the Oxnard, CA 7.5-minute U.S. Geological Survey quadrangle. (Figure 1-2); elevations range from approximately 87 to 92 feet above mean sea level (amsl).

The Project site, formerly the El Rio Elementary School Campus, consists of approximately 10.24 acres of developed land with numerous vacant buildings (cafeteria, administration, classrooms, and two portable buildings). The school has been closed since 2008 and is currently utilized as a dispatch for school buses and storage. The proposed Project would include demolition of the existing buildings and structures to allow construction of the new mixed-use development.

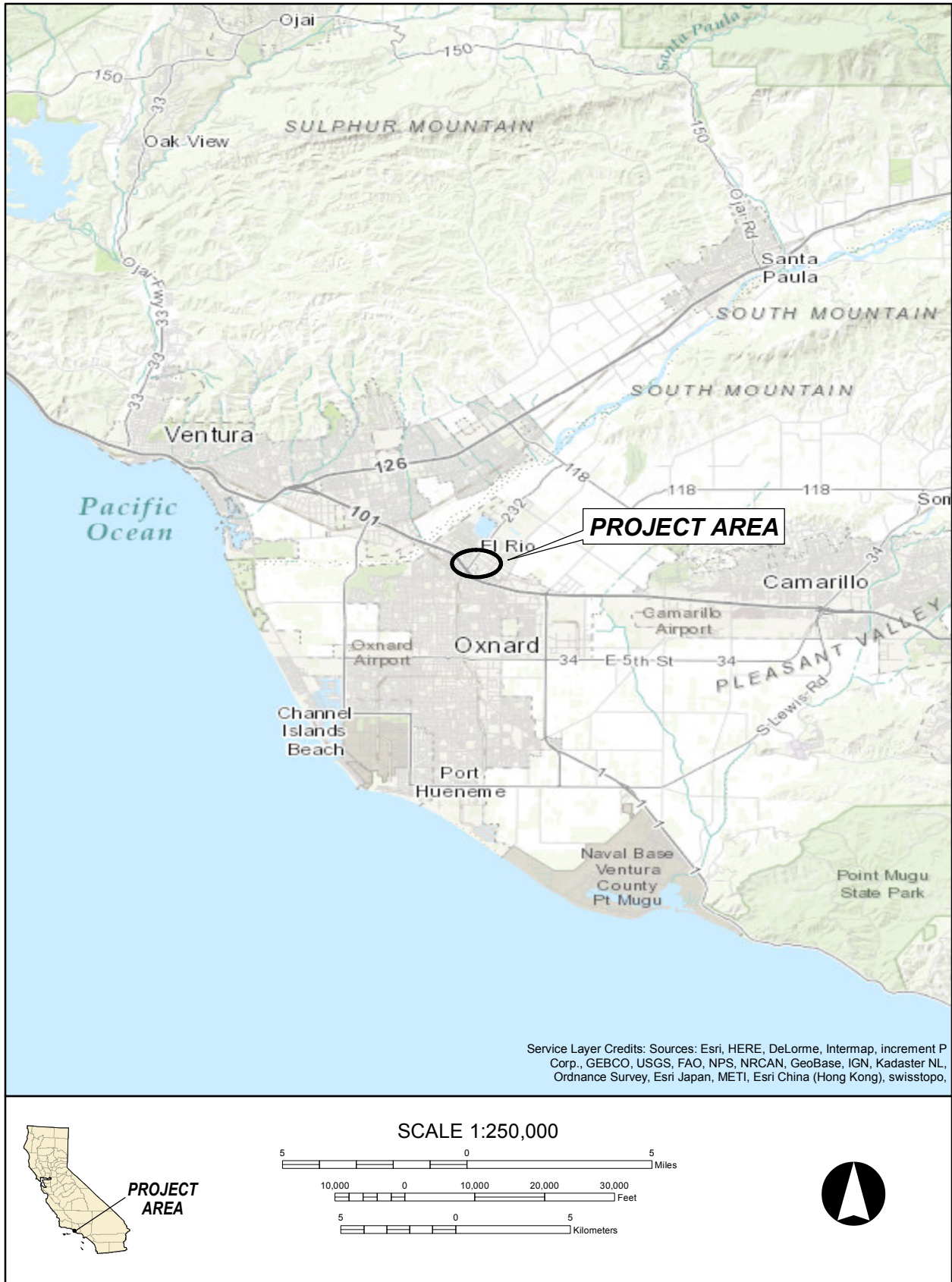
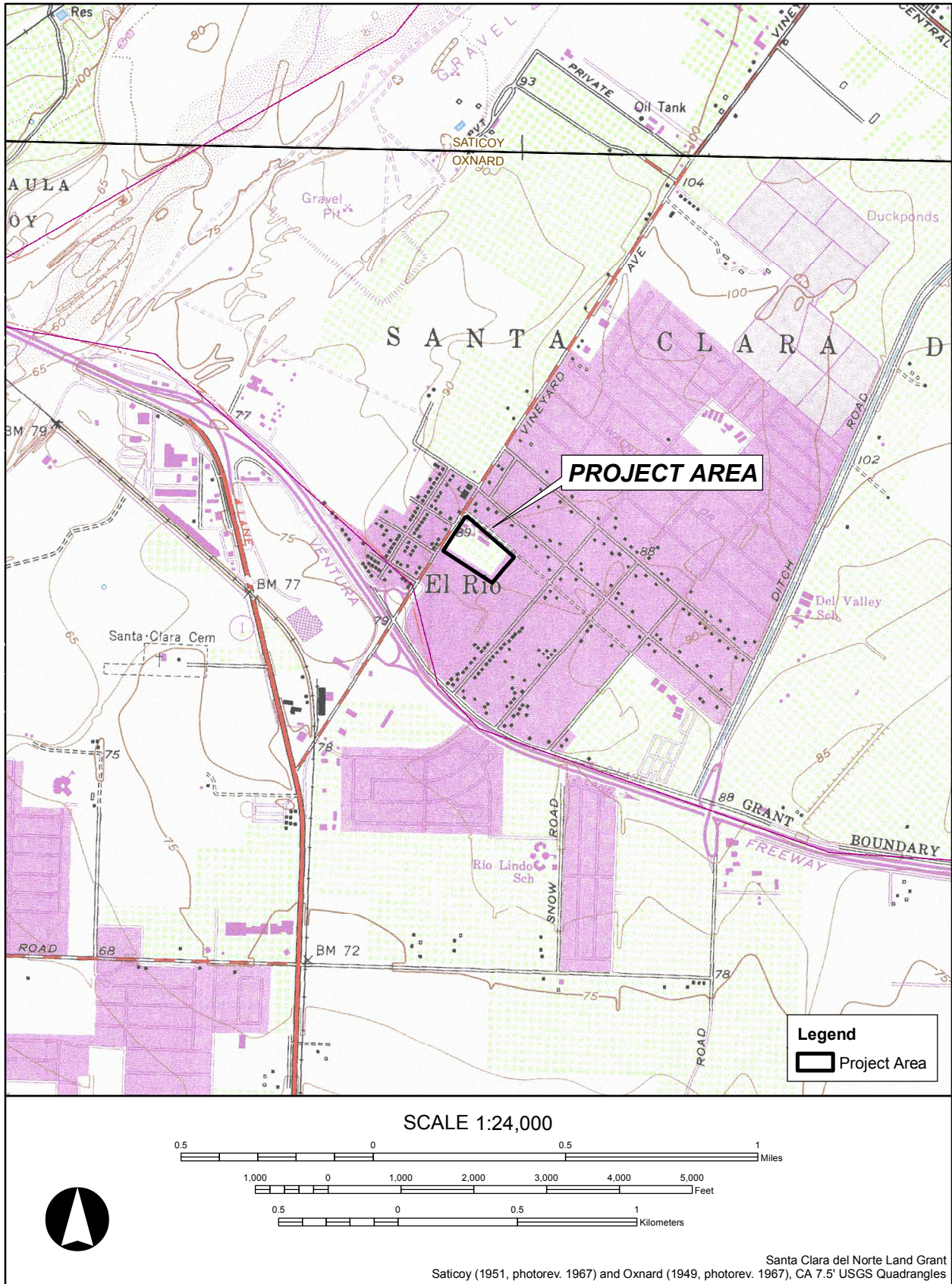

Figure 1 Project vicinity map.





**Figure 2 Project location map.**

## **1.2 REGULATORY CONTEXT**

### **1.2.1 California Environmental Quality Act**

The Project is subject to compliance with the CEQA, as amended. The CEQA Statutes and Guidelines (Title 14 California Code of Regulations [CCR] Section [§] 15064.5), direct lead agencies to determine whether a project will have a significant impact on significant historical resources. Generally, a cultural resource shall be considered historically significant if the resource is 45 years old or older; possesses integrity of location, design, setting, materials, workmanship, feeling, and association; and meets the requirements for listing in the California Register of Historical Resources (CRHR) under any one of the following criteria:

- 1) Is associated with events that have made a significant contribution to the broad patterns of California's history and cultural heritage;
- 2) Is associated with the lives of persons important in our past;
- 3) Embodies the distinctive characteristics of a type, period, region, or method of construction, or represents the work of an important creative individual, or possesses high artistic values; or,
- 4) Has yielded, or may be likely to yield, information important in prehistory or history [14 CCR § 15064.5].

The cited statutes and guidelines specify how cultural resources are to be managed in the context of proposed projects, such as the Rio Urbana Mixed Use Project. Briefly, archival and field surveys must be conducted, and identified cultural resources must be inventoried and evaluated in prescribed ways. Prehistoric and historical archaeological sites, as well as standing structures and other built-environment features deemed historically significant, must be considered in project planning and development. A project with an effect that may cause a substantial adverse change in the significance of a historical resource is a project that may have a significant effect on the environment (Public Resources Code [PRC] § 21084.1).

#### **1.2.1.1 Other State Statutes and Regulations**

##### **California Assembly Bill 52**

Signed into law in September 2014, California Assembly Bill 52 (AB 52) created a new class of resources – tribal cultural resources – for consideration under CEQA. Tribal cultural resources may include sites, features, places, cultural landscapes, sacred places, or objects with cultural value to a California Native American tribe that are included or determined to be eligible for inclusion in the California Register of Historical Resources, included in a local register of historical resources, or a resource determined by the lead CEQA agency, in its discretion and supported by substantial evidence, to be significant and eligible for listing on the California Register of Historical Resources. AB 52 requires that the lead CEQA agency consult in good faith with California Native American tribes that have requested a consultation for projects that may affect tribal cultural resources. The lead CEQA agency shall begin consultation with participating Native American tribes prior to the release of a negative declaration, mitigated negative declaration, or environmental impact report. Under AB 52, a project that has potential

to impact a tribal cultural resource such that it would cause a substantial adverse change constitutes a significant effect on the environment unless mitigation reduces such effects to a less than significant level.

### **Native American Heritage Commission**

PRC § 5097.91 established the Native American Heritage Commission (NAHC), whose duties include the inventory of places of religious or social significance to Native Americans and the identification of known graves and cemeteries of Native Americans on private lands. PRC § 5097.98 specifies a protocol to be followed when the NAHC receives notification of a discovery of Native American human remains from a county coroner.

### **1.3 REPORT ORGANIZATION**

This report documents the results of Æ’s intensive cultural resource investigation for the proposed Project. Chapter 1 has described the project and outlined the governing regulatory context. Chapter 2 synthesizes the natural and cultural setting of the Project area and surrounding region. Chapter 3 presents the results of the background research, which included a literature review and records search at the South Central Coastal Information Center (SCCIC), of the California Historical Resource Information System (CHRIS), housed at California State University, Fullerton. Chapter 4 details the Sacred Lands File search with the Native American Heritage Commission (NAHC), and Native American correspondence. The cultural resource survey methods employed during this investigation as well as findings are outlined in Chapter 5. The resource evaluation is presented in Chapter 6, with management recommendations provided in Chapter 7. This is followed by bibliographic references and appendices.



## 2 SETTING

This chapter describes the environmental and cultural setting of the region to provide a context for understanding the types, nature, and significance of cultural resources identified within the Project area. Environmental data are derived from field observations, background research, and from numerous cultural resource studies conducted in the area. The Project is within the territory traditionally used by the Chumash Native American group, and the ethnographic cultural setting discusses pertinent aspects of this group.

### 2.1 ENVIRONMENTAL SETTING

The Project area is on the Oxnard coastal plain within the Transverse Ranges geomorphic province of California (Norris and Webb 1976). The Transverse Ranges extend approximately 275 miles west to east from Point Arguello in Santa Barbara County to the Anacapa-Santa Monica Hollywood-Raymond-Cucamonga fault zone and the San Bernardino Mountains (Yerkes and Campbell 2005). Geographic features of the Transverse Ranges in the vicinity of the Project area include the Santa Susana and Topatopa Mountains and the low-lying Camarillo Hills; the Ventura Basin — a folded and faulted region of thick Cenozoic sediment and petroliferous deposits beneath the Oxnard coastal plain; the Santa Clara River; and the Channel Islands (Keller 1995; Winterer and Durham 1962). Specifically, the Project area is located adjacent to the Santa Clara River, which drains the northern Transverse Ranges and flows westward between the Santa Susana and Topatopa Mountains towards the Oxnard coastal plain and out into the Pacific Ocean. The dominant plant community in the vicinity is a coastal sage scrub, characterized by low-growing, drought-deciduous shrubs that have adapted to the semi-arid Mediterranean climate of coastal lowlands of Southern California. Common flora found within a coastal sage scrub community consist of California sagebrush (*Artemisia californica*), black sage (*Salvia mellifera*), white sage (*Salvia apiana*), California buckwheat (*Eriogonum fasciculatum*), coast brittle-bush (*Encelia californica*), golden yarrow (*Eriophyllum confertifolium*), and lemonade berry (*Rhus integrifolia*).

### 2.2 PREHISTORIC SETTING

Recent decades have witnessed the publication of many compilations and syntheses of prehistory in the central and south-central coast regions of California (e.g., Altschul and Grenda 2002; Arnold et al. 2004; Chartkoff and Chartkoff 1984; Erlandson 1994; Erlandson and Colten 1991; Erlandson and Glassow 1997; Fagan 2003; Glassow et al. 2007; Jones 1992; Jones et al. 2007; Moratto 1984; Raab and Jones 2004). These overviews provide a context for interpreting the archaeological record of Ventura County.

The cultural sequence in use today in the Chumash country originated with the research of David Banks Rogers during the early decades of the twentieth century (Rogers 1929) and has subsequently been expanded and refined. Olson (1930), Wallace (1955), and Greenwood (1972), among others, confirmed the applicability of Rogers' original cultural sequence to a broad area extending along the coast between Los Angeles and Monterey counties (although local variations were acknowledged). Warren (1968) established a new prehistoric chronology for coastal

southern and south-central California based upon cultural traditions and their adaptations to changing environments over time.

The most widely used chronological sequence in the Chumash area distinguishes Early, Middle, and Late periods. It was initially outlined by King (1981) and later revised to include additional radiocarbon dates (King 1990) and to incorporate refinements in our understanding of cultural developments (Arnold 1992). An overview of Late Holocene prehistory for the Santa Monica Mountains area has been compiled by Gamble and Russell (2002).

The prehistory of California's central coast spans the entire Holocene and may extend back to late Pleistocene times. In Malibu and in the Santa Barbara Channel region, the discovery of fluted projectile points indicates human use of the area possibly as early as 13,000 years ago (Erlandson et al. 1996; Stickel 2010), while sites on San Miguel and Santa Rosa islands have yielded radiocarbon dates older than 10,000 years (Erlandson 1991; Johnson et al. 2001). Although few known sites date to this earliest period (i.e., pre-10,000 years before present [B.P.]), they tend to be located on elevated landforms, and their presence on the Northern Channel Islands indicates early knowledge and use of marine resources.

Moratto (1984) refers to these early occupations as Paleocoastal. Population densities were probably low, judging from the limited number of sites dated to this period. Diagnostic tools associated with this time period have not been identified, although similarities with the San Dieguito Complex in Southern California (Wallace 1978; Warren 1967) have been suggested (Erlandson 1994). Cultural assemblages have few of the grinding implements common to subsequent periods. These sites are characterized by a strong maritime orientation and an apparent reliance on shellfish. Occupants are thought to have lived in small groups that had a relatively egalitarian social organization and a forager-type land-use strategy (Erlandson 1994; Glassow 1996; Greenwood 1972; Moratto 1984).

In San Luis Obispo County, excavations at CA-SLO-2 in Diablo Canyon revealed an occupation older than 9,000 years (Greenwood 1972), and investigations at CA-SLO-1797 indicate initial occupations as early as 10,300 B.P. (Fitzgerald 1998, 2000). Occupations within the area of what is now Vandenberg Air Force Base began by at least 9,000 years ago (Glassow 1990, 1996; Lebow et al. 2001, 2007). Beginning shortly after 9,000 years ago, sites are characterized by abundant milling tools, and the subsistence regime is broad, including plant foods, terrestrial animals, and shellfish (Glassow 1996; Glassow et al. 1988; Sutton and Gardner 2010). Populations during this time appear to have gradually increased, comprising small, dispersed groups with comparatively generalized tool kits, and a mixed subsistence regime that included heavy reliance on shellfish and a lesser emphasis on nearshore fish and terrestrial food sources (Erlandson 1991, 1994, 1997).

Site densities throughout the central coast are higher during the subsequent periods, suggesting increased population size and possibly better site preservation. Sites dating between about 8,000 and 6,500 years ago often have relatively high densities of manos and milling slabs that are typically associated with processing seeds. Such milling stones are diagnostic of this period (Moratto 1984; Sutton and Gardner 2010; Wallace 1955). Shellfish appears to have remained a dietary staple throughout the central coast (Erlandson 1994; Glassow and Wilcoxon 1988). However, terrestrial mammals composed a larger portion of the diet in the Vandenberg Air Force

Base area during this period than during any other time (Glassow 1996). Fish were a larger part of the diet than shellfish at Morro Bay in San Luis Obispo County, although shellfish were better represented during this period than during subsequent periods (Jones et al. 1994).

Early scholars associated sites of this age with inland knolls and terraces (e.g., Rogers 1929), but subsequent investigations revealed that coastal environments also were used (e.g., Glassow et al. 1988). Well-developed middens at many sites suggest a more sedentary and stable settlement system (Breschini et al. 1983). Glassow (1990, 1996) infers that occupants of Vandenberg Air Force Base sites during this time were sedentary and had begun using a collector-type (i.e., logistically mobile) land-use strategy. Burial practices suggest that society was primarily egalitarian (Glassow 1996).

Population densities appear to have decreased substantially between 6500 and 5000 B.P. throughout the region, and little is known about this period. It is possible that arid conditions associated with the Altithermal (a mid-Holocene period of predominantly warm/dry climate) degraded the environment to the point that only low population densities were possible (Glassow 1996; Glassow and Wilcoxon 1988).

After 5000 B.P., population densities increased to pre-6500 B.P. levels as conditions became cooler and moister. Between 5000 and 3000 B.P., mortars and pestles became increasingly common throughout the region, suggesting intensified use of acorns (Basgall 1987), although these implements may have been associated with processing pulpy roots or tubers (Glassow 1997). Along the Santa Barbara Channel coastline, use of shellfish declined as other animal foods became more important. Use of more diverse environmental settings is suggested (Erlandson 1997). At sites on Vandenberg Air Force Base, fish and sea mammals composed a larger part of the diet during this period. Large side-notched and stemmed projectile points became more prevalent in the archaeological record, presumably reflecting increased hunting, although Glassow (1996) suggests that proportions of terrestrial mammals do not surpass the pre-6500 B.P. levels. However, higher proportions of terrestrial mammals in archaeological assemblages are associated with this period in San Luis Obispo County. Increased logistical organization is suggested in this area (Jones et al. 1994; Jones and Waugh 1995). Proportions of obsidian (indicating exchange with other regions) increased after about 5000 B.P., particularly in San Luis Obispo County (Jones et al. 1994; Jones and Waugh 1995).

Cultural complexity appears to have increased around 3000–2500 B.P. Based on mortuary data from the Santa Barbara area, King (1990) suggests a substantial change in the social organization and political complexity about 3,000 years ago. According to King, high-status positions became hereditary and individuals began to accumulate wealth and control exchange systems. Arnold (1991, 1992) proposes that this evolutionary step in socioeconomic complexity occurred around 700–800 years ago. The period between 2,500 and 800 years ago is marked by increased cultural complexity and technological innovation. Fishing and sea mammal hunting became increasingly important, corresponding to development of the *tomol* (plank canoe), single-piece shell fishhooks, and harpoons (Glassow 1996; King 1990). The bow and arrow were also introduced during this period (Glenn 1990, 1991). Sites in San Luis Obispo County suggest that use of terrestrial mammals remained high. Proportions of imported obsidian continued to increase during this period (Jones et al. 1994).

Arnold (1992) proposes that the complex Chumash sociopolitical system known at historic contact evolved substantially during a brief period between A.D. 1150 and 1300, which she terms the Middle-Late Transitional Period. Arnold infers that decreased marine productivity caused by elevated sea-surface temperatures resulted in subsistence stress that allowed an elite population to control critical resources, labor, and key technologies, resulting in the hierarchical social organization and a monetary system. Although the issue of elevated sea-surface temperatures has been questioned and the inference of marine degradation and subsistence stress has been challenged (e.g., Raab et al. 1995), the full emergence of Chumash cultural complexity around this time is generally accepted.

The predecessors of the ethnographic Chumash, which Rogers (1929) termed Canaliño, are associated with a diverse material culture that included triangular projectile points and elaborate industries related to the production of flaked stone tools, steatite vessels, shell beads and ornaments, and plank canoes. This recent prehistoric period saw a gradual increase in the use of marine resources, fish and sea mammals, and the development of more complex political and economic systems, including a money economy, during the Middle and Late periods of Channel area prehistory (Arnold 1992; King 1990; Landberg 1965; Rogers 1929; Wallace 1955). Thus, there is clear evidence for long-term, in-place cultural development in the Santa Barbara Channel region.

### **2.3 ETHNOGRAPHIC SETTING**

The Project lies within traditional Chumash Indian territory, which extended along the coast from roughly Malibu Canyon, northward to San Luis Obispo, and from the Northern Channel Islands eastward to the edge of the San Joaquin Valley (Grant 1978a:505). The term Chumash came into use during the twentieth century when Kroeber (1925) extended its linguistics-derived use to include ethnic territory (Johnson and McLendon 1999; Klar et al. 1999). The Project area falls within the range of the Ventureño Chumash (Grant 1978b:518–519), comprising the southernmost range of the Chumash and encompassing much of present-day Ventura County and adjacent southwestern Los Angeles County (see Grant 1978a:Fig. 1).

Initial direct European contact with the Chumash began in 1542 during Juan Rodriguez de Cabrillo's explorations along the coast (Heizer 1972). In addition to accounts of this and other early expeditions, sources of information about the contact-era Chumash include analyses of mission records, ethnographic and linguistic records made during the nineteenth and early twentieth centuries, and archaeological investigations of sites occupied around the time of European contact (Grant 1978a, 1978b).

Early Spanish expeditions to the Santa Barbara Channel mainland described large coastal villages with as many as 800 to 1,000 residents and characterized by sweat lodges, semi-subterranean houses, communal dance areas, cemeteries, and other features that have also been documented archaeologically (Erlandson 1993; Gamble 1991). Interior mainland areas were less densely populated, but also included a number of larger communities (Johnson 1988).

Contact-era hunter-gatherer Chumash culture included a wide array of subsistence foods; well-developed technology and elaborate crafts; and an active exchange system linking island, mainland coast, and interior zones (King 1976). The ocean-going plank canoe, or *tomol*, figured

prominently in subsistence and cross-channel transportation. Specialists in canoe building techniques and other crafts belonged to one of the guild-like fraternal organizations that linked ritual and occupational specialists (Arnold 2001). Chumash political traditions were centered on permanent, largely autonomous settlements. The strength of inter-village ties varied and appears to have depended at least in part on the community's size, geographical position relative to trade routes and social networks, and the level of personal influence wielded by individual political leaders. Shifting patterns of inter-village animosities and alliances are also recorded (Johnson and McLendon 1999:29–35).

The material culture of the Chumash included a wide array of utilitarian items such as fishing nets, woven mats, baskets, shell and bone fishhooks, cooking slabs (some imported from Catalina Island), digging stick weights, and projectile points; finely made ornaments and bead types used in a variety of social, economic, and political contexts; and charmstones and other objects used for ritual and ceremonial purposes. Stone bowls, mortars, and other utilitarian objects were sometimes decorated with asphaltum inlaid with shell beads (Hudson and Blackburn 1982–1987).

Contact-era villages in the vicinity of the Project area were long-term, permanent settlements, many of which have been correlated with particular archaeological sites. This inland area was first visited by non-Indians in 1770 when the Portolá expedition was making its return trip, southward from the San Francisco Bay and Monterey areas, to San Diego. Additionally, most mission baptisms of Chumash from this area are recorded at San Buenaventura (founded in 1782) and San Fernando (founded in 1797).

Introduced European diseases took heavy tolls on the Native American populations. After 1770, survivors from some towns left to join larger communities associated with cattle ranches of Spanish settlers. Ventureño Chumash of the Santa Monica Mountains were among the last mainland populations to join the missions. However, by 1809, a majority of them had relocated to the missions at San Buenaventura and San Fernando (King and Johnson 1999).

## **2.4 HISTORICAL SETTING**

Members of the Portolá expedition in 1770 were among the earliest Europeans to travel through the area and record their observations, ushering in the historic era for this region. The mission system was established by the Catholic Church in cooperation with the Spanish government as a program of settlement and development (colonization) that spread from Baja California to Alta California (Starr 2005). The San Buenaventura Mission was constructed in 1782 as the ninth of 21 missions in Alta California, and is the closest mission to the community of El Rio. The missions were situated one-day's travel apart and were connected by El Camino Real, or the “Kings Highway.”

Mexico achieved independence from Spain in 1821. The mission system was continued under Mexican rule until 1833, when the Secularization Act was passed (Cleland 1978). Under this act, mission ownership was withdrawn from the Catholic Church, and land grants, also known as *ranchos*, were distributed amongst the prominent and wealthy families of Mexico and to reward soldiers for their service during the revolution. The agricultural-based economy established under the Spanish/Catholic Church regime continued to prosper. Between 1835 and 1846, more

than 600 land grants in Alta California were recorded with the Mexican government. Juan M. Sanchez received a land grant in 1837, which included the Project area, creating the Rancho Santa Clara del Norte. The Rancho Santa Clara del Norte extended from the Santa Clara River south to present-day Camarillo.

Following the 1848 transfer of California to the United States with the Treaty of Guadeloupe Hidalgo, *rancho* life continued relatively undisturbed in the general region of the Project area. Expansion of farming began in the 1870s with introduced new crops such as lima beans, sugar beets, fruit and nut trees, berries, cut flowers, and landscape nurseries.

### **Community of El Rio**

El Rio is an unincorporated community in Ventura County initially founded as the town of New Jerusalem in 1876. Simon Cohn, a Jewish immigrant from Germany, acquired a seven-acre parcel of land at the intersection of the Conejo Road (later to be called Ventura Boulevard/ State Route 101) and the Hueneme and Saticoy Road (later to be called Vineyard Avenue) from Christian Borchard in 1876. Cohn had initially come to the region with his brother, Morris Cohn, and had worked at his brother's general store in the nearby town of Saticoy before building his own store on his newly acquired land (San Buenaventura Research Associates 2014).

When Simon Cohn opened his first store, no other commercial buildings were located in the area, just scattered farmhouses. Cohn gradually acquired land on three of the four corners at the intersection of Vineyard Avenue and Ventura Boulevard. Two of Cohn's brothers built businesses at this intersection as well. The town began to grow through the 1870s and into the 1880s. In 1882 the first post office was opened in New Jerusalem with Simon Cohn serving as the postmaster. In 1895, the post office shortened the name of the town to Jerusalem, and a few months later in the same year, the name was changed to Elrio (all one word). In 1905 the post office name was finally changed to El Rio. While the post office closed in 1911, the community had adopted the name El Rio (San Buenaventura Research Associates 2014).

### **El Rio School**

The Rio School District was formed in 1885 with the establishment of a school building at Schiappa Prieta Ranch. Between two and eight students first attended the school, but enrollment quickly grew. By 1895 the local demand for schooling outgrew the building, which had been relocated and expanded, and a two-acre site was purchased to build a new school. The building was expanded in 1929, but no new schools were built within the district until the construction of the Neyland Acres School in 1941. In 1949 El Rio School was constructed. The Neyland Acres School and El Rio School were the only two schools within the district until the Rio Plaza School was constructed in 1954 and the Rio Real School was constructed in 1957. The school district now has nine campuses that include elementary and middle schools; average enrollment is 500-700 students in the elementary schools and 700 students in the middle schools (Rio School District 2017).

El Rio School was constructed in 1949 to address the growing enrollment needs of the El Rio School District. The campus was expanded in 1952 and 1953 with the addition of more classrooms, a multi-purpose building, and other renovations and additions. By 1967 the campus

was comprised of six buildings (NETROnline 2017). One of the classroom buildings was destroyed by a fire in 1984, but was replaced the following year with a larger building at a different location on the campus (Rio School District 2017). The location of the destroyed classroom building was repurposed as a parking lot. The school was closed in 2007 to be used as office space for Rio School District Maintenance staff (Leung 2014).

### 3

## CULTURAL RESOURCE LITERATURE AND RECORDS SEARCH

A cultural resource literature and records search was conducted on July 25, 2017 at the SCCIC, housed at the California State University, Fullerton. The records search included the entire Project area plus a 1-mile search radius (referred to as the Project “study area”). The objective of this records search was to determine whether any prehistoric or historical cultural resources have been recorded previously within the study area. Additional sources consulted during the archaeological literature and records search include the National Register of Historic Places, the Office of Historic Preservation Archaeological Determinations of Eligibility, and the Office of Historic Preservation Directory of Properties in the Historic Property Data File. There are no listed historic properties, historical resources, or historic landmarks recorded within the Project study area.

### 3.1 PREVIOUS INVESTIGATIONS

Results of this search indicate that no less than 37 investigations have been conducted previously within the Project study area; one of the previous investigations (VN-1102) encompassed the entire Project area (Table 3-1).

**Table 3-1**  
**Previous Cultural Studies within the Project Study Area**

SCCIC Document #	Date	Author(s)	Title
VN-00082	1977	Lopez, Robert	An Archaeological Survey of a Proposed Subdivision of the Bowman Merritt Ranch, Upper Ojai, Ventura County, California
VN-00347	1981	Hawthorne, Janice G.	Cultural Resource Reconnaissance and Impact Evaluation of a 14+ Mile Route for the Proposed Pumping Trough Pipeline and Lower Aquifer System Wells, County of Ventura, California
VN-00458	1985	Bissell, Ronald M.	Cultural Resources Evaluation. Oxnard Town Center Site, Ventura County, California
VN-00466	1985	Bissell, Ronald M.	The Cultural Resources of the Rose-Santa Clara Corridor Property, City of Oxnard, Ventura County, California
VN-00572	1988	Dames and Moore	Phase 1 Cultural Resources Survey Fiber Optic Cable Project, Burbank to Santa Barbara, California for Us Sprint Communications Company
VN-00860	1976	Lopez, Robert	An Archaeological Survey of the Area of the Proposed Vineyard Office Building El Rio, Ventura County, California
VN-00958	1991	Becker, Kenneth M.	A Cultural Resources Reconnaissance of the Del Norte Blending Station Pipeline, Approximately Seven Linear Miles in Oxnard and Camarillo, Ventura County, California
VN-00972	1990	Singer, Clay A. and John E. Atwood	Cultural Resources Survey and Impact Assessment for the Rose Avenue/Highway 101 in Terchange El Rio, Ventura County California



**Table 3-1  
Previous Cultural Studies within the Project Study Area**

<b>SCCIC</b>			
<b>Document #</b>	<b>Date</b>	<b>Author(s)</b>	<b>Title</b>
VN-00974	1990	Singer, Clay A., J. E. Atwood, K. M. F. Laustsen, and J. SUMAMAIT	Archaeological Monitoring for a Buried Telephone Conduit Along Vineyard Avenue in the Community of El Rio, Ventura County, California
VN-01040	1982	Stelle, Kenneth and Albert Gallardo	For Improvement of the Operational Characteristics of Route 101, the Ventura Freeway in Los Angeles and Ventura Counties, Between Route 405 in Los Angeles, and the Santa Clara River in Oxnard
VN-01102*	1977	Singer, Clay A.	Preliminary Cultural Resource Survey and Potential Impact Assessment for Thirteen Areas in Southern Ventura County, California
VN-01153	1991	Peak and Associates, Inc.	Class 3 Cultural Resource Assessment of the Proposed Carpinteria and Southern Reroutes, Santa Barbara, Ventura, and Los Angeles Counties, California
VN-01265	1992	Reed, L.W.	Consolidated Report: Cultural Resources Studies for the Proposed Pacific Pipeline Project
VN-01323	1994	Whitley, David S. and Joseph M. Simon	Phase 1 Archaeological Survey and Cultural Resources Assessment for the North El Rio Drain Project, Ventura County, California
VN-01520	1982	Romani, John F.	Archaeological Survey Report for the 07-LA/VEN 101 Project P.M. 17.1-38.2/0.0-22.7 07351 - 076620
VN-01539	1978	Huey, Gene	Phase 1 Archaeological Survey VEN 101 P.m. 4.1/23.0 Freeway Widening and Pavement Reconstruction
VN-01711	1993	Romani, John F.	Improvements to US Highway 101 Between Vineyard Avenue and Johnson Drive, in the Cities of Oxnard and San Buenaventura, Ventura County, Ca Supplemental Archaeological Survey Report
VN-01730	1989	Bissell, Ronald M.	Historic Property Survey Report US Highway 101 Improvements Between Vineyard Avenue in Oxnard to Johnson Drive in Ventura
VN-01878	2000	Iverson, Gary	Proposed Bridge Replacement on Interstate Route 101: Vineyard Avenue to Johnson Drive
VN-01925	2000	Maki, Mary K.	Phase I Archaeological Survey of Approximately 15.8 Linear Miles for the El Rio Sewer Project, El Rio, Ventura Co.
VN-02006	2002	Lopez, Robert	An Archaeological Reconnaissance of the Three Acres Involved in the Proposed Expansion of the Honda of Oxnard Automobile Agency Within the City of Oxnard, Ventura County, California
VN-02007	2001	Mason, Roger D.	Cultural Resources Record Search and Literature Review Report for an AT&T Telecommunications Facility: Number Ov71 Esplanade Drive City of Oxnard Ventura County, California
VN-02012	1999	W & S Consultants	Phase I Archaeological Survey for the Rio Del Valle Middle School Gymnasium Study Area, Ventura County, California
VN-02402	2006	Billat, Lorna	SCE Gonzales Substation/la-0902a
VN-02431	2003	Simon, Joseph M.	Phase I Archaeological Survey for 300 West Straube Street, Oxnard, Ventura County, California

**Table 3-1  
Previous Cultural Studies within the Project Study Area**

SCCIC Document #	Date	Author(s)	Title
VN-02440	2005	Shepard, Richard S.	Phase I Cultural Resources Assessment: Santa Clara Mortuary and Mausoleum Project, Oxnard, Ventura County, California
VN-02458	2003	Maki, Mary K.	Phase I Archaeological Survey of Approximately 1.5 Linear Miles for the Oxnard Boulevard Bicycle and Pedestrian Facilities Project Oxnard, Ventura County, California
VN-02464	2002	Simon, Joseph M.	Phase I Archaeological Survey of 1701 Auto Center Drive, City of Oxnard, Ventura County, California
VN-02504	2006	Arrington, Cindy and Nancy Sikes	Cultural Resources Final Report of Monitoring and Findings for the Qwest Network Construction Project State of California: Volumes I and II
VN-02831	2010	Schmidt, James J.	SCE Maulhardt 16kV DSP Project Archaeological Monitoring Program: Southwest Corner of Vineyard Avenue and Myrtle Street, City of Oxnard, California
VN-02933	2011	Toren, A. George	Phase I Archaeological Investigation for the City of Oxnard Recycled Water Project New Alignment
VN-02978	2004	Sharpe, Jim and Durio, Lori	Groundwater Recovery Enhancement and Treatment (GREAT) Program, Cultural Resources Inventory Report
VN-02986	2004	Unknown	Environmental Analysis Onshore Component of BHP Billiton LNG International Inc. Cabrillo Port Project
VN-03094	2002	Foster, John A.	Historic Resource Evaluation Report- Mason Avenue At-Grade Crossing and Safety Improvements Project, Los Angeles City, California
VN-03102	2009	Stewart, Noah	relinquish State-owned right of way to the City of Oxnard - State Route 1 (VEN1) from Pleasant Valley Road (PM 15.1) to the intersection of VEN 1 and US 101
VN-03111	2012	Bonner, Wayne and Crawford, Kathleen	Cultural Resources Records Search and Site Visit Results for T-Mobile West, LLC Candidate SV00267A (VY201 City National Bank), 500 East Esplanade Drive, Oxnard, Ventura County, California
VN-03241	2010	Anonymous	Summary of the Artifact Assemblage from Site P-56-001304, Shea Homes Riverpark Project, City of Oxnard, Ventura County, California

\* - Previous studies that intersect the Project area

### **3.2 RESOURCES REPORTED WITHIN 1 MILE OF THE PROJECT AREA**

The records search also indicated that eight cultural resources have been identified previously within the study area, including one prehistoric archaeological site (a partial, isolated burial) and seven built-environment resources (single family residences, commercial properties, and a bridge). None of the previously identified cultural resources are within the Project area. A brief description of each of the resources is provided in Table 3-2 below.

**Table 3-2  
Cultural Resources within the Project Study Area**

<b>Primary</b>	<b>Trinomial</b>	<b>Resource Type</b>	<b>Description</b>
56-001304	CA-VEN-1304	Archaeological Site	Partial, isolated prehistoric Native American burial
56-150007		Built-environment	Doud House, single family residence constructed in 1919; 1671 Ventura Blvd
56-152253		Built-environment	Single family residence constructed circa 1935; 301 Myrtle Street
56-152254		Built-environment	Single family residence constructed circa 1935; Fattarelli property; 266 Myrtle Street
56-152869		Built-environment	Commercial property constructed circa 1965; 2611 Wagon Wheel Road
56-152870		Built-environment	Single family residence constructed circa 1950; 2432 Colonia
56-152871		Built-environment	Wagon Wheel Motel and Restaurant, commercial property constructed circa 1945; 2751 Wagon Wheel Road
56-153062		Built-environment	El Rio Underpass; bridge

## NATIVE AMERICAN CONSULTATION

Æ contacted the NAHC on August 2, 2017, for a review of the Sacred Lands File to determine if any known Native American cultural properties (e.g., traditional use or gathering areas, places of religious or sacred activity) are present within or adjacent to the Project area. The NAHC responded on August 4, 2017, stating that the records search failed to indicate the presence of Native American traditional cultural places within the immediate Project area. The NAHC suggested that six Native American individuals and organizations be contacted to solicit information regarding cultural resource issues related to the proposed Project. These individuals and organizations were contacted by email or letter on August 11, 2017, with the exception of one individual whose contact information only included a phone.

Individuals/organizations contacted at the recommendation of the NAHC include:

- Kenneth Kahn, Chairperson of the Santa Ynez Band of Chumash Indians
- Julie Lynn Tumamait-Stenslie, Chair of the Barbareno/Ventureno Band of Mission Indians
- Patrick Tumamait (Chumash)
- Mia Lopez (Coastal Band of Chumash Nation)
- Eleanor Arrellanes, Barbareno/Ventureno Band of Mission Indians
- Raudel Joe Banuelos, Jr., Barbareno/Ventureno Band of Mission Indians

The NAHC did not provide a mailing address or email address for Ms. Mia Lopez. As such, Ms. Lopez was contacted by telephone on August 14, 2017. A message was left for Ms. Lopez requesting to speak with her regarding the Project. The Sacred Lands File search request letter, the response from the NAHC including the list of suggested contacts, an example of the request for information letter, and the responses received are included in Appendix A.

Æ conducted follow-up telephone calls with the Native American groups and individuals on August 29, 2017. As a result of this effort, a response was received from only one tribal group, the Santa Ynez Band of Chumash Indians. The Santa Ynez Band of Chumash Indians deferred to the tribes local to the Oxnard area, specifically the Barbareno/Ventureno Band of Mission Indians.

A table of responses summarizing consultation with Native American groups and/or individuals consulted is presented in Appendix A.

## 5

# SURVEY METHODS AND RESULTS

## 5.1 SURVEY METHODS

Æ archaeologist Gena Granger performed an intensive pedestrian survey of the approximately 10-acre Project area on August 10, 2017. The survey was conducted by walking parallel transects spaced at 10- to 15-meter (33- to 50-foot) intervals, when possible. All areas likely to contain or exhibit archaeologically or historically sensitive cultural resources were inspected carefully to ensure that visible, potentially significant cultural resources were discovered and documented. Additionally, the surveyor investigated any unusual landforms, contours, soil changes, features (e.g., road cuts, drainages), and other potential cultural site markers. A Daily Work Record was completed that documented survey personnel, hours worked, weather, ground surface visibility, vegetation, soils, exposure/slope, topography, natural depositional environments, and any evidence of cultural materials.

For purposes of this study, *cultural resources* are defined as any location that contains material culture greater than 45 years old. *Built-environment resources* are those that are associated with buildings (e.g., house, barns, or sheds), structures (e.g., roads, canals, or transmission lines), and objects (e.g., boundary markers). An archaeological *site* is generally a locus of previous human activity at which the preponderance of evidence suggests repeated and patterned use over time, or multiple classes of activities. In contrast, an *isolated find* refers to one or more culturally modified and transportable objects representing a single activity, locus, or event that is not found in the context of a site as defined above. In order for the material culture to be considered important and/or significant from an archaeological perspective, the material culture should retain some degree of integrity, as the contextual information is paramount in providing valuable insight and/or advancements in our understanding of prehistoric and historical human culture.

## 5.2 SURVEY RESULTS

The Project area consists of the former El Rio Elementary School campus and includes eight standing buildings, paved walkways, two parking lots, and a large vacant field that appears to have been previously utilized as a playground and ball field for the school. Ground visibility in the immediate vicinity of the structures and parking lots was limited due to the existing hardscapes. In contrast, ground visibility within the vacant field was very good and was composed of silty, gray soils which were likely imported fill deposits; no native soils were observed within the area.

One built-environment resource, the El Rio School campus, was identified and documented within the Project area. A description of the school campus is provided below and the Department of Parks and Recreation (DPR) forms that document the resource are attached in Appendix B. No historical or prehistoric archaeological materials or features were noted within the survey area.



**Figure 5-1 Overview of the Project area (school buildings in the distance); view to the northwest**



**Figure 5-2 School Building in the Project area; view to the southeast**



### 5.2.1 El Rio School Campus

The El Rio School campus is comprised of five academic and administrative buildings located on APN 145-0-232-010. The campus was initially constructed in 1949 with a second major phase of construction between 1950 and 1952. The campus has undergone several changes over time, including the loss of a building due to fire and the construction of additional buildings. Building A, Building B, Building C, Building D, and Building F were all erected between 1949 and 1952. In addition to the historic period buildings, the property includes athletic fields, covered walkways, landscape elements such as paved walkways and benches, and non-historic buildings including the 1998 classroom wing (Building E).

The buildings are all utilitarian in design and display no distinctive features. The campus features mature trees, landscaped vegetation, athletic fields, covered walkways, and hardscape elements including parking lots and sidewalks. The following are historic-period buildings that are potential contributors to the district:

**Building A** is a one-story utilitarian style administrative building constructed between 1949 and 1952. The concrete building features a flat roof and a rectangular plan. The primary entrance is on the west elevation beneath a covered walkway that connects to Building F (Figure 5-3). The north elevation features double hung and multi-pane windows with security bars. The east elevation features no fenestration or doors.



**Figure 5-3 North and west elevations of Building A, facing southeast.**

**Building B** is a two-story utilitarian style cafeteria/auditorium constructed of concrete between 1949 and 1952. It has an irregular plan with a low pitched front gabled roof and a large decorative grid pattern. The west elevation features no fenestration. An off-center entrance on the south elevation is recessed beneath a cantilevered overhang. An off-center entrance on the north elevation is similarly recessed beneath a cantilevered overhang. A building extension is located on the south elevation. A portion of the extension is two stories then steps down to one story. The extension is constructed of concrete and features a flat roof. The south elevation of the extension features entrance doors, a band of double-hung windows with security bars, and exhaust vents on the second story. The east elevation features three picture windows on the extension, three picture windows with security bars and double entrance doors beneath a flat roof overhang supported by posts (Figure 5-2).

**Building C** is a two-story utilitarian style classroom building constructed between 1949 and 1952. The concrete building has a rectangular plan and a medium pitched gabled roof that extends into a covered walkway supported by posts on the south elevation (Figure 5-4). A flat-roofed one-story pop out on the northwest corner of the building forms a partial cantilevered overhang. There are two entrance doors and windows covered with plywood. Above the flat roof on the main building is a band of windows with security bars. The remainder of the north elevation features regularly spaced doors. The east elevation features a flat roof overhang supported by posts and two sets of windows on the second floor. The south elevation features regularly spaced doors and windows beneath the overhang and a covered walkway that connects to Building D.



**Figure 5-4 South and east elevations of Building C, facing northwest.**



**Building D** is a two-story utilitarian style classroom building constructed between 1949 and 1952. The concrete building has a rectangular plan and a medium pitched gabled roof that extends into a covered walkway supported by posts on the south elevation. The north elevation features regularly spaced doors. The east and west elevations feature flat roof overhangs supported by posts and two sets of windows on the second floor; the east elevation features a covered walkway that connects to Building C. The south elevation features regularly spaced doors and windows beneath the overhang.

**Building F** is a two-story utilitarian style classroom building constructed between 1949 and 1952. The concrete building has a rectangular plan and a medium pitched gabled roof that extends into a covered walkway supported by posts on the south elevation. The north elevation features regularly spaced doors and windows and a covered walkway that connects to Building A (Figure 5-6). The west elevation features a flat roof overhang supported by posts and two sets of windows on the second floor. The south elevation features regularly spaced doors and windows beneath the overhang.



**Figure 5-5 North and east elevations of Building F, facing southwest.**

**Building E** is a non-historic building constructed in 1985. Additional non-historic elements include a portable classroom and a utility shed.

## 6 RESOURCE EVALUATION

This study identified and documented one historical cultural resource, the former El Rio School campus, within the Project area. To evaluate the significance of this cultural resource, data obtained during the fieldwork were supplemented with archival information on the property. Generally, a cultural resource is considered historically significant if it is 45 years old or older, meets the requirements for listing on the CRHR under any one of the criteria defined in 14 CCR § 15064.5 (see Section 1.2.1), and possesses integrity of location, design, setting, materials, workmanship, feeling, and association.

### 6.1 EL RIO SCHOOL CAMPUS

The El Rio School campus was initially constructed in 1949 with a second major phase of construction between 1950 and 1952. The campus has undergone several changes over time, including the loss of a building due to fire and the construction of additional buildings.

While the school was initially founded in 1949, it is not the earliest school constructed by the Rio School District or among the earliest schools constructed in the area. Research has yielded no information to suggest that significant events related to the history of the United States, California, or Oxnard are directly associated with this school, nor are any significant changes to education or school administration. As such, no information has been found to suggest that the school is directly associated with historical events of importance in local, state, or national history (CRHR Criterion 1).

While many students have attended the school, and there have been many faculty members over the years, the research does not suggest that any are persons of historical significance or that the campus is directly associated with people of state and national significance (CRHR Criterion 2).

The school campus is utilitarian in design and is essentially similar to other schools constructed in the mid-twentieth century throughout the United States. The design and layout of the school do not represent any dramatic departure from traditional school design, and research has yielded no information regarding the architect or builder of the campus; however, it is unlikely that this represents the work of a master (CRHR Criterion 3).

Finally, the El Rio School campus has not yielded and is unlikely to yield archaeological information important to the study of local, state, or national history (CRHR Criterion 4). Given these considerations, the El Rio School campus meets none of the CRHR significance criteria and is not considered a historical resource under CEQA.

## MANAGEMENT RECOMMENDATIONS

Æ conducted an intensive pedestrian survey of the Project area and identified and documented one historical cultural resource. As noted in the previous section, the El Rio School campus, is not considered eligible for listing on the CRHR. No further management is recommended for this resource, as it does not meet criteria for listing on the CRHR.

The intensive pedestrian survey of the Project area failed to identify any prehistoric or historic archaeological resources; however, the records search indicated that an isolated, partial burial was uncovered while excavating for a storm drain adjacent to Vineyard Avenue less than a quarter mile from the Project area (Kirkish 2010). As such, there is potential to encounter subsurface cultural deposits within the Project area. Given the potential to discover archaeological deposits in subsurface contexts, Æ recommends that a qualified archaeologist monitor all Project-related ground-disturbing activities.

In the unlikely event that potentially significant archaeological materials are encountered during construction, all work must be halted in the vicinity of the discovery until a qualified archaeologist can visit the site and assess the significance of the finds. As well, Health and Safety Code § 7050.5, State CEQA Guidelines 15064.5(e), and Public Resources Code (PRC) § 5097.98 mandate the process to be followed in the unlikely event of an accidental discovery of any human remains in a location other than a dedicated cemetery. Specifically, the Ventura County Coroner must be notified within 24 hours of the discovery of potentially human remains. The Coroner must then determine within two working days if the remains are subject to his or her authority. If the Coroner recognizes the remains to be Native American, he or she must contact the NAHC by phone within 24 hours. The NAHC then designates a Most Likely Descendant (MLD) with respect to the human remains within 48 hours of notification. The MLD will then have the opportunity to recommend to the Project proponent means for treating or disposing of, with appropriate dignity, the human remains and associated grave goods within 24 hours of notification. Finally, if the Project area is expanded to include areas not covered by this or other recent cultural resource investigations, additional cultural resource studies may be required.

## 8 REFERENCES

- Altschul, Jeffrey H., and Donn R. Grenda  
2002 *Islanders and Mainlanders: Prehistoric Context for the Southern California Bight*. SRI Press, Tucson, Arizona.
- Arnold, Jeanne  
1991 Transformation of a Regional Economy: Sociopolitical Evolution and the Production of Valuables in Southern California. *American Antiquity* 56:953–962.  
1992 Complex Hunter-Gatherer-Fishers of Prehistoric California: Chiefs, Specialists, and Maritime Adaptations of the Channel Islands. *American Antiquity* 57:60–84.  
2001 The Chumash in World and Regional Perspectives. In *The Origins of a Pacific Coast Chieftdom: The Chumash of the Channel Islands*, edited by Jeanne E. Arnold, pp. 1–19. University of Utah Press, Salt Lake City.
- Arnold, Jeanne E., Michael R. Walsh, and Sandra E. Hollimon  
2004 The Archaeology of California. *Journal of Archaeological Research* 12(1):1–73.
- Basgall, Mark E.  
1987 Resource Intensification among Hunter-Gatherers: Acorn Economies in Prehistoric California. *Research in Economic Anthropology* 9:21–52.
- Breschini, Gary S., Trudy Haversat, and R. Paul Hampson  
1983 A Cultural Resources Overview of the Coast and Coast-Valley Study Areas. Coyote Press, Salinas, California.
- Chartkoff, Joseph L., and Kerry Kona Chartkoff  
1984 *The Archaeology of California*. Stanford University Press, Stanford, California.
- Cleland, Robert Glass  
1978 *The Irvine Ranch*. San Marino, California: The Huntington Library
- Erlandson, Jon M.  
1991 Early Maritime Adaptations on the Northern Channel Islands. In *Hunters and Gatherers of Early Holocene Coastal California*, edited by Jon M. Erlandson and Roger H. Colten, pp. 101–111. Perspectives in California Archaeology, vol. 1. Institute of Archaeology, University of California, Los Angeles.

Erlandson, Jon M. (continued)

1993 *Cultural Setting*. In *Archaeological Investigations at CA-SBA-1731: A Transitional Middle-to-Late Period Site on the Santa Barbara Channel*, edited by Jon M. Erlandson and Joyce Gerber, pp. 19–27. Dames & Moore, Santa Barbara, California. Prepared for Exxon Company, U.S.A.

1994 *Early Hunter-Gatherers of the California Coast*. Plenum, New York.

1972 1997 *The Middle Holocene along the California Coast*. In *Archaeology of the California Coast during the Middle Holocene*, edited by Jon M. Erlandson and Michael A. Glassow, pp. 1–10. *Perspectives in California Archaeology*, vol. 4. Institute of Archaeology, University of California, Los Angeles.

Erlandson, Jon M., and Roger H. Colten, editors

1991 *Hunter-Gatherers of Early Holocene Coastal California*. *Perspectives in California Archaeology* 1, Jeanne E. Arnold, series editor. Institute of Archaeology, University of California, Los Angeles.

Erlandson, Jon M., and Michael A. Glassow, editors

1997 *Archaeology of the California Coast during the Middle Holocene*. *Perspectives in California Archaeology*, 4, Jeanne E. Arnold, series editor. Institute of Archaeology, University of California, Los Angeles.

Erlandson, Jon M., Douglas J. Kennett, B. Lynn Ingram, Daniel A. Guthrie, Don P. Morris, Mark A. Tveskov, G. James West, and Phillip L. Walker

1996 *An Archaeological and Paleontological Chronology for Daisy Cave (CA-SMI-261), San Miguel Island, California*. *Radiocarbon* 38(2):355–373.

Fagan, Brian

2003 *Before California: An Archaeologist Looks at Our Earliest Inhabitants*. Rowman and Littlefield, Lanham, Maryland.

Fitzgerald, Richard T.

1998 *The Ground Stone Assemblage of the Cross Creek Site (CA-SLO-1797): A Reexamination of the Millingstone Horizon in Central California*. Paper presented at the 32<sup>nd</sup> Annual Meeting of the Society for California Archaeology, San Diego, California.

2000 *Cross Creek: An Early Holocene/Millingstone Site*. California State Water Project, Coast Branch Series, Paper 12. San Luis Obispo County Archaeological Society, San Luis Obispo, California.

Gamble, Lynne

1991 *Organization of Activities at the Historic Settlement of Helo': A Chumash Political, Economic, and Religious Center*. Ph.D. dissertation, University of California, Santa Barbara, California.

Gamble, Lynn H., and Glenn S. Russell

- 2002 A View from the Mainland: Late Holocene Cultural Developments Among the Ventureño Chumash and the Tongva. In *Catalysts to Complexity: Late Holocene Societies of the California Coast*, edited by Jon M. Erlandson and Terry L. Jones, pp. 101-126. Cotsen Institute of Archaeology, University of California, Los Angeles.

Glassow, Michael A.

- 1990 *Archaeological Investigations on Vandenberg Air Force Base in Connection with the Development of Space Transportation System Facilities*, with contributions by Jeanne E. Arnold, G. A. Batchelder, Richard T. Fitzgerald, Brian K. Glenn, D. A. Guthrie, Donald L. Johnson, and Phillip L. Walker. Department of Anthropology, University of California, Santa Barbara. Submitted to the National Park Service, Interagency Archaeological Services Branch, Western Region Office, San Francisco, California. NPS Contract CX-8099-2-0004.
- 1996 *Purisimeño Chumash Prehistory: Maritime Adaptations along the Southern California Coast*. Case Studies in Archaeology. Jeffrey Quilter, series editor. Harcourt Brace College Publishers, San Diego, California.
- 1997 Middle Holocene Cultural Development in the Central Santa Barbara Channel Region. In *Archaeology of the California Coast during the Middle Holocene*, edited by Jon M. Erlandson and Michael A. Glassow, pp. 73–90. Perspectives in California Archaeology, vol. 4. Institute of Archaeology, University of California, Los Angeles.

Glassow, Michael A., Lynn H. Gamble, Jennifer E. Perry, and Glenn S. Russell

- 2007 Prehistory of the Northern California Bight and the Adjacent Transverse Ranges. In *California Prehistory: Colonization, Culture, and Complexity*, edited by Terry L. Jones and Kathryn A. Klar, pp. 191–214. AltaMira Press, Lanham, Maryland.

Glassow, Michael, and Larry Wilcoxon

- 1988 Coastal Adaptations near Point Conception, California, with Particular Regard to Shellfish Exploitation. *American Antiquity* 53(1):36–51.

Glassow, Michael A., Larry R. Wilcoxon, and Jon Erlandson

- 1988 Cultural and Environmental Change during the Early Period of Santa Barbara Channel Prehistory. In *The Archaeology of Prehistoric Coastlines*, edited by Geoff N. Bailey and John E. Parkington, pp. 64–77. Cambridge University Press.

Glenn, Brian

- 1990 Typological Analysis of Projectile Points. In *Archaeological Investigations on Vandenberg Air Force Base in Connection with the Development of Space Transportation System Facilities*, vol. II, edited by Michael A. Glassow, pp. A4-1–A4-45. Department of Anthropology, University of California, Santa Barbara. Submitted to USDI National Park Service, Western Region Interagency Archeological Services, San Francisco, Contract No. CX 8099-2-0004.

Glenn, Brian (cont.)

- 1991 *Typological Analysis of Projectile Points Recovered from Excavation on Vandenberg Air Force Base, Santa Barbara County, California*. Master's thesis, University of California, Santa Barbara.

Grant, Campbell

- 1978a Chumash: Introduction. In *California*, edited by Robert F. Heizer, pp. 505–508. Handbook of North American Indians, vol. 8, William C. Sturtevant, general editor. Smithsonian Institution, Washington, D.C.
- 1978b Eastern Coastal Chumash. In *California*, edited by Robert F. Heizer, pp. 509–519. Handbook of California Indians, vol. 8, William C. Sturtevant, general editor. Smithsonian Institution, Washington, D.C.

Greenwood, Roberta

- 1972 Obispeño and Purisimeño Chumash. In *California*, edited by Robert F. Heizer, pp. 520–523. Handbook of North American Indians, vol. 8, William C. Sturtevant, general editor. Smithsonian Institution, Washington, D.C.

Heizer, Robert F.

- 1973 *California's Oldest Historical Relic?* Robert H. Lowie Museum of Anthropology, University of California, Berkeley, California.

Hudson, Travis, and Thomas. C. Blackburn

- 1982 *Food Procurement and Transportation*. The Material Culture of the Chumash Interaction Sphere, I. Ballena Press Anthropological Papers, 25. Ballena Press/Santa Barbara Museum of Natural History Cooperative Publication, Los Altos and Santa Barbara, California.
- 1983 *Food Preparation and Shelter*. The Material Culture of the Chumash Interaction Sphere, II. Ballena Press Anthropological Papers, 27. Ballena Press/Santa Barbara Museum of Natural History Cooperative Publication, Los Altos and Santa Barbara, California.
- 1984 *Clothing, Ornamentation, and Grooming*. The Material Culture of the Chumash Interaction Sphere, III. Ballena Press Anthropological Papers, 28. Ballena Press/Santa Barbara Museum of Natural History Cooperative Publication, Menlo Park and Santa Barbara, California.
- 1986 *Ceremonial Paraphernalia, Games, and Amusement*. The Material Culture of the Chumash Interaction Sphere, IV. Ballena Press Anthropological Papers, 30. A Ballena Press/Santa Barbara Museum of Natural History Cooperative Publication, Menlo Park, and Santa Barbara, California.
- 1987 *Manufacturing Processes, Metrology, and Trade*. The Material Culture of the Chumash Interaction Sphere, V. Ballena Press Anthropological Papers, 31. Ballena Press/Santa Barbara Museum of Natural History Cooperative Publication, Menlo Park and Santa Barbara, California.

Johnson, John

- 1988 *Chumash Social Organization: An Ethnohistoric Perspective*. Ph.D. dissertation, Department of Anthropology, University of California, Santa Barbara, California.

Johnson, John, and Sally McLendon

- 1999 Chumash Social History after Mission Secularization. In *Cultural Affiliation and Lineal Descent of Chumash Peoples in the Channel Islands and the Santa Monica Mountains*, vol. 1, by Sally McLendon and John R. Johnson, pp. 131–177. National Park Service Archeology and Ethnography Program, Washington, D.C.

Johnson, John R., Thomas W. Stafford, Jr., Henry O. Ajie, and Don P. Morris

- 2001 Arlington Springs Revisited. In *Proceedings of the Fifth California Islands Symposium*, edited by D. R. Brown, K. C. Mitchell, and H. W. Chaney, pp. 541–545. Santa Barbara Museum of Natural History, Santa Barbara, California.

Jones, Terry L., editor

- 1992 *Essays on the Prehistory of Maritime Archaeology*. Center for Archaeological Research at Davis, Publication 10. University of California, Davis, California.

Jones, Terry L., Nathan E. Stevens, Deborah A. Jones, Richard T. Fitzgerald, and Mark G. Hylkema

- 2007 The Central Coast: A Midlatitude Milieu. In *California Prehistory: Colonization, Culture, and Complexity*, edited by Terry L. Jones and Kathryn A. Klar, pp. 125–146. AltaMira Press, Lanham, Maryland.

Jones, Terry L., and Georgie Waugh

- 1995 *Central California Coastal Prehistory: A View from Little Pico Creek*. Perspectives in California Archaeology, vol. 3, Jeanne M. Arnold, senior series editor. Institute of Archaeology, University of California, Los Angeles.

Jones, T. L., G. M. Brown, L. M. Raab, J. L. McVickar, W. G. Spaulding, D. J. Kennett, A. York, and P. L. Walker

- 1999 Environmental Imperatives Reconsidered: Demographic Crises in Western North America during the Medieval Climatic Anomaly. *Current Anthropology* 40(2):137–170.

Keller, M.A.

- 1995 Ventura Basin Province (013) in D. Gautier, G.L. Dolton, K.I. Takahashi, and K.L. Varnes, eds., National Assessment of United States Oil and Gas Resources—Results, Methodology, and Supporting Data. U.S. Geological Survey Digital Data Series 30.

King, Chester D.

- 1976 Chumash Intervillage Economic Exchange. In *Native Californians: A Theoretical Retrospective*, edited by L. J. Bean and T. Blackburn. Ballena Press, Ramona, California.



1981 *The Evolution of Chumash Society: A Comparative Study of Artifacts Used in Social System Maintenance in the Santa Barbara Channel Region before A.D. 1804*. Ph.D. dissertation, Department of Anthropology, University of California, Davis, California.

1990 *Evolution of Chumash Society: A Comparative Study of Artifacts Used for Social System Maintenance in the Santa Barbara Channel Region before A.D. 1804*. The Evolution of North American Indians, edited by David Hurst Thomas. Garland, New York.

King, Chester, and John R. Johnson

1999 The Chumash Social Political Groups in the Santa Monica Mountains. Chapter 6 in *Final Report: Cultural Affiliation and Lineal Descent of Chumash Peoples in the Channel Islands and the Santa Monica Mountains*, Volume 1, prepared by Sally McLendon and John R. Johnson, pp. 67–92. Submitted to National Park Service Archaeology and Ethnography Program. Santa Barbara Museum of Natural History and Hunter College, City University of New York.

Kirkish, Alex

2010 DPR form for P-56-001304/CA-VEN-1304. On file at the South Central Coastal Information Center, California State University, Fullerton.

Klar, Kathryn, Kenneth Whistler, and Sally McLendon

1999 The Chumash Languages: An Overview. In *Cultural Affiliation and Lineal Descent of Chumash Peoples in the Channel Islands and the Santa Monica Mountains*, vol. 1, by Sally McLendon and John R. Johnson, pp. 21–27. National Park Service Archeology and Ethnography Program, Washington, D.C.

Kroeber, Alfred L.

1925 *Handbook of the Indians of California*. Bureau of American Ethnology Bulletin 78. Smithsonian Institution, Washington, D.C.

Landberg, Leif

1965 *The Chumash Indians of Southern California*. Southwest Museum Papers No. 19. Los Angeles.

Lebow, Clayton G., Douglas R. Harro, Rebecca L. McKim, and Carole Denardo

2001 *Archaeological Excavations at CA-SBA-246, An Early Holocene Site on Vandenberg Air Force Base, Santa Barbara County, California*. Applied EarthWorks, Inc., Fresno, California, for Tetra Tech, Inc., Santa Barbara, California. Submitted to U.S. Air Force, 30 CES/CEV, Vandenberg Air Force Base, California. USAF Contract F04684-95-C-0045, Work Request No. 39.

Lebow, Clayton G., Rebecca L. McKim, Douglas R. Harro, Ann M. Munns, and Carole Denardo

2007 Littoral Adaptations throughout the Holocene: Archaeological Investigations at the Honda Beach Site (CA-SBA-530), Vandenberg Air Force Base, Santa Barbara County, California. 2 vols. Applied EarthWorks, Inc., Lompoc, California. Submitted

- to U.S. Air Force, 30th Civil Engineer Squadron, Environmental Flight (30 CES/CEVNC), Vandenberg Air Force Base, California.
- Leung, Wendy  
 2014 “Rio Board to Pick Developer for Old School Site.” *Ventura County Star*, May 27, 2014.
- Moratto, Michael J.  
 1984 *California Archaeology*. Academic Press, New York and London. Reprinted, with new Introduction, 2004, Coyote Press, Salinas, California.
- NETROnline  
 2017 Historic Aerials, 1967, 1978, 1994, 2005. <https://www.historicaerials.com/viewer>. Accessed 8.3.17.
- Norris, R. M., and Webb, R. W.  
 1976 *Geology of California*. John Wiley & Sons, New York.
- Olson, Ronald L.  
 1930 Chumash Prehistory. University of California Publications in American Archaeology and Ethnology 28(1):1–22.
- Raab, L. Mark, Katherine Bradford, Judith F. Porcasi, and William J. Howard  
 1995 Return to Little Harbor, Santa Catalina Island, California: A Critique of the Marine Paleotemperature Model. *American Antiquity* 60(2):287–308.
- Raab, L. Mark, and Terry L. Jones, editors  
 2004 *Prehistoric California: Archaeology and the Myth of Paradise*. University of Utah Press, Salt Lake City, Utah.
- Rio School District  
 2017 “About Rio School District.” <http://rioschools.org/district/district-history/>. Accessed 8.3.17.
- Rogers, David Banks  
 1929 *Prehistoric Man of the Santa Barbara Coast*. Santa Barbara Museum of Natural History, Santa Barbara, California.
- San Buenaventura Research Associates  
 2014 *Historic Context Statement and Reconnaissance Survey for the Eastern Oxnard Plain of Ventura County, CA*. Prepared for the County of Ventura Planning Division, December 2014.
- Starr, Kevin  
 2005 *California. A History*. New York: Modern Library

Stickel, E. Gary

- 2010 Ice Age Man in Malibu: The Clovis Culture Discovery at the Farpoint Site. Presentation to the Pacific Coast Archaeological Society, March 11, Irvine, California.

Sutton, Mark Q., and Jill K. Gardner

- 2010 Reconceptualizing the Encinitas Tradition of Southern California. *Pacific Coast Archaeological Society Quarterly* 42(4):1–64.

Wallace, William J.

- 1955 A Suggested Chronology for Southern California Coastal Archaeology. *Southwest Journal of Anthropology* 11:214–230.

- 1978 Post Pleistocene Archaeology, 9000 to 2000 B.C. In: *California Indians*, edited by R.F. Heizer and M. A. Whipple, pp. 186–210. University of California Press, Los Angeles, California.

Warren, Claude N.

- 1967 The San Dieguito Complex: A Review and Hypothesis. *American Antiquity* 32(2):168-185

- 1968 Cultural Tradition and Ecological Adaptation on the Southern California Coast. In *Archaic Prehistory in the Western United States*, edited by C. Irwin-Williams, pp. 1–14. Eastern New Mexico University Contributions in Anthropology 1(3).

Winterer, E. L., and D. L. Durham

- 1962 Geology of Southeastern Ventura Basin Los Angeles County, California. U.S. Geological Survey Professional Paper 334-H, U.S.

Yerkes, R. F., and R. H. Campbell

- 2005 Preliminary Geologic Map of the Los Angeles 30' x 60' Quadrangle, Southern California. United States Geological Survey, Open-File Report OF-97-254, scale 1:24000.

## **APPENDIX A**

### **Native American Coordination**

**NATIVE AMERICAN HERITAGE COMMISSION**

Environmental and Cultural Department  
1550 Harbor Blvd., ROOM 100  
West SACRAMENTO, CA 95691  
(916) 373-3710  
Fax (916) 373-5471



August 4, 2017

Roberta Thomas  
Applied EarthWorks

Email to: [rthomas@appliedearthworks.com](mailto:rthomas@appliedearthworks.com)

RE: Meridian – Rio Urbana Mixed Use Project, Ventura County

Dear Ms. Thomas,

A record search of the Native American Heritage Commission (NAHC) Sacred Lands File (SLF) was completed for the information you have submitted for the above referenced project. The results were negative. However, the absence of specific site information in the SLF does not preclude the presence of cultural resources in any project area. Other sources for cultural resources should also be contacted for information regarding known and/or recorded sites.

Enclosed is a list of Native Americans tribes who may have knowledge of cultural resources in the project area. I suggest you contact all of those indicated, if they cannot supply information, they might recommend others with specific knowledge. By contacting all those listed, your organization will be better able to respond to claims of failure to consult with the appropriate tribe. If a response has not been received within two weeks of notification, the Commission requests that you follow-up with a telephone call to ensure that the project information has been received.

If you receive notification of change of addresses and phone numbers from any of these tribes, please notify me. With your assistance we are able to assure that our lists contain current information. If you have any questions or need additional information, please contact me at [steven.quinn@nahc.ca.gov](mailto:steven.quinn@nahc.ca.gov).

Sincerely,

A handwritten signature in blue ink that reads "Steven Quinn".

Steven Quinn  
Program Analyst

**Native American Heritage Commission  
Native American Contacts  
8/4/2017**

Santa Ynez Band of Chumash Indians  
Kenneth Kahn, Chairperson  
P.O. Box 517 Chumash  
Santa Ynez , CA 93460  
kkahn@santaynezchumash.org  
(805) 688-7997  
(805) 686-9578 Fax

Barbareno/Ventureno Band of Mission Indians  
Raudel Joe Banuelos, Jr.  
331 Mira Flores Court Chumash  
Camarillo , CA 93012  
(805) 427-0015

Barbareno/Ventureno Band of Mission Indians  
Julie Lynn Tumamait-Stennsle, Chair  
365 North Poli Ave Chumash  
Ojai , CA 93023  
jtumamait@hotmail.com  
(805) 646-6214

Barbareno/Ventureno Band of Mission Indians  
Patrick Tumamait  
992 El Camino Corto Chumash  
Ojai , CA 93023  
(805) 216-1253 Cell

Coastal Band of the Chumash Nation  
Mia Lopez  
Chumash  
(805) 324-0135

Barbareno/Ventureno Band of Mission Indians  
Eleanor Arrellanes  
P.O. Box 5687 Chumash  
Ventura , CA 93005  
(805) 701-3246

This list is current only as of the date of this document and is based on the information available to the Commission on the date it was produced.

Distribution of this list does not relieve any person of statutory responsibility as defined in Section 7050.5 of the Health and Safety Code, Section 5097.94 of the Public Resource Section 5097.98 of the Public Resources Code.

**This list is only applicable for contacting local Native Americans with regard to cultural resources assessments for the proposed Meridian – Rio Urbana Mixed Use Project, Ventura County.**

## Sacred Lands File & Native American Contacts List Request

### NATIVE AMERICAN HERITAGE COMMISSION

915 Capitol Mall, RM 364  
Sacramento, CA 95814  
(916) 653-4082  
(916) 657-5390 – Fax  
nahc@pacbell.net

*Information Below is Required for a Sacred Lands File Search*

Date: August 2, 2017

Project: Meridian – Rio Urbana Mixed Use Project (AE #3721)

County: Ventura

USGS Quadrangle Name: Oxnard

Township \_\_ Range \_\_ Section(s) (sections? Landgrants?) Santa Clara del Norte and Rio de Santa Clara Landgrants

Company/Firm/Agency: Applied EarthWorks, Inc.

Contact Person: Roberta Thomas

Street Address: 133 N. San Gabriel Blvd., Suite 201

City: Pasadena Zip: 91107

Phone: (626) 578-0119

Fax:

Email: [rthomas@appliedearthworks.com](mailto:rthomas@appliedearthworks.com)

Project Description:

The proposed Project would include demolition of the existing uses (former location of El Rio Elementary School Campus) to allow the construction of a new mixed-use development which includes 182 condominium residential units and a 15,000-square foot office building containing the Rio School District Administrative Offices. There will be ground disturbance associated with the Project. Applied EarthWorks, Inc. has been retained to conduct a cultural resource investigation of the Rio Urbana Mixed Use Project in accordance with the California Environmental Quality Act.

August 11, 2017

Kenneth Kahn, Chairperson  
Santa Ynez Band of Chumash Indians  
P.O. Box 517  
Santa Ynez, CA 93460  
Transmitted via email to [kkahn@santaynezchumash.org](mailto:kkahn@santaynezchumash.org)

**Re:** Cultural Resource Investigation for the Rio Urbana Mixed Use Development Project, Ventura County, California

Dear Mr. Kahn,

On behalf of Meridian Consultants, LLC, Applied EarthWorks, Inc. (Æ) is conducting a cultural resource study, in compliance with the California Environmental Quality Act (CEQA), for the proposed Rio Urbana Mixed Use Development Project (Project) near the city of Oxnard, in Ventura County, California. The Project proposes to develop a new mixed-use development which includes residential units and an office building containing the Rio School District Administrative Offices. The Project area is depicted on the Oxnard, Calif. 7.5' USGS quadrangle map, within the Santa Clara del Norte and Rio de Santa Clara Landgrants (see attached map).

A cultural resource literature review and records search conducted at the South Central Coastal Information Center (SCCIC) housed at California State University, Fullerton, indicates that no less than 37 cultural resource studies have been conducted within a one-mile radius of the Project area; one of these studies encompasses the entire Project area. The records search also indicated that eight cultural resources have been identified within a one-mile radius of the Project area; none of which have been recorded within the Project boundaries. These eight resources consist of seven historic-period built-environment resources and one prehistoric archaeological resource. The prehistoric archaeological resource is a partial, isolated burial.

Æ performed a cultural resource survey of the Project area on August 11, 2017. Close attention was paid to soils, vegetation, and natural and human-modified landforms. Naturally occurring rocks were inspected for any indication of prehistoric or historic human modification. During the survey, one historic-period built-environment resource (the former El Rio Elementary School campus) was identified. No prehistoric archaeological resources were identified as a result of the survey.

As part of the cultural resource assessment of the Project area, Æ requested a search of the Native American Heritage Commission's (NAHC's) *Sacred Lands File* on August 2, 2017. The NAHC responded on August 4, 2017 indicating that no Native American cultural resources were identified within the immediate Project vicinity. However, should your records show that cultural properties exist within or near the Project area shown on the enclosed map, please contact me at (626) 578-0119 (ext. 116) or via e-mail at [rthomas@appliedearthworks.com](mailto:rthomas@appliedearthworks.com). If I do not hear from you within in the next two weeks, I will contact you with a follow-up phone call or email.

Your comments are very important to us, and to the successful completion of this Project. I look forward to hearing from you in the near future. Thank you, in advance, for taking the time to review this request.

Respectfully yours,



Roberta Thomas, M.A., RPA  
Associate Archaeologist  
Applied EarthWorks, Inc.



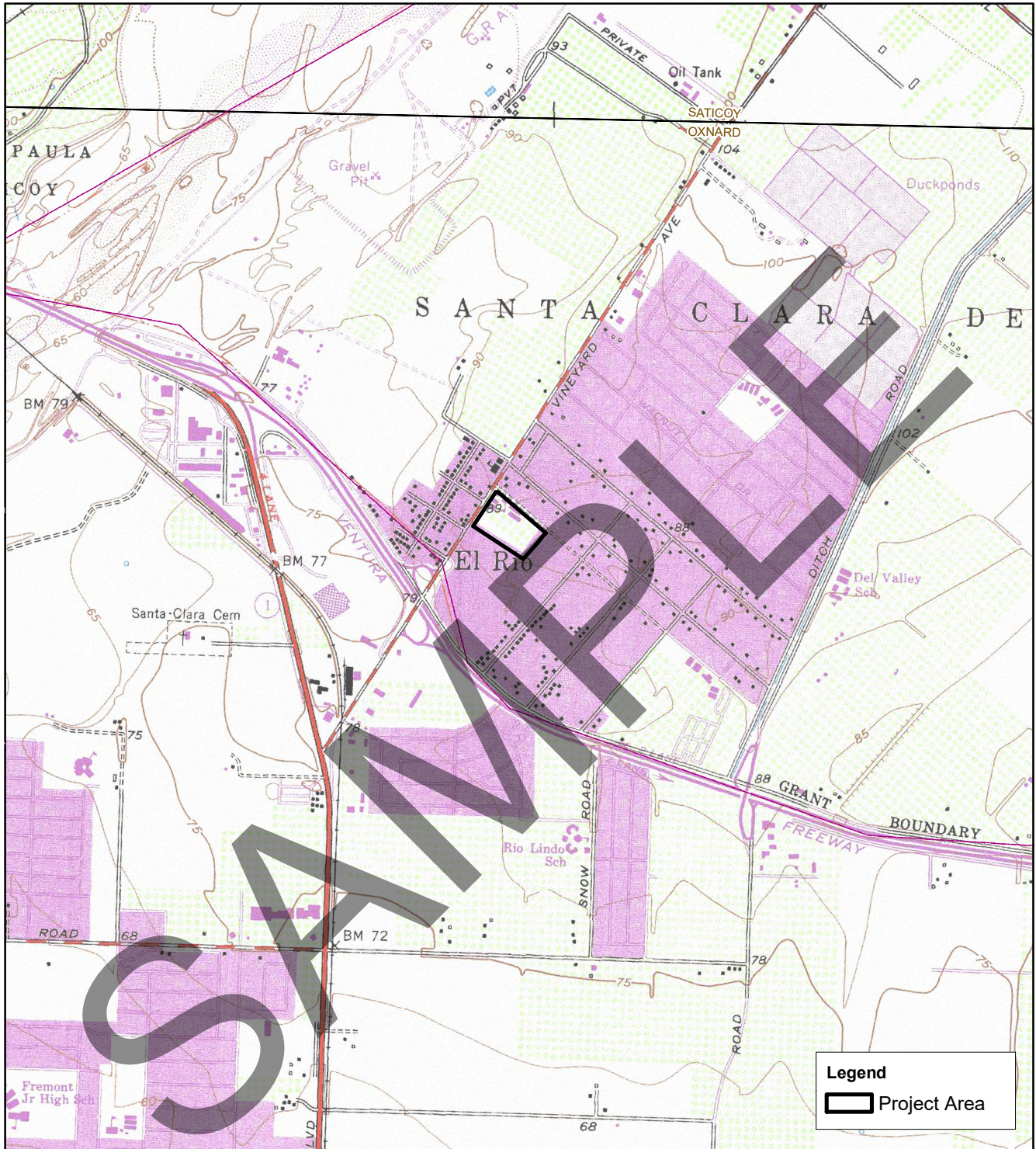

SCALE 1:24,000

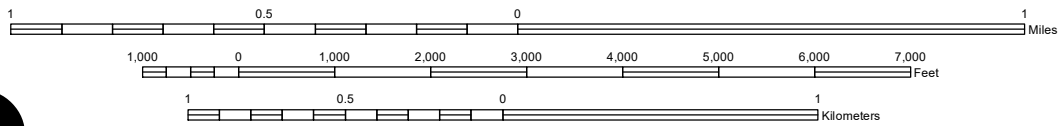

Santa Clara del Norte and Rio de Santa Clara Landgrants  
 Oxnard and Saticoy (1953-PR1979), CA 7.5' USGS Quadrangle

Records Search location map for the *Rio Urbana Mixed-Use Project - AE3721*.

**LIST OF NATIVE AMERICAN CONTACTS AND RECORD OF RESPONSES**

<b>Name</b>	<b>Date &amp; Time of Correspondence</b>	<b>Responses</b>
Kenneth Kahn Chairperson Santa Ynez Band of Chumash Indians	August 11, 2017  August 29, 2017	Scoping letter sent via email.  Transferred to Freddy Romero as he is the one that usually responds to cultural resource inquiries. Mr. Romero asked if local tribes (specifically the Barbareno/Ventureno Band of Mission Indians) have been contacted and indicated that the Tribe defers to the local tribes in the Oxnard area unless those tribes specifically request their involvement.
Julie Lynn Tumamait-Stennslie Chairperson Barbareno/Ventureno Band of Mission Indians	August 11, 2017  August 29, 2017	Scoping letter sent via email.  Voicemail message left on the number provided. No response received to date.
Patrick Tumamait Barbareno/Ventureno Band of Mission Indians	August 11, 2017  August 29, 2017	Scoping letter sent via USPS standard mail.  Voicemail message left on the number provided. No response received to date.
Mia Lopez Coastal Band of Chumash Nation	August 14, 2017  August 29, 2017	No mailing or email address was provided for Ms. Lopez. A phone call was made and a voicemail message was left regarding the Project.  Voicemail message left on the number provided. No response received to date.
Eleanor Arrellanes Barbareno/Ventureno Band of Mission Indians	August 11, 2017  August 29, 2017	Scoping letter sent via USPS standard mail.  Voicemail message left on the number provided. No response received to date.
Raudel Joe Banuelos, Jr. Barbareno/Ventureno Band of Mission Indians	August 11, 2017  August 29, 2017	Scoping letter sent via USPS standard mail.  Voicemail message left on the number provided. No response received to date.

## **APPENDIX B**

### **Non-confidential DPR Form**

**Other Listings**  
**Review Code**

**Reviewer**

**Date**

Page 1 of 16

\*Resource Name or #: (Assigned by recorder) El Rio School

**P1. Other Identifier:**

**P2. Location:** a. **County** Ventura  Not for Publication  Unrestricted  
b. **USGS 7.5' Quad** Oxnard **Date** 1952 (photorevised 1979)

T. 2N , R. 22W; NE ¼ of SE ¼ of **Sec. 27**

c. **Address:** 2714 E. Vineyard Avenue **City** Oxnard **Zip** 93036

d. **Zone** 11S 300201 mE/ 3790381 mN/

e. **Other Locational Data** (e.g., parcel #, legal description, directions to resource, additional UTM's, etc., when appropriate): The Assessor's Parcel Number (APN) is listed as 145-0-232-010

**P3a. Description** (Describe resource and its major elements. Include design, materials, condition, alterations, size, setting, and boundaries):

The El Rio School campus is comprised of five academic and administrative buildings. The campus was initially constructed in 1949 with a second major phase of construction between 1950 and 1952. The campus has undergone several changes over time, including the loss of a building due to fire and the construction of additional buildings. Building A, Building B, Building C, Building D, and Building F were all constructed between 1949 and 1952. In addition to the historic period buildings, the property includes athletic fields, covered walkways, landscape elements such as paved walkways and benches, and non historic buildings including a 1998 classroom wing (Building E). The non historic period building is a non-contributing element to a possible district.

**P3b. Resource Attributes** (List all attributes and codes): HP15: Educational Buildings

**P4. Resources Present:**  Building  Structure  Object  Site  District  Element of District  Other:

**P5. Photograph or Drawing:** (Photograph required for buildings, structures, and objects.) Photographs taken August 10, 2017. See continuation sheets for photographs.

**P6. Date Constructed/Age and Source:** 1949-1952  
 Prehistoric  Historic  Both

**P7. Owner and Address:** Rio School District, 2500 E. Vineyard Avenue, #100, Oxnard CA 93036

**P9. Date Recorded:** August 2017

**P10. Type of Survey:**  Intensive  Reconnaissance  Other  
**Describe:**

**P11. Report Citation** (Provide full citation or enter "none"): Roberta Thomas and Justin Castells. *Phase I Cultural Resource Assessment for the Rio Urbana Mixed Use Development Project*, Ventura County, California; Prepared by Applied EarthWorks, Inc., Pasadena, CA, for Meridian Consultants, LLC. 2017

**Attachments:**  None  Location Map  Site Map  Continuation Sheet  Building, Structure, and Object Record  Archaeological Record  District Record  Linear Feature Record  Milling Station Record  Rock Art Record  Artifact Record  Photograph Record  Other:



**D1. Historic Name:** El Rio School **D2.Common Name:** El Rio Elementary School

**\*D3. Detailed Description** (Discuss overall coherence of the district, its setting, visual characteristics, and minor features. List all elements of district.):

El Rio School is located on APN 145-0-232-010 within the community of El Rio within the City of Oxnard's Sphere of Influence in Ventura County, CA. The potential district is comprised of several buildings. The buildings are all utilitarian in design and display with no distinctive features. The campus contains mature trees, landscaped vegetation, athletic fields, covered walkways, and hardscape elements including parking lots and sidewalks. The following are historic-period buildings that are potential contributors to the district:

#### **Building A**

Building A is a one-story utilitarian style administrative Building constructed between 1949 and 1952. The concrete building features a flat roof and a rectangular plan. The primary entrance is on the west elevation beneath a covered walkway that connects to Building F. The north elevation features double hung and multi-pane windows with security bars. The east elevation features no fenestration or doors.

#### **Building B**

Building B is a two-story utilitarian style cafeteria/auditorium constructed of concrete between 1949 and 1952. It has an irregular plan with a low pitched front gabled roof and a large decorative grid pattern. The west elevation features no fenestration. An off-center entrance on the south elevation is recessed beneath a cantilevered overhang. An off-center entrance on the north elevation is similarly recessed beneath a cantilevered overhang. A building extension is located on the south elevation. A portion of the extension is two stories then steps down to one story. The extension is constructed of concrete and features a flat roof. The south elevation of the extension features entrance doors, a band of double-hung windows with security bars, and exhaust vents on the second story. The east elevation features three picture windows on the extension, three picture windows with security bars and double entrance doors beneath a flat roof overhang supported by posts.

#### **Building C**

Building C is a two-story utilitarian style classroom building constructed between 1949 and 1952. The concrete building has a rectangular plan and a medium pitched gabled roof that extends into a covered walkway supported by posts on the south elevation. A flat-roofed one-story pop out on the northwest corner of the building forms a partial cantilevered overhang. There are two entrance doors and windows covered with plywood. Above the flat roof on the main building is a band of windows with security bars. The remainder of the north elevation features regularly spaced doors. The east elevation features a flat roof overhang supported by posts and two sets of windows on the second floor. The south elevation features regularly spaced doors and windows beneath the overhang and a covered walkway that connects to Building D.

#### **Building D**

Building D is a two-story utilitarian style classroom building constructed between 1949 and 1952. The concrete building has a rectangular plan and a medium pitched gabled roof that extends into a covered walkway supported by posts on the south elevation. The north elevation features regularly spaced doors. The east and west elevations feature flat roof overhangs supported by posts and two sets of windows on the second floor; the east elevation features a covered walkway that connects to Building C. The south elevation features regularly spaced doors and windows beneath the overhang.

#### **Building F**

Building F is a two-story utilitarian style classroom building constructed between 1949 and 1952. The concrete building has a rectangular plan and a medium pitched gabled roof that extends into a covered walkway supported by posts on the south elevation. The north elevation features regularly spaced doors and windows and a covered walkway that connects to Building A. The west elevation features a flat roof overhang supported by posts and two sets of windows on the second floor. The south elevation features regularly spaced doors and windows beneath the overhang.

Building E is a non-historic building constructed in 1985. Additional non-historic elements include a portable classroom and a utility shed.

Recorded by: Applied Earthworks, Inc. Date August 2017

Continuation  Update

**\*D4. Boundary Description** (Describe limits of district and attach map showing boundary and district elements.):  
El Rio School is entirely located within APN 145-0-232-010.

**\*D5. Boundary Justification:**  
No buildings or structures associated with El Rio School are located outside the boundaries of APN 145-0-232-010.

**D6. Significance: Theme** Educational facilities **Area:** El Rio, CA

**Period of Significance** 1949-1967 **Property Type** school **Applicable Criteria** N/A  
(Discuss district's importance in terms of its historical context as defined by theme, period of significance, and geographic scope. Also address the integrity of the district as a whole.)

#### Community of El Rio

El Rio is an unincorporated community in Ventura County initially founded as the town of New Jerusalem in 1876. Simon Cohn, a Jewish immigrant from Germany, acquired a seven acre parcel of land at the intersection of the Conejo Road (later to be called Ventura Boulevard/ State Route 101) and the Hueneme and Saticoy Road (later to be called Vineyard Avenue) from Christian Borchard in 1876. Cohn had initially came to the region with his brother, Morris Cohn, and had worked at his brother's general store in the nearby town of Saticoy before building his own store on his newly acquired land (San Buenaventura Research Associates 2014).

When Simon Cohn opened his first store, no other commercial buildings were located in the area, just scattered farmhouses. Cohn gradually acquired land on three of the four corners at the intersection of Vineyard Avenue and Ventura Boulevard. Two of Cohn's brothers built businesses at this intersection as well. The town began to grow through the 1870s and into the 1880s. In 1882 the first post office was opened in New Jerusalem with Simon Cohn serving as the postmaster. In 1895, the post office shortened the name of the town to Jerusalem, and a few months later in the same year, the name was changed to Elrio (all one word). In 1905 the post office name was finally changed to El Rio. While the post office closed in 1911, the community had adopted the name El Rio (San Buenaventura Research Associates 2014).

#### El Rio Elementary School

The Rio School District was formed in 1885 with the establishment of a school building at Schiappa Prieta Ranch. Between two and eight students first attended the school, but enrollment quickly grew. By 1895 the local demand for schooling outgrew the building, which had been relocated and expanded, and a two-acre site was purchased to build a new school. The building was expanded in 1929, but no new schools were built within the district until the construction of the Neyland Acres School in 1941. In 1949 El Rio School was constructed. The Neyland Acres School and El Rio School were the only two schools within the district until the Rio Plaza School was constructed in 1954 and the Rio Real School was constructed in 1957. The school district now has nine campuses that include elementary and middle schools; average enrollment is 500-700 students in the elementary schools and 700 students in the middle schools (Rio School District 2017).

El Rio School was constructed in 1949 to address the growing enrollment needs of the El Rio School District. The campus was expanded in 1952 and 1952 with the addition of more classrooms, a multi-purpose building, and other renovations and additions. By 1967 the campus was comprised of six buildings (NETROnline 2017). One of the classroom buildings was destroyed by a fire in 1984, but was replaced the following year with a larger building at a different location on the campus (Rio School District 2017). The location of the destroyed classroom building was repurposed as a parking lot. The school was closed in 2007 to be used as office space for Rio School District Maintenance staff (Leung 2014).

Recorded by: Applied Earthworks, Inc. Date August 2017

Continuation  Update

### Evaluation

**CRHR Criterion 1:** No information has been found to suggest that El Rio School is directly associated with historical events of importance in local, state, or national history under CRHR Criterion 1. While the school was initially founded in 1949, it is not the earliest school constructed by the Rio School District or among the earliest schools constructed in the area. Research has yielded no information to suggest that significant events related to the history of the United States, California, or Oxnard are directly associated with this school, nor are any significant changes to education or school administration. The design and layout of the school does not represent any dramatic departure from traditional school design. Therefore, El Rio School is not eligible for inclusion of CRHR under Criterion 1.

**CRHR Criterion 2:** No information has been found to suggest that El Rio School is directly associated with the productive life of a person of importance in local, state, or national history under CRHR Criterion 2. While there have been many students to attend the school and many faculty members over the years, the research conducted does not suggest that any are persons of historical significance or that the campus is directly associated with people of state and national significance. Therefore, El Rio School is not eligible for inclusion of CRHR under Criterion 2.

**CRHR Criterion 3:** El Rio School does not appear to embody the distinctive characteristics of a type, period, region, or method of construction; represent the work of an important creative individual, or possess high artistic value. The school is utilitarian in design and is essentially similar to other schools constructed in the mid-twentieth century throughout the United States. Research has yielded no information regarding the architect or builder of the campus, however; it is unlikely that this represent the work of a master. Therefore, El Rio School is not eligible for inclusion of CRHR under Criterion 3.

**CRHR Criterion 4:** El Rio School does not meet CRHR Criterion 4 since it has not yielded and is unlikely to yield information important in prehistory or history. This criterion is typically reserved for archaeological resources, ruins, or rare built-environments resources of which little is already known, that are considered to be the sole sources of historical data. Therefore, El Rio School is not eligible for inclusion of CRHR under Criterion 4.

**\*D7. References** (Give full citations including the names and addresses of any informants, where possible.):

Leung, Wendy

2014 "Rio Board to Pick Developer for Old School Site." Ventura County Star, May 27, 2014.

NETROnline

2017 Historic Aerials, 1967, 1978, 1994, 2005. <https://www.historicaerials.com/viewer>. Accessed 8.3.17.

Rio School District

2017 "About Rio School District." <http://rioschools.org/district/district-history/>. Accessed 8.3.17.

San Buenaventura Research Associates

2014 *Historic Context Statement and Reconnaissance Survey for the Eastern Oxnard Plain of Ventura County, CA*. Prepared for the County of Ventura Planning Division, December 2014

**\*D8. Evaluator:** Justin Castells, Applied EarthWorks, Inc., 3550 E. Florida Ave., Suite H, Hemet, CA 92544  
**Date of Evaluation:** August 2017

**Other Listings**  
**Review Code**

**Reviewer**

**Date**

Page 5 of 16

\*Resource Name or #: (Assigned by recorder) Building A

**P1. Other Identifier:**

**P2. Location:** a. County Ventura  Not for Publication  Unrestricted  
b. USGS 7.5' Quad Oxnard Date 1952 (photorevised 1979)  
T. 2N , R. 22W; NE ¼ of SE ¼ of Sec. 27  
c. Address: 2714 E. Vineyard Avenue City Oxnard Zip 93036  
d. Zone 11S 300201 mE/ 3790417 mN/

e. Other Locational Data (e.g., parcel #, legal description, directions to resource, additional UTM's, etc., when appropriate): The Assessor's Parcel Number (APN) is listed as 145-0-232-010

**P3a. Description** (Describe resource and its major elements. Include design, materials, condition, alterations, size, setting, and boundaries):

Building A is a one-story utilitarian style administrative Building constructed between 1949 and 1952. The concrete building features a flat roof and a rectangular plan. The primary entrance is on the west elevation beneath a covered walkway that connects to Building F. The north elevation features double hung and multi-pane windows with security bars. The east elevation features no fenestration or doors.

**P3b. Resource Attributes** (List all attributes and codes): HP15: Educational Buildings

**P4. Resources Present:**  Building  Structure  Object  Site  District  Element of District  Other:

**P5. Photograph or Drawing:** (Photograph required for buildings, structures, and objects.) Photographs taken August 10, 2017. See continuation sheets for photographs.

**P6. Date Constructed/Age and Source:** Between 1949 and 1952  
 Prehistoric  Historic  Both

**P7. Owner and Address:** Rio School District, 2500 E. Vineyard Avenue, #100, Oxnard CA 93036

**P9. Date Recorded:** August 2017

**P10. Type of Survey:**  Intensive  Reconnaissance  Other  
**Describe:**

**P11. Report Citation** (Provide full citation or enter "none"): Roberta Thomas and Justin Castells. *Phase I Cultural Resource Assessment for the Rio Urbana Mixed Use Development Project*, Ventura County, California; Prepared by Applied EarthWorks, Inc., Pasadena, CA, for Meridian Consultants, LLC. 2017

**Attachments:**  None  Location Map  Site Map  Continuation Sheet  Building, Structure, and Object Record  Archaeological Record  District Record  Linear Feature Record  Milling Station Record  Rock Art Record  Artifact Record  Photograph Record Other:





**North and west elevations of Building A, facing southeast**





South and west elevations of Building B, facing northeast

**Other Listings**  
**Review Code**

**Reviewer**

**Date**

Page 9 of 16

\*Resource Name or #: (Assigned by recorder) Building C

**P1. Other Identifier:**

**P2. Location:** a. **County** Ventura  Not for Publication  Unrestricted  
b. **USGS 7.5' Quad** Oxnard **Date** 1952 (photorevised 1979)  
T. 2N , R. 22W; NE ¼ of SE ¼ of **Sec. 27**  
c. **Address:** 2714 E. Vineyard Avenue **City** Oxnard **Zip** 93036  
d. **Zone** 11S 300244 mE/ 3790381 mN/  
e. **Other Locational Data** (e.g., parcel #, legal description, directions to resource, additional UTM's, etc., when appropriate): The Assessor's Parcel Number (APN) is listed as 145-0-232-010

**P3a. Description** (Describe resource and its major elements. Include design, materials, condition, alterations, size, setting, and boundaries):

Building C is a two-story utilitarian style classroom building constructed between 1949 and 1952. The concrete building has a rectangular plan and a medium pitched gabled roof that extends into a covered walkway supported by posts on the south elevation. A flat-roofed one-story pop out on the northwest corner of the building forms a partial cantilevered overhang. There are two entrance doors and windows covered with plywood. Above the flat roof on the main building is a band of windows with security bars. The remainder of the north elevation features regularly spaced doors. The east elevation features a flat roof overhang supported by posts and two sets of windows on the second floor. The south elevation features regularly spaced doors and windows beneath the overhang and a covered walkway that connects to Building D.

**P3b. Resource Attributes** (List all attributes and codes): HP15: Educational Buildings

**P4. Resources Present:**  Building  Structure  Object  Site  District  Element of District  Other:

**P5. Photograph or Drawing:** (Photograph required for buildings, structures, and objects.) Photographs taken August 10, 2017. See continuation sheets for photographs.

**P6. Date Constructed/Age and Source:** Between 1949 and 1952  
 Prehistoric  Historic  Both

**P7. Owner and Address:** Rio School District, 2500 E. Vineyard Avenue, #100, Oxnard CA 93036

**P9. Date Recorded:** August 2017

**P10. Type of Survey:**  Intensive  Reconnaissance  Other  
**Describe:**

**P11. Report Citation** (Provide full citation or enter "none"): Roberta Thomas and Justin Castells. *Phase I Cultural Resource Assessment for the Rio Urbana Mixed Use Development Project*, Ventura County, California; Prepared by Applied EarthWorks, Inc., Pasadena, CA, for Meridian Consultants, LLC. 2017

**Attachments:**  None  Location Map  Site Map  Continuation Sheet  Building, Structure, and Object Record  Archaeological Record  District Record  Linear Feature Record  Milling Station Record  Rock Art Record  Artifact Record  Photograph Record  Other:



**South and east elevations of Building C, facing northwest**



**Other Listings**  
**Review Code**

**Reviewer**

**Date**

Page 11 of 16

\*Resource Name or #: (Assigned by recorder) Building D

**P1. Other Identifier:**

**P2. Location:** a. County Ventura  Not for Publication  Unrestricted  
b. USGS 7.5' Quad Oxnard **Date** 1952 (photorevised 1979)  
T. 2N , R. 22W; NE ¼ of SE ¼ of **Sec.** 27  
c. Address: 2714 E. Vineyard Avenue **City** Oxnard **Zip** 93036  
d. Zone 11S 300245 mE/ 3790356 mN/  
e. Other Locational Data (e.g., parcel #, legal description, directions to resource, additional UTM's, etc., when appropriate): The Assessor's Parcel Number (APN) is listed as 145-0-232-010

**P3a. Description** (Describe resource and its major elements. Include design, materials, condition, alterations, size, setting, and boundaries):

Building D is a two-story utilitarian style classroom building constructed between 1949 and 1952. The concrete building has a rectangular plan and a medium pitched gabled roof that extends into a covered walkway supported by posts on the south elevation. The north elevation features regularly spaced doors. The east and west elevations feature flat roof overhangs supported by posts and two sets of windows on the second floor; the east elevation features a covered walkway that connects to Building C. The south elevation features regularly spaced doors and windows beneath the overhang.

**P3b. Resource Attributes** (List all attributes and codes): HP15: Educational Buildings

**P4. Resources Present:**  Building  Structure  Object  Site  District  Element of District  Other:

**P5. Photograph or Drawing:** (Photograph required for buildings, structures, and objects.) Photographs taken August 10, 2017. See continuation sheets for photographs.

**P6. Date Constructed/Age and Source:** Between 1949 and 1952  
 Prehistoric  Historic  Both

**P7. Owner and Address:** Rio School District, 2500 E. Vineyard Avenue, #100, Oxnard CA 93036

**P9. Date Recorded:** August 2017

**P10. Type of Survey:**  Intensive  Reconnaissance  Other  
**Describe:**

**P11. Report Citation** (Provide full citation or enter "none"): Roberta Thomas and Justin Castells. *Phase I Cultural Resource Assessment for the Rio Urbana Mixed Use Development Project*, Ventura County, California; Prepared by Applied EarthWorks, Inc., Pasadena, CA, for Meridian Consultants, LLC. 2017

**Attachments:**  None  Location Map  Site Map  Continuation Sheet  Building, Structure, and Object Record  Archaeological Record  District Record  Linear Feature Record  Milling Station Record  Rock Art Record  Artifact Record  Photograph Record  Other:



**North and east elevations of Building D, facing southwest**

**Other Listings**  
**Review Code**

**Reviewer**

**Date**

Page 13 of 16

\*Resource Name or #: (Assigned by recorder) Building F

**P1. Other Identifier:**

**P2. Location:** a. **County** Ventura  Not for Publication  Unrestricted  
b. **USGS 7.5' Quad** Oxnard **Date** 1952 (photorevised 1979)  
T. 2N , R. 22W; NE ¼ of SE ¼ of **Sec.** 27  
c. **Address:** 2714 E. Vineyard Avenue **City** Oxnard **Zip** 93036  
d. **Zone** 11S 300201 **mE/** 3790381 **mN/**

e. **Other Locational Data** (e.g., parcel #, legal description, directions to resource, additional UTM's, etc., when appropriate): The Assessor's Parcel Number (APN) is listed as 145-0-232-010

**P3a. Description** (Describe resource and its major elements. Include design, materials, condition, alterations, size, setting, and boundaries):

Building F is a two-story utilitarian style classroom building constructed between 1949 and 1952. The concrete building has a rectangular plan and a medium pitched gabled roof that extends into a covered walkway supported by posts on the south elevation. The north elevation features regularly spaced doors and windows and a covered walkway that connects to Building A. The west elevation features a flat roof overhang supported by posts and two sets of windows on the second floor. The south elevation features regularly spaced doors and windows beneath the overhang.

**P3b. Resource Attributes** (List all attributes and codes): HP15: Educational Buildings

**P4. Resources Present:**  Building  Structure  Object  Site  District  Element of District  Other:

**P5. Photograph or Drawing:** (Photograph required for buildings, structures, and objects.) Photographs taken August 10, 2017. See continuation sheets for photographs.

**P6. Date Constructed/Age and Source:** 1959  
 Prehistoric  Historic  Both

**P7. Owner and Address:** Rio School District, 2500 E. Vineyard Avenue, #100, Oxnard CA 93036

**P9. Date Recorded:** August 2017

**P10. Type of Survey:**  Intensive  Reconnaissance  Other  
**Describe:**

**P11. Report Citation** (Provide full citation or enter "none"): Roberta Thomas and Justin Castells. *Phase I Cultural Resource Assessment for the Rio Urbana Mixed Use Development Project*, Ventura County, California; Prepared by Applied EarthWorks, Inc., Pasadena, CA, for Meridian Consultants, LLC. 2017

**Attachments:**  None  Location Map  Site Map  Continuation Sheet  Building, Structure, and Object Record  Archaeological Record  District Record  Linear Feature Record  Milling Station Record  Rock Art Record  Artifact Record  Photograph Record  Other:





North and east elevations of Building F, facing southwest





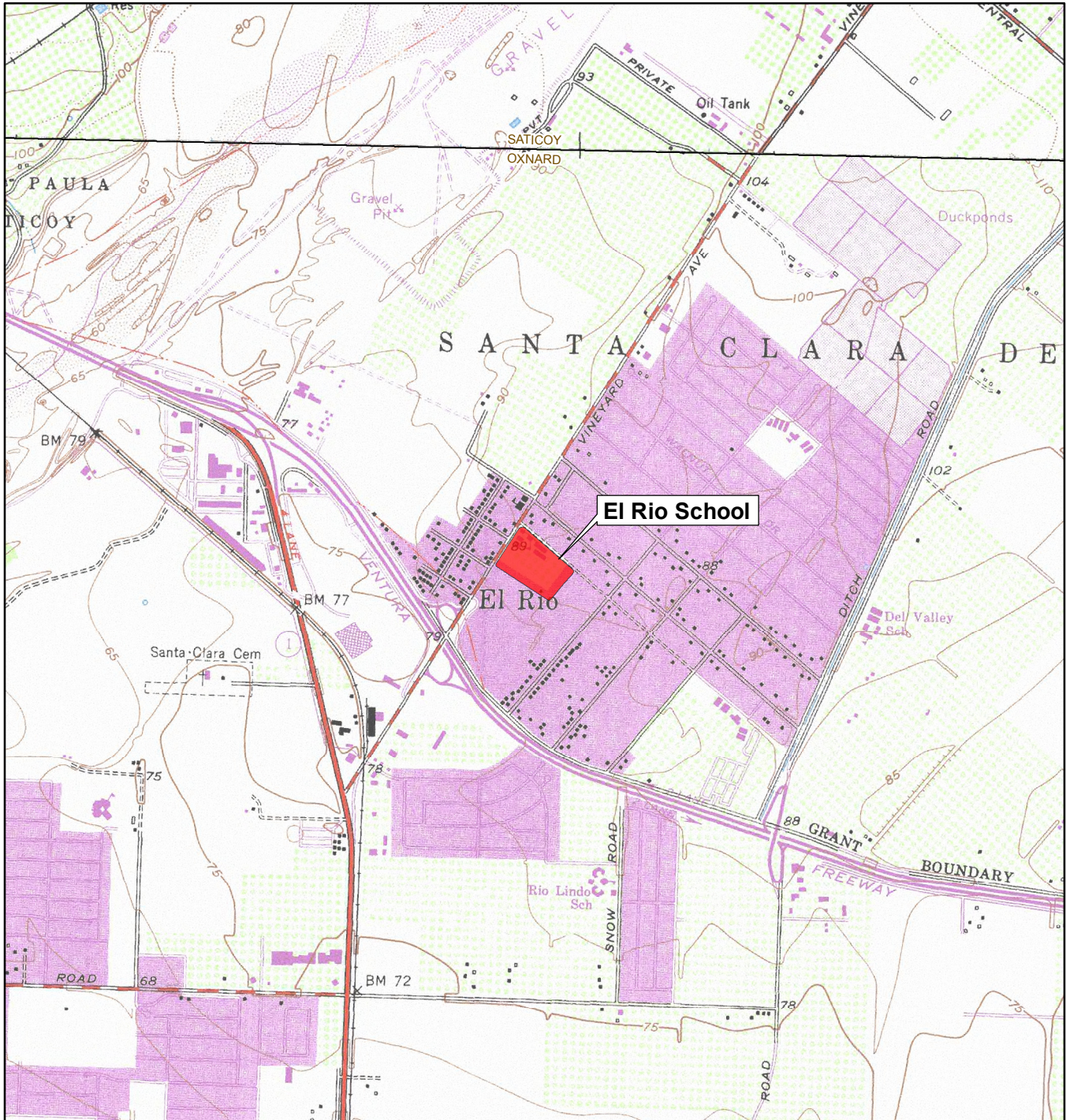

SCALE 1:24,000

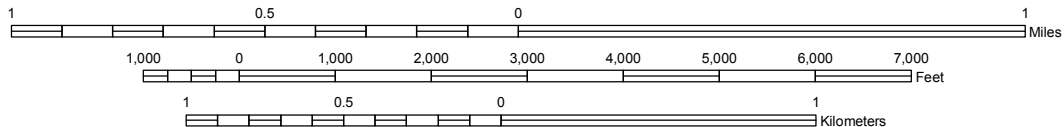

TRUE NORTH



August 17, 2017

Mr. Christ Kirikian  
Senior Environmental Scientist  
Meridian Consultants, LLC.  
910 Hampshire Road, Suite V  
Westlake Village, California 91361

***RE: Paleontological Resource Assessment for the Rio Urbana Mixed-Use Project, Ventura County, California***

Dear Mr. Kirikian:

At the request of Meridian Consultants, LLC, Applied EarthWorks, Inc. (Æ) performed a paleontological resource assessment for the Rio Urbana Mixed-Use Project (Project) in Ventura County, California. The scope of work included a museum records search, a literature and geologic map review, and preparation of this technical memorandum (memo). This memo, which serves as a summary of our findings, was written in accordance with the guidelines set forth by the Society of Vertebrate Paleontology (SVP) (2010) and will satisfy the requirements of the California Environmental Quality Act (CEQA).

### **Project Description and Background**

The Project is located in the Community of El Rio within the City of Oxnard Sphere of Influence. It is situated along East Vineyard Avenue, northeast of U.S. Route 101 and southwest of Rio School Lane, approximately one mile east of the Santa Clara River (Attachment 1). Specifically, the Project is mapped within portions of the Santa Clara del Norte Landgrant on the Oxnard CA 7.5-minute U.S. Geological Survey quadrangle. The Project area consists of approximately 10.24 acres of developed land with numerous vacant buildings (cafeteria, administration, classrooms, and two portable buildings) that was formerly the El Rio Elementary School (closed since 2008). The Project would include demolition of the existing buildings to allow for the construction of a new mixed-use development which includes 182 condominium residential units and a 15,000 square foot office building containing the Rio School District Administrative Offices.

### **Regulatory Context**

Paleontological resources cannot be replaced once they are destroyed. Therefore, paleontological resources are considered nonrenewable scientific resources and are protected under the CEQA. Specifically, in Section V(c) of Appendix G of the CEQA Guidelines, the “Environmental Checklist Form,” the question is posed: “Will the project directly or indirectly destroy a unique paleontological resource or site or unique geologic feature?” In order to determine the uniqueness of a given paleontological resource, it must first be identified or recovered (i.e., salvaged). Therefore, mitigation of adverse impacts to paleontological resources is mandated by CEQA. Paleontological resources are also addressed under the Resources Section in the Goals, Policies, and Procedures of the Ventura County General Plan, which state the following:



**Goal 1.** Identify, inventory, preserve and protect the paleontological and cultural resources of Ventura County (including archaeological, historical and Native American resources) for their scientific, educational and cultural value.

**Goal 2.** Enhance cooperation with cities, special districts, other appropriate organizations, and private landowners in acknowledging and preserving the County's paleontological and cultural resources.

**Policy 1.** Discretionary developments shall be assessed for potential paleontological and cultural resource impacts, except when exempt from such requirements by CEQA. Such assessments shall be incorporated into a countywide paleontological and cultural resource database.

**Policy 2.** Discretionary development shall be designed or re-designed to avoid potential impacts to significant paleontological or cultural resources whenever possible. Unavoidable impacts, whenever possible, shall be reduced to a less than significant level and/or shall be mitigated by extracting maximum recoverable data. Determinations of impacts, significance and mitigation shall be made by qualified archaeological (in consultation with recognized local Native American groups), historical or paleontological consultants, depending on the type of resource in question.

**Policy 3.** Mitigation of significant impacts on cultural or paleontological resources shall follow the Guidelines of the State Office of Historic Preservation, the State Native American Heritage Commission, and shall be performed in consultation with professionals in their respective areas of expertise [County of Ventura, 2013:23].

The Project area is located within the City of Oxnard Sphere of Influence; as such, development of the Project is subject to the protection and preservation of paleontological resources as described in the Environmental Resources section of the City of Oxnard General Plan (2009), which states:

**Goal ER-11.** Identification, protection, and enhancement of the City's archaeological, historical, and paleontological resources.

**Goal ER-11.1 Identification of Archaeological Resources.** In the event that archaeological/paleontological resources are discovered during site excavation, continue to require that grading and construction work on the project site is suspended until the significance of the features can be determined by a qualified archaeologist/paleontologist. [City of Oxnard, 2009:5-9].

## **Paleontological Resource Potential**

Absent specific agency guidelines, most professional paleontologists in California adhere to the guidelines set forth by the SVP (2010) to determine the course of paleontological mitigation for a given project. These guidelines establish protocols for the assessment of the paleontological resource potential of underlying geologic units and outline measures to mitigate adverse impacts that could result from project development. Using baseline information gathered during a paleontological resource assessment, the paleontological resource potential of the geologic unit(s) (or members thereof) underlying a Project area can be assigned to one of four categories defined by the SVP (2010). These categories include high, undetermined, low, and no paleontological resource potential.



## Methodology

In order to assess whether a particular project area has the potential to contain significant fossil resources at the subsurface, it is necessary to review published geologic mapping to determine the geology and stratigraphy of the area. Geologic units are considered to be “sensitive” for paleontological resources if they are known to contain significant fossils anywhere in their extent. Therefore, a search of pertinent local and regional museum repositories for paleontological localities within and nearby the project area is necessary to determine whether or not fossil localities have been previously discovered within a particular rock unit. For this Project, a museum records search was conducted at the Los Angeles County Museum of Natural History (LACM) on July 19, 2017.

## Resource Context

The Project area is situated on the Oxnard coastal plain within the Transverse Ranges geomorphic province of California (Norris and Webb, 1976). A geomorphic province is a region of unique topography and geology that is distinguished from other regions based on its landforms and diastrophic history. The Transverse Ranges extend approximately 275 miles west to east from Point Arguello in Santa Barbara County to the Anacapa-Santa Monica Hollywood-Raymond-Cucamonga fault zone and the San Bernardino Mountains (Yerkes and Campbell, 2005). The Transverse Ranges are primarily composed of pre-Cenozoic intrusive igneous and metamorphic bedrock with overlying Cenozoic volcanic, marine, and terrestrial sedimentary deposits. Geographic features of the Transverse Ranges in the vicinity of the Project area include the Santa Susana and Topatopa Mountains and the low-lying Camarillo Hills; the Ventura Basin — a folded and faulted region of thick Cenozoic sediment and petroliferous deposits beneath the Oxnard coastal plain; the Santa Clara River; and the Channel Islands (Keller, 1995; Winterer and Durham, 1962). Specifically, the Project area is located adjacent to the Santa Clara River, which drains the northern Transverse Ranges and flows westward between the Santa Susana and Topatopa Mountains towards the Oxnard coastal plain and out into the Pacific Ocean. Major faults near the Project area include the Oak Ridge thrust and the Simi fault (Southern California Earthquake Data Center, 2017). In general, active uplift and erosion in the Transverse Ranges has produced steep canyons, rugged topography, numerous landslides, and extensive alluvial sedimentation (Morton and Miller, 2006).

According to the California Geological Survey *Geologic Map of the Oxnard 7.5' Quadrangle* (Clahan, 2003), the Project area is directly underlain by Quaternary alluvial deposits of late Holocene age (Qa) (Attachment 1). This unit was generally derived as overbank fluvial material from the nearby Santa Clara River and is composed of unconsolidated, poorly sorted, fine-to medium-grained sand, clay, and fine gravel. The Quaternary alluvial deposits exhibit typical unidirectional flow sedimentary structures, including scour and incised channel features. Local stream terrace deposits are common in the unit. Holocene alluvial deposits such as these are typically too young to contain fossilized material; however, these deposits may be underlain at an unknown depth by older, finer-grained Pleistocene alluvial deposits that may be sensitive for paleontological resources (McLeod, 2017). Similar Pleistocene sedimentary deposits have proven to yield scientifically significant paleontological resources throughout southern California from the coastal areas to the inland valleys (Springer et al., 2009). Near Pierpont Bay, north of the mouth of the Santa Clara River in the City of Ventura, approximately six miles from the Project area, previous excavations yielded fossil specimens of Pleistocene bison, horse, and seal. In



addition, several fossil specimens of mammoth were identified in the vicinity of the Project area near Camarillo (UCMP online database, 2017). These specimens were identified within Pleistocene age marine to nonmarine deposits similar to those that likely underlie the Project area at an unknown depth.

### **Records Search Results**

The LACM reports that there are no previously recorded vertebrate fossil localities in the Project area or in the immediate vicinity from within the Quaternary alluvial deposits. However, LACM museum collections identify at least two vertebrate localities (LACM 3204 and [CIT] 211) that were recorded nearby from within older fine-grained Pleistocene sedimentary deposits. According to McLeod (2017), these Pleistocene sedimentary deposits are likely similar to older deposits that underlie the younger Quaternary alluvial deposits at an unknown depth within the Project area. Locality LACM 3204 was identified southwest of the Project area in Harmon Canyon and yielded a vertebrate fossil specimen of horse (*Equus* sp.), depth of recovery not reported. Locality LACM [CIT] 211 was identified further northwest of the Project area and yielded a specimen of sea duck (*Chendytes lawi*) from Pleistocene marine sedimentary deposits (McLeod, 2017).

### **Findings and Recommendations**

Based on the literature review and museum records search results, the paleontological sensitivity was determined in accordance with the SVP's (2010) sensitivity scale. The Quaternary alluvium mapped at the surface of the Project area is determined to have a low paleontological resource potential because the deposits are likely too young to contain fossilized material. Therefore, impacts to paleontological resources are not anticipated as a result of the Project and further paleontological resource management is not recommended. However, should Project-related ground-disturbing activities extend into buried sensitive Pleistocene age alluvial deposits, then further paleontological resource consultation may be required. In the event an unanticipated fossil discovery is made during the course of Project development, then in accordance with SVP (2010) guidelines, a qualified professional Paleontologist should be retained in order to examine the find and to determine if further paleontological resources mitigation is warranted.

It has been a pleasure assisting you with this Project. If you have any questions, please do not hesitate to me at [hclifford@appliedearthworks.com](mailto:hclifford@appliedearthworks.com) or (626) 578-0119.

Sincerely,

Heather Clifford  
Associate Paleontologist/Geologist  
Applied EarthWorks, Inc.



## References

- City of Oxnard, 2011, Goals and Policies, City of Oxnard 2030 General Plan. Development Services Department Planning Division, September 2011.
- County of Ventura, 2013, Goals, Policies, and Programs, Ventura County General Plan. Last Amended by the Ventura County Board of Supervisors on October 22, 2013.
- Keller, M.A., 1995, Ventura Basin Province (013) *in* D. Gautier, G.L. Dolton, K.I. Takahashi, and K.L. Varnes, eds., National Assessment of United States Oil and Gas Resources—Results, Methodology, and Supporting Data. U.S. Geological Survey Digital Data Series 30.
- McLeod, S. A., 2017, Unpublished museum collections fossil locality records for the geographic region of the Rio School District Project, Ventura County, California. Natural History Museum of Los Angeles County.
- Morton, D.M., and Miller, F.K., 2006, Geologic Map of the San Bernardino and Santa Ana 30' x 60' Quadrangles, California. U.S. Geological Survey Open-File Report OF-2006-1217, scale 1:100,000.
- Norris, R. M., and Webb, R. W., 1976, Geology of California. John Wiley & Sons, New York.
- Society of Vertebrate Paleontology (SVP), 2010, Standard Procedures for the Assessment and Mitigation of Adverse Impacts to Paleontological Resources. Society of Vertebrate Paleontology Impact Mitigation Guidelines Revision Committee.
- Southern California Earthquake Data Center (SCEDC), 2017, Historical Earthquakes and Significant Faults in Southern California. U.S. Geological Survey (USGS) and the Southern California Earthquake Center (SCEC), Pasadena, CA, last updated September 6, 2013.
- Springer, K., Scott, E., Sagebiel, J.C., and Murray, L.K., 2009, The Diamond Valley Lake Local Fauna - Late Pleistocene Vertebrates from Inland Southern California, *in* Albright, L.B., III, ed., Papers on Geology, Vertebrate Paleontology, and Biostratigraphy in Honor of Michael O. Woodburne. Museum of Northern Arizona Bulletin 65, Flagstaff, Arizona.
- UCMP online database, 2017, Locality Search, Collections. University of California Museum of Paleontology, Berkeley, CA.
- Winterer, E. L., and D. L. Durham, 1962, Geology of Southeastern Ventura Basin Los Angeles County, California. U.S. Geological Survey Professional Paper 334-H, U.S.
- Yerkes, R. F., and R. H. Campbell, 2005, Preliminary Geologic Map of the Los Angeles 30' x 60' Quadrangle, Southern California. United States Geological Survey, Open-File Report OF-97-254, scale 1:24000.





SCALE 1:24,000

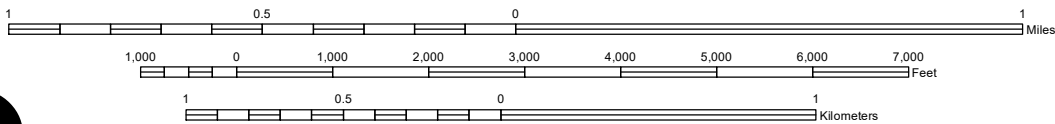

Santa Clara del Norte Landgrant  
 Oxnard (1953-PR1979), CA 7.5' USGS Quadrangle  
 Geology: Clahan (2003)

Attachment 1 - Geologic Units and Paleontological Sensitivity in the Rio Urbana Mixed-Use Project Area

# Appendix F

---

MS4 Compliance and Onsite Drainage Letter



*Delivering excellence through experience*

1672 Donlon Street  
Ventura, CA 93003  
Local 805 654-6977  
Fax 805 654-6979  
www.jdscivil.com

ALD01.5659  
January 10, 2017  
Revised March 25, 2019

City of Oxnard  
Paul Wendt  
305 West Third Street  
Oxnard, CA 93030

**Subject: Rio Urbana Apartments, Vineyard Ave. and Rio School Lane**

Dear Paul:

A 167 unit single family residence is being proposed on the 9.9 acre site located on the corner of Vineyard Ave and Rio School Lane. The site is currently located within the County of Ventura, but will be annexed into the City of Oxnard. Rio School Lane will be annexed as well and made into a private street owned by Pacific Co. With the inclusion of Rio School Lane the proposed site will be 10.5 acres. 1.1 acres of the 10.5 acre site will be dedicated to the Rio School District and both the 1.1 acre lot and 9.4 acre lot will have an infiltration system and drain to the City of Oxnard Storm Drain located in Vineyard Ave. This letter addresses the MS4 stormwater compliance and the onsite drainage.

**Drainage Patterns**

Currently 4.3 acres of the site is open space or lawn that allows runoff to flow overland in a southeast direction. Flow in this area ponds in various low spots throughout the site, while high flows runoff from the site and are eventually captured in the City of Oxnard storm drain located in Vineyard Avenue. The remaining 5.6 acres is paved parking and school buildings. All runoff in this area is directed to the surface opening for the Vineyard Ave Storm Drain through surface flow. Rio School Lane is currently crowned and runs off towards both sides of the street. Runoff on the north side of the street drains northeast towards the adjacent properties and ponds in various locations onsite.

In the developed condition stormwater runoff will be directed to multiple inlets throughout the site that connect to the onsite drainage system. Rio School Lane will drain towards inlets on the south side of the street, while the adjacent properties will continue to drain away from the street. Both the 1.1 acre and 9.4 acre lots will have individual drainage systems, a CDS unit and an infiltration basin. Low flows entering the inlets will be routed through a CDS unit before entering an infiltration basin. High flows that exceed the required volume of infiltration will be routed through the infiltration basin and released to the 54" City of Oxnard storm drain located in Vineyard Ave.

K:\ALD15659\Hydro\Prelim Hydro\DAC Hydro Letter 2019-03-25.doc

ENGINEERS

PLANNERS

SURVEYORS

## **Storm Water Flows**

Storm water flows for the undeveloped condition were calculated using the City of Oxnard Cook's Method. The Cook's method was used on the entire paved area and grass area and a weighted average was used. The calculations, included herein, show the undeveloped runoff per acre to be  $q_{10}= 1.56$  cfs/ac,  $q_{50}= 2.65$  cfs/ac, and  $q_{100}= 3.12$  cfs/ac. The total calculated runoff from the entire project is summarized in the table below.

Area (acres)	Q10 (cfs)	Q50 (cfs)	Q100 (cfs)
10.5	16.4	27.8	32.8

Storm water flows in the developed condition were calculated using the City of Oxnard's Cook's Method for the entire area of the project site. The calculations, included herein, show the developed runoff per acre to be  $q_{10}=2.07$  cfs/ac,  $q_{50}= 3.52$  cfs/ac, and  $q_{100}= 4.14$  cfs/ac. The total calculated runoff from the entire project is summarized in the table below.

Area (acres)	Q10 (cfs)	Q50 (cfs)	Q100 (cfs)
10.5	21.6	36.8	43.3

## **Infiltration**

Since land disturbing activities on this site encompass more than 5,000 square feet of impervious area, the proposed improvements need to comply with the County of Ventura's MS4 stormwater requirements. The overall disturbed area exceeds 50% of the entire site, therefore infiltration is required for the entire project property. Infiltration will be accommodated in the proposed underground basin.

Preliminary sizing for the infiltration aspect of the underground basin has been performed per the County of Ventura Technical Guidance Manual and percolation testing results provided by Workman Engineering. Four percolation tests were performed throughout the site at a depth of 5 feet. To be conservative the lowest rate of 5.14 in/hr was used in our calculations. Using a combined safety factor of 4.5, the design percolation rate was calculated at 1.14 in/hr. With our design percolation rate the max depth of infiltration is 6.85', only 5.5' of infiltration is being used.

Within the residential 9.4 acre lot the minimum infiltration volume is 23,618 CF. Using underground perforated CMP surrounded by crushed rock, 24,900 CF of infiltration is being proposed, 1,282 CF more than the minimum. The proposed excess storage at this stage is to provide room for adjustments during final design, at which point infiltration will not be provided beyond what is required. Pretreatment requirements within the City of Oxnard require the entire infiltration volume and 80% of the 50-micron particle size to be pretreated before infiltration. To achieve these standards a CDS unit sized by Contech is being proposed. Within the 1.1 acre lot that will be dedicated to the Rio School District a minimum of 2,763 CF of infiltration is required.

Similar CMP will be used to achieve an infiltration volume of 2,905 CF, 142 CF more than required. A CDS unit will also be utilized to achieve pretreatment requirements.

Subarea A and B is proposed porous pavement that will capture and treat the runoff from the entrances. Runoff from this area will not be captured in the private system.

### **Detention**

The proposed site will drain to the City of Oxnard 54" storm drain located in Vineyard Ave. As-Builts for the storm drain (1985-022A) show a Q10 capacity of 99 cfs and a "future" Q10 of 25 cfs. The "future" Q10 value is believed to be the current Q10 that resulted from the construction of the Stroube Drain. The runoff that was tributary to this drain prior to the Stroube drain and no longer is tributary, resulted in an excess of capacity for the drain. Due to the capacity, we propose to release the entire Q10 (21.6 cfs) to the City storm drain. The resulting Q10 increase on the site is 5.2 cfs which will result in a Q10 for the public storm drain of roughly 30 cfs. The public storm drain in Vineyard Avenue will still have the capacity for an additional 69 cfs. Due to the available accommodation of the public storm drain, no on-site detention is being proposed.

The FEMA flood map shows the site is not within the at risk flood zone. Finished floor elevations will be set so that they are at least one foot above the Q100 water surface elevation.

The intent of this preliminary study is to show that the design of this project meets the current City of Oxnard requirements. This study will be used as a basis for final design.

Sincerely,  
**Jensen Design & Survey, Inc.**

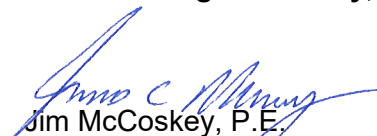
  
James C. McCoskey, P.E.  
Senior Civil Engineer



### **List of Enclosures**

#### **Hydrology**

- Drainage Exhibit
- Cook's Method Calculations

#### **Water Quality/Infiltration**

- SQDV Calculations
- Infiltration Area Calculations
- Percolation Test Results
- CDS – Stormwater Treatment Detail.
- Vineyard Storm Drain As-Builts

# Hydrology



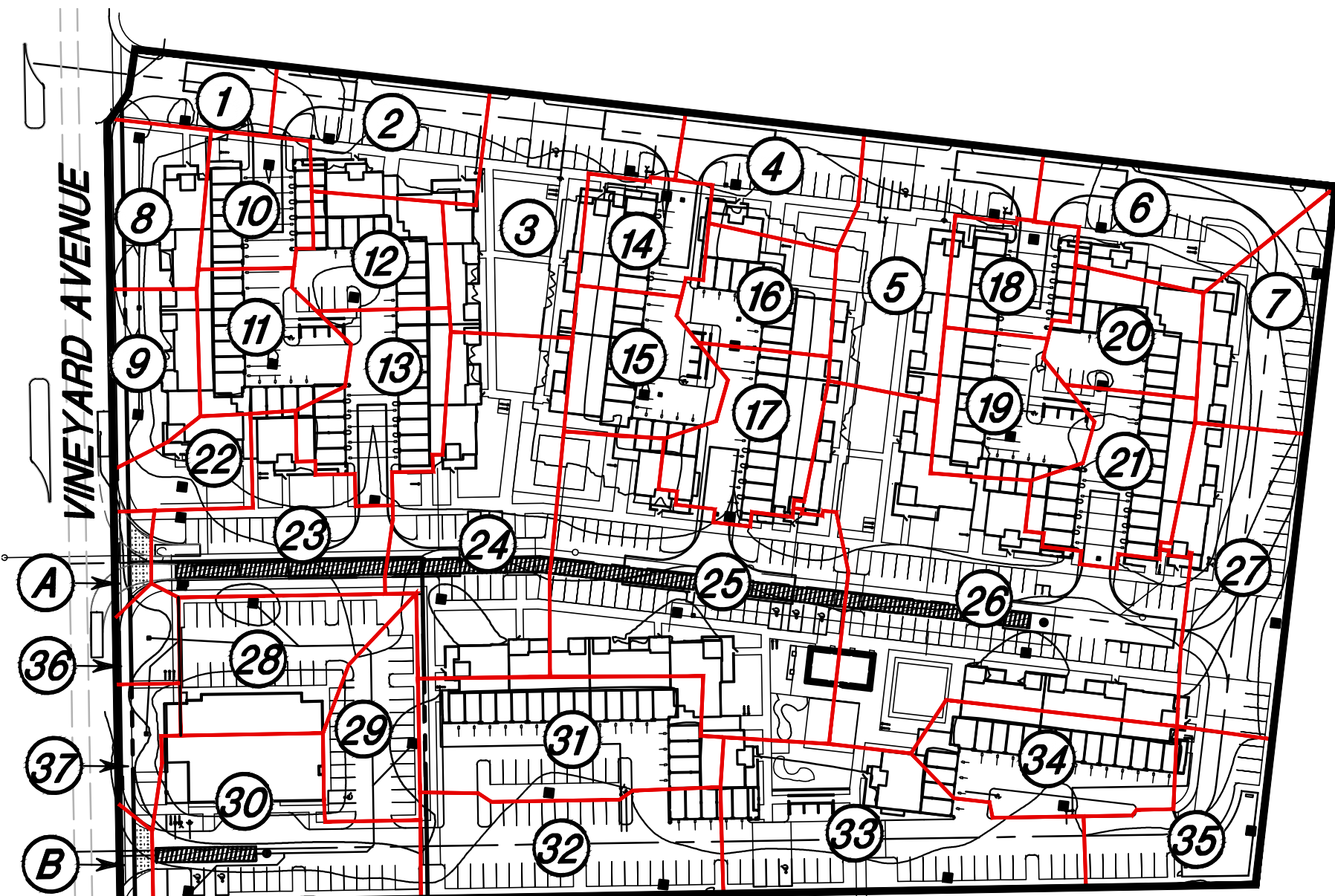

**LEGEND**

- DRAIN INLET
- ① SUB-AREA NUMBER
- ▬ WATERSHED AREA BOUNDARY
- ▬ WATERSHED SUB-AREA BOUNDARY
- PROPOSED CDS UNIT
- ▨ PROPOSED INFILTRATION AREAS

Undeveloped Conditions Storm Water Flows			
Area (acres)	Q10 (cfs)	Q50 (cfs)	Q100 (cfs)
10.5	16.4	27.8	32.8

Developed Conditions Storm Water Flows			
Area (acres)	Q10 (cfs)	Q50 (cfs)	Q100 (cfs)
10.5	21.6	36.8	43.3

q (cfs/ac)	
Q <sub>10</sub>	1.79
Q <sub>50</sub>	3.04
Q <sub>100</sub>	3.58

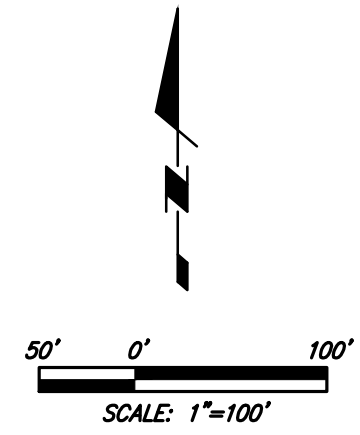

Porous Pavement					
A	1557	0.04	0.07	0.13	0.15
B	1331	0.03	0.06	0.11	0.13
Onsite Drainage					
Subarea	Area (ft)	Area (ac.)	Q <sub>10</sub> (cfs)	Q <sub>50</sub> (cfs)	Q <sub>100</sub> (cfs)
1	5272	0.12	0.25	0.43	0.50
2	11450	0.26	0.54	0.93	1.09
3	17372	0.40	0.83	1.40	1.65
4	9269	0.21	0.44	0.75	0.88
5	16205	0.37	0.77	1.31	1.54
6	12368	0.28	0.59	1.00	1.18
7	10873	0.25	0.52	0.88	1.03
8	8752	0.20	0.42	0.71	0.83
9	7723	0.18	0.37	0.62	0.73
10	6837	0.16	0.32	0.55	0.65
11	8998	0.21	0.43	0.73	0.86
12	7818	0.18	0.37	0.63	0.74
13	10491	0.24	0.50	0.85	1.00
14	6748	0.15	0.32	0.55	0.64
15	9418	0.22	0.45	0.76	0.90
16	7818	0.18	0.37	0.63	0.74
17	10149	0.23	0.48	0.82	0.96
18	6748	0.15	0.32	0.55	0.64
19	9418	0.22	0.45	0.76	0.90
20	7818	0.18	0.37	0.63	0.74
21	10148	0.23	0.48	0.82	0.96
22	5448	0.13	0.26	0.44	0.52
23	13298	0.31	0.63	1.07	1.26
24	23484	0.54	1.12	1.90	2.23
25	31247	0.72	1.48	2.53	2.97
26	41015	0.94	1.95	3.31	3.90
27	16242	0.37	0.77	1.31	1.54
28	13080	0.30	0.62	1.06	1.24
29	9612	0.22	0.46	0.78	0.91
30	16807	0.39	0.80	1.36	1.60
31	16989	0.39	0.81	1.37	1.61
32	14913	0.34	0.71	1.21	1.42
33	21057	0.48	1.00	1.70	2.00
34	11908	0.27	0.57	0.96	1.13
35	9955	0.23	0.47	0.80	0.95
36	2701	0.06	0.13	0.22	0.26
37	3235	0.07	0.15	0.26	0.31
<b>Total</b>	<b>449636.00</b>	<b>10.5</b>	<b>21.6</b>	<b>36.8</b>	<b>43.3</b>



1672 DONLON STREET  
 VENTURA, CALIF. 93003  
 PHONE 805/654-6977  
 FAX 805/654-6979

**MODIFIED COOKS- UNDEVELOPED GRASS AREA**

Project: Admin Job No. 1ADMN.0001.ADM Sheet: 1 of 1  
 Watershed: 5 Designed: Robert Harvey Date: Jan 18,2018  
 Concentration Point: Undeveloped Checked \_\_\_\_\_ Date: \_\_\_\_\_

**Watershed Constants:**

Drainage Area 4.3 Acres  
 Length 455 Feet  
 Width 411.67 Feet  
 Length/Width 1.11  
 Soil Type 5  
 Fall 1 Feet  
 Slope 0.22 %  
 Shape Correction Factor 114.8  
 RI-Correction Factor 123 %

**Computation of "C"**

Type of Development	"C" Factor	Present	Future
Undeveloped	40-45	100%	
Residential	60		0%
Commercial & Industrial	70		0%

Composite "C" Factor (Plate 62 Oxnard Standards)  
 Runoff: Q (from Curve): 2.55 x L/W Factor 1.15 x RI Factor 1.23

Frequency		Frequency Factor	<u>Q</u>		<u>g</u>	
20%	Q <sub>5</sub>	65%	<u>2.34</u>	cfs	<u>0.54</u>	cfs/ac
10%	Q <sub>10</sub>	100%	<u>3.60</u>	cfs	<u>0.84</u>	cfs/ac
4%	Q <sub>25</sub>	135%	<u>4.86</u>	cfs	<u>1.13</u>	cfs/ac
2%	Q <sub>50</sub>	170%	<u>6.12</u>	cfs	<u>1.42</u>	cfs/ac
1%	Q <sub>100</sub>	200%	<u>7.20</u>	cfs	<u>1.67</u>	cfs/ac



**MODIFIED COOKS- UNDEVELOPED PAVED AREA**

Project: Admin Job No. 1ADMN.0001.ADM Sheet: 1 of 1  
 Watershed: 5 Designed: Robert Harvey Date: Jan 18,2018  
 Concentration Point: \_\_\_\_\_ Checked \_\_\_\_\_ Date: \_\_\_\_\_  
**Commercial & Industrial**

**Watershed Constants:**

Drainage Area 6.2 Acres  
 Length 540 Feet  
 Width 500.13 Feet  
 Length/Width 1.08  
 Soil Type 5  
 Fall 1 Feet  
 Slope 0.19 %  
 Shape Correction Factor 114.8  
 RI-Correction Factor 123 %

**Computation of "C"**

<u>Type of Development</u>	<u>"C" Factor</u>	<u>Present</u>	<u>Future</u>
Undeveloped	40-45	100%	
Residential	60		0%
Commercial & Industrial	70		100%

Composite "C" Factor (Plate 62 Oxnard Standards)  
 Runoff: Q (from Curve): 9.07 x L/W Factor 1.15 x RI Factor 1.23

<u>Frequency</u>		<u>Frequency Factor</u>	<u>Q</u>		<u>g</u>	
20%	Q <sub>5</sub>	65%	8.33	cfs	1.34	cfs/ac
10%	Q <sub>10</sub>	100%	12.81	cfs	2.07	cfs/ac
4%	Q <sub>25</sub>	135%	17.29	cfs	2.79	cfs/ac
2%	Q <sub>50</sub>	170%	21.78	cfs	3.51	cfs/ac
1%	Q <sub>100</sub>	200%	25.62	cfs	4.13	cfs/ac

**Weighted Average:**  
 Q10=4.3ac/10.5ac x 0.84 cfs/ac + 6.2ac/10.5ac x 2.07 cfs/ac = 1.56 cfs/ac  
 Q50=4.3ac/10.5ac x 1.42 cfs/ac + 6.2ac/10.5ac x 3.51cfs/ac = 2.65 cfs/ac  
 Q100=4.3ac/10.5ac x 1.67 cfs/ac + 6.2ac/10.5ac x 4.13 cfs/ac = 3.12 cfs/ac

**MODIFIED COOKS- PROPOSED HYDROLOGY CALCULATIONS**

Project: Admin Job No. 1ADMN.0001.ADM Sheet: 1 of 1  
 Watershed: 12 Designed: Robert Harvey Date: Jan 18,2018  
 Concentration Point: \_\_\_\_\_ Checked \_\_\_\_\_ Date: \_\_\_\_\_  
**Commercial & Industrial**

**Watershed Constants:**

Drainage Area 10.5 Acres  
 Length 835 Feet  
 Width 547.76 Feet  
 Length/Width 1.52  
 Soil Type 5

Fall 1 Feet  
 Slope 0.12 %

Shape Correction Factor 112.0  
 RI-Correction Factor 123 %

**Computation of "C"**

<u>Type of Development</u>	<u>"C" Factor</u>	<u>Present</u>	<u>Future</u>
Undeveloped	40-45	100%	
Residential	60		0%
Commercial & Industrial	70		100%

Composite "C" Factor (Plate 62 Oxnard Standards)  
 Runoff: Q (from Curve): 14.11 x L/W Factor 1.12 x RI Factor 1.23

<u>Frequency</u>		<u>Frequency Factor</u>	<u>Q</u>		<u>g</u>	
20%	Q <sub>5</sub>	65%	<u>12.63</u>	cfs	<u>1.20</u>	cfs/ac
10%	Q <sub>10</sub>	100%	<u>19.43</u>	cfs	<u>1.85</u>	cfs/ac
4%	Q <sub>25</sub>	135%	<u>26.23</u>	cfs	<u>2.50</u>	cfs/ac
2%	Q <sub>50</sub>	170%	<u>33.03</u>	cfs	<u>3.15</u>	cfs/ac
1%	Q <sub>100</sub>	200%	<u>38.86</u>	cfs	<u>3.70</u>	cfs/ac



# Water Quality/Infiltration



PROJECT: Rio Urbana

J.N. ALD 01.5659

DESCRIPTION: SQDV Calculations

DATE: 01/22/2018

## Urban Runoff Quality Management

$$P_0 = aC P_6$$

$$a_{48HR} = 1.963$$

$$P_6 = 0.60'' \text{ (per Figure 5.3)}$$

$$C = 0.858 (0.79)^3 - 0.78 (0.79)^2 + 0.774 (0.79) + 0.04$$

$$C = 0.558$$

$$P_0 = (1.963)(0.558)(0.60'') = 0.692''$$

9.4 Acre site:

$$SQDV = 0.692'' \cdot 9.4 \text{ AC} \cdot \frac{1 \text{ ft}}{12 \text{ in}} \cdot \frac{43560 \text{ ft}^2}{1 \text{ AC}}$$

$$SQDV = 23,618 \text{ ft}^3$$

$$\text{Pipe Area} = 41.5 \text{ SF}$$

$$\text{Pipe Length} = \frac{23,618 \text{ ft}^3}{41.5 \text{ ft}^2} = 569 \text{ LF}$$

1.1 Acre site:

$$SQDV = 0.692'' \cdot 1.1 \text{ AC} \cdot \frac{1 \text{ ft}}{12 \text{ in}} \cdot \frac{43,560 \text{ ft}^2}{1 \text{ AC}}$$

$$SQDV = 2,763 \text{ ft}^3$$

$$\text{Pipe Length} = \frac{2,763 \text{ ft}^3}{41.5 \text{ ft}^2} = 67 \text{ LF}$$

**Table 6.4 - Infiltration Facility Safety Factor Determination Worksheet**

Factor Category		Factor Description	Assigned Weight (w)	Factor Value (v)	Product (p) $p = w*v$
A	Suitability Assessment	Soil Assessment Method	0.25	2	0.5
		Predominant Soil texture	0.25	2	0.5
		Soil Variability	0.25	2	0.5
		Depth to groundwater / impervious layer	0.25	2	0.5
		<b>Suitability Assessment Safety Factor <math>S_A =</math></b>			
B	Design	Tributary Area Size	0.25	2	0.5
		Level of pre-treatment / expected sediment loads	0.25	2	0.5
		Redundancy	0.25	3	0.75
		Compaction during construction	0.25	2	0.5
		<b>Design Safety Factor <math>S_B =</math></b>			

**Combined Safety Factor =  $S_A * S_B =$  4.5**

<b>Step 2: Determine the design percolation rate</b>				
2-1	Enter measured soil percolation rate (in/hr) 0.5 in/hr minimum. $P_{measured}$	$P_{measured} =$	5.14	in/hr
2-2	Determine percolation rate correction factor, $S_A$ based on suitability assessment (see Section 6 INF-1, Table 6-2)	$S_A =$	2	
2-3	Determine percolation rate correction factor, $S_B$ based on design (see Section 6 INF-1)	$S_B =$	2.25	
2-4	Calculate Combine safety factor, $S = S_A * S_B$	$S =$	4.5	
2-5	Calculate the design percolation rate (in/hr) $P_{design} = P_{measured}/S$	$P_{design} =$	1.142	in/hr
<b>Step 3: Calculate the surface area</b>				
3-1	Enter required drain time (hours, 72 hours max, t)	t =	72	hr
3-2	Calculate max. depth of runoff that can be infiltrated within the t (ft), $d_{max} = P_{design} * t / 12$	$d_{max} =$	6.853	ft
3-3	For Basins, Select ponding depth $d_p$ such that $d_p \leq d_{max}$	$d_p =$	5.5	ft
3-6	Enter the time to fill infiltration basin with water (use 2 hours for most designs), T	T =	2	hrs
3-7	Calculate Infiltrating surface area for infiltration basin $A_b = SQDV / (TP_{design} / 12 + d_p)$	$A_b =$	485.6	sf

<b>Step 2: Determine the design percolation rate</b>				
2-1	Enter measured soil percolation rate (in/hr) 0.5 in/hr minimum. $P_{measured}$	$P_{measured} =$	5.14	in/hr
2-2	Determine percolation rate correction factor, $S_A$ based on suitability assessment (see Section 6 INF-1, Table 6-2)	$S_A =$	2	
2-3	Determine percolation rate correction factor, $S_B$ based on design (see Section 6 INF-1)	$S_B =$	2.25	
2-4	Calculate Combine safety factor, $S = S_A * S_B$	$S =$	4.5	
2-5	Calculate the design percolation rate (in/hr) $P_{design} = P_{measured}/S$	$P_{design} =$	1.142	in/hr
<b>Step 3: Calculate the surface area</b>				
3-1	Enter required drain time (hours, 72 hours max, t)	$t =$	72	hr
3-2	Calculate max. depth of runoff that can be infiltrated within the t (ft), $d_{max} = P_{design} * t / 12$	$d_{max} =$	6.853	ft
3-3	For Basins, Select ponding depth $d_p$ such that $d_p \leq d_{max}$	$d_p =$	5.5	ft
3-6	Enter the time to fill infiltration basin with water (use 2 hours for most designs), T	$T =$	2	hrs
3-7	Calculate Infiltrating surface area for infiltration basin $A_b = SQDV / (TP_{design} / 12 + d_p)$	$A_b =$	4150.5	sf



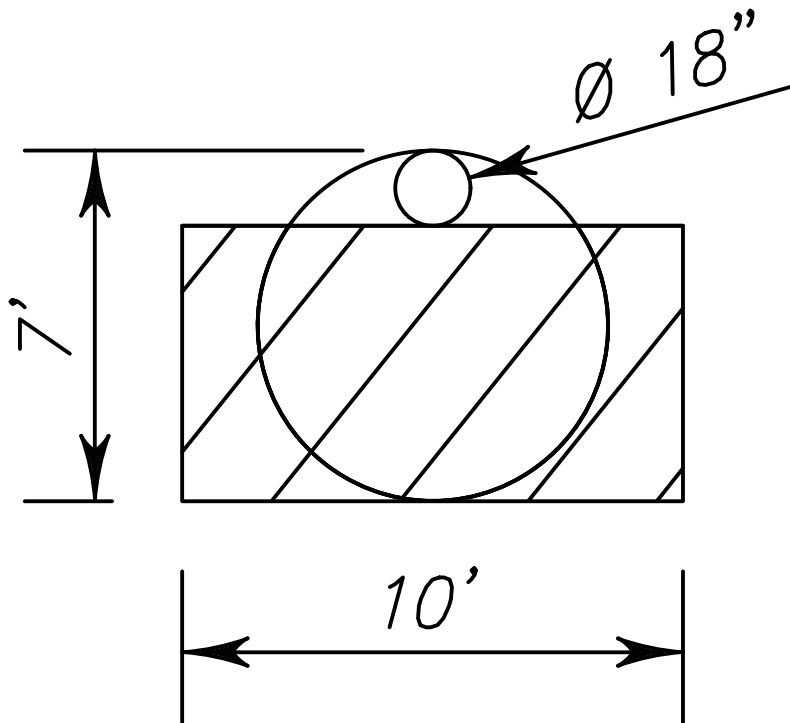

USABLE PIPE AREA= 32.4 SF  
 STONE AREA= 22.6 SF  
 USABLE STONE AREA (40%)= 9.1 SF  
 TOTAL AREA= 41.5 SF  
 MIN. LENGTH OF PIPE= 569.1 FT

 USABLE AREA

41.5 SF \* 600' = 24,900 CF



1672 DONLON STREET  
 VENTURA, CALIF. 93003  
 PHONE 805/654-6977  
 FAX 805/654-6979

**INFILTRATION AREA EXHIBIT**  
**RIO URBANA APARTMENTS**

**SHEET**  
**1 OF 1**  
 Jan 18, 2018



3639 Harbor Boulevard - Suite 116      Ventura, CA 93001      805-302-9381      [markworkmanpe@yahoo.com](mailto:markworkmanpe@yahoo.com)

December 8, 2016  
 Revised: January 11, 2017  
 File No. WE14-080340

**Pacific West Communities**  
 430 E. State Street, Suite 100  
 Eagle, Idaho 83616

**Storm Water Detention Infiltration Test Report**  
 182-Unit Multi-Family Residential and Commercial Development,  
 Proposed Rio Urbana, Vineyard Avenue and Rio School Lane,  
 City of Oxnard.

In accordance with your authorization, we have prepared this infiltration test report for use in determining the absorption rate for design of the storm water detention system for the proposed Rio Urbana residential and commercial development project on the subject property. This report presents the results of our field infiltration testing. Our scope of services included (1) visiting the site to perform field infiltration testing, (2) reviewing the results of the field infiltration testing, and (3) preparing this report to document our efforts and conclusions.

**Field Infiltration Testing**

Field infiltration testing was performed by a representative of this firm on December 7, 2016 to determine the absorption rate of the subsurface soils for design of the proposed storm water detention system. Eight 12 inch by 12 inch wide test pits were excavated at variable depths (see Test Pit Log, Plate 2). The infiltration testing was performed in accordance with MS4 requirements and Appendix C of the Technical Guidance Manual for Stormwater Quality Control Measures. Readings were taken at 30-minute intervals for a period of 4 hours in the test pits. The test results are included below.

Test Pit Number	TP-1	TP-2	TP-3	TP-4	TP-5	TP-6	TP-7	TP-8
Depth (Feet)	1	1	1	1	5	5	5	5
Stabilized Rate (Inches / Hour / Square Foot)	2.35	3.22	4.15	4.15	5.14	11.94	8.53	11.94

**Groundwater**

Groundwater was encountered in the exploratory boring at a depth of 35 feet, and stabilized at 33 feet, below the existing ground surface. Mapping of historically shallowest groundwater included within the Seismic Hazard Zone Report of the Oxnard 7.5-Minute Quadrangle (CGS, 2002) indicates the depth to groundwater is approximately 20 feet below grade.

**Conclusions**

Based on the infiltration tests, a design absorption capacity of 2.35 inch per hour per square foot should be used in evaluation of the absorption capacity of the landscape areas, bio swale area (if any), permeable pavement areas (if any), and a design absorption capacity of 5.14 inches per hour per square foot should be used in evaluation of the absorption capacity of subsurface storm water infiltration systems.

**Remarks**

If you have any questions, or if we may be of any further assistance, please do *not* hesitate to call. Thank you for the opportunity to be of professional service. We look forward to being of continued service.

Respectfully submitted,

**WORKMAN ENGINEERING & CONSULTING**

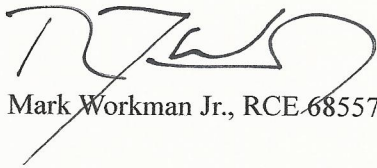

R. Mark Workman Jr., RCE 68557





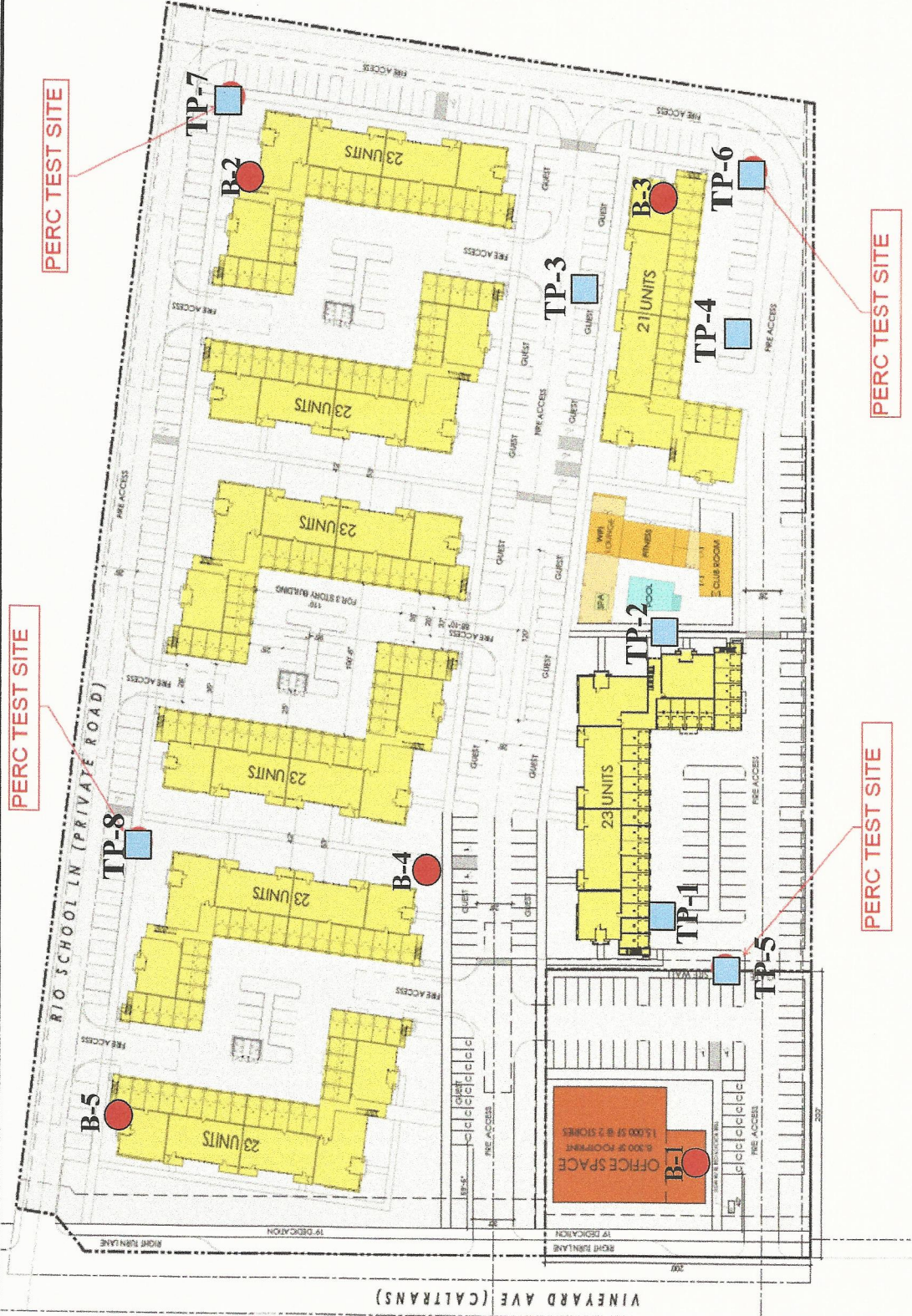

**LEGEND**

- TP-8 Approximate Location of Infiltration Test Pit
- B-5 Approximate Location of Exploratory Boring

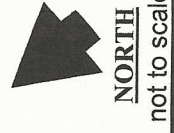

Reference: Base Map Provided by KTYG Architecture and Planning



**Aldersgate**  
El Rio School, Oxnard

FILE NO. WE14-080340

Plate 1

**PLOT PLAN**



PROJECT : Aldersgate Investments, LLC TEST PIT LOG : TP-1 – TP-8

FILE NO : WE14-080340 DATE : 12/7/16

LOCATION : El Rio School, Oxnard LOGGED BY : MW

- 1. Artificial Fill (Af): Light brown fine grained silty sand, well compacted, dry.
- 2. Native Soil (Ns): Light brown fine grained silty sand, locally porous, medium dense, dry.
- 3. Alluvium (Qa): Light brown well graded sand with small cobbles, dense, dry.

SCALE: 1" = 5'

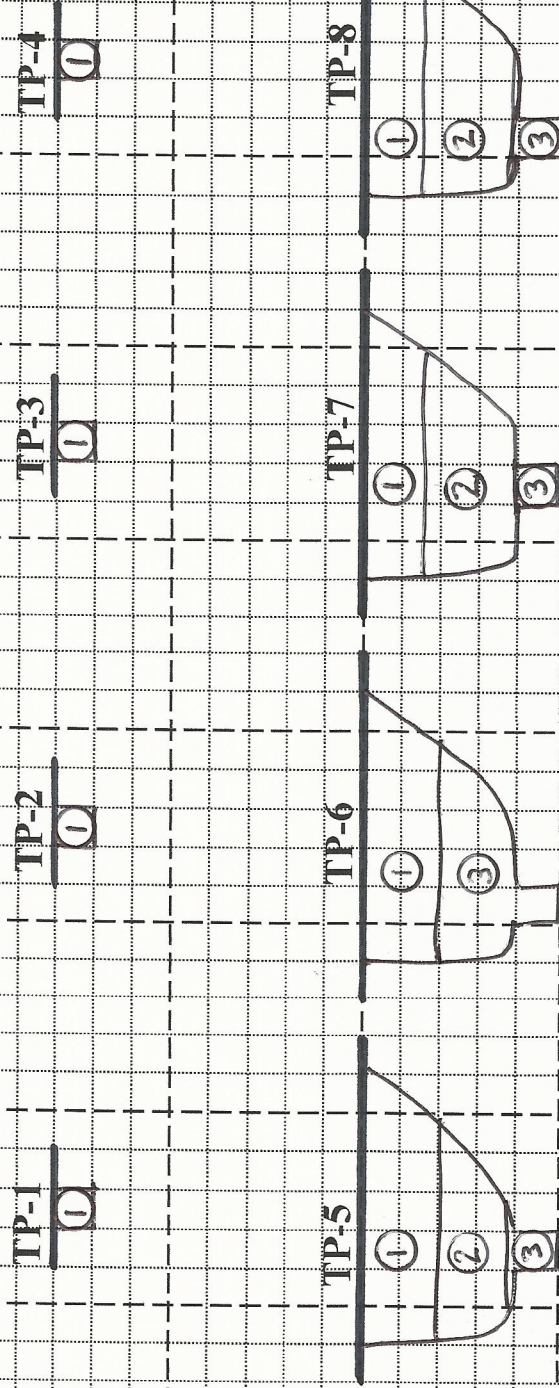

PLATE 2.1



# WORKMAN ENGINEERING & CONSULTING

3639 Harbor Boulevard – Suite 116

Ventura, CA 93001

805.302.9381

markworkmanpe@yahoo.com

## PERFORMANCE TEST DATA WORKSHEET

*TP-1 - TP-8*

**JOB ADDRESS:** El Rio School, Oxnard

**FILE NO.:** WE14-080340

**CLIENT NAME:** Aldersgate

**TEST CONDUCTED BY:** AR

**DATE/TIME PRESATURATED:** 12/6/16

**TEMPERATURE:** Warm

**DATE TESTED:** 12/7/16

**WEATHER CONDITIONS:** Sunny

### TP-1

**Stabilized Rate (in/hr): 6.00**

EXCAVATION DEPTH: 0'

DIAMETER OF TEST HOLE: 12"

TIME INTERVAL: 0:30

TESTED DEPTH: 1.0'

TEST HOLE NO.: TP-1

INITIAL HEIGHT(IN.): 12.00

TIME	TIME INTERVAL	HEIGHT	DROP	PERC RATE	REMARKS
10:25 AM	****	12.000	****	****	INITIAL FILL
10:55 AM	30	8.500	3.500	7.00	
	****	12.000	****	****	REFILL
11:25 AM	30	8.750	3.250	6.50	
	****	12.000	****	****	REFILL
11:55 AM	30	9.000	3.000	6.00	
	****	12.000	****	****	REFILL
12:25 PM	30	9.500	2.500	5.00	
	****	12.000	****	****	REFILL
12:55 PM	30	9.000	3.000	6.00	
	****	12.000	****	****	REFILL
01:25 PM	30	9.000	3.000	6.00	
	****	12.000	****	****	REFILL
01:55 PM	30	9.000	3.000	6.00	

$$R_f = \frac{(2*d_1 - \Delta d)}{13.5} + 1$$

$$R_f = 2.55556$$

Design Infiltration Rate = Measured Percolation Rate / R<sub>f</sub>

$$\text{Design Infiltration Rate} = 2.34783$$



TP-2

**Stabilized Rate (in/hr): 8.00**

EXCAVATION DEPTH: 0'	DIAMETER OF TEST HOLE: 12"	TIME INTERVAL: 0:30
TESTED DEPTH: 1.0'	TEST HOLE NO.: TP-2	INITIAL HEIGHT(IN.): 12.00

TIME	TIME INTERVAL	HEIGHT	DROP	PERC RATE	REMARKS
10:30 AM	****	12.000	****	****	INITIAL FILL
11:00 AM	30	7.000	5.000	10.00	
11:30 AM	30	7.250	4.750	9.50	REFILL
12:00 PM	30	7.500	4.500	9.00	REFILL
12:30 PM	30	7.500	4.500	9.00	REFILL
01:00 PM	30	8.000	4.000	8.00	REFILL
01:30 PM	30	8.000	4.000	8.00	REFILL
02:00 PM	30	8.000	4.000	8.00	REFILL

$$R_f = \frac{(2*d_1 - \Delta d)}{13.5} + 1$$

$$R_f = 2.48148$$

Design Infiltration Rate = Measured Percolation Rate / R<sub>f</sub>

$$\text{Design Infiltration Rate} = 3.22388$$

TP-3

**Stabilized Rate (in/hr): 10.00**

EXCAVATION DEPTH: 0'	DIAMETER OF TEST HOLE: 12"	TIME INTERVAL: 0:30
TESTED DEPTH: 1.0'	TEST HOLE NO.: TP-3	INITIAL HEIGHT(IN.): 12.00

TIME	TIME INTERVAL	HEIGHT	DROP	PERC RATE	REMARKS
10:35 AM	****	12.000	****	****	INITIAL FILL
11:05 AM	30	6.000	6.000	12.00	
	****	12.000	****	****	REFILL
11:35 AM	30	6.000	6.000	12.00	
	****	12.000	****	****	REFILL
12:05 PM	30	6.500	5.500	11.00	
	****	12.000	****	****	REFILL
12:35 PM	30	6.500	5.500	11.00	
	****	12.000	****	****	REFILL
01:05 PM	30	7.000	5.000	10.00	
	****	12.000	****	****	REFILL
01:35 PM	30	7.000	5.000	10.00	
	****	12.000	****	****	REFILL
02:05 PM	30	7.000	5.000	10.00	

$$R_f = \frac{(2*d_1 - \Delta d)}{13.5} + 1$$

$$R_f = 2.40741$$

Design Infiltration Rate = Measured Percolation Rate / R<sub>f</sub>

$$\text{Design Infiltration Rate} = 4.15385$$



TP-4

**Stabilized Rate (in/hr): 10.00**

EXCAVATION DEPTH: 0'	DIAMETER OF TEST HOLE: 12"	TIME INTERVAL: 0:30
TESTED DEPTH: 1.0'	TEST HOLE NO.: TP-4	INITIAL HEIGHT(IN.): 12.00

TIME	TIME		PERC			REMARKS
	INTERVAL	HEIGHT	DROP	RATE		
10:40 AM	****	12.000	****	****		INITIAL FILL
11:10 AM	30	6.000	6.000	12.00		
	****	12.000	****	****		REFILL
11:40 AM	30	6.000	6.000	12.00		
	****	12.000	****	****		REFILL
12:10 PM	30	6.250	5.750	11.50		
	****	12.000	****	****		REFILL
12:40 PM	30	6.250	5.750	11.50		
	****	12.000	****	****		REFILL
01:10 PM	30	7.000	5.000	10.00		
	****	12.000	****	****		REFILL
01:40 PM	30	7.000	5.000	10.00		
	****	12.000	****	****		REFILL
02:10 PM	30	7.000	5.000	10.00		

$$R_f = \frac{(2*d_1 - \Delta d)}{13.5} + 1$$

$$R_f = 2.40741$$

Design Infiltration Rate = Measured Percolation Rate / R<sub>f</sub>

$$\text{Design Infiltration Rate} = 4.15385$$

TP-5

**Stabilized Rate (in/hr): 12.00**

EXCAVATION DEPTH: 4.0'	DIAMETER OF TEST HOLE: 12"	TIME INTERVAL: 0:30
TESTED DEPTH: 5.0'	TEST HOLE NO.: TP-5	INITIAL HEIGHT(IN.): 12.00

TIME	TIME INTERVAL	HEIGHT	DROP	PERC RATE	REMARKS
10:45 AM	****	12.000	****	****	INITIAL FILL
11:15 AM	30	0.000	12.000	24.00	
	****	12.000	****	****	REFILL
11:45 AM	30	4.000	8.000	16.00	
	****	12.000	****	****	REFILL
12:15 PM	30	5.000	7.000	14.00	
	****	12.000	****	****	REFILL
12:45 PM	30	5.500	6.500	13.00	
	****	12.000	****	****	REFILL
01:15 PM	30	6.000	6.000	12.00	
	****	12.000	****	****	REFILL
01:45 PM	30	6.000	6.000	12.00	
	****	12.000	****	****	REFILL
02:15 PM	30	6.000	6.000	12.00	

$$R_f = \frac{(2*d_1 - \Delta d)}{13.5} + 1$$

$$R_f = 2.33333$$

Design Infiltration Rate = Measured Percolation Rate / Rf

$$\text{Design Infiltration Rate} = 5.14286$$

## TP-6

**Stabilized Rate (in/hr): 23.00**

EXCAVATION DEPTH: 4.0'	DIAMETER OF TEST HOLE: 12"	TIME INTERVAL: 0:30
TESTED DEPTH: 5.0'	TEST HOLE NO.: TP-6	INITIAL HEIGHT(IN.): 12.00

TIME	TIME INTERVAL	HEIGHT	DROP	PERC RATE	REMARKS
10:50 AM	****	12.000	****	****	INITIAL FILL
11:20 AM	30	0.000	12.000	24.00	
	****	12.000	****	****	REFILL
11:50 AM	30	0.250	11.750	23.50	
	****	12.000	****	****	REFILL
12:20 PM	30	0.250	11.750	23.50	
	****	12.000	****	****	REFILL
12:50 PM	30	0.500	11.500	23.00	
	****	12.000	****	****	REFILL
01:20 PM	30	0.500	11.500	23.00	
	****	12.000	****	****	REFILL
01:50 PM	30	0.500	11.500	23.00	
	****	12.000	****	****	REFILL
02:20 PM	30	0.500	11.500	23.00	

$$R_f = \frac{(2*d_1 - \Delta d)}{13.5} + 1$$

$$R_f = 1.92593$$

Design Infiltration Rate = Measured Percolation Rate / R<sub>f</sub>

$$\text{Design Infiltration Rate} = 11.9423$$

TP-7

**Stabilized Rate (in/hr): 18.00**

EXCAVATION DEPTH: 4.0'      DIAMETER OF TEST HOLE: 12"      TIME INTERVAL: 0:30  
 TESTED DEPTH: 5.0'      TEST HOLE NO.: TP-7      INITIAL HEIGHT(IN.): 12.00

TIME	TIME INTERVAL	HEIGHT	DROP	PERC RATE	REMARKS
10:55 PM	****	12.000	****	****	INITIAL FILL
11:25 PM	30	0.000	12.000	24.00	
	****	12.000	****	****	REFILL
11:55 PM	30	2.250	9.750	19.50	
	****	12.000	****	****	REFILL
12:25 AM	30	2.500	9.500	19.00	
	****	12.000	****	****	REFILL
12:55 AM	30	2.500	9.500	19.00	
	****	12.000	****	****	REFILL
01:25 AM	30	3.000	9.000	18.00	
	****	12.000	****	****	REFILL
01:55 AM	30	3.000	9.000	18.00	
	****	12.000	****	****	REFILL
02:25 AM	30	3.000	9.000	18.00	

$$R_f = \frac{(2*d_1 - \Delta d)}{13.5} + 1$$

$$R_f = 2.11111$$

Design Infiltration Rate = Measured Percolation Rate / Rf

Design Infiltration Rate = 8.52632



# TP-8

**Stabilized Rate (in/hr): 23.00**

EXCAVATION DEPTH: 4.0'	DIAMETER OF TEST HOLE: 12"	TIME INTERVAL: 0:30
TESTED DEPTH: 5.0'	TEST HOLE NO.: TP-8	INITIAL HEIGHT(IN.): 12.00

TIME	TIME INTERVAL	HEIGHT	DROP	PERC RATE	REMARKS
10:55 PM	****	12.000	****	****	INITIAL FILL
11:25 PM	30	0.000	12.000	24.00	
	****	12.000	****	****	REFILL
11:55 PM	30	0.000	12.000	24.00	
	****	12.000	****	****	REFILL
12:25 AM	30	0.250	11.750	23.50	
	****	12.000	****	****	REFILL
12:55 AM	30	0.250	11.750	23.50	
	****	12.000	****	****	REFILL
01:25 AM	30	0.500	11.500	23.00	
	****	12.000	****	****	REFILL
01:55 AM	30	0.500	11.500	23.00	
	****	12.000	****	****	REFILL
02:25 AM	30	0.500	11.500	23.00	

$$R_f = \frac{(2*d_1 - \Delta d)}{13.5} + 1$$

$$R_f = 1.92593$$

Design Infiltration Rate = Measured Percolation Rate / Rf

$$\text{Design Infiltration Rate} = 11.9423$$

1.1 ACRE SITE CDS UNIT

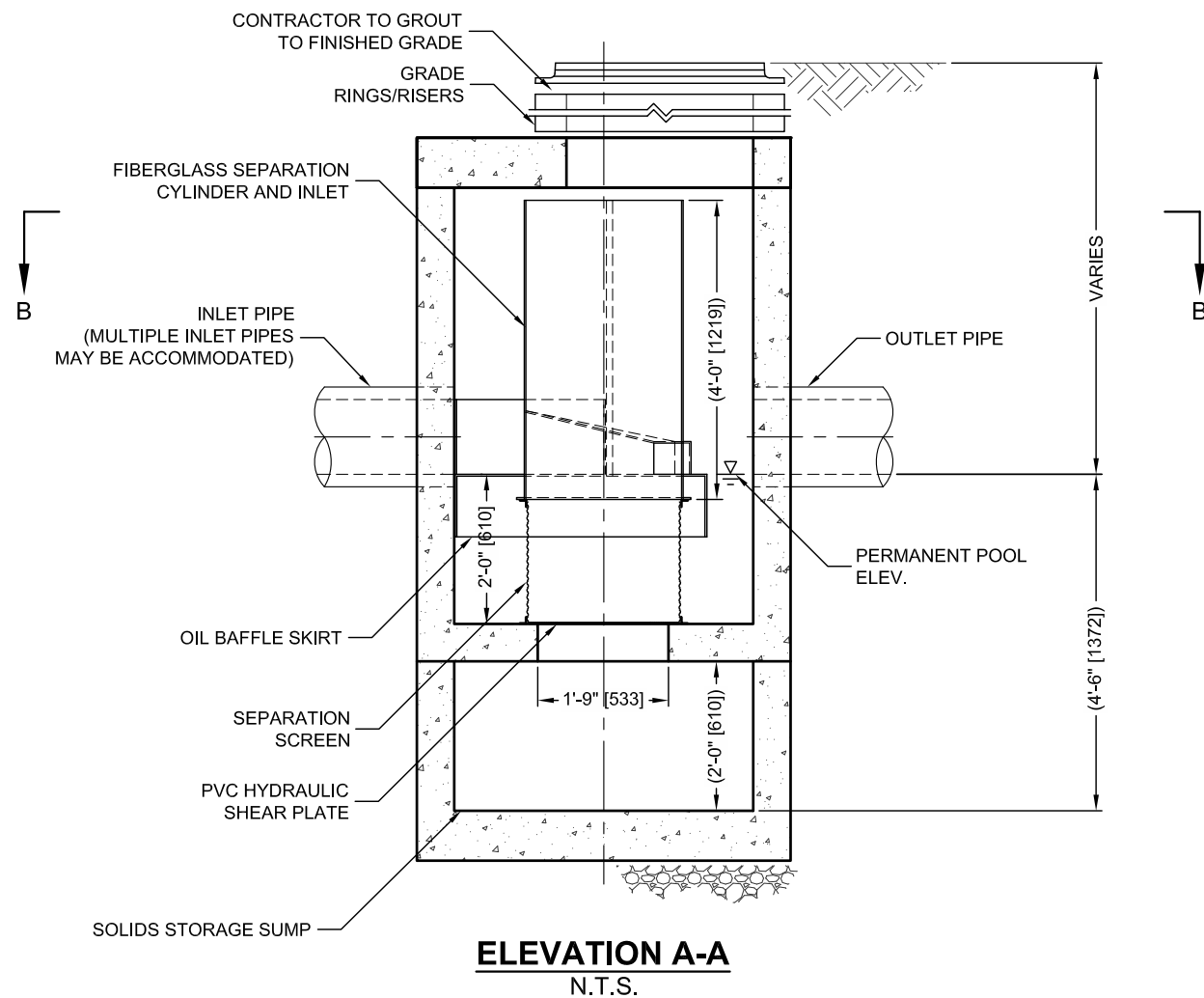
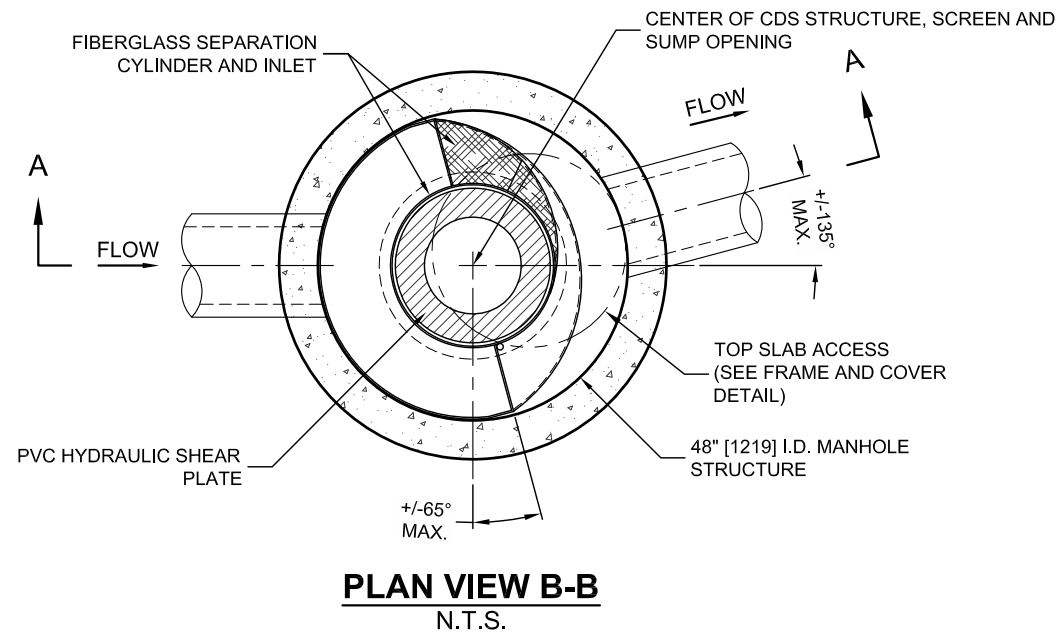

CDS2015-4-C DESIGN NOTES

CDS2015-4-C RATED TREATMENT CAPACITY IS 0.7 CFS [19.8 L/s], OR PER LOCAL REGULATIONS. MAXIMUM HYDRAULIC INTERNAL BYPASS CAPACITY IS 10.0 CFS [283 L/s]. IF THE SITE CONDITIONS EXCEED 10.0 [283 L/s] CFS, AN UPSTREAM BYPASS STRUCTURE IS REQUIRED.

THE STANDARD CDS2015-4-C CONFIGURATION IS SHOWN. ALTERNATE CONFIGURATIONS ARE AVAILABLE AND ARE LISTED BELOW. SOME CONFIGURATIONS MAY BE COMBINED TO SUIT SITE REQUIREMENTS.

**CONFIGURATION DESCRIPTION**

- GRATED INLET ONLY (NO INLET PIPE)
- GRATED INLET WITH INLET PIPE OR PIPES
- CURB INLET ONLY (NO INLET PIPE)
- CURB INLET WITH INLET PIPE OR PIPES
- SEPARATE OIL BAFFLE (SINGLE INLET PIPE REQUIRED FOR THIS CONFIGURATION)
- SEDIMENT WEIR FOR NJDEP / NJCAT CONFORMING UNITS

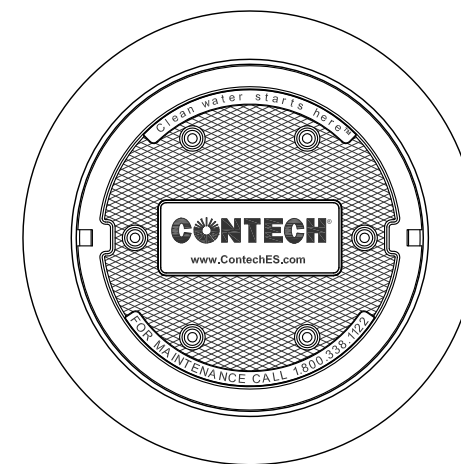

**SITE SPECIFIC DATA REQUIREMENTS**

STRUCTURE ID	
WATER QUALITY FLOW RATE (CFS OR L/s)	*
PEAK FLOW RATE (CFS OR L/s)	*
RETURN PERIOD OF PEAK FLOW (YRS)	*
SCREEN APERTURE (2400 OR 4700)	*
PIPE DATA:	I.E. MATERIAL DIAMETER
INLET PIPE 1	* * *
INLET PIPE 2	* * *
OUTLET PIPE	* * *
RIM ELEVATION	*
ANTI-FLOTATION BALLAST	WIDTH HEIGHT
	* *
NOTES/SPECIAL REQUIREMENTS:	
* PER ENGINEER OF RECORD	

**GENERAL NOTES**

1. CONTECH TO PROVIDE ALL MATERIALS UNLESS NOTED OTHERWISE.
2. DIMENSIONS MARKED WITH ( ) ARE REFERENCE DIMENSIONS. ACTUAL DIMENSIONS MAY VARY.
3. FOR FABRICATION DRAWINGS WITH DETAILED STRUCTURE DIMENSIONS AND WEIGHTS, PLEASE CONTACT YOUR CONTECH ENGINEERED SOLUTIONS LLC REPRESENTATIVE. [www.ContechES.com](http://www.ContechES.com)
4. CDS WATER QUALITY STRUCTURE SHALL BE IN ACCORDANCE WITH ALL DESIGN DATA AND INFORMATION CONTAINED IN THIS DRAWING.
5. STRUCTURE SHALL MEET AASHTO HS20 AND CASTINGS SHALL MEET HS20 (AASHTO M 306) LOAD RATING, ASSUMING GROUNDWATER ELEVATION AT, OR BELOW, THE OUTLET PIPE INVERT ELEVATION. ENGINEER OF RECORD TO CONFIRM ACTUAL GROUNDWATER ELEVATION.
6. PVC HYDRAULIC SHEAR PLATE IS PLACED ON SHELF AT BOTTOM OF SCREEN CYLINDER. REMOVE AND REPLACE AS NECESSARY DURING MAINTENANCE CLEANING.

**INSTALLATION NOTES**

- A. ANY SUB-BASE, BACKFILL DEPTH, AND/OR ANTI-FLOTATION PROVISIONS ARE SITE-SPECIFIC DESIGN CONSIDERATIONS AND SHALL BE SPECIFIED BY ENGINEER OF RECORD.
- B. CONTRACTOR TO PROVIDE EQUIPMENT WITH SUFFICIENT LIFTING AND REACH CAPACITY TO LIFT AND SET THE CDS MANHOLE STRUCTURE (LIFTING CLUTCHES PROVIDED).
- C. CONTRACTOR TO ADD JOINT SEALANT BETWEEN ALL STRUCTURE SECTIONS, AND ASSEMBLE STRUCTURE.
- D. CONTRACTOR TO PROVIDE, INSTALL, AND GROUT PIPES. MATCH PIPE INVERTS WITH ELEVATIONS SHOWN.
- E. CONTRACTOR TO TAKE APPROPRIATE MEASURES TO ASSURE UNIT IS WATER TIGHT, HOLDING WATER TO FLOWLINE INVERT MINIMUM. IT IS SUGGESTED THAT ALL JOINTS BELOW PIPE INVERTS ARE GROUTED.

I:\STORMWATER\COMMOFS\22 CDS40 STANDARD DRAWINGS\INLINE (CDS-C)\DWG\CDS2015-4-C-DTL.DWG 5/13/2014 5:52 PM



THIS PRODUCT MAY BE PROTECTED BY ONE OR MORE OF THE FOLLOWING U.S. PATENTS: 6,788,040; 6,841,720; 6,911,585; 6,981,762. RELATED FOREIGN PATENTS, OR OTHER PATENTS PENDING.



[www.ContechES.com](http://www.ContechES.com)  
9025 Centre Pointe Dr., Suite 400, West Chester, OH 45069  
800-338-1122 513-645-7000 513-645-7993 FAX

CDS2015-4-C  
INLINE CDS  
STANDARD DETAIL



**CDS ESTIMATED NET ANNUAL SOLIDS LOAD REDUCTION  
 BASED ON THE RATIONAL RAINFALL METHOD  
 BASED ON AN AVERAGE PARTICLE SIZE OF 50 MICRONS  
 Vineyard Avenue and Rio School Lane - Site 1  
 Oxnard, CA**

Area	<b>1.1</b>	acres	Rainfall Station #	<b>23</b>	
Weighted C	<b>0.89</b>		(select from Rainfall Data column D)		
Tc	<b>5</b>	minutes	Particle size	<b>50</b>	microns
CDS Model	<b>2015-4</b>	(select from pulldown)	CDS Treatment Capacity	0.7	cfs
Diameter			CDS Hydraulic Capacity	10.0	cfs

<u>Rainfall Intensity<sup>1</sup></u> (in/hr)	<u>Percent Rainfall Volume<sup>1</sup></u>	<u>Cumulative Rainfall Volume</u>	<u>Total Flowrate (cfs)</u>	<u>Treated Flowrate (cfs)</u>	<u>Operating Rate (%)</u>	<u>Removal Efficiency (%)</u>	<u>Incremental Removal (%)</u>
0.04	9.9%	9.9%	0.04	0.04	5.59	95.3	9.4
0.08	19.8%	29.7%	0.08	0.08	11.19	93.4	18.5
0.12	14.0%	43.7%	0.12	0.12	16.78	91.5	12.8
0.16	10.1%	53.9%	0.16	0.16	22.38	89.6	9.1
0.20	7.8%	61.7%	0.20	0.20	27.97	87.7	6.9
0.24	6.4%	68.1%	0.23	0.23	33.57	85.8	5.5
0.28	5.6%	73.6%	0.27	0.27	39.16	83.9	4.7
0.32	4.1%	77.8%	0.31	0.31	44.75	82.0	3.4
0.36	3.6%	81.4%	0.35	0.35	50.35	80.1	2.9
0.40	2.9%	84.3%	0.39	0.39	55.94	78.2	2.3
0.44	2.5%	86.8%	0.43	0.43	61.54	76.3	1.9
0.48	1.7%	88.5%	0.47	0.47	67.13	74.4	1.3
0.52	2.1%	90.6%	0.51	0.51	72.73	72.4	1.5
0.56	1.4%	92.0%	0.55	0.55	78.32	70.5	1.0
0.60	0.6%	92.6%	0.59	0.59	83.91	68.6	0.4
0.64	0.1%	92.7%	0.63	0.63	89.51	66.7	0.1
0.68	0.9%	93.7%	0.67	0.67	95.10	64.8	0.6
0.72	0.3%	94.0%	0.70	0.70	100.00	63.2	0.2
0.76	0.9%	94.9%	0.74	0.70	100.00	63.2	0.5
0.80	0.6%	95.5%	0.78	0.70	100.00	63.2	0.4

84.5

Removal Efficiency Adjustment<sup>2</sup> = 0.0%

Predicted % Annual Rainfall Treated = 97.3%

**Predicted Net Annual Load Removal Efficiency = 84.5%**

1 - Based on 10 years of 15-minute rainfall data from NCDC Station 9666 in Los Angeles County, CA

2 - Reduction due to use of 60-minute data for a site that has a time of concentration less than 30-minutes.

9.4 ACRE CDS UNIT

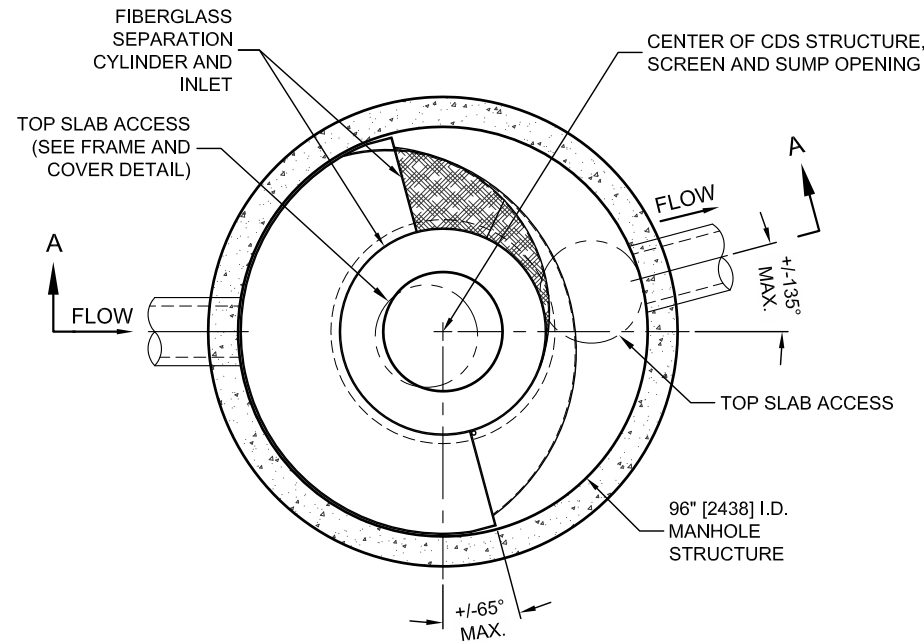

**PLAN VIEW B-B**  
N.T.S.

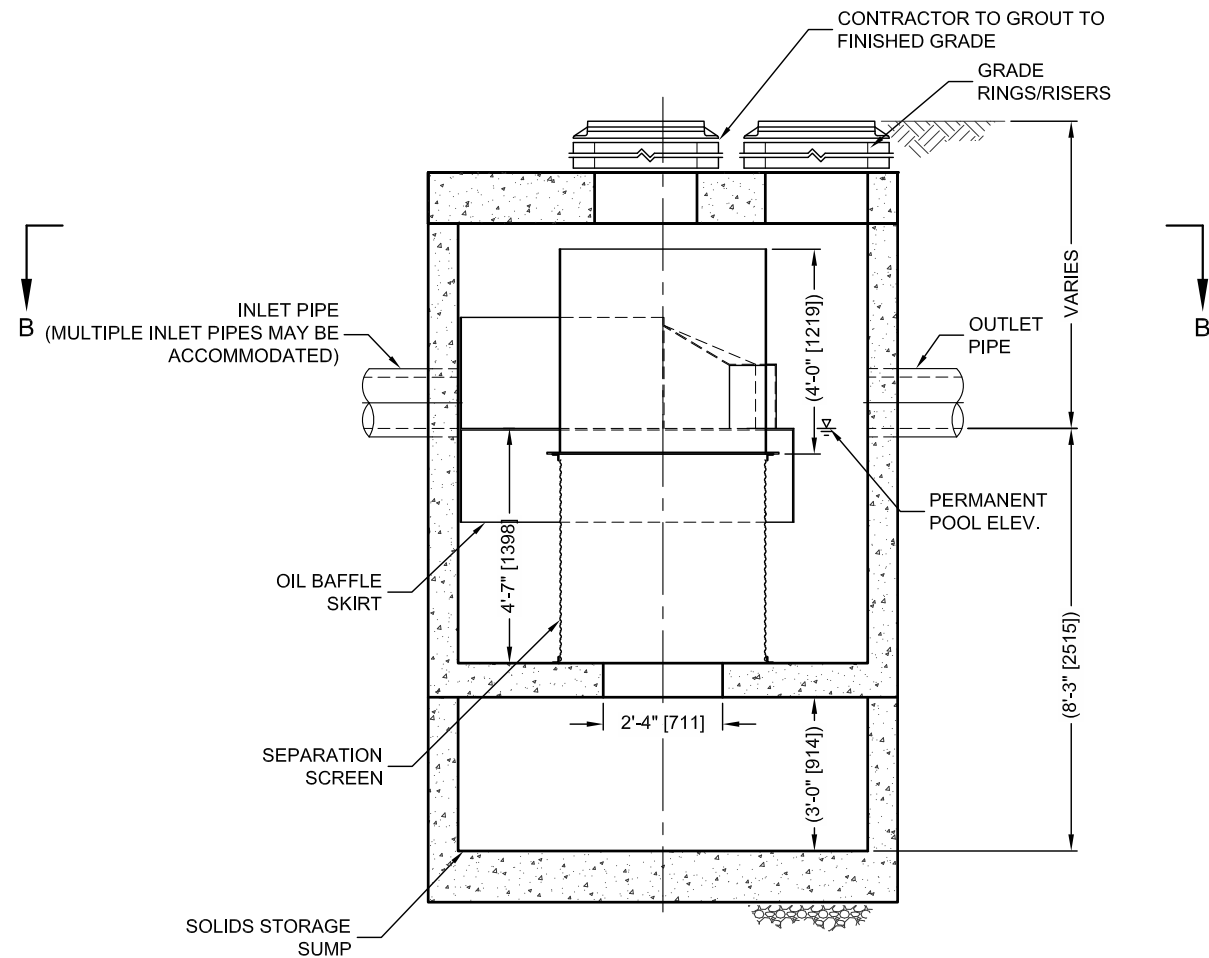

**ELEVATION A-A**  
N.T.S.



THIS PRODUCT MAY BE PROTECTED BY ONE OR MORE OF THE FOLLOWING U.S. PATENTS: 6,788,848; 6,841,722; 6,911,565; 6,981,762. RELATED FOREIGN PATENTS, OR OTHER PATENTS PENDING.

CDS4040-8-C DESIGN NOTES

CDS4040-8-C RATED TREATMENT CAPACITY IS 6.0 CFS [169.9 L/s], OR PER LOCAL REGULATIONS. MAXIMUM HYDRAULIC INTERNAL BYPASS CAPACITY IS 30.0 CFS [850 L/s]. IF THE SITE CONDITIONS EXCEED 30.0 CFS [850 L/s], AN UPSTREAM BYPASS STRUCTURE IS REQUIRED.

THE STANDARD CDS4040-8-C CONFIGURATION IS SHOWN. ALTERNATE CONFIGURATIONS ARE AVAILABLE AND ARE LISTED BELOW. SOME CONFIGURATIONS MAY BE COMBINED TO SUIT SITE REQUIREMENTS.

**CONFIGURATION DESCRIPTION**

- GRATED INLET ONLY (NO INLET PIPE)
- GRATED INLET WITH INLET PIPE OR PIPES
- CURB INLET ONLY (NO INLET PIPE)
- CURB INLET WITH INLET PIPE OR PIPES
- SEPARATE OIL BAFFLE (SINGLE INLET PIPE REQUIRED FOR THIS CONFIGURATION)
- SEDIMENT WEIR FOR NJDEP / NJCAT CONFORMING UNITS

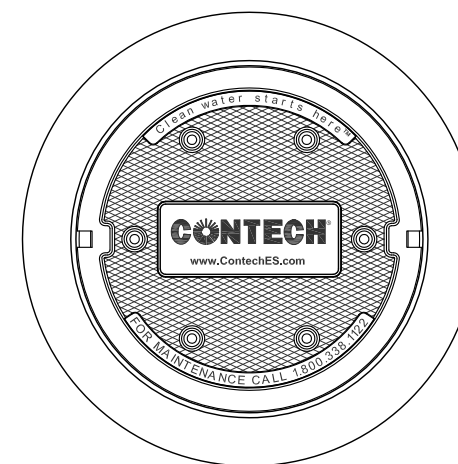

**FRAME AND COVER**  
(DIAMETER VARIES)  
N.T.S.

**SITE SPECIFIC DATA REQUIREMENTS**

STRUCTURE ID				
WATER QUALITY FLOW RATE (CFS OR L/s)				*
PEAK FLOW RATE (CFS OR L/s)				*
RETURN PERIOD OF PEAK FLOW (YRS)				*
SCREEN APERTURE (2400 OR 4700)				*
PIPE DATA:	I.E.	MATERIAL	DIAMETER	
INLET PIPE 1	*	*	*	
INLET PIPE 2	*	*	*	
OUTLET PIPE	*	*	*	
RIM ELEVATION				*
ANTI-FLOTATION BALLAST	WIDTH	HEIGHT		
	*	*		
NOTES/SPECIAL REQUIREMENTS:				
* PER ENGINEER OF RECORD				

**GENERAL NOTES**

1. CONTECH TO PROVIDE ALL MATERIALS UNLESS NOTED OTHERWISE.
2. DIMENSIONS MARKED WITH ( ) ARE REFERENCE DIMENSIONS. ACTUAL DIMENSIONS MAY VARY.
3. FOR FABRICATION DRAWINGS WITH DETAILED STRUCTURE DIMENSIONS AND WEIGHTS, PLEASE CONTACT YOUR CONTECH ENGINEERED SOLUTIONS LLC REPRESENTATIVE. www.ContechES.com
4. CDS WATER QUALITY STRUCTURE SHALL BE IN ACCORDANCE WITH ALL DESIGN DATA AND INFORMATION CONTAINED IN THIS DRAWING.
5. STRUCTURE SHALL MEET AASHTO HS20 AND CASTINGS SHALL MEET HS20 (AASHTO M 306) LOAD RATING, ASSUMING GROUNDWATER ELEVATION AT, OR BELOW, THE OUTLET PIPE INVERT ELEVATION. ENGINEER OF RECORD TO CONFIRM ACTUAL GROUNDWATER ELEVATION.
6. PVC HYDRAULIC SHEAR PLATE IS PLACED ON SHELF AT BOTTOM OF SCREEN CYLINDER. REMOVE AND REPLACE AS NECESSARY DURING MAINTENANCE CLEANING.

**INSTALLATION NOTES**

- A. ANY SUB-BASE, BACKFILL DEPTH, AND/OR ANTI-FLOTATION PROVISIONS ARE SITE-SPECIFIC DESIGN CONSIDERATIONS AND SHALL BE SPECIFIED BY ENGINEER OF RECORD.
- B. CONTRACTOR TO PROVIDE EQUIPMENT WITH SUFFICIENT LIFTING AND REACH CAPACITY TO LIFT AND SET THE CDS MANHOLE STRUCTURE (LIFTING CLUTCHES PROVIDED).
- C. CONTRACTOR TO ADD JOINT SEALANT BETWEEN ALL STRUCTURE SECTIONS, AND ASSEMBLE STRUCTURE.
- D. CONTRACTOR TO PROVIDE, INSTALL, AND GROUT PIPES. MATCH PIPE INVERTS WITH ELEVATIONS SHOWN.
- E. CONTRACTOR TO TAKE APPROPRIATE MEASURES TO ASSURE UNIT IS WATER TIGHT, HOLDING WATER TO FLOWLINE INVERT MINIMUM. IT IS SUGGESTED THAT ALL JOINTS BELOW PIPE INVERTS ARE GROUTED.



www.ContechES.com  
9025 Centre Pointe Dr., Suite 400, West Chester, OH 45069  
800-338-1122 513-645-7000 513-645-7993 FAX

CDS4040-8-C  
INLINE CDS  
STANDARD DETAIL





**CDS ESTIMATED NET ANNUAL SOLIDS LOAD REDUCTION  
 BASED ON THE RATIONAL RAINFALL METHOD  
 BASED ON AN AVERAGE PARTICLE SIZE OF 50 MICRONS  
 Vineyard Avenue and Rio School Lane - Site 2  
 Oxnard, CA**

Area	<b>9.4</b>	acres	Rainfall Station #	<b>23</b>	
Weighted C	<b>0.89</b>		(select from Rainfall Data column D)		
Tc	<b>5</b>	minutes	Particle size	<b>50</b>	microns
CDS Model	<b>4040</b>	(select from pulldown)	CDS Treatment Capacity	6.0	cfs
Diameter			CDS Hydraulic Capacity	30.0	cfs

<u>Rainfall Intensity<sup>1</sup></u> (in/hr)	<u>Percent Rainfall Volume<sup>1</sup></u>	<u>Cumulative Rainfall Volume</u>	<u>Total Flowrate (cfs)</u>	<u>Treated Flowrate (cfs)</u>	<u>Operating Rate (%)</u>	<u>Removal Efficiency (%)</u>	<u>Incremental Removal (%)</u>
0.04	9.9%	9.9%	0.31	0.31	5.22	95.4	9.4
0.08	19.8%	29.7%	0.63	0.63	10.44	93.7	18.6
0.12	14.0%	43.7%	0.94	0.94	15.66	91.9	12.9
0.16	10.1%	53.9%	1.25	1.25	20.89	90.1	9.1
0.20	7.8%	61.7%	1.57	1.57	26.11	88.3	6.9
0.24	6.4%	68.1%	1.88	1.88	31.33	86.5	5.5
0.28	5.6%	73.6%	2.19	2.19	36.55	84.8	4.7
0.32	4.1%	77.8%	2.51	2.51	41.77	83.0	3.4
0.36	3.6%	81.4%	2.82	2.82	46.99	81.2	2.9
0.40	2.9%	84.3%	3.13	3.13	52.21	79.4	2.3
0.44	2.5%	86.8%	3.45	3.45	57.43	77.7	1.9
0.48	1.7%	88.5%	3.76	3.76	62.66	75.9	1.3
0.52	2.1%	90.6%	4.07	4.07	67.88	74.1	1.5
0.56	1.4%	92.0%	4.39	4.39	73.10	72.3	1.0
0.60	0.6%	92.6%	4.70	4.70	78.32	70.5	0.4
0.64	0.1%	92.7%	5.01	5.01	83.54	68.8	0.1
0.68	0.9%	93.7%	5.33	5.33	88.76	67.0	0.6
0.72	0.3%	94.0%	5.64	5.64	93.98	65.2	0.2
0.76	0.9%	94.9%	5.95	5.95	99.21	63.4	0.6
0.80	0.6%	95.5%	6.27	6.00	100.00	63.2	0.4

85.2

Removal Efficiency Adjustment<sup>2</sup> = 0.0%

Predicted % Annual Rainfall Treated = 97.5%

**Predicted Net Annual Load Removal Efficiency = 85.2%**

1 - Based on 10 years of 15-minute rainfall data from NCDC Station 9666 in Los Angeles County, CA

2 - Reduction due to use of 60-minute data for a site that has a time of concentration less than 30-minutes.

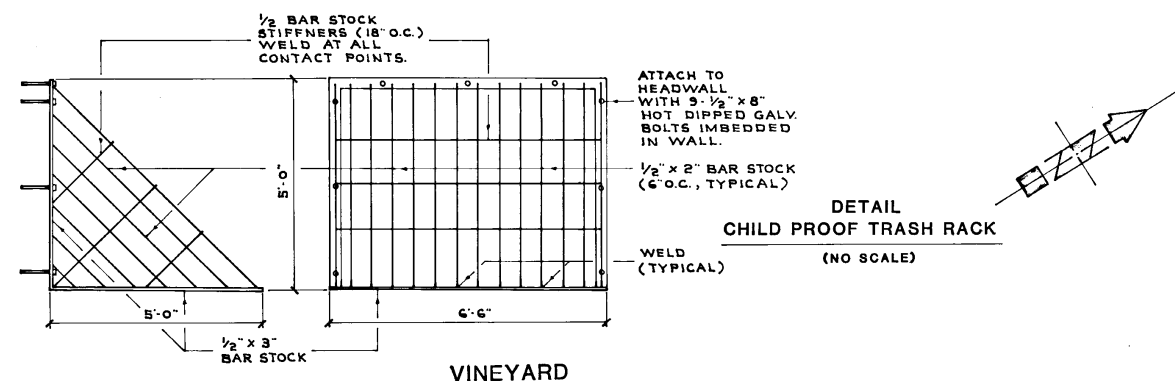
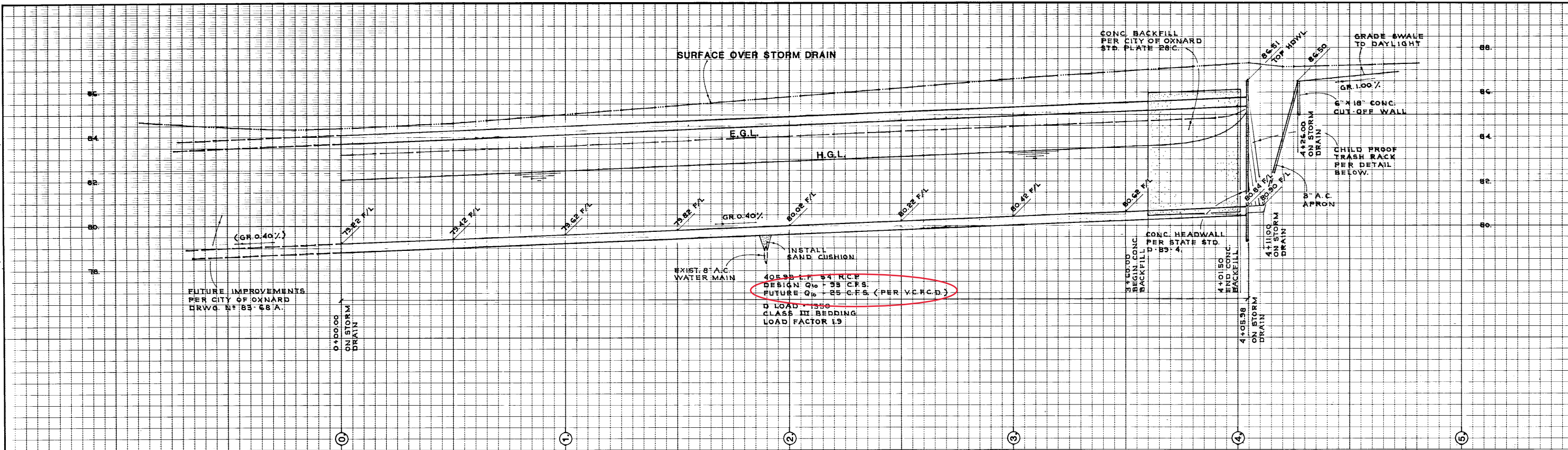

MYRTLE STREET  
VENTURA & BOULEVARD  
(FRONTAGE ROAD)

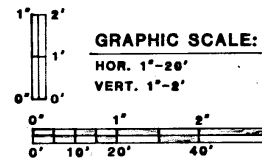
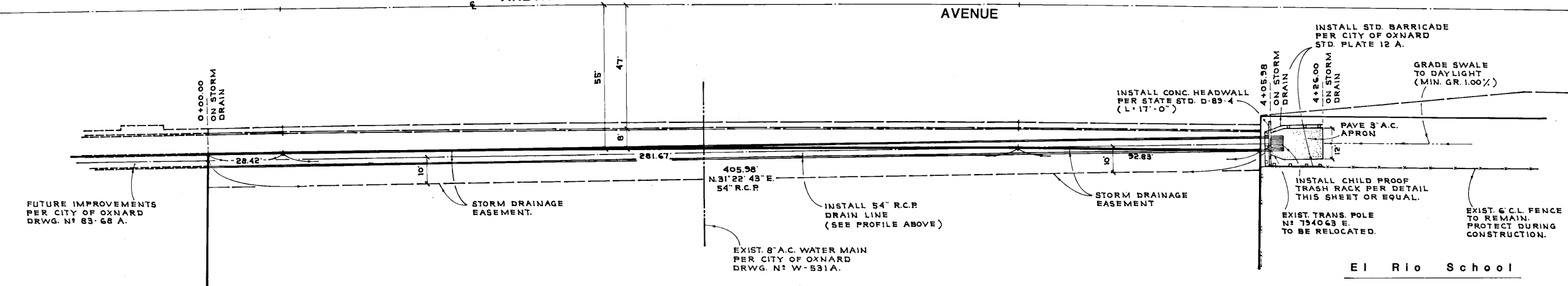

THESE PLANS HAVE BEEN REVIEWED FOR POSSIBLE CONSTRUCTION CONFLICTS:

UTILITY CO.	SIGNATURE	TITLE	DATE
SO. CAL. GAS	<i>[Signature]</i>	Service Planner	4-24-85
EDISON	<i>[Signature]</i>	ENR. SUPERVISOR	4-24-85
CABLE T.V.	<i>[Signature]</i>	CONSTR. COORDINATOR	4-22-85

CAL-TRANS ENCROACHMENT PERMIT NO. \_\_\_\_\_

PREPARED BY:  
**Robert Martin & Associates**  
ENGINEERS & SURVEYORS  
VENTURA, CALIFORNIA  
*[Signature]*  
ROBERT E. MARTIN R.C.E. 11822 DATES

REVISIONS			CITY OF OXNARD, CALIFORNIA DEPARTMENT OF PUBLIC WORKS	
MARK	DATE	DESCRIPTION	BY	

P.D. NO. 417  
PARCEL MAP NO. 85-2  
STORM DRAIN PLAN & PROFILE  
VINEYARD AVENUE

APPROVED BY: *[Signature]* ASSIST. PUBLIC WORKS DIR. R.C.E. 1955A DATE: 4-25-85

APPROVAL RECOMMENDED BY: *[Signature]* DATE: 4-25-85

SCALE: HORIZ. 1"=20' VERT. 1"=2'

DRAWN BY: B. W. CHECKED BY: *[Signature]* DATE: 4-25-85

SHEET NO. 2 OF 4  
DRAWING NUMBER 85-22A

# Appendix G

---

Noise Study

**Noise Study**  
**for the**  
**Rio Urbana Project**

**Prepared for**

The Pacific West Communities  
430 E. State Street, Suite 100  
Eagle, Idaho 83616

**Prepared by**

Meridian Consultants LLC  
910 Hampshire Road, Suite V  
Westlake Village, CA 91361

**August 2017**

# Table of Contents

Section	Page
1. Executive Summary.....	1
2. Introduction .....	2
3. Noise Descriptors.....	5
4. Methodology.....	10
5. Noise Standards .....	13
6. Existing Conditions.....	16
7. Noise Analysis .....	21
8. General Plan Consistency.....	30
9. Cumulative Noise Analysis.....	31
10. Recommendations .....	36

## Appendices

- A Noise Monitoring Data Sheets
- B Roadway Traffic Noise Spreadsheets
- C Construction Noise Data Spreadsheets

## Figures

Figure		Page
1	Regional Location Map .....	3
2	Project Site Aerial.....	4
3	Common Noise Levels.....	8
4	Noise Attenuation by Barriers .....	9
5	Noise Monitoring Locations.....	12
6	Land Use Compatibility to Noise.....	14

## Tables

Table		Page
1	Noise Descriptors .....	6
2	Significance of Changes in Operational Roadway Noise Exposure.....	13
3	Exterior Noise Standards .....	16
4	Ambient Noise Measurements .....	17
5	Existing Roadway Noise Levels .....	18
6	Typical Maximum Noise Levels for Construction Equipment.....	22
7	Construction Noise Estimates.....	23
8	Construction Vibration Levels Estimates .....	25
9	Existing plus Project .....	26
10	City of Oxnard 2030 General Plan Applicable Goals and Policies .....	30
11	Cumulative plus Project .....	32

## 1. EXECUTIVE SUMMARY

This Noise Study assesses and discusses the potential noise and vibration impacts that may occur with the implementation of the Rio Urbana Project (“Project”), located in Oxnard, California. The analysis describes the existing environment in the Project area, estimates future noise and vibration levels at surrounding land uses resulting from construction and operation of the Project, and identified the potential for significant impacts. An evaluation of the Project’s contribution to potential cumulative noise impacts is also provided. The study summarizes the potential for the Project to conflict with applicable noise and vibration regulations, standards, and thresholds. The findings of the analyses are as follows:

- Construction activities would potentially result in short-term and temporary noise impacts to nearby noise-sensitive receptors due to on-site construction equipment and activities. Implementation of noise attenuation techniques and placement of the construction-staging area and earthmoving equipment away from noise-sensitive sites would lower construction noise levels.
- Construction of the Project would generate sporadic, temporary vibration effects adjacent to the Project area but would not be expected to exceed the significance thresholds.
- Operation of the Project would generate noise from Project-related traffic or from on-site sources (parking structure, loading dock area, refuse collection area, mechanical equipment) that would not exceed the significance thresholds.
- Noise associated with cumulative construction activities would be reduced to the degree reasonably and technically feasible through proposed mitigation measures for each individual project and compliance with locally adopted and enforced noise ordinances. Given that construction activities would be required to comply with the City’s allowable hours and would be temporary, construction-related noise would not be significant.
- Noise associated with cumulative operational sources would not be significant.
- Due to the rapid attenuation characteristics of ground-borne vibration and distance of the cumulative projects to the Project site, no potential exists for cumulative construction- or operational-period impacts with respect to ground-borne vibration.

## 2. INTRODUCTION

The purpose of this noise report is to assess and discuss the impact of potential noise impacts that may occur with the implementation of the Rio Urbana Project (“Project”), located in Oxnard, California. The regional location of the proposed Project is depicted in **Figure 1, Regional Location Map**. The noise report analyzes short-term noise and ground-borne vibration impacts associated with the Project. The report also discusses the applicable, federal, State, and local noise and vibration regulations; the applicable noise and vibration thresholds; the methodology used to analyze potential noise and vibration impacts; and the modeled roadway noise.

### Project Description

The Project site consists of approximately 10.24 acres of developed land with numerous vacant buildings (cafeteria, administration, classrooms, and two portable buildings) that was formerly the El Rio Elementary School campus. The school has been closed since 2008 and is currently utilized as a dispatch for school buses and storage. The proposed Project would include demolition of the existing uses to allow the construction of a new mixed-use development that includes 182 condominium residential units and a 15,000-square-foot office building containing the Rio School District Administrative offices.

The surrounding environment includes residential development to the north and west, commercial development to the south, and general commercial uses to the east. Regional access to the Project site is provided by Highway US 101 (US 101) to the south.



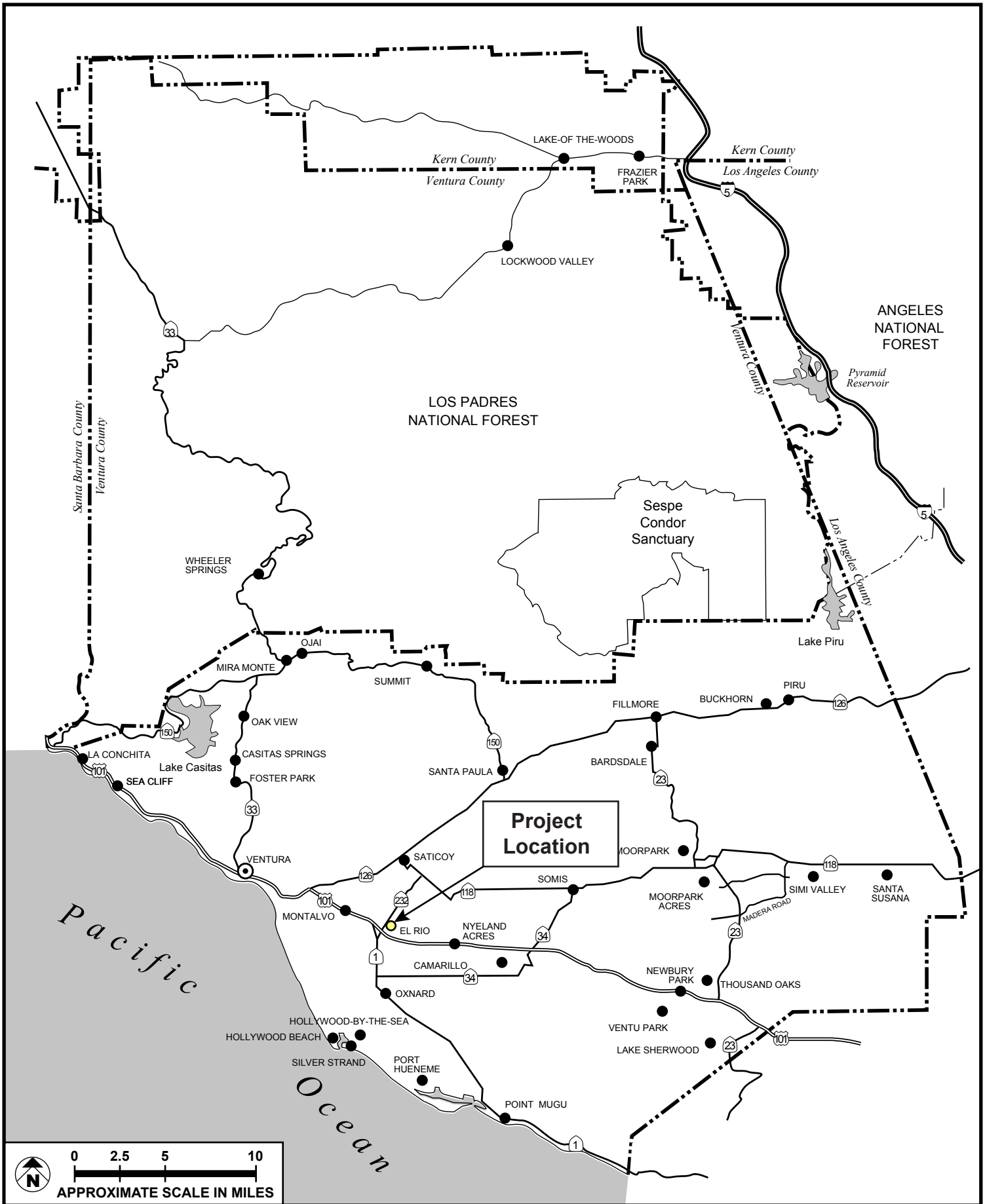

SOURCE: Meridian Consultants, LLC - August 2017

FIGURE 1





FIGURE 2



### 3. NOISE DESCRIPTORS

#### Fundamentals of Sound

Because the human ear does not respond uniformly to sounds at all frequencies, sound-pressure level alone is not a reliable indicator of loudness. For example, the human ear is less sensitive to low and high frequencies than to the medium frequencies that more closely correspond to human speech. In response to the sensitivity of the human ear to certain sound frequencies, the A-weighted noise level, referenced in units of dBA, was developed to better correspond with people's subjective judgment of sound levels. To support assessing a community reaction to noise, scales have been developed that average sound-pressure levels over time and quantifies the result in terms of a single numerical descriptor. Several scales have been developed that address community noise levels. The equivalent sound level (Leq) is the average A-weighted sound level measured over a given time interval. Leq can be measured over any period but is typically measured for 1-minute, 15-minute, 1-hour, or 24-hour periods.

**Table 1, Noise Descriptors**, identifies various noise descriptors developed to measure sound levels over different periods of time.

**Table 1**  
**Noise Descriptors**

Term	Definition
Decibel (dB)	The unit for measuring the volume of sound equal to 10 times the logarithm (base 10) of the ratio of the pressure of a measure sound to a reference pressure.
A-weighted decibel (dBA)	A sound measurement scale that adjusts the pressure of individual frequencies according to human sensitivities. The scale accounts for the fact that the region of highest sensitivity for the human ear is between 2,000 and 4,000 cycles per second (hertz).
Hertz (Hz)	The frequency of the pressure vibration, which is measured in cycles per second.
Kilo hertz (kHz)	One thousand cycles per second.
Equivalent sound level (Leq)	The sound level containing the same total energy as a time varying signal over a given time period. The Leq is the value that expresses the time averaged total energy of a fluctuating sound level. Leq can be measured over any time period, but is typically measured for 1-minute, 15-minute, 1-hour, or 24-hour periods.
Community noise equivalent level (CNEL)	A rating of community noise exposure to all sources of sound that differentiates between daytime, evening, and nighttime noise exposure. These adjustments add 5 dBA for the evening, 7:00 PM to 10:00 PM, and add 10 dBA for the night, 10:00 PM to 7:00 AM. The 5 and 10 dB penalties are applied to account for increased noise sensitivity during the evening and nighttime hours. The logarithmic effect of adding these penalties to the 1-hour Leq measurements typically results in a CNEL measurement that is within approximately 3 dBA of the peak-hour Leq. <sup>a</sup>
Nighttime (Lnight)	Lnight is the average noise exposure during the hourly periods from 10:00 PM to 7:00 AM.
Sound pressure level	The sound pressure is the force of sound on a surface area perpendicular to the direction of the sound. The sound pressure level is expressed in dB.
Ambient noise	The level of noise that is all encompassing within a given environment, being usually a composite of sounds from many and varied sources near to and far from the observer. No specific source is identified in the ambient environment.

<sup>a</sup> California Department of Transportation, *Technical Noise Supplement; A Technical Supplement to the Traffic Noise Analysis Protocol*, (Sacramento, California: November 2009, pp. N51–N54).

A doubling of sound energy results in a 3 dBA increase in sound, which means that a doubling of sound wave energy (e.g., doubling the volume of traffic on a roadway) would result in a barely perceptible change in sound level. In general, changes in a noise level of less than 3 dBA are not noticed by the human ear.<sup>1</sup> Changes from 3 to 5 dBA may be noticed by some individuals who are extremely sensitive to changes in noise. An increase of greater than 5 dBA is readily noticeable, while the human ear perceives a 10 dBA increase in sound level to be a doubling of sound volume.

Noise sources can generally be categorized in two types: (1) point sources, such as stationary equipment; and (2) line sources, such as a roadway. Sound generated by a point source typically diminishes (attenuates) at a rate of 6 dBA for each doubling of distance from the source to the receptor at acoustically hard sites, and at a rate of 7.5 dBA at acoustically soft sites.<sup>2</sup> A hard, or reflective, site consists of asphalt, concrete, or very hard-packed soil, which does not provide any excess ground-effect attenuation. An acoustically soft or absorptive site is characteristic of normal earth and most ground with vegetation. As an example, a 60 dBA noise level measured at 50 feet from a point source at an acoustically hard site would be 54 dBA at 100 feet from the source and would be 48 dBA at 200 feet from the source. Noise from the same point source at an acoustically soft site would be 52.5 dBA at 100 feet and 45 dBA at 200 feet from the source. Sound generated by a line source typically attenuates at a rate of 3 dBA and 4.5 dBA per doubling of distance from the source to the receptor for hard and soft sites, respectively.<sup>3</sup> Noise levels generated by a variety of activities are shown in **Figure 3, Common Noise Levels**. Manmade or natural barriers can also attenuate sound levels, as illustrated in **Figure 4, Noise Attenuation by Barriers**.

---

1 US Department of Transportation, Federal Highway Administration, *Fundamentals and Abatement of Highway Traffic Noise* (Springfield, VA: Author, September 1980), 81.

2 US Department of Transportation, *Fundamentals and Abatement* (September 1980), 97.

3 US Department of Transportation, *Fundamentals and Abatement* (September 1980), 97.

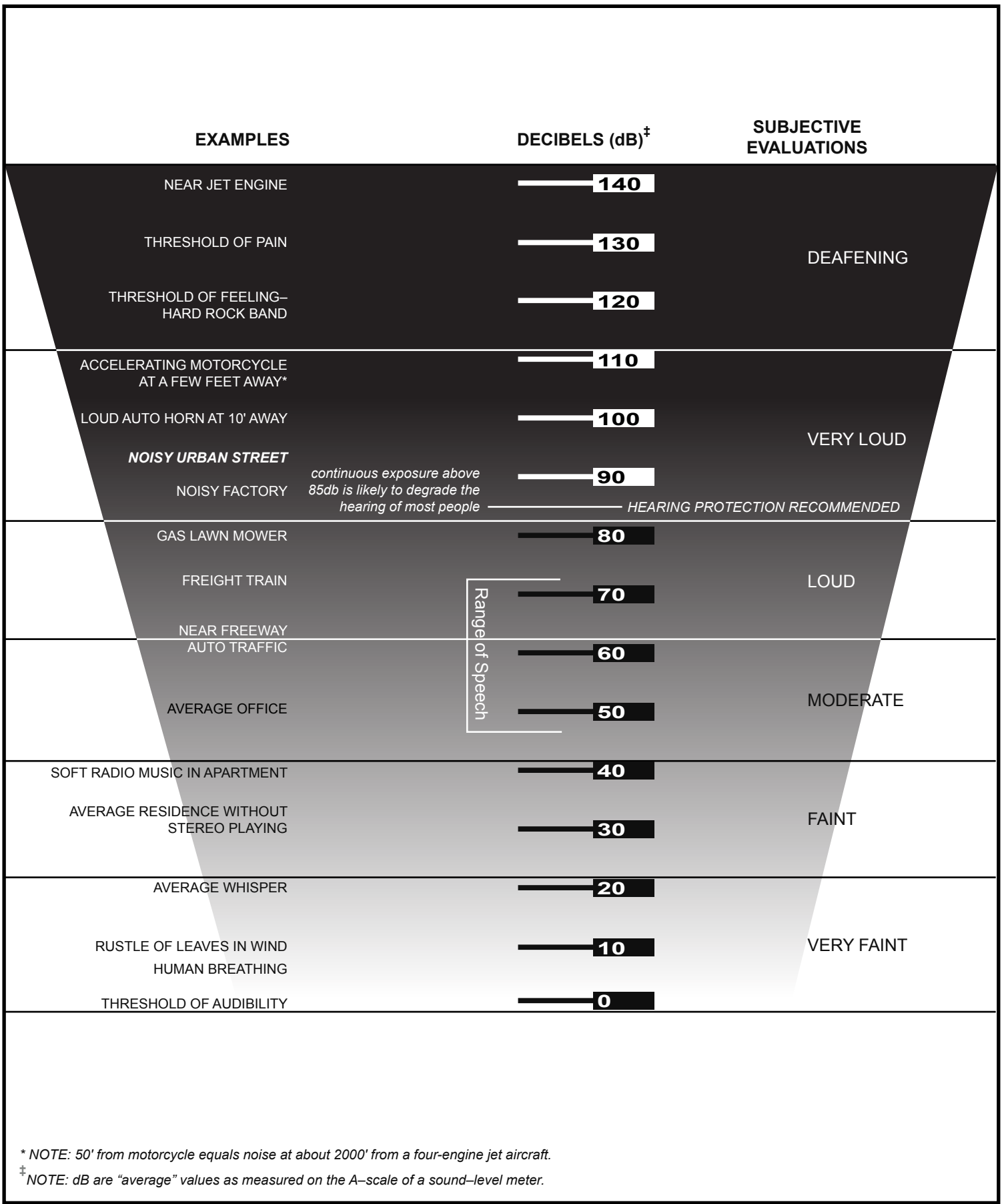
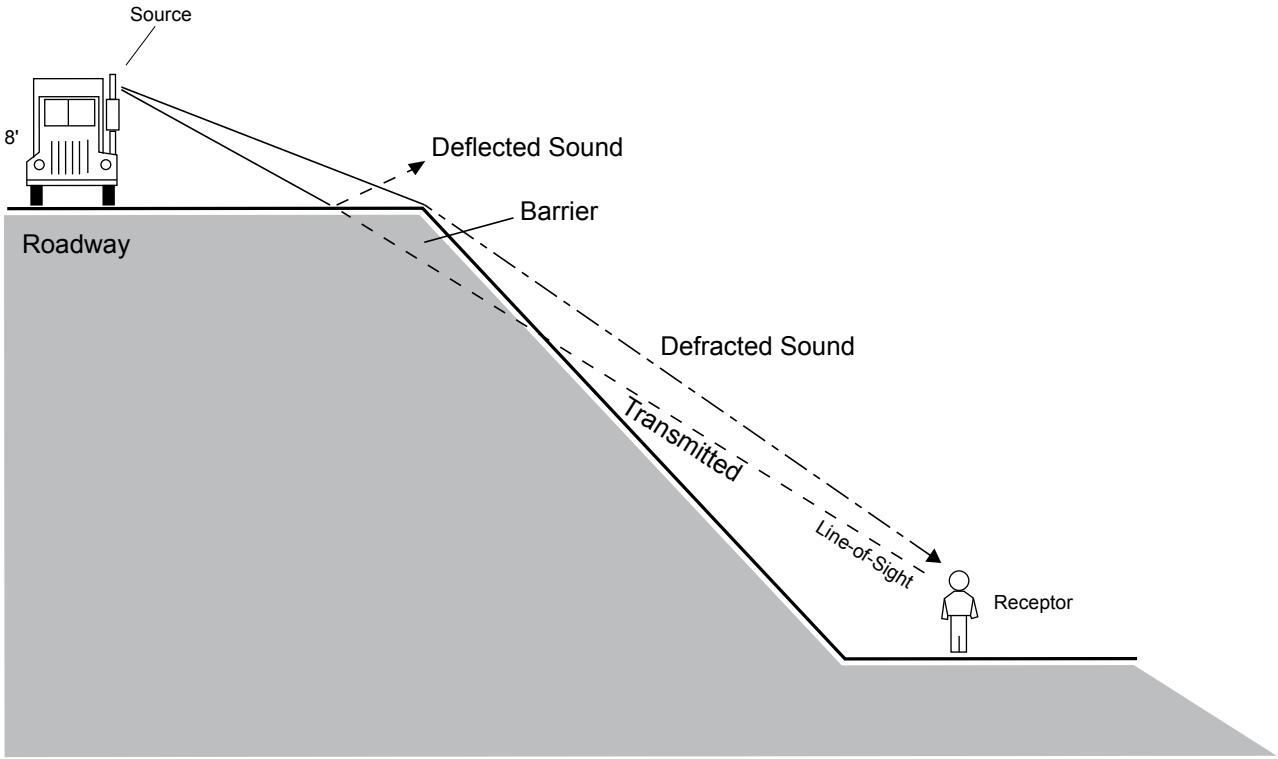
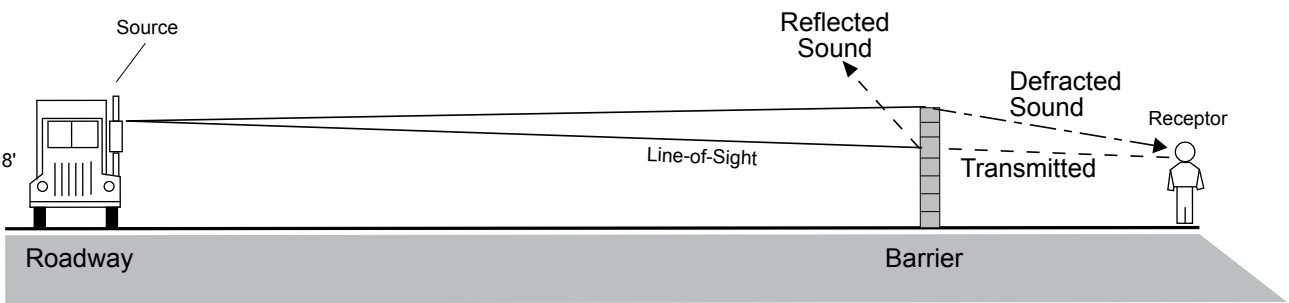

FIGURE 3



"Barrier Effect" Resulting from Differences in Elevation.



"Barrier Effect" Resulting from Typical Soundwall.

FIGURE 4

## **Fundamentals of Vibration**

Vibration is commonly defined as an oscillatory motion through a solid medium in which the motion's amplitude can be described in terms of displacement, velocity, or acceleration. The peak particle velocity (PPV) or the root-mean-square (RMS) velocity is usually used to describe vibration amplitudes. PPV is defined as the maximum instantaneous peak of the vibration signal, while RMS is defined as the square root of the average of the squared amplitude of the signal. PPV is typically used for evaluating potential building damage, whereas RMS is typically more suitable for evaluating human response to ground-borne vibration. The RMS vibration velocity level can be presented in inches per second or in VdB (a decibel unit referenced to 1 microinch per second). Commonly, ground-borne vibration generated by man-made activities (i.e., road traffic, construction activity) attenuates rapidly with distance from the source of the vibration.

The vibration velocity level threshold of perception for humans is approximately 65 VdB. A vibration velocity of 75 VdB is the approximate dividing line between barely perceptible and distinctly perceptible levels for many people. Most perceptible indoor vibration is caused by sources within buildings, such as the operation of mechanical equipment, the movement of people, or the slamming of doors. Typical outdoor sources of perceptible ground-borne vibration are construction equipment, steel-wheeled trains, and traffic on rough roads. If a roadway is smooth, the ground-borne vibration from traffic is barely perceptible. The range of interest is from approximately 50 VdB, which is the typical background vibration velocity, to 100 VdB, which is the general threshold where minor damage can occur in fragile buildings.

## **4. METHODOLOGY**

### **Construction Scenario**

Project construction is estimated to begin the first quarter of 2018 and end on or around mid-2020. Construction would occur over six phases: (1) demolition, which would last approximately 20 days; (2) site preparation which would last approximately 3 days; (3) grading which would last approximately 6 days; (4) building construction which would last approximately 220 days; (5) architectural coating which would last approximately 30 days; and (6) paving which would last approximately 10 days.

### **Roadway Noise**

Traffic noise levels were modeled using the Federal Highway Administration (FHWA) Noise Prediction Model. That model calculates the average noise level in dBA CNEL along a given roadway segment based on traffic volumes, vehicle mix, posted speed limits, roadway geometry, and site conditions. The model calculates noise associated with a specific line source and the results characterize noise generated by motor vehicle traffic along the specific roadway segment. The noise model assumes a "hard" site condition



(i.e., providing for the minimum amount of sound attenuation allowed by the traffic noise model), a 6.0 dBA noise reduction per doubling of distance, and no barriers between the roadway and receivers.

The model incorporates an alpha factor that characterizes the surface conditions of the area. An acoustically hard site uses an alpha factor of zero, while an acoustically soft site uses an alpha factor of 0.5. The greater the alpha factor, the greater the noise attenuates with increasing distance. Average vehicle noise rates utilized in the FHWA model have been modified to reflect average vehicle noise rates identified for California by the California Department of Transportation (“Caltrans”). According to data collected by Caltrans, California automobile noise is 0.8 to 1.0 dBA louder than national levels, while medium and heavy truck noise is 0.3 to 3.0 dBA quieter than national levels. Roadway traffic data were obtained from the traffic impact study for the proposed Project. Noise levels were evaluated with respect to the following modeled traffic scenarios:

- Existing (2017)
- Existing (2017) with Project
- Cumulative
- Cumulative with Project

## **Ambient Noise Measurements**

Noise level monitoring was conducted by Meridian Consultants on July 6, 2017, at 5 locations within the Project area vicinity, as shown in **Figure 5, Noise Monitoring Locations**. Noise level monitoring was conducted for 15-minute intervals at each location using a Larson Davis Model 831 sound-level meter. This meter satisfies the American National Standards Institute (ANSI) standard for general environmental noise measurement instrumentation. The ANSI specifies several types of sound-level meters according to their precision. Types 1, 2, and 3 are referred to as “precision,” “general-purpose,” and “survey” meters, respectively. Most measurements carefully taken with a Type 1 sound-level meter will have a margin of error not exceeding 1 dB.

The Larson Davis Model 831 is a Type 1 precision sound-level meter. This meter meets all requirements of ANSI S1.4-1983 and ANSI1.43-1997 Type 1 standards, as well as International Electrotechnical Commission (IEC) IEC61672-1 Ed. 1.0, IEC60651 Ed 1.2, and IEC60804 Type 1, Group X standards.

The sound-level meter was located approximately 5 feet above ground and was covered with a Larson Davis windscreen. The sound-level meter was field calibrated with an external calibrator prior to operation.



SOURCE: Google Earth - 2017

FIGURE 5



Noise Monitoring Locations



## 5. NOISE STANDARDS

### Federal Transit Administration Standards

The Federal Transit Administration (FTA) has recommended noise criteria related to traffic-generated noise, as shown in **Table 2, Significance of Changes in Operational Roadway Noise Exposure**. These recommendations can be used as guidance to determine whether or not a change in traffic would result in “substantial” permanent increase in noise. The allowable noise exposure increase is reduced with increasing ambient existing noise exposure, such that higher ambient noise levels have a lower allowable noise exposure increase.

---

**Table 2**  
**Significance of Changes in Operational Roadway Noise Exposure**

Existing Noise Exposure (dBA Ldn or Leq)	Allowable Noise Exposure Increase (dBA Ldn or Leq)
45–49	7
50–54	5
55–59	3
60–64	2
65–74	1
75+	0

Source: Federal Transit Administration (2006).





---

### State of California Noise Standards

The State of California, Office of Planning and Research has published, with regard to community noise exposure, recommended guidelines for land use compatibility. These guidelines rate land use compatibility in terms of being *normally acceptable*, *normally unacceptable*, and *clearly unacceptable*. Each jurisdiction is required to consider these guidelines when developing a General Plan Noise Element and when determining acceptable noise levels within its community. These guidelines are representative of various land uses that include residential, commercial/mixed-use, industrial, and public facilities. **Figure 6, State Land Use Compatibility to Noise**, identifies the acceptable limit of noise exposure for various land use categories within the State. Noise exposure for multi-family uses is “normally acceptable” when the CNEL at exterior residential locations is between 50 and 65 dBA; “conditionally acceptable” when the CNEL is between 60 and 70 dBA; and “normally unacceptable” when the CNEL exceeds 70 dBA. These guidelines apply to noise sources such as vehicular traffic, aircraft, and rail movements.

In addition, the California Commission of Housing and Community Development officially adopted interior noise standards in 1974. In 1988, the Building Standards Commission approved revisions to the standards (Title 24, Part 2, California Code of Regulations). As revised, Title 24 establishes an interior noise standard of 45 dBA CNEL for residential space.

LAND USE CATEGORY	COMMUNITY NOISE EXPOSURE Ldn or CNEL, dB							
	50	55	60	65	70	75	80	
Residential - Low Density Single Family, Duplex, Mobile Homes	White	White	White	White	White	White	White	White
Residential - Multi Family	White	White	White	White	White	White	White	White
Transient Lodging - Motels, Hotels	White	White	White	White	White	White	White	White
Schools, Libraries Churches, Hospitals, Nursing Homes	White	White	White	White	White	White	White	White
Auditoriums, Concert Halls, Amphitheatres	White	White	White	White	White	White	White	White
Sports Arena, Outdoor Spectator Sports	White	White	White	White	White	White	White	White
Playgrounds, Neighborhood Parks	White	White	White	White	White	White	White	White
Golf Courses, Riding Stables, Water Recreation, Cemeteries	White	White	White	White	White	White	White	White
Office Buildings, Business Commercial and Professional	White	White	White	White	White	White	White	White
Industrial, Manufacturing Utilities, Agriculture	White	White	White	White	White	White	White	White

-  **NORMALLY ACCEPTABLE**  
Specified land use is satisfactory, based upon the assumption that any buildings involved are of normal conventional construction, without any special noise insulation requirements.
-  **CONDITIONALLY ACCEPTABLE**  
New construction or development should be undertaken only after a detailed analysis of the noise reduction requirements is made and needed noise insulation features included in the design. Conventional construction, but with closed windows and fresh air supply systems or air conditioning will normally suffice.
-  **NORMALLY UNACCEPTABLE**  
New construction or development should generally be discouraged. If new construction or development does proceed, a detailed analysis of the noise reduction requirements must be made and needed noise reduction features included in the design.
-  **CLEARLY UNACCEPTABLE**  
New construction or development should generally not be undertaken.

SOURCE: California Governor's Office of Planning and Research, State of California General Plan Guidelines, Appendix C: Guidelines for the Preparation and Content of Noise Elements of the General Plan, October 2003.

FIGURE 6

## City of Oxnard 2030 General Plan

The City's General Plan establishes a number of goals and policies to provide an acceptable noise environment for noise-sensitive developments within the City.<sup>4</sup> The implementation measures for the Noise Element policies include but are not limited to noise study triggers, site design considerations, traffic-calming measures, and coordination with other local agencies, regional agencies, state agencies, and federal agencies. The applicable goals include:

- Goal SH-5: A quiet and safe residential and working environment in terms of exposure to and/or generation of noise;
- Goal SH-6: Consideration of noise levels and impacts in the land use planning and development process

## Noise Ordinance

As part of the City's Noise Ordinance, properties within the City are assigned a noise zone based on their corresponding land use, as shown in **Table 3, Exterior Noise Standards**, which identified the allowable exterior sound standards and corresponding time of day for each of the noise zones identified in the City's noise ordinance. Residential properties are designated as Noise Zone I, commercial properties are designated as Noise Zone II, and industrial districts are designated as Noise Zone III. According to the City of Oxnard Land Use Designation Map,<sup>5</sup> the existing Project site is designated for school use. However, the General Plan Amendment would change the land use designation from School to Residential Medium and Commercial Office Building. As such, the exterior noise standards for Zone I and Zone II would apply for this Project.

---

4 City of Oxnard, *2030 General Plan Goals & Policies* (adopted October 2011).

5 *City of Oxnard 2030 General Plan Map*, <https://www.oxnard.org/wp-content/uploads/2016/03/203020GENERAL20PLAN2030x402009.14V3-1.pdf>.

**Table 3**  
**Exterior Noise Standards**

<b>Zone</b>	<b>Designated Zone</b>	<b>Time Interval</b>	<b>Allowable Exterior Sound Level (CNEL)</b>
Zone I	Residential	7:00 AM–10:00 PM	55
		10:00 PM–7:00 AM	50
Zone II	Commercial	7:00 AM–10:00 PM	65
		10:00 PM–7:00 AM	60
Zone III	Industrial	Anytime	70
Zone IV	Near Railroad/US 101	Anytime	70

*Source: City of Oxnard, Noise Ordinance, art. IX, sec. 7-185.*

In addition, with respect to residential uses, the interior sound level may not exceed 45 dBA between the hours of 10:00 PM and 7:00 AM and 50 dBA between 7:00 AM and 10:00 PM for a period of 5 or minutes in any hour. Furthermore, the allowable interior level plus 5 dBA cannot be exceeded for more than one minute in an hour and the allowable interior level plus 10 dBA cannot be exceeded for any period of time.

## **6. EXISTING CONDITIONS**

### **Ambient Noise Levels**

Short-term sound monitoring was conducted at five locations to measure the ambient sound environment in the Project vicinity. (See **Appendix A** for the data sheets.) Measurements were taken over 15-minute intervals at each location between the hours of 7:57 AM and 9:27 AM, as indicated in **Table 4, Ambient Noise Measurements**. **Figure 5** depicts locations where ambient noise measurements were conducted. As shown in **Table 4**, ambient noise levels ranged from a low of 53.4 dBA along Rio School Lane (Site 1) to a high of 73.3 dBA on the corner of E. Vineyard Avenue and Rio School Lane (Site 2). Higher ambient noise levels were located along E. Vineyard Avenue due to heavy vehicular traffic.

**Table 4**  
**Ambient Noise Measurements**

Location Number/Description	Time Period	Noise Source	dBA Leq
1 Along Rio School Lane; northeast portion of the site	12:28 PM–12:43 PM	Light vehicular traffic along Rio School Lane	53.4
2 Corner of E. Vineyard Avenue and Rio School Lane; northwest portion of the site	12:08 PM–12:23 PM	Heavy vehicular traffic along E. Vineyard Avenue	73.3
3 Along E. Vineyard Avenue; southwest portion of the site	11:50 AM–12:05 PM	Heavy vehicular traffic along E. Vineyard Avenue	71.3
4 Southeast portion of the site	11:31 AM–11:46 AM	Pedestrian and parking lot activity	55.2
5 Across E. Vineyard Avenue	12:54 PM – 1:09 PM	Heavy vehicular traffic along E. Vineyard Avenue	72.1

Source: Refer to **Appendix A** for noise monitoring data sheets.  
Note: dBA = A-weighted decibels; Leq = average equivalent sound level.

## Existing Off-Site Roadway Noise Levels

The average daily trips (ADTs) for local roadway segments were obtained from the traffic impact analysis for the Project prepared by Associated Transportation Engineers.<sup>6</sup> The estimated existing roadway noise levels are provided in **Table 5, Existing Roadway Noise Levels**. As indicated in **Table 5**, the existing modeled vehicle-generated noise levels along roadway segments near the proposed Project site range from a low of 31.9 dBA CNEL at Stroube Street, west of Vineyard Avenue (Intersection 2), to a high of 67.5 dBA CNEL at Vineyard Avenue, south of the US 101 SB off-ramp (Intersection 5).

<sup>6</sup> Associated Transportation Engineers, *Rio Urbana Residential and Office Development Traffic and Circulation Study*, July 25, 2017.

**Table 5  
Existing Roadway Noise Levels**

<b>Intersection #</b>	<b>Roadway Segment</b>	<b>Time Period</b>	<b>Roadway Noise Level (dBA CNEL)</b>
<b><i>Vineyard Avenue</i></b>			
1	North of E. Stroube Street	AM	65.0
		PM	65.3
<b><i>Vineyard Avenue</i></b>			
1	South of E. Stroube Street	AM	65.2
		PM	65.2
2	North of Rio School Lane	AM	65.6
		PM	65.0
<b><i>Stroube Street</i></b>			
1	East of Vineyard Avenue	AM	49.6
		PM	48.1
<b><i>Stroube Street</i></b>			
1	West of Vineyard Avenue	AM	47.0
		PM	46.8
<b><i>Vineyard Avenue</i></b>			
2	South of Rio School Lane	AM	65.6
		PM	65.0
3	North of River Park Boulevard	AM	65.5
		PM	65.7
<b><i>Stroube Street</i></b>			
2	East of Vineyard Avenue	AM	39.9
		PM	34.5
<b><i>Stroube Street</i></b>			
2	West of Vineyard Avenue	AM	35.6
		PM	31.9
<b><i>Vineyard Avenue</i></b>			
3	South of River Park Boulevard	AM	67.1
		PM	67.0
4	North of US 101 NB off-ramp	AM	67.1
		PM	66.9
<b><i>River Park Boulevard</i></b>			
3	East of Vineyard Avenue	AM	59.2
		PM	59.1



Intersection #	Roadway Segment	Time Period	Roadway Noise Level (dBA CNEL)
<b><i>River Park Boulevard</i></b>			
3	West of Vineyard Avenue	AM	59.5
		PM	58.3
<b><i>Vineyard Avenue</i></b>			
4	South of US 101 NB off-ramp	AM	67.2
		PM	66.9
5	North of US 101 SB off-ramp	AM	67.3
		PM	67.0
<b><i>US 101 NB Off-Ramp</i></b>			
4	East of Vineyard Avenue	AM	54.0
		PM	53.2
<b><i>US 101 NB Off-Ramp</i></b>			
4	West of Vineyard Avenue	AM	48.8
		PM	49.8
<b><i>Vineyard Avenue</i></b>			
5	South of US 101 SB off-ramp	AM	67.5
		PM	67.3
6	North of Esplanade Drive	AM	67.9
		PM	67.4
<b><i>US 101 SB Off-Ramp</i></b>			
5	East of Vineyard Avenue	AM	51.8
		PM	53.6
<b><i>US 101 SB Off-Ramp</i></b>			
5	West of Vineyard Avenue	AM	52.5
		PM	54.2
<b><i>Vineyard Avenue</i></b>			
6	South of Esplanade Drive	AM	67.5
		PM	66.8
<b><i>Esplanade Drive</i></b>			
6	East of Vineyard Avenue	AM	53.8
		PM	52.0
<b><i>Esplanade Drive</i></b>			
6	West of Vineyard Avenue	AM	55.6
		PM	64.2
<b><i>Rose Avenue</i></b>			
7	North of W. Stroube Street	AM	64.3
		PM	64.3

Intersection #	Roadway Segment	Time Period	Roadway Noise Level (dBA CNEL)
<b>W. Stroube Street</b>			
7	West of Rose Avenue	AM	47.9
		PM	49.7
<b>Rose Avenue</b>			
7	South of W. Stroube Street	AM	64.8
		PM	65.0
8	North of River Park Boulevard	AM	64.7
		PM	65.0
<b>River Park Boulevard</b>			
8	East of Rose Avenue	AM	62.8
		PM	58.9
<b>River Park Boulevard</b>			
8	West of Rose Avenue	AM	52.9
		PM	50.9
<b>Rose Avenue</b>			
8	South of River Park Boulevard	AM	67.3
		PM	66.1
9	North US 101 NB off-ramp	AM	67.3
		PM	66.2
<b>US 101 NB Off-Ramp</b>			
9	East of Rose Avenue	AM	55.8
		PM	55.4
<b>US 101 NB Off-Ramp</b>			
9	West of Rose Avenue	AM	51.1
		PM	47.5
<b>Rose Avenue</b>			
9	South of US 101 NB off-ramp	AM	68.2
		PM	67.5
10	North of US 101 SB off-ramp	AM	68.0
		PM	67.4
<b>US 101 SB Off-Ramp</b>			
10	East of Rose Avenue	AM	50.2
		PM	51.5
<b>US 101 SB Off-Ramp</b>			
10	West of Rose Avenue	AM	55.4
		PM	54.7

Intersection #	Roadway Segment	Time Period	Roadway Noise Level (dBA CNEL)
<b>Rose Avenue</b>			
10	South of US 101 SB off-ramp	AM	68.9
		PM	68.3

Source: Traffic noise model results are provided in **Appendix B**.

Note: Roadway noise levels are modeled 75 feet from the center of the roadway.

## Vibration Conditions

Based on field observations, the primary source of existing ground-borne vibration in the vicinity of the Project Site is vehicle traffic on local roadways. According to the FTA,<sup>7</sup> typical road traffic-induced vibration levels are unlikely to be perceptible by people. Trucks and buses typically generate ground-borne vibration velocity levels of approximately 63 VdB (at a 50-foot distance), and these levels could reach 72 VdB when trucks and buses pass over bumps in the road. A vibration level of 72 VdB is above the 60 VdB level of perceptibility.

## 7. NOISE ANALYSIS

### Construction

#### Construction Noise

Construction activities that would occur during the construction phases (demolition, site preparation, grading, building construction, architectural coating, and paving) would generate both steady-state and episodic noise that would be heard both on and off the Project site. Estimated noise levels associated with the Project could occur as close as 90 feet from the nearest residence. Typical maximum noise levels and duty cycles of representative types of equipment are presented in **Table 6, Typical Maximum Noise Levels for Construction Equipment**. Construction equipment noise would not be constant because of the variations of power, cycles, and equipment locations. For maximum noise events, this analysis considers equipment operating at the edge of the property line of the Project site.

<sup>7</sup> Federal Transit Administration, *Transit Noise and Vibration Impact Assessment* (2004).

**Table 6**  
**Typical Maximum Noise Levels for Construction Equipment**

Equipment Description	Noise Level at 50 feet (dBA)	Typical Duty Cycle (%)
Auger drill rig	84	20
Backhoe	78	40
Chain saw	84	20
Compressor (air)	78	40
Concrete mixer truck	79	40
Concrete pump truck	81	20
Concrete/Industrial saw	90	20
Crane	81	16
Dozer	82	40
Dump truck	76	40
Excavator	81	40
Front end loader	79	40
Generator (25 kVA or less)	73	50
Generator (more than 25 kVA)	81	50
Grader	85	40
Paver	77	50
Pneumatic tool	85	50
Pump	81	50
Rock drill	81	20
Scraper	84	40
Tractor	84	40
Vacuum excavator (vac-truck)	85	40
Vibratory concrete mixer	80	20

*Source: U.S. DOT, FHWA Construction Equipment and Noise Level Ranges.*  
*Note: kVA = kilovolt-ampere*

As mentioned previously, sound generated by the construction noise source typically diminishes at a rate of 6 dBA over hard surfaces, such as asphalt, and 7.5 dBA over soft surfaces, such as vegetation, for each doubling of distance. Barriers—such as walls, berms, or buildings, and elevation differences—can also reduce sound levels by up to 20 dBA.<sup>8</sup>

The potential noise impact generated during construction depends on the phase of construction and the percentage of time the equipment operates over the workday. Building construction would be the noisiest

<sup>8</sup> Caltrans, *Technical Noise Supplement* (1998), pp. 33–40, 123–131.

phase of construction, lasting approximately 5 months at various locations throughout the Project site. However, construction noise estimates used for the analysis are representative of worst-case conditions because it is very unlikely that all the equipment contained on site would operate simultaneously.

The noise levels at the various distances from construction activity are shown in **Table 7, Construction Noise Estimates**. Construction equipment operates at its noisiest levels for certain percentages of time during operation. Equipment such as excavators, graders, and loaders would operate at different percentages over the course of an hour.<sup>9</sup> Standard exhaust mufflers for all equipment and the break in line of sight to a house or apartment would reduce construction noise levels approximately 7 dBA.

**Table 7**  
**Construction Noise Estimates**

Receptor ID	Distance from Project Site (feet) <sup>a</sup>	Estimated Construction Noise Levels by Phase						Ambient Noise Leq (dBA)	Maximum Noise Exceedance, Leq (dBA)
		Demolition	Site Preparation	Grading	Building Construction	Paving	Architectural Coating		
REC-1	95	79.7	78.4	78.2	81.0	76.1	68.4	72.1	+9.4
REC-2	90	80.2	78.9	78.7	81.5	76.6	68.9	73.3	+8.8
REC-3	195	73.5	72.2	72.0	74.8	69.9	62.2	53.4	+21.4

Source: Construction noise data sheets are provided in **Appendix C**.

Note: dBA = A-weighted decibel; Leq = equivalent sound level.

<sup>a</sup> Distance to source is the closest piece of operating equipment to the receptors that are closest to construction activities occurring at the Project site. As such, other receptors would experience lower levels of noise than those estimated for these receptors.

Equipment estimates and noise levels used for the analysis during the construction phases (demolition, site preparation, grading, building construction, paving, and architectural coating) are representative of worst-case conditions because it is very unlikely that all the equipment contained on the Project site would operate simultaneously. Construction activities would be limited to Monday through Friday between 7:00 AM and 7:00 PM; Saturday between 8:00 AM and 5:00 PM; and at no time on Sundays or holidays.

Receptor 1 (REC-1) is a single-family residential unit located 95 feet to the southwest of the Project boundary across E. Vineyard Avenue (as shown in **Figure 5**). When all pieces of equipment are operating at the same time at the edge of the Project boundary, which is a conservative estimate, construction noise levels at this site would increase ambient noise levels by approximately 9.4 dB.

<sup>9</sup> Federal Highway Administration, *Traffic Noise Model* (2006).

Receptor 2 (REC-2) is a single-family residential unit located 90 feet to the west of the Project boundary across E. Vineyard Avenue (as shown in **Figure 5**). When all pieces of equipment are operating at the same at the edge of the Project boundary, which is a conservative estimate, construction noise levels at this site would increase ambient noise levels by 8.8 dB.

Receptor 3 (REC-3) is a single-family residential unit located 195 feet to the north of the Project boundary across Rio School Lane (as shown in **Figure 5**). It is important to note these residences are facing toward E. Stroube Street, and are shielded by trees and other vegetation. As such, when all pieces of equipment are operating at the same time at the edge of the Project boundary without any noise-shielding reductions, which is a conservative estimate, construction noise levels at this site would increase ambient noise levels by 21.4 dB.

With implementation of the recommended **Mitigation Measure N-1**, construction activities would include the use of a sound curtain, which would result in a minimum of 15 dBA reduction. For instance, a sound curtain with a sound transmission classification rating of 25 could reduce noise levels from 15 to 22 dBA on both side of the equipment where the curtain is installed.<sup>10</sup> Furthermore, standard exhaust mufflers for all equipment and the break in line of sight to a sensitive receptor would reduce construction noise levels by approximately 7 dBA. As such, with implementation of these recommended measures, construction noise impacts would not be considered significant.

### ***Construction Traffic***

In addition to equipment-generated noise associated with construction activities, construction traffic would generate noise along access routes to the Project site. The major pieces of heavy equipment would be moved on to the site only one time for each construction activity.

Each phase of construction would result in varying levels of intensity and the number of construction personnel. The construction workforce would consist of approximately 13 worker trips per day and 875 total hauling trips during demolition (removal of approximately 192,304 square feet of building and concrete material); 8 worker trips per day during site preparation; 10 worker trips per day and 2,125 total hauling trips during grading (import of approximately 17,000 cubic yards); 214 worker trips per day and 52 total vendor trips during building construction; 15 worker trips per day during paving; and 43 worker trips per day during architectural coating.

---

10 Behrens and Associates Environmental Noise Control, "Temporary Compressor Sound Walls," <http://www.drillingnoisecontrol.com/tempcompressor.html>.

## Construction Vibration

**Table 8, Construction Vibration Levels Estimates**, lists the vibration source levels at varying distances of the assumed construction equipment to be used for during construction. As shown in **Table 8**, dozers are capable of producing approximately 0.021 inches per second PPV and would not generate vibration levels in excess of 0.5 inches per second PPV. As such, the single-family residential units (REC-1, REC-2, REC-3) located nearest to the Project site with regard to construction vibration activities would not be affected as a result of attenuation of ground-borne vibration. Furthermore, construction activities would be restricted to daytime hours when people are the least sensitive to vibration intrusions.

**Table 8**  
**Construction Vibration Levels Estimates**

Equipment	Inches per Second PPV at Adjusted Distance		
	90 feet	95 feet	195 feet
Air compressor	0.013	0.012	0.004
Backhoe	0.018	0.016	0.006
Cement and mortar mixer	0.006	0.005	0.000
Concrete saw	0.003	0.002	0.001
Crane	0.008	0.008	0.003
Dozer	0.021	0.019	0.007
Forklift	0.006	0.005	0.002
Grader	0.010	0.010	0.003
Generator	0.003	0.002	0.001
Paver	0.009	0.009	0.003
Roller	0.006	0.005	0.002
Scraper	0.008	0.008	0.003
Welder	0.006	0.005	0.002

*Source: Office of Planning and Environment, Federal Transit Administration, Transit Noise and Vibration Impact Assessment, FTA-VA-90-1003-06 (May 2006), 12-9.*

## Operation

### Roadway Noise

Roadway noise levels were modeled to determine if operation of the proposed Project would result in exceedance of the City's interior and exterior noise standards for residential and commercial uses along utilized roadways. In addition, roadway noise levels were modeled to determine if operation of the proposed Project would increase roadway noise levels greater than 5 dBA or more along residential uses

when post-Project noise levels are less than 60 dBA; 3 dBA or more when post-Project noise levels are between 60 and 65 dBA; and 1.5 dBA or more when post-Project noise levels are greater than 65 dBA. The model considers roadway noise levels from local street segments that would have an increase or decrease in vehicle traffic as a result of the proposed Project.

### Existing plus Project

**Table 9, Existing plus Project**, illustrates the change in CNEL from existing traffic volumes and existing plus project traffic volumes. The difference in traffic noise between existing conditions and Project conditions represents the increase in noise attributable to Project-related traffic. As shown in **Table 9**, maximum noise level increases along roadways adjacent to residential and commercial uses by traffic from the proposed Project would range from a low of 0.0 dBA (several locations throughout the vicinity of the Project area) to a high of 8.1 dBA at Stroube Street, east of Vineyard Avenue (Intersection 2). The roadway noise level along Stroube Street would be 42.6 dBA CNEL, and would fall below the residential and commercial exterior noise level standard.

The proposed Project interior noise levels by traffic would be attenuated by 25 dBA from outdoor noise levels. Roadway noise levels at Rose Avenue, south of the US 101 SB off-ramp (Intersection 10) would be 68.9 dBA CNEL, similar to existing conditions. Based on attenuation from outdoor to indoor noise levels, interior noise levels would be 43.0 dBA, below the 45 dBA threshold for residential and commercial uses.

**Table 9  
Existing plus Project**

Intersection #	Roadway Segment	Time Period	Existing	Existing plus Project	Change
			dBA CNEL		
<b><i>Vineyard Avenue</i></b>					
1	North of E. Stroube Street	AM	65.0	65.1	0.1
		PM	65.3	65.4	0.1
<b><i>Vineyard Avenue</i></b>					
1	South of E. Stroube Street	AM	65.2	65.3	0.1
		PM	65.2	65.3	0.1
2	North of Rio School Lane	AM	65.6	65.6	0.0
		PM	65.0	65.1	0.1
<b><i>Stroube Street</i></b>					
1	East of Vineyard Avenue	AM	49.6	49.8	0.2
		PM	48.1	48.3	0.2
<b><i>Stroube Street</i></b>					
1	West of Vineyard Avenue	AM	47.0	47.0	0.0



Intersection #	Roadway Segment	Time Period	Existing	Existing plus	Change
			Project		
			dBA CNEL		
		PM	46.8	46.8	0.0
<b>Vineyard Avenue</b>					
2	South of Rio School Lane	AM	65.6	65.7	0.1
		PM	65.0	65.1	0.1
3	North of River Park Boulevard	AM	65.5	65.6	0.1
		PM	65.7	65.8	0.1
<b>Stroube Street</b>					
2	East of Vineyard Avenue	AM	39.9	44.4	4.5
		PM	34.5	42.6	8.1
<b>Stroube Street</b>					
2	West of Vineyard Avenue	AM	35.6	35.6	0.0
		PM	31.9	31.9	0.0
<b>Vineyard Avenue</b>					
3	South of River Park Boulevard	AM	67.1	67.2	0.1
		PM	67.0	67.1	0.1
4	North of US 101 NB off-ramp	AM	67.1	67.2	0.1
		PM	66.9	67.0	0.1
<b>River Park Boulevard</b>					
3	East of Vineyard Avenue	AM	59.2	59.2	0.0
		PM	59.1	59.1	0.0
<b>River Park Boulevard</b>					
3	West of Vineyard Avenue	AM	59.5	59.5	0.0
		PM	58.3	58.3	0.0
<b>Vineyard Avenue</b>					
4	South of US 101 NB off-ramp	AM	67.2	67.3	0.1
		PM	66.9	66.9	0.0
5	North of US 101 SB off-ramp	AM	67.3	67.4	0.1
		PM	67.0	67.1	0.1
<b>US 101 NB Off-Ramp</b>					
4	East of Vineyard Avenue	AM	54.0	54.0	0.0
		PM	53.2	53.2	0.0
<b>US 101 NB Off-Ramp</b>					
4	West of Vineyard Avenue	AM	48.8	49.0	0.2
		PM	49.8	50.1	0.3
<b>Vineyard Avenue</b>					
5	South of US 101 SB off-ramp	AM	67.5	67.6	0.1

Intersection #	Roadway Segment	Time Period	Existing	Existing plus Project	Change
			dBA CNEL		
6	North of Esplanade Drive	PM	67.3	67.4	0.1
		AM	67.9	67.9	0.0
		PM	67.4	67.4	0.0
<b>US 101 SB Off-Ramp</b>					
5	East of Vineyard Avenue	AM	51.8	51.8	0.0
		PM	53.6	53.6	0.0
<b>US 101 SB Off-Ramp</b>					
5	West of Vineyard Avenue	AM	52.5	52.7	0.2
		PM	54.2	54.3	0.1
<b>Vineyard Avenue</b>					
6	South of Esplanade Drive	AM	67.5	67.5	0.0
		PM	59.9	59.9	0.0
<b>Esplanade Drive</b>					
6	East of Vineyard Avenue	AM	53.8	53.8	0.0
		PM	52.0	52.0	0.0
<b>Esplanade Drive</b>					
6	West of Vineyard Avenue	AM	59.7	59.7	0.0
		PM	55.6	55.6	0.0
<b>Rose Avenue</b>					
7	North of W. Stroube Street	AM	64.3	64.3	0.0
		PM	64.3	64.4	0.1
<b>W. Stroube Street</b>					
7	West of Rose Avenue	AM	47.9	48.2	0.3
		PM	49.7	49.9	0.2
<b>Rose Avenue</b>					
7	South of W. Stroube Street	AM	64.8	64.8	0.0
		PM	65.0	65.0	0.0
8	North of River Park Boulevard	AM	64.7	64.7	0.0
		PM	65.0	65.0	0.0
<b>River Park Boulevard</b>					
8	East of Rose Avenue	AM	62.8	62.8	0.0
		PM	58.9	58.9	0.0
<b>River Park Boulevard</b>					
8	West of Rose Avenue	AM	52.9	52.9	0.0
		PM	50.9	50.9	0.0
<b>Rose Avenue</b>					

Intersection #	Roadway Segment	Time Period	Existing	Existing plus Project	Change
			dBA CNEL		
8	South of River Park Boulevard	AM	67.3	67.3	0.0
		PM	66.1	66.1	0.0
9	North US 101 NB off-ramp	AM	67.3	67.3	0.0
		PM	66.2	66.2	0.0
<b>US 101 NB Off-Ramp</b>					
9	East of Rose Avenue	AM	55.8	55.8	0.0
		PM	55.4	55.4	0.0
<b>US 101 NB Off-Ramp</b>					
9	West of Rose Avenue	AM	51.1	51.1	0.0
		PM	47.5	47.5	0.0
<b>Rose Avenue</b>					
9	South of US 101 NB off-ramp	AM	68.2	68.2	0.0
		PM	67.5	67.5	0.0
10	North of US 101 SB off-ramp	AM	68.0	68.1	0.1
		PM	67.4	67.4	0.0
<b>US 101 SB Off-Ramp</b>					
10	East of Rose Avenue	AM	50.2	50.2	0.0
		PM	51.5	51.5	0.0
<b>US 101 SB Off-Ramp</b>					
10	West of Rose Avenue	AM	55.4	55.5	0.1
		PM	54.7	54.7	0.0
<b>Rose Avenue</b>					
10	South of US 101 SB off-ramp	AM	68.9	68.9	0.0
		PM	68.3	68.3	0.0

Source: Traffic noise model results are provided in **Appendix B**.

Note: Roadway noise levels are modeled 75 feet from the center of the roadway.

## HVAC Systems

The Project would introduce various stationary noise sources, including HVAC systems, which would be located either on the roof, the side of a structure or on the ground. Typically, this type of equipment produces noise levels of approximately 56.0 dBA. This equipment would be screened and integrated in architectural design of the building and would further attenuate sound emanating from the HVAC systems. As the sound distance doubles to 100 feet from the equipment, sound levels would be 50 dBA. As such, the use of such equipment would not generate levels that would substantially elevate the ambient noise environment.

## 8. GENERAL PLAN CONSISTENCY

Table 10, City of Oxnard 2030 General Plan Applicable Goals & Policies evaluates the Project’s consistency with the applicable goals provided in the City’s General Plan to determine whether the Project will result in adverse impacts to noise. Based on the evaluation, the Project would be consistent with all feasible and applicable goals listed in the City’s General Plan.

**Table 10**  
**City of Oxnard 2030 General Plan Applicable Goals & Policies**

Goal	Policy	Consistency
SH-5: A quiet and safe residential and working environment in terms of exposure to and/or generation of noise.	SH-5.2: <u>State Noise Insulation Standards</u> . Continue to enforce State Noise Insulation Standards for projects in high noise environments and require developers to comply with noise mitigation measures, designed by an acoustical engineer.	<b>Consistent.</b> The Project would be compliant with the latest Title 24 requirements which includes standards for new construction of, and additions and alterations to, residential and non-residential buildings. As discussed above, interior noise levels would be below the 45 dBA threshold for the residential and commercial uses.
SH-6: Consideration of noise levels and impacts in the land use planning and development process.	SH-6.1: <u>Construction Noise Control</u> . Provide best practices guidelines to developers for reducing potential noise impacts on surrounding land uses.	<b>Consistent.</b> Implementation of noise-attenuation techniques would ensure that noise remains as low as possible during construction.
	SH-6.2: <u>Limiting Construction Activities</u> . Continue to limit construction activities to the hours of 7:00 AM to 7:00 PM, Monday through Saturday. No construction shall occur after hours, on Sundays, or national holidays without permission from the City	<b>Consistent.</b> Implementation of noise-attenuation techniques would ensure that noise remains as low as possible during construction. More specifically, recommended noise attenuation measure would schedule high noise-producing activities between the hours of 7:00 AM and 5:00 PM to minimize disruption on sensitive uses.
	SH-6.3. <u>Buffering of Sensitive Receptors</u> . Require noise buffering and/or other construction treatments in development located near major streets, highways, the airport, railroad tracks, or other significant noise sources as recommended by a noise analysis.	<b>Consistent.</b> Roadway noise levels would fall below the residential and commercial exterior noise level standard. Interior noise levels would fall below the 45 dBA threshold for residential and commercial uses.
	SH-6.4. <u>New Development Noise Compatibility</u> . Require that proposed development projects not generate more noise than that classified as “satisfactory” based on CEQA Thresholds of significance on nearby property.	<b>Consistent.</b> Implementation of noise-attenuation techniques would ensure that noise remains as low as possible during construction. In addition, roadway noise levels would fall below the residential and commercial exterior noise level standard. Stationary noise sources, including HVAC systems, would be screened and integrated in architectural design of the building; thus the equipment would not generate levels

Goal	Policy	Consistency
	SH-6.13. <u>Noise Acceptable for Open Windows and Patios</u> . Continue to require noise analysis of proposed development projects as part of the environmental review process and the required mitigation measures to reduce noise impacts to acceptable levels within outside activity areas and within residential structures without relying on mechanical ventilation, if feasible.	that would substantially elevate the ambient noise environment.  <b>Consistent.</b> As discussed above, roadway noise levels would fall below the residential and commercial exterior noise level standard. In addition, interior noise levels would fall below the 45 dBA threshold for residential and commercial uses. As such, noise would be acceptable for open windows and patios.

## 9. CUMULATIVE NOISE ANALYSIS

For purposes of this analysis, development of the related projects will be considered to contribute to cumulative noise impacts. Noise by definition is a localized phenomenon, and drastically reduces as distance from the source increases. As a result, only project and growth in the general area of the Project site would contribute to cumulative noise impacts.

### Construction

Noise impacts are localized in nature and decrease with distance. Cumulative construction noise impacts have the potential to occur when multiple construction projects in the local area generate noise within the same time frame and contribute to the local ambient noise environment. The nearest related projects (Oakmont Senior Living, The Village, Wagon Wheel) are located approximately 0.6 miles to the east. Based on the noise levels generated by construction activities associated with the Project site, the duration of construction activities (intermittently over 18 months), and the proximity of the sensitive receptors, construction noise from the Project would contribute to the cumulative noise environment. It is expected that, as with the Project, the related projects would implement best management practices, which would minimize any noise-related nuisances during construction. Therefore, the combined construction noise impact of the related projects and the Project's contribution would not cause a significant cumulative impact.

Related projects are not located close enough to the Project site (approximately 0.6 miles) to result in vibration impacts from concurrent construction. Therefore, the combined vibration impact of the related projects and the Project's contribution would not cause a significant cumulative impact.

## Operation

The Project would not result in significant cumulative impacts during operation. Cumulative development from related projects would not result in significant cumulative impacts in terms of a substantial permanent increase in ambient noise levels. A substantial permanent increase is most likely to originate from an increase in noise levels due to roadway traffic. For the purposes of this analysis, an increase of 3 dBA at any roadway location is considered a significant impact, and the resulting noise level increase above 3 dBA would exceed the land use compatibility criteria.

### ***Traffic-Related Noise***

A substantial permanent increase is most likely to originate from an increase in noise levels due to roadway traffic. **Table 11, Cumulative plus Project**, illustrates the change in CNEL from cumulative traffic volumes and cumulative plus Project traffic volumes. As shown in **Table 11**, maximum cumulative noise level increases along roadways adjacent to residential and commercial uses by traffic from the proposed Project would range from a low of 0.0 dBA (several locations throughout the vicinity of the Project area) to a high of 0.3 dBA at Stroube Street, west of Rose Avenue (Intersection 7).

The proposed Project interior noise levels by attributed by roadway traffic would be attenuated by 25 dBA from outdoor noise levels. Roadway noise levels at Rose Avenue, south of the US 101 SB off-ramp (Intersection 10), would be 69.1 dBA CNEL, similar to existing conditions. Based on attenuation from outdoor to indoor noise levels, interior noise levels would be 44.1 dBA, below the 45 dBA threshold for residential and commercial uses.

**Table 11**  
**Cumulative plus Project**

Intersection #	Roadway Segment	Time Period	Cumulative plus Project		Change
			Cumulative	dBA CNEL	
<b><i>Vineyard Avenue</i></b>					
1	North of E. Stroube Street	AM	65.2	65.2	0.0
		PM	65.5	65.5	0.0
<b><i>Vineyard Avenue</i></b>					
1	South of E. Stroube Street	AM	65.4	65.4	0.0
		PM	65.4	65.4	0.0
2	North of Rio School Lane	AM	65.8	65.8	0.0
		PM	65.1	65.1	0.0
<b><i>Stroube Street</i></b>					
1	East of Vineyard Avenue	AM	49.8	49.8	0.0

Intersection #	Roadway Segment	Time Period	Cumulative	Cumulative plus	Change
				Project	
				dBA CNEL	
		PM	48.3	48.3	0.0
<b>Stroube Street</b>					
1	West of Vineyard Avenue	AM	47.0	47.0	0.0
		PM	46.8	46.8	0.0
<b>Vineyard Avenue</b>					
2	South of Rio School Lane	AM	65.8	65.8	0.0
		PM	65.1	65.1	0.0
3	North of River Park Boulevard	AM	65.8	65.8	0.0
		PM	65.9	65.9	0.0
<b>Stroube Street</b>					
2	East of Vineyard Avenue	AM	43.3	43.3	0.0
		PM	41.7	41.7	0.0
<b>Stroube Street</b>					
2	West of Vineyard Avenue	AM	35.6	35.6	0.0
		PM	31.9	31.9	0.0
<b>Vineyard Avenue</b>					
3	South of River Park Boulevard	AM	67.3	67.3	0.0
		PM	67.2	67.2	0.0
4	North of US 101 NB off-ramp	AM	67.3	67.3	0.0
		PM	67.2	67.2	0.0
<b>River Park Boulevard</b>					
3	East of Vineyard Avenue	AM	59.2	59.2	0.0
		PM	59.2	59.2	0.0
<b>River Park Boulevard</b>					
3	West of Vineyard Avenue	AM	59.7	59.7	0.0
		PM	58.5	58.5	0.0
<b>Vineyard Avenue</b>					
4	South of US 101 NB off-ramp	AM	67.6	67.6	0.0
		PM	67.4	67.4	0.0
5	North of US 101 SB off-ramp	AM	67.7	67.7	0.0
		PM	67.4	67.5	0.1
<b>US 101 NB Off-Ramp</b>					
4	East of Vineyard Avenue	AM	54.7	54.7	0.0
		PM	54.4	54.4	0.0
<b>US 101 NB Off-Ramp</b>					
4	West of Vineyard Avenue	AM	49.1	49.1	0.0

Intersection #	Roadway Segment	Time Period	Cumulative	Cumulative plus	Change
				Project	
				dBA CNEL	
		PM	50.1	50.1	0.0
<b>Vineyard Avenue</b>					
5	South of US 101 SB off-ramp	AM	68.7	68.7	0.0
		PM	67.9	67.9	0.0
6	North of Esplanade Drive	AM	68.2	68.2	0.0
		PM	67.7	67.7	0.0
<b>US 101 SB Off-Ramp</b>					
5	East of Vineyard Avenue	AM	54.2	54.2	0.0
		PM	53.8	53.8	0.0
<b>US 101 SB Off-Ramp</b>					
5	West of Vineyard Avenue	AM	54.4	54.4	0.0
		PM	54.6	54.7	0.1
<b>Vineyard Avenue</b>					
6	South of Esplanade Drive	AM	68.1	68.1	0.0
		PM	67.2	67.2	0.0
<b>Esplanade Drive</b>					
6	East of Vineyard Avenue	AM	56.0	56.0	0.0
		PM	54.4	54.4	0.0
<b>Esplanade Drive</b>					
6	West of Vineyard Avenue	AM	60.5	60.5	0.0
		PM	57.0	57.0	0.0
<b>Rose Avenue</b>					
7	North of W. Stroube Street	AM	64.9	65.0	0.1
		PM	64.7	64.7	0.0
<b>W. Stroube Street</b>					
7	West of Rose Avenue	AM	47.9	48.2	0.3
		PM	49.7	49.9	0.2
<b>Rose Avenue</b>					
7	South of W. Stroube Street	AM	65.4	65.4	0.0
		PM	65.3	65.4	0.0
8	North of River Park Boulevard	AM	65.3	65.4	0.1
		PM	65.6	65.6	0.0
<b>River Park Boulevard</b>					
8	East of Rose Avenue	AM	63.3	63.3	0.0
		PM	60.3	60.3	0.0



Intersection #	Roadway Segment	Time Period	Cumulative	Cumulative plus Project	Change
			dBA CNEL	dBA CNEL	
<b>River Park Boulevard</b>					
8	West of Rose Avenue	AM	53.9	53.9	0.0
		PM	52.5	52.5	0.0
<b>Rose Avenue</b>					
8	South of River Park Boulevard	AM	67.7	67.7	0.0
		PM	66.5	66.5	0.0
9	North of US 101 NB off-ramp	AM	67.7	67.7	0.0
		PM	66.6	66.6	0.0
<b>US 101 NB Off-Ramp</b>					
9	East of Rose Avenue	AM	56.2	56.2	0.0
		PM	55.7	55.7	0.0
<b>US 101 NB Off-Ramp</b>					
9	West of Rose Avenue	AM	51.3	51.3	0.0
		PM	47.8	47.8	0.0
<b>Rose Avenue</b>					
9	South of US 101 NB off-ramp	AM	68.5	68.5	0.0
		PM	67.8	67.8	0.0
10	North of US 101 SB off-ramp	AM	68.3	68.3	0.0
		PM	67.7	67.7	0.0
<b>US 101 SB Off-Ramp</b>					
10	East of Rose Avenue	AM	50.3	50.3	0.0
		PM	51.6	51.6	0.0
<b>US 101 SB Off-Ramp</b>					
10	West of Rose Avenue	AM	55.7	55.7	0.0
		PM	55.2	55.2	0.0
<b>Rose Avenue</b>					
10	South of US 101 SB off-ramp	AM	69.1	69.1	0.0
		PM	68.6	68.6	0.0

Source: Traffic noise model results are provided in **Appendix B**.

Note: Roadway noise levels are modeled 75 feet from the center of the roadway.

## Stationary Noise

With regard to stationary sources, cumulative significant noise impacts may result from cumulative development. Stationary sources of noise that could be introduced in the area by cumulative projects could include mechanical equipment, loading docks, and parking lots. Since these projects would be

required to adhere to the City of Oxnard noise standards, all the stationary sources would be required to provide shielding or other noise abatement measures so as not to cause a substantial increase in ambient noise levels. Moreover, due to distance, it is unlikely that noise from multiple cumulative projects would interact to create a significant combined noise impact. As such, it is not anticipated that a significant cumulative increase in permanent ambient noise levels would occur.

## **10. RECOMMENDATIONS**

The following noise attenuation measures are provided to reduce noise impacts during construction activities.

**N-1:** For all construction-related activities, noise-attenuation techniques shall be employed as needed to ensure that noise remains as low as possible during construction, specifically at REC-1 through REC-3. The following noise-attenuation techniques shall be incorporated into contract specifications to reduce the impact of construction noise:

- Ensure that construction equipment is properly muffled according to industry standards and in good working condition.
- Place noise-generating construction equipment and locate construction-staging areas away from sensitive uses, where feasible.
- Schedule high noise-producing activities between the hours of 7:00 AM and 5:00 PM to minimize disruption on sensitive uses.
- Implement noise attenuation measures to the extent feasible, which may include but are not limited to temporary noise barriers or noise blankets around stationary construction noise sources.
- Use electric air compressors and similar power tools rather than diesel equipment, where feasible.
- All stationary construction equipment (e.g., air compressors, generators, impact wrenches, etc.) shall be operated as far away from residential uses as possible and shall be shielded with temporary sound barriers, sound aprons, or sound skins.
- Construction-related equipment, including heavy-duty equipment, motor vehicles, and portable equipment, shall be turned off when not in use for more than 30 minutes.
- Clearly post construction hours, allowable workdays, and the phone number of the job superintendent at all construction entrances to allow for surrounding owners to contact the job superintendent. If the City or the job superintendent receives a complaint, the superintendent shall investigate, take appropriate corrective action, and report the action taken to the reporting party.

**APPENDIX A**

---

**Noise Monitoring Data Sheets**



Summary	
File Name on Meter	831_Data.006
File Name on PC	SLM_0003006_831_Data_006.00.ldbin
Serial Number	0003006
Model	Model 831
Firmware Version	2.313
User	
Location	
Job Description	
Note	

Measurement	
Description	
Start	2017-07-06 12:28:13
Stop	2017-07-06 12:44:14
Duration	00:16:01.1
Run Time	00:16:00.4
Pause	00:00:00.7
Pre Calibration	2017-07-06 11:26:26
Post Calibration	None
Calibration Deviation	---

Overall Settings			
RMS Weight	A Weighting		
Peak Weight	A Weighting		
Detector	Slow		
Preamp	PRM831		
Microphone Correction	Off		
Integration Method	Linear		
OBA Range	Low		
OBA Bandwidth	1/1 and 1/3		
OBA Freq. Weighting	A Weighting		
OBA Max Spectrum	Bin Max		
Gain	20.0 dB		
Overload	123.4 dB		
	<b>A</b>	<b>C</b>	<b>Z</b>
Under Range Peak	56.0	53.0	58.0 dB
Under Range Limit	24.6	25.0	32.0 dB
Noise Floor	15.5	15.9	20.7 dB

Results			
LAeq	53.4 dB		
LAE	83.2 dB		
EA	22.969 µPa²h		
EAS	688.775 µPa²h		
EA40	3.444 mPa²h		
LApeak (max)	2017-07-06 12:42:16	82.7 dB	
LASmax	2017-07-06 12:28:13	65.6 dB	
LASmin	2017-07-06 12:42:45	49.8 dB	
SEA	-99.9 dB		
LAS > 65.0 dB (Exceedance Counts / Duration)	0	0.0 s	
LAS > 85.0 dB (Exceedance Counts / Duration)	0	0.0 s	
LApeak > 135.0 dB (Exceedance Counts / Duration)	0	0.0 s	
LApeak > 137.0 dB (Exceedance Counts / Duration)	0	0.0 s	
LApeak > 140.0 dB (Exceedance Counts / Duration)	0	0.0 s	

Community Noise	Ldn	LDay 07:00-22:00	LNight 22:00-07:00	Lden	LDay 07:00-19:00	LEvening 19:00-22:00	LNight 22:00-07:00	dB
	53.3	53.3	-99.9	53.3	53.3	-99.9	-99.9	

LCeq	64.7 dB
LAeq	53.3 dB
LCeq - LAeq	11.3 dB
LAlaq	54.9 dB
LAeq	53.3 dB
LAlaq - LAeq	1.6 dB

	A		C		Z	
	dB	Time Stamp	dB	Time Stamp	dB	Time Stamp
Leq	53.3		64.7		72.3	
Ls(max)	65.6	2017/07/06 12:28:13	69.8	2017/07/06 12:28:13	85.5	2017/07/06 12:33:21
Lf(max)	64.4	2017/07/06 12:29:35	71.4	2017/07/06 12:38:06	90.2	2017/07/06 12:33:21
Li(max)	74.0	2017/07/06 12:28:13	75.7	2017/07/06 12:28:13	92.3	2017/07/06 12:33:21
Ls(min)	49.8	2017/07/06 12:42:45	61.5	2017/07/06 12:37:07	65.3	2017/07/06 12:37:11
Lf(min)	49.0	2017/07/06 12:42:44	60.1	2017/07/06 12:37:22	63.0	2017/07/06 12:37:44
Li(min)	49.3	2017/07/06 12:42:44	62.2	2017/07/06 12:37:06	66.9	2017/07/06 12:32:14
LPeak(max)	82.7	2017/07/06 12:42:16	83.5	2017/07/06 12:42:16	94.5	2017/07/06 12:33:21

# Overloads	0
Overload Duration	0.0 s
# OBA Overloads	6.0
OBA Overload Duration	14.3 s

Dose Settings		
Dose Name	OSHA-1	OSHA-2
Exchange Rate	5	5 dB
Threshold	90	80 dB
Criterion Level	90	90 dB
Criterion Duration	8	8 h

Results		
Dose	-99.9	-99.9 %
Projected Dose	-99.9	-99.9 %
TWA (Projected)	-99.9	-99.9 dB
TWA (t)	-99.9	-99.9 dB
Lep (t)	38.6	38.6 dB

Statistics	
LAS5.00	55.4 dB
LAS10.00	54.9 dB
LAS33.30	53.6 dB
LAS50.00	52.9 dB
LAS66.60	52.4 dB
LAS90.00	51.5 dB

Calibration History					
Preamp	Date	dB re. 1V/Pa	6.3	8.0	10.0
PRM831	2017-07-06 11:26:26	-26.1	51.8	66.2	58.9
PRM831	2017-07-05 10:50:32	-26.0	46.5	43.4	55.7
PRM831	2017-07-05 10:50:17	-26.0	42.5	50.4	51.8
PRM831	2017-06-21 13:26:03	-25.9	45.5	56.2	49.1
PRM831	2017-06-21 08:45:40	-25.8	27.9	44.4	42.5
PRM831	2017-06-21 08:37:13	-26.0	30.9	35.0	21.8
PRM831	2017-06-21 06:00:37	-26.0	12.5	11.6	9.3

12.5	16.0	20.0	25.0	31.5	40.0	50.0	63.0	80.0	100	125	160	200	250	315	400	500	630	800	1000	1250	1600	2000	2500	3150	4000	5000	6300	8000	10000	12500	16000	20000
64.4	67.0	54.6	64.4	60.7	60.2	73.5	64.8	60.2	58.8	56.8	52.5	51.1	51.3	47.7	43.4	43.8	41.5	35.3	114.0	49.0	28.3	64.9	30.2	59.2	34.0	33.9	34.3	35.8	36.8	38.1	39.0	40.8
63.8	59.3	51.2	50.2	47.9	48.2	46.9	39.2	46.9	53.1	68.0	49.7	73.9	73.5	64.7	66.3	64.3	62.0	48.6	114.0	49.3	31.7	65.1	30.5	59.0	33.7	33.7	34.5	35.9	37.1	38.0	38.8	40.9
42.3	57.2	49.2	50.1	49.1	42.1	49.6	48.7	47.1	46.9	48.1	46.9	47.2	43.8	37.8	43.2	39.5	31.2	31.4	113.9	49.0	28.9	64.9	30.2	59.0	33.5	33.8	34.4	35.5	36.5	37.5	39.0	40.8
49.7	45.8	60.8	61.8	51.3	50.8	56.9	56.1	58.1	54.0	55.0	52.9	54.4	45.2	41.6	34.5	35.1	27.1	30.6	113.9	48.9	28.2	65.9	30.2	57.8	33.3	33.5	34.7	35.2	36.8	37.7	38.9	40.7
37.4	44.0	45.2	57.8	49.3	49.6	52.7	52.5	53.6	52.8	63.0	41.2	44.9	47.5	48.9	53.0	39.8	32.5	30.5	114.2	49.2	28.3	64.2	29.6	55.7	32.2	32.0	31.9	32.0	32.0	31.4	30.5	29.5
25.9	33.5	30.4	32.5	30.2	24.7	21.1	23.7	19.3	29.8	26.4	16.2	23.4	26.4	23.7	28.4	26.8	26.7	27.8	29.2	30.2	30.5	31.8	32.9	35.2	34.9	56.2	37.7	38.4	39.5	41.2	41.5	42.6
10.2	4.5	4.1	4.3	6.1	5.9	0.6	-1.9	4.4	4.6	-2.8	-4.5	-5.8	-7.9	-3.0	-3.8	-4.8	-2.9	-2.2	-3.3	-4.2	-2.1	-1.4	-0.4	0.0	1.2	1.7	3.5	3.4	4.6	5.9	7.5	9.1



Summary	
File Name on Meter	831_Data.004
File Name on PC	SLM_0003006_831_Data_004.00.ldbin
Serial Number	0003006
Model	Model 831
Firmware Version	2.313
User	
Location	
Job Description	
Note	

Measurement	
Description	
Start	2017-07-06 12:08:31
Stop	2017-07-06 12:24:32
Duration	00:16:01.2
Run Time	00:16:00.6
Pause	00:00:00.6
Pre Calibration	2017-07-06 11:26:26
Post Calibration	None
Calibration Deviation	---

Overall Settings			
RMS Weight	A Weighting		
Peak Weight	A Weighting		
Detector	Slow		
Preamp	PRM831		
Microphone Correction	Off		
Integration Method	Linear		
OBA Range	Low		
OBA Bandwidth	1/1 and 1/3		
OBA Freq. Weighting	A Weighting		
OBA Max Spectrum	Bin Max		
Gain	20.0 dB		
Overload	123.4 dB		
	<b>A</b>	<b>C</b>	<b>Z</b>
Under Range Peak	56.0	53.0	58.0 dB
Under Range Limit	24.6	25.0	32.0 dB
Noise Floor	15.5	15.9	20.7 dB

Results			
LAeq	73.3 dB		
LAE	103.1 dB		
EA	2.255 mPa²h		
EAS	67.593 mPa²h		
EA40	337.967 mPa²h		
LApeak (max)	2017-07-06 12:20:20	104.9 dB	
LASmax	2017-07-06 12:20:21	91.2 dB	
LASmin	2017-07-06 12:19:23	55.9 dB	
SEA	-99.9 dB		
LAS > 65.0 dB (Exceedance Counts / Duration)	14	881.0 s	
LAS > 85.0 dB (Exceedance Counts / Duration)	3	6.4 s	
LApeak > 135.0 dB (Exceedance Counts / Duration)	0	0.0 s	
LApeak > 137.0 dB (Exceedance Counts / Duration)	0	0.0 s	
LApeak > 140.0 dB (Exceedance Counts / Duration)	0	0.0 s	

Community Noise	Ldn	LDay 07:00-22:00	LNight 22:00-07:00	Lden	LDay 07:00-19:00	LEvening 19:00-22:00	LNight 22:00-07:00	dB
	73.2	73.2	-99.9	73.2	73.2	-99.9	-99.9	dB

LCeq	80.1 dB
LAeq	73.2 dB
LCeq - LAeq	6.9 dB
LAlaq	75.4 dB
LAeq	73.2 dB
LAlaq - LAeq	2.2 dB

	A		C		Z	
	dB	Time Stamp	dB	Time Stamp	dB	Time Stamp
Leq	73.2		80.1		84.6	
Ls(max)	91.2	2017/07/06 12:20:21	93.8	2017/07/06 12:20:21	96.6	2017/07/06 12:20:21
Lf(max)	94.4	2017/07/06 12:20:21	96.7	2017/07/06 12:20:21	100.8	2017/07/06 12:20:21
Li(max)	95.3	2017/07/06 12:20:21	97.6	2017/07/06 12:20:21	103.0	2017/07/06 12:18:36
Ls(min)	55.9	2017/07/06 12:19:23	66.7	2017/07/06 12:09:49	69.7	2017/07/06 12:09:50
Lf(min)	54.9	2017/07/06 12:19:22	65.5	2017/07/06 12:09:49	67.2	2017/07/06 12:09:49
Li(min)	55.4	2017/07/06 12:19:22	67.0	2017/07/06 12:09:49	70.4	2017/07/06 12:09:50
LPeak(max)	104.9	2017/07/06 12:20:20	108.5	2017/07/06 12:20:20	110.8	2017/07/06 12:20:21

# Overloads	0
Overload Duration	0.0 s
# OBA Overloads	50.0
OBA Overload Duration	812.5 s

Dose Settings		
Dose Name	OSHA-1	OSHA-2
Exchange Rate	5	5 dB
Threshold	90	80 dB
Criterion Level	90	90 dB
Criterion Duration	8	8 h



Results		
Dose	0.00	0.02 %
Projected Dose	0.07	0.75 %
TWA (Projected)	37.4	54.7 dB
TWA (t)	12.9	30.2 dB
Lep (t)	58.5	58.5 dB

Statistics	
LAS5.00	77.6 dB
LAS10.00	76.1 dB
LAS33.30	72.6 dB
LAS50.00	71.0 dB
LAS66.60	69.0 dB
LAS90.00	64.1 dB

Calibration History					
Preamp	Date	dB re. 1V/Pa	6.3	8.0	10.0
PRM831	2017-07-06 11:26:26	-26.1	51.8	66.2	58.9
PRM831	2017-07-05 10:50:32	-26.0	46.5	43.4	55.7
PRM831	2017-07-05 10:50:17	-26.0	42.5	50.4	51.8
PRM831	2017-06-21 13:26:03	-25.9	45.5	56.2	49.1
PRM831	2017-06-21 08:45:40	-25.8	27.9	44.4	42.5
PRM831	2017-06-21 08:37:13	-26.0	30.9	35.0	21.8
PRM831	2017-06-21 06:00:37	-26.0	12.5	11.6	9.3

12.5	16.0	20.0	25.0	31.5	40.0	50.0	63.0	80.0	100	125	160	200	250	315	400	500	630	800	1000	1250	1600	2000	2500	3150	4000	5000	6300	8000	10000	12500	16000	20000
64.4	67.0	54.6	64.4	60.7	60.2	73.5	64.8	60.2	58.8	56.8	52.5	51.1	51.3	47.7	43.4	43.8	41.5	35.3	114.0	49.0	28.3	64.9	30.2	59.2	34.0	33.9	34.3	35.8	36.8	38.1	39.0	40.8
63.8	59.3	51.2	50.2	47.9	48.2	46.9	39.2	46.9	53.1	68.0	49.7	73.9	73.5	64.7	66.3	64.3	62.0	48.6	114.0	49.3	31.7	65.1	30.5	59.0	33.7	33.7	34.5	35.9	37.1	38.8	40.9	
42.3	57.2	49.2	50.1	49.1	42.1	49.6	48.7	47.1	46.9	48.1	46.9	47.2	43.8	37.8	43.2	39.5	31.2	31.4	113.9	49.0	28.9	64.9	30.2	59.0	33.5	33.8	34.4	35.5	36.5	37.5	39.0	40.8
49.7	45.8	60.8	61.8	51.3	50.8	56.9	56.1	58.1	54.0	55.0	52.9	54.4	45.2	41.6	34.5	35.1	27.1	30.6	113.9	48.9	28.2	65.9	30.2	57.8	33.3	33.5	34.7	35.2	36.8	37.7	38.9	40.7
37.4	44.0	45.2	57.8	49.3	49.6	52.7	52.5	53.6	52.8	63.0	41.2	44.9	47.5	48.9	53.0	39.8	32.5	30.5	114.2	49.2	28.3	64.2	29.6	55.7	32.2	32.0	31.9	32.0	32.0	31.4	30.5	29.5
25.9	33.5	30.4	32.5	30.2	24.7	21.1	23.7	19.3	29.8	26.4	16.2	23.4	26.4	23.7	28.4	26.8	26.7	27.8	29.2	30.2	30.5	31.8	32.9	35.2	34.9	56.2	37.7	38.4	39.5	41.2	41.5	42.6
10.2	4.5	4.1	4.3	6.1	5.9	0.6	-1.9	4.4	4.6	-2.8	-4.5	-5.8	-7.9	-3.0	-3.8	-4.8	-2.9	-2.2	-3.3	-4.2	-2.1	-1.4	-0.4	0.0	1.2	1.7	3.5	3.4	4.6	5.9	7.5	9.1



Summary	
File Name on Meter	831_Data.003
File Name on PC	SLM_0003006_831_Data_003.00.lbin
Serial Number	0003006
Model	Model 831
Firmware Version	2.313
User	
Location	
Job Description	
Note	

Measurement	
<b>Description</b>	
Start	2017-07-06 11:50:26
Stop	2017-07-06 12:06:28
Duration	00:16:01.5
Run Time	00:16:00.9
Pause	00:00:00.6
Pre Calibration	2017-07-06 11:26:26
Post Calibration	None
Calibration Deviation	---

Overall Settings			
RMS Weight	A Weighting		
Peak Weight	A Weighting		
Detector	Slow		
Preamp	PRM831		
Microphone Correction	Off		
Integration Method	Linear		
OBA Range	Low		
OBA Bandwidth	1/1 and 1/3		
OBA Freq. Weighting	A Weighting		
OBA Max Spectrum	Bin Max		
Gain	20.0 dB		
Overload	123.4 dB		
	<b>A</b>	<b>C</b>	<b>Z</b>
Under Range Peak	56.0	53.0	58.0 dB
Under Range Limit	24.6	25.0	32.0 dB
Noise Floor	15.5	15.9	20.7 dB

Results			
LAeq	71.3 dB		
LAE	101.2 dB		
EA	1.471 mPa²h		
EAS	44.086 mPa²h		
EA40	220.428 mPa²h		
LApeak (max)	2017-07-06 11:58:15	101.4 dB	
LASmax	2017-07-06 12:03:30	83.8 dB	
LASmin	2017-07-06 12:06:24	54.8 dB	
SEA	-99.9 dB		
LAS > 65.0 dB (Exceedance Counts / Duration)	21	685.7 s	
LAS > 85.0 dB (Exceedance Counts / Duration)	0	0.0 s	
LApeak > 135.0 dB (Exceedance Counts / Duration)	0	0.0 s	
LApeak > 137.0 dB (Exceedance Counts / Duration)	0	0.0 s	
LApeak > 140.0 dB (Exceedance Counts / Duration)	0	0.0 s	

Community Noise	Ldn	LDay 07:00-22:00	LNight 22:00-07:00	Lden	LDay 07:00-19:00	LEvening 19:00-22:00	LNight 22:00-07:00	dB
	71.4	71.4	-99.9	71.4	71.4	-99.9	-99.9	dB

LCeq	81.0 dB
LAeq	71.4 dB
LCeq - LAeq	9.6 dB
LAlaq	73.1 dB
LAeq	71.4 dB
LAlaq - LAeq	1.7 dB

	A		C		Z	
	dB	Time Stamp	dB	Time Stamp	dB	Time Stamp
Leq	71.4		81.0		86.4	
Ls(max)	83.8	2017/07/06 12:03:30	97.0	2017/07/06 11:56:18	98.5	2017/07/06 11:52:40
Lf(max)	86.9	2017/07/06 11:58:15	99.6	2017/07/06 11:56:17	102.7	2017/07/06 11:53:22
Li(max)	89.3	2017/07/06 11:58:15	100.6	2017/07/06 11:56:17	105.1	2017/07/06 11:53:22
Ls(min)	54.8	2017/07/06 12:06:24	66.9	2017/07/06 12:02:56	70.5	2017/07/06 12:04:33
Lf(min)	54.2	2017/07/06 12:06:24	65.3	2017/07/06 12:02:56	68.1	2017/07/06 12:02:56
Li(min)	54.7	2017/07/06 12:06:23	67.9	2017/07/06 12:02:56	71.3	2017/07/06 12:04:33
LPeak(max)	101.4	2017/07/06 11:58:15	108.6	2017/07/06 11:58:15	109.7	2017/07/06 12:01:58

# Overloads	0
Overload Duration	0.0 s
# OBA Overloads	46.0
OBA Overload Duration	838.7 s

Dose Settings		
Dose Name	OSHA-1	OSHA-2
Exchange Rate	5	5 dB
Threshold	90	80 dB
Criterion Level	90	90 dB
Criterion Duration	8	8 h

Results		
Dose	-99.9	0.02 %
Projected Dose	-99.9	0.46 %
TWA (Projected)	-99.9	51.2 dB
TWA (t)	-99.9	26.6 dB
Lep (t)	56.6	56.6 dB

Statistics	
LAS5.00	77.0 dB
LAS10.00	75.2 dB
LAS33.30	70.3 dB
LAS50.00	67.6 dB
LAS66.60	64.7 dB
LAS90.00	60.0 dB

Calibration History					
Preamp	Date	dB re. 1V/Pa	6.3	8.0	10.0
PRM831	2017-07-06 11:26:26	-26.1	51.8	66.2	58.9
PRM831	2017-07-05 10:50:32	-26.0	46.5	43.4	55.7
PRM831	2017-07-05 10:50:17	-26.0	42.5	50.4	51.8
PRM831	2017-06-21 13:26:03	-25.9	45.5	56.2	49.1
PRM831	2017-06-21 08:45:40	-25.8	27.9	44.4	42.5
PRM831	2017-06-21 08:37:13	-26.0	30.9	35.0	21.8
PRM831	2017-06-21 06:00:37	-26.0	12.5	11.6	9.3

12.5	16.0	20.0	25.0	31.5	40.0	50.0	63.0	80.0	100	125	160	200	250	315	400	500	630	800	1000	1250	1600	2000	2500	3150	4000	5000	6300	8000	10000	12500	16000	20000
64.4	67.0	54.6	64.4	60.7	60.2	73.5	64.8	60.2	58.8	56.8	52.5	51.1	51.3	47.7	43.4	43.8	41.5	35.3	114.0	49.0	28.3	64.9	30.2	59.2	34.0	33.9	34.3	35.8	36.8	38.1	39.0	40.8
63.8	59.3	51.2	50.2	47.9	48.2	46.9	39.2	46.9	53.1	68.0	49.7	73.9	73.5	64.7	66.3	64.3	62.0	48.6	114.0	49.3	31.7	65.1	30.5	59.0	33.7	33.7	34.5	35.9	37.1	38.0	38.8	40.9
42.3	57.2	49.2	50.1	49.1	42.1	49.6	48.7	47.1	46.9	48.1	46.9	47.2	43.8	37.8	43.2	39.5	31.2	31.4	113.9	49.0	28.9	64.9	30.2	59.0	33.5	33.8	34.4	35.5	36.5	37.5	39.0	40.8
49.7	45.8	60.8	61.8	51.3	50.8	56.9	56.1	58.1	54.0	55.0	52.9	54.4	45.2	41.6	34.5	35.1	27.1	30.6	113.9	48.9	28.2	65.9	30.2	57.8	33.3	33.5	34.7	35.2	36.8	37.7	38.9	40.7
37.4	44.0	45.2	57.8	49.3	49.6	52.7	52.5	53.6	52.8	63.0	41.2	44.9	47.5	48.9	53.0	39.8	32.5	30.5	114.2	49.2	28.3	64.2	29.6	55.7	32.2	32.0	31.9	32.0	32.0	31.4	30.5	29.5
25.9	33.5	30.4	32.5	30.2	24.7	21.1	23.7	19.3	29.8	26.4	16.2	23.4	26.4	23.7	28.4	26.8	26.7	27.8	29.2	30.2	30.5	31.8	32.9	35.2	34.9	56.2	37.7	38.4	39.5	41.2	41.5	42.6
10.2	4.5	4.1	4.3	6.1	5.9	0.6	-1.9	4.4	4.6	-2.8	-4.5	-5.8	-7.9	-3.0	-3.8	-4.8	-2.9	-2.2	-3.3	-4.2	-2.1	-1.4	-0.4	0.0	1.2	1.7	3.5	3.4	4.6	5.9	7.5	9.1



Summary	
File Name on Meter	831_Data.002
File Name on PC	SLM_0003006_831_Data_002.00.ldbin
Serial Number	0003006
Model	Model 831
Firmware Version	2.313
User	
Location	
Job Description	
Note	

Measurement	
<b>Description</b>	
Start	2017-07-06 11:31:32
Stop	2017-07-06 11:47:35
Duration	00:16:03.4
Run Time	00:16:02.2
Pause	00:00:01.2
Pre Calibration	2017-07-06 11:26:26
Post Calibration	None
Calibration Deviation	---

Overall Settings			
RMS Weight	A Weighting		
Peak Weight	A Weighting		
Detector	Slow		
Preamp	PRM831		
Microphone Correction	Off		
Integration Method	Linear		
OBA Range	Low		
OBA Bandwidth	1/1 and 1/3		
OBA Freq. Weighting	A Weighting		
OBA Max Spectrum	Bin Max		
Gain	20.0 dB		
Overload	123.4 dB		
	<b>A</b>	<b>C</b>	<b>Z</b>
Under Range Peak	56.0	53.0	58.0 dB
Under Range Limit	24.6	25.0	32.0 dB
Noise Floor	15.5	15.9	20.7 dB

Results			
LAeq	55.2 dB		
LAE	85.2 dB		
EA	36.506 µPa²h		
EAS	1.093 mPa²h		
EA40	5.463 mPa²h		
LApeak (max)	2017-07-06 11:32:57	92.5 dB	
LASmax	2017-07-06 11:46:48	69.3 dB	
LASmin	2017-07-06 11:35:34	52.3 dB	
SEA	-99.9 dB		
LAS > 65.0 dB (Exceedance Counts / Duration)	1	2.0 s	
LAS > 85.0 dB (Exceedance Counts / Duration)	0	0.0 s	
LApeak > 135.0 dB (Exceedance Counts / Duration)	0	0.0 s	
LApeak > 137.0 dB (Exceedance Counts / Duration)	0	0.0 s	
LApeak > 140.0 dB (Exceedance Counts / Duration)	0	0.0 s	

Community Noise	Ldn	LDay 07:00-22:00	LNight 22:00-07:00	Lden	LDay 07:00-19:00	LEvening 19:00-22:00	LNight 22:00-07:00	dB
	55.3	55.3	-99.9	55.3	55.3	-99.9	-99.9	dB

LCeq	67.3 dB
LAeq	55.3 dB
LCeq - LAeq	11.9 dB
LAlaq	58.8 dB
LAeq	55.3 dB
LAlaq - LAeq	3.5 dB

	A		C		Z	
	dB	Time Stamp	dB	Time Stamp	dB	Time Stamp
Leq	55.3		67.3		75.2	
Ls(max)	69.3	2017/07/06 11:46:48	77.2	2017/07/06 11:39:47	87.2	2017/07/06 11:32:11
Lf(max)	77.2	2017/07/06 11:46:48	79.5	2017/07/06 11:34:28	92.2	2017/07/06 11:38:09
Li(max)	81.2	2017/07/06 11:46:48	82.5	2017/07/06 11:34:28	95.0	2017/07/06 11:38:09
Ls(min)	52.3	2017/07/06 11:35:34	63.8	2017/07/06 11:47:07	66.0	2017/07/06 11:33:13
Lf(min)	51.5	2017/07/06 11:33:07	61.9	2017/07/06 11:38:30	64.2	2017/07/06 11:33:13
Li(min)	52.0	2017/07/06 11:35:32	64.2	2017/07/06 11:47:06	66.9	2017/07/06 11:33:13
LPeak(max)	92.5	2017/07/06 11:32:57	91.5	2017/07/06 11:33:00	97.7	2017/07/06 11:38:09

# Overloads	0
Overload Duration	0.0 s
# OBA Overloads	27.0
OBA Overload Duration	74.8 s

Dose Settings		
Dose Name	OSHA-1	OSHA-2
Exchange Rate	5	5 dB
Threshold	90	80 dB
Criterion Level	90	90 dB
Criterion Duration	8	8 h

Results		
Dose	-99.9	-99.9 %
Projected Dose	-99.9	-99.9 %
TWA (Projected)	-99.9	-99.9 dB
TWA (t)	-99.9	-99.9 dB
Lep (t)	40.6	40.6 dB

Statistics	
LAS5.00	57.1 dB
LAS10.00	56.2 dB
LAS33.30	55.1 dB
LAS50.00	54.7 dB
LAS66.60	54.3 dB
LAS90.00	53.6 dB

Calibration History					
Preamp	Date	dB re. 1V/Pa	6.3	8.0	10.0
PRM831	2017-07-06 11:26:26	-26.1	51.8	66.2	58.9
PRM831	2017-07-05 10:50:32	-26.0	46.5	43.4	55.7
PRM831	2017-07-05 10:50:17	-26.0	42.5	50.4	51.8
PRM831	2017-06-21 13:26:03	-25.9	45.5	56.2	49.1
PRM831	2017-06-21 08:45:40	-25.8	27.9	44.4	42.5
PRM831	2017-06-21 08:37:13	-26.0	30.9	35.0	21.8
PRM831	2017-06-21 06:00:37	-26.0	12.5	11.6	9.3

12.5	16.0	20.0	25.0	31.5	40.0	50.0	63.0	80.0	100	125	160	200	250	315	400	500	630	800	1000	1250	1600	2000	2500	3150	4000	5000	6300	8000	10000	12500	16000	20000
64.4	67.0	54.6	64.4	60.7	60.2	73.5	64.8	60.2	58.8	56.8	52.5	51.1	51.3	47.7	43.4	43.8	41.5	35.3	114.0	49.0	28.3	64.9	30.2	59.2	34.0	33.9	34.3	35.8	36.8	38.1	39.0	40.8
63.8	59.3	51.2	50.2	47.9	48.2	46.9	39.2	46.9	53.1	68.0	49.7	73.9	73.5	64.7	66.3	64.3	62.0	48.6	114.0	49.3	31.7	65.1	30.5	59.0	33.7	33.7	34.5	35.9	37.1	38.0	38.8	40.9
42.3	57.2	49.2	50.1	49.1	42.1	49.6	48.7	47.1	46.9	48.1	46.9	47.2	43.8	37.8	43.2	39.5	31.2	31.4	113.9	49.0	28.9	64.9	30.2	59.0	33.5	33.8	34.4	35.5	36.5	37.5	39.0	40.8
49.7	45.8	60.8	61.8	51.3	50.8	56.9	56.1	58.1	54.0	55.0	52.9	54.4	45.2	41.6	34.5	35.1	27.1	30.6	113.9	48.9	28.2	65.9	30.2	57.8	33.3	33.5	34.7	35.2	36.8	37.7	38.9	40.7
37.4	44.0	45.2	57.8	49.3	49.6	52.7	52.5	53.6	52.8	63.0	41.2	44.9	47.5	48.9	53.0	39.8	32.5	30.5	114.2	49.2	28.3	64.2	29.6	55.7	32.2	32.0	31.9	32.0	32.0	31.4	30.5	29.5
25.9	33.5	30.4	32.5	30.2	24.7	21.1	23.7	19.3	29.8	26.4	16.2	23.4	26.4	23.7	28.4	26.8	26.7	27.8	29.2	30.2	30.5	31.8	32.9	35.2	34.9	56.2	37.7	38.4	39.5	41.2	41.5	42.6
10.2	4.5	4.1	4.3	6.1	5.9	0.6	-1.9	4.4	4.6	-2.8	-4.5	-5.8	-7.9	-3.0	-3.8	-4.8	-2.9	-2.2	-3.3	-4.2	-2.1	-1.4	-0.4	0.0	1.2	1.7	3.5	3.4	4.6	5.9	7.5	9.1





Summary	
File Name on Meter	831_Data.007
File Name on PC	SLM_0003006_831_Data_007.00.lbin
Serial Number	0003006
Model	Model 831
Firmware Version	2.313
User	
Location	
Job Description	
Note	

Measurement	
<b>Description</b>	
Start	2017-07-06 12:54:37
Stop	2017-07-06 13:10:40
Duration	00:16:02.8
Run Time	00:16:01.5
Pause	00:00:01.3
Pre Calibration	2017-07-06 11:26:26
Post Calibration	None
Calibration Deviation	---

Overall Settings			
RMS Weight	A Weighting		
Peak Weight	A Weighting		
Detector	Slow		
Preamp	PRM831		
Microphone Correction	Off		
Integration Method	Linear		
OBA Range	Low		
OBA Bandwidth	1/1 and 1/3		
OBA Freq. Weighting	A Weighting		
OBA Max Spectrum	Bin Max		
Gain	20.0 dB		
Overload	123.4 dB		
	<b>A</b>	<b>C</b>	<b>Z</b>
Under Range Peak	56.0	53.0	58.0 dB
Under Range Limit	24.6	25.0	32.0 dB
Noise Floor	15.5	15.9	20.7 dB

Results			
LAeq	72.1 dB		
LAE	101.8 dB		
EA	1.685 mPa²h		
EAS	50.458 mPa²h		
EA40	252.290 mPa²h		
L <sub>Apeak</sub> (max)	2017-07-06 12:59:17	109.9 dB	
L <sub>ASmax</sub>	2017-07-06 12:59:18	93.1 dB	
L <sub>ASmin</sub>	2017-07-06 13:06:50	56.4 dB	
SEA	-99.9 dB		
L <sub>AS</sub> > 65.0 dB (Exceedance Counts / Duration)	25	748.4 s	
L <sub>AS</sub> > 85.0 dB (Exceedance Counts / Duration)	1	3.8 s	
L <sub>Apeak</sub> > 135.0 dB (Exceedance Counts / Duration)	0	0.0 s	
L <sub>Apeak</sub> > 137.0 dB (Exceedance Counts / Duration)	0	0.0 s	
L <sub>Apeak</sub> > 140.0 dB (Exceedance Counts / Duration)	0	0.0 s	

Community Noise	L <sub>dn</sub>	L <sub>Day</sub> 07:00-22:00	L <sub>Night</sub> 22:00-07:00	L <sub>den</sub>	L <sub>Day</sub> 07:00-19:00	L <sub>Evening</sub> 19:00-22:00	L <sub>Night</sub> 22:00-07:00	dB
	72.0	72.0	-99.9	72.0	72.0	-99.9	-99.9	dB

L <sub>Ceq</sub>	80.1 dB
L <sub>Aeq</sub>	72.0 dB
L <sub>Ceq</sub> - L <sub>Aeq</sub>	8.1 dB
L <sub>Aleq</sub>	75.3 dB
L <sub>Aeq</sub>	72.0 dB
L <sub>Aleq</sub> - L <sub>Aeq</sub>	3.4 dB

	A		C		Z	
	dB	Time Stamp	dB	Time Stamp	dB	Time Stamp
Leq	72.0		80.1		82.4	
L <sub>s</sub> (max)	93.1	2017/07/06 12:59:18	96.5	2017/07/06 12:59:18	96.5	2017/07/06 12:59:18
L <sub>f</sub> (max)	99.0	2017/07/06 12:59:18	102.4	2017/07/06 12:59:18	102.5	2017/07/06 12:59:18
L <sub>l</sub> (max)	100.5	2017/07/06 12:59:17	103.6	2017/07/06 12:59:17	103.6	2017/07/06 12:59:17
L <sub>s</sub> (min)	56.4	2017/07/06 13:06:50	69.9	2017/07/06 13:03:18	72.7	2017/07/06 13:09:03
L <sub>f</sub> (min)	55.3	2017/07/06 13:06:49	67.5	2017/07/06 13:05:30	71.3	2017/07/06 13:00:47
L <sub>l</sub> (min)	55.7	2017/07/06 13:06:49	70.9	2017/07/06 13:03:19	72.9	2017/07/06 13:09:03
L <sub>Peak</sub> (max)	109.9	2017/07/06 12:59:17	111.1	2017/07/06 12:59:17	111.3	2017/07/06 12:59:17

# Overloads	0
Overload Duration	0.0 s
# OBA Overloads	75.0
OBA Overload Duration	649.7 s

Dose Settings			
Dose Name	OSHA-1	OSHA-2	
Exchange Rate	5	5	dB
Threshold	90	80	dB
Criterion Level	90	90	dB
Criterion Duration	8	8	h

Results		
Dose	0.00	0.03 %
Projected Dose	0.12	0.79 %
TWA (Projected)	41.4	55.1 dB
TWA (t)	16.9	30.6 dB
Lep (t)	57.2	57.2 dB

Statistics	
LAS5.00	76.3 dB
LAS10.00	74.3 dB
LAS33.30	70.6 dB
LAS50.00	68.2 dB
LAS66.60	66.0 dB
LAS90.00	60.2 dB

Calibration History					
Preamp	Date	dB re. 1V/Pa	6.3	8.0	10.0
PRM831	2017-07-06 11:26:26	-26.1	51.8	66.2	58.9
PRM831	2017-07-05 10:50:32	-26.0	46.5	43.4	55.7
PRM831	2017-07-05 10:50:17	-26.0	42.5	50.4	51.8
PRM831	2017-06-21 13:26:03	-25.9	45.5	56.2	49.1
PRM831	2017-06-21 08:45:40	-25.8	27.9	44.4	42.5
PRM831	2017-06-21 08:37:13	-26.0	30.9	35.0	21.8
PRM831	2017-06-21 06:00:37	-26.0	12.5	11.6	9.3

12.5	16.0	20.0	25.0	31.5	40.0	50.0	63.0	80.0	100	125	160	200	250	315	400	500	630	800	1000	1250	1600	2000	2500	3150	4000	5000	6300	8000	10000	12500	16000	20000
64.4	67.0	54.6	64.4	60.7	60.2	73.5	64.8	60.2	58.8	56.8	52.5	51.1	51.3	47.7	43.4	43.8	41.5	35.3	114.0	49.0	28.3	64.9	30.2	59.2	34.0	33.9	34.3	35.8	36.8	38.1	39.0	40.8
63.8	59.3	51.2	50.2	47.9	48.2	46.9	39.2	46.9	53.1	68.0	49.7	73.9	73.5	64.7	66.3	64.3	62.0	48.6	114.0	49.3	31.7	65.1	30.5	59.0	33.7	33.7	34.5	35.9	37.1	38.0	38.8	40.9
42.3	57.2	49.2	50.1	49.1	42.1	49.6	48.7	47.1	46.9	48.1	46.9	47.2	43.8	37.8	43.2	39.5	31.2	31.4	113.9	49.0	28.9	64.9	30.2	59.0	33.5	33.8	34.4	35.5	36.5	37.5	39.0	40.8
49.7	45.8	60.8	61.8	51.3	50.8	56.9	56.1	58.1	54.0	55.0	52.9	54.4	45.2	41.6	34.5	35.1	27.1	30.6	113.9	48.9	28.2	65.9	30.2	57.8	33.3	33.5	34.7	35.2	36.8	37.7	38.9	40.7
37.4	44.0	45.2	57.8	49.3	49.6	52.7	52.5	53.6	52.8	63.0	41.2	44.9	47.5	48.9	53.0	39.8	32.5	30.5	114.2	49.2	28.3	64.2	29.6	55.7	32.2	32.0	31.9	32.0	32.0	31.4	30.5	29.5
25.9	33.5	30.4	32.5	30.2	24.7	21.1	23.7	19.3	29.8	26.4	16.2	23.4	26.4	23.7	28.4	26.8	26.7	27.8	29.2	30.2	30.5	31.8	32.9	35.2	34.9	56.2	37.7	38.4	39.5	41.2	41.5	42.6
10.2	4.5	4.1	4.3	6.1	5.9	0.6	-1.9	4.4	4.6	-2.8	-4.5	-5.8	-7.9	-3.0	-3.8	-4.8	-2.9	-2.2	-3.3	-4.2	-2.1	-1.4	-0.4	0.0	1.2	1.7	3.5	3.4	4.6	5.9	7.5	9.1

**APPENDIX B**

---

**Roadway Traffic Noise Spreadsheets**

**Project Name**  
**Weekday AM Peak Hour Volumes**

rev. (Date)

Intersection: 1  
 Vineyard Avenue & W. Stroube Street

If Peak Hour = 6% of ADT, Scaling Factor = 16.667  
 If Peak Hour = 7% of ADT, Scaling Factor = 14.286  
 If Peak Hour = 8% of ADT, Scaling Factor = 12.5  
 If Peak Hour = 9% of ADT, Scaling Factor = 11.111  
 If Peak Hour = 10% of ADT, Scaling Factor = 10

**Vineyard Avenue**

Southbound

	right	through	left
Existing	20	1,003	42
Exising plus Proj	20	1,010	42
Cumulative	20	1,038	42
Cumlative plus P	20	1,038	42

Westbound

	right	through	left
Existing	50	32	134
Exising plus Proj	50	32	144
Cumulative	50	32	144
Cumlative plus P	50	32	144

W N E  
 S

Northbound

	left	through	right
Existing	28	899	68
Exising plus Proj	28	904	76
Cumulative	28	944	76
Cumlative plus P	28	944	76

Eastbound

	left	through	right
Existing	60	31	26
Exising plus Proj	60	31	26
Cumulative	60	31	26
Cumlative plus P	60	31	26

W. Stroube Street

ADT

Road	Vineyard Avenue		W. Stroube Street	
	North of	South of	East of	West of
Leg				
Cross Street	W. Stroube Street		Vineyard Avenue	
Existing	16,592.0	17,264.0	2,856.0	1,576.0
Exising plus Proj	16,688.0	17,504.0	3,000.0	1,576.0
Cumulative	17,232.0	18,048.0	3,000.0	1,576.0
Cumlative plus P	17,232.0	18,048.0	3,000.0	1,576.0

**NOISE LEVEL CONTOURS - Existing Plus Project Weekday Off-Site ADT Volumes**

ROADWAY NAME Segment	Land Use	Lanes	Median Width	ADT Volume	Design Speed (mph)	Dist. from Center Receptor (ft)	Barrier Attn. (dB(A))	Vehicle Mix		dB(A) CNEL	Traffic Volumes								Ref. Energy Levels			Dist Adj	Ld A	Le			Ln									
								Medium Trucks	Heavy Trucks		Day	Eve	Night	MTd	HTd	MTe	HTe	MTn	HTn	A	MT			HT	Total	A	MT	HT	Total	A	MT	HT	Total			
<b>Vineya</b>																																				
Existing		2	10	16,592	40	75	0	0	1.8%	0.7%	65.0	12,892	2,107	1,593	261	103	15	3	22	9	67.4	76.3	81.2	-1.8	64.4	56.6	57.4	65.8	61.5	49.0	47.2	61.8	48.3	47.1	48.2	52.6
Existing plus Pr		2	10	16,688	40	75	0	0	1.8%	0.7%	65.1	12,967	2,119	1,602	263	104	15	3	23	9	67.4	76.3	81.2	-1.8	64.5	56.6	57.4	65.8	61.5	49.0	47.3	61.9	48.3	47.1	48.2	52.7
Cumulative		2	10	17,232	40	75	0	0	1.8%	0.7%	65.2	13,389	2,188	1,654	271	107	16	3	23	10	67.4	76.3	81.2	-1.8	64.6	56.7	57.6	65.9	61.6	49.2	47.4	62.0	48.4	47.3	48.3	52.8
Cumulative plus		2	10	17,232	40	75	0	0	1.8%	0.7%	65.2	13,389	2,188	1,654	271	107	16	3	23	10	67.4	76.3	81.2	-1.8	64.6	56.7	57.6	65.9	61.6	49.2	47.4	62.0	48.4	47.3	48.3	52.8
<b>Vineya</b>																																				
Existing		2	10	17,264	40	75	0	0	1.8%	0.7%	65.2	13,414	2,193	1,657	272	108	16	3	23	10	67.4	76.3	81.2	-1.8	64.6	56.7	57.6	65.9	61.6	49.2	47.4	62.0	48.4	47.3	48.3	52.8
Existing plus Pr		2	10	17,504	40	75	0	0	1.8%	0.7%	65.3	13,601	2,223	1,680	275	109	16	3	24	10	67.4	76.3	81.2	-1.8	64.7	56.8	57.6	66.0	61.7	49.2	47.5	62.1	48.5	47.4	48.4	52.9
Cumulative		2	10	18,048	40	75	0	0	1.8%	0.7%	65.4	14,023	2,292	1,733	284	113	16	4	24	10	67.4	76.3	81.2	-1.8	64.8	56.9	57.8	66.1	61.8	49.4	47.6	62.2	48.6	47.5	48.5	53.0
Cumulative plus		2	10	18,048	40	75	0	0	1.8%	0.7%	65.4	14,023	2,292	1,733	284	113	16	4	24	10	67.4	76.3	81.2	-1.8	64.8	56.9	57.8	66.1	61.8	49.4	47.6	62.2	48.6	47.5	48.5	53.0
<b>W.</b>																																				
Existing		1	0	2,856	15	75	0	0	1.8%	0.7%	49.6	2,219	363	274	45	18	3	1	4	2	50.8	65.4	74.5	-1.8	44.5	42.2	47.3	49.9	41.5	34.7	37.1	43.5	28.3	32.8	38.1	39.5
Existing plus Pr		1	0	3,000	15	75	0	0	1.8%	0.7%	49.8	2,331	381	288	47	19	3	1	4	2	50.8	65.4	74.5	-1.8	44.7	42.5	47.5	50.1	41.7	34.9	37.3	43.7	28.5	33.0	38.3	39.7
Cumulative		1	0	3,000	15	75	0	0	1.8%	0.7%	49.8	2,331	381	288	47	19	3	1	4	2	50.8	65.4	74.5	-1.8	44.7	42.5	47.5	50.1	41.7	34.9	37.3	43.7	28.5	33.0	38.3	39.7
Cumulative plus		1	0	3,000	15	75	0	0	1.8%	0.7%	49.8	2,331	381	288	47	19	3	1	4	2	50.8	65.4	74.5	-1.8	44.7	42.5	47.5	50.1	41.7	34.9	37.3	43.7	28.5	33.0	38.3	39.7
<b>W.</b>																																				
Existing		1	0	1,576	15	75	0	0	1.8%	0.7%	47.0	1,225	200	151	25	10	1	0	2	1	50.8	65.4	74.5	-1.8	41.9	39.7	44.7	47.3	38.9	32.1	34.5	40.9	25.7	30.2	35.5	36.9
Existing plus Pr		1	0	1,576	15	75	0	0	1.8%	0.7%	47.0	1,225	200	151	25	10	1	0	2	1	50.8	65.4	74.5	-1.8	41.9	39.7	44.7	47.3	38.9	32.1	34.5	40.9	25.7	30.2	35.5	36.9
Cumulative		1	0	1,576	15	75	0	0	1.8%	0.7%	47.0	1,225	200	151	25	10	1	0	2	1	50.8	65.4	74.5	-1.8	41.9	39.7	44.7	47.3	38.9	32.1	34.5	40.9	25.7	30.2	35.5	36.9
Cumulative plus		1	0	1,576	15	75	0	0	1.8%	0.7%	47.0	1,225	200	151	25	10	1	0	2	1	50.8	65.4	74.5	-1.8	41.9	39.7	44.7	47.3	38.9	32.1	34.5	40.9	25.7	30.2	35.5	36.9

(1) Alpha Factor: Coefficient of absorption relating to the effects of the ground surface.  
 An alpha factor of 0 indicates that the site is an acoustically "hard" site such as asphalt.  
 An alpha factor of 0.5 indicates that the site is an acoustically "soft" site such as

Assumed 24-Hour Day Evening Night  
 Total ADT Volume 77.70% 12.70% 9.60%  
 Medium-Duty Trucks 87.43% 5.05% 7.52%  
 Heavy-Duty Trucks 89.10% 2.84% 8.06%

**Project Name**  
**Weekday PM Peak Hour Volumes**

rev. (Date)

Intersection: 1  
 Vineyard Avenue & W. Stroube Street

If Peak Hour = 6% of ADT, Scaling Factor = 16.667  
 If Peak Hour = 7% of ADT, Scaling Factor = 14.286  
 If Peak Hour = 8% of ADT, Scaling Factor = 12.5  
 If Peak Hour = 9% of ADT, Scaling Factor = 11.111  
 If Peak Hour = 10% of ADT, Scaling Factor = 10

ADT

**Vineyard Avenue**

Southbound

	right	through	left
Existing	20	1,135	49
Existing plus Proj	20	1,139	49
Cumulative	20	1,205	49
Cumulative plus	20	1,205	49

Westbound

	right	through	left
Existing	46	6	103
Existing plus Proj	46	6	109
Cumulative	46	6	109
Cumulative plus	46	6	109

Road	Vineyard Avenue		W. Stroube Street	
	North of	South of	East of	West of
Leg				
Cross Street	W. Stroube Street		Vineyard Avenue	
Existing	17,928.0	17,536.0	1,992.0	1,504.0
Existing plus Proj	18,016.0	17,752.0	2,120.0	1,504.0
Cumulative	18,648.0	18,384.0	2,120.0	1,504.0
Cumulative plus	18,648.0	18,384.0	2,120.0	1,504.0

Eastbound

	left	through	right
Existing	99	23	30
Existing plus Proj	99	23	30
Cumulative	99	23	30
Cumulative plus	99	23	30

Northbound

	left	through	right
Existing	10	892	22
Existing plus Proj	10	899	32
Cumulative	10	912	32
Cumulative plus	10	912	32

W      N  
           S      E

W. Stroube Street



**Project Name**  
**Weekday AM Peak Hour Volumes**

rev. (Date)

Intersection: 2  
 Vineyard Avenue & Rio School Lane

If Peak Hour = 6% of ADT, Scaling Factor = 16.667  
 If Peak Hour = 7% of ADT, Scaling Factor = 14.286  
 If Peak Hour = 8% of ADT, Scaling Factor = 12.5  
 If Peak Hour = 9% of ADT, Scaling Factor = 11.111  
 If Peak Hour = 10% of ADT, Scaling Factor = 10

ADT

**Vineyard Avenue**

Southbound

	right	through	left
Existing	2	1,295	14
Existing plus Proj	2	1,295	31
Cumulative	2	1,323	31
Cumulative plus	2	1,323	31

Westbound

	right	through	left
Existing	9		6
Existing plus Proj	17		26
Cumulative	17		26
Cumulative plus	17		26

Road	Vineyard Avenue		Rio School Lane	
	North of	South of	East of	West of
Leg	Rio School Lane		Vineyard Avenue	
Existing	18,848.0	18,864.0	304.0	112.0
Existing plus Proj	19,088.0	19,256.0	856.0	112.0
Cumulative	19,632.0	19,608.0	664.0	112.0
Cumulative plus	19,632.0	19,608.0	664.0	112.0

Eastbound

	left	through	right
Existing	0	0	7
Existing plus Proj	0	0	7
Cumulative	0	0	7
Cumulative plus	0	0	7

Northbound

	left	through	right
Existing	5	1,036	9
Existing plus Proj	5	1,041	33
Cumulative	5	1,081	9
Cumulative plus	5	1,081	9

W      N      E  
           S

Rio School Lane



**NOISE LEVEL CONTOURS - Existing Plus Project Weekday Off-Site ADT Volumes**

ROADWAY NAME Segment	Land Use	Lanes	Median Width	ADT Volume	Design Speed (mph)	Dist. from Center to Receptor	Alpha Factor (1)	Barrier Attn. dB(A)	Vehicle Mix		dB(A) CNEL	Traffic Volumes								Ref. Energy Levels Dist																
									Medium Trucks	Heavy Trucks		Day	Eve	Night	MTd	HTd	MTe	HTe	MTn	HTn	A	MT	HT	Adj	A	MT	HT	Total	A	MT	HT	Total	A	MT	HT	Total
<b>Vineyard Avenue n/o Rio</b>																																				
Existing		3	0	18,848	40	75	0	0	1.8%	0.7%	65.6	14,645	2,394	1,809	297	118	17	4	26	11	67.4	76.3	81.2	-1.8	65.0	57.1	58.0	66.3	62.0	49.6	47.8	62.4	48.8	47.7	48.7	53.2
Existing plus Project		3	0	19,088	40	75	0	0	1.8%	0.7%	65.6	14,831	2,424	1,832	300	119	17	4	26	11	67.4	76.3	81.2	-1.8	65.0	57.2	58.0	66.4	62.1	49.6	47.9	62.5	48.9	47.7	48.8	53.3
Cumulative		3	0	19,632	40	75	0	0	1.8%	0.7%	65.8	15,254	2,493	1,885	309	122	18	4	27	11	67.4	76.3	81.2	-1.8	65.2	57.3	58.1	66.5	62.2	49.7	48.0	62.6	49.0	47.9	48.9	53.4
Cumulative plus Project		3	0	19,632	40	75	0	0	1.8%	0.7%	65.8	15,254	2,493	1,885	309	122	18	4	27	11	67.4	76.3	81.2	-1.8	65.2	57.3	58.1	66.5	62.2	49.7	48.0	62.6	49.0	47.9	48.9	53.4
<b>Vineyard Avenue s/o Rio</b>																																				
Existing		3	0	18,864	40	75	0	0	1.8%	0.7%	65.6	14,657	2,396	1,811	297	118	17	4	26	11	67.4	76.3	81.2	-1.8	65.0	57.1	58.0	66.3	62.0	49.6	47.8	62.4	48.8	47.7	48.7	53.2
Existing plus Project		3	0	19,256	40	75	0	0	1.8%	0.7%	65.7	14,962	2,446	1,849	303	120	18	4	26	11	67.4	76.3	81.2	-1.8	65.1	57.2	58.1	66.4	62.1	49.6	47.9	62.5	48.9	47.8	48.8	53.3
Cumulative		3	0	19,608	40	75	0	0	1.8%	0.7%	65.8	15,235	2,490	1,882	309	122	18	4	27	11	67.4	76.3	81.2	-1.8	65.2	57.3	58.1	66.5	62.2	49.7	48.0	62.6	49.0	47.9	48.9	53.4
Cumulative plus Project		3	0	19,608	40	75	0	0	1.8%	0.7%	65.8	15,235	2,490	1,882	309	122	18	4	27	11	67.4	76.3	81.2	-1.8	65.2	57.3	58.1	66.5	62.2	49.7	48.0	62.6	49.0	47.9	48.9	53.4
<b>Rio School Lane e/o Vineyard</b>																																				
Existing		2	0	304	15	75	0	0	1.8%	0.7%	39.9	236	39	29	5	2	0	0	0	0	50.8	65.4	74.5	-1.8	34.8	32.5	37.6	40.2	31.8	24.9	27.4	33.7	18.6	23.1	28.3	29.8
Existing plus Project		2	0	856	15	75	0	0	1.8%	0.7%	44.4	665	109	82	13	5	1	0	1	0	50.8	65.4	74.5	-1.8	39.3	37.0	42.1	44.7	36.3	29.4	31.9	38.2	23.1	27.6	32.8	34.3
Cumulative		2	0	664	15	75	0	0	1.8%	0.7%	43.3	516	84	64	10	4	1	0	1	0	50.8	65.4	74.5	-1.8	38.2	35.9	41.0	43.6	35.2	28.3	30.8	37.1	22.0	26.5	31.7	33.2
Cumulative plus Project		2	0	664	15	75	0	0	1.8%	0.7%	43.3	516	84	64	10	4	1	0	1	0	50.8	65.4	74.5	-1.8	38.2	35.9	41.0	43.6	35.2	28.3	30.8	37.1	22.0	26.5	31.7	33.2
<b>Rio School Lane w/o</b>																																				
Existing		2	0	112	15	75	0	0	1.8%	0.7%	35.6	87	14	11	2	1	0	0	0	0	50.8	65.4	74.5	-1.8	30.4	28.2	33.2	35.9	27.4	20.6	23.1	29.4	14.2	18.7	24.0	25.5
Existing plus Project		2	0	112	15	75	0	0	1.8%	0.7%	35.6	87	14	11	2	1	0	0	0	0	50.8	65.4	74.5	-1.8	30.4	28.2	33.2	35.9	27.4	20.6	23.1	29.4	14.2	18.7	24.0	25.5
Cumulative		2	0	112	15	75	0	0	1.8%	0.7%	35.6	87	14	11	2	1	0	0	0	0	50.8	65.4	74.5	-1.8	30.4	28.2	33.2	35.9	27.4	20.6	23.1	29.4	14.2	18.7	24.0	25.5
Cumulative plus Project		2	0	112	15	75	0	0	1.8%	0.7%	35.6	87	14	11	2	1	0	0	0	0	50.8	65.4	74.5	-1.8	30.4	28.2	33.2	35.9	27.4	20.6	23.1	29.4	14.2	18.7	24.0	25.5

(1) Alpha Factor: Coefficient of absorption relating to the effects of the ground surface. An alpha factor of 0 indicates that the site is an acoustically "hard" site such as asphalt. An alpha factor of 0.5 indicates that the site is an acoustically "soft" site such as vegetative ground cover.

Assumed 24-Hour Traffic Distribution:	Day	Evening	Night
Total ADT Volumes	77.70%	12.70%	9.60%
Medium-Duty Trucks	87.43%	5.05%	7.52%
Heavy-Duty Trucks	89.10%	2.84%	8.06%

**Project Name**  
**Weekday PM Peak Hour Volumes**

rev. (Date)

Intersection: 2  
 Vineyard Avenue & Rio School Lane

If Peak Hour = 6% of ADT, Scaling Factor = 16.667  
 If Peak Hour = 7% of ADT, Scaling Factor = 14.286  
 If Peak Hour = 8% of ADT, Scaling Factor = 12.5  
 If Peak Hour = 9% of ADT, Scaling Factor = 11.111  
 If Peak Hour = 10% of ADT, Scaling Factor = 10

ADT

Road	Vineyard Avenue		Rio School Lane	
	North of	South of	East of	West of
Leg				
Cross Street	Rio School Lane		Vineyard Avenue	
Existing	16,552.0	16,528.0	88.0	48.0
Existing plus Proj	16,768.0	16,896.0	560.0	48.0
Cumulative	16,992.0	17,016.0	456.0	48.0
Cumulative plus	16,992.0	17,016.0	456.0	48.0

**Vineyard Avenue**

Southbound

	right	through	left
Existing	2	1,127	5
Existing plus Proj	2	1,127	15
Cumulative	2	1,127	15
Cumulative plus	2	1,127	15

Westbound

	right	through	left
Existing	3		1
Existing plus Proj	13		27
Cumulative	13		27
Cumulative plus	13		27

Northbound

	left	through	right
Existing	1	932	2
Existing plus Proj	1	939	15
Cumulative	1	967	2
Cumulative plus	1	967	2

Eastbound

	left	through	right
Existing	0	0	3
Existing plus Proj	0	0	3
Cumulative	0	0	3
Cumulative plus	0	0	3

Rio School Lane

W      N      E  
           S

**2**  
**NOISE LEVEL CONTOURS - Existing Plus Project Weekday Off-Site ADT Volumes**

												Traffic Volumes					Ref. Energy Levels Dist				Ld			Le			Ln																							
ROADWAY NAME Segment	Land Use	Lanes	Median Width	ADT Volume	Design Speed (mph)	Dist. from Center to Receptor	Alpha Factor (1)	Barrier Attn. dB(A)	Vehicle Mix		dB(A) CNEL	Day	Eve	Night	MTd	HTd	MTe	HTe	MTn	HTn	A	MT	HT	Adj	A	MT	HT	Total A	MT	HT	Total A	MT	HT	Total A	MT	HT	Total													
<b>Vineyard Avenue n/o Rio</b>																																																		
Existing		3	0	16,552	40	75	0	0	1.8%	0.7%	65.0	12,861	2,102	1,589	260	103	15	3	22	9	67.4	76.3	81.2	-1.8	64.4	56.6	57.4	65.8	61.4	49.0	47.2	61.8	48.3	47.1	48.2	52.6														
Existing plus Project		3	0	16,768	40	75	0	0	1.8%	0.7%	65.1	13,029	2,130	1,610	264	105	15	3	23	9	67.4	76.3	81.2	-1.8	64.5	56.6	57.5	65.8	61.5	49.0	47.3	61.9	48.3	47.2	48.2	52.7														
Cumulative		3	0	16,992	40	75	0	0	1.8%	0.7%	65.1	13,203	2,158	1,631	267	106	15	3	23	10	67.4	76.3	81.2	-1.8	64.5	56.7	57.5	65.9	61.6	49.1	47.3	62.0	48.4	47.2	48.3	52.8														
Cumulative plus Project		3	0	16,992	40	75	0	0	1.8%	0.7%	65.1	13,203	2,158	1,631	267	106	15	3	23	10	67.4	76.3	81.2	-1.8	64.5	56.7	57.5	65.9	61.6	49.1	47.3	62.0	48.4	47.2	48.3	52.8														
<b>Vineyard Avenue s/o Rio</b>																																																		
Existing		3	0	16,528	40	75	0	0	1.8%	0.7%	65.0	12,842	2,099	1,587	260	103	15	3	22	9	67.4	76.3	81.2	-1.8	64.4	56.6	57.4	65.8	61.4	49.0	47.2	61.8	48.2	47.1	48.2	52.6														
Existing plus Project		3	0	16,896	40	75	0	0	1.8%	0.7%	65.1	13,128	2,146	1,622	266	105	15	3	23	10	67.4	76.3	81.2	-1.8	64.5	56.7	57.5	65.9	61.5	49.1	47.3	61.9	48.3	47.2	48.3	52.7														
Cumulative		3	0	17,016	40	75	0	0	1.8%	0.7%	65.1	13,221	2,161	1,634	268	106	15	3	23	10	67.4	76.3	81.2	-1.8	64.5	56.7	57.5	65.9	61.6	49.1	47.4	62.0	48.4	47.2	48.3	52.8														
Cumulative plus Project		3	0	17,016	40	75	0	0	1.8%	0.7%	65.1	13,221	2,161	1,634	268	106	15	3	23	10	67.4	76.3	81.2	-1.8	64.5	56.7	57.5	65.9	61.6	49.1	47.4	62.0	48.4	47.2	48.3	52.8														
<b>Rio School Lane e/o Vineyard</b>																																																		
Existing		2	0	88	15	75	0	0	1.8%	0.7%	34.5	68	11	8	1	1	0	0	0	0	50.8	65.4	74.5	-1.8	29.4	27.1	32.2	34.8	26.4	19.6	22.0	28.4	13.2	17.7	23.0	24.4														
Existing plus Project		2	0	560	15	75	0	0	1.8%	0.7%	42.6	435	71	54	9	3	1	0	1	0	50.8	65.4	74.5	-1.8	37.4	35.2	40.2	42.9	34.4	27.6	30.1	36.4	21.2	25.7	31.0	32.5														
Cumulative		2	0	456	15	75	0	0	1.8%	0.7%	41.7	354	58	44	7	3	0	0	1	0	50.8	65.4	74.5	-1.8	36.5	34.3	39.3	42.0	33.5	26.7	29.2	35.5	20.3	24.8	30.1	31.6														
Cumulative plus Project		2	0	456	15	75	0	0	1.8%	0.7%	41.7	354	58	44	7	3	0	0	1	0	50.8	65.4	74.5	-1.8	36.5	34.3	39.3	42.0	33.5	26.7	29.2	35.5	20.3	24.8	30.1	31.6														
<b>Rio School Lane w/o</b>																																																		
Existing		2	0	48	15	75	0	0	1.8%	0.7%	31.9	37	6	5	1	0	0	0	0	0	50.8	65.4	74.5	-1.8	26.7	24.5	29.6	32.2	23.8	16.9	19.4	25.7	10.6	15.1	20.3	21.8														
Existing plus Project		2	0	48	15	75	0	0	1.8%	0.7%	31.9	37	6	5	1	0	0	0	0	0	50.8	65.4	74.5	-1.8	26.7	24.5	29.6	32.2	23.8	16.9	19.4	25.7	10.6	15.1	20.3	21.8														
Cumulative		2	0	48	15	75	0	0	1.8%	0.7%	31.9	37	6	5	1	0	0	0	0	0	50.8	65.4	74.5	-1.8	26.7	24.5	29.6	32.2	23.8	16.9	19.4	25.7	10.6	15.1	20.3	21.8														
Cumulative plus Project		2	0	48	15	75	0	0	1.8%	0.7%	31.9	37	6	5	1	0	0	0	0	0	50.8	65.4	74.5	-1.8	26.7	24.5	29.6	32.2	23.8	16.9	19.4	25.7	10.6	15.1	20.3	21.8														

(1) Alpha Factor: Coefficient of absorption relating to the effects of the ground surface. An alpha factor of 0 indicates that the site is an acoustically "hard" site such as asphalt. An alpha factor of 0.5 indicates that the site is an acoustically "soft" site such as vegetative ground cover.

Assumed 24-Hour Traffic Distribution:	Day	Evening	Night
Total ADT Volumes	77.70%	12.70%	9.60%
Medium-Duty Trucks	87.43%	5.05%	7.52%
Heavy-Duty Trucks	89.10%	2.84%	8.06%

**Project Name**  
**Weekday AM Peak Hour Volumes**

rev. (Date)

Intersection: 3  
 Vineyard Avenue & River Park Boulevard

If Peak Hour = 6% of ADT, Scaling Factor = 16.667  
 If Peak Hour = 7% of ADT, Scaling Factor = 14.286  
 If Peak Hour = 8% of ADT, Scaling Factor = 12.5  
 If Peak Hour = 9% of ADT, Scaling Factor = 11.111  
 If Peak Hour = 10% of ADT, Scaling Factor = 10

ADT

**Vineyard Avenue**

Southbound

	right	through	left
Existing	64	1,018	31
Existing plus Proj	67	1,055	31
Cumulative	67	1,083	31
Cumulative plus	67	1,083	31

Westbound

	right	through	left
Existing	100	126	362
Existing plus Proj	100	126	362
Cumulative	100	126	365
Cumulative plus	100	126	365

Road	Vineyard Avenue		River Park Boulevard	
	North of	South of	East of	West of
Leg	River Park Boulevard		Vineyard Avenue	
Existing	18,304.0	26,552.0	7,496.0	7,984.0
Existing plus Proj	19,032.0	27,232.0	7,496.0	8,032.0
Cumulative	19,576.0	28,184.0	7,576.0	8,360.0
Cumulative plus	19,576.0	28,184.0	7,576.0	8,360.0

Eastbound

	left	through	right
Existing	57	74	341
Existing plus Proj	60	74	341
Cumulative	60	74	353
Cumulative plus	60	74	353

Northbound

	left	through	right
Existing	336	1,018	244
Existing plus Proj	336	1,066	244
Cumulative	365	1,106	251
Cumulative plus	365	1,106	251

W      N  
           S      E

River Park Boulevard

**NOISE LEVEL CONTOURS - Existing Plus Project Weekday Off-Site ADT Volumes**

													Traffic Volumes					Ref. Energy Levels				Ln													
ROADWAY NAME	Land Use	Median	ADT	Design Speed	Dist. to Receptor	Dist. from Center	Alpha	Barrier Attn.	Vehicle Mix		dB(A)	Day	Eve	Night	MTd	HTd	MTe	HTe	MTn	HTn	A	MT	HT	Adj	A	MT	HT	Total A	MT	HT	Total A	MT	HT	Total	
Segment		Lanes	Volume	(mph)	Factor (1)	to	(dB(A))		Medium Trucks	Heavy Trucks	CNEL																								
<b>Vineyard Avenue n/o River</b>																																			
Existing		3	18,304	40	75	0	0	1.8%	0.7%	65.5	14,222	2,325	1,757	288	114	17	4	25	10	67.4	76.3	81.2	-1.8	64.9	57.0	57.8	66.2	61.9	49.4	47.7	62.3	48.7	47.6	48.6	53.1
Existing plus Project		3	19,032	40	75	0	0	1.8%	0.7%	65.6	14,788	2,417	1,827	300	119	17	4	26	11	67.4	76.3	81.2	-1.8	65.0	57.2	58.0	66.4	62.1	49.6	47.8	62.4	48.9	47.7	48.8	53.3
Cumulative		3	19,576	40	75	0	0	1.8%	0.7%	65.8	15,211	2,486	1,879	308	122	18	4	26	11	67.4	76.3	81.2	-1.8	65.2	57.3	58.1	66.5	62.2	49.7	48.0	62.6	49.0	47.8	48.9	53.4
Cumulative plus Project		3	19,576	40	75	0	0	1.8%	0.7%	65.8	15,211	2,486	1,879	308	122	18	4	26	11	67.4	76.3	81.2	-1.8	65.2	57.3	58.1	66.5	62.2	49.7	48.0	62.6	49.0	47.8	48.9	53.4
<b>Vineyard Avenue s/o River</b>																																			
Existing		3	26,552	40	75	0	0	1.8%	0.7%	67.1	20,631	3,372	2,549	418	166	24	5	36	15	67.4	76.3	81.2	-1.8	66.5	58.6	59.5	67.8	63.5	51.0	49.3	63.9	50.3	49.2	50.2	54.7
Existing plus Project		3	27,232	40	75	0	0	1.8%	0.7%	67.2	21,159	3,458	2,614	429	170	25	5	37	15	67.4	76.3	81.2	-1.8	66.6	58.7	59.6	67.9	63.6	51.2	49.4	64.0	50.4	49.3	50.3	54.8
Cumulative		3	28,184	40	75	0	0	1.8%	0.7%	67.3	21,899	3,579	2,706	444	176	26	6	38	16	67.4	76.3	81.2	-1.8	66.7	58.9	59.7	68.1	63.8	51.3	49.5	64.2	50.6	49.4	50.5	55.0
Cumulative plus Project		3	28,184	40	75	0	0	1.8%	0.7%	67.3	21,899	3,579	2,706	444	176	26	6	38	16	67.4	76.3	81.2	-1.8	66.7	58.9	59.7	68.1	63.8	51.3	49.5	64.2	50.6	49.4	50.5	55.0
<b>River Park Boulevard e/o</b>																																			
Existing		2	7,496	30	75	0	0	1.8%	0.7%	59.2	5,824	952	720	118	47	7	1	10	4	62.5	73.1	80.3	-1.8	57.4	51.2	54.3	59.7	54.4	43.6	44.1	55.1	41.2	41.7	45.0	47.8
Existing plus Project		2	7,496	30	75	0	0	1.8%	0.7%	59.2	5,824	952	720	118	47	7	1	10	4	62.5	73.1	80.3	-1.8	57.4	51.2	54.3	59.7	54.4	43.6	44.1	55.1	41.2	41.7	45.0	47.8
Cumulative		2	7,576	30	75	0	0	1.8%	0.7%	59.2	5,887	962	727	119	47	7	2	10	4	62.5	73.1	80.3	-1.8	57.4	51.2	54.3	59.8	54.4	43.6	44.2	55.1	41.2	41.7	45.1	47.8
Cumulative plus Project		2	7,576	30	75	0	0	1.8%	0.7%	59.2	5,887	962	727	119	47	7	2	10	4	62.5	73.1	80.3	-1.8	57.4	51.2	54.3	59.8	54.4	43.6	44.2	55.1	41.2	41.7	45.1	47.8
<b>River Park Boulevard w/o</b>																																			
Existing		2	7,984	30	75	0	0	1.8%	0.7%	59.5	6,204	1,014	766	126	50	7	2	11	5	62.5	73.1	80.3	-1.8	57.7	51.5	54.6	60.1	54.7	43.9	44.4	55.4	41.5	42.0	45.4	48.1
Existing plus Project		2	8,032	30	75	0	0	1.8%	0.7%	59.5	6,241	1,020	771	126	50	7	2	11	5	62.5	73.1	80.3	-1.8	57.7	51.5	54.6	60.1	54.7	43.9	44.5	55.4	41.5	42.0	45.4	48.1
Cumulative		2	8,360	30	75	0	0	1.8%	0.7%	59.7	6,496	1,062	803	132	52	8	2	11	5	62.5	73.1	80.3	-1.8	57.9	51.7	54.8	60.3	54.9	44.1	44.6	55.6	41.7	42.2	45.6	48.3
Cumulative plus Project		2	8,360	30	75	0	0	1.8%	0.7%	59.7	6,496	1,062	803	132	52	8	2	11	5	62.5	73.1	80.3	-1.8	57.9	51.7	54.8	60.3	54.9	44.1	44.6	55.6	41.7	42.2	45.6	48.3

(1) Alpha Factor: Coefficient of absorption relating to the effects of the ground surface. An alpha factor of 0 indicates that the site is an acoustically "hard" site such as asphalt. An alpha factor of 0.5 indicates that the site is an acoustically "soft" site such as vegetative ground cover.

Assumed 24-Hour Traffic Distribution:	Day	Evening	Night
Total ADT Volumes	77.70%	12.70%	9.60%
Medium-Duty Trucks	87.43%	5.05%	7.52%
Heavy-Duty Trucks	89.10%	2.84%	8.06%

**Project Name**  
**Weekday PM Peak Hour Volumes**

rev. (Date)

Intersection: 3  
 Vineyard Avenue & River Park Boulevard

If Peak Hour = 6% of ADT, Scaling Factor = 16.667  
 If Peak Hour = 7% of ADT, Scaling Factor = 14.286  
 If Peak Hour = 8% of ADT, Scaling Factor = 12.5  
 If Peak Hour = 9% of ADT, Scaling Factor = 11.111  
 If Peak Hour = 10% of ADT, Scaling Factor = 10

ADT

**Vineyard Avenue**

Southbound

	right	through	left
Existing	51	1,092	108
Existing plus Proj	55	1,140	108
Cumulative	55	1,206	108
Cumulative plus	55	1,206	108

Westbound

	right	through	left
Existing	50	52	214
Existing plus Proj	50	52	214
Cumulative	50	52	219
Cumulative plus	50	52	219

Road	Vineyard Avenue		River Park Boulevard	
	North of	South of	East of	West of
Leg				
Cross Street	River Park Boulevard		Vineyard Avenue	
Existing	19,128.0	26,072.0	7,448.0	6,104.0
Existing plus Proj	19,768.0	26,664.0	7,448.0	6,152.0
Cumulative	20,400.0	27,568.0	7,496.0	6,376.0
Cumulative plus	20,400.0	27,568.0	7,496.0	6,376.0

Eastbound

	left	through	right
Existing	55	97	355
Existing plus Proj	57	97	355
Cumulative	57	97	369
Cumulative plus	57	97	369

Northbound

	left	through	right
Existing	153	1,035	410
Existing plus Proj	153	1,061	410
Cumulative	167	1,074	411
Cumulative plus	167	1,074	411

W      N  
           S      E

River Park Boulevard

**NOISE LEVEL CONTOURS - Existing Plus Project Weekday Off-Site ADT Volumes**

ROADWAY NAME Segment	Land Use	Median Lanes	ADT Volume	Design Dist. from		Barrier Attn.	Vehicle Mix		dB(A) CNEL	Traffic Volumes								Ref. Energy Levels Dist			Ld			Le			Ln									
				Speed (mph)	Center to Receptor		Alpha Factor (1)	Medium Trucks		Heavy Trucks	Day	Even	Night	MTd	HTd	MTe	HTe	MTn	HTn	A	MT	HT	Adj	A	MT	HT	Total	A	MT	HT	Total	A	MT	HT	Total	
<b>Vineyard Avenue n/o River</b>																																				
Existing		3	0	19,128	40	75	0	0	1.8%	0.7%	65.7	14,862	#####	#####	301	119	17	4	26	11	67.4	76.3	81.2	-1.8	65.1	57.2	58.0	66.4	62.1	49.6	47.9	62.5	48.9	47.7	48.8	53.3
Existing plus Project		3	0	19,768	40	75	0	0	1.8%	0.7%	65.8	15,360	#####	#####	311	123	18	4	27	11	67.4	76.3	81.2	-1.8	65.2	57.3	58.2	66.5	62.2	49.8	48.0	62.6	49.0	47.9	48.9	53.4
Cumulative		3	0	20,400	40	75	0	0	1.8%	0.7%	65.9	15,851	#####	#####	321	127	19	4	28	12	67.4	76.3	81.2	-1.8	65.3	57.5	58.3	66.7	62.4	49.9	48.1	62.8	49.2	48.0	49.1	53.6
Cumulative plus Project		3	0	20,400	40	75	0	0	1.8%	0.7%	65.9	15,851	#####	#####	321	127	19	4	28	12	67.4	76.3	81.2	-1.8	65.3	57.5	58.3	66.7	62.4	49.9	48.1	62.8	49.2	48.0	49.1	53.6
<b>Vineyard Avenue s/o River</b>																																				
Existing		3	0	26,072	40	75	0	0	1.8%	0.7%	67.0	20,258	#####	#####	410	163	24	5	35	15	67.4	76.3	81.2	-1.8	66.4	58.5	59.4	67.7	63.4	51.0	49.2	63.8	50.2	49.1	50.1	54.6
Existing plus Project		3	0	26,664	40	75	0	0	1.8%	0.7%	67.1	20,718	#####	#####	420	166	24	5	36	15	67.4	76.3	81.2	-1.8	66.5	58.6	59.5	67.8	63.5	51.1	49.3	63.9	50.3	49.2	50.2	54.7
Cumulative		3	0	27,568	40	75	0	0	1.8%	0.7%	67.2	21,420	#####	#####	434	172	25	5	37	16	67.4	76.3	81.2	-1.8	66.6	58.8	59.6	68.0	63.7	51.2	49.4	64.1	50.5	49.3	50.4	54.9
Cumulative plus Project		3	0	27,568	40	75	0	0	1.8%	0.7%	67.2	21,420	#####	#####	434	172	25	5	37	16	67.4	76.3	81.2	-1.8	66.6	58.8	59.6	68.0	63.7	51.2	49.4	64.1	50.5	49.3	50.4	54.9
<b>River Park Boulevard e/o</b>																																				
Existing		2	5	7,448	30	75	0	0	1.8%	0.7%	59.1	5,787	946	715	117	46	7	1	10	4	62.5	73.1	80.3	-1.8	57.3	51.1	54.3	59.7	54.4	43.5	44.1	55.1	41.2	41.7	45.0	47.7
Existing plus Project		2	5	7,448	30	75	0	0	1.8%	0.7%	59.1	5,787	946	715	117	46	7	1	10	4	62.5	73.1	80.3	-1.8	57.3	51.1	54.3	59.7	54.4	43.5	44.1	55.1	41.2	41.7	45.0	47.7
Cumulative		2	5	7,496	30	75	0	0	1.8%	0.7%	59.2	5,824	952	720	118	47	7	1	10	4	62.5	73.1	80.3	-1.8	57.4	51.2	54.3	59.7	54.4	43.6	44.1	55.1	41.2	41.7	45.0	47.8
Cumulative plus Project		2	5	7,496	30	75	0	0	1.8%	0.7%	59.2	5,824	952	720	118	47	7	1	10	4	62.5	73.1	80.3	-1.8	57.4	51.2	54.3	59.7	54.4	43.6	44.1	55.1	41.2	41.7	45.0	47.8
<b>River Park Boulevard w/o</b>																																				
Existing		2	15	6,104	30	75	0	0	1.8%	0.7%	58.3	4,743	775	586	96	38	6	1	8	3	62.5	73.1	80.3	-1.8	56.5	50.3	53.4	58.9	53.5	42.7	43.3	54.2	40.3	40.9	44.2	46.9
Existing plus Project		2	15	6,152	30	75	0	0	1.8%	0.7%	58.3	4,780	781	591	97	38	6	1	8	3	62.5	73.1	80.3	-1.8	56.5	50.3	53.5	58.9	53.6	42.8	43.3	54.3	40.4	40.9	44.2	47.0
Cumulative		2	15	6,376	30	75	0	0	1.8%	0.7%	58.5	4,954	810	612	100	40	6	1	9	4	62.5	73.1	80.3	-1.8	56.7	50.5	53.6	59.1	53.7	42.9	43.5	54.4	40.5	41.0	44.4	47.1
Cumulative plus Project		2	15	6,376	30	75	0	0	1.8%	0.7%	58.5	4,954	810	612	100	40	6	1	9	4	62.5	73.1	80.3	-1.8	56.7	50.5	53.6	59.1	53.7	42.9	43.5	54.4	40.5	41.0	44.4	47.1

(1) Alpha Factor: Coefficient of absorption relating to the effects of the ground surface. An alpha factor of 0 indicates that the site is an acoustically "hard" site such as asphalt. An alpha factor of 0.5 indicates that the site is an acoustically "soft" site such as vegetative ground cover.

Assumed 24-Hour Traffic Distribution:	Day	Evening	Night
Total ADT Volumes	77.70%	12.70%	9.60%
Medium-Duty Trucks	87.43%	5.05%	7.52%
Heavy-Duty Trucks	89.10%	2.84%	8.06%

**Project Name**  
**Weekday AM Peak Hour Volumes**

rev. (Date)

Intersection: 4  
 Vineyard Avenue & US-101 NB Off-Ramp

If Peak Hour = 6% of ADT, Scaling Factor = 16.667  
 If Peak Hour = 7% of ADT, Scaling Factor = 14.286  
 If Peak Hour = 8% of ADT, Scaling Factor = 12.5  
 If Peak Hour = 9% of ADT, Scaling Factor = 11.111  
 If Peak Hour = 10% of ADT, Scaling Factor = 10

**Vineyard Avenue**

Southbound

	right	through	left
Existing	296	1,401	
Existing plus Proj	312	1,422	
Cumulative	316	1,456	
Cumulative plus	316	1,456	

Westbound

	right	through	left
Existing	266		492
Existing plus Proj	280		492
Cumulative	284		539
Cumulative plus	284		539

Northbound

	left	through	right
Existing		1,336	200
Existing plus Project		1,370	200
Cumulative		1,450	306
Cumulative plus Project		1,450	306

Eastbound

	left	through	right
Existing			
Existing plus Project			
Cumulative			
Cumulative plus Project			

W      N      E  
           S

US-101 NB Off-Ramp

ADT

Road	Vineyard Avenue		US-101 NB Off-Ramp	
	North of	South of	East of	West of
Cross Street	US-101 NB Off-Ramp		Vineyard Avenue	
Existing	26,392.0	27,432.0	7,664.0	2,368.0
Existing plus Proj	27,072.0	27,872.0	7,776.0	2,496.0
Cumulative	28,048.0	30,008.0	9,032.0	2,528.0
Cumulative plus	28,048.0	30,008.0	9,032.0	2,528.0



**2**  
**NOISE LEVEL CONTOURS - Existing Plus Project Weekday Off-Site ADT Volumes**

ROADWAY NAME Segment	Land Use	Lanes	Median Width	ADT Volume	Design Dist. from			Barrier Attn. dB(A)	Vehicle Mix		dB(A) CNEL	Traffic Volumes								Ref. Energy Levels Dist																
					Speed (mph)	Center to Receptor	Factor (1)		Medium Trucks	Heavy Trucks		Day	Eve	Night	MTd	HTd	MTe	HTe	MTn	HTn	A	MT	HT	Adj	A	MT	HT	Total	A	MT	HT	Total	A	MT	HT	Total
<b>Vineyard Avenue n/o US-101</b>																																				
Existing		3	0	26,392	40	75	0	0	1.8%	0.7%	67.1	20,507	3,352	2,534	415	165	24	5	36	15	67.4	76.3	81.2	-1.8	66.5	58.6	59.4	67.8	63.5	51.0	49.3	63.9	50.3	49.1	50.2	54.7
Existing plus Project		3	0	27,072	40	75	0	0	1.8%	0.7%	67.2	21,035	3,438	2,599	426	169	25	5	37	15	67.4	76.3	81.2	-1.8	66.6	58.7	59.5	67.9	63.6	51.1	49.4	64.0	50.4	49.3	50.3	54.8
Cumulative		3	0	28,048	40	75	0	0	1.8%	0.7%	67.3	21,793	3,562	2,693	441	175	25	6	38	16	67.4	76.3	81.2	-1.8	66.7	58.9	59.7	68.1	63.7	51.3	49.5	64.1	50.5	49.4	50.5	54.9
Cumulative plus Project		3	0	28,048	40	75	0	0	1.8%	0.7%	67.3	21,793	3,562	2,693	441	175	25	6	38	16	67.4	76.3	81.2	-1.8	66.7	58.9	59.7	68.1	63.7	51.3	49.5	64.1	50.5	49.4	50.5	54.9
<b>Vineyard Avenue s/o US-101</b>																																				
Existing		3	0	27,432	40	75	0	0	1.8%	0.7%	67.2	21,315	3,484	2,633	432	171	25	5	37	15	67.4	76.3	81.2	-1.8	66.6	58.8	59.6	68.0	63.6	51.2	49.4	64.0	50.4	49.3	50.4	54.8
Existing plus Project		3	0	27,872	40	75	0	0	1.8%	0.7%	67.3	21,657	3,540	2,676	439	174	25	6	38	16	67.4	76.3	81.2	-1.8	66.7	58.8	59.7	68.0	63.7	51.3	49.5	64.1	50.5	49.4	50.4	54.9
Cumulative		3	0	30,008	40	75	0	0	1.8%	0.7%	67.6	23,316	3,811	2,881	472	187	27	6	41	17	67.4	76.3	81.2	-1.8	67.0	59.2	60.0	68.4	64.0	51.6	49.8	64.4	50.8	49.7	50.7	55.2
Cumulative plus Project		3	0	30,008	40	75	0	0	1.8%	0.7%	67.6	23,316	3,811	2,881	472	187	27	6	41	17	67.4	76.3	81.2	-1.8	67.0	59.2	60.0	68.4	64.0	51.6	49.8	64.4	50.8	49.7	50.7	55.2
<b>US-101 NB Off-Ramp e/o</b>																																				
Existing		3	0	7,664	15	75	0	0	1.8%	0.7%	54.0	5,955	973	736	121	48	7	2	10	4	50.8	65.4	74.5	-1.8	48.8	46.6	51.6	54.3	45.8	39.0	41.5	47.8	32.6	37.1	42.4	43.9
Existing plus Project		3	0	7,776	15	75	0	0	1.8%	0.7%	54.0	6,042	988	746	122	48	7	2	11	4	50.8	65.4	74.5	-1.8	48.9	46.6	51.7	54.3	45.9	39.1	41.5	47.9	32.7	37.2	42.5	43.9
Cumulative		3	0	9,032	15	75	0	0	1.8%	0.7%	54.7	7,018	1,147	867	142	56	8	2	12	5	50.8	65.4	74.5	-1.8	49.5	47.3	52.3	55.0	46.6	39.7	42.2	48.5	33.4	37.8	43.1	44.6
Cumulative plus Project		3	0	9,032	15	75	0	0	1.8%	0.7%	54.7	7,018	1,147	867	142	56	8	2	12	5	50.8	65.4	74.5	-1.8	49.5	47.3	52.3	55.0	46.6	39.7	42.2	48.5	33.4	37.8	43.1	44.6
<b>US-101 NB Off-Ramp w/o</b>																																				
Existing		1	0	2,368	15	75	0	0	1.8%	0.7%	48.8	1,840	301	227	37	15	2	0	3	1	50.8	65.4	74.5	-1.8	43.7	41.4	46.5	49.1	40.7	33.8	36.3	42.6	27.5	32.0	37.2	38.7
Existing plus Project		1	0	2,496	15	75	0	0	1.8%	0.7%	49.0	1,939	317	240	39	16	2	0	3	1	50.8	65.4	74.5	-1.8	43.9	41.7	46.7	49.3	40.9	34.1	36.5	42.9	27.7	32.2	37.5	38.9
Cumulative		1	0	2,528	15	75	0	0	1.8%	0.7%	49.1	1,964	321	243	40	16	2	1	3	1	50.8	65.4	74.5	-1.8	43.9	41.7	46.8	49.4	41.0	34.1	36.6	42.9	27.8	32.3	37.5	39.0
Cumulative plus Project		1	0	2,528	15	75	0	0	1.8%	0.7%	49.1	1,964	321	243	40	16	2	1	3	1	50.8	65.4	74.5	-1.8	43.9	41.7	46.8	49.4	41.0	34.1	36.6	42.9	27.8	32.3	37.5	39.0

(1) Alpha Factor: Coefficient of absorption relating to the effects of the ground surface. An alpha factor of 0 indicates that the site is an acoustically "hard" site such as asphalt. An alpha factor of 0.5 indicates that the site is an acoustically "soft" site such as vegetative ground cover.

Assumed 24-Hour Traffic Distribution:	Day	Evening	Night
Total ADT Volumes	77.70%	12.70%	9.60%
Medium-Duty Trucks	87.43%	5.05%	7.52%
Heavy-Duty Trucks	89.10%	2.84%	8.06%

**Project Name**  
**Weekday PM Peak Hour Volumes**

rev. (Date)

Intersection: 4  
 Vineyard Avenue & US-101 NB Off-Ramp

If Peak Hour = 6% of ADT, Scaling Factor = 16.667  
 If Peak Hour = 7% of ADT, Scaling Factor = 14.286  
 If Peak Hour = 8% of ADT, Scaling Factor = 12.5  
 If Peak Hour = 9% of ADT, Scaling Factor = 11.111  
 If Peak Hour = 10% of ADT, Scaling Factor = 10

**Vineyard Avenue**

Southbound

	right	through	left
Existing	374	1,311	
Existing plus Proj	395	1,338	
Cumulative	396	1,418	
Cumulative plus	396	1,418	

Westbound

	right	through	left
Existing	233		370
Existing plus Proj	240		370
Cumulative	242		559
Cumulative plus	242		559

Northbound

	left	through	right
Existing		1,325	201
Existing plus Project		1,344	201
Cumulative		1,372	255
Cumulative plus Project		1,372	255

Eastbound

	left	through	right
Existing			
Existing plus Project			
Cumulative			
Cumulative plus Project			

W      N      E  
           S

ADT

Road	Vineyard Avenue		US-101 NB Off-Ramp	
Leg	North of	South of	East of	West of
Cross Street	US-101 NB Off-Ramp		Vineyard Avenue	
Existing	25,944.0	25,656.0	6,432.0	2,992.0
Existing plus Proj	26,536.0	26,024.0	6,488.0	3,160.0
Cumulative	27,424.0	28,832.0	8,448.0	3,168.0
Cumulative plus	27,424.0	28,832.0	8,448.0	3,168.0

US-101 NB Off-Ramp

**NOISE LEVEL CONTOURS - Existing Plus Project Weekday Off-Site ADT Volumes**

ROADWAY NAME Segment	Land Use	Lanes	Median Width	ADT Volume	Design Dist. from		Barrier Attn. dB(A)	Vehicle Mix		dB(A) CNEL	Traffic Volumes										Ref. Energy Levels Dist															
					Speed (mph)	Center to Receptor (1)		Medium Trucks	Heavy Trucks		Day	Eve	Night	MTd	HTd	MTe	HTe	MTn	HTn	A	MT	HT	Adj	A	MT	HT	Total	A	MT	HT	Total	A	MT	HT	Total	
<b>Vineyard Avenue n/o US-101</b>																																				
Existing		2	0	25,944	40	75	0	0	1.8%	0.7%	66.9	20,158	3,295	2,491	408	162	24	5	35	15	67.4	76.3	81.2	-1.8	66.3	58.5	59.3	67.7	63.4	50.9	49.1	63.8	50.2	49.0	50.1	54.6
Existing plus Project		2	0	26,536	40	75	0	0	1.8%	0.7%	67.0	20,618	3,370	2,547	418	166	24	5	36	15	67.4	76.3	81.2	-1.8	66.4	58.6	59.4	67.8	63.5	51.0	49.2	63.8	50.3	49.1	50.2	54.7
Cumulative		2	0	27,424	40	75	0	0	1.8%	0.7%	67.2	21,308	3,483	2,633	432	171	25	5	37	15	67.4	76.3	81.2	-1.8	66.6	58.7	59.5	67.9	63.6	51.1	49.4	64.0	50.4	49.3	50.3	54.8
Cumulative plus Project		2	0	27,424	40	75	0	0	1.8%	0.7%	67.2	21,308	3,483	2,633	432	171	25	5	37	15	67.4	76.3	81.2	-1.8	66.6	58.7	59.5	67.9	63.6	51.1	49.4	64.0	50.4	49.3	50.3	54.8
<b>Vineyard Avenue s/o US-101</b>																																				
Existing		2	0	25,656	40	75	0	0	1.8%	0.7%	66.9	19,935	3,258	2,463	404	160	23	5	35	14	67.4	76.3	81.2	-1.8	66.3	58.4	59.3	67.6	63.3	50.8	49.1	63.7	50.1	49.0	50.0	54.5
Existing plus Project		2	0	26,024	40	75	0	0	1.8%	0.7%	66.9	20,221	3,305	2,498	410	162	24	5	35	15	67.4	76.3	81.2	-1.8	66.4	58.5	59.3	67.7	63.4	50.9	49.2	63.8	50.2	49.0	50.1	54.6
Cumulative		2	0	28,832	40	75	0	0	1.8%	0.7%	67.4	22,402	3,662	2,768	454	180	26	6	39	16	67.4	76.3	81.2	-1.8	66.8	58.9	59.8	68.1	63.8	51.4	49.6	64.2	50.6	49.5	50.5	55.0
Cumulative plus Project		2	0	28,832	40	75	0	0	1.8%	0.7%	67.4	22,402	3,662	2,768	454	180	26	6	39	16	67.4	76.3	81.2	-1.8	66.8	58.9	59.8	68.1	63.8	51.4	49.6	64.2	50.6	49.5	50.5	55.0
<b>US-101 NB Off-Ramp e/o</b>																																				
Existing		3	0	6,432	15	75	0	0	1.8%	0.7%	53.2	4,998	817	617	101	40	6	1	9	4	50.8	65.4	74.5	-1.8	48.1	45.8	50.9	53.5	45.1	38.2	40.7	47.0	31.9	36.4	41.6	43.1
Existing plus Project		3	0	6,488	15	75	0	0	1.8%	0.7%	53.2	5,041	824	623	102	40	6	1	9	4	50.8	65.4	74.5	-1.8	48.1	45.9	50.9	53.5	45.1	38.3	40.7	47.1	31.9	36.4	41.7	43.1
Cumulative		3	0	8,448	15	75	0	0	1.8%	0.7%	54.4	6,564	1,073	811	133	53	8	2	11	5	50.8	65.4	74.5	-1.8	49.2	47.0	52.1	54.7	46.3	39.4	41.9	48.2	33.1	37.6	42.8	44.3
Cumulative plus Project		3	0	8,448	15	75	0	0	1.8%	0.7%	54.4	6,564	1,073	811	133	53	8	2	11	5	50.8	65.4	74.5	-1.8	49.2	47.0	52.1	54.7	46.3	39.4	41.9	48.2	33.1	37.6	42.8	44.3
<b>US-101 NB Off-Ramp w/o</b>																																				
Existing		1	0	2,992	15	75	0	0	1.8%	0.7%	49.8	2,325	380	287	47	19	3	1	4	2	50.8	65.4	74.5	-1.8	44.7	42.4	47.5	50.1	41.7	34.9	37.3	43.7	28.5	33.0	38.3	39.7
Existing plus Project		1	0	3,160	15	75	0	0	1.8%	0.7%	50.1	2,455	401	303	50	20	3	1	4	2	50.8	65.4	74.5	-1.8	44.9	42.7	47.7	50.4	41.9	35.1	37.6	43.9	28.7	33.2	38.5	40.0
Cumulative		1	0	3,168	15	75	0	0	1.8%	0.7%	50.1	2,462	402	304	50	20	3	1	4	2	50.8	65.4	74.5	-1.8	44.9	42.7	47.7	50.4	41.9	35.1	37.6	43.9	28.7	33.2	38.5	40.0
Cumulative plus Project		1	0	3,168	15	75	0	0	1.8%	0.7%	50.1	2,462	402	304	50	20	3	1	4	2	50.8	65.4	74.5	-1.8	44.9	42.7	47.7	50.4	41.9	35.1	37.6	43.9	28.7	33.2	38.5	40.0

(1) Alpha Factor: Coefficient of absorption relating to the effects of the ground surface. An alpha factor of 0 indicates that the site is an acoustically "hard" site such as asphalt. An alpha factor of 0.5 indicates that the site is an acoustically "soft" site such as vegetative ground cover.

Assumed 24-Hour Traffic Distribution:	Day	Evening	Night
Total ADT Volumes	77.70%	12.70%	9.60%
Medium-Duty Trucks	87.43%	5.05%	7.52%
Heavy-Duty Trucks	89.10%	2.84%	8.06%

**Project Name**  
**Weekday AM Peak Hour Volumes**

rev. (Date)

Intersection: 5  
 Vineyard Avenue & US-101 SB Off-Ramp

If Peak Hour = 6% of ADT, Scaling Factor = 16.667  
 If Peak Hour = 7% of ADT, Scaling Factor = 14.286  
 If Peak Hour = 8% of ADT, Scaling Factor = 12.5  
 If Peak Hour = 9% of ADT, Scaling Factor = 11.111  
 If Peak Hour = 10% of ADT, Scaling Factor = 10

**Vineyard Avenue**

Southbound

	right	through	left
Existing	217	1,683	
Existing plus Proj	228	1,693	
Cumulative	231	1,774	
Cumulative plus	231	1,774	

Eastbound

	left	through	right
Existing	336		146
Existing plus Proj	356		146
Cumulative	360		485
Cumulative plus	360		485

Westbound

	right	through	left
Existing			
Existing plus Project			
Cumulative			
Cumulative plus Project			

Northbound

	left	through	right
Existing		1,189	585
Existing plus Project		1,203	585
Cumulative		1,385	1,036
Cumulative plus Project		1,385	1,036

W    N    E  
           S

US-101 SB Off-Ramp

ADT

Road	Vineyard Avenue		US-101 SB Off-Ramp	
	North of	South of	East of	West of
Cross Street	US-101 SB Off-Ramp		Vineyard Avenue	
Existing	27,400.0	28,824.0	4,680.0	5,592.0
Existing plus Proj	27,840.0	29,016.0	4,680.0	5,840.0
Cumulative	30,000.0	37,440.0	8,288.0	8,608.0
Cumulative plus	30,000.0	37,440.0	8,288.0	8,608.0

NOISE LEVEL CONTOURS - Existing Plus Project Weekday Off-Site ADT Volumes

												Traffic Volumes								Ref. Energy Levels Dist							Ld			Le			Ln														
ROADWAY NAME	Land Use	Lanes	Median Width	ADT Volume	Design Speed (mph)	Dist. from Center to Receptor	Dist. from Alpha Factor (1)	Barrier Attn. dB(A)	Vehicle Mix Medium Trucks	Vehicle Mix Heavy Trucks	dB(A) CNEL	Day	Eve	Night	MTd	HTd	MTe	HTe	MTn	HTn	A	MT	HT	Adj	A	MT	HT	Total A	MT	HT	Total A	MT	HT	Total A	MT	HT	Total										
<b>Vineyard Avenue n/o US-101</b>																																															
Existing												3	15	27,400	40	75	0	0	1.8%	0.7%	67.3	21,290	3,480	2,630	431	171	25	5	37	15	67.4	76.3	81.2	-1.7	66.7	58.9	59.7	68.1	63.7	51.3	49.5	64.1	50.5	49.4	50.4	54.9	
Existing plus Project												3	15	27,840	40	75	0	0	1.8%	0.7%	67.4	21,632	3,536	2,673	438	174	25	6	38	16	67.4	76.3	81.2	-1.7	66.8	58.9	59.8	68.1	63.8	51.3	49.6	64.2	50.6	49.5	50.5	55.0	
Cumulative												3	15	30,000	40	75	0	0	1.8%	0.7%	67.7	23,310	3,810	2,880	472	187	27	6	41	17	67.4	76.3	81.2	-1.7	67.1	59.3	60.1	68.4	64.1	51.7	49.9	64.5	50.9	49.8	50.8	55.3	
Cumulative plus Project												3	15	30,000	40	75	0	0	1.8%	0.7%	67.7	23,310	3,810	2,880	472	187	27	6	41	17	67.4	76.3	81.2	-1.7	67.1	59.3	60.1	68.4	64.1	51.7	49.9	64.5	50.9	49.8	50.8	55.3	
<b>Vineyard Avenue s/o US-101</b>																																															
Existing												3	15	28,824	40	75	0	0	1.8%	0.7%	67.5	22,396	3,661	2,767	454	180	26	6	39	16	67.4	76.3	81.2	-1.7	66.9	59.1	59.9	68.3	64.0	51.5	49.7	64.3	50.8	49.6	50.7	55.2	
Existing plus Project												3	15	29,016	40	75	0	0	1.8%	0.7%	67.6	22,545	3,685	2,786	457	181	26	6	39	16	67.4	76.3	81.2	-1.7	67.0	59.1	59.9	68.3	64.0	51.5	49.8	64.4	50.8	49.7	50.7	55.2	
Cumulative												3	15	37,440	40	75	0	0	1.8%	0.7%	68.7	29,091	4,755	3,594	589	234	34	7	51	21	67.4	76.3	81.2	-1.7	68.1	60.2	61.0	69.4	65.1	52.6	50.9	65.5	51.9	50.8	51.8	56.3	
Cumulative plus Project												3	15	37,440	40	75	0	0	1.8%	0.7%	68.7	29,091	4,755	3,594	589	234	34	7	51	21	67.4	76.3	81.2	-1.7	68.1	60.2	61.0	69.4	65.1	52.6	50.9	65.5	51.9	50.8	51.8	56.3	
<b>US-101 SB Off-Ramp e/o</b>																																															
Existing												1	0	4,680	15	75	0	0	1.8%	0.7%	51.8	3,636	594	449	74	29	4	1	6	3	50.8	65.4	74.5	-1.8	46.6	44.4	49.4	52.1	43.6	36.8	39.3	45.6	30.4	34.9	40.2	41.7	
Existing plus Project												1	0	4,680	15	75	0	0	1.8%	0.7%	51.8	3,636	594	449	74	29	4	1	6	3	50.8	65.4	74.5	-1.8	46.6	44.4	49.4	52.1	43.6	36.8	39.3	45.6	30.4	34.9	40.2	41.7	
Cumulative												1	0	8,288	15	75	0	0	1.8%	0.7%	54.2	6,440	1,053	796	130	52	8	2	11	5	50.8	65.4	74.5	-1.8	49.1	46.9	51.9	54.6	46.1	39.3	41.8	48.1	32.9	37.4	42.7	44.2	
Cumulative plus Project												1	0	8,288	15	75	0	0	1.8%	0.7%	54.2	6,440	1,053	796	130	52	8	2	11	5	50.8	65.4	74.5	-1.8	49.1	46.9	51.9	54.6	46.1	39.3	41.8	48.1	32.9	37.4	42.7	44.2	
<b>US-101 SB Off-Ramp w/o</b>																																															
Existing												1	0	5,592	15	75	0	0	1.8%	0.7%	52.5	4,345	710	537	88	35	5	1	8	3	50.8	65.4	74.5	-1.8	47.4	45.2	50.2	52.8	44.4	37.6	40.0	46.4	31.2	35.7	41.0	42.4	
Existing plus Project												1	0	5,840	15	75	0	0	1.8%	0.7%	52.7	4,538	742	561	92	36	5	1	8	3	50.8	65.4	74.5	-1.8	47.6	45.3	50.4	53.0	44.6	37.8	40.2	46.6	31.4	35.9	41.2	42.6	
Cumulative												1	0	8,608	15	75	0	0	1.8%	0.7%	54.4	6,688	1,093	826	135	54	8	2	12	5	50.8	65.4	74.5	-1.8	49.3	47.0	52.1	54.7	46.3	39.4	41.9	48.3	33.1	37.6	42.8	44.3	
Cumulative plus Project												1	0	8,608	15	75	0	0	1.8%	0.7%	54.4	6,688	1,093	826	135	54	8	2	12	5	50.8	65.4	74.5	-1.8	49.3	47.0	52.1	54.7	46.3	39.4	41.9	48.3	33.1	37.6	42.8	44.3	

(1) Alpha Factor: Coefficient of absorption relating to the effects of the ground surface. An alpha factor of 0 indicates that the site is an acoustically "hard" site such as asphalt. An alpha factor of 0.5 indicates that the site is an acoustically "soft" site such as vegetative ground cover.

Assumed 24-Hour Traffic Distribution:	Day	Evening	Night
Total ADT Volumes	77.70%	12.70%	9.60%
Medium-Duty Trucks	87.43%	5.05%	7.52%
Heavy-Duty Trucks	89.10%	2.84%	8.06%

**Project Name**  
**Weekday PM Peak Hour Volumes**

rev. (Date)

Intersection: 5  
 Vineyard Avenue & US-101 SB Off-Ramp

If Peak Hour = 6% of ADT, Scaling Factor = 16.667  
 If Peak Hour = 7% of ADT, Scaling Factor = 14.286  
 If Peak Hour = 8% of ADT, Scaling Factor = 12.5  
 If Peak Hour = 9% of ADT, Scaling Factor = 11.111  
 If Peak Hour = 10% of ADT, Scaling Factor = 10

**Vineyard Avenue**

Southbound

	right	through	left
Existing	431	1,198	
Existing plus Proj	445	1,211	
Cumulative	435	1,463	
Cumulative plus	449	1,476	

Westbound

	right	through	left
Existing			
Existing plus Project			
Cumulative			
Cumulative plus Project			

Northbound

	left	through	right
Existing		1,155	896
Existing plus Project		1,163	896
Cumulative		1,208	940
Cumulative plus Project		1,216	940

Eastbound

	left	through	right
Existing	396		200
Existing plus Proj	407		200
Cumulative	400		293
Cumulative plus	411		293

W      N      E  
           S

US-101 SB Off-Ramp

ADT

Road	Vineyard Avenue		US-101 SB Off-Ramp	
	North of	South of	East of	West of
Leg				
Cross Street	US-101 SB Off-Ramp		Vineyard Avenue	
Existing	25,440.0	27,592.0	7,168.0	8,216.0
Existing plus Proj	25,808.0	27,760.0	7,168.0	8,416.0
Cumulative	28,048.0	31,232.0	7,520.0	9,024.0
Cumulative plus	28,416.0	31,400.0	7,520.0	9,224.0

2

**NOISE LEVEL CONTOURS - Existing Plus Project Weekday Off-Site ADT Volumes**

ROADWAY NAME Segment	Land Use	Median Lanes	ADT Volume	Design Dist. from		Barrier Attn.	Vehicle Mix		dB(A) CNEL	Traffic Volumes								Ref. Energy Levels Dist																	
				Speed (mph)	Center to Receptor		Alpha Factor (1'	Medium Trucks		Heavy Trucks	Day	Eve	Night	MTd	HTd	MTe	HTe	MTn	HTn	A	MT	HT	Adj	A	MT	HT	Total	A	MT	HT	Total	A	MT	HT	Total
<b>Vineyard Avenue n/o US-101</b>																																			
Existing		3	25,440	40	75	0	0	1.8%	0.7%	67.0	19,767	#####	#####	400	159	23	5	34	14	67.4	76.3	81.2	-1.7	66.4	58.5	59.4	67.7	63.4	51.0	49.2	63.8	50.2	49.1	50.1	54.6
Existing plus Project		3	25,808	40	75	0	0	1.8%	0.7%	67.1	20,053	#####	#####	406	161	23	5	35	15	67.4	76.3	81.2	-1.7	66.5	58.6	59.4	67.8	63.5	51.0	49.3	63.9	50.3	49.1	50.2	54.7
Cumulative		3	28,048	40	75	0	0	1.8%	0.7%	67.4	21,793	#####	#####	441	175	25	6	38	16	67.4	76.3	81.2	-1.7	66.8	59.0	59.8	68.2	63.8	51.4	49.6	64.2	50.6	49.5	50.5	55.0
Cumulative plus Project		3	28,416	40	75	0	0	1.8%	0.7%	67.5	22,079	#####	#####	447	177	26	6	38	16	67.4	76.3	81.2	-1.7	66.9	59.0	59.8	68.2	63.9	51.4	49.7	64.3	50.7	49.6	50.6	55.1
<b>Vineyard Avenue s/o US-101</b>																																			
Existing		3	27,592	40	75	0	0	1.8%	0.7%	67.3	21,439	#####	#####	434	172	25	5	37	16	67.4	76.3	81.2	-1.7	66.7	58.9	59.7	68.1	63.8	51.3	49.5	64.2	50.6	49.4	50.5	55.0
Existing plus Project		3	27,760	40	75	0	0	1.8%	0.7%	67.4	21,570	#####	#####	437	173	25	6	38	16	67.4	76.3	81.2	-1.7	66.8	58.9	59.7	68.1	63.8	51.3	49.6	64.2	50.6	49.5	50.5	55.0
Cumulative		3	31,232	40	75	0	0	1.8%	0.7%	67.9	24,267	#####	#####	492	195	28	6	42	18	67.4	76.3	81.2	-1.7	67.3	59.4	60.3	68.6	64.3	51.8	50.1	64.7	51.1	50.0	51.0	55.5
Cumulative plus Project		3	31,400	40	75	0	0	1.8%	0.7%	67.9	24,398	#####	#####	494	196	29	6	43	18	67.4	76.3	81.2	-1.7	67.3	59.4	60.3	68.6	64.3	51.9	50.1	64.7	51.1	50.0	51.0	55.5
<b>US-101 SB Off-Ramp e/o</b>																																			
Existing		1	7,168	15	75	0	0	1.8%	0.7%	53.6	5,570	910	688	113	45	7	1	10	4	50.8	65.4	74.5	-1.8	48.5	46.2	51.3	53.9	45.5	38.7	41.1	47.5	32.3	36.8	42.1	43.5
Existing plus Project		1	7,168	15	75	0	0	1.8%	0.7%	53.6	5,570	910	688	113	45	7	1	10	4	50.8	65.4	74.5	-1.8	48.5	46.2	51.3	53.9	45.5	38.7	41.1	47.5	32.3	36.8	42.1	43.5
Cumulative		1	7,520	15	75	0	0	1.8%	0.7%	53.8	5,843	955	722	118	47	7	1	10	4	50.8	65.4	74.5	-1.8	48.7	46.4	51.5	54.1	45.7	38.9	41.3	47.7	32.5	37.0	42.3	43.7
Cumulative plus Project		1	7,520	15	75	0	0	1.8%	0.7%	53.8	5,843	955	722	118	47	7	1	10	4	50.8	65.4	74.5	-1.8	48.7	46.4	51.5	54.1	45.7	38.9	41.3	47.7	32.5	37.0	42.3	43.7
<b>US-101 SB Off-Ramp w/o</b>																																			
Existing		1	8,216	15	75	0	0	1.8%	0.7%	54.2	6,384	#####	789	129	51	7	2	11	5	50.8	65.4	74.5	-1.8	49.1	46.8	51.9	54.5	46.1	39.2	41.7	48.1	32.9	37.4	42.6	44.1
Existing plus Project		1	8,416	15	75	0	0	1.8%	0.7%	54.3	6,539	#####	808	132	52	8	2	11	5	50.8	65.4	74.5	-1.8	49.2	46.9	52.0	54.6	46.2	39.3	41.8	48.2	33.0	37.5	42.8	44.2
Cumulative		1	9,024	15	75	0	0	1.8%	0.7%	54.6	7,012	#####	866	142	56	8	2	12	5	50.8	65.4	74.5	-1.8	49.5	47.2	52.3	54.9	46.5	39.7	42.1	48.5	33.3	37.8	43.1	44.5
Cumulative plus Project		1	9,224	15	75	0	0	1.8%	0.7%	54.7	7,167	#####	886	145	58	8	2	12	5	50.8	65.4	74.5	-1.8	49.6	47.3	52.4	55.0	46.6	39.7	42.2	48.6	33.4	37.9	43.1	44.6

(1) Alpha Factor: Coefficient of absorption relating to the effects of the ground surface. An alpha factor of 0 indicates that the site is an acoustically "hard" site such as asphalt. An alpha factor of 0.5 indicates that the site is an acoustically "soft" site such as vegetative ground cover.

Assumed 24-Hour Traffic Distribution:	Day	Evening	Night
Total ADT Volumes	77.70%	12.70%	9.60%
Medium-Duty Trucks	87.43%	5.05%	7.52%
Heavy-Duty Trucks	89.10%	2.84%	8.06%

**Project Name**  
**Weekday AM Peak Hour Volumes**

rev. (Date)

Intersection: 6  
 Vineyard Avenue & Esplanade Drive

If Peak Hour = 6% of ADT, Scaling Factor = 16.667  
 If Peak Hour = 7% of ADT, Scaling Factor = 14.286  
 If Peak Hour = 8% of ADT, Scaling Factor = 12.5  
 If Peak Hour = 9% of ADT, Scaling Factor = 11.111  
 If Peak Hour = 10% of ADT, Scaling Factor = 10

ADT

**Vineyard Avenue**

Southbound

	right	through	left
Existing	300	1,563	205
Existing plus Proj	302	1,571	205
Cumulative	322	1,569	292
Cumulative plus	324	1,577	292

Westbound

	right	through	left
Existing	354	65	214
Existing plus Proj	354	65	214
Cumulative	485	86	485
Cumulative plus	485	86	485

Road	Vineyard Avenue		Esplanade Drive	
	North of	South of	East of	West of
Leg	Esplanade Drive		Vineyard Avenue	
Existing	31,192.0	28,672.0	7,464.0	8,576.0
Existing plus Proj	31,376.0	28,816.0	7,464.0	8,616.0
Cumulative	33,680.0	32,488.0	12,392.0	10,272.0
Cumulative plus	33,864.0	32,632.0	12,392.0	10,312.0

Eastbound

	left	through	right
Existing	212	24	281
Existing plus Proj	215	24	281
Cumulative	273	33	350
Cumulative plus	276	33	350

W      N      E  
           S

Northbound

	left	through	right
Existing	190	1,265	71
Existing plus Proj	190	1,275	71
Cumulative	220	1,269	168
Cumulative plus	220	1,279	168

Esplanade Drive



**NOISE LEVEL CONTOURS - Existing Plus Project Weekday Off-Site ADT Volumes**

ROADWAY NAME Segment	Land Use	Lanes	Median Width	ADT Volume	Design Dist. from		Barrier Attn. dB(A)	Vehicle Mix		dB(A) CNEL	Traffic Volumes								Ref. Energy Levels Dist																	
					Speed (mph)	Center to Receptor Factor (1)		Medium Trucks	Heavy Trucks		Day	Eve	Night	MTd	HTd	MTe	HTe	MTn	HTn	A	MT	HT	Adj	A	MT	HT	Total A	MT	HT	Total A	MT	HT	Total A			
<b>Vineyard Avenue n/o US-101</b>																																				
Existing		3	15	31,192	40	75	0	0	1.8%	0.7%	67.9	24,236	3,961	2,994	491	195	28	6	42	18	67.4	76.3	81.2	-1.7	67.3	59.4	60.2	68.6	64.3	51.8	50.1	64.7	51.1	50.0	51.0	55.5
Existing plus Project		3	15	31,376	40	75	0	0	1.8%	0.7%	67.9	24,379	3,985	3,012	494	196	29	6	42	18	67.4	76.3	81.2	-1.7	67.3	59.4	60.3	68.6	64.3	51.9	50.1	64.7	51.1	50.0	51.0	55.5
Cumulative		3	15	33,680	40	75	0	0	1.8%	0.7%	68.2	26,169	4,277	3,233	530	210	31	7	46	19	67.4	76.3	81.2	-1.7	67.6	59.8	60.6	69.0	64.6	52.2	50.4	65.0	51.4	50.3	51.3	55.8
Cumulative plus Project		3	15	33,864	40	75	0	0	1.8%	0.7%	68.2	26,312	4,301	3,251	533	211	31	7	46	19	67.4	76.3	81.2	-1.7	67.6	59.8	60.6	69.0	64.7	52.2	50.4	65.0	51.5	50.3	51.4	55.9
<b>Vineyard Avenue s/o</b>																																				
Existing		3	15	28,672	40	75	0	0	1.8%	0.7%	67.5	22,278	3,641	2,753	451	179	26	6	39	16	67.4	76.3	81.2	-1.7	66.9	59.1	59.9	68.3	63.9	51.5	49.7	64.3	50.7	49.6	50.6	55.1
Existing plus Project		3	15	28,816	40	75	0	0	1.8%	0.7%	67.5	22,390	3,660	2,766	453	180	26	6	39	16	67.4	76.3	81.2	-1.7	66.9	59.1	59.9	68.3	64.0	51.5	49.7	64.3	50.8	49.6	50.7	55.1
Cumulative		3	15	32,488	40	75	0	0	1.8%	0.7%	68.1	25,243	4,126	3,119	511	203	30	6	44	18	67.4	76.3	81.2	-1.7	67.5	59.6	60.4	68.8	64.5	52.0	50.3	64.9	51.3	50.1	51.2	55.7
Cumulative plus Project		3	15	32,632	40	75	0	0	1.8%	0.7%	68.1	25,355	4,144	3,133	514	204	30	6	44	18	67.4	76.3	81.2	-1.7	67.5	59.6	60.4	68.8	64.5	52.0	50.3	64.9	51.3	50.2	51.2	55.7
<b>Esplanade Drive e/o Vineyard</b>																																				
Existing		1	0	7,464	15	75	0	0	1.8%	0.7%	53.8	5,800	948	717	117	47	7	1	10	4	50.8	65.4	74.5	-1.8	48.6	46.4	51.5	54.1	45.7	38.8	41.3	47.6	32.5	37.0	42.2	43.7
Existing plus Project		1	0	7,464	15	75	0	0	1.8%	0.7%	53.8	5,800	948	717	117	47	7	1	10	4	50.8	65.4	74.5	-1.8	48.6	46.4	51.5	54.1	45.7	38.8	41.3	47.6	32.5	37.0	42.2	43.7
Cumulative		1	0	12,392	15	75	0	0	1.8%	0.7%	56.0	9,629	1,574	1,190	195	77	11	2	17	7	50.8	65.4	74.5	-1.8	50.8	48.6	53.7	56.3	47.9	41.0	43.5	49.8	34.7	39.2	44.4	45.9
Cumulative plus Project		1	0	12,392	15	75	0	0	1.8%	0.7%	56.0	9,629	1,574	1,190	195	77	11	2	17	7	50.8	65.4	74.5	-1.8	50.8	48.6	53.7	56.3	47.9	41.0	43.5	49.8	34.7	39.2	44.4	45.9
<b>Esplanade Drive w/o</b>																																				
Existing		2	0	8,576	30	75	0	0	1.8%	0.7%	59.7	6,664	1,089	823	135	53	8	2	12	5	62.5	73.1	80.3	-1.8	57.9	51.7	54.9	60.3	55.0	44.1	44.7	55.7	41.8	42.3	45.6	48.3
Existing plus Project		2	0	8,616	30	75	0	0	1.8%	0.7%	59.7	6,695	1,094	827	136	54	8	2	12	5	62.5	73.1	80.3	-1.8	58.0	51.7	54.9	60.3	55.0	44.2	44.7	55.7	41.8	42.3	45.6	48.4
Cumulative		2	0	10,272	30	75	0	0	1.8%	0.7%	60.5	7,981	1,305	986	162	64	9	2	14	6	62.5	73.1	80.3	-1.8	58.7	52.5	55.6	61.1	55.7	44.9	45.5	56.4	42.5	43.1	46.4	49.1
Cumulative plus Project		2	0	10,312	30	75	0	0	1.8%	0.7%	60.5	8,012	1,310	990	162	64	9	2	14	6	62.5	73.1	80.3	-1.8	58.7	52.5	55.7	61.1	55.8	44.9	45.5	56.5	42.6	43.1	46.4	49.1

(1) Alpha Factor: Coefficient of absorption relating to the effects of the ground surface. An alpha factor of 0 indicates that the site is an acoustically "hard" site such as asphalt. An alpha factor of 0.5 indicates that the site is an acoustically "soft" site such as vegetative ground cover.

Assumed 24-Hour Traffic Distribution:	Day	Evening	Night
Total ADT Volumes	77.70%	12.70%	9.60%
Medium-Duty Trucks	87.43%	5.05%	7.52%
Heavy-Duty Trucks	89.10%	2.84%	8.06%

**Project Name**  
**Weekday PM Peak Hour Volumes**

rev. (Date)

Intersection: 6  
 Vineyard Avenue & Esplanade Drive

If Peak Hour = 6% of ADT, Scaling Factor = 16.667  
 If Peak Hour = 7% of ADT, Scaling Factor = 14.286  
 If Peak Hour = 8% of ADT, Scaling Factor = 12.5  
 If Peak Hour = 9% of ADT, Scaling Factor = 11.111  
 If Peak Hour = 10% of ADT, Scaling Factor = 10

**Vineyard Avenue**

Southbound

	right	through	left
Existing	160	1,024	353
Exising plus Proj	163	1,034	353
Cumulative	201	1,026	493
Cumulative plus	204	1,036	493

Westbound

	right	through	left
Existing	114	12	61
Exising plus Proj	114	12	61
Cumulative	157	18	108
Cumulative plus	157	18	108

Eastbound

	left	through	right
Existing	87	17	82
Exising plus Proj	87	17	82
Cumulative	104	39	94
Cumulative plus	106	39	94

Northbound

	left	through	right
Existing	57	1,731	66
Exising plus Proj	57	1,737	66
Cumulative	116	1,733	254
Cumulative plus	116	1,739	254

W      N      E  
           S

ADT

Road	Vineyard Avenue		Esplanade Drive	
	North of	South of	East of	West of
Leg				
Cross Street	Esplanade Drive		Vineyard Avenue	
Existing	27,752.0	24,168.0	4,984.0	3,320.0
Exising plus Proj	27,904.0	24,296.0	4,984.0	3,344.0
Cumulative	29,712.0	26,648.0	8,552.0	4,576.0
Cumulative plus	29,880.0	26,776.0	8,552.0	4,616.0

Esplanade Drive

NOISE LEVEL CONTOURS - Existing Plus Project Weekday Off-Site ADT Volumes

ROADWAY NAME Segment	Land Use	Lanes	Median Width	ADT Volume	Design Dist. from			Barrier Attn. dB(A)	Vehicle Mix		dB(A) CNEL	Traffic Volumes								Ref. Energy Levels Dist																
					Speed (mph)	Center to Receptor (1)	Alpha Factor (1)		Medium Trucks	Heavy Trucks		Day	Eve	Night	MTd	HTd	MTe	HTe	MTn	HTn	A	MT	HT	Adj	A	MT	HT	Total A	MT	HT	Total A	MT	HT	Total A		
<b>Vineyard Avenue n/o</b>																																				
Existing		3	15	27,752	40	75	0	0	1.8%	0.7%	67.4	21,563	3,525	2,664	437	173	25	6	38	16	67.4	76.3	81.2	-1.7	66.8	58.9	59.7	68.1	63.8	51.3	49.6	64.2	50.6	49.5	50.5	55.0
Existing plus Project		3	15	27,904	40	75	0	0	1.8%	0.7%	67.4	21,681	3,544	2,679	439	174	25	6	38	16	67.4	76.3	81.2	-1.7	66.8	58.9	59.8	68.1	63.8	51.4	49.6	64.2	50.6	49.5	50.5	55.0
Cumulative		3	15	29,712	40	75	0	0	1.8%	0.7%	67.7	23,086	3,773	2,852	468	185	27	6	40	17	67.4	76.3	81.2	-1.7	67.1	59.2	60.0	68.4	64.1	51.6	49.9	64.5	50.9	49.8	50.8	55.3
Cumulative plus Project		3	15	29,880	40	75	0	0	1.8%	0.7%	67.7	23,217	3,795	2,868	470	186	27	6	40	17	67.4	76.3	81.2	-1.7	67.1	59.2	60.1	68.4	64.1	51.6	49.9	64.5	50.9	49.8	50.8	55.3
<b>Vineyard Avenue s/o</b>																																				
Existing		3	15	24,168	40	75	0	0	1.8%	0.7%	66.8	18,779	3,069	2,320	380	151	22	5	33	14	67.4	76.3	81.2	-1.7	66.2	58.3	59.1	67.5	63.2	50.7	49.0	63.6	50.0	48.9	49.9	54.4
Existing plus Project		3	15	24,296	40	75	0	0	1.8%	0.7%	66.8	18,878	3,086	2,332	382	152	22	5	33	14	67.4	76.3	81.2	-1.7	66.2	58.3	59.2	67.5	63.2	50.8	49.0	63.6	50.0	48.9	49.9	54.4
Cumulative		3	15	26,648	40	75	0	0	1.8%	0.7%	67.2	20,705	3,384	2,558	419	166	24	5	36	15	67.4	76.3	81.2	-1.7	66.6	58.7	59.6	67.9	63.6	51.2	49.4	64.0	50.4	49.3	50.3	54.8
Cumulative plus Project		3	15	26,776	40	75	0	0	1.8%	0.7%	67.2	20,805	3,401	2,570	421	167	24	5	36	15	67.4	76.3	81.2	-1.7	66.6	58.8	59.6	68.0	63.6	51.2	49.4	64.0	50.4	49.3	50.3	54.8
<b>Esplanade Drive e/o Vineyard</b>																																				
Existing		1	0	4,984	15	75	0	0	1.8%	0.7%	52.0	3,873	633	478	78	31	5	1	7	3	50.8	65.4	74.5	-1.8	46.9	44.7	49.7	52.3	43.9	37.1	39.5	45.9	30.7	35.2	40.5	41.9
Existing plus Project		1	0	4,984	15	75	0	0	1.8%	0.7%	52.0	3,873	633	478	78	31	5	1	7	3	50.8	65.4	74.5	-1.8	46.9	44.7	49.7	52.3	43.9	37.1	39.5	45.9	30.7	35.2	40.5	41.9
Cumulative		1	0	8,552	15	75	0	0	1.8%	0.7%	54.4	6,645	1,086	821	135	53	8	2	12	5	50.8	65.4	74.5	-1.8	49.2	47.0	52.1	54.7	46.3	39.4	41.9	48.2	33.1	37.5	42.8	44.3
Cumulative plus Project		1	0	8,552	15	75	0	0	1.8%	0.7%	54.4	6,645	1,086	821	135	53	8	2	12	5	50.8	65.4	74.5	-1.8	49.2	47.0	52.1	54.7	46.3	39.4	41.9	48.2	33.1	37.5	42.8	44.3
<b>Esplanade Drive w/o</b>																																				
Existing		2	0	3,320	30	75	0	0	1.8%	0.7%	55.6	2,580	422	319	52	21	3	1	4	2	62.5	73.1	80.3	-1.8	53.8	47.6	50.7	56.2	50.8	40.0	40.6	51.5	37.6	38.1	41.5	44.2
Existing plus Project		2	0	3,344	30	75	0	0	1.8%	0.7%	55.6	2,598	425	321	53	21	3	1	5	2	62.5	73.1	80.3	-1.8	53.8	47.6	50.8	56.2	50.9	40.1	40.6	51.6	37.7	38.2	41.5	44.3
Cumulative		2	0	4,576	30	75	0	0	1.8%	0.7%	57.0	3,556	581	439	72	29	4	1	6	3	62.5	73.1	80.3	-1.8	55.2	49.0	52.1	57.6	52.2	41.4	42.0	52.9	39.0	39.5	42.9	45.6
Cumulative plus Project		2	0	4,616	30	75	0	0	1.8%	0.7%	57.0	3,587	586	443	73	29	4	1	6	3	62.5	73.1	80.3	-1.8	55.2	49.0	52.2	57.6	52.3	41.5	42.0	53.0	39.1	39.6	42.9	45.7

(1) Alpha Factor: Coefficient of absorption relating to the effects of the ground surface. An alpha factor of 0 indicates that the site is an acoustically "hard" site such as asphalt. An alpha factor of 0.5 indicates that the site is an acoustically "soft" site such as vegetative ground cover.

Assumed 24-Hour Traffic Distribution:	Day	Evening	Night
Total ADT Volumes	77.70%	12.70%	9.60%
Medium-Duty Trucks	87.43%	5.05%	7.52%
Heavy-Duty Trucks	89.10%	2.84%	8.06%

**Project Name**  
**Weekday AM Peak Hour Volumes**

rev. (Date)

Intersection: 7  
 Rose Avenue & W. Stroube Street

If Peak Hour = 6% of ADT, Scaling Factor = 16.667  
 If Peak Hour = 7% of ADT, Scaling Factor = 14.286  
 If Peak Hour = 8% of ADT, Scaling Factor = 12.5  
 If Peak Hour = 9% of ADT, Scaling Factor = 11.111  
 If Peak Hour = 10% of ADT, Scaling Factor = 10

ADT

**Rose Avenue**

Southbound

	right	through	left
Existing	22	860	
Existing plus Proj	29	860	
Cumulative	22	896	
Cumulative plus	29	896	

Eastbound

	left	through	right
Existing	0		103
Existing plus Proj	5		106
Cumulative	0		103
Cumulative plus	5		106

Westbound

	right	through	left
Existing			
Existing plus Project			
Cumulative			
Cumulative plus Project			

Northbound

	left	through	right
Existing	116	864	
Existing plus Proj	119	864	
Cumulative	116	1,106	
Cumulative plus	119	1,106	

W N E  
 S

Road	Rose Avenue		W. Stroube Street	
	North of	South of	East of	West of
Leg				
Cross Street	W. Stroube Street		Rose Avenue	
Existing	13,968.0	15,544.0	0.0	1,928.0
Existing plus Proj	14,064.0	15,592.0	0.0	2,072.0
Cumulative	16,192.0	17,768.0	0.0	1,928.0
Cumulative plus	16,288.0	17,816.0	0.0	2,072.0

W. Stroube Street

NOISE LEVEL CONTOURS - Existing Plus Project Weekday Off-Site ADT Volumes

ROADWAY NAME Segment	Land Use	Lanes	Median Width	ADT Volume	Design Speed (mph)	Dist. from Center to Receptor	Alpha Factor (1)	Barrier Attn. dB(A)	Vehicle Mix		dB(A) CNEL	Traffic Volumes								Ref. Energy Levels		Dist. Ld			Le			Ln									
									Medium Trucks	Heavy Trucks		Day	Eve	Night	MTd	HTd	MTe	HTe	MTn	HTn	A	MT	HT	Total	A	MT	HT	Total	A	MT	HT	Total					
<b>Rose Avenue n/o W. Stroube Street</b>																																					
Existing		2	15	13,968	40	75	0	0	1.8%	0.7%	64.3	10,853	1,774	1,341	220	87	13	3	19	8	67.4	76.3	81.2	-1.8	63.7	55.8	56.7	65.0	60.7	48.3	46.5	61.1	47.5	46.4	47.4	51.9	
Existing plus Project		2	15	14,064	40	75	0	0	1.8%	0.7%	64.3	10,928	1,786	1,350	221	88	13	3	19	8	67.4	76.3	81.2	-1.8	63.7	55.9	56.7	65.1	60.8	48.3	46.5	61.2	47.6	46.4	47.5	52.0	
Cumulative		2	15	16,192	40	75	0	0	1.8%	0.7%	64.9	12,581	2,056	1,554	255	101	15	3	22	9	67.4	76.3	81.2	-1.8	64.3	56.5	57.3	65.7	61.4	48.9	47.2	61.8	48.2	47.0	48.1	52.6	
Cumulative plus Project		2	15	16,288	40	75	0	0	1.8%	0.7%	65.0	12,656	2,069	1,564	256	102	15	3	22	9	67.4	76.3	81.2	-1.8	64.4	56.5	57.3	65.7	61.4	48.9	47.2	61.8	48.2	47.1	48.1	52.6	
<b>Rose Avenue s/o W. Stroube Street</b>																																					
Existing		2	15	15,544	40	75	0	0	1.8%	0.7%	64.8	12,078	1,974	1,492	245	97	14	3	21	9	67.4	76.3	81.2	-1.8	64.2	56.3	57.1	65.5	61.2	48.7	47.0	61.6	48.0	46.9	47.9	52.4	
Existing plus Project		2	15	15,592	40	75	0	0	1.8%	0.7%	64.8	12,115	1,980	1,497	245	97	14	3	21	9	67.4	76.3	81.2	-1.8	64.2	56.3	57.2	65.5	61.2	48.7	47.0	61.6	48.0	46.9	47.9	52.4	
Cumulative		2	15	17,768	40	75	0	0	1.8%	0.7%	65.4	13,806	2,257	1,706	280	111	16	4	24	10	67.4	76.3	81.2	-1.8	64.8	56.9	57.7	66.1	61.8	49.3	47.6	62.2	48.6	47.4	48.5	53.0	
Cumulative plus Project		2	15	17,816	40	75	0	0	1.8%	0.7%	65.4	13,843	2,263	1,710	280	111	16	4	24	10	67.4	76.3	81.2	-1.8	64.8	56.9	57.7	66.1	61.8	49.3	47.6	62.2	48.6	47.5	48.5	53.0	
<b>W. Stroube Street e/o Rose Avenue</b>																																					
Existing		0	0	0	40	75	0	0	1.8%	0.7%	#NUM!	0	0	0	0	0	0	0	0	0	67.4	76.3	81.2	-1.8	#NUM!	#NUM!	#NUM!	#NUM!	#NUM!	#NUM!	#NUM!	#NUM!	#NUM!	#NUM!	#NUM!	#NUM!	#NUM!
Existing plus Project		0	0	0	40	75	0	0	1.8%	0.7%	#NUM!	0	0	0	0	0	0	0	0	0	67.4	76.3	81.2	-1.8	#NUM!	#NUM!	#NUM!	#NUM!	#NUM!	#NUM!	#NUM!	#NUM!	#NUM!	#NUM!	#NUM!	#NUM!	#NUM!
Cumulative		0	0	0	40	75	0	0	1.8%	0.7%	#NUM!	0	0	0	0	0	0	0	0	0	67.4	76.3	81.2	-1.8	#NUM!	#NUM!	#NUM!	#NUM!	#NUM!	#NUM!	#NUM!	#NUM!	#NUM!	#NUM!	#NUM!	#NUM!	#NUM!
Cumulative plus Project		0	0	0	40	75	0	0	1.8%	0.7%	#NUM!	0	0	0	0	0	0	0	0	0	67.4	76.3	81.2	-1.8	#NUM!	#NUM!	#NUM!	#NUM!	#NUM!	#NUM!	#NUM!	#NUM!	#NUM!	#NUM!	#NUM!	#NUM!	#NUM!
<b>W. Stroube Street w/o Rose Avenue</b>																																					
Existing		1	0	1,928	15	75	0	0	1.8%	0.7%	47.9	1,498	245	185	30	12	2	0	3	1	50.8	65.4	74.5	-1.8	42.8	40.5	45.6	48.2	39.8	32.9	35.4	41.8	26.6	31.1	36.4	37.8	
Existing plus Project		1	0	2,072	15	75	0	0	1.8%	0.7%	48.2	1,610	263	199	33	13	2	0	3	1	50.8	65.4	74.5	-1.8	43.1	40.8	45.9	48.5	40.1	33.3	35.7	42.1	26.9	31.4	36.7	38.1	
Cumulative		1	0	1,928	15	75	0	0	1.8%	0.7%	47.9	1,498	245	185	30	12	2	0	3	1	50.8	65.4	74.5	-1.8	42.8	40.5	45.6	48.2	39.8	32.9	35.4	41.8	26.6	31.1	36.4	37.8	
Cumulative plus Project		1	0	2,072	15	75	0	0	1.8%	0.7%	48.2	1,610	263	199	33	13	2	0	3	1	50.8	65.4	74.5	-1.8	43.1	40.8	45.9	48.5	40.1	33.3	35.7	42.1	26.9	31.4	36.7	38.1	

(1) Alpha Factor: Coefficient of absorption relating to the effects of the ground surface. An alpha factor of 0 indicates that the site is an acoustically "hard" site such as asphalt. An alpha factor of 0.5 indicates that the site is an acoustically "soft" site such as vegetative ground cover.

Assumed 24-Hour Traffic Distribution:	Day	Evening	Night
Total ADT Volumes	77.70%	12.70%	9.60%
Medium-Duty Trucks	87.43%	5.05%	7.52%
Heavy-Duty Trucks	89.10%	2.84%	8.06%

**Project Name**  
**Weekday PM Peak Hour Volumes**

rev. (Date)

Intersection: 7  
 Rose Avenue & W. Stroube Street

If Peak Hour = 6% of ADT, Scaling Factor = 16.667  
 If Peak Hour = 7% of ADT, Scaling Factor = 14.286  
 If Peak Hour = 8% of ADT, Scaling Factor = 12.5  
 If Peak Hour = 9% of ADT, Scaling Factor = 11.111  
 If Peak Hour = 10% of ADT, Scaling Factor = 10

ADT

**Rose Avenue**

Southbound

	right	through	left
Existing	29	912	
Existing plus Proj	33	912	
Cumulative	29	1,001	
Cumulative plus	33	1,001	

Westbound

	right	through	left
Existing			
Existing plus Project			
Cumulative			
Cumulative plus Project			

Road	Rose Avenue		W. Stroube Street	
	North of	South of	East of	West of
Leg				
Cross Street	W. Stroube Street		Rose Avenue	
Existing	14,072.0	16,432.0	0.0	2,888.0
Existing plus Proj	14,160.0	16,472.0	0.0	3,016.0
Cumulative	15,368.0	17,728.0	0.0	2,888.0
Cumulative plus	15,456.0	17,768.0	0.0	3,016.0

Eastbound

	left	through	right
Existing	4		183
Existing plus Proj	11		186
Cumulative	4		183
Cumulative plus	11		186

Northbound

	left	through	right
Existing	145	814	
Existing plus Proj	147	814	
Cumulative	145	887	
Cumulative plus	147	887	

W N E  
 S

W. Stroube Street



**Project Name**  
**Weekday AM Peak Hour Volumes**

rev. (Date)

Intersection: 8  
 Rose Avenue & River Park Boulevard

If Peak Hour = 6% of ADT, Scaling Factor = 16.667  
 If Peak Hour = 7% of ADT, Scaling Factor = 14.286  
 If Peak Hour = 8% of ADT, Scaling Factor = 12.5  
 If Peak Hour = 9% of ADT, Scaling Factor = 11.111  
 If Peak Hour = 10% of ADT, Scaling Factor = 10

ADT

**Rose Avenue**

Southbound

	right	through	left
Existing	28	797	148
Existing plus Proj	28	800	148
Cumulative	69	833	153
Cumulative plus	69	836	153

Westbound

	right	through	left
Existing	219	185	902
Existing plus Proj	219	185	902
Cumulative	262	242	971
Cumulative plus	262	242	971

Road	Rose Avenue		River Park Boulevard	
	North of	South of	East of	West of
Leg				
Cross Street	River Park Boulevard		Rose Avenue	
Existing	15,136.0	27,864.0	17,528.0	6,112.0
Existing plus Proj	15,184.0	27,912.0	17,528.0	6,112.0
Cumulative	17,728.0	30,488.0	19,608.0	7,696.0
Cumulative plus	17,776.0	30,536.0	19,608.0	7,696.0

Eastbound

	left	through	right
Existing	7	95	232
Existing plus Proj	7	95	232
Cumulative	50	133	236
Cumulative plus	50	133	236

Northbound

	left	through	right
Existing	217	693	642
Existing plus Proj	217	696	642
Cumulative	232	849	690
Cumulative plus	232	852	690

W      N      E  
           S

River Park Boulevard



**NOISE LEVEL CONTOURS - Existing Plus Project Weekday Off-Site ADT Volumes**

ROADWAY NAME Segment	Land Use	Median Lanes	ADT Volume	Design Dist. from		Barrier Attn. dBA	Vehicle Mix		dB(A) CNEL	Traffic Volumes								Ref. Energy Levels Dist																	
				Speed (mph)	Center to Receptor		Alpha Factor (1)	Medium Trucks		Heavy Trucks	Day	Eve	Night	MTd	HTd	MTe	HTe	MTn	HTn	A	MT	HT	Adj	A	MT	HT	Total	A	MT	HT	Total	A	MT	HT	Total
<b>Rose Avenue n/o River Park</b>																																			
Existing		2	15,136	40	75	0	0	1.8%	0.7%	64.7	11,761	#####	#####	238	94	14	3	20	9	67.4	76.3	81.2	-1.8	64.1	56.2	57.0	65.4	61.1	48.6	46.9	61.5	47.9	46.7	47.8	52.3
Existing plus Project		2	15,184	40	75	0	0	1.8%	0.7%	64.7	11,798	#####	#####	239	95	14	3	21	9	67.4	76.3	81.2	-1.8	64.1	56.2	57.0	65.4	61.1	48.6	46.9	61.5	47.9	46.8	47.8	52.3
Cumulative		2	17,728	40	75	0	0	1.8%	0.7%	65.3	13,775	#####	#####	279	111	16	4	24	10	67.4	76.3	81.2	-1.8	64.7	56.9	57.7	66.1	61.8	49.3	47.5	62.2	48.6	47.4	48.5	53.0
Cumulative plus Project		2	17,776	40	75	0	0	1.8%	0.7%	65.4	13,812	#####	#####	280	111	16	4	24	10	67.4	76.3	81.2	-1.8	64.8	56.9	57.7	66.1	61.8	49.3	47.6	62.2	48.6	47.4	48.5	53.0
<b>Rose Avenue s/o River Park</b>																																			
Existing		2	27,864	40	75	0	0	1.8%	0.7%	67.3	21,650	#####	#####	439	174	25	6	38	16	67.4	76.3	81.2	-1.8	66.7	58.8	59.7	68.0	63.7	51.3	49.5	64.1	50.5	49.4	50.4	54.9
Existing plus Project		2	27,912	40	75	0	0	1.8%	0.7%	67.3	21,688	#####	#####	439	174	25	6	38	16	67.4	76.3	81.2	-1.8	66.7	58.9	59.7	68.1	63.7	51.3	49.5	64.1	50.5	49.4	50.4	54.9
Cumulative		2	30,488	40	75	0	0	1.8%	0.7%	67.7	23,689	#####	#####	480	190	28	6	41	17	67.4	76.3	81.2	-1.8	67.1	59.2	60.1	68.4	64.1	51.7	49.9	64.5	50.9	49.8	50.8	55.3
Cumulative plus Project		2	30,536	40	75	0	0	1.8%	0.7%	67.7	23,726	#####	#####	481	190	28	6	41	17	67.4	76.3	81.2	-1.8	67.1	59.2	60.1	68.4	64.1	51.7	49.9	64.5	50.9	49.8	50.8	55.3
<b>River Park Boulevard e/o</b>																																			
Existing		2	17,528	30	75	0	0	1.8%	0.7%	62.8	13,619	#####	#####	276	109	16	3	24	10	62.5	73.1	80.3	-1.8	61.1	54.8	58.0	63.4	58.1	47.3	47.8	58.8	44.9	45.4	48.7	51.5
Existing plus Project		2	17,528	30	75	0	0	1.8%	0.7%	62.8	13,619	#####	#####	276	109	16	3	24	10	62.5	73.1	80.3	-1.8	61.1	54.8	58.0	63.4	58.1	47.3	47.8	58.8	44.9	45.4	48.7	51.5
Cumulative		2	19,608	30	75	0	0	1.8%	0.7%	63.3	15,235	#####	#####	309	122	18	4	27	11	62.5	73.1	80.3	-1.8	61.5	55.3	58.5	63.9	58.6	47.7	48.3	59.3	45.4	45.9	49.2	51.9
Cumulative plus Project		2	19,608	30	75	0	0	1.8%	0.7%	63.3	15,235	#####	#####	309	122	18	4	27	11	62.5	73.1	80.3	-1.8	61.5	55.3	58.5	63.9	58.6	47.7	48.3	59.3	45.4	45.9	49.2	51.9
<b>River Park Boulevard w/o</b>																																			
Existing		1	6,112	15	75	0	0	1.8%	0.7%	52.9	4,749	776	587	96	38	6	1	8	3	50.8	65.4	74.5	-1.8	47.8	45.5	50.6	53.2	44.8	38.0	40.4	46.8	31.6	36.1	41.4	42.8
Existing plus Project		1	6,112	15	75	0	0	1.8%	0.7%	52.9	4,749	776	587	96	38	6	1	8	3	50.8	65.4	74.5	-1.8	47.8	45.5	50.6	53.2	44.8	38.0	40.4	46.8	31.6	36.1	41.4	42.8
Cumulative		1	7,696	15	75	0	0	1.8%	0.7%	53.9	5,980	977	739	121	48	7	2	10	4	50.8	65.4	74.5	-1.8	48.8	46.5	51.6	54.2	45.8	39.0	41.4	47.8	32.6	37.1	42.4	43.8
Cumulative plus Project		1	7,696	15	75	0	0	1.8%	0.7%	53.9	5,980	977	739	121	48	7	2	10	4	50.8	65.4	74.5	-1.8	48.8	46.5	51.6	54.2	45.8	39.0	41.4	47.8	32.6	37.1	42.4	43.8

(1) Alpha Factor: Coefficient of absorption relating to the effects of the ground surface. An alpha factor of 0 indicates that the site is an acoustically "hard" site such as asphalt. An alpha factor of 0.5 indicates that the site is an acoustically "soft" site such as vegetative ground cover.

Assumed 24-Hour Traffic Distribution:	Day	Evening	Night
Total ADT Volumes	77.70%	12.70%	9.60%
Medium-Duty Trucks	87.43%	5.05%	7.52%
Heavy-Duty Trucks	89.10%	2.84%	8.06%

**Project Name**  
**Weekday PM Peak Hour Volumes**

rev. (Date)

Intersection: 8  
 Rose Avenue & River Park Boulevard

If Peak Hour = 6% of ADT, Scaling Factor = 16.667  
 If Peak Hour = 7% of ADT, Scaling Factor = 14.286  
 If Peak Hour = 8% of ADT, Scaling Factor = 12.5  
 If Peak Hour = 9% of ADT, Scaling Factor = 11.111  
 If Peak Hour = 10% of ADT, Scaling Factor = 10

ADT

**Rose Avenue**

Southbound

	right	through	left
Existing	36	951	118
Exising plus Proj	36	954	118
Cumulative	72	1,040	197
Cumulative plus	72	1,043	197

Westbound

	right	through	left
Existing	92	38	188
Exising plus Proj	92	38	188
Cumulative	97	62	251
Cumulative plus	97	62	251

Road	Rose Avenue		River Park Boulevard	
	North of	South of	East of	West of
Leg				
Cross Street	River Park Boulevard		Rose Avenue	
Existing	16,536.0	20,944.0	6,992.0	3,880.0
Exising plus Proj	16,576.0	20,984.0	6,992.0	3,880.0
Cumulative	18,736.0	23,264.0	9,768.0	5,528.0
Cumulative plus	18,776.0	23,304.0	9,768.0	5,528.0

Eastbound

	left	through	right
Existing	44	76	171
Exising plus Proj	44	76	171
Cumulative	79	166	190
Cumulative plus	79	166	190

Northbound

	left	through	right
Existing	120	826	362
Exising plus Proj	120	828	362
Cumulative	122	857	448
Cumulative plus	122	859	448

W      N  
           S      E

River Park Boulevard

**NOISE LEVEL CONTOURS - Existing Plus Project Weekday Off-Site ADT Volumes**

ROADWAY NAME Segment	Land Use	Median Lanes	ADT Volume	Design Dist. from		Barrier Attn.	Vehicle Mix		dB(A) CNEL	Traffic Volumes								Ref. Energy Levels Dist																		
				Speed (mph)	Center to Receptor		Alpha Factor (1)	Medium Trucks		Heavy Trucks	Day	Even	Night	MTd	HTd	MTe	HTe	MTn	HTn	A	MT	HT	Adj	A	MT	HT	Total	A	MT	HT	Total	A	MT	HT	Total	
<b>Rose Avenue n/o River Park</b>																																				
Existing		2	15	16,536	40	75	0	0	1.8%	0.7%	65.0	12,848	#####	#####	260	103	15	3	22	9	67.4	76.3	81.2	-1.8	64.4	56.6	57.4	65.8	61.5	49.0	47.2	61.9	48.3	47.1	48.2	52.7
Existing plus Project		2	15	16,576	40	75	0	0	1.8%	0.7%	65.0	12,880	#####	#####	261	103	15	3	22	9	67.4	76.3	81.2	-1.8	64.5	56.6	57.4	65.8	61.5	49.0	47.3	61.9	48.3	47.1	48.2	52.7
Cumulative		2	15	18,736	40	75	0	0	1.8%	0.7%	65.6	14,558	#####	#####	295	117	17	4	25	11	67.4	76.3	81.2	-1.8	65.0	57.1	58.0	66.3	62.0	49.5	47.8	62.4	48.8	47.7	48.7	53.2
Cumulative plus Project		2	15	18,776	40	75	0	0	1.8%	0.7%	65.6	14,589	#####	#####	295	117	17	4	25	11	67.4	76.3	81.2	-1.8	65.0	57.1	58.0	66.3	62.0	49.6	47.8	62.4	48.8	47.7	48.7	53.2
<b>Rose Avenue s/o River Park</b>																																				
Existing		2	15	20,944	40	75	0	0	1.8%	0.7%	66.1	16,273	#####	#####	330	131	19	4	28	12	67.4	76.3	81.2	-1.8	65.5	57.6	58.4	66.8	62.5	50.0	48.3	62.9	49.3	48.2	49.2	53.7
Existing plus Project		2	15	20,984	40	75	0	0	1.8%	0.7%	66.1	16,305	#####	#####	330	131	19	4	28	12	67.4	76.3	81.2	-1.8	65.5	57.6	58.4	66.8	62.5	50.0	48.3	62.9	49.3	48.2	49.2	53.7
Cumulative		2	15	23,264	40	75	0	0	1.8%	0.7%	66.5	18,076	#####	#####	366	145	21	5	31	13	67.4	76.3	81.2	-1.8	65.9	58.1	58.9	67.3	62.9	50.5	48.7	63.3	49.7	48.6	49.7	54.1
Cumulative plus Project		2	15	23,304	40	75	0	0	1.8%	0.7%	66.5	18,107	#####	#####	367	145	21	5	32	13	67.4	76.3	81.2	-1.8	65.9	58.1	58.9	67.3	63.0	50.5	48.7	63.3	49.8	48.6	49.7	54.1
<b>River Park Boulevard e/o</b>																																				
Existing		2	5	6,992	30	75	0	0	1.8%	0.7%	58.9	5,433	888	671	110	44	6	1	9	4	62.5	73.1	80.3	-1.8	57.1	50.9	54.0	59.4	54.1	43.3	43.8	54.8	40.9	41.4	44.7	47.5
Existing plus Project		2	5	6,992	30	75	0	0	1.8%	0.7%	58.9	5,433	888	671	110	44	6	1	9	4	62.5	73.1	80.3	-1.8	57.1	50.9	54.0	59.4	54.1	43.3	43.8	54.8	40.9	41.4	44.7	47.5
Cumulative		2	5	9,768	30	75	0	0	1.8%	0.7%	60.3	7,590	#####	938	154	61	9	2	13	6	62.5	73.1	80.3	-1.8	58.5	52.3	55.4	60.9	55.5	44.7	45.3	56.2	42.3	42.8	46.2	48.9
Cumulative plus Project		2	5	9,768	30	75	0	0	1.8%	0.7%	60.3	7,590	#####	938	154	61	9	2	13	6	62.5	73.1	80.3	-1.8	58.5	52.3	55.4	60.9	55.5	44.7	45.3	56.2	42.3	42.8	46.2	48.9
<b>River Park Boulevard w/o</b>																																				
Existing		1	0	3,880	15	75	0	0	1.8%	0.7%	50.9	3,015	493	372	61	24	4	1	5	2	50.8	65.4	74.5	-1.8	45.8	43.6	48.6	51.3	42.8	36.0	38.5	44.8	29.6	34.1	39.4	40.9
Existing plus Project		1	0	3,880	15	75	0	0	1.8%	0.7%	50.9	3,015	493	372	61	24	4	1	5	2	50.8	65.4	74.5	-1.8	45.8	43.6	48.6	51.3	42.8	36.0	38.5	44.8	29.6	34.1	39.4	40.9
Cumulative		1	0	5,528	15	75	0	0	1.8%	0.7%	52.5	4,295	702	531	87	34	5	1	7	3	50.8	65.4	74.5	-1.8	47.3	45.1	50.2	52.8	44.4	37.5	40.0	46.3	31.2	35.7	40.9	42.4
Cumulative plus Project		1	0	5,528	15	75	0	0	1.8%	0.7%	52.5	4,295	702	531	87	34	5	1	7	3	50.8	65.4	74.5	-1.8	47.3	45.1	50.2	52.8	44.4	37.5	40.0	46.3	31.2	35.7	40.9	42.4

(1) Alpha Factor: Coefficient of absorption relating to the effects of the ground surface. An alpha factor of 0 indicates that the site is an acoustically "hard" site such as asphalt. An alpha factor of 0.5 indicates that the site is an acoustically "soft" site such as vegetative ground cover.

Assumed 24-Hour Traffic Distribution:	Day	Evening	Night
Total ADT Volumes	77.70%	12.70%	9.60%
Medium-Duty Trucks	87.43%	5.05%	7.52%
Heavy-Duty Trucks	89.10%	2.84%	8.06%

**Project Name**  
**Weekday AM Peak Hour Volumes**

rev. (Date)

Intersection: 9  
 Rose Avenue & US-101 NB Off-Ramp

If Peak Hour = 6% of ADT, Scaling Factor = 16.667  
 If Peak Hour = 7% of ADT, Scaling Factor = 14.286  
 If Peak Hour = 8% of ADT, Scaling Factor = 12.5  
 If Peak Hour = 9% of ADT, Scaling Factor = 11.111  
 If Peak Hour = 10% of ADT, Scaling Factor = 10

ADT

**Rose Avenue**

Southbound

	right	through	left
Existing	499	1,345	
Existing plus Proj	499	1,348	
Cumulative	529	1,424	
Cumulative plus	529	1,427	

Westbound

	right	through	left
Existing	122		402
Existing plus Proj	125		402
Cumulative	190		421
Cumulative plus	193		421

Road	Rose Avenue		US-101 NB Off-Ramp	
	North of	South of	East of	West of
Leg	US-101 NB Off-Ramp		Rose Avenue	
Existing	27,528.0	33,312.0	11,728.0	3,992.0
Existing plus Proj	27,576.0	33,360.0	11,776.0	3,992.0
Cumulative	30,120.0	35,768.0	12,920.0	4,232.0
Cumulative plus	30,168.0	35,816.0	12,968.0	4,232.0

US-101 NB Off-Ramp

Eastbound

	left	through	right
Existing			
Existing plus Project			
Cumulative			
Cumulative plus Project			

Northbound

	left	through	right
Existing		1,475	942
Existing plus Project		1,475	945
Cumulative		1,622	1,004
Cumulative plus Project		1,622	1,007

W      N      E  
           S

**NOISE LEVEL CONTOURS - Existing Plus Project Weekday Off-Site ADT Volumes**

ROADWAY NAME Segment	Land Use	Lanes	Median Width	ADT Volume	Design Dist. from		Barrier Attn. dB(A)	Vehicle Mix		dB(A) CNEL	Traffic Volumes										Ref. Energy Levels Dist						Le			Ln						
					Speed (mph)	Center to Receptor Factor (1)		Medium Trucks	Heavy Trucks		Day	Eve	Night	MTd	HTd	MTe	HTe	MTn	HTn	A	MT	HT	Adj	A	MT	HT	Total	A	MT	HT	Total	A	MT	HT	Total	
<b>Rose Avenue n/o US-101 NB</b>																																				
Existing		3	15	27,528	40	75	0	0	1.8%	0.7%	67.3	21,389	3,496	2,643	433	172	25	5	37	16	67.4	76.3	81.2	-1.7	66.7	58.9	59.7	68.1	63.8	51.3	49.5	64.1	50.6	49.4	50.5	55.0
Existing plus Project		3	15	27,576	40	75	0	0	1.8%	0.7%	67.3	21,427	3,502	2,647	434	172	25	5	37	16	67.4	76.3	81.2	-1.7	66.7	58.9	59.7	68.1	63.8	51.3	49.5	64.2	50.6	49.4	50.5	55.0
Cumulative		3	15	30,120	40	75	0	0	1.8%	0.7%	67.7	23,403	3,825	2,892	474	188	27	6	41	17	67.4	76.3	81.2	-1.7	67.1	59.3	60.1	68.5	64.1	51.7	49.9	64.5	51.0	49.8	50.9	55.3
Cumulative plus Project		3	15	30,168	40	75	0	0	1.8%	0.7%	67.7	23,441	3,831	2,896	475	188	27	6	41	17	67.4	76.3	81.2	-1.7	67.1	59.3	60.1	68.5	64.2	51.7	49.9	64.5	51.0	49.8	50.9	55.3
<b>Rose Avenue s/o US-101 NB</b>																																				
Existing		3	15	33,312	40	75	0	0	1.8%	0.7%	68.2	25,883	4,231	3,198	524	208	30	7	45	19	67.4	76.3	81.2	-1.7	67.6	59.7	60.5	68.9	64.6	52.1	50.4	65.0	51.4	50.3	51.3	55.8
Existing plus Project		3	15	33,360	40	75	0	0	1.8%	0.7%	68.2	25,921	4,237	3,203	525	208	30	7	45	19	67.4	76.3	81.2	-1.7	67.6	59.7	60.5	68.9	64.6	52.1	50.4	65.0	51.4	50.3	51.3	55.8
Cumulative		3	15	35,768	40	75	0	0	1.8%	0.7%	68.5	27,792	4,543	3,434	563	223	33	7	48	20	67.4	76.3	81.2	-1.7	67.9	60.0	60.8	69.2	64.9	52.4	50.7	65.3	51.7	50.6	51.6	56.1
Cumulative plus Project		3	15	35,816	40	75	0	0	1.8%	0.7%	68.5	27,829	4,549	3,438	564	223	33	7	48	20	67.4	76.3	81.2	-1.7	67.9	60.0	60.8	69.2	64.9	52.4	50.7	65.3	51.7	50.6	51.6	56.1
<b>US-101 NB Off-Ramp s/o</b>																																				
Existing		2	0	11,728	15	75	0	0	1.8%	0.7%	55.8	9,113	1,489	1,126	185	73	11	2	16	7	50.8	65.4	74.5	-1.8	50.6	48.4	53.4	56.1	47.6	40.8	43.3	49.6	34.4	38.9	44.2	45.7
Existing plus Project		2	0	11,776	15	75	0	0	1.8%	0.7%	55.8	9,150	1,496	1,130	185	73	11	2	16	7	50.8	65.4	74.5	-1.8	50.6	48.4	53.5	56.1	47.7	40.8	43.3	49.6	34.5	39.0	44.2	45.7
Cumulative		2	0	12,920	15	75	0	0	1.8%	0.7%	56.2	10,039	1,641	1,240	203	81	12	3	17	7	50.8	65.4	74.5	-1.8	51.0	48.8	53.9	56.5	48.1	41.2	43.7	50.0	34.9	39.4	44.6	46.1
Cumulative plus Project		2	0	12,968	15	75	0	0	1.8%	0.7%	56.2	10,076	1,647	1,245	204	81	12	3	18	7	50.8	65.4	74.5	-1.8	51.1	48.8	53.9	56.5	48.1	41.2	43.7	50.0	34.9	39.4	44.6	46.1
<b>US-101 NB Off-Ramp w/o</b>																																				
Existing		1	0	3,992	15	75	0	0	1.8%	0.7%	51.1	3,102	507	383	63	25	4	1	5	2	50.8	65.4	74.5	-1.8	45.9	43.7	48.7	51.4	42.9	36.1	38.6	44.9	29.8	34.2	39.5	41.0
Existing plus Project		1	0	3,992	15	75	0	0	1.8%	0.7%	51.1	3,102	507	383	63	25	4	1	5	2	50.8	65.4	74.5	-1.8	45.9	43.7	48.7	51.4	42.9	36.1	38.6	44.9	29.8	34.2	39.5	41.0
Cumulative		1	0	4,232	15	75	0	0	1.8%	0.7%	51.3	3,288	537	406	67	26	4	1	6	2	50.8	65.4	74.5	-1.8	46.2	43.9	49.0	51.6	43.2	36.4	38.8	45.2	30.0	34.5	39.8	41.2
Cumulative plus Project		1	0	4,232	15	75	0	0	1.8%	0.7%	51.3	3,288	537	406	67	26	4	1	6	2	50.8	65.4	74.5	-1.8	46.2	43.9	49.0	51.6	43.2	36.4	38.8	45.2	30.0	34.5	39.8	41.2

(1) Alpha Factor: Coefficient of absorption relating to the effects of the ground surface. An alpha factor of 0 indicates that the site is an acoustically "hard" site such as asphalt. An alpha factor of 0.5 indicates that the site is an acoustically "soft" site such as vegetative ground cover.

Assumed 24-Hour Traffic Distribution:	Day	Evening	Night
Total ADT Volumes	77.70%	12.70%	9.60%
Medium-Duty Trucks	87.43%	5.05%	7.52%
Heavy-Duty Trucks	89.10%	2.84%	8.06%

**Project Name**  
**Weekday PM Peak Hour Volumes**

rev. (Date)

Intersection: 9  
 Rose Avenue & US-101 NB Off-Ramp

If Peak Hour = 6% of ADT, Scaling Factor = 16.667  
 If Peak Hour = 7% of ADT, Scaling Factor = 14.286  
 If Peak Hour = 8% of ADT, Scaling Factor = 12.5  
 If Peak Hour = 9% of ADT, Scaling Factor = 11.111  
 If Peak Hour = 10% of ADT, Scaling Factor = 10

ADT

**Rose Avenue**

Southbound

	right	through	left
Existing	217	1,109	
Existing plus Proj	217	1,112	
Cumulative	234	1,264	
Cumulative plus	234	1,267	

Westbound

	right	through	left
Existing	106		415
Existing plus Proj	108		415
Cumulative	139		448
Cumulative plus	141		448

Road	Rose Avenue		US-101 NB Off-Ramp	
	North of	South of	East of	West of
Leg	US-101 NB Off-Ramp		Rose Avenue	
Existing	21,120.0	28,464.0	10,776.0	1,736.0
Existing plus Proj	21,160.0	28,504.0	10,808.0	1,736.0
Cumulative	23,448.0	30,768.0	11,416.0	1,872.0
Cumulative plus	23,488.0	30,808.0	11,448.0	1,872.0

US-101 NB Off-Ramp

Eastbound

	left	through	right
Existing			
Existing plus Project			
Cumulative			
Cumulative plus Project			

Northbound

	left	through	right
Existing		1,208	826
Existing plus Project		1,208	828
Cumulative		1,294	840
Cumulative plus Project		1,294	842

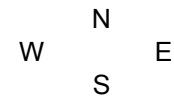

**NOISE LEVEL CONTOURS - Existing Plus Project Weekday Off-Site ADT Volumes**

ROADWAY NAME Segment	Land Use	Median Lanes	ADT Volume	Design Dist. from		Barrier Attn. dBA	Vehicle Mix		dB(A) CNEL	Traffic Volumes								Ref. Energy Levels Dist																		
				Speed (mph)	Center to Receptor (ft)		Alpha Factor (1)	Medium Trucks		Heavy Trucks	Day	Even	Night	MTd	HTd	MTe	HTe	MTn	HTn	A	MT	HT	Adj	A	MT	HT	Total	A	MT	HT	Total	A	MT	HT	Total	
<b>Rose Avenue n/o US-101 NB</b>																																				
Existing		3	15	21,120	40	75	0	0	1.8%	0.7%	66.2	16,410	#####	#####	332	132	19	4	29	12	67.4	76.3	81.2	-1.7	65.6	57.7	58.6	66.9	62.6	50.1	48.4	63.0	49.4	48.3	49.3	53.8
Existing plus Project		3	15	21,160	40	75	0	0	1.8%	0.7%	66.2	16,441	#####	#####	333	132	19	4	29	12	67.4	76.3	81.2	-1.7	65.6	57.7	58.6	66.9	62.6	50.2	48.4	63.0	49.4	48.3	49.3	53.8
Cumulative		3	15	23,448	40	75	0	0	1.8%	0.7%	66.6	18,219	#####	#####	369	146	21	5	32	13	67.4	76.3	81.2	-1.7	66.0	58.2	59.0	67.4	63.1	50.6	48.8	63.5	49.9	48.7	49.8	54.3
Cumulative plus Project		3	15	23,488	40	75	0	0	1.8%	0.7%	66.6	18,250	#####	#####	370	146	21	5	32	13	67.4	76.3	81.2	-1.7	66.0	58.2	59.0	67.4	63.1	50.6	48.8	63.5	49.9	48.7	49.8	54.3
<b>Rose Avenue s/o US-101 NB</b>																																				
Existing		3	15	28,464	40	75	0	0	1.8%	0.7%	67.5	22,117	#####	#####	448	178	26	6	39	16	67.4	76.3	81.2	-1.7	66.9	59.0	59.8	68.2	63.9	51.4	49.7	64.3	50.7	49.6	50.6	55.1
Existing plus Project		3	15	28,504	40	75	0	0	1.8%	0.7%	67.5	22,148	#####	#####	449	178	26	6	39	16	67.4	76.3	81.2	-1.7	66.9	59.0	59.9	68.2	63.9	51.4	49.7	64.3	50.7	49.6	50.6	55.1
Cumulative		3	15	30,768	40	75	0	0	1.8%	0.7%	67.8	23,907	#####	#####	484	192	28	6	42	17	67.4	76.3	81.2	-1.7	67.2	59.4	60.2	68.6	64.2	51.8	50.0	64.6	51.0	49.9	51.0	55.4
Cumulative plus Project		3	15	30,808	40	75	0	0	1.8%	0.7%	67.8	23,938	#####	#####	485	192	28	6	42	17	67.4	76.3	81.2	-1.7	67.2	59.4	60.2	68.6	64.2	51.8	50.0	64.6	51.0	49.9	51.0	55.4
<b>US-101 NB Off-Ramp e/o</b>																																				
Existing		2	0	10,776	15	75	0	0	1.8%	0.7%	55.4	8,373	#####	#####	170	67	10	2	15	6	50.8	65.4	74.5	-1.8	50.3	48.0	53.1	55.7	47.3	40.4	42.9	49.2	34.1	38.6	43.8	45.3
Existing plus Project		2	0	10,808	15	75	0	0	1.8%	0.7%	55.4	8,398	#####	#####	170	67	10	2	15	6	50.8	65.4	74.5	-1.8	50.3	48.0	53.1	55.7	47.3	40.4	42.9	49.3	34.1	38.6	43.9	45.3
Cumulative		2	0	11,416	15	75	0	0	1.8%	0.7%	55.7	8,870	#####	#####	180	71	10	2	15	6	50.8	65.4	74.5	-1.8	50.5	48.3	53.3	56.0	47.5	40.7	43.2	49.5	34.3	38.8	44.1	45.6
Cumulative plus Project		2	0	11,448	15	75	0	0	1.8%	0.7%	55.7	8,895	#####	#####	180	71	10	2	15	6	50.8	65.4	74.5	-1.8	50.5	48.3	53.3	56.0	47.5	40.7	43.2	49.5	34.3	38.8	44.1	45.6
<b>US-101 NB Off-Ramp w/o</b>																																				
Existing		1	0	1,736	15	75	0	0	1.8%	0.7%	47.5	1,349	220	167	27	11	2	0	2	1	50.8	65.4	74.5	-1.8	42.3	40.1	45.1	47.8	39.3	32.5	35.0	41.3	26.1	30.6	35.9	37.4
Existing plus Project		1	0	1,736	15	75	0	0	1.8%	0.7%	47.5	1,349	220	167	27	11	2	0	2	1	50.8	65.4	74.5	-1.8	42.3	40.1	45.1	47.8	39.3	32.5	35.0	41.3	26.1	30.6	35.9	37.4
Cumulative		1	0	1,872	15	75	0	0	1.8%	0.7%	47.8	1,455	238	180	29	12	2	0	3	1	50.8	65.4	74.5	-1.8	42.6	40.4	45.5	48.1	39.7	32.8	35.3	41.6	26.5	31.0	36.2	37.7
Cumulative plus Project		1	0	1,872	15	75	0	0	1.8%	0.7%	47.8	1,455	238	180	29	12	2	0	3	1	50.8	65.4	74.5	-1.8	42.6	40.4	45.5	48.1	39.7	32.8	35.3	41.6	26.5	31.0	36.2	37.7

(1) Alpha Factor: Coefficient of absorption relating to the effects of the ground surface. An alpha factor of 0 indicates that the site is an acoustically "hard" site such as asphalt. An alpha factor of 0.5 indicates that the site is an acoustically "soft" site such as vegetative ground cover.

Assumed 24-Hour Traffic Distribution:	Day	Evening	Night
Total ADT Volumes	77.70%	12.70%	9.60%
Medium-Duty Trucks	87.43%	5.05%	7.52%
Heavy-Duty Trucks	89.10%	2.84%	8.06%

**Project Name**  
**Weekday AM Peak Hour Volumes**

rev. (Date)

Intersection: 10  
 Rose Avenue & US-101 SB Off-Ramp

If Peak Hour = 6% of ADT, Scaling Factor = 16.667  
 If Peak Hour = 7% of ADT, Scaling Factor = 14.286  
 If Peak Hour = 8% of ADT, Scaling Factor = 12.5  
 If Peak Hour = 9% of ADT, Scaling Factor = 11.111  
 If Peak Hour = 10% of ADT, Scaling Factor = 10

ADT

**Rose Avenue**

Southbound

	right	through	left
Existing	146	1,598	
Existing plus Proj	149	1,598	
Cumulative	187	1,636	
Cumulative plus	190	1,636	

Westbound

	right	through	left
Existing			
Existing plus Project			
Cumulative			
Cumulative plus Project			

Road	Rose Avenue		US-101 SB Off-Ramp	
	North of	South of	East of	West of
Leg	US-101 SB Off-Ramp		Rose Avenue	
Existing	33,184.0	40,064.0	3,272.0	10,792.0
Existing plus Proj	33,232.0	40,112.0	3,272.0	10,840.0
Cumulative	35,512.0	42,072.0	3,320.0	11,352.0
Cumulative plus	35,560.0	42,120.0	3,320.0	11,400.0

Eastbound

	left	through	right
Existing	303		900
Existing plus Proj	303		903
Cumulative	320		912
Cumulative plus	320		915

Northbound

	left	through	right
Existing		2,101	409
Existing plus Project		2,104	409
Cumulative		2,296	415
Cumulative plus Project		2,299	415

W    N    E  
           S

US-101 SB Off-Ramp



**NOISE LEVEL CONTOURS - Existing Plus Project Weekday Off-Site ADT Volumes**

ROADWAY NAME Segment	Land Use	Median Lanes	ADT Volume	Design Speed (mph)	Dist. from Center to Receptor (ft)	Alpha Factor (1)	Barrier Att. dB(A)	Vehicle Mix Medium Trucks	Vehicle Mix Heavy Trucks	dB(A) CNEL	Traffic Volumes								Ref. Energy Levels Dist Ld																	
											Day	Eve	Night	MTd	HTd	MTe	HTe	MTn	HTn	A	MT	HT	Adj	A	MT	HT	Total	A	MT	HT	Total	A	MT	HT	Total	
<b>Rose Avenue n/o US-101 SB</b>																																				
Existing		3	0	33,184	40	75	0	0	1.8%	0.7%	68.0	25,784	####	####	522	207	30	7	45	19	67.4	76.3	81.2	-1.8	67.5	59.6	60.4	68.8	64.5	52.0	50.3	64.9	51.3	50.1	51.2	55.7
Existing plus Project		3	0	33,232	40	75	0	0	1.8%	0.7%	68.1	25,821	####	####	523	207	30	7	45	19	67.4	76.3	81.2	-1.8	67.5	59.6	60.4	68.8	64.5	52.0	50.3	64.9	51.3	50.1	51.2	55.7
Cumulative		3	0	35,512	40	75	0	0	1.8%	0.7%	68.3	27,593	####	####	559	221	32	7	48	20	67.4	76.3	81.2	-1.8	67.7	59.9	60.7	69.1	64.8	52.3	50.5	65.2	51.6	50.4	51.5	56.0
Cumulative plus Project		3	0	35,560	40	75	0	0	1.8%	0.7%	68.3	27,630	####	####	560	222	32	7	48	20	67.4	76.3	81.2	-1.8	67.8	59.9	60.7	69.1	64.8	52.3	50.6	65.2	51.6	50.4	51.5	56.0
<b>Rose Avenue s/o US-101 SB</b>																																				
Existing		3	0	40,064	40	75	0	0	1.8%	0.7%	68.9	31,130	####	####	631	250	36	8	54	23	67.4	76.3	81.2	-1.8	68.3	60.4	61.2	69.6	65.3	52.8	51.1	65.7	52.1	51.0	52.0	56.5
Existing plus Project		3	0	40,112	40	75	0	0	1.8%	0.7%	68.9	31,167	####	####	631	250	36	8	54	23	67.4	76.3	81.2	-1.8	68.3	60.4	61.2	69.6	65.3	52.8	51.1	65.7	52.1	51.0	52.0	56.5
Cumulative		3	0	42,072	40	75	0	0	1.8%	0.7%	69.1	32,690	####	####	662	262	38	8	57	24	67.4	76.3	81.2	-1.8	68.5	60.6	61.5	69.8	65.5	53.0	51.3	65.9	52.3	51.2	52.2	56.7
Cumulative plus Project		3	0	42,120	40	75	0	0	1.8%	0.7%	69.1	32,727	####	####	663	263	38	8	57	24	67.4	76.3	81.2	-1.8	68.5	60.6	61.5	69.8	65.5	53.0	51.3	65.9	52.3	51.2	52.2	56.7
<b>US-101 SB Off-Ramp e/o</b>																																				
Existing		1	0	3,272	15	75	0	0	1.8%	0.7%	50.2	2,542	416	314	51	20	3	1	4	2	50.8	65.4	74.5	-1.8	45.1	42.8	47.9	50.5	42.1	35.2	37.7	44.1	28.9	33.4	38.6	40.1
Existing plus Project		1	0	3,272	15	75	0	0	1.8%	0.7%	50.2	2,542	416	314	51	20	3	1	4	2	50.8	65.4	74.5	-1.8	45.1	42.8	47.9	50.5	42.1	35.2	37.7	44.1	28.9	33.4	38.6	40.1
Cumulative		1	0	3,320	15	75	0	0	1.8%	0.7%	50.3	2,580	422	319	52	21	3	1	4	2	50.8	65.4	74.5	-1.8	45.1	42.9	47.9	50.6	42.1	35.3	37.8	44.1	29.0	33.4	38.7	40.2
Cumulative plus Project		1	0	3,320	15	75	0	0	1.8%	0.7%	50.3	2,580	422	319	52	21	3	1	4	2	50.8	65.4	74.5	-1.8	45.1	42.9	47.9	50.6	42.1	35.3	37.8	44.1	29.0	33.4	38.7	40.2
<b>US-101 SB Off-Ramp w/o</b>																																				
Existing		3	0	10,792	15	75	0	0	1.8%	0.7%	55.4	8,385	####	####	170	67	10	2	15	6	50.8	65.4	74.5	-1.8	50.3	48.1	53.1	55.8	47.3	40.5	43.0	49.3	34.1	38.6	43.9	45.4
Existing plus Project		3	0	10,840	15	75	0	0	1.8%	0.7%	55.5	8,423	####	####	171	68	10	2	15	6	50.8	65.4	74.5	-1.8	50.3	48.1	53.1	55.8	47.3	40.5	43.0	49.3	34.1	38.6	43.9	45.4
Cumulative		3	0	11,352	15	75	0	0	1.8%	0.7%	55.7	8,821	####	####	179	71	10	2	15	6	50.8	65.4	74.5	-1.8	50.5	48.3	53.3	56.0	47.5	40.7	43.2	49.5	34.3	38.8	44.1	45.6
Cumulative plus Project		3	0	11,400	15	75	0	0	1.8%	0.7%	55.7	8,858	####	####	179	71	10	2	15	6	50.8	65.4	74.5	-1.8	50.5	48.3	53.4	56.0	47.6	40.7	43.2	49.5	34.4	38.9	44.1	45.6

(1) Alpha Factor: Coefficient of absorption relating to the effects of the ground surface. An alpha factor of 0 indicates that the site is an acoustically "hard" site such as asphalt. An alpha factor of 0.5 indicates that the site is an acoustically "soft" site such as vegetative ground cover.

Assumed 24-Hour Traffic Distribution:	Day	Evening	Night
Total ADT Volumes	77.70%	12.70%	9.60%
Medium-Duty Trucks	87.43%	5.05%	7.52%
Heavy-Duty Trucks	89.10%	2.84%	8.06%

**Project Name**  
**Weekday PM Peak Hour Volumes**

rev. (Date)

Intersection: 10  
 Rose Avenue & US-101 SB Off-Ramp

If Peak Hour = 6% of ADT, Scaling Factor = 16.667  
 If Peak Hour = 7% of ADT, Scaling Factor = 14.286  
 If Peak Hour = 8% of ADT, Scaling Factor = 12.5  
 If Peak Hour = 9% of ADT, Scaling Factor = 11.111  
 If Peak Hour = 10% of ADT, Scaling Factor = 10

ADT

**Rose Avenue**

Southbound

	right	through	left
Existing	194	1,320	
Existing plus Proj	197	1,320	
Cumulative	248	1,421	
Cumulativeplus P	251	1,421	

Eastbound

	left	through	right
Existing	210		734
Existing plus Proj	210		737
Cumulative	237		795
Cumulativeplus P	237		798

Westbound

	right	through	left
Existing			
Existing plus Project			
Cumulative			
Cumulativeplus Project			

Northbound

	left	through	right
Existing		1,813	551
Existing plus Project		1,815	551
Cumulative		1,886	557
Cumulativeplus Project		1,888	557

W      N  
           S      E

Road	Rose Avenue		US-101 SB Off-Ramp	
	North of	South of	East of	West of
Leg				
Cross Street	US-101 SB Off-Ramp		Rose Avenue	
Existing	28,296.0	35,344.0	4,408.0	9,104.0
Existing plus Proj	28,336.0	35,384.0	4,408.0	9,152.0
Cumulative	30,336.0	37,272.0	4,456.0	10,240.0
Cumulativeplus P	30,376.0	37,312.0	4,456.0	10,288.0

US-101 SB Off-Ramp

**NOISE LEVEL CONTOURS - Existing Plus Project Weekday Off-Site ADT Volumes**

ROADWAY NAME Segment	Land Use	Lanes	Median Width	ADT Volume	Design Speed (mph)	Dist. from Center to Receptor (ft)	Alpha Factor (1)	Barrier Attn. dB(A)	Vehicle Mix		dB(A) CNEL	Traffic Volumes								Ref. Energy Levels Dist																	
									Medium Trucks	Heavy Trucks		Day	Eve	Night	MTd	HTd	MTe	HTe	MTn	HTn	A	MT	HT	Adj	A	MT	HT	Total	A	MT	HT	Total	A	MT	HT	Total	
<b>Rose Avenue n/o US-101 SB</b>																																					
Existing		3	0	28,296	40	75	0	0	1.8%	0.7%	67.4	21,986	3,594	2,716	445	176	26	6	38	16	67.4	76.3	81.2	-1.8	66.8	58.9	59.7	68.1	63.8	51.3	49.6	64.2	50.6	49.4	50.5	55.0	
Existing plus Project		3	0	28,336	40	75	0	0	1.8%	0.7%	67.4	22,017	3,599	2,720	446	177	26	6	38	16	67.4	76.3	81.2	-1.8	66.8	58.9	59.7	68.1	63.8	51.3	49.6	64.2	50.6	49.5	50.5	55.0	
Cumulative		3	0	30,336	40	75	0	0	1.8%	0.7%	67.7	23,571	3,853	2,912	477	189	28	6	41	17	67.4	76.3	81.2	-1.8	67.1	59.2	60.0	68.4	64.1	51.6	49.9	64.5	50.9	49.7	50.8	55.3	
Cumulative plus Project		3	0	30,376	40	75	0	0	1.8%	0.7%	67.7	23,602	3,858	2,916	478	189	28	6	41	17	67.4	76.3	81.2	-1.8	67.1	59.2	60.0	68.4	64.1	51.6	49.9	64.5	50.9	49.8	50.8	55.3	
<b>Rose Avenue s/o US-101 SB</b>																																					
Existing		3	0	35,344	40	75	0	0	1.8%	0.7%	68.3	27,462	4,489	3,393	556	220	32	7	48	20	67.4	76.3	81.2	-1.8	67.7	59.9	60.7	69.1	64.7	52.3	50.5	65.1	51.5	50.4	51.5	55.9	
Existing plus Project		3	0	35,384	40	75	0	0	1.8%	0.7%	68.3	27,493	4,494	3,397	557	221	32	7	48	20	67.4	76.3	81.2	-1.8	67.7	59.9	60.7	69.1	64.7	52.3	50.5	65.1	51.6	50.4	51.5	55.9	
Cumulative		3	0	37,272	40	75	0	0	1.8%	0.7%	68.6	28,960	4,734	3,578	587	232	34	7	50	21	67.4	76.3	81.2	-1.8	68.0	60.1	60.9	69.3	65.0	52.5	50.8	65.4	51.8	50.6	51.7	56.2	
Cumulative plus Project		3	0	37,312	40	75	0	0	1.8%	0.7%	68.6	28,991	4,739	3,582	587	233	34	7	51	21	67.4	76.3	81.2	-1.8	68.0	60.1	60.9	69.3	65.0	52.5	50.8	65.4	51.8	50.6	51.7	56.2	
<b>US-101 SB Off-Ramp e/o</b>																																					
Existing		1	0	4,408	15	75	0	0	1.8%	0.7%	51.5	3,425	560	423	69	27	4	1	6	2	50.8	65.4	74.5	-1.8	46.4	44.1	49.2	51.8	43.4	36.5	39.0	45.3	30.2	34.7	39.9	41.4	
Existing plus Project		1	0	4,408	15	75	0	0	1.8%	0.7%	51.5	3,425	560	423	69	27	4	1	6	2	50.8	65.4	74.5	-1.8	46.4	44.1	49.2	51.8	43.4	36.5	39.0	45.3	30.2	34.7	39.9	41.4	
Cumulative		1	0	4,456	15	75	0	0	1.8%	0.7%	51.6	3,462	566	428	70	28	4	1	6	3	50.8	65.4	74.5	-1.8	46.4	44.2	49.2	51.9	43.4	36.6	39.1	45.4	30.2	34.7	40.0	41.5	
Cumulative plus Project		1	0	4,456	15	75	0	0	1.8%	0.7%	51.6	3,462	566	428	70	28	4	1	6	3	50.8	65.4	74.5	-1.8	46.4	44.2	49.2	51.9	43.4	36.6	39.1	45.4	30.2	34.7	40.0	41.5	
<b>US-101 SB Off-Ramp w/o</b>																																					
Existing		3	0	9,104	15	75	0	0	1.8%	0.7%	54.7	7,074	1,156	874	143	57	8	2	12	5	50.8	65.4	74.5	-1.8	49.6	47.3	52.4	55.0	46.6	39.7	42.2	48.6	33.4	37.9	43.1	44.6	
Existing plus Project		3	0	9,152	15	75	0	0	1.8%	0.7%	54.7	7,111	1,162	879	144	57	8	2	12	5	50.8	65.4	74.5	-1.8	49.6	47.4	52.4	55.0	46.6	39.8	42.2	48.6	33.4	37.9	43.2	44.6	
Cumulative		3	0	10,240	15	75	0	0	1.8%	0.7%	55.2	7,956	1,300	983	161	64	9	2	14	6	50.8	65.4	74.5	-1.8	50.1	47.8	52.9	55.5	47.1	40.3	42.7	49.1	33.9	38.4	43.7	45.1	
Cumulative plus Project		3	0	10,288	15	75	0	0	1.8%	0.7%	55.2	7,994	1,307	988	162	64	9	2	14	6	50.8	65.4	74.5	-1.8	50.1	47.9	52.9	55.6	47.1	40.3	42.7	49.1	33.9	38.4	43.7	45.1	

(1) Alpha Factor: Coefficient of absorption relating to the effects of the ground surface. An alpha factor of 0 indicates that the site is an acoustically "hard" site such as asphalt. An alpha factor of 0.5 indicates that the site is an acoustically "soft" site such as vegetative ground cover.

Assumed 24-Hour Traffic Distribution:	Day	Evening	Night
Total ADT Volumes	77.70%	12.70%	9.60%
Medium-Duty Trucks	87.43%	5.05%	7.52%
Heavy-Duty Trucks	89.10%	2.84%	8.06%

**APPENDIX C**

---

**Construction Noise Data Spreadsheets**

**Project Title:** Rio Urbana Mixed Use

**Receptor:** REC-1

**Parameters**

**Construction Hours:** 11 Daytime hours (7:00 AM to 7:00 PM)  
 0 Evening hours (7:00 PM to 10:00 PM)  
 0 Nighttime hours (10:00 PM to 7:00 AM)

**Calculation**

<b>Construction Phase</b>	<b>Number of</b>	<b>Acoustical</b>	<b>Actual Noise Level</b>	<b>Distance</b>	<b>Leq</b>	<b>Estimate Noise Shielding</b>
<b>Equipment Type</b>	<b>Units</b>	<b>Usage Factor</b>	<b>At 50 feet, Lmax</b>	<b>Feet</b>		<b>dBA</b>
<b>Demolition</b>						
Concrete Saw	1	0.2	90	95	77.4	0
Backhoe	3	0.4	78	95	73.2	0
Dozer	1	0.4	82	95	72.4	0
<b>Site Preparation</b>						
Grader	1	0.4	85	95	75.4	0
Scraper	1	0.4	84	95	74.4	0
Backhoe	1	0.4	78	95	68.4	0
<b>Grading/Excavation</b>						
Grader	1	0.4	85	95	75.4	0
Dozer	1	0.4	82	95	72.4	0
Backhoe	2	0.4	78	95	71.5	0
<b>Building Construction</b>						
Crane	1	0.16	81	95	67.5	0
Forklift, 40 HP	2	1	82	95	79.4	0
Generator	1	0.5	81	95	72.4	0
Backhoe	1	0.4	78	95	68.4	0
Welder/Torch	3	0.4	74	95	69.2	0
<b>Paving</b>						
Concrete Mixer	1	0.4	79	95	69.4	0
Paver	2	0.5	77	95	71.4	0
Paver	2	0.5	77	95	71.4	0
Roller	2	0.2	80	95	70.4	0
Backhoe	1	0.4	78	95	68.4	0
<b>Architectural Coating</b>						
Compressor	1	0.4	78	95	68.4	0

**Project Title:** Rio Urbana Mixed Use

**Receptor:** REC-2

**Parameters**

**Construction Hours:** 11 Daytime hours (7:00 AM to 7:00 PM)  
 0 Evening hours (7:00 PM to 10:00 PM)  
 0 Nighttime hours (10:00 PM to 7:00 AM)

**Calculation**

<b>Construction Phase</b>	<b>Number of</b>	<b>Acoustical</b>	<b>Actual Noise Level</b>	<b>Distance</b>	<b>Leq</b>	<b>Estimate Noise Shielding</b>
<b>Equipment Type</b>	<b>Units</b>	<b>Usage Factor</b>	<b>At 50 feet, Lmax</b>	<b>Feet</b>		<b>dBA</b>
<b>Demolition</b>						
					<b>80.2</b>	
Concrete Saw	1	0.2	90	90	77.9	0
Backhoe	3	0.4	78	90	73.7	0
Dozer	1	0.4	82	90	72.9	0
<b>Site Preparation</b>						
					<b>78.9</b>	
Grader	1	0.4	85	90	75.9	0
Scraper	1	0.4	84	90	74.9	0
Backhoe	1	0.4	78	90	68.9	0
<b>Grading/Excavation</b>						
					<b>78.7</b>	
Grader	1	0.4	85	90	75.9	0
Dozer	1	0.4	82	90	72.9	0
Backhoe	2	0.4	78	90	71.9	0
<b>Building Construction</b>						
					<b>81.5</b>	
Crane	1	0.16	81	90	67.9	0
Forklift, 40 HP	2	1	82	90	79.9	0
Generator	1	0.5	81	90	72.9	0
Backhoe	1	0.4	78	90	68.9	0
Welder/Torch	3	0.4	74	90	69.7	0
<b>Paving</b>						
					<b>76.6</b>	
Concrete Mixer	1	0.4	79	90	69.9	0
Paver	2	0.5	77	90	71.9	0
Paver	2	0.5	77	90	71.9	0
Roller	2	0.2	80	90	70.9	0
Backhoe	1	0.4	78	90	68.9	0
<b>Architectural Coating</b>						
					<b>68.9</b>	
Compressor	1	0.4	78	95	68.9	0

**Project Title:** Rio Urbana Mixed Use

**Receptor:** REC-3

**Parameters**

**Construction Hours:** 11 Daytime hours (7:00 AM to 7:00 PM)  
 0 Evening hours (7:00 PM to 10:00 PM)  
 0 Nighttime hours (10:00 PM to 7:00 AM)

**Calculation**

<b>Construction Phase</b>	<b>Number of</b>	<b>Acoustical</b>	<b>Actual Noise Level</b>	<b>Distance</b>	<b>Leq</b>	<b>Estimate Noise Shielding</b>
<b>Equipment Type</b>	<b>Units</b>	<b>Usage Factor</b>	<b>At 50 feet, Lmax</b>	<b>Feet</b>		<b>dBA</b>
<b>Demolition</b>						
					<b>73.5</b>	
Concrete Saw	1	0.2	90	195	71.2	0
Backhoe	3	0.4	78	195	67.0	0
Dozer	1	0.4	82	195	66.2	0
<b>Site Preparation</b>						
					<b>72.2</b>	
Grader	1	0.4	85	195	69.2	0
Scraper	1	0.4	84	195	68.2	0
Backhoe	1	0.4	78	195	62.2	0
<b>Grading/Excavation</b>						
					<b>72.0</b>	
Grader	1	0.4	85	195	69.2	0
Dozer	1	0.4	82	195	66.2	0
Backhoe	2	0.4	78	195	65.2	0
<b>Building Construction</b>						
					<b>74.8</b>	
Crane	1	0.16	81	195	61.2	0
Forklift, 40 HP	2	1	82	195	73.2	0
Generator	1	0.5	81	195	66.2	0
Backhoe	1	0.4	78	195	62.2	0
Welder/Torch	3	0.4	74	195	63.0	0
<b>Paving</b>						
					<b>69.9</b>	
Concrete Mixer	1	0.4	79	195	63.2	0
Paver	2	0.5	77	195	65.2	0
Paver	2	0.5	77	195	65.2	0
Roller	2	0.2	80	195	64.2	0
Backhoe	1	0.4	78	195	62.2	0
<b>Architectural Coating</b>						
					<b>62.2</b>	
Compressor	1	0.4	78	195	62.2	0

# Appendix H

---

Revised Traffic and Circulation Study



---

---

**RIO URBANA RESIDENTIAL AND OFFICE PROJECT  
OXNARD, CALIFORNIA**

---

**REVISED TRAFFIC AND CIRCULATION STUDY**

---

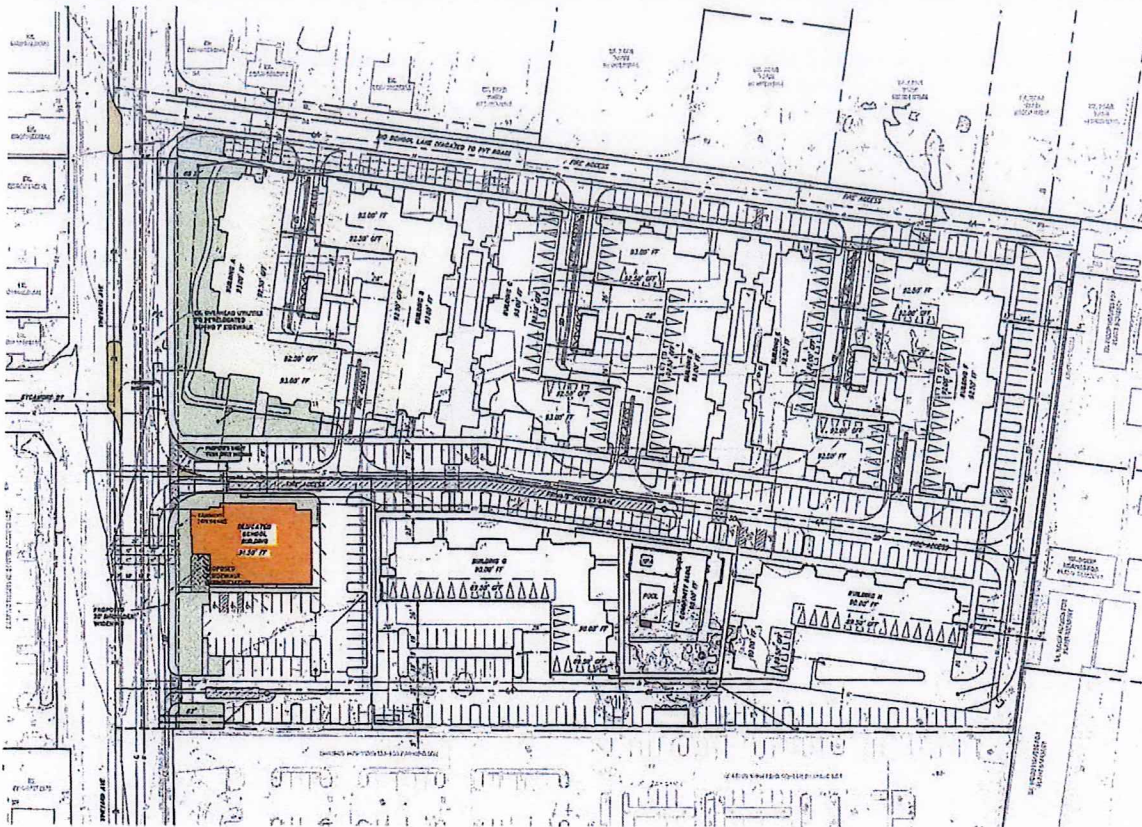

---

April 27, 2018

ATE Project 17053

---

Prepared for:

The Pacific Companies  
430 E. Street, Suite 100  
Eagle, Idaho 83616

---



**ASSOCIATED TRANSPORTATION ENGINEERS**

100 N. Hope Avenue, Suite 4, Santa Barbara, CA 93110-1686 • (805) 687-4418 • FAX (805) 682-8509



# ASSOCIATED TRANSPORTATION ENGINEERS

100 N. Hope Avenue, Suite 4, Santa Barbara, CA 93110 • (805) 687-4418 • FAX (805) 682-8509

Since 1978

Richard L. Pool, P.E.  
Scott A. Schell, AICP, PTP

April 27, 2018

Mr. Caleb Roope  
The Pacific Companies  
430 E. State Street, Suite 100  
Eagle, Idaho 83616

***REVISED TRAFFIC AND CIRCULATION STUDY FOR THE RIO URBANA RESIDENTIAL AND OFFICE PROJECT - CITY OF OXNARD***

Associated Transportation Engineers (ATE) has prepared the following revised traffic and circulation study for the Rio Urbana Residential and Office Project. The study examines existing and future traffic conditions within the study-area and assesses the traffic and circulation impacts associated with the project. It our understanding that the results of the study will be used by the City of Oxnard to process the project's development application.

We appreciate the opportunity to assist the Pacific Companies with this project.

Associated Transportation Engineers

By: Scott A. Schell, AICP, PTP  
Vice President

TABLE OF CONTENTS

INTRODUCTION ..... 1

PROJECT DESCRIPTION ..... 1

EXISTING CONDITIONS ..... 1

    Existing Street Network ..... 1

    Existing Volumes and Levels of Service ..... 4

IMPACT THRESHOLD CRITERIA ..... 8

PROJECT GENERATED TRAFFIC VOLUMES ..... 8

    Project Trip Generation ..... 8

    Existing Use Trip Generation ..... 8

    Project Trip Distribution and Assignment ..... 9

PROJECT-SPECIFIC IMPACTS ..... 9

CUMULATIVE (EXISTING + APPROVED/PENDING PROJECTS) CONDITIONS ..... 13

    Cumulative + Project Impacts ..... 17

PROJECT SITE ACCESS ..... 19

PROJECT MITIGATION MEASURES ..... 26

VENTURA COUNTY GENERAL PLAN CONSISTENCY ..... 27

VENTURA COUNTY CONGESTION MANAGEMENT PROGRAM ..... 27

    Intersection Operation ..... 27

REFERENCES AND PERSONS CONTACTED ..... 28

TECHNICAL APPENDIX ..... 29



## LIST OF TABLES

Table 1 - Existing Peak Hour Levels of Service . . . . .	7
Table 2 - Project Trip Generation . . . . .	8
Table 3 - Existing + Project A.M. Peak Hour Levels of Service . . . . .	9
Table 4 - Existing + Project P.M. Peak Hour Levels of Service . . . . .	12
Table 5 - Approved/Pending Projects Trip Generation . . . . .	13
Table 6 - Cumulative Peak Hour Levels of Service . . . . .	15
Table 7 - Cumulative + Project A.M. Peak Hour Level of Service . . . . .	17
Table 8 - Cumulative + Project P.M. Peak Hour Level of Service . . . . .	17
Table 9 - Left-Turn Storage at Vineyard Avenue/Sycamore Street Intersection . . . . .	19
Table 10 - Left-Turn Storage at Vineyard Avenue/Sycamore Street Intersection . . . . .	21
Table 11 - Signal Warrant Results . . . . .	26

## LIST OF FIGURES

Figure 1	Existing Street Network/Project Site Location . . . . .	2
Figure 2	Project Site Plan . . . . .	3
Figure 3	Intersection Lane Geometries and Traffic Controls . . . . .	5
Figure 4	Existing Traffic Volumes . . . . .	6
Figure 5	Project Trip Distribution and Assignment . . . . .	10
Figure 6	Existing + Project Traffic Volumes . . . . .	11
Figure 7	Cumulative Traffic Volumes . . . . .	14
Figure 8	Vineyard Avenue/Esplanade Drive Improvements . . . . .	16
Figure 9	Cumulative + Project Traffic Volumes . . . . .	18
Figure 10	Project Driveway Volumes (Unsignalized) . . . . .	20
Figure 11	Project Trip Distribution and Assignment . . . . .	22
Figure 12	Existing + Project Traffic Volumes (Signalized) . . . . .	23
Figure 13	Cumulative + Project Traffic Volumes (Signalized) . . . . .	24
Figure 14	Project Driveway Volumes (Signalized) . . . . .	25

## INTRODUCTION

The following traffic study contains an analysis of the potential traffic and circulation impacts associated with the Rio Urbana Residential and Office Project (the "Project"), located in the City of Oxnard. The guidelines set forth in the City of Oxnard's Traffic Impact Study standards were utilized in formatting the various sections of the traffic study. The study provides information relative to existing, existing + project, cumulative (existing + approved/pending projects) and cumulative + project traffic conditions. Site access and circulation are also addressed. This revised traffic study addresses comments proved by City staff on the initial traffic study prepared July 25, 2017.

## PROJECT DESCRIPTION

As shown on Figure 1, the Rio Urbana Residential and Office Project is located at 2714 Vineyard Avenue, north of U.S. Highway 101 in the City of Oxnard. The Project is proposing to redevelop the existing Rio Mesa Elementary School site which currently houses the school district's offices and a bus storage yard. The Project will construct a new 15,000 square-foot office building and 182 residential condominium units. Access to the Project site will be provided via 2 driveway connections to Vineyard Avenue and 4 connections to Rio School Lane. The Project driveways on Vineyard Avenue will be restricted to right-turns inbound and outbound only. As part of the Project, the Vineyard Avenue/Rio Lane School intersection will be restricted to left-turns inbound and no left-turns outbound. The Project site plan is illustrated on Figure 2.

## EXISTING CONDITIONS

### Existing Street Network

The Project site is served by a circulation system comprised of arterial and collector streets, which are illustrated on Figure 1. The major roadways serving the site are discussed in the following text.

**U.S. Highway 101**, located south of the Project site, is a multi-lane freeway which serves as a major arterial for the City and is the principal inter-city route along this portion of the Pacific Coast. The segment of U.S. Highway 101 in the study-area is 6 to 8-lane facility. Regional access between the freeway and the Project site is provided via the Vineyard Avenue and Rose Avenue interchanges.

**Vineyard Avenue**, located on the west side of the Project site, is a 4- to 6-lane north-south roadway that extends east from Patterson Avenue to Los Angeles Avenue in unincorporated Ventura County. Vineyard Avenue serves both residential and commercial land-uses in the study-area. Vineyard Avenue is signalized at Esplanade Drive, the U.S. Highway 101 ramps, Riverpark Boulevard, and Stroube Street. Vineyard Avenue will provide direct access to the Project via two right-turn in/right-turn out driveway connections.



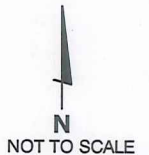
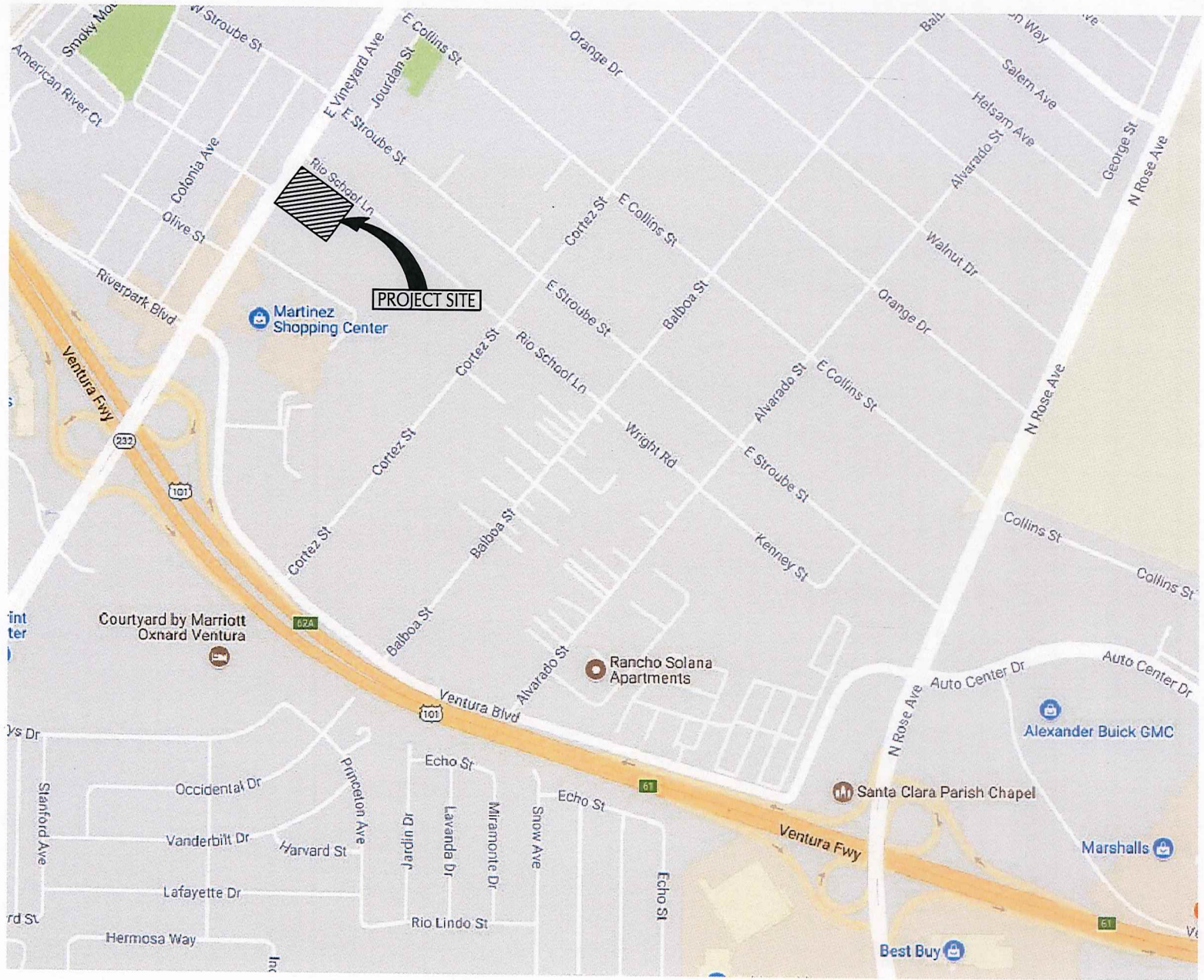

ASSOCIATED  
TRANSPORTATION  
ENGINEERS

EXISTING STREET NETWORK/PROJECT LOCATION

FIGURE 1

EKM - ATE#17053



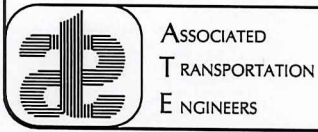
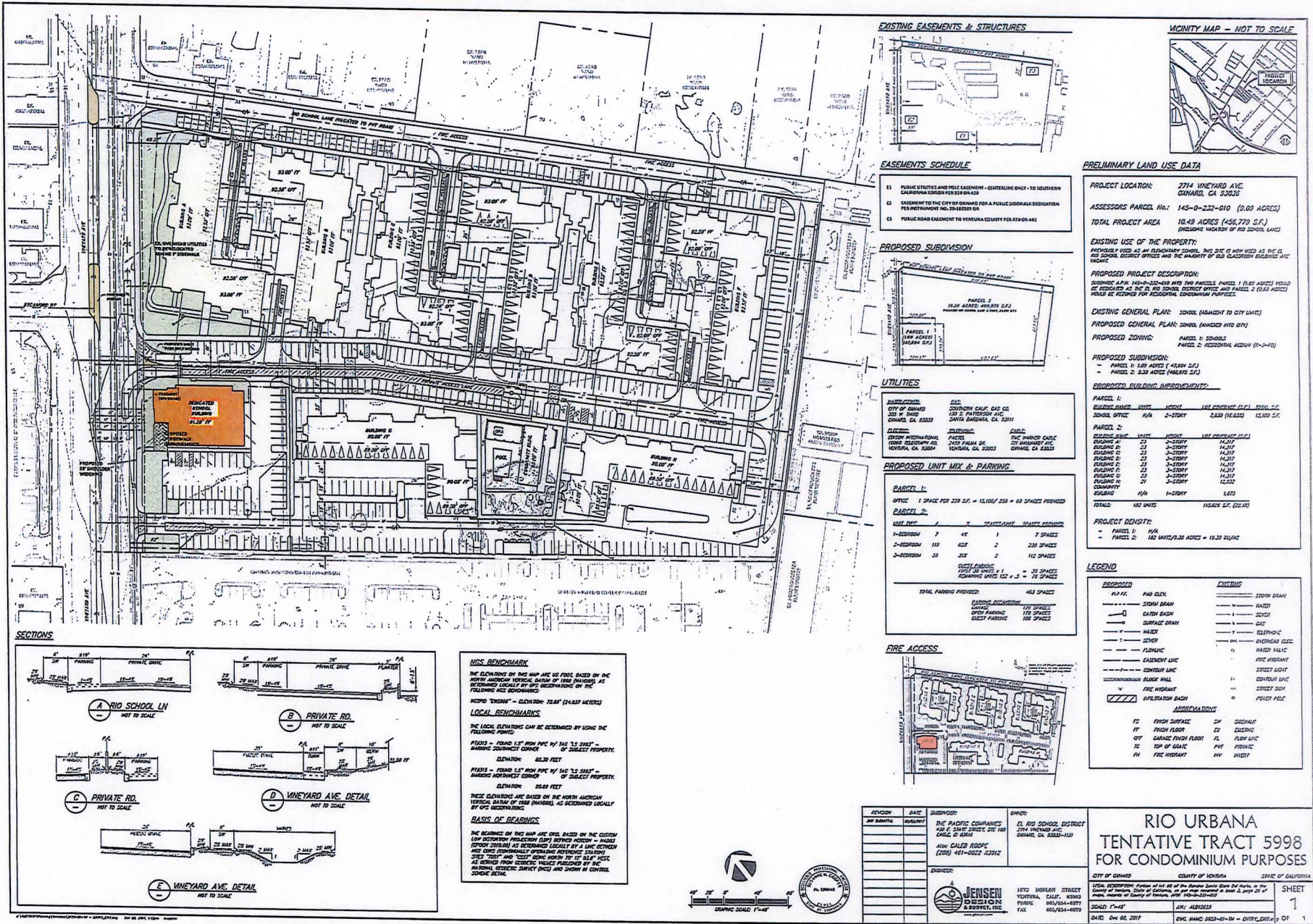

PROJECT SITE PLAN



**Rose Avenue**, located east of the Project site is a 2- to 6-lane north-south arterial roadway extending from Pleasant Valley Road to State Route 118 (Los Angeles Avenue). Within the study-area, Rose Avenue serves both residential and commercial land-uses. Rose Avenue is signalized at the U.S. Highway 101 ramps and Auto Center Drive.

**Esplanade Drive**, located south of the Project site, is a 2-lane local roadway that extends east from Oxnard Boulevard to Vineyard Avenue. Esplanade Drive serves primarily commercial uses in the study-area. The Vineyard Avenue/Esplanade Drive intersection is signalized.

**Riverpark Boulevard**, is a 2-lane north-south roadway that extends from Forest Park Boulevard in the River Park development to Vineyard Avenue. Riverpark Boulevard serves the residential and commercial land-uses in the River Park development. The Vineyard Avenue/Riverpark Boulevard intersection is signalized.

**Rio School Lane**, located adjacent on the north side of the Project site is a 2-lane east-west private roadway that extends east from Vineyard Avenue terminating at the eastern boundary of the Project site. Rio School Lane serves primarily commercial land-uses in the study-area. Rio School Lane will provide direct access to the Project site via 3 driveway connections. The Rio School Lane/Vineyard Avenue intersection is STOP-Sign controlled.

**Stroube Street**, is a 2-lane east-west local roadway that extends from Detroit Drive to Rose Avenue. Stroube Street serves primarily residential and commercial land-uses in the study-area. The Rose Avenue/Stroube Street intersection is STOP-Sign controlled.

**Sycamore Street**, is a 2-lane east-west local roadway that extends from Detroit Drive to Vineyard Avenue. Sycamore Street serves primarily residential and commercial land-uses in the study-area. The Vineyard Avenue/Sycamore Street intersection is STOP-Sign controlled. The eastbound approach is restricted to right-turns outbound only. As part of the Project the driveway will be restricted to right-turns inbound and outbound only.

## **Existing Volumes and Levels of Service**

### Intersection Operations

Figure 3 illustrates the existing traffic controls and geometries for the study-area intersections. The Existing A.M. and P.M. peak hour traffic volumes at the study-area intersections are illustrated on Figure 4. These volumes were collected in March of 2016, March of 2017 and June of 2017 for this study and are included in the Technical Appendix.



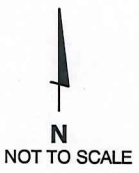
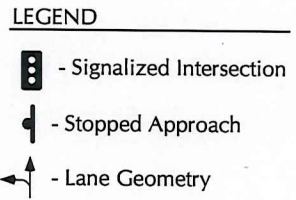
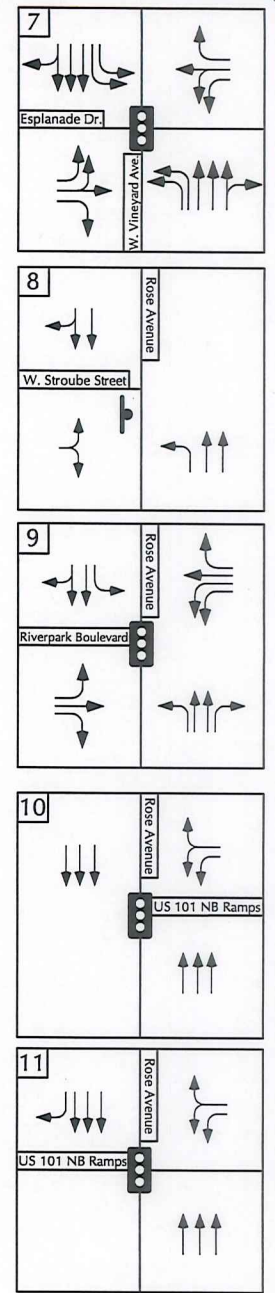
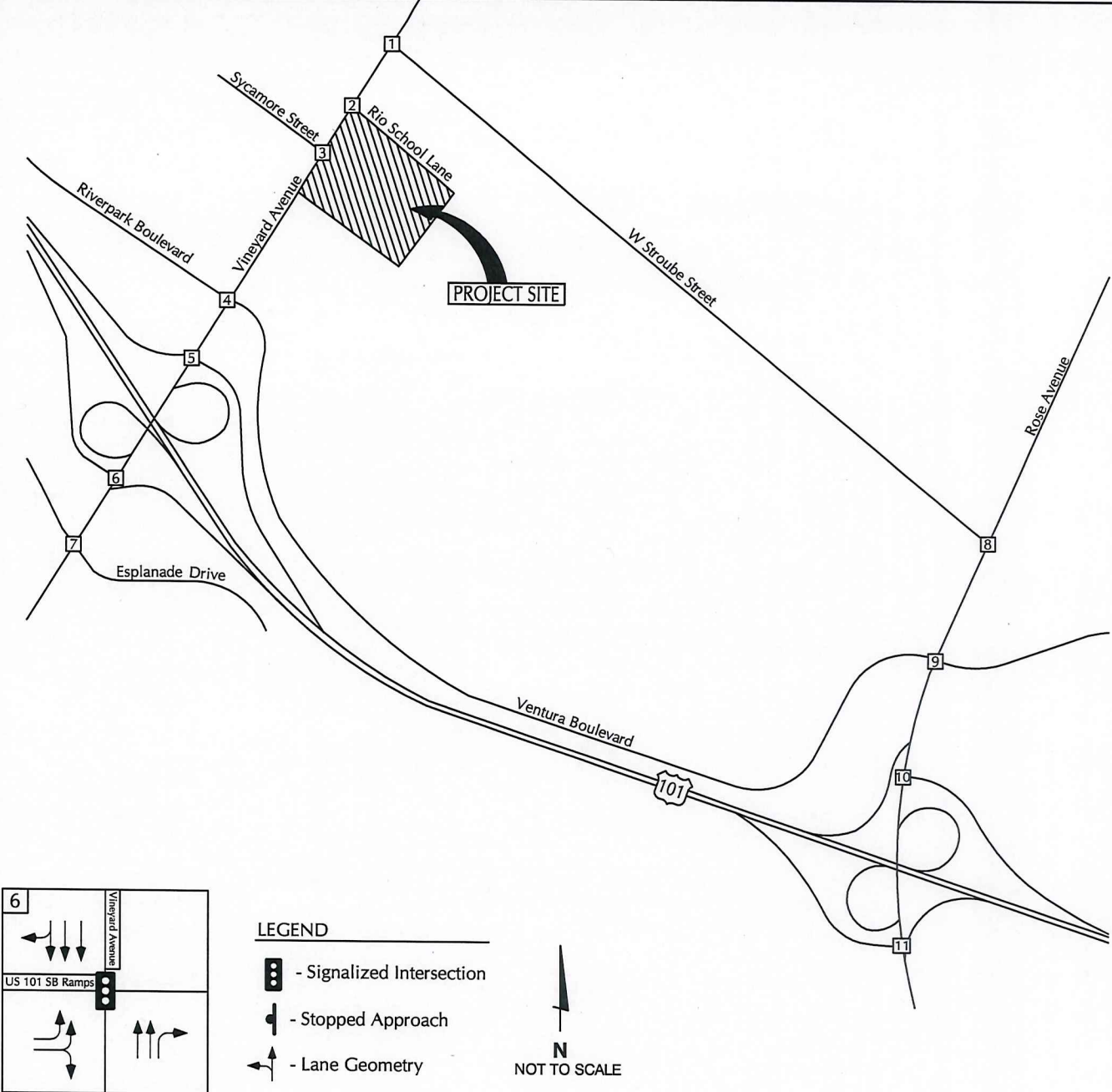
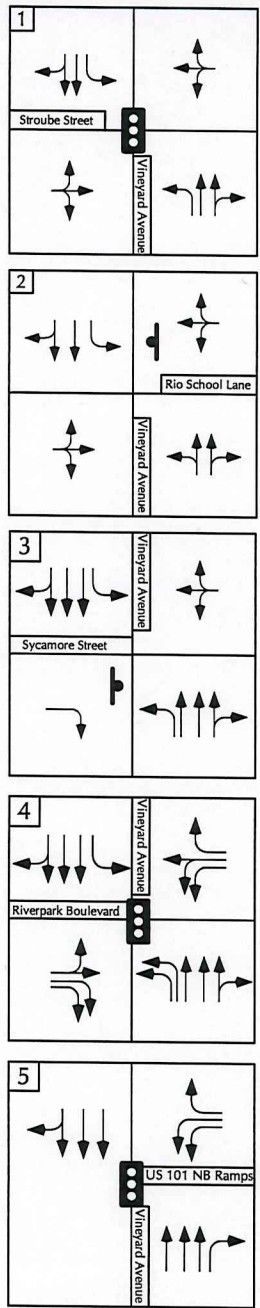

ASSOCIATED  
 TRANSPORTATION  
 ENGINEERS

INTERSECTION LANE GEOMETRIES AND TRAFFIC CONTROLS

FIGURE 3

1	42(49) 1003(135) 20(20)	(46)50 (6)32 (103)134	60(99) 31(23) 26(30)	(22)68 (892)899 (10)28
2	14(5) 1295(127) 2(2)	(3)9 (1)6	00(00) 00(00) 7(3)	(2)9 (932)1036 (1)5
3	3(6) 1180(1224) 52(47)	(4)6 (3)0	26(30)	(4)4 (978)996 (45)62 (1)13
4	31(108) 1018(1092) 64(51)	(50)100 (52)126 (214)362	57(55) 74(97) 341(355)	(4)10244 (1035)1018 (153)336
5	1401(1311) 296(374)	(233)266 (370)492		(201)200 (1325)1336

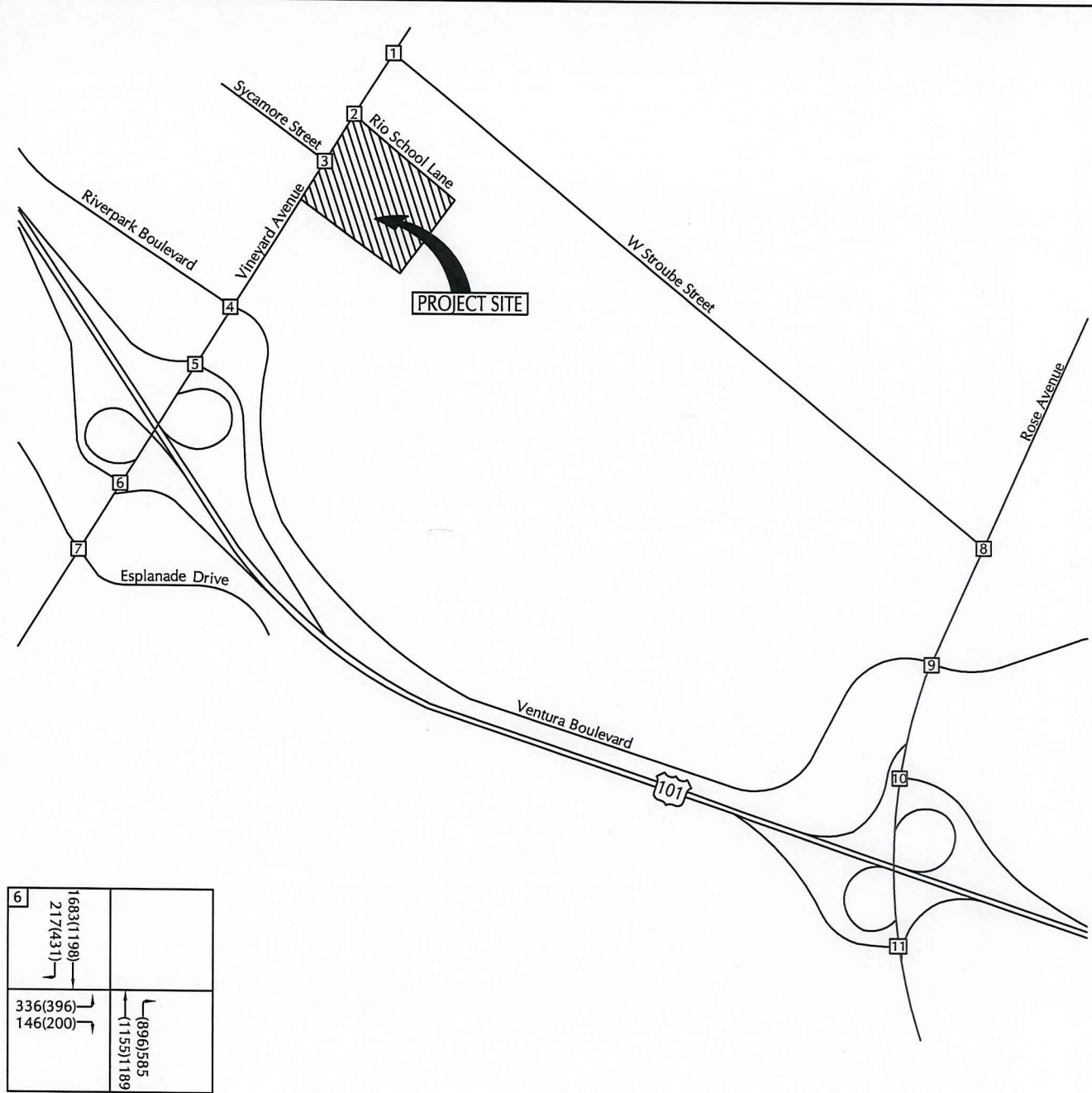

7	502(553) 695(1420) 006(091)	(114)354 (12)65 (61)214	212(87) 24(17) 281(82)	(99)17 (167)15921 (45)061
8	860(912) 22(29)	(814)864	0(4) 103(183)	(145)116
9	148(118) 797(951) 28(36)	(92)219 (38)185 (188)902	7(44) 95(76) 232(171)	(362)642 (826)693 (120)217
10	1345(1109) 499(217)	(106)122 (415)402		(826)942 (1208)1475
11	1598(1320) 146(194)	(551)409 (1813)2101	303(210) 900(734)	



ASSOCIATED  
 TRANSPORTATION  
 ENGINEERS

EXISTING TRAFFIC VOLUMES

FIGURE 4

Traffic flow on urban arterials is most constrained at intersections. Therefore, a detailed analysis of traffic flows must examine the operating conditions of critical intersections during peak travel periods. In rating intersection operations, "Levels of Service" (LOS) A through F are used, with LOS A indicating free flow operations and LOS F indicating congested operations (more complete definitions of levels of service are included in the Technical Appendix). In the City of Oxnard LOS "C" is the acceptable operating standard for intersections.

Existing levels of service for the study-area intersections were calculated using the Intersection Capacity Utilization (ICU) methodology for signalized intersections and the Highway Capacity Manual unsignalized methodology as required by the City of Oxnard. Worksheets illustrating the level of service calculations are contained in the Technical Appendix for reference. Table 1 lists the Existing levels of service for the six study-area intersections during the A.M. and P.M. peak hour periods.

**Table 1**  
**Existing Peak Hour Levels of Service**

Intersection	Control Type	A.M. Peak Hour		P.M. Peak Hour	
		ICU/Delay	LOS	ICU/Delay	LOS
Vineyard Avenue/Stroube Street	Signal	0.56	LOS A	0.55	LOS A
Vineyard Avenue/Rio School Lane	STOP-Sign	1.0 sec.	LOS A	1.0 sec.	LOS A
Vineyard Avenue/Sycamore Street	STOP-Sign	1.0 sec.	LOS A	1.0 sec.	LOS A
Vineyard Avenue/Riverpark Boulevard	Signal	0.55	LOS A	0.56	LOS A
U.S. Highway 101 NB Ramps/Vineyard Avenue	Signal	0.50	LOS A	0.52	LOS A
U.S. Highway 101 SB Ramps/Vineyard Avenue	Signal	0.53	LOS A	0.55	LOS A
Vineyard Avenue/Esplanade Drive	Signal	0.56	LOS A	0.63	LOS B
Rose Avenue/Stroube Street	STOP-Sign	15.3 sec.	LOS C	12.3 sec.	LOS B
Rose Avenue/Auto Center Drive	Signal	0.55	LOS A	0.77	LOS C
U.S. Highway 101 NB Ramps/Rose Avenue	Signal	0.42	LOS A	0.47	LOS A
U.S. Highway 101 SB Ramps/Rose Avenue	Signal	0.61	LOS B	0.69	LOS B

The data presented in Table 1 indicate that the study-area intersections currently operate at LOS C or better during the A.M. peak hour and P.M. peak hour periods, which meets the City's LOS C standard.



## IMPACT THRESHOLD CRITERIA

The City of Oxnard’s criteria for evaluating project impacts at intersections is based on the change in ICU/LOS attributable to the project. The City of Oxnard has established LOS C as the threshold of significance for determining project impacts at intersections. If the addition of project traffic increases the ICU by 0.02 or more at an intersection operating at LOS C or worse, it should be mitigated to the ICU level identified without the project traffic. These criteria were used to determine the significance of the impacts generated by the project at the study-area intersections.

## PROJECT GENERATED TRAFFIC VOLUMES

### Project Trip Generation

Trip generation estimates were calculated for the Rio Urbana Residential and Office Project based on the rates presented in the Institute of Transportation Engineers (ITE), Trip Generation, 9<sup>th</sup> Edition, for Residential Condominiums (Land-Use Code #230) and Single Tenant Office Buildings (Land Use Code #715)<sup>1</sup>. Table 2 summarizes the average daily, A.M. and P.M. peak hour trip generation estimates developed for the Project.

**Table 2**  
**Project Trip Generation**

Land Use	Size	ADT		A.M. Peak Hour		P.M. Peak Hour	
		Rate	Trips	Rate	Trips	Rate	Trips
Condominium	182 units	5.81	1,057	0.44	80 (14/66)	0.52	95 (64/31)
Office	15,000 sq.ft.	11.65	175	1.80	27 (24/3)	1.74	26 (4/22)
Total Project Trip Generation:			1,232		107 (38/69)		121 (68/53)

The data presented in Table 2 show that the Project would generate 1,232 average daily trips (ADT), 107 A.M. peak hour trips, and 121 P.M. peak hour trips. The trip generation presented in Table 2 was used for the traffic analysis.

### Existing Use Trip Generation

The Project site is currently occupied by the old Rio Mesa Elementary School campus and is currently being used by the school district for office space and a bus storage yard. Trip generation estimates for the current uses housed on the Project site were developed based on 24-hour traffic counts conducted at the Project site driveways (count data contained in the

<sup>1</sup> Trip Generation, Institute of Transportation Engineers, 9<sup>th</sup> Edition, 2013.

Technical Appendix for reference). The existing uses housed on the Project site generate 261 ADT, 28 A.M. peak hour trips, and 32 P.M. peak hour trips.

### Project Trip Distribution and Assignment

The project-generated A.M. and P.M. peak hour traffic volumes were distributed and assigned to the study-area intersections based on travel data derived from the existing traffic volumes as well as a general knowledge of the population, employment and commercial centers in the Oxnard/Ventura area. Figure 5 illustrates the trip distribution and assignment assumed for the Project's trips. Figure 6 illustrates the Existing + Project traffic volumes.

### PROJECT-SPECIFIC IMPACTS

Levels of service were calculated for the study-area intersections assuming the Existing + Project volumes. Tables 3 and 4 show the results of the calculations and identify the Project's impacts based on the City of Oxnard thresholds.

**Table 3  
Existing + Project A.M. Peak Hour Levels of Service**

Intersection	Existing		Existing + Project		Change	Impact?
	ICU/Delay	LOS	ICU/Delay	LOS		
Vineyard Avenue/Stroube Street	0.56	LOS A	0.57	LOS A	0.01	No
Vineyard Avenue/Rio School Lane	1.0 sec.	LOS A	1.0 sec.	LOS A	0.0 sec.	No
Vineyard Avenue/Sycamore Street	1.0 sec.	LOS A	1.5 sec.	LOS A	0.5 sec.	No
Vineyard Avenue/Riverpark Boulevard	0.55	LOS A	0.55	LOS A	0.00	No
U.S. Highway 101 NB Ramps/Vineyard Avenue	0.50	LOS A	0.51	LOS A	0.01	No
U.S. Highway 101 SB Ramps/Vineyard Avenue	0.53	LOS A	0.54	LOS A	0.01	No
Vineyard Avenue/Esplanade Drive	0.56	LOS A	0.56	LOS A	0.00	No
Rose Avenue/Stroube Street	15.3 sec.	LOS C	17.1 sec.	LOS C	1.8 sec.	No
Rose Avenue/Auto Center Drive	0.55	LOS A	0.55	LOS A	0.00	No
U.S. Highway 101 NB Ramps/Rose Avenue	0.42	LOS A	0.42	LOS A	0.00	No
U.S. Highway 101 SB Ramps/Rose Avenue	0.58	LOS A	0.58	LOS A	0.00	No

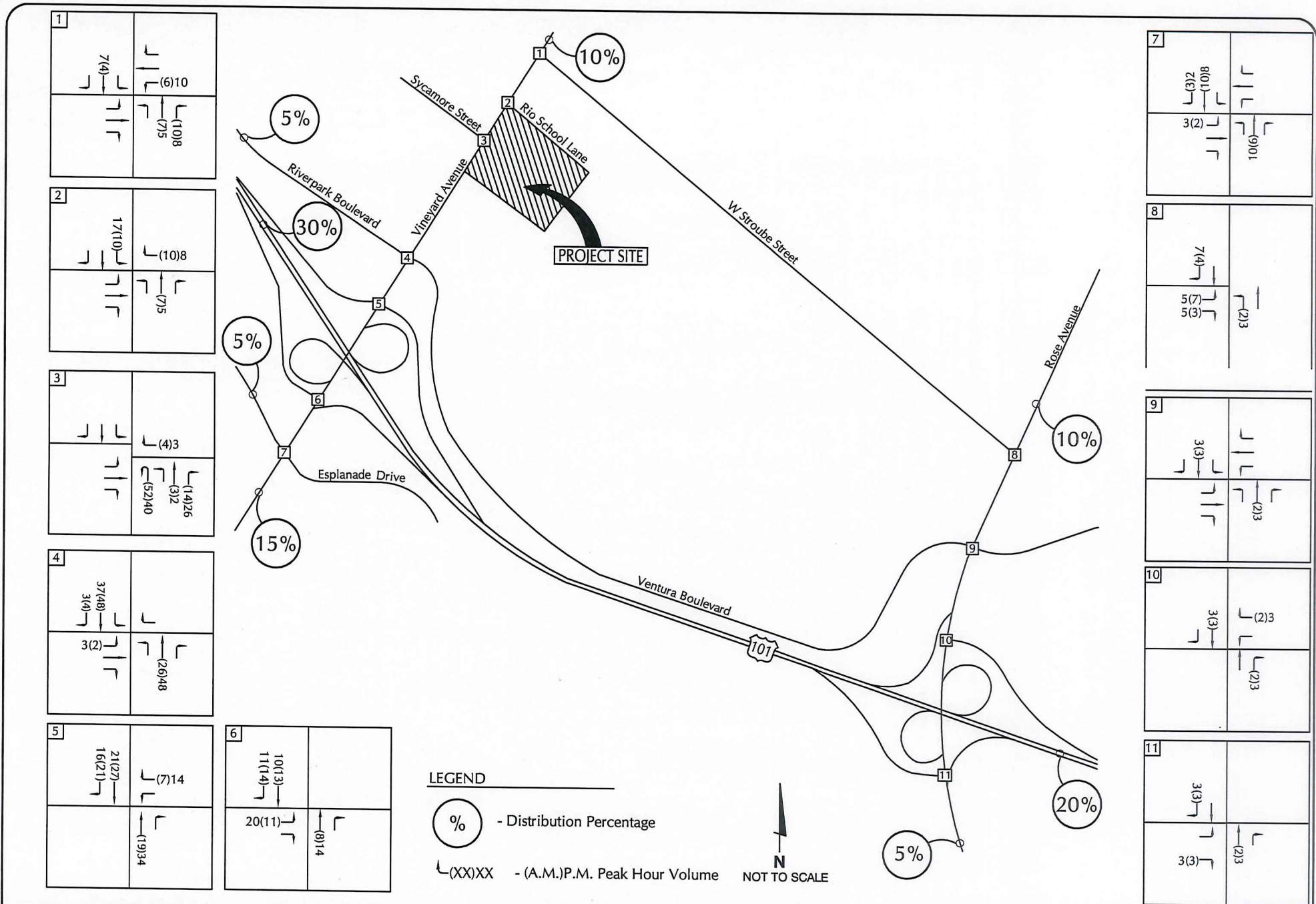

PROJECT TRIP DISTRIBUTION AND ASSIGNMENT  
 (SYCAMORE UNSIGNALIZED)

FIGURE 5



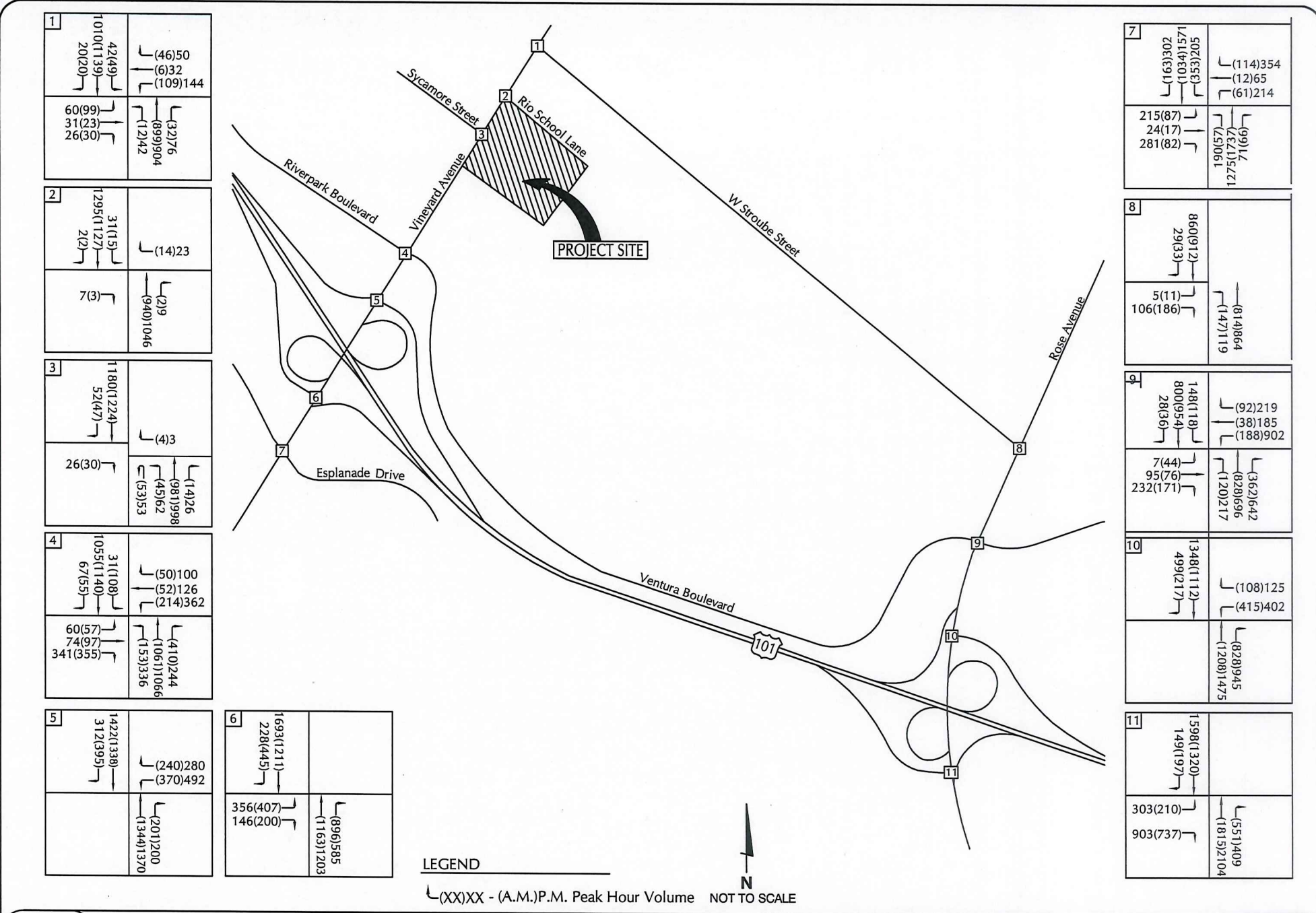

FIGURE 6

**Table 4**  
**Existing + Project P.M. Peak Hour Levels of Service**

Intersection	Existing		Existing + Project		Change	Impact?
	ICU/Delay	LOS	ICU/Delay	LOS		
Vineyard Avenue/Stroube Street	0.55	LOS A	0.56	LOS A	0.01	No
Vineyard Avenue/Rio School Lane	1.0 sec.	LOS A	1.0 sec.	LOS A	0.0 sec.	No
Vineyard Avenue/Sycamore Street	1.0 sec.	LOS A	1.6 sec.	LOS A	0.6 sec.	No
Vineyard Avenue/Riverpark Boulevard	0.56	LOS A	0.57	LOS A	0.01	No
U.S. Highway 101 NB Ramps/Vineyard Avenue	0.52	LOS A	0.54	LOS A	0.02	No
U.S. Highway 101 SB Ramps/Vineyard Avenue	0.55	LOS A	0.56	LOS A	0.01	No
Vineyard Avenue/Esplenade Drive	0.63	LOS B	0.63	LOS B	0.00	No
Rose Avenue/Stroube Street	12.3 sec.	LOS B	13.0 sec.	LOS B	0.7 sec.	No
Rose Avenue/Auto Center Drive	0.77	LOS C	0.77	LOS C	0.00	No
U.S. Highway 101 NB Ramps/Rose Avenue	0.47	LOS A	0.47	LOS A	0.00	No
U.S. Highway 101 SB Ramps/Rose Avenue	0.69	LOS B	0.69	LOS B	0.00	No

The data presented in Tables 3 and 4 indicate that the Project would not generate significant impacts to the study-area intersections based on the City of Oxnard's traffic impact thresholds during the A.M. or the P.M. peak hour periods.



## CUMULATIVE (EXISTING + APPROVED/PENDING PROJECTS) CONDITIONS

The City of Oxnard requires that intersections be analyzed with the addition of traffic generated by projects which have been approved or are pending within the project study-area. Trip generation estimates were developed for the cumulative developments using the rates presented in the ITE, *Trip Generation*, 9<sup>th</sup> Edition. Table 5 summarizes the average daily, A.M. and P.M. peak hour trip generation estimates for the approved/pending projects.

**Table 5**  
**Approved/Pending Projects Trip Generation**

No.	Project	Land Use	Size	ADT	A.M. Peak Hour	P.M. Peak Hour
1.	Oakmont Senior Living	Assisted Living	85 units	172	5	14
2.	The Village	Multi-Family Res.	88 units	580	40	51
3.	The Village	Multi-Family Res.	78 units	514	36	45
4.	The Village	Multi-Family Res.	144 units	949	66	84
5.	Ventura/Vineyard Homes	Single Family Res.	152 units	1,447	114	152
6.	River Park Senior	Senior Residential	136 units	275	8	23
7.	Wagon Wheel The Village	Multi-Family Res. Retail Commercial	219 units 16,303 sq.ft.	1,443 722	101 22	127 44
8.	Veranda	Single-Family Res.	95 units	904	71	95
9.	Westerly River Park	Single-Family Res.	69 units	657	52	69
10.	V. C. Credit Union	Bank	3,391 sq.ft.	230	0	41
11.	Shoe City	Retail Commercial	17,513 sq.ft.	776	23	47
12.	The Point	Retail Commercial	45,000 sq.ft.	1,922	43	167
13.	Esplanade Gateway	Coffee Shop Retail Commercial	1,836 sq.ft. 5,000 sq.ft.	762	97	37
14.	The Collection - River Park	Retail Commercial	40,000 sq.ft.	1,708	38	148
15.	Campus at Topa Towers	Restaurant Retail Commercial	8,350 sq.ft. 15,240 sq.ft.	1,062 675	90 22	82 41
16.	Third Tower	Office	300,000 sq.ft.	3,308	468	447
17.	Gold Coast Transit	Trip Generation from Penfield & Smith TIA		2,263	153	78
18.	Audi of Oxnard	Auto Dealership	35,064 sq.ft.	939	76	97
19.	Food 4 Less Center	Retail Commercial Gas Station	75,776 sq.ft. 14 pumps	3,236 2,360	73 170	281 194
<b>Total Trips:</b>				<b>21,965</b>	<b>1,427</b>	<b>2,066</b>

As shown in Table 5 the approved/pending projects would generate a total of 21,965 average daily trips, 1,427 A.M. peak hour trips and 2,066 P.M. peak hour trips. Traffic generated by the approved/pending projects was distributed and assigned to the study-area intersections based on the location of each project, recent traffic studies, as well as a general knowledge of the population, employment and commercial centers in Oxnard and surrounding Ventura County area. Figure 7 illustrates the Cumulative peak hour traffic volumes at the study-area intersections.

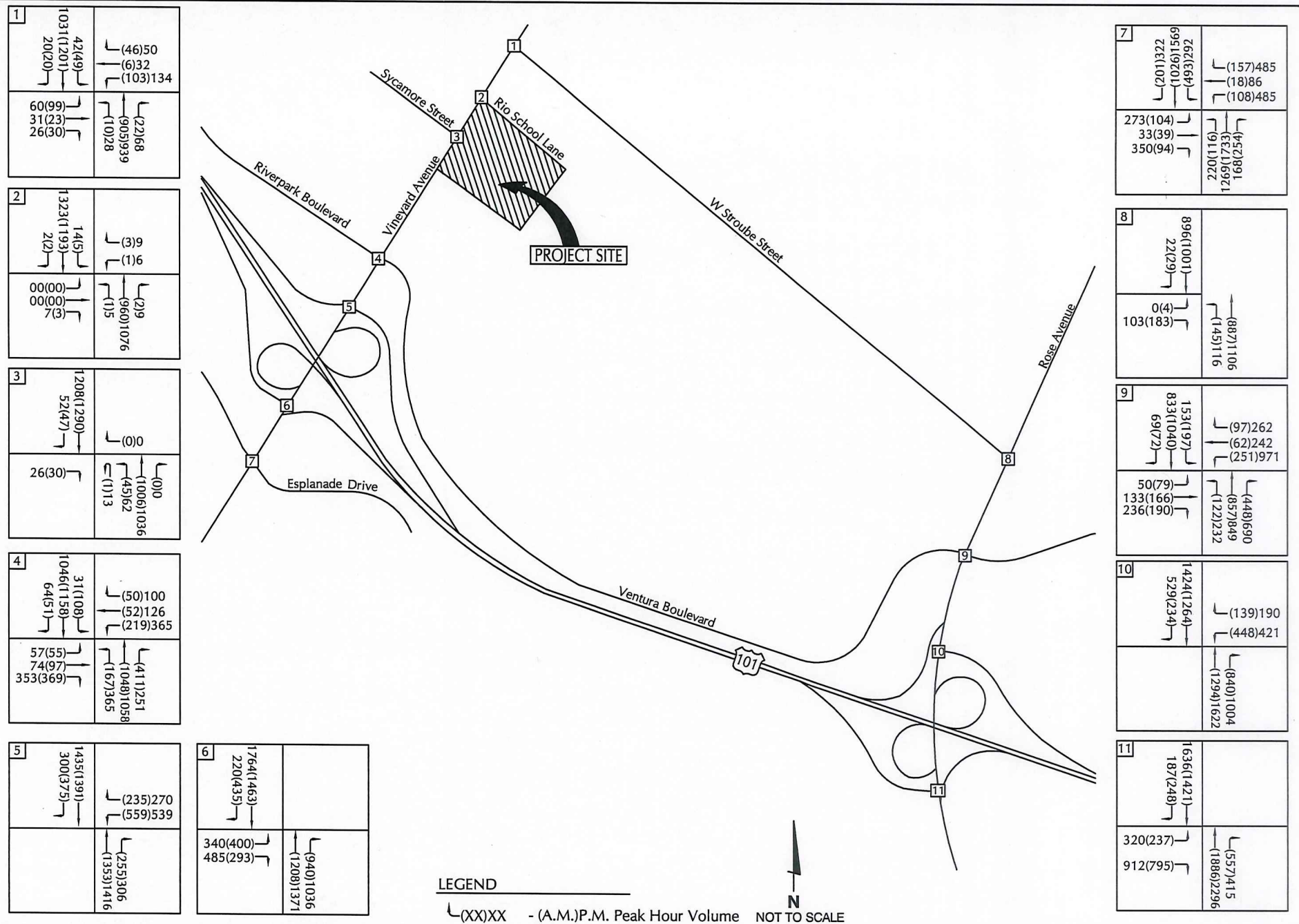

CUMULATIVE TRAFFIC VOLUMES  
 (SYCAMORE UNSIGNALIZED)

FIGURE 7



ASSOCIATED  
 TRANSPORTATION  
 ENGINEERS



The Third Tower project will be required to improve the Vineyard Avenue/Esplanade Drive intersection. As illustrated on Figure 8, an additional through lane and a through/right-turn lane will be provided on the northbound approach; an additional left-turn lane will be provided on the eastbound approach; and an additional right-turn lane will be provided on the westbound approach. At the Rose Avenue/Auto Center Drive intersection, the City will re-stripe the northbound approach to provide a second right-turn lane. The intersection improvements are assumed to be in place for the cumulative analysis. The Cumulative levels of service for the study-area intersections are shown in Table 6.

**Table 6**  
**Cumulative Peak Hour Levels of Service**

Intersection	Control Type	A.M. Peak Hour		P.M. Peak Hour	
		ICU/Delay	LOS	ICU/Delay	LOS
Vineyard Avenue/Stroube Street	Signal	0.58	LOS A	0.55	LOS A
Vineyard Avenue/Rio School Lane	STOP-Sign	1.0 sec.	LOS A	1.0 sec.	LOS A
Vineyard Avenue/Sycamore Street	STOP-Sign	1.0 sec.	LOS A	1.0 sec.	LOS A
Vineyard Avenue/Riverpark Boulevard	Signal	0.55	LOS A	0.58	LOS A
U.S. Highway 101 NB Ramps/Vineyard Avenue	Signal	0.54	LOS A	0.53	LOS A
U.S. Highway 101 SB Ramps/Vineyard Avenue	Signal	0.61	LOS B	0.67	LOS B
Vineyard Avenue/Esplanade Drive	Signal	0.52	LOS A	0.66	LOS B
Rose Avenue/Stroube Street	STOP-Sign	16.7 sec.	LOS B	12.6 sec.	LOS B
Rose Avenue/Auto Center Drive	Signal	0.61	LOS B	<b>0.83</b>	<b>LOS D</b>
U.S. Highway 101 NB Ramps/Rose Avenue	Signal	0.45	LOS A	0.53	LOS A
U.S. Highway 101 SB Ramps/Rose Avenue	Signal	0.61	LOS B	0.74	LOS C

The data presented in Table 6 indicate that the Rose Avenue/Auto Center Drive intersection would operate at LOS D during the P.M. peak hour period with the addition of Cumulative traffic volumes.





VINEYARD AVENUE/ESPLANADE DRIVE IMPROVEMENTS

FIGURE 8

EKM - ATE#17053



ASSOCIATED  
TRANSPORTATION  
ENGINEERS



## Cumulative + Project Impacts

Levels of service were calculated for the study-area intersections assuming the Cumulative + Project volumes illustrated on Figure 9. Tables 7 and 8 show the results of the calculations and identify the impacts of the Project based on City of Oxnard thresholds.

**Table 7**  
**Cumulative + Project A.M. Peak Hour Levels of Service**

Intersection	Cumulative		Cumulative + Proj.		Change	Impact?
	ICU/Delay	LOS	ICU/Delay	LOS		
Vineyard Avenue/Stroube Street	0.58	LOS A	0.59	LOS A	0.01	No
Vineyard Avenue/Rio School Lane	1.0 sec.	LOS A	1.0 sec.	LOS A	0.0 sec.	No
Vineyard Avenue/Sycamore Street	1.0 sec.	LOS A	1.6 sec.	LOS A	0.6 sec.	No
Vineyard Avenue/Riverpark Boulevard	0.55	LOS A	0.56	LOS A	0.01	No
U.S. Highway 101 NB Ramps/Vineyard Avenue	0.54	LOS A	0.55	LOS A	0.01	No
U.S. Highway 101 SB Ramps/Vineyard Avenue	0.61	LOS B	0.62	LOS B	0.01	No
Vineyard Avenue/Esplanade Drive	0.52	LOS A	0.52	LOS A	0.00	No
Rose Avenue/Stroube Street	16.7 sec.	LOS C	19.1 sec.	LOS C	2.4 sec.	No
Rose Avenue/Auto Center Drive	0.61	LOS B	0.61	LOS B	0.00	No
U.S. Highway 101 NB Ramps/Rose Avenue	0.45	LOS A	0.45	LOS A	0.00	No
U.S. Highway 101 SB Ramps/Rose Avenue	0.61	LOS B	0.61	LOS B	0.00	No

**Table 8**  
**Cumulative + Project P.M. Peak Hour Levels of Service**

Intersection	Cumulative		Cumulative + Proj.		Change	Impact?
	ICU/Delay	LOS	ICU/Delay	LOS		
Vineyard Avenue/Stroube Street	0.55	LOS A	0.57	LOS A	0.02	No
Vineyard Avenue/Rio School Lane	1.0 sec.	LOS A	1.0 sec.	LOS A	0.0 sec.	No
Vineyard Avenue/Sycamore Street	1.0 sec.	LOS A	1.3 sec.	LOS A	0.3 sec.	No
Vineyard Avenue/Riverpark Boulevard	0.58	LOS A	0.59	LOS A	0.01	No
U.S. Highway 101 NB Ramps/Vineyard Avenue	0.53	LOS A	0.55	LOS A	0.02	No
U.S. Highway 101 SB Ramps/Vineyard Avenue	0.67	LOS B	0.68	LOS B	0.01	No
Vineyard Avenue/Esplanade Drive	0.66	LOS B	0.67	LOS B	0.01	No
Rose Avenue/Stroube Street	12.6 sec.	LOS B	13.5 sec.	LOS B	0.9 sec.	No
Rose Avenue/Auto Center Drive	<b>0.83</b>	<b>LOS D</b>	<b>0.83</b>	<b>LOS D</b>	0.00	No
U.S. Highway 101 NB Ramps/Rose Avenue	0.53	LOS A	0.53	LOS A	0.00	No
U.S. Highway 101 SB Ramps/Rose Avenue	0.74	LOS C	0.74	LOS C	0.00	No

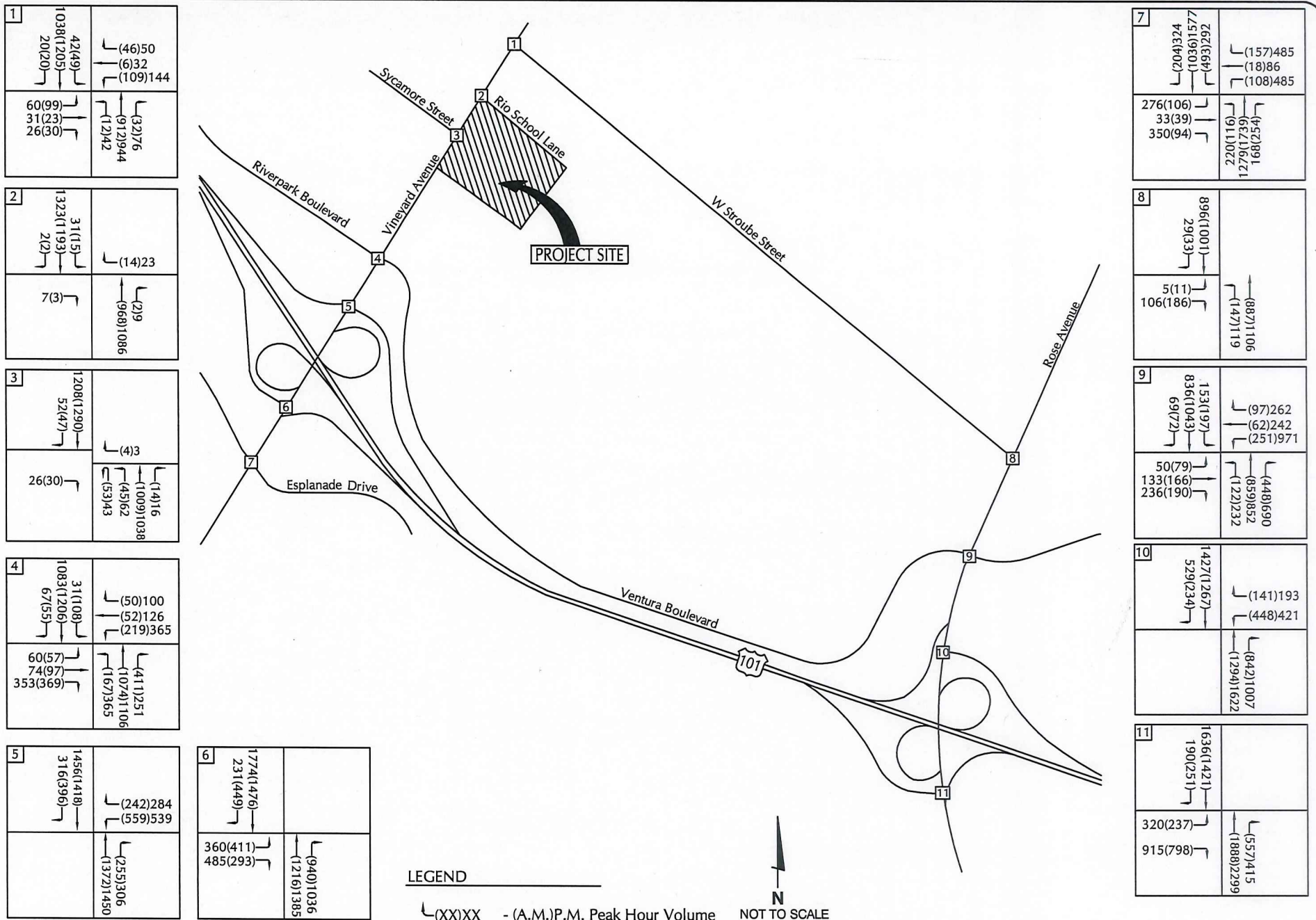

LEGEND

(XX)XX - (A.M.)P.M. Peak Hour Volume NOT TO SCALE



CUMULATIVE + PROJECT TRAFFIC VOLUMES  
 (SYCAMORE UNSIGNALIZED)

FIGURE 9



ASSOCIATED  
 TRANSPORTATION  
 ENGINEERS



The data presented in Tables 7 and 8 indicate that the Project would not generate significant cumulative impacts to the study-area intersections based on the City of Oxnard’s traffic impact thresholds during the A.M. or the P.M. peak hour periods.

## PROJECT SITE ACCESS

### Proposed Site Access

As illustrated on Figure 2, access to the Project site would be provided by two driveways on Vineyard Avenue and four driveways on Rio School Lane. The two Project driveways on Vineyard Avenue will be restricted to right-turns in and out only due to the raised left-turn median on Vineyard Avenue. The Project driveways will be designed and constructed to City of Oxnard design standards. The Project will be required to complete any and all necessary roadway improvements on Vineyard Avenue and Rio School Lane along its frontage.

ATE utilized the Synchro software and companion SimTraffic simulation model to evaluate the operation of the unsignalized Vineyard Avenue/Sycamore Street intersection. The unsignalized intersection would operate at LOS “A” during the A.M. and P.M. peak hour periods. Figure 10 illustrates the Project driveway volumes.

Vehicle queuing was also evaluated at the intersection using the SimTraffic simulation model. Table 9 shows the 95<sup>th</sup> percentile queue lengths for the northbound left-turn movement at the intersection with “Existing + Project” and “Cumulative + Project” traffic volumes. The 95<sup>th</sup> percentile queue length is the queue that is exceeded 5% of the time during the peak hour periods. Table 9 shows that the 95<sup>th</sup> percentile queues lengths will not exceed the 140 feet of storage provided in the northbound left-turn lane. Note that the change in queues lengths (approximately 1 car length 25') is a reflection in the change in the allocation of green times at the traffic upstream traffic signal which allows gaps in the southbound traffic flow. The SimTraffic queue lengths for all study-area intersections are contained in the Technical Appendix.

**Table 9  
Left-Turn Storage Requirements at the Vineyard Avenue/Sycamore Street Intersection  
(Unsignalized)**

Movement	Existing Storage	95% Queue Length			
		Existing + Project		Cumulative + Project	
		A.M. Peak	P.M. Peak	A.M. Peak	P.M. Peak
Northbound Left-Turn	140 feet	77 feet	78 feet	50 feet	56 feet

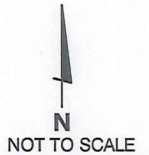
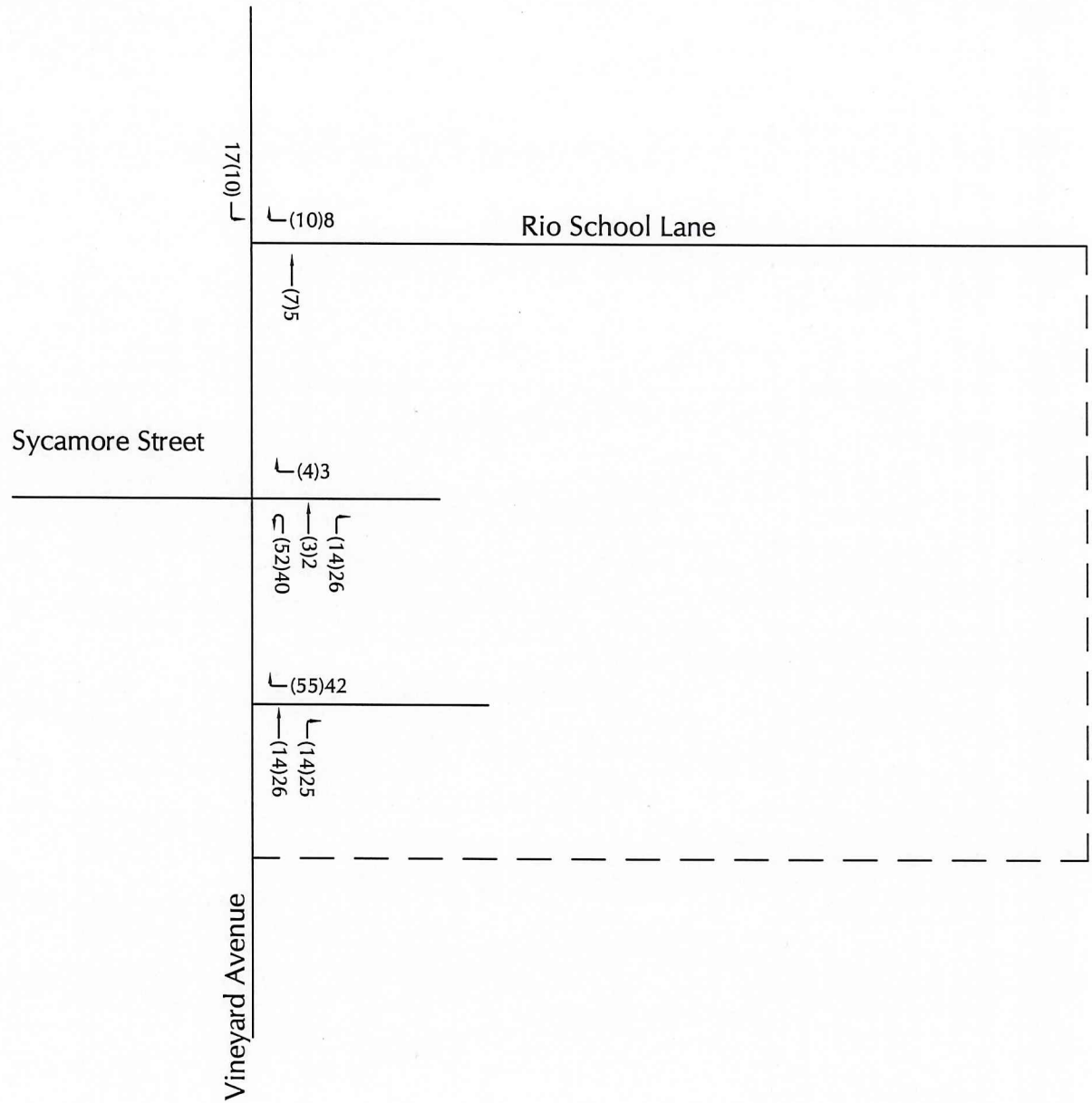

FIGURE 10

PROJECT DRIVEWAY VOLUMES (UNSIGNALIZED)



ASSOCIATED  
TRANSPORTATION  
ENGINEERS



Alternative Site Access

An alternative access plan was reviewed that also provides two driveways on Vineyard Avenue and four driveways on Rio School Lane. The northern Project driveway on Vineyard Avenue would be signalized and aligned opposite Sycamore Street allowing full access. The southern Project driveway on Vineyard Avenue would be restricted to right-turns in and out only due to the raised left-turn median on Vineyard Avenue. The alternative Project access would require the site layout to be redesigned. The Project driveways will be designed and constructed to City of Oxnard design standards.

ATE utilized the Synchro software and companion SimTraffic simulation model to evaluate the operation of the signalized Vineyard Avenue/Sycamore Street intersection. Project trips were reassigned to the adjacent street system as illustrated on Figure 11. Existing + Project traffic volumes are illustrated on Figure 12. Cumulative + Project traffic volumes are illustrated on Figure 13. The signalized Vineyard Avenue/Sycamore Street intersection would operate at LOS "A" during the A.M. and P.M. peak hour periods. Figure 14 illustrates the Project driveway volumes.

Vehicle queuing was also evaluated at the intersection using the SimTraffic simulation model. Table 10 shows the 95<sup>th</sup> percentile queue lengths for the northbound left-turn movement at the intersection with Existing + Project and Cumulative + Project traffic volumes. The 95<sup>th</sup> percentile queue length is the queue that is exceeded 5% of the time during the peak hour periods. Table 10 shows that the 95<sup>th</sup> percentile queues lengths will not exceed the existing store for the northbound length turn movement at the signalized intersection. Note that the change in queues lengths (approximately 1 car length 25') is a reflection in the change in the allocation of green times and signal phasing, which assumes co-ordinated signal optimization for each scenario. The SimTraffic queue lengths for all study-area intersections are contained in the Technical Appendix.

**Table 10**  
**Left-Turn Storage Requirements at the Vineyard Avenue/Sycamore Street Intersection**  
**(Signalized)**

Movement	Existing Storage	95% Queue Length			
		Existing + Project		Cumulative + Project	
		A.M. Peak	P.M. Peak	A.M. Peak	P.M. Peak
Northbound Left-Turn	140 feet	53 feet	128 feet	72 feet	108 feet

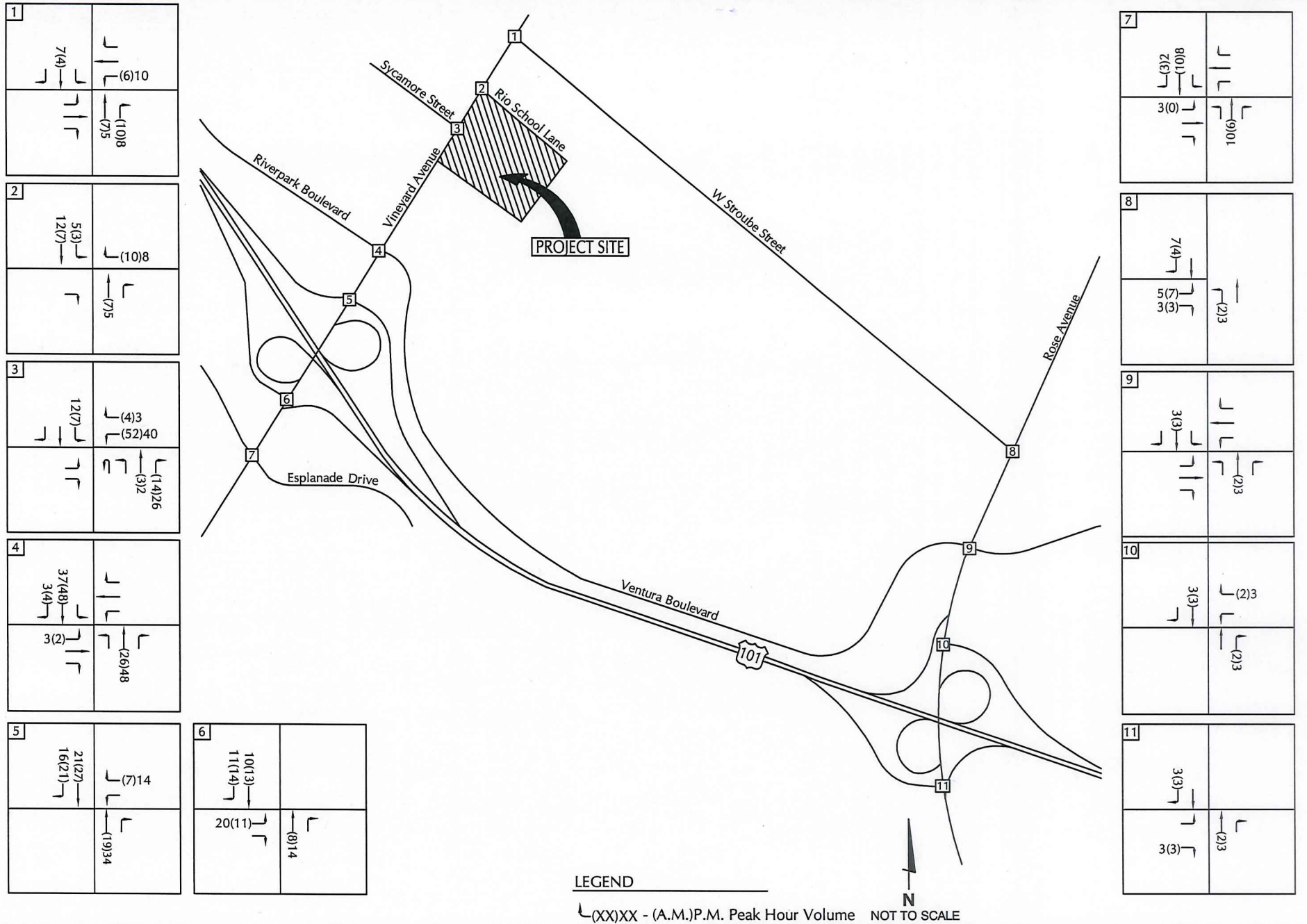

PROJECT TRIP DISTRIBUTION AND ASSIGNMENT  
 (SYCAMORE SIGNALIZED)

FIGURE 11



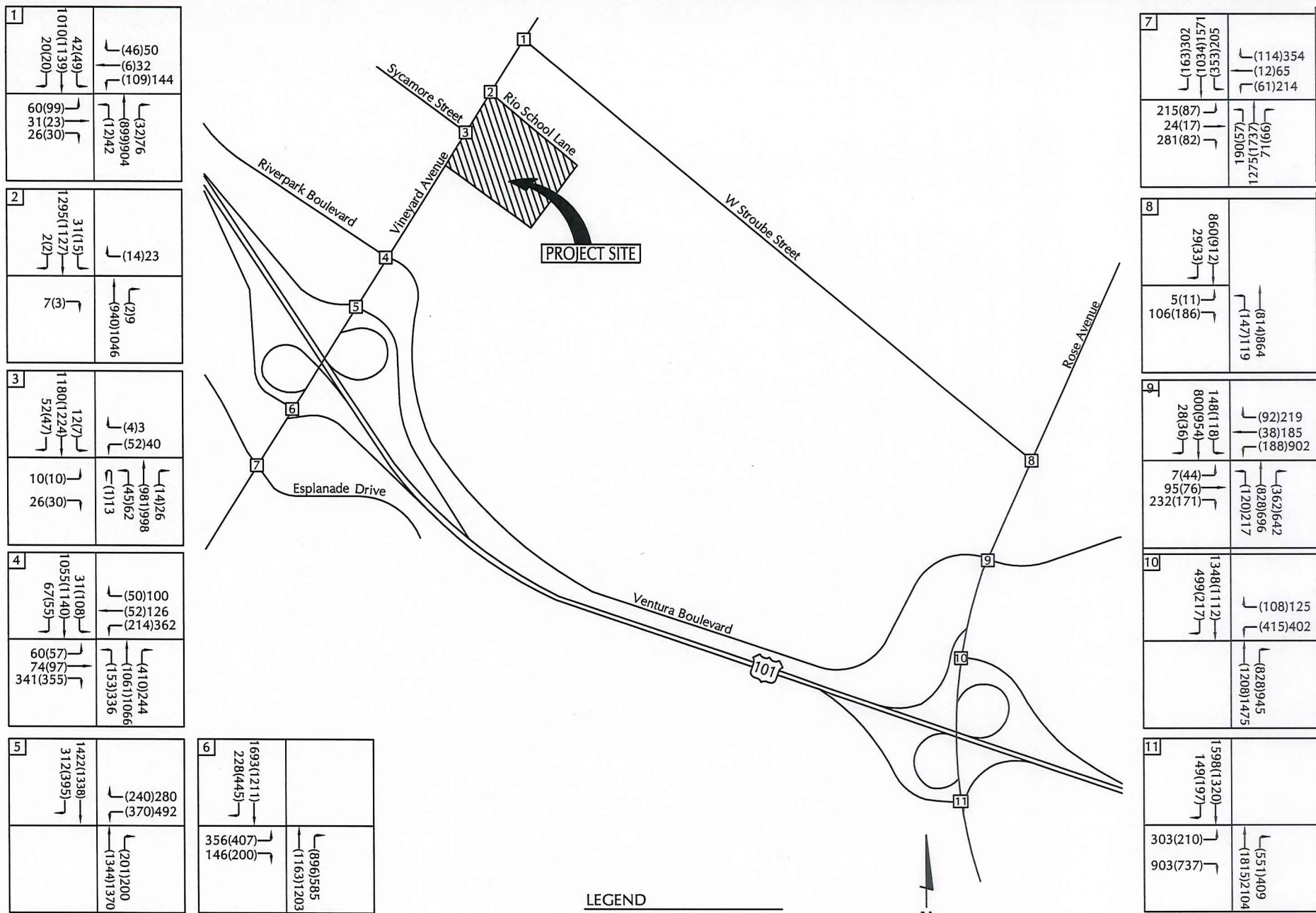

EXISTING + PROJECT TRAFFIC VOLUMES  
 (SYCAMORE SIGNALIZED)

FIGURE 12



ASSOCIATED  
 TRANSPORTATION  
 ENGINEERS



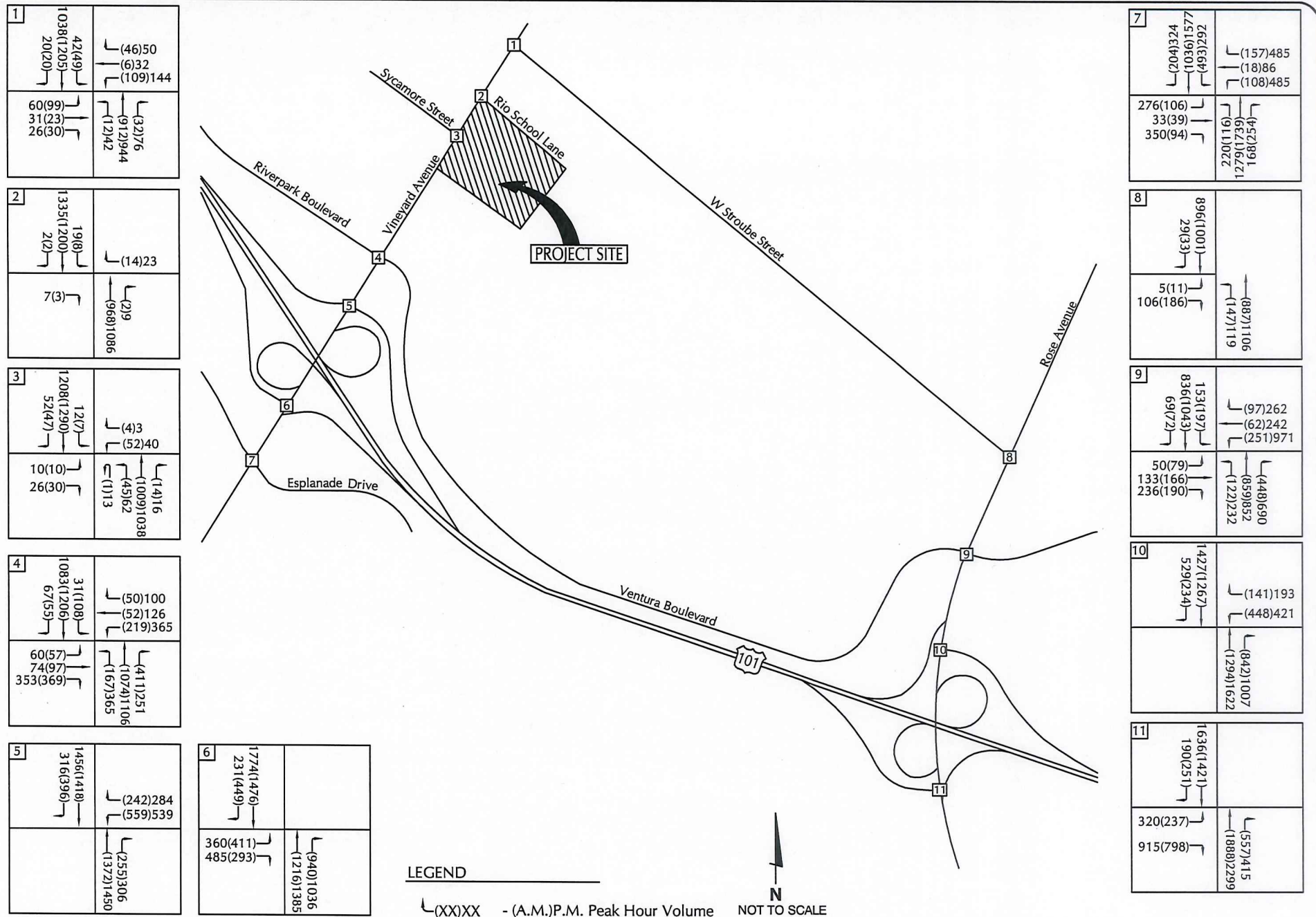

CUMULATIVE + PROJECT TRAFFIC VOLUMES  
 (SYCAMORE SIGNALIZED)

FIGURE 13



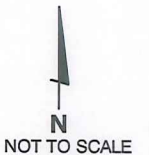
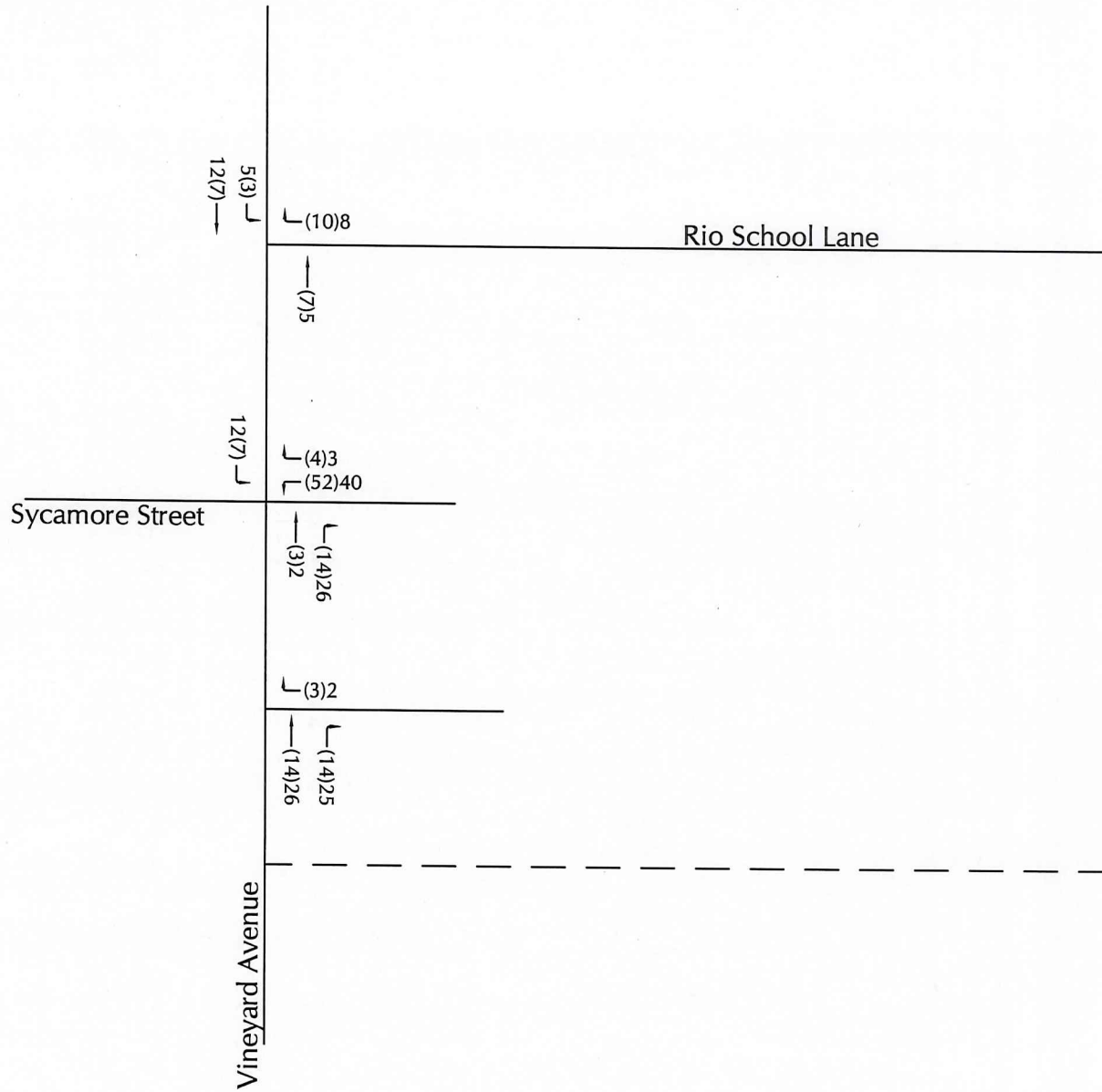

NOT TO SCALE

PROJECT DRIVEWAY VOLUMES (SIGNALIZED)

FIGURE 14



ASSOCIATED  
 TRANSPORTATION  
 ENGINEERS

## Signal Warrant Analysis

A signal warrant analysis was conducted assuming full access with the project driveway aligned opposite the Vineyard Avenue/Sycamore Street intersection. The traffic signal warrant analysis was completed based on the Manual on Uniform Traffic Control Devices (MUTCD), California Supplement. The MUTCD provides 9 signal warrants as guidance in determining the need for traffic signal installation. ATE evaluated the need for traffic signals at the Vineyard Avenue/Sycamore Street intersection based on the Four Hour and the Crash Experience warrant criteria. The posted speed limit on Vineyard Avenue is 35 MPH, therefore the urban warrants apply. Table 11 summarizes the results of the signal warrant analysis.

**Table 11**  
**Signal Warrant Results**

Warrant	Type	Warrant Satisfied ?	
		Existing + Project	Cumulative + Project
#3	Four Hour	No	No
#7	Crash Experience	No	No

The Existing + Project and Cumulative + Project driveway volumes are illustrated on Figure 14. The approach volumes on the minor street at the intersection do not satisfy the Four Hour Vehicular Volume warrant under any scenario. In order to satisfy the Four Hour Vehicular Volume warrant, a minimum of 80 exiting vehicles per hour are necessary on the minor street approach. The peak exiting traffic volumes generated by the Project are below 80 vehicles per hour (56 A.M. peak hour vehicles and 43 P.M. peak hour vehicles).

The number of reported crashes at the intersection within the most recent 12 month period is less than 5 and do not satisfy Crash Experience Warrant. In order to satisfy the Crash Experience warrant, a minimum of 5 reported crashes are necessary. Collision Summary Report provided by City staff is contain in the Technical Appendix.

### **PROJECT MITIGATION MEASURES**

Based on the City of Oxnard traffic impact thresholds, it was determined that the Project would not have a significant impact to any of the study-area intersections. Thus no mitigation measures were developed for the study-area intersections under the City's jurisdiction. The project would, however, be required to pay the City's traffic mitigation fees to off-set its contribution to cumulative traffic increases in the City.



## VENTURA COUNTY GENERAL PLAN CONSISTENCY

The City of Oxnard and Ventura County have executed a "Reciprocal Traffic Mitigation Agreement" wherein the City and the County agree that a pro-rata share of the cost of mitigations will be collected by each agency for identified traffic impacts in the other jurisdiction. The Project would be consistent with the Ventura County General Plan by complying with the terms of the "Reciprocal Traffic Mitigation Agreement" between the City of Oxnard and the County of Ventura approved on February 2, 1993.

## VENTURA COUNTY CONGESTION MANAGEMENT PROGRAM

According to the County's Congestion Management Program (CMP), the minimum acceptable standard for traffic operations is LOS E.<sup>2</sup> However, so that local jurisdictions are not unfairly penalized for existing congestion, CMP locations currently operating in the LOS F range are considered acceptable.

### Intersection Operation

The study-area intersections along Vineyard Avenue and Rose Avenue are included in the County's CMP. The intersections are all expected to operate at LOS D or better with the addition of Cumulative + Project peak hour volumes, and thus would not exceed the CMP LOS E standard.



---

Traffic LOS Monitoring for the Ventura County Congestion Management Program,  
Ventura County Transportation Commission, 2009.

## REFERENCES AND PERSONS CONTACTED

### Associated Transportation Engineers

Scott A. Schell, AICP, PTP, Principal Planner  
Darryl F. Nelson, Senior Transportation Planner  
Erica K. Monson, Traffic Technician I

### Persons Contacted

Earnel Bihis, City of Oxnard

### References

Highway Capacity Manual, Transportation Research Board, National Research Council, 2000.

Trip Generation, Institute of Transportation Engineers, 9th Edition, 2013.

Traffic LOS Monitoring for the Ventura County Congestion Management Program, Ventura County Transportation Commission, 2009.

Financial Plaza Tower III Final EIR Addendum, May 2002.

Starbucks Traffic and Circulation Study, ATE, August 2016.

Audi of Oxnard Traffic and Circulation Study, ATE, November 2016.

Campus at Topa Towers Traffic and Circulation Study, ATE, April 2017.



# Appendix I

---

Wet Utility Preliminary Investigation and Domestic Water Supply and Demand Memorandum

# WET UTILITY PRELIMINARY INVESTIGATION

---

**RIO URBANA (TENTATIVE TRACT MAP 5998)**  
**APN: 145-0-232-010**

**2714 Vineyard Avenue**  
**Oxnard, CA 93036**

*prepared for:*

The Pacific Companies  
Attn: Caleb Roope  
430 E. State Street, Suite 100  
Eagle, ID 93616

*prepared by:*

Jensen Design & Survey, Inc.  
1672 Donlon St.  
Ventura, CA 93003



*Prepared on:*  
August 21, 2017

*This page was intentionally left blank*

## 1.0 PROJECT BACKGROUND

### 1.1 PROJECT DESCRIPTION & LOCATION

The Pacific Companies (Client/Applicant) in partnership with El Rio School District (Property Owner) proposes to entitle, annex, and develop the El Rio School District property located at 2714 Vineyard Avenue in the unincorporated area of El Rio adjacent to the City of Oxnard's city limit boundary. This project is within the City of Oxnard's Sphere of Influence, CURB Boundaries, Water and Sewer Master Plans, and is being processed through the City of Oxnard as Planning and Zoning Permit No. PZ17-500-05 for a large lot subdivision and annexation (Tentative Tract Map 5998, TTM 5998). The first proposed lot includes a 15,100 square foot commercial office space located along Vineyard Avenue. This lot is designated for the El Rio School District new office headquarters. The second proposed lot is designated for residential condominium purposes including a mixture of one-, two-, and three- bedrooms units totaling 182 units.

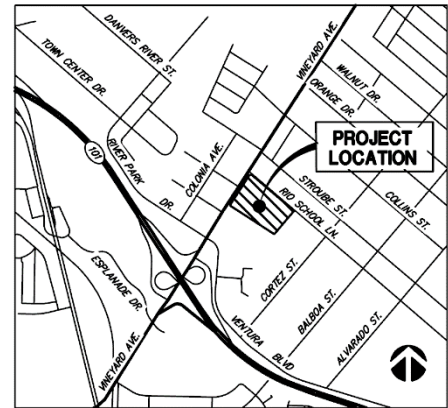

### 1.2 HISTORICAL USES

Since 1949, El Rio School District has owned the property. From 1949 to 2005, Rio Elementary School operated at this location until moving locations to the present day Rio Real School. From 2006-2014, the site served as a number of uses including: the operating location for California Conservation Core until 2009; the El Rio School District Office and Dispatch headquarters until 2014, and; from 2014 to present, the Site is used as the Dispatch Headquarters for the El Rio School District Vehicle Fleet.

### 1.3 REPORT OBJECTIVE

On May 5<sup>th</sup>, 2017, the City of Oxnard issued the Applicant 'Pre-DAC Comments' identifying the need for a technical study assessing *Wet Utilities*. A subsequent conversation with Contract Planner for the City (Chris Williamson), clarified specific details the City identified as beneficial to Study to adequately inform potential environmental impacts of wet utilities for the City's Initial Study/Environmental Assessment (Initial Study). This Initial Study is to be performed by the Lead Agency (City of Oxnard) and will assess the project's compliance with California Environmental Quality Act (CEQA). For the Lead Agency, this Wet Utility Preliminary Investigation will assess existing and proposed water usage and sewer loading associated with the Rio Urbana project. There is also a 1<sup>st</sup> – Level assessment of the City's existing Recycled Water pipeline infrastructure in proximity to the project site and general feasibility for connecting.

## 2.0 EXISTING & PROPOSED SEWER GENERATION

The historical land use as an elementary school on the Project Site supported 46 adult persons and 770 elementary-aged students. The landscaping of the school site amounts to 4.31 acres of irrigated land. The following table provides a detailed breakdown for the “Existing Sewer Loading” for the Elementary School Site. The total existing sewer loading to the City of Oxnard’s 10” VCP (vitrified clay pipeline) located in Vineyard Avenue 67’ offset from the property line amounts to 10.58 GPM (ADD, average daily demand). See Sewer Atlas P-12 & P-13 (Appendix A)

### EXISTING SEWER LOADING

Ex. People	Persons	GPD/Person*	GPD	GPM	
Staff	11	20	220	0.15	
Teachers	35	20	700	0.49	
Students	770	15	11,550	8.02	
				<b>8.66</b>	<b>gpm (ADD)</b>

\* City of Oxnard Standard Plate 43 for assumptions per person

Ex. Landscape		
Grass	4.31	Ac.
Use (Assumed)	3.1	AF/yr/Ac
Use (Assumed)	<b>1.92</b>	<b>gpm (ADD)</b>

**TOTAL 10.58 GPM (ADD)**

The proposed project contains two land uses: office and residential. The office component will be around 15,100 square feet of building and support 61 employees. Using the City of Oxnard’s Standard Plate #43 (Appendix B), the following table provides a detailed breakdown for the “Proposed Sewer Loading” associated with the proposed uses of the project, TTM 5998. As the TTM 5998 shows (Appendix C), the proposed Point of Connection to the City’s sewer pipe would be located just south of Sycamore Street with a potential invert elevation of 79.90’.

### PROPOSED SEWER LOADING

#### El Rio Community

Bedrooms	No. Units	gpd/unit*	gpd (ADD)	gpm (ADD)	
1	7	150	1,050	0.73	
2	119	200	23,800	16.53	
3	56	250	14,000	9.72	
				<b>26.98</b>	<b>gpm (ADD)</b>

\* City of Oxnard Standard Plate 43 for assumptions per person

#### Office Building

Employees	gpd/person*	gpd	gpm (ADD)
61	20	1,220	<b>0.85</b>

<b>Total gpm (ADD) Proposed Demand</b>	<b>27.83 gpm (ADD)</b>
--	------------------------

### 3.0 EXISTING & PROPOSED WATER USE

Standard Plates #43 (Appendix B) from the City of Oxnard was applied to the sewer generation analysis of the project as detailed in the above section. For existing and proposed water usage numbers, no City Standard Plates exists. As a result, this study applies an industry standard assumption to obtain the following table of existing and proposed water usages. The proposed domestic waterline connection to the City’s 12” concrete domestic water pipeline (Unit ID# 13-PT01) is shown on TTM 5998 and provided in this Study as Appendix C. It is anticipated the existing ¾” domestic water meter serving the school site could be abandoned if desired – upon preliminary research, it appears this ¾” domestic water connection is with the City of Oxnard 10” VCP in Vineyard.

#### EXISTING WATER USE

<b>12.11</b>	<b>GPM (ADD)</b> (Based on 1.18 * Sewer Generation + Landscape)
--------------	---

#### PROPOSED WATER USE

<b>32.74</b>	<b>GPM (ADD)</b> (Based on 1.18 * Sewer Generation, and; assumes recycled water will be used to irrigate)
--------------	---

### 4.0 SEWER CAPACITY

The Rio Urbana Project Site is included in the boundary area of the City of Oxnard’s Wastewater Master Plan Update (September 2008). This Master Plan includes the City Limit Boundaries and City Urban Restrictive Boundaries (CURB). Land use projections used for creating the Wastewater Master Plan were based on the adopted 2020 General Plan. In Figure 3-5 of the General Plan, the Project Site was identified as a Redevelopment Area.

The Project Site disposes of wastewater into the City’s existing 10” trunk sewer line in Vineyard Avenue/Highway 232. There is inconclusive data in the City’s Wastewater Master Plan (2008) and the City’s Integrated Waste Master Plan (2015) to establish a sewer capacity of the 10” trunk sewer in Vineyard/Highway 232 at this time.

## **5.0 RECYCLED WATER CONNECTION – 1<sup>ST</sup> LEVEL ANALYSIS**

---

The existing Recycled Water Distribution Pipeline is shown in Appendix D and sourced from the City of Oxnard Public Works Integrated Master Plan, PM 4.2. The nearest location for a potential point of connection is at Riverpark Boulevard and Colonia Avenue. The second closest connection is at the corner of Forest Park Boulevard and Vineyard Avenue/ Highway 232. See Appendix E for an exhibit showing a first-level analysis of two (2) Alternatives showing Point of Connections and a general Alignment for a Recycled Water pipeline connection to the Project Site.

Based on the Integrated Master Plan for Recycled Water, the maximum available flow to the Riverpark Area at the point of connection is 1,750 gpm at 60 psi (Table 3 of Integrated Master Plan, PM 4.2. In 2040, Table 4 of the Integrated Master Plan (PM 4.2). The Integrated Master Plan states the Riverpark Development will have a maximum required flow of 651 gpm at 117 psi. This maximum flow is based on ultimate projects planned for build out as recommended in PM 2.5 (through 2040). At the time of the analysis, the El Rio School site was not included.

For several reasons, a connection to the City's Recycled Water Pipeline is not reasonably feasible. Two major factors contributing to this analysis include a) the Project Site is not included in the Integrated Master Plan for the Recycled Water Facilities, and b) the distance required to connect the Project Site to a Recycled Water line is over 1,450 L.F. of open trench pipeline design and construction. The land uses affected by a potential alignment are single-family residences for approximately 1,300 L.F. The remaining open trench construction of the pipeline would require a crossing over Caltrans right of way along Vineyard Avenue/Highway 232.

## **6.0 APPENDICES**

---

- Appendix A: Sewer Atlas P-12 & P-13
- Appendix B: City Standard Plate #43
- Appendix C: TTM 5998
- Appendix D: Integrated Master Plan PM 4.2
- Appendix E: Recycled Water Connection Feasibility (1<sup>st</sup>- Level Analysis)

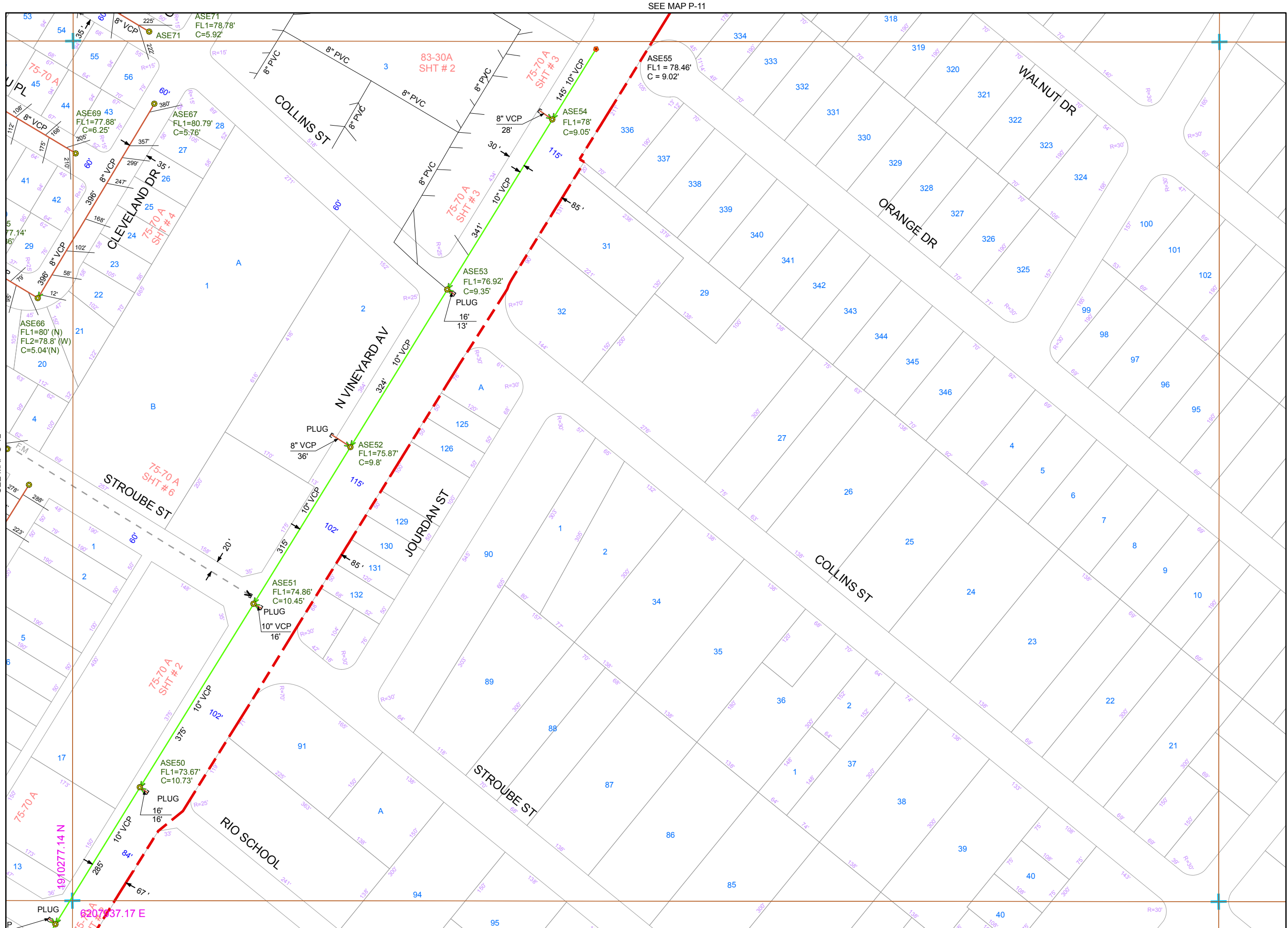

SEE MAP O-12

SEE MAP P-11

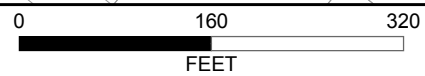

DATUM NOTE: ALL ELEVATIONS ARE ON CITY OF OXNARD DATUM UNLESS OTHERWISE SHOWN. AN ASTERISK (\*) INDICATES N.G.V. DATUM.



SEE MAP P-13



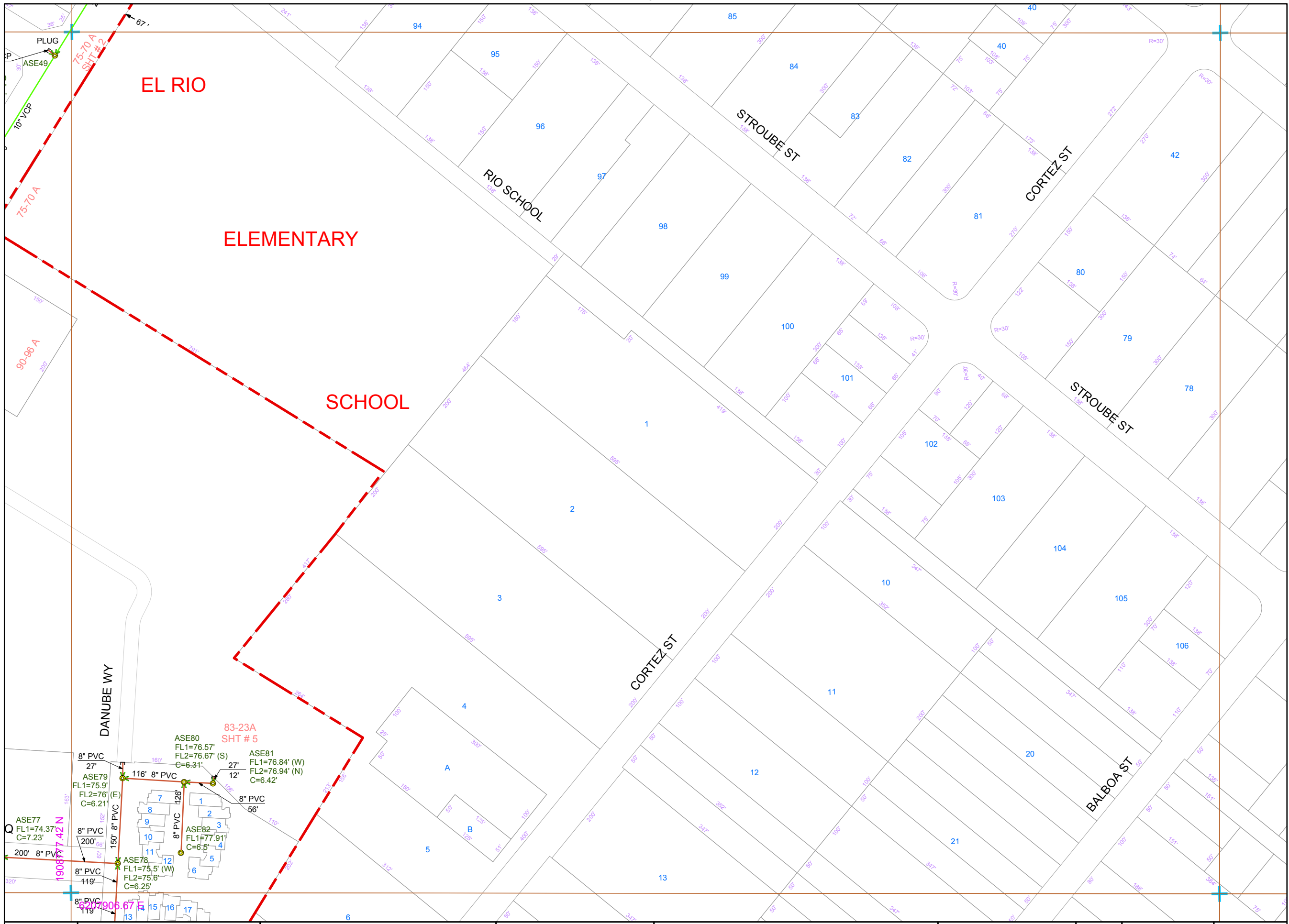

SEE MAP O-13

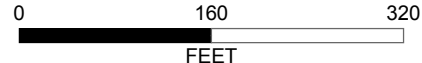

DATUM NOTE: ALL ELEVATIONS ARE ON CITY OF OXNARD DATUM UNLESS OTHERWISE SHOWN. AN ASTERISK (\*) INDICATES N.G.V. DATUM.



# AVERAGE SEWAGE FLOW RATES

<u>TYPE OF DEVELOPMENT</u>	<u>GALLONS/PERSON/DAY</u>
Airport .....	15 per employee 4 per passenger
Factories.... No showers .....	20 per employee
With showers .....	30 per employee
Cafeteria - Add industrial waste and BOD load	
Offices .....	20 per employee
Stores (Not including food & laundry waste) 100	per 1000 Sq.Ft. space
(Per shift) .....	400 per toilet 15 per employee
Laundries (Coin operated) .....	300 per machine
Per customer....	50 per wash
Service Station .....	1000 for first bay
.....	500 for each additional
.....	10 per car served
Swimming Pools .....	10 per employee
.....	4 per swimmer
With hot water.....	8 per swimmer
Theaters.....	5 per seat
Drive in .....	5 per space
Assembly & Dance Halls....	2 per seat or customer
Church - Small .....	4 per seat
Large & with kitchen .....	6 per seat
Bowling Alleys - Pool Parlors .....	75 per lane or table
Country Clubs .....	75 per member
Add .....	25 per non-member
Camps - Resort (Limited Plumbing)....	50 per person
(Luxury)....	120 per person
Youth & Recreation .....	50 per camper
Tent Campground (toilets only)	25 per camper
Central stations w/showers..	35 per camper
Vacation cottages.. .....	200 per cottage
Picnic Parks (toilets only)...	10 per person
(w/bath house & flush toilets)	15 per person
Camper & Travel Trailers	
Without hook up.. .....	50 per space
w/water and sewer hook up...	120 per space
Camps - Summer and Seasonal .....	50 per person
Construction .....	50 per person
Day Camps no meal served .....	20 per person

REV. APPR. BY DATE

 <p>CITY OF <b>Oxnard</b></p>	<b>GENERAL REQUIREMENTS - SEWER</b>		STANDARD PLAN
	DRAWN: SOHER	CKD. <i>Jay Hotel</i>	APPR. BY <i>Benjamin J. Wong</i>
Public Works Department			SHEET 1 OF 2

# AVERAGE SEWAGE FLOW RATES

<u>TYPE OF DEVELOPMENT</u>	<u>GALLONS/PERSON/DAY</u>
Mobil Home Parks (Average) .....	180 per space
(Delux).. .....	225 per space
Overnight & Travel Trailer .....	150 per space
Restaurants - Cafeterias.. .....	15 per employee
Add Kitchen Waste.. .....	7 per meal served
Add Garbage Grinder .....	1 per meal served
Toilet & Kitchen Waste .....	10 per customer
Day time Operation .....	70 per seat space
24-hr. Operation... .....	100 per seat space
Curb Service .....	50 per car
With Tavern, add... .....	2 per customer
<b>Schools and Colleges</b>	
Staff and Office... .....	20 per person
Elementry students. ....	15 per student
Intermediate and High .....	20 per student
Day Schools w/cafeteria only....	15 per student
w/showers .....	20 per student
Boarding school.... .....	80 per student
College Dormitories .....	85 per student
<b>Hospitals</b> .....	100 per bed
.....	150 per patient & Staff
Institutions (Resident) .....	100 per person
Nursing homes .....	100 per person
Rest homes .....	100 per person
Convalescent .....	85 per bed
<b>Hotel/Motels - No private bath</b> .....	100 per room (2 persons)
with Private bath .....	150 per room (2 persons)
<b>Apartment Buildings:</b>	
Bachelor or Single	
Dwelling units (Studio) .....	100 per dwelling unit
1 bedroom dwelling unit .....	150 per dwelling unit
2 bedroom dwelling unit .....	200 per dwelling unit
3 bedroom dwelling unit .....	250 per dwelling unit





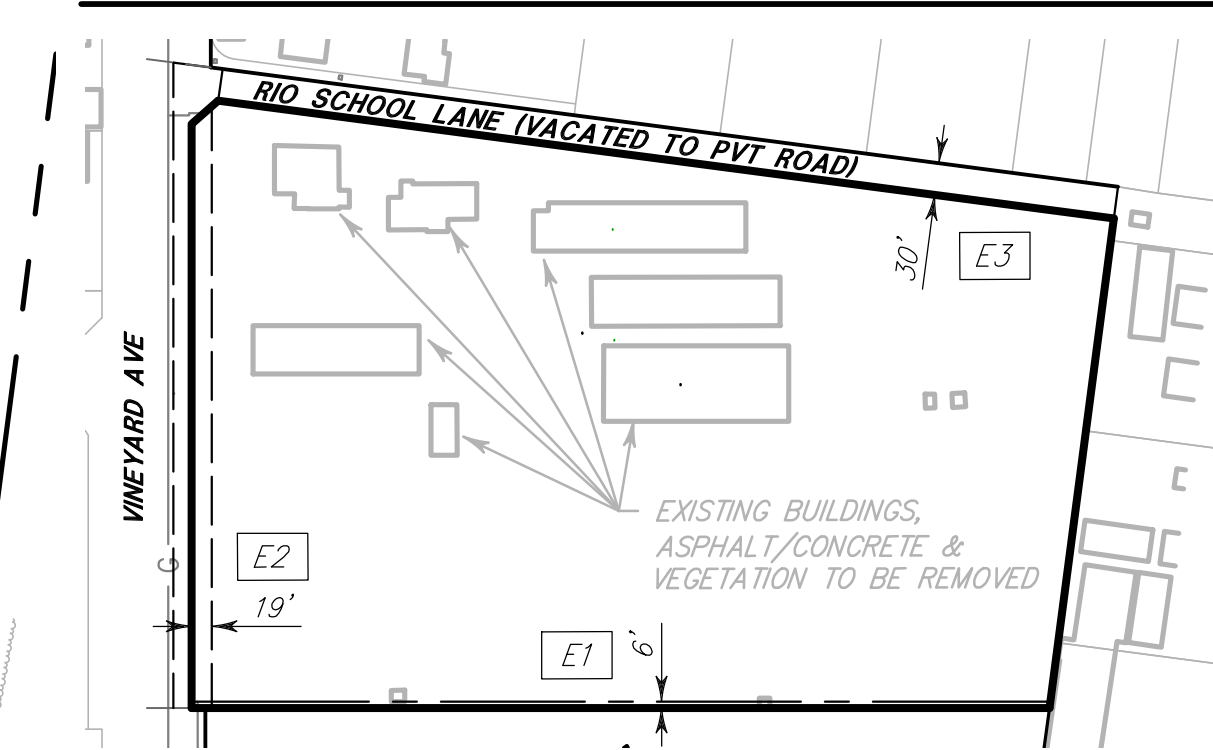

**EXISTING EASEMENTS & STRUCTURES**



**EASEMENTS SCHEDULE**

- E1 PUBLIC UTILITIES AND POLE EASEMENT - CENTERLINE ONLY - TO SOUTHERN CALIFORNIA EDISON PER 958 OR 420
- E2 EASEMENT TO THE CITY OF OXNARD FOR A PUBLIC SIDEWALK DEDICATION PER INSTRUMENT NO. 90-180309 OR
- E3 PUBLIC ROAD EASEMENT TO VENTURA COUNTY PER 878 OR 402

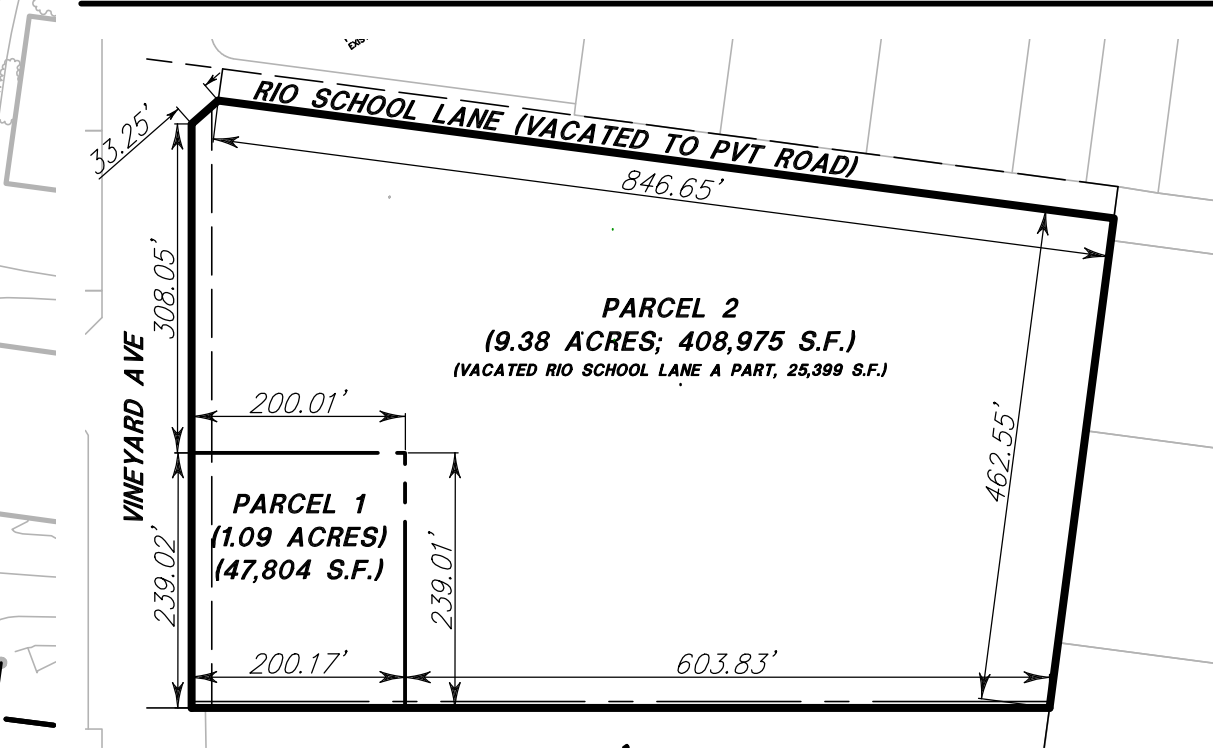
**PROPOSED SUBDIVISION**



**UTILITIES**

**WATER/SEWER:** CITY OF OXNARD, 305 W. THIRD OXNARD, CA. 93030  
**GAS:** SOUTHERN CALIF. GAS CO., 130 S. PATTERSON AVE., SANTA BARBARA, CA. 93111  
**ELECTRIC:** EDISON INTERNATIONAL, 10060 TELEGRAPH RD., VENTURA, CA. 93004  
**TELEPHONE:** PACTEL, 2459 PALMA DR., VENTURA, CA. 93003  
**CABLE:** TIME WARNER CABLE, 721 MULHART AVE., OXNARD, CA. 93030

**PROPOSED UNIT MIX & PARKING**

**PARCEL 1:**  
OFFICE 1 SPACE PER 250 S.F. = 15,100 / 250 = 60 SPACES PROVIDED

**PARCEL 2:**

UNIT TYPE	#	%	SPACES/UNIT	SPACES PROVIDED
1-BEDROOM	7	4%	1	7 SPACES
2-BEDROOM	119	65%	2	238 SPACES
3-BEDROOM	56	31%	2	112 SPACES

**GUEST PARKING:**  
FIRST 30 UNITS x 1 = 30 SPACES  
REMAINING UNITS 152 x .5 = 76 SPACES

**TOTAL PARKING PROVIDED: 463 SPACES**

**PARKING BREAKDOWN:**  
GARAGE 179 SPACES  
OPEN PARKING 178 SPACES  
GUEST PARKING 106 SPACES

**VICINITY MAP - NOT TO SCALE**

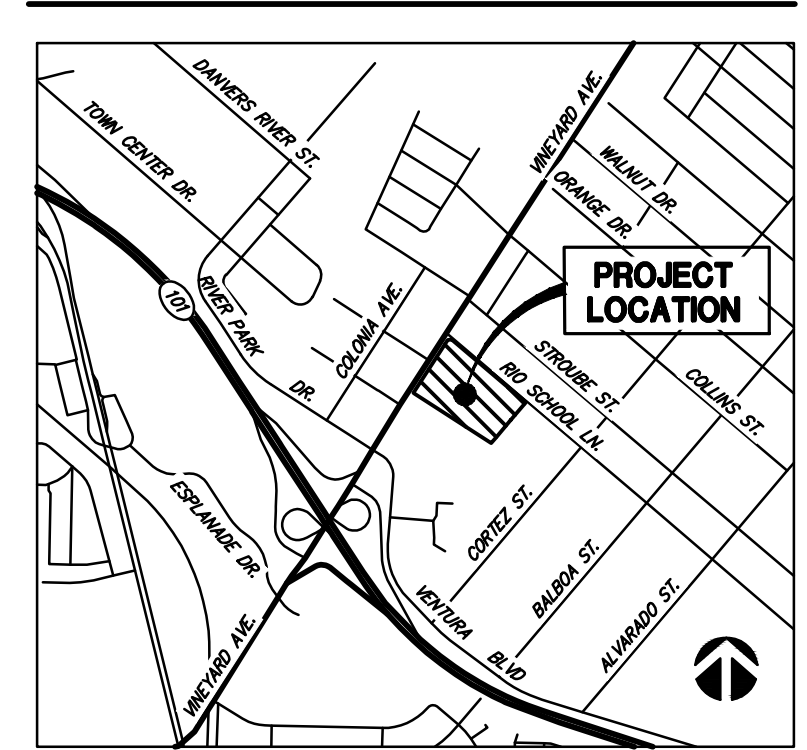

**PRELIMINARY LAND USE DATA**

**PROJECT LOCATION:** 2714 VINEYARD AVE. OXNARD, CA 93036

**ASSESSORS PARCEL No.:** 145-0-232-010 (9.09 ACRES)

**TOTAL PROJECT AREA:** 10.49 ACRES (456,779 S.F.) (INCLUDING VACATION OF RIO SCHOOL LANE)

**EXISTING USE OF THE PROPERTY:** PREVIOUSLY USED AS AN ELEMENTARY SCHOOL, THIS SITE IS NOW USED AS THE EL RIO SCHOOL DISTRICT OFFICES AND THE MAJORITY OF OLD CLASSROOM BUILDINGS ARE VACANT.

**PROPOSED PROJECT DESCRIPTION:** SUBDIVIDE A.P.N. 145-0-232-010 INTO TWO PARCELS. PARCEL 1 (1.09 ACRES) WOULD BE DEDICATED AS THE EL RIO SCHOOL DISTRICT OFFICE AND PARCEL 2 (9.38 ACRES) WOULD BE REZONED FOR RESIDENTIAL CONDOMINIUM PURPOSES.

**EXISTING GENERAL PLAN:** SCHOOL (ADJUNCT TO CITY LIMITS)

**PROPOSED GENERAL PLAN:** SCHOOL (ANNEXED INTO CITY)

**PROPOSED ZONING:** PARCEL 1: SCHOOLS  
PARCEL 2: RESIDENTIAL MEDIUM (R-3-PD)

**PROPOSED SUBDIVISION:**  
- PARCEL 1: 1.09 ACRES (47,804 S.F.)  
- PARCEL 2: 9.38 ACRES (408,975 S.F.)

**PROPOSED BUILDING IMPROVEMENTS:**

PARCEL 1:	BUILDING NAME	UNITS	HEIGHT	LOT COVERAGE (S.F.)	TOTAL S.F.
	SCHOOL OFFICE	N/A	2-STORY	7,830 (16.03%)	15,100 S.F.

PARCEL 2:	BUILDING NAME	UNITS	HEIGHT	LOT COVERAGE (S.F.)
	BUILDING A:	23	3-STORY	14,317
	BUILDING B:	23	3-STORY	14,317
	BUILDING C:	23	3-STORY	14,317
	BUILDING D:	23	3-STORY	14,317
	BUILDING E:	23	3-STORY	14,317
	BUILDING F:	23	3-STORY	14,317
	BUILDING G:	23	3-STORY	14,317
	BUILDING H:	21	3-STORY	12,932
	COMMUNITY BUILDING	N/A	1-STORY	1,875
<b>TOTALS:</b>		<b>182 UNITS</b>		<b>115,026 S.F. (28.1%)</b>

**PROJECT DENSITY:**  
- PARCEL 1: N/A  
- PARCEL 2: 182 UNITS/9.38 ACRES = 19.38 DU/AC

**SECTIONS**

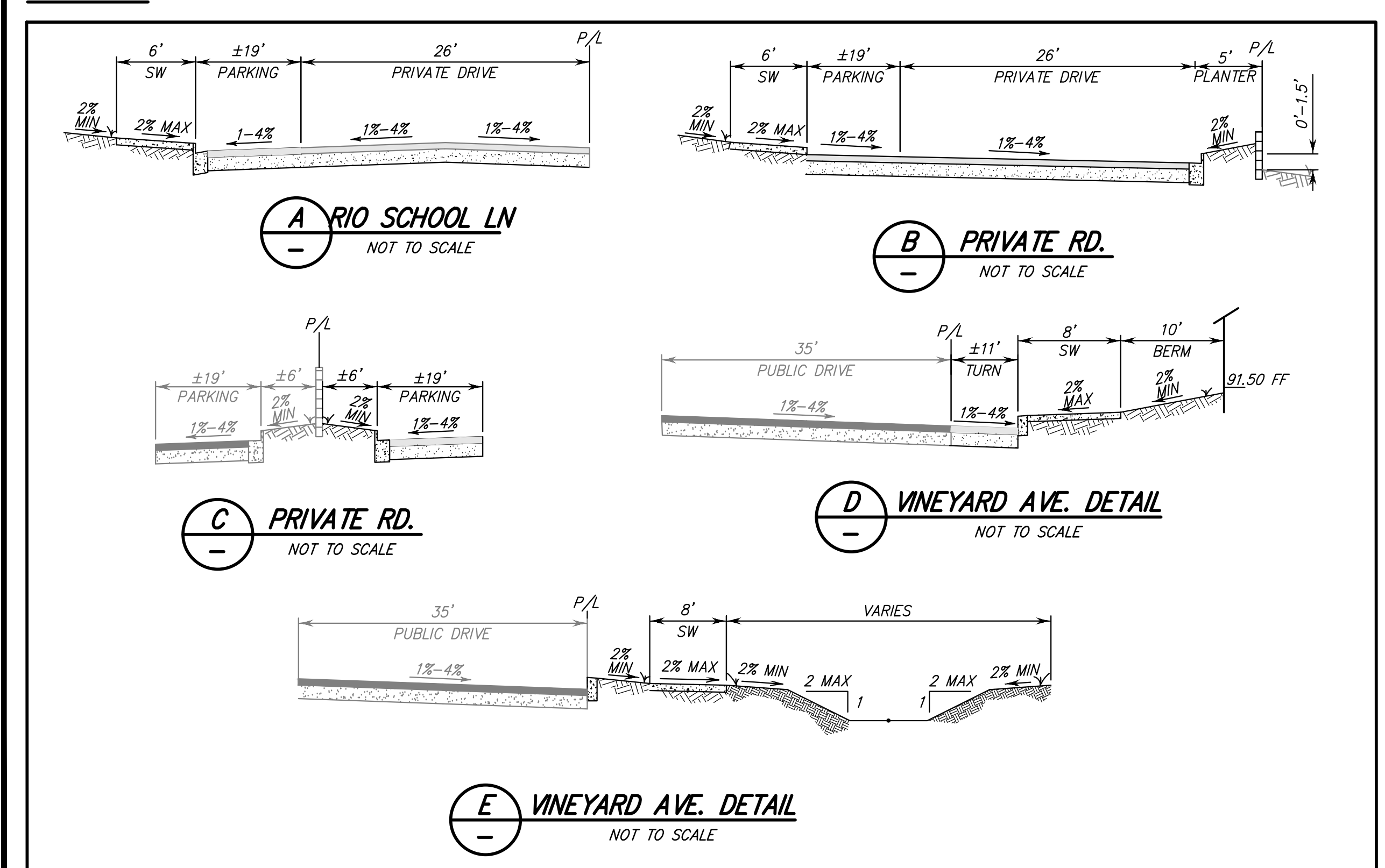

**NGS BENCHMARK**  
THE ELEVATIONS ON THIS MAP ARE US FOOT, BASED ON THE NORTH AMERICAN VERTICAL DATUM OF 1988 (NAVD88), AS DETERMINED LOCALLY BY GPS OBSERVATIONS ON THE FOLLOWING NGS BENCHMARKS:  
NGSPID "EW5966" - ELEVATION: 78.86' (24.037 METERS)

**LOCAL BENCHMARKS**  
THE LOCAL ELEVATIONS CAN BE DETERMINED BY USING THE FOLLOWING POINTS:  
PT#315 - FOUND 1.5" IRON PIPE W/ TAG "LS 5983" - MARKING SOUTHWEST CORNER OF SUBJECT PROPERTY.  
ELEVATION: 88.30 FEET  
PT#315 - FOUND 1.5" IRON PIPE W/ TAG "LS 5983" - MARKING NORTHWEST CORNER OF SUBJECT PROPERTY.  
ELEVATION: 90.89 FEET  
THESE ELEVATIONS ARE BASED ON THE NORTH AMERICAN VERTICAL DATUM OF 1988 (NAVD88), AS DETERMINED LOCALLY BY GPS OBSERVATIONS.

**BASIS OF BEARINGS**  
THE BEARINGS ON THIS MAP ARE GRID, BASED ON THE CUSTOM LOW DISTORTION PROJECTION (LDP) DEFINED HEREON - NAD83 (EPOCH 2010.00) AS DETERMINED LOCALLY BY A LINE BETWEEN NGS CORNS (CONTINUALLY OPERATING REFERENCE STATION) SITES "TOS1" AND "CSS1" BEING NORTH 70° 12' 03.8" WEST, AS DERIVED FROM GEODETIC VALUES PUBLISHED BY THE NATIONAL GEODETIC SURVEY (NGS) AND SHOWN IN CONTROL SCHEME DETAIL.

**FIRE ACCESS**

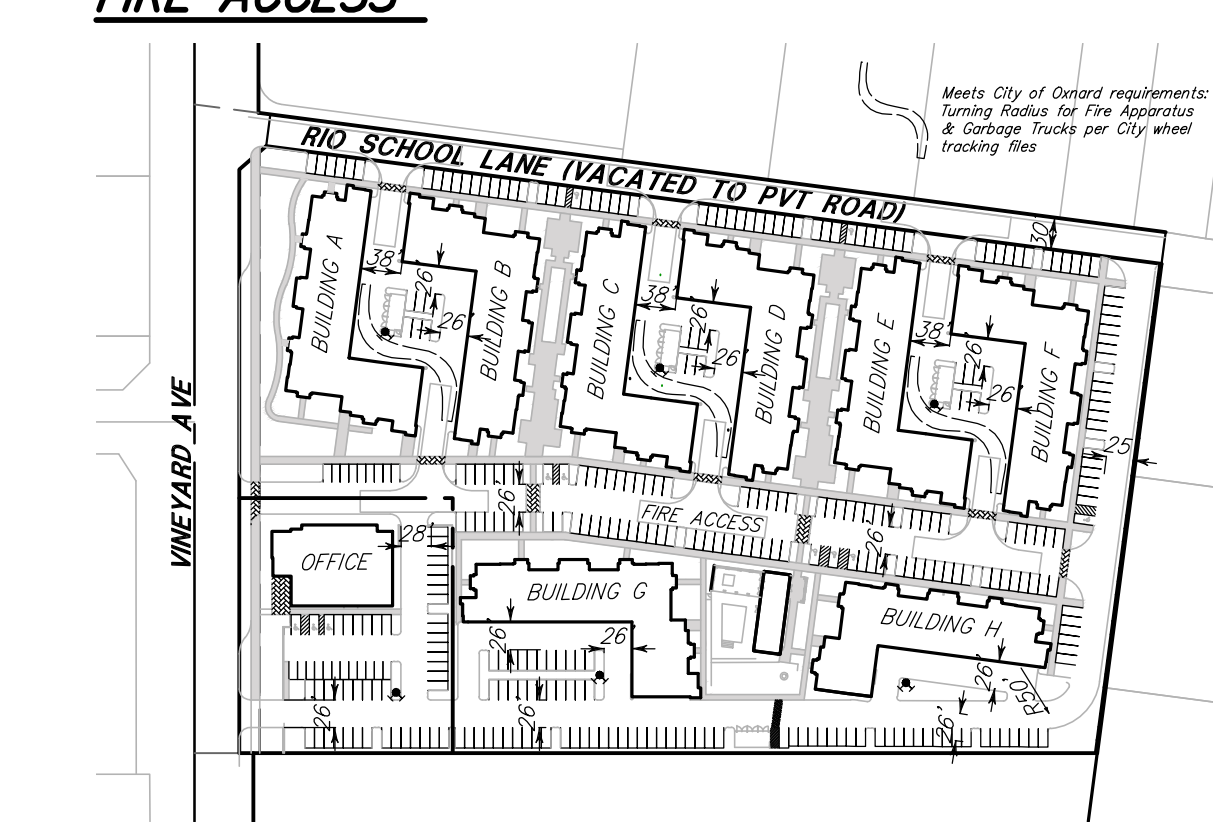

REVISION	DATE	SUBDIVIDER:	OWNER:
2ND SUBMITTAL	06/02/2017	THE PACIFIC COMPANIES 430 E. STATE STREET, STE 100 EAGLE, ID 83616 Attn: CALEB ROOPE (208) 461-0022 X3012	EL RIO SCHOOL DISTRICT 2714 VINEYARD AVE. OXNARD, CA. 93035-1131
		ENGINEER: JENSEN DESIGN & SURVEY, INC. www.jscsvt.com	1672 DONLON STREET VENTURA, CALIF. 93003 PHONE 805/654-6977 FAX 805/654-6979

**RIO URBANA  
TENTATIVE TRACT 5998  
FOR CONDOMINIUM PURPOSES**

CITY OF OXNARD COUNTY OF VENTURA STATE OF CALIFORNIA

LEGAL DESCRIPTION: Portion of lot 90 of the Rancho Santa Clara Del Norte, in the County of Ventura, State of California, as per map recorded in book 3, page 26 of maps, records of County of Ventura, A.P.N. 145-0-231-010

SCALE: 1"=40' J.N.: ALD15859 DATE: Jun 12, 2017 DWG. NAME: 5659-01-TM.dwg

**SHEET 1 OF 1**



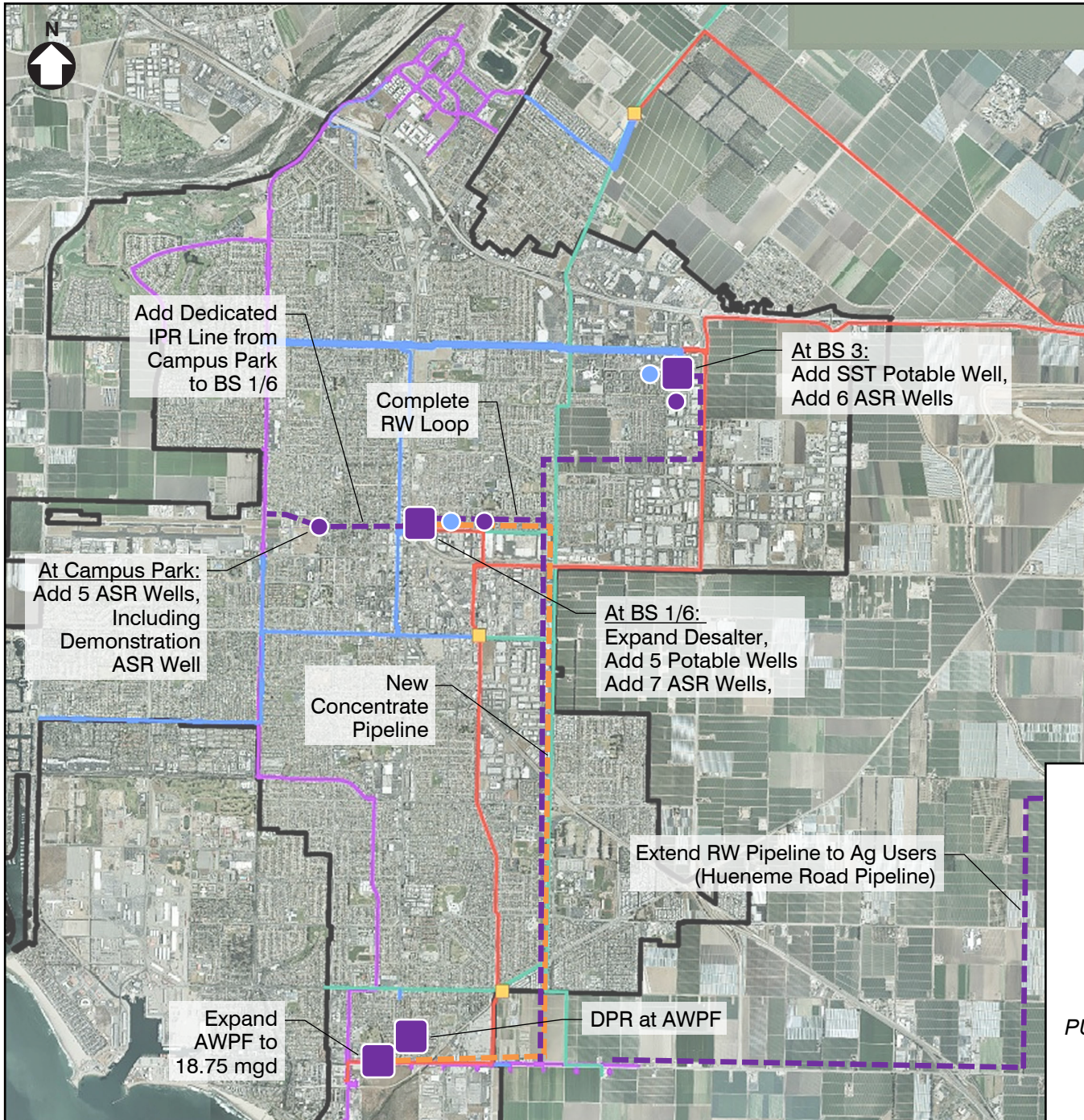

LEGEND	
Existing Transmission Lines:	
<span style="color: red;">—</span>	CMWD Pipeline
<span style="color: green;">—</span>	O-H Pipeline
<span style="color: purple;">—</span>	RW Distribution
<span style="color: blue;">—</span>	Potable Distribution
Recommended New Transmission Lines and Wells:	
<span style="color: orange;">—</span>	New Concentrate Pipeline
<span style="color: purple;">—</span>	RW Distribution
<span style="color: blue;">●</span>	New Potable Wells
<span style="color: purple;">●</span>	New ASR Wells

**NOTE:**

1. This figure is schematic in nature. The recycled water distribution and potable distribution are independent systems.

**RECOMMENDED  
WATER/RECYCLED WATER  
PROJECTS**

FIGURE 7

CITY OF OXNARD  
PM NO. 2.5 - WATER SUPPLY AND  
TREATMENT ALTERNATIVES  
PUBLIC WORKS INTEGRATED MASTER PLAN



CITY OF  
**OXNARD**  
CALIFORNIA



**carollo**  
Engineers...Working Wonders With Water®





**OVERVIEW**

1 inch = 1,000 feet

- Project Site
- City Recycled Waterline
- Alt 2 - R.W. Connection
- City Boundary
- Alt 1 - R.W. Connection

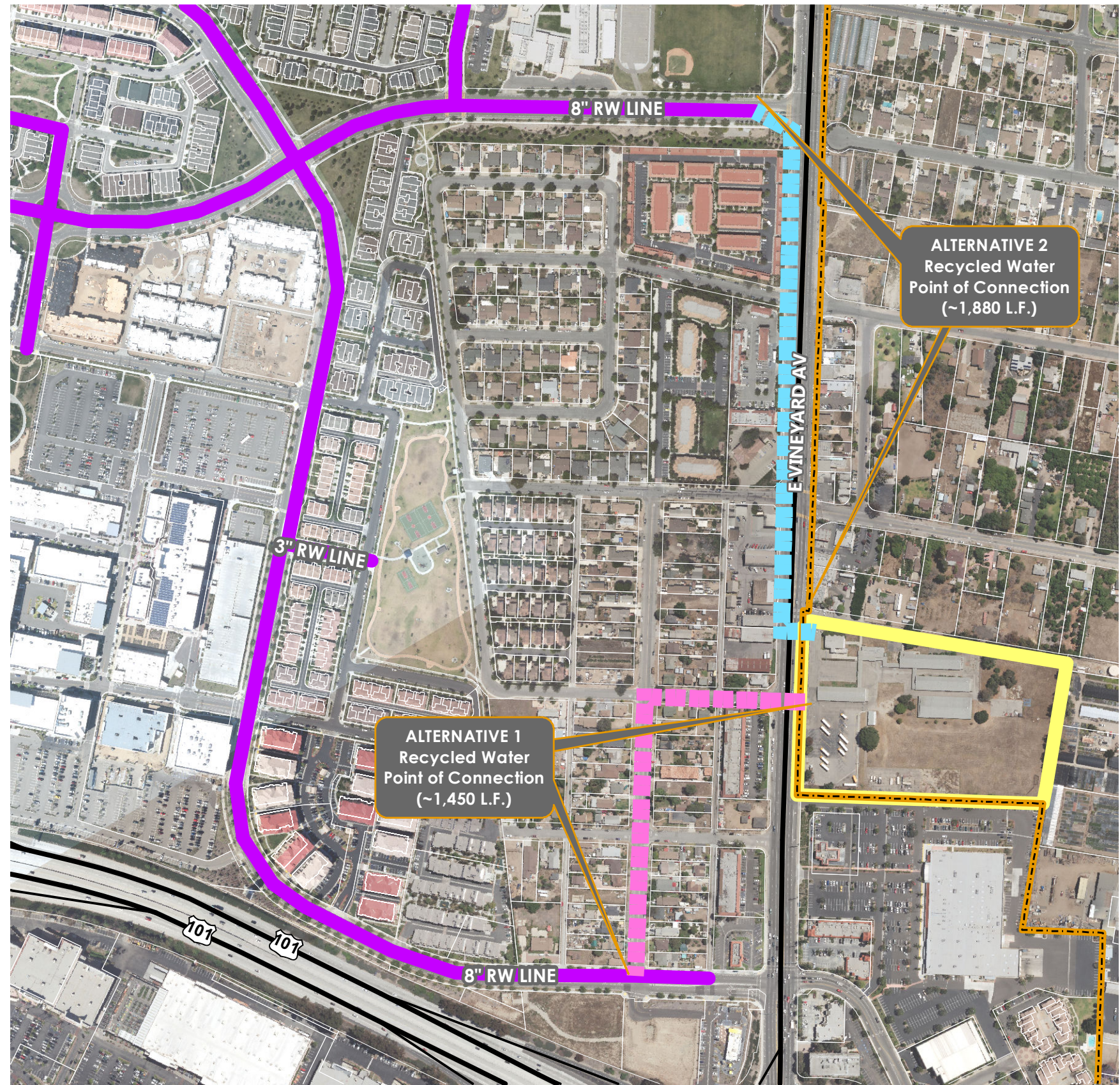

**ALTERNATIVES | POINT OF CONNECTION & ALIGNMENT**

1 inch = 400 feet

Path: J:\ALD15659\_Data\GIS\RecycledWater\_Feasibility.mxd

Parcel boundaries on this exhibit are a graphical representation only. They should not be used in place of record boundary information and/or field survey data and do not accurately define property boundaries.







1672 Donlon Street  
Ventura, CA 93003  
Local 805 654-6977  
Fax 805 654-6979  
www.jdscivil.com

ALD01.5659  
April 4, 2019

## TECHNICAL MEMORANDUM

To: Thien Ng, Assistant Public Works Director, City of Oxnard

Copy: Kathleen Mallory, Planning Manager, City of Oxnard  
Joel Kirchenstein, Rio School District, Co-Applicant  
Caleb Roope, Pacific Communities, Co-Applicant  
Tony Talamante, P.E., Consultant to Pacific Communities

### **RE: Proposed Rio Urbana Residential and Commercial Office Development Domestic Water Supply and Demand**

The Rio Urbana Residential and Commercial Office Building Project has been submitted to the City of Oxnard Planning Department for review. The project will entail the demolition of the former El Rio School facilities for the proposed development and construction of 167 for sale residential unit community and a 15,100 square foot commercial office building for the Rio School District administrative needs. The property currently is within unincorporated County of Ventura and annexation into the City of Oxnard is proposed. As part of the annexation, groundwater pumping rights, established by Fox Canyon Groundwater Management Agency, will be transferred to the City of Oxnard in compliance with City of Oxnard CEQA Guidelines, May 2017, Water Neutrality Policy. This Technical Memorandum presents the analysis of projected water demand for the project, and the proposed transfer of pumping rights to the City of Oxnard from active Rio School District groundwater wells.

#### Rio School District Fox Canyon Groundwater History

Historically, the domestic water supply for Rio School District facilities has been provided by a combination of three active ground water wells and domestic water connections with the City of Oxnard and United Water Conservation District. Prior to the proposed reductions in allocations from the Fox Canyon Ground Water Basin, the Rio School District was allowed to pump 100.240 AFY (acre feet per year) without incurring surcharges for over-pumping. Fox Canyon GMA is in process of conducting hearings to adopt an Ordinance which will require well owners to reduce groundwater pumping and reduce transferable allocation and pumping rights. Based on well pumping information provided by Rio School District and a courtesy review by Fox Canyon GMA, pumping a maximum of 52.074 AFY, including the well on the proposed project site parcel, will be allowed once the Ordinance is adopted. Currently, the well on Rio Urbana project site would have an allocation of 10.483 AFY per the proposed future Ordinance with the remaining amount of 41.591 AFY allocated to the other two wells to be held by the Rio School District.

## **Rio Urbana Project Demand**

The water demand for the Rio Urbana Project is made up of three components:

- 1) Domestic water use by residents
- 2) Commercial water use for the commercial office building
- 3) Landscape irrigation for the entire project.

## **Rio Urbana Projected Domestic Water Use by Residence**

The City of Oxnard has not developed a specific water demand calculation methodology for domestic use in high density attached units and apartments utilizing the current standards for water conservation fixtures and measures. For this project, as a comparative analysis it has been agreed to use water demand for a recently constructed nearby high density apartment project of similar size and product design. This comparable project contains 224 residential units and water meter readings for approximately two years from the City of Oxnard Water Department. The comparable project and the Rio Urbana project design requirements utilize the current industry standards for water saving fixtures and other measures as required by state and local regulations.

Utilizing the household size (number of persons per unit) defined in the California Plumbing Code the per capita domestic water use per day for the comparable project was determined to be 45.82 gallons per day per person. Using this per capita factor, based on the projected number of residents for the Rio Urbana project (543 people), the domestic water demand is estimated to be 27.87 AFY. Understanding not all projects are identical, occupancies can vary and change, and other variables, a 20% contingency was added to equal a total residential demand of 33.45 AFY. This water demand is equivalent to 55 gallons per person per day, which is the target value of the State of California Assembly Bill 1668 and State of California Senate Bill 606 state as use per person per day.

## **Project Commercial Water Use for the commercial office Building**

The commercial office building is approximately 15,100 square feet. Using the City of Oxnard standard plate 43, the applicable sewer generation rate is 300 gallons per day per 1,000 square feet. Since the proposed building is approximately 15,100 square feet the resulting sewer generation is 4,530 gallons per day and using a 1.2 multiplier for water demand, at the resulting water demand estimate is 5,436 gallons of water per day. This calculates to a conservative 6.089 AFY water demand. It is unknown at the time how the office building will be occupied and number of occupants. Based on comparison of sewage generation to actual water demand, it can be established the calculation is conservative.

## **Landscape Irrigation**

Landscape irrigation system will be designed for both spray and drip irrigation. The Landscape Architect has provided yearly water consumption calculations using the State of California landscape calculator. The calculator output is provided in the appendices. Results of the calculator show total irrigation for the entire site to be 0.860 AFY water demand. The landscape design palette will be conditioned to meet the City of Oxnard current "drought tolerant" standards.



**Rio Urbana Projected Water Demand Summary**

Residential Domestic Water	33.450 AFY
Commercial Office Building Water	6.089 AFY
Landscape Irrigation	0.860 AFY
<b>Total:</b>	<b>40.399 AFY</b>

**Fox Canyon Groundwater Allocation Transfer**

As stated above, the Rio Urbana project site and Rio School District would be currently allowed to pump 52.074 AFY from the existing wells of which 41.591 AFY is allocated to two existing wells located on neighboring Rio School District property and 10.483 AFY allocated to the well on the Rio Urbana project site parcel. The Rio Urbana project development and the Rio School District are in a position to transfer 40.399 AFY of groundwater pumping allocation to the City of Oxnard in compliance with City of Oxnard CEQA Guidelines, May 2017, Water Neutrality Policy, The Rio School District will maintain ownership of 11.675 AFY to meet the school facility needs in addition to the 6.089 transferred to the Rio School District commercial office building. The Rio School District expects the remaining allocation will be adequate to provide their water needs along with their current services connections to United Water Conservation District and City of Oxnard water lines. Although Fox Canyon GMA is currently in the process of revising their allocation transfer program as part of the SGMA work, they are aware this M&I to M&I transfer request will soon be submitted. The co-applicants will submit application and documents, including this letter, to Fox Canyon GMA to initiate the formal transfer process upon City of Oxnard approval of the proposed project water demand and allocation transfer.

Please contact us if you have any questions.

Sincerely,

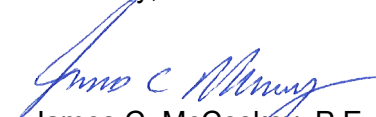
  
James C. McCoskey, P.E.  
Senior Civil Engineer I  
Jensen Design & Survey, Inc.



**Mosaic**

	# Units	S.F.	PPL per Unit**	People Extended	Total People	Meter 1 (gal./day)	Meter 2 (gal./day)	Ave. Total Use (gal./day)	90% Occupancy # People	Ave. Per Person (gal./day)
1 - Bedroom*	144	730-745	2	288	528	9896	11879	21775	475.2	45.82
2 - Bedroom	80	988-1096	3	240						
224					City Data Between Jan. 2017 & Aug. 2018					
					Assumed 90% Occupied					

**Rio Urbana**

	# Units	S.F.	PPL per Unit**	People Extended	Total People	Demand from Mosaic (gal./day/person)	Rio Urbana Demand (AFY)	20% Contingency	Total Rio Urbana Demand (AFY)
1 - Bedroom	5	841	2	10	543	45.82	27.87	5.57	<b>33.45</b>
2 - Bedroom	115	901-1192	3	345					
3 - Bedroom	47	N/A	4	188					
167					Assumed 100% Occupied				

\* Mosaic has 5 units that are studio units

\*\* Per California Plumbing Code

Jensen Design & Survey, Inc.

4/2/2019