



Memorandum

To: Amber Sharpe, David J. Powers & Associates, Inc.
From: Robert Del Rio, T.E.
Huy Tran, T.E.
Date: March 29, 2019
Subject: Carpenters Training Center Trip Generation and Operations Analysis

Hexagon Transportation Consultants, Inc. has completed a trip generation and operations analysis for the proposed Carpenters Training Center located at 18640 Madrone Parkway, Morgan Hill, CA. The proposed project site is currently vacant and located on the northeast quadrant of the Madrone Parkway and Lightpost Way intersection. Carpenters is currently operating a training center in the project vicinity located at 485 Woodview Avenue. The proposed project will consist of a new 55,000-square-foot training facility that will replace the existing 34,000-square-foot Woodview Avenue training facility and increase the enrollment from 100 to 150 students per day. The project site location and the surrounding study area are shown on Figure 1. The project site plan is shown on Figure 2

Scope of Study

The purpose of the trip generation and operations analysis is to evaluate the magnitude of traffic that would be added to the roadway system due to the proposed project and to determine whether a comprehensive traffic study is required for the proposed project. The analysis consists of an evaluation of trip generation and peak-hour intersection level of service analysis at intersections in the immediate vicinity of the project site. In addition, per CMP guidelines, an evaluation to document that the proposed project would not add traffic equal to at least one percent of capacity of any freeway segments area was completed. Traffic conditions were evaluated for the following scenarios:

Existing Conditions. Existing conditions were represented by existing peak-hour traffic volumes on the existing roadway network. Existing traffic volumes were obtained from peak-hour turning-movement counts conducted in May 2018 and February 2019.

Existing Plus Project Conditions. Existing plus project peak-hour traffic volumes were estimated by adding to the existing traffic volumes the additional traffic that would be generated by the proposed project. Existing plus project conditions were evaluated relative to existing conditions in order to determine the effects of the proposed project on existing traffic conditions.

Year 2025 Cumulative Conditions. Year 2025 Cumulative conditions represent future traffic volumes on the future transportation network. Year 2025 Cumulative conditions include traffic growth projected to occur in the Year 2025 without the proposed project.

Year 2025 Cumulative with Project Conditions. Year 2025 Cumulative with project consists of Year 2025 Cumulative traffic conditions with the addition of project traffic.

Project Trip Generation Estimates

The magnitude of traffic produced by a new development is typically estimated by applying the size of the project to the applicable trip generation rates contained in the Institute of Transportation Engineers (ITE) *Trip Generation Manual 10th Edition*.

However, since the proposed project consists of the replacement of the existing Carpenters Training Center in the vicinity of the project site and will include similar site uses, trip generation of the proposed project was estimated utilizing trip generation rates developed based on driveway counts at the existing training facility. The driveway counts were completed on Thursday, February 14, 2019. For comparison, and validation purposes, the trip estimates based on the driveway counts were compared with those estimated using ITE trip rates for light industrial uses.

Classes at the existing Carpenters Training Center begin at 7:00 AM and end at 4:30 PM. Therefore, all students and staff arrive before the typical morning commute period of 7:00-9:00 AM and depart just after 4:30 PM, which is during the typical evening commute period between 4:00-6:00 PM. However, as a conservative approach, the morning peak-hour trips of the training center were used for the typical 7:00-9:00 AM peak-hour analysis. In addition, trips from the existing Carpenters Training Center were not subtracted from the trips estimated for the proposed new training facility since the existing facility can be re-occupied by other users.

The comparison of trip generation estimates based on the driveway counts with those estimated using ITE trip rates indicated that the use of the rates established based on the driveway counts of the existing training facility would result in estimated trips for the proposed project that are greater than those estimated using the ITE rates. Therefore, trip rates based on driveway counts at the existing facility were used to estimate trips for the proposed project since they are more reflective of the expected mode of travel of students and staff associated with the proposed new and expanded facility.

Using trip rates derived from the driveway counts, it is estimated that the proposed project will generate 138 trips (135 inbound and 3 outbound) during the AM peak hour and 137 trips (2 inbound and 135 outbound) during the PM peak hour. The trip generation estimates for proposed project are presented in Table 1.

The directional distribution of site-generated traffic to and from the project area for the proposed training center was estimated based on information obtained from Carpenters regarding the existing student and staff population (current zip codes), existing travel patterns, and the location of complementary land uses. The peak-hour project trips associated with the proposed project were added to the transportation network in accordance with the distribution pattern discussed above. Figures 1 and 3 show the project trip distribution and assignment of project trips at the study intersections, respectively.

Year 2025 Project Trip Generation Estimates

Peak hour project trips associated with the adopted General Plan land uses for the project site are included within the 2035 General Plan forecasts and traffic volumes. However, the land uses assumed for the project site as part of the General Plan are general in nature (20,000 s.f. of industrial space, 2,000 s.f. of office space, and 2,000 s.f. of retail space). The proposed project now provides for a site-specific development plan with defined land use types. Therefore, the development of Year 2025 with Project Cumulative traffic volumes involved adjusting the Year 2025 cumulative traffic volumes to reflect the proposed development plan.

Hexagon prepared trip estimates for the project site land uses included in the City's GP traffic model and the proposed development plan. The land use of the proposed development plan is of greater

intensity than those assumed in the General Plan. The proposed development plan would result in 120 more AM peak hour trips and 114 more PM peak hour trips at the project site when compared with the land uses included in the City's current General Plan. The net new project trip generation under Year 2035 General Plan conditions are presented in Table 2.

Intersection Level of Service Analysis

Traffic conditions at the study intersections were analyzed for the weekday AM and PM peak hours of traffic. The weekday AM peak hour of traffic generally falls within the 7:00 to 9:00 AM period and the weekday PM peak hour is typically in the 4:00 to 6:00 PM period. It is during these times that the most congested traffic conditions occur on a typical weekday.

Signalized Intersection Analysis

The City of Morgan Hill level of service methodology is TRAFFIX, which is based on the 2000 *Highway Capacity Manual* (HCM) method for signalized intersections. TRAFFIX evaluates signalized intersections operations based on average delay time for all vehicles at the intersection. Since TRAFFIX is also the CMP-designated intersections level of service methodology, the City of Morgan Hill methodology employs the CMP defaults values for the analysis parameters, which include adjusted saturation flow rates to reflect conditions in Santa Clara County. All intersections within the City of Morgan Hill are required to meet the City's LOS standard of LOS D, with the exception of the following:

- **LOS F** for Downtown intersections and segments including at Main/Monterey, along Monterey Road between Main and Fifth Street, and along Depot Street at First through Fifth Street;
- **LOS E** for the following intersections and freeway zones:
 - Main Avenue and Del Monte Avenue
 - Main Avenue and Depot Street
 - Dunne Avenue and Del Monte Avenue
 - Dunne Avenue and Monterey Avenue
 - Dunne Avenue and Church Street
 - Dunne Avenue and Depot Street
 - Cochrane Road and Monterey Road
 - Tennant Avenue and Monterey Road
 - Tennant Avenue and Butterfield Boulevard
 - Cochrane Road Freeway Zone: from Madrone Parkway/Cochrane Plaza to Cochrane Road/DePaul Drive
 - Dunne Avenue Freeway Zone: from Walnut Grove Drive/East Dunne Avenue to Condit Road/East Dunne Avenue
 - Tennant Avenue Freeway Zone: from Butterfield Boulevard/Tennant Avenue to Condit Road/Tennant Avenue

According to the City of Morgan Hill level of service guidelines, a development is said to create a significant adverse impact on traffic conditions at a signalized intersection if for either peak hour:

1. The level of service at the intersection degrades from an acceptable level (LOS D or LOS E as identified above) under existing conditions to an unacceptable level (LOS E or F) under project conditions, or
2. The level of service at the intersection is an unacceptable level (LOS E or F as identified above) under existing conditions and the addition of project trips causes the average critical delay to increase by four (4) or more seconds *and* the volume-to-capacity ratio (V/C) to increase by 0.01.

An exception to this rule applies when the addition of project traffic reduces the amount of average delay for critical movements (i.e., the change in average delay for critical movements is negative). In this case, the threshold of significance is an increase in the critical V/C value by 0.01 or more.

Level of Service Results

The results of the intersection level of service analysis show that all of the study intersections currently operate and are projected to continue to operate at acceptable LOS C or better conditions under existing plus project and Year 2025 Cumulative with project conditions during the AM and PM peak hours (See Table 3). Therefore, the project would not have a significant impact at any of the intersections.

Freeway Segment Analysis

The results of the CMP freeway level of service analysis under existing plus project conditions are summarized in Table 4. Traffic volumes on the study freeway segments under existing plus project conditions were estimated by adding project trips to the existing volumes obtained from the 2016 CMP Annual Monitoring Report. The results show that the project would not cause an increase in traffic volumes of one percent or more of freeway capacity on any freeway segments currently operating at an unacceptable LOS F, nor would the addition of project traffic result in the degradation of LOS on any freeway segment currently operating at an acceptable LOS E to an unacceptable LOS F. Therefore, based on CMP impact criteria, the proposed project would not have a significant impact on freeways.

Site Access

The evaluation of site access is based on the January 28, 2019 site plan prepared by RMW Architecture and Interiors. Site access was evaluated to determine the adequacy of the site's access points with regard to the following: traffic volume, geometric design, and sight distance.

The project site is proposed to be served by two driveways at the 90-degree curve on Madrone Parkway as shown in Figure 2.

Driveway Design

The City of Morgan Hill Design Standards specify a minimum width of 16 feet and maximum width of 36 feet for commercial/industrial driveways. The site plan indicates that one driveway is proposed to be approximately 25 feet wide and the other to be approximately 31 feet wide. Therefore, the dimensions of the two driveways meet the City's standards.

Sight Distance

Adequate sight distance will be required at each of the project driveways. The project driveways should be free and clear of any obstructions to provide adequate sight distance, thereby ensuring that exiting vehicles can see pedestrians on the sidewalk and other vehicles traveling on Madrone Parkway. Any landscaping and signage should be located in such a way to ensure an unobstructed view for drivers exiting the site.

Adequate sight distance (sight distance triangles) should be provided at the project driveways in accordance with the *American Association of State Highway Transportation Officials (AASHTO)* standards. Sight distance triangles should be measured approximately 10 feet back from the traveled way. Providing the appropriate sight distance reduces the likelihood of a collision at a driveway or intersection and provides drivers with the ability to exit a driveway and locate sufficient gaps in traffic flow. The minimum acceptable sight distance is often considered the AASHTO stopping sight distance.

Sight distance requirements vary depending on the roadway speeds. The posted speed limit along Madrone Parkway is 35 miles per hour (mph). The AASHTO stopping sight distance for a facility with a posted speed limit of 35 mph is 250 feet. Thus, a driver exiting the project driveways must be able to see 250 feet in both directions along Madrone Parkway.

Based on the project site plan and observations in the field, vehicles exiting the project site driveways can see more than 250 in both directions on Madrone Parkway. Therefore, it can be concluded that each of the project driveways would meet the AASHTO minimum stopping sight distance standards.

Project Driveway Operations

Based on the project trip generation and trip assignment, it is estimated that a maximum of 96 trips would enter and exit the site at the project driveways during the AM and PM peak hours. The estimated project trips at each of the project driveways is shown on Figure 3. Based on the relatively low traffic volumes on Madrone Parkway, operational issues are not expected to occur at the project driveways on Madrone Parkway.

Transit, Pedestrian and Bicycle Analysis

The project site is not directly served by any transit services. However, three VTA bus routes run along Cochrane Road with bus stops near the intersection of Sutter Boulevard and Cochrane Road, which is approximately 0.4 of a mile from the project site. A typical mode split in Morgan Hill would be a three percent transit share. Assuming up to three percent transit mode share for the project equates to no more than four transit riders during each of the peak hours. The transit ridership demands of the proposed project can be accommodated by the existing transit facilities.

Pedestrian generators in the project vicinity include the retail land uses and bus stops along Cochrane Road. Madrone Parkway has sidewalks on both sides of the street and would provide a safe connection for pedestrians between the project site and other surrounding land uses in the area.

There are several bike lanes and bike paths in the vicinity of the project site. Bike lanes are provided along the entire lengths of Cochrane Road, Butterfield Boulevard, and Sutter Boulevard. It is expected that bicycle trips would comprise no more than one percent of the total project-generated trips. Thus, the project could potentially generate no more than one new bicycle trip during each of the peak hours. The demand generated by the proposed project could be accommodated by the existing bicycle facilities in the vicinity of the project site.

Traffic Study Requirements

The need for the preparation of a comprehensive traffic impact analysis for a particular development is based on its estimated trip generation and its effect on surrounding transportation facilities. The City of Morgan Hill requires the completion of a full traffic impact analysis if one of the following criteria are met:

1. Generates 100 or more net new peak hour trips; except that projects located in the 14-block Downtown Core area are exempt from this requirement. Net new peak hour trips are defined as the number of trips generated by the proposed development minus trips generated by existing development on the project site. (This threshold is consistent with the Valley Transportation Authority (VTA) policy.)
2. Adds 50 to 99 net new peak hour trips to the roadway system where nearby intersections are currently operating at or below the City's LOS standard, or projected to operate at or below the City's LOS standard with traffic added by approved developments; except that projects located

in the 14-block Downtown Core area are exempt from this requirement. Adjacent or nearby intersections are defined as intersections to which the proposed development or proposed land use change adds 10 or more vehicle peak hour trips per lane.

3. Creates a transportation issue that City staff requests to have analyzed.

The proposed project will result in the addition of 138 AM peak hour trips and 137 PM peak hour trips to the roadway system under existing plus project conditions.

However, a review of intersection levels of service at the selected study intersections indicates that all study intersections are currently and are projected to continue to operate at acceptable conditions during each of the peak hours. The addition of project traffic at each of the study intersections would not result in a significant impact based on the City's impact criteria. Additionally, the freeway segment analysis indicates that the project is not projected to add one percent to any freeway segments in the area.

Therefore, the evaluation of trip generation and intersection operations concludes that the proposed project will not result in significant impacts to intersections or freeway segments in the project area. However, City staff ultimately determines the need for traffic studies for new development.

Figure 1
Site Location, Study Intersections, and Project Trip Distribution

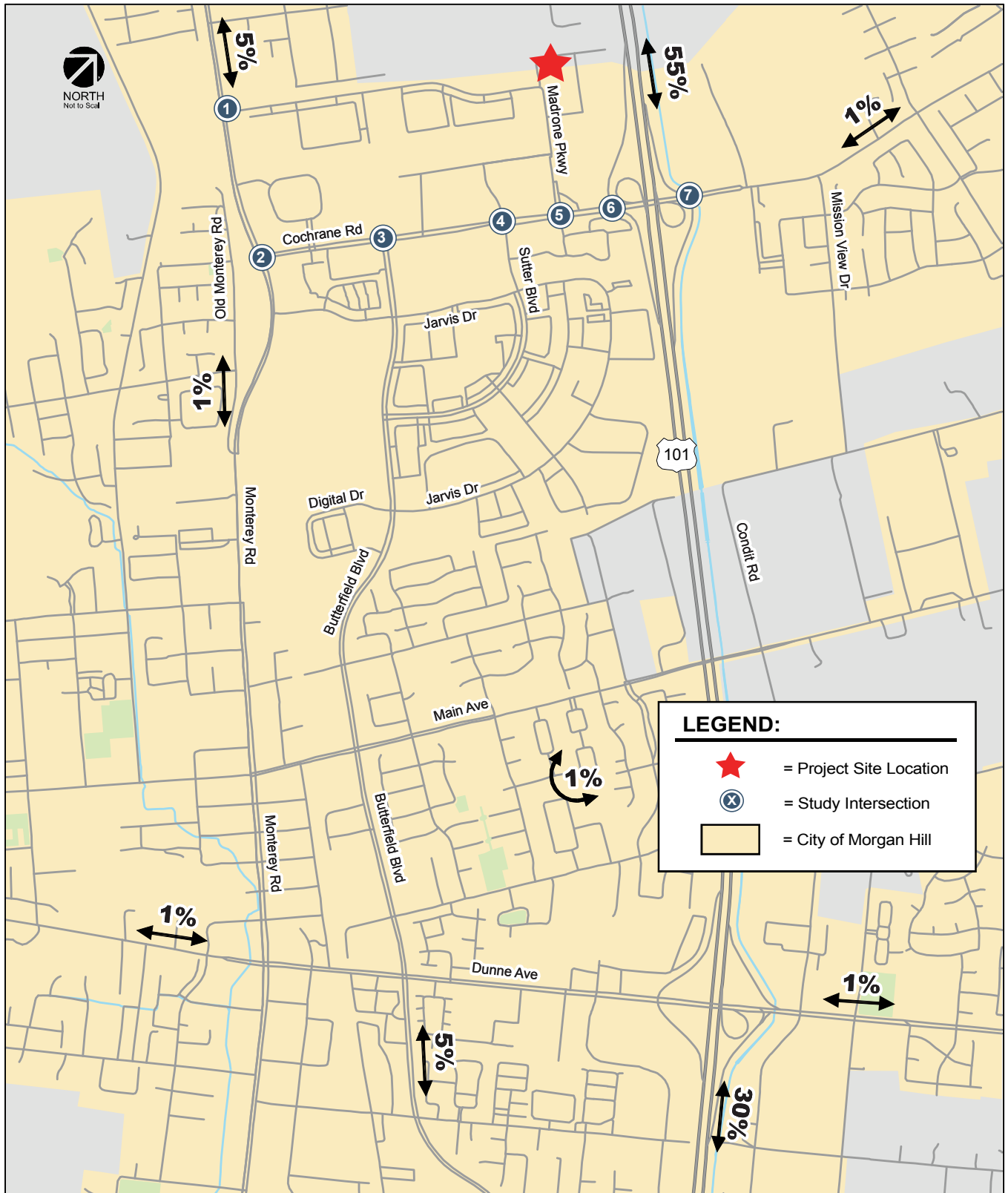
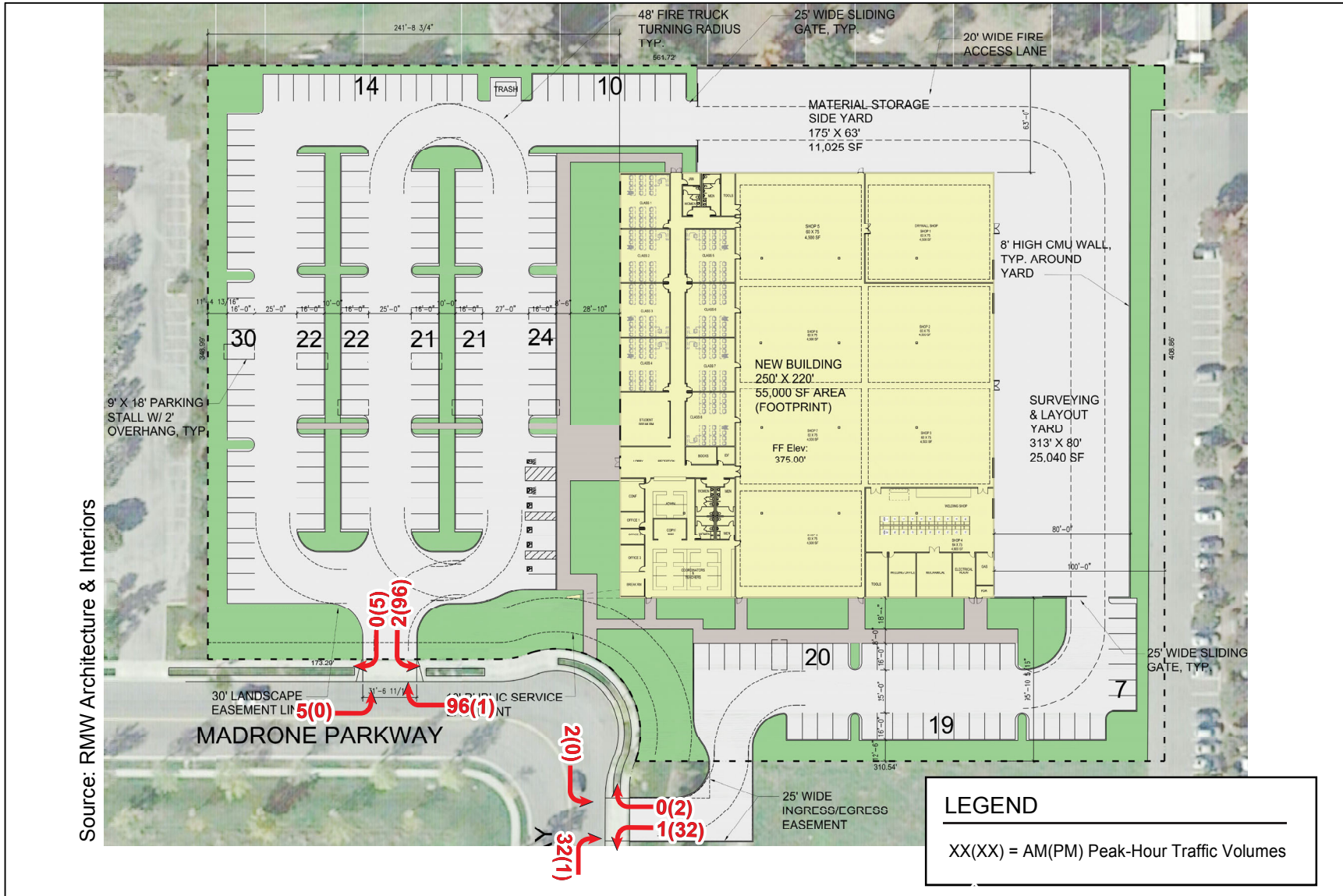

Figure 2
Site Plan and Project Trips at Site Access Points



Source: RMW Architecture & Interiors

**Table 1
Project Trip Generation Estimates**

Land Use	Size	AM Peak Hour ²						PM Peak Hour					
		Rate	Split		Trip			Rate	Split		Trip		
			In	Out	In	Out	Total		In	Out	In	Out	Total
Trip Generation Counts¹													
Existing Carpenters Training Center	100 Students	0.92	98%	2%	90	2	92	0.91	1%	99%	1	90	91
Estimate of Project Traffic Based on Trip Generation Counts													
Proposed Carpenters Training Center	150 Students	0.92	98%	2%	135	3	138	0.91	1%	99%	2	135	137
Estimate of Project Traffic Based on ITE Rates (for Comparison Purposes)													
General Light Industrial (ITE LU 110) ³	55,000 Square Feet	0.70	88%	12%	34	5	39	0.63	13%	87%	5	30	35
Notes:													
¹ Driveway counts at the existing Carpenters Training Center located at 485 Woodview Avenue were collected on February 14, 2019.													
² Classes at the existing facility began at 7:00 AM and ended 4:30 PM on the count day. Therefore, the AM peak-hour trips shown represent traffic that arrived prior to the typical AM peak commute period (7:00 - 9:00 AM).													
³ ITE Trip Generation Manual, 10 th Edition 2017													

**Table 2
General Plan Project Trip Generation Estimates**

Land Use	ITE Land Use Code ²	Size	AM Peak Hour						PM Peak Hour					
			Rate	Split		Trip			Rate	Split		Trip		
				In	Out	In	Out	Total		In	Out	In	Out	Total
Proposed Land Use														
Carpenters Training Center ¹	--	150 Students	0.92	98%	2%	135	3	138	0.91	1%	99%	2	135	137
Approved Land Uses³														
General Light Industrial	110	20,000 Square Feet	0.70	88%	12%	12	2	14	0.63	13%	87%	2	11	13
Shopping Center	820	2,000 Square Feet	0.94	62%	38%	1	1	2	3.81	48%	52%	4	4	8
General Office Building	710	2,000 Square Feet	1.16	86%	14%	2	0	2	1.15	16%	84%	0	2	2
Sub-Total						15	3	18				6	17	23
Net Change (Proposed - Approved Uses)						120	0	120				-4	118	114
Notes:														
¹ Based on driveway counts of the existing Carpenters Training Center located at 485 Woodview Avenue collected on February 14, 2019.														
² ITE Trip Generation Manual, 10 th Edition 2017														
³ Approved land uses for the project site were obtained from the 2035 General Plan.														

**Figure 3
Proposed Project Trip Assignment**

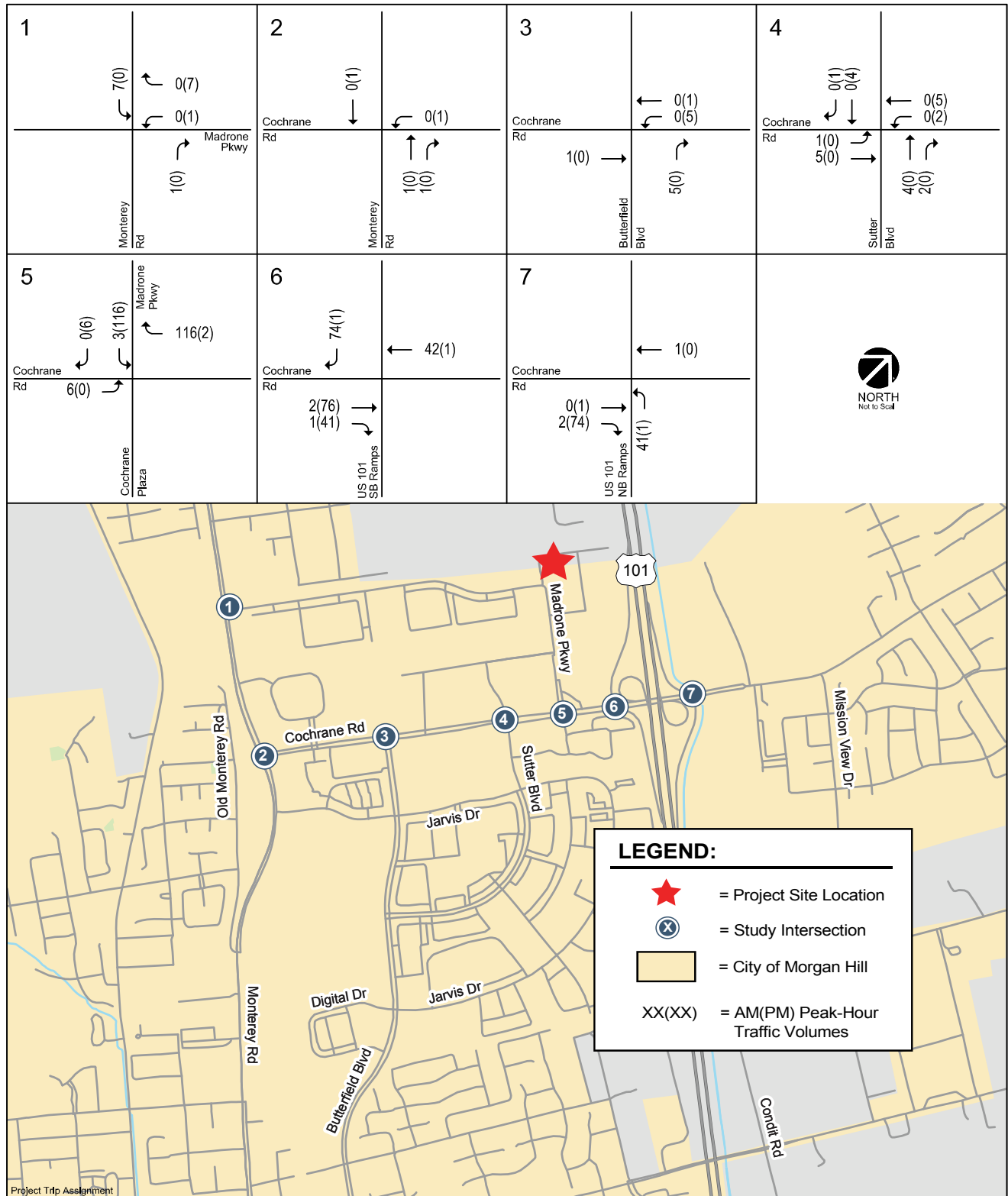

Table 3
Intersection Level of Service Summary

Int. #	Intersection	LOS Standard	Peak Hour	Count Date	Existing		Existing Plus Project				Cumulative		Cumulative Plus Project			
					Avg. Delay	LOS	Avg. Delay	LOS	Incr. In Crit. Delay	Incr. In Crit. V/C	Avg. Delay	LOS	Avg. Delay	LOS	Incr. In Crit. Delay	Incr. In Crit. V/C
1	Monterey Road and Madrone Parkway	D	AM	02/28/19	9.4	A	9.6	A	0.3	0.005	13.0	B	13.2	B	0.3	0.004
			PM	02/28/19	9.8	A	9.8	A	0.0	0.001	14.2	B	14.2	B	0.0	0.000
2	Monterey Road and Cochrane Road	E	AM	05/08/18	28.1	C	28.1	C	0.0	0.000	26.9	C	26.9	C	0.0	0.000
			PM	05/08/18	24.0	C	24.0	C	0.0	0.000	27.2	C	27.2	C	0.0	0.000
3	Butterfield Boulevard and Cochrane Road	D	AM	05/08/18	12.8	B	12.8	B	0.0	0.000	21.1	C	21.1	C	0.0	0.000
			PM	05/08/18	14.7	B	14.8	B	0.1	0.003	27.8	C	27.8	C	0.0	0.001
4	Sutter Boulevard and Cochrane Road	D	AM	05/08/18	17.6	B	17.6	B	0.0	0.001	17.4	B	17.4	B	0.0	0.000
			PM	05/08/18	18.3	B	18.3	B	0.1	0.003	21.9	C	21.9	C	0.0	0.000
5	Madrone Parkway/Cochrane Plaza and Cochrane Road	E	AM	05/08/18	19.1	B	18.8	B	-0.2	0.084	18.5	B	18.6	B	0.1	0.001
			PM	05/08/18	31.4	C	32.9	C	1.3	0.036	29.1	C	31.0	C	1.9	0.035
6	US 101 SB Ramps and Cochrane Road	E	AM	05/08/18	12.8	B	13.1	B	0.2	0.024	14.2	B	14.7	B	0.4	0.023
			PM	05/08/18	16.5	B	16.5	B	0.3	0.022	19.9	B	20.3	C	1.0	0.020
7	US 101 NB Ramps and Cochrane Road	E	AM	05/08/18	8.6	A	9.0	A	0.3	0.014	10.4	B	10.8	B	0.3	0.012
			PM	05/08/18	11.3	B	11.3	B	0.0	0.001	12.1	B	12.1	B	0.0	0.000

**Table 4
Freeway Segment Level of Service Summary**

#	Freeway Segment	Direction	Peak Hour	Existing Plus Project											Project Trip				
				Mixed-Flow Lane						HOV Lane					Mixed-Flow Lane		HOV Lane		
				Avg. Speed ¹	# of Lanes ¹	Capacity (vph)	Volume	Density	LOS	Avg. Speed ¹	# of Lanes ¹	Capacity (vph)	Volume	Density	LOS	Volume	% of Capacity	Volume	% of Capacity
1	US 101 from Masten Avenue to San Martin Avenue	NB	AM	66	3	6,900	4,801	24	C	--	--	--	--	--	41	0.59	--	--	
		NB	PM	67	3	6,900	3,201	16	B	--	--	--	--	--	1	0.01	--	--	
2	US 101 from San Martin Avenue to Tennant Avenue	NB	AM	20	3	6,900	5,021	84	F	--	--	--	--	--	41	0.59	--	--	
		NB	PM	67	3	6,900	3,401	17	B	--	--	--	--	--	1	0.01	--	--	
3	US 101 from Tennant Avenue to East Dunne Avenue	NB	AM	16	3	6,900	4,461	93	F	--	--	--	--	--	41	0.59	--	--	
		NB	PM	66	3	6,900	4,361	22	C	--	--	--	--	--	1	0.01	--	--	
4	US 101 from East Dunne Avenue to Cochrane Road	NB	AM	41	3	6,900	6,321	51	E	--	--	--	--	--	41	0.59	--	--	
		NB	PM	66	3	6,900	3,771	19	C	--	--	--	--	--	1	0.01	--	--	
5	US 101 from Cochrane Road to Burnett Avenue (Lane Drop)	NB	AM	64	3	6,900	6,152	32	D	66	1	1,650	1,520	23	C	2	0.03	0	0.00
		NB	PM	66	3	6,900	4,622	23	C	70	1	1,650	852	12	B	62	0.90	12	0.73
6	US 101 from Burnett Avenue (Lane Drop) to Sheller Avenue	NB	AM	65	3	6,900	6,051	31	D	62	1	1,650	2,171	35	D	1	0.01	1	0.06
		NB	PM	43	3	6,900	6,395	50	E	70	1	1,650	849	12	B	65	0.94	9	0.55
7	US 101 from Sheller Avenue to Lane Drop (SB)	NB	AM	66	3	6,900	5,311	27	D	65	1	1,650	1,951	30	D	1	0.01	1	0.06
		NB	PM	66	3	6,900	3,828	19	C	70	1	1,650	1,066	15	B	58	0.84	16	0.97
8	US 101 from Lane Drop (SB) to SR 85	NB	AM	66	3	6,900	4,562	23	C	67	1	1,650	1,140	17	B	2	0.03	0	0.00
		NB	PM	67	3	6,900	3,665	18	B	70	1	1,650	499	7	A	65	0.94	9	0.55
9	US 101 from SR 85 to Lane Drop (SB)	SB	AM	67	4	9,200	4,055	15	B	67	1	1,650	549	8	A	65	0.71	9	0.55
		SB	PM	66	4	9,200	5,021	19	C	70	1	1,650	1,470	21	C	1	0.01	0	0.00
10	US 101 from Lane Drop (SB) to Sheller Avenue	SB	AM	67	3	6,900	3,460	17	B	67	1	1,650	824	12	B	60	0.87	14	0.85
		SB	PM	48	3	6,900	6,481	45	D	50	1	1,650	2,400	48	E	1	0.01	0	0.00
11	US 101 from Sheller Avenue to Burnett Avenue (Lane Drop)	SB	AM	67	3	6,900	3,263	16	B	67	1	1,650	551	8	A	63	0.91	11	0.67
		SB	PM	30	3	6,900	5,761	64	F	40	1	1,650	2,440	61	F	1	0.01	0	0.00
12	US 101 from Burnett Avenue (Lane Drop) to Cochrane Road	SB	AM	67	3	6,900	3,474	17	B	--	--	--	--	--	74	1.07	--	--	
		SB	PM	19	3	6,900	4,791	84	F	--	--	--	--	--	1	0.01	--	--	
13	US 101 from Cochrane Road to East Dunne Avenue	SB	AM	67	3	6,900	3,001	15	B	--	--	--	--	--	1	0.01	--	--	
		SB	PM	42	3	6,900	6,341	50	E	--	--	--	--	--	41	0.59	--	--	
14	US 101 from East Dunne Avenue to Tennant Avenue	SB	AM	67	3	6,900	3,601	18	B	--	--	--	--	--	1	0.01	--	--	
		SB	PM	42	3	6,900	6,341	50	E	--	--	--	--	--	41	0.59	--	--	
15	US 101 from Tennant Avenue to San Martin Avenue	SB	AM	67	3	6,900	2,801	14	B	--	--	--	--	--	1	0.01	--	--	
		SB	PM	36	3	6,900	6,201	57	E	--	--	--	--	--	41	0.59	--	--	
16	US 101 from San Martin Avenue to Masten Avenue	SB	AM	67	3	6,900	2,601	13	B	--	--	--	--	--	1	0.01	--	--	
		SB	PM	47	3	6,900	6,531	46	D	--	--	--	--	--	41	0.59	--	--	

¹ Source: Santa Clara Valley Transportation Authority Congestion Management Program Monitoring Study, 2016.
Bold indicates unacceptable LOS.

**Carpenters Training Center Expansion Trip
Generation and Operations Analysis
Technical Appendices**

March 29, 2019

Appendix A

Traffic Counts

Hexagon Transportation Consultants, Inc.

8070 Santa Teresa Boulevard, Suite 230
 Gilroy, CA 95020
 Phone 408-840-7410

Carpenters Training Center Trip Generation Counts

Date: 2/14/2019
 Counter: Huy
 Intersection Name: Carpenters Training Center
 Weather: Clear Morgan Hill

Start Time	IN	OUT	TOTAL
Before 7:00	90	2	92
7:00	0	0	0
7:15	2	0	2
7:30	0	1	1
7:45	1	0	1
8:00	0	0	0
8:15	1	0	1
8:30	0	2	2
8:45	0	0	0
4:00	1	1	2
4:15	0	7	7
4:30	0	78	78
4:45	0	4	4
5:00	0	0	0
5:15	0	1	1
5:30	0	0	0
5:45	0	0	0

Maximum Peak-Hour

IN	OUT	TOTAL
90	2	92

1	90	91
---	----	----

Traffic Data Service

San Jose, CA
 (408) 622-4787
 tdsbay@cs.com

File Name : 2AM FINAL
 Site Code : 00000002
 Start Date : 2/28/2019
 Page No : 2

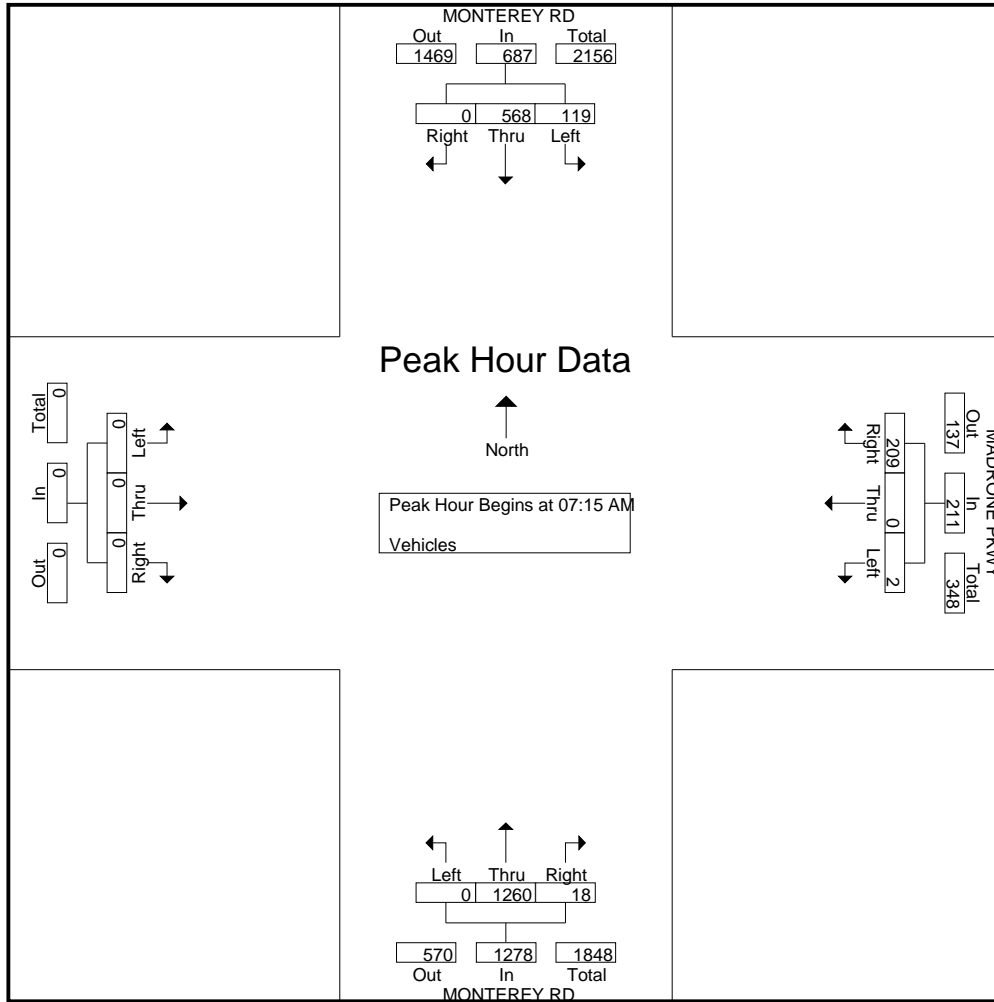

Traffic Data Service

San Jose, CA
(408) 622-4787
 tdsbay@cs.com

File Name : 2PM FINAL
 Site Code : 00000002
 Start Date : 2/28/2019
 Page No : 1

Groups Printed- Vehicles

Start Time	MONTEREY RD Southbound					MADRONE PKWY Westbound					MONTEREY RD Northbound					Eastbound					Int. Total
	Right	Thru	Left	Peds	App. Total	Right	Thru	Left	Peds	App. Total	Right	Thru	Left	Peds	App. Total	Right	Thru	Left	Peds	App. Total	
04:00 PM	0	496	60	0	556	36	0	1	1	38	6	102	0	0	108	0	0	0	0	0	702
04:15 PM	0	505	88	0	593	41	0	4	0	45	5	109	0	0	114	0	0	0	0	0	752
04:30 PM	0	521	69	0	590	38	0	7	0	45	1	121	0	0	122	0	0	0	0	0	757
04:45 PM	0	510	57	0	567	28	0	5	0	33	3	76	0	0	79	0	0	0	0	0	679
Total	0	2032	274	0	2306	143	0	17	1	161	15	408	0	0	423	0	0	0	0	0	2890
05:00 PM	0	469	67	0	536	41	0	5	0	46	0	104	0	0	104	0	0	0	0	0	686
05:15 PM	0	484	73	0	557	44	0	6	0	50	5	101	0	0	106	0	0	0	0	0	713
05:30 PM	0	489	74	0	563	34	0	8	0	42	4	97	0	0	101	0	0	0	0	0	706
05:45 PM	0	425	47	0	472	25	0	7	0	32	3	94	0	0	97	0	0	0	0	0	601
Total	0	1867	261	0	2128	144	0	26	0	170	12	396	0	0	408	0	0	0	0	0	2706
Grand Total	0	3899	535	0	4434	287	0	43	1	331	27	804	0	0	831	0	0	0	0	0	5596
Apprch %	0	87.9	12.1	0		86.7	0	13	0.3		3.2	96.8	0	0		0	0	0	0	0	
Total %	0	69.7	9.6	0	79.2	5.1	0	0.8	0	5.9	0.5	14.4	0	0	14.8	0	0	0	0	0	

Start Time	MONTEREY RD Southbound					MADRONE PKWY Westbound					MONTEREY RD Northbound					Eastbound					Int. Total
	Right	Thru	Left	Peds	App. Total	Right	Thru	Left	Peds	App. Total	Right	Thru	Left	Peds	App. Total	Right	Thru	Left	Peds	App. Total	
Peak Hour Analysis From 04:00 PM to 05:45 PM - Peak 1 of 1																					
Peak Hour for Entire Intersection Begins at 04:00 PM																					
04:00 PM	0	496	60		556	36	0	1		37	6	102	0		108	0	0	0		0	701
04:15 PM	0	505	88		593	41	0	4		45	5	109	0		114	0	0	0		0	752
04:30 PM	0	521	69		590	38	0	7		45	1	121	0		122	0	0	0		0	757
04:45 PM	0	510	57		567	28	0	5		33	3	76	0		79	0	0	0		0	679
Total Volume	0	2032	274		2306	143	0	17		160	15	408	0		423	0	0	0		0	2889
% App. Total	0	88.1	11.9			89.4	0	10.6			3.5	96.5	0			0	0	0		0	
PHF	.000	.975	.778		.972	.872	.000	.607		.889	.625	.843	.000		.867	.000	.000	.000		.000	.954

Traffic Data Service

San Jose, CA
 (408) 622-4787
 tdsbay@cs.com

File Name : 2PM FINAL
 Site Code : 00000002
 Start Date : 2/28/2019
 Page No : 2

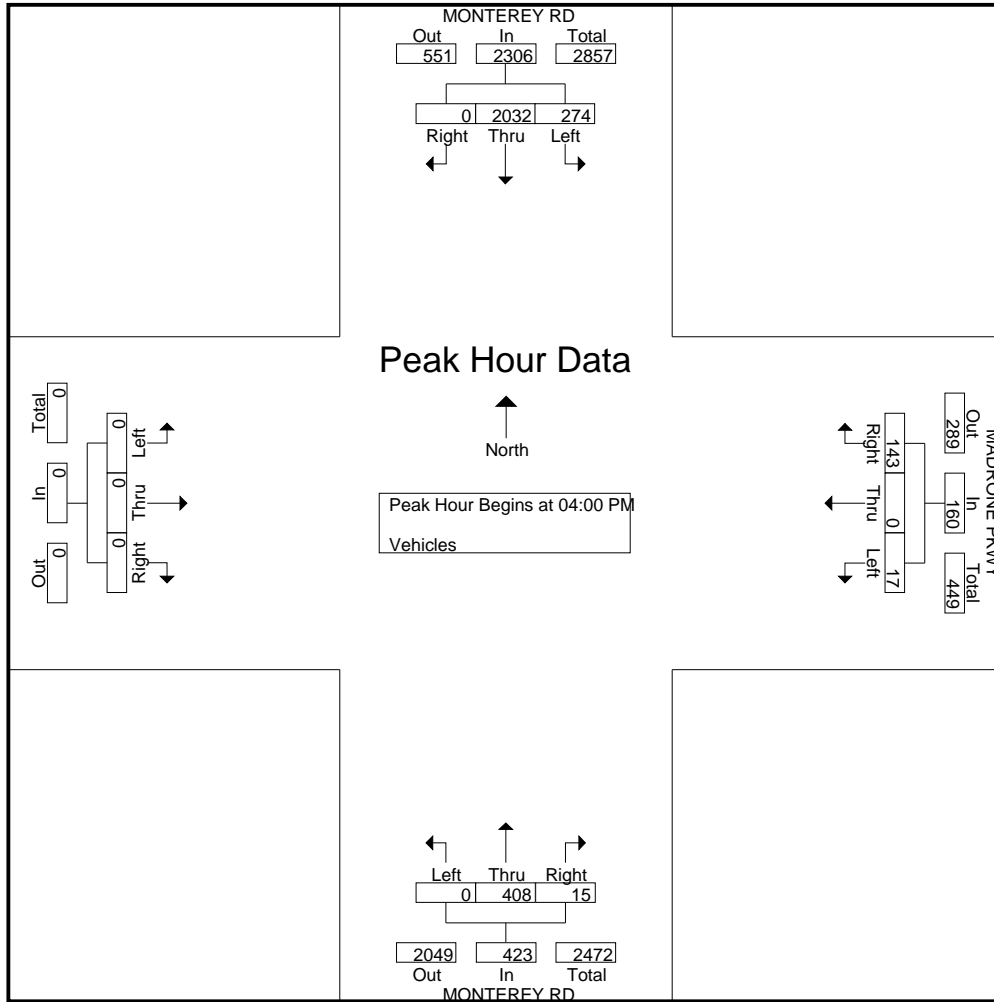



(303) 216-2439
www.alltrafficdata.net

Location: 1 MONTEREY RD & COCHRANE RD AM

Date and Start Time: Tuesday, May 8, 2018

Peak Hour: 07:15 AM - 08:15 AM

Peak 15-Minutes: 07:45 AM - 08:00 AM

Peak Hour - All Vehicles

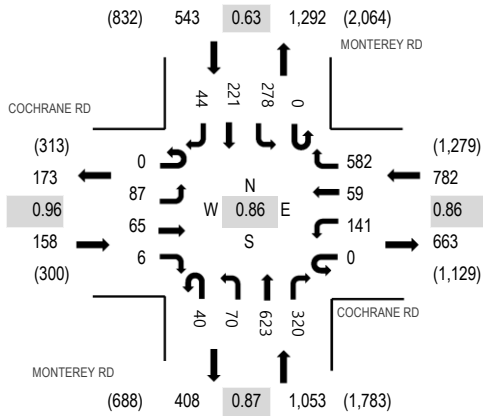

Peak Hour - Pedestrians/Bicycles in Crosswalk

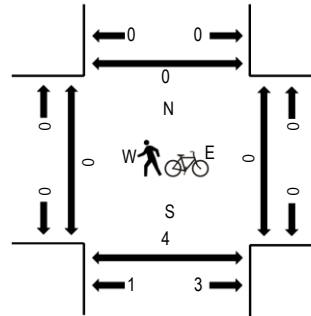

Note: Total study counts contained in parentheses.

Traffic Counts

Interval Start Time	COCHRANE RD Eastbound				COCHRANE RD Westbound				MONTEREY RD Northbound				MONTEREY RD Southbound				Total	Rolling Hour	Pedestrian Crossings			
	U-Turn	Left	Thru	Right	U-Turn	Left	Thru	Right	U-Turn	Left	Thru	Right	U-Turn	Left	Thru	Right			West	East	South	North
7:00 AM	0	21	20	1	0	17	12	107	5	14	134	60	0	29	16	5	441	2,272	0	0	0	0
7:15 AM	0	18	19	0	0	32	8	74	11	18	150	74	0	43	20	11	478	2,536	0	0	2	0
7:30 AM	0	24	17	0	0	28	14	190	10	22	151	77	0	52	24	7	616	2,511	0	0	0	0
7:45 AM	0	20	19	2	0	33	15	179	8	18	180	97	0	79	80	7	737	2,315	0	0	0	0
8:00 AM	0	25	10	4	0	48	22	139	11	12	142	72	0	104	97	19	705	1,922	0	0	1	0
8:15 AM	0	17	21	1	0	37	10	80	8	21	97	76	0	44	30	11	453		0	0	0	0
8:30 AM	0	20	13	3	0	35	12	84	12	16	92	64	0	29	31	9	420		0	0	0	0
8:45 AM	0	10	13	2	0	41	4	58	4	16	52	59	0	38	37	10	344		0	0	0	0

Peak Rolling Hour Flow Rates

Vehicle Type	Eastbound				Westbound				Northbound				Southbound				Total
	U-Turn	Left	Thru	Right	U-Turn	Left	Thru	Right	U-Turn	Left	Thru	Right	U-Turn	Left	Thru	Right	
Articulated Trucks	0	0	0	0	0	0	0	3	0	0	1	1	0	2	0	0	7
Lights	0	87	63	6	0	139	56	571	40	70	616	315	0	263	219	43	2,488
Mediums	0	0	2	0	0	2	3	8	0	0	6	4	0	13	2	1	41
Total	0	87	65	6	0	141	59	582	40	70	623	320	0	278	221	44	2,536



(303) 216-2439
www.alltrafficdata.net

Location: 1 MONTEREY RD & COCHRANE RD PM
Date and Start Time: Tuesday, May 8, 2018
Peak Hour: 04:00 PM - 05:00 PM
Peak 15-Minutes: 04:30 PM - 04:45 PM

Peak Hour - All Vehicles

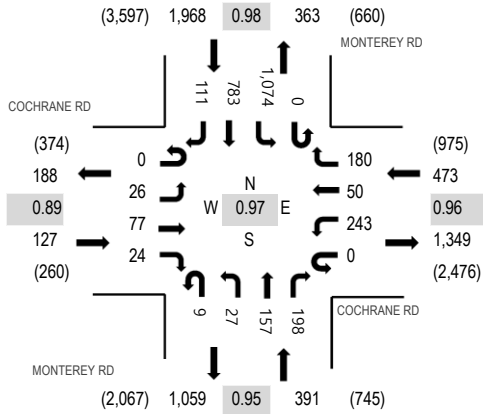

Note: Total study counts contained in parentheses.

Peak Hour - Pedestrians/Bicycles in Crosswalk

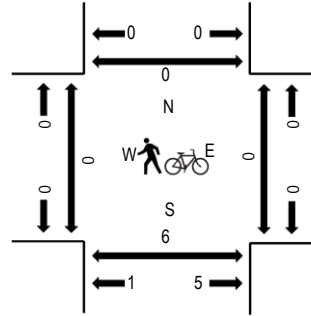

Traffic Counts

Interval Start Time	COCHRANE RD Eastbound				COCHRANE RD Westbound				MONTEREY RD Northbound				MONTEREY RD Southbound				Total	Rolling Hour	Pedestrian Crossings			
	U-Turn	Left	Thru	Right	U-Turn	Left	Thru	Right	U-Turn	Left	Thru	Right	U-Turn	Left	Thru	Right			West	East	South	North
4:00 PM	0	4	18	5	0	67	18	49	2	4	34	54	0	250	189	29	723	2,959	0	0	1	0
4:15 PM	0	9	19	5	0	59	17	45	4	6	43	50	0	269	207	21	754	2,924	0	0	1	0
4:30 PM	0	5	20	6	0	71	11	48	1	12	36	45	0	288	186	30	759	2,868	0	0	0	0
4:45 PM	0	8	20	8	0	46	4	38	2	5	44	49	0	267	201	31	723	2,766	0	0	2	0
5:00 PM	0	9	26	5	0	63	17	49	5	10	23	42	0	232	174	33	688	2,618	0	0	1	0
5:15 PM	0	6	22	5	0	67	12	52	4	10	16	46	0	213	218	27	698		0	0	0	0
5:30 PM	0	5	25	4	0	78	8	40	4	8	35	56	0	213	163	18	657		0	0	0	0
5:45 PM	0	7	16	3	0	71	18	27	3	6	28	58	0	178	141	19	575		0	0	0	0

Peak Rolling Hour Flow Rates

Vehicle Type	Eastbound				Westbound				Northbound				Southbound				Total
	U-Turn	Left	Thru	Right	U-Turn	Left	Thru	Right	U-Turn	Left	Thru	Right	U-Turn	Left	Thru	Right	
Articulated Trucks	0	0	0	0	0	0	0	3	0	0	0	1	0	5	0	0	9
Lights	0	26	76	24	0	243	50	173	9	27	153	195	0	1,062	771	111	2,920
Mediums	0	0	1	0	0	0	0	4	0	0	4	2	0	7	12	0	30
Total	0	26	77	24	0	243	50	180	9	27	157	198	0	1,074	783	111	2,959



(303) 216-2439
www.alltrafficdata.net

Location: 3 BUTTERFIELD BLVD & COCHRANE RD AM

Date and Start Time: Tuesday, May 8, 2018

Peak Hour: 07:30 AM - 08:30 AM

Peak 15-Minutes: 07:45 AM - 08:00 AM

Peak Hour - All Vehicles

Peak Hour - Pedestrians/Bicycles in Crosswalk

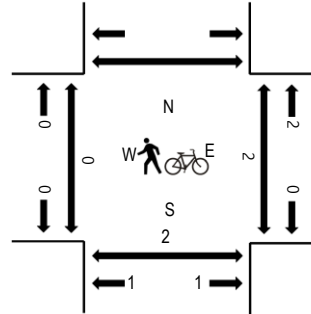
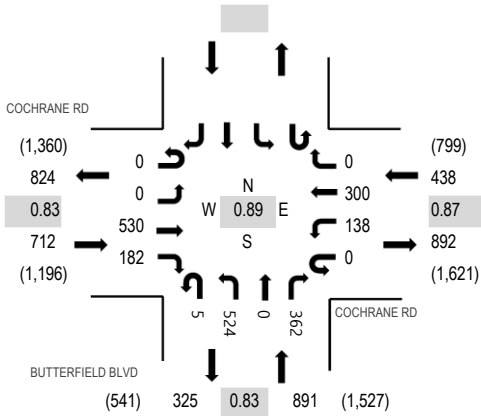

Note: Total study counts contained in parentheses.

Traffic Counts

Interval Start Time	COCHRANE RD Eastbound				COCHRANE RD Westbound				BUTTERFIELD BLVD Northbound				BUTTERFIELD BLVD Southbound				Total	Rolling Hour	Pedestrian Crossings			
	U-Turn	Left	Thru	Right	U-Turn	Left	Thru	Right	U-Turn	Left	Thru	Right	U-Turn	Left	Thru	Right			West	East	South	North
7:00 AM	0	0	114	16	0	23	42	0	0	0	100	0	122									
7:15 AM	0	0	111	17	0	27	61	0	0	0	82	0	107									
7:30 AM	0	0	107	34	0	26	68	0	0	0	176	0	107									
7:45 AM	0	0	171	44	0	39	72	0	0	0	159	0	87									
8:00 AM	0	0	131	52	0	30	76	0	0	0	126	0	100									
8:15 AM	0	0	121	52	0	43	84	0	5	5	63	0	68									
8:30 AM	0	0	90	23	0	39	60	0	1	1	78	0	58									
8:45 AM	0	0	85	28	0	42	67	0	0	0	46	0	42									

Peak Rolling Hour Flow Rates

Vehicle Type	Eastbound				Westbound				Northbound				Southbound				Total
	U-Turn	Left	Thru	Right	U-Turn	Left	Thru	Right	U-Turn	Left	Thru	Right	U-Turn	Left	Thru	Right	
Articulated Trucks	0	0	4	0	0	3	4	0	0	2	0	0					13
Lights	0	0	514	173	0	133	282	0	5	515	0	343					1,965
Mediums	0	0	12	9	0	2	14	0	0	7	0	19					63
Total	0	0	530	182	0	138	300	0	5	524	0	362					2,041



(303) 216-2439
www.alltrafficdata.net

Location: 3 BUTTERFIELD BLVD & COCHRANE RD PM

Date and Start Time: Tuesday, May 8, 2018

Peak Hour: 04:00 PM - 05:00 PM

Peak 15-Minutes: 04:00 PM - 04:15 PM

Peak Hour - All Vehicles

Peak Hour - Pedestrians/Bicycles in Crosswalk

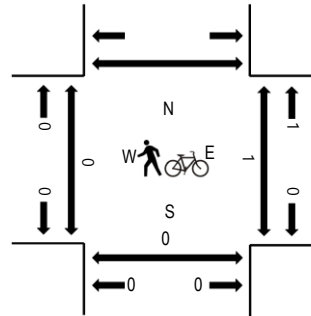
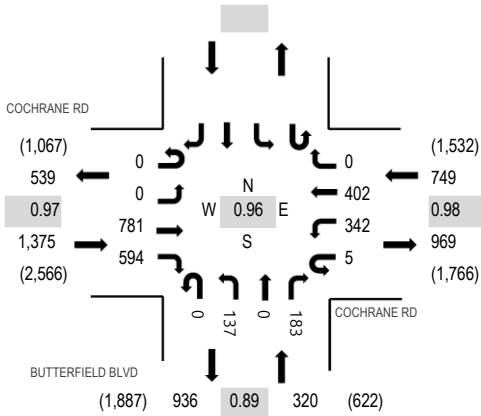

Note: Total study counts contained in parentheses.

Traffic Counts

Interval Start Time	COCHRANE RD Eastbound				COCHRANE RD Westbound				BUTTERFIELD BLVD Northbound				Southbound				Total	Rolling Hour	Pedestrian Crossings			
	U-Turn	Left	Thru	Right	U-Turn	Left	Thru	Right	U-Turn	Left	Thru	Right	U-Turn	Left	Thru	Right			West	East	South	North
4:00 PM	0	0	188	149	1	100	129	0	0	29	0	43	0	0	0	0	639	2,444	0	0	0	
4:15 PM	0	0	184	149	1	79	82	0	0	47	0	42	0	0	0	0	584	2,422	0	0	0	
4:30 PM	0	0	223	130	1	87	112	0	0	39	0	47	0	0	0	0	639	2,436	0	0	0	
4:45 PM	0	0	186	166	2	76	79	0	0	22	0	51	0	0	0	0	582	2,337	0	0	0	
5:00 PM	0	0	171	156	0	93	100	0	0	44	0	53	0	0	0	0	617	2,276	0	1	3	
5:15 PM	0	0	159	157	0	101	98	0	0	33	0	50	0	0	0	0	598		0	0	0	
5:30 PM	0	0	148	128	0	90	107	0	0	28	0	39	0	0	0	0	540		0	0	0	
5:45 PM	0	0	142	130	1	95	98	0	1	20	0	34	0	0	0	0	521		0	0	2	

Peak Rolling Hour Flow Rates

Vehicle Type	Eastbound				Westbound				Northbound				Southbound				Total
	U-Turn	Left	Thru	Right	U-Turn	Left	Thru	Right	U-Turn	Left	Thru	Right	U-Turn	Left	Thru	Right	
Articulated Trucks	0	0	3	2	0	1	4	0	0	1	0	0	0	0	0	0	11
Lights	0	0	768	587	5	332	392	0	0	133	0	176	0	0	0	0	2,393
Mediums	0	0	10	5	0	9	6	0	0	3	0	7	0	0	0	0	40
Total	0	0	781	594	5	342	402	0	0	137	0	183	0	0	0	0	2,444



(303) 216-2439
www.alltrafficdata.net

Location: 5 SUTTER BLVD & COCHRANE RD AM

Date and Start Time: Tuesday, May 8, 2018

Peak Hour: 07:30 AM - 08:30 AM

Peak 15-Minutes: 07:45 AM - 08:00 AM

Peak Hour - All Vehicles

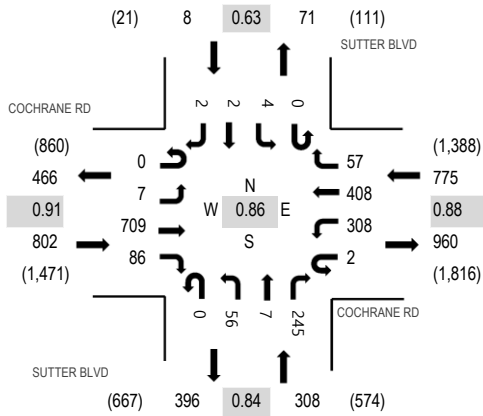

Peak Hour - Pedestrians/Bicycles in Crosswalk

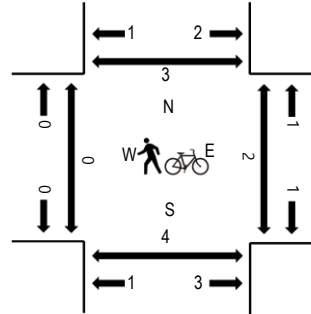

Note: Total study counts contained in parentheses.

Traffic Counts

Interval Start Time	COCHRANE RD Eastbound				COCHRANE RD Westbound				SUTTER BLVD Northbound				SUTTER BLVD Southbound				Total	Rolling Hour	Pedestrian Crossings			
	U-Turn	Left	Thru	Right	U-Turn	Left	Thru	Right	U-Turn	Left	Thru	Right	U-Turn	Left	Thru	Right			West	East	South	North
7:00 AM	0	1	207	6	0	44	66	2	0	7	1	65	0	1	1	0	401	1,818	0	0	0	0
7:15 AM	0	0	178	9	1	57	84	5	0	22	0	74	0	1	0	0	431	1,885	1	0	0	1
7:30 AM	0	0	193	14	0	71	90	6	0	7	1	54	0	0	0	1	437	1,893	0	2	0	1
7:45 AM	0	3	184	43	1	83	112	17	0	15	0	89	0	0	1	1	549	1,819	0	0	1	0
8:00 AM	0	2	183	18	1	69	92	13	0	21	0	67	0	2	0	0	468	1,636	0	0	1	2
8:15 AM	0	2	149	11	0	85	114	21	0	13	6	35	0	2	1	0	439		0	0	1	0
8:30 AM	0	2	142	6	0	58	88	10	0	10	3	38	0	2	3	1	363		0	0	0	1
8:45 AM	0	0	111	7	0	80	104	14	0	10	2	34	0	2	0	2	366		0	0	0	0

Peak Rolling Hour Flow Rates

Vehicle Type	Eastbound				Westbound				Northbound				Southbound				Total
	U-Turn	Left	Thru	Right	U-Turn	Left	Thru	Right	U-Turn	Left	Thru	Right	U-Turn	Left	Thru	Right	
Articulated Trucks	0	0	3	0	0	3	6	0	0	0	1	3	0	1	0	0	17
Lights	0	7	684	83	2	298	388	57	0	56	6	222	0	3	2	2	1,810
Mediums	0	0	22	3	0	7	14	0	0	0	0	20	0	0	0	0	66
Total	0	7	709	86	2	308	408	57	0	56	7	245	0	4	2	2	1,893



(303) 216-2439
www.alltrafficdata.net

Location: 5 SUTTER BLVD & COCHRANE RD PM

Date and Start Time: Tuesday, May 8, 2018

Peak Hour: 04:15 PM - 05:15 PM

Peak 15-Minutes: 04:30 PM - 04:45 PM

Peak Hour - All Vehicles

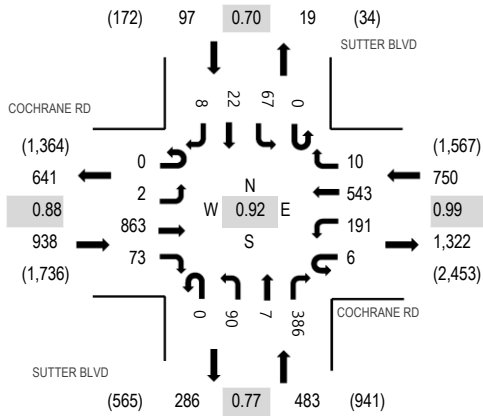

Peak Hour - Pedestrians/Bicycles in Crosswalk

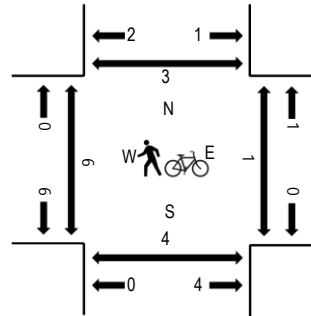

Note: Total study counts contained in parentheses.

Traffic Counts

Interval Start Time	COCHRANE RD Eastbound				COCHRANE RD Westbound				SUTTER BLVD Northbound				SUTTER BLVD Southbound				Total	Rolling Hour	Pedestrian Crossings			
	U-Turn	Left	Thru	Right	U-Turn	Left	Thru	Right	U-Turn	Left	Thru	Right	U-Turn	Left	Thru	Right			West	East	South	North
4:00 PM	0	1	208	28	0	40	141	2	0	29	5	131	0	12	2	5	604	2,258	0	0	0	2
4:15 PM	0	1	196	27	4	54	127	4	0	21	1	88	0	5	4	2	534	2,268	0	0	0	0
4:30 PM	0	1	252	17	1	43	140	2	0	26	3	106	0	21	4	3	619	2,268	2	0	2	0
4:45 PM	0	0	201	15	0	46	117	2	0	21	2	76	0	16	3	2	501	2,178	1	0	0	1
5:00 PM	0	0	214	14	1	48	159	2	0	22	1	116	0	25	11	1	614	2,158	2	1	2	2
5:15 PM	0	0	188	16	1	49	159	1	0	18	0	84	0	15	2	1	534		0	0	1	1
5:30 PM	0	0	167	16	0	46	166	2	0	34	0	76	0	16	4	2	529		3	0	2	1
5:45 PM	0	0	154	20	0	53	154	3	0	14	1	66	0	13	3	0	481		2	2	3	0

Peak Rolling Hour Flow Rates

Vehicle Type	Eastbound				Westbound				Northbound				Southbound				Total
	U-Turn	Left	Thru	Right	U-Turn	Left	Thru	Right	U-Turn	Left	Thru	Right	U-Turn	Left	Thru	Right	
Articulated Trucks	0	0	5	0	0	7	7	0	0	0	0	0	0	1	1	0	21
Lights	0	2	848	71	6	176	526	10	0	89	6	379	0	66	19	8	2,206
Mediums	0	0	10	2	0	8	10	0	0	1	1	7	0	0	2	0	41
Total	0	2	863	73	6	191	543	10	0	90	7	386	0	67	22	8	2,268



(303) 216-2439
www.alltrafficdata.net

Location: 6 COCHRANE PLAZA & COCHRANE RD AM
Date and Start Time: Tuesday, May 8, 2018
Peak Hour: 07:30 AM - 08:30 AM
Peak 15-Minutes: 07:45 AM - 08:00 AM

Peak Hour - All Vehicles

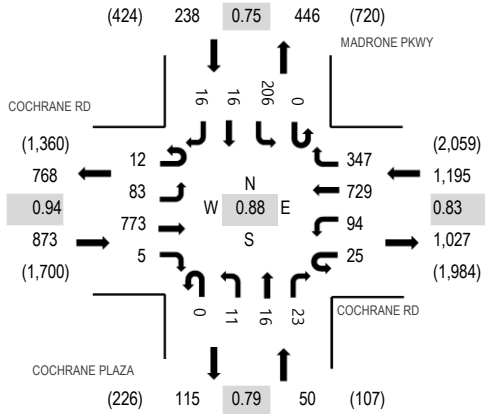

Peak Hour - Pedestrians/Bicycles in Crosswalk

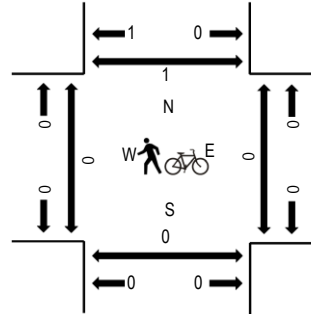

Note: Total study counts contained in parentheses.

Traffic Counts

Interval Start Time	COCHRANE RD Eastbound				COCHRANE RD Westbound				COCHRANE PLAZA Northbound				COCHRANE PLAZA Southbound				Total	Rolling Hour	Pedestrian Crossings			
	U-Turn	Left	Thru	Right	U-Turn	Left	Thru	Right	U-Turn	Left	Thru	Right	U-Turn	Left	Thru	Right			West	East	South	North
7:00 AM	1	23	233	4	4	23	101	43	0	2	3	9	0	32	4	3	485	2,223	0	0	0	1
7:15 AM	2	12	231	0	6	17	135	47	0	1	3	15	0	42	2	4	517	2,298	0	0	0	0
7:30 AM	2	18	210	2	5	18	159	71	0	3	3	4	0	48	5	7	555	2,356	0	0	0	0
7:45 AM	2	18	218	2	8	18	214	120	0	3	9	5	0	44	3	2	666	2,263	0	0	0	0
8:00 AM	3	24	185	1	8	27	148	72	0	3	1	9	0	75	3	1	560	2,067	0	0	0	0
8:15 AM	5	23	160	0	4	31	208	84	0	2	3	5	0	39	5	6	575		0	0	0	1
8:30 AM	5	19	155	2	8	22	136	54	0	2	2	6	0	36	4	11	462		0	0	0	0
8:45 AM	1	16	122	1	7	27	184	50	0	2	2	10	0	41	5	2	470		0	0	0	0

Peak Rolling Hour Flow Rates

Vehicle Type	Eastbound				Westbound				Northbound				Southbound				Total
	U-Turn	Left	Thru	Right	U-Turn	Left	Thru	Right	U-Turn	Left	Thru	Right	U-Turn	Left	Thru	Right	
Articulated Trucks	0	0	9	0	0	0	9	2	0	0	0	0	0	2	0	0	22
Lights	12	83	724	5	24	92	703	341	0	11	16	23	0	202	16	16	2,268
Mediums	0	0	40	0	1	2	17	4	0	0	0	0	0	2	0	0	66
Total	12	83	773	5	25	94	729	347	0	11	16	23	0	206	16	16	2,356



(303) 216-2439
www.alltrafficdata.net

Location: 6 COCHRANE PLAZA & COCHRANE RD PM

Date and Start Time: Tuesday, May 8, 2018

Peak Hour: 04:15 PM - 05:15 PM

Peak 15-Minutes: 04:30 PM - 04:45 PM

Peak Hour - All Vehicles

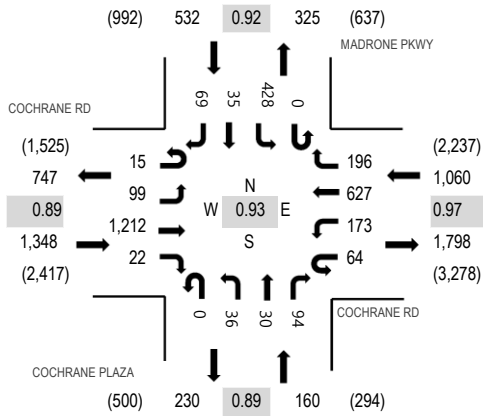

Peak Hour - Pedestrians/Bicycles in Crosswalk

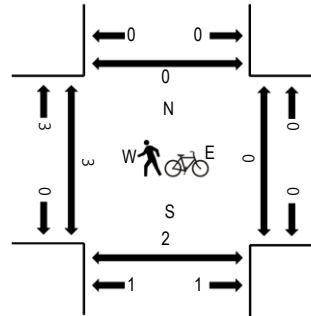

Note: Total study counts contained in parentheses.

Traffic Counts

Interval Start Time	COCHRANE RD Eastbound				COCHRANE RD Westbound				COCHRANE PLAZA Northbound				MADRONE PKWY Southbound				Total	Rolling Hour	Pedestrian Crossings			
	U-Turn	Left	Thru	Right	U-Turn	Left	Thru	Right	U-Turn	Left	Thru	Right	U-Turn	Left	Thru	Right			West	East	South	North
4:00 PM	4	15	305	3	24	43	135	58	0	9	7	15	1	91	11	15	736	3,044	0	0	0	0
4:15 PM	6	22	279	6	19	46	154	58	0	5	10	21	0	99	11	14	750	3,100	2	0	0	0
4:30 PM	2	24	345	6	20	43	162	40	0	12	9	25	0	117	10	18	833	3,081	0	0	0	0
4:45 PM	2	23	293	4	16	42	138	42	0	14	5	24	0	97	9	16	725	2,908	0	0	2	0
5:00 PM	5	30	295	6	9	42	173	56	0	5	6	24	0	115	5	21	792	2,896	1	0	0	0
5:15 PM	2	35	229	5	19	59	180	44	0	7	10	22	0	103	11	5	731		0	0	0	1
5:30 PM	2	18	217	5	17	49	189	54	0	4	5	17	0	61	9	13	660		1	0	0	0
5:45 PM	6	24	196	3	31	54	189	32	0	5	9	24	0	109	18	13	713		0	0	0	2

Peak Rolling Hour Flow Rates

Vehicle Type	Eastbound				Westbound				Northbound				Southbound				Total
	U-Turn	Left	Thru	Right	U-Turn	Left	Thru	Right	U-Turn	Left	Thru	Right	U-Turn	Left	Thru	Right	
Articulated Trucks	0	1	5	0	0	0	15	4	0	0	0	0	0	2	0	0	27
Lights	15	98	1,193	22	63	173	596	190	0	35	30	94	0	422	34	68	3,033
Mediums	0	0	14	0	1	0	16	2	0	1	0	0	0	4	1	1	40
Total	15	99	1,212	22	64	173	627	196	0	36	30	94	0	428	35	69	3,100



(303) 216-2439
www.alltrafficdata.net

Location: 7 US101 SB RAMPS & COCHRANE RD AM
Date and Start Time: Tuesday, May 8, 2018
Peak Hour: 07:30 AM - 08:30 AM
Peak 15-Minutes: 07:45 AM - 08:00 AM

Peak Hour - All Vehicles

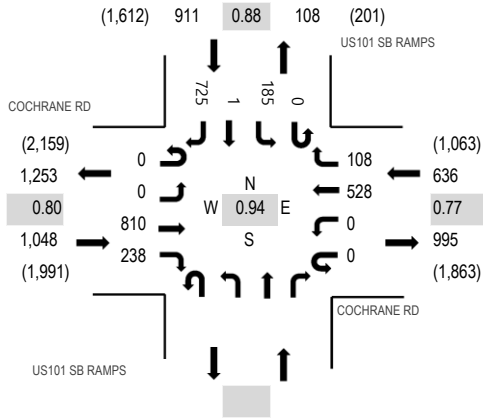

Peak Hour - Pedestrians/Bicycles in Crosswalk

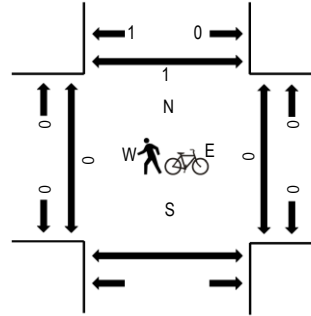

Note: Total study counts contained in parentheses.

Traffic Counts

Interval Start Time	COCHRANE RD Eastbound				COCHRANE RD Westbound				US101 SB RAMPS Northbound				US101 SB RAMPS Southbound				Total	Rolling Hour	Pedestrian Crossings			
	U-Turn	Left	Thru	Right	U-Turn	Left	Thru	Right	U-Turn	Left	Thru	Right	U-Turn	Left	Thru	Right			West	East	South	North
7:00 AM	0	0	240	42	0	0	60	11					0	30	1	109	493	2,311	0	0	0	
7:15 AM	0	0	201	40	0	0	63	28					0	26	0	159	517	2,480	0	0	0	
7:30 AM	0	0	188	64	0	0	110	39					0	45	0	162	608	2,595	0	0	0	
7:45 AM	0	0	178	50	0	0	179	27					0	61	0	198	693	2,495	0	0	0	
8:00 AM	0	0	257	71	0	0	118	18					0	36	0	162	662	2,355	0	0	1	
8:15 AM	0	0	187	53	0	0	121	24					0	43	1	203	632		0	0	0	
8:30 AM	0	0	172	54	0	0	108	23					0	33	0	118	508		0	0	0	
8:45 AM	0	0	127	67	0	0	103	31					0	39	0	186	553		0	0	0	

Peak Rolling Hour Flow Rates

Vehicle Type	Eastbound				Westbound				Northbound				Southbound				Total
	U-Turn	Left	Thru	Right	U-Turn	Left	Thru	Right	U-Turn	Left	Thru	Right	U-Turn	Left	Thru	Right	
Articulated Trucks	0	0	8	2	0	0	7	2					0	2	0	7	28
Lights	0	0	767	222	0	0	515	101					0	175	1	701	2,482
Mediums	0	0	35	14	0	0	6	5					0	8	0	17	85
Total	0	0	810	238	0	0	528	108					0	185	1	725	2,595



(303) 216-2439
www.alltrafficdata.net

Location: 7 US101 SB RAMPS & COCHRANE RD PM

Date and Start Time: Tuesday, May 8, 2018

Peak Hour: 04:30 PM - 05:30 PM

Peak 15-Minutes: 05:00 PM - 05:15 PM

Peak Hour - All Vehicles

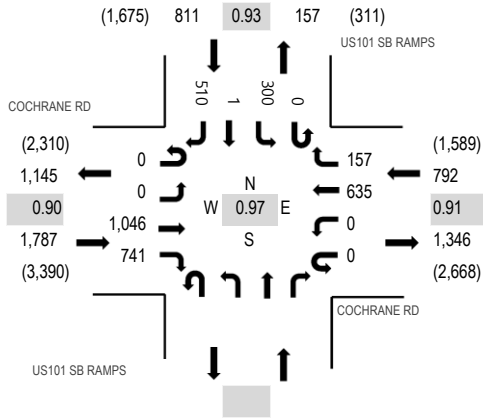

Peak Hour - Pedestrians/Bicycles in Crosswalk

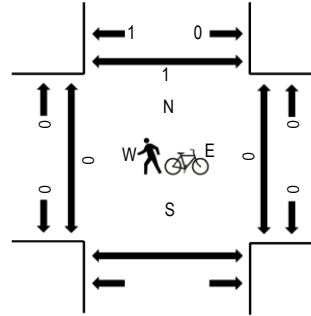

Note: Total study counts contained in parentheses.

Traffic Counts

Interval Start Time	COCHRANE RD Eastbound				COCHRANE RD Westbound				US101 SB RAMPS Northbound				US101 SB RAMPS Southbound				Total	Rolling Hour	Pedestrian Crossings			
	U-Turn	Left	Thru	Right	U-Turn	Left	Thru	Right	U-Turn	Left	Thru	Right	U-Turn	Left	Thru	Right			West	East	South	North
4:00 PM	0	0	279	188	0	0	159	37					0	55	0	113	831	3,289	0	0	0	0
4:15 PM	0	0	228	188	0	0	167	34					0	80	0	97	794	3,335	0	0	0	0
4:30 PM	0	0	307	193	0	0	157	35					0	56	0	122	870	3,390	0	0	0	0
4:45 PM	0	0	219	205	0	0	149	37					0	74	1	109	794	3,350	0	0	0	0
5:00 PM	0	0	273	177	0	0	158	38					0	87	0	144	877	3,365	0	0	0	0
5:15 PM	0	0	247	166	0	0	171	47					0	83	0	135	849		0	0	0	1
5:30 PM	0	0	221	122	0	0	185	44					0	113	0	145	830		0	0	0	0
5:45 PM	0	0	252	125	0	0	132	39					0	94	0	167	809		0	0	0	1

Peak Rolling Hour Flow Rates

Vehicle Type	Eastbound				Westbound				Northbound				Southbound				Total
	U-Turn	Left	Thru	Right	U-Turn	Left	Thru	Right	U-Turn	Left	Thru	Right	U-Turn	Left	Thru	Right	
Articulated Trucks	0	0	7	7	0	0	11	0					0	0	0	5	30
Lights	0	0	1,026	729	0	0	618	156					0	298	1	489	3,317
Mediums	0	0	13	5	0	0	6	1					0	2	0	16	43
Total	0	0	1,046	741	0	0	635	157					0	300	1	510	3,390



(303) 216-2439
www.alltrafficdata.net

Location: 8 US101 NB RAMPS & COCHRANE RD AM

Date and Start Time: Tuesday, May 8, 2018

Peak Hour: 07:30 AM - 08:30 AM

Peak 15-Minutes: 07:45 AM - 08:00 AM

Peak Hour - All Vehicles

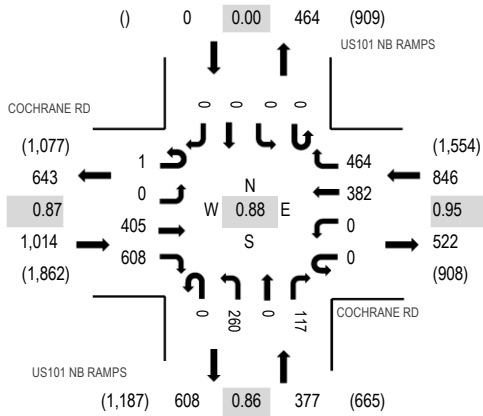

Peak Hour - Pedestrians/Bicycles in Crosswalk

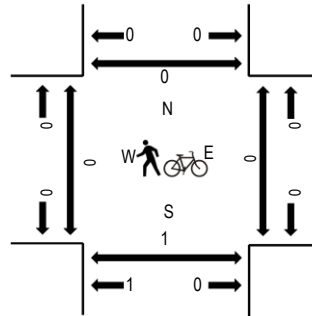

Note: Total study counts contained in parentheses.

Traffic Counts

Interval Start Time	COCHRANE RD Eastbound				COCHRANE RD Westbound				US101 NB RAMPS Northbound				US101 NB RAMPS Southbound				Total	Rolling Hour	Pedestrian Crossings			
	U-Turn	Left	Thru	Right	U-Turn	Left	Thru	Right	U-Turn	Left	Thru	Right	U-Turn	Left	Thru	Right			West	East	South	North
7:00 AM	0	0	47	211	0	0	52	144	0	22	0	17	0	0	0	0	493	2,142	0	0	1	0
7:15 AM	0	0	56	172	0	0	69	144	0	21	0	20	0	0	0	0	482	2,208	0	0	0	0
7:30 AM	0	0	73	162	0	0	101	127	0	51	0	18	0	0	0	0	532	2,237	0	0	1	0
7:45 AM	0	0	132	163	0	0	121	99	0	90	0	30	0	0	0	0	635	2,171	0	0	0	0
8:00 AM	0	0	110	157	0	0	78	124	0	54	0	36	0	0	0	0	559	1,939	0	0	0	0
8:15 AM	1	0	90	126	0	0	82	114	0	65	0	33	0	0	0	0	511		0	0	0	0
8:30 AM	0	0	83	121	0	0	67	88	0	64	0	43	0	0	0	0	466		0	0	0	0
8:45 AM	0	0	83	75	0	0	75	69	0	64	0	37	0	0	0	0	403		0	0	0	0

Peak Rolling Hour Flow Rates

Vehicle Type	Eastbound				Westbound				Northbound				Southbound				Total
	U-Turn	Left	Thru	Right	U-Turn	Left	Thru	Right	U-Turn	Left	Thru	Right	U-Turn	Left	Thru	Right	
Articulated Trucks	0	0	3	8	0	0	1	4	0	7	0	3	0	0	0	0	26
Lights	1	0	386	571	0	0	372	454	0	251	0	108	0	0	0	0	2,143
Mediums	0	0	16	29	0	0	9	6	0	2	0	6	0	0	0	0	68
Total	1	0	405	608	0	0	382	464	0	260	0	117	0	0	0	0	2,237



(303) 216-2439
www.alltrafficdata.net

Location: 8 US101 NB RAMPS & COCHRANE RD PM

Date and Start Time: Tuesday, May 8, 2018

Peak Hour: 05:00 PM - 06:00 PM

Peak 15-Minutes: 05:15 PM - 05:30 PM

Peak Hour - All Vehicles

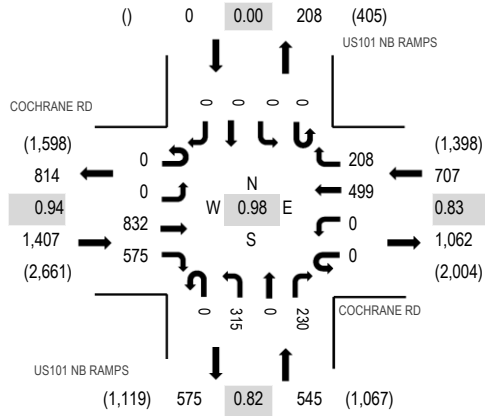

Peak Hour - Pedestrians/Bicycles in Crosswalk

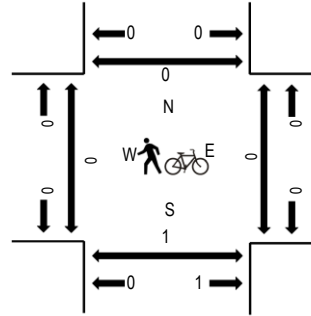

Note: Total study counts contained in parentheses.

Traffic Counts

Interval Start Time	COCHRANE RD Eastbound				COCHRANE RD Westbound				US101 NB RAMPS Northbound				US101 NB RAMPS Southbound				Total	Rolling Hour	Pedestrian Crossings			
	U-Turn	Left	Thru	Right	U-Turn	Left	Thru	Right	U-Turn	Left	Thru	Right	U-Turn	Left	Thru	Right			West	East	South	North
4:00 PM	0	0	148	145	0	0	117	54	0	74	0	61	0	0	0	0	599	2,467	0	0	0	0
4:15 PM	0	0	193	135	0	0	122	41	0	81	0	56	0	0	0	0	628	2,529	0	0	0	0
4:30 PM	0	0	186	154	0	0	132	56	0	65	0	53	0	0	0	0	646	2,582	0	0	0	0
4:45 PM	0	0	183	110	0	0	123	46	0	70	0	62	0	0	0	0	594	2,613	0	0	2	0
5:00 PM	0	0	206	162	0	0	124	47	0	75	0	47	0	0	0	0	661	2,659	0	0	0	0
5:15 PM	0	0	200	143	0	0	126	43	0	100	0	69	0	0	0	0	681		0	0	0	0
5:30 PM	0	0	205	118	0	0	144	76	0	74	0	60	0	0	0	0	677		0	0	0	0
5:45 PM	0	0	221	152	0	0	105	42	0	66	0	54	0	0	0	0	640		0	0	1	0

Peak Rolling Hour Flow Rates

Vehicle Type	Eastbound				Westbound				Northbound				Southbound				Total
	U-Turn	Left	Thru	Right	U-Turn	Left	Thru	Right	U-Turn	Left	Thru	Right	U-Turn	Left	Thru	Right	
Articulated Trucks	0	0	0	9	0	0	0	0	0	6	0	0	0	0	0	0	15
Lights	0	0	828	555	0	0	495	207	0	303	0	223	0	0	0	0	2,611
Mediums	0	0	4	11	0	0	4	1	0	6	0	7	0	0	0	0	33
Total	0	0	832	575	0	0	499	208	0	315	0	230	0	0	0	0	2,659

Appendix B

Intersection Volume Summaries

Intersection Number: 1
 Traffic Node Number: 1324
 Intersection Name: Monterey Road and Madrone Parkway
 Peak Hour: AM
 Count Date: 2/28/19

Scenario:	Movements												Int. Total
	North Approach			East Approach			South Approach			West Approach			
	RT	TH	LT	RT	TH	LT	RT	TH	LT	RT	TH	LT	
Existing Conditions	0	568	119	209	0	2	18	1260	0	0	0	0	2,176
Project Trips	0	0	7	0	0	0	1	0	0	0	0	0	8
Existing Plus Project Conditions	0	568	126	209	0	2	19	1,260	0	0	0	0	2,184
Year 2025 Cumulative	0	758	191	312	0	3	18	1,631	0	0	0	0	2,912
Proposed Project Trips	0	0	7	0	0	0	1	0	0	0	0	0	8
Adopted GP Project Trips	0	0	-1	0	0	0	0	0	0	0	0	0	-1
Net Project Trips	0	0	6	0	0	0	1	0	0	0	0	0	7
Year 2025 Cumulative Plus Project	0	758	197	312	0	3	19	1,631	0	0	0	0	2,919

Intersection Number: 2
 Traffic Node Number: 101
 Intersection Name: Monterey Road and Cochrane Road
 Peak Hour: AM
 Count Date: 5/8/18

Scenario:	Movements												Int. Total
	North Approach			East Approach			South Approach			West Approach			
	RT	TH	LT	RT	TH	LT	RT	TH	LT	RT	TH	LT	
Existing Conditions	44	221	278	582	59	141	320	623	110	6	65	87	2,536
Project Trips	0	0	0	0	0	0	1	1	0	0	0	0	2
Existing Plus Project Conditions	44	221	278	582	59	141	321	624	110	6	65	87	2,538
Year 2025 Cumulative	45	332	349	615	59	170	371	925	110	6	65	87	3,132
Proposed Project Trips	0	0	0	0	0	0	1	1	0	0	0	0	2
Adopted GP Project Trips	0	0	0	0	0	0	-1	0	0	0	0	0	-1
Net Project Trips	0	0	0	0	0	0	0	1	0	0	0	0	1
Year 2025 Cumulative Plus Project	45	332	349	615	59	170	371	926	110	6	65	87	3,133

Intersection Number: 3
 Traffic Node Number: 103
 Intersection Name: Butterfield Boulevard and Cochrane Road
 Peak Hour: AM
 Count Date: 5/8/18

Scenario:	Movements												Int. Total
	North Approach			East Approach			South Approach			West Approach			
	RT	TH	LT	RT	TH	LT	RT	TH	LT	RT	TH	LT	
Existing Conditions	0	0	0	0	300	138	362	0	529	182	530	0	2,041
Project Trips	0	0	0	0	0	0	5	0	0	0	1	0	6
Existing Plus Project Conditions	0	0	0	0	300	138	367	0	529	182	531	0	2,047
Year 2025 Cumulative	1	35	68	75	405	191	373	98	597	266	576	12	2,694
Proposed Project Trips	0	0	0	0	0	0	3	5	0	0	1	0	9
Adopted GP Project Trips	0	-1	0	0	0	0	-2	-3	0	0	-1	0	-7
Net Project Trips	0	-1	0	0	0	0	1	2	0	0	0	0	2
Year 2025 Cumulative Plus Project	1	34	68	75	405	191	374	100	597	266	576	12	2,696

Intersection Number: 4
 Traffic Node Number: 105
 Intersection Name: Sutter Boulevard and Cochrane Road
 Peak Hour: AM
 Count Date: 5/8/18

Scenario:	Movements												Int. Total
	North Approach			East Approach			South Approach			West Approach			
	RT	TH	LT	RT	TH	LT	RT	TH	LT	RT	TH	LT	
Existing Conditions	2	2	4	57	408	310	245	7	56	86	709	7	1,893
Project Trips	0	0	0	0	0	0	2	4	0	0	5	1	12
Existing Plus Project Conditions	2	2	4	57	408	310	247	11	56	86	714	8	1,905
Year 2025 Cumulative	3	2	4	57	679	403	321	8	69	106	861	11	2,521
Proposed Project Trips	0	0	0	0	0	0	1	2	0	0	3	1	7
Adopted GP Project Trips	0	0	0	0	0	0	-1	-2	0	0	-2	-1	-6
Net Project Trips	0	0	0	0	0	0	0	0	0	0	1	0	1
Year 2025 Cumulative Plus Project	3	2	4	57	679	403	321	8	69	106	862	11	2,522

Intersection Number: 5
 Traffic Node Number: 106
 Intersection Name: Madrone Parkway/Cochrane Plaza and Cochrane Road
 Peak Hour: AM
 Count Date: 5/8/18

Scenario:	Movements												Int. Total
	North Approach			East Approach			South Approach			West Approach			
	RT	TH	LT	RT	TH	LT	RT	TH	LT	RT	TH	LT	
Existing Conditions	16	16	206	347	729	119	23	16	11	5	773	95	2,356
Project Trips	0	0	3	116	0	0	0	0	0	0	0	6	125
Existing Plus Project Conditions	16	16	209	463	729	119	23	16	11	5	773	101	2,481
Year 2025 Cumulative	21	16	216	347	1,062	119	23	16	11	5	973	99	2,907
Proposed Project Trips	0	0	3	116	0	0	0	0	0	0	0	4	123
Adopted GP Project Trips	-1	0	-1	-5	0	0	0	0	0	0	0	-3	-10
Net Project Trips	-1	0	2	111	0	0	0	0	0	0	0	1	113
Year 2025 Cumulative Plus Project	20	16	218	458	1,062	119	23	16	11	5	973	100	3,020

Intersection Number: 6
 Traffic Node Number: 107
 Intersection Name: US 101 Southbound Ramps and Cochrane Road
 Peak Hour: AM
 Count Date: 5/8/18

Scenario:	Movements												Int. Total
	North Approach			East Approach			South Approach			West Approach			
	RT	TH	LT	RT	TH	LT	RT	TH	LT	RT	TH	LT	
Existing Conditions	725	1	185	0	528	0	0	0	0	238	810	0	2,487
Project Trips	74	0	0	0	42	0	0	0	0	1	2	0	119
Existing Plus Project Conditions	799	1	185	0	570	0	0	0	0	239	812	0	2,606
Year 2025 Cumulative	797	1	242	0	784	0	0	0	0	284	972	0	3,078
Proposed Project Trips	74	0	0	0	42	0	0	0	0	1	2	0	119
Adopted GP Project Trips	-2	0	0	0	-3	0	0	0	0	0	-1	0	-6
Net Project Trips	72	0	0	0	39	0	0	0	0	1	1	0	113
Year 2025 Cumulative Plus Project	869	1	242	0	823	0	0	0	0	285	973	0	3,191

Intersection Number: 7
 Traffix Node Number: 108
 Intersection Name: US 101 Northbound Ramps and Cochrane Road
 Peak Hour: AM
 Count Date: 5/8/18

Scenario:	Movements												Int. Total
	North Approach			East Approach			South Approach			West Approach			
	RT	TH	LT	RT	TH	LT	RT	TH	LT	RT	TH	LT	
Existing Conditions	0	0	0	464	382	0	117	0	260	0	405	0	1,628
Project Trips	0	0	0	0	1	0	0	0	41	2	0	0	44
Existing Plus Project Conditions	0	0	0	464	383	0	117	0	301	2	405	0	1,672
Year 2025 Cumulative	0	0	0	598	497	0	169	0	434	7	534	0	2,239
Proposed Project Trips	0	0	0	0	1	0	0	0	41	2	0	0	44
Adopted GP Project Trips	0	0	0	0	-1	0	0	0	-2	0	0	0	-3
Net Project Trips	0	0	0	0	0	0	0	0	39	2	0	0	41
Year 2025 Cumulative Plus Project	0	0	0	598	497	0	169	0	473	9	534	0	2,280

Intersection Number: 1
 Traffic Node Number: 1324
 Intersection Name: Monterey Road and Madrone Parkway
 Peak Hour: PM
 Count Date: 2/28/19

Scenario:	Movements												Int. Total
	North Approach			East Approach			South Approach			West Approach			
	RT	TH	LT	RT	TH	LT	RT	TH	LT	RT	TH	LT	
Existing Conditions	0	2032	274	143	0	17	15	408	0	0	0	0	2,889
Project Trips	0	0	0	7	0	1	0	0	0	0	0	0	8
Existing Plus Project Conditions	0	2,032	274	150	0	18	15	408	0	0	0	0	2,897
Year 2025 Cumulative	0	2,384	337	185	0	17	15	565	0	0	0	0	3,502
Proposed Project Trips	0	0	0	7	0	1	0	0	0	0	0	0	8
Adopted GP Project Trips	0	0	0	-1	0	0	0	0	0	0	0	0	-1
Net Project Trips	0	0	0	6	0	1	0	0	0	0	0	0	7
Year 2025 Cumulative Plus Project	0	2,384	337	191	0	18	15	565	0	0	0	0	3,509

Intersection Number: 2
 Traffic Node Number: 101
 Intersection Name: Monterey Road and Cochrane Road
 Peak Hour: PM
 Count Date: 5/8/18

Scenario:	Movements												Int. Total
	North Approach			East Approach			South Approach			West Approach			
	RT	TH	LT	RT	TH	LT	RT	TH	LT	RT	TH	LT	
Existing Conditions	111	783	1074	180	50	243	198	157	36	24	77	26	2,959
Project Trips	0	1	0	0	0	1	0	0	0	0	0	0	2
Existing Plus Project Conditions	111	784	1,074	180	50	244	198	157	36	24	77	26	2,961
Year 2025 Cumulative	111	947	1,225	195	50	324	259	285	36	24	77	26	3,557
Proposed Project Trips	0	1	0	0	0	1	0	0	0	0	0	0	2
Adopted GP Project Trips	0	0	0	0	0	-1	0	0	0	0	0	0	-1
Net Project Trips	0	1	0	0	0	0	0	0	0	0	0	0	1
Year 2025 Cumulative Plus Project	111	948	1,225	195	50	324	259	285	36	24	77	26	3,558

Intersection Number: 3
 Trafix Node Number: 103
 Intersection Name: Butterfield Boulevard and Cochrane Road
 Peak Hour: PM
 Count Date: 5/8/18

Scenario:	Movements												Int. Total
	North Approach			East Approach			South Approach			West Approach			
	RT	TH	LT	RT	TH	LT	RT	TH	LT	RT	TH	LT	
Existing Conditions	0	0	0	0	402	347	183	0	137	594	781	0	2,444
Project Trips	0	0	0	0	1	5	0	0	0	0	0	0	6
Existing Plus Project Conditions	0	0	0	0	403	352	183	0	137	594	781	0	2,450
Year 2025 Cumulative	4	77	103	89	441	403	206	48	241	629	968	4	3,210
Proposed Project Trips	0	5	0	0	1	3	0	0	0	0	0	0	9
Adopted GP Project Trips	0	-3	0	0	-1	-2	-1	-1	0	0	0	0	-8
Net Project Trips	0	2	0	0	0	1	-1	-1	0	0	0	0	1
Year 2025 Cumulative Plus Project	4	79	103	89	441	404	205	47	241	629	968	4	3,211

Intersection Number: 4
 Trafix Node Number: 105
 Intersection Name: Sutter Boulevard and Cochrane Road
 Peak Hour: PM
 Count Date: 5/8/18

Scenario:	Movements												Int. Total
	North Approach			East Approach			South Approach			West Approach			
	RT	TH	LT	RT	TH	LT	RT	TH	LT	RT	TH	LT	
Existing Conditions	8	22	67	10	543	197	386	7	90	73	863	2	2,268
Project Trips	1	4	0	0	5	2	0	0	0	0	0	0	12
Existing Plus Project Conditions	9	26	67	10	548	199	386	7	90	73	863	2	2,280
Year 2025 Cumulative	11	23	67	11	755	275	495	7	104	84	1,194	3	3,028
Proposed Project Trips	1	2	0	0	3	1	0	0	0	0	0	0	7
Adopted GP Project Trips	-1	-2	0	0	-2	-1	0	-1	0	0	-1	0	-8
Net Project Trips	0	0	0	0	1	0	0	-1	0	0	-1	0	-1
Year 2025 Cumulative Plus Project	11	23	67	11	756	275	495	6	104	84	1,193	3	3,027

Intersection Number: 5
 Traffic Node Number: 106
 Intersection Name: Madrone Parkway/Cochrane Plaza and Cochrane Road
 Peak Hour: PM
 Count Date: 5/8/18

Scenario:	Movements												Int. Total
	North Approach			East Approach			South Approach			West Approach			
	RT	TH	LT	RT	TH	LT	RT	TH	LT	RT	TH	LT	
Existing Conditions	69	35	428	196	627	237	94	30	36	22	1212	114	3,100
Project Trips	6	0	116	2	0	0	0	0	0	0	0	0	124
Existing Plus Project Conditions	75	35	544	198	627	237	94	30	36	22	1,212	114	3,224
Year 2025 Cumulative	76	35	435	208	892	237	94	30	36	22	1,632	116	3,812
Proposed Project Trips	4	0	116	2	0	0	0	0	0	0	0	0	122
Adopted GP Project Trips	-3	0	-6	-2	0	0	0	0	0	0	0	-1	-12
Net Project Trips	1	0	110	0	0	0	0	0	0	0	0	-1	110
Year 2025 Cumulative Plus Project	77	35	545	208	892	237	94	30	36	22	1,632	115	3,922

Intersection Number: 6
 Traffic Node Number: 107
 Intersection Name: US 101 Southbound Ramps and Cochrane Road
 Peak Hour: PM
 Count Date: 5/8/18

Scenario:	Movements												Int. Total
	North Approach			East Approach			South Approach			West Approach			
	RT	TH	LT	RT	TH	LT	RT	TH	LT	RT	TH	LT	
Existing Conditions	510	1	300	0	635	0	0	0	0	741	1046	0	3,233
Project Trips	1	0	0	0	1	0	0	0	0	41	76	0	119
Existing Plus Project Conditions	511	1	300	0	636	0	0	0	0	782	1,122	0	3,352
Year 2025 Cumulative	597	1	416	0	824	0	0	0	0	858	1,355	0	4,051
Proposed Project Trips	1	0	0	0	1	0	0	0	0	41	76	0	119
Adopted GP Project Trips	-1	0	0	0	-1	0	0	0	0	-3	-3	0	-8
Net Project Trips	0	0	0	0	0	0	0	0	0	38	73	0	111
Year 2025 Cumulative Plus Project	597	1	416	0	824	0	0	0	0	896	1,428	0	4,162

Intersection Number: 7
 Traffic Node Number: 108
 Intersection Name: US 101 Northbound Ramps and Cochrane Road
 Peak Hour: PM
 Count Date: 5/8/18

Scenario:	Movements												Int. Total
	North Approach			East Approach			South Approach			West Approach			
	RT	TH	LT	RT	TH	LT	RT	TH	LT	RT	TH	LT	
Existing Conditions	0	0	0	208	499	0	230	0	315	0	832	0	2,084
Project Trips	0	0	0	0	0	0	0	0	1	74	1	0	76
Existing Plus Project Conditions	0	0	0	208	499	0	230	0	316	74	833	0	2,160
Year 2025 Cumulative	0	0	0	277	714	0	298	0	374	28	1,153	0	2,844
Proposed Project Trips	0	0	0	0	0	0	0	0	1	74	1	0	76
Adopted GP Project Trips	0	0	0	0	0	0	0	0	-1	-3	-1	0	-5
Net Project Trips	0	0	0	0	0	0	0	0	0	71	0	0	71
Year 2025 Cumulative Plus Project	0	0	0	277	714	0	298	0	374	99	1,153	0	2,915

Appendix C

Level of Service Calculations

City of Morgan Hill
Carpenters Training Center

Level Of Service Computation Report
2000 HCM Operations (Future Volume Alternative)
Existing AM

Intersection #1324: Monterey Road and Madrone Parkway

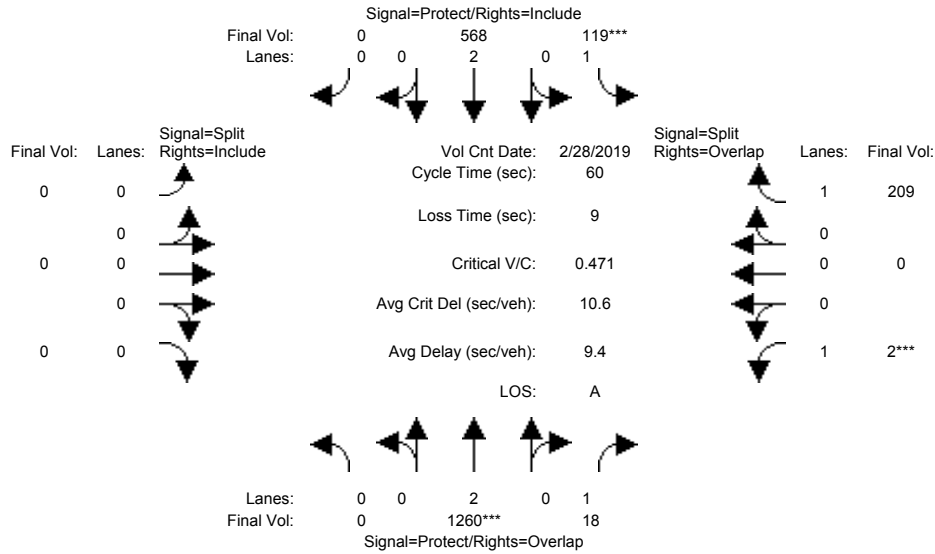

Street Name:	Monterey Road						Madrone Parkway					
	North Bound			South Bound			East Bound			West Bound		
Movement:	L	T	R	L	T	R	L	T	R	L	T	R
Min. Green:	0	10	10	7	10	0	0	0	0	10	0	10
Y+R:	4.0	4.0	4.0	4.0	4.0	4.0	4.0	4.0	4.0	4.0	4.0	4.0

Volume Module:	>>	Count	Date:	28 Feb 2019	<<											
Base Vol:	0	1260	18	119	568	0	0	0	0	2	0	209				
Growth Adj:	1.00	1.00	1.00	1.00	1.00	1.00	1.00	1.00	1.00	1.00	1.00	1.00				
Initial Bse:	0	1260	18	119	568	0	0	0	0	2	0	209				
Added Vol:	0	0	0	0	0	0	0	0	0	0	0	0				
PasserByVol:	0	0	0	0	0	0	0	0	0	0	0	0				
Initial Fut:	0	1260	18	119	568	0	0	0	0	2	0	209				
User Adj:	1.00	1.00	1.00	1.00	1.00	1.00	1.00	1.00	1.00	1.00	1.00	1.00				
PHF Adj:	1.00	1.00	1.00	1.00	1.00	1.00	1.00	1.00	1.00	1.00	1.00	1.00				
PHF Volume:	0	1260	18	119	568	0	0	0	0	2	0	209				
Reduct Vol:	0	0	0	0	0	0	0	0	0	0	0	0				
Reduced Vol:	0	1260	18	119	568	0	0	0	0	2	0	209				
PCE Adj:	1.00	1.00	1.00	1.00	1.00	1.00	1.00	1.00	1.00	1.00	1.00	1.00				
MLF Adj:	1.00	1.00	1.00	1.00	1.00	1.00	1.00	1.00	1.00	1.00	1.00	1.00				
Final Volume:	0	1260	18	119	568	0	0	0	0	2	0	209				

Saturation Flow Module:												
Sat/Lane:	1900	1900	1900	1900	1900	1900	1900	1900	1900	1900	1900	1900
Adjustment:	0.92	1.00	0.92	0.92	1.00	0.92	0.92	1.00	0.92	0.92	1.00	0.92
Lanes:	0.00	2.00	1.00	1.00	2.00	0.00	0.00	0.00	0.00	1.00	0.00	1.00
Final Sat.:	0	3800	1750	1750	3800	0	0	0	0	1750	0	1750

Capacity Analysis Module:												
Vol/Sat:	0.00	0.33	0.01	0.07	0.15	0.00	0.00	0.00	0.00	0.00	0.00	0.12
Crit Moves:	****			****						****		
Green Time:	0.0	34.0	44.0	7.0	41.0	0.0	0.0	0.0	0.0	10.0	0.0	17.0
Volume/Cap:	0.00	0.59	0.01	0.58	0.22	0.00	0.00	0.00	0.00	0.01	0.00	0.42
Delay/Veh:	0.0	8.8	2.2	29.4	3.6	0.0	0.0	0.0	0.0	20.9	0.0	18.1
User DelAdj:	1.00	1.00	1.00	1.00	1.00	1.00	1.00	1.00	1.00	1.00	1.00	1.00
AdjDel/Veh:	0.0	8.8	2.2	29.4	3.6	0.0	0.0	0.0	0.0	20.9	0.0	18.1
LOS by Move:	A	A	A	C	A	A	A	A	A	C	A	B
HCM2k95thQ:	0	14	0	5	4	0	0	0	0	0	0	7

Note: Queue reported is the number of cars per lane.

City of Morgan Hill
Carpenters Training Center

Level Of Service Computation Report
2000 HCM Operations (Future Volume Alternative)
Existing Plus Project AM

Intersection #1324: Monterey Road and Madrone Parkway

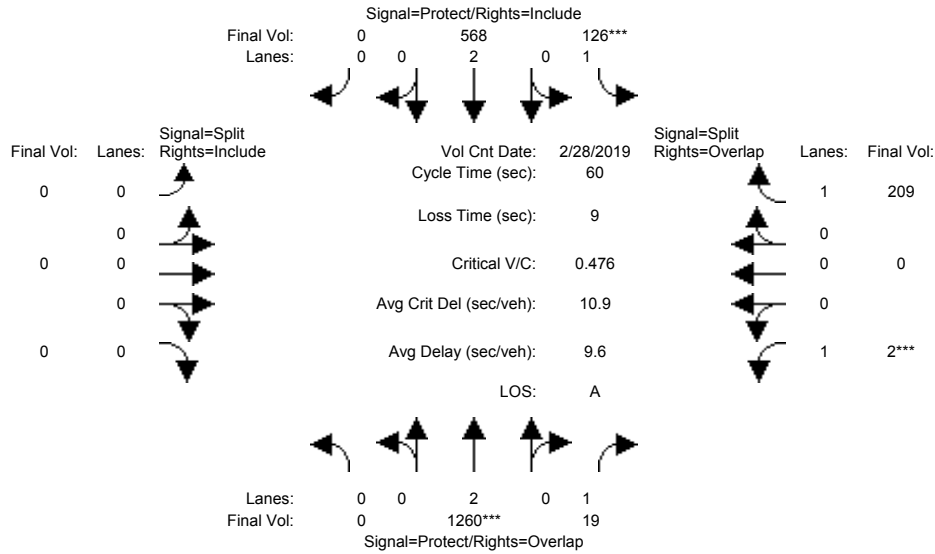

Street Name:	Monterey Road						Madrone Parkway					
	North Bound			South Bound			East Bound			West Bound		
Approach:	North Bound			South Bound			East Bound			West Bound		
Movement:	L	T	R	L	T	R	L	T	R	L	T	R
Min. Green:	0	10	10	7	10	0	0	0	0	10	0	10
Y+R:	4.0	4.0	4.0	4.0	4.0	4.0	4.0	4.0	4.0	4.0	4.0	4.0

Volume Module:	>>	Count	Date:	28 Feb 2019	<<							
Base Vol:	0	1260	18	119	568	0	0	0	0	2	0	209
Growth Adj:	1.00	1.00	1.00	1.00	1.00	1.00	1.00	1.00	1.00	1.00	1.00	1.00
Initial Bse:	0	1260	18	119	568	0	0	0	0	2	0	209
Added Vol:	0	0	1	7	0	0	0	0	0	0	0	0
PasserByVol:	0	0	0	0	0	0	0	0	0	0	0	0
Initial Fut:	0	1260	19	126	568	0	0	0	0	2	0	209
User Adj:	1.00	1.00	1.00	1.00	1.00	1.00	1.00	1.00	1.00	1.00	1.00	1.00
PHF Adj:	1.00	1.00	1.00	1.00	1.00	1.00	1.00	1.00	1.00	1.00	1.00	1.00
PHF Volume:	0	1260	19	126	568	0	0	0	0	2	0	209
Reduct Vol:	0	0	0	0	0	0	0	0	0	0	0	0
Reduced Vol:	0	1260	19	126	568	0	0	0	0	2	0	209
PCE Adj:	1.00	1.00	1.00	1.00	1.00	1.00	1.00	1.00	1.00	1.00	1.00	1.00
MLF Adj:	1.00	1.00	1.00	1.00	1.00	1.00	1.00	1.00	1.00	1.00	1.00	1.00
Final Volume:	0	1260	19	126	568	0	0	0	0	2	0	209

Saturation Flow Module:												
Sat/Lane:	1900	1900	1900	1900	1900	1900	1900	1900	1900	1900	1900	1900
Adjustment:	0.92	1.00	0.92	0.92	1.00	0.92	0.92	1.00	0.92	0.92	1.00	0.92
Lanes:	0.00	2.00	1.00	1.00	2.00	0.00	0.00	0.00	0.00	1.00	0.00	1.00
Final Sat.:	0	3800	1750	1750	3800	0	0	0	0	1750	0	1750

Capacity Analysis Module:												
Vol/Sat:	0.00	0.33	0.01	0.07	0.15	0.00	0.00	0.00	0.00	0.00	0.00	0.12
Crit Moves:	****			****						****		
Green Time:	0.0	33.7	43.7	7.3	41.0	0.0	0.0	0.0	0.0	10.0	0.0	17.3
Volume/Cap:	0.00	0.59	0.01	0.59	0.22	0.00	0.00	0.00	0.00	0.01	0.00	0.41
Delay/Veh:	0.0	9.1	2.2	29.3	3.6	0.0	0.0	0.0	0.0	20.9	0.0	17.8
User DelAdj:	1.00	1.00	1.00	1.00	1.00	1.00	1.00	1.00	1.00	1.00	1.00	1.00
AdjDel/Veh:	0.0	9.1	2.2	29.3	3.6	0.0	0.0	0.0	0.0	20.9	0.0	17.8
LOS by Move:	A	A	A	C	A	A	A	A	A	C	A	B
HCM2k95thQ:	0	14	0	5	4	0	0	0	0	0	0	7

Note: Queue reported is the number of cars per lane.

City of Morgan Hill
Carpenters Training Center

Level Of Service Computation Report
2000 HCM Operations (Future Volume Alternative)
Cumulative AM

Intersection #1324: Monterey Road and Madrone Parkway

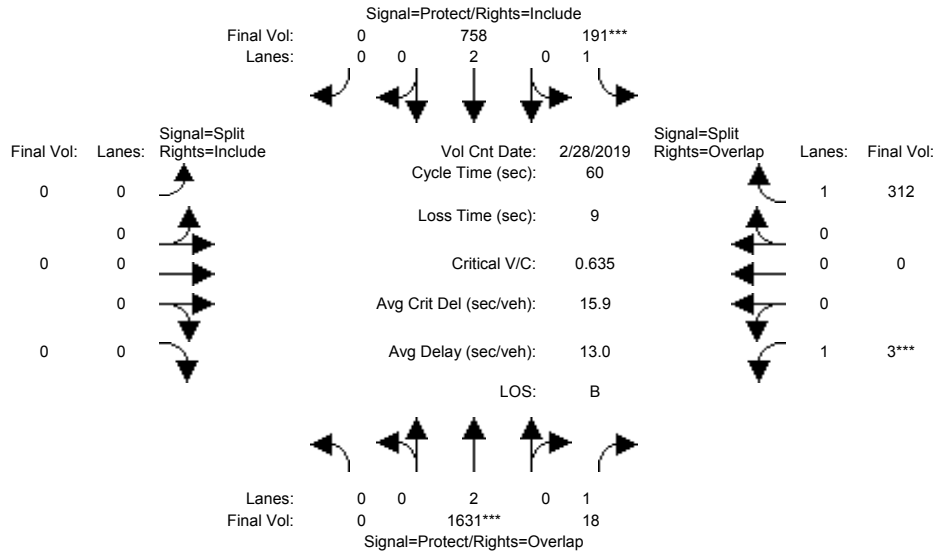

Street Name:	Monterey Road						Madrone Parkway					
	North Bound			South Bound			East Bound			West Bound		
Approach:	North Bound			South Bound			East Bound			West Bound		
Movement:	L	T	R	L	T	R	L	T	R	L	T	R
Min. Green:	0	10	10	7	10	0	0	0	0	10	0	10
Y+R:	4.0	4.0	4.0	4.0	4.0	4.0	4.0	4.0	4.0	4.0	4.0	4.0

Volume Module:	>>	Count	Date:	28 Feb 2019	<<							
Base Vol:	0	1631	18	191	758	0	0	0	0	3	0	312
Growth Adj:	1.00	1.00	1.00	1.00	1.00	1.00	1.00	1.00	1.00	1.00	1.00	1.00
Initial Bse:	0	1631	18	191	758	0	0	0	0	3	0	312
Added Vol:	0	0	0	0	0	0	0	0	0	0	0	0
PasserByVol:	0	0	0	0	0	0	0	0	0	0	0	0
Initial Fut:	0	1631	18	191	758	0	0	0	0	3	0	312
User Adj:	1.00	1.00	1.00	1.00	1.00	1.00	1.00	1.00	1.00	1.00	1.00	1.00
PHF Adj:	1.00	1.00	1.00	1.00	1.00	1.00	1.00	1.00	1.00	1.00	1.00	1.00
PHF Volume:	0	1631	18	191	758	0	0	0	0	3	0	312
Reduct Vol:	0	0	0	0	0	0	0	0	0	0	0	0
Reduced Vol:	0	1631	18	191	758	0	0	0	0	3	0	312
PCE Adj:	1.00	1.00	1.00	1.00	1.00	1.00	1.00	1.00	1.00	1.00	1.00	1.00
MLF Adj:	1.00	1.00	1.00	1.00	1.00	1.00	1.00	1.00	1.00	1.00	1.00	1.00
Final Volume:	0	1631	18	191	758	0	0	0	0	3	0	312

Saturation Flow Module:												
Sat/Lane:	1900	1900	1900	1900	1900	1900	1900	1900	1900	1900	1900	1900
Adjustment:	0.92	1.00	0.92	0.92	1.00	0.92	0.92	1.00	0.92	0.92	1.00	0.92
Lanes:	0.00	2.00	1.00	1.00	2.00	0.00	0.00	0.00	0.00	1.00	0.00	1.00
Final Sat.:	0	3800	1750	1750	3800	0	0	0	0	1750	0	1750

Capacity Analysis Module:												
Vol/Sat:	0.00	0.43	0.01	0.11	0.20	0.00	0.00	0.00	0.00	0.00	0.00	0.18
Crit Moves:	****			****			****			****		
Green Time:	0.0	32.7	42.7	8.3	41.0	0.0	0.0	0.0	0.0	10.0	0.0	18.3
Volume/Cap:	0.00	0.79	0.01	0.79	0.29	0.00	0.00	0.00	0.00	0.01	0.00	0.58
Delay/Veh:	0.0	13.0	2.5	40.7	3.8	0.0	0.0	0.0	0.0	20.9	0.0	19.3
User DelAdj:	1.00	1.00	1.00	1.00	1.00	1.00	1.00	1.00	1.00	1.00	1.00	1.00
AdjDel/Veh:	0.0	13.0	2.5	40.7	3.8	0.0	0.0	0.0	0.0	20.9	0.0	19.3
LOS by Move:	A	B	A	D	A	A	A	A	A	C	A	B
HCM2k95thQ:	0	22	0	8	6	0	0	0	0	0	0	10

Note: Queue reported is the number of cars per lane.

City of Morgan Hill
Carpenters Training Center

Level Of Service Computation Report
2000 HCM Operations (Future Volume Alternative)
Cumulative Plus Project AM

Intersection #1324: Monterey Road and Madrone Parkway

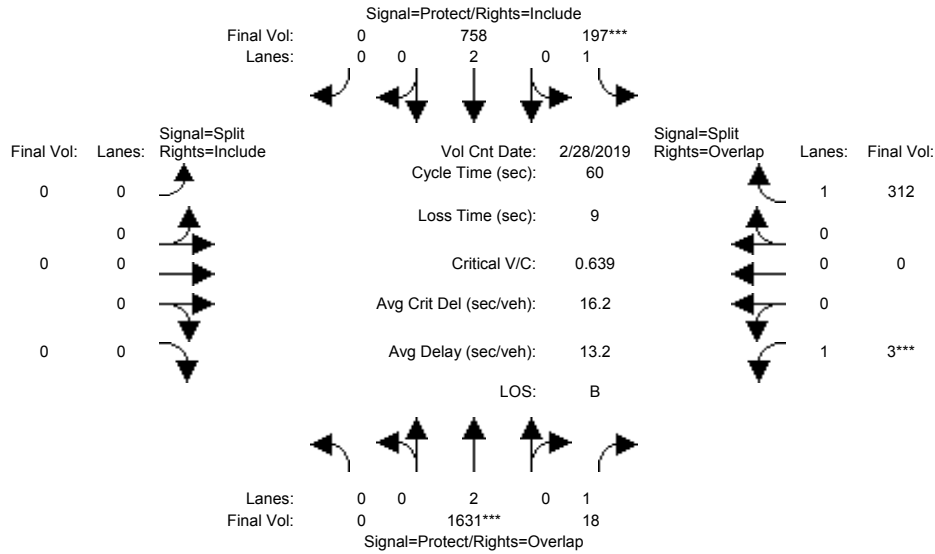

Street Name:	Monterey Road						Madrone Parkway					
	North Bound			South Bound			East Bound			West Bound		
Approach:	L	T	R	L	T	R	L	T	R	L	T	R
Min. Green:	0	10	10	7	10	0	0	0	0	10	0	10
Y+R:	4.0	4.0	4.0	4.0	4.0	4.0	4.0	4.0	4.0	4.0	4.0	4.0

Volume Module:	>>	Count	Date:	28 Feb 2019	<<							
Base Vol:	0	1631	18	191	758	0	0	0	0	3	0	312
Growth Adj:	1.00	1.00	1.00	1.00	1.00	1.00	1.00	1.00	1.00	1.00	1.00	1.00
Initial Bse:	0	1631	18	191	758	0	0	0	0	3	0	312
Added Vol:	0	0	0	6	0	0	0	0	0	0	0	0
PasserByVol:	0	0	0	0	0	0	0	0	0	0	0	0
Initial Fut:	0	1631	18	197	758	0	0	0	0	3	0	312
User Adj:	1.00	1.00	1.00	1.00	1.00	1.00	1.00	1.00	1.00	1.00	1.00	1.00
PHF Adj:	1.00	1.00	1.00	1.00	1.00	1.00	1.00	1.00	1.00	1.00	1.00	1.00
PHF Volume:	0	1631	18	197	758	0	0	0	0	3	0	312
Reduct Vol:	0	0	0	0	0	0	0	0	0	0	0	0
Reduced Vol:	0	1631	18	197	758	0	0	0	0	3	0	312
PCE Adj:	1.00	1.00	1.00	1.00	1.00	1.00	1.00	1.00	1.00	1.00	1.00	1.00
MLF Adj:	1.00	1.00	1.00	1.00	1.00	1.00	1.00	1.00	1.00	1.00	1.00	1.00
Final Volume:	0	1631	18	197	758	0	0	0	0	3	0	312

Saturation Flow Module:												
Sat/Lane:	1900	1900	1900	1900	1900	1900	1900	1900	1900	1900	1900	1900
Adjustment:	0.92	1.00	0.92	0.92	1.00	0.92	0.92	1.00	0.92	0.92	1.00	0.92
Lanes:	0.00	2.00	1.00	1.00	2.00	0.00	0.00	0.00	0.00	1.00	0.00	1.00
Final Sat.:	0	3800	1750	1750	3800	0	0	0	0	1750	0	1750

Capacity Analysis Module:												
Vol/Sat:	0.00	0.43	0.01	0.11	0.20	0.00	0.00	0.00	0.00	0.00	0.00	0.18
Crit Moves:	****			****						****		
Green Time:	0.0	32.5	42.5	8.5	41.0	0.0	0.0	0.0	0.0	10.0	0.0	18.5
Volume/Cap:	0.00	0.79	0.01	0.79	0.29	0.00	0.00	0.00	0.00	0.01	0.00	0.58
Delay/Veh:	0.0	13.2	2.6	40.8	3.8	0.0	0.0	0.0	0.0	20.9	0.0	19.0
User DelAdj:	1.00	1.00	1.00	1.00	1.00	1.00	1.00	1.00	1.00	1.00	1.00	1.00
AdjDel/Veh:	0.0	13.2	2.6	40.8	3.8	0.0	0.0	0.0	0.0	20.9	0.0	19.0
LOS by Move:	A	B	A	D	A	A	A	A	A	C	A	B
HCM2k95thQ:	0	23	0	8	6	0	0	0	0	0	0	10

Note: Queue reported is the number of cars per lane.

City of Morgan Hill
Carpenters Training Center

Level Of Service Computation Report
2000 HCM Operations (Future Volume Alternative)
Existing PM

Intersection #1324: Monterey Road and Madrone Parkway

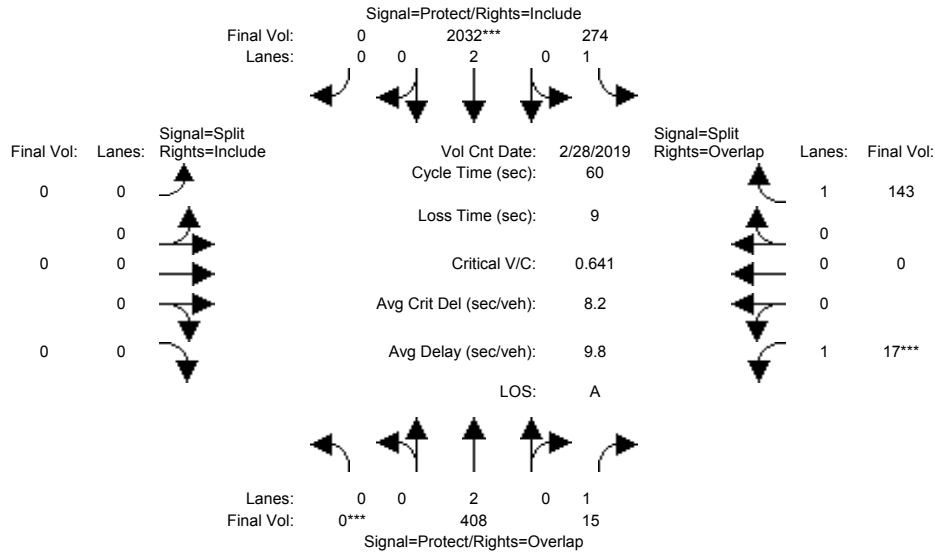

Street Name:	Monterey Road						Madrone Parkway					
	North Bound			South Bound			East Bound			West Bound		
Approach:	L	T	R	L	T	R	L	T	R	L	T	R
Min. Green:	0	10	10	7	10	0	0	0	0	10	0	10
Y+R:	4.0	4.0	4.0	4.0	4.0	4.0	4.0	4.0	4.0	4.0	4.0	4.0

Volume Module:	>>	Count	Date:	28 Feb 2019	<<							
Base Vol:	0	408	15	274	2032	0	0	0	0	17	0	143
Growth Adj:	1.00	1.00	1.00	1.00	1.00	1.00	1.00	1.00	1.00	1.00	1.00	1.00
Initial Bse:	0	408	15	274	2032	0	0	0	0	17	0	143
Added Vol:	0	0	0	0	0	0	0	0	0	0	0	0
PasserByVol:	0	0	0	0	0	0	0	0	0	0	0	0
Initial Fut:	0	408	15	274	2032	0	0	0	0	17	0	143
User Adj:	1.00	1.00	1.00	1.00	1.00	1.00	1.00	1.00	1.00	1.00	1.00	1.00
PHF Adj:	1.00	1.00	1.00	1.00	1.00	1.00	1.00	1.00	1.00	1.00	1.00	1.00
PHF Volume:	0	408	15	274	2032	0	0	0	0	17	0	143
Reduct Vol:	0	0	0	0	0	0	0	0	0	0	0	0
Reduced Vol:	0	408	15	274	2032	0	0	0	0	17	0	143
PCE Adj:	1.00	1.00	1.00	1.00	1.00	1.00	1.00	1.00	1.00	1.00	1.00	1.00
MLF Adj:	1.00	1.00	1.00	1.00	1.00	1.00	1.00	1.00	1.00	1.00	1.00	1.00
Final Volume:	0	408	15	274	2032	0	0	0	0	17	0	143

Saturation Flow Module:												
Sat/Lane:	1900	1900	1900	1900	1900	1900	1900	1900	1900	1900	1900	1900
Adjustment:	0.92	1.00	0.92	0.92	1.00	0.92	0.92	1.00	0.92	0.92	1.00	0.92
Lanes:	0.00	2.00	1.00	1.00	2.00	0.00	0.00	0.00	0.00	1.00	0.00	1.00
Final Sat.:	0	3800	1750	1750	3800	0	0	0	0	1750	0	1750

Capacity Analysis Module:												
Vol/Sat:	0.00	0.11	0.01	0.16	0.53	0.00	0.00	0.00	0.00	0.01	0.00	0.08
Crit Moves:	****				****					****		
Green Time:	0.0	21.1	31.1	19.9	41.0	0.0	0.0	0.0	0.0	10.0	0.0	29.9
Volume/Cap:	0.00	0.30	0.02	0.47	0.78	0.00	0.00	0.00	0.00	0.06	0.00	0.16
Delay/Veh:	0.0	14.2	7.0	16.5	8.1	0.0	0.0	0.0	0.0	21.1	0.0	8.3
User DelAdj:	1.00	1.00	1.00	1.00	1.00	1.00	1.00	1.00	1.00	1.00	1.00	1.00
AdjDel/Veh:	0.0	14.2	7.0	16.5	8.1	0.0	0.0	0.0	0.0	21.1	0.0	8.3
LOS by Move:	A	B	A	B	A	A	A	A	A	C	A	A
HCM2k95thQ:	0	5	0	8	23	0	0	0	0	1	0	3

Note: Queue reported is the number of cars per lane.

City of Morgan Hill
Carpenters Training Center

Level Of Service Computation Report
2000 HCM Operations (Future Volume Alternative)
Existing Plus Project PM

Intersection #1324: Monterey Road and Madrone Parkway

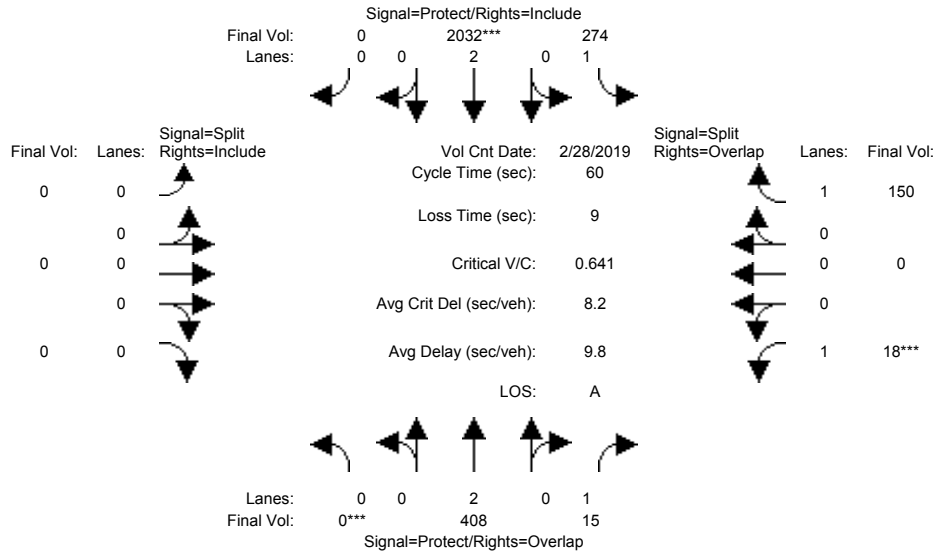

Street Name:	Monterey Road						Madrone Parkway					
	North Bound			South Bound			East Bound			West Bound		
Approach:												
Movement:	L	T	R	L	T	R	L	T	R	L	T	R
Min. Green:	0	10	10	7	10	0	0	0	0	10	0	10
Y+R:	4.0	4.0	4.0	4.0	4.0	4.0	4.0	4.0	4.0	4.0	4.0	4.0

Volume Module:	>>	Count	Date:	28 Feb 2019	<<							
Base Vol:	0	408	15	274	2032	0	0	0	0	17	0	143
Growth Adj:	1.00	1.00	1.00	1.00	1.00	1.00	1.00	1.00	1.00	1.00	1.00	1.00
Initial Bse:	0	408	15	274	2032	0	0	0	0	17	0	143
Added Vol:	0	0	0	0	0	0	0	0	0	1	0	7
PasserByVol:	0	0	0	0	0	0	0	0	0	0	0	0
Initial Fut:	0	408	15	274	2032	0	0	0	0	18	0	150
User Adj:	1.00	1.00	1.00	1.00	1.00	1.00	1.00	1.00	1.00	1.00	1.00	1.00
PHF Adj:	1.00	1.00	1.00	1.00	1.00	1.00	1.00	1.00	1.00	1.00	1.00	1.00
PHF Volume:	0	408	15	274	2032	0	0	0	0	18	0	150
Reduct Vol:	0	0	0	0	0	0	0	0	0	0	0	0
Reduced Vol:	0	408	15	274	2032	0	0	0	0	18	0	150
PCE Adj:	1.00	1.00	1.00	1.00	1.00	1.00	1.00	1.00	1.00	1.00	1.00	1.00
MLF Adj:	1.00	1.00	1.00	1.00	1.00	1.00	1.00	1.00	1.00	1.00	1.00	1.00
Final Volume:	0	408	15	274	2032	0	0	0	0	18	0	150

Saturation Flow Module:												
Sat/Lane:	1900	1900	1900	1900	1900	1900	1900	1900	1900	1900	1900	1900
Adjustment:	0.92	1.00	0.92	0.92	1.00	0.92	0.92	1.00	0.92	0.92	1.00	0.92
Lanes:	0.00	2.00	1.00	1.00	2.00	0.00	0.00	0.00	0.00	1.00	0.00	1.00
Final Sat.:	0	3800	1750	1750	3800	0	0	0	0	1750	0	1750

Capacity Analysis Module:												
Vol/Sat:	0.00	0.11	0.01	0.16	0.53	0.00	0.00	0.00	0.00	0.01	0.00	0.09
Crit Moves:	****				****					****		
Green Time:	0.0	21.1	31.1	19.9	41.0	0.0	0.0	0.0	0.0	10.0	0.0	29.9
Volume/Cap:	0.00	0.30	0.02	0.47	0.78	0.00	0.00	0.00	0.00	0.06	0.00	0.17
Delay/Veh:	0.0	14.2	7.0	16.5	8.1	0.0	0.0	0.0	0.0	21.1	0.0	8.4
User DelAdj:	1.00	1.00	1.00	1.00	1.00	1.00	1.00	1.00	1.00	1.00	1.00	1.00
AdjDel/Veh:	0.0	14.2	7.0	16.5	8.1	0.0	0.0	0.0	0.0	21.1	0.0	8.4
LOS by Move:	A	B	A	B	A	A	A	A	A	C	A	A
HCM2k95thQ:	0	5	0	8	23	0	0	0	0	1	0	3

Note: Queue reported is the number of cars per lane.

City of Morgan Hill
Carpenters Training Center

Level Of Service Computation Report
2000 HCM Operations (Future Volume Alternative)
Cumulative PM

Intersection #1324: Monterey Road and Madrone Parkway

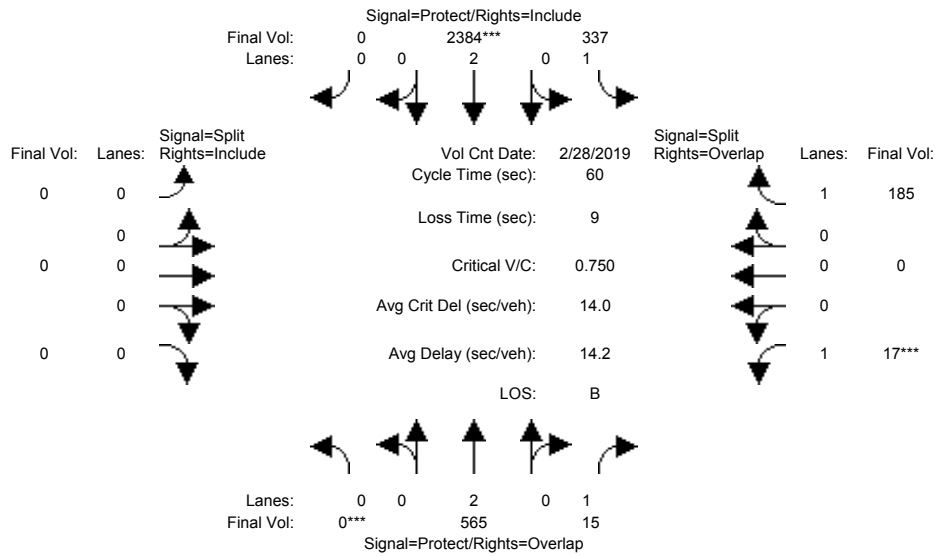

Street Name:	Monterey Road						Madrone Parkway					
	North Bound			South Bound			East Bound			West Bound		
Approach:	L	T	R	L	T	R	L	T	R	L	T	R
Min. Green:	0	10	10	7	10	0	0	0	0	10	0	10
Y+R:	4.0	4.0	4.0	4.0	4.0	4.0	4.0	4.0	4.0	4.0	4.0	4.0

Volume Module:	>>	Count	Date:	28 Feb 2019	<<						
Base Vol:	0	565	15	337	2384	0	0	0	17	0	185
Growth Adj:	1.00	1.00	1.00	1.00	1.00	1.00	1.00	1.00	1.00	1.00	1.00
Initial Bse:	0	565	15	337	2384	0	0	0	17	0	185
Added Vol:	0	0	0	0	0	0	0	0	0	0	0
PasserByVol:	0	0	0	0	0	0	0	0	0	0	0
Initial Fut:	0	565	15	337	2384	0	0	0	17	0	185
User Adj:	1.00	1.00	1.00	1.00	1.00	1.00	1.00	1.00	1.00	1.00	1.00
PHF Adj:	1.00	1.00	1.00	1.00	1.00	1.00	1.00	1.00	1.00	1.00	1.00
PHF Volume:	0	565	15	337	2384	0	0	0	17	0	185
Reduct Vol:	0	0	0	0	0	0	0	0	0	0	0
Reduced Vol:	0	565	15	337	2384	0	0	0	17	0	185
PCE Adj:	1.00	1.00	1.00	1.00	1.00	1.00	1.00	1.00	1.00	1.00	1.00
MLF Adj:	1.00	1.00	1.00	1.00	1.00	1.00	1.00	1.00	1.00	1.00	1.00
Final Volume:	0	565	15	337	2384	0	0	0	17	0	185

Saturation Flow Module:												
Sat/Lane:	1900	1900	1900	1900	1900	1900	1900	1900	1900	1900	1900	1900
Adjustment:	0.92	1.00	0.92	0.92	1.00	0.92	0.92	1.00	0.92	0.92	1.00	0.92
Lanes:	0.00	2.00	1.00	1.00	2.00	0.00	0.00	0.00	0.00	1.00	0.00	1.00
Final Sat.:	0	3800	1750	1750	3800	0	0	0	0	1750	0	1750

Capacity Analysis Module:												
Vol/Sat:	0.00	0.15	0.01	0.19	0.63	0.00	0.00	0.00	0.00	0.01	0.00	0.11
Crit Moves:	****				****					****		
Green Time:	0.0	19.0	29.0	22.0	41.0	0.0	0.0	0.0	0.0	10.0	0.0	32.0
Volume/Cap:	0.00	0.47	0.02	0.53	0.92	0.00	0.00	0.00	0.00	0.06	0.00	0.20
Delay/Veh:	0.0	16.7	8.1	15.7	13.9	0.0	0.0	0.0	0.0	21.1	0.0	7.4
User DelAdj:	1.00	1.00	1.00	1.00	1.00	1.00	1.00	1.00	1.00	1.00	1.00	1.00
AdjDel/Veh:	0.0	16.7	8.1	15.7	13.9	0.0	0.0	0.0	0.0	21.1	0.0	7.4
LOS by Move:	A	B	A	B	B	A	A	A	A	C	A	A
HCM2k95thQ:	0	8	0	10	32	0	0	0	0	1	0	4

Note: Queue reported is the number of cars per lane.

City of Morgan Hill
Carpenters Training Center

Level Of Service Computation Report
2000 HCM Operations (Future Volume Alternative)
Cumulative Plus Project PM

Intersection #1324: Monterey Road and Madrone Parkway

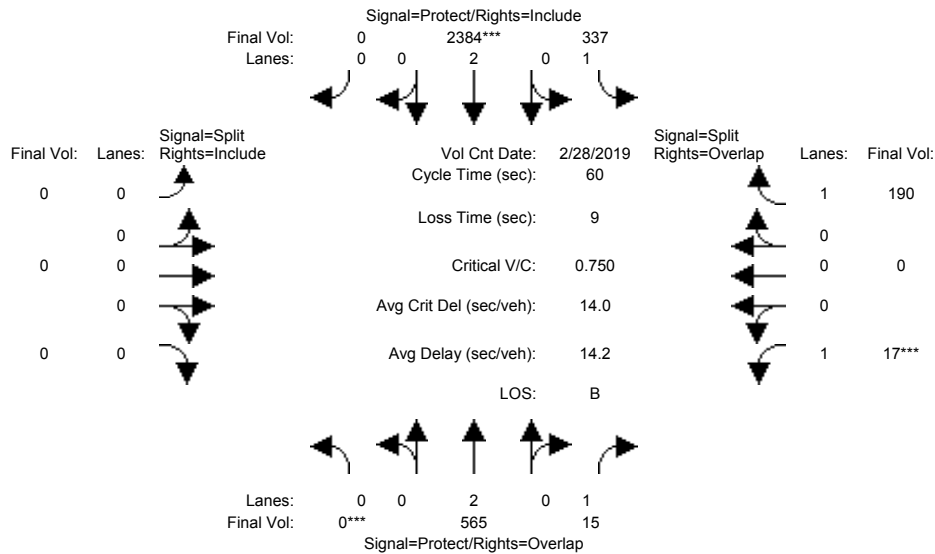

Street Name:	Monterey Road						Madrone Parkway					
	North Bound			South Bound			East Bound			West Bound		
Approach:	L	T	R	L	T	R	L	T	R	L	T	R
Min. Green:	0	10	10	7	10	0	0	0	0	10	0	10
Y+R:	4.0	4.0	4.0	4.0	4.0	4.0	4.0	4.0	4.0	4.0	4.0	4.0

Volume Module:	>>	Count	Date:	28 Feb 2019	<<						
Base Vol:	0	565	15	337	2384	0	0	0	17	0	185
Growth Adj:	1.00	1.00	1.00	1.00	1.00	1.00	1.00	1.00	1.00	1.00	1.00
Initial Bse:	0	565	15	337	2384	0	0	0	17	0	185
Added Vol:	0	0	0	0	0	0	0	0	0	0	5
PasserByVol:	0	0	0	0	0	0	0	0	0	0	0
Initial Fut:	0	565	15	337	2384	0	0	0	17	0	190
User Adj:	1.00	1.00	1.00	1.00	1.00	1.00	1.00	1.00	1.00	1.00	1.00
PHF Adj:	1.00	1.00	1.00	1.00	1.00	1.00	1.00	1.00	1.00	1.00	1.00
PHF Volume:	0	565	15	337	2384	0	0	0	17	0	190
Reduct Vol:	0	0	0	0	0	0	0	0	0	0	0
Reduced Vol:	0	565	15	337	2384	0	0	0	17	0	190
PCE Adj:	1.00	1.00	1.00	1.00	1.00	1.00	1.00	1.00	1.00	1.00	1.00
MLF Adj:	1.00	1.00	1.00	1.00	1.00	1.00	1.00	1.00	1.00	1.00	1.00
Final Volume:	0	565	15	337	2384	0	0	0	17	0	190

Saturation Flow Module:												
Sat/Lane:	1900	1900	1900	1900	1900	1900	1900	1900	1900	1900	1900	1900
Adjustment:	0.92	1.00	0.92	0.92	1.00	0.92	0.92	1.00	0.92	0.92	1.00	0.92
Lanes:	0.00	2.00	1.00	1.00	2.00	0.00	0.00	0.00	0.00	1.00	0.00	1.00
Final Sat.:	0	3800	1750	1750	3800	0	0	0	0	1750	0	1750

Capacity Analysis Module:												
Vol/Sat:	0.00	0.15	0.01	0.19	0.63	0.00	0.00	0.00	0.00	0.01	0.00	0.11
Crit Moves:	****				****					****		
Green Time:	0.0	19.0	29.0	22.0	41.0	0.0	0.0	0.0	0.0	10.0	0.0	32.0
Volume/Cap:	0.00	0.47	0.02	0.53	0.92	0.00	0.00	0.00	0.00	0.06	0.00	0.20
Delay/Veh:	0.0	16.7	8.1	15.7	13.9	0.0	0.0	0.0	0.0	21.1	0.0	7.4
User DelAdj:	1.00	1.00	1.00	1.00	1.00	1.00	1.00	1.00	1.00	1.00	1.00	1.00
AdjDel/Veh:	0.0	16.7	8.1	15.7	13.9	0.0	0.0	0.0	0.0	21.1	0.0	7.4
LOS by Move:	A	B	A	B	B	A	A	A	A	C	A	A
HCM2k95thQ:	0	8	0	10	32	0	0	0	0	1	0	4

Note: Queue reported is the number of cars per lane.

City of Morgan Hill
Carpenters Training Center

Level Of Service Computation Report
2000 HCM Operations (Future Volume Alternative)
Existing AM

Intersection #101: Monterey Road and Cochrane Road

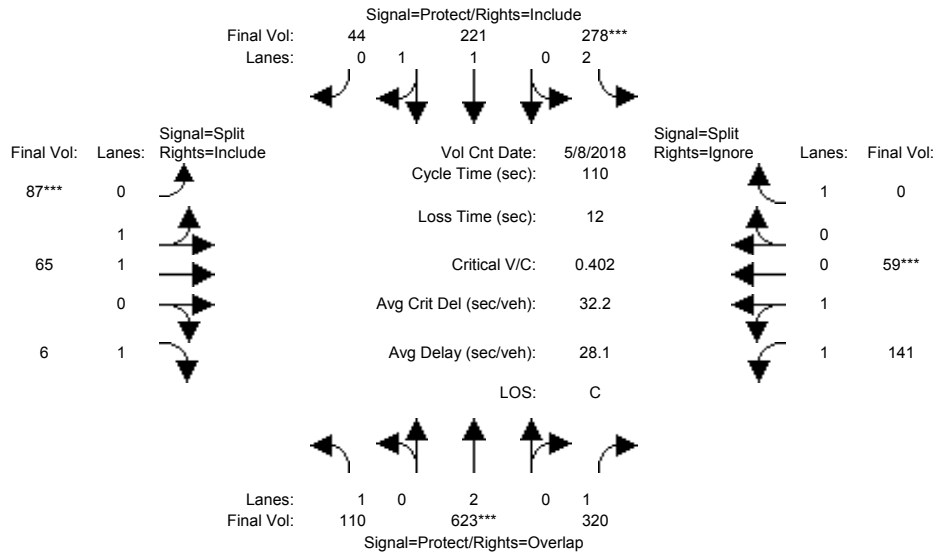

Street Name:	Monterey Road						Cochrane Road					
	North Bound			South Bound			East Bound			West Bound		
Approach:	L	T	R	L	T	R	L	T	R	L	T	R
Min. Green:	7	10	10	7	10	10	10	10	10	10	10	10
Y+R:	4.0	4.0	4.0	4.0	4.0	4.0	4.0	4.0	4.0	4.0	4.0	4.0

Volume Module:	>>	Count	Date:	8 May 2018	<<												
Base Vol:	110	623	320	278	221	44	87	65	6	141	59	582					
Growth Adj:	1.00	1.00	1.00	1.00	1.00	1.00	1.00	1.00	1.00	1.00	1.00	1.00					
Initial Bse:	110	623	320	278	221	44	87	65	6	141	59	582					
Added Vol:	0	0	0	0	0	0	0	0	0	0	0	0					
PasserByVol:	0	0	0	0	0	0	0	0	0	0	0	0					
Initial Fut:	110	623	320	278	221	44	87	65	6	141	59	582					
User Adj:	1.00	1.00	1.00	1.00	1.00	1.00	1.00	1.00	1.00	1.00	1.00	0.00					
PHF Adj:	1.00	1.00	1.00	1.00	1.00	1.00	1.00	1.00	1.00	1.00	1.00	0.00					
PHF Volume:	110	623	320	278	221	44	87	65	6	141	59	0					
Reduct Vol:	0	0	0	0	0	0	0	0	0	0	0	0					
Reduced Vol:	110	623	320	278	221	44	87	65	6	141	59	0					
PCE Adj:	1.00	1.00	1.00	1.00	1.00	1.00	1.00	1.00	1.00	1.00	1.00	0.00					
MLF Adj:	1.00	1.00	1.00	1.00	1.00	1.00	1.00	1.00	1.00	1.00	1.00	0.00					
FinalVolume:	110	623	320	278	221	44	87	65	6	141	59	0					

Saturation Flow Module:												
Sat/Lane:	1900	1900	1900	1900	1900	1900	1900	1900	1900	1900	1900	1900
Adjustment:	0.92	1.00	0.92	0.83	0.98	0.95	0.92	1.00	0.92	0.93	0.95	0.92
Lanes:	1.00	2.00	1.00	2.00	1.66	0.34	1.00	1.00	1.00	1.42	0.58	1.00
Final Sat.:	1750	3800	1750	3150	3085	614	1750	1900	1750	2503	1047	1750

Capacity Analysis Module:												
Vol/Sat:	0.06	0.16	0.18	0.09	0.07	0.07	0.05	0.03	0.00	0.06	0.06	0.00
Crit Moves:	****			****			****			****		
Green Time:	28.4	44.8	60.3	24.1	40.6	40.6	13.6	13.6	13.6	15.4	15.4	0.0
Volume/Cap:	0.24	0.40	0.33	0.40	0.19	0.19	0.40	0.28	0.03	0.40	0.40	0.00
Delay/Veh:	32.6	23.3	14.0	37.1	23.7	23.7	45.2	44.0	42.4	43.6	43.6	0.0
User DelAdj:	1.00	1.00	1.00	1.00	1.00	1.00	1.00	1.00	1.00	1.00	1.00	1.00
AdjDel/Veh:	32.6	23.3	14.0	37.1	23.7	23.7	45.2	44.0	42.4	43.6	43.6	0.0
LOS by Move:	C	C	B	D	C	C	D	D	D	D	D	A
HCM2k95thQ:	6	14	12	9	6	6	7	4	0	6	6	0

Note: Queue reported is the number of cars per lane.

City of Morgan Hill
Carpenters Training Center

Level Of Service Computation Report
2000 HCM Operations (Future Volume Alternative)
Existing Plus Project AM

Intersection #101: Monterey Road and Cochrane Road

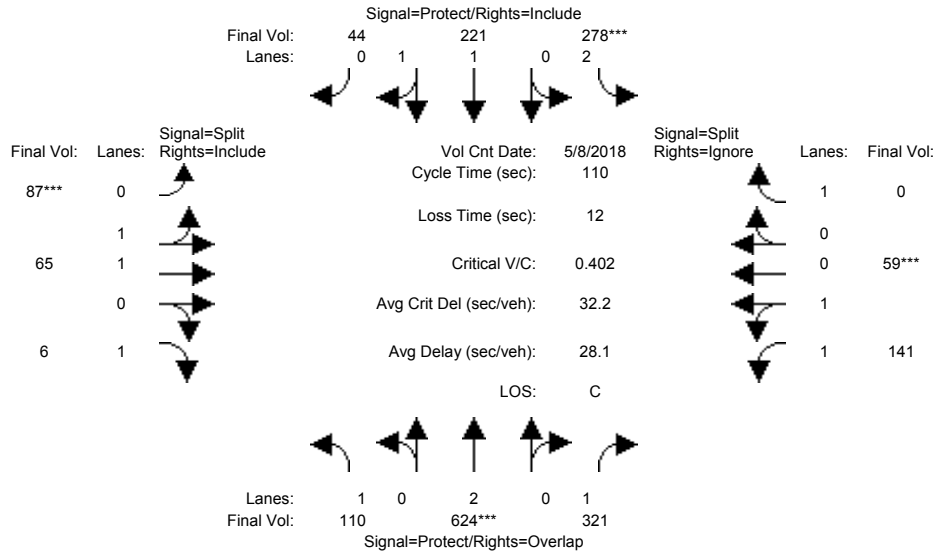

Street Name:	Monterey Road						Cochrane Road					
	North Bound			South Bound			East Bound			West Bound		
Approach:	L	T	R	L	T	R	L	T	R	L	T	R
Min. Green:	7	10	10	7	10	10	10	10	10	10	10	10
Y+R:	4.0	4.0	4.0	4.0	4.0	4.0	4.0	4.0	4.0	4.0	4.0	4.0

Volume Module:	>>	Count	Date:	8 May 2018	<<												
Base Vol:	110	623	320	278	221	44	87	65	6	141	59	582					
Growth Adj:	1.00	1.00	1.00	1.00	1.00	1.00	1.00	1.00	1.00	1.00	1.00	1.00					
Initial Bse:	110	623	320	278	221	44	87	65	6	141	59	582					
Added Vol:	0	1	1	0	0	0	0	0	0	0	0	0					
PasserByVol:	0	0	0	0	0	0	0	0	0	0	0	0					
Initial Fut:	110	624	321	278	221	44	87	65	6	141	59	582					
User Adj:	1.00	1.00	1.00	1.00	1.00	1.00	1.00	1.00	1.00	1.00	1.00	0.00					
PHF Adj:	1.00	1.00	1.00	1.00	1.00	1.00	1.00	1.00	1.00	1.00	1.00	0.00					
PHF Volume:	110	624	321	278	221	44	87	65	6	141	59	0					
Reduct Vol:	0	0	0	0	0	0	0	0	0	0	0	0					
Reduced Vol:	110	624	321	278	221	44	87	65	6	141	59	0					
PCE Adj:	1.00	1.00	1.00	1.00	1.00	1.00	1.00	1.00	1.00	1.00	1.00	0.00					
MLF Adj:	1.00	1.00	1.00	1.00	1.00	1.00	1.00	1.00	1.00	1.00	1.00	0.00					
Final Volume:	110	624	321	278	221	44	87	65	6	141	59	0					

Saturation Flow Module:												
Sat/Lane:	1900	1900	1900	1900	1900	1900	1900	1900	1900	1900	1900	1900
Adjustment:	0.92	1.00	0.92	0.83	0.98	0.95	0.92	1.00	0.92	0.93	0.95	0.92
Lanes:	1.00	2.00	1.00	2.00	1.66	0.34	1.00	1.00	1.00	1.42	0.58	1.00
Final Sat.:	1750	3800	1750	3150	3085	614	1750	1900	1750	2503	1047	1750

Capacity Analysis Module:												
Vol/Sat:	0.06	0.16	0.18	0.09	0.07	0.07	0.05	0.03	0.00	0.06	0.06	0.00
Crit Moves:	****			****			****			****		
Green Time:	28.4	44.9	60.3	24.1	40.6	40.6	13.6	13.6	13.6	15.4	15.4	0.0
Volume/Cap:	0.24	0.40	0.33	0.40	0.19	0.19	0.40	0.28	0.03	0.40	0.40	0.00
Delay/Veh:	32.6	23.2	14.0	37.2	23.7	23.7	45.2	44.0	42.4	43.6	43.6	0.0
User DelAdj:	1.00	1.00	1.00	1.00	1.00	1.00	1.00	1.00	1.00	1.00	1.00	1.00
AdjDel/Veh:	32.6	23.2	14.0	37.2	23.7	23.7	45.2	44.0	42.4	43.6	43.6	0.0
LOS by Move:	C	C	B	D	C	C	D	D	D	D	D	A
HCM2k95thQ:	6	14	12	9	6	6	7	4	0	6	6	0

Note: Queue reported is the number of cars per lane.

City of Morgan Hill
Carpenters Training Center

Level Of Service Computation Report
2000 HCM Operations (Future Volume Alternative)
Cumulative AM

Intersection #101: Monterey Road and Cochrane Road

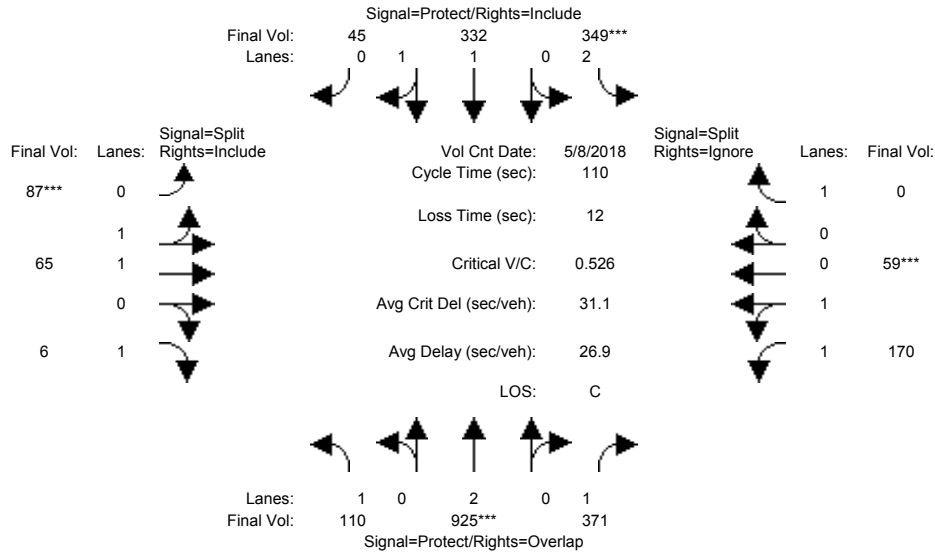

Street Name:	Monterey Road						Cochrane Road					
	North Bound			South Bound			East Bound			West Bound		
Approach:	L	T	R	L	T	R	L	T	R	L	T	R
Min. Green:	7	10	10	7	10	10	10	10	10	10	10	10
Y+R:	4.0	4.0	4.0	4.0	4.0	4.0	4.0	4.0	4.0	4.0	4.0	4.0

Volume Module:	>>	Count	Date:	8 May 2018	<<							
Base Vol:	110	925	371	349	332	45	87	65	6	170	59	615
Growth Adj:	1.00	1.00	1.00	1.00	1.00	1.00	1.00	1.00	1.00	1.00	1.00	1.00
Initial Bse:	110	925	371	349	332	45	87	65	6	170	59	615
Added Vol:	0	0	0	0	0	0	0	0	0	0	0	0
PasserByVol:	0	0	0	0	0	0	0	0	0	0	0	0
Initial Fut:	110	925	371	349	332	45	87	65	6	170	59	615
User Adj:	1.00	1.00	1.00	1.00	1.00	1.00	1.00	1.00	1.00	1.00	1.00	0.00
PHF Adj:	1.00	1.00	1.00	1.00	1.00	1.00	1.00	1.00	1.00	1.00	1.00	0.00
PHF Volume:	110	925	371	349	332	45	87	65	6	170	59	0
Reduct Vol:	0	0	0	0	0	0	0	0	0	0	0	0
Reduced Vol:	110	925	371	349	332	45	87	65	6	170	59	0
PCE Adj:	1.00	1.00	1.00	1.00	1.00	1.00	1.00	1.00	1.00	1.00	1.00	0.00
MLF Adj:	1.00	1.00	1.00	1.00	1.00	1.00	1.00	1.00	1.00	1.00	1.00	0.00
Final Volume:	110	925	371	349	332	45	87	65	6	170	59	0

Saturation Flow Module:												
Sat/Lane:	1900	1900	1900	1900	1900	1900	1900	1900	1900	1900	1900	1900
Adjustment:	0.92	1.00	0.92	0.83	0.98	0.95	0.92	1.00	0.92	0.93	0.95	0.92
Lanes:	1.00	2.00	1.00	2.00	1.75	0.25	1.00	1.00	1.00	1.49	0.51	1.00
Final Sat.:	1750	3800	1750	3150	3258	442	1750	1900	1750	2635	915	1750

Capacity Analysis Module:												
Vol/Sat:	0.06	0.24	0.21	0.11	0.10	0.10	0.05	0.03	0.00	0.06	0.06	0.00
Crit Moves:	****			****			****			****		
Green Time:	28.5	50.9	64.4	23.2	45.6	45.6	10.4	10.4	10.4	13.5	13.5	0.0
Volume/Cap:	0.24	0.53	0.36	0.53	0.25	0.25	0.53	0.36	0.04	0.53	0.53	0.00
Delay/Veh:	32.5	21.3	12.2	39.3	21.1	21.1	49.2	47.2	45.3	46.4	46.4	0.0
User DelAdj:	1.00	1.00	1.00	1.00	1.00	1.00	1.00	1.00	1.00	1.00	1.00	1.00
AdjDel/Veh:	32.5	21.3	12.2	39.3	21.1	21.1	49.2	47.2	45.3	46.4	46.4	0.0
LOS by Move:	C	C	B	D	C	C	D	D	D	D	D	A
HCM2k95thQ:	6	20	13	12	8	8	7	5	0	8	8	0

Note: Queue reported is the number of cars per lane.

City of Morgan Hill
Carpenters Training Center

Level Of Service Computation Report
2000 HCM Operations (Future Volume Alternative)
Cumulative Plus Project AM

Intersection #101: Monterey Road and Cochrane Road

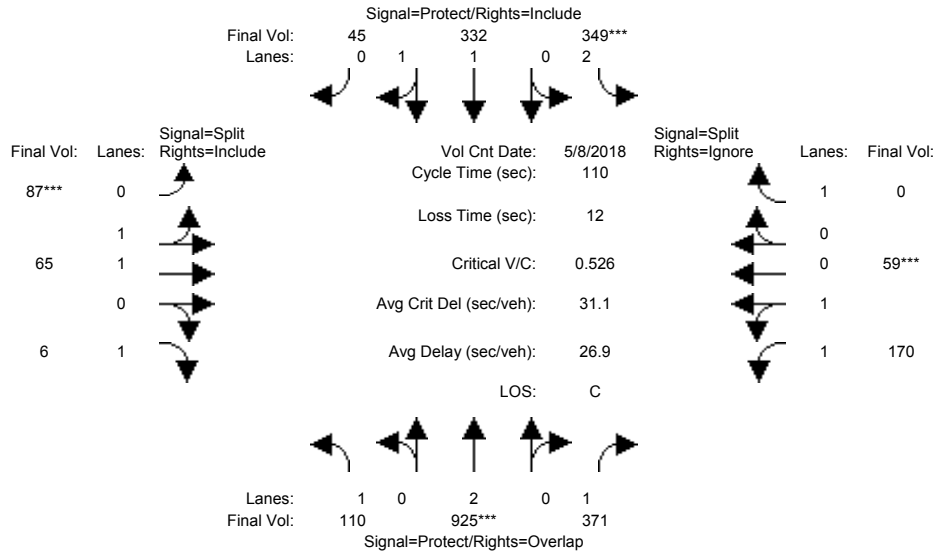

Street Name:	Monterey Road						Cochrane Road					
	North Bound			South Bound			East Bound			West Bound		
Approach:	L	T	R	L	T	R	L	T	R	L	T	R
Min. Green:	7	10	10	7	10	10	10	10	10	10	10	10
Y+R:	4.0	4.0	4.0	4.0	4.0	4.0	4.0	4.0	4.0	4.0	4.0	4.0

Volume Module:	>>	Count	Date:	8 May 2018	<<							
Base Vol:	110	925	371	349	332	45	87	65	6	170	59	615
Growth Adj:	1.00	1.00	1.00	1.00	1.00	1.00	1.00	1.00	1.00	1.00	1.00	1.00
Initial Bse:	110	925	371	349	332	45	87	65	6	170	59	615
Added Vol:	0	0	0	0	0	0	0	0	0	0	0	0
PasserByVol:	0	0	0	0	0	0	0	0	0	0	0	0
Initial Fut:	110	925	371	349	332	45	87	65	6	170	59	615
User Adj:	1.00	1.00	1.00	1.00	1.00	1.00	1.00	1.00	1.00	1.00	1.00	0.00
PHF Adj:	1.00	1.00	1.00	1.00	1.00	1.00	1.00	1.00	1.00	1.00	1.00	0.00
PHF Volume:	110	925	371	349	332	45	87	65	6	170	59	0
Reduct Vol:	0	0	0	0	0	0	0	0	0	0	0	0
Reduced Vol:	110	925	371	349	332	45	87	65	6	170	59	0
PCE Adj:	1.00	1.00	1.00	1.00	1.00	1.00	1.00	1.00	1.00	1.00	1.00	0.00
MLF Adj:	1.00	1.00	1.00	1.00	1.00	1.00	1.00	1.00	1.00	1.00	1.00	0.00
Final Volume:	110	925	371	349	332	45	87	65	6	170	59	0

Saturation Flow Module:												
Sat/Lane:	1900	1900	1900	1900	1900	1900	1900	1900	1900	1900	1900	1900
Adjustment:	0.92	1.00	0.92	0.83	0.98	0.95	0.92	1.00	0.92	0.93	0.95	0.92
Lanes:	1.00	2.00	1.00	2.00	1.75	0.25	1.00	1.00	1.00	1.49	0.51	1.00
Final Sat.:	1750	3800	1750	3150	3258	442	1750	1900	1750	2635	915	1750

Capacity Analysis Module:												
Vol/Sat:	0.06	0.24	0.21	0.11	0.10	0.10	0.05	0.03	0.00	0.06	0.06	0.00
Crit Moves:	****			****			****			****		
Green Time:	28.5	50.9	64.4	23.2	45.6	45.6	10.4	10.4	10.4	13.5	13.5	0.0
Volume/Cap:	0.24	0.53	0.36	0.53	0.25	0.25	0.53	0.36	0.04	0.53	0.53	0.00
Delay/Veh:	32.5	21.3	12.2	39.3	21.1	21.1	49.2	47.2	45.3	46.4	46.4	0.0
User DelAdj:	1.00	1.00	1.00	1.00	1.00	1.00	1.00	1.00	1.00	1.00	1.00	1.00
AdjDel/Veh:	32.5	21.3	12.2	39.3	21.1	21.1	49.2	47.2	45.3	46.4	46.4	0.0
LOS by Move:	C	C	B	D	C	C	D	D	D	D	D	A
HCM2k95thQ:	6	20	13	12	8	8	7	5	0	8	8	0

Note: Queue reported is the number of cars per lane.

City of Morgan Hill
Carpenters Training Center

Level Of Service Computation Report
2000 HCM Operations (Future Volume Alternative)
Existing PM

Intersection #101: Monterey Road and Cochrane Road

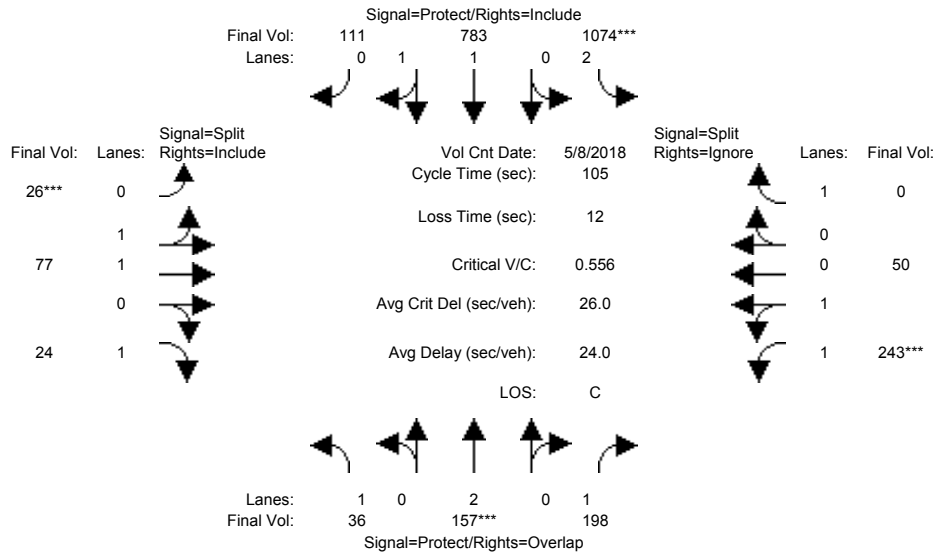

Street Name:	Monterey Road						Cochrane Road					
	North Bound			South Bound			East Bound			West Bound		
Approach:	L	T	R	L	T	R	L	T	R	L	T	R
Min. Green:	7	10	10	7	10	10	10	10	10	10	10	10
Y+R:	4.0	4.0	4.0	4.0	4.0	4.0	4.0	4.0	4.0	4.0	4.0	4.0

Volume Module:	>>	Count	Date:	8 May 2018	<<												
Base Vol:	36	157	198	1074	783	111	26	77	24	243	50	180					
Growth Adj:	1.00	1.00	1.00	1.00	1.00	1.00	1.00	1.00	1.00	1.00	1.00	1.00					
Initial Bse:	36	157	198	1074	783	111	26	77	24	243	50	180					
Added Vol:	0	0	0	0	0	0	0	0	0	0	0	0					
PasserByVol:	0	0	0	0	0	0	0	0	0	0	0	0					
Initial Fut:	36	157	198	1074	783	111	26	77	24	243	50	180					
User Adj:	1.00	1.00	1.00	1.00	1.00	1.00	1.00	1.00	1.00	1.00	1.00	0.00					
PHF Adj:	1.00	1.00	1.00	1.00	1.00	1.00	1.00	1.00	1.00	1.00	1.00	0.00					
PHF Volume:	36	157	198	1074	783	111	26	77	24	243	50	0					
Reduct Vol:	0	0	0	0	0	0	0	0	0	0	0	0					
Reduced Vol:	36	157	198	1074	783	111	26	77	24	243	50	0					
PCE Adj:	1.00	1.00	1.00	1.00	1.00	1.00	1.00	1.00	1.00	1.00	1.00	0.00					
MLF Adj:	1.00	1.00	1.00	1.00	1.00	1.00	1.00	1.00	1.00	1.00	1.00	0.00					
FinalVolume:	36	157	198	1074	783	111	26	77	24	243	50	0					

Saturation Flow Module:												
Sat/Lane:	1900	1900	1900	1900	1900	1900	1900	1900	1900	1900	1900	1900
Adjustment:	0.92	1.00	0.92	0.83	0.98	0.95	0.95	0.98	0.92	0.93	0.95	0.92
Lanes:	1.00	2.00	1.00	2.00	1.74	0.26	0.52	1.48	1.00	1.66	0.34	1.00
Final Sat.:	1750	3800	1750	3150	3240	459	934	2765	1750	2944	606	1750

Capacity Analysis Module:												
Vol/Sat:	0.02	0.04	0.11	0.34	0.24	0.24	0.03	0.03	0.01	0.08	0.08	0.00
Crit Moves:	****			****			****			****		
Green Time:	14.9	10.0	24.2	58.8	53.9	53.9	10.0	10.0	10.0	14.2	14.2	0.0
Volume/Cap:	0.15	0.43	0.49	0.61	0.47	0.47	0.29	0.29	0.14	0.61	0.61	0.00
Delay/Veh:	39.8	45.7	36.0	16.1	16.6	16.6	44.7	44.7	44.0	45.0	45.0	0.0
User DelAdj:	1.00	1.00	1.00	1.00	1.00	1.00	1.00	1.00	1.00	1.00	1.00	1.00
AdjDel/Veh:	39.8	45.7	36.0	16.1	16.6	16.6	44.7	44.7	44.0	45.0	45.0	0.0
LOS by Move:	D	D	D	B	B	B	D	D	D	D	D	A
HCM2k95thQ:	2	6	12	24	17	17	4	4	2	9	9	0

Note: Queue reported is the number of cars per lane.

City of Morgan Hill
Carpenters Training Center

Level Of Service Computation Report
2000 HCM Operations (Future Volume Alternative)
Existing Plus Project PM

Intersection #101: Monterey Road and Cochrane Road

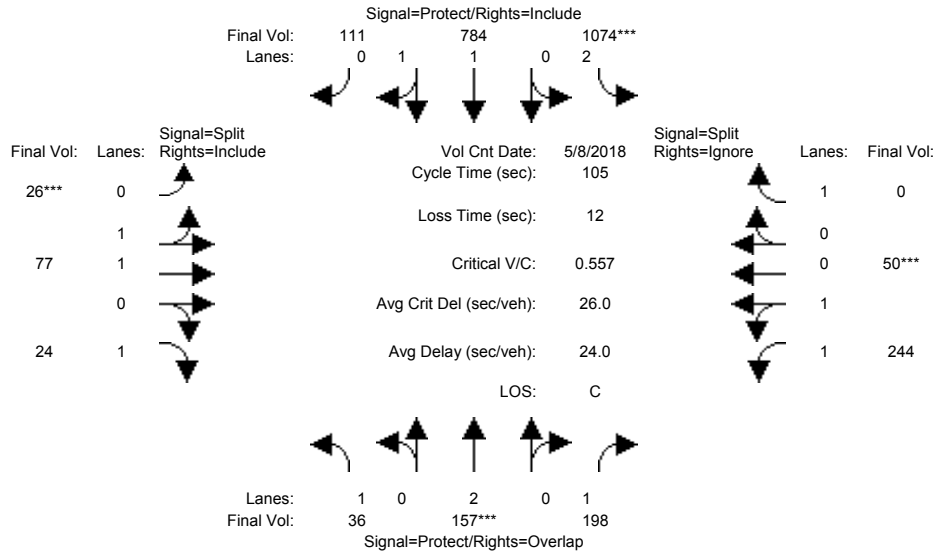

Street Name:	Monterey Road						Cochrane Road					
	North Bound			South Bound			East Bound			West Bound		
Approach:	L	T	R	L	T	R	L	T	R	L	T	R
Min. Green:	7	10	10	7	10	10	10	10	10	10	10	10
Y+R:	4.0	4.0	4.0	4.0	4.0	4.0	4.0	4.0	4.0	4.0	4.0	4.0

Volume Module:	>>	Count	Date:	8 May 2018	<<							
Base Vol:	36	157	198	1074	783	111	26	77	24	243	50	180
Growth Adj:	1.00	1.00	1.00	1.00	1.00	1.00	1.00	1.00	1.00	1.00	1.00	1.00
Initial Bse:	36	157	198	1074	783	111	26	77	24	243	50	180
Added Vol:	0	0	0	0	0	0	0	0	0	0	0	0
PasserByVol:	0	0	0	0	0	0	0	0	0	0	0	0
Initial Fut:	36	157	198	1074	784	111	26	77	24	244	50	180
User Adj:	1.00	1.00	1.00	1.00	1.00	1.00	1.00	1.00	1.00	1.00	1.00	0.00
PHF Adj:	1.00	1.00	1.00	1.00	1.00	1.00	1.00	1.00	1.00	1.00	1.00	0.00
PHF Volume:	36	157	198	1074	784	111	26	77	24	244	50	0
Reduct Vol:	0	0	0	0	0	0	0	0	0	0	0	0
Reduced Vol:	36	157	198	1074	784	111	26	77	24	244	50	0
PCE Adj:	1.00	1.00	1.00	1.00	1.00	1.00	1.00	1.00	1.00	1.00	1.00	0.00
MLF Adj:	1.00	1.00	1.00	1.00	1.00	1.00	1.00	1.00	1.00	1.00	1.00	0.00
Final Volume:	36	157	198	1074	784	111	26	77	24	244	50	0

Saturation Flow Module:												
Sat/Lane:	1900	1900	1900	1900	1900	1900	1900	1900	1900	1900	1900	1900
Adjustment:	0.92	1.00	0.92	0.83	0.98	0.95	0.95	0.98	0.92	0.93	0.95	0.92
Lanes:	1.00	2.00	1.00	2.00	1.75	0.25	0.52	1.48	1.00	1.66	0.34	1.00
Final Sat.:	1750	3800	1750	3150	3241	459	934	2765	1750	2946	604	1750

Capacity Analysis Module:												
Vol/Sat:	0.02	0.04	0.11	0.34	0.24	0.24	0.03	0.03	0.01	0.08	0.08	0.00
Crit Moves:	****			****			****			****		
Green Time:	14.8	10.0	24.3	58.7	53.9	53.9	10.0	10.0	10.0	14.3	14.3	0.0
Volume/Cap:	0.15	0.43	0.49	0.61	0.47	0.47	0.29	0.29	0.14	0.61	0.61	0.00
Delay/Veh:	39.8	45.7	35.9	16.1	16.6	16.6	44.7	44.7	44.0	45.0	45.0	0.0
User DelAdj:	1.00	1.00	1.00	1.00	1.00	1.00	1.00	1.00	1.00	1.00	1.00	1.00
AdjDel/Veh:	39.8	45.7	35.9	16.1	16.6	16.6	44.7	44.7	44.0	45.0	45.0	0.0
LOS by Move:	D	D	D	B	B	B	D	D	D	D	D	A
HCM2k95thQ:	2	6	12	24	17	17	4	4	2	9	9	0

Note: Queue reported is the number of cars per lane.

City of Morgan Hill
Carpenters Training Center

Level Of Service Computation Report
2000 HCM Operations (Future Volume Alternative)
Cumulative PM

Intersection #101: Monterey Road and Cochrane Road

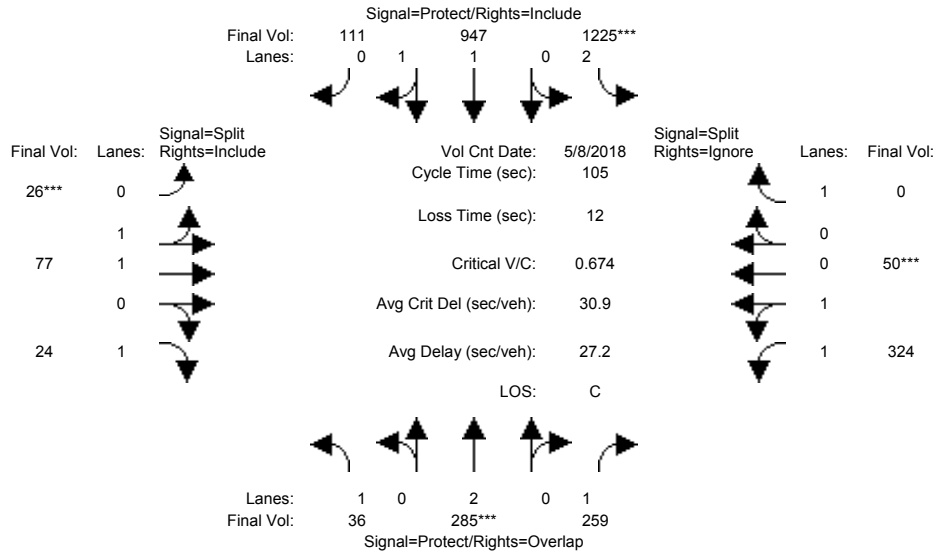

Street Name:	Monterey Road						Cochrane Road					
	North Bound			South Bound			East Bound			West Bound		
Approach:												
Movement:	L	T	R	L	T	R	L	T	R	L	T	R
Min. Green:	7	10	10	7	10	10	10	10	10	10	10	10
Y+R:	4.0	4.0	4.0	4.0	4.0	4.0	4.0	4.0	4.0	4.0	4.0	4.0

Volume Module:	>>	Count	Date:	8 May 2018	<<											
Base Vol:	36	285	259	1225	947	111	26	77	24	324	50	195				
Growth Adj:	1.00	1.00	1.00	1.00	1.00	1.00	1.00	1.00	1.00	1.00	1.00	1.00				
Initial Bse:	36	285	259	1225	947	111	26	77	24	324	50	195				
Added Vol:	0	0	0	0	0	0	0	0	0	0	0	0				
PasserByVol:	0	0	0	0	0	0	0	0	0	0	0	0				
Initial Fut:	36	285	259	1225	947	111	26	77	24	324	50	195				
User Adj:	1.00	1.00	1.00	1.00	1.00	1.00	1.00	1.00	1.00	1.00	1.00	0.00				
PHF Adj:	1.00	1.00	1.00	1.00	1.00	1.00	1.00	1.00	1.00	1.00	1.00	0.00				
PHF Volume:	36	285	259	1225	947	111	26	77	24	324	50	0				
Reduct Vol:	0	0	0	0	0	0	0	0	0	0	0	0				
Reduced Vol:	36	285	259	1225	947	111	26	77	24	324	50	0				
PCE Adj:	1.00	1.00	1.00	1.00	1.00	1.00	1.00	1.00	1.00	1.00	1.00	0.00				
MLF Adj:	1.00	1.00	1.00	1.00	1.00	1.00	1.00	1.00	1.00	1.00	1.00	0.00				
Final Volume:	36	285	259	1225	947	111	26	77	24	324	50	0				

Saturation Flow Module:												
Sat/Lane:	1900	1900	1900	1900	1900	1900	1900	1900	1900	1900	1900	1900
Adjustment:	0.92	1.00	0.92	0.83	0.98	0.95	0.95	0.98	0.92	0.93	0.95	0.92
Lanes:	1.00	2.00	1.00	2.00	1.78	0.22	0.52	1.48	1.00	1.74	0.26	1.00
Final Sat.:	1750	3800	1750	3150	3312	388	934	2765	1750	3075	475	1750

Capacity Analysis Module:												
Vol/Sat:	0.02	0.08	0.15	0.39	0.29	0.29	0.03	0.03	0.01	0.11	0.11	0.00
Crit Moves:	****			****			****			****		
Green Time:	12.8	10.9	26.3	56.7	54.9	54.9	10.0	10.0	10.0	15.4	15.4	0.0
Volume/Cap:	0.17	0.72	0.59	0.72	0.55	0.55	0.29	0.29	0.14	0.72	0.72	0.00
Delay/Veh:	41.7	51.9	36.8	19.7	17.1	17.1	44.7	44.7	44.0	47.6	47.6	0.0
User DelAdj:	1.00	1.00	1.00	1.00	1.00	1.00	1.00	1.00	1.00	1.00	1.00	1.00
AdjDel/Veh:	41.7	51.9	36.8	19.7	17.1	17.1	44.7	44.7	44.0	47.6	47.6	0.0
LOS by Move:	D	D	D	B	B	B	D	D	D	D	D	A
HCM2k95thQ:	3	12	16	29	20	20	4	4	2	12	12	0

Note: Queue reported is the number of cars per lane.

City of Morgan Hill
Carpenters Training Center

Level Of Service Computation Report
2000 HCM Operations (Future Volume Alternative)
Cumulative Plus Project PM

Intersection #101: Monterey Road and Cochrane Road

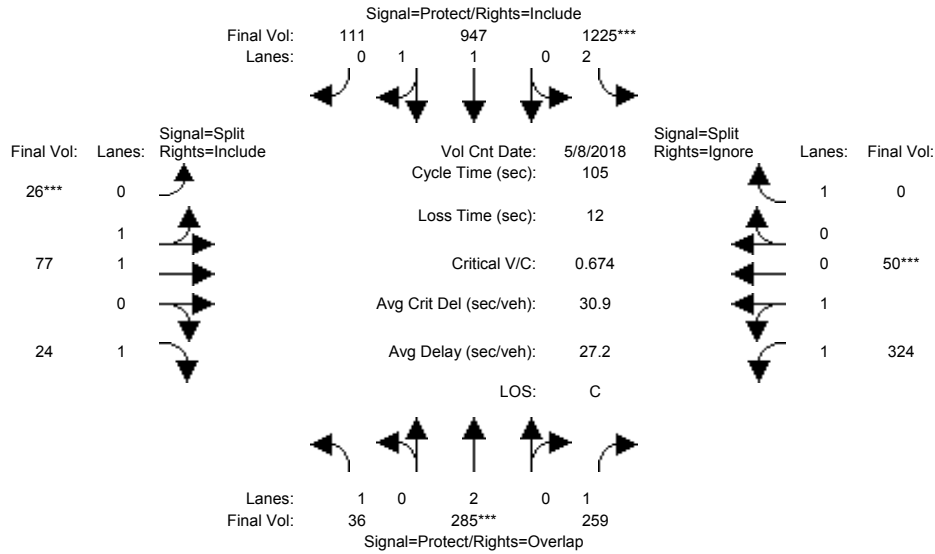

Street Name:	Monterey Road						Cochrane Road					
	North Bound			South Bound			East Bound			West Bound		
	L	T	R	L	T	R	L	T	R	L	T	R
Min. Green:	7	10	10	7	10	10	10	10	10	10	10	10
Y+R:	4.0	4.0	4.0	4.0	4.0	4.0	4.0	4.0	4.0	4.0	4.0	4.0

Volume Module:	>>	Count	Date:	8 May 2018	<<											
Base Vol:	36	285	259	1225	947	111	26	77	24	324	50	195				
Growth Adj:	1.00	1.00	1.00	1.00	1.00	1.00	1.00	1.00	1.00	1.00	1.00	1.00				
Initial Bse:	36	285	259	1225	947	111	26	77	24	324	50	195				
Added Vol:	0	0	0	0	0	0	0	0	0	0	0	0				
PasserByVol:	0	0	0	0	0	0	0	0	0	0	0	0				
Initial Fut:	36	285	259	1225	947	111	26	77	24	324	50	195				
User Adj:	1.00	1.00	1.00	1.00	1.00	1.00	1.00	1.00	1.00	1.00	1.00	0.00				
PHF Adj:	1.00	1.00	1.00	1.00	1.00	1.00	1.00	1.00	1.00	1.00	1.00	0.00				
PHF Volume:	36	285	259	1225	947	111	26	77	24	324	50	0				
Reduct Vol:	0	0	0	0	0	0	0	0	0	0	0	0				
Reduced Vol:	36	285	259	1225	947	111	26	77	24	324	50	0				
PCE Adj:	1.00	1.00	1.00	1.00	1.00	1.00	1.00	1.00	1.00	1.00	1.00	0.00				
MLF Adj:	1.00	1.00	1.00	1.00	1.00	1.00	1.00	1.00	1.00	1.00	1.00	0.00				
Final Volume:	36	285	259	1225	947	111	26	77	24	324	50	0				

Saturation Flow Module:												
Sat/Lane:	1900	1900	1900	1900	1900	1900	1900	1900	1900	1900	1900	1900
Adjustment:	0.92	1.00	0.92	0.83	0.98	0.95	0.95	0.98	0.92	0.93	0.95	0.92
Lanes:	1.00	2.00	1.00	2.00	1.78	0.22	0.52	1.48	1.00	1.74	0.26	1.00
Final Sat.:	1750	3800	1750	3150	3312	388	934	2765	1750	3075	475	1750

Capacity Analysis Module:												
Vol/Sat:	0.02	0.08	0.15	0.39	0.29	0.29	0.03	0.03	0.01	0.11	0.11	0.00
Crit Moves:	****			****			****			****		
Green Time:	12.8	10.9	26.3	56.7	54.9	54.9	10.0	10.0	10.0	15.4	15.4	0.0
Volume/Cap:	0.17	0.72	0.59	0.72	0.55	0.55	0.29	0.29	0.14	0.72	0.72	0.00
Delay/Veh:	41.7	51.9	36.8	19.7	17.1	17.1	44.7	44.7	44.0	47.6	47.6	0.0
User DelAdj:	1.00	1.00	1.00	1.00	1.00	1.00	1.00	1.00	1.00	1.00	1.00	1.00
AdjDel/Veh:	41.7	51.9	36.8	19.7	17.1	17.1	44.7	44.7	44.0	47.6	47.6	0.0
LOS by Move:	D	D	D	B	B	B	D	D	D	D	D	A
HCM2k95thQ:	3	12	16	29	20	20	4	4	2	12	12	0

Note: Queue reported is the number of cars per lane.

City of Morgan Hill
Carpenters Training Center

Level Of Service Computation Report
2000 HCM Operations (Future Volume Alternative)
Existing AM

Intersection #103: Butterfield Boulevard and Cochrane Road

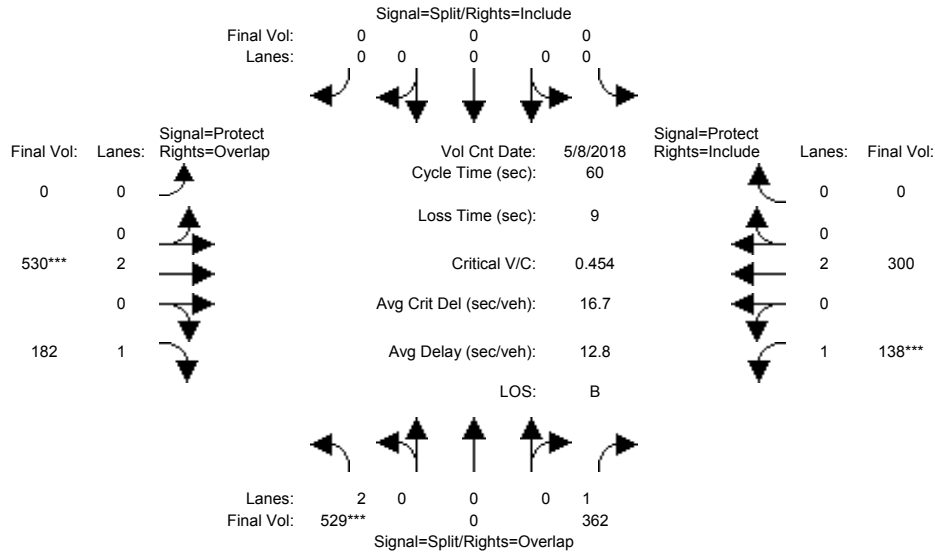

Street Name:	Butterfield Boulevard						Cochrane Road					
Approach:	North Bound			South Bound			East Bound			West Bound		
Movement:	L	T	R	L	T	R	L	T	R	L	T	R
Min. Green:	10	0	10	0	0	0	0	10	10	7	10	0
Y+R:	4.0	4.0	4.0	4.0	4.0	4.0	4.0	4.0	4.0	4.0	4.0	4.0

Volume Module:	>>	Count	Date:	8 May 2018	<<							
Base Vol:	529	0	362	0	0	0	0	530	182	138	300	0
Growth Adj:	1.00	1.00	1.00	1.00	1.00	1.00	1.00	1.00	1.00	1.00	1.00	1.00
Initial Bse:	529	0	362	0	0	0	0	530	182	138	300	0
Added Vol:	0	0	0	0	0	0	0	0	0	0	0	0
PasserByVol:	0	0	0	0	0	0	0	0	0	0	0	0
Initial Fut:	529	0	362	0	0	0	0	530	182	138	300	0
User Adj:	1.00	1.00	1.00	1.00	1.00	1.00	1.00	1.00	1.00	1.00	1.00	1.00
PHF Adj:	1.00	1.00	1.00	1.00	1.00	1.00	1.00	1.00	1.00	1.00	1.00	1.00
PHF Volume:	529	0	362	0	0	0	0	530	182	138	300	0
Reduct Vol:	0	0	0	0	0	0	0	0	0	0	0	0
Reduced Vol:	529	0	362	0	0	0	0	530	182	138	300	0
PCE Adj:	1.00	1.00	1.00	1.00	1.00	1.00	1.00	1.00	1.00	1.00	1.00	1.00
MLF Adj:	1.00	1.00	1.00	1.00	1.00	1.00	1.00	1.00	1.00	1.00	1.00	1.00
FinalVolume:	529	0	362	0	0	0	0	530	182	138	300	0

Saturation Flow Module:												
Sat/Lane:	1900	1900	1900	1900	1900	1900	1900	1900	1900	1900	1900	1900
Adjustment:	0.83	1.00	0.92	0.92	1.00	0.92	0.92	1.00	0.92	0.92	1.00	0.92
Lanes:	2.00	0.00	1.00	0.00	0.00	0.00	0.00	2.00	1.00	1.00	2.00	0.00
Final Sat.:	3150	0	1750	0	0	0	0	3800	1750	1750	3800	0

Capacity Analysis Module:												
Vol/Sat:	0.17	0.00	0.21	0.00	0.00	0.00	0.00	0.14	0.10	0.08	0.08	0.00
Crit Moves:	****						****			****		
Green Time:	22.2	0.0	32.6	0.0	0.0	0.0	0.0	18.4	40.6	10.4	28.8	0.0
Volume/Cap:	0.45	0.00	0.38	0.00	0.00	0.00	0.00	0.45	0.15	0.45	0.16	0.00
Delay/Veh:	14.6	0.0	8.2	0.0	0.0	0.0	0.0	17.0	3.6	23.3	8.8	0.0
User DelAdj:	1.00	1.00	1.00	1.00	1.00	1.00	1.00	1.00	1.00	1.00	1.00	1.00
AdjDel/Veh:	14.6	0.0	8.2	0.0	0.0	0.0	0.0	17.0	3.6	23.3	8.8	0.0
LOS by Move:	B	A	A	A	A	A	A	B	A	C	A	A
HCM2k95thQ:	9	0	8	0	0	0	0	8	3	5	3	0

Note: Queue reported is the number of cars per lane.

City of Morgan Hill
Carpenters Training Center

Level Of Service Computation Report
2000 HCM Operations (Future Volume Alternative)
Existing Plus Project AM

Intersection #103: Butterfield Boulevard and Cochrane Road

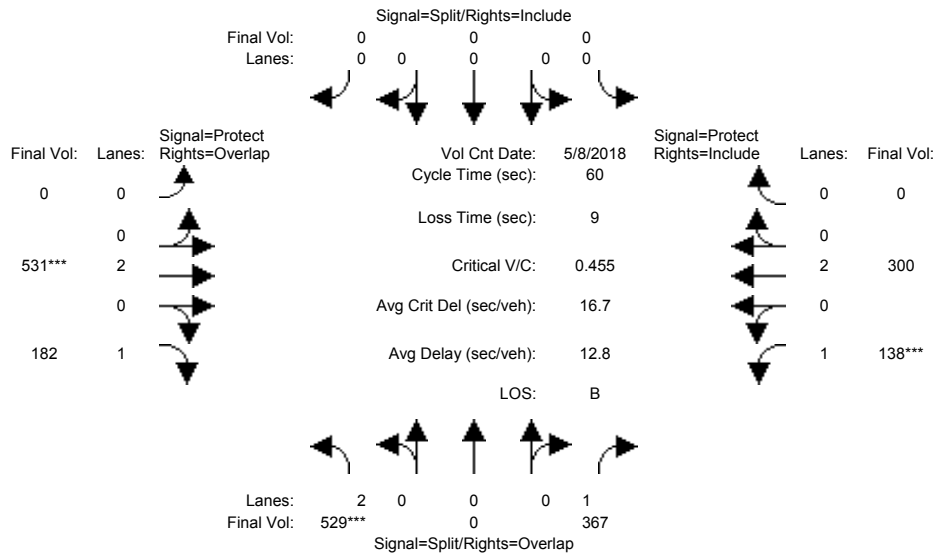

Street Name:	Butterfield Boulevard						Cochrane Road					
	North Bound			South Bound			East Bound			West Bound		
Approach:	North Bound			South Bound			East Bound			West Bound		
Movement:	L	T	R	L	T	R	L	T	R	L	T	R
Min. Green:	10	0	10	0	0	0	0	10	10	7	10	0
Y+R:	4.0	4.0	4.0	4.0	4.0	4.0	4.0	4.0	4.0	4.0	4.0	4.0

Volume Module:	>>	Count	Date:	8 May 2018	<<							
Base Vol:	529	0	362	0	0	0	0	530	182	138	300	0
Growth Adj:	1.00	1.00	1.00	1.00	1.00	1.00	1.00	1.00	1.00	1.00	1.00	1.00
Initial Bse:	529	0	362	0	0	0	0	530	182	138	300	0
Added Vol:	0	0	5	0	0	0	0	1	0	0	0	0
PasserByVol:	0	0	0	0	0	0	0	0	0	0	0	0
Initial Fut:	529	0	367	0	0	0	0	531	182	138	300	0
User Adj:	1.00	1.00	1.00	1.00	1.00	1.00	1.00	1.00	1.00	1.00	1.00	1.00
PHF Adj:	1.00	1.00	1.00	1.00	1.00	1.00	1.00	1.00	1.00	1.00	1.00	1.00
PHF Volume:	529	0	367	0	0	0	0	531	182	138	300	0
Reduct Vol:	0	0	0	0	0	0	0	0	0	0	0	0
Reduced Vol:	529	0	367	0	0	0	0	531	182	138	300	0
PCE Adj:	1.00	1.00	1.00	1.00	1.00	1.00	1.00	1.00	1.00	1.00	1.00	1.00
MLF Adj:	1.00	1.00	1.00	1.00	1.00	1.00	1.00	1.00	1.00	1.00	1.00	1.00
Final Volume:	529	0	367	0	0	0	0	531	182	138	300	0

Saturation Flow Module:												
Sat/Lane:	1900	1900	1900	1900	1900	1900	1900	1900	1900	1900	1900	1900
Adjustment:	0.83	1.00	0.92	0.92	1.00	0.92	0.92	1.00	0.92	0.92	1.00	0.92
Lanes:	2.00	0.00	1.00	0.00	0.00	0.00	0.00	2.00	1.00	1.00	2.00	0.00
Final Sat.:	3150	0	1750	0	0	0	0	3800	1750	1750	3800	0

Capacity Analysis Module:												
Vol/Sat:	0.17	0.00	0.21	0.00	0.00	0.00	0.00	0.14	0.10	0.08	0.08	0.00
Crit Moves:	****						****			****		
Green Time:	22.2	0.0	32.6	0.0	0.0	0.0	0.0	18.4	40.6	10.4	28.8	0.0
Volume/Cap:	0.45	0.00	0.39	0.00	0.00	0.00	0.00	0.45	0.15	0.45	0.16	0.00
Delay/Veh:	14.6	0.0	8.2	0.0	0.0	0.0	0.0	17.0	3.6	23.3	8.8	0.0
User DelAdj:	1.00	1.00	1.00	1.00	1.00	1.00	1.00	1.00	1.00	1.00	1.00	1.00
AdjDel/Veh:	14.6	0.0	8.2	0.0	0.0	0.0	0.0	17.0	3.6	23.3	8.8	0.0
LOS by Move:	B	A	A	A	A	A	A	B	A	C	A	A
HCM2k95thQ:	9	0	8	0	0	0	0	8	3	5	3	0

Note: Queue reported is the number of cars per lane.

City of Morgan Hill
Carpenters Training Center

Level Of Service Computation Report
2000 HCM Operations (Future Volume Alternative)
Cumulative AM

Intersection #103: Butterfield Boulevard and Cochrane Road

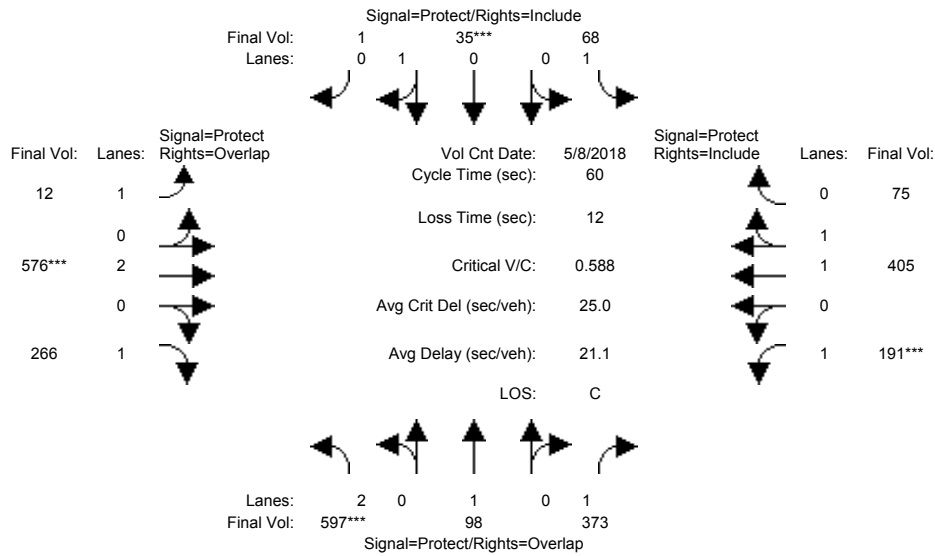

Street Name:	Butterfield Boulevard						Cochrane Road					
	North Bound			South Bound			East Bound			West Bound		
Approach:	L	T	R	L	T	R	L	T	R	L	T	R
Min. Green:	7	10	10	7	10	10	7	10	10	7	10	10
Y+R:	4.0	4.0	4.0	4.0	4.0	4.0	4.0	4.0	4.0	4.0	4.0	4.0

Volume Module:	>>	Count	Date:	8 May 2018	<<							
Base Vol:	597	98	373	68	35	1	12	576	266	191	405	75
Growth Adj:	1.00	1.00	1.00	1.00	1.00	1.00	1.00	1.00	1.00	1.00	1.00	1.00
Initial Bse:	597	98	373	68	35	1	12	576	266	191	405	75
Added Vol:	0	0	0	0	0	0	0	0	0	0	0	0
PasserByVol:	0	0	0	0	0	0	0	0	0	0	0	0
Initial Fut:	597	98	373	68	35	1	12	576	266	191	405	75
User Adj:	1.00	1.00	1.00	1.00	1.00	1.00	1.00	1.00	1.00	1.00	1.00	1.00
PHF Adj:	1.00	1.00	1.00	1.00	1.00	1.00	1.00	1.00	1.00	1.00	1.00	1.00
PHF Volume:	597	98	373	68	35	1	12	576	266	191	405	75
Reduct Vol:	0	0	0	0	0	0	0	0	0	0	0	0
Reduced Vol:	597	98	373	68	35	1	12	576	266	191	405	75
PCE Adj:	1.00	1.00	1.00	1.00	1.00	1.00	1.00	1.00	1.00	1.00	1.00	1.00
MLF Adj:	1.00	1.00	1.00	1.00	1.00	1.00	1.00	1.00	1.00	1.00	1.00	1.00
Final Volume:	597	98	373	68	35	1	12	576	266	191	405	75

Saturation Flow Module:												
Sat/Lane:	1900	1900	1900	1900	1900	1900	1900	1900	1900	1900	1900	1900
Adjustment:	0.83	1.00	0.92	0.92	0.95	0.95	0.92	1.00	0.92	0.92	0.98	0.95
Lanes:	2.00	1.00	1.00	1.00	0.97	0.03	1.00	2.00	1.00	1.00	1.68	0.32
Final Sat.:	3150	1900	1750	1750	1750	50	1750	3800	1750	1750	3121	578

Capacity Analysis Module:												
Vol/Sat:	0.19	0.05	0.21	0.04	0.02	0.02	0.01	0.15	0.15	0.11	0.13	0.13
Crit Moves:	***				***			***		***		
Green Time:	16.0	15.3	24.5	10.7	10.0	10.0	9.1	12.8	28.8	9.2	12.9	12.9
Volume/Cap:	0.71	0.20	0.52	0.22	0.12	0.12	0.05	0.71	0.32	0.71	0.60	0.60
Delay/Veh:	22.8	17.8	14.0	21.4	21.4	21.4	21.8	24.9	9.8	32.7	22.5	22.5
User DelAdj:	1.00	1.00	1.00	1.00	1.00	1.00	1.00	1.00	1.00	1.00	1.00	1.00
AdjDel/Veh:	22.8	17.8	14.0	21.4	21.4	21.4	21.8	24.9	9.8	32.7	22.5	22.5
LOS by Move:	C	B	B	C	C	C	C	C	A	C	C	C
HCM2k95thQ:	12	3	10	3	1	1	0	10	6	8	8	8

Note: Queue reported is the number of cars per lane.

City of Morgan Hill
Carpenters Training Center

Level Of Service Computation Report
2000 HCM Operations (Future Volume Alternative)
Cumulative Plus Project AM

Intersection #103: Butterfield Boulevard and Cochrane Road

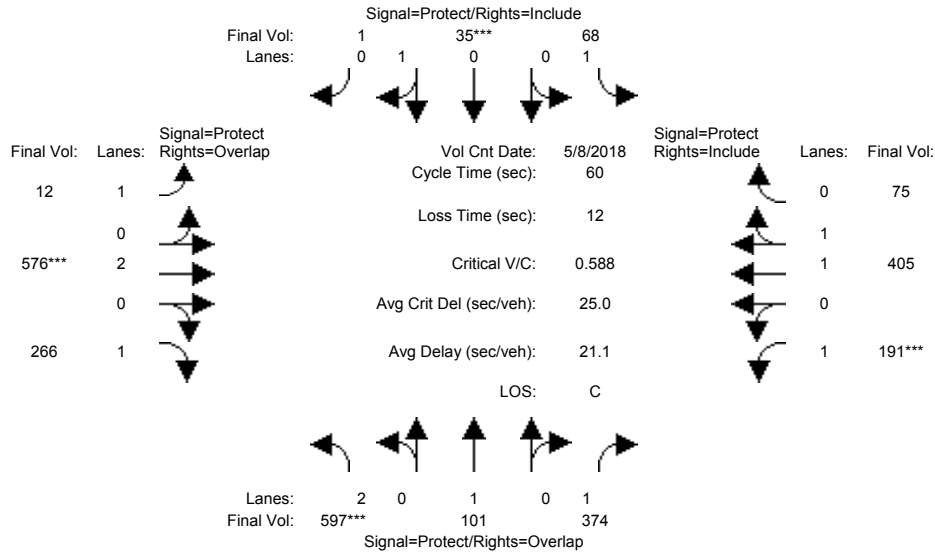

Street Name:	Butterfield Boulevard						Cochrane Road					
	North Bound			South Bound			East Bound			West Bound		
Movement:	L	T	R	L	T	R	L	T	R	L	T	R
Min. Green:	7	10	10	7	10	10	7	10	10	7	10	10
Y+R:	4.0	4.0	4.0	4.0	4.0	4.0	4.0	4.0	4.0	4.0	4.0	4.0

Volume Module:	>>	Count	Date:	8 May 2018	<<							
Base Vol:	597	98	373	68	35	1	12	576	266	191	405	75
Growth Adj:	1.00	1.00	1.00	1.00	1.00	1.00	1.00	1.00	1.00	1.00	1.00	1.00
Initial Bse:	597	98	373	68	35	1	12	576	266	191	405	75
Added Vol:	0	3	1	0	0	0	0	0	0	0	0	0
PasserByVol:	0	0	0	0	0	0	0	0	0	0	0	0
Initial Fut:	597	101	374	68	35	1	12	576	266	191	405	75
User Adj:	1.00	1.00	1.00	1.00	1.00	1.00	1.00	1.00	1.00	1.00	1.00	1.00
PHF Adj:	1.00	1.00	1.00	1.00	1.00	1.00	1.00	1.00	1.00	1.00	1.00	1.00
PHF Volume:	597	101	374	68	35	1	12	576	266	191	405	75
Reduct Vol:	0	0	0	0	0	0	0	0	0	0	0	0
Reduced Vol:	597	101	374	68	35	1	12	576	266	191	405	75
PCE Adj:	1.00	1.00	1.00	1.00	1.00	1.00	1.00	1.00	1.00	1.00	1.00	1.00
MLF Adj:	1.00	1.00	1.00	1.00	1.00	1.00	1.00	1.00	1.00	1.00	1.00	1.00
Final Volume:	597	101	374	68	35	1	12	576	266	191	405	75

Saturation Flow Module:												
Sat/Lane:	1900	1900	1900	1900	1900	1900	1900	1900	1900	1900	1900	1900
Adjustment:	0.83	1.00	0.92	0.92	0.95	0.95	0.92	1.00	0.92	0.92	0.98	0.95
Lanes:	2.00	1.00	1.00	1.00	0.97	0.03	1.00	2.00	1.00	1.00	1.68	0.32
Final Sat.:	3150	1900	1750	1750	1750	50	1750	3800	1750	1750	3121	578

Capacity Analysis Module:												
Vol/Sat:	0.19	0.05	0.21	0.04	0.02	0.02	0.01	0.15	0.15	0.11	0.13	0.13
Crit Moves:	***				***			***		***		
Green Time:	16.0	15.3	24.5	10.7	10.0	10.0	9.1	12.8	28.8	9.2	12.9	12.9
Volume/Cap:	0.71	0.21	0.52	0.22	0.12	0.12	0.05	0.71	0.32	0.71	0.60	0.60
Delay/Veh:	22.8	17.8	14.1	21.4	21.4	21.4	21.8	24.9	9.8	32.7	22.5	22.5
User DelAdj:	1.00	1.00	1.00	1.00	1.00	1.00	1.00	1.00	1.00	1.00	1.00	1.00
AdjDel/Veh:	22.8	17.8	14.1	21.4	21.4	21.4	21.8	24.9	9.8	32.7	22.5	22.5
LOS by Move:	C	B	B	C	C	C	C	C	A	C	C	C
HCM2k95thQ:	12	3	11	3	1	1	0	10	6	8	8	8

Note: Queue reported is the number of cars per lane.

City of Morgan Hill
Carpenters Training Center

Level Of Service Computation Report
2000 HCM Operations (Future Volume Alternative)
Existing PM

Intersection #103: Butterfield Boulevard and Cochrane Road

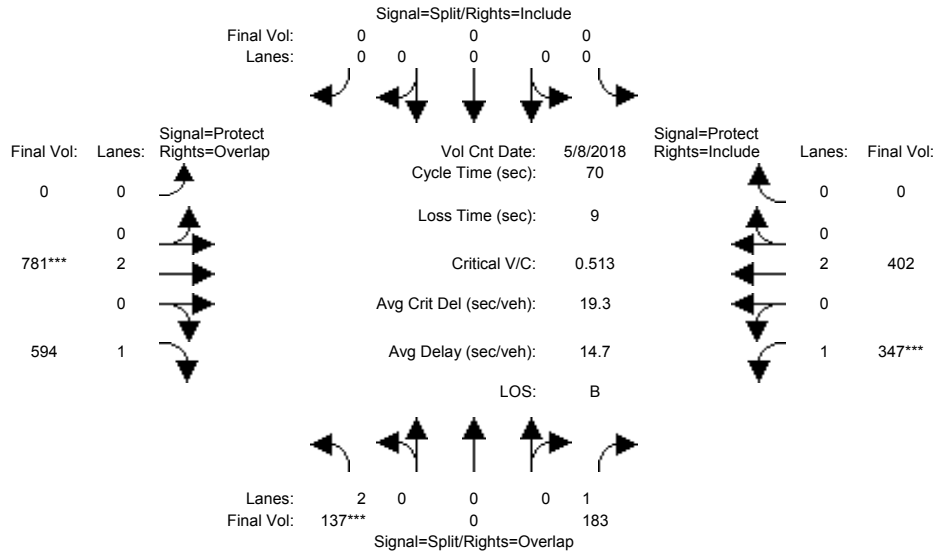

Street Name:	Butterfield Boulevard						Cochrane Road					
	North Bound			South Bound			East Bound			West Bound		
Approach:	North Bound			South Bound			East Bound			West Bound		
Movement:	L	T	R	L	T	R	L	T	R	L	T	R
Min. Green:	10	0	10	0	0	0	0	10	10	7	10	0
Y+R:	4.0	4.0	4.0	4.0	4.0	4.0	4.0	4.0	4.0	4.0	4.0	4.0

Volume Module:	>>	Count	Date:	8 May 2018	<<							
Base Vol:	137	0	183	0	0	0	0	781	594	347	402	0
Growth Adj:	1.00	1.00	1.00	1.00	1.00	1.00	1.00	1.00	1.00	1.00	1.00	1.00
Initial Bse:	137	0	183	0	0	0	0	781	594	347	402	0
Added Vol:	0	0	0	0	0	0	0	0	0	0	0	0
PasserByVol:	0	0	0	0	0	0	0	0	0	0	0	0
Initial Fut:	137	0	183	0	0	0	0	781	594	347	402	0
User Adj:	1.00	1.00	1.00	1.00	1.00	1.00	1.00	1.00	1.00	1.00	1.00	1.00
PHF Adj:	1.00	1.00	1.00	1.00	1.00	1.00	1.00	1.00	1.00	1.00	1.00	1.00
PHF Volume:	137	0	183	0	0	0	0	781	594	347	402	0
Reduct Vol:	0	0	0	0	0	0	0	0	0	0	0	0
Reduced Vol:	137	0	183	0	0	0	0	781	594	347	402	0
PCE Adj:	1.00	1.00	1.00	1.00	1.00	1.00	1.00	1.00	1.00	1.00	1.00	1.00
MLF Adj:	1.00	1.00	1.00	1.00	1.00	1.00	1.00	1.00	1.00	1.00	1.00	1.00
Final Volume:	137	0	183	0	0	0	0	781	594	347	402	0

Saturation Flow Module:												
Sat/Lane:	1900	1900	1900	1900	1900	1900	1900	1900	1900	1900	1900	1900
Adjustment:	0.83	1.00	0.92	0.92	1.00	0.92	0.92	1.00	0.92	0.92	1.00	0.92
Lanes:	2.00	0.00	1.00	0.00	0.00	0.00	0.00	2.00	1.00	1.00	2.00	0.00
Final Sat.:	3150	0	1750	0	0	0	0	3800	1750	1750	3800	0

Capacity Analysis Module:												
Vol/Sat:	0.04	0.00	0.10	0.00	0.00	0.00	0.00	0.21	0.34	0.20	0.11	0.00
Crit Moves:	****						****			****		
Green Time:	10.0	0.0	35.0	0.0	0.0	0.0	0.0	26.0	36.0	25.0	51.0	0.0
Volume/Cap:	0.30	0.00	0.21	0.00	0.00	0.00	0.00	0.55	0.66	0.55	0.15	0.00
Delay/Veh:	27.3	0.0	9.9	0.0	0.0	0.0	0.0	17.9	14.4	19.1	2.9	0.0
User DelAdj:	1.00	1.00	1.00	1.00	1.00	1.00	1.00	1.00	1.00	1.00	1.00	1.00
AdjDel/Veh:	27.3	0.0	9.9	0.0	0.0	0.0	0.0	17.9	14.4	19.1	2.9	0.0
LOS by Move:	C	A	A	A	A	A	A	B	B	B	A	A
HCM2k95thQ:	3	0	5	0	0	0	0	12	19	12	3	0

Note: Queue reported is the number of cars per lane.

City of Morgan Hill
Carpenters Training Center

Level Of Service Computation Report
2000 HCM Operations (Future Volume Alternative)
Existing Plus Project PM

Intersection #103: Butterfield Boulevard and Cochrane Road

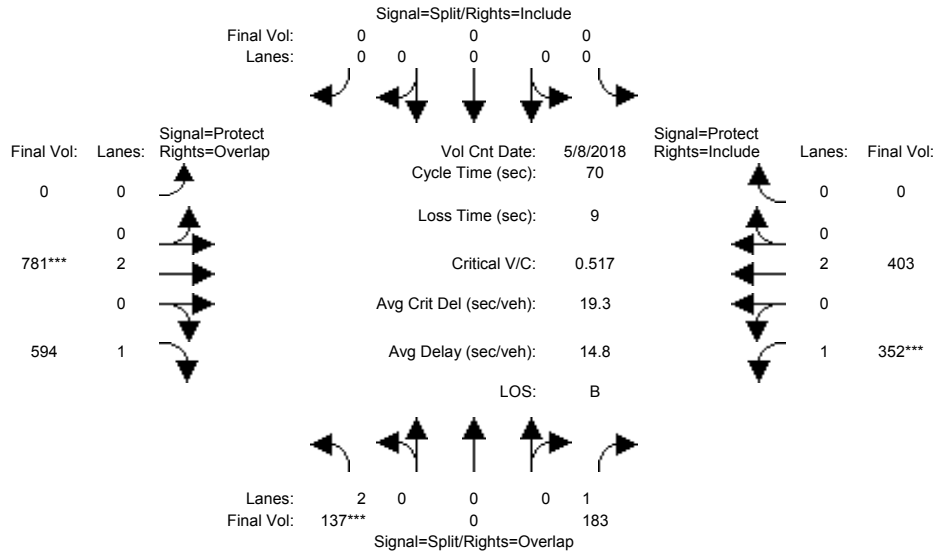

Street Name:	Butterfield Boulevard						Cochrane Road					
	North Bound			South Bound			East Bound			West Bound		
Approach:	North Bound			South Bound			East Bound			West Bound		
Movement:	L	T	R	L	T	R	L	T	R	L	T	R
Min. Green:	10	0	10	0	0	0	0	10	10	7	10	0
Y+R:	4.0	4.0	4.0	4.0	4.0	4.0	4.0	4.0	4.0	4.0	4.0	4.0

Volume Module:	>>	Count	Date:	8 May 2018	<<							
Base Vol:	137	0	183	0	0	0	0	781	594	347	402	0
Growth Adj:	1.00	1.00	1.00	1.00	1.00	1.00	1.00	1.00	1.00	1.00	1.00	1.00
Initial Bse:	137	0	183	0	0	0	0	781	594	347	402	0
Added Vol:	0	0	0	0	0	0	0	0	0	5	1	0
PasserByVol:	0	0	0	0	0	0	0	0	0	0	0	0
Initial Fut:	137	0	183	0	0	0	0	781	594	352	403	0
User Adj:	1.00	1.00	1.00	1.00	1.00	1.00	1.00	1.00	1.00	1.00	1.00	1.00
PHF Adj:	1.00	1.00	1.00	1.00	1.00	1.00	1.00	1.00	1.00	1.00	1.00	1.00
PHF Volume:	137	0	183	0	0	0	0	781	594	352	403	0
Reduct Vol:	0	0	0	0	0	0	0	0	0	0	0	0
Reduced Vol:	137	0	183	0	0	0	0	781	594	352	403	0
PCE Adj:	1.00	1.00	1.00	1.00	1.00	1.00	1.00	1.00	1.00	1.00	1.00	1.00
MLF Adj:	1.00	1.00	1.00	1.00	1.00	1.00	1.00	1.00	1.00	1.00	1.00	1.00
FinalVolume:	137	0	183	0	0	0	0	781	594	352	403	0

Saturation Flow Module:												
Sat/Lane:	1900	1900	1900	1900	1900	1900	1900	1900	1900	1900	1900	1900
Adjustment:	0.83	1.00	0.92	0.92	1.00	0.92	0.92	1.00	0.92	0.92	1.00	0.92
Lanes:	2.00	0.00	1.00	0.00	0.00	0.00	0.00	2.00	1.00	1.00	2.00	0.00
Final Sat.:	3150	0	1750	0	0	0	0	3800	1750	1750	3800	0

Capacity Analysis Module:												
Vol/Sat:	0.04	0.00	0.10	0.00	0.00	0.00	0.00	0.21	0.34	0.20	0.11	0.00
Crit Moves:	****						****			****		
Green Time:	10.0	0.0	35.2	0.0	0.0	0.0	0.0	25.8	35.8	25.2	51.0	0.0
Volume/Cap:	0.30	0.00	0.21	0.00	0.00	0.00	0.00	0.56	0.66	0.56	0.15	0.00
Delay/Veh:	27.3	0.0	9.8	0.0	0.0	0.0	0.0	18.1	14.6	19.0	2.9	0.0
User DelAdj:	1.00	1.00	1.00	1.00	1.00	1.00	1.00	1.00	1.00	1.00	1.00	1.00
AdjDel/Veh:	27.3	0.0	9.8	0.0	0.0	0.0	0.0	18.1	14.6	19.0	2.9	0.0
LOS by Move:	C	A	A	A	A	A	A	B	B	B	A	A
HCM2k95thQ:	3	0	5	0	0	0	0	13	19	12	3	0

Note: Queue reported is the number of cars per lane.

City of Morgan Hill
Carpenters Training Center

Level Of Service Computation Report
2000 HCM Operations (Future Volume Alternative)
Cumulative PM

Intersection #103: Butterfield Boulevard and Cochrane Road

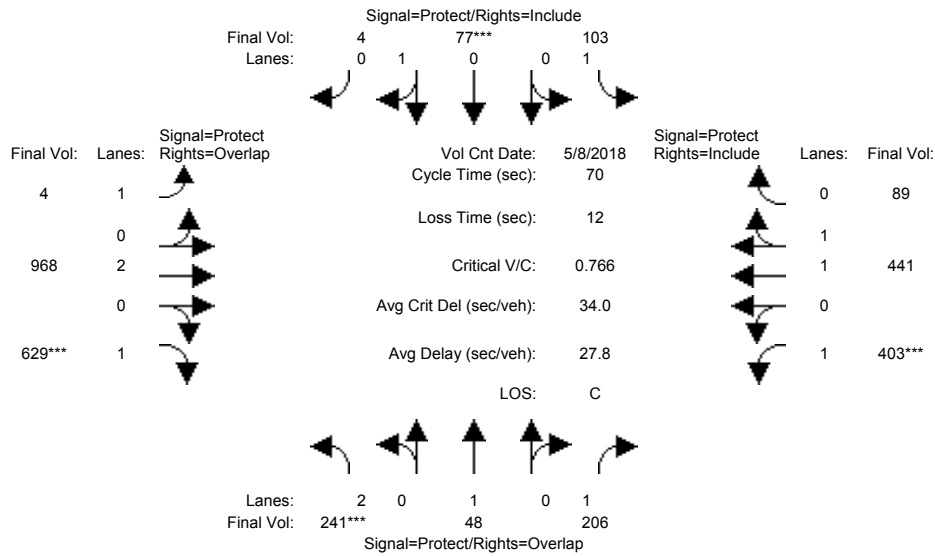

Street Name:	Butterfield Boulevard						Cochrane Road					
	North Bound			South Bound			East Bound			West Bound		
Approach:	L	T	R	L	T	R	L	T	R	L	T	R
Min. Green:	7	10	10	7	10	10	7	10	10	7	10	10
Y+R:	4.0	4.0	4.0	4.0	4.0	4.0	4.0	4.0	4.0	4.0	4.0	4.0

Volume Module:	>>	Count	Date:	8 May 2018	<<							
Base Vol:	241	48	206	103	77	4	4	968	629	403	441	89
Growth Adj:	1.00	1.00	1.00	1.00	1.00	1.00	1.00	1.00	1.00	1.00	1.00	1.00
Initial Bse:	241	48	206	103	77	4	4	968	629	403	441	89
Added Vol:	0	0	0	0	0	0	0	0	0	0	0	0
PasserByVol:	0	0	0	0	0	0	0	0	0	0	0	0
Initial Fut:	241	48	206	103	77	4	4	968	629	403	441	89
User Adj:	1.00	1.00	1.00	1.00	1.00	1.00	1.00	1.00	1.00	1.00	1.00	1.00
PHF Adj:	1.00	1.00	1.00	1.00	1.00	1.00	1.00	1.00	1.00	1.00	1.00	1.00
PHF Volume:	241	48	206	103	77	4	4	968	629	403	441	89
Reduct Vol:	0	0	0	0	0	0	0	0	0	0	0	0
Reduced Vol:	241	48	206	103	77	4	4	968	629	403	441	89
PCE Adj:	1.00	1.00	1.00	1.00	1.00	1.00	1.00	1.00	1.00	1.00	1.00	1.00
MLF Adj:	1.00	1.00	1.00	1.00	1.00	1.00	1.00	1.00	1.00	1.00	1.00	1.00
Final Volume:	241	48	206	103	77	4	4	968	629	403	441	89

Saturation Flow Module:												
Sat/Lane:	1900	1900	1900	1900	1900	1900	1900	1900	1900	1900	1900	1900
Adjustment:	0.83	1.00	0.92	0.92	0.95	0.95	0.92	1.00	0.92	0.92	0.98	0.95
Lanes:	2.00	1.00	1.00	1.00	0.95	0.05	1.00	2.00	1.00	1.00	1.65	0.35
Final Sat.:	3150	1900	1750	1750	1711	89	1750	3800	1750	1750	3078	621

Capacity Analysis Module:												
Vol/Sat:	0.08	0.03	0.12	0.06	0.05	0.05	0.00	0.25	0.36	0.23	0.14	0.14
Crit Moves:	***				***				***	***		
Green Time:	7.0	10.0	29.3	7.0	10.0	10.0	16.9	21.7	28.7	19.3	24.1	24.1
Volume/Cap:	0.77	0.18	0.28	0.59	0.32	0.32	0.01	0.82	0.88	0.84	0.42	0.42
Delay/Veh:	41.4	26.7	13.6	35.3	27.6	27.6	20.2	27.1	30.7	35.9	17.8	17.8
User DelAdj:	1.00	1.00	1.00	1.00	1.00	1.00	1.00	1.00	1.00	1.00	1.00	1.00
AdjDel/Veh:	41.4	26.7	13.6	35.3	27.6	27.6	20.2	27.1	30.7	35.9	17.8	17.8
LOS by Move:	D	C	B	D	C	C	C	C	C	D	B	B
HCM2k95thQ:	7	2	6	7	4	4	0	18	25	17	8	8

Note: Queue reported is the number of cars per lane.

City of Morgan Hill
Carpenters Training Center

Level Of Service Computation Report
2000 HCM Operations (Future Volume Alternative)
Cumulative Plus Project PM

Intersection #103: Butterfield Boulevard and Cochrane Road

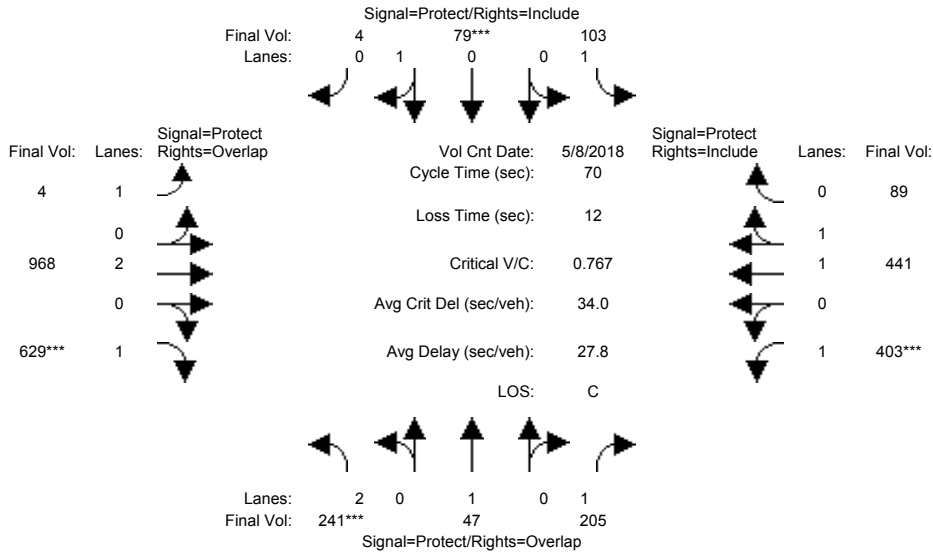

Street Name:	Butterfield Boulevard						Cochrane Road					
	North Bound			South Bound			East Bound			West Bound		
Approach:	North Bound			South Bound			East Bound			West Bound		
Movement:	L	T	R	L	T	R	L	T	R	L	T	R
Min. Green:	7	10	10	7	10	10	7	10	10	7	10	10
Y+R:	4.0	4.0	4.0	4.0	4.0	4.0	4.0	4.0	4.0	4.0	4.0	4.0

Volume Module:	>>	Count	Date:	8 May 2018	<<							
Base Vol:	241	48	206	103	77	4	4	968	629	403	441	89
Growth Adj:	1.00	1.00	1.00	1.00	1.00	1.00	1.00	1.00	1.00	1.00	1.00	1.00
Initial Bse:	241	48	206	103	77	4	4	968	629	403	441	89
Added Vol:	0	-1	-1	0	2	0	0	0	0	0	0	0
PasserByVol:	0	0	0	0	0	0	0	0	0	0	0	0
Initial Fut:	241	47	205	103	79	4	4	968	629	403	441	89
User Adj:	1.00	1.00	1.00	1.00	1.00	1.00	1.00	1.00	1.00	1.00	1.00	1.00
PHF Adj:	1.00	1.00	1.00	1.00	1.00	1.00	1.00	1.00	1.00	1.00	1.00	1.00
PHF Volume:	241	47	205	103	79	4	4	968	629	403	441	89
Reduct Vol:	0	0	0	0	0	0	0	0	0	0	0	0
Reduced Vol:	241	47	205	103	79	4	4	968	629	403	441	89
PCE Adj:	1.00	1.00	1.00	1.00	1.00	1.00	1.00	1.00	1.00	1.00	1.00	1.00
MLF Adj:	1.00	1.00	1.00	1.00	1.00	1.00	1.00	1.00	1.00	1.00	1.00	1.00
Final Volume:	241	47	205	103	79	4	4	968	629	403	441	89

Saturation Flow Module:												
Sat/Lane:	1900	1900	1900	1900	1900	1900	1900	1900	1900	1900	1900	1900
Adjustment:	0.83	1.00	0.92	0.92	0.95	0.95	0.92	1.00	0.92	0.92	0.98	0.95
Lanes:	2.00	1.00	1.00	1.00	0.95	0.05	1.00	2.00	1.00	1.00	1.65	0.35
Final Sat.:	3150	1900	1750	1750	1713	87	1750	3800	1750	1750	3078	621

Capacity Analysis Module:												
Vol/Sat:	0.08	0.02	0.12	0.06	0.05	0.05	0.00	0.25	0.36	0.23	0.14	0.14
Crit Moves:	****				****		****		****	****		
Green Time:	7.0	10.0	29.3	7.0	10.0	10.0	16.9	21.7	28.7	19.3	24.1	24.1
Volume/Cap:	0.77	0.17	0.28	0.59	0.32	0.32	0.01	0.82	0.88	0.84	0.42	0.42
Delay/Veh:	41.4	26.7	13.6	35.3	27.7	27.7	20.2	27.1	30.7	35.9	17.8	17.8
User DelAdj:	1.00	1.00	1.00	1.00	1.00	1.00	1.00	1.00	1.00	1.00	1.00	1.00
AdjDel/Veh:	41.4	26.7	13.6	35.3	27.7	27.7	20.2	27.1	30.7	35.9	17.8	17.8
LOS by Move:	D	C	B	D	C	C	C	C	C	D	B	B
HCM2k95thQ:	7	2	6	7	4	4	0	18	25	17	8	8

Note: Queue reported is the number of cars per lane.

City of Morgan Hill
Carpenters Training Center

Level Of Service Computation Report
2000 HCM Operations (Future Volume Alternative)
Existing AM

Intersection #105: Sutter Boulevard and Cochrane Road

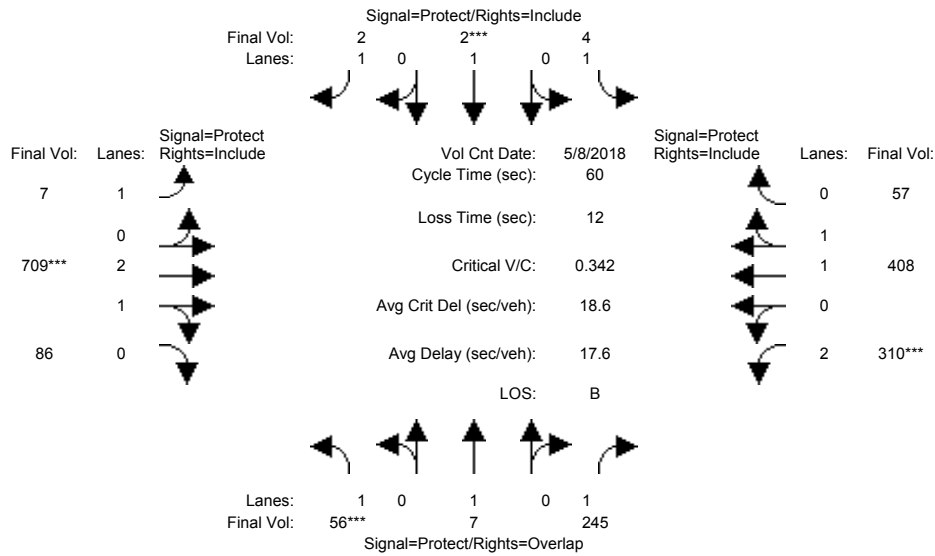

Street Name:	Sutter Boulevard						Cochrane Road					
	North Bound			South Bound			East Bound			West Bound		
Approach:	North Bound			South Bound			East Bound			West Bound		
Movement:	L	T	R	L	T	R	L	T	R	L	T	R
Min. Green:	7	10	10	7	10	10	7	10	10	7	10	10
Y+R:	4.0	4.0	4.0	4.0	4.0	4.0	4.0	4.0	4.0	4.0	4.0	4.0

Volume Module:	>>	Count	Date:	8 May 2018	<<							
Base Vol:	56	7	245	4	2	2	7	709	86	310	408	57
Growth Adj:	1.00	1.00	1.00	1.00	1.00	1.00	1.00	1.00	1.00	1.00	1.00	1.00
Initial Bse:	56	7	245	4	2	2	7	709	86	310	408	57
Added Vol:	0	0	0	0	0	0	0	0	0	0	0	0
PasserByVol:	0	0	0	0	0	0	0	0	0	0	0	0
Initial Fut:	56	7	245	4	2	2	7	709	86	310	408	57
User Adj:	1.00	1.00	1.00	1.00	1.00	1.00	1.00	1.00	1.00	1.00	1.00	1.00
PHF Adj:	1.00	1.00	1.00	1.00	1.00	1.00	1.00	1.00	1.00	1.00	1.00	1.00
PHF Volume:	56	7	245	4	2	2	7	709	86	310	408	57
Reduct Vol:	0	0	0	0	0	0	0	0	0	0	0	0
Reduced Vol:	56	7	245	4	2	2	7	709	86	310	408	57
PCE Adj:	1.00	1.00	1.00	1.00	1.00	1.00	1.00	1.00	1.00	1.00	1.00	1.00
MLF Adj:	1.00	1.00	1.00	1.00	1.00	1.00	1.00	1.00	1.00	1.00	1.00	1.00
Final Volume:	56	7	245	4	2	2	7	709	86	310	408	57

Saturation Flow Module:												
Sat/Lane:	1900	1900	1900	1900	1900	1900	1900	1900	1900	1900	1900	1900
Adjustment:	0.92	1.00	0.92	0.92	1.00	0.92	0.92	0.99	0.95	0.83	0.98	0.95
Lanes:	1.00	1.00	1.00	1.00	1.00	1.00	1.00	2.66	0.34	2.00	1.75	0.25
Final Sat.:	1750	1900	1750	1750	1900	1750	1750	4993	606	3150	3246	454

Capacity Analysis Module:												
Vol/Sat:	0.03	0.00	0.14	0.00	0.00	0.00	0.00	0.14	0.14	0.10	0.13	0.13
Crit Moves:	***			***			***			***		
Green Time:	7.0	10.0	22.7	7.0	10.0	10.0	12.8	18.3	18.3	12.7	18.2	18.2
Volume/Cap:	0.27	0.02	0.37	0.02	0.01	0.01	0.02	0.47	0.47	0.47	0.41	0.41
Delay/Veh:	24.9	20.9	13.8	23.5	20.9	20.9	18.7	17.1	17.1	21.2	16.9	16.9
User DelAdj:	1.00	1.00	1.00	1.00	1.00	1.00	1.00	1.00	1.00	1.00	1.00	1.00
AdjDel/Veh:	24.9	20.9	13.8	23.5	20.9	20.9	18.7	17.1	17.1	21.2	16.9	16.9
LOS by Move:	C	C	B	C	C	C	B	B	B	C	B	B
HCM2k95thQ:	3	0	8	0	0	0	0	8	8	6	7	7

Note: Queue reported is the number of cars per lane.

City of Morgan Hill
Carpenters Training Center

Level Of Service Computation Report
2000 HCM Operations (Future Volume Alternative)
Existing Plus Project AM

Intersection #105: Sutter Boulevard and Cochrane Road

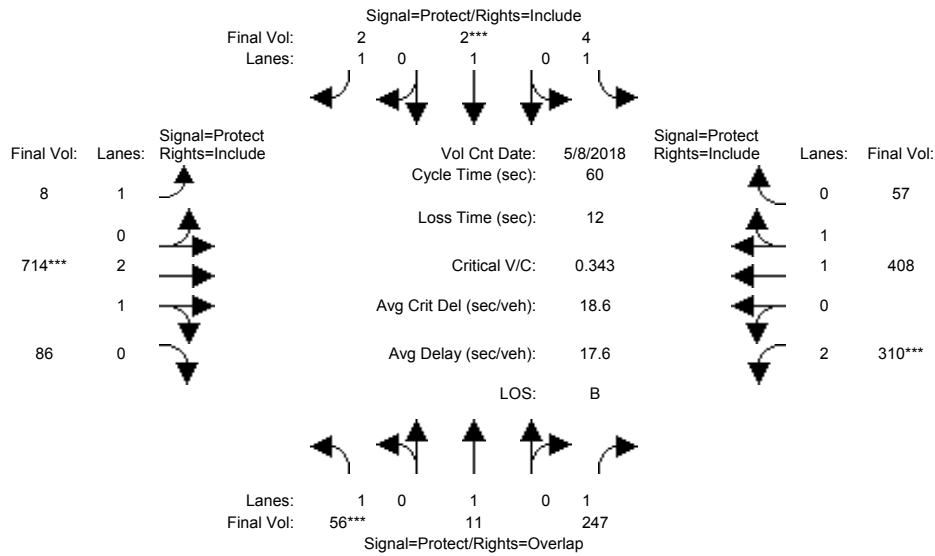

Street Name:	Sutter Boulevard						Cochrane Road					
	North Bound			South Bound			East Bound			West Bound		
Approach:	North Bound			South Bound			East Bound			West Bound		
Movement:	L	T	R	L	T	R	L	T	R	L	T	R
Min. Green:	7	10	10	7	10	10	7	10	10	7	10	10
Y+R:	4.0	4.0	4.0	4.0	4.0	4.0	4.0	4.0	4.0	4.0	4.0	4.0

Volume Module:	>>	Count	Date:	8 May 2018	<<							
Base Vol:	56	7	245	4	2	2	7	709	86	310	408	57
Growth Adj:	1.00	1.00	1.00	1.00	1.00	1.00	1.00	1.00	1.00	1.00	1.00	1.00
Initial Bse:	56	7	245	4	2	2	7	709	86	310	408	57
Added Vol:	0	4	2	0	0	0	1	5	0	0	0	0
PasserByVol:	0	0	0	0	0	0	0	0	0	0	0	0
Initial Fut:	56	11	247	4	2	2	8	714	86	310	408	57
User Adj:	1.00	1.00	1.00	1.00	1.00	1.00	1.00	1.00	1.00	1.00	1.00	1.00
PHF Adj:	1.00	1.00	1.00	1.00	1.00	1.00	1.00	1.00	1.00	1.00	1.00	1.00
PHF Volume:	56	11	247	4	2	2	8	714	86	310	408	57
Reduct Vol:	0	0	0	0	0	0	0	0	0	0	0	0
Reduced Vol:	56	11	247	4	2	2	8	714	86	310	408	57
PCE Adj:	1.00	1.00	1.00	1.00	1.00	1.00	1.00	1.00	1.00	1.00	1.00	1.00
MLF Adj:	1.00	1.00	1.00	1.00	1.00	1.00	1.00	1.00	1.00	1.00	1.00	1.00
FinalVolume:	56	11	247	4	2	2	8	714	86	310	408	57

Saturation Flow Module:												
Sat/Lane:	1900	1900	1900	1900	1900	1900	1900	1900	1900	1900	1900	1900
Adjustment:	0.92	1.00	0.92	0.92	1.00	0.92	0.92	0.99	0.95	0.83	0.98	0.95
Lanes:	1.00	1.00	1.00	1.00	1.00	1.00	1.00	2.67	0.33	2.00	1.75	0.25
Final Sat.:	1750	1900	1750	1750	1900	1750	1750	4997	602	3150	3246	454

Capacity Analysis Module:												
Vol/Sat:	0.03	0.01	0.14	0.00	0.00	0.00	0.00	0.14	0.14	0.10	0.13	0.13
Crit Moves:	****			****			****			****		
Green Time:	7.0	10.0	22.6	7.0	10.0	10.0	12.8	18.4	18.4	12.6	18.2	18.2
Volume/Cap:	0.27	0.03	0.37	0.02	0.01	0.01	0.02	0.47	0.47	0.47	0.41	0.41
Delay/Veh:	24.9	21.0	13.9	23.5	20.9	20.9	18.7	17.1	17.1	21.3	16.9	16.9
User DelAdj:	1.00	1.00	1.00	1.00	1.00	1.00	1.00	1.00	1.00	1.00	1.00	1.00
AdjDel/Veh:	24.9	21.0	13.9	23.5	20.9	20.9	18.7	17.1	17.1	21.3	16.9	16.9
LOS by Move:	C	C	B	C	C	C	B	B	B	C	B	B
HCM2k95thQ:	3	0	8	0	0	0	0	8	8	6	7	7

Note: Queue reported is the number of cars per lane.

City of Morgan Hill
Carpenters Training Center

Level Of Service Computation Report
2000 HCM Operations (Future Volume Alternative)
Cumulative AM

Intersection #105: Sutter Boulevard and Cochrane Road

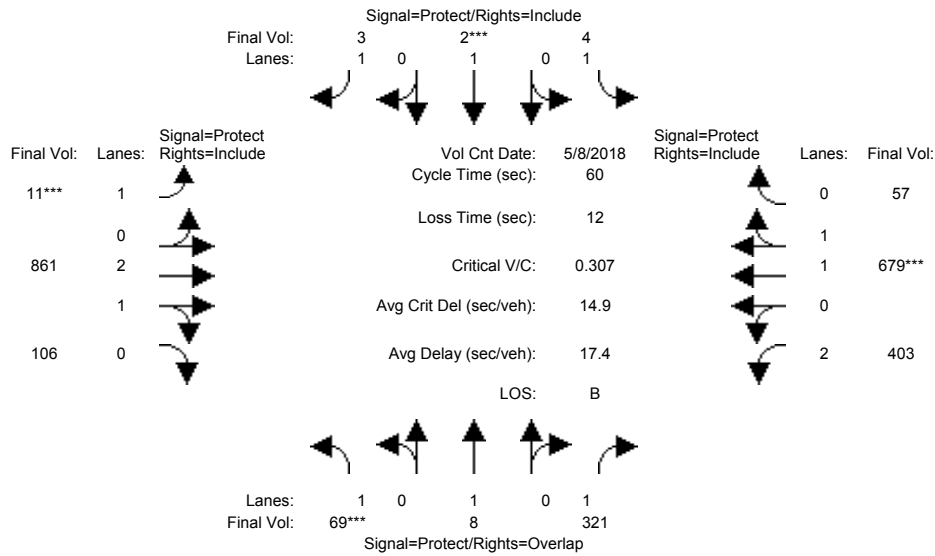

Street Name:	Sutter Boulevard						Cochrane Road					
	North Bound			South Bound			East Bound			West Bound		
Approach:												
Movement:	L	T	R	L	T	R	L	T	R	L	T	R
Min. Green:	7	10	10	7	10	10	7	10	10	7	10	10
Y+R:	4.0	4.0	4.0	4.0	4.0	4.0	4.0	4.0	4.0	4.0	4.0	4.0

Volume Module:	>>	Count	Date:	8 May 2018	<<											
Base Vol:	69	8	321	4	2	3	11	861	106	403	679	57				
Growth Adj:	1.00	1.00	1.00	1.00	1.00	1.00	1.00	1.00	1.00	1.00	1.00	1.00				
Initial Bse:	69	8	321	4	2	3	11	861	106	403	679	57				
Added Vol:	0	0	0	0	0	0	0	0	0	0	0	0				
PasserByVol:	0	0	0	0	0	0	0	0	0	0	0	0				
Initial Fut:	69	8	321	4	2	3	11	861	106	403	679	57				
User Adj:	1.00	1.00	1.00	1.00	1.00	1.00	1.00	1.00	1.00	1.00	1.00	1.00				
PHF Adj:	1.00	1.00	1.00	1.00	1.00	1.00	1.00	1.00	1.00	1.00	1.00	1.00				
PHF Volume:	69	8	321	4	2	3	11	861	106	403	679	57				
Reduct Vol:	0	0	0	0	0	0	0	0	0	0	0	0				
Reduced Vol:	69	8	321	4	2	3	11	861	106	403	679	57				
PCE Adj:	1.00	1.00	1.00	1.00	1.00	1.00	1.00	1.00	1.00	1.00	1.00	1.00				
MLF Adj:	1.00	1.00	1.00	1.00	1.00	1.00	1.00	1.00	1.00	1.00	1.00	1.00				
Final Volume:	69	8	321	4	2	3	11	861	106	403	679	57				

Saturation Flow Module:												
Sat/Lane:	1900	1900	1900	1900	1900	1900	1900	1900	1900	1900	1900	1900
Adjustment:	0.92	1.00	0.92	0.92	1.00	0.92	0.92	0.99	0.95	0.83	0.98	0.95
Lanes:	1.00	1.00	1.00	1.00	1.00	1.00	1.00	2.66	0.34	2.00	1.84	0.16
Final Sat.:	1750	1900	1750	1750	1900	1750	1750	4985	614	3150	3413	287

Capacity Analysis Module:												
Vol/Sat:	0.04	0.00	0.18	0.00	0.00	0.00	0.01	0.17	0.17	0.13	0.20	0.20
Crit Moves:	***			***			***			***		
Green Time:	7.0	10.0	23.2	7.0	10.0	10.0	7.0	17.8	17.8	13.2	24.0	24.0
Volume/Cap:	0.34	0.03	0.47	0.02	0.01	0.01	0.05	0.58	0.58	0.58	0.50	0.50
Delay/Veh:	25.4	21.0	14.4	23.5	20.9	20.9	23.7	18.5	18.5	22.2	13.7	13.7
User DelAdj:	1.00	1.00	1.00	1.00	1.00	1.00	1.00	1.00	1.00	1.00	1.00	1.00
AdjDel/Veh:	25.4	21.0	14.4	23.5	20.9	20.9	23.7	18.5	18.5	22.2	13.7	13.7
LOS by Move:	C	C	B	C	C	C	C	B	B	C	B	B
HCM2k95thQ:	3	0	10	0	0	0	0	10	10	8	10	10

Note: Queue reported is the number of cars per lane.

City of Morgan Hill
Carpenters Training Center

Level Of Service Computation Report
2000 HCM Operations (Future Volume Alternative)
Cumulative Plus Project AM

Intersection #105: Sutter Boulevard and Cochrane Road

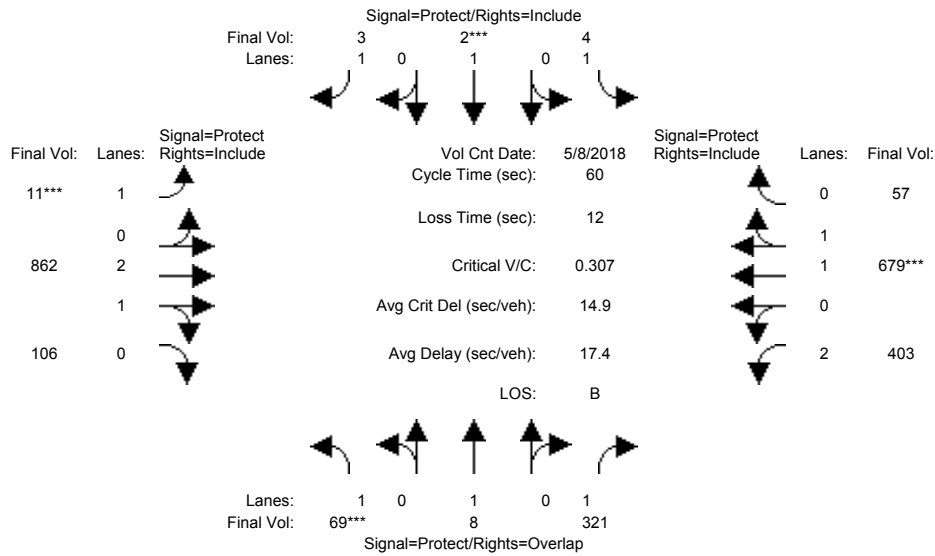

Street Name:	Sutter Boulevard						Cochrane Road					
	North Bound			South Bound			East Bound			West Bound		
Approach:	L	T	R	L	T	R	L	T	R	L	T	R
Min. Green:	7	10	10	7	10	10	7	10	10	7	10	10
Y+R:	4.0	4.0	4.0	4.0	4.0	4.0	4.0	4.0	4.0	4.0	4.0	4.0

Volume Module:	>>	Count	Date:	8 May 2018	<<							
Base Vol:	69	8	321	4	2	3	11	861	106	403	679	57
Growth Adj:	1.00	1.00	1.00	1.00	1.00	1.00	1.00	1.00	1.00	1.00	1.00	1.00
Initial Bse:	69	8	321	4	2	3	11	861	106	403	679	57
Added Vol:	0	0	0	0	0	0	0	1	0	0	0	0
PasserByVol:	0	0	0	0	0	0	0	0	0	0	0	0
Initial Fut:	69	8	321	4	2	3	11	862	106	403	679	57
User Adj:	1.00	1.00	1.00	1.00	1.00	1.00	1.00	1.00	1.00	1.00	1.00	1.00
PHF Adj:	1.00	1.00	1.00	1.00	1.00	1.00	1.00	1.00	1.00	1.00	1.00	1.00
PHF Volume:	69	8	321	4	2	3	11	862	106	403	679	57
Reduct Vol:	0	0	0	0	0	0	0	0	0	0	0	0
Reduced Vol:	69	8	321	4	2	3	11	862	106	403	679	57
PCE Adj:	1.00	1.00	1.00	1.00	1.00	1.00	1.00	1.00	1.00	1.00	1.00	1.00
MLF Adj:	1.00	1.00	1.00	1.00	1.00	1.00	1.00	1.00	1.00	1.00	1.00	1.00
Final Volume:	69	8	321	4	2	3	11	862	106	403	679	57

Saturation Flow Module:												
Sat/Lane:	1900	1900	1900	1900	1900	1900	1900	1900	1900	1900	1900	1900
Adjustment:	0.92	1.00	0.92	0.92	1.00	0.92	0.92	0.99	0.95	0.83	0.98	0.95
Lanes:	1.00	1.00	1.00	1.00	1.00	1.00	1.00	2.66	0.34	2.00	1.84	0.16
Final Sat.:	1750	1900	1750	1750	1900	1750	1750	4986	613	3150	3413	287

Capacity Analysis Module:												
Vol/Sat:	0.04	0.00	0.18	0.00	0.00	0.00	0.01	0.17	0.17	0.13	0.20	0.20
Crit Moves:	***			***			***			***		
Green Time:	7.0	10.0	23.2	7.0	10.0	10.0	7.0	17.8	17.8	13.2	24.0	24.0
Volume/Cap:	0.34	0.03	0.47	0.02	0.01	0.01	0.05	0.58	0.58	0.58	0.50	0.50
Delay/Veh:	25.4	21.0	14.4	23.5	20.9	20.9	23.7	18.5	18.5	22.2	13.7	13.7
User DelAdj:	1.00	1.00	1.00	1.00	1.00	1.00	1.00	1.00	1.00	1.00	1.00	1.00
AdjDel/Veh:	25.4	21.0	14.4	23.5	20.9	20.9	23.7	18.5	18.5	22.2	13.7	13.7
LOS by Move:	C	C	B	C	C	C	C	B	B	C	B	B
HCM2k95thQ:	3	0	10	0	0	0	0	10	10	8	10	10

Note: Queue reported is the number of cars per lane.

City of Morgan Hill
Carpenters Training Center

Level Of Service Computation Report
2000 HCM Operations (Future Volume Alternative)
Existing PM

Intersection #105: Sutter Boulevard and Cochrane Road

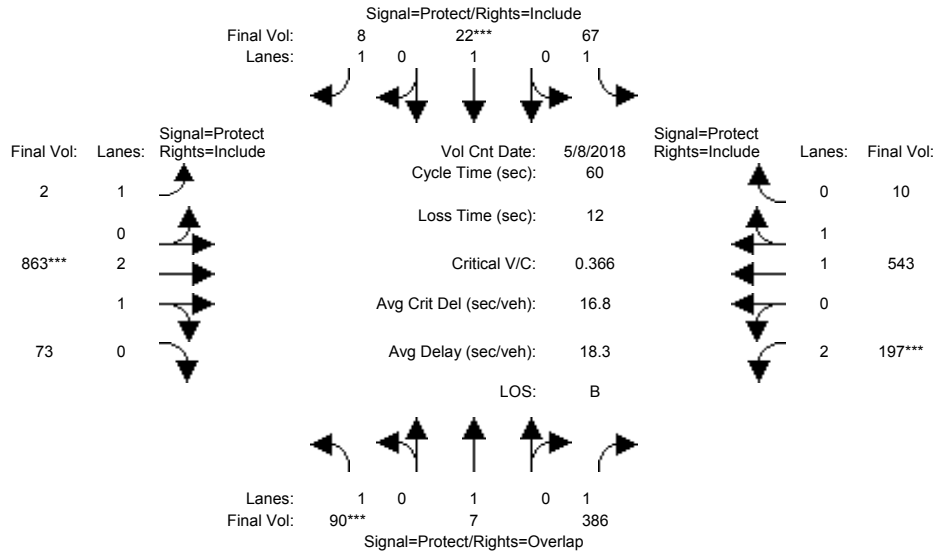

Street Name:	Sutter Boulevard						Cochrane Road					
	North Bound			South Bound			East Bound			West Bound		
Approach:	North Bound			South Bound			East Bound			West Bound		
Movement:	L	T	R	L	T	R	L	T	R	L	T	R
Min. Green:	7	10	10	7	10	10	7	10	10	7	10	10
Y+R:	4.0	4.0	4.0	4.0	4.0	4.0	4.0	4.0	4.0	4.0	4.0	4.0

Volume Module:	>>	Count	Date:	8 May 2018	<<											
Base Vol:	90	7	386	67	22	8	2	863	73	197	543	10				
Growth Adj:	1.00	1.00	1.00	1.00	1.00	1.00	1.00	1.00	1.00	1.00	1.00	1.00				
Initial Bse:	90	7	386	67	22	8	2	863	73	197	543	10				
Added Vol:	0	0	0	0	0	0	0	0	0	0	0	0				
PasserByVol:	0	0	0	0	0	0	0	0	0	0	0	0				
Initial Fut:	90	7	386	67	22	8	2	863	73	197	543	10				
User Adj:	1.00	1.00	1.00	1.00	1.00	1.00	1.00	1.00	1.00	1.00	1.00	1.00				
PHF Adj:	1.00	1.00	1.00	1.00	1.00	1.00	1.00	1.00	1.00	1.00	1.00	1.00				
PHF Volume:	90	7	386	67	22	8	2	863	73	197	543	10				
Reduct Vol:	0	0	0	0	0	0	0	0	0	0	0	0				
Reduced Vol:	90	7	386	67	22	8	2	863	73	197	543	10				
PCE Adj:	1.00	1.00	1.00	1.00	1.00	1.00	1.00	1.00	1.00	1.00	1.00	1.00				
MLF Adj:	1.00	1.00	1.00	1.00	1.00	1.00	1.00	1.00	1.00	1.00	1.00	1.00				
Final Volume:	90	7	386	67	22	8	2	863	73	197	543	10				

Saturation Flow Module:												
Sat/Lane:	1900	1900	1900	1900	1900	1900	1900	1900	1900	1900	1900	1900
Adjustment:	0.92	1.00	0.92	0.92	1.00	0.92	0.92	0.99	0.95	0.83	0.97	0.95
Lanes:	1.00	1.00	1.00	1.00	1.00	1.00	1.00	2.76	0.24	2.00	1.96	0.04
Final Sat.:	1750	1900	1750	1750	1900	1750	1750	5163	437	3150	3633	67

Capacity Analysis Module:												
Vol/Sat:	0.05	0.00	0.22	0.04	0.01	0.00	0.00	0.17	0.17	0.06	0.15	0.15
Crit Moves:	****				****			****		****		
Green Time:	7.0	10.0	18.4	7.0	10.0	10.0	12.8	22.6	22.6	8.4	18.2	18.2
Volume/Cap:	0.44	0.02	0.72	0.33	0.07	0.03	0.01	0.44	0.44	0.44	0.49	0.49
Delay/Veh:	26.2	20.9	23.1	25.3	21.2	21.0	18.6	14.2	14.2	24.3	17.4	17.4
User DelAdj:	1.00	1.00	1.00	1.00	1.00	1.00	1.00	1.00	1.00	1.00	1.00	1.00
AdjDel/Veh:	26.2	20.9	23.1	25.3	21.2	21.0	18.6	14.2	14.2	24.3	17.4	17.4
LOS by Move:	C	C	C	C	C	C	B	B	B	C	B	B
HCM2k95thQ:	5	0	16	3	1	0	0	8	8	4	8	8

Note: Queue reported is the number of cars per lane.

City of Morgan Hill
Carpenters Training Center

Level Of Service Computation Report
2000 HCM Operations (Future Volume Alternative)
Existing Plus Project PM

Intersection #105: Sutter Boulevard and Cochrane Road

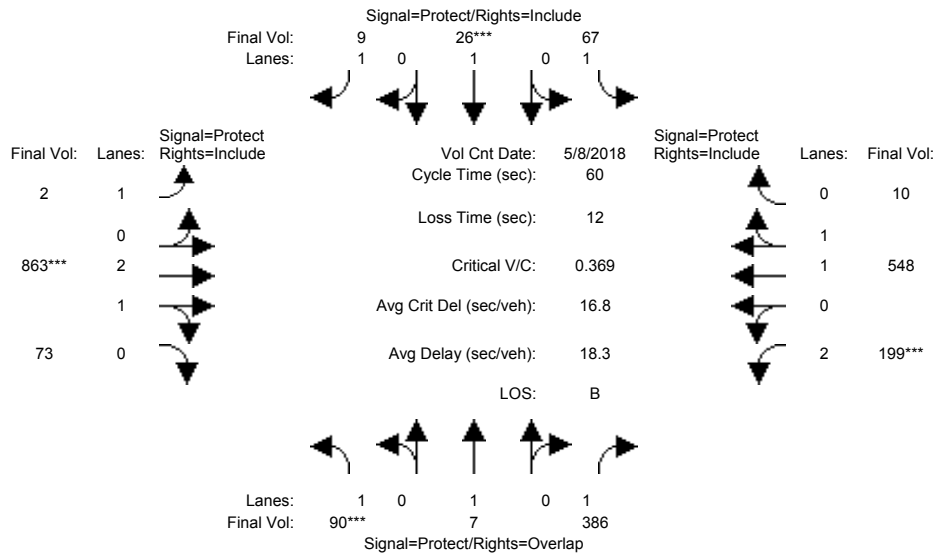

Street Name:	Sutter Boulevard						Cochrane Road					
	North Bound			South Bound			East Bound			West Bound		
Approach:	L	T	R	L	T	R	L	T	R	L	T	R
Min. Green:	7	10	10	7	10	10	7	10	10	7	10	10
Y+R:	4.0	4.0	4.0	4.0	4.0	4.0	4.0	4.0	4.0	4.0	4.0	4.0

Volume Module:	>>	Count	Date:	8 May 2018	<<											
Base Vol:	90	7	386	67	22	8	2	863	73	197	543	10				
Growth Adj:	1.00	1.00	1.00	1.00	1.00	1.00	1.00	1.00	1.00	1.00	1.00	1.00				
Initial Bse:	90	7	386	67	22	8	2	863	73	197	543	10				
Added Vol:	0	0	0	0	4	1	0	0	0	2	5	0				
PasserByVol:	0	0	0	0	0	0	0	0	0	0	0	0				
Initial Fut:	90	7	386	67	26	9	2	863	73	199	548	10				
User Adj:	1.00	1.00	1.00	1.00	1.00	1.00	1.00	1.00	1.00	1.00	1.00	1.00				
PHF Adj:	1.00	1.00	1.00	1.00	1.00	1.00	1.00	1.00	1.00	1.00	1.00	1.00				
PHF Volume:	90	7	386	67	26	9	2	863	73	199	548	10				
Reduct Vol:	0	0	0	0	0	0	0	0	0	0	0	0				
Reduced Vol:	90	7	386	67	26	9	2	863	73	199	548	10				
PCE Adj:	1.00	1.00	1.00	1.00	1.00	1.00	1.00	1.00	1.00	1.00	1.00	1.00				
MLF Adj:	1.00	1.00	1.00	1.00	1.00	1.00	1.00	1.00	1.00	1.00	1.00	1.00				
Final Volume:	90	7	386	67	26	9	2	863	73	199	548	10				

Saturation Flow Module:												
Sat/Lane:	1900	1900	1900	1900	1900	1900	1900	1900	1900	1900	1900	1900
Adjustment:	0.92	1.00	0.92	0.92	1.00	0.92	0.92	0.99	0.95	0.83	0.97	0.95
Lanes:	1.00	1.00	1.00	1.00	1.00	1.00	1.00	2.76	0.24	2.00	1.96	0.04
Final Sat.:	1750	1900	1750	1750	1900	1750	1750	5163	437	3150	3634	66

Capacity Analysis Module:												
Vol/Sat:	0.05	0.00	0.22	0.04	0.01	0.01	0.00	0.17	0.17	0.06	0.15	0.15
Crit Moves:	****				****			****		****		
Green Time:	7.0	10.0	18.5	7.0	10.0	10.0	12.8	22.5	22.5	8.5	18.2	18.2
Volume/Cap:	0.44	0.02	0.72	0.33	0.08	0.03	0.01	0.45	0.45	0.45	0.50	0.50
Delay/Veh:	26.2	20.9	23.0	25.3	21.2	21.0	18.6	14.2	14.2	24.3	17.5	17.5
User DelAdj:	1.00	1.00	1.00	1.00	1.00	1.00	1.00	1.00	1.00	1.00	1.00	1.00
AdjDel/Veh:	26.2	20.9	23.0	25.3	21.2	21.0	18.6	14.2	14.2	24.3	17.5	17.5
LOS by Move:	C	C	C	C	C	C	B	B	B	C	B	B
HCM2k95thQ:	5	0	16	3	1	0	0	8	8	4	8	8

Note: Queue reported is the number of cars per lane.

City of Morgan Hill
Carpenters Training Center

Level Of Service Computation Report
2000 HCM Operations (Future Volume Alternative)
Cumulative PM

Intersection #105: Sutter Boulevard and Cochrane Road

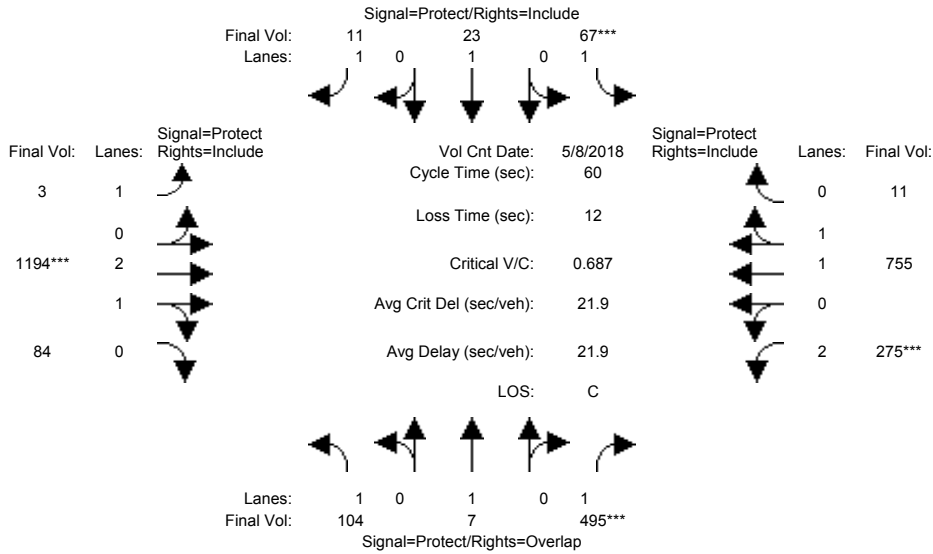

Street Name:	Sutter Boulevard						Cochrane Road					
	North Bound			South Bound			East Bound			West Bound		
Approach:	North Bound			South Bound			East Bound			West Bound		
Movement:	L	T	R	L	T	R	L	T	R	L	T	R
Min. Green:	7	10	10	7	10	10	7	10	10	7	10	10
Y+R:	4.0	4.0	4.0	4.0	4.0	4.0	4.0	4.0	4.0	4.0	4.0	4.0

Volume Module:	>>	Count	Date:	8 May 2018	<<							
Base Vol:	104	7	495	67	23	11	3	1194	84	275	755	11
Growth Adj:	1.00	1.00	1.00	1.00	1.00	1.00	1.00	1.00	1.00	1.00	1.00	1.00
Initial Bse:	104	7	495	67	23	11	3	1194	84	275	755	11
Added Vol:	0	0	0	0	0	0	0	0	0	0	0	0
PasserByVol:	0	0	0	0	0	0	0	0	0	0	0	0
Initial Fut:	104	7	495	67	23	11	3	1194	84	275	755	11
User Adj:	1.00	1.00	1.00	1.00	1.00	1.00	1.00	1.00	1.00	1.00	1.00	1.00
PHF Adj:	1.00	1.00	1.00	1.00	1.00	1.00	1.00	1.00	1.00	1.00	1.00	1.00
PHF Volume:	104	7	495	67	23	11	3	1194	84	275	755	11
Reduct Vol:	0	0	0	0	0	0	0	0	0	0	0	0
Reduced Vol:	104	7	495	67	23	11	3	1194	84	275	755	11
PCE Adj:	1.00	1.00	1.00	1.00	1.00	1.00	1.00	1.00	1.00	1.00	1.00	1.00
MLF Adj:	1.00	1.00	1.00	1.00	1.00	1.00	1.00	1.00	1.00	1.00	1.00	1.00
Final Volume:	104	7	495	67	23	11	3	1194	84	275	755	11

Saturation Flow Module:												
Sat/Lane:	1900	1900	1900	1900	1900	1900	1900	1900	1900	1900	1900	1900
Adjustment:	0.92	1.00	0.92	0.92	1.00	0.92	0.92	0.98	0.95	0.83	0.97	0.95
Lanes:	1.00	1.00	1.00	1.00	1.00	1.00	1.00	2.80	0.20	2.00	1.97	0.03
Final Sat.:	1750	1900	1750	1750	1900	1750	1750	5231	368	3150	3647	53

Capacity Analysis Module:												
Vol/Sat:	0.06	0.00	0.28	0.04	0.01	0.01	0.00	0.23	0.23	0.09	0.21	0.21
Crit Moves:			****	****				****		****		
Green Time:	8.7	14.1	21.6	7.0	12.4	12.4	9.7	19.4	19.4	7.4	17.2	17.2
Volume/Cap:	0.41	0.02	0.79	0.33	0.06	0.03	0.01	0.70	0.70	0.70	0.72	0.72
Delay/Veh:	24.4	17.6	23.7	25.3	19.1	19.0	21.2	19.1	19.1	31.0	21.8	21.8
User DelAdj:	1.00	1.00	1.00	1.00	1.00	1.00	1.00	1.00	1.00	1.00	1.00	1.00
AdjDel/Veh:	24.4	17.6	23.7	25.3	19.1	19.0	21.2	19.1	19.1	31.0	21.8	21.8
LOS by Move:	C	B	C	C	B	B	C	B	B	C	C	C
HCM2k95thQ:	5	0	20	3	1	0	0	13	13	6	13	13

Note: Queue reported is the number of cars per lane.

City of Morgan Hill
Carpenters Training Center

Level Of Service Computation Report
2000 HCM Operations (Future Volume Alternative)
Cumulative Plus Project PM

Intersection #105: Sutter Boulevard and Cochrane Road

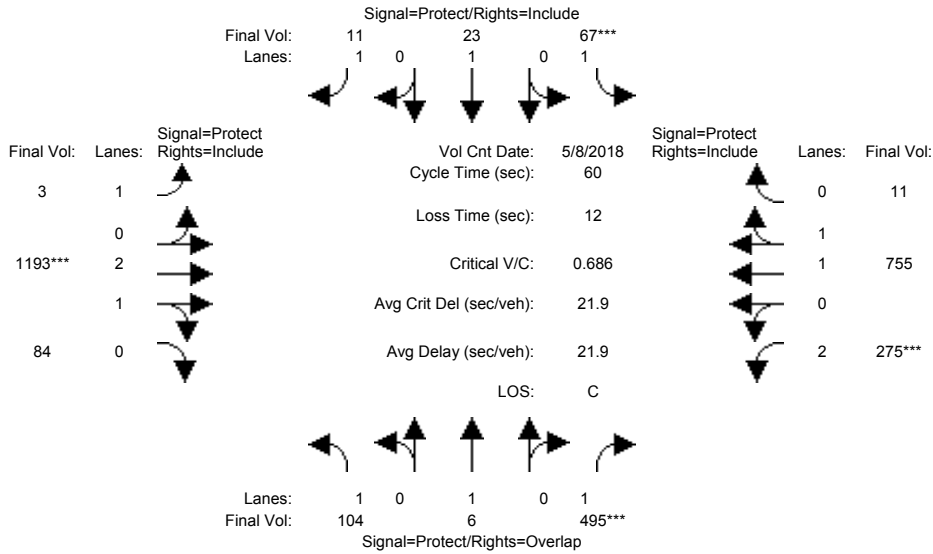

Street Name:	Sutter Boulevard						Cochrane Road					
	North Bound			South Bound			East Bound			West Bound		
Approach:	L	T	R	L	T	R	L	T	R	L	T	R
Min. Green:	7	10	10	7	10	10	7	10	10	7	10	10
Y+R:	4.0	4.0	4.0	4.0	4.0	4.0	4.0	4.0	4.0	4.0	4.0	4.0

Volume Module:	>>	Count	Date:	8 May 2018	<<							
Base Vol:	104	7	495	67	23	11	3	1194	84	275	755	11
Growth Adj:	1.00	1.00	1.00	1.00	1.00	1.00	1.00	1.00	1.00	1.00	1.00	1.00
Initial Bse:	104	7	495	67	23	11	3	1194	84	275	755	11
Added Vol:	0	-1	0	0	0	0	0	-1	0	0	0	0
PasserByVol:	0	0	0	0	0	0	0	0	0	0	0	0
Initial Fut:	104	6	495	67	23	11	3	1193	84	275	755	11
User Adj:	1.00	1.00	1.00	1.00	1.00	1.00	1.00	1.00	1.00	1.00	1.00	1.00
PHF Adj:	1.00	1.00	1.00	1.00	1.00	1.00	1.00	1.00	1.00	1.00	1.00	1.00
PHF Volume:	104	6	495	67	23	11	3	1193	84	275	755	11
Reduct Vol:	0	0	0	0	0	0	0	0	0	0	0	0
Reduced Vol:	104	6	495	67	23	11	3	1193	84	275	755	11
PCE Adj:	1.00	1.00	1.00	1.00	1.00	1.00	1.00	1.00	1.00	1.00	1.00	1.00
MLF Adj:	1.00	1.00	1.00	1.00	1.00	1.00	1.00	1.00	1.00	1.00	1.00	1.00
Final Volume:	104	6	495	67	23	11	3	1193	84	275	755	11

Saturation Flow Module:												
Sat/Lane:	1900	1900	1900	1900	1900	1900	1900	1900	1900	1900	1900	1900
Adjustment:	0.92	1.00	0.92	0.92	1.00	0.92	0.92	0.98	0.95	0.83	0.97	0.95
Lanes:	1.00	1.00	1.00	1.00	1.00	1.00	1.00	2.80	0.20	2.00	1.97	0.03
Final Sat.:	1750	1900	1750	1750	1900	1750	1750	5231	368	3150	3647	53

Capacity Analysis Module:												
Vol/Sat:	0.06	0.00	0.28	0.04	0.01	0.01	0.00	0.23	0.23	0.09	0.21	0.21
Crit Moves:			****	****			****			****		
Green Time:	8.7	14.1	21.6	7.0	12.4	12.4	9.7	19.4	19.4	7.4	17.2	17.2
Volume/Cap:	0.41	0.01	0.79	0.33	0.06	0.03	0.01	0.70	0.70	0.70	0.72	0.72
Delay/Veh:	24.4	17.6	23.7	25.3	19.1	19.0	21.2	19.1	19.1	31.0	21.8	21.8
User DelAdj:	1.00	1.00	1.00	1.00	1.00	1.00	1.00	1.00	1.00	1.00	1.00	1.00
AdjDel/Veh:	24.4	17.6	23.7	25.3	19.1	19.0	21.2	19.1	19.1	31.0	21.8	21.8
LOS by Move:	C	B	C	C	B	B	C	B	B	C	C	C
HCM2k95thQ:	5	0	20	3	1	0	0	13	13	6	13	13

Note: Queue reported is the number of cars per lane.

City of Morgan Hill
Carpenters Training Center

Level Of Service Computation Report
2000 HCM Operations (Future Volume Alternative)
Existing AM

Intersection #106: Madrone Parkway/Cochrane Plaza and Cochrane Road

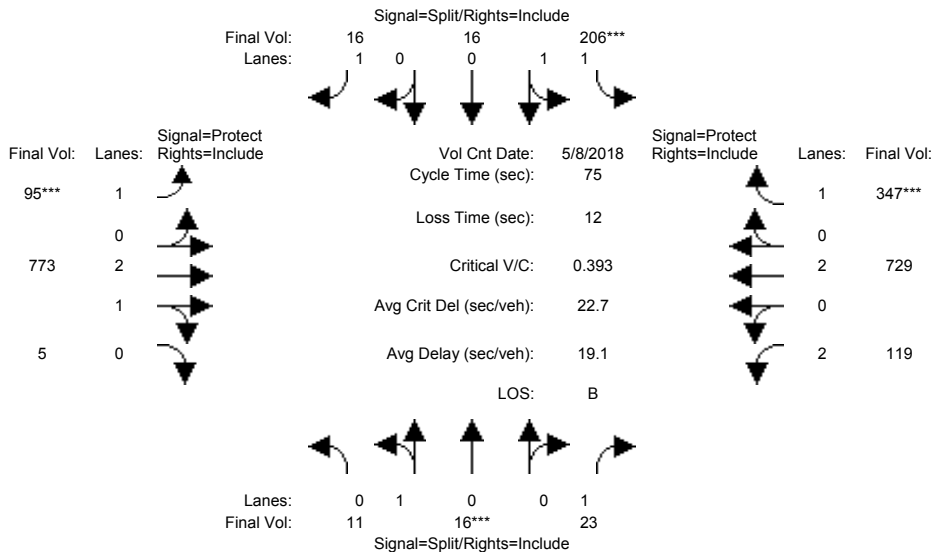

Street Name:	Madrone Parkway/Cochrane Plaza						Cochrane Road					
	North Bound			South Bound			East Bound			West Bound		
Movement:	L	T	R	L	T	R	L	T	R	L	T	R
Min. Green:	10	10	10	10	10	10	7	10	10	7	10	10
Y+R:	4.0	4.0	4.0	4.0	4.0	4.0	4.0	4.0	4.0	4.0	4.0	4.0

Volume Module:	>>	Count	Date:	8 May 2018	<<												
Base Vol:	11	16	23	206	16	16	95	773	5	119	729	347					
Growth Adj:	1.00	1.00	1.00	1.00	1.00	1.00	1.00	1.00	1.00	1.00	1.00	1.00					
Initial Bse:	11	16	23	206	16	16	95	773	5	119	729	347					
Added Vol:	0	0	0	0	0	0	0	0	0	0	0	0					
PasserByVol:	0	0	0	0	0	0	0	0	0	0	0	0					
Initial Fut:	11	16	23	206	16	16	95	773	5	119	729	347					
User Adj:	1.00	1.00	1.00	1.00	1.00	1.00	1.00	1.00	1.00	1.00	1.00	1.00					
PHF Adj:	1.00	1.00	1.00	1.00	1.00	1.00	1.00	1.00	1.00	1.00	1.00	1.00					
PHF Volume:	11	16	23	206	16	16	95	773	5	119	729	347					
Reduct Vol:	0	0	0	0	0	0	0	0	0	0	0	0					
Reduced Vol:	11	16	23	206	16	16	95	773	5	119	729	347					
PCE Adj:	1.00	1.00	1.00	1.00	1.00	1.00	1.00	1.00	1.00	1.00	1.00	1.00					
MLF Adj:	1.00	1.00	1.00	1.00	1.00	1.00	1.00	1.00	1.00	1.00	1.00	1.00					
Final Volume:	11	16	23	206	16	16	95	773	5	119	729	347					

Saturation Flow Module:												
Sat/Lane:	1900	1900	1900	1900	1900	1900	1900	1900	1900	1900	1900	1900
Adjustment:	0.95	0.95	0.92	0.93	0.95	0.92	0.92	0.98	0.95	0.83	1.00	0.92
Lanes:	0.41	0.59	1.00	1.86	0.14	1.00	1.00	2.98	0.02	2.00	2.00	1.00
Final Sat.:	733	1067	1750	3294	256	1750	1750	5564	36	3150	3800	1750

Capacity Analysis Module:												
Vol/Sat:	0.02	0.02	0.01	0.06	0.06	0.01	0.05	0.14	0.14	0.04	0.19	0.20
Crit Moves:	****			****			****			****		
Green Time:	10.0	10.0	10.0	10.5	10.5	10.5	9.1	25.4	25.4	17.1	33.4	33.4
Volume/Cap:	0.11	0.11	0.10	0.45	0.45	0.07	0.45	0.41	0.41	0.17	0.43	0.45
Delay/Veh:	28.8	28.8	28.7	30.2	30.2	28.1	32.1	19.2	19.2	23.4	14.5	14.8
User DelAdj:	1.00	1.00	1.00	1.00	1.00	1.00	1.00	1.00	1.00	1.00	1.00	1.00
AdjDel/Veh:	28.8	28.8	28.7	30.2	30.2	28.1	32.1	19.2	19.2	23.4	14.5	14.8
LOS by Move:	C	C	C	C	C	C	C	B	B	C	B	B
HCM2k95thQ:	1	1	1	6	6	1	4	9	9	3	11	11

Note: Queue reported is the number of cars per lane.

City of Morgan Hill
Carpenters Training Center

Level Of Service Computation Report
2000 HCM Operations (Future Volume Alternative)
Existing Plus Project AM

Intersection #106: Madrone Parkway/Cochrane Plaza and Cochrane Road

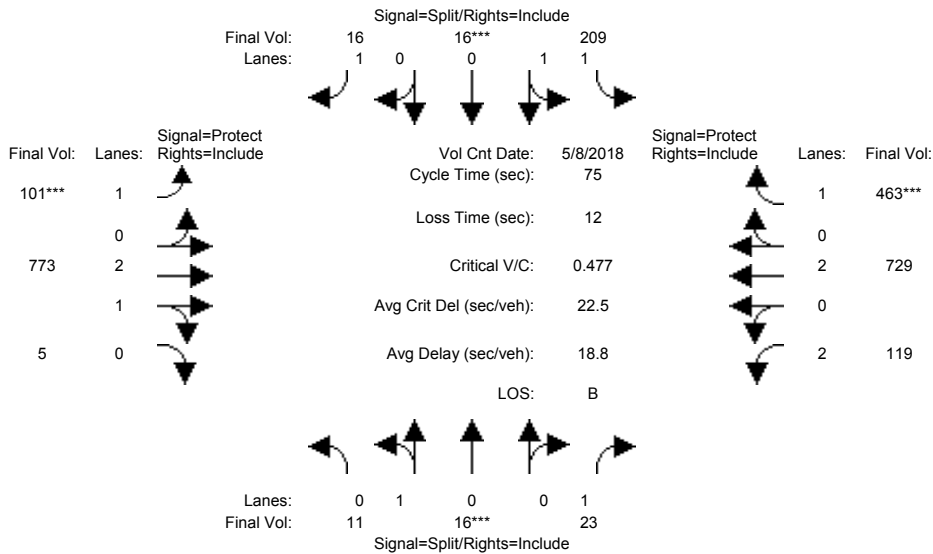

Street Name:	Madrone Parkway/Cochrane Plaza						Cochrane Road					
	North Bound			South Bound			East Bound			West Bound		
Approach:	North Bound			South Bound			East Bound			West Bound		
Movement:	L	T	R	L	T	R	L	T	R	L	T	R
Min. Green:	10	10	10	10	10	10	7	10	10	7	10	10
Y+R:	4.0	4.0	4.0	4.0	4.0	4.0	4.0	4.0	4.0	4.0	4.0	4.0

Volume Module:	>>	Count	Date:	8 May 2018	<<											
Base Vol:	11	16	23	206	16	16	95	773	5	119	729	347				
Growth Adj:	1.00	1.00	1.00	1.00	1.00	1.00	1.00	1.00	1.00	1.00	1.00	1.00				
Initial Bse:	11	16	23	206	16	16	95	773	5	119	729	347				
Added Vol:	0	0	0	3	0	0	6	0	0	0	0	116				
PasserByVol:	0	0	0	0	0	0	0	0	0	0	0	0				
Initial Fut:	11	16	23	209	16	16	101	773	5	119	729	463				
User Adj:	1.00	1.00	1.00	1.00	1.00	1.00	1.00	1.00	1.00	1.00	1.00	1.00				
PHF Adj:	1.00	1.00	1.00	1.00	1.00	1.00	1.00	1.00	1.00	1.00	1.00	1.00				
PHF Volume:	11	16	23	209	16	16	101	773	5	119	729	463				
Reduct Vol:	0	0	0	0	0	0	0	0	0	0	0	0				
Reduced Vol:	11	16	23	209	16	16	101	773	5	119	729	463				
PCE Adj:	1.00	1.00	1.00	1.00	1.00	1.00	1.00	1.00	1.00	1.00	1.00	1.00				
MLF Adj:	1.00	1.00	1.00	1.00	1.00	1.00	1.00	1.00	1.00	1.00	1.00	1.00				
Final Volume:	11	16	23	209	16	16	101	773	5	119	729	463				

Saturation Flow Module:												
Sat/Lane:	1900	1900	1900	1900	1900	1900	1900	1900	1900	1900	1900	1900
Adjustment:	0.95	0.95	0.92	0.93	0.95	0.92	0.92	0.98	0.95	0.83	1.00	0.92
Lanes:	0.41	0.59	1.00	1.86	0.14	1.00	1.00	2.98	0.02	2.00	2.00	1.00
Final Sat.:	733	1067	1750	3298	252	1750	1750	5564	36	3150	3800	1750

Capacity Analysis Module:												
Vol/Sat:	0.02	0.02	0.01	0.06	0.06	0.01	0.06	0.14	0.14	0.04	0.19	0.26
Crit Moves:	****			****			****			****		
Green Time:	10.0	10.0	10.0	10.0	10.0	10.0	7.7	25.7	25.7	17.3	35.3	35.3
Volume/Cap:	0.11	0.11	0.10	0.48	0.48	0.07	0.56	0.41	0.41	0.16	0.41	0.56
Delay/Veh:	28.8	28.8	28.7	30.8	30.8	28.6	36.1	18.9	18.9	23.2	13.2	15.2
User DelAdj:	1.00	1.00	1.00	1.00	1.00	1.00	1.00	1.00	1.00	1.00	1.00	1.00
AdjDel/Veh:	28.8	28.8	28.7	30.8	30.8	28.6	36.1	18.9	18.9	23.2	13.2	15.2
LOS by Move:	C	C	C	C	C	C	D	B	B	C	B	B
HCM2k95thQ:	1	1	1	6	6	1	5	9	9	3	10	15

Note: Queue reported is the number of cars per lane.

City of Morgan Hill
Carpenters Training Center

Level Of Service Computation Report
2000 HCM Operations (Future Volume Alternative)
Cumulative AM

Intersection #106: Madrone Parkway/Cochrane Plaza and Cochrane Road

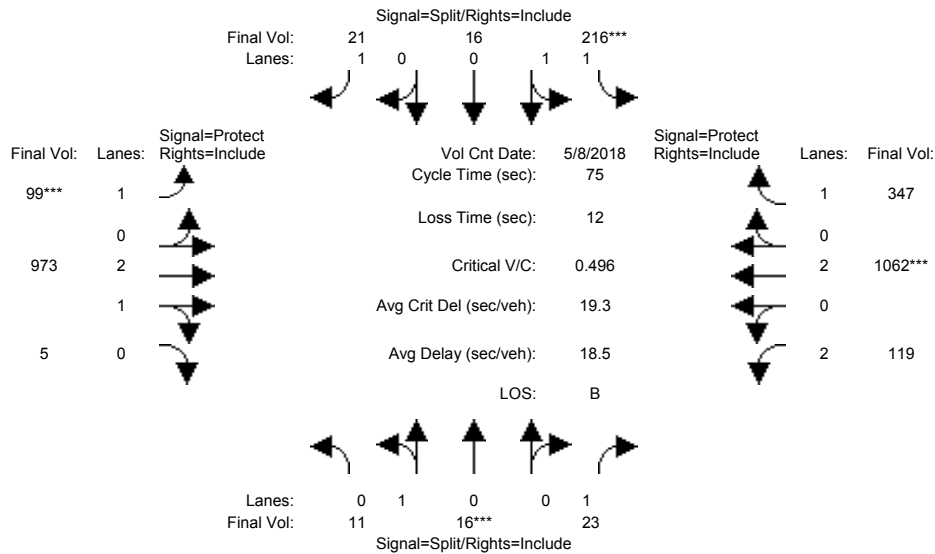

Street Name:	Madrone Parkway/Cochrane Plaza						Cochrane Road					
	North Bound			South Bound			East Bound			West Bound		
Approach:	North Bound			South Bound			East Bound			West Bound		
Movement:	L	T	R	L	T	R	L	T	R	L	T	R
Min. Green:	10	10	10	10	10	10	7	10	10	7	10	10
Y+R:	4.0	4.0	4.0	4.0	4.0	4.0	4.0	4.0	4.0	4.0	4.0	4.0

Volume Module:	>>	Count	Date:	8 May 2018	<<												
Base Vol:	11	16	23	216	16	21	99	973	5	119	1062	347					
Growth Adj:	1.00	1.00	1.00	1.00	1.00	1.00	1.00	1.00	1.00	1.00	1.00	1.00					
Initial Bse:	11	16	23	216	16	21	99	973	5	119	1062	347					
Added Vol:	0	0	0	0	0	0	0	0	0	0	0	0					
PasserByVol:	0	0	0	0	0	0	0	0	0	0	0	0					
Initial Fut:	11	16	23	216	16	21	99	973	5	119	1062	347					
User Adj:	1.00	1.00	1.00	1.00	1.00	1.00	1.00	1.00	1.00	1.00	1.00	1.00					
PHF Adj:	1.00	1.00	1.00	1.00	1.00	1.00	1.00	1.00	1.00	1.00	1.00	1.00					
PHF Volume:	11	16	23	216	16	21	99	973	5	119	1062	347					
Reduct Vol:	0	0	0	0	0	0	0	0	0	0	0	0					
Reduced Vol:	11	16	23	216	16	21	99	973	5	119	1062	347					
PCE Adj:	1.00	1.00	1.00	1.00	1.00	1.00	1.00	1.00	1.00	1.00	1.00	1.00					
MLF Adj:	1.00	1.00	1.00	1.00	1.00	1.00	1.00	1.00	1.00	1.00	1.00	1.00					
Final Volume:	11	16	23	216	16	21	99	973	5	119	1062	347					

Saturation Flow Module:												
Sat/Lane:	1900	1900	1900	1900	1900	1900	1900	1900	1900	1900	1900	1900
Adjustment:	0.95	0.95	0.92	0.93	0.95	0.92	0.92	0.98	0.95	0.83	1.00	0.92
Lanes:	0.41	0.59	1.00	1.86	0.14	1.00	1.00	2.98	0.02	2.00	2.00	1.00
Final Sat.:	733	1067	1750	3305	245	1750	1750	5571	29	3150	3800	1750

Capacity Analysis Module:												
Vol/Sat:	0.02	0.02	0.01	0.07	0.07	0.01	0.06	0.17	0.17	0.04	0.28	0.20
Crit Moves:	****			****			****			****		
Green Time:	10.0	10.0	10.0	10.0	10.0	10.0	7.2	28.0	28.0	15.0	35.8	35.8
Volume/Cap:	0.11	0.11	0.10	0.49	0.49	0.09	0.59	0.47	0.47	0.19	0.59	0.42
Delay/Veh:	28.8	28.8	28.7	30.9	30.9	28.7	37.7	18.0	18.0	25.1	14.7	13.1
User DelAdj:	1.00	1.00	1.00	1.00	1.00	1.00	1.00	1.00	1.00	1.00	1.00	1.00
AdjDel/Veh:	28.8	28.8	28.7	30.9	30.9	28.7	37.7	18.0	18.0	25.1	14.7	13.1
LOS by Move:	C	C	C	C	C	C	D	B	B	C	B	B
HCM2k95thQ:	1	1	1	7	7	1	5	11	11	3	16	11

Note: Queue reported is the number of cars per lane.

City of Morgan Hill
Carpenters Training Center

Level Of Service Computation Report
2000 HCM Operations (Future Volume Alternative)
Cumulative Plus Project AM

Intersection #106: Madrone Parkway/Cochrane Plaza and Cochrane Road

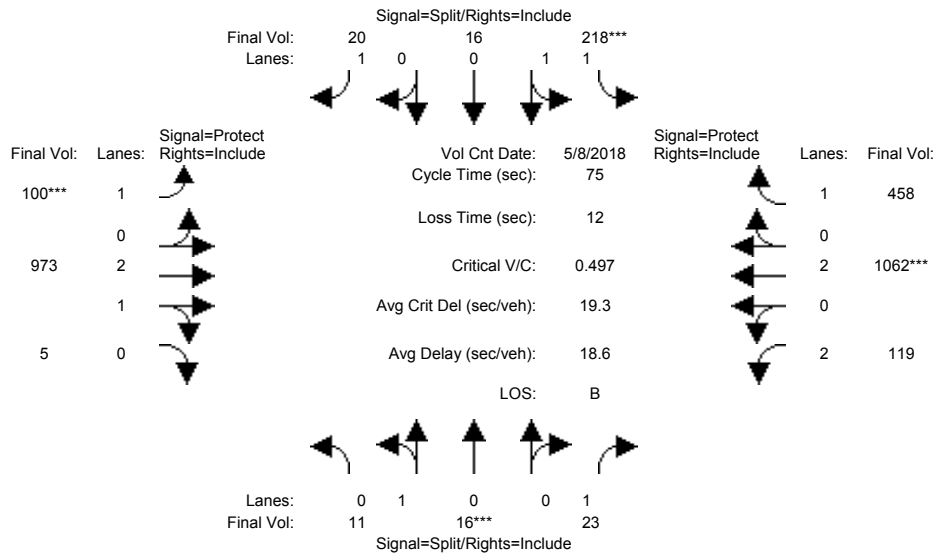

Street Name:	Madrone Parkway/Cochrane Plaza						Cochrane Road					
	North Bound			South Bound			East Bound			West Bound		
Approach:	North Bound			South Bound			East Bound			West Bound		
Movement:	L	T	R	L	T	R	L	T	R	L	T	R
Min. Green:	10	10	10	10	10	10	7	10	10	7	10	10
Y+R:	4.0	4.0	4.0	4.0	4.0	4.0	4.0	4.0	4.0	4.0	4.0	4.0

Volume Module:	>>	Count	Date:	8 May 2018	<<											
Base Vol:	11	16	23	216	16	21	99	973	5	119	1062	347				
Growth Adj:	1.00	1.00	1.00	1.00	1.00	1.00	1.00	1.00	1.00	1.00	1.00	1.00				
Initial Bse:	11	16	23	216	16	21	99	973	5	119	1062	347				
Added Vol:	0	0	0	2	0	-1	1	0	0	0	0	111				
PasserByVol:	0	0	0	0	0	0	0	0	0	0	0	0				
Initial Fut:	11	16	23	218	16	20	100	973	5	119	1062	458				
User Adj:	1.00	1.00	1.00	1.00	1.00	1.00	1.00	1.00	1.00	1.00	1.00	1.00				
PHF Adj:	1.00	1.00	1.00	1.00	1.00	1.00	1.00	1.00	1.00	1.00	1.00	1.00				
PHF Volume:	11	16	23	218	16	20	100	973	5	119	1062	458				
Reduct Vol:	0	0	0	0	0	0	0	0	0	0	0	0				
Reduced Vol:	11	16	23	218	16	20	100	973	5	119	1062	458				
PCE Adj:	1.00	1.00	1.00	1.00	1.00	1.00	1.00	1.00	1.00	1.00	1.00	1.00				
MLF Adj:	1.00	1.00	1.00	1.00	1.00	1.00	1.00	1.00	1.00	1.00	1.00	1.00				
Final Volume:	11	16	23	218	16	20	100	973	5	119	1062	458				

Saturation Flow Module:												
Sat/Lane:	1900	1900	1900	1900	1900	1900	1900	1900	1900	1900	1900	1900
Adjustment:	0.95	0.95	0.92	0.93	0.95	0.92	0.92	0.98	0.95	0.83	1.00	0.92
Lanes:	0.41	0.59	1.00	1.87	0.13	1.00	1.00	2.98	0.02	2.00	2.00	1.00
Final Sat.:	733	1067	1750	3307	243	1750	1750	5571	29	3150	3800	1750

Capacity Analysis Module:												
Vol/Sat:	0.02	0.02	0.01	0.07	0.07	0.01	0.06	0.17	0.17	0.04	0.28	0.26
Crit Moves:	****			****			****			****		
Green Time:	10.0	10.0	10.0	10.0	10.0	10.0	7.3	28.0	28.0	15.0	35.7	35.7
Volume/Cap:	0.11	0.11	0.10	0.49	0.49	0.09	0.59	0.47	0.47	0.19	0.59	0.55
Delay/Veh:	28.8	28.8	28.7	31.0	31.0	28.7	37.7	18.0	18.0	25.1	14.8	14.7
User DelAdj:	1.00	1.00	1.00	1.00	1.00	1.00	1.00	1.00	1.00	1.00	1.00	1.00
AdjDel/Veh:	28.8	28.8	28.7	31.0	31.0	28.7	37.7	18.0	18.0	25.1	14.8	14.7
LOS by Move:	C	C	C	C	C	C	D	B	B	C	B	B
HCM2k95thQ:	1	1	1	7	7	1	5	11	11	3	16	15

Note: Queue reported is the number of cars per lane.

City of Morgan Hill
Carpenters Training Center

Level Of Service Computation Report
2000 HCM Operations (Future Volume Alternative)
Existing PM

Intersection #106: Madrone Parkway/Cochrane Plaza and Cochrane Road

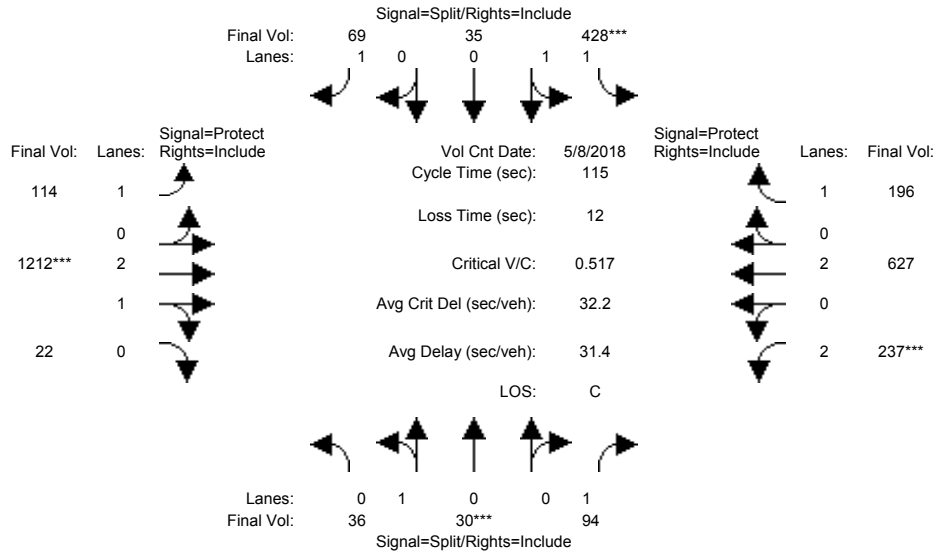

Street Name:	Madrone Parkway/Cochrane Plaza						Cochrane Road					
	North Bound			South Bound			East Bound			West Bound		
Movement:	L	T	R	L	T	R	L	T	R	L	T	R
Min. Green:	10	10	10	10	10	10	7	10	10	7	10	10
Y+R:	4.0	4.0	4.0	4.0	4.0	4.0	4.0	4.0	4.0	4.0	4.0	4.0

Volume Module:	>>	Count	Date:	8 May 2018	<<							
Base Vol:	36	30	94	428	35	69	114	1212	22	237	627	196
Growth Adj:	1.00	1.00	1.00	1.00	1.00	1.00	1.00	1.00	1.00	1.00	1.00	1.00
Initial Bse:	36	30	94	428	35	69	114	1212	22	237	627	196
Added Vol:	0	0	0	0	0	0	0	0	0	0	0	0
PasserByVol:	0	0	0	0	0	0	0	0	0	0	0	0
Initial Fut:	36	30	94	428	35	69	114	1212	22	237	627	196
User Adj:	1.00	1.00	1.00	1.00	1.00	1.00	1.00	1.00	1.00	1.00	1.00	1.00
PHF Adj:	1.00	1.00	1.00	1.00	1.00	1.00	1.00	1.00	1.00	1.00	1.00	1.00
PHF Volume:	36	30	94	428	35	69	114	1212	22	237	627	196
Reduct Vol:	0	0	0	0	0	0	0	0	0	0	0	0
Reduced Vol:	36	30	94	428	35	69	114	1212	22	237	627	196
PCE Adj:	1.00	1.00	1.00	1.00	1.00	1.00	1.00	1.00	1.00	1.00	1.00	1.00
MLF Adj:	1.00	1.00	1.00	1.00	1.00	1.00	1.00	1.00	1.00	1.00	1.00	1.00
Final Volume:	36	30	94	428	35	69	114	1212	22	237	627	196

Saturation Flow Module:												
Sat/Lane:	1900	1900	1900	1900	1900	1900	1900	1900	1900	1900	1900	1900
Adjustment:	0.95	0.95	0.92	0.93	0.95	0.92	0.92	0.98	0.95	0.83	1.00	0.92
Lanes:	0.55	0.45	1.00	1.85	0.15	1.00	1.00	2.94	0.06	2.00	2.00	1.00
Final Sat.:	982	818	1750	3282	268	1750	1750	5500	100	3150	3800	1750

Capacity Analysis Module:												
Vol/Sat:	0.04	0.04	0.05	0.13	0.13	0.04	0.07	0.22	0.22	0.08	0.17	0.11
Crit Moves:	****			****			****			****		
Green Time:	12.0	12.0	12.0	27.9	27.9	27.9	17.9	47.1	47.1	16.1	45.3	45.3
Volume/Cap:	0.35	0.35	0.52	0.54	0.54	0.16	0.42	0.54	0.54	0.54	0.42	0.28
Delay/Veh:	49.1	49.1	51.4	38.6	38.6	34.5	44.9	26.0	26.0	47.3	25.5	24.0
User DelAdj:	1.00	1.00	1.00	1.00	1.00	1.00	1.00	1.00	1.00	1.00	1.00	1.00
AdjDel/Veh:	49.1	49.1	51.4	38.6	38.6	34.5	44.9	26.0	26.0	47.3	25.5	24.0
LOS by Move:	D	D	D	D	D	C	D	C	C	D	C	C
HCM2k95thQ:	5	5	8	15	15	4	8	20	20	9	15	10

Note: Queue reported is the number of cars per lane.

City of Morgan Hill
Carpenters Training Center

Level Of Service Computation Report
2000 HCM Operations (Future Volume Alternative)
Existing Plus Project PM

Intersection #106: Madrone Parkway/Cochrane Plaza and Cochrane Road

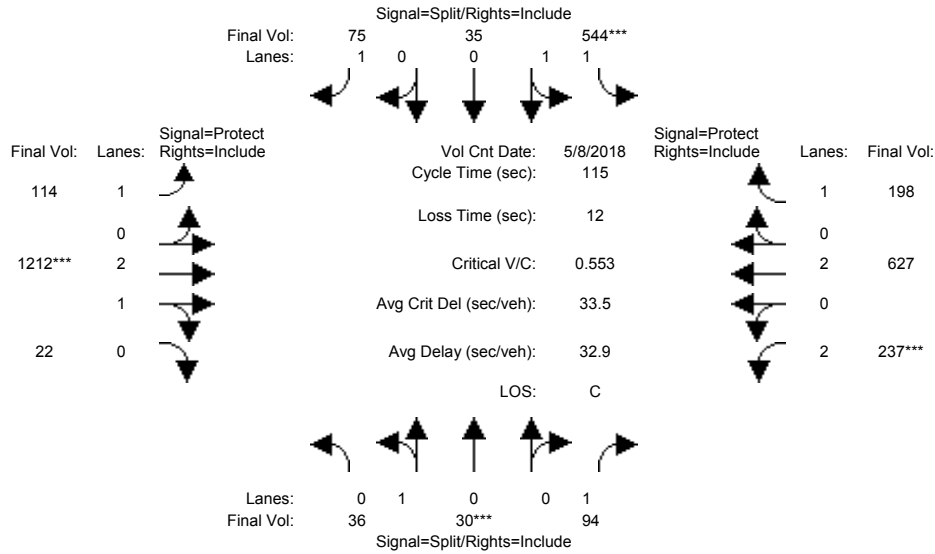

Street Name:	Madrone Parkway/Cochrane Plaza						Cochrane Road					
	North Bound			South Bound			East Bound			West Bound		
Movement:	L	T	R	L	T	R	L	T	R	L	T	R
Min. Green:	10	10	10	10	10	10	7	10	10	7	10	10
Y+R:	4.0	4.0	4.0	4.0	4.0	4.0	4.0	4.0	4.0	4.0	4.0	4.0

Volume Module:	>>	Count	Date:	8 May 2018	<<											
Base Vol:	36	30	94	428	35	69	114	1212	22	237	627	196				
Growth Adj:	1.00	1.00	1.00	1.00	1.00	1.00	1.00	1.00	1.00	1.00	1.00	1.00				
Initial Bse:	36	30	94	428	35	69	114	1212	22	237	627	196				
Added Vol:	0	0	0	116	0	6	0	0	0	0	0	2				
PasserByVol:	0	0	0	0	0	0	0	0	0	0	0	0				
Initial Fut:	36	30	94	544	35	75	114	1212	22	237	627	198				
User Adj:	1.00	1.00	1.00	1.00	1.00	1.00	1.00	1.00	1.00	1.00	1.00	1.00				
PHF Adj:	1.00	1.00	1.00	1.00	1.00	1.00	1.00	1.00	1.00	1.00	1.00	1.00				
PHF Volume:	36	30	94	544	35	75	114	1212	22	237	627	198				
Reduct Vol:	0	0	0	0	0	0	0	0	0	0	0	0				
Reduced Vol:	36	30	94	544	35	75	114	1212	22	237	627	198				
PCE Adj:	1.00	1.00	1.00	1.00	1.00	1.00	1.00	1.00	1.00	1.00	1.00	1.00				
MLF Adj:	1.00	1.00	1.00	1.00	1.00	1.00	1.00	1.00	1.00	1.00	1.00	1.00				
Final Volume:	36	30	94	544	35	75	114	1212	22	237	627	198				

Saturation Flow Module:												
Sat/Lane:	1900	1900	1900	1900	1900	1900	1900	1900	1900	1900	1900	1900
Adjustment:	0.95	0.95	0.92	0.93	0.95	0.92	0.92	0.98	0.95	0.83	1.00	0.92
Lanes:	0.55	0.45	1.00	1.88	0.12	1.00	1.00	2.94	0.06	2.00	2.00	1.00
Final Sat.:	982	818	1750	3335	215	1750	1750	5500	100	3150	3800	1750

Capacity Analysis Module:												
Vol/Sat:	0.04	0.04	0.05	0.16	0.16	0.04	0.07	0.22	0.22	0.08	0.17	0.11
Crit Moves:	****			****			****			****		
Green Time:	11.2	11.2	11.2	32.7	32.7	32.7	16.8	44.1	44.1	15.1	42.4	42.4
Volume/Cap:	0.38	0.38	0.55	0.57	0.57	0.15	0.45	0.57	0.57	0.57	0.45	0.31
Delay/Veh:	50.0	50.0	53.5	36.0	36.0	30.9	46.1	28.4	28.4	48.9	27.7	26.1
User DelAdj:	1.00	1.00	1.00	1.00	1.00	1.00	1.00	1.00	1.00	1.00	1.00	1.00
AdjDel/Veh:	50.0	50.0	53.5	36.0	36.0	30.9	46.1	28.4	28.4	48.9	27.7	26.1
LOS by Move:	D	D	D	D	D	C	D	C	C	D	C	C
HCM2k95thQ:	5	5	8	18	18	4	8	21	21	9	15	10

Note: Queue reported is the number of cars per lane.

City of Morgan Hill
Carpenters Training Center

Level Of Service Computation Report
2000 HCM Operations (Future Volume Alternative)
Cumulative PM

Intersection #106: Madrone Parkway/Cochrane Plaza and Cochrane Road

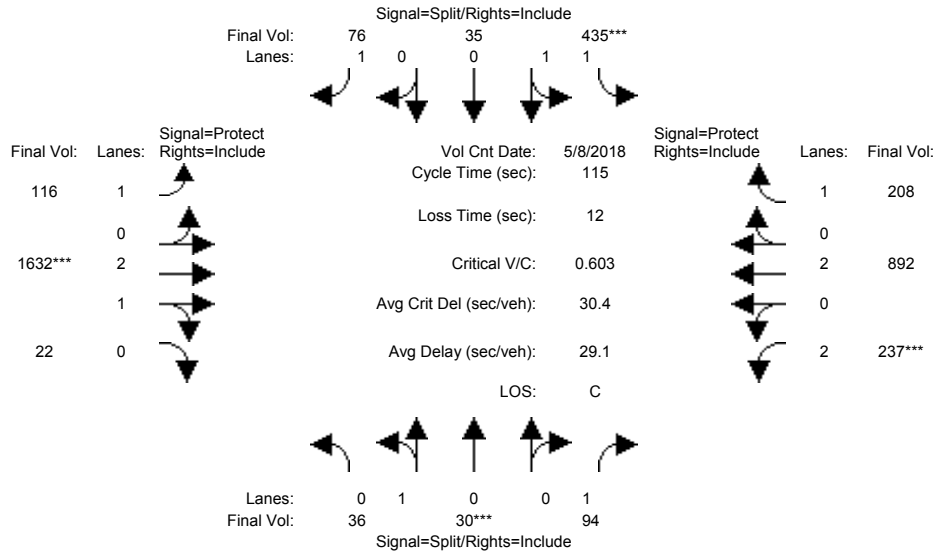

Street Name:	Madrone Parkway/Cochrane Plaza						Cochrane Road					
	North Bound			South Bound			East Bound			West Bound		
Movement:	L	T	R	L	T	R	L	T	R	L	T	R
Min. Green:	10	10	10	10	10	10	7	10	10	7	10	10
Y+R:	4.0	4.0	4.0	4.0	4.0	4.0	4.0	4.0	4.0	4.0	4.0	4.0

Volume Module:	>>	Count	Date:	8 May 2018	<<												
Base Vol:	36	30	94	435	35	76	116	1632	22	237	892	208					
Growth Adj:	1.00	1.00	1.00	1.00	1.00	1.00	1.00	1.00	1.00	1.00	1.00	1.00					
Initial Bse:	36	30	94	435	35	76	116	1632	22	237	892	208					
Added Vol:	0	0	0	0	0	0	0	0	0	0	0	0					
PasserByVol:	0	0	0	0	0	0	0	0	0	0	0	0					
Initial Fut:	36	30	94	435	35	76	116	1632	22	237	892	208					
User Adj:	1.00	1.00	1.00	1.00	1.00	1.00	1.00	1.00	1.00	1.00	1.00	1.00					
PHF Adj:	1.00	1.00	1.00	1.00	1.00	1.00	1.00	1.00	1.00	1.00	1.00	1.00					
PHF Volume:	36	30	94	435	35	76	116	1632	22	237	892	208					
Reduct Vol:	0	0	0	0	0	0	0	0	0	0	0	0					
Reduced Vol:	36	30	94	435	35	76	116	1632	22	237	892	208					
PCE Adj:	1.00	1.00	1.00	1.00	1.00	1.00	1.00	1.00	1.00	1.00	1.00	1.00					
MLF Adj:	1.00	1.00	1.00	1.00	1.00	1.00	1.00	1.00	1.00	1.00	1.00	1.00					
Final Volume:	36	30	94	435	35	76	116	1632	22	237	892	208					

Saturation Flow Module:												
Sat/Lane:	1900	1900	1900	1900	1900	1900	1900	1900	1900	1900	1900	1900
Adjustment:	0.95	0.95	0.92	0.93	0.95	0.92	0.92	0.98	0.95	0.83	1.00	0.92
Lanes:	0.55	0.45	1.00	1.85	0.15	1.00	1.00	2.96	0.04	2.00	2.00	1.00
Final Sat.:	982	818	1750	3286	264	1750	1750	5525	74	3150	3800	1750

Capacity Analysis Module:												
Vol/Sat:	0.04	0.04	0.05	0.13	0.13	0.04	0.07	0.30	0.30	0.08	0.23	0.12
Crit Moves:	****			****			****			****		
Green Time:	10.3	10.3	10.3	24.4	24.4	24.4	15.0	54.5	54.5	13.9	53.3	53.3
Volume/Cap:	0.41	0.41	0.60	0.62	0.62	0.20	0.51	0.62	0.62	0.62	0.51	0.26
Delay/Veh:	51.2	51.2	56.9	42.8	42.8	37.6	48.4	23.1	23.1	51.3	21.9	19.0
User DelAdj:	1.00	1.00	1.00	1.00	1.00	1.00	1.00	1.00	1.00	1.00	1.00	1.00
AdjDel/Veh:	51.2	51.2	56.9	42.8	42.8	37.6	48.4	23.1	23.1	51.3	21.9	19.0
LOS by Move:	D	D	E	D	D	D	D	C	C	D	C	B
HCM2k95thQ:	6	6	9	16	16	5	8	25	25	9	19	9

Note: Queue reported is the number of cars per lane.

City of Morgan Hill
Carpenters Training Center

Level Of Service Computation Report
2000 HCM Operations (Future Volume Alternative)
Cumulative Plus Project PM

Intersection #106: Madrone Parkway/Cochrane Plaza and Cochrane Road

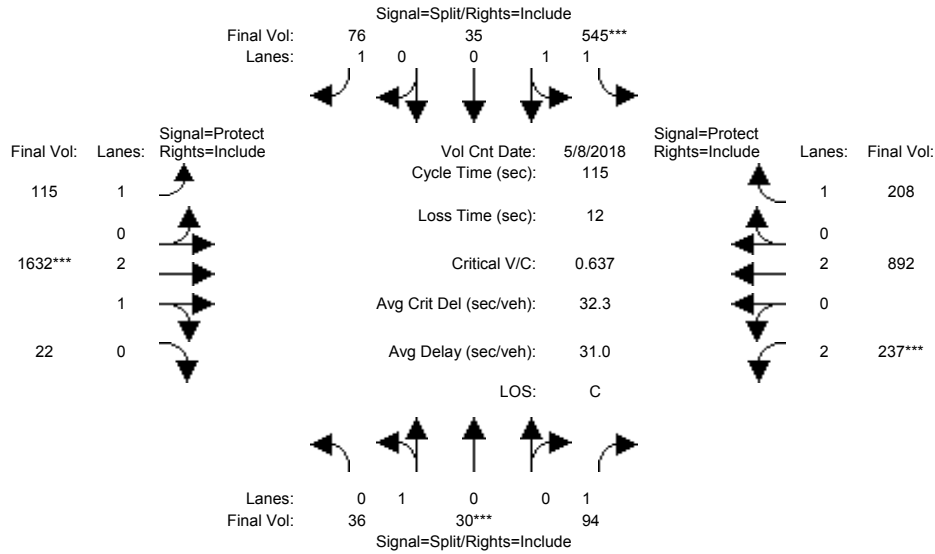

Street Name:	Madrone Parkway/Cochrane Plaza						Cochrane Road					
	North Bound			South Bound			East Bound			West Bound		
Movement:	L	T	R	L	T	R	L	T	R	L	T	R
Min. Green:	10	10	10	10	10	10	7	10	10	7	10	10
Y+R:	4.0	4.0	4.0	4.0	4.0	4.0	4.0	4.0	4.0	4.0	4.0	4.0

Volume Module:	>>	Count	Date:	8 May 2018	<<											
Base Vol:	36	30	94	435	35	76	116	1632	22	237	892	208				
Growth Adj:	1.00	1.00	1.00	1.00	1.00	1.00	1.00	1.00	1.00	1.00	1.00	1.00				
Initial Bse:	36	30	94	435	35	76	116	1632	22	237	892	208				
Added Vol:	0	0	0	110	0	0	-1	0	0	0	0	0				
PasserByVol:	0	0	0	0	0	0	0	0	0	0	0	0				
Initial Fut:	36	30	94	545	35	76	115	1632	22	237	892	208				
User Adj:	1.00	1.00	1.00	1.00	1.00	1.00	1.00	1.00	1.00	1.00	1.00	1.00				
PHF Adj:	1.00	1.00	1.00	1.00	1.00	1.00	1.00	1.00	1.00	1.00	1.00	1.00				
PHF Volume:	36	30	94	545	35	76	115	1632	22	237	892	208				
Reduct Vol:	0	0	0	0	0	0	0	0	0	0	0	0				
Reduced Vol:	36	30	94	545	35	76	115	1632	22	237	892	208				
PCE Adj:	1.00	1.00	1.00	1.00	1.00	1.00	1.00	1.00	1.00	1.00	1.00	1.00				
MLF Adj:	1.00	1.00	1.00	1.00	1.00	1.00	1.00	1.00	1.00	1.00	1.00	1.00				
Final Volume:	36	30	94	545	35	76	115	1632	22	237	892	208				

Saturation Flow Module:												
Sat/Lane:	1900	1900	1900	1900	1900	1900	1900	1900	1900	1900	1900	1900
Adjustment:	0.95	0.95	0.92	0.93	0.95	0.92	0.92	0.98	0.95	0.83	1.00	0.92
Lanes:	0.55	0.45	1.00	1.88	0.12	1.00	1.00	2.96	0.04	2.00	2.00	1.00
Final Sat.:	982	818	1750	3336	214	1750	1750	5525	74	3150	3800	1750

Capacity Analysis Module:												
Vol/Sat:	0.04	0.04	0.05	0.16	0.16	0.04	0.07	0.30	0.30	0.08	0.23	0.12
Crit Moves:	****			****			****			****		
Green Time:	10.0	10.0	10.0	28.5	28.5	28.5	14.1	51.4	51.4	13.1	50.4	50.4
Volume/Cap:	0.42	0.42	0.62	0.66	0.66	0.18	0.54	0.66	0.66	0.66	0.54	0.27
Delay/Veh:	51.6	51.6	58.1	40.8	40.8	34.2	50.0	25.6	25.6	53.3	24.0	20.8
User DelAdj:	1.00	1.00	1.00	1.00	1.00	1.00	1.00	1.00	1.00	1.00	1.00	1.00
AdjDel/Veh:	51.6	51.6	58.1	40.8	40.8	34.2	50.0	25.6	25.6	53.3	24.0	20.8
LOS by Move:	D	D	E	D	D	C	D	C	C	D	C	C
HCM2k95thQ:	6	6	9	20	20	5	8	26	26	10	20	9

Note: Queue reported is the number of cars per lane.

City of Morgan Hill
Carpenters Training Center

Level Of Service Computation Report
2000 HCM Operations (Future Volume Alternative)
Existing AM

Intersection #107: US 101 Southbound Ramps and Cochrane Road

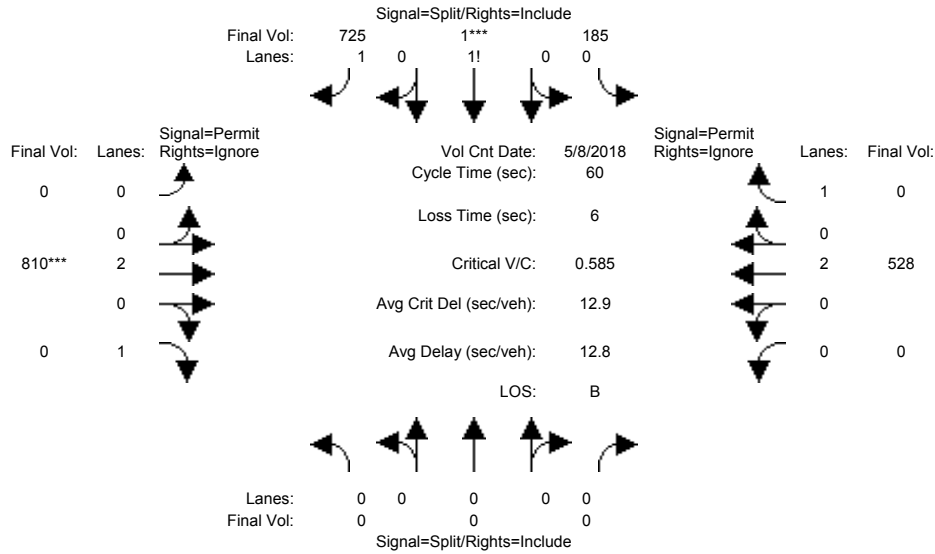

Street Name:	US 101 Southbound Ramps						Cochrane Road					
	North Bound			South Bound			East Bound			West Bound		
Movement:	L	T	R	L	T	R	L	T	R	L	T	R
Min. Green:	0	0	0	10	0	10	0	10	10	0	10	10
Y+R:	4.0	4.0	4.0	4.0	4.0	4.0	4.0	4.0	4.0	4.0	4.0	4.0

Volume Module:	>>	Count	Date:	8 May 2018	<<							
Base Vol:	0	0	0	185	1	725	0	810	238	0	528	0
Growth Adj:	1.00	1.00	1.00	1.00	1.00	1.00	1.00	1.00	1.00	1.00	1.00	1.00
Initial Bse:	0	0	0	185	1	725	0	810	238	0	528	0
Added Vol:	0	0	0	0	0	0	0	0	0	0	0	0
PasserByVol:	0	0	0	0	0	0	0	0	0	0	0	0
Initial Fut:	0	0	0	185	1	725	0	810	238	0	528	0
User Adj:	1.00	1.00	1.00	1.00	1.00	1.00	1.00	1.00	0.00	1.00	1.00	0.00
PHF Adj:	1.00	1.00	1.00	1.00	1.00	1.00	1.00	1.00	0.00	1.00	1.00	0.00
PHF Volume:	0	0	0	185	1	725	0	810	0	0	528	0
Reduct Vol:	0	0	0	0	0	0	0	0	0	0	0	0
Reduced Vol:	0	0	0	185	1	725	0	810	0	0	528	0
PCE Adj:	1.00	1.00	1.00	1.00	1.00	1.00	1.00	1.00	0.00	1.00	1.00	0.00
MLF Adj:	1.00	1.00	1.00	1.00	1.00	1.00	1.00	1.00	0.00	1.00	1.00	0.00
FinalVolume:	0	0	0	185	1	725	0	810	0	0	528	0

Saturation Flow Module:												
Sat/Lane:	1900	1900	1900	1900	1900	1900	1900	1900	1900	1900	1900	1900
Adjustment:	0.92	1.00	0.92	0.92	0.92	0.92	0.92	1.00	0.92	0.92	1.00	0.92
Lanes:	0.00	0.00	0.00	0.33	0.01	1.66	0.00	2.00	1.00	0.00	2.00	1.00
Final Sat.:	0	0	0	590	3	2907	0	3800	1750	0	3800	1750

Capacity Analysis Module:												
Vol/Sat:	0.00	0.00	0.00	0.31	0.31	0.25	0.00	0.21	0.00	0.00	0.14	0.00
Crit Moves:					****			****				
Green Time:	0.0	0.0	0.0	32.1	32.1	32.1	0.0	21.9	0.0	0.0	21.9	0.0
Volume/Cap:	0.00	0.00	0.00	0.59	0.59	0.47	0.00	0.59	0.00	0.00	0.38	0.00
Delay/Veh:	0.0	0.0	0.0	10.0	10.0	8.8	0.0	16.1	0.0	0.0	14.3	0.0
User DelAdj:	1.00	1.00	1.00	1.00	1.00	1.00	1.00	1.00	1.00	1.00	1.00	1.00
AdjDel/Veh:	0.0	0.0	0.0	10.0	10.0	8.8	0.0	16.1	0.0	0.0	14.3	0.0
LOS by Move:	A	A	A	A	A	A	A	B	A	A	B	A
HCM2k95thQ:	0	0	0	15	15	11	0	12	0	0	7	0

Note: Queue reported is the number of cars per lane.

City of Morgan Hill
Carpenters Training Center

Level Of Service Computation Report
2000 HCM Operations (Future Volume Alternative)
Existing Plus Project AM

Intersection #107: US 101 Southbound Ramps and Cochrane Road

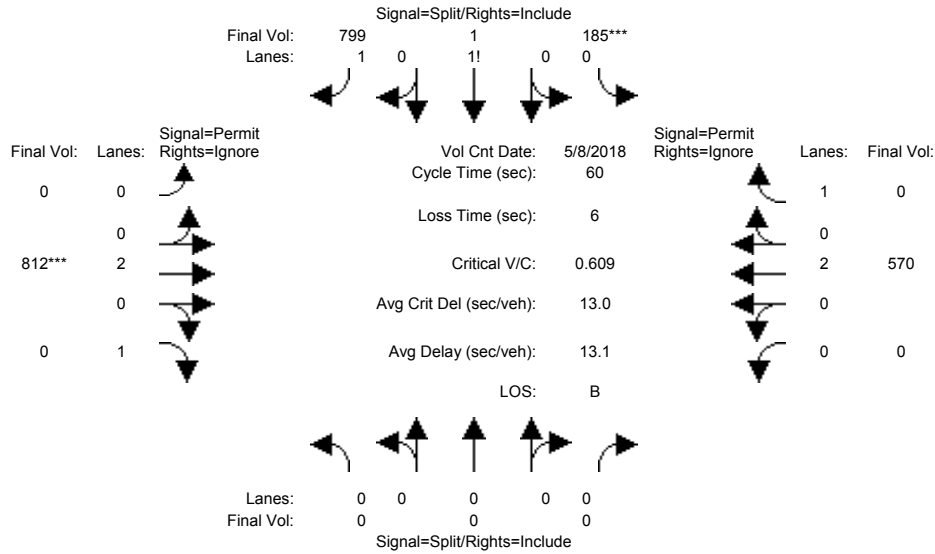

Street Name:	US 101 Southbound Ramps						Cochrane Road					
	North Bound			South Bound			East Bound			West Bound		
Movement:	L	T	R	L	T	R	L	T	R	L	T	R
Min. Green:	0	0	0	10	0	10	0	10	10	0	10	10
Y+R:	4.0	4.0	4.0	4.0	4.0	4.0	4.0	4.0	4.0	4.0	4.0	4.0

Volume Module:	>>	Count	Date:	8 May 2018	<<												
Base Vol:	0	0	0	185	1	725	0	810	238	0	528	0					
Growth Adj:	1.00	1.00	1.00	1.00	1.00	1.00	1.00	1.00	1.00	1.00	1.00	1.00					
Initial Bse:	0	0	0	185	1	725	0	810	238	0	528	0					
Added Vol:	0	0	0	0	0	74	0	2	1	0	42	0					
PasserByVol:	0	0	0	0	0	0	0	0	0	0	0	0					
Initial Fut:	0	0	0	185	1	799	0	812	239	0	570	0					
User Adj:	1.00	1.00	1.00	1.00	1.00	1.00	1.00	1.00	0.00	1.00	1.00	0.00					
PHF Adj:	1.00	1.00	1.00	1.00	1.00	1.00	1.00	1.00	0.00	1.00	1.00	0.00					
PHF Volume:	0	0	0	185	1	799	0	812	0	0	570	0					
Reduct Vol:	0	0	0	0	0	0	0	0	0	0	0	0					
Reduced Vol:	0	0	0	185	1	799	0	812	0	0	570	0					
PCE Adj:	1.00	1.00	1.00	1.00	1.00	1.00	1.00	1.00	0.00	1.00	1.00	0.00					
MLF Adj:	1.00	1.00	1.00	1.00	1.00	1.00	1.00	1.00	0.00	1.00	1.00	0.00					
Final Volume:	0	0	0	185	1	799	0	812	0	0	570	0					

Saturation Flow Module:												
Sat/Lane:	1900	1900	1900	1900	1900	1900	1900	1900	1900	1900	1900	1900
Adjustment:	0.92	1.00	0.92	0.92	0.92	0.92	0.92	1.00	0.92	0.92	1.00	0.92
Lanes:	0.00	0.00	0.00	0.31	0.01	1.68	0.00	2.00	1.00	0.00	2.00	1.00
Final Sat.:	0	0	0	553	3	2944	0	3800	1750	0	3800	1750

Capacity Analysis Module:													
Vol/Sat:	0.00	0.00	0.00	0.33	0.33	0.27	0.00	0.21	0.00	0.00	0.15	0.00	
Crit Moves:				****							****		
Green Time:	0.0	0.0	0.0	33.0	33.0	33.0	0.0	21.0	0.0	0.0	21.0	0.0	
Volume/Cap:	0.00	0.00	0.00	0.61	0.61	0.49	0.00	0.61	0.00	0.00	0.43	0.00	
Delay/Veh:	0.0	0.0	0.0	9.8	9.8	8.6	0.0	16.9	0.0	0.0	15.1	0.0	
User DelAdj:	1.00	1.00	1.00	1.00	1.00	1.00	1.00	1.00	1.00	1.00	1.00	1.00	
AdjDel/Veh:	0.0	0.0	0.0	9.8	9.8	8.6	0.0	16.9	0.0	0.0	15.1	0.0	
LOS by Move:	A	A	A	A	A	A	A	B	A	A	B	A	
HCM2k95thQ:	0	0	0	16	16	12	0	12	0	0	8	0	

Note: Queue reported is the number of cars per lane.

City of Morgan Hill
Carpenters Training Center

Level Of Service Computation Report
2000 HCM Operations (Future Volume Alternative)
Cumulative AM

Intersection #107: US 101 Southbound Ramps and Cochrane Road

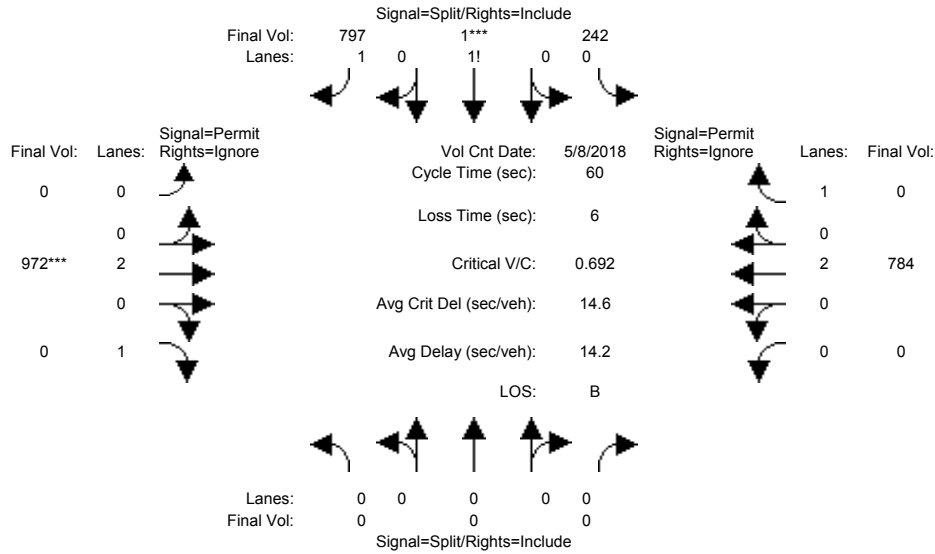

Street Name:	US 101 Southbound Ramps						Cochrane Road					
	North Bound			South Bound			East Bound			West Bound		
Movement:	L	T	R	L	T	R	L	T	R	L	T	R
Min. Green:	0	0	0	10	0	10	0	10	10	0	10	10
Y+R:	4.0	4.0	4.0	4.0	4.0	4.0	4.0	4.0	4.0	4.0	4.0	4.0

Volume Module:	>>	Count	Date:	8 May 2018	<<							
Base Vol:	0	0	0	242	1	797	0	972	284	0	784	0
Growth Adj:	1.00	1.00	1.00	1.00	1.00	1.00	1.00	1.00	1.00	1.00	1.00	1.00
Initial Bse:	0	0	0	242	1	797	0	972	284	0	784	0
Added Vol:	0	0	0	0	0	0	0	0	0	0	0	0
PasserByVol:	0	0	0	0	0	0	0	0	0	0	0	0
Initial Fut:	0	0	0	242	1	797	0	972	284	0	784	0
User Adj:	1.00	1.00	1.00	1.00	1.00	1.00	1.00	1.00	0.00	1.00	1.00	0.00
PHF Adj:	1.00	1.00	1.00	1.00	1.00	1.00	1.00	1.00	0.00	1.00	1.00	0.00
PHF Volume:	0	0	0	242	1	797	0	972	0	0	784	0
Reduct Vol:	0	0	0	0	0	0	0	0	0	0	0	0
Reduced Vol:	0	0	0	242	1	797	0	972	0	0	784	0
PCE Adj:	1.00	1.00	1.00	1.00	1.00	1.00	1.00	1.00	0.00	1.00	1.00	0.00
MLF Adj:	1.00	1.00	1.00	1.00	1.00	1.00	1.00	1.00	0.00	1.00	1.00	0.00
FinalVolume:	0	0	0	242	1	797	0	972	0	0	784	0

Saturation Flow Module:												
Sat/Lane:	1900	1900	1900	1900	1900	1900	1900	1900	1900	1900	1900	1900
Adjustment:	0.92	1.00	0.92	0.92	0.92	0.92	0.92	1.00	0.92	0.92	1.00	0.92
Lanes:	0.00	0.00	0.00	0.37	0.01	1.62	0.00	2.00	1.00	0.00	2.00	1.00
Final Sat.:	0	0	0	660	3	2837	0	3800	1750	0	3800	1750

Capacity Analysis Module:												
Vol/Sat:	0.00	0.00	0.00	0.37	0.37	0.28	0.00	0.26	0.00	0.00	0.21	0.00
Crit Moves:					****			****				
Green Time:	0.0	0.0	0.0	31.8	31.8	31.8	0.0	22.2	0.0	0.0	22.2	0.0
Volume/Cap:	0.00	0.00	0.00	0.69	0.69	0.53	0.00	0.69	0.00	0.00	0.56	0.00
Delay/Veh:	0.0	0.0	0.0	11.9	11.9	9.5	0.0	17.5	0.0	0.0	15.5	0.0
User DelAdj:	1.00	1.00	1.00	1.00	1.00	1.00	1.00	1.00	1.00	1.00	1.00	1.00
AdjDel/Veh:	0.0	0.0	0.0	11.9	11.9	9.5	0.0	17.5	0.0	0.0	15.5	0.0
LOS by Move:	A	A	A	B	B	A	A	B	A	A	B	A
HCM2k95thQ:	0	0	0	20	20	13	0	15	0	0	11	0

Note: Queue reported is the number of cars per lane.

City of Morgan Hill
Carpenters Training Center

Level Of Service Computation Report
2000 HCM Operations (Future Volume Alternative)
Cumulative Plus Project AM

Intersection #107: US 101 Southbound Ramps and Cochrane Road

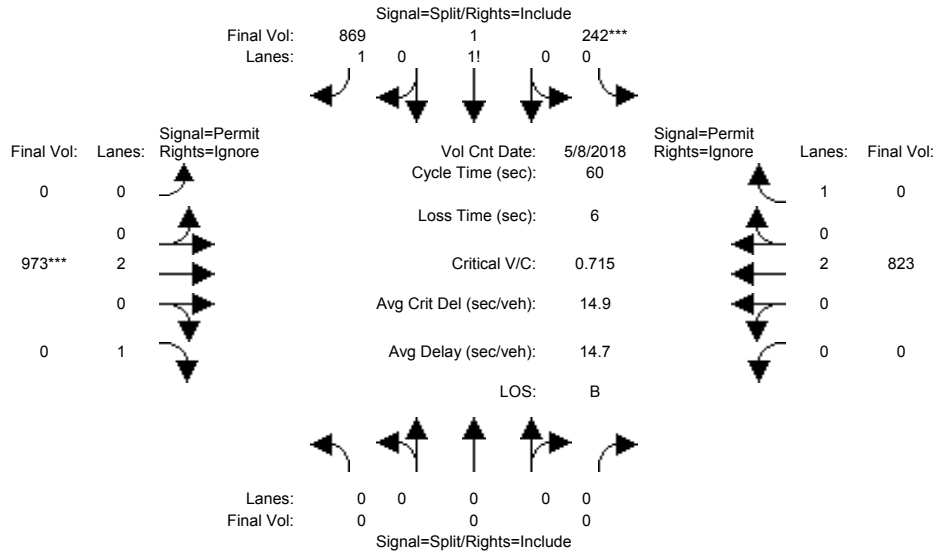

Street Name:	US 101 Southbound Ramps						Cochrane Road					
	North Bound			South Bound			East Bound			West Bound		
Movement:	L	T	R	L	T	R	L	T	R	L	T	R
Min. Green:	0	0	0	10	0	10	0	10	10	0	10	10
Y+R:	4.0	4.0	4.0	4.0	4.0	4.0	4.0	4.0	4.0	4.0	4.0	4.0

Volume Module:	>>	Count	Date:	8 May 2018	<<							
Base Vol:	0	0	0	242	1	797	0	972	284	0	784	0
Growth Adj:	1.00	1.00	1.00	1.00	1.00	1.00	1.00	1.00	1.00	1.00	1.00	1.00
Initial Bse:	0	0	0	242	1	797	0	972	284	0	784	0
Added Vol:	0	0	0	0	0	72	0	1	0	0	39	0
PasserByVol:	0	0	0	0	0	0	0	0	0	0	0	0
Initial Fut:	0	0	0	242	1	869	0	973	284	0	823	0
User Adj:	1.00	1.00	1.00	1.00	1.00	1.00	1.00	1.00	0.00	1.00	1.00	0.00
PHF Adj:	1.00	1.00	1.00	1.00	1.00	1.00	1.00	1.00	0.00	1.00	1.00	0.00
PHF Volume:	0	0	0	242	1	869	0	973	0	0	823	0
Reduct Vol:	0	0	0	0	0	0	0	0	0	0	0	0
Reduced Vol:	0	0	0	242	1	869	0	973	0	0	823	0
PCE Adj:	1.00	1.00	1.00	1.00	1.00	1.00	1.00	1.00	0.00	1.00	1.00	0.00
MLF Adj:	1.00	1.00	1.00	1.00	1.00	1.00	1.00	1.00	0.00	1.00	1.00	0.00
Final Volume:	0	0	0	242	1	869	0	973	0	0	823	0

Saturation Flow Module:												
Sat/Lane:	1900	1900	1900	1900	1900	1900	1900	1900	1900	1900	1900	1900
Adjustment:	0.92	1.00	0.92	0.92	0.92	0.92	0.92	1.00	0.92	0.92	1.00	0.92
Lanes:	0.00	0.00	0.00	0.35	0.01	1.64	0.00	2.00	1.00	0.00	2.00	1.00
Final Sat.:	0	0	0	625	3	2872	0	3800	1750	0	3800	1750

Capacity Analysis Module:													
Vol/Sat:	0.00	0.00	0.00	0.39	0.39	0.30	0.00	0.26	0.00	0.00	0.22	0.00	
Crit Moves:				****							****		
Green Time:	0.0	0.0	0.0	32.5	32.5	32.5	0.0	21.5	0.0	0.0	21.5	0.0	
Volume/Cap:	0.00	0.00	0.00	0.71	0.71	0.56	0.00	0.71	0.00	0.00	0.60	0.00	
Delay/Veh:	0.0	0.0	0.0	11.9	11.9	9.4	0.0	18.4	0.0	0.0	16.5	0.0	
User DelAdj:	1.00	1.00	1.00	1.00	1.00	1.00	1.00	1.00	1.00	1.00	1.00	1.00	
AdjDel/Veh:	0.0	0.0	0.0	11.9	11.9	9.4	0.0	18.4	0.0	0.0	16.5	0.0	
LOS by Move:	A	A	A	B	B	A	A	B	A	A	B	A	
HCM2k95thQ:	0	0	0	21	21	14	0	15	0	0	12	0	

Note: Queue reported is the number of cars per lane.

City of Morgan Hill
Carpenters Training Center

Level Of Service Computation Report
2000 HCM Operations (Future Volume Alternative)
Existing PM

Intersection #107: US 101 Southbound Ramps and Cochrane Road

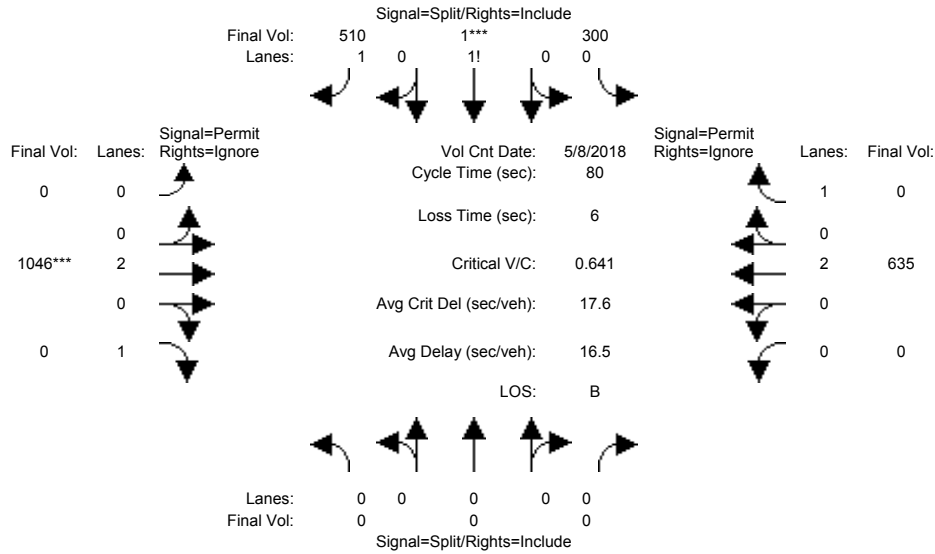

Street Name:	US 101 Southbound Ramps						Cochrane Road					
	North Bound			South Bound			East Bound			West Bound		
Movement:	L	T	R	L	T	R	L	T	R	L	T	R
Min. Green:	0	0	0	10	0	10	0	10	10	0	10	10
Y+R:	4.0	4.0	4.0	4.0	4.0	4.0	4.0	4.0	4.0	4.0	4.0	4.0

Volume Module:	>>	Count	Date:	8 May 2018	<<							
Base Vol:	0	0	0	300	1	510	0	1046	741	0	635	0
Growth Adj:	1.00	1.00	1.00	1.00	1.00	1.00	1.00	1.00	1.00	1.00	1.00	1.00
Initial Bse:	0	0	0	300	1	510	0	1046	741	0	635	0
Added Vol:	0	0	0	0	0	0	0	0	0	0	0	0
PasserByVol:	0	0	0	0	0	0	0	0	0	0	0	0
Initial Fut:	0	0	0	300	1	510	0	1046	741	0	635	0
User Adj:	1.00	1.00	1.00	1.00	1.00	1.00	1.00	1.00	0.00	1.00	1.00	0.00
PHF Adj:	1.00	1.00	1.00	1.00	1.00	1.00	1.00	1.00	0.00	1.00	1.00	0.00
PHF Volume:	0	0	0	300	1	510	0	1046	0	0	635	0
Reduct Vol:	0	0	0	0	0	0	0	0	0	0	0	0
Reduced Vol:	0	0	0	300	1	510	0	1046	0	0	635	0
PCE Adj:	1.00	1.00	1.00	1.00	1.00	1.00	1.00	1.00	0.00	1.00	1.00	0.00
MLF Adj:	1.00	1.00	1.00	1.00	1.00	1.00	1.00	1.00	0.00	1.00	1.00	0.00
FinalVolume:	0	0	0	300	1	510	0	1046	0	0	635	0

Saturation Flow Module:												
Sat/Lane:	1900	1900	1900	1900	1900	1900	1900	1900	1900	1900	1900	1900
Adjustment:	0.92	1.00	0.92	0.92	0.92	0.92	0.92	1.00	0.92	0.92	1.00	0.92
Lanes:	0.00	0.00	0.00	0.54	0.01	1.45	0.00	2.00	1.00	0.00	2.00	1.00
Final Sat.:	0	0	0	944	3	2553	0	3800	1750	0	3800	1750

Capacity Analysis Module:												
Vol/Sat:	0.00	0.00	0.00	0.32	0.32	0.20	0.00	0.28	0.00	0.00	0.17	0.00
Crit Moves:					****			****				
Green Time:	0.0	0.0	0.0	39.6	39.6	39.6	0.0	34.4	0.0	0.0	34.4	0.0
Volume/Cap:	0.00	0.00	0.00	0.64	0.64	0.40	0.00	0.64	0.00	0.00	0.39	0.00
Delay/Veh:	0.0	0.0	0.0	16.0	16.0	12.9	0.0	18.8	0.0	0.0	15.8	0.0
User DelAdj:	1.00	1.00	1.00	1.00	1.00	1.00	1.00	1.00	1.00	1.00	1.00	1.00
AdjDel/Veh:	0.0	0.0	0.0	16.0	16.0	12.9	0.0	18.8	0.0	0.0	15.8	0.0
LOS by Move:	A	A	A	B	B	B	A	B	A	A	B	A
HCM2k95thQ:	0	0	0	21	21	12	0	18	0	0	10	0

Note: Queue reported is the number of cars per lane.

City of Morgan Hill
Carpenters Training Center

Level Of Service Computation Report
2000 HCM Operations (Future Volume Alternative)
Existing Plus Project PM

Intersection #107: US 101 Southbound Ramps and Cochrane Road

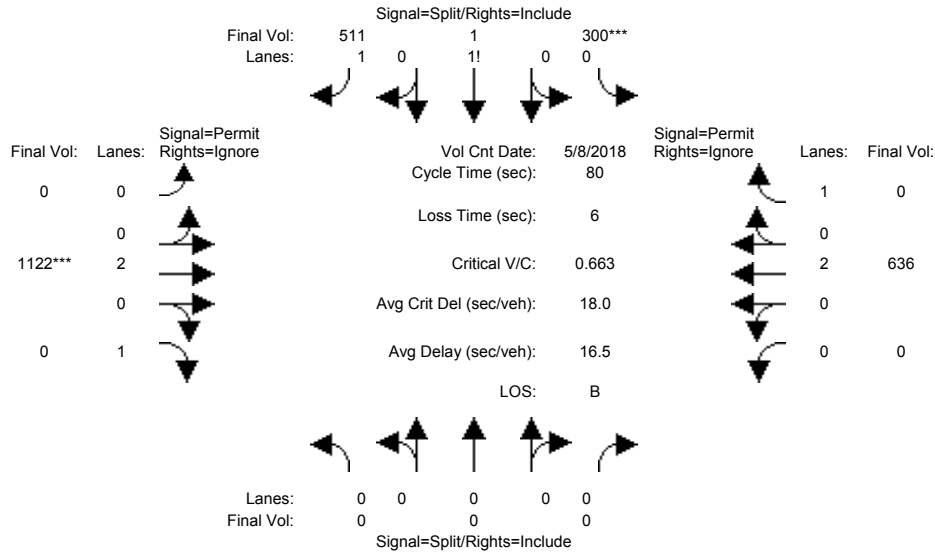

Street Name:	US 101 Southbound Ramps						Cochrane Road					
	North Bound			South Bound			East Bound			West Bound		
Movement:	L	T	R	L	T	R	L	T	R	L	T	R
Min. Green:	0	0	0	10	0	10	0	10	10	0	10	10
Y+R:	4.0	4.0	4.0	4.0	4.0	4.0	4.0	4.0	4.0	4.0	4.0	4.0

Volume Module:	>>	Count	Date:	8 May 2018	<<							
Base Vol:	0	0	0	300	1	510	0	1046	741	0	635	0
Growth Adj:	1.00	1.00	1.00	1.00	1.00	1.00	1.00	1.00	1.00	1.00	1.00	1.00
Initial Bse:	0	0	0	300	1	510	0	1046	741	0	635	0
Added Vol:	0	0	0	0	0	1	0	76	41	0	1	0
PasserByVol:	0	0	0	0	0	0	0	0	0	0	0	0
Initial Fut:	0	0	0	300	1	511	0	1122	782	0	636	0
User Adj:	1.00	1.00	1.00	1.00	1.00	1.00	1.00	1.00	0.00	1.00	1.00	0.00
PHF Adj:	1.00	1.00	1.00	1.00	1.00	1.00	1.00	1.00	0.00	1.00	1.00	0.00
PHF Volume:	0	0	0	300	1	511	0	1122	0	0	636	0
Reduct Vol:	0	0	0	0	0	0	0	0	0	0	0	0
Reduced Vol:	0	0	0	300	1	511	0	1122	0	0	636	0
PCE Adj:	1.00	1.00	1.00	1.00	1.00	1.00	1.00	1.00	0.00	1.00	1.00	0.00
MLF Adj:	1.00	1.00	1.00	1.00	1.00	1.00	1.00	1.00	0.00	1.00	1.00	0.00
Final Volume:	0	0	0	300	1	511	0	1122	0	0	636	0

Saturation Flow Module:	
Sat/Lane:	1900 1900 1900 1900 1900 1900 1900 1900 1900 1900 1900 1900
Adjustment:	0.92 1.00 0.92 0.92 0.92 0.92 0.92 1.00 0.92 0.92 1.00 0.92
Lanes:	0.00 0.00 0.00 0.53 0.01 1.46 0.00 2.00 1.00 0.00 2.00 1.00
Final Sat.:	0 0 0 943 3 2553 0 3800 1750 0 3800 1750

Capacity Analysis Module:	
Vol/Sat:	0.00 0.00 0.00 0.32 0.32 0.20 0.00 0.30 0.00 0.00 0.17 0.00
Crit Moves:	****
Green Time:	0.0 0.0 0.0 38.4 38.4 38.4 0.0 35.6 0.0 0.0 35.6 0.0
Volume/Cap:	0.00 0.00 0.00 0.66 0.66 0.42 0.00 0.66 0.00 0.00 0.38 0.00
Delay/Veh:	0.0 0.0 0.0 17.3 17.3 13.7 0.0 18.5 0.0 0.0 14.9 0.0
User DelAdj:	1.00 1.00 1.00 1.00 1.00 1.00 1.00 1.00 1.00 1.00 1.00 1.00
AdjDel/Veh:	0.0 0.0 0.0 17.3 17.3 13.7 0.0 18.5 0.0 0.0 14.9 0.0
LOS by Move:	A A A B B B A B A A B A
HCM2k95thQ:	0 0 0 22 22 12 0 20 0 0 10 0

Note: Queue reported is the number of cars per lane.

City of Morgan Hill
Carpenters Training Center

Level Of Service Computation Report
2000 HCM Operations (Future Volume Alternative)
Cumulative PM

Intersection #107: US 101 Southbound Ramps and Cochrane Road

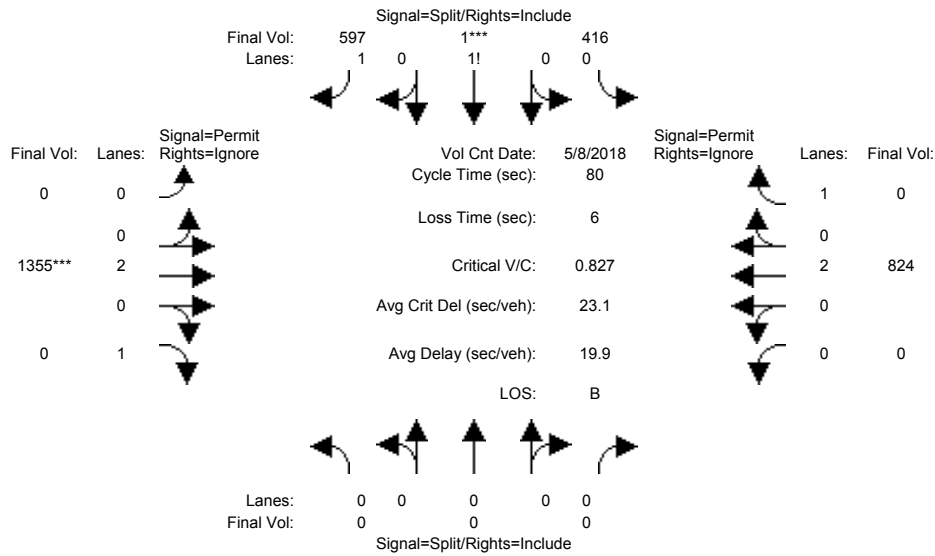

Street Name:	US 101 Southbound Ramps						Cochrane Road					
	North Bound			South Bound			East Bound			West Bound		
Movement:	L	T	R	L	T	R	L	T	R	L	T	R
Min. Green:	0	0	0	10	0	10	0	10	10	0	10	10
Y+R:	4.0	4.0	4.0	4.0	4.0	4.0	4.0	4.0	4.0	4.0	4.0	4.0

Volume Module:	>>	Count	Date:	8 May 2018	<<							
Base Vol:	0	0	0	416	1	597	0	1355	858	0	824	0
Growth Adj:	1.00	1.00	1.00	1.00	1.00	1.00	1.00	1.00	1.00	1.00	1.00	1.00
Initial Bse:	0	0	0	416	1	597	0	1355	858	0	824	0
Added Vol:	0	0	0	0	0	0	0	0	0	0	0	0
PasserByVol:	0	0	0	0	0	0	0	0	0	0	0	0
Initial Fut:	0	0	0	416	1	597	0	1355	858	0	824	0
User Adj:	1.00	1.00	1.00	1.00	1.00	1.00	1.00	1.00	0.00	1.00	1.00	0.00
PHF Adj:	1.00	1.00	1.00	1.00	1.00	1.00	1.00	1.00	0.00	1.00	1.00	0.00
PHF Volume:	0	0	0	416	1	597	0	1355	0	0	824	0
Reduct Vol:	0	0	0	0	0	0	0	0	0	0	0	0
Reduced Vol:	0	0	0	416	1	597	0	1355	0	0	824	0
PCE Adj:	1.00	1.00	1.00	1.00	1.00	1.00	1.00	1.00	0.00	1.00	1.00	0.00
MLF Adj:	1.00	1.00	1.00	1.00	1.00	1.00	1.00	1.00	0.00	1.00	1.00	0.00
Final Volume:	0	0	0	416	1	597	0	1355	0	0	824	0

Saturation Flow Module:												
Sat/Lane:	1900	1900	1900	1900	1900	1900	1900	1900	1900	1900	1900	1900
Adjustment:	0.92	1.00	0.92	0.92	0.92	0.92	0.92	1.00	0.92	0.92	1.00	0.92
Lanes:	0.00	0.00	0.00	0.58	0.01	1.41	0.00	2.00	1.00	0.00	2.00	1.00
Final Sat.:	0	0	0	1017	2	2480	0	3800	1750	0	3800	1750

Capacity Analysis Module:												
Vol/Sat:	0.00	0.00	0.00	0.41	0.41	0.24	0.00	0.36	0.00	0.00	0.22	0.00
Crit Moves:				****			****					
Green Time:	0.0	0.0	0.0	39.5	39.5	39.5	0.0	34.5	0.0	0.0	34.5	0.0
Volume/Cap:	0.00	0.00	0.00	0.83	0.83	0.49	0.00	0.83	0.00	0.00	0.50	0.00
Delay/Veh:	0.0	0.0	0.0	22.1	22.1	13.7	0.0	23.8	0.0	0.0	16.8	0.0
User DelAdj:	1.00	1.00	1.00	1.00	1.00	1.00	1.00	1.00	1.00	1.00	1.00	1.00
AdjDel/Veh:	0.0	0.0	0.0	22.1	22.1	13.7	0.0	23.8	0.0	0.0	16.8	0.0
LOS by Move:	A	A	A	C	C	B	A	C	A	A	B	A
HCM2k95thQ:	0	0	0	32	32	15	0	27	0	0	14	0

Note: Queue reported is the number of cars per lane.

City of Morgan Hill
Carpenters Training Center

Level Of Service Computation Report
2000 HCM Operations (Future Volume Alternative)
Cumulative Plus Project PM

Intersection #107: US 101 Southbound Ramps and Cochrane Road

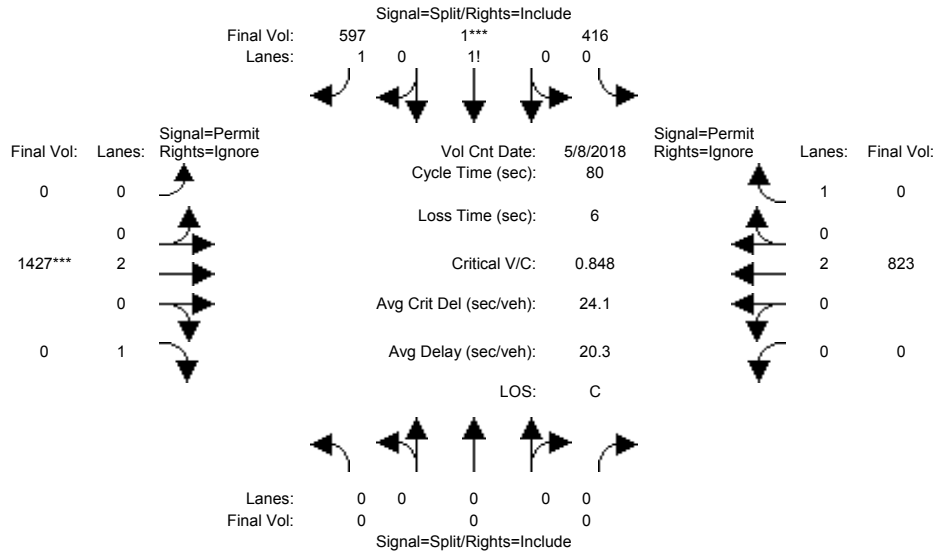

Street Name:	US 101 Southbound Ramps						Cochrane Road					
	North Bound			South Bound			East Bound			West Bound		
Movement:	L	T	R	L	T	R	L	T	R	L	T	R
Min. Green:	0	0	0	10	0	10	0	10	10	0	10	10
Y+R:	4.0	4.0	4.0	4.0	4.0	4.0	4.0	4.0	4.0	4.0	4.0	4.0

Volume Module:	>>	Count	Date:	8 May 2018	<<							
Base Vol:	0	0	0	416	1	597	0	1355	858	0	824	0
Growth Adj:	1.00	1.00	1.00	1.00	1.00	1.00	1.00	1.00	1.00	1.00	1.00	1.00
Initial Bse:	0	0	0	416	1	597	0	1355	858	0	824	0
Added Vol:	0	0	0	0	0	0	0	72	38	0	-1	0
PasserByVol:	0	0	0	0	0	0	0	0	0	0	0	0
Initial Fut:	0	0	0	416	1	597	0	1427	896	0	823	0
User Adj:	1.00	1.00	1.00	1.00	1.00	1.00	1.00	1.00	0.00	1.00	1.00	0.00
PHF Adj:	1.00	1.00	1.00	1.00	1.00	1.00	1.00	1.00	0.00	1.00	1.00	0.00
PHF Volume:	0	0	0	416	1	597	0	1427	0	0	823	0
Reduct Vol:	0	0	0	0	0	0	0	0	0	0	0	0
Reduced Vol:	0	0	0	416	1	597	0	1427	0	0	823	0
PCE Adj:	1.00	1.00	1.00	1.00	1.00	1.00	1.00	1.00	0.00	1.00	1.00	0.00
MLF Adj:	1.00	1.00	1.00	1.00	1.00	1.00	1.00	1.00	0.00	1.00	1.00	0.00
FinalVolume:	0	0	0	416	1	597	0	1427	0	0	823	0

Saturation Flow Module:												
Sat/Lane:	1900	1900	1900	1900	1900	1900	1900	1900	1900	1900	1900	1900
Adjustment:	0.92	1.00	0.92	0.92	0.92	0.92	0.92	1.00	0.92	0.92	1.00	0.92
Lanes:	0.00	0.00	0.00	0.58	0.01	1.41	0.00	2.00	1.00	0.00	2.00	1.00
Final Sat.:	0	0	0	1017	2	2480	0	3800	1750	0	3800	1750

Capacity Analysis Module:												
Vol/Sat:	0.00	0.00	0.00	0.41	0.41	0.24	0.00	0.38	0.00	0.00	0.22	0.00
Crit Moves:				****			****					
Green Time:	0.0	0.0	0.0	38.6	38.6	38.6	0.0	35.4	0.0	0.0	35.4	0.0
Volume/Cap:	0.00	0.00	0.00	0.85	0.85	0.50	0.00	0.85	0.00	0.00	0.49	0.00
Delay/Veh:	0.0	0.0	0.0	24.0	24.0	14.3	0.0	24.1	0.0	0.0	16.1	0.0
User DelAdj:	1.00	1.00	1.00	1.00	1.00	1.00	1.00	1.00	1.00	1.00	1.00	1.00
AdjDel/Veh:	0.0	0.0	0.0	24.0	24.0	14.3	0.0	24.1	0.0	0.0	16.1	0.0
LOS by Move:	A	A	A	C	C	B	A	C	A	A	B	A
HCM2k95thQ:	0	0	0	33	33	15	0	28	0	0	13	0

Note: Queue reported is the number of cars per lane.

City of Morgan Hill
Carpenters Training Center

Level Of Service Computation Report
2000 HCM Operations (Future Volume Alternative)
Existing AM

Intersection #108: US 101 Northbound Ramps and Cochrane Road

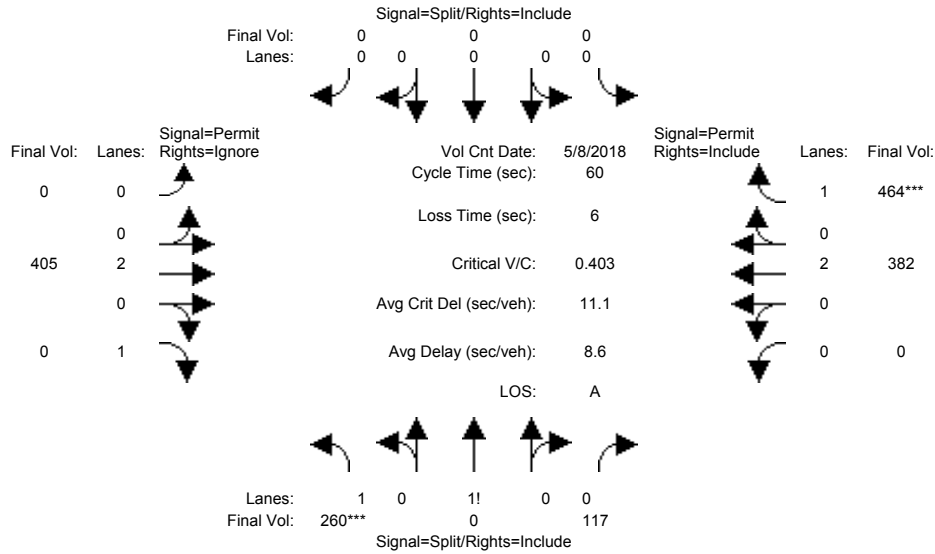

Street Name:	US 101 Northbound Ramps						Cochrane Road					
	North Bound			South Bound			East Bound			West Bound		
Movement:	L	T	R	L	T	R	L	T	R	L	T	R
Min. Green:	10	0	10	0	0	0	0	10	10	0	10	10
Y+R:	4.0	4.0	4.0	4.0	4.0	4.0	4.0	4.0	4.0	4.0	4.0	4.0

Volume Module:	>>	Count	Date:	8 May 2018	<<							
Base Vol:	260	0	117	0	0	0	0	405	0	0	382	464
Growth Adj:	1.00	1.00	1.00	1.00	1.00	1.00	1.00	1.00	1.00	1.00	1.00	1.00
Initial Bse:	260	0	117	0	0	0	0	405	0	0	382	464
Added Vol:	0	0	0	0	0	0	0	0	0	0	0	0
PasserByVol:	0	0	0	0	0	0	0	0	0	0	0	0
Initial Fut:	260	0	117	0	0	0	0	405	0	0	382	464
User Adj:	1.00	1.00	1.00	1.00	1.00	1.00	1.00	1.00	0.00	1.00	1.00	1.00
PHF Adj:	1.00	1.00	1.00	1.00	1.00	1.00	1.00	1.00	0.00	1.00	1.00	1.00
PHF Volume:	260	0	117	0	0	0	0	405	0	0	382	464
Reduct Vol:	0	0	0	0	0	0	0	0	0	0	0	0
Reduced Vol:	260	0	117	0	0	0	0	405	0	0	382	464
PCE Adj:	1.00	1.00	1.00	1.00	1.00	1.00	1.00	1.00	0.00	1.00	1.00	1.00
MLF Adj:	1.00	1.00	1.00	1.00	1.00	1.00	1.00	1.00	0.00	1.00	1.00	1.00
FinalVolume:	260	0	117	0	0	0	0	405	0	0	382	464

Saturation Flow Module:												
Sat/Lane:	1900	1900	1900	1900	1900	1900	1900	1900	1900	1900	1900	1900
Adjustment:	0.92	1.00	0.92	0.92	1.00	0.92	0.92	1.00	0.92	0.92	1.00	0.92
Lanes:	1.53	0.00	0.47	0.00	0.00	0.00	0.00	2.00	1.00	0.00	2.00	1.00
Final Sat.:	2671	0	829	0	0	0	0	3800	1750	0	3800	1750

Capacity Analysis Module:												
Vol/Sat:	0.10	0.00	0.14	0.00	0.00	0.00	0.00	0.11	0.00	0.00	0.10	0.27
Crit Moves:	****											****
Green Time:	18.8	0.0	18.8	0.0	0.0	0.0	0.0	35.2	0.0	0.0	35.2	35.2
Volume/Cap:	0.31	0.00	0.45	0.00	0.00	0.00	0.00	0.18	0.00	0.00	0.17	0.45
Delay/Veh:	15.8	0.0	16.9	0.0	0.0	0.0	0.0	5.8	0.0	0.0	5.7	7.3
User DelAdj:	1.00	1.00	1.00	1.00	1.00	1.00	1.00	1.00	1.00	1.00	1.00	1.00
AdjDel/Veh:	15.8	0.0	16.9	0.0	0.0	0.0	0.0	5.8	0.0	0.0	5.7	7.3
LOS by Move:	B	A	B	A	A	A	A	A	A	A	A	A
HCM2k95thQ:	6	0	9	0	0	0	0	3	0	0	3	11

Note: Queue reported is the number of cars per lane.

City of Morgan Hill
Carpenters Training Center

Level Of Service Computation Report
2000 HCM Operations (Future Volume Alternative)
Existing Plus Project AM

Intersection #108: US 101 Northbound Ramps and Cochrane Road

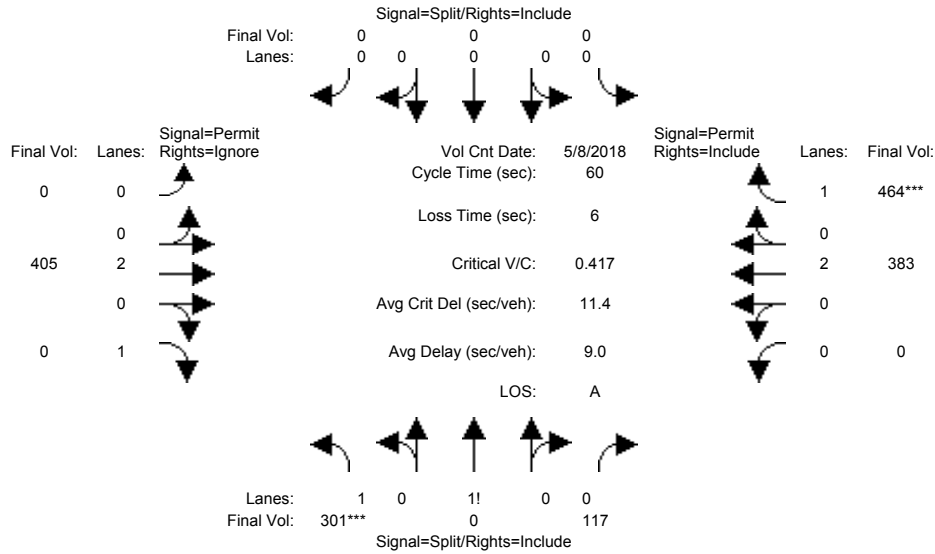

Street Name:	US 101 Northbound Ramps						Cochrane Road					
	North Bound			South Bound			East Bound			West Bound		
Movement:	L	T	R	L	T	R	L	T	R	L	T	R
Min. Green:	10	0	10	0	0	0	0	10	10	0	10	10
Y+R:	4.0	4.0	4.0	4.0	4.0	4.0	4.0	4.0	4.0	4.0	4.0	4.0

Volume Module:	>>	Count	Date:	8 May 2018	<<							
Base Vol:	260	0	117	0	0	0	0	405	0	0	382	464
Growth Adj:	1.00	1.00	1.00	1.00	1.00	1.00	1.00	1.00	1.00	1.00	1.00	1.00
Initial Bse:	260	0	117	0	0	0	0	405	0	0	382	464
Added Vol:	41	0	0	0	0	0	0	0	2	0	1	0
PasserByVol:	0	0	0	0	0	0	0	0	0	0	0	0
Initial Fut:	301	0	117	0	0	0	0	405	2	0	383	464
User Adj:	1.00	1.00	1.00	1.00	1.00	1.00	1.00	1.00	0.00	1.00	1.00	1.00
PHF Adj:	1.00	1.00	1.00	1.00	1.00	1.00	1.00	1.00	0.00	1.00	1.00	1.00
PHF Volume:	301	0	117	0	0	0	0	405	0	0	383	464
Reduct Vol:	0	0	0	0	0	0	0	0	0	0	0	0
Reduced Vol:	301	0	117	0	0	0	0	405	0	0	383	464
PCE Adj:	1.00	1.00	1.00	1.00	1.00	1.00	1.00	1.00	0.00	1.00	1.00	1.00
MLF Adj:	1.00	1.00	1.00	1.00	1.00	1.00	1.00	1.00	0.00	1.00	1.00	1.00
FinalVolume:	301	0	117	0	0	0	0	405	0	0	383	464

Saturation Flow Module:												
Sat/Lane:	1900	1900	1900	1900	1900	1900	1900	1900	1900	1900	1900	1900
Adjustment:	0.92	1.00	0.92	0.92	1.00	0.92	0.92	1.00	0.92	0.92	1.00	0.92
Lanes:	1.56	0.00	0.44	0.00	0.00	0.00	0.00	2.00	1.00	0.00	2.00	1.00
Final Sat.:	2735	0	765	0	0	0	0	3800	1750	0	3800	1750

Capacity Analysis Module:												
Vol/Sat:	0.11	0.00	0.15	0.00	0.00	0.00	0.00	0.11	0.00	0.00	0.10	0.27
Crit Moves:	****											****
Green Time:	19.7	0.0	19.7	0.0	0.0	0.0	0.0	34.3	0.0	0.0	34.3	34.3
Volume/Cap:	0.33	0.00	0.46	0.00	0.00	0.00	0.00	0.19	0.00	0.00	0.18	0.46
Delay/Veh:	15.3	0.0	16.3	0.0	0.0	0.0	0.0	6.2	0.0	0.0	6.2	7.9
User DelAdj:	1.00	1.00	1.00	1.00	1.00	1.00	1.00	1.00	1.00	1.00	1.00	1.00
AdjDel/Veh:	15.3	0.0	16.3	0.0	0.0	0.0	0.0	6.2	0.0	0.0	6.2	7.9
LOS by Move:	B	A	B	A	A	A	A	A	A	A	A	A
HCM2k95thQ:	6	0	9	0	0	0	0	4	0	0	4	11

Note: Queue reported is the number of cars per lane.

City of Morgan Hill
Carpenters Training Center

Level Of Service Computation Report
2000 HCM Operations (Future Volume Alternative)
Cumulative AM

Intersection #108: US 101 Northbound Ramps and Cochrane Road

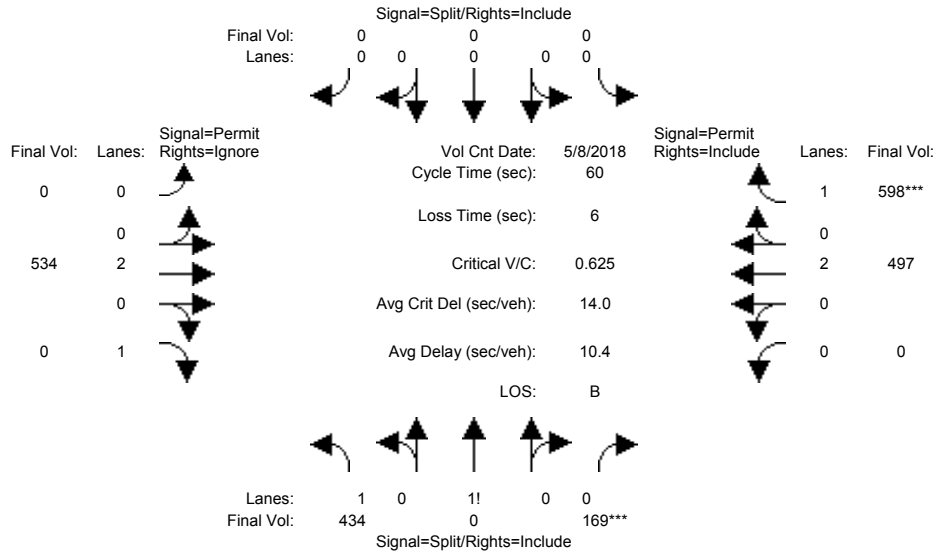

Street Name:	US 101 Northbound Ramps						Cochrane Road					
	North Bound			South Bound			East Bound			West Bound		
Movement:	L	T	R	L	T	R	L	T	R	L	T	R
Min. Green:	10	0	10	0	0	0	0	10	10	0	10	10
Y+R:	4.0	4.0	4.0	4.0	4.0	4.0	4.0	4.0	4.0	4.0	4.0	4.0

Volume Module:	>>	Count	Date:	8 May 2018	<<							
Base Vol:	434	0	169	0	0	0	0	534	7	0	497	598
Growth Adj:	1.00	1.00	1.00	1.00	1.00	1.00	1.00	1.00	1.00	1.00	1.00	1.00
Initial Bse:	434	0	169	0	0	0	0	534	7	0	497	598
Added Vol:	0	0	0	0	0	0	0	0	0	0	0	0
PasserByVol:	0	0	0	0	0	0	0	0	0	0	0	0
Initial Fut:	434	0	169	0	0	0	0	534	7	0	497	598
User Adj:	1.00	1.00	1.00	1.00	1.00	1.00	1.00	1.00	0.00	1.00	1.00	1.00
PHF Adj:	1.00	1.00	1.00	1.00	1.00	1.00	1.00	1.00	0.00	1.00	1.00	1.00
PHF Volume:	434	0	169	0	0	0	0	534	0	0	497	598
Reduct Vol:	0	0	0	0	0	0	0	0	0	0	0	0
Reduced Vol:	434	0	169	0	0	0	0	534	0	0	497	598
PCE Adj:	1.00	1.00	1.00	1.00	1.00	1.00	1.00	1.00	0.00	1.00	1.00	1.00
MLF Adj:	1.00	1.00	1.00	1.00	1.00	1.00	1.00	1.00	0.00	1.00	1.00	1.00
FinalVolume:	434	0	169	0	0	0	0	534	0	0	497	598

Saturation Flow Module:												
Sat/Lane:	1900	1900	1900	1900	1900	1900	1900	1900	1900	1900	1900	1900
Adjustment:	0.92	1.00	0.92	0.92	1.00	0.92	0.92	1.00	0.92	0.92	1.00	0.92
Lanes:	1.56	0.00	0.44	0.00	0.00	0.00	0.00	2.00	1.00	0.00	2.00	1.00
Final Sat.:	2734	0	766	0	0	0	0	3800	1750	0	3800	1750

Capacity Analysis Module:												
Vol/Sat:	0.16	0.00	0.22	0.00	0.00	0.00	0.00	0.14	0.00	0.00	0.13	0.34
Crit Moves:	****											****
Green Time:	21.2	0.0	21.2	0.0	0.0	0.0	0.0	32.8	0.0	0.0	32.8	32.8
Volume/Cap:	0.45	0.00	0.62	0.00	0.00	0.00	0.00	0.26	0.00	0.00	0.24	0.62
Delay/Veh:	15.2	0.0	17.4	0.0	0.0	0.0	0.0	7.2	0.0	0.0	7.1	10.7
User DelAdj:	1.00	1.00	1.00	1.00	1.00	1.00	1.00	1.00	1.00	1.00	1.00	1.00
AdjDel/Veh:	15.2	0.0	17.4	0.0	0.0	0.0	0.0	7.2	0.0	0.0	7.1	10.7
LOS by Move:	B	A	B	A	A	A	A	A	A	A	A	B
HCM2k95thQ:	9	0	14	0	0	0	0	5	0	0	5	17

Note: Queue reported is the number of cars per lane.

City of Morgan Hill
Carpenters Training Center

Level Of Service Computation Report
2000 HCM Operations (Future Volume Alternative)
Cumulative Plus Project AM

Intersection #108: US 101 Northbound Ramps and Cochrane Road

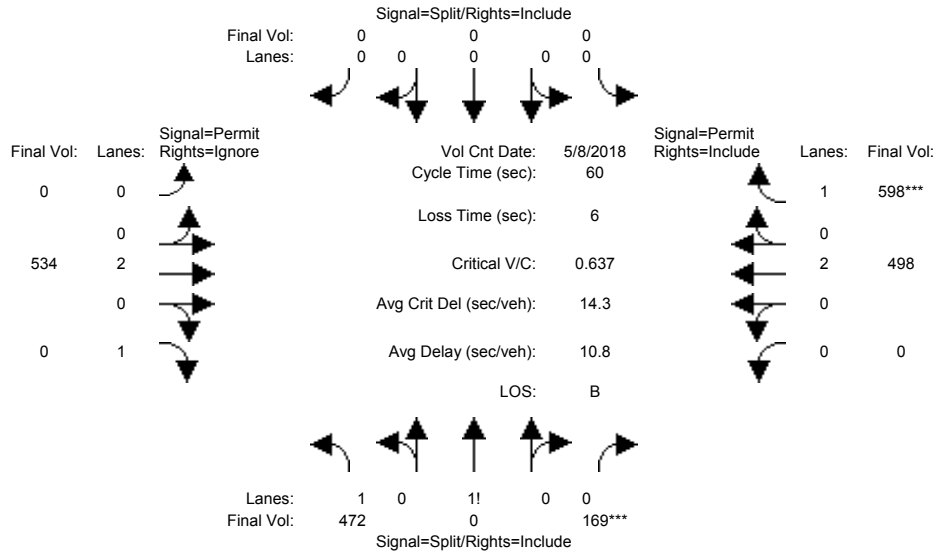

Street Name:	US 101 Northbound Ramps						Cochrane Road					
	North Bound			South Bound			East Bound			West Bound		
Approach:	L	T	R	L	T	R	L	T	R	L	T	R
Min. Green:	10	0	10	0	0	0	0	10	10	0	10	10
Y+R:	4.0	4.0	4.0	4.0	4.0	4.0	4.0	4.0	4.0	4.0	4.0	4.0

Volume Module:	>>	Count	Date:	8 May 2018	<<							
Base Vol:	434	0	169	0	0	0	0	534	7	0	497	598
Growth Adj:	1.00	1.00	1.00	1.00	1.00	1.00	1.00	1.00	1.00	1.00	1.00	1.00
Initial Bse:	434	0	169	0	0	0	0	534	7	0	497	598
Added Vol:	38	0	0	0	0	0	0	0	1	0	1	0
PasserByVol:	0	0	0	0	0	0	0	0	0	0	0	0
Initial Fut:	472	0	169	0	0	0	0	534	8	0	498	598
User Adj:	1.00	1.00	1.00	1.00	1.00	1.00	1.00	1.00	0.00	1.00	1.00	1.00
PHF Adj:	1.00	1.00	1.00	1.00	1.00	1.00	1.00	1.00	0.00	1.00	1.00	1.00
PHF Volume:	472	0	169	0	0	0	0	534	0	0	498	598
Reduct Vol:	0	0	0	0	0	0	0	0	0	0	0	0
Reduced Vol:	472	0	169	0	0	0	0	534	0	0	498	598
PCE Adj:	1.00	1.00	1.00	1.00	1.00	1.00	1.00	1.00	0.00	1.00	1.00	1.00
MLF Adj:	1.00	1.00	1.00	1.00	1.00	1.00	1.00	1.00	0.00	1.00	1.00	1.00
Final Volume:	472	0	169	0	0	0	0	534	0	0	498	598

Saturation Flow Module:												
Sat/Lane:	1900	1900	1900	1900	1900	1900	1900	1900	1900	1900	1900	1900
Adjustment:	0.92	1.00	0.92	0.92	1.00	0.92	0.92	1.00	0.92	0.92	1.00	0.92
Lanes:	1.58	0.00	0.42	0.00	0.00	0.00	0.00	2.00	1.00	0.00	2.00	1.00
Final Sat.:	2770	0	730	0	0	0	0	3800	1750	0	3800	1750

Capacity Analysis Module:												
Vol/Sat:	0.17	0.00	0.23	0.00	0.00	0.00	0.00	0.14	0.00	0.00	0.13	0.34
Crit Moves:	****											
Green Time:	21.8	0.0	21.8	0.0	0.0	0.0	0.0	32.2	0.0	0.0	32.2	32.2
Volume/Cap:	0.47	0.00	0.64	0.00	0.00	0.00	0.00	0.26	0.00	0.00	0.24	0.64
Delay/Veh:	14.9	0.0	17.2	0.0	0.0	0.0	0.0	7.6	0.0	0.0	7.5	11.2
User DelAdj:	1.00	1.00	1.00	1.00	1.00	1.00	1.00	1.00	1.00	1.00	1.00	1.00
AdjDel/Veh:	14.9	0.0	17.2	0.0	0.0	0.0	0.0	7.6	0.0	0.0	7.5	11.2
LOS by Move:	B	A	B	A	A	A	A	A	A	A	A	B
HCM2k95thQ:	10	0	15	0	0	0	0	5	0	0	5	17

Note: Queue reported is the number of cars per lane.

City of Morgan Hill
Carpenters Training Center

Level Of Service Computation Report
2000 HCM Operations (Future Volume Alternative)
Existing PM

Intersection #108: US 101 Northbound Ramps and Cochrane Road

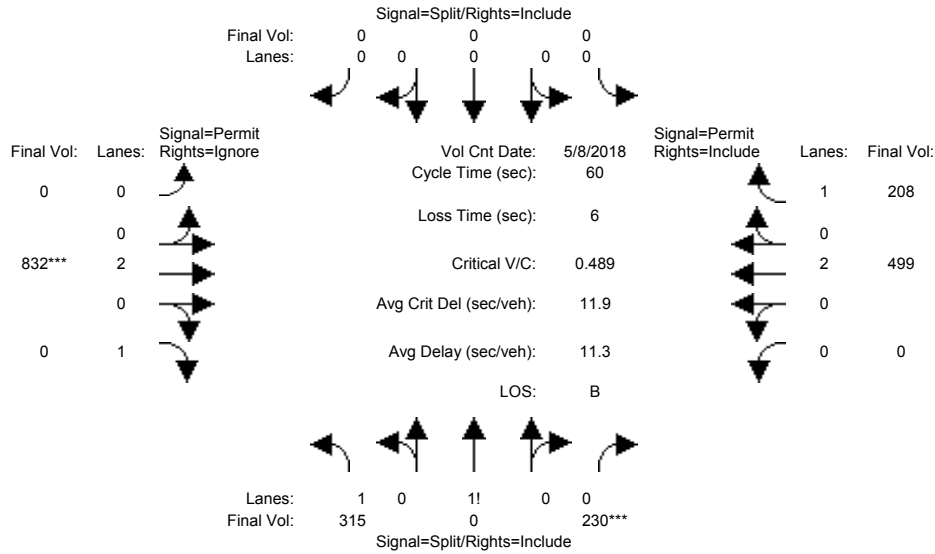

Street Name:	US 101 Northbound Ramps						Cochrane Road					
	North Bound			South Bound			East Bound			West Bound		
Movement:	L	T	R	L	T	R	L	T	R	L	T	R
Min. Green:	10	0	10	0	0	0	0	10	10	0	10	10
Y+R:	4.0	4.0	4.0	4.0	4.0	4.0	4.0	4.0	4.0	4.0	4.0	4.0

Volume Module:	>>	Count	Date:	8 May 2018	<<							
Base Vol:	315	0	230	0	0	0	0	832	0	0	499	208
Growth Adj:	1.00	1.00	1.00	1.00	1.00	1.00	1.00	1.00	1.00	1.00	1.00	1.00
Initial Bse:	315	0	230	0	0	0	0	832	0	0	499	208
Added Vol:	0	0	0	0	0	0	0	0	0	0	0	0
PasserByVol:	0	0	0	0	0	0	0	0	0	0	0	0
Initial Fut:	315	0	230	0	0	0	0	832	0	0	499	208
User Adj:	1.00	1.00	1.00	1.00	1.00	1.00	1.00	1.00	0.00	1.00	1.00	1.00
PHF Adj:	1.00	1.00	1.00	1.00	1.00	1.00	1.00	1.00	0.00	1.00	1.00	1.00
PHF Volume:	315	0	230	0	0	0	0	832	0	0	499	208
Reduct Vol:	0	0	0	0	0	0	0	0	0	0	0	0
Reduced Vol:	315	0	230	0	0	0	0	832	0	0	499	208
PCE Adj:	1.00	1.00	1.00	1.00	1.00	1.00	1.00	1.00	0.00	1.00	1.00	1.00
MLF Adj:	1.00	1.00	1.00	1.00	1.00	1.00	1.00	1.00	0.00	1.00	1.00	1.00
Final Volume:	315	0	230	0	0	0	0	832	0	0	499	208

Saturation Flow Module:												
Sat/Lane:	1900	1900	1900	1900	1900	1900	1900	1900	1900	1900	1900	1900
Adjustment:	0.92	1.00	0.92	0.92	1.00	0.92	0.92	1.00	0.92	0.92	1.00	0.92
Lanes:	1.41	0.00	0.59	0.00	0.00	0.00	0.00	2.00	1.00	0.00	2.00	1.00
Final Sat.:	2461	0	1039	0	0	0	0	3800	1750	0	3800	1750

Capacity Analysis Module:												
Vol/Sat:	0.13	0.00	0.22	0.00	0.00	0.00	0.00	0.22	0.00	0.00	0.13	0.12
Crit Moves:	****									****		
Green Time:	27.2	0.0	27.2	0.0	0.0	0.0	0.0	26.8	0.0	0.0	26.8	26.8
Volume/Cap:	0.28	0.00	0.49	0.00	0.00	0.00	0.00	0.49	0.00	0.00	0.29	0.27
Delay/Veh:	10.4	0.0	11.9	0.0	0.0	0.0	0.0	11.9	0.0	0.0	10.6	10.6
User DelAdj:	1.00	1.00	1.00	1.00	1.00	1.00	1.00	1.00	1.00	1.00	1.00	1.00
AdjDel/Veh:	10.4	0.0	11.9	0.0	0.0	0.0	0.0	11.9	0.0	0.0	10.6	10.6
LOS by Move:	B	A	B	A	A	A	A	B	A	A	B	B
HCM2k95thQ:	6	0	11	0	0	0	0	10	0	0	6	5

Note: Queue reported is the number of cars per lane.

City of Morgan Hill
Carpenters Training Center

Level Of Service Computation Report
2000 HCM Operations (Future Volume Alternative)
Existing Plus Project PM

Intersection #108: US 101 Northbound Ramps and Cochrane Road

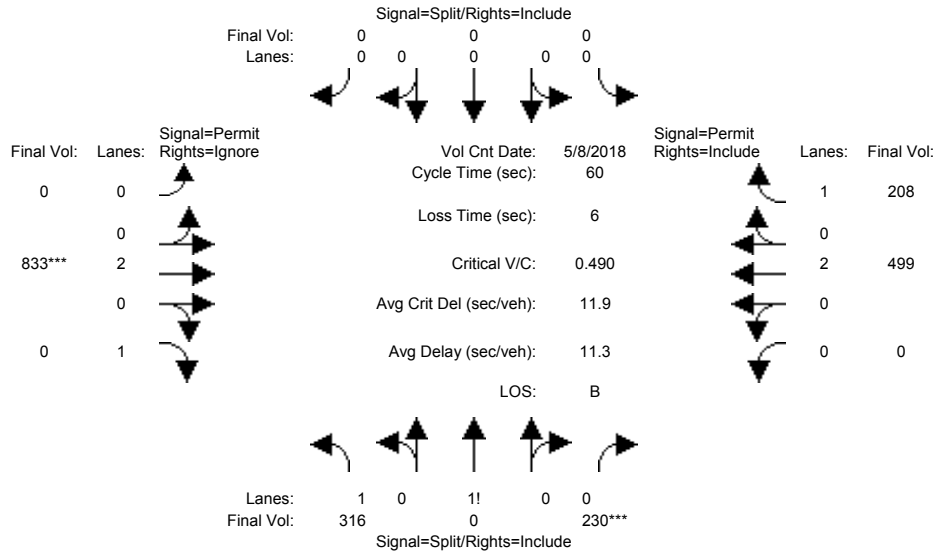

Street Name:	US 101 Northbound Ramps						Cochrane Road					
	North Bound			South Bound			East Bound			West Bound		
Movement:	L	T	R	L	T	R	L	T	R	L	T	R
Min. Green:	10	0	10	0	0	0	0	10	10	0	10	10
Y+R:	4.0	4.0	4.0	4.0	4.0	4.0	4.0	4.0	4.0	4.0	4.0	4.0

Volume Module:	>>	Count	Date:	8 May 2018	<<							
Base Vol:	315	0	230	0	0	0	0	832	0	0	499	208
Growth Adj:	1.00	1.00	1.00	1.00	1.00	1.00	1.00	1.00	1.00	1.00	1.00	1.00
Initial Bse:	315	0	230	0	0	0	0	832	0	0	499	208
Added Vol:	1	0	0	0	0	0	0	1	74	0	0	0
PasserByVol:	0	0	0	0	0	0	0	0	0	0	0	0
Initial Fut:	316	0	230	0	0	0	0	833	74	0	499	208
User Adj:	1.00	1.00	1.00	1.00	1.00	1.00	1.00	1.00	0.00	1.00	1.00	1.00
PHF Adj:	1.00	1.00	1.00	1.00	1.00	1.00	1.00	1.00	0.00	1.00	1.00	1.00
PHF Volume:	316	0	230	0	0	0	0	833	0	0	499	208
Reduct Vol:	0	0	0	0	0	0	0	0	0	0	0	0
Reduced Vol:	316	0	230	0	0	0	0	833	0	0	499	208
PCE Adj:	1.00	1.00	1.00	1.00	1.00	1.00	1.00	1.00	0.00	1.00	1.00	1.00
MLF Adj:	1.00	1.00	1.00	1.00	1.00	1.00	1.00	1.00	0.00	1.00	1.00	1.00
FinalVolume:	316	0	230	0	0	0	0	833	0	0	499	208

Saturation Flow Module:												
Sat/Lane:	1900	1900	1900	1900	1900	1900	1900	1900	1900	1900	1900	1900
Adjustment:	0.92	1.00	0.92	0.92	1.00	0.92	0.92	1.00	0.92	0.92	1.00	0.92
Lanes:	1.41	0.00	0.59	0.00	0.00	0.00	0.00	2.00	1.00	0.00	2.00	1.00
Final Sat.:	2463	0	1037	0	0	0	0	3800	1750	0	3800	1750

Capacity Analysis Module:												
Vol/Sat:	0.13	0.00	0.22	0.00	0.00	0.00	0.00	0.22	0.00	0.00	0.13	0.12
Crit Moves:	****						****					
Green Time:	27.2	0.0	27.2	0.0	0.0	0.0	0.0	26.8	0.0	0.0	26.8	26.8
Volume/Cap:	0.28	0.00	0.49	0.00	0.00	0.00	0.00	0.49	0.00	0.00	0.29	0.27
Delay/Veh:	10.4	0.0	11.9	0.0	0.0	0.0	0.0	12.0	0.0	0.0	10.6	10.6
User DelAdj:	1.00	1.00	1.00	1.00	1.00	1.00	1.00	1.00	1.00	1.00	1.00	1.00
AdjDel/Veh:	10.4	0.0	11.9	0.0	0.0	0.0	0.0	12.0	0.0	0.0	10.6	10.6
LOS by Move:	B	A	B	A	A	A	A	B	A	A	B	B
HCM2k95thQ:	6	0	11	0	0	0	0	10	0	0	6	5

Note: Queue reported is the number of cars per lane.

City of Morgan Hill
Carpenters Training Center

Level Of Service Computation Report
2000 HCM Operations (Future Volume Alternative)
Cumulative PM

Intersection #108: US 101 Northbound Ramps and Cochrane Road

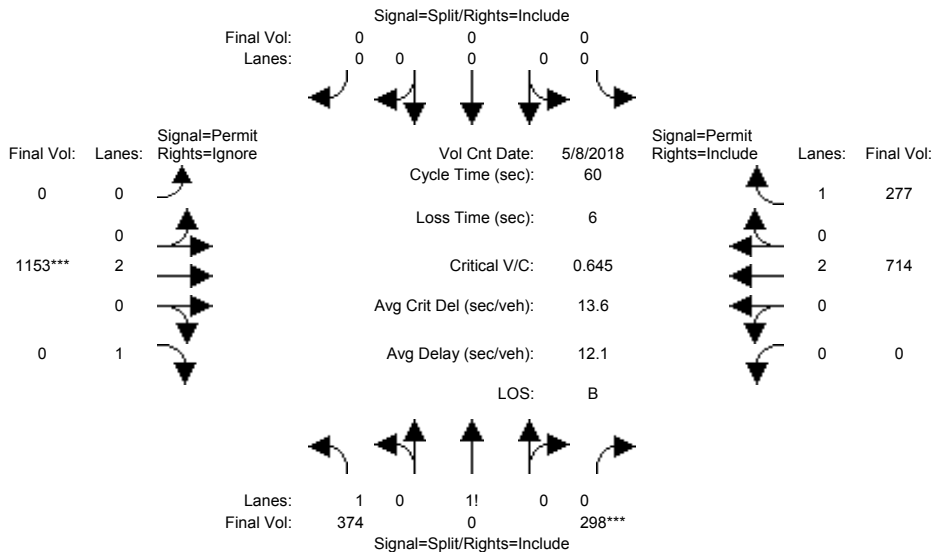

Street Name:	US 101 Northbound Ramps						Cochrane Road					
	North Bound			South Bound			East Bound			West Bound		
Movement:	L	T	R	L	T	R	L	T	R	L	T	R
Min. Green:	10	0	10	0	0	0	0	10	10	0	10	10
Y+R:	4.0	4.0	4.0	4.0	4.0	4.0	4.0	4.0	4.0	4.0	4.0	4.0

Volume Module:	>>	Count	Date:	8 May 2018	<<							
Base Vol:	374	0	298	0	0	0	0	1153	28	0	714	277
Growth Adj:	1.00	1.00	1.00	1.00	1.00	1.00	1.00	1.00	1.00	1.00	1.00	1.00
Initial Bse:	374	0	298	0	0	0	0	1153	28	0	714	277
Added Vol:	0	0	0	0	0	0	0	0	0	0	0	0
PasserByVol:	0	0	0	0	0	0	0	0	0	0	0	0
Initial Fut:	374	0	298	0	0	0	0	1153	28	0	714	277
User Adj:	1.00	1.00	1.00	1.00	1.00	1.00	1.00	1.00	0.00	1.00	1.00	1.00
PHF Adj:	1.00	1.00	1.00	1.00	1.00	1.00	1.00	1.00	0.00	1.00	1.00	1.00
PHF Volume:	374	0	298	0	0	0	0	1153	0	0	714	277
Reduct Vol:	0	0	0	0	0	0	0	0	0	0	0	0
Reduced Vol:	374	0	298	0	0	0	0	1153	0	0	714	277
PCE Adj:	1.00	1.00	1.00	1.00	1.00	1.00	1.00	1.00	0.00	1.00	1.00	1.00
MLF Adj:	1.00	1.00	1.00	1.00	1.00	1.00	1.00	1.00	0.00	1.00	1.00	1.00
Final Volume:	374	0	298	0	0	0	0	1153	0	0	714	277

Saturation Flow Module:												
Sat/Lane:	1900	1900	1900	1900	1900	1900	1900	1900	1900	1900	1900	1900
Adjustment:	0.92	1.00	0.92	0.92	1.00	0.92	0.92	1.00	0.92	0.92	1.00	0.92
Lanes:	1.39	0.00	0.61	0.00	0.00	0.00	0.00	2.00	1.00	0.00	2.00	1.00
Final Sat.:	2425	0	1075	0	0	0	0	3800	1750	0	3800	1750

Capacity Analysis Module:												
Vol/Sat:	0.15	0.00	0.28	0.00	0.00	0.00	0.00	0.30	0.00	0.00	0.19	0.16
Crit Moves:	****			****								
Green Time:	25.8	0.0	25.8	0.0	0.0	0.0	0.0	28.2	0.0	0.0	28.2	28.2
Volume/Cap:	0.36	0.00	0.65	0.00	0.00	0.00	0.00	0.65	0.00	0.00	0.40	0.34
Delay/Veh:	11.7	0.0	14.9	0.0	0.0	0.0	0.0	12.9	0.0	0.0	10.5	10.2
User DelAdj:	1.00	1.00	1.00	1.00	1.00	1.00	1.00	1.00	1.00	1.00	1.00	1.00
AdjDel/Veh:	11.7	0.0	14.9	0.0	0.0	0.0	0.0	12.9	0.0	0.0	10.5	10.2
LOS by Move:	B	A	B	A	A	A	A	B	A	A	B	B
HCM2k95thQ:	8	0	16	0	0	0	0	15	0	0	9	7

Note: Queue reported is the number of cars per lane.

City of Morgan Hill
Carpenters Training Center

Level Of Service Computation Report
2000 HCM Operations (Future Volume Alternative)
Cumulative Plus Project PM

Intersection #108: US 101 Northbound Ramps and Cochrane Road

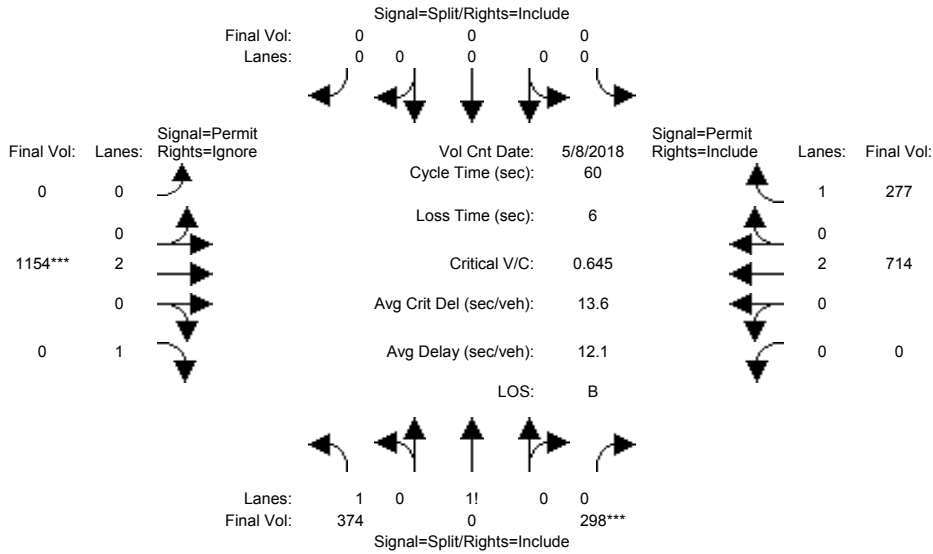

Street Name:	US 101 Northbound Ramps						Cochrane Road					
	North Bound			South Bound			East Bound			West Bound		
Movement:	L	T	R	L	T	R	L	T	R	L	T	R
Min. Green:	10	0	10	0	0	0	0	10	10	0	10	10
Y+R:	4.0	4.0	4.0	4.0	4.0	4.0	4.0	4.0	4.0	4.0	4.0	4.0

Volume Module:	>>	Count	Date:	8 May 2018	<<							
Base Vol:	374	0	298	0	0	0	0	1153	28	0	714	277
Growth Adj:	1.00	1.00	1.00	1.00	1.00	1.00	1.00	1.00	1.00	1.00	1.00	1.00
Initial Bse:	374	0	298	0	0	0	0	1153	28	0	714	277
Added Vol:	0	0	0	0	0	0	0	1	72	0	0	0
PasserByVol:	0	0	0	0	0	0	0	0	0	0	0	0
Initial Fut:	374	0	298	0	0	0	0	1154	100	0	714	277
User Adj:	1.00	1.00	1.00	1.00	1.00	1.00	1.00	1.00	0.00	1.00	1.00	1.00
PHF Adj:	1.00	1.00	1.00	1.00	1.00	1.00	1.00	1.00	0.00	1.00	1.00	1.00
PHF Volume:	374	0	298	0	0	0	0	1154	0	0	714	277
Reduct Vol:	0	0	0	0	0	0	0	0	0	0	0	0
Reduced Vol:	374	0	298	0	0	0	0	1154	0	0	714	277
PCE Adj:	1.00	1.00	1.00	1.00	1.00	1.00	1.00	1.00	0.00	1.00	1.00	1.00
MLF Adj:	1.00	1.00	1.00	1.00	1.00	1.00	1.00	1.00	0.00	1.00	1.00	1.00
FinalVolume:	374	0	298	0	0	0	0	1154	0	0	714	277

Saturation Flow Module:												
Sat/Lane:	1900	1900	1900	1900	1900	1900	1900	1900	1900	1900	1900	1900
Adjustment:	0.92	1.00	0.92	0.92	1.00	0.92	0.92	1.00	0.92	0.92	1.00	0.92
Lanes:	1.39	0.00	0.61	0.00	0.00	0.00	0.00	2.00	1.00	0.00	2.00	1.00
Final Sat.:	2425	0	1075	0	0	0	0	3800	1750	0	3800	1750

Capacity Analysis Module:												
Vol/Sat:	0.15	0.00	0.28	0.00	0.00	0.00	0.00	0.30	0.00	0.00	0.19	0.16
Crit Moves:	****						****					
Green Time:	25.8	0.0	25.8	0.0	0.0	0.0	0.0	28.2	0.0	0.0	28.2	28.2
Volume/Cap:	0.36	0.00	0.65	0.00	0.00	0.00	0.00	0.65	0.00	0.00	0.40	0.34
Delay/Veh:	11.7	0.0	14.9	0.0	0.0	0.0	0.0	12.9	0.0	0.0	10.5	10.2
User DelAdj:	1.00	1.00	1.00	1.00	1.00	1.00	1.00	1.00	1.00	1.00	1.00	1.00
AdjDel/Veh:	11.7	0.0	14.9	0.0	0.0	0.0	0.0	12.9	0.0	0.0	10.5	10.2
LOS by Move:	B	A	B	A	A	A	A	B	A	A	B	B
HCM2k95thQ:	8	0	16	0	0	0	0	15	0	0	9	7

Note: Queue reported is the number of cars per lane.