

Appendix E

Geotechnical Report



**PRELIMINARY GEOTECHNICAL INVESTIGATION REPORT
VALLEYS EDGE MULTI-USE DEVELOPMENT
DOE MILL/HONEY RUN SPECIAL PLANNING AREA
CHICO, CALIFORNIA**

Updated February 27, 2019

This document was prepared for use only by the client, only for the purposes stated, and within a reasonable time from issuance. Non-commercial, educational, and scientific use of this report by regulatory agencies is regarded as a “fair use” and not a violation of copyright. Regulatory agencies may make additional copies of this document for internal use. Copies may also be made available to the public as required by law. The reprint must acknowledge the copyright and indicate that permission to reprint has been received.



February 27, 2019
File: 1679

Mr. Bill Brouhard
Valleys Edge
2550 Lakewest Drive, Suite 50
Chico, California 95928

**Subject: Preliminary Geotechnical Investigation Report
Valleys Edge Multi-Use Development
Doe Mill/Honey Run Special Planning Area, Chico, California**

Dear Mr. Brouhard:

GEOPlus is pleased to present the attached updated preliminary geotechnical investigation report for the proposed Valleys Edge multi-use development north of Skyway and Honey Run Road in Chico, California. Per the City of Chico General Plan 2030, this project is comprised almost entirely of the Doe Mill/Honey Run Special Planning Area. This report has been updated from the February 10, 2015 report prepared by GEOPlus, Inc., which has since become GEOPlus Partners. The purpose of our investigation was to explore and evaluate the subsurface conditions at various locations across the site in order to provide geotechnical design and construction recommendations for project infrastructure features including general grading, for roadways, underground utility installations and asphalt concrete pavement, and preliminary geotechnical design and construction information for structure foundations, retaining walls and concrete slabs-on-grade.

We understand the planned development site consists of 1,448 acres with initial development to be focused off Skyway in the southwestern portion of the site. As such our 2015 investigation at the site was concentrated on the 540 acres with limited investigation of the remainder of the site. Since limited project design details are available at this time, limited geotechnical design and construction recommendations are presented which are suitable for project infrastructure. This report does not include recommendations for final design of structural improvements such as structure foundations, concrete slab-on-grade, and/or retaining walls. Details of these aspects of the project are still in planning phases; as such will require additional review, site investigation and analysis by GEOPlus as pertinent design details become available.

Based on the results of our field investigation and laboratory testing program, it is our professional opinion the site can be made suitable for the planned residential and light commercial development. However, largely due to the presence of surficial and near-surface hard bedrock, geotechnical issues that will impact the project design and construction include the following:

- Excavation for utilities, foundations and roadways;
- Fill construction with coarse materials;

- Perched groundwater and springs;
- Seepage through utility backfill and pavement section base;
- Cut-fill transitions resulting in differential settlement within fills; and
- Water-feature water retention.

These concerns will require modifications in the schedule and/or approach to site grading and possibly to planned utilities, structures and pavements during site development. General recommendations to reduce potential adverse effects of these issues as well as general information regarding the geotechnical aspects of project design and construction are presented in the following report.

Recommendations provided herein are contingent on the provisions outlined in the Additional Services and Limitations sections of this report. The project Owner should become familiar with these provisions in order to assess further involvement by GEOPlus Partners and other potential impacts to the proposed project. Reports presenting design level geotechnical recommendations will be required prior to final site development for various structures and improvements as pertinent improvement details become known.

We appreciate the opportunity to provide our services for this project. If you have questions regarding this report or if we may be of further assistance, please contact the undersigned.

Sincerely,

GEOPlus Partners

John L. Finnigsmier
General Partner

Traver E. "Corky" Metcalf, Jr.
General Partner

JLF:TEM:jlf/tem

TABLE OF CONTENTS

SECTION	PAGE
1. INTRODUCTION.....	1
1.1 GENERAL.....	1
1.2 PROPOSED DEVELOPMENT.....	1
1.3 PREVIOUS INVESTIGATION.....	2
1.4 Purpose and scope of services.....	Error! Bookmark not defined.
2. GEOLOGIC AND SEISMIC CONDITIONS.....	4
2.1 REGIONAL AND LOCAL GEOLOGIC SETTING.....	4
2.2 FAULTING AND SEISMICITY.....	4
2.3 SITE GEOLOGY.....	6
2.3.1 Tuscan Formation.....	6
2.3.2 Alluvium.....	10
2.3.3 Springs and Seepage.....	10
2.3.4 NRCS Soil Mapping.....	11
2.4 POTENTIAL GEOLOGIC HAZARDS.....	12
2.4.1 Ground Rupture.....	12
2.4.2 Seismic Ground Motions.....	12
2.4.3 Seismically Induced Liquefaction.....	13
2.4.4 Slope Instability.....	13
2.4.5 Expansive Soils.....	13
2.4.6 Flooding.....	13
2.5 SITE HYDROGEOLOGY.....	14
3. SITE CONDITIONS.....	15
3.1 GENERAL SURFACE DESCRIPTION.....	15
3.2 FIELD EXPLORATION.....	16
3.3 SUBSURFACE FINDINGS.....	16
3.4 GROUNDWATER.....	18
4. PRELIMINARY CONCLUSIONS AND RECOMMENDATIONS.....	19
4.1 GENERAL.....	19
4.2 EXCAVATABILITY.....	19
4.2.1 Potential Borrow Areas.....	21
4.3 SUITABILITY OF EXCAVATED MATERIAL FOR USE AS FILL.....	21
4.4 SEEPAGE THROUGH LAHAR FRACTURES AND COARSE FILL.....	22
4.5 CUT - FILL TRANSITION AND DIFFERENTIAL FILL SETTLEMENT.....	23
4.6 SOIL CORROSIVE PROPERTIES.....	24
4.7 SITE PREPARATION.....	24
4.7.1 Removals/Over-excavation.....	24
4.7.2 Stripping and Grubbing.....	25
4.7.3 Existing Utilities, Wells, and/or Foundations.....	25
4.7.4 Scarification and Compaction.....	25
4.8 TEMPORARY EXCAVATIONS.....	26
4.8.1 General.....	26
4.8.2 Excavation Characteristics.....	27
4.8.3 Construction Considerations.....	27
4.9 CUT AND FILL SLOPES.....	27
4.10 ENGINEERED FILL.....	28
4.10.1 Materials.....	28
4.10.2 Compaction Criteria.....	29

4.11	TRENCH BACKFILL	30
	4.11.1 Materials	30
	4.11.2 Compaction Criteria.....	31
4.12	SPREAD FOUNDATIONS.....	32
	4.12.1 General.....	32
	4.12.2 Estimated Settlement	32
4.13	CBC SEISMIC DESIGN PARAMETERS.....	33
4.14	RETAINING WALLS	33
4.15	CONCRETE SLABS SUPPORTED-ON-GRADE.....	34
	4.15.1 Subgrade Preparation	34
	4.15.2 Rock Capillary Break.....	35
	4.15.3 Interior Concrete Slabs-On-Grade Construction Considerations	35
	4.15.4 Surface Drainage.....	36
4.16	PAVEMENTS.....	36
	4.16.1 General.....	36
	4.16.2 Asphalt Concrete Pavement Section Recommendations	37
5.	REFERENCES.....	41
6.	ADDITIONAL SERVICES AND LIMITATIONS	42
6.1	ADDITIONAL STUDIES	42
6.2	LIMITATIONS.....	42

PLATES

- 1 Site Location and Topographic Map
- 2 Site Development Plan
- 3 Site Exploration and Geologic Map
- 4 Storm Drain Trench Subdrain Detail
- 5 Utility Trench and Street Seepage Control Details

APPENDICES

- A 2015 Field Investigation
- B 2015 Laboratory Testing
- C 2015 Caterpillar D-10 Trial Ripping Operation

**PRELIMINARY GEOTECHNICAL INVESTIGATION REPORT
PROPOSED MULTI-USE DEVELOPMENT
DOE MILL/HONEY RUN SPECIAL PLANNING AREA**

1. INTRODUCTION

1.1 GENERAL

In this report we present the results of our preliminary geotechnical investigation for the proposed Multi-Use Development to be located northeast of Skyway and Honey Run Road in Chico, California. Per the City of Chico General Plan 2030, the project area is almost entirely within the Doe Mill/Honey Run Special Planning Area. The site location relative to existing streets and topographic features is shown on Plate 1.

This report is an update of the Preliminary Geotechnical Investigation Report prepared for the site by GEOPlus, Inc. in 2015 (GEOPlus, Inc., 2015a). It has been updated to reflect the current development plan, current California Building Code criteria and subsequent geotechnical investigative work. GEOPlus, Inc. became GEOPlus Partners in 2016; however, the authors of this report remain the same as for 2015 report.

This report includes our preliminary information and recommendations related to the geotechnical aspects of project design and construction. Additional geotechnical engineering analysis and recommendations should be performed after definitive plans for the proposed development has been determined. The conclusions and recommendations presented in this report are based on the subsurface conditions encountered at the locations of our explorations and the provisions and requirements outlined in the Additional Services and Limitations sections of this report. The preliminary recommendations presented herein should not be extrapolated to other areas or used for other projects without our prior review.

1.2 PROPOSED DEVELOPMENT

The proposed development concept has not been finalized at this time; however, we understand a planned community development including some light-commercial with very low to medium-high density residential development is being considered for the site. The entire site consists of 1,448 acres; however, development is proposed about half of the total acreage. Primary access to

the development will be from Skyway on the south side and an extension of East 20th Street on the north side. Planned commercial developments are proposed to be on the lower reaches of the southern mesa within the western portion of the initial development area. The initial development area will also include senior housing with recreational facilities. At total build-out the development may include about 2,770 residential units. Features that may be included in the development include commercial and residential structures, infrastructure including roads and utilities, storm-water detention facilities, recreational facilities, pedestrian trails and open-space. A general illustration of the current development plan is shown on Plate 2. When detailed development plans become available, the recommendations presented in this report should be reviewed for consistency with the project as actually designed, and appropriate, supplemental study undertaken to prepare project-specific geotechnical engineering design and construction recommendations for the project.

1.3 PREVIOUS INVESTIGATION

In 2015 GEOPlus, Inc. performed investigations at the project site and prepared a Preliminary Geotechnical Investigation Report dated February 10, 2015 (GEOPlus, Inc. file nos. 1481/15R501). The current development plan, as shown on Plate 2 is very similar to the development plan addressed in the 2015 report. To further assess challenges presented by the shallow volcanic rock at the site, GEOPlus, Inc. observed a D-10 Trial Ripping Operation. Results from this operation were summarized in a June 4, 2015 document, which is included with this report as Appendix C.

GEOPlus, Inc. also prepared a Preliminary Hydrogeologic Assessment for the project site dated May 21, 2010 (GEOPlus, Inc. file nos. 1333/10P272). Results of this assessment are briefly summarized in Section 2.5 of this report.

1.4 PURPOSE AND SCOPE OF SERVICES

The purpose of our investigation was to explore and evaluate the subsurface conditions, primarily within the western portion of the site in order to provide design-level geotechnical engineering design and construction recommendations for infrastructure development consisting of underground utilities and asphalt concrete pavements, and to provide preliminary geotechnical engineering information pertaining to development of proposed residential and commercial structure foundations and concrete slabs-on-grade, bridge/culvert foundations, and retaining walls. The scope of our services included the following:

- A review of available subsurface information contained in our files pertinent to the project site.
- Geologic evaluation of subsurface earth units, geologic conditions, and seismic hazards based on review of available literature, maps, aerial photographs, and a site reconnaissance.
- Exploration of the subsurface conditions at various locations on the site using nineteen (19) backhoe test pits and fifteen (15) air-track borings.
- Limited laboratory testing of representative samples obtained during the field investigation to evaluate relevant engineering parameters of the subsurface soils.
- Engineering analyses on which to base preliminary geotechnical recommendations for site development.
- Preparation of this report which includes:
 - A description of the surface and subsurface site conditions encountered during our field investigation.
 - A description of the site geologic setting and possible, associated geology related hazards.
 - Preliminary recommendations related to the geotechnical aspects of:
 - Site preparation and engineered fill;
 - Temporary excavations, and trench backfill’
 - Permanent slopes and erosion protection;
 - Foundation design and construction;
 - California Building Code (CBC) seismic site coefficients for use in structural analysis;
 - Concrete slabs supported-on-grade;
 - Asphalt concrete pavements; and
 - Appendices which include a summary of our field investigation and laboratory testing programs.

2. GEOLOGIC AND SEISMIC CONDITIONS

2.1 REGIONAL AND LOCAL GEOLOGIC SETTING

The project site is located within the northern portion of the Great Valley Geologic Province of California. The Province is characterized by thousands of feet of marine and non-marine (continental) sedimentary rocks, and volcanic rocks that have accumulated within a large down-warped basin, known as the Great Valley, over the last about 100 million years (DWR, 2014). In the Chico area, the rock formations and sediments exposed are generally Tertiary (about 65 to 2 million years old and younger) and Quaternary (less than 2 million years old). The Tertiary rocks are dominated by the Tuscan formation, which includes up to 1500 feet of volcanic mudflows (lahars) with lesser amounts of volcanic conglomerate and sandstone (Helley and Harwood, 1985 and DWR, 2014). The Tuscan formation rocks and older and underlying Tertiary rocks are exposed in the hills east of Chico and north to east of Red Bluff (Harwood et al, 1981 and Harwood and Helley, 1987). The Quaternary sediments are generally semi- to unconsolidated-continental river system and tributary stream deposits with a few interbedded volcanic ash units. The Quaternary sediments mantle the Tertiary rock formations on the valley floor (Helley and Harwood, 1985 and DWR, 2014).

The Sierra foothills on the east side of Chico are the surface expression of the Chico Monocline, a broad upwarping caused by uplift on the east side of the Chico Monocline fault, located a few miles east of Chico. The fault has folded the Tuscan formation it into a monocline, such that the formation rocks dip as much as 25° to the west-southwest on the west side of the fault. With distance to the east the Tuscan formation rocks become relatively horizontal. Butte County gets its name from the geomorphic structures (buttes) formed by uplift and subsequent erosion of the Tuscan formation in the Sierra foothills. Uplift on the Chico Monocline fault is estimated to have occurred largely between 1 million and 2½ million years ago (DWR, 2014; Harwood et al, 1981; and Harwood and Helley, 1987).

2.2 FAULTING AND SEISMICITY

Butte County and the Great Valley geologic province are not characterized by an abundance of active faulting. The site is not located within an Earthquake Fault Zone designated by the State of California (Hart and Bryant, 2007). Published mapping by the California Geological Survey

(CGS) indicates the closest active fault system considered to have ruptured the ground surface is Cleveland Hills fault located about 22 miles southeast of the site (Jennings and Bryant 2010 and Saucedo, 1992). This fault produced an M5.7 earthquake in 1975 that is widely believed to be associated with unprecedented fluctuation in the level of Lake Oroville (Topozada and Cramer, 1984). This 1975 earthquake also produced ground rupture.

A review of potentially active fault mapping by the United States Geological Survey (USGS) and CGS (Jennings and Bryant, 2010 and Saucedo, 1992 and Harwood and Helley, 1987) indicate that a few potentially active faults exist in the region. The closest known fault considered to be potentially active, therefore a potential seismic source, is the Chico Monocline fault located 1 to 2 miles east of the project site. The Magalia fault, Paradise fault and Cohasset Ridge faults are located approximately 11, 13 and 16 miles northeast of the site, respectively. The Paynes Peak fault is located approximately 25 miles southeast of the site. These faults, unlike the Chico Monocline fault, have well defined surface expressions, and like the Chico Monocline fault, are lumped together as part of the of the Foothills fault system seismic source by the California Geological Survey (Cao, et al., 2003). Two deep and distant aftershocks associated with the above described 1975 Oroville earthquake are attributed to the southern end of the Chico Monocline fault (Harwood and Helley, 1987). The southern end of the Corning Fault, concealed beneath the Sacramento Valley alluvium, is located about 24 miles west of the site. The Corning fault has experienced several small earthquakes during historic time and is considered a possible source of moderate to strong earthquakes as well (Harwood and Helley, 1987).

Relative to historical seismicity, CGS Map Sheet 49 (Topozada et al, 2000) and a USGS on-line earthquake catalogue (USGS, 2019) indicates that nine M5 or greater earthquakes, and one of M6 or greater, have been reported to have occurred within about 60 miles of the site during the period of 1800-2019. None to minor structural damage in the Chico area has been reported to be associated with these earthquakes. Four of these earthquakes occurred in the area of the Mohawk Valley / Indian Valley fault zone located roughly 50 miles northeast of the site. The following Table 1 lists these earthquakes, dates of occurrence, and respective distances from the site.

**TABLE 1:
SIGNIFICANT EARTHQUAKES NEAR CHICO, CALIFORNIA**

<i>Date</i>	<i>Magnitude (M)</i>	<i>Approximate distance & direction from site (km)</i>	<i>Location (Approx.)</i>
January 7, 1881	5.0	22 W	Los Molinos
April 29, 1888	6.2	55 E	Portola
June 23, 1909	5.9	42 SE	Camptonville
April 15, 1928	5.5	49 W	Newville
February 8, 1940	5.7	20 N	Cohasset
July 7, 1946	5.0	54 NE	Lassen Peak
March 20, 1950	5.5	52 NE	Lassen Peak
August 1, 1975	5.7	22 SE	Oroville
August 10, 2001	5.2	60 E	Quincy
May 24, 2013	5.7	49 NE	Westwood

References: *CDMG Map Sheet 49 (Topozada et al, 2000)* and *on-line Earthquake Catalogue (USGS, 2019)*. Seismographic values for magnitude (M) are used as available, moment magnitude is used where available, otherwise Richter (local) magnitude or surface wave magnitude is used.

2.3 SITE GEOLOGY

2.3.1 Tuscan Formation

The site is located along the western margin of the Chico Monocline. The primary geologic formation exposed along the Chico Monocline is the Tuscan formation, which typically consists of a thickly-bedded sequence of westward-dipping Pliocene-age volcanic mudflows (lahars) and conglomerates. Rock exposed at the surface of the site is mapped by Harwood et al (1981) and Helley and Harwood (1985) as unit C of the Tuscan formation. Unit C is denoted as Ttc on Plate 3, Site Exploration and Geologic Map. Tuscan formation units B and A underlie unit C at many locations on the Chico Monocline, but are not mapped within the study area. As shown on Plate 3, unit B (map symbol Ttb) is mapped across Little Chico Creek to the north of the site.

Per Harwood et al (1981) unit C is described as predominantly lahars composed of angular to subrounded volcanic fragments (cobbles and boulders) as much as 10 feet in diameter in a matrix of gray-tan volcanic mudstone. Composition and texture of fragments and ratio of fragments to matrix are highly variable. Lahar deposits are reversely graded (coarser fragments tend to be more concentrated at the top of individual lahars) and range in thickness from 2 to 35 feet.

Upper and lower contacts are sharp (See photo 7 below). The total thickness of unit C is in excess of 150 feet.

Thin conglomerate lenses and channel fills are present between lahar units. These were observed in a few areas of the site within eroded stream channels. The observed conglomerate was generally weakly to well-cemented gravel and cobble conglomerate with occasional sandstone layers. Where observed the conglomerate ranged from about 2 to 8 feet in thickness (See Photos 5 and 6 below).

Surface exposures of the lahar are common all over the site, particularly on the treeless mesas and on slopes between the mesas (See Photos 1 and 4 below). Areas where hard lahar is exposed at the surface or beneath a very thin mantle of soil are referred to by the local contractors as “lava cap”. On the aerial photograph base map of Plate 3, larger areas of rock outcrop on slopes are visible as darker brown and gray patches above and/or below tree lines. Rock outcrop as small ledges are also common within the tree lines at the margins of the broad mesas (See Photo 2 below).

The individual lahar units dip approximately 5 degrees to the southwest at the site. The general trend of topography on the site roughly follows the dip of the lahar units. Many of the tree lines visible on the air photo base map of Plate 3 also generally follow the boundaries between lahar units. Many of the tree lines are marked by boulder fields and/or lahar ledges indicative of the boundaries between individual lahars (See Photo 3 below).



Photo 1: Typical gentle to moderate slope with scattered lahar surface exposures among thin soil cover areas with grass, and scattered surface cobble and boulder. Photo taken at Section 118



Photo 2: Lahar ledge outcrop at break from gentle to moderate slope. The ledge pictured, located between Sections 115 and 118, is 3- to 4-feet high.



Photo 3: Boulder field at slope break on south side of Section 118. Boulders are up to 7-feet nominal dimension.



Photo 4: Doe Mill Road at Section 232. Lahar has been exposed by removing 2 to 5 inches of soil. Red lines demark two NNE trending, near vertical fractures within the lahar that are common to the site and vicinity.



Photo 5: 3 foot thick conglomerate lens beneath 4 foot thick lahar layer at ravine within Section 118. More lahar underlies conglomerate lens, which is of limited lateral extent. Note the rounded cobble in the conglomerate vs the more angular clasts within the lahar.



Photo 6: 6 foot thick section of sandstone and conglomerate within storm drain trench exposure at the end the existing paved Doe Mill Road (Section 226). Per the trenching contractor, very hard lahar underlies the conglomerate at the bottom of the photo.



Photo 7: 3 layers within lahar unit likely representing multiple pulses of flow at ravine within Section 118. Red lines demark the top and bottom of the middle layer.

Fracturing within the lahars is very widely spaced (generally greater than 10 feet). Many of the more continuous fractures are visible on the Plate 3 aerial photograph, especially on the broad treeless mesas. The light colored lineaments that generally trend north, northeast and/or west-northwest illustrate the location of these fractures. Photo 4 above shows a field exposure of two north-northeast trending fractures exposed along Doe Mill Road. Per Harwood et al (1981), most of these fractures are representative of cooling fractures. However, the long, continuous and north trending fractures visible in the eastern portion of the site are representative of tension fractures related to flexure of the Chico Monocline. Several of these continuous flexure fractures are shown on Plate 3. They are readily visible on the aerial photograph by the light colored lineaments and linear alignment of oak trees.

2.3.2 Alluvium

The only other geologic unit mapped on the site is alluvium (map symbol Qal on Plate 3) associated with two major drainages crossing the site. These alluvial terrace and stream channel deposits consist of unconsolidated sand, gravel, cobble and silt. On-site these deposits are generally less than about 4 feet in thickness and are located in the lowest portions of the site near the northwest and south margins of the site.

2.3.3 Springs and Seepage

Our field observations were made on several occasions during January of 2015. Water was observed flowing within Little Chico Creek and Comanche Creek at the north and south margins of the site throughout January. Water was observed flowing within the north and central drainages, as well as several tributaries during early January, but ceased in the latter part of the month after a several rainless weeks. Four spring / seepage areas off the main drainages were observed in late January as marked on Plate 3. These spring areas appear to be related to boundaries between individual lahar units and/or conglomerate lenses. The concentration of trees along lahar unit boundaries at slope breaks indicates that seasonal groundwater flows along the boundaries. Also, many of the trees on the broad mesa areas are located along fractures or at fracture intersections indicating that the fractures act as pathways for seasonal groundwater flow.

2.3.4 NRCS Soil Mapping

A review of the National Resource Conservation Service’s Web Soil Survey (NRCS, 2014) indicates that the vast majority of the site is mantled with thin soils of the Doemill-Jokerst soil series. Basically where the Tuscan unit C rock underlies the site this soil unit is present. The soil basically consists of a one inch A horizon of gravelly loam and up to 14 inches of B horizon soils also consisting of gravelly loam. Micro features on gentle slopes include mounds, which are readily visible on the broad treeless mesas (See photos 8 and 9 below). Averaged engineering properties listed for this soil per NRCS (2014) include the following:

pH	6.7
% clay	19
% sand	32
% silt	48
plasticity index	13
liquid limit	31



Photo 8: Soil mounds on gently sloping lava cap terrain at Section 110/111. Mounds are evident by the taller and lighter colored grass.



Photo 9: Soil Mounds on gently sloping lava cap terrain at Section 204

Per NRCS (2014), areas underlain by alluvium are mantled with soils of the Clearhayes-Hamslough soil series, which consists of gravelly sandy loam and extremely gravelly sandy loam up to about 48 inches in thickness. Averaged engineering properties listed for this soil per NRCS (2014) include the following:

pH	7.3
% clay	25
% sand	56
% silt	16
Plasticity Index	20
Liquid Limit	41

2.4 POTENTIAL GEOLOGIC HAZARDS

2.4.1 Ground Rupture

Ground rupture hazard is generally evaluated in California on the basis of the presence of active faults by Alquist-Priolo (AP) Earthquake Fault Zones Act definitions (Special Publication 42, Hart and Bryant, 2007). AP faults are defined by the State as those having evidence of displacement within the past 11,000 years (i.e. Holocene epoch). The closest AP fault zone is the Cleveland Hills fault located more than 20 miles south of the site. The nearest mapped potentially active fault is the Chico Monocline fault, but as described in Section 2.2 and per Hart and Bryant (2007), this fault is not considered to present a surface rupture hazard. As such, the potential for surface fault rupture to occur at this site is considered very low.

2.4.2 Seismic Ground Motions

Chico and the northern Sacramento Valley in general are in an area of low seismicity relative to other areas of California. However, the possibility of an earthquake generated on a distant regional fault, may subject the site to moderate or strong shaking. Faulting and historical seismicity are described in Section 2.2 and Seismic design parameters for use in structural analyses are presented in Section 4.13, Table 5.

2.4.3 Seismically Induced Liquefaction

Seismically induced liquefaction is a phenomenon, which occurs in generally loose, saturated, and sandy and/or gravelly alluvium of Holocene or latest Pleistocene age, when subject to moderate or strong seismic shaking. Since the site is devoid of alluvial deposits thicker than about 4 feet in maximum thickness, it is our professional opinion that seismically induced liquefaction is not a geologic hazard of concern at this site.

2.4.4 Slope Instability

Site topography is variable across the site; however, no landslides or evidence of slope instability were observed on the site. In general, the Tuscan formation is not associated with landsliding. In some locations where steep bluffs are present a rock-toppling hazard does exist; however, no such bluffs exist on the site.

We understand that cut and fill slopes for the project will not likely exceed 15 feet; hence, provided that earthwork cut and fill slopes are constructed as recommended in subsequent sections of this report slope instability should not be a hazard for the project.

2.4.5 Expansive Soils

No expansive soils or bedrock material were observed on the site; and as such, expansive soils are not considered a potential hazard for the project. Additionally, per Figure S-3 of the Chico 2030 General Plan (City of Chico, 2011) the site is not within an area anticipated to contain moderately or highly expansive soils. Any soils imported to the site should be tested prior to importing to confirm that they are of low expansion potential or non-expansive. Should moderately expansive or higher expansion potential soil be imported to the site, specific geotechnical engineering design and construction recommendations should be developed to reduce potential future problems to improvements from the use of these soils.

2.4.6 Flooding

The site is not downslope of any major reservoirs and contains no stock ponds. Per Figure S-2 of the City of Chico (2011), the site is not within potential dam failure inundation areas from Black Butte Reservoir, Whiskeytown Reservoir or Shasta Lake. Additionally, per the City of Chico (2011), Figure S-1, none of the site lies within a 100-year flood zone as defined by FEMA in

2009. Localized flooding in areas immediately adjacent to the 4 major drainages crossing the site may occur from time to time; however, we understand that greenbelt areas are planned around these drainages.

2.5 SITE HYDROGEOLOGY

GEOPlus' Hydrogeologist, William Bergmann, CHG prepared a Preliminary Hydrogeologic Assessment of the project site, the results of which were documented in a brief report dated May 21, 2010 (GEOPlus, Inc., 2010). Following is a summary of the conclusions presented in the 2010 Assessment:

- The predominant geologic material observed at the site is well lithified lahar rock of the Tuscan formation unit C. It is commonly known that the lahar is relatively impermeable and therefore restricts water transmission.
- Fractures observed in the lahar were generally discontinuous, tight and widely spaced which would not suggest the potential for active recharge. It can be expected that limited water migration could occur along these fractures; however, based on the tight fracture apertures and wide spacing between fractures, the volume and rate of water that could reach an underlying aquifer should not have a significant impact to groundwater quality or quantity. This conclusion is further supported by the great thickness of the lahar layers separating the drainage channels from underlying aquifers.
- Unit B of the Tuscan formation which underlies unit C is the primary aquifer unit of the formation and outcrops of this unit were not observed on-site. Furthermore, the basal tuff unit of unit C was not observed on-site either.
- Beds of poorly cemented granular geologic material, were not observed in thicknesses or bedding attitudes conducive for groundwater recharge.
- Alluvial material that could potentially recharge shallow aquifers were of the site are limited to areas that have been excluded from proposed project development and are proposed to remain in their natural state. This use restriction should mitigate on-site impacts to groundwater recharge in these areas.

It is our professional opinion that the hydrogeologic conditions of the site have not changed and the conclusions of the 2010 assessment remain valid considering the current development plan.

3. SITE CONDITIONS

3.1 GENERAL SURFACE DESCRIPTION

The subject property encompasses 1,448 acres and is bounded by residential subdivisions along Little Chico Creek to the north, a City of Chico bike path (Potter Road) and undeveloped property to the west, Skyway and Honey Run Road to the south, and undeveloped property to the east. The boundaries of the project and the proposed development plan, as presently envisioned, are shown on Plate 2. Initial development is planned for the southwestern portion of the site with access from Skyway.

As illustrated on Plate 1, Site Location and Topographic Map, the site is characterized by gentle to moderately sloping terrain generally descending to the west-southwest. Based on the USGS 7½-minute topographic maps for the Chico and Hamlin Quadrangles, the site elevation ranges from about 550 feet (MSL) at the northeast corner to about 250 feet near the southwest corner. The southern portion of the site is traversed by Comanche Creek and two un-named seasonal drainages traverse the central and northern portions of the site; these are labeled as the northern and central drainages on Plate 1. These drainages all trend generally west-southwest. Two broad, relatively treeless mesas dominate the site topography between Comanche Creek and the central drainage, and between the northern drainage and the north boundary of the site.

Existing vegetation on the site is predominantly short grass and weeds (to about 6-inch tall) with oak woodland occurring generally along the edges of the mesas, on slope breaks within the drainages, and along the stream banks. As shown on Plate 3, the woodlands generally occur as somewhat linear bands. The woodland vegetation consists predominantly of blue oak, interior live oak and buck brush, with scattered digger pines.

Existing improvements observed on the site include high-voltage electric transmission towers and lines which traverse the site from the northwest corner to the south central portion of the site. A dirt road follows this easement across the entire site and is clearly visible on Plate 3. A second transmission line traverses the southern margin of the site from west to east. The old Doe Mill Road, traverses the north mesa from the end of the paved Doe Mill Road at the western margin of the property to the northeast corner of the site. This road exposes the lahar surface “lava cap” through almost its entire length. Old wooden buildings and what appears to be a well are present

at the west margin of the site near the south end of the bike path. Rock fences traverse the site in many areas and wire fences are present in some locations as well.

3.2 FIELD EXPLORATION

The field exploration program for this project consisted of performing a geologic reconnaissance, drilling 15 holes with an air-track drill, and excavating 19 test pits with a tractor-mounted backhoe.

The geologic reconnaissance was performed by our engineering geologist to map the distribution of geologic units and observe other pertinent geologic information, i.e. seepage areas and bedrock/soil exposures. Our interpretation of site geologic/earth units is shown on Plate 3, the Site Exploration and Geologic Map.

Subsurface exploration was performed by both air-track drilling and excavating test pits. The air-track drilling was performed to provide qualitative information regarding the type and relative strength of the bedrock underlying the site. Test pit excavations were then made at select locations based on the findings of the geologic reconnaissance and air-track drilling to provide further indication and samples of the surficial soils and weathered bedrock materials. Air-track drill holes are designated as A-1 through A-15 and test pits designated as TP-1 through TP-19. Further discussion of the field exploration program is presented in Appendix A.

In June of 2015, GEOPlus, Inc. observed a trial ripping operation with a Caterpillar D-10 dozer to further assess excavation challenges presented by the shallow lahar rock identified in 2015 Preliminary Geotechnical Investigation Report. Results from this operation were summarized in a June 4, 2015 document (GEOPlus, Inc., 2015b), which is included with this report as Appendix C.

3.3 SUBSURFACE FINDINGS

The site is mantled with relatively thin soil deposits, ranging from less than ½-foot to about 1½-foot thick, underlain by Tuscan formation Unit C lahar. The surficial soils contain variable amounts of gravel, sand and cobble, and occasionally boulder. The soils classify as clayey sand (SC), clayey sand with gravel and cobble, and as sandy lean clay (CL) with gravel and cobble. Based on laboratory testing, these soils are typically of low to medium plasticity and very low to

low expansion potential. The soils encountered are generally consistent with those described for the site by NRCS Web Soil Survey (See Section 2.3.4)

The underlying bedrock formation consists predominantly of variably weathered and variably strong lahar. The lahar appears as a fine-grained matrix of mud, volcanic ash, sand and gravel with inclusions of andesitic gravel, cobble and boulder. Across the vast majority of the site, the lahar is hard upon first encountering beneath a thin mantle of soil, particularly on the broad mesa areas. This condition is typically referred to by the local contractors as “lava cap”. In some areas the surface of the lahar is weathered allowing for penetration with the backhoe of a few inches to a maximum of about 5 feet. Test pits in which some excavation into the lahar with the backhoe was achievable are shown in green on Plate 3.

For a summary of observations during the Caterpillar D-10 dozer trial ripping operation conducted in June of 2015, see GEOPlus, Inc. (2015b), which is included with this report as Appendix C.

The air track drilling exploration was concentrated on the broad mesa areas in attempt to determine if the hard lahar at the surface continued to great depth or if softer lahar units, or conglomerate were present beneath. Based on the air track drilling, the lahar is generally hard and gray (slightly weathered) for considerable depth; however, in some locations softer and weathered (brown) lahar units were encountered after penetrating 6 to 12 feet of hard gray lahar. The weathered lahar units ranged from one to several feet thick where encountered. Very little conglomerate was encountered within the air track borings. Boring A-8 was drilled adjacent to an eroded ravine exposing about 6 feet of conglomerate to “ground truth” the drilling operation and make sure that the conglomerate was readily discernible in the drill cuttings. Whereas the lahar cuttings were generally very fine, the conglomerate cuttings contained an abundance of rounded gravel. **See also Section 2.3.1 for further discussion and photographs of the Tuscan formation rock encountered on the site.**

Several laboratory tests including Atterberg Limits (ASTM D4318) and Expansion Index tests (ASTM D4829) were performed on samples of the soils and weathered bedrock materials encountered on-site to evaluate the plasticity and expansion potential. The results indicate the surficial soils are of low to moderate plasticity with very low to low expansion potential. The weathered lahar (**Ttc**) excavated from Test Pit TP-8, when processed to soil consistency, is highly plastic, but of low expansion potential. The results of these tests are briefly summarized in Table 2, below.

**TABLE 2:
ATTERBERG LIMITS AND EXPANSION INDEX TEST RESULTS**

Location	Depth (ft)	Liquid Limit (LL)	Plasticity Index (PI)	Expansion Index (EI)	USCS Classification & Geologic Unit
TP-1	0 to 1	33	13	25	SC/CL
TP-5	0 to 1	30	8	13	SC/CL
TP-8	4 to 5	60	24	-	MH (Ttc)

- No EI test performed; however, R-Value test showed very low expansion pressure.

A discussion of the field exploration program is presented in Appendix A of this report. Detailed descriptions of the subsurface conditions encountered during our field investigation are presented in tabular form on the Summary of Air-Track Borings and Summary of Test Pits within Appendix A. A detailed discussion of the laboratory testing program and results are presented in Appendix B of this report.

3.4 GROUNDWATER

At the time of our field investigation, free groundwater was not encountered within the air-track borings or in test pits. Moist to wet soils were encountered in the test pits above the soil/rock interface. See Section 2.3.3 for a discussion regarding observed springs and seepage conditions.

4. PRELIMINARY CONCLUSIONS AND RECOMMENDATIONS

4.1 GENERAL

Based on the results of our field investigation and laboratory testing program, it is our professional opinion the site should be generally suitable for the proposed multi-use development. However, this site does present several significant development planning and design challenges from a geotechnical perspective. These factors include:

- Excavatability of the strong lahar bedrock;
- Suitability of on-site materials for use as engineered fill, select material or landscape soil;
- Seepage through lahar fractures/cracks and coarse fill material;
- Limited amount of on-site soil for fill construction and/or landscape activities;
- Cut-fill transitions and differential settlement within deeper fills; and
- Foundation resistance to lateral and uplift loads.

Preliminary recommendations to reduce potential adverse effects of these conditions as well as general information regarding the geotechnical aspects of project design and construction are presented in the following sections of this report.

4.2 EXCAVATABILTIY

Based on the results of our field investigation, the Caterpillar D-10 trial ripping operation performed in 2015, and observation of grading in adjacent areas, the exposed lahar bedrock is generally impenetrable to moderate excavation effort, and resistant to heavy excavation effort such as the Caterpillar D-10 bull dozer with single shank ripper. The generally slightly weathered and sometimes highly weathered lahar surface was exposed in all 19 test pits; the backhoe was only capable of scraping the surface of the lahar in 10 of the test pits. Of the nine test pits where minimal excavation into or beneath the lahar was possible (1 to 2 feet penetration), most were located very near the boundary of proposed open space areas.

Historically excavations in the lahar at other sites north and west of the proposed development have been made by either ripping with a Caterpillar D-10 bull dozer equipped with a single shank ripper or use of specialized rock trenching equipment, i.e. a “rock wheel”. Based on our

observations of the materials exposed in these subdivisions and the storm drain currently under construction around the Belvedere Heights subdivision at the northwest corner of this site, it appears that in these areas the lahar units are generally thin (1 to 5 feet) and underlain by a conglomerate which is more easily excavated than the lahar.

Our reconnaissance and subsurface explorations indicate that on this site, the lahar is much more prevalent and the conglomerate much more rare than in nearby areas where development in the Tuscan formation has occurred. Air-track drilling rates and cuttings indicate slightly weathered, resistant lahar is present across the vast majority of the mesa areas where planned development is concentrated. Occasional thin layers of lahar that were softer and more weathered were encountered and rare thin layers of conglomerate and/or weak sandstone were encountered as well, but generally beneath several feet of hard lahar. The slightly weathered and hard lahar layers will be more resistant and inhibit excavation efficiency. Where encountered, the more weathered and “softer” lahar should be more amenable to excavation with the Caterpillar D-10 bull dozer with single shank ripper. Additionally, where present, conglomerate should be more amendable to excavation with the Caterpillar D10 bull dozer with a single shank ripper.

The lahar matrix material is not strong compared to other types of rock, i.e. basalt or granitic rock, which when only slightly weathered are commonly very difficult to excavate; however, it is the very limited fracturing present within the lahar that makes excavation very difficult. The fracture spacing is typically greater than about 10 feet in nearly vertical in orientation; this makes breaking up the rock with conventional excavation equipment very difficult. The use of mechanical rock breaking equipment, blasting and/or chemical rock breaking may be necessary. Rock trenchers can typically move through the lahar; however, they do have more trouble in portions of the lahar with higher concentrations of andesite boulders, which the local contractors sometimes call “blue rock”.

A summary of observations for the Caterpillar D-10 Trial Ripping Operation presented in Appendix C of this report. Some key observations during the trial were as follows:

- Extensive ripping and cross-ripping of the lahar is required;
- The excavated material is very coarse and angular; and
- With depth, moisture content of the lahar increased resulting in slightly easier ripping and breaking down of the excavation spoils with repeated passes of the dozer.

See Appendix C for greater detail of observations at the 10 individual trial locations.

4.2.1 Potential Borrow Areas

Our field investigation indicates that within low areas of the site with very gentle slopes the lahar weathering profile extends much deeper. Air track boring A-12 was drilled in the low area of the northern drainage and softer and weathered lahar was encountered to a depth of 10 feet. We understand that a small lake may be proposed here; as such, excavation of the weathered material to create a lake may prove to be much easier at this location and may generate a fair amount of suitable material for use as engineered fill for use in other area of the site. Although subsurface investigation was not performed due to proposed open space, a similar topographic condition is present adjacent to Comanche Creek in the southern portion of the site near Honey Run Road. This location may also have a significant depth of weathered lahar that could be mined for engineered fill.

Based on the presence of a significant amount of conglomerate within the Belvedere Heights subdivision and conglomerate exposed within the storm drain trench adjacent to the existing paved Doe Mill Road, it appears that a fairly wide channel deposit of conglomerate may extend to the south of Doe Mill Road onto the site. This area has also been proposed at present to be open space; as such subsurface investigation was not performed. However, if a fair amount of conglomerate is present in this area, it could prove to be another borrow area for engineered fill and further investigation may be warranted. As noted previously in this report, prior developments in the area have shown that the conglomerate is generally less challenging to excavate than the lahar.

4.3 SUITABILITY OF EXCAVATED MATERIAL FOR USE AS FILL

Soil - The feasibility of using native soil material for engineered fill will depend on the contractor's excavation and processing methods to address organic materials, cobbles and boulders. Surficial soils on large portions of the site are in low mounds (to 18 inches in maximum height) interspersed within exposed lahar with various amounts of cobbles and boulders. Processing the soils will require removing vegetation and/or organic material, and screening to remove over-sized materials. The soils are generally of low to medium plasticity (low expansion potential) and after processing the soil should be suitable for use as engineered fill.

Lahar – The lahar includes andesite cobbles and boulders in a fine grained matrix of mud, volcanic ash, sand and fine gravel. The excavation process is expected to generate lahar

fragments that should undergo degradation during excavation. Processing and/or screening will be necessary to remove cobble and boulder greater than 6 inches in size in order to use the material for engineered fill. Such material may be void-rich even after processing and compacting, depending on the actual breakdown of the material. Use of soil and/or geotextile separation/filter fabrics may be necessary to prevent migration of finer materials into voids in compacted coarse fill.

Crushing the fine-grained matrix of the lahar may produce materials suitable for uses such as pervious sand and/or gravel drainage materials. While crushing lahar and screening to produce aggregate base for roadway construction may be feasible, it is not known whether crushing will produce sufficient amount of appropriate sand and gravel sizes, nor whether such materials will meet Caltrans standards for material durability (R-value, Sand Equivalent and Durability Index) specified for pavement base material aggregate.

Conglomerate – Conglomerate material should be suitable for use as engineered fill provided it is processed to remove cobble greater than 6 inches in size. Due to the coarse nature of the conglomerate, soil separation measures (soil and/or geotextile filter material) may be necessary to inhibit migration of finer materials into compacted fill's matrix. When crushed and processed this material may meet Caltrans durability requirements and be suitable for use as aggregate base material since the sand, gravel and cobble constituents are generally stronger than the fine-grained matrix material of the lahar.

Andesite Cobble and Boulder - Andesite cobble and boulder material, whether derived from the site surface or from excavation in the lahar, should be suitable for construction of rockery retaining walls and/or landscaping purposes. When crushed and processed this material may meet Caltrans durability requirements and be more suitable for use as aggregate base material since it is stronger than the fine-grained matrix of the lahar.

4.4 SEEPAGE THROUGH LAHAR FRACTURES AND COARSE FILL

Surficial soft/wet areas were observed on-site that appeared to be the result of seepage accumulating and/or flowing from between individual lahar units, within fractures of the lahar and/or as moisture perching atop the lahar, due to the generally low hydraulic conductivity of the lahar. Structures placed partially or totally on lahar should incorporate measures to collect and convey seepage that surfaces beneath the structure foot print and divert it away from the

structure. Concrete slabs-on-grade support should include robust vapor retardation measures as well.

Underground utility trenches and pavement subgrades will tend to both intercept and collect seepage from natural sources as well as from future rainfall, runoff and landscape irrigation. Seepage accumulation in pavement baserock sections is a primary cause of premature pavement distress and failure. As such it will be necessary to incorporate subsurface drainage measures in the project to collect and divert seepage to suitable retention/disposal features. Recommended provisions for collecting and diverting utility trench backfill and baserock seepage are presented on Plate 4 - Storm drain Trench Subdrain Detail, and Plate 5 - Utility Trench and Street Seepage Control Details.

We anticipate that fill processed from on-site lahar, cobble and boulder and/or conglomerate will produce relatively coarse fill materials that will readily transmit seepage. Appropriate measures such as soil filters and/or geotextile fabrics will likely be necessary to control erosion and/or protect intrusion of finer materials into coarser fill.

4.5 CUT - FILL TRANSITION AND DIFFERENTIAL FILL SETTLEMENT

Depending on the final development plans, it is possible that some structures may be located on building pads created by both cutting and filling. The transition across the cut and fill can result in slab distress in the form of cracking and slab settlement due to the difference in the compressibility between native rock and engineered fill. Options should be incorporated into the design and construction of structures subject to this condition to reduce the potential for distress associated with differential settlement. These options may include:

1. Over-excavate the cut side of the site and reconstruct the cut side to final grade with engineered fill; or,
2. Deepen foundations on the fill portion of the site to extend through engineered fill and bear in the same native materials as encountered on the cut side of the site. Addition of supplemental steel reinforcement may be necessary to reduce distress associated with differential settlement beneath concrete slabs-on-grade may be necessary if the settlement and distress is estimated to be unacceptable. Where severe conditions exist it may be appropriate to construct structural floors supported on concrete foundations.

The first option, while more common, may be less likely due to the presence of strong rock and the associated effort to excavate the rock. Where excavation is reasonably feasible, this is considered more desirable where concrete slabs-on-grade will be constructed since this approach, when properly constructed, produces a more uniform building pad with respect to settlement. The depth of over-excavation on the cut side of the building pad should be evaluated for each site based on the difference in the cut and fill thickness. Over excavation should extend at least 5 feet beyond the edge of the proposed improvements (including concrete slab-on-grade sidewalks). The over excavated area should be reconstructed to grade according to the standards for engineered fill. Specific recommendations for fill construction should be provided based on the actual depths of the cut and fill, taking into consideration the materials the cut and fill will be comprised of.

The second option is considered less desirable where concrete slabs-on-grade are planned since the slab-on-grade will be subjected to eventual settlement of the fill. The magnitude of slab settlement and/or distress could be reduced by supporting the fill portion of the slab on select granular, compacted engineered fill. While not only supporting the slab, the backfill gradation could be controlled such that the backfill could also serve to drain seepage that may accumulate beneath the structure and convey it to appropriate discharge locations.

4.6 SOIL CORROSIVE PEOPERTIES

Review of National Resource Conservation Service (NRCS) web soil survey (NRCS, 2014) data for the Doemill-Jokerst and Jokerst-Doemill series soils expected to be encountered on the site are predominantly coarse with silt and some clay. Soil pH ranges from 5.6 to 7.8, while salinity ranges from 0.0 to 0.5 mmhos/cm. While the pH values provided by the survey indicate that corrosion potential to buried structures and/or steel encased in concrete should be low, specific analysis of site soils including pH, electrical resistivity, chloride and sulfate content should be performed on the site soils when grading and utility plans are developed.

4.7 SITE PREPARATION

4.7.1 Removals/Over-excavation

Test pit excavations were backfilled with the excavated soil. Backfill was loosely placed and not compacted to the requirements typically specified for engineered fill. Structures, slabs-on-grade, or pavements located over these areas may experience excessive settlement. Therefore, removal

and compaction of test pit backfill is recommended prior to construction of improvements over these areas.

Within the alluvial areas and other isolated locations where near surface loose/soft soils may exist for depths greater than one foot, over-excavation should be performed to remove loose/soft near surface soils prior to placement of engineered fill or structural improvements.

4.7.2 Stripping and Grubbing

Prior to general site grading, grass, organic topsoil and any debris should be stripped and disposed of outside the construction limits. We estimate the depth of stripping to be 1 to 2 inches over most of the site. Deeper stripping or grubbing may be required where concentrations of organic soils, tree roots and stumps, or debris are encountered during site grading. Stripped topsoil (less any debris) may be stockpiled and reused for landscape purposes; however, this material should not be incorporated into any engineered fill unless the organic content is less than 3%.

4.7.3 Existing Utilities, Wells, and/or Foundations

Abandoned farm outbuildings and a possible well (location shown on Plate 1), rock and wire fences and overhead electric lines and support towers were the only improvements existing on the site when the field investigation was performed. Although not encountered during our field investigation, it is possible that other abandoned utility lines, septic tanks, cesspools, and/or foundations may exist on site. If these features are encountered within the area of construction, they should be removed and disposed of off-site. All excavations resulting from removal activities should be cleaned of loose or disturbed material (including all previously-placed backfill) and dish-shaped (with sides sloped 3(h):1(v) or flatter) to permit access for compaction equipment. Existing wells not to be used in the development should be abandoned in accordance with Butte County Environmental Health Division's requirements.

4.7.4 Scarification and Compaction

Following site stripping and any required over-excavation, areas consisting of soil or completely weathered bedrock that will receive engineered fill or to be used for the future support of structures or concrete slabs supported-on-grade be scarified to a depth of at least 8 inches unless, the fill is constructed directly atop hard rock as approved by the Geotechnical Engineer.

Soil should be uniformly moisture-conditioned to between 0 and 3 percent above the optimum moisture content and compacted to at least 90 percent of the maximum dry density as determined by ASTM (American Society for Testing and Materials) Test Method D 1557¹.

Within pavement areas consisting of soil the scarified subgrade should be compacted to at least 95 percent relative compaction to a depth of 12 inches.

In-place scarification and compaction may not be adequate to densify all disturbed soil within areas grubbed or otherwise disturbed below a depth of about 12 inches. Therefore, over-excavation of disturbed soil, scarification and compaction of the exposed subgrade, and replacement with engineered fill may be required to sufficiently densify all disturbed soil.

Following stripping, zones of loose surface soil present on the site should be over-excavated and replaced as engineered fill. The depth of over-excavation of loose soils is anticipated to be less than 12 inches in most areas.

Should site grading be performed during or subsequent to wet weather, near-surface site soils may be significantly above optimum moisture content. Perched groundwater may also develop above cemented soils and/or bedrock, saturating near-surface materials. This condition could hamper equipment maneuverability and efforts to compact site soils to the recommended compaction criteria. Disking to aerate, chemical treatment, replacement with drier material, stabilization with a geotextile fabric or grid, or other methods may be required to reduce excessive soil moisture and facilitate earthwork operations.

4.8 TEMPORARY EXCAVATIONS

4.8.1 General

The near-surface soils encountered during our field investigation consisted predominantly of sandy clay and clayey sand with varying amounts of gravel, cobble and boulder. Where present these soils may stand about 1½ horizontal to 1 vertical in shallow temporary excavations. Excavations into strong lahar (lava cap) and conglomerate will stand near vertical, although

¹ *This test procedure should be used wherever relative compaction, maximum dry density, or optimum moisture content is referenced within this report.*

existing near vertical fractures in the rock may result in local instability. Excavations deeper than 4 feet, where access by construction personnel is required, should be shored or sloped back in accordance with applicable CAL-OSHA regulations.

4.8.2 Excavation Characteristics

Hard lahar bedrock is predominant at the site and more limited occurrences of conglomerate bedrock were encountered. Historically in the vicinity the Tuscan formation lahar has been excavated with significant difficulty using a Caterpillar D-10 bull dozer equipped with a single shank ripper and/or specialized rock trenching equipment. The use of mechanical rock breaking equipment, blasting and/or chemical rock breaking may be necessary. For a more detailed discussion of rock excavation conditions anticipated for this site, see Section 4.2 of this report.

4.8.3 Construction Considerations

Heavy construction equipment, building materials, excavated soil, and vehicular traffic should not be allowed within 1/3 the slope height from the top of any excavation. Where the stability of adjoining buildings, walls, or other structures is endangered by excavation operations, support systems such as shoring, bracing, or underpinning may be required to provide structural stability and to protect personnel working within the excavation. Shoring, bracing, or underpinning required for the project (if any) should be designed by a professional engineer registered in the State of California.

During wet weather, earthen berms or other methods should be used to prevent runoff water from entering all excavations. All runoff water and/or groundwater encountered within the excavation(s) should be collected and disposed of outside the construction limits.

4.9 CUT AND FILL SLOPES

Cut slopes in native materials will likely expose a thin layer of soil overlying lahar and possibly conglomerate. The surficial soils should be stable at gradients of 2:1 (2 horizontal to 1 vertical). Cut in the lahar/conglomerate should be stable at gradients of ½:1, except where highly weathered or uncemented layers are encountered, or where adverse fractures are present. While fills constructed with native soil and/or bedrock should generally be stable at gradients of 2:1, appropriate subsurface drainage requirements for slopes should be evaluated on site specific data. Slopes constructed of coarse materials could be made stable at steeper gradients. The final

geotechnical investigation report prepared for the project should explore planned cut and fill slope locations and provide final guidance regarding stable slope configurations and drainage design.

Fill placed on existing fill or natural slopes steeper than 5(h):1(v) should be keyed and benched into the existing slope. In general, keyways should extend into firm, undisturbed soil and/or bedrock, be a minimum of 10 feet wide, 2 to 3 feet deep (below existing site grade), and extend the full length of the slope. Additionally, fill slopes exceeding 30 feet in vertical height should include at least one terrace as outlined in Appendix J of the California Building Code (CBC), latest edition.

To reduce the potential for surface erosion and sloughing, all fill slopes should be vegetated with deep-rooted perennial grasses. We recommend the fill slope be compacted to the edge of slope, then trimmed to final plan dimension. Where cut slopes encountered lahar or conglomerate, the potential for surface erosion is considered essentially nil, and it does not make sense to attempt to establish vegetation on such cut. To further reduce the potential for surface erosion, a berm or "V" ditch may be located at the top of slopes subject to significant overland water flows in order to intercept and redirect surface runoff from above the slope.

Subsurface seepage may be encountered seasonally along cut slopes and/or fractures that traverse onsite rock and overlying surficial soils. This potential seepage may result in the overland flow of water adversely impacting proposed project features. Therefore, we recommend the project Civil Engineer and Geotechnical Engineer review proposed grading plans with respect to the subsurface information available in this report in order to assess potential impacts to the proposed project (if any) and to plan the final geotechnical investigation to develop additional subsurface information in or to develop mitigation measures (if required).

4.10 ENGINEERED FILL

4.10.1 Materials

We anticipate surficial on site soils and mined and/or processed on-site rock will be used for engineered fill. All soils used for engineered fill should be nearly-free of organic or other deleterious debris, have low to moderate plasticity, and have a maximum particle size less than 6 inches in maximum dimension. In general, well-graded mixtures of gravel, sand, low plasticity silt, and small quantities of cobbles, rock fragments, and/or clay are acceptable for use as

engineered fill. Specific requirements for low-expansion potential engineered fill as well as applicable test procedures to verify material suitability are provided in Table 3, below.

TABLE 3: LOW EXPANSION POTENTIAL ENGINEERED FILL REQUIREMENTS			
Fill Requirement		Test Procedures	
		ASTM¹	Caltrans²
<i>Gradation</i>			
Sieve Size	Percent Passing		
6 inch	100	D422	202
3-inch	90-100	D422	202
¾ inch	50-100	D422	202
No. 200	5-50	D422	202
<i>Plasticity</i>			
Liquid Limit	Plasticity Index		
<65	<30	D 4318	204
<i>Organic Content</i>			
Less than 3%		D 2974	---
<i>Expansion Potential (ASTM D-4829)</i>			
Less than 30		D4829	---
¹ American Society for Testing and Materials Annual Book of ASTM Standards (latest edition)			
² State of California, Department of Transportation, Standard Test Methods (latest edition)			

4.10.2 Compaction Criteria

Native or imported materials to be used for engineered fill shall meet the requirements listed in Table 3 (above), should be placed at a uniform moisture content of 0 to 3 percent above optimum and compacted to at least 90 percent relative compaction. Fills deeper than 5 feet should be compacted to at least 95 percent relative compaction. The upper 12 inches of pavement subgrades should be compacted to at least 95 percent relative compaction. Disking and/or blending may be required to uniformly moisture condition soils used for engineered fill.

Where fill consists of predominantly coarse, granular material derived from on-site rock, it will not be feasible to test such soils using the conventional nuclear gauge method (ADTM D6938)

and produce reliable results. In such cases it will be necessary to use a procedural/method specification approach for addressing fill construction compliance. Such specification will depend on the gradation of the fill material and the equipment used to compact the fill. Based on our experience with construction of coarse material fill, it will likely require full-time multiple passes with a large, self-propelled compactor, such as a Caterpillar 815 and/or 825 to compact an 8-inch loose lift. Such specification should be developed by the project Geotechnical Engineer on-site, and will include full-time observation during construction to assess compaction compliance with project specifications.

4.11 TRENCH BACKFILL

4.11.1 Materials

Pipe zone backfill (i.e., material beneath and in the immediate vicinity of the pipe) should consist of native or imported soil less than one inch in maximum dimension; trench zone backfill (i.e., material placed between the pipe zone backfill and finished subgrade) may consist of natural or crushed native soil limited to 3 inches in maximum size, and which meets the requirements for engineered fill provided above.

If import or crushed native material is used for pipe or trench zone backfill, we recommend it consist of fine-grained sand. Coarse-grained sand and/or gravel may also be used for pipe or trench zone backfill provided the material is protected from potential for other materials (native soil or processed native materials) migrating into the relatively void spaces present in this type of material.

Recommendations provided above for pipe zone backfill are minimum requirements only. More stringent material specifications may be required to fulfill local codes and/or manufacturers requirements for specific types of pipes. We recommend the project Civil Engineer develop these material specifications based on planned pipe types, bedding conditions, and other factors beyond the scope of this study.

Since temporary perched water is likely to develop above aquitards such as hard rock, coarse trench backfill will collect seepage along the trench. Utility trenches excavated into hard lahar/conglomerate will collect and transmit seepage as well. Adverse effects of this water migration include potential seepage beneath or into structures located below street level and water migration beneath or through pavements. Where gravel or other coarse-grained soils are

used for trench backfill, including pipe bedding, the recommendations presented in Table 4 should be applied to the following situations:

TABLE 4 UNDERGROUND UTILITY TRENCH PIPE BACKFILL	
<i>Condition</i>	<i>Recommended Design/Construction Action</i>
First Floor Construction At or Near Elevation of Adjacent Street Grade	Slope utility trench down away from structure to reduce water migration beneath structure
First Floor Construction Below Adjacent Street Grade	Construct barrier in trench beneath foundation (or point of penetration) to reduce water migration into structure along trench. Barrier should extend at least 2 feet beyond the edges of foundation and extend from bottom of trench to above bottom of footing. Footing penetrations should be caulked with waterproof, flexible caulking.
Trenches Extending From High to Low Topographical Areas	Install seepage collection/drain in lower portion of trench to remove seepage collecting in backfill and dispose of seepage in storm drain inlet or other suitable location.

Plate 4, Storm Drain Trench Subdrain Detail, shows a means of collecting and disposing of utility trench seepage.

4.11.2 Compaction Criteria

All trench backfill should be placed and compacted in accordance with recommendations provided above for engineered fill (See Section 4.10). Mechanical compaction is recommended; ponding or jetting should be avoided especially in areas supporting structural loads or beneath concrete slabs supported-on-grade, pavements, or other improvements.

4.12 SPREAD FOUNDATIONS

4.12.1 General

It is anticipated that conventional shallow, reinforced concrete spread footings will be used for support of the proposed structures (buildings, bridges, and retaining walls). Location and design load information for structures are not available at this time; additional site-specific surface/subsurface exploration and/or engineering analysis will be required to develop recommendations for foundation bearing pressures and lateral force resistance parameters. In general, allowable dead plus live load bearing pressures in engineered fill constructed with native surface soils or processed on site coarse material are on the order of 2,000 to 4,000 psf. Allowable bearing pressures for foundations bearing on the strong, undisturbed Tuscan formation materials may approach 8,000 psf.

Footings for single story structures should be at least 12 inches wide; two-story and commercial structures should have minimum dimensions in accordance with the California Building Code requirements. Footing embedment depth will vary depending on whether the structure is supported on hard lahar bedrock, conglomerate, engineered fill and in cases combinations of these materials. Resistance to lateral loads may be developed by passive soil pressure, friction between the foundation and underlying material, and where foundation excavation is restricted and passive soil pressure inadequate, by rock dowels grouted into bedrock. Passive soil equivalent fluid pressure for lateral resistance may range from 250 to 350 pounds per cubic foot, while friction resistance may range from 0.25 to 0.40. Where excavation into the lahar is not reasonably feasible and the foundation cannot be embedded, foundation resistance to lateral and uplift forces may be achieved by grouting steel rock dowels into the lahar. Rock dowel size, spacing, and required embedment depth will depend on the structure load demand while resistance to shear and uplift will depend on the thickness and strength of the rock, factored by the dowel proximity to natural rock discontinuities such as fractures. Specific foundation parameter values should be evaluated after grading plans are developed.

4.12.2 Estimated Settlement

Total settlement of an individual foundation will vary depending on the plan dimensions of the foundation and the actual load supported, and whether the foundation is supported on 1) entirely hard rock, 2) a combination of hard rock and relatively thin engineered fill (less than 5 feet), or 3) engineered fill of differential thickness. On-site rock should have low compressibility

characteristics. Settlement of foundations is expected to occur rapidly and should be essentially complete shortly after initial application of the loads. Settlements on the order of ½ inch or less are anticipated where foundations are supported by engineered fill or hard bedrock.

4.13 CBC SEISMIC DESIGN PARAMETERS

The site is in a region of low seismic activity relative to other areas of California, but could be subjected to strong ground shaking during the life of the project. Therefore, structures at this site should be designed in accordance with applicable seismic provisions of the building codes. Structures should be designed for lateral force requirements as set forth in Section 1613 of the CBC (2016). Parameters for input to seismic modeling are provided in Table 5, below, on the basis of information contained in this report, CBC 2016 requirements, and ASCE 7-10, as follows:

TABLE 5 2016 CBC SEISMIC DESIGN PARAMETERS			
<i>Seismic Design Parameter</i>	<i>Reference</i>	<i>Symbol</i>	<i>Recommended Value</i>
Site Class	CBC Section 1613.3.2	A-F	C
Spectral Response Acceleration (short period)	CBC Figure 1613.3.1(1)*	S _s	0.616g
Spectral Response Acceleration (1 sec. period)	CBC Figure 1613.3.1(2)*	S ₁	0.270g
Site Coefficient (short period)	CBC Table 1613.3.3(1)*	F _a	1.154
Site Coefficient (long period)	CBC Table 1613.3.3(2)*	F _v	1.530
Spectral Response Acceleration (short period) - 5% damped	CBC Equations 16-39*	S _{DS}	0.473g
Spectral Response Acceleration (1 sec. period) – 5% damped	CBC Equations 16-40*	S _{D1}	0.275g
Peak Ground Acceleration	ASCE 7-10 Eq. 11.8-1*	PGA _M	0.284g
* Values obtained from http://earthquake.usgs.gov/designmaps/us/application.php			

4.14 RETAINING WALLS

It is anticipated that retaining walls will be used to support elevation differentials for the project since retaining walls minimize space requirements relative to conventional engineered fill slopes. Given the significant amount of boulder present on the site, in conjunction with the potential for

generation of boulder size material from excavation of the lahar, rockery protective and retaining walls will likely be included in the project. Conventional concrete or masonry-block retaining walls may also be constructed.

Conventional concrete or masonry-block retaining walls and retaining rockery walls should be designed to resist the earth pressures retained by compacted backfill, and any lateral force that will be applied to the wall due to surface loads placed at or near the wall during or after construction. Earth pressure values will depend on the engineering properties of the backfill material (compacted unit weight and friction angle) and inclusion or omission of internal wall drainage. As such, equivalent lateral fluid density may range from 40 to 95 pounds per cubic foot for static design analysis depending on whether the wall is drained or not drained, and free to rotate or rotation is restricted. The additional force on walls due to site seismicity is dependent on site seismicity, unit weight of the backfill and the height of wall.

Rockery retaining or protective wall design will be dependent on the quantity, size and weight of rock available for use, backfill unit weight and friction angle (for retaining walls) and inter-rock friction, in addition to lateral forces resulting from surcharge and seismic loads. Protective rockery walls may be used where required excavation cuts are stable, and the wall does not support lateral loads.

Specific geotechnical engineering design and construction recommendations for conventional and rockery retaining walls and rockery protective wall design and construction should be included in a design-level report once potential wall locations, types and heights are known. Recommendations should include wall drainage and backfill type as well as backfill compaction recommendations.

4.15 CONCRETE SLABS SUPPORTED-ON-GRADE

4.15.1 Subgrade Preparation

Prior to constructing concrete slabs supported-on-grade, surficial soil and/or rock should be processed as recommended in the SITE PREPARATION and ENGINEERED FILL sections of this report. Scarification and compaction may not be required if floor slabs are to be placed directly on undisturbed engineered fill which has maintained the soil moisture condition when compacted or when placed directly on weathered rock as recommended by the Geotechnical Engineer.

4.15.2 Rock Capillary Break

In order to provide enhanced concrete slab subgrade support, we recommend the cut or compacted subgrade be overlain with a minimum 4-inch thickness of compacted crushed rock. If this layer is desired to also serve as a capillary break, there should be less than 5 percent by weight passing the No. 4 sieve size. A capillary break material is intended to reduce the potential for soil moisture migrating upwards toward the slab.

4.15.3 Interior Concrete Slabs-On-Grade Construction Considerations

Subsurface moisture and moisture vapor naturally migrate upward through the soil and, where the soil is covered by a structure or pavement, moisture will collect. To reduce the impact of this subsurface moisture and the potential impact of introduced moisture (such as landscape irrigation or plumbing leaks) the current industry standard is to place a vapor retarder on the compacted crushed rock layer (described above). This membrane typically consists of visqueen or polyvinyl plastic sheeting at least 10-mil in thickness. It should be noted that although capillary break and vapor barrier systems are currently the industry standard, this system may not be completely effective in preventing floor slab moisture problems. These systems will not “moisture proof” the floor slab nor will it assure floor slab moisture transmission rates will meet floor-covering manufacturer standards. The design and construction of such systems are dependent on the proposed use and design of the structure. All elements of structure design and function should be considered in the slab-on-grade floor design. Structure design and construction may have a greater role in perceived moisture problems since sealed buildings/rooms or inadequate ventilation may result in excessive moisture in a building and affect indoor air quality.

Various factors such as surface grades, landscaping, adjacent planters, the quality of slab concrete, and the low permeability of the onsite soils and rock affect slab moisture control performance. In many cases, perceived floor moisture problems are the result of improper curing of floor slabs and flooring adhesives, not excessive slab moisture transmission. We recommend coordinating with a flooring consultant experienced in the area of concrete slab-on-grade floors for specific recommendations regarding your proposed flooring applications.

Special precautions must be taken during the placement and curing of all concrete slabs. High water-cement ratio of the concrete and/or improper curing procedures used during either hot or cold weather conditions could lead to excessive shrinkage, cracking, or curling in the slabs.

High water-cement ratio and/or improper curing may also increase the water vapor permeability of concrete. We recommend all concrete mix design, mixing and placement and curing operations be performed in accordance with the American Concrete Institute (ACI) Manual (current edition).

It is emphasized that we are not concrete slab-on-grade floor moisture proofing experts. We make no guarantee nor provide any assurance that use of the capillary break/vapor retarder system will reduce concrete slab-on-grade floor moisture penetration to any specific rate or level, particularly those required by floor covering manufacturers. The designers and builders should consider all available measures for slab moisture protection.

4.15.4 Surface Drainage

Foundation and slab performance depends greatly on adequate perimeter drainage of the structure. This drainage should be maintained both during construction and over the entire life of the project. The ground surface around structures should be graded such that water flows readily away from structures without ponding. In general, all areas within five feet of structures should slope away at gradients of at least 2 percent. Densely vegetated areas should have minimum gradients of at least 5 percent away from structures in the first 5 feet.

Planters should be designed and constructed such that applied water will not seep into the foundation areas or beneath slabs and pavement. In general, the elevation of exterior grades should not be higher than the elevation of the subgrade beneath the slab to help prevent water intrusion beneath slabs. In any event, residents should be instructed to limit irrigation to the minimum actually necessary to properly sustain landscaping plants. Should excessive irrigation, waterline breaks, or unusually high rainfall occur, saturated zones and “perched” groundwater should be expected. Potential sources of water such as water pipes, drains, swimming pools, garden ponds, and the like should be frequently examined for signs of leakage or damage. Any such leakage or damage should be promptly repaired.

4.16 PAVEMENTS

4.16.1 General

One resistance value (R-value) test was performed on a representative sample of the weathered lahar encountered within test pit TP-8 at the site. A laboratory R-value of 25 was obtained from

this sample considered representative of the weaker subgrade materials likely to be encountered within shallow cut areas and fill areas. Based on the hard lahar encountered in the near surface over the majority of the site, an R-value of 50 was estimated to represent the pavement subgrade “soil” across much of the site. Note that 50 is the highest R-Value that Caltrans pavement design procedures allow for subgrade materials. Once final grading plans have been developed, this information should be reviewed to determine the applicability of these recommendations. If subsurface soil and/or rock conditions vary from these materials, additional R-value testing may be prudent to refine the final design.

4.16.2 Asphalt Concrete Pavement Section Recommendations

Preliminary pavement sections presented in Tables 6 and 7 below are based on the R-values of 25 and 50 and current Caltrans design procedures. Traffic indices between 4.5 and 9.0 were assumed for the design of pavement sections. Caltrans design procedures for asphalt concrete pavements provide sections in units of feet, rounded to the nearest 0.05 feet. We have also provided sections in units of inches, rounded to the nearest ½ inch. Sections provided below **do not** include a Gravel Equivalent Safety Factor of 0.2 (as recommended by Caltrans). The traffic index used for design should be determined by the project Civil Engineer and local regulations. Changes in the traffic indexes will affect the corresponding pavement section thickness.

TABLE 6
RECOMMENDED ASPHALT CONCRETE
PAVEMENT SECTIONS - R-Value = 25

<i>Assumed Traffic Index</i>	<i>Asphalt Concrete</i>		<i>Aggregate Base</i>	
	<i>(feet)</i>	<i>(inches)</i>	<i>(feet)</i>	<i>(inches)</i>
4.5	0.17	2.0	0.65	7.5
5.0	0.17	2.5	0.75	9.0
5.5	0.20	2.5	0.80	9.5
6.0	0.20	2.5	0.90	10.5
6.5	0.25	3.0	0.95	11.5
7.0	0.25	3.0	1.05	12.5
7.5	0.30	3.5	1.10	13.5
8.0	0.30	3.5	1.20	15.0
8.5	0.35	4.0	1.30	15.5
9.0	0.35	4.5	1.40	16.0

**TABLE 7
RECOMMENDED ASPHALT CONCRETE
PAVEMENT SECTIONS - R-Value = 50**

<i>Assumed Traffic Index</i>	<i>Asphalt Concrete</i>		<i>Aggregate Base</i>	
	<i>(feet)</i>	<i>(inches)</i>	<i>(feet)</i>	<i>(inches)</i>
4.5	0.17	2.0	0.35	4.0
5.0	0.17	2.5	0.40	4.5
5.5	0.20	2.5	0.40	4.5
6.0	0.20	2.5	0.50	5.5
6.5	0.25	3.0	0.50	6.0
7.0	0.25	3.0	0.55	6.5
7.5	0.30	3.5	0.55	7.0
8.0	0.30	3.5	0.65	8.5
8.5	0.35	4.0	0.65	8.0
9.0	0.35	4.5	0.75	8.0

Pavement sections provided above are contingent on the following recommendations being implemented during construction.

- All pavement subgrades should be prepared as recommended in the SITE PREPARATION and ENGINEERED FILL sections of this report.
- The moisture content of *low expansion potential subgrade soils* must be 0 to 3 percent above optimum moisture content (to a depth of at least 12 inches below finished subgrade) at the time of aggregate base placement. Recommended soil moisture contents should be established either during site earthwork grading and/or final subgrade preparation and maintained up to the time of aggregate base placement. The depth of wetting should extend at least 12 inches below finished subgrade and should be verified by GEOPlus just prior to placing baserock.
- Subgrade soils should be in a stable, non-pumping condition at the time aggregate base materials are placed and compacted.
- Aggregate base materials should meet current Caltrans specifications for Class 2 aggregate baserock and be compacted to at least 95 percent relative compaction.
- Adequate drainage (both surface and subsurface) should be provided such that the subgrade soils and aggregate base materials are not allowed to become wet.

Recommended provisions for collecting and diverting baserock seepage are presented on Plate 5, Utility Trench and Street Seepage Control Details.

- Asphalt paving materials and placement methods should meet current Caltrans specifications for asphalt concrete.
- All concrete curbs separating pavement and landscaped areas should extend into the subgrade and below the bottom of adjacent aggregate base materials.

5. REFERENCES

-
- Cao T., Bryant W.A., Rowshandel B., Branum D., and Wills C.J. (2003), The Revised 2002 California Probabilistic Seismic Hazards Maps, California Geological Survey, June 2003.
- City of Chico (2011); Chico 2030 General Plan, April 2011.
- DWR (2014), Geology of the Northern Sacramento Valley, California: State of California Natural Resources Agency, Department of Water Resources Northern Regional Office, June 2014.
- GEOPlus, Inc. (2010), Preliminary Hydrogeologic Assessment, Honey Run – Doe Mill Project, Potter Lane and Honey Run, Chico, California, file no. 1333 report No. 10P272.
- GEOPlus, Inc. (2015a), Preliminary Geotechnical Investigation Report Valleys Edge Multi-Use Development Skyway at Honey Run Road, Chico, CA, file no. 1481, report no. 15R501.
- GEOPlus, Inc. (2015b), Caterpillar D-10 Trial Ripping Operation Valleys Edge Multi-Use Development Site, Chico, CA June 2&3, 2015, file no. 1481, document no. 15M537.
- Hart E.W. and Bryant W.A. (2007), Fault-Rupture Hazard Zones in California: California Geological Survey, Special Publication 42, 2007 interim revision edition, 38p.
- Harwood D.S. and Helley E.J. (1987). Late Cenozoic Tectonism of the Sacramento Valley, California: U.S. Geological Survey Professional Paper 1359.
- Harwood D.S., and Helley E.J. and Doukas, M.P. (1981), Geologic Map of the Chico Monocline and Northeastern part of the Sacramento Valley, California, 1:62,500: United States Geological Survey Map I-1238.
- Helley E.J. and Harwood D.S. (1985), Geologic Map of the Late Cenozoic Deposits of the Sacramento Valley and Northern Sierran Foothills, California, 1:62,500: United States Geological Survey Map MF-1790.
- California Building Standards Commission (2017) California Code of Regulation Title 24, Part 2, Volume 2 – California Building Code.
- Jennings C.W. and Bryan W.A. (2010), Fault Activity Map of California, California Geological Survey Geologic Data Map Series, Map No. 6.
- NRCS (2014), Web Soil Survey: <http://www.websoilsurvey.nrcs.usda.gov>.
- Saucedo G.J., (1992), Map Showing Recency of Faulting, Chico Quadrangle, California (Map No. 7A), 1:250,000 in California Department of Conservation Division of Mines and Geology Regional Geologic Map Series, Geologic Map of the Chico Quadrangle.
- Topozada T., Branum D., Petersen M., Hallstrom C., Cramer C., Reichle M. (2000), Epicenters of and Areas Damaged by $M \geq 5$ California Earthquakes, 1800-1999: California Department of Conservation Division of Mines and Geology Map Sheet 49.
- Topozada T.R., Cramer C.H. (1984), Induced Seismicity at Lake Oroville, California: California Division of Mines and Geology Open File Report 84-25 SAC.
- USGS (2019), Earthquake Hazards Program – Earthquake Archives: <http://www.earthquake.usgs.gov/earthquakes/search>.

6. ADDITIONAL SERVICES AND LIMITATIONS

6.1 ADDITIONAL STUDIES

Due to the preliminary nature of this study and currently unknown specifics of project design, additional geotechnical investigation and evaluation will be necessary to address specific building and bridge foundations, retaining structures, water features and other elements of the project. GEOPlus Partners will provide work scope and cost outlines to address these items and prepare design level geotechnical reports as project planning and construction progresses. GEOPlus Partners also provides construction observation and testing during excavation, earthwork, roadway and structure construction.

6.2 LIMITATIONS

Recommendations contained in this preliminary report are based on our field observations and subsurface explorations, limited laboratory tests, and our present knowledge of the proposed construction. It is possible that soil, rock, and groundwater conditions could vary between or beyond the points explored. We have prepared this preliminary report in substantial accordance with the generally accepted geotechnical engineering practice as it exists in the site area at the time of our study. No warranty is expressed or implied.

This preliminary report may be used only by the client and only for the purposes stated, within a reasonable time from its issuance. Land use, site conditions (both onsite and off-site) or other factors may change over time, and additional work may be required with the passage of time. Any party other than the client who wishes to use this report shall notify GEOPlus Partners of such intended use. Based on the intended use of the report, GEOPlus Partners may require that additional work be performed and that an updated report be issued. Non-compliance with any of these requirements by the client or anyone else will release GEOPlus Partners from any liability resulting from the use of this report by any unauthorized party.

Reference: USGS, 7.5-Minute Topographic Quadrangles, Chico, CA and Hamlin Canyon, CA

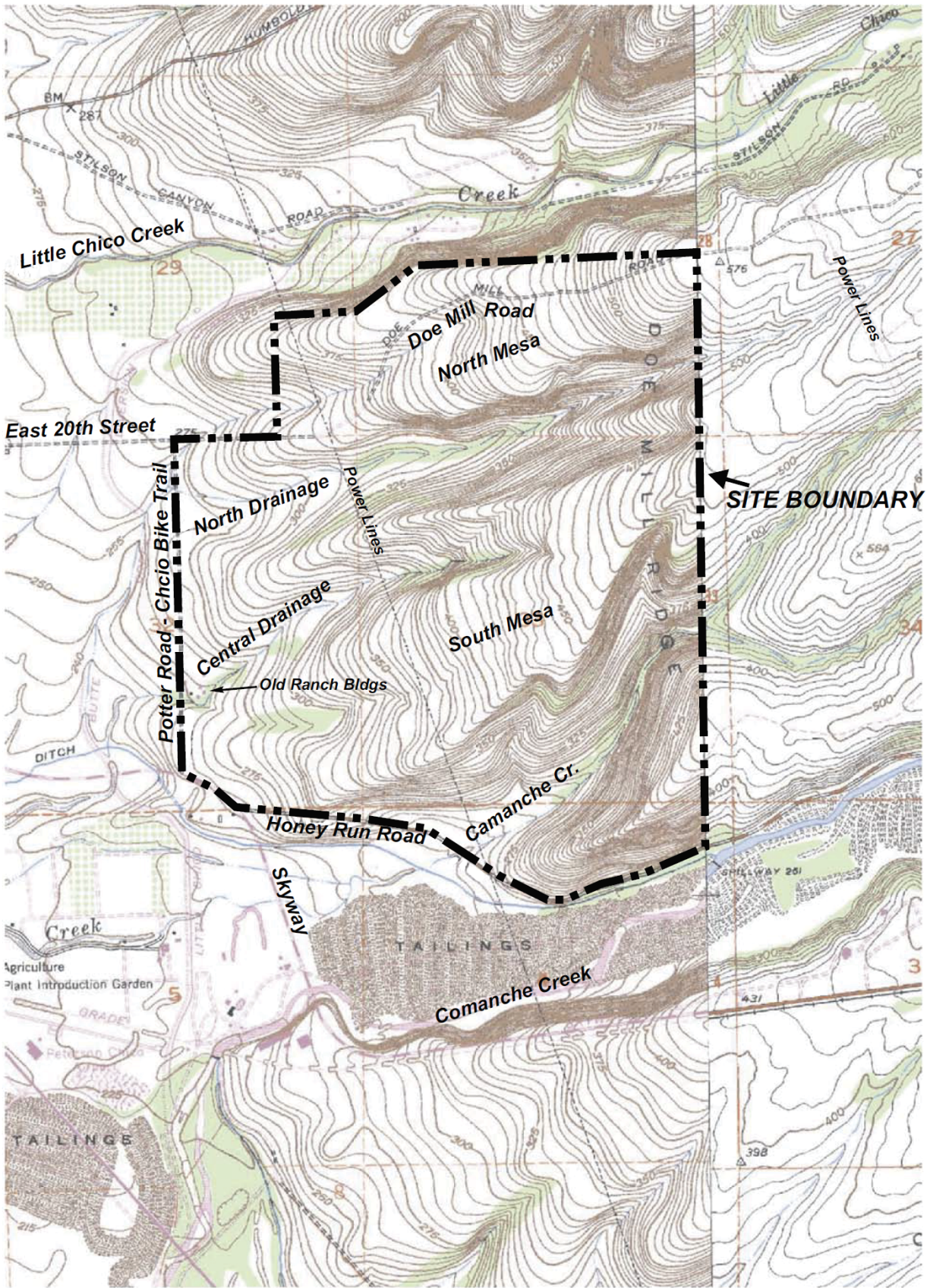

Drawn by: JLF
Project No.: 1679
Date: 02-26-19
Document No.: 19D016

SITE LOCATION & TOPOGRAPHIC MAP
VALLEYS EDGE MULTI-USE PROJECT
DOE MILL/HONEY RUN SPA
CHICO, CALIFORNIA

PLATE
1

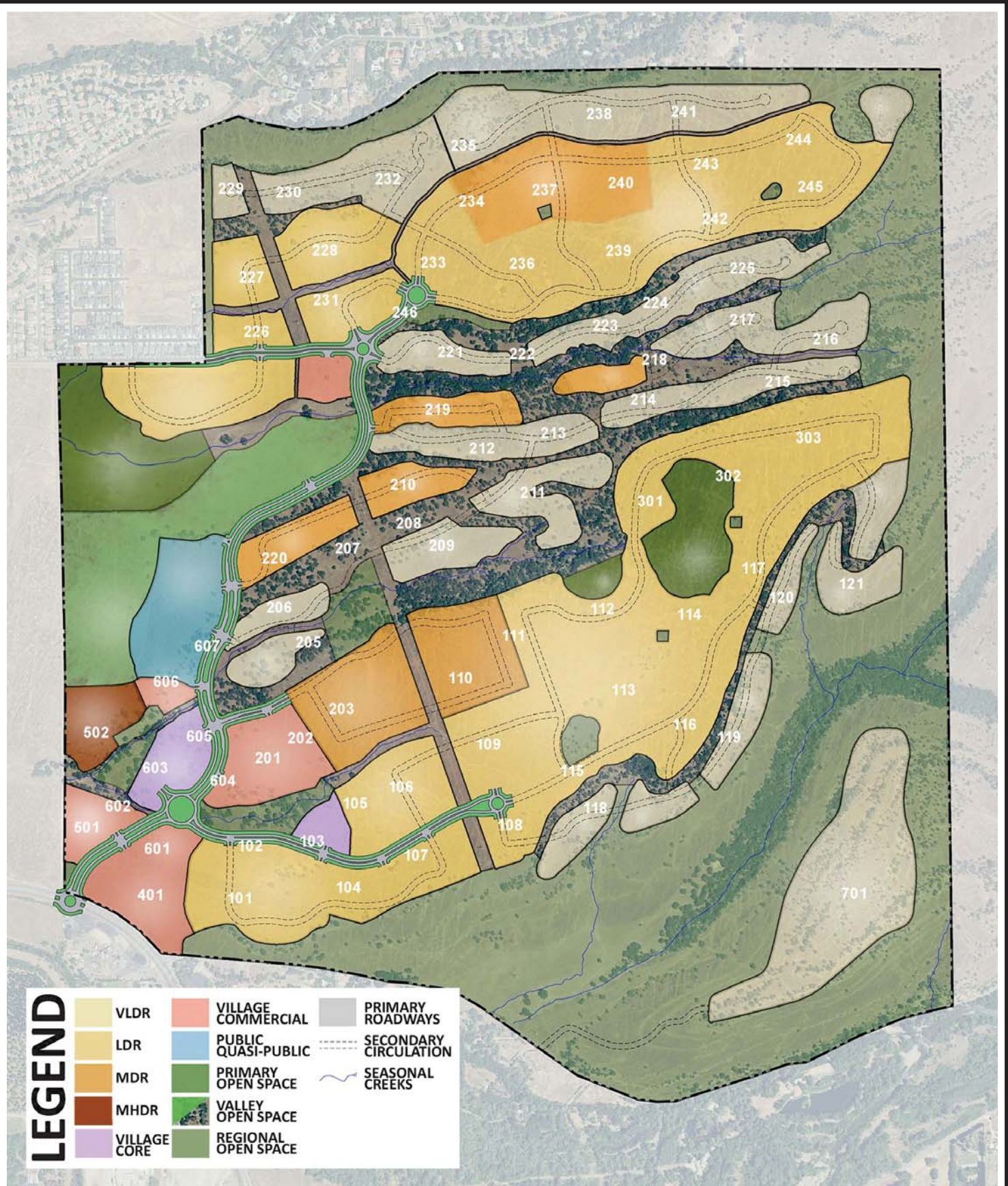

LEGEND

- | | | | | | |
|--|--------------|--|---------------------|--|-----------------------|
| | VLDR | | VILLAGE COMMERCIAL | | PRIMARY ROADWAYS |
| | LDR | | PUBLIC QUASI-PUBLIC | | SECONDARY CIRCULATION |
| | MDR | | PRIMARY OPEN SPACE | | SEASONAL CREEKS |
| | MHDR | | VALLEY OPEN SPACE | | |
| | VILLAGE CORE | | REGIONAL OPEN SPACE | | |

Reference: Plate 2 reference map provided by Valleys Edge



Drawn by: JLF
 Project No.: 1679
 Date: 02-26-19
 Document No.: 19D017

SITE DEVELOPMENT PLAN
 VALLEYS EDGE MULTI-USE PROJECT
 DOE MILL/HONEY RUN SPA
 CHICO, CALIFORNIA



PLATE
2



EXPLANATION

Qal Alluvial terrace and stream channel alluvium. Unconsolidated sand, gravel, cobble and silt generally less than 3 feet thick. Off-site includes dredger tailings and some Red Bluff formation

Ttc Tuscan formation unit C: Predominantly lahars with minor interbedded lenses and channel fills of volcanic conglomerate and sandstone. Lahar units are generally a well consolidated matrix of volcanic ash, mud, sand and gravel with variable content of cobble and boulder size clasts of very hard andesite. Outcrops occur throughout the site due to very thin soil cover, but most notably at slope breaks where the lahar commonly forms discontinuous ledges 1 to 5 feet high.

Ttb Tuscan formation unit B: Well consolidated lahars with nearly equal amounts of interbedded volcanic conglomerate and sandstone. Unit occurs only off-site to north.

-  Geologic unit contact
-  Continuous north trending and nearly vertical fractures associated with flexure of the Chico Monocline. Note that many other less continuous, north and northeast trending fractures are visible in photo as light colored lineaments. Fracturing within the lahar is generally widely spaced (greater than 10 feet).

-  Backhoe test pit - green where backhoe could penetrate 6 inches to 3 ft. Into weathered rock
-  Air track drill boring
-  Spring / Seepage area

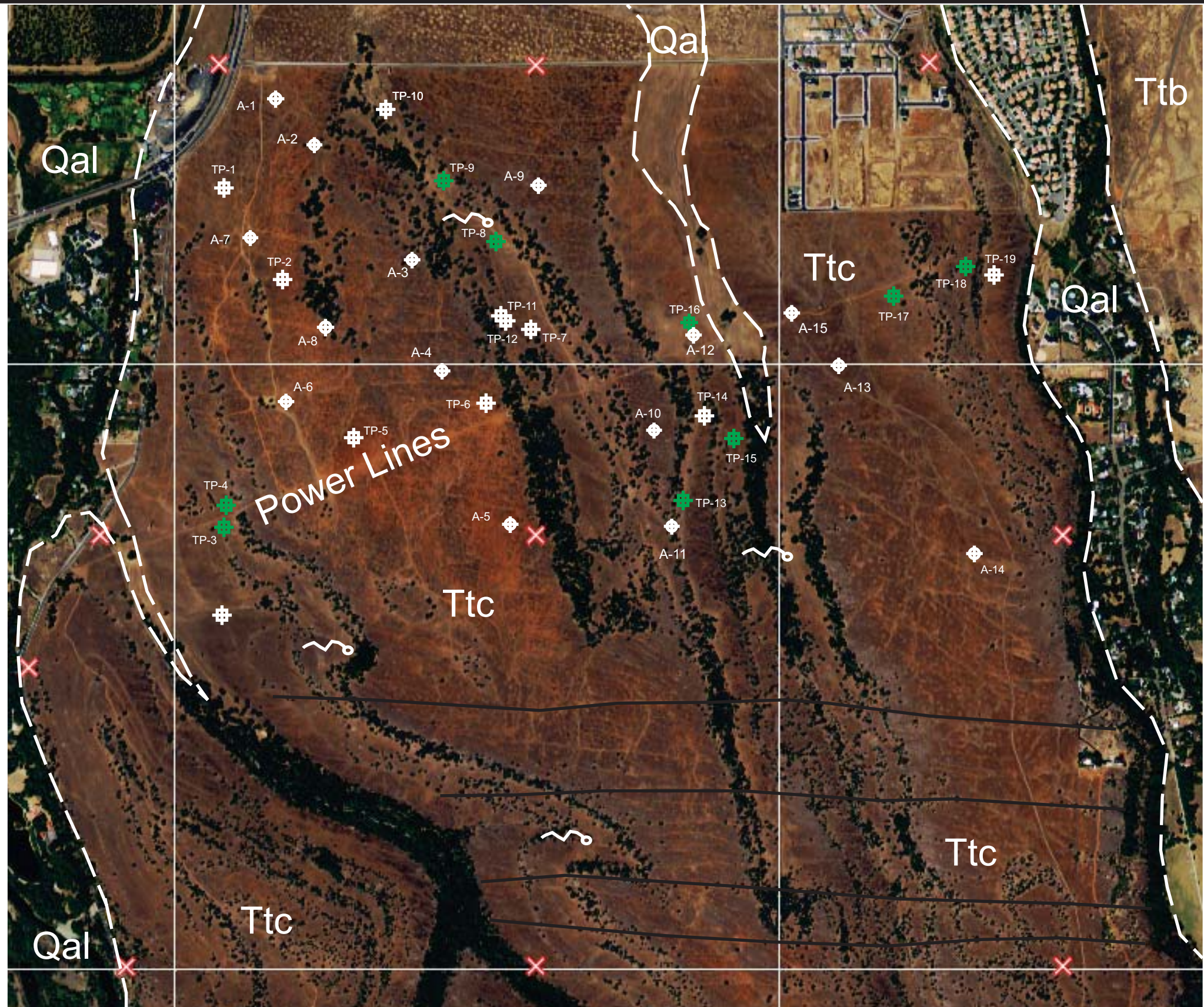
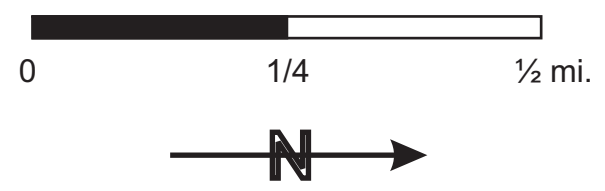

Base photograph Source: Unifted, Sheet 1 of 1 dated March 2010 (aerial photography 2009), project no. 10079 by Rolls Anderson & Rolls.

Drafted by: JLF
Date: 2/26/2019
Project No.: 1679
Document No.: 19D018



SITE EXPLORATION AND GEOLOGIC MAP
VALLEYS EDGE MULTI-USE DEVELOPMENT PLAN
DOE MILL/HONEY RUN SPA
CHICO, CALIFORNIA

Plate 3

STORM DRAIN TRENCH SUBDRAIN DETAIL
Screen and Seepage Diversion Gravel and Filter Fabric Wrap

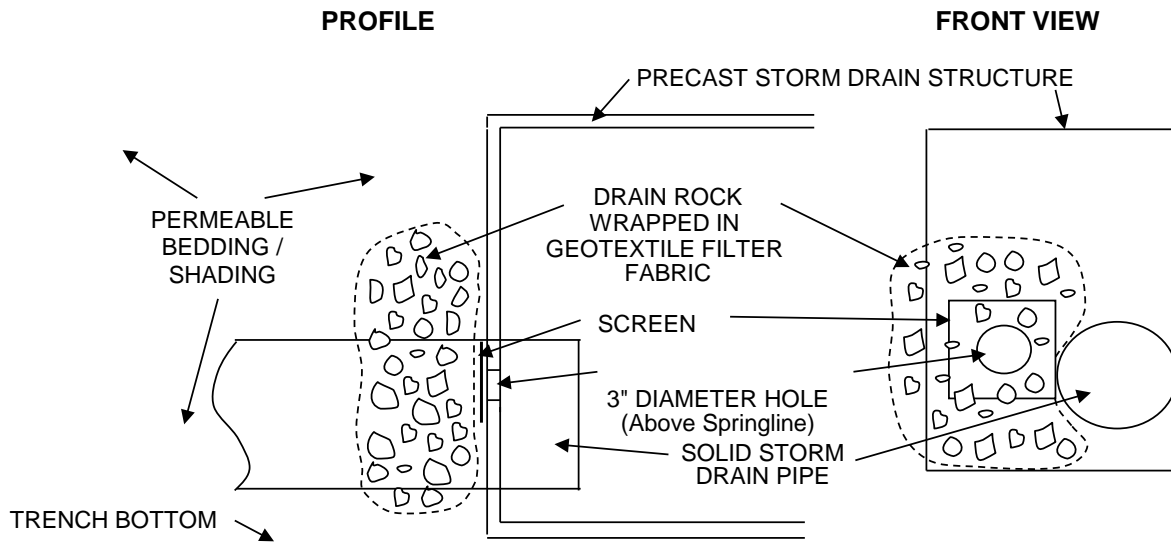

NOT TO SCALE

NOTES:

- 1 Permeable pipe bedding and shading should consist of durable, granular materials meeting the pipe manufacturer's specifications, and with less than 5% passing the #200 sieve.
- 2 Geotextile filter fabric should have an apparent opening size (AOS), U. S. Standard Sieve, of between 40 and 70, a permeability of at least 0.2 centimeters per second, a minimum flow rate of 50 gallons per minute per square foot of fabric, and a minimum puncture strength of 75 pounds.
- 3 Woven geotextile fabrics are less susceptible to clogging than non-woven fabrics. Therefore, in areas subjected to sustained subsurface flows, a woven fabric may be used.
- 4 Geotextile filter fabric should be placed in accordance with manufacturer's recommendations.
- 5 Surfaces to receive geotextile filter fabric should be free of loose or extraneous materials and sharp objects that might damage the filter fabric during installation.
- 6 Subdrainage should be disposed either into storm drain structures (drain inlets, catch basins, or man-holes), or conveyed into solid pipe connected to the storm drain structures. Where conveyed directly into the drain inlet, catch basin or man-hole, a 3-inch diameter inlet hole should be drilled through the structure at an elevation above springline of the outgoing pipe. A minimum of 2 cubic feet of drain rock (100 percent passing 1-inch screen and 95 percent retained on the No. 4 sieve) should be wrapped in geosynthetic filter fabric (properties presented above). A corrosion resistant screen should be placed between the fabric and storm drain structure to keep the filter fabric and drain rock from entering the drain inlet, catch basin or man-hole.



**STORM DRAIN TRENCH SUBDRAIN
 DETAIL**

**Valleys Edge Multi-Use
 Doe Mill/Honey Run SPA
 Chico, California**

PLATE

4

Drawn By: JLF
 Project No. 1679

Date: 2/26/2019
 Doc. No. 19D021

Edge of Road

Storm Drain Pipe

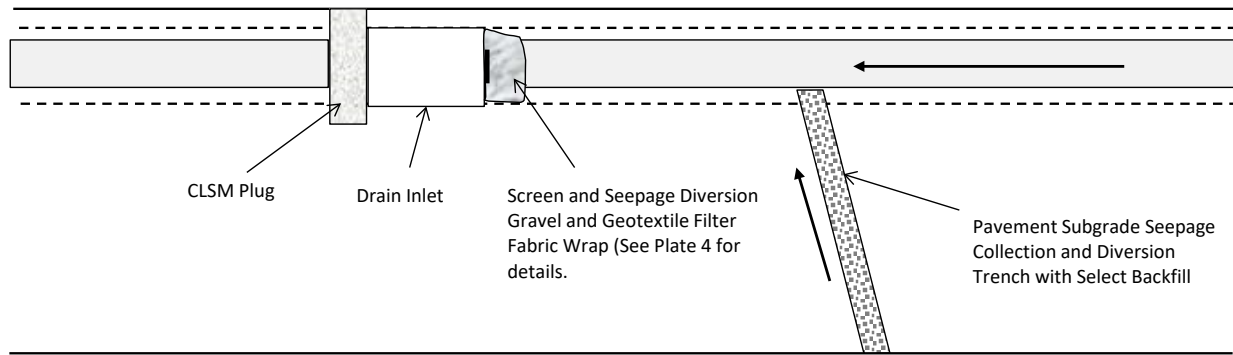

Edge of Road

PLAN

Asphalt Concrete

Class 2 Aggregate Base

Permeable Backfill

Storm Drain Pipe

Bottom of Excavation

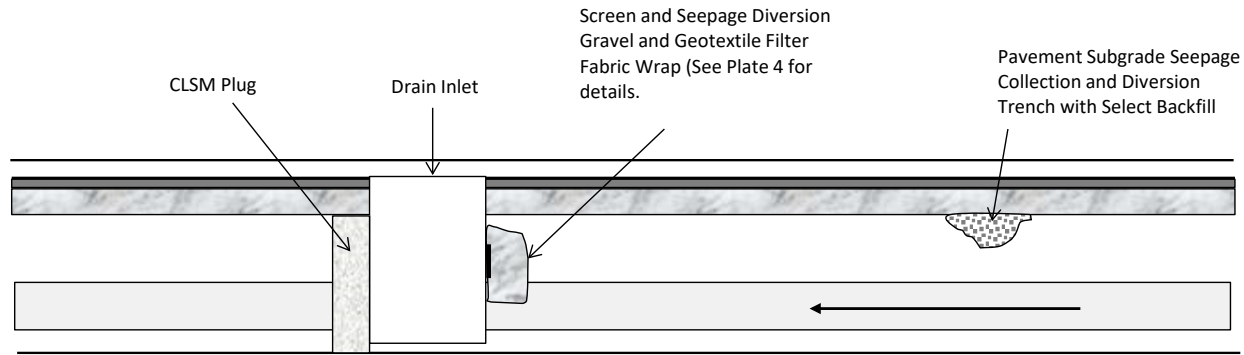

SECTION

**Pavement Subgrade Seepage
Collection and Diversion
Trench Select Backfill
Gradation**

Screen Size	% Passing
1"	100
3/4"	50 to 100
No. 4	5 to 30
No. 30	0 to 15
No. 200	0 to 5



UTILITY TRENCH AND STREET SEEPAGE CONTROL DETAILS

Valleys Edge Multi-Use Project
Doe Mill/Honey Run SPA
Chico, California

PLATE

5

Drafted By:	TEM	Project No.	1679
Date:	2/26/2019	Document No.	19D020

APPENDIX A:
FIELD INVESTIGATION

The subsurface conditions at the site were explored on January 21st for air-track drilling and January 26th for test pit exploration. Fifteen holes were drilled using an Ingersoll Rand IR-370 air-track drill rig to depths ranging from 16 to 20 feet. Drill logs were maintained by our Engineering Geologist base on drill rates and visual observation of the drill cuttings.

Nineteen test pits were excavated to depths ranging from less than ½ to 5 feet beneath existing grades. The test pits were excavated using a Caterpillar 420D tractor-mounted backhoe equipped with a 3-foot-wide bucket. Our geotechnical engineer maintained logs of the test pits, visually classified soils and rock encountered according to the Unified Soil Classification System (see Plate A-1) and obtained bulk samples of the subsurface materials.

Tabular format logs of the air track drill borings and test pits are presented on pages A-2 through A-5 and A-6 through A-9 of this appendix. The approximate locations of the air-track borings and test pits performed for this investigation are shown on Plate 3 of this report. Rock is described in accordance with the Rock Description Criteria, Plate A-2.

In our test pits representative bulk samples of each soil strata encountered were collected from the test pit excavations, packaged, and sealed in the field to reduce moisture loss and returned to our Anderson laboratory for further testing. After the test pits were completed they were backfilled with the excavated soil. Backfill was loosely placed and not compacted to the requirements typically specified for engineered fill. Structures, slabs-on-grade, or pavements located over these areas may experience excessive settlement. Removal and compaction of test pit fill is recommended prior to construction of improvements over these areas.

LIST OF ATTACHMENTS

The following plates are attached and complete Appendix A.

Plate A-1	Unified Soil Classification System
Plate A-2	Rock Description Criteria

LOGS OF AIR TRACK DRILL RIG BORINGS
MULTI-USE DEVELOPMENT, CHICO, CALIFORNIA

BORING NO. A-1		
Depth Range (ft.)	Drill Rate (ft./min.)	Material Description
0-½		Soil - sandy silt with gravel – red, wet, soft
½-3	4	Lahar - gray, slightly weathered, hard
3-7	6	Lahar - gray, slightly weathered, moderately hard
7-9	3	Andesite cobbles or boulder within lahar - dark gray, fresh, hard
10-16	5	Lahar - gray, slightly weathered, hard

BORING NO. A-2		
Depth Range (ft.)	Drill Rate (ft./min.)	Material Description
0-½		Soil - sandy silt with gravel – red, wet, soft
½-9	5	Lahar - gray, slightly weathered, hard
9-10	9	Lahar - gray-brown, highly weathered, weak
10-16	5	Lahar - gray, slightly weathered, hard

BORING NO. A-3		
Depth Range (ft.)	Drill Rate (ft./min.)	Material Description
0-½		Soil - sandy silt with gravel – red, wet, soft
½-7	5	Lahar - gray, slightly weathered, hard
7-10	9	Lahar - brown, highly weathered, weak
10-11	3	Andesite cobbles or boulder within lahar, dark gray, fresh, hard
11-13	5	Lahar - gray, slightly weathered, hard
13-16	9	Lahar - brown, highly weathered, weak

BORING NO. A-4		
Depth Range (ft.)	Drill Rate (ft./min.)	Material Description
0-1		Soil - sandy silt with gravel – red, wet, soft
1-14	4	Lahar - gray, slightly weathered, hard
14-17	9	Lahar? - gray-brown, slightly weathered, weak, with abundant angular andesite fine gravel size fragments in cuttings

- NOTES:
1. Borings logged by John L. Finnigsmier, CEG on January 21, 2015
 2. Drilled with an Ingersoll Rand IR-370 air-track rig

LOGS OF AIR TRACK DRILL RIG BORINGS
MULTI-USE DEVELOPMENT, CHICO, CALIFORNIA

BORING NO. A-5		
Depth Range (ft.)	Drill Rate (ft./min.)	Material Description
0-1		Soil - sandy silt with gravel – red, wet, soft
1-10	5	Lahar - gray, slightly weathered, hard
10-12	3	Andesite cobbles or boulder within lahar, dark gray, fresh, hard
12-16	5	Lahar - gray, slightly weathered, hard

BORING NO. A-6		
Depth Range (ft.)	Drill Rate (ft./min.)	Material Description
0-½		Soil - sandy silt with gravel – red, wet, soft
½-7	5	Lahar - gray, slightly weathered, hard
7-9	3	Andesite cobbles or boulder within lahar, dark gray, fresh, hard
9-16	5	Lahar - gray, slightly weathered, hard

BORING NO. A-7		
Depth Range (ft.)	Drill Rate (ft./min.)	Material Description
0-1½		Soil - sandy silt with gravel – red, wet, soft
1½-3	3	Andesite cobbles or boulder within lahar, dark gray, fresh, hard
3-6	4	Lahar - gray, slightly weathered, hard
6-11	6	Lahar - gray, slightly weathered, moderately hard
11-12	3	Andesite cobbles or boulder within lahar, dark gray, fresh, hard
12-16	4	Lahar - gray, slightly weathered, hard

BORING NO. A-8		
Depth Range (ft.)	Drill Rate (ft./min.)	Material Description
0-4	4	Lahar - gray, slightly weathered, hard
4-12	8	Conglomerate - gray, slightly weathered, weak, cuttings include many rounded gravel clasts
12-17	5	Lahar - gray, slightly weathered, hard

- NOTES:
1. Borings logged by John L. Finnigsmier, CEG on January 21, 2015
 2. Drilled with an Ingersoll Rand IR-370 air-track rig

LOGS OF AIR TRACK DRILL RIG BORINGS
MULTI-USE DEVELOPMENT, CHICO, CALIFORNIA

BORING NO. A-9		
Depth Range (ft.)	Drill Rate (ft./min.)	Material Description
0-1		Soil - sandy silt with gravel – red, wet, soft
1-11	5	Lahar - gray, slightly weathered, hard
11-12½	3	Andesite cobbles or boulder within lahar, dark gray, fresh, hard
12½-16	5	Lahar - gray, slightly weathered, hard

BORING NO. A-10		
Depth Range (ft.)	Drill Rate (ft./min.)	Material Description
0-8	5	Lahar - gray, slightly weathered, hard
8-10	3	Andesite cobbles or boulder within lahar, dark gray, fresh, hard
10-12	7	Lahar - gray, slightly weathered, moderately hard
12-14	5	Lahar - gray, slightly weathered, hard
14-17	10	Sand – brown, fine, appears uncemented

BORING NO. A-11		
Depth Range (ft.)	Drill Rate (ft./min.)	Material Description
0-1		Soil - sandy silt with gravel – red, wet, soft
1-5	5	Lahar - gray, slightly weathered, hard
5-8	9	Lahar – gray-brown, highly weathered, weak
8-9	3	Andesite cobbles or boulder within lahar, dark gray, fresh, hard
9-12	9	Lahar – gray-brown, highly weathered, weak
12-16	5	Lahar - gray, slightly weathered, hard

BORING NO. A-12		
Depth Range (ft.)	Drill Rate (ft./min.)	Material Description
0-½		Soil - sandy silt with gravel – red, wet, soft
½-10	9	Lahar – gray-brown, highly weathered, weak
10-20	5	Lahar - gray, slightly weathered, hard

- NOTES:
1. Borings logged by John L. Finnigsmier, CEG on January 21, 2015
 2. Drilled with an Ingersoll Rand IR-370 air-track rig

LOGS OF AIR TRACK DRILL RIG BORINGS
MULTI-USE DEVELOPMENT, CHICO, CALIFORNIA

BORING NO. A-13		
Depth Range (ft.)	Drill Rate (ft./min.)	Material Description
0-½		Soil - sandy silt with gravel – red, wet, soft
½-12	5	Lahar - gray, slightly weathered, hard
12-16	3	Andesite cobbles or boulder within lahar, dark gray, fresh, hard

BORING NO. A-14		
Depth Range (ft.)	Drill Rate (ft./min.)	Material Description
0-1		Soil - sandy silt with gravel – red, wet, soft
1-5	4	Lahar - gray, slightly weathered, hard
5-6	9	Lahar – gray-brown, highly weathered, weak
6-10	5	Lahar - gray, slightly weathered, hard
10-13	3	Andesite cobbles or boulder within lahar, dark gray, fresh, hard
13-16	5	Lahar - gray, slightly weathered, hard

BORING NO. A-15		
Depth Range (ft.)	Drill Rate (ft./min.)	Material Description
0-9		Lahar - gray, slightly weathered, hard
9-12	5	Andesite cobbles or boulder within lahar, dark gray, fresh, hard
12-16	3	Lahar - gray, slightly weathered, hard

- NOTES:
1. Borings logged by John L. Finnigsmier, CEG on January 21, 2015
 2. Drilled with an Ingersoll Rand IR-370 air-track rig

SUMMARY OF TEST PIT OBSERVATIONS
VALLEYS EDGE MULTI-USE DEVELOPMENT, CHICO, CA

Essentially soil and rock observations are grouped into 3 broad categories as follows:

- These pits were located on the broad very gently sloping mesas within soil mounds separated by low areas underlain by hard lahar. The exposed areas of lahar contain numerous surficial cobbles and/or boulders. In some cases the trench extended across the entire soil mound, while in some cases it did not.

Test Pit No.	Length of Excavation (ft.)	Depth of Soil in Inches from Surface at 5-foot Intervals	Average Depth of Soil (in.)	Soil Description
1	20	9, 12, 12, 12, 5	10	Clayey Sand (SC), brown, wet, medium stiff, with trace gravel and cobble
2	30	3, 9, 12, 12, 9, 8, 6	8+	Sandy Lean Clay (CL), red-brown, wet, medium stiff with gravel and cobble
5	25	4, 5, 7, 7, 8, 8	6+	Sandy Lean Clay (CL), red-brown, wet, medium stiff, with trace gravel and cobble
6	25	4, 10, 11, 11, 8, 1	7+	Sandy Lean Clay (CL), wet, medium stiff, trace cobble and boulder

SUMMARY OF TEST PIT OBSERVATIONS

VALLEYS EDGE MULTI-USE DEVELOPMENT, CHICO, CA

- The following test pits were excavated on the broad mesas in areas where distinct mounding was not apparent, or on other gently sloping areas between tree lines underlain by strong lahar at shallow depth;

Test Pit No.	Length of Excavation (ft.)	Depth of Soil in Inches from Surface at 5-foot Intervals	Average Depth of Soil (in.)	Soil Description
7	11	9, 10, 9	9+	Clayey Sand (SC), red-brown, wet, loose to medium dense, with trace gravel, some cobble
10	10	8, 16, 13	12+	Sandy Lean Clay (CL), red-brown, wet, medium stiff, with gravel and trace cobble
11	11	10, 11, 9	10	Sandy Lean Clay (CL), red-brown, moist to wet, medium stiff, with trace gravel and cobble
12	7	11, 11, 11	11	Sandy Lean Clay (CL), red-brown, moist to wet, medium stiff, trace cobble and boulder
14	10	0 to 4"	3	Sandy Lean Clay (CL), red-brown, wet, medium stiff, trace gravel
19	24	4, 5, 8, 8, 10, 8	7+	Sandy Lean Clay (CL), red-brown, moist to wet, medium stiff, trace gravel

SUMMARY OF TEST PIT OBSERVATIONS

VALLEYS EDGE MULTI-USE DEVELOPMENT, CHICO, CA

- The following pits were typically excavated deeper than 12 inches in gently sloping terrain generally downslope of distinct slope breaks. The bedrock surface, generally lahar but in some cases conglomerate, in these pits was weathered sufficiently that modest excavation into the rock was achieved with the backhoe;

Test Pit No.	Length of Excavation (ft.)	Depth of Soil in Inches from Surface	Average Depth of Soil (in.)	Soil Description
3	NA	0 to ~11 ~11 to 23 ~23 to 30		Clayey Sand (SC), red-brown, wet, medium dense, with trace gravel and cobble Clayey Gravel (GC), brown, wet, medium dense to dense, with cobble Lahar, brown, weak, highly weathered
4	NA	0 to ~ 12 ~12 to 43		Clayey Sand (SC), red-brown, moist to wet, medium stiff, with gravel and trace cobble Conglomerate, red-brown, weak, highly weathered
8	NA	0 to ~ 22" ~22 to 60		Clayey Sand (SC), wet, medium stiff, with trace gravel and cobble Lahar, red-brown, very weak, decomposed to highly weathered
9	NA	0 to 6 ~6 to 24 ~24 to 38		Clayey Gravel (GC), red-brown, wet, medium dense, with some cobble Lahar, red-brown, decomposed, very weak Lahar, gray-brown, highly weathered, weak
13	NA	0 to 12 ~12 to 24		Sandy Lean Clay (CL), red-brown, wet, medium stiff, trace gravel Lahar, gray-brown, highly weathered, weak
15	NA	0 to 7 ~7 to 17		Sandy Lean Clay (CL), red-brown, moist to wet, medium stiff, with cobble Lahar, gray-brown, highly weathered, weak
16	NA	0 to 10 ~10 to 30		Clayey Sand (SC), red-brown, moist to wet, medium stiff, with gravel Lahar, gray-brown, highly weathered, weak

SUMMARY OF TEST PIT OBSERVATIONS
VALLEYS EDGE MULTI-USE DEVELOPMENT, CHICO, CA

Test Pit No.	Length of Excavation (ft.)	Depth of Soil in Inches from Surface	Average Depth of Soil (in.)	Soil Description
17	NA	0 to 9 ~9 to 27		Silty Clay (CL-ML), red-brown, wet, medium stiff, some gravel and cobble Lahar, gray-brown, highly weathered, weak
18	NA	0 to 10 ~10 to 14 ~14 to 20 ~ 20+		Sandy Lean Clay (CL), red-brown, moist to wet, some gravel and cobble Cobble with Lean Clay (GC), red-brown, moist to wet Lahar, brown, very weak, decomposed Lahar, gray-brown, highly weathered, weak

SOIL CLASSIFICATION CHART

MAJOR DIVISIONS			SYMBOLS		TYPICAL DESCRIPTIONS
			GRAPH	LETTER	
COARSE GRAINED SOILS MORE THAN 50% OF MATERIAL IS LARGER THAN NO. 200 SIEVE SIZE	GRAVEL AND GRAVELLY SOILS MORE THAN 50% OF COARSE FRACTION RETAINED ON NO. 4 SIEVE	CLEAN GRAVELS (LITTLE OR NO FINES)		GW	WELL-GRADED GRAVELS, GRAVEL - SAND MIXTURES, LITTLE OR NO FINES
		GRAVELS WITH FINES (APPRECIABLE AMOUNT OF FINES)		GP	POORLY-GRADED GRAVELS, GRAVEL - SAND MIXTURES, LITTLE OR NO FINES
		GRAVELS WITH FINES (APPRECIABLE AMOUNT OF FINES)		GM	SILTY GRAVELS, GRAVEL - SAND - SILT MIXTURES
		GRAVELS WITH FINES (APPRECIABLE AMOUNT OF FINES)		GC	CLAYEY GRAVELS, GRAVEL - SAND - CLAY MIXTURES
	SAND AND SANDY SOILS MORE THAN 50% OF COARSE FRACTION PASSING ON NO. 4 SIEVE	CLEAN SANDS (LITTLE OR NO FINES)		SW	WELL-GRADED SANDS, GRAVELLY SANDS, LITTLE OR NO FINES
		SANDS WITH FINES (APPRECIABLE AMOUNT OF FINES)		SP	POORLY-GRADED SANDS, GRAVELLY SAND, LITTLE OR NO FINES
		SANDS WITH FINES (APPRECIABLE AMOUNT OF FINES)		SM	SILTY SANDS, SAND - SILT MIXTURES
		SANDS WITH FINES (APPRECIABLE AMOUNT OF FINES)		SC	CLAYEY SANDS, SAND - CLAY MIXTURES
FINE GRAINED SOILS MORE THAN 50% OF MATERIAL IS SMALLER THAN NO. 200 SIEVE SIZE	SILTS AND CLAYS LIQUID LIMIT LESS THAN 50		ML	INORGANIC SILTS AND VERY FINE SANDS, ROCK FLOUR, SILTY OR CLAYEY FINE SANDS OR CLAYEY SILTS WITH SLIGHT PLASTICITY	
			CL	INORGANIC CLAYS OF LOW TO MEDIUM PLASTICITY, GRAVELLY CLAYS, SANDY CLAYS, SILTY CLAYS, LEAN CLAYS	
			OL	ORGANIC SILTS AND ORGANIC SILTY CLAYS OF LOW PLASTICITY	
	SILTS AND CLAYS LIQUID LIMIT GREATER THAN 50		MH	INORGANIC SILTS, MICACEOUS OR DIATOMACEOUS FINE SAND OR SILTY SOILS	
			CH	INORGANIC CLAYS OF HIGH PLASTICITY	
			OH	ORGANIC CLAYS OF MEDIUM TO HIGH PLASTICITY, ORGANIC SILTS	
HIGHLY ORGANIC SOILS				PT	PEAT, HUMUS, SWAMP SOILS WITH HIGH ORGANIC CONTENTS

NOTE: DUAL SYMBOLS ARE USED TO INDICATE BORDERLINE SOIL CLASSIFICATIONS















UNIFIED SOIL CLASSIFICATION SYSTEM

PLATE

Valleys Edge Multi-Use Project
Skyway at Honey Run Road
Chico, California

A-1

Drafted by: TEM	Project No.: 1481
Date: 2/10/15	Doc. No.: 15D073

SYMBOL	ROCK TYPE	SYMBOL	ROCK TYPE	SYMBOL	ROCK TYPE
	BRECCIA		SILTSTONE		SCHIST
	CLAYSTONE		MUDSTONE		SANDSTONE
	CONGLOMERATE		TUFF		GRAYWACKE
	GREENSTONE		LIMESTONE		GRANITE

WEATHERING

DESIGNATION	CRITERIA
DECOMPOSED	ROCK REDUCED TO SOIL WITH RELICT ROCK TEXTURE/STRUCTURE; GENERALLY MOLDED AND CRUMBLING BY HAND.
HIGHLY WEATHERED	ENTIRE MASS DISCOLORED; ALTERATION PERVAIDING NEARLY ALL ROCK WITH SOME SLIGHTLY WEATHERED POCKETS NOTICEABLE; SOME MINERALS MAY BE LEACHED.
MODERATELY WEATHERED	DISCOLORING EVIDENT; SURFACE PITTING AND ALTERATION PENETRATING WELL BELOW SURFACE; WEATHERING "HALOS" EVIDENT; 10 TO 50 % OF ROCK ALTERED.
SLIGHTLY WEATHERED	SLIGHT DISCOLORATION ON SURFACE; SLIGHT ALTERATION ALONG DISCONTINUITIES; LESS THAN 10% OF ROCK VOLUME ALTERED.
UNWEATHERED	NO EVIDENCE OF CHEMICAL/MECHANICAL ALTERATION.

FRACTURE SPACING

DESIGNATION	CRITERIA
CRUSHED	SPACING < 1 INCH
INTENSELY FRACTURED	SPACING 1 TO 3 INCHES
MODERATELY FRACTURED	SPACING 3 TO 1 FOOT
SLIGHTLY FRACTURED	SPACING 1 TO 4 FEET
VERY SLIGHTLY FRACTURED	SPACING GREATER THAN 4 FEET









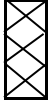

HARDNESS/STRENGTH

DESIGNATION	CRITERIA
SOFT	CAN BE READILY INDENTED, GROOVED, OR GOUGED WITH FINGERNAIL OR CARVED WITH KNIFE; BREAKS WITH MODERATE TO LIGHT MANUAL PRESSURE
VERY WEAK	CAN BE GROOVED/GOUGED EASILY BY SHARP PICK WITH LIGHT PRESSURE; CAN BE SCRATCHED BY FINGERNAIL; BREAKS UNDER MODERATE MANUAL PRESSURE.
WEAK	CAN BE GROOVED/GOUGED 2MM DEEP BY KNIFE OR SHARP PICK WITH MODERATE TO HEAVY PRESSURE; BREAKS WITH LIGHT HAMMER BLOW OR HEAVY MANUAL PRESSURE.
MODERATELY HARD	CAN BE SCRATCHED WITH A KNIFE OR SHARP PICK WITH LIGHT TO MODERATE PRESSURE; BREAKS WITH MODERATE HAMMER BLOW.
HARD	CAN BE SCRATCHED WITH A KNIFE OR SHARP PICK; BREAKS WITH REPEATED HAMMER BLOWS.
VERY HARD	CANNOT BE SCRATCHED WITH A KNIFE OR SHARP PICK; BREAKS WITH REPEATED HAMMER BLOWS.
EXTREMELY HARD	CANNOT BE SCRATCHED WITH A KNIFE OR SHARP PICK; CAN ONLY BE CHIPPED WITH REPEATED HAMMER BLOWS.

Modified from US Bureau of Reclamation Engineering Geology Field Manual.

		ROCK DESCRIPTION CRITERIA Valleys Edge Multi-Use Project Skyway at Honey Run Road Chico, California	PLATE A-2

LOG SYMBOLS

	BULK BAG/SAMPLE	-4	PERCENT FINER THAT THE NO. 4 SIEVE (ASTM D-422)
	MODIFIED CALIFORNIA SAMPLER (2-1/2 INCH OUTSIDE DIAMETER)	-200	PERCENT FINER THAT THE NO. 200 SIEVE (ASTM D-422)
	CALIFORNIA SAMPLER (3-INCH OUTSIDE DIAMETER)	LL	LIQUID LIMIT (ASTM D-4318)
	STANDARD PENETRATION SPLIT SPOON SAMPLER (2-INCH OUTSIDE DIAMETER)	PI	PLASTIC INDEX (ASTM D-4318)
	ROCK CORE	TXCU	CU TRIAXIAL COMPRESSION (ASTM D4767)
	SHELBY TUBE	EI	EXPANSION INDEX (ASTM D4829)
	CONTINUOUS CORE	COL	COLLAPSE TEST (ASTM D4546)
	WATER LEVEL (LEVEL WHERE FIRST ENCOUNTERED)	UC	UNCONFINED COMPRESSION (ASTM D-2166)
	WATER LEVEL (LEVEL AFTER COMPLETION)	MC	MOISTURE CONTENT (ASTM D-2216)
	SEEPAGE		

GENERAL NOTES

1. LINES SEPARATING STRATA ON THE LOGS REPRESENT APPROXIMATE BOUNDARIES ONLY. ACTUAL TRANSITIONS MAY BE GRADUAL.
2. NO WARRANTY IS PROVIDED AS TO THE CONTINUITY OF SOIL CONDITIONS BETWEEN INDIVIDUAL SAMPLE LOCATIONS.
3. LOGS REPRESENT GENERAL SOIL CONDITIONS OBSERVED AT THE POINT OF EXPLORATION ON THE DATE INDICATED.
4. IN GENERAL, UNIFIED SOIL CLASSIFICATION SYSTEM DESIGNATIONS PRESENTED ON THE LOGS WERE EVALUATED BY VISUAL METHODS. WHERE LABORATORY TESTS WERE PERFORMED, THE DESIGNATIONS REFLECT THE LABORATORY TEST RESULTS.



LOG KEY

**Valleys Edge Multi-Use Project
Skyway at Honey Run Road
Chico, California**

PLATE

A-3

Drafted by: TEM	Project No.: 1481
Date: 2/10/2015	Doc. No.: 15D073

APPENDIX B:
LABORATORY TESTING

Laboratory tests were performed on selected samples to aid in soil classification and to evaluate physical properties of the soils that may affect the geotechnical aspects of project design and construction. A description of the laboratory testing program is presented below; a summary of all laboratory tests performed is presented on the Summary of Laboratory Tests, Plate B-1.

Sieve Analysis

Sieve analyses tests were performed to evaluate the gradational characteristics of the material and to aid in soil classification. Tests were performed in general accordance with ASTM Test Method D 422. Results of these tests are summarized on the Plate B-1 and plotted on B-2.

Atterberg Limits

Atterberg Limits tests were performed to aid in soil classification and to evaluate the plasticity characteristics of the material. Additionally, test results were correlated to published data to evaluate the shrink/swell potential of near-surface site soils. Tests were performed in general accordance with ASTM Test Method D 4318. Results of these tests are presented on Plate B-1 and plotted on Plate B-3.

Expansion Index

Expansion index (EI) tests were performed on remolded, fine-grained soil samples from Test Pit Nos. TP-1 and TP-5. Test procedures were in general accordance with ASTM D4829. Results of this test are summarized on Plate B-1, and may be compared to the table presented below to qualitatively evaluate the expansion potential of the near-surface site soils.

Expansion Index	Potential Expansion
0-20	Very low
21-50	Low
51-90	Medium
91-130	High
Above 130	Very High

R-Value

One resistance value (R-value) test was performed on a bulk soil sample obtained from Test Pit TP-8 to evaluate pavement support characteristics of the near-surface on-site soils. Testing was performed by Pavement Engineering Inc. (PEI) in accordance with California Test 301 procedure. Results of this test are presented following Plate B-3.

LIST OF ATTACHMENTS

The following plates are attached and complete Appendix B.

Plate B-1	Summary of Laboratory Tests
Plate B-2	Gradation Test Results
Plate B-3	Atterberg Limits Test Results
	R-Value Test Result

LABORATORY TEST RESULTS

Test Pit No.	Depth (feet)	Dry Unit Weight (lb/ft ³)	Moisture Content (%)	Particle Size / Percentage Passing								Atterberg Limits		Other Tests
				3"	3/4"	No. 4	No. 10	No. 30	No. 50	No. 100	No. 200	Liquid Limit	Plastic Index	
TP-1	0 to 1			100	98	84	61	72	68	63	58	33	13	Expansion Index = 25
TP-5	0 to 1			100	91	86	79	75	71	60	53	30	8	Expansion Index = 13
TP-8	4 to 5			100	71	47	43	36	32	28	26	60	24	R-value = 25

Project No.: 1481
 Doc.No.: 15D073
 Drafted by: TEM
 Date: 2-10-15



SUMMARY OF LABORATORY TEST RESULTS

Valleys Edge Multi-Use Project
 Skyway at Honey Run Road
 Chico, California

PLATE

B-1

APPENDIX C:

Caterpillar D-10 Trial Ripping Operation Valleys Edge Multi-Use Development Site, Chico, CA June 2 & 3, 2015

A Caterpillar D-10 bull-dozer equipped with a single shank ripper was used to perform trial ripping operations at various locations on the site. The purpose of this operation was to improve understanding of the excavatability of the on-site lahar rock so that the design team can better estimate excavation production rates for evaluation of development costs.

On June 2 the dozer, operated by Danny of Community Construction, ripped 10 locations across the site for periods of minutes to about 1 hour at each site. On June 3 the dozer returned to attempt deeper ripping at 2 locations where harder rock was encountered the previous day. However, only one location was worked on June 3 due to equipment break-down. John L. Finnigsmier, CEG, of GEOPlus observed the trial ripping; following is a summary of the observed ripping at each location.

1 - Planned pond location west of area 210 and north of area 220:

Within about 15 minutes an area about 50feet long and 30feet wide was excavated between 1 and 5½ feet in depth with little difficulty. Ripping was hardly necessary. The upper about 18 inches of material encountered consisted of soil. Below 18 inches the materials consisted of decomposed to highly weathered lahar that was friable to very weak, moist, and broke-up readily under the weight of the dozer.

2 - Top of broad ridge at area 210:

Ripping was performed for about 45 minutes in an area about 90feet long by 20feet wide. The excavation varied from about 1½ to 2 feet in depth at termination. This location had 4 to 8 inches of soil underlain by lahar that was highly weathered for the upper few inches and only slightly weathered below. The upper 12 inches (below existing grade) ripped fairly easily while ripping from 12 to 24 inches took most of the 45 minutes. The material excavated in the 12- to 24-inch depth range was about 20% ¾" minus and contained predominantly 8- to 24-inch rock pieces that were moderately hard and dry. The rock pieces did break with repeated dozer passes.

3 - Along planned road alignment at mid-slope between areas 208 and 211:

Ripping and excavation was performed for about 10 minutes. The upper 12 inches of material consisted of soil. Below about 12 inches the material encountered consisted of highly weathered and weak lahar that readily broke into 8"minus material with about 50% being ¾" minus. The rippers penetrated to about 30 inches and were meeting much greater resistance at that depth.

4 - Area 211 on lower portion of slope about 150 feet south of area 208

Two passes of about 60 feet in length was made. 4 to 6 inches of soil was found to overlie moderately hard and slightly weathered lahar. The rippers generally did not penetrate more 12 inches below the ground surface.

5 - On broad southern mesa at margin of areas 203 & 204

At this location the ground surface is marked by soil mounds about 12 inches high surrounded by areas of exposed lahar or very thin soil (1-2 inches). The ground surface is littered with basalt cobble and boulders up to about 2 feet in diameter.

On June 2 lengthwise ripping and cross-ripping of an area about 90 by 20 feet was performed for 1 hour. Upon the first several passes, the rippers generally did not penetrate more than 8 inches. After the hour of ripping, 12 to 18 inches (depth) of material could be pushed out of the excavation with the dozer blade. Ripper penetration generally did not exceed about 24 inches. Perhaps 70 yd³ of material has been pushed out of the excavation. The material excavated in the 12- to 24-inch depth range was about 30% ¾" minus and contained predominantly 6- to 18-inch rock pieces that were moderately hard and dry. The rock pieces did break with repeated dozer passes.

On June 3 Danny began working the site at 0900 and worked until 1215 when equipment breakdown occurred. Between 0900 and 1100, the excavation had been deepened to 3- feet for a length of about 70 feet and a width of about 20 feet. This is perhaps 90 yd³ of additional excavation. Below a depth of about 3½ feet, ripping became notably easier and the moisture content of the rock was clearly higher. By 1215, the excavation was 4 to 4½ feet deep and 60feet long by 20feet wide (~50 yd³). The ripper has penetrated as deep as 6 feet. Danny noted a clear decrease in resistance to the ripper below about 3½ feet. The ripper could penetrate 12 to 18 inches with each pass in the 4- to 6-foot depth range. The more moist rock at depth was slightly softer, based on hammer blows and scratch resistance, but still moderately hard.

Note that the excavation yardage estimates relative to time are limited by the confined work area; hence, are not particularly representative of true production rates. Also, both Daryl (Nordic Industries) and Danny indicated that in their experience with ripping of the lahar east of Chico, excavation production rates typically improve below depths of 3 to 4 feet, where the moisture content increases.

6 - On broad southern mesa near intersection of area 105, 106 & 107

At this location the ground surface is marked by soil mounds about 12 inches high surrounded by areas of exposed lahar or very thin soil (1 to 2 inches). The ground surface is littered with basalt cobble and boulders up to about 2 feet in diameter. Two passes of about 60 feet in length were made. Rippers penetrated generally 6 to 10 inches and encountered a very thin soil veneer over moderately hard, dry and slightly weathered lahar.

7 - On broad southern mesa at area 601 south of dry creek channel

At this location the ground surface is marked by soil mounds about 12 inches high surrounded by areas of exposed lahar or very thin soil (1 to 2 inches). The ground surface is littered with basalt cobble and boulders up to about 2 feet in diameter. Two passes of about 60 feet in length were made along the same line. Rippers penetrated 1 to 2 inches within the first 20 feet and generally

6 to 10 inches, thereafter. The second pass penetrated 2 to 4 inches in the first 20 feet and 12 to 16, thereafter. A third pass in the first 20 feet penetrated 3 to 8 inches. Daryl noted that he has commonly encountered isolated harder spots like this, but they are rippable with a little more concentrated effort.

8 - On broad southern mesa at area 603 north of dry creek channel

Two passes of about 60 feet in length were made along the same line. Rippers penetrated generally 6 to 10 inches on the first pass and 8 to 14 inches on the second. Slightly weathered lahar was found to underlie 3 to 6 inches of soil.

9 - Area 607 on south descending slope, about 100 feet north of creek channel

One pass with the ripper was made for a length of about 70 feet. The ripper penetrated about 18 inches for the full length and only soil with small cobble was encountered.

10 - Phase 4 area, north of area 606 and west of area 220 – planned ball field area

At this location the ground surface is marked by soil mounds about 12 inches high surrounded by areas of exposed lahar or very thin soil (1 to 2 inches). The ground surface is littered with basalt cobble and boulders up to about 18 inches in diameter. Two passes of about 60 feet in length were made. The rippers penetrated about 4 to 10 inches.